

---

Konrad-Zuse-Zentrum für Informationstechnik Berlin  
Heilbronner Str. 10, D-10711 Berlin-Wilmersdorf, Germany

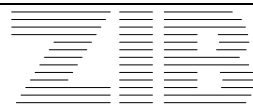

Ralf Borndörfer  
Martin Grötschel  
Andreas Löbel

## **Alcuin's Transportation Problems and Integer Programming**

# Alcuin's Transportation Problems and Integer Programming

Ralf Borndörfer      Martin Grötschel      Andreas Löbel\*

**Abstract.** The need to solve *transportation problems* was and still is one of the driving forces behind the development of the mathematical disciplines of graph theory, optimization, and operations research. Transportation problems seem to occur for the first time in the literature in the form of the four "River Crossing Problems" in the book *Propositiones ad acuendos iuvenes*. The *Propositiones*—the oldest collection of mathematical problems written in Latin—date back to the 8th century A.D. and are attributed to Alcuin of York, one of the leading scholars of his time, a royal advisor to Charlemagne at his Frankish court.

Alcuin's river crossing problems had no impact on the development of mathematics. However, they already display all the characteristics of today's large-scale real transportation problems. From our point of view, they could have been the starting point of combinatorics, optimization, and operations research. We show the potential of Alcuin's problems in this respect by investigating his problem 18 about a wolf, a goat and a bunch of cabbages with current mathematical methods. This way, we also provide the reader with a leisurely introduction into the modern theory of integer programming.

**Keywords.** Transportation Problems, Integer Programming, Alcuin of York

**Mathematics Subject Classification (1991).** 90C10, 90-01, 90B06, 01A35

## 1 Introduction

The book *Propositiones ad acuendos iuvenes* seems to be the oldest collection of mathematical problems written in Latin. It aims at teaching students some basic skills in logic thinking and problem solving. The collection was probably written at the end of the 8th century A.D. and is attributed to Alcuin, see Folkerts and Gericke (1993), an Anglo-Saxon monk, born in York in 735, one of the leading scholars of his time, head of the Frankish court school at Aachen and a royal advisor of Charlemagne, see Fleckenstein (1993). Hadley and Singmaster (1992) contains an English translation of Alcuin's problems, Folkerts and Gericke (1993) the Latin "original" together with a German translation. Both papers also discuss the history of the problems tracing most

---

\*Konrad-Zuse-Zentrum für Informationstechnik Berlin, Heilbronner Straße 10, 10711 Berlin-Wilmersdorf, Germany

of them back to ancient Chinese, Egyptian, Greek etc. sources. There is one notable exception. The four “River Crossing Problems” (No. 17–20) seem to appear for the first time in Alcuin’s book. We quote here the Singmaster and Hadley translation:

17. *Propositio de tribus fratribus singulas habentibus sorores* — About three friends and their sisters.

Three friends each with a sister needed to cross a river. Each one of them coveted the sister of another. At the river they found only a small boat, in which only two of them could cross at a time. How did they cross the river without any of the women being defiled by the men?

18. *Propositio de lupo et capra et fasciculo cauli* — About a wolf, a goat and a bunch of cabbages.

A man had to take a wolf, a goat and a bunch of cabbages across the river. The only boat he could find could only take two of them at a time. But he had been ordered to transfer all of these to the other side in good condition. How could this be done?

19. *Propositio de viro et muliere ponderantibus plastrum* — About a very heavy man and woman.

A man and woman, each the weight of a cartload, with two children who together weigh as much as a cartload, have to cross a river. They find a boat which can only take one cartload. Make the transfer if you can, without sinking the boat.

20. *Propositio de ericiis* — About Hedgehogs.

The Latin text seems to be defective. It seems to say: “About a male and female hedgehog with two young, having weight, wanting to cross a river.”

One can obviously view these problems as *transportation problems* subject to side constraints. Such problems have — in the centuries to come — played prominent roles in shaping the mathematical disciplines of Discrete Mathematics (Combinatorics and Graph Theory), Optimization (Linear and Integer Programming) and Operations Research.

The river crossing problems do not seem to have had any impact on the development of mathematics. They were merely conceived as recreational mathematics. From today’s point of view they could have been the starting point of combinatorics and optimization — as we will point out in this paper. But history took a different line. The roots of *combinatorics* seem to lie in counting objects and arranging numbers such as the construction of magic squares. Counting formulas and magic squares can be found in Hindu and Chinese culture more than two thousand years ago. Surprisingly, there can almost no literature on combinatorics be found in the classical Western civilization. Substantial progress, in particular in the study of magic squares, was made by Chinese and Islamic scholars in the period from 900 to 1300 A.D. Although there was some transmission of this knowledge to the West it was not until the 17th and 18th century that European mathematicians took up the subject seriously. Pascal’s work on “his” triangle, motivated by his and Fermat’s famous correspondence on games of chance around 1654, Leibniz’ Dissertation *De Arte Combinatorica* in 1666

and Jakob I Bernoulli's paper *Ars Conjectandi*, published posthumous in 1713, mark the beginnings of modern combinatorics; Euler's paper on the bridges of Königsberg of 1735 gave birth to the area of graph theory. Note again that Euler's work was inspired by a (recreational) transportation problem. A detailed account of the history of combinatorics can be found in Biggs, Lloyd, and Wilson (1995).

Also around the end of the 17th century the foundations of *optimization* were laid through the calculus of variations. A prominent example of this type is the discovery of the brachystochrone by Jakob I Bernoulli and Euler in 1697<sup>1</sup>. However, modern optimization only took off in the 20th century. Its rapid development was and still is closely connected to the progress in computing technology. The origins of *linear programming*, probably the most intensively used optimization technique and the most cost-saving mathematical tool, can again be traced back to transportation problems. Independent developments in the Soviet Union by Kantorovich (1939) (mathematical methods for the organization and planning of production), for which he received the 1975 Nobel Prize in Economics, and in the United States (logistics for the war in the Pacific in the early 1940s) resulted in a general mathematical theory and powerful algorithmic tools that are able to solve linear programs of extremely large scale (see Dantzig (1963) and Lenstra, Rinnooy Kan, and Schrijver (1991) for the history).

Transportation problems often have *integrality constraints* because of the indivisibility of commodities or transportation units and, therefore, they also give rise to the study of *combinatorial* or *integer programs*. Problems of this type are the famous travelling salesman problem (see Hoffman and Wolfe (1985) for its history), the assignment and transportation problem (discussed in Hitchcock (1941) and Koopmans (1947)), network and multicommodity flow and vehicle routing problems (Assad, Ball, Bodin, and Golden (1983), Desrochers, Desrosiers, and Soumis (1984)). An important early example is the case of the Berlin air lift in 1948/1949, which is extensively discussed in Padberg (1995).

What has all this to do with Alcuin? The point is that Alcuin's river crossing problems could have been the beginning of all these developments. The aim of our paper is to show the potential of his problems in this respect and — in this way — to provide the reader with a leisurely introduction into the modern theory of integer programming and its algorithmic techniques.

## 2 Alcuin's Solution of his Transportation Problems

Alcuin did not develop general solution procedures for his problems. He simply stated his solution. For problem 18, it reads:

*"I would take the goat and leave the wolf and the cabbage. Then I would return and take the wolf across. Having put the wolf on the other side I would take the goat back over. Having left that behind, I would take the cabbage across. I would then row across again, and having picked up the goat take it over once more. By this procedure*

---

<sup>1</sup>The brachystochrone problem was also solved by Jakob's younger brother Johann I, who posed the problem to the "deeper thinking mathematicians" of his time in 1696, Euler, de l'Hôpital and Leibniz, but Jakob Bernoulli's and Euler's methods led to the invention of the calculus of variations.

there would be some healthy rowing, but no lacerating catastrophe.”

Figures 1–2a give a pictorial description of the solution.

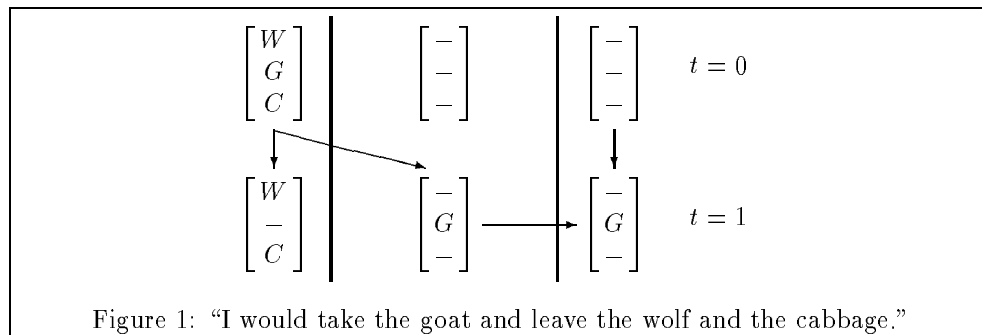

We can only guess how Alcuin arrived at his solutions. But it is very likely that a combination of trial and error, enumeration, and the use of logic implications was used — just as schoolchildren confronted with such problems today would do it.

From our modern point of view, no mathematical theory was developed. Problems were solved by ad-hoc methods. This approach was still in use just one hundred years ago, as is pointed out in Pressman and Singmaster (1989), where a detailed history of problem 17 is given with its generalization to more than three couples and the additional use of an island in the river. Authors describing such variations and generalizations of Alcuin’s transportation problems during the last 1200 years often reported wrong solutions. The errors were (and still are, if ad-hoc enumerative reasoning is used) due to the fact that, in general, the number of possibilities grows extremely fast when additional parameters are introduced. Nowadays this phenomenon is called *combinatorial explosion*. There is no way to avoid it. But today we know reasonable ways to control or structure the “space of solutions”.

### 3 The Modern Approach

Our aim in this paper is to describe a general technique — based on geometry (polyhedral theory) and linear programming — with which Alcuin’s transportation problems (and their variants and generalizations) can be mathematically modelled and solved<sup>2</sup>. In fact, we describe the methodology currently in use to solve truly large-scale integer programs coming up in practice. We sketch a few of these applications in the final section of this paper.

To show the technique we concentrate on problem 18 about a wolf, a goat, and a bunch of cabbages. It should be clear from our description how the other transporta-

<sup>2</sup>Our approach is by no means the only modern mathematical method suitable to attack Alcuin’s transportation problems. For instance, Bondy and Murty (1976) suggest in exercise 1.8.4 to solve problem 18 as a shortest path problem in a certain state-time graph. This approach is simpler than ours, however, it illustrates other techniques than the ones we want to discuss and is not as general.

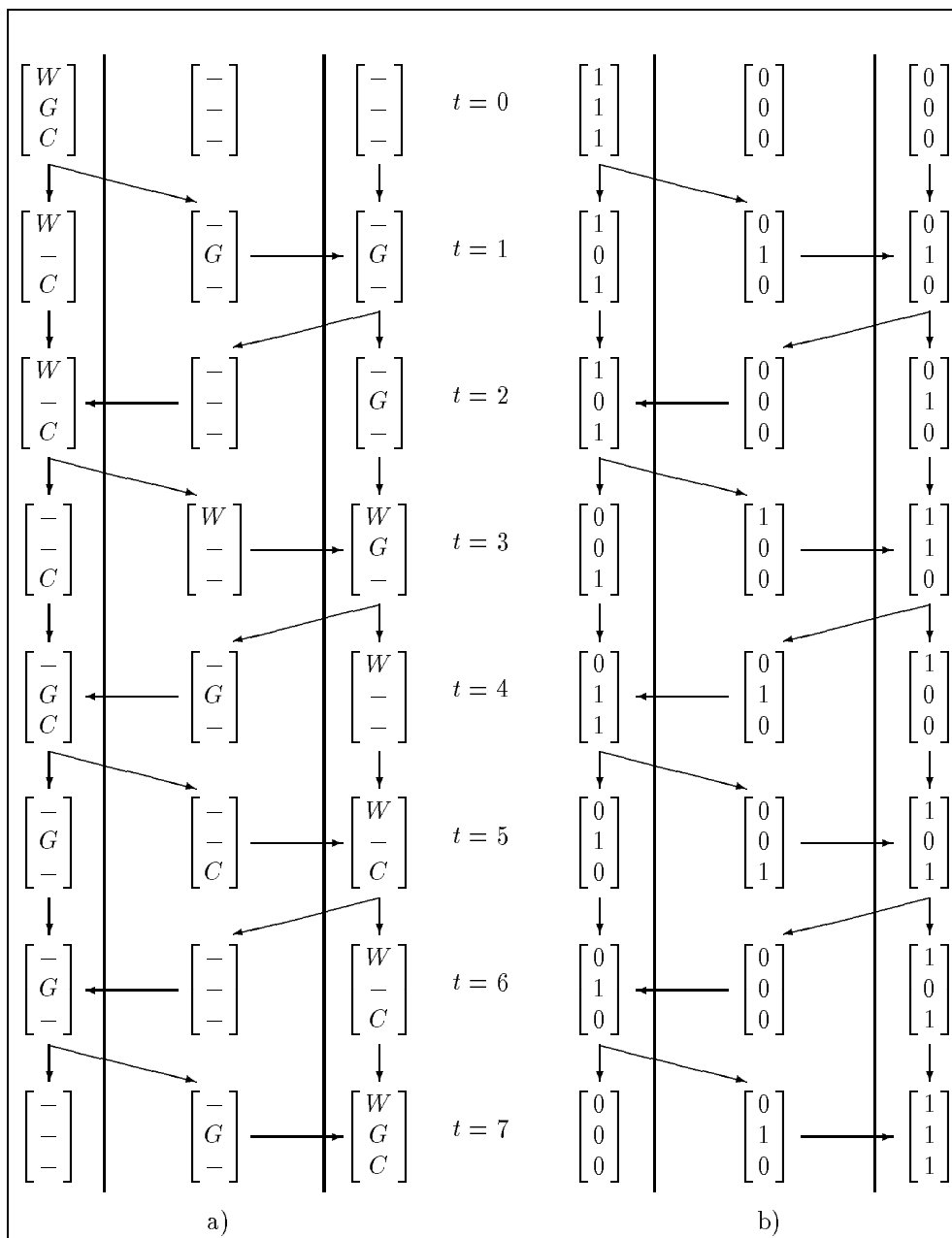

Figure 2: "Then I would return and take the wolf across. Having put the wolf on the other side I would take the goat back over. Having left that behind, I would take the cabbage across. I would then row across again, and having picked up the goat take it over once more."

tion problems can be handled. We are, of course, aware that problem 18 is quite simple and that we are using a steam hammer to crack a nut. But the technique we describe is very flexible and applies to all kinds of generalizations. The wolf-goat-cabbage problem is not only just a nice example where the modelling technique can be described easily. In fact, quite surprisingly, all the mathematical difficulties that arise in integer programming already appear here.

Our starting point is the symbolic description of Alcuin's solution shown in Figures 1–2a. We want to transform this description into a representation that admits the use of algebraic and geometric techniques and is suitable for computation.

We indicated the presence of a wolf, goat, or cabbage by writing  $W$ ,  $G$ , or  $C$  and the absence by '-'. Instead of  $W$ ,  $G$ , and  $C$ , we could also write 1 and instead of '-' write 0. To remember whether 1 stands for  $W$ ,  $G$ , or  $C$  we (arbitrarily) fix an order of the symbols. We agree that symbols always appear in triples, the first symbol in the triple referring to the wolf, the second to the goat, and the third to the cabbage. For example, with this convention the “old” triple  $(W, -, C)$  now reads  $(1, 0, 1)$ . Applying this procedure to Figure 2a yields Figure 2b. The advantage of this representation is that we can “compute with wolves, goats, and cabbages” using standard algebra without introducing special rules for this particular case.

Having introduced numbers we now bring *vector spaces* into play. The general technique is the following: We assume that we have a (finite) set  $N$  of  $n$  elements. We (arbitrarily) number the elements  $1, \dots, n$  and define a vector  $\chi = (\chi_1, \dots, \chi_n)$  where the components are indexed by the elements of  $N$ . If  $M$  is a subset of  $N$  we can represent  $M$  by an  $n$ -component vector

$$\chi^M = (\chi_1^M, \dots, \chi_n^M)$$

where

$$\chi_i^M := \begin{cases} 1, & \text{if } i \in M \\ 0, & \text{if } i \notin M \end{cases} \quad i = 1, \dots, n.$$

The vector  $\chi^M$  is called the *characteristic* or *incidence vector* of the subset  $M$  of  $N$ . In our case of problem 18 the given set  $N$  consists of the wolf, the goat, and the cabbage. The wolf is the first element and thus represented by the number 1, the goat gets number 2, and the cabbage 3. This way  $N = \{1, 2, 3\}$  is a representation of the wolf, the goat, and the cabbage and, therefore, every 0/1-vector  $\chi^M$  with three components can be viewed as the incidence vector of a “wolf-goat-cabbage configuration”  $M$ .

There are several ways (and it is not completely straightforward) how to model the full problem 18 using this technique. We describe one version that is somewhat redundant but conceptionally clear.

Our approach is to view a solution of problem 18 as a sequence of *states* at different points in time. Let us begin at time  $t = 0$  (again this is just a convention). We introduce three vectors

$$\begin{aligned} x(0) &= (x(0, 1), x(0, 2), x(0, 3)) \in \{0, 1\}^3 \\ y(0) &= (y(0, 1), y(0, 2), y(0, 3)) \in \{0, 1\}^3 \\ z(0) &= (z(0, 1), z(0, 2), z(0, 3)) \in \{0, 1\}^3 \end{aligned}$$

with the following meaning:  $x(0)$  represents the incidence vector of the wolf-goat-cabbage configuration on one side (we call it the left-hand side) of the river,  $y(0)$  the incidence vector of the wolf-goat-cabbage configuration in the boat, and  $z(0)$  the incidence vector on the other side (the right-hand side) of the river, all at time  $t = 0$ . The initial configuration (the state at time  $t = 0$ ) in problem 18 is

$$\begin{aligned}x(0) &= (1, 1, 1) \\y(0) &= (0, 0, 0) \\z(0) &= (0, 0, 0).\end{aligned}\tag{1}$$

(Clearly, our approach could handle any other initial state.) Now we have to make some conventions to record the transformation of states when items are shipped across the river. Let us denote by

$$x(t), y(t), z(t) \in \{0, 1\}^3,$$

as above, the states on the left bank, the boat and the right bank, respectively, at time  $t = 0, 1, 2, \dots$ . The states  $x(t)$  and  $z(t)$  correspond to the wolf-goat-cabbage configuration after the  $t$ -th shipment has been completed, while  $y(t)$  records the boat configuration for the  $t$ -th shipment. This convention implies that

$$\left. \begin{aligned}x(t+1) &= x(t) - y(t+1) \\z(t+1) &= z(t) + y(t+1)\end{aligned} \right\} \text{ if } t \geq 0 \text{ is even}\tag{2}$$

$$\left. \begin{aligned}x(t+1) &= x(t) + y(t+1) \\z(t+1) &= z(t) - y(t+1)\end{aligned} \right\} \text{ if } t \geq 0 \text{ is odd.}\tag{3}$$

These equations are algebraic representations of the *state transitions*. Equation (2) describes the transition when an item is shipped from the right-hand side to the left-hand side, i.e., when  $t$  is even, while equation (3) models shipments from the left to the right when  $t$  is odd. For instance, if we ship the goat from the left bank to the right bank at time  $t = 1$  we would obtain the states  $x(1)$ ,  $z(1)$  from the initial states at the (even) time zero, the ship configuration  $y(1) = (0, 1, 0)$ , and equations (2) through

$$\begin{aligned}x(1) &= x(0) - y(1) = (1, 1, 1) - (0, 1, 0) = (1, 0, 1) \\z(1) &= z(0) + y(1) = (0, 0, 0) + (0, 1, 0) = (0, 1, 0).\end{aligned}$$

The relations (2) and (3) are not sufficient because we have to guarantee feasibility of the states according to Alcuin's stipulations. Since the man rowing the boat can take only one item at a time, we have to introduce additional inequalities

$$y(t, 1) + y(t, 2) + y(t, 3) \leq 1 \quad t = 1, 2, \dots\tag{4}$$

We interpret Alcuin's phrase "... transfer ... in good condition" that certain wolf-goat-cabbage configurations are not allowed. 'Wolf and goat' or 'goat and cabbage'



are not permitted on the same side without the man. We can take this into account by adding so-called *set constraints* to the model. The constraint

$$x(t) \in \left\{ \begin{pmatrix} 0 \\ 0 \\ 0 \end{pmatrix}, \begin{pmatrix} 1 \\ 0 \\ 0 \end{pmatrix}, \begin{pmatrix} 0 \\ 1 \\ 0 \end{pmatrix}, \begin{pmatrix} 0 \\ 0 \\ 1 \end{pmatrix}, \begin{pmatrix} 1 \\ 0 \\ 1 \end{pmatrix} \right\} \quad \text{if } t \geq 0 \text{ is odd,} \quad (5)$$

which is equivalent to stipulating

$$x(t) \in \{0, 1\}^3 \setminus \left\{ \begin{pmatrix} 1 \\ 1 \\ 1 \end{pmatrix}, \begin{pmatrix} 1 \\ 1 \\ 0 \end{pmatrix}, \begin{pmatrix} 0 \\ 1 \\ 1 \end{pmatrix} \right\} \quad \text{if } t \geq 0 \text{ is odd,}$$

requires that whenever the man is not on the left bank, i.e.,  $t$  is odd, a configuration consisting of all three items, the wolf and the goat, or the goat and the cabbage is not permitted.

The modelling of the constraint for the right bank follows the same principle, but needs one more thought. Our aim is to ship all items from the left to the right, i.e., to reach a configuration  $z(t) = (1, 1, 1)$ . Clearly, when  $z(t) = (1, 1, 1)$  is reached for the first time, say at time  $t_0$ ,  $t_0$  must be odd because a last item has to be moved by the man from the left to the right. When this happens we consider our problem solved and don't want further shipments to occur, i.e., we wish the states to be  $x(t) = (0, 0, 0)$ ,  $y(t) = (0, 0, 0)$ , and  $z(t) = (1, 1, 1)$  for all  $t > t_0$ . Thus, we do not exclude the state  $z(t) = (1, 1, 1)$  from our *state space* for  $t$  even. Therefore, our set constraint for the right bank reads

$$z(t) \in \left\{ \begin{pmatrix} 0 \\ 0 \\ 0 \end{pmatrix}, \begin{pmatrix} 1 \\ 0 \\ 0 \end{pmatrix}, \begin{pmatrix} 0 \\ 1 \\ 0 \end{pmatrix}, \begin{pmatrix} 0 \\ 0 \\ 1 \end{pmatrix}, \begin{pmatrix} 1 \\ 0 \\ 1 \end{pmatrix}, \begin{pmatrix} 0 \\ 1 \\ 1 \end{pmatrix} \right\} \quad \text{if } t \geq 0 \text{ is even.} \quad (6)$$

At this point we have arrived at a proper mathematical model of Alcuin's problem 18 in the following sense. For every set of 0/1-vectors  $x(t), y(t), z(t) \in \{0, 1\}^3$ ,  $t = 0, 1, 2, \dots$ , satisfying the constraints (1)–(6) and  $z(t_0) = (1, 1, 1)$  for some  $t_0 \geq 0$ , there is a feasible shipment of the wolf, the goat, and the bunch of cabbages such that all three items arrive on the right bank of the river at time  $t_0$ . Conversely, every solution of Alcuin's problem 18 can be encoded into a set of 0/1-vectors as above.

The formulation above is not finite, just as problem 18 is not, since we could always add a few irrelevant additional shipments producing arbitrarily long sequences. As one can see from his solution, Alcuin was clearly interested in a minimum number of shipments. This brings up the optimization aspect and ways to make the problem finite.

One possibility to introduce a finite *time horizon* is to count the number  $L$  of possible states  $x(t)$ ,  $t$  odd, on the left bank and observe that, whenever a certain state  $x(t)$ ,  $t$  odd, appears for a second time, say  $x(s) = x(t)$ , where  $s < t$  and  $s$  and  $t$  odd, then all shipments in the time interval between  $s$  and  $t$  were unnecessary. The set constraints (5) imply that there are at most  $L := 5$  different feasible wolf-goat-cabbage

configurations for  $t$  odd on the left bank, and thus, if a feasible solution exists, there must be one with at most  $T = 2L - 1 = 2 \cdot 5 - 1 = 9$  shipments.

Using this or similar observations we can introduce a finite time horizon  $T$ , and therefore Alcuin's problem 18 can be viewed as a finite *combinatorial problem*. More precisely, by adding the "final state constraint"

$$z(T) = (1, 1, 1) \quad (7)$$

we can conclude that the wolf, the goat, and the cabbage can be shipped from the left to the right-hand side if and only if the following system (1)–(8) has a feasible solution.

$$\begin{aligned} x(0) &= (1, 1, 1) \\ y(0) &= (0, 0, 0) \end{aligned} \quad (1)$$

$$z(0) = (0, 0, 0)$$

$$\left. \begin{aligned} x(t+1) &= x(t) - y(t+1) \\ z(t+1) &= z(t) + y(t+1) \end{aligned} \right\} \text{if } 0 \leq t \leq T-1 \text{ is even} \quad (2)$$

$$\left. \begin{aligned} x(t+1) &= x(t) + y(t+1) \\ z(t+1) &= z(t) - y(t+1) \end{aligned} \right\} \text{if } 0 \leq t \leq T-1 \text{ is odd} \quad (3)$$

$$y(t, 1) + y(t, 2) + y(t, 3) \leq 1 \quad 0 \leq t \leq T \quad (4)$$

$$x(t) \in \left\{ \begin{pmatrix} 0 \\ 0 \\ 0 \end{pmatrix}, \begin{pmatrix} 1 \\ 0 \\ 0 \end{pmatrix}, \begin{pmatrix} 0 \\ 1 \\ 0 \end{pmatrix}, \begin{pmatrix} 0 \\ 0 \\ 1 \end{pmatrix}, \begin{pmatrix} 1 \\ 0 \\ 1 \end{pmatrix} \right\} \text{if } 0 \leq t \leq T \text{ is odd} \quad (5)$$

$$z(t) \in \left\{ \begin{pmatrix} 0 \\ 0 \\ 0 \end{pmatrix}, \begin{pmatrix} 1 \\ 0 \\ 0 \end{pmatrix}, \begin{pmatrix} 0 \\ 1 \\ 0 \end{pmatrix}, \begin{pmatrix} 0 \\ 0 \\ 1 \end{pmatrix}, \begin{pmatrix} 1 \\ 0 \\ 1 \end{pmatrix}, \begin{pmatrix} 1 \\ 1 \\ 1 \end{pmatrix} \right\} \text{if } 0 \leq t \leq T \text{ is even} \quad (6)$$

$$z(T) = (1, 1, 1) \quad (7)$$

$$x(t), y(t), z(t) \in \{0, 1\}^3 \quad 0 \leq t \leq T \quad (8)$$

Let us introduce some abbreviations at this point. Combining the 3-dimensional vectors  $x(t)$ ,  $y(t)$  and  $z(t)$  for all  $T + 1$  time periods  $t = 0, 1, \dots, T$  into  $3 \cdot (T + 1)$ -dimensional vectors

$$x := (x(0), x(1), \dots, x(T)) \in \mathbb{R}^{3 \cdot (T+1)},$$

$$y := (y(0), y(1), \dots, y(T)) \in \mathbb{R}^{3 \cdot (T+1)},$$

$$z := (z(0), z(1), \dots, z(T)) \in \mathbb{R}^{3 \cdot (T+1)},$$

and those into a  $3 \cdot 3 \cdot (T + 1)$ -dimensional vector

$$u := (x, y, z) \in \mathbb{R}^{3 \cdot 3 \cdot (T+1)},$$

Alcuin's problem 18 is to decide whether there is a solution  $u = (x, y, z)$  to the system (1)–(8).

There are different solutions of Alcuin's problem. It is therefore reasonable to compare the "quality" of different solutions by the evaluation of certain criteria. In mathematical language this means that we transform the combinatorial problem into a *combinatorial optimization problem* by introducing an *objective function* that evaluates the quality of solutions. There are, as usual, many options.

The most natural option is to minimize the number of trips the man has to do. This is probably what Alcuin had in mind. One is therefore tempted to minimize the function

$$\sum_{t=0}^T \sum_{i=1}^3 y(t, i) \tag{9}$$

which, unfortunately, does not do the job. Namely, this function just counts the loaded trips since, whenever the man crosses the river with one item (the boat carries at most one) at time  $t$ , exactly one of the three variables  $y(t, 1)$ ,  $y(t, 2)$  and  $y(t, 3)$  is equal to one while the others are zero. But this function does not count the unloaded trips. Thus, unloaded trips can be "added" to any optimum solution without affecting optimality.

A typical "trick" in optimization, with which such situations can be handled, is *scaling*. We replace the objective function 9, which has only 0/1-coefficients, by

$$\sum_{t=0}^T 3^t \sum_{i=1}^3 y(t, i). \tag{10}$$

For any feasible solution  $(x, y, z)$  of (1)–(8), set

$$t_{\max}(x, y, z) := \max\{t \mid \sum_{i=1}^3 y(t, i) = 1\},$$

i.e.,  $t_{\max}$  is the time of the last nonempty shipment. Now suppose that  $(x, y, z)$  and  $(x', y', z')$  are two feasible solutions of (1)–(8) with  $t_0 = t_{\max}(x, y, z) < t'_0 = t_{\max}(x', y', z')$ . Then the choice of the scaling factors implies that

$$\sum_{t=0}^T 3^t \sum_{i=1}^3 y(t, i) < 3^{t_0+1} \leq 3^{t'_0} \leq \sum_{t=0}^T 3^t \sum_{i=1}^3 y'(t, i).$$

Hence if  $(x, y, z)$  is a feasible solution of (1)–(8) achieving a minimum value with respect to the objective function (10) then  $t_{\max}(x, y, z)$  is the minimum number of trips necessary to take the wolf, the goat, and the bunch of cabbages across.

There are other "tricks" to count the number of trips. We could introduce auxiliary "counting variables" that are one as long as the river is crossed. In our case we would define 0/1-variables  $w(t)$  for  $t = 1, \dots, T$  satisfying

$$\begin{aligned} w(t) &\geq \sum_{i=1}^3 y(t, i) & t = 1, \dots, T, \\ w(t) &\geq w(t+1) & t = 1, \dots, T-1. \end{aligned}$$

Then the objective function

$$\sum_{t=1}^T w(t) \tag{11}$$

would count the number of river crossings, and any minimum solution with respect to this function would be best in Alcuin's sense. Although this modelling technique is quite general (other cases can be handled similarly) optimizers do not like auxiliary 0/1-variables since they usually lead to further difficulties that we cannot discuss here. Another possibility, in the particular case of Alcuin's problem 18, is to minimize the function

$$\sum_{t=0}^T \sum_{i=1}^3 x(t, i) \tag{12}$$

that models the aim to remove all items from the left bank as soon as possible. A way to see that minimizing (12) is the same as finding the minimum number of river crossings is as follows: By rearranging the state transition equations (2) and (3) we obtain the relations

$$x(t) = x(t+1) + (-1)^t y(t+1) \quad 0 \leq t \leq T-1. \tag{13}$$

Substituting (13) into the objective function (12) yields

$$\begin{aligned} -\sum_{t=0}^T (-1)^t t \sum_{i=1}^3 y(t, i) + T \sum_{i=1}^3 \underbrace{x(T, i)}_{=0} &= -\sum_{t=0}^T (-1)^t t \sum_{i=1}^3 y(t, i) \\ &= \begin{aligned} &y(1, 1) + y(1, 2) + y(1, 3) \\ &- 2y(2, 1) - 2y(2, 2) - 2y(2, 3) \\ &+ 3y(3, 1) + 3y(3, 2) + 3y(3, 3) \\ &- \dots \\ &+ Ty(T, 1) + Ty(T, 2) + Ty(T, 3). \end{aligned} \end{aligned} \tag{14}$$

(Note that  $x(T, i) = 0$  since all items have to be removed from the left bank at time  $t = T$  because of the final state condition (7).) We see that objective (14) essentially adds up the time periods where an item is first shipped to the right-hand side of the river plus a penalty of at least one for each item that is transported twice over the river. Thus (14) will yield a minimum solution in Alcuin's sense. This, however, is not necessarily so in generalizations of problem 18.

As we have indicated, there is no unique natural way to model Alcuin's problem 18. But we hope that it has become clear that the general approach to formulate problem 18 as a 0/1-optimization problem is quite flexible. Using similar observations and "tricks", generalizations and variants of problem 18 can be modelled easily. Different objective functions and further or other restrictions can be taken into account without difficulty. It should also be apparent how Alcuin's other transportation problems can be phrased in this way.

Summarizing the discussion of this section, we have shown that Alcuin's problem 18 is equivalent to finding an optimum solution to the following 0/1-optimization problem (15) with  $T = 9$ , which is the problem that we are going to discuss further in subsequent sections. The choice of one of the three (or more) possible objective functions is a matter of taste. We always try to avoid auxiliary variables. That is why we rule out (11). Objective function (10) has large coefficients (which sometimes results in numerical problems), thus we opt for (12).

$$\begin{aligned}
& \text{minimize} && \sum_{t=0}^T \sum_{i=1}^3 x(t, i) \\
& \text{subject to} && \\
& && x(0) = (1, 1, 1) \\
& && y(0) = (0, 0, 0) \\
& && z(0) = (0, 0, 0) \\
& && \left. \begin{aligned} x(t+1) &= x(t) - y(t+1) \\ z(t+1) &= z(t) + y(t+1) \end{aligned} \right\} && \text{if } 0 \leq t \leq T \text{ is even} \\
& && \left. \begin{aligned} x(t+1) &= x(t) + y(t+1) \\ z(t+1) &= z(t) - y(t+1) \end{aligned} \right\} && \text{if } 0 \leq t \leq T \text{ is odd} \\
& && y(t, 1) + y(t, 2) + y(t, 3) \leq 1 && 0 \leq t \leq T \quad (15) \\
& && x(t) \in \left\{ \begin{pmatrix} 0 \\ 0 \\ 0 \end{pmatrix}, \begin{pmatrix} 1 \\ 0 \\ 0 \end{pmatrix}, \begin{pmatrix} 0 \\ 1 \\ 0 \end{pmatrix}, \begin{pmatrix} 0 \\ 0 \\ 1 \end{pmatrix}, \begin{pmatrix} 1 \\ 0 \\ 1 \end{pmatrix} \right\} && \text{if } 0 \leq t \leq T \text{ is odd} \\
& && z(t) \in \left\{ \begin{pmatrix} 0 \\ 0 \\ 0 \end{pmatrix}, \begin{pmatrix} 1 \\ 0 \\ 0 \end{pmatrix}, \begin{pmatrix} 0 \\ 1 \\ 0 \end{pmatrix}, \begin{pmatrix} 0 \\ 0 \\ 1 \end{pmatrix}, \begin{pmatrix} 1 \\ 0 \\ 1 \end{pmatrix}, \begin{pmatrix} 1 \\ 1 \\ 1 \end{pmatrix} \right\} && \text{if } 0 \leq t \leq T \text{ is even} \\
& && z(T) = (1, 1, 1) \\
& && x(t), y(t), z(t) \in \{0, 1\}^3 && 0 \leq t \leq T
\end{aligned}$$

## 4 The Integer Programming Approach

We would like to solve Alcuin's problem 18 by means of integer programming methodology. The current model (15), however, is not suitable for this approach because of the set constraints. Constraints of this type can (occasionally) be exploited by *dynamic programming* or other *search* or *implicit enumeration techniques* in case the state or search spaces can be efficiently reduced. We do not discuss these methods here.

Our approach is to reformulate the set constraints geometrically by means of linear inequalities (and integrality requirements).

Let us look at the set constraints

$$x(t) \in \left\{ \begin{pmatrix} 0 \\ 0 \\ 0 \end{pmatrix}, \begin{pmatrix} 1 \\ 0 \\ 0 \end{pmatrix}, \begin{pmatrix} 0 \\ 1 \\ 0 \end{pmatrix}, \begin{pmatrix} 0 \\ 0 \\ 1 \end{pmatrix}, \begin{pmatrix} 1 \\ 0 \\ 1 \end{pmatrix} \right\} \quad \text{if } t \geq 0 \text{ is odd.}$$

We view the five 3-dimensional 0/1-vectors

$$x^1 := \begin{pmatrix} 0 \\ 0 \\ 0 \end{pmatrix}, x^2 := \begin{pmatrix} 1 \\ 0 \\ 0 \end{pmatrix}, x^3 := \begin{pmatrix} 0 \\ 1 \\ 0 \end{pmatrix}, x^4 := \begin{pmatrix} 0 \\ 0 \\ 1 \end{pmatrix}, x^5 := \begin{pmatrix} 1 \\ 0 \\ 1 \end{pmatrix},$$

describing the set of possible  $x$ -states, as points in  $\mathbb{R}^3$ . The *convex hull* of these points

$$\text{conv}\{x^1, x^2, x^3, x^4, x^5\} := \left\{ x \in \mathbb{R}^3 \mid x = \sum_{i=1}^5 \lambda_i x^i, \lambda_i \geq 0, \sum_{i=1}^5 \lambda_i = 1 \right\}$$

forms a *polytope* that we call the  $x$ -state polytope. By a general theorem due to Weyl

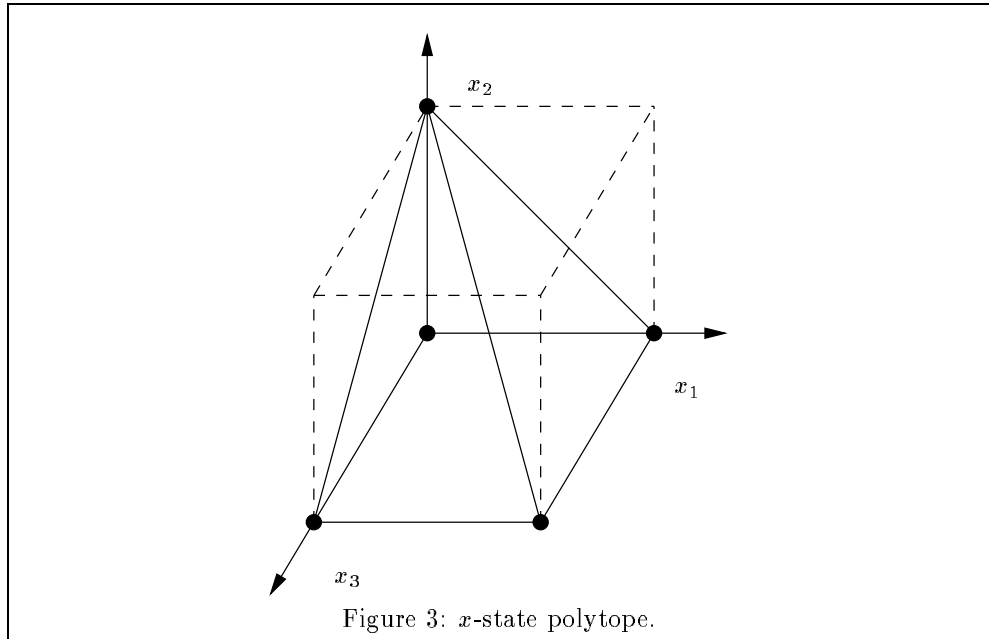

and Minkowski, see Schrijver (1989), there is, for every finite set  $V$  of points in  $\mathbb{R}^n$ , a finite set of inequalities  $Ax \leq b$  whose solution set is equal to the convex hull of  $V$ , and vice versa, for every bounded set  $P$  that is the solution set of some inequality system  $Ax \leq b$ , there is a finite set  $V$  whose convex hull is equal to  $P$ .

So we know that it is possible to find a system  $Ax \leq b$  of inequalities with

$$\text{conv}\{x^1, x^2, x^3, x^4, x^5\} = \{x \in \mathbb{R}^3 \mid Ax \leq b\}.$$

In this case one easily computes

$$\text{conv} \left\{ \begin{pmatrix} 0 \\ 0 \\ 0 \end{pmatrix}, \begin{pmatrix} 1 \\ 0 \\ 0 \end{pmatrix}, \begin{pmatrix} 0 \\ 1 \\ 0 \end{pmatrix}, \begin{pmatrix} 0 \\ 0 \\ 1 \end{pmatrix}, \begin{pmatrix} 1 \\ 0 \\ 1 \end{pmatrix} \right\} = \left\{ \begin{array}{l} x_1 \geq 0 \\ x_2 \geq 0 \\ x_3 \geq 0 \\ x_1 + x_2 \leq 1 \\ x_2 + x_3 \leq 1 \end{array} \right\}.$$

Similarly, we get a  $z$ -state polytope by observing that

$$\text{conv} \left\{ \begin{pmatrix} 0 \\ 0 \\ 0 \end{pmatrix}, \begin{pmatrix} 1 \\ 0 \\ 0 \end{pmatrix}, \begin{pmatrix} 0 \\ 1 \\ 0 \end{pmatrix}, \begin{pmatrix} 0 \\ 0 \\ 1 \end{pmatrix}, \begin{pmatrix} 1 \\ 0 \\ 1 \end{pmatrix}, \begin{pmatrix} 1 \\ 1 \\ 1 \end{pmatrix} \right\} = \left\{ \begin{array}{l} z_1 \geq 0 \\ z_2 \geq 0 \\ z_3 \geq 0 \\ z_1 \leq 1 \\ z_3 \leq 1 \\ -z_1 + z_2 + z_3 \leq 1 \\ z_1 + z_2 - z_3 \leq 1 \end{array} \right\}.$$

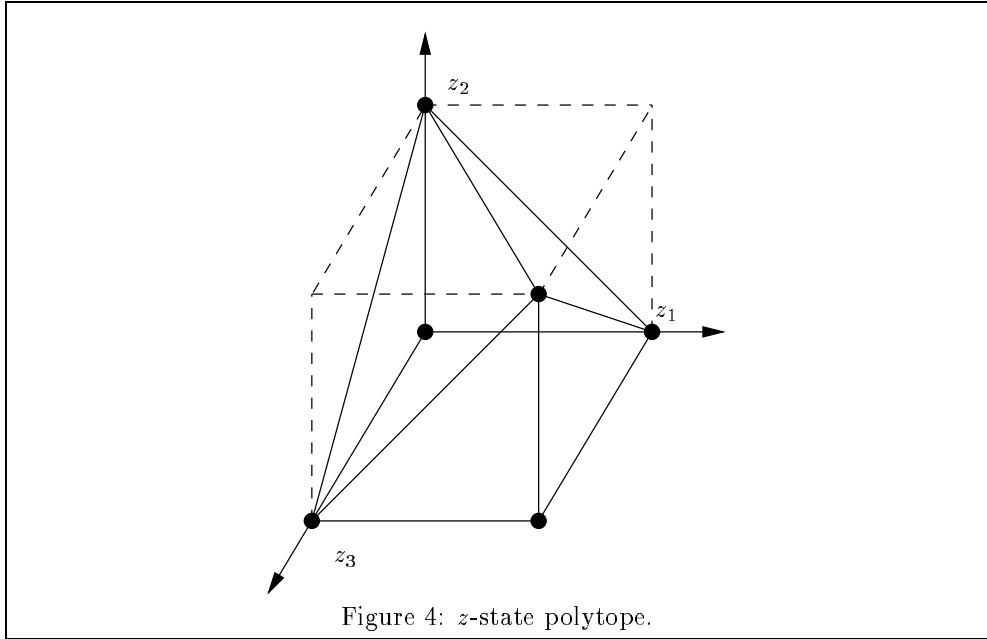

There are general techniques to determine, given a finite set of points in  $\mathbb{R}^n$ , an inequality system describing the convex hull of these points (such as Fourier-Motzkin elimination or the double description method, see Padberg (1995) or Tschernikow (1971)). These methods are inherently exponential. In other words, there are examples of a few points that need an enormous number of inequalities for the description of the convex hull.

In our case we are lucky and we can use the observation above to set up the integer programming problem we are aiming at. We simply replace all the set constraints by the corresponding inequality systems as in (16). One may be tempted to believe

$$\begin{aligned}
& \text{minimize} && \sum_{t=0}^T \sum_{i=1}^3 x(t, i) \\
& \text{subject to} && \\
& && x(0) = (1, 1, 1) \\
& && y(0) = (0, 0, 0) \\
& && z(0) = (0, 0, 0) \\
& \left. \begin{aligned} x(t+1) &= x(t) - y(t+1) \\ z(t+1) &= z(t) + y(t+1) \end{aligned} \right\} && \text{if } 0 \leq t \leq T \text{ is even} \\
& \left. \begin{aligned} x(t+1) &= x(t) + y(t+1) \\ z(t+1) &= z(t) - y(t+1) \end{aligned} \right\} && \text{if } 0 \leq t \leq T \text{ is odd} \\
& && y(t, 1) + y(t, 2) + y(t, 3) \leq 1 && 0 \leq t \leq T \\
& \left. \begin{aligned} x(t, 1) + x(t, 2) &\leq 1 \\ x(t, 2) + x(t, 3) &\leq 1 \end{aligned} \right\} && \text{if } 0 \leq t \leq T \text{ is odd} \\
& \left. \begin{aligned} -z(t, 1) + z(t, 2) + z(t, 3) &\leq 1 \\ z(t, 1) + z(t, 2) - z(t, 3) &\leq 1 \end{aligned} \right\} && \text{if } 0 \leq t \leq T \text{ is even} \\
& && z(T) = (1, 1, 1) \\
& && 0 \leq x(t, i), y(t, i), z(t, i) \leq 1 && 0 \leq t \leq T, 1 \leq i \leq 3 \\
& && x(t), y(t), z(t) \in \{0, 1\}^3 && 0 \leq t \leq T
\end{aligned} \tag{16}$$

that the integrality stipulations are not necessary since we found complete linear descriptions for the *individual* set constraints. But — as we will see in a minute — this is not so! What we have achieved, however, is the following: The description (16) is an *integer linear programming model* of Alcuin’s problem 18, i.e., a description by means of linear constraints and integrality stipulations only. Why is this linear integer model (16) better than the old model (15)? The point is that if we delete the integrality constraints from (16) we obtain an optimization problem over a system of linear equations and inequalities, a so-called *linear program*, with the property that all feasible integral solutions of this linear program are exactly the solutions of Alcuin’s problem 18. This linear program (17) is called the *LP relaxation* of the integer program (16). The reason for making all these efforts is that there is good commercial and public domain software available that solves linear programs, even of very large size, quite easily.

Does that approach — formulating a problem as an integer linear program and dropping the integrality constraints — solve Alcuin’s problem? Unfortunately not! Namely, if we solve the LP relaxation (17) we get the solution shown in Figure 5.



$$\begin{aligned}
& \text{minimize} && \sum_{t=0}^T \sum_{i=1}^3 x(t, i) \\
& \text{subject to} && \\
& && x(0) = (1, 1, 1) \\
& && y(0) = (0, 0, 0) \\
& && z(0) = (0, 0, 0) \\
& \left. \begin{aligned} x(t+1) &= x(t) - y(t+1) \\ z(t+1) &= z(t) + y(t+1) \end{aligned} \right\} && \text{if } 0 \leq t \leq T \text{ is even} \\
& \left. \begin{aligned} x(t+1) &= x(t) + y(t+1) \\ z(t+1) &= z(t) - y(t+1) \end{aligned} \right\} && \text{if } 0 \leq t \leq T \text{ is odd} \\
& && y(t, 1) + y(t, 2) + y(t, 3) \leq 1 && 0 \leq t \leq T \\
& \left. \begin{aligned} x(t, 1) + x(t, 2) &\leq 1 \\ x(t, 2) + x(t, 3) &\leq 1 \end{aligned} \right\} && \text{if } 0 \leq t \leq T \text{ is odd} \\
& \left. \begin{aligned} -z(t, 1) + z(t, 2) + z(t, 3) &\leq 1 \\ z(t, 1) + z(t, 2) - z(t, 3) &\leq 1 \end{aligned} \right\} && \text{if } 0 \leq t \leq T \text{ is even} \\
& && z(T) = (1, 1, 1) \\
& && 0 \leq x(t, i), y(t, i), z(t, i) \leq 1 && 0 \leq t \leq T, 1 \leq i \leq 3
\end{aligned} \tag{17}$$

$x(0) = (1.0, 1.0, 1.0)$	$y(0) = (0.0, 0.0, 0.0)$	$z(0) = (0.0, 0.0, 0.0)$
$x(1) = (1.0, 0.0, 1.0)$	$y(1) = (0.0, 1.0, 0.0)$	$z(1) = (0.0, 1.0, 0.0)$
$x(2) = (1.0, 0.0, 1.0)$	$y(2) = (0.0, 0.0, 0.0)$	$z(2) = (0.0, 1.0, 0.0)$
$x(3) = (0.5, 0.0, 0.5)$	$y(3) = (0.5, 0.0, 0.5)$	$z(3) = (0.5, 1.0, 0.5)$
$x(4) = (0.5, 0.0, 0.5)$	$y(4) = (0.0, 0.0, 0.0)$	$z(4) = (0.5, 1.0, 0.5)$
$x(5) = (0.0, 0.0, 0.0)$	$y(5) = (0.5, 0.0, 0.5)$	$z(5) = (1.0, 1.0, 1.0)$
$x(6) = (0.0, 0.0, 0.0)$	$y(6) = (0.0, 0.0, 0.0)$	$z(6) = (1.0, 1.0, 1.0)$
$x(7) = (0.0, 0.0, 0.0)$	$y(7) = (0.0, 0.0, 0.0)$	$z(7) = (1.0, 1.0, 1.0)$
$x(8) = (0.0, 0.0, 0.0)$	$y(8) = (0.0, 0.0, 0.0)$	$z(8) = (1.0, 1.0, 1.0)$
$x(9) = (0.0, 0.0, 0.0)$	$y(9) = (0.0, 0.0, 0.0)$	$z(9) = (1.0, 1.0, 1.0)$

Figure 5: Fractional solution of LP-relaxation.

We observe that it is not integral, i.e., the integrality stipulations in (16) were in fact necessary!

Although this is “illegal”, we interpret the fractional optimum solution. The interpretation is illustrated in Figure 6. The man first ships the goat ( $y(1, 2) = 1$ ) from left to right, returns, then ships half the wolf and half the cabbage ( $y(3, 1) = y(3, 3) = 0.5$ )

from left to right, returns, and ships the remaining half of the wolf and the cabbage ( $y(5, 1) = y(5, 3) = 0.5$ ) to the right. This “solution” does not violate any of the

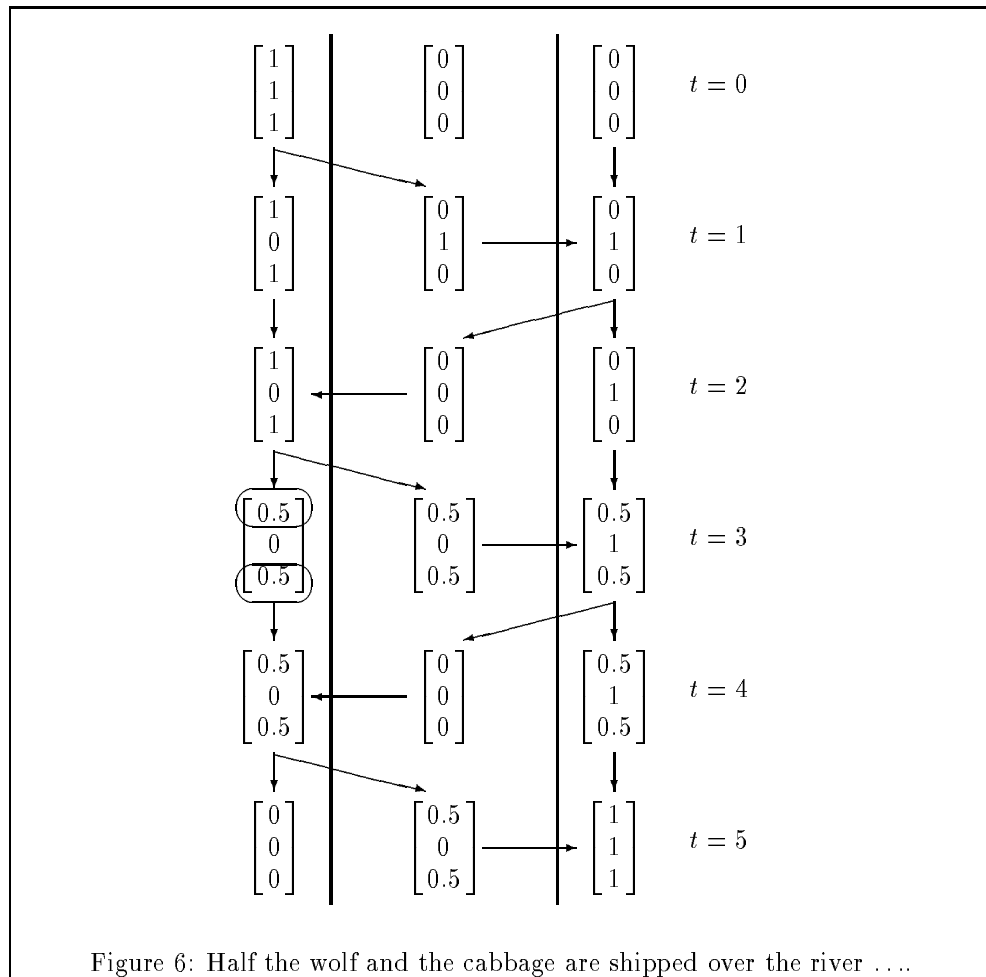

inequalities of the LP relaxation (17) and requires only 5 shipments, but is certainly not what Alcuin had in mind. The point here is simply that the numbers 0 and 1 are indicating the presence or absence of an item. They are *indicator variables* and not *numeric variables* from which we can take fractions. Fractional values of indicator variables have no meaning in the “real world” — although we could not withstand the temptation to talk about half a wolf. So, was all this effort just funny nonsense? Of course not, otherwise we would not have written this paper. As often in mathematics, we go through infeasible domains to arrive at our aim. How we do that will be described in the next sections.

## 5 The Polyhedral Approach and Cutting Planes

The first attempt to solve the integer programming version (16) of Alcuin's problem 18 using only linear programming was not successful. But by extending the idea that we described in Section 4 to reformulate the set constraints we get on the right track. Let us look again at the integer program (16). The set of integral vectors

$$V := \{u = (x, y, z) \in \mathbb{R}^{3 \cdot 3 \cdot (T+1)} \mid (x, y, z) \text{ satisfies (16)}\},$$

i.e., the set of solutions of Alcuin's problem 18, is finite. Thus the convex hull  $P$  of  $V$  forms a polytope, and just as for the set constraints (5) and (6), the theorem of Weyl and Minkowski implies the existence of a finite system of inequalities  $Au \leq b$  with

$$\text{conv } V = P = \{u \mid Au \leq b\}.$$

It is well known from polyhedral theory that the set of *vertices* (extreme points) of  $P$  is a subset of  $V$ . In fact, since  $V \subseteq \{0, 1\}^{3 \cdot 3 \cdot (T+1)}$  it is easy to see that  $V$  is *exactly* the set of vertices of  $P$ . But the integer program (16) asks for an element of  $V$  with minimum objective value, i.e., for a vertex of  $P$  with minimum objective value.

Now a simple but fundamental observation of linear programming is the fact that, for any linear objective function  $c^T u$ , the minimum value of the LP

$$\min_{u \in P} c^T u = \begin{array}{ll} \text{minimize} & c^T u \\ \text{subject to} & Au \leq b \end{array}$$

is attained at a vertex of  $P$ . The famous *simplex method* exploits exactly this observation. It first finds a vertex of  $P$  (in simplex terminology: a basic feasible solution) and then iteratively moves from one vertex to a neighboring vertex with smaller objective function value, until an optimum vertex is reached. Since this vertex is a point in  $V$ , our integer program is solved.

We have already mentioned that it is generally very difficult to find all the inequalities describing  $P$ . For example, there are natural ways to formulate the well known travelling salesman problem as an integer program resulting, for  $n$  cities, in *travelling salesman polytopes* in dimension  $n(n-1)/2$  with  $\frac{1}{2}(n-1)!$  vertices, see Grötschel and Padberg (1985). Table 1 shows for  $5 \leq n \leq 10$  the number of vertices and the number of *facets* (inequalities necessary to describe the polytope) of the travelling salesman polytope. This table, composed from Christof and Reinelt (1995) and Padberg (1995), gives a glimpse of the enormous growth that may occur here.

$n$	5	6	7	8	9	10
Vertices	12	60	360	2,520	20,160	181,440
Facets	20	100	3,437	194,187	42,104,442	51,043,900,866

Table 1: Combinatorial explosion in the TSP-polytope.

In general, it is practically impossible to compute all the necessary inequalities. Even if we could do that it is simply out of question to input them into a computer code

and solve the resulting LP. Nevertheless, there are ways to use this approach algorithmically as we will illustrate.

Let us first “do the impossible”. Alcuin’s problem is still in the range of problem sizes where one can compute all the feasible integer solutions and a complete description of their convex hull by linear inequalities. We did that using the program PORTA (Christof (1994)).

Setting the time horizon to  $T := 9$  we obtain an integer program in  $3 \cdot 3 \cdot (T + 1) = 3 \cdot 3 \cdot 10 = 90$  variables where the first 9 variables are fixed to  $x(0) = (1, 1, 1)$ ,  $y(0) = (0, 0, 0)$ ,  $z(0) = (0, 0, 0)$  due to Alcuin’s initial condition and where we require  $z(9) = (1, 1, 1)$ , as outlined in the description of our model, as the “terminal state” meaning wolf, goat, and cabbage have to be on the right bank in the end.

We determined all vertices (integral and fractional) of the LP relaxation and took all feasible integral solutions to generate the linear inequalities (facets) and linear equations that are necessary to describe the convex hull of the integral points in  $\mathbb{R}^{90}$ . The result is displayed in Table 2. All the 20 different integral solutions of Alcuin’s

Dimension	Fractional vertices	Integral solutions	Equations	Facets
90	2,261	20	79	16

Table 2: Complete description of the convex hull.

problem and the complete list of 16 inequalities and 79 equations describing their convex hull can be found in the Appendix in Figures 8 and 9.

The number of equations and inequalities is so small that every commercial LP code solves the resulting LP in a matter of milliseconds. Using the objective function (10) or (12) we obtain exactly the 0/1-representation of Alcuin’s solution and have thus succeeded in solving the integer program as a linear program.

In general, however, we don’t have the list of all inequalities. In such a case we use what is called the *cutting plane approach* in combinatorial optimization. This is done as follows.

We first solve the “natural LP relaxation” of the given integer program. In our case, that would be the LP (17). If the optimum solution — say  $u^*$  — found is integral we are done (since we are solving an optimization problem over a set larger than the set of integral solutions). If it is not integral (like in our case the solution in Figure 5 happened to be) we search for an inequality or an equality from the complete system describing the convex hull that is violated by the current fractional solution  $u^*$ . Such an inequality/equation is called a *cutting plane*, as it cuts the current solution off. We modify our present LP by adding the inequality/equation found (of course, in practice we will not only add one cutting plane, but usually as many as we can find – provided that the LP does not get too large) and resolve the LP. We iterate this process until an integral solution is found.

We have done that with Alcuin’s problem. The first LP-solution listed in Figure 5 was fractional. This solution does not satisfy the equation (53)

$$z(4, 1) + z(4, 2) + z(4, 3) = 1$$

of the complete description listed in Figure 9. In fact, in the LP solution we have

$$z(4, 1) + z(4, 2) + z(4, 3) = 1/2 + 1 + 1/2 = 2.$$

Thus we can use this equation as a cutting plane and add it to the LP. The optimum solution of the new LP was again fractional. We found the new cutting plane

$$y(3, 2) + y(4, 1) + y(4, 3) + y(5, 2) - y(6, 2) \leq 0,$$

which is inequality (10) from the complete description. We also added this inequality to the LP. The optimum solution of the third LP was integral and again Alcuin's solution.

So with just two additional cutting planes we were able to produce a *provably* optimum integral solution (by solving three linear programs). This rather surprising result is not just a strike of luck. There is a general theory often termed the "polynomial time equivalence of optimization and separation" worked out in detail in Grötschel, Lovász, and Schrijver (1988) which explains this favorable behavior. Even a short outline of this theory is beyond the scope of this paper.

We did not explain how we determine cutting planes. In Alcuin's case this is easy. Since we have an explicit list of all necessary inequalities and equations, we can simply substitute the fractional solution into the inequalities/equations. As the list is complete and the fractional solution is not in the convex hull of the integral points there must be at least one inequality/equation that is violated and we can use this as a cutting plane. In general, however, this approach requires too much computational effort, even if someone gave us the complete description for free, since the complete systems describing polyhedra associated with combinatorial optimization problems tend to have exponentially many inequalities (see the TSP case already mentioned). That difficulty can be dealt with by means of so-called *separation algorithms*. The associated theory can be found in Grötschel, Lovász, and Schrijver (1988).

Making this theory practical, i.e., coming up with algorithms that solve problems of the real world efficiently, requires a lot of additional, often problem specific work. We refer the interested reader to Padberg and Grötschel (1985) for a discussion of the TSP case in this respect.

The same approach also applies when we do not know complete inequality systems describing the convex hull, which, in fact, is the usual case. The cutting plane method is again based on separation algorithms, but these implicitly or explicitly search only parts of the (existing but unknown) complete system. In such a case we may be lucky and find an optimum integral solution (in our case, the initial LP plus only two more inequalities described above would result in such a case), but in general we are not guaranteed to terminate with an integral optimum solution. If that happens, and in practical applications this is usually so, we still have a way out. This is described in the next section.

## 6 Branch and Bound

We have arrived at a state where our LP solver has determined an optimum non-integral solution of our current LP relaxation of the integer program and where our

separation algorithms were unable to find a further cutting plane. In Alcuin’s problem 18 that could have been after the solution of the initial LP relaxation if we had not been able to compute the inequality system in Figure 9.

At such a point, practice has shown that it is not a bad idea to do something (theoretically) trivial. We resort to (partial) enumeration and combine this with some heuristics.

So let us summarize the current situation. We have a fractional solution of the last LP relaxation at hand. Its objective function value provides by construction a *lower bound*  $c_L$  for the (unknown) optimum value  $c_{\text{opt}}$  of the integer program, i.e.,

$$c_L \leq c_{\text{opt}}.$$

Now, in practical applications one usually implements several heuristics that try to find “good” feasible solutions using various problem specific search and improvement techniques. The best such feasible solution provides an upper bound  $c_U$  for  $c_{\text{opt}}$ .

$$\begin{array}{ccccc} c_L & \leq & c_{\text{opt}} & \leq & c_U \\ \text{lower bound} & & \text{optimal solution} & & \text{upper bound} \\ & & \text{(unknown)} & & = \text{best known solution} \end{array}$$

Let us look at the relative error  $\epsilon = \frac{c_U - c_L}{c_L}$  (assuming  $c_L > 0$ ). If  $\epsilon = 0$  (i.e.  $c_U = c_L = c_{\text{opt}}$ ) we are done. In many applications the data are somewhat “soft” or “fuzzy” and practitioners are perfectly happy with a situation where  $\epsilon = 0.1$ . That means that we have a feasible solution with value  $c_U$  that is *guaranteed* to differ from the optimum value  $c_{\text{opt}}$  by at most 10%.

In Alcuin’s case we could use his solution with value  $c_U = \sum x(t, i) = 12$  whereas our LP-solution gives a lower bound  $c_L = 9$ . We are not satisfied with the resulting gap of  $33\frac{1}{3}\%$ . That is why we turn to partial enumeration. Using some rule (to be determined by problem specific investigation) we choose one of the variables having a fractional value. In our case we choose  $x(3, 1)$ , i.e., the wolf variable on the left bank in time period three, whose value is 0.5 in our LP solution. In an optimum solution this value must be either 0 or 1. So we create two new subproblems consisting of the old LP plus one of the additional requirements  $x(3, 1) = 0$  or  $x(3, 1) = 1$ . This creation of two new subproblems splits the set of feasible integral solutions into two distinct subsets and is called a *branching step*.

Now we solve each of the resulting new LPs with our LP solver (possibly using the generation of new cutting planes, in which case we call the procedure *branch and cut*). In each subproblem we get new lower bounds and possibly, running further heuristics, also new upper bounds. If the lower bound at a subproblem is larger than or equal to the best current upper bound we can stop investigating this subproblem since it provably does not contain an integral solution that is better than the current best. This is the *bounding* or *fathoming step* with which we can trim the *search tree* that is generated by iteratively applying the fixing of variables as described above.

The search tree that is obtained in Alcuin’s case is shown in Figure 7. We already described how we created two new subproblems from the initial LP relaxation. Solving the LP at subproblem 2 — arising from fixing the wolf variable  $x(3, 1)$  to 0 — yields

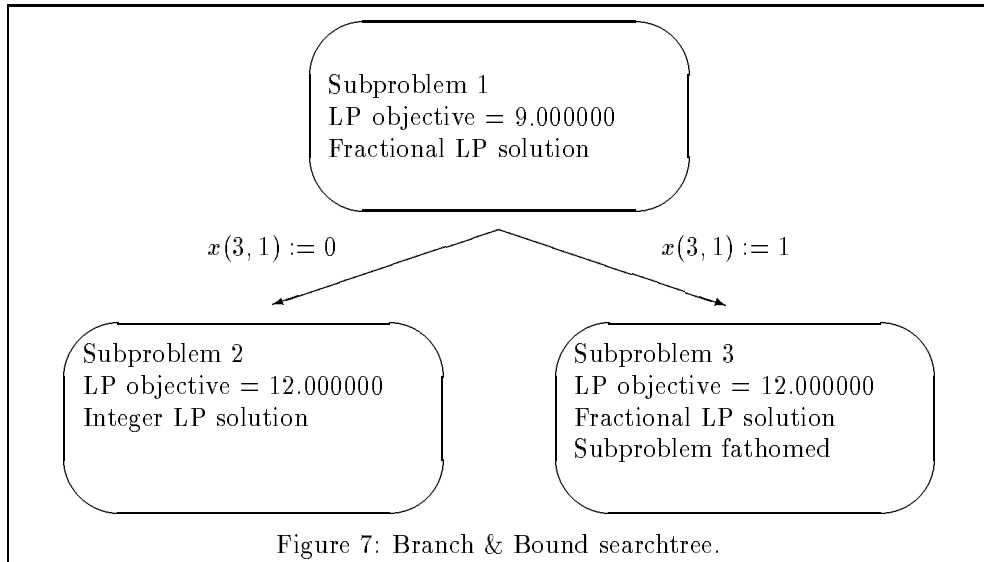

Alcuin’s integral solution with objective value 12. We already knew this solution, so our upper bound of 12 is not improved, but since we solved subproblem 2 to (integral) optimality, we can stop processing it. A better solution could, however, still be found in subproblem 3 that we got from the LP relaxation by fixing  $x(3, 1)$  to 1. Solving this LP yields a fractional solution with value 12. This value is a lower bound on the objective value of all fractional and integral solutions in subproblem 3. But since this objective value equals the value of the best known solution, there cannot be any better integer solution in subproblem 3 and we have fathomed it. So by just examining three subproblems in the searchtree we once more arrived at Alcuin’s solution and proved it to be optimal (with respect to objective (12) and thus also with respect to (10)) again.

The search tree could, in principle, consist of  $2^{90}$  nodes turning this approach into (hopelessly ineffective) complete enumeration. In case both the LPs solved on the run and the heuristics provide good bounds on the optimum value the search tree often is of manageable size, as in our case.

This enumerative technique called *branch and bound* or *implicit enumeration* or *branch and cut* or the like guarantees the finiteness of the branch and cut procedure that we described – at least theoretically. In Alcuin’s case we could easily prove that his solution is optimal.

## 7 Transportation Problems

Alcuin’s problems 17, ..., 20 are certainly not transportation problems that appear in practical applications. We have chosen problem 18 to show how — in our times

— transportation problems are modelled and solved. Surprisingly, problem 18 displays all the difficulties in mathematical modelling and in algorithmically solving real transportation problems of today. In fact, the mathematical techniques and the algorithmic ideas that we sketched in the previous sections are exactly the methods with which large-scale transportation and other combinatorial optimization problems are attacked at present.

It is simply impossible to survey here all the variants of transportation problems that are used in practice and dealt within the mathematics and operations research literature. The Handbook “Network Models” by Ball, Magnanti, Monma, and Nemhauser (1995) contains several chapters that discuss various types of transportation problems (travelling salesman; watchman routes; assignment, minimum cost and multicommodity flow problems; path planning), the survey articles Desrochers, Desrosiers, and Soumis (1984) and Assad, Ball, Bodin, and Golden (1983) contain broad overviews of the subject and classifications of the problem types. A survey of the field of combinatorial optimization can be found in Grötschel and Lovász (1995). The polyhedral methods of integer programming emphasized in this paper are described in more detail in the articles Grötschel and Padberg (1985) and Padberg and Grötschel (1985).

We are currently working on two special and really large-scale logistics problems: bus scheduling in Hamburg and the transportation of disabled persons in Berlin.

The bus scheduling problem is the following. The transportation company of a city has decided (taking many additional requirements and side constraints into account) on a network of lines where buses regularly run. Moreover, the timetable for the bus trips has been determined. The company has several bus depots and types of vehicles. For each trip it is known which vehicle type from which depot can serve it. The task is to assign the vehicles to the trips such that each trip is served by a “legal vehicle” and such that the fleet size is minimized and the cost of the “unloaded trips” (move of a bus without passengers between two trips, or from or to the depot) is as small as possible. This problem can be modelled as a special integral multicommodity flow problem. In case of the city of Hamburg, the mathematical model has about 30 million integral variables. We can solve the problem to optimality on fast SUN workstations in about two days of CPU time.

The city of Berlin operates a fleet of about 100 special buses that can carry 2 to 4 wheel chairs simultaneously. Every disabled person in Berlin is entitled to order rides (under certain side constraints) that will be provided by this system. About 23,000 people currently subscribe to the system and order between 1,000 and 1,500 rides a day on the average. The problem is to schedule the individual rides into buses so that timely service is provided and the overall cost is as small as possible. We have modelled this task, to be solved day by day, as a so-called set partitioning problem, requiring the solution of an integer program

$$\begin{array}{ll} \text{minimize} & c^T x \\ \text{subject to} & \\ & Ax = \mathbf{1} \\ & x \in \{0, 1\}^n \end{array}$$

where  $A$  is a 0/1-matrix with 1,000 to 1,500 rows and 100,000 to 1 million columns



and  $\mathbf{1}$  a vector all of whose components are 1. We are unable, at present, to solve this problem to optimality, but we can generate, in a few hours of CPU time, feasible solutions with costs provably at most 10% to 20% above the (unknown) minimum value. A first version of this system started operation in Berlin in June 1995 and resulted in considerable savings (about 25%) compared to the previously used “scheduling by hand”.

## References

- Assad, A., Ball, M., Bodin, L., and Golden, B. (1983). Routing and scheduling of vehicles and crews. *Computers & Operations Research*, 10(2):63–211.
- Ball, M. O., Magnanti, T. L., Monma, C. L., and Nemhauser, G. L. (1995). *Network Models, Handbooks in Operations Research and Management Science*, volume 7. Elsevier Science B.V., Amsterdam.
- Biggs, N. L., Lloyd, E. K., and Wilson, R. J. (1995). The history of combinatorics. In Graham, Grötschel, and Lovász (1995), chapter 44.
- Bondy, J. A. and Murty, U. S. R. (1976). *Graph Theory with Applications*. American Elsevier, New York, and Macmillan, London.
- Butzer, P. L. and Lohrmann, D., editors (1993). *Science in Western and Eastern Civilization in Carolingian Times*. Birkhäuser Verlag, Basel.
- Christof, T. (1994). PORTA – A Polyhedron Representation Transformation Algorithm, version 1.2.1. Written by T. Christof (Univ. Heidelberg), revised by A. Löbel and M. Stoer, available from the ZIB electronic library ELIB via [elib@zib-berlin.de](mailto:elib@zib-berlin.de), or by anonymous ftp from [elib.zib-berlin.de](ftp://elib.zib-berlin.de), in the directory /pub/mathprog/polyth.
- Christof, T. and Reinelt, G. (1995). Parallel cutting plane generation for the TSP. In Fritzon, P. and Finmo, L., editors, *Parallel Programming and Applications*, pages 163–169. IOS Press.
- Dantzig, G. B. (1963). *Linear Programming and Extensions*. Princeton University Press, Princeton.
- Desrochers, M., Desrosiers, J., and Soumis, F. (1984). Routing with time windows by column generation. *Networks*, 14:545–565.
- Fleckenstein, J. (1993). Alcuin im Kreis der Hofgelehrten Karls des Grossen. In Butzer and Lohrmann (1993).
- Folkerts, M. and Gericke, H. (1993). Die Alkuin zugeschriebenen propositiones ad acuendos iuvenes (Aufgaben zur Schärfung des Geistes der Jugend). In Butzer and Lohrmann (1993).
- Graham, R., Grötschel, M., and Lovász, L., editors (1995). *Handbook of Combinatorics*, volume 2. Elsevier Science B.V., Amsterdam.
- Grötschel, M. and Lovász, L. (1995). Combinatorial optimization. In Graham, Grötschel, and Lovász (1995), chapter 28.

- Grötschel, M., Lovász, L., and Schrijver, A. (1988). *Geometric algorithms and combinatorial optimization*. Springer Verlag, Berlin.
- Grötschel, M. and Padberg, M. (1985). Polyhedral theory. In Lawler, Lenstra, Rinnooy Kan, and Shmoys (1985), chapter 8.
- Hadley, J. and Singmaster, D. (1992). Problems to sharpen the young. *The Mathematical Gazette*, 76(475):102–126.
- Hitchcock, F. L. (1941). The distribution of a product from several sources to numerous localities. *J. Math. Phys.*, 20:224–230.
- Hoffman, A. J. and Wolfe, P. (1985). History. In Lawler, Lenstra, Rinnooy Kan, and Shmoys (1985), chapter 1.
- Kantorovich, L. (1939). *Mathematical Methods in the Organization and Planning of Production*. Publication House of the Leningrad State University. Translated in *Management Science*, Vol. 6, 1960, pp. 366-422.
- Koopmans, T. C. (1947). Optimum utilization of the transportation system. In *Proceedings of the International Statistical Conferences*, Washington D.C. (Vol. 5 reprinted as Supplement to *Econometrica*, Vol. 17, 1949).
- Lawler, E. L., Lenstra, J. K., Rinnooy Kan, A. H. G., and Shmoys, D. B., editors (1985). *The Traveling Salesman Problem*. John Wiley & Sons Ltd., Chichester.
- Lenstra, J. K., Rinnooy Kan, A. H. G., and Schrijver, A., editors (1991). *History of Mathematical Programming*. Elsevier Science B.V., Amsterdam.
- Padberg, M. (1995). *Linear Optimization and Extensions*. Springer Verlag, Berlin.
- Padberg, M. and Grötschel, M. (1985). Polyhedral computations. In Lawler, Lenstra, Rinnooy Kan, and Shmoys (1985), chapter 9.
- Pressman, I. and Singmaster, D. (1989). The jealous husbands and The missionaries and cannibals. *The Mathematical Gazette*, 73(464):73–81.
- Schrijver, A. (1989). *Theory of Linear and Integer Programming*. John Wiley & Sons Ltd., Chichester.
- Tschernikow, S. (1971). *Lineare Ungleichungen*. VEB Deutscher Verlag der Wissenschaften, Berlin.

```
( 1) 11100000010101001010100001000111001100110101000100011101010000101000010111000000111000000111
( 2) 11100000010101001010100001000111001100110101000100011101010000101010000101010000101000010111
( 3) 111000000101010010101000010100001011110010001010100101010000101000010111000000111000000111
( 4) 111000000101010010101000010100001011110010001010100101010000101010000101010000101000010111
( 5) 11100000010101001010100001010100001010100001000111001100110101000100011101010000101000010111
( 6) 111000000101010010101000010101000010101000010100001011110010001010100101010000101000010111
( 7) 11100000010101001010100001000111001100110101000010101100110101000100011101010000101000010111
( 8) 11100000010101001010100001000111001100110101000100011101010000101000010111010010101000010111
( 9) 111000000101010010101000010001110011001101010001000111010110011000100011101010000101000010111
(10) 11100000010101001010100001000111001100110101000100011101110100001010100101010000101000010111
(11) 11100000010101001010100001000111001110101100010001110011001110101000100011101010000101000010111
(12) 11100000010101001010100001000111001110101100010100001011110010001010100101010000101000010111
(13) 111000000101010010101000010100001011101001010001110011001110101000100011101010000101000010111
(14) 111000000101010010101000010100001011101001010100001011110010001010100101010000101000010111
(15) 111000000101010010101000010100001011110010001010100101010000101000010111010010101000010111
(16) 1110000001010100101010000101000010111100100010101001010110011000100011101010000101000010111
(17) 111000000101010010101000010100001011110010001010100101110100001010100101010000101000010111
(18) 111000000101010010101000010100001011110010001100010011110010001010100101010000101000010111
(19) 111000000101010010111010000101010010101000010001110011001110101000100011101010000101000010111
(20) 111000000101010010111010000101010010101000010100001011110010001010100101010000101000010111
```

Figure 8: List of all integer solutions of Alcuin's problem 18 for  $T = 9$ .

Dimension of the space = 90

Minimal system of equations

- |                   |   |
|-------------------|---|
| ( 1) $y(0,1) = 0$ | (41) $x(0,2) = 1$                                     |
| ( 2) $y(0,2) = 0$ | (42) $x(0,1) = 1$                                     |
| ( 3) $y(0,3) = 0$ | (43) $y(7,2)-z(7,2) = 0$                              |
| ( 4) $z(0,1) = 0$ | (44) $x(4,2)-y(4,2) = 0$                              |
| ( 5) $z(0,2) = 0$ | (45) $y(3,3)-z(3,3) = 0$                              |
| ( 6) $z(0,3) = 0$ | (46) $y(3,1)-z(3,1) = 0$                              |
| ( 7) $x(1,2) = 0$ | (47) $x(2,2)-y(2,2) = 0$                              |
| ( 8) $y(1,1) = 0$ | (48) $x(7,2)+y(7,2) = 1$                              |
| ( 9) $y(1,3) = 0$ | (49) $x(5,2)+x(5,3)-z(5,1) = 0$                       |
| (10) $z(1,1) = 0$ | (50) $x(3,3)+y(3,3)-z(3,2) = 0$                       |
| (11) $z(1,3) = 0$ | (51) $y(9,2)+z(8,2) = 1$                              |
| (12) $y(2,1) = 0$ | (52) $x(8,2)-y(9,2) = 0$                              |
| (13) $y(2,3) = 0$ | (53) $z(4,1)+z(4,2)+z(4,3) = 1$                       |
| (14) $z(2,1) = 0$ | (54) $x(4,3)-z(4,1)-z(4,2) = 0$                       |
| (15) $z(2,3) = 0$ | (55) $x(2,3) = 1$                                     |
| (16) $x(3,2) = 0$ | (56) $z(2,2)-x(3,1)+y(3,2)-y(4,1)-z(4,1) = 0$         |
| (17) $z(6,2) = 0$ | (57) $z(6,3)+y(7,3) = 1$                              |
| (18) $x(7,1) = 0$ | (58) $x(7,2)-y(9,2)+y(8,2) = 0$                       |
| (19) $x(7,3) = 0$ | (59) $z(6,1)+y(7,1) = 1$                              |
| (20) $x(8,1) = 0$ | (60) $x(4,2)-x(5,2)-y(5,2) = 0$                       |
| (21) $x(8,3) = 0$ | (61) $x(4,3)-2z(4,1)-x(5,1)+x(5,2)-y(5,1)+y(5,2) = 0$ |
| (22) $y(8,1) = 0$ | (62) $x(3,1)-x(3,3)-y(3,3)+y(4,1)+z(4,1) = 0$         |
| (23) $y(8,3) = 0$ | (63) $x(2,2)-y(3,2) = 0$                              |
| (24) $x(9,1) = 0$ | (64) $x(5,2)-y(5,1)-y(5,2)-y(5,3)+y(6,2) = 0$         |
| (25) $x(9,2) = 0$ | (65) $x(3,3)-x(4,3)+y(4,3) = 0$                       |
| (26) $x(9,3) = 0$ | (66) $x(5,2)-x(5,3)-z(5,3)+y(6,2) = 0$                |
| (27) $y(9,1) = 0$ | (67) $z(5,3)+y(6,1)+y(6,2)-y(7,1) = 1$                |
| (28) $y(9,3) = 0$ | (68) $z(5,2)-y(6,2) = 0$                              |
| (29) $z(9,2) = 1$ | (69) $x(6,1)-y(7,1) = 0$                              |
| (30) $z(9,1) = 1$ | (70) $x(5,1)+x(5,2)+x(5,3)-y(5,1)-y(5,2)-y(5,3) = 0$  |
| (31) $z(8,3) = 1$ | (71) $z(4,1)-x(5,2)-x(5,3)+y(5,1) = 0$                |
| (32) $z(8,1) = 1$ | (72) $x(6,2) = 1$                                     |
| (33) $z(7,3) = 1$ | (73) $x(5,2)+y(6,2) = 1$                              |
| (34) $z(7,1) = 1$ | (74) $x(4,1)-x(4,3)+2z(4,1)-x(5,2)-y(5,2) = 0$        |
| (35) $x(2,1) = 1$ | (75) $x(6,3)-y(7,3) = 0$                              |
| (36) $z(1,2) = 1$ | (76) $y(6,1)+y(6,2)+y(6,3)-y(7,1)-y(7,3) = 0$         |
| (37) $y(1,2) = 1$ | (77) $y(3,3)-y(4,3)+z(4,1)-x(5,2)-y(5,2) = 0$         |
| (38) $x(1,3) = 1$ | (78) $y(3,1)-y(4,1)-z(4,1) = 0$                       |
| (39) $x(1,1) = 1$ | (79) $z(9,3) = 1$                                     |
| (40) $x(0,3) = 1$ |   |

Inequalities (list of all facets)					
( 1)	-y(3,2)				$\leq 0$
( 2)	-y(4,1)				$\leq 0$
( 3)	-y(4,3)				$\leq 0$
( 4)	-y(5,2)				$\leq 0$
( 5)	-y(5,3)				$\leq 0$
( 6)		-y(6,3)			$\leq 0$
( 7)			-y(8,2)		$\leq 0$
( 8)		+y(6,3)	-y(7,3)		$\leq 0$
( 9)			+y(7,1)+y(7,3)+y(8,2)-y(9,2)		$\leq 0$
(10)	+y(3,2)+y(4,1)+y(4,3)+y(5,2)	-y(6,2)			$\leq 0$
(11)		-y(6,2)-y(6,3)	+y(7,3)		$\leq 0$
(12)		+y(6,2)+y(6,3)-y(7,1)-y(7,3)			$\leq 0$
(13)		-y(5,2)-y(5,3)+y(6,2)+y(6,3)	-y(7,3)		$\leq 0$
(14)				+y(9,2)	$\leq 1$
(15)		+y(5,2)+y(5,3)			$\leq 1$
(16)		+y(5,3)	-y(6,3)	+y(7,3)	$\leq 1$

Figure 9: Complete linear description of the convex hull of the polytope associated with Alcuin's problem 18 for  $T = 9$ .