

ANDREAS BETKER<sup>1</sup>  
DIRK KOSIANKOWSKI<sup>1</sup>  
CHRISTOPH LANGE<sup>1</sup>  
FRANK PFEUFFER<sup>2</sup>  
CHRISTIAN RAACK<sup>2</sup>  
AXEL WERNER<sup>2</sup>

## **Energy efficiency in extensive multilayer core and regional networks with protection**

<sup>1</sup> Deutsche Telekom AG, Telekom Innovation Laboratories, Winterfeldtstr. 21, D-10781 Berlin, {andreas.betker, dirk.kosiankowski, christoph.lange}@telekom.de

<sup>2</sup> Zuse Institute Berlin (ZIB), Takustr. 7, D-14195 Berlin, Germany, {pfeuffer, raack, werner}@zib.de

This research has been supported by the German Federal Ministry of Economics and Technology (BMWi) within the IT2Green program ([www.it2green.de](http://www.it2green.de)) and the DFG research Center MATHEON

Herausgegeben vom  
Konrad-Zuse-Zentrum für Informationstechnik Berlin  
Takustraße 7  
D-14195 Berlin-Dahlem

Telefon: 030-84185-0  
Telefax: 030-84185-125

e-mail: [bibliothek@zib.de](mailto:bibliothek@zib.de)  
URL: <http://www.zib.de>

ZIB-Report (Print) ISSN 1438-0064  
ZIB-Report (Internet) ISSN 2192-7782

# Energy efficiency in extensive multilayer core and regional networks with protection\*

Andreas Betker<sup>†</sup>    Dirk Kosiankowski<sup>†</sup>    Christoph Lange<sup>†</sup>    Frank Pfeuffer<sup>‡</sup>  
Christian Raack<sup>‡</sup>    Axel Werner<sup>‡</sup>

## Abstract

Energy-efficient operation of large telecommunication networks is an important issue today and in the near future. Given that the energy consumption rises with the ever increasing demand for capacity and network speed, there is a growing interest in strategies for a sustainable network management. It is a well-known fact that traffic demands vary significantly over time, most notably in day/night- and in weekly cycles. This provides the main potential for energy-saving strategies. We study the question of how much power is necessary to operate a network with state-of-the-art hardware during peak or low-traffic times. The study respects realistic side constraints, such as protection requirements and routing schemes, and takes the special structure of an extensive nation-wide optical network, including backbone and regional sections, into account. We formulate mixed integer programming models for the corresponding optimization problems using predictions for traffic matrices, as well as state-of-the-art hardware and power models. We address questions as the following: How much energy is spent in the core and in metro regions of the network and how big are the savings in low-demand scenarios if we always assume the system power-minimum in these situations? What is the influence of different hardware on the overall energy consumption? How much do different routing schemes or protection scenarios restrict potential energy savings?

**Keywords:** telecommunications, network design, routing, energy efficiency

## 1 Introduction

Telecommunication networks are large nation-wide distributed systems that consume significant amounts of electricity. From a national economy's point of view the sustainability aspect is important to consider, especially in the light of climate change. Furthermore, these networks' power consumption causes considerable energy bills for operators. Therefore, energy efficiency of telecommunication networks has gained increasing interest in research and industry in the recent past.

Conventionally, network capacity is planned and provided based on peak traffic – with capacity reserves included – constantly over time. However, demands show significant temporal fluctuation on different time scales, cf. Figures 1(a) and 1(b). Therefore, a promising direction for network energy efficiency improvements is a load-adaptive network operation coupling the provided capacity to the real – varying – traffic demands.

---

\*This research has been supported by the German Federal Ministry of Economics and Technology (BMW) within the IT2Green program ([www.it2green.de](http://www.it2green.de)) and the DFG research Center MATHEON

<sup>†</sup>Deutsche Telekom AG, Telekom Innovation Laboratories, Winterfeldtstr. 21, D-10781 Berlin, {*andreas.betker, dirk.kosiankowski, christoph.lange*}@telekom.de

<sup>‡</sup>Zuse Institute Berlin (ZIB), Takustr. 7, D-14195 Berlin, Germany, {*pfeuffer, raack, werner*}@zib.de

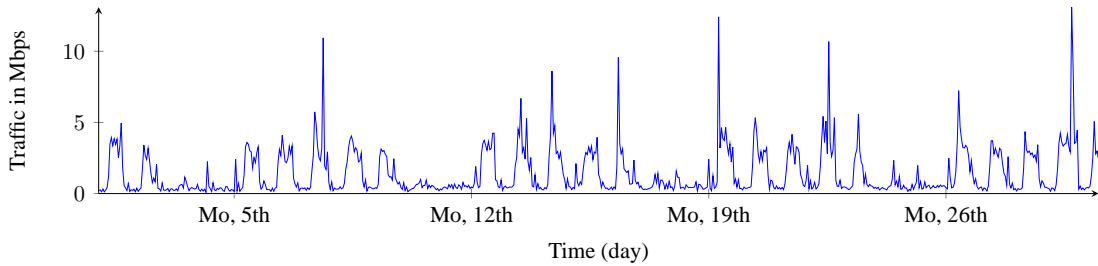

(a) 1 month – Aggregation in intervals of 1 hour during March 2012.

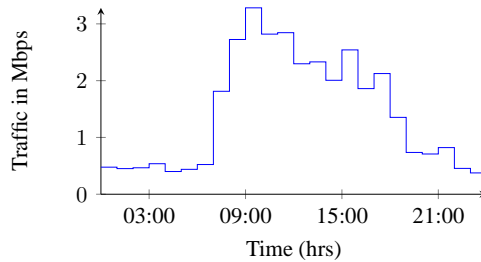

(b) 1 day – Aggregation in intervals of 1 hour and averaged over all working days of March 2012.

Figure 1: Total IP traffic at the Friedrichshafen city hall. Traffic is usually high on business days and before noon, and low on weekends and holidays and throughout the night.

The work presented in this article is focused on the potential of power saving in a nation-wide telecommunication network based on IP-over-DWDM (Internet Protocol over Dense Wavelength Division Multiplexing) and Ethernet-over-WDM architecture. We consider the network core and metropolitan regions but ignore the access network. Earlier work in this direction has been presented, for instance, in Hülsermann et al. [8] and Idzikowski et al. [10]. We refer to Idzikowski et al. [9] for a thorough discussion of relevant literature and to Heddeghem and Idzikowski [6] for a list of frequently used acronyms. Heddeghem and Idzikowski [6] and Heddeghem et al. [7] collect extensive material regarding the power consumption of multilayer networks, which serves as a numerical basis.

In this paper we consider the following question: Given an existing network with state-of-the-art hardware and traffic demands for busy hour as well as low-traffic time, what is the minimal amount of power (in watts) that is needed to route the occurring traffic, under the assumption that the routing can be reconfigured according to the situation and that unnecessary hardware can be deactivated? To answer this, we solve a suitable mixed integer program to obtain a power-optimal routing in the backbone in both the IP-layer, as well as the optical layer.

Assumptions on network topology, hardware, and routing conditions, as well as the demand matrices used in this study are described in detail in the next section. The most notable features we address are the following:

- A realistic, nation-wide network including an IP-over-WDM core architecture and regional sections based on Ethernet technology.
- Traffic originating at regional nodes, plus peering and international transit traffic.
- Network failure protection in the optical domain and diverse routing schemes in the IP domain.
- Computations based on the power consumption of the complete network equipment, assuming state-of-the-art hardware.

## 2 Modelling the problem

In this section we provide a detailed description of the input used for our studies, that is, we introduce network topology and architecture, the different demand scenarios, and the mathematical model used to compute power-optimal configurations. We also illuminate practical side constraints, such as routing schemes and network protection.

### Network topology and architecture.

Basis of our model is a hierarchical nation-wide optical network, which coincides with real existing structures to a great extent; see Figure 2. The given network instance consists of 918 nodes in total and is subdivided into ten regional parts (metro networks) containing 898 nodes and the core network (backbone) with 20 nodes. The backbone, comprising 29 links, is responsible for long-distance traffic transport.

For resiliency purposes there are always two backbone nodes per city, in different locations. Each

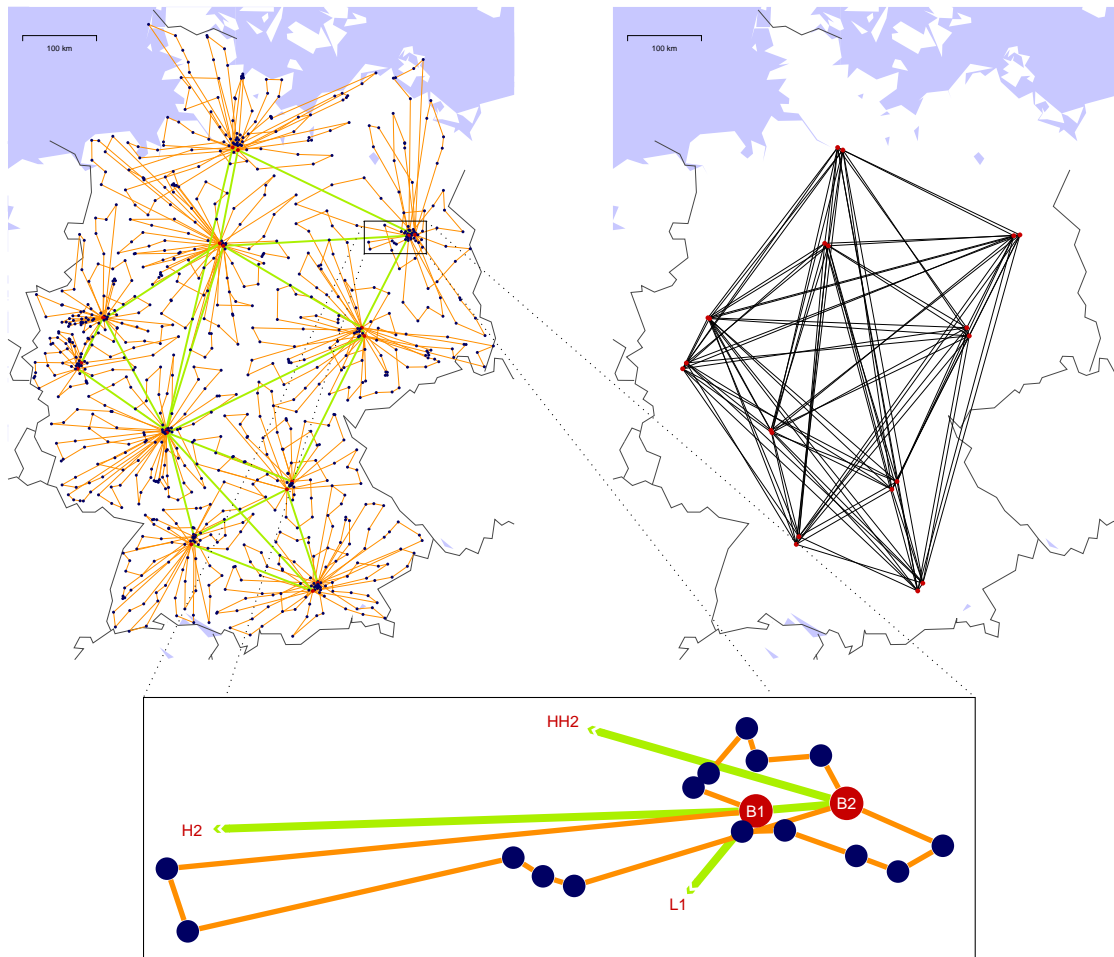

Figure 2: Used network structure with regional (orange) and backbone (green) sections; physical fiber network (above left), virtual IP network (above right), and a close-up of a backbone node pair with three of its regional half rings (below)

regional node is connected to the backbone over one of 180 half rings, where every half ring disjointly connects up to five regional nodes to both of their corresponding backbone nodes, cf. Figures 2 and 3.

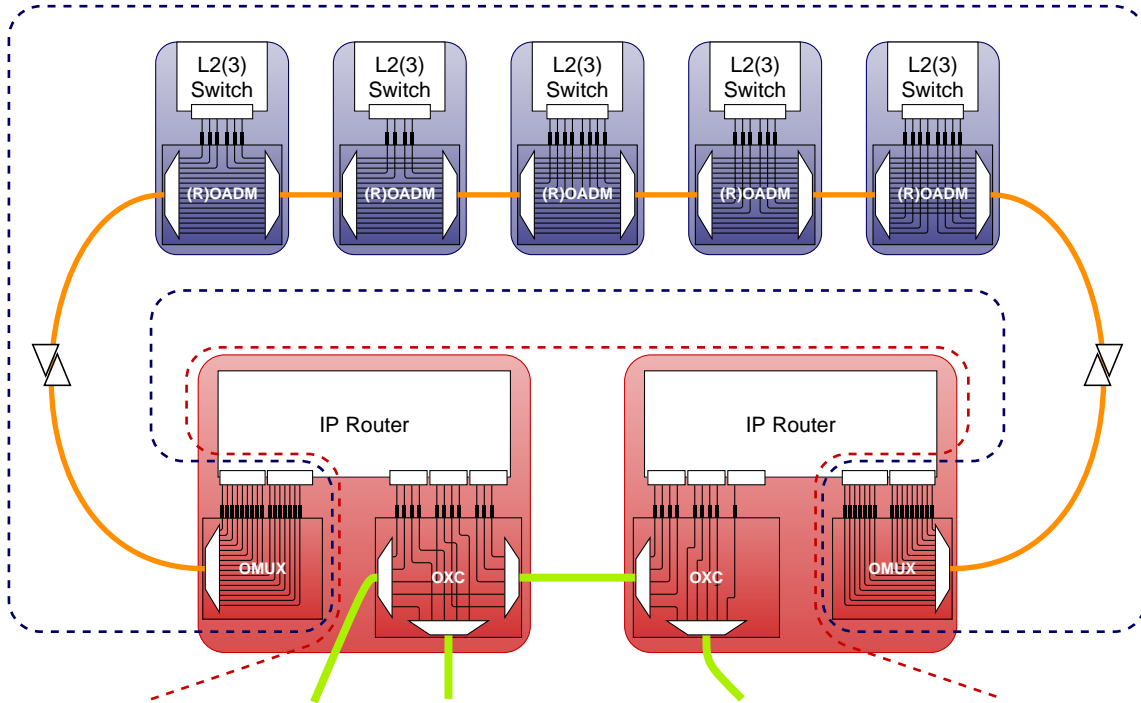

Figure 3: Five regional nodes (blue) in a half ring (orange), connected to the backbone network (green) via a backbone node pair (red); devices within the blue and red dashed circumference count towards power consumption in the regional and backbone domain, respectively

In the backbone we assume an IP-over-DWDM architecture, also see [8] or [9], with a partly meshed IP layer: The backbone nodes are partitioned into two sets such that the two backbone nodes of each city belong to different partitions; within each of the two partitions all backbone nodes are pairwise connected by IP links, and an additional IP link in each city connects the two local backbone nodes, cf. Figure 2. All nodes of core and metro networks are interconnected by a network of optical fibers which in the core network may carry up to 80 optical WDM channels of capacity 10 Gbps, and in the regional rings up to 40 lightpaths of capacity 10 Gbps – for comparison, we also consider a 1 Gbps scenario for the metro part, while the specifications for the backbone remain unchanged. To refresh the optical signals, an optical line amplifier (OLA) is used every 80 km of fiber in the backbone, as well as on the two backbone-connecting links in each regional half ring. Backbone nodes are equipped with IP routers and optical cross connects (OXC), where optical channels can either be terminated and handed over to the IP router, or optically bypassed. Similarly, regional nodes contain Ethernet aggregation switches and (reconfigurable) optical add/drop multiplexers (ROADM). Traffic at the regional nodes is always directly transmitted to the associated backbone node, bypassing intermediate metro locations, and terminated at the backbone node by a WDM terminal (optical multiplexer, OMUX).

To terminate one optical channel in the backbone (metro network) the respective OXC (ROADM) has to be equipped with a transponder, connected to a free port at one of the port cards (line cards) installed at the IP router (Ethernet aggregation switch). A lightpath provides a virtual capacitated link between its end-nodes. Virtual links form a virtual capacitated topology or layer and can be used to

## BACKBONE SECTION

	Equipment	Table	Power cons.
IP/MPLS	CRS-1 Fabric Card Shelf	3	8100 W
	Cisco CRS-3 16-slot shelf	2,3	2401 W
	Slot/Port Card CRS-3 MSC, 14×10G	3	536 W
WDM 80λ	Cisco 15454 MSTP OXC degree $N$	13	$(150+N \cdot 160)$ W
	OLA Cisco 15454 MSTP EDFA	11	200 W
	Transponder card Cisco 15454 MSTP 10G	9	35 W

## REGIONAL SECTION

	Equipment	Table	Power cons.	
10 G	Ethernet aggregation	Chassis: Juniper EX8216	4,5	1080 W
		Line Cards: Juniper EX8200-8XS, 8×10G	4,5	299 W
	WDM aggregation	Cisco 15454 MSTP WDM terminal (OMUX)	12	230 W
	40λ	Cisco 15454 MSTP ROADM 40ch	13	436 W
		OLA Cisco 15454 MSTP EDFA	11	200 W
		Transponder card Cisco 15454 MSTP 10G	9	35 W
IP conn. to backbone	Slot/Port Card CRS-3 MSC, 14×10G	3	536 W	
1 G	Ethernet aggregation	Chassis: Juniper EX8216	4,5	1080 W
		Line Cards: Juniper EX8200-48F, 48×1G	4,5	185 W
	WDM aggregation	Cisco 15454 MSTP WDM terminal (OMUX)	12	230 W
	40λ	Cisco 15454 MSTP ROADM 40ch	13	436 W
		OLA Cisco 15454 MSTP EDFA	11	200 W
		Transponder card Cisco 2-channel SFP WDM	3 in [3]	5 W
IP conn. to backbone	Slot/Port Card CRS-1 MSC-B, 42×1G	3 in [2]	473 W	

Table 1: Network equipment and power consumption taken from tables in [2], [3] and [6]

transport IP (Ethernet) traffic. In this respect, we also speak of IP links. The precise equipment we assumed for the computations, as well as the corresponding power consumption, is given in Table 1.

To protect against single link failures in the backbone, we assume that every IP link must be realized by two link-disjoint paths in the optical layer. Furthermore, we assume that each half ring maintains enough capacity so that traffic from each regional node can be routed in both directions; additionally, each of the two backbone nodes in a city must be able to take over the complete traffic originating within the adjacent half rings. In this way, the network is protected against link or node failures in regional rings, but also to some extent against backbone node failures.

### Traffic demands.

The basis of the traffic model is a combination of the forecasts [4] and [5] and other non-public forecasts. In 2012 about 40 million private and business access lines will generate a peak data flow of 3 Tbps within the regional networks. A share of 90% of the traffic remains in the region, but is managed over a backbone node, the remaining 10% are guided over the backbone to other regions.

To determine realistic values for the peak demands between regional and backbone nodes, as well as between pairs of backbone nodes, we used statistics about the number of consumers connected to

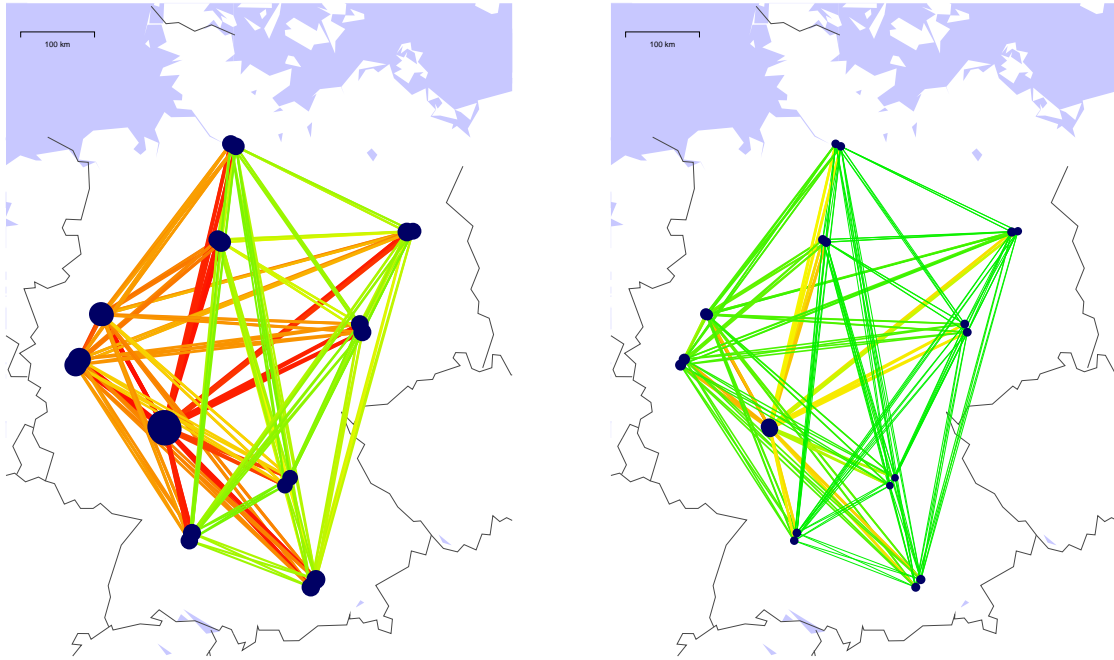

Figure 4: Peak (left) and night (right) traffic demand matrices. Links with traffic of 1 Gbps or less are green (■), those with 10 Gbps are orange (■), and those with 40 Gbps or more are red (■). The size of the nodes reflect their observed traffic.

each regional node and information about which of the two associated backbone nodes each regional node is primarily connected to. The (undirected) demand between a pair of backbone nodes that are not both in the same city was assumed to be directly proportional to the number of consumers connected via regional half rings to either of the two. The demand between a pair of backbone nodes in the same city was assumed to be 0. Finally, the demand between a regional node and an associated backbone node was also computed to be directly proportional to the number of consumers at that regional node.

In addition to customer traffic we assume about 1.3 Tbps of IP peering traffic and about 0.4 Tbps of IP transit traffic. Every backbone node serves as both a peering and a transit point, and the distribution of this IP traffic share inside the backbone depends on the peering/transit point utilization. The resulting peak traffic matrix is visualized in Figure 4.

Traffic fluctuates significantly over a day. In our traffic model, a temporal correspondence between the regional and the backbone traffic curves is assumed. Measurements have shown that during night-times the customer traffic demand drops down to 20% of the peak flow, while IP peering/transit traffic drops down to about 25% at night (see [1]). This yields a night traffic demand matrix, see Figure 4. Eventually, the daily traffic distribution used for the computations were obtained by interpolating between the peak and night demand matrices, with weights computed according to an average working day from data collected at the Friedrichshafen city hall (see Figure 1(b)).

### Mathematical model and optimization.

The task of the optimization is to compute a power-optimal hardware configuration in the regional as well as the backbone network, together with a traffic routing serving the given demand. Considering several demand scenarios for different times, we effectively assume that the network can be rebuilt in



each of the scenarios, that is, we ignore any constraints concerning reconfigurability of the network when changing from one scenario to another. The resulting power consumption in every scenario thus serves as a lower bound estimate and the presented possible energy savings are upper bound estimates.

In a first step of the optimization we compute the power consumption in the regional network. Due to the special ring structure of the regional network and because regional demand is always sent directly to the corresponding backbone node, the routing of the regional demands and hence also the equipment configuration is predetermined and no optimization of the routing is possible. Given a demand value for every regional node, we simply count the necessary interfaces, channels, and ports, and we set up the hardware (Ethernet aggregation switches, line cards, WDM transponders, WDM terminals, ROADMs, OLAs, cf. Table 1) accordingly. In order to cope with possible link or node failures, enough capacity is provided to send the same traffic from a regional node in both directions to the corresponding backbone nodes. The resulting total number of channels terminated at a backbone location  $i$  results in a certain number of line card slots  $q_i^R$  that have to be provided at the corresponding IP-router. This information is used in the subsequent optimization of the backbone network.

To compute a power-optimal routing in the backbone section of the network, a mixed integer program (MIP) is solved, which is given below. It simultaneously optimizes the routing in both the IP

$$\begin{aligned}
\min \quad & \text{(total power consumption)} \quad \sum_{i \in V} (E_P p_i + E_S q_i + E_L r_i + E_F w_i + E_O) + \sum_{e \in E} E_e z_e \\
\text{subject to} \quad & \sum_{\{i,j\} \in L} (f_{i,j}^k - f_{j,i}^k) = \begin{cases} 1 & \text{if } i = s_k, \\ -1 & \text{if } i = t_k, \\ 0 & \text{else} \end{cases} \quad \forall i \in V, k \in K \quad (1) \\
& \sum_{\{u,v\} \in E} (g_{v,u}^\ell - g_{u,v}^\ell) = \begin{cases} y_\ell & \text{if } i = s_\ell, \\ -y_\ell & \text{if } i = t_\ell, \\ 0 & \text{else} \end{cases} \quad \forall v \in V, \ell \in L \quad (2) \\
& f_{j,i}^k + f_{j,i}^k - f_\ell^k = 0 \quad \forall \ell = \{i, j\} \in L, k \in K \quad (3) \\
& \sum_{k \in K} d_k f_\ell^k - c y_\ell \leq 0 \quad \forall \ell \in L \quad (4) \\
& g_{u,v}^\ell + g_{v,u}^\ell - g_e^\ell = 0 \quad \forall e = \{u, v\} \in E, \ell \in L \quad (5) \\
& \sum_{e \in E} g_e^\ell - M z_e \leq 0 \quad \forall e \in E \quad (6) \\
& \sum_{\ell \in L} y_\ell - p_i = 0 \quad \forall i \in V \quad (7) \\
& p_i - M_P q_i \leq 0 \quad \forall i \in V \quad (8) \\
& q_i^R + q_i - M_S r_i \leq 0 \quad \forall i \in V \quad (9) \\
& r_i - M_L w_i \leq 1 \quad \forall i \in V \quad (10) \\
& w_i \leq 1 \quad \forall i \in V \quad (11) \\
& f, g, z, y, p, q, r, w \geq 0 \\
& g, z, y, p, q, r, w \quad \text{integral}
\end{aligned}$$

layer (graph  $G = (V, L)$ ) with nodes  $V$  and virtual IP links  $L$ ) and the optical layer (graph  $H = (V, E)$ )

with nodes  $V$  and fiber links  $E$ ) to minimize the power consumed by the devices.  $V$  corresponds to the 20 nodes in the backbone network. We denote by  $K$  the set of backbone demands. Every demand  $k \in K$  has a source node  $s_k \in V$ , a target node  $t_k \in V$ , and a demand value  $d_{(s_k, t_k)} \geq 0$  as described in the previous section. We also abbreviate  $d_k := d_{(s_k, t_k)}$ . A virtual link  $\ell \in L$  has source  $s_\ell \in V$  and target  $t_\ell \in V$ .

The routing (IP flow) on virtual links  $\{i, j\} \in L$  is described by variables  $f_{i,j}^k$  and  $f_{j,i}^k$  for every demand  $k \in K$ . Similarly, the realization of a virtual link  $\ell \in L$  on physical links  $\{u, v\} \in E$  is modeled by variables  $g_{u,v}^\ell$  and  $g_{v,u}^\ell$ . For simplicity, we introduce variables  $f_\ell^k$  and  $g_e^\ell$  to abbreviate the total flow on virtual links  $\ell \in L$  and physical links  $e \in E$ , respectively; cf. Constraints (3) and (5). Variables  $y_\ell$  count the number of 10 G optical channels corresponding to the virtual IP link  $\ell \in L$ , while variables  $z_e$  count the number of fibers on a fiber link  $e \in E$ . For every location  $i \in V$ , variables  $p_i$ ,  $q_i$ ,  $r_i$ , and  $w_i$  denote the total number of provided 10 G ports, line cards (14×10 G), line card shelves (Cisco CRS-3), and fabric card shelves (Cisco CRS), respectively.

The linear objective minimizes the total power consumption in watts. Here  $E_P$ ,  $E_S$ ,  $E_L$ ,  $E_F$ ,  $E_O$ , and  $E_e$  represent the consumption of the ports (together with the WDM transponders), line cards, line card shelves, fabric card shelves, OXCs, and fibers, respectively. The consumption of a fiber includes the power consumed by multiplexer, demultiplexer, and preamplifier at both end-nodes of the fiber (corresponding to the node degree dependent cost of the OXCs in Table 1) and the consumption of the necessary OLAs along the fiber.

Constraints (1) and (2), together with the integrality of the  $g$  variables guarantee a feasible routing of demands in the IP layer and a feasible routing of channels in the optical layer, respectively. The capacity constraints (4) and (6) ensure enough channel capacity to route the demands on virtual links and enough fiber capacity to realize the channels using physical fiber links, respectively. We set  $c := 10$  (Gbps per channel) and  $M := 80$  (channels per fiber). Equation (7) connects the number of channels needed on links in the optical layer with the number of ports at the nodes. Constraints (8) to (10) state that enough hardware must be provided at the nodes to support the routing: line cards based on the number of ports ( $M_P := 14$  ports per line card), line card shelves based on the number of line cards ( $M_S := 16$  line card slots per shelf), and if there is more than one shelf at node  $i$  then Inequality (10) guarantees the installation of a fabric card shelf. By (11) we allow for only one fabric card shelf per node; thus, the maximum number of line card shelves is  $M_L + 1 := 9$ . Recall that  $q_i^R$  denotes the number of line cards needed for terminating the signals from the metro network, which is computed beforehand, as described above.

By changing the various constants in the model, it can easily be applied to different actual hardware. Furthermore, it can be adapted to account for other routing and protection schemes, which we describe in the following.

**Routing restrictions: IP/MPLS vs. IP/OSPF.** Since there is no restriction on the IP flow variables  $f$  in the model above, the IP flow between two demand end-nodes may be split up and distributed arbitrarily over different paths. We hence implicitly assume a routing protocol such as MPLS (multiprotocol label switching) with a flexible path management. If the path management is limited by routing protocols such as OSPF (open shortest path first) we may set  $f_{i,j}^k \in \{0, 1\}$  for all  $\{i, j\} \in L$ ,  $k \in K$ , which forces the flows to take a single path in the IP layer.

**Survivability.** We consider protection against two types of failures: failure of half rings in the regional sections and failure of optical links in the backbone.

As the optimization for the metro network already provides for link capacity in both directions

within each half ring, it remains to ensure that regional demands in a half ring failure case can still be handled by the same backbone configuration. This is modelled by changing the backbone demands to the worst case for every node, respectively. Essentially we assume that a backbone node must be able to handle all the traffic of regional half-rings connected to it, If all  $q_i^R$  regional line cards at a backbone node  $i$  or all fibers leaving node  $i$  towards the attached regional section fail at once, all regional traffic in this regional section has to be routed by the other backbone node of this city. However, we assume that this happens at not more than one backbone node at the same time. That is, the demand between two backbone nodes  $s, t \in V$  (not in the same city) either stays unchanged as  $d_{(s,t)}$  (no failure), increases to  $d_{(s,t)} + d_{(\hat{s},t)}$  (failure at  $\hat{s}$ ), or increases to  $d_{(s,t)} + d_{(s,\hat{t})}$  (failure at  $\hat{t}$ ), where  $\hat{s}$  and  $\hat{t}$  denote the other backbone node in the same city as  $s$  and  $t$ , respectively. Assuming the worst of these two cases, demands have to be changed accordingly:

$$d_{(s,t)} \rightarrow d_{(s,t)} + \max\{d_{(s,\hat{t})}, d_{(\hat{s},t)}\}.$$

In a similar way the traffic is mapped to  $\hat{s}$  and  $\hat{t}$  if nodes  $s$  or  $t$  fail, respectively. Obviously, this also covers regional node failures, in the sense that the traffic from the two disconnected parts of the ring can be routed via the two associated backbone nodes.

To incorporate protection against link failures in the backbone we change constraints (2) and (7) to

$$\sum_{\{u,v\} \in E} (g_{v,u}^\ell - g_{u,v}^\ell) = \begin{cases} 2y_\ell & \text{if } i = s_\ell, \\ -2y_\ell & \text{if } i = t_\ell, \\ 0 & \text{else} \end{cases} \quad \forall v \in V, \ell \in L$$

$$\sum_{\ell \in L} 2y_\ell - p_i = 0 \quad \forall i \in V.$$

This way the network capacity in the backbone is doubled. Then, by adding the constraint

$$g_e^\ell \leq y_\ell, \quad \forall \ell \in L, e \in E,$$

it is guaranteed that at most half of the channels corresponding to the same IP link pass the same physical fiber link. Hence even in case of single fiber link failures there will be enough channel capacity to still route all demands. This model is close to optical 1+1 and 1:1 protection. However, since we do not explicitly model a dedicated link-disjoint backup channel for every optical connection, one might have to adapt the IP-routing in case of a failure.

**Additional constraints.** The following constraints can be added to the above model without changing the solution space but potentially strengthening the LP relaxation.

Because of capacity slacks there might be circulation flows in the solution. These can be removed without changing the value of the solution. One way to avoid most of these circulations is adding the bound constraints

$$f_\ell^k \leq 1 \quad \forall k \in K, \ell \in L$$

to the system. Similarly we may add

$$g_e^\ell \leq y_\ell \quad \forall \ell \in L, e \in E$$

also in the model without protection.

Given node  $i \in V$  let  $d_i := \sum_{k \in K: i=s_k} d_k + \sum_{k \in K: i=t_k} d_k$  be the corresponding node traffic. We denote by  $L_i \subseteq L$  all IP links starting or terminating in  $i$ . Clearly, all channels corresponding to links in  $L_i$  have to provide sufficient capacity to handle the node traffic demand. Furthermore, as all nodes have to be interconnected by channels, the number of channels on all links has to suffice to establish a spanning tree in the network. Thus,

$$\sum_{\ell \in L_i} y_\ell \geq \left\lceil \frac{d_i}{c} \right\rceil \quad \forall i \in V \quad \text{and} \quad \sum_{\ell \in L} y_\ell \geq |V| - 1.$$

In a similar way we conclude that the minimum number of fibers ending in  $i$  depends on the number of terminating channels, and there have to be sufficiently many fibers to interconnect all nodes:

$$\sum_{e \in E_i} z_e \geq \left\lceil \frac{\lceil d_i/c \rceil}{M} \right\rceil \quad \forall i \in V \quad \text{and} \quad \sum_{e \in E} z_e \geq |V| - 1.$$

Here  $E_i$  denotes the set of all fiber links ending in  $i$ . In the case of survivability in the backbone, as described in the previous paragraph, the latter constraints can be strengthened to

$$\sum_{e \in E_i} z_e \geq \left\lceil 2 \frac{\lceil d_i/c \rceil}{M} \right\rceil \quad \forall i \in V \quad \text{and} \quad \sum_{e \in E} z_e \geq |V|.$$

### 3 Results

Tables 2 and 3 give a summary of the computational results. Stated are power consumption values for the different network sections under various routing schemes and protection scenarios for the backbone (with protection of regional half rings always active), at peak traffic times and during the night, as described in Section 2, as well as for a reference scenario, in which all connections are realized via shortest paths in the graph. Besides the total power consumption values, it lists the respective contributions by IP routers and WDM hardware for the backbone network; likewise, for the metro network the contributions towards total power consumption by the different parts is given: Ethernet switches at regional nodes, IP router line cards used for regional traffic at the backbone nodes, and WDM hardware at the backbone nodes and within the half rings. The MIP for backbone routing was solved using CPLEX 12.3, with remaining optimality gaps below 5%.

**Backbone.** Table 2 shows that the computed power consumption of the backbone network during low-traffic times decreases by 30 – 54% compared to peak hours, and even by 50 – 63% in comparison to the (straight-forward operating) reference network, where the higher relative decreases are achieved in the scenarios with optical link failure protection. Furthermore, forcing single-path IP routing increases power consumption only marginally (less than 6%), while protection constraints result in considerably higher increases of about 75% (peak traffic) and 20% (night traffic). The larger portion of the power in the backbone is consumed at the IP layer, which results in a higher potential for savings. However, the larger relative savings (of more than 50%) are obtained in the optical layer.

Figure 5 illustrates network operations in the single-path scenario with protection against optical link failure. Red connections indicate higher utilization of links, which is achieved in the optimized solutions. Figure 6 shows the development of the power consumption values over one average day, for which the hourly traffic was computed as described in Section 2, as well as the total energy consumption on that day, i.e. the integral of the power consumption values over time. The power-unaware refer-

Net. section	IP routing/protection	Layer	Reference	Peak	Night
Backbone (10 G)	single-path IP traffic (OSPF)/ WDM links protected	<b>total</b>	<b>242 004</b>	<b>203 370</b>	<b>92 584</b>
		IP	154 344	126 910	63 564
		WDM	87 660	76 460	29 020
	split IP traffic (MPLS)/ WDM links protected	<b>total</b>	<b>242 004</b>	<b>191 914</b>	<b>89 856</b>
		IP	154 344	121 014	61 956
		WDM	87 660	70 900	27 900
	single-path IP traffic (OSPF)/ unprotected	<b>total</b>	<b>153 956</b>	<b>116 234</b>	<b>78 676</b>
		IP	103 326	76 964	59 276
		WDM	50 630	39 270	19 400
	split IP traffic (MPLS)/ unprotected	<b>total</b>	<b>153 956</b>	<b>111 474</b>	<b>77 510</b>
		IP	103 326	74 284	58 740
		WDM	50 630	37 190	18 770
Regional (10 G)	standard devices	<b>total</b>		<b>2 027 105</b>	<b>1 984 358</b>
		Eth. agg.		1 238 641	1 238 342
		IP conn.		88 976	73 968
	load-adaptive devices	<b>total</b>		<b>1 476 410</b>	<b>1 426 453</b>
		Eth. agg.		690 550	683 041
		IP conn.		86 372	71 364
			WDM	699 488	672 048

Table 2: Power consumption (W) in different network sections and layers assuming different routing and protection scenarios with 10 G hardware in regional sections

ence hardware configuration constantly consumes 242 kW (see Table 2), which sums up to 5 808 kWh per day. The power consumption of the optimal hardware configuration that is computed for the demand of each hour follows the demand curve over the day. A backbone network with the possibility to switch its hardware configuration hourly would then consume 3 066 kWh per day, saving 47%. Note that this value should be seen as an upper bound on the possible energy savings, as current networks are not yet designed to flexibly switch hardware on and off.

**Metro region.** By far the most power is consumed in the regional sections and at the same time the potential for savings is negligible here, with only slightly above 2% (2 027 kW compared to 1 984 kW, see Table 2). This has mainly two reasons. First, the routing in the regional section is fixed and can not be optimized according to the traffic state as it can be done in the backbone. Second, the channel granularity of 10 G is relatively large for the metro region such that for almost all regional nodes one 10 G connection has to be provided and also suffices, independently of peak or night traffic. This means that even with peak traffic only one slot at the Ethernet switch and only one port at the corresponding line card is active.

A way to save energy also in the metro network is to develop switches as well as line cards that are able to adapt their power consumption to the traffic load. This can be achieved by introducing *load-adaptive devices*, that is, line-cards that can switch off their individual ports and switches that can switch off individual line-card slots, as well as regulate fans and cooling, cf. [11]. To evaluate the potentials of load-adaptive devices, we assumed that in the regional section line-cards and switches consume energy proportionally to the number of used ports and slots, respectively, with a maximum

Net. section	IP routing/protection	Layer	Reference	Peak	Night
Backbone (10 G)	single-path IP traffic (OSPF)/ WDM links protected	<b>total</b>	<b>393 820</b>	<b>371 850</b>	<b>92 724</b>
		IP	306 160	294 390	63 564
		WDM	87 660	77 460	29 160
Regional (1 G)	standard devices	<b>total</b>		<b>2 153 078</b>	<b>1 759 520</b>
		Eth. agg.		1 139 300	1 135 970
		IP conn.		156 090	44 462
	WDM		857 688	579 088	
	load-adaptive devices	<b>total</b>		<b>1 633 766</b>	<b>1 224 371</b>
		Eth. agg.		625 416	604 605
IP conn.			150 661	40 678	
		WDM		857 688	579 088

Table 3: Power consumption (W) in different network sections and layers assuming OSPF routing and WDM link failure protection with 1 G hardware in regional sections

consumption based on the values in Table 1, and a minimum (offset) consumption of 540 W for the Ethernet switch and 150 W for the line cards (50% of the maximum consumption), cf. Figure 7. These settings are in line with the definitions and measurements in [11]. We still assumed that the devices can be switched off and consume no power when not in use. Table 2 shows that using such load-adaptive devices may save about 25% of the total power in the metro region. Because of the fixed ring routing and the large granularity of the capacity modules (10 G links) there are still no further savings in the night when the demand drops. This, however, changes if we use smaller capacities to dimension the regional links. As shown by Table 3, using a finer channel granularity of 1 G in the regional sections significantly increases the gap between power consumption at low-traffic and peak hours – at the expense of increased power consumption at peak times due to the higher number of ports and WDM transponders needed. Clearly, whether to use fine or coarse granular channels in the field strongly depends on the corresponding equipment power values and also on the concrete demand fluctuations over time.

## 4 Summary

We have studied the question of how much energy can be saved due to demand fluctuations in state-of-the-art telecommunication networks focusing on the backbone but also on regional sections. The study is based on reasonable assumptions on the network structure and architecture including important side-constraints such as routing restrictions and resilience requirements. We used a nation-wide reference network with 918 nodes. Based on sophisticated mixed integer programming models we evaluated the potential for power savings in different scenarios. Highlighting the main results we find that

- Whether to have single-path routing or more flexible IP routing schemes has almost no effect on the power consumption.
- Resilience requirements strongly increase the power consumption (up to 75% increase compared to the unprotected network). However, the potential for power savings during low traffic times is much larger in protected networks, such that in the low-traffic scenario the consumption of unprotected and protected solutions differ considerably less (by only 20%).
- In general, the potential for (relative) power savings is larger in the backbone, where the rout-

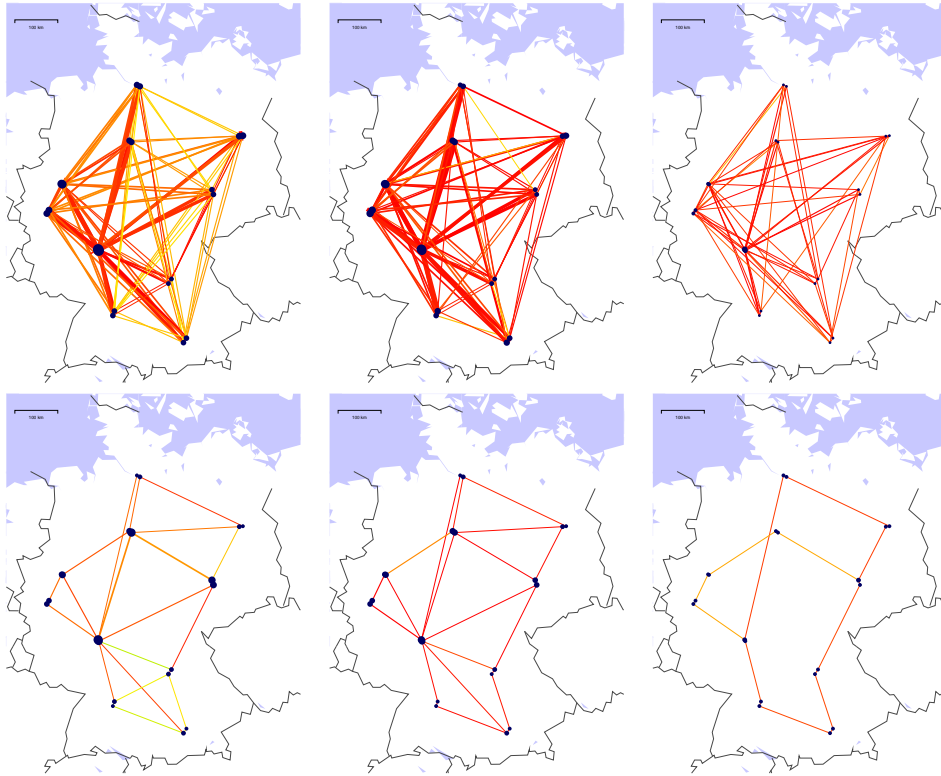

Figure 5: Backbone IP layer (above) and WDM layer (below) in the reference network (left), and in peak and night-time traffic scenarios (middle and right); red connections indicate high utilization

ing can be adjusted in a flexible way. However, power consumption in the backbone is on a relatively small level compared to the regional part, where the potential for savings is small, due to low flexibility in the routing.

- Significant savings also in the regional sections can be achieved by introducing load-adaptive devices (switches, line cards, etc.). This is true in particular if the consumption of these devices can be adjusted in small steps with preferably fine-granular changes of capacity and power. The smallest power consumption in low-traffic scenarios has been obtained with load-adaptive devices and 1 G ports.

We plan to extend the work presented here in several directions:

- Consider OTN technology, which is frequently used in backbone networks and can have interesting effects on routing flexibility and power consumption.
- Use more refined demand scenarios, describing traffic over a complete time-period (day/week/month).
- In practice some devices, such as transponders, would rather be left running during low-traffic hours, since they need much time to recalibrate after having been switched on; this results in a more fine-grained power and device modelling.
- Extend the modelling to guarantee full node-protection in the backbone.

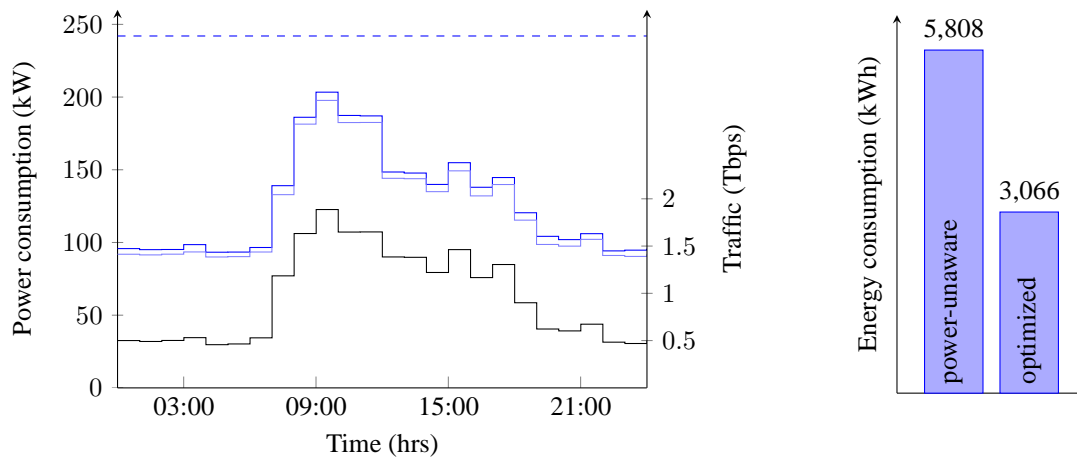

Figure 6: Power consumption (left) of the backbone network with single-path IP routing and WDM link failure protection for the reference (i.e., power-unaware) network design (dashed blue), for the optimized backbone network (solid blue), lower bound of MIP (light blue) and traffic demand (black) hourly over one average day; energy consumption (right) of the backbone network per day

## Acknowledgements

This work has been carried out within the project DESI (Durchgängig Energie-Sensible IKT-Produktion – Pervasively Energy-Efficient ICT Production)<sup>1</sup>, supported by the IT2Green program<sup>2</sup> of the German Federal Ministry of Economics and Technology (BMWi) and the DFG Research Center MATHEON<sup>3</sup>. The authors are grateful to Filip Idzikowski for many helpful hints and comments on network equipment.

## References

- [1] German internet exchange traffic statistics, 2012.  
<http://www.de-cix.net/about/statistics>.
- [2] Cisco Systems. Cisco CRS Series 42 port Gigabit Ethernet Interface Module, 2012.  
[http://www.cisco.com/en/US/prod/collateral/routers/ps5763/data\\_sheet\\_c78-553672.pdf](http://www.cisco.com/en/US/prod/collateral/routers/ps5763/data_sheet_c78-553672.pdf).
- [3] Cisco Systems. Cisco 2-Channel SFP WDM Transponder, 2012.  
[http://www.cisco.com/en/US/prod/collateral/modules/ps5455/ps6575/product\\_data\\_sheet0900aecd80395a59.pdf](http://www.cisco.com/en/US/prod/collateral/modules/ps5455/ps6575/product_data_sheet0900aecd80395a59.pdf).
- [4] Cisco Systems. Cisco visual networking index 2011–2016, 2012.  
[http://www.cisco.com/web/solutions/sp/vni/vni\\\_forecast\\\_highlights/index.html](http://www.cisco.com/web/solutions/sp/vni/vni\_forecast\_highlights/index.html).

<sup>1</sup>[www.desi-it2green.de](http://www.desi-it2green.de)

<sup>2</sup>[www.it2green.de](http://www.it2green.de)

<sup>3</sup>[www.matheon.de](http://www.matheon.de)



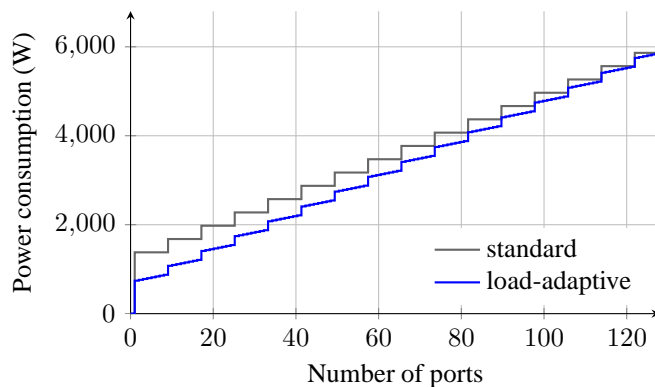

Figure 7: Power consumption of one Ethernet switch in the metro region as a function of the number of active 10 G ports. In both cases, standard and load-adaptive, every eight ports a new line card is switched on, up to a total of 16 line cards. However, in the load-adaptive case the power consumption of a line-card depends on the number of active ports and the chassis power consumption depends on the number of active line-cards with an offset of 540 W for the chassis and 150 W for the line card.

- [5] Deutsche Telekom. Third quarter report, 2011.  
<http://www.telekom.com/investor-relations/publications/financial-reports/19304>.
- [6] W. Van Heddeghem and F. Idzikowski. Equipment power consumption in optical multilayer networks – source data. Technical Report IBCN-12-001-01, Ghent Univ., 2012.  
<http://powerlib.intec.ugent.be>.
- [7] W. Van Heddeghem, F. Idzikowski, W. Vereecken, D. Colle, M. Pickavet, and P. Demeester. Power consumption modeling in optical multilayer networks. *Photonic Network Communications*, 24:86–102, 2012.  
<http://dx.doi.org/10.1007/s11107-011-0370-7>.
- [8] R. Hülsermann, Ch. Lange, D. Kosiankowski, and A. Gladisch. Analysis of the energy efficiency in IP over WDM networks with load-adaptive operation. In *Photonische Netze*, volume 228 of *ITG-Fachbericht*, pages 162–168. VDE-Verlag, 2011.
- [9] F. Idzikowski, S. Orlowski, Ch. Raack, H. Woesner, and A. Wolisz. Dynamic routing at different layers in IP-over-WDM networks – Maximizing energy savings. *Optical Switching and Networking, Special Issue on Green Communications*, 8(3):181–200, 2011.  
<http://opus.kobv.de/zib/volltexte/2010/1230/>.
- [10] F. Idzikowski, L. Chiaraviglio, and F. Portoso. Optimal design of green multi-layer core networks. In *Proceedings of the 3rd International Conference on Future Energy Systems: Where Energy, Computing and Communication Meet*, pages 15:1–15:9. ACM, 2012.  
<http://doi.acm.org/10.1145/2208828.2208843>.
- [11] Ch. Lange, R. Schlenk, and H. Lehmann. Network element characteristics for traffic load adaptive network operation. In *Photonische Netze*, volume 233 of *ITG-Fachbericht*, pages 124–131. VDE-Verlag, 2012.