

Konrad-Zuse-Zentrum
für Informationstechnik Berlin

Takustraße 7
D-14195 Berlin-Dahlem
Germany

RALF BORNDÖRFER MARIKA NEUMANN MARC E. PFETSCH

The Steiner Connectivity Problem

Supported by the DFG Research Center MATHEON "Mathematics for key technologies".

ZIB-Report 09-07 (April 2010)

The Steiner Connectivity Problem[§]

Ralf Borndörfer* Marika Neumann* Marc E. Pfetsch**

Abstract

The Steiner connectivity problem is a generalization of the Steiner tree problem. It consists in finding a minimum cost set of simple paths to connect a subset of nodes in an undirected graph. We show that polyhedral and algorithmic results on the Steiner tree problem carry over to the Steiner connectivity problem; namely, the Steiner cut and the Steiner partition inequalities, as well as the associated polynomial time separation algorithms, can be generalized. Similar to the Steiner tree case, a directed formulation, which is stronger than the natural undirected one, plays a central role.

1 Introduction

The *Steiner connectivity problem* (SCP) can be described as follows. We are given an undirected graph $G = (V, E)$, a set of *terminal nodes* $T \subseteq V$, and a set of (simple) *paths* \mathcal{P} in G . The paths have nonnegative costs $c \in \mathbb{R}_+^{\mathcal{P}}$. The problem is to find a set of paths $\mathcal{P}' \subseteq \mathcal{P}$ of minimal cost $\sum_{p \in \mathcal{P}'} c_p$ that *connect the terminals*, i.e., such that for each pair of distinct terminal nodes $t_1, t_2 \in T$ there exists a path from t_1 to t_2 in G that is completely covered by paths of \mathcal{P}' . We can assume w.l.o.g. that every edge is covered by a path, i.e., for every $e \in E$ there is a $p \in \mathcal{P}$ such that $e \in p$; in particular, G has no loops. Figure 1 gives an example of a Steiner connectivity problem and a feasible solution.

The SCP is a generalization of the *Steiner tree problem* (STP), in which all paths contain exactly one edge. Similar to the STP with nonnegative costs, see [13, 15, 16] for an overview, there exists always an optimal solution of the SCP that is *minimally connected*, i.e., if we remove any path from the solution, there exist at least two terminals which are not connected. However, in contrast to the STP, an optimal solution of the Steiner connectivity problem does not necessarily form a tree, see again Figure 1.

The SCP is a special case of the *line planning problem*, see [3] and the references therein for a detailed description. The line planning problem can be defined as follows. We are given a public transportation network $G = (V, E)$, a set of (simple) line paths \mathcal{P} , and a passenger demand matrix $(d_{uv}) \in \mathbb{N}^{V \times V}$, which gives the number

[§]Supported by the DFG Research Center MATHEON “Mathematics for key technologies”

*Zuse Institute Berlin, Takustr. 7, 14195 Berlin, Germany; Email borndorfer@zib.de, marika.neumann@zib.de

**Institute for Mathematical Optimization, TU Braunschweig, Pockelsstr. 14, 38106 Braunschweig, Germany; Email m.pfetsch@tu-bs.de

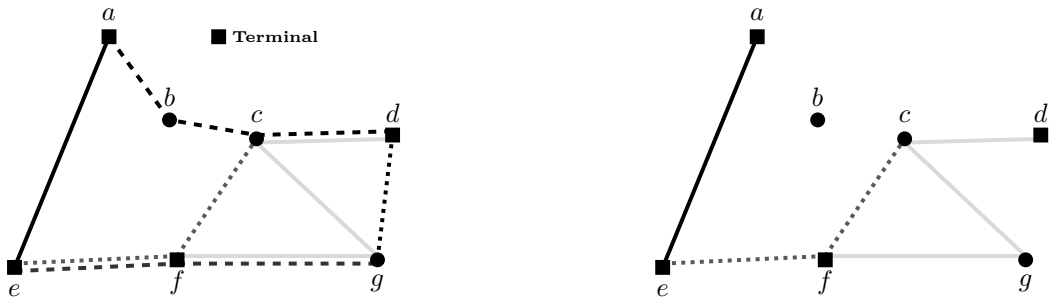

Figure 1: Example of a Steiner connectivity problem. *Left:* A graph with four terminal nodes ($T = \{a, d, e, f\}$) and six paths ($\mathcal{P} = \{p_1 = (a, b, c, d), p_2 = (e, f, g), p_3 = (a, e), p_4 = (e, f, c), p_5 = (g, d), p_6 = (f, g, c, d)\}$). *Right:* A feasible solution with three paths ($\mathcal{P}' = \{p_3, p_4, p_6\}$).

of passengers who want to travel between different stations in the network. The edges of G have nonnegative travel times $\tau \in \mathbb{R}_+^E$, the paths have nonnegative costs $c \in \mathbb{R}_+^{\mathcal{P}}$ and capacities $\kappa \in \mathbb{R}_+^{\mathcal{P}}$. The problem is to find a set of line paths $\mathcal{P}' \subseteq \mathcal{P}$ with associated frequencies $f_p \in \mathbb{R}_+$, $p \in \mathcal{P}'$, and a passenger routing, such that the overall capacities $\sum_{p \in \mathcal{P}', e \in p} f_p \cdot \kappa_p$ on the edges $e \in E$ suffice to transport all passengers. There are two possible objectives: to minimize the travel time, or to minimize the cost of the line paths.

The connection between the line planning problem and the SCP is that the line paths \mathcal{P}' usually connect all stations with positive supply and/or demand. More precisely, let (T, F) be the *demand graph* of the line planning problem, where $T = \{v \in V \mid \sum_u (d_{uv} + d_{vu}) > 0\}$ is the set of nodes with positive supply or demand, and $F = \{\{u, v\} \mid d_{uv} + d_{vu} > 0\}$ a set of *demand edges*. Then the following holds: If the demand graph is connected, then the set of line paths \mathcal{P}' of a solution of the line planning problem is a solution of the SCP associated with the graph G , terminal set T , and costs c . In other words, if we neglect travel times of the passengers, as well as capacities and frequencies of the lines, the line planning problem with connected demand graph reduces to the Steiner connectivity problem. In this way, the SCP captures the connectivity aspect of the line planning problem. This connection motivates studying the SCP.

A natural question is whether one can transfer structural results and algorithms from the Steiner tree problem to the Steiner connectivity problem. It will turn out that this can indeed be done in many cases. In particular, an important result (see Chopra and Rao [4]) in the STP literature states that the undirected IP formulation of the STP, including all so-called Steiner partition inequalities, is dominated by a certain family of directed formulations. Using this connection, a super class of the Steiner partition inequalities can be separated in polynomial time. We will show that similar results hold for the SCP as well. Namely, a directed formulation of the Steiner connectivity problem, which can be interpreted as an extended formulation, produces a strong relaxation of the Steiner connectivity problem via projection to the original space of variables; see, e.g., Vanderbeck and Wolsey [19] for a discussion of extended formulations. The directed formulation that we use, however, is constructed differently than in the STP case and must be strengthened by so-called flow-balance constraints to obtain an analogous result. Subtle differences also come up in the

complexity analysis. For instance, the SCP is also solvable in polynomial time for a fixed number of terminals, but it is NP-hard in the case $T = V$.

The article is structured as follows. It starts with a combinatorial discussion of the Steiner connectivity problem in Section 2. We show that the SCP is equivalent to a suitably constructed directed Steiner tree problem. This relation yields polynomial time algorithms for the SCP in some cases. In Section 3, we give three integer programming formulations for the SCP based on the transformation in Section 2, namely, an undirected cut formulation, a directed cut formulation, and a contracted directed cut formulation. We compare these formulations and their LP relaxations. An analysis of the polytope associated with the undirected cut formulation follows in Section 4. We state necessary and sufficient conditions for the Steiner partition inequalities to be facet defining. We also derive a polynomial time separation algorithm for a super class of the Steiner partition inequalities. This algorithm is based on the directed cut formulation of the SCP. This shows that directed models provide tight formulations for the SCP, similar as for the STP. These theoretical results are illustrated by computations for large scale real-world transportation networks in Section 5.

2 Relation to Directed Steiner Trees & Complexity

We show in this section the equivalence of the SCP and a suitably constructed directed Steiner tree problem. The *directed Steiner tree problem* (DSTP) is the following: Given a directed graph and a set of terminal nodes T , we have to find a minimum cost set B of arcs that connect a *root node* $r \in T$ to each other terminal $t \in T \setminus \{r\}$, i.e., there exists a directed path from r to t in B . If the costs of the arcs are nonnegative, which we assume, there exists a solution that is a directed tree (an arborescence).

Consider an SCP with undirected graph $G = (V, E)$, a set of paths \mathcal{P} , terminals $T \subseteq V$, and nonnegative costs $c \in \mathbb{R}_+^{\mathcal{P}}$. Define a digraph $D' = (V', A')$, which we call *Steiner connectivity digraph*. Its node set is

$$V' := T \cup \{v_p, w_p \mid p \in \mathcal{P}\}.$$

We choose some terminal node $r \in T$ as root node and define the following arcs $a \in A'$ and costs c'_a :

$$\begin{aligned} a &= (r, v_p), & c'_a &:= 0, & \forall p \in \mathcal{P} \text{ with } r \in p, \\ a &= (v_p, w_p), & c'_a &:= c_p, & \forall p \in \mathcal{P}, \\ a &= (w_{\tilde{p}}, v_p), & c'_a &:= 0, & \forall p, \tilde{p} \in \mathcal{P}, p \neq \tilde{p}, p \text{ and } \tilde{p} \text{ have} \\ & & & & \text{a node } v \in V \text{ in common,} \\ a &= (w_p, t), & c'_a &:= 0, & \forall p \in \mathcal{P}, \forall t \in T \setminus \{r\} \text{ with } t \in p. \end{aligned}$$

Figure 2 illustrates our construction. Note that choosing different root nodes results in different Steiner connectivity digraphs and hence different associated DSTPs. However, we will show in Proposition 2.2 that the solutions of an SCP and any associated DSTP are all equivalent, independent of the choice of the root node. For

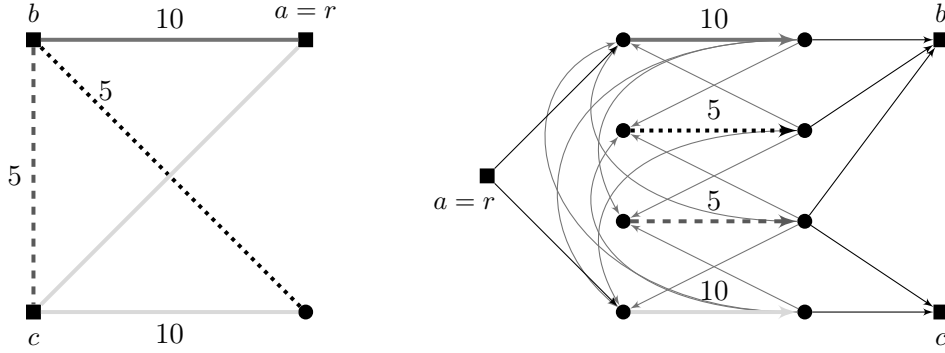

Figure 2: A Steiner connectivity problem and its associated directed Steiner tree problem. *Left:* Graph G with four paths and three terminal nodes. The numbers on the paths indicate costs. *Right:* Associated Steiner connectivity digraph D' . The numbers on the arcs are the costs; the default value is zero.

ease of notation, we will therefore omit the root node whenever the results are independent of r . Polyhedral results can depend on the choice of the root node, see Remark 3.9 below. In such cases we will include the root node in the notation.

A DSTP associated with an SCP has the following properties.

- Lemma 2.1.** 1. The only arc with target node w_p is (v_p, w_p) , for all $p \in \mathcal{P}$.
 2. The only arc with source node v_p is (v_p, w_p) , for all $p \in \mathcal{P}$.
 3. Each simple directed (r, t) -path, $t \in T \setminus \{r\}$, has the general form $(r, v_{p_1}, w_{p_1}, \dots, v_{p_k}, w_{p_k}, t)$, $k \geq 1$.

Proposition 2.2. The following holds for an SCP and an associated DSTP: For each solution of one problem there exists a solution of the other problem with the same objective value. In particular, the optimal objective value of an associated DSTP is independent of the choice of the root node.

Proof. Assume $\tilde{\mathcal{P}}$ is a solution of SCP. Then let

$$\tilde{A} := A' \setminus \{(v_p, w_p) \mid p \notin \tilde{\mathcal{P}}\}.$$

The arcs in \tilde{A} connect the root r with each terminal $t \in T \setminus \{r\}$ via a directed path. Moreover, $\sum_{a \in \tilde{A}} c'_a = \sum_{p \in \tilde{\mathcal{P}}} c'_{v_p w_p} = \sum_{p \in \tilde{\mathcal{P}}} c_p$.

For the converse, assume that \tilde{A} is a solution of the DSTP. We show that

$$\tilde{\mathcal{P}} := \{p \in \mathcal{P} \mid (v_p, w_p) \in \tilde{A}\}$$

is a solution of the corresponding SCP with the same cost. To this purpose, consider the root node r and some terminal $t \in T \setminus \{r\}$; these nodes are connected by a simple directed path in D' using only arcs in \tilde{A} . Each such path has the form $(r, v_{p_1}, w_{p_1}, \dots, v_{p_k}, w_{p_k}, t)$, $k \geq 1$ (see Lemma 2.1), with $(v_{p_i}, w_{p_i}) \in \tilde{A}$, $i = 1, \dots, k$, that is, $p_i \in \tilde{\mathcal{P}}$, $i = 1, \dots, k$. Due to the construction of D' , p_1 contains r , p_i and p_{i+1} , $i = 1, \dots, k-1$, have at least one node in common, and p_k contains t . Hence, we can find a path from r to t in G that is covered by $p_1, \dots, p_k \in \tilde{\mathcal{P}}$. Since the paths

are undirected, every two terminals $t_1, t_2 \in T$, $t_1, t_2 \neq r$, can be connected via r , i.e., $\tilde{\mathcal{P}}$ connects T . Furthermore, $\sum_{p \in \tilde{\mathcal{P}}} c_p = \sum_{p \in \tilde{\mathcal{P}}} c'_{v_p w_p} = \sum_{a \in \tilde{A}} c'_a$.

These arguments hold for every root node. \square

Since the Steiner connectivity problem is a generalization of the Steiner tree problem, it is strongly NP-hard in general. The relation to the associated DSTP, however, exhibits a number of polynomially solvable cases.

Corollary 2.3. *SCP is solvable in polynomial time for $|T| = k$, k constant.*

Proof. This follows from the complexity results for the directed Steiner tree problem, see Feldman and Ruhl [7]. \square

Note that the case $|T| = 2$ can be solved by a directed shortest path computation in the Steiner connectivity digraph.

In contrast to the STP, however, we can show the following.

Proposition 2.4. *SCP is strongly NP-hard for $T = V$, even for unit costs.*

Proof. We reduce the set covering problem to the Steiner connectivity problem. In a set covering problem we are given a finite set S and a set $\mathcal{M} \subseteq 2^S$. The problem is to find a subset $\mathcal{M}' \subseteq \mathcal{M}$ of minimal cardinality $|\mathcal{M}'|$, such that for all $s \in S$ there exists an $M \in \mathcal{M}'$ with $s \in M$.

Given a set covering instance, we define a Steiner connectivity instance in a graph $G = (V, E)$ as follows: The nodes are $V = S \cup \{v\} = T$ with v being one extra node. Let us write $V = \{s_0, s_1, s_2, \dots\}$, where $v = s_0$. All nodes are terminals. We first assume that G is a complete graph and later remove all edges that are not covered by paths after their construction. For each set $M \in \mathcal{M}$ order the elements in M arbitrarily and construct a path beginning in node v and passing through all nodes of M in the given order. The cost of each such path is 1.

It is easy to see that a cover \mathcal{M}' with at most k elements exists if and only if a set of paths exists that connects all nodes with cost at most k , $k \geq 0$. \square

Corollary 2.5. *SCP is strongly NP-hard for $|T| = |V| - k$, k constant.*

Proof. We add k isolated nodes to the graph G in the proof of Proposition 2.4. \square

Proposition 2.6. *Unless $P = NP$, there exists no polynomial time α -approximation algorithm for SCP with $\alpha = \gamma \cdot \log |V|$, $\gamma \leq 1$.*

Proof. The transformation in Proposition 2.4 is approximation preserving, since there exists a cost preserving bijection between the solutions of a set covering instance and its corresponding Steiner connectivity instance. It has been shown that the set covering problem is not approximable in the sense that there exists no polynomial time approximation algorithm with approximation factor smaller than logarithmic (in the number of nodes) unless $P = NP$, see Feige [6]. \square

3 Integer Programming Formulations

We propose in this section three integer programming formulations for the SCP. The first one (SCP_{cut}) is the natural cut formulation, the second one ($\text{SCP}_{arc^+}^r$) is a directed cut formulation based on the equivalence between the SCP and its associated DSTP, the third one (SCP_{con}^r) is also a directed cut formulation, but in a smaller space. It will turn out that ($\text{SCP}_{arc^+}^r$) and (SCP_{con}^r) are equivalent and dominate (SCP_{cut}).

The section uses the following notation. For a vector $x \in \mathbb{R}^n$ and an index set $I \subseteq \{1, \dots, n\}$, let $x|_I = x_I$ be the restriction of x onto the subspace indexed by I . Let $P_{LP}(F)$ be the polyhedron associated with the LP relaxation of an IP formulation F . Then $P_{LP}(F)|_I$ is the orthogonal projection of $P_{LP}(F)$ on the subspace of variables indexed by I .

3.1 Cut Formulation

The *cut formulation* is as follows:

$$\begin{aligned}
 (\text{SCP}_{cut}) \quad & \min && \sum_{p \in \mathcal{P}} c_p x_p \\
 & \text{(i) s.t.} && \sum_{p \in \mathcal{P}_{\delta(W)}} x_p \geq 1 && \forall \emptyset \neq W \cap T \neq T, W \subseteq V \\
 & && x_p \in \{0, 1\} && \forall p \in \mathcal{P}.
 \end{aligned}$$

Here, x_p is a 0/1-variable that indicates whether path p is chosen ($x_p = 1$) or not ($x_p = 0$). Furthermore, $\mathcal{P}_{\delta(W)} := \{p \in \mathcal{P} \mid \delta(W) \cap p \neq \emptyset\}$ is the set of all paths that cross the cut $\delta(W) = \{e \in E \mid |e \cap W| = 1\}$ at least one time. If $\delta(W)$ is an (s, t) -cut for some terminal nodes $s, t \in T$, i.e., if $s \notin W, t \in W$, we call $\mathcal{P}_{\delta(W)}$ an (s, t) -*Steiner path cut* or shortly a *Steiner path cut*; a Steiner path cut $\mathcal{P}_{\delta(W)}$ with $|\mathcal{P}_{\delta(W)}| = 1$ is a *Steiner path bridge*. For given x , the *capacity of a Steiner path cut* $\mathcal{P}_{\delta(W)}$ is $\sum_{p \in \mathcal{P}_{\delta(W)}} x_p$, and we denote the inequalities (SCP_{cut})(i) as *Steiner path cut constraints*; they state that the capacity of each Steiner path cut must be at least one. It is easy to see that (SCP_{cut}) is a valid formulation for the SCP.

If each path has length 1, i.e., contains only one edge, the sets $\delta(W)$ and $\mathcal{P}_{\delta(W)}$ are equal. In this case the Steiner connectivity problem reduces to a Steiner tree problem, and the Steiner path cut constraints reduce to the so-called *Steiner cut constraints*.

Replacing the Steiner path cut constraints by the inequalities

$$\sum_{e \in \delta(W)} \sum_{p: e \in p} x_p \geq 1 \quad \forall \emptyset \neq W \cap T \neq T, W \subseteq V$$

produces the integer program

$$\begin{aligned}
(\text{SCP}_{cut}^w) \quad & \min && \sum_{p \in \mathcal{P}} c_p x_p \\
\text{(i)} \quad & \text{s.t.} && \sum_{e \in \delta(W)} \sum_{p: e \in p} x_p \geq 1 && \forall \emptyset \neq W \cap T \neq T, W \subseteq V \\
& && x_p \in \{0, 1\} && \forall p \in \mathcal{P}.
\end{aligned}$$

This *weak cut formulation* is also a correct IP formulation of the SCP. Note that the left hand side of a *weak Steiner path cut constraint* (SCP_{cut}^w) (i) counts how often each path crosses the cut $\delta(W)$. These inequalities can be seen as a direct generalization of the Steiner cut constraints for the STP. However, they are clearly dominated by the Steiner path cut constraints.

Some Steiner path cut constraints are themselves dominated by others. In fact, the non-dominated ones correspond to minimal disconnecting sets. A set $\mathcal{P}' \subseteq \mathcal{P}$ is a *disconnecting set* if there exist two terminal nodes which are not connected via $\mathcal{P} \setminus \mathcal{P}'$.

Lemma 3.1. *Minimal disconnecting sets are minimal Steiner path cuts (w.r.t. inclusion) and vice versa.*

Proof. “ \Rightarrow ”: Let $\mathcal{P}' \subseteq \mathcal{P}$ be a minimal disconnecting set, and let $s, t \in T$ be two terminal nodes that are disconnected. Define W to be the nodes reachable from t via $\mathcal{P} \setminus \mathcal{P}'$. Note that $s \notin W$ and $t \in W$, and hence $\mathcal{P}_{\delta(W)}$ is an (s, t) -Steiner path cut. We claim that $\mathcal{P}_{\delta(W)} = \mathcal{P}'$.

- Assume $p \in \mathcal{P}_{\delta(W)} \setminus \mathcal{P}'$. Hence, p connects some node u in $V \setminus W$ to some node $v \in W$. By definition of W , $\mathcal{P} \setminus \mathcal{P}'$ connects v and t , and since $p \in \mathcal{P} \setminus \mathcal{P}'$ connects u and v , $\mathcal{P} \setminus \mathcal{P}'$ connects u and t . It follows that $u \in W$, a contradiction. Hence, $\mathcal{P}_{\delta(W)} \subseteq \mathcal{P}'$.
- Conversely, assume $p \in \mathcal{P}' \setminus \mathcal{P}_{\delta(W)}$. Since $\mathcal{P}_{\delta(W)} \subseteq \mathcal{P}'$ is a disconnecting set for s and t , it follows that \mathcal{P}' is not minimal, another contradiction.

Finally, $\mathcal{P}_{\delta(W)}$ is minimal w.r.t. inclusion, because otherwise $\mathcal{P}' = \mathcal{P}_{\delta(W)}$ would not be minimally disconnecting.

“ \Leftarrow ”: Let $W \subseteq V$ with $\emptyset \neq W \cap T \neq T$, such that $\mathcal{P}_{\delta(W)}$ is minimal w.r.t. inclusion. Then $\mathcal{P}_{\delta(W)}$ is a disconnecting set, because no terminal in W is connected to a terminal in $V \setminus W$ via $\mathcal{P} \setminus \mathcal{P}_{\delta(W)}$. We claim that $\mathcal{P}_{\delta(W)}$ is also a minimal disconnecting set. Suppose not; then there is some smaller disconnecting set $\mathcal{P}' \subsetneq \mathcal{P}_{\delta(W)}$, which we can assume to be minimal. By the forward direction of the proof, $\mathcal{P}' = \mathcal{P}_{\delta(W')}$ for some set $W' \subseteq V$, $\emptyset \neq W' \cap T \neq T$. It follows that $\mathcal{P}_{\delta(W')} = \mathcal{P}' \subsetneq \mathcal{P}_{\delta(W)}$, i.e., $\mathcal{P}_{\delta(W)}$ was not minimal w.r.t. inclusion, a contradiction. \square

The number of the Steiner path cut constraints can be exponential in the size of the input. However, the associated separation problem, i.e., to decide whether a given point \hat{x} is feasible for the LP relaxation of (SCP_{cut}) or to find a violated Steiner path cut constraint, can be solved in polynomial time. Namely, this problem can be formulated as a family of max flow/min cut problems in the Steiner connectivity

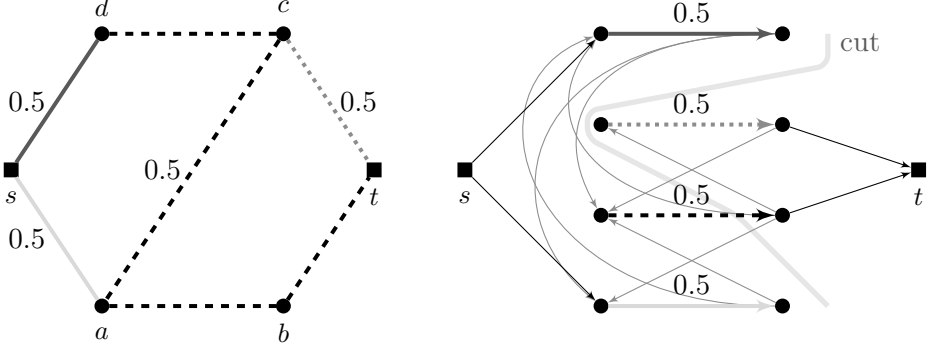

Figure 3: *Left:* Graph G with four paths ($p_1 = (s, d)$, $p_2 = (c, t)$, $p_3 = (d, c, a, b, t)$, $p_4 = (s, a)$) with value 0.5 and two terminal nodes s and t . *Right:* Corresponding directed graph D' . Here, each arc has capacity 0.5. The minimum directed (s, t) -cut has value 0.5 and corresponds to the Steiner path cut $\mathcal{P}' = \{p_3\}$ in G .

digraph $D' = (V', A')$ that was defined in Section 2. Consider some nonnegative vector $\hat{x} \geq 0$. We define the following *standard arc capacities* $\kappa = \kappa(\hat{x})$ for D' :

$$\begin{aligned}
a = (r, v_p), & \quad \kappa_a := \hat{x}_p, & \quad \forall p \in \mathcal{P} \text{ with } r \in p, \\
a = (v_p, w_p), & \quad \kappa_a := \hat{x}_p, & \quad \forall p \in \mathcal{P}, \\
a = (w_{\tilde{p}}, v_p), & \quad \kappa_a := \min\{\hat{x}_p, \hat{x}_{\tilde{p}}\}, & \quad \forall p, \tilde{p} \in \mathcal{P}, p \neq \tilde{p}, p \text{ and } \tilde{p} \text{ have} \\
& \quad \text{a node } v \in V \text{ in common,} \\
a = (w_p, t), & \quad \kappa_a := \hat{x}_p, & \quad \forall p \in \mathcal{P}, \forall t \in T \setminus \{r\} \text{ with } t \in p.
\end{aligned}$$

Figure 3 illustrates this construction. The following holds.

Lemma 3.2. *Let $t \in T \setminus \{r\}$ be a terminal node. If the Steiner connectivity digraph D' has standard capacities $\kappa = \kappa(\hat{x})$, there exists a directed (r, t) -cut with minimum capacity in D' such that all arcs over this cut are of the form (v_p, w_p) , $p \in \mathcal{P}$.*

Proof. Let $\delta^-(W)$ be a directed (r, t) -cut with $W \subseteq V \setminus \{r\}$. We show that we can convert this cut into the required form such that the resulting cut $\delta^-(\tilde{W})$ has weight not larger than $\delta^-(W)$. Thus, if $\delta^-(W)$ has minimum capacity, then $\delta^-(\tilde{W})$ has minimum capacity as well.

- Assume $(r, v_p) \in \delta^-(W)$, i.e., $v_p \in W$. We set $\tilde{W} = W \setminus \{v_p\} \cup \{w_p\}$ and get $\delta^-(\tilde{W}) \subseteq \delta^-(W) \setminus \{(r, v_p)\} \cup \{(v_p, w_p)\}$, because (v_p, w_p) is the only arc with source node v_p and target node w_p , recall statements 1 and 2 of Lemma 2.1. Furthermore, $(v_p, w_p) \in \delta^-(\tilde{W})$ and $\kappa_{rv_p} = \kappa_{v_p w_p}$. Hence, $\delta^-(\tilde{W})$ has capacity not larger than $\delta^-(W)$.
- If $(w_p, t) \in \delta^-(W)$, we set $\tilde{W} = W \setminus \{v_p\} \cup \{w_p\}$ and argue as above.
- Assume $(w_{\tilde{p}}, v_p) \in \delta^-(W)$, $p \neq \tilde{p}$, and $\hat{x}_p \leq \hat{x}_{\tilde{p}}$. In this case, we set $\tilde{W} = W \setminus \{v_p\} \cup \{w_p\}$ and get $\delta^-(\tilde{W}) \subseteq \delta^-(W) \setminus \{(w_{\tilde{p}}, v_p)\} \cup \{(v_p, w_p)\}$, again because of statements 1 and 2 of Lemma 2.1. Furthermore, $(v_p, w_p) \in \delta^-(\tilde{W})$ and $\kappa_{w_{\tilde{p}} v_p} = \kappa_{v_p w_p}$. Hence, $\delta^-(\tilde{W})$ has capacity not larger than $\delta^-(W)$.
- Assume $(w_{\tilde{p}}, v_p) \in \delta^-(W)$, $p \neq \tilde{p}$, and $\hat{x}_{\tilde{p}} \leq \hat{x}_p$. In this case we set $\tilde{W} = W \setminus \{v_{\tilde{p}}\} \cup \{w_{\tilde{p}}\}$ and argue similarly.

In all cases, the set W changes in such a way that nodes w_p enter W and nodes v_p leave W . Hence all steps can be repeated until the cut has the desired form. \square

We call a cut of the form stated in Lemma 3.2 a *standard cut*; then Lemma 3.2 can be rephrased as stating that there exists a minimum capacity directed (r, t) -cut in a Steiner connectivity digraph with standard capacities which is a standard cut.

Proposition 3.3. *Let $\kappa \in \mathbb{R}_+^A$ and $\hat{x} \in \mathbb{R}_+^{\mathcal{P}}$ be capacities for D' and G , respectively, such that $\kappa_a = \hat{x}_p$ for all $a = (v_p, w_p) \in A'$, $p \in \mathcal{P}$. Then there is a one-to-one correspondence between minimal directed (r, t) -standard cuts in D' (w.r.t. root node r) and minimal (r, t) -Steiner path cuts in G , and the capacities are equal.*

Proof. “ \Rightarrow ”: Consider a directed (r, t) -standard cut $\delta^-(W')$ in D' . We first show that $\delta^-(W')$ gives rise to an (r, t) -disconnecting set

$$\mathcal{P}' = \{p \in \mathcal{P} \mid (v_p, w_p) \in \delta^-(W')\}$$

in G . Assume there exists a path from r to t in G that is covered by paths in $\mathcal{P} \setminus \mathcal{P}'$ (i.e., \mathcal{P}' is not a disconnecting set). Let p_1, \dots, p_k be the paths that are used in this order when traversing the path. Then $(r, v_{p_1}, w_{p_1}, \dots, v_{p_k}, w_{p_k}, t)$ is a path from r to t in D' that uses only arcs in $A' \setminus \delta^-(W')$. This is a contradiction to the assumption that $\delta^-(W')$ is a directed (r, t) -standard cut in D' .

Now let $\delta^-(W')$ be minimal and suppose \mathcal{P}' is not. Then there exists a smaller (r, t) -disconnecting set $\mathcal{P}'' \subset \mathcal{P}'$. Consider for some path $p \in \mathcal{P}' \setminus \mathcal{P}''$ the arc $(v_p, w_p) \in \delta^-(W')$. As $\delta^-(W')$ is a minimal disconnecting set in D' , there is an (r, t) -path $(r, v_{p_1}, w_{p_1}, \dots, v_{p_k}, w_{p_k}, t)$ in $A' \setminus \delta^-(W') \cup \{p\}$. But then p_1, \dots, p_k is a set of paths in $\mathcal{P} \setminus \mathcal{P}' \cup \{p\} \subseteq \mathcal{P} \setminus \mathcal{P}''$ that connect r and t in G , i.e., \mathcal{P}'' is not an (r, t) -disconnecting set. This is a contradiction. Therefore \mathcal{P}' is minimally disconnecting and, by Lemma 3.1, \mathcal{P}' is a minimal (r, t) -Steiner path cut.

“ \Leftarrow ”: Let \mathcal{P}' be an (r, t) -Steiner path cut. Then \mathcal{P}' is an (r, t) -disconnecting set in G . Define

$$W' = \{t\} \cup \{w_p \mid p \in \mathcal{P}'\} \cup W'',$$

where W'' is the set of nodes from which t can be reached using arcs in the set $A' \setminus \{(v_p, w_p) \mid p \in \mathcal{P}'\}$. Then we show that $\delta^-(W')$ is a directed (r, t) -standard cut in D' , namely,

$$\delta^-(W') = \{(v_p, w_p) \mid p \in \mathcal{P}'\}.$$

It is clear that $\delta^-(W') \supseteq \{(v_p, w_p) \mid p \in \mathcal{P}'\}$, because the only node that can be reached from v_p is w_p . To show equality, consider the following cases:

- Assume $(r, v_p) \in \delta^-(W')$ for some $p \in \mathcal{P}$. If $p \in \mathcal{P}'$, then $v_p \notin W'$, a contradiction. If $p \notin \mathcal{P}'$ then t can be reached from v_p via arcs in $A' \setminus \{(v_p, w_p) \mid p \in \mathcal{P}'\}$. Hence, there is an (r, t) -path covered by $p \in \mathcal{P} \setminus \mathcal{P}'$, a contradiction.
- Assume $(w_p, t) \in \delta^-(W')$ for some $p \in \mathcal{P}$. For both cases $p \in \mathcal{P}'$ and $p \notin \mathcal{P}'$ we have $w_p \in W'$, a contradiction.
- Assume $(v_p, w_p) \in \delta^-(W')$ for some $p \in \mathcal{P} \setminus \mathcal{P}'$. Then $w_p \in W'$, i.e., t can be reached from w_p via arcs in $A' \setminus \{(v_p, w_p) \mid p \in \mathcal{P}'\}$, but $v_p \notin W'$, a contradiction.
- Assume $(w_{\tilde{p}}, v_p) \in \delta^-(W')$ for some $p, \tilde{p} \in \mathcal{P}$. Then $w_{\tilde{p}} \notin W'$ and $v_p \in W'$. This implies that t can be reached from v_p via arcs in $A' \setminus \{(v_p, w_p) \mid p \in \mathcal{P}'\}$. But then t can also be reached from $w_{\tilde{p}}$ via arcs in $A' \setminus \{(v_p, w_p) \mid p \in \mathcal{P}'\}$, a contradiction.

Now assume that \mathcal{P}' is a minimal (r, t) -Steiner path cut (i.e., a minimal (r, t) -disconnecting set via Lemma 3.1) and $\delta^-(W')$ is not, i.e., there exists a standard cut $\delta^-(W'') \subset \delta^-(W') = \{(v_p, w_p) \mid p \in \mathcal{P}'\}$. Then by the forward argument of the proof there exists a disconnecting set $\mathcal{P}'' \subsetneq \mathcal{P}'$, a contradiction.

“ \Leftrightarrow ”: It is easy to see that in both cases \mathcal{P}' and $\delta^-(W')$ have the same capacity, and that the constructions in the two directions of the proof pair the same cuts. \square

Remark 3.4. Note that Proposition 3.3 holds for *all* capacities such that $\kappa_a = \hat{x}_p$ for all $a = (v_p, w_p) \in A'$, $p \in \mathcal{P}$, not only for standard capacities.

Theorem 3.5. *The separation problem for Steiner path cut constraints can be solved in polynomial time.*

Proof. Computing for every two terminals $s, t \in T$ a minimum (s, t) -cut in D' with respect to standard capacities, using s as root node, can be done in polynomial time. If and only if the value of this cut is smaller than 1, we can find a violated Steiner path cut constraint by transforming this cut into a standard cut via Lemma 3.2 and then apply Proposition 3.3. This can also be done in polynomial time. \square

3.2 Directed Cut Formulation

Our second formulation of the SCP is the well-known *directed cut formulation* for the associated DSTP [4]:

$$\begin{aligned}
 (\text{SCP}_{arc}) \quad & \min && \sum_{a \in A'} c'_a y_a \\
 \text{(i)} \quad & \text{s.t.} && \sum_{a \in \delta^-(W')} y_a \geq 1 && \forall W' \subseteq V' \setminus \{r\}, W' \cap T \neq \emptyset \\
 & && y_a \in \{0, 1\} && \forall a \in A'.
 \end{aligned}$$

Note that the solutions of (SCP_{arc}) are *supersets* of directed Steiner trees for the terminal set T . The separation problem for the *directed Steiner cut constraints* (SCP_{arc}) (i) consists of solving $|T| - 1$ min-cut problems, i.e., for each $t \in T \setminus \{r\}$ one has to find a minimum (r, t) -cut in D' . This can be done in polynomial time.

(SCP_{arc}) can be interpreted as an extended formulation of (SCP_{cut}) by identifying arcs (v_p, w_p) and paths $p \in \mathcal{P}$. We define

$$A'_{\mathcal{P}} = \{(v_p, w_p) \in A' \mid p \in \mathcal{P}\}$$

and write $y|_{\mathcal{P}} = y|_{A'_{\mathcal{P}}}$ to simplify the notation. Then, Proposition 2.2 states that if y is an integer solution of (SCP_{arc}) , its projection on the subspace of “path-arcs” gives rise to a solution $x = y|_{\mathcal{P}}$ of (SCP_{cut}) via $x_p = y_{v_p w_p}$, $p \in \mathcal{P}$, and vice versa. This relation also holds for the LP relaxations of (SCP_{cut}) and (SCP_{arc}) .

Lemma 3.6. $P_{LP}(\text{SCP}_{cut}) = P_{LP}(\text{SCP}_{arc})|_{\mathcal{P}}$.

Proof. “ \supseteq ”: Let $\hat{y} \in P_{LP}(\text{SCP}_{arc})$, i.e., \hat{y} satisfies all directed (r, t) -Steiner cuts for some root r and every terminal $t \in T \setminus \{r\}$. By Proposition 3.3 and Remark 3.4, the

vector $\hat{x} = \hat{y}|_{\mathcal{P}}$ satisfies all (r, t) -Steiner path cuts for every terminal $t \in T \setminus \{r\}$. Since any (s, t) -Steiner path cut is either an (r, s) - or an (r, t) -Steiner path cut, $\hat{y}|_{\mathcal{P}}$ also satisfies the (s, t) -Steiner path cuts for all $s, t \in T \setminus \{r\}$, i.e., $\hat{y}|_{\mathcal{P}} = \hat{x} \in P_{LP}(\text{SCP}_{cut})$.

“ \subseteq ”: Let $\hat{x} \in P_{LP}(\text{SCP}_{cut})$, in particular, \hat{x} satisfies the (s, t) -Steiner path cuts for all $s, t \in T$ and hence all (r, t) -Steiner path cuts for some fixed root r . We define $\hat{y} \in \mathbb{R}^A$ by setting $\hat{y} = \kappa(\hat{x})$ according to the standard capacity definition, i.e., in particular, $\hat{y}|_{\mathcal{P}} = \hat{x}$. By Proposition 3.3, the vector \hat{y} satisfies all directed (r, t) -standard cuts, and by Lemma 3.2, all directed (r, t) -cuts, i.e., $\hat{y} \in P_{LP}(\text{SCP}_{arc})$. \square

Corollary 3.7. *The optimal objective values of the LP relaxations of (SCP_{arc}) and (SCP_{cut}) are equal. In particular, the objective value of the LP relaxation of (SCP_{arc}) is independent of the choice of the root node r .*

Proof. This follows from Lemma 3.6, since $c'|_{\mathcal{P}} = c$ and $c'|_{A \setminus A_{\mathcal{P}}} = 0$. \square

In contrast to the Steiner tree problem, where the directed formulation dominates the undirected formulation immediately, the undirected and the directed cut formulation for the SCP are equivalent in terms of quality and tractability. However, it is known that directed cut formulations for the STP can easily be strengthened by a small number of inequalities that one can write down explicitly. It will turn out that in our case such a strengthening dominates a large class of facet defining Steiner partition inequalities for the undirected formulation of the SCP, see Section 4.

The construction is as follows. Since we assume nonnegative costs, there is always an optimal solution of the associated DSTP that is a directed tree. Each non-terminal node that is contained in such a cost minimal directed Steiner tree has at least one outgoing arc and at most one incoming arc. Therefore, the so-called *flow balance inequalities* can be added to (SCP_{arc}) :

$$\sum_{a \in \delta^-(v)} y_a \leq \sum_{a \in \delta^+(v)} y_a \quad \forall v \in V' \setminus T.$$

These inequalities have been studied by Polzin [13, 14] in the context of the Steiner tree problem. Because of the special form of the Steiner connectivity digraph and the objective function, it suffices to consider the flow balance constraints only for the nodes $v_p, p \in \mathcal{P}$. Appending these flow balance constraints produces the following *strengthened directed cut formulation* for the SCP:

$$\begin{aligned} (\text{SCP}_{arc+}^r) \quad \min \quad & \sum_{a \in A'} c'_a y_a \\ \text{s.t.} \quad & \sum_{a \in \delta^-(W')} y_a \geq 1 && \forall W' \subseteq V' \setminus \{r\}, W' \cap T \neq \emptyset \\ & y_{v_p w_p} \geq \sum_{a \in \delta^-(v_p)} y_a && \forall (v_p, w_p) \in A' (p \in \mathcal{P}) \\ & y_a \in \{0, 1\} && \forall a \in A'. \end{aligned}$$

The solutions of (SCP_{arc+}^r) are branchings that contain a directed Steiner tree for terminal set T plus possible additional arcs that enter the terminals $T \setminus \{r\}$. Since

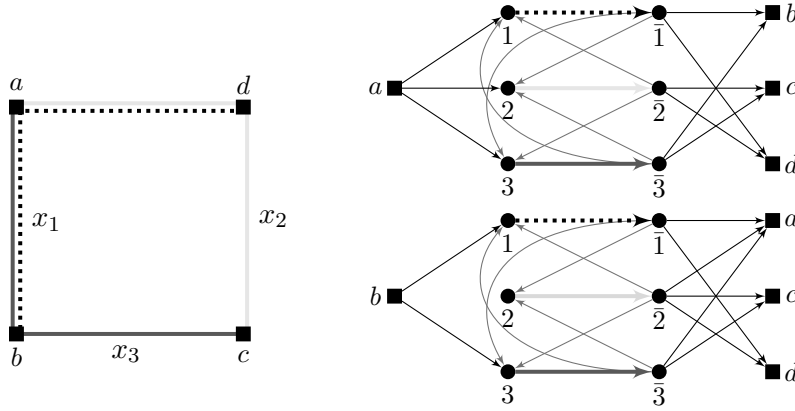

Figure 4: An SCP instance showing that choosing different roots leads to different solutions of the LP relaxation of (SCP_{arc+}^r) . Choosing node a as root allows to set all path values to 0.5 in the LP relaxation of (SCP_{arc+}^a) . This solution is not possible for the LP relaxation of (SCP_{arc+}^b) , when b is chosen as root.

(SCP_{arc}) always has an optimal solution that is a directed Steiner tree, the optimal objective values of (SCP_{arc+}^r) and (SCP_{arc}) are equal.

Corollary 3.8. $P_{LP}(\text{SCP}_{cut}) = P_{LP}(\text{SCP}_{arc})|_{\mathcal{P}} \supseteq P_{LP}(\text{SCP}_{arc+}^r)|_{\mathcal{P}}$.

Remark 3.9. The objective value of the LP relaxation of (SCP_{arc+}^r) is not independent of the choice of the root node, see Figure 4.

3.3 Contracted Directed Cut Formulation

A third formulation of the SCP arises from the directed cut formulation by contracting the “path-arcs” (v_p, w_p) , $p \in \mathcal{P}$, i.e., we consider a contracted Steiner connectivity digraph $D'' = (V'', A'') = D' / \{(v_p, w_p) \mid p \in \mathcal{P}\}$. Let v_p be the node that arises from contracting the arc (v_p, w_p) , i.e., $V'' = V' \setminus \{w_p \mid p \in \mathcal{P}\} = T \cup \{v_p \mid p \in \mathcal{P}\}$. Analogously, we identify arcs in A'' and A' , i.e., $A'' = A' \setminus A'_{\mathcal{P}}$ (here $(w_p, v) \in A'$ corresponds to $(v_p, v) \in A''$). Furthermore, let $c''_a = c_p$ for $a = (u, v_p) \in A'$, $p \in \mathcal{P}$, and 0 otherwise, i.e., the path costs are shifted to the ingoing arcs of a node v_p . D'' can be interpreted as a “terminal and path intersection digraph” more directly than D' . The *strengthened contracted directed cut formulation* reads as follows:

$$\begin{aligned}
 (\text{SCP}_{con+}^r) \quad & \min \quad \sum_{a \in A''} c''_a y_a \\
 \text{(i)} \quad & \text{s.t.} \quad \sum_{a \in \delta^-(W'')} y_a \geq 1 \quad \forall W'' \subseteq V'' \setminus \{r\}, W'' \cap T \neq \emptyset \\
 \text{(ii)} \quad & 1 \geq \sum_{a \in \delta^-(v_p)} y_a \quad \forall v_p \in V'' (p \in \mathcal{P}) \\
 & y_a \in \{0, 1\} \quad \forall a \in A''.
 \end{aligned}$$

The constraints (SCP_{con+}^r) (ii) are the *contracted flow balance constraints*. The solutions of (SCP_{con+}^r) are branchings that contain a directed Steiner tree for terminal

set T plus possible additional arcs that enter the terminals $T \setminus \{r\}$. The optimal objective values of (SCP_{arc+}^r) and (SCP_{con+}^r) are equal.

Lemma 3.10. $P_{LP}(\text{SCP}_{con+}^r) = P_{LP}(\text{SCP}_{arc+}^r)|_{A''}$.

Proof. “ \supseteq ”: Let $y' \in P_{LP}(\text{SCP}_{arc+}^r)$ and $y'' = y'|_{A''}$. Then y' satisfies all directed (r, t) -Steiner cuts for root r and each terminal $t \in T \setminus \{r\}$. Consider a directed (r, t) -Steiner cut $\delta^-(W'')$ in D'' . Let

$$W' := W'' \cup \{w_p | v_p \in W'', p \in \mathcal{P}\}.$$

Then $W' \subseteq V' \setminus \{r\}$ and $t \in W' \cap T$, i.e., $\delta^-(W') \subseteq A'$ is an (r, t) -Steiner cut in D' . Moreover, identifying A'' and $A' \setminus A'_p$, we have $\delta^-(W') = \delta^-(W'')$. It follows that

$$\sum_{\substack{a \in \delta^-(W') \\ a \in A'}} y'_a \geq 1 \quad \Rightarrow \quad \sum_{\substack{a \in \delta^-(W'') \\ a \in A''}} y''_a \geq 1,$$

i.e., $y'' = y'|_{A''}$ satisfies the directed (r, t) -Steiner cut inequality for $\delta^-(W'')$. Now consider $\delta^-(v_p)$ for $p \in \mathcal{P}$. Again identifying A'' and $A' \setminus A'_p$, we have

$$1 \geq y'_{v_p w_p} \geq \sum_{\substack{a \in \delta^-(v_p) \\ a \in A'}} y'_a \quad \Rightarrow \quad 1 \geq \sum_{\substack{a \in \delta^-(v_p) \\ a \in A''}} y''_a,$$

i.e., $y'' = y'|_{A''}$ satisfies the contracted flow balance constraint for $\delta^-(v_p)$. It follows that $y'' = y'|_{A''} \in P_{LP}(\text{SCP}_{con+}^r)$.

“ \subseteq ”: Let $y'' \in P_{LP}(\text{SCP}_{con+}^r)$. Then y'' satisfies all directed (r, t) -Steiner cuts for root r and all $t \in T \setminus \{r\}$ in D'' as well as the contracted flow balance constraints for all nodes $v_p \in V''$. We define $y \in \mathbb{R}^{A'}$ as

$$y'|_{A''} := y'', \quad y'_p := \sum_{a \in \delta^-(v_p)} y''_a, \quad p \in \mathcal{P},$$

and show that $y' \in P_{LP}(\text{SCP}_{arc+}^r)$. By definition of y' , the flow balance constraints at the nodes v_p are satisfied, since by the contracted flow balance constraints, $y'_p \leq 1$ for every $p \in \mathcal{P}$. It remains to show that $\sum_{a \in \delta^-(W')} y'_a \geq 1$ for all (r, t) -Steiner cuts. Let $B = \delta^-(W')$ be an (r, t) -Steiner cut in D' . We distinguish two cases: $(v_p, w_p) \notin \delta^-(W')$ for all $p \in \mathcal{P}$ or there exists a $p \in \mathcal{P}$ such that $(v_p, w_p) \in \delta^-(W')$.

- Let $(v_p, w_p) \notin \delta^-(W')$ for all $p \in \mathcal{P}$, i.e., we have either $v_p, w_p \in W'$ or $v_p, w_p \notin W'$ for each $p \in \mathcal{P}$. Let

$$W'' := W' \setminus \{w_p | p \in \mathcal{P}\}.$$

Then $W'' \subseteq V'' \setminus \{r\}$ and $t \in W'' \cap T$, i.e., $\delta^-(W'') \subseteq A''$ is an (r, t) -Steiner cut in D'' and, analogous to the forward direction, $\delta^-(W'') = \delta^-(W')$, again identifying A'' and $A' \setminus A'_p$. It follows

$$\sum_{\substack{a \in \delta^-(W'') \\ a \in A''}} y''_a \geq 1 \quad \Rightarrow \quad \sum_{\substack{a \in \delta^-(W') \\ a \in A'}} y'_a \geq 1.$$

- Now let $p \in \mathcal{P}$ such that $(v_p, w_p) \in \delta^-(W')$, i.e., $w_p \in W'$ and $v_p \notin W'$. In this case, we set $\hat{W}' = W' \cup \{v_p\}$ and get a new (r, t) -Steiner cut with $\delta^-(\hat{W}') \subseteq \delta^-(W') \cup \{(u, v_p) \mid u \in V'\} \setminus \{(v_p, w_p)\}$. Using $y'_{v_p w_p} = \sum_{a \in \delta^-(v_p)} y'_a$, we get

$$\sum_{a \in \delta^-(W')} y'_a \geq \sum_{a \in \delta^-(\hat{W}')} y'_a.$$

Note that this operation moved v_p into \hat{W}' . Iterating over all $p \in \mathcal{P}$ with $(v_p, w_p) \in \delta^-(W')$, the situation is reduced to the first case.

This shows the claim. \square

Corollary 3.11. *The optimal objective values of the LP relaxations of $(\text{SCP}_{\text{con}+}^r)$ and of $(\text{SCP}_{\text{arc}+}^r)$ are equal.*

Proof. The proof of Lemma 3.10 shows the following. If y'' is a solution of $(\text{SCP}_{\text{con}+}^r)$ then there exists a solution y' of $(\text{SCP}_{\text{arc}+}^r)$ that satisfies all flow balance constraints with equality and $y'|_{A''} = y''$. Moreover,

$$\sum_{a \in A''} c''_a y''_a = \sum_{p \in \mathcal{P}} \sum_{a \in \delta^-(v_p)} c''_a y''_a = \sum_{p \in \mathcal{P}} c'_{v_p w_p} y'_{v_p w_p} = \sum_{a \in A'} c'_a y'_a.$$

This shows that the optimal objective value of the LP relaxation of $(\text{SCP}_{\text{arc}+}^r)$ is not larger than the optimal objective value of the LP relaxation of $(\text{SCP}_{\text{con}+}^r)$.

Conversely, if y' is a solution of $(\text{SCP}_{\text{arc}+}^r)$, by Lemma 3.10, $y'' = y'|_{A''}$ is a feasible solution of $(\text{SCP}_{\text{con}+}^r)$ that satisfies

$$\sum_{a \in A'} c'_a y'_a = \sum_{p \in \mathcal{P}} c'_{v_p w_p} y'_{v_p w_p} \geq \sum_{p \in \mathcal{P}} \sum_{a \in \delta^-(v_p)} c''_a y''_a = \sum_{a \in A''} c''_a y''_a.$$

This shows the reverse inequality. \square

Remark 3.12. Dropping the contracted flow balance constraints from formulation $(\text{SCP}_{\text{con}+}^r)$ to obtain a *contracted directed cut formulation* $(\text{SCP}_{\text{con}}^r)$, one can show similarly that $P_{LP}(\text{SCP}_{\text{con}}^r) = P_{LP}(\text{SCP}_{\text{arc}}^r)|_{A''}$ and that the objective values of the associated LPs are equal.

We have seen that $(\text{SCP}_{\text{arc}+}^r)$ is a common extended formulation of $(\text{SCP}_{\text{cut}})$ and $(\text{SCP}_{\text{con}}^r)$ and, albeit slightly larger than $(\text{SCP}_{\text{con}}^r)$, $(\text{SCP}_{\text{arc}+}^r)$ is easier to relate to $(\text{SCP}_{\text{cut}})$. For this reason, the succeeding sections will investigate the latter relation.

4 Polyhedral Analysis

In this section, we investigate the polytope that is associated with the cut formulation of the Steiner connectivity problem. We analyze a class of facet defining Steiner partition inequalities, and discuss the corresponding separation problem. Let

$$P_{\text{SCP}} := \text{conv} \{ \mathbf{x} \in \{0, 1\}^{\mathcal{P}} \mid \mathbf{x} \text{ satisfies all Steiner path cut constraints} \}$$

be the *Steiner connectivity polytope*. We assume that the Steiner connectivity polytope is non-empty, i.e., the graph G is connected, and each edge is covered by at least one path of \mathcal{P} .

In the two-terminal case, a complete description can be given.

Proposition 4.1. *The polytope associated with (SCP_{cut}) is integral for $|T| = 2$.*

Proof. This follows from Lemma 3.6 and the fact that the polytope associated with (SCP_{arc}) is integral for two terminal nodes (see, e.g., Cornuéjols [5]). \square

In general, (SCP_{cut}) is a special set covering problem. Therefore, the results of Balas and Ng [2] imply:

Lemma 4.2. *P_{SCP} is full dimensional if and only if there exists no Steiner path bridge.*

Lemma 4.3. *The polytope associated with a Steiner connectivity problem without Steiner path bridges has the following properties:*

1. *The inequality $x_p \geq 0$ defines a facet of P_{SCP} if and only if $|\mathcal{P}_{\delta(W)}| \geq 3$ for all W with $p \in \mathcal{P}_{\delta(W)}$ and $\emptyset \neq W \cap T \neq T$.*
2. *All inequalities $x_p \leq 1$ define facets of P_{SCP} .*
3. *All facet defining inequalities $\alpha^T x \geq \alpha_0$ for P_{SCP} have $\alpha \geq 0$ if $\alpha_0 > 0$.*
4. *A Steiner path cut inequality for $\emptyset \neq W \cap T \neq T$ is facet defining if and only if the following two properties are satisfied:*
 - (a) *There exists no W' , $\emptyset \neq W' \cap T \neq T$, such that $\mathcal{P}_{\delta(W')} \subsetneq \mathcal{P}_{\delta(W)}$, i.e., $\mathcal{P}_{\delta(W)}$ is not dominated.*
 - (b) *For every two W_1, W_2 , $\emptyset \neq W_i \cap T \neq T$, with $|\mathcal{P}_{\delta(W_i)} \setminus \mathcal{P}_{\delta(W)}| = 1$, $i = 1, 2$ and $\mathcal{P}_{\delta(W_1)} \setminus \mathcal{P}_{\delta(W)} = \mathcal{P}_{\delta(W_2)} \setminus \mathcal{P}_{\delta(W)}$, we have*

$$|\mathcal{P}_{\delta(W_1)} \cap \mathcal{P}_{\delta(W_2)} \cap \mathcal{P}_{\delta(W)}| \geq 1.$$

5. *The only nontrivial facet defining inequalities for P_{SCP} with integer coefficients and righthand side equal to 1 are Steiner path cut constraints.*

In the following, we assume P_{SCP} to be full dimensional.

4.1 Steiner Partition Inequalities

Lemma 4.3 characterizes completely which inequalities of the IP formulation (SCP_{cut}) define facets of the Steiner connectivity polytope. We investigate in this section inequalities arising from node partitions as one important example of an additional class of facets.

Let $P = (V_1, \dots, V_k)$ be a *Steiner partition* of the node set V , i.e., P partitions V and $V_i \cap T \neq \emptyset$ for $i = 1, \dots, k$ and $k \geq 2$. Let $G_P = (V_P, E_P)$ be the graph that arises from contracting each node set $V_i \subseteq V$ to a single node $V_i \in V_P$ (let us denote by V_i a node set in a partition of G as well as a node in the shrunk graph G_P). Note that G_P can have parallel edges but no loops; loops are contracted. Consider a path $p \in \mathcal{P}$: p gives rise to a contracted (not necessarily simple) path in G_P , which we

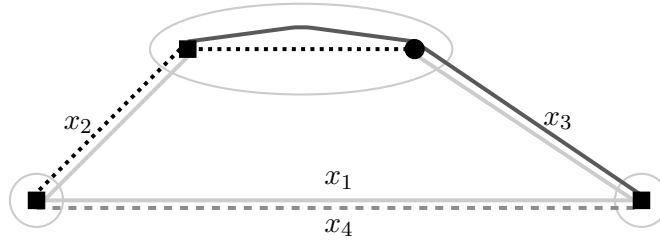

Figure 5: The Steiner partition inequality $2x_1 + x_2 + x_3 + x_4 \geq 2$ is facet defining (node sets of the Steiner partition encircled).

also denote by p . We say that p contains V_i , in formulas $V_i \in p$, if p contains a node of V_i (even if a path $p \in \mathcal{P}$ contains only a single node of G_P). Furthermore, let \mathcal{P}_P denote the set of paths $p \in \mathcal{P}$ that contain at least two distinct shrunk nodes in G_P , in formulas

$$\mathcal{P}_P = \{p \in \mathcal{P} \mid \exists V_i, V_j \in V_P, V_i \neq V_j, V_i \in p, V_j \in p\},$$

and $\bar{\mathcal{P}} := \mathcal{P} \setminus \mathcal{P}_P$ its complement. Finally, $G[V_i]$ is the graph induced by the nodes V_i .

Lemma 4.4. *The Steiner partition inequality*

$$\sum_{p \in \mathcal{P}_P} a_p x_p \geq k - 1, \quad (1)$$

$$a_p := |\{V \in V_P : V \in p\}| - 1$$

is valid for the Steiner connectivity polytope P_{SCP} .

Note that the inequality can also be stated as $\sum_{p \in \mathcal{P}} a_p x_p \geq k - 1$, because $a_p = 0$ for $p \notin \mathcal{P}_P$. If $k = 2$, the partition inequality is a Steiner path cut constraint. An example of a (facet defining) Steiner partition inequality can be seen in Figure 5.

Proof of Lemma 4.4. We have to show that each 0/1-solution x^* of the Steiner connectivity problem satisfies

$$\sum_{p \in \mathcal{P}_P} a_p x_p^* \geq k - 1.$$

The coefficient a_p , $p \in \mathcal{P}$, counts the number of shrunk nodes that p contains minus one, i.e., a_p is the maximum number of edges that p can contribute to a spanning tree in G_P . Note that the number a_p is in general smaller than the number of times that p crosses the multi-cut induced by the Steiner partition.

Consider the solution x^* on the shrunk graph G_P . Since each node set V_i , $i = 1, \dots, k$, contains a terminal node, the shrunk graph G_P has to be connected by the solution x^* , i.e., the (paths of the) support of x^* must contain a spanning tree in G_P . This means that the support of x^* contains at least $k - 1$ edges in G_P . \square

The following two propositions give sufficient and necessary conditions for a Steiner partition inequality to be facet defining for the SCP. The sufficient conditions are analogous to those for the Steiner tree polytope, see Grötschel and Monma [10].

Proposition 4.5. *A Steiner partition inequality is facet defining if the following properties are satisfied.*

1. $G[V_i]$ is connected by $\bar{\mathcal{P}}$, $i = 1, \dots, k$.
2. $G[V_i]$ contains no Steiner path bridge in $\bar{\mathcal{P}}$, i.e., there is no Steiner path cut $\mathcal{P}_{\delta(W)} \subseteq \bar{\mathcal{P}}$ with $|\mathcal{P}_{\delta(W)}| = 1$ for $W \subseteq V_i$, $\emptyset \neq W \cap T \neq T \cap V_i$, $i = 1, \dots, k$.
3. Each path contains at most two nodes in G_P , i.e., $a_p \in \{0, 1\}$ for all $p \in \mathcal{P}$.
4. G_P is 2-node-path-connected, i.e., if we remove any node with all adjacent paths, the resulting graph is connected. (An edge is removed if it is no longer covered by paths.)

Proof. Let $P = (V_1, \dots, V_k)$ be a Steiner partition in G and consider the corresponding partition inequality $a^T x = \sum_{p \in \mathcal{P}_P} a_p x_p \geq k - 1$. Assume that properties 1 to 4 are satisfied. Let $b^T x = \beta$ be an equation such that

$$F_a = \{x \in P_{\text{SCP}} \mid a^T x = k - 1\} \subseteq F_b = \{x \in P_{\text{SCP}} \mid b^T x = \beta\}$$

and such that F_b is a facet of P_{SCP} .

We first show that $b_p = 0$ for all $p \in \bar{\mathcal{P}}$. Since $p \in \bar{\mathcal{P}}$, p is completely contained in $G[V_j]$ for some $j \in \{1, \dots, k\}$. Let $\mathcal{P}' \subseteq \mathcal{P}_P$ be a minimal set of paths connecting G_P , i.e., for each two nodes in G_P there exists a path that is completely covered by paths in \mathcal{P}' and if we remove any path of \mathcal{P}' then there are at least two nodes in G_P that are not connected. Since all paths contain at most two different nodes of G_P (property 3), we have $|\mathcal{P}'| = k - 1$. Set $M = \mathcal{P}' \cup \bar{\mathcal{P}}$ and $M' = M \setminus \{p\}$. Since each $G[V_i]$, $i = 1, \dots, k$, is connected by paths of $\bar{\mathcal{P}}$ (property 1) and p is not a Steiner path bridge for $G[V_j]$ (property 2), $\chi^M, \chi^{M'} \in P_{\text{SCP}}$ and $a^T \chi^M = a^T \chi^{M'} = k - 1$, where χ^M is the incidence vector of M . Thus, $b^T \chi^M = b^T \chi^{M'}$ which implies $b_p = 0$.

Let $p, q \in \mathcal{P}_P$, $p \neq q$. Consider the graph $\hat{G}_P = (V_P, \mathcal{P}_P)$ in which p is an edge between V_i and V_j if it contains V_i and V_j (recall that $p \in \mathcal{P}_P$ contains exactly two nodes, see property 3). Since G_P is 2-node-path-connected, \hat{G}_P is 2-node-connected and there exists a cycle C in \hat{G}_P containing p and q . Let \mathcal{P}' be a tree in \hat{G}_P containing $C \setminus \{p\}$. Then $\mathcal{P}'' = \mathcal{P}' \setminus \{q\} \cup \{p\}$ is also a tree in \hat{G}_P . Set $M = \mathcal{P}' \cup \bar{\mathcal{P}}$ and $M' = \mathcal{P}'' \cup \bar{\mathcal{P}}$. Then $\chi^M, \chi^{M'} \in F_a$ and $0 = b^T \chi^M - b^T \chi^{M'} = b_q - b_p$. This implies that $b \in \{0, \lambda\}^{\mathcal{P}}$, $\lambda \geq 0$, using part 3 of Lemma 4.3. Hence, $b^T x$ is a multiple of $a^T x$. This proves that $a^T x \geq k - 1$ defines a facet of P_{SCP} . \square

Different from the Steiner tree case (cf. [10]), properties 1 to 3 are not necessary in the Steiner connectivity case, see Figure 5 (property 3), Figure 6 (left: property 1, right: property 2) for examples. Property 4 is necessary, see Proposition 4.6 below.

We now derive necessary conditions. Let $\Phi_{V_i}(\mathcal{P})$ be the V_i -contraction of \mathcal{P} , i.e., contract every path $p \in \mathcal{P}$ iteratively in the following way until no reduction is possible anymore:

- If p contains the edges $\{u, v\}$ and $\{v, w\}$, and $v \notin V_i$ then contract $\{u, v\}$ and $\{v, w\}$ to $\{u, w\}$.
- If $p = (\{u_1, u_2\}, \{u_2, u_3\}, \dots, \{u_{r-1}, u_r\})$, $r \geq 2$, with $u_1 \notin V_i$ then contract p to $p = (\{u_2, u_3\}, \dots, \{u_{r-1}, u_r\})$.

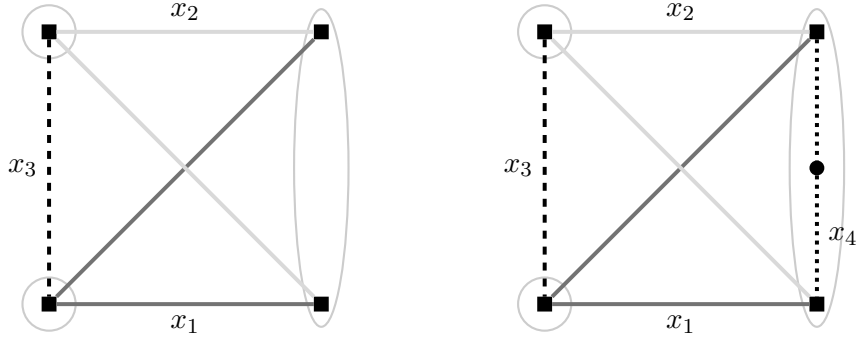

Figure 6: Examples of facet defining Steiner partitions that do not satisfy properties 1 (left) and 2 (right) of Proposition 4.5. In both examples the Steiner partition consists of three node sets which are marked gray. The square (terminal) nodes have to be connected.

- If $p = (\{u_1, u_2\}, \{u_2, u_3\}, \dots, \{u_{r-1}, u_r\})$, $r \geq 2$, with $u_r \notin V_i$ then contract p to $p = (\{u_1, u_2\}, \{u_2, u_3\}, \dots, \{u_{r-2}, u_{r-1}\})$.

Proposition 4.6. *If the Steiner partition inequality (1) is facet defining for a Steiner partition P with at least three partition sets, then the following properties have to be satisfied:*

1. *The shrunk graph G_P is 2-node-path-connected.*
2. *Either $G[V_i]$ is connected or for each two subsets V_i' and V_i'' of V_i such that $V_i' \cup V_i'' = V_i$ and V_i' is disconnected from V_i'' , there exists a path $p \in \mathcal{P}_P$ which contains at least one node of V_i' and one node of V_i'' for all $i = 1, 2, \dots, k$.*
3. *For each $G[V_i]$ the set of paths $\Phi_{V_i}(\mathcal{P})$ does not contain a Steiner path bridge with respect to $G[V_i]$, i.e., if we remove any $\tilde{p} \in \Phi_{V_i}(\mathcal{P})$ then every two terminal nodes in $G[V_i]$ are still connected by paths of $\Phi_{V_i}(\mathcal{P}) \setminus \{\tilde{p}\}$.*
4. *If two terminal nodes s and t in some $G[V_i]$ are connected by a path $p' \in \mathcal{P}_P$, then these terminals must be also connected by $\bar{\mathcal{P}}$ or we can subdivide V_i into V_i' and V_i'' , $V_i = V_i' \cup V_i''$, such that $s \in V_i'$, $t \in V_i''$, and V_i' and V_i'' are not connected by $\bar{\mathcal{P}}$. In the second case for each $V_j \in p'$, $V_j \neq V_i$, there exists a path $p'' \in \mathcal{P}_P$ with $V_j \notin p''$, and $V_i' \in p''$, $V_i'' \in p''$.*

Proof. In the following let $P = (V_1, \dots, V_k)$, $k \geq 3$, be a Steiner partition with corresponding partition inequality $\sum_{p \in \mathcal{P}_P} a_p x_p \geq k - 1$.

1. Assume G_P is not 2-node-path-connected. In this case there exists a node V_i in G_P which is an articulation node in the following sense: If V_i and all paths incident to V_i are removed from G_P , then the resulting graph is not connected (by the remaining paths). Suppose w.l.o.g. that V_i separates V_1, \dots, V_{i-1} from V_{i+1}, \dots, V_k . Let $G_1 = G_P[V_1, \dots, V_i]$ and $G_2 = G_P[V_i, \dots, V_k]$, see Figure 7. Let k_1 be the number of nodes of G_1 and k_2 be the number of nodes of G_2 . Recall that the number of nodes of G_P is k . Note that V_i is a node of G_1 and G_2 . Therefore we have $k = k_1 + k_2 - 1$.
We construct a smaller Steiner partition $P' = \{V_1 \cup \dots \cup V_{i-1} \cup V_i, \dots, V_k\}$ which contains all nodes of $G_2 \setminus \{V_i\}$ and all nodes of G_1 as a single node. Let the resulting Steiner partition inequality be $\sum_{p \in \mathcal{P}_{P'}} a'_p x_p \geq k_2 - 1$.

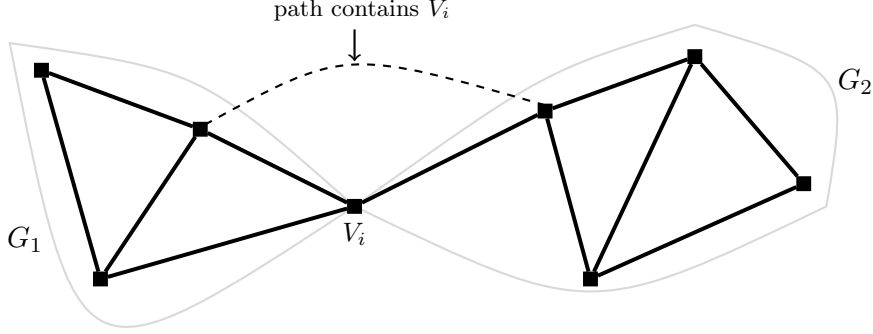

Figure 7: The graph G_P in the proof of Proposition 4.6 part 1 is not 2-node-path-connected and V_i is an articulation node. Each path that connects G_1 and G_2 (dashed in the picture) contains V_i .

Similarly, we construct a Steiner partition $P'' = \{V_1, \dots, V_i \cup V_{i+1} \cup \dots \cup V_k\}$ which contains all nodes of $G_1 \setminus \{V_i\}$ and all nodes of G_2 as a single node. We get the partition inequality $\sum_{p \in \mathcal{P}_{P''}} a_p'' x_p \geq k_1 - 1$.

The sum of these two partition inequalities is equal to the partition inequality for P . Indeed, $k_1 - 1 + k_2 - 1 = k_1 + k_2 - 2 = k - 1$, and $a_p' + a_p'' = a_p$, see Figure 7. Hence, Inequality (1) does not define a facet.

2. Assume w.l.o.g. $G[V_1]$ is not connected and there exists no path connecting different components of $G[V_1]$. Let $V_1' \subset V_1$ be the node set of one connected component of $G[V_1]$ such that $(V_1 \setminus V_1') \cap T \neq \emptyset$. Since G is connected (and every edge is covered by at least one path) there is a node set V_j , $j \in \{2, \dots, k\}$, say V_2 , such that V_1' and V_2 are connected by a path. We construct a new Steiner partition $P' = (V_1 \setminus V_1', V_1' \cup V_2, V_3, \dots, V_k)$ and get the partition inequality $\sum_{p \in \mathcal{P}_{P'}} a_p' x_p \geq k - 1$. Let $\hat{\mathcal{P}} = \{p \in \mathcal{P}_P \mid V_1' \in p, V_2 \in p\}$, i.e., $\hat{\mathcal{P}}$ contains all paths that connect V_1' and V_2 . One can easily verify that

$$a_p' = \begin{cases} a_p - 1 & \text{if } p \in \hat{\mathcal{P}} \\ a_p & \text{otherwise (since } V_1' \text{ is not connected to } (V_1 \setminus V_1')). \end{cases}$$

Since $|\hat{\mathcal{P}}| \geq 1$, the partition inequality for P is the sum of the partition inequality for P' and the inequalities $x_p \geq 0$ for all $p \in \hat{\mathcal{P}}$. Therefore, the partition inequality for P is not facet defining.

3. Assume there is a Steiner path bridge $\tilde{p} \in \Phi_{V_i}(\mathcal{P})$ with respect to $G[V_i]$. Let V_i' and $V_i'' := V_i \setminus V_i'$ be two components of $G[V_i]$ that contain terminal nodes which are only connected by $\tilde{p} \in \Phi_{V_i}(\mathcal{P})$. Then $P' = (V_1, \dots, V_i', V_i'', \dots, V_k)$ is a Steiner partition. Let the corresponding partition inequality be $\sum_{p \in \mathcal{P}_{P'}} a_p' x_p \geq k$. We claim that this partition inequality plus the upper bound inequality $-x_{\tilde{p}} \geq -1$ of \tilde{p} is equal to the partition inequality for P .

The partition P' only differs from P in splitting the node set V_i . Because \tilde{p} is the only path that connects V_i' and V_i'' , we have $\mathcal{P}_{P'} = \mathcal{P}_P \cup \{\tilde{p}\}$. Furthermore, there is no path in \mathcal{P}_P (except \tilde{p} , if $\tilde{p} \in \mathcal{P}_P$) that contains V_i' and V_i'' . Therefore the coefficients of all these paths stay the same: $a_p = a_p'$ for all $p \in \mathcal{P}_{P'} \setminus \{\tilde{p}\}$. For $\tilde{p} \in \mathcal{P}_P$ we get $a_{\tilde{p}}' = a_{\tilde{p}} + 1$.

4. Assume w.l.o.g. that there are two terminal nodes s and t in $G[V_1]$ that are connected by a path $p' \in \mathcal{P}_P$ and not connected by paths in $\bar{\mathcal{P}}$. Let V_1' be the nodes reachable from s via paths in $\bar{\mathcal{P}}$ and $V_1'' := V_1 \setminus V_1'$. This shows that the

first or the second case of the first part of the statement must hold.

Furthermore, assume w.l.o.g. that $V_2 \in p'$ and there is no path $p'' \in \mathcal{P}_P$ such that $V_1' \in p''$, $V_1'' \in p''$, and $V_2 \notin p''$. Consider the Steiner partitions $P' := (V_1', V_1'', V_2, \dots, V_k)$ and $P'' := (V_1 \cup V_2, V_3, \dots, V_k)$ with corresponding partition inequalities

$$\sum_{p \in \mathcal{P}_{P'}} a'_p x_p \geq k \quad \text{and} \quad \sum_{p \in \mathcal{P}_{P''}} a''_p x_p \geq k - 2,$$

respectively. We show that 2 times the partition inequality for P is dominated by the sum of the partition inequalities for P' and P'' . For the right hand side, we obtain:

$$k + k - 2 = 2 \cdot k - 2 = 2 \cdot (k - 1).$$

For the left hand sides and $p \in \mathcal{P}$, we observe that

$$a'_p = \begin{cases} a_p + 1 & \text{if } V_1' \in p, V_1'' \in p \\ a_p & \text{otherwise} \end{cases} \quad a''_p = \begin{cases} a_p - 1 & \text{if } V_1 \in p, V_2 \in p \\ a_p & \text{otherwise.} \end{cases}$$

We claim that $2 \cdot a_p \geq a'_p + a''_p$. Indeed, the only case in which this is not trivially satisfied is when $V_1' \in p$ and $V_1'' \in p$ (and thus $V_1 \in p$), but $V_2 \notin p$. But this case contradicts our assumptions. □

4.2 Separating the Steiner Partition Inequalities

Grötschel, Monma, and Stoer [11] showed that separating the Steiner partition inequalities for the Steiner tree problem is NP-hard. This implies that the separation of the Steiner partition inequalities for the Steiner connectivity problem is also NP-hard. However, we show in the following that the Steiner partition inequalities for the SCP are satisfied by all points in $P_{LP}(\text{SCP}_{arc^+}^r)|_{\mathcal{P}}$. This implies that the separation problem for a superclass of Steiner partition inequalities can be solved in polynomial time.

Theorem 4.7. $P_{LP}(\text{SCP}_{arc^+}^r)|_{\mathcal{P}}$ satisfies all Steiner partition inequalities.

Proof. Let $y^* \in P_{LP}(\text{SCP}_{arc^+}^r)$. We show that the projection $x_p^* = y_{v_p w_p}^*$ satisfies all Steiner partition inequalities.

Consider an arbitrary Steiner partition $P = (V_1, \dots, V_k)$ in G and the corresponding partition inequality $\sum_{p \in \mathcal{P}_P} a_p x_p \geq k - 1$. W.l.o.g. we assume that $r \in V_k$. Consider the following chain of inequalities

$$\sum_{p \in \mathcal{P}_P} a_p x_p^* \stackrel{(1)}{\geq} \sum_{p \in \mathcal{P}_P} a_p \sum_{a \in \delta^-(v_p)} y_a^* \stackrel{(2)}{\geq} \sum_{i=1}^{k-1} \sum_{a \in \delta^-(W_i)} y_a^* \stackrel{(3)}{\geq} k - 1,$$

where $W_i := \{t \in T \setminus \{r\} \mid t \in V_i\} \cup \{v_p, w_p \mid V_i \in p\}$, for $i = 1, \dots, k - 1$.

Inequality (1): Scaling the flow balance constraints $x_p^* = y_{v_p w_p}^* \geq \sum_{a \in \delta^-(v_p)} y_a^*$ by a_p and summing up gives (1).

Inequality (3): Each node set W_i ($i = 1, \dots, k-1$) contains at least one terminal node, but not the root node r . Hence, the arc set $\delta^-(W_i)$ is a directed Steiner cut between root r and W_i . Therefore, $\sum_{a \in \delta^-(W_i)} y_a^* \geq 1$ must hold. Summing over all these cuts gives (3).

Inequality (2): All arcs in the cuts $\delta^-(W_i)$, $i = 1, \dots, k-1$, are of the form $(r, v_p) \in A'$ or $(w_{\tilde{p}}, v_p) \in A'$ for $p, \tilde{p} \in \mathcal{P}$. Denote by $\mathcal{V}_p := \{V_i \mid V_i \in p, i = 1, \dots, k\}$ the set of shrunk nodes contained in p ; then $|\mathcal{V}_p| - 1 = a_p$. The proof proceeds by establishing a relation between a_p and the number of times an arc entering v_p appears in the cuts $\delta^-(W_i)$, $i = 1, \dots, k-1$.

Consider an arc $(r, v_p) \in A'$. Then the following chain of equations holds:

$$a_p = |\mathcal{V}_p| - 1 = |\mathcal{V}_p \setminus \{V_k\}| = |\{W_i \mid (r, v_p) \in \delta^-(W_i), i = 1, \dots, k-1\}|. \quad (2)$$

Here, $(r, v_p) \in A'$ implies $V_k \in p$ ($r \in V_k$) and this yields $|\mathcal{V}_p| - 1 = |\mathcal{V}_p \setminus \{V_k\}|$. Moreover, $(r, v_p) \in \delta^-(W_i)$ implies $V_i \in p$. Taking the union for $i = 1, \dots, k-1$ yields $|\mathcal{V}_p \setminus \{V_k\}| = |\{W_i \mid (r, v_p) \in \delta^-(W_i), i = 1, \dots, k-1\}|$. Multiplying Equation (2) with $y_{rv_p}^*$ gives

$$\begin{aligned} a_p y_{rv_p}^* &= |\{W_i \mid (r, v_p) \in \delta^-(W_i), i = 1, \dots, k-1\}| \cdot y_{rv_p}^* \\ &= \sum_{i=1}^{k-1} \sum_{(r, v_p) \in \delta^-(W_i)} y_{rv_p}^*. \end{aligned} \quad (3)$$

Consider an arc $(w_{\tilde{p}}, v_p) \in A'$. Then the following chain of equations and inequalities holds

$$a_p = |\mathcal{V}_p| - 1 \geq |\mathcal{V}_p \setminus \mathcal{V}_{\tilde{p}}| \geq |\{W_i \mid (w_{\tilde{p}}, v_p) \in \delta^-(W_i), i = 1, \dots, k-1\}|. \quad (4)$$

Here, $(w_{\tilde{p}}, v_p) \in A'$ implies $\mathcal{V}_p \cap \mathcal{V}_{\tilde{p}} \neq \emptyset$ and this yields $|\mathcal{V}_p| - 1 \geq |\mathcal{V}_p \setminus \mathcal{V}_{\tilde{p}}|$. Moreover, $(w_{\tilde{p}}, v_p) \in \delta^-(W_i)$ implies $V_i \in p$ and $V_i \notin \tilde{p}$. Taking the union for $i = 1, \dots, k-1$ yields $|\mathcal{V}_p \setminus \mathcal{V}_{\tilde{p}}| \geq |\{W_i \mid (w_{\tilde{p}}, v_p) \in \delta^-(W_i), i = 1, \dots, k-1\}|$. Multiplying inequality (4) by $y_{w_{\tilde{p}}v_p}^*$ gives

$$\begin{aligned} a_p y_{w_{\tilde{p}}v_p}^* &\geq |\{W_i \mid (w_{\tilde{p}}, v_p) \in \delta^-(W_i), i = 1, \dots, k-1\}| \cdot y_{w_{\tilde{p}}v_p}^* \\ &= \sum_{i=1}^{k-1} \sum_{(w_{\tilde{p}}, v_p) \in \delta^-(W_i)} y_{w_{\tilde{p}}v_p}^*. \end{aligned} \quad (5)$$

Summing (3) and (5) over all arcs (r, v_p) and $(w_{\tilde{p}}, v_p)$ gives inequality (2):

$$\begin{aligned} &\sum_{p \in \mathcal{P}_P} a_p \sum_{a \in \delta^-(v_p)} y_a^* = \sum_{p \in \mathcal{P}} a_p \sum_{a \in \delta^-(v_p)} y_a^* \\ &= \sum_{(r, v_p) \in A'} a_p y_{rv_p}^* + \sum_{(w_{\tilde{p}}, v_p) \in A'} a_p y_{w_{\tilde{p}}v_p}^* \stackrel{(3) \text{ and } (5)}{\geq} \sum_{i=1}^{k-1} \sum_{a \in \delta^-(W_i)} y_a^*. \end{aligned}$$

This shows the claim. \square

Proposition 4.8. *The separation problem for $P_{LP}(\text{SCP}_{arc+}^r)|_{\mathcal{P}}$ can be solved in polynomial time.*

Proof. Let $P = \{y \in \mathbb{R}^n \mid Ay \geq b, y \geq 0\}$ be a polyhedron, $I \subseteq \{1, \dots, n\}$, and $x^* \in \mathbb{R}^I$ be a vector. If the optimization problem for P is solvable in polynomial time then the separation problem “ $x^* \in P|_I$?” for the projection is solvable in polynomial time. This follows from the equivalence of optimization and separation and its consequences, see Grötschel, Lovász, and Schrijver [9] (intersect P with the affine space $y|_I = x^*$). In our case, the LP relaxation of (SCP_{arc+}^r) can be solved in polynomial time. This implies the claim. \square

In the following, we give a direct algorithm to generate a violated cut. Let $x^* \in [0, 1]^{\mathcal{P}}$ be the point to be separated; denote $\tilde{A} = A'_{\mathcal{P}} = \{(v_p, w_p) \in A' \mid p \in \mathcal{P}\}$ and $A'' = A' \setminus A'_{\mathcal{P}}$. The separation problem is to find a vector $y \in P_{LP}(\text{SCP}_{arc+}^r)$ with $y|_{\mathcal{P}} = x^*$ or to find a separating cutting plane. Consider the following reformulation of the inequality system associated with (SCP_{arc+}^r) with $y|_{\mathcal{P}} = x^* =: y^*$:

$$\begin{aligned} \sum_{a \in \delta^-(W), a \in A''} y_a &\geq 1 - \sum_{a \in \delta^-(W), a \in \tilde{A}} y_a^* \quad \forall W \subseteq V' \setminus \{r\}, W \cap T \neq \emptyset \\ - \sum_{a \in \delta^-(v_p)} y_a &\geq -y_{v_p w_p}^* \quad \forall (v_p, w_p) \in A' \\ y_a &\geq 0 \quad \forall a \in A''. \end{aligned} \quad (6)$$

Let $\mathcal{W} := \{W \subseteq V' \setminus \{r\} \mid W \cap T \neq \emptyset\}$. By the Farkas lemma either inequality system (6) or the following inequality system has a solution:

$$\begin{aligned} \sum_{W \in \mathcal{W}} \left(1 - \sum_{a \in \delta^-(W), a \in \tilde{A}} y_a^*\right) \cdot \mu_W - \sum_{p \in \mathcal{P}} y_{v_p w_p}^* \pi_p &> 0 \\ \sum_{W \in \mathcal{W}: a \in \delta^-(W)} \mu_W - \sum_{p \in \mathcal{P}: a \in \delta^-(v_p)} \pi_p &\leq 0 \quad \forall a \in A'' \\ \mu_W &\geq 0 \quad \forall W \in \mathcal{W} \\ \pi_p &\geq 0 \quad \forall p \in \mathcal{P}. \end{aligned} \quad (7)$$

This feasibility problem can be solved by a column generation procedure. In fact, given dual variables y''_a , $a \in A''$, the pricing problem for the μ -variables is to find a cut $\delta^-(W)$, $W \subseteq V' \setminus \{r\}$, $W \cap T \neq \emptyset$, which has capacity smaller than 1 with respect to the arc capacities (y'', y^*) or to conclude that no such cut exists.

If $y \notin P_{LP}(\text{SCP}_{arc+}^r)$ for $y|_{\mathcal{P}} = x^*$, then there exist π^* and μ^* which satisfy (7). In particular, we have

$$\begin{aligned} \sum_{W \in \mathcal{W}} \left(1 - \sum_{a \in \delta^-(W), a \in \tilde{A}} y_a^*\right) \cdot \mu_W^* - \sum_{p \in \mathcal{P}} y_{v_p w_p}^* \pi_p^* &> 0 \\ \iff \sum_{W \in \mathcal{W}} \left(1 - \sum_{(v_p, w_p) \in \delta^-(W)} x_p^*\right) \cdot \mu_W^* - \sum_{p \in \mathcal{P}} x_p^* \pi_p^* &> 0. \end{aligned}$$

Then

$$\sum_{W \in \mathcal{W}} \mu_W^* \leq \sum_{W \in \mathcal{W}} \sum_{p: (v_p, w_p) \in \delta^-(W)} \mu_W^* x_p + \sum_{p \in \mathcal{P}} \pi_p^* x_p$$

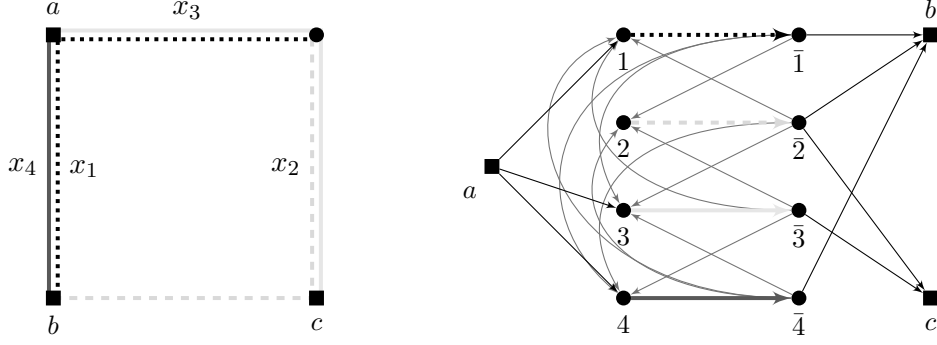

Figure 8: The inequality $x_1 + x_2 + x_3 + x_4 \geq 2$ is valid but not a partition inequality.

is a cutting plane that separates $x^* = y|_{\mathcal{P}}$ from the Steiner connectivity polytope.

Corollary 4.9. *If $x^* \in P_{LP}(\text{SCP}_{cut})$ does not satisfy all Steiner partition inequalities, one can construct a cutting plane that separates x^* from the Steiner connectivity polytope in polynomial time.*

Proof. A solution of (7) with polynomial support can be constructed in polynomial time. \square

$(\text{SCP}_{arc^+}^r)|_{\mathcal{P}}$ implicitly contains other constraints that do not correspond to partition inequalities. In the following we call these inequalities *generalized Steiner partition inequalities*.

Example 4.10. Figure 8 shows a generalized Steiner partition inequality which is not a Steiner partition inequality. Consider the inequality $x_1 + x_2 + x_3 + x_4 \geq 2$. Because the right hand side is 2, a Steiner partition would consist of three node sets, each of which must include at least one terminal node. However, in every possible partition at least one path contains all three partition nodes.

We show that this cut can be separated with our direct method as follows. Let $x^* \in P_{LP}(\text{SCP}_{cut})$ with $x_1^* = x_2^* = x_3^* = 0.5$ and $x_4^* = 0$. Obviously x^* satisfies all Steiner cut inequalities but not $x_1 + x_2 + x_3 + x_4 \geq 2$. Consider inequality set (6) for two specific node sets $W_b^0 := \{\bar{1}, 2, \bar{2}, \bar{4}, b\}$ and $W_c^0 := \{2, \bar{2}, \bar{3}, c\}$

$$\begin{array}{rcl}
y_{\bar{3}2} & \geq 1 - y_{\bar{1}\bar{1}}^* - y_{\bar{4}\bar{4}}^* & (W_b^0) \\
y_{\bar{1}2} + y_{\bar{4}2} & \geq 1 - y_{\bar{3}\bar{3}}^* & (W_c^0) \\
-y_{a1} - y_{\bar{2}1} - y_{\bar{3}1} - y_{\bar{4}1} & \geq -y_{\bar{1}\bar{1}}^* & \\
-y_{\bar{1}2} - y_{\bar{3}2} - y_{\bar{4}2} & \geq -y_{\bar{2}\bar{2}}^* & \\
-y_{a3} - y_{\bar{1}3} - y_{\bar{2}3} - y_{\bar{4}3} & \geq -y_{\bar{3}\bar{3}}^* & \\
-y_{a4} - y_{\bar{1}4} - y_{\bar{2}4} - y_{\bar{3}4} & \geq -y_{\bar{4}\bar{4}}^* &
\end{array}$$

and the corresponding inequality set (7) (μ_t corresponds to W_t^0 , $t = b, c$)

$$(1 - y_{\bar{1}\bar{1}}^* - y_{\bar{4}\bar{4}}^*)\mu_b + (1 - y_{\bar{3}\bar{3}}^*)\mu_c - \pi_1 \cdot y_{\bar{1}\bar{1}}^* - \pi_2 \cdot y_{\bar{2}\bar{2}}^* - \pi_3 \cdot y_{\bar{3}\bar{3}}^* - \pi_4 \cdot y_{\bar{4}\bar{4}}^* > 0$$

$$\begin{array}{rcl}
\mu_b - \pi_2 & \leq 0 & \\
\mu_c - \pi_2 & \leq 0 & \\
\mu_b, \mu_c & \geq 0 & \\
\pi_i & \geq 0 & i = \{1, 2, 3, 4\}.
\end{array}$$

A valid solution for the second system is $\mu_b = \mu_c = 1$, $\pi_2 = 1$, and all other variables set to 0. Since $y_{11}^* = x_1^* = 0.5$, $y_{22}^* = x_2^* = 0.5$, $y_{33}^* = x_3^* = 0.5$, and $y_{44}^* = x_4^* = 0$, the value of the first inequality in this system is 0.5. This yields the cutting plane

$$(1 - x_1 - x_4) + (1 - x_3) - x_2 \leq 0 \Leftrightarrow x_1 + x_2 + x_3 + x_4 \geq 2.$$

4.3 A Separation Heuristic for the Generalized Steiner partition inequalities

The construction in Example 4.10 can be generalized to develop a *separation heuristic* for the generalized Steiner partition inequalities that is based on a relaxation of (SCP_{arc}^r) but uses only a small subset of directed (r, t) -Steiner cut inequalities. Such a reduction can alleviate the computational complexity of the exact separation procedure, which requires the solution of the feasibility problem (7) by a column generation algorithm in the projection step. The crucial point in this procedure is the selection of the cutsets. We tried different approaches and discuss the one that worked best.

The heuristic can formally be described as follows. We first choose arbitrarily a terminal node as root node $r \in T$. Then we consider for each of the remaining terminal nodes $t \in T \setminus \{r\}$ the set $\mathcal{P}_t^0 \subseteq \mathcal{P}$ of paths that contain t , and we define the node set

$$W_t^0 := \{t\} \cup \{w_p \mid p \in \mathcal{P}_t^0\} \cup \{v_p \mid p \in \mathcal{P}_t^0, r \notin p\}.$$

Then $\delta^-(W_t^0)$ forms a directed (r, t) -cut in the Steiner connectivity digraph. In fact, it is easy to see that

$$\delta^-(W_t^0) = \{(v_p, w_p) \in A' \mid p \in \mathcal{P}_t^0, r \in p\} \cup \{(w_{\tilde{p}}, v_p) \in A' \mid \tilde{p} \notin \mathcal{P}_t^0, p \in \mathcal{P}_t^0, r \notin p\}.$$

We then extend \mathcal{P}_t^0 by all paths that intersect at least one path in \mathcal{P}_t^0 , i.e.,

$$\mathcal{P}_t^1 := \mathcal{P}_t^0 \cup \{p \in \mathcal{P} \mid \exists \tilde{p} \in \mathcal{P}_t^0 : p \cap \tilde{p} \neq \emptyset\}$$

to obtain the node set

$$W_t^1 := \{t\} \cup \{w_p \mid p \in \mathcal{P}_t^1\} \cup \{v_p \mid p \in \mathcal{P}_t^1, r \notin p\}.$$

Repeating this construction until all paths are reached, produces a sequence of path and node sets

$$\mathcal{P}_t^0 \subset \mathcal{P}_t^1 \subset \dots \subset \mathcal{P}_t^{j(t)+1} = \mathcal{P} \quad \text{and} \quad W_t^0 \subset W_t^1 \subset \dots \subset W_t^{j(t)+1}$$

and corresponding directed (r, t) -Steiner cuts

$$\delta^-(W_t^i) = \{(v_p, w_p) \in A' \mid p \in \mathcal{P}_t^i, r \in p\} \cup \{(w_{\tilde{p}}, v_p) \in A' \mid \tilde{p} \notin \mathcal{P}_t^i, p \in \mathcal{P}_t^i, r \notin p\} \quad (8)$$

for each $t \in T \setminus \{r\}$, $i = 0, \dots, j(t)$. The heuristic then relaxes the feasibility problem (7) by setting $\mathcal{W} := \{W_t^i \mid t \in T \setminus \{r\}, i = 0, \dots, j(t)\}$. For very large problems, we even use $\mathcal{W} := \{W_t^i \mid t \in T \setminus \{r\}, 0 \leq i \leq k\}$ for some small number k .

5 Computational Results

In this section, we computationally compare the LP relaxations of four formulations of the Steiner connectivity problem, namely,

- the weak cut formulation (SCP_{cut}^w),
- the cut formulation (SCP_{cut}),
- the strengthened directed cut formulation (SCP_{arc+}^r), cf. Section 3, and
- a fourth formulation (SCP_{cut+}^w), which extends the weak cut formulation (SCP_{cut}^w) by cutting planes computed using the separation heuristic of Section 4.3.

The advantage of the weak cut formulation (SCP_{cut}^w) is its compactness. This formulation has the smallest number of variables and inequalities. Moreover, the separation problem for the weak Steiner path cut constraints can be solved in the original undirected graph. The second formulation (SCP_{cut}) requires the construction of the Steiner connectivity digraph to solve the separation problem. The third formulation (SCP_{arc+}^r) uses the arcs of the Steiner connectivity digraph as variables. Note that the size of the Steiner connectivity digraph depends on the number and length of paths in the original graph, which can become very large. For this reason our strongest formulation, the strengthened directed cut formulation (SCP_{arc+}^r), becomes intractable for large problems. Our fourth formulation (SCP_{cut+}^w) therefore tries to combine the compactness of the weak cut formulation with the quality of the strengthened directed cut formulation by projecting cuts that are separated heuristically from a small set of judiciously chosen directed Steiner cuts back into the original space of variables. We will now give computational evidence that this approach does indeed work.

5.1 Instances

We test our formulations on six transportation networks that we denote as China, Dutch, SiouxFalls, Anaheim, Potsdam, and Chicago. Instances Anaheim, SiouxFalls, and Chicago use the graphs of the street networks with the same names from the Transportation Network Test Problems Library of Bar-Gera [18]. Instances China, Dutch, and Potsdam correspond to public transportation networks. The Dutch network was introduced by Bussieck [8] in the context of line planning. The Potsdam data were provided to us in a joint project on line planning by the local public transport company ViP Verkehrsgesellschaft Potsdam GmbH. The China instance is artificial; we constructed it as a showcase example, connecting the twenty biggest cities in China by the 2009 high speed train network.

All instances are associated with an OD matrix that gives the number of passengers who want to travel between each pair of nodes. We define as terminals all stations with positive supply or demand, i.e., such that there exists a positive entry in the corresponding row or column of the OD matrix. The paths can then be interpreted as possible lines (e.g., bus lines in the street networks) to connect the terminals/OD nodes. For each network, we consider two instances of the Steiner connectivity problem involving different path lengths, namely, one instance with paths of length three (instances with suffix 1) and one instance with paths of length five (instances

Table 1: Street and public transportation networks. The columns are as follows: name of the instance, number of terminals, number of nodes, number of edges, number of paths, and number of nodes and arcs of the associated Steiner connectivity digraph. (We inserted all terminals twice into the Steiner connectivity digraph in order to use them as sources and sinks at the same time; this speeds up the computations.) The last column gives the length of the paths.

name	$ T $	$ V $	$ E $	$ \mathcal{P} $	$ V' $	$ A' $	$ p $
China1	20	20	98	68	176	2 798	3
China2	20	20	98	343	726	65 873	5
Dutch1	23	23	106	91	228	5 585	3
Dutch2	23	23	106	437	920	126 227	5
SiouxFalls1	24	24	124	115	278	6 513	3
SiouxFalls2	24	24	124	527	1 102	129 608	5
Anaheim1	38	454	1 344	2 544	5 164	229 369	3
Anaheim2	38	454	1 344	5 975	12 026	2 734 865	5
Potsdam1	107	885	3 572	1 196	2 606	36 905	3
Potsdam2	107	885	3 572	1 528	3 270	118 631	5
Chicago1	386	909	3 672	5 536	11 844	785 244	3
Chicago2	386	909	3 672	10 373	21 518	5 938 444	5

Table 2: LP values and computation time for four formulations of the Steiner connectivity problem. An ‘*’ indicates that the time limit of five hours was reached.

name	(SCP_{cut}^w)		(SCP_{cut})		(SCP_{arc+}^r)		(SCP_{cut+}^w)	
	value	time	value	time	value	time	value	time
China1	5.000	0.0	5.000	0.0	6.333	139.0	6.333	0.1
China2	3.786	0.0	3.786	1.0	4.000	1024.4	3.895	1.5
Dutch1	7.000	0.0	7.000	0.0	7.500	3.0	7.333	0.1
Dutch2	4.333	0.0	4.333	2.2	4.500	105.3	4.500	2.4
SiouxFalls1	6.000	0.0	6.000	0.0	7.551	*	7.667	0.2
SiouxFalls2	4.000	0.0	4.000	5.9	4.485	*	4.600	3.1
Anaheim1	36.667	33.9	36.240	*	40.531	*	37.435	567.9
Anaheim2	25.833	363.5	25.804	*	26.000	*	25.833	304.4
Potsdam1	71.129	456.6	71.333	196.0	75.280	*	73.706	3 457.4
Potsdam2	46.463	114.2	46.500	405.7	49.110	*	47.326	504.0
Chicago1	96.900	793.5	96.900	7 050.0	101.285	*	127.167	1 066.5
Chicago2	65.178	439.1	65.183	*	66.476	*	74.360	10 074.3

with suffix 2). These paths are constructed between each pair of nodes, if possible. The instances were reduced by some preprocessing, see [3].

Table 1 gives some statistics on these instances. It shows the number of nodes, edges, and arcs for the networks and the associated Steiner connectivity digraphs as well as the number of paths for all instances. One can see that the number of arcs of the Steiner connectivity digraph, which is the number of variables in the strengthened directed cut formulation (SCP_{arc+}^r) , is nearly quadratic in the number of paths \mathcal{P} .

Table 3: Comparison between the weak cut formulation amended by the separation heuristic and the strong directed cut formulation. The table shows both LP values at roughly the time that is needed to solve (SCP_{cut+}^w) .

name	(SCP_{arc+}^r)		(SCP_{cut+}^w)	
	value	time	value	time
China1	5.386	0.1	6.333	0.1
China2	3.786	1.7	3.895	1.5
Dutch1	7.233	0.1	7.333	0.1
Dutch2	4.333	2.6	4.500	2.4
SiouxFalls1	6.035	0.2	7.667	0.2
SiouxFalls2	4.023	3.8	4.600	3.1
Anaheim1	36.989	568.0	37.435	567.9
Anaheim2	25.000	304.0	25.824	304.4
Potsdam1	74.361	3 459.0	73.706	3 457.4
Potsdam2	47.650	511.0	47.326	504.0
Chicago1	100.394	1 124.0	127.167	1 066.5
Chicago2	66.378	10 620.0	74.360	10 074.3

5.2 Results

Table 2 presents computational results on solving the LP relaxations of the four models (SCP_{cut}^w) , (SCP_{cut}) , (SCP_{arc+}^r) , and (SCP_{cut+}^w) using unit costs for the paths. It lists the LP values and the computation times in CPU seconds. An ‘*’ in the time column indicates that the time limit of five hours was reached. All computations were done with version 1.2.0 of SCIP [1, 17] on an Intel Quad-Core 2, 3.0 GHz computer (in 64 bit mode) with 6 MB cache, running Linux and 16 GB of memory. We use the simplex method of CPLEX 12.1 [12] as LP-solver (in single core mode). We have also tried the barrier method, but did not obtain consistently better results.

We used the cuts around the terminal nodes to initialize all formulations. Then a cutting plane algorithm depending on the formulation was run until no improvement could be made or the time limit was exceeded (formulations (SCP_{cut}^w) , (SCP_{cut}) , and (SCP_{arc+}^r)); the separation heuristic was stopped if we did not find a cut or if the LP value did not change for three rounds of cuts (formulation (SCP_{cut+}^w)). For instances China, Dutch, SiouxFalls, Anaheim, and Potsdam, the heuristic considered all cuts associated with node sets $\mathcal{W} := \{W_t^i \mid t \in T \setminus \{r\}, i = 0, \dots, j(t)\}$. For the very big Chicago instances, which have $|T| \cdot |\mathcal{P}| \geq 500\,000$, we considered only the first two levels of neighborhoods, i.e., $\mathcal{W} := \{W_t^i \mid t \in T \setminus \{r\}, 0 \leq i \leq 1\}$, see Section 4.3.

The weak cut formulation (SCP_{cut}^w) has the shortest computation times and is only for three instances slightly worse than the cut formulation (SCP_{cut}) , which always takes much longer. Hence, it is not worthwhile to construct the Steiner connectivity digraph only to separate the strong Steiner path cut constraints. However, the Steiner connectivity digraph is the key to improve the LP bound significantly via the strengthened cut formulation (SCP_{arc+}^r) . For China1, for example, the directed formulation produces a 26% improvement of the LP value. The weakness of this model is the long computation time and the memory consumption. For Chicago2, (SCP_{arc+}^r) gets close to the memory limit (95%).

Model (SCP_{cut+}^w) combines the compactness of the weak cut formulation with the quality of the strengthened directed cut formulation. Its memory consumption can be controlled very well via the definition of the considered cuts, such that we get below 50% for Chicago2. There is a loss of quality sometimes, but note that (SCP_{cut+}^w) yields even better LP bounds than (SCP_{arc+}^r) for instances SiouxFalls1 and SiouxFalls2, as well as for the very large instances Chicago1 and Chicago2, within the given time limit. Table 3 compares the LP values of (SCP_{arc+}^r) and (SCP_{cut+}^w) after roughly the amount of time that is needed to solve (SCP_{cut+}^w) . In all but two instances, (SCP_{cut+}^w) provides a better LP value than (SCP_{arc+}^r) . In this way, the weak cut formulation amended by the separation heuristic for generalized Steiner partition inequalities achieves a quality almost as good as (SCP_{arc+}^r) , while running times and memory requirements are kept within tolerable limits.

References

- [1] Tobias Achterberg. SCIP: Solving Constraint Integer Programs. *Math. Programming Computation*, 1(1):1–41, 2009.
- [2] Egon Balas and Shu Ming Ng. On the set covering polytope: I. All the facets with coefficients in $\{0,1,2\}$. *Mathematical Programming*, 43:57–69, 1989.
- [3] Ralf Borndörfer, Martin Grötschel, and Marc E. Pfetsch. A column-generation approach to line planning in public transport. *Transportation Science*, 41(1):123–132, 2007.
- [4] Sunil Chopra and M. Rao. The Steiner tree problem I: Formulations, compositions and extension of facets. *Mathematical Programming*, 64(2):209–229, 1994.
- [5] Gerard Cornuéjols. *Combinatorial Optimization: Packing and Covering*. CBMS-NSF regional conference series in applied mathematics; 74. SIAM, Berlin, 2001.
- [6] Uriel Feige. A threshold of $\ln n$ for approximating set-cover. *Proceedings of the 28th ACM Symposium on Theory of Computing*, pages 314–318, 1996.
- [7] Jon Feldman and Matthias Ruhl. The directed steiner network problem is tractable for a constant number of terminals. In *IEEE Symposium on Foundations of Computer Science*, pages 299–308, 1999.
- [8] Michael Bussieck GAMS. lop.gms: Line optimization. <http://www.gams.com/modlib/libhtml/lop.htm>.
- [9] Martin Grötschel, László Lovász, and Alexander Schrijver. *Geometric Algorithms and Combinatorial Optimization*, volume 2 of *Algorithms and Combinatorics*. Springer, 1988.
- [10] Martin Grötschel and Clyde L. Monma. Integer polyhedra arising from certain network design problems with connectivity constraints. *SIAM Journal on Discrete Mathematics*, 3(4):502–523, 1990.

- [11] Martin Grötschel, Clyde L. Monma, and Mechthild Stoer. Computational results with a cutting plane algorithm for designing communication networks with low-connectivity constraints. *Operations Research*, 40:309–330, 1992.
- [12] IBM. ILOG CPLEX. <http://www-01.ibm.com/software/integration/optimization/cplex/>.
- [13] Tobias Polzin. *Algorithms for the Steiner Problems in Networks*. PhD thesis, University of Saarland, 2003.
- [14] Tobias Polzin and Siavash Vahdati Daneshmand. A comparison of Steiner tree relaxations. *Discrete Applied Mathematics*, 112:241–261, 2001.
- [15] Hans Jürgen Prömel and Angelika Steger. *The Steiner Tree Problem*. Vieweg, Braunschweig/Wiesbaden, 2002.
- [16] S. Raghavan and Thomas L. Magnanti. Network connectivity. In Mauro Dell’Amico, Francesco Maffioli, and Silvano Martello, editors, *Annotated Bibliographies in Combinatorial Optimization*, pages 335–354. Wiley, Chichester, 1997.
- [17] SCIP – Solving Constraint Integer Programs, documentation. <http://scip.zib.de>.
- [18] Transportation network test problems. <http://www.bgu.ac.il/~bargera/tntp/>.
- [19] François Vanderbeck and Laurence Wolsey. Reformulation and decomposition of integer programs. In Michael Jünger, Thomas Liebling, Denis Naddef, George L. Nemhauser, William Pulleyblank, Gerhard Reinelt, Giovanni Rinaldi, and Laurence Wolsey, editors, *50 Years of Integer Programming 1958–2008*, chapter 13, pages 431–502. Springer Verlag, Berlin Heidelberg, 2010.