

Polyhedral Subdivisions and Projections of Polytopes

vorgelegt von
Diplom-Mathematiker
Jörg Rambau
aus Berlin

Vom Fachbereich 3 Mathematik
der Technischen Universität Berlin
zur Erlangung des akademischen Grades eines
Doktors der Naturwissenschaften
genehmigte Dissertation

Promotionsausschuß:

Vorsitzender:
Berichter:
Berichter:

Prof. Dr. Jochen Becker
Prof. Dr. Günter M. Ziegler
Prof. Dr. Raimund Seidel

Tag der wissenschaftlichen Aussprache

7. Oktober 1996

Berlin 1996

D 83

ZUSAMMENFASSUNG

Die vorliegende Dissertation beschäftigt sich mit strukturellen Fragen in der Theorie der polyedrischen Unterteilungen von Punktkonfigurationen. Hierbei sind vor allem globale Eigenschaften der Menge aller Unterteilungen einer gegebenen Punktkonfiguration von Interesse. Eine wichtige ungelöste Frage in diesem Zusammenhang ist die folgende: Ist es immer möglich, von einer beliebigen Triangulierung einer gegebenen Punktkonfiguration zu jeder anderen Triangulierung derselben Konfiguration zu gelangen, indem man sogenannte bistellare Operationen durchführt? Mit anderen Worten, ist die Menge aller Triangulierungen einer gegebenen Punktkonfiguration stets bistellar zusammenhängend?

Die Ergebnisse der vorliegenden Doktorarbeit liefern auf zwei Seiten dieser nach wie vor offenen Frage Fortschritte:

- Die Menge aller durch eine Polytopprojektion induzierten Unterteilungen ist nicht immer — in einem verallgemeinerten Sinne — bistellar zusammenhängend. Dieses Resultat wird durch ein Gegenbeispiel zur sogenannten „Verallgemeinerten Baues Vermutung“ erzielt.
- Die Menge aller Triangulierungen eines zyklischen Polytops bildet eine beschränkte Halbordnung. Die Überdeckungsrelationen sind gerichtete bistellare Operationen. Für zyklische Polytope ist die obige Frage nach bistellarem Zusammenhang also positiv beantwortet.

In der Einleitung wird das mathematische Umfeld der betrachteten Strukturen näher beleuchtet: Die „Verallgemeinerte Baues Vermutung“ steht in Verbindung mit verschiedensten mathematischen Konzepten, angefangen von kombinatorischen Modellen von Schleifenräumen bis hin zu Diskriminanten von Polynomen in mehreren Variablen. Die Triangulierungs-Halbordnungen von zyklischen Polytopen sind zugleich natürliche Verallgemeinerungen der gut studierten Tamari-Verbände in der Ordnungstheorie. Außerdem existiert ein Zusammenhang mit den höheren Bruhat-Ordnungen, die ähnliche Struktureigenschaften aufweisen.

Ein Nebenprodukt der Untersuchungen ist die Schälbarkeit aller Triangulierungen von zyklischen Polytopen ohne neue Ecken. Das ist um so interessanter, da die meisten Triangulierungen von zyklischen Polytopen nicht-regulär sind.

ABSTRACT

The present dissertation deals with the structure of polyhedral subdivisions of point configurations. Of particular interest are the global properties of the set of all subdivisions of a given point configuration. An important open problem in this context is the following: can one always transform any triangulation of a given point configuration to any other triangulation of the same configuration by means of bistellar operations? In other words, is the set of all triangulations of a given point configuration always bistellarly connected?

The results presented in this thesis contribute progress from two directions.

- The set of all subdivisions that are induced by a polytope projection is in general not bistellarly connected in a generalized sense. This result is obtained by constructing a counterexample to the so-called “Generalized Baues Conjecture.”
- The set of all triangulations of a cyclic polytope forms a bounded poset. The covering relations are given by increasing bistellar operations. Thus we get an affirmative answer to the above question in the case of cyclic polytopes.

In the introduction, the mathematical environment of the structures under consideration is illuminated. The “Generalized Baues Conjecture” has connections to various mathematical concepts, such as combinatorial models for loop spaces, discriminants of polynomials in several variables, etc. The triangulation posets of cyclic polytopes are natural generalizations of the well-studied Tamari lattices in order theory. Moreover, there is a connection to the higher Bruhat orders, which have similar structural properties.

As a by-product, the investigations yield the shellability of all triangulations of cyclic polytopes without new vertices. This is in particular interesting because most triangulations of cyclic polytopes are non-regular.

VORWORT

Im Sommer 1993 erhielt ich, noch in Bochum weilend, recht bald nach meiner Bewerbung im Graduiertenkolleg „Algorithmische Diskrete Mathematik“, aus Berlin einen Anruf: „Ziegler, guten Tag. Ich habe Ihre Diplomarbeit gelesen . . . Können Sie nächste Woche nach Berlin kommen?“ (Um meine Überraschung einzuordnen, muß man wissen, daß es nicht jedem Mathematiker widerfährt, daß nach dem Studium irgendetwas seine Diplomarbeit liest.)

Ich konnte nach Berlin kommen. Und damit entschied sich, daß ich mich von nun an mehr der diskreten Mathematik als der algebraischen Topologie widmen sollte. Bald merkte ich, daß die moderne diskrete Mathematik sich durchaus der Methoden vieler mathematischer Disziplinen, auch der Topologie, bedient. Somit stellte mein Wechsel weniger eine komplette Neuorientierung, als vielmehr eine natürliche Schwerpunktverlagerung dar. Nichtsdestoweniger bedeutete ein Promotionsprojekt in einem neuen Spezialgebiet in der auf zweieinhalb Jahre beschränkten Stipendienzeit ein kleines Wagnis für alle Beteiligten. Daher sollen hier alle diejenigen erwähnt werden, die zum Gelingen dieses Unterfangens beigetragen haben.

Die Ergebnisse dieser Doktorarbeit wurden erzielt während meiner Zeit im Graduiertenkolleg *Algorithmische Diskrete Mathematik*, gefördert durch die *Deutsche Forschungsgemeinschaft* (GRK 219/2–96). Für die Aufnahme in das Kolleg zum ersten April 1994 und mein Promotionsstipendium, durch das die zweieinhalbjährige Forschungsarbeit erst ermöglicht worden ist, sowie für die Übernahme zahlreicher Reisekosten bedanke ich mich hiermit sehr herzlich. Dem *Konrad-Zuse-Zentrum für Informationstechnik Berlin* und der *Technischen Universität Berlin* danke ich für die Bereitstellung eines fabelhaft ausgestatteten Arbeitsplatzes.

Das alles wäre jedoch nicht möglich gewesen ohne die Aufnahme als Doktorand bei meinem Betreuer *Günter Ziegler*, dem ich daher zu großem Dank verpflichtet bin. Schon bei meinem ersten Berlin-Besuch hat er es verstanden, mich in zwei Stunden für eine Reihe von mathematischen Problemen zu begeistern, deren Lösung gleich für mehrere Dissertationen gereicht hätte. Sein Büro stand für mich immer offen, und ich mußte nie lange auf eine Besprechung warten. Gleichzeitig habe ich mich nie unter Druck gesetzt gefühlt, selbst in Phasen der Stagnation, die bei jeder Forschungstätigkeit wohl unvermeidlich sind.

Häufig konnten durch seine Hinweise mathematischen Argumente vereinfacht

und dadurch verdeutlicht werden; als ein sorgfältiger und kritischer Leser meiner Notizen hat er oft zur Verbesserung der schriftlichen Darstellung meiner Gedanken beigetragen. Vor allem Kapitel 2 dieser Arbeit hat durch ihn als Ko-Autor des zugrundeliegenden Artikels gewonnen. Darüberhinaus hat er mich immer dabei unterstützt, auf Konferenzen mit anderen Wissenschaftlern zusammenzutreffen, was mir viele Kontakte und bleibende Eindrücke verschafft hat. Ohne ihn wäre diese Dissertation nicht zustande gekommen.

In der *Arbeitsgruppe Diskrete Mathematik* der TU-Berlin sind Mathematikerinnen und Mathematiker mit recht unterschiedlichem Hintergrund versammelt. Auch diese Dissertation reicht in verschiedene Teilgebiete der Mathematik hinein und hat daher von der Vielfalt der Gedanken in dieser schillernden Arbeitsgruppe profitiert. Ich habe mich sehr wohl gefühlt und möchte hiermit für die schöne Arbeitsatmosphäre Dank sagen.

Diskussionen mit *Anders Björner*, *Peter McMullen*, *Nicolai Mnëv*, *Gil Kalai* und *Carl Lee* haben meine Zeit als Doktorand, und damit auch diese Arbeit, bereichert. In diesem Zusammenhang geht mein besonderer Dank an *Jesus de Loera* für sein nützliches Programm PUNTOS. Ich danke ihm und *Victor Reiner* für die hilfreichen Kommentare zu Kapitel 3.

Die unangenehme Aufgabe des Korrektur-Lesens haben *Eva-Maria Feichtner*, *Frank Lutz*, *Jürgen Richter-Gebert* und *Andreas Schulz* übernommen. Etwaige verbliebene Tippfehler sind sicher darauf zurückzuführen, daß ich ihre Korrekturen nicht richtig übertragen habe. Insbesondere danke ich *Laura Anderson*, die sich bereit gefunden hat, die Germanismen in der englischen Sprache dieser Arbeit zu reduzieren.

Es ist mir ein Anliegen, mich an dieser Stelle besonders herzlich bei meiner Freundin *Nicole Koch* zu bedanken, die während der letzten zweieinhalb Jahre die Lasten einer großen räumlichen Entfernung mitgetragen hat; ihre Nähe hat meine Arbeit sehr befördert.

Schließlich, aber um so herzlicher, danke ich meinen *Eltern* für ihre Unterstützung zu jeder Zeit meiner Ausbildung. Im ideellen Bereich haben sie durch ihre Wertschätzung von Wissen meine Motivation zu lernen stets gefördert; durch ihre materielle Unterstützung zur Zeit meines Mathematik-Studiums haben sie mir immer den Rücken frei gehalten. Ihnen sei diese Arbeit herzlichst zugeeignet.

Jörg Rambau

Berlin, im Juni 1996

PREFACE

In summer 1993, when I was still living in Bochum, I received a phone call from Günter Ziegler in Berlin concerning my application for the graduate school “Algorithmische Diskrete Mathematik.” He told me that he had read my “Diplomarbeit” and asked me to come to Berlin.

I did come to Berlin. This was the starting point for me to deal with discrete mathematics rather than algebraic topology. I noticed soon that modern discrete mathematics is intertwined with many mathematical fields, including topology. So this change of my main matter of study was quite natural. Nevertheless, a research project in a new field was a little bit risky for everyone involved with this, especially because my stipend was restricted to two-and-a-half years. Hence, all those people who contributed to the success of this undertaking shall be mentioned in the following.

The results presented in this doctoral thesis were obtained during my membership in the graduate school *Algorithmische Diskrete Mathematik*, supported by the *Deutsche Forschungsgemeinschaft* (GRK 219/2–96). I thank them for my admission on April 1, 1994, the stipend, and the travel support that made possible this research. Moreover, I thank *Konrad-Zuse-Zentrum für Informationstechnik Berlin* and *Technische Universität Berlin* for providing me with excellent working environments.

This all would not have been possible without being accepted as a doctoral student in the group of *Günter Ziegler*. Hence, I am especially indebted to him. Already during my first visit to Berlin, he succeeded in making me feel enthusiastic about several mathematical problems, and a solution of any of them would have been sufficient for a dissertation. He was constantly present when I needed his advice. At the same time, I never felt myself pushed by him, even in those periods of stagnation that are typically involved in research.

Often his hints simplified, and hence clarified, my mathematical arguments. As a critical and careful reader of anything I wrote, he contributed many improvements to my writings. In particular, Chapter 2 has gained a lot from his co-authorship in the corresponding paper. In addition to that, he always supported my interaction with other mathematicians. This led to many experiences which influenced my work. Without him this thesis would not have been written.

The group “*Discrete Mathematics*” of the TU-Berlin is a collection of mathematicians with quite different backgrounds. This dissertation drew from various

mathematical fields, thereby profiting from the wide range of viewpoints in the group. I want to thank everybody in this group for creating this constantly pleasant working atmosphere.

Discussions with *Anders Björner*, *Peter McMullen*, *Nicolai Mnëv*, *Gil Kalai*, and *Carl Lee* have enriched my time as a doctoral student, and thus this thesis. In this context, my special thanks go to *Jesus de Loera* for his useful program PUNTOS. I thank him and *Victor Reiner* for their helpful comments on Chapter 3.

The tiresome task of proof-reading the manuscript was executed by *Eva-Maria Feichtner*, *Frank Lutz*, *Jürgen Richter-Gebert*, and *Andreas Schulz*. Remaining typos are certainly due to my incorrect transferring of their corrections. In particular, I thank *Laura Anderson* who turned some “Germish” in this thesis into English.

At this point it is my special desire to say my warmest thanks to my girlfriend *Nicole Koch*. Her closeness, despite the large physical distance between us, also supported this work.

Finally, I am grateful to my *parents* for their constant support during my education. Their high regard of knowledge always motivated me to learn new things; their financial support during my studies helped me to concentrate on mathematics. This thesis is most warmly dedicated to them.

Jörg Rambau

Berlin, June 1996

CONTENTS

Zusammenfassung	iii
Abstract	v
Vorwort	vii
Preface	ix
1 Introduction	1
1.1 Objects of Study	3
1.1(a) Polyhedral Subdivisions and Triangulations	3
1.1(b) Projections and Subdivisions	7
1.2 Links to Other Fields	13
1.2(a) Computational Geometry	13
1.2(b) Order Theory	15
1.2(c) Oriented Matroid Theory	16
1.2(d) Combinatorial Models	18
1.2(e) Polynomials in Several Variables	23
2 The Generalized Baues Conjecture	27
2.1 Introduction	27
2.2 Functions on the Chamber Complex	31
2.3 Validity in Low Codimension	37
2.4 How to Construct a Counterexample	42
2.5 An Explicit Counterexample	46
3 Triangulations of Cyclic Polytopes	55
3.1 Introduction	55
3.2 A Combinatorial Framework for Triangulations	60
3.3 Cyclic Polytopes	63
3.4 Special Triangulations of Cyclic Polytopes	67
3.5 The Higher Stasheff-Tamari Orders	74
3.6 Shellability	80
3.7 Higher Bruhat Orders	83

3.8	The Connection between $\mathcal{B}(n-2, d-1)$ and $\mathcal{S}_1(n, d)$	86
A	Glossary of Basic Concepts	93
A.1	Partially Ordered Sets	93
A.2	Topology	95
A.3	Polytopes	98
A.4	Polytopal and Simplicial Complexes	101
A.5	Oriented Matroids	103
B	Notation	107
	Bibliography	111
	Index	117
	Curriculum Vitae	123

LIST OF FIGURES

1.1	Polyhedral subdivisions.	3
1.2	A regular triangulation and possible heights.	4
1.3	T_{Z^+} and T_{Z^-} in dimension 3.	5
1.4	Bistellar operations.	6
1.5	Chamber complexes of a simplex and a pyramid projection.	8
1.6	Induced and coherent subdivisions.	10
1.7	An example for the poset of all induced subdivisions.	11
1.8	A non-completable partial triangulation.	15
1.9	The “non-Pappus” tiling.	18
1.10	The string space of a 3-simplex.	22
1.11	The secondary polytope of $\{0, 1, 2\} \subset \mathbb{R}$	25
2.1	The face $F_{q,\psi}$ induced by $\psi \in (\mathbb{R}^{d-d'})^*$	32
2.2	The normal fan relation.	34
2.3	The pairwise cone condition.	37
2.4	The twist of σ	40
2.5	An example for a locally coherent function.	43
2.6	The “basket ball obstruction.”	44
2.7	The fibers of the basket ball obstruction.	45
2.8	The vertex-facet incidence matrix of P^{deg}	47
2.9	A sketch of $\pi^{\text{deg}} : P^{\text{deg}} \rightarrow Q^{\text{deg}}$	48
2.10	An isolated element.	49
2.11	The vertex-facet incidence matrix of P	51
2.12	The chamber complex of π	52
3.1	The canonical projection and characteristic sections.	65
3.2	The expansion of F' in T	69
3.3	The compression of H' in T	71
3.4	Increasing flips in $\mathcal{S}_1(6, 1)$ respectively $\mathcal{S}_1(5, 2)$	75
3.5	Finding an increasing flip in $\mathcal{S}_1(8, 1)$	78

CHAPTER 1

INTRODUCTION

Subdivisions of mathematical objects are powerful tools in various frameworks. Examples can be found in combinatorial geometry, convex geometry, algebraic geometry, combinatorial topology, computational geometry, and numerical analysis. As a special case, *triangulations* are useful for the computation of volumes of polyhedra, the resolution of singularities, the homeomorphism test of piecewise linear manifolds, surface interpolation, and the numerical solution of partial differential equations. First, one solves the problem on the *simplices* of a triangulation (which is usually simple), and then one glues the partial solutions together, according to the incidences of the triangulation.

There are two principle kinds of subdivisions:

- subdivisions with arbitrary vertices (which shall not be considered here, see NABUTOVSKY & BEN-AV [56] and NABUTOVSKY [55] for a treatment of this concept),
- subdivisions with vertices in a given point set (which are referred to as *triangulations of point configurations*).

Because, even in the second case, there are many subdivisions of an object — and the quality of the solutions to most problems depends on the special choice — it is worthwhile to find subdivisions that are as good as possible in some sense.

*

In this thesis we study *spaces of subdivisions* from the point of view of polytope theory. The notion of “spaces” is to indicate that we are after the *global interaction* between several subdivisions of the same object. Getting a hand on the structure of such spaces can help to find subdivisions with special properties. The structure of the space of subdivisions of a point configuration is usually given by certain *local transformations* that are theoretically and algorithmically easy to handle. In the case of triangulations we are concerned with the so-called *bistellar operations*, a simple modification on a small portion of a triangulation. One of the main structural problems in this context is to decide whether or not these local transformations allow us to transform any subdivision to any other subdivision.

While in dimension 2 the answer is well-known to be affirmative for every point configuration, in higher dimensions this remains an open problem. This thesis contributes progress from two quite different directions.

- In Chapter 2 we show that the space of all *restricted* subdivisions of a point configuration may be disconnected, thus disproving the *Generalized Baues Conjecture*, posed by BILLERA, KAPRANOV & STURMFELS [9]. (Hence, we have a *negative* result for a generalized setting.)
- In Chapter 3 we illuminate the well-behaved structure of the space of all triangulations of a *cyclic polytope*. (Hence, a certain special case leads to a *positive* result.)

Although these approaches benefit from different areas of mathematics — mainly geometry and topology in Chapter 2, in contrast to combinatorics dominating Chapter 3 — they are linked by the description of subdivisions and corresponding local transformations by means of *polytope projections*. The intuition leading to the main ideas is in both cases drawn from these *geometric* representations. We do not claim originality for this point of view (see, e. g., BILLERA & STURMFELS [11, 12] and GELFAND, KAPRANOV & ZELEVINSKY [28]); in this thesis, however, various (partially known) types of arguments are turned into *systematic* methods of investigation. In Chapter 2, our formal treatment of the *fibers* over the *chambers* of a polytope projection takes us to a construction method for counterexamples to the Generalized Baues Conjecture; in Chapter 3, closer inspection of the behavior of *circuits* and *facets* of cyclic polytopes with respect to a certain projection flag leads us to the main result.

*

The concepts and results investigated in this thesis are not isolated. Besides the link to computational geometry, there are several relations to order theory, oriented matroid theory, topology, and algebra that are not obvious. In Section 1.2 we describe the landscape of connections to these fields. Before that, our main objects of study are introduced in Section 1.1. Chapter 2 contains the new results about the Generalized Baues Conjecture. It is based on joint work with ZIEGLER [61], which will be published in *Discrete & Computational Geometry*. In Chapter 3 the results concerning triangulations of cyclic polytopes are collected, based on a preprint of the author [60], which will appear in *Mathematika*. Both chapters are in principle self-contained and may be read separately. In Appendix A, important notions and results from various areas needed in this thesis are recalled. Appendix B lists the notation used in this thesis.

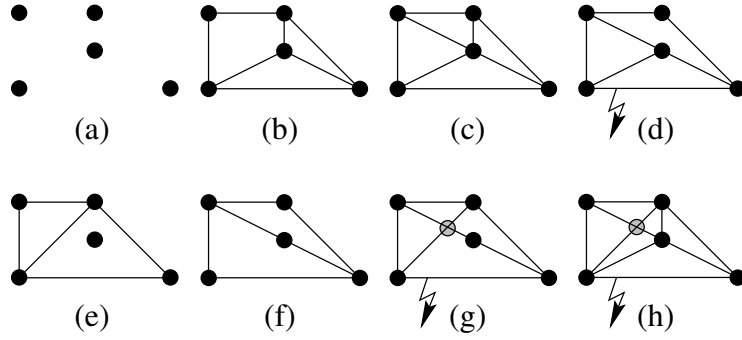

FIGURE 1.1: A planar point configuration \mathcal{A} where three of the points are collinear (a), a polyhedral subdivision (b), a triangulation (c), and a dissection of \mathcal{A} that is not a polyhedral subdivision (d); two triangulations (e) and (f) that do not use all points of \mathcal{A} , their common refinement (g) leading to a new (grey) vertex not in \mathcal{A} , and the common refinement of all triangulations of \mathcal{A} (h). Hence, (g) and (h) are polyhedral subdivisions of $\text{conv}(\mathcal{A})$, but not of \mathcal{A} .

1.1 OBJECTS OF STUDY

Here we explain the fundamental concepts investigated in this thesis, and — aiming at its title — the connection between subdivisions and projections. Background and notation is given in Appendix A and B, respectively.

1.1(a) Polyhedral Subdivisions and Triangulations

Figures 1.1 and 1.2 illustrate the following definitions.

Definition 1.1.1. Let P be a polytope in \mathbb{R}^d . A *polyhedral* (or *polytopal*) *subdivision* of P is a polytopal complex \mathcal{C} in \mathbb{R}^d (any two elements of \mathcal{C} intersect in a common face) with underlying set $|\mathcal{C}| = P$.

Let \mathcal{A} be a finite set of points in \mathbb{R}^d . A *polyhedral subdivision* of \mathcal{A} is a polyhedral subdivision of $\text{conv}(\mathcal{A})$ with vertices in \mathcal{A} .

If \mathcal{C} and \mathcal{C}' are polyhedral subdivisions of \mathcal{A} such that for all $R \in \mathcal{C}$ there is a $R' \in \mathcal{C}'$ with $R \subseteq R'$, then \mathcal{C} is a *refinement* of \mathcal{C}' . The *common refinement* of \mathcal{C} and \mathcal{C}' is the polyhedral subdivision of $\text{conv}(\mathcal{A})$

$$\mathcal{C} \wedge \mathcal{C}' := \{R \cap R' : R \in \mathcal{C}, R' \in \mathcal{C}'\}.$$

A polyhedral subdivision \mathcal{C} of \mathcal{A} in \mathbb{R}^d is *regular* if there are heights α_i for every point $a_i \in \mathcal{A}$ such that \mathcal{C} is *combinatorially isomorphic* to the complex of

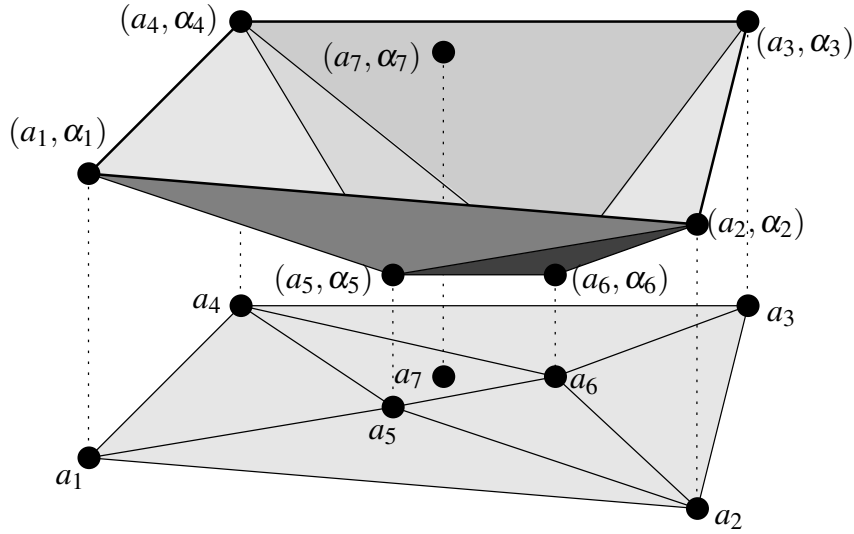

FIGURE 1.2: A regular triangulation and possible heights.

lower faces of the polytope

$$\text{conv} \left\{ (a_i, \alpha_i) \in \mathbb{R}^{d+1} : a_i \in \mathcal{A} \right\}.$$

Here *lower faces* are faces in directions with a negative $(d+1)$ -st coordinate. If a polyhedral subdivision \mathcal{C} is a simplicial complex then it is a *triangulation* of \mathcal{A} .

Note that in general the common refinement of two polyhedral subdivisions of a point configuration \mathcal{A} fails to be a polyhedral subdivision of \mathcal{A} .

We now get to the crucial concept of *bistellar operations* on triangulations of point configurations. We follow the setting in the paper of EDELMAN & REINER [21]. For a setting based on oriented matroids, see DE LOERA [43]. The following lemma makes things work.

Lemma 1.1.2. *Any set Z of $(d+2)$ points whose convex hull is of dimension d has exactly two triangulations, denoted by T_{Z^+} and T_{Z^-} .*

Figure 1.3 shows an example, where Z consists of 5 points in strictly convex position in \mathbb{R}^3 . Observe that the first triangulation consists of 2, the second one of 3 simplices.

Definition 1.1.3 (Bistellar Operations). Let T be a triangulation of \mathcal{A} , where $d = \dim(\mathcal{A})$ and $e \leq d$. Let Z be an $(e+2)$ -subset of \mathcal{A} . Assume that the following conditions are satisfied.

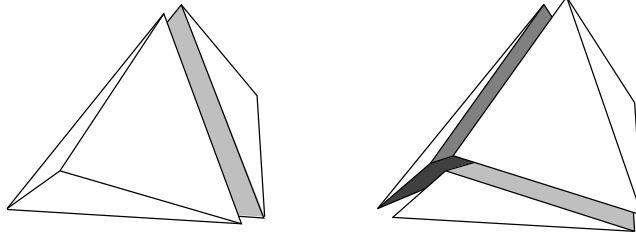

FIGURE 1.3: The two triangulations T_{Z^+} and T_{Z^-} of a set Z of 5 points in convex position in dimension 3.

- (i) The polytope $\text{conv}(Z)$ is of dimension e ,
- (ii) T_{Z^+} (respectively T_{Z^-}) is a subcomplex of T , and
- (iii) all maximal e -simplices in T_{Z^+} (respectively T_{Z^-}) have the same link L in T .

Then

$$T' := (T \setminus (T_{Z^+} * L)) \cup (T_{Z^-} * L) \quad \text{respectively} \quad T' := (T \setminus (T_{Z^-} * L)) \cup (T_{Z^+} * L)$$

is a new triangulation of \mathcal{A} , and we say T' is obtained from T by a *bistellar operation (supported) on Z* .

Because these transformations are *local* in nature, they are used in many algorithms that start from some triangulation of a point configuration, perform bistellar operations, and (should) end up with some special triangulation. In dimension 2 this is known to work well; in dimensions larger than 2, however, it is open whether or not the set of all triangulations of a given point configuration is connected with respect to bistellar operations. (This contrasts the *bistellar equivalence of simplicial polytopes and spheres* investigated by EWALD [25] and PACHNER [57, 58].)

All possible types of *planar* bistellar operations are illustrated in Figure 1.4. If we are concerned with a point configuration in general position, then all bistellar operations are supported on sets of $(d + 2)$ points, and we may neglect the link condition.

Definition 1.1.4. Let \mathcal{A} be a point configuration in \mathbb{R}^d . Then the *graph $\mathcal{G}_{\mathcal{A}}$* of all triangulations of \mathcal{A} is the graph whose vertex set is the set of all triangulations of \mathcal{A} and where two triangulations are connected by an edge if and only if they differ by a bistellar operation.

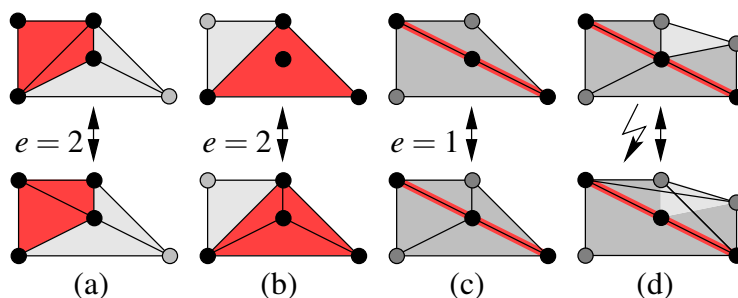

FIGURE 1.4: A bistellar operation supported (black points) on a convex quadrangle (edge flip) (a), on a triangle with an inner point (stellar operation) (b), on a line segment with an inner point (c), and an example where the link condition is not met (d).

Problem 1.1.5. *Is the graph $\mathcal{G}_{\mathcal{A}}$ of all triangulations of \mathcal{A} connected for every point configuration \mathcal{A} ?*

The problem for the subgraph $\mathcal{G}_{\mathcal{A}}^{\text{reg}}$ of all regular triangulations of \mathcal{A} was solved affirmatively by GELFAND, KAPRANOV & ZELEVINSKY [28] (see Sections 1.1(b) and 1.2(e)). However, even such innocent-looking simple polytopes as the 4-cube, the product of two 3-simplices (DE LOERA [44]), and the cyclic polytope $C(12, 8)$ (BILLERA, GELFAND & STURMFELS [8]) admit non-regular triangulations. Moreover, bistellar operations do not in general preserve regularity. Indeed, regularity is not a combinatorial concept; it depends heavily on the particular geometric realization.

What evidence supports a conjecture in the affirmative for the general problem? Of course, the proof in dimension 2 is very simple, but beyond this? For arbitrary d and $n > d$, is there at least one non-trivial configuration of n points in \mathbb{R}^d that has a connected triangulation graph?

In a recent paper EDELMAN & REINER [21] attack, among other things, the latter question by examining the set of triangulations of the standard cyclic polytope $C(n, d)$. Their result in this context reads as follows (see also Section 1.2(b)).

Theorem 1.1.6. (EDELMAN & REINER [21])

The graph of all triangulations of the cyclic polytope $C(n, d)$ is the Hasse diagram of a poset. If $d \leq 3$ then this poset is a lattice, and for $d \leq 5$ and all $n > d$ the graph of all triangulations of the cyclic polytope $C(n, d)$ is connected.

A systematic treatment of the combinatorics of standard cyclic polytopes and special constructions for the cyclic case give us the desired “friendly universal

example” in Chapter 3. From the perspective of this part of the introduction, the essential result of Chapter 3 is the following.

Theorem 1.1.7. (see Chapter 3, Theorem 3.1.1)

The graph of all triangulations of the cyclic polytope $C(n, d)$ is the Hasse diagram of a bounded poset. In particular, it is connected.

We refer to the paper on *weakly neighborly polytopes* by BAYER [6] concerning enumerative results that apply to triangulations of cyclic polytopes in even dimensions.

1.1(b) Projections and Subdivisions

In the following, some aspects of the interaction between projections of polytopes and polyhedral subdivisions of polytopes are sketched. A formal way to deal with the combinatorics of polytope projections is one of the main concepts of Chapter 2. It leads to the solution of the *Generalized Baues Problem*, which has received a considerable amount of attention in the theory of polyhedral subdivisions (see, for example, [9], [14], [63, Introduction, Section 4], [22]).

Definition 1.1.8. Let $P \in \mathbb{R}^d$ and $Q \in \mathbb{R}^{d'}$ be polytopes, and let $\hat{\pi} : \mathbb{R}^d \rightarrow \mathbb{R}^{d'}$ be an affine map with $\hat{\pi}(P) = Q$. We call

$$\pi := \hat{\pi}|_P : \begin{cases} P & \rightarrow Q, \\ p & \mapsto \hat{\pi}(p), \end{cases}$$

a *polytope projection*.

For $q \in Q$, the polytope

$$P_q := \left\{ x \in \mathbb{R}^d : \pi(x) = q \right\}$$

is called the *fiber* of π over q .

We refer to work of BALAS & OOSTEN [4] and LOVÁSZ & SCHRIJVER [46] for the optimization viewpoint, and FILLIMAN [26] for algebraic aspects of polytope projections.

Some of the faces of the preimage of a polytope projection can be recovered from the faces of its image.

Lemma 1.1.9. (see, e. g., ZIEGLER [75, Lemma 7.11])

Let $\pi : P \rightarrow Q$ be a polytope projection. If F is a face of Q then $\pi^{-1}(F)$ is a face of P . The preimage of the face Q^ψ under π is the face $P^{\pi^(\psi)}$ with $\pi^*(\psi) = \psi \circ \pi \in (\mathbb{R}^d)^*$.*

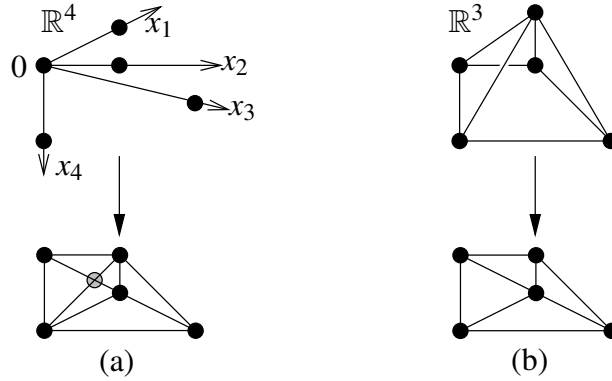

FIGURE 1.5: The chamber complexes of the projections of a 4-simplex (a) and of a 3-dimensional pyramid (b) to a planar point configuration \mathcal{A} .

An important notion connecting projections and polyhedral subdivisions is the *chamber complex* of (P, π) .

Lemma 1.1.10. *Let $\pi : P \rightarrow Q$ be a polytope projection. Then the closures of the connected components of the set*

$$Q \setminus \{ \pi(F) : F \text{ a face of } P, \dim(F) < \dim(Q) \}$$

are finitely many polytopes. Together with all their faces, they form a polyhedral subdivision $\Gamma(P, \pi)$ of Q .

Moreover, $\Gamma(\Delta_d, \pi)$ is the common refinement of all polyhedral subdivisions of the point configuration $\pi(\text{vert}(\Delta_d))$. This equals the common refinement of all regular subdivisions of $\pi(\text{vert}(\Delta_d))$; in particular, $\Gamma(\Delta_d, \pi)$ is shellable.

Definition 1.1.11. $\Gamma(P, \pi)$ is the *chamber complex* of (P, π) . Its elements are called *chambers* of (P, π) .

Note that the chamber complex itself is not a polyhedral subdivision of the point configuration $\pi(\text{vert}(P))$ because in general it has more vertices than P . Figure 1.5 indicates that the chamber complex contains information about the facial structure of the projected polytope. We will describe the chamber complex in a somewhat different manner in Chapter 2. There we develop a formalism to precisely deal with the combinatorics of chambers. For the picture of a non-trivial chamber complex of a polytope projection constructed in this thesis, see Figure 2.12 in Chapter 2.

Generalizing the *secondary polytope* of GELFAND, KAPRANOV & ZELEVINSKY [28], BILLERA & STURMFELS [11] constructed a new polytope from a polytope projection $\pi : P \rightarrow Q$, the *fiber polytope* of (P, π) .

Definition 1.1.12. Let $\pi : P \rightarrow Q$ be a polytope projection. The *fiber polytope* of (P, π) is the polytope

$$\Sigma(P, \pi) := \frac{1}{\text{vol}(Q)} \sum_{\sigma \text{ facet of } \Gamma(P, \pi)} \text{vol}(\sigma) \cdot P_{q_\sigma},$$

where the sum denotes the Minkowski sum of the fibers P_{q_σ} in \mathbb{R}^d and q_σ is the barycenter of the chamber σ .

Given a d -dimensional point configuration \mathcal{A} of n points in \mathbb{R}^d , the *secondary polytope* of \mathcal{A} is defined as

$$\Sigma(\mathcal{A}) := (d + 1) \text{vol}(\text{conv}(\mathcal{A})) \cdot \Sigma(\Delta_{n-1}, \pi_{\mathcal{A}}).$$

Here $\pi_{\mathcal{A}} : \Delta_{n-1} \rightarrow \mathcal{A}$ is the projection that sends the n vertices of the $(n - 1)$ -dimensional standard simplex $\Delta_{n-1} = \text{conv}\{e_i : i = 1, \dots, n\}$ in \mathbb{R}^n to the points in \mathcal{A} . (This projection is canonical up to permutation of coordinates.)

The main result achieved by BILLERA & STURMFELS [11] is that the faces of the fiber polytope $\Sigma(P, \pi)$ are in one-to-one correspondence with certain polyhedral subdivisions of Q that we briefly describe now. Note that in their setting it is necessary to consider projections of distinct faces of P that project to the same sets in Q as distinct polytopes. Such a polytope $R \subseteq Q$ is labelled by the set of vertices of the projecting face F_R . A face R' of R is always labelled by the vertex set of the inclusion-maximal face $F_{R'}$ with $F_{R'} \subseteq F_R$ and $\pi(F_{R'}) = R'$. This makes the intersection condition of a polyhedral subdivision \mathcal{C} considerably more restrictive: the intersection of the *label sets* of two polytopes in \mathcal{C} must be the *label set* of a face of both. Moreover, this results in regarding subdivisions with different label sets as distinct, even if they are geometrically the same.

Definition 1.1.13. Let $P \in \mathbb{R}^d$ and $Q \in \mathbb{R}^{d'}$. A polyhedral subdivision \mathcal{C} of Q is *induced* by the polytope projection $\pi : P \rightarrow Q$, or π -*induced* for short, if every element R in \mathcal{C} is the projection of a proper face F_R of P .

A π -induced subdivision \mathcal{C} of Q is π -*coherent* if there is a linear functional $\psi \in (\mathbb{R}^{d-d'})^*$ such that

$$\pi^{-1}(q)^\psi = \pi^{-1}(q) \cap F_R \quad \text{for all } q \in \text{relint} R \text{ and all } R \in \mathcal{C}.$$

A π -induced subdivision \mathcal{C} of Q is *tight* if $\dim(F_R) = \dim(R)$ for all $R \in \mathcal{C}$. The set of all π -induced (respectively all π -coherent) subdivisions of Q — with differently labelled subdivisions regarded as distinct — is partially ordered by refinement. It is denoted by $\omega(P, \pi)$ and $\omega_{\text{coh}}(P, \pi)$, respectively.

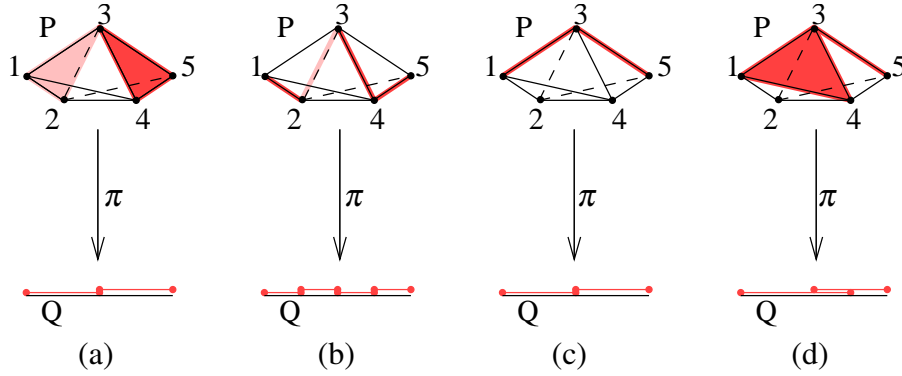

FIGURE 1.6: The induced non-tight subdivision $\{123, 345\}$ (a), the tight induced non-coherent subdivision $\{12, 23, 34, 45\}$ (b), the tight coherent subdivision $\{13, 35\}$ (c), and the set of faces $\{134, 35\}$, which does not induce any subdivision of Q (d).

Figure 1.6 illustrates these definitions for the projection of a bipyramid over a triangle to an interval. (The notion of a *locally coherent string* in Chapter 2 is equivalent to the notion of an induced subdivision.)

In case P is a simplex then the set of all π -induced subdivisions of Q is in fact the set of *all* polyhedral subdivisions of $\pi(\text{vert}(P))$, while the set of all π -coherent subdivisions of Q corresponds to the set of all *regular* subdivisions of $\pi(\text{vert}(P))$. In both cases the tight subdivisions correspond to *triangulations* of $\pi(\text{vert}(P))$. The bistellar operations (see Definition 1.1.3) can easily be recovered in the poset of π -induced subdivisions: An edge (T_1, T_2) in the graph $\mathcal{G}_{\pi(\text{vert}(P))}$ of all triangulations of $\pi(\text{vert}(P))$ corresponds to a common covering relation of T_1 and T_2 in $\omega(P, \pi)$.

If P is a general polytope, then we may interpret the π -induced subdivisions as *restricted polyhedral subdivisions*. That means, the “pieces” of the subdivision must stem from the face lattice of the polytope P . In this case two tight subdivisions covered by a common element might be viewed as a *generalized bistellar operation*. Therefore, the above setting provides a more general framework to investigate the global behaviour of sets of subdivisions than the graph of all triangulations.

Theorem 1.1.14. (BILLERA & STURMFELS [11])

Let $P \in \mathbb{R}^d$ and $Q \in \mathbb{R}^{d'}$ be polytopes, and let $\pi : P \rightarrow Q$ be a polytope projection. The face lattice of the fiber polytope $\Sigma(P, \pi)$ is anti-isomorphic to the poset $\omega_{\text{coh}}(P, \pi)$ of all π -coherent induced subdivisions of $Q = \pi(P)$.

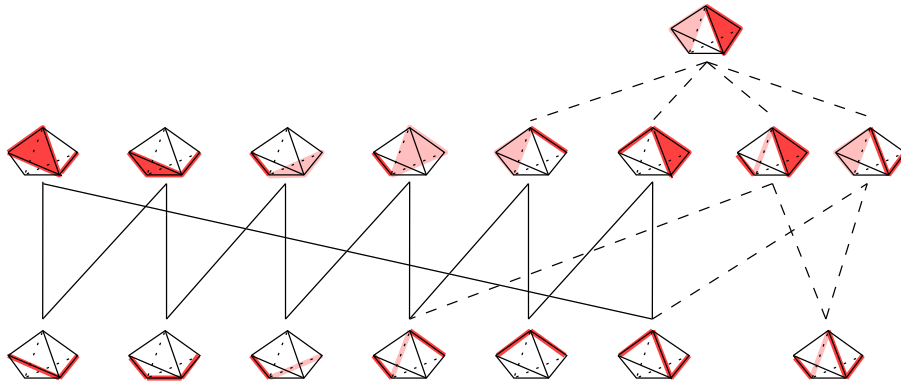

FIGURE 1.7: The poset $\omega(P, \pi)$ where P is a bipyramid over a triangle in \mathbb{R}^3 , projecting via π to an interval Q in \mathbb{R} . Indicated are the inducing faces in P rather than subdivisions of Q . Note that its order complex is not homeomorphic, but homotopy-equivalent to a 1-sphere. The subposet indicated by the solid drawn covering relations is the poset $\omega_{\text{coh}}(P, \pi)$ of all π -coherent subdivisions of Q , which is isomorphic to a hexagon (picture based on ZIEGLER [75, p. 297]).

This result makes it possible to unify the setting of some remarkable concepts that have been developed earlier, e. g., the *associahedron*, independently found by LEE [42] and by HAIMAN [33], which models the set of triangulations of convex n -gons, the already mentioned *secondary polytope* by GELFAND, KAPRANOV & ZELEVINSKY [28] (see also Section 1.2(e)), which models the set of regular triangulations of the convex hull of a point configuration, and the *monotone path polytope* [75, Chapter 9], which models the set of monotone edge paths in a polytope. A slight generalization of the fiber polytope construction was used by REINER & ZIEGLER [62] to prove that certain combinatorially defined cell complexes associated to *Coxeter groups* are in fact the face lattices of convex polytopes, such as the *permuto-associahedron*.

A natural question is whether the poset of *all* induced subdivisions has some “friendly” structure. It turns out that the best possible structure one can expect is the following (see Figure 1.7).

Definition 1.1.15 (Generalized Baues Conjecture). (BILLERA, KAPRANOV & STURMFELS [9])

We say that for $d \geq 1$ and $d - d' \geq 0$ the Generalized Baues Conjecture holds if the following is true: For all polytope projections $\pi : P \rightarrow Q$, where $P \in \mathbb{R}^d$ and $Q \in \mathbb{R}^{d'}$, the poset $\omega(P, \pi)$ of all π -induced subdivisions of $Q = \pi(P)$ is homo-

topology equivalent to the poset $\omega_{\text{coh}}(P, \pi)$ of all π -coherent subdivisions of Q . In particular, it is homotopy equivalent to a sphere of dimension $d - d' - 1$.

An affirmative answer to this conjecture, at least for all $\pi : P \rightarrow Q$ where P is a simplex, would easily imply an affirmative answer to Problem 1.1.5. The conjecture was motivated by the following result, which settled the original Baues conjecture [5] (see Section 1.2(d)).

Theorem 1.1.16. (BILLERA, KAPRANOV & STURMFELS [9])
The Generalized Baues Conjecture holds for $d' = 1$.

In the same paper, BILLERA, KAPRANOV & STURMFELS stated, without proof, the correctness of the Generalized Baues Conjecture in the case where P is a simplex and $d' = 2$. A written proof for the generic case can be found in EDELMAN & REINER [22].

Chapter 2 of this thesis gives a slightly different approach, stressing the structure of the “inducing faces” in P instead of the elements of the subdivision. Using topological methods, we will prove another special case of the generalized Baues conjecture. The general conjecture, however, will be disproved, leading to the following theorem.

Theorem 1.1.17. (see Chapter 2, Theorem 2.1.7)

For $d - d' \leq 2$, the Generalized Baues Conjecture holds. There is, however, a 5-polytope P^{deg} with 10 vertices and 36 facets projecting onto a triangle Q^{deg} in the plane via a degenerate polytope projection $\pi^{\text{deg}} : P^{\text{deg}} \rightarrow Q^{\text{deg}}$ such that the poset of π^{deg} -induced subdivisions has an isolated element. Furthermore, there is a simplicial 5-polytope P with 10 vertices and 42(!) facets projecting onto a hexagon in the plane via a non-degenerate projection $\pi : P \rightarrow Q$ such that the poset of π -induced subdivisions is not connected.

In the spirit of the setting of the Generalized Baues Conjecture, the results in Chapter 3 on triangulations of the cyclic polytope $C(n, d)$ are obtained by the following considerations. There is a *projection flag*

$$\mathbb{R}^{n-1} \supset \Delta_{n-1} = C(n, n-1) \rightarrow \cdots \rightarrow C(n, d) \rightarrow \cdots \rightarrow C(n, 1) = [1, n] \subset \mathbb{R},$$

given by successive deletion of the last coordinate (see BILLERA & STURMFELS [12] for more information on projection flags and *iterated fiber polytopes*).

The triangulations of $C(n, d)$ are exactly the tight induced subdivisions with respect to the projection $\pi_{n,d} : \Delta_{n-1} \rightarrow C(n, d)$ that deletes the last $n - d - 1$ coordinates. This map trivially factorizes into projections of the projection flag. The preimage of a triangulation of $C(n, d)$ in $C(n, d + 1)$ is a *piecewise linear section* which uniquely determines this triangulation. This viewpoint was introduced by

EDELMAN & REINER [21]. We obtain the main result of Chapter 3 by getting a hand on the combinatorics of this projection step. In this context our theorem reads as follows.

Theorem 1.1.18. (see Chapter 3, Theorem 3.1.1)

The tight $\pi_{n,d}$ -induced subdivisions of the cyclic polytope $C(n, d)$ form a bounded poset $\mathcal{S}_1(n, d)$. Its elements correspond to certain equivalence classes of maximal chains in $\mathcal{S}_1(n, d - 1)$.

It would be of interest whether the techniques of Chapter 3 could clarify the structure of the poset $\omega(P, \pi_{n,d})$ of all $\pi_{n,d}$ -induced subdivisions of $C(n, d) = \pi_{n,d}(\Delta_{n-1})$.

1.2 LINKS TO OTHER FIELDS

In this section we sketch a few connections between the problems attacked in this thesis and other fields of mathematics.

1.2(a) Computational Geometry

Most investigations of subdivisions in computational geometry consider triangulations of point configurations in the plane. Usually one assumes that all points are in general position (no three on a line and no four on a circle) and that every point must appear in some triangle of a triangulation. This leads to the notion of *edge-flipping operations*. These are special cases of the bistellar operations in Definition 1.1.3, namely where the set Z consists of 4 points in strictly convex position. These edge-flipping operations are used to construct particular triangulations, such as the *Delaunay triangulation*, from arbitrary starting triangulations (see the diploma thesis by MERTSCH [50] for an overview on optimality considerations).

Definition 1.2.1. Let \mathcal{A} be a point configuration in \mathbb{R}^d in general position (no $d + 1$ points coplanar, no $d + 2$ points on a sphere). The *Delaunay triangulation* $T_D(\mathcal{A})$ is the unique triangulation of \mathcal{A} for which every sphere spanned by the $d + 1$ points of a simplex in $T_D(\mathcal{A})$ contains no other point of \mathcal{A} .

In order to bound the complexity of an “edge-flipping” algorithm, the *edge-flipping distance* $d_{\mathcal{A}}(T_1, T_2)$ between two triangulations T_1 and T_2 of \mathcal{A} is of special interest. This is the minimal number of edge-flipping operations that is necessary to transform T_1 into T_2 . The *edge-flipping diameter* $d(\mathcal{A})$ of \mathcal{A} is the maximum of all $d_{\mathcal{A}}(T_1, T_2)$ taken over all triangulations T_1 and T_2 of \mathcal{A} . It is an

easy exercise to show by induction that the graph of all triangulations of a planar point configuration is connected.

If \mathcal{A} is in strictly convex position then edge-flipping operations correspond exactly to bistellar operations, and we have the following.

Theorem 1.2.2. (SLEATOR, TARJAN & THURSTON [67])

Let Q_n be a convex n -gon. Then

$$\begin{aligned} d(Q_n) &\leq 2n - 10 \quad \text{for } n > 12, \\ d(Q_n) &= 2n - 10 \quad \text{for infinitely many } n. \end{aligned}$$

For general planar point configurations with inner points there is the following result, where now edge-flipping operations are considerably more restrictive than bistellar operations.

Theorem 1.2.3. (HANKE, OTTMANN & SCHUIERER [34])

Let \mathcal{A} be a set of points in the plane in general position, T_1 and T_2 two triangulations of \mathcal{A} , and let $\#(T_1, T_2)$ be the number of intersections of edges of T_1 and edges of T_2 . Then

$$d_{\mathcal{A}}(T_1, T_2) \leq \#(T_1, T_2) \leq (3n - 2n_b - 3)^2,$$

where n_b is the number of vertices of $\text{conv}(\mathcal{A})$.

Other results were achieved for the edge-flipping distance in general (non-convex) *simple polygons* in the plane. These are n -gons where several nodes of the boundary are not in convex position, the so-called *reflex vertices*. Although this does not completely fit in our (convex) framework, we cite the corresponding theorem.

Theorem 1.2.4. (HURTADO, NOY & URRUTIA [37])

Let $Q_{n,k}$ be a simple polygon with k reflex vertices. Then the diameter $d(Q_{n,k})$ is at most $O(n + k^2)$.

There are simple 3-dimensional configurations (see Figure 1.8) for which certain *partial* triangulations (simplicial complexes that do not cover the complete convex hull) cannot be completed to a triangulation (see CHIN & WANG [19] for a characterizing approach). This indicates the difficulty of Problem 1.1.5 in dimensions greater than 2.

On the other hand, for practical applications in computational geometry there is a way to by-pass Problem 1.1.5. By an *incremental* algorithm, it is always possible to find the *unique regular triangulation* $\mathcal{R}_w(\mathcal{A})$ of \mathcal{A} with respect to given weights $w : \mathcal{A} \rightarrow \mathbb{R}$ on the points by means of bistellar operations. This requires, however, bistellar operations in their full generality. For example, if the weight function w is constant, one gets the Delaunay triangulation.

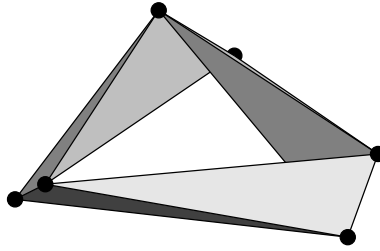

FIGURE 1.8: This partial triangulation of a twisted prism over a triangle cannot be completed to a triangulation without new vertices.

Theorem 1.2.5. (EDELSBRUNNER & SHAH [24])

For all point configurations $\mathcal{A} \subset \mathbb{R}^d$ in general position and all weights $w: \mathcal{A} \rightarrow \mathbb{R}$, there is an algorithm finding the triangulation $\mathcal{R}_w(\mathcal{A})$ by adding the points one by one and performing bistellar operations in between. If the points are added in a random sequence and the history of bistellar operations is stored then the expected running time is of order $O(n \log n + n^{\lceil d/2 \rceil})$. This is also the order of the number of simplices in some special triangulations.

1.2(b) Order Theory

Triangulations of a convex n -gon have been studied from a purely combinatorial point of view for quite a long time. Starting in 1962, TAMARI [72] investigated the poset \mathcal{T}_n of all complete binary bracketings of a string of length $n - 1$. Its elements turned out to be in one-to-one correspondence with the triangulations of a convex n -gon without new vertices. Moreover, the covering relations in \mathcal{T}_n correspond to edge-flipping operations that have a certain direction.

Definition 1.2.6. Let T_n be the set of all complete binary bracketings of a string S of length $n - 1$. Define

$$((AB)C) < (A(BC)) \quad \text{for substrings } A, B, C \text{ of } S.$$

Then the transitive closure of “ $<$ ” defines a partial order “ \leq ” on T_n . In view of Theorem 1.2.7 below, the poset (T_n, \leq) is called the *Tamari lattice* \mathcal{T}_n .

Theorem 1.2.7. (HUANG & TAMARI [36])

\mathcal{T}_n is a lattice.

The covering relations in \mathcal{T}_n can also be considered as directed *rotations in binary trees*, giving a link to computer science. The geometric connection is as follows.

Lemma 1.2.8. \mathcal{T}_n is isomorphic to the set of all triangulations of the n -gon Q_n where the vertices $1, \dots, n$ are ordered counter-clockwise. A covering relation in \mathcal{T}_n corresponds to an edge-flipping operation in a quadrangle (i, j, k, l) with $i < k < j < l$ that replaces the diagonal (i, j) with (k, l) .

The diameter of the Hasse diagram of \mathcal{T}_n is just the edge-flipping diameter of Q_n , and thus the bounds by SLEATOR, TARJAN & THURSTON [67] (see the previous section) apply to \mathcal{T}_n . Additionally, PALLO [59] found an $O(n^{3/2})$ -algorithm to explicitly compute the distance of two elements of \mathcal{T}_n .

The secondary polytope for this special case was found independently by HAIMAN [33] and LEE [42] before the general theory of secondary polytopes was developed by GELFAND, KAPRANOV & ZELEVINSKY [28].

Theorem 1.2.9. (HAIMAN [33], LEE [42], also MILNOR [52])
The Hasse diagram of \mathcal{T}_n is the edge graph of an $(n - 3)$ -polytope, the associahedron.

Using methods of formal concept analysis, GEYER [31] found some more involved order theoretic facts about \mathcal{T}_n . We omit them here because the corresponding notions have no obvious connection to the geometry of triangulations.

The paper by EDELMAN & REINER [21], which we already mentioned at the end of Section 1.1(a), presents a natural geometric generalization of \mathcal{T}_n . There are *increasing bistellar operations* for triangulations of the cyclic polytope $C(n, d)$, which coincide in the special case $d = 2$ with the directed edge-flipping operations (see Section 3.5 for a detailed discussion). This yields a partial order on the set of all triangulations of $C(n, d)$, the *(first) higher Stasheff-Tamari order* $\mathcal{S}_1(n, d)$.

Our positive result in Chapter 3 shows that at least the boundedness of \mathcal{T}_n survives in $\mathcal{S}_1(n, d)$. Moreover, the correspondence between equivalence classes of maximal chains in $\mathcal{S}_1(n, d - 1)$ and elements in $\mathcal{S}_1(n, d)$ (see Theorem 1.1.18) yields an additional order theoretic structure. The same property holds for the *higher Bruhat order* $\mathcal{B}(m, k)$ of MANIN & SCHECHTMAN [48], further studied by ZIEGLER [74]. A connection between these two classes of posets was first detected by KAPRANOV & VOEVODSKY [40]; it will be an object of intensive study in Section 3.8 of this thesis.

1.2(c) Oriented Matroid Theory

The framework of oriented matroids is by now a well-developed tool to study various kinds of combinatorial problems. At the same time, it has become a source of problems that are interesting in their own right. We sketch the connection between the unsolved *Extension Space Conjecture* and the Generalized Baues Conjecture, which is provided by the *Bohne-Dress Theorem*.

Definition 1.2.10. The *extension poset* of an oriented matroid \mathcal{M} is the set $\mathcal{E}(\mathcal{M})$ of all extensions of \mathcal{M} , partially ordered by the weak map relation. The order complex $\Delta^{\mathcal{E}}(\mathcal{M})$ of $\mathcal{E}(\mathcal{M})$ is called the *extension space* of \mathcal{M} .

Conjecture 1.2.11 (Extension Space Conjecture). *Let \mathcal{M} be a realizable oriented matroid of rank d on n points. Then $\Delta^{\mathcal{E}}(\mathcal{M})$ has the homotopy type of a $(d-1)$ -sphere.*

That the realizability assumption is essential was shown by MNĚV & RICHTER-GEBERT [53]. They constructed oriented matroids with even *disconnected* extension spaces. Their result “killed” an older “extension space conjecture” that did not assume realizability.

STURMFELS & ZIEGLER [71] derived affirmative answers to the extension space conjecture for *strongly euclidean oriented matroids*, in particular for $d \leq 3$, for $n \leq d+2$, and for the *alternating oriented matroid* $\mathcal{Z}(n, d)$. The latter example is the oriented matroid of the vector configuration of homogenous coordinates of the vertices of the standard cyclic polytope $C(n, d)$.

Definition 1.2.12. A *zonotope* is a polytope $Z \subset \mathbb{R}^d$ that is the projection of a hypercube, or, equivalently, the Minkowski sum of finitely many line segments $[-v_i, +v_i] \subset \mathbb{R}^d$, where $V := \{v_1, \dots, v_n\}$ is a configuration of vectors in \mathbb{R}^d . The *oriented matroid* $\mathcal{M}(Z)$ of Z is defined as the oriented matroid of V . This oriented matroid has rank $\dim(V)$.

Definition 1.2.13. Let Z be a zonotope. A (*weak*) *zonotopal tiling* of Z is a collection \mathcal{Z} of zonotopes that forms a polyhedral subdivision of Z .

A new proof of the following theorem may be found in RICHTER-GEBERT & ZIEGLER [64].

Theorem 1.2.14 (Bohne-Dress Theorem). (BOHNE [16])

Let Z be a zonotope given by a vector configuration $V \subset \mathbb{R}^d$. There is a one-to-one correspondence between the set of all zonotopal tilings \mathcal{Z} of Z and the oriented matroid liftings $\widehat{\mathcal{M}}(Z)$ of $\mathcal{M}(Z)$.

Figure 1.9 shows a zonotopal tiling corresponding to the non-realizable oriented matroid given by the so-called “non-Pappus” pseudoline configuration.

A zonotope Z may be viewed as the projection $\pi(C_n)$ of the n -cube C_n . All those zonotopes that can appear in a zonotopal tiling of Z are projections of faces of the n' -cube for some n' , possibly larger than n ; thus all zonotopal tilings of Z are π' -induced, where $\pi'(C_{n'}) = Z$. Hence, a proof of the Generalized Baues Conjecture in the special case of hypercube projections would imply a “well-behaved” structure of the set of all single-element liftings of a realizable oriented matroid.

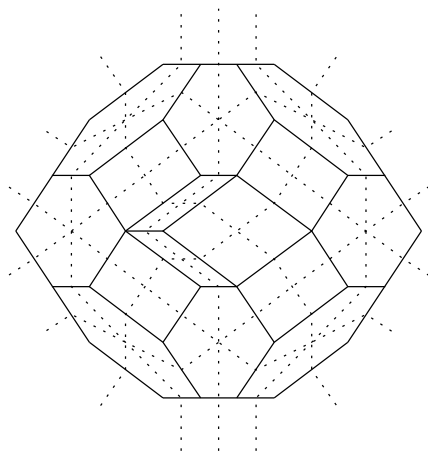

FIGURE 1.9: A zonotopal tiling corresponding to a non-realizable oriented matroid. This is indicated by the dotted “pseudolines” that form a configuration violating Pappus’ Theorem (picture from ZIEGLER [75, p. 220]).

Moreover, via oriented matroid duality, this “cubical” Generalized Baues Conjecture is in fact equivalent to the extension space conjecture (see [63, Introduction] for an overview of concepts in oriented matroid theory). Recently, a connection even between the set of all triangulations of a point configuration and the extension space of its oriented matroid was drawn by SANTOS [65].

We only note here that there are several concepts of *triangulations of oriented matroids* around. The first one was introduced by BILLERA & MUNSON [10], another one fitting in the theory of *combinatorial differential manifolds* (see MACPHERSON [47]) was given by ANDERSON [2] (see SANTOS [65] for more information).

Our negative result in Chapter 2 shows that for a successful attack to the extension space conjecture via the cubical Generalized Baues Conjecture it is essential to take into account the particular structure of cube projections.

1.2(d) Combinatorial Models

When dealing with topological problems, it is often useful to work with special combinatorial objects related to the topological spaces under consideration, rather than with the topological spaces themselves. For example, *triangulations* of topological spaces lead to simplicial complexes that carry the complete topological information about the original space within their combinatorial structure. There are

two quite different links between the Generalized Baues Conjecture and the theory of combinatorial models of topological spaces: loop spaces and finite-dimensional Grassmannians.

Combinatorial models of the finite-dimensional Grassmannians are closely related to oriented matroids. The *real Grassmann manifold* $G_k(\mathbb{R}^d)$, or *Grassmannian* for short, is the space of all k -dimensional subspaces of \mathbb{R}^d with the usual quotient topology, where $V \sim W$ if and only if $\text{lin}(V) = \text{lin}(W)$ for $V = (v_1, \dots, v_k)$ and $W = (w_1, \dots, w_k)$ in $(\mathbb{R}^d)^k$. The oriented matroids $\mathcal{M}(V)$ and $\mathcal{M}(W)$ of equivalent representatives $V \sim W$ coincide. Thus, the set of all *realizable* oriented matroids on d points of rank k with the topology inherited by the weak map relation can be regarded as a model of $G_k(\mathbb{R}^d)$. But the realizability assumption disturbs the combinatorial shape of the model; there is no combinatorial criterion known to check realizability efficiently. (For additional problems occurring in this stratification see STURMFELS [69].)

So a natural idea is to bring all oriented matroids on d points of rank k — realizable or not — into the game, forming the *MacPhersonian* $MacP(d, k)$. This was actually done by GELFAND & MACPHERSON [30] who conjectured that $MacP(d, k)$ is homotopy equivalent to $G_k(\mathbb{R}^d)$, which is in fact true if $k \leq 3$ (see BABSON [3] and MNĚV & ZIEGLER [54]).

A generalization of this concept is the *OM-Grassmannian* (we refer to BABSON [3], MNĚV & ZIEGLER [54], and RICHTER-GEBERT [63, Introduction, Section 4]).

Definition 1.2.15. Let \mathcal{M}^d be an oriented matroid of rank d on the set $[n]$. The *OM-Grassmannian* of \mathcal{M} is the poset

$$\mathcal{G}_k(\mathcal{M}^d) := \left\{ \mathcal{N}^k : \mathcal{N}^k \text{ is a rank } k \text{ strong image of } \mathcal{M}^d \right\},$$

partially ordered by the weak map relation.

The unifying conjecture is the following.

Conjecture 1.2.16. *If \mathcal{M}^d is realizable, then the order complex of its OM-Grassmannian $\mathcal{G}_k(\mathcal{M}^d)$ is homotopy equivalent to the real Grassmannian $G_k(\mathbb{R}^d)$ for all $1 \leq k < n$.*

For $k \leq 2$ there are affirmative results. For $\mathcal{M}^d = \mathcal{F}^d$ we get the MacPhersonian $MacP(d, k)$. In the case $k = d - 1$ we are again concerned with the extension space conjecture, inheriting the corresponding partial results. Further affirmative partial answers to the extension space conjecture would support inductive approaches to this problem.

The *model theory of loop spaces* deals with the construction of combinatorial models for the loop space ΩX of X , which is the space of all closed paths in a

topological space X , endowed with a certain topology. The source of the Generalized Baues Conjecture actually lies in this field. The original Baues Conjecture belongs to the purely combinatorial part of a whole theory developed by — among others — ADAMS [1], MILGRAM [51], and BAUES [5]. The exact setting of this framework requires much more insight into category theory than we can present here. Thus, we restrict ourselves to a sketch of the situation.

In the book *The Geometry of Loop Spaces* by BAUES [5] a general model theorem is presented, which roughly states the following: If X is a space glued together from standard building blocks, then, under certain conditions, its loop space ΩX is glued together from certain path spaces of the standard building blocks. The following version of the model theorem is still a rough sketch of the exact setting.

Theorem 1.2.17 (Model Theorem for Loop Spaces, sketch). (BAUES [5])

Let \mathcal{K} be a collection of abstract objects K with the following properties.

- (i) Every $K \in \mathcal{K}$ has a facial structure,
- (ii) for every $K \in \mathcal{K}$ all faces of K are again in \mathcal{K} and have the inherited facial structure,
- (iii) every $K \in \mathcal{K}$ is a face of another K' in \mathcal{K} and has the inherited facial structure,
- (iv) for every $K \in \mathcal{K}$ there is a topological standard realization $\rho(K)$ of K that is homeomorphic to a ball,
- (v) there is another collection $\Omega\mathcal{K}$ of abstract objects satisfying (i), (ii), and (iii) with the following property: for every $K \in \mathcal{K}$ there is an object ΩK and a corresponding topological standard realization $L(\Omega K)$ that is (weakly) homotopy equivalent to a certain path space $\Omega\rho(K)$ of $\rho(K)$,
- (vi) for every $K \in \mathcal{K}$ the boundary $\partial L(\Omega K)$ is homotopy equivalent to a sphere of appropriate dimension.

Let X be a topological space that is the topological realization $[C]_\rho$ of a complex C consisting of building blocks K from \mathcal{K} . Then there is a construction that builds up a complex ΩC from the building blocks ΩK in $\Omega\mathcal{K}$ such that the topological realization $[\Omega C]_L$ of ΩC is (weakly) homotopy equivalent to the loop space ΩX of X . In other words, the following formula holds:

$$[\Omega C]_L \sim \Omega[C]_\rho.$$

Because a closer inspection of this construction is outside the scope of this thesis, we restrict ourselves to the problem of guaranteeing the assumptions of the theorem.

We briefly sketch how one gets ΩK for building blocks K that are abstract contractible cell complexes containing at least two vertices. Let $\Omega(\rho(K), x_s, x_t)$ be the space of all paths in $\rho(K)$ starting at $x_s \in \rho(K)$ and terminating at $x_t \in \rho(K)$, where $x_s := \rho(s_K)$ and $x_t := \rho(t_K)$ correspond to vertices s_K and t_K in K . This *path space* is (via certain topological constructions) related to the loop space of $\rho(K)$. We construct a model $\Omega(K, s, t)$ for $\Omega(\rho(K), x_s, x_t)$. To any element F of K we assign vertices $s(F)$ and $t(F)$ of F with the following properties:

$$\begin{aligned} s(K) &= s_K, \\ t(K) &= t_K, \\ s(F') &= s(F) \quad \text{if } F' \text{ is a face of } F \text{ and } s(F) \in F', \\ t(F') &= t(F) \quad \text{if } F' \text{ is a face of } F \text{ and } t(F) \in F'. \end{aligned}$$

The pair (s, t) is called a *double stippling* on K . A *cellular string* in (K, s, t) with respect to the double stippling (s, t) is a sequence (F_0, \dots, F_m) of faces of K such that $s(F_i) = t(F_{i-1})$ for all $i = 0, \dots, m$. The set $\omega(K, s, t)$ of all cellular strings in K is partially ordered by refinement, i. e.,

$$\begin{aligned} (F_0, \dots, F_m) \leq (G_0, \dots, G_k) &: \iff \\ &\text{there are } -1 = i_0 < \dots < i_{k+1} = m \text{ with:} \\ &(F_{i_v+1}, \dots, F_{i_{v+1}}) \text{ is a cellular string in } G_v \text{ for all } v = 0, \dots, k. \end{aligned}$$

The (*cellular*) *string complex* $\Omega K = \Omega(K, s, t)$ (see Figure 1.10) is a certain abstract cell complex that induces this partial order via its facial relations. We may interpret this model as follows: for any path w from x_s to x_t in $\rho(K)$ consider the string of those faces of $\rho(K)$ that are visited by w . This string gives rise to a cellular string in K , thus to a cell in ΩK .

The crucial part in applications of the Model Theorem, as far as our framework is concerned, is the construction of the *spherical desuspensions* $L(\Omega K)$. These are the standard realizations satisfying (v) and (vi) of Theorem 1.2.17. Constructing a spherical desuspension $L(\Omega K)$ roughly means finding a topological cell complex with spherical boundary that carries the combinatorial structure of ΩK within its incidences and is “consistent” for all K .

One straightforward attempt is to consider a topological realization of the *order complex* of ΩK , which is the first barycentric subdivision of ΩK . Its boundary is just a topological realization of the order complex of $\Omega K \setminus \{K\}$. If this boundary is always homotopy equivalent to a sphere, then we are done. For the special case of double-stipplings on a polytope coming from a generic linear functional this

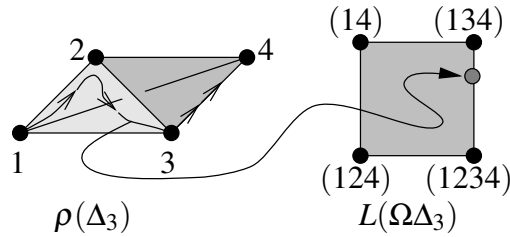

FIGURE 1.10: The string space of the 3-simplex stippled by minimal and maximal vertex. It is modelled by a 2-cube. The indicated path going first through the face $\{1, 2, 3\}$ and then along the edge $\{3, 4\}$ corresponds to the grey point in the relative interior of the edge $\{(134), (1234)\}$ of the square.

is exactly the problem that is addressed by the Generalized Baues Conjecture for $d' = 1$.

The following considerations lead to the original Baues Conjecture. If we are concerned with a triangulated topological space X , so that \mathcal{K} is the set of all abstract simplices with standard realizations, then the string complex for the n -simplex Δ_n is combinatorially equivalent to an $(n - 1)$ -cube (see Figure 1.10). Hence, by the Model Theorem, the loop space ΩX of X is (weakly) homotopy equivalent to a certain space glued together from cubes. Continuing this process with ΩX instead of X leads to the string complex of the n -cube, which turns out to be the $(n - 1)$ -permutahedron, the convex hull of all permutations of $[n - 1]$, viewed as vectors in \mathbb{R}^{n-1} .

The next step, however, yields string complexes that cannot be realized as polytopes. They even fail to be homeomorphic to balls. To apply the Model Theorem, however, it would be sufficient to come up with realizations whose boundary is homotopy equivalent to a sphere. The Baues Conjecture is roughly as follows.

Conjecture 1.2.18 (Baues Conjecture). (BAUES [5])

The boundary of the string complex of a permutahedron has the homotopy type of a sphere.

Here is our connection: assume that $\rho(K)$ is a permutahedron with face lattice K , and the double stippling on K is given by a generic linear functional ψ on $\rho(K)$. Then the first barycentric subdivision of the string complex ΩK coincides with the order complex of the poset of all ψ -induced subdivisions. The minimal and the maximal vertex of $\rho(K)$ with respect to ψ correspond to the fixed base points

in $\rho(K)$. Thus, the proof of the case $d' = 1$ of the Generalized Baues Conjecture by BILLERA, KAPRANOV & STURMFELS [9] implies the Baues Conjecture.

Our negative result in Chapter 2 can be regarded as an obstruction for modelling *iterated loop spaces* in one step, even if there were a similar model theorem around (which — to the knowledge of the author — is not the case).

1.2(e) Polynomials in Several Variables

While examining discriminants of polynomials in several variables, GELFAND, KAPRANOV & ZELEVINSKY [28] have detected a very surprising connection to the combinatorics of coherent subdivisions. We try to give a rough idea of what is going on. Details are contained in the book *Discriminants, Resultants and Multidimensional Determinants* by the same authors [29]. For the following, let A be a finite set of monomials $x^z := x_1^{z_1} \dots x_d^{z_d}$ in d variables, and let \mathbb{C}^A denote the space of all polynomials with complex coefficients all of whose monomials belong to A . Moreover, for a monomial $x^z \in A$ let $v(x^z) := z = (z_1, \dots, z_d)$ be the corresponding lattice point in \mathbb{R}^d , and let \mathcal{A} be the configuration of all $v(x^z)$ for $x^z \in A$ in \mathbb{R}^d .

Definition 1.2.19. The A -discriminant $\Delta_A(f)$ of a formal polynomial

$$f = \sum_{x^z \in A} a_z x^z \in \mathbb{C}^A$$

is a certain polynomial in the coefficients a_z of f which vanishes whenever f has a multiple root (x_1, \dots, x_d) with all $x_i \neq 0$. For a collection of formal polynomials

$$f_1 = \sum_{x^z \in A} a_{1,z} x^z, \quad \dots, \quad f_m = \sum_{x^z \in A} a_{m,z} x^z, \in \mathbb{C}^A$$

the A -resultant $R_A(f_1, \dots, f_m)$ of f_1, \dots, f_m is a certain polynomial in the coefficients $a_{1,z}, \dots, a_{m,z}$ of f_1, \dots, f_m which vanishes whenever f_1, \dots, f_m have a common root. The *principal A -determinant* $E_A(f)$ of a formal polynomial $f \in \mathbb{C}^A$ is the following A -resultant, viewed as a polynomial in the coefficients a_z of f .

$$E_A(f) := R_A \left(x_1 \frac{\partial f}{\partial x_1}, \dots, x_d \frac{\partial f}{\partial x_d}, f \right).$$

Note that the argument “ f ” in the notation of the principal A -determinant $E_A(f)$ is only a formal parameter denoting a “generic” element of \mathbb{C}^A ; it does not mean that E_A depends on some special polynomial f . Thus, we write E_A for the principal A -determinant whenever the formal parameter “ f ” is not needed.

The key step in the “translation” from polynomials to polytopes is the *Newton polytope* of a polynomial f .

Definition 1.2.20. The *Newton polytope* of a formal polynomial $f(x_1, \dots, x_d)$ in d variables is the convex hull

$$N(f) := \text{conv}(\mathcal{A}) = \text{conv} \{ v(x^z) : x^z \text{ is a monomial of } f \} \subset \mathbb{R}^d$$

of all lattice points in \mathbb{R}^d corresponding to monomials in f .

Before we state the theorem, we want to cite the original definition of the secondary polytope by GELFAND, KAPRANOV & ZELEVINSKY [28].

Definition 1.2.21 (Secondary Polytope). Let A be a finite set of monomials, and let \mathcal{A} be the corresponding point configuration. Moreover, assume that $\text{conv}(\mathcal{A})$ is d -dimensional in \mathbb{R}^d . For any triangulation T of \mathcal{A} , let

$$\phi_T := \begin{cases} A & \rightarrow \mathbb{R}, \\ z & \mapsto \sum_{S \in T: z \in \text{vert}(S)} \text{vol}(S), \end{cases}$$

be its *characteristic function*. The *secondary polytope* of A is defined as

$$\Sigma(A) := \text{conv} \left\{ \phi_T \in \mathbb{R}^A : T \text{ is a triangulation of } \mathcal{A} \right\} \subset \mathbb{R}^A.$$

Theorem 1.2.22. (GELFAND, KAPRANOV & ZELEVINSKY [28])

The Newton polytope of the principal A -determinant E_A coincides with the secondary polytope $\Sigma(\mathcal{A})$ of the point configuration \mathcal{A} corresponding to the monomials in A .

We present a very simple example in order to illustrate that the three possible constructions for the secondary polytope really lead to the *same* polytope rather than only to an isomorphic one. Figure 1.11 illustrates the fiber polytope version.

Example 1.2.23. Let $A = \{1, x^1, x^2\}$, and thus $\mathcal{A} = \{0, 1, 2\}$. Let $f \in \mathbb{C}^A$, that is, $f = ax^2 + bx + c$. Then $\Delta_A(f) = b^2 - 4ac$, which vanishes if and only if f has a double root.

► *The Newton polytope:* The principal A -determinant is

$$E_A = ac(b^2 - 4ac) = ab^2c - 4a^2c^2,$$

thus its Newton polytope is the one-dimensional polytope in \mathbb{R}^3 spanned by the points $(1, 2, 1)^T$ and $(2, 0, 2)^T$.

► *The original secondary polytope:* There are exactly two triangulations of $\{0, 1, 2\}$, given by $T_1 = \{[0, 1], [1, 2]\}$ and $T_2 = \{[0, 2]\}$. The characteristic functions are given by

$$\begin{array}{lll} \phi_{T_1}(0) = 1, & \phi_{T_1}(1) = 2, & \phi_{T_1}(2) = 1, \\ \phi_{T_2}(0) = 2, & \phi_{T_2}(1) = 0, & \phi_{T_2}(2) = 2, \end{array}$$

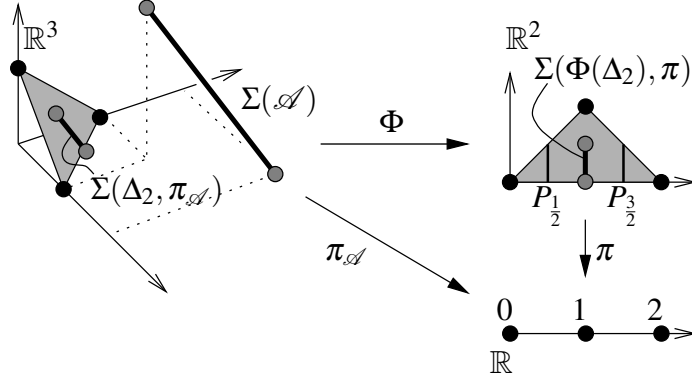
FIGURE 1.11: The secondary polytope of $\{0, 1, 2\} \subset \mathbb{R}$.

and their convex hull in \mathbb{R}^3 is (up to permutation of coordinates) again the segment spanned by $(1, 2, 1)^T$ and $(2, 0, 2)^T$.

► *The fiber polytope:* The projection $\pi_{\mathcal{A}} : \Delta_2 \rightarrow [0, 2]$ is given (up to permutation of coordinates) by

$$\pi_{\mathcal{A}}(1, 0, 0)^T := 0, \quad \pi_{\mathcal{A}}(0, 1, 0)^T := 1, \quad \pi_{\mathcal{A}}(0, 0, 1)^T := 2.$$

We perform the affine transformation Φ on Δ_{n-1} given by the linear transformation

$$\Phi' : \begin{cases} \mathbb{R}^3 \rightarrow \mathbb{R}^3, \\ x \mapsto \begin{pmatrix} 0 & 1 & 2 \\ 0 & 1 & 0 \\ 1 & 1 & 1 \end{pmatrix} \cdot x, \end{cases}$$

and by deleting the last (constant) coordinate. We obtain the polytope projection $\mathbb{R}^2 \supset \Phi(\Delta_2) \rightarrow [0, 2]$ given by

$$\pi(0, 0)^T := 0, \quad \pi(1, 1)^T := 1, \quad \pi(2, 0)^T := 2.$$

There are two facets in the chamber complex of this projection, namely the two segments $[0, 1]$ and $[1, 2]$. Their barycenters are $\frac{1}{2}$ and $\frac{3}{2}$, respectively. We have

$$P_{\frac{1}{2}} = [0, \frac{1}{2}] \times \frac{1}{2}, \quad P_{\frac{3}{2}} = [0, \frac{1}{2}] \times \frac{3}{2},$$

and hence we get the fiber polytope of $(\Phi(\Delta_{n-1}), \pi)$ as

$$\begin{aligned} \Sigma(\Phi(\Delta_{n-1}), \pi) &= \frac{1}{\text{vol}([0, 2])} \cdot (\text{vol}([0, 1]) \cdot ([0, \frac{1}{2}] \times \frac{1}{2}) + \text{vol}([1, 2]) \cdot ([0, \frac{1}{2}] \times \frac{3}{2})) \\ &= [0, \frac{1}{2}] \times 1. \end{aligned}$$

This polytope is transformed back by Φ^{-1} yielding

$$\Sigma(\Delta_{n-1}, \pi_{\mathcal{A}}) = \text{conv}\left\{\left(\frac{1}{4}, \frac{1}{2}, \frac{1}{4}\right)^T, \left(\frac{1}{2}, 0, \frac{1}{2}\right)^T\right\}.$$

After rescaling we get the result

$$\Sigma(\mathcal{A}) = 2 \cdot 2 \cdot \Sigma(\Delta_{n-1}, \pi_{\mathcal{A}}) = \text{conv}\{(1, 2, 1)^T, (2, 0, 2)^T\}.$$

CHAPTER 2

THE GENERALIZED BAUES CONJECTURE

Associated with every projection $\pi : P \rightarrow \pi(P)$ of a polytope P one has a partially ordered set of all “locally coherent strings”: the families of proper faces of P that project to valid subdivisions of $\pi(P)$, partially ordered by the natural inclusion relation.

The “Generalized Baues Conjecture” posed by Billera, Kapranov & Sturmfels [9] asked whether this partially ordered set always has the homotopy type of a sphere of dimension $\dim(P) - \dim(\pi(P)) - 1$. We show that this is true in the cases when $\dim(\pi(P)) = 1$ (see [9]) and when $\dim(P) - \dim(\pi(P)) \leq 2$, but fails in general.

For an explicit counterexample we produce a non-degenerate projection of a 5-dimensional, simplicial, 2-neighborly polytope P with 10 vertices and 42 facets to a hexagon $\pi(P) \subseteq \mathbb{R}^2$. The construction of the counterexample is motivated by a geometric analysis of the relation between the fibers in an arbitrary projection of polytopes.

This chapter is based on a joint work with ZIEGLER [61].

2.1 INTRODUCTION

In this chapter we study the poset $\omega(P, \pi)$ of all “locally coherent strings” (defined below) associated with a projection of a convex polytope. In particular, we prove a new special case of the Generalized Baues Conjecture about the homotopy type of this poset, and disprove the Conjecture by explicit counterexamples in the general case.

The investigation of the posets $\omega(P, \pi)$ is motivated by problems that are concerned with the global (topological) structure of a restricted set of subdivisions of a fixed compact space. Such problems appear in very different frameworks, among them

- model theory of loop spaces (see Section 1.2(d) and, e. g., the work by ADAMS [1] and BAUES [5]),
- spaces of triangulations of manifolds (see NABUTOVSKY [55] for recent work),

- triangulations of point configurations and local transformations (see Section 1.2(a) and, e. g., EDELSBRUNNER & SHAH [24] and JOE [38, 39]),
- extension spaces of oriented matroids (see Section 1.2(c) and STURMFELS & ZIEGLER [71]), and
- finite models of the finite-dimensional Grassmannians (see Section 1.2(d) and, e. g., MACPHERSON [47] and MNĚV & ZIEGLER [54]).

The Generalized Baues Conjecture, whose precise setting we now introduce, directly applies to several of the situations we have just listed, and provides a prototypical model for the others.

Let $\pi : P \rightarrow \pi(P)$ be a projection of polytopes. Here we assume that P is a d -polytope in \mathbb{R}^d , $\pi(P)$ is a d' -polytope in $\mathbb{R}^{d'}$, and $\pi : \mathbb{R}^d \rightarrow \mathbb{R}^{d'}$ is an affine map. If π maps more than one vertex of P to a single point in $\pi(P)$ we call π *degenerate*, while π is *weakly non-degenerate* otherwise. If each affine dependence between projections of vertices $\pi(v_1), \pi(v_2), \dots, \pi(v_k)$ is induced by an affine dependence between the vertices v_1, \dots, v_k in P , then we call π (*strongly*) *non-degenerate*. The main objects of study in this chapter are the following.

Definition 2.1.1. A *locally π -coherent string* — or a *locally coherent string* for short — is a collection \mathcal{F} of nontrivial faces of P (that is, faces different from P and from \emptyset), such that

- $\{\pi(F) : F \in \mathcal{F}\}$ is a polytopal subdivision of $\pi(P)$ without repetitions, that is, the sets $\pi(F)$ are distinct polytopes which form a polytopal complex with union $\pi(P)$, and
- $\pi(F) \subseteq \pi(F')$ implies $F = F' \cap \pi^{-1}(\pi(F))$, for $F, F' \in \mathcal{F}$.

The finite set of all locally π -coherent strings is partially ordered by

$$\mathcal{F} \leq \mathcal{F}' \quad : \iff \quad \bigcup \mathcal{F} \subseteq \bigcup \mathcal{F}'.$$

The resulting partially ordered set (poset) of locally π -coherent strings is denoted by $\omega(P, \pi)$. A string $\mathcal{F} \in \omega(P, \pi)$ is called

- *tight* if $\dim(\pi(F)) = \dim(F)$ for all $F \in \mathcal{F}$,
- *globally π -coherent* — or *coherent* for short — if there exists a linear functional $\psi \in (\mathbb{R}^d)^* \setminus \{0\}$ such that π can be factorized into

$$\pi : P \xrightarrow{(\pi, \psi)} \{(\pi(x), \psi(x)) : x \in P\} \xrightarrow{pr_1} \pi(P),$$

such that $(\pi, \psi)(\mathcal{F})$ is locally pr_1 -coherent. The subposet of all coherent strings is denoted by $\omega_{\text{coh}}(P, \pi) \subseteq \omega(P, \pi)$. \square

For part (a) of the following useful Lemma see ZIEGLER [75, Chapter 9]. Part (b) is an immediate consequence.

Lemma 2.1.2. (Properties of tight strings)

- (a) *A locally coherent string is minimal in $\omega(P, \pi(P))$ if and only if it is tight.*
- (b) *If a tight locally coherent string is maximal then it is an isolated element in $\omega(P, \pi(P))$.*

Definition 2.1.1 is equivalent to the definition of the set of all π -induced subdivisions of $\pi(P)$, denoted “ $\mathcal{S}(P, \pi(P))$,” and the set of all π -induced subdivisions of $\pi(P)$, denoted “ $\mathcal{S}_{\text{coh}}(P, \pi(P))$,” in the paper of BILLERA, KAPRANOV & STURMFELS [9] (see Section 1.1(b)). Since in general there may be many different locally π -coherent strings that determine the same polytopal subdivision of $\pi(P)$, we emphasize by our notation that one is dealing with objects in P rather than with subdivisions of $\pi(P)$.

BILLERA & STURMFELS [11] (see also ZIEGLER [75, Thm. 9.6]) showed that the subposet $\omega_{\text{coh}}(P, \pi)$ is isomorphic to the poset of proper faces of the *fiber polytope* $\Sigma(P, \pi)$ of the projection π , a convex polytope of dimension $d - d'$. Thus, the order complex (simplicial complex of chains, see Definition A.1.5) of $\omega_{\text{coh}}(P, \pi)$ is homeomorphic to a sphere of dimension $d - d' - 1$. In general, the poset $\omega(P, \pi)$ is strictly larger than $\omega_{\text{coh}}(P, \pi)$, and not homeomorphic to a sphere (see Figure 1.7). However, in 1980 BAUES conjectured in his work on a model theorem for loop spaces [5] (in somewhat different language) that for $d' = 1$ the poset $\omega(P, \pi)$ of all locally coherent strings is homotopy equivalent to the sphere S^{d-2} (see Conjecture 1.2.18). In 1991, Billera, Kapranov & Sturmfels extended this to the following conjecture.

Conjecture 2.1.3 (Generalized Baues Conjecture). (BILLERA, KAPRANOV & STURMFELS [9], see also [70, Sect. 5])

For every projection $\pi : P \rightarrow \pi(P)$ of a d -polytope $P \subseteq \mathbb{R}^d$ to a d' -polytope $\pi(P) \subseteq \mathbb{R}^{d'}$, the poset $\omega(P, \pi)$ of all locally π -coherent strings is homotopy equivalent to the $(d - d' - 1)$ -sphere.

Even stronger, $\omega_{\text{coh}}(P, \pi)$ is a retract of $\omega(P, \pi)$: the inclusion map

$$\omega_{\text{coh}}(P, \pi) \hookrightarrow \omega(P, \pi)$$

is a homotopy equivalence.

Even for projections of reasonably small and simple polytopes, the poset of all locally coherent strings can be large and complicated. Up to now, the main positive result motivating the Generalized Baues Conjecture was the following theorem, which settled the original conjecture by BAUES [5].

Theorem 2.1.4. (BILLERA, KAPRANOV & STURMFELS [9])

The Generalized Baues Conjecture holds for $d' \leq 1$.

Actually, in [9] this is formulated only for the case where the projection is non-degenerate. However, the proof can be extended to the general case without greater difficulty.

Theorem 2.1.5. (Partial results for special polytopes P)

- *If P is a simplex and $\dim(\pi(P)) \leq 2$, then the Generalized Baues Conjecture holds ([9], a proof was recently presented by EDELMAN & REINER in [22]).*
- *If P is a hypercube and $\dim(\pi(P)) \leq 2$ or $\dim(P) - \dim(\pi(P)) \leq 3$, then the Generalized Baues Conjecture holds (see STURMFELS & ZIEGLER [71]).*

We refer to BJÖRNER [14], BILLERA & STURMFELS [11], STURMFELS [70], and MNĚV & ZIEGLER [54] for related discussions. Our main positive result is the following special case.

Theorem 2.1.6. *The Generalized Baues Conjecture holds for $d - d' \leq 2$.*

After preliminary work on the structure of locally coherent strings (including a characterization theorem in terms of functions on the chamber complex) in Section 2.2, we will prove Theorem 2.1.6 in Section 2.3.

Theorem 2.1.7. *The Generalized Baues Conjecture is false in general for $d' \geq 2$ and $d - d' \geq 3$.*

In Section 2.4 we present a construction method for polytope projections that have isolated elements in their posets of all locally coherent strings, thus proving Theorem 2.1.7. In order to provide more geometric and combinatorial intuition for “what goes wrong here,” we present explicit coordinates for two counterexamples in Section 2.5, together with simple, independent proofs that these polytope projections violate the Generalized Baues Conjecture. These proofs depend on “hands-on” knowledge of the face lattices of the polytopes, as can be obtained from Fourier-Motzkin elimination (or any similar convex hull algorithm).

The first example is one special instance of the construction method of Section 2.4. It is an extremely degenerate projection $\pi^{\text{deg}} : P^{\text{deg}} \rightarrow \pi(P^{\text{deg}}) =: Q^{\text{deg}}$, where P^{deg} is a 5-polytope with 10 vertices and 36 facets and Q^{deg} is a triangle. Each vertex of P^{deg} is projected by π^{deg} either to a vertex or to the center of the triangle Q^{deg} . In this case $\omega(P^{\text{deg}}, \pi^{\text{deg}})$ has an isolated element.

The second example — obtained by perturbation of the vertices of the first — is a strongly non-degenerate projection $\pi : P \rightarrow \pi(P) =: Q$, where P is a 2-neighborly, simplicial 5-polytope with 10 vertices and 42(!) facets, and Q is a

hexagon. Here $\omega(P, \pi)$ is disconnected: the locally coherent strings of one connected component all have three special 2-faces of P in common.

By Theorems 2.1.4 and 2.1.6, these counterexamples have both minimal dimension and codimension. They easily imply that the Generalized Baues Conjecture also fails in any higher dimension and codimension.

The most interesting cases of the Generalized Baues Conjecture that remain open are the following:

- P is a simplex, and $\dim(\pi(P)) > 2$
(directly relevant for triangulations and their local transformations),
- P is a hypercube, for $\dim(\pi(P)) > 2$ and $\dim(P) - \dim(\pi(P)) > 3$
(important for extension spaces of oriented matroids).

2.2 FUNCTIONS ON THE CHAMBER COMPLEX

In this section we point out two crucial facts. The first one describes a basic property of the chamber complex of a polytope projection, the second one is a “local coherence condition” in terms of the normal fans of the fibers of the projection.

Given any linear or affine function ψ on a space that contains the polytope P , we use P^ψ to denote the set of all points in P on which ψ is maximal. This set P^ψ is a *face* of P , and all nonempty faces of P have this form ($\psi = 0$ corresponds to P itself). We use $L(P)$ to denote the *face lattice* of P : the set of all faces of $P \subseteq \mathbb{R}^d$, partially ordered by inclusion. This includes the *trivial faces* \emptyset and P .

For a polytope projection $\pi : P \rightarrow \pi(P) =: Q$ as above, the *chamber complex* Γ is the set of intersections of all images of faces of P that contain a given point in Q , that is,

$$\Gamma := \{ \sigma(q) : q \in Q \},$$

where

$$\sigma(q) := \bigcap \{ \pi(F) : q \in \pi(F), F \in L(P) \}$$

is the *chamber* of $q \in Q$. (It can be shown that Γ is a polytopal complex subdividing Q . The chamber complex Γ is the common refinement of all π -coherent subdivisions of Q , and therefore shellable.)

There is no loss of generality if we assume from now on that the projection map $\pi : \mathbb{R}^d \rightarrow \mathbb{R}^{d'}$ is the restriction to the last d' coordinates. For any $q \in Q$, the *fiber* of q is the polytope

$$P_q := \left\{ x \in \mathbb{R}^{d-d'} : (x, q) \in P \right\}.$$

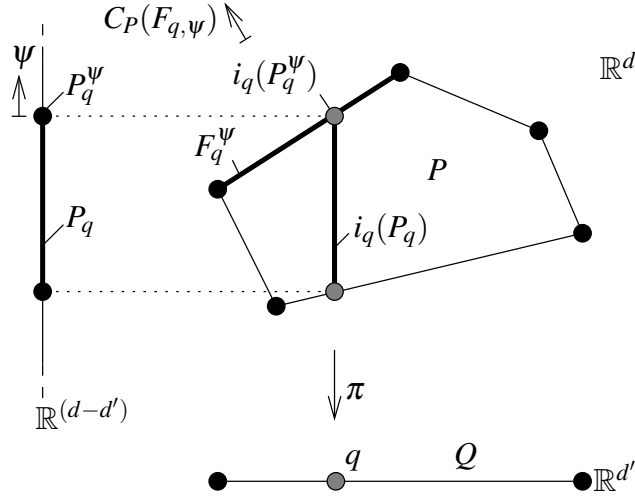

FIGURE 2.1: The face $F_{q, \psi}$ induced by $\psi \in (\mathbb{R}^{d-d'})^*$.

Thus, we consider the fibers as full-dimensional polytopes P_q in the (fixed) vector space $\mathbb{R}^{d-d'}$ (compare Section 1.1(b), where the fibers are considered as subsets of \mathbb{R}^d). Whenever we need to interpret a fiber as a subset of \mathbb{R}^d we write $i_q(P_q)$, where $i_q(x) := (x, q) \in \mathbb{R}^d$. The (surjective) map $i_q^* : (\mathbb{R}^d)^* \rightarrow (\mathbb{R}^{d-d'})^*$ is as usual defined by $i_q^*(\alpha)(x) := \alpha(i_q(x)) = \alpha(x, q)$.

The nonempty faces of the fibers P_q can be represented in the form P_q^ψ , where ψ is a linear functional $\psi \in (\mathbb{R}^{d-d'})^*$. Now, if P_q^ψ is any nonempty face of a fiber P_q , then we use $[\psi]$ to denote the (closed, polyhedral) cone in $(\mathbb{R}^{d-d'})^*$ of all linear functions that are maximal on the face P_q^ψ of P_q . This set $[\psi]$ is the *normal cone* of the face P_q^ψ . If q' is another point that lies in the relative interior of the same chamber of the chamber complex as p , then the normal cones of the face P_q^ψ of P_q and $P_{q'}^\psi$ of $P_{q'}$ coincide. (That is, the fibers P_q and $P_{q'}$ are *normally equivalent*, see, e. g., BILLERA & STURMFELS [11].) Thus, we can use the notation $[\psi]_\sigma$ for the normal cone of the face that ψ defines in the fiber, called the *normal cone over σ induced by ψ* . Moreover, let $N(\sigma)$ denote the fan consisting of all normal cones over σ , the *normal fan over σ* (that is, the normal fan of the fiber over a point in the relative interior of σ).

For each face P_q^ψ of a fiber P_q , there is a unique minimal face of P that contains P_q^ψ (the intersection of all faces that contain P_q^ψ). We use $F_{q, \psi}$ to denote this face of P corresponding to the face P_q^ψ of P_q . For its normal cone in $(\mathbb{R}^d)^*$ we use the notation $C_P(F_{q, \psi})$. Figure 2.1 depicts the situation for $d = 2$ and $d' = 1$.

The following Lemma collects the elementary basic facts.

Lemma 2.2.1. (Elementary Facts)

The faces of the polytope P , of the fibers P_q , and the chambers $\sigma \in \Gamma$, are related as follows.

(i) The chamber of $q \in Q$ is given by

$$\sigma(q) = \bigcap_{\psi \in (\mathbb{R}^{d-d'})^*} \pi(F_{q,\psi}).$$

(ii) For all $q \in Q$ and $\psi, \psi' \in (\mathbb{R}^{d-d'})^*$,

$$P_q^\psi < P_q^{\psi'} \iff F_{q,\psi} < F_{q,\psi'}$$

(iii) For all $q, q' \in Q$ and $\psi \in (\mathbb{R}^{d-d'})^*$,

$$\begin{aligned} q' \in \text{relint } \pi(F_{q,\psi}) &\implies F_{q',\psi} = F_{q,\psi}, \\ q' \in \partial \pi(F_{q,\psi}) &\implies F_{q',\psi} \subset F_{q,\psi}, \\ \pi(F_{q',\psi}) \subset \pi(F_{q,\psi}) &\iff F_{q',\psi} \subset F_{q,\psi}, \\ \pi(F_{q_1,\psi} \cap \dots \cap F_{q_k,\psi}) &= \pi(F_{q_1,\psi}) \cap \dots \cap \pi(F_{q_k,\psi}). \end{aligned}$$

(iv) Let $q' \in \sigma(q)$, $q \in Q$, $x \in P_q^\psi$, $x' \in P_{q'}^\psi$ and $\alpha \in C_P(F_{q,\psi})$. Then

$$i_{q'}^*(\alpha)(x') = i_q^*(\alpha)(x).$$

(v) The normal cone $C_P(F_{q,\psi})$ of $F_{q,\psi}$ in $(\mathbb{R}^d)^*$ is mapped by i_q^* onto the normal cone of P_q^ψ in $(\mathbb{R}^{d-d'})^*$.

(vi) For each face F of P , there exist $q \in Q$ and $\psi \in (\mathbb{R}^{d-d'})^*$ such that

$$F = F_{q,\psi}.$$

As a corollary of (iii), we get that, if ψ is fixed, the face $F_{q,\psi}$ does not change if q moves in the relative interior of the chamber $\sigma(q)$. Hence, with each chamber σ and each functional ψ we can associate a well-defined face of P , via

$$F_{\sigma,\psi} := F_{q,\psi}, \quad q \in \text{relint}(\sigma).$$

The following ‘‘normal fan relation’’ of the chamber complex was used in the special case $d' = 1$ by BILLERA, KAPRANOV & STURMFELS [9] in their proof of the Baues Conjecture. Here we state its general validity.

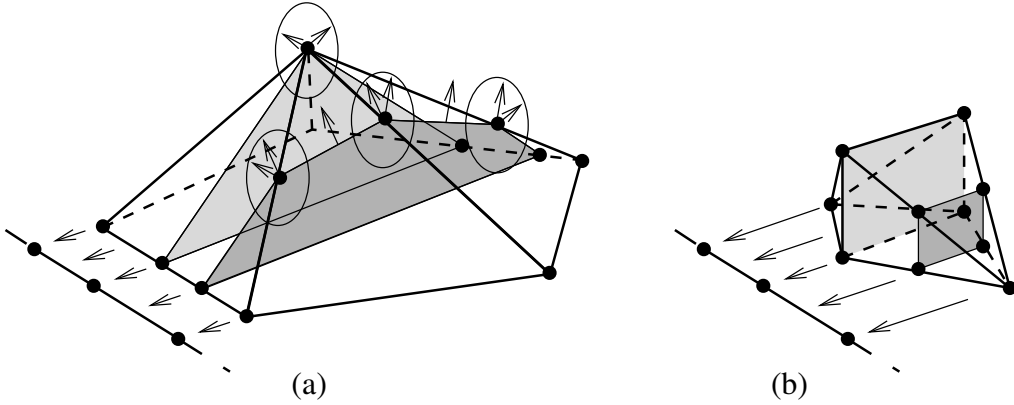

FIGURE 2.2: The normal fan relation.

Lemma 2.2.2. *If τ is a face of σ in the chamber complex Γ , then for each $\psi \in (\mathbb{R}^{d-d'})^*$ the normal cone over τ defined by ψ is contained in the corresponding normal cone over σ :*

$$\tau < \sigma \in \Gamma \implies [\psi]_\sigma \subseteq [\psi]_\tau.$$

Hence, the normal fan over σ is a refinement of the normal fan over τ :

$$N(\sigma) \preceq N(\tau).$$

Proof. Let $\phi = i_q^*(\alpha)$ be a linear functional on $(\mathbb{R}^{d-d'})^*$ in $[\psi]_\sigma$ with $q \in \text{relint}(\sigma)$ and some α in the normal cone $C_P(F_{\sigma,\psi})$ of $F_{\sigma,\psi}$ in P by Lemma 2.2.1(v). Then

$$\phi = i_q^*(\alpha) \in i_q^*(C_P(F_{\sigma,\psi})).$$

But this is contained in $i_{q'}^*(C_P(F_{\sigma,\psi}))$ for each $q' \in \sigma$ (Lemma 2.2.1(iv)), especially for $q' \in \tau$.

We know from Lemma 2.2.1(iii) that if τ is a face of σ then $F_{\tau,\psi}$ is a (not necessarily proper) face of $F_{\sigma,\psi}$ for all $\psi \in (\mathbb{R}^{d-d'})^*$. Hence, from Lemma 2.2.1(v) we derive

$$i_{q'}^*(C_P(F_{\sigma,\psi})) \subseteq i_{q'}^*(C_P(F_{\tau,\psi})) = [\psi]_\tau,$$

which completes the proof. \square

Remark 2.2.3. In general we cannot expect a strict refinement (see Figure 2.2(b)), because the map $i_{q'}^*$ does not preserve strict inclusions if the projection is degenerate. But if we restrict ourselves to non-degenerate projections then the cone inclusion has to be proper for at least one $\psi \in (\mathbb{R}^{d-d'})^*$, and therefore the fan refinement is strict. \square

The following proposition describes the relations between the fibers over adjacent chambers even metrically.

Proposition 2.2.4. *Let $\sigma \in \Gamma$ be a chamber with vertices v_1, \dots, v_k and*

$$q = \sum_{i=1}^k \lambda_i v_i$$

with $\lambda_i \geq 0$ and $\sum_{i=1}^k \lambda_i = 1$.

Then P_q is the Minkowski sum of the fibers over the vertices of σ , scaled as in the representation of q in σ ,

$$P_q = \sum_{i=1}^k \lambda_i P_{v_i}.$$

Proof. Consider the polytope projection

$$\pi_\sigma : P_\sigma := \pi^{-1}(\sigma) \rightarrow \sigma.$$

In this special case the fiber over each vertex v_i of σ is the convex hull of vertices $v_{i,1}, \dots, v_{i,l(i)}$ of P_σ and these are the only vertices of P_σ . This yields the claim after a straightforward computation. \square

Corollary 2.2.5. *The normal fan over the relative interior of a chamber $\sigma \in \Gamma$ is exactly the common refinement of the normal fans over the faces of σ .* \square

Any locally coherent string can be interpreted as a function which associates a face of P_q to every point $q \in Q$ in some “locally coherent” way. This selection must be constant (in the sense that the same face $F_{\sigma, \psi}$ is chosen) in the relative interior of every chamber. No locally coherent string can contain a whole d' -dimensional fiber P_q for some $q \in Q$, because this would imply that P itself is contained in that string. Complete fibers P_q of dimension smaller than d' — e. g., for q in the boundary of Q — can always be expressed by non-zero normal vectors. (For example, if a fiber consists only of one vertex any non-zero vector will do the job.) Hence, we will interpret the selection functions as functions from Γ to $S^{d-d'-1}$, where $\psi_\sigma \in S^{d-d'-1}$ induces a face of a fiber over σ — which is a proper one whenever the fiber is full-dimensional — and therefore a proper face of P .

The following criterion (see BILLERA, KAPRANOV & STURMFELS [9] for the case $d' = 1$) describes the admissible selection functions in terms of normal cones.

Proposition 2.2.6. (Cone Condition)

A function

$$\psi : \begin{cases} \Gamma & \rightarrow S^{d-d'-1} \\ \sigma & \mapsto \psi_\sigma \end{cases}$$

defines a locally π -coherent string of Q via

$$\mathcal{F}(\psi) := \{ F_{\sigma, \psi_{\sigma}} : \sigma \in \Gamma \}$$

if and only if for all $\sigma, \tau \in \Gamma$ with $\tau < \sigma$ one has

$$\text{relint}[\psi_{\sigma}]_{\sigma} \subseteq \text{relint}[\psi_{\tau}]_{\tau}.$$

Furthermore, every locally coherent string arises from a selection function ψ in this way. Two functions ψ and ψ' define the same string, $\mathcal{F}(\psi) = \mathcal{F}(\psi')$, if and only if $[\psi_{\sigma}]_{\sigma} = [\psi'_{\sigma}]_{\sigma}$ holds for all $\sigma \in \Gamma$. \square

The proof is a careful check of definitions, where Lemma 2.2.1 yields the necessary details.

Definition 2.2.7. A function ψ as in Proposition 2.2.6 is called *locally coherent*. Two functions ψ, ψ' are *equivalent* if they define the same locally coherent string. In this case we write

$$[\psi] = [\psi']$$

for their equivalence class. \square

Because of Lemma 2.2.2 the crucial function values are just those over the chambers of maximal dimension.

Proposition 2.2.8. (Pairwise Cone Condition)

The cone condition in Proposition 2.2.6 is equivalent to the following:

$$[\psi_{\sigma_1}]_{\sigma_1 \cap \sigma_2} = [\psi_{\sigma_2}]_{\sigma_1 \cap \sigma_2}$$

for all d' -dimensional chambers $\sigma_1, \sigma_2 \in \Gamma$ such that $\sigma_1 \cap \sigma_2 \neq \emptyset$. Any function that respects the pairwise cone condition for the chambers of dimension d' can be completed to a locally coherent function. \square

Figure 2.3 illustrates Propositions 2.2.6 and 2.2.8 for the situation $d = 3$ and $d' = 1$: A choice of 1 over σ_2 and 5 over σ_3 is locally coherent and would imply the choice of 3 over σ_{23} . If 2 is chosen over σ_2 then 5 is not a consistent choice over σ_3 . However, in this case 6 or 7 are “good choices” over σ_3 — with respect to the pairwise cone condition — which both determine 4 over σ_{23} . Observe that for example the open normal cone at 6 is the intersection of the open normal cones at 8 and 4 (compare Corollary 2.2.5).

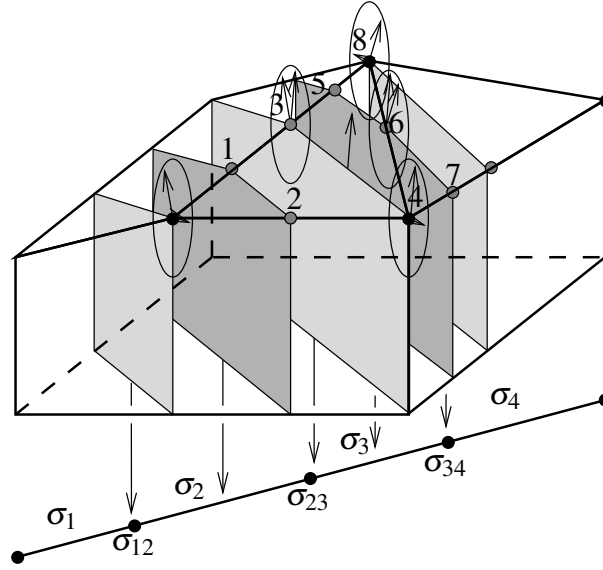

FIGURE 2.3: The pairwise cone condition.

2.3 VALIDITY IN LOW CODIMENSION

In this section we prove Theorem 2.1.6, by presenting an explicit retraction of the following models of the order complexes of $\omega(P, \pi)$ and $\omega_{\text{coh}}(P, \pi)$, namely

$$\Omega = \{ \psi \in (S^1)^\Gamma : [\psi_\sigma]_\tau = [\psi_\tau]_\tau \text{ for all } \tau \leq \sigma \in \Gamma \},$$

and

$$\Omega_{\text{coh}} = \{ \psi \in (S^1)^\Gamma : \psi_\sigma = \psi_\tau \text{ for all } \tau, \sigma \in \Gamma \}.$$

The topology of the order complexes coincides with the topology induced by the canonical metric on $\Omega, \Omega_{\text{coh}} \subseteq (S^1)^\Gamma$, induced from $(S^1)^\Gamma$ viewed as a product of copies of the metric space S^1 (see Section A.2).

Let $\sigma \in \Gamma$. From now on we call two values ψ_1 and ψ_2 in S^1 *locally coherent with respect to σ* , if

$$[\psi_1]_\sigma = [\psi_2]_\sigma.$$

A function

$$\psi : \Gamma \rightarrow S^1$$

defines a locally coherent string if and only if all function values of intersecting chambers are pairwise locally coherent with respect to the intersection of their preimages. (This is the pairwise cone condition of Proposition 2.2.8.)

The crucial observation for the situation in codimension 2 is that the local coherence property reduces to a distance property for function values in the universal cover of S^1 : if we replace two locally coherent function values by values in the closed interval they span, then they stay locally coherent. In higher codimension this fails in general.

Proof of Theorem 2.1.6. We proceed in seven steps.

Step 1: From now on we write q_σ for the *barycenter* of the chamber $\sigma \in \Gamma$. For a function

$$\psi : \begin{cases} \Gamma & \rightarrow S^1 \\ \sigma & \mapsto \psi_\sigma \end{cases}$$

that defines a locally coherent string, let

$$\widehat{\psi} : Q \rightarrow S^1$$

be the unique piecewise linear function on Q with

$$\widehat{\psi}(q_\sigma) = \psi_\sigma$$

for all chambers $\sigma \in \Gamma$. Here “piecewise linear” means that whenever q is in the simplex spanned by the barycenters of the chambers σ_i , $i = 1, \dots, k$, with barycentric coordinates $\lambda_1, \dots, \lambda_k \geq 0$ and $\sum_{i=1}^k \lambda_i = 1$, its function value is given by

$$\widehat{\psi}(q) = \frac{\sum_{i=1}^k \lambda_i \widehat{\psi}(q_{\sigma_i})}{\|\sum_{i=1}^k \lambda_i \widehat{\psi}(q_{\sigma_i})\|}.$$

This yields a well-defined continuous function: the function ψ defines a locally coherent string and thus the function values on pairwise adjacent chambers lie inside some open hemisphere in S^1 (see Corollary 2.2.5).

Step 2: For the rest of the proof, let σ_0 be a fixed chamber of Γ , let $\psi : \Gamma \rightarrow S^1$ be a locally coherent function, and $\psi_0 := \psi_{\sigma_0}$ its value for σ_0 . For $\lambda \in S^1$, let

$$\Phi_\lambda : \begin{cases} \{z \in \mathbb{C} : \|z\| = 1\} & \rightarrow S^1 \\ 1 & \mapsto \lambda \end{cases}$$

be an isometry that coordinatizes S^1 . Let

$$w : [0, 1] \rightarrow Q$$

be a path in Q that starts at q_{σ_0} . Then

$$\widehat{\psi}_*(w) : \begin{cases} [0, 1] & \rightarrow S^1 \\ t & \mapsto (\widehat{\psi} \circ w)(t) \end{cases}$$

is a path in S^1 that starts at ψ_0 .

Step 3: Let

$$p : \begin{cases} \mathbb{R} & \rightarrow \{z \in \mathbb{C} : \|z\| = 1\} \\ t & \mapsto \exp(2\pi it) \end{cases}$$

be the universal covering of $\{z \in \mathbb{C} : \|z\| = 1\}$ and let

$$p_\lambda : \begin{cases} \mathbb{R} & \rightarrow S^1 \\ t & \mapsto (\Phi_\lambda \circ p)(t) \end{cases}$$

be the universal covering of S^1 where the parameter λ describes different coordinate systems on S^1 . For a path

$$u : [0, 1] \rightarrow S^1$$

with $u(0) = \lambda$, let

$$L_\lambda(u) := L_{p_\lambda}(u, 0) : [0, 1] \rightarrow \mathbb{R}$$

be its lifting with $L_\lambda(u)(0) = 0$. We know from the theory of coverings that liftings of paths that are homotopic relative $\partial[0, 1]$ have the same endpoint.

Step 4: We will now lift the “distance” between the considered function values to \mathbb{R} in order to get maximum and minimum values.

Definition 2.3.1. We define the *twist of ψ* to be the following function:

$$twist_\psi : \begin{cases} \Gamma & \rightarrow \mathbb{R} \\ \sigma & \mapsto L_{\psi_0}(\widehat{\psi}_*)(w)(1), \end{cases}$$

where $w : [0, 1] \rightarrow Q$ is a path from q_{σ_0} to q_σ . □

In other words: coordinatize S^1 properly, take a path from the barycenter of σ_0 to the barycenter of σ , consider the corresponding path induced by the piecewise linear extension $\widehat{\psi}$ of ψ , and take the endpoint of its lifting to \mathbb{R} . This is well-defined by step 3 because all paths in Q are homotopic. From the definition we get that $twist_\psi(\sigma_0) = 0$. Figure 2.4 shows the twist of the chamber σ .

A locally coherent string is globally coherent if and only if it can be described by a function ψ with $twist_\psi(\Gamma) = \{0\}$. In addition we have $p_{\psi_0} \circ twist_\psi = \widehat{\psi}$, which makes it possible to recover the function ψ from its twist or to define a new function ψ' by simply changing the twist of ψ (with twist of σ_0 unchanged) and projecting it via p_{ψ_0} .

Step 5: The following lemma shows that local coherence in this special case is preserved under “pushing together” lifted function values — this is the crucial point that cannot be generalized to higher codimension.

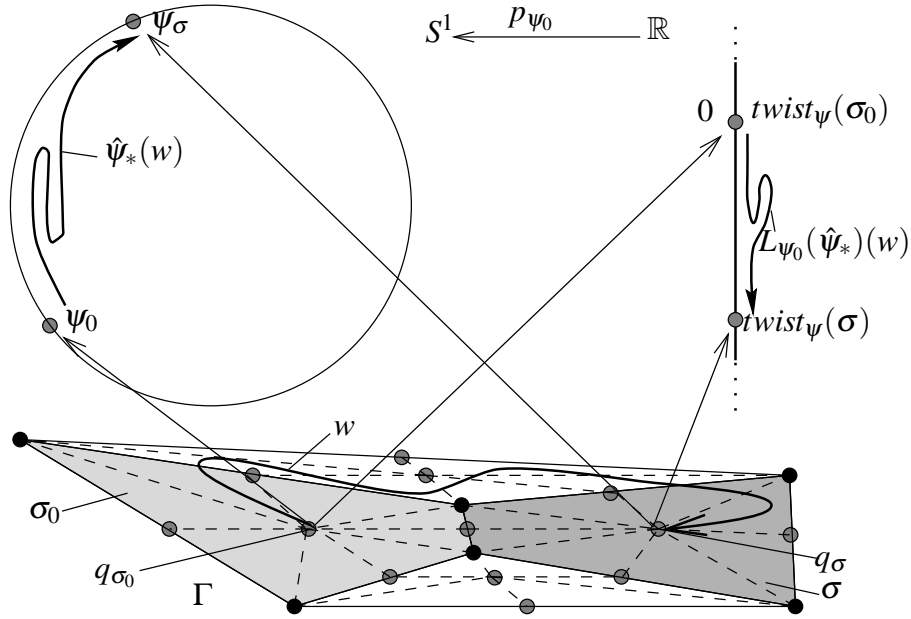
FIGURE 2.4: The twist of σ .

Lemma 2.3.2. *Let $\psi : \Gamma \rightarrow S^1$ be a locally coherent function, in particular, ψ_{σ_1} , $\psi_{\sigma_{12}}$, and ψ_{σ_2} are pairwise locally coherent with respect to $\sigma_{12} := \sigma_1 \cap \sigma_2$. Without loss of generality, let $\text{twist}_\psi(\sigma_1) < \text{twist}_\psi(\sigma_2)$. Then each pair of values ψ_1, ψ_2 contained in the arc*

$$p_{\psi_0}([\text{twist}_\psi(\sigma_1), \text{twist}_\psi(\sigma_2)]) \subset S^1$$

is locally coherent with respect to σ_{12} as well. \square

Proof. Let $w_{0,1} : [0, 1] \rightarrow Q$ be an arbitrary path from q_{σ_0} to q_{σ_1} . Moreover, let $w_{1,2} : [0, 1] \rightarrow Q$ be the polygonal path (this is the reason why we defined the twist via paths rather than via straight lines!) which leads straight from q_{σ_1} to $q_{\sigma_{12}}$ and then straight from $q_{\sigma_{12}}$ to q_{σ_2} . (The following will not depend on the parametrization.) Because of local coherence over σ_{12} , we have

$$\begin{aligned} \psi_{\sigma_1} &\in \text{relint}[\psi_{\sigma_{12}}]_{\sigma_{12}}, \\ \psi_{\sigma_2} &\in \text{relint}[\psi_{\sigma_{12}}]_{\sigma_{12}}, \\ \psi_{\sigma_{12}} &\in \text{relint}[\psi_{\sigma_{12}}]_{\sigma_{12}}. \end{aligned}$$

By definition, each q on the straight line from q_{σ_1} to $q_{\sigma_{12}}$ is mapped by $\widehat{\psi}$ to a point between $\widehat{\psi}(q_{\sigma_1}) = \psi_{\sigma_1}$ and $\widehat{\psi}(q_{\sigma_{12}}) = \psi_{\sigma_{12}}$. (“Between” is well-defined because all these points lie in the same pointed cone $[\psi_{\sigma_{12}}]_{\sigma_{12}}$.) Analogously, each q

on the straight line from $q_{\sigma_{12}}$ to q_{σ_2} is mapped by $\widehat{\psi}$ to a point between $\widehat{\psi}(q_{\sigma_{12}}) = \psi_{\sigma_{12}}$ and $\widehat{\psi}(q_{\sigma_2}) = \psi_{\sigma_2}$.

Hence, we get

$$\widehat{\psi}_*(w_{1,2})(t) \in \text{relint}[\psi_{\sigma_{12}}]_{\sigma_{12}} \quad \text{for all } t \in [0, 1].$$

Therefore, if we compute the twist of ψ_1 and ψ_2 using the paths $w_{0,1}$ and $w_{0,1} \cdot w_{1,2}$ (the concatenation of $w_{0,1}$ and $w_{1,2}$), we get that all values in the interval $[twist_{\psi}(\sigma_1), twist_{\psi}(\sigma_2)]$ project into the open cone $\text{relint}[\psi_{\sigma_{12}}]_{\sigma_{12}}$, and hence produce local coherent pairs. \square

If a twist is extremal, then there is only one direction in \mathbb{R} with other twist values. That means we can “retwist” all chambers that yield this extremal value until their twist meets the next occurring different twist. So at the next step we will introduce a “twist cutoff” homotopy.

Step 6: Let $M(\psi)$ be the maximum of all absolute values of ψ -twists taken over all chambers $\sigma \in \Gamma$. Define

$$twist_{\psi}(\sigma, t) : \begin{cases} \Gamma \times [0, 1] & \rightarrow \mathbb{R} \\ (\sigma, t) & \mapsto \max\{\min\{twist_{\psi}(\sigma), tM(\psi)\}, -tM(\psi)\}. \end{cases}$$

Step 7: Now we are in position to define the final “retwist”-homotopy. Let

$$\psi_t : \begin{cases} \Gamma & \rightarrow S^1 \\ \sigma & \mapsto p_{\psi_0}(twist_{\psi}(\sigma, t)). \end{cases}$$

Then $\psi_1(\sigma) = \psi_{\sigma}$ and $\psi_0(\sigma) = \psi_0$ for all $\sigma \in \Gamma$. Hence, $\psi_1 = \psi \in \Omega$ and $\psi_0 \in \Omega_{\text{coh}}$. This yields the desired retraction

$$H : \begin{cases} \Omega \times [0, 1] & \rightarrow S^1 \\ (\psi, t) & \mapsto \psi_t \end{cases}$$

with

$$H(\Omega, 1) = \text{id}_{\Omega} \quad \text{and} \quad H(\Omega, 0) = \Omega_{\text{coh}}.$$

This retraction is continuous in t by definition. It is continuous in ψ because it contracts distances between all functions ψ_1 and ψ_2 in $(S^1)^{\Gamma}$ according to the maximum metric d , whenever

$$d(\psi_1, \psi_2) < \delta \quad \text{with} \quad \delta := 2 - \max\{d([\psi]_{\sigma}) : \psi \in (S^1)^{\Gamma}, \sigma \in \Gamma\} > 0.$$

Since the diameter $d((S^1)^{\Gamma})$ of $(S^1)^{\Gamma}$ is bounded by 2, we are done by Corollary A.2.4. \square

This proof and the proof of Theorem 2.1.4 in the paper of BILLERA, KAPRANOV & STURMFELS [9] suggest a duality between the geometric situations in the case $\dim(Q) = 1$ and the case $\dim(P) - \dim(Q) = 2$, as one would expect from an oriented matroid perspective (see also BILLERA, GELFAND & STURMFELS [8]):

- In the case of dimension 1 the polytope Q is linearly ordered and therefore has a “maximum chamber” with local coherence condition only in one direction. The retraction can start at this chamber moving its function value to that of the next adjacent chamber, no matter what the dimension of the image sphere is.
- In the case of codimension 2 the chambers can yield a very complicated structure of local coherence conditions between their function values, but in this case the lifting of the image of this structure can be retracted in \mathbb{R} easily starting from its boundary, i. e., from the extremal values.

Analysis of the key points in the proof of Theorem 2.1.6 also led us to the crucial structures for the counterexamples in Sections 2.4 and 2.5.

2.4 HOW TO CONSTRUCT A COUNTEREXAMPLE

In this section we introduce the main idea for the construction of a counterexample in dimension $\dim(Q) = 2$ and codimension $\dim(P) - \dim(Q) = 3$. We start with a configuration of three two-dimensional chambers $\sigma_1, \sigma_2, \sigma_3$ that form a subdivision Γ of Q (see Figure 2.5(a)). The corresponding edges in the boundary of Q are τ_1, τ_2 , and τ_3 . We denote $\sigma_i \cap \sigma_j$ by σ_{ij} , and thus the inner vertex $\sigma_1 \cap \sigma_2 \cap \sigma_3$ by σ_{123} . Analogously, we set $\tau_i \cap \tau_j =: \tau_{ij}$.

We want to construct functions $\psi : \Gamma \rightarrow S^2$ that satisfy the “local coherence condition” (Proposition 2.2.6) with respect to the fiber structure of some polytope projection. First we assign to each σ_i a fixed value ψ_{σ_i} in S^2 such that the cone spanned by the ψ_{σ_i} in $(\mathbb{R}^3)^*$ is full-dimensional. Since ψ ought to be locally coherent, this leads to several restrictions on the possible structures of the normal fans over the chambers.

There is a consistent choice for $\psi_{\sigma_{12}}$ only if ψ_{σ_1} and ψ_{σ_2} lie in the same open cone of the normal fan over $\text{relint}(\sigma_{12})$. In general, this open cone (which describes the correct selections for $\psi_{\sigma_{12}}$) does not contain ψ_{σ_3} . These cones are the crucial ones because for local coherence at the inner vertex σ_{123} , we just have to choose a vector in the open cone of the normal fan over σ_{123} that contains the rest of the configuration, which is always possible (see Lemma 2.2.2). The generic topological picture of the situation in the sphere S^2 is as in Figure 2.5(b), which is a superposition of cones from the normal fans over σ_{ij} and σ_{123} .

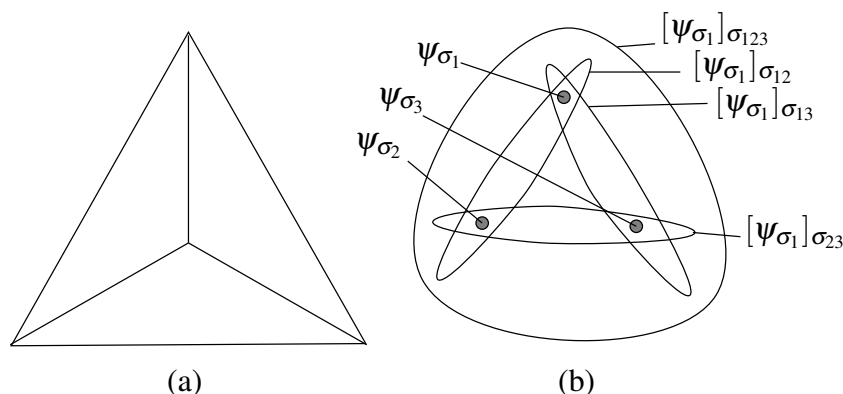

FIGURE 2.5: A simple chamber complex (a) and a sketch for a possible “locally coherent” choice of function values on this complex (b).

If the vectors ψ_{σ_i} are in general position with respect to some fiber structure, then the locally π -coherent string \mathcal{F}_0 they determine in a polytope projection that induces this fiber structure is tight. In the following we describe what “has to go wrong” to get a fiber structure in which this tight string is not dominated by a non-tight string $\mathcal{F} > \mathcal{F}_0$. (In this case the tight string *is stuck*: this is the situation of Lemma 2.1.2(b)).

To get from \mathcal{F}_0 to \mathcal{F} , we have to move at least one of the vectors ψ_{σ_i} to a more special position, that is, to the boundary of the normal cone it lies in. One can now see that for every movement of a function value of a maximal chamber — say ψ_{σ_1} — to a face of the normal cone associated with an edge, say $\psi_{\sigma_{12}}$, requires a movement of the other normal vector — here ψ_{σ_2} — contained in that cone to the *same* face in order to stay locally coherent.

The idea is now to produce a configuration of normal cones of the fibers such that for each cone corresponding to the starting values of the function ψ no face is reachable by both the function values of the maximal chambers in a way such that the intermediate functions stay locally coherent.

Consider the “basket ball” with three segments in Figure 2.6(a): the normal fan of a triangle in \mathbb{R}^3 intersected with the 2-sphere. We take three perturbed copies of this configuration such that the superposition locally looks as in Figure 2.6(b). The rounded triangle bounding the configuration sketches the normal cone of ψ_{σ_1} over σ_{123} (its exact shape is not important, it could have, for example, more than 6 extremal rays). Together with the three basket balls it provides the three triangular “prisons” which the function values are placed into. These function values are pairwise locally coherent because ψ_{σ_1} and ψ_{σ_2} lie in the same cone $[\psi_{\sigma_1}]_{\sigma_{12}}$ over

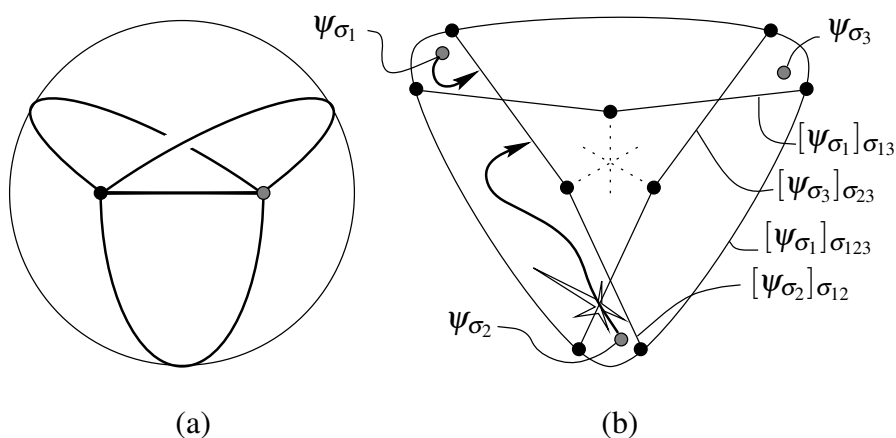

FIGURE 2.6: The “basket ball obstruction.”

σ_{12} , and so on. There is no possibility to push the function values to more special position without violating the pairwise cone condition.

Assume, without loss of generality, ψ_{σ_1} moves to a face of $[\psi_{\sigma_1}]_{\sigma_{12}}$ while no other function value has reached a more special position earlier. Then ψ_{σ_2} has to move to the same face at the same moment — but then it must have passed over a face of $[\psi_{\sigma_3}]_{\sigma_{23}}$ in the meantime: a contradiction (see the “funny star-like thing,” a flash where the contradiction occurs, in Figure 2.6(b)).

In the same manner all possibilities of moving function values over the 2-chambers fail. Hence, this provides an obstruction for homotopies on the starting function ψ which we call the *basket ball obstruction*.

The configuration of Figure 2.6 is realized by the following innocent-looking construction that is illustrated in Figure 2.7.

- Let $\pi : \mathbb{R}^5 \rightarrow \mathbb{R}^2$ be the projection to the last two coordinates.
- Put three triangles into \mathbb{R}^5 in the following way: each triangle projects down to one vertex of the triangle Q , such that the superposition of their normal fans in \mathbb{R}^3 (basket balls!) locally looks like the configuration inside $[\psi_1]_{\sigma_{123}}$ in Figure 2.6(b) — the *local* basket ball obstruction.
- Let $\widetilde{P^{\text{deg}}}$ be their convex hull in \mathbb{R}^5 . At this point the normal fan over σ_{123} is the common refinement of the three basket balls (Corollary 2.2.5).
- Position a single vertex into \mathbb{R}^5 such that it projects to the 0-cell σ_{123} in the center of Γ . The resulting fiber over σ_{123} will just be the convex hull

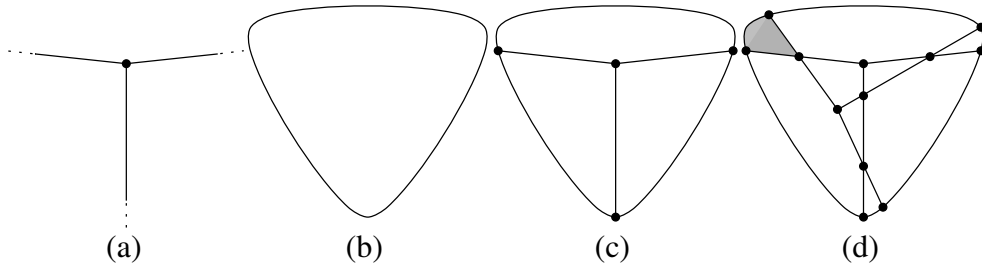

FIGURE 2.7: A part of the normal fan over the vertex τ_{12} of Q (a), over σ_{123} (b), over the corresponding edge σ_{12} (c), and over the adjacent 2-dimensional chamber σ_1 (d). If ψ_{σ_1} is chosen in the interior of the shaded cone, and if ψ_{σ_2} and ψ_{σ_3} are chosen analogously with respect to the rotational symmetry we get the basket ball obstruction of Figure 2.6.

of the old fiber over σ_{123} and the new vertex. Choose the new vertex v in such a way that its normal cone in the fiber realizes the cone $[\psi_1]_{\sigma_{123}}$ of Figure 2.6(b). (From the primal point of view we put the vertex “beyond” those faces of the fiber that have normal cones in the local basket ball obstruction. Hence, in the new normal fan over σ_{123} the local basket ball obstruction is replaced by the normal cone of the new vertex.) The resulting polytope $P^{\text{deg}} = \text{conv}(\widetilde{P^{\text{deg}}}, v)$ has 10 vertices.

- Because of Proposition 2.2.2, the normal fans over the edges σ_{ij} of Γ are the common refinement of the normal fan over σ_{123} and the normal fan over the corresponding vertex of Q . Over a vertex of Q there is one basket ball and over σ_{123} there is a fan that contains a cone that “locks” the basket ball obstruction into one cone.
- Define the function values on σ_i as in Figure 2.6(b) and the function values on σ_{ij} somewhere inside the corresponding cones $[\psi_{\sigma_i}]_{\sigma_{ij}} = [\psi_{\sigma_j}]_{\sigma_{ij}}$.
- Complete this function on the boundary of Q (Proposition 2.2.8). This yields a tight locally coherent string that is not dominated by a coarser one, i. e., an isolated element in $\omega(P, \pi)$ (see Lemma 2.1.2(b)). \square

In Section 2.5 we will present a version of P^{deg} with explicit coordinates in \mathbb{R}^5 . Moreover, we will slightly perturb the vertices of P^{deg} to get a simplicial, non-degenerate counterexample P . For each of them we will provide another, simple way to see that it violates the Generalized Baues Conjecture.

2.5 AN EXPLICIT COUNTEREXAMPLE

Throughout this section we use homogeneous coordinates in order to get a nice threefold rotational symmetry for Q^{deg} and Q without square roots. We use projections that delete the first three coordinates. The following list contains as rows the (homogeneous) coordinates for ten points in \mathbb{R}^5 in convex position.

```

DIM = 6
CONE_SECTION
( 1)  1      0      0      1      0      0
( 2)  0      3/2    1      1      0      0
( 3)  0      1      3/2    1      0      0

( 4)  0      1      0      0      1      0
( 5)  1      0      3/2    0      1      0
( 6)  3/2    0      1      0      1      0

( 7)  0      0      1      0      0      1
( 8)  3/2    1      0      0      0      1
( 9)  1      3/2    0      0      0      1

(10)  2      2      2      1/3    1/3    1/3
END

```

The first nine rows correspond to the three triangles of the abstract construction in Section 2.4, the tenth one represents the additional vertex. The chamber complex of the projection to the last three coordinates is as in Figure 2.5(a). The normal fans of the three triangles in \mathbb{R}^3 form the basket ball obstruction. The additional vertex yields the midpoint of the chamber complex and bounds the obstruction over the edges of the chamber complex. Figure 2.9 is an attempt to visualize the construction.

The above listing is in correct input format for the PORTA program, written by CHRISTOF [20]. This program easily produces a complete list of all 36 facets of P , and the vertex-facet incidence matrix in Figure 2.8.

The following tight locally coherent string — where the faces $F_1^{\text{deg}}, F_2^{\text{deg}}, F_3^{\text{deg}}$ (compare Figure 2.10) are given by their vertices labelled as in the listing above — will correspond to the three given function values in Figure 2.6.

$$\mathcal{F}_0^{\text{deg}} := \{(1, 4, 10), (4, 7, 10), (7, 1, 10)\}.$$

Once we have this, it is very easy to see independently from Section 2.4 that this is a counterexample to the Generalized Baues Conjecture. To form a strictly coarser string, we must replace at least one of the faces $F_1^{\text{deg}}, F_2^{\text{deg}}, F_3^{\text{deg}}$ in $\mathcal{F}_0^{\text{deg}}$

strong validity table :

\ P					
\ O					
I \ I					
N \ N	1	6		#	
E \ T					
Q \ S					
S \					

1	.***. *.*** :	5	19	.***. *.*** :	5
2	*...* **... :	5	20	.***. *.*** :	5
3	*...* .*** :	5	21	.***. *.*** :	5
4	...* .*** :	5	22	.***. *.*** :	5
5	..*.. .*** :	5	23	.***. *.*** :	5
6	...** *.*** :	5	24	.***. *.*** :	5
7	.*... *.*** :	5	25	.***. *.*** :	5
8	***.. *.*** :	5	26	.***. *.*** :	5
9	***.. *.*** :	5	27	.***. *.*** :	5
10	...** .*** :	6	28	.***. *.*** :	5
11	***.. .*** :	6	29	.***. *.*** :	5
12	***** *... :	6	30	.***. *.*** :	5
13	*.*** *.*** :	5	31	.***. *.*** :	5
14	**.*. *.*** :	5	32	.***. *.*** :	5
15	*...* .*** :	5	33	.***. *.*** :	5
16	...** *.*** :	5	34	.***. *.*** :	5
17	*...* .*** :	5	35	.***. *.*** :	5
18	**.*. *.*** :	5	36	.***. *.*** :	5

			#	21121 12112	
	\			06606 60667	

FIGURE 2.8: The vertex-facet incidence matrix of P^{deg} .

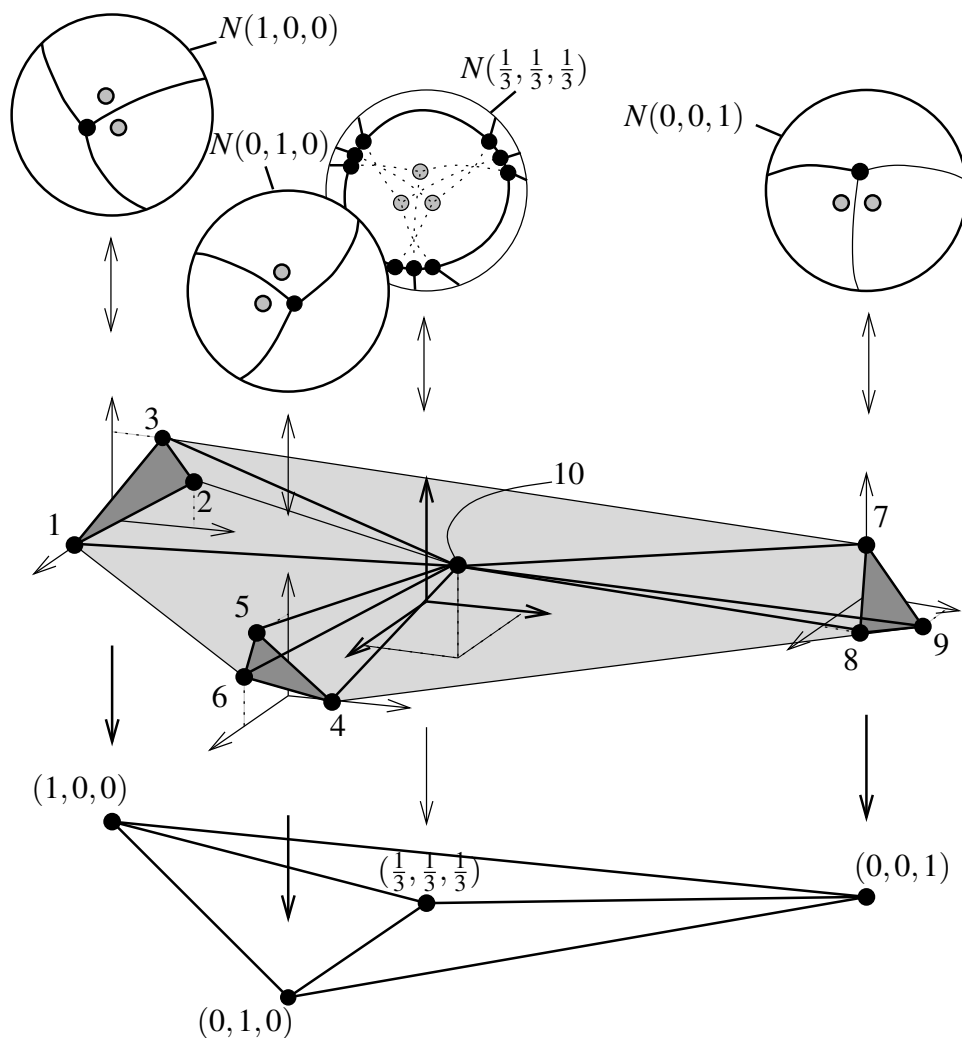

FIGURE 2.9: A sketch of $\pi^{\text{deg}} : P^{\text{deg}} \rightarrow Q^{\text{deg}}$: Over each vertex of Q^{deg} one perturbed basket ball is positioned. Adding the tenth vertex in the middle provides a bounding cone around the basket ball obstruction. (The grey vertices and the dotted lines are drawn to indicate the positions of the fans with respect to each other.) The 5-polytope P^{deg} is the convex hull of the three dark triangles — each of them in an \mathbb{R}^3 over one vertex of Q^{deg} — and the additional vertex (10) in the middle.

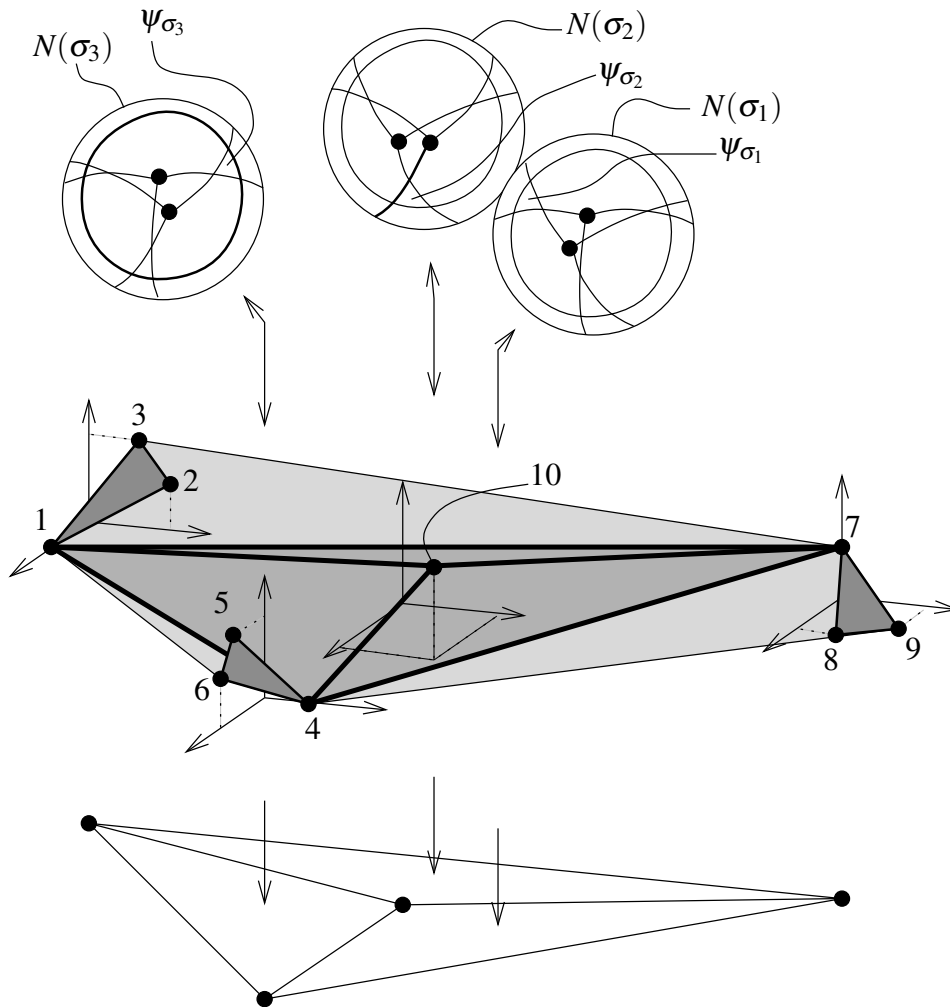

FIGURE 2.10: The medium-dark triangles correspond to the isolated locally coherent string $\{(1, 4, 10), (4, 7, 10), (7, 1, 10)\}$ that is defined by the function values ψ_{σ_1} , ψ_{σ_2} , and ψ_{σ_3} for the chambers σ_1 , σ_2 , and σ_3 .

by a face \hat{F}_i^{deg} of P^{deg} that contains F_i^{deg} . This can be described by adding one or more vertices to F_i^{deg} such that we get a face. From the definition of a locally coherent string it follows that a new vertex v has to be added (combinatorially) to all faces of $\mathcal{F}_0^{\text{deg}}$ whose projection contains $\pi(v)$.

From the vertex-facet incidence matrix we can compute for each face F in $\mathcal{F}_0^{\text{deg}}$ all sets V of vertices in $P^{\text{deg}} \setminus F$ such that $\text{vert}(F) \cup V$ are the vertices of a face in P^{deg} . They correspond exactly to the faces in the *link of F in P^{deg}* denoted by $\text{lk}(F) := \text{lk}_{P^{\text{deg}}}(F)$. It turns out that all links are 4-gons, namely

$$\begin{aligned}\text{lk}(1, 4, 10) &= (2, 9, 8, 6), \\ \text{lk}(4, 7, 10) &= (5, 3, 2, 9), \\ \text{lk}(7, 1, 10) &= (8, 6, 5, 3).\end{aligned}$$

Because of the rotational symmetry, it suffices to test the vertices in the link of $(1, 4, 10)$. For example, adding vertex 2 to the face $(1, 4, 10)$ requires adding vertex 2 to the face $(7, 1, 10)$ because $\pi(7, 1, 10)$ contains $\pi(2)$ — but vertex 2 is not contained in the link of $(7, 1, 10)$. Analogous contradictions occur in all other cases. This proves that $\mathcal{F}_0^{\text{deg}}$ is in fact an isolated element in $\omega(P^{\text{deg}}, \pi)$. This example corresponds exactly to the construction at the end of Section 2.4. \square

The coordinates of P^{deg} can be slightly perturbed in order to make the projection non-degenerate. We claim that the following listing contains the coordinates of a simplicial, non-degenerate counterexample P .

```
DIM = 6
CONE_SECTION
( 1)  1      0      0      1      0      0
( 2)  0      3/2    1      1     -1/11  -1/21
( 3)  0      1      3/2    1     -1/20  -1/10

( 4)  0      1      0      0      1      0
( 5)  1      0      3/2   -1/21   1     -1/11
( 6) 3/2     0      1     -1/10   1     -1/20

( 7)  0      0      1      0      0      1
( 8) 3/2     1      0     -1/11  -1/21   1
( 9)  1      3/2    0     -1/20  -1/10   1

(10)  2      2      2      1/3     1/3     1/3
END
```

All the vertices of P project to pairwise different points in the plane. We again inspect the vertex-facet incidence matrix, see Figure 2.11. Each facet has exactly

strong validity table :

\ P							
\ O							
I \ I							
N \ N		1		6		#	
E \ T							
Q \ S							
S \							
1		.***** *.... :		5		22	*....* **...* :
2		*....* *.... :		5		23	*...* ..**.. :
3		***** *.... :		5		24	..**** ..**.. :
4		*....* **... :		5		25	.****. .**... :
5		*....* *.... :		5		26	*....* ****.. :
6		***** *.... :		5		27	*....* *.*** :
7		*....* ****.. :		5		28	..**.* *.*** :
8	** **..* :		5		29	..**.* ..*** :
9		**..* ..**.. :		5		30	**..* ..*** :
10		***.. *...* :		5		31	*.*** ..*** :
11		***.. ..**.. :		5		32	..**.. ..*** :
12		...* ***** :		5		33	***.. ..**.. :
13		*...* ..*** :		5		34	..**.. ..*** :
14	* ***** :		5		35	**... ..*** :
15		*... ..*** :		5		36	...* *.*** :
16		****** :		5		37	*... ..*** :
17		*...* *...* :		5		38* ****.. :
18		*...* *...* :		5		39* *.*** :
19		*...* *...* :		5		40* ..*** :
20		***.. *...* :		5		41	*... ..*** :
21		**..* *...* :		5		42	..**.. ..*** :
					#	21221	22122
					\ /	38038	03807

FIGURE 2.11: The vertex-facet incidence matrix of P .

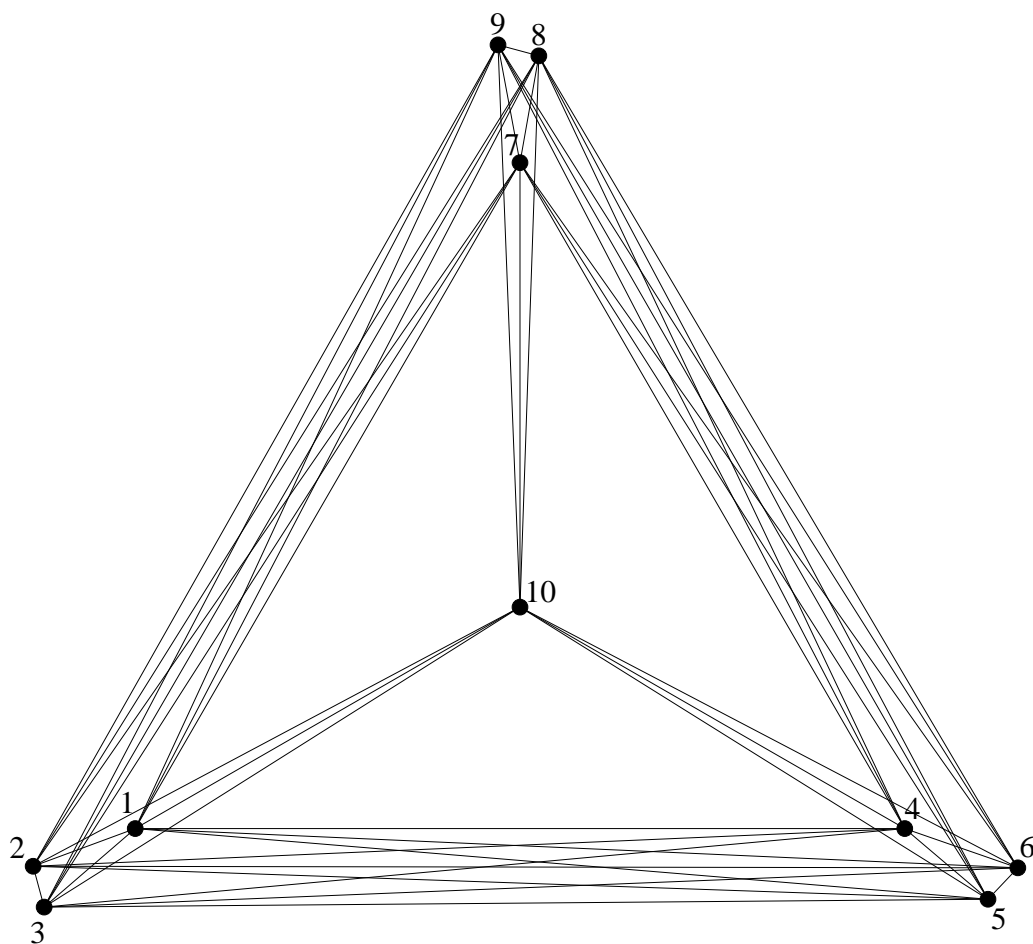
FIGURE 2.12: The chamber complex of π .

five vertices, so P is a simplicial polytope. Consider the chamber complex of the projection in Figure 2.12 — a computer-generated drawing which also shows that P is 2-neighborly. The projections of the three faces $(1, 4, 10)$, $(4, 7, 10)$, and $(7, 1, 10)$ do not cover Q . However, for chambers that are not covered we find, for example, the following tight completion:

$$\begin{aligned} \mathcal{F}_0 := \{ & (1, 4, 10), (1, 2, 4), (2, 3, 4), (3, 4, 5), \\ & (4, 7, 10), (4, 5, 7), (5, 6, 7), (6, 7, 8), \\ & (7, 1, 10), (7, 8, 9), (8, 9, 1), (9, 1, 2) \}. \end{aligned}$$

This is not an isolated element in $\omega(P, \pi)$, because there are local changes possible on the new faces. For example, the faces $(1, 2, 4)$ and $(2, 3, 4)$ are dominated by $(1, 2, 3, 4)$, etc. However, a local change of $(1, 4, 10)$, $(4, 7, 10)$, or $(7, 1, 10)$, is not possible. To see this, we first check that no facet of P contains more than one of these three faces. Consider again Figure 2.12. If, without loss of generality, we take any face F in P that contains $(1, 4, 10)$ we observe that some new edge of F projects into the interior of $\pi(4, 7, 10)$ or $\pi(7, 1, 10)$. (The link of $(1, 4, 10)$ is again $(2, 9, 8, 6)$, etc.) For example, if we replace $(1, 4, 10)$ by $(1, 2, 4, 10)$ — a simplex — the projection of the new edge $(2, 10)$ cuts through the interior of $\pi(7, 1, 10)$. But then we have produced overlapping projections, a contradiction to the fact that every locally coherent string defines a polyhedral subdivision after projection.

We see that *any* locally coherent string in the connected component of \mathcal{F}_0 *must* contain the three faces $(1, 4, 10)$, $(4, 7, 10)$, and $(7, 1, 10)$. But obviously there is the following locally coherent string where the face $(1, 4, 7)$ replaces the three “rigid” faces:

$$\begin{aligned} \mathcal{F}_1 := \{ & (1, 4, 7), (1, 2, 4), (2, 3, 4), (3, 4, 5), \\ & (4, 5, 7), (5, 6, 7), (6, 7, 8), \\ & (7, 8, 9), (8, 9, 1), (9, 1, 2) \}. \end{aligned}$$

Thus we conclude that there are at least two connected components in $\omega(P, \pi)$, in contradiction to the Generalized Baues Conjecture. \square

CHAPTER 3

TRIANGULATIONS OF CYCLIC POLYTOPES

In 1995, EDELMAN & REINER suggested two partial orders $\mathcal{S}_1(n, d)$ and $\mathcal{S}_2(n, d)$ on the set of all triangulations of the cyclic d -polytope $C(n, d)$ with n vertices. Both posets are generalizations of the well-studied Tamari lattice. While $\mathcal{S}_2(n, d)$ is bounded by definition, the same is not obvious for $\mathcal{S}_1(n, d)$. In the paper by EDELMAN & REINER the bounds of $\mathcal{S}_2(n, d)$ were also confirmed for $\mathcal{S}_1(n, d)$ whenever $d \leq 5$, leaving the general case as a conjecture.

In this chapter their conjecture is answered in the affirmative for all d , using several new functorial constructions. This yields the first class of polytopes with no bound on the dimension and on the number of vertices for which the set of all triangulations is known to be connected by bistellar operations. Moreover, a structure theorem is presented, stating that the elements of $\mathcal{S}_1(n, d + 1)$ are in one-to-one correspondence to certain equivalence classes of maximal chains in $\mathcal{S}_1(n, d)$. By similar methods, it is proved that all triangulations of cyclic polytopes are shellable. In order to clarify the connection between $\mathcal{S}_1(n, d)$ and the higher Bruhat order $\mathcal{B}(n - 2, d - 1)$ of MANIN & SCHECHTMAN, we define an order-preserving map from $\mathcal{B}(n - 2, d - 1)$ to $\mathcal{S}_1(n, d)$, thereby concretizing a result by KAPRANOV & VOEVODSKY in the theory of ordered n -categories.

3.1 INTRODUCTION

In this chapter we examine the structure of the *first higher Stasheff-Tamari order* $\mathcal{S}_1(n, d)$ on the set of *all triangulations of the cyclic polytope* $C(n, d)$ (definitions below), introduced by EDELMAN & REINER [21]. It turns out that it is similarly structured as the higher Bruhat order $\mathcal{B}(n - 2, d - 1)$ of MANIN & SCHECHTMAN [48]; in particular, it is bounded.

*

Given a *triangulation* of the convex hull of a finite point configuration in Euclidean d -space that is not satisfying a certain quality measure, can one find a better, or even the best triangulation (with respect to this measure) by performing a finite sequence of (computationally cheap) local transformations? A necessary condition for the latter case is that any possible triangulation is accessible by this

kind of transformation. In particular, a repeatedly posed question in combinatorial and computational geometry (see for example BILLERA, KAPRANOV & STURMFELS [9], EDELSBRUNNER [23, Open Problem 8], and JOE [38, Conjecture 1]) is whether or not any two triangulations of (the convex hull of) a given finite point configuration in Euclidean space of dimension d can be connected by a sequence of *bistellar operations*.

For $d = 2$ the answer is affirmative, as is for the restriction to *regular triangulations* (by the work of GELFAND, KAPRANOV & ZELEVINSKY [28]). For $d \geq 3$ and general triangulations, however, the problem is open in spite of many attacks in this direction.

Similar problems attained attention in several fields of pure mathematics. This led to remarkable new concepts, such as the *secondary polytope* defined by GELFAND, KAPRANOV & ZELEVINSKY [28]), further studied by BILLERA, FILIMAN & STURMFELS [7] and BILLERA, GELFAND & STURMFELS [8]. The theoretical question behind this all is the following: Has the set of *all* triangulations of a point configuration a well-behaved *global* structure with respect to local transformations? A far-reaching generalization of this question to *restricted polyhedral subdivisions* was answered in the negative in Chapter 2 (see also RAMBAU & ZIEGLER [61]).

The cyclic d -polytope $C(n, d)$ with n vertices appears on the scene as a combinatorially well-understood natural generalization of (convex) n -gons to higher dimensions. The triangulations of an n -gon form the extensively studied Tamari lattice — which one is definitely willing to consider as a good-natured structure in this context. (For a historical background on Tamari lattices and their different combinatorial interpretations, we refer to the paper by EDELMAN & REINER [21] and references given there.) The natural question now is which properties of the Tamari lattices survive in higher dimensions.

Since, in general, there are many non-regular triangulations of cyclic polytopes (see BILLERA, GELFAND & STURMFELS [8] and DE LOERA, HOŞTEN, SANTOS & STURMFELS [45]) it is not a priori clear that the set of all triangulations of the cyclic polytope $C(n, d)$ is well-behaved. In the paper by EDELMAN & REINER [21] two poset structures $\mathcal{S}_1(n, d)$ and $\mathcal{S}_2(n, d)$ are defined on this set, both generalizing the Tamari lattice and hence quite interesting from a purely combinatorial point of view. In the following we sketch their definitions.

The triangulations of the cyclic polytope $C(n, d)$ are in one-to-one correspondence to the piecewise linear sections from $C(n, d)$ into $C(n, d + 1)$, according to the projection from $C(n, d + 1)$ onto $C(n, d)$ that deletes the last coordinate. EDELMAN & REINER [21] suggest two partial orders on all piecewise linear sections, and hence on the set of all triangulations of $C(n, d)$.

The *first higher Stasheff-Tamari order* $\mathcal{S}_1(n, d)$ is defined by a covering relation between two sections if exactly one $(d + 1)$ -simplex fits between them in

$C(n, d + 1)$; the section that contains the upper facets of this simplex is defined to be greater than the other one. This corresponds to an *increasing bistellar flip* that replaces the lower facets of the $(d + 1)$ -simplex by the upper facets. Thus, we get a purely *combinatorial* description of this poset in terms of local transformations. The *second higher Stasheff-Tamari order* $\mathcal{S}_2(n, d)$ is defined *geometrically* via pointwise comparison of the heights of the sections.

While $\mathcal{S}_2(n, d)$ has a unique minimal element $\mathcal{F}^l(n, d + 1)$ (the set of *lower* facets of $C(n, d + 1)$) and a unique maximal element $\mathcal{F}^u(n, d + 1)$ (the set of *upper* facets of $C(n, d + 1)$), the same is not obvious for $\mathcal{S}_1(n, d)$. On the other hand, the local structure of $\mathcal{S}_1(n, d)$ is clear by definition while the covering relations in $\mathcal{S}_2(n, d)$ are a priori unknown.

This led to the following conjectures and results by EDELMAN & REINER.

- For even d , both $\mathcal{S}_1(n, d)$ and $\mathcal{S}_2(n, d)$ are self-dual [21, Prop. 2.11, true in general].
- $\mathcal{S}_1(n, d)$ coincides with $\mathcal{S}_2(n, d)$ [21, Conj. 2.6, true for $d \leq 3$].
- $\mathcal{F}^l(n, d + 1)$ is the unique minimal element of $\mathcal{S}_1(n, d)$ [21, Conj. 2.7a, true for $d \leq 5$].
- $\mathcal{F}^u(n, d + 1)$ is the unique maximal element of $\mathcal{S}_1(n, d)$ [21, Conj. 2.7b, true for $d \leq 4$].
- Any two triangulations of $C(n, d)$ are connected by a sequence of bistellar operations [21, Conj. 2.8, true for $d \leq 5$].
- $\mathcal{S}_1(n, d)$, respectively $\mathcal{S}_2(n, d)$, is a lattice [21, Conj. 2.13, true for $d \leq 3$].
- In any interval of $\mathcal{S}_1(n, d)$, respectively $\mathcal{S}_2(n, d)$, distinct subsets of coatoms have different meets [21, Conj. 2.14, true for $d \leq 3$].

Our main Theorem answers their Conjectures 2.7a, 2.7b, and 2.8 affirmatively and points out the connections between the triangulation posets in different dimensions. Its proof is completed in Section 3.5, using the functorial constructions in Section 3.3 which we consider as interesting in their own right.

Theorem 3.1.1. (Main Result)

- (i) *For all n and all $d < n$, the first higher Stasheff-Tamari order $\mathcal{S}_1(n, d)$ is bounded. The unique minimal element is the set $\mathcal{F}^l(n, d + 1)$ of lower facets, the unique maximal element is the set $\mathcal{F}^u(n, d + 1)$ of upper facets of $C(n, d + 1)$. In particular, the set of all triangulations of $C(n, d)$ is bistellarly connected.*

- (ii) *The elements of $\mathcal{S}_1(n, d+1)$ are in bijection with the equivalence classes of maximal chains in $\mathcal{S}_1(n, d)$ under the following equivalence relation: Two maximal chains are equivalent if they differ only by a permutation of their increasing bistellar operations.*
- (iii) *Two maximal chains in $\mathcal{S}_1(n, d)$ are equivalent if and only if they differ by a sequence of interchanges of consecutive bistellar operations that correspond to non-adjacent $(d+1)$ -simplices in $C(n, d+1)$.*
- (iv) *All triangulations of cyclic polytopes are shellable.*

The following list of implications demonstrates the quantitative consequences of the main Theorem and the constructions provided in Section 3.3.

Corollary 3.1.2. *For all n and all $d < n$, the following hold:*

- (i) *For odd d , $\mathcal{S}_1(n, d)$ is a ranked poset with rank function*

$$r(T) := \#\mathcal{F}^l(n, d+1) - \#T \quad \text{for all } T \in \mathcal{S}_1(n, d).$$

- (ii) *The number of simplices in a triangulation of $C(n, d)$ lies between the number $\binom{n - \lceil d/2 \rceil - 1}{\lfloor d/2 \rfloor}$ of upper facets and the number $\binom{n - \lceil (d+1)/2 \rceil}{\lfloor (d+1)/2 \rfloor}$ of lower facets of $C(n, d+1)$. In particular, for even d all triangulations of $C(n, d)$ consist of $\binom{n - d/2 - 1}{d/2}$ simplices. (That the latter fact is actually true for all weakly neighborly polytopes, was proved by BAYER [6].)*
- (iii) *The length of a maximal chain in the poset $\mathcal{S}_1(n, d)$ lies between the number $\binom{n - \lceil (d+1)/2 \rceil - 1}{\lfloor (d+1)/2 \rfloor}$ of upper facets and the number $\binom{n - \lceil d/2 \rceil - 1}{\lfloor d/2 \rfloor + 1}$ of lower facets of $C(n, d+2)$. In particular, for odd d the length of any maximal chain in $\mathcal{S}_1(n, d)$ equals $\binom{n - (d+1)/2 - 1}{(d+1)/2}$.*
- (iv) *For even d , the diameter of the Hasse-diagram of the poset $\mathcal{S}_1(n, d)$ is between $\binom{n - d/2 - 2}{d/2}$ and twice this value; for odd d , it is equal to $\binom{n - (d+1)/2 - 1}{(d+1)/2}$.*

Theorem 3.1.1 points out a similarity to the structure of the higher Bruhat order $\mathcal{B}(n-2, d-1)$, a certain generalization of the weak Bruhat order on the symmetric group, defined by MANIN & SCHECHTMAN [48] (see also ZIEGLER [74]). Previously, KAPRANOV & VOEVODSKY [40] reported the existence of an order-preserving surjection from $\mathcal{B}(n-2, d-1)$ onto a poset structure on the set of all triangulations of $C(n, d)$ that is inherited by a certain ordered n -category. Unfortunately, it is not clear whether their poset structure is equivalent to $\mathcal{S}_1(n, d)$. This led us to the investigations in Section 3.8 where we present an explicit order-preserving map \mathcal{T} from $\mathcal{B}(n-2, d-1)$ to $\mathcal{S}_1(n, d)$ that should help to get a

more concrete idea of the connections between higher Bruhat orders and higher Stasheff-Tamari orders. Furthermore, we relate some of the functorial constructions for higher Bruhat orders to similar constructions for higher Stasheff-Tamari orders.

In Section 3.7 we will recall the main definitions and results in the framework of higher Bruhat orders. Additionally, we answer a question posed by ZIEGLER [74] on the existence of an order-preserving embedding of $\mathcal{B}(n, k)$ into $\mathcal{B}(n+1, k+1)$ affirmatively.

The following three problems concerning the higher Stasheff-Tamari orders remain open:

- Is $\mathcal{S}_1(n, d)$ equal to $\mathcal{S}_2(n, d)$?
- Is $\mathcal{S}_1(n, d)$ or $\mathcal{S}_2(n, d)$ a lattice?
- Is \mathcal{T} surjective; in particular, is \mathcal{T} the map suggested by KAPRANOV & VOEVODSKY?

*

Throughout this chapter the following notation is used:

- For a set L and “ $<_l$ ” a linear order on L , we denote by $L_{<_l}$ the set L linearly ordered with “ $<_l$.”
- Numbers in brackets (i_1, \dots, i_n) denote the set $\{i_1, \dots, i_n\}_{<}$ which is linearly ordered with $i_v < i_{v+1}$ for $v = 1, \dots, n-1$.
- Let L be a set. For a subset $S \subseteq L$, let $\complement S = \complement_L S$ be the complement $L \setminus S$ of S in L .
- For a set L and two sets K and K' of subsets of L such that $S \cap S' = \emptyset$ for all $S \in K$ and $S' \in K'$, let $K * K' := \{S \cup S' : S \in K, S' \in K'\}$ be the join of K and K' .
- For a set K of subsets of L and $S_0 \in K$, the *deletion of S_0 from K* is the set $K \setminus S_0 := \{S \in K : S \cap S_0 = \emptyset\}$, and the *contraction of S_0 in K* is the set $K/S_0 := \{S \setminus S_0 : S \in K, S \supseteq S_0\}$.
- For integers $a < b$, the interval $[a, b]$ is the set $\{a, a+1, \dots, b-1, b\}$, and $]a, b[$ is the set $\{a+1, \dots, b-1\}$,
- $[n]$ denotes the interval $[1, n]$, and $]n[$ is the interval $]1, n[$.

3.2 A COMBINATORIAL FRAMEWORK FOR TRIANGULATIONS

In this section we present a combinatorial concept of triangulations that is similar to that of DE LOERA [43]. Dealing with vertex labels when investigating triangulations is formally justified by the following considerations that are closely related to the theory of abstract simplicial complexes.

Definition 3.2.1. Let \mathcal{L} be a finite set, the *label set*. A *combinatorial d -simplex* in \mathcal{L} is a $(d+1)$ -element-subset S of \mathcal{L} . Its $(k+1)$ -subsets are called *k -faces* of S , and its d -subsets *facets* of S .

If $\ell : \mathcal{L} \rightarrow \mathbb{R}^N$ is an injective function with $\ell(\mathcal{L}) =: \mathcal{A}$, and $S \subset \mathcal{L}$ is a combinatorial d -simplex corresponding to affinely independent points then the convex hull $\sigma = \text{conv } \ell(S)$ of $\ell(S)$ is the *geometric d -simplex* with vertex set $\text{vert } \sigma = \ell(S)$ and label set $\text{lab}(\sigma) = S$ with respect to ℓ , the *labelling function*.

A *combinatorial simplicial complex* in \mathcal{L} is a set K of combinatorial simplices in \mathcal{L} . Its k -simplices are the k -faces of its elements. (That is, we identify the usual abstract simplicial complexes with their set of inclusion-maximal faces; see Section A.4 in the appendix.) A set Δ of geometric simplices σ with the property that the set $\{\text{lab}(\sigma) : \sigma \in \Delta\}$ of label sets is a combinatorial simplicial complex, and that

$$\text{conv}(\text{vert } \sigma \cap \text{vert } \tau) = \sigma \cap \tau \quad \text{for all } \sigma, \tau \in \Delta,$$

is a *geometric simplicial complex*.

A combinatorial simplicial complex K' is a *combinatorial subcomplex* of K if all simplices of K' are faces of simplices in K . A *geometric subcomplex* is defined analogously.

For a combinatorial simplicial complex K in \mathcal{L} and a combinatorial simplex S_0 in \mathcal{L} , the *combinatorial link* of S_0 in K is defined as

$$\text{lk}_K(S_0) := \{S \setminus S_0 : S \in K, S_0 \subseteq S\};$$

the *combinatorial star* of S_0 in K is defined by

$$\text{st}_K(S_0) := \{S \in K : S_0 \subseteq S\},$$

and the *combinatorial antistar* of S_0 in K is the complex

$$\text{ast}_K(S_0) := \{S \in K : S \cap S_0 = \emptyset\}.$$

If K is a combinatorial simplicial complex in \mathcal{L} , and S_0 is a combinatorial simplex in \mathcal{L}' where \mathcal{L} and \mathcal{L}' are disjoint, then the *combinatorial join* of K and S_0 is the complex

$$K * S_0 := \{S \cup S_0 : S \in K\}.$$

The convex hull $\text{conv } \mathcal{A}$ of \mathcal{A} is a d -polytope if the affine hull of \mathcal{A} is \mathbb{R}^d . For $\mathcal{A}' \subset \mathcal{A}$, the polytope $\text{conv } \mathcal{A}'$ is a *facet* of $\text{conv } \mathcal{A}$, if $\text{conv } \mathcal{A}'$ is the $(d-1)$ -dimensional intersection of \mathcal{A} with a hyperplane H such that one closed halfspace defined by H contains $\text{conv } \mathcal{A}$. In this case the label set $\text{lab}(\mathcal{A}')$ is a *combinatorial facet* of ℓ . Note that the set of facets of a *simplicial* polytope (all facets are simplices) forms a simplicial complex.

If $Z = (Z^+, Z^-)$ is a pair of disjoint inclusion minimal subsets Z^+ and Z^- of \mathcal{L} with the property

$$\text{conv } \ell(Z^+) \cap \text{conv } \ell(Z^-) \neq \emptyset$$

then Z is called a *minimal combinatorial dependence* in ℓ , or — for short — a *circuit* of ℓ . The set $\text{supp}(Z) = Z^+ \cup Z^-$ is the *support* of Z . The set Z^+ is the *positive part* and the set Z^- is the *negative part* of Z .

The triple $\mathcal{P}(\ell) = (\mathcal{L}, \mathcal{F}_\ell, \mathcal{Z}_\ell)$, where \mathcal{Z}_ℓ denotes the set of all circuits of ℓ , and \mathcal{F}_ℓ is the set of all combinatorial facets of ℓ , is the *combinatorial polytope* of ℓ .

If Δ a geometric simplicial complex with vertices in \mathcal{A} such that $\text{conv } \mathcal{A} = \bigcup_{\sigma \in \Delta} \sigma$ then Δ is called a *triangulation* of \mathcal{A} . In this case the set T of label sets of the simplices in Δ is a *combinatorial triangulation* of $\mathcal{P}(\ell)$.

We will sometimes call the geometric objects *geometric interpretations* of the corresponding combinatorial ones, which themselves are said to be *combinatorial models* for their geometric counterparts.

A combinatorial, label-based handling of triangulations is made possible by the following proposition. We present a complete elementary proof because this characterization is fundamental for this chapter.

Proposition 3.2.2. *Let \mathcal{L} be a finite set, and let $\ell : \mathcal{L} \rightarrow \mathbb{R}^d$ be injective with $\ell(\mathcal{L}) =: \mathcal{A}$. Furthermore, let $\mathcal{P}(\ell) = (\mathcal{L}, \mathcal{F}_\ell, \mathcal{Z}_\ell)$ be the combinatorial polytope of ℓ . A non-empty subset T of the $(d+1)$ -subsets of \mathcal{L} is a combinatorial triangulation of ℓ if and only if*

- (UP) *for all $S \in T$ and all facets F of S either F is contained in some $F' \in \mathcal{F}_\ell$, or there is another simplex $S' \in T$ such that $S' \supset F$ (Union Property), and*
- (IP) *there is no circuit $Z \in \mathcal{Z}_\ell$ with $Z^+ \subset S$ and $Z^- \subset S'$ for combinatorial simplices $S, S' \in T$ (Intersection Property).*

Proof. We first prove that (UP) and (IP) are necessary. Let T be a combinatorial triangulation with respect to some geometric triangulation Δ of the point set \mathcal{A} , given by $\ell : \mathcal{L} \rightarrow \mathbb{R}^d$. Assume there is a combinatorial facet F of some combinatorial d -simplex S in T that is not contained in some F' in \mathcal{F}_ℓ , such that there is no other combinatorial d -simplex in T containing F . Then the corresponding

$(d-1)$ -simplex $\tau := \text{conv } \ell(F)$ is contained in only one simplex $\sigma := \text{conv } \ell(S)$ of Δ .

Let H be a supporting hyperplane of τ such that its closed positive half-space H^+ contains σ . Let q_τ be the barycenter of τ . Because τ is not a facet of $P = \text{conv}(\mathcal{A})$, there is a point x_0 in P lying in the open negative halfspace $\text{relint}(H^-)$. Connect q_τ and x_0 by a segment I . This segment is completely contained in P since P is convex.

Δ is a triangulation. Hence, there must be at least one d -simplex σ_{x_0} that contains x_0 . Either σ_{x_0} contains q_τ or not. If it does then σ_{x_0} must contain the complete $(d-1)$ -simplex τ as a facet since q_τ lies in the relative interior of τ , and the intersection of τ and σ_{x_0} must be a face of both. But this is a contradiction.

If σ_{x_0} does not contain q_τ then the segment I intersects the boundary of σ_{x_0} in a point q_{x_0} . Consider the mid-point x_1 of q_τ and q_{x_0} on I . This point is neither contained in τ nor in σ_{x_0} . Since I lies completely in P , there must be a new d -simplex σ_{x_1} in Δ containing x_1 . This procedure shows either a contradiction as above or an infinite sequence of d -simplices in Δ , which is a contradiction too. Hence, Property (UP) is necessary.

In order to show the necessity of Property (IP) assume that there are combinatorial d -simplices S and S' in T and a circuit $Z = (Z^+, Z^-)$ in $\mathcal{L}(n, d)$ such that Z^+ is contained in S and Z^- is contained in S' . Then by the definition of circuits

$$\text{conv } \ell(Z^+) \cap \text{conv } \ell(Z^-) \neq \emptyset,$$

and their minimality implies that there are geometric simplices in Δ , namely $\text{conv } \ell(Z^+)$ and $\text{conv } \ell(Z^-)$ the relative interiors of which intersect, a contradiction. Hence, Property (IP) is necessary as well.

Let T be a collection of $(d+1)$ -subsets of \mathcal{L} (that is, $T \subseteq \binom{\mathcal{L}}{d+1}$) satisfying (UP) and (IP). Then T gives rise to a set $\Delta := \{\text{conv } \ell(S) : S \in T\}$ of geometric simplices. We must show that every point in P lies in at least one d -simplex σ in Δ and that for every pair of simplices σ and σ' we have $\text{conv}(\text{vert } \sigma \cap \text{vert } \sigma') = \sigma \cap \sigma'$.

Let x be an arbitrary point in P . Since T is non-empty, we find a combinatorial d -simplex S_0 in T . Hence, there is a simplex $\sigma_0 := \ell(S_0)$ in Δ . Consider a segment I from an inner point x_0 of σ_0 to x that does not meet any $(d-2)$ -simplex of Δ . Such a line exists because of the concept of general position. This segment is completely contained in P and meets exactly one facet τ of σ_0 unless $x \in \text{relint}(\sigma_0)$. If this intersection point q_τ equals x then we are done. Otherwise this facet is not a facet of P because then q_τ is an interior point of I and I is contained in P . Hence, the label set F of τ is not in \mathcal{F}_ℓ , and we find another combinatorial d -simplex S_1 in T containing F corresponding to a geometric d -simplex σ_1 containing τ . The segment I meets the interior of σ_1 because of the

general position property of I . Choose an arbitrary point x_1 in $I \cap \text{relint}(\sigma_1)$. Note that the distance between x_1 and x is strictly smaller than the distance between x_0 and x . Therefore, by repeating this procedure we will reach a d -simplex σ_r lying in Δ and containing x .

Now assume that there are geometric d -simplices σ and σ' in Δ with label sets S respectively S' in T and $\text{conv}(\text{vert } \sigma \cap \text{vert } \sigma') \subset \sigma \cap \sigma'$. Since $\sigma \supseteq \sigma \cap \sigma'$ and $\sigma' \supseteq \sigma \cap \sigma'$, there are inclusion-minimal faces τ of σ and τ' of σ' with $\text{conv}(\text{vert } \tau \cap \text{vert } \tau') \supseteq \sigma \cap \sigma'$. From the minimality assumption we get $\text{relint}(\tau) \cap \text{relint}(\tau') \neq \emptyset$, hence, by Radon's Theorem, there are minimal, vertex-disjoint faces ρ of τ and ρ' of τ' with $\text{relint}(\rho) \cap \text{relint}(\rho') \neq \emptyset$. Set $Z^+ := \text{lab}(\rho)$ and $Z^- := \text{lab}(\rho')$. Then Z^+ and Z^- are disjoint and $\text{conv}(\ell(Z^+)) \cap \text{conv}(\ell(Z^-)) \neq \emptyset$. Hence, (Z^+, Z^-) lies in \mathcal{Z}_ℓ , where Z^+ is contained in S , and Z^- is contained in S' . However, this contradicts the assumption that T has Property (IP). \square

Pairs of simplices with property (IP) are called *admissible*.

3.3 CYCLIC POLYTOPES

In this section we recall the basic definitions and theorems related to cyclic polytopes in a combinatorial language.

Definition 3.3.1. Let \mathcal{L} be a linearly ordered set, and let $t : \mathcal{L} \rightarrow \mathbb{R}$, $i \mapsto t_i$ be a strictly monotone function.

The d -dimensional *cyclic polytope* $C(\mathcal{L}, d, t)$, labelled by \mathcal{L} , parametrized by t is the convex hull of the points $v_d(t_1), \dots, v_d(t_n)$ with

$$v_d(x) := (x, x^2, \dots, x^d) \in \mathbb{R}^d.$$

For simplicity, we set $C(n, d, t) := C([n], d, t)$.

The main reason for the fact that triangulations of cyclic polytopes can be treated effectively in a purely combinatorial way are the following well-known properties that follow from the special structure of Vandermonde-determinants.

The first one — Gale's famous Evenness Criterion — characterizes the set $\mathcal{F}_{v_d \circ t}$ of all combinatorial facets of $C(\mathcal{L}, d, t)$. The following notion allows us to state that criterion in a compact way.

Definition 3.3.2. Let L be a linearly ordered set and S a subset of L . An element $s_0 \in \mathbb{C}S$ is an *even gap* in S if $\#\{s \in S : s > s_0\}$ is even, otherwise it is an *odd gap*.

Theorem 3.3.3 (Gale's Evenness Criterion). [32] *An ordered subset F of the vertex set of the cyclic polytope $C(\mathcal{L}, d, t)$ is a facet if and only if between any two*

vertices not in F there is an even number of vertices in F . Equivalently, F is a facet of $C(\mathcal{L}, d, t)$ if and only if either all gaps in F are even or all gaps in F are odd. \square

The second one describes the form of those sets of vertices of $C(\mathcal{L}, d, t)$ whose convex hulls intersect in the relative interior of both. Hence, this determines $\mathcal{C}_{v_d \circ t}$.

Theorem 3.3.4. [15] *The circuits of $C(\mathcal{L}, d, t)$ are the alternating $(d+2)$ -subsets of \mathcal{L} , i. e., the pairs (Z^o, Z^e) and (Z^e, Z^o) , where Z^o is the set of odd elements (z_1, z_3, z_5, \dots) , and Z^e is the set of even elements (z_2, z_4, z_6, \dots) of $Z = (z_1, \dots, z_{d+2})$. \square*

The combinatorial polytopes $\mathcal{P}(v_d \circ t)$ are identical for all t because the strictly monotone function t does not affect the assertions of these criteria. This means that the combinatorial study of triangulations of cyclic polytopes with any parametrization is equivalent to the investigation of combinatorial triangulations of the combinatorial polytopes $\mathcal{P}(v_d \circ t)$.

Definition 3.3.5. The combinatorial polytope $C(\mathcal{L}, d) := \mathcal{P}(v_d \circ t)$ of $v_d \circ t : \mathcal{L} \rightarrow \mathbb{R}^d$ is called the *cyclic d -polytope with vertices labelled by \mathcal{L}* . The set of its combinatorial facets is denoted by $\mathcal{F}(\mathcal{L}, d)$, the set of its circuits is written as $\mathcal{Z}(\mathcal{L}, d)$. Those combinatorial facets with only odd gaps are the *upper facets*, the set of which is denoted by $\mathcal{F}^u(\mathcal{L}, d)$; those with only even gaps are the *lower facets* of $C(\mathcal{L}, d)$, denoted by $\mathcal{F}^l(\mathcal{L}, d)$.

The set of circuits Z with maximal element z_{d+2} in Z^+ is denoted by $\mathcal{Z}^+(n, d)$, the set of circuits having their maximal element in Z^- is written as $\mathcal{Z}^-(n, d)$. The cyclic polytope labelled by $[n]$ is denoted by $C(n, d)$.

Note that in odd dimensions there are polytopes that have the same face lattice as $C(n, d, t)$ but a different circuit structure (see [15]); this leads to completely different triangulations.

Remark 3.3.6. Geometric Meaning (see Figure 3.1): Consider for some strictly monotone $t : [n] \rightarrow \mathbb{R}$ the projection

$$p = p(n, d) : \begin{cases} C(n, d+1, t) & \rightarrow C(n, d, t), \\ (x_1, \dots, x_d, x_{d+1}) & \mapsto (x_1, \dots, x_d). \end{cases}$$

Moreover, consider for some geometric triangulation Δ of $C(n, d, t)$ the unique piecewise linear section (linear on each simplex $\sigma \in \Delta$)

$$s_\Delta : \begin{cases} C(n, d, t) & \rightarrow C(n, d+1, t), \\ \sigma & \xrightarrow{\text{linear}} \text{conv}(v_{d+1} \circ t(\text{lab}(\sigma))), \quad \forall \sigma \in \Delta. \end{cases}$$

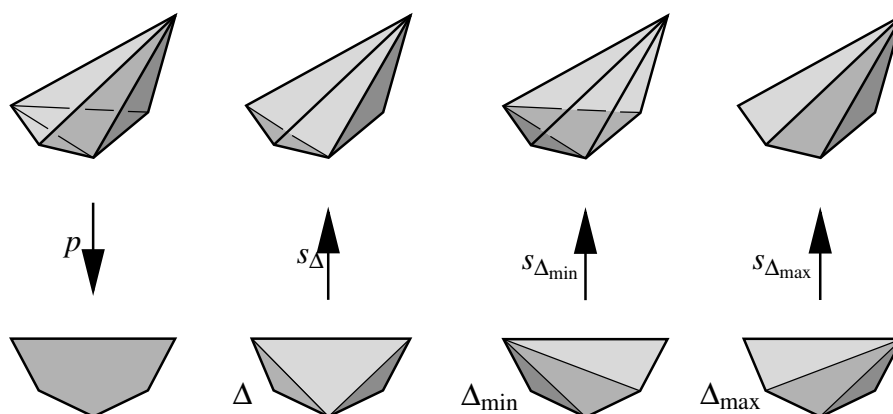

FIGURE 3.1: The canonical projection $p : C(5, 3) \rightarrow C(5, 2)$ and characteristic sections corresponding to triangulations of $C(5, 2)$.

Then any triangulation Δ of $C(n, d, t)$ can be recovered from its *characteristic section* s_Δ .

The upper facets $\mathcal{F}^u(n, d+1)$ of $C(n, d+1)$ are the sets of those facets of $C(n, d+1, t)$ that can be seen from a point in \mathbb{R}^{d+1} with large positive $(d+1)$ -th coordinate (geometric upper facets of $C(n, d+1, t)$), the lower facets $\mathcal{F}^l(n, d+1)$ label the sets of those facets of $C(n, d+1, t)$ that can be seen from a point in \mathbb{R}^{d+1} with large negative $(d+1)$ -th coordinate (geometric lower facets of $C(n, d+1, t)$). The geometric upper (respectively lower) facets project down to $C(n, d, t)$ without overlapping. Therefore, their projections define geometric triangulations of $C(n, d, t)$.

The support $\text{supp}(Z)$ of any circuit $Z = (Z^+, Z^-)$ in $C(n, d)$ corresponds to the label set of a unique $(d+1)$ -simplex in $C(n, d+1, t)$ where its set of geometric upper facets belongs to the elements of the star of the positive part Z^+ in $\text{supp}(Z)$, and its set of geometric lower facets corresponds to the elements of the star of the negative part Z^- in $\text{supp}(Z)$.

Lemma 3.3.7. (Elementary Facts)

- (i) $\mathcal{F}^l(n, d+1)$ and $\mathcal{F}^u(n, d+1)$ are combinatorial triangulations of the cyclic polytope $C(n, d)$.
- (ii) Every facet in $\mathcal{F}^u(n, d)$ contains n .
- (iii) If a pair of simplices S_1 and S_2 is not admissible then there exists a circuit in $\mathcal{L}(n, d)$ with maximal element $z_{d+2} = \max(S_1 \cup S_2)$.

- (iv) If a $(d-1)$ -simplex F is the common facet of the admissible pair (S_1, S_2) then $S_1 \setminus F$ lies in an odd gap of F and $S_2 \setminus F$ lies in an even gap of F , or vice versa. \square

Remark 3.3.8. The circuits of $C(n, d)$ can be visualized in a table that consists of columns numbered from 1 to n and rows corresponding to Z^+ and Z^- , where a star “*” in column i and row Z^ε means that $i \in Z^\varepsilon$, $\varepsilon \in \{+, -\}$. The stars can then be connected by a zig-zag-path with $(d+2)$ nodes. For example, if $n = 6$, $d = 3$, and $Z = ((1, 3, 5), (2, 4))$ we get the following table:

	1	2	3	4	5	6
Z^+	*		*		*	
Z^-		*		*		

If the rows are filled with stars corresponding to two simplices then these two simplices are admissible if and only if each zig-zag-path connects at most $(d+1)$ stars. For instance, if $n = 6$, $d = 3$, $S = (1, 3, 4, 5)$, and $S' = (2, 3, 4, 6)$ the table looks as follows:

	1	2	3	4	5	6
S	*		*	*	*	
S'		*	*	*		*

The reader will easily find a zig-zag-path connecting even $6 > d+2$ stars, showing that S, S' is not an admissible pair.

Obviously all $C(\mathcal{L}, d)$ with $\#\mathcal{L} = n$ are isomorphic to $C(n, d)$. From now on we are exclusively dealing with combinatorial triangulations of $C(n, d)$, and we will leave out the “combinatorial” attribute whenever this is not confusing.

The following Propositions — consequences of Theorems 3.3.3 and 3.3.4 — relate cyclic polytopes with different parameters. We use the notation $F = (f_1, \dots, f_d)$ for $F \in \mathcal{F}(n, d)$ and $Z = (z_1, \dots, z_{d+2})$ for $Z \in \mathcal{Z}(n, d)$.

Proposition 3.3.9. (Functorial Facet Properties)

$$\mathcal{F}^u(n+1, d+1) = \mathcal{F}^l(n, d) * \{n+1\},$$

$$\mathcal{F}^l(n+1, d+1) = \mathcal{F}^u(n, d) * \{n+1\}$$

$$\cup \{F \setminus n \cup \{j, j+1\} : F \in \mathcal{F}^u(n, d), j \in]f_{d-1}, n[\},$$

$$\mathcal{F}^u(n-1, d-1) = \text{lk}_{\mathcal{F}^l(n, d)}(n),$$

$$\mathcal{F}^l(n-1, d-1) = \text{lk}_{\mathcal{F}^u(n, d)}(n),$$

$$\mathcal{F}^u(n-1, d) = \text{ast}_{\text{lk}_{\mathcal{F}^u(n, d)}(n)}(n-1) * \{n-1\},$$

$$\mathcal{F}^l(n-1, d) = \text{ast}_{\mathcal{F}^l(n, d)}(n). \quad \square$$

Proposition 3.3.10. (Functorial Circuit Properties)

$$\begin{aligned}
\mathcal{Z}^+(n+1, d+1) &= \{ (Z^+ \cup \{j\}, Z^-) : (Z^+, Z^-) \in \mathcal{Z}^-(n, d), j > z_{d+2} \}, \\
\mathcal{Z}^-(n+1, d+1) &= \{ (Z^+, Z^- \cup \{j\}) : (Z^+, Z^-) \in \mathcal{Z}^+(n, d), j > z_{d+2} \}, \\
\mathcal{Z}^+(n-1, d-1) &= \{ (Z^+, Z^- \setminus z_{d+2}) : (Z^+, Z^-) \in \mathcal{Z}^-(n, d) \}, \\
\mathcal{Z}^-(n-1, d-1) &= \{ (Z^+ \setminus z_{d+2}, Z^-) : (Z^+, Z^-) \in \mathcal{Z}^+(n, d) \}, \\
\mathcal{Z}^+(n-1, d) &= \{ (Z^+, Z^-) \in \mathcal{Z}^+(n, d) : n \notin \text{supp}(Z) \}, \\
\mathcal{Z}^-(n-1, d) &= \{ (Z^+, Z^-) \in \mathcal{Z}^-(n, d) : n \notin \text{supp}(Z) \}. \quad \square
\end{aligned}$$

The following proposition is the combinatorial description for the geometric connection provided by the projection $p(n, d)$ between $(d+1)$ -simplices in $C(n, d, t)$ and the minimal affine dependencies in $C(n, d, t)$.

Proposition 3.3.11. (Functorial Circuit-Facet Relations)

For $Z \in \mathcal{Z}^+(n, d)$ and $\text{supp}(Z)$ considered as a simplicial complex, we have

$$\begin{aligned}
\text{st}_{\text{supp}(Z)}(Z^+) &= \mathcal{F}^u(\text{supp}(Z), d+1), \\
\text{st}_{\text{supp}(Z)}(Z^-) &= \mathcal{F}^l(\text{supp}(Z), d+1). \quad \square
\end{aligned}$$

3.4 SPECIAL TRIANGULATIONS OF CYCLIC POLYTOPES

In this section we show nice functorial constructions of triangulations of cyclic polytopes.

Definition 3.4.1. For a set T of $(d+1)$ -subsets of $[n]$, define

$$\begin{aligned}
\hat{T} &:= T * \{n+1\} \\
&\cup \{S \setminus s_{d+1} \cup \{j, j+1\} : S = (s_1, \dots, s_{d+1}) \in T, j \in]s_d, s_{d+1}[\}, && \text{(extension)} \\
T/n &:= \text{lk}_T(n), && \text{(contraction)} \\
T \setminus n &:= \text{ast}_T(n) \cup \text{ast}_{\text{lk}_T(n)}(n-1) * \{n-1\}. && \text{(deletion)}
\end{aligned}$$

Theorem 3.4.2. Let $T \in S(n, d)$. Then the following hold:

- (i) \hat{T} is a triangulation of $C(n+1, d+1)$,
- (ii) T/n is a triangulation of $C(n-1, d-1)$,
- (iii) $T \setminus n$ is a triangulation of $C(n-1, d)$.

Proof. For each assertion, we verify the Union Property (UP) and the Intersection Property (IP) of Proposition 3.2.2. Recall that we have to show — roughly speaking — that

- all simplices are pairwise admissible, and that
- each facet of a simplex is either a facet of the cyclic polytope or appears in at least one other simplex.

The reader may get a picture from the proof by inspecting the tables suggested in Remark 3.3.8, using that circuits correspond to zig-zag-paths and facets to sets with only even or only odd gaps.

Part (ii) is true because the link of a triangulation of any polytope at some vertex triangulates the corresponding vertex figure, and for cyclic polytopes this vertex figure is cyclic with the correct parameters. This follows from Propositions 3.3.9 and 3.3.10 and well-known properties of vertex figures (see, e. g., GRÜNBAUM [32]).

The proof of (UP) (i). The following abbreviations are used:

$$\begin{aligned} A &:= T * \{n+1\}, \\ B &:= \{S \setminus s_{d+1} \cup \{j, j+1\} : S \in T, j \in]s_d, s_{d+1}[\}. \end{aligned}$$

Let $F = (f_1, \dots, f_{d+1})$ be a facet of a simplex S in $A \setminus \mathcal{F}(n+1, d+1)$.

► *The case $f_{d+1} = n+1$.* By Proposition 3.3.9, $F \setminus n+1$ is not in $\mathcal{F}(n, d)$, because otherwise $(F \setminus n+1) \cup \{n+1\}$ is a facet of $C(n+1, d+1)$. Since T has the Union Property, there must be a simplex $F' \in T$ with $F \setminus n+1 \subset F'$ and $F' \neq F$. Hence,

$$F \subset \underbrace{F' \cup n+1}_{\substack{\neq S \\ \text{since } F' \neq F}} \in \hat{T}.$$

► *The case $F \in T$, $f_{d+1} - f_d > 1$.* Then

$$F \subset \underbrace{F \setminus f_{d+1} \cup \{f_{d+1} - 1, f_{d+1}\}}_{\substack{\neq S \\ \text{since } n+1 \in S}} \in \hat{T}.$$

► *The case $F \in T$, $f_{d+1} - f_d = 1$.* By Proposition 3.3.9, $F \setminus f_d$ is not in $\mathcal{F}(n, d)$, because either f_{d+1} is an inner singleton in $F \setminus f_d$ or $f_{d+1} = n$ with the consequence that $(F \setminus f_d) \setminus n \cup \{n-1, n\} = F$ is a facet of $C(n+1, d+1)$. The Union Property in T leads to the existence of a simplex $F' = (f'_1, \dots, f'_{d+1})$ in T with $F \setminus f_d \subset F'$ and $F' \neq F$. The Intersection Property in T implies either

$$f'_{d+1} = f_{d+1}, \quad f'_{d-1} = f_d, \quad (*)$$

	1	n
$F^{(1)} = F'$	f'_{d-1} f'_{d+1}
$F^{(2)}$	$f_{d-1}^{(2)}$ $f_d^{(2)}$ $f_{d+1}^{(2)}$
\vdots			\vdots
$F^{(r-1)}$	$f_{d-1}^{(r-1)}$ $f_d^{(r-1)}$ $f_{d+1}^{(r-1)}$
$F^{(r)} = F''$... f_k'' ...	f_d'' f_{d+1}''

 FIGURE 3.2: The expansion of F' in T .

or that

$$f'_{d+1} > f_{d+1}, \quad f'_{d-1} = f_{d-1}. \quad (**)$$

(Compare Lemma 3.3.7(iv).)

In the first case (*) we get

$$F \subset \underbrace{F' \setminus f'_{d+1} \cup \{f_{d+1} - 1, f_{d+1}\}}_{\substack{\neq S \\ \text{since } n+1 \in S}} \in \hat{T}.$$

In the second case (**) we know that $F' \setminus f'_d$ is not in $\mathcal{F}(n, d)$. Performing the same steps for $F' \setminus f'_d$ yields a finite sequence $F' = F^{(1)}, F^{(2)}, \dots, F^{(r)} = F''$ (where $F^{(\mu)} = (f_1^{(\mu)}, \dots, f_{d+1}^{(\mu)})$ for $\mu \in \{1, \dots, r\}$) of simplices in T with

$$\begin{aligned} f''_{d+1} &= f_{d+1}^{(r-1)} > f_{d+1}^{(r-2)} > \dots > f_{d+1}, \\ f''_d &= f_{d-1}^{(r-1)} = f_{d-1}^{(r-2)} = \dots = f_{d-1} < f_d = f_{d+1} - 1, \end{aligned}$$

where at step (r) we end up in case (*) because case (**) can occur at most $n - f_{d+1}$ times. This leads to

$$F \subset \underbrace{F'' \setminus f''_{d+1} \cup \{f_{d+1} - 1, f_{d+1}\}}_{\substack{\neq S \\ \text{since } n+1 \in S}} \in \hat{T}.$$

For further use, we refer to this sequence as the *expansion* of F' .

Now let $F = (f_1, \dots, f_{d+1})$ be a facet of the simplex $S = G \setminus g_{d+1} \cup \{j, j+1\}$ in B , such that F is not a facet of $C(n+1, d+1)$, with $G = (g_1, \dots, g_{d+1})$ in T .

► *The case $F = S \setminus j+1$, $j = f_{d+1} > f_d + 1 = g_d + 1$.* Then

$$F \subset \underbrace{G \setminus g_{d+1} \cup \{j-1, j\}}_{\substack{\neq S \\ \text{since } j+1 \in S}} \in \hat{T}.$$

► *The case $F = S \setminus j + 1$, $j = f_{d+1} = f_d + 1 = g_d + 1$.* Then we proceed as follows. $G \setminus g_d$ is not in $\mathcal{F}(n, d)$. Hence, there is another simplex $G' = (g'_1, \dots, g'_{d+1})$ in T with $G \setminus g_d \subset G'$. Consider the expansion $G' = G^{(1)}, G^{(2)}, \dots, G^{(r)} = G''$ of G' . We have

$$g''_{d+1} \geq f_{d+1}, \quad g''_d = f_{d-1} < f_d = f_{d+1} - 1,$$

and therefore

$$F \subset \underbrace{G'' \setminus g''_{d+1} \cup \{f_{d+1} - 1, f_{d+1}\}}_{\substack{\neq S \\ \text{since } j+1 \in S, j+1 > f_{d+1}}} \in \hat{T}.$$

► *The case $F = S \setminus j$, $j + 1 < g_{d+1}$.* Then

$$F \subset \underbrace{G \setminus g_{d+1} \cup \{j + 1, j + 2\}}_{\substack{\neq S \\ \text{since } j \in S, j > g_d}} \in \hat{T}.$$

► *The case $F = S \setminus j$, $j + 1 = g_{d+1}$.* Then

$$F = G \subset \underbrace{G \cup \{n + 1\}}_{\substack{\neq S \\ \text{since } n + 1 \notin S}} \in \hat{T}.$$

► *The case $F = S \setminus g_i$, $1 \leq i \leq d$.* In this case $G \setminus g_i$ is not in $\mathcal{F}(n, d)$ because otherwise $(G \setminus g_i) \setminus g_{d+1} \cup \{j, j + 1\} = F$ is a facet of $C(n + 1, d + 1)$ by Proposition 3.3.9. Hence, we find a simplex $H = (h_1, \dots, h_{d+1})$ in T with $G \setminus g_i \in H$ and $H \neq G$.

(*) If $h_{d+1} = g_{d+1}$ and $h_d < j$ then

$$F \subset \underbrace{H \setminus h_{d+1} \cup \{j, j + 1\}}_{\substack{\neq S \\ \text{since } H \neq G, h_{d+1} = g_{d+1}}} \in \hat{T}.$$

(**) If $h_{d+1} = g_{d+1}$ and $h_d = j$ then either $h_{d+1} = j + 1$ and thus $F = H$, or $h_{d+1} > j + 1$, whence

$$F = H \subset \underbrace{H \cup \{n + 1\}}_{\substack{\neq S \\ \text{since } n + 1 \notin S}} \in \hat{T} \quad \text{in the first case,}$$

$$F \subset \underbrace{H \setminus h_{d+1} \cup \{j + 1, j + 2\}}_{\substack{\neq S \\ \text{since } j + 2 \notin S}} \in \hat{T} \quad \text{in the second case.}$$

	1	j	n		
$H^{(1)} = H'$...	h'_{d-1}	h'_d	...	h'_{d+1}
$H^{(2)}$...	$h^{(2)}_{d-1}$	$h^{(2)}_d$...	$h^{(2)}_{d+1}$
\vdots							
$H^{(r-1)}$...	$h^{(r-1)}_{d-1}$	$h^{(r-1)}_d$...	$h^{(r-1)}_{d+1}$
$H^{(r)} = H''$...	h''_{d-1}	...	h''_d	...	h''_{d+1}

 FIGURE 3.3: The compression of H' in T .

(***) If $h_{d+1} = g_{d+1}$ and $h_d > j$ then $h_d > g_d + 1$ and hence $h_d - h_{d-1} > g_d + 1 - g_d = 1$. Therefore, $H \setminus h_{d+1}$ is not in $\mathcal{F}(n, d)$ because h_d is an inner singleton. This implies that there is a simplex $H' = (h'_1, \dots, h'_{d+1})$ in T with $H \setminus h_{d+1} \subset H'$. The Intersection Property in T leads to

$$h'_{d+1} = h_d > j, \quad h'_d < h_d.$$

Performing the above step with H' instead of H induces a finite sequence (the *compression* of H') $H' = H^{(1)}, H^{(2)}, \dots, H^{(r)} = H''$, where for H'' case (*) or case (**) must occur because the d -th element decreases monotonely. Then

$$h''_d \leq j < h^{(r-1)}_d = h''_{d+1},$$

and the constructions in (*) and (**) work with H'' instead of H as well.

(****) If $h_{d+1} > g_{d+1}$ then $H \setminus h_d$ is not a facet of $C(n, d)$, i. e., we find a simplex $H' = (h'_1, \dots, h'_{d+1})$ in T with $H \setminus h_d \subset H'$ and $H' \neq H$, and we can finish the proof by using the expansion of H' .

The proof of (IP) (i). We must show that any pair of simplices (R, S) with $R = (r_1, \dots, r_{d+2})$ and $S = (s_1, \dots, s_{d+2})$ in \hat{T} is admissible. Without loss of generality $\max(R \cup S) \in R$. There are three different cases:

► *The case $R \in A, S \in A$.* It is well-known that a pyramid over a simplicial complex is again a simplicial complex, i. e., it has the Intersection Property.

► *The case $R \in B, S \in B$.* There are $R' = (r'_1, \dots, r'_{d+1})$ and $S' = (s'_1, \dots, s'_{d+2})$ in T such that

$$\begin{aligned} R &= R' \setminus r'_{d+1} \cup \{j, j+1\}, & r'_d &< j < r'_{d+1}, \\ S &= S' \setminus s'_{d+1} \cup \{k, k+1\}, & s'_d &< k < s'_{d+1}. \end{aligned}$$

Without loss of generality, $j \geq k$. Assume (R, S) is not admissible. Then, by Lemma 3.3.7, there exists a circuit $Z \in \mathcal{L}^+(n+1, d+1)$ with $\text{supp}(Z) = (z_1, \dots, z_{d+3})$ and

$$Z^+ \subset R, \quad Z^- \subset S, \quad z_{d+3} = r_{d+2} = j+1.$$

By Proposition 3.3.10, we know that $Z' := (Z^+ \setminus z_{d+3}, Z^-)$ is a circuit in $\mathcal{Z}^-(n, d)$ with

$$(Z')^+ \subset R \setminus \{j+1\}, \quad (Z')^- \subset S, \quad z'_{d+2} \leq k+1 \leq s'_{d+1}.$$

Hence, $z'_{d+1} < j$ and $z'_d < k$. Therefore,

$$(Z')^+ \subset R', \quad (Z')^- \setminus \{z'_{d+2} \cup s'_{d+1}\} \subset S'.$$

But then

$$Z'' := \underbrace{((Z')^+)}_{\subset R'} \cup \underbrace{((Z')^- \setminus \{z'_{d+2} \cup s'_{d+1}\})}_{\subset S'}$$

is a circuit in $\mathcal{Z}^-(n, d)$ showing that (R', S') is not admissible; contradiction.

► *The case $R \in A, S \in B$.* There are $R' = (r'_1, \dots, r'_{d+2})$ and $S' = (s'_1, \dots, s'_{d+2})$ in T with

$$\begin{aligned} R &= R' \cup \{n+1\}, \\ S &= S' \setminus s'_{d+1} \cup \{k, k+1\}, \quad s'_d < k < s'_{d+1}. \end{aligned}$$

Assume again that (R, S) is not admissible. Let $Z \in \mathcal{Z}^+(n+1, d+1)$ be a circuit with $\text{supp}(Z) = (z_1, \dots, z_{d+3})$ such that

$$Z^+ \subset R, \quad Z^- \subset S, \quad z_{d+3} = r_{d+2} = n+1.$$

Then

$$Z' := \underbrace{(Z^+ \setminus \{n+1\})}_{\subset R'} \cup \underbrace{(Z^- \setminus \{z_{d+2} \cup s'_{d+1}\})}_{\subset S'}$$

is a circuit in $\mathcal{Z}^-(n, d)$ showing that (R', S') is not admissible; contradiction.

The proof of (UP) (iii). In order to simplify notation we set

$$\begin{aligned} A &:= \text{ast}_T(n), \\ B &:= \text{ast}_{\text{lk}_T(n)}(n-1) * \{n-1\}. \end{aligned}$$

We bring some known facts into a useful form:

- (a) Let F be a facet of $C(n-1, d-1)$ that does not contain $n-1$. Then $(F, n-1)$ is a facet of $C(n-1, d)$.
- (b) Let F be a facet of $C(n, d)$ that does not contain n . Then F is a facet of $C(n-1, d)$.
- (c) $\text{st}_T(n) \cup \text{ast}_T(n) = T$, $\text{st}_T(n) \cap \text{ast}_T(n) = \text{lk}_T(n)$.

Because of (c), all boundary facets of A are contained in $\text{lk}_T(n)$ or are facets of $C(n, d)$ that do not contain n . Then by (b) all boundary facets of A that are not facets of $C(n-1, d)$ are contained in $\text{lk}_T(n)$. Now let F be an element of $\text{lk}_T(n)$ but not a facet of $C(n-1, d)$. If $n-1 \notin F$ then $(F, n-1) \in T \setminus n$. If $n-1 \in F$ then by (a) we know that $F \setminus (n-1)$ is not a facet of $C(n, d)/n$. Hence, there is a simplex S in $\text{ast}_{\text{lk}_T(n)}(n-1)$ that contains $F \setminus (n-1)$ and therefore $F \subset (S, n-1) \in T \setminus n$.

Now let F be a facet in B that is not in $\mathcal{F}(n-1, d)$. If $n-1 \notin F$, then F is contained in $\text{ast}_{\text{lk}_T(n)}(n-1)$ and there must be a simplex in A containing F since there is such a simplex for all elements of $\text{lk}_T(n)$ by (c). If $n-1 \in F$, then — by (a) — $F \setminus (n-1)$ is not a facet of $\text{lk}_T(n)$. Hence, there must be a simplex S in $\text{ast}_{\text{lk}_T(n)}(n-1)$ containing $F \setminus (n-1)$, and therefore the simplex $(S, n-1)$ is in B and contains F , which completes the proof.

The proof of (IP) (iii). The simplices in A are pairwise admissible because they are part of T , the simplices in B are pairwise admissible because B is a pyramid over a set of admissible simplices. Therefore, assume there are $S_1 \in A$ and $S_2 \in B$ and a circuit Z with $Z^+ \subseteq S_1$ and $Z^- \subseteq S_2$, where $n-1 \in S_2$ by definition. If $n-1 \notin Z^-$ then $S'_2 := S_2 \setminus (n-1) \cup n$ and S_1 are not admissible either; contradiction because S_1 and S'_2 are in T . But if we replace $n-1$ by n in Z then we get a circuit Z' that again shows that S_1 and S'_2 are not admissible. \square

Corollary 3.4.3. *Any triangulation of the cyclic d -polytope $C(n, d)$ with n vertices induces*

- a canonical triangulation \hat{T} of $C(n+1, d+1)$ containing T as the link of $n+1$,
- a canonical triangulation T/n of $C(n-1, d-1)$ which is the link of n ,
- a canonical triangulation $T \setminus n$ of $C(n-1, d)$ containing the antistar of n as a subcomplex, and
- a canonical triangulation δT defined as $\hat{T} \setminus n+1$ of $C(n, d+1)$ containing T as a subcomplex. \square

Remark 3.4.4. All these constructions — except for the link — are specific for cyclic polytopes and are incorrect for some more general polytopes.

In order to demonstrate that triangulating cyclic polytopes is nevertheless non-trivial, we provide an example showing that they are not *greedily triangulable*.

Example 3.4.5. Let $n = 8$, $d = 5$ and

$$\begin{aligned} S_1 &:= (3, 4, 5, 6, 7, 8), \\ S_2 &:= (1, 2, 3, 6, 7, 8), \\ S_3 &:= (1, 2, 3, 4, 5, 6). \end{aligned}$$

Every pair of these simplices is admissible.

However, consider the facet $F := (1, 3, 6, 7, 8)$ of S_2 : it is not a facet of $C(8, 5)$. Hence, in any triangulation T of $C(8, 5)$ that contains S_1 , S_2 , and S_3 there must be a simplex S' containing F . But all three possibilities for such a simplex produce non-admissible pairs. Therefore, there is no such triangulation. Hence, one can get stuck by triangulating a cyclic polytope.

3.5 THE HIGHER STASHEFF-TAMARI ORDERS

In this section we describe the notion of increasing bistellar operations, or *flips*, (as suggested by EDELMAN & REINER [21]) in terms of our set-up. This leads to a combinatorial definition of the first higher Stasheff-Tamari order $\mathcal{S}_1(n, d)$. In contrast to this, the geometric definition of the second higher Stasheff-Tamari order $\mathcal{S}_2(n, d, t)$ is related to a geometric interpretation $\mathcal{S}_1(n, d, t)$ of $\mathcal{S}_1(n, d)$. Specific properties of cyclic polytopes lead to a simple proof of Theorem 3.1.1.

The set of all triangulations of $C(n, d)$, respectively $C(n, d, t)$, is denoted by $S(n, d)$, respectively $S(n, d, t)$.

Definition 3.5.1. An *increasing (bistellar) flip set* in $T \in S(n, d)$ is a simplex $\tilde{S} \in \binom{[n]}{d+2}$ with the property that the set of simplices $\mathcal{F}^l(\tilde{S}, d+1)$ is a subset of T .

For all $(d+2)$ -subsets \tilde{S} of $[n]$, we have the *increasing flip function* of \tilde{S}

$$\text{flip}_{\tilde{S}} : \begin{cases} S(n, d) & \rightarrow S(n, d), \\ T & \mapsto \begin{cases} T \setminus \mathcal{F}^l(\tilde{S}, d+1) \\ \cup \mathcal{F}^u(\tilde{S}, d+1) & \text{if } \mathcal{F}^l(\tilde{S}, d+1) \subseteq T \\ T & \text{otherwise.} \end{cases} \end{cases}$$

Remark 3.5.2. By Proposition 3.3.11, this definition is equivalent to the notion of directed bistellar operations in EDELMAN & REINER [21].

Remark 3.5.3. Geometric Meaning (see Figure 3.4): Let $t : [n] \rightarrow \mathbb{R}$ be strictly monotone. Let Δ be a geometric triangulation of $C(n, d, t)$ labelled by T , and let Δ' be a geometric triangulation of $C(n, d, t)$ defined by the labels of $\text{flip}_{\tilde{S}}(T)$ for some increasing flip \tilde{S} in $T \in S(n, d)$. Then the geometric lower facets of the $(d+1)$ -simplex $\tilde{\sigma} := v_{d+1} \circ t(\tilde{S})$ in $C(n, d+1, t)$ are contained in the characteristic section s_{Δ} , the geometric upper facets lie in $s_{\Delta'}$, and elsewhere the sections coincide.

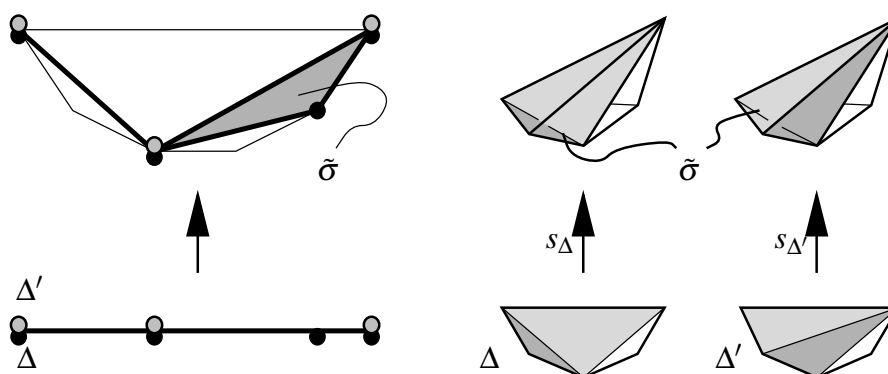

FIGURE 3.4: Increasing flips in $\mathcal{S}_1(6, 1)$ respectively $\mathcal{S}_1(5, 2)$.

Definition 3.5.4. (EDELMAN & REINER [21])

The *first higher Stasheff-Tamari order* on $S(n, d)$ is defined via

$$T_1 \leq_1 T_2 \iff T_2 = \text{flip}_{\tilde{\sigma}_r} \circ \dots \circ \text{flip}_{\tilde{\sigma}_1}(T_1)$$

for some sequence $(\tilde{\sigma}_1, \dots, \tilde{\sigma}_r)$ in $\binom{[n]}{d+2}$. The set of all triangulations of $C(n, d)$ with this partial order is denoted by $\mathcal{S}_1(n, d)$.

The *second higher Stasheff-Tamari order* on $S(n, d, t)$ is defined via

$$\Delta_1 \leq_2 \Delta_2 \iff s_{\Delta_1}(x)_{d+1} \leq s_{\Delta_2}(x)_{d+1} \quad \text{for all } x \in C(n, d, t),$$

that is, s_{Δ_1} lifts $C(n, d)$ weakly lower than s_{Δ_2} . It is written as $\mathcal{S}_2(n, d, t)$.

Remark 3.5.5. The triangulation $\mathcal{F}^l(n, d+1)$ is locally minimal, the triangulation $\mathcal{F}^u(n, d+1)$ is locally maximal in $\mathcal{S}_1(n, d, t)$.

Moreover, $\mathcal{F}^l(n, d+1)$ represents the unique (thus global) minimal element, and $\mathcal{F}^u(n, d+1)$ the unique maximal element of $\mathcal{S}_2(n, d, t)$, for all strictly monotone $t : [n] \rightarrow \mathbb{R}$.

EDELMAN & REINER [21, Conjecture 2.6] conjectured that $\mathcal{S}_1(n, d)$ is the correct combinatorial model for $\mathcal{S}_2(n, d)$, that is, $\mathcal{S}_2(n, d, t)$ coincides with $\mathcal{S}_1(n, d, t)$ for all strictly monotone $t : [n] \rightarrow \mathbb{R}$. Theorem 3.1.1 shows that, at least the maximal and minimal elements of both partial orders coincide.

In order to prove this, we introduce in the following for all T in $S(n, d)$ a partial order on the set of their simplices. In this context the notion of the parity of “gaps” in linearly ordered sets of Definition 3.3.2 is again useful.

Definition 3.5.6. To each $S \in \binom{[n]}{d+1}$ we assign a unique string by

$$\Gamma: \begin{cases} \binom{[n]}{d+1} \rightarrow \{o, *, e\}^n \\ S \mapsto (\gamma_1, \dots, \gamma_n), \\ \text{with } \gamma_i = \begin{cases} e & \text{if } i \notin S \text{ and } \#\{j \in S : j > i\} \text{ even,} \\ * & \text{if } i \in S, \\ o & \text{if } i \notin S \text{ and } \#\{j \in S : j > i\} \text{ odd.} \end{cases} \end{cases}$$

(Here the letter “ e ” denotes an *even gap*, the letter “ o ” an *odd gap* in S , while “ $*$ ” corresponds to an element of S .)

Let “ $\prec_{(o*e)}$ ” be the lexicographic order on $\binom{[n]}{d+1}$ induced by Γ and the linear order of letters “ $o \prec_{(o*e)} * \prec_{(o*e)} e$.”

Definition 3.5.7. For S_1 and S_2 in $T \in S(n, d)$ with $\#(S_1 \cup S_2) = d + 2$, define the relation

$$S_1 \prec S_2 \iff S_1 \cap S_2 \in \mathcal{F}^u(S_1, d) \cap \mathcal{F}^l(S_2, d).$$

Moving from one simplex of a triangulation to an adjacent one can either be considered as moving an element or moving a gap of the support.

Lemma 3.5.8. Let $T \in S(n, d)$ and $S_1, S_2 \in T$ with $S_1 \prec S_2$. Set $S_{12} := S_1 \cap S_2$, $S_1 \setminus S_{12} =: i_1$, and $S_2 \setminus S_{12} =: i_2$.

1. If i_2 is an even gap in S_1 then i_1 is an even gap in S_2 and $i_1 < i_2$, that is, “ \prec ” moves even gaps to the left.
2. If i_2 is an odd gap in S_1 then i_1 is an odd gap in S_2 and $i_1 > i_2$, that is, “ \prec ” moves odd gaps to the right.
3. A gap changes parity if and only if it lies between i_1 and i_2 .

Proof. The assumptions imply that S_2 is obtained from S_1 by deleting an odd element i_1 from S_1 and adding an even gap $i_2 \notin S_1$ to S_{12} , or equivalently, the gap i_2 moves to position i_1 .

If $i_1 < i_2$ then i_2 is an even gap in S_1 , and i_1 is an even gap in S_2 , i. e., the even gap at i_2 moves to the left. If $i_2 < i_1$ then i_2 is an odd gap in S_1 , and i_1 is an odd gap in S_2 , i. e., the odd gap at i_2 moves to the right.

The third assertion is true because for any label $i \notin \{i_1, i_2\}$ not between i_1 and i_2 the number of elements to the right stays constant. \square

Corollary 3.5.9. The transitive closure of “ \prec ” is a partial order on the set of all d -simplices in $\binom{[n]}{d+1}$. A d -simplex S is minimal if and only if all of its lower facets are contained in $\mathcal{F}^l(n, d)$; it is maximal if and only if all of its upper facets are in $\mathcal{F}^u(n, d)$.

Proof. By Lemma 3.5.8, we have that

$$S_1 \prec S_2 \implies S_1 \prec_{(o^*e)} S_2.$$

Hence, “ \prec ” is acyclic, thus defining a partial order. \square

Remark 3.5.10. Geometric Meaning: Let Δ be a triangulation of $C(n, d, t)$. Corollary 3.5.9 tells us that the repeated transition from one simplex $\sigma \in \Delta$ to an adjacent one docking from below does not create any cycles.

One cannot expect a similar property for triangulations of general polytopes, as is shown by the strongly non-regular triangulation of the *twisted capped prism* in LEE [41].

Now the following proposition can be proved by combining combinatorial and geometric facts.

Proposition 3.5.11. *Let $T \in S(n, d) \setminus \mathcal{F}^u(n, d+1)$ and $\tilde{T} \in S(n, d+1)$ such that T is a subcomplex of \tilde{T} . Then there is a $(d+1)$ -simplex $\tilde{S} \in \tilde{T}$ that defines an increasing flip in T .*

Similarly, if $T \in S(n, d) \setminus \mathcal{F}^l(n, d+1)$ there is a $(d+1)$ -simplex that defines a decreasing flip in T .

Proof. Choose a simplex S in $T \setminus (\mathcal{F}^u(n, d+1) \cap T)$. Since S is not an upper facet of $C(n, d+1)$, condition (UP) for \tilde{T} implies that there must be a simplex \tilde{S} in \tilde{T} containing S as a *lower* facet. (Either S is a lower facet of $C(n, d)$, and hence a lower facet of a simplex in \tilde{T} , or S lies in two different simplices of \tilde{T} , and not both of them can simultaneously contain S as an upper facet because of (IP).)

We now choose a geometric interpretation by fixing $t : [n] \rightarrow \mathbb{R}$ strictly monotone. This gives rise to geometric interpretations $C(n, d, t)$ of $C(n, d)$, $C(n, d+1, t)$ of $C(n, d+1)$, $\tilde{\Delta}$ of \tilde{T} , Δ of T , and $\tilde{\sigma}$ of \tilde{S} . Because T is a subcomplex of \tilde{T} , we know that its characteristic section s_Δ is a subcomplex of $\tilde{\Delta}$. But then $\tilde{\sigma}$ lies weakly above the section s_Δ because at least one of its lower facets, namely $s_\Delta(\sigma)$, is contained in s_Δ .

If there exists a lower facet $F_l \in \mathcal{F}^l(\tilde{S}, d+1)$ of \tilde{S} that is not contained in T then either F_l is a lower facet of $C(n, d+1)$ — which is impossible because between the geometric interpretation σ' of F_l and the lower facets of $C(n, d+1, t)$ lies the section s_Δ — or there is a simplex $\tilde{S}' \in \tilde{T}$ with $F_l \subset \tilde{S}'$ and $\tilde{S}' \prec \tilde{S}$, the geometric interpretation of which is still lying weakly above the section. By continuing this process, we will — by Corollary 3.5.9 — end up with a simplex $\tilde{S}'' \in \tilde{T}$ with $\mathcal{F}^l(\tilde{S}'', d+1) \subseteq T$ (see Figure 3.5). The decreasing flip can be found analogously.

We know that all geometric interpretations have the same combinatorial structure, thus the proof is complete. \square

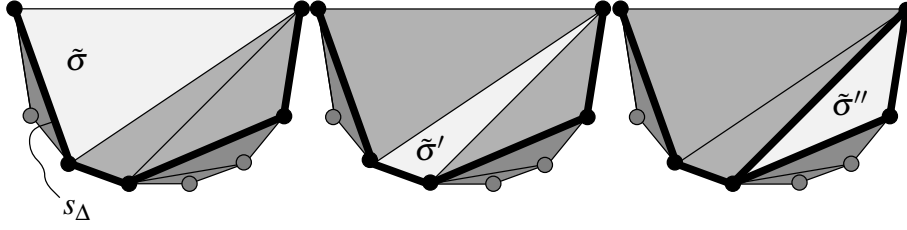
FIGURE 3.5: Finding an increasing flip in $\mathcal{S}_1(8, 1)$.

The special form of the increasing (decreasing) flips in Proposition 3.5.11 leads to the following result.

Corollary 3.5.12. *Let \tilde{T} be a triangulation of $C(n, d+1)$. Then every linear extension “ \prec_l ” of “ \prec ” on \tilde{T} defines a maximal chain in $\mathcal{S}_1(n, d)$ via*

$$\mathcal{F}^l(n, d+1) = T_0 \prec_l T_1 \prec_l \dots \prec_l T_{r-1} \prec_l T_r = \mathcal{F}^u(n, d+1),$$

where

$$\tilde{T} = \{\tilde{S}_1, \tilde{S}_2, \dots, \tilde{S}_r\}, \quad \tilde{S}_1 \prec_l \tilde{S}_2 \prec_l \dots \prec_l \tilde{S}_r. \quad \square$$

Proof of Theorem 3.1.1. In order to prove (i), we show that any triangulation of $C(n, d)$ is on a chain from $\mathcal{F}^l(n, d+1)$ to $\mathcal{F}^u(n, d+1)$. Let T be an arbitrary triangulation of $C(n, d)$. By Theorem 3.4.3, δT is a triangulation of $C(n, d+1)$ containing T as a subcomplex. Thus, by Proposition 3.5.11 and induction, we can connect T to $\mathcal{F}^u(n, d+1)$ by a sequence of increasing flips (compare Figure 3.5), and to $\mathcal{F}^l(n, d+1)$ by a sequence of decreasing flips, which implies the assertion.

For the proof of (ii), observe that, by the definition of increasing bistellar flips, any chain

$$c : \mathcal{F}^l(n, d+1) \prec_l \dots \prec_l \mathcal{F}^u(n, d+1)$$

from $\mathcal{F}^l(n, d+1)$ to $\mathcal{F}^u(n, d+1)$ defines a triangulation T_c of $C(n, d+1)$ via

$$T_c := \{\tilde{S}_1, \dots, \tilde{S}_r\},$$

hence factoring out the order of c . For the converse, let \tilde{T} be an arbitrary triangulation of $C(n, d+1)$. Then, by Corollary 3.5.12,

$$c_{\tilde{T}} := T_{\prec_{(o^*e)}}$$

is a chain in $\mathcal{S}_1(n, d)$ from $\mathcal{F}^l(n, d+1)$ to $\mathcal{F}^u(n, d+1)$.

Part (iii) follows directly from Corollary 3.5.12. \square

The central roles of the triangulations \hat{T} , T/n , $T \setminus n$, $\delta(T)$ are underlined by the following additional results.

Lemma 3.5.13. (Functorial Flip Properties)

If \tilde{S} is an increasing flip from T to T' then

$$(\tilde{S})_{\prec_l} := \{ \tilde{S} \setminus \tilde{s}_{d+2} \cup \{j, j+1\} : \tilde{s}_{d+1} < j < \tilde{s}_{d+2} \}_{\prec_l}$$

is a decreasing flip sequence from \hat{T} to \hat{T}' ,

$$(\tilde{S}/n) := \begin{cases} (\tilde{S} \setminus \{n\}) & \text{if } n \in \tilde{S}, \\ () & \text{otherwise,} \end{cases}$$

is an increasing flip from T/n to T'/n ,

$$(\tilde{S} \setminus n) := \begin{cases} (\tilde{S}) & \text{if } n \notin \tilde{S}, \\ (\tilde{S} \setminus \{n\} \cup \{n-1\}) & \text{if } n \in \tilde{S}, n-1 \notin \tilde{S}, \\ () & \text{otherwise,} \end{cases}$$

is a decreasing flip sequence from $T \setminus n$ to $T' \setminus n$, where “ \prec_l ” is any linear extension of “ \prec .” \square

In other words, there are the following maps of posets.

Proposition 3.5.14. (Functorial Order Properties)

(i) The map

$$\hat{\cdot} : \begin{cases} \mathcal{S}_1(n, d) & \rightarrow \mathcal{S}_1(n+1, d+1), \\ T & \mapsto \hat{T}, \end{cases}$$

is order-reversing.

(ii) The map

$$\cdot/n : \begin{cases} \mathcal{S}_1(n, d) & \rightarrow \mathcal{S}_1(n-1, d-1), \\ T & \mapsto T/n, \end{cases}$$

is order-reversing.

(iii) The map

$$\cdot \setminus n : \begin{cases} \mathcal{S}_1(n, d) & \rightarrow \mathcal{S}_1(n-1, d), \\ T & \mapsto T \setminus n, \end{cases}$$

is order-preserving.

(iv) *The map*

$$\delta : \begin{cases} \mathcal{S}_1(n, d) & \rightarrow \mathcal{S}_1(n, d+1), \\ T & \mapsto \delta(T), \end{cases}$$

is order-reversing. □

Corollary 3.5.15. *Every chain in $\mathcal{S}_1(n, d)$ that corresponds to a flip sequence $(\tilde{T}) := (\tilde{S}_1, \dots, \tilde{S}_r)$ gives rise to flip sequences*

(i) $(\tilde{T}) \widehat{\prec}_l$ in $\mathcal{S}_1(n+1, d+1)$,

(ii) $(\tilde{T}/n) \prec_l$ in $\mathcal{S}_1(n-1, d-1)$,

(iii) $(\tilde{T} \setminus n) \prec_l$ in $\mathcal{S}_1(n-1, d)$, and

(iv) $\delta(\tilde{T}) \prec_l$ in $\mathcal{S}_1(n, d+1)$. □

3.6 SHELLABILITY

In this section we present another application of the partial order property of the simplices in a triangulation of a cyclic polytope, namely that all triangulations (without new vertices) of a cyclic polytope are shellable. This fact is far from trivial because there exists, for example, a non-shellable triangulation of a convex 3-polytope with all vertices in convex position, namely a perturbed version of Rudin's non-shellable tetrahedron (see [73]).

Theorem 3.6.1. *All $T \in \mathcal{S}_1(n, d)$ are shellable. A shelling order on the simplices of T is given by first shelling the star of n in T corresponding to a shelling order on the link of n in T , and then shelling the rest of T according to a reversed linear extension of " \prec ," for example " $\succ_{(o*e)}$."*

The rest of this section is devoted to the proof of Theorem 3.6.1, which implies Theorem 3.1.1(iv). We start with some lemmas that are intuitively plausible when one considers the geometric interpretations. With the results of Section 3.3, however, we have tools at hand that provide more security.

Lemma 3.6.2. *Let S be a d -simplex in $\binom{[n]}{d+1}$. A face $G \subseteq [n]$ is the intersection of lower facets of S if and only if S is of the form*

$$S = (G_{\#(S \setminus G)}, s_{\#(S \setminus G)}, \dots, \underbrace{G_2}_{\text{odd}}, s_2, \underbrace{G_1}_{\text{odd}}, s_1),$$

$$G = G_1 \cup G_2 \cup \dots \cup G_{\#(S \setminus G)}, \quad s_1, s_2, \dots, s_{\#(S \setminus G)} \in S \setminus G.$$

G is the intersection of upper facets of S if and only if S is of the form

$$S = (G_{\#(S \setminus G)}, s_{\#(S \setminus G)}, \underbrace{G_{\#(S \setminus G) - 1}, \dots, s_2}_{\text{odd}}, \underbrace{G_1}_{\text{odd}}, s_1, \underbrace{G_0}_{\text{odd}}),$$

$$G = G_0 \cup G_1 \cup \dots \cup G_{\#(S \setminus G)}, \quad s_1, s_2, \dots, s_{\#(S \setminus G)} \in S \setminus G.$$

Proof. If there were two elements in $S \setminus G$ separated by an even number of elements in G then leaving them out separately in S would produce gaps of different parity. From this the claim follows. \square

Lemma 3.6.3. *Let $S \in \binom{[n]}{d+1}$. If G is the intersection of lower (upper) facets of S then G is not contained in any upper (lower) facet of $C(n, d)$.*

Proof. If $d = 1$, everything is clear. Let G be the intersection of lower facets $F^{(1)}, \dots, F^{(r)}$ of $S = (s_1, \dots, s_{d+1})$. Then all $F^{(i)}$ contain only even gaps, in particular they contain $s_d < s_{d+1} \leq n$. Assume G is contained in some upper facet $F = (f_1, \dots, f_d)$ of $C(n, d)$. Then F contains s_d and n . Consider $F' := F \setminus \{n\}$, a lower facet of $C(n-1, d-1)$, and the $(d-1)$ -simplex $S' := S \setminus \{s_{d+1}\}$. The sets

$$F^{(i)} \setminus \{f_{d-1}^{(i)}, f_d^{(i)}\} \cup \{s_d\}, \quad i = 1, \dots, r,$$

are upper facets of S' , and their intersection is contained in F' (because $s_d \in F'$); contradiction by the following paragraph and induction.

If G is the intersection of upper facets $F^{(1)}, \dots, F^{(r)}$ of $S = (s_1, \dots, s_{d+1})$ then all $F^{(i)}$ contain only odd gaps, in particular, they contain s_{d+1} . Assume G is contained in some lower facet $F = (f_1, \dots, f_d)$ of $C(n, d)$. Then F contains s_{d+1} as well, so $f_d \geq s_{d+1}$. Therefore, we may assume, without loss of generality, that $n = f_d$. Since F contains only even gaps, we have $f_{d-1} = f_d - 1$. Consider $F' := F \setminus \{f_{d-1}, f_d\} \cup \{n-1\} = F \setminus n$ which is an upper facet of $C(n-1, d-1)$. The sets

$$F^{(i)} \setminus \{s_{d+1}\}, \quad i = 1, \dots, r,$$

are lower facets of the $(d-1)$ -simplex $S' := S \setminus \{s_{d+1}\}$, and their intersection is contained in F' (because $n \geq s_{d+1}$); contradiction by the previous paragraph and induction. \square

Lemma 3.6.4. *Let $T \in \mathcal{S}_1(n, d)$ and $S_1 \neq S_2 \in T$. If $S_1 \cap S_2$ is not contained in any upper (lower) facet of S_1 , i. e., is the intersection of lower (upper) facets of S_1 , then it is contained in some upper (lower) facet of S_2 .*

Proof. Assume $S_1 \cap S_2$ is the intersection of lower (upper) facets of S_1 and also the intersection of lower (upper) facets of S_2 . We show by induction that $S_1 \cup S_2$

contains the support of a circuit Z in $\mathcal{Z}(n, d)$ with $S_1 \subseteq Z^+$ and $S_2 \subseteq Z^-$. If $d = 1$ then everything is clear.

Both S_1 and S_2 are of the form given in Lemma 3.6.2, in particular, we may set $S_1 = (S'_1, s_1)$ and $S_2 = (S'_2, s_2)$ with $s_1 > s'_2$ for all $s'_2 \in S'_2$ and $s_2 > s'_1$ for all $s'_1 \in S'_1$. If $S'_1 = S'_2$ then $s_1 \neq s_2$ and (S'_1, s_1, s_2) supports a circuit Z in $\mathcal{Z}(n, d)$ with $S_1 \subseteq Z^+$ and $S_2 \subseteq Z^-$, showing that (S_1, S_2) is not admissible; contradiction. If $S'_1 \neq S'_2$ then $S'_1 \cap S'_2$ is the intersection of upper or the intersection of lower facets of S'_1 , and the same for S'_2 , by Lemma 3.6.2. Hence, by the induction hypothesis, $S'_1 \cup S'_2$ contains the support of a circuit Z' in $\mathcal{Z}(n-1, d-1)$ with $Z^+ \subseteq S'_1$ and $Z^- \subseteq S'_2$. Without loss of generality, $z_{d+1} = \max(S'_1 \cup S'_2) \in S'_1$. Then $Z := (Z^+, Z^- \cup \{s_2\})$ is a circuit (recall that $s_2 > s'_1$ for all $s'_1 \in S'_1$) in $\mathcal{Z}(n, d)$ proving that (S_1, S_2) is not admissible; contradiction. \square

Definition 3.6.5. Let $T \in \mathcal{S}_1(n, d)$ and $T' \subseteq T$. An upper (lower) facet F of a simplex $S \in T'$ is a *free upper (lower) facet* of T' if F is neither a facet of $C(n, d)$ nor a facet of some other simplex in T' .

Proposition 3.6.6. Let $T \in \mathcal{S}_1(n, d)$ and $T' \subseteq T$ such that T' contains no free upper facet. Then the intersection of T' with any simplex $S \in T \setminus T'$ having all upper facets in T' equals the union of the upper facets of S .

Proof. Let $G \subseteq S \cap T'$ be not contained in any upper facet of S . Let S' be a simplex in T' with $G \subseteq S'$ that is maximal with respect to “ \prec .” By Lemma 3.6.4, G is contained in some upper facet F' of S' that is not a facet of $C(n, d)$ by Lemma 3.6.3. Thus, there is a simplex S'' with $S'' \neq S'$ and $F' \subset S''$. But then $S'' \succ S'$; contradiction to the maximality of S' . \square

Lemma 3.6.7. Let $T \in \mathcal{S}_1(n, d)$. Then $\text{st}_T(n)$ contains no free upper facets.

Proof. Every simplex in $\text{st}_T(n)$ contains n , thus any upper facet in $\text{st}_T(n)$ contains n , so it cannot be contained in a simplex outside $\text{st}_T(n)$. \square

Proof of Theorem 3.6.1. A triangulation of $C(n, 1)$ is just a dissection of an interval, thus shellable. Let $d > 1$ and $T \in \mathcal{S}_1(n, d)$. Assume that all triangulations of $C(n-1, d-1)$ are proven to be shellable. Then we know that $\text{lk}_T(n) \in \mathcal{S}_1(n-1, d-1)$ is shellable. Let $(\text{lk}_T(n))_{\prec_{d-1}}$ denote a shelling order of $\text{lk}_T(n)$. Then $(\text{st}_T(n))_{\prec_{d-1}}$ is a canonical shelling order of $\text{st}_T(n)$.

Now pick any linear extension “ \succ_I ” of “ \succ .” We claim that

$$(\text{ast}_T(n))_{\succ_I} =: (S^{(1)}, \dots, S^{(r)})$$

completes $(\text{st}_T(n))_{\prec_{d-1}}$ to a shelling order on T . Let $T^{(0)} := \text{st}_T(n)$ and

$$T^{(i)} := \text{st}_T(n) \cup S^{(1)} \cup \dots \cup S^{(i)}, \quad i = 1, \dots, r.$$

We know by Lemma 3.6.7 that there is no free upper facet in $T^{(0)} = \text{st}_T(n)$. Since “ \succ_l ” extends “ \succ ,” all upper facets of the i -th element $S^{(i)}$ in $(\text{ast}_T(n))_{\succ_l}$ are contained in $T^{(i-1)}$ for all $i = 1, \dots, r$. Hence, there are no free upper facets in $T^{(i)}$ for all $i = 1, \dots, r$. Thus, by Proposition 3.6.6, the intersection of $S^{(i)}$ and $T^{(i-1)}$ is indeed the union of these upper facets, in particular pure of dimension $d - 1$ for all $i = 1, \dots, r$, which proves the Theorem by induction. \square

3.7 HIGHER BRUHAT ORDERS

In this section we recall the basic definitions and theorems in the framework of higher Bruhat orders and answer a question by ZIEGLER [74]. Let \mathcal{L} be a linearly ordered finite set. The reader may consider \mathcal{L} as the set $[n]$, without loss of generality.

Definition 3.7.1. (MANIN & SCHECHTMAN [48], ZIEGLER [74])

- For some $(k + 1)$ -subset $P := (p_1, \dots, p_{k+1})$ of \mathcal{L} , the set of its k -subsets

$$\mathcal{P} = \binom{P}{k} = \{P \setminus p_v : v = 1, \dots, k + 1\}$$

is a k -packet of \mathcal{L} . It is naturally ordered by $P \setminus p_v < P \setminus p_\mu \iff \mu < v$, the *lexicographic order*.

- An ordering α of $\binom{\mathcal{L}}{k}$ is *admissible* if the elements of any $(k + 1)$ -packet appear in lexicographic or in reverse-lexicographic order. Two orderings α and α' are *equivalent* if they differ by a sequence of interchanges of two neighbors that do not lie in a common packet.
- The *inversion set* $\text{inv}(\alpha)$ of an admissible ordering α is the set of all $(k + 1)$ -subsets of \mathcal{L} whose k -subsets appear in reverse-lexicographic order in α .
- A set U of $(k + 1)$ -subsets of \mathcal{L} is *consistent* if its intersection with any $(k + 1)$ -packet \mathcal{P} of \mathcal{L} is a beginning or an ending segment of \mathcal{P} with respect to the lexicographic order on \mathcal{P} .
- The set of all equivalence classes of admissible orders of $\binom{\mathcal{L}}{k}$, partially ordered by single-step-inclusion of inversion sets. That is, $[\alpha] \leq [\alpha']$ if and only if

$$\text{inv}(\alpha) = U_1 \subset U_2 \subset \dots \subset U_K = \text{inv}(\alpha')$$

with $\#U_v \setminus U_{v-1} = 1$ and all U_v are admissible — is the *higher Bruhat order* $\mathcal{B}(\mathcal{L}, k)$, where $\mathcal{B}(n, k)$ denotes $\mathcal{B}([n], k)$.

- For an inversion set $U \in \mathcal{B}(\mathcal{L}, k)$, define

$$\partial U := \left\{ I \in \binom{\mathcal{L}}{k+2} : I \setminus i_1 \notin U, I \setminus i_{k+2} \in U \right\}.$$

The structure of $\mathcal{B}(\mathcal{L}, k)$ does of course only depend on the cardinality of \mathcal{L} , but the general setting leads to some advantages in the notation of functorial constructions. For simplicity, however, we switch now to $\mathcal{B}(n, k)$.

Theorem 3.7.2. (MANIN & SCHECHTMAN [48], ZIEGLER [74])

The higher Bruhat order $\mathcal{B}(n, k)$ is a ranked poset with rank function $r(U) = \#U$. Moreover, it has a unique minimal element $\hat{0}_{n,k} = \emptyset$ and a unique maximal element $\hat{1}_{n,k} = \binom{[n]}{k+1}$. \square

The following Theorem gives a more geometric insight into the structure of higher Bruhat orders.

Theorem 3.7.3. (ZIEGLER [74])

The higher Bruhat order $\mathcal{B}(n, k)$ is isomorphic to

1. *the set of all consistent sets U of $(k+1)$ -subsets of $[n]$ with single-step-inclusion-order,*
2. *the set of (equivalence classes of) extensions of the cyclic hyperplane arrangement $X^{n,n-k-1}$ by a new pseudo-hyperplane in general position, partially ordered by single-step-inclusion of the sets of vertices on “the negative side,”*
3. *the set of maximal chains of inversion sets in $\mathcal{B}(n, k-1)$ — corresponding to orders of k -sets — modulo equivalence of admissible orders. \square*

The following notations for deletion and contraction in $\mathcal{B}(n, k)$ provide intuition via the corresponding notions in $X^{n,n-k-1}$.

Definition 3.7.4. For $U \in \mathcal{B}(n, k)$, define

$$U/n := \{ I \setminus n : n \in I, I \in U \}, \quad (\text{contraction})$$

$$U \setminus n := \{ I \in U : n \notin I \}. \quad (\text{deletion})$$

In order to construct inversion sets in $\mathcal{B}(n+1, k+1)$ from inversion sets in $\mathcal{B}(n, k)$ and in $\mathcal{B}(n, k+1)$, the following Theorem is useful.

Theorem 3.7.5. (ZIEGLER [74])

*Let U be an inversion set in $\mathcal{B}(n, k)$, and let V be an inversion set in $\mathcal{B}(n, k+1)$. Then $U' := V \cup U * (n+1)$ is consistent if and only if*

$$\partial U \subseteq V \quad \text{and} \quad \partial \mathbb{C}U \subseteq \mathbb{C}V. \quad \square$$

Corollary 3.7.6. *The following maps from $\mathcal{B}(n, k)$ to $\mathcal{B}(n+1, k+1)$ are injective:*

$$U \mapsto \tilde{U} := U * (n+1) \cup \partial U, \quad (\text{extension})$$

$$U \mapsto \hat{U} := U * (n+1) \cup \delta(U) = U * (n+1) \cup (U \setminus n)^\wedge, \quad (\text{expansion})$$

where $\delta(U)$ is defined as

$$\delta(U) := \{ I \in \binom{[n]}{k+2} : I \setminus i_{k+2} \in U \}. \quad \square$$

The extension is not order-preserving in general. But the following definition yields a canonical single-step-inclusion order for the expansion of U from an arbitrary single-step-inclusion order of U .

Definition 3.7.7. For some $U \in \mathcal{B}(n, k)$ with a given single-step-inclusion-order $\Omega(U) = (\Omega(U'), I)$, define the following order $\hat{\Omega}$: For $n = k+1$, start with

$$\hat{\Omega}(\{[n]\}^\wedge) := ([n+1])$$

corresponding to $\Omega(\{[n]\}) = ([n])$ in $\mathcal{B}(n, k)$. If $n > k+1$ and $\hat{\Omega}(\hat{U}')$ is already constructed then define

$$\hat{\Omega}(\hat{U}) := \left(\hat{\Omega}(\hat{U}'), \hat{\Omega}(\partial I), I \cup \{n+1\}, \hat{\Omega}(\delta I \setminus \partial I) \right),$$

where the orders on ∂I and $\delta I \setminus \partial I$ are given by restriction of $\hat{\Omega}((U \setminus n)^\wedge)$.

Proposition 3.7.8. *For all $U \in \mathcal{B}(n, k)$ and all single-step-inclusion orders Ω of U , the order $\hat{\Omega}$ is a single-step-inclusion order of the expansion \hat{U} of U in $\mathcal{B}(n+1, k)$.*

Proof. The following properties make sure that no cycles are produced:

$$\begin{aligned} \delta(U) \setminus n &= \delta(U \setminus n), \\ \partial(U) \setminus n &= \partial(U \setminus n). \end{aligned}$$

At each single-step-inclusion step all packets in $\mathcal{B}(n, k+1)$ are consistent by induction. From the remaining packets only those containing $I \cup \{n+1\}$ are involved.

If $n \notin I$ then the order increases just by $I \cup \{n\}$ which is consistent because Ω is a single-step-inclusion order of U and \hat{U}' is already ordered consistently.

Let n be in I . For all packets \mathcal{P} containing $I \cup \{n+1\}$, either $\mathcal{P}/n+1$ is completely contained in U or only I meets U . In the first case the only element $P \setminus a'$ of $\mathcal{P} \setminus n+1$ comes before $I \cup \{n+1\}$ in $\hat{\Omega}$, in the second case $I \cup \{n+1\}$ is positioned after $P \setminus n+1$ in $\hat{\Omega}$; both cases lead to consistent orders on \mathcal{P} . \square

From this we derive the promised result.

Theorem 3.7.9. *The expansion*

$$\hat{\cdot} : \begin{cases} \mathcal{B}(n, k) & \rightarrow \mathcal{B}(n+1, k+1), \\ U & \mapsto \hat{U}, \end{cases}$$

is an order-preserving embedding that maps $\hat{0}_{n,k}$ to $\hat{0}_{n+1,k+1}$ and $\hat{1}_{n,k}$ to $\hat{1}_{n+1,k+1}$. \square

3.8 THE CONNECTION BETWEEN $\mathcal{B}(n-2, d-1)$ AND $\mathcal{S}_1(n, d)$

In this section we present an order-preserving map from the higher Bruhat order $\mathcal{B}([n], d-1) \cong \mathcal{B}(n-2, d-1)$ to the poset $\mathcal{S}_1(n, d)$ of all triangulations of $C(n, d)$. This map is obtained by two different constructions, each of them providing complementary parts of the properties claimed. It is not quite clear whether this map coincides with the map suggested by Kapranov & Voevodsky [40].

We start with some additional specific properties of triangulations of cyclic polytopes.

Lemma 3.8.1. *Let $T \in \mathcal{S}_1(n, d)$. Then for each $(d-1)$ -subset (s_2, \dots, s_d) there is at most one simplex $S \in T$ with $S = (s_1, s_2, \dots, s_d, s_{d+1})$ for some $s_1 < s_2$ and some $s_{d+1} > s_d$.*

Proof. Assume there were $S \neq S' \in T$ and

$$\begin{aligned} S &= (s_1, s_2, \dots, s_d, s_{d+1}), \\ S' &= (s'_1, s_2, \dots, s_d, s'_{d+1}). \end{aligned}$$

Either $s_1 \neq s'_1$ or $s_{d+1} \neq s'_{d+1}$. If $s_1 < s'_1$ then define

$$Z := \begin{cases} (s_1, s'_1, \dots, s_d, s'_{d+1}) & \text{if } d \text{ even,} \\ (s_1, s'_1, \dots, s_d, s_{d+1}) & \text{if } d \text{ odd.} \end{cases}$$

In any case, $Z^+ \subseteq S$ and $Z^- \subseteq S'$.

The cases $s_1 > s'_1$, $s_{d+1} < s'_{d+1}$, and $s_{d+1} > s'_{d+1}$ are analogous. \square

Definition 3.8.2. For $S := (s_1, \dots, s_{d+1}) \in T \in \mathcal{S}_1(n, d)$, let $X_S := (s_2, \dots, s_d)$ be the *central set* of S . The number $l_S := s_1$ is called the *left boundary*, the number $r_S := s_{d+1}$ the *right boundary* of X_S in T .

Since there are no multiple central sets in triangulations of cyclic polytopes, we have the following simple representation.

Corollary 3.8.3. Any triangulation T of $C(n, d)$ is determined by its set of central sets and their boundaries. \square

Lemma 3.8.4. In every triangulation T of $C(n, d)$ every interval of length $(d-1)$ in $[2, n-1]$ appears as a central set of some simplex $S \in T$.

Proof. Here is a proof for d odd: Let T be in $\mathcal{S}_1(n, d)$ and I an interval of length $d-1$. From Gale's evenness criterion it follows that I is contained in exactly two facets of $C(n, d)$, namely $(1, I)$ and (I, n) . Therefore, there must be a simplex S_1 in the triangulation T containing $(1, I)$.

If $S_1 = (1, I, r)$ we are done. Otherwise $S_1 = (1, l_1, I)$. Because (l_1, I) is not a facet of $C(n, d)$, there must be another simplex $S_2 \in T$ with $(l_1, I) \subseteq S_2$. If $S_2 = (l_1, I, r)$ we are done. Otherwise we proceed as above. Because of Lemma 3.8.1, at each step we have $l_i < l_{i+1}$. Hence, there must be a k and an r such that the simplex $S_k = (l_{k-1}, I, r)$ is in T .

The case where d is even is analogous, where the corresponding facets of $C(n, d)$ are $(i_1 - 1, I)$ and $(I, i_d + 1)$ and the sequence of the l_k is decreasing. \square

We start now to construct a map by defining a natural family of functions on $\mathcal{S}_1(n, d)$.

Definition 3.8.5. For an element $I = (i_1, \dots, i_d) \in \binom{[n]}{d}$, define the map

$$\text{flip}_I : \begin{cases} \mathcal{S}_1(n, d) & \rightarrow \mathcal{S}_1(n, d), \\ T & \mapsto \begin{cases} \text{flip}_{(l, I, r)}(T) & \text{if } (l, I, r) \text{ is an increasing flip,} \\ T & \text{otherwise.} \end{cases} \end{cases}$$

For an inversion set $U \in \mathcal{B}([n], d-1)$, let $\Omega(U) = (I_i)_{i=1, \dots, \#U}$ be a single-step-inclusion-order of the elements of U , i. e., $\bigcup_{i=1}^K I_i$ is consistent for all $K = 1, \dots, \#U$. The *flip-map* $\mathcal{T}_{\text{flip}}$ is now defined as follows:

$$\mathcal{T}_{\text{flip}} : \begin{cases} \mathcal{B}([n], d-1) & \rightarrow \mathcal{S}_1(n, d), \\ U & \mapsto \text{flip}_{I_{\#U}} \circ \dots \circ \text{flip}_{I_1}(\mathcal{F}^l(n, d)). \end{cases}$$

Remark 3.8.6. At this point it is not obvious that this definition is independent of the special order $\Omega(U) = (I_i)_{i=1, \dots, \#U}$ of U . Up to now, we only know that $\mathcal{T}_{\text{flip}}$ maps each pair $(U, \Omega(U))$ to a triangulation in $\mathcal{S}_1(n, d)$, where $U \in \mathcal{B}([n], d-1)$ and $\Omega(U)$ is a single-step inclusion order of its elements. It is order-preserving in the sense that if $U < U'$ and $\Omega(U), \Omega(U')$ are corresponding single-step inclusion orders with the property that $\Omega(U)$ is an initial segment of $\Omega(U')$, then $\mathcal{T}_{\text{flip}}(U, \Omega(U)) < \mathcal{T}_{\text{flip}}(U', \Omega(U'))$.

Definition 3.8.7. For $i \in I \in \binom{[n]}{d}$, define the *index* of i in I as

$$\text{ind}_I(i) := k \quad \text{if } I = (i_1, \dots, i = i_k, \dots, i_d).$$

Definition 3.8.8. For an inversion set $U \in \mathcal{B}([n], d-1)$, define the *central set* of U as

$$X_U := \left\{ X = (x_1, \dots, x_{d-1}) \in \binom{[n]}{d-1} : \begin{array}{l} X \cup j \in U \quad \forall j \in [n] \setminus X : \\ \quad x_1 < j < x_{d-1}, \\ \quad d - \text{ind}_{X \cup j}(j) \text{ even,} \\ X \cup j \notin U \quad \forall j \in [n] \setminus X : \\ \quad x_1 < j < x_{d-1}, \\ \quad d - \text{ind}_{X \cup j}(j) \text{ odd.} \end{array} \right.$$

Definition 3.8.9. For an inversion set $U \in \mathcal{B}([n], d-1)$, define the *left boundary function* of U as

$$\lambda_U : \begin{cases} X_U & \rightarrow [n], \\ X & \mapsto \begin{cases} \max \{ l \in [n] : (l, X) \notin U \} & \text{for } d \text{ odd,} \\ \max \{ l \in [n] : (l, X) \in U \} & \text{for } d \text{ even,} \end{cases} \end{cases}$$

and the *right boundary function* of U as

$$\rho_U : \begin{cases} X_U & \rightarrow [n], \\ X & \mapsto \min \{ r \in [n] : (X, r) \notin U \}, \end{cases}$$

with the additional notation

$$\min(\emptyset) := n \quad \text{and} \quad \max(\emptyset) := 1.$$

Definition 3.8.10. Now define the *direct map* \mathcal{T}_{dir} as

$$\mathcal{T}_{\text{dir}} : \begin{cases} \mathcal{B}([n], d-1) & \rightarrow \mathcal{S}_1(n, d), \\ U & \mapsto \{ (\lambda_U(X), X, \rho_U(X)) : X \in X_U \}. \end{cases}$$

Remark 3.8.11. Here it is neither obvious that $\mathcal{T}_{\text{dir}}(U)$ is indeed a triangulation nor that the map is order-preserving, but it is uniquely defined.

Proposition 3.8.12. Let U and $U' := U \cup \{I\}$ be inversion sets in $\mathcal{B}([n], d-1)$. Define the following two properties for some $i_k \in I, 1 < k < d-1$.

Property A: $I \setminus i_k \in X_U$ but $I \setminus i_k \notin X_{U'}$,

Property B: $I \setminus i_k \notin X_U$ but $I \setminus i_k \in X_{U'}$.

Then the following hold:

- (i) If i_k has Property A then all $i_m \in I$ with $m \equiv k \pmod{2}$ have Property A as well,

(ii) If i_k has Property B then all $i_m \in I$ with $m \equiv k \pmod{2}$ have Property B as well.

Proof. From Definition 3.8.8 we know that

- i_k has Property A if and only if $d - k$ is odd and i_k has Property C, namely
 - $\text{ind}_{I \setminus i_k \cup j}(j)$ is even for all $j \notin I$ with $i_1 < j < i_{d-1}$ and $I \setminus i_k \cup j \in U$, and
 - $\text{ind}_{I \setminus i_k \cup j}(j)$ is odd for all $j \notin I$ with $i_1 < j < i_{d-1}$ and $I \setminus i_k \cup j \notin U$,
- i_k has Property B if and only if $d - k$ is even and i_k has Property C.

In the sequel we will show that Property C for i_k induces Property C for all $i_m \in I$.

Assume $i_k \in I$ has Property C. Let $j \notin I, i_1 < j < i_d$ be arbitrary. (If there is no such j we are done.) Consider the inversion $J := (I \cup j) \setminus i_k$. From Property C we know that J has Property D, namely

$$J \subseteq \begin{cases} U & \text{if } \text{ind}_J(j) \text{ even,} \\ \bar{U} & \text{if } \text{ind}_J(j) \text{ odd.} \end{cases}$$

Now we investigate the d -packet $P := I \cup J$. Because both U and U' are consistent, the complete segment that starts at a neighbor of $I = P \setminus j$ and contains $J = P \setminus i_k$ must have property D as well as J , and the complementary segment must have exactly the contrapositive property \bar{D} . That means, by parsing the packet P from one end to the other “having property D” switches at $I = P \setminus j$.

In other words, $I \setminus i_m \cup j \in U$ if and only if $I \setminus i_k \cup j \in U$ for all i_m lying on the same side of j as i_k in P and $I \setminus i_m \cup j \in U$ if and only if $I \setminus i_k \cup j \notin U$ for all i_m lying on the opposite side of j as i_k .

Additionally, if m is congruent k modulo 2 then $\text{ind}_{I \setminus i_m \cup j}(j)$ is congruent $\text{ind}_{I \setminus i_k \cup j}(j)$ modulo 2 if and only if i_m lies on the same side of j as i_k in P , but — since j was arbitrary — this means that i_m has Property C. \square

Remark 3.8.13. The above Proposition roughly states that for $I \setminus i_m$ “being contained in the central set of U ” for all possible m only depends on whether I is in U — not on whether some inversion $I \setminus i_m \cup j$ is in U — whenever this is correct for one m .

Proposition 3.8.14. *Let U and U' as above. Then the following hold for all $1 < l < i_1$ and $i_{d-1} < r < n$:*

$$\begin{aligned} (l, I \setminus i_k) \in U &\iff (l, I \setminus i_m) \in U \quad \text{for all } m \equiv k \pmod{2}, \\ (I \setminus i_k, r) \in U &\iff (I \setminus i_m, r) \in U \quad \text{for all } m \equiv k \pmod{2}. \end{aligned}$$

Proof. The proof is analogous to the proof of Proposition 3.8.12 with j replaced by l, r . \square

Theorem 3.8.15. *The maps $\mathcal{T}_{\text{flip}}$ and \mathcal{T}_{dir} coincide.*

Proof. We will show that $\mathcal{T}_{\text{flip}}(U) = \mathcal{T}_{\text{dir}}(U)$ for all $U \in \mathcal{B}(\lfloor n, d-1)$. Because $\mathcal{B}(\lfloor n, d-1)$ has a unique minimal element \emptyset , we can proceed by induction on $\#U$.

The proof for $U = \emptyset$ is a simple computation. Therefore, we assume that the claim is true for some inversion set U , and we will show that then the claim is also true for all consistent $U' := U \cup \{I\}$.

It remains to check the following points:

1. If $\mathcal{T}_{\text{dir}}(U') \neq \mathcal{T}_{\text{dir}}(U)$ then there exist $1 \leq l < i_1$ and $i_d < r \leq n$ such that (l, I, r) is an increasing flip in $\mathcal{T}_{\text{flip}}(U) = \mathcal{T}_{\text{dir}}(U)$, and
2. if the $(d+2)$ -set (l, I, r) is an increasing flip in $\mathcal{T}_{\text{flip}}(U) = \mathcal{T}_{\text{dir}}(U)$ then $\mathcal{T}_{\text{dir}}(U') = \text{flip}_I \mathcal{T}_{\text{dir}}(U)$.

From Proposition 3.8.12 it follows that the assertions 1 and 2 are correct as far as the central sets of U or U' , resp., are concerned.

From Proposition 3.8.14 and the corresponding definitions in 3.8.9 we get that in the situations of both 1 and 2 the left and right boundary functions are constant on the sets $I \setminus i_k$ with $1 < k < d-1$, i. e., there exist l and r with $1 < l < i_1$ and $i_{d-1} < r < n$ such that

$$\lambda_U(I \setminus i_k) = l, \quad \rho_U(I \setminus i_k) = r.$$

Moreover, it follows that

$$\begin{aligned} \lambda_U(I \setminus i_1) &= \begin{cases} i_1 & \text{for } d \text{ odd,} \\ l & \text{for } d \text{ even,} \end{cases} & \rho_U(I \setminus i_1) &= r, \\ \lambda_U(I \setminus i_{d-1}) &= l, & \rho_U(I \setminus i_{d-1}) &= i_{d-1}. \end{aligned}$$

After having added I to the inversion set U , we have

$$\begin{aligned} \lambda_{U'}(I \setminus i_k) &= \begin{cases} l & \text{for } d \text{ odd,} \\ i_1 & \text{for } d \text{ even,} \end{cases} & \rho_{U'}(I \setminus i_k) &= r, \\ \lambda_{U'}(I \setminus i_1) &= l, & \rho_{U'}(I \setminus i_1) &= r, \\ \lambda_{U'}(I \setminus i_{d-1}) &= l, & \rho_{U'}(I \setminus i_{d-1}) &= r. \end{aligned}$$

With this the proof of Theorem 3.8.15 is complete. \square

Corollary 3.8.16. *The map*

$$\mathcal{T} := \mathcal{T}_{\text{flip}} = \mathcal{T}_{\text{dir}}$$

is well-defined and order-preserving. □

We finish our investigations by stating — as a bonus track without a proof — the following connections between the constructions of this chapter.

Proposition 3.8.17. (Functorial Relations)

$$\begin{aligned}\mathcal{T}(\hat{U}) &= (\mathcal{T}(U))^\wedge, \\ \mathcal{T}(U \setminus n - 1) &= \mathcal{T}(U) \setminus n, \\ \mathcal{T}(\delta U) &= \delta \mathcal{T}(U).\end{aligned}$$

The analogous property for the link does not hold in general! □

APPENDIX A

GLOSSARY OF BASIC CONCEPTS

We recall some basic facts about partially ordered sets, topology, polytopes, polytopal complexes, and oriented matroids.

A.1 PARTIALLY ORDERED SETS

The notation used in this section is based on the book of STANLEY [68, Chapter III].

Definition A.1.1. Let S be a finite set. A *partial order* on S is a binary relation “ \leq ” on S that is reflexive, antisymmetric, and transitive. That is,

- (i) $x \leq x$ for all $x \in S$,
- (ii) $x \leq y$ and $y \leq x$ implies $x = y$, and
- (iii) $x \leq y$ and $y \leq z$ implies $x \leq z$.

The pair $\mathcal{S} = (S, \leq)$ is called a *partially ordered set*, or a *poset*, for short. Consider a binary relation “ $<$ ” on S that is irreflexive, antisymmetric, and acyclic. That is,

- (i) $x \not< x$ (x is not related to x by “ $<$ ”) for all $x \in S$,
- (ii) $x < y$ implies $y \not< x$, and
- (iii) there is no chain of relations $x < \dots < x$.

Then the *transitive closure* “ \leq ” of “ $<$ ” is the partial order given by

$$x \leq y : \iff \text{either } x = y \text{ or } x = x_1 < \dots < x_r = y \text{ for some } x_1, \dots, x_r \in S.$$

A *chain* in \mathcal{S} is a totally ordered subset of S . Its *length* is the number of elements minus one. The *interval* $[x, y]$ in \mathcal{S} is the set of all $z \in S$ with $x \leq z$ and $z \leq y$ with the induced partial order. If $[x, y] = (\{x, y\}, \leq)$ then y is a *cover* of x and $x < y$ denotes the corresponding *covering relation*. \mathcal{S} is *bounded* if there is

a unique *maximal* and a unique *minimal* element in \mathcal{S} , that means, if $\mathcal{S} = [\hat{0}, \hat{1}]$ for suitable $\hat{0}$ and $\hat{1}$ in S . $\mathcal{S} \setminus \{\hat{0}, \hat{1}\}$ is called the *proper part* of \mathcal{S} .

\mathcal{S} is *graded*, or *ranked*, if it is bounded and every maximal chain has the same length. The length of a maximal chain in $[\hat{0}, x]$ is the *rank* of x . The *rank* of \mathcal{S} is the rank of $\hat{1}$.

\mathcal{S} is a *lattice* if it is bounded and every two elements x and y in S have a unique minimal *upper bound* $x \vee y$ in \mathcal{S} , called the *join* of x and y , and a unique maximal *lower bound* $x \wedge y$ in \mathcal{S} , called the *meet* of x and y .

The minimal elements of the proper part of a graded lattice are called *atoms*, the maximal elements *coatoms*. If every element in S is the join of atoms in \mathcal{S} then \mathcal{S} is *atomic*. \mathcal{S} is *coatomic* if every element in S is the meet of coatoms in \mathcal{S} .

Definition A.1.2. A map $f : (S, \leq_S) \rightarrow (R, \leq_R)$ is *order-preserving*, respectively *order-reversing*, if $f(x) \leq_R f(y)$, respectively $f(y) \leq_R f(x)$, for all $x \leq_S y$ in S .

Isomorphisms are order-preserving, *anti-isomorphisms* are order-reversing bijections in the category of posets.

Definition A.1.3. The *Hasse diagram* of a poset $\mathcal{S} = (S, \leq)$ is a directed graph with vertex set S . Two vertices x and y in S are connected by an arc from x to y if and only if y covers x . In a drawing of this graph usually all arcs are directed upwards, whence the arrows are omitted.

The following example will appear in much more general form in Sections 3.7 and 3.8.

Example A.1.4. Let S_n be the set of all permutations on n elements, where $[n] = \{1, \dots, n\}$ is linearly ordered with $1 < \dots < n$. For a permutation π , let $\text{inv}(\pi)$ be the set of all pairs (i, j) with $1 \leq i < j \leq n$ and $\pi(i) > \pi(j)$. We set $\pi \leq \sigma$ if and only if $\text{inv}(\pi) \subseteq \text{inv}(\sigma)$. The poset (S_n, \leq) is the *weak (Bruhat) order* on S_n .

We end this section with a definition of the *order complex* of a poset, which is the standard translation of combinatorial structures into topology.

Definition A.1.5. Let $\mathcal{S} = (S, \leq)$ be a poset. The (abstract) simplicial complex (see Section A.4)

$$\Delta(\mathcal{S}) := \{R \subset S : R \text{ is a chain in } \mathcal{S}\}$$

is the *order complex* of \mathcal{S} .

A.2 TOPOLOGY

For details, we refer to the book “Topology and Geometry” by BREDON [17].

Definition A.2.1. A *topological space* is a pair (X, \mathcal{O}) where X is a set and \mathcal{O} is the *topology* on X , that is, a family of subsets of X , called *open sets*, such that

- (i) the empty set and X are open,
- (ii) the intersection of two open sets is open,
- (iii) the union of any collection of open sets is open.

If the topology on X is fixed, we often denote the topological space (X, \mathcal{O}) by X .

A subfamily \mathcal{B} of open sets is a *basis* of \mathcal{O} if every open set is the union of sets in \mathcal{B} . It is a *subbasis* if the set of all finite intersections of sets in \mathcal{B} is a basis. In these cases we say that \mathcal{B} *generates* \mathcal{O} .

Let (X, \mathcal{O}) be a topological space and $x \in X$. A subset $N \subseteq X$ is a *neighborhood* of x if there is an open set $O \in \mathcal{O}$ with $x \in O$ and $O \subseteq N$. Let (Y, \mathcal{U}) be another topological space. A function $f : X \rightarrow Y$ is *continuous at x* if for any neighborhood N of $f(x)$ the set $f^{-1}(N)$ is a neighborhood of x . A function f is *continuous* if it is continuous at every $x \in X$. A *homeomorphism* is a bijective continuous map whose inverse is continuous as well.

What we really need is the standard topology of metric spaces, as on the Euclidean space \mathbb{R}^d .

Definition A.2.2. A *metric space* is a pair (X, d) where X is a set and d is a map from $X \times X$ to \mathbb{R} such that

- (i) $d(x, y) \geq 0$, and $d(x, y) = 0$ if and only if $x = y$,
- (ii) $d(x, y) = d(y, x)$,
- (iii) $d(x, z) \leq d(x, y) + d(y, z)$.

If $d(X) := \sup_{x, y \in X} d(x, y)$ exists then it is called the *diameter* of X . If the metric on X is fixed, we often denote the metric space (X, d) by X .

The *topology induced by d on X* is generated by the *open balls* $B(x_0, r) := \{x \in X : d(x, x_0) < r\}$ for $x_0 \in X$ and $r \in \mathbb{R}$.

From now on all spaces are assumed to be metric spaces.

Lemma A.2.3. Let (X, d) and (X', d') be metric spaces. Then $f : X \rightarrow X'$ is continuous if and only if for all $\varepsilon > 0$ and all $x \in X$ there is a $\delta > 0$ such that $d'(f(x), f(y)) < \varepsilon$ for all $y \in X$ with $d(x, y) < \delta$.

Corollary A.2.4. *If for $f : (X, d) \rightarrow (X', d')$ there is a constant c with*

$$d'(f(x), f(y)) \leq c \cdot d(x, y) \quad \text{for all } x, y \in X,$$

then f is continuous.

Lemma A.2.5. *The product*

$$(X, d) \times (X', d') := (X \times X', \max(d, d'))$$

is a metric space.

The following example is important in Section 2.3.

Example A.2.6. The 1-dimensional standard sphere

$$S^1 := \{z \in \mathbb{C} : \|z\| = 1\}$$

is a metric space with the induced metric of \mathbb{C} . Its diameter is 2.

The product $S^1 \times \cdots \times S^1$ is a metric space with the maximum metric

$$d((z_1, \dots, z_k), (z'_1, \dots, z'_k)) := \max(\|z'_1 - z_1\|, \dots, \|z'_k - z_k\|).$$

This gives again a diameter of 2.

Definition A.2.7. Let $f, g : X \rightarrow Y$ be continuous. A *homotopy from f to g* is a continuous (in both coordinates) map

$$H : \begin{cases} X \times [0, 1] & \rightarrow Y, \\ (x, t) & \mapsto H(x, t), \end{cases}$$

such that

$$H(x, 0) = f(x) \quad \text{and} \quad H(x, 1) = g(x).$$

Let $A \subseteq X$ be a subspace of X . If H is a homotopy from f to g with $H(x, t) = f(x) = g(x)$ for all $x \in A$ then H is a homotopy *relative* A . The maps f and g are *homotopic* (relative A) if there exists a homotopy from f to g (relative A).

A continuous map $f : X \rightarrow Y$ is a *homotopy equivalence* if there exists a function $g : Y \rightarrow X$ such that $g \circ f : X \rightarrow X$ is homotopic to the identity id_X on X , and $f \circ g : Y \rightarrow Y$ is homotopic to the identity id_Y on Y . In the case that such a map exists, X and Y are *homotopy equivalent*. If X is homotopy equivalent to a point then X is *contractible*.

Definition A.2.8. A *path* in X from x_0 to x_1 is a continuous function $w : [0, 1] \rightarrow X$ with $x_0 = w(0)$ and $x_1 = w(1)$. A path w in X is *null-homotopic* if it is homotopic to a constant function $x_0 : [0, 1] \rightarrow X$. Two paths w, v in X are homotopic *relative* $\partial[0, 1]$ if w is homotopic to v by a homotopy relative $\{0, 1\} \subset [0, 1]$. In particular $v(0) = w(0)$ and $v(1) = w(1)$. For two paths $w, v : [0, 1] \rightarrow X$ in X with $w(1) = v(0)$, the *concatenation* of w and v is the path

$$w \cdot v : \begin{cases} [0, 1] & \rightarrow X, \\ t & \mapsto \begin{cases} w(2t) & \text{if } 0 \leq t \leq \frac{1}{2}, \\ v(2t - 1) & \text{if } \frac{1}{2} \leq t \leq 1. \end{cases} \end{cases}$$

If $w(0) = w(1)$ then w is a *closed* path. Given a continuous function $f : X \rightarrow Y$ and a path w in X we define the path $f_*(w) := f \circ w : [0, 1] \rightarrow Y$ in Y .

X is *path-connected* if for any two points x and y in X there is a path in X from x to y . It is *1-connected* if it is path-connected, and all paths are null-homotopic.

Lemma A.2.9. If w and v are paths homotopic relative $\partial[0, 1]$ in X and $f : X \rightarrow Y$ is continuous then the paths $f_*(w)$ and $f_*(v)$ are homotopic relative $\partial[0, 1]$ in Y .

Definition A.2.10. Let X be a topological space. A continuous function p from a topological space \tilde{X} onto X is a *covering* of X if for all $x \in X$ there is an open set $O_x \subset X$ with $x \in O_x$ such that

- (i) the set $p^{-1}(O_x)$ is the disjoint union of finitely many open sets $\tilde{O}_x^{(i)}$ in \tilde{X} , where $i = 1, \dots, r$,
- (ii) the restricted projection $p|_{\tilde{O}_x^{(i)}} : \tilde{O}_x^{(i)} \rightarrow O_x$ is a homeomorphism for all $i = 1, \dots, r$.

For a path w in X and a covering $p : \tilde{X} \rightarrow X$, the *lifting of w with starting point* $\tilde{x}_0 \in p^{-1}(w(0))$ is the unique path $L_p(w, \tilde{x}_0) : [0, 1] \rightarrow \tilde{X}$ with $L_p(w, \tilde{x}_0)(0) = \tilde{x}_0$ and $p_*(L_p(w, \tilde{x}_0)) = w$.

The *universal covering* of X is a covering $p : \tilde{X} \rightarrow X$ where \tilde{X} is 1-connected.

Example A.2.11. The exponential function

$$\exp : \begin{cases} \mathbb{R} & \rightarrow S^1, \\ t & \mapsto \exp(2\pi it), \end{cases}$$

describes the universal covering of the standard 1-sphere $S^1 \subset \mathbb{C}$, the set of all complex numbers with absolute value 1.

Theorem A.2.12 (Lifting Theorem). Let $p : \tilde{X} \rightarrow X$ be a covering, and let w, v be paths homotopic relative $\partial[0, 1]$. Then $L_p(w, \tilde{x}_0)$ and $L_p(v, \tilde{x}_0)$ are homotopic relative $\partial[0, 1]$ for all $\tilde{x}_0 \in p^{-1}(w(0))$.

A.3 POLYTOPES

Detailed information about classical polytope theory can be found in *Convex Polytopes* by GRÜNBAUM [32], more recent concepts may be found in *Lectures on Polytopes* by ZIEGLER [75].

In the sequel we assume some familiarity with elementary linear algebra. The equivalences in the following definitions are non-trivial.

Definition A.3.1. A bounded subset P in the affine space \mathbb{R}^d is a *polytope* if it is the convex hull

$$\text{conv}(V) := \left\{ \sum_{i=1}^n \lambda_i v_i \in \mathbb{R}^d : \sum_{i=1}^n \lambda_i = 1, \lambda_i \geq 0, i = 1, \dots, n \right\}$$

of a finite set of points $V := \{v_1, \dots, v_n\}$ in \mathbb{R}^d , or, equivalently, if it is the intersection $P(A, b)$ of finitely many closed affine halfspaces $H_{a_1, \beta_1}^-, \dots, H_{a_m, \beta_m}^-$, where $A := (a_1, \dots, a_m) \in \mathbb{R}^{d \times m}$ and $b = (\beta_1, \dots, \beta_m)^T \in \mathbb{R}^m$, and

$$H_{a_i, \beta_i}^- := \left\{ x \in \mathbb{R}^d : a_i^T x \leq \beta_i \right\}, \quad i = 1, \dots, m.$$

The *dimension* of P is the dimension of the affine hull $\text{aff}(V)$ of V . If the dimension of P equals d then P is *full-dimensional*.

If P is contained in one of the closed affine halfspaces defined by an affine hyperplane H in \mathbb{R}^d then H is called a *supporting hyperplane*. The intersection $F_H := P \cap H$ of P with a supporting hyperplane H is a *face* of P .

If ψ is a linear functional in $(\mathbb{R}^d)^*$ then the set P^ψ of all points in P that have maximal values under ψ among all points in P is the *face of P in direction ψ* .

Faces of dimension 0 are *vertices*. We denote the set of vertices by $\text{vert}(P)$. Faces of dimension 1 are *edges*, and faces of dimension $\dim(P) - 1$ are *facets* of P . The only face of dimension $\dim(P)$ is P itself. The faces of dimension strictly between (-1) and $\dim(P)$ are called *proper*. The union of all proper faces of P is the *boundary* of P , denoted by ∂P . The set of all faces of P , partially ordered by inclusion, is the *face lattice* of P (for a glossary on partially ordered sets see Section A.1).

The *relative interior* $\text{relint}(P)$ of P is the interior of P in its affine hull $\text{aff}(P)$, or, equivalently, $P \setminus \partial P$.

Definition A.3.2. A *polyhedral cone* C is the *conical hull*

$$\text{cone}(V) := \left\{ \sum_{i=1}^n \lambda_i v_i \in \mathbb{R}^d : \lambda_i \geq 0, i = 1, \dots, n \right\}$$

of a finite set of vectors $V = \{v_1, \dots, v_n\}$ in \mathbb{R}^d , or, equivalently, the intersection $P(A, 0)$ of finitely many closed linear halfspaces $H_{a_1}^-, \dots, H_{a_m}^-$, where $A := \{a_1, \dots, a_m\} \subset \mathbb{R}^d$, and

$$H_{a_i}^- := \left\{ x \in \mathbb{R}^d : a_i^T x \leq 0 \right\}.$$

The *dimension* of C is the dimension of the linear hull $\text{lin}(V)$ of V . If the dimension of C equals d then C is *full-dimensional*.

If C is contained in the positive closed linear halfspace H^- defined by a linear hyperplane H in \mathbb{R}^d then H is called a *supporting hyperplane*. The intersection $F_H := C \cap H$ of C with a supporting hyperplane H is a *face* of C .

If ψ is a linear functional in $(\mathbb{R}^d)^*$ then the set C^ψ of all points in C that have maximal values under ψ among all points in C is the *face of C in direction ψ* .

If there is a face of dimension 0 (in fact this may only be the zero-vector), then C is *pointed*. Faces of dimension 1 are *rays*, faces of dimension $\dim(C) - 1$ are *facets* of C . The only face of dimension d is C itself. The faces of dimension strictly between (-1) and d are called *proper*. The union of all proper faces of C is the *boundary* of C , denoted by ∂C . The set of all faces of C partially ordered by inclusion is the *face lattice* of C .

The *relative interior* of C is the interior of C in its linear hull $\text{lin}(C)$, or, equivalently, $C \setminus \partial C$.

The “vertex versions” of these definitions give immediately that a projection of a polytope P (a cone C) is again a polytope (cone), while the “halfspace-version” implies that the intersection of a polytope (cone) with a closed halfspace is a polytope (cone) as well. From another point of view, one can consider each polytope (cone) with n vertices (rays) and m facets as a projection of the $(n - 1)$ -dimensional affine (n -dimensional linear) standard simplex in \mathbb{R}^n , and, at the same time, as the intersection of the $(m - 1)$ -dimensional affine (m -dimensional linear) standard simplex in \mathbb{R}^m with an affine (linear) subspace. In fact, this *double description* is used in some algorithms to transform the different representations into each other (e. g. the program “porta” by CHRISTOF [20]).

In this thesis cones are needed to describe sets of (dual) vectors $\psi \in (\mathbb{R}^d)^*$ that determine a face P^ψ of a polytope P (see Chapter 2).

Definition A.3.3. A *fan* in \mathbb{R}^d is a family \mathcal{F} of non-empty polyhedral cones in \mathbb{R}^d with the properties that

- (i) every non-empty face of a cone in \mathcal{F} is contained in \mathcal{F} itself, and
- (ii) the intersection of any two non-empty cones in \mathcal{F} is a face of both.

If $\mathbb{R}^d = \bigcup_{F \in \mathcal{F}} F$ then the fan is *complete*. \mathcal{F} is *pointed* if $0 \in \mathcal{F}$.

For complete fans \mathcal{F} and \mathcal{F}' with the property that for all $C \in \mathcal{F}$ there is a $C' \in \mathcal{F}'$ with $C \subseteq C'$, we say that \mathcal{F} is a *refinement* of \mathcal{F}' .

The *common refinement* of \mathcal{F} and \mathcal{F}' is the fan

$$\mathcal{F} \wedge \mathcal{F}' := \{C \cap C' : C \in \mathcal{F}, C' \in \mathcal{F}'\}.$$

Definition A.3.4. Let P be a polytope in \mathbb{R}^d and F be a face of P . Then the set

$$N_{P,F} := \left\{ \psi \in (\mathbb{R}^d)^* : F \subseteq P^\psi \right\}$$

is the *closed normal cone* of F in P . The polyhedral fan

$$\mathcal{N}_P := \{N_{P,F} : F \text{ is a face of } P\}$$

is the *normal fan* of P .

We continue our glossary by listing some basic constructions on polytopes.

Lemma A.3.5. Let $P, P' \subset \mathbb{R}^d$ and $Q \subset \mathbb{R}^{d'}$ be polytopes. Then the following constructions produce polytopes, where $\{0\}^d$ is the zero-vector in \mathbb{R}^d .

$$P \times Q = \left\{ (p, q) \in \mathbb{R}^{d+d'} : p \in P, q \in Q \right\}, \quad (\text{product})$$

$$P + P' = \left\{ p + p' \in \mathbb{R}^d : p \in P, p' \in P' \right\}, \quad (\text{Minkowski sum})$$

$$P * Q = \text{conv}((P \times \{0\}^{d'} \times \{1\}) \cup (\{0\}^d \times Q \times \{-1\})), \quad (\text{join})$$

and, if $\{0\}^d \in \text{relint}(P)$ and $\{0\}^{d'} \in \text{relint}(Q)$,

$$P \oplus Q = \text{conv}((P \times \{0\}^{d'}) \cup (\{0\}^d \times Q)). \quad (\text{direct sum})$$

The following natural objects arise as special cases of the above constructions:

- A *prism* over P is a polytope $P \times I$ where I is an interval in \mathbb{R} ,
- the *pyramid* over $P \subset \mathbb{R}^d$ with apex $p \in \mathbb{R}^d$ is the polytope $P * \{p\}$,
- a *bipyramid* over P may be constructed as $P \oplus I$ where I is an interval in \mathbb{R} containing 0 in its interior.

In this setting the *d-dimensional simplex* can be considered as an iterated pyramid starting from a point, the *d-dimensional hypercube* C_d is just an iterated prism starting from a point, and the *d-dimensional cross-polytope* C_d^Δ is an iterated symmetric bipyramid starting from 0 and proceeding with the interval $[-1, 1]$.

How many k -faces can a d -polytope with n vertices have? This was completely answered in 1970 by MCMULLEN [49]; his proof uses the *shellability* of polytopes (see Section A.4). Already in the last century SCHLÄFLI [66] had sort of postulated that polytopes are shellable, before it was finally proved in 1970 by BRUGESSER & MANI [18] with a surprisingly simple argument.

Because the polytopes that realize these upper bounds are of special interest in Chapter 3 of this thesis, we give here a definition of *k -neighborly* and *cyclic polytopes*, and cite the famous *Upper Bound Theorem*.

Definition A.3.6. A polytope P is *k -neighborly* if every subset of its vertices with at most k elements is the vertex set of a face of P .

Definition A.3.7. The *standard cyclic d -polytope with n vertices* is the convex hull of the points $(i, i^2, \dots, i^d)^T \in \mathbb{R}^d$, where i runs from 1 to n . A *cyclic polytope* is a polytope with the same face lattice as the standard cyclic polytope.

In odd dimensions there is a slight difference between standard cyclic polytopes and non-standard cyclic polytopes, because in contrast to standard cyclic polytopes there are cyclic polytopes where the convex hulls of certain subsets of vertices are not cyclic (see BISZTRICZKY & KÁROLYI [13] for a characterization).

Lemma A.3.8. *The cyclic d -polytopes are $\lfloor \frac{d}{2} \rfloor$ -neighborly.*

Theorem A.3.9 (Upper Bound Theorem). (MCMULLEN [49])

For all $k = 1, \dots, d - 1$, any d -polytope P with n vertices has at most as many k -faces as the cyclic d -polytope with n vertices. If equality holds for one k with $\lfloor \frac{d}{2} \rfloor \leq k < d$ then P is $\lfloor \frac{d}{2} \rfloor$ -neighborly.

A.4 POLYTOPAL AND SIMPLICIAL COMPLEXES

We refer to ZIEGLER [75, Lecture 5] for details.

Definition A.4.1. A (geometric) *polytopal complex* \mathcal{C} in \mathbb{R}^d is a collection of polytopes in \mathbb{R}^d such that

- (i) the empty set is in \mathcal{C} ,
- (ii) for any $P \in \mathcal{C}$ all faces of P are in \mathcal{C} ,
- (iii) the intersection of any two polytopes in \mathcal{C} is a face of both.

The dimension of \mathcal{C} is the largest dimension of a polytope in \mathcal{C} , the union $|\mathcal{C}|$ of all polytopes in \mathcal{C} is called the *underlying set of \mathcal{C}* . The *facets* are the inclusion-maximal elements of \mathcal{C} . If all facets are of the same dimension then \mathcal{C} is *pure*. Two polytopal complexes \mathcal{C} and \mathcal{C}' are *combinatorially isomorphic* if there is a bijection from \mathcal{C} to \mathcal{C}' preserving the incidence relations.

If all polytopes in \mathcal{C} are simplices then \mathcal{C} is a (geometric) *simplicial complex*.

As an example of a polytopal complex, consider the set of all faces of a polytope. Another example is a *polyhedral subdivision* of a point configuration (see Section 1.1(a)).

Definition A.4.2. Let \mathcal{C} be a pure d -dimensional polytopal complex. A *shelling* of \mathcal{C} is an ordering (F_1, F_2, \dots, F_r) of its facets such that

- (i) ∂F_1 has a shelling, and
- (ii) for all $i = 1, \dots, r$ the set $F_i \cap (F_1 \cup \dots \cup F_{i-1})$ is a beginning segment of a shelling of ∂F_i .

Here a shelling of a 0-dimensional complex is just any linear ordering of its vertices. A polytopal complex is *shellable* if it has a shelling.

The following theorem led to the proof of the Upper Bound Theorem by McMULLEN [49] (see Section A.3, Theorem A.3.9).

Theorem A.4.3. (BRUGESSER & MANI [18])

Every polytope is shellable. In particular, every regular polyhedral subdivision is shellable.

In the case of simplicial complexes things are easier because of the following simple lemma.

Lemma A.4.4. *If \mathcal{C} is a pure d -dimensional simplicial complex, then an ordering (F_1, F_2, \dots, F_r) of its facets is a shelling of \mathcal{C} if and only if $F_i \cap (F_1 \cup \dots \cup F_{i-1})$ is of pure dimension $(d - 1)$ for all $i = 1, \dots, r$.*

Since any subset of vertices of a simplex is the vertex set of a face, it is more convenient to describe a simplicial complex in terms of the associated *abstract simplicial complex* in the set of its vertices.

Definition A.4.5. Let \mathcal{L} be a finite set. An *abstract simplicial complex* in \mathcal{L} is a non-empty family K of subsets of \mathcal{L} that is closed under taking subsets. That is, if $S \in K$ and $S' \subseteq S$ then S' is also in K . The union of all sets in K is the *support* $\text{supp}(K) \subseteq \mathcal{L}$ of K . The *dimension* of K is the maximal cardinality of a set in K minus 1.

There is no real difference between the concepts of geometric and abstract simplicial complexes. This is shown by the following lemma.

Lemma A.4.6. *For every d -dimensional abstract simplicial complex K with n vertices, there is a geometric simplicial complex Δ in \mathbb{R}^{2d-1} that is combinatorially isomorphic to K .*

This is best possible in general, and the proof requires tools. It is, however, trivial to embed an abstract simplicial complex into \mathbb{R}^n . We will need the following standard operations on abstract simplicial complexes.

Definition A.4.7. Let K be an abstract simplicial complex in \mathcal{L} and $S_0 \in K$ a simplex in K . Then the following abstract simplicial complexes are defined.

$$\begin{aligned} \text{st}_K(S_0) &:= \{S \in K : S \cup S_0 \in K\}, & (\text{star}) \\ \text{ast}_K(S_0) &:= \{S \in K : S \cap S_0 = \emptyset\}, & (\text{antistar}) \\ \text{lk}_K(S_0) &:= \{S \in K : S \cup S_0 \in K, S \cap S_0 = \emptyset\}. & (\text{link}) \end{aligned}$$

If K' is another abstract simplicial complex in \mathcal{L} with $\text{supp}(K) \cap \text{supp}(K') = \emptyset$ then the *join* of K and K' is defined as

$$K * K' := \{S \cup S' : S \in K, S' \in K'\}. \quad (\text{join})$$

A.5 ORIENTED MATROIDS

Further information can be found in the book *Oriented Matroids* by BJÖRNER, LAS VERGNAS, STURMFELS, WHITE & ZIEGLER [15]. A shorter introduction to important modern concepts in oriented matroid theory is by RICHTER-GEBERT [63].

Definition A.5.1. Let E be a finite set. For *sign vectors* $X \in \{-, 0, +\}^E$, we define

$$\begin{aligned} 0^E &:= (0, \dots, 0), \\ \text{supp}(X) &:= \{e \in E : X_e \neq 0\}, & (\text{support}) \\ X^+ &:= \{e \in E : X_e = +\}, & (\text{positive part}) \\ X^- &:= \{e \in E : X_e = -\}, & (\text{negative part}) \\ S(X, Y) &:= \{e \in E : X_e = -Y_e \neq 0\}, & (\text{separation}) \\ (X \circ Y)_e &:= \begin{cases} X_e & \text{if } X_e \neq 0, \\ Y_e & \text{otherwise.} \end{cases} & (\text{composition}) \end{aligned}$$

A set \mathcal{V}^* of sign vectors in $\{-, 0, +\}^E$ is a set of *covectors* in E if it satisfies the following conditions.

(CV0) $0^E \in \mathcal{V}^*$,

(CV1) $X \in \mathcal{V}^*$ implies $-X \in \mathcal{V}^*$,

(CV2) $X, Y \in \mathcal{V}^*$ implies $X \circ Y \in \mathcal{V}^*$,

(CV3) if $X, Y \in \mathcal{V}^*$ and $e \in S(X, Y)$, then there exists $Z \in \mathcal{V}^*$ such that $Z_e = 0$ and $Z_f = (X \circ Y)_f = (Y \circ X)_f$ for all $f \notin S(X, Y)$.

An *oriented matroid* is a pair $\mathcal{M} = (E, \mathcal{V}^*)$, where E is a finite set, and \mathcal{V}^* is a set of covectors in E .

The *big face lattice* $\mathcal{F}(\mathcal{M})$ of an oriented matroid \mathcal{M} is the poset (\mathcal{V}^*, \leq) , where “ \leq ” denotes the inclusion of supports. The *rank* $r(\mathcal{M})$ of \mathcal{M} is the rank of $\mathcal{F}(\mathcal{M})$. A non-zero covector with inclusion-minimal support is called a *cocircuit*.

For $E' \subset E$, the *restriction* of $X \in \{-, 0, +\}^E$ to E' is the sign vector $X_{E'} \in \{-, 0, +\}^{E'}$ on E' that coincides with X on E' . We define

$$\mathcal{V}^* \setminus E' := \{X_{E \setminus E'} : X \in \mathcal{V}^*\}, \quad (\text{deletion})$$

$$\mathcal{V}^* / E' := \left\{ X_{E \setminus E'} : X \in \mathcal{V}^*, X_{E'} = 0^{E'} \right\}. \quad (\text{contraction})$$

This gives rise to the corresponding oriented matroids

$$\begin{aligned} \mathcal{M} \setminus E' &:= (E \setminus E', \mathcal{V}^* \setminus E'), \\ \mathcal{M} / E' &:= (E \setminus E', \mathcal{V}^* / E'). \end{aligned}$$

An element $e \in E$ is a *loop* of \mathcal{M} if $X_e = 0$ for all $X \in \mathcal{V}^*$. It is a *coloop* if $r(\mathcal{M} \setminus e) < r(\mathcal{M})$. A *(one-element) lifting* of \mathcal{M} is an oriented matroid $\widehat{\mathcal{M}}$ on $E \uplus g$ such that $\mathcal{M} = \widehat{\mathcal{M}} / g$ and g is not a loop of $\widehat{\mathcal{M}}$. A *(single-element) extension* of \mathcal{M} is an oriented matroid on $E \uplus g$ such that $\mathcal{M} = \widehat{\mathcal{M}} \setminus g$ and g is neither a loop nor a coloop of $\widehat{\mathcal{M}}$.

Let \mathcal{M} and \mathcal{N} be oriented matroids on E . \mathcal{N} is a *strong image* of \mathcal{M} if every covector of \mathcal{N} is also a covector of \mathcal{M} . \mathcal{N} is a *weak image* of \mathcal{M} if \mathcal{M} and \mathcal{N} are of the same rank, and for every covector X of \mathcal{N} there is a covector Y of \mathcal{M} with $X \leq Y$. We write $\mathcal{N} \leq \mathcal{M}$ if \mathcal{N} is a weak image of \mathcal{M} . This yields a partial order “ \leq ” on the set of all oriented matroids, the *weak map relation*.

Definition A.5.2. Let $V = (v_1, \dots, v_n)$ be a vector configuration in \mathbb{R}^d . The *oriented matroid* $\mathcal{M}(V)$ of V is defined by its ground set $[n] := \{1, \dots, n\}$ and its set of covectors

$$\mathcal{V}^*(V) := \left\{ (\text{sign}(\psi(v_1)), \dots, \text{sign}(\psi(v_n))) : \psi \in (\mathbb{R}^d)^* \right\} \subseteq \{-, 0, +\}^n.$$

The oriented matroid \mathcal{F}^d of d linearly independent vectors in \mathbb{R}^d is called the *free oriented matroid* on d elements. An oriented matroid \mathcal{M} is *realizable* if $\mathcal{M} = \mathcal{M}(V)$ for some vector configuration V .

The reader may get a picture of covectors by thinking of some linear oriented hyperplane (corresponding to the ψ in the definition above) in \mathbb{R}^d partitioning the vectors in V into vectors on the hyperplane, vectors on its positive, and vectors on its negative side, thus defining a sign vector. Alternatively, one can consider the *arrangement of hyperplanes* given by the vectors in V , viewed as normal vectors of hyperplanes H_{v_i} in \mathbb{R}^d . This arrangement divides \mathbb{R}^d into cells. For every open cell c , we get a sign-vector $\sigma(c)$ corresponding to a covector by setting

$$\sigma(c)_i = \begin{cases} + & \text{if } c \text{ is on the positive side of } H_{v_i}, \\ - & \text{if } c \text{ is on the negative side of } H_{v_i}, \\ 0 & \text{if } c \text{ is on } H_{v_i}. \end{cases}$$

Vertices in this cell decomposition correspond to cocircuits. The latter interpretation may be generalized to *pseudosphere arrangements* on the d -sphere with certain intersection properties. This generalization encompasses all oriented matroids via the *Topological Representation Theorem* by FOLKMAN & LAWRENCE [27].

APPENDIX B

NOTATION

\mathcal{A}	a point configuration
$\text{ast}_K(S)$	the antistar of the simplex S in K
$\mathcal{B}(m, k)$	the higher Bruhat order on the set of all consistent subsets of $\binom{[m]}{k+1}$
$C(n, d)$	the cyclic d -polytope with n vertices
\mathbb{C}^A	the set of all complex polynomials with monomials in A
$\text{cone}(V)$	the conical hull of V
$\text{conv}(\mathcal{A})$	the convex hull of \mathcal{A}
\mathcal{C}	a polytopal complex
$ \mathcal{C} $	the underlying set of \mathcal{C}
$\mathcal{C} \wedge \mathcal{C}'$	the common refinement of \mathcal{C} and \mathcal{C}'
$\Delta(\mathcal{S})$	the order complex of \mathcal{S}
Δ_n	the n -dimensional standard simplex
$\Delta_A(f)$	the A -discriminant of f
$\dim(P)$	the dimension of P
$\lceil d \rceil$	the smallest integer greater than or equal to d
$\lfloor d \rfloor$	the largest integer smaller than or equal to d
$E_A(f)$	the principal A -determinant of f
$\mathcal{E}(\mathcal{M})$	the extension space of \mathcal{M}
e_i	the i -th unit vector $(0, \dots, \underbrace{1}_i, \dots, 0)^T$
$\text{flip}_{\mathcal{S}}$	the increasing flip function
$\mathcal{F}(n, d)$	the set of all facets of $C(n, d)$
$\mathcal{F}^l(n, d)$	the set of all lower facets of $C(n, d)$
$\mathcal{F}^u(n, d)$	the set of all upper facets of $C(n, d)$
\mathcal{F}^d	the free oriented matroid on d elements
$f _X$	the function f restricted to X
$\mathcal{G}_{\mathcal{A}}$	the graph of all triangulations of \mathcal{A}
$\mathcal{G}_{\mathcal{A}}^{\text{reg}}$	the graph of all regular triangulations of \mathcal{A}
$\Gamma(P, \pi)$	the chamber complex of (P, π)
$G_k(\mathbb{R}^d)$	the Grassmannian of all k -dimensional subspaces of \mathbb{R}^d
$\mathcal{G}_k(\mathcal{M}^d)$	the OM-Grassmannian of \mathcal{M}^d
\mathcal{L}	a linearly ordered label set

ℓ	a labelling function $\mathcal{L} \rightarrow \mathcal{A}$
$\text{lin}(V)$	the linear span of V
$\text{lk}_K(S)$	the link of the simplex S in K
\mathcal{M}	an oriented matroid
$\widehat{\mathcal{M}}$	a one-element lifting of \mathcal{M}
$\mathcal{M}(V)$	the oriented matroid of the vector configuration V
$\text{MacP}(d, k)$	the MacPhersonian
$N(\sigma)$	normal fan over the chamber σ
$N(f)$	the Newton polytope of f
$[n]$	the set $\{1, \dots, n\}$
$]n[$	the set $\{2, \dots, n-1\}$
$g(n) = O(f(n))$	there is a constant c such that $g(n) \leq c \cdot f(n)$ for all n
$\Omega(U)$	a single-step inclusion order of U
ΩX	the loop space of X
$\omega(P, \pi)$	the poset of all locally coherent strings of (P, π)
$\omega_{\text{coh}}(P, \pi)$	the poset of all globally coherent strings of (P, π)
P	a polytope
P^ψ	the face of P in direction ψ
P_q	the fiber over $q \in Q$ for some projection $\pi : P \rightarrow Q$
$\pi : P \rightarrow Q$	a polytope projection
π^*	the dual map of π
$[\psi]_\sigma$	the normal cone in $N(\sigma)$ in direction ψ
$\text{relint } P$	the relative interior of P
$R_A(f_1, \dots, f_m)$	the A -resultant of f_1, \dots, f_m
\mathbb{R}^d	the d -dimensional euclidean space
$(\mathbb{R}^d)^*$	the dual space of \mathbb{R}^d
$(S)_{<_l}$	the set S linearly ordered with “ $<_l$ ”
$S \uplus S'$	the disjoint union of S and S'
$\complement S$	the complement of S
$\#S$	the cardinality of S
$\binom{S}{k}$	the set of all k -element subsets of S
$S_1 \prec S_2$	an upper facet of S_1 is a lower facet of S_2
$S_1 \prec_{(o^*e)} S_2$	S_1 is less than S_2 with respect to their strings of even/odd gaps
$\text{st}_K(S)$	the star of the simplex S in K
$S(n, d)$	the set of all triangulations of $C(n, d)$
$\mathcal{S}_1(n, d)$	the first higher Stasheff-Tamari order on $S(n, d)$
$\mathcal{S}_2(n, d)$	the second higher Stasheff-Tamari order on $S(n, d)$
$s_\Delta : C(n, d) \rightarrow C(n, d+1)$	the characteristic section of Δ
$\Sigma(P, \pi)$	the fiber polytope of (P, π)
$\Sigma(\mathcal{A})$	the secondary polytope of \mathcal{A}
\mathcal{T}_n	the Tamari lattice

U	an inversion set
X_U, λ_U, ρ_U	the central set, the left, and the right boundary function of U
V	a set of vectors in euclidean space
\mathcal{V}^*	the set of covectors of an oriented matroid
$\text{vert}(P)$	the set of vertices of P
$\text{vol}(P)$	the volume of P
v^T	the transposed vector/matrix of v
$w_1 \cdot w_2$	the concatenation of the paths w_1 and w_2
X	a topological respectively a metric space
∂X	the boundary of X
Z	a circuit
Z^+	positive part of Z
Z^-	negative part of Z
$\mathcal{Z}(n, d)$	the set of all circuits of $C(n, d)$
$\mathcal{Z}^+(n, d)$	the set of all circuits of $C(n, d)$ with maximal element in Z^+ .
$\mathcal{Z}^-(n, d)$	the set of all circuits of $C(n, d)$ with maximal element in Z^-
$\ z\ $	the norm $\sqrt{a^2 + b^2}$ of a complex number $z = ai + b$

BIBLIOGRAPHY

- [1] J. FRANK ADAMS, *On the cobar construction*, Proceedings of the National Academy of Science **42** (1956), 409–412.
- [2] LAURA ANDERSON, *All euclidean combinatorial differential manifolds are PL manifolds*, Preprint, October 1995.
- [3] ERIC K. BABSON, *A combinatorial flag space*, Ph.D. thesis, MIT, 1993.
- [4] EGON BALAS and MAARTEN OOSTEN, *On the dimension of projected polyhedra*, Technical Report #MSRR-612, Management Science Research Group, Graduate School of Industrial Administration, Carnegie Mellon University, Pittsburgh, April 1995.
- [5] HANS JOACHIM BAUES, *Geometry of loop spaces and the cobar construction*, Memoirs of the American Mathematical Society **25** (1980), 1–171.
- [6] MARGARET M. BAYER, *Equidecomposable and weakly neighborly polytopes*, Isreal Journal of Mathematics **81** (1993), 301–320.
- [7] LOUIS J. BILLERA, PAUL FILLIMAN, and BERND STURMFELS, *Constructions and complexity of secondary polytopes*, Advances in Mathematics **83** (1990), 155–179.
- [8] LOUIS J. BILLERA, ISRAIL M. GELFAND, and BERND STURMFELS, *Duality and minors of secondary polyhedra*, Journal of Combinatorial Theory, Series B **57** (1993), 258–268.
- [9] LOUIS J. BILLERA, MIKHAIL M. KAPRANOV, and BERND STURMFELS, *Cellular strings on polytopes*, Proceedings of the American Mathematical Society **122** (1994), 549–555.
- [10] LOUIS J. BILLERA and BETH SPELLMAN MUNSON, *Triangulations of oriented matroids and convex polytopes*, SIAM Journal of Algebraic Discrete Methods **5** (1984), 515–525.
- [11] LOUIS J. BILLERA and BERND STURMFELS, *Fiber polytopes*, Annals of Mathematics **135** (1992), 527–549.

- [12] ———, *Iterated fiber polytopes*, *Mathematika* **41** (1994), 348–363.
- [13] TIBOR BISZTRICZKY and GYULA KÁROLYI, *Subpolytopes of cyclic polytopes*, Preprint, 1995.
- [14] ANDERS BJÖRNER, *Essential chains and homotopy types of posets*, *Proceedings of the American Mathematical Society* **402** (1992), 1179–1181.
- [15] ANDERS BJÖRNER, MICHEL LAS VERGNAS, BERND STURMFELS, NEIL WHITE, and GÜNTER M. ZIEGLER, *Oriented matroids*, *Encyclopedia of Mathematics*, vol. 46, Cambridge University Press, Cambridge, 1993.
- [16] JOCHEN BOHNE, *Eine kombinatorische Analyse zonotopaler Raumaufteilungen*, Dissertation 1992, Fachbereich Mathematik, Universität Bielefeld; Preprint 92-041, Sonderforschungsbereich 343 “Diskrete Strukturen in der Mathematik,” 1992, 100 pp.
- [17] GLEN E. BREDON, *Topology and Geometry*, *Graduate Texts in Mathematics*, vol. 139, Springer, New York Berlin Heidelberg, 1993.
- [18] HEINZ BRUGESSER and PETER MANI, *Shellable decompositions of cells and spheres*, *Mathematica Scandinavica* **29** (1971), 197–205.
- [19] FRANCIS Y. CHIN and CAO AN WANG, *On the difficulty of greedy tetrahedralization of points in 3-d*, 7th Canadian Conference on Computational Geometry (Quebec, City), August 1995.
- [20] THOMAS CHRISTOF, *Porta — a polyhedron representation transformation algorithm (revised by Andreas Loebel and Mechthild Stoer)*, ZIB electronic library eLib; WWW: <http://elib.ZIB-Berlin.DE>; anonymous ftp: <ftp.zib-berlin.de>, <directory/pub/mathprog/polyth/porta>.
- [21] PAUL H. EDELMAN and VICTOR REINER, *The higher Stasheff-Tamari posets*, Preprint, July 1995, *Mathematika*, to appear.
- [22] ———, *Visibility complexes and the Baues Problem for triangulations in the plane*, Preprint, 1995.
- [23] HERBERT EDELSBRUNNER, *Algorithms in Geometry and Topology*, Course script 497, University of Illinois, Urbana-Champaign, Spring 1993.
- [24] HERBERT EDELSBRUNNER and NIMISH R. SHAH, *Incremental topological flipping works for regular triangulations*, *Proceedings of the 8th annual ACM Symposium on Computational Geometry (Berlin)*, ACM press, 1992, pp. 43–52.

- [25] GÜNTER EWALD, *Über stellare Äquivalenz konvexer Polytope*, Resultate der Mathematik **1** (1978), 54–60.
- [26] PAUL FILLIMAN, *Exterior algebra and projections of polytopes*, Discrete & Computational Geometry **5** (1990), 305–322.
- [27] JON FOLKMAN and JIM LAWRENCE, *Oriented matroids*, Journal of Combinatorial Theory, Series B **25** (1978), 199–236.
- [28] IZRAIL M. GELFAND, MIKHAIL M. KAPRANOV, and ANDREI V. ZELEVINSKY, *Discriminants of polynomials in several variables and triangulations of Newton polyhedra*, Leningrad Mathematical Journal **2** (1991), 449–505.
- [29] ———, *Discriminants, resultants, and multidimensional determinants*, Mathematics: Theory & Applications, Birkhäuser, Boston, 1994.
- [30] IZRAIL M. GELFAND and ROBERT D. MACPHERSON, *A combinatorial formula for the Pontrjagin classes*, Bulletin of the American Mathematical Society **26** (1992), 304–309.
- [31] WINFRIED GEYER, *On Tamari lattices*, Discrete Mathematics **133** (1994), 99–122.
- [32] BRANKO GRÜNBAUM, *Convex Polytopes*, Interscience, London, 1967.
- [33] MARK HAIMAN, *Constructing the associahedron*, Manuscript, unpublished, 1989.
- [34] SABINE HANKE, THOMAS OTTMANN, and SVEN SCHUIERER, *The edge-flipping distance of triangulations*, In Hinrichs [35].
- [35] KLAUS H. HINRICHS (ed.), *Abstracts of the 12th European Workshop on Computational Geometry (CG '96)*, Report No. 7/96-I, Institut für Informatik, Westfälische Wilhelms-Universität Münster, 1996.
- [36] SAMUEL HUANG and DOV TAMARI, *Problems of associativity: A simple proof for the lattice property of systems ordered by a semi-associative law*, Journal of Combinatorial Theory, Series A **13** (1972), 7–13.
- [37] FERRAN HURTADO, MARC NOY, and JORGE URRUTIA, *Flipping edges on triangulations*, In Hinrichs [35].
- [38] BARRY JOE, *Three dimensional triangulations from local transformations*, SIAM Journal of Scientific Statistical Computation **10** (1989), 718–741.

- [39] ———, *Construction of three-dimensional Delaunay triangulations using local transformations*, *Computer Aided Geometric Design* **8** (1991), 123–142.
- [40] MIKHAIL M. KAPRANOV and VLADIMIR A. VOEVODSKY, *Combinatorial-geometric aspects of polycategory theory: pasting schemes and higher Bruhat orders (list of results)*, *Cahiers de Topologie et Géométrie différentielle catégoriques* **32** (1991), 11–27.
- [41] CARL LEE, *Triangulations of polytopes*, Preprint, July 1995; *CRC Handbook of Discrete and Computational Geometry*, (Jacob E. Goodman and Joseph O’Rourke, eds.), to appear.
- [42] ———, *Applied geometry and discrete mathematics: Regular triangulations of convex polytopes*, *The Victor Klee Festschrift* (Peter Gritzmann and Bernd Sturmfels, eds.), American Mathematical Society, Providence, RI, 1991, pp. 443–456.
- [43] JESÚS A. DE LOERA, *Triangulations of polytopes and computational algebra*, Ph.D. thesis, Cornell University, 1995.
- [44] ———, *Non-regular triangulations of products of simplices*, *Discrete & Computational Geometry* **15** (1996), 253–264.
- [45] JESÚS A. DE LOERA, SERKAN HOŞTEN, FRANCISCO SANTOS, and BERND STURMFELS, *The polytope of all triangulations of a point configuration*, *Documenta Mathematica* **1** (1996), 103–119.
- [46] LASZLO LOVÁSZ and ALEXANDER SCHRIJVER, *Cones of matrices and set functions and 0-1 optimization*, *SIAM Journal of Optimization* **1** (1991), 166–190.
- [47] ROBERT D. MACPHERSON, *Combinatorial differential manifolds*, *Topological Methods in Modern Mathematics: A Symposium in Honor of John Milnor’s Sixtieth Birthday*, Stony Brook NY, 1991 (Lisa R. Goldberg and Anthon V. Phillips, eds.), Publish or Perish, Houston TX, 1993, pp. 203–221.
- [48] YURII I. MANIN and VADIM V. SCHECHTMAN, *Arrangements of hyperplanes, higher braid groups and higher Bruhat orders*, *Advanced Studies in Pure Mathematics* **17** (1989), 289–308.
- [49] PETER MCMULLEN, *The maximum number of faces of a convex polytope*, *Mathematika* **17** (1970), 179–184.

-
- [50] ANDREAS MERTSCH, *Triangulierungen und Dreiecks-Bézier-Flächen*, Diplomarbeit, Fachbereich Mathematik, Universität Hamburg, 1991.
- [51] R. JAMES MILGRAM, *Iterated loop spaces*, *Annals of Mathematics* **84** (1966), 386–403.
- [52] JOHN W. MILNOR, Communicated by James D. Stasheff, unpublished.
- [53] NICOLAI E. MNĚV and JÜRGEN RICHTER-GEBERT, *Constructions of oriented matroids with disconnected extension space*, *Discrete & Computational Geometry* **10** (1993), 271–285.
- [54] NIKOLAI E. MNĚV and GÜNTER M. ZIEGLER, *Combinatorial models for the finite-dimensional Grassmannians*, *Discrete & Computational Geometry* **10** (1993), 241–250.
- [55] ALEXANDER NABUTOVSKY, *Extremal triangulations of manifolds*, Preprint, 1994.
- [56] ALEXANDER NABUTOVSKY and RADEL BEN-AV, *Noncomputability arising in dynamical triangulation model of four-dimensional quantum gravity*, *Communications in Mathematical Physics* **157** (1993), 93–98.
- [57] UDO PACHNER, *Bistellare Äquivalenz kombinatorischer Mannigfaltigkeiten*, *Archiv der Mathematik* **30** (1978), 89–98.
- [58] ———, *Über die bistellare Äquivalenz simplizialer Sphären und Polytope*, *Mathematische Zeitschrift* **176** (1981), 565–576.
- [59] JEAN-MARCEL PALLO, *A distance metric on binary trees using lattice-theoretic measures*, *Information Processing Letters* **34** (1990), 113–116.
- [60] JÖRG RAMBAU, *Triangulations of cyclic polytopes and higher Bruhat orders*, Preprint No. 496/1996, Fachbereich Mathematik, TU-Berlin, Mathematika, to appear.
- [61] JÖRG RAMBAU and GÜNTER M. ZIEGLER, *Projections of polytopes and the Generalized Baues Conjecture*, Preprint No. 429/1995, Fachbereich Mathematik, TU-Berlin, *Discrete & Computational Geometry*, to appear.
- [62] VICTOR REINER and GÜNTER M. ZIEGLER, *Coxeter-associahedra*, *Mathematika* **41** (1994), 364–393.
- [63] JÜRGEN RICHTER-GEBERT, *New construction methods for oriented matroids*, Ph.D. thesis, Royal Institute of Technology, Department of Mathematics, Stockholm, 1992.

- [64] JÜRGEN RICHTER-GEBERT and GÜNTER M. ZIEGLER, *Zonotopal tilings and the Bohne-Dress theorem*, Proceedings “Jerusalem Combinatorics ’93” (Helene Barcelo and Gil Kalai, eds.), Contemporary Mathematics, vol. 178, American Mathematical Society, 1994, pp. 211–232.
- [65] FRANZISCO SANTOS, *The polytope of all triangulations of an oriented matroid*, Manuscript, March 1996.
- [66] LUDWIG SCHLÄFLI, *Theorie der vielfachen Kontinuität (written 1850–1852)*, Denkschriften der Schweizerischen naturforschenden Gesellschaft, vol. 38, Zürcher and Furrer, Zürich, 1901, pp. 1–237. Reprinted in: *Ludwig Schläfli: 1814–1895, Gesammelte Mathematische Abhandlungen, vol. I*, Birkhäuser, Basel 1950, pp. 167–387.
- [67] DANIEL D. SLEATOR, ROBERT E. TARJAN, and WILLIAM P. THURSTON, *Rotation distance, triangulations, and hyperbolic geometry*, Journal of the American Mathematical Society **1** (1988), 647–681.
- [68] RICHARD P. STANLEY, *Enumerative Combinatorics, Volume I*, Wadsworth & Brooks/Cole, Monterey, 1986.
- [69] BERND STURMFELS, *On the matroid stratification of Grassmann varieties, specialization of coordinates, and a problem of N. White*, Advances in Mathematics **75** (1989), 202–211.
- [70] ———, *Fiber polytopes: A brief overview*, Special Differential Equations (Masaaki Yoshida, ed.), Kyushu University, Fukuoka, 1991, pp. 117–124.
- [71] BERND STURMFELS and GÜNTER M. ZIEGLER, *Extension spaces of oriented matroids*, Discrete & Computational Geometry **10** (1993), 23–45.
- [72] DOV TAMARI, *The algebra of bracketings and their enumeration*, Nieuw Archief voor Wiskunde **X** (1962), 131–146.
- [73] GÜNTER M. ZIEGLER, *Shelling polyhedral 3-balls and 4-polytopes*, Preprint-No. 473/1995, Fachbereich Mathematik, TU-Berlin.
- [74] ———, *Higher Bruhat orders and cyclic hyperplane arrangements*, Topology **32** (1993), 259–279.
- [75] GÜNTER M. ZIEGLER, *Lectures on polytopes*, Graduate Texts in Mathematics, vol. 152, Springer, New York, 1995, *Updates, Corrections, and more* available at <http://www.math.tu-berlin.de/~ziegler>.

INDEX

- 1-connected, 97
- A-discriminant, 23
- A-resultant, 23
- abstract simplicial complex, 102
- admissible
 - ordering, 84
 - pairs of simplices, 63
- alternating oriented matroid, 17
- anti-isomorphism of posets, 94
- antistar, 103
- arrangement of hyperplanes, 105
- associahedron, 11
- atom, 94
- atomic, 94

- barycenter, 38
- basis, 95
- basket ball obstruction, 43–46, 48
- Baues conjecture, 22
- big face lattice, 104
- bipyramid, 100
- bistellar
 - equivalence, 5
 - operation, 1, 5, 10, 13–15, 55, 56
- Bohne-Dress theorem, 16, 17
- boundary
 - of a cone, 99
 - of a polytope, 98
 - of an inversion set, 84
- bounded poset, 93

- cellular
 - string, 21
 - string complex, 21
- central set
 - of a simplex, 87
 - of an inversion set, 88
- chain in a poset, 93
- chamber, 2, 8, 31, 32–36, 42
- chamber complex, 8, 31, 32–36, 42, 46, 51
- characteristic
 - function, 24
 - section, 65, 75, 78
- circuit, 61
- closed
 - normal cone, 100
 - path, 97
- coatom, 94
- coatomic, 94
- cocircuit, 104
- coherent subdivision, 9, 10, 12, 23, 29
- coloop, 104
- combinatorial
 - antistar, 60
 - cyclic polytope, 64
 - differential manifold, 18
 - facet, 61
 - join, 60
 - link, 60
 - model, 61
 - for a loop space, 19
 - for the Grassmannian, 19
 - polytope, 61
 - simplex, 60
 - simplicial complex, 60
 - star, 60
 - subcomplex, 60
 - triangulation, 61
- combinatorially isomorphic
 - complexes, 101
 - subdivisions, 3

- common refinement
 - of fans, 99
 - of subdivisions, 3
- complete fan, 99
- composition, 103
- compression in a triangulation, 71
- concatenation of paths, 41, 96
- conical hull, 98
- consistent, 84
- continuous, 95
 - at a point, 95
- contractible, 96
- contraction of an element
 - in a set, 59
 - in a triangulation, 67
 - in an inversion set, 85
 - in an oriented matroid, 104
- covector, 103
- cover in a poset, 93
- covering of a topological space, 97
- covering relation, 93
- Coxeter groups, 11
- cross-polytope, 100
- cyclic polytope, 2, 6, 7, 12, 13, 16, 55, 56, 63–67, 100, 101

- degenerate, 28
- Delaunay triangulation, 13
- deletion of an element
 - in a set, 59
 - in a triangulation, 67
 - in an inversion set, 85
 - in an oriented matroid, 104
- diameter, 42, 95
- dimension
 - of a cone, 98
 - of a polytope, 98
 - of an abstract simplicial complex, 102
- direct map, 89
- direct sum, 100

- double description, 99
- double stippling, 21

- edge, 98
- edge-flipping
 - diameter, 13
 - distance, 13
 - operation, 13
- equivalent
 - admissible orderings, 84
 - locally coherent functions, 36
- even gap, 63, 76
- expansion
 - in a triangulation, 69
 - of an inversion set, 85
- extension, 104
 - of a triangulation, 67
 - of an inversion set, 85
 - poset, 17
 - space, 17
- extension space conjecture, 17

- face
 - of a combinatorial simplex, 60
 - of a cone, 99
 - in direction ψ , 99
 - of a polytope, 98
 - in direction ψ , 31, 98
- face lattice
 - of a cone, 99
 - of a polytope, 31, 98
- facet
 - of a combinatorial simplex, 60
 - of a complex, 101
 - of a cone, 99
 - of a polytope, 61, 98
- fan, 99
- fiber, 2, 7, 31, 32–36
- fiber polytope, 9, 29
- flip map, 88
- free

- lower facet, 82
- oriented matroid, 104
- upper facet, 82
- full-dimensional
 - cone, 98
 - polytope, 98
- functorial
 - circuit properties, 67
 - circuit-facet relations, 67
 - facet properties, 66
 - flip properties, 79
 - order properties, 79
 - relations, 91
- Gale's evenness criterion, 63
- generalized Baues conjecture, 2, 7, 11, 12, 29, 42–46
- generalized bistellar operation, 10
- generator, 95
- geometric
 - interpretation, 61, 74, 78
 - simplex, 60
 - simplicial complex, 60
 - subcomplex, 60
- globally coherent string, 28, 39
- graded poset, 94
- graph of all triangulations, 5
- Grassmannian, 19
- greedily triangulable, 74
- Hasse diagram, 94
- higher Bruhat order, 16, 55, 58, 84, 87–91
- higher Stasheff-Tamari order
 - first, 16, 55, 56, 75
 - second, 57, 75
- homeomorphism, 95
- homotopic, 96
 - relative $\partial[0, 1]$, 39, 96
- homotopy
 - equivalence, 96
- equivalent, 96
 - of functions, 96
 - relative a subset, 96
- hypercube, 100
- increasing
 - bistellar flip set, 74
 - bistellar operation, 16, 57, 74
 - flip function, 75
 - flip set, 74
- incremental triangulation, 14
- index, 88
- induced subdivision, 9, 11, 29
- intersection property, 61
- interval in a poset, 93
- inversion set, 84
- isomorphism of posets, 94
- iterated fiber polytope, 12
- iterated loop space, 23
- join
 - in a poset, 94
 - of polytopes, 100
 - of simplicial complexes, 103
- k -neighborly, 100
- k -packet, 84
- label set, 60
- labelling function, 60
- lattice, 94
- left boundary
 - function, 89
 - of a simplex, 87
- length of a chain, 93
- lexicographic order, 84
- lifting, 104
 - of a path, 39, 97
- lifts weakly lower, 75
- link, 50, 103
- locally coherent
 - function, 36, 38, 40, 42–46

- function values, 37, 50
- string, 10, 28, 35, 38, 39, 42–46, 49–51
- loop, 104
- lower
 - face, 4
 - facet, 57, 64, 77, 81–83
- lower bound in a poset, 94
- MacPhersonian, 19
- maximal element in a poset, 93
- meet in a poset, 94
- metric space, 95
- minimal
 - combinatorial dependence, 61
 - element in a poset, 93
- Minkowski sum, 100
- model theorem for loop spaces, 20
- monotone path polytope, 11
- negative part
 - of a circuit, 61
 - of a sign vector, 103
- neighborhood, 95
- neighborly, 100
- Newton polytope, 24
- non-degenerate, 28
- normal cone, 32, 100
 - over a chamber, 32, 33–36, 42–46
- normal fan, 100
 - over a chamber, 32, 33–36, 42–46
- normally equivalent, 32
- null-homotopic, 96
- odd gap, 63, 76
- OM-Grassmannian, 19
- one-element lifting, 104
- open
 - ball, 95
 - set, 94
- order complex, 11, 17, 19, 21, 29, 94
- order-preserving map, 94
- order-reversing map, 94
- oriented matroid, 104
 - of a vector configuration, 104
 - of a zonotope, 17
- parametrized cyclic polytope, 63
- partial order, 93
- partial triangulation, 14, 74
- partially ordered set, 93
- path, 96
- path space, 21
- path-connected, 97
- permutahedron, 22
- permuto-associahedron, 11
- piecewise linear section, 12
- planar bistellar operation, 5
- pointed
 - cone, 99
 - fan, 99
- polyhedral
 - cone, 98
 - subdivision, 101
 - of a point configuration, 3, 10
 - of a polytope, 3
- polytopal complex, 101
- polytope, 61, 98
- polytope projection, 2, 7, 30–36, 44–46, 48, 56, 64
- poset, 93
- positive part
 - of a circuit, 61
 - of a sign vector, 103
- principal A -determinant, 23
- prism, 100
- product
 - of metric spaces, 37, 96
 - of polytopes, 100
- proper
 - face
 - of a cone, 99
 - of a polytope, 98

- part of a poset, 93
- pseudosphere arrangement, 105
- pure, 101
- pyramid, 100
- rank
 - in a poset, 94
 - of a poset, 94
 - of an oriented matroid, 104
- ranked poset, 94
- ray, 99
- real Grassmann manifold, 19
- realizable oriented matroid, 19, 104
- refinement
 - of a fan, 99
 - of a subdivision, 3
- reflex vertex, 14
- regular
 - subdivision, 3, 10
 - triangulation, 3, 10, 56
 - triangulation for weights, 14
- regular triangulation, 6
- relative interior
 - of a cone, 99
 - of a polytope, 98
- restricted polyhedral subdivision, 10, 56
- restriction, 104
- right boundary
 - function, 89
 - of a simplex, 87
- rotations in binary trees, 15
- secondary polytope, 9, 11, 56
 - example, 24
 - via characteristic functions, 24
 - via fiber polytope, 9
- separation, 103
- shellability, 100
- shellable, 102
- shelling, 101
- sign vector, 103
- simple polygon, 14
- simplex, 100
- simplicial
 - complex, 101
 - polytope, 61
- single-element extension, 104
- spherical desuspension, 21
- standard
 - cyclic polytope, 101
- star, 103
- strong image, 104
- strongly
 - euclidean oriented matroid, 17
 - non-degenerate, 28
- subbasis, 95
- support
 - of a bistellar operation, 5
 - of a circuit, 61
 - of a sign vector, 103
 - of a simplicial complex, 102
- supporting hyperplane
 - of a cone, 99
 - of a polytope, 98
- Tamari lattice, 15
- tight
 - induced subdivision, 9
 - locally coherent string, 28, 43, 46, 50, 51
- topological space, 94
- topology, 94
 - induced by a metric, 95
- transitive closure, 93
- triangulation, 1
 - of a cyclic polytope, 2, 6, 12, 16, 55, 67–74, 79–83, 87, 88
 - of a point configuration, 4, 10, 13–16, 18, 24, 28, 55, 61
 - of a polytope, 4
 - of a topological space, 18, 27
 - of an oriented matroid, 18

- trivial face of a polytope, 31
- twist function, 39
- twisted capped prism, 77

- underlying set of a complex, 101
- union property, 61
- universal covering, 39, 97
- upper bound in a poset, 94
- upper bound theorem, 100, 101, 102
- upper facet, 57, 64, 81–83

- vertex, 98

- weak Bruhat order, 58, 94
- weak image, 104
- weak map relation, 104
- weakly
 - neighborly polytope, 7
 - non-degenerate, 28

- zonotopal tiling, 17
- zonotope, 17

CURRICULUM VITAE

JÖRG RAMBAU

geboren am 9. Juni 1966 in Gevelsberg

1972–1976: Grundschule

1976–1985: Gymnasium in Wetter (Ruhr)

Juni 1985: Abitur

1985–1987: Zivildienst bei der Arbeiterwohlfahrt in Gevelsberg

1987–1993: Mathematikstudium an der Ruhruniversität Bochum

März 1993: Diplom mit Spezialgebiet “Algebraische Topologie,” Betreuer: Professor Ralph Stöcker, Bochum

1993–1996: Doktorand mit Spezialgebiet “Diskrete Geometrie”

1994–1996: Stipendiat im Graduiertenkolleg “Algorithmische Diskrete Mathematik” am Konrad-Zuse-Zentrum für Informationstechnik (ZIB) und an der Technischen Universität Berlin, Betreuer: Professor Günter M. Ziegler.