

FRANK H. LUTZ<sup>1</sup>

# **Triangulated Manifolds with Few Vertices: Centrally Symmetric Spheres and Products of Spheres**

---

<sup>1</sup>*Main address:* Technische Universität Berlin, Fakultät II - Mathematik und Naturwissenschaften, Institut für Mathematik, Sekr. MA 6-2, Straße des 17. Juni 136, D-10623 Berlin, Germany, [lutz@math.tu-berlin.de](mailto:lutz@math.tu-berlin.de). *Additional address:* Konrad-Zuse-Zentrum für Informationstechnik Berlin (ZIB), Takustraße 7, D-14195 Berlin, Germany, [lutz@zib.de](mailto:lutz@zib.de).

# Triangulated Manifolds with Few Vertices: Centrally Symmetric Spheres and Products of Spheres

Frank H. Lutz

Let  $M$  be a simplicial manifold with  $n$  vertices. We call  $M$  *centrally symmetric* if it is invariant under an involution  $I$  of its vertex set which fixes no face of  $M$ . Obviously, the number of vertices of a centrally symmetric (triangulated) manifold is even,  $n = 2k$ , and, without loss of generality, we may assume that the involution is presented by the permutation  $I = (1\ k+1)(2\ k+2)\cdots(k\ 2k)$ . The boundary complex  $\partial C_k^\Delta$  of the  $k$ -dimensional crosspolytope  $C_k^\Delta$  is clearly centrally symmetric with respect to the standard antipodal action, and a subset  $F \subseteq \{1, 2, \dots, 2k\}$  is a face of  $\partial C_k^\Delta$  if and only if it does not contain any *minimal non-face*  $\{i, k+i\}$  for  $1 \leq i \leq k$ . Hence, every centrally symmetric manifold with  $2k$  vertices appears as a subcomplex of the boundary complex of the  $k$ -dimensional crosspolytope.

Free  $\mathbb{Z}_2$ -actions on spheres are at the heart of the Borsuk-Ulam theorem, which has an abundance of applications in topology, combinatorics, functional analysis, and other areas of mathematics (see the surveys of Steinlein [50], [51], and the recent book of Matoušek [33]). Centrally symmetric spheres therefore constitute an important class of triangulated spheres for which we have a strong interest in understanding their combinatorial properties, like the range of possible  $f$ -vectors, or even more basic, what kind of examples are there at all?

Centrally symmetric products of spheres are the next more general class of centrally symmetric manifolds. They show that certain lower bounds on the numbers of vertices of centrally symmetric manifolds are tight.

The aim of this paper is to give a survey of the known results concerning centrally symmetric polytopes, spheres, and manifolds. We further enumerate *nearly neighborly* centrally symmetric spheres and centrally symmetric products of spheres with dihedral or cyclic symmetry on few vertices, and we present an infinite series of vertex-transitive nearly neighborly centrally symmetric 3-spheres.

## 1 General Properties of Centrally Symmetric Spheres

One way to obtain centrally symmetric spheres is as boundary complexes of centrally symmetric simplicial polytopes. A  $d$ -dimensional polytope  $P \subset \mathbb{R}^d$  is *centrally symmetric* if we can translate  $P$  such that  $P = -P$ . If  $d > 0$ , then, by convexity, the involution  $I : x \mapsto -x$  of  $\mathbb{R}^d$  does not fix any non-trivial face of  $P$ , and  $P$  has an even number of vertices,  $n = 2k$ . Regular  $2k$ -gons, the icosahedron, and crosspolytopes  $C_k^\Delta$  are immediate examples of centrally symmetric simplicial polytopes. The dodecahedron and  $d$ -dimensional cubes are centrally symmetric, but not simplicial.

Not every centrally symmetric sphere needs to be polytopal, and even if so, resulting realizations need not be centrally symmetric. Centrally symmetric simplicial  $(d-1)$ -spheres have at least  $2d$  vertices, with the boundary complex  $\partial C_d^\Delta$  of the  $d$ -dimensional crosspolytope  $C_d^\Delta$  as the unique centrally symmetric  $(d-1)$ -sphere with exactly  $2d$  vertices.

We recall that for the class of *all* simplicial spheres, the upper bound theorem of McMullen [34] for polytopal spheres and of Stanley [48] for simplicial spheres (see Novik [36] for generalizations to odd-dimensional and certain even-dimensional simplicial manifolds) as well as the lower bound theorem of Barnette ([4, p. 354], [5]) and Kalai [18] give restrictions on the numbers  $f_i$  of  $i$ -dimensional faces of a simplicial sphere for  $0 \leq i \leq d-1$ : A simplicial  $(d-1)$ -sphere with  $n$  vertices has at most as many  $i$ -faces as the boundary sphere of the corresponding cyclic  $d$ -polytope  $C_d(n)$  and at least as many  $i$ -faces as the boundary sphere of a stacked  $d$ -polytope on  $n$  vertices. In contrast, much less is known on  $f$ -vectors  $f = (f_0, \dots, f_{d-1})$  of centrally symmetric  $d$ -polytopes respectively  $(d-1)$ -spheres.

Stanley [49] proved lower bounds (conjectured by Bárány and Lovász [3] and by Björner) on the numbers of faces of  $d$ -dimensional centrally symmetric polytopes with  $n = 2k \geq 2d$  vertices (see Novik [37] for an alternative and more geometric proof):

$$f_i \geq 2^{i+1} \binom{d}{i+1} + 2(k-d) \binom{d}{i}, \quad 0 \leq i \leq d-2,$$

$$f_{d-1} \geq 2^d + 2(k-d)(d-1).$$

These bounds are sharp for *stacked centrally symmetric  $d$ -polytopes*, which are obtained from the  $d$ -dimensional crosspolytope by stellarly subdividing  $n-k$  successive pairs of antipodal facets.

A simplicial  $(d-1)$ -sphere  $S$  is  *$l$ -neighborly* if every set of  $l$  (or less) vertices forms a face of  $S$ . The  $d$ -simplex  $\Delta_d$  (respectively, its boundary  $\partial\Delta_d$ ) with  $d+1$  vertices is  $(d+1)$ -neighborly, and for  $n \geq d+2$ , the cyclic polytope  $C_d(n)$  is  $\lfloor \frac{d}{2} \rfloor$ -neighborly, but not  $(\lfloor \frac{d}{2} \rfloor + 1)$ -neighborly. Simplicial spheres (respectively, simplicial polytopes) are called *neighborly* if they are  $\lfloor \frac{d}{2} \rfloor$ -neighborly.

Analogously, a centrally symmetric  $(d-1)$ -sphere  $S$  with  $n = 2k$  vertices is *centrally  $l$ -neighborly* if every set of  $l$  vertices, which does not contain a

minimal non-face  $\{i, k + i\}$  for  $1 \leq i \leq k$ , is a face of  $S$ , i.e., if  $S$  has the  $(l - 1)$ -skeleton of the crosspolytope  $C_k^\Delta$ . The  $d$ -dimensional crosspolytope  $C_d^\Delta$  with  $2d$  vertices is centrally  $d$ -neighborly. A centrally symmetric  $(d - 1)$ -sphere with  $n = 2k$  vertices is *nearly neighborly* if it is centrally  $\lfloor \frac{d}{2} \rfloor$ -neighborly, i.e., if  $f_i = 2^{i+1} \binom{k}{i+1}$  for  $i \leq \frac{d}{2} - 1$ , with  $f_i$  being determined by the Dehn-Sommerville equations for  $i > \frac{d}{2} - 1$ .

Along the lines of the proof of the upper bound theorem for simplicial spheres, Adin [1] and Stanley (cf. [16]) showed independently that a centrally symmetric simplicial  $(d - 1)$ -sphere with  $2k$  vertices has at most as many  $i$ -faces as a nearly neighborly centrally symmetric  $(d - 1)$ -sphere with  $2k$  vertices would have, if such exists. Novik [38] extended this result to all odd-dimensional centrally symmetric manifolds; see also [39].

The boundaries of regular polygons with  $2k \geq 4$  vertices and suspensions thereof with  $2k + 2$  vertices provide examples of centrally symmetric 1- and 2-spheres for all possible numbers of vertices. Since centrally 1-neighborliness is a trivial property, every centrally symmetric 2-sphere is nearly neighborly, and, moreover, is realizable as the boundary complex of a centrally symmetric 3-polytope; see Mani [32].

Grünbaum observed [11, p. 116] that the centrally symmetric 4-polytope  $G_{2,4+2}^4 := \text{conv}\{\pm e_1, \dots, \pm e_4, \pm \mathbb{1}\} \subset \mathbb{R}^4$  on  $2 \cdot 4 + 2$  vertices is simplicial and nearly neighborly, but that there are *no* nearly neighborly centrally symmetric 4-polytopes with  $n \geq 12 = 2 \cdot 4 + 4$  vertices. In fact, McMullen and Shephard [35] proved that centrally symmetric  $d$ -polytopes with  $n \geq 2d + 4$  vertices are at most centrally  $\lfloor \frac{d+1}{3} \rfloor$ -neighborly. Hence, there are no nearly neighborly centrally symmetric  $d$ -polytopes with  $n \geq 2d + 4$  vertices *for all*  $d \geq 4$ . According to Pfeifle [40, Ch. 10] also nearly neighborly centrally symmetric  $d$ -dimensional fans on  $2d + 4$  rays do not exist for all even  $d \geq 4$  and all odd  $d \geq 11$ . Schneider [42] gave an asymptotic lower bound for the maximal possible  $l = l(d, s)$  for which there are centrally  $l$ -neighborly  $d$ -polytopes with  $2(d + s)$  vertices. However, Burton [9] showed that, for fixed dimension  $d \geq 4$ , centrally symmetric  $d$ -polytopes with sufficiently many vertices *cannot* be centrally 2-neighborly.

In contrast to the situation for centrally symmetric polytopes, Grünbaum constructed nearly neighborly centrally symmetric 3-spheres with 12 and 14 vertices; see [10], [12], and [13].

### **Centrally Symmetric Upper Bound Conjecture** (Grünbaum [13])

*There are nearly neighborly centrally symmetric  $(d - 1)$ -spheres with  $n$  vertices for all  $d \geq 2$  and even  $n = 2k \geq 2d$ .*

Since being centrally  $\lfloor \frac{d}{2} \rfloor$ -neighborly is preserved under suspension and since  $\lfloor \frac{d}{2} \rfloor = \lfloor \frac{d+1}{2} \rfloor$  for all even  $d$ , it suffices to construct *odd-dimensional* nearly neighborly centrally symmetric  $(d - 1)$ -spheres for all even numbers  $n \geq 2d$  of vertices in order to verify Grünbaum's centrally symmetric upper bound conjecture.

Grünbaum's conjecture is trivial for 1- and 2-spheres, but also holds for 3- and 4-spheres.

**Theorem 1** (Jockusch [16]) *There is an infinite family  $J_{2k}^3$ ,  $k \geq 4$ , of nearly neighborly centrally symmetric 3-spheres with  $2k$  vertices. Moreover, the suspensions  $S^0 * J_{2k}^3$  form a family of nearly neighborly centrally symmetric 4-spheres with  $2k + 2$  vertices for  $k \geq 4$ .*

Jockusch constructs the series  $J_{2k}^3$  by induction. He starts with the boundary complex  $J_8^3 = \partial C_4^\Delta$  of the 4-dimensional crosspolytope with 8 vertices. For the induction step he chooses a 3-ball  $B_{2k}$  with image  $B_{2k}^I$  under the central symmetry  $I$  such that their intersection  $B_{2k} \cap B_{2k}^I$  does not contain any facet of  $J_{2k}^3$ . He then removes the balls  $B_{2k}$  and  $B_{2k}^I$  from  $J_{2k}^3$  and sews in two new balls  $(2k + 1) * \partial B_{2k}$  and  $(2k + 2) * \partial B_{2k}^I$  to obtain the 3-sphere  $J_{2k+2}^3$ . The way Jockusch chooses the balls  $B_{2k}$  (the balls  $B_{2k}$  and  $B_{2k}^I$  contain all the vertices of  $J_{2k}^3$ , but have no interior edges, respectively), he ensures that  $J_{2k+2}^3$  remains centrally symmetric and nearly neighborly in every step.

**Theorem 2** (McMullen and Shephard [35]) *For even  $d$ , let the polytope  $H_{2d+2}^d := \text{conv}(\Delta_d \cup -\Delta_d)$  be the joint convex hull of a regular  $d$ -simplex  $\Delta_d$  (with center 0) and its image  $-\Delta_d$  under the map  $I : x \mapsto -x$ . Then  $H_{2d+2}^d$  is nearly neighborly and has the group  $S_{d+1} \times \mathbb{Z}_2$  as its vertex-transitive geometric automorphism group.*

Grünbaum [11, p. 116] has shown that there is only one combinatorial type of a nearly neighborly centrally symmetric 4-polytope with 10 vertices, i.e.,  $G_{2,4+2}^4$  and  $H_{2,4+2}^4$  are combinatorially isomorphic (in fact, for all even  $d$   $G_{2,d+2}^d := \text{conv}\{\pm e_1, \dots, \pm e_d, \pm 1\}$  is combinatorially isomorphic to  $H_{2d+2}^d$ ).

In odd dimensions  $d + 1$  the polytope  $H_{2(d+1)+2}^{d+1}$  is not simplicial. However,  $\text{conv}((\Delta_d \cup -\Delta_d) \cup \{\pm e_{d+1}\}) \subset \mathbb{R}^{d+1}$  is a nearly neighborly centrally symmetric  $(d + 1)$ -dimensional polytope on  $2d + 4$  vertices with boundary  $\partial \text{conv}((\Delta_d \cup -\Delta_d) \cup \{\pm e_{d+1}\}) = S^0 * H_{2d+2}^d$ .

If  $d$  is even, then, on the combinatorial level, the sphere  $\partial H_{2d+2}^d$  can be obtained from the boundary complex  $\partial C_d^\Delta$  of the crosspolytope  $C_d^\Delta$  with  $2d$  vertices by Jockusch's construction: We start with  $\partial C_d^\Delta$  and compose a simplicial ball  $B_{2d}$  as follows. Let the  $(d - 1)$ -simplex  $1 \cdots d$  belong to  $B_{2d}$  and also all  $d$ -simplices  $1 \cdots k_1^I \cdots k_j^I \cdots d$ , where  $j = 1, \dots, \frac{d-2}{2}$  the numbers  $1 \leq k_1 < \dots < k_j \leq d$  are replaced by their images under the involution  $I = (1 \ d+1)(2 \ d+2) \cdots (d \ 2d)$ . This collection of simplices  $B_{2d}$  forms indeed a ball (with boundary consisting of all  $(d - 2)$ -faces  $1 \cdots k_1^I \cdots \widehat{s} \cdots k_{(d-2)/2}^I \cdots d$  with vertex  $s \in \{1, \dots, d\}$ ,  $s \neq k_i$ , deleted). Moreover,  $B_{2d}$  and  $B_{2d}^I$  have the desired property that

- every  $i$ -face,  $0 \leq i \leq \lfloor \frac{d}{2} \rfloor - 2$ , of  $\partial C_d^\Delta$  is contained in the boundaries of the two balls,

- but no  $(\lfloor \frac{d}{2} \rfloor - 1)$ -face of  $\partial C_d^\Delta$  occurs as an interior face of the two balls.

If we remove the balls  $B_{2d}$  and  $B_{2d}^I$  from  $\partial C_d^\Delta$  and sew in the new balls  $(2d + 1) * \partial B_{2d}$  and  $(2d + 2) * \partial B_{2d}^I$ , then the resulting sphere is centrally symmetric and nearly neighborly. In fact, it is isomorphic to  $\partial H_{2d+2}^d$ .

Besides the odd-dimensional polytopal spheres  $\partial H_{2d+2}^d$ , Björner, Paffenholz, Sjöstrand, and Ziegler [6] have recently constructed asymptotically many even-dimensional non-polytopal nearly neighborly centrally symmetric  $(d - 1)$ -spheres with  $2d + 2$  vertices that are Bier spheres.

Let us summarize the unsatisfactory present situation that we have for centrally symmetric polytopes and spheres:

*Stanley [49] (and Novik [37]) proved a lower bound theorem for centrally symmetric polytopes, but not for centrally symmetric spheres.*

*Grünbaum's centrally symmetric upper bound conjecture [13] might well hold for spheres (but is wrong for polytopes).*

*There are nearly neighborly centrally symmetric  $d$ -polytopes with  $2d + 2$  vertices (McMullen and Shephard [35]) and nearly neighborly centrally symmetric 3-spheres with  $n = 2k \geq 8$  vertices (Jockusch [16]), but not much is known beyond these examples.*

*According to Burton [9], centrally symmetric  $d$ -polytopes with sufficiently many vertices cannot be centrally 2-neighborly.*

In view of the result of Burton, presently not even a good guess for an upper bound conjecture for centrally symmetric polytopes is available. Moreover, we severely lack constructions that yield centrally symmetric polytopes or spheres with many faces.

## 2 Enumeration Results for Nearly Neighborly Spheres

One approach to obtain nearly neighborly centrally symmetric spheres, at least on few vertices, is by computer enumeration. In [7], combinatorial 3-manifolds are enumerated up to 10 vertices.

**Theorem 3** [7] *There are exactly two non-isomorphic nearly neighborly centrally symmetric 3-spheres with  $n = 10$  vertices, the Grünbaum sphere  $G_{10}^4$  and the Jockusch sphere  $J_{10}^3$ .*

With the present enumeration techniques, an enumeration of *all* nearly neighborly centrally symmetric 3-spheres with 12 vertices is already far out of reach. However, results for larger numbers of vertices can be achieved by restricting the enumeration to more symmetric triangulations.

In [27] we enumerated combinatorial 3-manifolds with a vertex-transitive automorphism group on up to 15 vertices and found, besides  $\partial C_4^\Delta$  and the

Grünbaum sphere  $G_{10}^4$ , two vertex-transitive nearly neighborly centrally symmetric 3-spheres with 12 vertices and one with 14 vertices. Apart from one example with 12-vertices, these spheres have a transitive cyclic automorphism group. It therefore seemed promising to search for nearly neighborly centrally symmetric spheres with a vertex-transitive cyclic (or dihedral) group action on more vertices and in higher dimensions  $d$ .

The standard dihedral and cyclic group action on the set  $\{1, \dots, 2k\}$ , with generators  $a_{2k} = (123 \dots 2k)$  and  $b_{2k} = (1 \ 2k)(2 \ 2k-1) \dots (k \ k+1)$  of  $D_{2k} = \langle a_{2k}, b_{2k} \rangle$  and  $\mathbb{Z}_{2k} = \langle a_{2k} \rangle$ , respectively, bring along a large number of small orbits of  $(d+1)$ -sets. However, many of these orbits can be neglected if we are interested in centrally symmetric triangulations only: We delete all orbits containing facets  $F$  for which  $F \cap F^I \neq \emptyset$ , with respect to the involution  $I = (12 \dots 2k)^k = (1 \ k+1) \dots (k \ 2k)$ , in a preprocessing step before starting the enumeration program MANIFOLD\_VT [29]. Every nearly neighborly centrally symmetric example that we find we label with a unique symbol  $\frac{d}{nn} n_z^{di/cy}$  denoting the  $z$ -th isomorphism type of a nearly neighborly centrally symmetric  $d$ -sphere listed for the dihedral/cyclic group action on  $n = 2k$  vertices. For fixed  $d$  and  $n = 2k$ , we first process the dihedral and then the cyclic action. The described search was carried out in [27, Ch. 4] for 3-spheres with up to 16 vertices and has since then be extended to 22 vertices.

Table 1: Nearly neighborly centrally symmetric spheres with cyclic symmetry.

$d \setminus n$	6	8	10	12	14	16	18	20	22
2	1	0	0	0	0	0	0	0	0
3	–	1	1	1	1	5	10	9	12
4	–	–	1	0	0	?	?	?	?
5	–	–	–	1	2	3	?	?	?
6	–	–	–	–	1	0	?	?	?
7	–	–	–	–	–	1	12	?	?

**Theorem 4** *There are nearly neighborly centrally symmetric 3-spheres with a vertex-transitive cyclic group action on  $n = 2k$  vertices for  $4 \leq k \leq 11$ . Moreover, there are nearly neighborly centrally symmetric  $d$ -spheres with a vertex-transitive cyclic group action on  $n = 2k$  vertices for  $(d, n) = (5, 14)$ ,  $(5, 16)$ ,  $(7, 18)$ , but none for  $(d, n) = (4, 12)$ ,  $(4, 14)$ ,  $(6, 16)$ . (Table 1 gives the respective numbers of spheres found by enumeration.)*

If  $d = 2$ , then the boundaries of the tetrahedron, the octahedron, and the icosahedron are the only vertex-transitive triangulations of the 2-sphere  $S^2$ : By Euler’s formula,  $f_0 - f_1 + f_2 = 2$ , and double counting,  $2f_1 = 3f_2$ , it follows that every triangulated 2-sphere with  $n$  vertices has  $f$ -vector  $f = (n, 3n - 6, 2n - 4)$ . If the triangulation is vertex-transitive, then every vertex has the same number,

say  $q$ , of neighbors and is contained in exactly  $q$  triangles. Double counting yields  $2f_1 = nq$ , or, equivalently,  $(6 - q)n = 12$ . The last equation has three non-negative solutions  $(n, q) = (4, 3)$ ,  $(6, 4)$ , and  $(12, 5)$ . The only possible examples corresponding to these values are the boundaries of the tetrahedron, octahedron, and icosahedron. In particular, it follows that the boundary of the octahedron is the only centrally symmetric 2-sphere with a vertex-transitive cyclic group action.

**Centrally Symmetric Cyclic Upper Bound Conjecture** *For all odd dimensions  $d - 1 \geq 1$  and even  $n = 2k \geq 2d$ , there is a nearly neighborly centrally symmetric  $(d - 1)$ -sphere with a vertex-transitive cyclic group action on  $n$  vertices.*

The conjecture is trivial for  $d - 1 = 1$  and clearly implies Grünbaum's upper bound conjecture for centrally symmetric spheres in odd, but also in even dimensions. (The latter follows by suspending the respective odd-dimensional examples.)

**Conjecture 5** *If  $d$  is even, then the boundary complex of the  $d$ -dimensional crosspolytope on  $n = 2d$  vertices is the only nearly neighborly centrally symmetric  $d$ -sphere with a vertex-transitive cyclic group action.*

In Table 2, we list some of the spheres that we found by enumeration. The complete list of spheres is available online at [28]. If a sphere is centrally  $l$ -neighborly, i.e., if it has the  $(l - 1)$ -skeleton of the corresponding cross-polytope, then we display the entry  $f_l$  in italics (the entry  $n = f_0$  of the  $f$ -vector is listed separately in Column 2 of the table). In Column 5 we list the respective orbit generators together with the corresponding orbit sizes as subscripts.

For some of the examples their full combinatorial automorphism group is larger than the dihedral or cyclic symmetry, indicated by the superscript  $di$  or  $cy$  in Table 2. However, only few of the examples admit a dihedral symmetry.



Table 2: Nearly neighborly centrally symmetric spheres with dihedral/cyclic group action.

$d$	$n$	$f$ -vector	Type	List of orbits	Remarks
2	6	(12,8)	${}^2_{nn}6_1^{di}$	123 <sub>6</sub> 135 <sub>2</sub>	$\partial C_3^\Delta$ , [27, ${}^2_6 11$ ]
$\infty$	3	(24,32,16)	${}^3_{nn}8_1^{di}$	1234 <sub>8</sub> 1247 <sub>8</sub>	$\partial C_4^\Delta$ , $CS_8^3$ , [27, ${}^3_8 11^{44}$ ]
	10	(40,60,30)	${}^3_{nn}10_1^{di}$	1234 <sub>10</sub> 1245 <sub>10</sub> 1258 <sub>10</sub>	[27, ${}^3_{10} 22$ ]
	12	(60,96,48)	${}^3_{nn}12_1^{cy}$	1234 <sub>12</sub> 1246 <sub>12</sub> 126 11 <sub>12</sub> 135 10 <sub>12</sub>	$CS_{12}^3$ , [27, ${}^3_{12} 11$ ]
	14	(84,140,70)	${}^3_{nn}14_1^{cy}$	1234 <sub>14</sub> 1245 <sub>14</sub> 125 10 <sub>14</sub> 126 10 <sub>14</sub> 126 12 <sub>14</sub>	[27, ${}^3_{14} 11$ ]
	16	(112,192,96)	${}^3_{nn}16_1^{cy}$	1234 <sub>16</sub> 1246 <sub>16</sub> 1268 <sub>16</sub> 128 15 <sub>16</sub> 135 14 <sub>16</sub> 13 10 13 <sub>16</sub>	$CS_{16}^3$ , [31, ${}^3_{16} 156$ ]
			${}^3_{nn}16_2^{cy}$	1234 <sub>16</sub> 1248 <sub>16</sub> 1268 <sub>16</sub> 126 15 <sub>16</sub> 1357 <sub>16</sub> 138 10 <sub>16</sub>	[31, ${}^3_{16} 55$ ]
			${}^3_{nn}16_3^{cy}$	1234 <sub>16</sub> 1248 <sub>16</sub> 128 15 <sub>16</sub> 135 12 <sub>16</sub> 135 14 <sub>16</sub> 137 14 <sub>16</sub>	[31, ${}^3_{16} 58$ ]
			${}^3_{nn}16_4^{cy}$	1234 <sub>16</sub> 124 15 <sub>16</sub> 1357 <sub>16</sub> 136 10 <sub>16</sub> 137 14 <sub>16</sub> 13 10 13 <sub>16</sub>	[31, ${}^3_{16} 63$ ]
			${}^3_{nn}16_5^{cy}$	1237 <sub>16</sub> 1238 <sub>16</sub> 126 15 <sub>16</sub> 128 15 <sub>16</sub> 1357 <sub>16</sub> 13 10 13 <sub>16</sub>	[31, ${}^3_{16} 55$ ]
			${}^3_{nn}16_6^{cy}$	1234 <sub>16</sub> 124 15 <sub>16</sub> 125 15 <sub>16</sub> 125 17 <sub>16</sub> 137 14 <sub>16</sub> 147 14 <sub>16</sub> 14 11 15 <sub>16</sub>	
	18	(144,252,126)	${}^3_{nn}18_1^{cy}$	1234 <sub>18</sub> 1245 <sub>18</sub> 1256 <sub>18</sub> 126 12 <sub>18</sub> 128 12 <sub>18</sub> 128 15 <sub>18</sub> 159 13 <sub>18</sub>	
			${}^3_{nn}18_2^{cy}$	1234 <sub>18</sub> 1248 <sub>18</sub> 128 12 <sub>18</sub> 12 12 17 <sub>18</sub> 137 14 <sub>18</sub> 147 11 <sub>18</sub> 147 14 <sub>18</sub>	
			${}^3_{nn}18_3^{cy}$	1234 <sub>18</sub> 1249 <sub>18</sub> 125 13 <sub>18</sub> 125 17 <sub>18</sub> 129 15 <sub>18</sub> 12 13 15 <sub>18</sub> 147 12 <sub>18</sub>	
			${}^3_{nn}18_4^{cy}$	1234 <sub>18</sub> 1249 <sub>18</sub> 126 13 <sub>18</sub> 126 17 <sub>18</sub> 129 16 <sub>18</sub> 12 13 16 <sub>18</sub> 147 12 <sub>18</sub>	
			${}^3_{nn}18_5^{cy}$	1234 <sub>18</sub> 124 14 <sub>18</sub> 126 14 <sub>18</sub> 126 17 <sub>18</sub> 138 13 <sub>18</sub> 147 11 <sub>18</sub> 147 14 <sub>18</sub>	
			${}^3_{nn}18_6^{cy}$	1234 <sub>18</sub> 124 15 <sub>18</sub> 125 15 <sub>18</sub> 125 17 <sub>18</sub> 137 14 <sub>18</sub> 147 14 <sub>18</sub> 14 11 15 <sub>18</sub>	
${}^3_{nn}18_7^{cy}$			1235 <sub>18</sub> 1236 <sub>18</sub> 1249 <sub>18</sub> 126 14 <sub>18</sub> 129 14 <sub>18</sub> 1358 <sub>18</sub> 149 15 <sub>18</sub>		
${}^3_{nn}18_8^{cy}$			1235 <sub>18</sub> 1236 <sub>18</sub> 124 14 <sub>18</sub> 1269 <sub>18</sub> 129 14 <sub>18</sub> 1358 <sub>18</sub> 138 13 <sub>18</sub>		
${}^3_{nn}18_9^{cy}$			1236 <sub>18</sub> 1237 <sub>18</sub> 1247 <sub>18</sub> 1248 <sub>18</sub> 125 12 <sub>18</sub> 128 12 <sub>18</sub> 147 11 <sub>18</sub>		
${}^3_{nn}18_{10}^{cy}$			1236 <sub>18</sub> 1237 <sub>18</sub> 125 17 <sub>18</sub> 127 12 <sub>18</sub> 12 12 17 <sub>18</sub> 1369 <sub>18</sub> 139 14 <sub>18</sub>		

Table 2: Nearly neighborly centrally symmetric spheres (continued).

$d$	$n$	$f$ -vector	Type	List of orbits	Remarks
	20	(180,320,160)	${}^3_{nn}20_1^{cy}$ $- {}^3_{nn}20_9^{cy}$		[28]
	22	(220,396,198)	${}^3_{nn}22_1^{cy}$ $- {}^3_{nn}22_{12}^{cy}$		[28]
4	10	(40,80,80,32)	${}^4_{nn}10_1^{di}$	12345 <sub>10</sub> 12359 <sub>10</sub> 12458 <sub>10</sub> 13579 <sub>2</sub>	$\partial C_5^\Delta$ , [27, ${}^4_{10}1_1^{39}$ ]
5	12	(60,160,240, 192,64)	${}^5_{nn}12_1^{di}$	123456 <sub>12</sub> 12346 <sub>11</sub> <sub>12</sub> 12356 <sub>10</sub> <sub>24</sub> 12469 <sub>11</sub> <sub>12</sub> 12569 <sub>10</sub> <sub>4</sub>	$\partial C_6^\Delta$ , [27, ${}^5_{12}1_1^{293}$ ]
	14	(84,280,490, 420,140)	${}^5_{nn}14_1^{di}$ ${}^5_{nn}14_2^{di}$	123456 <sub>14</sub> 123467 <sub>28</sub> 1234712 <sub>14</sub> 12367 <sub>12</sub> <sub>28</sub> 12457 <sub>10</sub> <sub>28</sub> 1247 <sub>10</sub> <sub>13</sub> <sub>14</sub> 1256 <sub>10</sub> <sub>11</sub> <sub>14</sub> 123456 <sub>14</sub> 12346 <sub>12</sub> <sub>28</sub> 1234712 <sub>14</sub> 12356 <sub>11</sub> <sub>28</sub> 12467 <sub>10</sub> <sub>28</sub> 1247 <sub>10</sub> <sub>13</sub> <sub>14</sub> 1256 <sub>10</sub> <sub>11</sub> <sub>14</sub>	[27, ${}^5_{14}1_1^{49}$ ] [27, ${}^5_{14}1_1^7$ ]
	16	(112,448,864, 768,256)	${}^5_{nn}16_1^{cy}$ ${}^5_{nn}16_2^{cy}$ ${}^5_{nn}16_3^{cy}$	123456 <sub>16</sub> 123467 <sub>16</sub> 123478 <sub>16</sub> 12348 <sub>13</sub> <sub>16</sub> 1234 <sub>13</sub> <sub>15</sub> <sub>16</sub> 12378 <sub>12</sub> <sub>16</sub> 1238 <sub>12</sub> <sub>13</sub> <sub>16</sub> 123 <sub>12</sub> <sub>13</sub> <sub>15</sub> <sub>16</sub> 123 <sub>12</sub> <sub>14</sub> <sub>15</sub> <sub>16</sub> 12468 <sub>11</sub> <sub>16</sub> 1246 <sub>11</sub> <sub>15</sub> <sub>16</sub> 1248 <sub>11</sub> <sub>13</sub> <sub>16</sub> 124 <sub>11</sub> <sub>13</sub> <sub>15</sub> <sub>16</sub> 1267 <sub>11</sub> <sub>12</sub> <sub>16</sub> 1268 <sub>11</sub> <sub>13</sub> <sub>16</sub> 1358 <sub>10</sub> <sub>14</sub> <sub>16</sub> 123456 <sub>16</sub> 123467 <sub>16</sub> 123478 <sub>16</sub> 12348 <sub>13</sub> <sub>16</sub> 1234 <sub>13</sub> <sub>15</sub> <sub>16</sub> 12378 <sub>12</sub> <sub>16</sub> 1238 <sub>12</sub> <sub>13</sub> <sub>16</sub> 123 <sub>12</sub> <sub>13</sub> <sub>15</sub> <sub>16</sub> 123 <sub>12</sub> <sub>14</sub> <sub>15</sub> <sub>16</sub> 12468 <sub>15</sub> <sub>16</sub> 1248 <sub>13</sub> <sub>15</sub> <sub>16</sub> 1267 <sub>11</sub> <sub>12</sub> <sub>16</sub> 1268 <sub>11</sub> <sub>13</sub> <sub>16</sub> 1268 <sub>11</sub> <sub>15</sub> <sub>16</sub> 128 <sub>11</sub> <sub>13</sub> <sub>15</sub> <sub>16</sub> 1358 <sub>12</sub> <sub>14</sub> <sub>16</sub> 123456 <sub>16</sub> 123467 <sub>16</sub> 123478 <sub>16</sub> 12348 <sub>13</sub> <sub>16</sub> 1234 <sub>13</sub> <sub>15</sub> <sub>16</sub> 12378 <sub>12</sub> <sub>16</sub> 1238 <sub>12</sub> <sub>15</sub> <sub>16</sub> 1238 <sub>13</sub> <sub>15</sub> <sub>16</sub> 123 <sub>12</sub> <sub>14</sub> <sub>15</sub> <sub>16</sub> 12467 <sub>13</sub> <sub>16</sub> 1246 <sub>11</sub> <sub>13</sub> <sub>16</sub> 1246 <sub>11</sub> <sub>15</sub> <sub>16</sub> 12478 <sub>13</sub> <sub>16</sub> 124 <sub>11</sub> <sub>13</sub> <sub>15</sub> <sub>16</sub> 1267 <sub>11</sub> <sub>12</sub> <sub>16</sub> 1357 <sub>10</sub> <sub>12</sub> <sub>16</sub>	

Table 2: Nearly neighborly centrally symmetric spheres (continued).

$d$	$n$	$f$ -vector	Type	List of orbits	Remarks
6	14	(84,280,560, 672,448,128)	${}^6_{nn}14_1^{di}$	1234567 <sub>14</sub> 123457 <sub>13</sub> <sub>14</sub> 123467 <sub>12</sub> <sub>28</sub> 123567 <sub>11</sub> <sub>14</sub> 12357 <sub>11</sub> <sub>13</sub> <sub>14</sub> 12367 <sub>11</sub> <sub>12</sub> <sub>14</sub> 12457 <sub>10</sub> <sub>13</sub> <sub>14</sub> 12467 <sub>10</sub> <sub>12</sub> <sub>14</sub> 13579 <sub>11</sub> <sub>13</sub> <sub>2</sub>	$\partial C_7^\Delta$ , [27, ${}^6_{14}57_1$ ]
7	16	(112,448,1120, 1792,1792, 1024,256)	${}^7_{nn}16_1^{di}$	12345678 <sub>16</sub> 1234568 <sub>15</sub> <sub>16</sub> 1234578 <sub>14</sub> <sub>32</sub> 1234678 <sub>13</sub> <sub>32</sub> 123468 <sub>13</sub> <sub>15</sub> <sub>16</sub> 123478 <sub>13</sub> <sub>14</sub> <sub>16</sub> 123568 <sub>12</sub> <sub>15</sub> <sub>32</sub> 123578 <sub>12</sub> <sub>14</sub> <sub>32</sub> 123678 <sub>12</sub> <sub>13</sub> <sub>16</sub> 124578 <sub>11</sub> <sub>14</sub> <sub>16</sub> 12468 <sub>11</sub> <sub>13</sub> <sub>15</sub> <sub>16</sub> 12478 <sub>11</sub> <sub>13</sub> <sub>14</sub> <sub>16</sub>	$\partial C_8^\Delta$
	18	(144,672,2016, 3780,4200, 2520,630)	${}^7_{nn}18_1^{cy}$ $-{}^7_{nn}18_{10}^{cy}$		[28]
			${}^7_{nn}18_1^{di}$	12345678 <sub>18</sub> 12345689 <sub>36</sub> 1234569 <sub>16</sub> <sub>18</sub> 1234589 <sub>16</sub> <sub>36</sub> 12346789 <sub>18</sub> 1234679 <sub>14</sub> <sub>36</sub> 123467 <sub>14</sub> <sub>17</sub> <sub>36</sub> 123469 <sub>14</sub> <sub>17</sub> <sub>18</sub> 1234789 <sub>14</sub> <sub>36</sub> 123478 <sub>14</sub> <sub>15</sub> <sub>36</sub> 123489 <sub>14</sub> <sub>15</sub> <sub>18</sub> 1235689 <sub>13</sub> <sub>36</sub> 123569 <sub>13</sub> <sub>16</sub> <sub>36</sub> 123589 <sub>13</sub> <sub>16</sub> <sub>36</sub> 123678 <sub>13</sub> <sub>14</sub> <sub>18</sub> 123689 <sub>13</sub> <sub>14</sub> <sub>36</sub> 124578 <sub>12</sub> <sub>15</sub> <sub>18</sub> 124579 <sub>12</sub> <sub>15</sub> <sub>36</sub> 124589 <sub>15</sub> <sub>16</sub> <sub>18</sub> 124679 <sub>12</sub> <sub>17</sub> <sub>36</sub> 12479 <sub>12</sub> <sub>14</sub> <sub>15</sub> <sub>18</sub> 12479 <sub>12</sub> <sub>14</sub> <sub>17</sub> <sub>18</sub> 12569 <sub>12</sub> <sub>13</sub> <sub>16</sub> <sub>18</sub>	
			${}^7_{nn}18_2^{di}$	12345678 <sub>18</sub> 12345689 <sub>36</sub> 1234569 <sub>16</sub> <sub>18</sub> 1234589 <sub>16</sub> <sub>36</sub> 12346789 <sub>18</sub> 1234679 <sub>14</sub> <sub>36</sub> 123467 <sub>14</sub> <sub>17</sub> <sub>36</sub> 123469 <sub>14</sub> <sub>17</sub> <sub>18</sub> 1234789 <sub>14</sub> <sub>36</sub> 123478 <sub>14</sub> <sub>15</sub> <sub>36</sub> 123489 <sub>14</sub> <sub>15</sub> <sub>18</sub> 1235689 <sub>16</sub> <sub>36</sub> 123568 <sub>13</sub> <sub>16</sub> <sub>36</sub> 123678 <sub>13</sub> <sub>14</sub> <sub>18</sub> 123689 <sub>13</sub> <sub>14</sub> <sub>36</sub> 123689 <sub>13</sub> <sub>16</sub> <sub>36</sub> 124578 <sub>12</sub> <sub>15</sub> <sub>18</sub> 124589 <sub>12</sub> <sub>15</sub> <sub>36</sub> 124589 <sub>15</sub> <sub>16</sub> <sub>18</sub> 124679 <sub>12</sub> <sub>17</sub> <sub>36</sub> 12479 <sub>12</sub> <sub>14</sub> <sub>15</sub> <sub>18</sub> 12479 <sub>12</sub> <sub>14</sub> <sub>17</sub> <sub>18</sub> 12569 <sub>12</sub> <sub>13</sub> <sub>16</sub> <sub>18</sub>	

### 3 A Transitive Series of Nearly Neighborly Spheres

In this section, we prove the centrally symmetric cyclic upper bound conjecture for  $d = 3$  for all numbers  $n = 4m \geq 8$  of vertices.

**Theorem 6** *There is an infinite series of nearly neighborly centrally symmetric 3-spheres  $CS_{4m}^3$  with a transitive cyclic group action on  $4m$  vertices for  $m \geq 2$ .*

*Proof.* Let the permutation  $g = (1, 2, \dots, 4m)$  be the generator of the standard transitive cyclic group action on the vertex set  $\{1, 2, \dots, 4m\}$ . We define a series of 3-dimensional simplicial complexes  $CS_{4m}^3$  in terms of the orbit generators of Table 3: Let every orbit generator  $ijkl_{4m}$ , with the orbit-size as index, contribute an orbit of  $4m$  tetrahedral facets  $ijkl, (i+1)(j+1)(k+1)(l+1), \dots, (i+4m)(j+4m)(k+4m)(l+4m)$  to the simplicial complex  $CS_{4m}^3$ , where the vertex-labels are to be taken modulo  $4m$ .

Table 3: The series  $CS_{4m}^3$ .

Sphere	List of Orbits			
$CS_8^3$	1234 <sub>8</sub>	1247 <sub>8</sub>		
$CS_{12}^3$	1234 <sub>12}</sub>	1249 <sub>12}</sub>	129 11 <sub>12}</sub>	1358 <sub>12}</sub>
$CS_{16}^3$	1234 <sub>16}</sub>	124 11 <sub>16}</sub>	12 11 13 <sub>16}</sub> 12 13 15 <sub>16}</sub>	1358 <sub>16}</sub> 137 10 <sub>16}</sub>
...				
$CS_{4m}^3$	1234 <sub>4m}</sub>	124(2m+3) <sub>4m}</sub>	12(2m+3)(2m+5) <sub>4m}</sub> 12(2m+5)(2m+7) <sub>4m}</sub> ...	1358 <sub>4m}</sub> 137 10 <sub>4m}</sub> ...
			12(4m-3)(4m-1) <sub>4m}</sub>	13(2m-1)(2m+2) <sub>4m}</sub>

By construction,  $CS_{4m}^3$  is invariant under the standard vertex-transitive cyclic symmetry, in particular, it is invariant under the involution  $I := (1, 2, \dots, 4m)^{2m} = (1, 2m+1)(2, 2m+2) \dots (2m, 4m)$ . No (non-empty) face of  $CS_{4m}^3$  is fixed under  $I$ , which easily can be verified by inspecting the defining orbits of  $CS_{4m}^3$ . Hence,  $CS_{4m}^3$  is a centrally symmetric 3-dimensional simplicial complex.

In the following, we will prove that  $CS_{4m}^3$  is a 3-sphere by showing that  $CS_{4m}^3$  is a 3-manifold of Heegaard genus one with a Heegaard diagram that has one crossing (cf. [25], [44, Sec. 63]). Moreover, we will see that  $CS_{4m}^3$  is nearly neighborly.

In order to verify that  $CS_{4m}^3$  is a 3-manifold, we need to show that the link of every of its vertices is a triangulated 2-sphere. Since  $CS_{4m}^3$  is vertex-transitive, it suffices to analyze the link of vertex 1. The vertex-links of ver-

tex 1 in the complexes  $CS_8^3$ ,  $CS_{12}^3$ ,  $CS_{16}^3$ , and  $CS_{20}^3$  are depicted in the Figures 1, 2, 3, and 4, respectively. The complex  $CS_{4m}^3$  consists of  $2m - 2$  orbits that contribute four triangles each to the link of vertex 1. The orbits can be grouped into four different types: The basic orbits  $1234_{4m}$  (contributing white triangles) and  $124(2m + 3)_{4m}$  (contributing shaded triangles) in the columns 2 and 3 of Table 3 and the two series of orbits in the columns 4 and 5 of Table 3 (contributing triangles with vertical and horizontal stripes, respectively). The striped triangles form four different regions I–IV of  $2m - 4$  triangles each, half of them vertically and half of them horizontally striped, respectively. Topologically, each of the four regions is a disc, but displays a different kind of “cristallographic growth” when we increase  $m$ . For example, region II consists of the  $m - 2$  vertically striped triangles  $2(2m + 3)(2m + 5)$ ,  $2(2m + 5)(2m + 7)$ ,  $\dots$ ,  $2(4m - 3)(4m - 1)$  and of the  $m - 2$  horizontally striped triangles  $4(2m + 3)(2m + 5)$ ,  $4(2m + 5)(2m + 7)$ ,  $\dots$ ,  $4(4m - 3)(4m - 1)$ . It is easy to check that the four regions I–IV together with the four white triangles and the four shaded triangles form a 2-sphere. Hence,  $CS_{4m}^3$  is a 3-manifold.

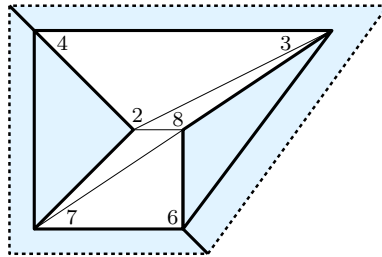

Figure 1: The link of vertex 1 in  $CS_8^3$ .

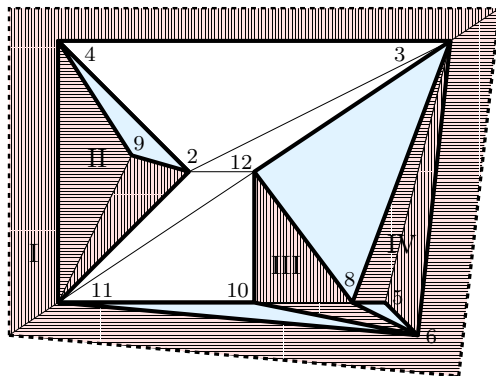

Figure 2: The link of vertex 1 in  $CS_{12}^3$ .

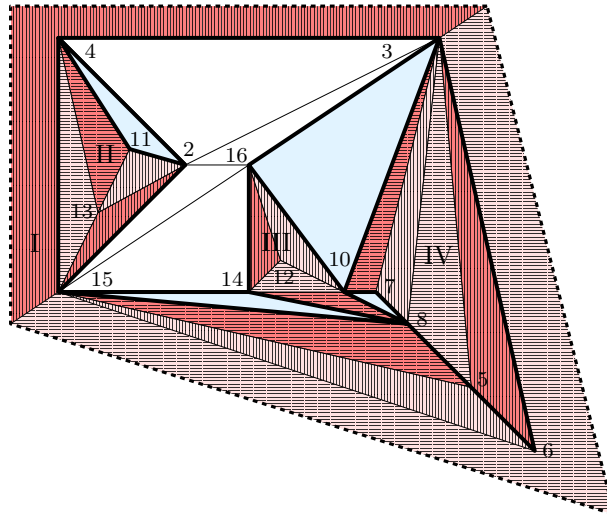

Figure 3: The link of vertex 1 in  $CS_{16}^3$ .

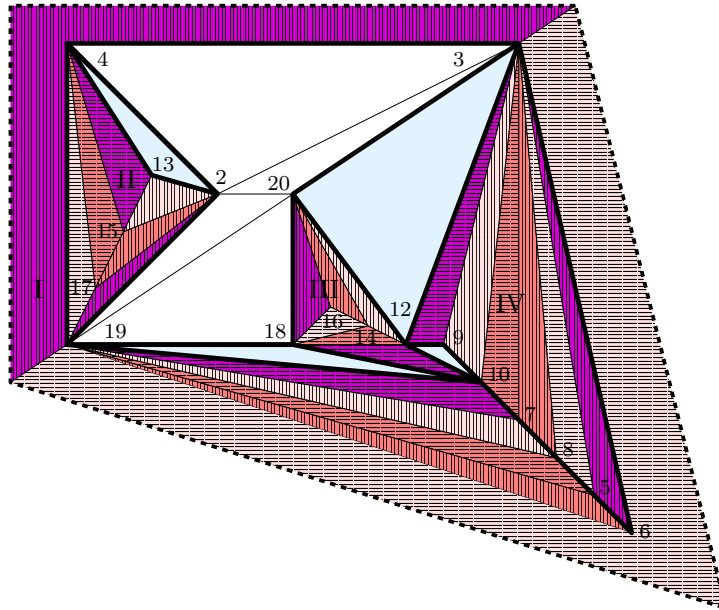

Figure 4: The link of vertex 1 in  $CS_{20}^3$ .

The triangulated 3-manifold  $CS_{4m}^3$  contains as a 2-dimensional subcomplex a vertex-transitive 2-torus  $T_{4m}^2$  with orbit generators  $123_{4m}$  and  $13(2m+2)_{4m}$ . We will show that this triangulated 2-torus  $T_{4m}^2$  splits  $CS_{4m}^3$  into two parts,  $T_{4m}^3$  and  $(T_{4m}^3)^g$ , each of which is a triangulated solid 3-torus and is mapped onto the other side by the glide reflection  $g = (1, 2, \dots, 4m)$  of the 2-torus  $T_{4m}^2$ . The 2-torus  $T_8^2$  is depicted in Figure 5 with the orbits  $123_8$  and  $136_8$  forming

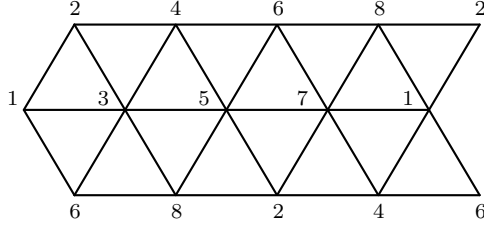

Figure 5: The 2-torus  $T_8^2$ .

the upper eight and the lower eight triangles, respectively. In Figures 6, 7, and 8, the tori  $T_8^2$ ,  $T_{12}^2$ , and  $T_{16}^2$  form the respective base grids. In Figure 6, we glue “on top” of the upper eight triangles of  $T_8^2$  every second tetrahedron of the orbit  $1234_8$ , i.e., the tetrahedra  $1234$ ,  $3456$ ,  $5678$ , and  $1278$ , as well as “on top” of the lower eight triangles of  $T_8^2$  every second tetrahedron of the orbit  $1247_8$ , i.e., the tetrahedra  $1247$ ,  $1346$ ,  $3568$ , and  $2578$ . From the figure we see that every “top” triangular face of one of the upper four tetrahedra appears also as a “top” triangular face of one of the lower four tetrahedra. Hence, the tetrahedra of the upper half fit together with the tetrahedra of the lower half to form a solid 3-torus  $T_8^3$  whose boundary is, as the “back side”, the torus  $T_8^2$ . In general, we also glue “on top” of the upper  $4m$  triangles of  $T_{4m}^2$  every second tetrahedron of the basic orbit  $1234_{4m}$ . “On top” of the lower  $4m$  triangles of  $T_{4m}^2$ , however, we first glue every second tetrahedron of the basic orbit  $124(2m+3)_{4m}$  and then every second tetrahedron of the orbits alternatingly from the columns 5 and 4 of Table 3. Upon completion, the “top” triangles of the upper part fit together with the “top” triangles of the lower part to form a solid 3-torus  $T_{4m}^3$ . Since  $T_{4m}^3$  contains every second tetrahedron of the orbits of  $CS_{4m}^3$ , its image  $(T_{4m}^3)^g$  under the cyclic shift  $g = (1, 2, \dots, 4m)$  has as its facets precisely the remaining tetrahedra of  $CS_{4m}^3$  and, hence, is again a solid 3-torus. Thus we have established that  $CS_{4m}^3$  has a Heegaard splitting of genus one into the two solid tori  $T_{4m}^3$  and  $(T_{4m}^3)^g$ .

The Heegaard diagram of  $CS_{4m}^3$  consists of the middle torus  $T_{4m}^2$  together with a meridian circle  $c$  of  $T_{4m}^3$  and a meridian  $c'$  of  $(T_{4m}^3)^g$ . As meridian of  $T_{4m}^3$  we take  $c := (2m+1)(2m+3), \dots, (4m-3)(4m-1), (4m-1)(4m), (4m)(2m+1)$  on  $T_{4m}^2$ . Its image  $c' := c^g = (2m+2)(2m+4), \dots, (4m-2)(4m), (4m)1, 1(2m+2)$  under the glide reflection  $g$  is a meridian of  $(T_{4m}^3)^g$  and intersects  $c$  in the one crossing point  $4m$ . Since a 3-manifold  $M$  is a 3-sphere if it has a genus one Heegaard diagram with one crossing point, we are done.

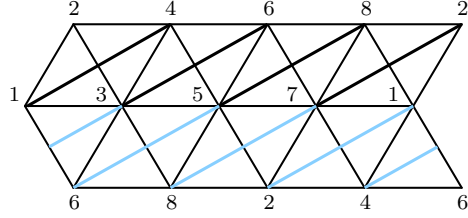

Figure 6: The solid 3-torus  $T_8^3$ .

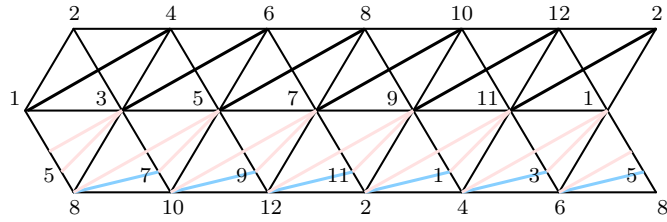

Figure 7: The solid 3-torus  $T_{12}^3$ .

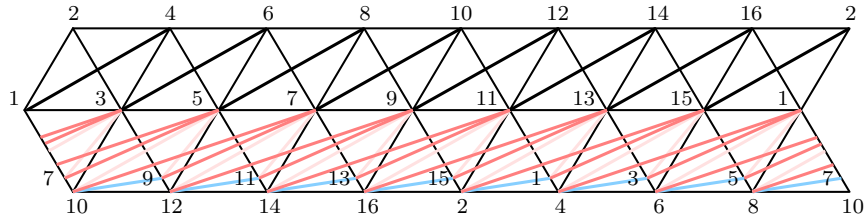

Figure 8: The solid 3-torus  $T_{16}^3$ .

It remains to show that the centrally symmetric 3-sphere  $CS_{4m}^3$  is nearly neighborly. Since the  $f$ -vector  $(f_0, f_1, f_2, f_3)$  of a 3-manifold is already determined by the number of vertices  $f_0$  and the number of facets  $f_3$  via Euler's formula  $f_0 - f_1 + f_2 - f_3 = 0$  and the Dehn-Sommerville equation  $f_2 = 2f_3$ , it follows directly from the number and sizes of the defining orbits that  $CS_{4m}^3$  has  $f$ -vector  $(4m, 8m^2 - 4m, 16m^2 - 16m, 8m^2 - 8m)$ . Since  $8m^2 - 4m = \binom{4m}{2} - 2m$ , the centrally symmetric 3-sphere  $CS_{4m}^3$  has the 1-skeleton of the corresponding cross-polytope  $C_{4m}^\Delta$  on  $4m$  vertices and, therefore, is nearly neighborly.  $\square$

**Corollary 7** *The nearly neighborly centrally symmetric 3-spheres  $CS_{4m}^3$  are not obtainable by Jockusch's construction for  $m \geq 3$ .*



*Proof.* The 3-balls  $B_{2k}$  in Jockusch's construction are chosen such that they contain all vertices of  $J_{2k}^3$ , but not the star of any edge of  $J_{2k}^3$ . In particular, the boundary 2-spheres  $\partial B_{2k}$  are stacked spheres and occur as the link of the vertices  $2k + 1$  in  $J_{2k+2}^3$ . On the contrary, the vertex-links in the spheres  $CS_{4m}^3$  are not stacked.  $\square$

Although the proof of correctness for the examples of Theorem 6 is rather straight forward, it is, in general, not at all obvious how we can find or construct *series of vertex-transitive triangulations* of spheres or of other manifolds. In the case of the series  $CS_{4m}^3$  the generating orbits were discovered by examining the examples of Table 2, but all attempts failed so far to extend the series to or to find alternative series on  $4m + 2$  vertices for  $m \geq 2$ .

Most surprising, however, is that we presently know of *merely five basic infinite series* of vertex-transitive triangulations of spheres:

- the boundary complexes of even-dimensional cyclic polytopes  $C_d(n)$ ,
- the boundary complexes of bicyclic 4-polytopes  $BiC(p, q; n)$  of Smilansky [45] for appropriate parameters  $p, q$ , and  $n$  (cf. also [8] and [43]),
- the boundary complexes of cross-polytopes  $C_d^\Delta$ ,
- the boundary complexes of the McMullen-Shephard polytopes  $H_{2d+2}^d$  for even  $d$ ,
- and the spheres  $CS_{4m}^3$  for  $m \geq 3$ .

In addition, the multiple join product  $(S^d)^{*r}$  and the wreath product  $\partial\Delta_r \wr S^d$  of Joswig and Lutz [17] provide two constructions to obtain *derived series* of vertex-transitive spheres for every vertex-transitive simplicial sphere  $S^d$ . This way, it is even possible to get series of vertex-transitive non-PL spheres [17].

The boundaries of tricyclic or multicyclic polytopes might yield further series of vertex-transitive spheres, but it is seemingly a difficult problem to determine for which parameters these polytopes are simplicial. (Three examples of simplicial tricyclic 6-polytopes were identified in [27, Ch. 2].)

Various series of vertex-transitive triangulations of surfaces can be found in the literature; see, for example, [2], [15], [24], and [41].

In higher dimensions, however, we know, apart from the above vertex-transitive spheres, of only one additional three-parameter family  $M_k^d(n)$  of vertex-transitive triangulations due to Kühnel and Lassmann [24]. The combinatorial manifolds  $M_k^d(n)$  on  $n \geq 2^{d-k}(k+3) - 1$  vertices for  $k = 1, \dots, d-1$  are  $k$ -sphere bundles over the  $(d-k)$ -dimensional torus and are invariant under the standard vertex-transitive action of the dihedral group  $D_n$ . In particular,  $M_1^d(n)$  is a vertex-transitive triangulation of the  $d$ -dimensional torus with  $n \geq 2^{d+1} - 1$  vertices, and, as an additional case,  $M_d^d(d+2)$  is the boundary of the  $(d+1)$ -simplex; see also [20], [22], and [23].

## 4 Products of Spheres

The following inequalities hold for centrally symmetric combinatorial 2- and 4-manifolds  $M$  with Euler characteristic  $\chi(M)$ .

**Theorem 8** (Kühnel [21]) *Let  $M$  be a centrally symmetric surface with  $n = 2k$  vertices. Then*

$$-3(\chi(M) - 2) \leq 4^2 \binom{\frac{1}{2}(k-1)}{2}, \quad (1)$$

*with equality if and only if  $M$  contains the 1-skeleton of the  $k$ -dimensional crosspolytope  $C_k^\Delta$ , i.e., if  $M$  is centrally 2-neighborly.*

**Theorem 9** (Sparla [46, 4.8], [47]) *Let  $M$  be a centrally symmetric combinatorial 4-manifold with  $n = 2k$  vertices. Then*

$$10(\chi(M) - 2) \leq 4^3 \binom{\frac{1}{2}(k-1)}{3}, \quad (2)$$

*with equality if and only if  $M$  contains the 2-skeleton of the  $k$ -dimensional crosspolytope  $\partial C_k^\Delta$ , i.e., if  $M$  is centrally 3-neighborly.*

There are essentially two ways to make use of these bounds. For fixed number  $n = 2k$  of vertices they give restrictions on the Euler characteristic  $\chi(M)$  of a centrally symmetric combinatorial 2- respectively 4-manifold  $M$  with  $n$  vertices. On the other hand, they provide *lower bounds* on the number of vertices  $n$  of a centrally symmetric combinatorial 2- respectively 4-manifold  $M$  with *given* Euler characteristic  $\chi(M)$ .

Sparla conjectured a generalization of these bounds to centrally symmetric combinatorial  $2r$ -manifolds.

**Conjecture 10** (Sparla [46, 4.11], [47]) *Let  $M$  be a centrally symmetric combinatorial  $2r$ -manifold with  $n = 2k$  vertices. Then*

$$(-1)^r \binom{2r+1}{r+1} (\chi(M) - 2) \leq 4^{r+1} \binom{\frac{1}{2}(k-1)}{r+1}, \quad (3)$$

*with equality if and only if  $M$  contains the  $r$ -skeleton of the  $k$ -dimensional crosspolytope  $\partial C_k^\Delta$ , i.e., if  $M$  is centrally  $(r+1)$ -neighborly.*

Sparla's conjecture is known to hold for  $r = 1$  and  $r = 2$  (see above) as well as in the following cases (cf. [39] and [46, 4.12]):

- $n = 4r + 2$ , where we trivially have  $M = \partial C_{2r+1}^\Delta$ ,
- $n \geq 4r + 4$  and  $\begin{cases} \chi(M) \leq 2 & \text{if } r \text{ is even,} \\ \chi(M) \geq 2 & \text{if } r \text{ is odd,} \end{cases}$
- $n \geq 6r + 3$  (Novik [39]).

For the sphere products  $S^r \times S^r$  we have  $(-1)^r(\chi(S^r \times S^r) - 2) = 2$ , since  $\chi(S^r \times S^r) = 4$  if  $r$  is even and  $\chi(S^r \times S^r) = 0$  if  $r$  is odd. In particular, for  $n = 4r + 4$ , i.e., for  $k = 2r + 2$ , the inequality (3) becomes equality,  $2^{\binom{2r+1}{r+1}} = 4^{r+1} \binom{\frac{1}{2}(2r+1)}{r+1}$  (see [46, p. 70]). Therefore, Sparla's conjecture, if true, would imply that centrally symmetric combinatorial triangulations of the sphere products  $S^r \times S^r$  with  $4r + 4$  vertices must contain the  $r$ -skeleton of  $\partial C_{2r+2}^\Delta$ .

**Conjecture 11** (Sparla [47]) *There are centrally  $(r + 1)$ -neighborly triangulations of the sphere products  $S^r \times S^r$  on  $4r + 4$  vertices.*

A centrally 2-neighborly triangulation of the 2-torus with 8 vertices is well known (cf. [27,  ${}^2 8_1^{15}$ ]). Centrally 3-neighborly triangulations of the product  $S^2 \times S^2$  were first found by Sparla [46] and by Lassmann and Sparla [26]: There are precisely three centrally 3-neighborly triangulations of  $S^2 \times S^2$  with 12 vertices that have a vertex-transitive cyclic group action.

Our search for nearly neighborly centrally symmetric spheres with the program MANIFOLD\_VT also produced centrally symmetric triangulations of  $d$ -dimensional products of spheres with  $n = 2d + 4$  vertices, denoted by the symbols  $\times_z^d n_z^{di/cy}$ . In fact, we completely enumerated all such manifolds with a vertex-transitive cyclic or dihedral group action for the parameters listed in Table 4. For 8-manifolds with 20 vertices, an enumeration was only possible for the dihedral group action.

**Theorem 12** *For the products of spheres*

$$\begin{array}{ccccccc} S^1 \times S^1, & S^2 \times S^1, & S^3 \times S^1, & S^4 \times S^1, & S^5 \times S^1, & S^6 \times S^1, & S^7 \times S^1, \\ & & S^2 \times S^2, & S^3 \times S^2, & & S^5 \times S^2, & \\ & & & & S^3 \times S^3, & S^4 \times S^3, & S^5 \times S^3, \\ & & & & & & S^4 \times S^4 \end{array}$$

*there are centrally symmetric (combinatorial) triangulations with a vertex-transitive dihedral group action on  $n = 2d + 4$  vertices. However, there is no sphere product  $S^4 \times S^2$  with a vertex-transitive cyclic group action on 16 vertices and no sphere product  $S^6 \times S^2$  with a vertex-transitive dihedral group action on 20 vertices.*

**Proof.** The examples of Theorem 12 are listed in Table 4. We used the program BISTELLAR [30] to verify that in each case the link of vertex 1 and therefore, by vertex-transitivity, all vertex-links are combinatorial spheres. Hence, the examples are combinatorial manifolds. The homology of the manifolds was computed with the program HOMOLOGY by Heckenbach [14] and, in each case, is that of a product of spheres.

The topological types of the examples  $S^{d-1} \times S^1$  were determined in [24], and Sparla [46] showed that the examples  $\times_1^4 12_1^{cy}$ ,  $\times_2^4 12_2^{cy}$ , and  $\times_1^4 12_1^{di}$  are triangulations of  $S^2 \times S^2$ . All remaining examples are simply connected, since they are at

least centrally 3-neighborly. Each  $d$ -dimensional example occurs as a subcomplex of the  $(d + 1)$ -dimensional boundary sphere  $\partial C_{d+2}^\Delta$  of the crosspolytope  $C_{d+2}^\Delta$ . According to Kreck [19] every simply connected  $d$ -dimensional submanifold of the sphere  $S^{d+1}$  with the homology of  $S^{d-r} \times S^r$ ,  $1 < r \leq d/2$ , is homeomorphic to  $S^{d-r} \times S^r$ . Therefore, all the examples of Table 4 are products of spheres.  $\square$

**Conjecture 13** *There is a centrally  $(\lfloor \frac{d}{2} \rfloor + 1)$ -neighborly (combinatorial) triangulation of every product of spheres  $S^{\lceil \frac{d}{2} \rceil} \times S^{\lfloor \frac{d}{2} \rfloor}$  with a vertex-transitive dihedral group action on  $n = 2d + 4$  vertices.*

Table 4: Centrally symmetric products of spheres with  $n=2d+4$  vertices and cyclic group action.

$d$	$n$	Manifold	$f$ -vector	Type	List of orbits	Remarks
2	8	$S^1 \times S^1$	(24,16)	$2 \times 8_1^{di}$	123 <sub>8</sub> 136 <sub>8</sub>	[24, $M_1^2(8)$ ], [27, ${}^2 8_1^{15}$ ]
3	10	$S^2 \times S^1$	(40,60,30)	$3 \times 10_1^{di}$	1235 <sub>20</sub> 1245 <sub>10</sub>	[52], [24, $M_2^3(10)$ ], [27, ${}^3 10_3^3$ ]
4	12	$S^3 \times S^1$	(60,120,120,48)	$4 \times 12_2^{di}$	12346 <sub>24</sub> 12356 <sub>24</sub>	[24, $M_3^4(12)$ ], [27, ${}^4 12_1^{12}$ ]
		$S^2 \times S^2$	(60,160,180,72)	$4 \times 12_1^{cy}$	12345 <sub>12</sub> 12356 <sub>12</sub> 1236 11 <sub>12</sub> 12569 <sub>12</sub> 1269 11 <sub>12</sub> 1358 10 <sub>12</sub>	[46, $M_1$ ], [27, ${}^4 12_1^{11}$ ]
				$4 \times 12_2^{cy}$	12345 <sub>12</sub> 12356 <sub>12</sub> 1236 11 <sub>12</sub> 1256 10 <sub>12</sub> 1269 11 <sub>12</sub> 1358 10 <sub>12</sub>	[46, $M = M_2$ ], [47], [27, ${}^4 12_1^{124}$ ]
5	14	$S^4 \times S^1$	(84,210,280, 210,70)	$5 \times 14_1^{di}$	123457 <sub>28</sub> 123467 <sub>28</sub> 123567 <sub>14</sub>	[46, $M_3$ ], [27, ${}^4 12_1^{28}$ ]
		$S^3 \times S^2$	(84,280,490, 420,140)	$5 \times 14_2^{di}$	123467 <sub>28</sub> 12346 12 <sub>28</sub> 123567 <sub>14</sub> 12357 11 <sub>28</sub> 12457 13 <sub>14</sub> 1246 10 12 <sub>28</sub>	[24, $M_4^5(14)$ ] [27, ${}^5 14_8^3$ ] [27, ${}^5 14_9^3$ ]
6	16	$S^5 \times S^1$	(112,336,560, 560,336,96)	$6 \times 16_2^{di}$	1234568 <sub>32</sub> 1234578 <sub>32</sub> 1234678 <sub>32}</sub>	[24, $M_5^6(16)$ ]

Table 4: Centrally symmetric products of spheres (continued).

$d$	$n$	$f$ -vector	Type	List of orbits	Remarks
		$S^3 \times S^3$	(112,448,1120, 1568,1120,320)	${}^6_1 16^{cy}$	1234567 <sub>16</sub> 1234578 <sub>16</sub> 123458 15 <sub>16</sub> 123478 13 <sub>16</sub> 12347 13 14 <sub>16</sub> 12348 13 15 <sub>16</sub> 1234 13 14 15 <sub>16</sub> 123568 15 <sub>16</sub> 123678 12 <sub>16</sub> 12368 12 13 <sub>16</sub> 12368 13 15 <sub>16</sub> 12378 12 13 <sub>16</sub> 124578 11 <sub>16</sub> 12457 11 14 <sub>16</sub> 12458 11 14 <sub>16</sub> 12478 11 13 <sub>16</sub> 1247 11 13 14 <sub>16</sub> 1248 11 13 15 <sub>16</sub> 1268 11 13 15 <sub>16</sub> 1357 10 12 14 <sub>16</sub>
				${}^6_1 16^{di}$	1234567 <sub>16</sub> 1234578 <sub>32</sub> 123458 14 <sub>16</sub> 123478 13 <sub>32</sub> 123567 12 <sub>16</sub> 12356 12 15 <sub>32</sub> 123578 12 <sub>32</sub> 12358 12 15 <sub>16</sub> 12378 12 13 <sub>16</sub> 12458 11 14 <sub>16</sub> 12467 11 13 <sub>16</sub> 12468 11 13 <sub>32</sub> 1247 11 13 14 <sub>32</sub> 1357 10 12 14 <sub>16</sub>
7	18	$S^6 \times S^1$	(144,504,1008, 1260,1008, 504,126)	${}^7_1 18^{di}$	12345679 <sub>36</sub> 12345689 <sub>36</sub> 12345789 <sub>36</sub> 12346789 <sub>18}</sub> [24, $M_6^7(18)$ ]
		$S^5 \times S^2$	(144,672,1764, 2772,2688, 1512,378)	${}^7_2 18^{di}$	12345689 <sub>36</sub> 1234568 16 <sub>36</sub> 12345789 <sub>36</sub> 1234579 15 <sub>36</sub> 12346789 <sub>18}</sub> 1234679 17 <sub>36</sub> 123468 14 16 <sub>36</sub> 1235679 17 <sub>18}</sub> 123579 13 15 <sub>36</sub> 123579 13 17 <sub>36</sub> 124579 15 17 <sub>18}</sub> 12468 12 14 16 <sub>36}</sub>
		$S^4 \times S^3$	(144,672,2016, 3780,4200, 2520,630)	${}^7_3 18^{di}$	1234579 15 <sub>36}</sub> 1234579 17 <sub>36}</sub> 1234679 14 <sub>36}</sub> 1234679 17 <sub>36}</sub> 123467 14 17 <sub>36}</sub> 1234689 14 <sub>36}</sub> 1234689 16 <sub>36}</sub> 123479 14 15 <sub>36}</sub> 1235679 13 <sub>36}</sub> 1235679 17 <sub>18}</sub> 1235689 13 <sub>36}</sub> 1235689 16 <sub>36}</sub> 123569 16 17 <sub>36}</sub> 1235789 13 <sub>36}</sub> 123589 15 16 <sub>36}</sub> 123679 13 14 <sub>36}</sub> 123689 13 14 <sub>36}</sub> 123789 13 15 <sub>18}</sub> 124589 15 16 <sub>18}</sub>
8	20	$S^7 \times S^1$	(180,720,1680, 2520,2520,1680, 720,160)	${}^8_2 20^{di}$	12345678 10 <sub>40}</sub> 12345679 10 <sub>40}</sub> 12345689 10 <sub>40}</sub> 12345789 10 <sub>40}</sub> [24, $M_7^8(20)$ ]

Table 4: Centrally symmetric products of spheres (continued).

$d$	$n$	$f$ -vector	Type	List of orbits	Remarks
		$S^5 \times S^3$	$(180, 960, 3360, 7560, 10920, 9840, 5040, 1120)$	$\begin{smallmatrix} 8 \\ \times \\ 20 \\ 3 \end{smallmatrix} \begin{smallmatrix} di \\ \\ \\ \end{smallmatrix}$	12345689 10 <sub>40</sub> 12345689 17 <sub>40</sub> 1234568 10 19 <sub>40</sub> 1234569 10 18 <sub>40</sub> 12345789 10 <sub>40</sub> 1234578 10 16 <sub>40</sub> 1234579 10 18 <sub>40</sub> 123457 10 16 18 <sub>40</sub> 1234678 10 19 <sub>40</sub> 1234679 10 15 <sub>40</sub> 123467 10 15 19 <sub>40</sub> 123469 10 15 18 <sub>40</sub> 123469 15 17 18 <sub>40</sub> 123479 10 15 18 <sub>40</sub> 1235679 10 18 <sub>40</sub> 1235689 14 17 <sub>40</sub> 123568 14 17 19 <sub>40</sub> 123569 14 17 18 <sub>40</sub> 123578 10 16 19 <sub>40</sub> 123679 10 15 18 <sub>40</sub> 124579 10 16 18 <sub>40</sub> 124579 13 16 18 <sub>40</sub> 12458 10 13 16 17 <sub>40</sub> 124679 13 15 18 <sub>40</sub> 12469 10 13 15 18 <sub>40</sub> 12478 10 13 15 16 <sub>40</sub> 12478 10 13 15 19 <sub>40</sub> 12478 10 15 16 19 <sub>40</sub>
		$S^4 \times S^4$	$(180, 960, 3360, 8064, 12600, 12000, 6300, 1400)$	$\begin{smallmatrix} 8 \\ \times \\ 20 \\ 1 \end{smallmatrix} \begin{smallmatrix} di \\ \\ \\ \end{smallmatrix}$	123456789 <sub>20</sub> 12345679 10 <sub>40</sub> 1234567 10 18 <sub>20</sub> 1234569 10 17 <sub>40</sub> 12345789 16 <sub>40</sub> 1234578 16 19 <sub>40</sub> 1234579 10 16 <sub>40</sub> 123457 10 16 19 <sub>20</sub> 123459 10 16 17 <sub>20</sub> 12346789 15 <sub>20</sub> 1234679 10 18 <sub>40</sub> 1234679 15 18 <sub>40</sub> 123469 10 17 18 <sub>40</sub> 1234789 15 16 <sub>40</sub> 123479 10 16 18 <sub>40</sub> 1235679 10 14 <sub>40</sub> 123567 10 14 18 <sub>20</sub> 1235689 10 14 <sub>40</sub> 123568 10 14 17 <sub>40</sub> 12356 10 14 17 19 <sub>40</sub> 12356 10 14 18 19 <sub>20</sub> 1235789 14 16 <sub>20</sub> 123578 14 16 19 <sub>40</sub> 123579 10 14 16 <sub>40</sub> 12357 10 14 16 19 <sub>40</sub> 123589 10 14 16 <sub>40</sub> 123589 10 16 17 <sub>40</sub> 12358 10 14 16 19 <sub>20</sub> 123679 10 14 18 <sub>40</sub> 123679 14 15 18 <sub>40</sub> 12368 10 14 15 17 <sub>40</sub> 12369 10 14 15 18 <sub>20</sub> , 123789 14 15 16 <sub>20</sub> 124579 10 13 16 <sub>40</sub> 12457 10 13 16 19 <sub>20</sub> 12459 10 13 16 17 <sub>20</sub> 12467 10 13 15 18 <sub>20</sub> 124689 13 15 17 <sub>20</sub> 12468 10 13 15 17 <sub>40</sub> 12469 10 15 17 18 <sub>40</sub> 12469 13 15 17 18 <sub>40</sub> 12479 10 13 15 18 <sub>40</sub> 13579 12 14 16 18 <sub>20</sub>
		.....	.....	$\begin{smallmatrix} 8 \\ \times \\ 20 \\ \dots \end{smallmatrix} \begin{smallmatrix} cy \\ \\ \\ \end{smallmatrix}$	.....

## References

- [1] R. M. Adin. *Combinatorial Structure of Simplicial Complexes with Symmetry*. Dissertation. Hebrew University, Jerusalem, 1991, 56 pages.
- [2] A. Altshuler. Polyhedral realization in  $\mathbb{R}^3$  of triangulations of the torus and 2-manifolds in cyclic 4-polytopes. *Discrete Math.* **1**, 211–238 (1971).
- [3] I. Bárány and L. Lovász. Borsuk’s theorem and the number of facets of centrally symmetric polytopes. *Acta Math. Acad. Sci. Hung.* **40**, 323–329 (1982).
- [4] D. Barnette. A proof of the lower bound conjecture for convex polytopes. *Pac. J. Math.* **46**, 349–354 (1973).
- [5] D. Barnette. Graph theorems for manifolds. *Isr. J. Math.* **16**, 62–72 (1973).
- [6] A. Björner, A. Paffenholz, J. Sjöstrand, and G. M. Ziegler. Bier spheres and posets. [arXiv:math.CO/0311356v2](https://arxiv.org/abs/math/0311356v2), 2004, 15 pages; *Discrete Comput. Geom.*, to appear.
- [7] J. Bokowski, D. Bremner, F. H. Lutz, and A. Martin. Combinatorial 3-manifolds with 10 vertices. In preparation.
- [8] J. Bokowski and P. Schuchert. Equifaceted 3-spheres as topes of nonpolytopal matroid polytopes. *Discrete Comput. Geom.* **13**, 347–361 (1995).
- [9] G. R. Burton. The non-neighbourliness of centrally symmetric convex polytopes having many vertices. *J. Comb. Theory, Ser. A* **58**, 321–322 (1991).
- [10] B. Grünbaum. On the enumeration of convex polytopes and combinatorial spheres. ONR Technical Report, University of Washington, 1969.
- [11] B. Grünbaum. *Convex Polytopes*. Pure and Applied Mathematics **16**. Interscience Publishers, London, 1967. Second edition (V. Kaibel, V. Klee, and G. M. Ziegler, eds.), Graduate Texts in Mathematics **221**. Springer-Verlag, New York, NY, 2003.
- [12] B. Grünbaum. The importance of being straight. *Time Series and Stochastic Processes; Convexity and Combinatorics*, Proc. Twelfth Biennial Sem. Canadian Math. Congr., Vancouver, Canada, 1969 (R. Pyke, ed.), 243–254. Canadian Mathematical Congress, Montreal, 1970.
- [13] B. Grünbaum. On combinatorial spheres. *Combinatorial Structures and Their Applications*, Proc. Calgary Internat. Conf., Calgary, Canada, 1969 (R. Guy, H. Hanani, N. Sauer, and J. Schonheim, eds.), 119–122. Gordon and Breach, New York, NY, 1970.



- [14] F. Heckenbach. *Die Möbiusfunktion und Homologien auf partiell geordneten Mengen*. Thesis for Diploma at University Erlangen-Nuremberg, 1997. Computer program homology, <http://www.mi.uni-erlangen.de/~heckenb/>.
- [15] L. Heffter. Ueber das Problem der Nachbargebiete. *Math. Ann.* **38**, 477–508 (1891).
- [16] W. Jockusch. An infinite family of nearly neighborly centrally symmetric 3-spheres. *J. Comb. Theory, Ser. A* **72**, 318–321 (1995).
- [17] M. Joswig and F. H. Lutz. One-point suspensions and wreath products of polytopes and spheres. [arXiv:math.CO/0403494](https://arxiv.org/abs/math/0403494), 2004, 17 pages.
- [18] G. Kalai. Rigidity and the lower bound theorem 1. *Invent. Math.* **88**, 125–151 (1987).
- [19] M. Kreck. An inverse to the Poincaré conjecture. *Arch. Math.* **77**, 98–106 (2001).
- [20] W. Kühnel. Higherdimensional analogues of Császár’s torus. *Result. Math.* **9**, 95–106 (1986).
- [21] W. Kühnel. Centrally-symmetric tight surfaces and graph embeddings. *Beitr. Algebra Geom.* **37**, 347–354 (1996).
- [22] W. Kühnel and G. Lassmann. Neighborly combinatorial 3-manifolds with dihedral automorphism group. *Isr. J. Math.* **52**, 147–166 (1985).
- [23] W. Kühnel and G. Lassmann. Combinatorial  $d$ -tori with a large symmetry group. *Discrete Comput. Geom.* **3**, 169–176 (1988).
- [24] W. Kühnel and G. Lassmann. Permuted difference cycles and triangulated sphere bundles. *Discrete Math.* **162**, 215–227 (1996).
- [25] W. Kühnel and F. H. Lutz. Recognition of manifolds. To appear in *Triangulated Manifolds with Few Vertices* by Frank H. Lutz.
- [26] G. Lassmann and E. Sparla. A classification of centrally-symmetric and cyclic 12-vertex triangulations of  $S^2 \times S^2$ . *Discrete Math.* **223**, 175–187 (2000).
- [27] F. H. Lutz. *Triangulated Manifolds with Few Vertices and Vertex-Transitive Group Actions*. Dissertation. Shaker Verlag, Aachen, 1999, 146 pages.
- [28] F. H. Lutz. The Manifold Page, 1999–2004. <http://www.math.tu-berlin.de/diskregeom/stellar/>.
- [29] F. H. Lutz. MANIFOLD\_VT, Version Feb/1999. [http://www.math.tu-berlin.de/diskregeom/stellar/MANIFOLD\\_VT](http://www.math.tu-berlin.de/diskregeom/stellar/MANIFOLD_VT), 1999.

- [30] F. H. Lutz. BISTELLAR, Version Nov/2003. <http://www.math.tu-berlin.de/diskregeom/stellar/BISTELLAR>, 2003.
- [31] F. H. Lutz. Triangulated Manifolds with Few Vertices. In preparation.
- [32] P. Mani. Automorphismen von polyedrischen Graphen. *Math. Ann.* **192**, 279–303 (1971).
- [33] J. Matoušek. *Using the Borsuk-Ulam Theorem. Lectures on Topological Methods in Combinatorics and Geometry*. Universitext. Springer-Verlag, Berlin, 2003.
- [34] P. McMullen. The maximum numbers of faces of a convex polytope. *Mathematika* **17**, 179–184 (1970).
- [35] P. McMullen and G. C. Shephard. Diagrams for centrally symmetric polytopes. *Mathematika* **15**, 123–138 (1968).
- [36] I. Novik. Upper bound theorems for homology manifolds. *Isr. J. Math.* **108**, 45–82 (1998).
- [37] I. Novik. The lower bound theorem for centrally symmetric simple polytopes. *Mathematika* **46**, 231–240 (1999).
- [38] I. Novik. Remarks on the Upper Bound Theorem. *J. Comb. Theory, Ser. A* **104**, 201–206 (2003).
- [39] I. Novik. On face numbers of manifolds with symmetry. Preprint, 2003, 20 pages.
- [40] J. Pfeifle. *Extremal Constructions for Polytopes and Spheres*. Dissertation. Technische Universität Berlin, 2003, 128 pages.
- [41] G. Ringel. Über das Problem der Nachbargebiete auf orientierbaren Flächen. *Abh. Math. Sem. Univ. Hamburg* **25**, 105–127 (1961).
- [42] R. Schneider. Neighbourliness of centrally symmetric polytopes in high dimensions. *Mathematika* **22**, 176–181 (1975).
- [43] P. Schuchert. *Matroid-Polytope und Einbettungen kombinatorischer Mannigfaltigkeiten*. Dissertation. Verlag Shaker, Aachen, 1995, 136 pages.
- [44] H. Seifert and W. Threlfall. *A Textbook of Topology*. Pure and Applied Mathematics **89**. Academic Press, New York, NY, 1980.
- [45] Z. Smilansky. Bi-cyclic 4-polytopes. *Isr. J. Math.* **70**, 82–92 (1990).
- [46] E. Sparla. *Geometrische und kombinatorische Eigenschaften triangulierter Mannigfaltigkeiten*. Dissertation. Shaker Verlag, Aachen, 1997, 132 pages.

- [47] E. Sparla. An upper and a lower bound theorem for combinatorial 4-manifolds. *Discrete Comput. Geom.* **19**, 575–593 (1998).
- [48] R. P. Stanley. The upper bound conjecture and Cohen-Macaulay rings. *Studies Appl. Math.* **54**, 135–142 (1975).
- [49] R. P. Stanley. On the number of faces of centrally-symmetric simplicial polytopes. *Graphs Comb.* **3**, 55–66 (1987).
- [50] H. Steinlein. Borsuk’s antipodal theorem and its generalizations and applications: a survey. *Méthodes topologiques en analyse non linéaire: comptes rendus* (A. Granas, ed.). Séminaire de Mathématiques Supérieures, Séminaire Scientifique OTAN (NATO Adv. Study Inst.) **95**, 166–235. Université de Montréal, Montréal, 1985.
- [51] H. Steinlein. Spheres and symmetry: Borsuk’s antipodal theorem. *Topol. Methods Nonlinear Anal.* **1**, 15–33 (1993).
- [52] D. W. Walkup. The lower bound conjecture for 3- and 4-manifolds. *Acta Math.* **125**, 75–107 (1970).