

STUDIES IN CULTURAL CONTEXTS OF THE BIBLE

BAND 10

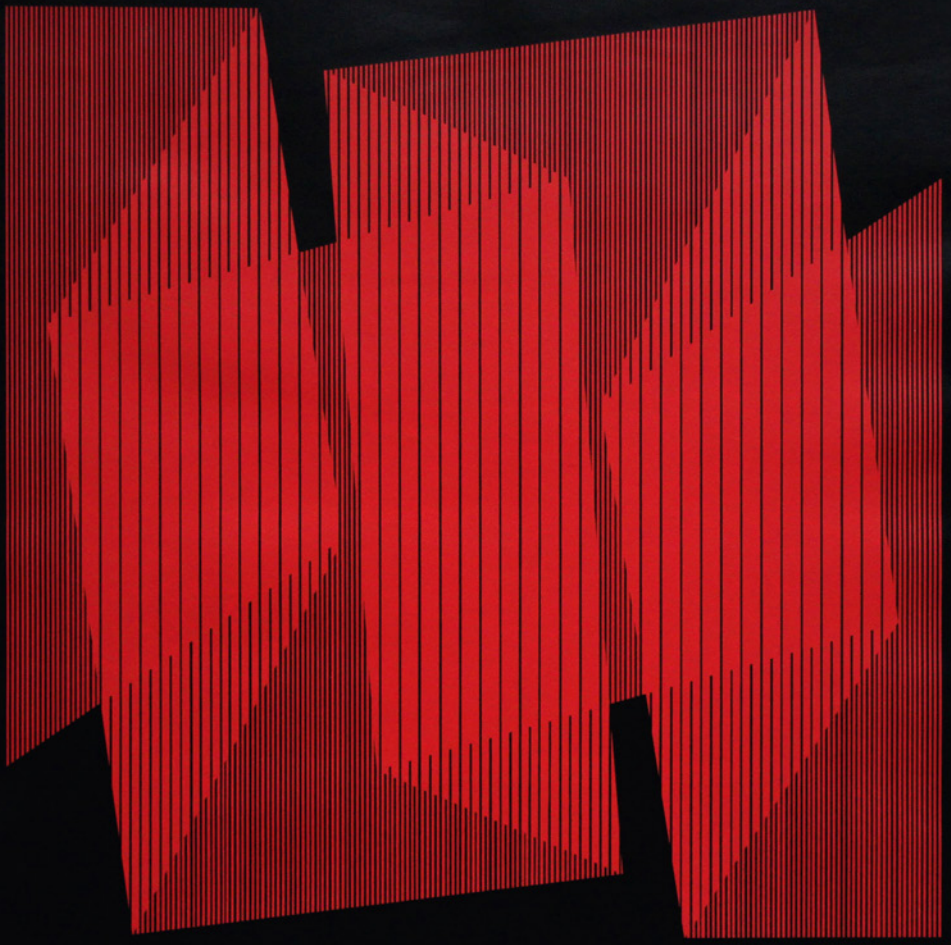

Sandra Huebenthal

Memory Theory in New Testament Studies

Exploring New Perspectives

BRILL | SCHÖNINGH

Memory Theory in New Testament Studies

Studies in Cultural Contexts of the Bible

Edited by

Sandra Huebenthal (Passau),
Anselm C. Hagedorn (Osnabrück),
Jacqueline Eliza Vayntrub (New Haven),
Zeba Crook (Ottawa)

Advisory Board

Christine Gerber, Thomas Hatina, Jeremy Hutton,
Corinna Körting, Laura Quick, Colleen Shantz,
Michael Sommer, Erin Vearncombe, Jakob Wöhrle,
Korinna Zamfir, Christiane Zimmermann

VOLUME 10

Sandra Huebenthal

Memory Theory in New Testament Studies

Exploring New Perspectives



BRILL | SCHÖNINGH



This is an open access title distributed under the terms of the CC BY-NC-ND 4.0 license, which permits any non-commercial use, distribution, and reproduction in any medium, provided no alterations are made and the original author(s) and source are credited. Further information and the complete license text can be found at <https://creativecommons.org/licenses/by-nc-nd/4.0/>

The terms of the CC license apply only to the original material. The use of material from other sources (indicated by a reference) such as diagrams, illustrations, photos and text samples may require further permission from the respective copyright holder.

DOI: <https://doi.org/10.30965/9783657790814>

We acknowledge support by the Open Access Publication Fund of University Library Passau.

Bibliographic information published by the Deutsche Nationalbibliothek.

The Deutsche Nationalbibliothek lists this publication in the Deutsche Nationalbibliografie; detailed bibliographic data available online: <http://dnb.d-nb.de>

© 2024 by the author. Published by Brill Schöningh, Wollmarktstraße 115, 33098 Paderborn, Germany, an imprint of the Brill-Group (Koninklijke Brill NV, Leiden, The Netherlands; Brill USA Inc., Boston MA, USA; Brill Asia Pte Ltd, Singapore; Brill Deutschland GmbH, Paderborn, Germany; Brill Österreich GmbH, Vienna, Austria)

Koninklijke Brill NV incorporates the imprints Brill, Brill Nijhoff, Brill Schöningh, Brill Fink, Brill mentis, Brill Wageningen Academic, Vandenhoeck & Ruprecht, Böhlau and V&R unipress.

www.brill.com

Brill Schöningh reserves the right to protect the publication against unauthorized use and to authorize dissemination by means of offprints, legitimate photocopies, microform editions, reprints, translations, and secondary information sources, such as abstracting and indexing services including databases.

Requests for commercial re-use, use of parts of the publication, and/or translations must be addressed to Brill Schöningh.

Cover illustration: "Cadmium Red" 1970, 24 × 24, ed 165. Stanczak Foundation.

Cover design: Evelyn Ziegler, Munich

Production: Brill Deutschland GmbH, Paderborn

ISSN 2629-9224

ISBN 978-3-506-79081-1 (hardback)

ISBN 978-3-657-79081-4 (e-book)

Table of Contents

Introduction VII

PART I

Social Memory and its Impact for the Study of the New Testament

1 Social and Cultural Memory in Biblical Exegesis: the Quest for an Adequate Application 3

2 “You cannot live with an experience that remains without a story:” Memory Theory and How Mark’s Gospel Narrates Experiences with Jesus 23

3 “Frozen Moments”: Early Christianity through the Lens of Social Memory Theory 41

PART II

A New Perspective on Intertextuality

4 What’s Form Got to Do with it? Preliminaries on the Impact of Social Memory Theory for the Study of Intertextuality 73

5 Proclamation Rejected, Truth Confirmed: Reading John 12:37–44 in a Social Memory Theoretical Framework 107

6 Collective Memory, Cultural Texts, and Mark’s Gospel 129

PART III

A New Perspective on Pseudepigraphy

7 Pseudepigraphy as a Strategy in Early Christian Identity Discourses: The Letter to the Colossians as a Test Case 163

8 Experience that Makes Itself Legible: Colossians and 2 Thessalonians as Fictional Texts 193

9	Generations: Social Memory Theory and the Letters to the Thessalonians	235
---	---	-----

PART IV

A New Perspective on Patristics

10	Polycarp Unchained: How Cultural Studies Can Enhance Patristic Research	263
	Bibliography	281
	Index of Original Publications	303
	Index of Tables	305
	Index of Ancient Sources	307
	Index of Authors	313

Introduction

If I take time to really look at what I'm seeing, there is no limit to the secrets unveiled.¹

Julian Stańczak (1928–2017), the artist whose print “Cadmium Red” is displayed on the cover of this book, is today remembered by many as the “Father of Op Art.” Julian Stańczak himself, however, never intended to start an art movement, neither did he ever refer to himself as the father of an art movement. “I didn’t know I was doing Op-art. I was trying to understand how I see, how we see altogether,” he explained in an interview. How and by what processes did he become the artist remembered as the “Father of Op Art”? Is it possible, 60 years after his exhibition “Optical Paintings” in Martha Jackson’s gallery in New York, to reconstruct how he, and not some other artist, came to be remembered in this way? These are precisely the types of questions that I am trying to answer in the essays contained in this book.

As human beings, we can have very different personal perspectives, insights, talents and limitations. The experience of dislocation in the years after World War II that affected the maternal side of my family and that was remembered in many conversations at family gatherings, was the starting point of my interest in the models for intergenerational commemoration and collective memory developed by Maurice Halbwachs and Aleida and Jan Assmann. Questions about how families and communities remember, interact and form identities have fascinated me ever since. In addition, my Roman Catholic background and the tradition of my church with its focus on tradition as second source of revelation besides Scripture made me especially curious about orality, ritual communication, and media change.

It is now exactly 40 years since Werner Kelber, with his seminal book *The Oral and the Written Gospel*, initiated the discussion of orality, written text, and media changes in the study of the New Testament. A decade before Jan Assmann coined the term *Traditionsbruch*, Werner Kelber saw a fundamental divide between orality and the written text. One generation later, a lot of work remains to be done, but memory theory is finally finding its way into the textbooks of our field and into the larger audiences of churches, congregations, and the general public.

Memory research has impacted and transformed earlier theories assuming authentic and stable oral traditions, making us more aware of how contingent

1 Julian Stańczak, <http://www.julianstanczak.com/index.php>, (02.05.2023).

the origins of the biblical canon really are. Close reading of the texts of the New Testament and emerging Christianity, informed by cultural studies, makes it inescapable that we are first and foremost dealing with identity texts. They are less about what happened, and more about what is remembered and how it is remembered, because what is remembered is central to self-understanding and identity, more than what actually happened.

This volume contains ten essays I have written during the last decade about Social Memory Theory (*kulturwissenschaftliche Gedächtnistheorie*) and its applications to the study of the New Testament. With these essays, I intend to explore areas where memory theory can make important contributions to New Testament Studies. The book contains a general introduction to *Social Memory Theory and its Impact for the Study of the New Testament* (part I), *New Perspectives on Intertextuality* (part II), *Pseudepigraphy* (part III) and *Patristics* (part IV). Five of the ten essays (chs. 1,3,4,5, and 10) have previously been published in English, three essays (chs. 6,7, and 8) have been translated from German, and two essays (chs. 2 and 9) were newly written for this volume.

I wish to express my gratitude to all who participated in the many discussions and with their agreement or disagreement helped me to test and refine concepts, ideas and particular readings. I am particularly grateful to all members of the various discussion panels at different sessions of EABS, ISBL, SBL, SNTS, and the Prague-Passau Symposium Series, which have become an essential part of our collaborative effort. I am deeply indebted to Werner Kelber and his pioneering work, but also to his dedication and tenacity in pursuing questions of orality, written text, tradition, and the role of media and media changes – up to this day.

I am thankful to Jörg Persch for initiating the Series Studies in *Cultural Contexts of the Bible* and to the co-editors of the series, Anselm Hagedorn, Zeba Crook, and Jaqueline Vayntrub for their trust in the manuscript. Martina Kayser and the team at Schönningh/Brill Deutschland guided me through the publication process, and I am especially grateful to Andrea Allen for revising my translations and making the essays more accessible for English-speaking audiences. I also owe gratitude to my team at the University of Passau, for their work in following up on the references, bibliography and for indexing.

A very special Dankeschön goes to Barbara Stańczak and the *Stanczak Foundation*. Barbara and Krzys Stańczak have not only permitted me to show Cadmium Red on the cover of this book, but also provided me with an unexpected and unforgettable encounter in the *LWL-Museum für Kunst und Kultur* in Münster/Germany, where we spend a morning sharing ideas and stories about memory, about identity and about the history of our families.

I was deeply moved when I realized during my encounter with Barbara and our visit to the museum that seeing art works, remembering the artists and sharing their stories with me was for Barbara what reading, discussing and understanding the New Testament with others is for me.

Frankfurt/Passau, May 2023

Sandra Huebenthal

PART I

*Social Memory and its Impact for the Study
of the New Testament*

Social and Cultural Memory in Biblical Exegesis: the Quest for an Adequate Application

The good news is that social memory theory has finally found its way into Biblical Studies. The bad news is that it is often unclear to what social memory theory really is about. Biblical scholars often import social memory theory into their work without being aware of the theoretical concept on which it is based – you cannot have social memory theory without a constructivist worldview accompanying it. Similarly, they are often unclear about their definitions. This last problem, of course, is not simply a problem for biblical scholarship; it is found in many other disciplines as well. The reception of the notions of memory and remembrance often “suffers from a remarkable lack of a theoretical foundation.”¹ Thus, working on these theoretical foundations will be a major task for biblical studies in the years to come.

Knowing that this is an enterprise requiring a thorough discussion, this paper can only represent a single voice in a larger choir and can concentrate on but one aspect of the phenomenon. The aim of this article is to shed light on the question of terminology in order to de-confuse the terms *social*, *collective* and *cultural memory* on the one hand and *soziales*, *kommunikatives* and *kulturelles Gedächtnis* on the other. Examples from recent German historical documentaries will help to clarify the different types of social memory – here *kommunikatives* and *kulturelles Gedächtnis* – and suggest a way in which the concepts can be applied to Biblical Studies.

1. The Current Discussion in Biblical Studies

What Johannes Fried has formulated for Medieval Studies also seems to hold true for Biblical Studies: most often recollection and memory remain grey areas.² Sadly enough they are usually taken up only when they appear useful to support one’s own idea or theoretical concept. In this line stand many

1 Siegfried J. Schmidt, “Memory and Remembrance: A Constructivist Approach,” in *Cultural Memory Studies: An International and Interdisciplinary Handbook*. Edited by Ansgar Nünning and Astrid Erll (Berlin: De Gruyter 2008), 191–202, 191.

2 Johannes Fried, *Der Schleier der Erinnerung. Grundzüge einer historischen Memorik* (München: Beck, 2004), 66.

publications dealing with the subject of memory and commemoration while ignoring the interdisciplinary research and discourse on social memory theory. In the end, they wind up discussing memory cultures but not cultural memory. The idea of talking about biblical texts *as* memory or to read them on the basis of social memory research seems odd to many scholars. The only area in biblical research where social memory theory has gained reasonable currency is the historical Jesus research and even there it is treated highly critically and discussed extremely controversially. It is notable but yet not surprising, that social memory theory is usually debated in connection with historical questions but not in connection with literary questions.

Biblical texts are usually not regarded as *commemorative artifacts* but rather as *tradition* and/or *testimonial*. This betrays another slant regarding commemoration in biblical studies: Memory theory tends to be viewed in terms of an aesthetic of *reception*, rather than in terms of an aesthetic of *production*. This not only explains the widespread ignoring of the constructivist character of these texts but also why biblical texts – Old Testament and New Testament alike – are for the most part understood as constituting a *Kulturelles Gedächtnis* (as will be shown below, the seemingly obvious translation as “cultural memory” is quite problematical. For this reason, I will continue to use the German terms in this paper). This identification might fit the current reader, but it does not fit the biblical authors – at least not the New Testament authors. The application of social memory theory to biblical texts is a matter of the point of view which is being taken. Whereas current readers would be right in claiming that the texts are dealing with the most *remote* past, New Testament authors – under the assumption that they were familiar with social memory theory – would probably rather claim that they were writing about the *recent* past.

Taking Assmann’s distinction seriously, Holly Hearon noted that Gospel texts should be seen as *kommunikatives* rather than as *kulturelles Gedächtnis*.³ She observes rightly that New Testament texts “may be said to function as social memory for Christian communities”. As I intend to show in this article, reading biblical texts as *kommunikatives Gedächtnis* is not the same as reading them as *kulturelles Gedächtnis*.

3 Holly Hearon, “The Story of ‘The Woman who anointed Jesus’ as Social Memory: A Methodological Proposal for the Study of Tradition as Memory,” in *Memory, Tradition, and Text: Uses of the Past in Early Christianity*. Edited by Alan Kirk and Tom Thatcher. SemSt 52. (Atlanta: Society of Biblical Literature, 2005), 99–118, 99.

2. Social Memory Theory

In the last two decades, innumerable publications have appeared dealing with memory theory both in the humanities and in the natural sciences. Nevertheless, there is neither *a single* definition of memory nor *a common* scientific approach. To meet the variety of memory concepts, the exchange between the disciplines not only helps to stimulate the research in every single field of work, but also broadens the horizon and opens new perspectives beyond each one's parochial point of view. Handbooks and lexica on the subject are usually interdisciplinary and their contributions range from neuroscientific to philosophical approaches.⁴ Research on memory must be seen *per se* as an interdisciplinary matter.

This means not only that each discipline should benefit from the ideas and results of the interdisciplinary discourse; it also indicates the need to model the discussion in each discipline in a way that relates the specific ideas and discussion results to this interdisciplinary discourse. Perspectives and methods will differ between the different fields of research, but there is no such thing as a memory theory worked out only for history or for psychology or for cultural science – the whole enterprise is trans- and interdisciplinary, and every contribution to a particular field must be related to the others in an interdisciplinary manner.

2.1 *Differences in Language and Terminology*

A stumbling block in the international discussion is posed by linguistic differences between English and German terminology. *Social Memory* is not the same as *Soziales Gedächtnis* and *Cultural Memory* does not equal *Kulturelles Gedächtnis*. But the difficulties start even earlier. In German, the terms *Gedächtnis* and *Erinnerung* refer clearly to two different things, but the English language does not make such a clear distinction: both notions are most often simply called *memory* (although “*Erinnerung*” is more properly translated as “recollection” or “recall”). Thus, *memory* has not one single meaning in English, but instead embraces a whole spectrum of closely related, but distinct meanings: “remembrance, recall, recollection, reminiscence, souvenir, commemoration, memorization”. As Aleida Assmann pointed out, these terms should not

4 Cf. Astrid Erll, and Ansgar Nünning, eds, *Cultural Memory Studies: An International and Interdisciplinary Handbook* (Berlin: de Gruyter, 2008); Nicolas Pethes and Jens Ruchatz, eds, *Gedächtnis und Erinnerung. Ein interdisziplinäres Lexikon* (Reinbek: Rowohlt, 2001).

be treated as synonyms: what they denominate varies between individual and collective, formal or informal acts of memory.⁵

This is not the only difference between the two languages. Dietrich Harth recently concluded that “already the words ‘*kulturell/cultural*’ have different semantic connotations in German and in English”: “Anglo-American usage locates ‘culture’ as a collective term for ideas, customs, and arts in contexts of society and civilization, while the lexeme ‘*Kultur*’ stands for the intellectual, artistic, and creative achievements of a community and is used to express the advanced development of humanity”⁶. Similar observations could be made for ‘*sozial/social*’. The difference ‘*Gedächtnis/memory*’ has already been mentioned above and is further complicated by the fact that *memory* is most often understood to designate a process, a force, or a repository, whereas *Gedächtnis* denotes rather the storage capacities, sensory impressions, and mental processes.⁷ Harth therefore leaves *kulturelles Gedächtnis* without translation in his contribution to the interdisciplinary handbook and I suggest following this practice for the sake of terminological clearness: Since *Kulturelles Gedächtnis* is not the same as *Cultural Memory* and *Social Memory* does not equal *Soziales Gedächtnis*, it is not a good idea to mingle the terms, it is better to separate them by retaining the different original language forms. A good deal of international misunderstandings might be avoided this way.

2.2 *Different Theoretical Approaches*

In the international discussions of social memory theory in Biblical Studies, there are not only terminological differences. My impression is that, broadly speaking, English-speaking scholars tend to adopt Maurice Halbwachs’ notion of *social* and *collective memory*, while German scholars tend to apply Aleida and Jan Assmann’s notion of *kommunikatives* and *kulturelles Gedächtnis*. These are not the same things and the fact that *social memory* has become more or less synonymous with *kommunikatives Gedächtnis* is not a development that helps to clarify the issue. What makes things even more complicated is Harald Welzer’s recent observation that “current research problems include

5 Aleida Assmann, *Einführung in die Kulturwissenschaft: Grundbegriffe, Themen, Fragestellungen* (Berlin: Erich Schmidt, 2006.²2008), 184.

6 Dietrich Harth, “The Invention of Cultural Memory,” in *Cultural Memory Studies: An International and Interdisciplinary Handbook*. Edited by Astrid Erll, Ansgar Nünning, and Sarah B. Young. Media and Cultural Memory 8 (Berlin: de Gruyter, 2008), 85–96, 87.

7 Harth, “The Invention of Cultural Memory,” 87.

the international heterogeneity of the field.⁸ In the Anglo-American realm, the level of synthesis is for now significantly below that of the German-language discourse of memory and remembering”.

But even when dealing with either Halbwachs’ or Assmanns’ concepts, most publications are not clear in terminology. This may be due to the fact, that the particular concepts overlap and “can only be strictly separated in a theoretical context” while their forms are closely linked and sometimes mingled in practice.⁹ But this is not the only reason. In an annotation in his PhD thesis about the historiographical Jesus, Anthony Le Donne neatly makes the point: “It is necessary to point out that the expressions ‘Social Memory’ and ‘Collective Memory’ have slightly different nuances: Halbwachs used the qualifier *sociaux* to describe ways that group ideologies inform individual memories. Collective Memory, rather, was used to connote memories shared and passed down by groups. As these concepts overlap, the terms ‘collective’ and ‘social’ are often used synonymously in current discussions. In fact, they are currently used synonymously with such frequency that their nuances vary from author to author.”¹⁰

The quotation shows both sides of the problem: on the one hand, the lack of distinction between the different set of terms used in Halbwachs’ concept and, on the other hand, the tendency to work exclusively with the notion of *Collective Memory* as coined by Halbwachs and to leave aside Assmann’s further distinction between *kommunikatives* and *kulturelles Gedächtnis*. This is not simply the result of a failure to appropriate Assmann’s research in Anglo-American biblical scholarship: Alan Kirk’s introduction to social and cultural memory in the Semeia-Volume *Memory, Tradition, and Text* gives an excellent summary of the whole discussion and its possible applications to Biblical studies.¹¹

Before I go on to suggest a subset of categorical distinctions that might help to facilitate the international biblical exchange and discussion, let us take a very brief look at the theoretical concepts and their foundation as discussed until now.

8 Harald Welzer, “Communicative Memory,” in *Cultural Memory Studies: An International and Interdisciplinary Handbook*. Edited by Astrid Erll, Ansgar Nünning, and Sarah B. Young. Media and Cultural Memory 8 (Berlin: de Gruyter, 2008), 285–98, 296.

9 Welzer, “Communicative Memory,” 285.

10 Anthony Le Donne, *The Historiographical Jesus. Memory, Typology, and the Son of David* (Waco: Baylor University Press, 2009), 42, n.8.

11 Alan Kirk, “Social and Cultural Memory,” in *Memory, Tradition, and Text: Uses of the Past in Early Christianity*. Edited by Alan Kirk and Tom Thatcher. SemSt 52 (Atlanta: Society of Biblical Literature, 2005), 1–24.

3. A Brief Theoretical Overview

3.1 *Maurice Halbwachs: Social and Collective Memory*

Maurice Halbwachs first introduced the idea that every form of memory is a social phenomenon.¹² Every act of remembering needs a social framework to enable the individual to (re-)construct the past. This social framework consists of a collective memory in which the individual has to localize his/her own memory in order to be able to understand, explain and communicate it and thus build up his/her identity. Halbwachs was well aware of the fact that it is not groups, but only individuals that can remember, thus he does not simply transfer the act of remembering from the individual to the group. His argument is rather that the group provides a socially constructed framework for the perception and estimation of individual memories. This spatio-temporal framework structures and models the memory of the individual: "Collective memories, then, are representations of the past in the minds of members of a community that contribute to the community's sense of identity".¹³

Halbwachs' theory distinguished two different categories of memory: *social* and *collective* memory. *Social memory* refers to the influence of the social framework on the individual's memory processes as s/he is forced to localize them within that very framework, *collective memory*, by contrast, denotes the process of the group in establishing the framework in which it semanticizes and actualizes events as memories. In both concepts, memory is thoroughly social and it deals with the social framework. The difference lies in the perspective: *social memory* is using the framework; *collective memory* is establishing it. The former interprets events in the light certain categories, the latter delivers the categories in terms of which this interpretation is made.

In daily life, both categories of memory constantly overlap and cannot easily be distinguished. One accidental difference is that whereas *social* memory tends to be ephemeral, *collective* memory tends to be stable. Another difference is that *social* memory generally deals with the past in a non-intentional

12 Maurice Halbwachs, *Les cadres sociaux de la mémoire*. Bibliothèque de l'Évolution de l'Humanité 8. Paris: Albin Michel, 2001 [Original edition 1925, German: Das Gedächtnis und seine sozialen Bedingungen. 3rd. Ed. Frankfurt am Main, 2006 [1985]; Maurice Halbwachs, *La mémoire collective*. Bibliothèque de l'Évolution de l'Humanité 28. Paris: Albin Michel, 1997 [Original edition 1949/1950; German: Das kollektive Gedächtnis, Stuttgart, 1967].

13 David Manier and William Hirst, "A Cognitive Taxonomy of Collective Memories," in *Cultural Memory Studies: An International and Interdisciplinary Handbook*. Edited by Astrid Erll, Ansgar Nünning, and Sarah B. Young. Media and Cultural Memory 8 (Berlin: de Gruyter, 2008), 253–62, 253.

way – Welzer called it a universe of formations of the past en passant –¹⁴; *collective* memory, by contrast, is an intentional formation of the past. A personal diary would pertain to the realm of *social* memory; whereas a family chronicle would rather represent the realm of *collective* memory.

Social memory is somehow the emotional glue that keeps a group together and this is quasi natural. *Collective* memory, however, is something a group does not have, but must create – especially in groups where not every individual knows every other individual; thus, it is expressed concretely in texts, images, and memorials and the like.¹⁵ *Collective* memory is something that is actively built up, not something passively received. This characteristic grows stronger, the bigger a group is and the further it moves away from its spatio-temporal origins. At this point, however, Halbwachs' and Assmann's ways separate. While Halbwachs differentiates between memory and "tradition" which he understands to include every organized and objectified form of memory – Aleida and Jan Assmann incorporate such phenomena into their theory as *kulturelles Gedächtnis*.

This difference reveals another aspect of Halbwachs' theory: Memory is not just a simple reconstruction of the past, but a (re-)construction of the past based on the needs of the present. Long after Halbwachs, neuro-scientific experiments have confirmed this theory and established the view that representation of the past is always modeled in relation to the needs of the present, so that memory is not a copy of the past, but a selective and perspective construct.¹⁶ This indicates how closely memory and identity are connected. That idea itself goes back at least to John Locke's times. What is new is the notion that the identity-forming process is not something that just happens to a community but something that can be controlled or modeled. The community is no longer the passive victim of the past but rather the active offender. Every remembering community is thus responsible for the history it passes on and for the patterns of identification it offers to its members. Identity is socially constructed via narration. For this reason, familiarizing the members of the group with the group's history in order to incorporate them into the group is a spatial task of every remembering community.¹⁷

14 Harald Welzer, "Das soziale Gedächtnis," in *Das soziale Gedächtnis. Geschichte, Erinnerung, Tradierung*. Edited by Harald Welzer (Hamburg: Hamburger Edition, 2001), 9–21, 12.

15 Assmann, *Einführung in die Kulturwissenschaft*, 191.

16 Jan Assmann, *Religion und kulturelles Gedächtnis. Zehn Studien*. 2nd ed. (München: Beck, 2004), 115.

17 Cf. Sandra Huebenthal, "Luke 24:13–35 and Social Memory in Luke," in *The Gospel of Luke*. Vol. 3 of *Biblical Interpretation in Early Christian Gospels*. LNTS 376. Edited by Thomas R. Hatina (London: T&T Clark, 2010), 85–95; Kirk, "Social and Cultural Memory," 4–5.

3.2 *Aleida and Jan Assmann: Kommunikatives und Kulturelles Gedächtnis*

The notion of memory as a social process and the question of how identity is built up and preserved within a memory group is the basis for Aleida and Jan Assmann's further development of Halbwachs' concept, distinguishing between *kommunikatives* and *kulturelles Gedächtnis* as subsets of Halbwachs' *collective memory*.¹⁸

The starting point is the reunification of tradition and memory into a single concept. Taking up the research of ethnologist Jan Vansina, Jan Assmann proposed, that historical awareness operates on two levels: the *most remote* past (*Ursprungszeit*) and the *recent* past, while there is often only very little or even a complete lack of knowledge concerning what is only the *more or less remote past*.¹⁹ This distinction is the key to Assmanns' concept of *kommunikatives* and *kulturelles Gedächtnis*. The former delineates a vivid, communicated, and identity forming memory, which spans a temporal framework of three to four generations. The latter describes the canonized cultural memory belonging to a community, by which the community normatively and formatively coins its self-image: in this sense it is often called *tradition*. The transition from one to the other is fluid and like *social* and *collective memory*, they tend to overlap.²⁰

Kommunikatives Gedächtnis is based on oral communication or some other form of direct interaction and thus limited both in time and in space. Without external storage media, the oral memory of a community has a temporal horizon of approximately 80–100 years. Within that temporal frame, episodic and (auto-) biographic memories are told, re-told and shared. These narratives remain vivid as long as the storytellers live on as members of the community. Once they pass away or otherwise leave the community, their contribution to the group's memory and identity begins to fade, if it is not transformed into another form. Welzer called this transformation "a willful agreement of the members of a group as to what they consider their own past to be, an interplay with the specific grand narrative of the we-group, and what meaning they ascribe to its past."²¹

18 Jan Assmann, *Das kulturelle Gedächtnis: Schrift, Erinnerung und politische Identität in frühen Hochkulturen*. 5th ed. (München: Beck, 2005), 45.

19 Assmann, *Religion und kulturelles Gedächtnis*, 48; Jan Assmann, "Communicative and Cultural Memory," in *Cultural Memory Studies: An International and Interdisciplinary Handbook*. Edited by Astrid Erll and Nünning Ansgar. Media and Cultural Memory 8. (Berlin: De Gruyter, 2008), 109–118, 112.

20 Assmann, *Das kulturelle Gedächtnis*, 48–65; Assmann, *Religion und kulturelles Gedächtnis*, 11–44.

21 Harald Welzer, "Communicative Memory," in *Cultural Memory Studies: An International and Interdisciplinary Handbook*. Edited by Astrid Erll, Ansgar Nünning, and Sarah B. Young. Media and Cultural Memory 8 (Berlin: de Gruyter, 2008), 285–98, 283.

In *kulturellem Gedächtnis*, memories are stabilized and maintained across generations. The temporal horizon is unlimited, as long as the memory is accepted by the remembering community or, in Jan Assmann's words: "Cultural memory reaches back into the past only so far as the past can be reclaimed as 'ours.'"²² *Kulturelles Gedächtnis* is organized and formed, conveyed by social practices and initiations. It is manifested in texts, rites, monuments, commemorations and observances. *Kulturelles Gedächtnis* is therefore not arbitrary, "whatever has made it into the active cultural memory has passed rigorous processes of selection"²³ and will be commemorated and celebrated in a certain way for a long time.

Kulturelles Gedächtnis thus is focused on central points of the past that are preserved for the present. But this is no mere re-presentation of an objective past. The past events tend to turn into symbolic figures which serve as carriers for remembrance: "in the context of cultural memory, the distinction between myth and history vanishes."²⁴ What seems, at first glance, to be an improper blending of fact and fiction, makes sense when one turns back to it for a second time: *Kulturelles Gedächtnis* does not memorialize history as such, but only the community's memory construct insofar as it has actual relevance for the members of the community. Not history as such is of interest to the memory group, but only remembered history and that is 'myth'²⁵. Remembering myth as founding stories of a community is never without intentions: Either it is regarded as the motor of growth or as the foundation of continuity.²⁶

The transition from *kommunikatives* to *kulturelles Gedächtnis* has to bridge what is called a *floating gap* at the end of the 80 to 100 year threshold by transforming those aspects of *kommunikatives Gedächtnis* that are intended to be preserved into another media. This process involves selection, modeling and canonization: "Communicative memory devalues certain aspects while placing more value on others, and also adds new elements."²⁷ In Halbwachs' terminology: the identity-constituting social framework that had been created

22 Assmann, "Communicative and Cultural Memory," 113.

23 Assmann, "Communicative and Cultural Memory," 100.

24 Assmann, "Communicative and Cultural Memory," 113; Assmann, *Das kulturelle Gedächtnis*, 52.

25 Assmann, *Das kulturelle Gedächtnis*, 52.

26 Assmann, *Das kulturelle Gedächtnis*, 75; Manier and Hirst, "A Cognitive Taxonomy of Collective Memories," 253.

27 Welzer, "Communicative Memory," 283; cf. Aleida Assmann, "Soziales und kollektives Gedächtnis." Vortrag im Panel 2 "Kollektives und soziales Gedächtnis" bei der Tagung "Kulturelles Gedächtnis. China zwischen Vergangenheit und Zukunft. Internationale Konferenz zum künstlerischen und politischen Umgang mit der eigenen Geschichte in China" der Bundeszentrale für politische Bildung 2006 [<http://www.bpb.de/files/0FW1JZ.pdf>], Huebenthal, "Luke 24:13–35 and Social Memory in Luke".

and established in *collective memory* becomes institutionalized and no longer limited in time.

The *floating gap* represents but one of two crisis moments in collective memory. The other can be more or less accurately dated to about forty years after the event. This threshold (*Epochenschwelle*)²⁸ marks “the point when it becomes apparent that the cohort of living carriers or memory is disappearing”²⁹. At this moment it becomes necessary to fix the living memory in a more enduring form if the community does not want to lose it. But this crisis of collective memory is also a great opportunity for the community. “Breakdowns in tradition” (*Traditionsbrüche*,³⁰) are accelerating shifts in memory media which often means that with scribal societies, writing becomes more and more important. Here it becomes clear that and why *kommunikatives* and *kulturelles Gedächtnis* constantly overlap and can be neatly separated only in theory. Both faculties of memory are not stable, but dynamic and constantly in flux.

4. Working with the Concepts

When working with these concepts, one must keep in mind that in both *kommunikativem* and *kulturellem Gedächtnis* experiences of crisis lead to transformation of memories and a change of media. The *floating gap* has a structural counterpart in the *forty-year threshold*, both lead to a change in the memory process and its communication and re-presentation. In *kommunikativem Gedächtnis*, too, canonization takes place, although on a different level.³¹

The further distinctions concerning *kulturelles Gedächtnis* will not be considered here, since my aim is to convey a basic understanding of the concept, its chances and difficulties. It is important to note that although Assmann’s concept is basically a further development of Halbwachs’ initial theory, this development does not operate on the same level. For this reason neither the concepts nor the terminology can be interchanged. What has complicated the issue is the fact that Assmann’s concept of *kommunikatives* and *kulturelles Gedächtnis* itself has undergone change in the course of its further development.

The initial idea was that *kommunikatives* and *kulturelles Gedächtnis* represent a subset of Halbwachs’ *collective memory*.³² Recent publications of both

28 Assmann, *Das kulturelle Gedächtnis*, 11.51; Assmann, *Religion und kulturelles Gedächtnis*, 29.

29 Kirk, “Social and Cultural Memory,” 6.

30 Assmann, *Religion und kulturelles Gedächtnis*, 88.

31 Huebenthal, “Luke 24:13–35 and Social Memory in Luke.”

32 Assmann, *Das kulturelle Gedächtnis*, 45.

Aleida and Jan Assmann, however, show a shift of the concept: “The term ‘communicative memory’ was introduced in order to delineate the difference between Halbwachs’ concept of ‘collective memory’ and our understanding of ‘cultural memory’”³³. Thus, *collective memory* is no longer the umbrella term but has become a counterpart to *kulturelles Gedächtnis* and so the terms *kommunikatives Gedächtnis* and *collective memory* become more and more equal and exchangeable: The “institutional character [of *kulturelles Gedächtnis*, S.H.] does not apply to what Halbwachs called collective memory and what we propose to rename communicative memory”³⁴. In a lecture on social and collective memory, Aleida Assmann, however, formulated the matter just the other way around, introducing a three-fold concept consisting of social memory and cultural memory, with collective memory as the middle ground between the two of them.³⁵

Both approaches alter the original idea: *Kulturelles Gedächtnis* is no longer a subset of *collective memory*. The distinction between *kommunikatives* and *kulturelles Gedächtnis* as well as the distinction between *kulturelles Gedächtnis* and *collective memory* is still operating, but they are now on the same level. This allows an extended alliance between the different concepts, and that is not necessarily for the worse. The price for this union, however, is the identification of *kommunikatives Gedächtnis* and *collective memory*. This could be confusing, since a) the terminology is not yet clear and b) scholars might not be working with the current model but with the older notions of *kommunikatives Gedächtnis* and *collective memory* and think them to be different concepts on different levels. Nevertheless, this further development of the theory can be very illuminative once the model becomes accepted.

4.1 *Modeling Social Memory Theory*

For the sake of clarity, I would like to offer the following model as a suggestion for terminology and categories for application of the different memory concepts. This model is based on the latest shift in Assmanns’ theory and is thus three-fold.³⁶ I am aware of the fact that these categories are analytical and theoretical; they cannot be separated in practice. Nevertheless, I regard it as a step forward. Both the terms and the descriptions are only proposals and are open to discussion and modification.

33 Assmann, “Communicative and Cultural Memory,” 110.

34 Assmann, “Communicative and Cultural Memory,” 111.

35 Assmann, “*Soziales und kollektives Gedächtnis*.”

36 Assmann, “Communicative and Cultural Memory”; Assmann, “*Soziales und kollektives Gedächtnis*.”

Table 1.1 Model for social and collective memory

Social Memory	Collective Memory	
	<i>kommunikatives Gedächtnis</i>	<i>kulturelles Gedächtnis</i>
emotional load (depending on carriers)	concise arrangement (depending on function)	institutional determination (depending on canon)
Characteristics: non-official, temporary, conversational, every day, experiential treasure of the group, multi-perspective, episodic, strictly oral, re-presentation through conversational remembering, memory talk, identity is conversationally fabricated	Characteristics: time limitation begins to dis- solve, one perspective begins to prevail, consolidation of a common history (“found- ing story”), pictures turn into icons, narrations into myths, scribal processes have started, identity is established through participation in rites, festivi- ties, commemorations	Characteristics: no longer limited in time, codified and canonized signs, mediated through education, identity is established through altercation and relation to the given concept, needs specialized carriers of memory, hierarchically structured
Forms: Individual traditions and genres of everyday communication	Forms: Individual traditions and genres of everyday communication	Forms: High degree of formation, ceremonial communication
Narratives: conversational, particular episodes (may have different perspectives on the issue), no chronology events (“fam- ily memory”), re-telling the episodes establishes identity, socially mediated organiza- tion principles for narrations	Narratives: fabrication of a (chrono-)logi- cal and structured narration with one perspective, (re-)contextualization or (re-)historization of episodes in the narration, thus: struggle for the “founding story” in a particular media (e.g. text)	Narratives: canonization of the narra- tions, especially “founding stories” and texts other- wise important
Sizes: Small groups, families, social groups deliver frames for individual memory (school class, military, travel groups and other peers)	Size: Communities of commemora- tions, larger than families, not every member always knows every other member, some- times even nations	Size: Larger groups as nations, states, religions, ethnic groups
Time Structure: Temporary/Recent past dissolving when carriers leave or pass away	Time Structure: Recent past 80-100 years, moving horizon of 3-4 inter- acting generations	Time Structure: Most remote past/ Absolute past historical, cultural time, mythical primordial time, “3000 years”

40-YEARS-THRESHOLD

FLOATING GAP

4.2 *Getting Customized to the Perspective: Two Examples from Multimedia*

Having worked out a terminology that might help to clarify the distinct categories group memories, I propose to step back and approach the subject from a different perspective before turning to biblical texts. To get accustomed to the idea of reading medial artifacts in the light of social memory theory, I will apply the theory to two recent German multimedia productions, one a film and the other a TV-series, both broadcasted on German TV. The discussion of these cases will show how closely identity-construction and memory are linked and thus give an idea wherein the chances and the difficulties of the concept lie.

The TV-series *Die Deutschen* (= We Germans), broadcasted in 2008, consisted of 10 sequels of 45-minute historical documentary. Regarded from a social memory perspective, *Die Deutschen* is an example of an attempt to establish a collective national identity via the medium of TV and can thus be regarded as a contribution to *kulturellem Gedächtnis*. The series began with the most remote past (936 C.E.) and ended in 1918 – safely before the *floating gap* of today's Germany. Interesting enough were the subjects and events the series recalled and also the way it displayed them: e.g. Otto the Great, who it claimed laid the foundation for a German feeling of togetherness, Martin Luther presented as a reformer und patron of the German language, and the democratic uprising of 1848. *Die Deutschen* mixed statements from historical sources, animated pictures, maps and chronology, and cross-faded historical paintings with fictional presentations of historical events. The format was highly emotional and meant not so much to be informative, as formative. The last sequel ending with the proclamation of the Weimar Republic (9.11.1918) represents an attempt to establish identity through memory figures and symbols suggesting that *Die Deutschen* are a nation of democrats. It is obvious that construction of collective identity is taking place here. It is mediated through episodic narratives which arouse distinctive feelings and modeled towards a certain reception of history by the choice, structure and presentation of the elements.

Clearly, it is no coincidence that 1000 years were chosen as the temporal framework for the series or that it was broadcasted in 10 parts and had an emotionally charged title. The idea of the series is to provide a social framework especially for young Germans. Thus it was supplemented by a huge package of supporting materials on the internet and by special materials for teachers. The series invited its viewers to recognize the displayed events as part of a common founding story and to accept them as part of their own past, thus providing a specific identity and a perspective for the future and for one's fellow citizens. Many other observations could be made about this example, but this should suffice for a first impression of how the theory works.

A second example is an attempt to coin collective memory in the film *Der Baader-Meinhof-Komplex* (2008). The film, originally a movie, deals with the first generation of the German terrorist group “Rote Armee Fraktion” and the events in 1977, which were later termed “*Deutscher Herbst*”. This film – by contrast to the series described above – recalls the recent past, only some 30 years after the events and is thus rather a contribution to *kommunikativem Gedächtnis*. It claims to be not simply a film, but in fact an authentic portrayal of the events. One method used to reach this aim is to model the scenes after the fashion of documentary press photos of the late 70s in order not to irritate people’s viewing habits. The effect is that the press photos seem now to be moving or, the other way around, the “film” that delivered these pictures is now finally brought to the movies. The approach is iconic and therefore emotional; nevertheless, the film claims to tell the authentic original story. However, the film, in fact, singles out one version of the *Deutscher Herbst* and thus silences the stream of other traditions regarding the events. This is a typical phenomenon of *kommunikatives Gedächtnis*, especially around the 40-year threshold. Competing versions of the same event are still circulating, but gradually the struggle for interpretive predominance and the question which version is right (according to the present needs of the community) gains more and more ground.

With the film, an attempt is made to narrow the streams of traditions to one perspective and thus canonize this memory and shape it into what is intended to be the collective memory. This is a common process in collective memory. The legal action taken by Juergen Ponto’s widow against the film for its presentation of her husband’s murder and also the public statement of his daughter, who complained that the film distorted collective memory and depicted the murder of her father in a humiliating manner, can both be explained by social memory theory. The development of the discussion on the film and the question whether the events of the *Deutscher Herbst* are presented and interpreted in the right way shows that, in this case, memory is still fluent and that different versions of the event are still in circulation. The struggle for an official version of this episode of the recent past is not yet over, but it is clear that it is already in the process of transformation into *kulturellem Gedächtnis*.

Both cases show how the construction of collective memories and social frameworks shaping identity are organized. They demonstrate the *productive aesthetic* aspect of social memory and show different incidents and strategies. In both cases, memory of past events is shaped in order to create identity. The past is constructed according to the needs of the present. Especially the attempt in *Die Deutschen* to consolidate a stable collective German identity prior to the Nazi Times is remarkable. Because the series ends with 09.11.1918

and the broadcasting started in November 2008, the impression is given that there was a straight road connecting 09.11.1918 with 09.11.1989, ignoring the detour of 09.11.1938 and the Nazi period, a historical event which is currently approaching the *floating gap*. One could easily get the impression that the Nazi period had no identity-generating character for the German collective identity and that today's self-awareness is rooted directly in the democratic movement of 1918. However, the tenacious struggle about the holocaust memorial in Berlin and more recently the controversy about the Center against Expulsion show that this is by no means the case. Nevertheless, the question how the Nazi period and the holocaust should to be commemorated in the German *kulturellem Gedächtnis* is still far from being resolved.

The two cases help to show that, when dealing with social memory theory, two perspectives have to be distinguished: a) the position of the artifact itself in relation to what it is about and b) the position of the recipient in relation to the artifact. Regarding the first perspective, the cases are quite obvious: *Die Deutschen* deals with the most remote past and is thus best seen as a contribution to *kulturellem Gedächtnis*; by contrast, *Der Baader-Meinhof-Komplex* addresses the recent past and can therefore be understood as a contribution to *kommunikativem Gedächtnis*. The second perspective is not relevant for both cases as the viewer's and the film's position is the same.

5. The Impact for Biblical Studies

How then are we to distinguish between artifacts of *kulturellem* and artifacts of *kommunikativem Gedächtnis* when dealing with biblical literature? Since the perspective of the current reader is not the same as that of the biblical author(s), we must ask whether this might alter the perspective on and the understanding of the corresponding text? My answer is: yes, and it especially affects New Testament texts.

5.1 *The Text's Perspective: Kulturelles or kommunikatives Gedächtnis?*

As we have seen, *kulturelles* and *kommunikatives Gedächtnis* can only be strictly separated in theory, not in practice and both consist of structurally similar canonization processes. Thus, for the question whether a biblical text should be regarded in the light of *kulturellem* or *kommunikativem Gedächtnis* it seems to me helpful to take a closer look at the context of text formation, which is easier to identify for New Testament than for Old Testament literature. As the New Testament texts have all been written roughly between 50 and 130 CE – which means 20 to 120 years after Christ's ministry, death and resurrection

and reflect back upon these events – they are not dealing with the remote, but with the recent past: this suggests reading them as *kommunikatives*, not as *kulturelles Gedächtnis*. This is especially evident for the narrative passages of the New Testament, since they narrate the founding events of Christianity. But also the argumentative texts reflect upon these events and exhibit the struggle for an interpretation adequate to their own situation.

Regarding its formative period, the post-Pauline literature can be located around the 40-years threshold which opens new perspectives for understanding these texts. Kirk/Thatcher have already formulated this idea in their survey of the Jesus tradition as social memory: “Jan Assmann’s discussion of the shift from forms of ‘communicative memory’ to the more enduring forms of ‘cultural memory’, and the transformations of representations of the past that can accompany this shift in the medium provides fresh leverage for understanding the emergence of the Gospels as written artifacts and on the transition from orality to writing in early Christianity”³⁷. Schröter has observed that, for both parts of the Bible, the development of heuristic models reflecting the construction of cultural identity through acts of commemoration is still in its infancy; till now, the issue has hardly been faced.³⁸

With Old Testament literature, the case is different. The processes which took place in the formation of Old Testament texts, especially in exilic times, should clearly be seen as belonging to *kulturellem Gedächtnis*, for they deal with the founding stories of the most remote past – a past, that even in exilic times was already very remote. Furthermore, the texts often appear to have undergone massive re-interpretation. It is this temporal distance that indicates the need to think of contributions to *kulturellem Gedächtnis* when dealing with Old Testament literature. Nevertheless, ideally, this supposition would have to be verified for each text individually; the suggested classification indicates a possibility, not a final result.

Methodically, reading New Testament texts as *kommunikatives Gedächtnis* means that one cannot presume to know exactly how the events memorialized in the texts really took place. Such a reading rather gives insight into the status of the memory group and its process of identity construction. In New Testament texts, both the fact and the manner in which the struggle for interpretation of the founding events by a particular group become tangible, bringing to light what each group understood to be their (founding) history. Reading

37 Alan Kirk and Tom Thatcher, “Jesus Tradition as Social Memory,” in *Memory, Tradition, and Text: Uses of the Past in Early Christianity*. Edited by Alan Kirk and Tom Thatcher. SemSt 52 (Atlanta: SBL Press, 2005), 24–42, 41.

38 Jens Schröter, “Gedächtnis II” in *RGG⁴ III* (Tübingen: Mohr Siebeck 2000), 525.

New Testament as *kulturelles Gedächtnis*, on the other hand, would mean discovering our own position in relation to this history and understanding it as part of our own identity. In my opinion these are totally different issues.

The two examples from the German media make this difference clear: while *Die Deutschen* invites the viewer to identify with the interpreted experience that has by now taken on the form of a canonized common history, the *Baader-Meinhof-Komplex* reveals an ongoing struggle for the correct understanding of the events it narrates, suggesting how a certain part of recent German history should be remembered as a part of the national identity of a re-united Germany. As the discussion of the film indicates, the quest for an adequate modus of remembrance is still being negotiated in discussion. In this process, only the medium *film* is post-modern, the underlying mechanisms of communication do not differ much from those of antiquity: collective memories have to be socially negotiated. Leaving aside the fact that the New Testament text does not address national identity, but only the identity of a much smaller memory group, the process of struggling for a Christian identity construction is quite similar; the only difference is that the negotiation process in the New Testament takes place in the medium of *text*. The Gospels represent different attempts to understand and remember the foundational events of Christianity. In the light of social memory theory, Luke and Matthew can be read as arguments with and alternative suggestions to Mark's narration; likewise, John can be seen as a *relecture* of the synoptic tradition. The aim in each case is not to historicize but rather to stabilize a current identity concept for the future.

5.2 *The Reader's Perspective: Reception Aesthetic or Production Aesthetic?*

When the New Testament was canonized, the vivid process of identity construction that is reflected in the New Testament texts became part of the *kulturelles Gedächtnis* of Christianity. This makes it possible to read New Testament texts both as *kommunikatives* and as *kulturelles Gedächtnis*, depending on the perspective taken by the reader. Especially in the canonical approach and in systematic reflection, the New Testament is seen as constituting a part of the Christian *kulturelles Gedächtnis*, which means that, like the Old Testament texts. It is read and used in the perspective of a *reception aesthetic*. Looking at Biblical Studies from this angle, it is hardly surprising that most of the scholars working with the canonical approach are Old Testament scholars.

The four-fold Gospel, however, also opens up the possibility of reading the New Testament as *kommunikatives* rather than simply as *kulturelles Gedächtnis*. From the perspective of *kommunikatives Gedächtnis*, four different versions of

the Jesus story can be read and each of them fosters a different early Christian identity construction. In this perspective, the process of the *kommunikatives Gedächtnis*, the struggle for a common past that constitutes the present and the future, is *frozen* so to speak in the New Testament texts, preserved like a snapshot. New Testament texts thus mirror details of the several *kommunikative Gedächtnisse* (plural) of early Christianity and reflect diverse processes of identity formation. In the process of emerging memory and identity, different strategies of formation and influence, from *relecture* to *pseudepigraphy*, can be observed. It is easy to see that, from this perspective, a whole new area of research is opening up.

Reading the four-fold Gospel as *kulturelles Gedächtnis* has a different effect. Here, the Gospels are read as the canonical decision to construct Christian identity in a pluriform and multi-perspective manner on the basis of the four different Gospels set alongside each other. The failure to understand this decision becomes evident already with the *Diatessaron* and it is manifested time and again in every attempt to harmonize the Gospels from early Christianity until today. Harmonizing the Gospels to tell a single story attempts to reduce the different *kommunikativen Gedächtnisse* (plural) to a single *kulturelles Gedächtnis* and is characteristic of a *reception aesthetic* that by no means ended with the canonization of the New Testament.

One of the difficulties of reducing the different narrations into a single foundation story is the problem of misunderstanding the different formats and applications. In the New Testament, the Gospels are stored first of all as texts and can be read as identity constructions of Early Christianity. In Christian Liturgy, however, the Gospel texts are staged and memorialized as parts of the common founding story of the church. To this end, they are turned back into episodes (“in those days”), separated from their literary context, and put into a new context of meaning. Collective memory is thus turned into *kulturelles Gedächtnis* and gains a *surplus de sens* that it did not have before. This difficulty affects New Testament studies when it takes a *production aesthetic* look at the texts and reads them as *kommunikatives Gedächtnis*. Thus, the interpretations given by New Testament Studies and those given by the liturgical staging can sometimes show massive divergence.

6. Conclusion

These insights are meant to clarify the opportunities and difficulties offered by an exegetical approach based on social memory theory that reads the New Testament as a *frozen moment* of the collective processes of establishing

memory and identity. The opportunity that lies in this approach has not yet been fully recognized. To realize it, not only interdisciplinary discourse and trans-disciplinary labor are necessary, but also the development of techniques and methods that help to read and understand biblical texts as memory in a scientific mode.

Biblical scholarship is only now starting to work on this project and one of the most urgent tasks is to appropriate the theoretical foundations laid down in the interdisciplinary discourse of neuro-sciences, sociology, psychology, history and cultural sciences and to coin the terms, techniques and methods necessary for a fruitful application to Biblical Studies. Anyone who claims to work with the concept of social memory has to set forth his/her criteria, relating them to the inner-theological and the interdisciplinary debates. Biblical scholarship should not claim an exceptional position: our texts are first of all texts.

One difficulty about introducing social memory theory into biblical studies remains to be discussed. The interdisciplinary discourse on the subject is still under development and often it cannot be appropriated in the depths necessary for an adequate application. Another difficulty is that social memory theory is complex and confusing in its terminology. It is not just a matter of wordplay when attempts are made to clear up the terminology: sound working with the concepts means importing hermeneutics that can be a real challenge to classical exegetical work. Thus, it is clear that biblical studies – like theology in general – has a backlog to work off when it comes to understanding and using social memory theory.

Two areas are of major interest: a) the recent interdisciplinary discourse on social memory theory has to be brought into biblical studies in a larger degree than has happened till now and b) within the exegetical discussion, there is need to explain more specifically – in terms of criteria and methods – what a serious application of the theory would entail. Especially as regards the latter, the exegetical discourse has hardly begun. It is, however, all the more necessary, when the reading of the New Testament texts shall be not only historical but also narratological, seeing them as expressions of *social memory*. I hope that the present reflections can serve as a stimulus to this enterprise.

“You cannot live with an experience that remains without a story:” Memory Theory and How Mark’s Gospel Narrates Experiences with Jesus

1. Introduction: Everyday Conversation¹

Everyday conversation and the motifs and cultural patterns from our current time can provide deeper insights into biblical texts. As these texts were not exclusively written for experts, but rather, aimed at the level of the public, examples from pop-culture might, at times, be more useful for our understanding than elaborate scholarly theories. The starting point for my reflections about experience, memory, and narrative is, therefore, an ordinary scene that has become classic for the genre of romantic comedies. The scene is simple: two people meet. One of them has recently met a new love interest and attempts to express her excitement to a friend:

“Oh, he is so great,” she exclaims.

“What is he like?” asks her friend.

“He is just wonderful,” she replies.

“How so?”

“I can’t describe it. He is just so amazing.”

“What do you mean?”

“He is simply fabulous ... just the partner I’ve always wanted.”

It is easy to see that this conversation goes nowhere. The two friends are not connecting; at least not in this exchange. What will eventually establish a connection between them is not an enthusiastic description from the woman who

* Max Frisch, *A Wilderness of Mirrors*, trans. Michael Bullock. (London: Methuen, 1965), 8.11. The original German reads: “Ein Mann hat eine Erfahrung gemacht und jetzt sucht er die Geschichte seiner Erfahrung.... Man kann nicht leben mit einer Erfahrung, die ohne Geschichte bleibt.” Frisch, *Mein Name sei Gantenbein*, 28th ed. (Frankfurt: Suhrkamp, 2000), 8.11.

1 This argument was first presented at the EABS/ISBL International Meeting 2018 in Helsinki and subsequently at the Annual Meeting of Irish Bible Association 2019 in Dublin, a faculty seminar at Pontifical University St. Patrick’s College Maynooth. Co. Kildare, and a guest lecture at Hussite Theological Faculty in Prague in 2022. I am grateful for the vivid discussion and impulses for further research that I received on these occasions.

has just met Mr. Fabulous, but instead, images, metaphors, or stories her friend can relate to from his or her own experience.

The conversation will eventually move beyond “great,” “wonderful,” and “fabulous,” most likely to an anecdote about the new partner. For example:

“He is incredibly attentive, you know. I’ve seen him several times before, be he made sure that we bumped into each other at the supermarket last week. You know my issues when it comes to reaching items from the top shelf. He must have waited there, because he just looked at me, smiled, and before my hand could even reach up, he had already grabbed the item and handed it to me saying, ‘Is this what you needed?’”

At this point, the story has become so much of a cliché that almost everyone can relate, or at least understand the idea. What makes this scene interesting is that the woman does not just give an account of what happened, but also interprets the events: “He is incredibly attentive.” “He made sure that ...” “He must have waited...”

The scene could have been viewed differently; however, this perspective is what will be passed on to her friend, and what will be retold by her friend on their wedding day as part of the couple’s story. However, a very different perspective on this scene will be shared if the couple breaks up. Both falling in and out of love will be shared by means of a story. The event in the supermarket will not change, but it will be framed differently after they are no longer romantically involved:

“How is it going with Mr. Fabulous? I haven’t seen the two of you for a while,” says the woman’s friend.

“Ah, don’t mention him. It’s over,” the woman replies.

“Really? My impression was that you were just made for each other.”

“Yeah, like chalk and cheese.”

“Come on, the most attentive person you’ve ever met ...?”

“He is not attentive. He is dominant. Remember what I have told you about when we met in this supermarket? He had already begun patronizing me with that stupid can....”

Taking a step back, the lesson to be taken from this scene, as well as from any other everyday conversation, is this: the moment that the woman and her friend connect is when an image, a metaphor, an experience, or a narrative structure is introduced, to which they both can relate. In our case, it was the cliché of the couple meeting in the supermarket in front of a big tower of canned goods. This scene was not only used to narrate their first real encounter, but it also served as a way to demonstrate the experience of meeting someone new who quickly became someone special.

Passing on an experience always needs a linguistic form. The most common way to share an experience is through the medium of a story. This might have a lot to do with the fact that humans remember and organize their experiences in what is called *episodic memory*. Episodic memory – in contrast to *semantic memory*, which only stores plain data such as numbers, dates, or formulas – facilitates the connecting and retaining of experiences with emotional markers in the form of stories. Many of our own experiences are stored in episodic memory and recalled and shared through the medium of a story.

2. Conversations about Jesus in Mark's Gospel

We can hear echoes of this in the Gospel narratives as well. Using the pattern introduced above, it is easy to imagine a conversation between someone who has met Jesus and someone who has not:

“Guess what? We have finally managed to hear this Jesus teach. He is truly amazing.”

“What did he say?”

“His words are overwhelming. Meeting him and listening to him really changed our lives. He is teaching with authority, you know. Not like the scribes.”

“Yes, I hear what you're saying. But what did he say? What is the content of his teaching?”

The fact that this fictitious dialogue resembles Mark 1:21–22 is no coincidence. The entire first chapter of Mark's Gospel, and much of the second and third, do not explicitly narrate what Jesus taught, but instead the impression he left on people. The Gospel explains that the audiences were astonished (ἐκπλήσσω, 1:22; 6:2; 7:37; 11:18), amazed (θαμβέω, 1:27; 9:15), and astounded (ἐξίστημι, 2:12; 3:21; 5:42; 6:52) by Jesus's teaching, and marveled at it (θαυμάζω, 5:20; 12:18), but does not reveal what Jesus actually said.

Genuine teaching is only narrated much later in the overall Gospel narrative. The first few chapters are dominated by Jesus's impact on people, not by what he says. He is portrayed as a charismatic, enigmatic, and authoritative person. After the prologue, the reader is told how Jesus calls the first disciples, Peter and Andrew (1:16–18), and James and John (1:19–20). When this small group arrives in Capernaum, Jesus teaches in the local synagogue on the Sabbath (1:21–22), casts out an unclean spirit, i.e., a demon (1:23–28), heals Peter's mother-in-law (1:29–31), and after the Sabbath, heals all those who are sick and demon-possessed in the city (1:32–34). Early in the morning, Jesus disappears and finds solitude for prayer (1:35) but is soon found as everybody

seeks and asks for him (1:36–37). At this point in the story, the reader has yet to hear Jesus talk a great deal apart from addressing Peter and Andrew with an authoritative call connected to a promise: “Come here, after me, and I will make you fishers of men (1:17).” He also spoke to the demon: “Be silenced and come out of him” (1:25). It is almost illogical that Jesus says to those who have found him the next morning, “Let us go somewhere else to the towns nearby, in order that I may preach there also; for that is what I came out for” (1:38, NAS), as the reader is left to wonder about the message of Jesus.

The narrator concludes: “And he went throughout Galilee, proclaiming the message in their synagogues and casting out demons” (1:39, NRS). At this point, the reader has heard several times (1:22, 26–28, 39) that Jesus preaches in the synagogues with authority, but apart from healing people and casting out demons, the reader still does not know exactly what he says. While the impression Jesus leaves on the audiences is well described, the content of what he says remains rather opaque. It seems that ancient readers had a very similar impression and were not very pleased with it either. It is telling that Matthew inserts the Sermon on the Mount just after Mark 1:21, leaving no doubt regarding the general direction and content of Jesus’s teaching, and Luke inserts Jesus’s inaugural sermon in Nazareth (4:16–30) at nearly the same place.

The fictitious conversation about Jesus could also have moved along different lines:

“Guess what? We have finally managed to hear this Jesus teach. He is really amazing.”

“What is he like?”

“He is a charismatic man with great authority, not like the scribes. He commands the demons, and they obey. Guess what happened in the synagogue ...?”

This version is also based on a story or a cultural pattern, to which the conversation partner can relate. Understanding the meaning of demon-possession, and the ubiquitous fear of demons in antiquity, putting the life-changing experience of an encounter with Jesus into a story is an extremely effective means of communication.² Read like this, exorcism and healing stories are not simply *accounts* but *reflections* about healing and liberating encounters with Jesus in

2 For a general survey of demons and demonology in different cultures in the first century, cf. *Das Böse, der Teufel und Dämonen/Evil, the devil, and demons*, ed. Jan Dochhorn, Susanne Rudnig-Zelt, and Benjamin Wold, WUNT II 412 (Tübingen: Mohr Siebeck, 2016); *Die Dämonen – Demons. Die Dämonologie der israelitisch-jüdischen und frühchristlichen Literatur im Kontext ihrer Umwelt*, ed. Armin Lange, Hermann Lichtenberger, and K. F. Diethard Römheld (Tübingen: Mohr Siebeck, 2003). A very instructive narrative introduction is provided in Bruce Longenecker, *The Lost Letters of Pergamum: A Story from the New Testament World* (Grand Rapids, MI: Baker, 2016).

the form of miracle stories. Vocation stories likely follow the same pattern: they narrate the life-changing encounter with Jesus in the medium of a vocation story, which – at least in the Markan version – is not comprehensible without further information. Why should grown-up fishermen follow a man they have never seen before on the basis of the strikingly odd promise that he will make them “fishers of men?” These stories are only understood in hindsight with attempts to articulate the experience of the healing and liberating presence of God through the medium of socially accepted narrative and interpretative patterns, or a story.

Based on experience, cultural conventions, and common sense, we can conclude that people have experienced Jesus. The encounter with him and his message altered their lives, and they wish to share their experiences. The opening chapters of Mark's Gospel, at least from 1:16 onward, can be read as accounts of these experiences. The episodes knitted together in the first chapter (or even chapters) say little about the character and message of Jesus, but speak volumes about people's experiences with him, the impression he made, and the impact he left on them.

3. Experience and Memory: The Theoretical Background of Semantic and Episodic Memory

“A man has been through an experience now he is looking for the story of his experience.... You cannot live with an experience that remains without a story.”³ The Swiss writer Max Frisch articulated this sentiment in his novel *Mein Name sei Gantenbein*: Storytelling is both the default way humans make sense of what they encounter, and how they pass on their perceptions of these experiences. The relationship between experience, truth, and fiction intrigued Frisch as an author. Besides his literary oeuvre, Frisch touched on the issue in several theoretical lectures, talks, and interviews. “All stories are external,” he says in one text, “you can't narrate the truth. That's the point. The truth is not a story, it does not have beginning and end, it is just there or it's not. It is a fracture in the world of our delusion. It is an experience but not a story.”⁴ The idea is as simple

3 Max Frisch, *A Wilderness of Mirrors*, trans. Michael Bullock (London: Methuen, 1965), 8.11. The original German reads: “Ein Mann hat eine Erfahrung gemacht und jetzt sucht er die Geschichte seiner Erfahrung.... Man kann nicht leben mit einer Erfahrung, die ohne Geschichte bleibt.” Max Frisch, *Mein Name sei Gantenbein*, 28th ed. (Frankfurt: Suhrkamp, 2000), 8.11.

4 Max Frisch, “Unsere Gier nach Geschichten.” Max Frisch, *Gesammelte Werke in zeitlicher Folge IV*, ed. Hans Mayer (Frankfurt: Suhrkamp, 1986), 262–64, 263: “Geschichten gibt es nur von außen. Unsere Gier nach Geschichten, woher kommt sie? Man kann die Wahrheit nicht

as it is intriguing. “What we really have,” Frisch says in another interview, “is experience, patterns of experience. Not only in the process of writing but also in the process of living, we are creating stories in order to express our patterns of experience, which make our experience legible.”⁵ The abbreviated version of this idea is simply: “The experience wants to make itself legible. It creates itself an occasion and thus it preferentially fabricates itself a past.”⁶

Frisch’s ideas have been confirmed by both neuro-scientific research and cultural studies, especially in regard to remembering and sharing memories. Based on the insights of Endel Tulving, today, higher-ranking systems of long-term memory are placed in two different categories: episodic and semantic memory. *Semantic memory*, also known as *knowledge system*, describes the area of facts without context, such as mathematical laws or vocabulary – facts every adult has acquired during his or her life. In *semantic memory*, these facts are stored without the context in which they were acquired. Applying vocabulary to a text in a foreign language works without remembering the specific ways in which the vocabulary was originally learned. This kind of information, such as where and how did I learn this, would be stored in *episodic memory*. This memory system does not only store the experiences themselves, but also the time and place tied to them, and quite often, the conscious emotional evaluation of the events.⁷

Semantic memory, understood as the depository of the individual’s knowledge of the world, has the characteristics of an encyclopedia. Learned data is usually safely and reliably stored in *semantic memory* and can be recalled without noteworthy alterations or loss, even after long periods of time. This is not the case for *episodic memory*, which has a dynamic nature. The recollection of

erzählen. Das ist’s. Die Wahrheit ist keine Geschichte, sie hat nicht Anfang und Ende, sie ist einfach da oder nicht, sie ist ein Riß durch die Welt unseres Wahns, eine Erfahrung, aber keine Geschichte,” (Translation SH).

5 “Max Frisch,” in Horst Bienek, *Werkstattgespräche mit Schriftstellern* (Munich: dtv 1965), 23–37, 36–37. “Was wir in Wahrheit haben, sind Erfahrungen, Erlebnismuster. Nicht nur, indem wir schreiben, auch indem wir leben, erfinden wir Geschichten, die unsere Erlebnismuster ausdrücken, die unsere Erfahrung lesbar machen.” (Translation: SH).

6 Frisch, “Unsere Gier nach Geschichten,” 263. “Die Erfahrung will sich lesbar machen. Sie erfindet sich ihren Anlaß. Und daher erfindet sie mit Vorliebe eine Vergangenheit.” (Translation: SH).

7 Cf Hans J. Markowitsch, “Bewußte und unbewußte Formen des Rememberns,” in *Das soziale Gedächtnis: Geschichte, Erinnerung, Tradierung*, ed. Harald Welzer (Hamburg: Hamburger Edition, 2001), 219–39, 222ff, see also Tulving’s and Markowitsch’s basic research, e.g., Tulving/Markowitsch, *Episodic and Declarative Memory*. In his later work, Tulving thus uses the term *autobiographic memory* understood as the “intersection of subjective time auto-noetic awareness and the self-experiencing self” (cit. Hans J. Markowitsch, *Das Gedächtnis: Entwicklung, Funktionen, Störungen* [Munich: Beck, 2009], 75).

episodic memories (with and without their emotional charge) is not subject to the same stability as *semantic memory*. Intriguingly, *semantic memory* seems to be a requirement for *episodic memory* and specific to humans.⁸ The memory systems of long-term-memory are not only subject to a certain hierarchy, but also organized differently on the level of the brain. *Semantic* and *episodic memory* are in different areas of the human brain, i.e., they are indeed two different systems.

The French sociologist, Maurice Halbwachs, made similar observations in his work, *La mémoire collective* (1939), but interpreted them differently. His concepts of *autobiographical memory* and *historical memory* can be understood as steps towards *episodic* and *semantic memory*, although their origin is distinctly different from neuroscience.⁹ This makes them interesting for our purposes, too, as Halbwachs's observations allow for the following presumptions: On the one hand, (historical) events can be memorized in different ways, and on the other hand, these recollections do not exist without emotions, otherwise one would remember them as something entirely alien. Remembering events with *emotional markers*¹⁰ is by nature denser and more personal than recalling dates and definitions.

It is interesting that when recalled, episodic information is constructed as past, while semantic information is perceived as present knowledge.¹¹ The different places and types of memory also suggest that data is stored in both systems. The historical date of the *Fall of the Berlin Wall* or 9/11 would therefore be encoded in *semantic memory*, while the personal recollection of what happened would be *episodic memory*. The difference between these two types of memory becomes obvious when they are recalled: Most people instantly know when both events occurred, and they are usually sure to remember where they were when the news hit them and how they felt. The latter usually comes across in images and short episodes. These episodes are not stored in a distinct order, however, so memories of these events are frequently dated November 9,

8 Cf. Harald Welzer, *Das kommunikative Gedächtnis: Eine Theorie der Erinnerung*, 2nd ed. (Munich: Beck, 2008).

9 Maurice Halbwachs, *The Collective Memory*, trans. Francis J. Ditter and Vida Yazdi Ditter (New York: Harper & Row Colophon Books, 1980), 52f. This observation is the nucleus of what later became the heavily debated and, in the end, false opposition of *memory* vs. *history*. Halbwachs himself points out this problematic opposition in his later work and concedes that the concept of *historical memory* was not a good choice (cf. Maurice Halbwachs, *Das kollektive Gedächtnis* [Stuttgart: Enke, 1967], 66).

10 Halbwachs does not work with the notion of *emotional markers*, but in my view, this concept is very helpful to understand his work. Welzer, *Das kommunikative Gedächtnis*, 171f, uses the term *social marker* instead.

11 Cf. Markowitsch, "Bewußte und unbewußte Formen der Erinnerung," 224.

1989 or September 11, 2001, but actually took place before or after those dates. Memories stored in *episodic memory* are never saved as “facts” or “data” as is the case in *semantic memory*.¹² The events, which will be remembered later, are encoded together with their context and emotional markers, making them interpreted perceptions. They are not objective imprints of the specific situation, but subjective impressions. When these situations are placed into *episodic memory*, they have already been semanticized by one’s own system of experiences and standards. This alone makes them perspective memories, and they will retain this attribute when they are recalled.

The processes of encoding and recalling do not exist without interference. William Stern concluded around 1900 that “flawless recollection is not the rule but the exception.”¹³ Knowledge about the different memory systems and neuroscientific research have long confirmed this suspicion and put an end to the notion of memory as hieratic blocks. Memory researchers of different disciplines accept that memory does not reproduce but instead, creates.¹⁴ Recalling *episodic memory* is not like accessing an image in an archive, but rather a new creation of the respective image. In the process of (re-)construction, just as in the process of encoding, this image is semanticized – and very often altered. This explains conflicting, and also false, memories.

When memories are created, different factors come into play, giving them their characteristic form. Stern termed the two most important factors, *selection* and *modelling*, and located them among personal experiences of the person who remembers.¹⁵ These insights have also been grasped more precisely by later research and are now known to be natural mechanisms of the human brain. Daniel L. Schacter describes the *seven sins of memory* in daily life as rather distracting and annoying, but necessary processes of the human brain,

12 The particular structure of *episodic memory* is still an unsolved riddle. Jan Assmann assumes a meaningful structure for *episodic memory*, too, and suggests, “As to their structure, we can perhaps make a further distinction between a visually organized, scenic memory and a narrative memory that is organized linguistically. Scenic memory tends to be incoherent and remote from meaning, while narrative memory tends to have a meaningful and coherent structure. And it is these connecting links that are socially mediated, according to Halbwachs’ theory.” Jan Assmann, *Religion and Cultural Memory: Ten Studies*, trans. Rodney Livingstone (Stanford, CA: Stanford University Press, 2006), 2.

13 William Stern, “Zur Psychologie der Aussage,” in *Zeitschrift für die gesamte Strafrechtswissenschaft* 22 (1920): 315–70, 327.

14 Cf. Daniel L. Schacter, *The Seven Sins of Memory: How the Mind Forgets and Remembers* (New York: Houghton Mifflin, 2002), 9.

15 Cf. Johannes Fried, *Der Schleier der Erinnerung: Grundzüge einer historischen Memorik* (Munich: Beck, 2004), 105.

which ensure its ongoing capacity to work.¹⁶ The disturbances of mnemonic processes appear to be necessary mechanisms of the selection and organization of memory. It is noteworthy that these processes take place on the level of the brain and are unconscious. Most people do not remember incorrectly or forget on purpose, but according to the standards and limits of their brains.

Although at first glance recollection and memory seem to be merely subjective processes which take place in the brain of each individual person, they are not conceivable without their context and social environment. Memory is always tied to socio-cultural contexts as well as being shaped and coined by them.¹⁷ Two different aspects must be considered here: on the one hand, the socio-cultural environment exerts a dominant influence on how an individual remembers, and on the other hand, how an individual communicates these memories.

In his work, *Les cadres sociaux de la mémoire* (1925), Maurice Halbwachs coined the idea that individual recollection is conditioned by the respective socio-cultural environment. This idea also pointed in the direction of later research. First, a clear distinction has to be made between the impulse to remember and its structural arrangement. Halbwachs rightly assumed that the personal memory of an individual interacts with the collective memory of his or her peer group. Accordingly, memory – both individual and social – is a social phenomenon that grows from the outside in and is formed by the kind of encounter an individual experiences with his or her environment, especially with close peer groups like family and a religious community. Therefore, individual memory is shaped and formed by both the language and ideas of one's peer group and by his or her communication patterns and evaluations. Individual memory, therefore, always takes place within a social framework. This socially mediated structure serves as a regulating factor for personal perception.

In Halbwachs's model, the memory of an individual human being interacts with the memories of the other members of the group. Emotional load is a decisive factor in this process. From the insights of neuro-scientific research, we know that episodes are encoded with emotional markers tied to them. Ignorant of the later neuro-scientific findings, Halbwachs assumed that the way an individual feels towards the group forms his or her memory and leads

16 Schacter, *Seven Sins of Memory*, mentions the following sins of memory: transience, absent-mindedness, blocking, misattribution, suggestibility, bias, and persistence.

17 For an introduction, cf. Astrid Erll, "Cultural Memory Studies: An Introduction" in *Cultural Memory Studies: An International and Interdisciplinary Handbook*, ed. Astrid Erll, Ansgar Nünning, and Sarah B. Young, Media and Cultural Memory 8 (Berlin: de Gruyter, 2008), 1–15.

to a specific position within the social framework – or otherwise, one may disagree or even work against this structure.¹⁸ In this process, emotion and influence play the part of selection criteria and amplifier: memories that have a stronger emotional charge are assigned a higher consciousness and rating than those with a weaker emotional charge. It is therefore irrelevant whether the emotional charge is positive (e.g., emotions of love, approval, sympathy, or the desire to belong) or negative (feelings of hostility, distrust, pain, or the desire to isolate). Through emotional markers, memories gain a certain relevance within the social framework. They disclose a broader perspective for an individual's self-understanding, which allows for new identities to form and interact within the group. Without reference to a social framework, Halbwachs concludes, the development of individual memory, and therefore identity, is not possible.¹⁹

One could say that memory and identity are inseparably knit together. As this is true for both individuals and groups, it also affects the sharing of experiences. Not only are experiences remembered and semanticized according to a particular social framework, but they are also passed on according to cultural patterns. We could, therefore, extend Frisch's statement: *Experience wants to be made accessible. It creates an occasion and preferentially fabricates a story according to an accepted social framework.*

4. Cultural Patterns and Experience in Mark's Gospel

Applying these findings to Mark's Gospel, we recognize that we are dealing with people's experiences articulated through story, but additionally, that these stories are semanticized and narrated according to a particular social framework and cultural patterns. It can be inferred that what people have encountered is placed into an accessible structure in order to make it easily understood by others.

Mark's Gospel is no exception to this rule. After the prologue, i.e., the first 15 verses, the reader has a clear idea about the cultural framework of the text. It is obvious that the text makes conscious use of Jewish scriptures, especially the book of Isaiah, using the prophecy and the book as a way to define a proper

18 E.g., Maurice Halbwachs, *Das Gedächtnis und seine sozialen Bedingungen*, 3rd ed. (Frankfurt: Suhrkamp, 2006), 143–49.

19 Halbwachs, *Das Gedächtnis und seine sozialen Bedingungen*, 121: "There is no possible memory outside those frames used by the people living in a society to secure and regain their recollections" (Translation SH).

understanding of Jesus. The initial quote in 1:2–3, a conflation of Isa 40:3, Exod 23:20, and Mal 3:1, proves to be programmatic: it initiates three different traditional threads running through the text – Malachi evokes Elijah, Exodus evokes Moses, and Isaiah evokes Isaiah.²⁰

The following lines, 1:4–8, introduce John the Baptist, whose role is not entirely clear to an unbiased reader at this point. Apart from preparing the way, what else is he assigned? Audiences familiar with Israel's Scriptures will soon realize that John's garments made of camel's hair and his leather belt once again references Elijah (2 Kings 1:8), a connection that will come up again several times throughout the Gospel. The place where he performs baptisms in the river Jordan intentionally references the people of Israel entering the promised land from the East. The immersion in the river Jordan represents another experience the people of Israel had involving water right before their forty years in the desert, and their exile was also brought together with all kinds of interesting and unexpected culinary experiences and tests. There is no need to continue this list of connections. As one can clearly see, the first eight verses of Mark's Gospel are a strong example of how the text is working within the framework and patterns from Israel's cultural memory.

This is not the extent of how Mark's Gospel deals with memory. The Gospel's protagonist, Jesus, also has an experience and the readers are invited to share in it. The baptism scene in 1:9–11 gives a detailed account of what happened and clearly fits into the cultural framework of the time using socially accepted motifs: Jesus sees the heavens opening and the Spirit descending on him like a dove. He hears a voice calling: "This is my beloved Son...." The prophet Isaiah is evoked once more as a structure,²¹ along with the idea of Jesus's special relationship to God through the motif of *Sonship*,²² both already alluded to in

20 Cf. Sandra Huebenthal, "Framing Jesus and understanding ourselves: Isaiah in Mark's Gospel and Beyond," in *Creative Fidelity, Faithful Creativity: The Reception of Jewish Scripture in Early Judaism & Christianity*, ed. Michael A. Daise and Dorota Hartmann (Naples: UniorPress 2022), 209–47, with reference to Omerzu, Heike. "Geschichte durch Geschichten: Zur Bedeutung jüdischer Traditionen für die Jesusdarstellung des Markusevangeliums," *EC* 2 (2011): 77–99, 83.

21 Here, especially Isa 61:1, but also Isa 40:9–11, Isa 52:7 LXX/Isa 40–55 in general and, as can be seen later, Isa 35:5–6. Cf. David Du Toit, "Treasuring Memory: Narrative Christology in and beyond Mark's Gospel: Miracle-Traditions as Test Case," *Early Christianity* 6 (2015): 334–53, 340.

22 In Jewish use, the word "son" expresses a general affiliation, which is not necessarily based on physical procreation. "Son" could denote both bodily lineage and affiliation with a particular group, profession, or people. Even an affiliation with God could be expressed by this word, for example the expression *Sons of God* for angels as members of the heavenly royal household (Gen 6:2–4, Job 1:6, 38:7, Ps 89:7). God calls Israel his *firstborn son*

the opening verse of the Gospel.²³ The narration of Jesus's experience during baptism is in line with how the text begins and introduces the protagonist. The following verses take this experience a step further: the Spirit places Jesus in the desert (the forty days references the motif of the people of Israel being put to the test in the desert) where he realizes the closeness of his relationship with God. Put to the test, Jesus is drawn into the cosmic battle of God vs. Satan, and along with the wild animals and angels serving him, he realizes that God is on his side and Satan cannot harm him. Indeed, Jesus's experience confirms that Satan has lost the cosmic battle. Everything is possible because God reigns (9:23; 10:27; 11:22–25).²⁴

After an unknown amount of time, Jesus begins to pass on his experience (1:14–15). Jesus's first words are often regarded as some kind of programmatic statement: *The kairos has been fulfilled and the kingdom of God has arrived. Change your ways and believe this good news.* Jesus has, it seems, coined his own formula for his experience in order to pass it on: *the kingdom of God has arrived.* In Mark's Gospel, Jesus proclaims this formula as a possible new world and invites everybody to join and share his experience.²⁵ The concept itself is shaped according to socially accepted cultural patterns, as research on the *basileia-motif* has proven.

(Exod 4:22; see also Hos 11:1) and the king or the (suffering and just) sage could also be called *Son of God* (Ps 2:7, 2 Sam 7:12–14, Sir 4:10, Wis 2:13–18, Jos. Asen. 6:2–6, 13:10). In some of the Qumran texts, the royal messiah could be referred to as *Son of God* (4Q 174 I: 10–13, 4Q246). In Mark's Gospel, the expression *Son of God* might simply reflect the tradition which understands Jesus as being closely affiliated with the Father, and the idea that he plays a special role in mediating salvation between God and humanity.

23 The text-critical question whether υἱοῦ θεοῦ was part of the original text is under discussion; the witnesses allow for both its presence and its absence. Carl Clifton Black, "Mark as Historian of God's Kingdom," *CBQ* 71 (2009): 65, notes laconically: "Adjudicating the text-critical problem in Mark 1:1, the jury remains out. When it will return with a generally acceptable verdict is anyone's guess." In one of the most recent contributions to the question, Tommy Wasserman, "The 'Son of God' Was in the Beginning (Mark 1:1)," *JTS* 62 (2011): 20–50, summarizes the arguments of both sides and, on the basis of the manuscripts ("earliest and strongest support," 50), the inner logic, and the likelihood of the title's omission in the copying process, supports the longer reading. Dean B. Deppe, "Markan Christology and the Omission of υἱὸς θεοῦ in Mark 1:1," *Filologia Neotestamentica* 21 (2008): 45, also questions the "new consensus...in textual critical circles that favors the omission," concluding likewise after evaluation of the arguments that "both external evidence and Markan Christology argue in favor of the inclusion of 'Son of God' in the first sentence of Mark's Gospel" (64). This contribution follows their rationale.

24 A similar notion can be found in Luke 10:18–20.

25 Sandra Huebenthal, "A Possible New World. How the Possible Worlds Theory Can Enhance Understanding of Mark," *Annali di Storia dell'Esegesi* 32 (2015): 393–14.

5. Two Ways of Sharing Experience: Formula and Narrative

It is intriguing to take an even closer look at how Jesus tries to communicate his message and experience. Mark's Gospel records him as passing on his message predominantly in two ways, either with a formula or through story. The first message the reader gets from Jesus is a formula for the *kingdom of God* (1:15), while the parables are a narrative that explain what it means. The two forms Jesus uses to pass on his experience are surprisingly close to the concepts of *semantic* and *episodic memory*. Not only does memory seem to work according to these patterns, but sharing experience also involves two forms: formula and story.²⁶

We are familiar with both forms of passing on experience from other New Testament texts as well. When it comes to the Pauline letters, we hardly find a narrative sequence at all. Paul mostly uses formulas to communicate his message. At a closer look, what we commonly refer to as "titular Christology" is nothing more than the use of formula. Several of these formulas appear in Mark's Gospel: *Christ, Son of God, Son of Man, Son of David*, but also *kingdom of God* and *Gospel*. The sentence Ἰησοῦ χριστοῦ, υἱοῦ θεοῦ that opens the Gospel is not a story. It is a formula. The same holds true for Jesus's first statement *the kingdom of God has arrived*.

Storytelling only begins later when the Gospel reveals what it means by referring to Jesus as *the anointed Son of God*, or how the *kingdom of God* can be understood and realized in this world. In terms of memory theory, other than the *semantic* verbalization of formula, for example, *A equals B*, narrative verbalization is *episodic*. Therefore, it is just like episodic memory, characterized by emotions and gaps which allow for connection and tuning in, and it has a high potential for the use of cultural patterns and a social framework.

Verbalization in formulas – χριστός, υἱός θεοῦ – usually requires a translation into a particular cultural context, mostly that of the target audience. What seems to be a disadvantage at first may actually turn out to be an advantage. The necessity to translate a formula into a new context and explain its meaning makes it more accessible and thus, successful. In a way, formulas are like shells that can be filled with life and meaning. Communication in formulas, though seemingly more complicated at first, is much easier for intercultural communication, especially when the formulas come with contact zones that provide

26 This does not imply that semantic memory or episodic memory can be found in the text itself. Semantic and episodic memory are features of the human brain, not characteristics of a text. The attempt to locate semantic or episodic memory in a text would be a category mistake.

further context. Paul could use the formulas *χριστός* and *υἱός θεοῦ* to connect to various target audiences including Jews, Greeks, and Romans because they all could relate in one way or another to these concepts.²⁷

Narrative verbalization or telling stories, on the other hand, seems to be easy at first glance because humans are *narrative animals*. The difficulties of stories only become visible when they move further away from their context of origin. Told in a different context, the same story might require a lot of explanation, and the necessity to explain increases with the local and temporal distance from its original context.²⁸ Compared to a formula, narrative verbalization often requires a double explanation: on the one hand, the narrative guise, i.e., both the elements of the story and how the story works, has to be explained – especially to later recipients who lack knowledge about the context. On the other hand, the experience itself that is verbalized in a story must be explained before it can be adapted or transferred to a different context to make it understandable by future recipients.

People who teach the Bible in schools or pastoral contexts are familiar with this problem. Jesus's exorcisms, to use an obvious example, require a lot of explanatory work for an average Western European or North American audience. It is not only that the concept of demons has changed dramatically since antiquity, the cultural patterns for exorcisms these audiences are familiar with are derived from movies and convey different plots. There is also the fact that possession is seen as a mental illness, and people do not share the ubiquitous fear of demons held by the average person in antiquity. This makes it more complicated to explain the significance of the liberating encounter with Jesus at the heart of the story. One might wonder whether it is indeed possible to communicate the message of Jesus's liberating presence by means of stories about exorcisms. The only problem is that the New Testament is full of them.

The same holds true for many of the parables: in order to understand the idea behind the story and relate to it, it is necessary to first understand the story and then make the *metaphoric transfer of meaning* the parable requires.²⁹

27 For a comprehensive introduction and test case, cf. Esther Kobel, *Paulus als interkultureller Vermittler: Eine Studie zur kulturellen Positionierung des Apostels der Völker*, Studies in Cultural Contexts of the Bible 1 (Paderborn: Brill, 2019).

28 Frederic Charles Bartlett was the first to observe that social frames in the form of cultural schemes shape both an individual's memory and his or her communicative transmission. Frederic Charles Bartlett, *Remembering: A Study in Experimental and Social Psychology* (Cambridge: 1932/1995).

29 This is the sixth feature of Ruben Zimmermann's definition for parables: "A parable is a short narrational (1) fictional (2) text that is related in the narrated world to known reality (3) but, by way of implicit or explicit transfer signals, makes it understood that the

This problem affects most of Jesus's parables, which makes them complex stories for today's people. Our weddings no longer include *Sons of the bridal chamber* (υἱοὶ τοῦ νυμφῶνος, 2:19)³⁰ nor virgins who go out to meet the bridegroom with lamps (Matt 25:1), and we have different ideas for storing money than wrapping it in napkins (Luke 19:30) or hiding it in the ground (Matt 25:25). This means that even the simplest parables require a lot of explanation: How did sowing and harvesting work in the first century in Galilee? What was the crop of one grain of wheat in those days? How did harvesting work, and who decided when it started, and so on?

Biblical stories are nevertheless held in high esteem, and not only because they narrate stories about Jesus. Narrativization is the verbalization of an experience, at times it is even the explanation of a formula, which serves as a summary of an event that is no longer accessible or comprehensible otherwise. Narrativization is a way of allowing others to relate to one's own experiences, enabling social connectivity. For understanding these stories, the crucial question is not "what happened," but rather, "what is the experience behind this story, and how does it relate to my own experiences?" Establishing a community does not work without these stories as a foundation; they allow for close contact and provide a way for people to relate to one other. They are means and medium for enabling connection, deepening contact, reflecting the relationships forged, and providing assurance.

Read this way, the stories narrated in Mark's Gospel are not historical, but processed experience. The same holds true for the Gospel itself as an overall narration: it does not store an historical account, but instead, gives a theologically edited experience that is verbalized in the form of a founding story and narrated based on identity formation. It is indeed *the beginning of the story of Jesus, the anointed Son of God as it is written in Isaiah*. This story is open-ended, which serves as a bridge into the lives and experiences of its audiences.

In Mark's Gospel, orality and literacy are combined insofar as the text has become a narration which records and preserves the experiences of a particular

meaning of the narration must be differentiated from the literal words of the text (4). In its appeal dimension (5) it challenges the reader to carry out a metaphoric transfer of meaning that is steered by contextual information (6)." Ruben Zimmermann, *Puzzling the Parables of Jesus: Methods and Interpretation*, trans. Janelle Ramaley and Dieter T. Roth (Minneapolis, MN: Fortress, 2015), 137. The definition was first published in Ruben Zimmermann, ed., "Die Gleichnisse Jesu: Eine Leseanleitung zum Kompendium," in *Kompendium der Gleichnisse Jesu*, (Gütersloh: Gütersloher Verlagshaus, 2007), 3–46.

30 Cf. Sandra Huebenthal, "Beziehung(s)feiern: Warum Fasten für die Söhne des Hochzeitssaals nicht in Frage kommt, in *Ästhetik, Sinnlicher Genuss und gute Manieren. Ein biblisches Menü in 25 Gängen. Festschrift für Hans-Winfried Jüngling SJ*, ed. Melanie Peetz and Sandra Huebenthal, ÖBS 50 (Berlin: Peter Lang, 2018), 305–27.

group of people at a particular time and place. The idea is not to preserve supposed “facts” but rather a particular *perspective* on the events and experiences. The struggle to accurately portray Jesus in Mark’s Gospel is done using both stories and formulas, and provides a fruitful background. Here, too, the Gospel values a certain perspective: according to Mark, Jesus is *the anointed son of God and eschatological messenger of the kingdom of God according to Isaiah*, regardless of how Jesus is viewed by early groups of followers.

Building on the work of Maurice Halbwachs and Aleida and Jan Assmann, I call this type of text – founding stories or perspective narrations on processing shared experience – “collective memory.”³¹ Collective memories do not negotiate or mediate history but provide a particular perspective on foundational events and experiences. Their perpetuation in a medium like Scripture, that is meant to last much longer than the ephemeral spoken word, is not meant to store the events – the data – but rather an interpretation of the events. It is a particular perspective that is meant to be preserved and this invites engagement. Textualization in the sense of perpetuation also serves to assure identity and is often related to the experience of crisis, as has been demonstrated by Halbwachs as well as the Assmanns’.

Narrative verbalization or storytelling always includes perspective and interpretation, and both are available for social negotiation. Groups gain their identity, to a large extent, from a shared perspective on a particular experience, but not necessarily from the shared experience itself. This can be seen in Mark’s Gospel. It is the different perceptions and interpretations of people’s experiences with Jesus and his message that connect or disconnect them, not the experience itself. The first cycle of stories in Mark 2:1–3:6 depicting controversy are a vivid illustration of this mechanism.

The shared identity of the Mark people – the groups of commemoration and narration behind Mark’s Gospel – is made up of their shared perspective on the experiences they had: Experiences with Jesus and his message, as well as their experience as a group of Jesus followers, which they interpret in light of Jesus’s life and their own socio-religious and cultural framework. With the textualization of Mark’s Gospel, the Mark people transfer this perspective into a more stable and lasting medium, and thus – consciously or unconsciously – lay the foundation for the Gospel as a literary genre.

31 For a comprehensive introduction cf. Sandra Huebenthal, *Reading the Gospel of Mark as a Text from Collective Memory* (Grand Rapids: Eerdmans, 2020). (Translation of Sandra Huebenthal, *Das Markusevangelium als kollektives Gedächtnis* FRLANT 257 2nd ed. [Göttingen: Vandenhoeck & Ruprecht, 2018]).

6. Conclusion

It is clear in Mark that Jesus appears like one of the one-hit-wonders of our time, and he seems to have one message, namely *the kingdom of God has arrived*. The rest of the Gospel is explication, unfolding what this idea means. Seen from the perspective that “a man has been through an experience, and now he is looking for the story of his experience,” this makes sense. The experience of closeness to God changes everything. Not only can this be inferred from Jesus's words, but also from the way he interacts with the world. Read this way, Mark narrates how people make sense of what they have encountered by knowing and being around Jesus, and they pass on their experiences in socially accepted patterns of stories about authoritative teaching and liberating exorcisms and healings.

Taking a step back and looking at the whole Gospel, Mark does something very similar: it begins with a formula (1:1–2) and it unfolds by means of a narrative. (1:16–16:8). In the prologue, the key points of the Gospel are brought together in formulas used as reading aids. Mark 1:1–2 details key experiences of the groups expressed as a concept through the narrative voice: *Jesus, the anointed Son of God as it is written in Isaiah*. Verse 1:15 is the main experience of the character, Jesus, again expressed as a concept in semantic communication: *The kairos has been fulfilled and the kingdom of God has arrived. Change your ways and believe this good news*. The rest of the story explains the following questions: What do these formulas mean? What framework is used to describe these experiences? The Gospel's core question, “Who, then, is this?” is answered in two ways. Mark does not only use formulas, and is, at the same time, eager to explain these concepts. The narrative develops what *χριστός, υἱός θεοῦ* and *βασιλεία τοῦ θεοῦ* mean, and how one can arrive at these conclusions.

The final message of the Gospel is the necessity to share it and pass it on to others. This will be done in both formulas and stories which are based on one's own experience. Remaining silent means not sharing this perspective. Read this way, the logical continuation of the Gospel narrative sounds like Mark 1:38 rather than 16:8. *“Let us go somewhere else to the towns nearby, in order that I may preach there also; for that is what I came out for.”*

“Frozen Moments”: Early Christianity through the Lens of Social Memory Theory

Informed by the cultural turn, I tend to read Biblical texts as artefacts of group memory.¹ This decision involves the question: What kind of group memory? Jan Assmann, building on the work of Maurice Halbwachs, has in his intriguing work introduced the idea of cultural memory which – simply speaking – understands texts as canonized normative and formative founding stories of a certain group.² Cultural Memory treasures the origins, the remote past a group refers to. Cultural Memory is formal, ceremonial, consists of codified or even canonized signs and is mediated through education. Identity is established through one’s relation to the received tradition. To adapt a famous phrase from Paul Watzlawick: *It is impossible not to relate to your tradition*. Cultural memory is what seems to have always been there and shapes our identities – whether we are aware of it or not and whether we like it or not. One of the most important characteristics is its temporal structure: Cultural memory deals with the remote past and how it shapes our identity, our present and our future.

One of Assmann’s examples to illustrate the mechanisms of cultural memory was the Book of Deuteronomy.³ Thus, the whole idea became quickly known to Old Testament/Hebrew Bible scholars and saw a controversial discussion. This is especially true of the idea of the *generational gap* in Deuteronomy that was expressed through the 40 years in the desert. The idea was criticized and Assmann was often accused of having taken it a little too literarily. The underlying idea thus had little chance to gain currency in the exegetical guild. This is unfortunate as it might yet prove fruitful for some issues that New Testament exegesis struggles with, but which never made it onto our agenda.

-
- 1 First drafts of this paper were presented at the New Testament Research Seminar, University of St Andrews, and at Neutestamentliches Oberseminar, Universität Mainz. The discussions were of great help for developing the concept that will hopefully be seeing a much more thorough investigation and detailed reflection in the near future. I would like to thank all students and colleagues who have shared their ideas and critical questions. N.T. Wright merits a special note of gratitude for encouraging me to use the title “frozen moments”.
 - 2 Cf. Jan Assmann, *Das kulturelle Gedächtnis. Schrift, Erinnerung und politische Identität in frühen Hochkulturen* (5th ed.; München, 2005) and Jan Assmann, *Religion und kulturelles Gedächtnis: Zehn Studien* (2nd ed.; München: Beck, 2004).
 - 3 Cf. Assmann, *Das kulturelle Gedächtnis*, 196–228.

As the generational gap is not part of cultural memory, it was of minor importance to the Old Testament/Hebrew Bible scholars who discussed Assmann's ideas. Besides the suspicion that Assmann might have taken the 40 years literally, this would be another reason why the idea has not been introduced to New Testament studies. It's about time to correct this mistake. The *generational gap* is meaningful for us and our work insofar as the New Testament texts and their distance from the events they reflect does not belong to the realm of *cultural memory*, but to the realm of *collective memory*. Or, if the times of crisis are your landmark: it is not (only) the *floating gap* of roughly 80–120 years after an event that stimulates the relevant processes of text production and media change New Testament scholars are dealing with, but even more the *generational gap* after roughly 40 years (or in case you prefer less fixed time corridors: 30–50 years).

For scholarly work, it is not sufficient to acknowledge that *cultural memory* has found its way into Biblical Scholarship. The change of paradigm that social memory theory brought about is much more sophisticated and merits being received and applied to our questions accordingly.

The accusation Assmann found himself being charged with is indeed unfair as the 40 years he assumed for the *generational gap* are also a genuine biblical category. Unfortunately, the Egyptologist Assmann has concentrated his research on the book of Deuteronomy. This might be one explanation for the fact that he overlooked that 40 years play a much more prominent role in the Bible and that especially the author of Acts is a supporter of his idea that 40 years mark the end of a generation of contemporary witnesses.⁴ Assmann's oversight is comprehensible. It indicates, however, the research limitations of individual disciplines and makes a powerful case for inter- and transdisciplinary research. As the patron saint of the *generational gap* has his dealings in the New Testament, Jan Assmann, who focussed on an Old Testament text, might have simply missed this support to his theory.

1. Generations in Acts

A brief glance at what happens in Acts is in order, before we turn to a closer look at how social memory theory can contribute to our understanding of Early Christian literature. Our "hero" in Acts, is Stephen. In 6:13–14 he is accused by false witnesses who say "This man never stops saying things against this holy

4 Cf. Assmann, *Das kulturelle Gedächtnis*, 217: "40 Jahre bedeutet das Ende einer Generation von Zeitzeugen".

place and the law; for we have heard him say that this Jesus of Nazareth will destroy this place and will change the customs that Moses handed down to us”. Read through the lens of social memory theory, Stephen is accused of violating the common cultural frame of reference and thus falling out of the interpretative community. Tora and temple are “canonical” in the sense that they are constitutive for the identity of Second Temple Judaism.

Acts 6:13–14 makes explicit that the whole argument is about the localization in cultural frames or the question which stance to take on tradition. If we are applying Maurice Halbwachs’s categories, “taking a stance” is specific to *social memory*, but not to *collective memory*. Halbwachs’s theory in a nutshell would run like this: In the case of *social memory*, identity formation takes place within a given social frame while *collective memory* fabricates and provides frames for future processes of identity formation.⁵

The Stephen episode thus deals with the trouble the characters experience within the process of claiming and defending their identity constructions within a given socio-cultural frame. This identity construction is challenged as being out of compliance with the majority. For all those who belong to *the way* as Luke terms the early followers (Acts 9:2; 18:25, 26; 19:9, 23; 24:14, 22), being part of Second Temple Judaism constitutes their identity and they are unwilling to reject it. Stephen’s sermon is a good example of the tendency to inscribe oneself into the normative and formative tradition of Second Temple Judaism. Stephen delivers a “canonical” sermon insofar as he refers back to Moses as part of common tradition in an emic perspective. For him the Scriptures of Israel are canonical insofar as they are identity markers. Peter has already done something similar in Acts 2–4 when he interpreted Jesus with reference to Israel’s history.

What makes Acts 7 intriguing from a social memory perspective is the fact that Stephen plays with the *generational gap* when he uses the reference to 40 years to make his case. Acts is not the only biblical text using this time span, but Stephen does so in an unexpected way. He divides Moses’ life into three periods of 40 years. As the audience (both in Acts and today) know from the

5 Cf. Halbwachs, Maurice: *La mémoire collective*, Bibliothèque de l’Évolution de l’Humanité 28, Paris: Albin Michel, 1997 [Original edition 1949/1950; German: *Das kollektive Gedächtnis*, Stuttgart 1967] and id. *Les cadres sociaux de la mémoire*, Bibliothèque de l’Évolution de l’Humanité 8, Paris: Albin Michel, 2001. [Original edition 1925, German: *Das Gedächtnis und seine sozialen Bedingungen*, Frankfurt am Main 32006 [1985]. For a more nuanced discussion of Halbwachs cf. Sandra Huebenthal, *Das Markusevangelium als kollektives Gedächtnis* (FRLANT 253; Göttingen: Vandenhoeck & Ruprecht, 2014), 126–131.

book of Deuteronomy (31:2; 34:7) that Moses died at the age of 120,⁶ no one stops short when Stephen says that Moses at the age of 40 killed an Egyptian (Acts 7:23–24). No one is surprised that at the age of 80, after he had spent 40 years in Midian where he fathered two sons, an angel appeared to him in the wilderness of Mount Sinai, in the flame of a burning bush (Acts 7:30). Nevertheless, both numbers appear nowhere in the Old Testament. Only the 40 years in the desert are referred to.

In his sermon, Stephen mentions three periods of forty years, each corresponding to roughly one generation. The logic of this classification works, for we can vividly imagine that Moses could only appear as an Israelite when he was grown up and that he had to hide after killing the Egyptian at least as long as the witnesses were alive – or to be on the safe side: for one generation. The same explanation is given in Numbers 14:33–34; 32:13; Joshua 5:6 and Psalm 95:10 for the forty years in the desert: “until all the nation, all the warriors who came out of Egypt, perished, not having listened to the voice of the Lord.” The forty years – or one generation – are deeply rooted in biblical tradition and Stephen uses that tradition in his sermon.

The book of Acts would make for an interesting case for a social memory reading even apart from the Stephen episode, as it allows for observations on two different levels.⁷ On the level of characters it is – as we have just seen – about *social memory* or identity formation within a given frame. On the level of the whole text Acts is, however, about *collective memory* and the fabrication of new frames for future – Christian – identity constructions. The same holds true for the other narrative texts of the New Testament. As the Gospels and Acts narrate *social memory*, they create *collective memory* and thus fabricate new frames of reference for Early Christian identity constructions.

2. Generations and Caesurae in the Exegetical Discourse

Stephen is not the only one who works with “generations”. Epochs or eras are still en vogue when it comes to understanding one’s own history, as well as

6 The Jewish wish “Ad Meah ve’esrim” (to one hundred and twenty) is derived from Moses’ age as stated in the Torah. The fact that Moses’ burial place is unknown turns him into an even more interesting *Erinnerungsfigur* (memory figure).

7 Acts does not treasure direct Jesus memories (the ascension had already been covered in Lk 24:51), but narrates the struggles of the early followers on their way to identity. According to Acts 11:26, it was in Antioch where they were first called “Christians”. This also means that calling the original community, the “Jerusalem URGEMEINDE” “Christian” or “the earliest Christians” would at least for Acts 1:1–11:25 be an anachronism.

the concepts of “caesura” and “change of time”. Times of crisis and scenarios of change have been well established as stimulants for text production and change of media in our discipline. Even though the *generational gap* has not yet found its proper place in our discourses, the 40 years appear frequently in the pertinent publications.

“Generation” and “epoch” are commonly used in research on pseudepigraphy. I’ve chosen a passage from Udo Schnelle’s *Introduction to the New Testament* – which is widely used in Germany – as a representative position. Similar arguments can be found in most of the introductory literature.

Schnelle claims that New Testament pseudepigraphy can be narrowed down to the time between 60 and 100 C.E., with the Protopaulines and the Letters of Ignatius serving as respective borders. He understands the time between 60 and 100 C.E. as an epoch of change and reorientation in the history of Early Christianity. The generation of the first witnesses was already dead, organizational structures for the whole of the church (“Gesamtkirche”, thus: the whole of the church, not the whole of the churches) had not yet seen the light of day; offices and functions within the communities only started to emerge and the problem of the delayed parousia became prominent. Furthermore, there were first persecutions and the painful process of the “parting of the ways.” Intensive arguments with heretics among the communities also shaped that period. As there were no longer people who had authority for the whole of the church, Schnelle argues further, the authors of pseudepigraphic letters appealed to the authorities of the past in order to accomplish their objectives in a changing situation of ecclesiastical history. Pseudepigraphy as well as anonymity were literary devices to gain influence and find adequate practical solutions dealing with the problems and conflicts in the last third of the first century. New Testament pseudepigraphy, Schnelle concludes, was thus integrated in a particular situation in the history of the church and ought to be understood as a successful attempt to come to terms with the core issues of the third generation of early Christianity. The goal of New Testament pseudepigraphy was not simply to secure the continuity of the apostolic tradition after the deaths of the apostles. In fact, the guiding idea was to re-voice the authority of the apostles in the context of the new situation. By referring back to the origins of tradition, they justified the authoritative character of their re-interpretation in the face of changed situations and new problems.⁸

8 Udo Schnelle, *Einleitung in das Neue Testament* (4th ed.; Göttingen: UTB, 2002), 327–328. (translation SH). The German original reads: *Die ntl. Pseudepigraphie ist zeitlich deutlich eingrenzbar, die meisten pseudepigraphischen Schriften entstanden zwischen 60 und 100 n.Chr., wobei die Protopaulinen und die Ignatiusbriefe die jeweilige Grenze bilden. Der genannte*

Udo Schnelle is not an isolated voice. The tendency to distinguish different generations or epochs can be found across the board. Depending on the underlying idea of Early Christian generations, pseudepigraphy is either dated into the second or – more commonly – third generation and usually understood to be a comprehensible and necessary historical and theological phenomenon. Schnelle regards New Testament pseudepigraphy as a “theologically legitimate and ecclesiologically necessary attempt to maintain the apostolic tradition in a situation of change and at the same time provide the necessary answers to new questions and situations.”⁹

The generic model supported by many scholars identifies three different stages. The first generation of original Christians is followed by a phase with orthonymous text production in the second generation (Paul) and a phase of pseudepigraphy and anonymous text production (both letters and narrative texts) in the third generation. As regards the texts of the third generation, pseudepigraphy refers back to the second generation and the anonymous Gospels refer back to the first or original generation of Christianity. It is only in the fourth generation, after a tradition has been established which could be referred to, that the authors – the great grandchildren as it were – dare again to write in their own name. The different suggestions to describe the time of pseudepigraphy as an epoch further share the tendency to establish a clear line between the pseudepigraphic phase and the following orthonymous fourth generation:

Zeitraum stellt innerhalb der Geschichte des Urchristentums eine Epoche des Umbruchs und der Neuorientierung dar. Die Generation der ersten Zeugen war gestorben, eine gesamtkirchliche Organisation existierte noch nicht, innersgemeindliche Ämter bildeten sich erst heraus, die Problematik der Parusieverzögerung trat voll in das Bewußtsein, es gab erste umfassende Verfolgungen und schließlich bestimmten sowohl die schmerzliche Loslösung vom Judentum als auch die intensive Auseinandersetzung mit Irrlehrern in den eigenen Reihen jene Zeit. (...) Weil es keine Persönlichkeiten mehr gab, die eine gesamtkirchliche Autorität besaßen, griffen die Verfasser pseudepigraphischer Schreiben auf die Autoritäten der Vergangenheit zurück, um ihren jeweiligen Zielen in der sich wandelnden kirchengeschichtlichen Situation einen adäquaten Ausdruck zu verleihen. Pseudepigraphie war ebenso wie Anonymität ein literarisches Mittel, um in den Problemen und Konflikten des letzten Drittels des 1. Jhs. n. Chr. Einfluß zu gewinnen und sachgemäße Lösungen zu finden. (...) Die neutestamentliche Pseudepigraphie war somit in eine ganz bestimmte zeitgeschichtliche Situation eingebunden und muß als gelungener Versuch der Bewältigung der zentralen Probleme der dritten urchristlichen Generation gesehen werden. Das Ziel der ntl. Pseudepigraphie bestand nicht nur darin, die Kontinuität der apostolischen Tradition in der Zeit nach dem Tod der Apostel sicherzustellen. Vielmehr sollte vor allem die Autorität der Apostel in der Gegenwart neu zur Sprache gebracht werden. Indem die Verfasser sich auf die Ursprünge der Tradition beriefen, begründeten sie den Verbindlichkeitsanspruch ihrer Neuinterpretation angesichts der in der Gegenwart neu aufgebrochenen Probleme.

9 Schnelle, *Einleitung*, 329 (translation SH).

Table 3.1 Exemplary temporal frame for pseudepigraphy in current exegetical literature

	Orthonymous Texts	Pseudepigraphy (letters) Anonymous texts (gospels)	Apostolic Fathers (orthonymous)
Schnelle		60–100	Ignatius' letters serve as border
Roloff		80–120	Mid-second-century
Pokorný/Heckel		Last third of the first century (But: 2 Peter: 110–130!!)	The authors of 1 Clement (96–100), Ignatius of Antioch (110–114), Polycarp (110– 115) or Hermas (2nd century) write again in their own name

It is striking that Schnelle and Roloff – although working with different numbers – both offer a time span of 40 years and make use of the term “generation”.¹⁰ Like Pokorný/Heckel,¹¹ they date the Apostolic Fathers or “church authors” (“Kirchenschriftsteller”) later, distinguishing them clearly from the pseudepigraphic phase. Taking both observations together, we are witnessing on the one hand the tendency to describe pseudepigraphy as a phenomenon of the last third of the first century and on the other hand the tendency to defend the turn of the century as the end of the era. Francis Watson has recently described a similar phenomenon for the production of the canonical Gospels in his book *Gospel Writing*.¹²

10 Cf. Jürgen Roloff: *Einführung in das Neue Testament* (Stuttgart: Reclam, 1995), 194: “Es handelt sich bei dieser Pseudepigraphie um ein spezifisches Phänomen der dritten christlichen Generation, das im Zusammenhang mit der Autoritätskrise der Zeit zwischen 80 und 120 zu sehen ist”.

11 Petr Pokorný Petr and Ulrich Heckel, *Einleitung in das Neue Testament*. (Tübingen: Mohr Siebeck, 2007).

12 Cf. Francis Watson, *Gospel Writing: A Canonical Perspective* (Grand Rapids: Baker, 2013), 5: “A picture begins to emerge of a research paradigm in which the construction of the object of investigation – the gospel testimony to Jesus – is determined by three fundamental decisions. The first is the decision to establish a *terminus ad quem* at the end of the first century, the date assigned to “the fourth gospel” which completes the canonical collection. In contrast, the second century is designated as the period of the earliest “apocryphal” gospels, the most important of which – the *Gospel of Thomas* – is conventionally dated to c. 110–140 to prevent any confusion with the canonical four. On this account, the ecclesial distinction between canonical and noncanonical gospels is a straightforward extrapolation from their period of origin; the year 100 C.E. is projected back onto early Christian history so as to establish a boundary between two epochs of gospel writing.

In both cases, we can observe a tendency or an unintentional attempt to separate what is by definition inseparable, namely the asynchronicity of social processes. In the case of pseudepigraphy, this implies that it is highly likely that in one place the production of pseudepigraphy continued while somewhere else this phase had already come to an end. Like the quest for the *Parting of the Ways* there is no fixed date, because we are not dealing with an event, but with a process. When one takes a closer look at the above-mentioned Introductions to the New Testament, this becomes obvious from their attempts to date the particular texts. Pokorný/Heckel, for instance, date 2 Peter around 110–130 C.E. – which would be after the “official end” of the pseudepigraphic phase at the end of the first century *and* contemporary with the letters of Ignatius and Polycarp (or even later).

Another peculiarity of the above argument for the formation of an “era of pseudepigraphy” is the fact that the authors usually argue exclusively from an emic point of view. The notion that pseudepigraphy as a strategy and the problems of the third generation it addresses could be relevant beyond the developments in Early Christianity is not addressed and the idea that this might not be a Christian singularity but rather an anthropological constant is rarely considered. To put it differently: An etic perspective on the phenomenon as just another example for the development of a *New Religious Movement* is never discussed, nor even mentioned. Approaching the issue from a cultural science or social memory perspective, it is, however, hard to avoid that comparison. This does not entail a denial of the specific Christian aspects. In my opinion, nothing is subtracted from the emic perspective of a unique phenomenon when an etic social memory perspective extends it. On the contrary, broadening the scope can be quite helpful to obtain a deeper understanding of the underlying mechanisms.

Martin Ebner’s contribution, “Von den Anfängen bis zur Mitte des 2. Jahrhunderts,” in *Ökumenisches Handbuch Kirchengeschichte* is another good example of the tendency to argue with generations and phases. Ebner’s attempt to link Early Christian generations/phases to the findings of cultural memory theory makes his contribution particularly interesting for our considerations.

In spite of gaps and grey zones, Ebner argues, the data allows for a categorization that leads to a *periodization* of the history of Early Christianity (“Urchristentum”). According to his model, the texts of the first phase could be

Against this, we should recognize that the canonical/noncanonical distinction is not given with the texts themselves but arises out of their reception. Gospel writing proceeds unabated before and after the moment *we* refer to as the “end of the first century”, and it is this ongoing process that is presupposed in the retrospective differentiation of the canonical few from the noncanonical many”.

characterized as *functional literature* (“Gebrauchsliteratur”) with the authentic Pauline letters serving as examples. This type of literature deals with actual problems in the communities and replaces oral communication. The second phase then is understood to be *memoria literature*. The caesura of memory literature coincides with the death of the great apostles: James in 62 CE, Peter and Paul presumably during the great Neronian persecution in 64 CE. From a cultural anthropological perspective, Ebner argues, the textualisation of their heritage coincides rather accurately with the time span of 40 years, when eye-witnesses cease and memory has to be transferred from *communicative* to *cultural memory*. Regarded historically, the year 70 C.E. was crucial for original Christianity: With the destruction of the Second Temple, the core identity marker of Second Temple Judaism was destroyed on the one hand while on the other hand Jesus’s doom prophecy against the temple, which led to his death, was fulfilled in a most humiliating way for the Jewish people. For all those who referred to the Jew Jesus, Ebner continues, this means that they have to address the question which stance they take on their Jewish roots and how they process this catastrophe theologically.

While the first caesura comes forward quite clearly, Ebner concludes, the second caesura which indicates the end of original Christianity is much more difficult to grasp. As regards content, it is best attached to the fact that Christian authors – once more clearly distinguishable – deliberately come forward, advertise or defend their religious beliefs, but in any case seek dialogue with their Pagan contemporaries. One example of this new phase are the writings of the Christian apologetics, which start with Justin, around 150 C.E.¹³ In

13 Martin Ebner, “Von den Anfängen bis zur Mitte des 2. Jahrhunderts.,” in *Von den Anfängen bis zum Mittelalter* (ed. T. Kaufmann et al.; vol. 1 of *Ökumenische Kirchengeschichte*, ed. T. Kaufmann et al.; Darmstadt: Wissenschaftliche Buchgesellschaft, 2006), 16 (translation SH). The original German reads: *Trotz dieser Leerstellen und Grauzonen ist folgende Kategorisierung möglich, die zugleich zu einer Periodisierung der Geschichte des Urchristentums führt: Die Schriften der ersten Phase lassen sich als Gebrauchsliteratur charakterisieren, exemplarisch repräsentiert durch die (authentischen) Paulusbriefe. Sie behandeln konkrete Gemeindeprobleme und ersetzen die mündliche Kommunikation. Die Schriften der zweiten Phase lassen sich als Memoria-Literatur begreifen. (...) Die Zäsur der Memoria-Literatur fällt ungefähr mit dem Tod der großen Apostel zusammen (Jakobus: 62 n. Chr.; Paulus und Petrus vermutlich während der großen neronischen Verfolgung: 64 n. Chr.). Kulturanthropologisch gesehen trifft die Verschriftlichung des Erbes ziemlich genau mit dem Zeitraum vom 40 Jahren zusammen, in dem die Zeitzeugen aussterben und die Erinnerung deshalb vom kommunikativen ins kulturelle Gedächtnis überführt werden muss. Historisch gesehen war das Jahr 70 n. Chr. für das Urchristentum entscheidend: Mit der Zerstörung des Tempels von Jerusalem fiel einerseits das Identitätssymbol des Judentums in Schutt und Asche, andererseits wurde die Unheilsprophezie Jesu gegen den Tempel, die ihm den Tod eingebracht hat, in für das jüdische Volk erniedrigender Form eingelöst. Für alle, die sich auf den Juden Jesus beriefen, stellte sich damit die Frage nach ihrer Einstellung zu ihren*

his latest book *Die ersten 100 Jahre des Christentums*, Udo Schnelle underlines this divide with the observation that the Christian apologies are a particular *Gattung* of the new epoch.¹⁴

Adding Ebner's observations to the approaches already mentioned, we gain a picture of the earliest Christian time that looks roughly like this:

Table 3.2 Epoch model of Earliest Christianity I

Time	Texts/Genre	Pragmatics
<i>Foundational Event: Life, Ministry, Death and Resurrection of Jesus</i>		
30–70	Authentic Letters (Paul)	<i>Functional Literature:</i> Deals with concrete issues (of a particular group/community), replaces oral communication
<i>Destruction of the Temple, Death of Eyewitnesses</i>		
70–150	Gospels, Deuteropauline Letters, Pastoral and Catholic Letters (Pseudepigraphy)	<i>Memory Literature:</i> Remembers Jesus and his heritage, extrapolates traditions
<i>Blurred Caesura</i>		
150–300	Authentic Letters (Apostolic Fathers):	<i>Functional Literature:</i> Deals with concrete issues (of a particular group/community), replaces oral communication
	Community orders/Church Orders (Didache)	Identity is constructed and safeguarded <i>ad intra</i> , drawing from (alleged) authorities. Later texts again refer back to the times of founding or its authorities (the later, the more florid)
	Apologies	Dialogue <i>ad extra</i>
	Acts of Martyrs (starting with Polycarp)	Fostering identity <i>ad intra</i>

jüdischen Wurzeln und der theologischen Verarbeitung dieser Katastrophe. Während diese erste Zäsur deutlich hervortritt, ist die zweite Zäsur die dann das Ende der urchristlichen Zeit anzeigt, schwierig zu fassen. Inhaltlich lässt sie sich am besten daran festmachen, dass christliche Schriftsteller – jetzt wieder eindeutig identifizierbar – bewusst nach außen treten, für ihre religiöse Einstellung um Verständnis werben bzw. sie verteidigen, auf jeden Fall aber den Dialog mit der Paganen Bevölkerung suchen, wie es in den Schriften der Apologeten, beginnend mit Justin, ab etwa 150 n. Chr. der Fall ist”.

14 Udo Schnelle, *Die ersten 100 Jahre des Christentums*: 30–130 n.Chr. (Stuttgart: UTB, 2015), 27–28. In this book, Schnelle also works with four early Christian generations.

What I find most intriguing about the model are the two caesuras. Ebner locates the first caesura after 40 years – together with Stephen and Jan Assmann you could say: after one generation. The second caesura is rather blurred, but nevertheless clearly after around 150, which would mathematically be roughly 120 years after the founding event.¹⁵ Ebner regards the first caesura as congruent with the transition from *communicative* to *cultural memory*.

3. Generations and Gaps in Social Memory Theory

At this point, it is helpful to pause for a moment and take another look at the categories and models of cultural and social memory theory which have been developed and inspired by building on the indispensable pioneering work of Maurice Halbwachs and Aleida and Jan Assmann.

The trinity consisting of *social*, *collective* and *cultural memory* suggested by Aleida Assmann that also parts with the concept *kommunikatives Gedächtnis* seems to be the best basis for the development of a matrix introducing different *kinds of social memory*.¹⁶ Thereby the differentiation between *social memory* and *collective memory* is oriented at Halbwachs' categories and the differentiation between *collective memory* and *cultural memory* is shaped according to Jan Assmanns' categories. The connection of this classification with the assumption of a *generational gap* within *collective memory* and the *floating gap* between *collective* and *cultural memory* leads to an ideal type model. In this model, *collective memory* is understood as the time span in the process of a community of commemoration when the founding story obtains its provisional final form and the stream of tradition is gradually pointed into one perspective. Things might still be fluent, but intensify or thicken into the

15 With those numbers, the accustomed dating of 1 Clem (96–100), Ignatius (110–114) and Pol. Phil (110–140), of course, causes problems. This might be one reason why the caesura is characterized as “blurred” or as Ebner puts it “schwierig zu fassen” (Ebner, “Von den Anfängen,” 16). Cf. also Schnelle, *Die ersten 100 Jahre*, 27: “Das Jahr 70 leitet die letzte Epoche des frühen Christentums ein, deren Ende schwer zu bestimmen ist. Allerdings kann für die Zeit um 130n.Chr. eine deutliche Verschiebung auf mehreren Ebenen festgestellt werden.”

16 Cf. Aleida Assmann, Aleida: *Soziales und kollektives Gedächtnis*. Vortrag im Panel 2 “Kollektives und soziales Gedächtnis” bei der Tagung “Kulturelles Gedächtnis. China zwischen Vergangenheit und Zukunft. Internationale Konferenz zum künstlerischen und politischen Umgang mit der eigenen Geschichte in China” der Bundeszentrale für politische Bildung 2006 [http://www.bpb.de/files/0FW1JZ.pdf].

direction of generally shared perception of the past that begins to find its distinct expression in externalizations such as texts.¹⁷

The further differentiation of the models builds on the insights of Aleida Assmann.¹⁸ As regards *social memory* she has observed it to be limited in time and forming in the medium of conversation. It dissolves with the death of its carriers and thus has a migrant temporal horizon. The character of *social memory* is rather nonofficial; it is shared by those who happen to have grown into a group. It can thus be said that *social memory* consists on the one hand of a group's treasure of experiences which is realized time and again. On the other hand, *social memory* is inserted in the material world of things (items for everyday use, the urban environment etc.). *Collective memory* on the other hand is no longer limited in time; mental images become icons and narratives turn in to myths. In *collective memory* one of the different perspectives prevails while *social memory* was still contained of multiple perspectives. In *collective memory*, (historical) experiences are disentangled from the particular circumstances of their formation and turned into stories removed from the current of time. Accordingly, duration and diffusion of *collective memory* are distinctly different from those of *social memory*. While *social memory* depends on its carriers and usually dissolves with their disappearance, *collective memory* is rather dependent on content. Stories will hence remain in *collective memory* as long as there are functional for the group and will only be replaced by other stories once they become dysfunctional. As regards its character, *collective memory* is more official. Aleida Assmann considers extending it even to religion and nation. Participation in this type of memory takes place through participation in rituals, festivities and commemoration days – each of them usually structured in a particular way. Executions such as (festive) processions or shared meals form part of this type of collective memory.

A good way to illustrate the difference between *social* and *collective memory* are family memories. As regards their structure and diffusion they would be count as *social memory*. Family memories further usually possess a large repertoire of individual episodes, but rarely *the* family history in one piece.¹⁹

17 The fact that such a model can be electrifying for the investigation of New Testament texts is hardly surprising as the model thrust accurately fitting into the time when the narrative texts of the New Testament are habitually assumed to have been textualized.

18 Cf. Assmann, *Soziales und kollektives Gedächtnis*.

19 Cf. Angelika Keppler, *Tischgespräche: Über Formen kommunikativer Vergesellschaftung am Beispiel der Konversation in Familien* (2nd ed.; Frankfurt am Main: Suhrkamp,

Other than it is the case in *collective memory* there is usually no initiation of textualization and family memories rarely refer to a *founding story* that gained its stable guise over a longer period of time. Quite the contrary, it is crucial for family memories that the narrative truth of a story – even though the story might always be told in a particular way – remains socially negotiable.

A clear-cut distinction between *social* and *collective memory*, however, remains hypothetical. Both concepts are confused in the scientific literature in that way authors sometimes work with Halbwachs' terminology and Assmann's differentiation at the same time. In both cases, however, a group's memory can still be formed. It has not yet received the final seclusion of *cultural memory*, although I deem the transition to be fluent. Whether a particular ritualized meal would best be seen as part of *social*, *collective* or *cultural memory* can often only be decided after a thorough analysis. At times, the demarcations can even blur. The characteristics *emotional charge* (social memory), *concise arrangement* (collective memory) and *institutional determination* (cultural memory) Aleida Assmann has introduced offer better orientation. They do, however, not include the question of orality and writing. It is nevertheless suggests itself that externalization process aimed at duration, fixation and diffusion do already take place in *collective memory*. I therefore consider it likely that text production reaches a new stage at this level which assigns the different versions of the remembered events a provisional final form. This form can, of course, still be subject to alterations which is – at least for individual texts – no longer the case in *cultural memory*. Aleida Assmann's insights clarify that the different formations of *collective* and *cultural memory* largely consist of structurally analogous processes. In both cases, the vivid and manifold stream of tradition(s) is narrowed to a single perspective. But even *cultural memory* is not a final form, as the versatile canon discussions in the religious and profane sphere indicate.

Neither *collective* nor *cultural memory* are static complexes, but dynamic formations and basically in a state of flux. It is also noteworthy that experiences of crisis lead to the transformation of memories and their transportation into different media both in *collective* and *cultural memory*. The *floating gap*, apparently a catalyst for the formation of *cultural memory*, as regards structure,

1995), 207 and ead.: “Soziale Formen individuellen Erinnerns,” in *Das soziale Gedächtnis: Geschichte, Erinnerung, Tradierung* (ed. H. Welzer; Hamburg: Hamburger Edition, 2001), 137–159, 156.

is similar to the *generational gap*, which also entails a chance of recollection processes, their representation and communication. *Collective memory*, too, sees canonization processes, even though on a different level than in *cultural memory* and with a different liability. What Jan Assmann has pointed out for *cultural memory*'s externalization processes into the media of scripture applies *mutatis mutandis* also to *collective memory*.²⁰

Jan Assmann further states that *Traditionsbrüche* (fractures in tradition) usually are stimuli for textualization.²¹ Here, too, the knowledge gained from investigating *cultural memory* can be applied to *collective memory*. In *collective memory*, too, fractures and upheavals cause change and relocation of memories with in communities of commemoration – at times the subsequent generation can even in the face of contemporary witnesses decide for an alternative interpretation if it better serves their identity construction.²² These new possible frames will, of course, also have to be socially negotiated before they can be accepted on a larger scale. In *collective memory* this process can take place both in oral and medial communication, in which the media might change in the course of time, but not the structure of the process itself.²³

20 Cf. Assmann, *Religion und kulturelles Gedächtnis*, 82: "Traditionen werden normalerweise nicht verschriftlicht. Geschieht das doch, verweist es auf eine Krise. Die Tendenz zur Verschriftlichung ist in Traditionen nicht unbedingt im Sinne einer inneren Entwicklungslogik angelegt. Der natürliche Weg der Tradition führt nicht zur Schrift, sondern zur Gewohnheit, nicht zur Explikation, sondern zum Implizit-Werden, zur Habitualisierung und Unbewußtmachung. Der Anstoß zur Verschriftlichung muß von außen kommen, und wo er kommt, verändert er Traditionen. Daher ist es sinnvoll, nach solchen äußeren Anstößen der Verschriftlichung zu fragen."

21 Cf. Assmann, *Religion und kulturelles Gedächtnis*, 88: "Traditionsbrüche bedeuten Verschriftlichungsschübe".

22 Jörn Rüsen, *Holocaust, Erinnerung, Identität*, in *Das soziale Gedächtnis: Geschichte, Erinnerung, Tradierung* (ed. H. Welzer; Hamburg: Hamburger Edition, 2001), 243–259, has demonstrated this phenomenon using examples of how Germans deal with the Holocaust.

23 See also Aleida Assmann, "Wie wahr sind Erinnerungen?" in *Das soziale Gedächtnis: Geschichte, Erinnerung, Tradierung* (ed. H. Welzer; Hamburg: Hamburger Edition, 2001), 103–122, 114.

Table 3.3 Forms of social memory (based on social/cultural memory theory)²⁴

Social Memory	Collective Memory		Cultural Memory
Recent Past (3–4 generations)	Recent Past (3–4 generations)		Remote past (mythic time of origins)
	<i>Generational Gap</i> (≈ after 30–50 years)		<i>Floating Gap</i> (≈ after 80–120 years)
Non-intentional dealing with the past	Past is consciously recalled and reshaped		
Localization within given frames	Fabrication of new frames		
	Change of Medium Leading Perspective prevails		
			(A new Change of Medium) Leading perspective is canonized)

For our questions, *social memory* as depicted in the left column is less relevant. As regards time, it has to be located simultaneously with *collective memory*, but is due to its different dynamics it is not considered in the following visualisations.

In order to get an idea what this model might or might not be able to explain and how it can contribute to our understanding of early Christian writings, the following sections will apply the model to different locations in time, starting today.

3.1 *Generations and Gaps in Our Own Times*

When we use the categories provided by social memory theory, our own location in time seen through the lens of social memory theory would look like this:

²⁴ For a more detailed version of the model and a discussion of its theoretical background cf. Huebenthal, *Markusevangelium*, 142–150.

Table 3.4 Collective memory: generations and gaps for our time

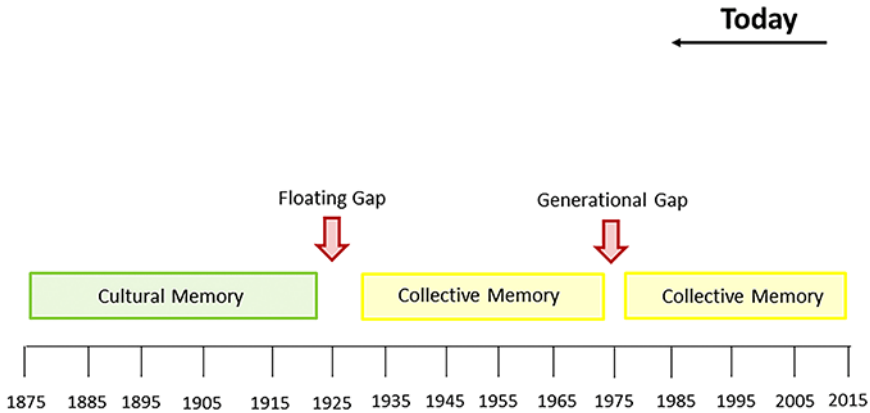

In keeping with the theory, for our generation the realm of *social* and *collective memory* would cover everything that happened between today and 80 to 120 years ago. *Collective memory* of our times would theoretically reach out to the late nineteenth century, to the invention of the diesel engine (1897) or the last days of the German Reich – to the Wilhelminian, of course, not the Third, but the fact that difference needs to be clarified nurtures the suspicion that already the Great War (World War I) is no longer part of European collective Memory. Taking a careful look at the exhibitions that currently memorize the great war in different countries (I have visited ones in Germany, Scotland and Austria), you gain the impression that the Great War has already become a part of *cultural memory*.

Cultural memory for us would be everything and anything that is no longer covered by *collective memory*. Here, we are talking about the German Reich, the Franco-Prussian or Franco-German War (1870–71), literary events like *Bloomsday*, but also conferences like the First Vatican Council. As already indicated, the end of the Great War, the October Revolution in Russia and the Armistice with Germany (or First Compiègne, 11.11.18) are *de facto* already parts of *cultural memory*.

As regards the times of crisis, for us the *generational gap* (one generation or forty years after the event) would be located roughly in the middle of the 1970s. Extending the time a little, we would talk about the time between 1970 and 1980. The Second Vatican Council for instance already lies beyond that gap and indeed, Catholics have more or less agreed on the understanding and reception of this council. Those who do not follow the consensus of the majority are taking the best route to leave the church.

Other examples would be the 1973 oil crisis or the NATO double-track-decision in 1979, which are still somehow vaguely remembered, but quite vividly present due to their impact on recent political and ecological perspectives. Americans might think of events like the Watergate scandal.²⁵ From a social memory perspective it is not surprising that roughly 40 years after the start of the ecological movement (and 35 years after the Green Party in Germany was founded) environmental protection is not only supported by a broad social consensus, but has also been met with by the churches. The topic of the encyclical *Laudato Si* is thus not very surprising, even beyond the zeitgeist and politics of the day.

The *floating gap*, on the other hand (the caesura after three generations or 80–120 years have gone by) looks back roughly speaking to the early 1930s. What happened around the time of the Nazis, the Shoah and the Second World War *and* is not yet being collectively remembered according to the results of broader social negotiations faces the danger of being forgotten in the next one or two decades. Both World Wars and their commemoration have already found their place in *cultural memory*, which can be easily guessed from the way they are remembered and commemorated across Europe.

A good example for something that did not make it into *cultural memory* is the railroad carriage of Compiègne. This railroad carriage is still part of the *collective memory* for both parties during the Second World War – which explains its significance for the Armistice with France (or Second Compiègne 22.06.40). In this moment, the railroad carriage became a collective symbol and much more than a simple carriage. Had Nazi Germany won the war, the carriage would have presumably continued its journey into cultural memory and turned into a lieu de memoire, instead of being scrapped in 1986. But as history has continued, it obtained only a brief *collective memory*. What made it into *cultural memory* instead were Stalingrad and the Hall of Mirrors in Versailles. By the way, a French museum still displays an identically constructed railroad car to recall the armistices. The 1940 armistice – our Second Compiègne – is recalled as the armistice of Rethondes. Another vehicle that is going to see a completely different fate is the bus that Rosa Parks was riding on in 1955 when she did not get up for a white passenger. This bus is on its way to become a *lieu de memoire* in the cultural memory of the United States of America.

25 I would like to thank Robert Cousland for pointing me to Watergate and for proof-reading the first version of this article.

3.2 Generations and Gaps in the First Century – Looking Forward

A next step brings us to the times of the New Testament and the question what the newly introduced categories might contribute to the understanding of the New Testament, its environment and contexts.

The founding events of Christianity – if we want to call them that – Jesus, his death and resurrection are believed to have taken place between 30 and 33 C.E. To make the calculation easier, I will work with the number 30 (without turning this into a historical suggestion). When we consider 30 C.E. to be our starting point, the *generational gap* would mathematically be between 60 and 80 C.E., and the *floating gap* between 110 and 150 C.E.:

Table 3.5 Generations and gaps in the first century

Jesus' Death

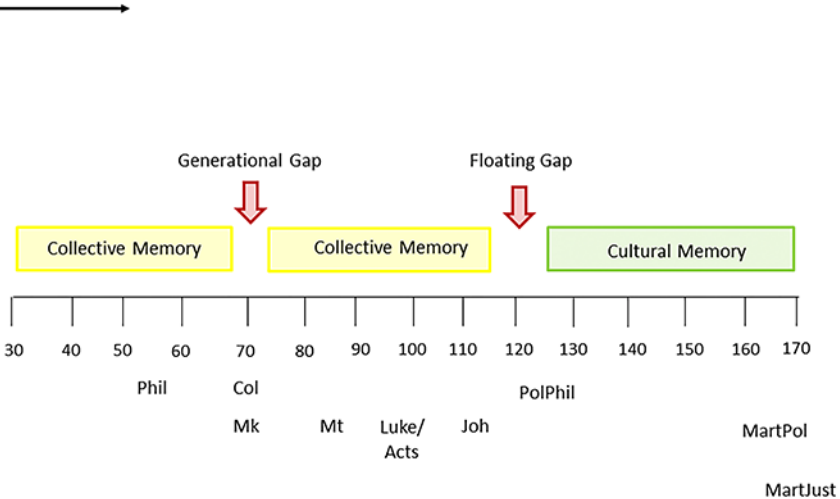

One restriction has, of course, to be mentioned right away. There is neither a unique *generational gap* nor a unique *floating gap* which opens once and for all. We are not dealing with a *one-size-fits-all* model. The strength of the model is rather that it allows for the gaps to open in different places at different times. That explains why similar developments have a different speed and a particular character depending on the individual location and context – one of the problems of the more stable models presented earlier. The flexibility causes trouble only when someone insists on a particular dating as it has sometimes been the case in older research. Whoever insists on a fixed point in time for the *Parting of the Ways* (possibly already around 70 C.E.) or the so-called *Synod of*

Javne as the moment for the closing of the Old Testament canon (I was taught both dates during my studies), will face problems when it comes to dating or contextualizing other texts. A model that allows for processes with differences in character and speed is a lot stronger.

When we take a model like the one Martin Ebner has suggested and team it with these observations, it is striking how well the descriptions of the different stages fit together. It almost seems as if biblical scholarship has unknowingly already been using the concept, but not been able to provide the theoretical background.

Table 3.6 Comparison of the two epoch models

Model Ebner	Caesura I after 40 years (around 70 C.E.) communicative => cultural Memory	Caesura II (after 120 years) around 150 C.E. <i>Explanation unclear</i>
Social Memory Theory	Generational Gap After one generation/40 years	Floating Gap After 80–120 years
	Change within collective memory (e.g. change of media)	collective => cultural memory (canonization tendencies)

After dissolving Ebner’s confusion of *generational gap* and *floating gap*, the first caesura that both models suggest is located after one generation or roughly, forty years, and we would call it *generational gap*. The second caesura or the *floating gap* would be located after 80–120 years and only then, it is possible to speak of the transition from *collective to cultural memory*.²⁶

26 Confusion about the terminology is comprehensible. In *Das kulturelle Gedächtnis*, Assmann argues “40 Jahre sind ein Einschnitt, eine Krise in der kollektiven Erinnerung. Wenn eine Erinnerung nicht verlorengehen soll, dann muß sie aus der biographischen in die kulturelle Erinnerung transformiert werden”. The term “kulturelle Erinnerung” is, however, not the same as “kulturelles Gedächtnis”, but the dichotomy rather refers to Halbwachs’ distinction between *social* and *collective memory*, without necessarily being concerned with time only. The term *Traditionsbruch*, which Assmann briefly introduced in *Das kulturelle Gedächtnis* and unfolded in more detail in *Religion und kulturelles Gedächtnis* is suited better to describe the phenomenon. In addition, at a later stage in the development of the theory, Jan and Aleida Assmann abandoned the concept *communicative memory* in favor of *collective memory*. Cf. Jan Assmann, “Communicative and Cultural Memory”, in *Cultural Memory Studies. An International and Interdisciplinary Handbook* (ed. A. Erl and A. Nünning; Media and Cultural Memory 8; Berlin: De Gruyter 2008), 109–118 and Assmann, *Soziales und kollektives Gedächtnis.*, for a discussion Huebenthal, *Markusevangelium* 142–150.

It is also quite surprising to see how well the New Testament texts fit into the time span described as the time of *collective memory*. This accuracy is even more surprising when the two gaps are added to the picture. Using the *generational gap* as a divider, it becomes apparent that texts that are commonly dated after the genuine Pauline letters fit nicely between the *generational gap* and the *floating gap*. Considering the fact that these texts – with Revelation being the exception to the rule – have been written either anonymously or as works of pseudepigraphy, this is quite remarkable.

The surprise, however, fades a little considering the significance the two gaps have. Both usually denote changes in the structure of a group's memory. Quite frequently, they are catalysts for a change of form or media, including the transition from orality to writing or the increased production of new genres.

Let me illustrate this with two brief examples. In his book *Gospel Writing*, Francis Watson has introduced a genre called *Sayings Collections*. These sayings collections, he argues, were gradually replaced by narrative gospels, not by a single act. Both genres consist of written texts and might simply represent different stages in the development of early Christian text production. The temporal dissonance – both genres co-exist – is preserved in Watson's approach and it could be explained with the *generational gap* and the change of media it tends to bring about.²⁷ Another case might be the origin of the genre "gospel" itself. As trivial as it sounds, the situation of change in media might have played a much bigger role commonly thought. In Mark's Gospel, a formerly loose network of (mainly orally transmitted) episodes was written down as a structured and self-contained narrative and in the course of this process the formerly *oral message* of the gospel was *textualized*. I do not deem it unlikely that the genre "gospel" as a coherent story was more or less invented by accident. It was, however, received with some enthusiasm and over time became formative for the genre as the later representative of the genre "gospel" show.²⁸

27 A related idea was already suggested by Werner Kelber in his seminal book *The Oral and the Written Gospel*, in which he proposed that the canonical gospel form had arisen out of a conflict with the genre of the so-called "sayings gospel". Cf. Werner Kelber, *The Oral and the Written Gospel: The Hermeneutics of Speaking and Writing in the Synoptic Tradition, Mark, Paul and Q.* (Philadelphia: Fortress, 1983), 90–139, 184–220.

28 Or, as Werner Kelber already phrased it in 1985: "Could Mark, one must ask, become the creator of a new literary form in the Christian tradition by merely bringing oral trends to their destined culmination?". Werner Kelber, "Apostolic Tradition and the Form of the Gospel." In *Imprints, Voiceprints, & Footprints of Memory. Collected Essays of Werner H. Kelber* (ed. W.Kelber; Atlanta: SBL Press, 2013), 11–32, 13.

Social memory theory allows on the one hand for pseudepigraphy and gospels as anonymous narrations to be explained as results of the *generational gap*. On the other hand it allows us to see the return to orthonymous texts as a consequence of the *floating gap* even independently of other historical events, which might have fostered them. One could even go so far as to say that particular developments within *collective memory* are prone to happen and that it is the type of event, which sets the course for the future developments. Without the Civil Rights Movements, Rosa Park’s bus would not have become an icon in the US-American *cultural memory*, but would be corroding peacefully on a scrap heap.

What I find very convincing about applying social memory theory is the fact that this lens can not only help one to understand the phenomena themselves, but is also able to provide a better understanding of the explanations given in other models. What makes the theory especially appealing to me is the fact that it does not work with its own dating of texts, but helps to a better understanding of the dating hypotheses suggested in the exegetical discourse. In some cases, it might even provide rationales for particular developments. Its ability to embrace and explain the findings of different strands of New Testament and Patristic scholarship makes it a powerful tool and a valuable help for interdisciplinary work, too.

The Jewish-Roman War and the destruction of the temple, as well as the disappearance and death of the eye-witnesses – two common explanations for the emergence of the Gospels, – fall into the *generational gap*. Social memory theory allows connecting and regarding them together with other events in a larger framework of changes, crises and traumata which might have been catalysts for the scribal process. The important point is that we are no longer dealing with monocausal explanations (which are never really satisfying), but with a whole bundle of reasons which can still be seen within the same framework.

A combination of the “classical” considerations of exegesis and introduction, as we have seen them with Schnelle, Roloff, Pokorný/Heckel and Ebner, teamed with the observations of social memory theory allows for the following epoch model for Early Christianity:

Table 3.7 Epoch Model of earliest Christianity II

Time	Text/Genre	Pragmatics	Social Memory Terminology
<i>Foundational Event: Life, Ministry, Death and Resurrection of Jesus</i>			
30–70	Authentic Letters (Paul)	<i>Functional Literature:</i> Deals with concrete issues (of a particular group/ community), replaces oral communication	Localization within given frames, the past is usually consciously recalled and reshaped, thus is collective rather than social memory
<i>Generational Gap (30–50 years)</i> <i>(Common explanations: Destruction of the Temple, Death of Eyewitnesses)</i>			
70–150	Gospels (Anonymous)	<i>Memory Literature:</i> Remembers Jesus and his heritage, extrapolates traditions	Drafting/“Finding” of traditions, fabrication of new frames for identity construction(s)
	Deuteropauline, Pastoral and Catholic Letters (Pseudepigraphy)	<i>Memory Literature:</i> Remembers Jesus and his heritage, extrapolates traditions	Individual texts can be read as snap-shots or frozen moments in a longer process of emerging early Christian identities
	Authentic Letters (Apostolic Fathers)	<i>Functional Literature:</i> Deals with concrete issues (of a particular group/ community), replaces oral communication	
<i>Floating Gap (80–120 years)</i> <i>(Commonly held to be a caesura, it is often not clear why)</i>			
150–300	Authentic Letters (Apostolic Fathers)	<i>Functional Literature:</i> Deals with concrete issues (of a particular group/ community), replaces oral communication	Tradition(s) are established and largely accepted. They can be referred to as the common (founding) story and drawing from them common identity can be constituted
	Ecclesiastical Constitutions	Drawing from (alleged) authorities, identity is constructed and safeguarded (ad intra)	
	Acts of Martyrs	Identity is constructed and safeguarded (ad intra), installation of reliable and authoritative witnesses	These traditions do not necessarily have to be historical or taken literally. On the contrary they are rarely questioned.
	Apologies/Apologetic Literature	Dialogue ad extra: Christianity enters the philosophical market	

3.3 Generations and Gaps in Early Christianity – Looking Backwards

Moving a step further in time, the framework for *collective* and *cultural memory* we have just pictured for the New Testament texts moves with us. This is a good moment to change perspective and look backwards once again. The temporal distance between Jesus’ death and resurrection (the *datum*, if you wish) does, of course, not change, but the early Christian author’s relationship to these events does. What is only 25 years ago for Paul might already be 50 years ago for Matthew and 100 years for Polycarp. The difference in temporal distances alone might explain why the texts deal so differently with the events and their impact – and why they are written in different genres.

Let us look at a few examples to get an idea. The examples introduced below are all still in a preliminary state, waiting to be investigated in greater detail, thus this is not more than a first sketch. However, I deem the heuristic value of this first draft to be sufficient to estimate the potential of the approach.

Table 3.8 Generations and gaps for Paul and Polycarp

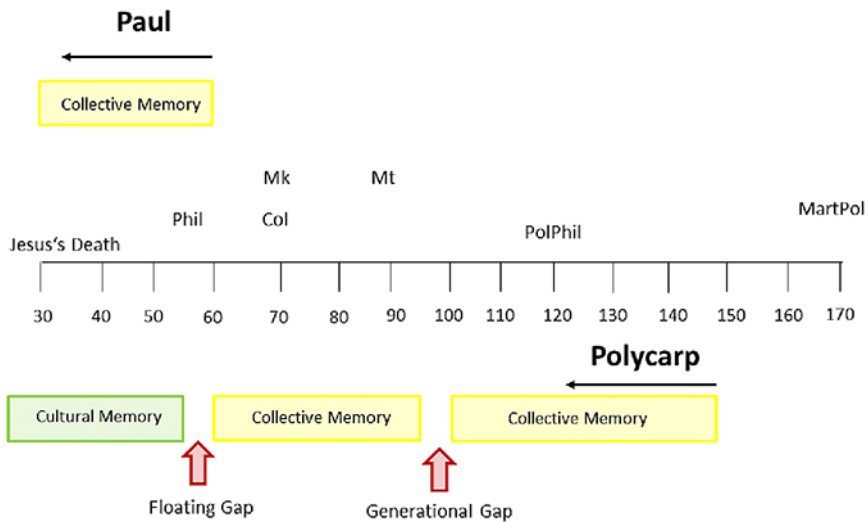

3.3.1 Paul and Acts

For Paul, Jesus’ death and resurrection, the formation of the Jerusalem community, his mission and the founding of the community in Philippi are events of the most recent past. They have taken place in his lifetime and he was even involved in some of them. Paul knew Kephass/Peter and James personally; he was the one who quarrelled with them about the question of the mission to the Gentiles (Gal. 2). All of this all happened in the span of *social* or *collective memory*.

For Acts, on the other hand, things look different. Whether Luke knew Peter, Paul or James face-to-face or had personal memories of the scuffle about the mission to the Gentiles and the agreements tied to it, remains unclear. His temporal and emotional distance could, next to pragmatic considerations and the knowledge how Early Christian history continued, explain why the meeting in Jerusalem²⁹ is depicted so differently in Acts than it is in Galatians. It might further explain why the (presumably failed) Pauline collection and the incident at Antioch are equally omitted. Paul does not oppose Peter to his face in Acts as he does in Galatians (Gal 2:11, 4), but Peter overcomes his doubts through a vision (Acts 1:9–16; 11:5–10). The issues which were still burning for Peter, Paul and James have already cooled down for the author of Acts. His text deals with other issues, which are addressed before the background of the founding generation, but nevertheless include the developments since then. The same holds true for the Deutero-Pauline letters. In these texts, too, later issues are addressed in the context of a narration about Paul. In both cases, Paul is established as an authority even though Acts is anxious to present a balanced view that does not lose out the Jerusalem “pillars” (Gal 2:9).

3.3.2 Synoptic Gospels

Let us change the scene. For Matthew, if we date the Gospel with the mainstream of the exegetical guild between 80 and 90 C.E., things look quite different compared to Paul’s times. The first generation of Christianity is dead, the temple is destroyed and the Gospel has – thanks to the Pauline mission – spread around the Mediterranean, but its followers remain a negligible minority. Early Christianity must have resembled a tiny network of emerging communities, about the size of today’s *New Religious Movements*, which separate from their mother communities and start to develop their own identifiable profile.

The Synoptics, especially Mark, are in – or beyond – the *generational gap* and look back to the founding events of Christianity as an already less recent past. They live in a time, when recollection and memory have to be negotiated differently; a time when new forms and media come up and when first traditions are built and defended. It is thus not surprising that the first narrative account of the founding events of Christianity appears at this point in time. Mark’s Gospel does not only react to different crises, but also offers a first self-contained and consistent narrative of Jesus memories in the form of a biography. It negotiates both different possible perceptions of Jesus and a suggestion for a stable Christian identity.³⁰

29 To avoid the anachronistic term “Council of the Apostles”.

30 I have elsewhere explained this idea in more depth; cf. Huebenthal, *Markusevangelium*, ead. “Von der Vita zur Geschichte des erinnerten Jesus. Überlegungen zum

A contemporary of Mark and his Gospel would be the figure biblical scholarship refers to as “Deutero-Paul”. This person is, of course, a scholarly fiction, as the Deutero-Pauline letters were hardly written by the same hand. Nevertheless, the author of Colossians, who is usually dated as being roughly contemporaneous with Mark, had to deal with similar issues and yet chose a completely different approach. Both texts address the crucial question of how to deal with the absence of the founder and authoritative figure commemorated in the text. Simply speaking, the Gospel of Mark works on the problem of an absent Christ while Colossians deals with the gap the absent Paul has created. In both cases, the text in the end replaces the absent person. David du Toit³¹ has convincingly worked out that mechanism for the Gospel of Mark and, with respect to Colossians, it is fairly common to argue that Paul’s temporal distance is compensated for by a local one.³² It is thus not too surprising that the fictive author locates Paul in prison. The concept of the text replacing the person can in a moderate form already be found in Eusebius’ writings. He explains that the Gospel of Matthew was written to substitute for the loss the addressees had to experience when Matthew parted from them: *For Matthew, who had at first preached to the Hebrews, when he was about to go to other peoples, committed his gospel to writing in his native tongue, and thus compensated those whom he was obliged to leave for the loss of his presence* (he 3.24.6).

One difference between the Gospels and the Deutero-Pauline letters is the fact that the Gospels are anonymous narrations, which remember the story of the founding events of Christianity. A pseudepigraphic letter like Colossians, on the other hand, written in the name of a well-known person and addressing current problems, nevertheless refers back to the past generation indirectly and commemorates one of the founding figures and his impact. When we read Colossians not only as a letter, but also as a story, it is quite revealing about Paul’s impact and informs the reader how he and his work should be

Markusevangelium.” in *Geschichte mit Gott. XV. Europäischer Kongress für Theologie. Veröffentlichungen der Wissenschaftlichen Gesellschaft für Theologie* (ed. M. Meyer-Blanck; Leipzig: Evangelische Verlagsanstalt 2016), 394–411. and ead. “Reading Mark as Collective Memory.” in *Social Memory and Social Identity in the Study of Early Judaism and Early Christianity* (ed. S. Byrskog, R. Hakola and J. Jokiranta; NTOA/StUNT; Göttingen: Vandenhoeck & Ruprecht, 2016), 69–87.

31 David S. Du Toit, *Der abwesende Herr: Strategien im Markusevangelium zur Bewältigung der Abwesenheit des Auferstandenen* (WMANT 111; Neukirchen-Vluyn, 2006).

32 See e.g., Ingrid Maisch, *Der Brief an die Gemeinde in Kolossä* (ThKNT 12; Stuttgart: Kohlhammer, 2003), 21 or Angela Standhartinger, “Der Brief an die Gemeinde in Kolossä und die Erfindung der ‘Haustafel.’” in *Kompendium Feministische Bibelauslegung* (ed. L. Schottroff and M.-T. Wacker; Gütersloh: Gütersloher Verlagshaus, 1998), 635–645, 635.

remembered and continued and how Christian identity can be drawn from that.³³

3.3.3 Polycarp

Let us change the scene one last time. Without getting bogged down in dating questions, one could say that for Polycarp the time of Jesus and the apostles was already part of the remote past. For him the founding events of Christianity are already beyond the *floating gap* or on their way into it.

When we use our own situation as a landmark, Jesus' crucifixion is for Polycarp – depending on the dating – about as far away as the end of the Great War is for us. The founding of the community in Philippi, which he addresses in his letter, is about as far away for Polycarp as the beginning of the Civil Rights Movement and Rosa Parks's refusal to give up her seat for a white passenger. Considering the temporal distance, the comparison with our own situation and distance to the events mentioned, it is immediately comprehensible that the recollection of these events and the discourse about them (must) have changed in the meantime.

It can be gathered from Polycarp's letter to the Philippians that the background of the community and especially its foundation through Paul and Paul's importance for the community are part of the shared history which also informs Polycarp's relation to the Philippians. Other than the Deutero-Pauline authors, Polycarp *can* refer to Pauline traditions as shared past or history and that is exactly what he does in the letter: *For neither I, nor any other such one, can come up to the wisdom of the blessed and glorified Paul. He, when among you, accurately and steadfastly taught the word of truth in the presence of those who were then alive. And when absent from you, he wrote you a letter, which, if you carefully study, you will find to be the means of building you up in that faith which has been given you, and which, being followed by hope, and preceded by love towards God, and Christ, and our neighbour, is the mother of us all* (Pol. Phil 3,2–3; 11.3).

For reasons of space, I cannot go into details, here, but there is one last thing that I find intriguing: In Polycarp's time the communities in Asia Minor had already taken the lead, but Christianity was still small in numbers. Helen Rhee postulates 40.000 faithful in the year 150, which would make them 0.07% of

33 Cf. Huebenthal, Sandra, "Pseudepigraphie als Strategie in frühchristlichen Identitätsdiskursen? Überlegungen am Beispiel des Kolosserbriefs" *SNTUA* 36 (2011): 63–94. and ead: "Erfahrung, die sich lesbar macht: Kol und 2 Thess als fiktionale Texte." in *Wie Geschichten Geschichte schreiben. Frühchristliche Literatur zwischen Faktualität und Fiktionalität* (ed. S. Luther, Susanne; J. Röder and E. Schmidt; WUNT II 395; Tübingen: Mohr Siebeck, 2015), 295–336.

the Empire’s population.³⁴ The social situation of this *New Religious Movement* might thus have changed a lot less than we imagine. Looking back from a temporal distance of almost 2000 years and living in a Christian context makes it hard to believe that even after four generations Christianity had not developed that much. What makes it especially difficult is the fact that we share Polycarp’s perspective: for us, too, Jesus’ death and resurrection are events of the remote past – and thus part of *cultural memory*.

4. Conclusions

These last thoughts take us home to our own times and the question how we read New Testament and Early Christian literature. When I work as a New Testament scholar, my own approach is to receive New Testament literature predominantly as artefacts or externalizations of *collective memories*. My rationale for this approach is the temporal distance of the authors from the events they recollect and process theologically.

As demonstrated, reading through the lens of social memory theory implies working with a particular model of the underlying processes of text production without trying to date the texts accurately. This approach is not a merely synchronic enterprise and still distinctly different from historical-critical readings. The diachronic perspective is always in the background as this approach anticipates earlier stages of an existing text. Without further data, however, it is next to impossible to reconstruct earlier stages of this text. Reading New Testament texts through the lens of social memory theory is the attempt to understand how identity is shaped and how texts provide frames for future processes of identity construction.

As regards method, this reading attitude implies the need to accept that it is impossible to say how the events recalled and interpreted in these texts actually took place. Such a reading rather provides insights into the current situation of a commemoration community (“Erinnerungsgemeinschaft”) and its processes of identity construction. New Testament texts allow us to witness how particular commemoration communities made sense of the founding events and their impact. The founding story of a particular commemoration community becomes also tangible upon closer reading. This can of course be

34 Cf. Helen Rhee, *Loving the Poor, Saving the Rich: Wealth, Poverty, and Early Christian Formation* (Grand Rapids: Baker, 2012), 43. Rhee estimates the total number of Christians in the Roman Empire at the end of the first century to have been roughly 40,000, which would be 0,07% of the total population, 760,000 for the year 225, which would be 1.27% and 6,300,000 in the year 300 which would be 10.5%.

a quite different sight for different groups represented in the New Testament and other Early Christian literature. It fosters the impression that the New Testament is a collection of frozen moments – snapshots of Early Christian identity construction processes at different places in different points of time.

Table 3.9 Differences between reading from etic and emic perspectives³⁵

Old Testament/ Hebrew Bible	Relation Text – Event	Cultural Memory	Etic	Which texts and canon formations exist and how did they come into existence? How do they shape + reflect the communities' identities?
	Relation Reader/ Interpretation Community – Event	Cultural Memory	Etic	How are or could these texts and canon formations have been interpreted in different interpretation communities over time?
Emic			How did our canon become our canon? How is our identity informed by our canon? How do we understand the texts today?	
New Testament	Relation Text – Event	Collective Memory	Etic	How do the texts reflect the events and what frames do they provide for identity construction?
			Cultural Memory	Etic
	Relation Reader/ Interpretation Community – Event	Collective Memory	Etic	How are or could these texts have been interpreted in different interpretation communities over time?
			Cultural Memory	Etic
				Emic

35 Regarding the Relation Text – Event, there is no emic perspective for the modern reader.

Reading the New Testament as an artefact of *cultural memory* on the other hand, is a completely different approach. With an emic perspective, it implies taking a stance on the tradition of one's own interpretation community and regarding the text as part of one's own identity. If it is a professional reading, it is the work of a theologian. The table below might help to clarify the differences. Having worked in different denominational and non-denominational academic contexts in Europe over the last five years, I have begun to develop a heuristic to help understanding some of the discourses and controversies in our disciplines. I use the questions as tools for understanding, not as categories for evaluation. My impression is that some of the most fiercely debated controversies could be settled knowing what the other person is really about.

As our own temporal distance to the New Testament texts is that of *cultural memory*, it should come as no surprise that the texts of the biblical canon are read and understood that way in the different Christian interpretation communities. Independently of their denomination, New Testament scholars tend to step out of line when we read Early Christian texts considering their time of origin using our own constructs of antique encyclopaediae to actualize them. This approach entails that we do not read the texts as parts of our own *cultural memory*, but as artefacts of the early Christians' *collective memory*. To actualize Early Christian Texts with an antique encyclopaedia further involves reading them as artefacts of *collective memory* with an etic perspective. *Nota bene*, this does *not* automatically mean to read them in a reception-aesthetic perspective – social memory-informed readings tend to be rather production aesthetic. It goes without saying that such a reading can only work by approximation.

The decision whether to read a New Testament or early Christian text as an artefact of *collective* or *cultural memory* already has an enormous impact on its actualisation.³⁶ Adding the distinction between etic and emic perspective allows for a helpful heuristic approach, one that not only maps different reading strategies, but is also a major help in explaining some of the current phenomena in the exegetical discourse. It explains for example why the *canonical approach* is usually represented by Old Testament/Hebrew Bible scholars.³⁷ It

36 Cf. Stefan Alkier, “Der 1. Thessalonicherbrief als kulturelles Gedächtnis”, in *Logos und Buchstabe. Mündlichkeit und Schriftlichkeit im Judentum und Christentum der Antike* (ed. G. Sellin and F. Vouga; TANZ 20; Tübingen: Narr, 1997), 175–194.

37 The first presentation of this thought at the EABS/ISBL Meeting in Vienna 2014 in a paper called “Mind the Gap! Why New Testament Scholars rarely join the Canonical Train” in the Session “The Multivalence of Canon” led to a controversial discussion with my Old Testament/Hebrew Bible colleagues. I guess this might also be due to the fact that these questions force scholars to take a stand and become visible as people who come

also sheds light on the question why merely emic approaches like *Theological Interpretation* tend to fall short and where some of their quarrels with biblical scholars come from. Although they might be faithful theologians, biblical scholars by definition have to adopt an etic perspective to make visible the frozen moments of identity construction preserved in biblical texts.

from a certain background and with a context and tradition that influence their work. For North-Atlantic Scholarship it is often still hard to accept, that we, too, do contextual exegesis, cf. Daniel Patte, "Contextual Reading of Mark and North Atlantic Scholarship," in *Mark* (ed. N.W. Duran, T. Okure and D. Patte; Minneapolis: Fortress, 2011), 197–213.

PART II

A New Perspective on Intertextuality

What's Form Got to Do with it? Preliminaries on the Impact of Social Memory Theory for the Study of Intertextuality

Καὶ ἐπειδὴν ἀθροίσῃ ἅπαντα ἢ τὰ πλείστα, πρῶτα μὲν ὑπόμνημα τι συνυφαινέτω αὐτῶν καὶ σῶμα ποιεῖτω ἀκαλλῆς ἔτι καὶ ἀδιάρθρωτον· εἶτα ἐπιθεὶς τὴν τάξιν ἐπαγέτω τὸ κάλλος καὶ χρωμνύτω τῇ λέξει καὶ σχηματίζετω καὶ ῥυθμίζετω.

After the writer has collected everything, or nearly everything, let the writer first weave together from them a rough draft and make a text that is still unadorned and disjointed. Then, after the writer has put it in proper arrangement, let the writer bring in beauty, give it a touch of style, shape it and bring it to order

Lucian of Samosata, *How to Write History* 48

Lucian's ideas about writing history, used in Mathew Larsen's inspiring study "Gospels before the Book"¹, display a process quite familiar to the work of researchers. Our work, too, is an ongoing process that comes with lots of unfinished notes and unpolished ideas which are, however, necessary to stimulate the scholarly discussion and advance scientific progress. Research conferences mainly consist of presentations of work-in-progress exhibiting all characteristics of unfinished and unpolished ideas. In a way, this is unavoidable given the fact that scholarly research is rarely about final results, but all the more about processes and thinking together. As you never walk alone on these ways, I feel encouraged to share some of my preliminary thoughts and unfinished notes on the impact of social memory theory for the study of biblical intertextuality and to invite my scholarly travel companions to think together.

In the last years of intensive research in the area of a social memory theoretical framework for reading biblical texts, my impression has become stronger that two areas which are researched independently, i.e. (biblical) intertextuality and social memory theory are indeed closely connected: intertextuality can be understood as a phenomenon of cultural memory and should hence

1 Cit. Matthew D.C. Larsen, *Gospels before the Book*. (New York: Oxford 2018), 107.

investigated in a wider context of oral culture. Although references to cultural memory usually surface as text-text-relations and are thus investigated by biblical scholars as a feature of text, insights of social memory theory and media history force us to look closer and dig deeper.

In the following preliminaries, I will share first ideas of what is designed to be a larger project aimed at a new perspective on the field. My starting point is the question what intertextuality is actually about (1), how it is typically researched in New Testament exegesis and what can be said about this approach on the basis of the insights of social memory theory and media history (2). I will then draft a first outline of a different approach to intertextuality and what this new perspective might imply for reading Early Christian texts (3). The test drills and probing will be undertaken with the example of Isaiah in the different strands of New Testament traditions and I will close my notes with a brief outlook on possible next steps to continue the research (4).

1. Approaching the Issue: Intertextuality and Its Application in Biblical Scholarship

A simple definition of intertextuality is that it describes and reflects the occurrence of texts in other texts. This broad definition covers all kinds of occurrences like a) materialistic occurrence (a book or scroll itself is mentioned; e.g. Luke 4:17; Acts 8:28), b) motifs (a motive from an another text emerges in a text, e.g. Luke 4:25–27; Rev 14:5; Mark 12:1–12), c) the structure of a text (a text is structured with recourse to another, e.g. John 1:1), or d) a particular genre (particular genre is used, e.g. Mt 1:1–18). The most common form of intertextuality is, however, the occurrence of a clearly recognizable sequence or passage of one text in another (e.g. Luke 4:18–16; Acts 8:32–33). Usually the length and recognizability of the character string in question is essential for determining whether this occurrence is manifest, latent or diffuse and the intertextual disposition is called quotation (= manifest), allusion (= latent) or echo (diffuse) as it is illustrated in this chart:²

² Cf. Sandra Huebenthal, *Transformation und Aktualisierung. Zur Rezeption von Sach 9–14 im Neuen Testament*, SBB 57 (Stuttgart: Katholisches Bibelwerk 2006), 51.

Table 4.1 Different types of intertextual dispositions as commonly used in biblical exegesis

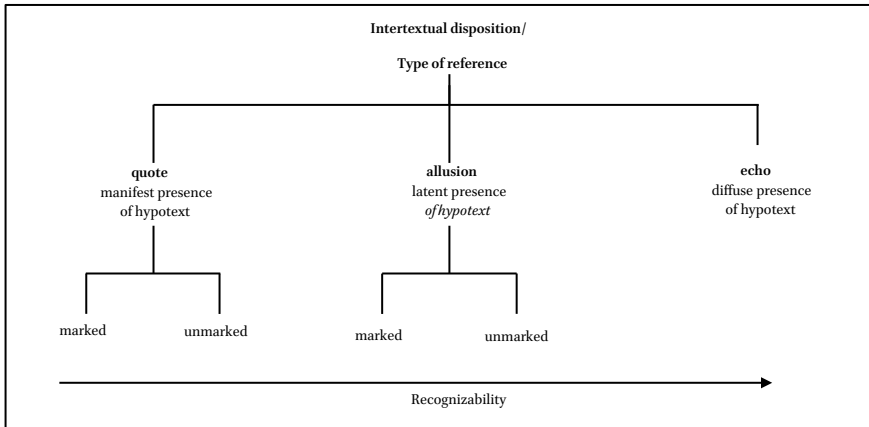

In biblical scholarship, most intertextual analyses address the occurrence of such clearly recognizable sequences of one text in another. Biblical scholarship in general and New Testament exegesis in particular is – or at least has been for quite some time – mostly interested in unambiguous allusions and quotations. There is a more refined taxonomy for quotations that distinguishes quotations with or without reference (mentioning the source of the quotation) and with or without fulfilment formula. These differences, too, can be lined out in a chart:

Table 4.2 Types of marked and unmarked quotes (here: Isa 53 in the New Testament)

	Without fulfillment formula	Fulfillment formula (e.g. ἵνα πληρωθῆ)
With reference (γέγραπται + source, e.g. ἡ γραφή, ταῖς γραφαῖς or specific source)	Rom 10:16	Mt 8:17 Luke 22:27 John 12:38
Without reference	Rom 15:21 Acts 8:32–33 1 Peter 2:22–25	

The clear categories of the table do, however, not imply that things are as clear and easy as in theory when it comes to texts themselves. Quite the contrary, very often not all the details provided in a New Testament quotation with reference and fulfilment formula are correct. A prime example is the opening

quotation in Mark 1:2–3; it does not have a proper fulfilment scheme, but an unambiguous reference to the prophet Isaiah. The problem is, however, that this quotation does not originate from Isaiah alone but is in fact a conflation of Isaiah 40:3; Malachi 3:1 and Exodus 23:20.

The seemingly flawed quotation in Mark 1:2–3 is a good point to start an inquiry how intertextuality is very often dealt with in biblical scholarship. Fueled by historical-critical exegesis and its predominant focus on the production of the biblical texts, one of the most important questions has been the one about the quotation's *Vorlage*. What kind of a text and manuscript of the Old Testament did the New Testament author have when he (the default assumption is that biblical authors are male) composed his text?

The quest for the *Vorlage* is interesting in several ways. It does not only answer questions about the influence on the New Testament text but also deepens the knowledge about Old Testament textual traditions and the familiarity of the New Testament author with his tradition. Investigating in this line of thought kills several birds with one stone: You learn both about Old and New Testament textual traditions and how well an author was versed in his own tradition, even down to the question what manuscript he might have used. Flawed quotations like Mark 1:2–3 could be explained either by a flawed *Vorlage*, by an Early Christian *testimonium* (a collection of quotations with a particular purpose), or simply by the author quoting from memory.

This approach also explains another trend in intertextual studies of the historical critical type: they usually only deal with individual quotations and tend to treat them as singularities, not as windows from one text into the other. In practice this means that researchers very often do not consider the context of the intertextual reference in question and investigate how this context might add to its meaning, but simply regard the quote as it occurs.

When you work on the assumption that quoting more or less equals proof-texting and quotations were mainly used to defend particular dogmatic positions, this does indeed make sense. It makes even more sense when you assume the existence of *testimonia* consisting of a selection of quotations for exactly this purpose. Here we encounter one of the major trends in a particular type of intertextual investigation: it focusses on production and is interested in a quotation's *Vorlage* and the purpose of its use in a particular situation – very often thought of as a defensive one that required a certain theological proof text.

Having this in mind, it is not surprising that in many cases, intertextuality ran the risk of becoming a new guise for old questions about tradition, motifs and influence. The direction of the investigation remains, as Thomas R. Hatina

has already put it almost twenty years ago,³ diachronic and is concerned with influence. What texts and traditions did the author know? What theological concepts did he use? When did particular concepts and ideas come into existence and how were they handed down? An intertextual study of that type can explain whether a particular author did or did not, maybe even could not yet know a particular tradition. Mark, for instance, has for a long time been considered to be either unaware of appearance narratives or to have deliberately suppressed them. Other authors like Polycarp some generations later who did not quotation from the Old Testament, were considered not to be familiar enough with it.

The attempt to reconstruct a particular author's knowledge of a particular text or tradition is not problematic as such, since intertextuality is also an indicator of the distribution of traditions and texts. It should, however, not be the only indicator for the fluency of a New Testament/Early Christian author of the biblical tradition or used for speculations about whether he came from a Jewish or Gentile background. The example of Polycarp's allegedly limited knowledge of the Old Testament tends to ignore the context and pragmatics of the letter in question. Even though some things had changed in Philippi since Paul's times, it still was a predominantly gentile group and hence there was little benefit from quoting the Old Testament. The common frame of reference for Polycarp and the Philippians was the Apostle Paul as the founder of the communities and their collective memory about him and that time. Referring to those days, Polycarp reminds the Philippians of their history and shared roots, which is much more useful for his argument than a chain of Old Testament quotations.

The historical-critical or production-oriented approach to the occurrence of texts in other texts is not the only way to investigate intertextual relations. The fact that it has been the most common way in biblical scholarship does not mean that it is the only or the best way to do it. In fact, it does not reflect what intertextuality, a literary concept formed in post-structuralism, really is about. "The historical critic, especially", Hatina argues, "is primarily concerned with the task of identifying written pre-texts and describing their function in new literary contexts. The propensity toward cause and effect structures and investigation is clearly contrary to the poststructuralist notion of 'text' and 'intertext.'"⁴ Taken seriously, intertextuality is not a game of detecting sources

3 Thomas R. Hatina, "Intertextuality in historical criticism in New Testament studies: Is there a relationship?," *BI* 7 (1999): 28–43.

4 Hatina, "Intertextuality", 35.

and investigating past traditions, but the recipient himself becomes a participant in the tradition. Seen this way, intertextuality is less a diachronic concept to track down influence, but a rather a synchronic enterprise that investigates relations between texts.

Since the literary turn and its shift in attention from production to reception, reader- or reception-oriented studies focusing on the receiving end and investigating how a particular text is or could be received by real or potential readers became more widespread in biblical scholarship. This approach is less about intention than about impact, and the whole range of *wirkungsgeschichtliche* and *rezeptionsgeschichtliche Studien* adds to this field. A third approach to intertextuality finally focusses on the text itself and investigates text-text-relations synchronically with regard to their literary and social context and domains. This approach does usually not construct authors and readers, but rather focusses on texts, how intertextual references change their meaning (which works both for hyper- and hypotext) and how this affects the understanding and interpretation of biblical texts.⁵ My own work the area of social memory theory and its contribution to the understanding of early Christian identity formation processes also falls into that category.

The introduction of intertextuality to biblical studies is to be welcomed, but nevertheless has some dangers. Like all new hermeneutical and methodological approaches, intertextuality, too, has been developed further when it was introduced to biblical scholarship and not all the developments were steps forward. In fact, in many contributions to the field, “intertextuality” was adopted as a fancy buzzword to resell old ideas. Very often, what is termed “intertextuality” is nothing else than traditional and old-fashioned *Motivkritik* or *Traditionskritik* dealing with dependence and influence. It is easy to see that this is not what the post-structuralist idea of intertextuality is about.

The criticism could even go a step further and maybe historical critical scholarship with its focus on production is not alone to blame. Intertextuality itself is a concept from the post-Gutenberg era, for it investigates relations of *written* texts, and this rings especially with historical critical presuppositions. To put it with Werner H. Kelber “Print was the medium in which modern biblical scholarship was born and from which it has acquired its formative methodological tools, exegetical conventions, and intellectual posture.”⁶ On average, historical critical scholarship does not sufficiently consider orality, performance and

5 Which does not mean that Umberto Eco's *model reader* or Wolfgang Iser's *implied reader* or something alike will not be constructed in these approaches. They do, however, remain within the boundaries of the text and are not projected into the extra-textual world.

6 Werner H. Kelber, “The ‘Gutenberg Galaxy’ and the Historical Study of the New Testament;” *OH/SA* 5 (2017), 1–16.

the pluriformity of manuscripts before the invention of Gutenberg's press. Identical manuscripts did not exist prior to the 15th century, thus investigating which version of the text a New Testament author has used is not only very speculative but also hermeneutically highly problematic: intertextuality as used by many New Testament scholars does not correct for biases about text that can only exist in the wake of Gutenberg's revolution. The bias extends not only to the tendency to dismiss orality (or to distort it by "textualizing" it), but also to the tendency to treat written texts as if they were stereographically printed copies, instead of hand-copied and unique items that capture hermeneutical and transmissional moments. In other words: "the typographic medium that has been a constitutive factor in the formation of modern biblical scholarship (...) has largely remained unacknowledged"⁷.

This problem has to be seen in its greater context. The criticism that historical critical scholarship has – or at least had – a tendency to focus one-sidedly on written manuscripts and neglect the oral culture from which the biblical texts originate, is not new. It has been directed to historical Jesus research for quite some time,⁸ but it is also an issue for intertextuality in its different modes of investigating text-text-relationships. Regardless which of the approaches is used, historical critical methods tend to focus on written texts, written pre-stages or sources and often even treat presumed oral sources like stable written texts, underestimating their oral environment, the fluidity of manuscripts and of the general idea of originality and the *equiprimordiality* of speech acts.⁹

7 Kelber, "Gutenberg Galaxy" 6.

8 A broader discussion of this problem was initiated by Chris Keith, "Memory and Authenticity. Jesus Tradition and What Really Happened," *ZNW* 102 (2011): 155–177. For a more detailed exchange of arguments cf. the contributions in Chris Keith and Anthony LeDonne, (ed.): *Jesus, Criteria, and the Demise of Authenticity* (London New York: T&T Clark International 2012). A helpful brief overview of the arguments is provided in the first chapter of Michael J. Kok, *The Gospel on the Margins. The Reception of Mark in the Second Century* (Minneapolis: Fortress, 2015), 25–26.

9 The term "equiprimordial" is the literal translation of Heidegger's *gleichursprünglich* and has been introduced to Biblical scholarship by Werner H. Kelber. In his essay "Anfangsprozesse der Verschriftlichung," (1992) he says with reference to A .B. Lord, *The Singer of Tales*: "that concepts such as 'Urtext' or 'Urwort' do not conform to the reality of oral composition" (16) and concludes "we, as the ones used to assuming one unique origin, in case we seriously want to put ourselves in the position of Jesus's linguistic reality, have to think through Heidegger's concept of 'equiprimordiality.' Each of Jesus's spoken words was 'equiprimordial' to his other spoken words. If one word was proclaimed three times, these words were not three versions of the one 'Urwort,' but three 'primordial' proclamations. Only scribality provided the opportunity to distinguish between a primary text and secondary versions." Werner H. Kelber, "Die Anfangsprozesse der Verschriftlichung im Frühchristentum," *ANRW* 26.1:3–62. Part 2, Principat, 26.1, ed. Hildegard Temporini and Wolfgang Haase (New York: de Gruyter, 1992), 1–63.17, translation SH.). See also Werner H. Kelber, "The Works of Memory: Christian Origins as MnemoHistory – A Response", in *Memory, Tradition, and Text: Uses of*

It is only after the invention of the printing press that identical copies of texts were available and soon became the standard – with profound consequences for the study of the bible: “As more and more texts were standardized, something suggested itself which in that form had never existed before: *the standard text* (...) As the print edition of the Greek New Testament, mechanically constructed and copied in steadily growing numbers, flourished in terms of prestige and influence, it came to convey the impression that it was the one and only text.”¹⁰ The consequences of this development still govern much of the scholarly reading: “Based on this concept of the *textual archetype*, a categorical thinking in terms of originality versus derivativeness, and primary versus secondary textual status penetrated the scholarly thinking of New Testament studies. To this day it provided the rationale for the construction of the critical editions, the stemmatological model of text criticism, the concept of early Jesus tradition, and the Quest of the historical Jesus sayings.”¹¹

The quest for a quote’s *Vorlage* links up with this problem, as it tends to operate within the same mindset. The not infrequent line of argument is that a faulty quotation is due to a flawed *Vorlage* or the author is falsely quoting from memory. In a recent contribution, Andrew Montanaro “proposes that the peculiarities of the OT quotations in John’s gospel can be described in terms of memory variants, ultimately showing that John was recalling the OT from memory”¹². His paper is a typical example for the attempt to apply memory theory to the area of intertextuality, production of gospels and handing down of traditions, whilst working with the assumption of stable Old Testament traditions, hence a difference between the New Testament use and the source can be established. Stating that “half of the Old Testament quotations in John’s gospel vary from their source texts”¹³, Montanaro insinuates that these source texts are available for comparison, which is not the case. The idea of assigning the differences between the source and the quotation to the New Testament author and his mental capacity (within the average fault tolerance of human memory that is widely researched) is missing the point as it works from the wrong assumptions. It is not only human memory that is fluid, but also the

the Past in Early Christianity, ed. Alan Kirk and Tom Thatcher, SemSt 52, (Atlanta: Society of Biblical Literature, 2005), 221–248, 237.

10 Kelber, “Gutenberg Galaxy”, 9 (emphasis original).

11 Kelber, “Gutenberg Galaxy”, 10 (emphasis original).

12 Andrew Montanaro “The Use of Memory in the Old Testament Quotations in John’s Gospel,” *NT* 59 (2017): 147–170, 148.

13 Montanaro “The Use of Memory”, 147.

textual tradition from the Old Testament.¹⁴ The possibility that the quote has been deliberately altered is usually not even considered, although this scenario is much more likely than the other two, once you accept the different rules in oral societies: “Scripture” (γραφή) or “written” (γέγραπται) does neither indicate “carved in stone” nor are the written sources completely stable.

What makes things even more difficult is the fact that the New Testament traditions – be they oral or written – are not stable either, as the discipline has recently been reminded of by Matthew Larsen in his book “Gospels before the Book”. On the background of a profound knowledge of text production and reception in antiquity, especially the first century CE, Larsen shows that even what we receive to be published *books* due to our own standards, must be understood differently in their original first and second century contexts: “One cannot distinguish between the fundamental tools of traditional historical criticism of the gospels such as redaction, source, and textual criticism without ideas like book, author, and publication. Yet all such ideas are foreign to the earliest centuries of the Common Era.”¹⁵ The result of his study is a confirmation of what recent textual criticism has been preaching to the scholarly congregation for quite some time now: Oral and written texts are subject to much greater variety than the standard historical critical position would tolerate, and this is not the exception, but the rule. Larsen’s focus on *hypomnemata* as a rather fluid genre on the transition from oral to written bearing more the characteristics of the former than the latter takes the issue one step further.¹⁶ The discussion what it might imply to understand Mark’s Gospel along with the Patristic textual evidence as *hypomneuma* is only beginning and has the potential to shatter the historical-critical consensus about Mark from a quite unexpected angle.

The idea of a “second orality” was a first step into the right direction but it is not enough for investigating what goes on behind the scenes of intertextual references. Our concepts need to be revised as well. *Testimonia*, one of the suggested solutions for seemingly flawed quotations like the one in Mark 1:2–3, is one of them. Even if *testimonia* existed in Mark’s days, we would not know

14 This point has already been driven home for the Qumran texts by Eugene Ulrich, *The Dead Sea Scrolls and the Origins of the Bible* (Grand Rapids: Eerdmans, 1999).

15 Larsen, *Gospels before the Book*, 149.

16 For an initial idea of *hypomnemata* as a particular textual form, cf. Larsen’s notes: “*Hypomnemata* lack ‘order’ (*taxis*) and are unfinished, unpolished and uncorrected. It is one of their characteristics, and not a flaw. Adding order to notes is an integral part of turning them into polished pieces of writing.” Further: “*Hypomnemata* were textual objects with a specific purpose. At their root, they are about remembering the already known, not informing about the not yet known.” Larsen, *Gospels before the Book*, 107.112.

what purpose they served in an oral culture. The assumption that they were collections of proof-texts or arguments might as well reflect the ideas of later generations and their theological issues which are projected back in time. In addition, we might once more be dealing with the problem of applying the standards of the Gutenberg eras to antiquity. In the early days, *testimonia* – if they existed – might have been nothing more than *aide-memoire* and could have played a variety of different roles in oral discourses. Whether they indeed existed in New Testament times is highly debatable. The first *testimonia* we can safely lay our hands on are as late as Cyprian of Carthage which brings us safely into the first half of the third century and at least hundred away from the New Testament authors. From a social memory point of view, inventory-taking and methodical presentation of important traditions – key pieces of what the early Christians have established as new frames for identity construction – of a manageable size is not surprising, thus the genre of *testimonia* fits very well into that later period.¹⁷

2. Theorizing about a Social Memory Theoretical Approach to Intertextuality

My suggestion is to broaden the scope and perceive intertextuality in the greater picture of cultural memory where it is one particular way of interacting with given cultural frames. With regard to media-theoretical or media-historical considerations this might be a more precise way to handle the concept and avoid the assumption of stable and unalterable traditions and texts prior to the Gutenberg Bible.

Let me present a first set of ideas of what changes when intertextuality is seen and used in the broader framework of social memory theory/

17 Cf. Pierre Jay, "Jesaja," *RAC* 17 (1996): 764–821. Jay terms the *testimonia* "eine Art Bestandsaufnahme u. methodische Darstellung der Schriftzitate (...), die im 3. Jh. im Dienste des christl. Glaubens klassisch geworden waren. (...) Cyprians *Testimonia* bestätigen, daß J. in der Zeit, in der systematische J.kommentare aufzutreten beginnen, als messianische Prophet par excellence galt, der Christus ebenso wie die Verwerfung Israels und das Heil der Heidenvölker vorausgesagt hat" (803–805). Herbert Haag, "Der Gottesknecht bei Deuterocesaja im Verständnis der Alten Kirche," *FZPhTh* 31 (1984): 343–377, 368, however, concludes that it is Cyprian who compiles "jene Blütenlese von Bibelstellen, die er für die Auseinandersetzung mit den Juden und für die Christologie" (368), which seems to imply a creative act on part of Cyprian, not simply a putting together of traditions handed down to him.

kulturwissenschaftliche Gedächtnistheorie.¹⁸ I begin with Tom Hatina's insight that by taking intertextuality seriously, the recipient himself becomes a participant in the tradition. Individuals or groups make use of intertextuality with the purpose of orientation, expression or creating a sense of familiarity and belonging. That is fairly close to what social memory theory is about.

The overall goals of investigating intertextual references from a social memory perspective are: a) analyzing how tradition and identity are negotiated and adapted to new situations, b) investigating how *cultural memory* (or in a more Halbwachsian way of phrasing it: social and cultural *frames*) are used to create meaning and c) how this changes in the course of time (by taking intertextual dispositions as uses of cultural frames as indicators for these processes). In short: the goal of the enquiry is to find out more about Early Christian identity formation.

Intertextuality from a social memory perspective does not wonder about the fluency of particular New Testament and Early Christian authors in their tradition (no mirror-reading), but analyses the presence (and absence!) of intertextual dispositions with regard to the pragmatics of the book in question. The alleged lack of particular references very often turns out to be due to the genre, target audience or pragmatics of a given text. There is little point for someone like Paul to use the Old Testament for making a point in a gentile audience, as long he is not confronted with an argument building scripture as it is the case e.g. in Galatians.

In general, intertextuality seen from a social memory perspective broadens the scope and moves from mere *text-text-relations* to the *reception of antecedent traditions which are in a broader sense related to the medium 'text'*. We are still dealing with text, but with texts seen in a broader cultural context. The main difference is that a social memory perspective on intertextuality does not look at isolated incidents or occurrences of Scripture in individual New Testament pericopae, but at larger portions of both hyper- and hypotext. One of the basic assumptions both for hermeneutics and method is that no text and no intertextual disposition is an island, but has to be considered both in its socio-cultural and literary context. Thus the quotes of Isaiah in Mark 1:2–3, 4:12, 7:6–7 and 11:17 not treated individually, but as connected phenomena within the use of Isaiah as a cultural frame in Mark.

18 For a brief survey of the differences in terminology and theoretical background of the two cf. Sandra Huebenthal, "Social and Cultural Memory in Biblical Exegesis: The Quest for an Adequate Application," in *Cultural Memory in Biblical Exegesis, Perspectives on Hebrew Scriptures and Its Contexts* 17, ed. Pernille Carstens, Trine Hasselbalch and Niels Peter Lemche (Piscataway, NJ: Gorgias, 2012), 171–216, 177–179.

For the socio-cultural context this implies awareness of an extended universe of texts and contexts in the background. Each cultural utterance, be it oral, textual or materialistic has to be seen in relation to its cultural context and engages with its religious and socio-cultural framework. In social memory theory this is called “cultural memory”. Although cultural memory *also* consists of texts, it is never *only* a textual entity, but the whole of tradition, ritual, text etc. referred to in a given social entity. It is important to keep in mind that first century cultural memory and socio-cultural frames change *and* differ from those of our own times. It might seem to be a commonplace, but the danger that the frames and questions of the researcher are injected into the texts is disturbingly real.¹⁹

For the literary context this implies that entire books have to be considered when investigating intertextual relationships. The literary context of the entire biblical book is a text’s context, not just the pericope or a reconstructed pre-stage of a particular text. The tendency to neglect literary contexts has been one of the blind spots of historical-critical exegesis. On the working level this means a thorough synchronic analysis of the entire text. Intertextuality is not about counting the quotes and allusions, but about how a text engages with another text. This means moving beyond the investigation of the individual reference the individual verse from Scripture and broadening the focus to further points of connectivity between the two texts in question, e.g. further allusions, motifs, etc.²⁰

19 This danger is lurking in almost all contexts of reading the Bible and all areas of exegetical research, cf. the general observations of John S. Kloppenborg, “Disciplined Exaggeration. The Heuristics of Comparison in Biblical Studies,” *NT* 59 (2017): 390–414; the assumption of Michael W. Holmes, “Dating the Martyrdom of Polcarp” *EC* 9 (2018): 181–200, 196 “Many (probably most) histories of the New Testament canon share a common weakness, namely a teleological perspective. They conceptualize the story of the New Testament canon from the perspective of its outcome: they know how the story ends and work from there back to its beginning. This leads to the tracing of a single line of development as though it were somehow ‘natural’ and inevitable, and no notice is taken of the other possible directions in which the whole process might have gone”; or the conclusion of Thomas R. Hatina, “Memory and Method: Theorizing John’s Mnemonic Use of Scripture” in *Biblical Interpretation in Early Christian Gospels: Volume 4: The Gospel of John*, ed. Thomas R. Hatina (London T&T Clark 2019), 219–236, 221: “In many cases, practitioners of diachronic approaches fail to advance a theory of transmission or simply assume one that is consistent with their emic framework”.

20 Cf. Sandra Huebenthal, “Wie kommen Schafe und Rinder in den Tempel? Die ‘Tempelaktion’ (Joh 2,13–22) in kanonisch-intertextueller Lektüre,” in *Intertextualität: Perspektiven auf ein interdisziplinäres Arbeitsfeld*, ed. Karin Herrmann and Sandra Huebenthal. (Aachen: Shaker, 2007), 69–81.

The fluidity of tradition in an oral setting also affects the “form” of intertextual relations. While form critical analyses are keen on tracing the sources of intertextual relations in order to find out more about the route a tradition has taken, they have difficulties with altered traditions and quotes that cannot be safely traced back to a clear source or are significantly different from it. While the standard assumption of form critical approaches to this phenomenon is a flawed *Vorlage*, the use of a (equally flawed or altered) *testimonium* or the author quoting for memory, the social memory theoretical approach to intertextuality takes a different turn. Understanding intertextuality as a phenomenon of making sense within given cultural frames, it is accounting for and expecting a creative use of this tradition and, in turn, for changes. This creative approach is an important part of identity formation by means of dealing with cultural frames. If the cultural frames and pattern are used to make sense of new experiences, these new experiences will over time become part of a group's tradition – and in turn change the initial frame. It is not surprising that a change in understanding affects the wording of the frame – in our case a quote from Scripture. Such a change of wording is especially to be expected in oral societies with a less closed concept even of written texts and of great heuristic value.

Approaching intertextuality from a social memory perspective, it could further be expected that alterations of the tradition in quotes from Israel's Scriptures, i.e. changes in wording, conflation of quotes, reading motives against the grain or creative new combinations of different motifs, happen more frequently in externalizations from collective memories than remnants from social memory. Building on the findings of Maurice Halbwachs it makes sense to assume that the fabrication of new frames for understanding in collective memory also alters the tradition they refer to. Thus, the question about the form of a particular intertextual reference and whether it deviates from its source is only the beginning and calls for further explanations. Determining the form of an intertextual relation says as little about its meaning as determining the genre of a particular text. It can, however, be a point of departure for further explanations.

Intertextuality from a social memory perspective finally assumes a different pragmatics. It does not think in categories of promise/fulfilment, but sees the use of the fulfilment-language as a strategy to inscribe or locate a particular interpretation in an existing tradition and thus as a strategy to become part of this tradition. This refers both to traditions with canonical or quasi-canonical status (as it is the case for Israel's Scriptures in Second Temple Judaism) and later to Early Christian texts referring back to New Testament text (as it is the

case for some of the later apocrypha). Tobias Nicklas has recently demonstrated this strategy convincingly for the Acts of Titus.²¹ The formula “this happened to fulfil the scripture” is thus an attempt to place or locate one’s experience and ideas in the existing tradition. Depending on the medium of communication, the temporal distance to the events or experience or the pragmatics of a particular text, this dealing with traditions has different phases and faces.

The huge benefit of analyzing intertextuality from a social memory perspective is that, because of its hermeneutical foundations which include sensitivity to both orality and changing contexts, it is much more flexible than other concepts. The recourse to previous traditions necessarily changes over time and this change must be taken into consideration. In social memory theory, the ever-changing *temporal horizon* of the groups is accounted for: The temporal (and local) distance of early Christian groups to the foundational events of Christianity almost necessarily implies alterations of terms, concepts and contexts. “Εὐαγγέλιον”, to use an obvious example, has a different meaning in the times of Paul, Mark, John, Justin, Marcion and Origen. While Paul would have understood it as the living proclamation (and rather used it as a verb), Mark with his written εὐαγγέλιον paves the way for a religious textual genre and the reception of Mark, by the later Synoptics as well as the Gospel-titles in the second century bear witness to this development.

This also means that the same text-text-relation, to use intertextual terminology, might denote different things in different texts and times. As all cats look alike in the dark, from the temporal distance of roughly two thousand years the use of the Old Testament in the New looks very much alike for the different books. A closer look at the texts, however, reveals that this is not the case and that there were been significant changes of meaning within a span of only a few decades. Especially with a growing temporal distance from the foundational events and texts reflecting their meaning for the early groups of Jesus followers, some ideas have already become traditions themselves. This means that what Paul or Mark was still struggling with might have become consensus and be referred to as *tradition* only a few decades later. Traces of this development can be found in the latest writings of the New Testament, and will become manifest in post-New Testament times.

21 Tobias Nicklas, “Die Akten des Titus: Rezeption ‘apostolischer’ Schriften und Entwicklung antik-christlicher ‘Erinnerungslandschaften,’” *EC* 8 (2017): 458–480.

3. Before the Floating Gap: Isaiah as a Cultural Frame in New Testament Texts

My first case for testing these theoretical assumptions was Isaiah and I began my research with an analysis how the prophet and his book feature in Mark's Gospel.²² Does Mark use Isaiah for proof-texting?²³ Does he use Isaiah's theological themes and schemes? How much of Isaiah does he use at all? And, finally, how does Isaiah emerge on the surface of gospel?

3.1 *The Reception of Isaiah in Mark*

A thorough investigation of the occurrence of Isaiah in Mark has brought me to the conclusion that the *beginning of the gospel of Jesus anointed Son of God, as it is written in Isaiah, the prophet* is not just a falsely ascribed quotation or a composition principle, but the most important frame the gospel offers to understand Jesus. The text depicts Jesus to be the *anointed Son of God*, God's final eschatological messenger who proclaims the arrival of God's reign as it was already prophesied in Isaiah and accompanied by the circumstances anticipated there: the eyes of the blind are opened, the ears of the deaf are first stopped, then unstopped, the lame walk and there is shouting for joy, because the tongue of the dumb is loosened. The two most prominent categories or titles to understand Jesus in the gospel's opening, *χριστός* and *υἱὸς τοῦ θεοῦ*, are also the two categories of reception that offer most connectivity for non-Jewish audiences. The gospel leaves no doubt, however, that they must be read in the light of and through the prophecy of Isaiah. Mark's proclamation of Jesus is framed in categories of and with regard to the prophet Isaiah.

Making visible the Isaian frames in Mark's gospel helps to understand how the text itself provides frames for understanding Jesus. Read as an externalization of collective memory and thus placed between the *generational gap* and the *floating gap*, the Gospel according to Mark does not only negotiate

22 Sandra Huebenthal, "The Gospel of Mark". in *Jesus Traditions in the First Three Centuries. Vol. 1: Gospel Literature and Additions to Gospel Literature*, ed. Chris Keith, Helen K. Bond, Christine Jacobi, and Jens Schröter (London: T&T Clark 2019), 41–72; Sandra Huebenthal, "Kollektives Gedächtnis, Kulturelle Rahmen und das Markusevangelium," in *Reading the Gospel of Mark in the Twenty-First Century*, BETL 301, ed. Geert van Oyen (Leuven: Peeters 2019), 217–250; Sandra Huebenthal, "Framing Jesus and understanding ourselves. Isaiah in Mark's Gospel and beyond," in: *Creative Fidelity, Faithful Creativity: The Reception of Jewish Scripture in Early Judaism & Christianity*, ed. Michael A Daise, and Dorota Hartmann (Naples: Unior Press, 2022), 209–47.

23 For reasons of convenience, I continue to use the traditional view of a one tangible author behind this text without making a claim that this is what happened behind the scenes of this text.

different frames, but by suggesting a particular way to make sense of the Jesus event it allows for collective identity constructions on that basis.²⁴ This does not exclude the possibility of a *different* perception of Jesus, e.g. as a returned Moses or Elijah (*redivivus*). It is indeed possible to understand Jesus as a prophet, Son of David or royal aspirant, but the people behind Mark's gospel express a different perception: at this time, in this place and in this text, Jesus is understood to be *the anointed Son of God according to Isaiah's prophecy*.

As regards methodology, the investigation of Isaiah in Mark also shows that the connection of narrative and intertextual analyses for reading an entire biblical book in a social/cultural memory theoretical perspective does not only help uncovering the book's theological profile, but also discloses which cultural frames are used to structure and organize memories of Jesus and which cultural frames are not (or no longer) used. For those standing behind the text, Mark's Gospel does not say, who Jesus *was*, but with the help of an Isaiah framework discloses who Jesus *is*. I would not be surprised if understanding Jesus as *God's anointed son* in terms of Isaiah was an identity marker of the group that gathered around the Gospel according to Mark.

The clear result of my investigation is that Mark's use of Isaiah is not about theological schemes or about naïve proof-texting, but rather about making sense of what happened on the basis his own cultural tradition or framework. The way Isaiah features in Mark rules out the idea that Mark has worked off particular topics and used a testimonium of proof-texts to get his message across.

With this in mind, an intriguing set of subsequent questions arose almost instantly: How does the story of Isaiah as a cultural frame continue in early Christianity? Do other New Testament writings exhibit a similar importance for and use of this particular text? Do they use the same parts of Isaiah in the same way? How does the reception of Isaiah and of the Christ event framed in terms of Isaiah change in the first generations of Jesus followers?

3.2 *Isaiah as a Cultural Frame*

Biblical scholarship has convincingly shown that in Second Temple Judaism in general Isaiah was widely used as a lens or a frame to understand one's own situation. The first generations of Jesus followers are part of this bigger picture and their handling of Isaiah is not an exception. Knowledge of Isaiah and

24 For a detailed discussion of this concept and its theoretical foundation in the work of Maurice Halbwachs and Jan and Aleida Assmann, cf. Sandra Huebenthal, *Das Markusevangelium als kollektives Gedächtnis*, FRLANT 253 (Göttingen: Vandenhoeck & Ruprecht 2018).

Isaian frames were current among the first generations of Jesus followers and they would have discussed their experiences with the help of these traditions. Some parts of Isaiah might have been introduced into the discourse of the first generations of Jesus followers already by Paul,²⁵ and not only Mark will have picked up current traditions and developed them further.

The process might have been different from the way it is often envisioned: if we mentally move from the authorial mastermind to a vital group this also renders it more plausible that debates have taken place among Jesus followers in different groups in the first generations of Christianity before the ideas were finally put to page. One key to a better understanding is to think less in terms of academic writing than in oral or even pastoral terms.²⁶ Mark then ceases to be a one-man-show and a lone genius author who gathered traditions quietly in his study or met other early Christian missionaries and preachers with whom he shared his knowledge, before he wrote the book to instruct his community.

The Pauline letters vividly portray smaller groups who were deeply engaged in worship, discussion and (missionary) work. Making sense of what they have experienced and how it informed their understanding of both themselves and the world was not left to the leaders of the group who informed the others about their decision, but a mutual and open process in which everyone was involved. In the end, the house group (*Hauskreis*) or bible study groups we know from our own times might be of much greater avail to get an idea how texts like Mark's Gospel came about and made use of socio-religious and cultural frames for understanding than the common idea of the community leader or evangelist acting all by himself.²⁷

A plausible scenario for the development in the next generation could look like this: Over time, the composition of the groups of Jesus followers changes. This is not only due to a larger temporal and, in most cases, spatial distance

25 Cf. Dietrich-Axel Koch, "The Quotations of Isaiah 8,14 and 28,16 in Romans 9,33 and 1Peter 2,6,8 as Test Case for Old Testament Quotations in the New Testament," *ZNW* 101 (2010): 223–240, 240.

26 In his *Forschungsüberblick* to the Gospel of Matthew, Matthias Konrad has proposed a related scenario regarding the formation of Matthew. He proposes a longer reflection process of the group behind the gospel together with the evangelist. This process reflected both (oral) traditions and scripture and was only eventually textualized. Cf. Matthias Konradt, "Die Rezeption der Schrift im Matthäusevangelium in der neueren Forschung," *ThLZ* 135 (2010): 919–932.

27 This parallel only works by approximation. In the first groups of Jesus followers, members would, of course, not have had their own bibles which they brought to the meetings. Here, the parallel might rather ring with the experiences of smaller communities with Bible-Sharing in Latin America or South Africa or the communities in the context of Liberation Theology.

from the Christ event, but also due to the fact that the groups become more variegated over time and more non-Jews join them. Another area of influence is the modified social environment of these groups, including different locations within the Roman Empire. We also have to take into account incidents like the Jewish-Roman War, the destruction of the Second Temple and the death of the first generation of Jesus followers.

A typical answer to all of these changes would be adjustments of the founding stories and identity forming patterns of the groups. In the case of references to Isaiah it could be expected that the influence of this particular *frame* diminishes with more non-Jews joining and dominating the groups. As Isaiah is not part of their own cultural memory, we would not expect to find a network of mostly unflagged references to an important text from the Jewish tradition in writings of the third generation of Jesus followers. It seems more likely that the groups retain references to Isaiah in a modified form which on the one hand respects the impact Isaiah's prophecy had for the first generations of Jewish Jesus-followers, and on the other hand takes into account that most of the members of the group(s) do not have a living connection to this tradition and will thus not be able to detect even the most obvious allusion.

One scenario could thus be that only a few "typical" points of reference from the book of Isaiah will be quoted in later texts and that they will over time turn into genuine "Christian" points of reference which are used and quoted without regard to their original context. Candidates for this scenario are Isa 6:9–10; 40:3; 61:1 or Isa 53, given that these quotations seem to feature prominently in the New Testament. It is easy to see that this scenario could also embrace the idea of *testimonia*. The idea behind this scenario still rings with form-critical investigations which do consider the individual quote without assuming the entire book of Isaiah to be the larger frame. A second scenario could be that the Isaian frame is retained, but has to be explained to those who are not familiar with it. In this case one could expect a similar amount of references to Isaiah, but with marking and explanation why it is important.

It is easy to visualize the scenarios: a survey of quotations of and allusions to Isaiah reveals whether the use of the book decreases on average and it is more or less the same quotations or clusters of references that occur to address the same questions and they all exhibit a similar (proto-)Christian connotation. The first insight from a survey of the use of Isaiah in the New Testament is that Isaiah seems to retain its significance. A cumulative visualization of the quotations of and allusions to Isaiah in the New Testament emphasizes this notion, as it is shown in table 4.3.²⁸

28 This visualization is built on data of Nestle Aland²⁸'s *Loci Citati Vel Allegati*, Steve Moyise and Marten J. J. Menken (Ed.), *Isaiah in the New Testament* (London, New York:

Table 4.3 Quotations of and allusions to Isaiah in the New Testament I

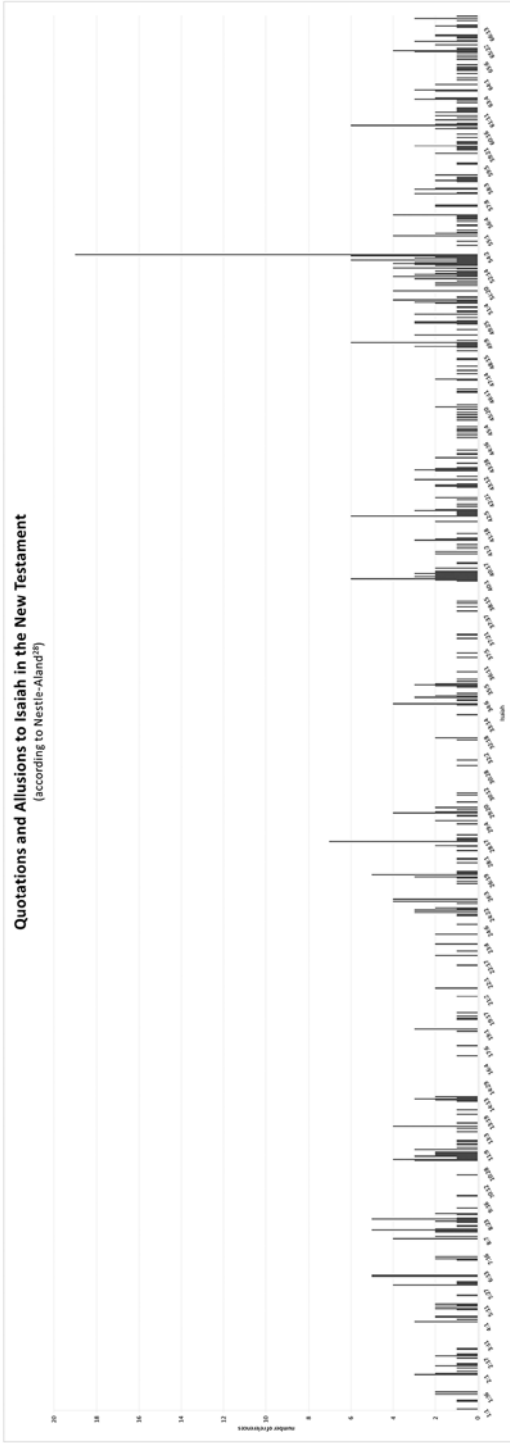

Although the exact number for the amount of identified references varies from source to source, Isaiah is undoubtedly the most frequently quoted text and text alluded to from the Hebrew Bible after the psalms.²⁹ A survey of the quotations from Isaiah in the New Testament indicates that the name “Isaiah” is only mentioned in the narrative texts and in Paul’s letter to the Romans. Although Paul makes use of Isaiah in all of his letters, he only mentions the name of the prophet in Romans, and with one exception (Rom 15:12) all of the quotations directly assigned to Isaiah occur in Rom 9–10 (9:27.28; 10:16.20.21).³⁰

A visualization of the estimated quotations of and allusions to Isaiah in the New Testament, broken down to the book and going beyond the direct quotes indicates as it is carried out in table 4.4, however, that things are not as easy as initially thought.³¹

Bloomsbury, 2005); Florian Wilk, “Die Geschichte des Gottesvolkes im Licht jesajanischer Prophetie: Neutestamentliche Perspektiven,” in *Josephus und das Neue Testament: Wechselseitige Wahrnehmungen: II. Internationales Symposium zum Corpus Judaico-Hellenisticum, 25.–28. Mai 2006 Greifswald*, WUNT 209, ed. Christfried Böttrich und Jens Herzer (Tübingen: Mohr Siebeck 2007), 245–264.

29 See e.g. Cf. Wilk, “Geschichte des Gottesvolkes,” 248, or Craig A. Evans, “From Gospel to Gospel: The Function of Isaiah in the New Testament,” in vol. 2 of *Writing and Reading the Scroll of Isaiah: Studies of an interpretative Tradition*, ed. Craig C. Broyles and Craig A. Evans (Leiden: Brill, 1997), 651–691, 651.

30 Even though Paul has quoted Isaiah already in his earlier letters, he only mentions the name in Romans, distinguishing him from other voices in Israel’s Scriptures like Moses and David, cf. Florian Wilk, “Paulus als Nutzer, Interpret und Leser des Jesajabuches,” in *Die Bibel im Dialog der Schriften: Konzepte intertextueller Bibellektüre*, NET 10, ed. Stefan Alkier and Richard B. Hays (Tübingen/Basel: Francke, 2005), 93–116, 96.

31 This visualization based on the *Loci Citati Vel Allegati* of Nestle Aland²⁸ can only provide a first and very coarse sketch and needs a much more thorough investigation.

Table 4-4 Quotations of and allusions to Isaiah in the New Testament II

Quotations and Allusions to Isaiah in the New Testament
(according to Nestle-Aland²⁸)

The impact of the Hebrew Bible does not diminish with more non-Jews joining the early groups of Jesus followers, nor do references to Isaiah generally decrease. It also does not imply that they are marked more clearly and/or are reduced to a set of “typical” references which are used to address particular topics. Once one goes beyond mere scratching the surface, it becomes clear that for the groups behind the New Testament texts Isaiah remains an important frame of reference. The trend might rather be that *if* Isaiah is mentioned and directly referred to, the book serves as a hermeneutical frame beyond the actual quotations and there is usually more of Isaiah to be found than the quotation (esp. Paul, Mark, Matt, Luke/Acts; John and 1 Peter). At least in one point the prediction proves to be correct: In cases where Isaiah is not directly referred to, no Isaian frame is found either (Deutero-Pauline letters, 1–3 John, Jude, 2 Peter). Hebrews and Revelation are special cases as they use the whole body of the Hebrew Bible as a frame of reference.

A closer look at the Gospel of Luke as a second test case also shows that the Isaian framework does not become less important or less visible.³² Quite the contrary: A closer reading reveals that the Isaian frame in Luke is not less prominent than in Mark, but only different in character. Luke’s Isaian frame is not only much more visible also to non-Jews it is also explained much better. Even those who do not know Isaiah will learn something about the prophet’s message and why it is and will remain important for the groups of Jesus followers. Those who are from a Jewish tradition will find Isaiah to be not only one of the main points of reference when it comes to a proper understanding of Jesus, but also the main point of reference to explain their own situation. Both the mixed communities of Jews and Gentiles and the rejection of this project by many members of Israel, seem to be predicted in Isaiah, up the fact that the anointed Son of God and eschatological messenger of God’s kingdom is ‘numbered with transgressors’ (Luke 22:37, quoting Isa 53:12). Contrary to initial expectations, Isaiah remains important for the groups of Jesus followers, whom we might call “Christians” according to Acts 11:26 now. In both Luke and Acts the message to the Gentile newcomers seems to be: The prophet Isaiah and his message might not have been part of your cultural heritage and tradition before you encountered Jesus, but *now* that you *are* Jesus followers, it has

32 Cf. Sandra Huebenthal, “Another Frozen Moment. Reading Luke in social memory theoretical framework,” *PIBA* 41/42 (2019): 23–43; Sandra Huebenthal, “Canon or Cultural Frame? Identity-Construction according to Luke,” in *Relationships of the Two Parts of the Christian Bible*, OSJCB 3, ed. Georg Steins, Philip Sumpter and Johannes Taschner (Göttingen: Vandenhoeck & Ruprecht, manuscript submitted).

become part of your tradition for otherwise it is impossible to understand both Jesus *and* the situation of the groups of Jesus followers.

3.3 *Further Questions and More Probes: Isa 52:13–53:12 in the New Testament Traditions*

It is obvious that the assumption, references to Isaiah decrease in number and range and/or become more stereotypical because the groups of Jesus followers have more non-Jewish members, is wrong – at least for New Testament times. A survey of references to Isaiah in the New Testament combined with a very preliminary analysis of the texts is sufficient to prove that this is not the case. It becomes likewise clear that the investigation of Isaian frames in New Testament requires more than counting and listing quotations, allusions and echoes and asking whether they have been quoted correctly. The use of different parts of Isaiah further exhibits a deep knowledge and living connection to the book of Isaiah on part of those who stand behind the New Testament. They turn to Isaiah to find answers to their situations and these answers differ over time.

The solution to this riddle might be found elsewhere and, again, social memory theory can prove helpful. It might turn out that the initial ideas – both the change in composition of the groups that must somehow bring about changes and the emergence of *testimonia* – are correct, just the temporal framework did not fit. As the discussion about the “Parting of the Ways”, which has recently become rather a “party of the ways”³³, has shown, the date of the estimated break around 70 or 130 CE was way too early, and the same applies to our question, too. The solution seems to be that the shift is both a matter of genre *and* time. From a social memory perspective, the assumption that things would change already in the second and third generation, is too early. Greater changes should rather be expected beyond than before the *floating gap* (80–120 years after the founding event) than beyond the *generational gap* (30–50 years after the founding events).³⁴

33 Tobias Nicklas. “Parting of the Ways? Probleme eines Konzepts”, in: *Juden, Christen, Heiden? Religiöse Inklusion und Exklusion in Kleinasien bis Decius*, WUNT I 400, Ed. Stefan Alkier and Hartmut Leppin (Tübingen: Mohr Siebeck 2018), 21–41, here 37–38 and Tobias Nicklas, *Jews and Christians? Second-Century ‘Christian’ Perspectives on the “Parting of the Ways”*, Annual Deichmann Lectures 2013 (Tübingen: Mohr Siebeck 2014).

34 For a more nuanced introduction to the different epochs of early Christianity in a social memory theoretical framework cf. Sandra Huebenthal, “Frozen Moments’ – Early Christianity through the Lens of Social Memory Theory”, in *Memory and Memories in Early Christianity*. WUNT I 398, ed. Simon Buttica and Enrico Norelli (Tübingen: Mohr Siebeck 2018), 17–43.

A third and more specific test dealing with Isaiah 52:13–53:12 can illustrate the idea. The direct quotations of the fourth servant song demonstrate how different cultural framing in form of intertextual disposition operates before and after the *generational gap* as well as the *floating gap*.

Paul and his use of Israel's Scriptures as a cultural frame take place before the *generational gap*. The expectation is that he will use cultural frames like Israel's Scriptures to understand his own situation. This is exactly what we witness in his references to the fourth servant song in Romans 10:16 (Isa 53:1) and 15:21 (Isa 52:15). References to Isaiah are not used to make sense of Jesus and his fate, but of Paul's own situation, in which Gentiles turn to Christ and receive the Gospel he proclaims while Jews do less so.³⁵

The context of Rom 10:14–18 should be taken into account for the evaluation of the quotation: Isa 53:1 is used here in order to analyze and understand Paul's own situation of preaching the good news about Jesus and not the situation and destiny of Jesus himself. The point is that in Paul's days the message of the gospel is not embraced by everyone. In the previous verses we read a more general reflection about faith and the acceptance of the gospel, flanked by quotations from i.e. Isa 28:16 and 52:7. As the argument continues, Isa 65:1 and 65:2 LXX will follow in short sequence. It is obvious that this passage does not serve to depict Jesus as Isaiah's suffering servant. The same holds true for Rom 15:21. The quotation from Isa 52:15 LXX here, too, does not say anything about Jesus, neither as a person nor about his fate, but is used once more to analyze the current state of the proclamation of the gospel and explain his decision within the common frame of reference. In short: Paul makes use of Isaiah as a cultural frame to understand and explain his own situation.

This is not to say that we do not also see the attempts of Paul trying to make more general statements about the Jesus event and its impact on groups of Jesus followers in his days as well. The approach is, however, still in the

35 Paul uses the same quotes, Isa 53:1 (Rom 10:16) and Isa 6:9f (Rom 11:8) as John 12:38–40, but in a completely different way. They are not used to understand Jesus, but the situation Paul himself is in, cf. Florian Wilk, "Paulus als Nutzer", 93–116; and J. Ross Wagner, "Isaiah in Romans and Galatians," in *Isaiah in the New Testament*, ed. Steve Moyise and Marten J. J. Menken (London & New York: Bloomsbury, 2005), 117–132, 118. We are seeing an example from the textbook for the difference between social memory (making sense of experiences by using existent frames: Paul) and collective memory (fabrication of new frames: John) This is not to say that we do not encounter first instances of Paul trying to make more general statements about the Jesus event and its impact on groups of Jesus followers in his days as well. The approach is, however, still in the medium of everyday conversation. Paul uses Israel's Scripture to make sense of his situation but he does on average not try to make his own experience part of this tradition and, other than the narrative tradition, he does not use fulfilment quotations.

medium of everyday conversation. Paul uses Israel's Scripture to make sense of his situation but he does on average not try to make his own experience part of this tradition (no *Fortschreibung der Tradition*) and he does not use fulfilment quotations in the same way as we find them in the gospels.³⁶ Or, as Rafael Rodriguez has recently put it: "Alignment rather than replacement characterizes how Paul relates to Moses's Torah and Israel's Messiah."³⁷ Romans 1:2–4.17 serve Paul's attempt to make sense of what he encounters and does so in the light of the Jewish tradition without inscribing himself and his situation into this tradition. If we stick with Maurice Halbwachs' distinction between *social* and *collective* memory, we see an example from the textbook: social memory is described as localization within given (cultural) frames while collective memory is the fabrication of new frames for identity construction. Both can happen at the same time – which is also visible in Paul. The latter is, however, all the more likely beyond the *generational gap*.

The use of the fourth servant song in the time between the *generational* and the *floating gap* – the time we would expect externalizations of collective rather than social memory – exhibits exactly that: we are dealing with memory literature remembering both Jesus' and Paul's heritage, i.e. texts that extrapolate traditions. Other than Romans, the narrative tradition of the New Testament does not use Isa 53 to understand their own situation, but rather

36 Menken begins his study about the use of Scripture in Matthew with an instructive survey of the fulfilment quotations in the whole of the New Testament. Maarten J. J. Menken, *Matthew's bible: The Old Testament text of the evangelist*. BETL 173. (Leuven: University Press, 2004), 1–10.

In the Gospel according to Mark, the name "Isaiah" is mentioned twice and is each time preceding a direct quotation, thus two of the five quotations from Isaiah are directly ascribed to Isaiah (Mark 1:2–3; 7:6.7). The trend continues in the other narrative texts of the New Testament: In Matthew six of the ten quotations from Isaiah are directly assigned to the prophet (Matt 3:3; 4:15–16; 8:17; 12:18; 13:13–15; 15:8–9) and three of them are flagged as fulfilment quotations (4:15–16; 8:17; 12:18). In Luke two of the six quotations from Isaiah are directly assigned (Luke 3:4–6; 4:18–19), one of them can be regarded as a fulfilment quotation (4:18–19); in Acts two of five quotations are directly assigned (Acts 8:32–33; 28:26). In John, finally, three of the four quotations are directly assigned (John 1:23; 12:38.40, the fourth, 6:45 is assigned to a prophet), two of them are flagged as fulfilment quotations (12:38.40). None of the quotations in the narrative texts is marked as a fulfilment quotation more than once and the only two passages from Isaiah that are quoted in all of the gospels are Isaiah 6:9–10 (Mark 4:12; Matt 13:13–15; Luke 8:10, John 12:40 and Acts 28:16) and Isa 40:3–5 (Mark 1:2–3; Matt 3:3; Luke 3:4–6; John 1:23). Both quotations serve as fulfilment quotations in one of the gospels and the latter quotation is in all the gospels directly assigned to Isaiah. In the other books of the New Testament, the references to Isaiah go entirely unflagged, but not necessarily unnoticed.

37 Rafael Rodriguez, *Jesus Darkly. Remembering Jesus with the New Testament*. (Nashville: Abingdon Press 2018), 10 (emphasis original).

that of Jesus and his fate – the founding events of the groups of Jesus followers. The texts do indeed go a step further than Paul: Israel's Scriptures are not only the frame of reference to understand Jesus and what happened to him but the Christ event is framed as part of this tradition. We are encountering the inscription of the foundational experience of Jesus followers into the existing frames as *Fortschreibung der biblischen Tradition*. Jesus has been foretold and announced in the biblical prophecy and the New Testament narrative tradition shows how the story continues. It is in these texts that Jesus gradually becomes identified with the suffering servant, until Luke/Acts and John also paint Jesus' Passion in these colors.

Paul might have marveled at John's use of Isa 53:1.³⁸ While he used the same verse in Rom 10:16 to address the problem that parts of Israel rejected the gospel, John connects the idea in 12:38 with the application of the servant tradition to Jesus.³⁹ To put it differently: while references to Isa 53 in earlier texts do not transport the notion of substitution in suffering,⁴⁰ in John the allusions and echoes around the 'typical quotations from Isaiah' in John 12 provide a stable Isaian frame and speaks much more clearly about Jesus as Isaiah's servant as it is the case in Mark and Matthew.

The New Testament narrative tradition (and Deutero-Pauline letters as the extended Pauline tradition) set the course for Christian identity constructions with their fabrication of new frames for understanding. While Mark could be read as a first attempt, still very much indebted to social memory, Matthew, Luke

38 Paul uses Isa 53 neither in a Christological nor in a soteriological way but in order to understand his own mission, cf. Wolfgang Kraus, "Jesaja 53 LXX im frühen Christentum – eine Überprüfung," in *Beiträge zur urchristlichen Theologiegeschichte*, BZNW 163, ed. Wolfgang Kraus. (Berlin [u.a.]: de Gruyter 2009), 149–182, 167 and Dietrich-Axel Koch, *Schrift als Zeuge des Evangeliums. Untersuchungen zur Verwendung und zum Verständnis der Schrift bei Paulus*, BHTh 69, (Tübingen: Mohr Siebeck, 1986), 232–239.

39 Cf. Sandra Huebenthal, "Proclamation rejected, truth confirmed. Reading John 12:37–44 in a social memory theoretical framework", in *Biblical Interpretation in Early Christian Gospels: Volume 4: The Gospel of John*, ed. Thomas R. Hatina (London T&T Clark 2019), 183–200.

40 That also applies to the quotations of 53:4 in Matt 8:17, Isa 53:7 in Acts 8:32–33 and Isa 53:12 in Luke 22:3; as Kraus, "Jesaja 53 LXX" has demonstrated. The problem with Isa 53 and the servant tradition in general might be that later readers who know the Songs of God's suffering servant as a hermeneutical frame for Jesus from their own times, sometimes run the risk of 'finding' it already in early traditions of the New Testament. The application of the servant tradition to Jesus seems to be, in fact, a later tradition. The assumption that Isaiah 53 as a hermeneutical lens to understand Jesus' death is also supported by Johannes Woyke, "Der leidende Gottesknecht (Jes 53)," in *Die Verheißung des Neuen Bundes: Wie alttestamentliche Texte im Neuen Testament fortwirken*. BThS 35, ed. Bernd Kollmann (Göttingen: Vandenhoeck & Ruprecht, 2010), 200–225.

and John provide foundational stories that work existing tradition into a new model. Using the terminology of Kenneth Gergen, they are *stabilizing* narratives, while Mark with his open end must be seen as a *regressive* narrative.⁴¹ As externalizations from collective memory make use of existing tradition, those standing behind the Gospels have to be fluent in this tradition in order to capture and preserve it for the future. Recent studies about the use of Isaiah in the New Testament assume that the authors of the New Testament had knowledge of the entire text of Isaiah, not only individual passages. This assumption goes hand in and with a tendency of moving away from a simple scheme of promise and fulfilment when it comes to investigate the Old Testament in the New.

Florian Wilk has convincingly shown not only that Paul knew the whole book of Isaiah but also demonstrates a chronological (and theological) development of the apostle's use of the scroll.⁴² Marten J. J. Menken has shown the same for Matthew⁴³ and Rouven Genz in presents in his study the state of research for Luke-Acts which he supports.⁴⁴ Given the range of different quotations and allusions as they are also displayed in chart D, I would assume

-
- 41 Formation and Negotiation of identity seems to play an important role for narrative organization, especially for groups. Kenneth Gergen accentuated the basic narrative forms *stabilizing*, *progressive* and *regressive* as regards their interplay with human relations. While *stabilizing* narrative are an important means to achieve certitude, that the others are indeed what or who they seem to be, people in the initial stages of relationships rather tell *progressive* stories, to elevate the value of the relationship and establish larger promises for the future. *Regressive* stories, finally, usually fulfill a compensatory function. They either canvass for empathy or serve the purpose to (newly) raise the force and motivation to reach a certain end (after all). In each of these cases the story is not only told for its own sake, but to establish a particular self-perception (of an individual or a group). In the end these stories are also identity-forming; identity formation is though and through a discursive trait. Cf. Kenneth Gergen, "Erzählung, Moralische Identität und historisches Bewusstsein," in *Erzählung, Identität, Historisches Bewusstsein*, ed. Jürgen Straub (Frankfurt am Main, Suhrkamp, 1998), 170–202, 177–181.
- 42 Florian Wilk has carried out extended research in this area. Cf. Florian Wilk, *Die Bedeutung des Jesajabuches für Paulus*, FRLANT 179 (Göttingen: Vandenhoeck & Ruprecht 1998); Wilk, "Geschichte des Gottesvolkes"; Florian Wilk, "Jesajanische Prophetie im Spiegel exegetischer Tradition: Zu Hintergrund und Sinngehalt des Schriftzitats in 1 Kor 2,9," in *Die Septuaginta – Entstehung, Sprache, Geschichte. 3. internationale Fachtagung veranstaltet von Septuaginta Deutsch (LXX.D), Wuppertal 22.–25. Juli 2010*, WUNT 286, ed. Siegfried Kreuzer and Martin Meiser. (Tübingen: Mohr Siebeck, 2012), 480–504; or Florian Wilk, "Paulus als Nutzer", 115.
- 43 Menken, *Matthew's Bible*, 279–283.
- 44 Rouven Genz, *Jesaja 53 als theologische Mitte der Apostelgeschichte: Studien zu ihrer Christologie und Ekklesiologie im Anschluss an Apg 8,26–40*, WUNT II 389 (Tübingen: Mohr Siebeck, 2015), 1–16.

the same for Mark and John. This also means that the first generations of Jesus followers retained a living connection to the Jewish tradition. Obviously, they did not work with testimonies but used the whole of Isaiah's prophecy.

4. Beyond the Floating Gap: Hypothesizing about the Next Steps

The million-dollar question is hence: What happens in Early Christianity after the time of the New Testament – or, in the terminology of social memory theory: what happens beyond the *floating gap*? On the way there we encounter 1 Peter, a letter that also makes direct use of Isaiah 53. Its change in argument and tone compared to Paul and the narrative tradition is remarkable. The larger context of the quotation in 2:22–25 is 1 Peter 2:18–25. This passage provides the part of a *haustafel* that addresses slaves and suggests that their behavior should be oriented towards Christ himself. The passage contains for the first time a connection of several references to Isa 53 applied to Jesus' fate and death.⁴⁵ One could say that in 1 Peter we finally we find something like a first "Christian" tradition which draws from Christian, not Jewish frames.⁴⁶ The difference between 1 Peter and the Gospels seems to be not only due to genre but also to the question where the text originates in terms of temporal distance to the foundational event. Is it before or after the generational gap and before or after the floating gap?

Similar observations can be made for Justin and his first Apology directed to the emperor Antonius Pius and composed around 150/155 CE. As regards the temporal distance from the foundational events, this text, too, is located

45 1 Peter is an especially intriguing case as quotations in 1 Pet 2:6.8 (the only instances where quotations from Isaiah are introduced as scripture) seem to be depended on Rom 9:33, as Koch, Quotations of Isaiah has shown. The references to Isa 65:17 and 66:22 in 1 Peter 3:13 might as well be referring to or coming from Revelation 21:1. In 1 Pet 2:22–25, the author indeed seems to use a Christian tradition based on Isa 53 cf. Cilliers Breytenbach, "Christus litt eurentwegen: Zur Rezeption von Jes 53 im 1. Petrusbrief," in *Deutungen des Todes Jesu im Neuen Testament*, ed. Jörg Frey and Jens Schröter. (Tübingen: Mohr Siebeck, 2nd ed 2012), 437–454; Kraus, "Jesaja 53 LXX", 172–174.

46 This is not to claim that 1 Peter is no longer familiar with Isaiah, but that an intra-Christian discussion and tradition of Isaiah might be in operation. If this has to lead to the conclusion that "the author of 1 Peter seldom strays from the church's standard proof texts (Isa. 8, 11, 28, 40, 53) and is clearly indebted to much traditional exegesis" (Steve Moyise, "Isaiah in 1 Peter," in: *Isaiah in the New Testament*, ed. Steve Moyise and Marten J. J. Menken (London, New York: Bloomsbury, 2005), 175–188, 188) is, however, debatable. A detailed investigation of Isaiah in 1 Peter with regard to interpretative frames might prove to be quite fruitful and support that the author's "indebtedness to Isaiah is clear and goes beyond mere proof-texting" (*ibid.*).

somewhere around the *floating gap*. Without going into detail here, it can be safely said that Justin displays a remarkable reading of Isa 53:12 in 1 Apol. 50,2 which is not in line with either the Hebrew or the LXX version. Here, too, the question is where the seemingly distorted quote comes from and the suspicion is once more rather by that Justin made use of a *testimonium*, than that he creatively interacted with the cultural frame applying it to his own situation and modelling it according to his needs.⁴⁷ As noted earlier, this is exactly what could be expected in the times of *collective memory*, especially when it comes to an identity constituting text for an audience with presumably no Jewish heritage. As already suspected for 1 Peter, we might be witnessing the beginning of a “Christian” tradition.

Regarding the questions of intertextuality and the formation of traditions, research beyond the floating gap has not yet been carried out with a social memory theoretical approach to intertextuality. New Testament research in this area heavily relies on the findings of Patristic scholarship in order establish a first understanding and to chart some of the texts and discourses. This field requires a thorough investigation and will be subject to one of my next research projects. From what I have read and analyzed so far, first conclusions can be drawn.

The narrative tradition of the New Testament plays a crucial role, and it is first and foremost the gospels as *foundational texts* with their still debated literary genre that are the *game changers*. Beyond the floating gap, the text we now consider to fall into the literary genre “gospel”, i.e. narrative texts about the founding events of Christianity quickly obtain some kind of proto-canonical status. This can be gathered from the addition of *Evangelienüberschriften* in the mid-second century and their reception as religious genre that is best

47 Cf. Christoph Marksches, “Der Mensch Jesus Christus im Angesicht Gottes. Zwei Modelle des Verständnisses von Jesaja 52,13–53,12 in der patristischen Literatur und deren Entwicklung”, in *Der leidende Gottesknecht*, FAT 14, ed. Bernd Janowski and Peter Stuhlmacher. (Tübingen: Mohr Siebeck, 1996), 197–249. Marksches argues “Einige Beobachtungen am Text deuten darauf hin, daß Justin diesen Vers einem *christlichen Testimonium* entnahm und als Überschrift dem ganzen Abschnitt voranstellte, den der aus der LXX zitierte: Der letzte Versteil von Jes 53,12 = 1Apol. 50,2 ist gegenüber der LXX bemerkenswert verändert und ähnelt der späteren Formulierung des Targum Onkelos; am besten erklärt er sich als ein vorjustinianischer Versuch der Übersetzung des *masoretischen* Textes. Die übrigen Zitate aus Jes 52/53 entsprechen allerdings bis Kap. 51,5 vollkommen korrekt der LXX-Version. Obwohl Justin also wohl ein *Testimonium* verwendete, hat er trotzdem den Textabschnitt sehr selbständig und bewusst theologisch gestaltet” (211). The intriguing question is once more whether it is indeed necessary to assume a *testimonium* here instead of a creative dealing with the tradition or if this assumption simply mirrors a default research paradigm.

compared to *Scripture*. Or, phrased differently: regardless of their literary genre, their status as foundational literature of Early Christianity sets the course for their further use. The moment they are received as normative and formative foundational texts – *Scripture* or a cultural frame – it is no longer important whether their literary genre is bios, historiography, *hypomnemata* or something else.

In the second half of the second century, the gospels have gradually become normative and formative foundational texts and parts of Christian cultural memory. They provide stable frames for Christian identity construction(s). In doing so they have also preserved Israel's Scripture as part of Christian cultural memory. The ever-increasing authoritative character of the gospels is a clear indicator for this process and the gospel titles as well as the debates with Marcion testify to that. The preservation of Israel's Scriptures as part of the Christian cultural memory did not go without debates. The Patristic commentaries on Israel's Scriptures, however, do in their own way bear witness to the success of the gospels in this regard.

Later generations who are no longer rooted in the cultural framework of Second Temple Judaism or have no Jewish heritage at all use the Gospels as frames of reference for their own identity construction and its defense both *ad intra* and *ad extra*. As Isaiah and his prophecy have been preserved in these foundational texts, the question is whether authors beyond the floating gap use and quote Isaiah in its original context or as part of an emerging *Christian* tradition. Here, again, there will be no one-size-fits-all model, as Christoph Marksches already has pointed out,⁴⁸ and his thoughts are a good starting point for a more thorough investigation. The recourse to the fourth servant song will be dependent on the situation, the subject and genre of the individual text and its target audience. Apologetic writings directed to or using Jewish dialogue partners will look different than those with or for a Gentile target audience.

As Christianity proceeds through time, there is less use of Israel's Scriptures alone to explain and understand the Christ event. Jesus and the gospels eventually become the new frame to understand Israel's Scriptures. The inscription of the Jesus followers into the cultural frame of Second Temple Judaism is followed by the *Vereinnahmung* of the frame, up the point where it is no longer possible to understand it on its own. After Israel's Scriptures had become the indispensable frame to understand Jesus, for Jesus followers Jesus, in turn, becomes the indispensable frame for reading Israel's Scriptures. This group is

48 Marksches, "Der Mensch Jesus Christus".

quickly growing out of Second Temple Judaism and will eventually become a distinguishable social and religious entity.

From a social memory point of view, this process is comprehensible and mirrors typical patterns of emerging social groups or emerging religions. It is no surprise that the debate what stance to take to the Jewish heritage became more pressing after the third generation and beyond the floating gap. The groups of Jesus followers are leaving the times of collective memories and need to find a clear stance to their own self-perception and identity. The downside of this – very successful – process only becomes visible in hindsight. With Jesus being indispensable for understanding Israel's Scripture, the way was paved for the Christian substitution of Judaism, a development with most devastating results. It needed the catastrophe of the 20th century to realize that there is something deeply flawed in the Christian texture and to initiate the process of a critical re-evaluation of our construction of Christian origins on a larger scale.

Biblical scholarship has the duty to move beyond these biases and limitations. Intertextuality in *social*, *collective*, and *cultural memory* has different goals and objectives. It is crucial not to confuse them. How urgent this task is, can be gathered from a last example tracing the interpretation of Isa 53:1/6:10 in John 12:37–43.⁴⁹ The standard assumption in this case, too, is that “both passages were widely known and used as early Christian proof-texts concerning Jewish unbelief (Isa. 53:1 in Rom. 10:16; Isa. 6:9–10 in Matt. 13:14–15; Acts 28:26–27; cf. Mark 4:12; Luke 8:10; Rom. 11:18)”⁵⁰ Hans Förster has recently asked whether we “are indeed dealing with a problematic text or whether the anti-Judaic translations and interpretations are caused by a problematic handling of the text”⁵¹. To put it differently: Is the idea of ‘proof’ and an apologetic interest of this passage rather a theological interpretation of later days than what the text was about?

One crucial point for the understanding of John 12:40 is the notoriously difficult part καὶ ἰάσομαι αὐτούς. Will the people be healed by God or not?⁵² In

49 For an exhaustive investigation of this quote cf. Sandra Huebenthal “Proclamation rejected”.

50 Catrin H. Williams, “Isaiah in John’s Gospel,” in *Isaiah in the New Testament*, ed. Stephen Moïse and Marten J.J. Menken. (London: Bloomsbury, 2005), 106–116, 108.

51 Hans Förster, “Ein Vorschlag für ein neues Verständnis von Joh 12,39–40,” *ZNW* 109 (2018): 51–75, 72 (my translation).

52 For the typical reading cf. Menken: “Wer das finale Verständnis der Stelle sicherstellen will, muß mit ἴνα μή übersetzen. Und wer die Stelle anführt als ‘Beweis’ dafür, daß ‘sie nicht glauben konnten’ (Joh 12,39), kann sie nur final verstehen.” Menken, Marten J.J. “Die Form des Zitats aus Jes 6,10 in Joh 12,40. Ein Beitrag zum Schriftgebrauch des vierten Evangelisten,” *BZ* (32) 1988: 189–209, 204.

many scholarly contributions, the answer is a blunt “no”. In his work on the use of Isa 52–53 in John, Daniel J. Brendsel states “therefore, John concludes the public ministry of Jesus with summary comments concerning the salvation-historical necessity of Jesus’s rejection by many in Israel (John 12:37–43). Jesus’s rejection by his own people is the fulfilment of the Servant’s experience of rejection (Isa 53:1 in John 12:38). Moreover, it is the climactic fulfillment of the obduracy judgment proclaimed at Isaiah’s commissioning (Isa 6:10 in John 12:40).”⁵³ The assumption of a “a salvation-historical necessity” is stunning. The wording reveals a Christian perspective in which the new frame for understanding, as it was introduced in John’s Gospel, has become canonized as a *Christian* frame of interpretation: Isaiah does no longer stand for himself, but is in the interpreted version part of Christian *cultural memory*. This is not what the Fourth Gospel is about but, in fact, an interpretation from a later theological perspective. In the same way, John 1:11 is not a promise that has to be fulfilled, but an evaluation of what has happened on part of the Johannine “we-group”. This evaluation serves the needs of the Johannine group in order to stabilize their frail identity in a situation of crisis, but backfires when seen as the only way of understanding both Isaiah’s prophecy and the recourse to it in John’s gospel, where it is prone to pave a very problematic theological road. The moment when the rejection of God’s people is seen as necessary prerequisite of Christian salvation-history, the intertextual reference discussed here almost naturally becomes one of the key texts to ‘prove’ that.

The discussion of the double quote from Isaiah in John 12 exhibits once more the problematic features of a particular approach to biblical intertextuality: a) the treatment of individual intertextual references instead of the whole contexts of both hypo- and hypertext, b) the assumption of an apologetic intention of the text (or at least the quote) in a Christological debate, c) the suspicion of the existence of collections of Christian or Christological proof-texts in New Testament times and d) the stability of the Old Testament textual tradition as well as e) the invariability of its use in Early Christianity.

It will take some time to overcome these biases, but the first steps have already been taken. Hans Förster, by reversing the causal connection has rightly pointed out that “the disrespect for the original context of Isa 6:10 in the modern translations has laid the basis that the assumption of a change of subject in Isa 6:10 could become exegetical consensus and the *locus classicus* of Israel’s obduracy.”⁵⁴ The danger of projecting later dogmatic decisions

53 Brendsel, *Isaiah Saw his Glory*, 213.

54 Förster, “Vorschlag”, 74–75 (my translation, emphasis original). In this perspective the text ceases to be a statement about those outside and instead becomes but a confirmation for

back into biblical texts is part will, remain as long as the notion of the stability of texts, traditions and their use prevails. The default historical-critical use of *intertexts* does not allow for the fluidity of traditions. That is why their form is so important.

The very moment when an intertextual reference is liberated from the straightjacket of historical-critical limitations, whole books are considered instead of putative collections of apologetic quotes, the heuristic value of the creative use of tradition in identity formation is acknowledged instead of mere source tracking and there is an allowance for change in the use of traditions over time, intertextual references can unfold their real potential. The form of the reference might then become an indicator for the larger context in which it is used and can lead to deeper understanding of its pragmatics. Determining the form of a text or an intertextual reference can only be the starting point for fascinating journeys to unexpected places in Early Christian identity formation processes.

those inside. As an identity-forming text it is necessarily much more concerned with stabilizing the portrait of the group than with ideas who the others are. For a more detailed theological investigation of the use of Isa 53 in Early Christianity and the danger of projecting back later dogmatic decisions into the biblical text cf. Kraus, "Jesaja 53 LXX".

Proclamation Rejected, Truth Confirmed: Reading John 12:37–44 in a Social Memory Theoretical Framework

Social memory theory provides a new approach to biblical texts. When I read New Testament texts in a social memory theoretical framework, I use *social memory theory* and its German equivalent *kulturwissenschaftliche Gedächtnistheorie* as a hermeneutical lens to clarify expectations of what kind of text I am about to encounter. Once my expectations are clarified, I read the text accordingly and aim to stick consistently to the established perspective considering what the text has to say about the processes of identity formation in its context of origin. After the reading is completed, I go back to my findings and evaluate them in order to see how they contribute to the understanding of the text.

In this contribution I will introduce a reading of the double quote from Isaiah in John 12:37–44 using this lens. Before I begin with the actual reading, I will provide a brief sketch of the underlying theoretical basis (1) in order to introduce the reader to social memory theory as it is used in this approach. The second step will be the clarification of my expectations about the Gospel of John as a memory text and the possible role of intertextual references in this text (2). I will after that conduct an exemplary reading of John 12:37–44 (3) und finally reflect upon the outcomes of this reading in a concluding passage (4).

1. Social Memory Theory and Reading New Testament Texts: Hermeneutical Preliminaries

The concept of collective memory was shaped by the French sociologist Maurice Halbwachs.¹ In his work *Les cadres sociaux de la mémoire*, Maurice Halbwachs coined the idea that individual recollection is conditioned by its socio-cultural environment. Halbwachs assumed that the personal memory of an individual interacts with the collective memory of its peer group.

1 For a comprehensive introduction into the underlying theory and general hermeneutical reflections cf. Sandra Huebenthal, *Das Markusevangelium als kollektives Gedächtnis*. FRLANT 257. (Göttingen: Vandenhoeck & Ruprecht, 2014), 77–156.

Accordingly, memory is a social phenomenon that grows into a person from the outside and forms through the kind of encounter the individual experiences with its environment, especially with close peer groups like the family and the religious community. Individual memory is formed by the language and concepts of the peer group, but also by its communication patterns and evaluations. Individual memory therefore always takes place within a social frame. The socially mediated frame serves as a regulative factor for personal perception.

This social frame is called *collective memory*. The individual locates his memories within this frame in order to be able to understand, interpret and communicate them. The act of remembering is not transferred from the individual to the group. The group only provides the frame for perception and judgment.

Halbwachs was further convinced that memory does not preserve the past as such, only parts in perspective. When recalled, these parts will not be re-found but constructed anew according to the needs of those who recall them. This means that the construction of the past, regardless whether it is undertaken by an individual or a group will not manage without creative elements depending on the social frame, within which it is actualized. As recollecting or memorizing also has a functional side, the past is always constructed according to the present.

Halbwachs' idea fulfills two goals. On the one hand it explains how the existence of social frames and the necessity for interaction with these frames coins the individual recollection of events. This process can be described with the term *social memory*. On the other hand, it explains how social frames add to the (re-) construction of events, i.e. how communities of commemoration semanticize events through their frames. This is called *collective memory* and the two processes have in common that they deal with the placement of memories within social frames.

When we read the Gospels according to these insights, they do not reveal who Jesus *was*, but who Jesus *is* for a particular group and why it is important to remember him in a particular way. The categories in which Jesus is remembered are provided by the Old Testament – the Bible of the first generations of Jesus followers. In order to make sense of what they experienced, they turned to their holy scriptures – or as Jan Assmann would say, to their *cultural memory* – as a frame of reference.

Initially introduced by Egyptologist Jan Assmann, the concept of *cultural memory* expands Halbwachs's hermeneutical approach. For our concerns here, we could start from the assumption that it tells the further story of the frames that are developed in *collective memory*. These frames will over time, develop further and become more and more stable. At some point, they will be so

stable that they have, in fact, become part of the shared experience of a larger group and refer to what the members of this group regard to be their foundational history or their culture. In this moment, we can with Assmann call these frames *cultural memory*. If we apply a circular movement, a new cycle begins: The frames that were newly developed in *collective memory* have become *cultural memory* and thus the new cultural frame a group will use to make sense of their own situations and experiences.

Research about how groups develop and change on the basis of the stories they share has further contributed the knowledge of the overall dynamics that applies to most groups. When groups move through time, they change and what they initially regard as something that has just happened a moment ago becomes 'the past'. In the beginning it is still perceived as a 'recent past' and group members will have vivid and variegated memories of what was a crucial experience or a founding moment for them. Over time, these memories become more distant and will eventually move to the realm of the more 'remote past' and even 'far remote past' to which they no longer have a living connection, only a mediated one. Individual group members will no longer have personal recollections nor will they know someone from the elder generation who has that, although everybody knows what the crucial moments in this past were. And this is not all: they also know why these moments were crucial and what they mean for the group today. This, too, is called *cultural memory*. The road from a vivid connection to the founding events to a more conventionalized cultural knowledge about them is rather short. It does not take more than three to four generations.

On the way from the vivid connection to the founding events to the conventionalized cultural knowledge, a group experiences two typical moments of crisis. The first moment is when the generation of those who have experienced these crucial moments, i.e. the grandparents, slowly hand over responsibility and retire. This usually happens 30–50 years after the events and this crisis is called *generational gap*. When the generation of the grandparents dies out and the second generation of the parents moves into retirement, handing over responsibility to their own children, a second moment of crisis arises. After roughly 80–120 years, the group moves into what is called the *floating gap*. Three generations have passed since the beginning when the grandchildren are running the business as grown-ups.

When this generation of the grandchildren takes over responsibility and raises their own children, the fourth generation, in the customs and traditions of the group, it will finally become visible how the identity of the group and their frames of reference have developed. It is still the fire that is passed on or are we dealing with the ashes? It is easy to see that the *floating gap* is the most

dangerous moment in the life of a group. One of the most interesting periods, on the other hand, is the time between *generational gap* and the *floating gap*. This is the moment when most of the negotiation and re-negotiation of the group's history, customs and values take place and when it is decided if and how this 'common past' is treasured. When we apply Halbwachs's categories, we can say that this is the time of fabricating new frames for understanding. In other words: it is the time of *collective memory*. The first generation might have initiated this process by passing on particular perspectives on their experiences informed by their cultural frame, but they might have done so in a more informal way and on a more day-to-day basis. There is no clear-cut model to describe this process and the different phases tend to overlap. Nevertheless, a rule of thumb is that the closer in time we are to the origin of a group, the more likely we are to encounter artifacts of *social memory* when examining the remnants of their discourses, while the further we proceed in time, the more likely we are to find artifacts of *collective memory* which usually occur in different media than the remnants of *social memory*.

When I apply this overall framework to the New Testament my question is what particular generation of Jesus-followers I will be dealing with and what kind of remnant of their discourse about the foundational events I will encounter when I read a particular text from the New Testament. Will I rather be confronted with artifacts of *social*, *collective* or even, *cultural memory*? What does that mean for understanding what is going on behind the scenes of these text? What issues are at stake for the groups behind these texts and how do the texts contribute to their own discourses of identity formation?

2. Expectations about John's Gospel as a Memory Text

2.1 *General Expectations*

The majority of Johannine scholars locate the origins of the Johannine scriptures in the area of Syria/Asia Minor. Many notices from the early church point to the area of Ephesus, addressing both the identity of the beloved disciple and the question of the Baptist's disciples who play a larger role in John than in the Synoptic tradition. The gospel is assumed to have been composed between 90–110 CE and in temporal proximity to 1–3 John, although there is no consensus whether the Gospel was written before or after the letters. One can further learn from Johannine scholars that the addressees of the Johannine scriptures have at least for some time lived rather independently of the streams of the Synoptic tradition. For them, active mission to the gentiles can be presupposed (11:51–52), and Jewish terms and customs are explained. It is also generally

assumed that the group has already parted with their *local* Synagogue (9:22; 12:42; 16:2) and that they are struggling to present themselves as legitimized heirs of Second Temple Judaism.²

When I team these insights with social memory theory, I expect John's gospel to be an artifact of *collective memory* that came about at some point between the *generational gap* and the *floating gap* and that is a lot closer to the *floating gap* than to the *generational gap*.³ Thus I assume a more advanced state of reflection about the founding events and how they have informed the group's identity. With further moving away from the temporal and local point of origin, i.e. the foundational events of Jesus, his life, death and resurrection, I further expect a more refined perspective and a more rounded overall narrative as well as a clearer and more tangible identity construction. In other words: the further away in time the clearer the interpretation and the identity forming character of this interpretation should be.

The closer we get to the *floating gap*, the more I would further expect authors and collectives to become visible as the carriers of tradition, i.e. a particular perspective on the founding events. And finally, with Early Christianity progressing in time I am expecting that texts on the brim to the *floating gap* also embrace or integrate traditions and approaches initially or for a certain period of time alien to their own ideas in an overall model. Just as Acts integrates a more 'ecclesial' version of Paul into its account than the 'Maverick' Paul we encounter in his own letters⁴ I would expect similar tendencies in John, given the fact that Acts and the Fourth Gospel both enjoy a similar production date.

A later stage of identity formation can usually offer that. Once a group has clarified who they are and want to be on the basis of their foundational experience ('who are we?'), the question of drawing borders to other groups ('who are we not?') comes into focus, and a third step will be the shift of attention from the inside to the outside and to questions of openness and points of connectivity for interested outsiders or newcomers. In other words: once a group

2 Cf. Hartwig Thyen, *Das Johannesevangelium*, HNT 6 (Tübingen: Mohr Siebeck, 2005), 576. For a summary of the discussion cf. Jörg Frey, "Das Bild 'der Juden' im Johannesevangelium und die Geschichte der johanneischen Gemeinde," in *Israel und seine Heilstraditionen im Johannesevangelium. Festgabe für Johannes Beutler zum 70. Geburtstag*, ed. Michael Labahn, Klaus Scholtissek and Angelika Strotmann. (Paderborn: Ferdinand Schöningh 2004), 33–53.

3 If I apply these concepts to the foundational events behind New Testament literature, I am in a time span between 50–70 CE for the generational gap and between 120–150 CE for the floating gap. Cf. Sandra Huebenthal, "Frozen Moments. Early Christianity through the Lens of Social Memory Theory," in: *Memory and Memories in Early Christianity*, ed. Simon Butticez and Enrico Norelli. WUNT 398 (Tübingen: Mohr Siebeck 2018), 17–43.

4 Cf. Luke Macnamara, "*Chosen Instrument*": *The Characterisation of Paul in Acts*. AnBib 215 (Rome: Gregorian Biblical Press, 2016).

has reached a consensus who they are and who they are not, they will eventually direct their attention to the outside world and how they will relate to it. It almost goes without saying that more often than not, these processes of identity formation require impulses from the outside world which often have the guise of traumatic or catastrophic events.

In short: In John's Gospel, I expect to find a clear profile of those standing behind the text. I further expect a unique presentation of and a likewise unique perspective on the foundational events as well as attempts to integrate other traditions, social forms of the movement of Jesus followers and also other models of community, as well as clear boundaries of the group compared to other groups who do not follow Jesus. I expect the group behind the text to be looking back on a process of identity formation based on their interpreted memories about Jesus and I also expect to find traces of these critical moments and decisions that have left their marks in the group's composition.⁵

2.2 *Expectations about the Role of Intertextual References*

As mentioned above, Halbwachs's concept of *social memory* implies that groups draw from the cultural frames – or their *cultural memory* – in order to make sense of their experiences. That they may understand what they encounter, they use the stories, motifs, metaphors and patterns from their own environment.

The same is to be expected for externalizations of collective memory in the medium of text. Thus, I am not only prepared to find traces of these cultural frames in an artifact of *collective memory*, but rather a direct interaction with and a discussion of these frames. As the dominant cultural frame for the Johannine group(s) is the Jewish Holy Scriptures and the time of late Second Temple Judaism and the aftermath of the Jewish-Roman War,⁶ it can

5 Similar approaches of reading John's Gospel as a "two level drama" have a long tradition since J. Louis Martyn's seminal work *History and Theology in the Fourth Gospel* (Louisville; London: Westminster Knox 1968; 1979; 2003). For a justified critique of this approach cf. e.g. Adele Reinhartz, "The Johannine Community and its Jewish Neighbors: A Reappraisal," in *What is John? Vol II: Literary and Social Readings of the Fourth Gospel*, ed. Fernando F. Segovia. (Atlanta: Scholars Press, 1998), 111–38; or Frey, "Das Bild 'der Juden'". My own approach is however, not aiming at a mirror-reading of the Fourth Gospel, but at the question whether I can find traces of typical processes of social negotiation of the past in the need of current identity formation in this text.

6 This is widely accepted among Biblical Scholars. Cf. Florian Wilk, "Die Geschichte des Gottesvolkes im Licht jesajanischer Prophetie: Neutestamentliche Perspektiven," in *Josephus und das Neue Testament: Wechselseitige Wahrnehmungen: II. Internationales Symposium zum Corpus Judaico-Hellenisticum*, 25–28. Mai 2006 Greifswald, Ed. Christfried Böttrich und Jens Herzer. WUNT 209 (Tübingen: Mohr Siebeck 2007), 245–264, or Catrin H. Williams, "Isaiah

be expected that John's Gospel will engage with this cultural framework and especially use Scripture to make its argument.

For my reading this means paying particular attention to intertextual referencing and the use of the Old Testament. In other words: Intertextuality is a crucial point to such a reading. Seen from the point of social memory theory, however, intertextuality has to be about much more than the search for quotes, their provenance and the question whether or not they are quoted correctly. It also has to go beyond questions of fulfillment schemes and proof-texting, which very often tend to project later theological questions into the biblical texts. In our case: the question is not whether John has used Isa 6:10 as a 'proof text' to explain Jewish obduracy to God's revelation in Christ,⁷ but how the gospel makes use of Isaiah as a frame of reference to understand what happened to Jesus and how this affects the understanding or identity of the group. The examination of intertextual references in a social memory theoretical setting is thus interested in the question a) which cultural framework these references originate from, b) why they are used and c) how that affects the (self-)understanding of the group. As I am expecting to deal with an artifact of *collective memory* in the case of John's gospel, it will be also important to analyze how the text uses intertextual referencing for the fabrication of new cultural frames for future identity constructions. In other words, I am prepared to encounter intertextuality not only as a reading aid to the experiences of the group, but a thorough engagement with Scripture that inscribes the group's experiences into the intertextual references and thus provides new frames.

We can clearly expect differences in dealing with cultural frames and, thus, intertextual references in texts of *social memory* and texts of *collective memory*, recalling Maurice Halbwachs's theory. Do the texts make use of existing cultural frames in order to understand their own situation, what would be expected in *social memory*, or do they begin to fabricate new frames for present and future understanding, i.e. frames, that are more and more different or detached from their context of origin and start to have a life of their own – and thus help building new or different and clearly distinguishable identity profiles? I am expecting to see the latter in the way John's Gospel deals with intertextual references to Isaiah as I am expecting a text from *collective memory*. The

in John's Gospel," in *Isaiah in the New Testament*: ed. Stephen Moyses and Marten J.J. Menken. NTSI. (London: Bloomsbury, 2005) 106–116; or Catrin H. Williams, "Seeing the Glory: The Reception of Isaiah's Call-Version in Jn 12.41," in *Judaism, Jewish identities, and the Gospel tradition: Essays in Honour of Maurice Casey*, ed. James G. Crossley (London: Equinox, 2010), 186–206.

7 For a reading that goes into that direction cf. Jonathan Lett, "The Divine Identity of Jesus as the Reason for Israel's Unbelief in John 12:36–43," *JBL* 135 (2016): 159–173.

test should be fairly simple: While Paul used references to Isaiah as a cultural frame in his letters to make sense of his own experiences and situation, John clearly moves a step forward and uses the references for the fabrication of new frames for identity formation.⁸

3. Exemplary Reading of John 12:37–43

3.1 *Isaiah in John*

The prophet Isaiah and the book carrying his name were of particular interest not only in Second Temple Judaism in general, but also for the different groups of emerging Christianity. Isaiah features prominently in the New Testament: In the Gospel according to Mark, the name “Isaiah” is mentioned twice and is each time preceding a direct quotation, thus two of the five quotations from Isaiah are directly ascribed to Isaiah (Mark 1:2–3; 7:6 .7). The trend continues in the other narrative texts of the New Testament: In Matthew six of the ten quotations from Isaiah are directly assigned to the prophet (Matt 3:3; 4:15–16; 8:17; 12:18; 13:13–15; 15:8–9) and three of them are flagged as fulfilment quotations (4:15–16; 8:17; 12:18). In Luke two of the six quotations from Isaiah are directly assigned (Luke 3:4–6; 4:18–19), one of them can be regarded as a fulfilment quotation (4:18–19); in Acts two of five quotations are directly assigned (Acts 8:32–33; 28:26). In John, finally, three of the four quotations are directly assigned (John 1:23; 12:38.40, the fourth, 6:45 is assigned to a prophet), two of them are flagged as fulfilment quotations (12:38.40). None of the quotations in the narrative texts is marked as a fulfilment quotation more than once and the only two passages from Isaiah that are quoted in all of the gospels are

8 Paul uses the same quotes, Isa 53:1 (Rom 10:16) and Isa 6:9f (Rom 11:8) as John 12:38–40, but in a completely different way. They are not used to understand Jesus, but the situation Paul himself is in, cf. Florian Wilk, “Paulus als Nutzer, Interpret und Leser des Jesajabuches,” in *Die Bibel im Dialog der Schriften: Konzepte intertextueller Bibellektüre*, ed. Stefan Alkier and Richard B. Hays. Neutestamentliche Entwürfe zur Theologie (Tübingen & Basel: Francke, 2005), 93–116; and J. Ross Wagner, “Isaiah in Romans and Galatians,” in *Isaiah in the New Testament*, ed. Steve Moyise and Marten J. J. Menken. NTSI. (London & New York: Bloomsbury, 2005), 117–132, 118. We are seeing an example from the textbook for the difference between social memory (making sense of experiences by using existent frames: Paul) and collective memory (fabrication of new frames: John) This is not to say that we do not encounter first instances of Paul trying to make more general statements about the Jesus event and its impact on groups of Jesus followers in his days as well. The approach is, however, still in the medium of everyday conversation. Paul uses Israel’s Scripture to make sense of his situation but he does on average not try to make his own experience part of this tradition and, other than the narrative tradition, he does not use fulfilment quotations.

Isaiah 6:9–10 (Mark 4:12; Matt 13:13–15; Luke 8:10, John 12:40 and Acts 28:16) and Isa 40:3–5 (Mark 1:2–3; Matt 3:3; Luke 3:4–6; John 1:23). Both quotations serve as fulfilment quotations in one of the gospels and the latter quotation is in all the gospels directly assigned to Isaiah.

John's gospel is similar to other New Testament texts. In addition to the four explicit quotes, 30–40 allusions to Isaiah can be found.⁹ Based on a first round of observations regarding the use of Isaiah in the Fourth Gospel, one can safely say a) that the text makes use of the entire book of Isaiah, not just particular parts,¹⁰ and b) that references to Isaiah mostly occur in the gospel's first part (chapters 1–12) and seem to “frame the beginning and end of John's narrative about Jesus' public ministry (1:19–12:50), and the unusually explicit naming of Isaiah on both occasions alerts attention to the prophet and his words”.¹¹ One can further say that c) some of the quotes reappear in John which have already been used by the Synoptics and that they are developed further. Additionally, d) new ideas are developed that are not necessarily based on the Synoptic tradition.

A closer look at the structure of the text, building on the observation that intertextual references to Isaiah in general (not only the direct quotes, but also the allusions) do mainly appear in the first 12 chapters of the text further indicates that these references mostly appear either in testimonies, narrator's comments or words directed to or against the *Ιουδαῖοι*. Two of the direct quotes (1:23 and 6:45) are part of the direct speech of characters,¹² the other two (12:38.40) are part of a narrator's comment and feature as a double quote. It is noteworthy in this context, that John's Gospel has two of these double quotes, the first one at the closure of the first part of the text in 12:38–40 (Isa 53:1/Isa 6:10) and the second one immediately after Jesus's death is confirmed in 19:36–37 (Exod 12:10.46/Zech 12:10). Both double quotes are narrator's comments and thus part of the reader communication of the text, not a feature of the narrated world. The first double quote draws a conclusion about Jesus's revelation to and time in “the world”. It explains both why Jesus's message has not been accepted and why the testimony of the Johannine group is not accepted either. The second double quote follows up on that idea and recalls once more the

9 For Reference cf. Steve Moyise and Marten J. J. Menken, eds., *Isaiah in the New Testament*. NTSI (London & New York: Bloomsbury, 2005) or Wilk, *Geschichte des Gottesvolkes*.

10 Cf. Jean Zumstein, *Das Johannesevangelium*. KEK II (Göttingen: Vandenhoeck & Ruprecht 2015), 466–467.

11 Williams: “Isaiah in John's Gospel”, 102.

12 Although one could discuss whether *καθώς εἶπεν Ἡσαΐας ὁ προφήτης* is really part of John the Baptist's words or not better understood as a narrator's comment.

importance of testimony in general. The marked positions of the quotes and their message clearly show their importance for the pragmatics of the text.

3.2 *The Double Quote in John 12:37–43*

I will start my reading with a typical analysis of the double quote to be able to compare this approach to my own findings.

- 37 Although he had performed so many signs in their presence,
they did not believe in him.
- 38 This was to fulfill the word spoken by the prophet Isaiah:
*Lord, who has believed our message,
and to whom has the arm of the Lord been revealed?*
- 39 And so they could not believe, because Isaiah also said,
40 *He has blinded their eyes and hardened their heart,
so that they might not look with their eyes,
and understand with their heart and turn –
and I would heal them.*
- 41 Isaiah said this because he saw his glory and spoke about him.
42 Nevertheless many, even of the authorities, believed in him.
But because of the Pharisees they did not confess it,
for fear that they would be put out of the synagogue;
43 for they loved human glory more than the glory that comes from God.¹³

In her analysis of the double quote, Cathrin Williams points out: “John concludes the account of Jesus’ public ministry with summary reflections dominated by two explicit quotations from the prophecies of Isaiah (12:37–43), Isa. 53:1 in verse 38 and Isa 6:10 in verse 40. Both passages were widely known and used as early Christian proof-texts concerning Jewish unbelief (Isa. 53:1 in Rom. 10:16; Isa. 6:9–10 in Matt. 13:14–15; Acts 28:26–27; cf. Mark 4:12; Luke 8:10; Rom. 11:18)”¹⁴ Williams assumes the existence and use of Early Christian proof-texts used for apologetic or explanatory purposes. A closer look at the texts exhibits, however, that it is a bit more complicated than that, as the different New Testament texts address different situations and different questions. While Paul for instance, in Romans deals with the situation of his own preaching and teaching, John makes use of the texts to understand what happened to Jesus and how this affects the group of Jesus followers in his own times.

Another important question is that of the originator of the double quote, or simply: who speaks? Again, Williams presents the typical approach: “As to the identity of the speaker of Isa. 53:1 in its Johannine setting, the most likely contenders are Jesus or Isaiah himself. From the immediate context of these

13 Unless otherwise indicated, all biblical quotes are taken from the NRSV.

14 Williams, “Isaiah in John’s Gospel” 108.

summary reflections it could be claimed that Jesus is envisaged as addressing God about people's lack of belief in him. However, although the use of a quotation formula to mark the fulfilment of a word spoken by Isaiah does not necessarily mean that the prophet is the speaker of the quotation. In this particular case it cannot be ruled out that Isaiah is the one understood to be addressing 'the Lord' and articulating the presently fulfilled unbelief in the message or report about Jesus.¹⁵

It is intriguing that Williams does not consider the most obvious solution, namely the narrator being the speaker of Isa. 53:1 in its Johannine setting. Using the experience of Isaiah to understand what happened to Jesus' proclamation also allows for the Jesus followers behind the Fourth Gospel to recognize their own situation in these terms and draw consolation from that. Just as the prophet Isaiah and his message were not believed, Jesus was not understood and likewise the group behind the gospel has made the experience of not being understood.

The power of the double quote, however, is even stronger: it assures the group of being right, while those who do not understand (regardless whether they are Jews or those who have left) are misguided. And even more: there is little point in trying to win them over or win them back, as this development fits the pattern of the rejected prophet. The second quote evokes this scenario as to be expected without resentment. On the other hand, the wider context of John 12:37–43 puts the situation in perspective, i.e. when read with the whole of Isaiah. Just as Isa. 6:8–10 should not be read without Isa 1:2–5, John 12:37–44 should not be read without John 12:20–36 and some Greeks coming to see Jesus.¹⁶

One crucial point for the understanding of John 12:40 is the notoriously difficult part *καὶ ἰάσομαι αὐτούς*. Will the people be healed by God or not?¹⁷ To put it differently: Is the idea of 'proof' and an apologetic interest of this passage more a theological interpretation of later days than what the text has in mind? Hans Förster has recently asked whether we "are indeed dealing with a problematic text or whether the anti-Judaic translations and interpretations are

15 Williams, "Isaiah in John's Gospel" 108–109.

16 As it happens in Lett, "Divine Identity".

17 For the typical reading cf. Menken: "Wer das finale Verständnis der Stelle sicherstellen will, muß mit ἴνα μή übersetzen. Und wer die Stelle anführt als 'Beweis' dafür, daß 'sie nicht glauben konnten' (Joh 12,39), kann sie nur final verstehen." Marten M. J.J. Menken, "Die Form des Zitats aus Jes 6,10 in Joh 12,40. Ein Beitrag zum Schriftgebrauch des vierten Evangelisten," *BZ* (32) 1988: 189–209, 204.

caused by a problematic handling of the text¹⁸. He argues convincingly that the standard translation and understanding that God will not heal his people is both against the text and the theology of Isaiah.

As indicated, the double quote from Isaiah is placed in the last scene of the first part of John's Gospel (1–12), before Jesus completely withdraws from the crowd and directs his attention to his disciples (13–17). Johannine scholarship has rightly called the passage 12:37–44 the epilogue of John 1–12, summarizing and commenting on Jesus' words and deeds in the world.¹⁹ This epilogue links up with the prologue (1:1–18) and picks up and comments on themes introduced there.²⁰

The prologue introduces the faith and the testimony of those behind the text: Jesus was sent to enlighten the world so that all people should become children of God. The group confesses in no uncertain terms:

- 9 The true light, which enlightens everyone, was coming into the world.
 10 He was in the world, and the world came into being through him;
 yet the world did not know him.
 11 He came to what was his own, and his own people did not accept him.

The dynamics are clear: The messenger has come into the world, but he was not accepted. This scheme appears twice, when the words about the Baptist are added: *He came as a witness to testify to the light, so that all might believe through him* (1:7). The prologue does not follow up on what happened to this testimony. This is told in the first (1:19–34) and third chapter (3:22–36). While the impact of John's testimony is not explicitly addressed, the hint in 3:24 that *he had not yet been thrown into prison* (3:24) indicates that it did not end well.

The speakers of the prologue also bear witness to a remarkable other fact. Although they know that *No one has ever seen God* (1:18) they can freely confess that they *have seen his glory, the glory as of a father's only son, full of grace and truth* (1:14) and they know that their testimony is true. Although the messenger was rejected, the message is confirmed, not least by their view of his glory.

18 Hans Förster, "Ein Vorschlag für ein neues Verständnis von Joh 12,39–40," *ZNW* 109 (2018): 51–75, 72 (my translation).

19 Zumstein, *Johannesevangelium*, 464–467. Zumstein notes correctly the different levels of the narrative and the structural location of this passage. Our text is not part of the narrative thread, but a reflection about what has happened in the story so far in retrospect. The reader is directed to an understanding of what was happened with the benefit of hindsight and informed what this means for his own times. Wengst assigns the same division of roles in his commentary. Klaus Wengst, *Das Johannesevangelium*. THKNT 4,2 (Stuttgart: Kohlhammer, 2004), 80.

20 Cf. Zumstein, *Johannesevangelium*, 466.

Is there another way to prove that their position is right? In the first twelve chapters of John, the reader follows the narrative of how Jesus came into the world, proclaimed in words and signs and how he was received. In the course of the events, Jesus meets different people and some encounters are shaped by longer exchanges with individuals about who he is and how salvation will come to *the world*. The narrator eagerly comments on the individual events lest the reader misunderstands the situations. From the beginning, Jesus' proclamation provokes controversy, which is also narrated at length. There is an ever-growing distance between him and the world, especially Jewish authorities. People more and more turn away from him and the Jewish reservation is carefully contrasted with Samaritans (4:1–42) and Greeks (12:20–21) coming closer. There is no doubt that *salvation is from the Jews* (4:22),²¹ nevertheless the tension between claim and reality becomes ever more visible. Uncertainty increases among Jesus' followers as well and first separations occur (6:60–71). The question becomes more pressing: how can those who remain with Jesus be sure that they are on the right side? Especially, before they have seen his glory?

The epilogue in 12:37–43 evaluates Jesus's proclamation to the world with the comfortable bias of hindsight. After Jesus has spoken his last public words in 12:35–36, he departs and hides from his interlocutors, crowds and most likely also some of the opponents. The narrator does not hesitate a moment to make use of the empty stage for his own explanation of "their" behavior.

It is relatively clear who "they" are: the crowds and the opponents from the previous scenes. The narrator summarizes that they did not believe in Jesus,²² in spite of all the signs he had performed in their midst. As the narrator has counted the signs, the reader knows what is referred to here. It is important to note that the text speaks of signs (σημεία), pointing out the deictic character of these deeds. Jesus works these signs as part of his mission, confirming that he is the one who was sent by God and is working in his authority. Within a Jewish cultural framework this is instantly comprehensible: God's prophets proclaim his message and work signs. Part of God's people believe them and change their ways, but in most cases they do not. Especially the leaders and rulers tend to turn a blind eye and a deaf ear to prophets and their message. More often

21 Cf. Thyen, *Johannesevangelium*, 572. The passage in John 4 is significantly underrated in the standard analysis of the double quote in John 12:38–40, which might be due to the fact that they rarely include an overall (narratological) analysis of the whole text, but work in separate units.

22 The use of the imperfect clarifies that this is not temporary, but final unbelief. Cf. Johannes Beutler, *Das Johannesevangelium. Kommentar* (Freiburg: Herder 2016), 367. Likewise Zumstein, *Johannesevangelium*, 467.

than not, the sign that a prophet is really a messenger of God, is that his message is not heard and his signs are not understood.

The rejected prophet is a classic motif of Old Testament prophetic literature. The same pattern is now applied to Jesus: he, too, has proclaimed and worked signs in the name of the Lord and he, too, has not been believed. The same pattern is further transparent for the group behind the Gospel. They, too, have born witness and were rejected. The question is now, what ‘fulfilled’ means in this context. Isa 53:1 does not contain a promise, rather a question. Thus ‘fulfilled’ might not be understood in the sense that a prophecy of old is finally fulfilled here; rather a pattern is once more repeated.²³ This pattern is unbelief in God’s messenger, which has been witnessed already by the book of Isaiah.

Once it is established that Jesus experiences something quite similar to Isaiah’s Servant (and many other prophets), the narrator turns to the question why this is the case. The crucial point is not that ‘they’ did not believe in Jesus, but why ‘they’ could not believe in him. Again, the narrator turns to Isaiah and refers to another part of the book. The quote presented here refers to the prophet’s commissioning vision in Isa 6:1–13 and addresses a sign the prophet will work with the result that the people will not understand him – and God will heal them. When Isaiah’s assignment is seen in the larger context of the book, it becomes clear that he is not sent to cause obduracy in God’s people by his signs, but rather that the reaction of the people to the prophet’s words will exhibit what is envisioned in Isa 6:8–10: deaf ears and blind eyes. This behavior is nothing caused by the prophet, as God complains about his sons who have turned their backs on him, and who do neither know nor understand already in Isa 1:2–5. Isaiah is now sent to these sons to deliver God’s message. They do not understand, because they cannot understand, but – and that is important – this is not the end.²⁴ There is a silver lining: God will come and heal his people. The vision depicts that some will stay true in faith, the exiled will eventually return, and in the end all nations will come to Zion.

The way Isa 6:10 is introduced in John 12:39, one might wonder whether the focus is on the obduracy of the people or rather that the blinded eyes and hardened heart are the expected reaction to the proclamation, i.e. they could not believe, because this is the normal reaction to a true prophet.²⁵ The passage uses forms of πιστεύω four times (V.37b; 38b; 39a; 42b), which is a clear sign for

23 Cf. Wengst, *Johannesevangelium*, 82: “So, wie es dem geheimnisvollen Knecht JHWHs ergangen ist, so ist es auch Jesus selbst ergangen. In seinem Schicksal wiederholt, bzw. ‘erfüllt’ sich das des Knechtes.”

24 Cf. Thyen, *Johannesevangelium*, 547.

25 Cf. Förster, “Vorschlag”, 72.

attention. The argument runs: they did not believe, and that is exactly what also happened to Isaiah's Servant, and they could not believe, because this is a typical reaction to the words of the true prophet and virtually confirms that the prophet is sent by God.²⁶

The true prophet, however, sees the glory and speaks about him. The question is what this means. For the reader, δόξα is a familiar concept. The 'we-group' has already given testimony in the prologue that they have seen *his glory* (1:14) and in 14:9 Jesus will provide the Johannine lens that the one who sees Jesus also sees the father. This idea seems to be applied to Isaiah, but the connection does in fact go deeper.

Building on observations of Craig Evans, Johannes Beutler almost thirty years ago demonstrated convincingly that Isa 52–53 stands in the background of John 12 and emphasized the significance of our passage. He explains the 'shift' to fulfilment language (12:38–39; 19:28.36–37) "to be of theological nature: as the signs in the first half of the gospel point to the heavenly origin of Jesus, so the quotations from the Old Testament in the second half introduce the mystery of the suffering, death and glorification of Jesus. The first quotation, our text from Isa 53:1 in John 12:38, bears considerable weight. The very fact that it introduces the passion of Christ, makes it very probable, that its origin from the fourth Song of the Suffering Servant is not accidental."²⁷ In later studies, Beutler develops the initial observation further and concludes that the Fourth Gospel has retained the title 'Son of Man' and equipped it with attributes of Isaiah's Servant, which in turn paves the way for the text's unique Christology. This unique perspective on Jesus becomes for the first time visible in John 12:20–36 and is inaugurated by the connection of the concepts 'glorification' (12:23.28) and 'exaltation' (12:32.34).²⁸

When John 12:20–44 is read as a whole, we are entering a field of intriguing intertextual references and theological reframing: Building on Isaiah, the text connects the concepts of Isaiah's Servant and the Son of Man by making use of the motifs 'light of the world', 'glorification' and 'exaltation', also drawing from an Isaian framework. The language of lifting up (exaltation and glorification)²⁹ provides links between both passages and can also be found in other parts of

26 Cf. Förster, "Vorschlag", 74: "Gerade dass er diese 'Zeichen' wirkt *und* ihm nicht geglaubt wird, erweist in nach dem Erfüllungszitat John 12,40 als wahren Propheten." See also Zumstein, *Johannesevangelium*, 469.

27 Johannes Beutler, "Greeks come to see Jesus (John 12,20f)," *Bib* 71 (1990): 333–347, 337.

28 Cf. Beutler, *Johannesevangelium* 359–366; Johannes Beutler, "Die Berufung des Andreas und des Philippus nach dem Johannesevangelium (Joh 1.35–46)," (offered to NTS).

29 Johannes Beutler, "La muerte de Jesús y su exaltación," *Revista de Cultura Teológica* 92 (2018): 143–157.

John's Gospel (3:14; 8:28), so we are not talking about isolated occurrences. Williams has further noted that the same connection of 'glorification' and 'exaltation' can also be found in the two quotes from Isaiah in the Hebrew version of the text:

- Isa. 6:1 MT: I saw the Lord sitting on a throne *exalted and lifted up*, and the hem of his robe filled the temple
- Isa. 52:13 MT: Behold, my servant shall prosper; he shall be *exalted and lifted up* and shall be very high.³⁰

This strengthens the argument, and she can safely conclude: "John thus combines Jesus' physical lifting-up on the cross with its interpretation as the moment of his exaltation. Where Isaiah speaks of the future exaltation and glorification of the Servant (53:12) before giving account of his humiliation and death (52:14–53:12), John interprets the exaltation and glorification of Jesus as evident in, rather than following, his humiliation and death. Jesus' death, for John, is the supreme disclosure of his divine glory."³¹

Once the Son of Man and the Servant are brought together, the new concept attracts more features from the Isaian tradition. Förster points out that it is the Servant's voice that is not heard in Isaiah 53:1 and that just like Jesus (8:12), the Servant is called 'Light of the nations' (Isa 49:6; 51:4). The similarities go even further, as the Servant's task is described to bring salvation to the end of the earth (Isa 49:6).³² Förster argues that the language used in John indicates that this is not a single instance, but that key elements of Johannine theology refer to the Isaian tradition. One other characteristic is that the Servant's work was without success. The efforts of the prophet or rather the Servant do not result in faith but in the eyes going blind and the hearts hardening. Förster also reads the healing of the man borne blind (9:1–41) in this light and sees an intertextual reference to Isa 6:10: while a miracle happens that was deemed impossible right in front of their eyes, the Pharisees do not 'see' who Jesus is.³³

Not so the prophet. He sees clearly. This passage seems to convey the message that Isaiah in his vision has seen the glory of Jesus. This is one way to read it,³⁴ but might distract from another possible reading, which links the motif to the prologue and sees a transparency for the Johannine group to relate to

30 Williams, "Isaiah in John's Gospel", 113 (emphasis original).

31 Williams, "Isaiah in John's Gospel", 115.

32 Förster, "Vorschlag" 71.

33 Förster, "Vorschlag" 71–72.

34 Williams, "Isaiah in John's Gospel" 118–115. I doubt the necessity for a historical reading like the one hinted at by Williams: "Isaiah was already understood in the first-century Jewish context as a visionary prophet and foreseer of the future" (112). The connection

the prophet's vision. In the prologue they confess that they have seen Jesus's glory and that they believe in him and bear witness. Approaching the double quote from this side makes it easier to understand the following words that in spite of that many, even of the authorities, believed in Jesus.³⁵ Obviously not all of 'them' did not believe. It looks rather like the focus of the passage is not on *belief*, but on what should naturally follow from belief: *confession and testimony*. This is the point in which the 'many' fail. Their insight and 'belief' does not become manifest in their words and deeds. Fear guides them, for they love human glory more than the glory that comes from God. Other than the prophet and the group behind the gospel who have 'seen' Jesus' glory, they are interested in the mundane glory and do not want to be excluded from their local (synagogue) community.³⁶

The target audience are not those *who cannot understand* anyways, but those *who have understood and do not act accordingly*.³⁷ The Fourth Gospel has a large emphasis on faith, testimony, and remaining in Jesus, as well as lengthy exhortations not to be afraid. Just as the disciples, the group shall not let their heart be troubled nor let it be fearful (14:27), but abide in Jesus as he abides in them (15:4). Incomprehension, even hostile incomprehension from the outside is one issue. The larger threat comes from the inside, from those who turn their backs and leave; those who no longer subscribe to the understanding of the group, to their foundational experience as it is verbalized it in the prologue: *And the Word became flesh and lived among us, and we have seen his glory, the glory as of a father's only son, full of grace and truth* (1:14). This self-understanding is not so much challenged by those outside, who cannot understand anyways, but it is largely threatened by those inside who dispense with it in order to have it easier in *the world*.

The second double quote in 19:36–37 supports this reading. For Johannine Jesus-followers, the moment when Jesus's glory becomes visible is the moment of his exaltation on the cross. This is already hinted at in our sequence, especially when 12:20–36 is added. In the very moment, the *hour*, when Jesus is exalted and his glory becomes fully visible, the also narrator also freezes the scene for a comment (19:35–37):

between the passages is theological, not historical in nature: The moment one subscribes to the Johannine perspective, Isaiah could not have seen anything else.

35 On the level of the text, this might refer e.g. to Nicodemus.

36 Cf. Wengst, *Johannesevangelium*, 86: "Die Durchsichtigkeit auf die Situation in der Zeit des Evangelisten zeigt sich in der Erwähnung des Synagogenausschlusses und in der Weise, in der hier von den Pharisäern die Rede ist."

37 Cf. Thyen, *Johannesevangelium*, 575.

- 35 He who saw this has testified so that you also may believe.
His testimony is true, and he knows that he tells the truth.
- 36 These things occurred so that the scripture might be fulfilled,
None of his bones shall be broken.
- 37 And again another passage of scripture says,
They will look on the one whom they have pierced

The structure of how the two quotes are introduced is parallel to 12:37–40. The first quote is introduced as a fulfillment of a word of Scripture, the second as ‘another passage says’. The one who ‘saw’ this moment like Isaiah and the group behind the Gospel bears witness and the goal is that ‘you’, the addressees of the text, believe. What is new in this passage is that the narrator explicitly states that this witness knows that his testimony is true and that he tells the truth. He knows both from experience and from Scripture, because the motifs from Scripture are repeated and thus fulfilled.

4. Insights from the Reading

What do we gain from this reading? First, what I read the Fourth Gospel, is pretty close to what I expected to find in the text: there is a tangible social entity behind the text, a group that clearly becomes audible as ‘we’ and has a particular take on the foundational events (cf. 1:14.16; 3:11; 4:22; 9:4; 21:24). This group has a clear and distinguishable profile and had to undergo processes of identity clarification connected to separation and loss which have become part of the group’s ‘genetic signature’ and that are thus visible in the narrative.³⁸

The group behind this text has gone a long and painful way until they have arrived at their stable self-image based on their experiences with Jesus and his message. Suffering is a huge issue in the Fourth Gospel and abiding is not for no reason stressed in the argument. Faith and testimony are the core themes of the text and having seen Jesus’s glory as the only Son of the Father fuels the faithful’s knowledge that Jesus prepares abodes for them in the eternal community with him and the Father in the Spirit. This is, in a few very coarse sketches, the new frame for identity construction that the Fourth Gospel offers to its community. To arrive at its stable foundational narrative in spite of all the crises and insecurities, it draws from the cultural frame of late Second Temple

38 I am thus not surprised to find attempts to ‘reconcile’ or ‘integrate’ other ways of following Jesus (cf. 21). Even if these other approaches are not fully embraced this sketch should offer connectivity to interested newcomers or members from other groups.

Judaism and Israel's scriptures. One key component is the insight that rejection of the proclamation actually confirms its truth.

Read within a social memory theoretical framework, one might conclude, that the Fourth Gospel processes experiences from the very recent past of the Johannine Jesu-followers: the painful exclusion from their local synagogue community which in turn might have led to discrimination and isolation, but for sure deprived them of an important part of their identity. In order to restore the threatened group identity and to persuade the members to abide, this situation is also reflected into the text and informs the way how the Fourth Gospel tells the story of Jesus. One key concept in the text – as in the other Johannine writings – is the question of 'abiding', be it with regard to one's personal relationship to Jesus or in the collective of the Johannine communities. Self-assurance and stabilization of identity due to experiences of existential crisis lie at the heart of these writings.

This implies a general re-orientation which can be traced theologically in the merge of the Son of Man and Isaiah's Servant, allowing for new perspectives: "the Servant has to pass through death, but he will be a source of salvation for all and hope (Is 42:4) and light (49:6) for the nations. The coming of the Greeks to Jesus is the coming of those who had not seen, to behold the lamb of God."³⁹ The group has eventually opened for Jesus-followers from a non-Jewish background and has also found a rationale for this step in Isaiah.

Is the Greeks' wish to 'see' Jesus already granted in the narrative? This question is answered differently. With regard to the world of the characters and on the basis of the text's understanding of Isa 52:15 LXX, Beutler is convinced that their wish is granted.⁴⁰ Daniel Brendsel, in his study on the use of Isaiah 52–53 in John 12 objects and it is worth reading the rationale of his conclusion: "In John 12, however, Jesus does not answer the Greek's request. Their request merely foreshadows the future. In order for those nations to 'see' aright, Jesus must first be 'lifted up' as Isaiah's Servant. And in order for him to be 'lifted up' thus, he must be rejected by 'his own' (see John 1:11; 8:28). Therefore, John concludes the public ministry of Jesus with summary comments concerning the salvation-historical necessity of Jesus's rejection by many in Israel (John 12:37–43). Jesus's rejection by his own people is the fulfilment of the Servant's experience of rejection (Isa 53:1 in John 12:38). Moreover, it is the climactic fulfillment

39 Beutler, "Greeks", 345–346.

40 Beutler, *Johannesevangelium*, 365.

of the obduracy judgment proclaimed at Isaiah's commissioning (Isa 6:10 in John 12:40)."⁴¹

Two points seem to be noteworthy. First, Brendsel's reading lacks the servant's 'exaltation' which is equally important in this context. The second, and more crucial point is that the rejection of Jesus is termed as "a salvation-historical necessity". The wording reveals a Christian perspective in which the new frame for understanding, as it was introduced in John's Gospel, has become canonized as a *Christian* frame of interpretation: Isaiah does no longer stand for himself, but is in the interpreted version part of Christian *cultural memory*. This is not what the Fourth Gospel is about but, in fact, an interpretation from a later theological perspective. In the same way, John 1:11 is not a promise that has to be fulfilled, but an evaluation of what has happened on part of the Johannine "we-group". This evaluation serves the needs of the Johannine group in order to stabilize their frail identity in a situation of crisis, but backfires when seen as the only way of understanding both Isaiah's prophecy and the recourse to it in John's gospel, where it is prone to pave a very problematic theological road. The moment when the rejection of God's people is seen as necessary prerequisite of Christian salvation-history, the intertextual reference discussed here almost naturally becomes one of the key texts to 'prove' that.

A methodological insight from my reading is that investigations of Isaiah in John often suffer from scholars not considering the different levels of the narrative. It thus escapes the attention that the use of Isaiah in our case is on the level of narrator's comments, which has to be considered for the interpretation. Is the passage using Isa 6:10 as a proof-text for the obduracy of Israel in the light of Jesus's proclamation or for the final rejection of God's people? Surely not. Förster rightly pointed out that "the disrespect for the original context of Isa 6:10 in the modern translations has laid the basis that the assumption of a change of subject in Isa 6:10 could become exegetical consensus and the *locus classicus* of Israel's obduracy."⁴² If we retain the perspective established with

41 Daniel J. Brendsel: *'Isaiah Saw his Glory': The Use of Isaiah 52–53 in John 12*. BZNW 208 (Berlin et al.: de Gruyter, 2014), 213.

42 Förster, "Vorschlag", 74–75 (my translation, emphasis original). Support for Förster's evaluation also comes from the Rabbinic tradition, cf. Wengst, *Johannesevangelium*, 84 who mentions bRHSh 17b; bMeg 17b and MekhJ Jitro (Ba Chodesch 1).

For a more detailed theological investigation of the use of Isa 53 in Early Christianity and the danger of projecting back later dogmatic decisions into the biblical text cf. Wolfgang Kraus, "Jesaja 53 LXX im frühen Christentum – eine Überprüfung," in *Beiträge zur urchristlichen Theologieggeschichte*, ed. Wolfgang Kraus. BZNW 163. (Berlin et al.: de Gruyter 2009), 149–182.

the help of biblical introduction and social memory theory the passage points into a different direction. It is first of all not a statement about those outside, but a confirmation for those inside. As an identity-forming text it is necessarily much more concerned with stabilizing the portrait of the group than with ideas who the others are. It does neither neglect the huge problems with its environment nor present them as minor quarrels.

Read from a memory perspective, the Fourth Gospel is a document of a group that is still searching for a stable group identity and seeks to establish a – to speak with Kenneth Gergen – stabilizing foundational narrative.⁴³ The gospel bears all signs of being written from a minority position, a position of defense, which explains its emphasis of testimony and justification in the face of serious challenge. Read against the canvas of late first/early second century developments, this challenge does not only come from the outside with a 'Jewish' or 'Pharisaic' majority position and the exclusion from the (local) Synagogue, but also from the inside, namely from a division of the group itself and an unknown number of members leaving. The crucial point is thus to address the need of the group to outline and stabilize their own identity first, before others and their evaluation enter the picture. This must not be forgotten when reading the Gospel as a foundational text of a particular group of Jesus-followers. Otherwise, there is a real danger that later Christian readers read their own situation and dogmatic standpoint into the text and evaluate the current Jewish minority position of their own times from the Christian majority position instead of examining the Johannine minority position compared to the Pharisaic majority position mirrored in the text. As an artifact from collective memory, the Fourth Gospel is the founding text of the Johannine group and thus about the identity of this particular group, and not a general theological statement about 'the others.'

43 Cf. Kenneth Gergen, "Erzählung, Moralische Identität und historisches Bewusstsein," in: *Erzählung, Identität, Historisches Bewusstsein*, ed. Jürgen Straub (Frankfurt am Main: Suhrkamp 1998), 170–202; 177–181.

Collective Memory, Cultural Texts, and Mark's Gospel

Die Erinnerung ist gerahmt, gepflegt und begrenzt durch die Identität, die in diesen Erinnerungen lebt und von ihnen getragen wird. Erzählungen, die ein "Wir" tragen, und von einem "Wir" gerahmt, gepflegt und begrenzt werden, nennen wir Mythen. Mythen sind kollektive Erinnerungsfiguren, narrative lieux de mémoire, "loci" einer Erinnerungskultur. Für Mythen ist es nicht entscheidend, ob sie sich auf wirkliche oder fiktive Ereignisse beziehen, sondern nur, ob sie ihren Ort haben in der Ordnung des Gedächtnisses, im Rahmen eines Erinnerns, das sie immer wieder neu erzählt, und eines Selbstbildes, das sich in diesem Erzählen seiner Wurzeln und Ziele, seiner Wahrheiten und Träume immer neu vergewissert.

Jan Assmann, Exodus, 101f.

1. Who Then is This?

After ten years of intensive research on questions at the intersection of cultural studies memory theory and New Testament texts, and collective memory and the Gospel of Mark, I am becoming more and more convinced that the core question of Mark's Gospel is the question of Jesus's identity. Or to say it along with the frightened disciples on the lake: "Who then is this?" (4:41).¹

Questions about who he is and how the "phenomenon of Jesus" can best be understood are repeatedly addressed in Mark's Gospel. The question of the disciples on the lake is only the beginning.² The people in Jesus's hometown also wonder where he learned all of this (6:2), and after his name becomes known (φανερών),³ a public discussion on this question begins, in which Herod Antipas also participates. About halfway through the narrative text, the

1 To allow readers of different backgrounds – and in this case also of different exegetical competence – to access these reflections, like the Gospel of Mark, a rather essayistic style has been chosen for this contribution, following the style of the original presentation.

2 Strictly speaking, the question about Jesus's identity begins in the synagogue of Capernaum, when those present ask themselves, "What this is?" (1:27), and these questions continue in the thoughts of the scribes (2:7). However, the question is not openly posed until 4:41.

3 6:14 suggests that Jesus's request not to be made φανερός (3:12) could not be realized, which is already referenced by the word of light in 4:22: οὐ γὰρ ἔστιν κρυπτὸν ἕάν μὴ ἴνα φανερωθῇ, οὐδὲ

protagonist takes up the discussion and asks his disciples directly, “Who do people say that I am?” (8:27), and, immediately after, “Who do you say that I am?” (8:29). It seems that Peter’s answer: *σὺ εἶ ὁ χριστός*, “you are the Anointed One” (8:29), and the experience on the mount of transfiguration answer this question for the time being, or at least put it on hold.⁴ It is brought up again during the passion narrative with the questioning by the high priest: “Are you the Anointed One, the Son of the Most High?” (14:61). And Pilate’s question: “Are you the King of the Jews?” (15:2). In response, there is largely silence on this front.

It is specifically in the first half of the Gospel where the question of Jesus’s identity is openly posed and discussed based on possible titles. After the descent from the mount of transfiguration, this entire topic is much less prominent. On the way to Jerusalem, the main issue is the rules for the circle of followers on their path of discipleship. This sequence is best understood regarding textual pragmatics: If Mark’s Gospel originated as an identity-forming text for or within a group of followers of Jesus, it makes sense to first establish who Jesus is before thinking about how following him is discernable in everyday life.⁵

The Gospel of Mark takes a stand on both points. If the core question of Mark’s Gospel is “Who then is this?” its core concern is to explain the experience of encountering Jesus and his message, but also makes sense of his life and destiny. This is not about who Jesus *was*, but about who Jesus *is*, and what this means for a particular group of Jesus followers. In this case, the community of commemoration and narration of Mark’s Gospel, which I call “Mark People” here for simplicity’s sake. This also makes the opening question more specific: It is not a matter of explaining who Jesus is *per se*, but of clarifying who Jesus is *for us*. The answer to this question will, therefore, not be objective, but bound to perspective. Understood this way, Mark’s Gospel tells what Jan Assmann calls a *foundational* story, and therefore offers a possible identity for this group of Jesus followers.⁶

ἐγένετο ἀπόκρυφον ἀλλ’ ἵνα ἔλθῃ εἰς φανερόν. In 7:24, the theme is repeated, although a different verb is used here: *λανθάνω*.

4 The appearances and disputes in the Jerusalem temple (11:1–12:44) are also about Jesus’s identity, combined with issues such as the question of authority, but here, the focus seems to be more on questions of teaching and understanding the Torah.

5 Cf. the thematic division *Constitution of the Community of Followers* (Mark 1:16–8:26) and *Organization of the Community of Followers* (Mark 8:27–11:10) in: Sandra Huebenthal, *Das Markusevangelium als kollektives Gedächtnis*, FRLANT 253 (Göttingen: Vandenhoeck & Ruprecht 2018), 208–33.

6 One of the first German-speaking biblical scholars to apply Jan Assmann’s findings on cultural memory to Mark’s Gospel was Hubert Frankemölle: “Als ältestes Evangelium, in den Wirren des ersten jüdisch-römischen Krieges um 70, vermutlich eher nach 70 (vgl. 13,1f;

Reading New Testament books while asking what cultural framework they use to preserve the collective memory of Jesus for the future is decidedly fascinating. In this study, I will broadly outline what this might look like in the case of the oldest narrative text in the New Testament canon without claiming to be exhaustive. To this end, I will first consider exemplary Jesus images and their interpretative framing in Mark's Gospel, focusing on examples from the opening and closing sections of the narrative text (II). Next, drawing on the transfiguration narrative, I will present the book of Isaiah as a central cultural framework for understanding Jesus in Mark's Gospel, also addressing methodological issues (III). Then, I will look at further development towards the Four-Gospel canon (IV). Since cultural frames affect ancient and contemporary listeners and readers of New Testament texts alike, the reflections conclude with an overview on how experiences with Jesus, to which a text like Mark's Gospel bears witness, can be understood in contemporary contexts (V).

15,38) veröffentlicht, enthält das Evangelium nach Markus als Erzählung die 'fundierende Geschichte' (Jan Assmann) der Jesusbewegung, die die Seitenreferenten Matthäus und Lukas für ihre Zeit und Gemeinde rezipierten und weitererzählten. Geschrieben wurde sie in handlungsorientierter Perspektive nicht primär zur Erinnerung an Vergangenes (etwa an den historischen Jesus), sondern zur Stärkung der Identität der Adressaten für ihren Weg in der Nachfolge Jesu." Huebert Frankemölle, *Frühjudentum und Urchristentum. Vorgeschichte – Verlauf – Auswirkungen* (Stuttgart: Kohlhammer, 2006), 296. A few months earlier, Werner H. Kelber, one of the pioneering researchers on orality and memory in biblical studies, expressed in his response to the contributions to the volume "Memory, Tradition, and Text," also following Assmann: "As far as the concept of *Traditionsbruch* is concerned, is it too far-fetched to draw an analogy with the Gospel of Mark in defining and illuminating its historical location at a seminal juncture in early Christian history? (...) If we date the Gospel some forty years after the death of the charismatic founding personality, and in all likelihood in the aftermath of the destruction of Jerusalem in 70 C.E., one could conceivably understand the document as a narrative mediation of a threefold crisis: the death of Jesus, the devastation of Jerusalem culminating in the conflagration of the temple, and the cessation of a generation of memories and memory carriers. Could we not be dealing here with an acute example of a *breach of tradition* that, following an initial trauma, was acutely compounded by a secondary dislocation some forty years later? Does not the Gospel make sense when we imagine its historical location at a point where present events severely challenged Jesus' commemorated past(s)? And could not the well-known 'oddness' of Mark's Gospel be an index of its particular situation that called for a reformulation and reorientation of the collective memories of Jesus?" Werner H. Kelber, "The Works of Memory: Christian Origins as MnemoHistory – a Response," in *Memory, Tradition, and Text: Uses of the Past in Early Christianity*, ed. Alan Kirk and Tom Thatcher, SemSt 52 (Atlanta: Society of Biblical Literature, 2005), 221–48. Huebenthal, *Das Markusevangelium als kollektives Gedächtnis*, was the first monograph to address this question.

2. Jesus Images and their Framing in Mark's Gospel

In order to tell its foundational story, the narrative of Mark's Gospel draws on available images, motifs, and interpretive frameworks. In short, it makes use of already existing cultural texts. In Mark's Gospel, some of these frames are brought into conversation in the form of different images of Jesus. In my view, it is not wrong to say that Mark's Gospel discusses and negotiates different interpretive frames. It gives its own answer to the question of how Jesus can best be understood using the cultural frames of the text's cultural environment.

2.1 *Jesus Images and Framings at the Beginning of the Gospel of Mark*

Processing these traditions, images, and motifs plays a decisive role in how they are introduced into the narrative. This can be particularly well observed in the beginning of the Mark's Gospel: In the first 15 verses of the book, everything is stated that is necessary to understand Jesus and the narrative that follows.⁷ The protagonist does make an appearance in this section, but before Jesus speaks for the first time in 1:15, most of the interpretive framing has already been done. In the opening sentence, three concepts are used that will emerge as key concepts in the course of the reading: *Gospel*, *Anointed One*, *Son of God*.⁸ The opening sentence has the character of a *paratext*: even those who

7 In exegetical secondary literature, Mark 1:1–15 is often considered to be an independent part preceding the actual story. Whether it is one piece – Rudolf Pesch, “Prologue” in *Das Markusevangelium: Kommentar zu Kap. 8,27–16,20*, HThKNT 2 (Freiburg im Breisgau: Herder, 1984); Wilfried Eckey, *Das Markusevangelium: Orientierung am Weg Jesu. Ein Kommentar*, 2nd ed. (Neukirchen-Vluyn: Neukirchener Verlag, 2008); Joel Marcus, *Mark 8–16. A New Translation, with Introduction and Commentary*, AB 27.2 (New Haven: Yale University Press, 2009); Joachim Gnllka, “Initium,” in *Mk 1–8,26*, Vol. 1 of *Das Evangelium nach Markus*, EKKNT 2.1 (Zürich: Benziger, 1978), cf. also Dieter Lüthmann, *Das Markusevangelium*, HNT 3 (Tübingen: Mohr Siebeck, 1987), and Adela Yarbro Collins, *Mark: A Commentary*, Hermeneia (Minneapolis: Fortress, 2007) – or divided into Mark 1:1–13 and Mark 1:14–5, with 1:14–5 acting as a hinge between the beginning and the first part, or forming the prelude to the first part – e.g. Martin Ebner, “Das Markusevangelium,” in *Einleitung in das Neue Testament*, ed. Martin Ebner and Stefan Schreiber (Stuttgart: Kolhammer, 2008), 154–83, following Bas M.F. Van Iersel, *Mark: A Reader-Response Commentary*, trans. W. H. Bisscheroux, JSNTSup 164 (Sheffield: Sheffield Academic Press, 1998); Richard T. France, *The Gospel of Mark: A Commentary on the Greek Text*, NIGTC (Grand Rapids: Eerdmans, 2002), and in her new commentary, Gudrun Guttenberger, *Das Evangelium nach Markus*, ZBK. 2 (Zürich: Theologischer Verlag, 2018) – is secondary for the insight that all the necessary information is present in Mark 1:1–15.

8 The text-critical question whether $\nu\iota\omicron\upsilon\ \theta\epsilon\omicron\upsilon$ actually belongs to the original Gospel of Mark remains unresolved. The textual witnesses suggest that both the shorter and the longer readings are plausible. The latest contributions to this question, after careful consideration of the arguments, tend again toward the longer reading. Cf. Tommy Wasserman, “The ‘Son of God’

only hear this first sentence develop an idea of what the narrative is about.⁹ Although it has not yet been conclusively clarified whether the text requires a greater amount of prior cultural knowledge to be comprehensible, or who the target audience is, it can be said that the first sentence introduces concepts that offer connectivity for different target audiences.

Gospel, Anointed One, and Son of God have undoubtedly been understood differently by their Jewish and Gentile recipients, and it may be a strength rather than a weakness that the text is accessible to both groups. Only the second and third sentences show more clearly which direction the journey will take. The reference to the prophet Isaiah and the book associated with his name situate the events, which will be narrated, within a Jewish frame of reference. Audiences who do not know the prophet will not be able to decide whether the quotation is correctly rendered and in what context it is found in Isaiah. However, they will recognize that the reference to Isaiah is important for understanding what will be told. Audiences familiar with the Torah and the Prophets, on the other hand, will sooner or later recognize that the intertextual disposition in Mark 1:2b–3 is not a quotation from Isaiah alone, but a mixed quotation from Exod 23:20, Mal 3:1, and Isa 40:3 LXX. Together, with the reference to Isaiah, two more threads for interpretation are opened here: Exod 23:20 alludes to the entry into the promised land – and thus the figure of Moses – and Mal 3:1 invokes the day of the Lord and the expected return of Elijah that precedes it, but only Isaiah is mentioned by name and emphasized.¹⁰

Without a break, John the Baptist is introduced in the following verses, 1:4–8. Whoever lacks the necessary prior knowledge, i.e., whoever does not know this figure or what role he will play, is clueless. At first it seems as if John is the announced messenger who will prepare the way of God, although it is

Was in the Beginning (Mark 1:1),” *JTS* 62 (2011): 20–50; Deppe, Dean B, “Markan Christology and the Omission of $\nu\acute{\iota}\delta\varsigma\ \theta\epsilon\omicron\upsilon$ in Mark 1:1,” *Filologia Neotestamentaria* 21 (2008): 45–64.

9 A modern analogy would be the title, subtitle, and cover of a book. This information is often sufficient for today’s readers to decide whether they want to read a book or not. The same might apply *mutatis mutandis* to the Gospel of Mark.

10 On the opening of the Moses, Elijah, and Isaiah passages in Mark’s Gospel, see the observations in Heike Omerzu, “Geschichte durch Geschichten: Zur Bedeutung jüdischer Traditionen für die Jesusdarstellung des Markusevangeliums,” *EC* 2 (2011): 77–99, which, together with the reflections of David S. Du Toit, “Treasuring Memory: Narrative Christology in and beyond Mark’s Gospel: Miracle-Traditions as Test Case,” *EC* 6 (2015): 334–53, and David S. Du Toit, “Gesalbter Gottessohn – Jesus als letzter Bote Gottes: Zur Christologie des Markusevangeliums in *was ihr auf dem Weg verhandelt habt: Beiträge zur Exegese und Theologie des Neuen Testaments*, FS Ferdinand Hahn, ed. Peter Müller and Christine Gerber (Neukirchen-Vluyn, Neukirchner, 2001), 37–50, represent an essential starting point for the reflections presented here.

not quite clear how this will happen. The place where John appears is the only resemblance to the place mentioned in Isaiah ἐν τῇ ἐρήμῳ (Mark 1:3–4). Thus, it is about a desert or wasteland. Audiences familiar with the Israel's Scriptures have a head start here as well: the Baptist's clothing, consisting of a hairy cloak and a leather belt, is reminiscent of Elijah (cf. 2 Kings 1:8), although Elijah's clothing, at least in the LXX version, differs somewhat from that of the Baptist in Mark's text.¹¹ Elijah is described as hairy, and the leather around his hips could also be an apron, while Mark clearly speaks of a garment of camel hair.¹² There is already a connection between John the Baptist to Elijah, and this will be confirmed in the course of the text. It is not Jesus who is the revenant of Elijah (*Elijah redivivus*), as Herod Antipas assumes (6:14–6), but John the Baptist. The fact that Jesus speaks to Elijah in the transfiguration scene (9:4) is a clear indication that he cannot be Elijah. On the descent from the mountain, this misunderstanding is finally cleared up by Jesus: John the Baptist is the returned Elijah.¹³

It is probably not by chance that the area where John baptizes in the Jordan reminds the audience of the people of Israel entering the promised land from the East. Also, the immersion in the Jordan references another experience the people of Israel had with water before their forty years in the desert, which was connected with all kinds of interesting and unexpected culinary experiences as well as trials. Here, we see that Mark's Gospel might not have been as "accessible" as it initially appeared. These experiences are only available

11 Unlike Mark 1:6 ἐνδεδυμένος τρίχας καμήλου καὶ ζώνην δερματίνην περὶ τὴν ὄσφυν αὐτοῦ, 2 Kings 1:8 states ἀνὴρ δασύς καὶ ζώνην δερματίνην περιεζωσμένος τὴν ὄσφυν αὐτοῦ. In connection with Zech 13:4 it can be said that the clothing in both cases identifies the prophet, but the connection of the Baptist with Elijah is primarily controlled by the context of Mark's Gospel.

12 The origin of the wild honey, however, is less clear. Judges 14:8f (Samson) as well as 1 Sam 14:25–9 (Jonathan), Deut 32:13 (Jacob), Ps 81:17, or Prov 25:16 offer themselves as reference texts, but none of them are quite convincing. The same applies to the locusts, and John the Baptist seems to be the only explicit locust eater in the Bible. Even if in Mark 1:6, the ascetic aspect might be in the foreground, his diet, which consists of proteins and carbohydrates, must have nourished him for quite a while in the desert. In exegetical secondary literature, the diet and clothing of the Baptist are not necessarily understood in the hermeneutical framework of the Scriptures of Israel, but rather in terms of contemporary and social history, cf. Gnllka, *Evangelium nach Markus*, 47: "Heuschrecken, die im Salzwasser gekocht und auf Kohlen geröstet werden, und wilder Honig gehören zur Nahrung des Wüstenbewohners," similarly Eduard Schweizer, *Das Evangelium nach Markus*, 17th ed., NTD 1 (Göttingen: Vandenhoeck & Ruprecht, 1989), 13, who sees the food of the simple nomads as a point of comparison.

13 The fact that the misunderstandings surrounding Elijah continue is made clear again in Mark 15:34–6 when the people under the cross believe Jesus is calling for Elijah.

to those familiar with the history, scriptures, and traditions of the people of Israel. Those who hear or read Mark's Gospel outside of this framework, and those who do not share the cultural memory of the people of Israel, are not able to understand the story until Jesus's baptism. On the other hand, those who remember walking through the wilderness with the people of Israel have already had previous experiences with the God of Israel and bring their corresponding expectations.¹⁴ Gentiles who become early followers of Jesus but don't have the same knowledge can enter into the history of salvation together with Jesus and experiences together with Jesus what they have experienced as the initiation into the circle of Jesus's followers: baptism.

This scene represents a clear break, which is also marked narratively in a special way: The baptism scene in the Jordan is designed in such a way that the listeners and readers of the Gospel in 1:10–1 share perspective of Jesus. Rising with him from the water, they see the heavens torn apart and the Spirit descending like a dove upon Jesus. Along with Jesus, they also hear the voice from the heavens: "You are my Son, the beloved, with you I am well pleased." The change from the narrator's perspective to the internal perspective of the character, Jesus, in 1:10–1 can be understood as an offer of identification for the listeners and readers. The same is true for the gap in 1:8, which is filled for the character, Jesus, in 1:9–11, because baptism is also a crucial turning point on the *ὁδός* of discipleship. However, the extent to which he or she can connect to the baptismal experience as a moment of special closeness to God and Jesus is up to each listener or reader. The way to do so, however, is open.¹⁵ Here, too, listeners and readers who are familiar with the tradition of Israel can

14 Jan Assmann states with reference to the Exodus: "Auf der Ebene *allgemeiner geistiger, vor allem zeitlicher Orientierung* geht es um den Ausstieg aus der mythischen Zeitordnung, in der die Menschen die Vergangenheit vor Augen und die Zukunft im Rücken hatten und sich bei der Bewältigung der Gegenwart an den zeitlosen Grundmustern des Mythos orientierten, hin zu einer geschichtlichen Zeitordnung, der die Vergangenheit im Rücken liegt und die Zukunft vor Augen steht, in Form einer Verheißung, die den Vätern das gelobte Land und in christlicher Deutung den Gläubigen das Paradies verheißt. Diese Wende lässt sich auch als Übergang von *historia divina*, Mythos als Göttergeschichte, zu *historia sacra*, Heilsgeschichte, verstehen, eine Geschichte, die der Gott Israels mit seinem auserwählten Volk hat." Jan Assmann, *Exodus: Die Revolution der Alten Welt* (Darmstadt: Wissenschaftliche Buchgesellschaft, 2015), 396. The Gentiles, who enter salvation history with Jesus, also learn about this concept through their encounter with Jesus the Jew.

15 Following Rom 6:3ff, the understanding of baptism as pointing to Jesus's death, and the parallels of baptism/death and resurrection, as found, e.g., in the Apostolic Constitutions, has greatly impacted the early church, cf. III, 17, "the descent into the water the dying together with Christ; the ascent out of the water the rising again with Him" (cf. V, 7; VI, 15). This text is quoted from: *The Apostolic Constitutions*, trans. James Donaldson, Ante-Nicene Fathers, Vol. 7. ed. Alexander Roberts, James Donaldson, and A. Cleveland Coxe (Buffalo,

understand this in a deeper way. The words from heaven that proclaim Jesus as the Son of God refer to Psalm 2:7. The Spirit descending on Jesus like a dove, read against the background of Isa 61:1, repeats the idea of anointing already mentioned in the first sentence.¹⁶ The protagonist of Mark's Gospel is introduced for the second time in a few verses as the *anointed Son of God*: after the heading in 1:1 and also in 1:10–11 by the voice from heaven and its accompaniments. Therefore, not only do the listeners and readers know that Jesus is *the anointed Son of God*, but also Jesus himself is informed about it by the highest authority of the narrated world.

In comparison with the Lucan version of the baptismal narrative (Luke 3:21–2), it becomes clear what the distinctive feature of the Markan version is this: In the Lucan version, the baptism itself is not narrated, but listeners and readers meet Jesus the moment afterwards, when the baptized Jesus (βαπτισθέντος) prays (προσευχομένου), or one could almost say: is absorbed in prayer. They, along with the other characters, witness the heavens opening and the Holy Spirit descending upon him in bodily form, like a dove, and a voice is heard from heaven. This voice uses the same words as the Markan version, but the effect is different. In Mark, Jesus, listeners, and readers see the heavens torn open and the Spirit descending upon him like a dove, and they hear God's voice. In Luke, everyone except the protagonist sees and hears what is happening. In Mark, the main character is informed by God of their special relationship, whereas in Luke's version, God reveals the special relationship with Jesus to the rest of the world. The listeners and readers of Mark's Gospel have an advantage over the characters, and this is left out in Luke's version. In Luke's Gospel, even in the narrated world, there is no excuse for not having recognized and confessed Jesus as the anointed Son of God. The fact that Luke makes the voice from heaven in the baptismal scene a public affair, seemingly reaching all but the main character, has two further implications: First, Jesus must have been previously aware of his relationship with God,¹⁷ and second, the possibility of the hearers' and readers' identification with the protagonist

NY: Christian Literature Publishing Co., 1886), revised and edited for New Advent by Kevin Knight, <http://www.newadvent.org/fathers/0715.htm> (January 4, 2023).

- 16 On the structural significance of Isa 61:1 LXX, see the discussion in Du Toit, *Treasuring Memory*, 339–43. Du Toit summarizes "... Jesus is presented in Mark 1:9–15 as the prophesied eschatological messenger of Isa 61:1, who (in the LXX version) is the bearer of God's spirit (πνεῦμα κυρίου ἐπ' ἐμέ) because God anointed him (οὐ εἶνεκεν ἔχρισέν με) – as narrated in Mark 1:9–11 – in order to proclaim good news to the poor (εὐαγγελίσασθαι πτωχοῖς (Isa.) – as narrated in Mark 1:14–15!" (ibid, 340). S.a. Du Toit, "Anointed Son of God," 39–40.
- 17 This is narrated in Luke's childhood story Luke 2:4–51, framed by two narratorial comments in 2:40, 52.

falls away. The changes in these few verses already suggest that Luke's Gospel has a different pragmatics than Mark's.

After the baptism episode, there is a rapid and abrupt change of scenery: the same Spirit casts Jesus εἰς τὴν ἔρημον, in other words: the main character also finds himself in the wasteland or desert, which was previously mentioned in Isaiah regarding the Baptist. Therefore, the question of who is the one sent as a messenger to prepare the way of the Lord is posed again. Whether the desert experience represents the people of Israel, or it is simply Jesus withdrawing to a lonely place is difficult to decipher given the range of meanings of the term ἔρημος and its different uses in Mark's Gospel. Lonely places seem to exist also around Capernaum. A retreat to one of these places, as the listener and reader will experience more often with Jesus, could contain *temptation by Satan, being with the (wild) beasts, and service of the angels*.¹⁸ However, the number forty suggests a connection with the time in the desert for the people of Israel, and Jesus's withdrawal also invokes interpretive frames from Israel's cultural memory. It becomes increasingly clear that Jesus, despite his openness to non-Jewish audiences, cannot be understood without his foundation in the people of Israel.

After the forty days in the desert, the prologue, or pre-history, of Mark's Gospel ends. In 1:14, the narrative begins anew after an undetermined period of time. How much time elapses between these forty days and the handing over of John the Baptist is unclear. It is equally unclear how much time elapses between the handing over of John the Baptist and the beginning of Jesus's preaching. All that is said is that after the handing over of the Baptist, Jesus comes (again) to Galilee and proclaims the *Gospel of God*: "The time is fulfilled and the kingdom of God has come near. Change your mind and believe in the gospel." The beginning of Jesus's preaching is not precisely marked in regard to time. The only event that is marked with a specific time is not the forty days in the wasteland or desert, but the handing over of John the Baptist. The beginning of the proclamation is connected with an experience of crisis. Jesus's incisive experience with God and his time (of processing or latency) in

18 Places designated as ἔρημοι τόποι are encountered more frequently in the first part of Mark's Gospel and may have a meaning beyond the "desert" especially regarding Mark 1:3, 4, 12, 13. As it becomes apparent in the course of the narrative, ἔρημος denotes not only a place of hostility to life but also a place of retreat (1:35, 45; 6:31f). Both narratives that deal with food are also associated with ἔρημοι τόποι (6:35; 8:4) and given the green grass (6:39) in 6:35–44, it is hard to think of it as a desert. Obviously, the ἔρημοι τόποι are not only physical places but also topoi in a figurative sense. On the different forms of ἔρημοι τόποι see also Bärbel Bosenius, *Der literarische Raum des Markusevangeliums*, WMANT 140 (Neukirchen-Vluyn: Neukirchener, 2014), 81–86, 170–72.

the wasteland or desert is joined by the additional intense event of the handing over (and presumably the death) of the Baptist.¹⁹

One can of course read the note in Mark 1:14 as if it only indicates a clear temporal separation between the Baptist's proclamation of repentance and Jesus's proclamation of the dawning kingdom of God. They did not proclaim their messages at the same time, and they were not in competition with each other.²⁰ Regarding the overall narrative, however, there is another possible interpretation: the readers, who share the experience of baptism with Jesus and see themselves in it. They also know about the broader history of Jesus and understand that the fate of the Baptist foreshadows the fate of Jesus.²¹ In both cases, the expression "tradition" (παράδοσις) is used. The sign that it will be Judas who hands Jesus over is placed early in the text (3:19), giving listeners and readers another advantage in understanding over the narrative characters, who are not even illuminated during the last supper (14:17–26). But, since Judas is not narrated out of the scene, they may not have understood who delivered Jesus until the arrest in Gethsemane. Just as Herodias finds a favorable opportunity (6:21) to seal the fate of John the Baptist, Judas also looks for a favorable opportunity for his scheme (14:11). The *analepsis* of the end of John the Baptist (6:17–29) is also connected to proclamation in the overall narrative, and it is narrated just as Jesus begins to send out the twelve (6:7–11). After the Baptist is buried by his disciples, those who were sent out return to Jesus and report back to him about what they have done and taught during that time (6:12–13, 30). Unlike the Baptist, however, it seems that Jesus is not buried by his disciples after his death, as not only do the twelve leave, but everyone else does, too (14:50). Even the most stout-hearted among them, in reference to Amos 2:16, flees naked on that day (14:51f). A connection between the disciples' flight on

19 It can be assumed that "incisive" also applies to the situation of Mark's people. The use of παράδοσις here clearly means betrayal, and the parallel fates of Jesus and John the Baptist show that even those who are close cannot be trusted. The notion of "handing down" appears early and is so prominently marked, and it is probably no accident, but rather indicates from the very first verses what kind of catastrophic ending Mark's Gospel is narrating.

20 Especially clear in Camille Focant, *The Gospel According to Mark* (Eugene, OR: Wipf & Stock, 2012), 54: "In putting them into narrative, Mark opts to clearly separate the two ministries, and the first has no other aim than preparing for the second. Such is, for the narrator and for his reader, the only relevant element of the story of John the Baptist."

21 Here, it is also evident through the narrative that the text cannot be addressed to audiences who are without prior knowledge, for they would understand nothing. The fact that Mark's Gospel presupposes a wealth of prior knowledge for Jewish and Gentile readers indicates that it cannot be a text for a mission or for a first contact with the message of Jesus. Such references can, however, be seen in the second reading of the Gospel.

the Mount of Olives (14:50–52) and the beginning of Jesus's preaching activity (1:15) is established by his own words. Jesus's words in 1:15 and 14:49 are the only two passages in the entire text of Mark that mention fulfillment: in 1:15, it is the *καίρός* and in 14:49, it is the *γρᾶφαί* that Jesus had previously mentioned to predict the disciples' flight (14:27).²² The fact that both passages are in broader contexts of *παραδίδωμι* is hardly a coincidence.

2.2 *Images of Jesus and Framing at the End of Mark's Gospel*

It is worthwhile to remain a moment longer at the end of the Markan narrative and to ask to what extent it references the beginning of the Gospel and its cultural framework. The prologue or pre-history to the narrative ends before the actual story begins in 1:16 with Jesus proclaiming the advent of the kingdom of God. This agenda is not changed during the Gospel, and it becomes more concrete. Narratively, the text unfolds how the kingdom of God manifests in the world and reveals what it means that his kingdom has dawned. The conflict with the opposition is ignited by this proclamation and the role that Jesus plays in it. Regardless of which image of Jesus is associated with his role – Jesus's own understanding as the *Son of Man*, that of the narrator as the *anointed Son of God*, or that of the opponent, a *heretical phenomenon* – the goal of the opposition is to eliminate the message and the messenger.²³

At first, it seems that their plan is working, because the messenger of the kingdom of God dies on the cross as a person guilty of high treason. The *titulus*, regardless of whether it is historically accurate or not,²⁴ indicates through the narrative that things have not gone smoothly: Jesus, who dies as *βασιλεὺς τῶν Ἰουδαίων*, has not proclaimed his own worldly kingdom, but the kingdom of God.²⁵ Even if this reflects the opponents' tactics in the court case, two of

22 Typical fulfillment quotations, as they are found especially in Matthew's Gospel, are not found in Mark except for the mentioned passages. Maarten Menken assumes that Matthew took over and expanded the concept of the fulfillment quotation from that very passage in Mark 14:49, cf. Maarten J. J. Menken, *Matthew's Bible: The Old Testament Text of the Evangelist*, BETL 173 (Leuven: University Press, 2004), 2.

23 On the different character perspectives and the resulting plot structure, see Huebenthal, *Das Markusevangelium als kollektives Gedächtnis*, 326–54.

24 Cf. Michael Theobald, "Ihr habt die Blasphemie gehört! (Mark 14:46). Warum der Hohe Rat in Jerusalem auf den Tod Jesu hinwirkte," *NT* 58 (2016): 233–58; also Niclas Förster, "Der titulus crucis. Demütigung der Judäer und Proklamation des Messias," *NT* 56 (2014): 113–33.

25 Jesus's proclamation of the advent of the kingdom of God anticipates that the title of king, which plays a central role in the passion, cannot be applied Jesus, since in the *βασιλεία τοῦ θεοῦ*, it is not Jesus but God who is king. It goes without saying that the interpolation of later Trinitarian concepts is not applicable here.

the key terms that have already appeared in the Gospel's title are reintroduced in the scene surrounding Jesus's death: *χριστός*, if only in the mockery of the high priests (15:32), and *υἱὸς θεοῦ*, in the words of the centurion under the cross (15:39), as well as implicitly in the question of the high priest (14:61). If Jesus's message was to die with him, this did not work, at least not in the narrative. It is, therefore, not surprising that, at this moment, the disciples become visible again: besides Mary Magdalene, Mary the mother of James and Jesus, Salome, who had already followed and served him in Galilee,²⁶ along with many other women who had gone up to Jerusalem with Jesus. There are definitely disciples present, though not the usual suspects.

Joseph of Arimathea, who eventually buries Jesus, is introduced as one who also welcomes the kingdom of God.²⁷ Joseph may not be introduced as a disciple of Jesus, but he is the one through whom the concept of the advent of God's kingship is introduced, which had only ever been used only by Jesus.²⁸ It is introduced both through the narrative characters and through the narrator. Obviously, the opponents' plan has not worked out: it is not over yet. The narrative closes with the young man in the tomb commissioning the women to tell the disciples that Jesus of Nazareth, the crucified – and risen – one, precedes them *εἰς τὴν Γαλιλαίαν*²⁹ where they will see him. The women's reaction to this commission is almost an ironic reflection of the beginning: while Jesus begins his preaching during a time of crisis, the women remain silent, at least for the time being, in the face of good news,³⁰ and a natural reaction of the listeners and readers to this conclusion is that this cannot be accurate.

Historical psychologist Kenneth Gergen, who has expanded the classic genre classification for the narratives of *comedy*, *romance*, *tragedy*, and *satire* to

26 On ἡκολούθουν in 15:41 cf. also 2:13.

27 On προσδέχομαι cf. 9:37 and 6:11, formed with δέχομαι.

28 The activity of the disciples sent out in 6:7–13 does not include message of the βασιλεία, but rather seems to prepare its proclamation through healings and conversions.

29 Cf. on 16:7 also 1:14.

30 On the use of the aorist form in Mark 16:8, cf. Stefan Alkier, "Auferweckung denken; oder, Wie das Markusevangelium mit seinen Wundergeschichten seine Leser theologisch bildet," *BL* 84 (2011): 258–67, 261. The women's non-compliance with the commission to proclaim the good news can also be understood as a counterpart to the unobserved silence commands (1:45; 7:36f). A repeated reading of Mark's text reinforces the impression that the question of how to pass on the message – remaining silent (16:8), proclaiming much (1:45), offering testimony in the wrong place or at the wrong time (5:19; 7:36f; 8:29f), or right proclamation (5:20) – might be another central problem for Mark. It is striking that the announcements made by Gentile characters (5:20; possibly also 15:39) and in Gentile areas (7:31–37, also 7:24–30) seem to be less problematic and more successful than those made by Jewish characters.

include the elemental forms of *stabilizing*, *progressive*, or *regressive*. Drawing on his observations, it can be said that although Mark's Gospel begins as a *progressive* narrative, promising a path to a greater future, the subtexts of loss, betrayal, and failure are audible from the beginning. They become so strong toward the end that the positive message of Jesus's resurrection is not told *progressively* but *regressively*.³¹ Furthermore, if one takes the compensatory function of regressive stories seriously, as postulated by Gergen, it can be said that this ending of Mark's Gospel also serves to persuade its audience, despite all adversity, not to abandon the goal of a lived community of discipleship in the face of the advent of the kingdom of God. This makes it clear why Mark's Gospel ends with the flight of the women from the tomb, analogous to the flight of the disciples on the Mount of Olives. If it is true that Mark's Gospel is a *progressive* story told *regressively*, there must be no apparition stories.³² They would equally undermine the impact of the narrative dynamic and the pragmatics of the narrative. The impulse "it must not end like this," that is still verbalized today when the entire text of Mark's Gospel is read until 16:8, only works with this end. And indeed, it is not over yet. The story of the Gospel continues in the lives of the hearers and readers of Mark's Gospel. The text is literally only the *beginning of the gospel of Jesus, the anointed Son of God*, and messenger of the kingdom of God.

31 Kenneth Gergen's extension of the classical genre classification also makes extended patterns such as the comedy-like romance or the heroic saga conceptually graspable. According to his findings, narrative and community always remain closely connected and mutually dependent, or to put it differently: narrative truth is a cultural agreement. In particular, the formation and negotiation of identity seems to play an important role in narrative structuring. Gergen has accentuated the elementary narrative forms *stabilizing*, *progressive*, and *regressive* for their interaction on interpersonal relationships: In close relationships, *stabilizing* narratives are the most important means of gaining certainty that others are what they seem. In the early stages of relationships, therefore, the use of *progressive* narratives is more likely to emphasize the specialness and value of the relationship and to establish promises of the future. *Regressive* narratives, on the other hand, usually serve a compensatory function by soliciting empathy or serving to arouse strength and motivation to achieve a particular goal. Cf. Gergen, Kenneth, "Erzählung, Moralische Identität und historisches Bewusstsein," in *Erzählung, Identität, Historisches Bewusstsein*, ed. Jürgen Straub (Frankfurt am Main, Suhrkamp, 1998), 170–202, 177–181.

32 Compared to Mark's rather *regressive* narrative, the other canonical Gospels are constructed differently. Especially Matthew and Luke, with their respective narrative arcs from Immanuel to the I-am-with-you-all-days (Matt), and from the prayer of an individual in the temple to the prayer of the group in the temple (Luke). But also, John is narrated in a *stabilizing way* and thus conveys certainty and security. From an exegetical point of view, it could be said that the textual pragmatics of Mark's Gospel must be different from that of the other Gospels simply because of its narrative form.

From this first look at the beginning and the end of the text, it can be stated that before Jesus presents his own plan,³³ it has already been unmistakably clarified by the narrator and narrative choreography how it is to be understood. Jesus's first words complete the picture: as the *anointed Son of God*, he is the eschatological messenger of the kingdom of God. His gospel of the advent of God's kingdom, however, seems to be at an end only at first glance, when the narrative text breaks off somewhat surprisingly in 16:8. The proclamation must continue in spite of loss and failure. The experience of existential crises will not stop the proclamation of the kingdom of God; it cannot and must not be the end. This message needs new messengers and is determined find them. It is precisely in the face of the greatest crisis that deep, new beginnings can take place.

3. Isaiah as the Central Framework for Understanding Jesus in Mark's Gospel, and the Return of the Methodological Questions

A close look at the narrative arc of Mark's Gospel shows that besides the understanding of Jesus by the Mark People, there is something else at play, which becomes visible (again) when this text is read and discussed with people less versed in the Bible or with interested non-Christians. In the first 15 verses of the narrative, a great deal of prior knowledge is assumed about what has not been said, even partially, and what will not be told in the rest of the Gospel. The text is obviously not written by and for people with little knowledge of the story of Jesus or its presupposed contexts. It is not that such readers do not understand anything – on the contrary, they are well integrated – but nevertheless, they find it more difficult to grasp the depth of the experiences that are processed and interpreted.

Gentile audiences may have understood “gospel” (εὐαγγέλιον) with an analogy of the *Imperial euangelia*. The term υἱός θεοῦ, referring to the emperor as *divi filius*, and placing the anointed one in the vicinity of any deity, makes it more convincing to assume because of the clear Jewish framing, that the εὐαγγέλιον at the beginning of Mark's Gospel refers to the good news Isaiah

33 And even here, the character is not free: Jesus's perspective is introduced by the narrator as the gospel of God. It is reasonable to assume that Jesus's gospel, as announced in 1:1, is not the same as the message Jesus proclaims in 1:14–15. In any case, it is somewhat striking that not even the protagonist of Mark's Gospel, who is legitimized by the highest authority within the narrative world, is allowed to say anything without the narrator commenting on it.

proclaims.³⁴ The term may well mirror the substantival use of the participle εὐαγγελιζόμενος in Isaiah 40:9, 52:7, and 61:1 LXX.³⁵ The reference to Isa 40:9–11 is particularly interesting here because it continues the Isaiah quote from Mark 1:3.³⁶ There will be a time when the announcements of Isa 35:5–6 will be fulfilled – provided people change. Then the Lord will come and, “like a shepherd, feed his flock and gather lambs with his arm and call in pregnant sheep” (Isa 49:11 LXX).³⁷ The call to return to God is another link between the Markan Jesus and Isaiah.

In Mark's Gospel, certain motifs and images are used to communicate the message to listeners and readers. In cultural studies research, this kind of meaning-making is called *framing* or *keying*.³⁸ Accordingly, in a cultural-studies reading, Mark's Gospel does not describe what happened, or what the memory community behind the text is sure to remember, discounting the error-prone nature of human memory. The memory of Jesus that is recorded in Mark's Gospel has a different purpose that becomes visible only in light of ancient notions of memory, in which memory is understood not simply *mimetically* but *heuristically*. To paraphrase Arthur Dewey, “The work of memory was not to re-present, not to reduplicate, but to construct, to deliver a place

34 See the summaries of the arguments on this question in Morna D. Hooker, “Isaiah in Mark's Gospel,” in *Isaiah in the New Testament*, ed. Steve Moyise and Maarten J.J. Menken (London, New York: Bloomsbury, 2005), 35–49, esp. 35–38, and Craig A. Evans, “From Gospel to Gospel: The Function of Isaiah in the New Testament,” in *Writing and Reading the Scroll of Isaiah: Studies of an Interpretative Tradition*, vol. 2, ed. Craig C. Broyles and Craig A. Evans (Leiden: Brill, 1997), 651–91, esp. 677–82.

35 Since the New Testament authors did not know the distinction between proto-Isaiah, deutero-Isaiah, and trito-Isaiah, any more than they knew the Songs of the Servant of God as separate and distinct units of the scroll of Isaiah, it does seem anachronistic to speak of *deutero-Isaiah* or *trito-Isaiah* here, as is generally the case in research.

36 Cf. Omerzu, *History through Stories*, 91.

37 This idea is probably echoed in the shepherd motif in Mark 6:34.

38 The introduction of the concepts of *framing* and *keying* into biblical studies discourse stems primarily from engagement with the work of Barry Schwartz, e.g., Barry Schwartz, “Collective Memory and the Social Change: The Democratization of George Washington,” in *American Sociological Review* 56 (1991): 221–36; and Barry Schwartz, *Abraham Lincoln and the Forge of National Memory* (Chicago: University of Chicago Press, 2000). The importance of Schwartz's contribution has been highlighted in particular by Alan Kirk, Tom Thatcher, Werner H. Kelber, and Chris Keith. Cf. Werner H. Kelber, “Commemoration of Jesus' Death,” in *Imprints, Voiceprints & Footprints of Memory: Collected Essays of Werner Kelber*, ed. Werner H. Kelber (Atlanta, GA: SBL Press, 2013), 293–95; Chris Keith and Tom Thatcher, “The Scar of the Cross: The Violence Ratio and the Earliest Christian Memories of Jesus,” in *Jesus, the Voice, and the Text: Beyond the Oral and the Written Gospel*, ed. Tom Thatcher (Waco: TX, Baylor University Press) 2008, 197–217.

for images.”³⁹ Understood in this way, memory does not simply depict, but rather, it unlocks, and thus serves as a framework for making sense of what has happened.

Reading Mark’s Gospel as a text that processes people’s experiences with Jesus and his message through *framing* or *keying* also means presupposing a certain way of dealing with tradition(s) and going a step further than just looking for these motifs. Unlike the classical approach, it is not a matter of determining the exact origins of individual elements or examining when and why they were processed into a text. A central difference between a tradition-critical investigation and “interpretative keying”⁴⁰ is that *Traditionskritik*, first, asks for sources, i.e.: origins, while *keying* works with memory figures or *topoi* and serves creative-constructive, but not explanatory purposes.⁴¹ *Keying* is about making sense of events that, as Luke’s Gospel puts it, *occurred among us*. In the case of Mark’s Gospel, this is the encounter with Jesus and his message of the advent of the kingdom of God. The opening quotation in Mark 1:2–3 is a good example to illustrate this difference: While traditional-historical exegesis recognizes an incorrect quotation and asks for the *Vorlage*, the supposedly corrupted quotation, the cultural studies approach, recognizes the programmatic character of the reference and the opening of three different threads of tradition that can be traced through the text as a framework of interpretation. As Heike Omerzu has shown, the reference to Malachi opens an *Elijah frame*, the allusion to Moses, a *Moses frame*, and the explicit mention of Isaiah, an *Isaiah frame*.⁴²

If one follows this last thread further, it becomes clear that the *beginning of the Gospel of Jesus, the anointed Son of God* does not start by chance *as it is written in the prophet Isaiah*. Isaiah also encounters an anointed one, and so the question is not so much *whether* the narrative choreography of Mark’s Gospel amounts to understanding Jesus as the anointed Son of God within the framework of Isaiah’s prophecy, but rather *how* it does so. One would perhaps expect

39 Arthur J. Dewey, “The Locus for Death: Social Memory and the Passion Narrative,” in *Memory, Tradition, and Text: Uses of the Past in Early Christianity*, ed. Alan Kirk and Tom Thatcher, SemSt 52 (Atlanta: SBL Press, 2005) 119–28, 126.

40 Cf. Kirk, Alan. “The Memory of Violence and the Death of Jesus in Q,” in *Memory, Tradition, and Text: Uses of the Past in Early Christianity*, ed. Alan Kirk and Tom Thatcher, SemSt 52 (Atlanta: SBL Press, 2005), 191–206.

41 Werner H. Kelber, “Memory and Violence, or: Genealogies of Remembering,” in *Imprints, Voiceprints & Footprints of Memory: Collected Essays of Werner Kelber*, ed. Werner H. Kelber (Atlanta, GA: SBL Press, 2013), 333–66, 361 (originally 2009).

42 Omerzu, *History through Stories*, 83.

the verse central to understanding Isa 61:1 LXX, "The Spirit of the Lord is upon me, for the Lord has anointed me to bring good tidings to the afflicted ..." to be quoted, as it is the case in Luke 4:18, to make sure that the message is received. However, if we think about the mediation of images of Jesus within existing cultural frames, they do not necessarily have to be made visible.⁴³ This is especially true when the aim is to make a text or motif heuristically serviceable and to invoke a particular memory figure or image. Such a procedure, of course, requires audiences who are familiar with the corresponding images – in this case Isaiah – or who will become familiar with them once they have recognized their significance for reading Mark. Pointing out to hearers and readers that Isaiah is necessary to understand the remembered Jesus in Mark's Gospel might be the reason why the first quotation is so clearly marked and assigned to Isaiah.

Here, too, a closer look reveals even more: The three different interpretive frames for understanding Jesus, which the mixed quotation in Mark 1:2–3 presents, are brought together once again in the transfiguration.⁴⁴ In this scene, Moses and Elijah step out of the interpretive structure and appear in person. In the story, the transfiguration functions as a turning point: It becomes clear that Jesus is neither the revenant of Moses nor of Elijah, but the eschatological messenger of the kingdom of God announced by Isaiah. A logical consequence is that the Elijah frame is no longer used after the transfiguration, while the references to Isaiah continue. The Moses frame also changes during the descent from the mount of transfiguration and becomes less important. The historical figure of Moses continues to be invoked as an authoritative lawgiver and part of the shared cultural memory of all inhabitants of the narrated world. As the text continues, it also becomes apparent that the Moses tradition has prophetic and eschatological sides that Mark's Gospel happily includes since they offer another explanatory model for Jesus's miracles. Jesus's authority can also be understood as that of an eschatological prophet *like Moses* promised in Deut 18:15–22 and 34:10–11.⁴⁵ The double pericope of the feeding and the

43 Cf. Kelber, *Memory and Violence*, 360–64.

44 See also the observations of Omerzu, *History through Stories*, and Du Toit, *Treasuring Memory*.

45 I am grateful to Martin Meiser for pointing out that the order of the words "listen to him" in the older manuscripts of Mark 9:7 and Matt 17:5 differ from the presumed model of Deut 18:15, which was secondarily adapted to Deut 18:15 in both Gospel texts. The rearrangement shows that the copyists not only recognized the interpretive framework, but wanted to make it even more visible.

walking on the sea (Mark 6:30–52) can also be read considering the Moses and Joshua traditions, as David du Toit has shown.⁴⁶

According to Du Toit, the idea of a *prophet like Moses*, along with the other Moses and Joshua traditions, provides a stable framework to structure and organize memories of Jesus.⁴⁷ Although this is less evident, the notion of Jesus as a *prophet like Moses* is stronger and more stable than the Elijah framework. Viewed together with the other Moses and Joshua traditions and linked to Isa 61:1, the concept of the eschatological messenger of the kingdom of God becomes the dominant image in Mark's Gospel. In terms of the construction of the narrative, after the transfiguration, the Moses frame moves more and more into the Isaiah frame until it is fully absorbed by it. Isaiah's anointed Son of God reveals all the characteristics of a *prophet like Moses*. In a similar way, the descent from the mount of transfiguration organizes the eschatological concepts. It is not Moses or Elijah, but Jesus, who is God's last and final messenger: he is the prophet God announced in Deut 18:15–22.⁴⁸

A closer look at the transfiguration also reveals how different traditions are negotiated in Mark's Gospel. A visible result of this negotiation process is its theological plea to understand Jesus against the background of Isaiah's prophecy. Regarding the history of exegesis, this is surprising in that it revives a discussion that seems to have been concluded long ago. The question whether Jesus is the deutero-Isaianic messenger of joy, which was negated by Hubert Frankemölle in 1989,⁴⁹ is now posed a second time – and receives a different answer. This second asking is not due to a (methodological) mistake of the scholar, nor is it due to new historical facts. Frankemölle has, on the contrary, opened a door with his contribution and posed questions that can only now be fully grasped hermeneutically and methodologically. His contribution reflects – in terms of exegesis and cultural studies – the reception contexts and research

46 The feeding stories seem especially relevant “if one considers that Num 27 is concerned with the nomination of Joshua (Greek: Jesus!) as Moses' successor, and who is presented in that passage as endowed with God's spirit (Num 27:18, cf. Deut 34:9), as a future bearer of Moses' splendour (27:20) as well as the one to whom Israel will be obedient in the future (27:20). In this connection, it should be recalled that Joshua's first acts as successor of Moses was the miraculous crossing of the Jordan (Jos 3–4), the restoration of the covenant (Jos 5) and the feeding of the masses with the fruits of the land (Jos 5 = termination of nourishment with manna),” Du Toit, *Treasuring Memory*, 348f.

47 Du Toit, *Treasuring Memory*, 348.

48 Du Toit, “Anointed Son of God,” 42.

49 Hubert Frankemölle, “Jesus als deuterojesajanischer Freudenbote? Zur Rezeption von Jes 52,7 und 61,1 im Neuen Testament, durch Jesus und in den Targumim,” *Vom Urchristentum zu Jesus: Für Joachim Gnülka (zum 60. Geburtstag am 8.12.1988)*, ed. Hubert Frankemölle (Stuttgart: Herder, 1989), 34–67.

paradigms of the time before the *cultural turn*, a turn towards the remembered Jesus, and the decisive impulses of oral history research. In his contribution to the Festschrift for Joachim Gnllka, Frankemölle considered “die sachlichen und methodischen Implikationen der These von Jesus als deuterojesajanischem Freudenboten nicht nur im Sinne des Markus, sondern auch für Jesus selbst,”⁵⁰ and posed the question: “Bieten die neutestamentlichen Texte wirklich genug Hinweise, dass die Vorstellung vom deuterojesajanischen Freudenboten wie auch der Begriff Evangelium von Jesus selbst bereits rezipiert wurde?”⁵¹ The question of Jesus as a deutero-Isaianic messenger of joy also becomes a test case for the *traditionsgeschichtliche Methode*. Frankemölle negates it because of hermeneutical considerations: “Bezüglich des Verhältnisses von Tradition und Redaktion verfügt bislang niemand über eine gesicherte Kriteriologie für die jeweilige Hypothese. (...) Gerade die Vielfalt der Thesen macht skeptisch, was die Sicherheit der Methodik betrifft.”⁵² His conclusion that traditions are anything but stable gets to the heart of the problem. It has taken some time for the repercussions of this insight – which were widely discussed at the General Meeting of SNTS in Cambridge the year before – to be acknowledged in biblical scholarship and to see the first attempts to find answers.⁵³

Frankemölle's contribution also deals with methodological questions, and this makes it especially interesting. Here, the additional value of a cultural studies exegesis becomes visible. Frankemölle's critical inquiries to *Traditionsgeschichte* are discussed in a similar form in the wake of the *Cultural Turn* when it comes to the criteria of historical Jesus research. Here, too, things have changed in the thirty years that have passed since Frankemölle's lecture in Cambridge: the path led from the question of Jesus's self-understanding through the various questions of plausibility to the growing realization that New Testament texts are first and foremost theological texts, in which people try to

50 Frankemölle, “Jesus als deuterojesajanischer Freudenbote,” 35.

51 Frankemölle, “Jesus als deuterojesajanischer Freudenbote,” 43. The wording of the question may be the reason why Du Toit does not make use of Frankemölle's ideas in either “Anointed Son of God” (2001) or *Treasuring Memory* (2015).

52 Frankemölle, “Jesus als deuterojesajanischer Freudenbote,” 54.

53 The beginnings of the discussion on the remembered Jesus started a good ten years later. Jens Schröter presented his seminal work *Erinnerung an Jesu Worte* in 1997, cf. Jens Schröter, *Erinnerung an Jesu Worte: Studien zur Rezeption der Logienüberlieferung in Markus, Q und Thomas*, WMANT 76 (Neunkirchen-Vluyn: Neukirchener Verlag), 199. Five years later, in 2002, James Dunn, in his Presidential Address at the General Meeting of the SNTS, addressed the problem of research on the Synoptic Question based mainly on Scripture, and in the process, decisively coined the term *Jesus Remembered*. Cf. James D.G. Dunn, “Altering the Default Setting: Re-envisaging the Early Transmission of the Jesus Tradition,” *NTS* 49 (2003): 139–75.

interpret their experiences within their own socio-cultural contexts and with the help of familiar religious motifs, literary forms, and cultural frameworks.⁵⁴ In the process, the different levels can still sometimes get confused. Joachim Gnllka's observation of Mark's text, "In Verbindung mit der Königsherrschaft Gottes begreift sich der Hintergrund dieses Evangeliums am besten von Deuterocesaja her," which Frankemölle puts in front of his contribution,⁵⁵ is unchallenged on the textual surface and can be understood *redaktionskritisch* as a contribution and theological achievement of the Markan redaction. It can likewise be understood as the literary answer of Mark's Gospel to the question, *Who then is this?* If one wants to answer these questions historically and asks about the origin of this tradition, tracing it back to Jesus, the ice becomes very thin, as Frankemölle shows: "Dass der theologiegeschichtliche Prozeß von Jesus ausging, ist dabei unbestritten." He concludes that "bei der Textarbeit jedoch kann es nur um mögliche Schritte von der synchronen Betrachtung zu diachronen Aspekten der Texte gehen."⁵⁶

Up to this point, the analysis is unchallenged even in exegesis after the *cultural turn*, and the *primacy of synchronicity*, which Michael Theobald called for forty years ago, and has indeed become an unchallengeable axiom, not only for historical-critical exegesis a generation later.⁵⁷ Frankemölle's second methodological conclusion confronts historical-critical research with a hermeneutical misunderstanding, namely that *Traditionskritik*, which stems from historical-critical hermeneutics, and intertextual analysis, which is hermeneutically at home in the poststructuralist paradigm, are not simply interchangeable:

Traditionskritik zielt auf die Erhellung der Vorgeschichte eines Textes und ist deutlich zu unterscheiden von intertextuellen Vergleichen. Gegen einen zum Teil heute außerordentlich weiten Begriff von Tradition sollte als Tradition

54 The number of contributions to this field have virtually exploded in the last fifteen years, and it is somewhat difficult to keep up with the latest developments in a timely manner. Without claiming to be exhaustive, I would like to mention here, in addition to the contributions by Schröter and Dunn, three other works that outline the field of discussion: Knut Backhaus, and Gerd Häfner, *Historiographie und fiktionales Erzählen. Zur Konstruktivität in Geschichtstheorie und Exegese* BThS, 86 (Neukirchen-Vluyn, Neukirchener, 2007); Keith Chris and LeDonne, Anthony, eds., *Jesus, Criteria, and the Demise of Authenticity* (London New York: T&T Clark International 2012); Jens Schröter and Christine Jacobi, eds., *Jesus Handbuch* (Tübingen: Mohr Siebeck, 2017).

55 Gnllka, *Evangelium nach Markus*, 65, cit. Frankemölle, "Jesus als deuterocesajanischer Freudenbote," 34f.

56 Frankemölle, "Jesus als deuterocesajanischer Freudenbote," 67.

57 Michael Theobald, "Der Primat der Synchronie vor der Diachronie als Grundaxiom der Literarkritik: Methodische Erwägungen an Hand von Mk 2,13–17 // Mt 9,9–13," *BZ* 22 (1978): 161–68.

das wahrgenommen werden, was ein Autor rezipiert (*traditum*) und selbst wieder tradiert (*traditio*). Traditionen sind Elemente, die im Text auftreten und nicht nur vor, sondern auch neben und nach ihm ein Eigenleben führen. Selbstverständlich gibt es in jüngeren Texten (etwa den Targumim und in der rabbinischen Literatur) ältere Traditionen, die vielleicht sogar so alt sind, daß sie selbst wieder als Tradition von neutestamentlichen Autoren rezipiert werden konnten, jedoch sind solche alte Traditionen nicht nur zu wünschen, sondern nach den anerkannten Kriterien nachzuweisen. Die These vom Judentum und Christentum als einem jeweils traditionspflegenden Milieu schließt die Notwendigkeit einer solchen Rückfrage nicht aus.⁵⁸

Here, it demonstrates what oral and memory research confirms, namely that memory and the handing down of tradition are by no means purely mechanical processes of faithful tradents. Instead, it is an eminently creative processes, and the handling of cultural frameworks is much more innovative than exegetical based on research coming from *Literarkritik* and *Formkritik*, which are living in the Gutenberg galaxy and derived from the written word, admittedly. Here, exegetical research could and can learn a lot from oral history, memory, and especially media research in the wake of the *cultural turn*. Frankemölle's concluding words anticipate where the journey will go:

Selbst dann, wenn es von Anfang an mehr, als man bisher annahm, in bereits schriftlicher Form vorlag, ist das Faktum der vier Evangelien ein Zeichen für Diskontinuität in Kontinuität, da nur so die 'Frohbotschaft' Jesu unter neuen Lebensbedingungen Heil und Befreiung stiftende Botschaft bleiben konnte. Dabei bleibt zu beachten, daß die 'Frohbotschaft' Jesu nicht nur von ihm selbst praxisorientiert verstanden wurde, sondern auch von den Evangelisten, was die Exegese methodisch zu beachten hätte.⁵⁹

This includes the adaptation of the message to the prerequisites of understanding and requirements of the contexts in which it is proclaimed. This form of inculturation demands sensitivity to the cultural frameworks in these contexts and is always a theological challenge. Cultural studies exegesis goes one step further here. It differs from *redaktionskritische* and narrative approaches in that it evaluates the insights gained from synchronic observations of the text in a memory-theoretical perspective and reads the biblical text as a foundational history that is identity-concrete. This precludes the continuation of traditions that have no point of reference in the context of the respective community of commemoration and narration, but at the same time accepts further creative developments due to the present situation and needs. The

58 Frankemölle, "Jesus als deuterojesajanischer Freudenbote," 67.

59 Frankemölle, "Jesus als deuterojesajanischer Freudenbote," 67.

diachronic perspective here does not refer to what happened, or which path the traditions took, until the final text, but understands this present text as a testimony of a concrete historical situation and takes it seriously as a snapshot of the formation processes of early Christian identity.⁶⁰ The focus is increasingly on the pragmatics: Why is the text shaped in this way? What clues does it offer to understand why the story – distinct from already existing texts – is told exactly as it is told? What is the experience behind it? “Die Methode der Gedächtnisgeschichte,” Jan Assmann summarizes, “fragt nicht danach, ‘wie es eigentlich gewesen,’ sondern danach, wie es erinnert wurde, das heißt, wann, warum, von wem, für wen, in welchen Formen diese Vergangenheit wichtig wurde.”⁶¹ The Jesus memory thereby always says more about the community of commemoration than about Jesus, and the framing of the Jesus event bears witness not to the history itself, but to the historical, theological, and cultural location of the memory community in question. Here, too, it is important to heed “den gedächtnistheoretischen Grundsatz zu beherzigen, dass die Vergangenheit niemals um ihrer selbst willen, sondern immer aus den Bedürfnissen einer Gegenwart heraus erinnert wird.”⁶²

When seen from this perspective, Mark’s Gospel tells the story of Jesus in such a way that, while it is equally accessible to Jewish and Gentile audiences, the Jewish interpretive frames outnumber the pagan ones, not only numerically, but also qualitatively.⁶³ But that is not all: among the Jewish interpretive frames that are interjected in Mark’s Gospel, Isaiah is the central point of reference for understanding Jesus and his message. What is true for the relationship between Jewish and Gentile interpretive frames in Mark’s Gospel seems to be true in a similar way for the relationship between Isaiah and the other Jewish interpretive frames. References to Isaiah are present throughout the entire macrotext, while other frames such as Moses, Elijah, or even the Son of David appear only in isolated passages or are incorporated into the Isaiah frame. Since I only analyzed the sequence Mark 6:7–8:26 in more detail in my *Habilitationsschrift*, and took a rather cursory look at the rest of the text, the

60 Cf. Sandra Huebenthal, “Frozen Moments’ – Early Christianity through the Lens of Social Memory Theory,” *Memory and Memories in Early Christianity*, WUNT I 398, ed. Simon Buttica and Enrico Norelli (Tübingen: Mohr Siebeck 2018), 17–43.

61 Assmann, *Exodus*, 55. Assmann continues: “Man kann die Fragerichtung aber auch umkehren und nicht von der Überlieferung ausgehend nach den historischen Ereignissen fragen, die ihnen zugrunde liegen könnten, sondern von den aus den Quellen und Bodenfunden bekannten Ereignissen ausgehend nach den Überlieferungen fragen, die sich an sie geknüpft haben könnten. Auch das gehört zur Gedächtnisgeschichte.”

62 Assmann, *Exodus*, 73.

63 Cf. Huebenthal, *Das Markusevangelium als kollektives Gedächtnis*, 306–08.

implications of this connection escaped me. The importance of the Isaian framework, as an aid to understanding Jesus as he is remembered in Mark's Gospel, only dawned on me in the course of my work on the contribution to Mark's Gospel for the handbook, *The Reception of Jesus in the First Three Centuries*.⁶⁴ In a small contribution to the framings of Isaiah in Mark's Gospel, building on David du Toit's observations and expanding them with theories of social remembering and cultural framing, I now support his thesis that Mark's Gospel remembers Jesus as the anointed Son of God and end-time prophet of God's reign in Isaian language and imagination, and narrates his fate as the fate of the prophetic admonisher and warner of his people.⁶⁵

When Jesus is remembered in Mark's Gospel in the categories of Isaiah's anointed Son of God, Moses, Elijah, or David, this says less about who Jesus really was or how he understood himself, but rather which motifs, forms, and frames available to early Jesus followers that they used to understand their encounter with Jesus and his message. The confrontation with different frames reflects the discussion regarding which categories were used to understand and remember Jesus – and, therefore, in which categories he should be understood and remembered in the future. The New Testament texts bear witness to such debates, and it is possible to work with these testimonies both synchronically and diachronically, for example, when comparing different books from the perspective of cultural studies and memory theory.⁶⁶

64 Sandra Huebenthal, "The Gospel of Mark," in *Jesus Traditions in the First Three Centuries. Vol. 1: Gospel Literature and Additions to Gospel Literature*, ed. Chris Keith, Helen K. Bond, Christine Jacobi, and Jens Schröter (London: T&T Clark 2019), 41–72.

65 Sandra Huebenthal, "Framing Jesus and Understanding Ourselves: Isaiah in Mark's Gospel and Beyond," in *Creative Fidelity, Faithful Creativity: The Reception of Jewish Scripture in Early Judaism & Christianity*, ed. Michael A. Daise and Dorothea Hartmann (Naples: Unior Press 2022), 209–47.

66 The effort is worthwhile because such a reading reveals, among other things, that Mark's Gospel *frames Jesus's death* differently than preceding texts like Paul or Q. While Paul emphasizes the Jewish martyr (Rom 3:3–26; 2 Cor 5:14) and increasingly places him in an imperial context, but otherwise has little interest in a narrative treatment, and Q generally omits Jesus's passion except for references linking it to the typical prophet's fate, the framing "fate of the suffering righteous" is palpable in Mark's Gospel, and has become more and more prevalent in the course of (reception) history. The Jewish martyr and the prophet's fate are thus not abandoned, but sublated in a Hegelian sense and become narratively subordinate to the concept of the suffering righteous. In Mark, accordingly, they do not appear at all, but are emphasized in the synoptic parallels (Luke 11:49–51// Matt 23:34–6; Matt 23:37–9// Luke 13:33–5). In John, Jesus's death has revelatory character (John 3:14; 8:28; 12:32–4) and is flanked by the Servant of God theme, which is used more in the Fourth Gospel than in the Synoptics as an interpretive framework for understanding Jesus's fate. On this approach, see Dewey, "The Locus for Death," and Arthur J. Dewey, "The Memorable Invention of the Death of Jesus," HTS Theologische Studien/Theological

Reading based on the different traditions and interpretation frameworks proves Mark's Gospel to be a text of collective memory, which provides frameworks for (new) understanding, and discusses, and ultimately enables, identity constructions.⁶⁷ The combination of narrative and intertextual analysis, as well as the comparison with other readings of the entire Gospel (*Ganzschriftlektüre*) within the framework of a cultural-scientific and memory-theoretical hermeneutics, not only makes theological profiles of the individual texts more visible, but it also makes it possible to understand which (cultural) frames are used to structure and organize memories of Jesus. The individual texts are thereby contributions to a discourse that is less concerned with historical truths than with social agreements. Mark's Gospel does not say who Jesus *was*, but who Jesus *is*. This may well differ for different groups of early Jesus followers and explains, in its own way, why the different Gospels preserve different memories of Jesus.

This experience shows how powerful one's own contexts and framings are, regardless of whether they are exegetical or dogmatic. When I develop a contribution to the question of a Markan Christology, contexts and (cultural) frames will accordingly play a greater role. Also, it raises awareness to the fact that *Christology* is an anachronistic term which, as Jens Schröter aptly put it at the conference, "Memory and the Reception of Jesus in Early Christianity," in London in the summer of 2016, with regard to the Gospel of Mark, and it often obscures more than it illuminates.⁶⁸ When I read Mark's Gospel, I replace the translation of the term *χριστός* as *Christ* or *Messiah*, which, in turn, implicitly imports later dogmatic concepts with *anointed*, in order to retain the openness of the term to different understandings.⁶⁹ When Peter refers to Jesus as

Studies 72 (2016): a3222. On the Servant of God theme in John, cf. Johannes Beutler, "Greeks come to see Jesus (John 12,20f)," *Bib* 71 (1990): 333–47, summarizing Johannes Beutler, *Das Johannesevangelium: Kommentar* (Freiburg, Herder, 2013), 364f.

67 This is a result of my study of the Gospel of Mark based on the research of Maurice Halbwachs and Aleida and Jan Assmann. Artifacts of collective memory differ from those of social memory in that they provide frames for identity construction, while artifacts of social memory locate themselves within existing frames: "Im *sozialen Gedächtnis* geschieht Identitätsbildung innerhalb eines Rahmens, im *kollektiven Gedächtnis* die Verfertigung von Rahmen für künftige Identitätsbildungsprozesse." Huebenthal, *Das Markusevangelium als kollektives Gedächtnis*, 131. For a brief summary of Halbwachs's theory, see *ibid.* 126–31.

68 The contribution was published as Sandra Huebenthal, "Suspended Christology," in *Christology in Mark's Gospel: Four Views*, ed. Anthony LeDonne (Grand Rapids: Zondervan 2021), 1–41. The other three views were provided by J.R. Daniel Kirk, Larry W. Hurtado (with Chris Keith), and Adam Winn.

69 On this point, reception-controlling pericopae titles, as found in some editions of the Bible, are often more confusing than enlightening. In the revised edition of the

anointed, this need not be a Christological confession at an inopportune time,⁷⁰ but rather, as du Toit has also convincingly shown, it can also be a reference to the Isaiah framework, which understands Jesus as the anointed Son of God following Isa 61:1. Read this way, Peter's knowledge is not coincidentally placed between the healing of a blind man and the transfiguration, which narratively further interprets what Peter has pronounced: Jesus is to be understood less in the sense of Moses and Elijah and more in the sense of Isaiah's prophecy.

4. The Gospel of Mark and the New Testament Canon

For later canonical readers, these sometimes very subtle differences are not always easy to recognize because they are socialized with different cultural frames. As Christians, we read Mark's Gospel within the framework of the Four-Gospel canon and the New Testament canon. We understand it in our respective interpretive communities, which, beyond all separation, have in common the tradition and confession of the Ecumenical Councils as a lens for Jesus. Again, the issue is not who Jesus *was*, but who Jesus *is*.

The extent to which the Four-Gospel canon alone shapes Mark's reception, and therefore also Jesus's reception, can be seen quite well in how the understanding and proclamation of Jesus's change between the levels of the world of characters or narrated world (a), and the world of narrator or narratorial

Einheitsübersetzung, the reception-controlling title "Peter's confession of Messiah" has been replaced by "Peter's confession of Christ," and the translation, like the revised Luther translation, now also reads in the text "You are the Christ" instead of formerly "You are the Messiah." This is a step into the right direction, even though "Christ" also incorporates later Christological conceptions. What "Christ/Messiah" means for us today has only developed in the course of time and must not simply be retrospectively and anachronistically projected back into the text of Mark, even if this may sometimes be difficult for us.

70 If we take, as a basis, the proposal of a theology of Mark's Gospel worked out by Markan research, which says that a complete confession of the Messiah can only take place after Jesus's death and resurrection, Peter's statement in 8:29 is something that the character cannot even know at this point in the narrative event (cf. the narrative solution in the parallel Matt 16:16–7 by a revelation). Strictly speaking, the same applies to the words of the centurion under the cross. Basically, he, too, cannot make a complete confession in the sense of the assumed Markan Christology. The solution to this dilemma, however, seems to lie less in the separation of different layers and historical and literary level(s) than in an expression of Markan theology. Rather, the supposed dilemma arises from historicizing argumentation or unconscious application of later Christological concepts to the Markan text that override the Gospel's own theological design, which understands Jesus as the *anointed Son of God* and the *eschatological messenger of the kingdom of God* from Isaiah's prophecy.

world (b) of Mark's Gospel and, in the further historical course, at the level of the final shape of the Four-Gospel canon (c):⁷¹

- a) In the narrated world of Mark's Gospel, Jesus, who sees himself as the *Son of Man*, proclaims the Gospel of the advent of the kingdom of God.
- b) In the narratorial world of Mark's Gospel, the narrator proclaims the gospel of Jesus, the anointed Son of God and eschatological messenger of the gospel of the advent of the kingdom of God of the Isaian prophecy, who seemed to understand himself as the Son of Man. When reading this lengthy and complicated sentence, it becomes clear that this message is too complex for (intergenerational) transmission. Accordingly, the last two parts of the sentence drop out, and the self-understanding of the character Jesus as the Son of Man is superimposed by the understanding of the narrator. In the end, it remains that Mark's Gospel is the Gospel of Jesus, the anointed Son of God, who proclaimed the advent of the kingdom of God.
- c) Regarding the Four-Gospel canon, what finally remains of the message of Mark's Gospel through complexity reduction and juxtaposition of different images of Jesus is that Mark's Gospel, together with the other three Gospels, proclaim the Gospel of Jesus, the Anointed One and Son of God, who opened a way to eternal life for human beings through his life, death, and resurrection.

These observations indicate how the perception of Jesus has changed due to the development and adaptation of theology to new situations and challenges. Later, theological, and especially Christological, approaches tend to *sublate* earlier ones in the Hegelian sense, so regarding the Four-Gospel canon, a "canonical" image of Jesus is found, but not necessarily a specific Markan contribution. The image of Jesus in Mark's Gospel finally merges into canonical Christology. Such a narrowing and eventual shutting down of the stream of tradition is a typical phenomenon of canonization in cultural memory. Different traditions and perspectives are narrowed down to one perspective.⁷²

71 In her book, *Mark's Jesus*, Elizabeth Struthers Malbon has convincingly worked out how strongly the view of the Markan narrator and the character Jesus differed in central points. Elisabeth Struthers Malbon, *Mark's Jesus: Characterization as Narrative Christology* (Waco, TX: Baylor University Press, 2009). On the different levels in the text and the additional value for exegetical research of keeping them apart, see Huebenthal, *Das Markusevangelium als kollektives Gedächtnis*, 309–54, further Sandra Huebenthal, "A Possible New World. How the Possible Worlds Theory Can Enhance Understanding of Mark," *Annali di Storia dell'Esegesi* 32 (2015): 393–14.

72 Cf Jan. Assmann, *Das kulturelle Gedächtnis: Schrift, Erinnerung und politische Identität in frühen Hochkulturen*, 5th ed. (München: Beck, 2005), 93–97.

Accordingly, certain ideas and interpretive frameworks are lost over time. Put differently: in new contexts, some words and concepts no longer generate echoes, while others trigger them all the more. The fact that perceptions and needs of groups change and must be accounted for is, in the nature of things, and it becomes apparent, once again, in cultural memory that history does not describe what happened, but what is remembered.⁷³ This is especially true for Jesus, because with the end of Mark's Gospel, the development does not stop, but the question of how to adequately understand Jesus continues to be discussed. The four canonical Gospels can therefore also be read as snapshots of a much larger and, in principle, unfinished process of conversation and negotiation of the question *Who then is this*, as the development of images of Jesus shows. The adoptianist tendency, which is still recognizable in Mark, is balanced by the other Jesus images in the New Testament canon,⁷⁴ and even with the Four-Gospel canon, the question is not conclusively answered because the dogmatic decisions of the ecumenical councils offer new frameworks for how Jesus is to be understood correctly.

As a result, it can be said that today's Christians no longer understand Jesus in the same religious and cultural framework as "Mark People." The memories of the experiences with Jesus, his message, and his fate, which are textualized in Mark's Gospel, are basically connectable for today's Christians. But at the same time, they are also foreign, because today's Christians are not well-versed in the remembered Jesus of Mark's Gospel, but with the remembered and

73 Jan Assmann has repeatedly expressed this thought in different places, among others following Maurice Halbwachs: "Halbwachs hat nämlich die Ansicht vertreten, dass es die Vergangenheit als solche gar nicht gibt, sondern nur als das Produkt einer Gegenwart, die aus ihren jeweiligen Sinnbedürfnissen heraus und nach Maßgabe ihrer Rahmenbedingungen rekonstruiert. Genauso wenig, so könnte man argumentieren, gibt es den Textsinn an sich eines Werkes der Vergangenheit; dieser ereignet sich immer nur in der Interaktion mit Lesern, die ihn aus ihren Sinnbedürfnissen und nach ihren gesellschaftlichen Rahmenbedingungen konstruieren." Jan Assmann, "Das kollektive Gedächtnis zwischen Körper und Schrift. Zur Gedächtnistheorie von Maurice Halbwachs," in *Erinnerung und Gesellschaft. Mémoire et Société: Hommage à Maurice Halbwachs (1877–1945)*, ed. Hermann Krapoth and Dennis Laborde, Jahrbuch für Soziologiegeschichte (Wiesbaden: Springer VS, 2005), 65–83, 68f.

74 At this point, one might well ask whether the inclusion by the other synoptics is to be understood as a way of faithful reception or rather as a fundamental criticism of the theological design of Mark's Gospel. The possibility that the Gospel of Matthew was conceived not only to correct or re-accentuate the text of Mark, but in the Hegelian sense to *sublate* it, is certainly worthy of discussion. Cf. Matthias Konrad, "Das Matthäusevangelium als judenchristlicher Gegenentwurf zum Markusevangelium," in *Studien zum Matthäusevangelium*, ed. Matthias Konrad. WUNT 358 (Tübingen: Mohr Siebeck, 2016), 43–68.

proclaimed Jesus of their respective community of faith. The experience of today's Christians with Jesus is thus interpreted within different frames than the experience of the Mark People in the first century.

The extent to which today's images of Jesus differ from the discourse of Mark's Gospel can be seen especially in pastoral work. I have conducted workshops in this area as an opportunity to ask the participants, after reading the entire text of Mark's Gospel and a brief presentation of his different images of Jesus, "Who then is this?" The answers were unaffected by what the faithful had just heard but remained within the framework of traditional or individual images of Jesus. This is not necessarily surprising, because the cultural frames in which a text like Mark's Gospel frames the experience of Jesus are foreign to contemporary Christians. A response such as, "*Mystery of faith, the I AM THERE is near in Jesus, I take off my shoes like Moses and cover my face like Elijah,*" indicates that points of connection to biblical tradition are indeed present – in this case even Moses and Elijah, who also appear in Mark's Gospel. However, the link looks quite different from that of Jesus followers in the first century. So far, no one in the workshops has made a direct reference to Isaiah, which also shows that the expression *Anointed One – Christ – Messiah*, unlike the first generations of Jesus followers, has long been detached from Isaiah and become independent as a genuinely Christian framework.

5. Making the Experience of Jesus Comprehensible and Understandable in New Contexts

This point could be taken up further, and my impression is increasingly that new evangelization can be understood as an attempt to understand one's own experiences with God in Jesus based on the Christian tradition. Admittedly, this requires an experience, which must be made visible or unearthed, otherwise faith remains external and empty. Especially in teacher training courses, students often have a hard time with Paul because they lack a direct encounter with Jesus and the experience that *God was pleased to reveal his Son in me* (cf. Gal 1:15f). Paul builds his theology on this idea, and it is therefore impossible for them to connect to it. It is *no longer I who live, but Christ who lives in me ...* (Gal 2:20) remains foreign to most young people.

Before the framing of an experience with Jesus and his message, the experience itself must stand. In this sense, (new) evangelization and new movements within the church can be understood, first, as an attempt to open new spaces for experience, to unearth them, or to initiate them in the first place. In this context, Pentecostal, charismatic, liberation theological or mystical

movements are facets of the same phenomenon and – just like early Christian groups – offer, in a second step, not only different spaces for experience but also different framings of these experiences. Pastoral theologians may be particularly interested in how these experiential spaces relate to contemporary cultures. Systematic theologians may be more interested in how they relate to church tradition. Church historians may be examining how such movements themselves develop the ecclesial frameworks. Biblical scholars are more likely to ask how these new spaces of experience and patterns of explanation are connected to the biblical testimony and whether and how they refer to it. What textual concepts do they use as a basis and what frames of reference employed? Is the Bible recited and interpreted as a sacred text (liturgical staging is also interpretation) or used as a cultural text in the sense of quotations and components as explanatory patterns?

A final excursion into everyday church life may illustrate that this is not just a dull theory. Not long ago, I attended a Catholic wedding ceremony that no longer focused on God and his love, but instead presented the couple themselves and the love between people as the path to salvation. Or put differently: for the explanation and visualization of what was staged and celebrated there, the religious framework was placed on an equal footing with other pop-cultural patterns of interpretation and explanation. The fact that this happened at all was less disturbing to me than the fact that it happened in a church. We have all become accustomed to the fact that the overwhelming, existential experience of (the power of) love is interpreted in all kinds of categories – also in pop-cultural patterns. But the fact that this took place so consistently and abruptly in the church, and not just to the side of, but in place of the traditional religious framing, and thus itself took on pseudo-religious traits, remains irritating. The church and the ecclesiastical ceremony were used merely as a shell that was filled anew. The Christian exultation culminated in the fact that the *main theme* from *Star Wars* followed the *Te Deum* without transition as a brilliant closing point when the couple left the church. It is good that the ceremony ended at this point, because the final sentence “*Love will be with you – always*” in reference to *Ben Kenobi’s* farewell words was literally in the air.⁷⁵

When it comes to collective memory, cultural texts, and Mark's Gospel, the question of what motifs and frames are used to interpret experiences and

75 The extent to which such phenomena have become widespread and how much they concern us, especially as experts, is also shown by the fact that in the plenary discussion of the paper in Leuven, and even more so afterwards in private conversations, it was not the professional questions that dominated, but those about possible ways of dealing with the phenomenon outlined, which many colleagues encounter in a similar form.

make them accessible is most important. The fact that non-religious motifs are used to convey religious experience is not in itself problematic. Jesus himself speaks in the Gospels in parables from everyday life, in the language people know, of the things they do not know. Likewise, it is not uncommon for everyday experiences to be framed and interpreted in religious categories, as is evident, for example, in the use of the terms “miracle” or “guardian angel.” At first, this is not problematic, because in these cases, a cultural framework is used, a common tradition that serves as an aid to understanding.

The wedding celebration described, on the other hand, shows that the common tradition is vanishing or perhaps already gone, and that the religious motifs for expressing one’s own experiences are no longer sufficient. The term “Gentile Christians” in the sense of baptized, for whom the absorption in alternative cultural frameworks of their time overrides the Christian identity, came to my mind. I am inclined to suspect that they either lack the central experience of encountering God in Jesus that makes the difference between outward form and inward involvement, or that it is eclipsed by other intense experiences. This new form of “Gentile Christianity” may not be as dissimilar to that of the first century as it appears at first glance. The new “Gentile Christians” I encountered at this wedding, who have used a church to stage their own imaginings, are socialized Catholics as former carolers and acolytes, as well as current members of the parish council, and are just as joyful as the generation of Christians in the Deuteropaulines who, attracted by seductive alternative offers, turned (again) more to the world than to the God of Israel and transcended the boundaries of what was still considered Christian. Read this way, a text like the Letter to the Colossians, is an interesting mirror for the problems of today’s Christians in the Western world.⁷⁶

In the New Testament, the response to such encounters on the margins is quite simple. Even if a text like Mark’s Gospel offers connectivity to Gentile Christians, it quickly becomes clear that there is *more* here than these frames of understanding, and that they are not sufficient to truly understand Jesus and Mark’s experience of his message. Analogously, film music in churches may also offer connectivity to those at the ecclesial margins, but it cannot replace

76 For an in-depth discussion of this question, cf. Sandra Huebenthal, “Verwurzelt in Christus und gegründet auf ihm, fest im Glauben,” Exegetische Betrachtungen zum Motto des Weltjugendtags 2011 / ‘Enracinés et fondés dans le Christ, affermis par la foi’: Approche biblique du thème des JMJ, in *Auf der Suche nach den Wurzeln: Vorbereitungen auf den XXVI. Weltjugendtag 2011 / En quête des racines: Préparation à la XXVI^e Journée Mondiale de la Jeunesse 2011*, ed. Pierre Guerigen (Düsseldorf: Verl.-Haus Altenberg, 2010), 18–61.

the religious framework. Applied to Mark's Gospel: *Gospel, Anointed One*, and *Son of God* offer connectivity for Gentile audiences, but these points of contact are not sufficient to understand who Jesus really is. Jesus can only serve as a counter-image to Roman categories and imperial propaganda once he is understood within the Jewish categories that the Gospel conveys and negotiates.⁷⁷ For the Mark People, the community of commemoration and narration behind Mark's Gospel, this is the anointed Son of God of Isaiah's scheme, who proclaims the kingdom of God as an eschatological messenger and suffers the fate of the prophet and divine messenger.

"So, a prophet like one of the prophets after all?" one might ask.

"No, much more than a prophet" say later readers of the Gospel, and their reading has become part of our cultural memory.

77 For a detailed discussion of this question from a cultural studies-memory theory perspective, see also Sandra Huebenthal, "Anti-Gospel Revisited," in *Reading the 'Political' in Jewish and Christian Texts*, ed. Julia Synder and Korinna Zamfir, BTS 38 (Leuven: Peeters 2020), 137–58.

PART III

A New Perspective on Pseudepigraphy

Pseudepigraphy as a Strategy in Early Christian Identity Discourses: The Letter to the Colossians as a Test Case

Those who read exegetical texts dating from the end of the last century surely have the impression that they come from a different era. Because of all that has transpired methodologically and hermeneutically in the last thirty years, almost every cherished position has been fundamentally reconsidered at least once, if not abandoned entirely. Research in the field of pseudepigraphy has not been spared the fundamental upheavals that have shaken the exegetical landscape in the wake of the various “turns” of the last decades.

For recent discussions about pseudepigraphy and the its current state, see the excellently presented volume *Pseudepigraphie und Verfasserfiktion in frühchristlichen Briefen*, edited by Jörg Frey, Jens Herzer, Martina Janßen, and Clare Rothschild.¹ Two paradigm shifts are indicated in particular, and these are worth exploring exegetically and examining exemplarily to get an impression of their theological and hermeneutical impact. On the one hand, there is an increased tendency to read pseudepigraphic texts as fictional – and thus as narrative – texts. On the other hand, there is the notion that pseudepigraphy does not relate to a normative tradition, but the opposite: tradition is only constructed through these texts. Both approaches, as different as they might seem at first glance, can be taken together in a cultural-scientific and memory-theoretical viewpoint, and this allows for a fresh perspective on the phenomenon of early Christian pseudepigraphy.

1. Paradigm Shift I: Pseudepigraphic Texts as Fictional Texts

Martina Janßen and Jörg Frey state in the introduction to their volume of collected essays that

1 Jörg Frey et al., eds., *Pseudepigraphie und frühchristliche Verfasserfiktion/Pseudepigraphy and Author Fiction in Early Christian Letters*, WUNT 246 (Tübingen: Mohr Siebeck, 2009). Martina Janßen's *Forschungsüberblick* offers a comprehensive overview of the milestones of pseudepigraphy research in New Testament scholarship, especially in the German-speaking world: Martina Janßen, *Unter falschem Namen: Eine kritische Forschungsbilanz frühchristlicher Pseudepigraphie*, ARGU 14 (Frankfurt: Peter Lang, 2003).

Pseudepigraphieforschung erschöpft sich nicht in dem Phänomen der Autorfiktion, sondern nimmt ebenso die Konstruktion des fiktiven Adressaten und der fiktiven Situation in den Blick. Gerade in Bezug auf letztgenannten Bereich wird gegenwärtig ein Desiderat deutlich, da zu oft die aus den Briefen rekonstruierte Situation als 'real' rezipiert wird und als Basis für historische Schlussfolgerungen dient.²

This notion is in line with the current discussions of the phenomenon in general: The conversation surrounding pseudepigraphy is often still characterized by a dogmatic, cognitive interest, and it is also dominated by the question of whether there are forgeries in the canon of Holy Scripture, and what implications this has for the concept of truth in relation to biblical texts.

The assumption that a pseudepigraphic letter, like the Letter to the Colossians, is not a letter but epistolary fiction, prompts a reconsideration of the issue. The exegetical discourse, as Janßen and Frey further explain, is guided by a particular perspective:

Die konsequente Deutung pseudepigraphischer Texte als fiktionale Literatur führt zu einer vertieften, interdisziplinär angelegten Auseinandersetzung mit antiken Fiktionalitätstheorien und zur Rezeption der entsprechenden altphilologischen Diskussion. Man nimmt pseudepigraphische Texte als fiktionale Literatur wahr und überträgt Elemente der Erzähltheorie auf fiktionale Briefe.³

However, the practical consequences of the theory that pseudepigraphic texts are fictional and can therefore be studied through narrative theory⁴ are occurring very slowly. The assumption that the text is not a *letter* but *epistolary fiction* has far-reaching effects that foster a profound rethinking of the exegetical field: one does not only have to assume that the author is fictitious, but also the addressee and narrative situation within the letter. The last point is highly

2 Martina Janßen and Jörg Frey, "Einführung," in *Pseudepigraphie und frühchristliche Verfälschung/Fiction and Author Fiction in Early Christian Letters*, Jörg Frey et al., eds., WUNT 246 (Tübingen: Mohr Siebeck, 2009), 3–24, 14. An example of this would be the location of Philemon's house church in Colossae based on situational fiction (*Situationsfiktion* of the Epistle to the Colossians). For a discussion of this approach, see Martin Ebner, "Der Philemonbrief," in *Einleitung in das Neue Testament*, ed. Martin Ebner and Stefan Schreiber (Stuttgart: Kolhammer, 2008), 397–407, 402f.

3 Janßen and Frey, "Einführung," 14.

4 Cf. Eckart Reinmuth, *Hermeneutik des Neuen Testaments* (Göttingen: Vandenhoeck & Ruprecht, 2002), 104: "Pseudonyme Texte sind im Blick auf ihre Verfasserschaft grundsätzlich als darstellende, als fiktionale Texte zu verstehen. Texte wie z.B. der Epheserbrief oder der erste Petrusbrief werden durch ihre Pseudonymisierung zu einem Teil der Pauluserzählung, bzw. der Petrus erzählung."

controversial, as can be seen, for example, in the discussion of the opponents in the Letter to the Colossians.

The paradigm shift outlined above also leads to changed research perspectives. The burning introductory questions are no longer about the author, reader, and context. Historical scenarios are still investigated, but less in search for the points described in the text. On the one hand, this is probably due to the realization that no text simply depicts reality, and the fact that the textual world always creates a reality without a direct extra-linguistic reference. On the other hand, during the paradigm shift in historical science, it is clear that every source is perspectival, and not even historiography is always reliable.⁵

Questions about the author of the letter (Paul, a secretary, Paul's disciple, or an independent theologian), its addressees, and its opponents, specifically their teachings ("Colossian philosophy"), dominated research for a long time. If it is now assumed that Colossians is a fictional letter, these questions are not obsolete, but the classical steps to answer them no longer apply. With the assumption of a fictional author *and* addressee, the view of the text changes: it is no longer understood as an authentic letter and thus can no longer – to use classical exegetical terminology – be regarded as factual.⁶ That is, the model where "Paul communicates with the Colossians and this communication has a direct reference to reality" must be abandoned. The research question is now whether and how the actual epistolary situation of pseudepigraphal writings can be surveyed.

In his *Hermeneutik des Neuen Testaments*, Eckart Reinmuth suggests "in pseudonymen Texten im Blick auf die kommunikative Situation zwischen der tatsächlichen und der fiktiven Briefsituation zu unterscheiden und beides differenziert auf die Ziele der Argumentation zu beziehen."⁷ He concludes that in pseudepigraphic texts, the fictional author appears in the role of the implicit

5 One could think, for example, of Sueton's *Lives of the Caesars*, whose re-evaluation of senatorial historiography could possibly also lead to a re-evaluation of the Roman emperors, for example in the case of Domitian – and would also influence the understanding of New Testament texts, especially Revelation. The assumption that Domitian was the first emperor to enforce the salutation "Dominus et Deus" can no longer be sustained if the source on which it is based is understood as tendentious historiography whose aim is to discredit the emperor by sketching him as if he had enforced this salutation. This would also change the understanding of John 20:24–9 or the interpretation of the Ephesians, if they build on this assumption. Cf. Peter Pilhofer, *Das Neue Testament und seine Welt* (Tübingen: Mohr Siebeck, 2010), 157–9, 340–4. This idea goes back to a paper by Stefan Pfeiffer, scholar of classical history, at the annual meeting of the AKN 2011 in Fulda.

6 On the distinction between factual and fictional narrative, see Matias Martínez and Michael Scheffel, *Einführung in die Erzähltheorie* (München: Beck, 2005), 9–19.

7 Reinmuth, *Hermeneutik des Neuen Testaments*, 104.

author, and the fictional addressees assume the role of the implicit ones. The two are purposefully not congruent, since the texts want to reach the intended, not the fictional fictitious addressees.⁸ Accordingly, adding to the situation of the fictional addressees, the state of the implicit addressees should also be investigated. Therefore, the fictional communication is used “um gegenwärtige Fragen im Horizont paulinischer Theologie zu bearbeiten.”⁹

While this idea is plausible, it requires some rethinking. It could lead to the assumption that the implicit author and implicit addressee are individual entities and can only be contained to the extra-textual environment by analyzing the real communicative situation. However, such a procedure would be a dead end as “implicit author” and “implicit reader” are, on the one hand, concepts that cannot be localized in the text but require abstraction. On the other hand, the real communicative situation cannot simply be deduced from the text – or from a filtered, fictional communicative situation – but requires a change of medium and mode. In the case of a pseudepigraphic letter, the “classical” way to reconstruct the situation from the text does *not* lead to the real context of the letter. To get a better idea of who wrote what, to whom, and why, and maybe even locate the situation historically, the text must be examined in a way that has rarely been considered in exegetical discussion: the *structural level of the entire work (Ebene des Werkganzen)*.

1.1 *Ansgar Nünning’s Communication-Theoretical Text Model as a Reading Lens*

The necessary change in perspective can be illustrated using a model from a narrative text analysis. For a better understanding of the different aspects, the use of the communication-theoretical model of narrative mediation (*kommunikationstheoretisches Modell erzählerischer Vermittlung*), which Ansgar Nünning developed in his dissertation, is a good choice.¹⁰ It makes it possible

8 Eckart Reinmuth, “Exkurs. Zur neutestamentlichen Paulus-Pseudepigraphie.” In *Die Briefe an die Philipper, Thessalonicher und an Philemon*. Translated and explained by Nikolaus Walter, Eckart Reinmuth and Peter Lampe. NTD 8,2. Göttingen: Vandenhoeck & Ruprecht 1998, 190–202, 194.

9 Ruben Zimmermann, “Unecht und doch wahr? Pseudepigraphie im Neuen Testament als theologisches Problem,” *Zeitschrift für Neues Testament* 12 (2003), 27–38, 34. Zimmermann continues: “Fiktive Texte zielen gerade nicht im ontologischen Sinne auf das Nicht-wirkliche, sondern können – so etwa nach dem funktionsgeschichtlichen Textmodell von W. Iser – als Reflexions- und Rekonstruktionsformen der Wirklichkeit begriffen werden” (36). Fiction does indeed communicate something about reality, just not in the form of direct reference, as it is assumed for factual texts.

10 Ansgar Nünning, *Grundzüge eines kommunikationstheoretischen Modells der erzählerischen Vermittlung. Die Funktion der Erzählinstanz in den Romanen George Eliots*. Horizonte – Studien zu Texten und Ideen der europäischen Moderne 2. (Trier: WVT 1989), 22–124.

to clearly decipher the different types of communication in a text and keep them separated as is often the case in exegetical discussion.¹¹

Table 7.1 Nünning's text model

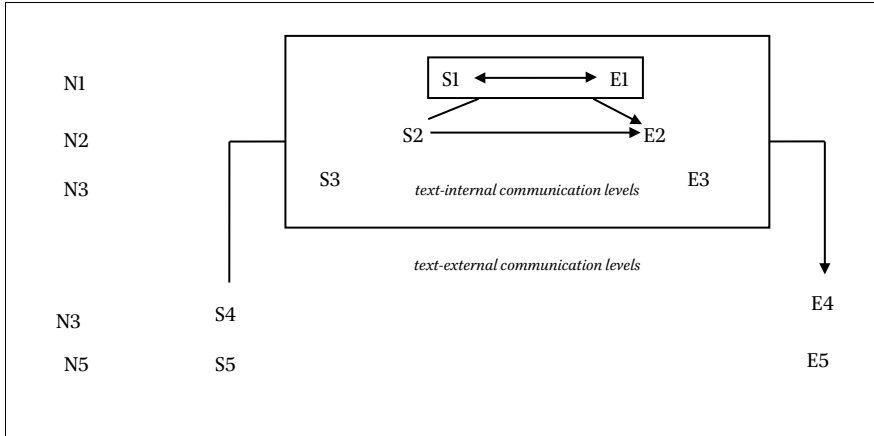

The communication-theoretical model of narrative mediation distinguishes between three text-internal (N1–N3) and two text-external levels of communication (N4–N5). On the *level of direct communication* or *level of the characters* (N1), a narrated “sending” character communicates with narrated “receiving”

11 Interestingly, there are hardly any exegeses that disclose which text model they are using. Ingrid Maisch's commentary on Colossians is a rare exception. In the introduction, Maisch explains on which levels her interpretation is located: “Die Beachtung der unterschiedlichen Ebenen und Rollen ist für das richtige Verständnis des (End-)Textes zu beachten: Ich lese einen kanonisch gewordenen Text (= Kol) und damit den alten Text eines Autors der Vergangenheit, der selbst die Fiktion eines noch älteren Textes (= Paulusbrief) aufbaut, weil zu seiner Zeit das Alte als normativ gilt und Paulus als Autorität verstanden wird. Die Auslegung muss die unterschiedlichen Kommunikationsebenen und die unterschiedlichen Rollen im Blick haben, sonst kann es geschehen, dass ich den Briefautor aus den 70er Jahren mit den Kolossern aus der Zeit von 60/61 (= Tod des Paulus, Erdbeben) in Kontakt treten lasse oder die den Kolossern empfohlenen Personen im Umfeld der wirklichen Adressaten suche. Daraus ergeben sich Konsequenzen: Bei der Auslegung des Textes (= Ebene 1) geht es um die Briefsituation (= Ebene 3), wobei die Intention des tatsächlichen Autors (= Ebene 2) jeweils mitbedacht werden muss.” Ingrid Maisch, *Der Brief an die Gemeinde in Kolossä*, ThKNT 12 (Stuttgart: Kohlhammer, 2003), 27. This reading perspective, expressed with the levels from Nünning's model exhibits a reading on the level N1 that repeatedly attempts to reach out to N4. N3 is not taken into account in her reading, as Maisch herself admits: “Die Unterscheidung von rekonstruiertem (d.h. vom Leser entworfenen Autor), und realistischem Autor, die in modernen Lesetheorien gemacht wird, wird hier nicht weiter verfolgt” (page 26 note 40).

characters: Jesus tells a parable to the crowd, or Paul addresses a community and gives them rules of conduct for living a Christian life. In narrative texts, N₁ is equivalent to character speech. The *level of narrative communication* (N₂) can only be gathered for narrative texts. Here, the narrator or narrative voice “narrates” how the sending and receiving characters come together: Jesus came to the lake, saw the large group of people, and had compassion on them. He taught them at length in the form of parables. Since letters consist exclusively of direct communication from a sending character and have no narrator, N₂ does not exist in letters.¹²

At the *structural level of the entire work* (N₃), the subject of the entire work communicates with the abstract recipient of the entire work. The level of the entire work is often described with the concepts “implicit author” and “implicit reader.” This sometimes includes an unconscious anthropomorphizing of both concepts, which is problematic. Not only does it open up speculation about the “author’s intention,” it supposedly provides criterion to judge the correctness of an interpretation. Such a view also loses sight of the macrotext, which is the actual point of reference. At the level of the entire work, no personal instances can be encountered, only abstract phenomena that must be worked out by empirical recipients. As an abstract construct, the structural level of the entire work can be understood as the sum of the structural contrast and correspondences resulting from the similarities and differences at the level of the characters. The point is to identify the elements that cannot be assigned to the characters, but nevertheless belong to the entire work. These elements can be the arrangement of arguments and their linguistic design, the building of narrative tension, the structure of perspectives, or the fictional system of values and norms, which only become visible when the work is considered in its entirety. At this level, it is also possible to detect the narrative tensions and frictions, which suggest an unreliable narrator or, in our case, pseudepigraphy.

When it comes to text-external communication, two levels can be distinguished: The *level of literature production/reception* (N₄) comprises the empirical author in his, her, or their role as a producer of literature (S₄), and the empirical reader in his, her, or their role as the recipient of literature (E₄). In other words, the empirical author writes down the text that the empirical addressees receive. He, she, or they is/are, therefore, are not the narrator, but the one who makes the internal reality of the text accessible to the empirical readers by encoding it in signs. On the *level of social roles* (N₅), the real author in his, her, or their various social roles (S₅) and the real reader in his, her, or their various social roles communicate (E₅) with each other.

¹² This excludes intradiegetic and metadiegetic narration.

When applying this model to the Letter to the Colossians, the levels N₂ and N₅ can be neglected. On the one hand, for reasons of genre, there is no narrator in Colossians, and on the other hand, the differentiation of the external elements of the work. This lies between the empirical author/reader as a member of society with a complex household (S₅/E₅), and the real author/reader in the role of literary producer or recipient (S₄/E₄), and it is not relevant for our consideration.¹³ For the problem examined here, it is sufficient to keep in mind that the levels of communication between N₄ and N₅ are not the same as the difference between historical and contemporary recipients.

When we subscribe to the idea that pseudepigraphy aims to continue the Pauline or Petrine narrative, it makes sense to take a closer look to see not only what story is told at the N₁ level, but to attempt to survey, at least to some extent, what story N₃ tells. Or to put it another way: for reasons of historical distance, the textual boundary cannot be easily overcome, and one cannot directly access N₄; therefore, a closer look at N₃ might provide hints to remove this textual boundary. The basic hermeneutic assumption is, of course, that no “hard facts” will be retrieved. Applied to the letter to the Colossians, three levels of communication can be established in a simplified form of Nünning’s model:

Table 7.2 Colossians in Nünning’s text model

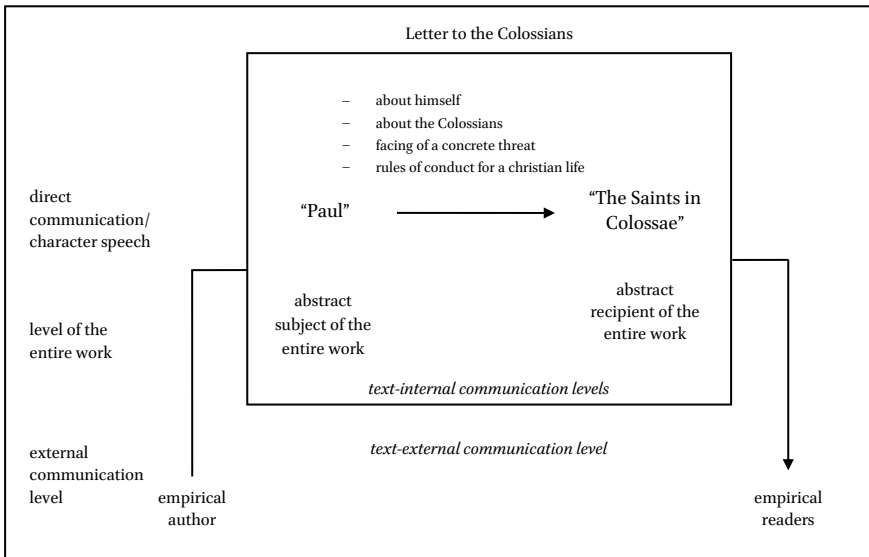

13 Nünning, *Grundzüge eines kommunikationstheoretischen Modells*, 26, issues a general warning against overtaxing role-theoretical differentiation, “weil die individuelle Sozialisationsgeschichte ungeachtet der jeweiligen Rolle unverändert bleibt und ein Produzent oder Rezipient ‘notwendig im Rahmen des Voraussetzungssystems operiert, das ihm als bürgerliches Subjekt zugeordnet werden muß.’”

On the *level of characters* (N₁), the fictional sending character, “Paul,” communicates with the fictional receiving characters, “the saints in Colossae,” who for reasons of genre, do not get a chance to answer. In the text, this is structured as follows: “Paul” addresses “the saints in Colossae,” to whom he communicates something about himself and them, and to whom he gives rules of conduct for living Christian life under a concrete threat. So much for the fictitious situation of the letter, which was long believed to be the real historical situation.

On the *level of the entire work* (N₃), a closer look reveals elements that cannot be directly assigned to “Paul” and “the saints in Colossae.” It can, e.g., be seen that the “Colossians” are not quite as orderly and firm in their faith in Christ as “Paul” joyfully states in 2:5. If this were so, and the gospel was bearing fruit and growing among the “Colossians” (1:5–6), there would be no reason to exhort them to receive the gospel by being rooted and built up in Christ or holding on to the tradition (2:6–7) – especially not repeatedly (cf. 1:23; 3:17). Apparently, the firmness of the faith of the “Colossians” was not as good as “Paul” describes it, and there was indeed greater confusion caused by alternative religious offers.¹⁴

On the *level of text-external communication* (N₄), an unspecifiable empirical author and likewise, unspecifiable empirical addressees, communicate with each other.

1.2 *Application of the Model to Colossians*

What does this imply for understanding Colossians? First of all, the different levels of communication can be distinguished more precisely. When the model is used to present an authentic Pauline letter, sender and addressee meet on level N₁ and level N₄; that is, both on the level of internal communication to the text *and* on the level of external communication. This connection allows for the drawing of conclusions about the communication situation from the

14 Ingrid Maisch's observations, where she describes the situation of the actual addressees of the Letter to the Colossians, also moves in this direction: “Sie ist einerseits durch ‘Ordnung und Festigkeit eures Glaubens’ (2,5) bestimmt, andererseits durch ihre Beeinflussbarkeit von Seiten der Umwelt (vgl. ‘keiner’, 2,4; ‘jemand’, 2,8.16; ‘die Menschen’ samt ihren Traditionen, Geboten und Lehren, 2,8.22; ‘Außenstehende’, 4,5). Sie haben sich mit der Welt arrangiert und nehmen auch andere religiöse Angebote wahr. Sie selbst sehen darin keine Absage an ihre Christus-Zugehörigkeit, während der Autor in dieser Spielart des Christlichen bereits den Keim zum Abfall erkennt und daher klare Alternativen aufbaut: Überlieferung der Menschen oder christliche Überlieferung, Christus oder die (Elemente der) Welt (2,8). Während die Gläubigen durch religiöse Praktiken und die Beobachtung von Tabuvorschriften eine größere Heilssicherheit erreichen wollen, werden sie durch den Brief auf Christus als das alleinige Fundament des Heils verwiesen.” Maisch, *Der Brief an die Gemeinde in Kolossä*, 23.

text itself. In a pseudepigraphic letter, this “duplication” of the character is not possible. Furthermore, the model shows that the pseudepigraphic nature of the writing cannot be described on the *level of the characters*, but only on the *level of the entire work*.

Nünning's *communication-theoretical model of narrative mediation* can also be used as a reading lens for the secondary literature on pseudepigraphy. On the basis of his model, one can identify three different ways to understand pseudepigraphy, and each of them can be assigned to a particular stage in the history of research:

- a) $S_1 = S_4$ and $E_1 = E_4$: Colossians as an authentic Pauline letter.
- b) $S_1 \neq S_4$ and $E_1 = E_4$: Colossians as pseudepigraphic letter.
- c) $S_1 \neq S_4$ and $E_1 \neq E_4$: Colossians as pseudepigraphal epistolary fiction.

A glance at the history of research on Colossians shows that the fictional nature of the text was not recognized for a long time and the *level of the characters* was identified with the *level of text-external communication*: The real Paul was believed to be writing to the real community in Colossae (a). In the next stage, the assumption that Colossians is a pseudepigraphic letter initially led to the assumption that the fictional communication situation was real (b). Based on Nünning's model, the hermeneutical difficulties of these attributions can be shown, because in both cases, the boundary of the text is crossed, and the text-internal communication level is dissolved into the text-external one. This is problematic because “Paul” remains within the text and cannot to be found in the real world. The communication levels N_1 and N_3 need to be kept apart as text-internal variables, and they need to be distinguished from the text-external situation. This is achieved when the letter is received as pseudepigraphic epistolary fiction (c). In this scenario, it is quite possible and intended that the empirical readers recognize themselves in the abstract recipients of the entire work, that is, that N_3 is transparent to N_4 .

If text-internal and text-external levels are equated in texts that are clearly recognizable as fictional writing, this has consequences for their interpretation. Projecting the supposed “implicit author” into the text-external reality usually implies additional or follow-up hypotheses that are not necessarily wrong but cannot be verified either. This is especially problematic when further hypotheses are added, and eventually, entire hypothesis-buildings are constructed. For the author-fiction of the Colossians, for example, this means that if Paul himself did not write the letter, but someone else did so in his name and authority, then it must be considered who this person could have been. This someone could have been, for example, a secretary of Paul or one

of his disciples. In the next step, this idea might lead to the assumption of a Pauline school or some other hierarchically structured organization of the post-Pauline era.¹⁵ These organizations would need to be investigated further in order to more clearly distinguish the author of Colossians from those of the other Deutero-Pauline letters. This would further differentiate the picture of the Pauline school and the post-Pauline ministerial tradition. On the one hand, the assumptions become increasingly speculative and dogmatic – as repeatedly appears in the literature – and on the other hand, the discussion moves further and further away from the biblical text. When working with follow-up hypotheses, therefore, caution is in order, and one must keep in mind that observations of the entire work cannot simply be applied to the world outside the text, i.e., to the extra-textual reality.

For the fictional level of communication between “Paul” and the “saints in Colossae” (N₁) the following story could be assumed: *Paul addresses the saints in Colossae, to whom he communicates something about himself and about them, and to whom he gives rules of conduct for a Christian life facing a concrete threat.* What “Paul” says about himself is part of the author fiction, and what he tells

15 In the case of this school of tradition, one may ask, with Martina Janßen, “wie tragfähig Analogien aus dem pagan-antiken Schulbetrieb für die Erklärung *neutestamentlicher* Pseudepigraphen sind.” Martina Janßen, “Antike (Selbst-)Aussagen über Beweggründe zur Pseudepigraphie,” in *Pseudepigraphie und frühchristliche Verfasserfiktion/Pseudepigraphie and Author Fiction in Early Christian Letters*, ed. Jörg Frey, Jens Herzer, Martina Janßen, and Claire Rothschild, WUNT 246 (Tübingen 2009), 125–79, 163. In recent years, a new discussion – prompted by the impulses of Thomas Schmeller, Tor Vegge, and Armin Baum – has emerged that questions the idea of a Pauline school. The existence of a Pauline school is rejected e.g., by Peter Pilhofer, who regards it as an apologetic conception. Pilhofer, *Das Neue Testament und seine Welt*, 216. On the criticism of the existence of a “Pauline school,” see also Marco Frenschkowski, “Pseudepigraphie und Paulusschule: Gedanken zur Verfasserschaft der Deuteropaulinen, insbesondere der Pastoralbriefe,” in *Das Ende des Paulus. Historische, theologische und literaturgeschichtliche Aspekte*, ed. Friedrich Wilhelm Horn, BZNW 106 (Berlin: De Gruyter 2001), 239–72, 253–62 and the summary of the discussion by Helmut Merkel, who concludes “Die Vorstellung von Paulusschülern, die im Namen des Lehrers Briefe verfassten, stammt aus den Anfängen der historisch-kritischen Erforschung des Neuen Testaments. Sie diene zunächst der Erklärung, wieso offenbar nicht von Paulus geschriebene Briefe mit seinem Namen im Kanon stehen. Je nach Geschmack konnte dabei der Schülerbegriff mehr die Nähe zum Lehrer (‘zwar nicht von Paulus selbst, aber doch immerhin von einem seiner Schüler’) oder eher die Entfernung (‘bloß von einem Schüler und deshalb nicht auf derselben Höhe’) signalisieren. Je stärker die Exegese zu differenzieren lernte, desto unbrauchbarer erwies sich der Schülerbegriff.” Helmut Merkel, “Der Lehrer Paulus und seine Schüler. Forschungsgeschichtliche Schlaglichter,” in *Religiöses Lernen in der biblischen, frühjüdischen und frühchristlichen Überlieferung*, ed. Beate Ego and Helmut Merkel, WUNT 180 (Tübingen: Mohr Siebeck 2005), 235–50, 250.

the “saints of Colossae” about themselves is part of the addressee fiction. Both remain in the narrated world or in on the level of the characters. This means that the “concrete threat” is also located there. It, too, is part of the narrative context and does not necessarily represent a historical fact.¹⁶

What kind of threatening situation is outlined in Colossians? According to the text model, the threat cannot be gathered from N₁, since this is the level of fictional communication, and it likewise cannot be gathered from N₄, since the textual world is not congruent with the real world, and this kind of reference to the extra-linguistic reality cannot be raised due to a lack of comparison (like other texts). Thus, the threatening situation can only be gathered from N₃. It is not directly present in the text, but has to be constructed by the recipients. Hints or building materials for this construction are, for example, the sequence of narrative statements, the generation of tension, the handling of time, comedy and irony, the character constellation(s), perspective structure or the fictional system of values and norms.¹⁷ These are parameters that can only be gathered by investigating the text as a whole.

This changes the direction of the question once more. We must take seriously that the level of real communication and the level of narrative mediation must be distinguished and separated. Therefore, the overall interpretation and contextualization of the text can no longer be based on individual elements from the level of narrative mediation and their possible reference to extra-textual reality, but the entire narrated world must be taken into consideration. The question is no longer: *Who are Paul's opponents?* Or, *what is the Colossian philosophy?* But rather: *Which experiences does Colossians reflect and in light of which situation?*¹⁸

16 This fact is an identifiable quantity that is external to the text but is also a reference to an extra-textual reality within the framework of a fictional text.

17 Cf. Nünning, *Grundzüge eines kommunikationstheoretischen Modells erzählerischer Vermittlung*, 31–40, which discusses criteria for distinguishing communication level N₃ from the other two text-internal communication levels.

18 The letter indicates that the community is facing an identity crisis and is perhaps even on the brim of dissolution. Cf. Angela Standhartinger, “Der Brief an die Gemeinde in Kolossä und die Erfindung der ‘Haustafel,’” in *Kompendium Feministische Bibelauslegung*, ed. Luise Schottroff and Marie-Theres Wacker (Gütersloh: Gütersloher Verlagshaus, 1998), 635–45, 638. What exactly is at stake is not clear, and this, too, is hardly a coincidence. If the situation of the real addressees can be too clearly recognized from a letter that is supposedly addressed to others, the epistolary fiction is ineffective. Therefore, a somewhat nebulous description is needed, which nevertheless reaches its goal – the self-understanding of the real addressees before the text.

1.3 *From a Fictitious Letter to Fictitious Opponents?*

Colossians can thus be seen as an orchestrated form of communication. After the proem (1:3–23) and the self-introduction of the apostle (1:24–25), the first and instructive theological part of the letter (2:6–41) opens the argument with the “philosophy” of the opponents. The attempts to locate this “Colossian philosophy” historically are many, but these have reached no consensus. This points to a question, which is posed and discussed similarly to the addressees, i.e., how real are the opponents in Colossians? This question cannot be shown with the help of Nünning’s textual model, and this question cannot be located on one of the communication levels of the text. Since the question about the opponents can be understood as part of epistolary fiction, it is on the level of the genre and can be answered with the distinction of *factual* vs. *fictional narration*. This, too, can be illustrated with examples from secondary exegetical literature: Time and again we can observe the assumption that the impossibility to reconstruct the “Colossian philosophy” is a *material* impossibility, i.e., the lack of material about them. For most interpreters, the data given in Colossians is simply too diffuse to be able to clearly distinguish a group of opponents.¹⁹ The implicit assumption is that Colossians is a factual letter. If one reads Colossians as a fictional letter, it makes sense to assume a *hermeneutical* impossibility and to argue – similar to the author fiction and addressee fiction – that the opponents are part of the “Paul narrative,” and simply cannot be projected to the text-external level.

If one takes the idea of a pseudepigraphal epistolary fiction further in a consistent way, the question about the opponents shifts from the level of real communication to the level of narrative mediation. Therefore, it does not

19 A glance into the exegetical discussion shows how difficult it is to find the generic doctrine and its representatives in view of this masquerade. Hans Hübner notes: “Von der kolossischen ‘Philosophie’ wissen wir nur durch den Kol. Und dort ist von ihr nur in polemischer Weise die Rede. Hinzu kommt, daß diese aggressiven Aussagen lediglich fragmentarischen Charakter haben. Eine systematische Darstellung der ‘Philosophie’ wird vom AuctCol nicht geboten. Aus Fragmenten aber, die nicht das Ganze abbilden, läßt sich kein zuverlässiges Bild gewinnen. Wir müssen also davon ausgehen, daß wir nur Teilinformationen – in welchem Ausmaß auch immer – besitzen, und diese noch in recht verzerrter Überlieferung.” Hans Hübner, *An Philemon. An die Kolosser: An die Epheser*, HNT 12 (Tübingen: Mohr Siebeck, 1997), 94. Nevertheless, there are still attempts, some of them very differentiated, to localize the opponents, cf. e.g., Peter Müller, “Gegner im Kolosserbrief: Methodische Überlegungen zu einem schwierigen Kapitel,” in *Beiträge zur urchristlichen Theologiegeschichte*, ed. Wolfgang Kraus, BZNW 163 (Berlin: De Gruyter, 2009), 365–94.

necessarily have a direct reference to the extra-textual reality.²⁰ To put it differently: The “Colossian philosophy” can be modeled after a real example, but it does not have to be. It can also be a lot more colorful and thus more fictitious than a real model. In the best sense, it is syncretistic, as it is presented in the letter, and the latter can be assumed. This helps epistolary fiction because the real addressees can recognize themselves in the fictional ones without having to identify with them.²¹ Accordingly, as Ingrid Maisch and Angela Standhartinger have pointed out, recent exegetical studies suggest that the opponents in Colossians are not a real group, but a construct.²² In the current discussion, very differentiated approaches can be found. Ulrich Luz rightly warns against supplementing the sparse statements of the text with material from the history of religion and advises to first examine what the text says, and only then comparing it to data from the history of religion.²³ Such a procedure starts at the level of the entire work and connects the findings with the world outside the text in a methodologically responsible way.

In his dissertation about the opponents in 1 John, Hansjörg Schmid has made groundbreaking observations that apply *mutatis mutandis* to Colossian epistolary fiction as well. Schmid chooses a guiding perspective for the treatment

20 Regarding this point, Colossians remains rather vague: even if one assumes it is a direct reference to an extra-textual reality, one could only say that Paul writes a letter to the Colossian community, and even though he doesn't know them, they are close to his heart during his imprisonment toward the end of his life. It is in a letter that he addresses a serious threat to the community, but it is unclear what exactly the threat consists of, or how Paul learned about it. That this threat is not diffuse, but concrete – at least that is the assumption – is shown by the concept of the “Colossian philosophy” (2:8), which, depending on the interpreter, is either Gnostic, Hellenistic-Pagan, or Jewish-esoteric, but in any case, it is syncretistic. Above all, the impression remains that the attempt to locate the letter in a particular historical situation leaves unanswered questions.

21 At this point, N₃ is transparent to N₄.

22 Maisch, *Der Brief an die Gemeinde in Kolossä*; in *Studien zur Entstehungsgeschichte und Intention des Kolosserbriefes*, ed. Angela Standhartinger, NTS 94 (Leiden: Brill, 1999). See also Nicole Frank, who assumes “dass Kol 2,16–23 nicht eine spezifische Irrlehre im Umfeld von Kolossä im Blick hat, sondern gerade vor dem Hintergrund der pseudepigraphischen Abfassungssituation als umfassende Handreichung für den christlichen Umgang mit abweichenden Lehrmeinungen zu verstehen ist.” Nicole Frank, “Der Kolosserbrief und die ‘Philosophia.’ Pseudepigraphie als Spiegel frühchristlicher Auseinandersetzungen um die Auslegung des paulinischen Erbes,” in *Pseudepigraphie und frühchristliche Verfasserfiktion/Pseudepigraphy and Author Fiction in Early Christian Letters*, ed. Jörg Frey, Jens Herzer, Martina Janßen, and Claire Rothschild, WUNT 246 (Tübingen: Mohr Siebeck, 2009), 411–32, 412.

23 Ulrich Luz, “Der Brief an die Kolosser,” in *Die Briefe an die Galater, Epheser und Kolosser*, ed. Becker Jürgen and Ulrich Luz, NTD 8.1 (Göttingen: Vandenhoeck & Ruprecht 1998), 215.

of the opponents in 1 John based on the question of how the text functions and the boundaries it draws:

Nicht wer die Gegner waren, lautet dann die Frage, sondern zu welchem Zweck und in welchem Zusammenhang überhaupt von Gegnern gesprochen wird. Dazu gilt es, in und nicht hinter den Text zu schauen. Der Schwerpunkt der Untersuchung verschiebt sich damit von der Gegnerfrage hin zu der Frage nach der Gemeindeidentität, für welche das Gegenbild eine zentrale Funktion besitzt.²⁴

This more text-oriented (pragmatic) approach assumes that the image of the opponents says more about the community than it does about them.²⁵ Applied to Colossians, this would mean that it is also not about the opponents, but the situation that has arisen for the Colossians because of their demands. In fact, this simplifies the reading because those introduced as μηδείς (no one) and μή τις (not anyone) remain quite understated and describe the situation of the “saints in Colossae.” “Paul” does not settle accounts with the opponents, but instead constructs a threatening situation for the addressees which gradually becomes more menacing.

Col 2:4 reads: “I say this so that no one may deceive you (παραλογίζομαι) with persuasive words.” The apostle is absent and trusts in the steadfastness of the addressees’ faith. A threat seems far away, and the exhortation is rather general. In 2:8, the threat becomes more concrete: “See that no one takes you captive through philosophy and empty deceit according to the tradition of men, according to the elementary principles of the world, rather than according to Christ!” Obviously, the deception has a definitive shape: a certain doctrine or list of requirements, which can be clearly distinguished from the gospel. At this point, “Paul,” once again, refers to the salvation that has come to Christians because of the redemptive act of Christ through baptism. The past constitutes the Christian’s present and should protect them against challenges in the future.

In 2:16, it becomes clear that this does not work: “Therefore, do not let anyone condemn you in matters of food and drink or of observing festivals, new

24 Hansjörg Schmid, *Gegner im 1. Johannesbrief? Zur Konstruktion und Selbstreferenz im johanneischen Sinn-system*, BWANT 159 (Stuttgart: Kohlhammer, 2002), 21.

25 This does not answer the question of how real the opponents are, but it also does not seem to be central for textual pragmatics. Schmid concludes: “Weder von der Textsorte her noch aufgrund des konstruktivistischen Textmodells ist definitiv zu entscheiden, ob es sich beim Gegnermotiv in 1 Joh um eine Fiktion oder Imagination handelt, die Gegner als eine rein fiktive Größe darstellen, oder ob zumindest eine reale Erfahrungsbasis zugrunde liegt.” Schmid, *Gegner im 1. Johannesbrief?*, 56.

moons, or sabbaths." The Colossians are confronted with strict requests regarding everyday religious life and its arrangement, until 2:18 finally reads: "Do not let anyone disqualify you, insisting on self-abasement and worship of angels, dwelling on visions, puffed up without cause by a human way of thinking."

The potential threat, which at first seems far away, comes closer with each verse, and becomes more and more tangible. Obviously, the Colossians are confronted with demands that have not yet overwhelmed them, but have the potential to do so and, at the very least, make them feel insecure. Thus, the threatening scenario culminates in the statement: "Why do you submit to regulations, 'Do not handle, Do not taste, Do not touch?'" (2:20–21).

The diffuse warning about seductions has turned into concrete commandments (ἐντάλματα, 2:22) in just a few verses. The theoretical background of these commandments, however, whether they are derived from Jewish or Gentile teachings, is unclear. The discussion is whether it is a disturbance that comes from the outside or from within. Is the previous teaching to be replaced by an entirely new one, or is it "only" supplemented by new elements? Both suggestions assume that the "Colossians" already have an (at least reasonably) stable Christian identity.²⁶ The addressee fiction, however, depicts believers who have heard about the gospel secondhand, not from the apostle himself, although still within the Pauline tradition. They have accepted the gospel and now *try to* align their lives to it. Obviously, their intentions are greater than their success. This is not, therefore, a group with a stable Christian identity, but a group in the process of discovering what a Christian identity could look like.

Colossians seems to deal with the problem of a turning to Christianity that is incomplete, i.e., their former strategies for coping with life remain as they are attached to their origin and identity – in this case, presumably a pagan one. Their assignment would look something like this: As Christians, they must find their way in a non-Christian world and learn to implement their change in status, which took place during their baptism, in the reality of their everyday lives.²⁷ Colossians shows how difficult this is for a group who lacks tradition and feels challenged and seduced by the world – represented by the religious and social environment from which they originate. The author of Colossians develops strategies for this challenge.

26 Cf. Maisch, *Der Brief an die Gemeinde in Kolossä*, 30–39. To remain in a biblical image: the hand is already on the plow, but the gaze goes back (Luke 9:62). People like that are likely to achieve nothing in the kingdom of God, neither in the Gospels nor in Colossians. That is why the author of Colossians calls on his addressees to commit themselves completely to Christ and new life in him, and to leave their old life and rituals behind.

27 Cf. Maisch, *Der Brief an die Gemeinde in Kolossä*, 24.

Viewed on a meta-level, Colossians thus becomes

ein allgemeines Schreiben, das die Probleme vieler Neubekehrter aufgreift und durch Ermahnungen und die Erinnerung an die Taufe einer Lösung zuführen will. Die *Adressaten* dürften daher unter Christen der ersten Generation zu suchen sein, die durch das allgemeine geistige Klima – geprägt durch pagane Religionen und den kleinasiatischen Synkretismus – in ihrem Glauben verunsichert sind.²⁸

Regarding this point, the “Colossians” resemble all later generations of Christians: The gospel has reached them, and they have accepted it. Now it must transform their lives and daily routines. The “saints in Colossae” become a cipher for all Christians: Their lives must change when confronted with the gospel, and this change must be reflected in their everyday lives. This process is repeatedly disturbed by the alternative, seductive offers for their identity construction. From this perspective, the question about the “Colossian philosophy” is resolved in a surprising yet insightful way.

Based on the considerations on the fictional nature of Colossians, it can be assumed, with all necessary caution, that a pretend, threatening situation is described in the text. “Paul” deals with this in a letter and develops his theology in the form of instructions for the faithful (and not an individual community) whom he does not know. In this situation, there must be a reason for both the empirical author and the empirical readers that Paul was chosen as the author’s pseudonym.

“Paul” is an authorial pseudonym from the near-deixis for readers of the second and third generations of early Christians.²⁹ The apostle is no longer alive when the letter is written, but he is still known. As Nicole Frank has shown in her PhD thesis, there are intertextual links between Colossians and the entire *Corpus Paulinum*.³⁰ This suggests that the empirical author was familiar with Pauline language and theology. At the same time, it is clear from the entire

28 Maisch, *Der Brief an die Gemeinde in Kolossä*, 23.

29 Cf. Marco Frenschkowski, “Erkannte Pseudepigraphie? Ein Essay über Fiktionalität, Antike und Christentum,” in *Pseudepigraphie und frühchristliche Verfasserfiktion/ Pseudepigraphy and Author Fiction in Early Christian Letters*, ed. Jörg Frey, Jens Herzer, Martina Janßen, and Claire Rothschild, WUNT 246 (Tübingen: Mohr Siebeck, 2009), 181–232, 225–27. Frenschkowski concludes that “die jüngste Vergangenheit ist autoritative Offenbarungszeit, nicht die Vergangenheit” (227), which also explains why early Christian pseudepigraphy, unlike non-Christian writings, chooses figures of near-deixis instead of (authoritative) figures of far-deixis.

30 Nicole Frank, *Der Kolosserbrief im Kontext des paulinischen Erbes: Eine intertextuelle Studie zur Auslegung und Fortschreibung der Paulustradition*, WUNT II 271 (Tübingen: Mohr Siebeck, 2009), esp. 327–72.

work that the author is addressing people who do not know Paul himself, and who are also unlikely to have noticed the stylistic changes when compared to the authentic Pauline letters. The addressees must have been quite distant from Paul in time and possibly in place.

What remains is this question: *why* would someone write a letter on behalf of a dead person (1:24), to a group of people who no longer exist, in order to discuss problems that concern others?

2. Paradigm Shift II: Pseudepigraphic Texts as Constructions of Authority

The possible answers to this question bring us to the second paradigm shift. It concerns the discussion about the intention of pseudepigraphy and is reflected less in the question of *who uses* the respective pseudonym, but rather *to which end* it is used. In addition, we can see a new range of answers to the question of, *what is the intention of pseudepigraphy?* These are different from the motivations that were previously discussed.

One example among many for a “classical” position on pseudepigraphy can be found in Jürgen Roloff’s *Einführung in das Neue Testament*. It is exemplary for the treatment of these questions and can be found in many *Introductions to the New Testament*:

Es handelt sich bei dieser Pseudepigraphie um ein spezifisches Phänomen der dritten christlichen Generation, das im Zusammenhang mit der Autoritätskrise der Zeit zwischen ca. 80 und 120 zu sehen ist. Nur die alten, längst dahingegangenen Autoritäten der Anfangszeit, vor allem die Apostel, galten als maßgeblich und vertrauenswürdig. Kirchliche Schriftsteller, die unter eigenem Namen schreiben, melden sich erst einige Zeit nach der Jahrhundertwende zu Wort.³¹

Two things are noteworthy here: the notion that pseudepigraphy is a *phenomenon of the third generation*, and the idea that it is the answer to a *crisis of authority*. Both can be found in this form or a similar one in most contributions on pseudepigraphy. It is often assumed that pseudepigraphy is a strategy to deal with the loss of authority or infighting in the early church.³² The basic

³¹ Jürgen Roloff, *Einführung in das Neue Testament* (Stuttgart: Reclam, 1995), 194.

³² Cf. Martina Janßen’s conclusion: “Trotz unterschiedlicher Akzente und Nomenklaturen sind die Überlegungen über die Deutung und die Bewertung frühchristlicher Pseudepigraphie zum großen Teil ‘austauschbar’; dies gilt über die hier dargestellten Positionen hinaus auch für etliche weitere Kommentarwerke und Einführungen. Die Beiträge entwerfen mit einigen Modifikationen ein gemeinsames Bild: Neutestamentliche

assumption is that the “old” positions differ little from the “new” ones in this area: regardless of whether the hypothesis of a scribe, Pauline school, or fictitious self-interpretation is used to explain the phenomenon, there is usually an assumption that tradition, the good origin, has fallen into crisis and must either be saved or updated into the new area.³³ In addition, the assumption that early Christian pseudepigraphy appears to be a temporary phenomenon, roughly located between 60 and 110 CE,³⁴ is a key component for the question about the relationship between authority and power in the early church. However, it is interesting to note here that at this later point in time, i.e., after 110 CE, the power dynamic has been clarified again so that Ignatius and Polycarp, could write in their own name and with their own authority.

This argument is grounded in a particular conception of the (self-)organization of ecclesiastical structures that was gradually developing during this period. The basic idea is this: The foundation in the Christ event was followed by a normative period of the apostles and eyewitnesses, who held an authority in matters of orthodoxy and orthopraxy. This ended with the death of the eyewitnesses and was characterized by disputes about the adequate preservation and continuation of the tradition, both in teaching and in the practices of the individual communities. During this time, the official structures were formed, on which the church fathers can fall back, and who then (depending on argument: again) possess authority over the entire church, allowing them to speak and make decisions with authority. Strictly speaking, we are dealing with four generations of early Christians: the founding generation (I), the generation of apostles and eyewitnesses (II), the generation who struggled with arguments

Pseudepigraphie dient in ihren unterschiedlichen Ausformungen der Sicherung und Aktualisierung apostolischer Autorität und Ursprungsnorm in der Zeit der inneren Krisis und des Autoritätsvakuums.” Janßen, *Unter falschem Namen*, 248f.

33 Michael Wolter expressed this in his *Habilitationsschrift* about the Pastoral Epistles: The task of the author(s) of the Pastoral Epistles was “in der Situation der Konsolidierung der Gemeinde und deren Bedrohung durch jüdisch-gnostische Irrlehrer ‘die lebendige apostolische Autorität in der Kirche gegenwärtig (zu) halten’ und das paulinische Erbe für seine Gegenwart neu zur Sprache zu bringen. Seine Intention richtete sich demnach auf die Herstellung von Kontinuität mit dem normativen Ursprung der apostolischen (paulinischen) Tradition.” Michael Wolter, *Die Pastoralbriefe als Paulustradition*, FRLANT 146 (Göttingen: Vandenhoeck & Ruprecht, 1988), 12–13.

34 Cf. for example Petr Pokorný and Ulrich Heckel, *Einleitung in das Neue Testament* (Tübingen: Mohr Siebeck, 2007), 623: “Die meisten neutestamentlichen Pseudepigraphen wurden in nachapostolischer Zeit verfasst, d.h. sie stammen nach dem Tod der Apostel von deren Schülern, sind ein Phänomen der zweiten oder dritten Generation und entstammen dem letzten Drittel des 1. Jh.s. Der Verfasser des 1. Clemensbriefs (96–100), Ignatius von Antiochien (110–114), Polykarp (etwa 110–115) oder Hermas (2. Jh.) schreiben wieder unter eigenem Namen.”

about the continuation of the tradition (III), and the generation of consolidation (IV). In this model, Paul belongs to generation II, Ignatius to generation IV, and the authors of the pseudepigraphs to generation III.³⁵

The benchmark of this explanatory model is the good or *normative* origin to which the pseudepigraphal authors refer in this case.³⁶ This normative origin is often assumed to be a *fact* or *datum* without further question. But even this conviction has become fragile. In the second edition of the *Einleitung in das Neue Testament* Ingo Broer says:

Für die Abfassung pseudepigraphischer Werke im christlichen Raum wird die besondere Bedeutung des Anfangs und Ursprungs eine wichtige Rolle gespielt haben, wie sie auch im Judentum gegeben war. (...) Mit der Ausbildung der Pseudepigraphie im Christentum könnte es sich ganz ähnlich verhalten. Denn diese wurde erst in nachapostolischer Zeit ausgebildet, als man bereits ein Bewusstsein für das Ende der apostolischen Zeit entwickelt hatte. Hinter diesen neutestamentlichen Pseudepigraphen steht die Absicht, die Normativität des Anfangs aufzuzeigen und vor allem die Kontinuität mit diesem Anfang trotz des Bruchs zwischen apostolischer und nachapostolischer Zeit durch die Bewahrung des von den Aposteln anvertrauten Gutes zu bewahren.³⁷

The way this is phrased shows how the perception of this phenomenon is gradually shifting. There is no mention of a “crisis of authority,” nor is it a matter of enforcing decisions already made, but rather of establishing continuity in the form of a tradition, which is achieved by connecting the present to a normative beginning. The cautious wording does not define the beginning and more strongly emphasizes its referential nature for pseudepigraphy.

This opens the door to critically question the construction of the *normative origin* and to ask whether the assumption of an authority for the entire church projects ecclesiastic concepts onto a time for which they are not proven. Additionally, this is rather improbable due to socio-historical considerations. Thus, Ruben Zimmermann rightly asks:

35 This list is, of course, very simplistic and can only be maintained in theory. In practice, the individual phases might have overlapped: While Ignatius wrote in his own name in Antioch in 110–114 CE, further pseudepigraphs like the Petrine Epistles were written elsewhere.

36 The explanatory model of the “authoritative tradition,” uses the Jewish context. In the wake of the *New Perspective*, it is certainly no coincidence that this model is currently gaining more weight in the discussion than the model of the Pauline school tradition, which originated in the Hellenistic context. Here, too, a new orientation seems to be emerging, which is accompanied by stronger reservations towards the school tradition. Cf. Janßen, *Antike (Selbst-)Aussagen über Beweggründe zur Pseudepigraphie*, 159–63.

37 Ingo Broer together with Hans-Ulrich Weidemann, *Einleitung in das Neue Testament* (Würzburg: Echter, 2010), 562f.

Gab es denn je zu einer Frühphase des Christentums diese 'gesamtkirchlichen Autoritäten'? Zeigen nicht die diversen aus den Schriften rekonstruierbaren Streitigkeiten, dass es das Idealbild einer harmonischen, von Aposteln geleiteten Urchristenheit nie gegeben hat? Mit wachsender Zeit hat es wohl kaum einen Verlust an Anerkennung, sondern eher eine Konzentration an (kirchenpolitischer) Macht gegeben, wie etwa die Clemensbriefe beweisen. Nicht der Mangel an Führungspersönlichkeiten, sondern eher ein bestimmtes Geschichtsbild, das die apostolische Zeit retrospektiv als Norm setzte, hat dazu beigetragen, dass die Pseudepigraphie in der zweiten und dritten Generation so bedeutsam wurde.³⁸

One can question further whether the idealized time of Christian origin was created in retrospect and driven by an imminent need for a future-oriented mindset, as well as a past that provided clues to master a current crisis. As Eckart Reinmuth puts it: "Der Text, der sich durch seine Pseudonymität scheinbar zu einem Element vergangener Geschichte macht, tut dies, um die aktuelle Botschaft dieser Geschichte, ihre Bedeutung zu umreißen und so zu einem Element der Identität der Adressaten zu werden."³⁹ This could have been achieved through the (re)contextualization of authentic words of Jesus or words later "found" (or even invented). Another possibility would be the fictitious reaction of someone from the days of origin to the current situation to answer *what would Paul do?*⁴⁰ Martina Janßen considers the use of the scheme of ancient *prosopopoiia* to be a plausible scenario: "Was hätte x.y. wohl gesagt angesichts ...' ist dabei leicht auf neutestamentliche Schriften zu übertragen. 'Was hätte Paulus wohl gesagt angesichts der kirchlichen Lage um 100 n. Chr.?'"⁴¹

This, however, raises the question of whether the guarantors of tradition, which are called on in the pseudepigraphic letters, were indeed received as authorities in these respective period(s) of time. Do not the very disputes exhibited in the authentic Pauline letters show that there were major controversies about orthodoxy and orthopraxy in the second generation, and that

38 Zimmermann, "Unecht und doch wahr," 33.

39 Reinmuth, "Exkurs," 200.

40 This strategy of actualizing foundational figures can still be observed today and contributes immensely to identity construction at crucial points. A modern example is the *What would Jesus do?* movement in evangelical youth group culture.

41 Janßen, "Antike (Selbst-)Aussagen über Beweggründe zur Pseudepigraphie," 132f. However, this does not necessarily refer to a special authority or salvific significance of the chosen figure, as e.g., Hermann Josef Riedl, *Anamnese und Apostolizität: Der Zweite Petrusbrief und das theologische Problem neutestamentlicher Pseudepigraphie*, RST 64 (Frankfurt: Peter Lang 2005), 240, assumes for 2 Peter. On *prosopopoeia* in ancient letters, see Karl Matthias Schmidt, *Mahnung und Erinnerung im Maskenspiel. Epistolographie, Rhetorik und Narrativik der pseudepigraphen Petrusbriefe*, HBS 38 (Freiburg: Herder, 2003), 91–102.

even Paul could not rely on his “apostolic authority?” To put it differently: Is the assumption of a normative and tradition-founding period of the early church not a concept that is based on a later understanding of the church? Here the paradigm shift becomes clearly visible and allows for a new assessment of the phenomenon: it is no longer the *text* that receives authority by the name of an authority from the past, but the text that gives authority to a *person* or *tradition* from the past. Or as Eve-Marie Becker puts it, “stellen Normativität und Autorität weniger die Voraussetzung als das Ziel paulinischer Pseudepigraphie dar.”⁴²

Colossians illustrates this quite well: The author fiction of Colossians, especially in Col 1:24– 2:5 shows a different version of Paul than the authentic Pauline letters. The “Paulus-Bild des Schreibens, das den Apostel als ‘Diener’ der *ganzen* Kirche in einer Weise zeichnet, die so eigentlich erst *im Rückblick* auf sein Lebenswerk insgesamt möglich war”⁴³ ultimately grants “Paul” with a greater significance than he may have actually had in his lifetime. The one who speaks of himself in the words ἐγὼ Παῦλος is the “Apostel schlechthin,”⁴⁴ and the apostolic authority that no one can bypass, even Epaphras, the founder of

42 Eve-Marie Becker, “Von Paulus zu ‘Paulus’: Paulinische Pseudepigraphie-Forschung als literaturwissenschaftliche Aufgabe,” in *Pseudepigraphie und frühchristliche Verfälscherfiktion/Pseudepigraphy and Author Fiction in Early Christian Letters*, ed. Jörg Frey, Jens Herzer, Martina Janßen, and Claire Rothschild, WUNT 246 (Tübingen: Mohr Siebeck, 2009), 363–86, 375. The whole passage, which initiated the cultural-scientific-memory-theoretical reflection on the phenomenon presented here, reads: “Allerdings ist bei dieser Charakterisierung paulinischer Pseudepigraphie zu fragen, *ob* und von *wem* zum Zeitpunkt der Abfassung der sog. Deutero- und Tritopaulinen Paulus als eine solche allgemein ‘anerkannte Autorität’ verstanden und seine Briefe als ‘normative’ Werke gelesen wurden: Wenn sich die pseudepigraphen Briefeschreiber literarisch-formal auf die Autorität des Paulus stützen, scheint das Phänomen der Pseudepigraphie in theologiegeschichtlicher Hinsicht doch eher anzuzeigen, dass es am Ende des 1. Jh. n. Chr. im Zuge konkurrierender Autoritätsansprüche überhaupt erst um die Fortschreibung und Durchsetzung paulinischer Autorität ging. Dementsprechend stellen Normativität und Autorität weniger die Voraussetzung als das Ziel paulinischer Pseudepigraphie dar, was – wenn wir Andreas Lindemann folgen – spätestens dann erreicht ist, wenn sich christliche Autoren wie der Verfasser des 1. Clemensbriefes ‘auf Paulus berufen und seine Briefe für ihre Argumentation in Anspruch nehmen.’”

43 Michael Theobald, “Der Kolosserbrief,” in *Einleitung in das Neue Testament*, ed. Martin Ebner and Stefan Schreiber, Studienbücher Theologie 6 (Stuttgart: Kohlhammer 2008), 425–39.

44 Eduard Lohse, *Die Briefe an die Kolosser und an Philemon* (KEK 9/2) (Göttingen: Vandenhoeck & Ruprecht, 1968), 251. Hübner, *An Philemon. An die Kolosser. An die Epheser*, 67, is right to the point: “Wer über das Evangelium spricht, vor allem über das Evangelium, das den Heiden, bzw. Heidenchristen verkündigt wird, der muß auch über Paulus sprechen!”

the Colossian community, acted according to this understanding of Paul. The apostle to the nations suffers vicariously for *all* Gentile Christians, even for those he does not know personally.⁴⁵

“Paul” introduces himself to the “saints in Colossae” as ἀπόστολος Χριστοῦ Ἰησοῦ διὰ θελήματος θεοῦ (1:1). This self-introduction is familiar from other Pauline letters, but with a striking difference: unlike in Rom 1:1 and 1 Cor 1:1, he no longer calls himself κλητὸς ἀπόστολος, but only ἀπόστολος. At first glance, this is not notable, because 2 Cor 1:1 and 2 Tim 1:1 have the same wording as Col 1:1. It should be noticed, however, that the latter two letters each have a predecessor that introduces Paul as an apostle, while Colossians (like Romans) is addressed to a foreign community. To this community, “Paul” confidently introduces himself an “apostle of Jesus Christ” (1:1) and “servant of the church” (1:24f). In this expression, too, the language has changed: on the one hand, ἐκκλησία, – in the authentic Pauline letters – is not a cipher for individual community but for some kind of universal church; and on the other hand, the connection with διάκονος is remarkable.⁴⁶ With θεοῦ διάκονοι 2 Cor 6:4 uses a related phrase, which is interesting because both use the keyword θλίψις, but they use it differently. When “Paul” speaks of his own suffering in his self-introduction, he uses the term πάθημα (1:24), but when he speaks of Christ’s afflictions, he uses θλίψις (1:24). In contrast to the authentic Pauline letters, the use of language is reversed. In these letters, πάθημα is used for the sufferings of Christ and θλίψις, for the afflictions of the apostle.⁴⁷ “Paul” and his fate are thus linguistically and structurally linked to the fate of Christ. In addition, both are now present in spirit but absent in the flesh (2:5). This close connection not only grants “Paul” a special relationship to Christ, and thus a special authority, but it also creates an analogy: “Paul” becomes part of Christ and a true messenger in Christ’s place (2 Cor 5:20). The connection via language and content also creates a line of tradition from Christ via “Paul” to the “saints in Colossae”: “Paul” completes Christ’s affliction in his own suffering for the faithful and becomes an unbreakable connection between Christ and the faithful.⁴⁸

45 Cf. Hübner, *An Philemon. An die Kolosser. An die Epheser*, 73.

46 The connection of διάκονος and ἐκκλησία only appears here, cf. Joachim Gnilka, *Der Kolosserbrief*, HThKNT 10 (Freiburg: Herder, 1980), 98. The use of the connection δοῦλος Χριστοῦ also changes: while Paul introduces himself using this title in the authentic Pauline letters, in Colossians, only Epaphras (4:12) is a slave of Christ.

47 Cf. Gnilka, *Der Kolosserbrief*, 94f.

48 Cf. also the observations of Josef Ernst, *Die Briefe an die Philipper, an Philemon, an die Kolosser, an die Epheser*, RNT 12 (Regensburg: Pustet, 1974), 183: “Dieser fleischliche, d.h. ganzheitlich-personale Dienst (ἐν τῇ σαρκί μου) erinnert unmissverständlich an den ‘Fleischesleib Christi,’ durch den Versöhnung geschenkt worden ist (1,22). Der persönliche Einsatz des Apostels steht im Zeichen des Opfers Christi. Es wird also schon rein

His suffering and his martyrdom (implicitly assumed in the letter) ultimately turn him into an authority figure: “es spricht der ‘erhöhte’ Paulus.”⁴⁹

With “Paul” being depicted as an apostle to the nations and a martyr, the Colossians’ choice of the author pseudonym cannot just have been because of the authority of an apostle. If this authority did not exist, but had to be established first, the pseudepigraphic letter to the Colossians has a double function: It is not only about the situation of the faithful to which “Paul” answers in Colossians, but also about how the church was being shaped, and Paul’s place in it. Such a reading leads us right into the discussion of early Christian identity discourses.

3. Synopsis: Pseudepigraphy as a Strategy in Early Christian Identity Discourses

Seen together, these two paradigm shifts point to a third one, which can be summarized by the term *cultural turn*. From the perspective of memory theory and cultural studies, the observations about the two paradigm shifts outlined above can be combined to create an overall perspective that – at least for Colossians – allows for new ways to understand the letter. I will now present a first draft for such an overall perspective, using insights from interdisciplinary research and discourses on social memory.⁵⁰

As we have seen regarding the question of the author’s intent, it is often concluded that a “Pauline” author was chosen to ascribe authority to the text. Therefore, Colossians is an authoritative application of Pauline theology intended for a later generation. The fictional self-interpretation of the apostle contributes to the preservation and further development of the Pauline heritage and supports Pauline identity construction (or that of the memory figure, “Paul”). But this is only one side: when we take the medium of a “letter”

terminologisch eine Verbindung zwischen dem Erlösungswerk Christi und den apostolischen Leiden angedeutet.”

49 Gnilka, *Der Kolosserbrief*, 23.

50 A first attempt to express this idea was published as Sandra Huebenthal, “Verwurzelt in Christus und gegründet auf ihm, fest im Glauben.” Exegetische Betrachtungen zum Motto des Weltjugendtags 2011 / ‘Enracinés et fondés dans le Christ, affermis par la foi’: Approche biblique du thème des JMJ. In *Auf der Suche nach den Wurzeln: Vorbereitungen auf den XXVI. Weltjugendtag 2011 / En quête des racines: Préparation à la XXVI^e Journée Mondiale de la Jeunesse 2011*, ed. Pierre Guerigen (Düsseldorf: Verl.-Haus Altenberg, 2010), 18–61.

seriously, Colossians is also about the identity construction of the addressees, which the text develops on the foil of a fictional threat.⁵¹

The addressee fiction includes believers who have heard and accepted the gospel not from the apostle himself, but from Pauline tradition – i.e., second hand – and who try to live their lives accordingly. The threat they are facing consists of alternative identities that do not correspond to the spirit of the gospel. The addressee fiction with its repeated use of “See to it that ...,” and references to the firmness and orderliness of faith (2:4) is exposed by further argumentation as the end goal rather than the starting point of the argumentation suggesting *on the level of the entire work* that Colossians does not describe Christians with a stable identity, but rather a people who are still searching for their own identity.

The empirical author would thus textualize a Pauline tradition that provides the empirical readers with suggestions about how to deal with their own situation. The draft of the fictional situation of the Colossians *on the level of the characters/in the narrated world* becomes a mirror for the empirical readers *on the level of the entire work*, in which they can recognize their own situation. What Colossians is not, however, is a window into Paul’s world.

Regarding the unanswered questions regarding the intention behind Colossians and the choice of the author pseudonym, the possible answers are as follows: Pseudepigraphal Pauline letters do not arise from a historical interest in the figure of the author, but aim to speak into the present situation. Normativity and authority are not prerequisites but the goal of author fiction. Pauline pseudepigraphy seeks to secure literary and apostolic continuity and is concerned with the actualization and interpretation of Pauline theology for later generations. Paul’s fictional self-interpretation, as it occurs in Colossians, is a theological and hermeneutical achievement that serves the development and protection of a particular image of Paul as a model for identification. The content that the pseudepigraphic Letter to the Colossians conveys is thus closely linked to the reception of the author fiction.

From the perspective of addressee fiction, pseudepigraphy allows for the projection of a problem back onto the past.⁵² The difficult situation of the pres-

51 Frank writes: “Mit der Abfassung eines Briefes unter dem Namen des Apostels sucht der Autor des Kolosserbriefes durch den Rückgriff auf die paulinische Überlieferung – als Wurzel der gemeinsamen Glaubenstradition und zugleich als geschichtliche Verankerung der Konstitution als christliche Gemeinschaft – eine identitäts- und orientierungsstiftende Funktion für die Gemeinden der zweiten und dritten Generation einzunehmen.” Frank, *Der Kolosserbrief im Kontext des paulinischen Erbes*, 3.

52 Zimmermann understands this course of action as a general principle of pseudepigraphy: “Eine Schrift wurde in eine fingierte Kommunikationssituation gestellt, um somit

ent appears more manageable through a letter that seems to have anticipated it: A test case emerges on the supposed *tabula rasa*. It was not only Max Frisch who summarized that every present situation creates the past it needs.⁵³ We also see the phenomenon in Colossian pseudepigraphy: the current situation leads to the construction of a past situation that offers a model of how to overcome the current challenge. The procedure of “finding” a tradition to facilitate self-understanding and understanding of others is culturally common and deeply human beyond the moral question of *real or forged*.

3.1 *The Contribution of Cultural Memory Theory*

Colossians was written during the second and third generation of early Christianity. If it is true that Colossians was written around 70–80 CE,⁵⁴ then roughly forty years had passed since Jesus’s death and resurrection. The generation of witnesses had largely disappeared by this time: Peter and Paul and James and John are no longer alive and thus cannot respond to the questions from the faithful. Early Christianity, however, has not yet been established in such a way that it has an authoritative framework and clear rules for small and large questions. Valid instruction does not yet exist for conflicts in orthodoxy nor in orthopraxy, i.e., neither for right belief nor for right behavior. There is still no authoritative center from which could solve these questions for the entire church. There is simply no universal church yet.

On the contrary, the New Testament clearly shows that Christianity as a social form and faith in Christ as a cultural framework were, at that time, a theology in the making, or better: theologies in the making.⁵⁵ What is clearly heretical from today’s perspective was not clearly heretical during that time. The disputes in early Christianity very sharp for a reason, and orthodox and

auf subtile Weise die eigene Situation zu thematisieren. Auch wenn in der Schrift selbst Autor und Adressaten einer ganz anderen geschichtlichen Zeit angehören, wollen die Texte doch eigentlich die Gegenwart der von ihnen intendierten Rezipienten erreichen. Der kommunikative ‘Umweg’ über eine fingierte geschichtliche Situation soll letztlich zu einer gelungeneren Verständigung führen, die bei einer direkten Auseinandersetzung zu schwierig oder heikel gewesen wäre.” Zimmermann, “Unecht und doch wahr,” 34.

53 The idea can be found in many places in Max Frisch’s oeuvre, but is most clearly in *Mein Name sei Gantenbein*: “Ein Mann hat eine Erfahrung gemacht, jetzt sucht der die Geschichte dazu – man kann nicht leben mit einer Erfahrung, die ohne Geschichte bleibt, so scheint es, und manchmal stelle ich mir vor, ein anderer habe genau die Geschichte meiner Erfahrung ...” Max Frisch, *Mein Name sei Gantenbein*, 28th ed. (Frankfurt: Suhrkamp, 2000), 11. A similar expression is already found on page 8: “Ein Mann hat eine Erfahrung gemacht, jetzt sucht er die Geschichte seiner Erfahrung ...”

54 Thus, about the same time as Mark’s Gospel, which was also written anonymously.

55 Cf. Hübner, *An Philemon. An die Kolosser. An die Epheser*, 96.

heretics, or better: those who were later received as orthodox and heretics, often looked confusingly similar. In this period, people were still struggling to find a *Christian* identity, not to mention *the* Christian identity.⁵⁶

Those who begin a tradition must first (re-)invent themselves. To achieve this, they need their own history and a daily routine from which orientation for the future could build upon. This also meant a confrontation with their milieu of origin. The development of a *Jewish* Christian identity had to address the question of what could and could not be adopted from Jewish heritage into a new form of life. The disputes in the New Testament about circumcision, food regulations, Torah, and Sabbath observance bear witness to this. The same is true of a *Gentile* Christian identity, that is, the group that came out of Hellenism. They had to come to terms with which parts of their pagan worldview and which of their strategies for living and coping with everyday life were compatible with being in Christ.⁵⁷ All of this forms the birth pains of Christianity and the struggle for a creation of the Christian identity. And it is twice as difficult when leaders and guiding principles are absent, and when no one can answer the all-consuming questions with authority.

Research in cultural studies has shown that the continuation of ideas and traditions is usually decided in the second, and especially the third, generation: at the time, when the founding fathers were no longer in charge, their children and grandchildren had to decide whether their history and traditions still held true. As a rule, this phase begins after about forty years and is completed after about one hundred years. The time in between is an exciting phase of identity exploration and formation. In that period, many things are still in flux and even if the basic direction is clear, readjustments can still be made here and there. Different versions of the same story are told side by side, and it is not clear which one will persist in the end. From the perspective of cultural memory theory, pseudepigraphy can also be understood as a *phenomenon of the third generation* – because at this time, the course is set for the continued existence and the further constitution of a group. New Testament writing

56 An example may clarify this, as Maisch, *Der Brief an die Gemeinde in Kolossä* 39–40, shows: The church, as it presents itself in the New Testament, is a church of Jewish Christians and Gentile Christians. But it is a long process until new Gentile converts and Jewish followers of the *Way*, as Luke refers to them in the Acts of the Apostles – probably another twenty years after the writing of the Epistle to the Colossians – become Gentile *Christians* and Jewish *Christians*. They, too, had to find a stable identity in this new situation and bring their Jewish or Gentile heritage into a strong connection with their new relationship with Christ. Later generations, who already had a tradition and could interact with it – through integration or by rejection – had it much easier.

57 Food regulations come to mind, but also an affiliation with ancient associations, mystery cults, and mythical practices.

seems to fall exactly into this exciting time between the *Generational Gap* (after about forty years) and the *Floating Gap* (after about a hundred years).⁵⁸ Pseudepigraphy is as much a third-generation phenomenon as the anonymous texts of the New Testament. From a cultural memory perspective, the same mechanism underlies both types of texts; they only have different connotations. While the pseudepigraphal texts invoke Paul (or another apostle) as the founding authority or guarantor of originality, as in the case of Colossians,⁵⁹ the anonymous texts directly refer back to Jesus as the founding figure.⁶⁰ In both cases the same mechanism is at work: a normative (founding) history creates a tradition into which the present generation must inscribe itself, or which it must relate to.⁶¹

When we apply the findings of cultural memory theory to the timeframe outlined above, we land roughly in the time of *collective memories*.⁶² Regarding

58 Cf. Jan Assmann, *Das kulturelle Gedächtnis: Schrift, Erinnerung und politische Identität in frühen Hochkulturen*, 5th ed. (München: Beck, 2005), 48–56.

59 At first glance, Jude is an exception, since it cannot be directly traced back to an apostle. However, the author fiction in Jude 1 suggests that “Jude” is the brother of James and also the brother of Jesus (cf. Mark 6:3; Matt 13:56). Jörg Frey suspects that the choice of author pseudonym and his connection to Jesus’s brother, James, instead of Jesus himself is “daher gleichermaßen ein Zeichen der Wirkung des Jakobus bzw. des Jakobusbriefs wie auch ein Indiz dafür, dass sich der reale Autor der ‘nachapostolischen’ Situation, in der er schrieb, bewusst war.” Therefore, author fiction “nicht nur oder sehr wenig der Legitimation des Schreibens und seines Inhalts, sondern primär der Zuordnung zu einer Traditionslinie, die durch die Gestalt des Jakobus markiert und durch den Jakobusbrief repräsentiert ist und verschiedenartigen Entwicklungen in der paulinisch-deuteropaulinischen Tradition kritisch gegenübertritt.” Jörg Frey, “Autorfiktion und Gegnerbild im Judasbrief und im Zweiten Petrusbrief ” in *Pseudepigraphie und frühchristliche Verfasserfiktion/Pseudepigraphy and Author Fiction in Early Christian Letters*, ed. Jörg Frey, Jens Herzer, Martina Janßen, and Claire Rothschild, WUNT 246 (Tübingen: Mohr Siebeck, 2009), 683–732, 690–91, 702.

60 Cf. Michael Wolter, “Die anonymen Schriften des Neuen Testaments. Annäherungsversuch an ein literarisches Phänomen,” *ZNW* 79 (1988): 1–16, 15–16.

61 Reinmuth’s notion of a “Pauline narrative” can also be read in this sense, even though the argument might have originally been meant differently: “Sie [the pseudepigraphs, S.H.] wurden nicht in einem ‘historischen’ Interesse geschrieben – etwa, um einen weiteren Paulusbrief in Umlauf zu bringen, sondern um in der Autorität des Paulus, als Teil der Paulusgeschichte, in die Gegenwart ihrer Kirche zu sprechen. Sie äußerten sich in den Diskursen ihrer Gegenwart, sprachen mit ihren Mitteln deren Themen und Probleme an und hatten an ihren Gegebenheiten teil” Reinmuth, *Hermeneutik des Neuen Testaments*, 106.

62 Cf. Sandra Huebenthal, “Social and Cultural Memory in Biblical Exegesis: The Quest for an Adequate Application,” in *Cultural Memory in Biblical Exegesis*, ed. Pernille Carstens, Trine Hasselbach, and Niels Peter Lemche, Perspectives on Hebrew Scriptures and Its Contexts 17 (Piscataway, NJ: Gorgias, 2012), 191–216.

the constitution of communities of commemoration, this phase does not (yet) have binding traditions. Instead, the traditions are socially negotiated, which usually takes the form of narrative (re)projections. It is quite common in this phase of socialization and commemoration that different versions of a story (or a tradition) stand side by side, and it is not (yet) officially decided which one should be normative for the future. When this process of negotiation – and, depending on the social form, the struggle for the “correct interpretation,” for orthodoxy and/or orthopraxy – is completed, only then does the group have binding histories and traditions to reference, for example, when dealing with opponents.⁶³ It looks like the New Testament bears witness to precisely this exciting and important period of early Christian socialization. It has, so to say “frozen” the moment of Christian identity formation and preserved the vivid debate in a canon that is binding for later generations. What has also been preserved in the process are strategies that were employed in the struggle for this identity. One of these strategies is *pseudepigraphy*, i.e., a later author from the second or third generation uses the supposed authority of a witness from the first generation.⁶⁴ In the case of Colossians, this is not just any witness. Paul, who had a certain interregional importance in his generation, was known – and in this respect, the choice of this authorial pseudonym in the near-deixis is completely understandable – to have written letters addressing issues the communities faced.

3.2 *An Initial Conclusion*

The pseudepigraphy achieves two things: the Paul-tradition is continued in a particular direction, and the addressees come into contact with a tradition that orients them. Understood in this way, Colossians can be read as a historical document that reflects the process of Christian identity formation during the second and third generations. Further investigation could be done on which different religious movements and syncretisms influenced the process at this time, considering the social and religious history. However, the challenge of forming a Christian identity and reconsidering their own religiosity

63 The canonization of texts is a further step and transfers the negotiation processes into cultural memory.

64 What became of the different ideas remains as uncertain as the question to whom Colossians was addressed and who wrote it. Only one thing seems certain: it must have worked, because otherwise it would be difficult to explain that Ephesians uses Colossians as the starting point for its own pseudepigraphic epistolary fiction. Colossians becomes the prototype of a strategy that can also be found in the Pastoral Epistles and the Catholic Epistles. It seems to have initiated a new phase of Christian identity formation that extended well into the second century.

in the face of real demands from the outside is not unique to the early church. On the one hand, the defense of the Christian way of life against religious dogmatism, and syncretistic arbitrariness on the other hand are also questions of today's faithful. Even though Colossians might seem far away at first glance in all its strangeness, it also provides a new perspective on one's own situation.

In both cases, it is a matter of actualizing foundational events for the current context through the authority of declared witnesses and guarantors of tradition. To put it differently: The question is how the normative and formative founding events are to be understood, and which future scenarios can be derived from them. This, too, is a matter of identity construction, and a case of the present creating its own, fictional past to influence the future. At this point, Colossians deviates from other Pauline letters, reflecting the other side of the identity discourse, i.e., how the apostle to the nations should be remembered.

In addition to this question, the Colossian epistolary fiction adds something important for the readers: by offering them a tradition they can connect with and into which they can inscribe themselves, it makes an important contribution to their identity construction. Read this way, Colossians has a lasting significance for later readers, whose own situation can become clearer against the background of reading the letter.⁶⁵ The challenge of retaining a Christian identity in the face of seductive, alternative identities remains crucial, not only in the ancient but also in the postmodern world.

65 Readings that support the self-assurance of later recipients have been provided, e.g., by Johannes Beutler and Rudolf Hoppe. Beutler concludes: "Jeder Kult, der sich demnach auf ein Stück geschaffene Wirklichkeit, und sei es ein Engel, richtet, geht vom Wege ab und missachtet Christus als das Haupt von allem. Jede asketische Praxis, die Teile der materiellen Welt ausgrenzt, verbietet oder für Tabu erklärt, nimmt die Universalität der Herrschaft Christi nicht ernst und besitzt nur den Schein von Weisheit und Philosophie." Johannes Beutler, "Das universale Heil in Christus nach dem Kolosserbrief" *GuL* 67 (1994): 403–13, 413. Hoppe notes, "Der Kol sagt uns in seiner eigenen Sprache, daß es sinnvoll ist, als Gemeinde in dieser Welt zu leben, Gottes Zusage zu feiern und so nicht in der Welt einfach aufzugeben; er sagt uns, daß der vom Glauben überzeugte Christ nicht mehr den geringsten Anlaß hat, sich vor der 'bösen Welt' zu ängstigen. Der Mut, dies auszusprechen und zu leben, ist Aufgabe jedes Christen, jeder Gemeinde und der ganzen Kirche. Vielleicht sollten die, die Verantwortung in unserer Kirche tragen, öfter den Kol lesen." Rudolf Hoppe, *Epheserbrief/Kolosserbrief*, SKK.NT 10 (Stuttgart: Katholisches Bibelwerk, 1987), 162.

Experience that Makes Itself Legible: Colossians and 2 Thessalonians as Fictional Texts

“Die Erfahrung will sich lesbar machen.
Sie erfindet sich ihren Anlaß.
Und daher erfindet sie mit Vorliebe eine Vergangenheit.”¹

“Die Fiktion entlarvt unsere Erfahrung der Realität,” Max Frisch said in his first poetics lecture, meaningfully named, *The Writer’s Journey: From Impulse to Imagination*. Delivered at New York City College in November 1981, he stated a few moments later that there is no fiction that is not based on experience.² At first glance, the writer’s thoughts seem far from the everyday life of New Testament scholarship – even when it deals with the question of the *referentiality* of biblical texts to extra-linguistic reality. This discourse rarely addresses the question of experience. On average, discussions about *factual* or *fictional* texts in the New Testament guild do not use the category of experience, but rather that of event and/or memory, and its sedimentary deposition in the various texts. The taxonomy of *factual*, *fictional*, and *fictional*, which is used in literary studies, seems to have hardly any relevance to hermeneutical differentiation in biblical studies so far.

A look at the established textbooks on New Testament introductions confirms this. The introductions to Colossians commonly ask questions about the Colossian philosophy and the location of community in relation to the ruins most likely caused by the earthquake of 60/61 AD. The introductions to 2 Thessalonians ask questions about the author and the heresy that deeply confuses the community. Both look for the events, facts, or realities that stand behind the texts and are expressed in them. The introductions are aware that the data is not quite as good as would be desirable for unambiguous insights, yet the texts often implicitly assume that both letters have a more or less direct

-
- 1 “Es gibt keine Fiktion, die nicht auf Erfahrung beruht.” Max Frisch, “Unsere Gier nach Geschichten,” in *Gesammelte Werke in zeitlicher Folge IV*, ed. Hans Mayer (Frankfurt: Suhrkamp, 1986), 262–64, 263.
 - 2 Max Frisch, *Schwarzes Quadrat: Zwei Poetikvorlesungen* (Frankfurt: Suhrkamp, 2008), 30. In a similar form, albeit with somewhat more explicit diction, Umberto Eco calls the function of narrative literature “dem Wust der Erfahrungen eine Form geben.” Umberto Eco, *Im Wald der Fiktionen. Sechs Streifzüge durch die Literatur* (München: Hanser, 1994), 117.

referentiality to extra-linguistic reality. As a result, both letters are read as factual texts.

What happens if, on the other hand, one reads Colossians and 2 Thessalonians as fictional texts and does not look for the memory of an event to be reflected in the texts, but rather, asks for possible experiences that have been communicated and sought a story for themselves?³ It becomes a story that a real author now tells to real readers.

In order to approach this question, I will proceed in three steps: first, I will present the current discussions in literary studies and compare it to current discussions in biblical studies. This will determine whether literary and biblical approaches differ and, if so, in what ways. Second, I will analyze two New Testament texts from the notoriously difficult field of interpretation of the *Deutero-Pauline* and *pseudepigraphal* writings, namely Colossians and 2 Thessalonians. The research question deals with how the reading of the two letters changes and what chances it offers for interpretation if both texts are consistently read according to the criteria of literary theory of fictionality. For this step, I will use established textbooks on introductions to the New Testament as a basis.⁴ Third, I will bring together the results of these readings and investigate their possible contribution to New Testament exegesis.

3 Recent developments in the discussion of pseudepigraphs indicate that it is not only methodologically possible, but also quite helpful, to read these texts as *narrative* texts. Martina Janßen and Jörg Frey, "Einführung," in *Pseudepigraphie und frühchristliche Verfasserfiktion/Pseudepigraphy and Author Fiction in Early Christian Letters*, ed. Jörg Frey, Jens Herzer, Martina Janßen, and Claire Rothschild, WUNT 246 (Tübingen: Mohr Siebeck, 2009), 3–24.

4 For a balanced survey, the following works were consulted for this essay: Paul J. Achtemeier, Joel B.M. Green, and Marianne M. Thompson, *Introducing the New Testament: Its Literature and Theology* (Grand Rapids: Eerdmans, 2001); Ingo Broer and Weidemann Hans-Ulrich, *Einleitung in das Neue Testament* (Würzburg: Echter, 2010); Delbert Royce Burkett, *An Introduction to the New Testament and the Origins of Christianity* (New York: Cambridge University Press, 2002); Hans Conzelmann and Andreas Lindemann, *Arbeitsbuch zum Neuen Testament* (Tübingen: Mohr Siebeck, 142004); Martin Ebner and Stefan Schreiber, eds., *Einleitung in das Neue Testament* (Stuttgart: Kohlhammer, 2008); Bart D. Ehrman, *The New Testament: A Historical Introduction to the Early Christian Writings* (New York: Oxford University Press, 2012); Howard Clark Kee, *The Beginnings of Christianity: An Introduction to the New Testament* (New York: Bloomsbury, 2005); Werner Georg Kümmel, *Einleitung in das Neue Testament* (Berlin: Evangelische Verlagsanstalt, 21983); Daniel Marguerat, eds., *Introduction au Nouveau Testament: Son histoire, son écriture, sa théologie* (Genf: Labor et Fides, 22001); Karl-Wilhelm Niebuhr et al., *Grundinformation Neues Testament: Eine bibelkundlich-theologische Einführung* (Göttingen: Vandenhoeck & Ruprecht, 2000); Peter Pilhofer, *Das Neue Testament und seine Welt. Eine Einführung* (Tübingen: Mohr Siebeck, 2010); Petr Pokorný and Ulrich Heckel, *Einleitung in das Neue Testament* (Tübingen: Mohr Siebeck, 2007); Jürgen Roloff, *Einführung in das Neue Testament* (Stuttgart: Reclam, 2003); Franz Josef Schierse, *Einleitung in das Neue Testament* (Düsseldorf: Patmos, 31984); Udo Schnelle,

1. Factual and Fictional Narration in Literary Studies

In their Einführung in die Erzähltheorie, Matias Martínez and Michael Scheffel identify two fundamental distinctions regarding the process of narrating, which can be found in different forms in most definitions of “narration.” On the one hand, they refer to the fact that a narration can be about real or invented events⁵ and, on the other hand, narration can be within the framework of everyday speech or within the framework of poetic speech.⁶ This allows one to distinguish between two pairs of characteristics: real vs. fictitious, and factual/authentic vs. fictional. Both pairs refer to different domains:⁷ real vs. fictitious concerns the reality character or the ontological status of what is said, and factual vs. fictional concerns the speech situation or the pragmatic status of the speech.

This also means that fictional speech, therefore, is not primarily about the content, but about the mode of reference of the verbal expression:

Dichtung wäre demnach als die Fiktion einer sprachlichen Äußerung anzusehen, d.h. als Repräsentation einer Rede ohne empirischen Objektbezug und ohne Verankerung in einem realen Situationskontext (...) Soll sie ihre Wirkung entfalten können, müssen wir ihre Rede als die authentische (wenn auch fiktive) Rede eines bestimmten (wenn auch fiktiven) Sprechers verstehen, die nicht auf nichts, sondern auf bestimmte (wenn auch fiktive) Dinge referiert.⁸

Einleitung in das Neue Testament (Göttingen: Vandenhoeck & Ruprecht, 72011); Stefan Schreiber, *Begleiter durch das Neue Testament* (Düsseldorf: Patmos, 72006); Gerd Theißen, *Das Neue Testament* (München: Beck, 2002).

5 Matias Martínez and Michael Scheffel, *Einführung in die Erzähltheorie* (München: Beck, 62005), 10.

6 Martínez and Scheffel, *Einführung in die Erzähltheorie*, 10.

7 Martínez and Scheffel, *Einführung in die Erzähltheorie*, 9–19.

8 Martínez and Scheffel, *Einführung in die Erzähltheorie*, 14. With Eco, one could call it a contract of fiction (*Fiktionsvertrag*): “Die Grundregel jeder Auseinandersetzung mit einem erzählenden Werk ist, daß der Leser stillschweigend einen Fiktionsvertrag mit dem Autor schließen muß, der das beinhaltet, was Coleridge ‘the willing suspension of disbelief’, die willentliche Aussetzung der Ungläubigkeit nannte – Der Leser muß wissen, daß das, was ihm erzählt wird, eine ausgedachte Geschichte ist, ohne darum zu meinen, daß der Autor ihm Lügen erzählt. Wie John Searle es ausgedrückt hat, der Autor tut einfach so, als ob er die Wahrheit sagt, und wir akzeptieren dem Fiktionsvertrag und tun so, als wäre das, was der Autor erzählt, wirklich geschehen.” Eco, *Im Wald der Fiktionen*, 103. Martínez and Scheffel illustrate this with a catchy example from Günter Grass’s *Die Blechtrommel*: “In diesem Sinne bedeutet etwa die klassische Eingangsformel ‘Es war einmal’ am Beginn eines Märchens wie ‘Es war einmal ein Müller, der war arm, aber er hatte eine schöne Tochter’ für uns als Rezipienten eben nicht nur ‘Glauben Sie nichts von dem, was Sie im folgenden hören bzw. lesen’, sondern immer auch so viel wie die Aufforderung: ‘Stellen Sie sich bitte vor, daß einmal ein Müller war, etc.’ Wer die Sätze der Blechtrommel als die Erinnerungen einer realen Person versteht,

The question that now arises is how recipients (can) know whether they are dealing with a *factual* or *fictional* utterance. Since *factual vs. fictional* characterizes the *pragmatic status* of a literary expression, one can note along with Martínez and Scheffel that: “Fiktional ist ein Text nicht an und für sich, sondern in einem bestimmten historischen und sozialen Kontext, d.h. er ist fiktional für ein Individuum, eine Gruppe, eine Gesellschaft, in einer bestimmten Situation, in einer bestimmten Epoche (...) Damit eine Rede als fiktional aufgefaßt wird, bedarf sie der Kontextmarkierung.”⁹

Context markers or *fiction signals* (Fiktionssignale) are therefore helpful in deciding whether a text is a *factual* or a *fictional* expression. This decision is related to the *pragmatic*, the *ontological* level. A text is not fictional *per se*, but only within a certain frame of reference. Here, again, the question of referentiality is crucial. The question is thus what fiction signals can look like in detail. In any case, they must be “metakommunikative, für den Rezipienten erkennbare Signale, ‘welche das normale Wirken der Regeln, die illokutionäre Akte und die Welt zueinander in Beziehung setzen, aufheben.’”¹⁰ Accordingly, these are not on the level of character speech or direct communication, but on the level of narrative mediation, or the level of the entire work.¹¹

In literary studies¹² *paratextual and contextual markers* are, e.g., the assignment of a certain text genre (novel, novella, etc.) and certain opening or

nach Oskars Geburtshaus in einer Straße mit dem historischen Namen Labesweg in Danzig sucht und Oskars Erzählung als Ganzes oder auch nur in Teilen (wie z.B. die Geschichte von der vergeblichen Verteidigung der polnischen Post) auf ihre historische Wahrhaftigkeit hin überprüft, verwechselt die Geschäftsgrundlage und liest einen Roman nach den pragmatischen Regeln einer realen Autobiographie. Wer sich aber in keinerlei Hinsicht die Existenz eines Trommlers namens Oskar und die Echtheit seiner Erzählung vorstellt, kommt nicht ins Spiel und bringt sich selbst um sein Lesevergnügen.” Martínez and Scheffel, *Einführung in die Erzähltheorie*, 14f.

- 9 Martínez and Scheffel, *Einführung in die Erzähltheorie*, 15. Fiction signals, they explain further, “sind für das Spiel der Fiktion doch unerlässlich. Ihre Existenz allein begründet, warum im Fall der fiktionalen Rede anders als im Fall der Lüge von einem Sprachspiel nach besonderen Regeln (statt von einem bloßen Regelverstoß) gesprochen werden kann.” Ibid.
- 10 Martínez and Scheffel, *Einführung in die Erzähltheorie*, 15. Wolfgang Iser notes that fiction signals “nicht etwa die Fiktion schlechthin, sondern den ‘Kontrakt’ zwischen Autor und Leser, dessen Regelungen den Text nicht als Diskurs, sondern als ‘inszenierten Diskurs’ ausweisen.” Wolfgang Iser, *Das Fiktive und das Imaginäre. Perspektiven literarischer Anthropologie* (Frankfurt: Suhrkamp, 1993), 35.
- 11 Since, for reasons of genre, the level of narrative mediation is absent in letters, signals of fiction can only be discerned at the level of the entire work.
- 12 In the *Metzler Lexikon Literatur- und Kulturtheorie* Ansgar Nünning defines as follows: “Zu den kontextuellen bzw. pragmatischen F.n zählen die Kommunikationssituation, der Verlag und die äußere Aufmachung eines Buches. Zu den paratextuellen und textuellen

closing formulas, but also *intratextual fiction signals* such as the “Anwendung von Verben innerer Vorgänge auf dritte Personen sowie eine Erweiterung des Tempussystems der Sprache, zu der z.B. die Kombination von Zeitadverbien, die auf die Zukunft verweisen, mit Verben, in der Zeitform des Präteritums gehört.”¹³ In other words: the basic toolkit of a classical omniscient narrator.¹⁴ As another (and readily overlooked) method of calling attention to fictionality, Martínez and Scheffel mention the *degree of self-reflexivity*: namely, “indem sie nämlich durch verschiedene Formen der Selbstreflexion ihren besonderen Status in Form und Inhalt reflektiert und sowohl die Grundlagen ihrer Produktion explizit macht als auch Anweisungen für ihre Rezeption enthält.”¹⁵

F.n gehören Titel und Untertitel, Formen und Untergliederung eines Textes, bestimmte Eingangs- und Schlussformel, Gattungsbezeichnungen sowie paratextuelle Elemente wie juristische Absicherungsformeln (...). Außerdem spielen der Gebrauch deiktischer Elemente, insbes. nicht referenzialisierbare Angaben über Ort, Zeit und Figuren, ein hohes Maß an Mehrdeutigkeit und intertextuellen Anspielungen auf andere literar. Texte sowie die Gesamtheit jener Darstellungsverfahren, die als spezifisch ‘literar.’ gelten, bei der Signalisierung von Fiktionalität und der Konstitution des unterschiedlichen Wirklichkeitsbezuges in literar. im Gegensatz zu nicht-fiktionalen Texten eine zentrale Rolle.” Ansgar Nünning, “Fiktionalitätssignale,” in *Metzler Lexikon Literatur- und Kulturtheorie*, ed. Ansgar Nünning (Stuttgart: Metzler, 42008), 202–3, 202. On the distinction between paratextual and textual fictional signals, see further Frank Zipfel, *Fiktion, Fiktivität, Fiktionalität. Analysen zur Fiktion in der Literatur und zum Fiktionsbegriff in der Literaturwissenschaft*, Allgemeine Literaturwissenschaft (Wuppertaler Schriften Berlin: Schmidt, 2001), 232–47.

13 Martínez and Scheffel, *Einführung in die Erzähltheorie*, 16.

14 In the introductory contribution to the volume *Wirklichkeitserzählungen*, Christian Klein and Matías Martínez describe the following problem for the *text-internal signals*: “Allerdings ermöglichen diese textinternen Signale keine trennscharfe Abgrenzung zwischen fiktionalen und faktualen Texten. Nicht alle fiktionalen Texte enthalten Charakteristika allwissenden Erzählens, weshalb diese Kennzeichen nicht als ein notwendiges Kriterium für Fiktionalität gelten können. Und andererseits greifen auch faktuale Texte, beispielsweise des Journalismus oder der Geschichtsschreibung, gelegentlich zu Darstellungsmitteln, die streng genommen den Standpunkt eines allwissenden Erzählers voraussetzen (z.B. die wörtliche Wiedergabe unprotokollierter Dialoge oder Aussagen über Gedanken und Gefühle historischer Personen), ohne jedoch deswegen ihren faktualen Geltungsanspruch aufzugeben; allerdings muss der Autor hier seine fiktionalisierenden Erzählverfahren durch den Verweis auf eigene Recherchen, Dokumente o.ä. als plausible Vermutungen faktual legitimieren. Folglich können solche textinternen Merkmale auch kein hinreichendes Kriterium für die Entscheidung sein, ob nun ein fiktionaler oder ein faktualer Erzähltext vorliegt – sie liefern allenfalls Hinweise und Signale. Die Klassifikation eines Textes als faktual oder fiktional ist eine Entscheidung, die letztlich auf textpragmatischer Ebene getroffen wird.” Christian Klein and Matias Martínez, eds., *Wirklichkeitserzählungen: Felder, Formen und Funktionen nicht-literarischen Erzählens* (Stuttgart: Metzler, 2009), 1–13, 4–5.

15 Martínez and Scheffel, *Einführung in die Erzähltheorie*, 16.

Suppose, now, that the *pragmatic analysis* has shown that a text is *fictional*. What does this mean for the communication process in which it is involved? In literary-theoretical text models for *narrative* texts, such as Ansgar Nünning's communication-theoretical text model, several different levels of communication can be distinguished.¹⁶ Since author and narrator¹⁷ coincide in factual texts, no distinction is usually made between different levels of communication for these texts: "Faktuale Texte sind Teil einer realen Kommunikationssituation, in der das reale Schreiben eines realen Autors einen Text produziert, der aus Sätzen besteht, die von einem realen Leser gelesen und als tatsächliche Behauptungen des Autors verstanden werden."¹⁸ This is different in the case of changes to fictional texts; they

sind ebenfalls Teil einer realen Kommunikationssituation, in der ein realer Autor Sätze produziert, die von einem realen Leser gelesen werden. Fiktionale Texte sind jedoch komplexer als faktuale, weil sie außer der realen auch noch einer zweiten, imaginären Kommunikationssituation angehören. Die fiktionale Erzählung richtet sich sowohl im imaginären als auch im realen Kontext an einen Leser und stellt damit eine 'kommunizierte Kommunikation' dar.¹⁹

For readers who are used to dealing with factual texts, or who expect a factual text, the question arises whether the sentences regarding the author, that are real but not authentic, still reference the extra-textual reality. If so, how should this reference be determined? One could ask, for example, how real is the reality that Jesus tells in his parables?²⁰

16 Cf. Ansgar Nünning, *Grundzüge eines kommunikationstheoretischen Modells der erzählerischen Vermittlung. Die Funktionen der Erzählinstanz in den Romanen George Eliots*, *Horizonte – Studien zu Texten und Ideen der europäischen Moderne 2* (Trier: WVT, 1989), 22–124. For an application of this model to pseudepigraphic letters with Colossians as a test case cf. Sandra Huebenthal, "Pseudepigraphie als Strategie in frühchristlichen Identitätsdiskursen? Überlegungen am Beispiel des Kolosserbriefs," *SNTSU* 36 (2011): 63–94.

17 In the case of the authentic Pauline letters, which are considered factual texts, *author* and *sending figure* for reasons of genre.

18 Martínez and Scheffel, *Einführung in die Erzähltheorie*, 17.

19 Martínez and Scheffel, *Einführung in die Erzähltheorie*, 17.

20 In literary studies, it is assumed that fictional and potential worlds are constructed close to reality, or to the encyclopedia of the recipients: "Mit anderen Worten, auch die unmöglichste Welt muß, um eine solche zu sein, als Hintergrund immer das haben, was in der wirklichen Welt möglich ist. Dies aber bedeutet: Die fiktiven Welten sind Parasiten der wirklichen Welt. Es gibt keine Regel, die vorschreibt, wie viele fiktive Elemente in einem Werk akzeptabel sind, es gibt hier im Gegenteil eine große Flexibilität: Formen wie beispielsweise das Märchen veranlassen uns auf Schritt und Tritt zu Korrekturen unseres Wissens von der wirklichen Welt. Doch alles, was im Text nicht ausdrücklich als

This is especially true when the same excerpts are authentic but fictional on a narrative level (or in the case of letters: the sending character). In literary studies, this dilemma is resolved as follows:

Durch das reale Schreiben eines realen Autors entsteht so ein Text, dessen imaginär authentische Sätze eine imaginäre Objektivität schaffen, die eine fiktive Kommunikationssituation, ein fiktives Erzählen und eine fiktive erzählte Geschichte umfaßt. Die fiktive Erzählung ist zugleich Teil einer realen wie einer imaginären Kommunikation und besteht deshalb je nach Sichtweise aus *real-inauthentischen* oder aus *imaginär-authentischen* Sätzen.²¹

When a pseudepigraphal author introduces himself as “Paul” and sends a message to a fictitious community referring to their (also fictitious) shared history, the text thereby creates a fictional situation that seems authentic but is not. However, since the pseudepigraphal letter was sent by a real author to a real audience, there is also real communication in which the author interacts with the readers via the fictional text.

The distinction of *two levels of communication*, which can have different meanings, suggests that the distinction between *factual* and *fictional* is a bit too coarse, or as Ruben Zimmermann says, “simplifizierend”:

Sie suggeriert, dass nur faktuale Erzählungen einen Realitätsbezug haben, fiktionale aber nicht. Allerdings sind auch ‘erfundene Geschichten’ Teil einer realen Kommunikation, sie speisen sich – wie z.B. die Gleichnisse – aus der realen Erfahrungswelt der Kommunikationsteilnehmer, sie erweisen sich insofern auch als Träger historischer Informationen und besitzen geschichtliche Wahrheitsfähigkeit.²²

In fact, the distinction *factual* or *fictional* runs the risk of losing sight of the second level of communication. Thus, the following situation can arise: The story on the *imaginary level of communication* is *fictional*, while on the *real level of communication* it is communicated with a *claim to authenticity* or *truthfulness*. This could mean for Colossians and 2 Thessalonians that we would be dealing with *fictional texts* that want to be understood as *authentic acts of*

verschieden von der wirklichen Welt erwähnt oder beschrieben wird, muß als übereinstimmend mit den Gesetzen und Bedingungen der wirklichen Welt verstanden werden.” Eco, *Im Wald der Fiktionen*, 122. On reality as the background of fictional stories, see also the chapter of the same name in Zipfel, *Fiktion, Fiktivität, Fiktionalität*, 82–90.

21 Martínez and Scheffel, *Einführung in die Erzähltheorie*, 17f.

22 Ruben Zimmermann, “Geschichtstheorien und Neues Testament: Gedächtnis, Diskurs, Kultur und Narration in der historiographischen Diskussion,” *Early Christianity* 2 (2011): 417–44, 438.

communication and refer to the extra-textual reality. This is somewhat easier to imagine if we assume that the *fictional content* of *authentic communication* does not refer to *events* but rather to *experiences*.

In their introductory contribution to the collected essays volume entitled, *Wirklichkeitserzählungen*, Christian Klein and Matías Martínez also note “dass die Opposition fiktional vs. faktual nicht trennscharf ist, sondern verschiedene Kombinationen und Hybridisierungen erlaubt.”²³ In order to do justice to this complexity and still obtain meaningful formats, they propose the following four subcategories:²⁴

- a) *Factual narratives with fictional narrative techniques* (referring to a true story using literary narrative techniques).
- b) *Factual narratives with fictional content* (referring to real events that do not exist).
- c) *Fictional narratives with factual content* (not referring to a true story, although they use real people or factual events).
- d) *Fictional narratives with factual speech mode* (staged as factual texts, although they are fictional and based on fictitious content).

This classification does more justice to the complexity of the texts and is also helpful for the reading of biblical texts: “Die Anwendung dieser Kategorien auf ntl. Texte könnte helfen, einige Missverständnisse zu vermeiden. So ändert sich die Beurteilung der urchristlichen Pseudepigraphie radikal, ob man sie als faktuale Texte mit fiktivem Inhalt (Kategorie 2) oder als fiktionale Texte mit faktualem Redemodus (Kategorie 4) einschätzt.”²⁵ A second taxonomy, presented by Klein and Martínez, also provides a better understanding of *reality narratives* (*Wirklichkeitserzählungen*).²⁶ This second taxonomy is less about self-understanding and more about the claim of the texts:²⁷

23 Klein and Martínez, *Wirklichkeitserzählungen*, 4.

24 Klein and Martínez, *Wirklichkeitserzählungen*, 4–5; see also Zimmermann, “Geschichtstheorien und Neues Testament,” 438–39.

25 Zimmermann, “Geschichtstheorien und Neues Testament,” 439.

26 Klein and Martínez, *Wirklichkeitserzählungen*, 6, provide the following definition: “Wirklichkeitserzählungen beanspruchen, auf reale, räumlich und zeitlich konkrete Sachverhalte und Ereignisse zu referieren und sind in diesem Sinne faktuale Erzählungen. Im Rahmen ihres faktualen Geltungsanspruchs lassen sich drei Varianten von Wirklichkeitserzählungen unterscheiden. Mit Wirklichkeitserzählungen ist der Anspruch verbunden, dass die dargestellten Ereignisse entweder (a) tatsächlich stattgefunden haben oder dass sie (b) stattfinden sollten oder dass sie (c) stattfinden werden.”

27 Klein and Martínez, *Wirklichkeitserzählungen*, 6.

- a) *Descriptive reality narratives* (representing real facts, claim of validity “true vs. false”).
- b) *Normative reality narratives* (representing desired states or examples, claim of validity “acting right vs. acting wrong”).
- c) *Predictive reality narratives* (representing expected future states of reality, claim of validity “plausible vs. implausible”).

Both taxonomies show that the field of texts with references to extra-textual reality is, at first glance, much broader than the opposite, *factual vs. fictional*. Thus, the assessment of early Christian pseudepigraphy also changes radically when read as descriptive or normative reality narratives. While this would be possible for normative reality narratives through a fictional text, it is impossible for the descriptive reality narratives.

2. Factual and Fictional Narration in New Testament Exegesis

In the same way that a factual narration is evidenced by reality, the usefulness of hermeneutical and methodological considerations is proven by the text. Accordingly, I will examine in a second step as to whether, and to what extent, the ideas presented above can *actually* be applied to New Testament texts. As a test case, I have chosen two letters from the New Testament which are widely regarded as *Deutero-Pauline*: The Letter to the Colossians and the Second Letter to the Thessalonians.

Why these two letters? Would not Colossians and Ephesians or the *Corpus Pastorale* be more obvious as objects of investigation because of their relationship? This is precisely what is not the goal of this study. Colossians and 2 Thessalonians are two different and independent texts, which – as two Deutero-Pauline writings – are part of a larger group of texts and refer to the same preceding corpus.²⁸ Colossians also lends itself to this study because it is the oldest example of New Testament pseudepigraphy. Second Thessalonians is more interesting than the *Corpus Pastorale*, which has no direct references to the authentic Pauline letters because of its connection with the authentic Pauline 1 Thessalonians. Also, the fact that the pseudepigraphal character of 2 Thessalonians is still controversial makes it an intriguing test case.

²⁸ The question of which authentic Pauline letters were known was not relevant. For the choice of these two texts, it was important that they both present themselves as Pauline letters.

Both letters continue the Pauline tradition, or the Pauline narrative. Since – unlike the *Catholic Epistles* – authentic Pauline letters exist, it is also possible to think about referentiality.²⁹ Finally, these two letters are interesting because of their thematic and stylistic differences: on the one hand, Colossians, is a generic letter (despite seemingly concrete opponents!) in an expansive style which has become a model for further pseudepigraphy, and on the other hand, 2 Thessalonians, reacts to very concrete situations and problems and closely follows the previous letter. Both obviously continue Pauline theology but do so in different ways, which makes the question of what kind of *experiences* they verbalize more interesting. They likely do not tell the same story.

An undeniable problem in applying the taxonomy from literary studies to biblical texts is that literary-scientific and exegetical conceptions of *factual* and *fictional* texts are not congruent. One difference between literary and exegetical conceptions is that a *pseudepigraphic letter* – even if it is a “double pseudepigraphy”³⁰ – is usually received as a *factual writing with author fiction* in exegetical discussions,³¹ whereas literary studies assumes a *fictional* text, arguing from the text’s self-understanding.

In biblical scholarship, one would only consider a text to be a piece of *pseudepigraphic epistolary fiction*³² or a fictional text (and consider a second communication situation) if the idea of pseudepigraphy is further developed

29 Second Thessalonians has 1 Thessalonians as a point of reference; Colossians has e.g., archaeology.

30 Thus, in addition to the *author fiction*, an *addressee fiction* is also assumed.

31 Cf. Trevor Thompson, “As If Genuine. Interpreting the Pseudepigraphic Second Thessalonians,” in *Pseudepigraphie und frühchristliche Verfasserfiktion/Pseudepigraphy and Author Fiction in Early Christian Letters*, ed. Jörg Frey, Jens Herzer, Martina Janßen, and Claire Rothschild, WUNT 246 (Tübingen: Mohr Siebeck, 2009), 471–88, 472f. “Although not acknowledged as such, commentators seem to borrow the basic reading assumptions (e.g. a real letter sent from an author to an intended audience) and interpretative approaches (e.g. the use of the text as a clear window into the life and experiences of the author and addressees) from the analysis of authentic Pauline texts to reconstruct the *Sitz im Leben* for the pseudepigraphic Second Thessalonians. The result of this approach is a long-standing interpretive tension.”

32 The assumption that the New Testament pseudepigraphs are epistolary *fictions*, that not only contain *author fiction* but also *addressee fiction* and *situational fiction*, is rather recent in exegetical discussions and still very controversial. Cf. Janßen/Frey, “Einführung,” 3–16, and Eckart Reinmuth’s observations that “Weder abstrakter und fiktiver Autor noch intendierte und fiktive Adressaten kommen freilich in pseudepigraphen Texten voll zur Deckung. Diese zwar tendenzielle, aber doch nicht restlos vollzogene Übereinstimmung ist vielmehr Voraussetzung ihrer tatsächlichen Wirkung. Denn diese Texte wollen die Gegenwart ihrer intendierten Rezipienten, nicht der fiktiven, erreichen. Immer geht es um die Absicht, das ‘Jetzt’ des Angeredeten in autorisierter Form zu erfassen” Eckart Reinmuth, “Exkurs. Zur neutestamentlichen Paulus-Pseudepigraphie,” in *Die Briefe an die*

on a consistent basis. And, if both *addressee* and *situational fiction* are added to the *author fiction*.³³ Thus, the question arises: are the categories that Klein/Martínez have introduced for literary discourse suitable for exegetical questions and biblical texts? Applying the categories, which were developed for reality narratives to early Christian texts, leads to the following insights:³⁴

- a) *Factual narratives with fictionalizing narrative techniques*: Acts, for example, can be understood as a text which refers to a true story but repeatedly uses literary narrative techniques. For example, in the speeches of the apostles or in the miracle stories. These narrative techniques are subject to literary narrative conventions, which are also used in Acts.
- b) *Factual narratives with fictitious contents*: New Testament pseudepigraphy belongs to this category: the letters understand themselves as authentic letters with real communication and situations, but they operate with fictitious content, and it is irrelevant whether this applies to *author*, *addressee* and/or *situational fiction*.
- c) *Fictional narratives with factual content*: This category applies not so much to genres, but to individual sequences, e.g., parables. In these cases, it is clear from the narrative situation that the narrator is about to tell a fictional story, i.e., a story that could have happened in this way and aims to convey a particular message.
- d) *Fictional narratives with a factual mode of speech*: This category most likely does not occur in the New Testament. The general idea is that these would have to be texts that clearly mark their fictionality and their fictional claims. Such a self-imagination is not found in the New Testament, and presumably, such texts would not have been canonized for this reason. A good example would be the correspondence between Paul and Seneca.

Philipper, Thessalonicher und an Philemon, trans. Nikolaus Walter, Eckart Reinmuth, and Peter Lampe, NTD 8,2 (Göttingen: Vandenhoeck & Ruprecht, 1998), 190–202, 194.

33 Timo Glaser says about pseudepigraphy, “dass zumeist vorausgesetzt wird, dass die Briefe ihre Autorität durch die gelungene Täuschung gewinnen, dass kaum gefragt wird, wie die Briefe unabhängig von der Frage ihrer Authentizität wirken und dass schließlich trotz des pseudonymen Charakters für die Briefe ein direkter Kommunikationsakt postuliert wird.” (Following Klein/Martínez, it would read: “a direct act of communication is exclusively postulated for the letters.”) Timo Glaser, “Erzählung im Fragment. Ein narratologischer Ansatz zur Auslegung pseudepigrapher Briefbücher,” in *Pseudepigraphie und frühchristliche Verfasserfiktion/ Pseudepigraphy and Author Fiction in Early Christian Letters*, ed. Jörg Frey, Jens Herzer, Martina Janßen, and Claire Rothschild, WUNT 246. (Tübingen: Mohr Siebeck, 2009), 267–94, 269.

34 I am indebted to Ruben Zimmermann for a better understanding of the individual categories and for sharing ideas about examples from the New Testament and ancient literature.

Colossians and 2 Thessalonians seem to be examples for category b). The question is how this insight – combined with the assumption that the second taxonomy for *Wirklichkeitserzählungen* sees them as *normative texts* – adds to exegetical queries? The additional value of the literary studies approach lies in a change of perspective, which allows one to work from the self-understanding of the texts and their pragmatics. This creates a broader spectrum of categories and understanding for pseudepigraphy, especially the question of referentiality and the different levels of communication, which become more important.

In an article on Colossians, I developed a new perspective on New Testament pseudepigraphy based on Ansgar Nünning's communication-theoretical text model, and formed the categories *authentic Pauline letter*, *pseudepigraphy*, and *pseudepigraphal epistolary fiction*. These categories were defined as follows: in an authentic Pauline letter (a), the narrated sending character (S₁), on the level of direct communication or level of the characters (N₁), and the empirical author (S₄), on the level of communication external to the text (N₄), correlate, as do the narrated receiving character (E₁) and the empirical readers (E₄). In a pseudepigraphal letter (b), the narrated sending character (S₁) does not correlate with the empirical author (S₄), while the narrated receiving characters (E₁) do correlate with the empirical readers (E₄). Finally, in pseudepigraphic epistolary fiction (c), neither the narrated sending character (S₁) and the empirical author (S₄), nor the narrated receiving character (E₁) and the empirical readers (E₄), correlate. In an overview, these findings can be presented as follows:³⁵

Table 8.1 Heuristics for reading exegetical secondary literature

a)	S ₁ =S ₄ and E ₁ =E ₄	Authentic letter of Paul
b)	S ₁ ≠S ₄ and E ₁ =E ₄	Pseudepigraphic letter
c)	S ₁ ≠S ₄ and E ₁ ≠E ₄	Pseudepigraphic epistolary fiction

These categories were helpful as a heuristic for reading exegetical secondary literature and New Testament introductions, but they have a crucial weakness: they do not address the question of the referentiality of the texts. Nünning's model distinguishes between levels of communication that are internal and external to the text but makes no statement about the referentiality of the text. Since this is a model from narrative theory, which assumes fictional texts, this is not surprising. For our question, however, this means that while a heuristic based on Nünning's model can depict *author* and *addressee fiction*, it cannot

35 Huebenthal, "Pseudepigraphie als Strategie," 70.

depict *fictional* itself, which is labelled as *situational fiction* in exegetical secondary literature. In the case of pseudepigraphy, however, this is problematic as exegetical discussion may assume, in category c), both an *author fiction* and an *addressee fiction*, and still regard the text to be *factual*, i.e., with an accurate depiction of the situation. Thus, the term *pseudepigraphic epistolary fiction* is inappropriate for these cases since the assumption is less *fictional* than *factual*. Accordingly, exegetical secondary literature does not label these cases *pseudepigraphic epistolary fiction* but instead, *double pseudepigraphy*.³⁶ It seems reasonable to readjust the original heuristic for exegetical discourse as follows:

Table 8.2 Advanced heuristics for exegetical secondary literature

a)	$S_1=S_4$ and $E_1=E_4$	Authentic letter of Paul	Factual writing
b)	$S_1 \neq S_4$ and $E_1=E_4$	Pseudepigraphic letter	Referentiality unclear
c)	$S_1 \neq S_4$ and $E_1 \neq E_4$	Double pseudepigraphy	
d)	$S_1 \neq S_4$ and $E_1 \neq E_4$	Pseudepigraphic epistolary fiction	Factual writing with fictional content

With this heuristic, the question of *factual vs. fictional* is not conclusively settled (although it would still have to be decided whether it ever can be). The benefit lies in the fact that referentiality finally comes into view as a variable of the process of understanding. Also, it becomes clear that crossing the textual boundary must come with a more precise determination of the assumed referentiality. In other words, in factual writing or an *authentic Pauline letter* (a), the situation depicted in the letter corresponds to real events and correspondence. Text-external and text-internal communication levels coincide, which the author correlates with the sending figure. The assumption of a *single or double pseudepigraphy* (b/c) is different: Here, there is a danger of conflating text-internal and text-external levels of communication when the pseudepigraphal author is mirrored back into reality (and thus, “doubled”), or when the fictional addressees are searched for on a map of the Roman Empire. To put it differently: The distortion coefficient, regarding referentiality, cannot be unambiguously determined without further external evidence such as other texts or archaeological artifacts, otherwise the argument runs the risk of being circular. If *pseudepigraphic epistolary fiction* or *factual writing with fictional content* is assumed, this problem does not arise because the entire text

36 Margret Mitchell calls this a “in doppelter Weise pseudepigraphen Text.” Margaret M. Mitchell, “Thessalonicherbriefe,” *RGG4 VIII* (2005): 360–62, 361.

is received as fictional. The question of referentiality, then, no longer arises for the level of the characters, but only for the level of communication external to the text. This has consequences for the research questions:³⁷ When we seriously consider that the level of communication external to the text and the level of the characters are separate and can be distinguished, the overall interpretation and contextualization cannot be justified from individual elements of the characters and their possible reference to extra-linguistic reality. Therefore, the entire world that the text creates must be considered. The question is no longer, *who are Paul's opponents, and what heresy are they propagating?* But instead, *what experiences and broader situations are depicted in the letter?*

Thus, the levels of communication are (again) clearly separated: in addition to the real communication situation, the imaginary communication situation becomes visible on the level of narrative mediation. This also changes the perception of the "story" that is told in the respective pseudepigraphal letter. This can be shown quite well in exegetical secondary literature and introductions to the New Testament, and will be demonstrated in the next section.

The question remains how the *referentiality* of the texts can be meaningfully investigated. Even if a direct reference to reality is assumed for *factual* letters, as is the case for the authentic Pauline letters, it can still be discussed whether an autograph, which is itself perspective-bound as it is written from a certain point of view, can objectively reach outside of reality. In a contribution about the interpretation of pseudepigraphic letter-books, Timo Glaser points out:

Zunächst ist jede Briefliteratur ein Stück Autodiegese, eine Art von Ich-Erzählung. Und entgegen dem Vorurteil, dass der Brief ein Spiegel der Seele sei, hat die Forschung mittlerweile immer stärker erkannt, dass auch in einem echten Brief der Briefschreiber ein Bild seiner selbst konstruiert und damit eher eine Art von Maske zeichnet, als dass er seinem Adressaten ein Spiegelbild präsentiert.³⁸

37 In his dissertation about the opponents in 1 John, Hansjörg Schmid has made groundbreaking observations that apply *mutatis mutandis* to Colossian epistolary fiction as well. Schmid chooses, as a guiding perspective for the treatment of the opponents in 1 John, the question of how the text functions and which boundaries it draws in which context: "Nicht wer die Gegner waren, lautet dann die Frage, sondern zu welchem Zweck und in welchem Zusammenhang überhaupt von Gegnern gesprochen wird. Dazu gilt es, in und nicht hinter den Text zu schauen. Der Schwerpunkt der Untersuchung verschiebt sich damit von der Gegnerfrage hin zu der Frage nach der Gemeindeidentität, für welche das Gegenbild eine zentrale Funktion besitzt." Hansjörg Schmid, *Gegner im 1. Johannesbrief? Zur Konstruktion und Selbstreferenz im johanneischen Sinnsystem* BWANT 159 (Stuttgart: Kohlhammer, 2002), 21. This more text-oriented (pragmatic) approach assumes that the image of the opponents says more about the community itself than the opponents.

38 Glaser, "Erzählung im Fragment," 271.

The question of unbroken referentiality is also posed for “real letters” and clearly exacerbates the problem for pseudepigraphy. The difficulty remains of how the reference to reality can be understood and examined in a pseudepigraphic text at all.³⁹ The point of connection must be in the communication situation at the text-pragmatic level. Accordingly, Glaser states:

Da ein Brief normalerweise die Fortführung eines bestehenden ‘Gesprächs’, also Ausschnitt aus einem Kommunikationsakt miteinander bekannter ist, verfügen beide Kommunikationspartner über ein gemeinsames Wissen, auf das in der Briefsituation zurückgegriffen werden kann, das jedoch nicht explizit vergegenwärtigt werden muss. Der externe, reale Leser dagegen verfügt nicht über dieses Wissen, so dass die Herausforderung für den Verfasser eines fiktionalen Briefverkehrs darin besteht, dieses Wissen zu vermitteln ohne dass die Fiktion eines realen Briefverkehrs gesprengt würde.⁴⁰

At this point, one could investigate the places where the letter unmasks itself by interjecting knowledge that the fictional addressees would have had, but not the real ones.⁴¹ In his contribution, Glaser provides a taxonomy for overdetermination and underdetermination of textual statements with regard to the external or internal reader, and executes it with examples from antiquity, including the *Corpus Pastorale*. He concludes:

Um das (so) vorhandene Hintergrundwissen der Leser zu aktivieren, stehen dem Autor diverse Möglichkeiten zur Verfügung, vorgängige Traditionen aufzugreifen, zu bearbeiten, zu kommentieren oder sogar erst zu erschaffen. Inwiefern der Autor damit in real geführte Diskussionen um die Hauptpersonen eintritt und wie er auf seine Leserschaft einwirken will, kann nicht durch eine rhetorische Analyse der Briefe allein herausgearbeitet werden, da dadurch reale und fiktionale Kommunikationsebene vertauscht werden.⁴²

39 Regarding this question, Glaser concludes: “In dieser Hinsicht unterscheidet sich ein pseudonymer Brief nicht von einem authentischen, wohl aber in seinem Wirklichkeitsbezug. Während der echte Brief direkt auf die Kommunikationssituation zwischen Sender und Empfänger einwirken will, vermag der fingierte Brief dies nicht. Der Verfasser mag sich zwar durch die Wahl eines Pseudonyms dessen Autorität aneignen und auf den Empfänger einwirken, er vermag jedoch nicht, die reziproke Beziehung zwischen dem genannten Verfasser und dem Empfänger zu beeinflussen. Insofern spiegelt der Brief mit fingierter Verfasserangabe ein Kommunikationsgeschehen vor, das er nicht konstruieren kann. Ähnlich verhält es sich mit solch fingierten Briefen, die als ‘doppelt-pseudonym’ bezeichnet werden, wenn sowohl der genannte Verfasser wie der genannte Empfänger nicht mit den realen identisch sind.” Glaser, “Erzählung im Fragment,” 272.

40 Glaser, “Erzählung im Fragment,” 273.

41 It would be worth pursuing this question both for Colossians and 2 Thessalonians. For reasons of space, this path will not be pursued further here.

42 Glaser, “Erzählung im Fragment,” 294.

How does this contribute to our question? The difficult question of whether and how one could infer from the text an extra-linguistic reality is still open, but the tools for approaching this question are becoming clearer. First of all, it has become clear that this question lies at the textual-pragmatic level and must be answered there. In doing so, it is crucial to keep separate the different levels of communication in the text and not conflate them. Since the construction of fictional communication can neither be gathered on the level of fictional or real communication, it must be on the level of the entire work. That is, it is not individual elements of the text that are to be examined in terms of their possible referentiality, but the text as a whole – if this is possible within the parameters of comparison. In other words, a rhetorical analysis of Colossians or 2 Thessalonians alone will not lead to the desired results if at least one other, preferably authentic, Pauline letter is not read and analyzed as well. Furthermore, even in the case of *pseudepigraphy* and *double pseudepigraphy*, a distorted referentiality is to be expected. This is because the author, to communicate with real readers, must stimulate their attitudes of reception and prior knowledge at the level of fictional communication, and in doing so, will shape events and traditions to suit his purpose. A clue to this may be the determination of the knowledge communicated in the text for explicit and implicit readers. These observations, too, will always have to be read against the pragmatics of the text.

3. Test Cases: Colossians and 2 Thessalonians in Exegetical Secondary Literature and Introductions to the New Testament

Although the chronological sequence of these Deutero-Pauline letters is probably reversed, i.e., Colossians was written *before* 2 Thessalonians, the reading impressions from the secondary literature will be presented here in the order 2 Thessalonians – Colossians. The reason is that the discussion of the *fictionality* or *referentiality* of both texts proceeds in different stages, which in my opinion, logically follow each other as the discussion in reversed chronological order shows.

3.1 *Second Thessalonians*

The discussion about the authenticity of 2 Thessalonians started mainly because it shows great similarities to 1 Thessalonians in some instances, but differs significantly in others. Why did Paul write two letters to the same community, which are partly congruent and partly contradictory in

content?⁴³ The question about the authenticity of 2 Thessalonians did not arise from internal considerations or by comparing it with historical facts, but by reading it side by side with the previous letter addressed to the same community. The initial research question was therefore: *How can a letter from the same author to the same community be so similar and yet so contradictory at the same time?*

What makes 2 Thessalonians so intriguing is the fact that arguments for or against Pauline authorship have been exchanged for quite some time with no consensus in sight.⁴⁴ With the insight from literary theory that the assignment of the label *factual* or *fictional* (which in this case is congruent with the question of authorship) is a textual pragmatic decision, 2 Thessalonians brings into view not only what implications, but also what presuppositions it has for the understanding and interpretation of the letter. And additionally, whether or not Pauline authorship is assumed. For Colossians, this question is, for the most part, not (or no longer) discussed in this form (and sharpness).

3.1.1 Second Thessalonians as an Authentic Pauline Letter

If 2 Thessalonians is read as an authentic Pauline letter,⁴⁵ there is no problem – at least not for the story the letter tells. Viewing the letter authentically, the fictional communication is received as follows: *Paul reacts to false teachers who*

43 Cf. Achtemeier, Green, Thompson, *Introducing the New Testament*, 443.

44 Cf. Trevor Thompson, “A Stone that Still Won’t fit. An Introductory Note for Edgar Krentz’s ‘A Stone that will not fit,’” in *Pseudepigraphie und frühchristliche Verfasserfiktion/Pseudepigraphy and Author Fiction in Early Christian Letters*, ed. Jörg Frey, Jens Herzer, Martina Janßen, and Claire Rothschild, WUNT 246 (Tübingen: Mohr Siebeck, 2009), 433–38. Edgar Krentz’s reflections presented at the 1983 SBL Annual Meeting are still seminal. In Krentz’s paper, which is printed in the anthology with a few revisions (for the first time in its entirety), there are clear statements like the following: “The style of the letter is of one piece, independent of Paul’s normal mode of writing. It runs through the entire letter. And the linguistic, stylistic peculiarities are precisely what raise the problem of authenticity. Two solutions are possible: One must either account for Paul’s variant style from the situation he faced or from the amanuensis he used, or one must accept the conclusion that another mind produced the letter, *tertium non daretur*.” Edgar Krentz, “A Stone that Will Not Fit,” in *Pseudepigraphie und frühchristliche Verfasserfiktion/Pseudepigraphy and Author Fiction in Early Christian Letters*, ed. Jörg Frey, Jens Herzer, Martina Janßen, and Claire Rothschild, WUNT 246 (Tübingen: Mohr Siebeck, 2009), 439–70, 455.

45 The authenticity of the writing (including the hypothesis that letter was written by a secretary) is assumed mostly by English-speaking authors, e.g., Achtemeier, Burkett, Kee, and Marshall/Travis/Paul. In German-speaking scholarship, Niebuhr holds this position. For an overview of the current discussion, see Thompson, “A Stone that Still Won’t Fit,” 435, and Schnelle, *Einleitung in das Neue Testament*, 359.

disturb the community with their eschatological statements, and given the delay of the Parousia, he presents a new eschatological “roadmap.” The letter is thus largely seen as a supplement and specification of 1 Thessalonians in times of a changed or changing situation.

Accordingly, research questions that arise from this reading focus on how Paul or the situation of the Thessalonians has changed since the writing of 1 Thessalonians. In addition, there is a discussion of who the false teachers of 2 Thessalonians might have been. The question about the pragmatics of the writing can be easily answered: Paul himself touches base with the community now in a changed situation and gives – as the founder of the community and an accepted authority – advice on how to deal with this situation.

3.1.2 Second Thessalonians as Pseudepigraphy

If 2 Thessalonians is read as a piece of pseudepigraphy,⁴⁶ the received story changes significantly: With Pauline authority, the idea of some “imminent-return-enthusiasts” (who possibly refer to Pauline preaching) in the community of Thessalonica is corrected. If it is presumed that Paul did not write the letter himself, it must first be proven why he could not have done so. This question has traditionally taken up a great deal of space in research since Wrede.⁴⁷ Here, we must distinguish between linguistic-stylistic⁴⁸ and

46 The majority of German-speaking scholars view 2 Thessalonians as a pseudepigraphic letter, although it is not always clear whether a scholar assumes single or double pseudepigraphy. Surveys of the current state of discussion are provided by Thompson, “A Stone that Still Won’t Fit,” 434 and Schnelle, *Einleitung in das Neue Testament*, 359, and Stefan Schreiber, “Der zweite Thessalonicherbrief,” in *Einleitung in das Neue Testament*, ed. Martin Ebner and Stefan Schreiber (Stuttgart: Kohlhammer, 2008), 440–49, 444. From the authors considered in this essay, the following opt for single pseudepigraphy: Marlene Crüsemann, *Die pseudepigraphen Briefe an die Gemeinde in Thessaloniki. Studien zu ihrer Abfassung und zur jüdisch-christlichen Sozialgeschichte*, BWANT 191 (Stuttgart: Kohlhammer, 2010), Andreas Dettwiler, “La deuxième épître aux Thessaloniens,” in *Introduction au Nouveau Testament. Son histoire, son écriture, sa théologie*, ed. Daniel Marguerat, Le Monde de la Bible 41 (Geneva: Labor et Fides, 2000), 293–303, Christina M. Kreinecker, *2. Thessaloniker*, Papyrologische Kommentare zum Neuen Testament 3 (Göttingen: Vandenhoeck & Ruprecht, 2010), Franz Laub, *1. und 2. Thessalonicherbrief*, NEB.NT 13 (Würzburg: Echter, 1985), and also Lindemann, Pokorný, Schierse, and Theissen.

47 “Zufall endlich und der eigentliche Zufall, dass alle diese Zufälle zusammentreffen. Einen solchen Zufall gibt es nicht. Deshalb muss die Annahme falsch sein, die ihn voraussetzt. Dies ist das ausschlaggebende Faktum, der zwar indirekte, aber wie mir scheint, äußerst starke, ja zwingende Beweis.” William Wrede, *Die Echtheit des 2. Thessalonicherbriefes*, TUGAL 24 (Leipzig: J. C. Hinrichs’sche Buchhandlung, 1903), 30.

48 Among the linguistic/philological studies, Kreinecker’s work has to be emphasized. In her papyrological study of 2 Thessalonians, she arrives at the following interesting conclusions: “Während Paulus als Briefschreiber gewandt genug ist, mit den Konventionen

theological⁴⁹ arguments. The latter refer not only to the evaluation of the theological approaches of the letter, but also to the construction of apostolicity or apostleship it communicates.

In addition, new and different research questions arise: In which situation was 2 Thessalonians written, and who aims to speak into which situation? At this point, the question of referentiality becomes important.⁵⁰ Trevor Thompson has aptly summed up the problem of historical inquiry or contextualization and reveals the dilemma of drawing conclusions from the textual level to the extra-textual reality – an issue all approaches struggle with:

The use of passages in the pseudepigraphic Second Thessalonians in order to reconstruct the document's *Sitz im Leben* is without a clearly defined method and results in interpretive inconsistencies. The identification of Second

frei umzugehen und sie in seinem Interesse zu nutzen, und dennoch im Großen und Ganzen im Rahmen seiner Möglichkeiten bleibt, gelingt dies dem Verfasser des 2Thess nicht. Denn bei seiner gezielten Nachahmung ist er an einigen Stellen zu weit gegangen, in 'paulinischer Hinsicht' ebenso wie im Blick auf die Briefkonventionen seiner eigenen Zeit, sodass der 2Thess gerade diesbezüglich als pseudepigraphisches Schreiben offengelegt werden kann (...) Mit diesen Beobachtungen lässt sich zudem die allgemeinere Hypothese aufstellen, dass der Verdacht auf Pseudepigraphie dort verstärkt vorzubringen ist, wo an sich übliche und bekannte Wendungen und Gedanken aus dem 'Original' zwar vorkommen, jedoch in Abweichung von Briefkonventionen im Brief selbst 'eingebaut' werden. Der pseudepigraphische Verfasser versteht zwar, Eigenheiten seines 'Vorbilds' zu erkennen und zu übernehmen, wendet sie aber entgegen der üblichen Briefkonventionen an und entlarvt sich nicht zuletzt genau dort selbst, wo er dem Original eigentlich am nächsten sein will." Kreinecker, *2. Thessaloniker*, 96f.

- 49 A good example for this is the question of the delay of the Parousia/expectation of imminent return, which does not necessarily refer to a specific point in time but may also be encountered at a later time. Cf. Pokorný and Heckel, *Einleitung in das Neue Testament*, 651.
- 50 An example for this is the question of whether the reference to the (undestroyed) temple in 2 Thess 2:4 identifies the letter as authentic or confirms that it should be read as part of the *author fiction*. The pseudepigraphal author knows that Paul could not have experienced the destruction of the temple, and this is precisely what makes the *author fiction* more credible (as kind of a "reverse *vaticinium ex eventu*"), cf. Broer and Weidemann, *Einleitung in das Neue Testament*, 464; Conzelmann and Lindemann, *Arbeitsbuch Neues Testament*, 238. Cf. also the remarks of Reinmuth, "Exkurs," 195: "Diese aktuelle Evidenz zeitgeschichtlicher Anspielungen, die zumeist in die Form prophetischer Zukunftsaussage gekleidet waren, ist zugleich ein entscheidendes Moment und Kriterium der modernen Identifikation pseudepigrapher Schriften. Die kritische Wissenschaft erkennt prophetische Ansagen bereits eingetretener Ereignisse (*vaticinia ex eventu*) an ihrer Konkretheit. Diese Konkretheit ist textintern eine relative, insofern die meisten *vaticinia ex eventu* eingebettet sind in Zukunftsschilderungen, die nicht bei der mit ihnen intendierten Gegenwart stehenbleiben. Textintern ist insofern der Übergang vom Konkreten ins Allgemeine entscheidend. Denn an diesem Umschlag lässt sich die Gegenwarts-Schnittstelle, in der die Rezipienten sich wissen können, erkennen."

Thessalonians as a pseudepigraphon turns our confident affirmations – based in a reading of the text – about the background of the document into complex and involved questions: Where if anywhere in the text does the identity of the actual author emerge from behind the mask of the ascribed authors and their narrated context? Do the historical reminiscences and past experiences of the ascribed authors resonate with the real experiences of the actual author? If so, to what extent and how would we know? Was there an actual persecution against Christians raging among perceived readers (1:4–10)? Was there a real letter being circulated in the name of Paul, Silvanus and Timothy (2:2)? Did some source truly claim that the Day of the Lord had come (2:2)? Was the actual author being maltreated (2 Thess 3:2)? Were idle individuals causing trouble by their refusal to work (2 Thess 3:7–13)? In terms of reconstructing a *Sitz im Leben* through the window of Second Thessalonians, does description ever end and truth begin?⁵¹

Here, we encounter, once more, the still unresolved question of whether and how the extra-textual reality can be inferred the world described in the text from without “the world of the written texts (...) moving from page to reality,”⁵² or the *narrated world* being put on one level with the *author's world*.⁵³ Thompson concludes his reflections stating that it is imperative for further research on 2 Thessalonians “to develop a rigorous model which adequately takes into consideration the complexities of working with a pseudepigraphon.”⁵⁴ Initial ideas have been presented in last years,⁵⁵ and a critical review of them is still needed.

51 Thompson, “As if Genuine,” 488.

52 Thompson, “As if Genuine,” 480.

53 Nota bene: This does not refer to the *narrated world* and the *narrator's world*, both of which are found in the text, but to crossing the textual boundary and inferring from the text to the extra-textual reality.

54 Thompson, “As if Genuine,” 488. In addition to seeking a hermeneutical model as a heuristic for pseudepigraphal texts, Thompson further suggests “a focus on the process of producing a pseudepigraphon in antiquity can offer new ways for thinking about how Second Thessalonians was composed to meet the goals of its actual author” (*ibid.*). Possibly included in this thought, but not explicitly expressed, is the equally important textual pragmatic side – not only *how*, but especially *why* a pseudepigraphic second letter to the Thessalonians might have been written is significant here.

55 Hanna Roose opts for reading the Pauline letters as “polyvalente Texte (...), die durch intertextuelle Bezüge – eben die deuteropaulinischen Schriften – ihren Bedeutungsspielraum verändern.” Second Thessalonians thus also becomes instructive for 1Thessalonians. Hanna Roose, “Die Thessalonicherbriefe im Kontext urchristlicher Überlieferungsprozesse. Methodische Reflexionen” in *Beiträge zur urchristlichen Theologiegeschichte*, ed. Wolfgang Kraus, BZNW 163 (Berlin: De Gruyter 2009), 343–64, 346. Cf. also Hanna Roose, “Polyvalenz durch Intertextualität im Spiegel der aktuellen Forschung zu den Thessalonicherbriefen,” *NTS* 51 (2005): 250–69. Eve-Marie Becker understands 2 Thessalonians as a contribution to a “Pauline discourse” that “im Sinne einer historischen und literarischen Quelle Einblick in die theologischen und theologiegeschichtlichen Konflikte um die Sicherung, Fortschreibung und Diskussion paulinischer

Regarding the question about the pragmatics of the text, there are two main approaches. One pursues the question of how the two letters are connected, and the other asks which image of the apostle is used and – in turn – which concept of leadership the letter seeks to communicate. The answers to the first question focus on the alternatives *replacing* or *supplementing* (the first letter),⁵⁶ with the majority of commentators opting for some form of supplement or commentary to 1 Thessalonians.⁵⁷ The second question does not only lead to questions of concepts of apostleship/apostolicity, but also to the general discussion of the phenomenon of pseudepigraphy.

Compared to 1 Thessalonians, the relationship between Paul and the Thessalonians has clearly changed: “Es ist nicht mehr so persönlich geprägt wie im ersten Brief; Paulus wird ansatzweise zum Vorbild stilisiert. Zugleich wird mehr Wert auf die apostolischen Überlieferungen und die Schriftlichkeit ihrer Vermittlung gelegt.”⁵⁸ On the one hand, the written Pauline traditions are prioritized compared to the oral ones, and on the other hand, the apostle himself takes on a different role: while 1 Thessalonians was about exhortations with regard to the world, and the apostle had more of an admonishing-moderating

Lehre.” Eve-Marie Becker, “Ὡς δὲ ἡμῶν in 2 Thess 2,2 als Hinweis auf einen verlorenen Brief,” *NTS* 55,1 (2009): 55–72, 69.

- 56 On the question of *replacing* or *supplementing*, cf. the reflections of Hanna Roose, who discusses this question in a framework of tradition and transmission history and concludes in connection with her own approach of the Paulines as polyvalent texts: “Das Programm der ‘Leseanweisung’ fordert jedenfalls eine synchrone Lektüre beider Thessalonicherbriefe. Tritt die Annahme hinzu, dass der 1. Thessalonicherbrief paulinisch, der 2. jedoch pseudepigraph ist, steht diese synchrone Lektüre für uns heute unter ‘deuteropaulinischen’ Vorzeichen. Wir müssten dem 1. Thessalonicherbrief mithin mindestens zwei unterschiedliche, d.h. für uns unterscheidbare, Lesarten zugestehen: eine ‘paulinische’ und eine ‘deuteropaulinische’. Neben die Frage nach der richtigen – in diesem Fall: paulinischen – Auslegung muss also die Frage nach den Bedeutungsspielräumen treten, die Texte eröffnen. Dieses Vorgehen führt uns historisch gesehen in eine spannende (Übergangs)Phase, in der paulinische Briefe nicht mehr umgeschrieben oder ersetzt, wohl aber noch (vor der Fixierung des Kanons) pseudonym ergänzt werden konnten” Roose, “Die Thessalonicherbriefe im Kontext urchristlicher Überlieferungsprozesse,” 364.
- 57 Roose’s approach follows such a new track. Cf. also the remarks of Schreiber: “Mit 2 Thess werden für uns erste Schritte einer spezifischen Paulus-Hermeneutik sichtbar. 2 Thess will also 1 Thess nicht ersetzen, bzw. als Fälschung diskreditieren – er würde sich ja die eigene Autorisierungsbasis entziehen, wenn er die Gültigkeit von Paulusbriefen in Frage stellt –, sondern interpretieren, auf eine neue Situation hin auslegen. Die Wirkung der ‘Imitation’ besteht dann im Wiedererkennen, Sich Wiederfinden in den vertrauten Formulierungen des Paulus, was der Identitätssicherung einer nach-pln Gemeinde dient.” Schreiber, “Der zweite Thessalonicherbrief,” 448.
- 58 Reinmuth, “Exkurs,” 159. Cf. also Krentz, “A Stone that Won’t Fit,” 468.

role (1 Thess 2:12; 4:1; 5:14: παρακαλῶ), he now becomes a role model (2 Thess 3:7.9) and an admonishing authority (2 Thess 3:6–10:12: παραγγέλλω):

Für die Orientierung der Leser hat der Apostel offensichtlich einen hohen Stellenwert. Nur so ist zu erklären, dass der Verfasser sich unter das Pseudonym des Apostels stellt und diesen so selbst eine Korrektur seiner Eschatologie im ersten Brief vornehmen lässt. Die mehrfachen Hinweise auf Briefe oder Worte des Apostels weisen in die gleiche Richtung. Das stimmt durchaus mit den echten Paulinen überein, wo das Wort des Apostels auch einen sehr hohen Stellenwert hat. Aber die Bedeutung des Evangeliums und v.a. die Verbindlichkeit der Tradition, die mit dem Wort oder dem Schreiben des Apostels gleichgesetzt wird, sowie die Verbindlichkeit des paulinischen Vorbilds weichen von den echten Paulusbriefen ab. Denn der dynamische Begriff des Evangeliums in den echten Paulusbriefen gerät im zweiten Brief in die Gefahr, zu einer statischen Größe zu werden und einfach mit der christlichen Wahrheit identifiziert zu werden, der man gehorchen muss, und der Apostel wird einfach zum nachzuahmenden Beispiel für einen ordentlichen Lebenswandel.⁵⁹

The argument is not only about the behavior of the community, but also about a particular concept of Paul as an apostle with authority for the entire church.⁶⁰

59 Broer and Weidemann, *Einleitung in das Neue Testament*, 475f.

60 For the argumentation cf., by way of example, Laub: "Als pseudepigraphischer Brief legt 2 Thess Zeugnis ab für eine Epoche, für die neben der Anonymität die pseudoapostolische Zuschreibung charakteristisches Mittel ist zur Bewahrung und Tradierung der Christusbotschaft. Daß die neutestamentlichen pseudepigraphischen Schriften durchweg apostolische Verfasserschaft beanspruchen, signalisiert in sich schon ein ausgeprägtes Verhältnis zum Ursprung als der Maßgabe für die Gegenwart, eine Denkweise, die für die antike Pseudepigraphie überhaupt charakteristisch ist. Für das Frühchristentum bezieht diese Orientierung am Ursprung als der Norm für die Gegenwart ihre spezifische Intensität aus der Überzeugung, daß das Christusgeschehen, in der Geschichte verifizierbar, letztgültiges eschatologisches Heilshandeln Gottes im Sohn war. So gesehen, gehört Identität und Kontinuität mit dem Ursprung wesensnotwendig zum Selbstverständnis der Kirche. Es war die kirchengeschichtlich unumgängliche Aufgabe der dritten, d.h. der sogenannten nachapostolischen Generation, der auch der Verfasser des 2 Thess angehört, dies erstmals zu reflektieren, und zwar umso intensiver, je mehr man sich vom Ursprung zeitlich entfernte, je länger das Ende ausblieb und je mehr neue Antworten gegeben werden mußten. Ergebnis dieser Reflexion ist die Idee des 'Apostolischen', wie sie u.a. in der Abfassung von 'Apostelbriefen' zum Ausdruck kommt. Auf dem paulinischen Missionsfeld kommt hinzu, daß Paulus mit seiner Praxis der Gemeindebriefe selber anregend im Sinn einer späteren pseudepigraphischen Zuschreibung gewirkt haben mag. So wie der Apostel die Zeit seiner Abwesenheit von den Gemeinden durch Briefe überbrückte und durch sie anwesend sein wollte, so überbrückt die 'Paulusschule' in nachpaulinischer Zeit die immer größer werdende zeitliche Distanz zum Apostel durch fingierte Briefe." Laub, *1. und 2. Thessalonicherbrief*, 41.

3.1.3 Second Thessalonians as Double Pseudepigraphy

If we not only assume author fiction but also addressee fiction for 2 Thessalonians,⁶¹ the received story changes further: With Pauline authority, the letter addresses difficulties related to the delay of the Parousia, which have arisen in congregations which are standing in the Pauline tradition. With this story, the research questions change, too, and the addressees come into focus. In the case of 2 Thessalonians, the assumed double pseudepigraphy does not imply, for the most part in the exegetical discourse, that addressee fiction means fictional addressees, but rather that the addressees are real, but not the Thessalonians themselves. It also infers that they are situated in the (closer or wider) local environment of the Thessalonian community.

While single pseudepigraphy focusses on the search for the author, double pseudepigraphy focusses on the search for the addressees. Broer and Weidemann's remarks are a good example for the way this question is approached:

Über die Empfänger des Schreibens lässt sich nichts sagen. Dass es auf direktem Weg nach Thessalonich ging, ist kaum anzunehmen, da man zu dem frühestmöglichen Zeitpunkt seines Erscheinens dort sicher um den Tod des Apostels gewusst hat und einen weiteren, jetzt erst bekanntwerdenden Paulusbrief dort deswegen nicht akzeptiert hätte. Die Adresse hängt also weniger mit der konkreten Empfängergemeinde als mit der starken Anlehnung an den ersten Brief zusammen. Offensichtlich soll die Eschatologie des ersten Briefes durch diesen Brief verdrängt werden, so dass die Vertreter der Nächsterwartung der Parusie mit dem ersten Thessalonicherbrief auch den Apostel als Stütze für ihre Theologie verlieren.⁶²

A little later, they continue: "Da sich der Brief aber direkt gegen den ersten Brief wendet, hat er auch dessen Adressaten im Blick, auch wenn der Brief kaum sofort nach seiner Abfassung nach Thessalonich geschickt, sondern auf andere Weise in den Kreislauf der Paulusbriefe eingeschleust wurde."⁶³ The question of the authority of the apostle and the authority of the letter, which was discussed for the *author fiction* under b), is answered as follows: "Der autoritative

61 From the authors considered in this essay, this approach is pursued by Broer and Weidemann, Mitchell Paul-Gerhard Müller, *Der erste und zweite Brief an die Thessalonicher*, RNT (Regensburg: Pustet, 2001), Schnelle, Schreiber, and Thompson.

62 Broer and Weidemann, *Einleitung in das Neue Testament*, 465. Broer places 2 Thessalonians in the last decades of the first century (469). The strategy used in Colossians seems to have made more sense here: a letter to a disappeared church can be more easily "smuggled into" a letter collection (483).

63 Broer and Weidemann, *Einleitung in das Neue Testament*, 465.

Status von 1Thess ist eine Voraussetzung für die Existenz von 2Thess, einem in doppelter Weise pseudepigraphischen Text.”⁶⁴

What connects readings b) and c) is the question about the people behind the text, on the producing or receiving end. This need does not necessarily involve the search for (and discovery of) a Pauline school or determining in miles the distance between Thessalonica and the place where 2 Thessalonians was addressed.⁶⁵ This reading works with the assumption that the letter deals with a real, i.e., a concrete and authentic problem. This, in turn, has implications for the pragmatics attributed to the text:

Eine christliche Prophetengruppe aus dem Raum der Adressaten selbst (also keine ‘Gegner’ von außen) reagierte auf das Ausbleiben der Parusie und auf anhaltende gesellschaftliche Marginalisierung mit einer konsequent eschatologischen Interpretation von pln Aussagen über die Naherwartung (1Thess 4,15.17) und der pln Überzeugung, dass bereits in der Gegenwart die Christen an Gottes endgültiger Rettung teilhaben und entsprechend leben können.⁶⁶

In contrast to the single pseudepigraphy, the double pseudepigraphy expands the possible range of the apostolic authority constructions: the apostle no longer speaks with authority only to the individual community, but to the broader community/communities.⁶⁷ The following remarks are a good example for this approach: “2 Thess stärkt das Überlieferungsprinzip und gibt dazu einen ‘hermeneutischen Schlüssel’ an die Hand. Bindende Orientierung an der Lehr-Tradition des Paulus (Terminus: παράδοσις/paradosis) wird wichtig für die Identität, die ‘Sinnwelt’ späterer Generationen in den pln Gemeinden.”⁶⁸

One hermeneutical difficulty, however, remains with the concept of “double pseudepigraphy,” namely, referentiality. Trevor Thompson puts it well: “As a document that is neither from the ascribed authors nor to the attributed addressees, any attempt to reconstruct the actual Sitz im Leben for the text faces the interpretive challenge of working with a literary fable.”⁶⁹

64 Mitchell, “Thessalonicherbriefe,” 361.

65 Cf. Schreiber: “Wir wissen, aber, dass die Paulusbriefe sehr bald unter den Gemeinden ausgetauscht wurden (vgl. Kol 4,16). 1 Thess lag also auch an anderen Orten vor. Damit müssen wir wohl auch von einer Adressatenfiktion ausgehen. Sichtbar ist nur der ‘geistige’ Ort von Verfasser und Adressaten: Sie verstanden sich in pln Tradition und lebten irgendwo im pln Missionsgebiet.” Schreiber, “Der zweite Thessalonicherbrief,” 446.

66 Schreiber, “Der zweite Thessalonicherbrief,” 445.

67 This can be seen even in Colossians and Ephesians: Colossians can easily be recognized as writing for a wider circle, and Ephesians presents itself (depending on the text-critical decision) as a circular letter.

68 Schreiber, “Der zweite Thessalonicherbrief,” 447.

69 Thompson, “As if Genuine,” 471.

3.1.4 Second Thessalonian as Pseudepigraphal Epistolary Fiction

The assumption that 2 Thessalonians is pseudepigraphal epistolary fiction⁷⁰ changes the received story of the letter once again: *An unknown author reacts to an imminent eschatological problem of his time by continuing the story (presumably known to the addressees) between Paul and the Thessalonians, and thereby reflects how the community should behave in a changed situation and in the face of "false" letters.*

How does this story change the interpretation of the letter? The assumption of an epistolary fiction changes the referentiality of the letter and also impacts the research questions: If it is no longer assumed that individual elements of the text have points of reference in reality, one no longer needs to search for particular persons, places, or events that could stand behind this text:

Freilich ist das neue Schreiben ein fiktionaler Text, der die vergangene Geschichte in der Perspektive seines Autors aufnimmt, darstellt und fortsetzt. Das aber bedeutet, daß die intendierten Adressaten des zweiten Briefes eine literarisch dargestellte Geschichte wahrnehmen, nämlich die der Kommunikation des 'Paulus' mit der Gemeinde in Thessalonich. Wieweit der Verfasser bei ihnen zusätzlich mündlich oder schriftlich vermittelte Kenntnisse, also flankierende Elemente dieser fiktionalen Geschichte voraussetzt, wissen wir nicht.⁷¹

In this case, the level of the fictional communication is received as a whole and, in turn, the question is which experiences might stand behind it, and how these experiences might be located in the context of early Christian identity formation and socialization. The experience of pastoral difficulties or pastoral issues that call for a solution seem to be projected onto a literary level: "Der Autor des 2 Thess spricht durch das Medium der Kommunikation des 'Paulus' mit seiner Gemeinde in Thessalonich die Kirche seiner Gegenwart an. Sie soll anhand der Unterweisung die 'Paulus' einst seiner Gemeinde gab, zur Bewertung und Bearbeitung eigener Probleme befähigt werden."⁷²

This way to approach the question also moves the textual pragmatics from the *author*, or the *author fiction*, to the *situation of the addressees*. No longer is the construction of Pauline authority or a past event (such as the threat to the community of Thessalonica through external false teachers or internal confusion) the main point of reference, but the experience of confusion and uncertainty in one's own community. This is textualized and historicized – or, as Max

⁷⁰ In the reviewed literature, this approach is pursued by Reinmuth.

⁷¹ Reinmuth, "Exkurs," 162.

⁷² Reinmuth, "Exkurs," 163.

Frisch would say: it seeks for its history. Accordingly, the idea for the textual pragmatics of 2 Thessalonians in this fourth approach could read,

Pseudo-Paulus bearbeitet mit seinem Brief eine beunruhigende Haltung in der Kirche seiner Gegenwart, die aktuelle Verfolgungserfahrungen, eschatologische Ungeduld und eine Aufkündigung des bisherigen Sozialverhaltens miteinander verband. Er setzt die Kommunikation des Paulus mit der Gemeinde in Thessalonich fort, weil er den Zusammenhang dieser Probleme im ersten Brief repräsentiert fand und dessen eschatologische Abschnitte als Belegtexte einer korrekturbedürftigen Naherwartung verstehen konnte. Der unbekannt Autor bediente sich bei seinem Vorgehen einer biblisch und frühjüdisch bezugten Konvention, die darin bestand, autoritative Texte aktualisierend, modifizierend oder sogar korrigierend weiterzuschreiben.⁷³

3.2 *Colossians*

For Colossians, similar questions as the ones for 2 Thessalonians are discussed. In research on Colossian questions about the author, the opponents and their philosophy are still more prevalent than questions about the addressees. The question of the historical location of the opponents and their doctrine, on the other hand, is discussed much more intensively for Colossians than for 2 Thessalonians. Regarding the question of authorship, two questions must be identified. One discusses which formal and theological features prove the authenticity or non-authenticity of the letter, and whether Paul, a secretary, a Pauline disciple, or an independent theologian was more likely to have penned the letter. These questions are all asked from a production-oriented point of view. The other discussion is about what implications a pseudepigraphon might have had for the early Christian situation regarding ecclesial structures and the reception of Paul. The areas of discussion are thus quite similar for Colossians and 2 Thessalonians. In contrast to 2 Thessalonians, however, the exegetical discussion about Colossians seems to be “a step further” because the question of *opponent* or *situational fiction* is treated more broadly, also regarding its *wirkungsgeschichtliche* implications.

3.2.1 Colossians as an Authentic Pauline Letter

If Colossians is seen as an authentic Pauline letter,⁷⁴ the received story reads something like this: Colossians originates from Paul's pastoral and missionary work and addresses the community in Colossae in the face of a concrete threat

⁷³ Reinmuth, “Exkurs,” 165.

⁷⁴ In the literature reviewed for this essay, this position is held by Achtemeier, Burkett, Marshall/Travis/Paul, Niebuhr, and Kümmel, partly in the form of the hypothesis of a Pauline secretary.

from opponents, who can be historically located in the area of Paul's work. The research questions connected with this reading deal with the location of the letter in Paul's ministry on the one hand, and on the other hand, with the reconstruction and historical location of the opponents.

In this context, it is also discussed that the letter shows stylistic and theological differences to the Proto-Pauline letters. These differences are explained, for example, by the secretary hypothesis or the assumption of a Pauline School.⁷⁵ This construction provides an explanation for the differences without having to assume a different author. The factual character of the letter, and its claim to direct referentiality are thus preserved:

Die Sprachgestalt des Kolosserbriefs macht Paulus als Verfasser unwahrscheinlich, die konkreten Situationsbezüge machen eine pseudepigraphie Entstehung unwahrscheinlich. Ist der Brief also weder paulinisch noch nachpaulinisch? Genau dies scheint die Antwort zu sein, die zumindest am wenigsten unwahrscheinlich ist. Man kann nämlich mit aller Vorsicht vermuten, dass ein Paulus-Mitarbeiter, vielleicht sogar der als Mitabsender genannte Timotheus, der tatsächliche Verfasser des Briefes ist. Das könnte den von Paulus unterscheidbaren Sprachstil ebenso erklären wie die situative Nähe zu ihm. Timotheus hätte in diesem Fall den Brief im Namen des Paulus, aber in eigenen Worten geschrieben und ihm dem Apostel abschließend zur Unterschrift vorgelegt.⁷⁶

The letter remaining as an authentic writing has consequences for its pragmatics: the theological shifts of Colossians in the area of ecclesiology⁷⁷ and eschatology⁷⁸ can thus be understood as Pauline, which also implicitly attaches more importance to them.

75 Karl Jaroš, who holds a minority opinion, assumes that all Pauline letters were written collaboratively and that it cannot be conclusively clarified which letters Paul wrote himself, which ones he dictated, or which ones he only provided his co-workers with oral guidelines for the final wording. This makes it easy to locate all the letters in Paul's environment: "Wenn ich eingangs Paulus in seiner Sprachdynamik mit einem eruptierenden Vulkan verglichen habe, so läßt sich für Eph, Kol, 1 Tim, 2 Tim, Tit und Hebr dieser Vergleich weiter verfolgen: Ihre Autoren verarbeiten eigenständig und mit manch neuem Material bereichert das Denken des Paulus. Die feurige, in die Luft katapultierende Lava ergießt sich nun in mehreren Strömen über das Land, um fruchtbaren Boden zu schaffen." For Colossians, Jaroš assumes the following scenario of origin: "Kol war vermutlich der erste Brief, den Paulus von seiner ersten römischen Gefangenschaft (60–62) von einem Mitarbeiter, Sekretär unter Vorgabe seiner Vorstellungen hat schreiben lassen." Karl Jaroš, *Das Neue Testament und seine Autoren. Eine Einführung* (Köln: Böhlau, 2008), 153, 163.

76 Niebuhr et al., *Grundinformation Neues Testament*, 265f.

77 Cf. e.g. Broer and Weidemann, *Einleitung in das Neue Testament*, 496–97.

78 Cf. for example Michael Theobald, "Der Kolosserbrief," in *Einleitung in das Neue Testament*, ed. Martin Ebner and Stefan Schreiber, Studienbücher Theologie 6 (Stuttgart: Kohlhammer, 2008), 425–39, 436–38.

The question about the opponents and their *philosophy* is always discussed, regardless of whether Colossians is read as an authentic Pauline letter, or simple or double pseudepigraphy. It can, however, be observed that the treatment of this question changes regarding the letter's assumed referentiality. While, quite comprehensibly, in the case of an authentic Pauline letter, direct referentiality is assumed,⁷⁹ those who regard the letter as single or double pseudepigraphy assume a stronger distortion of the opponents and their philosophy. In other words: in an authentic Pauline letter, the opponents are clearly recognizable as a historical group; in a pseudepigraphic letter, they can also be modeled according to the needs of the situation in which the letter is composed (which does not mean that the factual opponents change, only their description). This also has an impact on the pragmatics of the text: While an authentic Pauline letter illustrates a concrete historical case, a pseudepigraphal letter can easily use a (constructed) case for more fundamental considerations in Pauline tradition.

3.2.2 Colossians as Pseudepigraphy

If the letter to the Colossians is read as a pseudepigraphic letter,⁸⁰ the received story changes as follows: The author of Colossians claims Pauline authority to legitimize and enforce his position in and based on a concrete situation, in which the community is threatened by false doctrine. The changed story leads to altered research questions, especially with regard to authorship, which in turn changes the pragmatics. If it can be proven based on arguments that Colossians does not originate from Paul,⁸¹ the question arises as to who actually wrote the letter, and what changes this makes for the reception and the

79 However, this need not be done in a naïve transfer. On the contrary, since John M. G. Barclay, "Mirror-Reading a Polemical Letter: Galatians as a Text Case," *JSNT* 31 (1987): 73–93 (especially for the Proto-Pauline letters), the approaches to mirror-reading have become hermeneutically grounded and strongly differentiated. Cf. Nijay K. Gupta, "Mirror-Reading Moral Issues in Paul's Letters," *JSNT* 34 (2012): 361–81 with a brief outline of mirror-reading as a method and current literature. On attempts to locate the Colossian opponents and criticisms of mirror-reading, cf. Peter Müller, "Gegner im Kolosserbrief. Methodische Überlegungen zu einem schwierigen Kapitel," in *Beiträge zur urchristlichen Theologiegeschichte*, ed. Wolfgang Kraus, BZNW 163 (Berlin: De Gruyter, 2009), 365–94.

80 In the literature reviewed for this essay, Andreas Dettwiler, "L'épître aux Colossiens," in *Introduction au Nouveau Testament. Son histoire, son écriture, sa théologie*, ed. Daniel Marguerat, Le Monde de la Bible 41 (Geneva: Labor et Fides, 2000); Joachim Gnllka, *Der Kolosserbrief*, HThKNT 10 (Freiburg: Herder, 1980), Kee, Pilhofer, Roloff, Pokorný, Schnelle, Schreiber, and Theissen pursue this approach.

81 Since the pseudepigraphal authorship is a widely accepted consensus in German-speaking scholarship, the arguments are not repeated here.

Wirkungsgeschichte of the letter if Paul is no longer Paul. In addition, the question also remains regarding which situation of the Colossian community⁸² the letter speaks to and who the opponents are.⁸³

The search for the real person(s) behind “Paul” and “Timothy” is burdened with the problem of crossing the textual boundaries and “doubling” the authors into reality. The projection of the fictional authors into the text-external reality implies consequential hypotheses, which are not necessarily false, but cannot be verified either. For the autofiction of Colossians, this means that if Paul himself did not write the letter, but someone else borrowed his name and authority, the question arises as to who that might have been: a secretary of Paul or perhaps one of his disciples? This notion might lead to the idea of a Pauline School or other hierarchically structured organization of the post-Pauline era.⁸⁴ These organizations can then be further investigated to distinguish the author of Colossians more clearly from those of the other Deutero-Pauline letters. This would further theologically differentiate the picture of the Pauline school and office traditions in post-Pauline times. It is easy to see that the assumptions run the risk of becoming not only increasingly speculative and dogmatic, but also and more and more distant from the biblical text.

Regardless of who actually wrote the letter, the question of the real situation and opponents is still open:

-
- 82 Schierse offers an interesting approach to this when he writes that the false doctrine the letter fights “scheint bei den vom Erdbeben betroffenen Kolossern auf besonders fruchtbaren Bode gefallen zu sein. Ihre Merkmale, die auch die eigenartige Christologie des Kolosserbriefs erklären können, sind folgende: Vorausgesetzt ist die in der antiken Welt verbreitete Stimmung der Weltangst, ein Gefühl für die Brüchigkeit kosmischer Ordnungen, das durch Naturkatastrophen bestätigt und genährt wurde.” Franz Josef Schierse, *Einleitung in das Neue Testament*, (Düsseldorf: Patmos, 31984), 103.
- 83 Since the reconstruction of the opponents and their philosophy is also discussed when assuming a double pseudepigraphy, it will be addressed in greater detail in c) “Colossians as Double Pseudepigraphy.”
- 84 On the question of the school tradition, cf. Helmut Merkel’s summary: “Die Vorstellung von Paulusschülern, die im Namen des Lehrers Briefe verfassten, stammt aus den Anfängen der historisch-kritischen Erforschung des Neuen Testaments. Sie diente zunächst der Erklärung, wieso offenbar nicht von Paulus geschriebene Briefe mit seinem Namen im Kanon stehen. Je nach Geschmack konnte dabei der Schülerbegriff mehr die Nähe zum Lehrer (‘zwar nicht von Paulus selbst, aber doch immerhin von einem seiner Schüler’) oder eher die Entfernung (‘bloß von einem Schüler und deshalb nicht auf derselben Höhe’) signalisieren. Je stärker die Exegese zu differenzieren lernte, desto unbrauchbarer erwies sich der Schülerbegriff.” Helmut Merkel, “Der Lehrer Paulus und seine Schüler. Forschungsgeschichtliche Schlaglichter,” in *Religiöses Lernen in der biblischen, frühjüdischen und frühchristlichen Überlieferung*, ed. Beate Ego and Helmut Merkel, WUNT 180 (Tübingen: Mohr Siebeck, 2005), 235–50, 250.

Auszugehen ist vom konkreten Anlaß des Schreibens, der Bedrohung der Christen von Kolossä durch eine gefährliche Irrlehre. Was wir über diese erfahren, die Art und Weise der Auseinandersetzung ist so konkret, daß an der Aktualität für Kolossä nicht gezweifelt werden kann. Die Strategie des Schreibens besteht darin, daß die Gemeinde über Epaphras an das gültige und apostolische Evangelium zurückgebunden werden soll, das dieser ihr einst im Auftrag des Paulus verkündet hat.⁸⁵

Here, the pragmatics would be that Pauline authority is used to speak into a later situation, and that a burning issue of a later community shall be solved by using his authority. The letter thus addresses both the apostolic understanding/image of Paul and the constitution of the communities at the time of early Christian socialization.

The question of authorship, Paul's image, early Christian social forms, and the pragmatics of the letter are intrinsically linked. A look at the secondary literature shows that here, too, certain research paradigms are used for the interpretation of the texts:

In nachpaulinischer Zeit setzt verstärkt die Besinnung auf die Anfänge ein. Die Zeit des Ursprungs wird zur Norm, dies ist verknüpft mit der Einsicht dessen, was man dann das Apostolische genannt hat. An der Vergangenheit, die als überlegen empfunden wird, zu partizipieren ist eine auch den Griechen vertraute Vorstellung. Besonderes Gewicht erhält sie im Judentum. (...) Nur die Inanspruchnahme der großen Namen der Vergangenheit und die fiktive Rückversetzung in deren Zeit sichert die Autorität dieser Schriften ab.⁸⁶

The argumentation shows that the recollection of the – assumed or real – origin of the (Pauline) communities is connected to a certain understanding of the apostle Paul, which is invoked by the attribution of the letter to him. Thus, the category of “memory” also enters the scene.⁸⁷

85 Gnilka, *Der Kolosserbrief*, 20f.

86 Gnilka, *Der Kolosserbrief*, 25.

87 Cf. Roloff, *Einführung in das Neue Testament*, 202: “Die Erinnerung an Paulus gewinnt im Kolosserbrief – wie in sämtlichen deuteropaulinischen Briefen – an Bedeutung. Geschichte und Wirken des großen Heidenapostels erscheinen als konstitutive Bestandteile jenes Heilsgeschehens, dem sich die heidenchristlichen Gemeinden verdanken, und werden in das Kerygma (die Glauben weckende Heilsbotschaft) integriert.” For a discussion to which extent this is a reconstruction or rather a construction of memories with a specific purpose, see Huebenthal, “Pseudepigraphie als Strategie in frühchristlichen Identitätsdiskursen,” 78–85.

In recent years, the image of Paul and the reception of Paul have entered the research discourse primarily with the term “self-interpretation”⁸⁸:

In das Zentrum der Forschung rückte in den letzten Jahren die Frage nach der Paulusrezeption des Kol. Sowohl die Komposition dieses Briefes als auch die inhaltliche Argumentation weisen den Briefschreiber als Kenner paulinischer Theologie und damit als Paulusschüler aus. Dabei kommt der Person des Paulus eine entscheidende Rolle zu, denn sie gehört nun selbst in das zu verkündigende paulinische Evangelium. Der Brief erhebt damit den Anspruch, sowohl an der Person des Apostels als auch an seiner Theologie grundlegend orientiert zu sein. Inhaltlich handelt es sich aber nicht um eine wirkliche Weiterführung der paulinischen Theologie, sondern der Verfasser nimmt vorwiegend Traditionen des hellenistischen Judenchristentums auf und verbindet sie mit der Person des Apostels. Diese ‘Paulinisierung’ traditionellen Materials soll die Identität des Evangeliums sichern.⁸⁹

Regardless of whether one agrees with this position, it is evident that the Deutero-Pauline letters do not simply perpetuate traditions, but accentuate them, each its own form of the Pauline image, Pauline theology, and Pauline community. This means that, for the pragmatics of the texts, they do not simply speak with the same theological approach regarding a changed situation, but that the theological approach is adapted to the respective situation, and this changed orientation is (re-)connected to an origin that is introduced as authoritative.⁹⁰

88 Cf. Annette Merz’s seminal work, *Die fiktive Selbstausslegung des Paulus. Intertextuelle Studien zur Intention und Rezeption der Pastoralbriefe*, NTOA 52 (Göttingen/Fribourg: Vandenhoeck & Ruprecht, 2004).

89 Schnelle, *Einleitung in das Neue Testament*, 342.

90 For reasons of space, the general assessment of the pseudepigraphy will be dealt with only briefly. A short survey of the state of research can be found in this excerpt from Nicole Frank: “Zum einen gilt der Kolosserbrief nach heutigem Stand der Forschung als ältestes und überliefertes paulinisches Pseudepigraphon; zum anderen scheint er durch die ausgiebige inhaltliche Auseinandersetzung mit einer generischen *Philosophia* auch gleichsam eine paradigmatische Rekonstruktion der Genese frühchristlicher pseudepigraphischer Schriften zu erlauben: Die Verfasserfiktion erhält ihre Legitimation durch die akute Notwendigkeit, einer kursierenden Irrlehre mit dem Anspruch apostolischer Autorität entgegenzutreten zu können. Der klassische Disput über Legitimität resp. Illegitimität pseudepigraphischer Verfasserzuschreibung kann somit auf die Ebene der unmittelbaren Bedrohungssituation heruntergebrochen werden, innerhalb derer, zugespitzt formuliert, die Lageeinschätzung ‘Gefahr im Verzug’ besondere Maßnahmen rechtfertigt.” Nicole Frank, “Der Kolosserbrief und die ‘Philosophia’. Pseudepigraphie als Spiegel frühchristlicher Auseinandersetzungen um die Auslegung des paulinischen Erbes,” in *Pseudepigraphie und frühchristliche Verfasserfiktion/Pseudepigraphy and Author Fiction in Early Christian Letters*, ed. Jörg Frey, Jens Herzer, Martina Janßen, and Claire Rothschild, WUNT 246 (Tübingen: Mohr Siebeck, 2009), 411–32, 411.

3.2.3 Colossians as Double Pseudepigraphy

Reading Colossians as double pseudepigraphy further changes the received story of the letter:⁹¹ The rules of conduct communicated in the letter, with a claim to Pauline authority, refer to the concrete situation of the author. The addressees recognize themselves and the danger threatening them in the hints to the opponents and their philosophy. The two research questions that resurface with this reading, in addition to the location of the opponents and their philosophy, are the question of the actual addressees and their concrete situation on the one hand, and the question to what extent the letter had a broader claim than just reaching one community on the other hand.

Even if scholars agree that one can recognize, in the opponents of Colossians, a real group and its doctrine, they remain somewhat enigmatic. The attempts to locate this “Colossian philosophy” are legion, without reaching a consensus. Even if it is repeatedly assumed that Colossians sketches a historical situation, finding this situation remains difficult, since on closer inspection, the details the letter provides – even with careful mirror-reading – are not precise enough to reconstruct a clear philosophy. However, that this threat is not diffuse, but concrete, is demonstrated by the mere concept of the Colossian philosophy (2:8). Depending on the interpreter, this is deemed to be Gnostic, Hellenistic-Pagan, or Jewish-esoteric, but in all cases, syncretistic. The impression remains that the attempt to find a concrete historical situation of the letter leaves more questions open than it answers.

This, however, does not challenge the idea of the letter’s referentiality: the attempts to reconstruct the Colossian “philosophy” lament the fact that it is impossible for material reasons. For most interpreters, the information in the letter is simply too fragmentary, distorted, or diffuse to deduct a clear profile of the opponents.⁹² The implicit and underlying assumption is that Colossians is a factual letter which refers directly to an extra-textual reality. If

91 In the literature reviewed for this essay, Broer, Ehrmann, Lindemann, Michael Theobald, “Der Kolosserbrief,” in *Einleitung in das Neue Testament*, ed. Martin Ebner and Stefan Schreiber, Studienbücher Theologie 6 (Stuttgart: Kohlhammer, 2008), 425–39, and Michael Wolter, *Der Brief an die Kolosser. Der Brief an Philemon*, ÖKT.NT 12 (Gütersloh: Gütersloher Verlagshaus, 1993) hold this position.

92 How difficult it is to find the opponent’s doctrine and its representatives in view of this masking can be gathered from the discussion in exegetical secondary literature. Hans Hübner concludes: “Von der kolossischen ‘Philosophie’ wissen wir nur durch den Kol. Und dort ist von ihr nur in polemischer Weise die Rede. Hinzu kommt, daß diese aggressiven Aussagen lediglich fragmentarischen Charakter haben. Eine systematische Darstellung der ‘Philosophie’ wird vom AuctCol nicht geboten. Aus Fragmenten aber, die nicht das Ganze abbilden, läßt sich kein zuverlässiges Bild gewinnen. Wir müssen also davon ausgehen, daß wir nur Teilinformationen – in welchem Ausmaß auch immer – besitzen, und

one approaches the letters as a fictional text, it makes more sense to assume a hermeneutical impossibility, and to conclude that not only are the author fiction and addressee fiction part of the fictional Pauline narrative, but also the opponents. Therefore, it cannot be mirrored to the text-external level. In addition to these hermeneutical considerations, however, it was primarily the difficulties in reconstructing the opponents that led to a critical questioning of the idea that Colossians depicts a historical scenario with real opponents who threaten the Colossian community.

The problem of not being able to give an unambiguous answer to the question about the opponents also affects the question about the “real” addressees of the letter. They are difficult to locate with such a diffuse image of their opponents.⁹³ We seem to have reached a dead end here. One way out could be a closer look at the addressee fiction and to ask if the title “Colossae,” and the situation of the addressees as described in the letter, draws a more precise picture of the actual addressees.⁹⁴ But here, too, the field is limited, and the assumption that the real addressees are clearly recognizable behind the fictitious ones raises, once more, the question of the text’s referentiality.⁹⁵

diese noch in recht verzerrter Überlieferung.” Hans Hübner, *An Philemon. An die Kolosser. An die Epheser*, HNT 12 (Tübingen: Mohr Siebeck 1997), 94.

93 Thus, a conclusion like the one Broer and Weidemann phrase, is probably the utmost that can be said on the basis of the facts: “Dass der Verfasser des Kolosserbriefs ausgerechnet als Adresse die Gemeinde in Kolossä wählt, obwohl diese Gemeinde im übrigen Neuen Testament nicht erwähnt ist, und dass er darin keine Gefährdung seiner fingierten paulinischen Verfasserschaft sieht, ist für uns einigermaßen erstaunlich und wohl nur nachvollziehbar, wenn er den Untergang von Stadt und Gemeinde im Blick hat. Die vom Verfasser angegriffenen theologischen Ansichten dürften in der vom Verfasser eigentlich angezielten Adressatengemeinde ihre Heimat haben. (...) Die Gefahr für die Gemeinde geht von Betrügnern aus, die durch Vorspiegelung falscher Tatsachen die Gemeinde verunsichern.” Broer and Weidemann, *Einleitung in das Neue Testament*, 485.

94 The fact that the letter is not addressed to the community, but to the saints in Colossae (1:2) and that further the exchange of letters with the Laodiceans is exhorted (4:13–16), is considered an indication that the letter was addressed to communities in the Lycos valley. Thus, Lindemann assumes Laodicea to be actual addressees of the letter. A different approach is taken by Broer and Weidemann, who – without locating the addressees – sharp-sightedly land on the side of addressee fiction: “Allerdings war es vermutlich leichter, einen Brief des Apostels an eine zerstörte Gemeinde in den Kreislauf paulinischer Briefe einzuschleusen als einen Brief an eine noch existierende Gemeinde, von der man annehmen muss, dass sie wusste, dass ihr der Apostel keinen Brief geschrieben hat. Oder sollen wir davon ausgehen, dass die Gemeinden, die in einem Brief als Adressaten genannt wurden, so stolz darauf waren, dass jede Echtheitskritik unterblieb?” Broer and Weidemann, *Einleitung in das Neue Testament*, 483.

95 Thus, this approach can probably go no further than Theobald puts it: “Wenn der Autor ‘seinen’ Paulus die fiktiven Adressaten in Kolossä vor einer gewissen ‘Philosophie’ warnen

Exegetical secondary literature, on the other hand, seems to move in the direction of assigning the letter a wider circle of addressees rather than a single community because of its addressee fiction (1:2; 2:1; 4:13–16):

Dass das Schreiben an eine Gemeinde gerichtet ist, die nicht Paulus, sondern sein Mitarbeiter Epaphras gegründet hat, bietet dem realen Autor die Gelegenheit, die fiktiven Adressaten ausdrücklich zur Schar ‘all derer’ zu erweitern, ‘die mich persönlich nicht kennengelernt haben’ – was natürlich erst recht für die realen Adressaten des Schreibens der nach-pln Zeit gilt. Der ‘Eigenhändigkeitsvermerk’ samt Namensunterschrift in 4,18 spricht nicht gegen die Annahme eines Pseudepigraphons, sondern dient im Gegenteil der Authentizitätssimulation bzw. ‘Intensivierung’ der ‘Gegenwärtigkeit des Apostels in der nachapostolischen Kirche’. So gewiss es sich dabei um eine gewagte Fälschung handelt, das damit verbundene Interesse der ‘Fortschreibung’ pln Tradition wird man bei ihrer Beurteilung mitberücksichtigen.⁹⁶

This also raises the question of pragmatics. As already indicated under b), this approach primarily discusses the question of the further development of Paul’s image and Pauline theology for a later time. The expansion of the assumed circle of addressees in Ephesians, which reveals itself as a circular letter,⁹⁷ is congruent with an expansion of the claim. Here, it is no longer the situation of a single community that is addressed, but the experience of a concrete danger for an expanded community is clearly verbalized in such a way that a large circle of addressees can recognize themselves in it.

3.2.4 Colossians as Pseudepigraphic Epistolary Fiction

If the letter to the Colossians is finally viewed as pseudepigraphal epistolary fiction,⁹⁸ the received story reads something like this: *On the foil of the Colossian correspondence, the author exemplarily addresses the problem of new converts who have not yet fully settled into their identity as Christians. They are in danger of falling back into old habits because their encounter with the gospel*

lässt, dann darf man davon ausgehen, dass ihm entsprechende Gefahren der eigenen Zeit vor Augen standen. Die wenigen Stichworte (Speise, Trank, Feste, Engelverehrung, Gebote) mussten den Lesern genügen, um darin gegenwärtige Gefahren wiederzuerkennen.” Theobald, “Der Kolosserbrief,” 433.

96 Theobald, “Der Kolosserbrief,” 429.

97 Cf. Michael Theobald, “Der Epheserbrief,” in *Einleitung in das Neue Testament*, ed. Martin Ebner and Stefan Schreiber, Studienbücher Theologie 6 (Stuttgart: Kohlhammer, 2008), 408–24, 417.

98 In the literature reviews for this essay, Nicole Frank and Ingrid Maisch, *Der Brief an die Gemeinde in Kolossäm* ThKNT 12 (Stuttgart: Kohlhammer, 2003), and Angela Standhartinger, *Studien zur Entstehungsgeschichte und Intention des Kolosserbriefes*, NT.S 94 (Leiden: Brill, 1999) hold this position.

has not yet been sustainably manifested in their life and everyday practice. The distinction of real and fictional levels of communication used in this approach significantly alters the research questions for this text.⁹⁹

One important aspect is the proof of the fictionality of the entire letter or the hermeneutical the content-related argument why it does indeed make sense to read Colossians as pseudepigraphic epistolary fiction instead of a factual letter.¹⁰⁰ Although there are good arguments for this approach,¹⁰¹ it is (still) a minority position in the exegetical discourse.

The assumption that the letter is best understood as epistolary fiction changes the perspective on the letter as it begins with and is from the perspective of the addressees, which, in turn, also changes the view of and the question about the opponents:

In der aus dem Brief zu erhebenden Situation der 'Kolosser' spiegelt sich die Situation der tatsächlichen Adressaten. Sie ist einerseits durch 'Ordnung und Festigkeit eures Glaubens' (2,5) bestimmt, andererseits durch ihre Beeinflussbarkeit von Seiten der Umwelt. Sie haben sich mit der Welt arrangiert und nehmen auch andere religiöse Angebote wahr. Sie selbst sehen darin keine Absage an ihre Christus-Zugehörigkeit, während der Autor in dieser Spielart des

99 Cf. Frank's notes on this: "Welches (fiktionale) Bild zeichnet der Kolosserbrief im Blick auf seine Selbstverortung innerhalb eines bestimmten situativen Kontextes, der auf textueller Ebene durch die Koordinaten Autor – Adressaten – Gegner vorstrukturiert und definiert wird?" Frank, "Der Kolosserbrief und die 'Philosophia,'" 412.

100 For general considerations, cf. Standhartinger, *Studien zur Entstehungsgeschichte und Intention des Kolosserbriefes*, 181: "Aufgrund des fiktiven Charakters pseudepigrapher Briefe ist daher auch nicht anzunehmen, daß im Kol eine bestimmte reale Oppositionsgruppe beschrieben wird. Sollte überhaupt eine Oppositionsgruppe thematisiert sein, dann in einer der Pseudepigraphie entsprechenden offenen und mehrfach deutbaren Weise."

101 On the argumentation regarding content, cf. Frank, "Der Kolosserbrief und die 'Philosophia,'" 415: "Dieselbe sachlogische Rekonstruktion gilt entsprechend auch für die Lokalisierung der 'Gegner' im Kolosserbrief. Kol 2,8.16–23 als Referenz auf eine spezifische Gruppierung im Umfeld der intendierten Adressaten zu werten, würde voraussetzen, dass der pseudepigrapher Autor des Schreibens sich brieflich mit einer häretischen Strömung auseinandersetzt, die zu Lebzeiten Pauli in der Umgebung von Kolossä zu verorten gewesen sein müsste, wenn die Authentizitätsfiktion des Schreibens nicht gebrochen werden sollte, und dabei zugleich eine aktuelle Bedrohungslage abbildet, die zum Zeitpunkt der Briefabfassung eine solche autoritative Stellungnahme erforderlich machte. Gerade angesichts des ebenso disparaten wie stichwortartigen Charakters der in Kol 2,16–23 genannten Elemente der *Philosophia* erscheint es m.E. deutlich naheliegender, dass auch die Gegnerpolemik demselben universellen Anspruch folgt, wie er oben bereits für die grundsätzliche Ausrichtung des Kol $\acute{\epsilon}\nu\ \pi\alpha\nu\tau\acute{\iota}\ \tau\omega\ \kappa\acute{\omicron}\sigma\mu\omega$ skizziert wurde: Kol 2,6–23 will als allgemeine Handreichung für den Umgang mit abweichenden Lehren und Praktiken rezipiert werden und weist daher bewusst kein spezifisches Referenzprofil im Hinblick auf eine konkrete Gruppierung auf."

Christlichen bereits den Keim zum Abfall erkennt und daher klare Alternativen aufbaut: Überlieferung der Menschen oder christliche Überlieferung, Christus oder die Welt. Während die Gläubigen durch religiöse Praktiken und die Beobachtung von Tabuvorschriften eine größere Heilssicherheit erreichen wollen, werden sie durch den Brief auf Christus als das alleinige Fundament des Heils verwiesen.¹⁰²

For the construction of the opponents, this implies that “Colossian philosophy” can be modeled after a real image but does not have to be. It can also be a lot more colorful than its model. This is beneficial to epistolary fiction in that the real addressees can recognize themselves in the fictitious ones without having to identify with them.

The pragmatics of the text are then similar to that of approaches that read Colossians as an authentic Pauline letter: “Das vorrangige Interesse des Autors gilt nicht der Bewahrung oder Interpretation paulinischer Theologie, sondern dem eigenen pastoralen Anliegen, das mit Hilfe paulinischer Theologie zur Sprache gebracht wird”¹⁰³ The focus is on the addressees and assumes that the description of the opponents says more about the community than the opponents.¹⁰⁴ For Colossians, this would imply that it, too, is not about the opponents *per se*, but about the situation that has arisen for the Colossians because of the opponent’s demands. In fact, this significantly simplifies the reading, because those introduced as μηδεις (no one, 2:4.18) and μή τις (not anyone 2:8.16) remain quite pale and serve to describe the situation of the “saints in Colossae.” “Paul” does not settle accounts with opponents, but rather constructs a menacing situation of the addressees that gradually intensifies.

The diffuse warning that is not to be taken captive turns into concrete commands (ἐντάλματα, 2:22) within a few verses. However, it is not clear what theoretical background these commandments have and whether they are modeled after Jewish or Pagan teachings. The more general question is whether it is a disturbance coming from outside or from within the community. Should the teaching that the community has received be replaced by a new doctrine, or shall it “only” be supplemented by new elements? Both ideas assume that

102 Maisch, *Der Brief an die Gemeinde in Kolossä*, 23.

103 Maisch, *Der Brief an die Gemeinde in Kolossä*, 28.

104 This does not answer the question of how real the opponents are, but it also does not seem to be central for the pragmatics of the text. Accordingly, Schmid states: “Weder von der Textsorte her noch aufgrund des konstruktivistischen Textmodells ist definitiv zu entscheiden, ob es sich beim Gegnermotiv in 1 Joh um eine Fiktion oder Imagination handelt, die Gegner als eine rein fiktive Größe darstellen, oder ob zumindest eine reale Erfahrungsbasis zugrunde liegt.” Schmid, *Gegner im 1. Johannesbrief?*, 56.

the “Colossians” already have a (reasonably) stable Christian identity.¹⁰⁵ The addressee fiction, however, depicts the faithful as those who have heard about the gospel second hand, not from the apostle himself, but in Pauline tradition. They have accepted it and now try to live their lives according to the gospel. In this, the intention is obviously greater than the success. The “Colossians” are thus not a group with a stable Christian identity, but a group in the process of seeking and developing what it means to be believers in Christ.

Read this way, the problem that Colossians deals with is not a full turn to Christianity, which would imply a turning away from the strategies for coping with life of former social context – in this case presumably Pagan. The task of the addressees looks something like this: As Christians, they must “in einer nicht-christlichen Welt zurechtfinden und lernen, ihre in der Taufe vollzogene Statusänderung in der Realität ihres Alltags umzusetzen.”¹⁰⁶ Colossians also indicates how difficult this is for a group that lacks tradition and feels challenged and seduced by the world – represented by the religious and social environment from which it grows – and the author develops strategies for this situation.

On a meta-level, Colossians thus becomes

ein allgemeines Schreiben, das die Probleme vieler Neubekehrter aufgreift und durch Ermahnungen und die Erinnerung an die Taufe einer Lösung zuführen will. Die Adressaten dürften daher unter Christen der ersten Generation zu suchen sein, die durch das allgemeine geistige Klima – geprägt durch pagane Religionen und den kleinasiatischen Synkretismus – in ihrem Glauben verunsichert sind.¹⁰⁷

In this instance, the “Colossians” resemble all later generations of Christians: The gospel has reached them, and they have accepted it. Now the gospel must arrive in their lives and their daily practice and change it. The “saints in Colossae” thus become a cipher for all Christians: Their lives must change through the encounter with the gospel, and this change must be reflected in their daily lives. This process is repeatedly disturbed by seductive, alternative offers for identity construction. From this perspective, the question of the Colossian philosophy is resolved in a surprising, yet plausible way:¹⁰⁸

105 Cf. Maisch, *Der Brief an die Gemeinde in Kolossä*, 30–39. The author of Colossians calls on his addressees to commit themselves completely to Christ and the new life in him and to leave behind their old life with its rituals.

106 Maisch, *Der Brief an die Gemeinde in Kolossä*, 24.

107 Maisch, *Der Brief an die Gemeinde in Kolossä*, 23.

108 Cf. Maisch, *Der Brief an die Gemeinde in Kolossä*, 30: “Insgesamt will der Autor die tatsächlich angesprochene Gruppe, die sich hinter den ‘Kolossern’ verbirgt, darin

Der Kolosserbrief beansprucht durch seine (pseudonyme) apostolische Autorität eine Richtlinienfunktion in Fragen christlicher Gemeindepraxis. Durch den globalen Adressierungsanspruch wird diese als überindividuell gültige Leitlinie ausgewiesen – und mit demselben Anspruch werden jedwede religiösen Forderungen, die seitens konkurrierender Heilslehren an die Christen herangetragen werden könnten, als gegenstandslos zurückgewiesen.¹⁰⁹

What about the memory of Paul and the invocation of his authority in Colossians? To what extent does the letter contribute to a modified image of Paul? Regarding the author's intention, it is often concluded that the choice of the Pauline author was intended to ascribe authority to the text and that accordingly, Colossians is about an authority-supported application of Pauline theology for a later generation. The fictional self-interpretation of the apostle has something to do with the preservation and further development of the Pauline heritage and contributes to the identity construction of Paul (or the memory figure "Paul"). But this is only one side: If the text medium "letter" is taken seriously, Colossians is also about the identity construction of the addressees, which is developed on the foil of the fictional threat situation.¹¹⁰ The empirical author would thus textualize a Pauline tradition that provides the empirical readers with hints for dealing with their own situation. The design of the fictional Colossian situation, on the level of the characters, is a mirror for the empirical readers on the level of the entire work, in which they can recognize their own situation. What it is not, however, is a window into Paul's world.

For the so far unanswered question about the intention of Colossians and the choice of the author pseudonym, the following answers are possible: Pseudepigraphal Pauline letters do not arise from a historical interest in the figure of the author, but instead want to speak into their own situation. Normativity and authority are not the prerequisite but the goal of *author*

bestärken, das in der Taufe grundgelegte neue Leben ohne Ängste und Aufgeregtheiten, dafür in Dankbarkeit und Danksagung zu leben. Unterstützung bei diesem Vorhaben erhofft es sich von der Erinnerung an Paulus, dessen Autorität er auf sich überträgt und dessen mühevoll missionarische Existenz er wirkungsvoll als Motivation für die Annahme seiner postbaptismalen Katechese und Paränese einsetzt."

109 Frank, "Der Kolosserbrief und die 'Philosophia,'" 431.

110 Frank puts it as follows: "Mit der Abfassung eines Briefes unter dem Namen des Apostels sucht der Autor des Kolosserbriefes durch den Rückgriff auf die paulinische Überlieferung – als Wurzel der gemeinsamen Glaubens-tradition und zugleich als geschichtliche Verankerung der Konstitution als christliche Gemeinschaft – eine identitäts- und orientierungstiftende Funktion für die Gemeinden der zweiten und dritten Generation einzunehmen." Nicole Frank, *Der Kolosserbrief im Kontext des paulinischen Erbes. Eine intertextuelle Studie zur Auslegung und Fortschreibung der Paulustradition*, WUNT II 271 (Tübingen: Mohr Siebeck, 2009), 3.

fiction. Rather, Pauline pseudepigraphy pursues the goal of securing literary and apostolic continuity and is concerned with maintaining and interpreting Pauline theology for later generations. Paul's fictional self-interpretation, as it occurs in Colossians, is a theological and hermeneutical achievement that serves to develop and secure a particular image of Paul as a model for identification. The contents conveyed by the pseudepigraphic letter to the Colossians are closely linked to the reception of the *author fiction*.

From the point of view of *addressee fiction*, pseudepigraphy makes it possible to project a problem back into the past.¹¹¹ A difficult situation in the present becomes easier to deal with through a letter that seems to anticipate it: A precedent emerges on the supposed *tabula rasa*. Or as Max Frisch puts it, "Die Erfahrung will sich lesbar machen. Sie erfindet sich ihren Anlaß. Und daher erfindet sie mit Vorliebe eine Vergangenheit."¹¹² We can see something similar happening in Colossians: The current situation leads to the construction of a past that offers a model to deal with the current challenge. Read this way, Colossians does not describe a specific event, but contextualizes an experience that makes itself legible in this way.

4. Results

If one reads the exegetical discourses about Colossians and 2 Thessalonians next to each other, there is indeed some kind of chronological order for the critical inquiry regarding referentiality. First, the question of *author fiction* is discussed, then the question of *addressee fiction*, and last, and rather hesitantly, the question of *situational fiction*,¹¹³ which, at least implicitly, labels

111 Zimmermann sees a general principle of pseudepigraphy: "Eine Schrift wurde in eine fingierte Kommunikationssituation gestellt, um somit auf subtile Weise die eigene Situation zu thematisieren. Auch wenn in der Schrift selbst Autor und Adressaten einer ganz anderen geschichtlichen Zeit angehören, wollen die Texte doch eigentlich die Gegenwart der von ihnen intendierten Rezipienten erreichen. Der kommunikative 'Umweg' über eine fingierte geschichtliche Situation soll letztlich zu einer gelungeneren Verständigung führen, die bei einer direkten Auseinandersetzung zu schwierig oder heikel gewesen wäre." Ruben Zimmermann, "Unecht und doch wahr? Pseudepigraphie im Neuen Testament als theologisches Problem," *Zeitschrift für Neues Testament* 12 (2003): 27–38, 34.

112 Frisch, "Unsere Gier nach Geschichten," 263.

113 In general, most of the references to grievances/sufferings (2 Thessalonians) and opponents (Colossians) are deemed far too general for a precise localization. Cf. Reinmuth, "Exkurs," 165: "Die Erwähnung der Leiden ist nicht auf eine begrenzte, konkrete Situation in Thessalonich einzuschränken, sondern vom Verfasser offenbar als gültiges Merkmal kirchlicher Existenz seiner Gegenwart verstanden worden."

the respective writing as “fictional.” The current discourse about Colossians struggles with the *fictional situation*, while the discourse about 2 Thessalonians is more concerned with the question of *author fiction* and *addressee fiction*. Apparently, there is development from the assumption of *author fiction* to *addressee fiction* to *situational fiction*. Furthermore, the discussion in exegetical secondary literature on Colossians shows that *pseudepigraphal epistolary fiction* as a heuristic category is a useful reading lens for exegetical discussion.

But this is not the only result. It also becomes clear that the consistent application of the criteria from literary studies leads to the perception of the second level of communication that is described in studies about fictionality. The insights of literary studies make it possible to describe both levels of communication without getting lost in the maze of fiction and truth: In addition to the real level of communication between author and reader(s), there is a fictional level of a staged communication between a fictional sending character and a fictional addressee. Both levels are interconnected insofar as the author enters into a real exchange with the reader(s) through the staged communication. The beauty is that whatever is verbalized on the level of the fictional communication does not require any direct referentiality to reality, i.e.: the facts mentioned in the text do not necessarily refer to real events outside the text, but are nevertheless part of a real, authentic communication. This perspective changes the hermeneutical approach and exegetical view of the texts: The starting point is not the events behind the text, but experiences that make themselves legible in the *pseudepigraphal* letter. They are, in their own way, no less true and perspectival than the situation to which *authentic* letters refer.

Analogously to the fact that the authentic Pauline letters are understood as *Gelegenheitsschreiben* with a more general claim, the Deutero-Pauline letters can be read as exemplary cases which show more than the discussed case. The experiences that Colossians and 2 Thessalonians narrate are apparently the daily bread of early Christian communities and exhibit the problems of the formation and consolidation of a Christian identity in a non-Christian environment. Disappointed hopes and expectations are as much a part of the experience as the organizational issues of growing and developing communities. The inculturation of the Good News has to deal with the problem of differing opinions on theological questions (such as eschatology), but also on the questions of daily life, and to negotiate solutions. In the Deutero-Pauline letters, this makes itself readable in a story, in which Paul, a figure of the common history, apparently had quite similar problems and came up with strategies to solve these problems. These strategies do not necessarily have to originate from the Pauline era or from the past at all. If one takes Max Frisch's *From*

Impulse to Imagination seriously, contemporary ideas have found their tradition and history.

For the pragmatics of the texts, this means that both letters can be read and used both as foils for the processing of similar experiences of their own times and as starting points for identity constructions based on the history of the apostle with his communities. This is not to say that this would be different if authentic or pseudepigraphal Pauline letters were assumed. I would argue that pseudepigraphal epistolary fiction, which on the one hand claims to address a wider audience, and on the other hand reflects its own experiences based on a Pauline origin (i.e., indicates where its norms come from), will achieve this goal more easily.

The question of referentiality remains difficult, even with a clearer scaling of *fictional*ity. Whether and how the respective coefficient of distortion can be resolved remains unclear as long as there are no sources for comparison. This is not to say that there should be no questions or research on this point, but it must always be kept in mind that crossing of textual boundaries – i.e., conclusions from the level of narrative mediation to the level of real communication – remains hypothetical. For concrete exegetical work, this means that the fictive level of communication has to be described first, before considerations can begin about which experiences make themselves legible here, where they could possibly be located on the map of early Christian socialization, and which theological impulses they offer for the readers of their time. But also, for the self-understanding of today's recipients in front of the text. The first tentative steps in this direction suggest that it is an exciting field of research to re-read *pseudepigraphal* texts as *fictional* texts.

Generations: Social Memory Theory and the Letters to the Thessalonians

1. Orthonymous, Anonymous, and Pseudepigraphic Texts: A Question of Generation

The insights of *Kulturwissenschaftliche Gedächtnistheorie*/Social Memory Theory have provided scholars from many different areas, including biblical studies, with helpful new perspectives, taxonomies, and tools to analyze their subject(s).¹ In this contribution, I will introduce some of these insights, taxonomies, and tools, and use them to take a fresh look at a particular case in our field that has sparked controversy over time: the Thessalonian correspondence, and the question of “authenticity” (i.e., Pauline authorship) or “unauthenticity” (i.e., pseudepigraphic character) in 2 Thessalonians.² A generation – 40 years – after Edgar Krenz’s seminal SBL presentation, *A Stone that Will not*

-
- 1 This contribution is a reworked version of the SNTS seminar paper, “Generations: 1 and 2 Thessalonians through the Lens of Social Memory Theory,” which was discussed in the session “The Phenomenon of Pseudepigraphy” at the 76. SNTS general meeting in Leuven on 26 July 2022. Earlier versions of this idea were presented at *Charles University Prague and Universität Passau Seminar and Colloquium Series* in Passau (20 May 2022), a guest lecture at Universität Leipzig (6 July 2021), and on two occasions at Neutestamentliche Sozietät der Universität Mainz (6 December 2019 and 15 June 2021). I am most grateful for all the insights and comments I received from these discussions. A first version of this idea was published in Sandra Huebenthal, *Kulturwissenschaftliche Gedächtnistheorie und Neues Testament. Eine methodisch-hermeneutische Einführung* (Tübingen: Narr Franke Attempto 2022), 267–84.
- 2 Commentators of 2 Thessalonians must take a stance on this question before the first page of their work is penned to disclose their criteria. Regarding his 2019 commentary on 2 Thessalonians in the KEK Series, Tobias Nicklas notes: “Ich began meine Arbeit an 2 Thess deswegen so vorurteilsfrei wie dies eben möglich ist, und versuchte zunächst den Spuren meines Vorgängers im Kritisch-exegetischen Kommentar, Ernst von Dobschütz, zu folgen, welcher den Text für echt hielt, aber immer wieder Passagen einfügte, in denen er ihn unter der Voraussetzung des Unechtheit bearbeitete. Letztendlich jedoch erschienen mir die Argumente für die Pseudepigraphie des Textes zu drückend – und ich kommentierte 2 Thess durchgehend als einen pseudepigraphischen Text.” Nicklas Tobias: “Die Datierung des Zweiten Thessalonicherbriefes,” in *Die Datierung neutestamentlicher Pseudepigraphen*, ed. Wolfgang Grünstäudl and Karl Matthias Schmidt, *Wissenschaftliche Untersuchungen zum Neuen Testament* 400 (Tübingen: Mohr Siebeck), 203–4.

Fit, the discussion about the authenticity or unauthenticity of this letter is ongoing in the North American context.³

I will begin with a brief introduction into *Kulturwissenschaftliche Gedächtnistheorie*/Social Memory Theory and its perspective on “generations,” which differs from its use in our field and is a helpful addition to research.⁴ Drawing on *Kulturwissenschaftliche Gedächtnistheorie*/Social Memory Theory, I will further develop the category into a heuristic for New Testament and early Christian literature, arguing that different generations not only deal with different issues, but also produce different kinds of texts. I will then use these insights to read the two letters to the Thessalonians as artifacts of memory and explore whether they exhibit characteristics of different generations, or rather, belong to the same generation.

The benefit of this approach is that it works around loaded categories such as “authentic,” “unauthentic,” “fake,” or “pseudepigraphy” when trying to determine which generations the texts originate from, and where they can be found in regards to the time of their composition. I consider it a huge step forward to read the texts and explore whether they exhibit typical features from one generation or another, and only afterwards ask questions about their possible authorship and origin. Put in historical terms: to alter the classical order of source criticism and source analysis. In this process, the tools provided by *Kulturwissenschaftliche Gedächtnistheorie*/Social Memory Theory prove to be a complementary approach to reading and interpreting New Testament and early Christian texts.

I find this approach helpful as it limits controversial discussions on Pauline theology, such as the question of authenticity, and allows for a reading of 2 Thessalonians as a typical example for third/fourth generation discourses. It does so from an outside perspective that focusses on the general processes and patterns of social groups, independent of the specific issues of early Christianity, therefore broadening the scope. For me, the etic perspective on

3 Edgar Krentz, “A Stone that Will Not Fit,” in *Pseudepigraphie und frühchristliche Verfasserfiktion/Pseudepigraphy and Author Fiction in Early Christian Letters*, ed. Jörg Frey, Jens Herzer, Martina Janßen, and Claire Rothschild, WUNT 246 (Tübingen: Mohr Siebeck, 2009), 439–70. Cf. Thompson’s introduction, in which he calls it “the most comprehensive and detailed argument against the authenticity of Second Thessalonians in English,” Trevor Thompson, “A Stone that Still Won’t fit: An Introductory Note for Edgar Krentz’s ‘A Stone that Will Not Fit,’” in *Pseudepigraphie und frühchristliche Verfasserfiktion/Pseudepigraphy and Author Fiction in Early Christian Letters*, ed. Jörg Frey, Jens Herzer, Martina Janßen, and Claire Rothschild, WUNT 246 (Tübingen: Mohr Siebeck, 2009), 433–38, 434.

4 See also: Sandra Huebenthal, “Frozen Moments’ – Early Christianity through the Lens of Social Memory Theory,” in *Memory and Memories in Early Christianity*, ed. Simon Buttica and Enrico Norelli, WUNT I 398 (Tübingen, 2018), 17–43.

the letter, and the comparison with other typical developments in the third/fourth generation – or after a *generational gap* – is of great value to understanding the challenges and struggles of early Jesus followers. And – as a response – strategies in early Christian identity formation.

1.1 *Generations as a Heuristic Category in Biblical Studies*

From the different terms and concepts coined by *Kulturwissenschaftliche Gedächtnistheorie*/Social Memory Theory, the different forms of social memory (i.e., *social memory* and *collective memory*), and *generational gap* and *floating gap*, two times of crisis, are most relevant for New Testament studies. They might be a key to the formation and understanding of New Testament literature. The *generational gap* is significant as the New Testament texts and their temporal distance from the events they reflect do not belong to the mythical time of the absolute past i.e., the time of *cultural memory*, but to the recent past, i.e., the time of *collective memory*.

We can therefore conclude that it is the *generational gap*, 30–50 years after a significant event, and at the boundary of living three-generational memory, that stimulates the relevant processes of media change and textual production with which New Testament scholarship is concerned, and not the *floating gap* some 80–120 years after these events. When the insights of *Kulturwissenschaftliche Gedächtnistheorie*/Social Memory Theory are used as a reading aid for the findings of biblical scholarship/*Einleitungswissenschaft* on the formation of the New Testament scriptures, phenomena like the composition of foundational narratives or pseudepigraphy can be seen as contributions to the social negotiation processes of early Christian memory culture and identity formation.

As I have outlined in “Frozen Moments,”⁵ a combined model, containing the insights of biblical scholarship and social memory theory provides a helpful heuristic for reading the different texts and genres in the New Testament and beyond. It can explain phenomena like media changes towards narrative genres and offers complementary explanations to exegetical models. This is particularly helpful for the notoriously difficult question of dating. Here, the combined model does not offer new dating proposals, but rather helps to accentuate, better understand, and sometimes constructively criticize other dating proposals. Understood as an *epoch model of early Christianity*, it can serve as an interface to combine insights from New Testament as well as Patristic scholarship within one hermeneutical frame, which makes it a particularly helpful tool for interdisciplinary research.

5 Huebenthal, “Frozen Moments,” 26–36.

Table 9.1 Epoch Model for reading the different texts and genres in the New Testament and beyond⁶

Time	Text/Genre	Pragmatics	Social Memory Terminology
<i>Foundational Event: Life, Ministry, Death, and Resurrection of Jesus</i>			
30–70	Authentic Letters (Paul)	<i>Functional Literature:</i> Deals with concrete issues (of a particular group/community), replaces oral communication	Localization within given frames, the past is usually consciously recalled and reshaped, thus it is collective rather than social memory
<i>Generational Gap (30–50 years) (Common explanations: Destruction of the Temple, Death of Eyewitnesses)</i>			
70–150	Gospels (Anonymous)	<i>Memory Literature:</i> Remembers Jesus and his heritage, extrapolates traditions	Drafting/"Finding" of traditions, fabrication of new frames for identity construction(s)
	Deuteropauline, Pastoral and Catholic Letters (Pseudepigraphy)	<i>Memory Literature:</i> Remembers Jesus and his heritage, extrapolates traditions	Individual texts can be read as snap-shots or frozen moments in a longer process of emerging early Christian identities
	Authentic Letters (Apostolic Fathers)	<i>Functional Literature:</i> Deals with concrete issues (of a particular group/community), replaces oral communication	
<i>Floating Gap (80–120 years) (Commonly held to be a caesura, it is often not clear why)</i>			
150–300	Authentic Letters (Apostolic Fathers)	<i>Functional Literature:</i> Deals with concrete issues (of a particular group/community), replaces oral communication	Tradition(s) are established and largely accepted. They can be referred to as the common (founding) story and drawing from them common identity can be constituted These traditions do not necessarily have to be historical or taken literally. On the contrary, they are rarely questioned
	Ecclesiastical Constitutions	Drawing from (alleged) authorities, identity is constructed and safeguarded (ad intra)	
	Acts of Martyrs	Identity is constructed and safeguarded (ad intra), installation of reliable and authoritative witnesses	
	Apologies/Apologetic Literature	Dialogue ad extra: Christianity enters the philosophical market	

6 Huebenthal, "Frozen Moments," 36.

The epoch model shows that different genres seem to be produced at different times and with different pragmatics.⁷ The situation and needs of the groups seem to change especially in crisis – *generational* and *floating gap* – thus the transitions from second to third and from fourth to fifth generation are both particularly sensitive and relevant. Therefore, new and different problems arise. This is, however, not specific to the early generations of Jesus followers, but a cross-cultural phenomenon. In the following, when I assign particular texts and strategies to the third generation, I do so on the basis of the findings of *Kulturwissenschaftliche Gedächtnistheorie*/Social Memory Theory.

1.2 *Typical Features of Texts from the Third Generation*

In uncertain times, such as those experienced by the third generation in general, and also the third generation of Jesus followers, groups usually seek to connect with previous traditions or try to develop their own traditions. The two often go hand in hand. Eckart Reinmuth and Klaus-Michael Bull assume that the inclusion of traditions in the texts consciously places the authors in the history of interpretation and influence of their theological fathers and serves to legitimize their own position to help correct interpretations.⁸

When I rephrase this in the terminology of *Kulturwissenschaftliche Gedächtnistheorie*/Social Memory Theory, the third generation not only locates their experiences within the given framework of their cultural tradition (or *cultural memory*) – which is, according to Maurice Halbwachs, a typical process within *social memory* – but also fabricates new framework for identity construction, which is a typical process within *collective memory*.

This distinction between locating experiences within a given cultural framework and the fabrication of new (cultural) frames for identity construction by recourse to “our own” traditions is one of the most important indicators for the contextualization of traditions and texts in different generations. As a rule of thumb, texts that emerge beyond the *generational gap* have a much stronger tendency to fabricate new frames than texts that emerge before it, and this tendency is more evident as texts move toward the *floating gap*.

7 For an overview of different genres and pseudonyms in pseudepigraphy of Biblical/Second Temple Judaism, New Testament, and rarely Christian writings, cf. Sandra Huebenthal, “Pseudepigraphy,” in *Brill Encyclopedia of Early Christianity Online*, ed. David G. Hunter, Paul J.J. van Geest, Bert Jan Lietaert Peerbolte (2023), (http://dx.doi.org/10.1163/2589-7993_EECO_SIM_045227).

8 Eckart Reinmuth and Klaus-Michael Bull, *Proseminar Neues Testament Texte lesen, fragen lernen* (Neukirchen-Vluyn: Neukirchener, 2006), 52. A similar idea is expressed in Stefan Schreiber, “Pseudepigraphie als Problem der Einleitungswissenschaft,” in *Spurensuche zur Einleitung in das Neue Testament. Eine Festschrift im Dialog mit Udo Schnelle*, ed. Michael Labahn, FRLANT 269 (Göttingen: Vandenhoeck & Ruprecht, 2017), 221–58, 258.

The inclusion of tradition in the particular texts, however, can look very different. References to the Old Testament, which can already be found in the Pauline letters, are only one possibility to connect with or inscribe into tradition. Another possibility is the continuation of one's own traditions, as e.g., the household code of Ephesians (Eph 5:21–6:9) goes with the household code of Colossians (Col 3:18–4:1). The extrapolation (“Fortschreibung”) of a text or parts of a text is not uncommon. Another case from the New Testament epistolary literature is 2 Peter, which uses Jude almost completely and extrapolates it without citing it as a source. This strategy also occurs in the narrative texts: Matthew and Luke clearly extend and extrapolate Mark.

Another case of rewriting is pseudepigraphy. The difference to the Gospels is that it does not continue a text but an author. Colossians, to stay within this example, continues Paul. Pseudepigraphy can thus be understood as an attempt to both continue telling the story of the second generation and, by projecting it back into the time of the good beginning, present one's own problems as already solved in an earlier generation, according to the principle: *What would Paul have written?*⁹

Pseudepigraphic letters are not the only New Testament genre that emerges in the early third Christian generation: the Gospels, initially transmitted anonymously and most likely in smaller portions, also receive a written form – and thus a change in medium – during this period. For the Gospels, too, we can ask what strategies they offer for dealing with the challenges of their time.

Once more, a look at the pseudepigraphy helps. In Colossians, the problem of the absent apostle Paul is solved by replacing an insurmountable temporal distance (Paul being already dead) with an insurmountable local distance (Paul being in prison). Regarding the Gospels, the church fathers construct a similar scenario. In his church history, Eusebius of Caesarea says of Matthew: “For Matthew, who had at first preached to the Hebrews, when he was about to go to other peoples, committed his Gospel to writing in his native tongue, and thus compensated those whom he was obliged to leave for the loss of his presence” (Church History Book III, 24:6). Although we must not take everything Eusebius speculates about the first century during the fourth at face value,¹⁰

9 This was also the title of a thought-provoking and unpublished paper Christine Gerber presented at the BECS research seminar hosted by Australian Catholic University, 22 April 2021.

10 Cf. Sandra Huebenthal, “Erste Fragen für eine spätere Lektüre. Ein gedächtnistheoretisches Leseprogramm für Eusebs Kirchengeschichte,” in *Christlicher Glaube in seinen Anfängen. Kulturelle Begegnungen und theologische Antworten. Festschrift für Bernhard Heininger*, ed. Barbara Bargel and Annemarie Frank, Würzburger Theologie 20 (Würzburg: Echter, 2023), 179–204.

he did hit a nerve: The Gospels also compensate for absence. According to Eusebius, it is also the absence of the apostle (who is traditionally merged with the evangelist), but in fact it is the compensation of experiences of loss.¹¹

In both genres, texts – anonymous gospels as well as pseudepigraphal letters – while seemingly dealing with the current situation, also deal with more existential issues. They address the question of how to deal with absence: the absence of Jesus, the absence of the contemporary witnesses, the absence of Paul, but also the absence of the Temple. In addition, there is also an absence on the meta-level, i.e.: the lack of security of a (long) tradition, of a respected (and protected) religion after the destruction of the Second Temple. It is exactly these types of events that *Kulturwissenschaftliche Gedächtnistheorie*/Social Memory Theory calls *phenomena of crisis*.

Therefore, it is possible to say that in the New Testament, we find very different strategies for dealing with absence, each of which is creative and highly plausible when approached from the perspective of *Kulturwissenschaftliche Gedächtnistheorie*/Social Memory Theory:

- Pseudepigraphy works with the concept of the “absent apostle” and the temporal distance is overcome by some other distance, such as the local one. Examples of this strategy are, for example, Colossians and 2 Peter.
- In Mark, the end – the appearance stories “missing” from a canonical perspective – is narrated into the lives of the addressees. The body of Christ, which is not found in the tomb, can also be encountered in the broken bread and in the text itself. The text takes the place of the protagonist.
- Matthew ends with the affirmation that Jesus will be with them always, until the end of days and until the end of time. This concept is similar to Mark: the end is told into the lives of the readers, but while the Mark uses the regressive closure to activate,¹² Matthew conveys stability and security with its happy ending.
- After the respective announcement of the Risen Lord at the end of Luke, Acts continues the story of Jesus’s followers with the sending of the Spirit, thus opening a new chapter in which the Spirit leads the group in the place of Jesus.

11 This idea has been masterfully developed in David S. Du Toit, *Der abwesende Herr: Strategien im Markusevangelium zur Bewältigung der Abwesenheit des Auferstandenen*, WMANT 111 (Neukirchen-Vluyn: Neukirchener Verlag, 2006).

12 Cf. Sandra Huebenthal, *Reading the Gospel of Mark as a Text from Collective Memory* (Grand Rapids: Eerdmans, 2020), 129–33, 251–53; and Sandra Huebenthal, “Kollektives Gedächtnis, Kulturelle Texte und das Markusevangelium,” in *Reading the Gospel of Mark in the Twenty-First Century*, ed. Geert van Oyen, BETHL 301 (Leuven: Peeters, 2019), 217–50, 230–31.

- In John, both the beloved disciple as witness and guarantor of tradition and the Paraclete – the Comforter or Spirit – appear as helpers and identity guarantors, thus ensuring continuity.

All the texts use the technique or strategy of referring to foundational events. The strategy of the good beginning is somehow prolonged, and the narration of founding stories is therefore not only found in the letters, but also in the Gospels. Both genres only differ regarding the period of time they refer to: while the pseudepigraphic letters look back to the second generation of Jesus's followers, the anonymously transmitted gospels look back to the founding generation: Jesus himself.¹³ And – also important – by referencing the past, both create a tradition for the group, or in memory terms: fabricate frames for future identity constructions.

1.3 *Early Christian Generations and their Texts*

When we bring together different observations, we can recognize different generations of Jesus followers, with their different social and theological challenges, who have contributed to the texts that found their way into the New Testament. In this regard, the reading from *Kulturwissenschaftliche Gedächtnistheorie*/Social Memory Theory confirms and extends the findings of New Testament scholarship.

And this is not all. In New Testament scholarship, there is a general consensus on the dating of many of the texts. This is especially true for the Pauline Letters and the Gospels. For other texts, the dating is somewhat blurred (“last third first century,” etc.). The most striking differences regarding the dating of texts can be found with regard the so-called Deuteropauline Letters. Those who consider them to be Pauline letters date them earlier than who consider them to be pseudepigraphal. And Revelation is dated during the reign of Domitian or Trajan – 90s or 110s.

Looking at the proposals for dating the different books of the New Testament from the perspective of *Kulturwissenschaftliche Gedächtnistheorie*/Social Memory Theory and considering the different generations as well as the two periods of crisis, *generational gap* and *floating gap*, are helpful approaches to understanding them. One can get an idea of which questions preoccupy a particular generation, and what kinds of texts are typically produced at particular points in the history of the early Jesus followers. Distinguishing the genuine

13 A similar concept is used in Thomas R. Hatina, “Intertextual Transformations of Jesus: John as Mnemomyth,” in *Modern and Ancient Literary Criticism of the Gospels*, ed. Robert Matthew Calhoun, David P. Moessner, and Tobias Nicklas, *Wissenschaftliche Untersuchungen zum Neuen Testament* 451 (Tübingen: Mohr Siebeck, 2020), 429.

Pauline letters in the second generation as artifacts of *social memory* which were written before the *generational gap* and texts from later generations becomes more comprehensible.¹⁴ The later generations contribute the anonymously transmitted gospels and pseudepigraphy. Both phenomena belong to the third and – as it turns out – fourth generation, which is still part of the early Christian three-generation-memory. It is only after the *floating gap* that we gradually enter what is commonly called “Early Christianity,” i.e., a time in which the Christian identity has been consolidated in such a way that traditions have been found and safeguarded for authors to reference. This allows early Christian teachers of a new generation to enter the stage.

From the perspective of *Kulturwissenschaftliche Gedächtnistheorie*/Social Memory Theory, we can also say that the strategy of referencing earlier generations to prolong, extrapolate, or continue them into one’s own time is a typical phenomenon for the externalization of collective memories. It also narrows the stream of tradition from multiple perspectives to one leading or guiding perspective and creates first drafts of founding histories. In this situation, pseudepigraphy and the writing of foundational narratives are two sides of the same coin. It also makes sense that these processes are gradually coming to an end with the *floating gap*. Now the tradition – however it was shaped or “found” – should be stable enough to build on. A survey of New Testament texts using suggestions for dating from New Testament introductory literature and broken down according to groups and generations could look like this: Assigning them to specific authors in the second century makes clear that the anonymously transmitted gospels are attributed to memory figures/Erinnerungsfiguren, who played a role in the first generation of Jesus followers. It is a rational strategy to establish continuity beyond the floating gap. To phrase it differently: by attributing the Gospels to authors from the first generation, the floating gap is bridged, and later generations have a seemingly direct and personalized connection to the foundational events of their Christian identity through these texts.¹⁵

14 For a similar concept also based on memory theory cf. David E. Aune, see “Jesus Tradition and the Pauline Letters” in *Jesus in Memory, Traditions in Oral and Scribal Perspectives*, ed. Werner H. Kelber and Samuel Byrskog (Waco: Baylor, 2008), 63–86, 79–86.

15 First ideas regarding the “bridging of the Floating Gap” have been developed in Huebenthal, *Kulturwissenschaftliche Gedächtnistheorie und Neues Testament*, 301–15; and Sandra Huebenthal, “Polycarp Unchained: How Cultural Studies can enhance Patristic Research”: *Vetera Christianorum* 57 (2020): 131–45.

Table 9.2 Survey of New Testament text groups and early Christian generations¹⁶

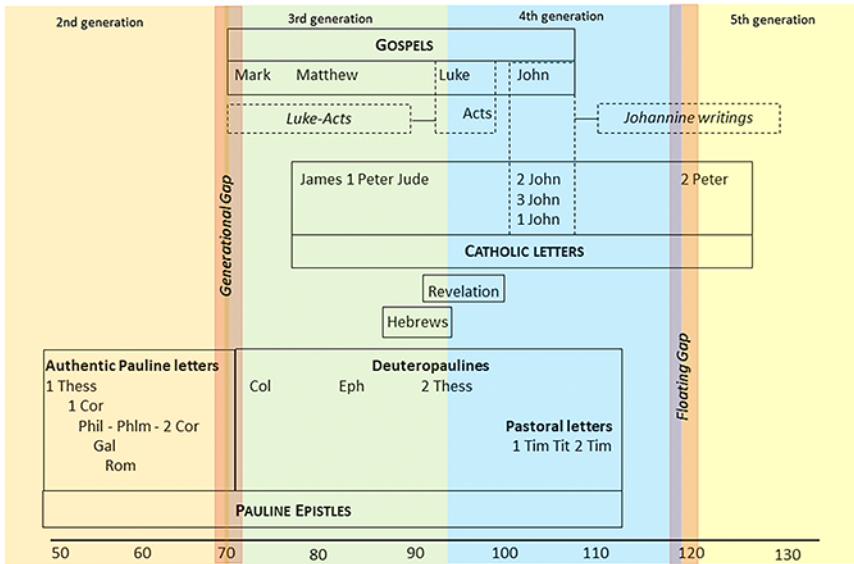

2. Generations: A Heuristic for Understanding 1 and 2 Thessalonians?

How do these insights add to our understanding of 1 and 2 Thessalonians? The question of dating the Thessalonian correspondence is still unresolved and controversial in biblical scholarship. The problem is not so much 1 Thessalonians, which is almost unanimously considered an authentic Pauline letter, and the oldest document of the New Testament,¹⁷ it is the letter we know as 2 Thessalonians that causes difficulties.

In scholarly debate, the question of the dating of 2 Thessalonians is closely tied to the question of the authorship of the letter: is it an orthonymous letter penned by Paul himself or a piece of pseudepigraphy written by a later author who only introduces himself as “Paul?” Such labeling can complicate

16 Cf. Huebenthal, *Kulturwissenschaftliche Gedächtnistheorie und Neues Testament*, 97.

17 Cf. Eckart D. Schmidt, “Gibt es Neues zur Frage nach Authentizität und Datierung des 1. Thessalonicherbriefs?” in *Der 1. Thessalonicherbrief und die frühe Völkermission des Paulus*, ed. Ulrich Mell und Michael Tilly, WUNT 479 (Tübingen: Mohr Siebeck, 2022), 15–44.

an unbiased examination of the letter if “pseudepigraphal” is equated with “forged” or “less important.”¹⁸

The problem can be avoided when the texts are read through the lens of Social Memory Theory and examined with the tools of *kulturwissenschaftliche Exegese*. Such a reading is not primarily interested in the question of authorship, but in the text itself, how it adds to the formation of group identity, and the question of whether it presents itself as an artifact of social or collective memory.

I will begin with rephrasing the question according to the terminology of *Kulturwissenschaftliche Gedächtnistheorie*/Social Memory Theory, then gather observations on both Thessalonian letters and evaluate them within the framework of memory theory. I will restrict myself to working with the theory, the methodological steps derived from it, and the biblical texts themselves to explore whether the approach works. For this reason, I have included almost no research or secondary literature on the Thessalonian correspondence.

2.1 *The Thessalonian Correspondence through the Lens of Social Memory Theory*

While research is largely unanimous that 1 Thessalonians is an authentic Pauline letter written around 50/51 in Corinth, and thus the oldest letter of the New Testament, the situation is quite different for 2 Thessalonians. Here, the positions differ strongly: Some read 2 Thessalonians as an authentic Pauline letter, others understand it as a pseudepigraphic letter written at the end of the first century, possibly in Asia Minor, and it is not even clear whether the text is addressed to the followers of Jesus in Thessalonica.¹⁹

If we reformulate these observations with the vocabulary that *kulturwissenschaftliche Gedächtnistheorie*/Social Memory Theory provides, we can

18 For 2 Thessalonians, cf. Gerd Lüdemann, *Die größte Fälschung des Neuen Testaments: Der Zweite Thessalonicherbrief* (Springe: zu Klampen, 2010); Bart D. Ehrman, *Forgery and Counterforgery: The Use of Literary Deceit in Early Christian Polemics* (Oxford: Oxford University Press, 2013), 170, even calls 2 Thessalonians “counterforgery,” thus also adding to a morally charged discourse about pseudepigraphy. For a survey cf. Sandra Huebenthal, “Pseudepigraphy,” in *Brill Encyclopedia of Early Christianity Online*, ed. David G. Hunter, Paul J.J. van Geest, Bert Jan Lietaert Peerbolte. (http://dx.doi.org/10.1163/2589-7993_EECO_SIM_045227.)

19 For an overview of the discussion cf. Sandra Huebenthal, “Erfahrung, die sich lesbar macht. Kol und 2 Thess als fiktionale Texte,” in *Wie Geschichten Geschichte schreiben. Frühchristliche Literatur zwischen Faktualität und Fiktionalität*, ed. Susanne Luther, Jörg Röder, and Eckart Schmidt, WUNT II 395 (Tübingen: Mohr Siebeck 2015), 295–336. In order to remain as unbiased as possible, I refrained from revisiting the article when I worked on this contribution.

state that 1 Thessalonians is dated in the second generation of early Jesus followers, while for 2 Thessalonians, it is debated whether it belongs to the second or to the third/fourth generation. If we include the concepts of Maurice Halbwachs and Aleida and Jan Assmann, in the case of 1 Thessalonians, we are dealing with an artifact of *social memory* that pre-dates the *generational gap*, locates experiences within existing cultural frames in everyday, informal communication, and discusses emerging issues within these existing cultural frames, too.

If 2 Thessalonians is also an authentic Pauline letter, it belongs to the same category, and we would have similar expectations. If, however, it was written as a pseudepigraphic letter at the end of the first century, it would instead be an artifact of *collective memory*. Written after the *generational gap* and at the fringes of the living three-generational memory, we would be dealing with a text that does not situate experiences within familiar and predetermined cultural frameworks, but fabricates new frameworks for future identity construction, drawing on its own traditions. The drafting or “finding” of traditions is a typical characteristic of this phase.

In other words: depending on whether 2 Thessalonians presents itself as an artifact of *social memory* in the second generation or as an artifact of *collective memory* in the third/fourth generation, a different way of dealing with the past and a different kind of argumentation is expected.

As we have seen, the different types of texts that are produced in the generations before and after the *generational gap* have different characteristics and serve different purposes. It should therefore be possible to distinguish these dissimilar text types based on relatively clear characteristics or features. Before the *generational gap*, both biblical scholarship/*Einleitungswissenschaft* and *Kulturwissenschaftliche Gedächtnistheorie*/Social Memory Theory grapple with orthonymous texts like the authentic Pauline letters. *Kulturwissenschaftliche Exegese*, as I would call my own approach, goes a step further and assumes that they are artifacts of *social* rather than *collective memory*. After the *generational gap*, and due to the change of media that usually comes with it, for artifacts of *collective memory*, one would expect new genres as well as anonymous or pseudepigraphic texts.

A brief overview of the different characteristics of artifacts of social, collective, and cultural memory as derived from *Kulturwissenschaftliche Gedächtnistheorie*/Social Memory Theory, not from biblical scholarship, would look like this:²⁰

20 For the development of the categories cf. Huebenthal, *Reading the Gospel of Mark as a Text from Collective Memory*, 164–72.

Table 9.3 Characteristics of artifacts of social and collective memory²¹

Social Memory	Collective Memory	
<i>Emotional charge</i> (depending on the carriers)	GENERATIONAL GAP AFTER ABOUT THIRTY TO FIFTY YEARS	<i>Concise design</i> (depending on the function)
Non-intentional preoccupation with the past, past construction en passant		The past is consciously called up and shaped
Refers to the present or immediate past (recent past), time of witnesses (dissolves with the departure or death of the bearers)		Concerns the immediate past (recent past), wandering time horizon of three to four generations
Small social groups such as families or peer groups that provide the framework for individual memory, living experience of a group, multi-perspective, unofficial/not institutionalized, thus everyday, discursive, episodic, limited in time		Memory communities, rather larger than families, not every member needs to know all other members
Discursive production of individual episodes in which different perspectives can stand side by side, no chronological arrangement of episodes (“family memory”), the organizational principles for narratives are socially mediated		Production of an overall narrative in a specific medium (e.g., text or change of media), in which a perspective asserts itself, in this context also temporal de-temporalization by locating individual episodes in a larger framework: (re-)contextualization and/or (re-)historicization in and through the overall narrative, incipient establishment of a common history (“founding myth”)
Locating one’s own situation and experience within given socio-cultural frameworks		Fabrication of new frameworks for future interpretations and identity constructions
Identity formation by recalling individual episodes (visualization through narration), discursive fabrication of identity		Formation of identity through acceptance and “inscription” in the overall narrative, e.g., through participation in rites, festivals, commemorative days, or ceremonies such as communal meals

FLOATING GAP AFTER ABOUT EIGHTY TO ONE HUNDRED YEARS

21 Cf. Huebenthal, *Kulturwissenschaftliche Gedächtnistheorie und Neues Testament*, 283.

Even if this taxonomy is convincing in theory, reality is more complex. Regarding pseudepigraphic letters the question is, of course, how exactly they can be distinguished from authentic ones. Similar questions can be asked regarding the Gospels, e.g., what exactly makes them textual artifacts of *collective memory* beyond the *generational gap*? Even if the theoretical distinction makes sense, it is not sufficient to simply adopt the dating provided by biblical scholarship/*Einleitungswissenschaft* and take the epoch model presented in the first part as gospel. In order to avoid circular reasoning and provide an independent approach, it is necessary to develop criteria for the different types of memory and formulate reading expectations for artifacts of *social* as well as *collective memory* on the basis of *kulturwissenschaftliche Gedächtnistheorie*, and then read the texts on the basis of these expectations. Only after this does it make sense to compare the results to findings of biblical scholarship/*Einleitungswissenschaft*. Once again, the order is reversed in comparison with traditional historical approaches: I will begin with the analysis of the sources with a particular method/set of questions, and only afterwards compare the results to the findings of classical source criticism.

This independent approach should be especially helpful for reading the New Testament epistolary literature, and the question of whether the individual letters contain signals that point to a writing before or after the *generational gap* – and thus to a writing of the second or third/fourth generation of early Christians. In other words: we will work with a new set of criteria beyond “developments in theology/theological thought” or comparison of language and style to approach the Thessalonian correspondence.²²

2.2 Social or Collective Memory? Reading Expectations

Depending on whether a text is a testimony of *social* or *collective memory*, a different way of dealing with the past and a different kind of argument can be expected. Texts from *social memory* can be expected to display everyday communication and/or functional literature (“Gebrauchsliteratur”) of a narrow or limited scope, dealing with concrete questions and problems of a particular memory group, and replacing oral communication rather than establishing things in principle and once-and-for-all. The experiences of the memory group,

22 For the recent discussion and application of criteria in German-speaking scholarship cf. Tobias Nicklas, *Der Zweite Thessalonicherbrief*, KEK NT 10/2 (Göttingen: Vandenhoeck und Ruprecht 2019), 41–55; Rudolf Hoppe, *Der zweite Thessalonikerbrief. Kommentar* (Freiburg: Herder, 2019), 33–44; Stefan Schreiber, *Der zweite Brief an die Thessalonicher*, ÖKT 13/2 (Gütersloh: Gütersloher 2017), 38–44; and – based on papyrological evidence – Christina Kreinecker, *2. Thessaloniker*, Papyrologische Kommentare zum Neuen Testament 3 (Göttingen: Vandenhoeck & Ruprecht 2010), 60–99.

and what is currently troubling them, can be found in the well-established sociocultural frameworks within which they are discussed. Accordingly, excursions into the shared cultural framework or shared experiences/shared history are to be expected. In the case of a group with strong Jewish roots, this is likely to be most evident in recourse to *Scripture*. Recourse to shared experiences and recollection of lively conversation with and within the group are also indications of discursive negotiation of truth. Accordingly, it is also to be expected that the text juxtaposes and discusses different perspectives (instead of prescribing one perspective). References to the different perspectives in the memory group can be made by mentioning names and groups, which are familiar to all participants. Identity formation in such a text should occur through the recollection of shared experiences and should happen rather discursively, with the past used less consciously as a basis for argumentation, but appearing in argumentation. Whoever claims authority in these times draws it from the common experience, but also from an encounter with Jesus, which legitimizes him/her in a special way as a messenger (apostle) of Christ, without therefore placing him/her on a higher level in a hierarchy.

In the case of texts from *collective memory*, the expectation is different. One would expect that these are, to a much greater extent, texts that serve to reassure identity and call upon the generation of the first witnesses as an aid to understanding. Concrete questions are clarified in a much more fundamental way and by recourse to the group's own traditions, with the founding generation enjoying stronger authority. Instead of a discursive negotiation of identity in which, in principle, all perspectives are initially of equal value, certain ideas have already been singled out as "guiding" or "leading" at this point, and the tendency to clarify questions in a fundamental way increases. A distinguishing feature is that in *collective memory*, a new and particular framework becomes visible in which the memory group can locate their experiences and discuss their issues. In Jan Assmann's terminology, the texts are "identity-concrete." In this process, the group's own traditions – regardless of whether they were formed on the basis of apostolic memory or "found" elsewhere – play an important role. The first drafts of a *founding history* become visible, as do the first attempts at more solid forms for rituals and participation in this history. Identity markers begin to emerge. This also means that the memory of common foundational experiences or shared history does not happen *en passant*, but quite consciously and intentionally. Authority is gained by recourse to the origin, to which the carriers and guarantors of tradition ("Traditionsträger") create conscious links. When it comes to reasoning, the carriers and guarantors of tradition no longer appear as an equal part of the group, but are singled out in a special way, and they are clearly recognizable as counterparts.

Applied to the Thessalonian correspondence, the question is therefore: Do the observations made regarding the text point to an artifact of *social* or *collective memory*? Once this is established, we can ask a) whether 2 Thessalonians looks more like a text of the second or third/fourth generation, and b) whether the text can be made plausible as an authentic Pauline letter.

3. Reading the Letters to the Thessalonians through the Lens of Social Memory Theory

Not all the analytical tools developed for *kulturwissenschaftliche Exegese*²³ are relevant to this question. For a good first impression, three guiding questions are sufficient to show the central differences between artifacts of social and collective memory:

- a) What relationship and common history with the senders and the addressees is assumed?
- b) What topics are negotiated, and how are they communicated? Are we dealing with multiple perspectives or one leading perspective? Are senders and addressees on equal footing?
- c) How does the text argue, i.e., what kind of social frames are used? Does the text make use of existing frames or develop its own traditions?

The undisputed 1 Thessalonians will be used as a “control” for the reading of 2 Thessalonians. First Thessalonians is assumed to fall into the category of *social memory* and can also be analyzed using these questions.²⁴

23 Sandra Huebenthal, *Kulturwissenschaftliche Gedächtnistheorie und Neues Testament* (Tübingen: Narr Franke Attempto 2022), 115–37.

24 The idea of this reading is not to compare the letters regarding structure, style, or theology, nor to read one through the lens of the other or reflect on their relationship. The focus of this reading deals with the question whether the texts exhibit features of *social memory* or *collective memory*. It would, of course, also be possible to read the letters as artifacts of *cultural memory*, as Stefan Alkier shows regarding 1 Thessalonians, cf. Stefan Alkier, “Der 1. Thessalonicherbrief als kulturelles Gedächtnis,” in *Logos und Buchstabe: Mündlichkeit und Schriftlichkeit im Judentum und Christentum der Antike*, ed. Gerhard Sellin and François Vouga, Texte und Arbeiten zum neutestamentlichen Zeitalter 20 (Tübingen: Narr, 1997), 175–94. This approach is, however, an emic reading of the letter from the perspective of later Christians, not an etic perspective on the text’s context of origin.

3.1 *Observations in First Thessalonians*

3.1.1 The Sender's History with the Addressees

Paul, Silvanus, and Timothy introduce themselves as the senders of the letter, writing to the assembly (ἐκκλησία) of the Thessalonians (1:1). The group in Thessalonica has turned from their own – Gentile – ways toward the gospel of Paul, Silvanus, and Timothy (1:9). As former Gentiles, they have come into or adopted a new identity and a foreign – Jewish – cultural frame. The letter catches up with this previous history and the senders situate the Thessalonians in this new and foreign cultural frame in order to integrate them into the community of Jesus followers. The Thessalonians, *in spite of persecution* (ἐν θλίψει πολλῇ) received the word with the *joy inspired by the Holy Spirit* (μετὰ χαρᾶς πνεύματος ἁγίου, 1:6). Just like the senders, they proclaim the word of the Lord (1:7–8), are models in the faith, and their mimesis of the communities in Judea (ὅτι τὰ αὐτὰ ἐπάθετε καὶ ὑμεῖς ὑπὸ τῶν ἰδίων συμφυλετῶν καθὼς καὶ αὐτοὶ ὑπὸ τῶν Ἰουδαίων, 2:14) puts them on a par not only with the Jewish communities of Jesus followers, but also with the senders. Through the common commitment to the gospel, and the common experiences of persecution and suffering, the senders and the addressees meet on equal footing.

The fact that the senders led the addressees to the gospel and to faith in Christ does not constitute a hierarchical relationship in which Paul, Silvanus, and Timothy are superior to the Thessalonians or have an advantage over them. If there is an advantage of the senders, it is based on time, not on content: Paul, Silvanus, and Timothy have been followers of Jesus for longer and thus have a greater experience. The shared history of senders and addressees consists of a successful evangelization and is also recalled that way (1:6–10). Consequently, the addressees are *brothers and sisters beloved of God* (ἀδελφοὶ ἠγαπημένοι) who, just like the senders, have God as their Father (1:3). This was not always the case. In 2:7–12, the shared history is illustrated by means of other family metaphors that establish closeness. The apostles acted as wet nurse (2:7) and father (2:11) to the Thessalonians, caring for and admonishing them as their own children. This, of course, is now a thing of the past, for senders and addressees meet as brothers and sisters at eye-level.²⁵ The family metaphors, together with the shared history, create a close bond. Paul, Silvanus, and Timothy appear to be in sync or on a par with the community: they experience

25 The address, brothers and sisters (ἀδελφοί), is used a total of fifteen times in 1 Thessalonians (1:4; 2:1, 6, 14, 17; 3:7; 4:1, 10, 13; 5:1, 4, 12, 14, 25–27), to which 4:6 must be added, where it is a matter of not taking advantage of one's brother, and 4:9, where it is a matter of brotherly love (φιλαδέλφια). The senders are also on the same level: in 3:2, Timothy is also called a brother.

the same things, share the challenge of discipleship, and are closely connected to the group through visits and the wish to visit each other. The letter refers several times to the common tasks, the shared fate of affliction, and the desire to remain connected.

3.1.2 The Issues, their Negotiation, and Ways of Communication

Questions about the *Day of the Lord* as the actual occasion of the letter appear only very late in 4:13–18 and 5:1–11 and are embedded in basic exhortations to or reminders of the right way of dealing with each other in 4:1–12 and 5:12–20. It is remarkable that basically only the explanations in 4:13–18 offer something new: the rest of the explanations repeat what is already known to the addressees and reinforce it. The content that reminds rather than teaches is preceded, as already indicated, by a longer reference to the common (and immediate) past and the present situation, from which, however, *no* demands are derived. On the contrary, the senders strive to be on an equal footing with the addressees, and they oblige the brothers and sisters to deal with their local problems themselves (esp. 5:12–22). The tone of the letter shows that the relationship between senders and addressees is cordial and unencumbered. They know and appreciate each other. The verb εὐχαριστέω is used in 1:2, 2:13 and 5:18, and the triad *faith* (πίστις) – *hope* (ἐλπίς) – *love* (ἀγάπη) is mentioned regarding the addressees in 1:3 and 5:8.

The meeting of senders and addressees at eye-level is also reflected linguistically. Not only are the addressees considered brothers and sisters (ἀδελφοί), but the common level of knowledge is explicitly invoked again and again. The phrase *as you know/you know* appears in different versions a total of nine times (1:5; 2:2, 11; 3:3–5; 4:2; 5:11), *you remember/you are witness* twice (2:9,10), that the senders *need not say anything* once (1:8), and that the addressees are already complying with the requests is explicitly stated in 4:1–10 and 5:11. The most obvious expression to describe the equal footing of senders and addressees can be found in 4:9, when the senders refer to the addressees as *taught by God* (θεοδίδακτοί). The references to shared knowledge reinforce the social construction of the common story, which is taken up again in the second part, where questions about everyday behavior are found (4:1–12 and 5:5–11), and a group ethos is set in motion that flanks the questions about the eschaton.

It is striking that Paul only writes in the first person singular or speaks of himself in a few places (2:18; 3:5; 5:7). The rest of the letter consistently uses first person plural. If this is a stylistic device, it is very well chosen, for it does not simply put the senders on par with the addressees but creates a strong immediacy (“Unmittelbarkeit”), as if senders and addressees have the same struggles and deal with the same issues. The group ethos thus becomes a

common concern and effort; accordingly, the brothers and sisters should also admonish and comfort one another. The frequent use of *you know* (οἶδατε) and *as you do* (καθὼς καὶ ποιεῖτε) gives the impression of a discursive negotiation in which the senders do not simply command. The most common verbs for exhortations are παρακαλέω with the meanings “to prompt, exhort, request” (2:12; 4:1, 10; 5:14), “comfort” (3:7; 4:18; 5:11), and “strengthen” (3:7), παραμυθέομαι: “to persuade, encourage, comfort” (2:12; 5:14), and ἐρωτάω: “to ask, inquire” in 4:1 and 5:12.

Imperatives occur comparatively rarely. The whole letter counts only twenty, and except for 4:18 (παρακαλεῖτε), they are all found in 5:11–26, where the senders ask the addressees to take their local challenges into their own hands. A proper *commandment* appears only in 5:27, when Paul, using one of the rare phrases, *beseeches* the addressees (ἐνορκίζω) to read the letter to all the brothers and sisters. This also makes clear that the letter serves as a substitute for a direct meeting (and oral communication). The request to read the letter aloud can be understood as an attempt to create an even greater immediacy and to bring the voices of Paul, Silvanus, and Timothy directly into the social negotiation processes of the group. The idea of reciprocity (missing one another, suffering together, praying for one another) is also repeated in the final verses (5:12–22, 27).

3.1.3 Justifications and Frames of Reference

Drawing from the common ethos, the senders shape the rules or maxims (*the will of God*, 4:3), but the Thessalonians, as already *taught by God* (θεοδιδάκτοι), do not need further instruction. Apart from that, they already learned everything from the apostles and therefore only need a gentle reminder. The justification is given *through the Lord Jesus* (4:2), but is immediately softened by the statement that, after all, the Thessalonians already behave this way. A justification through a word of the Lord is found explicitly in 4:15, and implicitly in 5:2f, and both are used without context. In addition, the Thessalonians are requested to *become imitators* (μίμησις) of the apostles *and of the Lord* (1:6).

The senders recall the common experiences and the share history within the framework of their evangelization as the most important frame of reference. “Gospel” is not to be understood as “memory,” but a living event. In the context of the family metaphor, *our message of the gospel* (τὸ εὐαγγέλιον ἡμῶν, 1:5) becomes the *gospel of God* (τὸ εὐαγγέλιον τοῦ θεοῦ, 2:9), and the *kingdom* and *glory* of God are also referred to in this context (2:12). The family metaphor is prevalent: through their common destiny, the Thessalonians are connected to the communities in Judea and thus integrated into a Jewish framework. This context surfaces very discreetly with hints to prophecy and Satan as

antagonist. The most prominent introduction to this Jewish frame in 4:13–5:11 is still authorized by words of the Lord, not by Israel's *Scriptures*. This makes sense for a group that has no Jewish roots and needs to learn that it now inherits them through its new identity in Christ. In a nutshell: 1 Thessalonians uses God, Jesus, and the Holy Spirit as authorities, as well as common beliefs that are discursively invoked, while *Scripture* does not appear as an authority.

3.2 *Observations in 2 Thessalonians*

3.2.1 The Sender's History with the Addressees?

The evangelization of the group is not recalled as an event of the immediate past, but seems to have been further in the past. The senders communicate through words and letters (2:2, 15; 3:17) and recall their visit in 3:7–9. However, they do not invoke shared past and common history *en passant* or recall the good relationship between them and the addressees, but they have a purpose to instruct. The letter does not display a lively connection or relationship with the addressees at the time the letter is written: the senders say almost nothing about themselves (except generalities in 1:7 and 3:2), make no references to a living shared history, and disclose no plans to visit the addressees. The senders seem much more distant, almost a bit removed.²⁶

3.2.2 The Issues, their Negotiation, and Ways of Communication

At first, the reason for the letter seems to be the concern that the group is about to leave their faith (1:3–12; 2:2–3). The senders affirm that those who trouble the group will be punished, and Jesus the Lord will inflict retribution on those who do not know God and do not obey the gospel of Jesus (1:7). The themes of persecution (*διωγμός*) and affliction (*θλίψις*, 1:4–5, cf. also 1 Thessalonians 1:6; 3:3, 4) also appear in 1 Thessalonians, but it is more developed here.

The letter explains that in the face of the threat, it is imperative to keep calm and carry on. Thus, the senders call on the addressees not to be intimidated (2:2–3), especially by word, speech, or writing that is supposed to be from the senders – insinuating that false letters and communication based on letters rather than personal contact do exist. Obviously, at least some of the addressees believe that the day of the Lord has already come (2:3). The senders, however, vehemently contradict this impression and tell the addressees: It will take time, and before the day of the Lord comes, there will be an apostasy from God,

²⁶ The different relationship of “Paul” and “the Thessalonians” is also reflected in Hanna Roose, *Der erste und zweite Thessalonicherbrief. Die Botschaft des Neuen Testaments* (Neukirchen-Vluyn: Neukirchener, 2016), 194–16.

which is described in 2:3–12. The explanations sound almost sectarian: apostasy is foretold, along with everything else that is due to happen before things get better again. In 2:3–12, the senders warn about lawlessness (*ἀνομία*, 2:7) and the lawless one (*ὁ ἄνομος*, 2:8–9) that threaten the group from within. In 3:6–13, there is a further warning against brothers and sisters in the faith who live disorderly lives (*ἀτάκτως*, 3:6.7.11), and thus also pose a threat. Both groups are to be avoided, and the addressees must recognize that the threat comes both from the inside *and* from the outside, although it remains relatively nebulous to readers as to exactly *who* the threats are and where they come from.

In this situation of persecution and temptation, suffering for the kingdom of God, perseverance, and steadfastness are essential: He who is steadfast will inherit the kingdom of God in the end (1:6–10). This passage seems to take up and presuppose what has unfolded in 1 Thessalonians 4 and 5, and in the argumentation, there are several references to the fact that the senders have already instructed the addressees orally and in writing (2:2.15): the day of the Lord and the union with Christ at the Parousia.

As a solution, the mimesis of the senders is ordered, their example is to be followed. This includes keeping away from those who lead a disorderly life (3:11), without saying exactly what the disorder consists of. The Thessalonians are to prove themselves worthy of their calling, so that Jesus's name may be glorified, and all who do not believe the truth must be judged (2:12; 3:14). This is followed by a call to hold fast to the traditions that have been passed down through the senders orally or by letter (2:15). It is now the senders who order the deviant group members to live a different life, not the community (unlike in 1 Thessalonians 5:12–22, the members sought instruction from one another in love and patience). The keywords “work” and “bread” are invoked several times in 3:6–12, thus connecting the time of the senders' visit to the current problems of the addressees. Obviously, there is social deviance, and the senders urge the addressees not to tolerate this behavior nor to cooperate with the deviant members (i.e., not to feed them), and otherwise, to quietly continue their own lives. For the addressees, it is important not to make common contact with the deviants and to behave quietly and inconspicuously.

For this purpose, the example of the senders is recalled several times (2:15; 3:4, 6, 10, 12, 14). It is no longer a matter of imitating Christ, but the senders (3:7.9); consequently, *the gospel of our Lord Jesus* (τῷ εὐαγγελίῳ τοῦ κυρίου ἡμῶν Ἰησοῦ, 1:8) becomes the gospel of the senders (οὗ εὐαγγελίου ἡμῶν, 2:14). Thus, the traditions (*παραδόσεις*, 2:15; cf. also 3:6) of the senders have to be kept. These traditions can be given oral or written meaning in this letter. The goal seems to be the return of the “disorderly” to the right path, modelled by the

teaching and example of the senders. Intriguingly, the senders do not refer to themselves as *apostles*, but only to their authority (ἐξουσία, 3:9) and that they are to be imitated as *typos* (τύπος, 3:9).

The tone is clearly distant, and appreciation and empathy are largely absent. Overall, the cordial relationship that characterized 1 Thessalonians seems to be missing. The triad, faith – hope – love, which was used twice in 1 Thessalonians with regard to the addressees, no longer appears. The first thanksgiving in 1:3 only mentions the *abundantly growing faith* (ὑπεραυξάνει ἡ πίστις ὑμῶν) and the *love of everyone toward each other* (ἡ ἀγάπη ἐνὸς ἐκάστου πάντων ὑμῶν εἰς ἀλλήλους), which supposedly grows among the addressees. *We must always give thanks* (εὐχαριστεῖν ὀφείλομεν πάντοτε) sounds equally clichéd both in 1:3 and the recapitulation, 2:13. This is especially the case as the addressees are first praised and then rebuked or disciplined.

The letter is consistently written in first person plural (“we”) and makes use of only a few imperatives (2:15 [2x]; 3:1, 10, 14, 15), but the tone is markedly different from 1 Thessalonians. When the addressees are asked to do something, the senders use “command/order” (παραγγέλλω, 3:4.6.10.12), while the more polite, “ask/exhort” (παρακαλέω), occurs only once in 3:12 in connection with an order, “ask/question” (ἔρωτάω) also occurs only once in 2:1.²⁷

3.2.3 Justifications and Frames of Reference

Unlike 1 Thessalonians, there is no indication or attempt to convey the impression that questions and problems are socially negotiated or at least discussed on an equal footing: The senders request that the group should distance themselves from those who live in a *disorderly* manner (ἀτάκτως, 3:6.7.11), and request that they pray for the senders to be *saved from wicked and evil people, for not all have faith* (3:2). They justify their request that the addressees should distance themselves from the “disorderly” with the tradition of the senders and their example, and then authoritatively exhort them *in Lord Jesus Christ* (3:12). The criterion for exclusion is a deviation from the teaching of the senders in the present letter (3:14).

The senders have given *typos* (τύπος, 3:9) through words, letters, and their visit, which the addressees are supposed to imitate. The reasoning is thus threefold: a) giving an example during their visit (referencing foundational events), b) instruction in word and letter (no discursive negotiation, but written instruction that is already available: there is thus a leading perspective) and c) authoritative assurance (reference back to Jesus in 3:6, 12; reference to own authority in 3:9). Frames of reference are a) the testimony of the senders

27 For a thorough analysis of the different verbs for petition or request cf. Kreinecker, 2. *Thessaloniker*, 76–95.

(believed by the addressees, 1:10), b) their gospel (2:14), and c) their tradition (3:6). The tradition that is referred in this letter is thus immune to (outside) criticism.

4. An Initial Conclusion

According to these observations – leaving aside the exegetical and theological evaluation of the letter, and the exegetical discussion on scenarios of origin – the following first conclusion can be drawn:

First Thessalonians tells the common story of senders and addressees from the immediate past, which is referenced again and again. The texts points to social and discursive processes of negotiation and a common struggle for truth, which is also expressed linguistically. The letter testifies to a lively relationship with disputes happening at eye-level, which is also evident in the openness to other positions. The senders try to integrate the addressees into a larger network (and thus into an existing tradition). All these observations suggest that 1 Thessalonians is a testimony of *social memory*.

Second Thessalonians, on the other hand, does not reveal a discursive negotiation of the current issues, but instead, the senders convey to the addressees, with authority, the leading perspective that is to be enforced. The shared history of senders and addressees becomes a self-created tradition that is invoked and instrumentalized. Thus, 3:7–10 does not seem recall the past *en passant* and without purpose, the past is invoked only to establish rules. In addition, external communication media, such as letters and traditions, are invoked as guarantors of tradition. The writing does not reveal a living relationship, but exposes a hierarchy: the senders command, and the addressees obey. This situation, which is clearly different from the one mirrored in 1 Thessalonians, suggests that the 2 Thessalonians is a testimony of *collective memory*.

If 2 Thessalonians appears as an artifact of collective memory, we must assume that it was written after the *generational gap* and thus in the next generation(s). This does not answer the question of who wrote the letter, and whether it is to be understood as an authentic Pauline letter or a pseudepigraphic letter, although it suggests that a letter that refers to the third/fourth generation cannot have been written by Paul. Who wrote the letter, when, and with what intention is another question, and it must be discussed separately. This includes the intriguing questions of why Paul (and Silvanus and Timothy) was chosen as the fictional sender and the Thessalonian community as the fictional addressees. It is also interesting to note that 2 Thessalonians already knows about communication, mainly through letters instead of personal exchanges, and insinuates the existence of false – fake – letters to unsettle the

addressees. In other words: we see a different use and knowledge of media compared to the second generation. Identity is likewise further developed and endangered – both from the inside and outside. The juxtaposition of implicit and explicit warnings against false letters and the *Eigenhändigkeitsvermerk* in 3:17 also raise suspicions about the time, date, and authenticity of the letter.

The first conclusions can be summarized like this:

Table 9.4 Summary of reading impressions²⁸

1 Thessalonians <i>Social Memory</i>	2 Thessalonians <i>Collective Memory</i>
<ul style="list-style-type: none"> – Shared history, social, and discursive processes of negotiation, common struggle (also linguistically/regarding language) – Lively relationship with discussions at eye-level, openness to other positions (addressees as θεοδιδακτοί/ believers) – Attempt to integrate the addresses into a larger network (and thus into an existing tradition) 	<ul style="list-style-type: none"> – No discursive negotiation of the issues at hand – Leading perspective is enforced – No living relationship with each other, hierarchical gradient – Shared history is invoked and branched out as a self-created tradition – External communication media (letters) are called upon as guarantors of the tradition

After reading both letters through the lens of *Social Memory Theory*, we can say that the analytical tools of *Kulturwissenschaftliche Exegese* provide us with satisfactory results and thus passed the practicability test. With more practice and refinement, they can be a complementary way to historical-critical methods when it comes to questions of the temporal location – to avoid the term “dating” – of texts. In addition, the new tools allow for a different perspective on the texts, which could be beneficial to further exegetical work. They complement the other results and can open up new ranges of questions and different perspectives for reading and understanding the texts.

It is also clear, that the considerations presented here can only provide a first and provisional peek through the keyhole and do so in rather raw sketches. It could, however, show that a proper analysis and interpretation of the Thessalonian correspondence would be an interesting and rewarding enterprise, especially alongside exegetical secondary literature and read against the findings from the fields of historical and literary source criticism, as well as theological considerations. This approach contributes to the claim

28 Cf. Huebenthal, *Kulturwissenschaftliche Gedächtnistheorie und Neues Testament*, 282.

that “Second Thessalonians research needs to develop a rigorous hermeneutical model which adequately takes into consideration the interpretative complexities of working with a pseudepigraphen.”²⁹ I find the analysis convincing that 2 Thessalonians is more likely to be a piece of pseudepigraphy and would therefore include questions about its pragmatics in further analysis.

What makes a reading through the lens of social memory theory attractive is the fact that both theological considerations and questions of historical and literary criticism take a back seat,³⁰ while the text itself is at the center. In addition, I find it most refreshing and rewarding to make use of the narratological toolkit, read the entire text, and approach it as a narrative that tells a story about the senders, addressees, relationships, and identity formation. I assume that it is no coincidence that Paul (and Silvanus and Timotheus) were adopted as fictional senders and that the fictional addressees are, once more, the Thessalonians. This would also be one of the questions I find most interesting to pursue: What are the pragmatics of continuing the story of Paul and the Thessalonian community, and what purpose could such a piece of pseudepigraphy serve for early Christian identity formation in the third or fourth generation?³¹

-
- 29 Trevor Thompson, “As If Genuine: Interpreting the Pseudepigraphic Second Thessalonians,” in *Pseudepigraphie und frühchristliche Verfasserfiktion/Pseudepigraphy and Author Fiction in Early Christian Letters*, ed. Jörg Frey, Jens Herzer, Martina Janßen, and Claire Rothschild, WUNT 246 (Tübingen: Mohr Siebeck, 2009), 471–88 488.
- 30 For a current research survey, cf. Stefan Schreiber, “Früher Paulus mit Spätfolgen. Eine Bilanz der neusten Thessalonikerbrief-Forschung,” *Theologische Revue* 103 (2007): 267–84 and Stefan Schreiber, “Orientierungsmarken? Im Irrgarten ‘klassischer’ und neuerer Datierungen der neutestamentlichen Pseudepigraphen,” in *Die Datierung neutestamentlicher Pseudepigraphen*, ed. Wolfgang Grünstäudl and Karl Matthias Schmidt, WUNT 470 (Tübingen: Mohr Siebeck, 2021), 4–35, 9–13, 30–31.
- 31 For this question, cf. the recent suggestions in Hanna Roose, “Polyvalenz durch Intertextualität im Spiegel der aktuellen Forschung zu den Thessalonikerbriefen,” *NTS* 51 (2005): 250–69; Taesong Roh, *Der zweite Thessalonikerbrief als Erneuerung apokalyptischer Zeitdeutung*, NTOA 62 (Göttingen: Vandenhoeck & Ruprecht 2007); Martin Karrer, “Der Zweite Thessalonikerbrief und Gottes Widersacher,” *Horizons in Biblical Theology* 29 (2007): 101–31; Eve-Marie Becker, “Ὡς δὲ ἡμῶν in 2 Thess 2,2 als Hinweis auf einen verlorenen Brief,” *NTS* 55,1 (2009): 55–72; Hanna Roose, “Die Thessalonikerbriefe im Kontext urchristlicher Überlieferungsprozesse: Methodische Reflexionen,” in *Beiträge zur urchristlichen Theologiegeschichte*, ed. Wolfgang Kraus, BZNW 163 (Berlin: De Gruyter, 2009), 343–64; Rudolf Hoppe: “Der 2 Thess als ‘Paulus’-Brief. Überlegungen zur Rezeption des 1 Thess durch den ‘Paulus’ des 2 Thess,” in *Aneignung durch Transformation. Beiträge zur Analyse von Überlieferungsprozessen im frühen Christentum; Festschrift für Michael Theobald*, ed. Wilfried Eisele, Christoph Schaefer, and Hans-Ulrich Weidemann, HBS 74 (Freiburg: Herder, 2013), 298–317 or Stefan Schreiber, *Der zweite Brief an die Thessaloniker*, ÖKT 13/2 (Gütersloh: Gütersloher, 2017), 70–72.

PART IV

A New Perspective on Patristics

Polycarp Unchained: How Cultural Studies Can Enhance Patristic Research

1. Introduction: The First Encounter with Polycarp's *Letter to the Philippians*¹

In the first half of the second century, between 120 and 135,² Polycarp, bishop of Smyrna, wrote a letter to the Christian community in Philippi. These were the early days before the Church as we know it existed. Christianity was more like a lab where different faiths and social systems were developed and tested.³ It was a time before the Creed was formulated and a time before the Sunday reading came from the New Testament – there was no New Testament, let alone a Canon. Early Christians tried to discover their identity, beliefs, and how they would organize themselves. If we trust patristic research, this generation was very much concerned with the question of genuine versus heretical faith.

In this time, Polycarp wrote a letter to the community in Philippi. A brief look at only a few lines of the letter gives a good impression of what this text is about: Ταῦτά ἀδελφοί οὐκ ἑμαυτῶ ἐπιτρέψας γράφω ὑμῖν περὶ δικαιοσύνης ἀλλ' ἐπεὶ ὑμεῖς προκαλέσασθέ με (3:1). Polycarp mentions that the Philippians have asked

1 This argument was first presented on the occasions of two job talks. I am grateful for the good discussion with the members of both boards after the presentations. I am especially indebted to Emmanuel Nathan who provided a catchy title that I would have never come up with on my own.

2 The dating of the letter is still subject to discussion. After revisiting the different arguments, especially Paul Hartog's survey of pros and cons in Paul Hartog, "The Unity of Philippians," in *Polycarp and the New Testament: The Occasion, Rhetoric, Theme and Unity of the Epistle to the Philippians and its Allusions to New Testament Literature*, ed. Jörg Frey, Martin Hengel and Otfried Hofius, WUNT II 134 (Tübingen: Mohr Siebeck, 2002), Pages 148–69.

Dating the letter around 120 CE seems most plausible to me. In this essay, however, I leave the question open as the underlying idea works with both suggestions for dating the letter.

3 Christoph Marksches, "Die Kirche in vorkonstantinischer Zeit: Von der Mitte des 2. bis zum Ende des 3. Jahrhunderts," (vol. 1 of *Von den Anfängen bis zum Mittelalter: Ökumenische Kirchengeschichte*; ed. Bernd Moeller; Darmstadt: Wissenschaftliche Buchgesellschaft, 2006), 59–98, 88: "Das lange dritte Jahrhundert ist einem Laboratorium zu vergleichen: Viele Christen experimentierten mit aus der philosophischen Debatte übernommenen Lösungen, um das, was sie als christliche Botschaft empfanden, vor den Gebildeten der Zeit zu vertreten. Ein Teil dieser Experimente wurde von der Mehrheitskirche akzeptiert, ein Teil nicht". Marksches also refers to the church as a laboratory in *Das antike Christentum: Frömmigkeit, Lebensformen, Institutionen* (Munich: Beck, 2006), 42.

him to comment on the idea of righteousness. In the next verses, Polycarp clarifies that he is only responding to some questions of the Philippians and would have otherwise not reached for ink and paper. Polycarp hints further at his familiarity with the traditions of the Philippian community: Paul himself did not only found it (1:3); it was also the first ἐκκλησία on the continent of Europe and, as it is commonly known, Paul's favorite community.

In his letter, Polycarp makes references to both the founding of the community through the μακαρίου καὶ ἐνδόξου Παύλου, the blessed and famous Paul, and to the letters he wrote (3:2). Just as Paul called the heavenly Jerusalem μήτηρ πάντων ἡμῶν, meaning "the mother of us all," in *Galatians* 4:26, referring back to Jewish heritage, Polycarp calls the faith that Paul has introduced to the Philippians *the mother of us all* (3:3). He is therefore indicating that Paul's teaching of the Gospel is the common ground and history connecting himself and the ἐκκλησία of Philippi. When referring back to their shared foundation, Polycarp refers to them as ἀδελφοί, meaning brothers and sisters, reflecting the terminology Paul uses in his letter to the Philippians (1:12; 3:1.13.17; 4:1.8.21).

The main topic of the letter is righteousness. There is, however, no theoretical righteousness; the question is: what does righteousness look like in everyday life? Instead of reading Polycarp's lengthy exhortations in *haustafel*-style, the following excerpts are offering a sufficient explanation: Ἀρχὴ δὲ πάντων χαλεπῶν φιλαργυρία (4:1), Polycarp claims, using a familiar saying from antiquity. The idea that "the love of money is the root of all evil" is so common that it is difficult to prove that Polycarp is quoting 1 Timothy here. The average person living in Symrna would have known the concept. It was common in both comedy and philosophy and can even be traced back to Plato's *Nomoi*.

Next to φιλαργυρία ("the love of money"), πλεονεξία ("covetousness") also appears so often in the letter that it is difficult to miss Polycarp's attempt to make a point here. Therefore, the frequent exhortations to ἐγκράτεια, usually received as chastity, could be read in the traditional sense of being able to master your desires, not only sexual desires, but all desires, including "the love of money" and "covetousness."

However, at first glance, Polycarp's main *paraenesis* in 9:1 seems to go in a completely different direction: Παρακαλῶ οὖν πάντας ὑμᾶς πειθαρχεῖν τῷ λόγῳ τῆς δικαιοσύνης καὶ ὑπομένειν πάσαν ὑπομονή. Ὑπομονή ("patience"), is connected to "righteousness" here, which is somewhat odd at first glance, but as we might suspect, Polycarp is up to something more than general exhortations (we will come back to that later).

As a concern with heresy is usually suspected for Polycarp's generation, we are not surprised by this reference: "For whosoever does not confess that Jesus Christ has come in the flesh, is antichrist; and whosoever does not confess the

testimony of the cross, is of the devil; and whosoever perverts the oracles of the Lord to his own lusts, and says that there is neither a resurrection nor a judgment, he is the first-born of Satan" (7:1). These words against Docetism and Libertinism sound so generic that the assumption that heresy is not Polycarp's main concern almost seems like a safe bet. Nevertheless, the danger that Docetist or Libertinist tendencies might have been assimilated into Christian faith could have been real for Polycarp's community in Smyrna, as well as the Philippian community Polycarp is addressing.

2. The Reception of Polycarp Today and in Antiquity

Before taking a closer look at the letter, we need to consider the reception of Polycarp's words. In regards to reception, it must be noted that the history of the text is difficult. Less than 10 Greek manuscripts have survived and they all end with 9:2. The remaining chapters are only accessible through Latin translations, which can be unreliable at times.⁴ Nevertheless, we presume that the Philippians received the entire letter.

There are few indications of what the Philippians actually read and understood, but the later reception of the letter is documented. We will begin with modern scholarly voices, which could pass as mainstream: "The letter itself has no such vivid personal interests as those of Ignatius. The good Polycarp was a much more commonplace person", claimed Fenton John Anthony Hort in 1895.⁵ Roughly sixty years later, Thomas F. Torrance concluded in his 1959 dissertation that "on the other hand, it may be that a mind such as Polycarp, essentially receptive by nature and lacking in originality, was not one to grasp best the principles of the new faith"⁶. It seems that Polycarp did not become any more enlightened during these six decades. Charles Nielsen picks up on

4 The problem of the rather meagre attestation of the letter is constantly deplored by commentators. There are only 8 (or 9) witnesses for the text. They all seem to rely on the same *Vorlage*, end in 9:2, and are then continued with the text of Barnabas, beginning at *Barn* 5,7. Eusebius *Hist. eccl.* 3,36.13–15 quotes chapters 9 and 13 (lacking the last verse) of the Greek version, and for the rest of the text the attestation rests on the problematic old Latin translation. Cf. H. Paulsen, *Die Briefe des Ignatius von Antiochia und der Brief des Polykarp von Smyrna* (Tübingen: Mohr Siebeck: Tübingen, 1985²), 111; Johannes B. Bauer, *Die Polykarpbriefe* (trans. Johannes Baptist Bauer; Göttingen: Vandenhoeck & Ruprecht, 1995), 13–18; Boudewijn A.G.M. Dehandschutter, "Der Polykarpbrief," in *Die Apostolischen Väter: Eine Einleitung* (ed. Wilhelm Pratscher; Göttingen: Vandenhoeck & Ruprecht, 2009), 130–46, 132.

5 Fenton J.A. Hort, *Six Lectures on the Ante-Nicene Fathers* (London: Macmillan, 1895), 42.

6 Thomas F. Torrance, *The Doctrine of Grace in the Apostolic Fathers* (Grand Rapids: Eerdmans, 1959), 90.

the idea a few years later: “Granted that he was not clever enough to become acquainted with all the dimensions of Old Testament thought, it is also obvious enough that he did not have the ability to grasp everything the apostles said either”⁷. It seems there is no real appreciation of Polycarp in modern scholarship. Kenneth Berding rightly points out in his summary that “scholars have tripped over each other to paint Polycarp as a simpleton”⁸. In his 1948 PhD thesis, Landon Miller wrote a quip that could pass as a bumper sticker summary of Polycarp: “Polycarp is not noted for his originality; he had no creative genius; he was a transmitter and not a maker; he did not dig wells; he only carried the water”⁹.

Having read the opinions of modern scholars, it is understandable why students at divinity schools are rarely introduced to Polycarp’s letter to the Philippians. This does not, however, answer the question of why Polycarp is held in such low esteem. It is true that both the style and language of his letter are plain: it is simple, easy to understand, and uses basic grammar. Commentators have also claimed that the topics he writes on are covered in more depth by other authors, specifically Paul or Ignatius, both of whom he imitates. He has also been accused of using a complete lack of rhetoric.¹⁰ It is unfortunate that what makes the letter a perfect example to be read by students in their lessons of κοινή Greek also disqualifies it as an object for theological study. Bauer consequently concludes that the letter is not a work of high theology.¹¹

7 Charles Nielsen, “Polycarp, Paul and the Scriptures,” *ATHR* 47 (1965): 199–216, 200.

8 Kenneth Berding, *Polycarp and Paul: An Analysis of Their Literary and Theological Relationship in Light of Polycarp’s Use of Biblical and Extra-Biblical Literature* (SVigChr 62; Leiden: Brill, 2002), 5.

9 David L. Miller, *An Anthology of the Theology of the Apostolic Fathers* (PhD diss., Southwestern Baptist Theological Seminary, 1948), 101.

10 Bauer, *Polykarpbriefe*, 12.

11 Bauer, *Polykarpbriefe*, 5: “Was Polykarp schrieb, ist kein Werk hoher Theologie, gibt aber einen wichtigen Einblick in die Situation der Kirche in Kleinasien im frühen 2. Jahrhundert.” In a similar way, Annegreth Bovon-Thurneysen concludes: “Der Brief an die Philipper des Polycarp wird in der heutigen Forschung allgemein als theologisch unbedeutendes Schriftstück beurteilt, das kaum einen originellen Gedanken enthält, sondern eine Aneinanderreihung von biblischen und außerkanonischen Zitaten darstellt. Von dieser Beurteilung her ist es sicherlich auch zu erklären, daß der Brief bisher fast nur in Bezug auf Einleitungsfragen untersucht worden ist. Dieser Vernachlässigung gegenüber stehen jedoch die urchristlichen Zeugnisse, die von Polycarp als einer bedeutenden geistigen Persönlichkeit reden. Polycarp wird vor allem als Zeuge der echten apostolischen Überlieferung beschrieben. Die Hochschätzung der Person des Polycarp im Altertum ist einer der Gründe, weshalb das einzige von ihm verbliebene Schriftstück auch in theologischer Hinsicht eine genaue Untersuchung verdient” (“Ethik und Eschatologie im Philipperbrief des Polykarp von Smyrna,” *ThZ* 29, 1973, 241–56, here 241).

This conclusion is made even more intriguing as the current and past receptions of Polycarp stand in stark contrast. Irenaeus, bishop of Lyon, who was born around 135 in Symrna, shares childhood memories of Polycarp in his letter to Florinus:

I can even describe the place where the blessed Polycarp used to sit and discourse – his going out, too, and his coming in – his general mode of life and personal appearance, together with the discourses which he delivered to the people; also, how he would speak of his familiar intercourse with John, and with the rest of those who had seen the Lord; and how he would call their words to remembrance. Whatsoever things he had heard from them respecting the Lord, both with regard to His miracles and His teaching, Polycarp having thus received from the eye-witnesses of the Word of life, would recount them all in harmony with the Scriptures. These things, through God's mercy which was upon me, I then listened to attentively, and treasured them up not on paper, but in my heart; and I am continually, by God's grace, revolving these things accurately in my mind (Eusebius, *Hist. eccl.* 5.20.6).

A similar evaluation of Polycarp can be found in Tertullian. He claims that Polycarp was inaugurated as bishop of Smyrna by John the apostle.¹² Both Irenaeus and Tertullian praise Polycarp as a defender of the faith, strongly opposed to heresy, and a balanced character when it came to negotiations. Polycarp died at an old age as a martyr in a spontaneous local uproar.¹³ What ultimately made him famous was the account of his martyrdom. It was the primer of a new literary genre, and it is commonly held that the worship of early Christian martyrs began with him.

3. The Common Patristic Research Perspective on Polycarp

When we turn back to recent receptions of Polycarp, of what is he actually being accused? One idea is that he lacks “vivid personal interests,” “originality,” and that he is not a “maker.” This obviously refers to Polycarp's cautious counseling in the letter. Ignatius is much more to the point, but he might have also been in a different situation and confronted with other issues. The second accusation calls Polycarp “not very clever” and “a commonplace person.” These claims are closely connected to one another, namely that Polycarp was both “lacking acquaintance with the Old Testament,” and unable to understand

¹² Tertullian, *Praescr.* 32.

¹³ Cf. Dehandschutter, *Polykarpbrief*, 131.

“what the apostles had said” and what forms “the basic principles of the new faith.”

This perception might rest on the fact that Polycarp never misses an opportunity to refer back to Paul, who founded the Philippian community. He almost always praises the community for its long tradition and for its wittiness. Towards the end of the letter Polycarp writes: “For I trust that you are well versed in the Sacred Scriptures, and that nothing is hid from you; but to me this privilege is not yet granted (12:1)”. The question is: does he really mean what he says, or is this an example of Polycarp’s supposedly non-existent rhetorical skills? One might also ask whether a church as important as Smyrna would respect a “commonplace person” as a bishop, and whether this person would actually be sent to Rome to negotiate questions of faith and practice.

If Polycarp was as plain, receptive, and uninventive as later commentators see him, the negotiations with Anicet, the bishop of Rome, on the Easter Controversy may have turned out differently. Polycarp, presumably the most important exponent of the Quartodecimans in Asia, went to Rome in about 156 to discuss when Easter should be celebrated with Anicet. Although they did not reach an agreement, neither of them regarded this as a reason to break off communion and initiate a schism. Irenaeus later notes in his letter to Victor:

But though matters were in this shape, they communed together, and Anicetus conceded the administration of the Eucharist in the church to Polycarp, manifestly as a mark of respect. And they parted from each other in peace, both those who observed, and those who did not, maintaining the peace of the whole church (Eusebius, *Hist. eccl.* 5.24.17).

A diplomatic negotiation is hardly what you would expect from a “commonplace person,” especially not regarding such a difficult matter. The two seem incompatible.

A fourth and last accusation provides one with an idea of what lies behind the general perception of Polycarp. He is said to be “a transmitter,” someone who is only “receptive,” who just “carries the water”. If we combine this last image with what we have learned from Irenaeus and Tertullian, it starts to make sense. A theologian who reads Tertullian’s and Irenaeus’ account cannot help thinking of *successio apostolica*, or an unbroken chain of witnesses. Polycarp becomes important for both being a martyr and being someone who stands in tradition. As Irenaeus phrased it: “Polycarp having thus received from the eye-witnesses the Word of life would recount them all in harmony with the Scriptures”¹⁴. That does not reflect someone who did not know the Scriptures,

¹⁴ Dirk Van Damme, “Polykarp von Smyrna,” *TRE* 27:25–28, 25: “Der Hinweis auf Polykarp hat bei Irenäus auch eine theologische Funktion: Neben der ‘institutionellen Sukzession’,

but only someone who, for unknown reasons, did not use them. In this case, the *argumentum e silentio* might simply be wrong.

Therefore, the larger picture is as follows: it is his life and death and his connection to the generation of the apostles rather than his writing that make Polycarp interesting for patristic and theological investigation. The writing of such an important witness would surely be searched for significant statements, for instance on opponents, heresies, and known scriptures, as these are issues that his generation faced. Other questions would be: what structural outline, what offices,¹⁵ what faith, even what liturgy did his church in Smyrna have? As Polycarp stands in the chain of transmission located at the edge of the New Testament, the question of which texts of the Old Testament and the emerging New Testament he knew and how he used them is of major importance, at least from a patristic point of view.¹⁶ The church historian's task is, of course, the development of the church.¹⁷ This perspective might be limited at second glance.

die er in jener der Bischöfe von Rom findet (*haer* III,3,3), weist er auch auf die 'Erinnerungssukzession' hin, die ebenfalls seine Lehre legitimiert".

- 15 Cf. Van Damme, *Polykarp von Smyrna*, 26: "Der Inhalt des Briefes besteht vor allem aus Reminiszenzen älterer christlicher Literatur. Polykarp kennt das Alte Testament nicht gut (Polyk 12,1), benutzt aber die Paulinen, die Pastoralbriefe, den 1. Petrus-, 1 Johannes- und 1 Clemensbrief. Das Hauptthema ist die 'Gerechtigkeit' (Polyk 3,1; 4,1; 9,1). Hauptübel ist die Geldsucht (4,1), der auch der Presbyter Valens und seine Gattin erlegen sein sollen (11); die einzig erwähnte Häresie ist der Dokerismus (7,1 mit Berufung auf 1 Joh 4,23f.). Polykarp bezeichnet sich selbst nicht als Bischof, scheint das Amt nicht zu kennen. Er wünscht, daß seine Adressaten '... den Presbytern und Diakonen wie Gott und Christus untertan [seien]...' (*Polyk* 5,3)".
- 16 In the sense of steps on the way to the canon, e.g. which scriptures did the author know and use? Frequently, this is connected with the distinction of Marcion's "canon". The purpose is clearly fueled by systematic or dogmatic considerations and leads to studies investigating 'dependencies,' which tend to ignore (a) the recent insights of text-critical and orality studies that the text of the New Testament is not as stable as it was long thought to be and (b) the results of literary studies and their impact on the investigation of text-text relations: "intertextuality." As Phillips and Aichele conclude, it "is not a matter of allusion or source tracking; it is a matter of transformation": Aichele George and Gary A. Phillips, "Exegesis, Eisegesis, Intergesis," in *Intertextuality and the Bible* (ed. George Aichele and Gary A. Phillips; Atlanta: SBL, 1995), 7–18, here 11.
- 17 Understood as a witness to the institutional development of Christianity or Christian institutions, cf. Dehandschutter, *Polykarpbrief*, 141: "Polyk ist ein kurzer Brief, geschrieben aus einem bestimmten Anlass, und kann nicht als Zusammenfassung wichtiger theologischer Themen, die in der ersten Hälfte des 2. Jh. gängig waren, gelten. Es macht daher kaum Sinn, ein solches Schreiben in die Entwicklung hin zum sogenannten 'Frühkatholizismus' einzuordnen. Der Brief lässt tatsächlich ein frühchristliches ekklesiologisches Verständnis erkennen". See also Van Damme, *Polykarp*, 27: "W. Bauer charakterisierte Polykarp als Kämpfer für die Einheit der kirchlichen Lehre und die Kirchenordnungen im Osten im Zusammenhang mit der Entwicklung des monarchischen Episkopats und den

This calls for a more detailed look. The main idea is that there is an unbroken chain of witnesses. In his letter to *Florinus*, Irenaeus mentions four generations: Jesus, John, Polycarp, and himself. For the patristic researcher, other witnesses of orthodox faith will follow, and names connected with heresy, for example, Marcion, are singled out. Such a chain of witnesses is a diachronic entity. The “patristic researcher” or “biblical scholar” of our time is located at the end of the chain, looking back on the entire sequence of events. The difference to second-century theologians is the location: on one hand, second-century theologians look back to the origins of Christianity, and on the other hand, as contemporaries, they are familiar with the situation of the text as it is similar to their own. Polycarp and the second-century theologians share almost the same context. This common framework gets lost in the patristic perspective. When it comes to Polycarp’s letter to the Philippians, patristics rarely considers the socio-historic context or investigate why Polycarp picked up ink and paper. They also rarely ask if some of his rhetoric and argumentation is because of Polycarp’s own social situation, the situation of the community, or the relationship he might have had with the Philippians. When it comes to reading an author like Polycarp, the standard historical approach is diachronic not synchronic. In other words, patristic readers are usually only informed by their own context.

Phrasing it in this way sounds as though Patristic research was strongly biased. Such an evaluation is too harsh and without regard for the achievements of generations of researchers. However, there seems to be a blind spot in the approach, and it is here that insight from Cultural Studies proves most helpful. This view is illustrated by the idea that there is “neither text nor interpreter without context”. Fernando Segovia, a Biblical scholar whose approach is informed by cultural studies, says that meaning emerges “as the result of an encounter between a socially and historically conditioned text and a socially and historically conditioned reader”¹⁸.

Taking Segovia’s insight seriously, it must be stated that the common patristic research perspective on Polycarp is less concerned with his social and historical conditions than its own. The danger of the diachronic perspective is

Ansprüchen der Kirche Roms. G. Strecker, der die zweite Auflage von Bauers Buch herausgab, hat diese Sicht scharf kritisiert; sie wird heutzutage als extrem oder gar phantasievoll angesehen. Polykarps Bedeutung liegt vielmehr in der Entwicklung des Märtyrerkults”.

18 Fernando F. Segovia, “Cultural Studies and Contemporary Bible Criticism: Ideological Criticism as Mode of Discourse,” in *Social Location and Biblical Interpretation in Global Perspective* (eds. Fernando F. Segovia and Mary A. Tolbert; vol. 2 of *Reading from This Place*; Minneapolis: Fortress Press, 1995), 1–17, 8.

that it is largely informed by the socio-historical context of modern researchers who tend to project their own worldview onto the texts. Contextual Historical Jesus Research and Social Memory Theory-informed perspectives on the formation of the Gospels reveals that “objective research” very often confuses presumptions, or “Vorverständnis”, and outcomes. The previously stated quotes are good examples of this scholarly bias.

To phrase it another way, every reader wears hermeneutical spectacles that determine the way he or she sees Polycarp’s letter to the Philippians. These spectacles are influenced by the reader’s own social context and bias. For example, a patristic reader would focus on the development of the early church, noting its organization, beliefs, liturgy, battle against paganism and heresy, and the scriptures it used. Polycarp’s impact on emerging Christianity is the main focus of these questions. This perspective is not entirely different from how Irenaeus and Tertullian looked back on Polycarp. Their reception was also diachronic and focused on Polycarp’s influence, but referencing him affected their theology and informed their writing.

For Irenaeus, Tertullian, and other second century theologians, Polycarp is important because his presence in the chain of witnesses helps to create a tradition that goes back to the origins of Christianity. This is a powerful weapon in the battle for the correct faith. To put it simply, building on Polycarp’s authority helps make the case for their side. Not because of his writing, but because of his martyrdom: being a witness for the orthodox faith.

Patristic readers have very different interests, as the conflict Irenaeus and Tertullian were engaged in is long over. For patristic readers, orthodoxy and heresy are history, not a current issue. From their perspective, the discussions of the second century are episodes in the longer history of the early church. *Nota bene*: for a long time, the research focus was the history of the early church, not the formation of early Christian identities. Therefore, it has often been more or less institutional history. This also explains why ecclesiastical implementations such as organization, liturgy, faith, and scripture tended to be more important than the actual socio-historical situations of the texts.

4. A Second Encounter with Polycarp’s Letter to the Philippians

Taking a second look at Polycarp’s letter to the Philippians, equipped with what we have learned from Fernando Segovia, and the “relecture” of the patristic reception, the focus will move to the socio-historical background of Polycarp, the ἐκκλησία at Philippi and how they are related.

The structure of Polycarp's letter to the Philippians is simple and consists of two main parts¹⁹. After opening with the usual introductions and acknowledging the request to write the letter, the first part consists of general exhortations for the conduct of the different groups in the community, and the second part is essentially a case study. The ending contains the normal "closing prayer" along with a note about copies of letters from Ignatius that Polycarp has enclosed at the communities' request. Polycarp closes with a recommendation of Crescens and his sister and then a final blessing.

As initially noted, the key issues of the letter are "righteousness", "love of money", "covetousness", and "patience." Polycarp and the Philippians of course knew the historical setting in which the letter was sent, but later readers are unaware of hidden agendas and have to closely examine the letter. These potential concealed meanings make the letter exciting. Polycarp likely has more to say than general exhortations, and this is clear early in the reading process, while discovering what is going on behind the scenes comes fairly late.²⁰ The meaning is revealed in the second main part toward the end of the letter, and after lengthy but normal exhortations:

Nimis contristatus sum pro Valente, qui presbyter factus est aliquando apud vos, quod sic ignoret is locum, qui datus est ei. Moneo itaque, ut abstinenceis vos ab avaritia et sitis casti et veraces. Abstinente vos ab omni malo (11:1).

Obviously, the reason the Philippians contacted Polycarp was not only for his thoughts on righteousness, but also because there was a real issue that needed resolving. *Valens* is, or at least was, a presbyter in the community, and there were financial wrongdoings that the text does not detail. It also seems that *Valens* has been released from office, but is still a member of the community. Therefore, the main questions seem to be: what should the community do now? What would be a *righteous* solution for these circumstances? Should *Valens* and his wife be excommunicated? Polycarp's counsel will be discussed shortly, after the following discussion.

19 Cf. Michael Theobald, "Paulus und Polykarp an die Philipper: Schlaglichter auf die frühe Rezeption des Basissatzes von der Rechtfertigung," in *Lutherische und Neue Paulusperspektive: Beiträge zu einem Schlüsselproblem der gegenwärtigen exegetischen Diskussion*, ed. Michael Bachmann, WUNT 182 (Tübingen: Mohr Siebeck, 2005), 349–88, 370.

20 In my experience this excitement of trying to find out what Polycarp was really up to is also shared by every group of modern readers with whom I have studied this text.

4.1 *Two Levels of Communication*

In 13:2, Polycarp states that he is enclosing copies of the letters of Ignatius at the Philippians' request, and that the contents of the letters will be beneficial. This short note is enlightening in two ways: first, it confirms that there is an exchange of letters or even collections of letters. From the perspective of cultural studies, this indicates that the Philippians were beginning to gather literary expressions of their "tradition" and saw themselves as part of a larger community. The way Polycarp introduces the enclosed letters indicates that they would become part of an archive that the Philippians will reference regarding their tradition, heritage, and identity. If this request is connected to the incident of members of the Philippian community escorting (προπέμψασιν, 1:1) "Ignatius, Zosimus, and Rufus," who were in chains along the *Via Egnatia*, the encounter must have had a huge impact on the community and the construction of their identity.

Second, noting that there is a rich exchange of letters and letter collections between the communities, Polycarp was confident that his letter would be read and discussed in the community of Philippi. When Polycarp prepared the main points of the letter, he was likely aware of the Philippian readers as well as the extended audience of ἀδελφοί, *i.e.* Christian brothers and sisters.

Therefore, the letter has not one, but two levels of communication: there is 1) the direct communication between Polycarp and the Philippians, and 2) the indirect communication with Polycarp and the extended audience. This wider audience includes communities within reach of the Philippians (*e.g.* Thessaloniki), and (as the letter is very likely to be stored with the other letters) later generations of Christians who will reengage with the letter, just as the Philippians learn from the letters of Ignatius that Polycarp enclosed. Christian communities compiling and saving meaningful letters is not new. In 2 Pet 3:16 there are hints of a collection of Pauline letters, and Col 4:16 urges the Colossians to exchange letters with the ἐκκλησία of Laodicea. Authors writing after the Pauline times are aware of the extended audience and use this knowledge in their letters.

When asked for remarks on δικαιοσύνη, this means that Polycarp knows that the advice he gives for dealing with the case of *Valens* could be regarded as a solution for similar cases. It is likely that Polycarp even used the Philippian's request and the case of *Valens* to speak to a broader meaning applicable for all Christians.²¹

21 Cf. Boudewijn A.G.M. Dehandschutter, "Polycarp's Epistle to the Philippians: An Early Example of 'Reception,'" in *The New Testament in Early Christianity* (ed. Jean-Marie Sevrin; Leuven: Leuven University Press, 1989), 275–91, 279.

4.2 *Theological Argument*

When Polycarp encourages the Philippians to have blameless dealings with the Gentiles in 10:2–3, the echo to the teachings of Matthew’s Gospel on both *δικαιοσύνη* and the handling of difficult situations among community member cannot be missed. Polycarp’s appeal to sort out the case of *Valens* among themselves echoes the Matthean *Sermon on the Mount* and the teaching about forgiving sins in Matthew 18.

Similar to the Matthean Jesus, Polycarp argues on the basis of reciprocity. “When we entreat the Lord to forgive us, we ought also ourselves to forgive”, he writes in 6:2, “because everyone will have to appear at Christ’s judgement-seat to give account”. In 8:1–2, when Polycarp calls Jesus “the pledge of righteousness”, the argument becomes clear and applicable. The faithful are enabled to forgive because they have experienced forgiveness and are called to pass on what they have received. The Philippians are called to “righteousness” (*δικαιοσύνη*) and “patience” (*ὑπομονή*) because in Christ, though his death and resurrection (2:2; 8:1), they have been saved. Living up to this grace-filled salvation means following Jesus, and the way to follow Jesus is the path of righteousness (6:2; 8:2; 10:1–2).

As previously stated, righteousness is never theoretical. Polycarp practically applies the concept for different groups in the community: husbands and wives, widows and deacons, youths and virgins, and presbyters. One of the keywords is *φιλαργυρία*. Next to *ἀδικία* (unrighteousness) and *πλεονεξία* (covetousness), it is placed at the beginning of the list of sins in 2:1. *Φιλαργυρία* is the opener of the *paraenesis* in 4:1, and the exhortations for widows (4:3), deacons (5:2), and presbyters (6:1) are also concerned with it. As one commentator remarks, it seems as if Polycarp interpreted the selected topic *περὶ τῆς δικαιοσύνης* meaning *περὶ τῆς φιλαργυρίας*.²²

What could be seen as a random list of topics has an actual purpose. Polycarp carefully sets the scene: the presbyters should be avoiding the love of money (*μακρὰν ὄντες φιλαργυρίας*, 6:1). They should not be quick to believe evil words against someone, nor should they be severe in punishment, for *πάντες ὀφειλέται ἐσμὲν ἁμαρτίας*, meaning, we are all sinners. Therefore, when we ask for forgiveness, we owe forgiveness to others as well, and this is a major part of *δικαιοσύνη*. The unbiased second-century reader would have viewed this as an isolated teaching, only to realize a few chapters later that this also applies to the *Valens* case.

22 Peter Pilhofer, *Die erste christliche Gemeinde Europas* (WUNT 87; vol. 1 of *Philippi*; Tübingen: Mohr Siebeck, 1995), 222.

Taking a pastoral approach, Polycarp argues that the conduct of Valens and his wife hurts the whole community. “Love of money” and “covetousness” are very common and endanger everyone in the community, as Polycarp’s counsel to husbands, wives, widows, deacons, and presbyters says clearly. The seriousness of the case is not downplayed, and Polycarp reminds the community, “we are all under a debt of sin” (6:1). This knowledge is something that everyone has to work out together. Other than heretics, who have to be singled out, *Valens* and his wife are not enemies, only “suffering and straying members” (11:4), who should be saved for the sake of the whole body, an image Polycarp clearly borrows from Paul’s famous body metaphor (1 Corinthians 12).

There is not a clear answer for the situation regarding money. The legal recourse open to the Pagans is not an option for the Philippian community, and Polycarp does not want them to appear like Pagans.²³ If the community viewed Polycarp as their patron, they may have been disappointed. Polycarp is concerned with the Philippian community and counsels them to find a way to deal with the issue on the basis of their Christian tradition.

4.3 *Christian Tradition*

This striking reference to Christian tradition is implicit in the text. When Polycarp refers to the long history of the Philippian community and its foundation in Pauline teaching, Paul’s letters, and the chain of witnesses from Paul to Ignatius and himself (6:3), he’s referring to an already existing Christian tradition the Philippians can build on (12:1).

Polycarp’s reference to a genuinely Christian tradition is a better explanation for the absence of quotes from the Old Testament than the Patristic suspicion about Polycarp’s unfamiliarity with it. Another reason could be the context of the Philippian community. As their framework is Pagan, Israel’s Scriptures are only part of their cultural identity because they are part of the Christian tradition. Therefore, Christian authorities like the Lord’s sayings (2:3; 7:1), Paul (3:2), and Ignatius would have had a greater impact in this community than the Old Testament, which is not part of their cultural memory.²⁴ Looking back

23 Cf. Pilhofer, *Philippi* 1, 222–223.

24 If this is true, the classic Patristic question of whether it is possible to reconstruct Polycarp’s knowledge of Scripture from his letter to the Philippians is biased, and *PolPhil* 12:1 is of no help to answer this question. Why should Polycarp quote the Old Testament when writing to a group whose cultural frame of reference does not include these traditions? Paul was likewise reluctant to quote Scripture in Philippians. One might wonder whether early Christian authors are allowed to use the phrase “sacred scripture” without everybody asking questions about canon. Cf. Dehandschutter, *Polykarpbrief*, 140: “Wir müssen davon ausgehen, dass Polykarps Rezeption der frühchristlichen Tradition nicht

from Polycarp, the initial encounter with Christ, the foundation of the community in Philippi, and the letter(s) they exchanged with Paul come dangerously close to the limitations of a three-generation-memory, either social or collective. This is described as the “floating gap” in orality studies and social memory theory, a period that witnesses to a change in dealing with what happened long ago.²⁵

Research about how communities develop and change based on the stories they share has contributed to knowledge about group dynamics more broadly. When groups move through time, changes occur. What is initially regarded as a recent event becomes “the past.” In the beginning, it is still perceived as “recent past” and group members have vivid and variegated memories of what was a crucial experience or a formative moment for them. Over time, these memories become more distant and eventually move to more “remote past” and even “far remote past,” to which they no longer have a living connection, only a mediated one. Individual group members no longer have personal recollections, and they do not know anyone who does, although there is a basic knowledge of critical historical moments. They also know why these moments were crucial, and what they mean for the community today. The road from a vivid connection to the foundational events to a more conventionalized cultural knowledge is rather short: It takes no more than three to four generations.

On this road from a vivid connection to the formative occurrences to conventionalized cultural knowledge, a group experiences two moments of crisis. The first moment is when the generation of those who have experienced these crucial moments, *i.e.* the grandparents, slowly hand over responsibility and retire. This usually happens 30 to 50 years after the events, and this crisis

im Lichte einer Kanonbildung beurteilt werden soll”. Michael W. Holmes’ refreshingly sobering conclusion is right to the point: “In short, we do know that Polycarp used a number of documents that are now part of the Pauline corpus; we do not know, however, the answers to the further questions this knowledge raises” *Polycarp’s Letter to the Philippians and the Writings that Later Formed the New Testament*, in Michael W. Holmes, “Polycarp’s Letter to the Philippians and the Writings that Later Formed the New Testament,” in *The Reception of the New Testament in the Apostolic Fathers*. (eds. Andrew F. Gregory and Christopher M. Tuckett; Oxford: Oxford University Press, 2007), 187–227, here 227.

25 The following paragraphs are borrowed from Sandra Huebenthal, “Proclamation rejected, truth confirmed: Reading John 12:37–44 in a social memory theoretical framework,” (ed. Thomas R. Hatina; in vol. 4 of *Biblical Interpretation in Early Christian Gospels: The Gospel of John*; London: T&T Clark, 2019), 183–200. For a comprehensive introduction into the underlying theory and general hermeneutical reflections cf. Huebenthal, *Reading Mark’s Gospel*, 85–178 and Sandra Huebenthal, “Frozen Moments’ – Early Christianity through the Lens of Social Memory Theory,” in *Memory and Memories in Early Christianity*, eds. Simon Buttica and Enrico Norelli, WUNT 398 (Tübingen: Mohr Siebeck, 2018), 17–43.

is called the *generational gap*. When the generation of the grandparents dies and the second generation of the parents moves into retirement, handing over responsibility to their own children, a second moment of crisis arises. After roughly 80 to 120 years, the group moves into what is called the *floating gap*. Three generations have passed since the beginning when the grandchildren ran the business as adults.

When this generation of the grandchildren takes over responsibility and raises their own children, the fourth generation, in the customs and traditions of the group, the identity of the group and the development of their frames of reference finally become visible. Is it still the fire that is passed on or are we dealing with the ashes? It is easy to see that the *floating gap* is the most dangerous moment in the life of a group. One of the most interesting periods, on the other hand, is the time between *generational gap* and the *floating gap*. This is the moment when most of the negotiation and re-negotiation of the group's history, customs, and values take place and when it is decided if and how this "common past" is treasured. This period is most interesting to New Testament scholars because it is the time when most of the New Testament books were written. Regardless of the letter's exact dating, Polycarp writes in close temporal proximity to the latest New Testament authors.

In his tradition-historical study – which is about dependence and influence, and thus does not engage with intertextuality and its hermeneutics – Kenneth Berding suggests that "Polycarp drew upon three streams of authority, the OT Scriptures, the teaching of Christ, and the apostolic writings (among which the Pauline writings are used the most). He did not seem to yet be asking the question of whether the apostolic writings were on the same level of as the OT, though he clearly considered them binding upon his own actions and those of his readers"²⁶. In other words, Polycarp used different sources of tradition to make his argument, some being part of the shared cultural heritage of the early Jesus followers (*i.e.* their cultural memory) like Israel's Scriptures, and some more recent and part of the three-generation collective memory of the early Jesus followers, like the teachings of the Lord (which does not necessarily point to written gospels) and the apostolic writings. It is interesting to see that the living voice of the Lord and the reference to the person Paul are still more important for Polycarp than the foundational narratives of the written gospels. When I read this within a memory-theoretical framework, it seems to suggest that, with Polycarp, we are on the cusp of the *floating gap* and the formation of a genuinely *Christian* cultural memory.

26 Berding, *Polycarp and Paul*, 190.

In this letter, Berding concludes, Polycarp imitates Paul. Berding provides no other possible reason for this imitation other than the Philippians' request to Polycarp to "write to them 'as Paul did' in the past" about righteousness, which explains this μίμησις.²⁷ As we have seen, social memory theory can offer a better approach regarding why Polycarp imitated Paul and to what end. The notion that Polycarp deliberately aimed to build on a *Christian* tradition has also been observed by Boudewijn Dehandschutter: "Polycarp was primarily looking for a specifically *Christian* paraenetical tradition, capable also of being similarly identified by the Philippians"²⁸. In other words, Polycarp built upon a specifically *Christian* cultural memory. This notion also locates Polycarp near the *floating gap* as he can – in addition to the Deutero-Pauline and Catholic Letters²⁹ – indeed build on such a shared tradition.

What social memory theory has empirically demonstrated and also crafted into theory is a helpful hermeneutical lens for reading the New Testament times as the formative period of Christianity, and it has also pointed out what is at stake in the early and mid-second century. The knowledge about the typical mechanisms in groups at the time of the *floating gap* combined with the dating of Polycarp's letter to the Philippians explains why Polycarp refers back to Paul as the founding or first generation for him and the Philippians. On the basis of this common heritage, Polycarp outlines a *Christian* identity in the first part of his letter before he addresses the *Valens* case on that foundation in the letter's second part and leaves it to the Philippians to properly apply it. It is well worth exploring the idea of whether the Christian writings of the early to mid-second century offer additional material that could be understood as attempts to bridge the floating gap.

27 Berding, *Polycarp and Paul*, 187. A similar argument can be found in Jonathon Lookadoo, "Polycarp, Paul, and the Letters to Timothy," *NovT* 59 (2017): 366–83. Both arguments share the same desideratum that they cannot explain why Polycarp operates the way he does.

28 Dehandschutter, *Polycarp's Epistle*, 285 emphasis original. Dehandschutter is likewise to the point when he concludes: "Before the middle of the century we cannot expect Polycarp to quote the first Gospel under the name of the apostle! The Gospel has authority because it contains the teaching of the Lord" (288).

29 For pseudepigraphy as a strategy in Early Christian Identity Discourses cf. Sandra Huebenthal, *Pseudepigraphie als Strategie in frühchristlichen Identitätsdiskursen? Überlegungen am Beispiel des Kolosserbriefs*, *SNTUA* (2011): 63–94.

5. Conclusions

What is the benefit of a cultural-scientific *close reading* of Polycarp's letter? First insights from such a reading are (a) that Polycarp is not writing a dogmatic tract, but addresses a concrete issue. The exhortation nevertheless has a *catholic* claim; (b) that the social context of the Philippian community has to be taken into account to understand the pragmatics of the letter; (c) that it becomes obvious that the argument is made in the light of a genuinely *Christian* tradition, not drawing from Judeo-Hellenistic models. Christ, the apostles, and martyrs serve as examples. This is a good explanation for why there is little reference to the Old Testament. It is not part of the Philippians' cultural memory. Finally, (d) in connection with the note on the copies of letters Polycarp encloses, the letter is an interesting snapshot of early Christian identity formation.

These first insights help us understand how cultural studies in general and, when it comes to cultural frames, social memory theory in particular can enhance patristic research. The common patristic approach is rather focused on the development of the early Church and Polycarp's impact and function for emerging Christianity. Cultural Studies, on the other hand, are intrigued by the context of texts and readers, focusing on the socio-historical, cultural, and religious situation of Polycarp and the Philippians. Their main interest is to find out more about early Christian identities, which they do not regard as a monolithic block, but as a variety of concepts. They are concerned with the question how tradition and identity are negotiated and adapted to new situations. The two different sets of questions are not mutually exclusive, but focus on different aspects. Combined, they help us achieve deeper insight and a more balanced understanding of the formation of Early Christianities and Christian identities in the early church.

Bibliography

- Achtemeier, Paul J., Joel B. Green, and Marianne Meye Thompson. *Introducing the New Testament: Its Literature and Theology*. Grand Rapids: Eerdmans, 2001.
- Aichele George, and Phillips, Gary A. "Exegesis, Eisegesis, Intergesis." Pages 7–18 in *Intertextuality and the Bible*. Edited by George Aichele and Gary A. Phillips. Atlanta: SBL, 1995.
- Alkier, Stefan. "Auferweckung denken; oder, Wie das Markusevangelium mit seinen Wundergeschichten seine Leser theologisch bildet." *BL* 84 (2011): 258–67.
- Alkier, Stefan. "Der 1. Thessalonicherbrief als kulturelles Gedächtnis." Pages 175–94 in *Logos und Buchstabe: Mündlichkeit und Schriftlichkeit im Judentum und Christentum der Antike*. Edited by Gerhard Sellin and François Vouga. Texte und Arbeiten zum neutestamentlichen Zeitalter 20. Tübingen: Narr, 1997.
- Apostolic Constitutions*. Translated by James Donaldson. Vol. 7 of *From Ante-Nicene Fathers*. Edited by Alexander Roberts, James Donaldson, and Arthur Cleveland Coxe. Buffalo, NY: Christian Literature Publishing Co., 1886. Rev. and enl. ed. for New Advent by Kevin Knight. <http://www.newadvent.org/fathers/0715.htm>.
- Assmann, Aleida. *Cultural Memory and Western Civilization: Functions, Media, Archives*. Translated by David Henry Wilson. Cambridge: Cambridge University Press, 2011.
- Assmann, Aleida. *Einführung in die Kulturwissenschaft: Grundbegriffe, Themen, Fragestellungen*. Berlin: Erich Schmidt, 2006. 2008².
- Assmann, Aleida. *Erinnerungsräume: Formen und Wandlungen des kulturellen Gedächtnisses*. Munich: Beck, 1999.
- Assmann, Aleida. "Soziales und kollektives Gedächtnis." Vortrag im Panel 2 "Kollektives und soziales Gedächtnis" bei der Tagung "Kulturelles Gedächtnis. China zwischen Vergangenheit und Zukunft. Internationale Konferenz zum künstlerischen und politischen Umgang mit der eigenen Geschichte in China" der Bundeszentrale für politische Bildung 2006 <http://www.bpb.de/files/0FW1JZ.pdf>.
- Assmann, Aleida. "Wie wahr sind Erinnerungen?" Pages 103–22 in *Das soziale Gedächtnis: Geschichte, Erinnerung, Tradierung*. Edited by Harald Welzer. Hamburg: Hamburger Edition, 2001.
- Assmann, Jan. "Communicative and Cultural Memory." Pages 109–18 in *Cultural Memory Studies: An International and Interdisciplinary Handbook*. Edited by Astrid Erll and Ansgar Nünning. Media and Cultural Memory 8. Berlin: De Gruyter, 2008.
- Assmann, Jan. *Cultural Memory and Early Civilization: Writing, Remembrance, and Political Imagination*. Translated by David Henry Wilson. Cambridge: Cambridge University Press, 2011. (See *Das kulturelle Gedächtnis*.)
- Assmann, Jan. *Das kulturelle Gedächtnis: Schrift, Erinnerung und politische Identität in frühen Hochkulturen*. Munich: Beck, 2005⁵.

- Assmann, Jan. *Exodus: Die Revolution der Alten Welt*. Darmstadt: Wissenschaftliche Buchgesellschaft, 2015.
- Assmann, Jan. *Religion und kulturelles Gedächtnis*. Zehn Studien. Munich: Beck, 2004².
- Assmann, Jan. "Das kollektive Gedächtnis zwischen Körper und Schrift. Zur Gedächtnistheorie von Maurice Halbwachs." Pages 65–83 in *Erinnerung und Gesellschaft: Mémoire et Société: Hommage à Maurice Halbwachs (1877–1945)*. Edited by Hermann Krapoth and Dennis Laborde. Jahrbuch für Soziologiegeschichte. Wiesbaden: Springer, 2005.
- Aune, David E. "Jesus Tradition and the Pauline Letters." Pages 63–86 in *Jesus in Memory, Traditions in Oral and Scribal Perspectives*. Edited by Werner H. Kelber and Samuel Byrskog. Waco: Baylor, 2008.
- Backhaus, Knut, and Gerd Häfner. *Historiographie und fiktionales Erzählen: Zur Konstruktivität in Geschichtstheorie und Exegese*. Biblisch-theologische Schwerpunkte 86. Neukirchen-Vluyn, Neukirchener Verlag, 2007.
- Barclay, John M.G. "Mirror-Reading a Polemical Letter: Galatians as a Text Case," *JSNT* 31 (1987): 73–93.
- Bartlett, Frederic Charles. *Remembering: A Study in Experimental and Social Psychology*. Cambridge: University Press, 1932.1995.
- Bauer, Johannes B. *Die Polykarpbriefe*. Translated by Johannes Baptist Bauer. Göttingen: Vandenhoeck & Ruprecht, 1995.
- Becker, Eve-Marie. "Von Paulus zu 'Paulus': Paulinische Pseudepigraphie-Forschung als literaturwissenschaftliche Aufgabe." Pages 363–86 in *Pseudepigraphie und frühchristliche Verfasserfiktion/Pseudepigraphy and Author Fiction in Early Christian Letters*. Edited by Jörg Frey, Jens Herzer, Martina Janßen and Claire Rothschild. Wissenschaftliche Untersuchungen zum Neuen Testament 246. Tübingen: Mohr Siebeck, 2009.
- Becker, Eve-Marie. "Ως δι' ἡμῶν in 2 Thess 2,2 als Hinweis auf einen verlorenen Brief." *NTS* 55,1 (2009): 55–72.
- Berding, Kenneth. *Polycarp and Paul: An Analysis of Their Literary and Theological Relationship in Light of Polycarp's Use of Biblical and Extra-Biblical Literature*. Vigiliae Christianae, Supplements 62. Leiden: Brill, 2002.
- Beutler, Johannes. *Das Johannesevangelium. Kommentar*. Freiburg im Breisgau: Herder, 2016².
- Beutler, Johannes. "Die Berufung des Andreas und des Philippus nach dem Johannesevangelium (Joh 1.35–46)." *NTS* 65 (2019): 461–76.
- Beutler, Johannes. "Das universale Heil in Christus nach dem Kolosserbrief." *GuL* 67 (1994): 403–13.
- Beutler, Johannes. "Greeks come to see Jesus (John 12,20f)." *Bib* 71 (1990): 333–47.
- Beutler, Johannes. "La muerte de Jesús y su exaltación," *RCT* 92 (2018): 143–57.

- Bosenius, Bärbel. *Der literarische Raum des Markusevangeliums*. Wissenschaftliche Monographien zum Alten und Neuen Testament 140. Neukirchen-Vluyn: Neukirchener Verlag, 2014.
- Bovon-Thurneysen, Annegreth. "Ethik und Eschatologie im Philipperbrief des Polykarp von Smyrna." *ThZ* 29 (1973): 241–56.
- Brendsel, Daniel J. *Isaiah saw his glory: the use of Isaiah 52–53 in John 12*. Beihefte zur Zeitschrift für die neutestamentliche Wissenschaft 208. Berlin: De Gruyter, 2014.
- Breytenbach, Cilliers. "Christus litt euretwegen: Zur Rezeption von Jes 53 im 1. Petrusbrief." Pages 437–54 in *Deutungen des Todes Jesu im Neuen Testament*. Edited by Jörg Frey and Jens Schröter. Tübingen: Mohr Siebeck, 2012².
- Broer, Ingo, and Hans-Ulrich Weidemann. *Einleitung in das Neue Testament*. Würzburg: Echter, 2010³.
- Burkett, Delbert Royce. *An Introduction to the New Testament and the origins of Christianity*. New York: Cambridge University Press, 2002.
- Collins, Adela Yarbro. *Mark: A Commentary*. Hermeneia. Minneapolis: Fortress, 2007.
- Conzelmann, Hans, and Andreas Lindemann. *Arbeitsbuch zum Neuen Testament*. Tübingen: Mohr Siebeck, 2004¹⁴.
- Crüsemann, Marlene. *Die pseudepigraphen Briefe an die Gemeinde in Thessaloniki: Studien zu ihrer Abfassung und zur jüdisch-christlichen Sozialgeschichte*. Beiträge zur Wissenschaft vom Alten und Neuen Testament 191. Stuttgart: Kohlhammer, 2010.
- Dehandschutter, Boudewijn A.G.M. "Der Polykarpbrief." Pages 130–46 in *Die Apostolischen Väter: Eine Einleitung*. Edited by Wilhelm Pratscher. Göttingen: Vandenhoeck & Rupprecht, 2009.
- Dehandschutter, Boudewijn A.G.M. "Polycarp's Epistle to the Philippians: An Early Example of 'Reception'." Pages 275–91 in *The New Testament in Early Christianity*. Edited by Jean-Marie Sevrin. Leuven: Leuven University Press, 1989.
- Deppe, Dean B. "Markan Christology and the Omission of $\nu\acute{\iota}\omicron\varsigma\ \theta\epsilon\omicron\upsilon$ in Mark 1:1." *EFN* 21 (2008): 45–64.
- Dettwiler, Andreas. "La deuxième épître aux Thessaloniens." Pages 293–303 in *Introduction au Nouveau Testament: Son histoire, son écriture, sa théologie*. Edited by Daniel Marguerat. Le Monde de la Bible 41. Geneva: Labor et Fides, 2000.
- Dettwiler, Andreas. "L'épître aux Colossiens." Pages 265–77 in *Introduction au Nouveau Testament: Son histoire, son écriture, sa théologie*. Edited by Daniel Marguerat. Le Monde de la Bible 41. Geneva: Labor et Fides, 2000.
- Dewey, Arthur J. "The Locus for Death: Social Memory and the Passion Narrative." Pages 111–28 in *Memory, Tradition, and Text: Uses of the Past in Early Christianity*. Edited by Alan Kirk and Tom Thatcher. Semitistische Studien 52. Atlanta: Society of Biblical Literature, 2005.

- Dewey, Arthur J. "The memorable invention of the death of Jesus." *HTS* 72(4) (2016).
- Du Toit, David S. *Der abwesende Herr: Strategien im Markusevangelium zur Bewältigung der Abwesenheit des Auferstandenen*. Wissenschaftliche Monographien zum Alten und Neuen Testament 111. Neukirchen-Vluyn: Neukirchener Verlag, 2006.
- Du Toit, David S. "'Gesalbter Gottessohn' – Jesus als letzter Bote Gottes: Zur Christologie des Markusevangeliums." Pages 37–50 in "... was ihr auf dem Weg verhandelt habt": *Beiträge zur Exegese und Theologie des Neuen Testaments: FS Ferdinand Hahn*. Edited by Peter Müller and Christine Gerber. Neukirchen-Vluyn, Neukirchener Verlag, 2001.
- Du Toit, David S. "Treasuring Memory: Narrative Christology in and beyond Mark's Gospel: Miracle-Traditions as Test Case." *EC* 6 (2015): 334–53.
- Dunn, James D.G. "Altering the Default Setting: Re-envisaging the Early Transmission of the Jesus Tradition." *NTS* 49 (2003): 139–75.
- Ebner, Martin. "Das Markusevangelium." Pages 154–83 in *Einleitung in das Neue Testament*. Edited by Martin Ebner and Stefan Schreiber. Stuttgart: Kohlhammer, 2008.
- Ebner, Martin. "Der Philemonbrief." Pages 397–407 in *Einleitung in das Neue Testament*. Edited by Martin Ebner and Stefan Schreiber. Stuttgart: Kohlhammer, 2008.
- Ebner, Martin. "Von den Anfängen bis zur Mitte des 2. Jahrhunderts." Pages 15–57 in *Von den Anfängen bis zum Mittelalter*. Edited by Thomas Kaufmann, Raymund Kottje, Bernd Moeller and Hubert Wolf. Ökumenische Kirchengeschichte 1. Darmstadt: Wissenschaftliche Buchgesellschaft, 2006.
- Ebner, Martin, and Stefan Schreiber, eds. *Einleitung in das Neue Testament*. Stuttgart: Kohlhammer, 2008.
- Eckey, Wilfried. *Das Markusevangelium: Orientierung am Weg Jesu: Ein Kommentar*. Neukirchen-Vluyn: Neukirchener Verlag, 2008².
- Eco, Umberto. *Im Wald der Fiktionen. Sechs Streifzüge durch die Literatur*. Munich: Hanser, 1994.
- Ehrman, Bart D., *Forgery and Counterforgery: The Use of Literary Deceit in Early Christian Polemics*. Oxford: Oxford University Press, 2013.
- Ehrman, Bart D. *The New Testament. A Historical Introduction to the Early Christian Writings*. New York: Oxford University Press, 2012⁵.
- Erl, Astrid and Ansgar Nünning, eds. *Cultural Memory Studies: An International and Interdisciplinary Handbook*. Berlin: De Gruyter, 2008.
- Erl, Astrid. "Cultural Memory Studies: An Introduction." Pages 1–15 in *Cultural Memory Studies: An International and Interdisciplinary Handbook*. Edited by Astrid Erl, Ansgar Nünning and Sarah B. Young. Media and Cultural Memory 8. Berlin: De Gruyter, 2008.
- Ernst, Josef. *Die Briefe an die Philipper, an Philemon, an die Kolosser, an die Epheser*. Regensburger Neues Testament 12. Regensburg: Pustet, 1974.

- Evans, Craig A. "From Gospel to Gospel: The Function of Isaiah in the New Testament." Pages 651–691 in vol. 2 of *Writing and Reading the Scroll of Isaiah: Studies of an interpretative Tradition*. Edited by Craig C. Broyles and Craig A. Evans. Leiden: Brill, 1997.
- Focant, Camille. *The Gospel according to Mark*. Eugene, OR: Wipf & Stock, 2012.
- Förster, Hans. "Ein Vorschlag für ein neues Verständnis von Joh 12,39–40." *ZNW* 109 (2018): 51–75.
- Förster, Niclas. "Der titulus crucis: Demütigung der Judäer und Proklamation des Messias." *NT* 56 (2014): 113–33.
- France, Richard T. *The Gospel of Mark: A Commentary on the Greek Text*. New international Greek Testament commentary 2. Grand Rapids: Eerdmans, 2002.
- Frank, Nicole. *Der Kolosserbrief im Kontext des paulinischen Erbes: Eine intertextuelle Studie zur Auslegung und Fortschreibung der Paulustradition*. Wissenschaftliche Untersuchungen zum Neuen Testament II 271. Tübingen: Mohr Siebeck, 2009.
- Frank, Nicole. "Der Kolosserbrief und die 'Philosophia': Pseudepigraphie als Spiegel frühchristlicher Auseinandersetzungen um die Auslegung des paulinischen Erbes." Pages 411–32 in *Pseudepigraphie und frühchristliche Verfasserfiktion/Pseudepigraphy and Author Fiction in Early Christian Letters*. Edited by Jörg Frey, Jens Herzer, Martina Janßen and Claire Rothschild. Wissenschaftliche Untersuchungen zum Neuen Testament 246. Tübingen: Mohr Siebeck, 2009.
- Frankemölle, Hubert. *Frühjudentum und Urchristentum: Vorgeschichte – Verlauf – Auswirkungen (4. Jahrhundert v.Chr. bis 4. Jahrhundert n.Chr.)*. Stuttgart: Kohlhammer, 2006.
- Frankemölle, Hubert. "Jesus als deuterojesajanischer Freudenbote? Zur Rezeption von Jes 52,7 und 61,1 im Neuen Testament, durch Jesus und in den Targumim." Pages 34–67 in *Vom Urchristentum zu Jesus: Für Joachim Gnilka (zum 60. Geburtstag am 8.12.1988)*. Edited by Hubert Frankemölle. Stuttgart: Herder, 1989.
- Frenschkowski, Marco. "Erkannte Pseudepigraphie? Ein Essay über Fiktionalität, Antike und Christentum." Pages 181–232 in *Pseudepigraphie und frühchristliche Verfasserfiktion/Pseudepigraphy and Author Fiction in Early Christian Letters*. Edited by Jörg Frey, Jens Herzer, Martina Janßen and Claire Rothschild. Wissenschaftliche Untersuchungen zum Neuen Testament 246. Tübingen: Mohr Siebeck, 2009.
- Frenschkowski, Marco. "Pseudepigraphie und Paulusschule: Gedanken zur Verfasserschaft der Deuteropaulinen, insbesondere der Pastoralbriefe." Pages 239–72 in *Das Ende des Paulus: Historische, theologische und literaturgeschichtliche Aspekte*. Edited by Friedrich Wilhelm Horn. Beihefte zur Zeitschrift für die neutestamentliche Wissenschaft 106. Berlin: De Gruyter, 2001.
- Frey, Jörg. "Das Bild 'der Juden' im Johannesevangelium und die Geschichte der johanneischen Gemeinde." Pages 33–53 in *Israel und seine Heilstraditionen im Johannesevangelium: Festgabe für Johannes Beutler zum 70. Geburtstag*. Edited by

- Michael Labahn, Klaus Scholtissek and Angelika Strotmann. Paderborn: Ferdinand Schöningh, 2004.
- Frey, Jörg. "Autorfiktion und Gegnerbild im Judasbrief und im Zweiten Petrusbrief." Pages 683–732 in *Pseudepigraphie und frühchristliche Verfasserfiktion/Pseudepigraphy and Author Fiction in Early Christian Letters*. Edited by Jörg Frey, Jens Herzer, Martina Janßen and Claire Rothschild. Wissenschaftliche Untersuchungen zum Neuen Testament 246. Tübingen: Mohr Siebeck, 2009.
- Frey, Jörg, Jens Herzer, Jens, Janßen, Martina, and Claire Rothschild, eds. *Pseudepigraphie und frühchristliche Verfasserfiktion/Pseudepigraphy and Author Fiction in Early Christian Letters*. Wissenschaftliche Untersuchungen zum Neuen Testament 246. Tübingen: Mohr Siebeck, 2009.
- Fried, Johannes. *Der Schleier der Erinnerung: Grundzüge einer historischen Memorik*. Munich: Beck, 2004.
- "Max Frisch." Pages 23–37 in *Horst Bienek: Werkstattgespräche mit Schriftstellern*. Munich: dtv 1965.
- Frisch, Max. *A Wilderness of Mirrors*. Translated by Michael Bullock. London: Methuen, 1965.
- Frisch, Max. *Mein Name sei Gantenbein*. Frankfurt am Main: Suhrkamp, 2000²⁸.
- Frisch, Max. *Schwarzes Quadrat: Zwei Poetikvorlesungen*. Frankfurt am Main: Suhrkamp, 2008.
- Frisch, Max. "Unsere Gier nach Geschichten." Pages 262–64 in vol. 4 of *Gesammelte Werke in zeitlicher Folge*. Edited by Hans Mayer. Frankfurt am Main: Suhrkamp, 1986.
- Genz, Rouven. *Jesaja 53 als theologische Mitte der Apostelgeschichte: Studien zu ihrer Christologie und Ekklesiologie im Anschluss an Apg 8,26–40*. Wissenschaftliche Untersuchungen zum Neuen Testament II 389. Tübingen: Mohr Siebeck, 2015.
- Gergen, Kenneth. "Erzählung, Moralische Identität und historisches Bewusstsein." Pages 170–202 in *Erzählung, Identität, Historisches Bewusstsein*. Edited by Jürgen Straub. Frankfurt am Main: Suhrkamp, 1998.
- Glaser, Timo. "Erzählung im Fragment: Ein narratologischer Ansatz zur Auslegung pseudepigrapher Briefbücher." Pages 267–94 in *Pseudepigraphie und frühchristliche Verfasserfiktion/Pseudepigraphy and Author Fiction in Early Christian Letters*. Edited by Jörg Frey, Jens Herzer, Martina Janßen and Claire Rothschild. Wissenschaftliche Untersuchungen zum Neuen Testament 246. Tübingen: Mohr Siebeck, 2009.
- Gnilka, Joachim. *Der Kolosserbrief*. Edited by Joachim Gnilka, Rudolf Pesch, Heinz Schürmann and Rudolf Schnackenburg. Herders theologischer Kommentar zum Neuen Testament 10. Freiburg im Breisgau: Herder, 1980.
- Gnilka, Joachim. *Mk 1–8,26*. Vol. 1 of *Das Evangelium nach Markus*. Evangelisch-katholischer Kommentar zum Neuen Testament 2.1. Zürich: Benziger, 1978.
- Gudehus, Christian, Ariane Eichenberg, and Harald Welzer, eds. *Gedächtnis und Erinnerung: Ein interdisziplinäres Handbuch*. Stuttgart: Metzler, 2010.

- Gupta, Nijay K. "Mirror-Reading Moral Issues in Paul's Letters." *JSNT* 34 (2012): 361–381.
- Guttenberger, Gudrun. *Das Evangelium nach Markus*. Zürcher Bibelkommentare 2. Zürich: Theologischer Verlag, 2018.
- Haag, Herbert. "Der Gottesknecht bei Deuterocesaja im Verständnis der Alten Kirche." *FZPhTh* 31 (1984): 343–77.
- Halbwachs, Maurice. *La mémoire collective*. Bibliothèque de l'Évolution de l'Humanité 28. Paris: Albin Michel, 1997 [Original edition 1949/1950; German: *Das kollektive Gedächtnis*, Stuttgart, 1967].
- Halbwachs, Maurice. *Les cadres sociaux de la mémoire*. Bibliothèque de l'Évolution de l'Humanité 8. Paris: Albin Michel, 2001 [Original edition 1925, German: *Das Gedächtnis und seine sozialen Bedingungen*. Frankfurt am Main, 2006/1985³].
- Halbwachs, Maurice. *The Collective Memory*. Translated by Francis J. Ditter and Vida Yazdi Ditter. New York: Harper & Row Colophon Books, 1980. (See *La mémoire collective* and *Das kollektive Gedächtnis*.)
- Harth, Dietrich. "The Invention of Cultural Memory." Pages 85–96 in *Cultural Memory Studies: An International and Interdisciplinary Handbook*. Edited by Astrid Erll, Ansgar Nünning and Sarah B. Young. Media and Cultural Memory 8. Berlin: De Gruyter, 2008.
- Hartog, Paul. "The Unity of *Philippians*." Pages 148–69 in *Polycarp and the New Testament: The Occasion, Rhetoric, Theme and Unity of the Epistle to the Philippians and its Allusions to New Testament Literature*. Edited by Jörg Frey, Martin Hengel and Otfried Hofius. Wissenschaftliche Untersuchungen zum Neuen Testament II 134. Tübingen: Mohr Siebeck, 2002.
- Hatina, Thomas R. "Intertextual Transformations of Jesus: John as Mnemomyth." Pages 416–40 in *Modern and Ancient Literary Criticism of the Gospels*. Edited by Robert Matthew Calhoun, David P. Moessner, and Tobias Nicklas. Wissenschaftliche Untersuchungen zum Neuen Testament 451. Tübingen: Mohr Siebeck, 2020.
- Hatina, Thomas R. "Intertextuality in historical criticism in New Testament studies: Is there a relationship?" *BI* 7 (1999): 28–43.
- Hatina, Thomas R. "Memory and Method: Theorizing John's Mnemonic Use of Scripture." Pages 219–36 in vol. 4 of *Biblical Interpretation in Early Christian Gospels: The Gospel of John*. Edited by Thomas R. Hatina. London: T&T Clark, 2019.
- Hearon, Holly. "The Story of 'The Woman who anointed Jesus' as Social Memory: A Methodological Proposal for the Study of Tradition as Memory." Pages 99–118 in *Memory, Tradition, and Text: Uses of the Past in Early Christianity*. Edited by Alan Kirk and Tom Thatcher. Semitistische Studien 52. Atlanta: Society of Biblical Literature, 2005.
- Holmes, Michael W. "Dating the Martyrdom of Polcarp." *EC* 9 (2018): 181–200.
- Holmes, Michael W. "Polycarp's Letter to the Philippians and the Writings that Later Formed the New Testament." Pages 187–227 in *The Reception of the New Testament*

- in the Apostolic Fathers*. Edited by Andrew F. Gregory and Christopher M. Tuckett, Oxford: Oxford University Press, 2007.
- Hooker, Morna D. "Isaiah in Mark's Gospel." Pages 35–49 in *Isaiah in the New Testament*. Edited by Steve Moyise and Maarten J.J. Menken. London: Bloomsbury, 2005.
- Hoppe, Rudolf. *Der zweite Thessalonikerbrief. Kommentar*. Freiburg: Herder, 2019.
- Hoppe, Rudolf. *Epheserbrief/Kolosserbrief*. Stuttgarter kleiner Kommentar: Neues Testament 10. Stuttgart: Katholisches Bibelwerk, 1987.
- Hoppe, Rudolf. "Der 2 Thess als 'Paulus'-Brief. Überlegungen zur Rezeption des 1 Thess durch den 'Paulus' des 2 Thess." Pages 298–317 in *Aneignung durch Transformation. Beiträge zur Analyse von Überlieferungsprozessen im frühen Christentum; Festschrift für Michael Theobald*. Edited by Wilfried Eisele, Christoph Schaefer, and Hans-Ulrich Weidemann. Herders biblische Studien 74. Freiburg: Herder 2013.
- Hort, Fenton J.A. *Six Lectures on the Ante-Nicene Fathers*, London: Macmillan, 1895.
- Hübner, Hans. *An Philemon: An die Kolosser: An die Epheser*. Handbuch zum Neuen Testament 12. Tübingen: Mohr Siebeck, 1997.
- Huebenthal, Sandra. *Das Markusevangelium als kollektives Gedächtnis*. Forschungen zur Religion und Literatur des Alten und Neuen Testaments 253. Göttingen: Vandenhoeck & Ruprecht, 2014. 2018².
- Huebenthal, Sandra. *Kulturwissenschaftliche Gedächtnistheorie und Neues Testament. Eine methodisch-hermeneutische Einführung* Tübingen. Narr Franke Attempto, 2022.
- Huebenthal, Sandra. *Reading the Gospel of Mark as a Text from Collective Memory*. Grand Rapids: Eerdmans, 2020.
- Huebenthal, Sandra. *Transformation und Aktualisierung: Zur Rezeption von Sach 9–14 im Neuen Testament*. Stuttgarter biblische Beiträge 57. Stuttgart: Katholisches Bibelwerk, 2006.
- Huebenthal, Sandra. "A Possible New World: How the Possible Worlds Theory Can Enhance Understanding of Mark." *ASE* 32 (2015): 393–414.
- Huebenthal, Sandra. "Another Frozen Moment: Reading Luke in social memory theoretical framework." *PIBA* 41/42 (2019): 23–43.
- Huebenthal, Sandra. "Anti-Gospel revisited". Pages 137–58 in *Reading the 'Political' in Jewish and Christian Texts*. Edited by Julia Synder and Korinna Zamfir. Biblical Tools and Studies 38. Leuven: Peeters, 2020.
- Huebenthal, Sandra. "Beziehung(s)feiern: Warum Fasten für die Söhne des Hochzeitsaals nicht in Frage kommt." Pages 305–27 in *Ästhetik, Sinnlicher Genuss und gute Manieren: Ein biblisches Menü in 25 Gängen: Festschrift für Hans-Winfried Jüngling SJ*. Edited by Melanie Peetz and Sandra Huebenthal. Österreichische biblische Studien 50. Berlin: Peter Lang, 2018.
- Huebenthal, Sandra. "Canon or Cultural Frame? Identity-Construction according to Luke." In *Relationships of the Two Parts of the Christian Bible*. Osnabrücker Studien

- zur Jüdischen und Christlichen Bibel 3. Edited by Georg Steins, Philip Sumpter and Johannes Taschner. Göttingen: Vandenhoeck & Ruprecht (manuscript submitted).
- Huebenthal, Sandra. "Erfahrung, die sich lesbar macht: Kol und 2 Thess als fiktionale Texte." Pages 295–336 in *Wie Geschichten Geschichte schreiben: Frühchristliche Literatur zwischen Faktualität und Fiktionalität*. Edited by Susanne Luther, Jörg Röder and Eckart Schmidt. Wissenschaftliche Untersuchungen zum Neuen Testament 395. Tübingen: Mohr Siebeck, 2015.
- Huebenthal, Sandra. "Erste Fragen für eine spätere Lektüre. Ein gedächtnistheoretisches Leseprogramm für Eusebs Kirchengeschichte." Pages 179–204 in *Christlicher Glaube in seinen Anfängen. Kulturelle Begegnungen und theologische Antworten. Festschrift für Bernhard Heining*. Edited by Barbara Bargel and Annemarie Frank. Würzburger Theologie 20. Würzburg: Echter, 2023.
- Huebenthal, Sandra. "Framing Jesus and understanding ourselves: Isaiah in Mark's Gospel and beyond." Pages 209–47 in *Creative Fidelity, Faithful Creativity: The Reception of Jewish Scripture in Early Judaism & Christianity*. Edited by Michael A. Daise and Dorota Hartmann. Naples: Unior Press, 2022.
- Huebenthal, Sandra. "'Frozen Moments' – Early Christianity through the Lens of Social Memory Theory." Pages 17–43 in *Memory and Memories in Early Christianity*. Edited by Simon Buttica and Enrico Norelli. Wissenschaftliche Untersuchungen zum Neuen Testament 398. Tübingen: Mohr Siebeck, 2018.
- Huebenthal, Sandra. "Kollektives Gedächtnis, Kulturelle Rahmen und das Markusevangelium." Pages 217–50 in *Reading the Gospel of Mark in the Twenty-First Century*. Edited by Geert van Oyen. Bibliotheca Ephemeridum Theologicarum Lovaniensium 301. Leuven: Peeters, 2019.
- Huebenthal, Sandra. "Luke 24:13–35 and Social Memory in Luke." Pages 85–95 in vol. 3 of *Biblical Interpretation in Early Christian Gospels: The Gospel of Luke*. Edited by Thomas R. Hatina. Library of New Testament studies 376. London: T&T Clark, 2010.
- Huebenthal, Sandra. "Proclamation rejected, truth confirmed: Reading John 12:37–44 in a social memory theoretical framework." Pages 183–200 in vol. 4 of *Biblical Interpretation in Early Christian Gospels: The Gospel of John*. Edited by Thomas R. Hatina. London: T&T Clark, 2019.
- Huebenthal, Sandra. "Pseudepigraphie als Strategie in frühchristlichen Identitätsdiskursen? Überlegungen am Beispiel des Kolosserbriefs." *SNTSU* 36 (2011): 63–94.
- Huebenthal, Sandra. "Pseudepigraphy." In *Brill Encyclopedia of Early Christianity Online*. Edited by David G. Hunter, Paul J.J. van Geest, Bert Jan Lietaert Peerbolte. 2023. (http://dx.doi.org/10.1163/2589-7993_EECO_SIM_045227).
- Huebenthal, Sandra. "Polycarp Unchained: How Cultural Studies can enhance Patristic Research." *Vetera Christianorum* 57 (2020): 131–45.

- Huebenthal, Sandra. "Reading Mark as Collective Memory." Pages 69–87 in *Social Memory and Social Identity in the Study of Early Judaism and Early Christianity*. Edited by Samuel Byrskog, Raimo Hakola and Jutta Jokiranta. Novum Testamentum et Orbis Antiquus / Studien zur Umwelt des Neuen Testaments 116. Göttingen: Vandenhoeck & Ruprecht, 2016.
- Huebenthal, Sandra. "Social and Cultural Memory in Biblical Exegesis: The Quest for an Adequate Application." Pages 191–216 in *Cultural Memory in Biblical Exegesis*. Edited by Pernille Carstens, Trine Hasselbach and Niels Peter Lemche. Perspectives on Hebrew Scriptures and Its Contexts 17. Piscataway, NJ: Gorgias, 2012.
- Huebenthal, Sandra. "Suspended Christology." Pages 1–41 in *Christology in Mark's Gospel: Four Views*. Edited by Anthony LeDonne. Grand Rapids: Zondervan, 2021.
- Huebenthal, Sandra. "The Gospel of Mark." Pages 41–72 in vol. 1 of *Jesus Traditions in the First Three Centuries: Gospel Literature and Additions to Gospel Literature*. Edited by Chris Keith, Helen K. Bond, Christine Jacobi and Jens Schröter. London: T&T Clark, 2019.
- Huebenthal, Sandra. "Verwurzelt in Christus und gegründet auf ihm, fest im Glauben." Exegetische Betrachtungen zum Motto des Weltjugendtags 2011 / 'Enracinés et fondés dans le Christ, affermis par la foi': Approche biblique du thème des JMJ. Pages 18–61 in *Auf der Suche nach den Wurzeln: Vorbereitungen auf den XXVI. Weltjugendtag 2011 / En quête des racines: Préparation à la XXVI^e Journée Mondiale de la Jeunesse 2011*. Edited by Pierre Guerigen. Düsseldorf: Verl.-Haus Altenberg, 2010.
- Huebenthal, Sandra. "Von der Vita zur Geschichte des erinnerten Jesus: Überlegungen zum Markusevangelium." Pages 394–411 in *Geschichte mit Gott: XV. Europäischer Kongress für Theologie. Veröffentlichungen der Wissenschaftlichen Gesellschaft für Theologie*. Edited by Michael Meyer-Blanck. Leipzig: Evangelische Verlagsanstalt, 2016.
- Huebenthal, Sandra. "'Wer ist dieser?': Mt 21,1–17 in intertextueller Lektüre." Pages 261–77 in *Der Bibelkanon in der Bibelauslegung: Beispiele exegesen und Methodenreflexionen*. Edited by Egbert Ballhorn and Georg Steins. Stuttgart: Kohlhammer, 2007.
- Huebenthal, Sandra. "'Wie kommen Schafe und Rinder in den Tempel? Die 'Tempelaktion' (Joh 2,13–22) in kanonisch-intertextueller Lektüre." Pages 69–81 in *Intertextualität: Perspektiven auf ein interdisziplinäres Arbeitsfeld*. Edited by Karin Herrmann and Sandra Huebenthal. Aachen: Shaker, 2007.
- Iser, Wolfgang. *Das Fiktive und das Imaginäre: Perspektiven literarischer Anthropologie*. Frankfurt am Main: Suhrkamp, 1993.
- Janßen, Martina. *Unter falschem Namen: Eine kritische Forschungsbilanz frühchristlicher Pseudepigraphie*. Arbeiten zur Religion und Geschichte des Urchristentums 14. Frankfurt am Main: Peter Lang, 2003.
- Janßen, Martina. "Antike (Selbst-)Aussagen über Beweggründe zur Pseudepigraphie." Pages 125–179 in *Pseudepigraphie und frühchristliche Verfasserfiktion/Pseudepigraphy*

- and Author Fiction in Early Christian Letters*. Edited by Jörg Frey, Jens Herzer, Martina Janßen and Claire Rothschild. Wissenschaftliche Untersuchungen zum Neuen Testament 246. Tübingen: Mohr Siebeck, 2009.
- Janßen, Martina, and Jörg Frey. "Einführung." Pages 3–24 in *Pseudepigraphie und frühchristliche Verfasserfiktion/Pseudepigraphy and Author Fiction in Early Christian Letters*. Edited by Jörg Frey, Jens Herzer, Martina Janßen and Claire Rothschild. Wissenschaftliche Untersuchungen zum Neuen Testament 246. Tübingen: Mohr Siebeck, 2009.
- Jaroš, Karl. *Das Neue Testament und seine Autoren: Eine Einführung*. Cologne: Böhlau, 2008.
- Jay, Pierre. "Jesaja." *RAC* 17 (1996): 764–821.
- Karrer, Martin. "Der Zweite Thessalonicherbrief und Gottes Widersacher." *Horizons in Biblical Theology* 29 (2007): 101–31.
- Kee, Howard Clark. *The Beginnings of Christianity: An Introduction to the New Testament*. New York: Bloomsbury, 2005.
- Keith, Chris, and Anthony LeDonne, eds. *Jesus, Criteria, and the Demise of Authenticity*. London: T&T Clark, 2012.
- Keith, Chris and Tom Thatcher. "The Scar of the Cross: The Violence Ratio and the Earliest Christian Memories of Jesus." Pages 197–217 in *Jesus, the Voice, and the Text: Beyond the Oral and the Written Gospel*. Edited by Tom Thatcher. Waco: TX, Baylor University Press, 2008.
- Keith, Chris. "Memory and Authenticity: Jesus Tradition and What Really Happened." *ZNW* 102 (2011): 155–77.
- Kelber, Werner. *The Oral and the Written Gospel: The Hermeneutics of Speaking and Writing in the Synoptic Tradition, Mark, Paul and Q*. Philadelphia: Fortress, 1983.
- Kelber, Werner H. "Apostolic Tradition and the Form of the Gospel." Pages 11–32 in *Imprints, Voiceprints, & Footprints of Memory: Collected Essays of Werner H. Kelber*. Edited by Werner Kelber. Atlanta: Society of Biblical Literature, 2013.
- Kelber, Werner H. "Commemoration of Jesus' Death." Pages 293–95 in *Imprints, Voiceprints & Footprints of Memory: Collected Essays of Werner Kelber*. Edited by Werner H. Kelber. Atlanta, GA: Society of Biblical Literature, 2013.
- Kelber, Werner H. "Die Anfangsprozesse der Verschriftlichung im Frühchristentum." Pages 1–63 in vol. 2 of *Aufstieg und Niedergang der römischen Welt* 26.1:3–62: *Principat*. Edited by Hildegard Temporini and Wolfgang Haase. New York: De Gruyter, 1992.
- Kelber, Werner H. "Memory and Violence, or: Genealogies of Remembering." Pages 333–66 in *Imprints, Voiceprints & Footprints of Memory: Collected Essays of Werner Kelber*. Edited by Werner H. Kelber. Atlanta, GA: Society of Biblical Literature, 2013.
- Kelber, Werner H. "The 'Gutenberg Galaxy' and the Historical Study of the New Testament." *OH/SA* 5 (2017): 1–16.

- Kelber, Werner H. "The Works of Memory: Christian Origins as MnemoHistory – A Response." Pages 221–48 in *Memory, Tradition, and Text: Uses of the Past in Early Christianity*. Edited by Alan Kirk and Tom Thatcher. Semitistische Studien 52. Atlanta: Society of Biblical Literature, 2005.
- Keppler, Angelika. *Tischgespräche: Über Formen kommunikativer Vergesellschaftung am Beispiel der Konversation in Familien*. Frankfurt am Main: Suhrkamp, 1995².
- Keppler, Angelika: "Soziale Formen individuellen Erinnerns." Pages 137–59 in *Das soziale Gedächtnis: Geschichte, Erinnerung, Tradierung*. Edited by Harald Welzer. Hamburg: Hamburger Edition, 2001.
- Kirk, Alan. "Social and Cultural Memory." Pages 1–24 in *Memory, Tradition, and Text: Uses of the Past in Early Christianity*. Edited by Alan Kirk and Tom Thatcher. Semitistische Studien 52. Atlanta: Society of Biblical Literature, 2005.
- Kirk, Alan. "The Memory of Violence and the Death of Jesus in Q." Pages 191–206 in *Memory, Tradition, and Text: Uses of the Past in Early Christianity*. Edited by Alan Kirk and Tom Thatcher. Semitistische Studien 52. Atlanta: Society of Biblical Literature, 2005.
- Kirk, Alan and Tom Thatcher. "Jesus Tradition as Social Memory." Pages 24–42 in *Memory, Tradition, and Text: Uses of the Past in Early Christianity*. Edited by Alan Kirk and Tom Thatcher. Semitistische Studien 52. Atlanta: Society of Biblical Literature, 2005.
- Klein, Christian, and Matias Martínez, eds. *Wirklichkeitserzählungen. Felder, Formen und Funktionen nicht-literarischen Erzählens*. Stuttgart: Metzler, 2009.
- Kloppenborg John S. "Disciplined Exaggeration: The Heuristics of Comparison in Biblical Studies." *NT* 59 (2017): 390–414.
- Kobel, Esther. *Paulus als interkultureller Vermittler: Eine Studie zur kulturellen Positionierung des Apostels der Völker*. Studies in Cultural Contexts of the Bible 1. Paderborn: Brill, 2019.
- Koch, Dietrich-Axel. "The Quotations of Isaiah 8,14 and 28,16 in Romans 9,33 and 1Peter 2,6.8 as Test Case for Old Testament Quotations in the New Testament." *ZNW* 101 (2010): 223–40.
- Koch, Dietrich-Axel. *Schrift als Zeuge des Evangeliums: Untersuchungen zur Verwendung und zum Verständnis der Schrift bei Paulus*. Beiträge zur historischen Theologie 69. Tübingen: Mohr Siebeck, 1986.
- Kok, Michael J. *The Gospel on the Margins: The Reception of Mark in the Second Century*. Minneapolis: Fortress, 2015.
- Konradt, Matthias. "Das Matthäusevangelium als judenchristlicher Gegenentwurf zum Markusevangelium." Pages 43–68 in *Studien zum Matthäusevangelium*. Edited by Matthias Konradt. Wissenschaftliche Untersuchungen zum Neuen Testament 358. Tübingen: Mohr Siebeck, 2016.

- Konradt, Matthias. "Die Rezeption der Schrift im Matthäusevangelium in der neueren Forschung." *ThLZ* 135 (2010): 919–32.
- Kraus, Wolfgang. "Jesaja 53 LXX im frühen Christentum – eine Überprüfung." Pages 149–82 in *Beiträge zur urchristlichen Theologiegeschichte*. Beihefte zur Zeitschrift für die neutestamentliche Wissenschaft 163. Edited by Wolfgang Kraus. Berlin: De Gruyter 2009.
- Kreinecker, Christina M. 2. *Thessaloniker*. Papyrologische Kommentare zum Neuen Testament 3. Göttingen: Vandenhoeck & Ruprecht, 2010.
- Krentz, Edgar. "A Stone that Will Not Fit." Pages 439–70 in *Pseudepigraphie und frühchristliche Verfasserfiktion/Pseudepigraphy and Author Fiction in Early Christian Letters*. Edited by Jörg Frey, Jens Herzer, Martina Janßen, and Claire Rothschild. Wissenschaftliche Untersuchungen zum Neuen Testament 246. Tübingen: Mohr Siebeck, 2009.
- Kümmel, Werner Georg. *Einleitung in das Neue Testament*. Berlin: Evangelische Verlagsanstalt, 1983²¹.
- Larsen, Matthew D.C. *Gospels before the Book*. New York: Oxford, 2018.
- Laub, Franz. 1. und 2. *Thessalonicherbrief*. Neue Echter-Bibel: Kommentar zum NT 13. Würzburg: Echter, 1985.
- Le Donne, Anthony. *The Historiographical Jesus. Memory, Typology, and the Son of David*. Waco: Baylor University Press, 2009.
- Lett, Jonathan. "The Divine Identity of Jesus as the Reason for Israel's Unbelief in John 12:36–43." *JBL* 135 (2016): 159–73.
- Lohse, Eduard. *Die Briefe an die Kolosser und an Philemon*. Kritisch-exegetischer Kommentar über das Neue Testament 9/2. Göttingen: Vandenhoeck & Ruprecht, 1968.
- Lookadoo, Jonathon. "Polycarp, Paul, and the Letters to Timothy." *NovT* 59 (2017): 366–83.
- Lüdemann, Gerd. *Die größte Fälschung des Neuen Testaments: Der Zweite Thessalonicherbrief*. Springe: zu Klampen, 2010.
- Lührmann, Dieter. *Das Markusevangelium*. Handbuch zum Neuen Testament 3. Tübingen: Mohr Siebeck, 1987.
- Luz, Ulrich. "Der Brief an die Kolosser." Pages 183–239 in *Die Briefe an die Galater, Epheser und Kolosser*. Edited by Jürgen Becker and Ulrich Luz. Das Neue Testament Deutsch 8,1. Göttingen: Vandenhoeck & Ruprecht, 1998.
- Macnamara, Luke. *My Chosen Instrument: The Characterisation of Paul in Acts*. *Analecta biblica* 215. Rome: Gregorian Biblical Press, 2016.
- Maisch, Ingrid. *Der Brief an die Gemeinde in Kolossä*. Theologischer Handkommentar zum Neuen Testament 12. Stuttgart: Kohlhammer, 2003.
- Malbon, Elisabeth Struthers. *Mark's Jesus: Characterization as Narrative Christology*. Waco, TX: Baylor University Press, 2009.

- Manier, David and William Hirst. "A Cognitive Taxonomy of Collective Memories." Pages 253–62 in *Cultural Memory Studies: An International and Interdisciplinary Handbook*. Edited by Astrid Erll, Ansgar Nünning, and Sarah B. Young. Media and Cultural Memory 8. Berlin: De Gruyter, 2008.
- Marcus, Joel. *Mark 8–16. A New Translation, with Introduction and Commentary*. Anchor Yale Bible Commentaries. New Haven: Yale University Press, 2009.
- Marguerat, Daniel, ed. *Introduction au Nouveau Testament: Son histoire, son écriture, sa théologie*. Genf: Labor et Fides, 2001².
- Markowitsch, Hans J. *Das Gedächtnis: Entwicklung, Funktionen, Störungen*. Munich: Beck, 2009.
- Markowitsch, Hans J. "Bewusste und unbewusste Formen des Erinnerns." Pages 219–39 in *Das soziale Gedächtnis: Geschichte, Erinnerung, Tradierung*. Edited by Harald Welzer. Hamburg: Hamburger Edition, 2001.
- Markschies, Christoph. *Das antike Christentum: Frömmigkeit, Lebensformen, Institutionen*. Munich: Beck, 2006.
- Markschies, Christoph. "Der Mensch Jesus Christus im Angesicht Gottes: Zwei Modelle des Verständnisses von Jesaja 52,13–53,12 in der patristischen Literatur und deren Entwicklung." Pages 197–249 in *Der leidende Gottesknecht*. Edited by Bernd Janowski and Peter Stuhlmacher. Forschungen zum Alten Testament 14. Tübingen: Mohr Siebeck, 1996.
- Markschies, Christoph. "Die Kirche in vorkonstantinischer Zeit: Von der Mitte des 2. bis zum Ende des 3. Jahrhunderts." Pages 59–98 in vol. 1 of *Von den Anfängen bis zum Mittelalter: Ökumenische Kirchengeschichte*. Edited by Bernd Moeller. Darmstadt: Wissenschaftliche Buchgesellschaft, 2006.
- Martínez, Matias, and Michael Scheffel. *Einführung in die Erzähltheorie*. Munich: Beck, 2005⁶.
- Martyn, J. Louis. *History and Theology in the Fourth Gospel*. Louisville: Westminster Knox, 1968.1979.2003.
- Menken, Maarten J.J. *Matthew's Bible: The Old Testament Text of the Evangelist*. Bibliotheca Ephemeridum theologicarum Lovaniensium 173. Leuven: University Press, 2004.
- Menken, Maarten J.J. "Die Form des Zitats aus Jes 6,10 in Joh 12,40: Ein Beitrag zum Schriftgebrauch des vierten Evangelisten." *BZ* 32 (1988): 189–209.
- Merkel, Helmut. "Der Lehrer Paulus und seine Schüler: Forschungsgeschichtliche Schlaglichter." Pages 235–50 in *Religiöses Lernen in der biblischen, frühjüdischen und frühchristlichen Überlieferung*. Edited by Beate Ego and Helmut Merkel. Wissenschaftliche Untersuchungen zum Neuen Testament 180. Tübingen: Mohr Siebeck, 2005.

- Merz, Annette. *Die fiktive Selbstausslegung des Paulus: Intertextuelle Studien zur Intention und Rezeption der Pastoralbriefe*. Novum testamentum et orbis antiquus 52. Göttingen: Vandenhoeck & Ruprecht, 2004.
- Miller, David L. "An Anthology of the Theology of the Apostolic Fathers." Ph.D. diss., Southwestern Baptist Theological Seminary, 1948.
- Mitchell, Margaret M. "Thessalonicherbriefe." Pages 360–62 in vol. 8 of *Religion in Geschichte und Gegenwart*⁴. Edited by Hans D. Betz, Don S. Browning, Bernd Janowski and Eberhard Jüngel. Tübingen: Mohr Siebeck, 2005.
- Montanaro, Andrew. "The Use of Memory in the Old Testament Quotations in John's Gospel." *NT* 59 (2017): 147–70.
- Moyise, Steve and Maarten J.J. Menken, eds. *Isaiah in the New Testament*. London: Bloomsbury, 2005.
- Moyise, Steve. "Isaiah in 1 Peter." Pages 175–188 in *Isaiah in the New Testament*. Edited by Steve Moyise and Marten J.J. Menken. London: Bloomsbury, 2005.
- Müller, Paul-Gerhard. *Der erste und zweite Brief an die Thessalonicher*. Regensburger Neues Testament. Regensburg: Pustet, 2001.
- Müller, Peter. "Gegner im Kolosserbrief: Methodische Überlegungen zu einem schwierigen Kapitel." Pages 365–94 in *Beiträge zur urchristlichen Theologiegeschichte*. Edited by Wolfgang Kraus. Beihefte zur Zeitschrift für die neutestamentliche Wissenschaft 163. Berlin: De Gruyter, 2009.
- Nicklas, Tobias. *Der Zweite Thessalonicherbrief*. Kritisch-Exegetischer Kommentar zum Neuen Testament 10/2. Göttingen: Vandenhoeck und Ruprecht, 2019.
- Nicklas, Tobias. *Jews and Christians? Second-Century 'Christian' Perspectives on the "Parting of the Ways" (Annual Deichmann Lectures 2013)*. Tübingen: Mohr Siebeck, 2014.
- Nicklas, Tobias. "Die Akten des Titus: Rezeption 'apostolischer' Schriften und Entwicklung antik-christlicher 'Erinnerungslandschaften!'" *EC* 8 (2017): 458–80.
- Nicklas Tobias. "Die Datierung des Zweiten Thessalonicherbriefes." Pages 203–17 in *Die Datierung neutestamentlicher Pseudepigraphen*. Edited by Wolfgang Grünstäudl and Karl Matthias Schmidt. Wissenschaftliche Untersuchungen zum Neuen Testament 470. Tübingen: Mohr Siebeck, 2021.
- Nicklas, Tobias. "Parting of the Ways? Probleme eines Konzepts." Pages 21–41 in *Juden, Christen, Heiden? Religiöse Inklusion und Exklusion in Kleinasien bis Decius*. Edited by Stefan Alkier and Hartmut Leppin. Wissenschaftliche Untersuchungen zum Neuen Testament 400. Tübingen: Mohr Siebeck, 2018.
- Niebuhr, Karl-Wilhelm, ed. *Grundinformation Neues Testament: Eine bibelkundlich-theologische Einführung*. Göttingen: Vandenhoeck & Ruprecht, 2000.
- Nielsen, Charles. "Polycarp, Paul and the Scriptures." *ATHR* 47 (1965): 199–216.

- Nünning, Ansgar. *Grundzüge eines kommunikationstheoretischen Modells der erzählerischen Vermittlung: Die Funktionen der Erzählinstanz in den Romanen George Eliots*. Horizonte – Studien zu Texten und Ideen der europäischen Moderne 2. Trier: WVT, 1989.
- Nünning, Ansgar. "Fiktionalitätssignale." Pages 202–3 in *Metzler Lexikon Literatur- und Kulturtheorie*. Edited by Ansgar Nünning. Stuttgart: Metzler, 2008⁴.
- Omerzu, Heike. "Geschichte durch Geschichten: Zur Bedeutung jüdischer Traditionen für die Jesusdarstellung des Markusevangeliums." *EC* 2 (2011): 77–99.
- Patte, Daniel. "Contextual Reading of Mark and North Atlantic Scholarship." Pages 197–213 *Mark*. Edited by Nicole W. Duran, Teresa Okure and Daniel Patte. Minneapolis: Fortress, 2011.
- Paulsen, Henning. *Die Briefe des Ignatius von Antiochia und der Brief des Polykarp von Smyrna*. Mohr Siebeck: Tübingen, 1985².
- Pesch, Rudolf. *Das Markusevangelium: Kommentar zu Kap. 8,27–16,20*. Herders theologischer Kommentar zum Neuen Testament 2. Freiburg im Breisgau: Herder, 1984.
- Pethes, Nicolas, and Jens Ruchatz, eds. *Gedächtnis und Erinnerung: Ein interdisziplinäres Lexikon*. Reinbek: Rowohlt, 2001.
- Pilhofer, Peter. *Das Neue Testament und seine Welt: Eine Einführung*. Tübingen: Mohr Siebeck, 2010.
- Pilhofer, Peter. Vol. 1 of *Philippi: Die erste christliche Gemeinde Europas*. Wissenschaftliche Untersuchungen zum Neuen Testament 87. Tübingen: Mohr Siebeck, 1995.
- Pokorný, Petr, and Ulrich Heckel. *Einleitung in das Neue Testament*. Tübingen: Mohr Siebeck, 2007.
- Reinhartz, Adele. "The Johannine Community and its Jewish Neighbors: A Reappraisal." Pages 11–38 in *What is John?* Vol. 2 of *Literary and Social Readings of the Fourth Gospel*. Edited by Fernando F. Segovia. Atlanta: Scholars Press, 1998.
- Reinmuth, Eckart. *Hermeneutik des Neuen Testaments*. Göttingen: Vandenhoeck & Ruprecht, 2002.
- Reinmuth, Eckart and Bull, Klaus-Michael. *Proseminar Neues Testament Texte lesen, fragen lernen*. Neukirchen-Vluyn: Neukirchener, 2006.
- Reinmuth, Eckart. "Exkurs: Zur neutestamentlichen Paulus-Pseudepigraphie." Pages 190–202 in *Die Briefe an die Philipper, Thessalonicher und an Philemon*. Translated by Nikolaus Walter, Eckart Reinmuth and Peter Lampe. Das Neue Testament Deutsch 8,2. Göttingen: Vandenhoeck & Ruprecht, 1998.
- Rhee, Helen. *Loving the Poor, Saving the Rich: Wealth, Poverty, and Early Christian Formation*. Grand Rapids: Baker, 2012.
- Riedl, Hermann J. *Anamnese und Apostolizität: Der Zweite Petrusbrief und das theologische Problem neutestamentlicher Pseudepigraphie*. Reformationsgeschichtliche Studien und Texte 64. Frankfurt am Main: Peter Lang, 2005.

- Rodriguez, Rafael. *Jesus Darkly: Remembering Jesus with the New Testament*. Nashville: Abingdon Press, 2018.
- Roh, Taesong. *Der zweite Thessalonicherbrief als Erneuerung apokalyptischer Zeitdeutung*. *Novum Testamentum et Orbis Antiquus / Studien zur Umwelt des Neuen Testaments* 62. Göttingen: Vandenhoeck & Ruprecht, 2007.
- Roloff, Jürgen. *Einführung in das Neue Testament*. Stuttgart: Reclam, 1995.
- Roose, Hanna. *Der erste und zweite Thessalonicherbrief*. Die Botschaft des Neuen Testaments. Neukirchen-Vluyn: Neukirchener, 2016.
- Roose, Hanna. "Die Thessalonicherbriefe im Kontext urchristlicher Überlieferungsprozesse: Methodische Reflexionen." Pages 343–364 in *Beiträge zur urchristlichen Theologiegeschichte*. Edited by Wolfgang Kraus. Beihefte zur Zeitschrift für die neutestamentliche Wissenschaft 163. Berlin: De Gruyter, 2009.
- Roose, Hanna. "Polyvalenz durch Intertextualität im Spiegel der aktuellen Forschung zu den Thessalonicherbriefen." *NTS* 51 (2005): 250–269.
- Rüsen, Jörn. "Holocaust, Erinnerung, Identität." Pages 243–259 in *Das soziale Gedächtnis: Geschichte, Erinnerung, Tradierung*. Edited by Harald Welzer. Hamburg: Hamburger Edition, 2001.
- Schacter, Daniel L. *The Seven Sins of Memory: How the Mind Forgets and Remembers*. New York: Houghton Mifflin, 2002.
- Schierse, Franz Josef. *Einleitung in das Neue Testament*. Düsseldorf: Patmos, 1984³.
- Schmid, Hansjörg. *Gegner im 1. Johannesbrief? Zur Konstruktion und Selbstreferenz im johanneischen Sinnsystem*. Beiträge zur Wissenschaft vom Alten und Neuen Testament 159. Stuttgart: Kohlhammer, 2002.
- Schmidt, Eckart D. "Gibt es Neues zur Frage nach Authentizität und Datierung des 1. Thessalonicherbriefs?" Pages 15–44 in *Der 1. Thessalonicherbrief und die frühe Völkermission des Paulus*. Edited by Ulrich Mell und Michael Tilly. Wissenschaftliche Untersuchungen zum Neuen Testament 479. Tübingen: Mohr Siebeck, 2022.
- Schmidt, Karl M. *Mahnung und Erinnerung im Maskenspiel: Epistolographie, Rhetorik und Narrativik der pseudepigraphen Petrusbriefe*. Herders biblische Studien 38. Freiburg im Breisgau: Herder, 2003.
- Schmidt, Siegfried J. "Memory and Remembrance: A Constructivist Approach." Pages 191–202 in *Cultural Memory Studies: An International and Interdisciplinary Handbook*. Edited by Ansgar Nünning and Astrid Erll. Berlin: De Gruyter, 2008.
- Schnelle, Udo. *Einleitung in das Neue Testament*, Göttingen: Vandenhoeck & Ruprecht, 2002⁴. 2011⁷.
- Schnelle, Udo. *Die ersten 100 Jahre des Christentums: 30–130 n.Chr.* Stuttgart: utb, 2015.
- Schreiber, Stefan. *Begleiter durch das Neue Testament*. Düsseldorf: Patmos, 2006⁷.

- Schreiber, Stefan. *Der zweite Brief an die Thessalonicher* (Ökumenischer Kommentar zum Neuen Testament 13/2). Gütersloh: Gütersloher, 2017.
- Schreiber, Stefan. "Der zweite Thessalonicherbrief." Pages 440–9 in *Einleitung in das Neue Testament*. Edited by Martin Ebner and Stefan Schreiber. Stuttgart: Kohlhammer, 2008.
- Stefan Schreiber, "Früher Paulus mit Spätfolgen. Eine Bilanz der neusten Thessalonicherbrief-Forschung." *Theologische Revue* 103 (2007): 267–84.
- Schreiber, Stefan. "Orientierungsmarken? Im Irrgarten 'klassischer' und neuerer Datierungen der neutestamentlichen Pseudepigraphen." Pages 9–35 in *Die Datierung neutestamentlicher Pseudepigraphen*. Edited by Wolfgang Grünstäudl and Karl Matthias Schmidt, Wissenschaftliche Untersuchungen zum Neuen Testament 470. Tübingen: Mohr Siebeck, 2021.
- Schreiber, Stefan. "Pseudepigraphie als Problem der Einleitungswissenschaft." Pages 221–58 in *Spurensuche zur Einleitung in das Neue Testament. Eine Festschrift im Dialog mit Udo Schnelle*. Edited by Michael Labahn. Forschungen zur Religion und Literatur des Alten und Neuen Testaments 269. Göttingen: Vandenhoeck & Ruprecht, 2017.
- Schröter, Jens. *Erinnerung an Jesu Worte: Studien zur Rezeption der Logienüberlieferung in Markus, Q und Thomas*. Wissenschaftliche Monographien zum Alten und Neuen Testament 76. Neunkirchen-Vluyn: Neukirchener Verlag, 1997.
- Schröter, Jens. "Artikel Gedächtnis: II." Page 525 in vol. 3 of *Religion in Geschichte und Gegenwart*⁴. Edited by Hans D. Betz, Don S. Browning, Bernd Janowski and Eberhard Jüngel. Tübingen: Mohr Siebeck, 2000.
- Schröter, Jens, and Christine Jacobi, eds. *Jesus Handbuch*. Tübingen: Mohr Siebeck, 2017.
- Schwartz, Barry. *Abraham Lincoln and the Forge of National Memory*. Chicago: University of Chicago Press, 2000.
- Schwartz, Barry. "Collective Memory and the Social Change: The Democratization of George Washington." *ASR* 56 (1991): 221–36.
- Schweizer, Eduard. *Das Evangelium nach Markus*. Das Neue Testament Deutsch 1. Göttingen: Vandenhoeck & Ruprecht, 1989¹⁷.
- Segovia, Fernando F. "Cultural Studies and Contemporary Bible Criticism: Ideological Criticism as Mode of Discourse." Pages 1–17 in *Social Location and Biblical Interpretation in Global Perspective*. Vol. 2 of *Reading from This Place*. Edited by Fernando F. Segovia and Mary A. Tolbert. Minneapolis: Fortress Press, 1995.
- Standhartinger, Angela. "Der Brief an die Gemeinde in Kolossä und die Erfindung der 'Haustafel'." Pages 635–45 in *Kompendium Feministische Bibelauslegung*. Edited by Luise Schottroff and Marie-Theres Wacker. Gütersloh: Gütersloher Verlagshaus, 1998.

- Standhartinger, Angela. *Studien zur Entstehungsgeschichte und Intention des Kolosserbriefes*. Supplements to Novum Testamentum 94. Leiden: Brill, 1999.
- Stern, William. "Zur Psychologie der Aussage." *Zeitschrift für die gesamte Strafrechtswissenschaft* 22 (1920): 315–70.
- Thatcher, Tom. "The Shape of John's Story: Memory-Mapping in the Fourth Gospel." Pages 209–40 in *Memory and Identity in Ancient Judaism and Early Christianity: A Conversation with Barry Schwartz*. Edited by Tom Thatcher. Semeia studies 78. Atlanta: Society of Biblical Literature, 2014.
- Theißen, Gerd. *Das Neue Testament*. Munich: Beck, 2002.
- Theobald, Michael. "Der Epheserbrief." Pages 408–24 in *Einleitung in das Neue Testament*. Edited by Martin Ebner and Stefan Schreiber. Studienbücher Theologie 6. Stuttgart: Kohlhammer, 2008.
- Theobald, Michael. "Der Kolosserbrief." Pages 425–39 in *Einleitung in das Neue Testament*. Edited by Martin Ebner and Stefan Schreiber. Studienbücher Theologie 6. Stuttgart: Kohlhammer 2008.
- Theobald, Michael. "Der Primat der Synchronie vor der Diachronie als Grundaxiom der Literarkritik: Methodische Erwägungen an Hand von Mk 2,13–17 // Mt 9,9–13." *BZ* 22 (1978): 161–68.
- Theobald, Michael. "'Ihr habt die Blasphemie gehört!' (Mk 14:46): Warum der Hohe Rat in Jerusalem auf den Tod Jesu hinwirkte." *NT* 58 (2016): 233–58.
- Theobald, Michael. "Paulus und Polykarp an die Philipper: Schlaglichter auf die frühe Rezeption des Basissatzes von der Rechtfertigung." Pages 349–88 in *Lutherische und Neue Paulusperspektive: Beiträge zu einem Schlüsselproblem der gegenwärtigen exegetischen Diskussion*. Edited by Michael Bachmann. Wissenschaftliche Untersuchungen zum Neuen Testament 182. Tübingen: Mohr Siebeck, 2005.
- Thompson, Trevor. "A Stone that Still Won't fit: An Introductory Note for Edgar Krentz's 'A Stone that will not fit.'" Pages 433–38 in *Pseudepigraphie und frühchristliche Verfasserfiktion/Pseudepigraphy and Author Fiction in Early Christian Letters*. Edited by Jörg Frey, Jens Herzer, Martina Janßen and Claire Rothschild. Wissenschaftliche Untersuchungen zum Neuen Testament 246. Tübingen: Mohr Siebeck, 2009.
- Thompson, Trevor. "As If Genuine: Interpreting the Pseudepigraphic Second Thessalonians." Pages 471–88 in *Pseudepigraphie und frühchristliche Verfasserfiktion/Pseudepigraphy and Author Fiction in Early Christian Letters*. Edited by Jörg Frey, Jens Herzer, Martina Janßen and Claire Rothschild. Wissenschaftliche Untersuchungen zum Neuen Testament 246. Tübingen: Mohr Siebeck, 2009.
- Thyen, Hartwig. *Das Johannesevangelium*. Handbuch zum Neuen Testament 6. Tübingen: Mohr Siebeck, 2005.
- Torrance, Thomas F. *The Doctrine of Grace in the Apostolic Fathers*. Grand Rapids: Eerdmans, 1959.

- Ulrich, Eugene. *The Dead Sea Scrolls and the Origins of the Bible*. Grand Rapids: Eerdmans, 1999.
- Van Damme, Dirk, "Polykarp von Smyrna." Pages 25–28 in vol. 27 of *Theologische Realenzyklopädie*, Berlin: De Gruyter, 1997.
- Van Iersel, Baastian M.F. *Mark: A Reader-Response Commentary*. Translated by W.H. Bisscheroux. Journal for the study of the New Testament, Supplement series 164. Sheffield: Sheffield Academic Press, 1998.
- Wagner, J. Ross. "Isaiah in Romans and Galatians." Pages 117–32 in *Isaiah in the New Testament*. Edited by Steve Moyise and Marten J.J. Menken. London: Bloomsbury, 2005.
- Wasserman, Tommy. "The 'Son of God' Was in the Beginning (Mark 1:1)." *JTS* 62 (2011): 20–50.
- Watson, Francis. *Gospel Writing: A Canonical Perspective*. Grand Rapids: Baker, 2013.
- Welzer, Harald. *Das kommunikative Gedächtnis: Eine Theorie der Erinnerung*. München: Beck, 2008².
- Welzer, Harald, ed. *Das soziale Gedächtnis: Geschichte, Erinnerung, Tradierung*. Hamburg: Hamburger Edition, 2001.
- Welzer, Harald. "Communicative Memory." Pages 285–98 in *Cultural Memory Studies: An International and Interdisciplinary Handbook*. Edited by Astrid Erll, Ansgar Nünning and Sarah B. Young. Media and Cultural Memory 8. Berlin: De Gruyter, 2008.
- Welzer, Harald. "Das soziale Gedächtnis." Pages 9–21 in *Das soziale Gedächtnis. Geschichte, Erinnerung, Tradierung*. Edited by Harald Welzer. Hamburg: Hamburger Edition, 2001.
- Wengst, Klaus. *Das Johannesevangelium*. Theologischer Handkommentar zum Neuen Testament 4,2. Stuttgart: Kohlhammer, 2004.
- Wilk, Florian. *Die Bedeutung des Jesajabuches für Paulus*. Forschungen zur Religion und Literatur des Alten und Neuen Testaments 179. Göttingen: Vandenhoeck & Ruprecht, 1998.
- Wilk, Florian. "Die Geschichte des Gottesvolkes im Licht jesajanischer Prophetie: Neutestamentliche Perspektiven." Pages 245–64 in *Josephus und das Neue Testament: Wechselseitige Wahrnehmungen: II. Internationales Symposium zum Corpus Judaeo-Hellenisticum, 25.–28. Mai 2006 Greifswald*. Wissenschaftliche Untersuchungen zum Neuen Testament 209. Edited by Christfried Böttrich and Jens Herzer. Tübingen: Mohr Siebeck, 2007.
- Wilk, Florian. "Jesajanische Prophetie im Spiegel exegetischer Tradition: Zu Hintergrund und Sinngehalt des Schriftzitats in 1 Kor 2,9." Pages 480–504 in *Die Septuaginta – Entstehung, Sprache, Geschichte: 3. internationale Fachtagung veranstaltet von Septuaginta Deutsch (LXX.D), Wuppertal 22.–25. Juli 2010*.

- Wissenschaftliche Untersuchungen zum Neuen Testament 286. Edited by Siegfried Kreuzer and Martin Meiser. Tübingen: Mohr Siebeck, 2012.
- Wilk, Florian. "Paulus als Nutzer, Interpret und Leser des Jesajabuches." Pages 93–116 in *Die Bibel im Dialog der Schriften: Konzepte intertextueller Bibellektüre*. Neutestamentliche Entwürfe zur Theologie 10. Edited by Stefan Alkier and Richard B. Hays. Tübingen: Francke, 2005.
- Williams, Catrin H. "Isaiah in John's Gospel." Pages 106–116 in *Isaiah in the New Testament: The New Testament and the Scriptures of Israel*. Edited by Stephen Moïse and Marten J.J. Menken. London: Bloomsbury, 2005.
- Williams, Catrin H. "Seeing the Glory: The Reception of Isaiah's Call-Version in Jn 12.41." Pages 186–206 in *Judaism, Jewish identities, and the Gospel tradition: Essays in Honour of Maurice Casey*. Edited by James G. Crossley. London: Equinox, 2010.
- Wolter, Michael, *Der Brief an die Kolosser/Der Brief an Philemon*. Ökumenischer Taschenbuchkommentar zum Neuen Testament 12. Gütersloh: Gütersloher Verlagshaus, 1993.
- Wolter, Michael. *Die Pastoralbriefe als Paulustradition*. Forschungen zur Religion und Literatur des Alten und Neuen Testaments 146. Göttingen: Vandenhoeck & Ruprecht, 1988.
- Wolter, Michael. "Die anonymen Schriften des Neuen Testaments. Annäherungsversuch an ein literarisches Phänomen." *ZNW* 79 (1988): 1–16.
- Woyke, Johannes. "Der leidende Gottesknecht (Jes 53)." Pages 200–225 in *Die Verheißung des Neuen Bundes: Wie alttestamentliche Texte im Neuen Testament fortwirken*. Biblisch theologische Studien 35. Edited by Bernd Kollmann. Göttingen: Vandenhoeck & Ruprecht, 2010.
- Wrede, William. *Die Echtheit des 2. Thessalonicherbriefes*. Texte und Untersuchungen zur Geschichte der altchristlichen Literatur 24. Leipzig: J.C. Hinrichs'sche Buchhandlung, 1903.
- Zimmermann, Ruben. "Unecht und doch wahr? Pseudepigraphie im Neuen Testament als theologisches Problem." *ZNT* 12 (2003): 27–38.
- Zimmermann, Ruben. "Die Gleichnisse Jesu: Eine Leseanleitung zum Kompendium." Pages 3–46 in *Kompendium der Gleichnisse Jesu*. Edited by Ruben Zimmermann. Gütersloh: Gütersloher Verlagshaus, 2007.
- Zimmermann, Ruben. "Geschichtstheorien und Neues Testament. Gedächtnis, Diskurs, Kultur und Narration in der historiographischen Diskussion." *EC* 2 (2011): 417–44.
- Zipfel, Frank. *Fiktion, Fiktivität, Fiktionalität: Analysen zur Fiktion in der Literatur und zum Fiktionsbegriff in der Literaturwissenschaft*. Allgemeine Literaturwissenschaft – Wuppertaler Schriften 2. Berlin: Erich Schmidt, 2001.
- Zumstein, Jean. *Das Johannesevangelium*. Kritisch-exegetischer Kommentar über das Neue Testament 2. Göttingen: Vandenhoeck & Ruprecht, 2015.

Index of Original Publications

Social and Cultural Memory in Biblical Exegesis: The Quest for an Adequate Application was originally published in: Carstens, Pernille; Hasselbalch, Trine; Lemche, Niels Peter (Ed.): *Cultural Memory in Biblical Exegesis* (Perspectives on Hebrew Scriptures and its Contexts 17). Piscataway NJ 2012, 175–199.

“You cannot live with an experience that remains without a story:” Memory Theory and How Mark’s Gospel Narrates Experiences with Jesus was written for this publication.

“Frozen Moments”: Early Christianity through the Lens of Social Memory Theory was originally published in: Buttica, Simon; Norelli, Enrico (Hg.) *Memory and Memories in Early Christianity* (WUNT 1). Tübingen 2018, 17–43.

What’s Form got to do with it? Preliminaries on the Impact of Social Memory Theory for the Study of Biblical Intertextuality was originally published in: David P. Moessner, Matthew Calhoun, and Tobias Nicklas (Hg.), *The Gospel and Ancient Literary Criticism: Continuing the Debate on Gospel Genre(s)*. WUNT 2. Tübingen 2020, 145–176.

Proclamation Rejected, Truth Confirmed. Reading John 12:37–44 in a Social Memory Theoretical Framework was originally published in: Hatina, Thomas R (Hg.), *Biblical Interpretation in Early Christian Gospels: Volume 4: The Gospel of John*. LNTS 613. London 2020, 183–200.

Collective Memory, Cultural Texts, and Mark’s Gospel is a translation of “Kollektives Gedächtnis, Kulturelle Texte und das Markusevangelium”, was originally published in: van Oyen, Geert (Hg.) *Reading the Gospel of Mark in the Twenty-First Century*. BETL 301. Leuven: Peeters 2019, 217–250.

Pseudepigraphy as a Strategy in Early Christian Identity Discourses? The Letter to the Colossians as a test case is a translation of “Pseudepigraphie als Strategie in frühchristlichen Identitätsdiskursen? Überlegungen am Beispiel des Kolosserbriefs” originally published in *SNTUA* 36 (2011), 63–94.

Experience that makes itself legible: Colossians and Second Thessalonians as Fictional Texts is a translation of “Erfahrung, die sich lesbar macht. Kol und 2 Thess als fiktionale Texte”, originally published in: Luther, Susanne; Röder, Jörg; Schmidt, Eckart (Hg.): *Wie Geschichten Geschichte schreiben. Frühchristliche Literatur zwischen Faktualität und Fiktionalität* (WUNT II 395). Tübingen 2015, 295–336.

Generations: Social Memory Theory and the Letters to the Thessalonians was written for this publication.

Polycarp Unchained: How Cultural Studies can enhance Patristic Research was originally published in *Vetera Christianorum* 57 (2020) 131–145.

Index of Tables

Table 1.1	Model for social and collective memory	14
Table 3.1	Exemplary temporal frame for pseudepigraphy in current exegetical literature	47
Table 3.2	Epoch model of Earliest Christianity I	50
Table 3.3	Forms of social memory (based on social/cultural memory theory)	55
Table 3.4	Collective memory: generations and gaps for our time	56
Table 3.5	Generations and gaps in the first century	58
Table 3.6	Comparison of the two epoch models	59
Table 3.7	Epoch Model of earliest Christianity II	62
Table 3.8	Generations and gaps for Paul and Polycarp	63
Table 3.9	Differences between reading from etic and emic perspectives	68
Table 4.1	Different types of intertextual dispositions as commonly used in biblical exegesis	75
Table 4.2	Types of marked and unmarked quotes (here: Isa 53 in the New Testament)	75
Table 4.3	Quotations of and allusions to Isaiah in the New Testament I	91
Table 4.4	Quotations of and allusions to Isaiah in the New Testament II	93
Table 7.1	Nünning's text model	167
Table 7.2	Colossians in Nünning's text model	169
Table 8.1	Heuristics for reading exegetical secondary literature	204
Table 8.2	Advanced heuristics for exegetical secondary literature	205
Table 9.1	Epoch Model for reading the different texts and genres in the New Testament and beyond	238
Table 9.2	Survey of New Testament text groups and early Christian generations	244
Table 9.3	Characteristics of artifacts of social and collective memory	247
Table 9.4	Summary of reading impressions	258

Index of Ancient Sources

Hebrew Bible/Old Testament

Genesis

6:2–4 33

Exodus

23:20 33, 76

Numbers

14:33–34 44

27:18 146

27:20 146

32:13 44

Deuteronomy

18:15–22 145, 146

31:2 44

32:13 134

34:7 44

34:9 146

34:10–11 145

Joshua

3–4 146

5 164

5:6 44

1 Samuel

14:25–9 134

2 Samuel

7:12–14 34

2 Kings

1:8 33, 134

Psalms

2:7 34, 136

81:17 134

89:7 33

95:10 44

Proverbs

25:16 134

Wisdom

2:13–18 34

Jesus Sirach

4:10 34

Isaiah

1:2–5 117, 120

6:1–13 120

6:8–10 117

6:9–10 96, 97, 90, 114, 115

6:10 103, 104, 113, 115, 116, 120,

122, 126

8 100

8:12 122

9:6 122

11 100

12:37–43 116

28 100

28:16 96

35:5–6 33, 143

40 100

40–55 33

40:3 33, 76, 90, 133

40:3–5 97, 115

40:9 143

40:9–11 33, 143

42:4 125

49:6 125, 122

49:11 143

51:4 122

52–53 104, 125, 121

52:7 33, 96, 143

52:13–53:12 95, 96

52:14–53:12 122

52:15 96, 125

53 75, 90, 97, 98, 100, 105, 121,

126

53:1 96, 97, 103, 104, 115,

116, 120, 122, 125,

144

53:7 97

53:12 94, 97, 122

61:1 33, 90, 96, 136, 143, 145,

146, 153

Isaiah (cont.)		1:9-11	33, 135
65:17	100	1:9-15	136
66:22	100	1:10-1	135
		1:10-11	136
Hosea		1:12	137
11:1	34	1:13	137
		1:14	137, 138
Zechariah		1:14-5	132
12:10	115	1:14-15	34, 136, 142
13:4	134	1:15	39, 132, 139
		1:16-8:26	130
Maleachi		1:17	26
3:1	33, 133	1:16-18	25
		1:16-16:8	39
		1:19.20	25
New Testament		1:21	26
		1:21-22	25
Matthew		1:22	25, 26
3:3	97, 114, 115	1:23-28	25
4:15-16	97, 144	1:25	26
8:17	98	1:26-28	26
8:17	97, 114	1:27	25
12:18	97, 144	1:29-31	25
13:13-15	97, 114, 115	1:32-34	25
13:56	189	1:35	25, 137
15:8-9	97, 114	1:36-37	26
16:16-7	153	1:38	39
17:5	145	1:39	26
18	274	1:45	137, 140
23:34-6	151	2:1-3:6	38
23:37-9	151	2:13-17	148
25:1	37	2:12	25
25:25	37	2:19	37
		3:19	138
Mark		3:21	25
1:1	34, 136	4:12	83, 97, 103, 115, 116
1:1-2	39	4:16-30	26
1:1-13	132	4:41	129
1:1-15	132	5:19	140
1-16	189	5:20	25, 140
1:2-3	33, 76, 81, 83, 97, 114, 115, 144, 145	5:42	25
		6:2	25, 129
1:2b-3	133	6:3	189
1:3	137, 143	6:7-8:26	150
1:3-4	134	6:7-11	138
1:4	137	6:12-13:30	138
1:4-8	33	6:14-6	134
1:6	134	6:17-29	138
1:8	135	6:21	138

6:30-52	146	4:16-30	26
6:31f.	137	4:17	74
6:34	143	4:18	145
6:35	137	4:18-19	97
6:35-44	137	4:25-27	74
6:39	137	4:18-19	114
6:52	25	8:10	97, 103, 115, 116
7:6-7	83	9:62	177
7:6.7	97, 114	10:18-20	34
7:24-30	140	11:49-51	151
7:31-37	140	13:33-5	151
7:36f.	140	19:30	37
7:37	25	22:3	98
8:4	13	22:27	75
8:27	130	22:37	94
8:27-11:10	130		
8:29	130, 153	John	
8:29f.	140	1:1	74
9:4	134	1:11	104
9:7	145	1:19-12:50	115
9:15	25	1:23	96, 114, 115
9:23	34	1:11	125, 126
10:27	34	1:35-46	121
11:17	83	2:13-22	84
11:18	25	2:20-21	152
11:22-25	34	2:32.34	121
12:1-12	74	3:14	151
12:18	25	4:23f.	269
14:11	138	6:45	114, 115
14:17-26	138	8:12	122
14:27	139	8:28	125, 151
14:46	140	9:1-41	122
14:49	139	9:22	111
14:50	138	11:51-52	110
14:50-52	139	12	98, 104, 121, 125
14:51f.	138	12:20-36	121, 117
14:61	130	12:20-44	121
15-16	189	12:23.28	121
15:2	130	12:32-4	151
15:34-6	134	12:37-43	103, 104, 114, 116
15:39	140	12:37-44	98, 107, 118, 117, 267
16:8	140, 141	12:37b	120
		12:38	75, 98, 104, 125
Luke		12:38-39	121
2:4-51	136	12:38-40	96, 114, 115, 119
2:40, 52	136	12:38b	120
3:4-6	97, 114, 115	12:39	103, 120
3:21-2	136	12:39a	120
4:16-18	74	12:40	103, 104, 115, 117, 126

John (cont.)		5:20	184
12:42	11	6:4	184
12:42b	120		
16:2	111	Galatians	
19:28	121	1:15-16	156
19:36-37	115, 121	2	63
20:24-9	165	2:1	64
		2:9	64
Acts		2:20	156
1:1-11:25	44	4	64
1:9-16	64	4:26	264
2	43		
2-4	43	Ephesians	
6:13-14	42, 43	5:21-6:9	240
7	43		
7:23-24	44	Colossians	
8:28	74	1:1	184
8:32-33	74, 75, 97, 98, 144	1:2	225, 226
11:5-10	64	1:3-23	171
11:26	44, 94	1:21	226
18:25	43	1:22	184
19:9	43	1:24	179, 184
22	43	1:24-25	171, 184
23	43	1:24-2-5	183
24:14	43	2:4	170, 176, 186, 228
26	43	2:5	170, 184, 227
28:16	97	2:6-23	175, 227
28:26	97, 114, 115	2:6-4:1	171
28:26-27	103, 116	2:8	170, 175, 176, 224, 227, 228
		2:16	170, 228
Romans		2:16-23	227
1:1	184	2:18	177, 228
1:2-4.17	97	2:20-21	177
3:3-26; 2	151	2:22	170, 177, 228
9:27.28	92	3:18-4:1	240
9:33	89	4:5	170
10:16	75, 92, 96, 98, 114, 116	4:13-16	225, 226
10:20.21	92	4:16	216
11:18	114, 116		
15:21	75, 96	1 Thessalonians	
		1:1	251, 252
1 Corinthians		1:2	252
1:1	184	1:3	251, 252
12	275	1:4	215
		1:5	253
2 Corinthians		1:6	251, 253
1:1	184	1:1-6	251
5:14	151	1:7-8	251

1:8	252
1:9	251
2:1	251
2:2	252
2:6	251
2:7	251
2:7-12	251
2:9	252, 253
2:19	252
2:11	251, 252
2:12	214, 253
2:13	252
2:14	251
2:17	251
2:18	252
3:2	251
3:3	252
3:4	252
3:5	252
3:7	251, 253
4:1	214, 251, 253
4:1-10	253
4:1-12	252
4:2	252, 253
4:3	253
4:6	251
4:9	251, 252
4:10	251, 253
4:13	251
4:13-18	252
4:13-5:11	254
4:18	253
5:1	251
5:1-11	252
5:4	251
5:5-11	252
5:7	252
5:8	252
5:11	252, 253
5:11-12	253
5:11-26	253
5:12	251, 253
5:12-20	252
5:12-22	252, 255
5:14	214, 253
5:18	252
5:25-27	251
5:27	253

2 Thessalonians	
1:4-10	212
1:3-12	254, 256
1:4-5	254
1:6	254
1:6-10	255
1:7	254
1:8	255
1:10	257
2:1	256
2:2	212, 254, 255
2:2-3	254
2:3	254
2:3-12	255
2:7	255
2:12	255
2:14	255, 257
2:13	256
2:15	254, 255, 256
3:1	256
3:2	212, 254, 256
3:3	254
3:4	254, 255, 256
3:6	256, 257
3:6-10	214
3:6-12	255
3:6-13	254, 255, 256
3:7	214, 255, 256
3:7-9	254
3:7-10:	257
3:7-13	212
3:9	214, 255, 256
3:10	255, 256
3:11	255, 256
3:12	214, 255, 256
3:14	255, 256
3:15	256
3:17	254, 258

2 Timothy	
1:1	184
1 Peter	
2:6	100
2:8	100
2:18-25	100
2:22-25	75
3:13	100

1 John
4:23f. 269

Jude
1 189

Revelation
14:5 74
21:1 100

Old Testament Pseudepigrapha

Joseph and Aseneth
6:2–6 34
13:10 34

Dead Sea Scrolls

4Q174 I: 10–13 34
4Q246 34

Rabbinic Works

Babylonian Talmud
bRHSh17b 126
bMeg17b 126

Mekhilta
Mekhij Jitro (Ba Chodesh) 1 126

Apostolic Fathers

Epistle of Barnabas
5:7 265

Polycarp, Letter to the Philippians
11:2 264
2:1 274
2:2 274
2:3 275
3:1 263, 264, 269
3:2 264, 275
3:2–3 66
3:3 264

3:13 265
3:17 264
4:1 264, 269, 274
4:3 274
4:8 264
4:21 264
6:1 274, 275
6:2 274
6:3 275
5:2 274
5:3 269
7:1 265, 269, 275
8:1 274
8:2 274
9:1 264, 269
9:2 265
10:1–2 274
10:2–3 274
11:1 272
11:3 66
1:4 275
12:1 268
12:4 275
13:2 272

Ignatius of Antioch, *Adversus Haereses*
III.3.3 269

Justin Martyr, *First Apology*
50,2 100

Tertullian, *De praescriptione haereticorum*
32 267

Ancient Christian Writings

Apostolic Constitutions
III.17 135
V.7 135
VI.15 135

Eusebius, *Church History*
3.24.6 65, 240
3.36.13–15 265
5.20.6 267
5.24.17 268

Index of Authors

- Achtemeier, Paul J. 194, 209, 218
Aichele, George 269
Alkier, Stefan 69, 92, 95, 114, 140, 250
Antoninus Pius 100
Assmann, Aleida VII, 5–6, 9–11, 13, 38,
51–54, 59, 88, 152, 246
Assmann, Jan VII, 6, 9, 10–11, 13, 18, 30, 38,
41–42, 51, 54, 59, 88, 108, 129, 130–131,
135, 150, 152, 154–155, 189, 246, 249
Aune, David E. 243
- Backhaus, Knut 148
Barclay, John M.G. 220
Bartlett, Frederic Charles 36
Bauer, Johannes B. 265–266, 270
Baum, Armin 172
Becker, Eve-Marie 183, 212–213, 259
Berding, Kenneth 266, 277–278
Beutler, Johannes 111, 119, 121, 125, 152, 191
Bosenius, Bärbel 137
Bovon-Thurneysen, Annegreth 266
Brendsel, Daniel J. 104, 125–126
Breytenbach, Cilliers 100
Broer, Ingo 181, 194, 211, 214–215, 219,
224–225
Bull, Klaus-Michael 239
Burkett, Delbert Royce 194, 209, 218
- Collins, Adela Yarbro 132
Conzelmann, Hans 194, 211
Cousland, Robert 57
Crüsemann, Marlene 210
Cyprian of Carthage 82
- Dehandschutter, Boudewijn A.G.M. 265,
267, 269, 273, 275, 278
Deppe, Dean B. 34, 133
Dettwiler, Andreas 210, 220
Dewey, Arthur J. 143–144, 151
Domitian 165, 242
Du Toit, David S. 33–34, 65, 133, 136,
145–147, 151, 153, 241
Dunn, James D.G. 147–148
- Ebner, Martin 48–51, 59, 61, 132, 164, 183,
194, 210, 219, 224, 226
- Eckey, Wilfried 132
Eco, Umberto 78, 193, 284
Ehrmann, Bart D. 224
Epaphras 183–184, 222, 226
Erll, Astrid 3, 5–8, 10, 31, 59
Ernst, Josef 184
Eusebius of Caesarea 240, 265
Evans, Craig A. 92, 121, 143
- Focant, Camille 138
Förster, Hans 103–104, 117–118, 120–122, 126
Förster, Niclas 139
France, Richard T. 132
Frank, Nicole 175, 178, 186, 223, 226–227, 230
Frankemölle, Hubert 130, 131, 146–149
Frenschkowski, Marco 172, 178
Frey, Jörg 100, 111–112, 163–164, 172, 175, 178,
183, 189, 194, 202–203, 209, 223, 236,
259, 263
Fried, Johannes 3, 30
Frisch, Max 23, 27–28, 32, 187, 193, 218,
231–232
- Genz, Rouven 99
Gergen, Kenneth 99, 127, 140–141
Glaser, Timo 203, 206–207
Gnilka, Joachim 132, 134, 146–148, 184–185,
220, 222
Gupta, Nijay K. 220
Guttenberger, Gudrun 132
- Haag, Herbert 82
Häfner, Gerd 148
Halbwachs, Maurice VII, 6–13, 29–32, 38,
41, 43, 51, 53, 59, 83, 85, 88, 97, 107–108,
110, 112–113, 152, 155, 239, 246
Harth, Dietrich 6
Hartmann, Dorota 33, 87, 151
Hartog, Paul 263
Hatina, Thomas R. 9, 76–77, 83–84, 98, 242,
276
Hearon, Holly 4
Holmes, Michael W. 84, 276
Hooker, Morna D. 143
Hoppe, Rudolf 191, 248, 259
Hort, Fenton J. A. 265

- Hübner, Hans 174, 183–184, 187, 224–225
 Huebenthal, Sandra IX, 9, 11–12, 33–34,
 37–38, 43, 55, 59, 64, 66, 74, 83–84,
 87–88, 94–95, 98, 103, 107, 111, 130–131,
 139, 150–152, 154, 158–159, 185, 189, 198,
 204, 222, 235–247, 250, 258, 276, 278
- Ignatius of Antioch 45, 47–48, 51, 180–181,
 265–267, 272–273, 275
- Iser, Wolfgang 78, 166, 196
- Janßen, Martin 163–164, 172, 175, 178–183,
 189, 194, 202–203, 209, 223, 236, 259
- Jaroš, Karl 219
- Jay, Pierre 82
- Karrer, Martin 259
- Kee, Howard Clark 194, 209, 220
- Keith, Chris 79, 87, 143, 148, 151–152
- Kelber, Werner H. VII–VIII, 60, 78–80, 131,
 143–145, 243
- Kenobi, Ben 157
- Keppler, Angelika 52
- Kirk, Alan 4, 7, 9, 12, 18, 80, 131, 143–144,
 283, 287
- Klein, Christian 197, 200, 203
- Kloppenborg, John S. 84
- Kobel, Esther 36
- Koch, Dietrich-Axel 89, 98, 100
- Kok, Michael J. 79
- Konradt, Matthias 89, 155
- Kraus, Wolfgang 98, 100, 105, 126, 174, 212,
 220, 259
- Kreinecker, Christina M. 210–211, 248, 256
- Krentz, Edgar 209, 213, 236
- Kümmel, Werner Georg 194, 218
- Larsen, Matthew D. C. 73, 81
- Laub, Franz 210, 214
- LeDonne, Anthony 79, 148, 152
- Lett, Jonathan 133
- Lohse, Eduard 183
- Longenecker, Bruce W. 26
- Lookadoo, Jonathon 278
- Lucian of Samosata 73
- Lüdemann, Gerd 245
- Lühmann, Dieter 132
- Luther, Susanne 66, 245
- Luz, Ulrich 175
- Macnamara, Luke 111
- Maisch, Ingrid 65, 167, 170, 175, 177–178, 188,
 226, 228–229
- Malbon, Elisabeth Struthers 154
- Manier, David 8, 11
- Marcion 86, 102, 269–270
- Marcus, Joel 132
- Marguerat, Daniel 194, 210, 220
- Markowitsch, Hans J. 28–29
- Markschies, Christoph 101–102, 263
- Martínez, Matias 165, 195–200, 203
- Martyn, J. Louis 112
- Menken, Maarten J.J. 90, 96–97, 99–100,
 103, 113–117, 139, 143
- Merkel, Helmut 172, 221
- Merz, Anette 223
- Miller, David L. 266
- Mitchell, Margaret M. 205, 215–216
- Montanaro, Andrew 80
- Moyise, Steve 90, 96, 100
- Müller, Paul-Gerhard 215
- Müller, Peter 133, 174, 220
- Nicklas, Tobias 86, 95, 235, 242, 248
- Niebuhr, Karl-Wilhelm 194, 209, 218–219
- Nielsen, Charles 265–266
- Nünning, Ansgar 3, 5–8, 10, 31, 59, 166–167,
 169, 171, 173–174, 196–198, 204
- Omerzu, Heike 33, 133, 143–145
- Origen 86
- Patte, Daniel 70
- Paulsen, Henning 265
- Pesch, Rudolf 132
- Pethes, Nicolas 5
- Pfeiffer, Stefan 165
- Phillips, Gary A. 269
- Pilhofer, Peter 165, 172, 194, 220, 274–275
- Pokorný, Petr 47–48, 61, 180, 194, 210–211,
 220
- Polycarp 47–48, 50, 63, 66–67, 77, 180, 243,
 263–279
- Reinhartz, Adele 112
- Reinmuth, Eckart 164–166, 182, 189,
 202–203, 211, 213, 217–218, 231, 239
- Rhee, Helen 66–67
- Riedl, Hermann J. 182

- Rodriguez, Rafael 97
 Roh, Taesong 259
 Roloff, Jürgen 47, 61, 179, 194, 220, 222
 Roose, Hanna 212–213, 254, 259
 Rothschild, Claire 163, 172, 175, 178, 183, 189,
 194, 202, 209, 223, 236, 259
 Rösen, Jörn 54
- Schacter, Daniel L. 30–31
 Scheffel, Michael 165, 195–199
 Schierse, Franz Josef 194, 210, 221
 Schmeller, Thomas 172
 Schmid, Hansjörg 175–176, 206, 228
 Schmidt, Eckart D. 244–245
 Schmidt, Karl M. 182, 197, 235, 259
 Schmidt, Siegfried J. 3
 Schnelle, Udo 45–47, 50–51, 61, 194,
 209–210, 215, 220, 223, 239
 Schreiber, Stefan 132, 164, 183, 194–195, 210,
 213, 215–216, 219–220, 224, 226, 239,
 248, 259
 Schröter, Jens 18, 100, 147–148, 151–152
 Schwartz, Barry 143
 Schweizer, Eduard 134
 Segovia, Fernando F. 112, 270–271
 Seneca 203
 Standhartinger, Angela 65, 173, 175, 226–227
 Stern, William 30
 Suetonius 165
- Tertullian 267–268, 271
 Thatcher, Tom 4, 7, 18, 80, 131, 143–144
 Theißen, Gerd 195
- Theobald, Michael 139, 148, 183, 219,
 224–226, 259, 272
 Thompson, Trevor 194, 202, 209–212,
 215–216, 236, 259
 Thyen, Hartwig 111, 119–120, 123
 Torrance, Thomas F. 265
 Tulving, Endel 28
- Ulrich, Eugene 81
- Van Damme, Dirk 268–269
 Van Iersel, Baastian M. F. 132
 Vansina, Jan 10
 Vegge, Tor 172
- Wagner, J. Ross 96, 114
 Wasserman, Tommy 34, 132
 Watson, Francis 47, 60
 Watzlawick, Paul 41
 Weidemann, Hans-Ulrich 181, 194, 211,
 214–215, 219, 225, 259
 Welzer, Harald 6–7, 9–11, 28–29, 53–54
 Wengst, Klaus 118, 120, 123, 126
 Wilk, Florian 92, 96, 99, 112, 114–115
 Williams, Catrin H. 103, 112–113, 115–117, 122
 Wolter, Michael 180, 189, 224
 Woyke, Johannes 98
 Wrede, William 210
- Zimmermann, Ruben 36–37, 166, 181–182,
 186–187, 199–200, 203, 231
 Zipfel, Frank 197, 199
 Zumstein, Jean 115, 118–119, 121