

**Universität Passau**  
Philosophische Fakultät

**On nation, homeland, and democracy: Toward a  
novel three-factor measurement model for  
nationalism and patriotism**  
Revisiting the nationalism-patriotism distinction

Publikationsbasierte Dissertation zur Erlangung des akademischen Grades  
Doktorin der Politikwissenschaft  
(Dr. rer. pol.)

vorgelegt von  
**Marlene Mußotter**  
Freiburg, 14. März 2023

Vorgeschlagener Erstgutachter: Prof. em. Dr. Horst-Alfred Heinrich  
Vorgeschlagener Zweitgutachter: Prof. Dr. Eldad Davidov

# Content

<b>1</b>	<b>Introduction .....</b>	<b>1</b>
<b>2</b>	<b>The nationalism-patriotism distinction .....</b>	<b>6</b>
2.1	<i>The evolution of the nationalism-patriotism distinction .....</i>	6
2.2	<i>Kosterman and Feshbach's work in the United States (1989) .....</i>	8
2.3	<i>Blank and Schmidt's work in Germany (2003).....</i>	10
2.4	<i>Criticism of the nationalism-patriotism distinction .....</i>	13
2.4.1	Conceptual critiques.....	13
2.4.2	Normative critiques.....	15
2.4.3	Empirical critiques .....	15
2.4.4	Theoretical critiques.....	17
2.5	<i>Summary .....</i>	19
<b>3</b>	<b>Reconceptualizing the nationalism-patriotism distinction: Toward a triad of attachments</b>	<b>22</b>
3.1	<i>Attachment .....</i>	23
3.2	<i>Nationalism: Attachment to the nation .....</i>	26
3.3	<i>Patriotism.....</i>	30
3.3.1	Attachment to the homeland .....	30
3.3.2	Attachment to democratic values .....	32
3.4	<i>Summary .....</i>	35
<b>4</b>	<b>Research hypotheses.....</b>	<b>38</b>
4.1	<i>Research on the relationship between authoritarianism, nationalism, and patriotism.....</i>	38
<b>5</b>	<b>Data and Methodology .....</b>	<b>40</b>
5.1	<i>Measures: Generating the item pool .....</i>	41
5.2	<i>Study 1: Development study.....</i>	44
5.2.1	Sample.....	44
5.2.2	Results.....	45
5.3	<i>Study 2: Validation study.....</i>	50
5.3.1	Sample.....	50
5.3.2	Survey measures .....	51
5.3.3	Results.....	51
5.4	<i>Study 3: Main study .....</i>	54
5.4.1	Sample.....	54
5.4.2	Survey Measures .....	55
5.4.3	Results.....	56
<b>6</b>	<b>Discussion and Conclusion .....</b>	<b>59</b>

**7 Bibliography..... 64**

**8 Appendix ..... 79**

**9 Annex ..... 100**

*Meinen Eltern, die mir Wurzeln und Flügel schenkten*

## Danksagung

An erster Stelle möchte ich meinem Doktorvater, Prof. em. Horst-Alfred Heinrich, für seine Betreuung danken. Er war während der gesamten Promotionszeit immer für mich da und hat an mich und meine Fähigkeiten von Anfang an geglaubt. Ich schätze es sehr, dass er mir so viel Forschungsfreiheit gab und mich meinen eigenen Weg gehen ließ. Er war außerdem derjenige, der mich während des Masterstudiums in die Politische Psychologie, mein späteres Forschungsfeld, einführte. Ich erkenne es ihm hoch an, dass er bereits damals viel mehr in mir gesehen hat, als ich in mir.

Ein großer Dank gebührt außerdem Prof. Eldad Davidov. Ich hätte mir keinen besseren Zweitgutachter vorstellen können! Auf ihn und seine methodische Expertise konnte ich mich während der gesamten Promotionszeit verlassen.

Ebenfalls danken möchte ich Prof. em. Peter Schmidt für die Erstellung des Drittgutachtens. Es ist für mich ein Privileg, die Forschungstradition, die er Ende der 90er zusammen mit Thomas Blank zur Nationalismus-Patriotismus Distinktion begründete, weiterzuführen.

Darüber hinaus möchte ich die Konrad-Adenauer-Stiftung erwähnen, die mich 2020 als Promotionsstipendiatin aufgenommen und diese Arbeit gefördert hat.

Ein ganz, ganz besonderer Dank gilt meiner ehemaligen Mentorin, Dr. Eunike Piwoni. Ohne sie und ihre wertvollen Ratschläge hätte ich diese Arbeit und den Weg in die Wissenschaft in dieser Form nicht geschafft. Ich schätze es sehr, dass aus unserem ursprünglichen Mentorenverhältnis eine schöne Freundschaft entstanden ist und wir weiterhin gemeinsam publizieren.

Die größte Dankbarkeit möchte ich meinem wunderbaren und großartigen Partner Moritz aussprechen. *You are my rock.*

Freiburg, 16.12.2023

Marlene Mußotter



# 1 Introduction

The field of nationalism studies is rife with binary distinctions. On the one hand, scholars have distinguished between different types of nationalism (for an overview, see Spencer & Wollman, 1998), the most prominent being civic versus ethnic nationalism (e.g., Ignatieff, 1993; Shulman, 2002; Reeskens & Hooghe, 2010; Larsen, 2017; Mader et al., 2021) which is commonly associated with Kohn's (1944; 1982) work on the rise of "Western" and "non-Western" (often termed "Eastern") nationalism.<sup>1</sup> In addition, scholars have proposed elite versus everyday nationalism (Fox & Miller-Idriss, 2008), weak versus low and strong versus high nationalism (Todorova, 2015), political versus quotidian nationalism (Bonikowski, 2016), inclusive versus exclusive nationalism (Tudor & Slater, 2019), liberal versus illiberal nationalism (Tamir, 2019b), and new versus old nationalism (Halikiopoulou & Vlandas, 2019). On the other hand, scholars have differentiated various types of patriotism, the most famous being constructive versus blind patriotism (Schatz et al., 1999). Others have advocated for genuine versus *pseudopatriotism* (Levinson et al., 1950), weak versus strong patriotism (Doob, 1964), active versus passive patriotism (Bar-Tal, 1993), symbolic versus blind patriotism (Parker, 2010), political versus cultural patriotism (Ariely, 2011), uncritical versus critical patriotism (Miller & Ali, 2014), conventional versus constructive patriotism (Sekerdej & Roccas, 2016; Sekerdej et al., 2023), and moderate versus extreme patriotism (Nathanson, 2020).

In political psychology,<sup>2</sup> the dichotomy between nationalism and patriotism has been used to explain people's attachments to the nation. It is one of the field's most influential binary distinctions, if not *the* most influential. To the author's knowledge, this is the first study to systematically revisit and further develop this distinction in both conceptual and empirical terms. Largely overlooked in previous research, studies on this distinction have proceeded along two distinct tracks that have evolved independently from each other. One dominant research tradition that dates back to the work of Kosterman and Feshbach (1989) commonly conceives of nationalism as the belief that one's nation is superior to others (e.g., De Figueiredo & Elkins, 2003; Huddy & Khatib, 2007; Davidov, 2009; Osborne et al., 2017; Satherly et al., 2019; Ariely,

---

<sup>1</sup> Note, that Kohn's work was originally inspired by, among other things, Meinecke's (1928) distinction between *Kulturnation* and *Staatsnation*.

<sup>2</sup> This work relies on Osborne and Sibley (2022: 4), who defined political psychology as a research field that investigates "how people shape and are shaped by the political world around them." Thus, political psychology focuses on the micro level (i.e., individuals and their political behavior).

2020; Molina & Preddie, 2020). Thus, it typically operationalizes nationalism through items such as “Generally, the more influence [COUNTRY] has on other nations, the better off they are”; “Other countries should make their government as much like ours as possible”; or “In view of [COUNTRY]’s moral and material superiority, it is only right that we should have the biggest say in deciding United Nations policy” (Kosterman & Feshbach, 1989: 264; see also Li & Brewer, 2004; Kimmelmeier & Winter, 2008; Osborne et al., 2017; Bizumic & Duckitt, 2018; Satherly et al., 2019). Studies that draw on the International Social Survey Programme (ISSP) dataset generally employ the following items: “Generally speaking, [COUNTRY] is a better country than most other countries” and “The world would be a better place if people from other countries were more like [NATIONALITY]” (e.g., Davidov, 2009; Ariely, 2012, 2020; Wamsler, 2022; see Feinstein & Bonikowski, 2021 or Rapp, 2022 on chauvinism). This line of research defines patriotism as an emotional attachment to one’s country, that is love of country (e.g., Kosterman & Feshbach, 1989; Sidanius et al., 1997; Li & Brewer, 2004; Satherly et al., 2019) and commonly employs items such as “I am proud to be a [NATIONALITY]”; “I am emotionally attached to [COUNTRY] and emotionally affected by its actions”; or “Although at times I may not agree with the government, my commitment to [COUNTRY] always remains strong” (Kosterman & Feshbach, 1989: 264; see also Li & Brewer, 2004; Kimmelmeier & Winter, 2008; Osborne et al., 2017; Satherly et al., 2019).

Another dominant research tradition, which originates from the work of Blank and Schmidt (2003), proposes a more encompassing notion of nationalism as it also stresses its strong association with an ethnic notion of nationhood (e.g., Dekker et al., 2003; Gangl et al., 2016; Huddy et al., 2021; Jenne et al., 2021). It not only employs pride item batteries such as pride in one’s nationality or one’s nation’s history (e.g., Blank & Schmidt, 2003; Latcheva, 2011; Wagner et al., 2012; Heinrich, 2016, 2020; for a critique on the general national pride item see Meitinger, 2018) to measure nationalism but also items that capture the importance of ethnic traits such as national ancestry (notably, Huddy et al., 2021). Moreover, this line of research defines patriotism as a strong adherence to democratic values and typically relies on ISSP pride items such as “How proud are you of the way democracy works?,” “How proud are you of the social security system?,” and “How proud are you of the fair and equal treatment of groups in society?” (e.g., Davidov, 2009; Ariely, 2011, 2012; Green et al., 2011; Konrad & Qari, 2012; Wagner et al., 2012; Huddy et al., 2021; Rapp, 2022; Wamsler, 2022; for a critique of the pride items, see Latcheva, 2011; for a further discussion on the pride items for nationalism and patriotism, see Mußotter, 2022).



In summary, one is confronted with two diverging research traditions with different notions of nationalism and patriotism and that consequently employ different measures to operationalize these types of attachments. Within these research traditions, nationalism and patriotism have largely been conceived as different types of national attachment (e.g., Kosterman & Feshbach, 1989; Sidanius et al., 1997; Satherly et al., 2019; Huddy et al., 2021). However, the *objects* of attachment that this study focuses on have received little attention to date. In the literature on political psychology and beyond, nationalism is considered to revolve around the nation (e.g., Terhune, 1964; Connor, 1978; Kosterman & Feshbach, 1989; Druckman, 1994; Blank & Schmidt, 2003; Primoratz, 2017; Osborne et al., 2017; Harari, 2018; Molina & Preddie, 2020; Huddy et al., 2021), the state (e.g., Hayes, 1937; Gellner, 1983; Breuilly, 1993; Ariely, 2011; Jenne et al., 2021), the nation-state (e.g., Kohn, 1982; De Lamater et al., 1969), the “national collective” (Weiss, 2003: 388), one’s “own group” (Blank & Schmidt, 2003: 289), one’s “own community” (Gangl et al., 2016: 868), the “ethnic or national community” (van Evera, 1994: 6), one’s nationality (Miller, 1997), or the government (Doob, 1964). Meanwhile, patriotism is assumed to center around the country, also known as the homeland (e.g., Kohn, 1939; Terhune, 1964; Citrin et al., 2001; Karasawa, 2002; Theiss-Morse, 2009; Osborne et al., 2017; Primoratz, 2017); the nation (e.g., Conover & Feldman, 1987; Kosterman & Feshbach, 1989; Blank & Schmidt, 2003; Ben-Porath, 2007; Sekerdej & Roccas, 2016; Osborne et al., 2017; Harari, 2018; Molina & Preddie, 2020; Huddy et al., 2021); the nation’s institutions and key principles (De Figueiredo & Elkins, 2003); the “particular characteristics and merits and achievements of one’s own nation” (MacIntyre, 1984: 4); the republic (e.g., Viroli, 1995); one’s “own group” (Blank & Schmidt, 2003: 289); one’s “own community” (Gangl et al., 2016: 868); one’s compatriots (Miller, 1997); the state (e.g., Heinrich, 2016); the constitution (Smith, 2021); the *polity* (MacMullen, 2014); or the constitutional culture (Müller, 2008a). In short, while there is at least partial agreement that nationalism and patriotism are different types of national attachment, there is disagreement about their specific objects of attachment. Moreover, these objects are distinct and should not be used interchangeably. In other words, the nation should be distinguished from other objects, such as the state, the regime, the constitution, or one’s own group.

To date, these two research traditions, i.e., the work of Kosterman and Feshbach (1989) on the one side and the work of Blank and Schmidt (2003) on the other side, have not been fully recognized as diverging, nor have they been brought into dialogue or systematically addressed. By synthesizing these lines of research and drawing on attachment literature, this study aims to

reconceptualize the binary distinction between nationalism and patriotism and to consequently operationalize the novel distinction. While acknowledging the strengths of this binary distinction, the study addresses its conceptual shortcomings, which a number of scholars have criticized (e.g., Billig, 1995; Canovan, 2000; Dekker et al., 2003; Brubaker, 2004; Bonikowski, 2016; Mylonas & Tudor, 2021). However, these shortcomings have received little attention to date. In the process, this study makes the first systematic attempt to reflect on and further develop this binary distinction. Importantly, it does not abandon the dichotomy as a whole, but seeks to contribute analytical clarity to refine it. In other words, it aims to disentangle different notions of nationalism and patriotism and thus strengthen the explanatory power of the distinction. To this end, three main research questions form the focus of the current study:

1. What are the conceptual (and related empirical) shortcomings of the nationalism-patriotism distinction?
2. How can this distinction be reconceptualized to achieve greater analytical clarity?
3. How can the reconceptualized distinction be operationalized in a theoretically robust manner?

This study makes three primary contributions, which are both substantive and methodological in nature. In the process, it seeks to advance research in nationalism studies in general and political psychology in particular. First and most importantly, it reconceptualizes the binary distinction between nationalism and patriotism and introduces a novel conceptual approach. By drawing on the attachment literature, it advocates for a more nuanced triad of attachments: nationalism that revolves around the nation, patriotism that centers on the homeland, and democratic patriotism with democracy as its object of attachment. To the author's knowledge, this is the first study to account for these objects of attachment, thus making a theoretical contribution. In the process, it both builds and expands on the existing scholarship. For instance, Dekker et al. (2003) offered a novel conceptualization and measure of nationalism but not patriotism. Similarly, Sekerdej and Roccas (2016) aimed to disentangle two types of patriotism (i.e., conventional patriotism versus constructive patriotism), but they did not consider nationalism. More recently, Huddy et al. (2021) synthesized the two different notions of nationalism, i.e., the belief in one's nation's superiority and an ethnic notion of nationhood, but mingled various concepts of patriotism without reflecting on their different understandings. The current study is distinct, as it not only accounts for these two research traditions on nationalism but also disentangles different concepts of patriotism (i.e., love of country and attachment to

democratic values), which have been overlooked in existing research. In short, this study focuses on and revisits the entirety of the binary distinction.

Second, in line with the proposed approach, the current study presents a novel and validated three-factor model for the measurement of nationalism, patriotism (i.e., love of country), and democratic patriotism. Thus, it goes beyond existing research by not only integrating but also simultaneously investigating two different concepts of patriotism within a single model. In total, it draws on data from three studies: two convenience samples in 2020 and 2021 that serve as development and validation study and a nationally representative sample in Germany in 2022 that is seen as the main dataset. By presenting a novel three-factor measurement model that aligns with the proposed reconceptualization, this study responds to calls to develop new and more theoretically robust measures of nationalism and patriotism (e.g., Dekker et al., 2003; Latcheva, 2011; Hanson & O'Dwyer, 2019).

Third, the measures were validated by testing the effect of authoritarianism on nationalism, patriotism (i.e., love of country), and democratic patriotism. Therefore, this study also provides new insights on the complex relationship between these types of attachment and authoritarianism, which have hitherto rarely been tested (however, see Blank, 2003 or Heinrich, 2016 in the context of Germany; Osborne et al., 2017 in the context of New Zealand). Investigating the model's effects on anti-Semitism, the measures are additionally supported. Thus, the study not only introduces a theoretically robust three-factor measurement model but also accounts for its authoritarian roots *and* its effects on out-group hostility.

The study is structured in three main parts as follows. First, the distinction between nationalism and patriotism is presented, with an emphasis on the works of Kosterman and Feshbach (1989) and Blank and Schmidt (2003). Thus, its evolution, conceptualization, operationalization, adoption, and criticism are described. Second, the novel conceptual approach and triad of attachments (i.e., nationalism, patriotism, and democratic patriotism) are introduced by drawing on attachment literature. Third, the study's empirical portion (i.e., the three studies that were conducted to develop and validate the novel three-factor measurement model) is presented. Lastly, the triad of attachments in general and the model's findings in particular are discussed, and avenues for future research are suggested.

## 2 The nationalism-patriotism distinction<sup>3</sup>

### 2.1 The evolution of the nationalism-patriotism distinction

In the 1920s, the social psychologist Floyd Allport (1927: 293) asserted that previous writers had not “fairly distinguished between nationalism and patriotism” despite the former being one of the main drivers of war. Thus, he initially highlighted the need to separate nationalism from patriotism. This dichotomy was subsequently employed by historians such as Deutsch (1953: 232; for a more recent account, see Harari, 2018; Lepore, 2019), who found that patriotism “is an effort or readiness to promote the interests of [...] the *patria*, i.e., country, whereas nationalism aims at promoting the interests of the *natio*, i.e., literally a group of common descent and upbringing [...] of complementary habits of communication.” Snyder (1954: 148) concurred, noting that nationalism revolved around “the independence and unity of the nation,” while patriotism involved the individual’s passion “to serve the object of his devotion – his country.” He further emphasized that the latter should be viewed as “a universal attribute of man in society throughout history,” while the former is “a relatively new phenomenon in modern history” (ibid.:148).

In the 1960s, the social psychologist Doob (1964) was the first to systematically examine the psychological foundations of patriotism and nationalism in the context of South Tyrol. He understood patriotism as “a conscious conviction of a person that his own welfare and that of the significant groups to which he belongs are dependent upon the preservation or expansion of both of the power and culture of his society” and viewed nationalism as “a set of uniform demands which people share, which arise from their patriotism [...] and which incline them to make personal sacrifices in behalf of their government’s aims” (ibid.: 6). By definition, he underscored the conceptual overlap of nationalism and patriotism. In Doob’s account, patriotism should be viewed as an “individual matter,” while nationalism is “most definitely social” (ibid.: 8). Notably, in the study’s first sentence, he described nationalism as “one of the most important problems, if not the most important one, of this century” (ibid.: 1). Without thoroughly engaging with Doob’s work, the distinction was then established in political

---

<sup>3</sup> Please note that this chapter is based on publication 1 (Mußotter, 2022), 2 (Bitschnau & Mußotter, 2022), and 4 (Piwoni & Mußotter, 2023).

psychology in the late 1980s by Kosterman and Feshbach in United States and in the late 1990s by Blank and Schmidt in Germany (2003; see also Blank et al., 1997).

Subsequently, without considering the pertinent literature on political psychology, Viroli (1995) strongly advocated for this distinction in political theory in the late 1990s. He aimed to disentangle both concepts that, so Viroli, have not been neatly separated in previous research. One of these accounts was that of Orwell (1968: 362), who defined patriotism as “devotion to a particular place and a particular way of life which one believes to be the best in the world but has not wish to force upon other people” and nationalism as striving for “more power and prestige [...] for the nation.” Viroli (1995: 1) claimed that the “language of patriotism [seeks to strengthen] love of the political institutions and the way of life that sustain the common liberty of a people, that is love of republic,” whereas “the language of nationalism [aims to] defend or reinforce the cultural, linguistic, and ethnic oneness and homogeneity of the people” (for a critique, see Yack, 1998). Like Snyder’s (1954: 148) “object of devotion,” Viroli (1995: 2) underscored different “objects of love” in nationalism and patriotism. That is, the object of love is the republic in patriotism and the nation in nationalism. Viroli also stressed their different *types* of love; while patriotism is shaped by a “charitable and generous love,” nationalism is defined by “an unconditional loyalty or an exclusive attachment” (ibid.: 2). Overall, he considered patriotism as “a formidable opponent for nationalism” (ibid.: 8).<sup>4</sup> More recently, the political theorist Smith (2021) also advocated for this distinction. According to Smith, nationalism is characterized by “a language of exclusion,” whereas patriotism is “a sentiment of gratitude and appreciation for who we are and what has made us” (ibid.: 9). While the former “views the world as a jungle full of threats,” the latter regards it as “a garden that need tending and pruning” and that, in particular, “provides a home and sense of place” (ibid.: 10). Thus, Smith advocated for the reclamation of patriotism, which he considered “the most fundamental political virtue” (ibid.: 4).<sup>5</sup>

To date, the nationalism-patriotism distinction has been largely applied in political psychology, particularly quantitative empirical research. By contrast, qualitative research that draws on the

---

<sup>4</sup> Interestingly, in the late 1990s, Viroli (1995: 15; see also Rorty, 1994) already indicated that the “left has allowed the right to have the monopoly over the language of patriotism.” Recently, this claim has gained renewed scholarly interest and repeated within (e.g., Smith, 2021) and beyond political theory (see e.g., Assmann, 2020; see also Kronenberg, 2013) and in the non-academic literature in Germany (e.g., Dorn, 2019; Brissa, 2021; see also Habeck, 2010).

<sup>5</sup> On whether patriotism is a virtue, see MacIntyre, 1984; Kateb, 2000; Keller, 2005; and Costa, 2020.

nationalism-patriotism distinction is scarce in political psychology. Except for two studies conducted in Austria (Fleiß et al., 2009; Latcheva, 2011), mixed-methods approaches are also rare. The next section describes the works of Kosterman and Feshbach (1989) and Blank and Schmidt (2003) to shed light on the two most influential research traditions in political psychology.

## 2.2 Kosterman and Feshbach's work in the United States (1989)

The distinction between nationalism and patriotism was originally conceptualized *and* operationalized by Kosterman and Feshbach (1989) in the United States. They criticized previous studies for obscuring the distinction between nationalism and patriotism and frequently but erroneously equating both concepts. Specifically, they claimed that prior research has “done little to boost the image of patriotism or to distinguish it from nationalism” (ibid.: 258). Thus, the authors implicitly *advocated* for this distinction between patriotism, defined as “feelings of attachment to America,” and nationalism, defined as the “view that America is superior and should be dominant” (ibid.: 260) from the beginning of their empirical study. Their goal was to show “the multidimensionality of patriotic and nationalistic attitudes and dispositions” (ibid.: 260).

Drawing on data from college students ( $N = 194$ ), high school students ( $N = 24$ ), and building contractors ( $N = 21$ ), they conducted an exploratory factor analysis (EFA) – a purely data-driven method that is used to identify underlying patterns in a number of items – on a 120-item questionnaire. Partly by relying on existing measures such as Loh's (1975) nationalism scale, they measured patriotism using items such as “I love my country” or “When I see the American flag flying, I feel great” and nationalism using items such as “Generally, the more influence America has on other nations, the better off they are” or “Other countries should make their governments as much like ours as possible” (ibid.: 264). The authors highlighted that the items used to measure patriotism target the “affect for America or “my country,” while the items used to tap nationalism capture “an ‘America-first’ or ‘superiority’ view relative to others” (ibid.: 263). Apart from a weak correlation between the two factors ( $r = .28$ ), their data supported the conceptual bifurcation between nationalism and patriotism as hypothesized.<sup>6</sup>

---

<sup>6</sup> Notably, what has often been neglected in existing accounts is that nationalism and patriotism were only two of the *six* factors that Kosterman and Feshbach's (1989) study yielded in total. The remaining factors were labeled

Using a multiple regression, the researchers found that nationalism positively correlates with support for nuclear policy ( $r = .68$ ), while patriotism does not ( $r = .18$ ), further validating the distinction. Thus, their initial assumption that nationalism would be strongly correlated with pro-nuclear armament views and that patriotism would be weakly correlated with such views (ibid.: 261) was empirically supported. In addition, an ANOVA that controlled for demographic variables demonstrated, among other findings, that Republicans are much more likely to possess nationalistic attitudes than Democrats and that those born outside of the United States also tend to be more nationalistic than natives. They concluded that patriotism and nationalism are “functionally different psychological dimensions” (ibid.: 272) that require clear separation. In closing, they stressed the importance of “a healthy patriotic spirit” they considered to be an effective countermeasure to a recurrent and, in particular, belligerent nationalism (ibid.: 273).

In summary, Kosterman and Feshbach’s (1989) study was the first to systematically develop and validate measures for the dichotomy between nationalism and patriotism and provide evidence of this distinction in the field of political psychology. Since then, their work has been a seminal reference in the field, as many scholars have heavily drawn on it to develop their own scale (e.g., Sidanius et al., 1997; Schatz et al., 1999) or applied their items within (e.g., Li & Brewer, 2004; Kimmelmeier & Winter, 2008; Molina et al., 2015) and beyond the United States (e.g., Karasawa 2002, in the context of Japan; Meier-Pesti & Kirchler, 2003, in the context of Austria; Weiss, 2003 for Austria and Eastern European countries such as Hungary or Poland; Osborne et al. 2017; Satherly et al. 2019; both in the context of New Zealand). However, it should be noted that, apart from the work of Ferenczi and Marshall (2013), the authors’ original eight-item battery scale for nationalism and 12-item battery scale for patriotism have not been fully replicated. Thus, the number of items used has varied. For instance, some scholars have employed two items for both patriotism (i.e., “I feel a great pride in the land that is our [COUNTRY]” and “Although at times I may not agree with the government, my commitment to [COUNTRY] always remains strong”) and nationalism (i.e., “Generally, the more influence [COUNTRY] has on other nations, the better off they are” and “Foreign nations have done some very fine things but they are still not as good as [COUNTRY]”); e.g., Osborne et al. 2017:

---

“internationalism,” “civil liberties,” “world government,” and “smugness.” The latter was defined as “the view that America, its symbols, and its people are simply ‘the best,’” which overlaps with their definition of nationalism (ibid.: 265).

1089, see also Satherly et al., 2019). Meanwhile, others have used five items (e.g., Li & Brewer, 2004) or six items (e.g., Schatz et al., 1999) for both nationalism and patriotism.

### 2.3 Blank and Schmidt's work in Germany (2003)

Inspired by Kosterman and Feshbach (1989), Blank and Schmidt (2003) conceptualized and operationalized the nationalism-patriotism distinction in Germany in the late 1990s. Like the US-American psychologists, they also assumed a clear-cut distinction between nationalism and patriotism from the beginning of their analysis. As implied in the title of their paper ("Nationalism or patriotism?"), they considered them as mutually exclusive concepts. Exclusively drawing on Levinson et al.'s (1950) work on genuine versus *pseudopatriotism* and Schatz et al.'s (1999) study on constructive versus blind patriotism, they stated that "nationalism is characterized by the following aspects, among others":<sup>7</sup> the idealization of one's nation, a desire for ethnic homogeneity, and an "uncritical acceptance of national, state, and political authorities" (ibid.: 292).<sup>8</sup> By contrast, patriotism "has been described as having the following aspects," in particular as a constructive attitude gauging the nation "from the basis of a critical conscience" that strongly embraces democratic principles and a heterogeneous notion of nationhood (ibid.: 292).

---

<sup>7</sup> Importantly, the term "among others" indicates that there are potentially more features that were been mentioned by the researchers at this point (for a further discussion, see also Mäs, 2005). Following Gerring (1999: 368), it remains unclear whether the mentioned features are necessary and thus "core features" or rather "peripheral features" of the concepts under investigation.

<sup>8</sup> It should be noted that Blank and Schmidt (2003: 294) claimed that "nationalism emphasizes the social comparison that derogates outgroups in the aspects of feelings of national superiority and idealization." This hints at social identity theory (SIT; Tajfel, 1974), which highlights the antagonism between in-group(s) and out-group(s). The theory holds that individuals strive for a positive self-concept and that, given the crucial importance of their group membership(s), they seek a positive social identity in support of their own self (Tajfel & Turner 1986). According to Tajfel (1974: 69), social identity is understood as "that part of a person's self-concept which derives from his knowledge of his membership of a social group (or groups) together with the value and emotional significance attached to that membership." Thus, individuals mainly define themselves via the groups that they are part of. Given the in-group bias inherent in one's social identity, they tend to make "favorable comparisons [...] between the in-group and some relevant out-groups [as] the in-group must be perceived as positively differentiated or distinct from relevant out-groups" (Tajfel & Turner 1986: 16). As persuasively argued by Brewer (1999: 478), "groups must maintain distinctiveness to survive." In other words, groups define themselves by the boundaries that they draw (for a thorough elaboration on boundary drawing, see Lamont & Molnár, 2002). Importantly, the need for positive distinctiveness does not *necessarily* mean the degradation of out-groups. Therefore, SIT should be viewed as a theory of *intergroup differentiation* and not, as frequently and erroneously postulated, out-group hostility (notably, Brown 2020; for a further critique of SIT, see Huddy, 2001; for a historical review of SIT, see Hornsey, 2008). Brewer (1999: 442) famously argued that "in-group love is not a necessary precursor of out-group hate." It should be noted that Mael and Tetric (1992) developed a scale for assessing social identity (i.e., identification with a psychological group or IDPG).



In contrast to Kosterman and Feshbach (1989), Blank and Schmidt conducted a confirmatory factor analysis and thus relied on a theory-driven approach. Drawing on representative panel survey data ( $N = 571$ ) from Germany in 1996<sup>9</sup>, they measured both attitudes almost exclusively using pride: patriotism was operationalized as pride in democratic institutions or the social security system, while nationalism was operationalized as pride in one's national history or in being German.<sup>10</sup> In contrast to previous research, especially the work of Noelle-Neumann and Köcher (1987), Blank and Schmidt aimed to show that "general national pride [captures] nationalism" and not other related topics such as national identity (ibid.: 297).<sup>11</sup> In their view, "feeling proud in such a way is an expression of self-attributing national achievements" and thus an indicator of nationalistic attitudes (ibid.: 297). While they drew on pride items that they developed themselves and employed in previous studies (Blank & Schmidt, 1993; Blank et al., 1997), the remaining items were adopted from the work of Schatz et al. (1999).<sup>12</sup> Three items for nationalism were drawn from the blind patriotism scale and the remaining patriotism items from the constructive patriotism scale. According to Blank and Schmidt, the latter served as an important element for "democratic aspects of patriotism or constitutional patriotism" (ibid.: 298).

Conducting a confirmatory factor analysis, they yielded a two-factor measurement model that supported their hypothesized distinction between nationalism and patriotism. In addition, they estimated structural equation models and found that nationalism is likely to increase both out-group hostility ( $\beta = .98/.98$ )<sup>13</sup> and anti-Semitism ( $\beta = .68/.81$ ), whereas patriotism is likely to decrease these types of out-group derogation ( $\beta = -.49/-.49$  for out-group hostility and  $\beta = -.41/-.48$  for anti-Semitism), which further validated their two-factor model. Moreover, they aimed to "reach quantitative conclusions concerning the numbers of East and West Germans

---

<sup>9</sup> It should be noted that this study was based on the third panel wave which consisted of Western ( $N = 396$ ) and Eastern ( $N = 175$ ) Germans (Blank & Schmidt 2003: 296).

<sup>10</sup> Without referring to Blank and Schmidt (2003), scholars beyond political psychology such as Wimmer (2018: 17) employed a very similar item (i.e., "How proud are you to be a citizen of your country?") to assess the extent to which "an individual has internalized a nationalist view of the social world."

<sup>11</sup> At this point, it is important to note that Noelle-Neumann and Köcher (1987) stressed the meaning and, in particular, the great potential of national pride. Thus, they called for greater national pride to be fostered in Germany. However, Blank and Schmidt (1993) objected to their study due to its lack of both conceptual and empirical clarity. They advocated for more caution in arguing for national pride per se which they saw as primarily associated with right-wing orientations. In so doing, they stressed the need to disentangle general pride from other, more specific forms of pride in collective goods and to distinguish it from national identity.

<sup>12</sup> Importantly, Schatz et al. (1999: 154) introduced the distinction between blind versus constructive patriotism to "clarify the relationship between patriotism and nationalism."

<sup>13</sup> It is important to note that the first value refers to Western Germany, whereas the latter to Eastern Germany.

who have patriotic or nationalistic attitudinal structures” (ibid.: 306) and conducted a latent class analysis (LCA).<sup>14</sup> Overall, they concluded that nationalism and patriotism are “distinct attitudes toward the nation” that “favor different concepts regarding the nation, the state, and the regime and define different social goals” (ibid.: 305).

It is important to note that Blank and Schmidt (2003) were not only interested in conceptualizing and operationalizing nationalism and patriotism but also aimed to investigate the extent to which both concepts are influenced by *national identity*, defined as “a positive, subjectively important bond” that constitutes the “status quo of the process of individuals identifying with a nation” (ibid.: 290). In short, they wanted to examine whether an individual must identify with their nation *to* possess either nationalistic or patriotic attitudes. What is more, they wanted to test in how far the three concepts – nationalism, patriotism, and national identity – are distinct.<sup>15</sup> Importantly, they measured national identity using three items, i.e., “For me, to be a citizen of the Federal Republic of Germany is important”, “For me, to have an inner tie to Germany means very much” and “For me, to possess German citizenship is important.”<sup>16</sup> Prior to their analysis, Blank and Schmidt assumed that “the higher the degree of national identity, the higher the degree of nationalism [and] patriotism” (ibid.: 295). In support of their hypothesis, they found national identity to be the cause of both nationalism ( $\beta = .87/.87$ ) and patriotism ( $\beta = .74/.74$ ).<sup>17</sup> That is, one must identify with one’s country to possess either nationalistic *or* patriotic attitudes (for similar results, see Blank, 2003). Furthermore, they found evidence for the distinctiveness of national identity, patriotism, and nationalism (for a critique, see Mäs, 2005). In short, the three factors are related but distinct. Although they did not close their study with an explicitly normative note, as Kosterman and Feshbach did, Blank and Schmidt clarified

---

<sup>14</sup> Conducting a LCA, Blank and Schmidt (2003) yielded six groups for nationalism for both Western and Eastern Germany, while they found five groups for patriotism for Western Germany and four groups for patriotism for Eastern Germany.

<sup>15</sup> Notably, the first of their five research questions was as follows: “Can nationalism and patriotism, as specific forms of support for one’s nation, be conceptually and empirically distinguished from national identity?” (ibid.: 290).

<sup>16</sup> It should be noted that Blank and Schmidt (2003: 296) explicitly stated that they “used three indicators by Kosterman and Feshbach (1989) to measure the degree of national identity”. However, upon closer examination (and as mentioned in the section 2.1) the US-American psychologists did not at all capture national identity. Instead, they aimed to show the dimensionality of patriotism and nationalism and yielded a total of six different factors (Kosterman & Feshbach, 1989).

<sup>17</sup> One reason why national identity had such a strong impact on (constitutional) patriotism is that two out of the three items captured citizenship (i.e., the relationship between the individual and the *state*) rather than national identity (i.e., the individual’s identification with the nation). Note, that here is large disagreement over the measures for national identity (for an overview of the different operationalizations of national identity, see Bruinsma and Mußotter (2023).

that patriotism is, by definition, the “essential counter-concept to nationalism” and fosters the inclusive co-existence needed in a multicultural society (ibid.: 292; for a further discussion on this normative component, see Bitschnau & Mußotter, 2022).

To date, the work of Blank and Schmidt (2003) has greatly influenced research on nationalism-patriotism distinction and their conceptualization and measures have been widely adopted (e.g., Fleiß et al., 2009; Davidov, 2009; Ariely, 2011, 2012; Green et al., 2011; Heinrich 2016, 2020; Wagner et al., 2012). However, it should be noted that their original seven-item scale for nationalism and six-item scale for patriotism have not been fully replicated in other studies; rather, scholars drawing on their work tend to only use a few items. For instance, Davidov (2009) and Heinrich (2016, 2020) employed three pride items for measuring patriotism. Overall, Blank and Schmidt’s (2003) study relied on three features that can be considered typical in scholarship on the nationalism-patriotism distinction: (1) claiming that nationalism and patriotism are distinct, (2) seeking empirical support by testing a two-factor measurement model, and (3) validating the two-factor model by investigating the effects of nationalism and patriotism on out-group hostility (see also De Figueiredo & Elkins, 2003; Latcheva, 2011; Green et al., 2011; Ariely, 2012; Wagner et al., 2012; Heinrich, 2016; Huddy & Del Ponte, 2019; Huddy et al., 2021).

## **2.4 Criticism of the nationalism-patriotism distinction**

Overall, the nationalism-patriotism distinction has not received substantial criticism. Indeed, objections have been mentioned only briefly, if at all, and lacked detail. It is only recently that scholars have begun to critically and thoroughly engage with the nationalism-patriotism distinction as a whole in both conceptual and empirical terms (notably, Mußotter, 2022; Bitschnau & Mußotter, 2022). Although earnest discussion has been largely absent from the discourse, existing critiques can be organized according to three different strands: conceptual critiques, normative critiques, and empirical critiques.

### *2.4.1 Conceptual critiques*

First, nationalism and patriotism have been criticized for being difficult to separate, albeit not in detail and depth. In the 1960s, social psychologists such as Doob (1964) had already posited that nationalism results from patriotism, which brings into question this clear-cut distinction. Similarly, Feshbach (1987: 322), who considered patriotism as “love of and pride in one’s country”, argued that “nationalism entails love of one's country” but is “complicated by power

and superiority elements” (ibid.: 315). Recently, Ioannou et al. (2021: 294) proposed a similar yet distinct viewpoint: nationalism and patriotism are both “bound by love of country,” but this love resembles “an intense passionate love toward a lover” in the former and the “love of children towards their parents” in the latter (ibid.: 296). Despite arguing that nationalism is distinct from patriotism because the former is characterized by the exclusion of others, Druckman (1994: 47) wondered whether nationalism was not a “more complex form of patriotism.” While Konrad and Qari (2012: 530; see also Harari, 2018) demonstrated a positive relationship between patriotism and tax compliance, they noted that “patriotism has a number of undesirable side-effects, particularly as it may turn into nationalism.”<sup>18</sup> Mader (2016) also critiqued the conceptual bifurcation between nationalism and patriotism, particularly the work of Blank and Schmidt (2003). Specifically, he argued that people who express pride in democratic achievements are also very likely to exhibit feelings of superiority. He thus advocated for a triad consisting of “civic pride, ethnoculturalism, and chauvinism,” which was empirically supported by a three-factor measurement model (ibid.: 436).<sup>19</sup>

Beyond social psychology, political theorists such as Viroli (1995: 2) who advocated for the distinction between nationalism and patriotism, also acknowledged “the similarities and nuances” between both concepts. Nationalism scholars such as Gellner (1983: 138) consider nationalism to be a “very distinct species of patriotism” and called into question their demarcation. Similarly, Brubaker (2004: 120) objected that the distinction — or, more precisely, its proponents — “neglect[ed] the intrinsic ambivalence and polymorphism of both.” Stressing their broad commonality, he rejected the dichotomy and synthesized both concepts. In the process, he maintained that both serve to “develop more robust forms of citizenship” or to “provide support for redistributive social policies” (ibid.: 115). While adhering to the distinction, historians such as Lepore (2019: 22) also acknowledged that “[it is] easy to confuse nationalism and patriotism, especially because they once meant more or less the same thing.” More recently, Bonikowski et al. (2021: 501) criticized the term “patriotism” as a “a misnomer

---

<sup>18</sup> Li and Brewer (2004) concur, but go into more detail. Using an experimental survey design, they show that patriotism can turn into nationalism, especially under situations of threat, underscoring the attachments’ context dependency.

<sup>19</sup> Despite criticizing Blank and Schmidt’s (2003) binary distinction, Mader’s (2016) approach did not significantly differ from theirs, as he employed, among other elements, the same pride items that they did, such as pride in the way that democracy works. To date, his triad has neither been discussed nor applied in political psychology. Notably, even Mader himself did not continue to apply this three-factor model but instead drew on the civic-ethnic dichotomy (e.g., Mader et al., 2021; Mader & Schoen, 2023).

for what is actually a core dimension of nationalist beliefs.” Overall, there has been no earnest debate over the conceptual overlap between nationalism and patriotism to date.

#### *2.4.2 Normative critiques*

Second, normative evaluations of nationalism and patriotism, which are dominant in both political psychology (e.g., Kosterman & Feshbach, 1989; Blank & Schmidt, 2003; Huddy et al., 2021) and political theory (e.g., Viroli, 1995; Smith, 2021), have received considerable criticism. In the late 1990s, Billig (1995: 17; see also Calhoun, 2017) claimed that “our patriotism is made to appear ‘natural,’ and thereby invisible, while nationalism is seen as a property of others.” Similarly, Canovan (2000: 415) argued that the distinction between a supposedly socially desirable patriotism and an ostensibly harmful nationalism is “a matter of intellectual curiosity [and] a rhetorical and political strategy.” Bonikowski (2016: 430) objected that political psychologists persistently consider nationalism as a “normative problem” and thus fail to investigate its multidimensionality with the necessary clarity. With regard to the pertinent literature, Hanson and O’Dwyer (2019: 792) posited that a “liberal bias” is embedded in the nationalism-patriotism discourse, as nationalism is seen as “bad,” while patriotism is seen as “good.” However, this critique has not been addressed to date (for a further discussion, see Bitschnau & Mußotter, 2022).

#### *2.4.3 Empirical critiques*

Third, criticisms of the predominant measures for nationalism and patriotism have been scarce. While Kosterman and Feshbach’s (1989) measures have not yet been discussed in any systematic manner, only two scholars (Latcheva, 2011; for a more thorough discussion, see Mußotter, 2022) have critically reflected on the pride items employed in Blank and Schmidt’s (2003) research traditions to date. According to Mußotter (2022), this measurement approach assumes that one must be proud of certain domains, such as history, sports, or the social security system, to be deemed a nationalist or (constitutional) patriot, which suffers from a simplistic either/or premise. Furthermore, more generally, the author indicated that political psychologists have largely failed to engage with the literature on pride despite relying on pride measures. As a result, they have not considered the distinction between authentic and hubristic pride, which might serve as a theoretical tool to better assess the complexities of pride (Tracy & Robins, 2007; Tracy et al., 2020). Moreover, Mußotter (2022) pointed at the valuable work of Wimmer (2017; 2018; see also Sidanius et al., 1997; Sidanius & Petrocik, 2001), who showed that the

degree of pride that a citizen expresses in his/her nation is highly dependent on his/her socio-economic status. In short, citizens with a comparatively high position are more likely to be proud of their nation. That is, in multiethnic countries, the dominant ethnic group tends to express more pride in the nation than ethnic minorities. Thus, Bonikowski (2016: 439) called for greater caution when “interpreting pride as a unitary phenomenon.” Indeed, pride is a highly contextually contingent concept and has an inherently competitive component: even from a pro-dichotomy position, using pride items to measure patriotism appears questionable (see also Heinrich, 2012). Moreover, Miller-Idriss and Rothenberg (2012: 133) conducted 90 semi-structured interviews with German citizens and found that participants had many ambiguous feelings towards their nation that “cannot be characterised easily as proud or not proud.” More importantly, many respondents “[struggled] with the very notion of pride.” Furthermore, qualitative research has revealed that the ISSP pride items that most scholars use are highly ambiguous and lead to severe issues with comprehension. By conducting 18 cognitive interviews with Austrian citizens, Latcheva (2011, for similar results, see Fleiß et al., 2009 in the case of Austria) demonstrated that the main challenge with the existing pride items is their “inappropriate use of the term pride” (ibid.: 1195). Most respondents posited that “one might be proud of own achievements but not of collective goods such as Austria’s political and economic system or the country’s history” (ibid.: 1195).<sup>20</sup> Based on these findings, she called for the development of new measures of national identity to overcome the empirical shortcomings inherent in the ISSP items. However, the critique of the pride-based measures has not yet been addressed. Instead, most scholars have continued to use the existing item batteries, although a few are aware of the items’ shortcomings. For instance, Heinrich (2016: 53) wondered whether “pride can be seen as generalized emotional expression of patriotism.” More recently, Huddy et al. (2021: 1013) explicitly acknowledged that quantitative research on the nationalism-patriotism distinction is marred by “different and sometimes conflicting definitions [and] measures.”

Apart from the questionable pride measures, Mußotter (2022) noted that the existing measures do not capture all the concepts’ core features, thus suffering from content validity. For instance, while stressing the authoritarian beliefs or the strive for ethnic homogeneity nationalism is

---

<sup>20</sup> This finding is reminiscent to the famous statement of the former German Federal President, Johannes Rau (2001), who found that “[y]ou can’t be proud of something that you didn’t achieve yourself, but you can be happy or grateful that you are German”.

constituted by, Blank and Schmidt (2003) did not employ any items that grasp these features. Instead, their items employed for measuring nationalism such as “German history makes me feel proud”, “The morale of the Germans should be a role model for other nations” or “The fact that Germany is the number one in Europe makes me feel proud” mainly target the belief in the superiority of one’s nation and thus only *one* of the few core features. As a result, a mismatch between the conceptual and the measurement level surfaces, especially if one advocates for an encompassing notion of nationalism as Blank and Schmidt (2003) do.

#### 2.4.4 *Theoretical critiques*

Beyond the three strands of critiques examined above, the current study opens a fourth line of critique that has received little attention to date: the theoretical underpinnings of the nationalism-patriotism distinction. Without going into detail, the only exception is Dekker et al. (2003: 346) who not only critiqued Kosterman and Feshbach’s work (1989) for its “conceptual confusion” but also a “lack of theory.”

Crucially, and what existing research has tended to neglect is that social identity theory (SIT; Tajfel, 1974; for the SIT’s main pillars, see section 2.3, FN 7), one of the most influential theories in the field of social psychology, has not been used to illuminate the dichotomy between nationalism and patriotism per se. Instead, it has been primarily used to explain either national identity (e.g., Theiss-Morse, 2009; Huddy & Del Ponte, 2019) or one type of attachment (i.e., patriotism). For instance, Bar-Tal (1993: 53) indicated that a “positive evaluation and social identity serve as a foundation for patriotic beliefs” and that “patriotism is the necessary addition to social identity.” Similarly, by emphasizing the “contribution of SIT to the study of patriotism,” Huddy and Khatib (2007: 74) aimed to explain patriotism but not the dichotomy itself.

Although the SIT itself is doubtlessly valuable and has been widely applied in a number of topics in the social sciences (notably, Brown, 2020), it is questionable whether and to which extent it can be used as a theoretical tool for the nationalism-patriotism distinction.<sup>21</sup> Notably, SIT focuses on the antagonism between in-groups and out-groups, but it remains unclear which

---

<sup>21</sup> Importantly, Brown (2020: 7) stressed that the “very generality of SIT’s formulation [...] is also something of a weakness.” Furthermore, other scholars (e.g., Hogg) concur and have claimed that SIT should rather be seen as a “grand theory [that is] almost untestable and unfalsifiable” (ibid.: 9).

types of in-groups patriotism and nationalism refer to. For instance, Blank and Schmidt (2003: 305) claimed that nationalism and patriotism are “attitudes towards the nation” that both presuppose a (positive) identification with one’s nation. In short, both need to feel attached to the nation, or, to put it in the words of Blank and Schmidt (*ibid.*: 305), “both concepts represent positive evaluations of one’s own group”. Similarly, De Figueiredo and Elkins (2003: 187) posited that “patriots and nationalists are alike in their deep esteem for the nation.”<sup>22</sup> Thus understood, both have the same in-group (i.e., the nation). However, the extent to which this common in-group is distinct remains unclear, especially since patriotism in the Habermasian sense is tied to democratic principles, not the nation itself.

In addition, while nationalism is, by definition, exclusionary (e.g., Blank & Schmidt, 2003; Lepore, 2019; Molina & Preddie, 2020; Smith, 2021) and thus implies out-groups, the types of out-groups that constitutional patriots should have are not explicitly stated or discussed. Especially, as Blank and Schmidt (2003: 294) believe that (constitutional) patriotism is shaped by “tolerance toward out-groups.” Similarly, Bar-Tal (1993: 51) indicated that patriotism mostly concerns “attachment to one’s group, without reference to out-groups.” A negative relationship between patriotism and out-group derogation has instantiated these assumptions (e.g., Blank & Schmidt, 2003; Latcheva, 2011; Wagner et al., 2012). Moreover, in-group bias and the resulting need for distinctiveness remains understudied, especially since patriotism is understood as “part of a positive in-group evaluation” and nationalism is viewed “as an intergroup differentiation” (Mummendey et al., 2001: 160). Similarly, De Figueiredo and Elkins (2003; see also Mummendey et al., 2001; Ariely, 2011) noted that patriotism is self-referential, while only nationalism is defined by constant comparisons to other nations. In other words, in contrast to nationalism, patriotism does not have a comparative dimension and thus does not seek a positive distinctiveness. Hence, with regard to the distinction under investigation in this study in general and patriotism in particular, the explanatory power of SIT remains unclear. Moreover, as Brown (2020: 15) persuasively argued, “SIT proposed only a ‘search for positive distinctiveness,’ without specifying whether [and in what form] that distinctiveness would be achieved.” Nevertheless, there is broad agreement that nationalism is,

---

<sup>22</sup> It should be noted that studies that call for a binary distinction between conventional and constructive patriotism, such as that of Sekerdej and Roccas (2016: 500), have made a similar argument and claimed that “both constructs involve identification with and love for one’s nation.”



by definition, exclusionary; derogates other nations and thus other people; and does not seek a positive distinctiveness per se.

## 2.5 Summary

Overall, there is considerable dissent within the research traditions of Kosterman and Feshbach (1989) and Blank and Schmidt (2003) in both conceptual and empirical terms. The current study aims to reconceptualize this distinction by accounting for and synthesizing these traditions. First, there is disagreement at the conceptual level. Specifically, scholars who work in the same research tradition as Blank and Schmidt (2003) have drawn on the Habermasian concept of constitutional patriotism, which strongly adheres to democratic principles. By contrast, scholars from the same research tradition as Kosterman and Feshbach (1989) conceive of patriotism as an emotional attachment that commonly manifests as love for and pride in one's country. Thus, we are faced with two significantly divergent concepts of patriotism that must be sharply differentiated. Apart from these two traditions, the discourse is generally marked by considerably different understandings of the term "patriotism." Some scholars conceive it as a simple love of one's country (e.g., Theiss-Morse, 2009), while others view it as love *and* pride in one's country (e.g., Kosterman & Feshbach, 1989; Citrin et al., 2001). Still others believe that it is synonymous with national pride or national attachment (e.g., Ariely, 2020), loyalty to the constitution or political regime (e.g., Smith, 2021), or a strong devotion to the republic (e.g., Viroli, 1995). Upon closer examination, these scholars differed not only in terms of their understanding of patriotism but also nationalism. While Kosterman and Feshbach (1989) defined nationalism as belief in the superiority of one's nation and an accompanying drive for national dominance, Blank and Schmidt's (2003) adhered to a broader definition. In their view, nationalism is not only marked by the belief in one's nation's superiority and the accompanying striving for dominance but also encompasses two additional components: a desire for ethnic homogeneity and blind obedience towards (national) authorities.

Moreover, there is no consensus within the two dominant research traditions over exactly what the distinction is intended to capture. While Kosterman and Feshbach (1989; see also Sidanius et al., 1997; Huddy et al., 2021) consider nationalism and patriotism to be types of national attachment, Blank and Schmidt (2003; see also Meier-Pesti & Kirchler, 2003; Heinrich, 2016, 2020; Osborne et al., 2017; Molina & Preddie, 2020) understand them as different types of

national identity.<sup>23</sup> In addition, other scholars view nationalism and patriotism as two types of sentiments (e.g., Sapountzis, 2008; Latcheva, 2011) or as forms of national pride (e.g., de Figueiredo & Elkins, 2003). Thus, some studies refer to nationalism and “nationalistic national pride” on the one hand and patriotism and “patriotic national pride” on the other (Blank, 2003: 276; see also Cohrs et al., 2004; Latcheva, 2011). To date, these different conceptions has received scant attention. In other words, whether or to which extent terms such as “identity,” “pride,” or “attitude” should be seen as distinct remains unclear.

Second, conceptual disagreement over nationalism and patriotism is reflected in considerable dissent over the measures for both concepts. Scholars in Kosterman and Feshbach’s (1989; see also Kimmelmeier & Winter, 2008; Satherly et al., 2019) research tradition have operationalized patriotism using items related to emotional attachment to one’s country and, among others, its national symbols. However, scholars in Blank and Schmidt’s (2003; see also Davidov, 2009; Ariely, 2011, 2021; Wagner et al., 2012) research tradition have measured patriotism through pride in the democratic institutions or social security system of one’s country. Strikingly, scholars such as Ariely have employed such pride items (e.g., pride in the national social security system) in some studies (e.g., Ariely, 2011) and items related to one’s closeness to the nation and national pride to measure patriotism in others (e.g., Ariely, 2020). In addition, some scholars have attempted to capture nationalism and patriotism using the same items. While Blank and Schmidt (2003; see also Blank, 2003) employed pride in one’s nationality to measure nationalism, Kimmelmeier and Winter (2008) used it to measure patriotism. In 2009, Davidov (2009) noted that there is no agreement in terms of how to operationalize nationalism and patriotism, which has shaped the field to date. Nevertheless, a correlation between patriotism and nationalism is a common empirical finding yielded in both research traditions to date (e.g., Conover & Feldman, 1987; Kosterman & Feshbach, 1989; Karasawa, 2002; Kimmelmeier & Winter, 2008; Latcheva, 2011; Wagner et al., 2012; Huddy et al., 2021) and calls into question any clear-cut distinctions between these concepts. Although

---

<sup>23</sup> Yet, as already indicated by Mäs (2005), it is worth mentioning that Blank and Schmidt’s (2003) terminology is inconsistent. That is, nationalism and patriotism are not only seen as “specific nation-related attitudes” (ibid.: 291) but also “specific forms of support for one’s nation,” “two types of attachment to one’s country” (ibid.: 290), “specific expressions of national identity” (ibid.: 291), or “multidimensional specific attitudinal syndromes” (ibid.: 292).

it has been corroborated in many studies, this correlation has yet to receive substantial attention (however, see Heinrich, 2016).<sup>24</sup>

Besides disparities in the two dominant strands of literature, there has also been disagreement about the pairing of nationalism and patriotism. For instance, several scholars have advocated for distinguishing between *chauvinism* and patriotism. Citrin (2001: 75) and colleagues found that nationalism was “unnecessarily confusing” and preferred the term “chauvinism,” which they understood as “an extreme and bounded loyalty, the belief in one’s country’s superiority, whether it is right or wrong.” Coenders and Scheepers (2003) even argued that nationalism encompasses two dimensions: chauvinism and patriotism. More recently, Huddy et al. (2021: 996) did not refer to nationalism but “ethno-religious chauvinism,” which is “a form of nationalism,” despite adhering to the nationalism-patriotism distinction. Moreover, scholars such as Ariely (2012, 2020) have employed the term “nationalism” in some publications and “national chauvinism” in others (Ariely, 2021). Thus, there is no consensus over whether chauvinism is synonymous with nationalism or a component of nationalism. In short, researchers are confronted with two distinct dichotomies.

In summary, the nationalism-patriotism distinction is widely applied in political psychology but suffers from a number of conceptual and related empirical shortcomings that have received little attention to date. This study seeks to systematically address these conceptual ambiguities and reconceptualize the binary distinction to add greater clarity to it. Thus, it offers a novel conceptual approach and accompanying measures.

---

<sup>24</sup> It should be noted that correlations between binary distinctions are far from uncommon in the social sciences. For instance, Sekerdej and Roccas (2016: 504) found a positive relationship between constructive and conventional patriotism ( $r = .51$ ), while scholars who adhere to the distinction between civic and ethnic nationalism have also demonstrated a positive correlation ( $r = .80$ ) between both types of nationalism (e.g., Reeskens & Hooghe, 2010: 591).

### 3 Reconceptualizing the nationalism-patriotism distinction: Toward a triad of attachments<sup>25</sup>

Based on the existing scholarship, it is clear that the main theme in the literature on the nationalism-patriotism distinction in political psychology is attachment. For instance, Sidanius et al. (1997: 106) considered nationalism a “right-wing form of national attachment” and patriotism “a more politically neutral form of national attachment.” Once again, this stresses the normative component of the distinction. Similarly, Bar-Tal (1993: 49; for more recent accounts see Satherly et al., 2019; Huddy et al., 2021) defined patriotism as attachment and understood it as a “binding affection between a person and his/her group and the land” that can evolve “in every ethnographic group which has an attachment to a certain geographical place.” Similarly, Kosterman and Feshbach (1989: 261) conceived of patriotism as “feelings of attachment to America.” Within political theory, the term “attachment” is also widely applied. Thus, Viroli (1995: 13) defined patriotism as love of the republic—that is, an “attachment to a particular republic with its particular way of living in freedom”—and nationalism as “exclusive attachment” (ibid.: 2). Historians such as Harari (2018) also denotes nationalism and patriotism as two different types of national attachments. In the literature beyond the nationalism-patriotism distinction, Levinson et al. (1950: 107) also employed the term attachment, defining *pseudopatriotism* as “blind attachment to certain national cultural values, uncritical conformity [...]”

At its core, the distinction aims to make sense of individuals’ attachment to a collective, be it the nation, the homeland, the country, the state, the national group, or another type of community (for further elaboration on the term “community,” see Mason, 2009; see also Tönnies, 2003 on the distinction between community and society). Thus, the conceptual approach offered in this study relies on the basic premise that individuals need to feel attached to a certain object or, more precisely, any type of collective. This need mainly stems from a fundamental human motivation: the need to belong (notably, Baumeister & Leary, 1995). Brewer (1991: 477) indicated that human beings have two opposing needs: the “need for validation and similarity to others” and the “need for uniqueness and individuation.” It is the former need that the distinction between nationalism and patriotism refers to. Smith (2021: 9; see also Doob, 1964; Freedman, 1998) argued that nationalism and patriotism “grow out of a

---

<sup>25</sup> Please note that this chapter is based on publication 3 (Mußotter, 2023a).

similar need to belong, but [...] move in quite different directions.”<sup>26</sup> More generally, Tamir (2019a: 51; see also Levinson et al., 1950; Doob, 1964) posited that “ideologies survive if, and only if, they fulfill some basic functional needs.”

### 3.1 Attachment

Although it is far from uncommon to regard nationalism and patriotism as different types of attachment, the term “attachment” and its precise meaning has rarely been analyzed. In this study, nationalism and patriotism are conceived as distinct types of attachment. Overall, attachment is similar but distinct from concepts such as feelings, sentiments, or emotions that are frequently but often thoughtlessly used in research on the nationalism-patriotism distinction (for an overview of these terms, their definitions and their distinctiveness, see von Scheve & Slaby, 2019).<sup>27</sup> In contrast to previous research, it engages with the literature on attachment to provide a more nuanced understanding of nationalism and patriotism. In the process, it follows the work of Scheidecker (2019: 73), which defines attachment as “an enduring affectional bond of humans to particular others, whether individual or collective, as well as to non-human actors such as animals, material possessions, places, or spiritual beings.” This definition builds and expands on Bowlby’s (1982: 668; see also Ainsworth, 1989) prominent work on attachment theory, which considers attachment “any form of behavior that results in a person attaining or maintaining proximity to some other clearly defined individual who is conceived as better able to cope with the world.” In the process, Bowlby stressed the importance of an “attachment figure [...] that provides a strong and pervasive feeling of security” (ibid.: 669).<sup>28</sup> There is agreement in the literature that attachment not only develops from birth onwards but is also

---

<sup>26</sup> It should be noted that attachment and belonging are intertwined but distinct. Belonging is generally defined as “a position in social structure, experienced through identification, embeddedness, connectedness and attachments” (Pfaff-Czernecka, 2013: 7; Mattes et al., 2019; see also Yuval-Davis 2006 on belonging and the politics of belonging).

<sup>27</sup> In the pertinent literature, it is far from uncommon to employ terms such as “patriotic feelings” (e.g., Wodak & Dawkins, 2017: 391), “feelings of patriotism” (e.g., Wodak & Dawkins, 2017: 392), “feelings of nationalism” (e.g., De Figueiredo & Elkins, 2003: 178), “nationalist sentiment” (e.g., Gellner, 1983: 1; Kimmelmeier & Winter 2008: 8719), or “patriotic sentiment” (e.g., Bonikowski & Di Maggio, 2016: 949). Moreover, scholars such as Conover and Feldman (1987) and Blank and Schmidt (2003: 294) have associated nationalism with “feelings of superiority.” In the literature beyond political psychology, patriotism has also been described as a “feeling” (e.g., Almond & Verba, 1963: 5).

<sup>28</sup> Based on Bowlby’s (1982) work, four types of attachment can be distinguished: fearful, dismissive, preoccupied, and secure. Notably, Ferenczi and Marshall (2013) systematically drew on Bowlby’s attachment theory and yielded a three-factor model of secure, preoccupied, fearful, and dismissive national attachment. It should be noted that they did not adhere to the nationalism-patriotism distinction but investigated attachment towards the nation in a more general manner.

characterized by six core features, such as persistence over time and across contexts, a strong bond with an “attachment figure [that] is not easily interchanged with another,” and its deeply emotional significance (Scheidecker, 2019: 78). It should be noted that these attachment figures can also change over time.

The terms “motherland” or “fatherland,” which are commonly used in nationalism studies, strongly allude to primary attachment figures (i.e., the mother and or the father; see Ferenczi & Marshall, 2013). In short, the nation or the homeland is metaphorically viewed as one’s caregiver.<sup>29</sup> For instance, Rousseau (1964: 258) maintained, “If we want the citizens to love their *patria*, let the homeland therefore show itself as the common mother of all citizens.” While he did not draw on attachment literature, Feshbach (1987: 322) assumed that “individual differences in early attachments are related to individual differences in national attachments” in general and that patriotism, which he defined as “love of and pride in one’s country,” is strongly associated with such familial attachments. According to him, the nation “offers a socially acceptable context in which early attachment needs can be expressed and analogous reinforcements obtained” (ibid.: 322). He found that patriotism was positively associated with early paternal attachments (i.e., strong attachment to the father compared to the mother), while nationalism was not, which supports his assumption. To date, Feshbach’s study is the only one to examine the relationship between familial attachments and national attachments but has received little attention. As a result, this relationship remains understudied.

When engaging with the literature on attachment, it is important to not only engage with the term “attachment” itself but also the term “object of attachment” (Scheidecker, 2019: 79).<sup>30</sup> Notably, similar terms, such as “object of devotion” (Snyder, 1954), “objects of love” (Viroli, 1995; see also Ioannou et al., 2021), “object of loyalty” (Oldenquist, 1982; Nathanson, 1990; Fletcher, 1995), “reference objects” (Primoratz, 2017), and “identification object” (Heinrich, 2016), have been mentioned in the nationalism-patriotism literature. For instance, Primoratz (2017) regarded patriotism and nationalism “as the same type of set of beliefs and attitudes that differ in terms of their objects.” While patriotism refers to the *patria* (i.e., the country),

---

<sup>29</sup> More generally, Smith (1991: 79) posited that the “family of the nation overrides and replaces the individual’s family but evokes similarly strong loyalties and vivid attachments.” Similarly, Stern (1995: 230) indicated that one of the features of nationalism is a tendency to “equate the nation symbolically with family [...]”

<sup>30</sup> The term “object of attachment” evokes the literature on attitude theory, especially the work of Eagly and Chaiken (1993: 1), who defined attitude as “a psychological tendency that is expressed by evaluating a particular entity with some degree of favor or disfavor.”

nationalism refers to the nation. Without considering these accounts, Müller (2008a: 73) employed the terms “objects of attachment” and “mode of attachment” in his general theory on constitutional patriotism. In his view, the “object of patriotic attachment is a specific constitutional culture that mediates between the universal and the particular, while the mode of attachment is one of critical judgement.” To date, none of these approaches has been discussed nor systematically considered in political psychology.

By drawing on the attachment literature and synthesizing the two dominant research traditions, this study advocates for a triad of attachments: nationalism, patriotism (i.e., love of country), and democratic patriotism. Its approach relies on four pillars. First, nationalism and patriotism are conceived as distinct types of attachment. Second, it focuses on the differing objects of attachment in nationalism and patriotism—nation, homeland, and democracy—that have hitherto received scant attention. Third, it follows Gerring (1999: 368) by considering the “core features” or constitutive elements of three concepts under investigation.<sup>31</sup> Fourth, as persuasively demonstrated by Satherly et al. (2019; see also Heinrich 2016), this approach posits nationalism and patriotism as distinct but not mutually exclusive attachments (for a further discussion, see Piwoni & Mußotter, 2023) for two main reasons: (1) it considers the correlation between nationalism and patriotism, which has been corroborated in a wide range of studies and questions the clear-cut distinction between these two concepts, and (2) it draws on the work of Tajfel (1970: 1313), who posited that “a dichotomy need not to be taken too seriously from an empirical point of view [as] few social scientists ever hope to find any pure examples of it in their data.” In short, the three kinds of attachments, i.e., nationalism, patriotism and democratic patriotism are ideal types.

Overall, this approach is considered to “travel” (Sartori, 1970: 1034), as it can be applied to various cases. In short, the objects of attachment do not only exist in one specific country or political culture<sup>32</sup> but nearly all over the world. In other words, the three objects of attachment—nation, homeland, democracy—are not only applicable to the German context that this study

---

<sup>31</sup> The term “core features” has also been employed in other studies to describe the essence of nationalism. For instance, Terhune (1964) highlighted three core features of nationalism, namely national ethnocentrism, national consciousness, and national aspiration. Similarly, Freedman (1998) listed five core features of nationalism, such as the primacy of the nation over other groups and a sense of belonging and membership.

<sup>32</sup> This study relies on the prominent work of Almond and Verba (1963: 13), who defined political culture as “attitudes towards the political system and its various parts, and attitudes towards the role of the self in the system” and as “the particular distribution of patterns of orientation towards political objects among the members of the nation” (ibid.: 15).

draws on but also many other countries. While the objects of nation and homeland can be found all over the world, all three objects of attachment are common in Western liberal democracies.

### 3.2 Nationalism: Attachment to the nation

One line of research on nationalism that dates back to the seminal work of Kosterman and Feshbach (1989) defines nationalism as the idealization of one's nation. In essence, this is the belief that one's nation is intrinsically superior to others (e.g., Conover & Feldman, 1987; Kosterman & Feshbach, 1989; Kimmelmeier & Winter, 2008; Osborne et al., 2017; Bizumic & Duckitt, 2018; Satherly et al., 2019; for a historical account see Harari, 2018). Based on the notion of superiority, striving for power and dominance over other nations, which is often reflected in claims that a nation should be a world leader, is another core feature of nationalism (e.g., Conover & Feldman, 1987; Kosterman & Feshbach, 1989; Blank & Schmidt, 2003; Li & Brewer, 2004; Kimmelmeier and Winter, 2008; Osborne et al., 2017).<sup>33</sup> As part of persistent competition among nations, there is broad agreement that nationalists feel entitled to impose their allegedly superior national morale on other nations and seek to expand their nation's influence abroad—primarily at the expense of others (Kosterman & Feshbach, 1989; Blank & Schmidt, 2003; de Figueiredo & Elkins, 2003). Notably, such a leadership claim is likely to be driven by a feeling of being chosen (Hayes, 1937; Kohn, 1939; Billig, 1995; Wehler, 2019) and anchored in the idea of fulfilling a national mission (Arendt, 1945).<sup>34</sup>

Another line of research that originates in the seminal work of Blank and Schmidt (2003) not only conceives of nationalism as the idealization of one's nation but also stresses an ethnic notion of nationhood. In other words, the nation's superiority is consistent with an exclusionary conception of nationhood, which underscores the importance of ethnic membership criteria

---

<sup>33</sup> Interestingly, Dekker et al. (2003) distinguished between national superiority and nationalism and advocated for a cumulative hierarchy of five national attitudes (i.e., national feeling, national liking, national pride, national preference, national superiority, and nationalism).

<sup>34</sup> It should be noted that, while the feeling of being chosen has not been considered in the political psychology literature, it is viewed a constitutive element of Christian nationalism, a specific type of nationalism underpinned by the belief that the United States was “founded as a Christian nation by (white) men,” is “blessed by God,” and “has a special role to place in God's plan for humanity” (Gorski & Perry, 2022, 4; see also Whitehead & Perry, 2020). Smith (2021: 202) indicated that “chosen-ness without humility can lead only to blasphemy and hubris.” More generally, this feature hints at the intricate relationship between nationalism and religion (for a discussion on this relationship, see Brubaker, 2012; see further Gorski & Türkmen-Dervisoglu, 2013 on the relationship between religion, nationalism, and violence). While both concepts *can be* related, they should be clearly distinguished. Snyder (1954: 23) stressed that, from a historical viewpoint, nationalism “may be regarded as a force that succeeded religion as a dominating power in the affairs of men [yet] the two need not to be confused.”



such as common descent (e.g., Terhune, 1964; Blank & Schmidt, 2003; for a more recent account, see Huddy et al., 2021; Jenne et al., 2021). These scholars agree that nationalism encompasses the imperative of ethnic homogeneity, which is reflected in the need to “keep [the] nation as pure as possible” (Dekker et al., 2003: 347; see also Blank, 2003; Ioannou et al., 2021). This notion is based on the premise that there are “genuine” or “true” members of the nation (see also Mounk, 2018) who can and must be distinguished from those who are not true or genuine. Thus, Molina and Preddie (2020: 417) defined nationalism as an “ethnocentric and dominance-oriented form of national identity.” Beyond political psychology, historians such as Lepore (2019: 23), who adheres to the nationalism-patriotism distinction, have concurred and claimed that “nationalism [has] come to mean [...] a hatred of other countries and their people and a hatred of people within your own country who [do not] belong to an ethnic, racial, or religious majority.” Similarly, Berns (2001: 7) argued that the idealization of one’s nation (i.e., nationalism) is accompanied by “a politics of ethnicity where what matters is blood, not political principle.” Consistent with these exclusionary notions, a large body of scholarship has substantiated a positive relationship between nationalism and anti-immigrant attitudes (Blank & Schmidt, 2003; de Figueiredo & Elkins, 2003; Latcheva, 2011; Wagner et al., 2012; Molina & Preddie, 2020; Huddy et al., 2021). In short, nationalism is seen as a robust predictor of out-group hostility.

In summary, the literature on nationalism includes two related but distinct research traditions. While the first more narrowly defines nationalism as belief in the superiority of one’s nation, the latter also more broadly encompasses the ethnic notion of nationhood. Overall, both lines of research are based on the premise that the world is categorized into nations and that individuals feel attached to only one nation (e.g., Kedourie, 1985; Dekker et al., 2003; Lepore, 2019; Brubaker, 2020). Within these research traditions and beyond, a wide variety of objects of attachment have been proposed. For instance, Hayes (1937: 6) viewed nationalism as a “condition of mind in which loyalty to the ideal or to the fact of one’s national state is superior to all other loyalties” and the (national) state as the main object of attachment. Similarly, Ariely (2011: 301) posited that nationalism “represents a comparative view of one state vis-à-vis another.” More recently, Jenne et al. (2021: 171) maintained that nationalism “holds that the

state belongs to the dominant ethnonational group to the exclusion [...] of non-national others” and emphasized the state as its object.<sup>35</sup>

By contrast, Doob (1964: 6) proposed the government as the object, as nationalists tend “to make personal sacrifices on behalf of their government’s aims.” In addition, scholars have used different objects in the *same* publication. For example, De Lamater et al. (1969: 320) simultaneously understood nationalism as “an individual’s attachment to his nation or country which leads him to desire more power to it” and as “one aspect of the broader problem of how individuals relate to the nation-state, how they are integrated into it.” Similarly, Gellner (1983: 1) defined nationalism as a “theory of political legitimacy, which requires that ethnic boundaries should not cut across political ones, and in particular, that ethnic boundaries within a given state [...] should not separate the power-holders from the rest” while underscoring that “nationalism engenders nations” (ibid.: 54). Moreover, Blank and Schmidt (2003: 305) found that nationalism and patriotism are “distinct attitudes toward the nation” that “favor different concepts regarding the nation, the state, and the regime and define different social goals.”

However, as Connor indicated in the late 1970s (1978, see also Brubaker, 2004), nationalism scholars should clearly distinguish between the nation and the state, as only the former is the main object of nationalism.<sup>36</sup> Dekker et al. (2003: 347; see also van Evera, 1994) indicated that nationalists strive to establish an independent state “for their particular nation,” which highlights the distinctiveness of these concepts. Thus, in line with Connor (1978) and several other scholars (e.g., Snyder, 1954; Smith, 1991; Druckman, 1994; Stern, 1995; Viroli, 1995; Barrington, 1997; Freedon, 1998; Primoratz, 2017; Lobera & Roch, 2022), this study defines the nation as the object of attachment to which nationalists feel devoted. It should be noted that

---

<sup>35</sup> This definition is similar to van den Berghe’s (1967: 18) notion of *Herrenvolk democracy* (i.e., “a parliamentary regime in which the exercise of power and suffrage is restricted, *de facto* and *de jure*, to the dominant group”).

<sup>36</sup> For the distinction between state and nation, see, for example, Seton-Watson (1977), Gellner (1983), Barrington (1997), Connor (1978), Spinner-Halev and Theiss-Morse (2003), or Guibernau (2004).

the nation<sup>37</sup> as object is one of the most central distinctions between nationalism and other seemingly similar but distinct phenomena, such as ethnocentrism or collective narcissism.<sup>38</sup>

As outlined above, the concept of the nation is closely intertwined with that of the people or, according to the second research tradition, a predominantly ethnic notion of nationhood. In other words, belief in the superiority of one's nation is strongly interwoven with belief in the superiority of one's people. Thus, nationalism, with the nation as its object of attachment, is shaped by five coherent core features: belief in the superiority of one's nation, a related belief in the superiority of one's people, belief that one's nation should strive for dominance, the feeling of being chosen, and the ethnic notion of nationhood.

In summary, this study defines nationalism as a specific type of attachment that relies on the following set of beliefs: the world is categorized into nations (that are ethnically homogeneous); everyone is born into one nation and can thus feel exclusively attached to this nation; one's nation is, by definition, superior to others and strives for dominance over other nations and people; in the process, it seeks to fulfill its national mission as a chosen nation and thus a chosen people; based on an ethnic notion of nationhood, the nation is one organic community bound by one ethnicity, one religion, and one culture; and, in the face of both internal and external enemies, this national purity and homogeneity is (increasingly) threatened and must thus be persistently defended.

---

<sup>37</sup> Importantly, there is no single agreed-upon definition of "nation" (for a further discussion, see Westle, 1999) but rather a plethora of definitions that range from Renan's ([1882]1996: 42) "daily plebiscite" to Smith's (1991: 14; for a critique see e.g., Guibernau, 2004) understanding of a "named human population sharing an historic territory, common myths, and historical memories, a mass public culture, a common economy and a common legal rights and duties for all members" and Anderson's (2006) "imagined political community". It should be noted that Weber (1978: 176) famously indicated that a nation, defined as a "community of sentiment which would adequately manifest itself in a state of its own," should be viewed as a concept that belongs to the "sphere of values." Importantly, and as indicated by Guibernau (2004: 132), there are "nations without states" (i.e., "territorial communities with their own identity and a desire for self-determination included within the boundaries of one or more state, with which, by and large, they do not identify"; for a more thorough elaboration, see Guibernau, 1999). This work follows Spinner-Halev and Theiss-Morse's (2003: 516) conception of the nation as "a limited political community that desires or has political recognition, has some territorial claims, and shares collective identity."

<sup>38</sup> While the nation is the object of attachment in nationalism, ethnocentrism specifically refers to "the ethnic group" (Bizumic & Sheppard, 2022: 200, see also for further differences between nationalism and ethnocentrism). Thus, the two concepts should be separated and nationalism is not, as is sometimes claimed, a "form of ethnocentrism" (see e.g., Gangl et al., 2016: 868). The same is true of the distinction between nationalism and collective narcissism: while nationalism centers on the concept of the nation, collective narcissism exclusively focuses on the rather diffuse term "(my) group" (Golec de Zavala & Cichocka, 2012). In addition, recent scholarship has suggested that collective narcissism can lead to nationalism, which further accentuates their distinctiveness (e.g., Golec de Zavala & Lantos, 2020). On the distinction between nationalism and populism, see Brubaker (2020); Bonikowski et al. (2019); or Heiskanen (2021).

### 3.3 Patriotism

The existing literature on patriotism displays a considerable lack of conceptual clarity. This is principally because patriotism, like nationalism, is a highly contested and historically and culturally contingent term whose meaning has changed over time (for an historical overview of its meaning, see in particular Dietz, 2020). By conducting a Q-methodology study in the United States, Sullivan et al. (1992: 231) found that patriotism can have very different meanings to different people, ranging from an emotional attachment to America over loyalty to political institutions and democracy to civic commitment that often targets the state. Based on Sullivan et al.'s (1992) findings and the political psychology literature and beyond, patriotism has been defined as love of country on the one hand (e.g., Bar-Tal, 1993; Citrin et al., 2001; Li & Brewer, 2004; Theiss-Morse, 2009) and a commitment to democratic values (e.g., Davidov, 2009; Ariely, 2011, 2012; Huddy et al., 2021; Wamsler, 2022) on the other. Huddy et al. (2021: 19) even understood it as a “mixture of love of country and civic conceptions of what defines the nation.” Thus, two different research traditions within the scholarship have resulted in distinct concepts of patriotism that, as this study showed, mainly stem from divergent objects of attachment: the country one the one hand and democracy on the other. To further disentangle these two concepts, two distinct types of patriotism are proposed in this dissertation: patriotism (i.e., love of country) and democratic patriotism. In the process, it also addresses criticisms levied against survey researchers who tend to “presume the validity of one, unidimensional understanding of patriotism, while alternative multidimensional understandings are not considered” (Theiss-Morse et al., 1991: 102).

#### 3.3.1 *Attachment to the homeland*

Across accounts in political psychology and beyond, patriotism is commonly understood in one dominant line of research as an emotional attachment to or simply love of country (Terhune, 1964; Conover & Feldman, 1987; Kosterman & Feshbach, 1989; Berns, 2001; de Figueiredo & Elkins, 2003; Li & Brewer, 2004; Keller, 2005; Kimmelmeier & Winter, 2008; Theiss-Morse, 2009; Primoratz, 2017).<sup>39</sup> In political theory, there is broad agreement that love for one's

---

<sup>39</sup> Derived from the Latin *patria* (fatherland), the term's definition is given as love for one's country by almost all major English dictionaries, including Merriam-Webster (1991), Collins (2006), and Cambridge (2013). The same holds for German dictionaries such as the Duden or the Digitales Wörterbuch der Deutschen Sprache. The former defines patriotism as “(leidenschaftliche) Liebe zum Vaterland” [(passionate) love for the fatherland], and the latter as “Liebe zum eigenen Vaterland” [love for one's own fatherland]. Notably, this definition is also used in

country mainly stems from the fact that it is one's country (Keller, 2005). Thus, patriotism is largely defined by an affective component. In the literature, the connection between patriotism and sentiment is noteworthy. Snyder (1954: 148) maintained that patriotism is not only a "universal attribute of man in society throughout history" but also "a powerful sentiment among all current peoples." Similarly, Kedourie (1985: 73) defined patriotism as "a mere sentiment of affection for one's country" and nationalism as a political doctrine. Likewise, Bar-Tal (1993: 51) noted that patriotism is "a more general and basic sentiment" that, in contrast to nationalism, does not concern the "self-determination of the group as a nation in a state" and "does [not] dictate the nature of political organization to the group." Moreover, Smith (2021: 9) considered patriotism as "a sentiment of gratitude and appreciation for who we are and what has made us."

There is a broad consensus that deep devotion to one's country implies making sacrifices for the homeland (Doob, 1964; Somerville, 1981; Bar-Tal, 1993; Stern, 1995; Viroli, 1995; Berns, 2001; Keller, 2005; Harari, 2018). Snyder (1954: 149) persuasively argued that patriotism entails "an act of service," which relies on the premise that the "best proof and test of love is willing service." Across accounts, there is also broad agreement that willingness to make sacrifices is mostly associated with a readiness to die for one's country (e.g., Bar-Tal, 1993; Stern, 1995; Primoratz, 2017; Smith, 2021)—that is, the affective component is often accompanied by a behavioral *intention*. According to Terhune (1964: 258), the "affective involvement" (i.e., love of one's country) is complemented by "goal involvement" (i.e., "the motivation to help one's country"). Importantly, as outlined in several accounts (e.g., Snyder, 1954; Somerville, 1981; Karasawa, 2002; Keller, 2005; Theiss-Morse, 2009; Primoratz, 2017), the *patria* (that is, the country or homeland) is the main object of attachment for patriots.<sup>40</sup>

Based on the above literature, patriotism is defined in this study by two coherent core features: love of country and strong loyalty to one's country. Importantly, it explicitly refrains from adding attributes such as "traditional patriotism" or "conventional patriotism" (see Sekerdej & Roccas, 2016), as these are seen as unnecessarily normative and imprecise in parts. What is

---

political discourse. For instance, the former German Federal President Johannes Rau (2001) once famously claimed that a "patriot is someone who loves his own fatherland. A nationalist is someone who despises the homelands of others". Thus, he described himself as a patriot.

<sup>40</sup> This work follows Kohn's (1939: 1006; see also Theiss-Morse, 2009) definition of the term "homeland" as the land "which the man naturally loves, the native village, or a valley, or a city, a small known territory known in all its credentials." There is consensus that patriotism is widespread, as even "tribes with nomadic habits showed an attachment to some particular valley especially associated with their life" (Snyder, 1954: 154).

more, those terms or what Levinson et al. (1950) called “genuine patriotism”<sup>41</sup> indicate that there are forms of “progressive,” “modern,” or “false” patriotism. The same is true of the term “homeland” (i.e., expressions such as “homeland patriotism”). Due to the broad agreement that patriotism is love of and loyalty to one’s country, such attributes are not seen as a requirement.

In summary, this study defines patriotism as specific type of attachment based on the following set of beliefs: the world is categorized into different homelands; everyone is born into one homeland and thus feels exclusively attached to this homeland; and, due to one’s strong loyalty and deep love for the homeland, one feels, by definition, obliged to make sacrifices for the homeland.

### 3.3.2 *Attachment to democratic values*

Another line of research, which strongly relies on the work of Blank and Schmidt (2003), draws on the concept of constitutional patriotism. The term was initially introduced in 1979 by Dolf Sternberger (1990:12; see also 1947) in Germany who famously claimed that the “fatherland is the constitution to which we give life”. Thus, he considered citizens not only as responsible subjects within a political community but also constitutional guards. Subsequently, the philosopher Jürgen Habermas coined the term constitutional patriotism in the late 1980s in light of the *Historikerstreit* (historian’s dispute). Most prominently, he held that “the only patriotism which does not alienate us from the West is a constitutional patriotism,” which he defined as “a commitment to universalist constitutional principles deeply embedded in convictions [that] has developed in the German culture nation only after and through Auschwitz” (Habermas, 1987: 75).

Largely overlooked in previous studies, the main question that preoccupied Habermas (1996) and other proponents of constitutional patriotism (Ingram, 1996; Cronin, 2003; Müller, 2008a)—was how to foster *social cohesion* in multicultural societies. In addition, they searched for an effective measure to tackle “the challenge of conceiving, justifying, and maintaining democratic rule” (Müller, 2008a: 77) and maintained that democratic values and principles are the necessary glue that binds diverse societies together (for a critique, see Canovan, 2000;

---

<sup>41</sup>*Genuine patriotism* is defined as “love of country and attachment to national values based on critical understanding” and stands in stark contrast to *pseudopatriotism*, considered as a “blind attachment to certain national cultural values, uncritical conformity with the prevailing group ways, and rejection of other nations as outgroups” (Levinson et al., 1950: 107).

Baumeister, 2007; see also Tamir 1993; 2019a or Gustavsson & Miller 2020 both on *liberal nationalism*; see further Laborde 2002 on *civic patriotism*). Thus, this type of attachment centers on the “norms and values at the heart of the constitution [...] and in particular, to the fair and democratic procedures” (Müller 2008a: 82). In essence, constitutional patriotism is defined as an attachment to democratic norms and principles (Cronin, 2003; Müller, 2008a) accompanied by great loyalty to (democratic) political institutions<sup>42</sup> (e.g., Viroli, 1995; Blank & Schmidt, 2003; Davidov, 2009; Ariely, 2011; Gorski & Perry, 2022; see also Smith 2021 on *enlightened patriotism*).<sup>43</sup> According to Cronin (2003: 4), “loyalty to democratic constitutional principles and the political institutions they structure [...] ground a rational form of collective identity” for pluralistic societies. Thus, constitutional patriotism should be viewed as a credible “competitor for conventional notions of nationality and emotional loyalty” (Müller, 2008a: 14). Drawing on Renan’s ([1882]1996: 42) prominent notion of the nation as a “daily plebiscite,” Habermas (1990: 636) advocated for a community based on a democratic consensus, not common descent and other ethnic conceptions of nationhood. In short, the *ethnos* is replaced by a *demos* (i.e., a community of *citizens* who share democratic values (for a thorough elaboration on *demos*, see e.g., Abizadeh, 2012). Largely neglected in existing accounts, constitutional patriotism is considered an enduring and, crucially, a political project (Müller, 2008a: 83; see also Cronin, 2003). Deliberately embracing a “constitutional culture that mediates between the universal and the particular,” constitutional patriotism is characterized by a transnational scope (ibid.: 89). Seeking to reconcile the tension between universalism and particularism, Müller (2008a: 88) emphasized that “it is certainly possible [...] to be attached to universalist principles and feel loyalty to a particular constitutional culture.”<sup>44</sup>

This line of research commonly employs the term “constructive patriotism” (e.g., Davidov, 2009; Ariely, 2011; Wamsler, 2022; Sekerdej et al., 2023), as it is seen as “kind of left and liberal orientation” (Davidov, 2009: 66), “critical form of national identity” (Molina & Preddie,

---

<sup>42</sup> Interestingly, Latcheva (2011: 1186) described this type of patriotism as “constructive or institutional patriotism.”

<sup>43</sup> According to Smith (2021: 4), patriotism is not only “a form of loyalty to one’s own” but “especially to one’s constitution or political regime”—that is, “inseparable from a decent democracy” (ibid.: 187).

<sup>44</sup> Without referring to Müller, Berns (2001:8) similarly claimed that “ours [i.e., American] is not a parochial patriotism; precisely because it comprises an attachment to principles that are universal, we cannot be indifferent to the welfare of others.” Similarly, Appiah (1997: 622) claimed that “we cosmopolitans can be patriots; loving our homeland, our loyalty to humankind does not deprive us of the capacity to care for the lives near by.” It should be noted that there is an ongoing discussion about whether particularism and universalism in political philosophy can be reconciled. See Papastephanou (2017) on the famous Rorty-Nussbaum debate of the 1990s or Laborde and Erez 2020 on *cosmopolitan patriotism*.

2020: 418), or “critical national attachment” (Sekerdej et al., 2023: 1). Thus understood, patriotism is defined as an attachment to democratic principles that, by definition, “has the potential to support tolerance toward out-groups” (Blank & Schmidt, 2003: 294; see also Davidov, 2009; Huddy et al., 2021; Wamsler, 2022). According to De Figueiredo and Elkins (2003: 178), it is strongly tied to “beliefs in the social system and values of one’s country.” Consistent with these associations, a negative relationship between patriotism and anti-immigration attitudes (e.g., Blank & Schmidt, 2003; de Figueiredo & Elkins, 2003; Latcheva, 2011; Konrad & Qari, 2012; Wagner et al., 2012; Huddy & Del Ponte, 2019; Huddy et al., 2021; for the negative relationship between patriotism and restrictive *immigration policies*, see Molina & Preddie, 2020) has been found in a number of pertinent studies. Importantly, and as outlined by Müller (2008a), patriotism is shaped by a strong cognitive character. However, patriotism is intended to serve as a basis for civic empowerment and encompasses a behavioral intention that should be recognized (Müller 2008a). Thus, it not only concerns attachment to democratic values themselves but also enforcing and enacting them. Müller (2008a) posited that society should consider itself as a political defense community not only but especially in times marked by anti-democratic currents.<sup>45</sup> As stressed in other accounts, patriots are assumed to feel a strong obligation “to move their country in a positive [i.e., a more democratic and egalitarian] direction” (Huddy & Khatib, 2007: 68; see also Sekerdej & Roccas, 2016).<sup>46</sup> Thus, civic engagement with society in general and democracy in particular is at the core of patriotism.

In this line of research, the object of attachment in patriotism is not, as is often but erroneously assumed, the nation (e.g., Blank & Schmidt, 2003), a particular constitutional culture or “a way of life or form of life or a kind of community” (Müller 2008a: 83) but democratic values. The object of attachment is not the constitution per se, which any state might have regardless of its political regime, but, more importantly, democracy and thus democratic values. In other words, attachment to a particular constitution is not necessarily attachment to democratic values. Thus, constitutional patriotism is not necessarily democratic. Accordingly, this study proposes a

---

<sup>45</sup> Importantly, these anti-democratic currents can be considered part of a broader phenomenon and thus manifestations of “democratic backsliding,” which is commonly defined as “state-led debilitation or elimination of any of the political institutions that sustain an existing democracy” (notably, see Bermeo, 2016: 5; see also Waldner & Lust, 2018; for a different perspective, see Lührmann and Lindberg, 2019 on *autocratization*).

<sup>46</sup> It should be noted that there is even an item employed to measure *constructive patriotism* (i.e., “People should work hard to move this country in a positive direction”; Sekerdej & Roccas, 2016: 502).



definition of patriotism with democratic values as its object of attachment called “democratic patriotism”<sup>47</sup> to replace the term “constitutional patriotism.” Importantly, the term does not have any normative connotations, as “democratic” is a rather neutral term. Because this type of patriotism aims “to enable and uphold a liberal democratic form of rule that free and equal citizens can justify to each other” (Müller, 2008a: 72), it is inherently limited to liberal democracies.<sup>48</sup>

In line with the abovementioned literature, democratic patriotism is defined by three coherent core features: strong democratic attachment, which results in firm support for democratic values; civic engagement with democracy and society as a whole; and support for social cohesion and inclusive coexistence. In contrast to nationalism and the other type of patriotism (i.e., love of country), it should be understood as an attachment to *values* rather than a collective, which refers to the nation in the case of nationalism and the homeland in the case of patriotism.

### 3.4 Summary

This study proposes a triad of three types of attachments: nationalism, which exclusively refers to the nation; patriotism, which centers on the concept of the homeland; and democratic patriotism, which features democracy as its object of attachment. At this point, it is important to highlight that, according to Fletcher (1995: 8), “one’s loyalty toward an object of loyalty

---

<sup>47</sup> It should be noted that the term “democratic patriotism” has already been used—albeit not in a systematic manner—in both the scholarly literature (e.g., Mounk, 2018: 208) and in political discourse in Germany, especially by the German Federal President Frank-Walter Steinmeier (2018; see also 2020), who advocated for democratic patriotism in several speeches. For instance, in his speech on 9 November 2018 he stated the following: “All of us who profess democracy, the millions who are committed to this country day after day [...] show by daily example that democratic patriotism is neither an abstraction nor a cerebral birth. The commitment of these citizens does not arise solely from cool reason or calculation, but for the vast majority from the depths of their hearts.” Notably, Steinmeier also adheres to the nationalism-patriotism distinction as he calls for fostering a democratic patriotism, while condemning a bellicose, aggressive nationalism.

<sup>48</sup> It should be noted that Müller (2008a) did not provide a definition of the term “democracy” nor clarified what he meant by democratic values. While acknowledging the plethora of definitions for democracy, this study relies on Morlino’s (2004: 12) work, which described a *good democracy* as “a stable institutional structure that realizes the liberty and equality of citizens through the legitimate and correct functioning of its institutions and mechanisms.” Overall, it is shaped by a “broadly legitimated regime that completely satisfies its citizens,” “in which the citizens, associations and communities of which it is composed enjoy at least a moderate level of liberty and quality,” and in which the “citizens themselves [...] have the power to check and evaluate whether the government pursues the objectives of liberty and equality according to the rule of law.” Thus, Morlino aimed to not only assess democracy itself but, more importantly, its *quality* in terms of content, procedures, and results. It should be noted that his definition of democracy is much more encompassing than more minimal definitions, such as Dahl’s (1971) prominent concept of *polyarchy* (i.e., an electoral democracy characterized by, among other elements, clean elections, freedom of association, universal suffrage, and an elected executive).

becomes evident in the light of competing and thus alternative objects of loyalty.” Thus, the three abovementioned objects of attachment (i.e., nation, homeland and democracy) are distinct and *can*—but do not have to be—viewed as competing objects. As indicated by Oldenquist (1982: 179), “most of our loyalties are nested” (i.e., one “may be loyal to one’s community but also to [one’s] country.” Importantly, and going slightly beyond Oldenquist’s (1982) claim, this approach maintains that—in line with attachment theory—it is possible to have a primary object of attachment. Thus, while one’s attachments might be nested, it is reasonable to assume that one is likely to rank objects of attachment. That is, individuals prioritize a certain object of attachment over other potential objects of attachment. Therefore, one may prioritize the nation as an object of attachment over others, such as the homeland or democratic values. Wimmer rightly (2018: 218) claimed that attachment centers on “how strongly individuals believe that they form part of one community *rather than* another.” Similarly, if people do not feel an attachment to their nation or homeland in the first place, they are very likely to feel attached to democracy (i.e., democratic values). In other words, so-called cosmopolitan citizens may not feel an attachment to their nation or homeland but are very likely to feel an attachment to democratic principles such as equality before the law or freedom of speech. They may not be overly concerned about whether they live in Germany, the Netherlands, Denmark, or another country, as long as it is a stable democracy that guarantees a fair degree of liberty.

In summary, the proposed conceptual approach is based on the following five interrelated assumptions:

1. Individuals need to feel attached to a certain object.
2. Nationalism and patriotism are distinct types of attachment.
3. Nationalism and patriotism have differing objects of attachment—nation, homeland, and democracy—and core features.
4. The three objects of attachment (i.e., nation, homeland, and democracy) *can* but do not have to be seen as competing objects of attachment.
5. Individuals are very likely to prioritize a certain object of attachment over other, alternative objects of attachment.

Moreover, nationalism and the two types of patriotism not only differ in terms of their objects of attachment and core features but also their goals. While both nationalism and democratic patriotism have political and partly societal goals, the literature on patriotism remains vague. There is agreement that nationalism, when understood in more narrow terms, is strongly

associated with the strive for power, dominance, and influence over other nations. When understood in broader terms, nationalism is closely tied with achieving—or, more precisely, restoring—the ethnic homogeneity that the nation is shaped by. Bonikowski (2016: 430) posited that nationalism “defines the ends of action” (i.e., its preferred outcomes are “domination over other nations and the policing of the nation’s symbolic boundaries against undesirable others”). Interestingly, Terhune (1964: 266) questioned whether the overarching goal of nationalism is simply “power per se.”

With regard to democratic patriotism, there is a consensus that it is intended to foster social cohesion in multicultural societies and viewed as an effective measure for upholding, strengthening, and, if necessary, defending liberal democracy. When understood as an enduring political project, it also strives to develop a transnational community based on a democratic consensus. In this context, the European Union is seen as an example of such a supranational community (notably, Müller, 2008b; Lacroix, 2002; for a critique, see e.g., Kumm, 2008).

With respect to patriotism, the literature remains unclear on political objectives. Bar-Tal (1993: 48), albeit not going into depth, seems to be one of the few scholars to underscore the need for patriotism, which he argued is “the most fundamental condition for group existence” and fosters group unity and cohesiveness. In contrast to nationalism, love of country is not associated with features such as power, dominance, or influence over other nations or peoples. In the 1950s, Snyder (1954: 148) claimed that “nationalism is inseparable from the idea of power; patriotism, on the other hand, is by nature defensive, both culturally and militarily.”

Overall, especially in context of attachment theory, the three proposed objects of attachment (i.e., nation, homeland, and democracy) are not given from birth onwards, in contrast to one’s primary attachment figures (i.e., one’s mother or father). Thus, while one is born to a nation or homeland, such attachments must be cultivated through political socialization. According to Berns (2001: 11), “no one is born loving his country; such love is not natural, but has to be somehow taught or acquired.” Similarly, Smith (2021: 188) maintained that “patriots are not born; they are made,” which suggests that patriotism “can be taught only through a long and deep engagement with the founding texts of our political tradition.”

## 4 Research hypotheses

Based on the suggested conceptual approach, the following main hypothesis was tested:

*H1*: Corresponding to the proposed triad of nationalism, patriotism, and democratic patriotism, a three-factor measurement model is expected to fit the data.

### 4.1 *Research on the relationship between authoritarianism, nationalism, and patriotism*

When dealing with authoritarianism, political psychologists commonly rely on the seminal work of Levinson et al. (1950: 227), who defined authoritarianism as “a general tendency to look down on those who were believed to be violating conventional norms” and as “a general disposition to glorify, to be subservient to and remain uncritical toward authoritative figures of the in-group and to take an attitude of punishing outgroup figures in the name of some moral authority.”<sup>49</sup> Another influential work is the one of Altemeyer and Altemeyer (1996: 6) who built and expanded on the research of Levinson et al. (1950) by introducing the term *right-wing authoritarianism*, which consists of three components: “authoritarian submission, authoritarian aggression, and conventionalism” and which is frequently employed in quantitative research.

In scholarship on the nationalism-patriotism distinction, there is broad agreement that nationalism is strongly associated with authoritarian beliefs on a conceptual level. In the late 1980s, Feshbach (1987: 322) claimed that nationalism might be caused by an “authoritarian parental style.” Likewise, Blank (2003: 262) considered nationalism a “nation-related aspect of authoritarianism.” Similarly, Blank and Schmidt (2003: 293) indicated that “nationalism supports the nation in areas where there are authoritarian structures between the nation and its citizens, or where such structures are aspired to.” Strikingly, Skitka (2005) even equated the two concepts by measuring nationalism using Altemeyer’s right-wing authoritarianism (RWA) scale.

The widely held assumption that nationalism is closely associated with authoritarian convictions has been substantiated in previous studies. For instance, Blank (2003) and Heinrich

---

<sup>49</sup> It should be noted that Levinson et al. (1950) primarily focused on explaining individuals’ inclination towards fascism, prejudices, and out-group hostility (particularly anti-Semitism) rather than authoritarianism itself. In short, the “potentially fascistic individual” was their main object of investigation (ibid: 1).

(2016) found an effect size of  $\beta = .29/.33$ <sup>50</sup> and  $\beta = .589/.566$ <sup>51</sup>, respectively, for the impact of authoritarianism on nationalism, both in the context of Germany.<sup>52</sup> In addition, Osborne et al. (2017) found a cross-lagged effect size of  $\beta = .114$  in the context of New Zealand (for similar results in the context of the United States, see Huddy & Khatib, 2007). Finally, Kimmelmeier and Winter (2008) demonstrated a positive correlation between authoritarianism and nationalism ( $r = .45$ ). Thus, the following hypothesis was also tested:

*H2a:* Authoritarianism is expected to have a positive effect on nationalism.

In the Habermasian sense, constitutional patriotism is assumed to be conceptually detached from authoritarian beliefs (e.g., Blank & Schmidt, 2003; Heinrich, 2016). In existing accounts, this assumption has been corroborated. For instance, Blank (2003) found that authoritarianism had a weak impact on patriotism ( $\beta = .23$ ). Notably, Heinrich (2016) demonstrated that authoritarianism had a negative effect ( $\beta = -.111/-.179$ ) on patriotism. Thus, the following hypothesis was tested:

*H2b:* Authoritarianism is expected to have a very weak effect on democratic patriotism.

When patriotism is understood as love of country, previous research has found that authoritarianism is positively correlated with patriotism. For instance, Kimmelmeier and Winter (2008) found a correlation of  $r = .51$  in the context of the United States, while Osborne et al. (2017) demonstrated a cross-lagged effect of  $\beta = .0036$  for the impact of authoritarianism on patriotism in the context of New Zealand. In line with these findings, the following hypothesis was tested:

*H2c:* Authoritarianism is expected to have a positive effect on patriotism.

In this study, authoritarianism serves to primarily validate the novel three-factor measurement model for nationalism, patriotism, and democratic patriotism. Consequently, authoritarianism is not seen as a concept under investigation; the study's focus lies on the triad of attachments.

---

<sup>50</sup> It should be noted that the first value refers to Western Germany, while the latter to Eastern Germany.

<sup>51</sup> It should be noted that the values are based on the findings of the LCA, whereby the first value refers to "nationalists and patriots together with the 'middle group'", while the latter to "nationalists and patriots only" (Heinrich, 2016: 54).

<sup>52</sup> Interestingly, Blank (2003: 277) found that authoritarianism had a slightly stronger effect on national identity ( $\beta = .41/.33$ ) than on nationalism.

## 5 Data and Methodology<sup>53</sup>

Using a theory-driven approach, the novel three-factor model of nationalism, patriotism and democratic patriotism was developed and validated in three different studies (i.e., two of which used convenience samples and one of which used a nationally representative sample) conducted in Germany and by running confirmatory factor analysis (CFA). It should be noted that the nationally representative study is viewed as the main study. The German context is particularly interesting. Due to the country's policy of *Vergangenheitsbewältigung* ("coming to terms with the past") with the dark chapter of Nazism, a strong national attachment was considered taboo for many years (e.g., Fulbrook, 1999; Miller-Idriss & Rothenberg, 2012; Wehler, 2019; Assmann, 2020). Whereas Germany was once primarily seen as an ethnically defined nation, a more civic conception of nationhood that heavily relies on the Habermasian constitutional patriotism coined in the 1980s has evolved over time (e.g., Piwoni, 2012; Mader et al., 2021). Thus, the case of Germany shows how national attachments and notions of nationhood can develop over time.

Generally, CFA is a widely applied method of investigating the unidimensionality and validity<sup>54</sup> of a measurement model in multivariate statistics (Brown, 2015). In contrast to exploratory factor analysis (EFA), CFA is not data-driven but theory-driven approach. Thus, the measurement model is based on concrete a priori assumptions that researchers hold about relationships between the relevant items and the factor that they are intended to measure before conducting the empirical analysis (Harrington, 2009; Brown, 2015). Thus, the measurement model is specified and subsequently tested via CFA. The main goal is to examine if whether the model fits the data. Overall, factor analysis relies on the assumption that there is a causal relationship between the latent variable and the respective items (i.e., correlations between the items are caused by a single latent factor). It is based on a so-called "reflective indicator model," which assumes that the items are determined by the factor and not vice versa, as in the case of a so-called "formative indicator model" (Bollen & Lennox, 1991; Goertz, 2006; for further discussion, see Edwards & Bagozzi, 2000).

---

<sup>53</sup> Please note that parts of the chapter are based on Mußotter (2023b).

<sup>54</sup> Validity refers to whether "a variable measures what it is supposed to measure" (Bollen, 1989: 184). Importantly, validity "does not reside in the tool but in how it is used" (De Vellis, 2017: 87).

## 5.1 Measures: Generating the item pool

Following De Vellis's (2017) guidelines for scale development, an item pool with a total of 27 items (see Table 1 in the Appendix) was generated. It encompassed 12 items for nationalism, four items for patriotism, and 10 items for democratic patriotism. These items were formulated based on the three objects of attachment and their core features. Going beyond existing measures that tend to refer to *multiple* and thus different objects of attachment (e.g., nation, government, system, or country) when measuring *one* specific type of attachment, each item explicitly referred to the object of attachment. Thus, items for nationalism targeted the nation, items for patriotism targeted the homeland, and items for democratic patriotism targeted democracy. The results from the only two mixed-methods studies conducted in this strand of literature (e.g., Latcheva, 2011; Fleiß et al., 2009, both in the context of Austria) suggest that current measures of pride suffer from a high degree of ambiguity that causes difficulties with comprehension; thus, the novel items were not based on pride.

Items for nationalism were generated to reflect the core features of nationalism: (1) belief in the superiority of one's nation ("Germany, Germany, above all, above all in the world");<sup>55</sup> (2) belief in the superiority of one's people ("The German people are more important than any other people in the world"); (3) striving for dominance over other nations ("Germany should be more ruthless in asserting its national interests against other countries" and "Germany has the right to tell other countries what to do"), which was also reflected in a leadership claim ("We Germans have a claim to leadership in the world"); (4) a feeling of chosen-ness ("We Germans are a chosen people"), which has hitherto not been operationalized in the pertinent literature; and (5) the imperative of ethnic homogeneity ("Only those who have German blood may be German," "Dual citizenship should be abolished," and "Minority protection in Germany is not important to me"), which is reflected in the belief in a "genuine" German people (i.e., Germans with German ancestry; "The genuine Germans are not respected enough in Germany"). The latter is often accompanied by a perception of threat ("Our German culture is threatened by foreign influences").

---

<sup>55</sup> This item refers to the first stanza of "*Lied der Deutschen*" (The Song of the Germans), the original German national anthem written by August Heinrich Hoffmann von Fallersleben in 1841. Notably, this stanza was sung during the period of National Socialism. After World War II, only the third stanza was officially declared as the national anthem.

Existing measures of nationalism include pride items such as “How proud are you of Germany being No.1 in Europe?” (Blank & Schmidt, 2003) and “How proud are you of being German” (Blank & Schmidt, 2003; Wagner et al., 2012) and non-pride items such as “Other countries should try to make their governments as much like ours as possible” (e.g., Kosterman & Feshbach, 1989; Karasawa, 2002; Li & Brewer, 2004) and “The first duty of an American is to honor the American flag” (Kosterman & Feshbach, 1989; Li & Brewer, 2004). In contrast to these measures, the novel items in this study aim to better capture these core features by explicitly mentioning terms such as “leadership claim in the world.” To this end, items from existing datasets, such as “National socialism also had its positive sides” from the ALLBUS 2018, the General Social Survey in Germany,<sup>56</sup> were also incorporated into the item pool. In comparison to established and admittedly very broad items such as “How proud are you of your country’s history?” (e.g., Blank & Schmidt, 2003; Ariely, 2011), the NS-item from the ALLBUS 2018 refers to a very specific historical period. Thus, it better targets nationalists’ tendency to glorify their nation’s past, particularly the minimization of Germany’s darkest chapter. Notably, going beyond existing measures, the items consistently refer to *Germany*, the nation, and thus the object of attachment that is strongly related to the German people.

In addition, items were generated for patriotism and corresponded to its core features: (1) love of country (“I love my country”)<sup>57</sup> and (2) loyalty to the country (e.g., “I feel obliged to remain loyal to my country”), accompanied by a willingness to make sacrifices for it—that is, readiness to die for it (e.g., “I am ready to die for my country” and “I am ready to kill for my country”; see Table 1). In contrast to existing items, such as “I feel great pride in the land that is our New Zealand” (Osborne et al., 2017:1089), “In general, I am glad to be American” (Kimmelmeier & Winter, 2008: 874), “American is an important part of my identity” (Kosterman & Feshbach, 1989; for a similar item, see Citrin et al., 2001), “I would describe myself as a patriot,” “The United States suffers when patriotism wanes” (Kimmelmeier & Winter, 2008), and “I like [COUNTRY]” (Sekerdej & Roccas, 2016: 502), these items were explicitly designed to capture

---

<sup>56</sup>Allbus (Allgemeine Bevölkerungsumfrage der Sozialwissenschaften) refers to one of the largest nationally representative studies in Germany that is conducted biennially since 1980. It serves as “a social monitoring of trends in attitudes, behavior, and societal change in the Federal Republic in Germany.” See <https://www.gesis.org/en/allbus/contents-search/study-profiles-1980-to-2021/2018>.

<sup>57</sup> It should be noted that Blank et al. (1997), Blank (2003), and Molina et al. (2015) employed this item to measure national identity. By contrast, scholars such as Kosterman and Feshbach (1989), Karasawa (2002), and Molina and Preddie (2020) used it to measure patriotism, while Sekerdej and Roccas (2016) used it to measure *conventional patriotism*.



*love* for and *loyalty* to one's *country*, not pride or identification with it. This effectively disentangles patriotism, national pride, and national identity.<sup>58</sup> In this study, it is argued that one can identify with one's country while not necessarily loving it (see also Theiss-Morse, 2009; for the empirical distinction between patriotism and national identity, see Blank & Schmidt, 2003; Blank, 2003; Huddy & Khatib, 2007). Similarly, patriotism is neither a type of pride nor synonymous with pride but much more complex.

Finally, items were generated for democratic patriotism and were consistent with its main features: (1) a strong democratic attachment to and firm support for democratic values ("The Basic Law should be the foundation of our societal coexistence," "Our fundamental democratic values are inviolable", "Minorities have to be respected in our country," and "Our democratic values also have to be defended abroad"), (2) civic engagement with democracy (e.g., "I feel obliged to stand up for our democracy") and society ("It is a civic obligation to assume responsibility for our society"), and (3) support for social cohesion ("Germany's social cohesion needs to be strengthened"; see Table 1). The items were designed to assess simple *support* for and *engagement* in democracy and thus *attachment* to democratic values in general ("democratic values" and "stand up for our democracy") and not evaluate rather diffuse pride in the current *performance* of democratic institutions or pride in the equally ambiguous "country's fair and equal treatment of all groups in society," as existing items do (e.g., Blank & Schmidt, 2003; Davidov, 2011; Wagner et al., 2012). Notably, all items consistently referred to *democracy* (i.e., democratic values) and thus the specific object of attachment.

---

<sup>58</sup> Notably, eminent nationalism scholars such as Brubaker (2004: 121) refer to "patriotic identification with one's country—the feeling that this is *my* country, and *my* government," thus conflating identity with patriotism. Similarly, Molina et al. (2015: 4) equated both concepts, as they referred to "national identification or an individual's love for her/his nation." Moreover, Gangl et al. (2016: 870) assessed patriotism through national pride and national identification (i.e., "identification with the local community"), thus conflating the three concepts.

## 5.2 Study 1: Development study

Employing a theory-driven approach, the overall purpose of the development study was to test the abovementioned item pool<sup>59</sup> and develop a theoretically robust and empirically valid three-factor measurement model. Estimating a structural equation model (SEM), the effect of authoritarianism on nationalism and the two types of patriotism was also investigated. In so doing, the concepts' construct validity, usually defined as that type of validity assessing “whether a measure relates to other observed variables in a way that is consistent with theoretically derived predictions”, is tested (Bollen, 1989: 188). Generally, a SEM builds and expands on CFA, as it enables researchers to investigate “the relations between indicators and latent variables and the relations between the latent variables in a single model” (Hoyle, 2012: 4).

### 5.2.1 Sample

Data was collected from a web-based survey<sup>60</sup> conducted between November 2020 and January 2021. After calculating missing values and conducting pairwise deletion, the final sample size was  $N = 316$ . The survey took a maximum of 20 minutes to complete, and no incentives were offered. With regard to gender, 62.86% of respondents were female, 36.10% were male, and 1.04% defined themselves as non-binary. The mean age of respondents was 37.06 years ( $SD = 16.637$ ). In terms of education, 56.40% had a university degree, 29.24% had a high school diploma, 5.74% had a certificate of secondary education, and 2.35% a certificate of lower secondary education. In addition, 12% of respondents reported a migration background,<sup>61</sup> while 87% were native Germans. In terms of party affiliation, a majority of respondents (46.18%) voted for the Greens, followed by Christian Democrats (CDU/CSU; 19.83%), Social Democrats (SPD; 9.63%), Left (Linke; 9.63%), Liberals (FDP; 3.68%), Right-Wing Populists (AfD; 2.27%), and other (Andere; 5.67%).

---

<sup>59</sup> Prior to conducting the development study in Germany, the newly developed items were reviewed by academic peers (i.e., political scientists who specialize in, among other methods, survey research). When wording ambiguities, double stimuli, or double negations were encountered, the items were adjusted.

<sup>60</sup> The web-based survey was conducted via LimeSurvey (<https://www.limesurvey.org/de>).

<sup>61</sup> Whether respondents held German citizenship was not assessed in this study. It should be noted that all respondents, both natives and those with a migration background, were included in the analysis.

To assess the construct validity of the three concepts, i.e., nationalism, and the two types of patriotism, the first stage of the study included various measures of authoritarianism, such as the Authoritarian Short Scale (Nießen et al., 2019; see Table 4 in the Appendix), while the second stage encompassed the newly generated item pool for nationalism, patriotism, and democratic patriotism (see Table 1). All items were ranked on a five-point Likert scale with a neutral response category in the middle (1 = strongly disagree, 5 = strongly agree).<sup>62</sup>

### 5.2.2 Results

Before running a CFA, the newly generated item pool of 27 items was subjected to an EFA in STATA 16.1 (StataCorp, 2021).

#### 5.2.2.1 Running an exploratory factor analysis with the original item pool

Based on conventional guidelines (e.g., Backhaus et al., 2018), the data was deemed suitable for an EFA (KMO = .8495). According to the Kaiser criterion, a two-factor solution was proposed (eigenvalues: 6.61, 2.64, 0.99; in order with proportion of variance accounted for by each factor of 54.39%, 21.80%, 8.21% of total variance). Since the third factor displayed an eigenvalue of 0.99 and the scree plot indicated a three-factor solution (see Figure 1 in the Appendix), three factors were retained.

One item (citizenship) had a unique KMO of under .50 and was subsequently eliminated. This is theoretically plausible, as this was the only item that did not capture any of the three objects of attachment but simple contentment with German citizenship. Thus, a novel EFA was conducted with 26 items in total, and the overall KMO was slightly higher than before (KMO = .8537). According to the Kaiser criterion, the same factor solution was proposed (eigenvalues: 6.61, 2.63, 0.99; in order with proportion of variance accounted for by each factor of 55.49%, 21.11%, 8.36% of total variance). Since the third factor displayed an eigenvalue of 0.99, three factors were retained. When performing varimax rotation, only items displaying factor loadings greater than .40 were kept. As a result, three items had to be eliminated, as they either did not load on any factors (defend and respons) or displayed negative factor loadings (order). Thus, a novel EFA was conducted with 23 items in total. Based on conventional guidelines, the data

---

<sup>62</sup> A five-point Likert scale with a neutral response category in the middle is commonly employed and recommended in the pertinent survey literature (see e.g., Menold & Bogner, 2015).

was deemed suitable ( $KMO = .8565$ ). According to the Kaiser criterion, the same factor solution was proposed (eigenvalues: 6.61, 2.28, 0.95; in order with proportion of variance accounted for by each factor of 59.39%, 20.28%, 8.52% of total variance). When performing varimax rotation, only items displaying factor loadings greater than .40 were kept. As a result, one item (abolish) was excluded. Thus, a novel EFA was conducted on the remaining 22 items ( $KMO = .8566$ ).

Finally, an EFA with 11 items in total was conducted. When performing varimax rotation, a three-factor solution was suggested (eigenvalues: 2.38, 1.48, 1.17; in order with proportion of variance accounted for by each factor of 54.15%, 33.66%, 25.60% of total variance). It should be noted that oblique rotation yielded identical results, which also suggests a three-factor structure. Only items that displayed factor loadings greater than .45 and did not show any cross-loadings were retained (see Table 2 for results of varimax rotation in the Appendix). As a result, a total of 11 items remained for nationalism and the two types of patriotism (see Table 3 in the Appendix).

#### *5.2.2.2 Testing the Three-Factor Measurement Model*

In line with the proposed triad, a three-factor measurement model for nationalism, patriotism, and democratic patriotism consisting of 11 items from the previous EFA was specified. It was estimated by running a CFA. <sup>63</sup> MLR was chosen as an estimator due to its robustness to non-normally distributed data (Brown, 2015). Based on the cut-off criteria set by Hu and Bentler (1999; for a critique, see e.g., Marsh et al., 2004), a model was deemed valid if (a) the SRMR was near .08 or lower, (b) the RMSEA was near .06 or lower, and (c) the CFI and TLI were near .95 or greater. Given these criteria, the model displayed a good fit (CFI = .984; TLI = .977; RMSEA = .028; 90% CI [.000, .053]; SRMR = .044; AIC = 6,217.938; BIC = 6,360.386). As shown in Figure 2 (see Appendix), all of the items were significant and displayed factor loadings greater than .61. The distinction between nationalism, patriotism, and democratic patriotism was empirically substantiated in the data, which supported Hypothesis H1.

Finally, further support was found for the three-factor model after running alternative two-factor models that demonstrated a worse fit. Both models, which merged nationalism and patriotism into a single factor (CFI = .865; TLI = .809; RMSEA = .080; 90% CI [.064, .097];

---

<sup>63</sup> All the study's analyses, i.e., confirmatory factor analyses as well as SEMs, are conducted with Mplus 8.4 (Muthen & Muthen 1998 – 2012).

SRMR = .069) and combined the two types of patriotism (CFI = .560; TLI = .379; RMSEA = .144; SRMR = .155), had to be rejected.

As shown in Figure 2, nationalism was captured using five items consistently associated with its relevant core features, such as belief in the superiority of one's nation and one's people and an ethnic conception of the nation. The reliability of the scale was considered to be good ( $\alpha = .81$ ;  $\omega = .83$ ).<sup>64</sup> Patriotism was assessed using two items that adequately reflected its core features: love and loyalty to the country. They also formed a reliable scale ( $\alpha = .75$ ).<sup>65</sup> Finally, democratic patriotism was measured using four items that center on the concept of democracy and the strength of attachment to democratic values. The scale was considered reliable ( $\alpha = .70$ ;  $\omega = .70$ ). Overall, the three types of attachment were measured using multiple items that were considered adequate for two main reasons. First, from a theoretical perspective, the measures captured the attachments' core features. Second, from a more empirical perspective, multiple items enabled the reduction of potential measurement errors (see Latcheva & Davidov, 2014).

In terms of factor correlations, nationalism and patriotism had a substantial amount of variance ( $r = .667$ ,  $p < .001$ ). All factor correlations were beneath the conventional threshold of .85; therefore, they did not need to be merged (Brown, 2015). By contrast, a negative correlation between nationalism and democratic patriotism ( $r = -.147$ ,  $p > .05$ ) was detected. Moreover, a very low correlation between democratic patriotism and patriotism ( $r = .195$ ,  $p < .05$ ) was found. Three negative error correlations were found: two between nationalism items ("genuine" and "chosen"; "interests" and "anthem") and one between two democratic patriotism items ("values" and "cohe").

The negative error correlations between nationalism items can be explained as follows. The desire for an ethnic homogeneity and thus an ethnic notion of nationhood might not necessarily be associated with the feeling of being a chosen people. In other words, nationalists who endorse the imperative of a nation of common descent and thus the importance of having national ancestry do not necessarily feel the need to fulfill a national mission as a chosen people,

---

<sup>64</sup> There is broad agreement that McDonald's  $\omega$  is preferred to Cronbach's  $\alpha$  due to its higher explanatory power (e.g., Trizano-Hermosilla & Alvarado, 2016). For both parameters, the same cutoff criteria are applied: values between 0.7 and 0.8 are seen as respectable, while values between 0.8 and 0.9 are considered very good (De Vellis 2017; Krebs & Menold, 2019).

<sup>65</sup> It should be noted that  $\omega$  cannot be calculated for factors consisting of two items.

and vice versa. At this stage, it is worth noting that some scholars differentiate between chauvinism (defined in this study as nationalism) and exceptionalism (notably, Feinstein & Bonikowski, 2021). The same is true of the second error correlation, the one between “interests” and “anthem”: firm support for ruthlessly pursuing Germany’s national interests against other nations is not necessarily accompanied by belief in the nation’s intrinsic superiority, and vice versa. In terms of democratic patriotism, the error correlation can be explained as follows. Embracing democratic values is not necessarily associated with a need to strengthen social cohesion, and vice versa. Thus, the promotion of social cohesion—an admittedly vague term that can be considered one of the most predominant buzzwords of the 21<sup>st</sup> century (see Forst, 2020; Kaube & Kieserling, 2022; for a thorough literature review on social cohesion, see Schiefer & van der Noll, 2017)—is frequently used by various (political) leaders, intellectuals, and citizens, be they patriots, democratic patriots, nationalists, or none of these. For instance, even right-wing populists who see themselves as “true” advocates for the “people” and the “general will” claim to strengthen the “community” and thus the “social cohesion” that the so-called “elite” has neglected or even ignored (notably, Mudde & Rovira Kaltwasser, 2017). Furthermore, social cohesion appears to be open to different readings and interpretations and can thus be framed from completely different political camps.

### *5.2.2.3 Construct Validity: Relationships Between Authoritarianism, Nationalism, and Patriotism*

The effect of authoritarianism (as measured on the Authoritarianism Short Scale; Nießen et al., 2019) on the three types of attachments was examined by running a SEM (MLR as estimator). While this scale contains nine items in total, four were employed for this analysis: “We should take strong action against misfits and slackers in society,” “Rules in society should be enforced without pity,” “Well-established behavior should not be questioned” and “It’s always best to do things in the usual ways”. The model’s fit with the data was deemed satisfactory (CFI = .961; TLI = .949; RMSEA = .038; 90% CI [.020,.053]; SRMR = .054). As shown in Figure 3 (see Appendix) and in line with Hypotheses H2a and H2c, authoritarianism was found to have a significant effect on nationalism ( $\beta = .502, p < .001$ ) and, surprisingly, an even greater effect on patriotism ( $\beta = .636, p < .001$ ). Consistent with Hypothesis H2b, no effect on democratic patriotism was found ( $\beta = .056, p > .05$ ). In addition, nationalism and patriotism were positively correlated ( $r = .521, p < .001$ ), while a negative correlation was found between nationalism and democratic patriotism ( $r = -.202, p > .05$ ). The correlation between the two types of patriotism was low ( $r = .230, p < .05$ ). In light of these divergent effects, the distinction between the three

types of attachments as a whole and the opposition between the two types of patriotism in particular were substantiated. Thus, the construct validity of the attachments was supported.

### 5.3 Study 2: Validation study

The purpose of Study 2 was to validate the three-factor measurement model with a different sample using CFA. The effect of authoritarianism on nationalism and the two types of patriotism were also examined using SEM. Finally, the relationship between the novel three-factor measurement model and Blank and Schmidt's (2003) two-factor measurement model for nationalism and patriotism was investigated by testing for convergent and discriminant validity and running a CFA.

#### 5.3.1 Sample

Data was collected from a web survey<sup>66</sup> conducted in Germany between May 2021 and July 2021. After calculating missing values and conducting pairwise deletion, the final sample size was  $N = 537$ .<sup>67</sup> The survey took a maximum of 10 minutes to complete, and a gift voucher of 20 euros was provided as an incentive. The study included the new measures of nationalism and two types of patriotism, Blank and Schmidt's two-factor measurement model (2003) for nationalism and patriotism, and three items from the Balanced Short Scale of Authoritarian Attitudes (B-RWA-6; Aichholzer & Zeglovits, 2015). All items were ranked on a five-point Likert scale with a neutral response category in the middle (1 = strongly disagree, 5 = strongly agree).

With regard to gender, 63.49% of respondents were female, 35.79% were male, and 0.72% defined themselves as non-binary. The mean age was 24.43 years ( $SD = 7.21$ , range = 17–65). In terms of level of education, 62.95% of respondents had a high school diploma, 18.53% had a first university degree, 12.77% had an advanced university degree (master's or *Staatsexamen*), and 4.14% had a PhD. In addition, 92.99% of respondents held German citizenship and 23.02% reported a migration background. In terms of political affiliation, a majority of respondents (49.46%) felt the greatest affinity with the Greens, followed by the Left (Linke; 10.97%), Social Democrats (SPD; 10.79%), Liberals (FDP; 8.63%), Christian Democrats (CDU; 8.45%), Christian Social Democrats (CSU; 4.14%), and other (7.19%).

---

<sup>66</sup> The web-based survey was conducted via LimeSurvey (<https://www.limesurvey.org/de>).

<sup>67</sup> Since the study's goal was to test the measurement model, both German and non-German citizens were included in the analysis. Notably, over 90% of respondents were German citizens. Thus, a robustness check was also conducted to estimate the model with German citizens only (see Figure 6).



### 5.3.2 Survey measures

*Nationalism and Patriotism:* The three-factor measurement model developed and validated in the development study was tested. Patriotism was operationalized using two items (i.e., “I love my country” and “I feel obliged to remain loyal to my country”). Democratic patriotism was measured using four items (i.e., “Our fundamental democratic values are inviolable,” “The Basic Law should be the foundation of our societal coexistence,” “I feel obliged to stand up for our democracy,” and “Germany’s societal cohesion needs to be strengthened”). Nationalism was measured using the following five items: “Germany, Germany, above all, above all in the world,” “Germany should be more ruthless in asserting its national interests against other countries,” “The German people are more important than any other people in the world,” “Genuine Germans are not respected enough in Germany,” and “We Germans are a chosen people.”

*Blank and Schmidt’s two-factor measurement model for nationalism and patriotism:* Four items from Blank and Schmidt’s nationalism scale (i.e., “How proud are you of German history?,” “How proud are you of German success in sports?,” “How proud are you of Germany being number one in Europe?,” and “How proud are you of being German?”) were employed. In the following, this factor is referred to as BS-nationalism. In addition, three items from Blank and Schmidt’s patriotism scale (i.e., “How proud are you of the way democracy works?,” “How proud are you of the social security system?,” and “How proud are you of the possibilities for political participation in Germany?”) were used. In the following, this factor is referred to as BS-patriotism.

*Authoritarianism:* Authoritarianism was measured using three items from the Balanced Short Scale of Authoritarian Attitudes (B-RWA-6; Aichholzer & Zeglovits, 2015): “We should be grateful for leaders who tell us exactly what we shall do and how,” “The age in which discipline and obedience for authority are some of the most important virtues should be over” and “It is important to also protect the rights of criminals”.

### 5.3.3 Results

#### 5.3.3.1 Testing the Three-Factor Measurement Model

To test the main hypothesis (Hypothesis H1), the three-factor measurement model was estimated by conducting a CFA. After dropping the very weak cohesion item that displayed a factor loading lower than .20 in the first run, the model demonstrated good fit (CFI = .981, TLI

= .972, RMSEA = .030; 90% CI [.008, .047]; SRMR = .038). Thus, the model contained 10 items (see Table 5 in the Appendix). As shown in Figure 4, all items except for one (anthem) displayed factor loadings greater than .50.

The three-factor model was further supported when two alternative two-factor models were run and found to have a worse fit. Both models, which merged nationalism and patriotism into a single factor (CFI = .687; TLI = .586; RMSEA = .117; 90% CI [.104, .129]); SRMR = .087) and combined the two types of patriotism (CFI = .804; TLI = .741; RMSEA = .092; 90% CI [.080, .105]; SRMR = .097), had to be rejected.

The two patriotism factors ( $r = .236, p < .001$ ) were weakly correlated and, in contrast to Study 1, patriotism and nationalism ( $r = .422, p < .001$ ) were moderately correlated. In line with previous findings, a negative correlation was detected between nationalism and democratic patriotism ( $r = -.280, p < .001$ ). In addition, a *negative* error correlation of -.203 was found between the items “love” (i.e., “I love my country”) and “demo” (i.e., “I feel obliged to stand up for our democracy.”) Notably, the items do not load on the same factor but are used to measure the two different types of patriotism. Thus, the item “love” assesses patriotism (i.e., love of and loyalty to one’s country), while the item “demo” captures democratic patriotism.

### 5.3.3.2 Construct Validity: Relationships Between Authoritarianism, Nationalism, and Patriotism

The effect of authoritarianism on nationalism and the two types of patriotism was investigated by conducting a SEM. Because one authoritarianism item (i.e., “It is important to also protect the rights of criminals”) displayed a factor loading lower than .30, it was eliminated. Thus, two items remained. The model showed good fit (CFI = .984; TLI = .978; RMSEA = .024; 90% CI [.000, .040]; SRMR = .037). In line with previous findings and Hypothesis H2a, authoritarianism was found to have a positive and significant effect on nationalism ( $\beta = .494, p < .001$ ). Moreover, in line with Hypothesis H2c, it was found to have an even greater effect on patriotism ( $\beta = .740, p < .001$ ). By contrast, it had no effect on democratic patriotism ( $\beta = .094, p > .05$ ), which provides evidence for Hypothesis H2b (see Figure 5). Finally, a low correlation between the two types of patriotism ( $r = .248, p < .05$ ) and a negative correlation between nationalism and democratic patriotism ( $r = -.377, p < .001$ ) were detected. Notably, no correlation was found between patriotism and nationalism ( $r = .100, p > .05$ ).

### 5.3.3.3 *Relationship between the three-factor measurement model and Blank and Schmidt's (2003) two-factor measurement model*

To test for convergent and discriminant validity, a five-factor model consisting of the novel three-factor model and Blank and Schmidt's two-factor model of nationalism (BS-nationalism) and patriotism (BS-patriotism) was estimated by running a CFA. The model fit the data well (CFI = .970; TLI = .961; RMSEA = .036; 90% CI [.026, .046]; SRMR = .042). As shown in Figure 7, all factor loadings except for one (anthem) were significant; that is, they displayed factor loadings greater than .50. With regard to the novel three-factor model, patriotism was correlated with nationalism ( $r = .437, p = 0.001$ ) and weakly correlated with democratic patriotism ( $r = .207, p = 0.001$ ). As in previous studies, a negative correlation was found between democratic patriotism and nationalism ( $r = -.277, p < 0.001$ ).

The convergent and discriminant validity of the novel model were both empirically supported. A positive correlation was detected between the novel nationalism and BS-nationalism ( $r = .658, p < .001$ ). By contrast, no correlation was found between BS-nationalism and democratic patriotism ( $r = .085, p = 0.218$ ). In addition, a very high correlation was found between BS-nationalism and patriotism ( $r = .988, p < .001$ ). By contrast, BS-patriotism was positively correlated with both democratic patriotism ( $r = .432, p < .001$ ) and patriotism ( $r = .536, p < .001$ ) and no relationship was found between BS-patriotism and the novel nationalism factor ( $r = .030, p = 0.603$ ). In line with previous studies (e.g., Latcheva, 2011; Wagner et al., 2012; Huddy et al., 2021), a positive correlation was detected between BS-patriotism and BS-nationalism ( $r = .606, p < .001$ ). Two error correlations were modelled between two BS-nationalism items, i.e., "pride in history" was correlated with both "pride in sports" and "pride in being number one". Notably, the latter correlation, i.e., pride in history with pride in being number one was negative, while the former one was positive.

## 5.4 Study 3: Main study

After the model was developed and tested with two convenience samples, it was investigated with a nationally representative sample; this is considered the main study. As in the previous two studies, the objective was to test the main hypothesis (Hypothesis H1) by running a CFA. While accounting for construct validity, the effects of authoritarianism on nationalism and the two types of patriotism were examined by estimating a SEM. In addition, the effects of the three different types of attachment on anti-Semitism were tested by conducting a SEM. This study goes beyond existing research by considering both the roots of the three attachments *and* their implications on out-group hostility.

### 5.4.1 Sample

Data was collected from a representative survey conducted in Germany in February 2022 by the institute Bilendi & respondi. As part of a research project titled “National and regional meaning of social cohesion: Conceptions and measurements of relevant constructs” led by the Research Institute for Social Cohesion, the data was collected through an online access panel. The sampling frame was a quota sample based on age, gender, level of education, and region. Among other elements, the study included the new and previously validated measures for nationalism, patriotism, and democratic patriotism (see Table 5), social dominance orientation, authoritarianism, and anti-Semitism. All items were ranked according to a five-point Likert scale with a neutral response category in the middle (1 = strongly disagree, 5 = strongly agree). After calculating missing values and conducting listwise deletion, the final sample size was  $N = 1,875$ .

With respect to gender, 49.76% of respondents identified as female and 50.24% identified as male. The sample was divided into three age groups: the first (ages 15–34) accounted for 26.51% of respondents, the second (ages 35–64) accounted for 49.23% of respondents, and the third (ages 65 and older) accounted for 24.27% of respondents. Regarding level of education, 32.21% of respondents had a lower secondary school diploma, 29.60% had a secondary school diploma, 4.69% had a college degree, 13.60% had a high school diploma, and 18.29% had a university degree (1.60% of the respondents were dropouts). Most respondents (94.99%) were

born in Germany.<sup>68</sup> In terms of political affiliation, 22.72% of respondents were affiliated with the Social Democrats (SPD), 17.01% with the Christian Democrats (CDU/CSU), and 13.76% with the Greens. Other listed affiliations included the Right-Wing Populists (AfD; 10.61%), Liberals (FDP; 10.45%), Left (Linke; 8.16%), and other (7.68%). Non-voters formed 9.60% of the sample.

#### 5.4.2 Survey Measures

*Nationalism and Patriotism:* The three-factor measurement model developed and validated in the two previous studies was tested. Patriotism was operationalized using two items (i.e., “I love my country” and “I feel obliged to remain loyal to my country”). Democratic patriotism was measured using three items (i.e., “Our fundamental democratic values are inviolable,” “The Basic Law should be the foundation of our societal coexistence,” and “I feel obliged to stand up for our democracy”). Nationalism was measured using the following five items: “Germany, Germany, above all, above all in the world,” “Germany should be more ruthless in asserting its national interests against other countries,” “The German people are more important than any other people in the world,” “Genuine Germans are not respected enough in Germany,” and “We Germans are a chosen people.”

*Authoritarianism:* Authoritarianism was measured using the Authoritarianism Short Scale (Nießen et al., 2019), which includes items such as “It’s always best to do things in the usual way” or “Rules in society should be enforced without pity” (see Table 4).

*Anti-Semitism:* Anti-Semitism was measured using three items of previous studies, i.e., “The interests of Jews in the country are different from the interests of the rest of the population”, “It is always better to be a little cautious with Jews” (both Kovács & Fischer, 2021) and “Many Jews are trying to take advantage from the past of the Third Reich to their advantage today”. (Bergmann & Erb, 1991a).

---

<sup>68</sup> Whether respondents held German citizenship and had a migration background was not assessed in this study. Instead, they were asked if their parents were born in Germany. In this case, 12.56% respondents had a mother and 11.04% had a father who was born outside of Germany. An additional robustness check was conducted to estimate the model with respondents ( $N = 203$ ) whose mother was not born in Germany and those whose father was not born in Germany ( $N = 231$ ). In other words, the model was tested for second-generation migrants (i.e., respondents who were born in Germany but had one non-German parent; see Figures 11 and 12).

### 5.4.3 Results

#### 5.4.3.1 Testing the Three-Factor Measurement Model

To test the main hypothesis (i.e., Hypothesis H1), the three-factor measurement model was estimated by running CFA (MLR as estimator). The model displayed a good fit (CFI = .968; TLI = .950; RMSEA = .063; 90% CI [.056, .071]; SRMR = .041). In addition, further support was found for the three-factor model when alternative two-factor models were run and yielded a worse fit. Both models, one of which merged nationalism and patriotism into one factor (CFI = .768; TLI = .693; RMSEA = .157; 90% CI [.150, .164]; SRMR = .124) and the other combined the two types of patriotism (CFI = .719; TLI = .628; RMSEA = .173; 90% CI [.166, .179]; SRMR = .168), had to be rejected. The items used to measure patriotism displayed factor loadings greater than .80 (see Figure 8 in the Appendix). The scale's reliability was deemed good ( $\alpha = .86$ ). The items used to measure nationalism had factor loadings greater than .70 and formed a reliable scale ( $\alpha = .90$ ;  $\omega = .90$ ). The items used to measure democratic patriotism displayed factor loadings greater than .66 and formed a reliable scale ( $\alpha = .79$ ;  $\omega = .80$ ).

Moderate correlations were found between the two types of patriotism ( $r = .418, p < .001$ ) and between nationalism and patriotism ( $r = .512, p < .001$ ). Moreover, a negative correlation was detected between nationalism and democratic patriotism ( $r = -.173, p < .001$ ; see Figure 5). All factor correlations were beneath the conventional threshold of .85; therefore, they did not need to be merged (Brown, 2015). As outlined above, alternative two-factor solutions had to be rejected, which further supported the three-factor model.

Three error correlations were allowed: two between nationalism items ("interests" and "genuine" as well as "people" and "anthem") and one between democratic patriotism items ("values" and "gg"). Importantly, in contrast to previous studies, all correlations were *not* negative but lower than .25 (for correlations between nationalism items) or lower than .35 (for correlations between democratic patriotism items). The correlations between nationalism items can be explained as follows: a drive to ruthlessly pursue national interests against other nations does not necessarily imply an ethnic notion of nationhood (i.e., the feeling that "true" Germans are not respected enough). The second correlation between the items "people" and "anthem" indicates that the idea that the German people are superior to other people is not automatically associated with belief in the superiority of one's nation. Apparently, respondents distinguished between people and nation. However, it is important to bear in mind that the item "anthem"

(i.e., “Germany, Germany, above all, above all in the world”) is admittedly pretty strong in terms of its wording. As a result, most respondents scored relatively low on this item, at least on average. In other words, the item’s wording must be taken into account and seen as a potential explanation for this correlation. Meanwhile, the correlation between democratic patriotism items can be explained as follows: endorsement of democratic values in general is not necessarily accompanied by support for the Basic Law, particularly the Basic Law as a fundamental component of societal coexistence. It is important to stress that the former item “demo” is formulated in a more general manner (i.e., “Our fundamental democratic values are inviolable”), while the item “gg” and thus the latter explicitly refers to the Basic Law, especially its function (i.e., to foster social cohesion). Thus, respondents appeared to distinguish between different levels: a more general level and a more concrete level.

#### *5.4.3.2 Construct Validity: Relationships Between Nationalism, Patriotism, and Authoritarianism*

A SEM (MLR as estimator) was conducted to investigate the effect of authoritarianism on nationalism and the two types of patriotism. The model displayed a satisfactory fit (CFI = .969; TLI = .957; RMSEA = .050; 90% CI [.045, .055]; SRMR = .035), and all standardized factor loadings were greater than .67 (see Figure 9 in the Appendix). Consistent with Hypothesis H2a, authoritarianism had a positive and significant effect on nationalism ( $\beta = .591, p < .001$ ) and, in line with Hypothesis H2c, a positive but slightly smaller effect on patriotism ( $\beta = .500, p < .001$ ). It should be noted that authoritarianism was measured using three items from the Authoritarianism Short Scale, two of which targeted conventionalism (“It’s always best to do things in the usual way” and “Well-established behavior should not be questioned”) and thus the third component of authoritarianism. The findings indicates that not only nationalism but also patriotism (i.e., love for and loyalty to one’s country), albeit to a lesser degree, stemmed from conventionalism, which is defined as “a high degree of adherence to the social conventions that are perceived to be endorsed by society and its established authorities” (Altemeyer & Altemeyer, 1996: 6). It is important to mention that conventionalism can be regarded as the “softest” component of authoritarianism compared to the other two components (i.e., authoritarian aggression and authoritarian submissiveness). In short, conventionalism is likely to be endorsed by many people and therefore more accepted. Items such as “Well-established behavior should not be questioned” are not explicitly indicative of authoritarian beliefs as such. The item used to measure patriotism (i.e., “I feel obliged to remain loyalty to my country”) implicitly alludes to such conformist behavior. In other words, the term “loyalty” itself may not

evoke any extreme associations but rather be seen as positive by many different people. Overall, this component of authoritarianism appears to be a robust predictor for both types of attachments. By contrast, there was almost no effect of authoritarianism on democratic patriotism ( $\beta = .112, p = .001$ ), which provides evidence for Hypothesis H2b. Thus, democratic patriots appear to be more detached regarding those conventions. Although it was also measured using a similar item as patriotism (i.e., “I feel obliged to stand up for our democracy”), respondents seemed to differentiate between the objects of attachment. Thus, loyalty to one’s country stands in contrast to loyalty—or, more precisely, commitment—to democracy. Finally, a moderate correlation between the two types of patriotism ( $r = .422, p < .001$ ) and a negative correlation between nationalism and democratic patriotism ( $r = -.302, p < .001$ ) were detected. Notably, a moderate correlation between patriotism and nationalism ( $r = .313, p < .001$ ) was found.

#### 5.4.3.3 *Construct Validity: Relationships Between Nationalism, Patriotism, and Anti-Semitism*

A SEM was conducted to estimate the effects of nationalism, patriotism and democratic patriotism on anti-Semitism. The model fit the data (CFI = .968; TLI = .955; RMSEA = .050; 90% CI [.045, .056]; SRMR = .037), and all standardized factor loadings were greater than .60 (see Figure 10 in the Appendix). The model was further validated by the divergent effects of nationalism and the two types of patriotism on anti-Semitism. Thus, nationalism had a positive effect on anti-Semitism ( $\beta = .593, p < .001$ ), while democratic patriotism had a negative effect on anti-Semitism ( $\beta = -.129, p < .001$ ). These findings are in line with those of Blank and Schmidt (2003), who found that nationalism leads to anti-Semitism, while (constitutional) patriotism does not. Interestingly, patriotism had no effect on anti-Semitism ( $\beta = .046, p < .05$ ). A factor correlation between both types of patriotism ( $r = .418, p < .001$ ) and between patriotism and nationalism were found ( $r = .509, p < .001$ ). Finally, a negative correlation between democratic patriotism and nationalism ( $r = -.174, p < .001$ ) was detected.



## 6 Discussion and Conclusion

This study makes the first systematic attempt to reflect on and further develop the prominent but flawed distinction between nationalism and patriotism, which is largely applied in the field of political psychology. It focused on three main questions: What are the conceptual (and related empirical) shortcomings of the nationalism-patriotism distinction? How can this distinction be reconceptualized to achieve greater analytical clarity? How can the reconceptualized distinction be operationalized in a theoretically robust way? Notably, it did not abandon the binary distinction as such, but aimed to further refine it. Addressing these questions, this study proposes a more nuanced triad of attachments: nationalism, which exclusively refers to the nation; patriotism, which centers on the homeland; and democratic patriotism, with democracy as its object of attachment. The outlined approach is based on the premise that individuals feel the need to embrace a certain object of attachment; thus, it emphasizes three objects of attachment—nation, homeland, and democracy—that have not yet received attention in the literature. Drawing on the literature on attachment, it synthesizes the two most influential research traditions, namely the work of Kosterman and Feshbach (1989) and the work of Blank and Schmidt (2003), which have neither been fully recognized as divergent nor systematically addressed. In the process, it offers a reconceptualization that accounts for the distinct objects of attachment in nationalism and patriotism and their core features. By providing greater analytical clarity, this study addresses conceptual ambiguities in the binary distinction that have been criticized but not systematically elaborated.

Based on three studies conducted in Germany (including a nationally representative study in 2022), the study introduces a novel and validated three-factor measurement model for nationalism, patriotism, and democratic patriotism. This model is distinct, as it not only operationalizes the two synthesized concepts of nationalism but also simultaneously integrates and investigates the two dominant types of patriotism (i.e., love of country and adherence to democratic values) in a single model. It is worth highlighting that alternative two-factor models were rejected in all three studies. Thus, the suggested reconceptualization, which requires a distinction to be made between the three types of attachments, their objects, and their core features, appears to be robust. As a result, this dissertation not only makes a substantial but also an empirical contribution to research on the nationalism-patriotism distinction by offering a reconceptualization of the dichotomy and its operationalization.

A result worth noting concerns the moderate factor correlations between both nationalism and patriotism and the two types of patriotism. Thus, as initially proposed, these three attachments are distinct but *not* mutually exclusive and should thus be seen as ideal types. The correlation between nationalism and patriotism indicates that individuals who express great love for their country are also more likely to hold nationalist beliefs, and vice versa. The correlation between the two types of patriotism suggests that an emotional attachment to one's country is likely to be accompanied by a strong democratic attachment, and vice versa. Furthermore, the negative correlation between democratic patriotism and nationalism reveals that democratic values and nationalistic beliefs appear to be difficult to reconcile. As previously outlined by a few scholars (e.g., Abizadeh, 2012; Gorski & Perry, 2022; for a further discussion on the relationship between nationalism and democracy, see e.g., Helbling, 2009), this study shows that democratic values tend to run counter to nationalistic attachment, and vice versa. Thus, democracy (i.e., democratic values) and the nation seem to be competing objects of attachment, while the homeland and the nation seem to be more related. However, future studies should investigate these three objects of attachment in more detail, including the respondents' different associations with regard to these similar but distinct objects—namely, nation, homeland, and democracy. At this stage, it would be fruitful to explore how individuals prioritize certain objects over other, alternative objects of attachment as a research avenue.

Notably, demonstrating that authoritarianism leads to both nationalism and, to a lesser degree, patriotism but not democratic patriotism supports the concepts' construct validity. Thus, this study is distinctive not only in its introduction of a validated three-factor model but also in its provision of deeper insights on the intricate relationships between these concepts. It contributes to research on the psychological antecedents of nationalism and patriotism, which existing scholarship has largely neglected (see Osborne et al., 2017). Strikingly, and in line with previous research (e.g., Osborne et al., 2017 on New Zealand), authoritarianism only had a slightly lower effect on patriotism than on nationalism. While theoretical approaches to this specific relationship are scarce, this finding can be explained as follows. Importantly, the authoritarianism scale used primarily consisted of items that targeted conventionalism. In contrast to the other two subdimensions, i.e., authoritarian aggression and authoritarian submissiveness, it targeted the “softest” and thus most socially accepted component of authoritarianism. This finding suggests that patriotism (i.e., love for and loyalty to one's country) arises from a strong adherence to social conventions. In the future, this result is worth investigating in greater detail.

Furthermore, the study not only defined, measured, and assessed the origins of these three types of attachment, i.e., nationalism, patriotism and democratic patriotism, but also their effects. It demonstrated that nationalism tends to increase anti-Semitism, while democratic patriotism tends to decrease it. Notably, patriotism did not have any effect on anti-Semitism. At this stage, three aspects are important to highlight. First, the model supports previous findings on the nationalism-patriotism distinction, which demonstrated that nationalism is likely to result in the derogation of out-groups (specifically, Jews), while democratic or constitutional patriotism (as it was previously called) does not. Second, the findings highlight the need to disentangle the two types of patriotism and their different objects of attachment, as democratic patriotism tends to decrease anti-Semitism, while patriotism was not found to have an effect on anti-Semitism. The latter finding and the relationship between love of and loyalty to one's country and anti-Semitism is worth exploring in more detail. So far, the result seems to align with Brewer's (1999: 442) famous claim that "in-group love is not a necessary precursor of out-group hate." Finally, the three-factor model and the proposed triad were once again substantiated when the model's implications on this type of out-group hostility were tested.

In the future, there are many promising ways to expand on the reconceptualization presented in this study and the three-factor model. In the following, five avenues for research are proposed. First, testing the model's validity in other countries is an important endeavor for future research.<sup>69</sup> In acknowledgement of the importance of context in empirical research, researchers should be aware of the inherent restriction of research on democratic patriotism to countries with democratic governments. Thus, the complete model and three types of attachment should be examined in the context of Western liberal democracies. For nondemocratic states, it is recommended to focus on nationalism and patriotism, which apply irrespective of political regime.

Second, drawing on Blank and Schmidt's (2003) study, it is worth investigating the effect of national identity on the three types of attachments (i.e., nationalism and the two types of patriotism). It is reasonable to assume that national identity might have a different impact on the three kinds of attachment. Thus, one might expect a stronger effect on nationalism, but a

---

<sup>69</sup> It should be noted that the three-factor measurement model has already been validated using data from a nationally representative sample ( $N = 1164$ ) in Denmark in 2022. Results can be made available on request.

smaller effect on democratic patriotism. Examining this relationship would clarify the distinctiveness of the concepts.

Third, it would be beneficial to build on findings about the three-factor model's effects on anti-Semitism in future studies. For example, it is worth investigating the model's implications for other types of out-group hostility (i.e., anti-immigrant attitudes). Currently, it seems especially important to test its implications for anti-Muslim attitudes (notably, Simonsen & Bonikowski, 2020; see also Helbling & Traunmüller, 2018), which have not received any attention in research on the nationalism-patriotism distinction.

Fourth, given that the three types of attachment are distinct but not mutually exclusive, it is important to investigate whether they form different groups, and, if so, how many by running an LCA. This will allow to examine the extent to which individuals hold these different attachments simultaneously to varying degrees. Moreover, the extent to which individuals prioritize a particular object of attachment over others can also be addressed. Apart from a few exceptions (Blank & Schmidt, 2003; Heinrich, 2016; Satherly et al., 2019), LCAs have been rarely conducted in research on the nationalism-patriotism distinction.

Finally, it is worth examining whether and how these three types of attachment have changed over time using panel data. Currently, it seems important to build on and extend previous studies that used experimental research designs to explore the conditions under which nationalism and the two different types of patriotism become salient and whether patriotism leads to nationalism (notably, Li & Brewer, 2004; Gangl et al., 2016).

Overall, this study departs from previous research by primarily focusing on the nationalism-patriotism distinction itself rather than the consequences of nationalism and patriotism. On a higher level, it systematically conceptualizes and measures nationalism and the two types of patriotism and underlines the need to approach them in a theoretically consistent and empirically rigorous way. By introducing a new conceptual approach and measurement model for nationalism, patriotism, and democratic patriotism, it advocates for developing less ambiguous concepts—the attachments, their respective objects, and their major dimensions—*before* operationalizing them. Thus, this study hopes to have contributed to a more nuanced understanding of these attachments and to provide greater clarity to the nationalism-patriotism distinction. It encourages the advancement of research on the triad's explanatory power and invites future studies to delve more deeply into the literature on attachment for investigations

of nationalism and patriotism. Empirically examining these types of attachments and their three objects of attachment—nation, homeland, and democracy—would doubtlessly be relevant in both academic and political terms.

## 7 Bibliography

- Abizadeh, A. (2012). On the demos and its kin: Nationalism, democracy, and the boundary problem. *American Political Science Review*, 106(4), 867–882.
- Aichholzer, J., & Zeglovits, E. (2015). Balancierte Kurzsкала autoritärer Einstellungen (B-RWA-6). [Balanced Short Scale of Authoritarian Attitudes] *Zusammenstellung sozialwissenschaftlicher Items und Skalen (ZIS)*. DOI: 10.6102/ zis239
- Ainsworth, M.S. (1989). Attachments beyond infancy. *American Psychologist*, 44(4), 709–716.
- Allport, F. (1927). The psychology of nationalism: The nationalist fallacy as a cause of war. *Harper's Monthly Magazine*, 291–301.
- Almond, G., & Verba, S. (1963). *The civic culture: Political attitudes and democracy in five nations*. Princeton University Press.
- Altemeyer, R.A., & Altemeyer, B. (1996). *The authoritarian specter*. Harvard University Press.
- Anderson, B. (2006). *Imagined communities. Reflections on the origin and spread of nationalism*. Verso.
- Appiah, K. (1997). Cosmopolitan patriots. *Critical Inquiry*, 23(3), 617–639.
- Arendt, H. (1945). Imperialism, nationalism, chauvinism. *The Review of Politics*, 7(4), 441–463.
- Ariely, G. (2011). Constitutional patriotism, liberal nationalism and membership in the nation: An empirical assessment. *Acta Politica*, 46(3), 294–319.
- Ariely, G. (2012). Globalization, immigration and national identity: How the level of globalization affects the relations between nationalism, constructive patriotism and attitudes toward immigrants, *Group Processes & Intergroup Relations*, 15(4), 539–557.
- Ariely, G. (2020). Measuring dimensions of national identity across countries: theoretical and methodological reflections. *National Identities*, 22(3), 265–282.
- Ariely, G. (2021). Living the past? Do historical legacies moderate the relationship between national chauvinism/cultural patriotism and xenophobic attitudes toward immigrants. *International Journal of Comparative Sociology*. Online first.
- Assmann, A. (2020). *Die Wiedererfindung der Nation. Warum wir sie fürchten und warum wir sie brauchen*. [The reinvention of the nation: Why we fear it and why we need it] C.H. Beck.
- Backhaus, K., Erichson, B., Plinke, W., & Weiber, R. (2018). *Multivariate Analysemethoden*. [Multivariate analysis methods] Springer.
- Bar-Tal, D. (1993). Patriotism as fundamental beliefs of group members. *Politics and the Individual*, 3(2), 45–62.
- Barrington, L. (1997). Nation and nationalism: The misuse of the key concepts in political science. *PS: Political Science and Politics*, 30(4), 712–716.

- Baumeister, R., & Leary, M. (1995). The need to belong: Desire for interpersonal attachments as a fundamental human motivation. *Psychological Bulletin*, 117(3), 497–529.
- Baumeister, A. (2007). Diversity and unity: The problem with constitutional patriotism. *European Journal of Political Theory*, 6(4), 483–503.
- Ben-Porath, S. (2007). Civic virtue out of necessity. Patriotism and democratic education. *Theory and Research in Education*, 5(1), 41–59.
- Bergmann, W., & Erb, R. (1991a). *Antisemitismus in der Bundesrepublik Deutschland. Ergebnisse der empirischen Forschung von 1946 – 1989*. [Anti-Semitism in the Federal Republic of Germany. Results of empirical research from 1946–1989] Leske & Budrich.
- Bermeo, N. (2016). On democratic backsliding. *Journal of Democracy*, 27(1), 5–19.
- Berns, W. (2001). *Making patriots*. University of Chicago Press.
- Billig, M. (1995). *Banal nationalism*. Sage.
- Bitschnau, M., & Mußotter, M. (2022). (National) pride and (conceptual) prejudice: Critical remarks on the distinction between nationalism and patriotism. *Journal of Political Ideologies*. Online first.
- Bizumic, B., & Sheppard, H. (2022). A political psychology of ethnocentrism. In D. Osborne & C. Sibley (Eds.), *The Cambridge Handbook of Political Psychology*. pp. 198–213. Cambridge University Press.
- Bizumic, B., & Duckitt, D. (2018). Investigating right wing authoritarianism with a very short authoritarianism scale. *Journal of Social and Political Psychology*, 6(1), 129–150.
- Blank, T. (2003). Determinants of national identity in East and West Germany: An empirical comparison of theories on the significance of authoritarianism, anomie, and general self-esteem. *Political Psychology*, 24(2), 259–288.
- Blank, T., & Schmidt, P. (2003). National identity in a united Germany: Nationalism or patriotism? An empirical test with representative data. *Political Psychology*, 24(2), 289–312
- Blank, T., & Schmidt, P. (1993). Verletzte oder verletzende Nation? Empirische Befunde zum Stolz auf Deutschland. [Hurt or hurting nation? Empirical results on pride in Germany] *Journal für Sozialforschung*, 33(4), 391–415.
- Blank, T., Schmidt, P., & Heinrich, H-A. (1997). Nationalismus und Patriotismus in Ost- und Westdeutschland: Ergebnisse einer repräsentativen Studie. [Nationalism and Patriotism in Eastern and Western Germany: Results of a Representative Study] In K.-S. Rehberg (Ed.), *Differenz und Integration: Die Zukunft moderner Gesellschaften*, pp. 860–865. Westdeutscher Verlag.
- Bollen, K. (1989). *Structural equations with latent variables*. Wiley.
- Bollen, K., & Lennox, R. (1991). Conventional wisdom on measurement: A structural equation perspective. *Psychological Bulletin*, 110(2), 305–314.
- Bonikowski, B. (2016). Nationalism in settled times. *Annual Review of Sociology*, 42, 427–449.

- Bonikowski, B., & Di Maggio, P. (2016). Varieties of American popular nationalism. *American Sociological Review*, 81(5), 949–980.
- Bonikowski, B., Halikiopoulou, D., Kaufmann, E., & Rooduijn, M. (2019). Populism and nationalism in a comparative perspective: a scholarly exchange. *Nations and Nationalism*, 25(1), 58–81.
- Bonikowski, B., Feinstein, Y., & Bock, S. (2021). The partisan sorting of “America”: How nationalist cleavages shaped the 2016 US presidential election. *American Journal of Sociology*, 127(2), 492–561.
- Bowlby, J. (1982). *Attachment and loss: Vol. I. Attachment* (2nd ed.). Basic Books.
- Breuilly, J. (1993). *Nationalism and the State*. Manchester University Press.
- Brewer, M. (1991). The social self: On being the same and different at the same time. *Personality and Social Psychological Bulletin*, 17(5), 475–482.
- Brewer, M. (1999). The psychology of prejudice: Ingroup love or outgroup hate? *Journal of Social Issues*, 55(3), 429–444.
- Brissa, E. (2021). *Flagge zeigen. Warum wir gerade jetzt Schwarz-Rot-Gold brauchen*. [Showing the flag. Why we need Black-Red-Gold right now] Siedler.
- Brown, T. (2015). *Confirmatory factor analysis for applied research*. Guildford Press.
- Brown, R. (2020). The social identity approach: Appraising the Tajfellian legacy. *British Journal of Social Psychology*, 59(1), 5–25.
- Bruinsma, B., & Mußotter, M. (2023). A move forward: Exploring national identity through non-linear principal component analysis in Germany. *Quality & Quantity*, 57(1), 885–903.
- Brubaker, R. (2004). In the name of the nation: reflections on nationalism and patriotism. *Citizenship Studies*, 8(2), 115–127.
- Brubaker, R. (2012). Religion and nationalism: Four approaches. *Nations and Nationalism*, 18(1), 2–20.
- Brubaker, R. (2020). Populism and nationalism. *Nations and Nationalism*, 26(1), 44–66.
- Calhoun, C. (2017). The rhetoric of nationalism. In M. Skey & M. Antonsich (Eds.), *Everyday nationhood: Theorising culture, identity and belonging after banal nationalism*. pp.17–30. Springer.
- Cambridge (2013). *Advanced Learner’s Dictionary* (4<sup>th</sup> Ed.). Cambridge University Press
- Canovan, M. (2000). Patriotism is not enough. *British Journal of Political Science*, 30(3), 413–432.
- Citrin, J., Wong, C., & Duff, B. (2001). The meaning of American national identity: Patterns of ethnic conflict and consensus. In D. A. Richard, J. Lee, & W. David (Eds.), *Social identity, intergroup conflict, and conflict reduction*. pp. 71–100. Oxford University Press.



- Coenders, M., & Scheepers, P. (2003). The effect of education on nationalism and ethnic exclusionism: An international comparison. *Political Psychology*, 24(2), 313–343.
- Cohrs, C., Dimitrova, D., Kalchevska, T., Tomova, I., Vasileva, M., & Moschner, B. (2004). Is patriotic national pride desirable? A differentiated analysis of its psychological meaning? *Zeitschrift für Sozialpsychologie*, 35(4), 201–215.
- Collins (2006). *Advanced Learner's English Dictionary* (5<sup>th</sup> Ed.). HarperCollins.
- Connor, W. (1978). A nation is a nation, is a state, is an ethnic group, is a...*Ethnic and Racial Studies*, 1(4), 377–400.
- Costa, M.V. (2020). Patriotism and civic virtue. In M. Sardic (Ed.). *Handbook of Patriotism*. pp. 213–226. Springer.
- Cronin, C. (2003). Democracy and collective identity: In defence of constitutional patriotism. *European Journal of Philosophy*, 11(1), 1–19.
- Dahl, R. A. (1971). *Polyarchy: Participation and Opposition*. Yale University Press.
- Davidov, E. (2009). Nationalism and constructive patriotism: A longitudinal test of comparability in 22 countries with the ISSP. *Political Analysis*, 23(1), 88–103.
- De Figueiredo, R., & Elkins, Z. (2003). Are patriots bigots? An inquiry into the vices of in-group pride. *American Journal of Political Science*, 47(1), 171–188.
- De Lamater, J.; Katz, D.; Kelman, H.C. (1969). On the nature of national involvement: A preliminary study. *Journal of Conflict Resolution*, 13(3), 320–357.
- De Vellis, R. (2017). *Scale development. Theory and applications*. Sage.
- Dekker, H.; Malova, D. & Hoogendoorn, S. (2003). Nationalism and its explanations. *Political Psychology*, 24(2), 345–376.
- Deutsch, K. W. (1953). *Nationalism and social communication: An inquiry into the foundations of nationality*. Wiley.
- Dietz, M.G. (2020). Patriotism: History and politics of a keyword. In M. Sardic (Ed.), *Handbook of Patriotism*. pp. 9–28. Springer.
- Doob, L. (1964). *Patriotism and nationalism: Their psychological foundations*. Yale University Press.
- Dorn, T. (2019). *Deutsch, nicht dumpf. Ein Leitfaden für aufgeklärte Patrioten* [German, not dull. A guideline for enlightened patriots]. Pantheon.
- Druckman, D. (1994). Nationalism, patriotism, and group loyalty: A social psychological perspective. *Mershon International Studies Review*, 38(1), 43–68.
- Eagly, A. H., & Chaiken, S. (1993). *The psychology of attitudes*. Harcourt, Brace, Jovanovich.
- Feinstein, Y., & Bonikowski, B. (2021). Nationalist narratives and anti-immigrant attitudes: exceptionalism and collective victimhood in contemporary Israel. *Journal of Ethnic and Migration Studies*, 47(3), 741–761.

- Ferenczi, N., & Marshall, T.C. (2013). Exploring attachment to the “homeland” and its association with heritage culture identification. *PLoS ONE*, 8(1): e53872.
- Feshbach, S. (1987). Individual aggression, national attachment, and the search for peace: Psychological perspectives. *Aggressive Behavior*, 13(5), 315–325.
- Fleiß, J., Höllinger, F., & Kuzmics, H. (2009). Nationalstolz zwischen Patriotismus und Nationalismus? [National pride between patriotism and nationalism?] *Berliner Journal für Soziologie*, 19(3), 409–434.
- Fletcher, G. (1995). *Loyalty: An essay on the morality of relationships*. Oxford University Press.
- Forst, Rainer (2020): Gesellschaftlicher Zusammenhalt. Zur Analyse eines sperrigen Begriffs [Social cohesion: On the analysis of an unwieldy term] In N. Deitelhoff, O. Groh-Samberg, M. Middell (Eds), *Gesellschaftlicher Zusammenhalt. Ein interdisziplinärer Dialog*. pp. 41–53. Campus Verlag.
- Fox, J. E., & Miller-Idriss, C. (2008). Everyday nationhood. *Ethnicities*, 8(4), 536–563.
- Fulbrook, M. (1999). *German national identity after the Holocaust*. Polity Press.
- Freedman, M. (1998). Is nationalism a distinct ideology? *Political Studies*, 46(4), 748–765.
- Gangl, K., Torger, B., & Kirchler, E. (2016). Patriotism’s impact on cooperation with the state: An experimental study on tax compliance. *Political Psychology*, 37(6), 867–881.
- Gellner, E. (1983). *Nations and nationalism*. Cornell University Press.
- Gerring, J. (1999). What makes a concept good? A criterial framework for understanding concept formation in the social sciences. *Polity*, 31(3), 357–393.
- Goertz, G. (2006). *Social science concepts. A User’s guide*. Princeton University Press.
- Golec de Zavala, A., & Cichocka, A. (2012). Collective narcissism and anti-Semitism in Poland. *Group Processes & Intergroup Relations*, 15(2), 213–229.
- Golec de Zavala, A., & Lantos, D. (2020). Collective narcissism and its social consequences: The bad and the ugly. *Current Directions in Psychological Science*, 29(3), 273–278.
- Gorski, P., & Türkmen-Dervisoglu, G. (2013). Religion, nationalism, and violence: An integrated approach. *Annual Review of Sociology*, 39, 193–210.
- Gorski, P., & Perry, S. (2022). *The flag and the cross. White christian nationalism and the threat to American democracy*. Oxford University Press.
- Green, E.G., Sarrasin, O., Fasel, N., & Starklé, C. (2011). Nationalism and patriotism as predictors of immigration attitudes in Switzerland: A municipality-level analysis. *Swiss Political Science Review*, 17(4), 369–393.
- Guibernau, M. (1999). *Nations without states: Political communities in a global age*. Blackwell Publishers.
- Guibernau, M. (2004). Anthony D. Smith on nations and national identity: a critical assessment. *Nations and Nationalism*, 10(1/2), 125–141.

- Gustavsson, G., & Miller, D. (2020). *Liberal nationalism and its critics: normative and empirical questions*. Oxford University Press.
- Habeck, R. (2010). *Patriotismus: Ein linkes Plädoyer*. [Patriotism: A left plea] Gütersloher Verlagshaus.
- Habermas, J. (1987). *Eine Art Schadensabwicklung: Kleine politische Schriften VI*. [A kind of settlement of damages. Small political writings VI.] Suhrkamp.
- Habermas, J. (1996). *Between facts and norms: Contributions to a discourse theory of law and democracy*. MIT Press.
- Habermas, J. (1990). Staatsbürgerschaft und nationale Identität. [Citizenship and national identity] In J. Habermas (Ed.), *Faktizität und Geltung. Beiträge zur Diskurstheorie des Rechts und des demokratischen Rechtsstaats*. pp. 632–660. Suhrkamp.
- Halikiopoulou, D., & Vlandas, T. (2019). What is new and what is nationalist about Europe's new nationalism? Explaining the rise of the far right in Europe. *Nations and Nationalism*, 25(2), 409–434.
- Hanson, K., & O'Dwyer, E. (2019). Patriotism and nationalism, left and right: A Q-methodology study of American national identity. *Political Psychology*, 40(4), 777–795.
- Harari, Y. (2018). *21<sup>ST</sup> lessons for the 21<sup>st</sup> century*. Random House Children's Books.
- Harrington, D. (2009). *Confirmatory factor analysis*. Oxford University Press.
- Hayes, C. (1937). *Essays on nationalism*. MacMillan.
- Heinrich, H-A. (2012). Emotions toward the nation. In S. Salzborn, E. Davidov & J. Reinecke (Eds.), *Methods, Theories, and Empirical Applications in the Social Sciences: Festschrift für Peter Schmidt*. pp. 227–234. Springer.
- Heinrich, H-A. (2016). Dimensional differences between nationalism and patriotism. In J. Grimm, L. Huddy, P. Schmidt, & J. Seethaler (Eds.), *Dynamics of national identity: Media and societal factors of what we are*. pp. 44–43. Routledge.
- Heinrich, H-A. (2020). Causal relationship or not? Nationalism, patriotism and anti-immigration attitudes in Germany. *Sociology of Race and Ethnicity*, 6(1), 76–91.
- Heiskanen, J. (2021). The nationalism-populism matrix. *Journal of Political Ideologies*, 26(3), 335–355.
- Helbling, M. (2009). Nationalism and democracy: Competing or complementary logics? *Living Reviews in Democracy*, 1–19.
- Helbling, M., & Traunmüller, R. (2018). What is islamophobia? Disentangling citizens' feelings toward ethnicity, religion and religiosity using a survey experiment. *British Journal of Political Science*, 50(3), 811–828.
- Hornsey, M. (2008). Social identity theory and self-categorization theory: A historical review. *Social and Personality Psychology Compass*, 2(1), 204–222.

- Hoyle, R. (2012). Introduction and background. In R. Hoyle (Ed.), *Handbook of Structural Equation Modeling*. pp. 3–16. Guildford Press.
- Hu, L., & Bentler, P.M. (1999). Cutoff criteria for fit-indexes in covariance structure analysis: Conventional criteria versus new alternatives. *Structural Equation Modeling*, 6(1), 1–55.
- Huddy, L. (2001). From social to political identity: A critical examination of Social Identity Theory. *Political Psychology*, 22(1), 127–156.
- Huddy, L., & Khatib, N. (2007). American patriotism, national identity, and political involvement. *American Journal of Political Science*, 51(1), 63–77.
- Huddy, L., & Del Ponte, A. (2019). National identity, pride, and chauvinism-their origins and consequences for globalization attitudes. In G. Gustavsson & D. Miller (Eds.), *Liberal nationalism and its critics: Normative and empirical questions*. pp. 38–58. Oxford University Press.
- Huddy, L., del Ponte, A., & Davies, C. (2021). Nationalism, patriotism, and support for the European Union. *Political Psychology*, 42(6), 995–1017.
- Ingram, A. (1996). Constitutional patriotism. *Philosophy & Social Criticism*, 22(6), 1–18.
- Ignatieff, M. (1993). *Blood and belonging: Journeys into the new nationalism*. BBC Books.
- Ioannou, M., Boot, M.; Wittingslow, R., & Mattos, A. (2021). Patriotism and nationalism as two distinct ways of loving one's country. In S. Cushing (Ed.), *New Philosophical Essays on Love and Loving*. pp. 293–314. Springer.
- Jenne, E. K., Hawkins, K. A., & Silva, B. C. (2021). Mapping populism and nationalism in leader rhetoric across North America and Europe. *Studies in Comparative International Development*, 56(2), 170–196.
- Karasawa, M. (2002). Patriotism, nationalism, and internationalism among Japanese citizens: An etic-emic approach. *Political Psychology*, 23(4), 645–666.
- Kaube, A., & Kieserling, A. (2022). *Die gespaltene Gesellschaft*. [The divided society] Rowohlt.
- Kateb, G. (2000). Is patriotism a mistake? *Social Research*, 67(4), 901–924.
- Keller, S. (2005). Patriotism as bad faith. *Ethics*, 115(3), 563–92.
- Kemmelmeier, M., & Winter, D.G. (2008). Sowing patriotism, but reaping nationalism? Consequences of exposure to the American flag. *Political Psychology*, 29(6), 859–879.
- Kohn, H. (1939). The nature of nationalism. *American Political Science Review*, 33(6), 1001–1021.
- Kohn, H. (1944). *The idea of nationalism: A study in its origins and background*. MacMillan.
- Kohn, H. (1982). *Nationalism: Its meaning and history*. Robert E. Krieger Publishing.
- Konrad, K. A., & Qari, S. (2012). The last refuge of a scoundrel? Patriotism and tax compliance. *Economica*, 79(315), 516–533.

- Kosterman, R., & Feshbach, S. (1989). Toward a measure of patriotic and nationalistic attitudes. *Political Psychology, 10*(2), 257–274.
- Kovács, A., & Fischer, G. (2021). Antisemitic Prejudices in Europe: Survey in 16 European Countries. Action and Protection League. <https://archive.jpr.org.uk/object-2408>
- Kumm, M. (2008). Why Europeans will not embrace constitutional patriotism. *International Journal of Constitutional Law, 6*(1), 117–136.
- Krebs, D., & Menold, N. (2019). Gütekriterien quantitativer Sozialforschung. [Quality criteria for quantitative research] In N. Baur & J. Blasius (Eds.), *Handbuch Methoden der empirischen Sozialforschung*. pp. 489–504. Springer.
- Kronenberg, V. (2013). *Patriotismus in Deutschland. Perspektiven für eine weltoffene Nation*. [Patriotism in Germany: Perspectives for a cosmopolitan nation] Springer.
- Laborde, C. (2002). From constitutional to civic patriotism. *British Journal of Political Science, 32*(4), 595–612
- Laborde, C., & Erez, L. (2020). Cosmopolitan patriotism as a civic ideal. *American Journal of Political Science, 64*(1), 191–203.
- Lacroix, J. (2002). For a European constitutional patriotism. *Political Studies, 50*(5), 944–958.
- Lamont, M., & Molnár, V. (2002). The study of boundaries in the social sciences. *Annual Review of Sociology, 28*, 167–195.
- Larsen, C.A. (2017). Revitalizing the civic and ethnic distinction: Perceptions of nationhood across two dimensions, 44 countries and two decades. *Nations and Nationalism, 23*(4), 970–993.
- Latcheva, R. (2011). Cognitive interviewing and factor-analytic techniques: A mixed-method approach to validity of survey items measuring national identity. *Quality & Quantity, 45*(6), 1174–1199.
- Latcheva, R., & Davidov, E. (2014). Skalen und Indizes. [Scales and Indexes] In N. Baur & J. Blasius (Eds.), *Handbuch Methoden der empirischen Sozialforschung*. pp. 745–756. Springer.
- Levinson, D. J., Frenkel-Brunswik, E., Sanford, R. N., & Adorno, T. W., (1950). *The authoritarian personality*. Harper.
- Li, Q., & Brewer, M. (2004). What does it mean to be an American? Patriotism, nationalism, and national identity after 9/11. *Political Psychology, 25*(5), 727–739.
- Lepore, J. (2019). *This America: The case for the nation*. Liveright.
- Lobera, J., & Roch, J. (2022). Nationalism, patriotism or national reference? A response to Jacopo Custodi. *Nations and Nationalism*. Online first.
- Loh, W. D. (1975). Nationalist attitudes in Quebec and Belgium. *Journal of Conflict Resolution, 19*(2), 217–249.
- Lührmann, A.; & Lindberg, S. (2019). A third wave of autocratization is here: what is new about it? *Democratization, 26*(7), 1095–1113.

- MacIntyre, A. (1984). Is patriotism a virtue?, The Lindley Lecture, University of Kansas.
- MacMullen, I. (2014). Doing without love: Civic motivation, affection, and identification. *Journal of Politics*, 76(1), 73–85.
- Mader, M. (2016). Stabilität und Wandel der nationalen Identität in der deutschen Bevölkerung. [Continuity and change of national identity in the German public] *Kölner Zeitschrift für Soziologie und Sozialpsychologie*, 68(3), 435–456.
- Mader, M.; Pesthy, M., & Schoen, H. (2021). Conceptions of national identity, turnout and party preference: Evidence from Germany. *Nations and Nationalism*, 27(3), 638–655.
- Mader, M., & Schoen, H. (2023). Stability of national-identity content: Level, predictors, and implications. *Political Psychology*. Online first.
- Mael, F. A., & Tetrick, L. E. (1992). Identifying organizational identification. *Educational and Psychological Measurement*, 52(4), 813–824.
- Marsh, H. W., Hau, K. T., & Wen, Z. (2004). In search of golden rules: Comment on hypothesis testing approaches to setting cutoff values for fit indexes and dangers in overgeneralizing Hu and Bentler's (1999) findings. *Structural Equation Modeling*, 11(3), 320–341.
- Mäs, M. (2005). *Regionalismus, Nationalismus und Fremdenfeindlichkeit*. [Regionalism, Nationalism, and Xenophobia] Springer VS.
- Mason, A. (2009). *Community, solidarity, and belonging. Levels of community and their normative significance*. Cambridge University Press.
- Mattes, D., Kasmani, O., Acker, M., & Heyeken, E. (2019). Belonging. In J. Slaby & C. von Scheve (Eds.), *Affective societies. Key concepts*. pp. 300–309. Routledge.
- Meinecke, F. (1928). *Weltbürgertum und Nationalstaat. Studien zur Genesis des deutschen Nationalstaats*. [Cosmopolitanism and nation-state: Studies on the evolution of the German nation-state] Oldenbourg.
- Meier-Pesti, K., & Kirchler, E. (2003). Nationalism and patriotism as determinants of European identity and attitudes towards the euro. *The Journal of Socio-Economics*, 32(6), 685–700.
- Meitinger, K. (2018). What does the general national pride item measure? Insights from web probing. *International Journal of Comparative Sociology*, 59(5-6), 428–450.
- Menold, N., & Bogner, K. (2015). Gestaltung von Ratingskalen in Fragebögen. [Designing Rating Scales and Questionnaires] *GESIS Survey Guidelines*. Mannheim. DOI: 10.15465/gesis-sg\_015
- Merriam-Webster (1991). *Ninth New Collegiate Dictionary* (9<sup>th</sup> Ed.). Merriam-Webster
- Miller, R. (1997). Killing for the homeland: Patriotism, nationalism and violence. *Journal of Ethics*, 1(2), 165–185.

- Miller, D., & Ali, S. (2014). Testing the national identity argument. *European Political Science Review*, 6(2), 237–259.
- Miller-Idriss, C., & Rothenberg, B. (2012). Ambivalence, pride and shame: conceptualisations of German nationhood. *Nations and Nationalism*, 18(1), 132–135.
- Molina, L., Philipps, N., & Sidanius, J. (2015). National and ethnic identity in the face of discrimination: Ethnic minority and majority perspectives. *Cultural Diversity and Ethnic Minority Psychology*, 21(2), 225–236.
- Molina, L., & Preddie, J. (2020). Threatening others: National identity and group threats predict immigration policy. *Analyses of Social Issues and Public Policy*, 20(1), 417–442.
- Morlino, L. (2004). What is a “good” democracy?. *Democratization*, 11(5), 10–32.
- Mounk, Y. (2018). *The people vs. democracy: Why our freedom is in danger and how to save it*. Harvard University Press.
- Mudde, C., & Kaltwasser, C. R. (2017). *Populism: A very short introduction*. Oxford University Press.
- Mummendey, A., Klink, A., & Brown, R. (2001). Nationalism and patriotism: National identification and out-group rejection. *British Journal of Social Psychology*, 40(2), 159–172.
- Mußotter, M. (2022). We do not measure what we aim to measure: Testing three measurement models for nationalism and patriotism. *Quality & Quantity*, 56(4), 2177–2197.
- Mußotter, M. (2023a). Über (nationale) Bindungen: Trias von Nationalismus, Vaterlandsliebe und demokratischem Patriotismus. *Zeitschrift für Kultur- und Kollektivwissenschaft*, 9(1), 31–68.
- Mußotter, M. (2023b). On nation, homeland, and democracy: Toward a novel three-factor measurement model for nationalism and patriotism. Evidence from two representative studies. *Political Psychology*. DOI: 10.1111/pops.12945.
- Muthén, L. K., & Muthén, B. (1998–2012). *Mplus User’s Guide*. Muthén & Muthén.
- Müller, J-W. (2008a). A general theory of constitutional patriotism. *International Journal of Constitutional Law*, 6(1), 72–95.
- Müller, J. W. (2008b). A European constitutional patriotism? The case restated. *European Law Journal*, 14(5), 542–557.
- Mylonas, H., & Tudor, M. (2021). Nationalism: what we know and what we still need to know. *Annual Review of Political Science*, 24, 109–132.
- Nathanson, S. (1990). On deciding whether a nation deserves our loyalty. *Public Affairs Quarterly*, 4(3), 287–298.
- Nathanson, S. (2020). Moderate patriotism. In M. Sardoč (Ed.), *Handbook of Patriotism*, pp. 141–161. Springer.

- Noelle-Neumann, E., & Köcher, R. (1987). *Die verletzte Nation: Über den Versuch der Deutschen, ihren Charakter zu ändern*. [The hurt nation: On the Germans' attempt to alter their character] Deutsche Verlagsanstalt.
- Oldenquist, A. (1982). Loyalties. *The Journal of Philosophy*, 79(4), 173–193.
- Orwell, G. (1968). *The collected essays, journalism and letters of George Orwell. Volume: My country right or left 1940-1943*. Harcourt.
- Osborne, D., Milojev, P., & Sibley, C. (2017). Authoritarianism and national identity: Examining the longitudinal effects of SDO and RWA on nationalism and patriotism. *Personality and Social Psychology Bulletin*, 43(8), 1086–1099.
- Osborne, D., & Sibley, C. (2022). *The Cambridge Handbook of Political Psychology*. Cambridge University Press.
- Parker, C. S. (2010). Symbolic versus blind patriotism: Distinction without difference? *Political Research Quarterly*, 63(1), 97–114.
- Papastephanou, M. (2017) Patriotism and pride beyond Richard Rorty and Martha Nussbaum, *International Journal of Philosophical Studies*, 25(4), 484–503.
- Pfaff-Czarnecka, J. (2013). Multiple belonging and the challenges to biographical navigation. MMG Working Paper 13–05. Max Planck Institute for the Study of Religious and Ethnic Diversity, Göttingen.
- Piwoni, E. (2012). *Nationale Identität im Wandel: Deutscher Intellektuellendiskurs zwischen Tradition und Weltkultur*. [National identity in transition: German intellectual discourse between tradition and world culture] Springer.
- Piwoni, E., & Mußotter, M. (2023). The evolution of the civic-ethnic distinction as a partial success story: lessons for the nationalism-patriotism distinction. *Nations and Nationalism*. Online first.
- Primoratz, I. (2017), Patriotism. In E. N. Zalta (Ed.), *Stanford encyclopedia of philosophy*. <https://plato.stanford.edu/archives/sum2017/entries/patriotism/> Accessed 26 January 2021.
- Rapp, C. (2022). The bond that binds or drives us apart? An empirical test of the national identity arguments in three countries. *European Political Science Review*. Online first.
- Rau, J. (2001). Speech of the German Federal President on 19 March 2001. <https://www.bundesregierung.de/breg-de/service/bulletin/rede-von-bundespraesident-johannes-rau-785406>. Accessed 10 March 2023.
- Renan, E. (1882 [1996]). What is a nation? In G. Eley & R.G. Suny (Eds.), *Becoming national: A reader*. pp.42–55. Oxford University Press.
- Reeskens, T., & Hooghe, M. (2010). Beyond the civic-ethnic dichotomy: investigating the structure of citizenship concepts across thirty-three countries. *Nations and Nationalism*, 16(4), 579–597.
- Rorty, R. (1994). The unpatriotic academy. *New York Times*. 13 February.



- Rousseau, J.-J. (1964). *Economie politique*. In J.-J. Rousseau (Ed), *Oeuvres Complètes*, Vol. 3. Gallimard.
- Sapountzis, A. (2008). Towards a critical social psychological account of national sentiments: Patriotism and nationalism revisited. *Sociological Personal Psychology Compass*, 2(1), 34–50.
- Sartori, G. (1970). Concept misformation in comparative politics. *American Political Science Review*, 64(4), 1033–1053.
- Satherly, N., Yogeewaran, K., Osborne, D., & Sibley, C. (2019). Differentiating between pure patriots and nationalistic patriots: A model of national attachment profiles and their sociopolitical attitudes. *International Journal of Intercultural Relations*, 72, 13–24.
- Schatz, R.T., Staub, E., & Lavine, H. (1999). On the varieties of national attachment: Blind versus constructive patriotism. *Political Psychology*, 20(1), 151–174.
- Schiefer, D., & van der Noll, J. (2017). The essentials of social cohesion: A literature review. *Social Indicators Research*, 132, 579–630.
- Scheidecker, G. (2019). Attachment. In J. Slaby & C. von Scheve (Eds.), *Affective societies. Key concepts*. pp. 73–84. Routledge.
- Sekerdej, M., & Roccas, S. (2016). Love versus loving criticism: Disentangling conventional and constructive patriotism. *British Journal of Social Psychology*, 55(3), 499–521.
- Sekerdej, M., Rugar, M., Jamróz-Dolińska, K., & Kołeczek, M. (2023). Greater expectations or less sugar-coating? Perceptual underpinnings of constructive patriotism. *British Journal of Social Psychology*. Online first.
- Seton-Watson, H. (1977). *Nations and states: An enquiry into the origins of nations and the politics of nationalism*. Routledge.
- Shulman, S. (2002). Challenging the civic/ethnic and West/East dichotomies in the study of nationalism. *Comparative Political Studies*, 35(5), 554–585.
- Sidanius, J.; Feshbach, S.; Levin, S., & Pratto, F. (1997). The interface between ethnic and national attachment: Ethnic pluralism or ethnic dominance? *The Public Opinion Quarterly*, 61(1), 102–133.
- Sidanius J., & Petrocik, J.R. (2001). Communal and national identity in a multiethnic state: a comparison of three perspectives. In R. Ashmore, L. Jussim & D. Wilder (Eds.), *Social Identity, Intergroup Conflict, and Conflict Reduction*, pp. 101–29. Oxford University Press.
- Simonsen, K. B., & Bonikowski, B. (2020). Is civic nationalism necessarily inclusive? Conceptions of nationhood and anti-Muslim attitudes in Europe. *European Journal of Political Research*, 59(1), 114–136.
- Skitka, L. (2005). Patriotism or nationalism? Understanding post-September 11, 2001, flag-display behavior. *Journal of Applied Social Psychology*, 35(10), 1995–2011.
- Smith, A. (1991). *National identity*. Penguin Press.

- Smith, S. (2021). *Reclaiming patriotism in an age of extremes*. Yale University Press.
- Snyder, L. (1954). *The meaning of nationalism*. Greenwood Press.
- Somerville, J. (1981). Patriotism and war. *Ethics*, 91(4), 568–578.
- Spencer, P., & Wollman, H. (1998) Good and bad nationalisms: A critique of dualism. *Journal of Political Ideologies*, 3(3), 255–274.
- Spinner-Halev, J., & Theiss-Morse, E. (2003). National identity and self-esteem. *Perspectives on Politics*, 1(3), 515–532.
- StataCorp. (2019). *Stata Statistical Software: Release 16*. College Station. StataCorp LLC.
- Steinmeier, F-W. (2018). Speech of the German Federal President on 9 November 2018. <https://www.bundespraesident.de/SharedDocs/Reden/DE/Frank-Walter-Steinmeier/Reden/2018/11/181109-Gedenkstunde-Bundestag.html>. Accessed 10 March 2023.
- Steinmeier, F-W. (2020). Speech of the German Federal President on 8 May 2020. <https://www.bundesregierung.de/breg-de/service/bulletin/rede-von-bundespraesident-dr-frank-walter-steinmeier-1752232>. Accessed 10 March 2023.
- Stern, P. (1995). Why do people sacrifice for their nations? *Political Psychology*, 16(2), 217–235.
- Sternberger, D. (1990). *Schriften X: Verfassungspatriotismus*. [Writings X: Constitutional Patriotism] Suhrkamp.
- Sternberger, D. (1947). Begriff des Vaterlands [Concept of the fatherland]. In D. Sternberger (Ed.) *Schriften IV. Staatsfreundschaft* pp. 9–33. Insel.
- Sullivan, J. L., Fried, A., & Dietz, M. G. (1992). Patriotism, politics, and the presidential election of 1988. *American Journal of Political Science*, 36(1), 200–234.
- Tajfel, H. (1970). Aspects of national and ethnic identity. *Social Science Information*, 9(3), 119–144.
- Tajfel, H. (1974). Social identity and intergroup behavior. *Social Sciences Information*, 13(2), 65–79.
- Tajfel, H., & Turner, J. C. (1986). The social identity theory of intergroup behavior. In S. Worchel & W. G. Austin (Eds.), *Psychology of intergroup relations*. pp. 7–24. Nelson-Hall.
- Tamir, Y. (1993). *Liberal nationalism*. Princeton University Press.
- Tamir, Y. (2019a). *Why nationalism?* Princeton University Press.
- Tamir, Y. (2019b). Not so civic: Is there a difference between ethnic and civic nationalism? *Annual Review of Political Science*, 22, 419–434.
- Terhune, K. (1964): Nationalism among foreign and American students: an exploratory study. *Journal of Conflict Resolution*, 8(3), 256–270.

- Theiss-Morse, E. (2009). *Who counts as an American? The boundaries of national identity*. Cambridge University Press.
- Theiss-Morse, E., Fried, A., Sullivan, J. L., & Dietz, M. (1991). Mixing methods: A multistage strategy for studying patriotism and citizen participation. *Political Analysis*, 3, 89–121.
- Todorova, M. (2015). Is there weak nationalism and is it a useful category? *Nations and Nationalism*, 21(4), 681–699.
- Tönnies, F. (2003). *Community and society*. Dover Publications.
- Tracy, J., Mercadante, E., Witkower, Z., & Cheng, J. (2020). The evolution of pride and social hierarchy. *Advances in Experimental Social Psychology*, 62, 51–114.
- Tracy, J., & Robins, R. (2007): The nature of pride. In J. Tracy, R. Robins & J. Tangney (Eds.), *The Self-Conscious Emotions: Theory and Research*. pp. 263–282. Guilford Press.
- Trizano-Hermosilla, I., & Alvarado, J. M. (2016). Best alternatives to Cronbach's alpha reliability in realistic conditions: congeneric and asymmetrical measurements. *Frontiers in Psychology*, 7, 769. DOI: 10.3389/fpsyg.2016.00769
- Tudor, M., & Slater, D. (2021). Nationalism, authoritarianism, and democracy: historical lessons from South and Southeast Asia. *Perspectives on Politics*, 19(3), 706–722.
- Van Evera, S. (1994). Hypotheses on nationalism and war. *International Security*, 18(4), 5–39.
- Viroli, M. (1995). *For love of country. An Essay on patriotism and nationalism*. Clarendon.
- Van den Berghe, P. (1967). *Race and racism*. Wiley.
- Von Scheve, C., & Slaby, J. (2019). Emotion, emotion concept. In C. von Scheve & J. Slaby (Eds), *Affective societies. Key concepts*. pp. 42–51. Routledge.
- Wagner, U., Becker, J., Christ, O., Pettigrew, T., & Schmidt, P. (2012). A longitudinal test of the relation between German nationalism, patriotism and out-group derogation. *European Sociological Review*, 28(3), 319–332.
- Waldner, D., & Lust, E. (2018). Unwelcome change: Coming to terms with democratic backsliding. *Annual Review of Political Science*, 21, 93–113.
- Wamsler, S. (2022). Violated entitlement and the nation: How feelings of relative deprivation shape nationalism and constructive patriotism. *International Journal of Comparative Sociology*. Online first.
- Weber, M. (1978). *Economy and society: An Outline of Interpretive Sociology*. Vol. 1. University of California Press.
- Westle, B. (1999). *Kollektive Identität im vereinten Deutschland. Nation und Demokratie in der Wahrnehmung der Deutschen*. [Collective identity in united Germany. Nation and Democracy in the German perception] Leske + Budrich.
- Whitehead, A. L., & Perry, S. L. (2020). *Taking America back for god: Christian nationalism in the United States*. Oxford University Press.

- Wimmer, A. (2018). *Why some countries come together while others fall apart*. Princeton University Press.
- Wimmer, A. (2017). Power and pride: national identity and ethno-political inequality around the world. *World Politics*, 69(4), 605–639.
- Wehler, H-U. (2019). *Nationalismus. Geschichte, Formen, Folgen*. [Nationalism. Story, Forms, Consequences] C.H. Beck.
- Weiss, H. (2003). A cross-national comparison of nationalism in Austria, the Czech and Slovak Republics, Hungary, and Poland. *Political Psychology*, 24(2), 377–401.
- Yack, B. (1998). Can patriotism save us from nationalism? Rejoinder to Viroli. *Critical Review*, 12(1-2), 203–206.
- Yuval-Davis, N. (2006). Belonging and the politics of belonging. *Patterns of Prejudice*, 40(3), 197–214.

## 8 Appendix

**Table 1**

*Original item pool of the Development Study (N = 316)*

	Item	English version
Nationalism		
	anthem	The verse “Germany, Germany, above all, above all in this world” should become part of the official national anthem.
	people	The German people are more important than any other people in the world.
	interests	Germany should be more ruthless in asserting its national interests against other countries.
	chosen	We Germans are a chosen people.
	genuine	Genuine Germans are not respected enough in Germany.
	tell	Germany has the right to tell other countries what to do.
	leader	We Germans have a claim to leadership in the world.
	blood	Only those who have German blood may be German.
	abolish	Dual citizenship should be abolished.
	NS	National Socialism also had its positive sides.
	minority	Minority protection in Germany is not important to me.
	threat	German culture is threatened by foreign influences.
Patriotism		
	love	I love my country.
	loyalty	I feel obliged to remain loyal to my country.
	die	I am ready to die for my country.
	kill	I am ready to kill for my country.
Democratic patriotism		
	gg	The Basic Law should be the foundation of our societal coexistence.
	values	Our fundamental democratic values are inviolable.

	demo	I feel obliged to stand up for our democracy.
	cohe	Germany's social cohesion needs to be strengthened.
	citizen	I am glad to have German citizenship.
	defend	Our democratic principles must also be defended abroad.
	history	Every German should take a critical look at German history.
	respons	It is a civic duty to take responsibility for our society.
	protect	Minorities are to be respected.
	order	Everyone must abide by the basic constitutional order of our country.
	emotion	I feel strongly emotional attached to the Federal Republic of Germany.

Note. All items are ranked on a five-point Likert scale (1 = strongly disagree; 5 = strongly agree).

*Original item pool of the Development Study (N = 316) – Original version*

	Item	German version
Nationalism		
	anthem	Die Strophe “Deutschland, Deutschland, über alles, über alles in der Welt” sollte Teil der offiziellen Nationalhymne werden.
	people	Das deutsche Volk ist wichtiger als alle anderen Völker der Welt.
	interests	Deutschland sollte seine nationalen Interessen rücksichtsloser gegenüber anderen Ländern durchsetzen.
	chosen	Wir Deutsche sind ein auserwähltes Volk.
	genuine	Die wahren Deutschen werden in Deutschland zu wenig geachtet.
	tell	Deutschland hat das Recht, anderen Ländern zu sagen, was sie tun sollen.
	leader	Uns Deutschen kommt ein Führungsanspruch in der Welt zu.
	blood	Nur wer deutschen Blutes ist, kann Deutscher sein.
	abolish	Die doppelte Staatsbürgerschaft sollte abgeschafft werden.
	NS	Der Nationalsozialismus hatte auch positive Seiten.
	minority	Der Schutz von Minderheiten in Deutschland ist mir nicht wichtig.
	threat	Die deutsche Kultur wird von fremden Einflüssen bedroht.
Patriotism		
	love	Ich liebe mein Vaterland.
	loyalty	Ich fühle mich dazu verpflichtet, meinem Vaterland die Treue zu halten.
	die	Ich bin dazu bereit, für mein Vaterland zu sterben.
	kill	Ich bin dazu bereit, für mein Vaterland zu töten.
Democratic patriotism		
	gg	Das Grundgesetz sollte das Fundament unseres gesellschaftlichen Zusammenlebens sein.
	values	Unsere demokratischen Grundwerte sind unantastbar.
	demo	Ich fühle mich dazu verpflichtet, mich für unsere Demokratie einzusetzen.

	cohe	Der gesellschaftliche Zusammenhalt Deutschlands sollte gestärkt werden.
	citizen	Ich bin froh darüber, die deutsche Staatsbürgerschaft zu besitzen.
	defend	Unsere demokratischen Prinzipien müssen auch außerhalb verteidigt werden.
	history	Jeder Deutsche sollte sich kritisch mit der deutschen Geschichte auseinandersetzen.
	respons	Es ist eine Bürgerpflicht, Verantwortung für unsere Gesellschaft zu übernehmen.
	protect	Minderheiten sind zu respektieren.
	order	Jeder muss sich an die demokratische Grundordnung unseres Landes halten.
	emotion	Ich fühle mich emotional stark mit der Bundesrepublik Deutschland verbunden.

Note. All items are ranked on a five-point Likert scale (1 = strongly disagree; 5 = strongly agree).



**Table 2**

*Results of Exploratory Factor Analysis (Varimax Rotation) of the Development Study (N = 316)*

Variable	Factor 1	Factor 2	Factor 3
anthem	.6937		
chosen	.6710		
cohe		.4896	
gg		.6351	
demo		.6254	
genuine	.5344		
interests	.5987		
people	.7306		
love			.6036
loyalty			.6279
values		.5919	

**Table 3***Final Items of the Development Study (N = 316)*

	Item	English version
Nationalism		
	anthem	The verse “Germany, Germany, above all, above all in this world” should become part of the official national anthem.
	people	The German people are more important than any other people in the world.
	interests	Germany should be more ruthless in asserting its national interests against other countries.
	chosen	We Germans are a chosen people.
	genuine	Genuine Germans are not respected enough in Germany.
Patriotism		
	love	I love my country.
	loyalty	I feel obliged to remain loyal to my country.
Democratic patriotism		
	gg	The Basic Law should be the foundation of our societal coexistence.
	values	Our fundamental democratic values are inviolable.
	demo	I feel obliged to stand up for our democracy.
	cohe	Germany’s social cohesion needs to be strengthened.

Note. All items are ranked on a five-point Likert scale (1 = strongly disagree; 5 = strongly agree).

*Final items of the Development Study (N = 316) – Original version*

Item	German version
<b>Nationalism</b>	
anthem	Die Strophe “Deutschland, Deutschland, über alles, über alles in der Welt“ sollte Teil der offiziellen Nationalhymne werden.
people	Das deutsche Volk ist wichtiger als alle anderen Völker der Welt.
interests	Deutschland sollte seine nationalen Interessen rücksichtloser gegenüber anderen Ländern durchsetzen.
chosen	Wir Deutsche sind ein auserwähltes Volk.
genuine	Die wahren Deutschen werden in Deutschland zu wenig geachtet.
<b>Patriotism</b>	
love	Ich liebe mein Vaterland.
loyalty	Ich fühle mich dazu verpflichtet, meinem Vaterland die Treue zu halten.
<b>Democratic patriotism</b>	
gg	Das Grundgesetz sollte das Fundament unseres gesellschaftlichen Zusammenlebens sein.
values	Unsere demokratischen Grundwerte sind unantastbar.
demo	Ich fühle mich dazu verpflichtet, mich für unsere Demokratie einzusetzen.
cohe	Der gesellschaftliche Zusammenhalts Deutschlands sollte gestärkt werden.

**Table 4***Items of the Authoritarianism Short Scale by Nießen et al. (2019)*

Item wording	Subdimension
We should take strong action against misfits and slackers in society.	Authoritarian aggression
Troublemakers should be made to feel that they are not welcome in society.	Authoritarian aggression
Rules in society should be enforced without pity.	Authoritarian aggression
We need strong leaders so that we can live safely in society.	Authoritarian submissiveness
People should leave important decisions in society to their leaders.	Authoritarian submissiveness
We should be grateful for leaders telling us exactly what to do.	Authoritarian submissiveness
Traditions should definitely be carried on and kept alive.	Conventionalism
Well-established behavior should not be questioned.	Conventionalism
It's always best to do things in the usual way.	Conventionalism

Note. All items are ranked on a five-point Likert scale (1 = strongly disagree; 5 = strongly agree).

**Table 5***Final Items of the Validation Study (N = 537) and for the Representative Study (N = 1875)*

Item	English version
<b>Nationalism</b>	
anthem	The verse “Germany, Germany, above all, above all in this world” should become part of the official national anthem.
people	The German people are more important than any other people in the world.
interests	Germany should be more ruthless in asserting its national interests against other countries.
chosen	We Germans are a chosen people.
genuine	Genuine Germans are not respected enough in Germany.
<b>Patriotism</b>	
love	I love my country.
loyalty	I feel obliged to remain loyal to my country.
<b>Democratic patriotism</b>	
gg	The Basic Law should be the foundation of our societal coexistence.
values	Our fundamental democratic values are inviolable.
demo	I feel obliged to stand up for our democracy.

Note. All items are ranked on a five-point Likert scale (1 = strongly disagree; 5 = strongly agree).

## Figures

Figure 1: Scree Plot of Exploratory Factor Analysis of the Development Study (N = 317)

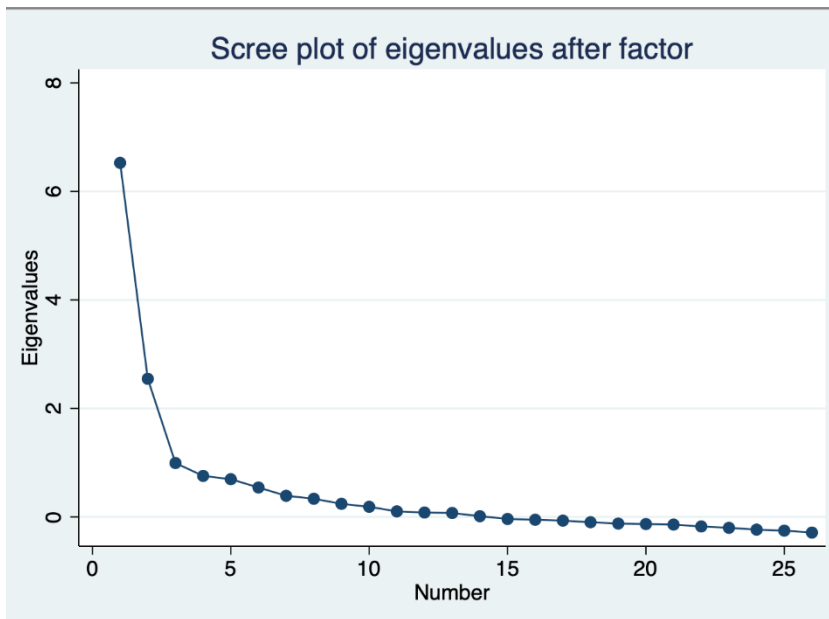

Figure 2: Three-factor measurement model for democratic patriotism (dpat), patriotism (pat) and nationalism (nat) in development study (N = 316) with completely standardized factor loadings

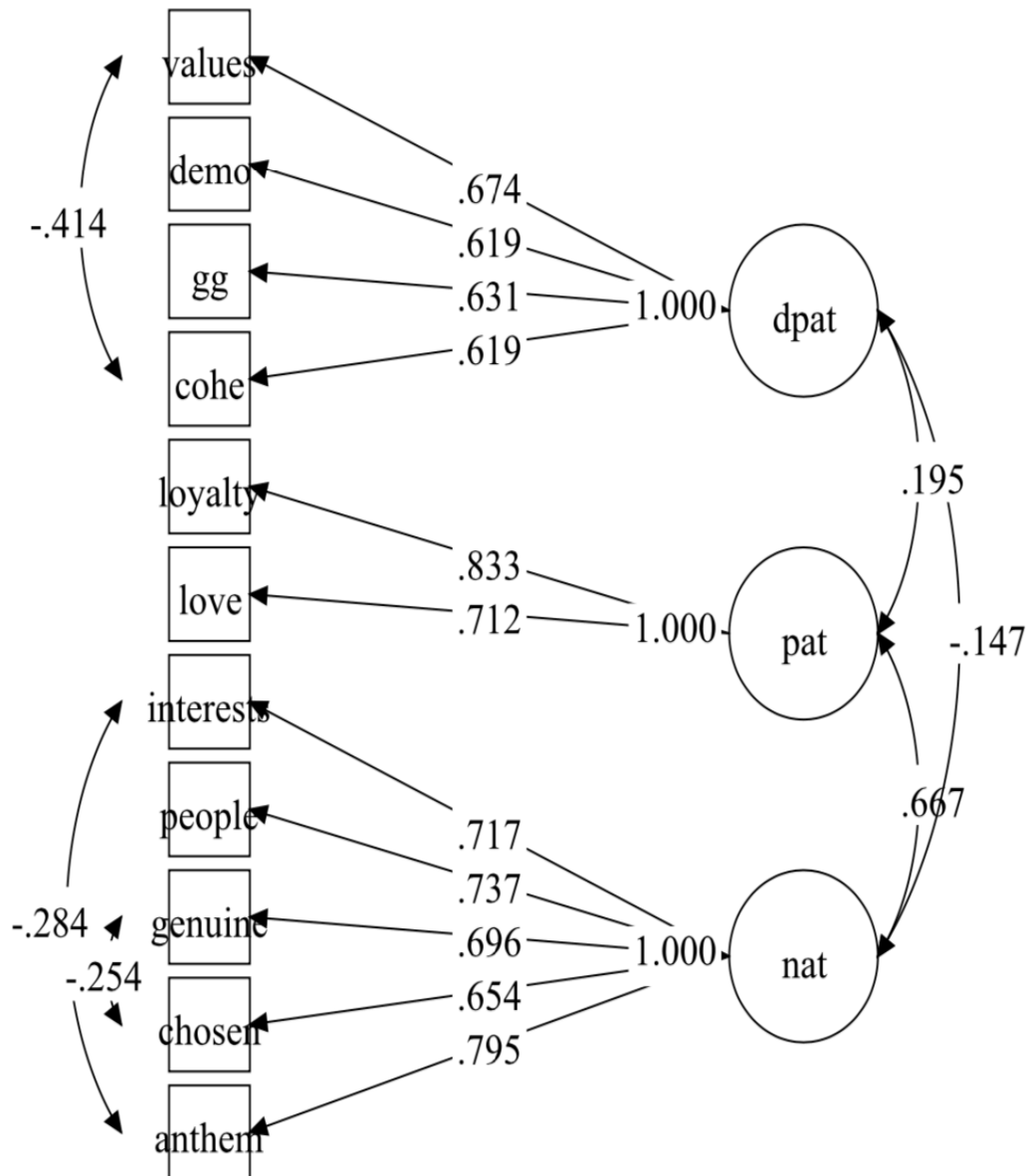

Figure 3: Structural equation model testing the effect of authoritarianism (auto) on nationalism (nat), patriotism (pat) and democratic patriotism (dpat) in development study (N = 316) with completely standardized factor loadings

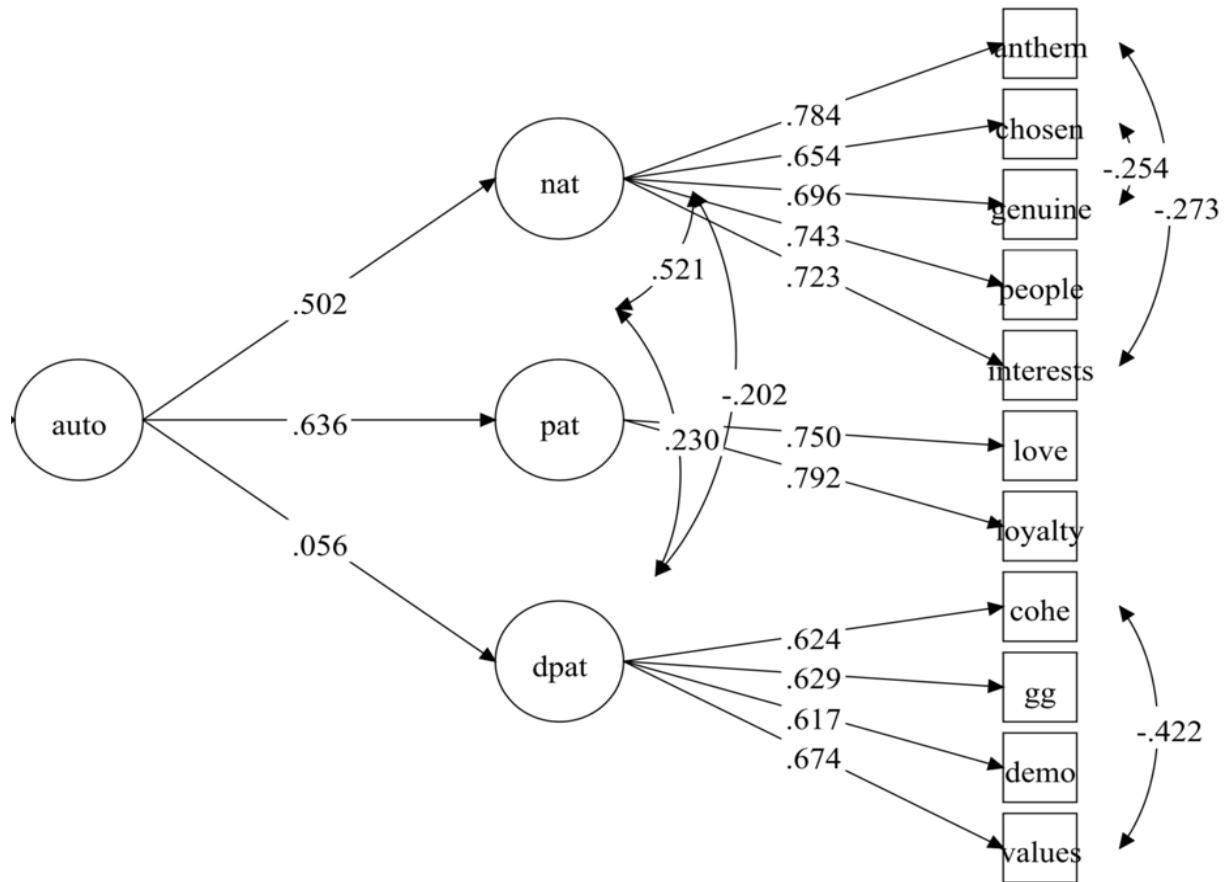



Figure 4: Three-factor measurement model for democratic patriotism (dpat), patriotism (pat), and nationalism (nat) in validation study (N = 537) with completely standardized factor loadings

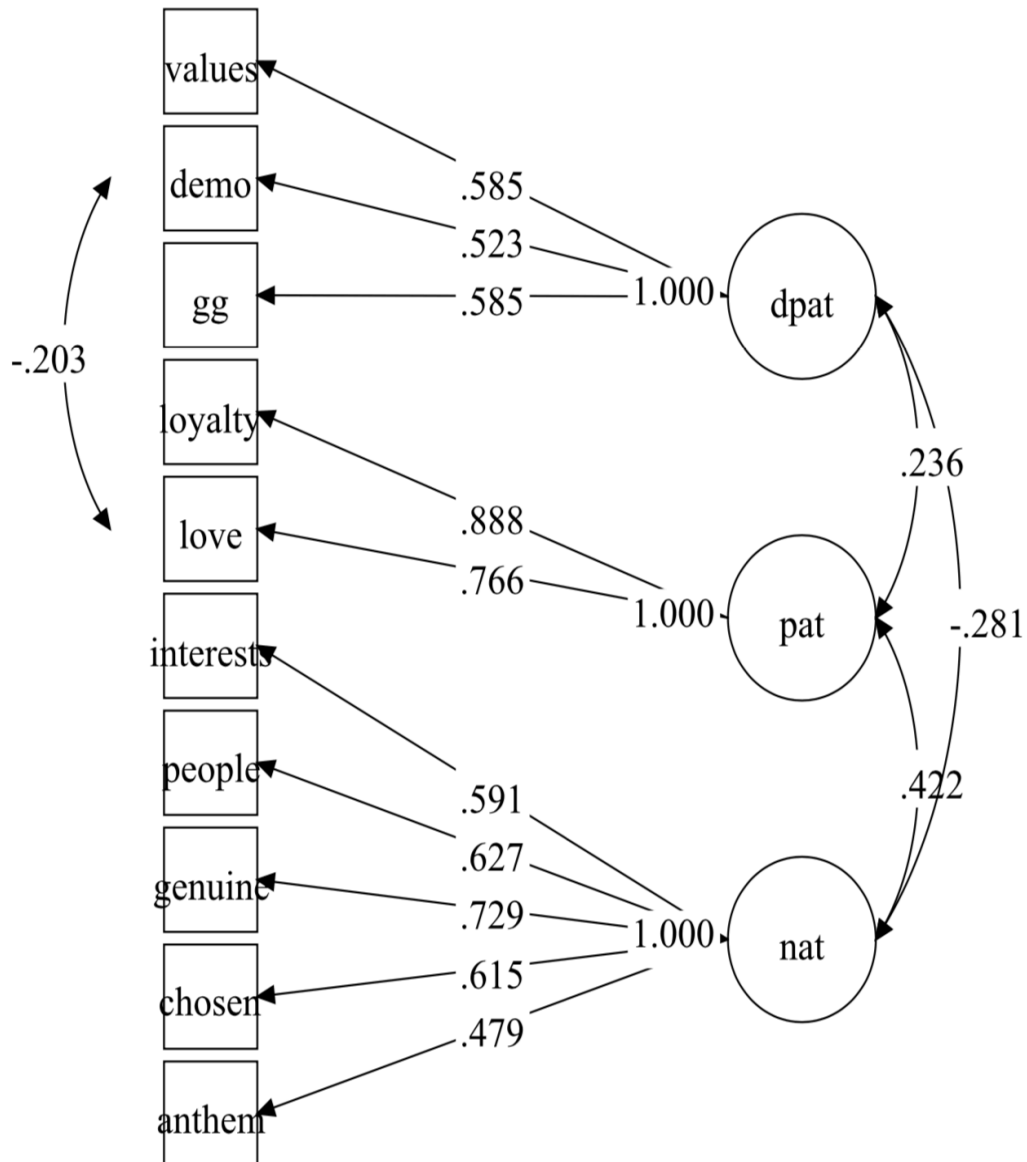

Figure 5: Structural equation model testing the effect of authoritarianism (auto) on nationalism (nat), patriotism (pat) and democratic patriotism (dpat) in validation study (N = 537) with completely standardized factor loadings

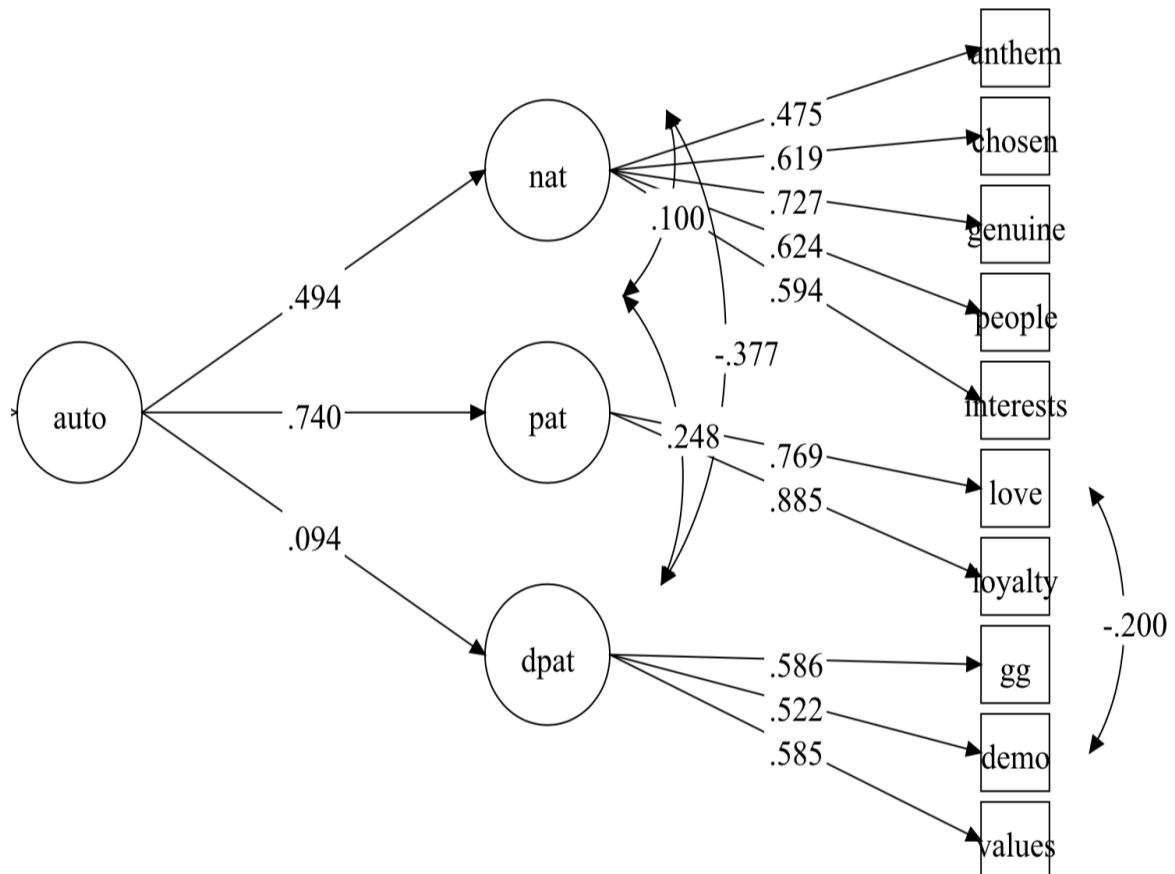

Figure 6: Robustness check: Three-factor measurement model for democratic patriotism (dpat), patriotism (pat), and nationalism (nat) in validation study with German citizens only (N = 502) with completely standardized factor loadings (CFI = .974; TLI = .962; RMSEA = .034; 90% CI [.014, .052]; SRMR = .041)

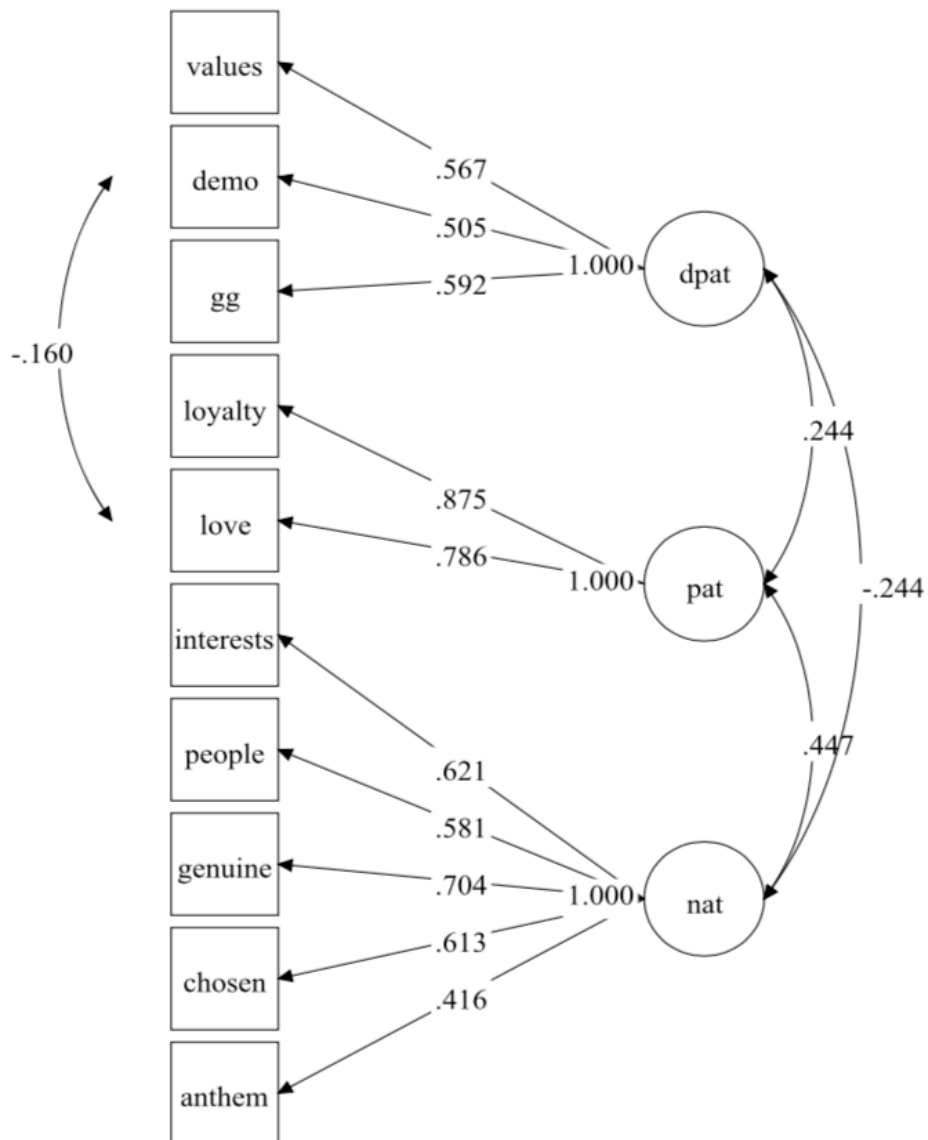

Figure 7: The relationships between the three-factor measurement model for nationalism (nat), patriotism (pat) and democratic patriotism (dpat) and Blank and Schmidt's (2003) two-factor measurement model for nationalism (bsnat) and patriotism (bspat) in validation study (N = 537) with completely standardized factor loadings

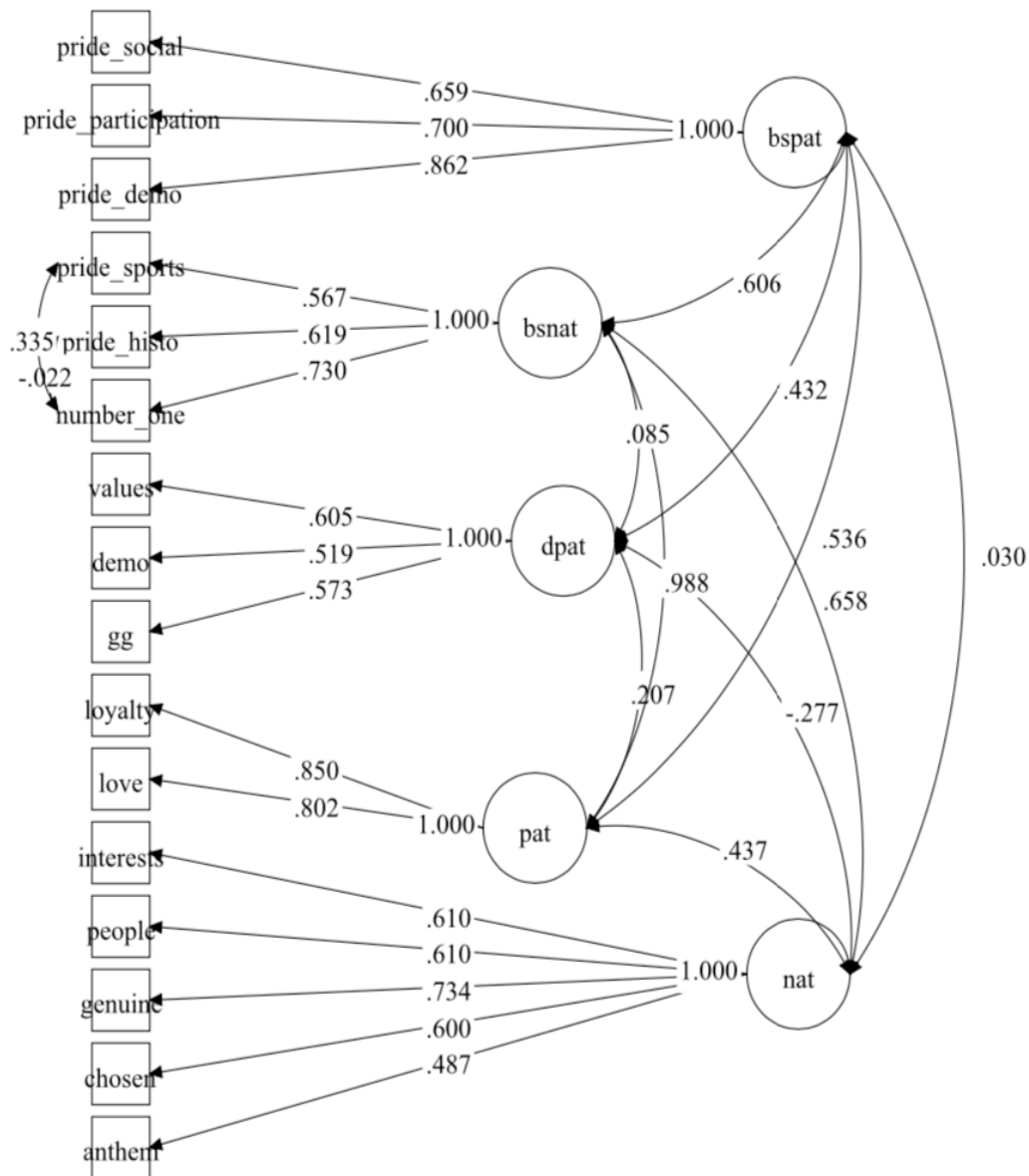

Figure 8: Three-factor measurement model for democratic patriotism (dpat), patriotism (pat) and nationalism (nat) in nationally representative study (N = 1875) with completely standardized factor loadings

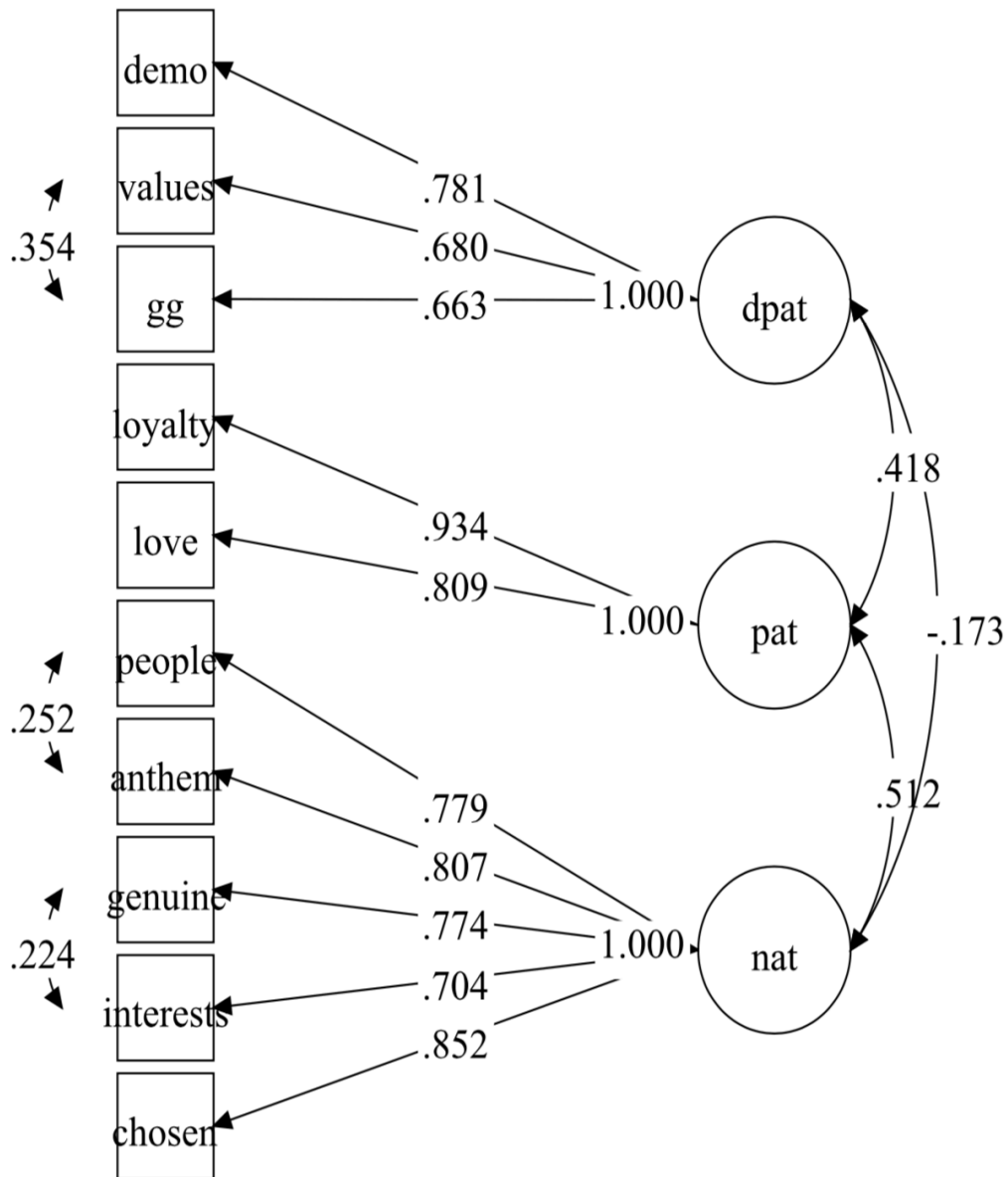

Figure 9: Structural equation model testing the effect of authoritarianism (auto) on nationalism (nat), patriotism (pat) and democratic patriotism (dpat) in nationally representative study (N = 1875) with completely standardized factor loadings

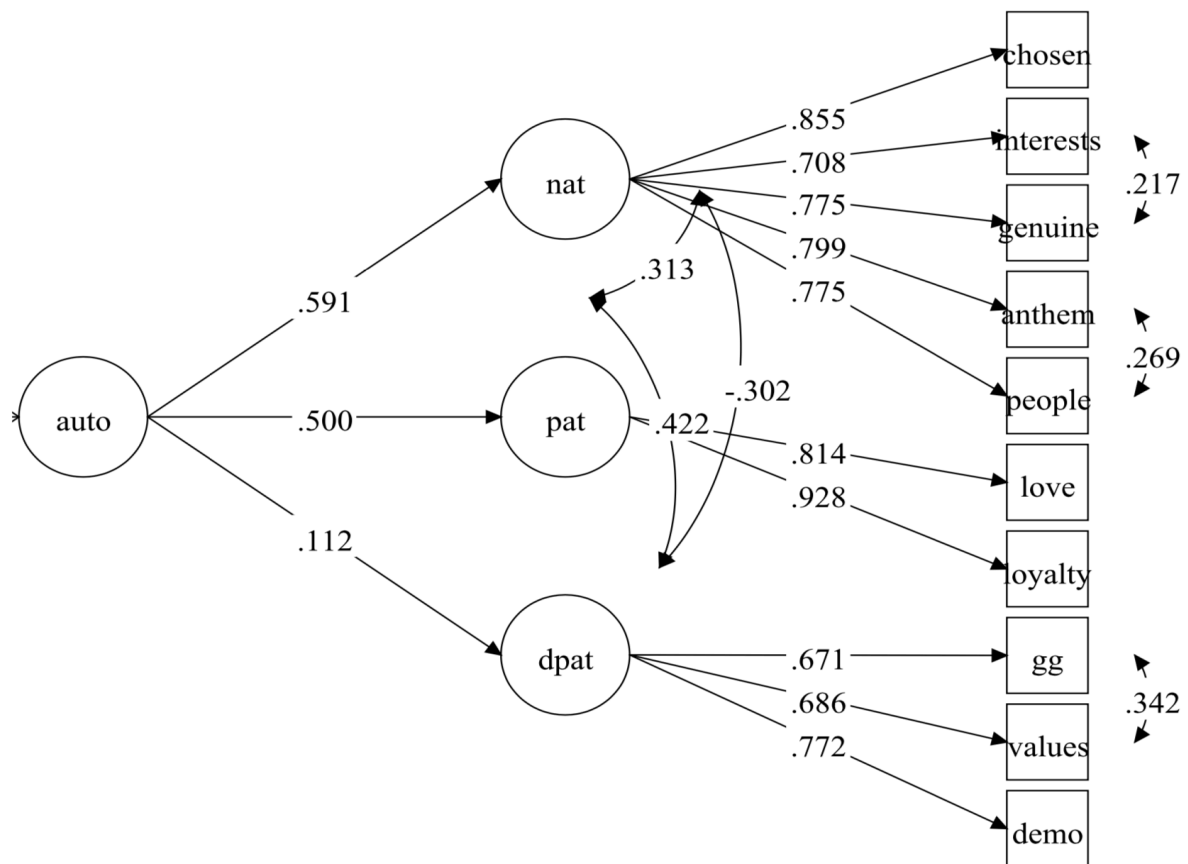

Figure 10: Structural equation model testing the effect of nationalism (nat), patriotism (pat) and democratic patriotism (dpat) on anti-Semitism (antsem) in nationally representative study (N = 1875) with completely standardized factor loadings

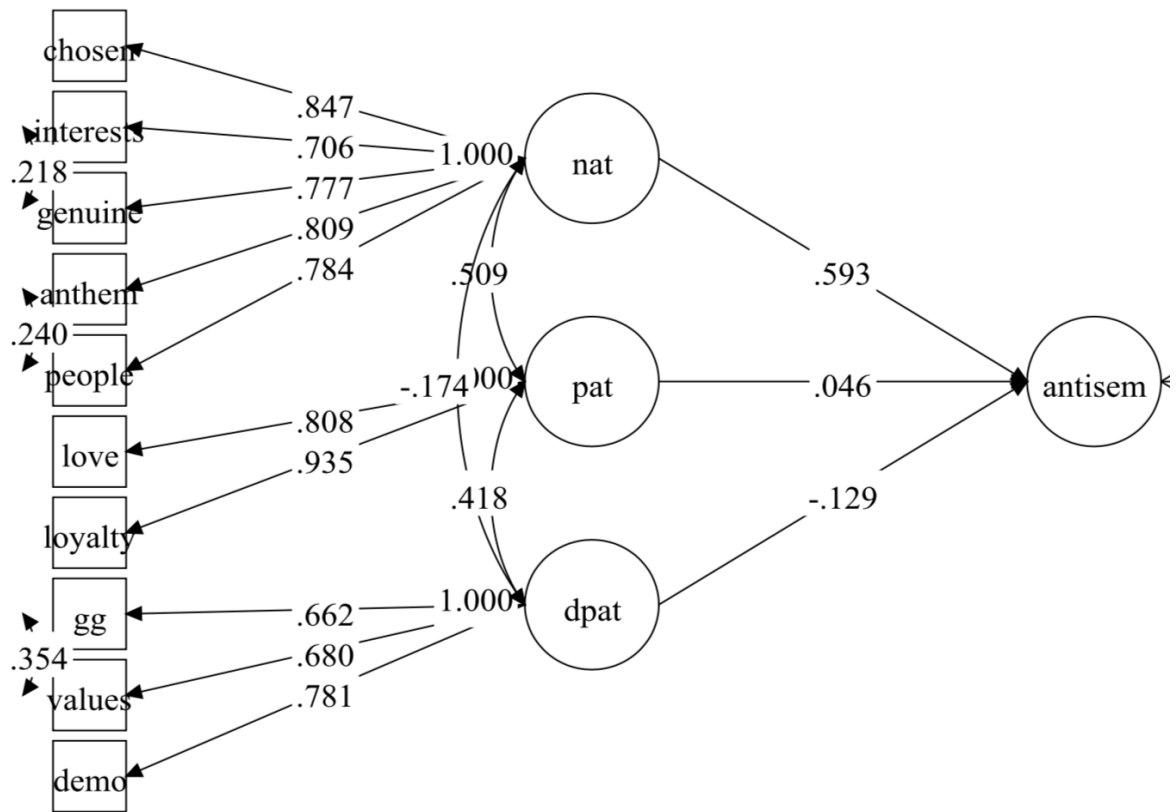

Figure 11: Robustness check: Three-factor measurement model for democratic patriotism (dpat), patriotism (tpat), and nationalism (nat) in nationally representative study with respondents who have only a non-German mother (N = 203) with completely standardized factor loadings (CFI = .961.; TLI = .941; RMSEA = .077; 90% CI [.052, .102]; SRMR = .048)

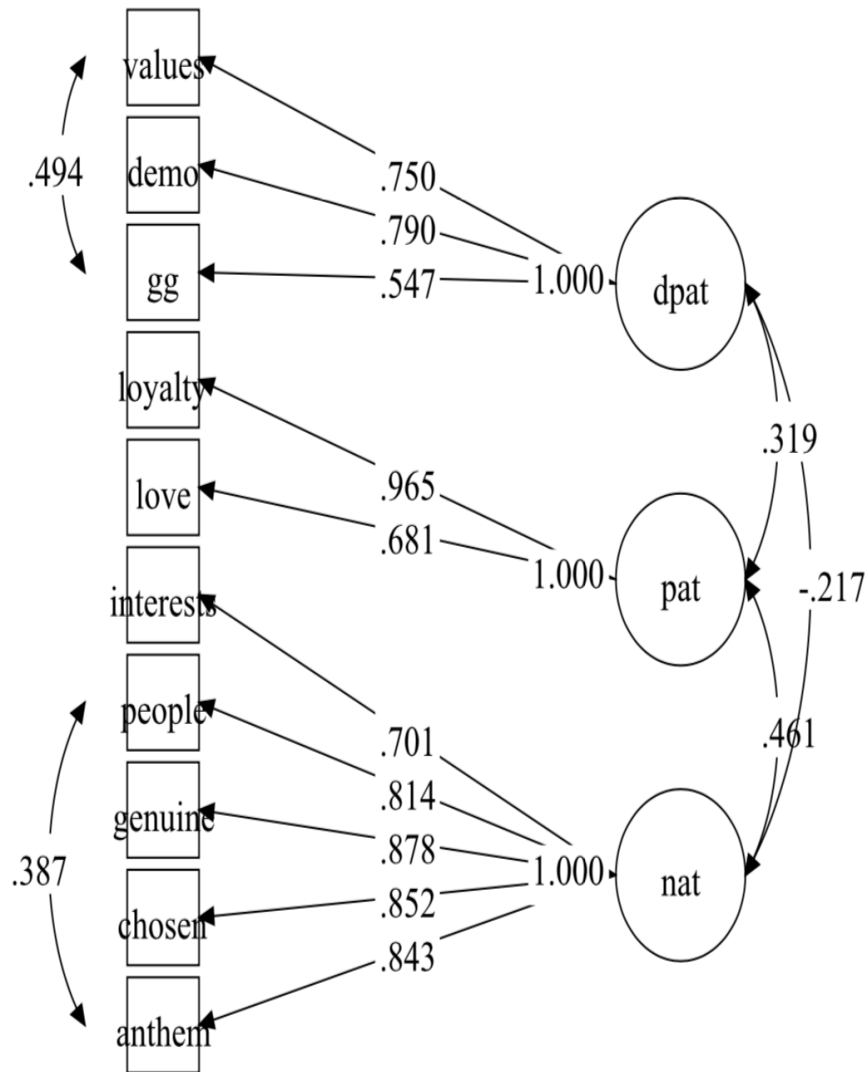
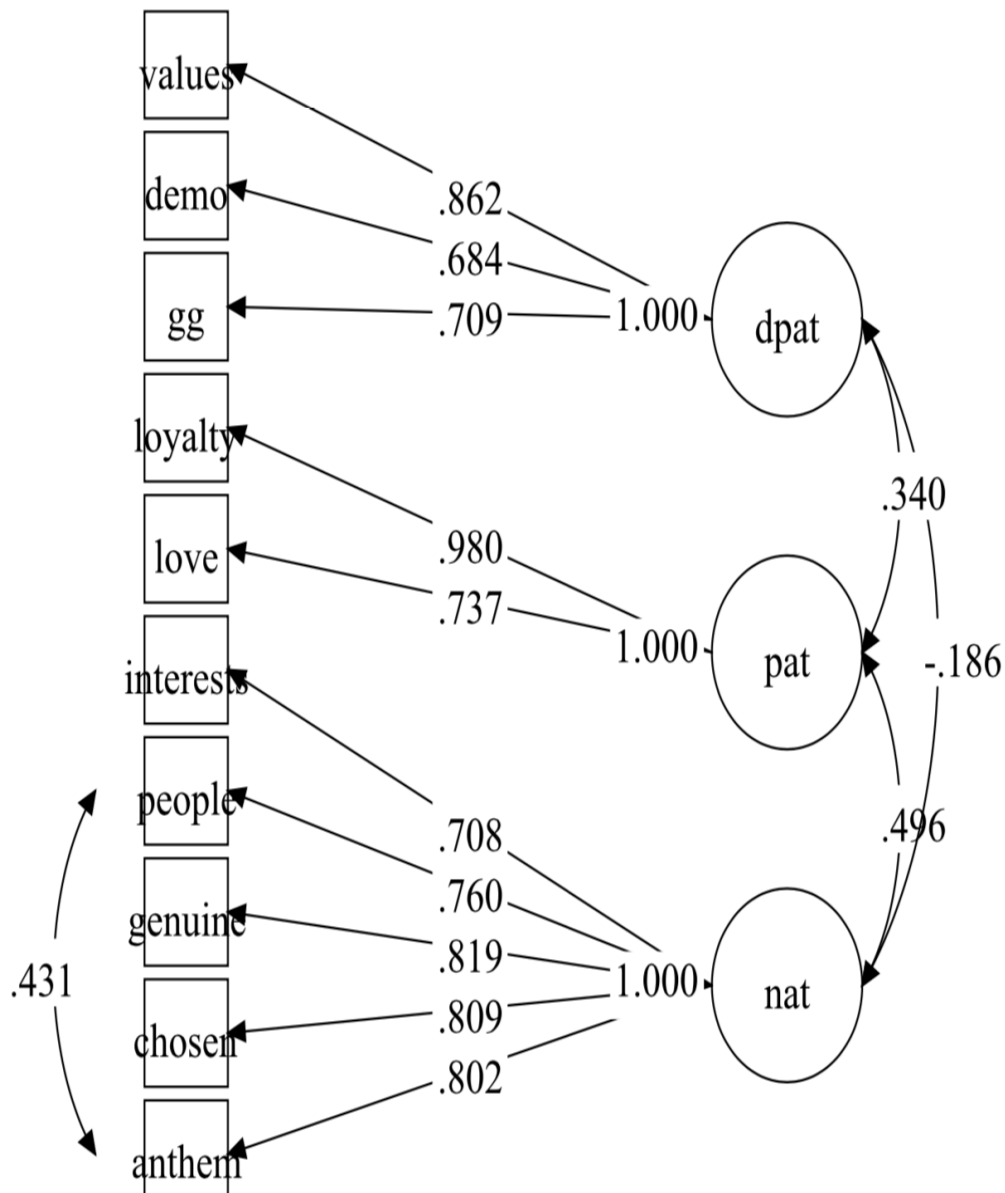



Figure 12: Robustness check: Three-factor measurement model for democratic patriotism (dpat), patriotism (pat), and nationalism (nat) in nationally representative study with respondents who have only a non-German father (N = 231) with completely standardized factor loadings (CFI = .972.; TLI = .959; RMSEA = .058; 90% CI [.032, .083]; SRMR = .045)



## 9 Annex

- 1 **Publication 1:** We do not measure what we aim to measure: Testing three measurement models for nationalism and patriotism
- 2 **Publication 2:** (National) pride and (conceptual) prejudice: Critical remarks on the distinction between nationalism and patriotism
- 3 **Publication 3:** Über (nationale) Bindungen: Trias von Nationalismus, Vaterlandsliebe und demokratischem Patriotismus
- 4 **Publication 4:** The evolution of the civic-ethnic distinction as a partial success story: Lessons for the nationalism-patriotism distinction
- 5 **Description of the author's contributions to the publications**



# We do not measure what we aim to measure: Testing Three Measurement Models for Nationalism and Patriotism

Marlene Mußotter<sup>1</sup> 

Accepted: 19 July 2021 / Published online: 29 July 2021  
© The Author(s) 2021

## Abstract

The measurement models for both nationalism and patriotism originally developed by Blank and Schmidt are broadly established. Despite their widespread usage in Germany and beyond, concerns have been voiced about the operationalisation of these nation-related concepts. However, in previous scholarship little attention has been devoted to systematically reviewing the models' validity. This paper's major goal is to contribute substantially to research on operationalising national attitudes by thoroughly examining how both nationalism and patriotism are measured and how valid the predominant measurement models really are. By running a confirmatory factor analysis, three measurement models based on the ISSP data of 2003 are replicated and empirically reviewed. By conducting a single-country analysis, the models are tested for the German case, including the evaluation of measurement invariance for both Eastern and Western Germany. Although the selected measurement models yield satisfying results, the paper identifies considerable shortcomings with regard to the way both nationalism and patriotism are empirically approached. It calls for a reconceptualising of the prevailing concept of pride and thus challenges the predominant operationalisation.

**Keywords** Nationalism · Patriotism · National attachment · Measures · Confirmatory factor analysis

## 1 Introduction

Nationalism and patriotism are fuzzy, yet much used and popular, concepts. While the former is generally understood as an aggressive, supremacist and uncritical attitude towards the nation and is considered to be on the rise (see Bonikowski 2016; Mylonas and Tudor 2021), the latter is termed an enlightened sense of community that takes pride in a commitment to democratic values (Kosterman and Feshbach 1989; Karasawa 2002; Blank and Schmidt 2003; Davidov 2009; Satherly et al. 2019; Huddy et al. 2021). The implication is that nationalism has to be curtailed (e.g., Mounk 2018), whereas patriotism is promoted as

---

✉ Marlene Mußotter  
marlene.mussotter@uni-passau.de

<sup>1</sup> Professorship of Methods of Empirical Social Sciences, University of Passau, Dr. Hans-Kapfinger-Straße 14b, 94032 Passau, Germany

a *civic virtue* (MacIntyre 1995; Ben-Porath 2007; Costa 2020) and as a socially desirable goal worth striving for.

To date, there have been remarkable approaches to measuring both concepts and to empirically assessing their impacts. For instance, a dominant strand of empirical research explores relationships such as that between nationalism, patriotism and anti-immigration attitudes (de Figueiredo and Elkins 2003; Wagner et al. 2012; Heinrich 2020; Simonsen and Bonikowski 2020). In addition, much valuable work has been done regarding the interrelation between patriotism, national identity and political attitudes (e.g., Huddy and Khatib 2007), between patriotism, nationalism and national identity (e.g., Li and Brewer 2004; Hanson and O'Dwyer 2019) and between patriotism, nationalism and internationalism (e.g., Kosterman and Feshbach 1989; Karasawa 2002). Despite the rich field of empirical research on both nationalism and patriotism, the current discourse is flawed by “[...]*la variety of scales and concepts that is characterised by conflicting and contradictory terminology and measurement*” (Huddy 2016: 18). Put differently, a number of measures have been applied, but the question of their validity, i.e., the way the conceptual level is translated into the measurement level, has received comparatively little attention in empirical scholarship. Concerns about the operationalisation of both nationalism and patriotism have only been raised by very few scholars, such as Bonikowski (2016), who criticised the current measures, without going into detail, for being too reductive. From a more qualitative perspective, comprehension difficulties have been detected concerning the pride items primarily used to measure nationalism and patriotism in the case of Austria (Latcheva 2011). However, existing accounts have missed reviewing the predominant models, or critically reflecting on their validity in a systematic fashion.

Taking this research gap as a point of departure, this paper distinguishes itself by taking a step back and by explicitly asking how nationalism and patriotism are measured and if we really measure what we aim to measure. In this sense, the concept of pride, which has been predominantly used to operationalise both nationalism and patriotism, is also taken into account. Running a confirmatory factor analysis, three measurement models used by Davidov (2009), Fleiß et al. (2009) and Ariely (2011), all standing in the research tradition of Blank and Schmidt (2003) and exemplifying the state of research, are systematically compared and reviewed. Addressing the empirical muddiness in current scholarship, attention is shifted to the way nationalism and patriotism are conceptualised and translated into measurement instruments, i.e., the way the empirical level is reflected in the numerical level. In this sense, light is cast on the models' content validity, i.e., the extent to which the measurements capture the core conceptual dimensions (e.g., Bollen 1989; De Vellis 2017).

By conducting a single-country analysis, the three models are tested for the German case, which is of special interest mainly for two reasons. First, there is broad agreement that Germans have a comparatively complicated relationship with their nation, resulting in the contested nature of national attitudes such as nationalism and patriotism (Bergsieker 2010; Miller-Idriss and Rothenberg 2012; Meitinger 2018; Assmann 2020). Second, there is no doubt that decades of post-war division have affected not only citizens' attitudes toward their nation, but also national cohesion in general. Regarding the historical experiences and national narratives in the former German Democratic Republic (GDR), differences between the reunified parts of Germany have been taken into account (e.g., Palmowski 2008; Giebler et al. 2020). For this reason, the models are also tested for measurement invariance, in order to investigate how valid they are for both regions.

This paper is organised into three sections. First, it addresses how both nationalism and patriotism are defined in the literature, followed by a brief discourse on pride as a group-based emotion. Then, a confirmatory factor analysis (CFA) for the three measurement

models is conducted. Lastly, the paper discusses the empirical results and closes with two major remarks aimed at improving future research on operationalising these national attitudes, which are currently gaining in importance.

## 2 Concepts

Zooming in on the academic discourse on national attitudes, one is faced with a plethora of conceptual distinctions. On the one hand, one counterposes different forms of nationalism, such as *ethnic* and *civic nationalism* (e.g., Ignatieff 1993), *Western* and *Eastern nationalism* (Kohn 1944), or *ardent, disengaged, restrictive* and *creedal nationalism* (Bonikowski and Di Maggio 2016). On the other hand, one contrasts diverse forms of patriotism, such as *military vs. civic patriotism* (Curti 1946), *genuine vs. pseudo-patriotism* (Levinson et al. 1950), *constructive vs. blind patriotism* (e.g., Schatz et al. 1999), *uncritical vs. critical patriotism* (Miller and Ali 2014), *extreme vs. moderate patriotism* (Nathanson 2020), as well as *symbolic patriotism* (Huddy and Khatib 2007), *robust patriotism, deflated patriotism, or ethical patriotism* (Primoratz 2017). This paper, however, focuses on the binary distinction between nationalism and patriotism, since the scholars referenced here adhere to this established terminology (for critical remarks on this dichotomy, see Brubaker 2004; Bonikowski 2016; Satherly et al. 2019).

Overall, nationalism rests on three fundamental premises. First, it is basically associated with the view whereby the world is categorised into nations – in social, cultural and political terms (e.g., Billig 1995; for further discussion, see Wimmer and Glick Schiller 2002 on *methodological nationalism*). Second, it is assumed that individuals must feel exclusively attached to one particular nation (Dekker et al. 2003; Brubaker 2020). Third, at its core is the belief that nationalistic attitudes emanate from authoritarian thought patterns (Blank and Schmidt 2003; Wessel 2019).

A dominant strand of empirical research defines nationalism as the idealisation of one's nation (Kosterman and Feshbach 1989; Blank and Schmidt 2003; Bonikowski 2016), i.e., the nation is seen as the highest (secular) authority people have to subordinate themselves to (e.g., Langewiesche 2002). Consequently, an unreflective allegiance to the nation, under any circumstances, is a constitutive element (for a more differentiated view, see Blank and Schmidt 2003). In this light, nationalists are assumed to support their nation whether it is right or wrong (e.g., de Figueiredo and Elkins 2003). Given these associations, nationalism is equated with feelings of superiority over other nations and with a desire for dominance (Kosterman and Feshbach 1989; Heinrich 2020; Osborne et al. 2017; for a more differentiated view, see e.g., Mylonas and Tudor 2021). Based on “[...] *downward comparisons with other nations*”, it is argued that one's nation and thus one's people, are superior to others (Kosterman and Feshbach 1989: 271). This position, perceived as undisputed, is fostered by comparisons with other nations that are regularly seen as weak and less competitive (de Figueiredo and Elkins 2003). Notably, nationalism revolves not only around feelings of superiority, but also around notions of competitiveness. The persistent “*struggle for power*” among nations is thus a central aspect (Hroch 2020: 8; for an opposing view, see e.g., Bonikowski 2016). Further, nationalism is associated with a feeling of “*chosen-ness*” (Billig 1995; Tamir 2019) and thus characterised by a “*narrative of exceptionalism*” (Feinstein and Bonikowski 2021). As a result, a leadership claim, as well as a mission claim, are derived. Nationalists feel entitled to impose their supposedly superior national morale on other nations and to seek to expand their nation's influence abroad (de Lamater et al.

1969; Kosterman and Feshbach 1989; Blank and Schmidt 2003). Concerning the conception of a people, nationalism is characterised by an imperative of homogeneity (Dekker et al. 2003; Wessel 2019) indicating that the people are primarily regarded as an organic community bound together by one ethnicity, one culture and one religion. Notably, a positive effect of social dominance orientation (SDO) on nationalism has been corroborated in a wide array of studies (Sidanius et al. 1997; Molina et al. 2015; Osborne et al. 2017) highlighting the impact of the most dominant ethnic group in this matter. Consistently, the literature on nationalism underlines a rather exclusionary conception of the nation based on ethnic membership criteria (e.g., Bonikowski 2016; Molina and Preddie 2020). Further, nationalism is marked by a narrative of threat (Schatz et al. 1999; Fukuyama 2018; Wessel 2019). Since the *national we* is (constantly) seen as threatened by a foreign *them*, it is argued that nationalists feel the need to defend their nation against any out-groups. Consistent with these exclusionary notions, as well as with the narrative described, the empirical findings indicating that nationalism reinforces anti-immigration attitudes have been corroborated by many studies (Blank and Schmidt 2003; de Figueiredo and Elkins 2003; Wagner et al. 2012; Molina and Preddie 2020). This evidence substantiates the argument that sees nationalism as the driving force for conflicts and wars (notably Wimmer 2018).

However, when examining nationalism's complexity, one needs to bear in mind its Janus-faced character. Considered a driving force behind the number of movements for independence in the eighteenth century (e.g., Mylonas and Tudor 2021), nationalism is also seen as an ideology of integration, effectively uniting collectives (e.g., Langewiesche 2002). Proponents of a "*liberal nationalism*", such as Yael Tamir (1990; 2019) and David Miller (1995; see also Gustavsson and Miller 2019), stress the latter aspect, asserting that nationalism has not only a destructive, but also a somewhat cohesive dimension, which scholars tend to overlook (Tamir 2019). Criticising the predominant interpretation of nationalism as chauvinistic, irrational and bellicose, adherents of liberal nationalism offer a more positive interpretation, reconciling nationalism and liberalism (for a critique, see Ariely 2011). In this sense, nationalism is assumed to fulfil basic human needs such as the "*need to belong*" or the desire "[...] *to enjoy a sense of stability and cross-generational continuity*" (ibid: 155). In addition, the importance of pre-political ties such as a common culture or a collective memory in constituting national unity is emphasised (Tamir 2019).

Although a universally applicable definition of patriotism is hard to find in scholarly discourse, there are a few core features on which most scholars agree. Generally, patriotism is termed as "*love of country*" (Schildkraut 2014: 454, see also Primoratz 2017; Gilbert and Garcia 2020) and associated with "[...] *feelings of affective attachment to country*" (Schatz et al. 1999: 153; see also Kosterman and Feshbach 1989; Osborne et al. 2017).<sup>1</sup> In this sense, it is unequivocally argued that patriots feel highly devoted to their homeland (notably Nathanson 2020).

Apart from these core emotional features, another strand of literature consistently defines patriotism as an enlightened sense of community that takes pride in a commitment to democratic and humanist values (Kosterman and Feshbach 1989; Satherly et al. 2019; Hanson and O'Dwyer 2019). Understood as a critical and constructive attitude towards the nation (Blank and Schmidt 2003; Sapountzis 2008; Kronenberg 2013), patriotism is promoted as a *civic virtue* (e.g., MacIntyre 1995; Kronenberg 2013; Costa 2020) and as a

<sup>1</sup> Given the definition by de Lamater et al. (1969: 320) of nationalism as an "[...] *individual's emotional attachment to his nation [...] which leads him to desire more power for it*", the conceptual conflation of nationalism and patriotism becomes evident at this point.

socially desirable goal worth striving for. From this point of view, patriotism appears as a civic counterpart not based on any downward comparisons, but rather self-referential (de Figueiredo and Elkins 2003; see also Mummendy et al. 2001). In the literature, there is broad agreement that patriotism implies respect and esteem for other nations and rejects any form of dominance or superiority (for a critical remark, see Mader 2016). Compared with nationalism, the nation is assumed to be bound not by ethnic, but by civic criteria such as loyalty to political institutions. In this sense, patriotism is associated with a more heterogeneous notion of the people and with a rather broad and inclusive definition of membership and belonging (Blank and Schmidt 2003; Kronenberg 2013; Huddy et al. 2021). Given these associations, a wide array of studies have shed empirical light on the negative relationship between patriotism and anti-immigration attitudes (Blank and Schmidt 2003; Wagner et al. 2012; Heinrich 2020; for an opposing view, see Cohrs et al. 2004).

Concerning this paper's case study, it is important to address the particular debate on patriotism in Germany. Originally promoted by Sternberger (1990), Habermas and Müller have been advocating a "*constitutional patriotism*" (Habermas 1992; Müller 2010). Resting on the assumption that cultural inclusiveness and national identity are hard to reconcile (for an opposing view, see the work of Laborde (2002) on *civic patriotism* or of Tamir (2019) on *liberal nationalism*), they claim that any form of national affiliation can only be regarded in political terms (Müller 2010). In this sense, constitutional patriotism advocates a specific form of citizenship that is mainly defined by "[...] *universalistic principles and procedures of the liberal democracy*" (ibid: 10). Given this normative framework, a common political culture based on a shared democratic consensus (Habermas 1992) replaces the nation as the primary point of reference. Dissenting from any kind of national attachment, this kind of patriotism is marked by a primarily cosmopolitan interpretation of citizenship (for a further discussion, see Laborde and Erez (2020) on *cosmopolitan patriotism*). Placing emphasis solely on democratic values, constitutional patriotism is assumed to successfully bind together diverse societies (e.g., Ingram 1996). Given these associations, however, it is open to debate if this kind of patriotism is rather a form of democratic attachment than a national attitude.

## 2.1 Pride as a group-based emotion

Although pride is not explicitly stated in the literature as a crucial prerequisite for either nationalism or patriotism, the predominant measurement models and thus the three models that this paper reviews, measure both nationalism and patriotism by means of this concept. As a result, pride items such as pride in the way democracy works are applied without further explanation. Given this consensus, it is worth briefly addressing the academic discourse on this concept in order to better assess how the conceptual level is translated into the measurement level.

Overall, pride is understood as a self-conscious emotion that people experience when reaching or surpassing "*important identity goals*" (Tracy et al. 2020: 53). Evidently, identity and pride are closely interlinked, yet to be distinguished (e.g., Ha and Hang 2015; Meitinger 2018; Choi et al. 2021). In research on pride, one differentiates between different kinds of pride, the most prevalent difference being seen as between *hubristic* and *authentic pride* (Tracy and Robins 2007; Tracy et al. 2020). While the former is linked to feelings of arrogance and superiority, the latter is associated with feelings of achievement and high self-esteem (Tracy and Robins 2007). Strikingly, only a very few scholars, such as Ha and Jang (2015), have linked this binary distinction with national attitudes, asserting

that patriotism is based on authentic pride, whereas nationalism is associated with hubristic pride. However, they fail to provide a thorough argument for their claim. In terms of national pride, one distinguishes between a more general kind described as *normative national pride* and a more domain-specific kind described as *grounded national pride* (Fabrykant and Magun 2015). In addition, Hjern (2003) counterposes these to a *national political pride* that is linked to civic criteria such as pride in political institutions and a *national cultural pride* that is primarily associated with pride in one's nation's history.

Drawing on the intergroup emotion theory (Smith and Mackie 2015), national pride is regarded as a group-based emotion. Contrasting individual-level with group-level emotions, this theory holds that group-based emotions such as pride are primarily activated “[...] by events that affect groups with which people identify even if the events do not directly affect the individual” (ibid: 350). For instance, people can take pride in a national sports team and are likely to feel anxious if their nation is threatened. Further, group-based emotions such as pride have a large impact on the behaviour of the social group concerned. Notably, scholarship on pride has shown evidence that pride is largely based on social comparisons (van Osch et al. 2018). In this sense, among others, Wimmer (2018; see also Bergsieker 2010; Sidanius et al. 1997) has shown that the degree of pride a citizen expresses towards her/his country is highly dependent on his/her status in society: if one has a comparatively high position, one is more likely to be proud of one's nation.

### 3 Data and Method

Generally, confirmatory factor analysis (CFA) is regarded as an established method for investigating the unidimensionality and validity of a scale (Harrington 2009; Brown 2015; Grimaccia and Naccaroto 2020). In contrast to exploratory factor analysis (EFA), CFA is mainly theory-driven, i.e., the measurement model is based on concrete assumptions that researchers hold about relationships between the items concerned and the factors they intend to measure. In this sense, the goal is to test if the factor structure previously suggested (in many cases) by an EFA can be empirically confirmed and preliminarily verified. In doing this, CFA primarily serves to investigate how far the model fits the data and how valid the model really is. Since this paper compares how Davidov (2009), Fleiß et al. (2009) and Ariely (2011) measure both nationalism and patriotism with the ISSP data of 2003 and reviews their models' validity, i.e., how far the conceptual level is translated into the measurement level, CFA is expected to serve as an appropriate tool. Drawing on conventional measurement standards (see Brown 2015), a model is considered valid a) if its fit-indices fulfil the required cut-off criteria, b) if the model is not flawed by any significant poor fits suggested in the modification indices and c) if the model is marked by high factor validity, i.e., if items display standardised factor loadings of over 0.55 and reflect well the factor concerned. Generally, these factor loadings are regarded as the correlation between the indicators and the factor they load onto. Conducting a CFA with Mplus (Version 8), the WLSMV estimator was used since this is the most accurate estimator for testing models that contain ordinal data (e.g., Brown 2015; Liu et al. 2017; DiStefano et al. 2019).<sup>2</sup>

<sup>2</sup> At this point, it is worth mentioning that none of the scholars referenced used WLSMV; they ran their models with an estimator such as maximum likelihood (Davidov 2009).



Concerning patriotism, it is noteworthy that all three models measure this concept with the same three pride indicators, namely pride in the way democracy works, pride in the social security system and pride in the fair and equal treatment of all groups in society. All items were measured on a unipolar scale ranging from 1 to 4 (1 = very proud, 4 = not proud at all).

In contrast, nationalism was measured quite differently. As displayed in Table 1, Ariely, as the first scholar operationalising liberal nationalism, used two pride indicators measured on a scale from 1 to 4 (1 = very proud, 4 = not proud at all), namely pride in arts and literature and pride in the nation's history. He contends that "[...] *these items reflect the liberal nationalist idea of a common cultural identity grounded in a specific history and culture*" (Ariely 2011:302).

Fleiß et al. (2009), conducting an exploratory factor analysis (EFA) for the case of Western Germany, operationalised nationalism through seven items. Three of these were related to pride: pride in the nation's history, pride in the nation's armed forces and pride in the nation's success in sports (see Table 2). All these items ranged on a scale from 1 to 4 (1 = very proud, 4 = not proud at all). Fleiß et al. (2009: 419) additionally included the factor "*general pride in the nation*". Contrary to this factor's name, it did not adhere to the concept of pride and referred to belief in the superiority of one's nation and uncritical loyalty to it. As shown in Table 2, items such as "*People should support their country even if the country is in the wrong*" or "*Generally, my country is better than most other countries*" were part of this scale. These items could assume values from 1 to 5 (1 = agree strongly, 5 = disagree strongly).

As depicted in Table 3, Davidov measured nationalism with two items exclusively targeting the superiority of one's nation and ranging on a scale from 1 to 5 (1 = agree strongly, 5 = disagree strongly).<sup>3</sup> By comparison with other scholars, this model did not adhere to any pride item batteries.

Given that these two items are also used by Fleiß et al. and that both studies apply the same items for patriotism, Davidov's model can be considered as nested under the model used by Fleiß et al. (Brown 2015).

The model test is applied for the German ISSP data from 2003 and encompasses Germany as a whole, as in Davidov's (2009) study. By contrast, Fleiß et al. (2009) and Ariely (2011) focused only on the Western part of Germany in their studies. In total, 1,287 Germans participated in the survey, 66.05% of whom came from the Western and 33.95% from the Eastern part. With respect to gender distribution, 50.43% of participants were male and 49.57% were female. The respondents' mean age was 47 years (SD = 17.090). Most of the respondents had a rather low level of education (over 39% had completed lower secondary school and over 32% middle school), while only 8% had completed university.

<sup>3</sup> Strikingly, these items have also been used in the US for measuring both nationalism (e.g. Huddy and Khatib 2007; Hanson and O'Dwer 2019) and chauvinism (e.g. Citrin et al. 2001; Mader 2016; Feinstein and Bonikowski 2021). Evidently, the distinction between nationalism and chauvinism remains open to debate.

**Table 1** Wording and distribution parameters of items used in the model of Ariely (2011)

Item	Item wording and scales	Mean	SD
<i>Patriotism</i>			
pride_demo	How proud are you of [COUNTRY] in the way democracy works? very proud = 1, 4 = not proud at all	2.53	.79
pride_social	How proud are you of [COUNTRY]'s social security system? very proud = 1, 4 = not proud at all	2.48	.83
pride_groups	How proud are you of [COUNTRY]'s fair and equal treatment of all groups in society? very proud = 1, 4 = not proud at all	2.73	.77
<i>Liberal Nationalism</i>			
pride_arts	How proud are you of [COUNTRY]'s achievements in arts and literature? very proud = 1, 4 = not proud at all	2.11	.74
pride_histo	How proud are you of [COUNTRY]'s history? very proud = 1, 4 = not proud at all	2.11	.74

**Table 2** Wording and distribution parameters of items used in the model of Fleiß et al. (2009)

Item	Item Wording and Scales	Mean	SD
<i>Patriotism</i>			
pride_demo	How proud are you of [COUNTRY] in the way democracy works? very proud = 1, 4 = not proud at all	2.53	.79
pride_social	How proud are you of [COUNTRY]'s social security system? very proud = 1, 4 = not proud at all	2.48	.83
pride_groups	How proud are you of [COUNTRY]'s fair and equal treatment of all groups in society? very proud = 1, 4 = not proud at all	2.73	.77
<i>Nationalism</i>			
citizen_country	I would rather be a citizen of [COUNTRY] than of any other country in the world. agree strongly = 1, 5 = disagree strongly	2.47	1.17
better_world	The world would be a better place if people from other countries were more like [COUNTRY NATIONALITY]. agree strongly = 1, 5 = disagree strongly	3.39	1.04
better_country	Generally speaking, [COUNTRY] is a better country than most other countries. agree strongly = 1, 5 = disagree strongly	2.99	1.09
support_wrong	People should support their country even if the country is in the wrong. agree strongly = 1, 5 = disagree strongly	3.49	1.18
pride_sports	How proud are you of [COUNTRY]'s achievements in sports? very proud = 1, 4 = not proud at all	2.12	.74
pride_army	How proud are you of [COUNTRY]'s armed forces? very proud = 1, 4 = not proud at all	2.84	.80
pride_histo	How proud are you of [COUNTRY]'s history? very proud = 1, 4 = not proud at all	2.72	.86

**Table 3** Wording and distribution parameters of items used in the model of Davidov (2009)

Item	Item Wording and Scales	Mean	SD
<i>Patriotism</i>			
pride_demo	How proud are you of [COUNTRY] in the way democracy works? very proud = 1, 4 = not proud at all	2.53	.79
pride_social	How proud are you of [COUNTRY]'s social security system? very proud = 1, 4 = not proud at all	2.48	.83
pride_groups	How proud are you of [COUNTRY]'s fair and equal treatment of all groups in society? very proud = 1, 4 = not proud at all	2.73	.77
<i>Nationalism</i>			
better_world	The world would be a better place if people from other countries were more like [COUNTRY NATIONALITY]. agree strongly = 1, 5 = disagree strongly	3.39	1.04
better_country	Generally speaking, [COUNTRY] is a better country than most other countries. agree strongly = 1, 5 = disagree strongly	2.99	1.09

**Table 4** Fit measures of all measurement models

	$\chi^2$	df	RMSEA	90% C.I	p for RMSEA	CFI	TLI	SRMR
Ariely	19.213	4	.064	.037 .094	.177	.985	.963	.019
Fleiß et al.	129.347	32	.061	.050 .072	.047	.956	.939	.037
Davidov	15.734	5	.041	.019 .065	.706	.990	.980	.020

**Table 5** Measurement models with completely standardised factor loadings for patriotism

	Ariely	Fleiß et al.	Davidov
Patriotism			
pride_demo	.675	.660	.706
pride_social	.761	.640	.684
pride_groups	.633	.667	.670

## 4 Empirical results

Overall, drawing on the pertinent cut-off criteria, the three models yielded reasonable fits (See Table 4).<sup>4</sup> The adjusted Davidov model showed the best fit of all (Chi = 15.734, df = 5, RMSEA = 0.041, SRMR = 0.020, CFI = 0.990, TLI = 0.980). The Ariely model also provided a very adequate fit (Chi = 19.213, df = 4, RMSEA = 0.064, SRMR = 0.019, CFI = 0.985, TLI = 0.963). The Fleiß model was first run with one nationalism factor, but this fitted poorly and had to be rejected (Chi = 447.709, df = 34, RMSEA = 0.122, SRMR = 0.070, CFI = 0.851, TLI = 0.755). When estimating the model with two nationalism factors (one referring to a general pride not adhering to pride items, while the other consisted of pride items only), the fit was much better (Chi = 129.347, df = 32, RMSEA = 0.061, SRMR = 0.037, CFI = 0.956, TLI = 0.939).

In terms of patriotism, the items' standardised factor loadings in all models were greater than 0.60 (see Table 5) and were statistically significant.

Since nationalism was operationalised differently in each of the three models, their items' statistical significance also differed, as shown in Table 6. When reviewing the three models, one problem occurred: the Davidov model demonstrated a so-called "*Heywood case*" (Brown 2015:162), indicating a negative error variance with regard to the better country item. Like Davidov (2009), the variable concerned was constrained to zero in order to handle this case. The second variable displayed a factor loading of 0.53 and was statistically significant.

When testing the Ariely model, the item referring to pride in history accounted for a rather poor factor loading of 0.44. In contrast, the second item – pride in the nation's achievements in arts and literature – yielded a reasonable factor loading of 0.65 and was highly significant.

With respect to the model of Fleiß et al., the factor loadings of the items addressing the general pride factor (NAT 1) ranged from 0.42 to 0.76. Apart from one exception, all

<sup>4</sup> Drawing on Hu and Bentler (1999; see also Brown 2015), a model is seen as valid if a) the SRMR is close to 0.08 or lower, b) the RMSEA is close to 0.06 or lower and c) the CFI and TLI are close to 0.95 or greater.

**Table 6** Measurement models with completely standardised factor loadings for nationalism

	Ariely	Fleiß et al.	Davidov
Nationalism			
pride_arts	.651		
pride_histo	.443	.597	
citizen_country		.427	
support_wrong		.559	
better_world		.762	.531
better_country		.750	1.00
pride_sports		.574	
pride_army		.708	

items were statistically significant and thus reflected the factor very well. The items targeting the nation's superiority displayed the highest standardised factor loadings of over 0.70. Concerning the second nationalism factor (NAT 2), the pride items' standardised factor loadings ranged from 0.57 to 0.70 and were all statistically significant. Strikingly, pride in the armed forces loaded the highest on that factor. Further, a correlation between the two nationalism factors of over 0.40 was evidenced.

In line with previous studies (e.g., Latcheva 2011; Satherly et al. 2019; Wagner et al. 2012; Huddy et al. 2021), a relatively high factor correlation between patriotism and nationalism of over 0.57 was found in the Ariely model, which might originate from the pride item batteries used for both patriotism and liberal nationalism. In a similar vein, the model of Fleiß et al. also showed a factor correlation of 0.44 between patriotism and the second factor of nationalism (NAT 2), consisting of pride items only. Although both factors evidently shared a considerable amount of variance, their factor correlation was below the threshold of 0.85 (Brown 2015: 28) and these did not need to be converged to one single factor. In contrast, the Davidov model displayed a standardised factor correlation of only 0.19 and the model of Fleiß et al. a correlation between the first nationalism factor (NAT 1) and patriotism of only 0.22. The findings in these cases might result from the fact that not only pride items, but also items not adhering to the concept of pride were applied to the measurement of both nationalism and patriotism.

#### 4.1 Validity across Western and Eastern Germany: testing measurement invariance

Prior to evaluating measurement invariance, a CFA with WLSMV as estimator was conducted in Mplus for each model, investigating both groups separately. Overall, as shown in Table 7, except for the model of Fleiß et al., all the models yielded a reasonable fit.

In order to examine the validity of the models across different groups, measurement invariance needs to be tested. Generally, one distinguishes between three different kinds of invariance: configural, metric and scalar invariance. If all kinds of variance are supported, full invariance is given.<sup>5</sup> According to Davidov, configural invariance is fulfilled if "[...]

<sup>5</sup> However, since scalar variance, as the most rigid form, is difficult to achieve, calls for alternative and thus less strict approaches, i.e., approximate rather than exact measurement invariance, have been voiced (e.g., Davidov et al. 2015; Cieciuch et al. 2018).

**Table 7** Fit measures of all measurement models for Western and Eastern Germany

	$\chi^2$	df	RMSEA	p for RMSEA	90% C.I	CFI	TLI	SRMR
<i>Ariely</i>								
Western Germany	11.848	3	.060	.271	.027 .097	.986	.953	.017
Eastern Germany	8.668	4	.052	.399	.000 .100	.990	.974	.023
<i>Fleiß et al.</i>								
Western Germany	103.966	32	.051	.394	.041 .063	.941	.918	.037
Eastern Germany	63.919	32	.048	.561	.030 .065	.959	.943	.042
<i>Davidov</i>								
Western Germany	15.545	5	.050	.448	.023 .079	.982	.963	.025
Eastern Germany	9.589	5	.046	.497	.000 .089	.988	.976	.027

a) a single model specifying the items that measure each construct fits the data, b) all item loadings are substantial and significant and c) the correlations between the factors are less than one". It serves as the baseline model and indicates that the constructs are measured by the same indicators in all groups. However, in order to examine if both Western and Eastern Germans have an equal notion of nationalism and patriotism, one needs to test for metric invariance. This level of invariance is supported if the model fit is not considerably worse than that of the configural model (Cieciuch et al. 2018). In order to compare the means between the respective constructs, a scalar invariance needs to be held, which is corroborated if the respective model fit is reasonable and does not demonstrate a considerably worse fit compared with the metric fit (Davidov 2009). When comparing the fits between the respective models, one draws on the pertinent cut-off criteria established by Chen (2007:501), who suggested that model fits should not display a change greater than "[...] -0.010 in CFI supplemented by a change greater than 0.015 in RMSEA or a change greater than 0.030 in SRMR [or when comparing a scalar to a metric model] a change in SRMR greater than 0.010".

Regarding the Ariely model, the configural invariance model displayed a reasonable fit and can thus be seen as fulfilled (RMSEA = 0.072, SRMR = 0.024, CFI = 0.981). As shown in Table 8, the fit of the metric invariance model was satisfying, but worse than that of the configural model (RMSEA = 0.085, SRMR = 0.030, CFI = 0.963). Drawing on Chen (2007), partial metric variance was supported, which means that both groups have not the same but a very similar understanding of national attitudes. Scalar invariance was not evidenced, since the fit of the scalar model was worse than the metric (RMSEA = 0.076, SRMR = 0.035, CFI = 0.949). Consequently, a solid empirical fundament for comparing means between the two factors is not provided.

Regarding Davidov, the configural invariance model yielded a reasonable fit (RMSEA = 0.059, SRMR = 0.033, CFI = 0.977). Therefore, this level of invariance can be considered as having been met. The metric invariance model was found to be a satisfying, but a slightly worse fit compared with the configural model (RMSEA = 0.067, SRMR = 0.051, CFI = 0.961). For this reason, metric invariance can be regarded as

**Table 8** MGCFA: Fit measures of the invariance test for all measurement models

	$\chi^2$	df	RMSEA	$\Delta$ RMSEA	SRMR	$\Delta$ SRMR	CFI	$\Delta$ CFI	TLI
<i>Ariely</i>									
Configural invariance	27.214	8	.072		.024		.981		.952
Metric invariance	47.819	11	.085	.013	.030	.006	.963	.018	.932
Scalar invariance	69.808	19	.076	.009	.035	.005	.949	.014	.946
<i>Fleiß et al.</i>									
Configural invariance	349.866	68	.101		.076		.771		.698
Metric invariance	383.294	76	.099	.002	.087	.011	.751	.020	.705
Scalar invariance	408.264	84	.097	.002	.090	.003	.737	.014	.718
<i>Davidov</i>									
Configural invariance	26.809	10	.059		.033		.977		.954
Metric invariance	41.655	13	.067	.008	.051	.018	.961	.016	.940
Scalar invariance	47.455	16	.063	.004	.060	.009	.957	.004	.946

fulfilled. The fit of the scalar invariance model was acceptable and did not considerably degrade the fit of the previous solution. Therefore, this allows for a comparison of means between the two factors across Eastern and Western Germany (RMSEA=0.063, SRMR=0.060, CFI=0.957).

Regarding Fleiß et al., the configural invariance model displayed a poor fit (RMSEA=0.101, SRMR=0.076, CFI=0.771). The metric invariance model also had to be rejected (RMSEA=0.099, SRMR=0.087, CFI=0.751). As a result, this model did not allow for any meaningful group comparisons between Eastern and Western Germany.

## 5 Discussion

The results show that there is a broad consensus concerning the operationalisation of patriotism by means of pride. In contrast, except for some similarities, different measurements have been applied to nationalism. In terms of validity, the models generally displayed reasonable fits and their factor

validity, i.e., the degree to which the items reflect the factor, was satisfying. However, when critically reflecting on the way the empirical level is translated into the numerical level, i.e., the way patriotism and nationalism are broadly defined in the literature and operationalised, a few distinct shortcomings involved in these measurements are worth illuminating.

Concerning patriotism, first, the models indicate that this concept is primarily attached to a sphere of (democratic) rationality and measures constitutional patriotism in the Habermasian sense. However, given the broad consensus on patriotism as “[...] *positive identification with and affective attachment toward the country* [...]” (Schatz et al. 1999: 153; see also Citrin et al. 2001) and “*love of country*” (Schildkraut 2014: 454), the models failed to reflect emotional attachment to the nation and thus the emotional core of the concept. In addition, looking at the definition of patriotism more closely, the distinction between national identity and patriotism was not as clear as had been assumed, but rather blurred. Although scholars tend to regard national identity as the overarching concept of both



nationalism and patriotism (e.g., Blank and Schmidt 2003; Hanson and O'Dwyer 2019), one is faced with a conceptual muddiness which is also mirrored in empirical terms. Notably, items such as "I love my country" were applied to measuring both national identity (e.g., Blank 2002; Molina et al. 2015) and patriotism (e.g., Kosterman and Feshbach 1989; Karasawa 2002; Molina and Preddie 2020). This was surprising, in so far as identification with the nation is obviously to be distinguished from love of country and the will to make sacrifices for it. Put differently, people can identify with the nation without necessarily feeling a strong emotional attachment to it. In future research, this relationship deserves further scrutiny in order to disentangle the conflation of the two concepts.

Second, the existing measurements are marked by a highly vague character in terms of validity (De Vellis 2017). Items such as "*proud of the way different groups are fairly treated*" make too much room for very different kinds of interpretations. Given the variety of religious, ethnic or political groups in Germany and also abroad, it remains unclear which types of groups are targeted or who actually counts as a group. Besides, it is open to debate if this item properly taps the concept's core features or reflects the high devotion to democratic values. Hence, it does not clearly assess the protection of minorities and thus targets a basic democratic principle that constitutional patriots are assumed to endorse. This wariness is also exemplified by other items such as "*proud of the way the democracy works*". On the one hand, this item targets the functionality and stability of the democratic system, but fails to assess the mere attachment to democratic principles associated with constitutional patriots. On the other hand, certainly, there are citizens who are in favour of the democratic system, or even content with the current state of democracy in Germany, but would not necessarily express pride in it. For instance, recently it has been evidenced that German citizens do support democracy in general, but are discontented with democratic procedures and the way these work in their country (Busch 2020). In this light, they would score rather low on this item and might appear to be unpatriotic. However, the predominant measurement approaches uniformly suggest that one can only be deemed to be a real patriot if one expresses pride in elements of Germany's national democracy. Conversely, it is assumed that if one is not proud one does not count as patriotic.

Now, turning to nationalism, three major concerns are identified. First, like the measurements of patriotism, a pride item battery was applied to the Ariely model as well as to parts of the model of Fleiß et al. related to the second nationalism factor. However, Miller and Ali (2014) stress that liberal nationalism does not imply pride as a central concept and they voice criticism of this measurement approach based on pride as resulting in a mismatch between the conceptual and the measurement level that deserves further examination. In addition, both scholars measure nationalism by means of pride in history – an obviously very vague term that can be interpreted in many different ways. At this point, it is questionable if this item properly taps the idealisation of one's nation and thus one's history that nationalists are associated with. Further, this item indicates that such glorification holds for both nationalists and liberal nationalists and thus equates the two concepts. However, since the scholars referenced aimed to measure different kinds of nationalism, one would have expected a more nuanced approach here. Given the rather poor factor loading of 0.44, pride in history does significantly reflect liberal nationalism and has to be reconsidered. In addition, this item highlights the lack of context that the predominant measures suffer from. Due to the Holocaust, Germans are rather cautious about expressing pride in their nation, especially in their history (Miller-Idriss and Rothenberg 2012; Miller and Ali 2014; Meitinger 2018; Assmann 2020). Thus it is reasonable to assume that one can possess nationalistic attitudes and strive for domination over other countries without being proud of Germany's history, as

expressed in this item. It is noteworthy that the lack of context is further highlighted by the different socialisation and thus divergent collective memories, of Western and Eastern Germans (e.g., Palmowski 2008; Giebler et al. 2020).

Second, upon closer examination, these items are not as clear and unambiguous as they should be to meet the conventional validity requirements. Items such as “*Generally, my country is better than most other countries*” entail a considerable degree of wariness. The question of which aspect of one’s country is assumed to be better in other countries arises here. At this point, one should also take into account this paper’s single-case analysis. Given its comparatively high standard of living and the political as well as economic stability, it is doubtless valid to argue that Germany is a better and safer place to live compared with other countries. However, assuming that this statement serves as a proper indicator of nationalism is misleading. If one finds Germany to be a comparatively better country, one is not necessarily a nationalist or a believer in one’s nation’s superiority.

Third, in terms of content validity, it is reasonable to assume that all the different measurements being used tap only a limited dimension of nationalism and fail to capture constitutive dimensions. For instance, the Davidov model applies only two items that both address belief in one’s nation’s superiority. Given the broad understanding of nationalism defined by downward comparison with other nations, as well as by the postulate of a nation’s homogeneity, all the models lack measurement of important elements. Further, neither is the narrative of threat captured in the measurements. Aside from this, targeting sports or the armed forces highlights the cognitive dimension emphasised in the applied measurements.

Overall, it seems as if pride items are applied here without critically reflecting on the concept itself. First, drawing on the intergroup emotion theory of pride (Smith and Mackie 2015), it remains unclear if the scholars referenced distinguish between pride as a group-based and as an individual-level emotion. In the current pride measurements, both levels can be triggered and thus the distinction has to be further explored. Second, the premise that pride is a self-conscious emotion that largely hinges on social comparisons (van Osch et al. 2018) challenges the claim that patriotism is rather self-referential and does not imply any comparisons with nationalism (e.g., de Figueiredo and Elkins 2003). Third, the core definition, according to which pride is experienced when “*important identity goals*” (Tracy 2020:53) are reached, remains unclear in this measurement context. Given that both nationalism and liberal nationalism are measured by the same item, namely pride in history, these identity goals are open to debate. Overall, in future research, the goals that patriots and nationalists are assumed to strive for deserve further scrutiny, especially with regard to the evidenced correlation and thus the contested distinction, between the two concepts. In addition, on a more general note, the question of whether pride is a proper or valid way to approach these concepts has to be raised. For instance, Gilbert and Garcia (2020) assert that patriotism, understood as love of country, does not imply pride as a prerequisite. Here, the distinction between love, affective attachment and pride remains rather vague and has to be further explored, since scholars such as Dekker et al. (2003) contrast national pride with nationalism. Evidently, empirical research on both nationalism and patriotism has largely overlooked the rich field of scholarship on pride and has failed to thoroughly take into account pertinent theories such as the intergroup emotion theory of pride (Smith and Mackie 2015). Put differently, scholars have primarily measured national attitudes via a concept that they have failed to study in a systematic fashion. As a result, a mismatch between the conceptual level and the measurement level is detected.

## 6 Conclusion

This paper's major goal was to contribute to research on operationalising national attitudes by thoroughly examining how both nationalism and patriotism are measured by Davidov (2009), Fleiß et al. (2009) and Ariely (2011) and how valid the predominant measurement models, in the research tradition of Blank and Schmidt (2003), really are. The way nationalism and patriotism are conceptualised and translated into measurement instruments, i.e., the way the empirical level is reflected in the numerical level, was the key concern in this study. Running a CFA, the models were tested for the German case by also evaluating their measurement invariance for both Eastern and Western Germany.

This study has shown that there is broad agreement on measuring patriotism, since all three models used the same pride scale. In contrast, different but partially overlapping operationalisations were used for nationalism. Overall, the three measurement models yielded satisfying statistical fits and the items reflected both factors pretty well.

The central contribution of this paper lies in highlighting substantial shortcomings regarding the way both nationalism and patriotism are measured. In this sense, three major concerns have been identified. First, the items are marked by a considerable amount of ambiguity, entailing challenges in terms of validity. Second, the models' content validity has to be called into question since constitutive dimensions, especially the emotional, are largely missing for both nationalism and patriotism. In this sense, all the models indicate that patriotism is primarily attached to a sphere of (democratic) rationality and they only tap constitutional patriotism in the Habermasian sense. However, the predominant approach tends to neglect and thus fails to empirically approach, patriotism in the sense traditionally defined as love of country. Third, the prevailing measurement approach is based on an assumption that has remained unquestioned to date. In terms of pride items, one can only be deemed a real patriot or a genuine nationalist if one takes pride in specific national achievements or institutions. Conversely, if one does not take pride in national accomplishments, one is regarded neither as a patriot nor as a nationalist. Due to the prevalent but problematic either/or premise, the measurements are flawed by a simplistic assumption that limits both concepts to the sphere of questionable pride items. Consequently, one can draw the conclusion that the measurement instruments rather tap different kinds of national pride and do not properly measure what they aim to measure. Therefore, the paper calls for more methodological rigour in the way these national attitudes are operationalised.

In light of these shortcomings, this paper closes with two remarks aimed at improving future research. First, it has been shown that scholarship on nationalism and patriotism largely tends to overlook research on pride and consequently draws on a concept without critically reflecting on its true meaning. However, since the predominant measurement models are based on pride item batteries, more account should be taken of research on pride in order to increase the measurements' validity and to disentangle the conceptual and empirical muddiness that current accounts suffer from. For instance, the intergroup emotion theory, dealing with group-based emotions such as national pride, is worth integrating when operationalising these nation-related concepts. At this point, the distinction between authentic and hubristic pride deserves further scrutiny on both conceptual and empirical levels. Examining the relationship between nationalism, patriotism and both kinds of pride seems to be a generative step towards approximating these concepts more closely. Moreover, when testing for measurement invariance, this paper has shown that the models do not hold sufficiently for both Eastern and Western Germany. Due to its context-sensitivity, pride should be treated more cautiously in empirical scholarship. Consequently, drawing

general conclusions on nationalism or patriotism in Germany as a whole seems to be problematic if differences within the country have not been sufficiently reflected on.

Second, it is worth developing and testing new measurements adhering to concepts other than pride. In this fashion, existing items such as “*Generally, Germany is better than other countries*” should be replaced by measurements that are less ambiguous in order to fully capture both nationalism and patriotism and to consequently enhance our understanding of how both national attitudes are currently gaining in importance.

**Acknowledgements** I would like to thank Marco Bitschnau, Bastiaan Bruinsma, Marlene Mauk, Eunike Piwoni and Kristina Simonsen for their valuable comments on an early draft of this paper as well as Peter Schmidt and Horst-Alfred Heinrich for their support. In addition, I am grateful for the feedback of two anonymous reviewers.

**Funding** Open Access funding enabled and organized by Projekt DEAL.

**Declarations**

**Conflict of interest** None.

**Open Access** This article is licensed under a Creative Commons Attribution 4.0 International License, which permits use, sharing, adaptation, distribution and reproduction in any medium or format, as long as you give appropriate credit to the original author(s) and the source, provide a link to the Creative Commons licence, and indicate if changes were made. The images or other third party material in this article are included in the article’s Creative Commons licence, unless indicated otherwise in a credit line to the material. If material is not included in the article’s Creative Commons licence and your intended use is not permitted by statutory regulation or exceeds the permitted use, you will need to obtain permission directly from the copyright holder. To view a copy of this licence, visit <http://creativecommons.org/licenses/by/4.0/>.

## References

- Ariely, G.: Constitutional patriotism, liberal nationalism and membership in the nation: An empirical assessment. *Acta Polit.* **46**(3), 294–319 (2011)
- Assmann, A.: *Die Wiedererfindung der Nation. Warum wir sie fürchten und warum wir sie brauchen.* C.H. Beck, München (2020)
- Bergsieker, H.: National pride and prejudice: The case of Germany. In: Karolewski, I., Suszycki, A. (eds.) *Multiplicity of Nationalism in Contemporary Europe*, pp. 151–174. Lexington Books, Lanham (2010)
- Ben-Porath, S.: Civic virtue out of necessity: Patriotism and democratic education. *Theory Res. Educ.* **5**(1), 41–59
- Billig, M.: *Banal Nationalism.* SAGE, London (1995)
- Blank, T.: *Gemeinnutz oder Eigenwohl? Motive und Erscheinungsformen nationaler Identität in Deutschland.* FRG e.V, Mannheim (2002)
- Blank, T., Schmidt, P.: National identity in a united Germany: Nationalism or patriotism? An empirical test with representative data. *Pol. Psychol.* **24**(2), 289–312 (2003)
- Bollen, K.: *Structural Equations with Latent Variables.* Wiley, New York (1989)
- Bonikowski, B.: Nationalism in settled times. *Annu. Rev. Sociol.* **42**(1), 427–449 (2016)
- Bonikowski, B., di Maggio, P.: Varieties of American popular nationalism. *Am Sociol. Rev.* **81**(5), 949–980 (2016)
- Brown, T.: *Confirmatory Factor Analysis for Applied Research.* Guildford Press, New York (2015)
- Brubaker, R.: In the name of the nation: Reflections on nationalism and patriotism. *Citizensh Stud.* **8**(2), 115–127 (2004)
- Brubaker, R.: Populism and Nationalism. *Nations Natl.* **26**(1), 44–66 (2020)
- Busch, K.: *Krise oder Unterstützung der (repräsentativen) Demokratie in Deutschland? Die Entwicklung der letzten zwei Jahrzehnte 1991–2018.* *ISI.* **65**, 7–14 (2020)
- Chen, F.F.: Sensitivity of goodness of fit Indexes to lack of measurement invariance. *Struct Equ Modeling* **14**(3), 464–504 (2007)

- Choi, S. Y., et al.: National identity can be comprised of more than pride: Evidence from collective memories of Americans and Germans. *J Appl Res Memory Cognition* (2021). <https://doi.org/10.1016/j.jar-mac.2020.09.004>
- Cieciuch, J., Davidov, E., Algesheimer, R., Schmidt, P.: Testing approximate measurement invariance of human values in the European Social Survey. *Sociol Methods Res.* **47**(4), 665–686 (2018)
- Citrin, J., Wong, C., Duff, B.: The meaning of American identity. Patterns of ethnic conflict and consensus. In: Ashmore, R., Jussim, J., Wilder, D. (eds.) *Social Identity, Intergroup Conflict and Conflict Reduction*. Oxford University Press, Oxford (2001)
- Cohrs, C., Dimitrova, D., Kalchevska, T., Tomova, I., Vasileva, M., Moschner, B.: Is Patriotic National Pride Desirable? A Differentiated Analysis of Its Psychological Meaning? *ZfS* **35**(4), 201–215 (2004)
- Costa, M.: Patriotism and civic virtue. In: M. Sarđoć (ed.) *Handbook of Patriotism*, pp. 213–226. Springer, Cham
- Curti, M.: *The roots of American loyalty*. Columbia University Press, New York, NY (1946)
- Davidov, E.: Measurement equivalence of nationalism and constructive patriotism in the ISSP: 34 countries in a comparative perspective. *Polit. Anal.* **17**(1), 64–82 (2009)
- Davidov, E., Cieciuch, J., Meulemann, B., Schmidt, P., Algesheimer, R., Hausherr, M.: The comparability of measurements of attitudes toward immigration in the European Social Survey: Exact vs. approximate measurement equivalence. *Public Opin. Q.* **79**, 244–266. (2015)
- Dekker, H., Malová, D., Hoogendoorn, S.: Nationalism and Its Explanations. *Pol. Psychol.* **24**(2), 345–376 (2003)
- De Figueiredo, R., Elkins, Z.: Are patriots bigots? An inquiry into the vices of in-group pride. *Am J Pol Sci.* **47**(1), 171–188 (2003)
- De Lamater, J., Katz, D., Kelman, H.: On the nature of national involvement: A preliminary study. *J Conflict Resol.* **13**(3), 320–357 (1969)
- De Vellis, R.: *Scale Development. Theory and Applications*. Sage, London (2017)
- DiStefano, C., McDaniel, H., Zhang, L., Shi, D., Jiang, Z.: Fitting large Factor Analysis models with ordinal data. *Educ Psychol Meas.* **79**(3), 417–436 (2019)
- Fabrykant, M.; Magun, V.: *Grounded and Normative Dimensions of National Pride in Comparative Perspective*. Higher School of Economics Research Paper No. WB BPR/62SOC/2015.ssrn.2599967. (2015)
- Feinstein, Y., Bonikowski, B.: Nationalist narratives and anti-immigrant attitudes: Exceptionalism and collective victimhood in contemporary Israel. *J. Ethn. Migr. Stud.* **47**(3), 741–761 (2021)
- Fleiß, J., Höllinger, F., Kuzmics, H.: Nationalstolz zwischen Patriotismus und Nationalismus? *Berl. J. Soziol.* **19**(3), 409–434 (2009)
- Fukuyama, F.: *Identität*. Hoffmann und Campe, Hamburg (2018)
- Giebler, H., Horvath, S., Weßels, B.: Legitimität der repräsentativen Demokratie in Ost und West. *ISI.* **65**, 3–7 (2020)
- Gilbert, M., Garica, I.: On patriotism. In: Sarđoć, M. (ed.) *Handbook of Patriotism*, pp. 271–286. Springer, Cham (2020)
- Grimaccia, E., Naccaroto, A.: Confirmatory factor analysis to validate a new measure of food insecurity: perceived and actual constructs. *Qual Quant* **54**(4), 1211–1232 (2020)
- Gustavsson, G., Miller, D.: *Liberal Nationalism and its Critics: Normative and Empirical Questions*. Oxford University Press, Oxford (2019)
- Ha, S., Jang, S.-I.: National identity, national pride and happiness: The case of South Korea. *Soc. Indic. Res.* **121**(2), 471–482 (2015)
- Habermas, J.: Staatsbürgerschaft und nationale Identität. In: ed. (1992). *Faktizität und Geltung. Beiträge zur Diskurstheorie des Rechts und des demokratischen Rechtsstaats*. Suhrkamp, Frankfurt (1990)
- Hanson, K., O'Dwyer, E.: Patriotism and nationalism, Left and Right: A Q-Methodology study of American national identity. *Pol. Psychol.* **40**(4), 777–795 (2019)
- Harrington, D.: *Confirmatory Factor Analysis*. Oxford University Press, Oxford (2009)
- Heinrich, H.-A.: Causal relationship or not? Nationalism, patriotism and anti-immigration attitudes in Germany. *Sociology of Race and Ethnicity.* **6**(1), 76–91 (2020)
- Hjerm, M.: National sentiments in Eastern and Western Europe. *Nationalities Papers* **31**(4), 413–429 (2003)
- Hroch, M.: The nation as the cradle of nationalism and patriotism. *Nations Natl.* **26**(1), 5–21 (2020)
- Hu, L., Bentler, P.M.: Cutoff criteria for fit-indexes in covariance structure analysis: Conventional criteria versus new alternatives. *Struct. Equ. Model.* **1**(1), 1–55 (1999)
- Huddy, L., Khatib, N.: American patriotism, national identity and political involvement. *Am J Pol Sci.* **51**(1), 63–77 (2007)
- Huddy, L.: Unifying national identity research: Interdisciplinary perspectives. In: Grimm, J., Huddy, L., Schmidt, P., Seethaler, J. (eds.) *Dynamics of national identity: Media and societal factors of what we are*. Routledge, Abingdon (2016)

- Huddy, L., del Ponte, A., Davies, C.: Nationalism, patriotism and support for the European Union. *Pol Psychol. Online First.* (2021)
- Ignatieff, M.: *Blood & Belonging: Journeys into the New Nationalism.* BBC Books, London (1993)
- Ingram, A.: Constitutional patriotism. *Philosophy & Social. Criticism* **22**(6), 1–18 (1996)
- Karasawa, M.: Patriotism, nationalism and internationalism among Japanese citizens: An Etic- Emic approach. *Pol. Psychol.* **23**(4), 645–666 (2002)
- Kohn, H.: *The Idea of Nationalism.* Macmillan, New York (1944)
- Kosterman, R., Feshbach, S.: Toward a measure of patriotic and nationalistic attitudes. *Pol. Psychol.* **10**(2), 257–274 (1989)
- Kronenberg, V.: *Patriotismus in Deutschland: Perspektiven für eine weltoffene Nation.* VS, Wiesbaden (2013)
- Laborde, C.: From constitutional to civic patriotism. *Br. J. Pol. Sc.* **32**(4), 595–612 (2002)
- Laborde, C., Erez, L.: Cosmopolitan patriotism as a civic ideal. *Am J Pol Sci.* **64**(1), 191–203 (2020)
- Langewiesche, D.: *Nation, Nationalismus. Nationalstaat in Deutschland und Europa.* C.H. Beck, München (2002)
- Latcheva, R.: Cognitive interviewing and factor-analytic techniques: A mixed-method approach to validity of survey items measuring national identity. *Qual Quant.* **45**(6), 1174–1199 (2011)
- Levinson, D.J., Adorno, T.W., Frenkel-Brunswik, E., Sanford, R.N.: *The Authoritarian Personality.* Harper, New York (1950)
- Li, Q., Brewer, M.: What does it mean to be an American? Patriotism, nationalism and American identity after September 11. *Pol. Psychol.* **25**(5), 727–739 (2004)
- Liu, Y., Millsap, R., West, S., Tein, J., Tanka, R., Grimm, K.: Testing measurement invariance in longitudinal data with ordered-categorical measures. *Psychol. Methods* **22**(3), 486–506 (2017)
- MacIntyre, A.: ‘Is patriotism a virtue?’ In R. Beiner (ed.), *Theorizing citizenship.* Albany, NY: State University of New York Press (1995)
- Mader, M.: Stabilität und Wandel der nationalen Identität in der deutschen Bevölkerung. *Kolner Z Soz Sozpsychol.* **68**, 435–456 (2016)
- Meitinger, K.: What does the general national pride item measure? Insights from web probing. *Int J Comp Sociol.* **59**(5), 428–450 (2018)
- Miller, D., Sundas, A.: Testing the national identity argument. *Eur Pol Sci Rev.* **6**(2), 237–259 (2014)
- Miller-Idriss, C., Rothenberg, B.: Ambivalence, pride and shame: Conceptualisations of German nationhood. *Nations Natl.* **18**(1), 132–155 (2012)
- Miller, D.: *On Nationality.* Oxford University Press, Oxford (1995)
- Molina, L., Philipps, N., Sidanius, J.: National and ethnic identity in the face of discrimination: Ethnic minority and majority perspectives. *Cultur. Divers. Ethnic Minor. Psychol.* **21**(2), 225–236 (2015)
- Molina, L., Preddie, J.: Threatening others: National identity and group threats predict immigration policy. *Anal. Soc. Issues Public Policy* **20**(1), 417–442 (2020)
- Mounk, Y.: *The People vs. Democracy: Why Our Freedom Is in Danger and How to Save It.* Harvard University Press, Cambridge, MA (2018)
- Müller, J.-W.: *Verfassungspatriotismus.* Suhrkamp, Berlin (2010)
- Mummendy, A., Klink, A., Brown, R.: Nationalism and patriotism: National identification and out-group rejection. *Br. J. Soc. Psychol.* **40**(2), 159–172 (2001)
- Mylonas, H., Tudor, M.: Nationalism: What we know and what we still need to know. *Annu. Rev. Political Sci.* **24**:109–32 (2021)
- Nathanson, S.: Moderate patriotism. In: Sardoč, M. (ed.) *Handbook of Patriotism*, pp. 141–161. Springer, Switzerland (2020)
- Osborne, D., Milojev, P., Sibley, C.: Authoritarianism and national identity: Examining the longitudinal effects of SDO and RWA on nationalism and patriotism. *Personality and Social Psychological Bulletin.* **43**(8), 1086–1099 (2017)
- Palmowski, J.: Citizenship, identity and community in the German Democratic Republic. In: Eley, G., Palmowski, J. (eds.) *Citizenship and National Identity in Twentieth-Century Germany.* Stanford University Press, Stanford (2008)
- Primoratz, I.: Patriotism. In: Zalta, E.N. (ed.) *Stanford Encyclopedia of Philosophy.* [https:// plato.stanford.edu/archives/sum2017/entries/patriotism/](https://plato.stanford.edu/archives/sum2017/entries/patriotism/) 2017. Accessed 26 January 2021
- Sapountzis, A.: Towards a critical social psychological account of national sentiments: Patriotism and nationalism revisited. *Soc Personal Psychol Compass.* **2**(1), 34–50 (2008)
- Satherly, N., Yogeewaran, K., Osborne, D., Sibley, C.: Differentiating between pure patriots and nationalistic patriots: A model of national attachment profiles and their socio-political attitudes. *Int J Intercult Rel.* **72**(1), 13–24 (2019)

- Schatz, R., Staub, E., Lavine, H.: On the varieties of national attachment: Blind versus constructive patriotism. *Pol. Psychol.* **20**(1), 151–172 (1999)
- Schildkraut, D.: Boundaries of American identity: Evolving understandings of “us.” *Annu. Rev. Pol. Sci.* **17**(1), 441–460 (2014)
- Sidanius, J., Feshbach, S., Levin, S., Pratto, F.: The interface between ethnic and national attachment. Ethnic pluralism or ethnic dominance? *Public Opinion Quarterly* **61**: 102–133 (1997)
- Simonsen, K., Bonikowski, B.: Is civic nationalism necessarily inclusive? Conceptions of nationhood and anti-Muslim attitudes in Europe. *Eur J Pol Res.* **59**(1), 114–136 (2020)
- Smith, E., Mackie, D.: Dynamics of group-based emotions: Insights from intergroup emotions theory. *Emot. Rev.* **7**(4), 349–354 (2015)
- Sternberger, D.: *Schriften: X: Verfassungspatriotismus*. Insel, Frankfurt (1990)
- Tamir, Y.: *Liberal Nationalism*. Princeton University Press, Princeton, NJ (1993)
- Tamir, Y.: *Why Nationalism*. Princeton University Press, Princeton, NJ (2019)
- Tracy, J., Mercadante, E., Witkower, Z., Cheng, J.: The evolution of pride and social hierarchy. *Adv Exp Soc Psychol.* **62**, 51–114 (2020)
- Tracy, J., Robins, R.: The nature of pride. In: Tracy, J., Robins, R., Tangney, J. (eds.) *The Self-Conscious Emotions: Theory and Research*, pp. 263–282. Guildford Press, London (2007)
- van Osch, Y., Zeelenberg, M., Breugelmans, S.: The self and others in the experience of pride. *Cogn. Emot.* **32**(2), 404–413 (2018)
- Wagner, U., Becker, J., Christ, O., Pettigrew, T., Schmidt, P.: A longitudinal test of the relation between German nationalism, patriotism and outgroup derogation. *Eur Sociol Rev.* **28**(5), 319–332 (2012)
- Wessel, J.: Nationen Und Nationalismus. *Neue Polit. Lit.* **64**(1), 81–104 (2019)
- Wimmer, A., Glick Schiller, N.: Methodological nationalism and the study of migration. *Eur J Sociol.* **43**(3), 217–240 (2002)
- Wimmer, A.: *Nation Building: Why Some Countries Come Together While Others Fall Apart*. Princeton University Press, Princeton, NJ (2018)

**Publisher's Note** Springer Nature remains neutral with regard to jurisdictional claims in published maps and institutional affiliations.



# (National) pride and (conceptual) prejudice: critical remarks on the distinction between patriotism and nationalism

Marco Bitschnau & Marlene Mußotter

To cite this article: Marco Bitschnau & Marlene Mußotter (2022): (National) pride and (conceptual) prejudice: critical remarks on the distinction between patriotism and nationalism, Journal of Political Ideologies, DOI: [10.1080/13569317.2022.2096301](https://doi.org/10.1080/13569317.2022.2096301)

To link to this article: <https://doi.org/10.1080/13569317.2022.2096301>



© 2022 The Author(s). Published by Informa UK Limited, trading as Taylor & Francis Group.



Published online: 21 Jul 2022.



Submit your article to this journal [↗](#)



Article views: 1526



View related articles [↗](#)



View Crossmark data [↗](#)



Citing articles: 1 View citing articles [↗](#)



## (National) pride and (conceptual) prejudice: critical remarks on the distinction between patriotism and nationalism

Marco Bitschnau <sup>a</sup> and Marlene Mußotter <sup>b</sup>

<sup>a</sup>Swiss Forum for Migration and Population Studies, University of Neuchâtel, Neuchâtel, Switzerland;

<sup>b</sup>Professorship of Methods of Empirical Social Research, University of Passau, Passau, Germany

### ABSTRACT

Patriotism and nationalism are typically conceptualized as two distinct if not conflicting forms of national attachment. Carrying a substantial normative dimension, the former is often linked to an enlightened sense of community that takes pride in the commitment to democratic values, whereas the latter is understood as an exclusionary and uncritical attachment to the nation. It is this dichotomy and the categorical assumptions at its core which this article subjects to critical appraisal largely missing from the debate. We first (a) address the confusion that comes from constructing national attachment as fixed and dualistic. Then, we (b) highlight the lack of contextual awareness in empirical research that employs scales and items regardless of geographical or temporal peculiarities. Finally, we (c) cast light on the implications entailed, in particular, the legitimacy provided to the civic ideal of a good and reasonable patriotism.

### Introduction

Patriotism and nationalism are strange terms. On the one hand, we are steadily confronted with them – be it that we are told about our patriotic duty to stay at home and avoid infecting others with COVID-19, or that we read about a ‘rise of nationalism’<sup>1</sup> that appears to sweep the planet. On the other hand, they often remain elusive. Just like the protagonist in Robert A. Heinlein’s classic *Stranger in a Strange Land*, they do not suffer from a lack of attention or interest but from a lack of clarity concerning their true nature. Not even the umbrella term under which to subsume them is clear: While some have proposed *national pride*,<sup>2</sup> others prefer *national attitude*,<sup>3</sup> *national attachment*<sup>4</sup> or *national identity*.<sup>5</sup> Others again describe the situation as even more diffuse, with ‘[n]ationalism, national pride, and patriotism [being used as] synonyms for national identity’.<sup>6</sup> A rather odd assessment, because, surely, there must be a difference between an identity and an emotion such as pride.<sup>7</sup> And surely there is more to both.

Yet, zooming in on both concepts adds to our confusion rather than resolving it. We soon find that there is not only a wide range of possibilities to subsume but also to subdivide patriotism and nationalism *iterum atque iterum*. Regarding the former, researchers have contraposed, inter alia, *military* to *civic patriotism*;<sup>8</sup> *genuine* to *pseudo-patriotism*;<sup>9</sup> *constructive* to *blind patriotism*<sup>10</sup> and *extreme patriotism* to *moderate*

**CONTACT** Marco Bitschnau  [marco.bitschnau@unine.ch](mailto:marco.bitschnau@unine.ch)

© 2022 The Author(s). Published by Informa UK Limited, trading as Taylor & Francis Group.

This is an Open Access article distributed under the terms of the Creative Commons Attribution-NonCommercial-NoDerivatives License (<http://creativecommons.org/licenses/by-nc-nd/4.0/>), which permits non-commercial re-use, distribution, and reproduction in any medium, provided the original work is properly cited, and is not altered, transformed, or built upon in any way.

*patriotism, robust patriotism, deflated patriotism or ethical patriotism*.<sup>11</sup> With regard to the latter, the distinction between *ethnic* and *civic nationalism*<sup>12</sup> has been highly influential for several decades; not to mention Tamir's *liberal nationalism*<sup>13</sup> or the *hegemonic, particularistic and marginal nationalisms* that Wirth once observed gaining traction in prewar Europe.<sup>14</sup> Already back then, he complained about a truly 'enormous literature' on the issue that 'has such wide ramifications and comprises such a variety and complexity of phenomena that its scientific study has appeared forbidding'.<sup>15</sup>

Nevertheless, in this article, we take no interest in the differences *between the various notions* of patriotism and nationalism. It suffices to say that there are (too) many of them. Instead, we want to devote our attention to the demarcation line *between the concepts as such*. In common parlance, in political rhetoric from Madrid to Muscat, but also in empirical scholarship,<sup>16</sup> this line is almost always constituted by a dichotomic presupposition that approves of patriotism but not of nationalism. Patriotism is often conceived in a Habermasian sense,<sup>17</sup> that is, as neither idealizing one's nation nor condoning its past transgressions but '[evaluating it] from the basis of a critical conscience'.<sup>18</sup> Good patriots, so the argument goes, support their country in a rational and reflective way, thoroughly rejecting all anti-democratic or anti-humanist inclinations. Nationalism, by contrast, is regarded as an ignorant and aggressive ideology that rests on notions of superiority and competition. We argue that both this dichotomy and its empirical manifestations engender numerous essential shortcomings.<sup>19</sup> To map them, we present a threefold critique: first of the arbitrariness and coarseness of the concepts, then of the lack of context in empirical studies operationalizing them, and lastly of the normative consequences and logical inconsistencies entailed. Of course, due to the constraints of a journal article, this critique is far from exhaustive. We nonetheless hope that our plea for more rigorous and conscious scholarship can be of value for the future analysis of nationalism.

## A threefold critique

### (1) *Blurred concepts*

Among the many problems regarding patriotism and nationalism, the most obvious stems from what we have already hinted at – namely, which in (mostly empirical) research, both concepts are often conceptualized in a dichotomic way that leaves very little room for nuance and subtlety. This is problematic for at least two reasons. First, because distinguishing between the supposedly innocent attachment to one's own nation (patriotism) and aggressive feelings of superiority towards other nations (nationalism) is not as obvious as it might appear.<sup>20</sup> In fact, a growing strand of literature suggests a considerable correlation between both<sup>21</sup> and contests the doctrine of a binary opposition. Second, because conducting such operationalizations<sup>22</sup> has 'spawned a variety of scales and concepts' that is both hard to assess and inherently 'characterized by conflicting and contradictory terminology and measurement'.<sup>23</sup> Instead of a reliable gold standard, there is only a confusing *mélange* of approaches that give rise to numerous imprecisions and misunderstandings.

For instance, both patriotism and nationalism are often conflated with related but fundamentally distinct concepts. Patriotism can be difficult to distinguish from support for democracy,<sup>24</sup> most notably in the case of items such as the *International Social Survey Programme*'s (ISSP) 'How proud are you of the way democracy works?'<sup>25</sup> At times, it may even seem as though it is only a proxy for pro-democratic attitudes within a largely unspecified national context. Nationalism, in turn, is frequently equated with nativism, protectionism, authoritarianism, and, most prominently, (right-wing) populism.<sup>26</sup> For both are 'intersecting and mutually implicated though not fully overlapping'<sup>27</sup> phenomena that have 'elective affinities and often – but not always – coincide',<sup>28</sup> there is an inherent risk to be led astray and consider nationalist politicians as populists or populist politicians as nationalists, although neither is a given.<sup>29</sup> The same also applies to chauvinism, an ideology that is sometimes defined as congruent with nationalism, sometimes as different but sharing certain features, and sometimes as completely detached. There are cases in which chauvinism (but not nationalism) has been associated with feelings of superiority, and others in which the same survey item has been utilized to prove either. To give but one example, both *better world* and *better country* items<sup>30</sup> indicate chauvinism for Feinstein and Bonikowski, Mader, and Raijman *et al.* but nationalism for Ariely and Davidov.<sup>31</sup>

While these inconsistencies are important, there is yet another layer of confusion that originates in the incongruity between the terminology used in scholarly discourse and the self-description of those this discourse is about. In fact, most political parties and individuals described as nationalist would probably reject the label because of its negative connotations and insist on being called patriots instead.<sup>32</sup> This is certainly true for most supporters of Europe's far right but also for many of the protesters who stormed the US Capitol on 6 January 2021 after having been told to 'peacefully and patriotically make [their] voices heard'.<sup>33</sup> And while these 'nationalists' regard themselves as patriots, many 'patriots' may consider themselves nothing but good democrats who remain unfazed by the more irrational and essentialist undercurrents of their nation. It may appear like a semantic question first and foremost – but in conjunction with all the vague boundaries outlined earlier, this manifest gap between self-image and public image corroborates that the distinction between patriotism and nationalism is blurred rather than sharp.

## **(2) Missing contexts**

On an empirical level, these conceptual difficulties are complemented by a widespread lack of acknowledging the context in which research on patriotism and nationalism is conducted. As context, we define in this article matters of *geography* and *time*; both are of supreme importance to the validity of any research design. We argue that although most empirical studies may have been carried out in consciousness of their contextual embeddedness, there always remains the risk of methodological decontextualization. Put differently, what has proved helpful in measuring concepts in one spatiotemporal context can be deficient or even counterproductive in another.

The limits of geography are perhaps more obvious, for it is often more intuitive that notions of attachment differ quantitatively and qualitatively across specific national contexts.<sup>34</sup> In Japan, they may be linked to religio-cultural traditions, in the US to civil liberties and in Germany to the challenges of *Vergangenheitsbewältigung* (working-off-

the-past).<sup>35</sup> Some cases are even more complex since they lack clarity about the object of attachment. Take Austria, for instance, where some ‘nationalists’ reject the concept of Austrian uniqueness because they regard themselves as Germans and their country as part of an indivisible German nation. This once popular sentiment receded after the Second World War but regained some popularity by the mid-1950s; not even half of the respondents (49%) to a 1956 Fessel institute poll agreed that Austria is a real nation, with almost as many expressing *deutschnationalist* views instead.<sup>36</sup> Although these views may again be marginalized today,<sup>37</sup> they still hint at a crucial contextual element that too often goes unnoticed in comparative scholarship. Of course, there are also examples of particularities that have found more consideration. One is the distinction between emic and etic forms of attachment introduced in Karasawa’s study of patriotism and nationalism in Japan.<sup>38</sup> Items such as ‘It is a desirable attitude for a Japanese citizen to worship at shrines and temples’<sup>39</sup> are clearly context-related and set themselves apart from the earlier work of Sakano<sup>40</sup> (who merely translated the scales of Kosterman and Feshbach<sup>41</sup> into Japanese).

They nonetheless are the exception rather than the rule, and, at times, even the most thoughtful appraisal of the national context may be insufficient in light of deeper subnational divisions.<sup>42</sup> In Germany, not only the country’s National Socialist past must be considered but also its East–West divide and the divergent notions of nation and state that have historically emanated from it.<sup>43</sup> In Belgium (Flanders) and Spain (Catalonia), there are powerful independence movements that may likewise affect how people position themselves with regard to their nation. Even more illustrative is the case of the United Kingdom, where the most dominant country, England, has appropriated the common signifier of *Britishness* in such a way that significant segments of the population consider it tantamount to *Englishness*. Yet most Scots would never equate them and see a marked difference between this imposed kind of *Britishness* and their own quasi-authentic *Scottishness*.<sup>44</sup> Last but not least, research from Israel, a state engaged in battles of identity and belonging since its foundation, shows that only little more than half of the Palestinian citizenry (53%) label themselves *Israelis*; a number that suggests a major disconnect between citizenship and national attachment.<sup>45</sup>

Besides geography, time is another major constraint to be aware of – manifestations of national attachment not only differ from country to country but are also subject to the eternal flow and tide of history. What is a source of collective pride today may be ridiculed or ignored tomorrow, and what symbolizes national unity in the present may have aroused little interest in the past. This makes it difficult to assess patriotism and nationalism in their current form by employing items, scales, and categories from previous decades, at least if done without any systematic re-evaluation. To give an illustrative example, one of the most interesting nationalism items (Nat\*-3) of Blank and Schmidt is about sports: ‘German success in sports makes me feel . . . (1, not proud; 5, very proud)’.<sup>46</sup> It obviously rests on the assumption that pride in the nation’s athletic achievements is not only crucial for the creation of a common identity but also linked to ‘feelings of superiority theoretically associated with nationalism’.<sup>47</sup> In the specific case of Germany, one would probably think about soccer when answering this item.<sup>48</sup> This is, after all, a country where the likes of Franz Beckenbauer and Fritz Walter are held in as high esteem as Hermann Hesse and Heinrich Böll; a country where *König Fußball* (‘King Soccer’) is known to reign supreme and was integral to the development of a positive

German postwar identity. Consider only the so-called *Miracle of Berne*<sup>49</sup> which was not only a major media event of the 1950s but also provided a powerful founding myth for the young republic.<sup>50</sup> By identifying the national soccer team with ‘German virtues’ such as ‘discipline, competitive strength and a never-slackening will’,<sup>51</sup> the connection between sports and the nation was reinforced and the Germanness of those wearing the *Adler auf der Brust* (‘Eagle on the chest’) underscored. Culturally Christian and homogeneous, they embodied a norm any German nationalist could easily relate to.

But times have changed and so has the public image of the *Mannschaft*. No longer does it stand for the imagined homogeneity of the past but rather for a vibrant, multicultural society in which immigrants from everywhere have found a new home.<sup>52</sup> From Poland-born Lukas Podolski and Miroslav Klose who spearheaded this shift with their electrifying performances during the 2006 FIFA World Cup (known in Germany as *Sommermärchen*)<sup>53</sup> to present star players like Antonio Rüdiger (Sierra Leonean mother) and Leroy Sané (Senegalese father): all recent successes of the team were built on an immigrant foundation, which once provoked the then-chairman of the far-right *Alternative für Deutschland*, Alexander Gauland, to explicitly exclude soccer from the sphere of the national. ‘It is no question of national identity any longer [. . .] The German or the English national teams have ceased being German or English in a traditional sense some time ago’,<sup>54</sup> he declared in a 2016 interview with *Spiegel*. Many diehard nationalists think along very similar lines. They see the growing ‘de-ethnicization of the nation’<sup>55</sup> in professional sports as threatening traditional modes of belonging and misrepresenting the real identity of their nation. Taking pride in such a blatantly non-national national team? Certainly not. Nativist outlets like *PI-News*<sup>56</sup> have consequently responded with scorn to what they see as just another instrument of *Umvolkungspropaganda*,<sup>57</sup> praising the ‘authentic character’ of teams like Hungary or Russia instead. In other words, there is no reason to believe that expressing pride in Germany’s multicultural national team should be seen as a serious indicator of nationalist sentiment today. The German squad that won the 1990 FIFA World Cup may have been favoured by nationalists and the general population alike; the multicultural, multiethnic, BLM-supporting,<sup>58</sup> and highly diverse squad of 2022 is not.<sup>59</sup>

One could further extend the scope of this argument because its wording (‘German success . . .’) does not necessarily confine ‘success’ to the national team alone. Instead, it may be understood as including club soccer as well, which is an area where the gap between national entrenchment and squad composition is particularly pronounced. Responding to the demands of internationalization and catering to a global audience,<sup>60</sup> Europe’s soccer clubs have long started to compete for talent from around the world,<sup>61</sup> weakening the traditional nexus between player nationality and team identity. When Bayern Munich beat Paris Saint-Germain in the final of the 2020 UEFA Champions League, the winning goal was scored by a Frenchman of Caribbean descent: Kingsley Coman. It remains an open question whether the French, the Germans, or simply all Bayern Munich supporters should be proud of his magnificent header. Casting sports aside, the temporal context is also relevant for numerous other items, including, in the case of Blank and Schmidt, Nat-5 (‘Due to Germany’s economic superiority . . .’) and Pat-2 (‘Germany’s social security system makes me . . .’).<sup>62</sup> The former because claims of economic superiority are inevitably dependent on momentary perception, and the latter because fierce criticism of

Germany's social security system has been rather common in recent years. Particularly, in view of Gerhard Schröder's controversial Hartz IV reforms,<sup>63</sup> open expressions of 'welfare pride' may not seem patriotic but strange and cynical to many Germans (not that those calling themselves patriots are likely to care about such issues in the first place).

### (3) *Problematic consequences*

These conceptual and contextual shortcomings also entail various consequences that go beyond the boundaries of empirical research and can only be addressed in a cursory manner here. First, there are obvious problems that stem directly from the normatively charged distinction between constructive patriotism and regressive nationalism. By praising patriotism as enlightened and promoting 'civic virtue'<sup>64</sup> while condemning nationalism as a dangerous and irrational deviation, many scholars make no pretence of which they view as morally superior. Some even argue that embracing a *healthy* patriotism fulfils a crucial preventive function since it protects society against the perils of violence and social erosion.<sup>65</sup> Although this patriotism-cohesion nexus has been called into question by more critical approaches,<sup>66</sup> it still affects the public perception of patriotism and nationalism greatly.<sup>67</sup> Presidents and senior politicians of different ideological leanings, from Germany's Frank-Walter Steinmeier to South Africa's Cyril Ramaphosa, do not grow tired of praising the unifying powers of patriotism incessantly, whereas an open commitment to nationalism is even rejected by those usually identified as nationalists.<sup>68</sup>

Of course, not all researchers subscribe to clear-cut distinctions and are blind to the normativity produced by casting patriotism and nationalism as moral opposites. Nor do they all sing endless paeans to the virtue of the former; to insinuate such would be as fallacious as denying normative imbalances altogether. Keller, for instance, posits that 'patriotism is absolutely unique in being connected, by its nature, to a disposition toward bad faith'<sup>69</sup> – and that this verdict is not limited to the 'unthinking, jingoistic forms of patriotism that are so easy to belittle' but likewise applies to 'patriotic dissidents, and to those whose patriotism is not really political in nature'.<sup>70</sup> However, the influence of these approaches is limited and rarely stretches beyond the boundaries of political philosophy. In empirical (i.e. most comparative and socio-psychological) scholarship, the 'good patriotism/bad nationalism' dichotomy remains widely accepted, as if it were a higher truth in need of perpetual confirmation. Hanson and O'Dwyer even speak of a 'liberal academic bias'<sup>71</sup> that prompts many researchers to link nationalism to suprematism,<sup>72</sup> irrespective of the fact that patriots may believe in the superiority of their communities as well: 'emotional' patriots by attaching a greater subjective value to them (Keller's 'rolling green fields and friendly farmers')<sup>73</sup> and Habermasian patriots because of their democratic nature. One may even ponder whether they are but *idealizers* of another type. While nationalists are accused of idealizing the nation and lacking the critical consciousness that reason prescribes, these patriots may be considered cast in the same mould – only that they idealize liberal democracy and its central features. As they depart from the conviction that there is no higher patriotic calling than defending humanist and democratic values,<sup>74</sup> they absolutize these values just like nationalists absolutize the greatness and glory of their nation. Understood in this way, the patriotic position would be neither



value-free nor particularly enlightened. Engaging with the various flaws of one's nation against the backdrop of a specific script is hardly proof of admirable consciousness if the script itself goes unquestioned.

Apart from this tendency to approach patriotism and nationalism in a normatively biased way, one may also point at logical inconsistencies that arise from the operationalization of the 'good patriotism/bad nationalism' dichotomy. For instance, if we (a) define patriotism as based on the 'loyalty to the universal principles and procedures of liberal democracy'<sup>75</sup> and (b) deduce that all those disloyal to these principles and procedures cannot be considered patriots, then we will be unable to find patriots in autocracies or countries governed by military juntas.<sup>76</sup> Neither will we find them among people who do not believe in the innate superiority of democracy or live their lives in ignorance of it; they may be nationalists, but patriotism remains, by definition, out of reach for them. While this may appear like a thought experiment, it has a foundation in empirical research: As mentioned before, many cross-national studies such as those of Ariely and Davidov use items such as 'How proud are you of the way democracy works?'<sup>77</sup> – implying that their respondents view the political system they live in as democratic and regard democracy as something to be proud of. Both assumptions seem premature and ignorant of those who may consider it an impractical or otherwise deficient form of government instead.<sup>78</sup> And, *nota bene*, a form of government that does not impede their patriotic commitment in the slightest.

Similar criticism may be raised against supposedly 'patriotic' items that aim at secondary democratic elements such as public welfare. We have already remarked that Blank and Schmidt ask for pride in the social security system,<sup>79</sup> which, again, necessitates both the existence of such a system and a pro-welfare consensus in society (i.e. a general agreement that it is positive and hence something *to be proud of*).<sup>80</sup> As a result, only those who live in countries in which these conditions are fulfilled can answer this question in the affirmative and score points on the patriotism scale. In contrast, citizens of countries without a welfare state are structurally incapable of proving their patriotism as this would require them to express pride in a redistributive mechanism they do not have or want. This leads to the slightly paradoxical situation that, if we take the definition of patriotism as *critical support of the nation based on humanist and democratic values* at face value, most of the world's population would encounter severe difficulties in their pursuit of being recognized as patriots. Instead, they would be conceptually sidelined by those who only regard democracies as legitimate and only democrats as patriotic.<sup>81</sup>

In line with this argument, one may also question the link between civic commitment and patriotism that is abundant in the literature.<sup>82</sup> The idea here is that patriots feel a strong obligation to 'move their country in a positive direction',<sup>83</sup> whereas nationalists prefer to simply revel in their resentment. Again, this is unconvincing since there is no good *a priori* reason to consider nationalists less engaged in moving their country forward. They may be at odds with 'patriots', academics, and the general population about the direction and the right means to move towards it – but this alone does not mean much. Approaching the subject with our preconceived idea of the social good may here blind us to the fact that nationalism has its own notion of commitment. We may not

approve of this notion and even repudiate it, but the attempt to resurrect the imagined glory of the past is not necessarily less *positive* than the further advancement of democratic standards. It is ultimately just a matter of perspective and preference.

## Concluding remarks

There is no doubt that having a grasp of both patriotism and nationalism is essential to approach the complex relationship between the phantasmal behemoth that is the nation and all those who draw their identity from it. Both concepts have been exhaustively examined in theoretical treatises and operationalized in empirical studies, yet their supposed dichotomy continues to raise more questions than it answers. In this contribution, we have presented three elements of critique that we consider particularly relevant, namely, the conceptual fuzziness of patriotism and nationalism, the neglect of time and space as contextual factors, and the consequences that arise from adopting a normatively charged perspective. Table 1 illustrates the concerns that emanate from this critique as well as some of the questions they bring forth.

**Table 1.** Elements of our critique.

	General (issue-related)	Specific (case-related)
<b>Concepts</b>	Demarcative I: Can PAT and NAT be distinguished in a meaningful and coherent way? Do they help us to understand national attachment?*	
	Traversal: Do problems arise from the difference between self-identification and ascription?	Demarcative II: Do existing survey items measure the right concept?
<b>Contexts</b>		Spatial: Are the selected items relevant for this country? Temporal: Are the selected items already outdated?
<b>Consequences</b>	Normative: How to avoid 'good PAT – bad NAT'?	Logical: How to deal with PAT in non-democratic societies?

\*Or, as remarked in the introduction, *national attitude*, *national identity*, *national pride*, etc.

Given these elements, we want to close with three remarks aimed at improving future research. First, given the 'conceptual stretching, i.e. the vague, amorphous conceptualizations<sup>84</sup> of patriotism and nationalism, we plea for more clarity in utilizing both terms. This applies in particular to empirical scholarship where it is often unclear if (and why) an item indicates patriotism, nationalism, or both. Criteria like concept differentiation and field utility could be valuable aids in this regard and deserve renewed attention.<sup>85</sup> Second, it must be brought to mind that even the most clearly defined concepts are only of limited use if they fall prey to contextual confusion. There is no doubt that the development of new measurement instruments is an important task and that cross-country research can greatly enrich our knowledge by allowing us to compare its different manifestations of national attachment. But if we want to obtain valid findings, it is also indispensable to increase our awareness of the context of each case and the limitations of cross-national surveys whose '[fundamental utility] derives from [their] generality<sup>86</sup> rather than their attention to detail. Ignoring contextual nuances may be less problematic in empirical studies that only compare a small number of countries from the same world region; but in case of transcontinental or even global comparisons,



turning a blind eye to them means disregarding reality in order to accommodate methodology. Third and last, since patriotism and nationalism are tainted by normative biases, the role of research in conferring doubtful legitimacy on patriotism while marginalizing critical views needs to be more thoroughly analysed and reflected.

## Notes

1. For a detailed discussion on this, see F. Bieber, 'Is Nationalism on the Rise? Assessing Global Trends', *Ethnopolitics*, 17 (2018), pp. 519–540.
2. E.g. R. J. P. De Figueiredo and Z. Elkins, 'Are Patriots Bigots? An Inquiry into the Vices of In-Group Pride', *American Journal of Political Science*, 47 (2003), pp. 171–188; S. Ha and S. I. Jang, 'National Identity, National Pride, and Happiness: The Case of South Korea', *Social Indicators Research*, 121 (2015), pp. 471–482; G. Ariely, 'The nexus between globalization and ethnic identity: A view from below', *Ethnicities*, 19 (2019), pp. 763–783.
3. E.g. H. Dekker, D. Malová and S. Hoogendoorn, 'Nationalism and Its Explanations', *Political Psychology*, 24 (2003), pp. 345–376; S. Nathanson, 'Moderate Patriotism', in M. Sardoč (Ed) *Handbook of Patriotism* (Cham: Springer, 2020), pp. 141–161.
4. E.g. N. Satherley, K. Yogeewaran, D. Osborne and C. Sibley, 'Differentiating between pure patriots and nationalistic patriots: A model of national attachment profiles and their socio-political attitudes', *International Journal of Intercultural Relations*, 72 (2019), pp. 13–24; L. Huddy, A. del Ponte and C. Davies, 'Nationalism, Patriotism, and Support for the European Union', *Political Psychology*, 42 (2021), pp. 995–1017.
5. E.g. T. Blank and P. Schmidt, 'National Identity in a United Germany: Nationalism or Patriotism? An Empirical Test with Representative Data', *Political Psychology*, 24 (2003), pp. 289–312; K. Hanson and E. O'Dwyer, 'Patriotism and Nationalism, Left and Right: A Q-Methodology Study of American National Identity', *Political Psychology*, 40 (2019), pp. 777–795; U. Wagner, J. Becker, O. Christ, T. Pettigrew and P. Schmidt, 'A Longitudinal Test of the Relation between German Nationalism, Patriotism, and Outgroup Derogation', *European Sociological Review*, 28 (2012), pp. 319–332. A comprehensive critique of Blank and Schmidt's use of national identity can be found in M. Mäs, *Regionalismus, Nationalismus und Fremdenfeindlichkeit* (Wiesbaden: Springer VS, 2005).
6. N. Kersting, 'Sport and National Identity: A Comparison of the 2006 and 2010 FIFA World Cups', *Politikon: South African Journal of Political Studies*, 34 (2007), pp. 277–293 (p. 279).
7. A general critique of using 'national pride' as a proxy for national identity has been made in K. Meitinger, 'What does the general national pride item measure? Insights from web probing', *International Journal of Comparative Sociology*, 59 (2018), pp. 428–450; M. Mußotter, 'We do not measure what we aim to measure: Testing three measurement models for nationalism and patriotism', *Quality & Quantity*, online first (2021), pp. 1–21. One may also note that pride has an inherently competitive component: even from a pro-dichotomy position, using pride items to measure patriotism appears thus deficient. See for details H.-A. Heinrich, 'Emotions toward the nation', in S. Salzborn, E. Davidov and J. Reinecke (Eds) *Methods, Theories, and Empirical Applications in the Social Sciences: Festschrift for Peter Schmidt* (Wiesbaden: Springer VS, 2012), pp. 227–234.
8. M. Curti, *The Roots of American Loyalty* (New York: Columbia University Press, 1946).
9. T. Adorno, E. Frenkel-Brunswik, D. Levinson and N. Sanford, *The Authoritarian Personality* (New York: Harper, 1950).
10. R. Schatz and E. Staub, 'Manifestations of blind and constructive patriotism. Personality correlates and individual-group relations', in D. Bar-Tal and E. Staub (Eds) *Patriotism: In The Lives of Individuals and Nations* (Chicago: Nelson-Hall, 1997), pp. 229–245; R. Schatz, E. Staub and H. Lavine, 'On the Varieties of National Attachment: Blind Versus Constructive Patriotism', *Political Psychology*, 20 (1999), pp. 151–174.

11. I. Primoratz, 'Patriotism', in E. Zalta (Ed) *Stanford Encyclopedia of Philosophy*, 2017, <https://plato.stanford.edu/archives/sum2017/entries/patriotism/>. For the first two types, see also S. Nathanson, 'Moderate Patriotism', *op. cit.*, Ref. 3.
12. E.g. M. Ignatieff, *Blood and Belonging: Journeys into the New Nationalism* (London: BBC Books, 1993).
13. Y. Tamir, *Liberal Nationalism* (Princeton: Princeton University Press, 1993); see also Y. Tamir, *Why Nationalism?* (Princeton: Princeton University Press, 2019); G. Gustavsson and D. Miller, *Liberal Nationalism and Its Critics: Normative and Empirical Questions* (Oxford: Oxford University Press, 2020).
14. L. Wirth, 'Types of Nationalism', *American Journal of Sociology*, 41 (1936), pp. 723–737.
15. Wirth, *ibid.*, p. 723.
16. E.g. T. Blank and P. Schmidt, 'National Identity in a United Germany', *op. cit.*, Ref. 5; E. Davidov, 'Measurement Equivalence of Nationalism and Constructive Patriotism in the ISSP: 34 Countries in a Comparative Perspective', *Political Analysis*, 17 (2009), pp. 64–82; H.-A. Heinrich, 'Causal Relationship or Not? Nationalism, Patriotism, and Anti-Immigration Attitudes in Germany', *Sociology of Race and Ethnicity*, 6 (2020), pp. 76–91.
17. J. Habermas, 'Staatsbürgerschaft und nationale Identität', in J. Habermas (Ed) *Faktizität und Geltung. Beiträge zur Diskurstheorie des Rechts und des demokratischen Rechtsstaats* (Frankfurt am Main: Suhrkamp, 1992), pp. 632–659; see also C. Cronin, 'Democracy and Collective Identity: In Defence of Constitutional Patriotism', *European Journal of Philosophy*, 11 (2003), pp. 1–28; A. Ingram, 'Constitutional patriotism', *Philosophy & Social Criticism*, 22 (1996), pp. 1–18; J.-W. Müller, *Verfassungspatriotismus* (Berlin: Suhrkamp, 2010).
18. Blank and Schmidt, 'National Identity in a United Germany', *op. cit.*, Ref. 5, p. 292.
19. An earlier critique of the distinction between *good and bad nationalisms* in different forms (e.g. liberal/illiberal; ethnic/civic) can be found in P. Spencer and H. Wollman, 'Good and bad nationalisms: A critique of dualism', *Journal of Political Ideologies*, 3 (1998), pp. 255–274.
20. E.g. B. Bonikowski, 'Nationalism in Settled Times', *Annual Review of Sociology*, 42 (2016), pp. 427–449; M. Canovan also highlights the blurred lines between both concepts, reminding us that the 'French republican version of nationalism has a good deal in common with [German] constitutional patriotism'. Canovan, 'Patriotism is Not Enough', *British Journal of Political Science*, 30 (2000), pp. 413–432 (p. 421).
21. E.g. R. Latcheva, 'Nationalism versus Patriotism, or the Floating Border? National Identification and Ethnic Exclusion in Post-communist Bulgaria', *Journal of Comparative Research in Anthropology and Sociology*, 29 (2010), pp. 187–215; Satherley, Yogeeswaran, Osborne and Sibley, 'Differentiating between pure patriots and nationalistic patriots', *op. cit.*, Ref. 4; Huddy, del Ponte and Davies, 'Nationalism, Patriotism, and Support for the European Union', *op. cit.*, Ref. 4.
22. E.g. G. Ariely, 'Constitutional patriotism, liberal nationalism and membership in the nation: An empirical assessment', *Acta Politica* 43 (2011), pp. 294–319; G. Ariely, 'Globalisation and the decline of national identity? An exploration across sixty-three countries', *Nations and Nationalism*, 18 (2012), pp. 461–482; Davidov, 'Measurement Equivalence of Nationalism and Constructive Patriotism in the ISSP', *op. cit.*, Ref. 16; R. Kosterman and S. Feshbach, 'Toward a Measure of Patriotic and Nationalistic Attitudes', *Political Psychology*, 10 (1989), pp. 257–274; Q. Li and M. B. Brewer, 'What Does It Mean to Be an American? Patriotism, Nationalism, and American Identity After 9/11', *Political Psychology*, 25 (2004), pp. 727–739.
23. L. Huddy, 'Unifying national identity research: Interdisciplinary perspectives', in J. Grimm, L. Huddy, P. Schmidt and J. Seethaler (Eds) *Dynamics of National Identity: Media and societal factors of what we are* (Abingdon: Routledge, 2016), pp. 9–24 (p. 18).
24. E.g. L. Huddy and N. Khatib, 'American Patriotism, National Identity, and Political Involvement', *American Journal of Political Science*, 51 (2007), pp. 63–77.
25. E.g. Ariely, 'Constitutional patriotism, liberal nationalism and membership in the nation', *op. cit.*, Ref. 22; Davidov, 'Measurement Equivalence of Nationalism and Constructive Patriotism in the ISSP', *op. cit.*, Ref. 16; R. Rajzman, E. Davidov, P. Schmidt and

- O. Hochman, 'What Does a Nation Owe Non-Citizens? National Attachment, Perception of Threat and Attitudes towards Granting Citizenship Rights in a Comparative Perspective', *International Journal of Comparative Sociology*, 49 (2008), pp. 195–220.
26. For the difference, see e.g. B. Bonikowski, D. Halikiopoulou, E. Kaufmann and M. Rooduijn, 'Populism and nationalism in a comparative perspective: a scholarly exchange', *Nations and Nationalism*, 25 (2019), pp. 58–91; R. Brubaker, 'Populism and nationalism', *Nations and Nationalism*, 26 (2020), pp. 44–66; B. De Cleen, 'Populism and nationalism', in C. Rovira Kaltwasser, P. Taggart, P. Ostiguy and P. Ochoa Espejo (Eds) *Oxford Handbook of Populism* (Oxford: Oxford University Press, 2017), pp. 342–362.
  27. Brubaker, 'Populism and nationalism', *op. cit.*, Ref. 26, p. 45.
  28. Bonikowski, Halikiopoulou, Kaufmann and Rooduijn, 'Populism and nationalism in a comparative perspective', *op. cit.*, Ref. 26, p. 60.
  29. Interestingly, hardly anything has been written about the relationship between populism and patriotism, although the latter is the concept most populists seem to refer to. Famous examples include the *PEGIDA* (Patriotic European against the Islamization of the Occident) movement as well as Florian Philippot's right-wing party *Les Patriotes*. One notable exception (dealing with the post-9/11 context in the US) is R. Curren, 'Patriotism, Populism, and Reactionary Politics since 9.11', in M. Sardoč (Ed) *Handbook of Patriotism* (Cham: Springer, 2020), pp. 741–761.
  30. Items such as 'The world would be a better place, if people from other countries were more like [my country]' and 'Generally, [my country] is better than most other countries'.
  31. E.g. Arieli, 'Globalisation and the decline of national identity?', *op. cit.*, Ref. 22; Davidov, 'Measurement Equivalence of Nationalism and Constructive Patriotism in the ISSP', *op. cit.*, Ref. 16; Y. Feinstein and B. Bonikowski, 'Nationalist narratives and anti-Immigrant attitudes: exceptionalism and collective victimhood in contemporary Israel', *Journal of Ethnic and Migration Studies*, 47 (2021), pp. 741–761; M. Mader, 'Stabilität und Wandel der nationalen Identität in der deutschen Bevölkerung', *Kölner Zeitschrift für Soziologie und Sozialpsychologie*, 68 (2016), pp. 435–456; Raijman, Davidov, Schmidt and Hochman, 'What Does a Nation Owe Non-Citizens?', *op. cit.*, Ref. 25.
  32. Studying exposure to the US flag, Kimmelmeier and Winter showed that even this symbol of civic patriotism is closely linked to nationalist sentiment. See M. Kimmelmeier and D. G. Winter, 'Sowing Patriotism, But Reaping Nationalism? Consequences of Exposure to the American Flag', *Political Psychology*, 29 (2008), pp. 859–879.
  33. D. Trump, as cited in Associated Press, 'Transcript of Trump's speech at rally before US Capitol riot', 14 January 2021, <https://apnews.com/article/election-2020-joe-biden-donald-trump-capitol-siege-media-e79eb5164613d6718e9f4502eb471f27>.
  34. H. Bergsieker, 'National Pride and Prejudice: The Case of Germany', in I. Karolewski and A. Suszycki (Eds) *Multiplicity of Nationalism in Contemporary Europe* (Lanham: Lexington Books, 2010), pp. 151–173.
  35. A term related to 'coming to terms' with the historical experience of National Socialist rule and state crimes. The translation as *working-off-the-past* is taken from S. Neiman, *Learning from the Germans* (New York: Farrar, Straus and Giroux, 2019).
  36. E. Bruckmüller, 'Die Entwicklung des Österreichbewusstseins', in R. Kriechbaumer (Ed) *Österreichische Nationalgeschichte nach 1945. Die Spiegel der Erinnerung: Die Sicht von innen. Österreichische Nationalgeschichte, Band 1* (Wien: Böhlau, 1998), pp. 369–396.
  37. The far-right *Freiheitliche Partei Österreichs* (FPÖ) and its predecessor, the *Verband der Unabhängigen* (VdU) have traditionally advocated this position, with the VdU's *Ausser Programm* describing Austria as a 'German state. Its politics shall serve the entire German people and must not be aimed against other German states'. This has gradually changed since the mid-1990s, even though influential FPÖ politicians such as Andreas Mölzer continued to beat the drum for their notion of German unity. See e.g. S. Frölich-Steffen, 'Die Identitätspolitik der FPÖ: Vom Deutschnationalismus zum Österreich-Patriotismus', *Österreichische Zeitschrift für Politikwissenschaften*, 33 (2004), pp. 281–295; D. Morrow,

- ‘Jörg Haider and the new FPÖ: beyond the democratic pale?’, in P. Hainsworth (Ed) *The Politics of the Extreme Right. From the Margins to the Mainstream* (London and New York: Pinter, 2000), pp. 33–63.
38. M. Karasawa, ‘Patriotism, Nationalism, and Internationalism Among Japanese Citizens: An Emic-Etic Approach’, *Political Psychology*, 23 (2002), pp. 645–666
  39. Karasawa, *ibid.*, p. 654.
  40. N. Sakano, ‘A comparative study of the “patriotism-nationalism” scale between Japan and the United States’, in S. Shibano (Ed) *Report to the Japanese Ministry of Education, Science, Sports, and Culture* (Grant-in-Aid for Scientific Research #01450044, 1992).
  41. Kosterman and Feshbach, ‘Toward a Measure of Patriotic and Nationalistic Attitudes’, *op. cit.*, Ref. 22.
  42. Bengt Muthén reminds us that we often use large-N samples without realizing that populations may consist of several subgroups with quite different characteristics. Muthén, ‘Latent Variable Modeling in Heterogeneous Populations’, *Psychometrika*, 54 (1989), pp. 557–585.
  43. E.g. O. Gabriel (Ed), *Politische Orientierungen und Verhaltensweisen im vereinigten Deutschland* (Wiesbaden: Springer VS, 2001); for conceptions of national identity in the GDR, see J. Palmowski, ‘Citizenship, Identity, and Community in the German Democratic Republic’, in G. Eley and J. Palmowski (Eds) *Citizenship and National Identity in Twentieth-Century Germany* (Stanford: Stanford University Press, 2008), pp. 73–94.
  44. See D. McCrone and F. Bechhofer, *Understanding National Identity* (Cambridge: Cambridge University Press, 2015).
  45. S. Smootha, *Arabs and Jews in Israel. Volume 1: Conflicting and Shared Attitudes in a Divided Society* (Boulder: Westview Press, 1989). We are, of course, well aware that this source may be considered outdated as well.
  46. Blank and Schmidt, ‘National Identity in a United Germany’, *op. cit.*, Ref. 5, p. 297.
  47. Blank and Schmidt, *ibid.*, p. 297. In general, such items are not uncommon, see e.g. R. Latcheva, ‘Nationalism versus Patriotism, or the Floating Border?’, *op. cit.*, Ref. 21; R. Latcheva, ‘Cognitive interviewing and factor-analytic techniques: a mixed method approach to validity of survey items measuring national identity’, *Quality & Quantity*, 45 (2011); pp. 1175–1199; Wagner, Becker, Christ, Pettigrew and Schmidt, ‘A Longitudinal Test of the Relation between German Nationalism, Patriotism, and Outgroup Derogation’, *op. cit.*, Ref. 5.
  48. Among the many items used by Bergsieker, one even explicitly mentions soccer: ‘I do not care how successful German athletes are (e.g. the soccer team)’. Bergsieker, ‘National Pride and Prejudice: The Case of Germany’, *op. cit.*, Ref. 34, p. 152. Of course, the fact that one does not care about something is hardly indicative of anything but a lack of interest. There may be plenty of zealous nationalists who are wholly uninterested in and ‘do not care’ about how their nation performs in dance or archery competitions.
  49. By beating a seemingly invincible Hungarian side (known as the *Mighty Magyars*) 3–2 after being 0–2 down, the German team sent shockwaves through world football, with the game soon gaining mythical status. While this sentiment was short-lived, interest in the ‘miracle’ grew again after its 50th anniversary in 2004. See D. Blecking, ‘Das “Wunder von Bern” 1954 – Zur politischen Instrumentalisierung eines Mythos’, *Historical Social Research/ Historische Sozialforschung*, 40 (2015), pp. 197–208.
  50. W. Pyta, ‘German football: a cultural history’, in A. Tomlinson and C. Young (Eds) *German Football: History, Culture, Society* (Abingdon: Routledge, 2006), pp. 1–23.
  51. Pyta, *ibid.*, p. 18.
  52. E.g. J. Gehring, ‘Race, ethnicity, and German identity: a media analysis of the 2010 world cup men’s national soccer team’, *Ethnic and Racial Studies*, 39 (2016), pp. 1962–1980; M. Stehle and B. Weber, ‘German Soccer, the 2010 World Cup, and Multicultural Belonging’, *German Studies Review*, 36 (2013), pp. 103–124; U. Merkel, ‘German football culture in the new millennium: ethnic diversity, flair and youth on and off the pitch’, *Soccer & Society*, 15 (2014), pp. 241–255.

53. Authors such as Kersting view the 2006 FIFA World Cup more critically, referring to it simultaneously as an ‘expression of patriotism’ and a ‘spontaneous expression of nationalism’. Kersting, ‘Sport and National Identity’, *op. cit.*, Ref. 6, p. 278.
54. A. Gauland, as cited in Spiegel, ‘Warum sich AfD-Vize Gauland nicht für einen Rassisten hält’, 27 June 2016, <https://www.spiegel.de/spiegel/alexander-gauland-partei-vize-der-afd-im-interview-a-1098612.html>
55. R. Poli, ‘The Denationalization of Sport: De-ethnicization of the Nation and Identity Deterritorialization’, *Sport in Society*, 10 (2007), pp. 646–661 (p. 654).
56. PI-News, ‘Der DFB als Werbeträger für die Umvolkung’, 16 May 2018, <http://www.pi-news.net/2018/05/der-dfb-als-werbetraeger-fuer-die-umvolkung/>.
57. The term *Umvolkung* (ethnicity inversion) denotes the concept of an alleged population replacement of ethnic Germans by (non-European and therefore non-assimilable) migrants. It is closely related to the *Great Replacement* conspiracy theory and refers to the same deterministic ‘demography is destiny’ narrative.
58. *Black Lives Matter*. Before their UEFA Euro 2020 match against England, the *Mannschaft* even ‘took the knee’ to protest police violence against Black people.
59. The same applies to other national teams as well. The success of the French side that won the 2018 FIFA World Cup, ‘overwhelmingly African, emphatically Black, and unapologetically Muslim’, was outwardly celebrated; yet beneath the orchestrated ‘cries of a restored national unity lurk[ed] a palpable fear of France’s rapidly growing non-white population [...]’. As a result, far-right commenters have lamented that this team is *not really French, does not feel French*, and represents nothing to be proud of. K. Beydoun, ‘Les Bleus and Black: A Football Elegy to French Colorblindness’, *Minnesota Law Review Headnotes*, 103 (2018), pp. 21–29 (p. 27).
60. H. Alberts, C. Kazimierz and J. Zaniewski, *The Internationalization of European Sports Teams and the Issue of National Citizenship: Can Sports Transcend Political Borders?* (Lewiston: Edwin Mellen Press, 2011).
61. Already in 2005, Premier League club Arsenal FC made history by fielding an entirely foreign matchday squad (consisting of players from e.g. Germany, Cameroon or Spain). By 2021–22, the share of non-English players in the Premier Leagues has increased to a record 65.3%. A similar trend can be observed in other European leagues.
62. Blank and Schmidt, ‘National Identity in a United Germany: Nationalism or Patriotism?’, *op. cit.*, Ref. 5, pp. 297–298. Both are ISSP items that also appear in other empirical studies, see e.g. Latcheva, ‘Nationalism versus Patriotism, or the Floating Border?’, *op. cit.*, Ref. 21.
63. T. Fleckenstein, ‘The Politics of Labour Market Reforms and Social Citizenship in Germany’, *West European Politics*, 35 (2012), pp. 847–868.
64. G. Ariely, ‘Why does patriotism prevail? Contextual explanations of patriotism across countries’, *Identities: Global Studies in Culture and Power*, 24 (2017), pp. 351–377 (p. 351); see also A. MacIntyre, ‘Is patriotism a virtue?’, in D. Matravers and J. Pike (Eds) *Debates in Contemporary Political Philosophy: An Anthology* (London and New York: Routledge, 2003), pp. 286–300; for an assessment of patriotism’s role in civic education, see e.g. S. Ben-Porath, ‘Civic virtue out of necessity: Patriotism and democratic education’, *Theory and Research in Education*, 5 (2007), pp. 41–59; M. Janowitz, *The Reconstruction of Patriotism: Education for Civic Consciousness* (Chicago: University of Chicago Press, 1983); for a general overview, see M. Costa, ‘Patriotism and Civic Virtue’, in M. Sarđoč (Ed) *Handbook of Patriotism* (Cham: Springer, 2020), pp. 213–226.
65. E.g. F. Fukuyama, *Identity: Contemporary Identity Politics and the Struggle for Recognition* (New York: Farrar, Straus and Giroux, 2018).
66. E.g. R. Arneson, ‘Against Patriotism and National Partiality’, in M. Sarđoč (Ed) *Handbook of Patriotism* (Cham: Springer, 2020), pp. 429–450; D. McCabe, ‘Patriotic Gore, Again’, *Southern Journal of Philosophy*, 35 (1997), pp. 203–223; S. Keller, ‘Patriotism as Bad Faith’, *Ethics*, 115 (2005), pp. 563–592. One may also reference the late George Kateb who



- once called patriotism ‘a mistake twice over: it is typically a grave moral error and its source is typically a state of mental confusion’. G. Kateb, ‘Is Patriotism a Mistake?’, *Social Research*, 67 (2000), pp. 901–924 (p. 901).
67. Mounk even likens nationalism to a half-wild animal one has to domesticate (or be torn to pieces by it). While this seems a colourful metaphor, it is not exceptional in political debates on the subject. See Y. Mounk, *The People vs. Democracy: Why Our Freedom Is in Danger and How to Save It* (Cambridge: Harvard University Press, 2018).
  68. F. Steinmeier, ‘Speech of the German Federal President on 8 May 2020’, 8 May 2020, <https://www.bundesregierung.de/breg-de/service/bulletin/rede-von-bundespraesident-dr-frank-walter-steinmeier-1752232>; C. Ramaphosa, ‘Address to the Nation’, 16 September 2020, <http://www.thepresidency.gov.za/speeches/statement-president-cyril-ramaphosa-progress-national-effort-contain-covid-19-pandemic%2C-union-buildings%2C-tshwane-2>.
  69. Keller, ‘Patriotism as Bad Faith’, *op. cit.*, Ref. 66, p. 590.
  70. S. Keller, *The Limits of Loyalty* (Cambridge: Cambridge University Press, 2007), p. 79
  71. Hanson and O’Dwyer, ‘Patriotism and Nationalism, Left and Right’, *op. cit.*, Ref. 5, p. 792.
  72. E.g. Huddy and Khatib, ‘American Patriotism, National Identity, and Political Involvement’, *op. cit.*, Ref. 24; Satherley, Yogeewaran, Osborne and Sibley, ‘Differentiating between pure patriots and nationalistic patriots’, *op. cit.*, Ref. 4; Heinrich, ‘Causal Relationship or Not? Nationalism, Patriotism, and Anti-Immigration Attitudes in Germany’, *op. cit.*, Ref. 16.
  73. Keller, *The Limits of Loyalty*, *op. cit.*, Ref. 70, p. 73.
  74. Müller, *Verfassungspatriotismus*, *op. cit.*, Ref. 17, p. 17.
  75. Müller, *Verfassungspatriotismus*, *op. cit.*, Ref. 17, p. 10. One might stress that these allegedly universal principles are not universal at all. They are derived from one particular tradition and, despite posing as universal, have always been in its service. Other perspectives can be tolerated in the Habermas-inspired understanding of patriotism, but this is ‘contingent upon a compulsory deference to a political constitution [...] established by the dominant [Western culture]’. Neither this constitution nor its values are supposed to be challenged or changed by e.g. immigrants who are nonetheless subject to their provisions. For De Genova, it follows that constitutional patriotism ‘retains an unseemly residue of civic nationalism deeply committed to [...] the political prerogatives of “natives”’. N. De Genova, ‘Migration and Race in Europe: The Trans-Atlantic Metastases of a Post-Colonial Cancer’, *European Journal of Social Theory*, 13 (2010), pp. 415–419 (p. 411).
  76. It could be argued that there are convinced democrats even in the most oppressive non-democracies, and this is certainly correct. But to be loyal to e.g. democratic institutions and procedures, more than an inner commitment is needed – namely, the existence of such institutions and procedures. If there is no democratic procedure at all, there is also no procedure one could be loyal to; it would be the same as being loyal to Napoleon III. or the House of Gryffindor. One may of course say that one is loyal to the *idea* of the procedure in an abstract sense, but this is not the same as being loyal to the procedure in the sense of a material reality.
  77. Ariely, ‘Constitutional patriotism, liberal nationalism and membership in the nation’, *op. cit.*, Ref. 22; Davidov, ‘Measurement Equivalence of Nationalism and Constructive Patriotism in the ISSP’, *op. cit.*, Ref. 16.
  78. Ariely and Davidov work primarily with democratic OECD countries, although the latter’s sample includes borderline cases such as Russia or Venezuela. However, the relevant question is not if non-democracies have been covered in practice but if they *could be covered in theory*.
  79. Blank and Schmidt, ‘National Identity in a United Germany’, *op. cit.*, Ref. 5, p. 298.
  80. Others use this item as well. For instance, Huddy and Khatib ask their respondents if they are ‘proud of their country’s social system?’ Huddy and Khatib, ‘American Patriotism, National Identity, and Political Involvement’, *op. cit.*, Ref. 24, p. 68. So do, inter alia, Ariely ‘Constitutional patriotism, liberal nationalism and membership in the nation’, *op.*

*cit.*, Ref. 22; Davidov, 'Measurement Equivalence of Nationalism and Constructive Patriotism in the ISSP', *op. cit.*, Ref. 16; Latcheva, 'Nationalism versus Patriotism, or the Floating Border?', *op. cit.*, Ref. 21.

81. Billig pointedly remarked that 'liberal Western academics find it easier to recognize nationalism in *others* than in themselves'. M. Billig, *Banal Nationalism* (London: Sage, 1995), p. 15. The formula *our patriotism – their nationalism* is indeed often employed to distinguish between the benevolent patriotism of 'advanced' nations and the dull and primitive nationalism those 'less advanced' espouse. Eventually, patriotism and nationalism become civilizationist categories that indicate different degrees of social development.
82. E.g. Hanson and O'Dwyer, 'Patriotism and Nationalism, Left and Right', *op. cit.*, Ref. 5; Kosterman and Feshbach, 'Toward a Measure of Patriotic and Nationalistic Attitudes', *op. cit.*, Ref. 22; Satherley, Yogeewaran, Osborne and Sibley, 'Differentiating between pure patriots and nationalistic patriots', *op. cit.*, Ref. 4.
83. Huddy and Khatib, 'American Patriotism, National Identity, and Political Involvement', *op. cit.*, Ref. 24.
84. G. Sartori, 'Concept Misformation in Comparative Politics', *American Political Science Review*, 64 (1970), pp. 1033–1053 (p. 1034).
85. J. Gerring, 'What Makes a Concept Good? A Criterial Framework for Understanding Concept Formation in the Social Sciences', *Polity*, 31 (1999), pp. 357–393.
86. Ariely, 'The nexus between globalization and ethnic identity', *op. cit.*, Ref. 2, p. 770.

## Acknowledgments

The authors would like to thank Gianni D'Amato, Jelena Dzankic, Philipp Lutz, Nikolas Roberts, and our two anonymous reviewers for helpful comments and remarks.

## Disclosure statement

No potential conflict of interest was reported by the author(s).

## ORCID

Marco Bitschnau  <http://orcid.org/0000-0002-2700-7259>

Marlene Mußotter  <http://orcid.org/0000-0002-6091-7326>

# Über (nationale) Bindungen

Die Trias von Nationalismus, Vaterlandsliebe und demokratischem Patriotismus

---

*Marlene Mußotter\**

## ABSTRACT

This article calls for revisiting the predominant nationalism-patriotism dichotomy, which has been largely applied in the field of political psychology to date. Zooming in on the distinction's conceptual shortcomings, it advocates for a more nuanced triad: nationalism, exclusively referring to the nation; patriotism, revolving around the homeland; and democratic patriotism, with democracy as its object of attachment. Drawing on attachment literature, this novel conceptual approach explicitly theorizes these three objects of attachment, which have hitherto rarely been considered. In so doing, the

---

\* *Marlene Mußotter, M.A.*, studierte Politikwissenschaft in Freiburg, Maastricht (NL) und Passau. Seit Oktober 2020 ist sie Promotionsstipendiatin der Konrad-Adenauer-Stiftung und seit Februar 2023 wissenschaftliche Mitarbeiterin bei Prof. Rohlfing an der Universität Passau. In ihrer (kumulativen) Dissertation mit dem Titel 'On nation, homeland and democracy: Toward a novel three-factor measurement model for nationalism and patriotism' entwickelt sie einen neuen theoretischen Ansatz sowie ein neues Messmodell für Nationalismus und Patriotismus. 2022 forschte sie als Gastwissenschaftlerin an der Universität Oxford (UK). Mitte März 2023 gab sie ihre Dissertation ab. Sie lehrte bisher an den Universitäten Passau, Freiburg und Bamberg.



article synthesizes the field's predominant research traditions that have not been fully recognized as diverging nor been simultaneously investigated. Introducing the distinction between nationalism, patriotism, i.e. love of country, and democratic patriotism, the article seeks to add more analytical clarity to the research on the nationalism-patriotism distinction.

## 1. EINLEITUNG

Die Nationalismus-Patriotismus-Dichotomie, die die Bindungen von Individuen zur Nation untersucht, ist eine der einflussreichsten Distinktionen im Feld der Politischen Psychologie<sup>1</sup>. Im Vergleich zu anderen Disziplinen, in denen Nationalismus primär als Meso- bzw. Makrophänomen im Sinne einer Ideologie oder einer sozialen Bewegung<sup>2</sup> betrachtet wird, steht hier die Mikroebene und damit das Verhältnis von Individuen zu ihrer Nation im Vordergrund. Das gegenwärtige Forschungsfeld ist von zwei verschiedenen Forschungstraditionen geprägt, die bisher kaum als divergierend wahrgenommen wurden. Ziel des vorliegenden Beitrags ist, diese näher zu analysieren und in einem neuen Ansatz zu synthetisieren.

Eine Tradition, die auf die Arbeiten von Kosterman und Feshbach in den späten 1980ern in den USA zurückgeht, definiert *Nationalismus* als Glaube an die eigene Überlegenheit der Nation und verwendet für dessen Operationalisierung Indikatoren, die auf diese Superiorität abzielen.<sup>3</sup> *Patriotismus* be- greift diese Tradition demgegenüber als eine emotionale Bindung und damit

- 
- 1 Generell befasst sich die Politische Psychologie mit dem Verhältnis zwischen Individuen und der politischen Umwelt und untersucht u.a., inwiefern Individuen die politische Landschaft prägen und von ihr geprägt werden (Osborne/Sibley 2022; für einen Überblick über die Politischen Psychologie in Deutschland s. Frank et al. 2015).
  - 2 Kedourie 1971; Gellner 1983; Özkırmılı 2017; Wehler 2019; zur Diskussion über Nationalismus als Ideologie s. Freedon 1998.
  - 3 Kosterman/Feshbach 1989; s.a. De Figueiredo/Elkins 2003; Huddy/Khatib 2007; Davidov 2009; Satherly et al. 2019; Ariely 2020. Indikatoren wie „Generally, the more influence [COUNTRY] has on other nations, the better off they are“; „Other countries should make their government as much like ours as possible“; or „In view of [COUNTRY]’s moral and material superiority, it is only

vor allem als Liebe zum eigenen Land. Sie nutzt für die empirische Forschung Messinstrumente, die genau diese Beziehung zum Land und in Teilen auch zu nationalen Symbolen erfassen.<sup>4</sup>

Eine andere Tradition, stark geprägt von den Arbeiten von Blank und Schmidt in den späten 1990ern in Deutschland, versteht *Nationalismus* nicht nur als Idealisierung der eigenen Nation, sondern betont *auch* deren ethnische Verfasstheit.<sup>5</sup> Sie zieht für die empirische Forschung Messinstrumente heran, die nicht nur den Stolz auf die eigene Nationalität oder die nationale Geschichte<sup>6</sup>, sondern auch dieses ethnische Verständnis (z.B. die Bedeutung nationaler Vorfahren) zu erfassen versuchen.<sup>7</sup> *Patriotismus* wird innerhalb dieser Forschungslinie als eine Bindung an demokratische Werte und Prinzipien definiert. Indikatoren, die den Stolz auf die demokratischen Institutionen und den Wohlfahrtsstaat umfassen, dienen hierfür als Standard.<sup>8</sup> Kurzum: Wir sind mit divergierenden Forschungstraditionen konfrontiert,

---

right that we should have the biggest say in deciding United Nations policy“ werden hierfür verwendet (Kosterman/ Feshbach, 1989, 264; s.a. Li/Brewer 2004; Kemmelmeier/Winter 2008; Osborne et al. 2017; Bizumic/Duckitt 2018; Satherly et al. 2019. Alternativ dazu werden Indikatoren aus *dem International Social Survey Programme* (ISSP) wie „Generally speaking, [COUNTRY] is a better country than most other countries“ und „The world would be a better place if people from other countries were more like [NATIONALITY]“ verwendet (s. Davidov 2009; Ariely 2012, 2020; Wamsler 2022).

4 Karasawa 2002; Kosterman/Feshbach 1989; Li/Brewer 2004; Satherly et al. 2019; Sidanius et al. 1997. Indikatoren wie „I am proud to be a [NATIONALITY]“; „I am emotionally attached to [COUNTRY] and emotionally affected by its actions“; oder „Although at times I may not agree with the government, my commitment to [COUNTRY] always remains strong“ werden dafür herangezogen (Kosterman/Feshbach 1989, 264; s.a. Li /Brewer 2004; Kemmelmeier/Winter 2008; Osborne et al. 2017; Satherly et al. 2019).

5 Blank/Schmidt 2003; s.a. Huddy et al. 2021.

6 Blank/Schmidt 2003; Latcheva 2011; Heinrich 2016, 2020;

7 Huddy et al. 2021.

8 Blank/Schmidt, 2003; s.a. Davidov 2009; Ariely 2011; Green et al. 2011; Wagner et al. 2012; Wamsler 2022. Zur Kritik an den Stolz-Indikatoren s. Latcheva 2011; Mußotter 2022.

die nicht nur verschiedene Definitionen, sondern auch distinkte Messinstrumente für Nationalismus und Patriotismus mit sich bringen.

Innerhalb dieser Forschungstraditionen und über sie hinaus werden Nationalismus und Patriotismus weitgehend als verschiedene Formen von Bindungen an die Nation betrachtet.<sup>9</sup> Trotz dieses Konsenses erstaunt es, dass die *Objekte* der jeweiligen Bindungen bisher nicht näher analysiert oder gar diskutiert werden. In der Politischen Psychologie und darüber hinaus werden verschiedene Bindungsobjekte für Nationalismus angeführt, ohne diese als solche zu kennzeichnen. Demzufolge bezieht sich Nationalismus auf die Nation,<sup>10</sup> den Staat,<sup>11</sup> den Nationalstaat,<sup>12</sup> das nationale Kollektiv<sup>13</sup>, die eigene Gruppe,<sup>14</sup> die ethnische oder nationale Gruppe,<sup>15</sup> oder die Regierung.<sup>16</sup> Das gleiche gilt für Patriotismus. In der Literatur wird angenommen, dass dieser sich auf das Heimatland,<sup>17</sup> die Nation,<sup>18</sup> die Institutionen und fundamentalen Prinzipien der Nation,<sup>19</sup> die Republik,<sup>20</sup> den Staat,<sup>21</sup> die Verfassung,<sup>22</sup> oder die Verfassungskultur<sup>23</sup> bezieht. Über die Bindungsobjekte der jeweiligen Konzepte herrscht in der einschlägigen Literatur also kein Konsens. Außer-

---

9 Kosterman/Feshbach 1989; Satherly et al. 2019; Huddy et al. 2021.

10 Terhune 1964; Connor 1978; Kosterman/Feshbach 1989; Druckmann 1994; Primoratz 2017; Blank/Schmidt 2003; Huddy et al. 2021.

11 Hayes 1937; Gellner 1983; Breuilley 1993.

12 Kohn 1965; De Lamater et al. 1969.

13 Weiss 2003.

14 Blank/Schmidt 2003.

15 Van Evera 2004.

16 Doob 1964.

17 Kohn 1939; Terhune 1964; Karasawa 2002; Theiss-Morse 2009; Primoratz 2017.

18 Kosterman/Feshbach 1989; Blank/Schmidt 2003; Ben-Porath 2005; Huddy et al. 2021.

19 De Figueiredo/Elkins 2003.

20 Viroli 1995.

21 Heinrich 2016

22 Smith 2021.

23 Müller 2008.

dem sind die Objekte durchaus zu unterscheiden: die Nation ist nicht gleichzusetzen mit dem Staat, der Verfassung oder der (wie auch immer definierten) nationalen Eigengruppe.

Zwei Ziele stehen im Fokus des vorliegenden Beitrags: zum einen sollen die zwei Forschungslinien analysiert und synthetisiert werden. Zum anderen soll vor dem Hintergrund der Bindungsliteratur die Dichotomie weiterentwickelt und analytisch präzisiert werden. In diesem Zusammenhang werden insbesondere die konzeptionellen Schwächen der Nationalismus-Patriotismus-Distinktion, die bisher kritisiert,<sup>24</sup> aber nicht adressiert wurden, behandelt. Der Beitrag nimmt eine Rekonzeptionalisierung der Dichotomie vor und plädiert für eine nuancierte Trias bestehend aus *Nationalismus*, mit der Nation<sup>25</sup> als Bindungsobjekt; *Patriotismus*, mit dem Vaterland<sup>26</sup> als Bin-

---

24 Billig 1995; Canovan 2000; Brubaker 2004; Bonikowski 2016; Mylonas/Tudor 2021.

25 In der akademischen Debatte herrscht keine Einigkeit über den Begriff der Nation; es gibt eine Vielzahl an Definitionen von Nation, die verschiedenen Forschungstraditionen zugeordnet werden können. Zum Beispiel stellt die Nation laut Renan (1996 [1882]) ein „daily plebiscite“ sowie eine „large scale solidarity“ dar, während Anderson (2006) sie bekanntlich als „imagined community“ auffasst. Der vorliegende Beitrag lehnt sich an Spinner-Halev/Theiss-Morse (2003, 516) an, die die Nation als eine politische Gemeinschaft begreifen, die u.a. nach politischer Anerkennung strebt. Zur näheren Erläuterung über die verschiedenen Definitionen von Nation s.u.a. Barrington 1997. In aktuelleren Beiträgen wie z.B. von Assmann (2020; s.a. Bröning 2019) oder auch Lepore (2019) wird für eine positive Umdeutung des teils eher negativ konnotierten Begriffs plädiert.

26 Der vorliegende Beitrag stützt sich auf Kohn (1939, 1006; s.a. Theiss-Morse 2009), der den Begriff Vaterland definiert als das Land, „which the man naturally loves, the native village, or a valley, or a city, a small known territory known in all its credentials.“ Auch dem Duden zufolge stellt das Vaterland das Land dar „aus dem man stammt, zu dessen Volk man gehört, dem man sich zugehörig fühlt“ (<https://www.duden.de/rechtschreibung/Vaterland>). In der einschlägigen Literatur besteht außerdem Einigkeit darüber, dass Patriotismus weit verbreitet ist. So merkt Snyder u.a. an, dass auch Nomadenstämme über eine starke Bindung zu einem bestimmten Ort verfügten (Snyder, 1954, 154).

dungsobjekt und *demokratischem Patriotismus* mit der Demokratie<sup>27</sup>, insbesondere den demokratischen Werten, als Bindungsobjekt. Damit baut er auf der bisherigen Literatur auf, geht zugleich aber auch über sie hinaus. Anders als etwa Huddy et al., die kürzlich die verschiedenen Verständnisse von Nationalismus, nicht aber die von Patriotismus zusammenbrachten,<sup>28</sup> unterzieht der vorliegende Beitrag die komplette Dichotomie einer kritischen Reflexion und entwickelt sie weiter.

Die Darstellung ist wie folgt gegliedert: Zunächst wird die Nationalismus-Patriotismus-Distinktion in ihren Grundzügen vorgestellt (2.). Anschließend wird der theoretische Ansatz, der sich auf die verschiedenen Bindungsobjekte sowie die Hauptcharakteristiken von Nationalismus und Patriotismus stützt, behandelt und die Trias von Nationalismus, Patriotismus und demokratischem Patriotismus beschrieben (3.). Der Beitrag schließt mit einem Ausblick auf zukünftige Forschungsfragen (4.).

- 
- 27 Diese Darstellung stützt sich auf Morlino (2004, 12), der eine (gute) Demokratie als „a stable institutional structure that realizes the liberty and equality of citizens through the legitimate and correct functioning of its institutions and mechanisms“ beschreibt. Insgesamt sei sie geprägt von einem „broadly legitimated regime that completely satisfies its citizens [...] and in which the citizens, associations and communities of which it is composed enjoy at least a moderate level of liberty and quality [and in which the] citizens themselves [...] have the power to check and evaluate whether the government pursues the objectives of liberty and equality according to the rule of law“. Es sei darauf hingewiesen, dass seine Definition von Demokratie viel umfassender ist als Minimaldefinitionen wie Dahls (1971) bekanntes Konzept der Polyarchie (d. h. eine Wahldeмократie, die unter anderem durch saubere Wahlen, Vereinigungsfreiheit, allgemeines Wahlrecht sowie eine gewählte Exekutive gekennzeichnet ist).
- 28 Huddy et al. 2021. Auch Dekker et al. (2003) setzten sich näher mit dem Konzept und der Messung von Nationalismus auseinander, berücksichtigten jedoch nicht die Dichotomie als solches.

## 2. DIE NATIONALISMUS-PATRIOTISMUS-DISTINKTION

### 2.1 Grundzüge der Distinktion

Die Distinktion zwischen Nationalismus und Patriotismus wurde von dem Sozialpsychologen Floyd Allport<sup>29</sup> in den 1920ern in den USA als Erstes erwähnt und anschließend von Historikern wie Deutsch und Snyder in den 1950ern aufgegriffen. Deutsch definiert den Begriff wie folgt:

Patriotism is an effort or readiness to promote the interests of [...] the patria, i.e., country, whereas nationalism aims at promoting the interests of the natio, i.e., literally a group of common descent and upbringing [...] of complementary habits of communication.<sup>30</sup>

Snyder nahm eine ähnliche Position ein: Ihm zufolge zielt der Nationalismus auf die „independence and unity of the nation“ ab, während der Patriotismus, definiert als „an individual’s passion“, das Ziel hat „to serve the object of his devotion – his country.“ Er betonte ferner, Letzteres sei als ein „universal attribute of man in society throughout history“ zu betrachten, Ersteres dagegen als „a relatively new phenomenon in modern history“.<sup>31</sup>

In den 1960ern wurde die Unterscheidung dann zum ersten Mal näher von dem Sozialpsychologen Leonard Doob untersucht. In seinem Hauptwerk befasste er sich mit den psychologischen Grundlagen von Nationalismus und Patriotismus. Doob verstand Patriotismus als

a conscious conviction of a person that his own welfare and that of the significant groups to which he belongs are dependent upon the preservation or expansion of both of the power and culture of his society<sup>32</sup>

---

29 Allport 1927.

30 Deutsch 1953, 232.

31 Snyder 1952, 148.

32 Doob 1964, 6.

und betrachtete Nationalismus als „a set of uniform demands which people share, which arise from their patriotism [...] and which incline them to make personal sacrifices in behalf of their government’s aims.“<sup>33</sup>

Ohne sich mit den Arbeiten von Doob näher auseinanderzusetzen, konzeptionalisierten und operationalisierten die beiden U.S.-amerikanischen Psychologen Kosterman und Feshbach diese Distinktion dann in den späten 1980ern in den USA. Sie zielten darauf ab, die Unterschiede zwischen Nationalismus und Patriotismus, die ihrer Ansicht nach bisher weitgehend missachtet wurden, empirisch zu untersuchen. Sie befanden, die bisherige Forschung habe zu wenig unternommen, „to boost the image of patriotism or to distinguish it from nationalism.“<sup>34</sup> Ihrer Ansicht nach ist Patriotismus als eine emotionale Bindung zum Land, d.h., Liebe zum und Stolz auf das Land, aufzufassen, Nationalismus dagegen als Glaube an die Überlegenheit der eigenen Nation und das damit einhergehende Dominanzstreben über andere Nationen.<sup>35</sup> Abgesehen von einer schwachen Korrelation zwischen Patriotismus und Nationalismus ( $r = .28$ ), bekräftigten die empirischen Ergebnisse ihre eingangs angenommene Distinktion. Darüber hinaus validierten sie diese Zweiteilung und demonstrierten, dass Nationalismus stark mit der Unterstützung von Atomkraft korreliert ( $r = .68$ ), während ein deutlich schwächerer Zusammenhang zwischen Patriotismus und diesem Faktor festzustellen war ( $r = .18$ ).<sup>36</sup> Sie kamen zu dem Schluss, dass Patriotismus und Nationalismus scharf voneinander abzugrenzen seien. Ferner betonten sie die Bedeutung eines „healthy patriotic spirit“, der für eine Nation nicht nur wünschenswert sei, sondern auch eine effektive Maßnahme gegen den wiederkehrenden, insbesondere aber aggressiven Nationalismus darstelle.<sup>37</sup>

In Deutschland begründeten Blank und Schmidt die Nationalismus-Patriotismus-Forschung in den späten 1990ern. Zwar hatten sie sich von Kos-

---

33 Ebd.

34 Kosterman/Feshbach 1989, 258.

35 Ebd., 260.

36 Ebd., 261.

37 Ebd., 273.

terman und Feshbach inspirieren lassen, stützten sich primär aber auf die Arbeiten von Schatz et al.<sup>38</sup> über die Unterscheidung zwischen blindem vs. konstruktivem Patriotismus. Blank und Schmidt zufolge zeichnet sich der Nationalismus durch verschiedene Merkmale wie die Idealisierung der Nation, ein ethnisches Nationsverständnis und eine unkritische Haltung gegenüber nationalen Autoritäten aus.<sup>39</sup> In Anlehnung an Habermas verstehen sie den Patriotismus als eine starke Bindung zu demokratischen Prinzipien, gepaart mit einer konstruktiv-kritischen Haltung zur Nation sowie einem zivilen Nationsverständnis.<sup>40</sup> Ihre eingangs angenommene Distinktion wurde von einem Zwei-Faktor-Messmodell empirisch gestützt. Darüber hinaus validierten sie diese Dichotomie und zeigten auf, dass Nationalismus, im Gegensatz zu Patriotismus, zu einer Ablehnung von Fremdgruppen ( $\beta = .98$ ) sowie antisemitischen Haltungen ( $\beta = .68$ ) führt. Außerdem kamen sie zu dem Ergebnis, dass Nationalismus, Patriotismus und nationale Identität drei verschiedene Konzepte sind.<sup>41</sup> Eine (positive) Identifikation mit der eigenen Nation ist jedoch notwendig, um nationalistische *oder* patriotische Einstellungen zu besitzen. Ähnlich wie Kosterman und Feshbach, wenn auch etwas subtiler, schlossen sie mit einer normativen Note: Ihrer Ansicht nach ist Patriotismus als der wünschenswerte Antagonist zu Nationalismus zu sehen.<sup>42</sup>

Zur gleichen Zeit, jedoch ohne auf die empirischen Arbeiten in der Politischen Psychologie Bezug zu nehmen, fand die Distinktion Eingang in die Politische Theorie.<sup>43</sup> Ähnlich wie Kostermann und Feshbach kritisierte der italienische Theoretiker Viroli die Gleichsetzung von Nationalismus und Patriotismus. Außerdem monierte er, dass damalige Vertreter der Distinktion,

---

38 Schatz et al. 1999. Bemerkenswert an dieser Stelle ist, dass Schatz et al. die Unterscheidung zwischen konstruktivem und blindem Patriotismus einführten, um Nationalismus und Patriotismus schärfer voneinander abzugrenzen (ebd., 154).

39 Blank/Schmidt 2003, 292.

40 Ebd.

41 Ebd.

42 Ebd. Für eine kritische Diskussion dieser normativen Komponente s. Bit-schnau/Mußotter 2022; s.a. Billig 1995; Canovan 2000.

43 Viroli 1995; für einen aktuelleren Beitrag s. Smith 2021.



wie zum Beispiel der Historiker Deutsch,<sup>44</sup> die Unterschiede der beiden bisher nicht sorgfältig herausgearbeitet hätten. In seinem Standardwerk *For love of country* unterstrich er die zentrale Bedeutung der verschiedenen „objects of love“,<sup>45</sup> die diese binäre Unterscheidung ausmache. Seiner Darstellung zufolge bezieht sich der Patriotismus auf die Republik, während sich der Nationalismus auf die Nation als Objekt der Liebe stützt. Viroli differenzierte jedoch nicht nur zwischen zwei Objekten, sondern auch zwischen zwei verschiedenen Formen der Liebe. So sei der Patriotismus von einer „charitable and generous love“, der Nationalismus dagegen von „unconditional loyalty or an exclusive attachment“ geprägt.<sup>46</sup> Auch Viroli versteht Nationalismus und Patriotismus als Gegensatzpaar, wobei letzterer zu bevorzugen und nur er zu fördern sei.

Unlängst hat auch der politische Theoretiker Smith diese binäre Unterscheidung befürwortet. Smith zufolge zeichnet sich der Nationalismus durch „a language of exclusion“ aus, während der Patriotismus „a sentiment of gratitude and appreciation for who we are and what has made us“ sei.<sup>47</sup> Während der Nationalismus die Welt als „jungle full of threats“ betrachte, sehe der Patriotismus sie als „garden that needs tending and pruning“ und der insbesondere als „home and sense of place.“<sup>48</sup> Smith plädiert daher für die Rückbesinnung auf den Patriotismus, den er für „the most fundamental political virtue“ hält.<sup>49</sup>

## 2.2 Kritik an der Nationalismus-Patriotismus Distinktion

Heute ist die Nationalismus-Patriotismus-Distinktion im Feld der Politischen Psychologie vorherrschend.<sup>50</sup> Trotz (oder vielleicht auch wegen) ihres großen Einflusses ist sie lange Zeit nur *en passant* kritisiert worden. Erst vor

---

44 Deutsch 1966.

45 Viroli 1995, 29.

46 Ebd.

47 Smith 2021, 9.

48 Ebd., 10

49 Ebd., 4. Zur Diskussion über Patriotismus als Tugend, s. MacIntyre 1984; Kateb 2000; Keller 2005; Costa 2020.

50 Li/Brewer 2004; Davidov 2009; Green et al. 2011; Ariely 2020; Huddy et al. 2021.

Kurzem haben Wissenschaftler\*innen damit begonnen, die Unterscheidung als solche umfassend, d.h. sowohl in konzeptioneller als auch in empirischer Sicht, kritisch zu reflektieren.<sup>51</sup> Die bisherige Kritik kann in drei Strömungen eingeteilt werden: konzeptionelle, normative und empirische Kritik. Der vorliegende Beitrag fokussiert sich im Folgenden auf den ersten Strang, da dieser für die anschließende Rekonzeptionalisierung der Dichotomie besonders relevant ist.<sup>52</sup>

Nationalismus und Patriotismus wurden bisher hauptsächlich für ihre diffezile bzw. mangelnde Trennschärfe kritisiert. Bereits in den 1960ern stellte Doob heraus, dass Nationalismus *per definitionem* durch Patriotismus verursacht werde.<sup>53</sup> Feshbach nahm in den 1980ern eine ähnliche Position ein. Er war der Ansicht, dass Nationalismus Patriotismus, d.h. Vaterlandsliebe, umfasse, sich jedoch durch Macht und Überlegenheitselemente auszeichne.<sup>54</sup> Wenngleich von der Distinktion überzeugt, warf Druckmann in den 1990ern die Frage auf, ob Nationalismus nicht eine komplexere Form von Patriotismus sei. Seiner Ansicht nach ist dem Nationalismus die Exklusion von anderen inhärent, jedoch enthält er patriotische Elemente wie die starke emotionale Bindung zum Land.<sup>55</sup> Umgekehrt, so Konrad und Qari, habe aber auch Patriotismus eine Reihe von unerwünschten Nebeneffekten und könne sich u.a. in Nationalismus wandeln.<sup>56</sup> Auch Mader kritisierte die binäre Unterscheidung, insbesondere die Arbeiten von Blank und Schmidt. Er vertrat die Position, dass Patriotismus im Sinne von Stolz auf demokratische Errungenschaften durchaus mit Überlegenheitsgefühlen einhergehen könne und plädierte für eine Trias von patriotischem Nationalstolz, völkisch-kulturalistischen Haltungen und Chauvinismus.<sup>57</sup> Über die Politische Psychologie hinaus zweifelten des Weiteren namhafte Nationalismusforscher wie Gellner an

---

51 Mußotter 2022; Bitschnau/Mußotter 2022.

52 Für eine nähere Erläuterung der drei Kritikstränge s. Piwoni/Mußotter 2023.

53 Doob 1964.

54 Feshbach 1987, 322.

55 Druckmann 1994.

56 Konrad/Qari 2012, 530; s.a. Gellner 1983 oder Li/Brewer 2004, die empirisch aufzeigten, dass sich Patriotismus insbesondere in Bedrohungskontexten in Nationalismus wandeln kann.

57 Mader 2016, 436.

der Trennschärfe der beiden Konzepte. Ähnlich wie Druckmann argumentierte Gellner, dass Nationalismus als eine sehr spezifische Form von Patriotismus zu verstehen sei.<sup>58</sup> Der Soziologe Rogers Brubaker monierte, dass die Distinktion, genauer gesagt, deren Vertreter\*innen, die Ambivalenz und Polysemie beider Konzepte negierten. Er forderte daher – als einer von bisher wenigen – dazu auf, die Distinktion zu verwerfen und beide Konzepte gleichzusetzen.<sup>59</sup> Auch die Historikerin Lepore erkennt die konzeptionelle Überlappung zwischen Nationalismus und Patriotismus an. Sie betonte jedoch, dass der Patriotismus durch Liebe, der Nationalismus dagegen durch Hass motiviert und somit von Ersterem zu trennen sei.<sup>60</sup> Obwohl eine positive und in Teilen sogar hohe Korrelation zwischen Nationalismus und Patriotismus in einer Vielzahl an Studien<sup>61</sup> wiederholt aufgezeigt wurde, erfuhr dieser empirische Befund, also die Überschneidung beider Bindungsformen, bisher kaum Beachtung. Anders ausgedrückt: es bleibt weiterhin unklar, inwiefern sich Nationalismus und Patriotismus voneinander unterscheiden und wenn ja, zu welchem Grad.

### **3. REKONZEPTIONALISIERUNG DER NATIONALISMUS-PATRIOTISMUS-DISTINKTION**

Bei genauerer Betrachtung der existierenden Literatur zeichnet sich ein Kernthema ab: Bindung. So bezeichnen Kosterman und Feshbach Patriotismus als „feelings of attachment to America“.<sup>62</sup> Eine ähnliche Position vertreten Sidanius et al.: Ihnen zufolge ist Nationalismus als „right-wing form of national attachment“, Patriotismus dagegen als „more politically neutral form of national attachment“ zu betrachten.<sup>63</sup> Bar-Tal definiert Patriotismus

---

58 Gellner 1983, 138.

59 Brubaker 2004, 120.

60 Lepore 2019, 24.

61 Karasawa 2002; Latcheva 2011; Wagner et al. 2012; Osborne et al. 2017; Huddy et al. 2021.

62 Kosterman/Feshbach 1989, 261.

63 Sidanius et al. 1997, 106.

als „Bindung zwischen einer Person und ihrer Gruppe und dem Land.“<sup>64</sup> Aber auch außerhalb der Politischen Psychologie ist der Begriff Bindung weit verbreitet. So betrachtet Viroli Patriotismus als Liebe zur Republik, genauer genommen als eine „attachment to a particular republic with its particular way of living in freedom“.<sup>65</sup> Der Historiker Harari begreift Nationalismus und Patriotismus als zwei verschiedene Formen nationaler Bindungen.<sup>66</sup>

Insgesamt beschreibt die Nationalismus-Patriotismus-Distinktion also die individuelle Bindung zu einem Kollektiv, genauer genommen zu einem Bindungsobjekt, sei es die Nation, das ‚Vaterland‘, das Land, der Staat, die (wie auch immer definierte) nationale Gruppe oder eine andere Form von Gemeinschaft.<sup>67</sup>

### 3.1 Bindung

Grundsätzlich gilt, dass Ideologien (wie z.B. der Nationalismus) nur überleben, wenn sie menschlichen Grundbedürfnissen entsprechen und diese auch erfüllen.<sup>68</sup> Um sich tiefergehend mit der Distinktion zu befassen, ist es ratsam, diese Bedürfnisse kurz zu benennen. Der Sozialpsychologin Brewer zufolge haben Individuen zwei konträre Grundbedürfnisse: sie sehnen sich einerseits nach Bestätigung von und Gemeinschaft mit anderen, andererseits aber auch nach Einzigartigkeit und Autonomie.<sup>69</sup> Bei der Nationalismus-Patriotismus-Distinktion ist v.a. ersterer von Relevanz. Davon ausgehend beruht der hier vorgeschlagene Ansatz auf der Prämisse, dass Individuen ein funda-

---

64 Bar-Tal 1983, 49; für aktuellere Beiträge siehe Satherly et al. 2019; Huddy et al. 2021.

65 Viroli 1995, 13.

66 Harari, 2018

67 Für eine sehr umfassende Behandlung mit dem Begriff Gemeinschaft s. Mason 2009.

68 Tamir, 2019, 51; s.a. Doob, 1964.

69 Brewer 1991.

mentales Zugehörigkeitsbedürfnis haben, das sich in dem Wunsch nach Bindungen zu einem Kollektiv manifestiert.<sup>70</sup> Der Philosoph und politische Theoretiker Smith betonte treffend: „Nationalism and patriotism grow out of a similar need to belong, but [...] move in quite different directions“.<sup>71</sup>

Obwohl in der Politischen Psychologie weitgehend Konsens darüber besteht, dass Nationalismus und Patriotismus verschiedene Arten von Bindungen zur Nation sind, wurde der Begriff und dessen Bedeutungsgehalt kaum näher analysiert. Um die Nationalismus-Patriotismus-Distinktion weiterzuentwickeln und analytisch zu präzisieren, lehnt sich der vorliegende Beitrag an die einschlägige Bindungsliteratur an. Generell ist Bindung von verwandten, jedoch distinkten Konzepten wie Emotionen und Gefühlen, die zwar oft, wenn auch unreflektiert, in der Nationalismus-Patriotismus-Forschung verwendet werden, zu unterscheiden.<sup>72</sup> Der vorliegende Beitrag stützt sich auf die Arbeit von Mulligan und Scherer: Sie definieren *Emotionen* als

an affective episode [that], has the property of intentionality (i.e., of being directed), [that] contains bodily changes (arousal, expression etc), that are felt [...], [that] contains a perceptual or intellectual episode, which has the property of intentionality [...] [and that] is triggered by at least one appraisal [and] is guided by at least one appraisal.<sup>73</sup>

In vergleichbarere Weise betrachten von Scheve und Slaby Emotionen als

---

70 Baumeister/Leary 1995. Die Begriffe Bindung und Zugehörigkeit sind jedoch nicht gleichzusetzen. Letzteres wird generell definiert als „a position in social structure, experienced through identification, embeddedness, connectedness and attachments“ (Pfaff-Czernecka 2013, 7).

71 Smith 2021, 9; s.a. Doob 1964; Freedon 1998.

72 So ist es üblich von patriotischen oder nationalistischen Gefühlen (Gellner 1983; Kimmelmeier/Winter 2008) zu sprechen. Für einen umfassenden Überblick über die verschiedenen Begriffe in der Emotionsforschung siehe von Scheve/Slaby 2019.

73 Mulligan/Scherer 2012, 346.

object- or situation-directed affective comportments that are sorted into culturally established and linguistically labeled categories or prototypes, such [...] as fear, anger, happiness, grief, envy, pride, shame and guilt.<sup>74</sup>

In der einschlägigen Literatur herrscht Konsens darüber, dass sich Emotionen auf bestimmte Ereignisse, Objekte und Situationen fokussieren und von relativ kurzer Dauer sind.<sup>75</sup> Hervorzuheben ist, dass *Gefühle* eine Dimension von Emotionen darstellen, beide Begriffe jedoch nicht gleichzusetzen sind.<sup>76</sup> Gefühle und Emotionen sind außerdem von Affekten abzugrenzen. Letztere werden definiert als „relational dynamics between evolving bodies in a setting“. Es geht hier um „encounters between bodies that involve a change – either enhancement or diminishment – in their respective capacities or micro-powers“.<sup>77</sup>

Im Gegensatz dazu wird *Bindung* als „enduring affectional bond of humans to particular others, whether individual or collective, as well as to non-human actors such as animals, material possessions, places, or spiritual beings“ definiert.<sup>78</sup> Diese Definition stützt sich in Teilen auf die von Bowlby, dem Begründer der Bindungstheorie. Demzufolge zählt unter Bindung „any form of behavior that results in a person attaining or maintaining proximity to some other clearly defined individual who is conceived as better able to cope with the world.“<sup>79</sup> Bowlby zufolge kommt der Bindungsfigur („attach-

---

74 von Scheve/Slaby 2019, 43.

75 Mulligan/Scherer 2012; von Scheve/Slaby 2019.

76 Mulligan und Scherer (2012, 345) heben hervor: „[Feeling] is possibly even more ill-defined than emotion, and we insist upon treating feeling as a component of emotion rather than as a synonym for the term emotion“. Die Autoren schlagen vor „to use feeling as the denominator for the integrative component of emotion, bringing together feedback or proprioception from all other components and making it available for mental representation and communication“ (ebd., 354). In einer früheren Publikation beschrieb Scherer (2005, 699) „feeling“ bereits als „the subjective emotional component of emotion, presumed to have an important monitoring and regulation function“; s.a. Thonhauser 2019.

77 Slaby/Mühlhoff 2019, 27.

78 Scheidecker 2019, 73.

79 Bowlby 1982, 668; s.a. Ainsworth 1989.

ment figure“) eine zentrale Bedeutung zu, weil sie ein starkes und tief sitzendes Gefühl von Sicherheit vermittelt.<sup>80</sup> In der Literatur herrscht weitgehend Konsens darüber, dass Bindungen von Geburt an aufgebaut werden und sich über sechs Hauptmerkmale, wie zum Beispiel der Dauerhaftigkeit über die Zeit und verschiedene Kontexte hinaus oder der starken Nähe zu der Bindungsfigur, die grundsätzlich schwer zu ersetzen ist, definieren.<sup>81</sup> Diese Bindungsfiguren können sich über die Zeit hin verändern. Festzuhalten ist, dass Bindungen eine emotionale Komponente *beinhalten*, jedoch nicht mit Emotionen gleichzusetzen sind, da sie u.a. über verschiedene Kontexte und Zeiträume hinaus bestehen und an eine spezifische Bindungsfigur, die – anlehnend an Bowlby – das menschliche Bedürfnis nach Sicherheit und Geborgenheit stillt, gekoppelt sind.

Auffallend ist, dass Begriffe wie „Mutterland“ oder „Vaterland“, die oft, wenn teils auch eher unreflektiert, in der Nationalismusforschung verwendet werden, stark an elterliche Bindungsfiguren erinnern.<sup>82</sup> Die Nation bzw. das Heimatland werden dieser Lesart zufolge als Bezugs- und Betreuungsperson dargestellt.<sup>83</sup> So schrieb bereits Rousseau: „If we want the citizens to love their *patria*, let the homeland therefore show itself as the common mother of all citizens.“<sup>84</sup> Ohne sich auf die Bindungsliteratur zu stützen, nahm auch Feshbach an, dass die individuellen Bindungserfahrungen in der Kindheit mit den individuellen Bindungen zur Nation, insbesondere mit dem Patriotismus, zusammenhängen.<sup>85</sup> Seine Annahmen wurden empirisch bekräftigt: So zeigte er anhand von U.S.-amerikanischen Daten auf, dass Patriotismus – im Gegensatz zu Nationalismus – positiv mit den frühkindlichen Bindungen zu den Eltern, insbesondere zu denen des Vaters, korrelieren. Die Liebe und der Stolz auf das eigene Land werden also durch die frühe Vater-Kind-Bezie-

---

80 Bowlby 1982, 669.

81 Scheidecker 2019, 78.

82 Für eine empirische Untersuchung zu den Begriffen Mutter- bzw. Vaterland vor dem Hintergrund der Bindungstheorie s. Ferenczi/Marshall 2013.

83 Darüber hinaus wird in der einschlägigen Literatur oft herausgestellt, dass Nationalismus die Nation symbolisch mit der Familie gleichsetzt (Smith 1991; Stern 1995).

84 Rousseau 1964, 258.

85 Feshbach 1987, 322.

hung besonders geprägt. Die Studie von Feshbach fand bisher wenig Beachtung im akademischen Diskurs, sodass der Zusammenhang zwischen familiären Bindungen und der Nationalismus-Patriotismus-Distinktion nicht näher untersucht wurde. Es bleibt also unklar, inwiefern die Bindung zu den Eltern kongruent mit der Bindung zu der Nation, der *patria* oder anderen Bindungsobjekten ist.

Für die Rekonzeptionalisierung der Dichotomie ist es indes zentral, sich nicht nur mit dem Begriff Bindung, sondern mit dem genauso wichtigen Begriff des Bindungsobjekts näher zu befassen.<sup>86</sup> Bemerkenswert ist, dass ähnliche Begriffe wie „object of love“,<sup>87</sup> „object of devotion“<sup>88</sup>, „object of loyalty“<sup>89</sup> oder auch „reference objects“<sup>90</sup> in dem Nationalismus-Patriotismus-Diskurs verbreitet sind. Primoratz zufolge sind Nationalismus und Patriotismus „the same type of set of beliefs and attitudes that differ in terms of their objects“.<sup>91</sup> Während der Patriotismus sich auf die *patria*, das Land, beziehe, habe der Nationalismus die Nation als Referenzobjekt. Müller scheint bisher der Einzige zu sein, der die Begriffe Bindungsobjekt und Bindungsmodus in Hinblick auf den Verfassungspatriotismus aufgreift.<sup>92</sup> Seiner Theorie zufolge ist das „object of patriotic attachment [...] a specific constitutional culture that mediates between the universal and the particular, while the mode of attachment is one of critical judgement“,<sup>93</sup> während der Modus, d.h. die Haltung des Verfassungspatrioten, konstruktiv und kritisch sei. Bis heute wurde jedoch keiner dieser Ansätze in der Politischen Psychologie zur Kenntnis genommen.

---

86 Scheidecker 2019, 79.

87 Viroli 1995.

88 Snyder 1952.

89 Oldenquist 1982; Nathanson 1990; Fletcher 1995.

90 Primoratz 2017.

91 Ebd.

92 Müller 2008a, 73.

93 Ebd.



### 3.2 Die Trias von Nationalismus, Vaterlandsliebe und demokratischem Patriotismus

Der vorliegende Beitrag schlägt nun eine Synthese der beiden divergierenden Forschungstraditionen unter expliziter Berücksichtigung der genannten Bindungsliteratur vor. Er plädiert für folgende Bindungstrias: Nationalismus, Patriotismus im Sinne von Liebe und Loyalität zum Vaterland und demokratischer Patriotismus. Der Ansatz basiert auf vier Pfeilern: Erstens werden Nationalismus und Patriotismus als verschiedene Formen von Bindungen und – im Gegensatz zu anderen Beiträgen – nicht als Typen von Nationalstolz<sup>94</sup>, Haltungen zur Nation<sup>95</sup> oder Typen von nationaler Identität<sup>96</sup> gesehen. Zweitens konzentriert sich der Ansatz auf die verschiedenen Bindungsobjekte – Nation, ‚Vaterland‘ und Demokratie – die bisher wenig Beachtung im akademischen Diskurs fanden. Drittens werden im Anschluss an Gerring die begriffkonstitutiven Kern- bzw. Hauptmerkmale der drei Bindungen herausgearbeitet.<sup>97</sup> Viertens, wie bereits von Satherly et al.<sup>98</sup> dargestellt, begreift der Ansatz Nationalismus und Patriotismus als distinkte, sich aber nicht gegenseitig ausschließende Bindungen.<sup>99</sup> Damit greift er zum einen die zuvor beschriebene konzeptionelle Kritik an der Trennschärfe sowie die wiederholt aufgezeigte empirische Korrelation zwischen Nationalismus und Patriotismus auf. Zum anderen berücksichtigt er Tajfels Mahnung: „a dichotomy need not to be taken too seriously from an empirical point of view [as] few social scientists ever hope to find any pure examples of it in their data“.<sup>100</sup> Kurzum: Nationalismus und Patriotismus sind als Idealtypen zu sehen.

---

94 De Figueiredo/Elkins 2003.

95 Blank/Schmidt 2003; Heinrich 2016.

96 Blank/Schmidt 2003; Hanson/O’Dwyer 2019.

97 Gerring 1999, 368.

98 Satherly et al. 2019.

99 Für eine nähere Erläuterung zu Nationalismus und Patriotismus als Idealtypen s. Piwoni/Mußotter 2023.

100 Tajfel 1970, 1313.

### 3.2.1 Nationalismus: die Bindung zur Nation

Folgt man der Forschungstradition, die auf die Arbeiten von Kosterman und Feshbach zurückgeht, ist Nationalismus als die Idealisierung der eigenen Nation zu definieren (s.o. 2.1.). Im Kern bedeutet dies der Glaube an die Überlegenheit der eigenen Nation.<sup>101</sup> Folgerichtig wird in dieser Forschungstradition das Streben nach Macht und Dominanz über andere Nationen, das sich meistens in dem Anspruch einer (globalen) Führungsrolle manifestiert, als eines der Hauptmerkmale von Nationalismus angesehen.<sup>102</sup> Man geht von einem anhaltenden Wettstreit zwischen den einzelnen Nationen aus, und es herrscht Konsens in der Literatur darüber, dass Nationalist\*innen sich dazu berufen fühlen, ihren als überlegen wahrgenommenen „Nationalcharakter“ anderen Nationen aufzuerlegen. Ihr Ziel ist, den Einfluss der eigenen, als überlegen wahrgenommenen Nation zu vergrößern – und zwar ohne Rücksicht auf andere Nationen.<sup>103</sup> Dieser Führungsanspruch geht meist, aber nicht immer, mit einem Gefühl des Auserwähltseins einher. Anders ausgedrückt: der Führungsrolle liegt oft die Idee zugrunde, eine „nationale“ Mission zu erfüllen.<sup>104</sup>

Die auf die Arbeiten von Blank und Schmidt zurückgehende Forschungstradition definiert Nationalismus hingegen nicht nur als Überhöhung der eigenen Nation, sondern unterstreicht *zusätzlich* deren eher engere, nämlich ethnonationale Konzeption (s.o. 2.1). Dies bedeutet, dass sogenannten ethnischen, allen voran angeborenen Mitglieds- bzw. Zugehörigkeitsmerkmalen wie (der Glaube an) die gemeinsame Abstammung Priorität eingeräumt wird.<sup>105</sup> Kurzum: die Nation wird im Sinne eines *ethnos*<sup>106</sup> als eine Abstammungsgemeinschaft betrachtet. Nach dem Verständnis dieser Forschungslinie stützt sich Nationalismus auf einen Imperativ ethnischer Homogenität. Mit den Worten von Dekker et al. lautet das Ziel: „[K]eep the nation as pure

---

101 Kosterman/Feshbach 1989; Kimmelmeier/Winter 2008; Osborne et al. 2017; Bizumic/Duckitt 2018; Satherly et al. 2019; s.a. Harari 2018.

102 Kosterman/Feshbach 1989; Blank/Schmidt 2003; Li/Brewer 2004; Kimmelmeier/Winter 2008; Osborne et al. 2017.

103 Kosterman/Feshbach 1989; Blank/Schmidt 2003.

104 Hayes 1937; Kohn 1939; Arendt 1945; Billig 1995; Wehler 2019.

105 Terhune 1964; Blank/Schmidt 2003; für einen aktuelleren Beitrag s. Huddy et al. 2021.

106 Wietschorke 2022.

as possible“.<sup>107</sup> Dies beruht vor allem auf der Prämisse, dass es „wahre“ bzw. „genuine“ Mitglieder der Nation gibt, die von denjenigen, die als „nicht wahr“ gelten, abgegrenzt werden müssen. Dieser Aspekt wird auch über die Politische Psychologie hinaus hervorgehoben. So ist die Historikerin Lepore, eine Befürworterin der Nationalismus-Patriotismus-Distinktion, der Ansicht, dass Nationalismus sich über den Hass auf andere Nationen und Völker sowie den Hass auf Menschen *innerhalb der Nation*, die nicht der religiösen oder ethnischen Mehrheit angehören, definiert.<sup>108</sup> In einer Vielzahl an Studien wurde ein positiver Zusammenhang zwischen Nationalismus und der Ablehnung von Migrant\*innen aufgezeigt. Anders ausgedrückt: Nationalismus gilt – zumindest diesem Verständnis nach – als robuster Prädiktor für Fremdenfeindlichkeit.<sup>109</sup>

Festzuhalten ist, dass die Politische Psychologie von zwei sich teils überlappenden, wenn auch unterschiedlichen Auffassungen von Nationalismus geprägt ist. Während erstere Nationalismus als Gaube an die Überlegenheit der eigenen Nation versteht und damit eine engere Definition vertritt, unterstreicht letztere zusätzlich dessen ethnische Nationsauffassung und vertritt damit eine noch umfassendere Definition. Grundsätzlich beruhen jedoch beide Traditionen auf der Prämisse, dass die Welt in Nationen eingeteilt ist und sich Individuen (nur) einer Nation zugehörig fühlen, sie also eine Bindung zu einer gewissen Nation aufbauen.<sup>110</sup>

Innerhalb dieser Forschungstraditionen und der Literatur darüber hinaus wird eine Vielzahl von Bindungsobjekten für Nationalismus angeführt. Zum Beispiel definiert Hayes Nationalismus als einen „a condition of mind in which loyalty to the ideal or to the fact of one’s national state is superior to

---

107 Dekker et al. 2003, 347; s.a. Blank 2003.

108 Lepore 2019, 23.

109 Blank/Schmidt 2003; de Figueiredo/Elkins 2003; Latcheva 2011; Wagner et al. 2012; Huddy et al. 2021. Hervorzuheben ist, dass die genannten Studien in dieser Forschungslinie fast ausschließlich den Begriff „Fremdenfeindlichkeit“ (anti-immigrant attitudes) oder „Fremdgruppenablehnung“ (out-group hostility) verwenden. Zum Zusammenhang zwischen Nationalismus und Rassismus s. Yuval-Davis 1993; Mosse 1995; Balibar 2011; für eine aktuellere Darstellung s. Elias et al. 2021; Rutland 2022.

110 Kedourie 1971; Dekker et al. 2003; Lepore 2019; Brubaker 2020.

all other loyalties“ und betrachtet damit den Staat als dessen Bindungsobjekt.<sup>111</sup> Auch Jenne et al. zufolge beruht Nationalismus auf der Prämisse „the state belongs to the dominant ethnonational group to the exclusion [...] of non-national others.“<sup>112</sup> Im Gegensatz dazu stellt laut Doob die Regierung das Bindungsobjekt dar.<sup>113</sup> Darüber hinaus ist bei genauer Sichtung der einschlägigen Literatur festzustellen, dass mehrere und damit verschiedene Bindungsobjekte *innerhalb* einer Publikation aufgeführt werden. So verstehen De Lamater et al. Nationalismus einerseits als eine „an individual’s attachment to his nation or country which leads him to desire more power to it“ andererseits als “one aspect of the broader problem of how individuals relate to the nation-state, how they are integrated into it.“<sup>114</sup> Ähnliches findet man bei Blank und Schmidt: Diese sind der Auffassung, dass Nationalismus und Patriotismus unterschiedliche Haltungen zur Nation darstellten, die „different concepts regarding the nation, the state, and the regime“ bevorzugen unter unterschiedliche soziale Ziele ausgaben.<sup>115</sup> Jedoch, und wie bereits in den späten 1980ern von Connor betont wurde, sollten die Begriffe Staat und Nation scharf voneinander getrennt werden, da nur Letzteres das Bindungsobjekt von Nationalismus darstelle.<sup>116</sup> Dekker et al. haben treffend hervorgehoben, dass Nationalist\*innen danach streben, ihren eigenen Staat für ihre Nation zu schaffen.<sup>117</sup> In Anlehnung an Connor und andere Positionen in der einschlägigen Literatur<sup>118</sup> definiert der vorliegende Beitrag die Nation als das

---

111 Hayes 1937.

112 Jenne et al. 2021, 171.

113 Doob 1964, 6.

114 De Lamater et al. 1969, 320.

115 Blank/Schmidt 2003, 305.

116 Connor 1978; s.a. Brubaker 2004.

117 Dekker et al. 2003, 347; s.a. Van Evera 1994. Zur Unterscheidung zwischen Nation und Staat s.u.a. Gellner 1983; Seton-Watson 1997; Barrington 1997. Guibernau (2004: 132) stellte zutreffend fest, dass es auch „Nationen ohne Staaten“ gibt (d.h. „territorial communities with their own identity and a desire for self-determination included within the boundaries of one or more state, with which, by and large, they do not identify“; für eine ausführlichere Erläuterung s. Guibernau, 1999).

118 Snyder 1952; Stern 1995; Viroli 1995; Deutsch 1966; Freedon 1998; Primoratz 2017; Wehler 2019.

Objekt, an das sich Nationalist\*innen gebunden fühlen. Er stützt sich u.a. auf Gellners bekannte Äußerung: “It is nationalism which engenders nations, and not the other way round.”<sup>119</sup>

Dabei wird die Konzeption der Nation, in Anlehnung an die Forschungstradition nach Blank und Schmidt, eng mit einem ethnischen Volksverständnis verwoben. Kurzum: der Glaube an die Überlegenheit der eigenen Nation ist stark mit an den Glauben an die Überlegenheit des eigenen, ethnisch homogenen Volkes gekoppelt.

Zusammenfassend zeichnet sich Nationalismus mit der Nation als Bindungsobjekt über fünf Hauptmerkmale aus: der Glaube an die Überlegenheit der eigenen Nation, der damit zusammenhängende Glaube an die Überlegenheit des eigenen Volkes, dem Streben nach nationaler Dominanz, dem Gefühl des Auserwähltseins sowie einem ethnischen Nationsverständnis. Nationalismus beruht somit auf der folgenden Glaubenskonstellation: Die Welt ist eingeteilt in Nationen, verstanden als ethnisch und kulturell homogene, organische (Abstammungs-) Gemeinschaften<sup>120</sup>. Jeder wird in einer Nation geboren und kann sich auch nur einer Nation zugehörig fühlen. Die eigene Nation ist anderen Nationen überlegen und hat damit auch das Recht, diese zu dominieren. Dem Selbstverständnis als auserwählte Nation und damit auch auserwähltes Volk folgend, hat sie eine nationale Mission zu erfüllen. Angesichts innerer *und* äußerer Feinde ist diese ethnische Homogenität und damit auch das nationale *Wir* (ständigen) Bedrohungen ausgesetzt und muss verteidigt werden.

### **3.2.2 Patriotismus**

Generell ist Patriotismus – genauso wie Nationalismus – als ein umstrittenes Konzept anzusehen, dessen Verwendung stark vom historischen Kontext abhängig ist. Die bestehende Patriotismusforschung weist daher, wenig überraschend, einen Mangel an konzeptioneller Klarheit auf. In Anlehnung an die einflussreichsten Studien in der Politischen Psychologie wird Patriotismus einerseits als ‚Vaterlandsliebe‘<sup>121</sup> und andererseits als starke Bindung zu demokratischen Werten verstanden.<sup>122</sup> Teilweise, z.B. bei Huddy et al., werden

---

119 Gellner, 1983, 55.

120 Für den Unterschied zwischen Gemeinschaft und Gesellschaft, s. Tönnies 2012.

121 Bar-Tal 1993; Li/Brewer 2004; Theiss-Morse 2009.

122 Davidov 2009; Ariely 2011; Huddy et al. 2021; Wamsler 2022.

beide Auffassungen auch explizit vereint und Patriotismus als „mixture of love of country and civic conceptions of what defines the nation“ definiert.<sup>123</sup> Festzuhalten ist, dass die Patriotismusforschung von zwei vorherrschenden Forschungstraditionen geprägt ist, die sich auf zwei verschiedene Bindungsobjekte beziehen – der *patria*, dem ‚Vaterland‘, auf der einen Seite und der Demokratie bzw. den demokratischen Werten auf der anderen. Aus diesem Grund soll zwischen zwei verschiedenen Arten von Patriotismus unterschieden werden: Patriotismus als ‚Vaterlandsliebe‘ und demokratischem Patriotismus. Der Kritik, wonach quantitative Studien oft nur von einem spezifischen Verständnis von Patriotismus ausgehen und dessen Ambiguität sowohl konzeptionell als auch empirisch vernachlässigen, wird damit Rechnung getragen.<sup>124</sup>

*Patriotismus: die Bindung zum ‚Vaterland‘.* Disziplinübergreifend, d.h. sowohl in der Politischen Psychologie als auch darüber hinaus, wird Patriotismus weitgehend als eine emotionale Bindung zum Land, gewöhnlich als ‚Vaterlandsliebe‘, verstanden.<sup>125</sup> In der einschlägigen Literatur fällt auf, dass Patriotismus häufig mit dem Begriff „Gefühl“ in Verbindung gebracht wird, ohne sich näher mit diesem zu befassen.<sup>126</sup> So schreibt Bar-Tal: „Patriotism does not dictate the nature of political organisation to the group; it is a more general and basic sentiment“.<sup>127</sup> Auch Smith betrachtet Patriotismus als ein „a sentiment of gratitude and appreciation for who we are and what has made us“.<sup>128</sup> Darüber hinaus herrscht Konsens, dass die tiefe Hingabe zum Land eine Opferbereitschaft für das Vaterland impliziert.<sup>129</sup> Wie in der Literatur

---

123 Huddy et al. 2021, 16.

124 Theiss-Morse 1993, 102.

125 Terhune 1964; Kosterman/Feshbach 1989; Li'/Brewer 2004; Kimmelmeier/Winter 2008; Theiss-Morse 2009; Primoratz 2017. Zur Kritik s.u.a. Keller 2005.

126 Auch wenn primär der Patriotismus mit diesem Begriff in Verbindung gebracht wird, fällt bei genauerer Sichtung der Literatur auf, dass es Ausnahmen dazu gibt und manche Autoren auch den Nationalismus als Gefühl beschreiben. Hier ist zum Beispiel Gellner (1983, 1) anzuführen, der Nationalismus als „a sentiment, or [...] a movement“ bezeichnet.

<sup>127</sup> Bar-Tal 1993, 51.

128 Smith 2021, 9.

129 Doob 1964; Bar-Tal 1993; Billig 1995; Viroli 1995.

oft betont wird, ist damit meistens die Bereitschaft gemeint, für das eigene Land zu sterben.<sup>130</sup> Wichtig hervorzuheben ist, dass die *patria*, also Heimat-, Vaterland‘, das Bindungsobjekt von Patriotismus darstellt.<sup>131</sup> Anlehnend an die oben genannte Literatur wird diese Form von Patriotismus über zwei Hauptmerkmale definiert: Liebe und Loyalität zum ‚Vaterland‘.<sup>132</sup>

*Demokratischer Patriotismus: Bindung zur Demokratie.* Eine andere Forschungslinie, die auf die Arbeiten von Blank und Schmidt zurückgeht, lehnt sich an das Konzept des Verfassungspatriotismus an. Dieses wurde ursprünglich von Sternberger im Jahre 1979 anlässlich des 30-jährigen Jubiläums des Grundgesetzes eingeführt. Das Konzept des Vaterlands, so Sternberger, finde erst in einer politischen, insbesondere aber „lebenden Verfassung“ sichtbaren Ausdruck.<sup>133</sup> Er verstand den Bürger in diesem Zusammenhang nicht nur als „mitdenkendes, mitverantwortliches Subjekt in der politischen Gemeinschaft“<sup>134</sup>, sondern auch als Verfassungsschützer. Die Verfassung lebt also vom Engagement der einzelnen Bürger. In den späten 1980ern wurde der Begriff vom Philosophen Habermas vor dem Hintergrund des Historikerstreits geprägt und in Teilen neu interpretiert. Dieser vertrat damals die Ansicht, dass der „einzige Patriotismus, der uns dem Westen nicht entfremdet“ der Verfassungspatriotismus, also „eine in Überzeugungen verankerte Bindung an universalistische Verfassungsprinzipien [...]“ sei.<sup>135</sup> Der Ausgangspunkt und damit die Kernfrage, die Habermas und andere Anhänger des Verfassungspatriotismus beschäftigte, lautete: Wie kann man den sozialen Zusammenhalt in multikulturellen Gesellschaften stärken?<sup>136</sup> Ihnen

---

130 Bar-Tal 1993; Stern 1995; Primoratz 2017; Smith 2021.

131 Snyder 1952; Karasawa 2002; Theiss-Morse 2009; Primoratz 2017.

132 Der vorliegende Beitrag verwendet ganz bewusst keine Attribute wie traditionell, klassisch oder konventionell, da diese fälschlicherweise suggerieren, dass es Formen wie „modernen“ oder „progressiven“ Patriotismus gibt.

133 Sternberger 1947, 28.

134 Ebd., 26.

135 Habermas 1992, 135.

136 Habermas 1992; Ingram 1996; Cronin 2003; Müller 2010; zur Kritik am Verfassungspatriotismus s. die Arbeiten von Tamir 2019 oder Gustavsson/Miller, 2020; zu *liberal nationalism*; s. Canovan, 2000; s. ferner Laborde, 2002 zu civic patriotism;

zufolge haben ausschließlich demokratische Werte und Prinzipien die für diverse Gesellschaften nötige Binde- und Kohäsionskraft, um ein inklusives Wir zu bilden. Wie bereits oben angedeutet, herrscht Konsens darüber, dass dieser Patriotismus als eine starke Bindung zu demokratischen Normen und Prinzipien zu verstehen ist.<sup>137</sup> Um es mit den Worten von Müller auszudrücken: „[...] die Loyalität des Verfassungspatrioten [...] gilt letztlich [...] universalisierbaren Normen und Prinzipien – und weder einer Kultur noch einem Volk.“<sup>138</sup> Verfassungspatriotismus ist somit als „credible competitor for conventional notions of nationality and emotional loyalty“ zu verstehen.<sup>139</sup> Vor diesem Zusammenhang stellt er generell ein anhaltendes, insbesondere aber ein politisches Projekt dar.<sup>140</sup> Der Verfassungspatriotismus beschränkt sich nicht (nur) auf den nationalen Kontext, sondern holt vielmehr – zumindest bei Habermas und Müller – zu einer transnationalen Perspektive aus. Denn laut Müller bezieht sich der Verfassungspatriotismus auf eine Verfassungskultur, die zwischen dem Universellen und dem Partikularen changiert.<sup>141</sup> Es ist also durchaus möglich, sich an universelle demokratische Prinzipien *und* gleichermaßen an eine bestimmten Verfassungskultur gebunden zu fühlen.<sup>142</sup> Der insbesondere in der Politischen Theorie stark diskutierte, vermeintliche Gegensatz zwischen dem Transnationalen und dem Partikularen lässt sich in Müllers Augen also auflösen, weil beides miteinander vereinbar ist.<sup>143</sup>

Im Anschluss an diese Literatur wird Patriotismus als eine demokratische Bindung aufgefasst, die auf eine inklusive, vielfältige Gesellschaft abzielt.<sup>144</sup> Der in Studien wiederholt aufgezeigte negative Zusammenhang zwischen dieser Art von Patriotismus und der Ablehnung von Migrant\*innen bestätigt

---

137 Viroli 1995; Blank/Schmidt 2003; Müller 2008; Davidov 2009; Ariely 2011; s.a. Smith 2021 zu enlightened patriotism.

138 Müller 2010, 73.

139 Müller 2008a, 14.

140 Cronin 2003; Müller 2010.

141 Müller 2008a, 72.

142 Ebd., 88.

143 S. dazu auch Appiah 1997; für einen aktuelleren Beitrag s. Laborde/Erez 2022 zu *cosmopolitan patriotism*.

144 Blank/Schmidt 2003; s.a. Davidov 2009; Huddy et al. 2021; Wamsler 2022.



diese Auffassung auch empirisch.<sup>145</sup> Folgt man Müller, wird man diesen Patriotismus als von einer stark kognitiven Komponente definiert betrachten müssen, die jedoch von einer Verhaltensabsicht begleitet wird. Es geht also nicht nur um die starke Bindung zu demokratischen Werten und Prinzipien, sondern auch darum, diesen praktischen, d.h. politischen, Ausdruck zu verleihen. Kurzum: sich nicht nur, aber insbesondere in Zeiten antidemokratischer Strömungen als „politische Verteidigungsgemeinschaft“ zu verstehen und als solche zu handeln und an der stetigen Optimierung demokratischer Institutionen mitzuwirken.<sup>146</sup> Daher zeichnet sich der Patriotismus durch ein Engagement für die Gesellschaft im Allgemeinen und die Demokratie im Besonderen aus.

Das Bindungsobjekt, auf das sich dieser Patriotismus bezieht, ist also nicht – wie in der bisherigen Forschung angenommen – die Nation<sup>147</sup>, der Staat, die (wie auch immer definierte) Eigengruppe oder gar die Verfassungskultur<sup>148</sup>, sondern die Demokratie bzw. die demokratischen Werte. Aus diesem Grund definiert der vorliegende Beitrag den Patriotismus mit der Demokratie als Bindungsobjekt als „demokratischen Patriotismus“.<sup>149</sup> Dieser

---

145 Blank/Schmidt 2003; Latcheva 2011; Wagner et al. 2012; Huddy/Del Ponte 2019; Huddy et al. 2021.

146 Müller 2010, 64.

147 Blank/Schmidt 2003.

148 Müller 2010.

149 Anzumerken ist, dass der Begriff „demokratischer Patriotismus“ bereits – wenn auch nicht systematisch – sowohl im akademischen Diskurs (z.B. Mounk 2018) als auch im politischen Diskurs in Deutschland, allen voran vom amtierenden Bundespräsidenten Frank-Walter Steinmeier (SPD) verwendet wurde. ~~Dieser~~. In der Rede vom 9. November 2018 betonte er zum Beispiel folgendes: „Wir alle, die wir uns zur Demokratie bekennen, die Millionen, die sich Tag um Tag für dieses Land engagieren, sie alle stehen in dieser Tradition. Sie zeigen durch tägliches Beispiel: Ein demokratischer Patriotismus ist keine Abstraktion und keine Kopfgeburt. Das Engagement dieser Bürgerinnen und Bürger entspringt doch nicht allein aus kühlem Verstand oder Berechnung, sondern bei den allermeisten aus tiefstem Herzen.“ (<https://www.bundespraesident.de/Shared-Docs/Reden/DE/Frank-Walter-Steinmeier/Reden/2018/11/181109-Gedenk->

soll den zugegebenermaßen irreführenden Begriff „Verfassungspatriotismus“ substituieren. Denn schließlich ist nicht die Verfassung als solche, die jeder Staat *unabhängig* von seinem politischen Regime besitzt, das Referenzobjekt, sondern vielmehr die Demokratie und damit die demokratischen Werte. Anders ausgedrückt: die Begriffe und die von ihnen bezeichneten Bindungsobjekte Nation, Staat, Demokratie, Verfassung und Regime sind voneinander zu trennen.

Den demokratischen Patriotismus kennzeichnen also drei Hauptmerkmale: eine starke Bindung an demokratische Werte, ein daraus resultierendes ziviles Engagement für die Demokratie im Besonderen und die Gesellschaft im Allgemeinen und die Unterstützung bzw. Förderung des sozialen Zusammenhalts in einer pluralistischen Gesellschaft. In Anlehnung an Habermas und Müller ist dieser, *per definitionem*, auf liberale Demokratien beschränkt.

Zusammenfassend nimmt der vorliegende Beitrag eine Rekonzeptionalisierung der Nationalismus-Patriotismus Distinktion vor und plädiert für eine nuancierte Bindungstrias: Nationalismus, mit der Nation als Bindungsobjekt; Patriotismus, der sich auf das ‚Vaterland‘ bezieht; und demokratischer Patriotismus, der die Demokratie, insbesondere die demokratischen Werte als Objekt umfasst.

### 3.2.3 Bindungshierarchie: das Verhältnis der drei Bindungsobjekte

Folgt man Fletcher,<sup>150</sup> demzufolge sich die Loyalität zu einem Objekt insbesondere vor dem Hintergrund konkurrierender und somit alternativer Loyalitätsobjekte manifestiert, *können* die drei Bindungsobjekte Nation, ‚Vaterland‘ und Demokratie einerseits als konkurrierend wahrgenommen werden. Andererseits dürften die meisten unserer Loyalitäten, wie Oldenquist treffend schreibt, miteinander verwoben sein. Man kann also loyal gegenüber seiner (lokalen) Gemeinschaft aber *auch* seinem Land sein.<sup>151</sup> Um beide Perspektiven zu berücksichtigen, geht der hier vorgeschlagene Ansatz von einem primären, vorherrschenden Bindungsobjekt aus. Anders ausgedrückt:

---

stunde-Bundestag.html.). Für eine aktuellere Quelle siehe die Rede von Steinmeier aus dem Jahr 2020: <https://www.bundesregierung.de/breg-de/service/bulletin/rede-von-bundespraesident-dr-frank-walter-steinmeier-1752232>.

150 Fletcher 1995, 8.

151 Oldenquist 1982, 179.

Auch wenn unsere verschiedenen Bindungsobjekte miteinander verwoben sind, können Prioritäten gesetzt und damit eine gewisse Hierarchie unter ihnen hergestellt werden. Kurzum: Man kann einem Bindungsobjekt Vorrang vor anderen, alternativen Objekten einräumen. Zum Beispiel kann man die Nation oder auch das ‚Vaterland‘ als primäres Bindungsobjekt begreifen und dieses über andere wie zum Beispiel der Demokratie stellen. Gleiches gilt für Fälle, in denen sich Individuen weder der Nation noch dem ‚Vaterland‘ zugehörig fühlen und somit keine Bindung zu diesen Objekten empfinden. Sogenannte bzw. sich als selbst definierende Weltbürger\*innen oder Kosmopolit\*innen fühlen sich mit hoher Wahrscheinlichkeit an die demokratischen Werten und Prinzipien gebunden und begreifen diese als primäres Bindungsobjekt und eben nicht die Nation oder das ‚Vater-/Heimatland‘.

Der konzeptionelle Ansatz basiert somit auf fünf zusammenhängenden Grundannahmen:

1. Individuen haben ein grundlegendes Bedürfnis nach Zugehörigkeit und somit nach Bindung zu einem spezifischen Objekt, d.h. nach einem spezifischen Kollektiv.
2. Nationalismus und Patriotismus umfassen verschiedene Typen von Bindungen.
3. Nationalismus und Patriotismus haben verschiedene Bindungsobjekte – Nation, Vaterland und Demokratie – und distinkte Hauptmerkmale.
4. Die drei verschiedenen Bindungsobjekte – Nation, Vaterland und Demokratie – können, müssen aber nicht unbedingt als konkurrierend und sich gegenseitig ausschließend gesehen werden.
5. Individuen können einzelnen Bindungsobjekten Priorität gegenüber anderen, alternativen Objekten, einräumen.

Darüber hinaus unterscheiden sich Nationalismus und die beiden verschiedenen Formen von Patriotismus nicht nur in Hinblick auf ihre Bindungsobjekte und ihre Hauptmerkmale, sondern auch in Bezug auf ihre politisch sowie sozial definierten Ziele. In der Literatur herrscht Einigkeit darüber, dass Nationalismus, im engeren Verständnis, auf Dominanzstreben über andere Nationen und (weltweiten) Einfluss abzielt. Nach dem noch weitergehenden Verständnis dient er darüber hinaus zur (Wieder)Herstellung ethnischer Homogenität. Bonikowski zufolge definiert Nationalismus „the ends of action“;

seine Ziele sind „domination over other nations and the policing of the nation’s symbolic boundaries against undesirable others“.<sup>152</sup>

In Bezug auf demokratischen Patriotismus herrscht in der Literatur Einstimmigkeit darüber, dass dieser den sozialen Zusammenhalt multikultureller Gesellschaften stärken soll. Außerdem wird er als eine effektive Maßnahme gesehen, die liberale Demokratie zu festigen, und, wenn nötig, auch zu verteidigen. Anknüpfend an Sternbergers „lebende Verfassung“ fungiert der Bürger dabei als verantwortungsbewusstes politisches Subjekt, das sich als Verfassungsschützer in einer wehrhaften Demokratie begreift. In Anlehnung an Habermas und insbesondere Müller ist hervorzuheben, dass der Verfassungspatriotismus, hier verstanden als demokratischer Patriotismus, eine demokratisch verankerte transnationale Gemeinschaft zum Ziel hat, die nationale Deutungsmuster zu überwinden versucht. Die Europäische Union als supranationale, auf demokratischen und rechtsstaatlichen Prinzipien basierende Gemeinschaft wird als ein Beispiel dafür diskutiert.<sup>153</sup>

In Bezug auf Patriotismus, definiert als Liebe und Loyalität zum ‚Vaterland‘, bleibt die Literatur in teleologischer Hinsicht unklar. Es herrscht zwar Konsens darüber, dass dieser als eine Bindung zum Land, d.h., Liebe und Loyalität zum Land, zu verstehen ist. Auf welche Frage dieser Patriotismus eine Antwort bietet, bzw. welche Ziele und Funktionen er hat, wurde bisher, in der Politischen Psychologie zumindest, vernachlässigt. Im Vergleich zum Nationalismus wird dieser nämlich nicht mit Macht- und Dominanzstreben über andere Nationen und damit auch Völker assoziiert. So bilanzierte der Historiker Snyder in den 1950ern: „Nationalism is inseparable from the idea of power; patriotism, on the other hand, is by nature defensive, both culturally and militarily“.<sup>154</sup> Snyders Auffassung scheint bis heute vorherrschend und darüber hinaus nicht näher untersucht worden zu sein.

## 4. CONCLUSIO

---

152 Bonikowski 2016, 430. Ohne näher ins Detail zu gehen, warf Terhune (1964) daher die Frage auf, ob das übergeordnete Ziel von Nationalismus nicht einfach Dominanz per se sei.

153 Lacroix 2002; Müller 2008b; für eine Kritik s. Kumm 2008.

154 Snyder 1952, 148.

Der vorliegende Beitrag zielte darauf ab, die in der Politischen Psychologie vorherrschende Nationalismus-Patriotismus-Distinktion kritisch zu reflektieren und analytisch zu präzisieren. Zu diesem Zweck wurden die divergierenden Forschungstraditionen synthetisiert und die einschlägige Bindungsliteratur rezipiert. Im Ergebnis plädiert er für eine nuancierte Bindungstrias: Nationalismus mit der Nation als Bindungsobjekt; Patriotismus mit dem ‚Vaterland‘ als Bindungsobjekt; und demokratischer Patriotismus mit der Demokratie, insbesondere den demokratischen Werten, als Bindungsobjekt.<sup>155</sup> Durch den Fokus auf die drei Bindungsobjekte, die bisher im akademischen Diskurs kaum wahrgenommen und analysiert wurden, beabsichtigt er, zu mehr analytischer Klarheit beizutragen. Er adressiert damit auch die wiederholt kritisierte Trennschärfe der Nationalismus-Patriotismus-Distinktion.

In Zukunft sollten diese drei Bindungsobjekte und insbesondere die Arten und Weisen, wie Menschen sich an sie binden, noch näher erforscht werden. Es gilt herauszufinden, welche Assoziationen diese drei Objekte hervorrufen und inwiefern sie als konkurrierend wahrgenommen werden. Zu welchem Grad und unter welchen Umständen Menschen Bindungsobjekte priorisieren, stellt in diesem Zusammenhang eine fruchtbare Forschungsfrage für weitere empirische Studien dar. Entscheidend ist, sich nicht nur den drei verschiedenen Bindungsobjekten, sondern auch den emotionalen „Modi“ der Bindungen an sie systematisch anzunähern.<sup>156</sup> Qualitative Gruppeninterviews sowie Mixed-Methods-Studien dienen dafür als geeignete methodisch Herangehensweise. Ferner plädiert der Beitrag dafür, die Nationalismus-Patriotismus-Forschung stärker mit anderen Disziplinen, insbesondere der Bindungsforschung und der Emotionssoziologie, stärker zu verzahnen.

Im Gegensatz zu bisherigen Studien zeichnet sich der vorliegende Beitrag dadurch aus, dass er sich mit der Distinktion *als solcher* näher befasst und diese kritisch reflektiert. Er konzentriert sich auf den bisher vernachlässigten Kern der Distinktion: die Bindungen von Individuen zu Nation, ‚Va-

---

155 Die Trias zwischen Nationalismus, Patriotismus und demokratischem Patriotismus wurde bereits in drei Studien, u.a. einer repräsentativen Studie in Deutschland 2022, in Form eines Drei-Faktor-Messmodells empirisch bekräftigt. Das Messmodell wurde außerdem in einer repräsentativen Studie in Dänemark 2022 validiert.

156 Müller 2010, 62.

terland‘ und demokratischen Werten – Bindungsobjekte, die von hoher aktueller gesellschaftspolitischer Relevanz sind. Der Beitrag hofft, mit der vorgeschlagenen Bindungstrias zu einem tieferen und vor allem differenzierteren Verständnis von Nationalismus und Patriotismus beizutragen und einen Impuls für die akademische Debatte zu liefern.

## LITERATUR

- Ainsworth: „Attachments beyond infancy“, in: *American Psychologist* 44/4, 1998, 709 ff.
- Allport: „The psychology of nationalism: The nationalist fallacy as a cause of war“, in: *Harper’s Monthly Magazine*, 1927, 291 ff.
- Anderson: *Imagined Communities. Reflections on the Origin and Spread of Nationalism*, 2006.
- Appiah: „Cosmopolitan patriots“, in: *Critical Inquiry* 23/3, 1997, 617 ff.
- Arendt: „Imperialism, nationalism, chauvinism“, in: *The Review of Politics* 7/4, 1945, 441 ff.
- Ariely: „Measuring dimensions of national identity across countries: theoretical and methodological reflections“, in: *National Identities* 22/3, 2020, 265 ff.
- Ariely: „Globalization, immigration and national identity: How the level of globalization affects the relations between nationalism, constructive patriotism and attitudes toward immigrants?“, in: *Group Processes & Inter-group Relations* 15/4, 2011, 539 ff.
- Ariely: „Constitutional patriotism, liberal nationalism and membership in the nation: An empirical assessment“, in: *Acta Politica* 46/3, 2011, 294 ff.
- Assmann: *Die Wiedererfindung der Nation. Warum wir sie fürchten und warum wir sie brauchen*, 2020.
- Balibar: „Racism and nationalism“, in: Balibar/Wallerstein (Hg.): *Race, Nation, Class: Ambiguous Identities*, 2011, 37 ff.
- Bar-Tal: „Patriotism as fundamental beliefs of group members“, in: *Politics and the Individual* 3/2, 1993, 45 ff.
- Barrington: „Nation and nationalism: The misuse of the key concepts in Political Science“, in: *PS: Political Science and Politics* 30/4, 1997, 712 ff.

- Baumeister/Leary: „The need to belong: Desire for interpersonal attachments as a fundamental human motivation“, in: *Psychological Bulletin* 117/3, 1995, 497 ff.
- Ben-Porath: „Civic virtue out of necessity. Patriotism and democratic education“, in: *Theory and Research in Education* 5/1, 2007, 41 ff.
- Billig: *Banal nationalism*, 1995.
- Bitschnau/Mußotter: „(National) Pride and (Conceptual) Prejudice: Critical remarks on the distinction between nationalism and patriotism“, in: *Journal of Political Ideologies* 2022, <https://doi.org/10.1080/13569317.2022.2096301> (letzter Aufruf: 28.02.2023)
- Bizumic/Duckitt: „Investigating right wing authoritarianism with a very short authoritarianism scale“, in: *Journal of Social and Political Psychology* 6/1, 2018, 129 ff.
- Blank: „Determinants of national identity in East and West Germany: An empirical comparison of theories on the significance of authoritarianism, anomie, and general self-esteem“, in: *Political Psychology* 24/2, 2003, 259 ff.
- Blank/Schmidt: „National identity in a united Germany: Nationalism or patriotism? An empirical test with representative data“, in: *Political Psychology* 24/2, 2003, 289 ff.
- Bonikowski: „Nationalism in settled times“, in: *Annual Review of Sociology* 42, 2016, 427 ff.
- Bowlby: *Attachment and loss*: Vol.1, 2. A., 1982.
- Breuilly: *Nationalism and the State*, 1993.
- Brewer: „The social self: On being the same and different at the same time“, in: *Personality and Social Psychological Bulletin* 17/5, 1991, 475 ff.
- Bröning: *Lob der Nation. Warum wir den Nationalstaat nicht den Rechtspopulisten überlassen dürfen*, 2019.
- Brubaker: „In the name of the nation: reflections on nationalism and patriotism“, in: *Citizenship Studies* 8/2, 2004, 115 ff.
- Brubaker: „Populism and nationalism“, in: *Nations and Nationalism* 26/1, 2020, 44 ff.
- Canovan: „Patriotism is not enough“, in: *British Journal of Political Science* 30/3, 2000, 413 ff.
- Connor: „A nation is a nation, is a state, is an ethnic group, is a...“, in: *Ethnic and Racial Studies* 1/4, 1978, 377 ff.

- Costa: „Patriotism and civic virtue“, in: Sardic (Hg.): *Handbook of Patriotism*, 2020, 213 ff.
- Cronin: „Democracy and collective identity: In defence of constitutional patriotism“, in: *European Journal of Philosophy* 11/1, 2003, 1 ff.
- Dahl: *Polyarchy: Participation and Opposition*, 1971.
- Davidov: „Nationalism and constructive patriotism: A longitudinal test of comparability in 22 countries with the ISSP“, in: *Political Analysis* 23/1, 2009, 88 ff.
- De Figueiredo/Elkins: „Are patriots bigots? An inquiry into the vices of in-group pride“, in: *American Journal of Political Science* 47/1, 2003, 171 ff.
- De Lamater et al.: „On the nature of national involvement: A preliminary study“, in: *Journal of Conflict Resolution* 13/3, 1964, 320 ff.
- Dekker et al.: „Nationalism and its explanations“, in: *Political Psychology* 24/2, 2003, 345 ff.
- Deutsch: *Nationalism and social communication: An inquiry into the foundations of nationality*, 1966.
- Doob: *Patriotism and nationalism: Their psychological foundations*, 1964.
- Druckman: „Nationalism, patriotism, and group loyalty: A social psychological perspective“, in: *Mershon International Studies Review* 38/1, 1994, 43 ff.
- Elias et al.: „Racism and nationalism during and beyond the COVID-19 pandemic“, in: *Ethnic and Racial Studies* 44/5, 2021, 783ff.
- Ferenczi/Marshall: „Exploring attachment to the “Homeland” and its association with heritage culture identification“, in: *PLoS ONE* 8/1: e53872. 2013.
- Feshbach: „Individual aggression, national attachment, and the search for peace: Psychological perspectives“, in: *Aggressive Behavior* 13/5, 1987, 315 ff.
- Fletcher: *Loyalty: An essay on the morality of relationships*, 1993.
- Frank et al.: „Zur Einführung: Politische Psychologie als interdisziplinäre Forschungsperspektive“, in: Faas et al. (Hg.): *Politische Psychologie*, 2015, 5 ff.
- Freeden: „Is nationalism a distinct ideology?“, in: *Political Studies*, 46/4, 1998, 748 ff.
- Gellner: *Nations and Nationalism*, 1983.



- Gerring: „What makes a concept good? A criterial framework for understanding concept formation in the social sciences“, in: *Polity* 31/3, 1999, 357 ff.
- Green et al.: „Nationalism and patriotism as predictors of immigration attitudes in Switzerland: A municipality-level analysis“, in: *Swiss Political Science Review* 17/4, 2011, 369 ff.
- Guibernau: *Nations without states: Political communities in a global age*, 1999.
- Guibernau: „Anthony D. Smith on nations and national identity: a critical assessment“, in: *Nations and Nationalism*, 10/1, 2004, 125ff.
- Gustavsson/Miller: *Liberal nationalism and its critics: normative and empirical questions*, 2020.
- Habermas: „Staatsbürgerschaft und nationale Identität“, in: ders (Hg.): *Faktizität und Geltung. Beiträge zur Diskurstheorie des Rechts und des demokratischen Rechtsstaats*, 1992.
- Hanson/O’Dwyer: „Patriotism and nationalism, left and right: A Q-methodology study of American national identity“, in: *Political Psychology* 40/4, 2019, 777 ff.
- Harari: *21 lessons for the 21<sup>st</sup> century*, 2018.
- Hayes: *Essays on nationalism*, 1937.
- Heinrich: „Dimensional differences between nationalism and patriotism“, in: Grimm et al. (Hg.): *Dynamics of national identity: Media and societal factors of what we are*, 2016, 44 ff.
- Heinrich: „Causal relationship or not? Nationalism, patriotism and anti-immigration attitudes in Germany“, in: *Sociology of Race and Ethnicity* 6/1, 2020, 76 ff.
- Huddy/Khatib: „American patriotism, national identity, and political involvement“, in: *American Journal of Political Science* 51/1, 2007, 63 ff.
- Huddy/Del Ponte: „National identity, pride, and chauvinism-their origins and consequences for globalization attitudes“, in: Gustavsson/Miller (Hg.): *Liberal nationalism and its critics: Normative and empirical questions*, 2019.
- Huddy et al.: „Nationalism, patriotism, and support for the European Union“, in: *Political Psychology* 42/6, 2021, 995 ff.
- Ingram: „Constitutional patriotism“, in: *Philosophy & Social Criticism* 22/6, 1996, 1 ff.

- Jenne et al.: „Mapping populism and nationalism in leader rhetoric across North America and Europe“, in: *Studies in Comparative International Development* 56/2, 2021, 170 ff.
- Karasawa: „Patriotism, nationalism, and internationalism among Japanese citizens: An etic-emic approach“, in: *Political Psychology* 23/4, 2002, 645 ff.
- Kateb: „Is patriotism a mistake?“, in: *Social Research* 76/4, 2000, 901 ff.
- Kedourie: *Nationalism in Asia and Africa*, 1971.
- Keller: „Patriotism as bad faith“, in: *Ethics*, 115/3, 2005, 563 ff.
- Kemmelmeier/Winter: „Sowing patriotism, but reaping nationalism? Consequences of exposure to the American flag“, in: *Political Psychology* 29/6, 2008, 859 ff.
- Kohn: „The nature of nationalism“, in: *American Political Science Review* 33/6, 1939, 1001 ff.
- Kohn: *Nationalism: Its meaning and its history*, 1965.
- Konrad/Qari: „The last refuge of a scoundrel? Patriotism and tax compliance“, in: *Economica* 79/315, 2012, 516 ff.
- Kosterman/Feshbach: „Toward a measure of patriotic and nationalistic attitudes“, in: *Political Psychology* 10/2, 1989, 257 ff.
- Kumm: „Why Europeans will not embrace constitutional patriotism“, in: *International Journal of Constitutional Law* 6/1, 2008, 117 ff.
- Laborde: „From constitutional to civic patriotism“, in: *British Journal of Political Science* 32/4, 2002, 595 ff.
- Laborde/Erez: „Cosmopolitan patriotism as a civic ideal“, in: *American Journal of Political Science* 64/1, 2020, 191 ff.
- Lacroix: „For a European constitutional patriotism“, in: *Political Studies* 50/5, 2002, 944 ff.
- Latcheva: „Cognitive interviewing and factor-analytic techniques: A mixed-method approach to validity of survey items measuring national identity“, in: *Quality & Quantity* 45/6, 2011, 1174 ff.
- Li/Brewer: „What does it mean to be an American? Patriotism, nationalism, and national Identity After 9/11“, in: *Political Psychology* 25/5, 2004, 727 ff.
- Lepore: *This America: The Case for the Nation*, 2019.
- MacIntyre: *Is patriotism a virtue? The Lindley Lecture*, 1984.

- Mader: „Stabilität und Wandel der nationalen Identität in der deutschen Bevölkerung“, in: *Kolner Zeitschrift für Soziologie und Sozialpsychologie* 68/3, 2016, 435 ff.
- Mason: *Community, solidarity, and belonging. Levels of community and their normative significance*, 2009.
- Morlino: „What is a ‚good‘ democracy?“, in: *Democratization* 11/5, 2004, 10 ff.
- Mosse: „Racism and nationalism“, in: *Nations and Nationalism* 1/2, 1995, 163 ff.
- Mounk: *The people vs. democracy: Why our freedom is in danger and how to save it*, 2018.
- Mulligan/Scherer: „Toward a working definition of emotion“, in: *Emotion Review* 4/4, 2012, 345 ff.
- Müller: „A general theory of constitutional patriotism“, in: *International Journal of Constitutional Law* 6/1, 2008a, 72 ff.
- Müller: „A European constitutional patriotism? The case restated“, in: *European Law Journal* 14/5, 2008b, 542 ff.
- Müller: *Verfassungspatriotismus*, 2010.
- Mußotter: „We do not measure what we aim to measure: Testing three measurement models of nationalism and patriotism“, in: *Quality & Quantity* 56/4, 2022, 2177 ff.
- Mylonas/Tudor: „Nationalism: what we know and what we still need to know“, in: *Annual Review of Political Science* 24, 2021, 109 ff.
- Nathanson: „On Deciding Whether a Nation Deserves Our Loyalty“, in: *Public Affairs Quarterly* 4/3, 1990, 287 ff.
- Oldenquist: „Loyalties“, in: *The Journal of Philosophy*, 79/4, 1982, 173 ff.
- Osborne et al.: „Authoritarianism and national Identity: Examining the longitudinal effects of SDO and RWA on nationalism and patriotism“, in: *Personality and Social Psychology Bulletin* 43/8, 2017, 1086 ff.
- Osborne/Sibley: *The Cambridge Handbook of Political Psychology*, 2022.
- Özkırımlı: *Theories of nationalism: A critical introduction*, 2017.
- Pfaff-Czarnecka: *Multiple belonging and the challenges to biographical navigation* (=MMG Working Paper 13–05), 2013.
- Piwoni/Mußotter: „The civic-ethnic dichotomy as a partial success story: a template for the development of the nationalism-patriotism distinction“, in: *Nations and Nationalism*, 2023 (online first).

- Primoratz: „Patriotism“, in: Zalta (Hg.): *Stanford encyclopedia of philosophy*, 2017, <https://plato.stanford.edu/archives/sum2017/entries/patriotism> (letzter Aufruf: 07.02.2023).
- Renan: „What is a nation?“, in: Eley/ Suny (Hg.): *Becoming national: A reader*, 1996 [1882].
- Rousseau : „Economie politique“, in : ders. (Hg.): *Œuvres Complètes*, Vol. 3, 1964.
- Rutland : „Racism and Nationalism“, in: *Nationalities Papers* 50/4, 2022, 629 ff.
- Satherly et al: „Differentiating between pure patriots and nationalistic patriots: A model of national attachment profiles and their sociopolitical attitudes“, in: *International Journal of Intercultural Relations* 72, 2019, 13 ff.
- Schatz et al.: „On the varieties of national attachment: Blind versus constructive patriotism“, in: *Political Psychology* 20/1, 1999, 151 ff.
- Scheidecker: „Attachment“, in: von Scheve/ Slaby (Hg.): *Affective Societies. Key Concepts*, 2019, 73 ff.
- Seton-Watson: *Nations and states: An enquiry into the origins of nations and the politics of nationalism*, 1977.
- Sidanius et al.: „The interface between ethnic and national attachment: Ethnic pluralism or ethnic dominance?“, in: *The Public Opinion Quarterly* 61/1, 1997, 102 ff.
- Smith: *National identity*, 1991.
- Smith: *Reclaiming patriotism in an age of extremes*, 2021.
- Snyder: *German nationalism: The tragedy of people*, 1952.
- Spinner-Halev/Theiss-Morse: „National Identity and Self Esteem“, in: *Perspectives on Politics* 1/3, 2003, 515 ff.
- Stern: „Why do people sacrifice for their Nations?“, in: *Political Psychology* 16/2, 1995, 217 ff.
- Sternberger: *Schriften X: Verfassungspatriotismus*, 1990.
- Sternberger: „Begriff des Vaterlands“, in: ders. (Hg.): *Schriften IV. Staatsfreundschaft*, 1947, 9 ff.
- Tajfel: „Aspects of national and ethnic identity“, in: *Social Science Information* 9/3, 1970, 119 ff.
- Tamir: *Why nationalism?*, 2019.
- Terhune: „Nationalism among foreign and American students: an exploratory study“, in: *Journal of Conflict Resolution* 8/3, 1964, 256 ff.

- Theiss-Morse: *Who counts as an American? The boundaries of national identity*, 2009.
- Thonhauser: „Feeling“, in: von Scheve/Slaby (Hg.): *Affective Societies. Key Concepts*, 2019, 52 ff.
- Tönnies: *Studien zu Gemeinschaft und Gesellschaft*, 2012.
- Van Evera.: „Hypotheses on nationalism and war“, in: *International Security* 18/4, 1994, 5 ff.
- Viroli: *For love of country. An essay on patriotism and nationalism*, 1995.
- Von Scheve/Slaby: „Emotion, emotion concept“, in: dies. (Hg.): *Affective Societies. Key Concepts*, 2019, 42 ff.
- Wagner et al.: „A longitudinal test of the relation between German nationalism, patriotism and out-group derogation“, in: *European Sociological Review* 28/3, 2012, 319 ff.
- Wamsler: „Violated entitlement and the nation: How feelings of relative deprivation shape nationalism and constructive patriotism“, in: *International Journal of Comparative Sociology*, 2022 (online first).
- Wehler: *Nationalismus. Geschichte, Formen, Folgen*, 2019. C.H. Beck.
- Weiss: „A cross-national comparison of nationalism in Austria, the Czech and Slovak Republics, Hungary, and Poland“, in: *Political Psychology* 24/2, 2003, 377 ff.
- Wietschorke.: „Volk“, in: Schmidt-Lauber/Liebig (Hg.): *Begriffe der Gegenwart. Ein kulturwissenschaftliches Glossar*, 2022, 271ff.
- Yuval-Davis: „Nationalism and Racism“, in: *Cahiers de recherche sociologique* 20, 1993, 183 ff.

# The evolution of the civic–ethnic distinction as a partial success story: Lessons for the nationalism–patriotism distinction

Eunike Piwoni  | Marlene Mußotter

Faculty of Arts and Humanities, University of Passau, Passau, Germany

## Correspondence

Eunike Piwoni, Faculty of Arts and Humanities, Chair for Sociology, University of Passau, Dr.-Hans-Kapfinger-Straße 14, Passau 94032, Germany.

Email: [eunike.piwoni@uni-passau.de](mailto:eunike.piwoni@uni-passau.de)

## Abstract

This article brings, for the first time, two of the most pivotal distinctions in nationalism studies into extended dialogue: the civic–ethnic distinction (CED) and the nationalism–patriotism distinction (NPD). By reviewing both the evolution of those distinctions over the previous decades and the ways in which they have been used in quantitative empirical research, we argue that the CED's evolution has been a partial success story, whereas discourse around the NPD has not seen substantial development. Despite lingering inconsistencies, researchers drawing on the CED have been successful in addressing different lines of critique and in using the CED as a heuristic for investigating notions of nationhood as expressed in public perceptions. In contrast, there has been only limited dialogue between theoretical and empirical approaches to the NPD. The article illustrates how research drawing on the NPD could profit from the CED's evolution. We close by providing a conceptual roadmap to guide the path towards more terminological clarity and to construct more theoretically robust measures for nationalism and patriotism. We specifically suggest that nationalism and patriotism should be consistently understood as ideal types that citizens can simultaneously hold to varying degrees.

This is an open access article under the terms of the [Creative Commons Attribution](https://creativecommons.org/licenses/by/4.0/) License, which permits use, distribution and reproduction in any medium, provided the original work is properly cited.

© 2023 The Authors. *Nations and Nationalism* published by Association for the Study of Ethnicity and Nationalism and John Wiley & Sons Ltd.

## KEYWORDS

civic nationalism, civic–ethnic distinction, ethnic–civic, national attachments, nationalism–patriotism distinction, nationhood/national identity, political psychology, surveys

## 1 | INTRODUCTION

Among the first elements that a new student of nationalism studies will discover is the field's preoccupation with binary distinctions such as civic vs. ethnic (see, e.g., Kohn, 1944), Western vs. Eastern (see, e.g., Plamenatz, 1973), liberal vs. illiberal (see, e.g., Tamir, 2019) and patriotism vs. chauvinism (see, e.g., Citrin et al., 2001; see also Spencer & Wollman, 1998 for what they called a 'cursory list' of 20 'dualistic distinctions'). More recently, yet more distinctions have been introduced aimed at making sense of nationalism's carrier groups (elite vs. everyday nationalism; see Fox & Miller-Idriss, 2008), the societal spheres in which nationalism is expressed (political vs. quotidian nationalism; see Bonikowski, 2016), nationalism's intensity (weak/low vs. strong/high nationalism; see Todorova, 2015) and diachronic aspects (new vs. old nationalism; see Halikiopoulou & Vlandas, 2019).

In quantitative empirical research, two of these distinctions have been particularly popular and widely applied. The first is the civic–ethnic distinction (CED), which is arguably nationalism studies' most discussed and utilised distinction in describing conceptions of nationhood (see, e.g., Larsen, 2017; see also Shulman, 2002, p. 554). The second is the nationalism–patriotism distinction (NPD), which is primarily used in the field of political psychology to make sense of people's attitudes towards their nation (see Blank & Schmidt, 2003; Kosterman & Feshbach, 1989). We present a joint review of the evolution of these two distinctions in the past decades with a particular focus on current quantitative scholarship.<sup>1</sup>

Except for the few articles drawing on the NPD that briefly mention the CED (e.g., Ariely, 2011), both strands have tended to ignore each other and have thus largely developed independently (but see Ariely, 2020 for an empirical investigation of both distinctions). To our knowledge, our paper is therefore the first to bring the CED and the NPD into extended dialogue, with the goal of improving empirical research drawing on the NPD.

Specifically, we outline the CED's current use in quantitative scholarship and the remaining inconsistencies based on a review of the CED's development and the ways the CED has been criticised, modified and applied in influential quantitative and qualitative studies. When comparing discourse around the NPD to the CED's evolution it becomes clear that the NPD can still learn important lessons from the CED's evolution. This is principally because there has been only limited dialogue between theoretical and empirical approaches to the NPD. In contrast to how debate around the CED has evolved and impacted empirical research, quantitative research drawing on the NPD has tended to neglect both the theoretical and normative critiques voiced by a number of scholars (see, e.g., Bonikowski, 2016) and has thus continued to employ 'different and sometimes conflicting definitions [and] measures' (Huddy et al., 2021, p. 1013). We particularly recommend that researchers applying the NPD in quantitative research consistently understand nationalism and patriotism as ideal types and as attachments citizens can hold simultaneously to varying degrees. We close by providing a conceptual roadmap that, we believe, contributes to arriving at a more consistent terminology and serves as a potential guideline for constructing more theoretically robust measures for examining nationalism and patriotism.

The article unfolds as follows: First, we outline how the CED has evolved over time in four phases. We subsequently detail the field's current consensus and remaining inconsistencies in relation to how the CED is used in quantitative scholarship. Second, we present a review and a critique concerning how the NPD has been discussed and applied. Third, to improve future research, we elaborate on how research on the NPD could learn from the CED's development.

## 2 | THE CED AND ITS EVOLUTION

### 2.1 | Phase 1: Kohn's original argument and popular definitions of the CED in the 1990s

The CED is commonly associated with Kohn's (1944, 1982) (see also Kohn, 1994) work on the rise of 'Western' and 'non-Western' (often termed 'Eastern') nationalism. Of course, and as outlined by many (see, e.g., Coakley, 2018), the intellectual origins of that distinction long predate Kohn and stem from, among other researchers, Meinecke (2019), who distinguished between the concepts of *Staatsnation* and *Kulturnation*, 18th-century philosophers Rousseau and Herder, and Renan's (1996) famous 1882 address '*Qu'est-ce qu'une qu'une nation?*' In this address, Renan defined the nation as 'an everyday plebiscite', a definition that has come to be regarded as capturing the core of the civic nation.

Importantly, Kohn's original argument goes beyond the differentiation between two types of nations. It encompasses the depiction of two contrasting paths of nationalist development in different regions: the West (Kohn discusses examples such as the United Kingdom, France, the Netherlands, Switzerland and the United States) and non-Western regions (Kohn refers to Germany, Russia and India). According to Kohn, nationalism in the West was a political phenomenon, whereas nationalism in non-Western regions adopted a cultural form and focused on folk culture, language and ethnicity. In addition, nationalisms in the West are not only described as 'civic' but also as 'voluntary', 'liberal' and 'rational', whereas those in non-Western regions are perceived as 'ethnic' and, in addition, as 'organic', 'illiberal' and 'irrational'.

Moreover, and as later outlined by many (see Phase 2), Kohn's characterisation encompasses a normative component: Western nationalism is taken to be superior, whereas nationalism in non-Western regions (or the East) is depicted as illiberal and thus inferior. Overall, Kohn amalgamated at least five dualistic distinctions: civic/ethnic, liberal/illiberal, Western/non-Western, rational/irrational, voluntary/organic.

In the decades following World War II, however, Kohn's use of the CED (by means of merging it with several other distinctions) and his characterisations of specific countries' nationalisms remained largely undisputed and were adopted by other authors (see, e.g., Greenfeld, 1992; Ignatieff, 1993; Plamenatz, 1973).

For example, Kohn's argument that German nationalism was based on 'the concept of "folk" which [...] lent itself more easily to the embroideries of imagination and the excitations of emotion' (Kohn, 1944, p. 331) has been accepted as a fact in the otherwise quite contentious debate about Germany's *Sonderweg* (Vick, 2003, p. 251). And the dissolutions of the Soviet Union, Yugoslavia and Czechoslovakia and the founding of new 'ethnic' nation-states seemed to particularly confirm Kohn's differentiation between supposedly 'liberal, civic, Western' vs. 'illiberal, ethnic, Eastern' nationalisms in empirical reality as argued, most prominently, by Ignatieff (1993).<sup>2</sup>

Ignatieff also provided a definition of the CED, describing 'the civic nation' as a 'community of equal, rights-bearing citizens, united in patriotic attachment to a shared set of political practices and values', (Ignatieff, 1993: 3–4) and 'the ethnic nation' as being based on 'the people's preexisting ethnic characteristics: their language, religion, customs, and traditions' (Ignatieff, 1993, p. 4). Moreover, Ignatieff points out that ethnic nationalism tells people to 'only trust those of your own blood' (1993, p. 6).

Smith provided another prominent definition of the CED (1991, p. 11) that differentiates between the 'civic model' of the nation, which he understood as being based on 'historic territory, legal-political community, legal-political equality of members, and common civic culture and ideology', and the 'ethnic nation' derived from descent and culture, particularly language and customs. Notably, those two definitions, which are much referred to in the literature (see, e.g., Shulman, 2002, p. 556; Spencer & Wollman, 1998, p. 261), define the 'ethnic model' of the nation as being based not only on descent but also on culture; they thus define, strictly speaking, an 'ethnocultural' model of the nation.

### 2.2 | Phase 2: Criticisms about

The CED, and particularly Kohn's approach to the CED, was extensively challenged around the turn of the 21st century. Contemporary scholars have also revitalised criticism of the CED (see Kaplan, 2022; Tamir, 2019; Todorova, 2015).



In our view, most criticisms can be grouped into four categories: critiques of linking the West versus East/non-West binary to the CED, critiques of normative bias, empirical critiques of the CED and theoretical critiques of the CED.

Addressing Kohn's original theory, which assigned civic nationalism to Western nation-states and ethnic nationalism to non-Western, particularly Eastern, nation-states, a number of critics have cast doubt on using geography as a reliable predictor of civic or ethnic nationalism. Kuzio (2002, pp. 24–29) demonstrated in detail how Kohn had selectively grouped countries that would match his argumentation while ignoring other examples from the same region that did not conform to his framework. Importantly, Kuzio's concerns relate to assigning specific civic and ethnic nations along a West versus East/non-West binary.

Advancing a second line of critique, Yack famously pointed out: 'The civic/ethnic dichotomy parallels a series of other contrasts that should set off alarm bells: not only Western/Eastern, but rational/emotive, voluntary/inherited, good/bad, *ours/theirs!*' [emphasis in original] (1996, p. 105). Spencer and Wollman (1998) also criticised that the CED had never been a neutral distinction and that its application had always carried normative baggage (see also Brubaker, 1999, pp. 63–67; Tamir, 2019, pp. 425–427). According to Spencer and Wollman (1998, p. 263), assigning the label 'civic' to a nation implies proffering that country a 'favoured nation status' and depicting it as open and superior (see also Tinsley, 2019 for an outline of the political consequences of the CED's normative impetus).

A third line of critique highlights that, in reality, there are neither purely civic nor ethnic nations. Smith pointed out that 'every nationalism contains civic and ethnic elements in varying degrees and different forms' (1991, p. 13), and Kuzio abundantly detailed that 'shared identity in Western civic states is not ethnically or culturally neutral but based upon that of the ethnic core' (2002, p. 31).

Contributing to this line of critique, Spencer and Wollman (1998, pp. 261–267) looked at France and Britain as common examples of the 'civic' model. Referring to those nations' citizenship rights (they argue there are no clear, unambiguous and consistent applications of the principle of *Jus soli*) and specific groups' (such as women or US slaves') limited possibilities 'of actively and politically expressing their assent to the nation' (1998, p. 263), Spencer and Wollman argued that empirical reality undermines the distinction between 'civic nations' and 'ethnic nations'.

In contrast to empirical criticisms challenging the existence of purely 'civic' and 'ethnic nations', theoretical critique contests the CED's conceptual robustness (see, e.g., Brubaker, 1999; Kymlicka, 1999; Nieguth, 1999; Nielsen, 1999). The essence of these criticisms holds that there is a difference between ethnic and cultural notions of nationhood and that the CED's 'ethnic' category encompasses analytically different bases of national identity.

Brubaker (1999, p. 60) argued that, when 'ethnic' is defined as referring to common descent, 'civic' must include references to common culture, which would make the category of civic nationalism 'too heterogeneous to be useful' and ethnic nationalism 'severely underpopulated'. Moreover, understanding 'ethnic' as 'ethnocultural' is no alternative to Brubaker either, as it would leave 'ethnic' as too broad a category (meaning that even separatist movements would have to be defined as 'ethnic'). He has also stated that 'civic' is 'equally ambiguous' (1999, p. 61) and that interpreting 'civic' in a strict sense would imply that a nation exists that is 'construed as a voluntary association of culturally unmarked individuals'. Brubaker's concern is thus that the CED is not 'an *exhaustive* way of classifying types or manifestations of nationalism' [emphasis in original] (1999, p. 62).

### 2.3 | Phase 3: Learning from the critique: A new perspective on the CED in qualitative and quantitative research

Despite prominent critiques, the CED did not disappear in the following decade. On the contrary, both qualitative and quantitative researchers began approaching the CED in ways reflective of the criticisms Kohn's original argument had received.

Moreover, they began operationalising the CED for the analysis of empirical data. Zubrzycki's (2001, 2002) work on Polish (and Québécois) nationalism is an important example in that regard (for a similar approach, see also Piwoni, 2013). Zubrzycki's (2001, p. 630) central argument is that the CED can be a useful tool of analysis 'if used as

ideal types following the Weberian method' as 'value-free constructs that we compare with reality' (see the second line of critique).

She further recommended that the 'ethnic/civic categories' could be useful to 'understand the conceptions of the nation in various cultural, social, political, and economic settings' (2001, p. 630) and 'actors' practices of nationalism' (2001, p. 630). Researchers, she maintained, should not frame entire nations as either ethnic or civic (see the first and third lines of critique).

Following a suggestion by Yack (1996), and thus not following the critique by Kymlicka (1999), Nielsen (1999) and Nieguth (1999), Zubrzycki (2001, p. 600, Footnote 26) operationalised the CED by subsuming 'distinctive cultural inheritance [that] centers on political symbols and political stories' under the category 'civic' and 'cultural inheritance [that] centers on language and stories about ethnic origins' under the category 'ethnic' (2001, p. 600; see also Yack, 1996). Drawing on that operationalisation, she analysed the preamble of Poland's 1997 constitution and the process by which it came into being and had been discussed by intellectuals. Although not explicitly engaging with scepticism regarding the CED's analytical purchase (see, e.g., Brubaker, 1999), her study demonstrated that her operationalisation of the CED had analytical value in explaining the various manifestations of ideas concerning the nation in her empirical data (see the fourth line of critique).

Quantitative researchers have also found means to both address criticisms and operationalise the CED. In 2002, Shulman followed Nieguth's (1999) and Kymlicka's (1999) critiques and differentiated between three bases for nationhood: ethnic, cultural and civic. Moreover, he embarked on testing the linkage of his operationalisation of the CED with the West vs. East/non-West binary. Employing International Social Survey Program (ISSP) data from 15 countries to tap into the bases of people's understandings of nationhood (national identity), Shulman's (2002, pp. 582–583) study indicated 'that the traditional civic-West/ethnic-East argument is a gross simplification of concepts of nationhood in the West, Central Europe, and Eastern Europe'. Thus, his study corroborated the first and third critiques outlined above. Moreover, his study demonstrated the usefulness of a modified variant of the CED as a heuristic to comprehend people's diverse notions of nationhood. Notably, however, he operationalised the CED to reflect the distinction between civic and cultural (and not ethnic) notions of nationhood.

In contrast to Shulman (2002), other quantitative researchers drawing on the CED applied it to distinguish between civic and ethnic (or, alternatively, ethnocultural) notions of nationhood. They neither substituted 'ethnic' for 'cultural' nor proposed a trichotomy (see Björklund, 2006; Hjerm, 1998a, 1998b; Jones & Smith, 2001a, 2001b; Kunovich, 2009 but see Janmaat, 2006). In that phase, a minimal consensus began emerging as to how this distinction should be operationalised: 'civic' by items suggesting national affiliation can be acquired through, for instance, respect for institutions and laws, and 'ethnic' (Jones & Smith, 2001a, 2001b use 'ascribed' instead of 'ethnic') by items indicating the importance of having lived in a country for most of one's life and a country being one's place of birth (see, e.g., Hjerm, 1998a, pp. 458–459; Hjerm, 1998b, pp. 339–340; Jones & Smith, 2001a, pp. 105–106; Jones & Smith, 2001b, pp. 48, 53; Kunovich, 2009, pp. 579–580; see Björklund, 2006 and Massey et al., 2003 for different operationalisations of 'ethnic'). Certain items, however, such as the importance of language or citizenship have been found to load differently depending on national contexts (see, e.g., Jones & Smith, 2001b).

In addition, the importance-items battery of the ISSP became the primary data source. Importantly, drawing on the CED did not come with ignoring the ambiguity of certain items used to indicate civic and ethnic notions and empirical complexity. Kunovich (2009, p. 581), for instance, discussed the sources of that multidimensionality and tried to solve the problem by creating 'additive and difference scores using separate measures of ethnic and civic national identity'. Overall, quantitative research drew on the CED but did not presuppose that civic and ethnic conceptions of nationhood were exclusive categories in empirical reality and/or assignable to specific societies.

Thus, after a phase of extensive critique, both qualitative scholars of nationalism and researchers using survey data were regarding the CED as 'a useful theoretical tool' (Kunovich, 2009, 574; Footnote 1) for making sense of empirical data. As pointed out by Kunovich (2009, 574; Footnote 1), the goal was to 'avoid reifying cases as ethnic or civic, disassociate normative value from the ethnic and civic concepts, and recognize diversity within and similarities across countries and regions'.

Engaging with Shulman's (2002) work, Reeskens and Hooghe (2010) went one step further and investigated the empirical validity of assigning specific items to the CED a priori and the cross-national equivalence of the distinction. Drawing on the 2003 ISSP data set, they conducted confirmatory and multigroup factor analyses for 33 countries. While they did not provide evidence for scalar invariance, their key findings were that ethnic and civic citizenship concepts could be clearly distinguished and that 'various items relate unambiguously to one of these two ideas' (Reeskens & Hooghe, 2010, p. 589). Most importantly, ethnic citizenship referred strongly to having national ancestry, whereas the most important criterion for civic citizenship was to obey national laws. Moreover, as various items had different meanings in various national contexts, it was impossible to rank countries on a civic–ethnic continuum.

Conducting multiclassification analysis (MCA), Larsen (2017) demonstrated that distinguishing between 'ethnic' and 'civic' perceptions of nationhood (combined with a differentiation between the mobilisation levels of nationalist attitudes) was useful for interpreting patterns in his data. Framing his research as a 'revitalization of the "civic" and "ethnic" distinction', he also suggested that his findings indicated 'a move towards mobilized ethnic nationalism in Eastern Europe' and that a 'stable non-mobilized civic nationalism prevails in many West European countries' (2017, p. 970). However, by pointing out that 'Kohn's historical account for the birth of nations lacks predictive power' and that countries 'are by no means locked into a fixed position' (2017, p. 987), he also intentionally distanced himself from Kohn's original argument.

Recent research has studied links between national conceptions and other attitudes/preferences (see, e.g., Erhardt et al., 2021; Lindstam et al., 2021; Mader et al., 2021; see also Helbling et al., 2016, who studied the link between elite rhetoric and national identity). Within this strand of literature, Lindstam et al. (2021, p. 100) have indicated that a 'substantial share of the German public (36/42 per cent) embraces both ethno-cultural and civic norms'. Furthermore, they argued that 'defining national identity in both ethno-cultural and civic terms is not in itself a contradiction; rather, it seems quite likely that many individuals understand national membership both as a function of sharing deep cultural and ancestral traits and ascribing to certain civic norms and values' (2021, p. 96). Overall, quantitative scholarship drawing on the CED has widely acknowledged that the two different kinds of conceptions of nationhood are ideal types that are not mutually exclusive in empirical reality.

### 3 | THE CED AS A PARTIAL SUCCESS STORY

After having outlined the four phases of the CED's evolution, we now wish to summarise the principal results of that evolution by investigating the minimal consensus currently informing quantitative empirical research. After that, we critically evaluate how the CED has been developed in reaction to the extensive criticism it received in Phase 2 and outline any remaining inconsistencies. Overall, we argue that the CED's evolution can be seen as a partial success story.

#### 3.1 | Elements of the current consensus

In current quantitative empirical research, the CED is predominantly understood as a conceptual pairing comprising two ideal-typical perceptions of nationhood: a civic notion according to which the nation is understood as a political community of citizens and an either ethnic or ethnocultural notion understanding the nation as a community of common descent or one of common descent and culture. Moreover, the CED is both understood and employed as a heuristic device for making sense of empirically existing notions of nationhood. There is also an empirically grounded consensus that civic and ethnic/ethnocultural notions of nationhood are not mutually exclusive and that they can co-exist (in a country, an individual, etc.).

Moreover, broad agreement exists over both the basis of operationalisation and the operationalisation itself. As demonstrated, the majority of quantitative scholars use the importance-items battery of the ISSP as their central data

source when researching people's conceptions of nationhood. In so doing, they rely on respondents' answers to the following prompt: 'Some people say that the following things are important for being truly [nationality]. Others say they are not important. How important do you think each of the following is ...' Eight different criteria are probed: being born in the country, having legal citizenship status, having lived in the country for most of one's life, speaking the dominant language, adhering to the dominant religion, respecting the laws, feeling a member of the community and having ancestors from that country. The number of items researchers consider can differ—several scholars have included eight (e.g., Helbling et al., 2016; Reeskens & Hooghe, 2010), whereas others have incorporated seven (e.g., Larsen, 2017) or six items in their analysis (e.g., Hjerm, 1998a). There is thus a common basis for operationalisation, and researchers who do not use the importance-items battery of the ISSP use comparable items for their surveys (see, e.g., Björklund, 2006; Lindstam et al., 2021). Moreover, there is also broad agreement over the operationalisation itself; it is common to rely on factor analysis and to yield a two-factor model, running a confirmatory factor analysis. In consequence, civic conceptions of nationhood are, for instance, captured by items revolving around the importance of feeling a member of a national community or respecting national laws, whereas ethnic/ethnocultural notions may be measured by items centring on the importance of having national ancestry or adhering to the dominant religion (e.g., Helbling et al., 2016; Lindstam et al., 2021; Reeskens & Hooghe, 2010).

### 3.2 | Critical evaluation: Successes and remaining inconsistencies

As outlined, there were four lines of critique regarding the CED: linking the West vs. East/non-West binary to the CED, normative bias and both empirical and theoretical critiques of the CED. In our opinion, quantitative researchers were particularly successful in addressing the first and third lines of critique by rejecting the notion that civic or ethnic/ethnocultural nations or nationalisms were extant forms. Moreover, the stereotyping of entire nations (or other empirical cases) as either civic or ethnic/ethnocultural is avoided. In addition, geographical location as a reliable predictor of the existence of either a civic or ethnic/ethnocultural nation (or civic or ethnic/ethnocultural notions of nationhood) has been rejected. In current quantitative research, the CED is both understood and employed as a heuristic device for comprehending empirically existing notions of nationhood as expressed in public perceptions. Overall, we suggest, there was much success in addressing and overcoming what had been the CED's principal limitation: 'its tendency to conflate categories of practice with categories of analysis' (Bonikowski, 2016, p. 430).

However, questions remain regarding the second and fourth lines of critique. Has, as several researchers have claimed (Zubrzycki, 2001, p. 630; Kunovich, 2009, p. 574, Footnote 1), empirical research managed to jettison the CED's normative baggage? Looking at how the authors of recent studies drawing on the CED have framed the relevance of their research, it is clear that ethnic/ethnocultural nationalism is (still) perceived as undesirable and 'feared' (Larsen, 2017, pp. 973–974). Reeskens and Hooghe (2010, p. 597) refer to 'the "ugly face" of ethnic nationalism'. Moreover, studies analysing the link between citizens' conceptions of national identity and opinion formation on immigration-related topics (see, e.g., Hjerm, 1998b; Lindstam et al., 2021; Simonsen & Bonikowski, 2020) have outlined several relevant findings. For example, in Germany, an 'ethno-cultural conception of nationhood reduces the willingness to aid refugees', while having a civic conception of nationhood 'has a positive effect' (Lindstam et al., 2021, p. 104). Similarly, scholars have revealed, also concerning Germany, that 'acceptance of ethnocultural criteria' is 'associated with increased support for (centre-) right and decreased support for (centre-) left parties' (Mader et al., 2021, p. 638; see also, e.g., Lubbers & Coenders, 2017). Against this backdrop, the claim that the CED is perceived as a value-free distinction—in the sense that 'civic' and 'ethnic/ethnocultural' represent, from the researcher's viewpoint, 'neutral' or equally desirable/undesirable options—must be qualified. We also suggest that researchers should be clear and transparent regarding how their own values impact the research process. However, a normative perception of the CED may now yield fewer problematic consequences given the now broadly shared consensus that a purely 'civic West' or a 'civic nation' simply does not exist.

As for the fourth line of critique (theoretical critique challenging the CED's conceptual robustness), we find that empirical research has been driven by research pragmatism. Researchers have taken the liberty of assigning,

in dialogue with existing literature, concrete elements or items to the CED (see Shulman, 2002; Zubrzycki, 2001). Alternatively, researchers have relied on data-driven procedures such as exploratory factor analysis, suggesting a two-factor solution for the CED (see, e.g., Björklund, 2006; Helbling et al., 2016; Jones & Smith, 2001b; Lindstam et al., 2021; Reeskens & Hooghe, 2010).

However, those creative adaptations of the CED to concrete research problems have still been informed by an understanding of the CED as encompassing a civic notion according to which the nation is understood as a political community of citizens and an either ethnic or ethnocultural notion understanding the nation as a community of common descent or one of common descent and culture.

Moreover, it is possible to both criticise a concept *and* use it creatively. Brubaker, for instance, is considered one of the CED's fiercest critics (e.g., Brubaker, 1999). Nevertheless, Brubaker's (1992) historical comparative analysis of citizenship laws, politics and policies in France and Germany—in which he applied the distinction between a 'political' and an 'ethnocultural' notion of nationhood to understand the patterns visible in his data—is regarded as a positive example of a nuanced application of the CED (see Zubrzycki, 2001, p. 656, Footnote 2; Reeskens & Hooghe, 2010, p. 580).

In any case, a creative use of the concept must not result in reification. Scholarship utilising the CED has not only revolved around theoretical categories such as nation, nationalism, national identity and citizenship but has also tended to merge the CED with those categories. Thus, to frame or interpret their findings, scholars may use expressions such as 'civic and ethnic nations' (e.g., Björklund, 2006), 'civic and ethnic nationalism' (e.g., Larsen, 2017), 'civic and ethnic national identity' (e.g., Kunovich, 2009) and 'civic and ethnic citizenship' (e.g., Reeskens & Hooghe, 2010). We believe that those terms are generally problematic, as they may be (mis-)understood as reifying specific nations, nationalisms, national identities, citizenship arrangements or attitudes towards citizenship as either civic or ethnic. Nonetheless, we also find that, despite using expressions such as those above, these scholars remain consistent in applying the CED as a heuristic tool. With few exceptions, the CED is employed to bring conceptions of nationhood to light in order to analyse the civic and ethnic or ethnocultural elements of those conceptions. Moreover, in line with that goal, these scholars use data that capture respondents' conceptions of nationhood (and not conceptions of citizenship), such as the importance-items battery of the ISSP. Nonetheless, it would serve the purpose of conceptual clarity if scholars consistently spoke of the CED as useful in grasping *notions of nationhood*.

Furthermore, notwithstanding the minimal consensus regarding the basis for operationalisation (importance-items battery of the ISSP or comparable items) and the use of data-driven methods, inconsistencies exist concerning the included items. First, variance regarding the number of items evokes questions such as why the importance of ancestry—which Reeskens and Hooghe (2010, p. 591) found to 'being the most characteristic and most powerful item' regarding the 'ethnic' concept—was not included by Larsen (2017). Second, and as cross-country-studies have demonstrated, several items, such as the importance of citizenship and language, load differently in distinct contexts. They are thus highly ambiguous and may be read differently by respondents in various national settings (see Jones & Smith, 2001b, pp. 49–50).

Despite these inconsistencies, we see partial success in the way the CED has been freed from stereotypical distinctions and developed as a heuristic for understanding notions of nationhood. Nevertheless, the 'inviability' of the CED continues to be debated in the field (see, for example, Kaplan, 2022; Tamir, 2019; Todorova, 2015). This notion of the CED's shortcomings is usually invoked with the aim of introducing alternative frameworks for the study of nationalism, such as liberal versus illiberal nationalism (Tamir, 2019) or distinguishing between national identity and national solidarity (Kaplan, 2022).

Several of those alternative distinctions, such as liberal versus illiberal nationalism, are akin to the CED (see Spencer & Wollman, 1998, who argue that many distinctions are highly interlinked). However, other concepts and distinctions (such as the distinction between weak/low vs. strong/high nationalism) consider aspects of nationalism other than the CED. In those cases, however, there is no need to invalidate the CED, which remains a useful tool for analysing notions of nationhood in a specified area of empirical reality. Perhaps ironically, several of the CED's critics do exactly that by drawing on the CED to interpret understandings of nationhood in specific contexts (see Bonikowski & diMaggio, 2016, p. 972; Tamir, 2019, pp. 431–432).

## 4 | THE NPD AND ITS EVOLUTION

The distinction between nationalism and patriotism was initially mentioned by the social psychologist Allport (1927) in the 1920s. It was subsequently employed by historians such as Snyder in the 1950s, who found that nationalism revolved around 'the independence and unity of the nation', whereas patriotism involved the individual's passion 'to serve the object of his devotion—his country' (1952, p. 148; for a more recent account, see Lepore, 2019). In the 1960s, the social psychologist, Doob (1964), was the first to systematically examine the psychological foundations of patriotism and nationalism. He understood the former as a 'conscious conviction of a person that his own welfare and that of the significant groups to which he belongs are dependent upon the preservation or expansion or both of the power and culture of his society', whereas the latter was 'a set of uniform demands which people share and which arise from their patriotism' (1964, p. 6). Notably, that definition underscored the commonality of the concepts.

Without engaging with Doob's work, the distinction was then established in political psychology by Kosterman and Feshbach in the late 1980s in the United States and, inspired by the former, in the late 1990s by Blank and Schmidt (2003) in Germany. Subsequently, without considering the pertinent literature in political psychology, Viroli (1995; for a more recent account, see Smith, 2021) strongly advocated for this distinction in political theory in the late 1990s. Viroli aimed to disentangle both concepts and criticised former accounts, such as that of Orwell (1968, p. 362), who defined patriotism as 'devotion to a particular place and a particular way of life which one believes to be the best in the world but has no wish to force upon other people', whereas nationalism was to strive for 'more power and more prestige [...] for the nation'. Viroli (1995, p. 1) claimed that the 'language of patriotism [seeks to strengthen] love of the political institutions and the way of life that sustain the common liberty of a people, that is love of republic', whereas the 'language of nationalism [aims to] defend or reinforce the cultural, linguistic, and ethnic oneness and homogeneity of the people'.

As previously mentioned, the distinction has been applied largely in political psychology and particularly in quantitative empirical research. Qualitative research drawing on the NPD is essentially non-existent in political psychology. Moreover, aside from two studies conducted in Austria (notably, Latcheva, 2011), mixed-method approaches are equally rare. Focusing on the most influential accounts in political psychology to date, the works of Kosterman and Feshbach (1989) and Blank and Schmidt (2003), we illustrate this distinction's evolution; that is, how it was originally conceptualised, operationalised, adopted and criticised.

### 4.1 | Phase 1: Origin of the NPD: Kosterman and Feshbach's and Blank and Schmidt's work

Without engaging with previous accounts, such as Doob's (1964), the distinction between nationalism and patriotism was originally conceptualised and operationalised by Kosterman and Feshbach (1989) in the United States. Seeking to measure patriotic and nationalistic attitudes, they conducted an exploratory factor analysis and thus a data-driven approach, with 120 items. Notably, from the very beginning of their analysis, they explicitly assumed a distinction between patriotism, defined as 'feelings of attachment to America' (1989, p. 261), and nationalism, understood as the belief in America's superiority and a striving for dominance over other nations. Partly relying on existing measures, they referred to the former with items such as 'I love my country' or 'When I see the American flag flying I feel great'. The latter were captured with items such as 'Generally, the more influence America has on other nations, the better off they are' or 'Other countries should make their government as much like ours as possible' (1989, p. 264). Apart from a weak correlation between nationalism and patriotism ( $r = .28$ ), their data supported the conceptual bifurcation as hypothesised. Concluding that patriotism and nationalism are 'functionally different psychological dimensions' (1989, p. 272), they closed with a normative note by stressing the importance of a 'healthy patriotic spirit' that they saw as an effective countermeasure to recurrent nationalism (1989, p. 273). Overall, the work of Kosterman and Feshbach was the first study to provide evidence for the distinction between nationalism and patriotism and has wielded substantial influence in political psychology. Thus, their conceptualisation and measures have been applied



by a number of scholars to date both within (e.g., Kimmelmeier & Winter, 2008; Li & Brewer, 2004) and outside the United States (see, e.g., Karasawa, 2002, for the case of Japan; Meier-Pesti & Kirchler, 2003, for the case of Austria; Satherley et al., 2019, for the case of New Zealand).

Building on the work of Kosterman and Feshbach (1989), Blank and Schmidt (2003) conceptualised and operationalised the NPD in Germany. From the onset of their analysis, they also assumed a clear-cut distinction between nationalism and patriotism and, as implied in their paper's title ('Nationalism or patriotism?'), they considered them mutually exclusive concepts. Notably, they draw on a *Habermasian* constitutional patriotism that is to be seen as the 'essential counter-concept to nationalism' (2003, p. 292). In contrast to more traditional and thus more prevalent understandings of patriotism widely understood as deriving from a love of country (e.g., De Figueiredo & Elkins, 2003; Kimmelmeier & Winter, 2008; Li & Brewer, 2004; Theiss-Morse, 2009), constitutional patriotism is explicitly defined by a strong adherence to democratic principles assumed to hold a multicultural society together. While adopting existing measures of the blind- and the constructive-patriotism scale by Schatz et al. (1999), Blank and Schmidt (2003) primarily relied on pride item-batteries they developed on their own. For instance, nationalism is captured by pride in being German or in Germany's history, whereas patriotism is reflected by pride in Germany's democratic institutions and its social security system. Running a confirmatory factor analysis, a two-factor model substantiated their assumption. Additionally, they found that nationalism leads to outgroup hostility and antisemitism, whereas patriotism does not, further instantiating their distinction. They concluded that nationalism and patriotism are 'distinct attitudes toward the nation' that 'favor different concepts regarding the nation, the state, and the regime and define different social goals' (2003, p. 305). The work of Blank and Schmidt has unquestionably wielded considerable influence in this research area. Their conceptualisation and measures have been adopted within (Heinrich, 2016; Wagner et al., 2012) and outside Germany (e.g., Ariely, 2011; Davidov, 2009 both for large cross-country analyses; Green et al., 2011 for the case of Switzerland).

Largely overlooked in previous accounts, there is considerable dissent *within* these traditions that can be identified in both conceptual and empirical terms. First, and as intimated above, there is disagreement on the conceptual level. Specifically, scholars working in the research tradition of Blank and Schmidt draw on *Habermasian* constitutional patriotism that strongly adheres to democratic and humanistic principles. However, those standing in the research tradition of Kosterman and Feshbach (1989) conceive of patriotism as an emotional attachment that is commonly manifested in a love for and pride in one's country. Obviously, this denotes two exceptionally varying notions of patriotism that must be sharply differentiated. Apart from these two traditions, the discourse is generally marred by quite different understandings of the term patriotism. Some conceive of it as simply love of country (e.g., Theiss-Morse, 2009), others as love and pride in one's country (e.g., Kosterman & Feshbach, 1989). Still others believe it to be synonymous with national pride or national attachment (e.g., Ariely, 2020), as loyalty to the constitution or political regime (e.g., Smith, 2021) or as signifying a strong devotion to the republic (e.g., Viroli, 1995).

Moreover, there is no consensus within the two dominant research traditions regarding exactly what the distinction is intended to capture. While Huddy et al. (2021; see also Satherley et al., 2019) consider nationalism and patriotism as kinds of national attachment, Blank and Schmidt (2003) (see also Heinrich, 2016) understand them as types of national attitude *and* forms of national identity. In addition, scholars outside these research traditions view them as forms of national pride (e.g., de Figueiredo & Elkins, 2003). To date, the usage of these different conceptions has received scant attention. Phrased differently, whether or the extent to which terms such as identity, pride or attitude should be seen as distinct has remained unclear.

Second, the conceptual disagreement is mirrored in considerable dissent over the measures. Scholars in the research tradition of Kosterman and Feshbach (1989) (see also Kimmelmeier & Winter, 2008, Satherley et al., 2019) operationalise patriotism by items revolving around the emotional attachment to one's country and, among others, to its national symbols. However, the tradition of Blank and Schmidt (2003) (see also Ariely, 2011; Davidov, 2009; Wagner et al., 2012) measures patriotism by pride in the democratic institutions or social security system of one's country. Strikingly, scholars such as Ariely employ these pride-items (e.g., pride in the national social security system) in some contributions (e.g., Ariely, 2011) and use items referring to one's closeness to the nation to tap patriotism

in others (e.g., Ariely, 2020). In addition, it is not uncommon to attempt to capture nationalism and patriotism with the same items. Whereas Blank and Schmidt (2003) employed pride in one's nationality for measuring nationalism, Kimmelmeier and Winter (2008) used it for measuring patriotism. In 2009, Davidov (2009) noted that there is no agreement in terms of operationalising nationalism and patriotism, and this lack of agreement shapes the field to date. Irrespective of this disagreement, a correlation between patriotism and nationalism is a common empirical finding that has shaped both research traditions to date (e.g., Huddy et al., 2021; Karasawa, 2002; Kimmelmeier & Winter, 2008; Kosterman & Feshbach, 1989; Wagner et al., 2012), placing any clear-cut distinctions in question. Though corroborated in many studies, this correlation has yet to receive substantial attention.

Aside from disparities within the two dominant strands of literature, there is also disagreement regarding the pairing of nationalism and patriotism. For instance, several accounts advocate for distinguishing chauvinism (and not: nationalism) from patriotism. Citrin (2001, p. 75) and colleagues found that nationalism was 'unnecessarily confusing' and thus preferred the term chauvinism, understood as 'an extreme and bounded loyalty, the belief in one's country's superiority, whether it is right or wrong'. Thus, there is no consensus as to whether chauvinism is synonymous with nationalism or a component of it. In short, researchers are confronted with two distinct dichotomies.

## 4.2 | Phase 2: Criticisms of the NPD

In contrast to the CED, the NPD has not received substantial criticism. Indeed, objections have been mentioned, if at all, only briefly and have lacked detail. Only recently have scholars begun to critically and thoroughly engage with the NPD in both conceptual and empirical terms (notably, Mußotter, 2022; see also Bitschnau & Mußotter, 2022). Though earnest discussion has been largely absent from the discourse, the existing critique can be structured into three different strands: conceptual critique, normative critique and empirical critique.

First, nationalism and patriotism have been criticised for being difficult to separate, albeit not in detail and depth. In the 1960s, social psychologists such as Doob (1964) had already posited that nationalism, by definition, results from patriotism, questioning the clear-cut distinction. Feshbach (1987, p. 315) concurred, considering patriotism as 'love of and pride in one's country', while claiming that 'nationalism entails love of one's country' but is additionally 'complicated by power and superiority elements' (1987, p. 322). Despite pointing out that nationalism was distinct from patriotism given that the former was inherently marked by the exclusion of others, Druckmann (1994, p. 48) wondered whether nationalism was not a 'more complex form of patriotism'. Beyond social psychology, nationalism scholars such as Gellner considered nationalism to be a 'very distinct species of patriotism' (1983, p. 138), calling their demarcation into question. Likewise, Brubaker (2004, p. 120) objected that the distinction 'neglect[ed] the intrinsic ambivalence and polymorphism of both'. Stressing their broad commonality, he rejected the distinction and synthesised both concepts. Overall, there has been no earnest debate over the concept's overlap to date.

Second, the normative evaluations of nationalism and patriotism, which are dominant in both political psychology (e.g., Kosterman & Feshbach, 1989) and political theory (e.g., Smith, 2021; Viroli, 1995), have received considerable criticism. In the late 1990s, Billig (1995, p. 17) had already claimed that 'our patriotism is made to appear 'natural', and thereby invisible, while nationalism is seen as a property of others'. Canovan (2000, p. 415) concurred that the distinction between a supposedly socially desirable patriotism and an ostensibly harmful nationalism was 'a matter of intellectual curiosity [and] a rhetorical and political strategy'. More recently, Bonikowski (2016, p. 430) objected that political psychologists persistently consider nationalism a 'normative problem', thus failing to investigate its multidimensionality with the necessary analytical clarity. However, this critique has hitherto not been addressed in any fashion.

Third, criticisms of the predominant measures for nationalism and patriotism have been scarce. To date, only two accounts (Latcheva, 2011; for a more thorough discussion see Mußotter, 2022) have critically reflected on the pride-items employed in the research tradition of Blank and Schmidt (2003). Specifically, qualitative research has revealed that the ISSP pride-items most scholars use are highly ambiguous and cause severe comprehension



difficulties (notably, Latcheva, 2011), underscoring the need to develop new measures. However, this critique has not yet been addressed. Instead, most scholars have continued to operate with the existing item-batteries, though a few scholars are aware of the items' shortcomings (e.g., Ariely, 2011; Heinrich, 2016; Huddy et al., 2021). Kosterman and Feshbach's (1989) measures have not yet been discussed in any systematic manner at all.

## 5 | LEARNING FROM THE CED: A ROADMAP FOR FURTHER DEVELOPING THE NPD

Over the previous pages, we have demonstrated there has been earnest debate on the CED over the previous decades. Because of that debate and through engagement with selected lines of critique, scholars were eventually able to advance and improve the CED and its application in quantitative empirical research. In contrast, similar debate has been absent in research concerning the NPD, and the discourse has not evolved substantially. In the context of the CED's evolution, we believe that a thorough reflection on criticism concerning the NPD would represent an initial step in the appropriate direction. In the following, we provide a (conceptual) roadmap that, we hope, not only stimulates a highly necessary debate but, more importantly, also offers a path forward regarding quantitative empirical research on the NPD.

First, and in order to achieve additional conceptual clarity and a more consistent terminology, we suggest conceiving of patriotism and nationalism as different kinds of attachment and for precisely separating nationalism and patriotism's distinct objects of attachment. In line with the field's more convincing accounts (e.g., Primoratz, 2017; Snyder, 1952), we propose considering patriotism as centring around the homeland and nationalism around the nation. Elaborating on these specific objects of attachment also enables a clear definition of the different forms of patriotism. Notably, constitutional patriotism, largely seen as a strong attachment to democracy, should not be equated with love of and loyalty to country. Moreover, stipulating the different objects of attachment serves to more effectively disentangle related yet fundamentally distinct terms—national pride, national identity, patriotism or nationalism—that are often erroneously equated. We also argue that patriotism, widely understood as love of country and thus revolving around the homeland, is not the same as national identity. One can identify with one's country while not necessarily having to love it. Likewise, patriotism and nationalism are neither kinds of pride nor synonymous with it but are much more complex. Given the hitherto understudied complexity of the term pride, further work must be undertaken to determine its meaning and, particularly, the differences between pride and love.

Further, we call for treating nationalism and chauvinism as synonymous, since the latter has not only been measured with the same items but also been exactly defined as the former (e.g., Huddy et al., 2021). Both are conceived of as an idealisation of one's nation accompanied by, as many maintain, an inherently exclusive notion of nationhood. This conceptual clarification is useful for arriving at a single and settled distinction (nationalism–patriotism).

Second, distinguishing nationalism and patriotism's different objects of attachment (nation and homeland or, in the case of constitutional patriotism, democracy) is conducive to constructing more theoretically robust measures. In contrast to scholarship on the CED, we have demonstrated that empirical research on the NPD is shaped by a considerable lack of agreement regarding measures. In our view, this primarily results from the different and often contradictory notions of patriotism and nationalism. For instance, patriotism involves a number of different items, such as love of country (e.g., Kosterman & Feshbach, 1989), attachment to national symbols (e.g., Kimmelmeier & Winter, 2008), closeness to the nation (e.g., Ariely, 2020) and pride in the social security system of one's country (e.g., Davidov, 2009). Importantly, conceptual disagreement is mirrored in empirical disagreement. Thus, we feel the need to systematically review extant metrics, focusing on the various objects of attachments these items refer to.

Third, given the correlation between nationalism and patriotism corroborated in a wide array of studies, it is important to arrive at a more nuanced understanding of the distinction. As illustrated, scholars drawing on the CED have widely acknowledged that the two different conceptions of nationhood are ideal types that are not mutually exclusive (e.g., Hjerm, 1998a; Kunovich, 2009; Lindstam et al., 2021; Mader et al., 2021; Reeskens & Hooghe, 2010). In contrast, nationalism and patriotism are predominantly seen as contradictory and thus seem to fall neatly into

black and white categories. Thus, future studies should consider these two attachments as ideal types rather than as fixed and mutually exclusive categories. Likewise, and in order to more accurately capture the complexities and ambivalences of people's attachments, future research should acknowledge that nationalism and patriotism can be held simultaneously to varying degrees. The study of Satherley et al. (2019) (see also Heinrich, 2016 for the case of Germany) regarding the case of New Zealand marks an important first step in that direction by pointing out that most citizens tend to concurrently hold both attachments to varying degrees. In so doing, researchers could grasp the differentiated, nuanced and often ambivalent bonds people have with their nation or other objects more precisely.

At this point, we further propose treating the normative perceptions and evaluations that have shaped quantitative empirical research on the NPD to date with more caution. Presupposing nationalism as uncritical and aggressive from the onset of the analysis while describing patriotism as constructive, tolerant and as the 'essential counter-concept to nationalism' (Blank & Schmidt, 2003, p. 292) is particularly momentous when perceiving those concepts as mutually exclusive. Doing so may result in labelling nations, individuals or other cases as either patriotic and thus 'good' or as nationalist and thus 'bad'. Therefore, earnestly engaging with 'the intrinsic ambivalence and polymorphism of both' (Brubaker, 2004, p. 120) may serve as a valuable first step for a more insightful application of the NPD.

With this article, we hope to have demonstrated how an engagement with the CED's evolution may inspire quantitative empirical scholarship on nationalism and patriotism. Future research could expand on our reflections by, for instance, examining how and to what extent theoretical accounts have regarded 'ethnic' notions of nationhood as associated with a 'nationalist' attitude and 'civic' notions as accompanying a 'patriotic' stance (see, e.g., Ignatieff, 1993, pp. 6–7). Likewise, future work could systematically examine whether and how certain criticisms of the NPD could also be directed towards the CED. Overall, we believe that a continuous dialogue between CED and NPD scholarship would be to the benefit of both and lead to more theoretically informed and empirically grounded scholarship.

## ACKNOWLEDGMENTS

Open Access funding enabled and organized by Projekt DEAL.

## ORCID

Eunike Piwoni  <https://orcid.org/0000-0002-4567-3175>

## ENDNOTES

- <sup>1</sup> Importantly, this article by no means claims to review all the literature in nationalism studies that discusses the NPD or the CED. We explicitly acknowledge that the CED and the NPD may be used in different ways in fields other than those presented in this article.
- <sup>2</sup> Notably, Ignatieff (1993, p. 189) was very critical of ethnic nationalism: 'What's wrong with the world is not nationalism itself. [...] What's wrong is the kind of nation, the kind of home that nationalists want to create and the means that they use to seek their ends. [...] It's the battle between the civic and the ethnic nation.'

## REFERENCES

- Allport, F. (1927). The psychology of nationalism: The nationalistic fallacy as a cause of war. *Harper's Monthly Magazine*, 155, 291–301.
- Ariely, G. (2011). Constitutional patriotism, liberal nationalism and membership in the nation: An empirical assessment. *Acta Politica*, 46(3), 294–319. <https://doi.org/10.1057/ap.2011.10>
- Ariely, G. (2020). Measuring dimensions of national identity across countries: Theoretical and methodological reflections. *National Identities*, 22(3), 265–282. <https://doi.org/10.1080/14608944.2019.1694497>
- Billig, M. (1995). *Banal Nationalism*. Sage.
- Bitschnau, M., & Mußotter, M. (2022). (National) pride and (conceptual) prejudice: Critical remarks on the distinction between nationalism and patriotism. *Journal of Political Ideologies*, 1–15. <https://doi.org/10.1080/13569317.2022.2096301>
- Björklund, F. (2006). The East European 'ethnic nation'—Myth or reality? *European Journal of Political Research*, 45(1), 93–121. <https://doi.org/10.1111/j.1475-6765.2005.00292.x>

- Blank, T., & Schmidt, P. (2003). National identity in a united Germany: Nationalism or patriotism? An empirical test with representative data. *Political Psychology*, 24(2), 289–312. <https://doi.org/10.1111/0162-895X.00329>
- Bonikowski, B. (2016). Nationalism in settled times. *Annual Review of Sociology*, 42, 427–449. <https://doi.org/10.1146/annurev-soc-081715-074412>
- Bonikowski, B., & DiMaggio, P. (2016). Varieties of American popular nationalism. *American Sociological Review*, 81(5), 949–980. <https://doi.org/10.1177/0003122416663683>
- Brubaker, R. (1992). *Citizenship and Nationhood in France and Germany*. Harvard University Press.
- Brubaker, R. (1999). The Manichean myth: Rethinking the distinction between 'civic' and 'ethnic' nationalism. In H. Kriesi, K. Armingeon, H. Siegrist, & A. Wimmer (Eds.), *Nation and National Identity: The European Experience in Perspective*. Ruegger.
- Brubaker, R. (2004). In the name of the nation: Reflections on nationalism and patriotism. *Citizenship Studies*, 8(2), 115–127. <https://doi.org/10.1080/1362102042000214705>
- Canovan, M. (2000). Patriotism is not enough. *British Journal of Political Science*, 30(3), 413, S000712340000017X–432. <https://doi.org/10.1017/S000712340000017X>
- Citrin, J., Wong, C., & Duff, B. (2001). The meaning of American national identity: Patterns of ethnic conflict and consensus. In R. D. Ashmore, L. Jussim, & D. Wilder (Eds.), *Social Identity, Intergroup Conflict, and Conflict Reduction*. Oxford University Press.
- Coakley, J. (2018). National identity and the Kohn dichotomy. *Nationalities Papers*, 46(2), 252–271. <https://doi.org/10.1080/00905992.2017.1360267>
- Davidov, E. (2009). Measurement equivalence of nationalism and constructive patriotism in the ISSP: Thirty-four countries in a comparative perspective. *Political Analysis*, 17(1), 64–82. <https://doi.org/10.1093/pan/mpn014>
- de Figueiredo, R. J. Jr., & Elkins, Z. (2003). Are patriots bigots? An inquiry into the vices of in-group pride. *American Journal of Political Science*, 47(1), 171–188. <https://doi.org/10.1111/1540-5907.00012>
- Doob, L. W. (1964). *Patriotism and Nationalism: Their Psychological Foundations*. Yale University Press.
- Druckman, D. (1994). Nationalism, patriotism, and group loyalty: A social psychological perspective. *Mershon International Studies Review*, 38(Supplement\_1), 43–68.
- Erhardt, J., Wamsler, S., & Freitag, M. (2021). National identity between democracy and autocracy: A comparative analysis of 24 countries. *European Political Science Review*, 13(1), 59–76. <https://doi.org/10.1017/S1755773920000351>
- Feshbach, S. (1987). Individual aggression, national attachment, and the search for peace: Psychological perspectives. *Aggressive Behavior*, 13(5), 315–325. [https://doi.org/10.1002/1098-2337\(1987\)13:5<315::AID-AB2480130508>3.0.CO;2-4](https://doi.org/10.1002/1098-2337(1987)13:5<315::AID-AB2480130508>3.0.CO;2-4)
- Fox, J. E., & Miller-Idriss, C. (2008). Everyday nationhood. *Ethnicities*, 8(4), 536–563. <https://doi.org/10.1177/1468796808088925>
- Gellner, E. (1983). *Nations and Nationalism*. Cornell University Press.
- Green, E. G., Sarrasin, O., Fasel, N., & Staerklé, C. (2011). Nationalism and patriotism as predictors of immigration attitudes in Switzerland: A municipality-level analysis. *Swiss Political Science Review*, 17(4), 369–393. <https://doi.org/10.1111/j.1662-6370.2011.02030.x>
- Greenfeld, L. (1992). *Nationalism: Five Roads to Modernity*. Harvard University Press.
- Halikioyopoulou, D., & Vlandas, T. (2019). What is new and what is nationalist about Europe's new nationalism? Explaining the rise of the far right in Europe. *Nations and Nationalism*, 25(2), 409–434. <https://doi.org/10.1111/nana.12515>
- Heinrich, H. A. (2016). Dimensional differences between nationalism and patriotism. In J. Grimm, L. Huddy, P. Schmidt, & J. Seethaler (Eds.), *Dynamics of National Identity: Media and Societal Factors of What We Are*. Routledge. <https://doi.org/10.4324/9781315746111-4>
- Helbling, M., Reeskens, T., & Wright, M. (2016). The mobilisation of identities: A study on the relationship between elite rhetoric and public opinion on national identity in developed democracies. *Nations and Nationalism*, 22(4), 744–767. <https://doi.org/10.1111/nana.12235>
- Hjerm, M. (1998a). National identity: A comparison of Sweden, Germany and Australia. *Journal of Ethnic and Migration Studies*, 24(3), 451–469. <https://doi.org/10.1080/1369183X.1998.9976644>
- Hjerm, M. (1998b). National identities, national pride and xenophobia: A comparison of four Western countries. *Acta Sociologica*, 41(4), 335–347. <https://doi.org/10.1177/000169939804100403>
- Huddy, L., Del Ponte, A., & Davies, C. (2021). Nationalism, patriotism, and support for the European Union. *Political Psychology*, 42(6), 995–1017. <https://doi.org/10.1111/pops.12731>
- Ignatieff, M. (1993). *Blood and Belonging: Journeys Into the New Nationalism*. BBC Books.
- Janmaat, J. G. (2006). Popular conceptions of nationhood in old and new European member states: Partial support for the ethnic-civic framework. *Ethnic and Racial Studies*, 29(1), 50–78. <https://doi.org/10.1080/01419870500352363>
- Jones, F. L., & Smith, P. (2001a). Individual and societal bases of national identity: A comparative multi-level analysis. *European Sociological Review*, 17(2), 103–118. <https://doi.org/10.1093/esr/17.2.103>
- Jones, F. L., & Smith, P. (2001b). Diversity and commonality in national identities: An exploratory analysis of cross-national patterns. *Journal of Sociology*, 37(1), 45–63. <https://doi.org/10.1177/144078301128756193>

- Kaplan, D. (2022). Distinguishing solidarity from identity in studies of nationhood: An alternative to the civic–ethnic dichotomy? *Nations and Nationalism*, 28(3), 760–776. <https://doi.org/10.1111/nana.12792>
- Karasawa, M. (2002). Patriotism, nationalism, and internationalism among Japanese citizens: An etic–emic approach. *Political Psychology*, 23(4), 645–666. <https://doi.org/10.1111/0162-895X.00302>
- Kemmelmeier, M., & Winter, D. G. (2008). Sowing patriotism, but reaping nationalism? Consequences of exposure to the American flag. *Political Psychology*, 29(6), 859–879. <https://doi.org/10.1111/j.1467-9221.2008.00670.x>
- Kohn, H. (1944). *The Idea of Nationalism: A Study in Its Origins and Background*. MacMillan.
- Kohn, H. (1982). *Nationalism: Its Meaning and History*. Robert E. Krieger Publishing.
- Kohn, H. (1994). *Western and Eastern Nationalisms*. Oxford University Press.
- Kosterman, R., & Feshbach, S. (1989). Toward a measure of patriotic and nationalistic attitudes. *Political Psychology*, 10(2), 257–274. <https://doi.org/10.2307/3791647>
- Kunovich, R. M. (2009). The sources and consequences of national identification. *American Sociological Review*, 74(4), 573–593. <https://doi.org/10.1177/000312240907400404>
- Kuzio, T. (2002). The myth of the civic state: A critical survey of Hans Kohn's framework for understanding nationalism. *Ethnic and Racial Studies*, 25(1), 20–39. <https://doi.org/10.1080/01419870120112049>
- Kymlicka, W. (1999). Misunderstanding nationalism. In R. Beiner (Ed.), *Theorizing Nationalism*. State University of New York Press.
- Larsen, C. A. (2017). Revitalizing the civic and ethnic distinction: Perceptions of nationhood across two dimensions, 44 countries and two decades. *Nations and Nationalism*, 23(4), 970–993. <https://doi.org/10.1111/nana.12345>
- Latcheva, R. (2011). Cognitive interviewing and factor-analytic techniques: A mixed method approach to validity of survey items measuring national identity. *Quality & Quantity*, 45(6), 1175–1199. <https://doi.org/10.1007/s11135-009-9285-0>
- Lepore, J. (2019). *This America: The Case for the Nation*. Liveright Publishing.
- Li, Q., & Brewer, M. B. (2004). What does it mean to be an American? Patriotism, nationalism, and American identity after 9/11. *Political Psychology*, 25(5), 727–739. <https://doi.org/10.1111/j.1467-9221.2004.00395.x>
- Lindstam, E., Mader, M., & Schoen, H. (2021). Conceptions of national identity and ambivalence towards immigration. *British Journal of Political Science*, 51(1), 93–114. <https://doi.org/10.1017/S0007123418000522>
- Lubbers, M., & Coenders, M. (2017). Nationalistic attitudes and voting for the radical right in Europe. *European Union Politics*, 18(1), 98–118. <https://doi.org/10.1177/1465116516678932>
- Mader, M., Pesthy, M., & Schoen, H. (2021). Conceptions of national identity, turnout and party preference: Evidence from Germany. *Nations and Nationalism*, 27(3), 638–655. <https://doi.org/10.1111/nana.12652>
- Massey, G., Hodson, R., & Sekulić, D. (2003). Nationalism, liberalism and liberal nationalism in postwar Croatia. *Nations and Nationalism*, 9(1), 55–82. <https://doi.org/10.1111/1469-8219.00075>
- Meier-Pesti, K., & Kirchler, E. (2003). Nationalism and patriotism as determinants of European identity and attitudes towards the euro. *The Journal of Socio-Economics*, 32(6), 685–700. <https://doi.org/10.1016/j.socrec.2003.10.006>
- Meinecke, F. (2019). *Weltbürgertum und Nationalstaat [Cosmopolitanism and the National State]*. Oldenbourg Wissenschaftsverlag.
- Mußotter, M. (2022). We do not measure what we aim to measure: Testing three measurement models for nationalism and patriotism. *Quality & Quantity*, 56(4), 2177–2197. <https://doi.org/10.1007/s11135-021-01212-9>
- Nieghuth, T. (1999). Beyond dichotomy: Concepts of the nation and the distribution of membership. *Nations and Nationalism*, 5(2), 155–173. <https://doi.org/10.1111/j.1354-5078.1999.00155.x>
- Nielsen, K. (1999). Cultural nationalism, neither ethnic nor civic. In R. Beiner (Ed.), *Theorizing Nationalism*. State University of New York Press.
- Orwell, G. (1968). *The Collected Essays, Journalism and Letters of George Orwell Volume II: My Country Right Or Left 1940–1943*. Harcourt.
- Piwoni, E. (2013). Latent but not less significant: The Holocaust as an argumentative resource in German national identity discourse. *German Politics and Society*, 31(3), 1–26. <https://doi.org/10.3167/gps.2013.310301>
- Plamenatz, J. (1973). Two types of nationalism. In E. Kamenka (Ed.), *Nationalism. The Nature And Evolution of An Idea*. Australian National University Press.
- Primoratz, I. (2017). Patriotism. In E. N. Zalta (Ed.), *Stanford encyclopedia of philosophy*. <https://plato.stanford.edu/archives/sum2017/entries/patriotism/> (Accessed 26 January 2021).
- Reeskens, T., & Hooghe, M. (2010). Beyond the civic–ethnic dichotomy: Investigating the structure of citizenship concepts across thirty-three countries. *Nations and Nationalism*, 16(4), 579–597. <https://doi.org/10.1111/j.1469-8129.2010.00446.x>
- Renan, E. (1996). *Qu'est-ce qu'une nation? Et autres écrits politiques*. Imprimerie Nationale.
- Satherley, N., Yogeeswaran, K., Osborne, D., & Sibley, C. G. (2019). Differentiating between pure patriots and nationalistic patriots: A model of national attachment profiles and their socio-political attitudes. *International Journal of Intercultural Relations*, 72, 13–24. <https://doi.org/10.1016/j.ijintrel.2019.06.005>
- Schatz, R. T., Staub, E., & Lavine, H. (1999). On the varieties of national attachment: Blind versus constructive patriotism. *Political Psychology*, 20(1), 151–174. <https://doi.org/10.1111/0162-895X.00140>

- Shulman, S. (2002). Challenging the civic/ethnic and West/East dichotomies in the study of nationalism. *Comparative Political Studies*, 35(5), 554–585. <https://doi.org/10.1177/0010414002035005003>
- Simonsen, K. B., & Bonikowski, B. (2020). Is civic nationalism necessarily inclusive? Conceptions of nationhood and anti-Muslim attitudes in Europe. *European Journal of Political Research*, 59(1), 114–136. <https://doi.org/10.1111/1475-6765.12337>
- Smith, A. D. (1991). *National Identity*. Penguin.
- Smith, S. B. (2021). *Reclaiming Patriotism in An Age of Extremes*. Yale University Press.
- Snyder, L. L. (1952). *German Nationalism: The Tragedy of People*. Stackpole Company.
- Spencer, P., & Wollman, H. (1998). Good and bad nationalisms: A critique of dualism. *Journal of Political Ideologies*, 3(3), 255–274. <https://doi.org/10.1080/13569319808420780>
- Tamir, Y. (2019). Not so civic: Is there a difference between ethnic and civic nationalism? *Annual Review of Political Science*, 22, 419–434. <https://doi.org/10.1146/annurev-polisci-022018-024059>
- Theiss-Morse, E. (2009). *Who Counts As An American?: The Boundaries of National Identity*. Cambridge University Press.
- Tinsley, M. (2019). Decolonizing the civic/ethnic binary. *Current Sociology*, 67(3), 347–364. <https://doi.org/10.1177/0011392117750212>
- Todorova, M. (2015). Is there weak nationalism and is it a useful category? *Nations and Nationalism*, 21(4), 681–699. <https://doi.org/10.1111/nana.12112>
- Vick, B. (2003). The origins of the German Volk: Cultural purity and national identity in nineteenth-century Germany. *German Studies Review*, 26(2), 241–256. <https://doi.org/10.2307/1433324>
- Viroli, M. (1995). *For Love of Country: An Essay on Patriotism and Nationalism*. Clarendon Press.
- Wagner, U., Becker, J. C., Christ, O., Pettigrew, T. F., & Schmidt, P. (2012). A longitudinal test of the relation between German nationalism, patriotism, and outgroup derogation. *European Sociological Review*, 28(3), 319–332. <https://doi.org/10.1093/esr/jcq066>
- Yack, B. (1996). The myth of the civic nation. *Critical Review*, 10(2), 193–211. <https://doi.org/10.1080/08913819608443417>
- Zubrzycki, G. (2001). 'We, the Polish Nation': Ethnic and civic visions of nationhood in post-communist constitutional debates. *Theory and Society*, 30(5), 629–668. <https://doi.org/10.1023/A:1013024707150>
- Zubrzycki, G. (2002). The classical opposition between civic and ethnic models of nationhood: Ideology, empirical reality and social scientific analysis. *Polish Sociological Review*, 139, 275–295.

**How to cite this article:** Piwoni, E., & Mußotter, M. (2023). The evolution of the civic–ethnic distinction as a partial success story: Lessons for the nationalism–patriotism distinction. *Nations and Nationalism*, 1–16. <https://doi.org/10.1111/nana.12944>

## Description of the author's contribution to the publications

**Both Article 1:** Mußotter, M. (2022). We do not measure what we aim to measure: Testing three measurement models for nationalism and patriotism. *Quality & Quantity*, 56(4), 2177–2197 and **Article 3:** Mußotter, M. (2023a): Über (nationale) Bindungen: Trias von Nationalismus, Vaterlandsliebe und demokratischem Patriotismus. *Zeitschrift für Kultur- und Kollektivwissenschaft* are single-author paper.

**Article 2:** Bitschnau, M., & Mußotter, M. (2022). (National) Pride and (conceptual) prejudice: Critical remarks on the distinction between nationalism and patriotism. *Journal of Political Ideologies*. DOI: 10.1080/13569317.2022.2096301

In this article, we critically reflect on the influential nationalism-patriotism distinction. In so doing, we present a threefold critique of the distinction: conceptual shortcomings, the lack of context in empirical studies with a special emphasis on the way nationalism and patriotism are measured, and finally the normative consequences entailed. We both developed the paper's concept together.

I wrote parts of the introduction such as the section on the conceptual disagreement. Thus, I highlighted that it still remains open do debate under which category nationalism and patriotism can be subsumed (p.1). What is more, I indicated that a number of scholars tend to conflate concepts such as national identity and patriotism (p.1). Apart from the nationalism-patriotism dichotomy, I stressed that many more distinctions such as the one between blind vs. constructive patriotism are employed within political psychology (p.2). I mainly contributed to the introduction's final section that zooms in on how the concepts under investigation are defined within this field, hinting at the conceptual shortcomings and the related empirical shortcomings (p.2).

I was also in charge of major sections of the first chapter titled "Blurred concepts". Thus, I described how the distinction has been operationalized to date, underscoring the lack of agreement on the measurement instruments (p.2 f). In so doing, I also highlighted that many empirical studies have yielded a positive correlation between both concepts, further questioning the distinction's clear-cut distinctiveness (p.2 f). What is more, I underscored that the measurement instruments for patriotism such as "How proud are you of the way democracy

works” do not necessarily target this kind of attachment, but rather distinct concepts such as contentment with democracy (p.3). Further, I wrote a section on the lack of terminology. Thus, I stressed that – despite using the same items – some scholars speak of “nationalism”, while some employ the term “chauvinism” (p.3).

Concerning the second chapter entitled “Missing contexts” I thoroughly elaborated on the lack of context this line of research has been marked over the last years (p.3 f). In so doing, I described how items that were originally developed in the U.S. by Kosterman and Feshbach (1989) in the late 80s were employed by other scholars such as Sakano who investigated nationalism and patriotism in Japan – without any further reflection and contextual awareness (p. 4). Moreover, I was responsible for the section of Blank and Schmidt’s (2003) seminal study on nationalism and patriotism. Zooming in on their pride-items, I illustrated the empirical shortcomings, in particular in terms of temporal context (p.4 and p.5). Although the items have been developed in the later 90s in Germany, they are still employed without any further re-examination.

Furthermore, I was in charge of major parts of the third chapter called “Problematic consequences”. I wrote this chapter’s first section, highlighting the normative components inherent in the nationalism-patriotism distinction. In so doing, I stressed that patriotism is praised as enlightened, while nationalism is condemned and largely seen as aggressive and hostile in the pertinent literature (p. 6). Further, I shed light on the distinction’s public perception. Put differently, the “good patriotism/bad nationalism” dichotomy has been established in both academic and political discourse. On the next page, I shed light on the logical inconsistencies that arise from the operationalization of the ‘good patriotism/bad nationalism’ dichotomy (p.7). In so doing, I zoomed in on, among other things, the shortcomings inherent in the patriotism items such as “How proud are you of the way democracy works”. In this chapter’s final section, I elaborated on the link between civic commitment and patriotism, and especially on the claim of Huddy and Khatib (2007) stressing that patriots feel the need to “move their country in a positive direction”.

Finally, I was in charge of a few sections of the conclusion. For instance, I highlighted the “conceptual stretching” and thus the myriad definitions of nationalism and patriotism, resulting in a lack of conceptual agreement that leads to empirical challenges that have not been

addressed yet. Further, I stressed the need to systematically develop new measurement instruments that are additionally (p. 8).

**Article 4:** Piwoni, E., & Mußotter, M. (2023). The evolution of the civic-ethnic distinction as a partial success story: lessons for the nationalism-patriotism distinction. *Nations and Nationalism*. DOI: 10.1111/nana.12944

In this article, we aim to bring the distinction between civic versus ethnic nationalism (CED) and the nationalism-patriotism distinction (NPD) into extended dialogue, with the goal of improving empirical research drawing on the NPD. We both developed the paper's concept together.

I was in charge of a few sections in the introduction. Thus, in the introduction's second paragraph, I highlighted that the paper focused on quantitative studies in which both distinctions have been employed, yet not been simultaneously analysed or discussed. Subsequently, I underscored the paper's merit. In so doing, I, among other things, wrote that a systematic review of both lines of research has been largely missing from existing accounts (p.1). In the introduction's third paragraph, I zoomed in on existing research on the nationalism-patriotism distinction and stressed that there has been only limited dialogue between theoretical and empirical approaches (p. 1).

Dr. Piwoni was in charge of the whole section on the CED. While familiar with research on the CED, she is a qualitative researcher, specialized on conducting different kinds of interviews. Thus, I assisted her in terms of quantitative studies that have been conducted in this line of research. Put differently, I scanned and reviewed the most influential quantitative studies in this research tradition. In chapter 2.3 I analysed influential studies such as the one of Shulman (2002) (p.5). Further, I reviewed the majority of quantitative studies and zoomed in on how they operationalized civic and ethnic notions of nationhood (p.5). What is more, I was in charge of the following section, describing the minimal consensus that emerged in this line of research (p.5 f). Further, I dealt with the seminal study of Reeskens and Hooghe (2010) and the more recent study of Larsen (2017) seeking to revitalize this distinction (p. 6). In chapter 3.1 I was responsible for the consensus on the operationalization of the CED, underscoring the significance of the ISSP importance-item battery (p. 7). In chapter 3.2 I was in charge of the section on the fourth line of critique. A few sections later, I mentioned that – despite of the minimal consensus – inconsistencies regarding a few items still remain (p. 8).



As I am an expert on the nationalism-patriotism distinction, I wrote the whole section on the NPD. In chapter 4 “The NPD and its evolution” I analysed the distinction’s evolution in different disciplines (p. 9). In chapter 4.1 entitled “Phase 1: Origin of the NPD: Kosterman and Feshbach and Blank and Schmidt’s work” I thoroughly analysed the two most predominant research traditions and zoomed in on the distinction’s conceptualization, operationalization and adaption (p.10). In chapter 4.2 “Phase 2: Criticism of the NPD” I presented the different lines of critique, i.e., conceptual, empirical and normative critique, that have been evolved yet not been systematically addressed (p.11).

Finally, I was responsible for most parts of the article’s conclusion “Learning from the CED: A roadmap for further developing the NPD” (p.12). In the first section, I suggested a reconceptualization of the binary distinction and thus called for a nuanced triad of nationalism, revolving around the nation; patriotism, i.e., love of country, that revolved around the homeland; and democratic patriotism, with democracy as its object of attachment. In the second section, I recommended to use this conceptual triad as a guideline to develop more theoretically robust measures for nationalism and the two different kinds of patriotism (p.12). On the next page, I suggested to perceive these kind of attachments – alike the CED – as ideal types rather than as mutually exclusive categories (p.13). In the final section, drawing on a convincing claim of Brubaker (2004), I stressed the need to treat the distinction’s normative components with more caution.