



ENGAGING WITH E-STATIC TEXTILES

Ramyah Gowrishankar

 Universität der Künste Berlin

**ArcInTexETN**   
Marie Skłodowska-Curie actions European Training Network (ETN)

  
DEC  
2020

# ENGAGING WITH E-STATIC TEXTILES:

An investigation into textile  
interaction design for shaping  
body-driven energy harvesting  
in the interior

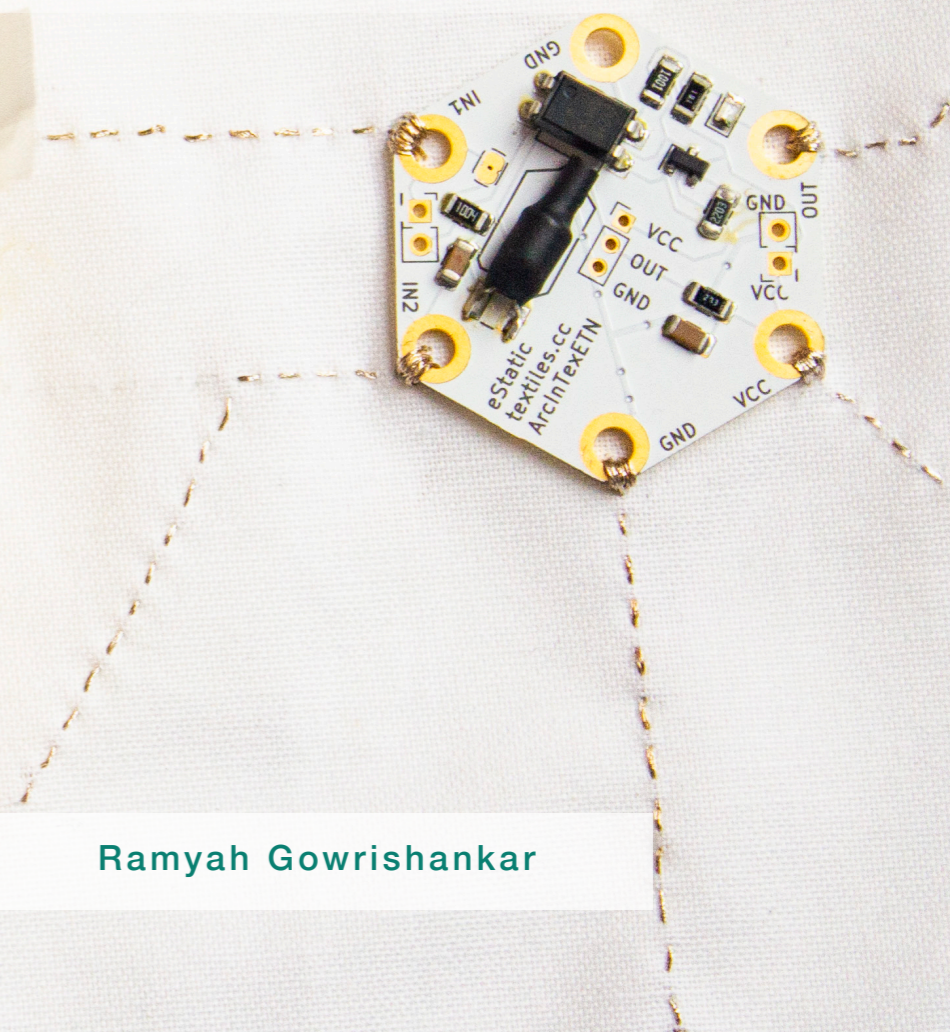

Ramyah Gowrishankar



This work is licensed under a [Creative Commons Attribution-ShareAlike 4.0 International License](https://creativecommons.org/licenses/by-sa/4.0/).

**Photos, videos and illustrations with other statements are excluded.**

# **Engaging with e-static textiles:**

An investigation into textile interaction design for shaping  
body-driven energy harvesting in the interior

Dissertation

zur Erlangung des akademischen Grades

**Doktoringenieur (Dr.-Ing.)**

an der Fakultät Gestaltung

der Universität der Künste Berlin

vorgelegt von

**Ramyah Gowrishankar, M.A.**



1. Gutachterin: Prof. Dr. Gesche Joost
2. Gutachterin: Prof. Dr. Berit Greinke



## **Declaration**

I hereby declare that I have completed the present dissertation independently and without inadmissible external support. I have not used any sources or tools other than those indicated in the work and have identified literal and analogous quotations.



Berlin, 07.10.2019. Ramyah Gowrishankar





## **Publications**

Gowrishankar, Ramyah, Katharina Bredies, and Salu Ylirisku. "A Strategy for Material-Specific e-Textile Interaction Design." In *Smart Textiles Fundamentals, Design, and Interaction*, edited by Stefan Schneegass and Oliver Amft, 233–57. Springer International Publishing, 2017. [https://doi.org/10.1007/978-3-319-50124-6\\_11](https://doi.org/10.1007/978-3-319-50124-6_11).

Gowrishankar, Ramyah. "Constructing Triboelectric Textiles with Weaving." In *Proceedings of the 2017 ACM International Symposium on Wearable Computers - ISWC '17*, 170–71. New York, USA: ACM Press, 2017. <https://doi.org/10.1145/3123021.3123037>.

## Abstract

**Key words:** e-textiles, human computer interaction, electrostatic textiles, static electricity, body-driven energy harvesting

Within the application context of interior spaces, this thesis investigates the emerging area of body-driven energy harvesting technologies from the perspective of human computer interaction (HCI) design. Upcoming innovations in new materials and low-power devices have enabled the conversion of body movements such as steps and arm movements into electrical energy for powering small computational things. Everyday interior spaces such as public buildings or homes can be fitted with new materials that harness human kinetic energy to produce electrical energy. Recent developments in the area of engineering and materials science aim to make these technologies more efficient. However, research about the implications of implementing them in the everyday from the perspective of the experiences and interactions of the people adopting these technologies is highly under-explored. In order to examine this design space, this research proposes to:

*identify emerging concerns and challenges brought by everyday engagement with electricity production that need to be addressed through an interaction design inquiry.*

To investigate the above proposition, a design program situated between the field of human computer interaction research and the practice of e-textile design is formulated with the aim to:

*Investigate, at the scale of the interior, how static electricity can bring new perspectives and possibilities for:*

- *ways of engaging with e-textiles, and*
- *designing interactions for energy harvesting with textiles*

The research sets up four research studies to systematically explore the design program. These research studies focus on four questions of how static electricity shapes e-textiles, how electrostatic textiles shape e-textile interactions, how e-static interactions shape everyday behaviours and how e-static studies shape energy interpretations. By developing a working knowledge of textile-based triboelectric generators, various body-generated electricity systems of different scales are envisioned. In the process of making, discovering and exploring different textile systems, questions regarding human interactions, material behaviours and the role of electricity in the everyday are discussed.

This thesis contributes to the practice of e-textiles by creating the foundational knowledge of using static electricity as a resource in e-textile design and development without needing specialised materials. Furthermore, it contributes to the field of human computer interaction research by further developing the topic of energy harvesting as a research area of interaction design. The thesis identifies two key areas for addressing challenges presented by body-driven energy harvesting with HCI which include considering accumulation of interactions over time and incorporating the electric properties of the body in interaction.

Additionally, practical outcomes of this research include:

- [www.estatictextiles.cc](http://www.estatictextiles.cc)- An online handbook for learning about and working with static electricity and e-textiles which includes tutorials and examples from the research process.
- E-static textiles prototyping board- A prototyping board developed for easy integration of static electricity and textiles to be used as an educational tool for designing and prototyping electrostatic energy-related interactions.

# Contents

<b>Abstract</b>	8
<b>List of figures</b>	14
<b>List of tables</b>	17
<b>Preface</b>	18
<b>Acknowledgements</b>	20
<b>1 Introduction</b>	23
<b>1.1 Point of departure for this dissertation</b>	23
<b>1.2 Taking a programmatic approach to design research</b>	25
1.2.1 <i>Programs, experiments and examples</i>	27
1.2.2 <i>Evaluating and concluding the program-experiment cycle</i>	30
1.2.3 <i>Results and theory development</i>	31
1.2.4 <i>Adopting a programmatic approach for this thesis– relevance and overview</i>	33
<b>1.3 Overview and structure of the thesis</b>	34
1.3.1 <i>Research proposition</i>	34
1.3.2 <i>The design program</i>	35
1.3.3 <i>Experiments</i>	36
1.3.4 <i>Results and contribution</i>	37
<b>2 Research frame: HCI, e-textiles and static electricity</b>	38
<b>2.1 HCI and e-textiles</b>	39
2.1.1 <i>The material turn in HCI research</i>	39
2.1.2 <i>E-textiles as computational material contributing to HCI knowledge</i>	44
2.1.3 <i>Material interactions: Making, acting and relating with computational things</i>	49
2.1.4 <i>Conclusion: Investigating everyday engagement with electricity through material interactions with e-textiles</i>	51
<b>2.2 E-textiles and static electricity</b>	53
2.2.1 <i>Energy harvesting from the human body</i>	53
2.2.2 <i>What is static electricity?</i>	57
2.2.3 <i>Static electricity as a textile-specific source of energy</i>	58
2.2.4 <i>Static electricity as an interactive aspect of textiles</i>	59
2.2.5 <i>Conclusion: Static electricity as a material property of e-textiles</i>	60

<b>2.3 Static electricity and HCI</b>	61
2.3.1 <i>Looking beyond efficiency of energy harvesting</i>	61
2.3.2 <i>Electrostatic macro generators</i>	65
2.3.3 <i>The human body as an integral part of the electrostatic circuit</i>	66
2.3.4 <i>Conclusion: Designing triboelectric generators is an issue of materiality oriented HCI</i>	67
<b>2.4 Formulating the program: Interaction design for energy harvesting with electrostatic textiles</b>	68
<b>3 Engaging with static electricity through textiles</b>	70
<b>3.1 Technical description of static electricity</b>	70
<b>3.2 Using the electrostatic generator circuit as working knowledge</b>	71
<b>3.3 Making, acting and relating with e-static textiles</b>	73
3.3.1 <i>Supporting material-specific interaction design methods in e-textiles</i>	73
3.3.2 <i>Interaction design approaches to making e-textiles</i>	74
3.3.3 <i>Interaction design approaches for acting with e-textiles</i>	76
3.3.4 <i>Interaction design approaches for relating with e-textiles</i>	78
3.3.5 <i>Summary of materiality oriented interaction design methods adopted from e-textile practices</i>	80
<b>3.4 Supporting multiple interpretations</b>	81
3.4.1 <i>Adopting embodied ideation methods</i>	81
3.4.2 <i>Envisioning through “interaction fictions”</i>	83
<b>3.5 Overview and structure of the research studies</b>	85
3.5.1 <i>Study 01: Material Exploration, how may static electricity shape textiles?</i>	87
3.5.2 <i>Study 02: Embodied Speculation, how may electrostatic textiles shape e-textile interactions?</i>	87
3.5.3 <i>Study 03: Interaction Fiction, how may electrostatic textile interactions shape everyday behaviours?</i>	88
3.5.4 <i>Study 04: How may e-static studies shape energy interpretations?</i>	88
<b>4 Study 01, Material Exploration: How may static electricity shape e-textiles?</b>	91
<b>4.1 Introduction</b>	91
<b>4.2 Outline</b>	91
<b>4.3 Examples: Electrostatic textiles</b>	93
<b>4.4 Observations</b>	101
<b>4.5 Discussion: Pro-static e-textile design</b>	103
<b>5 Study 02: Embodied Speculation, how may electrostatic textiles shape e-textile interactions?</b>	105
<b>5.1 Introduction</b>	105
<b>5.2 Outline</b>	105

5.2.1	<i>Scaling up the triboelectric circuit for supporting textile interactions</i>	106
5.2.2	<i>Electrostatic material interventions</i>	108
<b>5.3</b>	<b>Examples</b>	108
5.3.1	<i>Electrostatic cube installation</i>	108
5.3.2	<i>Electrostatic sleeping</i>	111
<b>5.4</b>	<b>Observations</b>	112
<b>5.5</b>	<b>Discussion: Designing e-static choreographies</b>	115
5.5.1	<i>Strategies for supporting electrostatic engagement through interactions</i>	117
<b>6</b>	<b>Study 03: Interaction fiction: How may e-static interactions shape every-day behaviours?</b>	119
<b>6.1</b>	<b>Introduction</b>	119
<b>6.2</b>	<b>Outline</b>	119
6.2.1	<i>Enacting electrostatic surfaces</i>	120
6.2.2	<i>Sketching interaction instances</i>	121
6.2.3	<i>Initial observations and categorisation of electrostatic interactions</i>	123
6.2.4	<i>Constructing narratives</i>	126
<b>6.3</b>	<b>Examples: Electrostatic interaction fictions</b>	126
<b>6.4</b>	<b>Discussion: Thinking through interaction fictions</b>	128
<b>7</b>	<b>Study 04: How may e-static studies shape energy interpretations?</b>	131
<b>7.1</b>	<b>Introduction</b>	131
<b>7.2</b>	<b>Outline</b>	131
<b>7.3</b>	<b>Observations</b>	134
<b>7.4</b>	<b>Examples</b>	138
7.4.1	<i>Static electricity as social currency</i>	138
7.4.2	<i>Static electricity as a drug</i>	139
7.4.3	<i>Electrostatic energy as a collective responsibility</i>	140
<b>7.5</b>	<b>Discussion: Electrostatic-energy interpretation matrix</b>	141
<b>8</b>	<b>Results and reflection: Electrostatic contributions to e-textile interaction design</b>	144
<b>8.1</b>	<b>Towards a materiality oriented e-textile interaction design approach</b>	145
8.1.1	<i>Defining e-textiles as a material system</i>	145
<b>8.2</b>	<b>Opportunities for incorporating static electricity in design and development of interior-scaled e-textiles</b>	148
<b>8.3</b>	<b>Resources and tools developed for supporting future work</b>	152
8.3.1	<i>Online handbook for working with e-static textiles</i>	152
8.3.2	<i>E-static textiles prototyping board</i>	153

<b>9 Discussion: Towards an interaction design perspective for body-driven energy harvesting</b>	158
<b>9.1 Accumulated interactions as an inquiry into sustainability of interactions</b>	158
<b>9.2 Open question: Human computer collaboration</b>	161
<b>9.3 Directions for future work</b>	163
<i>9.3.1 Resources and tools</i>	164
<b>10 Concluding remarks</b>	165
<b>Epilogue</b>	168
<b>References</b>	169
<b>APPENDICES</b>	183
<b>APPENDIX A: Resources and Tools</b>	185
<i>A.1 Online handbook: estatictextiles.cc</i>	186
<i>A.2 Clip-on tester</i>	188
<i>A.3 E-static textiles prototyping board</i>	190
<i>A.4 E-static textile workshop kit</i>	196
<b>APPENDIX B: Demonstrators- e-static textile interactions</b>	203
<i>B.1 Energy harvesting with e-static wall</i>	204
<i>B.2 Counting interactions with an e-static seat</i>	206
<b>APPENDIX C: Woven e-static textiles sample book</b>	209
<b>APPENDIX D: Supporting files (DVD)</b>	240
<b>APPENDIX E: Overview of courses and research activities in ArcInTex ETN</b>	243

## List of figures

Figure 1. The relation between the broader research interest, design program and experiments. (Redrawn from Brandt and Binder, “Experimental Design Research: Genealogy, Intervention, Argument.”, figure 2)	27
Figure 2. Programmatic research takes a cyclic approach.	31
Figure 3. Programmatic research cycles undertaken in the Ph.D. research.	33
Figure 4. The frame of this research is defined by the intersections between the overlapping areas of human computer interaction (HCI), electronic textiles (e-textiles) and interactive electrostatic energy harvesting technology.	38
Figure 5. Materiality oriented interaction design approaches identified within HCI for this research.	49
Figure 6. Types of body-driven energy harvesting sources. Adapted from Dagdeviren, Canan, Zhou Li, and Zhong Lin Wang. “Energy Harvesting from the Animal/Human Body for Self-Powered Electronics”, figure 1.	54
Figure 7. (Top-left) Energy harvesting sources and nodes on the human body. Illustration from Ernesto Ibarra et al., “HEH-BMAC: Hybrid Polling MAC Protocol for WBANs Operated by Human Energy Harvesting”. (Top-right) Human-powered wearable computing. Image from T. Starner, “Human-Powered Wearable Computing”, figure 2. (Bottom) Biomechanical energy harvesting. Image from Young-Man Choi et al., “Wearable Biomechanical Energy Harvesting Technologies,” <i>Energies</i> 10, no. 10 (September 25, 2017): 1483, <a href="https://doi.org/10.3390/en10101483">https://doi.org/10.3390/en10101483</a> , figure 1.	61
Figure 8. Triboelectric series: materials listed according to their tendency to gain or lose electrons. Figure of the table redrawn from <a href="http://eesemi.com/tribo_series.htm">http://eesemi.com/tribo_series.htm</a>	64
Figure 9. The triboelectric generator setup made from a PTFE sheet and two conductive sheets as illustrated in Mustafa Emre Karagozler et al., “Paper Generators”, figure 2c.	65
Figure 10. Two main working principles of triboelectric generator circuits. (Left) The person touches an electrode while moving the other electrostatic material. (Right) Layered materials where person interacts from the outside.	66
Figure 11. Details of an electrostatic harvesting circuit that uses the human body as part of the harvesting circuit.	67
Figure 12. Example of a scaled-up version of an electrostatic generator circuit developed during the thesis.	73
Figure 13. Spectrum of levels of engagement with e-textiles.	77
Figure 14. Overview of research studies and methods.	86



Figure 15. (Left) The clip-on tester. (Right) The tester is clipped to the sample and held with one hand while tapping or rubbing the fabric with the other hand. The LED lights up when enough voltage is generated.	92
Figure 16. Reading voltages generated by the electrostatic textile samples with an oscilloscope. (Left) Example of single layered samples placed over a conductive fabric connected to the oscilloscope. (Right) Example of a sample with integrated conductive elements that was directly connected to the oscilloscope.	92
Figure 17. Knotting techniques used in hand woven e-static textiles.	100
Figure 18. Sample 4a tufted with smaller conductive loops and filled in between with rows of plastic yarn.	101
Figure 19. Scaling up the triboelectric circuit and trying out different textile materials and interactions. (Left) Small piece of Teflon baking sheet over conductive fabric swatch. (Centre) Aluminium foil is used to make two conductive tiles connected to a diode bridge and multimeter. (Right) A piece of foil blanket on the floor provides a large conductive floor to explore the electrification process through playful interactions.	106
Figure 20. Example of electrostatic material intervention: wrapping chair with cling film.	107
Figure 21. Example of electrostatic material intervention: home slippers that collect the electrostatic charges generated through walking.	107
Figure 22. Sketch of the electrostatic cube setup. (Left) An LED is connected via a rectifier bridge to the electrodes in the cube. (Right) The LED lights up using the static electricity generated by the person and material moving inside the space.	109
Figure 23. Different configurations of conductive and electrostatic elements in the electrostatic cube installation.	109
Figure 24. Sequence frames from the video recordings of interactions. (Top) Conductive ceiling and floor. (Middle) hanging electrodes and electrostatic materials. (Bottom) Conductive floor and ceiling with suspended electrostatic material that can be pushed up and peeled away from the ceiling.	110
Figure 25. Electrostatic sleeping setup.	111
Figure 26. Examples of everyday electrostatic materials and objects.	113
Figure 27. Details showing aesthetic qualities of interacting with a soft electrostatic material in the interior-setup.	114
Figure 28. Screen shots from a video collage of electrostatic activities (anti-clockwise from top-right) Rubbing feet on carpet while sitting, rubbing feet on an electrostatic setup while working on a standing table, walking through an electrostatic curtain, sliding on the conductive floor over a textile, wiping the walls.	120
Figure 29. Examples of sketches of e-static interactions. Starting point: electrostatic set-ups as	

spatial interventions. (Left) Electrostatic door squeeze. (Centre) Conductive floor tiles. (Right) Tall floor carpet.	122
Figure 30. Examples of sketches of e-static interactions. Starting point: to use existing everyday objects prone to electrification. (Left) People rubbing their feet while watching TV. (Centre) Furry door knobs. (Right) Electrostatic yoga.	122
Figure 31. Examples of sketches of e-static interactions. Starting point: activities which involve moving with textiles. (Left) Wiping the kitchen floor with fabric. (Centre) Flapping a curtain. (Right) Tablecloth over conductive table.	122
Figure 32. Mapping e-static sketches according to effort and scale	124
Figure 33. Finding categories from sketches according to the level of engagement and motivation for interacting with static electricity.	125
Figure 34. Stills from some of the videos made by students for the first exercise of quick material explorations of the triboelectric circuit principle. Clockwise from top left: Dancing with a bronze statue and plastic sheet, laying synthetic material over railing while climbing down the stairs, interacting with a conductive table and plastic table cloth, head gear for rubbing, electrostatic materials catching the wind.	134
Figure 35. Examples of electrostatic interactions explored by students at the university building. (Left to right) churning action with a plastic sheet over a conductive pillar, a picnic blanket that collects e-static charges from people, sliding over the staircase railing, walking through an electrostatic curtain.	135
Figure 36. Examples of electrostatic interactions explored by students at the subway station. (Left to right) charging a phone by dragging it over the conductive railing, deliberately bumping into people in the train to collect electrostatic charges from them, an electrostatic plastic curtain for people to walk through, wearing a balloon hat that rubs against different surfaces.	135
Figure 37. Examples of electrostatic interactions explored by students at a shopping mall. (Left to right) surfaces that you rub your phone on to charge it, rubbing the railing while standing on an escalator, walking through a balloon structure that rubs your hair when you walk through, sliding on metal railing of a staircase.	135
Figure 38. Categories from video card analysis of the electrostatic interactions portrayed in the videos. (Top) Interior spaces and features. (Middle) Materials and qualities. (Bottom) Body parts involved in interactions and emerging qualities.	136
Figure 39. "Social rub": Examples of materials explorations, sketches and storyboards made by the group in preparation for the final work.	138
Figure 40. Static electricity as social currency: "Social rub": some screen shots.	138
Figure 41. "Synthofungus": Examples of materials explorations done to visualise the charge collection over the surface.	139

Figure 42. Static electricity as a drug– “Synthofungus”: some screen shots.	139
Figure 43. Group 3: “Collective energy”: Examples of materials explorations, sketches and story-boards made by the group in preparation for the final work.	140
Figure 44. Static electricity as a collective responsibility: some examples of narrative frames.	140
Figure 45. Developing a framework for materiality-oriented e-textile interaction design based on the research results.	147
Figure 46. E-static textiles prototyping board developed as a result of the research. See Appendix A.2 for further details and information.	153
Figure 47. Details of the E-static textiles prototyping board.	154
Figure 48. Stages of development of the e-static textiles prototyping board.	155
Figure 49. E-static textiles workshop kit developed during the thesis to be used in educational settings. Please refer to Appendix A.4 for further information about the workshop kit and supporting materials.	156
Figure 50. Examples of electrostatic setups made using the e-static textiles prototyping board. (Left) e-static wall. (Right) e-Static seat. Further information about these setups can be found in Appendix B.	156

## List of tables

Table 1. Summary of materiality oriented interaction design methods adopted from e-textiles.	80
Table 2. Yarn materials used to construct electrostatic textiles.	92
Table 3. Overview of voltage readings from the electrostatic textile samples.	102
Table 4. Matrix of the kinds of outputs that could be designed for electrostatic textile setups.	142
Table 5. Material-specific interaction design strategies for making, acting with and relating to e-textiles.	146
Table 6. Overview of interactions in Study 01 & Study 02.	150

## Preface

This research inquiry is part of ArcInTex ETN (Architecture, Interaction Design and Textiles European Training Network), which is a project funded by the European Union Marie Curie grant.<sup>1</sup> ArcInTex ETN aims to strengthen the foundations of design for more sustainable forms of future living by connecting Architecture, Interaction Design and Textiles in a training network of early-stage researchers.<sup>2</sup> The research project is divided into three work packages that explore this topic from three different scales– that of the body, the interior and the building. The research program consists of fifteen Ph.D. students distributed across universities and companies around Europe, with five students in each work package. My research position is situated in the work package that investigates the topic of “textile thinking for adaptive and responsive interior design at the scale of the interior.” Within this work package, my research investigates the specific given theme of “Designing for adaptive and responsive near-field interactions at the scale of the interior.”<sup>3</sup>

This dissertation is written from the perspective of an electronic textiles (or e-textiles) maker who is interested in investigating how textiles, both materially (textural, tangible qualities) as well as conceptually (as a knowledge system) can inform the design of new forms and interactions with computational things. Being a designer and a maker, working with materials, prototyping and hands-on explorations are an integral way of learning and understanding for me. Thus, this research closely follows a research through design

- 
1. Arcintex ETN was a three-year EU research project (2015-2018) funded by the Marie Sadlowska Curie research and innovation grant. ArcInTex is an international network of researchers and practitioners from the field of textiles, interaction design and architecture. The ETN project is a research consortium consisting of several universities and two companies across Europe.
  2. This description is rephrased from the ArcInTex ETN website: [www.arcintexetn.eu](http://www.arcintexetn.eu) Please see site for further information about the project.
  3. Specified in section 3.3, ESR 10 on <http://www.arcintexetn.eu/research/work-packages/>

approach<sup>4</sup> that relies heavily on hands-on explorations to not only drive the research work forward but also to arrive at the key research questions from the general theme of the ArcInTex ETN project. Thus, the foundation of this research work lies in the practice of e-textiles, however, it constantly reflects and responds to the broader conceptual themes and challenges of materiality oriented human computer interaction<sup>5</sup> while addressing the research outline of the ArcInTex ETN project.

- 
4. Please refer to Chapter 1, section 1.2 for further discussion on how the research through design approach is interpreted in this thesis.
  5. Please refer to Chapter 2, section 2.1 for a detailed description on materiality oriented HCI.

## Acknowledgements

This thesis could not have been completed without the generous help of several individuals and institutions.

Firstly, I would like to extend my deepest gratitude to my main supervisor, Prof. Dr. Gesche Joost. This work would not have been possible without her support and guidance. I would also like to sincerely thank my second supervisor, Prof. Dr. Berit Greinke, whose feedback and encouragement at different stages of the research project immensely improved this thesis. I am also extremely grateful to my thesis advisor, Prof. Dr. Katharina Bredies for all the support and critical discussions over the years that were crucial for shaping this research project.

My sincere thanks to the project coordinator, Prof. Lars Hallnäs; to the network manager, Agneta Nordlund Andersson; to my work package leader, Prof. Clare Johnston, and to the rest of the supervisors of the ArcInTex ETN community for their invaluable input and for creating a rich learning environment at every stage of the project. During this programme, I had the opportunity to undertake two research secondments, first at the Swedish School of Textiles and the second at the Eindhoven University of Technology. Both these exchanges were extremely valuable in guiding and propelling the doctoral research, and I am extremely grateful to the supervisors and colleagues for all the discussions and new inspirations. For this, I would like to thank Prof. Lars Hallnäs, Prof. Delia Dumitrescu, Dr. Hanna Landin, Prof. Linda Worbin, and Prof. Clemens Thornquist from the Swedish School of Textiles. I am also grateful to Dr. Oscar Tomico, Prof. Ron Wakkary, Dr. Kristina Andersen, Dr. Lenneke Kuijjer and Dr. Annika Hupfeld from the Eindhoven University of Technology for all the thought-provoking discussions that gave new perspectives to my research.

A warm thanks to my colleagues— Ana Piñeyro, Justé Peciulyte, Sara Lundberg, Svenja Keune, Iva Resetar, Daniel Suarez, Jyoti Kapur, Bastian Beyer, Marina Castan Cabrero, Vidmina Stasiulyte, Troy Nachtigall, Angella Mackey, Ana Ines Rodrigues, Marion

Bertin And Mila Svechtarova for making the four years of the project such an interesting and enjoyable experience.

I would also like to express my thanks to Tristan August from August and Piel Konstruktiv GbR for his help in developing and documenting the e-static textiles prototyping board. I kindly thank Prof. Linda Wörbin for inviting me to facilitate a workshop on e-static textiles at IKEA. Thank you to Marie Beuthel, Anne Wohlauf and Katharina Lorenz for the e-static brainstorming session and for their help with the video card game. Thanks to my student assistants, Jojo Shone and Jana Grewe for helping with the documentation of some of the research work and helping me to set up the project website. I would also like to thank Dr. Jussi Mikkonen and Riikka Townsend who have been part of my e-textile journey from the early years.

A special thanks to Corinna Schmidt, Marie Luise Schulz and Samantha Briehn from the Design Research Lab for their untiring support and help in manoeuvring through the financial administration and practicalities of conducting this research within the EU project frame at the UdK.

And of course, none of this would have been possible without the love, understanding and a lot of patience from my husband Jonathan Cremieux, my parents, and all my family and friends. Thank you!

This research was funded by the European Union's Horizon 2020 research and innovation programme under the Marie Skłodowska-Curie grant agreement No. 642328.







# 1 Introduction

## 1.1 Point of departure for this dissertation

Being surrounded by wireless data streams, digital clouds and continuously ‘connected’ objects and people, it is not difficult to realise that we are encompassed by a digitally rich physical space. The idea of the computer is increasingly moving away from the typical screen-and-keyboard setup and entering a multitude of everyday objects and spaces. A growing number of products and services in areas such as smart homes and cities rely heavily on distributed networks of sensors and computationally enabled objects and spaces. It has been estimated that by 2020 we will be surrounded by trillions of sensors around the world.<sup>6</sup> While the miniaturisation of the computer has created the possibility to seamlessly populate everyday spaces with computational elements, it has also raised the crucial challenge of finding environmentally friendly and sustainable solutions for powering such devices. Small low-power devices such as sensors, actuators and information processors in the contexts of internet of things (IoT), wearable computing and electronic textiles (or e-textiles) thus increasingly need ways of harvesting energy from their surroundings as a means to independently and sustainably power them.

Energy harvesting<sup>7</sup> is the conversion of ambient energy into usable electrical energy.<sup>8</sup>

---

6. As described in– Zhong Lin Wang, Jun Chen, and Long Lin, “Progress in Triboelectric Nanogenerators as a New Energy Technology and Self-Powered Sensors,” *Energy & Environmental Science* 8, no. 8 (2015): 2250–82, <https://doi.org/10.1039/C5EE01532D>.

7. Also known as energy scavenging.

8. Faruk Yildiz, “Energy Harvesting from Passive Human Power,” *Journal of Applied Science & Engineering Technology*, 2011, 5–16.

Although modern energy harvesting technologies, such as solar panels<sup>9</sup> or windmills,<sup>10</sup> have been around for several decades, low-power energy harvesting is a technology of the 21<sup>st</sup> Century.<sup>11</sup> Because they lower maintenance fees as they do not need to be replaced frequently and are more environmentally friendly than chemical batteries,<sup>12</sup> interest in energy harvesters has been growing in comparison to traditional batteries for powering wearable and other devices. Additionally, energy harvesting is also desirable in areas or situations where a stable supply of electricity is not possible.<sup>13</sup>

Various solutions for harvesting different kinds of environmental energy as a source of electricity for low-power devices already exist; for example, harnessing light energy from indoor sources such as light bulbs, radio frequency energy from other devices and antennas, or atmospheric changes such as temperature or pressure.<sup>14</sup> Apart from using environmental sources, a significant portion of this low-power energy harvesting research looks at the human body as a source of electrical energy for devices. Living subjects (humans and animals) have been seen as abundant sources of energy in chemical, thermal and mechanical forms.<sup>15</sup> Different kinds of material interventions in everyday situations are being introduced that actively engage the body to generate electrical energy, for example piezoelectric floor tiles<sup>16</sup> that harvest kinetic energy from people walking by. In this thesis, the energy harvesting systems that directly utilise the kinetic energy of humans as a source of electrical power are referred to as ‘body-driven energy harvesting’ devices.

There has been a growing body of work in engineering and materials science in the

- 
9. The first solar cell was discovered in 1953 by Calvin Fuller, Gerald Pearson and Daryl Chapin, however, the first low-cost solar cells were not developed until the early 1970s– Victoria C., “The History Of Solar Power | Experience,” 2017, accessed February 28, 2019, <https://www.experience.com/advice/careers/ideas/the-history-of-solar-power/>.
  10. As early as 1887, the first known wind turbine used to produce electricity was built in Scotland. The first megawatt-sized wind turbine was connected to a local electrical distribution grid in 1941– Zachary Shahan, “History of Wind Turbines - Renewable Energy World,” 2014, <https://www.renewableenergyworld.com/ugc/articles/2014/11/history-of-wind-turbines.html>.
  11. Bob Chao, “Making Low-Voltage Energy Harvesting Practical: Part 1 — The History of Energy Harvesting,” 2012, [https://www.electronicproducts.com/Power\\_Products/Invertors/Making\\_low-voltage\\_energy\\_harvesting\\_practical\\_Part\\_1\\_The\\_history\\_of\\_energy\\_harvesting.aspx](https://www.electronicproducts.com/Power_Products/Invertors/Making_low-voltage_energy_harvesting_practical_Part_1_The_history_of_energy_harvesting.aspx).
  12. Laurent Probst et al., “Energy Harvesting to Power the Rise of the Internet of Things - European Commission,” 2017, <https://ec.europa.eu/growth/tools-databases/dem/monitor/content/energy-harvesting-power-rise-internet-things>.
  13. Young-Man Choi et al., “Wearable Biomechanical Energy Harvesting Technologies,” *Energies* 10, no. 10 (September 25, 2017): 1483, <https://doi.org/10.3390/en10101483>.
  14. Fatih Ünlü, Lukas Wawrla, and Adriana Diaz, “Energy Harvesting Technologies for IoT Edge Devices,” 2018, <https://edna.iea-4e.org/library>.
  15. Canan Dagdeviren, Zhou Li, and Zhong Lin Wang, “Energy Harvesting from the Animal/Human Body for Self-Powered Electronics,” *Annual Review of Biomedical Engineering* 19, no. 1 (June 21, 2017): 85–108, <https://doi.org/10.1146/annurev-bioeng-071516-044517>.
  16. For example, “Pavegen - The Next Step,” accessed April 4, 2019, <http://www.pavegen.com/>.

field of e-textiles that present examples of novel nanomaterials and soft-technologies that enable energy harvesting close to and using the body, for example, piezoelectric<sup>17</sup> and triboelectric nanomaterials<sup>18</sup> that can be integrated into clothing, and other textile objects. Many of these technologies are still emerging and the primary focus has been on improving the efficiency of energy conversion in these soft materials<sup>19</sup>. While this is an important aspect of technology development, it is also useful to take a critical look at how the advancement and popularising of such technologies may redefine our expectations and experiences of textiles as well as electricity. Considering the emerging area of textile-based energy harvesting solutions that use the body, this research envisions a design space for exploring e-textile interactions for the purpose of engaging with electricity in everyday interior spaces. It is hoped that developing a critical discussion from the perspective of interaction design will inform future development and adoption of such computational devices.

We are aware that often new features of our everyday technologies can introduce new choreographies and influence our behaviours and experiences. For example, waving our hands at a motion detector to turn on a light might not have been considered normal behaviour twenty years ago, but today it is indeed a small inconvenience for saving valuable energy. Following this line of inquiry, this thesis explores the specific case of static electricity as an interactive material quality of e-textiles that is useful for engaging with electrical energy.

By developing different examples of actively engaging with static electricity through textiles, the research examines the emerging area of body-driven technology from the point of view of e-textile interaction design. Through the process of making, discovering and experiencing the different electrostatic (or e-static) textile setups, the research explores the questions—“*What new ways of engaging with e-textiles are enabled by static electricity?*” and “*What are the implications of actively engaging the human body in electricity generation on the way we design and relate to computational artefacts?*”.

The following section gives an overview of the research approach undertaken to further develop and systematically investigate the topic of e-textile interaction design for body-driven energy harvesting through static electricity. In the second half of the chapter, a detailed overview and structure of this thesis is outlined.

## 1.2 Taking a programmatic approach to design research

This thesis follows the approach to design research driven by program, experiments and examples. The notion of the programmatic research used in this dissertation stems from

---

17. For example, Anja Lund et al., “Energy Harvesting Textiles for a Rainy Day: Woven Piezoelectrics Based on Melt-Spun PVDF Microfibres with a Conducting Core,” *Npj Flexible Electronics* 2, no. 1 (2018): 9, <https://doi.org/10.1038/s41528-018-0022-4>.

18. For example, A Young Choi et al., “Corrugated Textile Based Triboelectric Generator for Wearable Energy Harvesting,” *Scientific Reports* 7, no. 1 (December 28, 2017): 45583, <https://doi.org/10.1038/srep45583>.

19. This is discussed further in Chapter 2, section 2.3.1.

the discussions around research through design (RtD) in the field of human computer interaction (HCI) design. In this section, I give a brief background and overview of the programmatic approach to design research in the context of HCI. Furthermore, I argue for its relevance as a research approach for this thesis.

Research through design is “an approach of conducting scholarly research that employs the methods, practices and processes of design practice with the intention of generating new knowledge”<sup>20</sup>. The term “research through design” (RtD) was first coined by Frayling<sup>21</sup> who described the multiple perspectives in which design and research come together—research about design, research for design and research through design. While research *for* and *about* design do not directly contribute to the knowledge of design practice, research *through* design must be relevant and contribute to the improvement of design practice.<sup>22</sup> Furthermore, RtD should be understood as constituting aspects of both research about and for design that produces original knowledge for the field of design.<sup>23</sup> But what constitutes original knowledge and how can it claim its relevance for design?

In their paper presenting exemplary design research, Binder and Redström examine three sources of knowledge production commonly associated with design.<sup>24</sup> These are namely—design theory (theory about design), design studies<sup>25</sup> and knowledge associated to the notion of “science of the artificial.”<sup>26,27</sup> They argue that albeit these three knowledge traditions contribute to our understanding of design, they fall short for a design research

- 
20. John Zimmerman and Jodi Forlizzi, “Research Through Design in HCI,” in *Ways of Knowing in HCI* (New York, Springer New York, 2014), 167–89, [https://doi.org/10.1007/978-1-4939-0378-8\\_8](https://doi.org/10.1007/978-1-4939-0378-8_8).
  21. Christopher Frayling, “Research in Art and Design,” *Royal College of Art Research Papers* 1, no. 1 (1993).
  22. Alain Findeli et al., “Research Through Design and Transdisciplinarity: A Tentative Contribution to the Methodology of Design Research,” 2008, <https://hal.archives-ouvertes.fr/hal-00995468>.
  23. Ibid.
  24. Thomas Binder and Johan Redström, “Exemplary Design Research,” in *Design Research Society Wonderground International Society Conference* (Lisbon, 2006), <http://redstrom.se/johan/abstracts/aexemplary.html>.
  25. Design theory traditionally aimed at understanding “the field of design as aesthetic expressions of socio-cultural conditions”, with no aim to produce knowledge directly useful for the designers. Design studies focuses on the acts of designing and develops models that help to identify how design thinking can be facilitated. Although design studies may contribute to the designers understanding of the environments and conditions of their own work. However, the main contribution of design studies is geared towards the epistemological question of how designers know.— As described in *ibid*.
  26. Herbert A. (Herbert Alexander) Simon, *The Sciences of the Artificial*, (M.I.T. Press, 1969); As referred to in Binder and Redström, “Exemplary Design Research.”
  27. Following the notion of the sciences of the artificial, design is taken as a broad term that is geared towards changing “existing states towards preferred ones” (Herbert A. Simon, *The Sciences of the Artificial*). This kind of knowledge is, therefore, directed towards prescribing strategies and procedures for designers to arrive at a good enough solution to the given design problem.— As described in Binder and Redström, “Exemplary Design Research.”

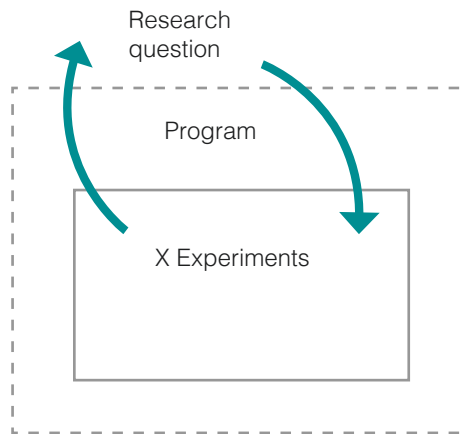

Figure 1. The relation between the broader research interest, design program and experiments. (Redrawn from Brandt and Binder, "Experimental Design Research: Genealogy, Intervention, Argument.", figure 2)

aiming at exploring new terrain for design and designers. The authors emphasise that such a design research would need an approach that is informed by and compatible with scholarly research but must acquire its credibility through other strategies grounded in design practice. They propose the notion of exemplary design research that is driven by programs, experiments and intervention<sup>28</sup> as one such approach to guide design research aiming at exploring new areas for design.

The research approach "is exemplary in the sense that it enables critical dissemination through examples of *what* could be done and *how*, i.e. examples that both express the possibilities of the design program as well as more general suggestions about (change to) design practice."<sup>29</sup> The research examples are thus developed within design programs which act as a foundation and frame for carrying out a series of experiments.<sup>30</sup>

### 1.2.1 Programs, experiments and examples

Figure 1, adapted from Brandt and Binder,<sup>31</sup> illustrates the relationship between the broader research interest, program and experiments. The question in this diagram points to the overall research area which shapes the design program. This research interest will typically have a larger scope than the program explored. The program frames and contextualises the broader research interest by proposing the possible.<sup>32</sup>

The design program, similar to a hypothesis in scientific research, takes a stance and

28. Ibid.

29. Ibid.

30. Johan Redström, "Some Notes on Program/Experiment Dialectics," in Nordic Design Research Conference 2011 (Helsinki, 2011), <https://doi.org/10.1145/122552.122557>.

31. Eva Brandt and Thomas Binder, "Experimental Design Research: Genealogy, Intervention, Argument," in IASDR 07 (Hongkong, 2007), <https://adk.elsevierpure.com/en/publications/experimental-design-research-genealogy-intervention-argument>.

32. Ibid.

presents some kind of concrete intention. However, instead of presenting a problem to be solved or tested, the design program is suggestive and remains open for interpretation and change.<sup>33</sup>

Brandt and Binder<sup>34</sup> clarify the difference in how a design program is interpreted in design practice and design research. In design practice, a program or brief plays the role of setting the goals for the design work and frames the space within which the designing happens. As the design work takes place, the design program, which has already been established as relevant, becomes more precise in terms of a finished design. Whereas a program in design research sets a frame to be challenged by experiments that “deliberately seek to establish the strength and scope of the program in relation to an overarching knowledge interest.”<sup>35</sup> As the research unfolds, it substantiates or challenges the hypothetical world view set out by the initial program.<sup>36</sup> Redström<sup>37</sup> emphasises that programs like this seem to blend what is normally considered through questions and answers in scientific research. “Instead of presenting a question to be answered, programs present propositions or proposals that need to be substantiated.<sup>38</sup>” And similar to how in the research process, the questions get reframed and the overall understanding of questions and answers evolve together, the programmatic approach in design research builds on the idea that research insights depend on the change that is driven by an interaction between program and experiment.<sup>39</sup> Therefore, the research process in a program does not aim to confirm or reject a hypothesis but takes an explorative stance that constantly dialogues with and challenges the design program.

The experiments are setup to actively engage with the program. “The mutual dependency of program and experiment stems from the program’s need for materialisation and the experiment’s need for precise frames.”<sup>40</sup> The role of the experiments is not to simply reject or confirm the validity of the program. Rather, the experiments act as exploratory probes into the implications of the program and how it can be refined to account for the issues brought forward by the experiments.<sup>41</sup>

Bang and Eriksen<sup>42</sup> further investigate the role of design experiments driven by the

---

33. Redström, “Some Notes on Program/Experiment Dialectics.”

34. Brandt and Binder, “Experimental Design Research: Genealogy, Intervention, Argument.”

35. Ibid.

36. Binder and Redström, “Exemplary Design Research.”

37. Redström, “Some Notes on Program/Experiment Dialectics.”

38. Ibid.

39. Ibid.

40. Ibid.

41. Binder and Redström, “Exemplary Design Research.”

42. Anne Louise Bang and Mette Agger Eriksen, “Experiments All the Way - Diagrams of Dialectics between a Design Research Program and Experiments,” *Artifact* 3, no. 2 (December 3, 2014): 4, <https://doi.org/10.14434/artifact.v3i2.3976>.

program by reflecting on their programmatic research project Xlab. Building on Schön's<sup>43</sup> definition of experiments, they propose three roles and characteristics of experiments for when one is working within a design program— a) as initiators or drivers of framing a program, b) as ways to reflect on and mature the research program serving as a vehicle for theory construction and knowledge generation and c) as a 'designerly' approach to the written knowledge dissemination and clarification of research contributions.

Design examples are collected during the different experiments as a representation or illustration of the potential of the design program. For example, if the design program seeks new approaches to design or explores a new language of form that may stem from the introduction of new materials, the design research must both be exemplary in the way that it must demonstrate that what is proposed by the program is actually possible and, additionally, present arguments that describe how pursuing such a line of inquiry is opportunistic for the design field concerned.<sup>44</sup> Thus, design examples can act as prototypes that demonstrate feasibility, but they can also become arguments in themselves that support critical reflection of the overall design program.<sup>45</sup>

Although the notion of program-driven research has been used in different research contexts,<sup>46</sup> the first program in the field of interaction design was introduced by the MIT Media Lab with the 'things that think' consortium in 1995.<sup>47</sup> The consortium brought together designers, engineers, artists and scientists to invent the future of digitally augmented objects and environments.<sup>48</sup> Hence, they emphasised that new application areas and opportunities for emerging information technologies could not come from technological innovation alone but needed a programmatic perspective that explored varied notions of technologies in use.<sup>49</sup>

Since the year 2000, several research initiatives in the field of HCI have been undertaken using the programmatic approach, especially with an aim to explore new ways of designing and to formulate new areas for design in HCI in response to emerging technological innovations. For example, slow technology<sup>50</sup> looked at how to design computational

---

43. Donald. Schoen, *The Reflective Practitioner: How Professionals Think In Action* (Basic Books, 1983), <http://cumincad.scix.net/cgi-bin/works/Show?9e1a>.

44. Binder and Redström, "Exemplary Design Research."

45. Johan Redström, "Designing Everyday Computational Things" (Dept. of Informatics, Göteborg University, 2001), <http://redstrom.se/johan/thesis/index.html>. p 36

46. For example, Bauhaus is one of the most influential design programs that has also served as a model for design education— Eva Brandt et al., *XLAB* (Copenhagen: The Danish Design School Press, 2011).

47. Binder and Redström, "Exemplary Design Research."

48. "Things That Think: Vision Statement," MIT media Lab, 1995, <https://ttd.media.mit.edu/vision/vision.html>.

49. Binder and Redström, "Exemplary Design Research."

50. Lars Hallnäs and Johan Redström, "Slow Technology – Designing for Reflection," *Personal and Ubiquitous Computing* 5, no. 3 (August 2001): 201–12, <https://doi.org/10.1007/PL00000019>.

things to facilitate critical reflection, and IT+textiles<sup>51</sup> was a program that explored new interactions with textiles, made possible through the combination of electronics and textiles. Rich interaction design<sup>52</sup> in the Netherlands formulated ways of designing everyday technologies with an emphasis on movement and spatial body skills. Static!<sup>53</sup> was a design program that proposed the consideration of technology in terms of energy aesthetics instead of energy efficiency<sup>54</sup>. Whereas these examples illustrate institution-level or larger project-level programs, the programmatic approach can also be undertaken at a smaller scale, that of an individual research inquiry, such as a Ph.D. thesis.<sup>55,56</sup>

1.2.2 Evaluating and concluding the program-experiment cycle  
Redström<sup>57,58</sup> describes the process for a programmatic research approach as having the following steps:

- i. Formulating the design program,
- ii. Realising the program by designing, implementing and evaluating design examples through experiments,
- iii. Reflection and formulation of results, e.g., by reporting on the experiences gained, formulating new working hypotheses and reformulating the design program.

Programmatic approach takes a cyclic approach that constantly formulates and refines the design program through the lens of experiments and examples (see Figure 2). In practice, the conclusion of a design program is often a matter of the amount of funding, time and resources.<sup>59</sup> However, it would be difficult to conclude a program without having enough examples that express and materialise it.<sup>60</sup> Binder and Redström<sup>61</sup> propose that a design program can be evaluated in multiple ways, for example, from the inside– that is,

---

51. Daniel Eriksson et al., IT+Textiles, ed. Redström Johan, Maria Redström, and Ramia Mazé (the Interactive Institute and the Swedish School of Textiles at the University of Borås, 2010), <https://www.tii.se/projects/ittextiles>.

52. Zimmerman and Forlizzi, "Research Through Design in HCI."

53. Ramia. Mazé, "Static! : Designing for Energy Awareness," (Arvinus, 2010).

54. Redström, "Some Notes on Program/Experiment Dialectics."

55. Jonas Löwgren, Henrik Svarrer Larsen, and Mads Hoby, "Towards Programmatic Design Research," *Designs for Learning* 6, no. 1–2 (December 1, 2013), <https://www.designsforlearning.nu/articles/abstract/53/>.

56. Bang and Eriksen, "Experiments All the Way - Diagrams of Dialectics between a Design Research Program and Experiments."

57. Redström, "Designing Everyday Computational Things." p26.

58. Redström, "Some Notes on Program/Experiment Dialectics."

59. Ibid.

60. Ibid.

61. Binder and Redström, "Exemplary Design Research."



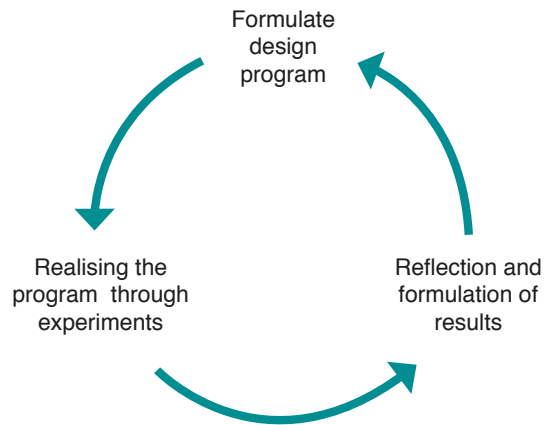

Figure 2. Programmatic research takes a cyclic approach.

on the basis of the extent of which it succeeds in fulfilling its own intentions and from the outside— that is, on the basis of the extent of the changes, developments or alternatives to existing theory and practice it suggests.<sup>62</sup>

Considering that the experiments undertaken constantly engage with the design program, the end of a research cycle could be said to be marked by a stage where it becomes possible, or even necessary to reformulate the program to account for new findings and generate new experiments.<sup>63</sup>

### 1.2.3 Results and theory development

The field of design research is maturing as researchers are defining its typologies and building new design theories.<sup>64</sup> However, there have been several discussions concerning what constitutes design theory and how it is formed through the practice of design research. Zimmerman et al.<sup>65</sup> have argued that theory in RtD takes the form of nascent theory. Nascent theory essentially emerges from exploratory work and often acts as a proposition of a new area that benefits from a discovery approach in order to articulate what the important relationships between phenomena might be. Theory matures through discourse as researchers substantiate, extend or refute aspects of the proposition.<sup>66</sup> In the field of HCI, theory has been historically inspired by many of its constituent disciplines, such as, psychological theories of human behaviour, engineering theories intended to

---

62. Ibid.

63. Ibid.

64. Jodi Forlizzi, Erik Stolterman, and John Zimmerman, "From Design Research to Theory : Evidence of a Maturing Field From Design Research to Theory : Evidence of a Maturing Field," in *lasdr*, 2009, 2889–98.

65. John Zimmerman, Erik Stolterman, and Jodi Forlizzi, "An Analysis and Critique of Research through Design," in *Proceedings of the 8th ACM Conference on Designing Interactive Systems - DIS '10* (New York, USA: ACM Press, 2010), 310, <https://doi.org/10.1145/1858171.1858228>.

66. Ibid.

improve HCI practice as well as anthropological theories to situate action and interaction.<sup>67</sup> Although these theories have informed design practice, design theory can also be intrinsically developed from within the research practice. Redström<sup>68</sup> argues that we may have to consider certain conceptual elements and structures produced and performed in research through design as theoretical even though they may not look like the kinds of theory we might be familiar with from other disciplines. He describes the difference between the need for theories in other disciplines versus in experimental design research as the difference between aiming for abstract images of the actual versus creating concrete images of the potential. That is, while the former aims at achieving the universal for support and stability, design needs theories that support conceptualising, making, communicating, collaborating, etc.<sup>69</sup> Hällnas<sup>70</sup> argues in a similar way emphasising that in experimental design we aim for qualitative results and the idea of verifiable knowledge about the design process; validated models and working methods do not work well in this context. He further describes experimental research as research through *defining*, in contrast to research through purely analytical studies. Design examples could be referred to as these kinds of definitions— that may be expressions of foundational insights or may become canonical examples stating a given concept.<sup>71</sup> Similar to the notion of nascent theory introduced earlier, these definitions through design experiments are inherently *transitional*.<sup>72</sup> This is to say that there cannot be a single definition of what design or designing is in general, but different alternatives can be explored, presented, argued for and critically examined and shared within design programs.

This thesis closely follows this approach and builds a theoretical contribution based on examples developed through experiments within a design program. The results of the thesis are an example of a design space emerging around the experience of adopting energy harvesting practices in the everyday. The next section delves deeper into how this research inquiry adopts the programmatic approach that shapes the thesis.

#### 1.2.4 Adopting a programmatic approach for this thesis— relevance and overview

This thesis proposes that an interaction design perspective will contribute to the emerging area of body-driven energy harvesting by introducing a design space that addresses the everyday experiences of people engaging with such technologies. A programmatic

---

67. Ibid.

68. Johan Redström, *Making Design Theory* (MIT Press, 2017), <https://mitpress.mit.edu/books/making-design-theory>.

69. Ibid. p25

70. Lars Hällnas and Johan Redström, *Interaction Design: Foundations, Experiments* (The interactive Institute, The Swedish School of Textiles and University College of Borås, 2006), [www.hb.se/th/ctf](http://www.hb.se/th/ctf).

71. Lars Hällnas, "Outline of a General Artistic Design Research Program," Borås: Smart Textiles Design Lab Research Outlet, 2017, 30, <http://hb.diva-portal.org/smash/record.jsf?pid=diva2%3A1169474&dswid=-6131>.

72. Redström, *Making Design Theory*.

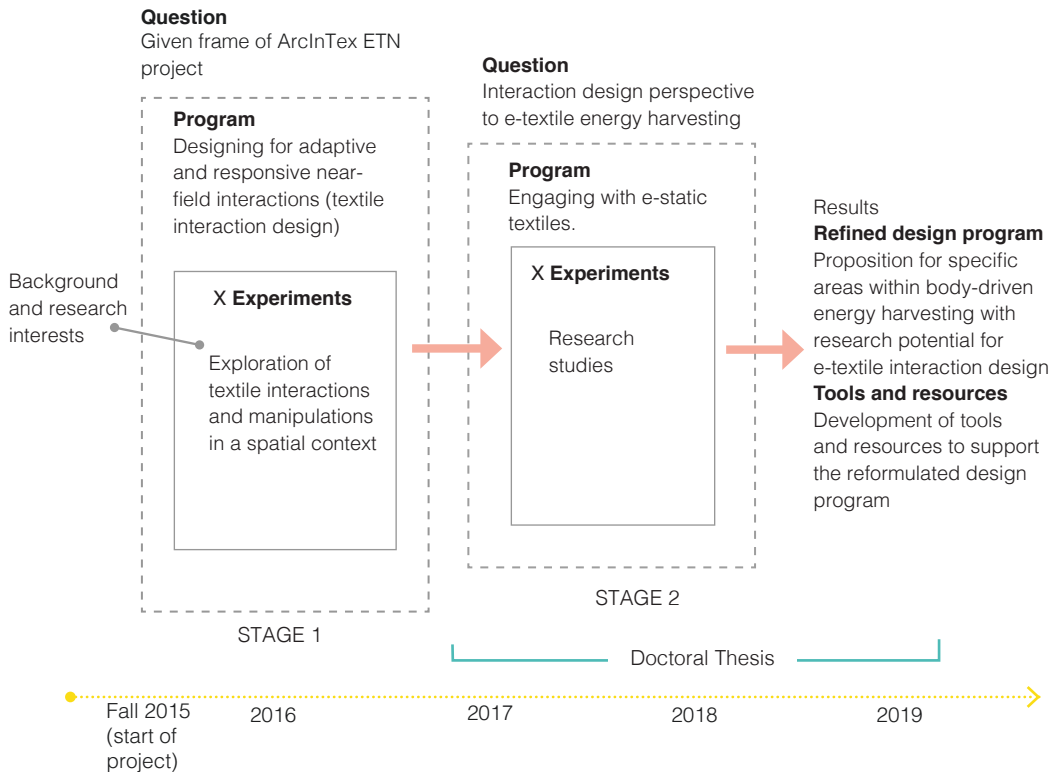

Figure 3. Programmatic research cycles undertaken in the project.

approach provides a systematic way of understanding, investigating and evaluating this research proposition.

The frame given by the ArcInTex ETN project provides a broad stage for this investigation by situating the research in the context of the interior scale relating to material innovations in the field of e-textiles. However, to get a deeper understanding of the opportunities and design challenges posed by interacting with energy harvesting materials and devices, there was a need to initiate a program where such everyday objects and interactions with textile materials may be envisioned, examined and discussed. Setting up a programmatic approach enabled the development of specific examples that firstly illustrate how such an interaction design inquiry may be shaped, and secondly, examine if and how they contribute to the design of everyday body-driven energy harvesting textiles.

The thesis closely follows the three-step approach to programmatic research presented by Redström, where two research cycles were undertaken in the duration of the entire project (see Figure 3). The first stage of the research cycle started with the open questions set out by the larger ArcInTex ETN project and the program defined by the research position. Here some external influences, such as my research background and interests, played an important role in how the program was interpreted to setup the experiments. In this stage, the experiments included exploration of textile interaction language in a

spatial context, which led to considering different energy harvesting solutions with textiles.<sup>73</sup> This first set of experiments led to the redefinition of the design program which marked the start of this thesis inquiry.

The reformulated design program for this thesis within the ArcInTex ETN project aimed at investigating an interaction design perspective to body-driven energy harvesting textiles in the context of interior environments. A design inquiry was thus shaped to enable engagement with static electricity through textiles. Several experiments were set up to investigate this design program. Furthermore, the reflections and insights from undertaking the programmatic research culminated with propositions for specific directions of inquiry for the HCI and e-textiles research community for designing and extending the scope of energy harvesting interior e-textiles. The outcomes of this thesis are therefore themselves programmatic in nature<sup>74</sup> and illustrate and discuss specific directions for future research in the field. The next section gives a more detailed outline of the overview and structure of this dissertation.

### 1.3 Overview and structure of the thesis

#### 1.3.1 Research proposition

Within the application context of interior spaces, this thesis investigates the emerging area of body-driven energy harvesting technologies from the perspective of HCI design. Upcoming innovations in new materials and low-power devices have enabled the conversion of body movements such as steps, or arm movements into electrical energy for powering small computational things.<sup>75</sup> Everyday interior spaces such as public buildings or homes can be fitted with new materials that harness human movements to produce electrical energy.

There has been an increasing interest and development in the area of engineering and materials science to make these technologies more efficient. However, research about the implications of implementing them in the everyday from the perspective of the experiences and interactions of the people adopting these technologies remains underexplored. In order to address and explore this design space, the broader research inquiry proposes to:

- *identify emerging concerns and challenges brought by everyday engagement with electricity production that need to be addressed through an interaction design inquiry.*

---

73. The work and experiments of this part of the research cycle are not included in this dissertation to keep it more comprehensible. Please refer to Appendix E for an overview of the research activities undertaken in the beginning of the project.

74. Hallnäs, "Outline of a General Artistic Design Research Program."

75. The term "computational things" is adopted from Hallnäs and Redström, "Interaction Design: Foundations, Experiments." Computational things refers to products and systems we design that are computational in their nature. They point to how we meet them in daily life– "as things that are not particularly different or more interactive than a door or a floor lamp, what makes them special is the way that the computational technology builds them as things".– Ibid.

This thesis argues that body-driven micro-energy harvesting technologies, that convert human energy into electrical energy, introduce a novel inter-dependent relationship between humans and computational things that needs to be studied through interaction design approaches. While energy harvesting technologies are not new, the increase in their ubiquity at a material level in our everyday environments and their closeness to the body raise new challenges for design that would be beneficial to address at an early stage of technology development. Following this line of inquiry, this research formulates a design program to investigate the specific case of electrostatic energy harvesting for e-textiles from the perspective of human-computer interaction design.

A detailed literature review and a survey of the state of the art in the fields of e-textiles, human computer interaction design and electrostatic energy harvesting is conducted in Chapter 2 to substantiate the above research proposition and formulate the design program.

### 1.3.2 The design program

The design program works with static electricity as an electrical property of textiles that can be harnessed through interactions in everyday interior spaces. Here the notion of the interior refers to the everyday built environments such as dwellings or workspaces. By developing different examples of actively engaging with static electricity through textiles, the research examines the emerging area of human-powered technology from the point of view of e-textile interaction design. It focuses on two key questions: *How can static electricity be used to introduce new ways of engaging with e-textiles and what opportunities and challenges emerge when designing interactions for energy harvesting with electrostatic textiles?*

Static electricity is a phenomenon commonly associated with prolonged interactions with textiles. In everyday life it is usually associated with getting electrically shocked when touching door handles or clothes clinging to the body. It is understandably considered an annoying and even dangerous phenomenon that is harmful for the body as well as electronic components. However, static electricity has recently emerged as a viable source of ambient energy in the area of low-power energy harvesting. Recent examples of nanogenerators in the field of e-textiles have been shown to convert electrostatic charges generated from repeated movement between materials into small amounts of electrical energy.<sup>76</sup> In the light of these new innovations, static electricity can be seen as a resource rather than a negative aspect of textiles. When managed appropriately, static electricity could translate the inherent material quality of certain types of textiles—their tendency to get electrified when in contact with human skin—as a way of powering or interacting with e-textiles. It also opens a design space for investigating new ways of engaging with electrical energy through the material of textiles.

Furthermore, the design program specifies the context of the design inquiry at the scale of the interior. This is an area of application that relates to the project requirement of the given ArcInTex ETN research frame but is also relevant to both areas of e-textile design

---

76. Please refer to Chapter 2 for examples and further description.

and energy harvesting. Textiles in the form of furnishings such as sofas or cushions and large surfaces such as carpets, wall tapestries or curtains provide an interesting entry point for developing energy harvesting interactions. Furthermore, the electrification of textile materials is supported by large surface interactions and modern-day climate controlled dry interiors. For this reason, considering the interior scale as a broad context for application for the design program is a useful case for the given research topic.

The design program thus calls for an interior-scaled investigation that brings together the fields of HCI research, the practice of e-textiles and the technical area of electrostatic (or e-static) energy harvesting. How these different areas are brought together to formulate this design program is presented at the end of Chapter 2 (Section 2.4).

### 1.3.3 Experiments

The thesis process involves a wide range of hands-on design experiments structured in the form of four research studies that explore different aspects of the design program. The four research studies each ask the following questions:

- *Study 01– How may static electricity shape e-textiles?*
- *Study 02– How may e-static textiles shape e-textile interactions?*
- *Study 03– How may e-static textile interactions shape everyday behaviours?*
- *Study 04– How may e-static studies shape energy interpretations?*

The area of electrostatic textiles is very new, with only a few examples of research and even fewer examples from e-textile design (outside of materials science). Before addressing the design program of engaging with electrostatic textiles, first a basic understanding of how to construct with static electricity was required. For this reason, the design inquiry into e-static textiles for this thesis starts at the level of the textile material. Study 01 looks at how an electrostatic textile generator could be made into textile substrates using existing textile production techniques. Study 02 takes the insights gained from Study 01 to further scale up the electrostatic setups to the scale of the interior to explore different interactions for engaging with static electricity. Study 03 learns from Study 01 and Study 02 to develop design narratives that explore the electrostatic interactions as part of everyday behaviours. Study 04 flips the perspective from interaction to output and discusses different interpretations and uses for the small surges of electricity that are produced through energy harvesting actions.

The four studies thus systematically explore different aspects of designing and interacting with static electricity through the material of textiles and the human body. The research methods followed in Study 01, 02 and 03 closely follow material-specific strategies in the field of e-textiles and HCI. An overview of the different research methods used to undertake the research studies is outlined in Chapter 3.

Chapters 4 to 7 of the thesis give a detailed account of each research study by presenting the main objectives, the outline of the experimental process and examples that form key

results. Furthermore, the reflections from undertaking each research study are discussed in relation to the design program and research inquiry.

#### 1.3.4 Results and contribution

Chapter 8 gives an overview of the key insights gained from each of the research studies to reflect on the overall results of the design inquiry undertaken. Two areas of results are examined. The first part of the research results contributes to the practice of e-textiles by creating foundational knowledge of using static electricity as a resource in e-textile design and development without needing specialised materials. A detailed reflection from applying a material-centric perspective to interaction design in the field of e-textiles is also presented.

Chapter 9 opens up the discussion to a broader research inquiry set out by the thesis; it elaborates on the research examples to discuss the implications of designing interactions for energy harvesting. It identifies two key aspects– that of accumulated interactions and the notion of human computer collaboration brought on by incorporating the electric properties of the body, as two areas for addressing challenges brought by body-driven energy harvesting within HCI.

Based on this reflection and formulation of results, the chapter concludes by refining the design program to guide further research. The proposed direction for future work is supported by the following practical outcomes:

- [www.estatictextiles.cc](http://www.estatictextiles.cc)- An online handbook for learning about and working with static electricity and e-textiles which includes tutorials and examples from the research process.
- E-static textiles prototyping board- A printed circuit board (PCB) developed for easy integration of static electricity and textiles to be used as an educational tool for designing and prototyping electrostatic energy-related interactions.

Chapter 10 wraps up the dissertation with a summary and concluding remarks.

## 2 Research frame: HCI, e-textiles and static electricity

In order to understand and develop an interaction design perspective for the emerging area of body-driven energy harvesting systems, this research builds on the material-centric view in HCI research and draws insights from the specific case of designing interactions with static electricity in the context of e-textiles. The three areas of human computer interaction design, e-textiles and research in static electricity are seen from the perspective of their shared concerns and the research frame is described further through the intersections between these overlapping areas (see Figure 4). Section 2.1, 2.2 and 2.3 each describe the overlapping concerns and opportunities between these three domains of

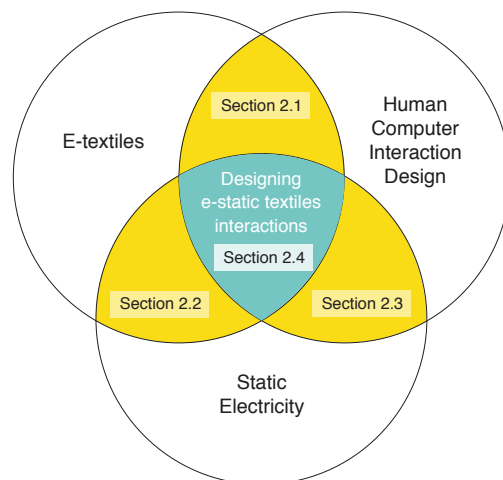

Figure 4. The frame of this research is defined by the intersections between the overlapping areas of human computer interaction (HCI), electronic textiles (e-textiles) and interactive electrostatic energy harvesting technology.



e-textiles, HCI and static electricity. In Section 2.4, these arguments are drawn together to shape this research inquiry and the design program for this dissertation.

## 2.1 HCI and e-textiles

This section first gives an overview of the development of the material-lens in the field of HCI. Furthermore, the research in e-textile design is framed as an area within the materiality-focused HCI which learns from and contributes to the field of HCI. In the latter half of the section, the different approaches from the material driven HCI are categorised into approaches for making, acting and relating to computational things. Building on this further, I argue for undertaking an investigation on everyday engagement with electricity through material interactions with e-textiles.

### 2.1.1 The material turn in HCI research

Since the beginning of the 21st century, there has been an increasing interest within the field of HCI research to consider the material and tangible qualities of computers in the design and experience of everyday technologies. This has been referred to as the material turn in HCI.<sup>77</sup> The notion of the “material” in HCI emerged from the concept of “tangible.”<sup>78</sup> In 1995, the idea of graspable user interfaces was introduced, which were an extension of a graphical user interface (GUI) into the physical world.<sup>79</sup> This work was later developed into the idea of tangible bits<sup>80</sup> and tangible user interfaces<sup>81</sup> that aspired to bridge the gap between cyberspace and the physical environment by making digital bits tangible.<sup>82</sup> The research framework of tangible user interfaces identified the increasing opportunities for embedding computational capabilities in everyday objects and thus aspired to interpret and merge the tactile richness of the physical world as a handler for digital data.<sup>83</sup> In contrast to similar research areas such as augmented reality, or ubiq-

---

77. Erica Robles and Mikael Wiberg, “Texturing the ‘Material Turn’ in Interaction Design,” in Proceedings of the Fourth International Conference on Tangible, Embedded, and Embodied Interaction - TEI '10 (New York, USA: ACM Press, 2010), 137, <https://doi.org/10.1145/1709886.1709911>.

78. Mikael Wiberg, Jofish Kaye, and Peter Thomas, “PUC Theme Issue: Material Interactions,” *Personal and Ubiquitous Computing* 18, no. 3 (June 9, 2013): 573–76, <https://doi.org/10.1007/s00779-013-0683-x>.

79. George W. Fitzmaurice, Hiroshi Ishii, and William A. S. Buxton, “Bricks: Laying the Foundations for Graspable User Interfaces,” in Proceedings of the SIGCHI Conference on Human Factors in Computing Systems - CHI '95 (New York, USA: ACM Press, 1995), 442–49, <https://doi.org/10.1145/223904.223964>.

80. Hiroshi Ishii and Brygg Ullmer, “Tangible Bits,” in Proceedings of the SIGCHI Conference on Human Factors in Computing Systems - CHI '97 (New York, USA: ACM Press, 1997), 234–41, <https://doi.org/10.1145/258549.258715>.

81. Brygg Ullmer and Hiroshi Ishii, “Emerging Frameworks for Tangible User Interfaces,” *IBM Systems Journal* 39, no. 3.4 (2000): 915–31, <https://doi.org/10.1147/sj.393.0915>.

82. Ishii and Ullmer, “Tangible Bits.”

83. *Ibid.*

uitous computing that support the ‘invisibility’ or disappearance of the computational elements into the physical world, tangible interface research aspired to engage in a direct, deliberate and tactile dialogue between people and computers using the tangible world.<sup>84</sup>

During the last two decades, different discourses have emerged to understand how computers merge into other objects and extend the role of interaction design from making efficiency-oriented tools for specific situations to designing technologies that are part of our everyday lives for a long period of time.<sup>85</sup> For example, there was an emerging concern that the computer, a device originally designed for the workplace, would bring a focus on efficiency to even our non-work-related activities. Challenging this work-oriented relationship to computers, approaches such as critical design<sup>86</sup>, ludic engagement<sup>87</sup> and slow technology<sup>88</sup> placed playfulness, creativity and critical reflection—rather than efficiency—at the centre of human-computer interaction. Building on this further, Hallnäs and Redström<sup>89</sup> have discussed a need for change in approach from “designing for use” to “the presence” of computational objects. They describe *presence* as a state for objects that have been ‘accepted’ into our lifeworld by attaining an expression-identity. They emphasised that this expressional identity was not its functional identity, which relates to the uses or tasks, but rather the additional meanings and relationships that connected it to our own life and rhythms. Consecutively, they argued that the goal for design was to make computational things that enabled different ways for people to relate to them in everyday life. Incorporating ambiguity and introducing unfamiliar behaviours in everyday objects were used as methods for challenging existing notions and provoking new interpretations of everyday technologies.<sup>90</sup>

---

84. Ibid.

85. Hallnäs and Redström, “Slow Technology – Designing for Reflection.”

86. Anthony Dunne and Fiona Raby, *Design Noir: The Secret Life of Electronic Objects* (Basel: Birkhäuser, 2001).

87. William Gaver et al., “The Drift Table: Designing for Ludic Engagement,” in *Proceedings of CHI 2004* (Vienna, Austria: ACM Press, 2004).

88. Hallnäs and Redström, “Slow Technology – Designing for Reflection.”

89. Lars Hallnäs and Johan Redström, “From Use to Presence: On the Expressions and Aesthetics of Everyday Computational Things,” *ACM Transactions on Computer-Human Interaction* 9, no. 2 (June 1, 2002): 106–24, <https://doi.org/10.1145/513665.513668>.

90. For example: –William Gaver, Jacob Beaver, and Steve Benford, “Ambiguity as a Resource for Design,” in *Proceedings of the Conference on Human Factors in Computing Systems - CHI '03* (New York, USA: ACM Press, 2003), 233, <https://doi.org/10.1145/642651.642653>;

Mark Blythe et al., “Anti-Solutionist Strategies: Seriously Silly Design Fiction Mark,” in *Proceedings of the 2016 CHI Conference on Human Factors in Computing Systems - CHI '16* (New York, USA: ACM Press, 2016), 4968–78, <https://doi.org/10.1145/2858036.2858482>;

Genevieve Bell, Mark Blythe, and Phoebe Sengers, “Making by Making Strange,” *ACM Transactions on Computer-Human Interaction* 12, no. 2 (June 2005): 149–73, <https://doi.org/10.1145/1067860.1067862>.

Taking a phenomenological approach,<sup>91</sup> the emergence of tangible interfaces was also marked by a re-examination of the dexterity of the whole body in interaction. There was an emphasis on *how* and not only *what* tasks are carried out.<sup>92</sup> This opened a design space for exploring interactions that focus on movements between actions, that use the whole body, support skill development and highlight the presence of the body in digital interactions.<sup>93</sup> For example, ‘hands only scenarios’<sup>94</sup> challenge the amount of attention paid on the appearance of digital objects in the design process. Rather than interactions being decided by the form of the objects, they focus on user actions by designing the objects based on specific body movements.<sup>95</sup> The notion of embodied design developed by Dourish, interpreted phenomenological ideas in relation to tangible and social computing.<sup>96</sup> The relationship between humans and computational things has been seen as dynamic and emerging through interaction.<sup>97</sup> Furthermore, digital interactions were understood as embodied phenomena which occur in real space-time, and engaging with artefacts results in creation, manipulation and sharing of meaning.<sup>98</sup>

As the new design space was opened by tangible user interfaces (TUI) for incorporating digital interactivity into everyday objects and spaces, the role of the interaction designer quickly started to change from designing the interface of the computer to designing a thing or environment in which a computer might be used to create a desired effect.<sup>99</sup>

- 
91. Phenomenology was a philosophical movement originally inaugurated by Edmund Husserl in the beginning of the 20th century and extended by others, which claimed to be a radical way of doing philosophy based on practice rather than a system. It critiqued the prominent cartesian approaches that focused on thought before action and highlighted the importance of human experiences in the life-world as a source of knowledge: as described in the book– Dermot. Moran, Introduction to Phenomenology (Routledge, 2000).
  92. Tom Djajadiningrat, Ben Matthews, and Marcelle Stienstra, “Easy Doesn’t Do It: Skill and Expression in Tangible Aesthetics,” *Personal and Ubiquitous Computing* 11, no. 8 (March 17, 2007): 657–76, <https://doi.org/10.1007/s00779-006-0137-9>.
  93. Mads Vedel Jensen, Jacob Buur, and Tom Djajadiningrat, “Designing the User Actions in Tangible Interaction,” in *Proceedings of the 4th Decennial Conference on Critical Computing between Sense and Sensibility - CC ’05* (New York, USA: ACM Press, 2005), 9, <https://doi.org/10.1145/1094562.1094565>.
  94. Jacob Buur, Mads Vedel Jensen, and Tom Djajadiningrat, “Hands-Only Scenarios and Video Action Walls,” in *Proceedings of the 2004 Conference on Designing Interactive Systems Processes, Practices, Methods, and Techniques - DIS ’04* (New York, USA: ACM Press, 2004), 185, <https://doi.org/10.1145/1013115.1013141>.
  95. Ibid.
  96. Paul Dourish, *Where the Action Is* (MIT Press, 2004), <http://mitpress.mit.edu/books/where-action>.
  97. Paul Dourish, “What We Talk about When We Talk about Context,” *Personal and Ubiquitous Computing* 8, no. 1 (February 1, 2004): 19–30, <https://doi.org/10.1007/s00779-003-0253-8>.
  98. Dourish, *Where the Action Is*.
  99. Anna Vallgård, “Giving Form to Computational Things: Developing a Practice of Interaction Design,” *Personal and Ubiquitous Computing* 18, no. 3 (June 4, 2013): 577–92, <https://doi.org/10.1007/s00779-013-0685-8>.

Following this line of inquiry, the research community, especially in the Netherlands, argued for adopting an industrial design perspective to designing interactive technology. For example, Djajadiningrat et al.<sup>100</sup> found that tangible interfaces were more than a representational issue that needed to semantically link affordances to interactions. They also needed to make a meaningful connection between the physical and the digital action. Researchers argued that as digital technology became integrated into everyday objects, it brought with it the ‘computeresque’ aesthetics— with every action and interface element looking and feeling the same despite the associated digital action. This perspective to interaction design thus focused on creating rich interactions that make the most of the perceptual-motor skills of human beings for more intuitive, meaningful couplings between appearance and actions and functions.<sup>101</sup> Examples such as the digital camera, alarm clock and heating controller<sup>102</sup> framed some of the key thinking and work behind designing for expressive and rich user interactions.

In 2005, Redström<sup>103</sup> proposed considering technology as another material in design. Materials, he argued, play an important role in design and craft practices and have been central for challenging the notion of form, expressions, aesthetics and envisioning what kinds of objects could be created in general. With computers entering different contexts of our everyday life, Redström argued that an emphasis on only function was not enough. We also needed to consider the textural and tactile experiences of touching, interacting and living with technical things. He claimed that this was not a mere issue of packaging but rather called for a change in how we approach shaping technology for people by considering the expressions, temporal aspects and form of new technical things from a material perspective.

Taking this further, Vallgård and Sokoler<sup>104</sup> proposed designing computational objects to be similar to the practice of ‘formgiving’ in crafting traditional materials (e.g. clay or wood), where developing hands-on practices that explore the open-endedness of material properties could lead to novel forms and expressions. They introduced “computational composites”<sup>105</sup> as new materials of which computational elements are an integral

---

100. Tom Djajadiningrat et al., “Tangible Products: Redressing the Balance between Appearance and Action,” *Personal and Ubiquitous Computing* 8, no. 5 (July 31, 2004): 294–309, <https://doi.org/10.1007/s00779-004-0293-8>.

101. Ibid.

102. Djajadiningrat, Matthews, and Stienstra, “Easy Doesn’t Do It: Skill and Expression in Tangible Aesthetics.”

103. Johan Redström, “On Technology as Material in Design,” *Design Philosophy Papers* 3, no. 2 (June 1, 2005): 39–54, <https://doi.org/10.2752/144871305X13966254124275>.

104. Anna Vallgård and Tomas Sokoler, “A Material Strategy: Exploring Material Properties of Computers,” *International Journal of Design* 4, no. 3 (2010): 1–14, <http://bada.hb.se:80/handle/2320/7294>.

105. Anna Vallgård and Johan Redström, “Computational Composites,” in *Proceedings of the SIGCHI Conference on Human Factors in Computing Systems - CHI '07* (New York, USA: ACM Press, 2007), 513, <https://doi.org/10.1145/1240624.1240706>.

constituent. They further presented some of the material properties of computational composites as being temporality, reversibility and accumulation, computed causality and connect-ability which can be explored through the design process. Going further, Wiberg and Robles<sup>106</sup> proposed the idea of computational compositions that explore the notion of texture to address the confluence of the material and digital. They emphasised that the early tangible interfaces, in an attempt to bridge the gap between bits and atoms, imposed a further categorisation and separation between the two. They suggested that the notion of ‘texture’, on the other hand, offered a vocabulary to address formal relations at the level of structure, surface, overall appearance and feel.

Considering the materiality of interactions, Redström introduced the notion of tangled interactions<sup>107</sup> that summarises two main approaches to interaction. The first, which is prevalent in ubiquitous computing, problematised the relationship between the action-potential of a physical object and its intended functions. The second is related to the ‘abstraction of the material’ in digital artefacts caused by the increasing disconnect between the internal and the surface complexity. While the first one moved away from the GUI thinking of metaphoric visual representation to an embodied movement-oriented view of interaction, the other supported the space-flexibility of GUIs and sought to add more ‘surface’ to compensate for the internal complexity. Challenging the boundary between these two approaches, he introduced a third perspective—that of expanding the expressivity of an existing ‘surface’ by adding multiple layers of interactions. For example, the interactive pillow<sup>108</sup> used in the situational context of where the pillow exists in one’s environment and what one ‘does’ with it. Another layer of functionality is added to the use-context of the pillow, which is the ability to communicate with a distant loved one by hugging the pillow.

While Redström introduced an approach of layering interactions, Buechley and P-Wilson<sup>109</sup> highlighted the similarities in values and approaches between the practices of crafting and working with electronics. Wiberg<sup>110</sup> discussed the need for a methodology specific to exploring interaction design from a material lens and looked to Schön’s<sup>111</sup> model of moving from details to the whole. Wiberg has proposed a framework that

---

106. Mikael Wiberg and Erica Robles, “Computational Compositions: Aesthetics, Materials, and Interaction Design,” *International Journal of Design* 4, no. 2 (2010), <http://www.ijdesign.org/index.php/IJDesign/article/view/757/301>.

107. Johan Redström, “Tangled Interaction,” *ACM Transactions on Computer-Human Interaction* 15, no. 4 (November 1, 2008): 1–17, <https://doi.org/10.1145/1460355.1460358>.

108. Ibid.

109. Leah Buechley and Hannah Perner-Wilson, “Crafting Technology,” *ACM Transactions on Computer-Human Interaction* 19, no. 3 (October 1, 2012): 1–21, <https://doi.org/10.1145/2362364.2362369>.

110. Mikael Wiberg, “Methodology for Materiality: Interaction Design Research through a Material Lens,” *Personal and Ubiquitous Computing* 18, no. 3 (May 29, 2013): 625–36, <https://doi.org/10.1007/s00779-013-0686-7>.

111. Schoen, *The Reflective Practitioner: How Professionals Think In Action*.

considers the interplay between details, wholeness, materials and textures to explore different levels of analysis in material-centred interaction design research. Other aspects of materiality in HCI have also been brought forward; such as Kwon et al.<sup>112</sup> who highlighted the importance of considering immaterial and materials. They introduced the term ‘immaterial materials’ (air, magnetism, light and sound) as another category of materials that comprise our physical world.

The material perspective in HCI seeks a unified understanding of the digital and the physical that is shaped simultaneously and experienced as a single material, rather than using materials to make better shells around miniature computers. In doing so, this perspective foregrounds both the materials for designing interactions and the design practice used to give form to material compositions.<sup>113</sup> In this way, the material turn in HCI indicates also a turn towards materiality oriented interaction design.<sup>114</sup> Going forward, I refer to the HCI research that is characterised by the material-turn described in this section as ‘materiality oriented HCI’.

### 2.1.2 E-textiles as computational material contributing to HCI knowledge

An e-textile refers to a textile substrate that incorporates capabilities for sensing (biometric or external), communication and power transmission to allow information processing devices to be networked together within a fabric.<sup>115</sup> E-textiles are often also referred to as smart textiles or wearables. However, there is a significant difference between these terms. E-textiles may use smart materials but are different from research in smart textiles which focus on developing new kinds of materials with advanced capabilities, such as stain resistance<sup>116</sup> or colour change,<sup>117</sup> and fall more in the purview of materials science.<sup>118</sup> Similarly, although some e-textile artefacts can be categorised under wearables or wearable computing, it is not the only area for e-textile application. Wearables refer to on-body

---

112. Hyosun Kwon, Hwan Kim, and Woohun Lee, “Intangibles Wear Materiality via Material Composition,” *Personal and Ubiquitous Computing* 18, no. 3 (June 4, 2013): 651–69, <https://doi.org/10.1007/s00779-013-0688-5>.

113. Wiberg, Kaye, and Thomas, “PUC Theme Issue: Material Interactions.”

114. Ibid.

115. Joanna Berzowska, “Electronic Textiles: Wearable Computers, Reactive Fashion, and Soft Computation,” *Textile: The Journal of Cloth and Culture* 3, no. 1 (2005): 58–75, <https://doi.org/10.2752/147597505778052639>.

116. For example, T. Yuranova et al., “Self-Cleaning Cotton Textiles Surfaces Modified by Photoactive SiO<sub>2</sub>/TiO<sub>2</sub> Coating,” *Journal of Molecular Catalysis A: Chemical* 244, no. 1 (2006): 160–67, <http://www.sciencedirect.com/science/article/pii/S1381116905006199>.

117. For example, B. Gauvreau et al., “Color-Changing and Color-Tunable Photonic Bandgap Fiber Textiles,” *Optics Express* 16, no. 20 (September 19, 2008): 15677, <https://doi.org/10.1364/OE.16.015677>.

118. Berzowska, “Electronic Textiles: Wearable Computers, Reactive Fashion, and Soft Computation.”

devices that can measure, monitor or assist in a person's everyday needs and activities.<sup>119</sup> These devices might be soft and textile-based, such as a heart rate monitoring sports-bra<sup>120</sup> or a knitted scarf-shaped music controller,<sup>121</sup> but they can also be hard-devices, such as activity tracker wrist-bands or smart phones that are worn or kept close to the body but do not use any textiles in their design or approach. E-textile artefacts essentially utilise textile materials or properties such as softness or flexibility in the design of their form and interaction. They might be wearable, but they can also refer to larger objects such as furniture, curtains, carpets, etc.

E-textiles gained popularity as an area of research in 1997 with the development of conductive fabric made from copper wrapped silk threads.<sup>122</sup> This work reinterpreted a traditional practice of incorporating metallic yarns in textiles as a means for carrying electricity within the textile substrate. Conductive yarns provided an entry point for re-imagining digital interfaces in a textile shape. Supported by the conceptual development of tangible interfaces that emerged around the same time,<sup>123</sup> e-textiles have been interpreted as a material form of computation, or as computational composites of which textiles and electronics are material constituents.<sup>124</sup> E-textile design is often a matter of negotiating and balancing different material properties while discovering and improvising with the tactile and experiential possibilities of combining textiles and electronics.<sup>125</sup>

The practice and research in the field of e-textiles have thus learnt from approaches in HCI as well as provided a rich medium for investigating and informing materiality oriented HCI design. As an example, the early prototypes of e-textiles presented in the year 2000, included an embroidered keypad<sup>126</sup> in which conductive yarn was used to embroider a soft numeric keypad on textiles. In the same year, the firefly dress by M.Orth showcased LED lights on a dress that flickered when the conductive parts on the dress touched

---

119. Cliff Randell, "Wearable Computing: A Review," 2006, <http://citeseerx.ist.psu.edu/viewdoc/summary?doi=10.1.1.60.7898>.

120. For example, Anonymous, "Adidas MiCoach Seamless Sports Bra," 2015, <http://shop.numetrex.com/product/adidas-micoach-seamless-sports-bra/>.

121. Ramyah Gowrishankar, Katharina Bredies, and Rosan Chow, "The Music Sleeve : Fabric As An Electronic Interface Medium," in *Nordic Design Research Conferences (North America 31 03 2011., 2011)*, <http://ocs.sfu.ca/nordes/index.php/nordes/2011/paper/view/400>.

122. E Rehmi Post and Margaret Orth, "Smart Fabric, or 'Wearable Clothing,'" in *Proceedings of the 1st IEEE International Symposium on Wearable Computers, ISWC '97 (Washington, DC, USA: IEEE Computer Society, 1997)*, 167--, <http://portal.acm.org/citation.cfm?id=851036.856432>.

123. As described in section 2.1.1: Material turn in HCI.

124. Wiberg and Robles, "Computational Compositions: Aesthetics, Materials, and Interaction Design."

125. Ramyah Gowrishankar and Katharina Bredies, "Investigating Interaction Design for E-Textiles Using Case-Transfer," in *Proceedings of Ambience, Scientific Conference for Smart Textiles (Tampere, 2014)*, <https://doi.org/ISSN 2342-4540>.

126. E. R. Post et al., "E-Broidery: Design and Fabrication of Textile-Based Computing," *IBM Systems Journal* 39, no. 3 (2000): 840–60, <https://doi.org/10.1147/sj.393.0840>.

as a result of the wearer's movements.<sup>127</sup> In 2004, Berzowska presented other materials such as thermo-chromic inks<sup>128</sup> and shape-memory alloy<sup>129</sup> that could be activated using conductive yarns to change the visual pattern and the form of the e-textile, respectively. These initial examples of e-textiles illustrate three key directions in how materiality oriented HCI is reflected in the way material qualities and digital functionality have been brought together—the keypad illustrates interpreting e-textiles as a tangible interface for controlling digital functions, and the firefly dress acts as a kind of sensor that responds to the wearer's natural movements. The third example involving visual and shape changing e-textiles illustrates their potential to act as displays or outputs for digital systems. Below, I develop these observations further.

### **E-textiles for exploring rich user interfaces**

E-textiles build on the tactile and transformative qualities of textiles as a resource for designing interactions. We manipulate and handle textiles on a daily basis, such as folding sheets, stretching the sleeve of a sweater, spreading a tablecloth, etc. Similar to the early tangible interface designers who used physical tokens as handlers for digital information,<sup>130</sup> e-textile designers have used textile objects as interfaces for the digital. E-textiles, such as project jacquard by Google<sup>131</sup> or Ralph Lauren's mp3 jacket,<sup>132</sup> bring interactions commonly used with digital devices, such as swiping, tapping or pressing, to the domain of textiles. Others have used the interactions specific to textiles, such as stretching or folding,<sup>133</sup> as starting points for developing e-textiles that may not directly resemble existing textile artefacts. A need for developing a form and interaction language based on everyday textile interactions that are specific to the material of e-textiles has been previously emphasised.<sup>134</sup>

---

127. Ibid.

128. Joanna Berzowska, "Very Slowly Animating Textiles: Shimmering Flower," in ACM SIGGRAPH 2004 Sketches, SIGGRAPH '04 (New York, USA: ACM, 2004), 34--, <https://doi.org/http://doi.acm.org/10.1145/1186223.1186266>.

129. Joanna Berzowska and Marcelo Coelho, "Kukkia and Vilkas: Kinetic Electronic Garments," in Ninth IEEE International Symposium on Wearable Computers, 2005, 82–85, [http://ieeexplore.ieee.org/xpls/abs\\_all.jsp?arnumber=1550790](http://ieeexplore.ieee.org/xpls/abs_all.jsp?arnumber=1550790).

130. For example, Durrell Bishop, "The Marble Answering Machine," *The Hand That Rocks the Cradle*, 1995, <https://www.v-must.net/biblio/marble-answering-machine>.

131. "Project Jacquard," Google ATAP, 2015, <https://www.google.com/atap/project-jacquard/>.

132. Technabob, "Wired Ralph Lauren Aero Type Ski Jacket Has iPod and Bluetooth Controls," [technabob.com/blog](http://technabob.com/blog), 2010, <http://technabob.com/blog/2010/01/02/wired-ralph-lauren-aero-type-ski-jacket/>.

133. For example, Hannah Perner-Wilson and Mika Satomi, "How To Get What You Want," [Kobakant.at](http://www.kobakant.at), accessed February 17, 2017, <http://www.kobakant.at/DIY/?cat=26>.

134. Ramyah Gowrishankar, Katharina Bredies, and Salu Ylirisku, "A Strategy for Material-Specific e-Textile Interaction Design," in *Smart Textiles Fundamentals, Design, and Interaction*, ed. Stefan Schneegass and Oliver Amft (Springer International Publishing, 2017), 233–57, [https://doi.org/10.1007/978-3-319-50124-6\\_11](https://doi.org/10.1007/978-3-319-50124-6_11).



Textiles provide a wide variety of textures and interactions that can be used as a resource to design rich user interactions.<sup>135</sup> They support materiality oriented HCI which calls for expressive and whole-body interactions to support the versatility and skill of the human body. Moreover, textiles enable the approach of rich user interactions to be applied at larger scales to explore full-body interactions and create interactive spaces.

### **E-textiles for developing context-based sensors**

Textiles populate our everyday environments in different forms such as objects, surfaces or spatial elements, and we interact with and manipulate textiles on a daily basis. Specific textile objects, such as a couch or a pillow, give a hint towards their use-context (e.g., sitting) or their location (e.g., bedroom). Using these inherent meanings in existing textile objects has provided a medium for observing human behaviours or following the needs of users on the fly.<sup>136</sup> Similarly, the reality of clothing being close to the body has opened up a variety of applications that can observe biometric data—like heart rate—from the wearer and can notify them of health-related issues.<sup>137</sup> Clothing also allows gestural recognition sensors to be placed close to the body to sense the wearer’s movements. For example, keyglove<sup>138</sup> triggers specific digital commands according to the different hand gestures of a person. Environmental data such as weather predictions, moisture and pollution levels have also been used as input for e-textile systems to provide location-specific insights to its users.<sup>139</sup>

Therefore, as context-based systems, e-textiles primarily make use of the different use-contexts of textiles when placing sensors to read context-based data. These kinds of e-textile artefacts may not necessarily engage in direct interactions but rather act as listeners for reading behaviours. In this way, these types of e-textiles may largely be considered as supporting ubiquitous computing rather than tangible interactions which focus on more direct, tactile engagement with materials for the purpose of digital manipulation. These products act as information tracking systems but do not include active manipulation of a textile interface. As a result, the design approach of these products often aligns more with ubiquitous computing research than with materiality oriented HCI research.

### **E-textiles for displaying material-expressions of computation**

Redström argues that new materials extend the expressions of technology.<sup>140</sup> For example,

---

135. Ibid.

136. For example, Madhup Chandra, Mark T. Jones, and Thomas L. Martin, “E-Textiles for Autonomous Location Awareness,” *IEEE Transactions on Mobile Computing* 6, no. 4 (April 2007): 367–80, <https://doi.org/10.1109/TMC.2007.51>.

137. J Vagott and R Parachuru, “An Overview of Recent Developments in the Field of Wearable Smart Textiles,” *Journal of Textile Science & Engineering* 08, no. 04 (August 8, 2018): 1–10, <https://doi.org/10.4172/2165-8064.1000368>.

138. Jeff Rowberg, “Keyglove,” 2011, <http://www.keyglove.net/>.

139. Diffus Design, “Climate Dress 2009,” accessed March 14, 2019, <http://diffus.dk/work/project-climate-dress/>.

140. Redström, “On Technology as Material in Design.”

the temporal form of a computational device manifested in space could take multiple forms. While an LCD screen might be one expression of displaying temporal form, new materials could introduce other ways of visualising the computational states of the object. E-textiles is a computational composite that offers opportunities for bringing textile qualities to the way it displays information. For example, researchers have explored the idea of dynamic patterns on textiles that could be changed on demand.<sup>141</sup> Taking this further, Dumitrescu and Persson<sup>142</sup> have used heat with textiles as a form of dynamic expression and created textile samples that burn away when the conductive yarn in them is electrified. The material transformations have enabled them to discuss reversible and non-reversible changes in the context of materiality oriented HCI.

While these examples present ways of programming dynamic behaviour in textiles, the everyday form language of textiles already embody some aspects of temporal forms that could be read as digital states of the computational textile. For example, a folded blanket versus an open blanket or measuring the extent of crumpling of the textile caused by the pulling of a string. These textile deformations have been explored in a workshop setting to get suggestions for use-cases depending on the nature of the textile deformations performed by the participants.<sup>143</sup>

The interaction design approaches in e-textiles have thus contributed to the discussion in the broader field of materiality oriented HCI research. Additionally, I see the body of textile-specific computational things as uniquely contributing to the larger field of HCI due to the wide contrast between the material qualities brought by textiles as well as the gestures and physical attributes usually associated with everyday technologies. Compared to other traditional materials, such as clay or wood, textiles provide a versatile range of production techniques and a much larger scope for manipulation, from fibre, yarn and textile substrates to objects of different scales and topologies. Textile techniques, thus provide a rich resource for combining, improvising and experimenting with textiles and electronics, making it an approachable material for designers to experiment with, rather than only for materials scientists (as in the case of, smart glass or e-paper, for example).

New technologies or integration techniques continuously present new opportunities for e-textiles to be more like textiles in appearance as well as behaviour. As the possibilities increase, the role of e-textile research has extended towards finding new opportunities as well as being critical of the implications of the everyday adoption of such technologies. E-textiles research thus relates to a broader understanding of materiality oriented HCI that looks at making computational things, studies behaviours and actions in use as well as explores new ways of relating with computational things.

---

141. Examples: Eriksson et al., IT+Textiles.

142. Delia Dumitrescu and Anna Persson, "Exploring Heat as Interactive Expressions for Knitted Structures," Nordes, March 31, 2011, <http://www.nordes.org/opj/index.php/n13/article/view/123>.

143. Gowrishankar, Bredies, and Ylirisku, "A Strategy for Material-Specific e-Textile Interaction Design."

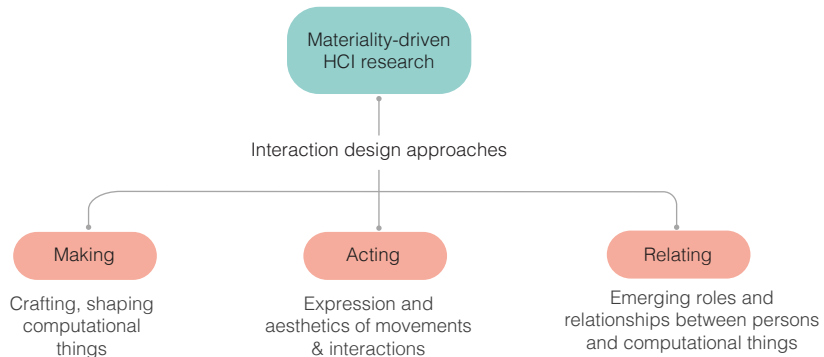

Figure 5. Materiality oriented interaction design approaches identified within HCI for this research.

### 2.1.3 Material interactions: Making, acting and relating with computational things

Section 2.1.1 described how the increasing miniaturisation of computational devices propelled a part of the research in HCI towards emphasising the material and tangible aspects of computational artefacts in the everyday. Since its emergence, the different works and publications presented under materiality oriented HCI have addressed different aspects of the combination of analogue and digital materials.

The historical overview presented in the beginning of the chapter also highlighted how the consideration of material interactions extended the overall scope of the HCI field from being concerned only with the interface between digital and physical to designing whole products, environments, behaviours and experiences. I broadly organise the different strategies for dealing with material interactions as materiality oriented approaches towards “making”, “acting with” and “relating to” computational artefacts in the everyday (see Figure 5). In the previous subsection, I described how e-textiles learn from and contribute to the field of materiality oriented HCI. However, an interaction design strategy specifically geared towards addressing material qualities of textiles in the field of e-textiles research is still lacking. The proposed categories of making, acting and relating thus aim to provide a systematic way of studying material interactions in the field of e-textiles. Below I unpack these categories further.

#### **Making computational things**

These approaches within the materiality oriented HCI specifically focus on the practice of combining, shaping and designing with computational and traditional materials. For example, the material strategy proposed by Vallgård and Sokoler<sup>144</sup> developed the idea of computational composites in which active and passive materials are understood to be constituents of the same material. The notion of crafting technology in HCI has been compared to traditional craft practices in that similarly skilful combinations of materials and aesthetics are used to make technological artefacts. For example, the kit of no parts by Perner-Wilson<sup>145</sup> presents a series of crafted electronic components using manufac-

144. Vallgård and Sokoler, “A Material Strategy: Exploring Material Properties of Computers.”

145. Hannah (Hannah Rosamonde) Perner-Wilson, “A Kit-of-No-Parts” (Massachusetts Institute of Technology, 2011), <http://dspace.mit.edu/handle/1721.1/67784>.

turing techniques of traditional crafts such as wood working, textile and paper crafts to build digital artefacts. Thus, the approaches towards making computational things are in search of a more unified understanding of the material and digital when dealing with the two at the same time and in a co-dependent manner from the beginning of the design process.

### **Acting with computational things**

This approach within the field of materiality oriented HCI is characterised by an emphasis on body movements, tactility and the aesthetic of interactions enabled by the form and materials of computational artefacts. For example, Djajadiningrat et al.<sup>146</sup> argue that digital technologies have continued to place demands on our cognitive abilities but have denied us the ability to develop bodily skills. They advocate a perceptual-motor centred approach to tangible interaction, “which capitalizes on the fit between physical objects and our motor abilities as well as on our sensory sensitivity to the rich expressiveness of physical objects, and develops interaction styles which value movement of the body as well as movement of product components.”<sup>147</sup> Similarly, Buur et al. emphasise focusing on user actions even before designing the form of the product.<sup>148</sup> Rich user interfaces<sup>149</sup> place a similar importance on movements and manipulations within the digital artefact that make a better connection between human action and the digital function. The notion of tangled interactions proposes the idea of layering expected interactions with objects with new digital meanings, for example, hugging a pillow would also send a message to a loved one.<sup>150</sup> The approaches of acting with computational things thus extend beyond the mere usability of an interface but call for a more performative stance where supporting interactions with the whole body through different movements and sensorial experiences play a central role in designing computational things.

### **Relating to computational things**

Another parallel line of inquiry triggered by the material turn in HCI was a need to re-define computers—with respect to their tangibility—alongside an aspiration to explore new interpretations for computational technologies in the everyday. For example, reacting to the always task-oriented relationship to computational devices, approaches such as slow technology<sup>151</sup> and reflective design<sup>152</sup> placed critical reflection, rather than efficiency, at the centre of human-computer relationships. While these approaches questioned the utilitarian role of computational things, others went to another extreme of exploring emerging

---

146. Djajadiningrat, Matthews, and Stienstra, “Easy Doesn’t Do It: Skill and Expression in Tangible Aesthetics.”

147. Ibid.

148. Buur, Jensen, and Djajadiningrat, “Hands-Only Scenarios and Video Action Walls.”

149. Joep Frens, “A Rich User Interface for a Digital Camera,” *Personal and Ubiquitous Computing* 10, no. 2–3 (August 26, 2005): 177–80, <https://doi.org/10.1007/s00779-005-0013-z>.

150. Redström, “Tangled Interaction.”

151. Hallnäs and Redström, “Slow Technology – Designing for Reflection.”

152. Phoebe Sengers et al., “Reflective Design,” in *Proceedings of AARHUS '05* (Aarhus, Denmark: ACM Press, 2005), 49–58.

relationships to computational objects that behaved independently of the human.<sup>153</sup> Hällnäs and Redström<sup>154</sup> have argued for interaction design to shift its focus from designing for use towards designing for computational things as co-habitants that become part of our everyday lives and adopt different roles and meanings with time. The opening up of possibilities for different ways of relating to computational things enabled by tangible computers looks to a conceptual shift rather than a search for more applications or products.

These three categories of materiality oriented HCI aspire to tackle the combination of bits and atoms from the different perspectives of making the object itself, and to focus on the richness of interactions enabled by the new material combinations as well as develop a deeper understanding of how embracing materiality in computational devices engages us differently in our everyday lives.

#### 2.1.4 Conclusion: Investigating everyday engagement with electricity through material interactions with e-textiles

In Chapter 1, I described the emerging body-driven energy harvesting systems as material interventions in the everyday that actively engage the body to generate electrical energy. These systems or objects could be approached as computational composites, that are composed from different materials (both active and passive, e.g., piezoelectric elements, textiles, electronics, etc.) and have the ability to harness kinetic energy from people through interactions. Following this idea, I argue that looking at body-driven energy systems from a materiality oriented HCI perspective gives us an opportunity to explore personal energy harvesting systems from the experiential point of view of the people involved.

In section 2.1.1, I described how the material turn in HCI was propelled by the concern that computers entering everyday aspects of our lives need alternative interpretations that extend beyond the notion of efficiency, towards an experience of use that considers computational things as cohabitants of our everyday spaces.<sup>155</sup> This perspective draws the attention towards expressions of interaction and materials in a design practice that places the computational and the material at the same level. Researchers of materiality oriented HCI have argued that exploring the new material properties of computationally enabled materials is crucial for finding relevant forms that support and explore new visions of how computational things could act for, with or despite of us.<sup>156</sup> From this argument for

---

153. Ron Wakkary et al., "Morse Things," in Proceedings of the 2017 Conference on Designing Interactive Systems - DIS '17 (New York, USA: ACM Press, 2017), 503–14, <https://doi.org/10.1145/3064663.3064734>.

154. Hällnäs and Redström, "From Use to Presence: On the Expressions and Aesthetics of Everyday Computational Things."

155. Ibid.

156. Lars Hällnäs, "On the Foundations of Interaction Design Aesthetics: Revisiting the Notions of Form and Expression," *International Journal of Design* 5, no. 1 (2011), <http://ijdesign.org/index.php/IJDesign/article/view/689/330>.

investigating new ways of relating to body-driven energy, it is as important to understand energy-harnessing materials in a different way as much as it is to understand ways of harvesting energy through material interactions. Therefore, for this research project to discuss the implications for interactive energy harvesting, an extensive exploration is first needed to understand the possibilities brought forward by these new materials.<sup>157</sup>

The expressivity and development of human-motor skills in interactions with rich user interfaces is an already well-researched area;<sup>158</sup> methods like the hands-only approach<sup>159</sup> or machine-cowboy<sup>160</sup> have emphasised the need to pay more attention to the physical choreographies of interactions enabled by computational technology. Following materiality oriented HCI to consider interactions specific to a set of materials would enable interaction-focused research while setting an open-ended exploration of energy generation through the body. E-textiles, from this perspective, would provide an opportune material to explore everyday engagement with electricity.

Additionally, undertaking materiality oriented HCI research in the practice of e-textiles helps to develop a material-specific methodology for e-textile development that is focused on textiles. In section 2.1.2, I introduced e-textiles as a form of material computation that continuously contributes to and learns from approaches in materiality oriented HCI. I showed that e-textiles has followed the approaches from tangible HCI research and has been often used to exemplify findings in the latter. Although there have been projects that approach e-textiles from the lens of interaction design, a holistic perspective on e-textile interaction design approaches is needed to truly support textile-specific interpretations in the use and adoption of e-textile artefacts. Furthermore, in section 2.1.3, I re-examine the developments in materiality oriented HCI to propose the categories of making, acting and relating with computational things as a systematic way of conducting materiality oriented HCI in this research.

Undertaking a materiality-focused interaction design study for investigating making, acting and relating with everyday electricity would therefore be a useful design case for:

- developing a textile-specific interaction design methodology for e-textile products and systems.
- re-examining the notion of electricity as a result of human-computer/ material interactions.

---

157. Ibid.

158. For example, Stephan Wensveen et al., "Freedom of Fun, Freedom of Interaction," *Interactions* 11, no. 5 (September 1, 2004): 59, <https://doi.org/10.1145/1015530.1015559>.

159. Buur, Jensen, and Djajadiningrat, "Hands-Only Scenarios and Video Action Walls."

160. Djajadiningrat, Matthews, and Stienstra, "Easy Doesn't Do It: Skill and Expression in Tangible Aesthetics."

## 2.2 E-textiles and static electricity

This section first gives an overview of the state of the art in the area of energy harvesting from the human body and argues for choosing static electricity as a case for undertaking this research in the context of e-textiles.

### 2.2.1 Energy harvesting from the human body

Consumer products that use human energy using the principle of electromagnetic induction, such as in bicycle dynamos or hand-cranked radios and flashlights,<sup>161</sup> have existed for several decades. Common interactions have included turning a crank, pulling a chord, pushing, squeezing or shaking a product as well as using a foot pedal—like in the bicycle—to convert human energy into electricity for products.<sup>162</sup> These kinds of gear-and-generator type harvesters are often bulky and lead to a high consumption of metabolic energy, but they can generate the highest power, up to 10 Watts.<sup>163</sup> While these types of generators are useful for high energy requiring products, the increasing demand for low-power and small energy harvesting solutions for components like sensors or wireless units in the context of wearables and e-textiles is supported by the development of other varied forms of kinetic, thermal and electrochemical micro-energy sources from the body.

In the following section, I give an overview of the recent developments in body-driven energy harvesting technologies. Furthermore, I argue that along with the technological developments in this area, there is an increasing need to address body-driven energy harvesting from the perspective of human computer interaction research.

#### **Types of micro-energy sources in the human body**

The first overview of different energy sources for microgeneration of power from the human body was presented in 1996 by Starner.<sup>164</sup> Arguing that batteries add weight and inconvenience to wearable computers, he explored the possibility of harnessing the energy from the wearer to power her device. He made a case for converting different kinds of energy sources, such as body heat, breath, blood pressure, upper limb motion, walking and finger motion. In 2004, following up on this work, Starner and Paradiso<sup>165</sup> presented prototypes for energy harvesting shoes using different harvesting technologies such as piezoelectric, rotary generator and hydraulic and pneumatic systems.

---

161. See chapter 2 of A.J. Jansen, "Human Power Empirically Explored" 2011, <https://repository.tudelft.nl/islandora/object/uuid%3A6a8f5511-432b-45b7-8e92-23a4dfbb4237>.

162. Ibid.

163. Choi et al., "Wearable Biomechanical Energy Harvesting Technologies."

164. T. Starner, "Human-Powered Wearable Computing," *IBM Systems Journal* 35, no. 3.4 (1996): 618–29, <https://doi.org/10.1147/sj.353.0618>.

165. Thad Starner and Joseph A. Paradiso, "Human Generated Power for Mobile Electronics," 2004, <https://www.semanticscholar.org/paper/Human-Generated-Power-for-Mobile-Electronics-Paradiso/a6164b19a636f61a018b7031b5c04210e24f5388>.

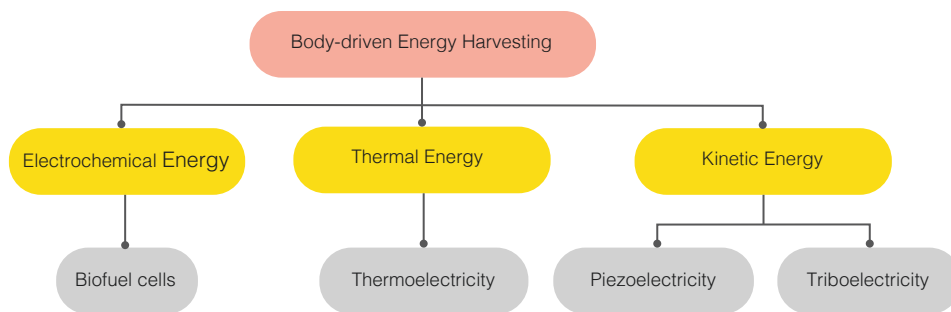

Figure 6. Types of body-driven energy harvesting sources. Adapted from Dagdeviren, Canan, Zhou Li, and Zhong Lin Wang. “Energy Harvesting from the Animal/Human Body for Self-Powered Electronics”, figure 1.

The Ph.D. thesis by Jansen<sup>166</sup> submitted in 2011 discussed the development of human-powered products that focus on conversion of muscular work into electricity. He reported that the number of human-powered consumer products available online from 2004 to 2010 had increased from 71 to 211. He merited this increase of human powered products to the general trend towards an increased environmental awareness along with the increased mobility and personalisation of consumer products.<sup>167</sup> This trend has continued until today, and with further advancements in new materials and energy harvesting technologies, novel body-driven energy harvesting solutions continue to emerge.

For example, the review by Dagdeviren et al.<sup>168</sup> summarises the different energy harvesting approaches from the bodies of living subjects for self-powered electronics. They describe three main areas of energy harvesting—electrochemical, thermoelectric and kinetic energy. Within kinetic energy, different principles are used, such as piezoelectricity and triboelectricity (see Figure 6). Below I give brief descriptions of each along with recent examples of related research.

#### Electrochemical energy harvesting

Electrochemical energy harvesting is based on bio fuel cells that use glucose, the primary source of energy in the bodies of living subjects, to generate electricity.<sup>169</sup> In their paper about enzymatic glucose biofuel cells, Slaughter et al.<sup>170</sup> argue that the idea of harvesting energy directly from living organisms by building from a biological model of the internal chemical mechanisms of a living organism is considerably more stable and reliable than

166. Jansen, “Human Power Empirically Explored.”

167. Ibid.

168. Dagdeviren, Li, and Wang, “Energy Harvesting from the Animal/Human Body for Self-Powered Electronics.”

169. Ibid.

170. Gymama Slaughter and Tanmay Kulkarni, “Enzymatic Glucose Biofuel Cell and Its Application,” *Journal of Biochips & Tissue Chips* 05, no. 01 (July 16, 2015), <https://doi.org/10.4172/2153-0777.1000110>.



systems based on mechanical motion. Sweat-lactate based fuel cells present another form of biofuel cell.<sup>171</sup> These are less invasive than the glucose-based cells as they can be stuck onto the skin as a skin patch and use biofluids, such as human perspiration and lactate, to generate small amounts of electrical energy.<sup>172</sup>

Biofuel cells are at an early stage of development. However, several examples can already be found in research. These include projects such as implanted biofuel cells in rats that power an LED or a small device such as a digital thermometer;<sup>173</sup> tattoo-shaped lactate-sensors powered with a bio fuel cell worn on the skin to monitor the level of exercise of the wearer;<sup>174</sup> and textile-based stretchable bio fuels to power wearable sensors and garments.<sup>175</sup>

### *Thermoelectric energy harvesting*

Thermoelectric generators can be used to harvest electrical energy from human body heat for the purpose of powering wearable electronics.<sup>176</sup> They use materials with high electrical conductivity and low thermal conductivity known as thermoelectric materials, which display the ability to generate power when exposed to a temperature gradient.<sup>177</sup> Thermoelectric energy harvesting involves placing the thermoelectric material on the body, while the other side is exposed to the ambient air. The temperature difference between the two sides of the thermoelectric material can then be converted into electricity.<sup>178</sup>

There have been several examples of wearable devices that harness thermal energy and

- 
171. Dagdeviren, Li, and Wang, "Energy Harvesting from the Animal/Human Body for Self-Powered Electronics."
  172. Amay J. Bandodkar, "Review—Wearable Biofuel Cells: Past, Present and Future," *Journal of The Electrochemical Society* 164, no. 3 (November 30, 2017): H3007–14, <https://doi.org/10.1149/2.0031703jes>.
  173. A. Zebda et al., "Single Glucose Biofuel Cells Implanted in Rats Power Electronic Devices," *Scientific Reports* 3, no. 1 (December 22, 2013): 1516, <https://doi.org/10.1038/srep01516>.
  174. Yuto Kato et al., "A Stretchable, Wearable Lactate Sensor with a Textile-Based Biofuel Cell," Meeting Abstracts MA2016-02, no. 44 (September 1, 2016): 3210–3210, <http://ma.ecsdj.org/content/MA2016-02/44/3210>.
  175. Itthipon Jeerapan et al., "Stretchable Biofuel Cells as Wearable Textile-Based Self-Powered Sensors.," *Journal of Materials Chemistry. A* 4, no. 47 (December 21, 2016): 18342–53, <https://doi.org/10.1039/C6TA08358G>.
  176. Melissa Hyland et al., "Wearable Thermoelectric Generators for Human Body Heat Harvesting (Abstract)," *Applied Energy* 182 (November 15, 2016): 518–24, <https://doi.org/10.1016/J.APENERGY.2016.08.150>.
  177. Linden K. Allison and Trisha L. Andrew, "A Wearable All-Fabric Thermoelectric Generator," *Advanced Materials Technologies*, January 22, 2019, 1800615, <https://doi.org/10.1002/admt.201800615>.
  178. M. Lossec et al., "Thermoelectric Generator Placed on the Human Body: System Modeling and Energy Conversion Improvements," *The European Physical Journal Applied Physics* 52, no. 1 (October 17, 2010): 11103, <https://doi.org/10.1051/epjap/2010121>.

also innovations in thermoelectric materials that better support on-body applications. For example, the first wearable thermoelectric device was introduced in 2004 and was in the form of a wireless sensor worn on the wrist.<sup>179</sup> New designs of thermoelectric generator systems have been developed to make them light-weight and flexible for wearable applications. Some examples of flexible thermoelectric energy harvesters include a polymer based thermoelectric generator by Vashaee and Shipman<sup>180</sup> and the flexible thermoelectric generator developed by Liu et al.<sup>181</sup> Other examples, such as thermoelectric generators made completely with textile materials by Linden et al.,<sup>182</sup> present further opportunities for integrating thermoelectric energy harvesting seamlessly into textiles.

### *Kinetic energy harvesting*

Kinetic energy harvesters harness the biomechanical energy from human motions, such as a foot strike, a joint motion or upper limb motions.<sup>183</sup> Energy harvesting principles for mechanical kinetic micro-energy mainly include piezoelectric and triboelectric.<sup>184</sup>

Piezoelectric materials create electrical charge when mechanically stressed.<sup>185</sup> These materials used in energy harvesting systems include single-crystal and textured piezoelectric ceramics, which are stiff, or polymer based piezoelectric materials (PVDF), which can be made into flexible films. These piezoelectric elements have been used, for example, in shoes<sup>186</sup> or sidewalks<sup>187</sup> to convert the body's kinetic energy from walking into electricity. Recent advancements in piezoelectric nanofibres<sup>188</sup> have enabled further seamless integration into textile materials, for example, for harnessing energy from the

---

179. Vladimir Leonov, "Energy Harvesting for Self-Powered Wearable Devices," in *Wearable Monitoring Systems*, ed. Annalisa Bonfiglio and Danilo De Rossi, 2011, 1–296, <https://doi.org/10.1007/978-1-4419-7384-9>.

180. Hyland et al., "Wearable Thermoelectric Generators for Human Body Heat Harvesting (Abstract)."

181. Haiyan Liu et al., "Design of a Wearable Thermoelectric Generator for Harvesting Human Body Energy" (Springer, Singapore, 2017), 55–66, [https://doi.org/10.1007/978-981-10-2404-7\\_5](https://doi.org/10.1007/978-981-10-2404-7_5).

182. Allison and Andrew, "A Wearable All-Fabric Thermoelectric Generator."

183. Choi et al., "Wearable Biomechanical Energy Harvesting Technologies."

184. Dagdeviren, Li, and Wang, "Energy Harvesting from the Animal/Human Body for Self-Powered Electronics."

185. Starnier and Paradiso, "Human Generated Power for Mobile Electronics."

186. For example, Jingjing Zhao and Zheng You, "A Shoe-Embedded Piezoelectric Energy Harvester for Wearable Sensors," *Sensors* 14, no. 7 (July 11, 2014): 12497–510, <https://doi.org/10.3390/s140712497>.

187. "Pavegen - The Next Step."

188. For example, Anja Lund et al., "Energy Harvesting Textiles for a Rainy Day: Woven Piezoelectrics Based on Melt-Spun PVDF Microfibres with a Conducting Core," *Npj Flexible Electronics* 2, no. 1 (2018): 9, <https://doi.org/10.1038/s41528-018-0022-4>;

Navneet Soin et al., "Novel '3-D Spacer' All Fibre Piezoelectric Textiles for Energy Harvesting Applications," *Energy & Environmental Science* 7, no. 5 (April 17, 2014): 1670, <https://doi.org/10.1039/c3ee43987a>.

movements of legs and elbow joints.<sup>189</sup>

### *Triboelectric energy harvesting*

A triboelectric generator<sup>190</sup> is an energy harvesting device that harnesses the electrostatic charges generated when different materials come into frictional contact.<sup>191</sup> The first triboelectric nanogenerator generating micro-watts for powering small devices was introduced in 2012.<sup>192</sup> Research in triboelectric nanogenerators has greatly improved this energy harvesting technology in recent years<sup>193</sup> with an increasing number of examples of textile implementations. For example, a corrugated textile-based triboelectric nanogenerator presented by Choi et al. in 2017, was shown to generate enough power to light 54 LEDs using the energy from footsteps.

This research uses triboelectricity or static electricity as a medium for investigating body-driven energy harvesting. The following subsections first give a brief introduction to static electricity followed by a more detailed overview of the recent developments in triboelectric generators in the field of e-textiles. Furthermore, an argument for why this research focuses on electrostatic energy harvesting is presented.

#### 2.2.2 What is static electricity?

When two different materials of the same temperature are brought in contact with each other, a transfer of electrons takes place across the interface. The amount of energy needed to remove an electron from the surface of a material to infinity is known as its work function. The electrons move from the material with a lower work function to the material in contact with a higher work function, thus creating a negative charge in the latter while the former becomes positively charged. This effect is known as contact electrification (or contact charging).<sup>194</sup> We have all experienced the effects of contact electrification, more commonly known as static electricity or triboelectricity when handling textiles. For example, the feeling of our hair rising up when removing a woollen cap or sweater.

Although static electricity is a well-known phenomenon, most of the research in the field of textiles has been aimed at minimising its effects.<sup>195</sup> Recently, however, static electricity has gained interest in the areas of renewable energy and design. In the subsections below,

---

189. G. De Pasquale and A. Somà, "Energy Harvesting from Human Motion with Piezo Fibers for the Body Monitoring by MEMS Sensors," in Symposium on Design, Test, Integration and Packaging of MEMS/MOEMS (DTIP) (Barcelona: IEEE, 2013), <https://ieeexplore.ieee.org/document/6559429>.

190. Also referred to as electrostatic generators.

191. Choi et al., "Corrugated Textile Based Triboelectric Generator for Wearable Energy Harvesting."

192. Feng-Ru Fan, Zhong-Qun Tian, and Zhong Lin Wang, "Flexible Triboelectric Generator," *Nano Energy* 1, no. 2 (March 1, 2012): 328–34, <https://doi.org/10.1016/J.NANOEN.2012.01.004>.

193. Wang, Chen, and Lin, "Progress in Triboelectric Nanogenerators as a New Energy Technology and Self-Powered Sensors."

194. Lüttgens, Günter and Norman Wilson. *Electrostatic Hazards*. Butterworth Heinemann, 1997.

195. *Ibid.*

I describe the related work in the field of energy harvesting in the context of e-textiles and design projects that have used static electricity with textiles in their design process.

### 2.2.3 Static electricity as a textile-specific source of energy

Having a sustainable source of energy for e-textiles, especially in the context of wearables, where the artefacts need to be comfortable and light-weight, has been recognised as one of the key challenges in the field.<sup>196</sup> This need for renewable energy sources for the field of tangible and ubiquitous computing is not new, however the textile-compatibility and efficiency of such technologies have improved considerably in recent years.<sup>197</sup> Presenting a historical review of the field of e-textiles, Hughes-Riley et al. highlight that the development of energy storage and scavenging within the field of e-textiles research have extended considerably since 2010.<sup>198</sup> This is characterised by the different energy harvesting and scavenging solutions being implemented at the level of nanofibers and yarns that enable the easy integration of such technologies into textiles without compromising the feel of the textiles.

The first flexible triboelectric generator in research was reported in 2012 in the work of Fan et al.<sup>199</sup> Since its emergence, triboelectric nanogenerators (or TENG) have shown to convert what was previously considered an unusable form of electricity into a considerable amount of micro-watts, enough for running small low-power devices.<sup>200</sup> Between 2014 and 2018, several papers presented applications for triboelectric generators; for example, woven structures for triboelectric nanogenerators for wearable applications by Zhou et al.<sup>201</sup> or Li et al.;<sup>202</sup> water-proof triboelectric systems for harsh environments by Guo et al.,<sup>203</sup> triboelectricity based acoustic energy harvesting and self-powered sound

---

196. T. Starner, "The Challenges of Wearable Computing: Part 1," *IEEE Micro* 21, no. 4 (2001): 44–52, <https://doi.org/10.1109/40.946681>.

197. Theodore Hughes-Riley et al., "A Historical Review of the Development of Electronic Textiles," *Fibers* 6, no. 2 (May 31, 2018): 34, <https://doi.org/10.3390/fib6020034>.

198. Ibid.

199. Fan, Tian, and Lin Wang, "Flexible Triboelectric Generator."

200. Wang, Chen, and Lin, "Progress in Triboelectric Nanogenerators as a New Energy Technology and Self-Powered Sensors."

201. Tao Zhou et al., "Woven Structured Triboelectric Nanogenerator for Wearable Devices," *ACS Applied Materials & Interfaces* 6, no. 16 (August 27, 2014): 14695–701, <https://doi.org/10.1021/am504110u>.

202. Xian Li and Ye Sun, "WearETE: A Scalable Wearable E-Textile Triboelectric Energy Harvesting System for Human Motion Scavenging," *Sensors*, 2017, <https://doi.org/10.3390/s17112649>.

203. Hengyu Guo et al., "A Water-Proof Triboelectric–Electromagnetic Hybrid Generator for Energy Harvesting in Harsh Environments," *Advanced Energy Materials* 6, no. 6 (March 1, 2016): 1501593, <https://doi.org/10.1002/aenm.201501593>.

recording by Fan et al.,<sup>204</sup> and self-powered sensors such as motion sensor alarms<sup>205</sup> or a wireless sensor node<sup>206</sup> using triboelectric nanogenerators. Using these different energy harvesting systems in combination, such as piezoelectric and triboelectric,<sup>207</sup> has also been explored to maximise the potential for generating electrical energy.

Compared to the other sources of energy such as piezoelectric, photovoltaic or thermoelectric, which require translating specific materials such as PVDF,<sup>208</sup> silicon diodes, or bismuth telluride (Bi<sub>2</sub>Te<sub>3</sub>)-based modules<sup>209</sup> into a textile shape, triboelectricity already occurs in textile material combinations. Being based on any two dielectric materials that come in contact with one another, an advantage of pursuing static electricity is that it can work without using environmentally hazardous materials.<sup>210</sup> It also forms a continuous source of electrification which, when managed safely, can contribute significantly to e-textile design and development.

#### 2.2.4 Static electricity as an interactive aspect of textiles

Apart from using static electricity as a source of electrical energy, some design projects have explored static electricity in textiles from the perspective of material behaviours, such as movements in light materials that are caused by the attractive and repulsive forces or the tingly feeling on skin when there is an electrostatic field present. In the tensed-up scarf project,<sup>211</sup> fine hair-like strands of a scarf were animated due to the electrostatic charges of the wearers body. Furthermore, the master's thesis project of Katsarou<sup>212</sup> explored static electricity as a design material in textile design by creating a large

---

204. Xing Fan et al., "Ultrathin, Rollable, Paper-Based Triboelectric Nanogenerator for Acoustic Energy Harvesting and Self-Powered Sound Recording," *ACS Nano* 9, no. 4 (April 28, 2015): 4236–43, <https://doi.org/10.1021/acsnano.5b00618>.

205. Yang Wang, Ya Yang, and Zhong Lin Wang, "Triboelectric Nanogenerators as Flexible Power Sources," *Npj Flexible Electronics* 1, no. 1 (2017): 10, <https://doi.org/10.1038/s41528-017-0007-8>.

206. Shuhua Wang et al., "Flow-Driven Triboelectric Generator for Directly Powering a Wireless Sensor Node," *Advanced Materials* 27, no. 2 (January 1, 2015): 240–48, <https://doi.org/10.1002/adma.201403944>.

207. Woo-Suk Jung et al., "High Output Piezo/Triboelectric Hybrid Generator," *Scientific Reports* 5 (March 20, 2015): 9309, <https://doi.org/10.1038/srep09309>.

208. Polyvinylidene fluoride (PVDF). See explanation in *Ibid*.

209. See for example Jeffrey J Urban, "Weaving a New World: Wearable Thermoelectric Textiles," *Current Trends in Fashion Technology & Textile Engineering* 2, no. 2 (January 18, 2017), <https://doi.org/10.19080/CTFTE.2018.02.555583>.

210. Peter Harrop, "Triboelectric Electricity Made Where Needed at Micro to Megawatts: IDTechEx Webinar," *IDTechEX Triboelectric Energy Harvesting Report*, 2016, <http://www.idtechex.com/research/webinars/triboelectric-electricity-made-where-needed-at-micro-to-megawatts-00087.asp>.

211. Clemens Winkler, "Tensed Up," 2010, <http://clemenswinkler.com/dipl/?cat=22>.

212. Stella Katsarou, "Exploring Static Electricity as Design Material for Woven and Hand-Tufted Textiles" (University of Borås/Swedish School of Textiles, 2014), <http://bada.hb.se/handle/2320/14080>.

installation with textiles tufted with polytetrafluoroethene (PTFE)<sup>213</sup> tape. And in the E-Static Shadows installation by Berzina et al.,<sup>214</sup> an immersive electrostatic space was created to investigate how electrostatic energy can play a role in designing interactive textile systems by making static electricity more visible.

#### 2.2.5 Conclusion: Static electricity as a material property of e-textiles

As reviewed in section 2.2.1, the development of energy harvesting or scavenging capabilities at the level of the yarn presents a significant potential in textile-driven products and applications that can retain the qualities of textile materials. However, a lot of these new materials are in the early stages of research, and they are difficult to access or explore outside the field of materials science.

The e-textile design community, on the other hand, is working with easily available versions, such as piezoelectric elements<sup>215</sup> or solar cells<sup>216</sup> in combination with textiles, to explore ways of incorporating renewable energy systems in their projects. In comparison, triboelectric systems can be easily constructed using existing textile materials, such as synthetic fabrics and conductive yarns or fabrics, without needing many specialised components. For example, the work of Post et al.<sup>217</sup> looked into harvesting contact charges with textiles and provided a demonstration of a dancer's skirt that used electrostatic charges, generated through the wearer's movements, to power a medallion light mounted on the waist line of the skirt.

Static electricity offers great potential for e-textile designers to incorporate everyday materials such as wool, polyester and conductive materials into their work to explore electrostatic energy from a design and interaction point of view. However, this area is less explored in the field of e-textile design. It can be speculated that this might be due to the low efficiency of such do-it-yourself (DIY) systems as compared to the nano-level triboelectric generators. However, as the technology rapidly develops (as described in section 2.2.2), I hypothesise that more focus will soon be needed on the design and application of such technologies in e-textile artefacts to support pleasurable use and experience.

In the previous section, I argued for taking a material-centric research approach to e-textiles for investigating everyday engagement with electricity. The current section gave an overview of different body-driven energy harvesting possibilities. I built on this by presenting triboelectricity, or static electricity as a form of energy that we experience

---

213. Commonly referred to under the trade name Teflon.

214. Zane Berzina and Jackson Tan, "E-Static Shadows," 2009, <http://www.zaneberzina.com/e-staticshadows09/Project.htm>.

215. For example, see <http://etextile-summercamp.org/2014/piezo-energy-harvesting/>

216. As an example, see clothing integrated with solar panel by fashion designer Pauline Van Dongen-Pauline van Dongen, "Solar Shirt," accessed July 15, 2019, <http://www.paulinevandongen.nl/project/wearable-solar-shirt/>.

217. E. Rehm Post and Kit Waal, "Electrostatic Power Harvesting for Material Computing," *Personal and Ubiquitous Computing* 15, no. 2 (August 18, 2010): 115–21, <https://doi.org/10.1007/s00779-010-0313-9>.

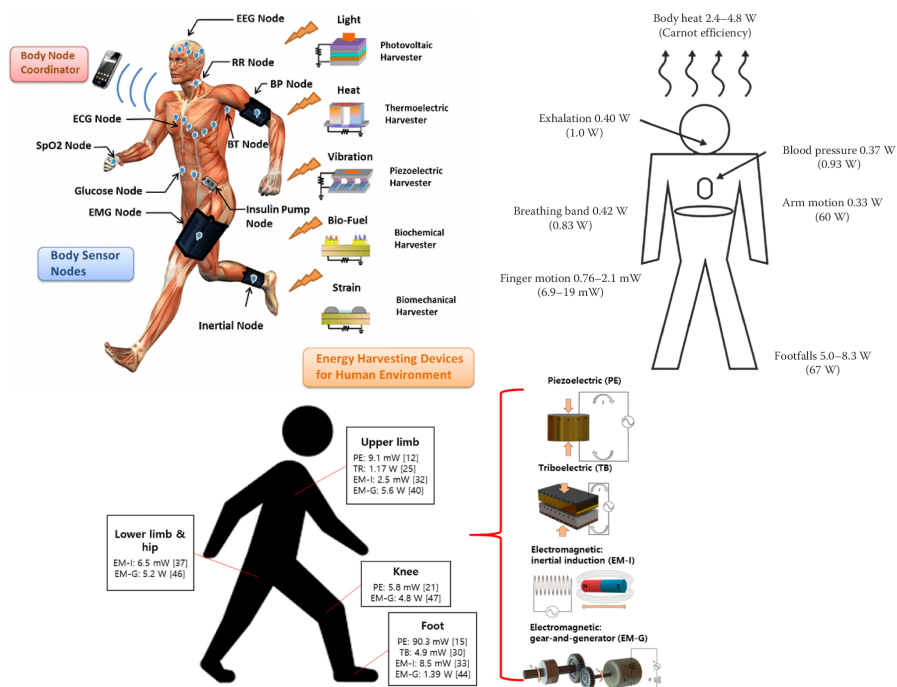

Figure 7. (Top-left) Energy harvesting sources and nodes on the human body. Illustration from Ernesto Ibarra et al., "HEH-BMAC: Hybrid Polling MAC Protocol for WBANs Operated by Human Energy Harvesting". (Top-right) Human-powered wearable computing. Image from T. Starner, "Human-Powered Wearable Computing", figure 2. (Bottom) Biomechanical energy harvesting. Image from Young-Man Choi et al., "Wearable Biomechanical Energy Harvesting Technologies," *Energies* 10, no. 10 (September 25, 2017): 1483, <https://doi.org/10.3390/en10101483>, figure 1.

with textile materials in the everyday. I argued that, compared to other micro-energy sources, triboelectricity is closely linked to how our bodies interact with textile materials. In recent years, triboelectricity in the context of textiles has shown immense progress, and examples of how to safely harness this energy have been developed. E-textile designers can learn from the research on TENG and use everyday objects as an inspiration to explore static electricity as a textile-specific source of energy.

Furthermore, building on the notion of computational composites presented in the previous section, I propose that static electricity, in comparison to other micro-energy sources described in this section, can be approached as a material property of e-textiles that can be supported and shaped through e-textile constructions and interaction design.

### 2.3 Static electricity and HCI

This section delves deeper into the approaches to harvesting static electricity and argues for undertaking a materiality oriented HCI inquiry into electrostatic energy harvesting with textiles.

#### 2.3.1 Looking beyond efficiency of energy harvesting

From the overview of different recent developments in micro energy harvesting in section 2.2, it becomes apparent that the human body has been increasingly measured

and studied to calculate different opportunities for electricity generation.

For example, describing a body-area network of sensors, Ibarra et al.<sup>218</sup> illustrate different body energy sources and nodes (see Figure 7, top-left). Going further, examples in papers by Choi et al.<sup>219</sup> or Starner<sup>220</sup> provide estimates of energy produced through different movements and activities performed by a human (see Figure 7, top-right and bottom).

Energy harvesting modules, such as piezoelectric and triboelectric modules, have developed to be placed directly on the body, whereas biofuel cells can be placed both on top and inside the body. Other energy harvesting solutions have taken advantage of the objects and environments that humans interact with, such as opening a laptop<sup>221</sup> or walking on the sidewalk.<sup>222</sup>

As described earlier in the chapter, the area of micro-power energy harvesting is in the early stages of development with a growing body of work. A significant portion of the research in body-driven energy harvesting aims toward optimising the technology for efficient conversion of energy and ease of incorporation into wearables. For example, in the paper about harvesting energy from living subjects, the authors describe how future research needs to focus on improving the output power and efficiency of the harvesters and increasing the biocompatibility.<sup>223</sup> Similarly, in reporting the progress in triboelectric nanogenerators, the researchers state the importance of optimising the generators by better understanding the charge transfer and establishing standard calibration systems.<sup>224</sup> This goal of improving the technology of body-driven energy harvesting solutions is undoubtedly important for the field to progress and support adoption of such technologies.

However, along with technology-development, there is a need to address the design of personal energy harvesting systems from the experiential point of view of the people involved. Body-driven energy harvesting systems directly utilise our bodies and have the potential to change how we understand electricity or how we relate to technology in the everyday. This research thus proposes to follow an alternative line of inquiry regarding energy harvesting technology— that of investigating how body-driven energy harvesting technologies present an opportunity to explore new ways of understanding the role of the human body in design and adoption of digital technology.

---

218. Ernesto Ibarra et al., "HEH-BMAC: Hybrid Polling MAC Protocol for WBANs Operated by Human Energy Harvesting," *Telecommunication Systems* 58, no. 2 (February 4, 2015): 111–24, <https://doi.org/10.1007/s11235-014-9898-z>.

219. Choi et al., "Wearable Biomechanical Energy Harvesting Technologies."

220. Starner, "Human-Powered Wearable Computing."

221. *Ibid.*

222. For example, "Pavegen - The Next Step."

223. Dagdeviren, Li, and Wang, "Energy Harvesting from the Animal/Human Body for Self-Powered Electronics."

224. Wang, Chen, and Lin, "Progress in Triboelectric Nanogenerators as a New Energy Technology and Self-Powered Sensors."



“Human-computer interaction is a discipline concerned with the design, evaluation, and implementation of interactive computing systems for human use and with the study of major phenomena surrounding them.<sup>225</sup>” In response to technological changes, the field of HCI focuses on issues of usability of technology along with asking questions regarding aesthetic, emotional, psychological, sociological and cultural aspects of technology adoption by people.<sup>226</sup> Body-driven energy harvesting is an emerging technology that closely engages the human body. Approaching energy harvesting from the perspective of human computer interaction design is thus crucial for critically reflecting on and proposing future directions for development.

Several projects have previously applied approaches of interaction design and design research to develop computational things that aim at making energy use more tangible and transparent for the users. For example, the research program *Static!*<sup>227</sup> illustrated different ways of informing the user of their energy consumption behaviours through design elements incorporated in everyday technologies. The doctoral thesis by Acharya<sup>228</sup> employed a strategy of visualising energy use using the local decorative practice of Rangoli making to generate a dialogue among different homes within a community around their energy practices. Different projects in the fields of new media art and design<sup>229</sup> have visualised energy-related data to create awareness and help people to reflect on and possibly change their everyday behaviours to become more energy-conscious in their everyday lives. However, a similar design initiative to explore and illustrate ways of better understanding energy-harvesting practices in the everyday is still lacking.

A research project that previously explored energy harvesting from the perspective of human computer interaction was the work of Pierce et al.<sup>230,231,232</sup> They propose ways of

---

225. Quote by Thomas T. Hewett et al., 1992. As written in article: Elizabeth Churchill, Anne Bowser, and Jennifer Preece, “Teaching and Learning Human-Computer Interaction | ACM Interactions,” accessed April 10, 2019, <http://interactions.acm.org/archive/view/march-april-2013/teaching-and-learning-human-computer-interaction>.

226. Ibid.

227. Mazé, “*Static!* : Designing for Energy Awareness.”

228. Karthik Acharya, *Opening the Electrome – Redefining Home for Energy Studies through Design Practice*, 2016, <https://shop.aalto.fi/p/534-opening-the-electrome/>.

229. For example, Helen Evans and Heiko Hansen, “*Pixelache | Nuage Vert - Vihreä Pilvi*,” 2008, accessed July 15, 2019, <https://www.pixelache.ac/pages/nuage-vert-vihrea-pilvi-e35f94a9-34ee-4523-b189-e75b918dd203>.

230. James Pierce and Eric Paulos, “Materializing Energy,” *Proceedings of the 8th ACM Conference on Designing Interactive Systems*, 2010, 113–22, <https://doi.org/10.1145/1858171.1858193>.

231. James Pierce and Eric Paulos, “Designing Everyday Technologies with Human-Power and Interactive Microgeneration,” in *Proceedings of the Designing Interactive Systems Conference on - DIS '12* (New York, USA: ACM Press, 2012), 602, <https://doi.org/10.1145/2317956.2318047>.

232. James Pierce and Eric Paulos, “Electric Materialities and Interactive Technology,” in *Proceedings of the SIGCHI Conference on Human Factors in Computing Systems - CHI '13* (New York, USA: ACM Press, 2013), 119, <https://doi.org/10.1145/2470654.2470672>.



Figure 8. Triboelectric series: materials listed according to their tendency to gain or lose electrons. Figure of the table redrawn from [http://eesemi.com/tribo\\_series.htm](http://eesemi.com/tribo_series.htm)

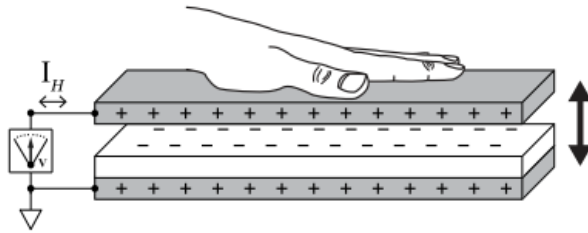

Figure 9. The triboelectric generator setup made from a PTFE sheet and two conductive sheets. (Illustration from Mustafa Emre Karagozler et al., “Paper Generators”, figure 2c.)

materialising energy that would otherwise have been designed as something intangible and undifferentiated. By foregrounding energy as a material, they introduce body-generated electricity through a phenomenological and interactive perspective that can be investigated as a sub-field of HCI. They describe electric-interactions as staying-on, directing about and switching on. Designing interactions in the context of collecting, keeping, sharing and activating energies guide their product and interaction design methods.

This thesis inquiry is deeply aligned with the work of Pierce et al. and builds on the approach of exploring and questioning the role of electricity that can be transferred from our own bodies to be collected, stored and shared. However, this dissertation focuses on the research area of e-textiles where developments in energy harvesting technologies are closely linked to new kinds of soft materials; this opens a design space for investigating body driven energy harvesting from the perspective of materiality oriented HCI with e-textiles. Following this line of inquiry can, therefore, further inform the development of an interaction design perspective on body-driven energy harvesting.

### 2.3.2 Electrostatic macro generators

The triboelectric series<sup>233</sup> (see Figure 8) arranges common materials in the order of their tendencies to gain or lose electrons. In this list, materials such as human skin, fur and wool sit on the top with a high tendency for gaining a positive charge (lose electrons), whereas synthetic materials such as PTFE (Teflon), polyester and plastics feature at the bottom of the list with a high tendency for gaining electrons and becoming negatively charged. When materials higher on the triboelectric series interact with materials listed lower than them, there is a flow of electrons from the former to the latter. This explains why we may see sparks while removing a polyester shirt or why our hair rises when removing a woollen cap. The electrostatic effect is increased when materials far apart on the triboelectric series interact with one another, for example, human skin interacting with synthetic materials such as polyester or PTFE would produce greater electrostatic charges than, for example, human skin and cat fur.

233. AlphaLab Inc., “The TriboElectric Series,” accessed March 28, 2017, <http://www.trifield.com/content/tribo-electric-series/>.

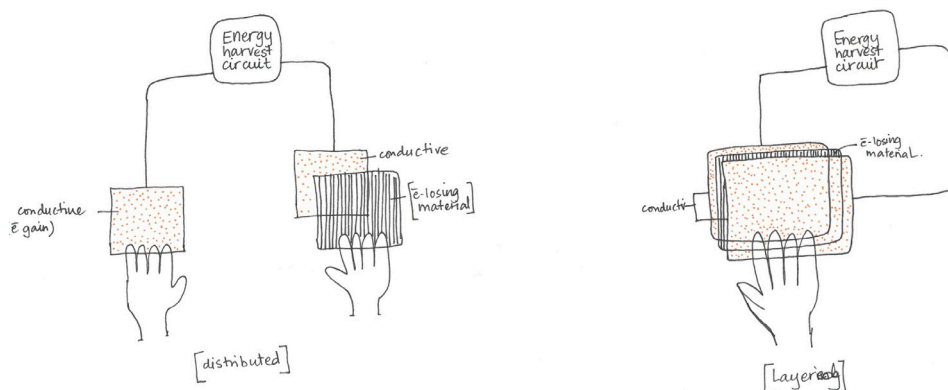

Figure 10. Two main working principles of triboelectric generator circuits. (Left) The person touches an electrode while moving the other electrostatic material. (Right) Layered materials where person interacts from the outside.

While the examples of nanogenerators described in the previous section present electrostatic harvesting technologies fabricated at the nano-scale, Karagozler et al.<sup>234</sup> illustrate the concept of “paper generators” which are energy harvesters based on contact electrification that use common materials and do not require microfabrication. “The operation of the paper generators relies on the movement of the two conductive sheets relative to each other and the electric field source, i.e., PTFE. As the relative positions of the sheets change, the distribution of the induced charges, the electric field, and the total capacitance between the sheets change, resulting in an electric potential difference between the conductors (see Figure 9). Hence, the mechanical movements of the sheets and the field source are converted into electrical potential energy that can do work.”<sup>235</sup>

Using this principle, they present five kinds of triboelectric generators from Teflon baking sheet (PTFE) and aluminium foil that can harness static electricity to power small components such as LEDs or e-paper displays in a children’s book. These five circuits could be further grouped into two main working principles (see Figure 10): one that layers the electrodes and the electrostatic material so that the person interacts from the outside, insulated from the harvester; and the other kind, which requires the person to touch one of the electrodes and, in this way, become part of the circuit supporting the flow of electrons.

The work presented in paper generators is relevant for this research as the technology of triboelectric generators is presented in a way that can be adopted and explored in the everyday context using found materials. Therefore, it provides a starting point for a design and material exploration that is accessible for e-textile and interaction designers.

234. Mustafa Emre Karagozler et al., “Paper Generators,” in Proceedings of the 26th Annual ACM Symposium on User Interface Software and Technology - UIST '13 (New York, USA: ACM Press, 2013), 23–30, <https://doi.org/10.1145/2501988.2502054>.

235. Ibid.

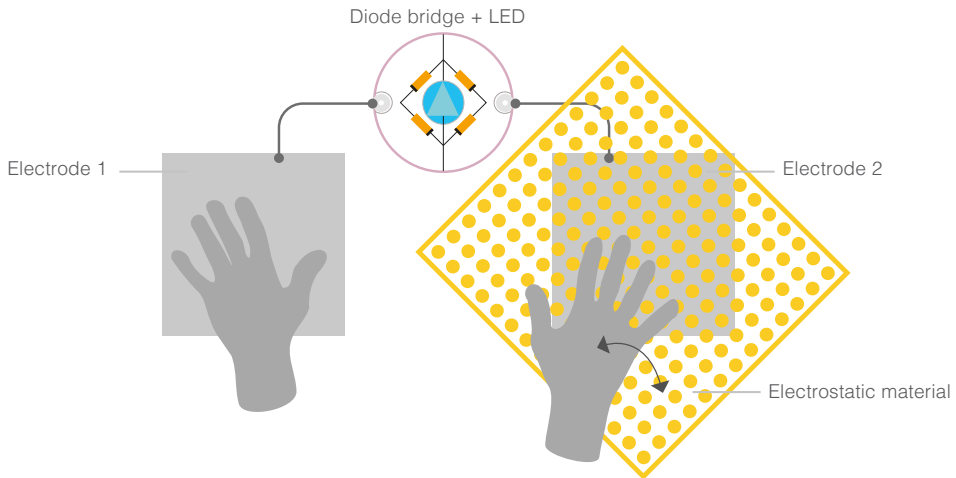

Figure 11. Details of an electrostatic harvesting circuit that uses the human body as part of the harvesting circuit.

Secondly, the triboelectric generator circuit configuration that involves the person touching the electrodes, places the person interacting with different materials at the centre of the energy harvesting system. It emphasises the need to address the interaction design for energy harvesting as it relates to how electrostatic materials and the people involved may move in relation to the electrodes. This aspect is elaborated on further in the next sub-section.

### 2.3.3 The human body as an integral part of the electrostatic circuit

Let us take another look at the circuit adapted from paper generators (see Figure 11) which utilises the human body as part of the harvesting circuit. It is made of two electrodes. One is insulated with a material that has a high tendency towards getting negatively charged when in contact with human skin. These kinds of negatively charging materials are referred to as electrostatic materials in this thesis. The two electrodes are connected to a rectifier circuit and an output, for example, a light emitting diode (LED). When a person rubs against the electrostatic material while in contact with the open electrode, the electrostatic charges generated through the interaction flow through the body to the circuit enabling the flow of electricity and lighting up the LED in short bursts.

In this setup, the person plays a crucial role in connecting and moving different kinds of materials. At the same time, human skin, which is listed on the top of the triboelectric series, is an essential aspect of the electrical setup that enables the circuit to work. In this way, both the kinetic energy as well the electrical quality of human skin is utilised in the energy harvesting system. The amount of electrostatic charges generated is directly linked to the nature of movements between textiles, the person and the electrodes. Considering this setup, the design of a triboelectric circuit could be framed as an interaction design problem which calls for reinterpreting forms and movements with textiles for generating electrical (or computational) meaning.

#### 2.3.4 Conclusion: Designing triboelectric generators is an issue of materiality oriented HCI

In this section, the working principle of a triboelectric generator circuit that works with found materials was presented. The triboelectric generator circuit utilises the body, electrostatic materials and electrodes in a configuration that supports the generation and flow of electrostatic charges produced in interaction. I argue that the energy harvesting circuit which directly utilises the kinetic energy of the body as well as the electrical property of the skin exemplifies a new way of engaging with computational artefacts. It presents a potential for further research in the context of energy harvesting from the perspective of human-computer interaction.

In section 2.1, I described the emerging interest within HCI research towards considering the materiality of computers. Traditional materials, such as textiles, have opened up new ways of embodying and relating to technology in the form of e-textiles and wearables. In section 2.2, I provided an outline of the electrical property inherent in textiles- the tendency to accumulate electrostatic charges in interaction with the body. This further extends the materiality discussion in HCI to investigate how static electricity could be supported and utilised as a new way of engaging with e-textiles and energy. The triboelectric generator circuit illustrated in this section follows this line of inquiry further into considering the human body itself as a material to be used for designing enjoyable human computer interactions.

Incorporating the material quality of the human body has already been used in the interaction and design of technological devices. For example, touch screens use skin conductance as an essential element for interfacing with digital devices. Similarly, Skintimacy<sup>236</sup>, a wearable device that turns the skin into a touch sensor, incorporates the human body as a tangible interface to interpret different tactile experiences into sound. In these examples, the electrical property of the human body becomes a sensor that can be interpreted by the connected computational elements. However, in the triboelectric circuit, this relation is taken further, whereby the human body is not only a sensor that distorts existing power signals, but it also actively participates in the generation of electrical energy for the system.

Following the materiality oriented HCI approach and considering the human body as a material in design opens the research potential for exploring new ways of engaging with the body and new relationships and roles for technology that may arise specific to users in different contexts. Investigating this through electrostatic interactions using the triboelectric generator circuit presents an opportunity to discover new implications for using the body as an active component of energy production.

---

236. Alexander Müller, Jochen Fuchs, and Konrad Röpke, "Skintimacy: Exploring Interpersonal Boundaries through Musical Interactions," in *Proceedings of the Fifth International Conference on Tangible, Embedded, and Embodied Interaction - TEI '11* (New York, USA: ACM Press, 2011), 403, <https://doi.org/10.1145/1935701.1935801>.

## 2.4 Formulating the program: Interaction design for energy harvesting with electrostatic textiles

With the larger motivation of developing a better understanding of how to actively engage human bodies in electricity generation from an interaction design perspective, this chapter made a case for using materiality oriented HCI, e-textiles and static electricity as an investigative frame for the research.

New innovation in low-power energy harvesting technologies are occurring at the scale of materials, where everyday objects and spaces are seen as an opportunity for embedding computational functions with the ability to power them using ambient and human energy. While technological solutions aim at increasing efficiency and integration, the approaches from materiality oriented HCI can bring concerns of experience, new understanding of energy and use from an everyday perspective of the people involved. As energy harvesting technologies increasingly use our bodies as sources of electrical energy, addressing the implications of how we understand and design technology becomes even more important.

Furthermore, I argue that static electricity and e-textiles provide an opportune medium to investigate body-generated energy harvesting from the perspective of materiality oriented HCI. E-textiles are a material form of computation that learns from and contributes to the field of HCI. Static electricity is a form of everyday electricity that is manifested through the interactions between the body and different kinds of textiles. The triboelectric generator circuit presents an apt example of actively involving the body while using the electrostatic property of human skin for generating electricity. Following this argument, this research undertakes a design inquiry into investigating different interactions and forms of engaging with static electricity and textiles with the body in the everyday using the triboelectric generator circuit as a guideline.

Building on the research frame developed in this chapter, the design program for this thesis is formulated as:

*At the scale of the interior, investigate how static electricity can bring new perspectives and possibilities for:*

- ways of engaging with e-textiles, and
- designing interactions for energy harvesting with textiles

The next chapter develops the program further by giving a detailed outline of the research methods and experimental setups used to realise the above design program with a focus on materiality oriented HCI.

### **3 Engaging with static electricity through textiles**

This chapter outlines the methods and research studies setup to implement and evaluate the proposed design program by applying knowledge and approaches from the field of materiality oriented HCI design. First, I give a summary of the technical description of what static electricity is. The second section makes a case for taking an electrostatic generator circuit as a guiding principle for exploring different interactions with static electricity in the everyday. The third section conducts an in-depth review of different interaction design approaches found in the field of e-textiles to categorise them into approaches of making, acting and relating. The fourth section describes additional approaches from HCI adopted in this research to support multiple interpretations in the process of designing. Furthermore, an overview of the different research studies and methods undertaken to investigate the design program are presented.

#### **3.1 Technical description of static electricity**

Before going forward with outlining the methods and approach undertaken in this research, I would like to give a short summary of the technical descriptions of static electricity covered in the previous chapter.

Static electricity is generated when different materials are rubbed together. A neutral atom has a balanced amount of positive and negative charges. When this atom comes in contact with another atom, some of its electrons will be attracted by the nucleus of the second atom. The rubbing action between materials can provide enough energy for the electrons from one atom to jump to the other when the contact is broken. The material which loses the electrons becomes positively charged, and the material that gains



electrons becomes negatively charged.<sup>237</sup> This effect is known as contact electrification or contact charging.<sup>238</sup>

The energy needed to remove an electron from the surface of a material to infinity is known as its work function.<sup>239</sup> Materials with higher work function have a higher tendency to gain electrons when in contact with materials with a lower work function. The triboelectric series (see Figure 8), arranges different materials in order of their tendency to gain or lose electrons when in contact with one another. Any of the materials will give up electrons and become positively charged if interacting with materials lower in the series.<sup>240</sup> In the context of electrostatic energy harvesting in this thesis, human skin is considered the primary material which interacts with textiles and other soft materials lower on the triboelectric series such as polyester, PTFE, PVC, etc.

Electrical energy is stored in materials which have a static charge. Given the opportunity, the extra electrons stored in materials will escape through any conductive medium, to a material that is positively charged or neutral (ground). These charges flow due to the electrical potential between the charged material and the ground. This potential is measured in the units of volts and is directly proportional to the charge of the materials<sup>241</sup> and the flow of charge is what constitutes static electricity, also known as triboelectricity. This is the basis behind the work of an electrostatic or triboelectric generator which guides the electrostatic charges through a circuit, instead of letting them dissipate into the ground or the atmosphere, causing hazards. The electrostatic generator circuit is taken as a starting point for exploring and designing interactions in this thesis. The next section delves deeper into this aspect.

### **3.2 Using the electrostatic generator circuit as working knowledge**

The electrostatic generator circuit discussed in Chapter 2 was used as the starting point for implementing the design program. The circuit is considered a form of ‘working knowledge’ that embodies the electrostatic phenomenon and visualises the accumulation of charges during interaction.

The idea of working knowledge here is adopted from Davis Baird’s book ‘Thing knowledge.’<sup>242</sup> In his book, Baird argues that material products, such as instruments or devices used and developed in scientific research, constitute knowledge that is different from theory. He describes three kinds of instrument epistemologies— models, working

---

237. Crow, Rita M. “Static Electricity: A Literature Review,” 1991. <http://adsabs.harvard.edu/abs/1991selr.rept.....C>.

238. Lüttgens and Wilson, *Electrostatic Hazards*.

239. *Ibid.*

240. Crow, “Static Electricity: A Literature Review.”

241. *Ibid.*

242. Davis. Baird, *Thing Knowledge : A Philosophy of Scientific Instruments* (University of California Press, 2004), <https://www.ucpress.edu/book/9780520232495/thing-knowledge>.

knowledge and encapsulated knowledge. Working knowledge involves instruments that display a phenomenon such as Faraday's motor, a device developed in 1821 that demonstrated electromagnetic rotations produced with an appropriately organised combination of electric and magnetic elements. Baird argued that such instruments constitute a material knowledge that is separate from the theoretical explanations they support. He explains this further using a series of examples from the history of technological advancements where skilled individuals have developed new versions and improvements of devices just from witnessing device demonstrations and without having any theoretical knowledge of the scientific phenomenon.<sup>243</sup>

Here, the electrostatic circuit is considered a form of working knowledge that presents a certain configuration of material properties that enables one to interact and visualise static electricity. This ability of the circuit to demonstrate electrostatic interactions can thus be explored and extended without dealing with theoretical or scientific explanations of the electrostatic phenomenon. Unlike the examples in Baird's book, the aim in this thesis is not to come up with theoretical explanations of the phenomenon, but to use the circuit to generate examples of different forms and material combinations to understand the different interactions it supports. The thesis does not seek to refine or optimise the circuit itself but rather to use it as a template for substituting different materials, interactions and configurations to explore different use-cases and forms of an electrostatic circuit.

The electrostatic circuit, which has a well-defined function—that of harvesting static electricity—is able to bring forward different interpretations depending on the context and nature of its implementation, while the inherent function of harvesting energy stays the same. Supporting the approach of research through design, a theoretical explanation of the inner workings of the electrostatic circuit was not enough; it needed to be built and experienced in order to get a deeper understanding of the implications in use.

The electrostatic circuit was thus taken as a template for a material system:

- that can be substituted with different materials having similar properties
- that can be scaled and re-shaped to explore different material interactions

As an example, Figure 12 illustrates an electrostatic circuit that is a reinterpreted and scaled up version of the triboelectric generator circuit developed in the thesis. It utilises the human body directly in the energy harvesting circuit.<sup>244</sup> This version was based on the same principle as the triboelectric generator circuit described in Chapter 2, however,

---

243. One such example in the book includes the development of a motor based on electromagnets by a blacksmith named Thomas Davenport which he succeeded in building after seeing a demonstration of the electromagnet made by Joseph Henry in the 1830s. Davenport accomplished this just by observation and experimentation and without having any theoretical knowledge of the scientific phenomenon.

244. This example of a triboelectric generator circuit was developed during the process of this research. Several initial explorations with static electricity and textiles based on the existing circuit during the initial stage of the research laid the foundation of this research inquiry. The different explorations are explained in detail in Chapters 4,5 and 6.

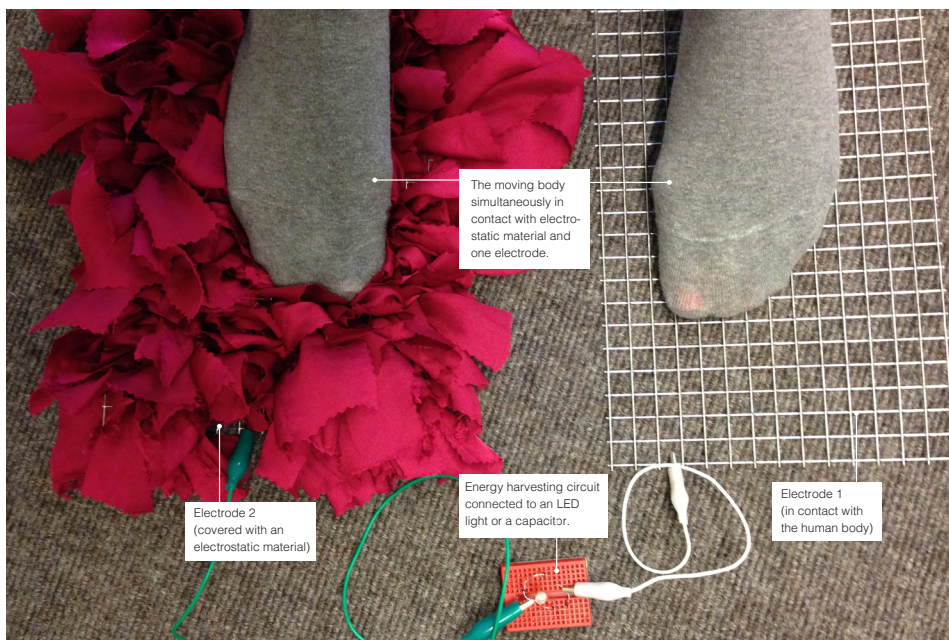

Figure 12. Example of a scaled-up version of an electrostatic generator circuit developed during the thesis.

the materials forming the original circuit (PTFE, aluminium foil) have been replaced by other similar materials from the triboelectric series, namely, polyester fabric and a metal mesh. A person can enable the flow of electricity by being in contact with the two electrodes via an electrostatic material. Within this interaction principle, there exist several ways of engaging and moving with materials to enable the flow of electrostatic charge through the circuit. This way, it was possible to undertake an investigation of different combinations of materials and circuit configurations to explore different contexts and ways of engaging with static electricity through e-textiles.

### 3.3 Making, acting and relating with e-static textiles

Section 2.3 made a case for categorising the approaches to materiality oriented HCI as approaches to *making*, *acting with* and *relating to* computational things. The approaches to making focus on constructing or integrating traditional and computational elements in a way that supports certain material qualities in the overall artefact. The approaches to acting with computational things emphasises the body movements and interactions supported by the material qualities of the computational thing. And approaches to relating with computational things seek to develop new ways of understanding the roles and values with which technological materials are designed and adopted in the everyday.

These three approaches are used to identify and carry out a materiality oriented interaction design investigation with e-textiles.

### 3.3.1 Supporting material-specific interaction design methods in e-textiles

I have previously argued that e-textiles are computational materials, and the research interests around e-textiles are closely aligned with the approaches in the larger field of materiality oriented HCI. In order to better understand the interaction design approaches within the field of e-textiles, I collected different examples of e-textile projects,<sup>245</sup> products and research in e-textiles and reviewed them for approaches regarding *making*, *acting* and *relating*. These categories are often overlapping within the same project, hence the examples chosen to illustrate the different categories point to a specific aspect of the e-textile rather than representing an approach for the entire project. Additionally, I present a short reflection on each of the approaches within e-textiles to select the ones that closely support the material interactions and textile qualities in the design process.

### 3.3.2 Interaction design approaches to making e-textiles

E-textiles bring together features and characteristics from two distinctive domains of electronics and textiles. Usually, textiles and electronics are considerably different from one another in terms of material, surface qualities as well as use contexts. The different elements or qualities are transferred from one medium to another in the development of e-textile products.<sup>246</sup> E-textile design is often a matter of negotiating and balancing the different material properties while discovering and improvising with new interactive possibilities and use contexts that emerge from these new combinations of textiles and electronics. Previous research has suggested that the transfer of aspects can happen at various levels and scales of the e-textile artefact.<sup>247</sup> Considering the making of e-textiles, I find three broad levels at which the transfer of aspects takes place:

#### **At the level of the artefact**

This illustrates an additive approach where both textiles and electronics are combined together with minimal change in the source material or object, for example, mounting LEDs onto a textile substrate to make a dress that lights up.<sup>248</sup> Here the general idea is characterised by bringing together electronics and textiles in their original forms to create an e-textile that is usually an existing textile object with added (e-)features. These e-textile artefacts are often understood as the sum of two distinct parallelly performing features, one textile and one computational, for example, a jacket and an mp3 player<sup>249</sup> or a curtain and a lighting device.<sup>250</sup>

---

245. This review is an extended version of my previous work: Gowrishankar and Bredies, "Investigating Interaction Design for E-Textiles Using Case-Transfer."

246. Ibid.

247. Ibid.

248. Example: CUTECIRCUIT, "Haute Couture," accessed September 12, 2018, <http://cutecircuit.com/haute-couture/>.

249. For example in, Technabob, "Wired Ralph Lauren Aero Type Ski Jacket Has iPod and Bluetooth Controls."

250. Aoife Wullur, "Shades of Light," 2011, <http://www.aoifewullur.com/projecten/shades-of-light/>.

### **At the level of manufacturing processes**

The design of e-textiles is mainly characterised by the integration of electronics and textiles manufacturing processes to shape the e-textile materials. For example, using weaving or knitting techniques to create different kinds of digital and analogue sensors with conductive yarns.<sup>251</sup> In some cases, electronic components have been translated into forms that can be attached easily to fabrics such as the LilyPad Arduino,<sup>252</sup> a sewable microcontroller. In other cases, textile elements have also been modified to support electronics better, such as conductive yarns that can be soldered. The shaping of e-textile artefacts at the level of manufacturing processes thus tries to follow and reinterpret the conventional techniques of constructing and assembling textile objects and electronics to support their seamless integration.

### **At the level of the fibre/ material behaviour**

E-textile artefacts are also shaped by the transfer of the material qualities of textiles into electronics. For example, computational elements try to better match the flexibility and softness of textiles in order to support textile practices in the making of e-textiles. This is sometimes done by making components miniaturised so they don't affect the physical quality of the overall material.<sup>253</sup> In other cases, such as stretchable electronics<sup>254</sup> or soft batteries,<sup>255</sup> components are made to match the deformations in textiles during construction and use.

### **Initial observations**

The three approaches to making e-textiles illustrate three different levels at which electronic components and textiles are combined. The first (level of the artefact) considers textiles in their existing forms such as pillow covers or clothing as a substrate to mount and hide computational elements. While this is useful for quickly trying out interaction concepts in existing contexts, it does not lead to new forms and interactions with e-textile artefacts.<sup>256</sup>

Integrating electronics or sensor capabilities during the construction of textile substrates results in materials that can be extremely textile-like but embed computational capacities.

---

251. Perner-Wilson and Satomi, "How to get what you want."

252. Leah Buechley et al., "The LilyPad Arduino: Using Computational Textiles to Investigate Engagement, Aesthetics, and Diversity in Computer Science Education," in *Proceeding of the Twenty-Sixth Annual SIGCHI Conference on Human Factors in Computing Systems, CHI '08* (New York, USA: ACM, 2008), 423–32, <https://doi.org/http://doi.acm.org/10.1145/1357054.1357123>.

253. Example: Jussi Mikkonen and Emmi Pouta, "Flexible Wire-Component for Weaving Electronic Textiles," in *2016 IEEE 66th Electronic Components and Technology Conference (ECTC)* (IEEE, 2016), 1656–63, <https://doi.org/10.1109/ECTC.2016.180>.

254. Thomas Vervust et al., "Stretchable and Washable Electronics for Embedding in Textiles," *MRS Proceedings* 1271 (January 1, 2010): 1271-JJ04-03, <https://doi.org/10.1557/PROC-1271-JJ04-03>.

255. Hang Qu, Oleg Semenikhin, and Maksim Skorobogatiy, "Flexible Fiber Batteries for Applications in Smart Textiles," *Smart Materials and Structures* 24, no. 2 (February 1, 2015): 025012, <https://doi.org/10.1088/0964-1726/24/2/025012>.

256. Gowrishankar and Bredies, "Investigating Interaction Design for E-Textiles Using Case-Transfer."

These can further be used as raw materials for further shaping new forms of interactive objects and spaces.<sup>257</sup> This approach opens up new kinds of textile objects based on their computational material qualities and directs the research into finding new ways of constructing electronics.<sup>258</sup>

The third approach to incorporating textile qualities into electronic components, such as stretchability or water-resistance, is an important aspect of retaining textile qualities in e-textile artefacts. However, this area of development usually lies within the domain of materials science and engineering.<sup>259</sup> Thus, from a design perspective, the integration and combinations of computational and textile elements happens more at the level of textile construction and artefacts.

### 3.3.3 Interaction design approaches for acting with e-textiles

Acting here refers to the physical gestures, body movements and the active material manipulations that are involved while using a particular e-textile artefact. It is concerned not only with the interface issue of mapping functions to gestures but also with balancing familiar and unfamiliar material properties to maintain relatable expectations yet provoke exploration. There are a few ways in which the interactive capabilities are presented in e-textiles:

#### **Interaction transfers**

In order to present textile objects as computational devices, often interaction gestures borrowed from electronic devices are implemented onto e-textile artefacts. The e-textile interfaces directly adopt the interface elements from electronic devices, such as buttons or touch pads, which allow one to push (e.g., a play button on a mp3 jacket<sup>260</sup>) or swipe the surface of fabric.<sup>261</sup> Although these types of interfaces take advantage of familiar operators and quickly communicate the device functions, they miss the opportunity to really use the material-specific properties of textiles for engaging with e-textiles. In other cases, interactions from our everyday handling of textiles, such as folding, stretching and turning inside out, which are specific to textile materials, are taken as the starting point for envisioning ways of acting with e-textile objects.<sup>262</sup> These e-textiles combine our knowledge of textile interactions for performing familiar digital actions; for example, in

---

257. As an example, see different e-textile concepts using knitted sensors in– Anna Persson, “Knitted Circuits for Visual and Tactile Interactive Expressions” 2009.

258. See for example, Irene Posch, “The Embroidered Computer,” accessed February 4, 2019, <http://www.ireneposch.net/the-embroidered-computer/>.

259. This is not to say that designers working closely with engineers cannot contribute to the development of new technologies, only that it is more common for designers to work with materials and technologies already available.

260. For example, Technabob, “Wired Ralph Lauren Aero Type Ski Jacket Has iPod and Bluetooth Controls.”

261. For example, “Project Jacquard.”, 2015

262. Gowrishankar, Bredies, and Ylirisku, “A Strategy for Material-Specific e-Textile Interaction Design.”

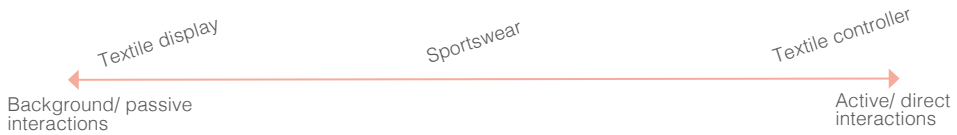

Figure 13. Spectrum of levels of engagement with e-textiles.

the turn-around controller,<sup>263</sup> the interaction of turning inside-out is used for dimming a light in the room.

These two cases above represent different directions of transfer, determined by whether an interaction familiar to electronics or textiles guides the design of the e-textile.<sup>264</sup> For example, the action of swiping on the surface of a fabric is an interface gesture that is transferred from electronics to textiles. In comparison, a knitted stretch sensor works with the material properties and construction techniques from textiles to identify certain “states” of the e-textile artefact to emulate the behaviour of a digital sensor. In this case, the direction of transfer is predominantly from textiles to electronics. While the first case presents significant technological development, the interface is not as material-specific as the latter case.

### **Layered interactions**

The approach of layered interactions seeks inspiration from the interactions normally associated with the underlying textile object. Following the idea of tangled interactions,<sup>265</sup> the usual behaviours and actions around specific textile objects are layered with a digital meaning. For example, walking on a carpet is used as a sensor for lighting up the carpet.<sup>266</sup>

### **Levels of engagement**

Another distinction that can be drawn in relation to acting with e-textile artefacts is according to the different levels of involvement it needs from the person. Let us consider the levels of engagement as a spectrum with one end requiring constant and direct involvement with an e-textile artefact, and the other end having e-textiles that function in the background and require no direct manipulations and contact with the materials (see Figure 13). It is important to mention that the notion of engagement here does not refer to cognitive involvement but a physical and deliberate one. The passive side of the spectrum uses textile properties or qualities in its interaction concept, but does not involve the user directly; for example, textile displays, such as the slow-moving display by Berzowska,<sup>267</sup>

263. Ramyah Gowrishankar, “Turn-inside-out Textile Interface,” accessed February 4, 2019, <https://narrativize.net/portfolio/turn-around-textile-interface/>.

264. This is also discussed in Gowrishankar and Bredies, “Investigating Interaction Design for E-Textiles Using Case-Transfer.”

265. Redström, “Tangled Interaction.”

266. For example, Linda Worbin, “Trace,” 2008, accessed February 4, 2019, <http://smarttextiles.se/trace-exhibited-in-london/>.

267. Berzowska, “Very Slowly Animating Textiles: Shimmering Flower.”

use the patterns changing on the textiles as a visual interaction or experience but do not directly involve the person touching or manipulating the e-textile. E-textiles in the areas of performance or sports-wear are situated somewhere in the middle of the spectrum where the person wearing the e-textiles gets direct feedback and could change behaviour to influence and, in a way, control the e-textiles. However, although the application of such e-textiles is in contexts where the person is active, the interactions with the e-textiles may not involve direct and active manipulation of the textile materials. The active side of this spectrum constitutes e-textile projects that use textiles as an input or manipulator for the use context. Instead of using pre-existing interface models, they try to find new ones that are more specific to textiles. For example, the “Music Sleeve”,<sup>268</sup> a knitted e-textile artefact for controlling music on the smartphone, looks for textile specific interactions such as knotting or the ability to manipulate objects inside soft textile layers to map the different digital states of the object.

### **Initial observations**

Considering interaction transfers presents an interesting opportunity to find new relationships between familiar textile actions and digital interpretations. For example, using textile specific actions such as ‘turning-inside-out’ or ‘folding-up’ can provide new inspirations for the shaping of and relating to computational things. On the other hand, the layered interaction approach provides an entry point for reinterpreting existing actions. Thus, a combination of these two approaches could provide a useful method for applying and exploring textile interactions in the context of e-textiles. Focusing on tangible interactions that support direct physical interaction with materials, the e-textiles interaction approach aligns more to the active side of the spectrum rather than to the passive observer level.

#### 3.3.4 Interaction design approaches for relating with e-textiles

Similar to the field of materiality oriented HCI, the research interests around e-textiles can also be seen as broadening from the artefact itself, to activities of use as well as to considering e-textiles as a conceptual lens for discussing new ways of relating with textiles and technology. While *acting* focuses on the behaviour of engaging with e-textiles, the idea of *relating* goes towards understanding more general meaning or roles attached to the e-textile artefact. The interaction design approaches to relating with e-textiles build on the use contexts of existing textile and computational artefacts as well as look at material properties to develop new ones.

### **Building on existing use-contexts**

Textile use-contexts are used as a resource for proposing new ways of relating to e-textile artefacts. Building on the parent field of wearable computing, a common use-context for e-textile development has been in the form of on-body artefacts such as clothing. e-Textiles built in the form of clothing have tried to enhance or add aspects to this already well-established relation between clothing and the body. For example, e-textiles in the context of healthcare take advantage of being close to the body to take biometric

---

268. Gowrishankar, Bredies, and Chow, “The Music Sleeve : Fabric As An Electronic Interface Medium.”



measurements from patients.<sup>269</sup> In other projects, such as the Twitter Dress,<sup>270</sup> the idea of clothing as a form of personal expression is interpreted as a digital display that projects a live twitter feed sent to the dress.

Textiles as furniture or upholstery is another context present in e-textile research. The relation between pieces of furniture to situations or activities, such as waiting or resting, have been used as a way of developing examples of e-textile applications. For example, the project Tic-tac Textiles<sup>271</sup> explores waiting in common areas as a space for social exchange through a subtle, tangible interface of a table cloth printed with thermo-chromic inks. In the project Bedtime Stories,<sup>272</sup> a woven bedspread of a child's bed is converted into an interactive story when looked through a specialised iPad application. These projects build on activities or behaviours that already exist around textile artefacts and introduce computational features to support or enhance these relationships.

### **Looking at material behaviours to establish new relations**

While the previous approach looked at textile objects as a whole, this one looks at the specific material behaviours of textiles as an inspiration for relating to computational things. Aspects such as the change in visual appearance due to wear and tear in textiles over a long period of use could point to different kinds of relationships- from being used everyday, to something precious being passed on through generations, to memories of accidents or events that might cause a change in the pattern on textiles.<sup>273</sup> These aspects, when programmed into the computational thing, can complement or contrast our expectations from traditional textiles. For example, the burnt tablecloth<sup>274</sup> explores irreversible changes caused to material by computation in contrast to the usual digital reversibility.

Alternatively, commonly expected behaviours from computers, such as efficiency or sensing capabilities, have also been adopted as a way to make textiles seem more like computers; for instance, future oriented fashion design concepts that tend to adopt machine-like or “computeresque” appearances to convey the idea of being “smart”. This perspective is also predominant in commercially available e-textile products that try to be like gadgets and sensing devices (e.g., soft sensors incorporated in sportswear<sup>275</sup>) and

---

269. Vagott and Parachuru, “An Overview of Recent Developments in the Field of Wearable Smart Textiles.”

270. CUTECIRCUIT, “Twitter Dress,” accessed February 4, 2019, <http://cutecircuit.com/media/media-twitter-dress/>.

271. A. Ernevi et al., “Tic Tac Textiles,” in Cumulus Lisbon, 2005, <http://redstrom.se/johan/abstracts/atitac.html>.

272. K. Kuusk, O. Tomico Plasencia, and G.R. Langereis, “Bedtime Stories : Weaving Traditions into Digital Technologies,” in Nordic Design Research Conference, 2013, <http://repository.tue.nl/770918>.

273. Anna Persson and Linda Worbin, “Designing Dynamic and Irreversible Textile Patterns, Using a Non-Chemical Burn-out (Ausbrenner) Technique,” *The Nordic Textile Journal*, 2008, 64–87, <http://hdl.handle.net/2320/4295>.

274. Dumitrescu and Persson, “Exploring Heat as Interactive Expressions for Knitted Structures.”

275. For example “Adidas MiCoach Seamless Sports Bra.”

attempt to make e-textile objects accurate, efficient and informative like computational devices.

**Initial observations**

The first approach to implementing existing use-contexts is a natural way of adding on or exploring new relationships with familiar objects or situations. These act as analogies for introducing new features or capabilities into everyday contexts. Like in the case of making and acting, using already existing understandings of what textiles are as well as how they feel and behave provides a rich resource.

While the above-mentioned approach of using use-contexts focuses more on what an e-textile could be at the moment of use, the approach of using material behaviours takes the aspect of time into account. The behaviours of textiles over time are used as inspiration for designing computational interactions. This approach opens up long-term considerations concerning interactions, whereby processes of change—not only the tangible aspect of materials—are taken into account. Both these approaches play an important role in designing with e-textiles and it would be beneficial if aspects of existing use-contexts and long-term interactions were considered within the interaction design process.

3.3.5 Summary of materiality oriented interaction design methods adopted from e-textile practices

This section examined the different interaction design approaches from the field of e-textiles in line with the approaches of making, acting and relating with computational things. Furthermore, I have identified and selected methods within each category that closely follow and support the material qualities of textiles. Table 1 summarises the different methods identified in this section.

Table 1. Summary of materiality oriented interaction design methods adopted from e-textiles.

<b>Materiality oriented approaches to-</b>	<u>MAKING E-TEXTILES</u>	<u>ACTING WITH E-TEXTILES</u>	<u>RELATING TO E-TEXTILES</u>
	<p><b>Using textile construction techniques</b> to reconstruct or integrate electronic components.</p> <p>For example, soft pressure sensors made by knitting with a combination of conventional and conductive yarns.</p>	<p><b>Using interaction transfers</b> from textiles to electronics.</p> <p>For example, using everyday textile interactions such as turning inside-out or stretching for digital interfacing.</p>	<p><b>Building on existing textile use-contexts.</b></p> <p>For example, using the context of sitting on a couch for digital interpretation.</p>
		<p><b>Layering interactions.</b></p> <p>For example, an existing interaction with a textile object such as hugging a pillow triggers a digital meaning, such as, sending an sms to a loved one.</p>	<p><b>Building on material behaviours.</b></p> <p>For example, using wear and tear textile materials with time as a design material to display temporal states.</p>

In the previous section, I described the electrostatic generator circuit as an interaction template for implementing the design program. In order to investigate electrostatic textiles from a materiality oriented HCI perspective, the selected methods are employed for making, acting and relating with the electrostatic generator circuit.

### 3.4 Supporting multiple interpretations

As discussed in section 1.2, a key aspect of undertaking a programmatic approach to design research is that the research process does not aim to confirm or reject a hypothesis but takes an explorative stance that constantly dialogues with and challenges the design program. The experiments are structured and have a purpose but, at the same time, remain open to interpretations.<sup>276</sup>

Body-driven electrostatic energy harvesting systems are an emerging technology, and a large part of the debate surrounding them is associated with a single narrative of power efficiency. Adopting an approach of supporting multiple interpretations is useful in bringing alternative perspectives, experiences and debates to the field of e-textiles and body-powered technologies from an early stage of the development process. Thus, in addition to adopting material-specific interaction design methods from the practice of e-textiles, the experiments intentionally keep the explorations of interacting with static electricity and textiles open-ended to support varied observations and interpretations that are rooted in experience rather than pre-conceived design ideas.

In doing so, the research experiments learn from two further approaches in HCI design research that support multiple interpretations during the design process. The first involves adopting methods from embodied ideation which support an active dialogue between the body and materials, and the second works with speculative narratives and design fiction, providing ways of engaging with topics that are not yet fully formed or defined. These are described further in the following subsections.

#### 3.4.1 Adopting embodied ideation methods

This research builds on the embodied design ideation approaches existing in the design and research of wearables and materiality oriented HCI. In the previous section, I described “acting with” interactive technology as one of the key foci of materiality oriented HCI. This aspect of HCI research brought the emphasis back on the versatility and skill of the human body in designing interactions which was previously overlooked in the cognition-centred interface design.<sup>277</sup> The research methods employed to investigate movement and expression in interaction design have involved actively exploring through the body. For example, Jensen et al.<sup>278</sup> studied videos of an industry conveyer belt worker to discuss how human actions can be skilled, involving a series of actions that follow one another in rhythmic flowing movements and use the whole body in the choreographies

---

276. Redström, “Some Notes on Program/Experiment Dialectics.”

277. Djajadiningrat et al., “Tangible Products: Redressing the Balance between Appearance and Action.”

278. Jensen, Buur, and Djajadiningrat, “Designing the User Actions in Tangible Interaction.”

designed around technical things. In making the rich user camera, Frens<sup>279</sup> relied on prototyping different alternatives to a standard digital camera interface and tried out different versions himself and with students to test and improve the interaction design during the process of development.<sup>280</sup> In order to explore different interactive behaviours for an intelligent lamp, Phillip Ross worked with professional dancers who embodied the lamp and the user to improvise and choreograph different relationships, attitudes and behaviours through action.<sup>281</sup> These different enactments enabled a dynamic and embodied way of exploring the concepts of ethics, notions of power, control and playfulness that can be embedded in 'smart' technology.

Similarly, the embodied ideation methods in the field of e-textiles and wearables work closely with the body as a way of discovering and revealing new interactions and opportunities. For example, Tomico and Wilde<sup>282</sup> explicate that the new experiential soft wearables are revealed from the emerging relationships between context, form, function, material and interaction. Through different examples, they argue that by placing materials close to the body and ideating through the body can allow a designer to combine language with movement in abstract ways to become personally accustomed to the context in which they design and relate functionality, materials and use through the means of the body.<sup>283</sup> Segura et al.<sup>284</sup> propose a method of embodied sketching, which encourages designers to view technology only as a part of that which sustains the whole activity, rather than overemphasising the role of technology as being the design goal and the main driver for the design process. The OWL project by Wilde and Andersen<sup>285</sup> explores how embodied experience and imagination could assist in the creation of unknown technologies. Instead of starting with a design brief or a set of technologies, the researchers designed a series of upholstered wearable dummies. These soft, and unfamiliar body-worn props were then used in fitting and interview sessions designed to invite different

---

279. Frens, "A Rich User Interface for a Digital Camera."

280. Ilpo Koskinen et al., *Design Research through Practice: From the Lab, Field, and Showroom* (Elsevier, 2011), <https://www.elsevier.com/books/design-research-through-practice/koskinen/978-0-12-385502-2>.

281. P.R. Ross and S.A.G. Wensveen, "Designing Behavior in Interaction : Using Aesthetic Experience as a Mechanism for Design," *International Journal of Design* 4, no. 2 (2010): 3–13, <https://research.tue.nl/en/publications/designing-behavior-in-interaction-using-aesthetic-experience-as-a>.

282. Oscar Tomico and Danielle Wilde, "Soft, Embodied, Situated & Connected: Enriching Interactions with Soft Wearables," *MUX: The Journal of Mobile User Experience* 5, no. 1 (December 17, 2016): 3, <https://doi.org/10.1186/s13678-016-0006-z>.

283. Ibid.

284. Elena Márquez Segura, Laia Turmo Vidal, and Asreen Rostami, "Bodystorming for Movement-Based Interaction Design," *Human Technology* 12, no. 2 (November 30, 2016): 193–251, <https://doi.org/10.17011/ht/urn.201611174655>.

285. Danielle Wilde and Kristina Andersen, "Doing Things Backwards: The OWL Project," in *Proceedings of the 21st Annual Conference of the Australian Computer-Human Interaction Special Interest Group on Design: Open 24/7 - OZCHI '09* (New York, New York, USA: ACM Press, 2009), <https://doi.org/10.1145/1738826.1738896>.

interpretations from the participants while experiencing the dummies on their bodies. This, in turn, encouraged the participants to contemplate their experience of wearing the dummy but also created a reflective space to talk about their own desires and needs as they described the dummies as technology. Following this line of inquiry in her Ph.D. thesis, Wilde<sup>286</sup> demonstrates that “beginning with the body to arrive at a technologically facilitated engagement leads not only to rich opportunities for playful interaction, but also affords access to complex and idiosyncratic information about how people learn in, through, and about their bodies.”<sup>287</sup>

This thesis adopts embodied ideation methods of prototyping electrostatic textiles by setting up and experiencing different electrostatic interventions in the space of the everyday. Enactments and video documentations are used to create, observe and reflect on electrostatic interactions with textiles. The idea that interaction creates meaning does not only hold for users during interaction but also for designers when gathering ideas and developing concepts.<sup>288</sup> Body-driven energy harvesting places the body and material interactions at the centre of the design process. As described by the examples above, embodied ideation in the form of prototyping different electrostatic textile setups and experiencing and interacting with them is used to explore new relationships and aspects of body-driven energy harvesting that otherwise may not become apparent.

### 3.4.2 Envisioning through “interaction fictions”

This thesis adopts narrative-oriented approaches of design fiction and speculative design to develop the idea of “interaction fictions”. Design fiction is a term coined by Bruce Sterling in his book *Shaping Things*.<sup>289</sup> Claiming to be writing design fiction for years, he described design fiction to be more practical and hands-on than science fiction.<sup>290</sup> Design fictions have been described as projections or extrapolations meant to explore near futures. They are speculations of what the “next now” would be like, always remembering that no possible future is out of the question.<sup>291</sup> Design fictions can take the form of narratives, short stories, films or even objects and semi-working prototypes.<sup>292</sup>

---

286. Danielle. Wilde, “Swing That Thing : Moving to Move : The Poetics of Embodied Engagement” (Monash University, 2011).

287. Ibid.

288. Caroline Hummels, Kees C. J. Overbeeke, and Sietske Klooster, “Move to Get Moved: A Search for Methods, Tools and Knowledge to Design for Expressive and Rich Movement-Based Interaction,” *Personal and Ubiquitous Computing* 11, no. 8 (October 16, 2007): 677–90, <https://doi.org/10.1007/s00779-006-0135-y>.

289. Bruce. Sterling, *Shaping Things* (MIT Press, 2005).

290. Ibid.

291. Julian Bleeker, “Design Fiction: A Short Essay on Design, Science, Fact and Fiction,” 2009.

292. Mark Blythe, “Research through Design Fiction: Narrative in Real and Imaginary Abstracts,” in *Proceedings of the 32nd Annual ACM Conference on Human Factors in Computing Systems - CHI '14* (New York, USA: ACM Press, 2014), 703–12, <https://doi.org/10.1145/2556288.2557098>.

Using narratives to convey ideas in the form of scenarios, personas or story boards is common in design practice. However, these kinds of narratives usually take on the role of illustrating product functionalities or user groups and remain largely uncritical.<sup>293,294</sup> Design fictions, on the other hand, are characterised by contradictions or conflicts that aim at opening up scenarios for the inclusion of social and political conflict in design thinking.<sup>295</sup> Emphasising concerns and questions around technology adoption, they are conceived primarily as critiques and provocations, as in the case of the critical design<sup>296</sup> of Dunne and Raby<sup>297</sup>.

Speculative design, similarly, also plays with contradictions to create a space to discuss alternate ways of being and to collectively redefine our relationship to reality.<sup>298</sup> Auger explains that words such as ‘fictions’, ‘speculative’, ‘probes’ or ‘critical’ when added to design have a common goal of dislocating an object or a narrative from everyday life, exposing their fictional or academic status.<sup>299</sup> He describes speculative design as dealing with “alternate presents” that are design proposals which utilise emerging and contemporary technologies but apply different ideologies or configurations than those currently directing product development.<sup>300</sup>

Different methodologies for working with design fictions and speculative design have been discussed. Auger presents different methods for crafting the speculation by bridging the fictional concepts to the familiar present. These bridging techniques include taking an ecological approach, where familiar settings or environments are used to present something unfamiliar, playing with the uncanny to provoke varied interpretations, using the idea of design fiction and borrowing techniques from observational comedy.<sup>301</sup> The questions and challenges engaging design fictions and speculative design are often complex. Bleeker<sup>302</sup> advises designers who tie fact and fiction together to become deliberate and revel in the messiness, the speculation and the confusion that arises when exploring

---

293. Bleecker, “Design Fiction: A Short Essay on Design, Science, Fact and Fiction.”

294. Blythe et al., “Anti-Solutionist Strategies: Seriously Silly Design Fiction Mark.”

295. Blythe, “Research through Design Fiction: Narrative in Real and Imaginary Abstracts.”

296. Dunne and Raby, *Design Noir: The Secret Life of Electronic Objects*.

297. Blythe, “Research through Design Fiction: Narrative in Real and Imaginary Abstracts.”

298. Anthony Dunne and Fiona Raby, *Speculative Everything : Design, Fiction, and Social Dreaming* (MIT Press, 2013).

299. James Auger, “Speculative Design: Crafting the Speculation,” *Digital Creativity*, 2013, <https://doi.org/10.1080/14626268.2013.767276>.

300. Ibid.

301. Ibid.

302. Bleecker, “Design Fiction: A Short Essay on Design, Science, Fact and Fiction.”

alternatives to established trends. Blythe et al.<sup>303</sup> take an anti-solutionist stance in their magic machines workshops to claim that lo-fi prototypes and crude representations are sometimes best to convey the complexity and provoke a discussion rather than aiming for slick, over-simplified forms of narration.

Design fictions create a discursive space within which new forms of cultural artefacts (futures/ alternate presents) might emerge, and it has become a significant means through which designers explore the present condition of the interface culture.<sup>304</sup> This thesis deals with an emerging technology of electrostatic energy harvesting with the body and textiles. While the embodied ideation approach described in the previous subsection provides methods for directly engaging with the electrostatic textile systems, design fictions enable the formulation of questions and illustrate contradictions that arise from the direct engagement. With a focus on interaction design, this research closely follows the actions, performances and body-movements supported by textile materials in electrostatic interactions. Thus, the interactions involved in electrostatic energy harvesting is itself taken as a point of departure for constructing design fictions.

Thus “interaction fictions” in this thesis act as design fictions that create a discursive space around the active and physical interactions between the people and electrostatic textile artefacts and spaces. The interaction fictions are crafted from the questions and challenges around designing interactions and envision how the interaction design of these systems may lead to different social and cultural practices around electrostatic textiles in the everyday.

### **3.5 Overview and structure of the research studies**

This research set out to outline an interaction design perspective into body-driven energy harvesting systems that draws from material interactions to investigate the experiences and everyday encounters of living with such technologies. Static electricity, which is generated as a result of interactions between textiles and humans, was taken as a design case for shaping an interaction design inquiry into body-driven energy harvesting in the context of e-textiles.

The electrostatic circuit was used in the form of working knowledge to be reinterpreted through different textile materials and techniques. Since there was no precedent to investigating static electricity from the perspective of interaction design, this research first developed a methodological frame consisting of making, acting and relating for interaction design with e-textiles. Using this as the foundation, four studies were set up. The first three addressed making, acting and relating with static electricity by reinterpreting the triboelectric circuit in the context of e-textiles. The fourth study explored the interpretations of the static electricity produced through interactions.

---

303. Blythe et al., “Anti-Solutionist Strategies: Seriously Silly Design Fiction Mark.”

304. Derek Hales, “Design Fictions an Introduction and Provisional Taxonomy,” *Digital Creativity* 24, no. 1 (2013): 1–10, <https://doi.org/10.1080/14626268.2013.769453>.

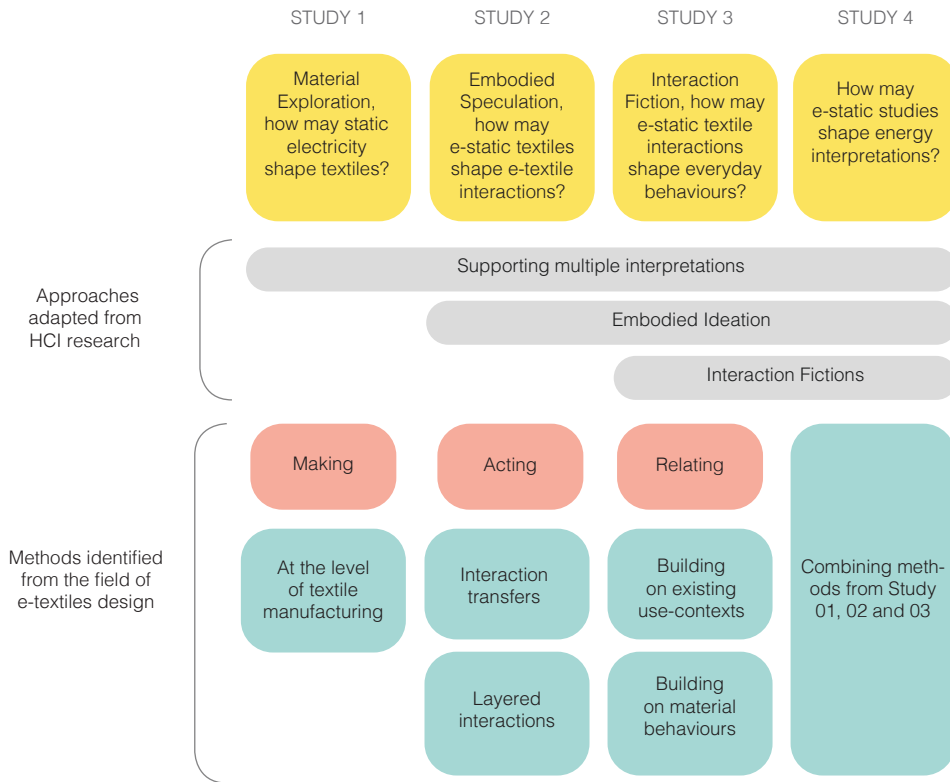

Figure 14. Overview of research studies and methods.

Below, I give a detailed overview of these four research studies along with the methods of making, acting and relating (see Figure 14) used in the investigations. Chapters 4 to 7 delve deeper into each of these studies describing the process, results and reflections from each. These chapters present the research studies using a structure of describing interaction design methods adapted from Hallnäs and Redström<sup>305</sup> that include the following sections:

- **Introduction:** Overview of the aims of the research study
- **Outline:** A description of the research process undertaken
- **Examples:** A selection of examples that illustrate key insights, questions or challenges within the research study
- **Observations:** Reflections and observations from the research process regarding the aims of the research study
- **Discussion:** Discussion and open questions regarding the examples of the research study in relation to the design program

305. Hallnäs and Redström, Interaction Design: Foundations, Experiments.



Each study builds on the insights and experience of undertaking the previous studies. The context of the interior is loosely used to situate the different experiments and provide a frame for generating ideas to envision interactions. It is also used as a driver for scaling up e-textile artefacts and interactions in the research studies as a means of developing examples of varied temporal and spatial qualities.

#### 3.5.1 Study 01: Material Exploration, how may static electricity shape textiles?

Study 01 focused on *making* e-textiles that support static electricity generation through interactions with the human body. This study took the form of a material exploration, where conductive and electrostatic materials were introduced within the textile construction to reconstruct the triboelectric circuit in a textile shape. The emphasis here was placed on how materials were introduced in the context of the textile fabric to enhance the generation of electrostatic charges and direct them through a circuit. The goal was to develop examples of ‘electrostatic textiles’, or textiles that translate the electrostatic circuit into a textile shape.

##### **Methods and outcomes**

An open-ended material exploration was undertaken with the goal of experimenting with different textile construction techniques and soft materials to re-construct the triboelectric circuit into the form of textile substrates. Methods of integrating elements from the triboelectric circuit and textile materials were explored at the level of textile construction using weaving, tufting and embroidery techniques. This material exploration resulted in several samples of electrostatic textiles; furthermore, it helped to develop an understanding of the electrostatic properties of the available materials that could be utilised in the design process. It also led to the re-interpretation of tools to test and visualise the electrostatic effects in textiles.

#### 3.5.2 Study 02: Embodied Speculation, how may electrostatic textiles shape e-textile interactions?

Study 02 addressed *acting with* static electricity and explored the interactions enabled by electrostatic textiles and set-ups. Following from the discussion in materiality oriented HCI that places emphasis on expressivity and whole-body interactions, this study focused on scaling up the triboelectric circuit to support varied interactions with soft materials for engaging with static electricity. The triboelectric circuit, in this case, was translated into a three-dimensional object, where engaging with the whole body played a crucial role. Textiles and the body became the basic materials that were put together to create electrostatic setups. Two such electrostatic objects, both immersive but of different scales, were explored.

##### **Methods and outcomes**

In e-textile and wearable research, the methods of embodied ideation have been used to speculate and imagine new forms and objects through material qualities of “stuff” at

hand.<sup>306</sup> Adopting this approach of embodied ideation from the field of HCI and combining it with the critical eye of speculative design, Study 02 was a prototyping driven investigation that involved using easily available materials, building quick setups, trying them out and noting initial observations and reflections. For scaling up the electrostatic circuit to explore different levels of engagement, the study employed material-specific e-textile interaction methods—identified in the previous section—of enabling active engagement, exploring interaction transfer from textiles to electronics and trying out layered interactions with existing textile objects prone to getting charged up. Scaling up the electrostatic circuit resulted in rethinking our everyday engagement with the interior space. It also led to developing a design strategy for engaging with electrostatic textiles in the everyday.

### 3.5.3 Study 03: Interaction Fiction, how may electrostatic textile interactions shape everyday behaviours?

Study 03 took a speculative approach to develop interaction scenarios for *relating* with electrostatic textiles and envisioned everyday behaviours and motivations for engaging with static electricity.

#### **Methods and outcomes**

This study undertook a narrative approach based on the arguments of speculative design and design fiction and worked with the idea of interaction fiction introduced earlier. The electrostatic interactions and setups created in Study 02 were used as a starting point for imagining situations, behaviours and actions in the everyday and exploring alternatives through sketching, enactments and writings. Interaction design methods from e-textiles for exploring different relationships by building on existing use contexts and material behaviours were used. The different examples of everyday situations and narratives created a repository of questions and issues regarding body-driven energy harvesting in the everyday. This study also enabled a theoretical reflection on scaling up interactions in physical space, as well as in time, in the context of everyday relationships to electricity generation.

### 3.5.4 Study 4: How may e-static studies shape energy interpretations?

While Study 01, 02 and 03 address different aspects of actively engaging with electrostatic energy in the everyday, Study 04 looked at electrostatic engagement from the perspective

---

306. Danielle Wilde, Anna Vallgård, and Oscar Tomico, "Embodied Design Ideation Methods," in Proceedings of the 2017 CHI Conference on Human Factors in Computing Systems - CHI '17 (New York, USA: ACM Press, 2017), 5158–70, <https://doi.org/10.1145/3025453.3025873>; Danielle. Wilde and Monash University. Faculty of Art and Design. Gallery.,

Swing That Thing : Moving to Move : The Poetics of Embodied Engagement (Monash University, 2011); Saskia Bakker, Alissa N. Antle, and Elise van den Hoven,

"Embodied Metaphors in Tangible Interaction Design," Personal and Ubiquitous Computing 16, no. 4 (June 12, 2011): 433–49, <https://doi.org/10.1007/s00779-011-0410-4>.

of the results of such interactions. The aim of this study was to explore different interpretations and forms for the small amounts of electricity generated through interaction.

### **Methods and outcomes**

The study was undertaken in the form of a week-long workshop at the Berlin University of the Arts. This workshop built on the insights and methods employed in the previous studies and led the participants through a series of exercises aimed at building interaction fictions with static electricity. During the workshop, three groups of four students (total 12 students) were given a basic introduction to static electricity and asked to explore different interactions and narratives for engaging with static electricity in the everyday. The final works presented by the students, in addition with other examples from the research process, were used as a basis for developing an “energy-interpretation matrix”. The matrix outlines different kinds of outputs that could be conceptualised through an interaction design investigation of energy harvesting technologies.



## **4 Study 01, Material Exploration: How may static electricity shape e-textiles?**

### **4.1 Introduction**

Study 01 starts with looking at the electrostatic circuit as a material system that can be reconfigured within a textile surface. Our interior environments incorporate different kinds of textile materials and objects of different scales, for example, pieces of furniture, rugs, curtains, cushions, etc. Incorporating the electrostatic circuit within interior textiles could potentially reinterpret how we engage with textile objects.

This study focused on the *making* of e-textiles that support the generation and use of electrostatic charges through interactions. It interpreted static electricity as a material property of e-textiles and aimed to develop examples of electrostatic textiles with different expressions. It was also important to work with existing textile production techniques that would enable the easy incorporation of available materials.

Following the presentation structure mentioned in the previous chapter, the next section gives an outline of the process undertaken in the study. A selected set of examples illustrating the main findings is presented in section 4.3. The key observations from the study are presented in section 4.4 followed by a discussion in section 4.5 regarding the results of the research study in relation to the design program.

### **4.2 Outline**

This research study took the form of a material exploration where different electrostatic and conductive materials were substituted within the electrostatic circuit forming different textile surfaces. Using the triboelectric series as a reference, three electrostatic

Table 2. Yarn materials used to construct electrostatic textiles.

PTFE	Plastics	Polyester
Conductive/ metal	Wool	Cotton



Figure 15. (Left) The clip-on tester. (Right) The tester is clipped to the sample and held with one hand while tapping or rubbing the fabric with the other hand. The LED lights up when enough voltage is generated.

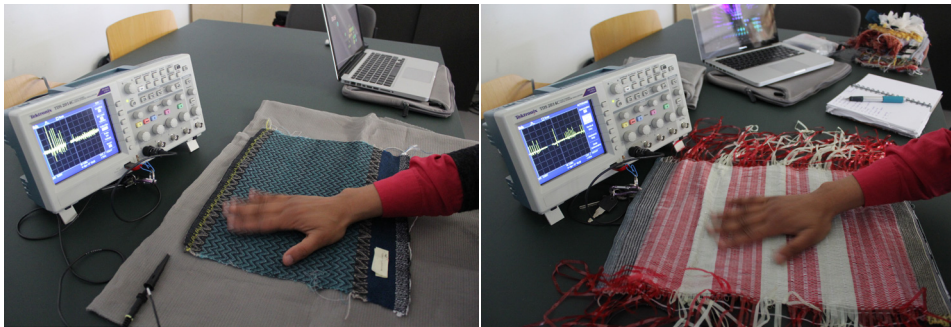

Figure 16. Reading voltages generated by the electrostatic textile samples with an oscilloscope. (Left) Example of single layered samples placed over a conductive fabric connected to the oscilloscope. (Right) Example of a sample with integrated conductive elements that was directly connected to the oscilloscope.

materials, namely polyester, PTFE and thin plastic foil<sup>307</sup> in combination with conductive yarns (see Table 2), were used to create different textile samples. Cotton and wool were used as supporting yarns in some of the samples.

After initial explorations with different textile materials, three textile construction techniques, weaving, rug-knotting and tufting, were chosen to explore the different structures and expressions of electrostatic textiles. These textile construction techniques were observed to support the electrostatic effect due to the close surface contact between the yarns of the fabric. Techniques such as knitting were left out, as it was observed to be less effective during the initial exploration; this was because the loops forming the knitted

307. This material resembled cellophane-like thin yarn that was available at the weaving studio where the samples were developed. This was a found material, and the exact composition of this yarn could not be traced.

structure have smaller contact between them.

The samples were made in an iterative way, and materials were chosen as per availability in the textile studio that met the material requirements needed for the electrostatic circuit. To visualise if electrostatic charges were generated in interaction, the samples were checked first using a self-made tester clip (see Figure 15). This tester module was another form of the electrostatic circuit that enabled a quick connection to textile substrates to observe if the attached LED lit up with interactions.<sup>308</sup>

As a next step, the samples were tested with an oscilloscope to get a broad idea of the voltages generated during a tapping interaction (see Figure 16). The samples without conductive elements were placed over an aluminium sheet attached to the oscilloscope. In the samples which incorporated conductive elements, the oscilloscope was connected directly to the conductive areas of the sample. The voltage readings from tapping ten times on each sample were recorded, and the average and standard deviation was calculated for each sample.<sup>309</sup> The voltage values for the selected samples are included in the examples illustrated in the next section.

### 4.3 Examples: Electrostatic textiles

The tables on the following pages (see pages 94–99) show selected examples of electrostatic textiles created by using weaving, knotting and tufting. The examples illustrate a collection of different textile surfaces and techniques that can be used to support electrostatic engagement with textiles.

#### Weaving

The woven samples (samples 1a to 1c and 2a to 2d) were made using combinations of PTFE, polyester and plastic film yarn as weft threads, woven over a cotton or polyester warp. Two sets of woven samples were developed: the first set (1a to 1c) was made with a single weave structure and the second set with a double weave structure. The single weaves were made using a number of different available materials and explored different textures and weave patterns.

The second set (2a to 2d) was made with selected materials in a double weave structure that incorporated conductive yarns. The electrostatic materials were used on the top layer and conductive yarns were inserted as weft yarns in the bottom layer in a way that the maximum amount of the conductive surface would be exposed to the inside of the fabric that touches the top electrostatic layer.

All woven samples except two were made using computer-aided arm looms. One of the double weave samples was woven using an industrial sampling loom. The samples were made with 16 or 8 shaft looms with either cotton or polyester as warp threads.<sup>310</sup>

---

308. Please refer to Appendix A.2 for further description of the clip-on tester.

309. Ramyah Gowrishankar, "Constructing Triboelectric Textiles with Weaving," in Proceedings of the 2017 ACM International Symposium on Wearable Computers - ISWC '17 (New York, USA: ACM Press, 2017), 170–71, <https://doi.org/10.1145/3123021.3123037>.

310. Please refer to Appendix C for more details on the looms and warp settings.

## SAMPLES OF ELECTROSTATIC TEXTILES

### 1. Single layered woven e-static textiles

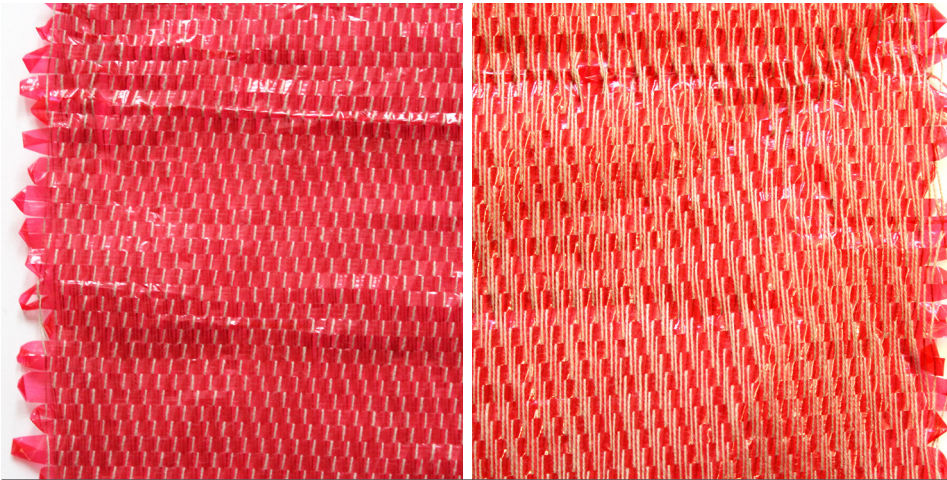

Sample 1(a)			
Textile Technique:	Size (cm):	Construction tool:	Avg (Std dev) Voltage
WEAVING	40 x 28	ARM computer loom 8 shafts	4.6 V (1.14)
<b>Materials</b> <u>Warp</u> : Cotton <u>Weft</u> : Plastic film yarn		<b>Method for incorporating electrode</b> External electrode	

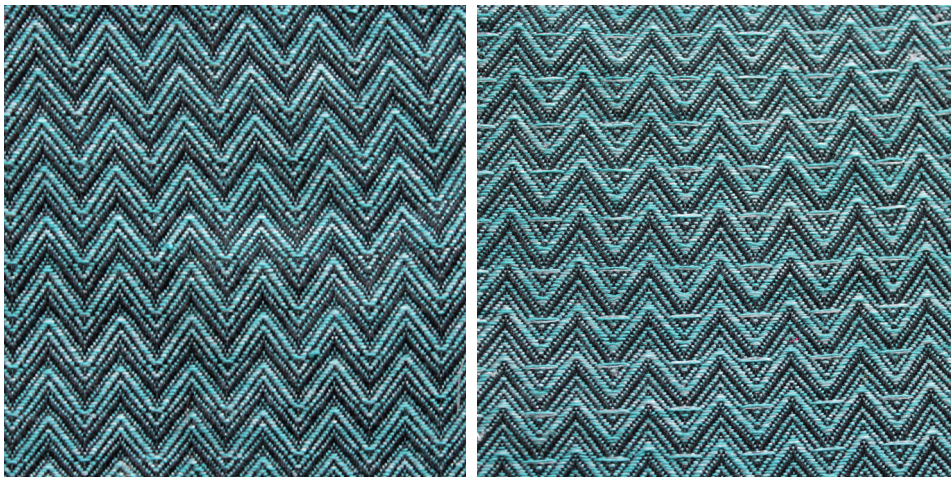

Sample 1(b)			
Textile Technique:	Size (cm):	Construction tool:	Avg (Std dev) Voltage
WEAVING	37 X 20	ARM computer loom 16 shafts	6.5 V (0.89)
<b>Materials</b> <u>Warp</u> : Polyester <u>Weft</u> : 2 yarns: Teflon & Polyester		<b>Method for incorporating electrode</b> External electrode	



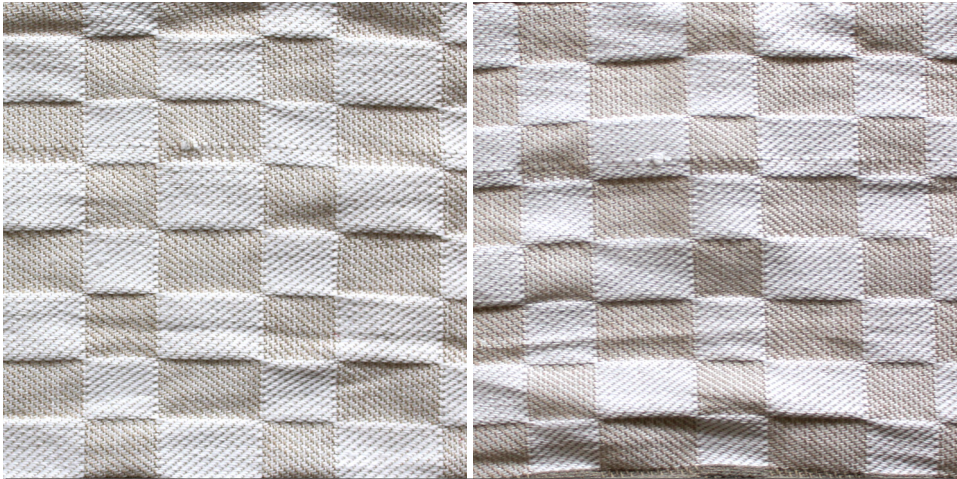

<b>Sample 1(c)</b>			
<b>Textile Technique:</b> WEAVING	<b>Size (cm):</b> 40 x 22	<b>Construction tool:</b> ARM computer loom 8 shafts	<b>Avg (Std dev) Voltage</b> 3.3 V(0.79)
<b>Materials</b> <u>Warp:</u> Cotton <u>Weft:</u> Polyester multi-filament soft yarn		<b>Method for incorporating electrode</b> External electrode	



<b>Sample 1(d)</b>			
<b>Textile Technique:</b> WEAVING	<b>Size (cm):</b> 23 X 27	<b>Construction tool:</b> Hand woven	<b>Avg (Std dev) Voltage</b> not measured
<b>Materials</b> <u>Warp:</u> Polyester <u>Weft:</u> Creative pipe cleaners (found-object)		<b>Method for incorporating electrode</b> The pipe cleaners have a conductive core made of twisted metal wires inside which the polyester fibres are held together.	

## 2. Double layered woven e-static textiles



Sample 2(a)			
Textile Technique:	Size (cm):	Construction tool:	Avg (Std dev) Voltage
WEAVING	30 X 14	ARM computer loom 16 shafts	4.5 V (1.59)
<b>Materials</b> Warp: Cotton Weft: Top- Teflon yarn Bottom- Polyester & conductive yarn		<b>Method for incorporating electrode</b> The bottom layer has rows of conductive yarn so that it is exposed to the inside of the fabric that is in contact with the top layer.	

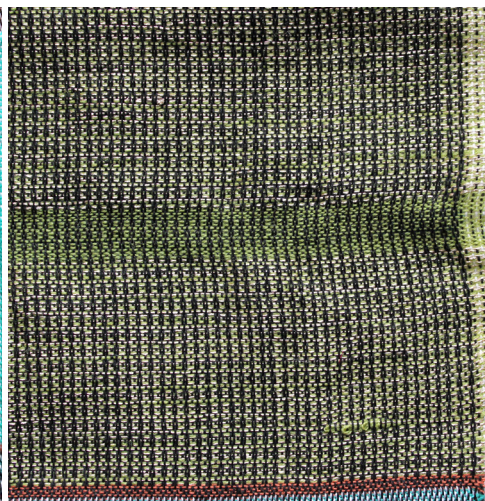
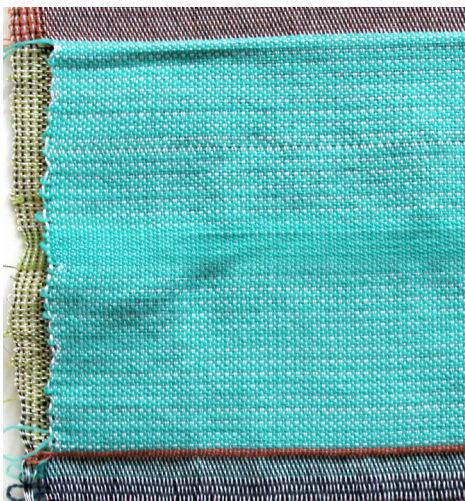

Sample 2(b)			
Textile Technique:	Size (cm):	Construction tool:	Avg (Std dev) Voltage
WEAVING	30 x11.5	ARM computer loom 16 shafts	3.6 V(0.7)
<b>Materials</b> Warp: Cotton Weft: Top- Polyester Bottom- Wool & conductive yarn		<b>Method for incorporating electrode</b> The bottom layer has rows of conductive yarn so that it is exposed to the inside of the fabric that is in contact with the top layer.	



<b>Sample 2(c)</b>			
<b>Textile Technique:</b>	<b>Size (cm):</b>	<b>Construction tool:</b>	<b>Avg (Std dev) Voltage</b>
WEAVING	30 x 38	ARM computer loom 8 shafts	4.6 V (1.14)
<b>Materials</b> Warp: Cotton Weft: Top- Plastic film yarn Bottom- Conductive yarn		<b>Method for incorporating electrode</b> The bottom layer has rows of conductive yarn so that it is exposed to the inside of the fabric that is in contact with the top layer.	



<b>SAMPLE 2 (d)</b>			
<b>Textile Technique:</b>	<b>Size (cm):</b>	<b>Construction tool:</b>	<b>Avg (Std dev) Voltage</b>
WEAVING	40 x 30	CC industrial sampling loom 16 shafts	7.7 V (2.79)
<b>Materials</b> Warp: Cotton Weft: Top- Polyester Bottom- Polyester & conductive yarn		<b>Method for incorporating electrode</b> The bottom layer has rows of conductive yarn so that it is exposed to the inside of the fabric that is in contact with the top layer.	

### 3. E-static textiles made using the rug knotting technique



Sample 3(a)			
Textile Technique:	Size (cm):	Construction tool:	Avg (Std dev) Voltage
RYA RUG KNOTTING	16 (diameter)	Hand woven	7.6 V (2.28)
<b>Materials</b> <u>Warp</u> : Conductive yarn <u>Weft</u> : Scraps of polyester fabric and conductive yarn		<b>Method for incorporating electrode</b> Conductive yarn as warp thread, insulated by the polyester fabric. Inserts of conductive yarn are also added as weft between polyester rows to increase contact points.	

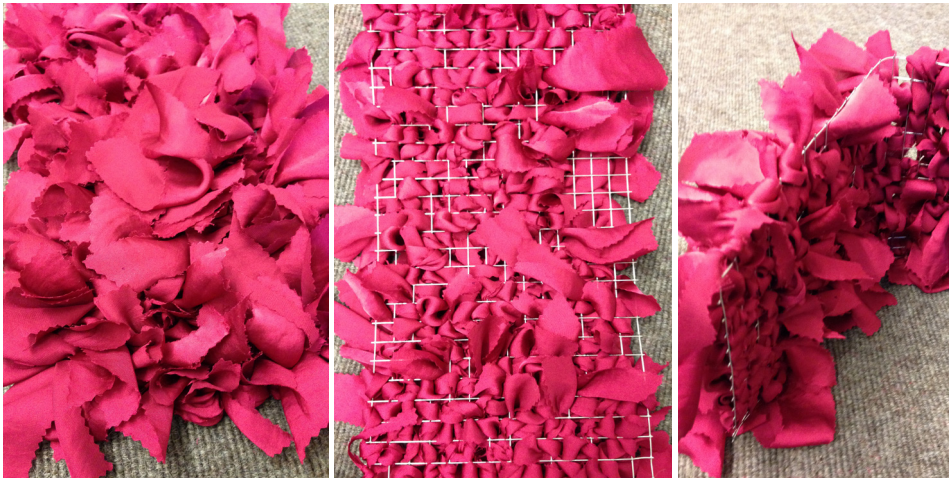

Sample 3(b)			
Textile Technique:	Size (cm):	Construction tool:	Avg (Std dev) Voltage
RYA RUG KNOTTING	18 X 35	Hand knotted	2.1 V (0.37)
<b>Materials</b> <u>Base</u> : Store-bought metal mesh <u>Weft</u> : Scraps of polyester fabric and conductive yarn		<b>Method for incorporating electrode</b> The metal mesh underneath acts as the electrode. The thick layer of knotted polyester fabric keeps the metal insulated. The metal mesh enables a flexible and malleable surface.	

### 3. Tufted e-static textiles



<b>Sample 4(a)</b>			
<b>Textile Technique:</b> TUFTING	<b>Size (cm):</b> 76 X 71	<b>Construction tool:</b> Hand tufted	<b>Avg (Std dev) Voltage</b> not measured
<b>Materials</b> <u>Warp:</u> Conductive yarn <u>Weft:</u> Scraps of polyester fabric and conductive yarn		<b>Method for incorporating electrode</b> Widely spaced rows of conductive yarn is tufted first and cut on the ends. The rows are connected together by sewing a horizontal row of conductive yarn. The plastic yarn is tufted in between with bigger loops insulating the underlying conductive loops.	

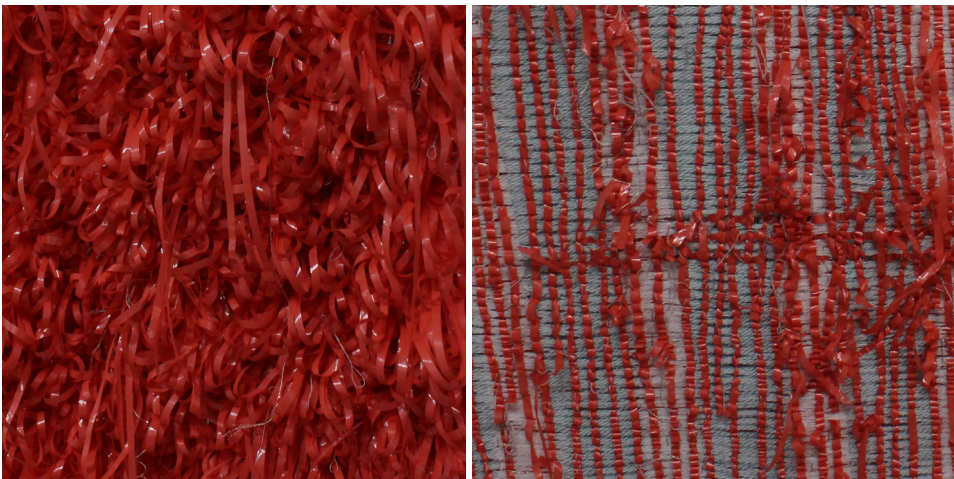

<b>SAMPLE: 4 (b)</b>			
<b>Textile Technique:</b> TUFTING	<b>Size (cm):</b> 32 X 30	<b>Construction tool:</b> Hand tufted	<b>Avg (Std dev) Voltage</b> 18.7 V (1.78)
<b>Materials</b> <u>Base:</u> Polyester and conductive yarn <u>Tufting yarn:</u> Plastic film yarn		<b>Method for incorporating electrode</b> The base fabric is pre-woven with conductive areas. The dense texture of tufted plastic yarn insulates the conductive yarn.	

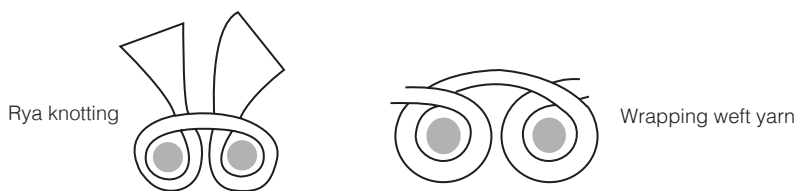

Figure 17. Knotting techniques used in hand woven e-static textiles.

One single layer construction was made using hand-weaving on a frame (Sample 1d). This variation was woven with creative pipe cleaners as weft, which are made from polyester fibres twisted between a couple of metal wires. This found object had a pre-assembled combination of electrostatic material wrapped around a conductive core, and the shape enabled it to be directly woven into a textile-like construction. This sample, due to the metal wires, retained its shape when reformed or bent.

### **Rug knotting**

Taking the weaving technique further, rug knotting techniques such as “Rya knotting” were used to work with electrostatic materials over a conductive warp (samples 3a and 3b). In this knotting technique, weft threads are wrapped around the conductive warp threads using knotting and wrapping techniques (see Figure 17). This way the conductive threads stayed in contact with the electrostatic material while being insulated from human skin.

Sample 3a was made using a circular frame wound with conductive warp threads. The small pieces of polyester fabric were wrapped around the warp threads using the Rya rug knotting technique. In Sample 3b, the underneath conductive warp was substituted with a store-bought metal mesh. Pieces of plastic sheets and polyester fabrics were then used to knot over this conductive mesh. The resulting structure is flexible and also retains its shape when bent. This technique of hand knotting was relatively time consuming, however, it produced a dense textured surface that worked well for contact electrification. Since small pieces of materials were used for knotting, it was possible to reuse the waste or scrap pieces of textiles. This technique thus also enables the reuse of things like plastic bags or packaging when crafting electrostatic surfaces. This configuration of having a stiff electrode with a soft electrostatic surface could be shaped into larger structures forming spatial elements within an interior and even designed to support people’s weight.

### **Tufting**

The tufted samples (4a and 4b) have furry textures made with plastic foil yarns. Two techniques were used to incorporate conductive threads into the tufting process. In Sample 4a, the conductive yarn was first tufted in wide spaced columns with a short loop length. The individual conductive lines were then connected together to form a single electrode area. The plastic foil yarn was then tufted densely between the conductive rows using longer loop lengths (see Figure 18). The dense plastic loops, in this way, stayed in contact with the underlying electrode while insulating the conductive surface at the same time. In sample 4b, the base fabric was first woven using an industrial sampling loom with conductive and polyester yarn. This base is then tufted over with plastic foil yarn.



Figure 18. Sample 4a tufted with smaller conductive loops and filled in between with rows of plastic yarn.

Tufting was found to be a relatively easy way to create large electrostatic surfaces in a time-efficient manner while having a lot of freedom for placing and creating conductive areas within the textile substrate.

#### 4.4 Observations

This study was a material exploration that resulted in several samples of electrostatic textiles that incorporate an electrostatic generator circuit as part of the textile substrate. These samples present a wide range of visual and textural expressions for combining conductive electrostatic materials using existing textile construction tools and techniques to support the accumulation and flow of electrostatic charges during interaction. Below I describe some of the key observations from undertaking the process of making e-static textiles.

##### **Scalable integration**

These textile samples were made from easily found materials and construction techniques which are already part of the textile practice at both handmade (e.g., Sample 3a) and industrial scales (e.g., Sample 2d). The weaving pattern of Sample 2b, made with the computer-aided handloom, was reconstructed using an industrial sampling loom for 2d. This provides a positive indication that the samples made in handlooms can be scaled up, with minor modifications, using industrial machines.

##### **Textile structures influence the amount of electrostatic charge**

From the voltage readings (see Table 3), it can be seen that the Teflon and polyester yarns woven in high density weaves, such as with an industrial loom, were the most electrostatic. Double layer structures worked well as a technique to incorporate electrodes, and the separation between the layers allowed for the two materials to come into close contact during tapping. It was observed that the electrification was easier to spot (lit LED even with slight tapping) in samples which had the weft yarns uniformly exposed to either side of the fabric. This provided a balance between the surface of the yarn being in contact with the body on one side and the electrode on the other side of the textile surface. An introduction of spacer materials (also synthetic) could enhance the effect further.

Table 3. Overview of voltage readings from the electrostatic textile samples.

Sample	Average (Standard Deviation) Voltage
1 (a)	4.6 V (1.14)
1 (b)	6.5 V (0.89)
1 (c)	3.3 V (0.79)
2 (a)	4.5 V (1.59)
2 (b)	3.6 V (0.7)
2 (c)	4.6 V (1.14)
2 (d)	7.7 V (2.79)
3 (a)	7.6 V (2.28)
3 (b)	2.1 V (0.37)
4 (b)	18.7 V (1.78)

The samples with the weft piles and tufted loops (for e.g., 3a, 4a) were also effective as the contact electrification was increased due to the larger surface area while also being more interesting to touch. The long light-weight strands, when electrified, would also move and respond to the hovering hand which made the interactions more engaging and the electrification process more apparent.

#### **LED as an effective way of visualising electrostatic interactions**

Although the voltage values were interesting to observe, the primary focus of this research was not to improve the efficiency of the voltage generation in the textiles but to explore the interactions and experiences of engaging with electricity through textile materials. For this reason, although an oscilloscope or a multimeter were occasionally used to check the voltage generated in interaction, the LED was found to be the most compelling way of communicating the effectiveness of the interaction visually.

An LED circuit, such as the tester clip (see Figure 15), also made it possible to easily test the textile samples during construction, since taking it to an oscilloscope was not always possible mid-production. The tester clip can be held with one hand, and clipped onto the textile surface to quickly check if the electrostatic charges generated are enough to light the LED. This tool could also be used to connect to existing textile surfaces in one's environment to explore and identify materials or objects that have a tendency to get electrostatically charged. Appendix A.2 has further details on the clip and a video demonstration of the clip is included in Appendix D.

#### **Interactions supported by electrostatic textiles**

The interactions or movements supported by the textile samples were largely limited to tapping and rubbing. Other interactions, such as flapping the textiles with considerable force, also sometimes worked in lighting the connected LED.

#### **Limitations of the study**

Although the textile samples illustrate a potential for further development, they constitute an initial set of explorations. The patterns and weave-structures used for construction



were mostly chosen from available programs in the studio. This study was thus mainly a technical exploration that trained textile designers could take forward to develop and design textile expressions specifically for electrostatic textiles.

Furthermore, the textile samples were tested to get a broad idea of the voltages produced. These results were used to illustrate the potential for further research. Improving material configurations and constructions to make the electrostatic charge generation more efficient was not the goal of this study. Moreover, environmental conditions, such as humidity and temperature, were not taken into account while measuring the voltages of the samples.

#### **4.5 Discussion: Pro-static e-textile design**

Static electricity in textiles is not a new area of research, however, until recently, it focused mainly on minimising the effects of static electricity rather than using it. There are several anti-static measures, such as antistatic coatings and sprays that diminish the effects of static electricity in textiles. One common way of making textiles antistatic is by adding conductive fibres into the textile substrate that disperse the electrostatic charges to the ground rather than letting them accumulate and lead to an electrical shock. For example, interior textiles or clothing can be induced with metal fibres that allow the electrostatic charges to flow into the ground and away from a person's body.

Alternatively, this study explored the idea of incorporating conductive elements into the textile substrate, not to disperse the charge, but to collect and guide it through an integrated circuit. The examples presented in this study can be said to take a 'pro-static' approach that sought to enhance or support the electrostatic behaviour of the materials and enable a flow of charge through the body while maintaining the safety of the person(s) involved.

The pro-static approach in e-textiles opens a design space for applying textile design knowledge to enable electrostatic interactions using existing manufacturing techniques. Further research in this specific area may result in aesthetic and functional innovations in the domain of interior textiles to support electrostatic charges through basic repeated interactions (e.g., tapping, walking over). Furthermore, electrostatic textiles would be well-suited for dry indoor climates where electrostatic charges are optimal. With further improvements in technology, these textiles could be applied in the everyday for harvesting triboelectric charges while introducing rich textures that need to be touched and interacted with for electricity generation.

However, the interactions in the small sized samples developed in the study were limited to tapping or rubbing, which do not fully explore the potential of textile transformations that can be supported by e-textiles. The scope of interactions supported by electrostatic textiles could be further extended by either scaling up the textile surface or by scaling up the structure of the constructions. This is the direction taken in Study 02.



## 5 Study 02: Embodied Speculation, how may electrostatic textiles shape e-textile interactions?

### 5.1 Introduction

The previous study aimed to translate the triboelectric circuit into textile substrates to explore different ways of making electrostatic textiles. However, these textile samples supported a narrow range of interactions including tapping and rubbing. Textiles are versatile materials that we manipulate in different ways in the everyday, such as folding, wrapping, turning-inside-out, etc. Furthermore, the interior provided a rich context for experimenting with large scale materials and movements for engaging with static electricity.

In order to broaden and scale-up the interactions for electrostatic engagement, the key objectives of Study 02 were to investigate *acting with* electrostatic textiles and to develop examples of large-scale interactions that highlight textile qualities in interaction and support the flow of electrostatic charges through the circuit.

### 5.2 Outline

This investigation adopted the approach of embodied ideation where experiences of actively engaging in building, interacting and observing the prototypes were used for discussing and further opening up the topic of electrostatic energy harvesting from an interaction design perspective.

In this study, the triboelectric circuit was scaled up to investigate *acting with* electrostatic textiles and setups through different kinds of interactions and body movements enabled



Figure 19. Scaling up the triboelectric circuit and trying out different textile materials and interactions. (Left) Small piece of Teflon baking sheet over conductive fabric swatch. (Centre) Aluminium foil is used to make two conductive tiles connected to a diode bridge and multimeter. (Right) A piece of foil blanket on the floor provides a large conductive floor to explore the electrification process through playful interactions.

by them. The triboelectric circuit was interpreted as a material system that can be distributed around the space or introduced around existing electrostatic objects.

There were two sets of explorations, the first focused on scaling up the electrostatic circuit to enable interacting with different parts of the body, and the second introduced material interventions around existing conductive objects or synthetic materials as a means to create new electrostatic setups in the everyday. The different triboelectric setups made during the explorations were connected to an LED circuit or a multimeter for visualising the electrostatic charges generated during interaction. Each of the two explorations led to the development of a test setup, which are introduced as examples in section 5.3. The explorations and examples described in this study were undertaken by me. Experiencing the setups first hand was useful in gaining an embodied understanding of engaging with static electricity. The key observations from making and interacting with the electrostatic setups in relation to the design program are presented in section 5.4, followed by a discussion in section 5.5 regarding an interaction design strategy for electrostatic engagement.

### 5.2.1 Scaling up the triboelectric circuit for supporting textile interactions

Figure 19 illustrates a simple triboelectric generator circuit from three scales of interaction. Each have two conductive elements as electrodes, one of which is insulated with a material that has a high tendency towards becoming negatively charged when in contact with human skin (e.g., materials that lie lower in the triboelectric series). These kinds of materials are referred to as “electrostatic material” in this thesis. The two electrodes are connected to a rectifier circuit and an output, e.g., an LED. When a person rubs against the electrostatic material while in contact with the open electrode, the electrostatic charges,

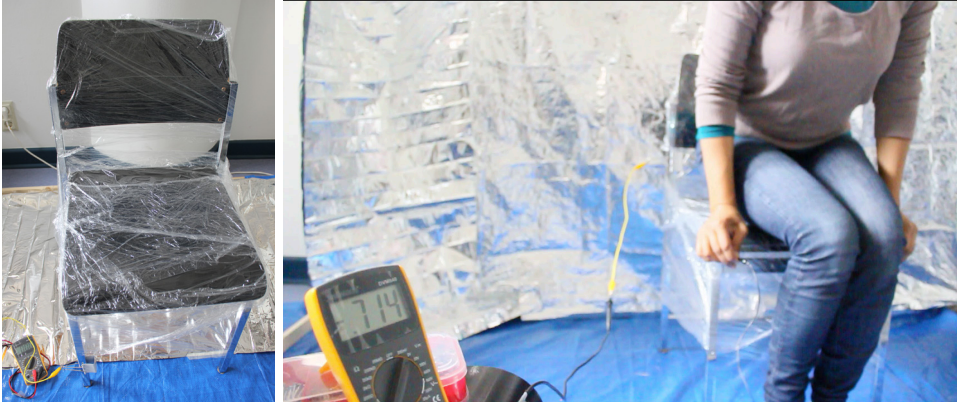

Figure 20. Example of electrostatic material intervention: wrapping chair with cling film.



Figure 21. Example of electrostatic material intervention: home slippers that collect the electrostatic charges generated through walking.

generated through the interaction, move through the body to the circuit enabling the flow of electricity and lighting up the LED in short bursts.

The method of introducing interaction transfers from the practice of e-textiles is employed here to support textile-related interactions and materials qualities to activate the triboelectric circuit. In the three images in Figure 19, the triboelectric circuit is scaled-up by increasing the size of the electrodes, thus giving more room for different kinds of interactions and materials to be introduced. In Figure 19-left, the triboelectric circuit consists of small swatches of materials that need to be tapped or hit with some force to activate. In Figure 19-centre, the electrodes were made from large pieces of aluminium foil that enabled me to step on the circuit while interacting with the electrostatic fabric with my hands and arms. Using this setup, I could also place the textile on top of the electrodes and step on and wipe the fabric with my feet. In the setup illustrated in Figure 19-right, the electrodes are scaled up even further and occupy a large part of the floor. Here, I could drag the fabric around with my feet as well as run and slide on it and over the electrode.

In the small-scale prototype, the interactions were limited to tapping and rubbing with the hand. The scaled-up setups enabled interactions that engaged other parts of the body for collecting electrostatic charges, such as combinations of feet, legs, and arms, to create movements in the electrostatic materials; for example, by waving or wiping the textiles while standing on the electrodes.

The electrodes in the explorations were constructed with aluminium foil taped to different surfaces. Different found materials, such as polyester fabrics, plastic sheets and other everyday objects, for instance, balloons or filling materials, were introduced into the circuit along with the different movements of the body, for example, shrugging, waving or wrapping the electrostatic materials around the body and electrodes. The objective here was not to collect exact measurements of voltages but to broadly rate interactions with respect to the presence of a significant amount of electrostatic charges, i.e., at least enough to make an LED light up.

### 5.2.2 Electrostatic material interventions

This investigation built on the method of layered interactions from the field of e-textiles. Here, our everyday interactions with objects were seen as an entry point to add an additional digital meaning. Thus, instead of constructing the electrostatic circuit from scratch, everyday objects with material properties that fit the triboelectric circuit were taken as a starting point for adding layered interactions. For example, Figure 20 shows an experiment where a chair with metal (conductive) legs was wrapped in cling film as a way of introducing electrostatic materials over conductive objects. Sitting or moving on the chair while connected to the circuit then produced small amounts of electrostatic charges. In another experiment (see Figure 21), a polyester home slipper is attached with extra electrostatic material and conductive fabric to increase its surface area and collect electrostatic charges generated through walking.

## 5.3 Examples

The projects described below represent the explorations of scaling up and of material interventions. The first example, electrostatic cube installation, presents different interactions and experiences enabled by scaling up the electrostatic circuit to an immersive interior space. The second example, electrostatic sleeping, follows the method of layering interactions to re-interpret an existing textile object and activity—that of sleeping in a sleeping bag—as an instance of everyday electrostatic engagement.

### 5.3.1 Electrostatic cube installation

This installation scaled up a DIY triboelectric generator circuit to make it a spatially immersive experience. The circuit mainly consisted of two electrodes that acted as different interior elements, such as a ceiling or a wall of an enclosed space, while soft synthetic materials and a person (me) played the role of collecting and directing electrostatic charges. The goal behind this exploration was to get an embodied understanding of immersing oneself as part of the triboelectric circuit. Engaging with an interior-scaled triboelectric circuit introduced a change in the perspective with which one interacts with textile materials to produce static electricity. The scaling up of movements and surfaces also supported the electrification process and made it more easily observable.

The installation consisted of a wooden frame constructed in the form of a cube of 2.5m long edges. This frame acted as a stage for spatially distributing the triboelectric circuit components in different ways. Easily available large materials, such as painters' plastic sheets and emergency blankets with one conductive side, were used to scale-up the

circuit. Figure 22 shows a sketch of the basic setup.

A total of 10 variations explored different material placements and human movements for energising the circuit (see Figure 23). For each setup, I performed a set of exploratory

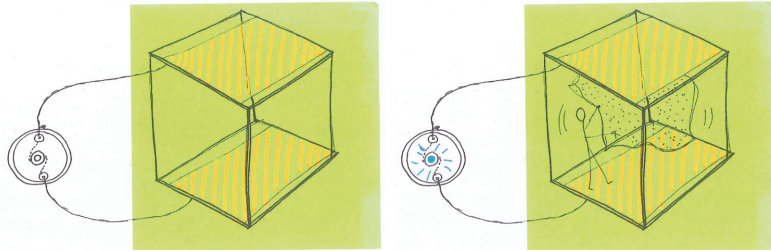

Figure 22. Sketch of the electrostatic cube setup. (Left) An LED is connected via a rectifier bridge to the electrodes in the cube. (Right) The LED lights up using the static electricity generated by the person and material moving inside the space.

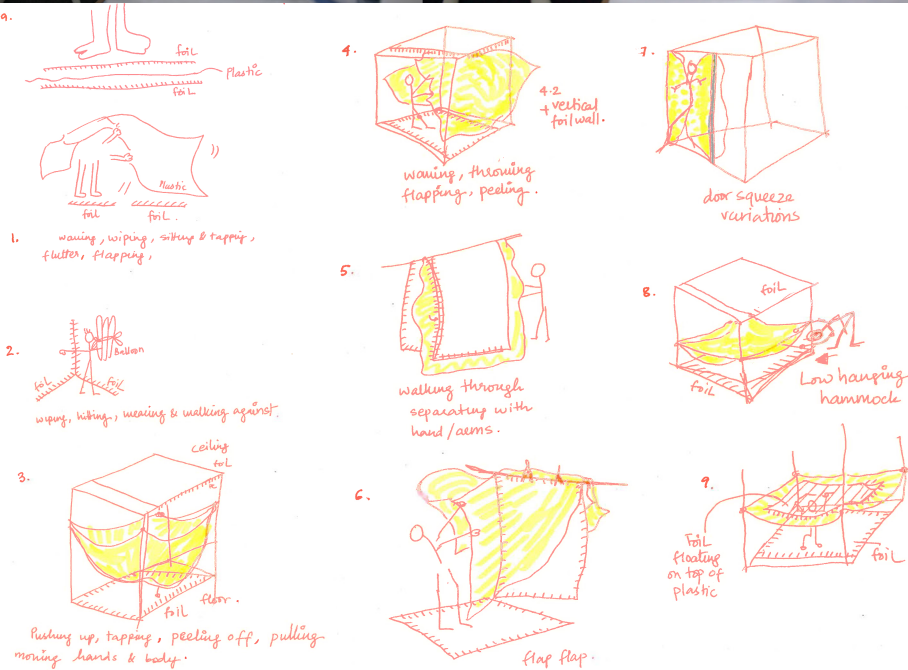
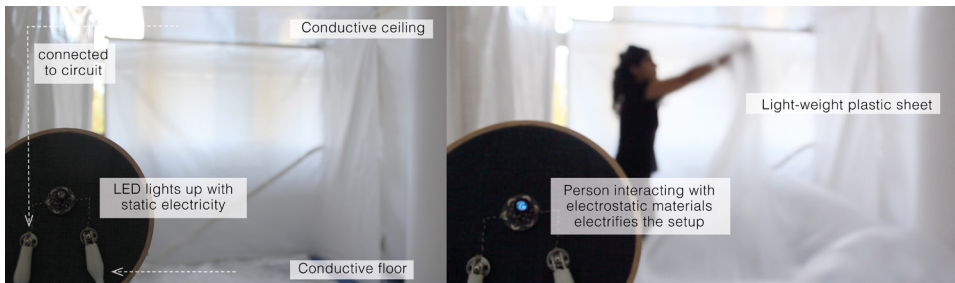

Figure 23. Different configurations of conductive and electrostatic elements in the electrostatic cube installation.

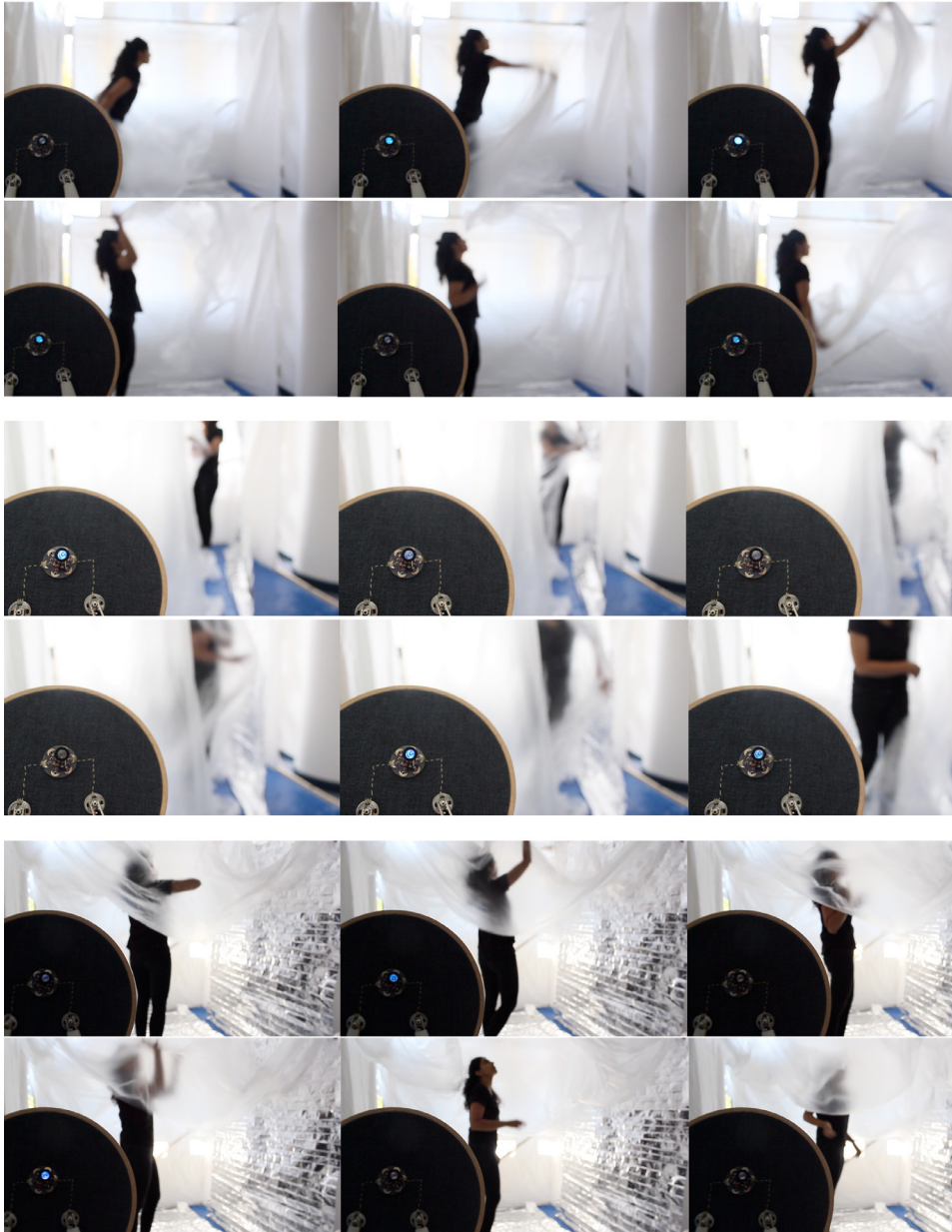

Figure 24. Sequence frames from the video recordings of interactions. (Top) Conductive ceiling and floor. (Middle) hanging electrodes and electrostatic materials. (Bottom) Conductive floor and ceiling with suspended electrostatic material that can be pushed up and peeled away from the ceiling.

movements to make the electrostatic material (plastic sheet) touch and separate from the electrodes (emergency blanket).<sup>311</sup> In Study 01, the electrostatic circuit in the form of textile samples represented objects and surfaces that were being interacted with from the

311. The videos of the different setups and interactions in the electrostatic cube are included in Appendix D.



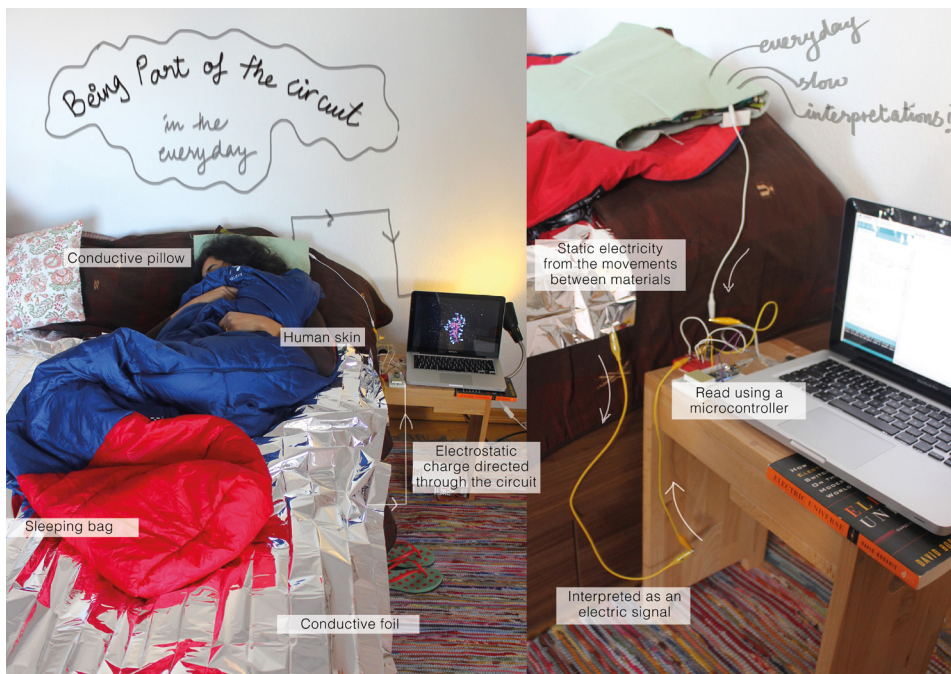

Figure 25. Electrostatic sleeping setup.

outside. In contrast, the electrostatic cube setups in Study 02 acted as an interior stage which enabled me to step into an electrostatically-rich environment to actively engage with my whole body and energise the space from the inside. Figure 24 illustrates examples of three interior setups that were activated through different interactions. The first set of images (Figure 24-top), illustrate a setup with a conductive floor and ceiling that act as two electrodes of the triboelectric circuit. By moving and waving around a large sheet of plastic, I became a material within the circuit who carried the flow of charge from one electrode to the other. In another setup (Figure 24-middle), the plastic and conductive materials hung down in the form of layered curtains. By walking through these materials, and pushing away and touching the separated materials I actively enabled the flow of charge through the spatial circuit. Similarly, in the third set of images (Figure 24- bottom), the interactions for energising the space involved pushing a loosely hanging electrostatic material towards the conductive ceiling while standing on a conductive floor. The performances for each setup were recorded as two-minutes long videos.<sup>312</sup> An LED connected to the circuit in the foreground of the video illustrated the electrification process. The LED lit up or flickered gently according to my performance in the spatial circuit (see Figure 24).

### 5.3.2 Electrostatic sleeping

While the electrostatic cube was a constructed space that enabled immersive electrostatic interactions, sleeping was recognised as an already existing immersive textile experience

312. Videos of all the electrostatic cube setups and interactions are included in Appendix D.

in the everyday. Building on the exploration of electrostatic textile interventions (section 5.2.2), a sleeping bag made from a thin polyester material was used to create an electrostatic setup in a familiar situation.

I constructed a triboelectric circuit with a sleeping bag on the bed for three nights in total. The polyester fabric of the sleeping bag became electrified with the movements of the body and contact with the skin. The sleeping bag was placed on a conductive foil on the bed which acted as an electrode in the circuit (see Figure 25). When sleeping in the sleeping bag, I became part of the circuit becoming integral to the flow of electric charge. There were two attempts made to observe the electrification during the night. In the first attempt, the voltages were directly measured using an Arduino and stored in a spreadsheet along with the time stamp. This system of measuring actual voltages was not robust and often crashed. In the second attempt, the changes in voltage were mapped to an analogue sensor connected to an Arduino. This was still found to be unreliable but worked sufficiently to broadly detect the changes in voltage caused by the electrification process rather than record exact voltage values.

## **5.4 Observations**

### **Everyday electrostatic materials**

Using the triboelectric series as reference, several everyday soft and synthetic materials were tried out with the scaled-up circuit. Examples of electrostatic materials that were found to be effective are illustrated in Figure 26.

### **Scale dependent interactions**

The interactions described in previous research, such as rubbing and tapping, were found to be less effective at a larger scale. At this scale, other interactions that supported contact and separation of materials in quick successions, such as waving large materials over the electrodes, sweeping, sliding or throwing, were more effective for supporting the flow of electrostatic charge. The extent of the surface area of materials in contact and the distance by which they were separated were directly proportional to the extent of the electrification process.

### **Immersive circuit experience**

Scaling up the circuit created a different relationship with respect to the body. Instead of being outside controlling or interacting with small parts with my hands, there was a possibility to interact with the whole body. The electrodes were placed on different sides of the constructed cube to guide the choreography and move the electrostatic material in the space. This created an experience of a performance within the circuit, foregrounding the movements of my body and the conductivity of the skin as essential components of the circuit.

### **Human movements forming or revealing electric potential**

Extending the previous observation, by immersing myself in the electrostatic cube and interacting with the kinetic and electrical potential of my body, I engaged in a collaborative performance with the space. This constructed interior space could be interpreted as having been designed with the potential for electrostatic engagement that was realised



Figure 26. Examples of everyday electrostatic materials and objects.

when a person (me) entered it, thereby transforming an otherwise dormant space into an electrically-active object.

### **Encountering material properties**

The plastic sheet and emergency blanket were chosen for their size, electrostatic and conductive properties. However, the interactions with the materials in the immersive setup revealed other properties such as sounds, textures, translucency or reflectivity that influenced the overall experience of the space. The light weight of the charged plastic sheet would get stuck to the conductive ceiling, which would need to be peeled off in a quick action. When the large sheet was thrown upwards, it would catch air, diffuse the light and slowly float back to the ground. Playing with these different qualities gave a rich experience of interacting with the electrostatic cube (see Figure 27).

### **Results hidden from interaction**

The LED, which illustrated the electrostatic charges generated in interaction, was facing the camera in the setup. I could not see the results of my movements in the cube during the interaction. Similarly, during the electrostatic sleeping, the feedback from the static electricity generation took place when I was asleep. Watching the recorded video after each session of the electrostatic cube interactions, I observed some movements that were especially effective and those that did not work at all. Inside the cube, while I had in mind the pointers from the previous observations, not getting immediate feedback led me to pay more attention to the materials at hand rather than be influenced by the feedback.



Figure 27. Details showing aesthetic qualities of interacting with a soft electrostatic material in the interior setup.

### **Being materially similar to other components**

The experience of inserting my body in a cocoon shaped sleeping bag connected to the circuit felt like being fitted in as a component. The electrical property of the human skin was being utilised here to activate the circuit and, like in the case of the electrostatic cube, there was no immediate feedback for the electrification process. This hinted towards a different kind of everyday relationship with technology that could be thought of as needing humans for their material properties rather than the other way around. Further research in this direction can give more insights into the desirable and undesirable qualities perceived by people for taking up such a role.

### **Limitations of the study**

Although Study 02 learnt from the textile constructions and interactions observed in the previous study, it mainly used readily available textiles and textile-like materials for the experiments. This was due to the need for larger materials, and not having large-sized samples of the constructed e-static fabrics. This limitation led to relying on materials or other found objects that met the requirements needed for constructing an electrostatic circuit. This constraint, however, in turn enabled an opportunity to engage more actively with the interior environment in this study.

In the process of conducting experiments with static electricity in this research, I gained an in-depth, hands-on knowledge of working and interacting with static electricity safely. However, there may be varied perceptions and attitudes towards engaging with static electricity close to the body in the context of energy harvesting. The purpose of this study was to gain theoretical insights on shaping an interaction design study. However, the desirability of engaging with electricity needs to be addressed in further detail with users, if one is designing services or applications based on these findings.

### **5.5 Discussion: Designing e-static choreographies**

The idea of “making electrical contacts” is an existing approach in e-textile design for thinking and developing different kinds of textile sensors and switches.<sup>313</sup> As an example, a soft switch can be made by layering two conductive textiles sandwiched with a spacer fabric, so that when the two sides are pressed the conductive textiles would momentarily make contact. When not pressed, the spacer fabric keeps the two conductive parts apart. This soft switch translates the mechanism of a normal switch as closing or opening a circuit. Taking this approach, an electrical circuit is distributed around a textile form so that a person, when manipulating certain parts of the textile, brings conductive parts together and apart (closing or opening a circuit). This has created a design space for exploring different textile interactions, or our everyday handling of textiles, as a resource for designing different kinds of soft sensors and switches.<sup>314</sup> For example, a knotting switch that when tied together connects two conductive parts to one another and enables the flow of electrical current through the circuit.

In the scaled-up electrostatic setups investigated in Study 02, the distribution of conductive and electrostatic parts of the circuit is extended beyond the textile surface itself. If an entire interior space is seen as a circuit with several opportunities to make connections for closing or opening the circuit, the electrostatic materials along with the person become crucial for how and where these connections are made.

E-textiles, in this case, could be seen as a distributed material system and e-textile interaction design could be described as a way to integrate the material properties through action. Additionally, in the case of electrostatic textile setups, e-textile interaction is

---

313. Also illustrated and explained in previous work: Gowrishankar, Bredies, and Ylirisku, “A Strategy for Material-Specific e-Textile Interaction Design.”

314. Several examples from the Kobakant repository of soft sensors and switches could be categorised as using this approach—Perner-Wilson and Satomi, “How To Get What You Want.”

not limited to making or breaking an electrical contact but also produces the electrical impulse that activates the circuit. The scaled-up electrostatic setups illustrate a proof of concept for approaching e-textile interaction design from the perspective of the moving body within a larger material system. This conceptual shift proposes an alternative approach to e-textile design that instead of focusing on the integration of textile and electronic elements within the same artefact, looks at e-textiles as a distributed system of material properties that may be integrated through human action.

Existing descriptions of e-textiles, such as computation that happens close to the body<sup>315</sup> or a computational composite<sup>316</sup> that can be shaped in the design process, have given a conceptual frame to the design and development of e-textile products and services. The description of e-textiles as a distributed material system in the interior, puts emphasis on the choreography and the role of the body acting between these materials. Building on the examples of this research study, I highlight some aspects of electrostatic interactions below that might become relevant for materiality oriented e-textile interaction design.

#### **Using the environment more actively**

In both examples of the electrostatic cube and the sleeping bag, the conductive and electrostatic properties of available materials and objects are used to engage with the energy harvesting circuit. Following this idea, e-textiles could use the material properties of existing objects in different contexts as resources for shaping e-textile setups and applications. The interaction design process would then focus on how a person may interpret, improvise and collaborate with their immediate surroundings to realise the “electrostatic-potential” of the e-textile setup.

#### **Space for improvisation and creativity**

Embedding the potential for interaction, rather than rules for interfacing, may allow for multiple interpretations by the people engaging with the system. Within each setup of the cube, there were different ways of moving and acting in the space to light the LED.<sup>317</sup> Similarly, the sleeping bag example may be extended to re-interpret other everyday objects and activities for building one’s own systems for electrostatic engagement. Considering e-textiles as setups rather than pre-manufactured artefacts could provide a design space for creative interpretations and improvisation as the person finds their own expression and way for linking the material parts through actions.

#### **Emphasis on movement and scales of interaction**

The electrostatic cube and the sleeping bag, both illustrated intentional interactions with e-textile systems, but called for different levels of activity. The distribution of material qualities around the space enabled whole-body interactions. Textiles can encourage different scales of interaction, such as a delicate tying of a small bow to a large throw of a bedspread. While a distribution of materials over a large space may call for whole-body

---

315. Berzowska, “Electronic Textiles: Wearable Computers, Reactive Fashion, and Soft Computation.”

316. Vallgård and Redström, “Computational Composites.”

317. Please see Appendix D for an overview of different interaction setups explored in the electrostatic cube.

engagement, the interaction design for a system distributed over a small area, such as a piece of clothing, could also be approached from a material-setup perspective.

#### 5.5.1 Strategies for supporting electrostatic engagement through interactions

Building on the theoretical, scientific explanation of static electricity along with the hands-on explorations of scaling up the triboelectric circuit helped to identify ideal conditions for maximising the electrostatic effect through interactions. For example, the best forms of material interactions for static electricity generation are those that involve maximum surface contact and interactions that enable repeated separation and contact between the different materials and the electrodes of the triboelectric circuit. From the textile constructions, certain surface textures, such as furry surfaces and soft large materials (e.g., plastic sheets and tightly-woven synthetic textiles), were identified as ideal for static electricity.

These hands-on insights from working with static electricity and textiles are presented below as a set of interaction design strategies for acting with e-static textiles to: firstly, increase and support the generation of electrostatic forces and secondly, to link body actions to everyday situations through interactions with materials.

The interaction design guidelines identified for working with static electricity were as follows:

- **Increase your surface area:** Static electricity is a surface phenomenon. The areas of the surfaces that rub against one another are directly proportional to the amount of the resulting electrification. The interior space has many surfaces that we barely come in contact with or are limited by our own surface area. By extending the surface area of electrostatic interactions, we can maximise the contact between different surfaces or introduce new interactions with existing surfaces.
- **Enable contact with more surfaces while moving:** The probability of electrification increases when the body comes in contact with more materials. Thus, in the design process, choose places or activities which involve coming in contact with soft surfaces or create situations or interventions that put materials in people's paths.
- **Prefer large and dynamic movements:** Moving in the most dynamic way between materials in relation to the electrodes increases electrostatic charge collection. Thus, scaled-up interactions that use the whole body to engage with large, soft electrostatic materials are ideal for electrostatic interactions.
- **Prefer synthetic and furry materials:** Soft surfaces made from synthetic materials are apt to becoming charged in relation to the human body. Furry materials have more surface area and thus support maximum electrification. In the design process, favour surfaces or introduce new surfaces made from synthetic soft and furry surfaces.





## **6 Study 03: Interaction fiction: How may e-static interactions shape everyday behaviours?**

### **6.1 Introduction**

This study aimed at investigating how engaging with electrostatic textiles may influence how we *relate to* notions of energy in the everyday. It builds on the insights and examples created in Study 01 and Study 02 to develop narratives that explore interactions and attitudes towards static electricity that may emerge if e-static textiles were adopted into the everyday.

### **6.2 Outline**

This study applied the interaction strategy discussed in the previous study (see Section 5.5.1) to envision everyday situations and interactions with electrostatic energy. This was done by following two lines of inquiry: The first developed examples of interactions and uses for electrostatic textiles. The second attempted to categorise and construct scenarios with the qualities of the interactions illustrated in the examples.

To collect examples of interaction instances, two sets of explorations were conducted. The first explored the strategies for e-static interaction design introduced in the previous chapter to enact different interactions with various fictional electrostatic surfaces in the interior. The second extended the exploration through sketching by working with the interaction design methods for *relating to* e-textiles (see Figure 14 on page 86), which included building on existing use cases and building on material behaviours.



Figure 28. Screen shots from a video collage of electrostatic activities (anti-clockwise from top-right) Rubbing feet on carpet while sitting, rubbing feet on an electrostatic setup while working on a standing table, walking through an electrostatic curtain, sliding on the conductive floor over a textile, wiping the walls.

The second line of inquiry included categorisation of the examples according to the scale of interaction and the amount of effort required to engage with the electrostatic textiles. These groupings paved the way for further envisioning scenarios and narratives for engaging with static electricity through textiles. Each of the above explorations and methods are outlined in further detail in the following subsections.

### 6.2.1 Enacting electrostatic surfaces

The e-textile samples made in the first study and the interaction design strategy (increasing one's surface area, enabling contact with more surfaces and preferring large movements) were taken as a starting point to envision interactions that may emerge from applying electrostatic surfaces into the everyday space. I recorded short enactments of different electrostatic actions with a video camera. The props for these video clips were made using prototypes constructed in previous explorations or from found materials (e.g.,

polyester fabric, PTFE tape, etc.) and objects (e.g., rug, electrostatic white board sheets) that have a tendency to get charged when in contact with the body.

The triboelectric circuit was interpreted as integrated into everyday spaces, and the videos showed different explorations of e-textile interventions. Some frames from the videos are illustrated in Figure 28,<sup>318</sup> for example, rubbing my feet on an electrostatic carpet while using my phone (see Figure 28, top-right) or having a ‘feet-rubbing’ electrostatic setup under a standing table (see Figure 28, top-left) that may nudge one to keep their feet moving and rubbing while standing on an electrode and, therefore, stay constantly engaged with electrostatic charges while working. This would not only keep us from staying still for a long time while on the computer but may also open up different kinds of e-textile interactions. PTFE tape curtains installed in doorways could enable contact with electrostatic materials every time we walk through interior spaces (see Figure 28, bottom-left). The slow movements of the electrostatically charged thin strips of the curtain also add an additional aesthetical quality to the space. Conductive areas on the floor of the interior may introduce playful ways of walking through the interior, such as running and sliding on an electrostatic surface over the conductive parts (see Figure 28, bottom-right). Electrostatic surfaces on the wall (see Figure 28, centre-right) may encourage new behaviours, such as rubbing and wiping it on an everyday basis, to collect electrostatic charges.

Enacting possible situations inspired by the interactions to activate triboelectric circuits helped to relate the material interactions from the previous studies to concrete situations, everyday objects and actions in interior spaces. By enacting the interactions, I could get a sense of the experience of having our interiors surrounded by these kinds of energy harvesting installations and what it may feel like to actively engage with static electricity on an everyday basis.

### 6.2.2 Sketching interaction instances

Following the same approach as with the video enactments, further ideas for interactions in the interior space were envisioned through sketching. The sketches used three starting points for exploring different electrostatic interactions. The first introduced electrostatic textiles or objects as spatial elements that would support triboelectric circuit interactions. The second used everyday objects prone to electrification, such as carpets or winter jackets, as a starting point to contextualise the interaction instances (method- building on existing use contexts). Finally, the third approach looked for activities which involve the handling of large textiles, such as wiping or spreading a tablecloth, to introduce an electrostatic interpretation (method- building on material behaviours).

Some of the sketches for each of the starting points are illustrated in Figures 29, 30 and 31.<sup>319</sup> Figure 29 illustrates examples of three sketches with a starting point of introducing spatial interventions. The first sketch (see Figure 29-left) illustrates a doorway fitted with large soft e-static pillows that leave people no other choice than to squeeze through

---

318. The video of electrostatic enactments is included in Appendix D.

319. Further examples of electrostatic sketches are included in Appendix D.

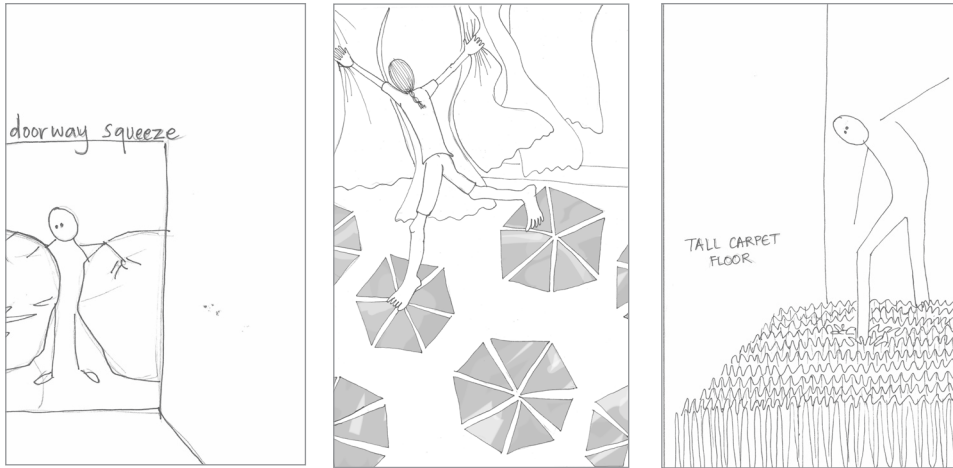

Figure 29. Examples of sketches of e-static interactions. Starting point: electrostatic set-ups as spatial interventions. (Left) Electrostatic door squeeze. (Centre) Conductive floor tiles. (Right) Tall floor carpet.

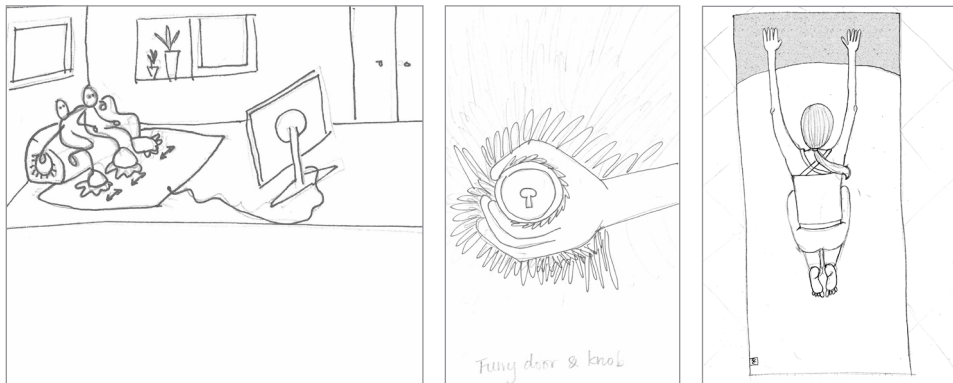

Figure 30. Examples of sketches of e-static interactions. Starting point: to use existing everyday objects prone to electrification. (Left) People rubbing their feet while watching TV. (Centre) Furry door knobs. (Right) Electrostatic yoga.

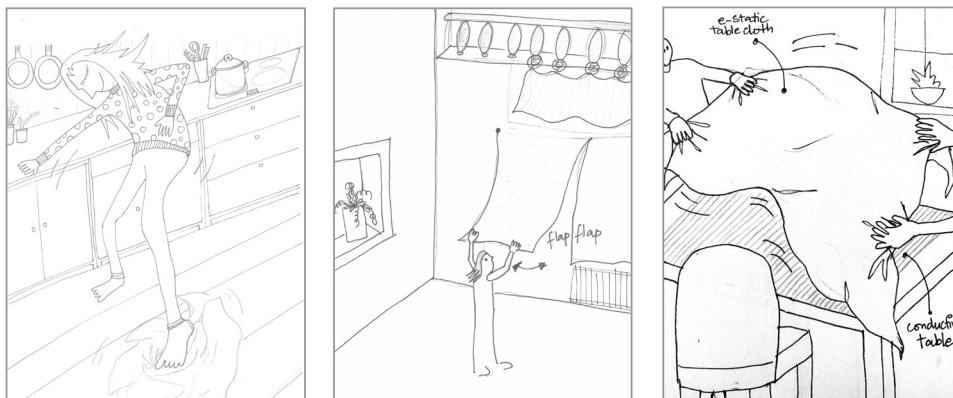

Figure 31. Examples of sketches of e-static interactions. Starting point: activities which involve moving with textiles. (Left) Wiping the kitchen floor with fabric. (Centre) Flapping a curtain. (Right) Tablecloth over conductive table.

them. The second sketch (see Figure 29-centre) envisions conductive patterns or tiles on the floor of a corridor in combination with hanging electrostatic materials. The people passing by would have the choice and possibility to move differently through the space to engage with these materials for energy harvesting. The third sketch (see Figure 29-right) illustrates an example of new versions of textile objects that may appear in the interior, such as a tall furry carpet. People may enjoy the soft textures while also engaging with static electricity as they walk through an interior space.

Figure 30 illustrates examples of the second approach of using existing objects that are prone to electrification as a starting point for envisioning electrostatic setups in the everyday. The first sketch (see Figure 30-left) envisions a scenario where a family powers the television by constantly rubbing their feet on a polyester rug. The second sketch (see Figure 30-centre) introduces an e-static material over a door knob, an object commonly associated with getting electrical shocks, to safely collect electrostatic charges. The third sketch (see Figure 30-right) interprets a yoga mat as an object which could collect electrostatic charges as the person on it moves and touches the mat during her exercise.

Figure 31 illustrates sketches that look at existing textile interactions in the everyday as a starting point for introducing triboelectric systems. Figure 31-left envisions wiping a conductive floor with a piece of cloth as an electrostatic interaction. Figure 31-centre imagines large electrostatic curtains hanging against conductive walls that would need to be shaken and waved periodically for generating static electricity. Figure 31-right reinterprets spreading a large electrostatic table cloth over a table as a way of generating electrostatic charges.

The sketching process, structured partially through these take-off points, otherwise took the form of an open exploration. The aim was to generate a large volume of interaction instances which then could be used for further analysis. Thus, an attempt was also made to think of different examples of different scales of interactions and sizes. Working with textiles was useful in opening up the explorations to different situations and sizes of objects, and the research study specifically took advantage of this aspect.

### 6.2.3 Initial observations and categorisation of electrostatic interactions

Everyday objects, interior spaces and situations that are already familiar to us in relation to static electricity formed a rich starting point for imagining different instances of deliberate engagement with static electricity. In most cases, the sketches illustrated moments or situations while leaving the motivation or applications for such interactions open for further interpretation. The different sketches were then organised according to the different qualities of interactions they illustrated to explore the emerging narratives behind those instances. For example, the sketches were organised according to the scale of interaction, the level of unfamiliarity of action, the level of unfamiliarity of object or situation, and according to the effort and skill that might be needed to perform the actions. These different categories grouped the electrostatic instances according to the qualities of the interaction rather than a use context.

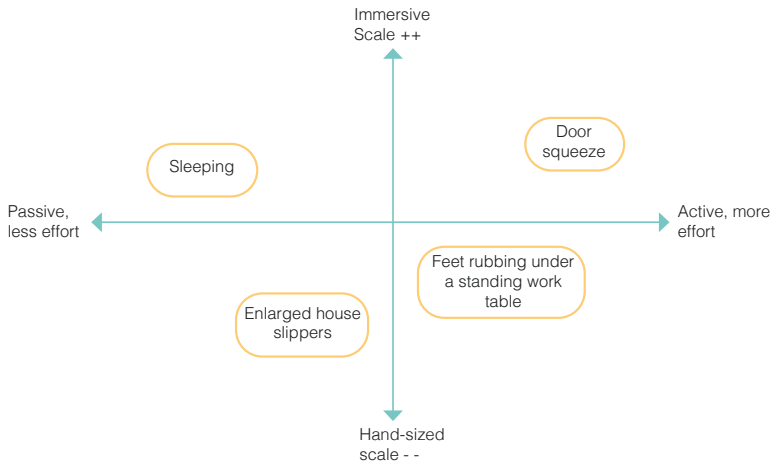

Figure 32. Mapping e-static sketches according to effort and scale

The interaction qualities of effort and scale were found to be most interesting for envisioning scenarios that the illustrations may have been a part of (see Figure 32). While some actions that required more effort and skill may be undesirable in some situations (for e.g., during an emergency), it may be attractive in others (e.g., as a sport). I realised that the idea of effort is also related to the familiarity of the action. Although, due to the context of static electricity, all the interactions have an element of unfamiliarity, there were some interactions that were more unusual than the others. For example, continuously rubbing your feet on the carpet while watching TV or working is a strange activity but as an interaction (feet rubbing on carpet), it is not an unfamiliar one. On the other hand, squeezing through a soft electrostatic doorway could be considered as requiring more effort while also being an unfamiliar textile interaction in the everyday context.

On the vertical axis, the scale of the interactions was also found to be relevant in developing narratives around the interactions. Some sketches showed interactions with an object, for example electrostatic home slippers that collect charges while walking. Other sketches illustrated more spatial, larger scale or immersive environments in which the person is engaging with an electrostatic setup, for example in the case of electrostatic sleeping. While objects might point towards mobile, personal electrostatic experiences, the spatial examples may include collective and situated electrostatic experiences.

Following the above insights, the sketches were mapped on the range of effort needed on one axis and scale of interaction on the other. This provided a base for motivations and contexts of use to emerge from the categorisations and helped to shape the electrostatic interaction fictions. Figure 33 illustrates an example of how the different sketches were grouped according to the level of engagement and motivation for interacting with static electricity. The sketches along with notes about the motivations and the activities they might point to helped to make connections and identify similar and dissimilar characteristics between different groupings. In the figure, three main attitudes or approaches for engaging with static electricity were identified. The first looked at electrostatic



engagement as a by-product of existing activities, such as in the case of the electrostatic yoga sketch (Figure 30-right). Here, the electrostatic circuit is introduced as an additional layer on existing objects and activities and might be considered as requiring minimal or no extra effort. Building on ideas such as feet rubbing under the standing table (Figure 28, top-left), the second group envisioned electrostatic engagement as a social etiquette that may be expected from the future citizens of technological societies. Here, certain activities, even though requiring a bit more effort, can be seen as motivated by other concerns such as health or a sense of social responsibility. The third approach, similar to the door-squeeze sketch (Figure 29-left) that gave little choice to the people who passed through the doorway, imagined electrostatic engagement as an activity that is enforced upon the people by the way interior spaces are designed. Identifying these qualities of interactions from the sketches formed the basis for developing examples of interaction fictions presented in the next section.

#### 6.2.4 Constructing narratives

The different interaction instances were mapped according to the effort and scale of interactions they portrayed. The extreme ends of the spectrum, the cases of least and maximum effort along with immersive and microscopic scale, were seen as containing the most provocative narratives. The middle areas could be interpreted in different ways where more effort is balanced with more enjoyment, such as learning something difficult to develop a skill or doing something for fun or enjoyment.

### 6.3 Examples: Electrostatic interaction fictions

Today, there is an increasing need for adopting renewable energy sources on one hand, and on the other, for developing new technologies that support alternative systems of energy production and distribution. Our bodies are sources of kinetic energy that could be converted into small amounts of electricity to power our devices.

Static electricity is a form of body-generated electricity. The small amounts of electric current produced are a result of the interaction between the moving body and different materials. This charge was not there before, the difference in potential between the different materials is generated through the movements between them. The three narratives developed from the sketches thus explore different relationships to electricity and consequently provoke alternative interpretations for energy in the everyday.

#### **Energy gardeners: Emergence of the electrified urbanites**

With the growing community of makers and DIY practitioners, energy harvesting becomes a part of everyday urban activities, such as balcony gardening or 3D printing. Motivated by the cause for supporting renewable clean energy, this community of people engage in body-generated electricity practices to contribute to their own energy needs. Even if this would not be a sufficient method to meet their entire energy needs, they take up the practice as a way to be actively involved with the subject of electricity use and



sustainable ways of living. They would show and encourage commitment to the topic by being involved with electricity production using their own bodies. They would have electrostatic installations at home that they actively interact with and also have electrostatic objects that they carry with them. This community of “energy gardeners” would campaign for the need for renewable forms of energy, invest in electrostatic technology and collect their own electricity in addition to what is available from the grid. Since textiles are the cheapest and most easily available source of e-static energy, there will be a rise of electrostatic installations and engagement within this community. There would be several levels of electrostatic setups in the interior that one would be able to acquire. The beginner level would be comprised of electrostatic objects or materials that would enable the collection of charges from the activities they already do, like walking around or sitting on a couch. The expert level of electrostatic engagement would require more physical effort and commitment from the energy gardeners, but would be capable of generating more electricity.

There will be a growing online community of energy gardeners who would publish DIY tutorials for building different kinds of textile installations for electrostatic engagements. They will share behaviours or movements most effective for energy harvesting; demonstrate examples and help each other with their everyday practices of electrostatic activities; and perhaps even offer advice on food supplements, exercises or skin care products that would support and maximise the effectiveness of electrostatic energy harvesting.

#### **Electrostatic etiquettes: Social energy norms**

With the growing digitisation of the world, electricity would gain multiple levels of importance. While it will be sourced through the wall plugs as we do today, it will also gain a social and ethical importance— like a greeting or saying thank you. Electricity would become a social gesture, that through body-generated electricity, a person could gift, contribute or use for displaying her good intentions. Even in small amounts, the “electric-actions” of citizens in the everyday would be considered normal social behaviour, such as holding the door open in the lift for an oncoming person or giving up your seat for an elderly passenger. Contributing one’s body energy would be considered a polite gesture, something expected out of future members of the community. Electrostatic walls in public and private spaces would enable people passing by to touch and rub against the surfaces to make an electricity contribution. People would be seen walking close to the walls in electrostatic corridors rather than in the middle of the space. It would be polite to go through someone’s cupboard of winter clothes when you visit their homes as your browsing through their clothing would contribute to their electricity pool. A gift of wiping your feet on your host’s carpet or an exchange of an electrostatic shock would be an appreciated social gesture. Through these small electrical-interactions you would show that you are deserving and a contributing member of the technologically rich electric society.

### **Electrostatic rules: Architectural laws**

In this scenario, electricity is considered a precious commodity. It would be mandatory for everyone entering a building to contribute towards the electricity use of the building. The architecture in the buildings would be designed in a way that the people would not be able to avoid passing through electrostatic areas. These rules would be enforced by the state and be integral to the building laws. Similar to the situation of going through a security gate or having a car make sure that the driver wears a safety belt, the building would ensure that every person entering contributes through electrostatic energy. For example, the doors would be fitted with electrostatic curtains that would collect electrostatic charges from people passing by, and the corridors would be made considerably narrower so that when a person walks through, she can't avoid touching the electrostatic walls. Interior places with the most movement, such as staircases or railway station platforms, would be fitted with electrostatic materials that would demand electrostatic charges from people passing by. The state would advertise this as a win-win situation for people who no longer would have to suffer any electrostatic shocks and would be doing something good to maintain the energy sustainability despite the small inconveniences— a feeling we might be already familiar with, for example, during long queues at the airport security check or when waving our hands around in a dark room to get light sensors to react and turn back on.

### **6.4 Discussion: Thinking through interaction fictions**

This study looked at the different interactions enabled by the triboelectric circuit to develop different attitudes and relationships with electrostatic energy using different interaction fictions.

The initial video enactments of electrostatic activities enabled an exploration of space and materials through the body. It put the interactions in focus, and brought forward qualities, such as repeating small actions over a long period of time or exaggerating body movements to increase contact with interior surfaces. This embodied exploration along with the more open-ended sketches illustrated different interactions for electrostatic engagement in the interior.

Engaging with static electricity in the different research experiments often required relatively high effort compared to the amount of electricity generated. This went against the very definition of a machine as something that makes work more efficient. However, it was this characteristic of the interactions that raised questions of effort and scale in relation to using the material property and energy of the body directly for digital use. It also provided a stage to explore how we perform for technology as much as it does for us. We know that computational things introduce certain choreographies of interactions.<sup>320</sup> We perform with textiles everyday, as much as we do with our mobile phones or washing machines. Today we experience several problems with some of these choreographies,

---

320. See for example, Nicolas Nova et al., "Curious Rituals: Gestural Interaction in the Digital Everyday," 2012, <https://curiousrituals.wordpress.com/2012/09/03/curious-rituals-book/>.

especially the ones that keep us static in front of a screen.<sup>321</sup> The approach of developing interaction fictions, as undertaken in this study, provides a way of exploring the bodily engagement that the emerging technologies might demand from us. Through narratives, we can explore different levels of engagement and qualities of interactions as well as challenge the direction of development for such technologies at an early stage.

#### **Working with technical plausibility**

The narratives in the study were developed on the basis of how the triboelectric generator circuit actually works. In this way, the interactions described are technically plausible although the forms and methods for implementing them are partially imagined. The interaction fictions discuss unusual behaviours, provoke varied interpretations of use and question the nature of engagement and the role of the human body in contributing to electrical energy. Building on existing technology anchored the narratives in reality, which is then used as a take-off point for asking questions and exploring future directions.

#### **Thinking in terms of repeated long-term interactions**

An aspect of working with interaction fictions about electrostatic textiles was that it emphasised the consideration of long-term interactions. This was supported by the nature of energy harvesting itself, where small actions can be collected, for example, in a battery. Interaction fictions called for a temporal scaling of actions to address choreographies as part of the everyday repeated rhythms of daily routines. It may be conceptually equated to stress test for a new material being developed, or computer simulations in architecture that evaluate the stability of a structure through different forces over time. Interaction fictions opened up a possibility to speculate on the behaviours that may arise around a given technology based on the kinds of interactions they support. Here it is also important to stress that the least effort is not always the most durable but rather the point would be to explore possibilities to think about the sustainability and desirability of actions introduced by new technologies.

---

321. See for example, David W. Dunstan et al., "Too Much Sitting – A Health Hazard," *Diabetes Research and Clinical Practice* 97, no. 3 (September 1, 2012): 368–76, <https://doi.org/10.1016/J.DIABRES.2012.05.020>.

Vodafone.de 70%

Social Rub

Thank you!

for harvesting energy  
for your city!  
you will be rewarded with

5%

## **7 Study 04: How may e-static studies shape energy interpretations?**

### **7.1 Introduction**

While electrical energy forms a direct output of the interaction with static electricity, it can also be interpreted as a measure of something else. Studies 01, 02 and 03 investigate the making, acting with and relating to electrostatic textiles from the perspective of engaging with materials in the everyday. However, these studies kept the output or the interpretations for the electricity generated open and broadly described as electrostatic charges. Study 04 addressed electrostatic engagement from the perspective of the results of the interactions; it investigated how the small amounts of electrostatic charges collected in the everyday might be used, what it could look like and what kind of experiences they may involve. This study thus aimed to explore and collect examples of different interpretations of energy and how we may relate to electrical energy differently if electrostatic energy harvesting was adopted into the everyday.

### **7.2 Outline**

This study built on the insights and methods employed in the previous studies and took the form of a week-long course aimed at developing interaction fictions with static electricity. The course was held at the Berlin University of the Arts (UdK). There were twelve students in total from product and fashion design bachelor's studies at the UdK. The course took the perspective of engaging with static electricity and textiles as a source of energy. The interpretation of energy was left open.

During the course, the students were introduced to the triboelectric circuit, and they were given different group exercises of short (15-20 minutes) and longer (1-2 days) lengths to

delve into the topic, experiment with materials and develop their own narratives. The goal of the course was to engage with static electricity as done in the thesis process and develop speculative scenarios that present new challenges or provocations for relating to electrical energy in the everyday. The different activities of the course are described in detail below:

Day 1:

#### *Introduction and warm up exercise*

The students were first introduced to my thesis topic on static electricity and textiles and given a broad overview to the approaches in speculative and critical design along with project examples. A plan for the following week was presented and the students were encouraged to be experimental, bold and provocative in their explorations. As embodied explorations were an important part of the process, the students were given small enactment exercises over the coffee break. Some were given a specific way to move or act, such as always being in touch with a wall when walking or to walk backwards or be blind folded and helped by a friend.

#### *Discovering the triboelectric circuit and interactions*

After a brief exchange of impressions from the warm-up exercise, we turned our focus to static electricity. A large triboelectric circuit was set up using aluminium foil on the floor, and a plastic sheet was used as an electrostatic material. A multimeter attached to the circuit displayed the voltages and changes that appeared with different interactions. This setup was used to demonstrate the circuit, try out different interactions and collectively discuss the ideal conditions needed for engaging with static electricity. It enabled the students to try out the circuit themselves while also understanding how static electricity works.

#### *Quick embodied explorations of the triboelectric circuit*

After the introduction to the triboelectric circuit, the students divided themselves into groups of 2 or 3. They were given different materials, conductive and electrostatic, and were asked to go around the university building and construct their own triboelectric circuits as well as take short videos and images of themselves interacting in different ways. They were given 15-20 minutes to come up with as many setups as possible. The aim of this exercise was to quickly try out different options without being too concerned with bigger ideas and to try out everything that came into mind. The other goal was to encourage students to relate to conductive things, spaces and surfaces from the perspective of textiles, static electricity and body movements.

#### *Developing short narrative enactments*

After the initial quick explorations, the students were divided into three groups of four people each and were given a location near the university to visit and develop a similar triboelectric setup, this time with a bit more consideration and narration. They were encouraged to take inspiration from the artefacts, people and kinds of activities and movements they encountered in the space. These three places were a shopping mall, a metro station and a university lobby. The videos were submitted to an online folder at the end of the day.

Day 2:

### Interaction analysis

The next day was started with analysing the videos made by the students in terms of categories and qualities of interactions. This session used an adapted version of the video-card analysis method.<sup>322</sup> First, all the videos were distributed among the groups of students to analyse interactions from the perspective of the interior spaces and elements featured, as well as considering the different materials, body parts and movements involved. For each identified element, the students made a “video card” which included a sketch of the interaction displayed in the video, the file name of the video for later reference and a description of their observations. After they had finished analysing their set of videos, they were asked to create groupings or categories from their video cards.

As a next step, the students were asked to place all the different video cards according to different qualities of interaction- such as effort, scale, fun, originality, social acceptance, pace of action and the number of people involved. Every arrangement was recorded and shared with all the students as reference for their next exercises.

### Constructing narratives

During the afternoon session, I presented some examples of speculative design narratives and the different forms they took – for example, a video clip or a newspaper article. There was a discussion on different possibilities for asking questions through speculative design methods.

After this discussion, the students returned to their groups to brainstorm ideas for their electrostatic future stories keeping in mind the interactions, categories and the short exercises they undertook so far. They were asked to keep the triboelectric circuit in mind but interpret it as they wished for their story or question.

### Discussion and Feedback

At the end of the day, each group presented their initial ideas and we discussed together the possibilities, ideas and suggestions stemming from each contribution.

Day 3-4

### Group work and feedback sessions

During the next two days, the groups worked on refining and preparing their final ideas. The format was left open as long as it would be a visual representation. During this time, I met with the groups separately for feedback and help as they needed. The students were also informed that their final ideas might be used as part of my thesis, and a written permission for using this work was obtained.

Day 5:

### Final presentation

The screening and presentation of the work of all groups was arranged, and was followed by a group discussion.

---

322. This session was facilitated by two colleagues from the Design Research Lab– Marie Beuthel and Anne Wohlauf.



Figure 34. Stills from some of the videos made by students for the first exercise of quick material explorations of the triboelectric circuit principle. Clockwise from top left: Dancing with a bronze statue and plastic sheet, laying synthetic material over railing while climbing down the stairs, interacting with a conductive table and plastic table cloth, head gear for rubbing, electrostatic materials catching the wind.

### 7.3 Observations

The students were quick to understand and work with the triboelectric circuit principles by trying out and asking questions. Some of the screenshots from the first set of quick videos are illustrated in Figure 34.<sup>323</sup> Each group explored different movements and spaces in the building. Some looked for conductive objects such as a bronze statue in the garden (see Figure 34, top-left) and table tops (see Figure 34, top-right) to use in the setup with electrostatic materials. Others placed conductive foils and plastic sheets freely in different spaces to perform with it, for example, placing a conductive sheet over a plastic roadblock (see Figure 34, bottom-left) or rubbing it on their bodies and hair (see Figure 34, bottom-right). In these explorations, the interactions and improvisations were the main focus, the setups in the explorations were not actually connected to a circuit. In the reflection session that followed, the students stated that they enjoyed the format of quick explorations and found it to be a good way to enter the topic. While in several of the explorations, the students directly engaged their bodies, they also found that natural elements, such as wind moving the materials against one another, gave an enjoyable experience to the interactions.

323. All videos submitted by the students during the course are included in Appendix D.





Figure 35. Examples of electrostatic interactions explored by students at the university building. (Left to right) Rubbing with a plastic sheet over a conductive pillar, a picnic blanket that collects e-static charges from people, sliding over the staircase railing, walking through an electrostatic curtain.

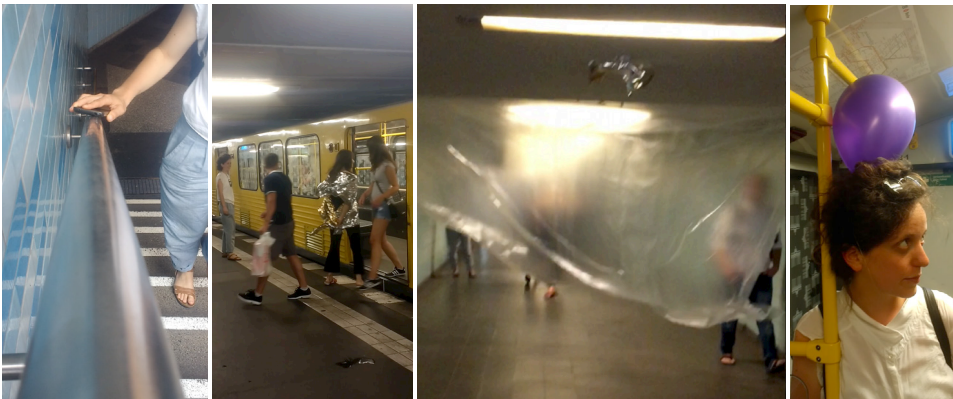
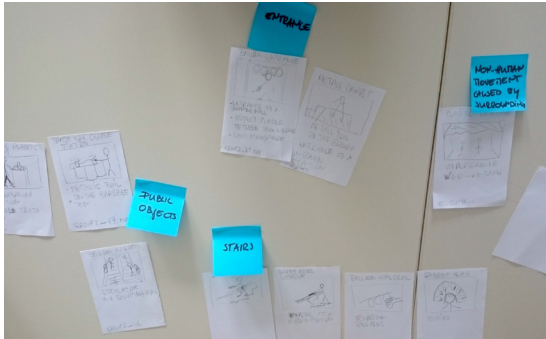

Figure 36. Examples of electrostatic interactions explored by students at the subway station. (Left to right) Charging a phone by dragging it over a conductive railing, deliberately bumping into people in the train to collect electrostatic charges from them, an electrostatic plastic curtain for people to walk through, wearing a balloon hat that rubs against different surfaces.



Figure 37. Examples of electrostatic interactions explored by students at a shopping mall. (Left to right) surfaces that you rub your phone on to charge it, rubbing the railing while standing on an escalator, walking through a balloon structure that rubs your hair when you walk through, sliding on metal railing of a staircase.



Public Objects	Entrance
Stairs	Non-human movements caused by surroundings (e.g. Windy areas)



Soft/Light	Disposable	Warm
Long lasting	Cold	Hard
Human	Metal	Plastic

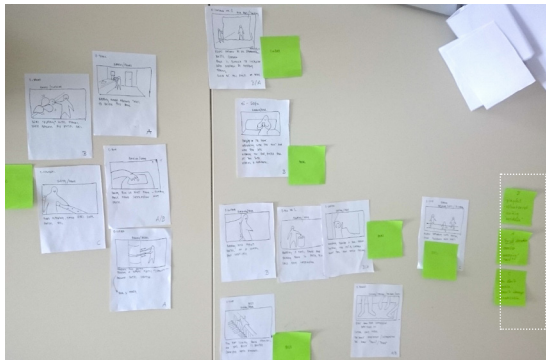

Hands	Full body	Bum (sitting)
Arms	Belly	Feet
<b>A</b> Forced Exercise Annoying?	<b>B</b> Playful Voluntary Inviting Avoidable	<b>C</b> You don't notice Doesn't interrupt

Figure 38. Categories from video card analysis of the electrostatic interactions portrayed in the videos. (Top) Interior spaces and features. (Middle) Materials and qualities. (Bottom) Body parts involved in interactions and emerging qualities.

The next task of going to a location and setting up electrostatic interactions yielded more mixed results. Although all the groups managed to make different videos, some, for example in the shopping mall, said they could not try out everything as they faced some interruptions and questions from the audience and the authorities. Nevertheless, each group had a set of videos and a range of interactions that they could analyse the next day. Some examples of the videos are illustrated in Figures 35, 36 and 37.

Some of the interactions the students explored in the university building (see Figure 35) included rubbing an electrostatic cloth on a pillar wrapped with conductive material, having a picnic on an electrostatic blanket, sliding on a conductive staircase to release electrostatic charges from clothes and walking through conductive curtains that collect electrostatic charges from the body. The interactions explored in the subway station

(see Figure 36) included wiping a mobile phone on the staircase railing to charge it and wearing conductive clothing in the subway station in order to collect or 'steal' electrostatic charges from other passengers and surfaces that might have gotten electrified while interacting with others. Other explorations in the subway station included an electrostatic curtain that the passengers had to move up or push out of the way in order to pass as well as a head gear made with electrostatic materials, such as a balloon, that would get charged as the person went about her daily commute. Some examples of interactions the students explored in the shopping mall (see Figure 37) were surfaces that you could rub your mobile phones on to charge them, including interactions with moving surfaces, such as an escalator railing or having a balloon installation that rubs your hair as you walk under it.

The three groups intuitively used familiar movements in spaces, familiar textile objects, material qualities and sometimes invented new or unfamiliar actions. For example, using the metal staircase railing as a surface to rub against was repeated by all groups. All of the groups also used sliding down the staircase railing as an example of electrostatic interaction (see Figures 35, 36 and 37). Reinterpreting familiar objects, such as a curtain or a picnic blanket that comes in contact with many people, was also something that the students found inspiration in. In some cases, the triboelectric circuit requirements provoked new interactions, such as churning a piece of electrostatic material around a conductive pillar (see Figure 35) or dressing up in conductive clothing and deliberately rubbing against people to collect their charges (see Figure 36). The actions were situated in the location given to them, but the spaces chosen by the students were seen to be overlapping and could be generalised. These patterns became more apparent in the following day during the video analysis.

The video analysis was an intense session that involved going through, naming and categorising interactions. The categories from the materials, the body part movements and interior spaces are shown in Figure 38. Placing interactions on different spectrums helped to highlight the range of interpretations and provided students with different means of comparison and opportunities to find inspiration from each other's explorations. The spatial elements in the videos often included transitory areas, such as staircases and doorways (see Figure 38-top). The three main materials listed were human, plastic and metal. The qualities listed included combinations or contrasts, such as warm/cold or hard/soft (see Figure 38-middle). Often the hard interiors or metal were juxtaposed with soft textiles or warm skin which brought forward an interesting aspect of the triboelectric circuit that could be used for designing interactions. The group analysing the interaction qualities and body parts listed different body parts (see Figure 38-bottom), such as the belly, which is a part of the body we do not often use with technology. The students also recognised and categorised the nature of interactions in the video as being voluntary, forced or unnoticeable.

In their last task of building on all the previous exercises and interactions for creating a visual narrative to express a concern or question regarding electrostatic energy futures, the three groups took very different directions. These are described as examples in the next section.

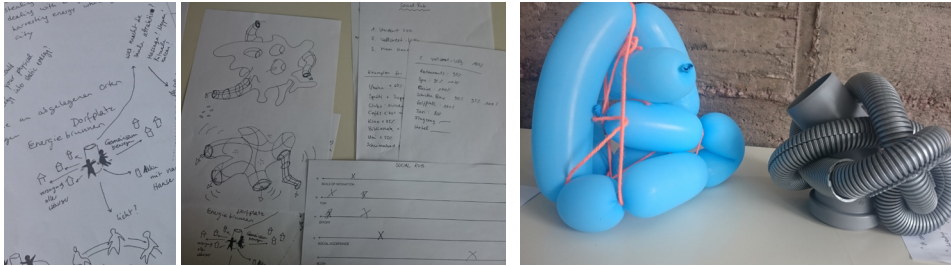

Figure 39. “Social rub”: Examples of materials explorations, sketches and storyboards made by the group in preparation for the final work.

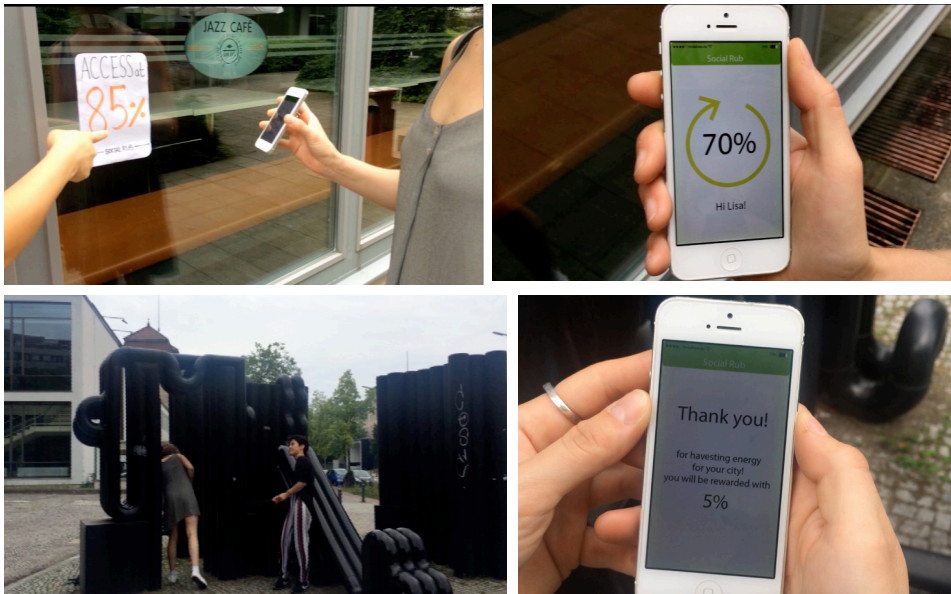

Figure 40. Static electricity as social currency: “Social rub”: some screen shots.

## 7.4 Examples

### 7.4.1 Static electricity as social currency

The first group explored energy from a social perspective. They asked the question of what would it be like if an energy-hungry city encouraged its residents to engage in electricity production in return for the participation in cultural activities that the city makes possible. The students were inspired by their earlier explorations and improvisations with materials in space. They constructed a satire where different social meeting points, like a café, would demand a certain score in an energy application on your smart phone called “Social Rub”<sup>324</sup>. In their narrative, when people do not have enough “energy score”, they would need to go to recharging stations for an “electrostatic rub”. Each person’s contribution of material and movements is noted and thanked by the city. However, they may still not have enough to afford all the cultural activities they would like to take part in and people would need to negotiate their energy currency amongst their friends. Some

324. Video included in Appendix D.

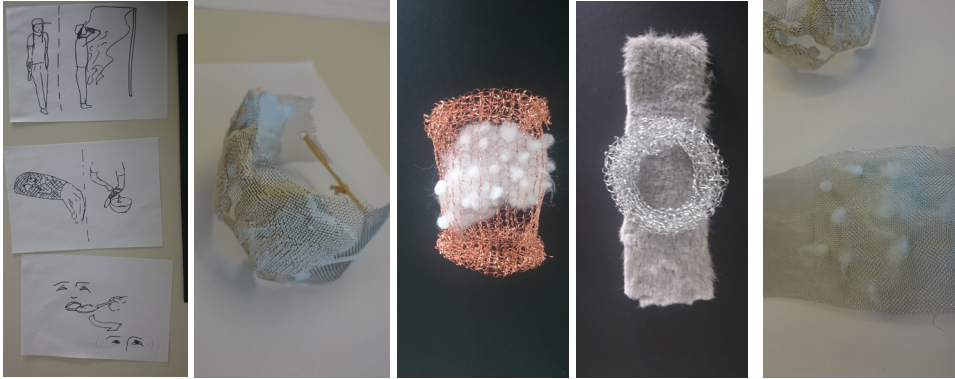

Figure 41. “Synthofungus”: Examples of materials explorations done to visualise the charge collection over the surface.



Figure 42. Static electricity as a drug– “Synthofungus”: some screen shots.

of the initial sketches and models for social rub sculptures explored by the students are illustrated in Figure 39. The screenshots from their video “social rub” are presented in Figure 40.

#### 7.4.2 Static electricity as a drug

The second group became interested in surface interactions and the idea of going around with a conductive textile that one can rub against other people or surfaces that other people have touched and collecting the charge for their own benefit. They started with the idea of stealing electrostatic charges from public spaces but became inspired by how they would show the collection of charges visually. They did several material tests trying different textures and materials for shaping this conductive collector for their video (see Figure 41). In this process, getting inspired by the mushroom-like forms they found in their explorations, they deviated into an idea of surface interactions as a new trend or

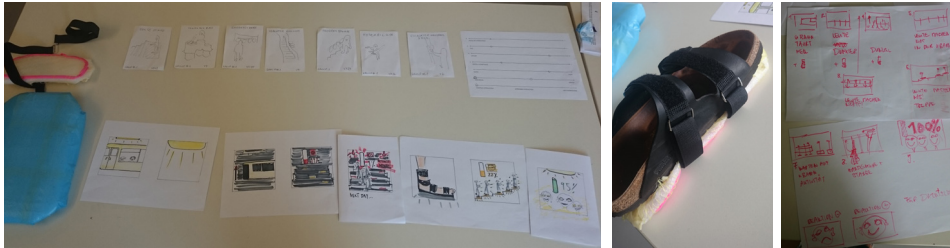

Figure 43. Group 3: "Collective energy": Examples of materials explorations, sketches and storyboards made by the group in preparation for the final work.



Figure 44. Static electricity as a collective responsibility: some examples of narrative frames.

energy drug (see Figure 42). The final video,<sup>325</sup> which they called "Synthofungus", was a conceptual montage where they close in on the interactions with different synthetic surfaces with a wearable device. They describe their future world as having unlimited supply of energy, and where energy harvesting is a self-indulgent and intoxicating act.

#### 7.4.3 Electrostatic energy as a collective responsibility

The third group imagined an energy crisis, where the underground rail, the only public transportation, is completely dependent on static electricity. Every passenger is responsible for contributing to the running of the train, to the extent that the train would slow down or even stop when the energy is low. The passengers while travelling need to constantly move and produce static electricity. They explored making props of shoes that would collect electrostatic charges (see Figure 43) and planned to make a collage style animation. In the end, they settled on a series of images that describes their world (see Figure 44). Their image series<sup>326</sup> illustrated all passengers as having an energy rating that indicated their ability to contribute towards powering the transport system. When people

325. Video included in Appendix D.

326. Included in Appendix D.

are low on energy, they must eat or find nourishment in order to get back to producing electricity with their bodies during their everyday commute. The group also thought about having higher energy ratings, and thus making it less physically demanding, for certain groups of people, such as the elderly and people with disabilities.

### **7.5 Discussion: Electrostatic-energy interpretation matrix**

The topic of the course did mention energy, but the interpretation of energy was left open to the students, and the three groups used energy in different ways. The last group followed a more conventional interpretation of electrical energy that is harvested in order to make other machines function. The first group interpreted energy as a social currency, where your energy contribution is recognised and made relevant in a social setting. They visualised this as energy playgrounds for everyone placed in the city, where one is socially pressured to play and contribute. The second group took a still broader interpretation of energy as something that is treated and consumed in a wasteful manner for personal pleasure.

Thinking through interactions was seen to bring out and highlight different material properties and also bring about new actions or behaviours. For example, in the different quick explorations, the quality of materials really came through, such as the lightness, translucency, the sounds and the stickiness to the body. However, the connections to the interaction and materials in the final works grew weaker. Some characteristics of the electrostatic interactions, such as rubbing against surfaces was incorporated, but the material juxtapositions and textiles or soft aspects were not carried through till the end. This was probably due to the larger story or idea taking foreground rather than building directly from what was done before. Generalising from specific interactions to larger concepts is a challenging task and, in retrospect, I think the locations or the materials that the students had worked with in the previous explorations could have been given as part of the final task. This might have encouraged the conceptual developments around more specific activities or objects.

In spite of these shortcomings, the different explorations and videos made by the students were able to provide a variety of examples and instances of how electrical energy is interpreted in the energy harvesting systems. In this section, I would like to unpack this further by building on the examples from the course as well as others developed in previous research studies (Chapters 4–6) to discuss the different approaches for addressing the output of electrostatic engagements.

#### **Immediate and delayed effects of electrostatic interaction**

In the interactions explored throughout this thesis, two temporalities of the electrostatic outputs could be considered. The first is an immediate direct conversion into electrical output, such as when tapping on the electrostatic textiles in a triboelectric circuit lights an attached LED. The other kind of interaction, as illustrated by the work of group 3, interprets energy as something collected through a series of interactions over time by several people. Here, each interaction may not produce a recognisable output, but it becomes significant when accumulated over time.

Table 4. Matrix of the kinds of outputs that could be designed for electrostatic textile setups.

Feedback		
Immediate	Immediate energy conversion	As a sensor/ switch
Examples	E.g., Walking through an electrostatic curtain makes LEDs light up.	E.g., Stroking the furry wall triggers purring sounds.

Feedback			
Collect over time/ Slow, delayed feedback	FOR THE OBJECT ITSELF	FOR THE SPACE	FOR THE PERSON INVOLVED
Interaction characteristic	<p><b>The interaction is “collected” for the object being interacted with.</b></p> <p>The electrostatic system collects the charges and interprets them within itself, which might be considered as a feature or a behaviour of the system.</p>	<p><b>The cumulative of the interactions is visualised or experienced collectively within the spatial context of the interaction.</b></p> <p>This implies the location specificity of the result of the interactions. The space where the interaction takes place is changed over time through the interactions. This could be relevant in semi-public or public spaces where multiple contributors could influence an outcome collectively.</p>	<p><b>The result of the interaction is detachable. The person interacting can take away the collected value of interactions.</b></p> <p>The output of the electrostatic interactions is relevant to the individual interacting with the system. This points to more personal objects or interactions that can be related to a single person or group.</p>
<p><b>Examples of electrostatic interactions</b></p> <p>- Electricity for energy</p> <p>-----</p> <p>- Electricity for experience</p>	<p>E.g.,</p> <p>Waving a tablecloth over a table everyday over time to collect energy for lighting it up for a special occasion dinner.</p> <p>-----</p> <p>Beating (cleaning) a rug over a period of time slowly changes its colour due to the electrostatic charges produced during the cleaning.</p>	<p>E.g.,</p> <p>By sleeping on an electrostatic bed at home one can energise not only herself but also her TV.</p> <p>-----</p> <p>The inhabitants of an apartment building change the painting on the wall by walking through a tall carpet. A new painting is started every two years and the old one is displayed in the building's common area.</p>	<p>E.g.,</p> <p>By sitting and bouncing on an electrostatic chair over time, a person can collect points that can be exchanged for goods, services or just for advertising their energy-engagement.</p> <p>-----</p> <p>A knitter can display her experience through the electrostatic memory embedded in her knitting needles.</p>



### **Electricity for energy and electricity for experiences**

Another distinction between the outputs of electrostatic harvesting systems in the different examples can be made regarding the interpretation of the electrical energy generated in interactions. In examples such as the energy for social sharing or those that convert the interactions into electricity, or in the case of the interaction fiction of the architectural laws described in the previous chapter (see section 6.3, page 128), the output is equated to the notion of electrical energy that is usable directly to power devices, lights, mobile phones, etc.

Alternatively, in other cases, the small electricity generated through the interactions is not considered to be the final outcome. Rather, the electrical impulses are used to inform or are interpreted as contributing to the computational system in a broader sense. In the example of social currency (section 7.4.1), the electricity collected is not directly used for powering devices but is equated to a social status that qualifies a person for cultural experiences offered in a city. Here the electricity acts as a kind of sensor that measures or estimates one's activities for another kind of qualitative result.

Taking this further, the electrostatic energy produced through interactions can still be extended in terms of the recipients of the output— for example, in the idea of social currency and *synthofungus* (sections 7.4.1 and 7.4.2), the recipients of the electrostatic engagement are individuals who do the actions. On the other hand, in the energy as social responsibility example (section 7.4.3), the electrostatic engagement of the participants is reflected in the common place, that is the train station. This of course indirectly benefits the individuals but the direct output of the electrostatic interactions is first reflected in the common space occupied by the participants. The third type of recipient, which is common in most energy harvesting devices, are the electrostatic artefacts themselves. For example, the electrostatic charges collected by a watch are used to power it.

### **Energy interpretation matrix**

This study aimed to develop examples of different interpretations for energy generated through electrostatic systems to complement the different discussions in the previous studies on making and engaging with such systems. Building on the results of the week-long course with students, I developed a matrix (see Table 4) of the kinds of outputs that could be designed for electrostatic textile setups. In the top part of the table, the interactions characterised by immediate feedback are categorised into two parts— one that directly converts the electrical energy into electrical output, e.g., an LED, and the second as sensor or a switch which immediately triggers a feedback.

In the bottom part of the matrix, the case of interactions collected slowly over a longer period of time is presented. The interactions are further categorised according to three primary target groups who may directly benefit from the voltages generated by the system. Each of the cases are illustrated by two examples, one that interprets electricity as energy and one that interprets it as a sensor for triggering other changes. This matrix intends to present a framework for designing different relationships to the electrical energy generated through body-engagement. This could be further extended with more work and research in the field.

## **8 Results and reflection: Electrostatic contributions to e-textile interaction design**

This research developed an interaction design inquiry for engaging with static electricity in the interior based on the idea of making, acting and relating with electrostatic textiles. The inquiry was set up in the form of four research studies that systematically explored the intersection of e-textile practice, materially oriented HCI and static electricity to provoke, ask questions and explore the design program aiming–

*to investigate, at the scale of the interior, how static electricity can bring new perspectives and possibilities for:*

- *ways of engaging with e-textiles, and*
- *designing interactions for energy harvesting with textiles*

In this chapter, I examine the research process undertaken and the examples developed to reflect on how they relate to the design program.

The chapter is divided into three sections. The first section discusses the results of the research work in relation to the first objective of the design program. Here, I first reflect on the methods followed in the research process to map out a materiality oriented interaction design approach for e-textiles. The second section of this chapter corresponds to the latter part of the program. It re-examines the research studies and results to reflect on and summarise key insights and opportunities from working with static electricity to design e-textile interactions for engaging with energy. The third section presents the tools and resources developed to support further research. This chapter contributes to the practice of e-textile interaction design within which the studies were situated.

## 8.1 Towards a materiality oriented e-textile interaction design approach

In this section, I examine outcomes from of the research studies in relation to applying a material-specific interaction design inquiry in the field of e-textiles for adopting electrostatic materials in the interior. I make a proposition for a materiality-focused interaction design strategy for the field of e-textiles based on this research process.

In Chapter 2 of the thesis, I described e-textiles as a computational material that learns from as well as contributes to the field of materiality oriented HCI research. Although there have been approaches to interaction design discussed in some e-textile projects,<sup>327</sup> an in-depth understanding of interaction design approaches specific to the computational material of e-textiles is less developed. In previous work,<sup>328</sup> I have argued that developing a material-specific interaction and form language for e-textiles is crucial for enabling rich and tactile experiences in use, as well as for collaboratively exploring new interpretations for soft technology. In section 2.1, I argued that the design study of everyday engagement with static electricity is useful for developing a textile-specific interaction design methodology.

In this section, I re-examine this proposition in view of the research studies. Building on the discussion raised in Study 02, I present a framework for textile-specific interaction design that builds on defining e-textiles as a material system integrated through human interactions.

### 8.1.1 Defining e-textiles as a material system

The research studies used the electrostatic harvesting circuit as a starting point for designing interactions with static electricity. The circuit is interpreted as a material system constituted of materials of certain properties (electrostatic, conductive, etc.) that need to be ‘activated’ through interactions. Study 01 constructed different versions of this material system using textiles and other soft conductive materials to translate the circuit into different forms of e-textiles. These e-textile substrates can be used independently or with other conductive objects or textiles to harvest electrostatic charges. Similarly, in Study 02, the electrostatic circuit was scaled up to represent an interior space where a person interacting with materials activated the space. These two studies illustrated that even when textiles and computational elements are not integrated into one single material, they can be brought together through interaction in a way that the whole system together with the conductive, electrostatic and human elements constitutes an e-textile system.

Following this idea, e-textiles could be defined as a material system consisting of textile-like materials as well as passive and active electronic elements that can be integrated into the same material or distributed around a space. The material system can be interpreted as an e-textile when the different materials (are made to) actively engage with one another with the help of a (human) participant.

---

327. For example, Lars Hallnäs and Johan Redström, “Textile Interaction Design,” *Nordic Textile Journal* 1 (2008): 104–15, <https://www.semanticscholar.org/paper/textile-interaction-design-Hallnäs-Redström/1ce8e5741a3f6bd9215baaac65bd76418fda8ad6>.

328. Gowrishankar, Bredies, and Ylirisku, “A Strategy for Material-Specific e-Textile Interaction Design.”

Table 5. Material-specific interaction design strategies for making, acting with and relating to e-textiles.

Interaction design approaches to making e-textiles	Interaction design approaches to acting with e-textiles	Interaction design approaches to relating with e-textiles
Re-interpreting textile construction techniques to form electronic components	Layering existing interactions with textiles with digital meanings.	Building on existing use-contexts of textiles to explore extended meanings.
	Interaction transfers- working with textile interactions as a resource for designing digital interactions.	Building on how textile material behaves in one context to transfer it to another context.

This definition of e-textiles foregrounds the material properties and interactions between the different parts of the system that are activated by a participant, for example, a person in a specific context. The design process would focus on supporting material qualities and interpretations specific to textiles for activating the e-textiles. The interaction design would explore, introduce and learn from the interactions between the materials and participants in given situations.

Furthermore, the frame of making, acting and relating form a broad framework within which the relationships between materials and participants could be explored from an early stage of the design process. The textile-specific interaction design methods identified in the thesis present examples of how to keep a material focus throughout the e-textile design and development process. In the following subsection I unpack this further.

### **Making, acting and relating as a methodological frame**

In Chapter 2, I argued that with the growing emphasis on materiality thinking in HCI, the notion of interaction design has expanded from being only concerned with the intersection (interface) between physical and digital to a holistic concern of shaping the digital and the physical together to envision acts of use<sup>329</sup> that enable and support rich human-material interactions over time. I categorised these approaches broadly into strategies for shaping computational things (*making*), for considering the actions surrounding computational things (*acting with*) and as approaches for exploring new relations and activities with computational things (*relating to*). Furthermore, I organised approaches to interaction design found in e-textile practice on the basis of making, acting and relating to identify the most material-specific ones (see Table 5). These methods were used in the research studies 01, 02 and 03 to systematically explore different interactions and forms of the electrostatic circuit.

Study 01 employed methods of making electrostatic textiles using textile construction techniques such as weaving, tufting and rug knotting. Applying the triboelectric circuit from the perspective of making computational things, enabled the integration of both the interactive qualities of textiles as well as those essential for a triboelectric circuit

329. Hallnäs, "On the Foundations of Interaction Design Aesthetics: Revisiting the Notions of Form and Expression."

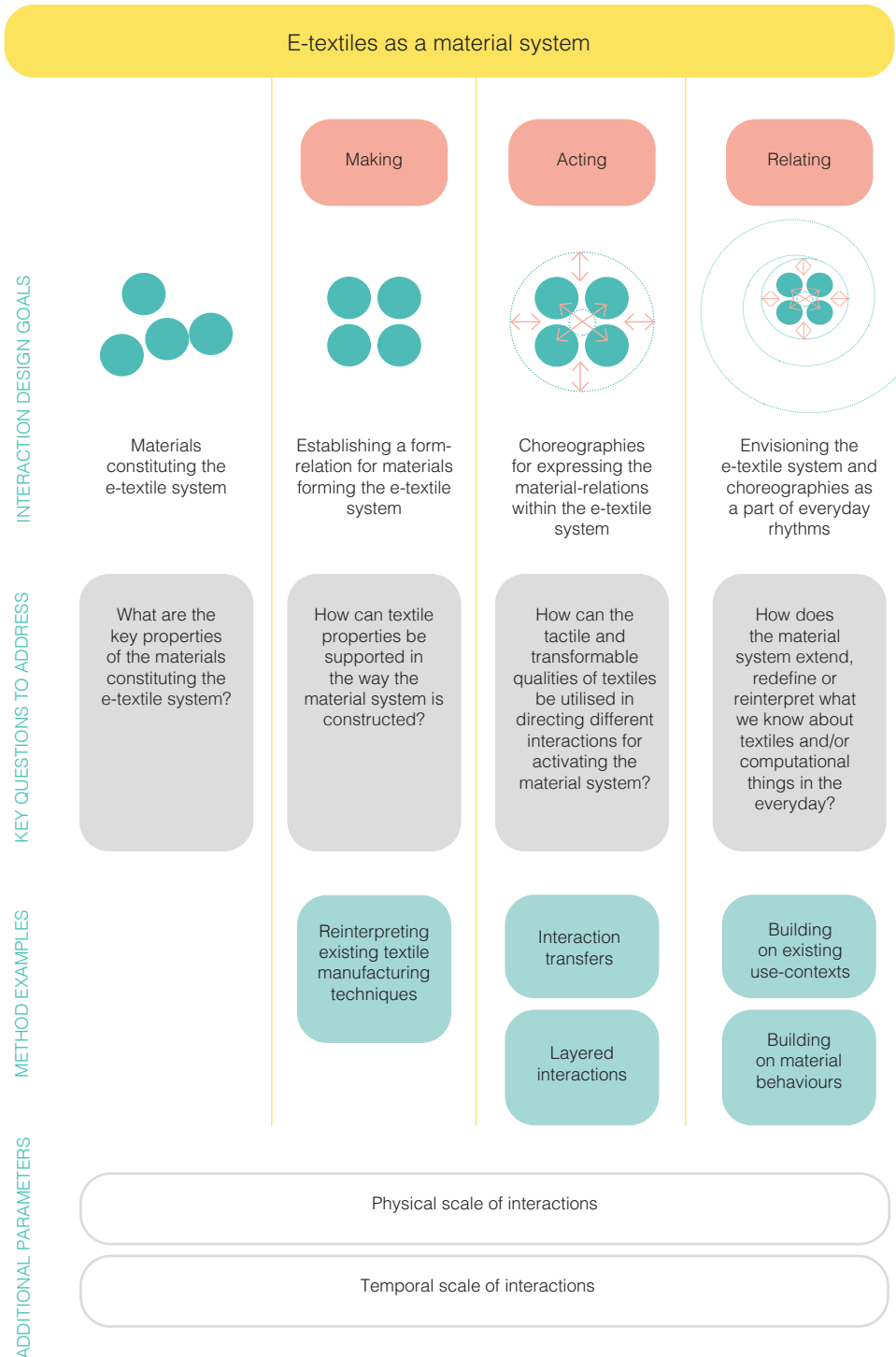

Figure 45. A framework for materiality-oriented e-textile interaction design based on the research results.

to work. Study 02 scaled up the triboelectric circuit to focus on interactions between material properties rather than the construction of an integrated material. Here, the ideation process followed the methods of layering existing interactions as well as interaction transfers to explore a number of movements and choreographies with soft materials for engaging with static electricity. The third study focused on relating with electrostatic textile setups and developed examples of interaction fictions by building on existing use contexts and the material behaviours of textiles.

The three studies illustrated a design process that considered different aspects of interaction design in one inquiry. The perspectives of making, acting and relating are often inter-dependent and exist in various degrees in e-textile projects. However, taking them as three distinct areas of concern enabled a high-level exploration of each while extending and experimenting with ideas and prototypes developed during the different steps of making, acting and relating. The three studies used the same technology- a triboelectric generator circuit- and explored it from the perspective of constructing a new material, scaling it up to observe body and material interactions and envisioning it as an everyday technology to critically examine its long-term social and behavioural effects. Additionally, following the selected materiality oriented methods, each study closely followed the material qualities of textiles and supported different kinds of material interactions that illustrate their own interaction language specific to the medium of electrostatic textiles.

Building on the above reflections, Figure 45 illustrates an initial model for a materiality oriented e-textile interaction design that could be used for designing active engagement with e-textile systems that foreground the material-properties of textiles. The approach is based on establishing a relationship between the material elements that need to be translated into a unified e-textile system. Following the approaches of making, acting and relating, the material system could be configured in different ways to generate multiple examples to critically examine directions for further development at early stages of an emerging technology or smart material in the context of e-textiles. Additional parameters, such as scaling up in space and time and considering different feedback times, are included as issues to address or incorporate while designing. The examples of specific methods identified in this thesis act as a starting point to support each approach. The e-textile community is invited to add additional methods and examples to develop this materiality oriented e-textile interaction design approach further.

## **8.2 Opportunities for incorporating static electricity in design and development of interior-scaled e-textiles**

In this section, I outline different opportunities and challenges for adopting static electricity as a design parameter for e-textile applications in the interior. This relates to the second part of the design program that sought to get a better understanding of designing interactions for energy harvesting with textiles.

### **Electrostatic energy harvesting with interior textiles**

Study 01 illustrated examples of textile substrates that support the collection and flow of electrostatic charges generated from the interactions between the human body and

textiles. These samples were made with easily available materials, such as polyester and plastics, that are used extensively in the interior textile industry. Furthermore, the electrostatic textile samples demonstrated that existing textile construction tools and techniques, such as weaving and tufting, can be used to construct electrostatic-friendly, or as the term introduced in Study 01, pro-static textiles. Furthermore, it was also shown that the production of these textiles can be scaled up to industrial weaving looms.

Some of the e-static samples were evaluated with an oscilloscope to get a rough idea of the voltage produced through interactions of tapping and rubbing.<sup>330</sup> The voltage generated in tightly woven fabrics with an integrated electrode layer ranged from 3.5 V to 6 V for pieces between 10 to 20 cm wide. This value increases when the same fabric is produced with an industrial machine using finer yarns and a higher yarn count. This is a promising result that illustrates the possibility for interior textiles to incorporate the potential for electrostatic energy harvesting. While the majority of triboelectric generator research, as presented in Section 2.3, is focused on the area of wearable and on-the-body applications, the results from Study 01 call for further investigation of triboelectric harvesting through textile interactions in the context of interior environments.

#### **Static electricity presents new ways of interacting with e-textiles**

The examples from studies 01 and 02 illustrate different shapes, textures and scales that a triboelectric generator circuit may adopt using textiles as a primary material for interaction. These different examples support a wide range of interactions and levels of engagement depending on the scale at which the triboelectric circuit was implemented. The interactions themselves were found to be not directly scalable, that is, interactions that worked at a small scale were not as effective at the larger scale. For example, with the textile samples in Study 01, rubbing and tapping hard on the textile surface was an effective way to generate some current. However, when the same setup was scaled up as an entire floor of electrostatic material over an electrode, jumping or walking on the surface became the least effective way of generating a voltage. At this scale, interactions with wider movements, such as waving or wiping, were much better for creating recognisable voltage outcomes. Thus, each instance of scaling up opened an exploration of e-textile interactions while keeping the basic setup of the triboelectric circuit the same.

Table 6 describes the interactions with textiles and the body for each scale of electrostatic setup in detail. In Study 01, the triboelectric circuit was scaled to the level of a textile substrate. The different materials were incorporated during the construction process in such a way that electrostatic materials would lay loosely over conductive threads. Interactions that made a strong impact, such as tapping or rubbing with the hand, provided enough energy to create a potential difference in the circuit. The interactions were more precise and repetitive, and since the conductive parts were so close to the electrostatic materials, they also required some force.

In Study 02, the scaled-up version of the triboelectric circuit in the form of an electrostatic cube installation and the sleeping bag set-up enabled the person to literally enter

---

330. The results of this study and the overview of voltage readings are reported in the publication—Gowrishankar, “Constructing Triboelectric Textiles with Weaving.”

Table 6. Overview of interactions in Study 01 & Study 02.

	<b>Interactions with textile materials enabled by e-static setups</b>
<b>Study 1</b>	Rubbing and tapping with the hand on the surface of the textile
<b>Study 2</b>	In the electrostatic cube example: Larger body movements with the textile- e.g. waving, throwing, wiping, flapping etc. In the sleeping bag example- sleeping inside, turning around, changing sleeping positions

the circuit. The circuit in this study was interpreted as an immersive object which was operated from within rather than from the outside as in the first study. Being inside this circuit, I had much more freedom of movement and space for improvisation with the electrostatic materials without compromising the voltage output. Thus, the resulting interactions were based more on the characteristics of the materials at hand. The large piece of plastic sheet in the electrostatic cube installation could be moved in several ways using the characteristics of the plastic sheet, such as its lightness or translucency. The interactions in this way were much more material-specific and relied on my knowledge and experience of handling textile-like materials.

Study 03 built on the idea that several surfaces in our everyday environment act as electrodes (e.g., the floor, wall or ceiling) and contain different kinds of electrostatic textile interventions that we encounter and manipulate. The interactions combine both textile surfaces (rubbing feet, tapping, touching) as well as that of whole-body interactions (waving, wiping, walking through). These interactions thus opened up the exploration of situations or instances where we are most likely to engage with large scale textiles or places in the interior where we are most mobile.

Thus, working with static electricity and textiles at different scales extended the scope of how we may interact with e-textiles for digital interfacing and energy harvesting. Additionally, scaling up can be used as a strategy for investigating full-body interactions with textile-based interior setups for the purpose of engaging with ambient energy.

### **New interpretations for energy collected through interactive textiles**

This research set out to investigate interaction design for energy harvesting with e-textiles using static electricity. Through the process of the research studies, it became apparent that the energy generated through static electricity in the explorations presented a considerable constraint on how it can be electrically expressed. Thus, the direct translation of electrostatic interaction with textiles is illustrated using an LED in this research. However, the limitation of the electronics that were accessible for this research was taken as an opportune starting point to explore, extend and interpret different ways of analysing the electrical output from such systems. The examples developed in studies 03 and 04 give an outline of how the qualities of interactions could lead to a larger design discussion concerning scenarios and attitudes towards energy harvesting.

In Study 03, the qualities of interactions, such as scale and levels of active engagement, led to three narrative scenarios which discuss different relationships between energy



producers and users, for example, where electrostatic engagement is a hobby shared by a community of urban energy farmers or a situation where energy is scarce and everyone is expected to contribute to the energy pool through electrostatic harvesting systems in public and semi-public areas. These interaction fictions thus provided a way to think about and address plausible scenarios at an early stage of the technology and could be a useful tool to enable designers and technologists to collaboratively discuss and develop directions for e-textile development from a critical perspective.

Interaction fictions can also be used to explore different interpretations and relationships to the energy produced with the body. This is illustrated in Study 04, which developed examples of alternative narratives for how electricity generation may be interpreted in everyday life. It was found that while the electrical energy could be used to power other devices, it could also be used as a sensor or a measure for other activities or qualities of interaction. The energy interpretation matrix developed as a result of Study 04 (see Table 4 on page 142) maps the different approaches for designing interactions with static electricity in different contexts.

#### **Addressing contradictions**

The experiments with static electricity and textiles raised several contradictions that emphasise some of the challenges brought by electrostatic harvesting in the interior. However, the contradictions described below can be seen as opportunities to provoke and engage the audience in a critical discourse or seen as challenges to be addressed in design and expression of electrostatic systems.

#### *Working with plastic and other synthetic materials*

Materials at the bottom of the triboelectric series that have a high tendency towards becoming negatively charged when in contact with skin mostly constitute synthetic materials. Incorporating these materials into electrostatic harvesting systems provides a way for re-using and recycling plastics, polyester and other slow and non-degrading materials. There are different kinds of textile objects in our homes and interior environment, such as rugs or curtains, that already use such materials in their construction. There are also techniques to recycle plastic wastes and bottles into soft yarns that can be made into textiles. The experiments in this research have illustrated a proof of concept of the different ways in which these recycled soft electrostatic materials may provide a way for engaging with static electricity in everyday interior spaces, such as one's home. Although this provides an opportunity for the area of electrostatic textiles, it must also address people's preferences towards natural materials. The home is also a place where people look for most comfort and cosiness, and natural and organic materials may be preferred for textiles that operate close to the body. Further research into how electrostatic materials would be perceived and adopted in relation to natural materials would be useful for guiding material development in this field.

#### *Effort and gain*

Energy cannot be created; it can only be transferred from one form into another. Thus, every form of kinetic body-generated energy harvesting system requires human effort to be converted into electrical energy. The central design challenge here is to find a balance

between motivation for electrical engagement and the perception of the electrical output to create desirable energy harvesting experiences. In Study 03, the interaction narratives explored examples of different relationships between effort and electrical gain. It is important to emphasise that the least effort or most efficient system may not be the most desirable one regarding the experience of the person involved. While a certain amount of efficiency is certainly useful, it does not need to be the only goal for technology development. Development of electrostatic textile systems need to consider different levels of engagement and involvement with electricity for designing different experiences and applications for electrostatic textile interactions.

#### *Direct engagement with electricity*

The electrostatic sleeping example in Study 02 re-interprets a daily activity of sleeping as a way of engaging with static electricity through textiles. The aim of this exploration was to generate examples of immersive textile interactions in the everyday that may result in electrostatic charges. The intention here was not to suggest products or application, and the examples were not tested or evaluated with users. Nevertheless, in informal discussion with colleagues and peers, this example created a varied response. To most it communicated a possibility and a realisation towards the extent of textile engagement that results in electrostatic charges. However, to some, it presented an extreme example of bringing electricity and magnetism uncomfortably close to the body. These two perspectives provide an interesting contradiction of perception that is relevant for body-driven energy harvesting with textiles- on one hand, it provides an opportunity to provoke and engage an active dialogue amongst people about the relationship between electrical energy and the body using static electricity, which is a phenomenon that already occurs close to the body. On the other hand, it highlights a design challenge for energy harvesting textiles and products to express their safety or risks to the people using them.

### **8.3 Resources and tools developed for supporting future work**

#### 8.3.1 Online handbook for working with e-static textiles

The research studies presented in this thesis have developed the foundational work on incorporating static electricity as a resource for designing interactions with e-textiles without needing specialised materials. Different materials, ways of integrating and developing circuits with textiles and conductive elements to safely generate and direct electrostatic charges have been explored. The different examples developed in the research, along with short tutorials and tips for getting started with static electricity are being compiled in the form of an online handbook under the website [www.estatictextiles.cc](http://www.estatictextiles.cc).<sup>331</sup>

The website is divided into three main pages. The first gives an introduction to what static electricity is and simple science experiments that one can do to engage and play with the electrostatic effect. The second page introduces the triboelectric generator circuit and different aspects of interacting with the circuit using the body and textile materials. Different examples from the thesis regarding scaling up interactions, immersive setups and everyday narrations are illustrated. The third page constitutes descriptions of

---

331. Please refer to Appendix A.1 for further information.

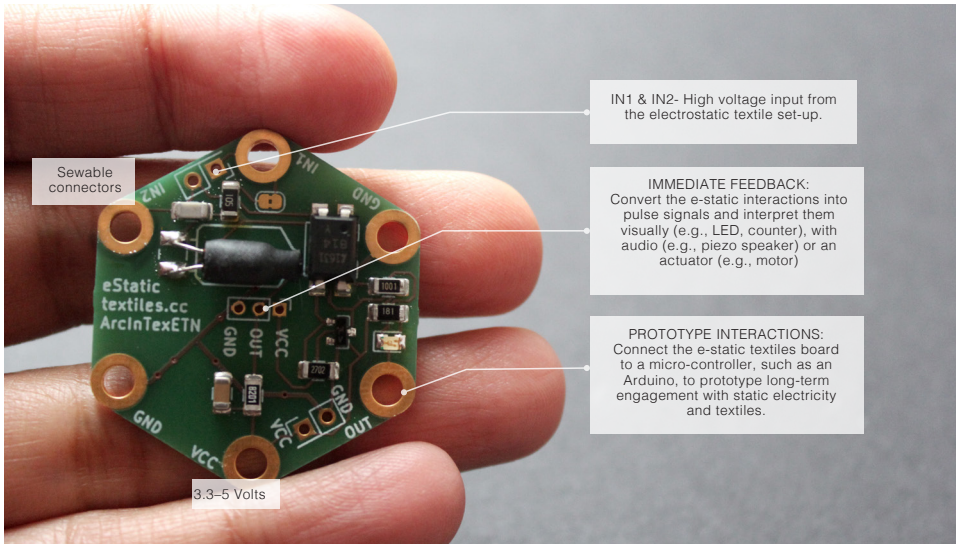

Figure 46. E-static textiles prototyping board developed as a result of the research. See Appendix A.2 for further details and information.

different tools and methods for prototyping. Here, examples of different ways of interpreting static electricity are mentioned along with tips for constructing and visualising electrostatic charges. Each of the pages link to different examples of experiments and explorations done during the thesis process.

This documentation is directed towards the e-textiles community and provides an introduction to static electricity and gives information on basic skills and knowledge needed to start safely exploring static electricity as a new way of engaging with e-textiles.

### 8.3.2 E-static textiles prototyping board

To support further research in the area of electrostatic textiles, a prototyping board (see Figure 46) was developed in collaboration with a Berlin-based electronic prototyping firm called Konstruktiv Berlin.<sup>332</sup> During the thesis project, although there were several examples that use an LED to visualise the electrostatic engagement, it was challenging to design working examples of more complex interactions or to prototype and explore long-term interactions. For example, in the case of electrostatic sleeping (section 5.3.2), the high voltage input was difficult to read and process using simple tools already familiar to the design community, such as an Arduino. In order to develop further examples of electrostatic interactions and prototype interactions, a specialised interface that could easily connect to electrostatic textiles was needed. The e-static textile prototyping board was thus developed to make it easy for others to connect high voltage inputs from electrostatic textiles and quickly start prototyping and exploring long-term interactions with static electricity and textiles.

The hexagonal-shaped e-static textiles prototyping board measures approximately 3.6

332. <https://konstruktiv-berlin.de/language/en/>

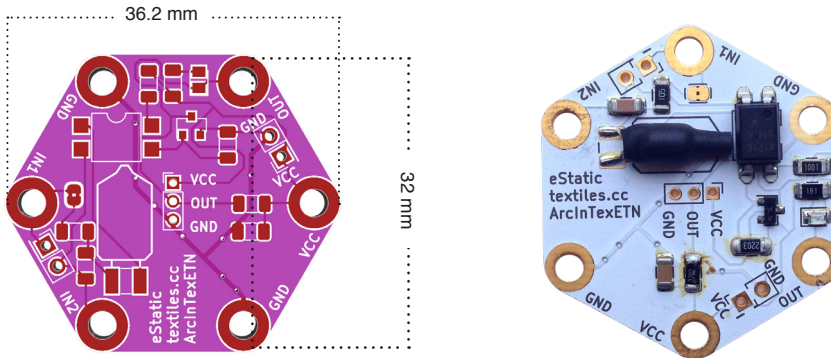

Figure 47. Details of the E-static textiles prototyping board.

cm by 3.2 cm and has five sewable connectors which make it easy to incorporate into e-textile projects (see Figures 46 and 47). The IN1 and IN2 pins are used for connecting to the high voltage inputs from the electrostatic setups. VCC is used for powering the board using a constant voltage between 3.3 and 5 volts. The GND pin connects to the ground and the OUT pin can be used to connect different outputs for visualising the electrostatic interactions. The OUT pin can also be connected to the interrupt pin of an Arduino to read and program complex interactions over a long period of time using the Arduino software platform. Along with the sewable connectors, each of the pins are also available as through-hole connectors where connectors for jumper cables or a battery can be soldered if needed.

The board was developed in various stages in collaboration with an electronic engineer at the prototyping firm (see Figure 48). The first stage included an initial prototype with roughly soldered components made after the first meeting and discussion of what I wanted the PCB to do. After testing the initial prototype, an outline for the shape of the board was designed by me, while the engineer designed the circuit layout and made further adjustments to the outline according to the technical requirements. The first batch of a few PCBs were manufactured and tested with the electrostatic textile samples developed during the thesis. After adjusting some of the component values and minor calibrations, a final set of the prototyping boards was manufactured.

The e-static textiles prototyping board is not an electrostatic harvester, rather it enables designers and makers to envision everyday engagement with static electricity using working prototypes. It can be used to detect the presence of electrostatic charges in interaction as a sensor for e-textile applications. It can also be used to prototype examples of energy harvesting interactions without being constrained by limitations of current harvesting capabilities. A detailed overview of the e-static textiles prototyping board and the technical descriptions is included in Appendix A.3. Instructions on how to get started with the board as well as examples of Arduino programs to enable easy incorporation into e-textile projects are also included in the above-mentioned website- [www.estatictextiles.cc](http://www.estatictextiles.cc).

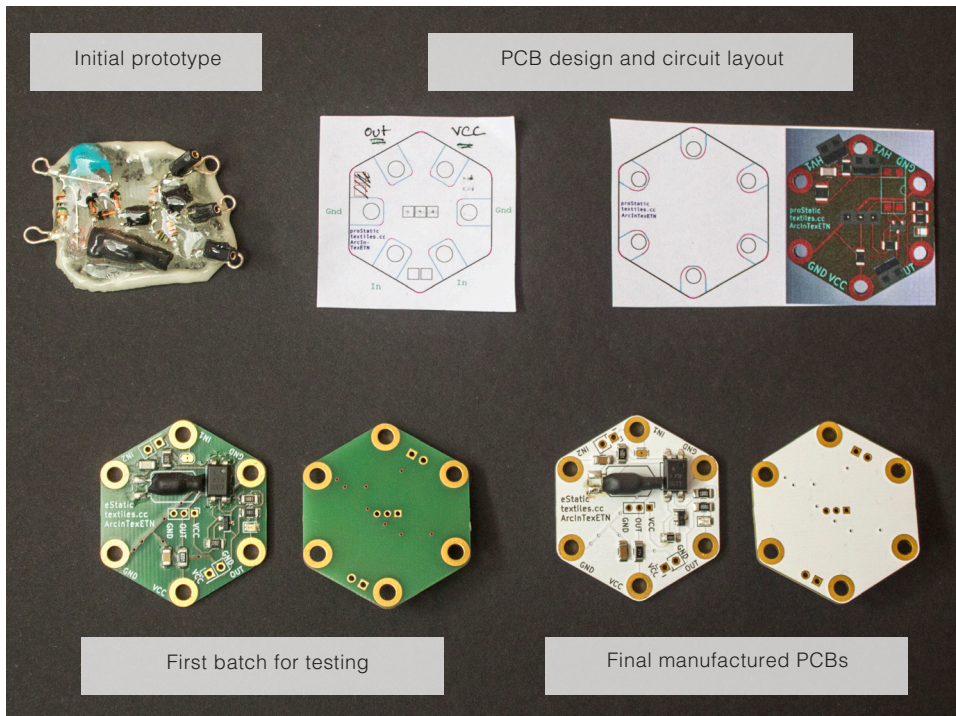

Figure 48. Stages of development of the e-static textiles prototyping board.

These prototyping boards are intended to be used in educational settings and workshops to introduce electrostatic energy as a resource for e-textile design. Additionally, a workshop kit including the PCB along with additional components and materials for working with static electricity and textiles has been developed (see Figure 49). The workshop kit includes an e-static textiles prototyping board, a simple LED circuit meant to be directly connected to e-static setups, an LED, a resistor and some conductive thread. The workshop kit also includes a series of handouts and illustrations that outline simple instructions for connecting and exploring different basic setups for engaging safely with static electricity and soft electrostatic materials. Please refer to Appendix A.4 for further details about the workshop kit and the supporting materials.

The prototyping boards were developed during the end of the thesis process. So far, these PCBs have been used in making demonstrators of electrostatic engagement supporting the thesis work (see Figure 50). The first demonstrator, named the e-static wall (see Figure 50-left) presents an electrostatic wall that can be stroked or rubbed while walking by. When enough electrostatic charges are accumulated, the lamp attached to the setup lights up. This setup uses the e-static prototyping board to explore interactions over a long period of time for energy harvesting. The second demonstrator, the e-static seat (see Figure 50-right), explores static electricity as a sensor for e-textile setups. The e-static prototyping board in this case is used to count and display the electrostatic

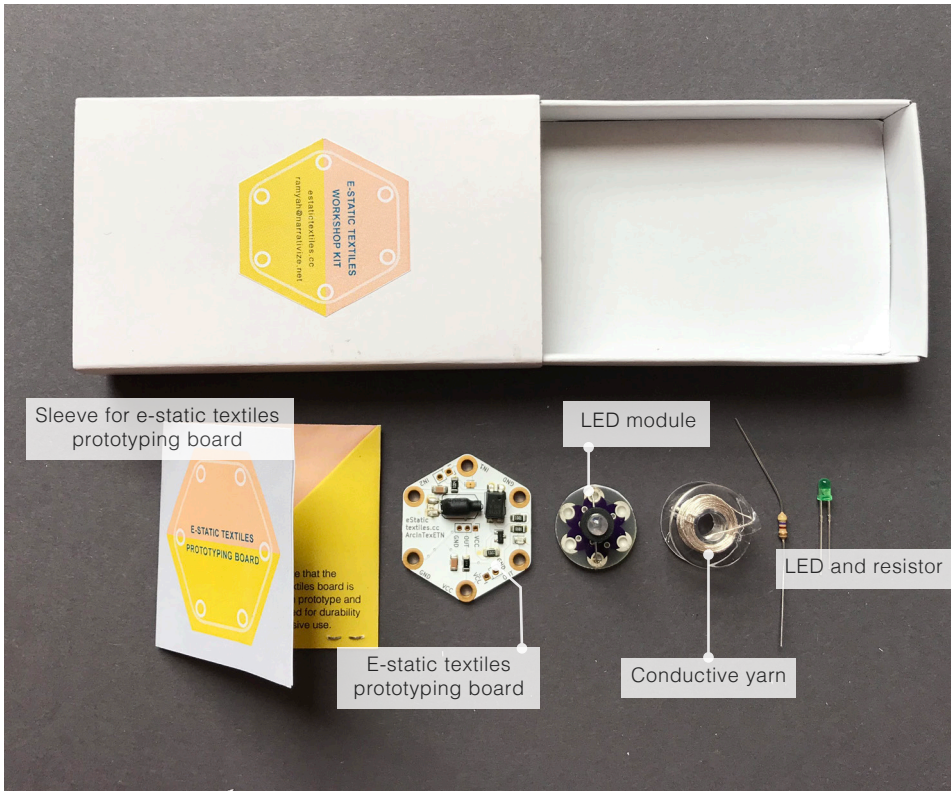

Figure 49. E-static textiles workshop kit developed during the thesis to be used in educational settings. Please refer to Appendix A.4 for further information about the workshop kit and supporting materials.



Figure 50. Examples of electrostatic setups made using the e-static textiles prototyping board. (Left) e-static wall. (Right) e-Static seat. Further information about these setups can be found in Appendix B.

charges generated when a person sits and moves on the seat. Please refer to Appendix B on page 203 for further details about the two demonstrators. Additionally, short video demonstrations of the setups are included in Appendix D.

Furthermore, a workshop about working with static electricity and textiles using the e-static prototyping board and the above-mentioned workshop kit was undertaken at IKEA, Sweden, in June 2019 with eight participants from different teams at the IKEA design department. During this half-day workshop, the participants were introduced to my thesis project and were guided through different explorations of engaging with static electricity using the e-static textiles workshop kit. Some impressions from this workshop are included in Appendix A.4.

The e-textile prototyping board together with the online handbook constitute concrete results of the research that aim at sharing the knowledge gained during this thesis process with the community of e-textile researchers and practitioners to start engaging with static electricity. A plan for working further with them is described in section 9.3, which presents directions for future work.

## 9 Discussion: Towards an interaction design perspective for body-driven energy harvesting

In the previous chapter, I described the research results and reflections in relation to the design program and contributions to the field of e-textile interaction design. In this chapter, I extend the discussion to relate the insights from investigating the design program to the broader research interests of the thesis which proposed to:

*identify emerging concerns and challenges brought by everyday engagement with electricity production that need to be addressed through an interaction design inquiry.*

I do so by drawing on the insights from the research studies to create an open discussion around two key aspects that may become important for the field of body-driven energy harvesting systems as an area within materiality oriented HCI. The first involves considering human computer interactions as accumulated series of actions over a long period of time rather than single instances of input and output. The second concerns involving the electric properties of the body as a collaborative aspect in human computer interaction.

The last section of the chapter builds on the discussion presented here to refine the original design program and proposes directions for future work.

### 9.1 Accumulated interactions as an inquiry into sustainability of interactions

In this section I will examine studies 03 and 04 with regard to the temporal scaling-up of the triboelectric circuit and delve deeper into the discussions regarding long-term interactions raised at the end of Chapter 6. I propose that the temporal scaling of interactions



relevant for energy harvesting could be shaped into an inquiry concerning the sustainability of interactions.<sup>333</sup>

Building on the insights from the previous studies involving interacting and activating e-textile setups, Study 03 interpreted the triboelectric circuit as a feature of the everyday environment. Applying the interaction strategies identified in Study 02, several situations, instances and interactions were envisioned for engaging with static electricity using enactments, videos and sketches. The focus in Study 3 shifted from trying to activate the triboelectric circuit through interactions to imagining it as a part of everyday rhythms and routines over a long period of time. This marked the temporal scaling of the triboelectric circuit. This was further supported by the apparent limitations of energy conversion efficiency of the electrostatic setups. The discussion at the end of Chapter 6 reflected on this inefficiency as a nudge towards considering the long-term implications of the physical choreographies introduced by emerging technologies. Here, I would like to develop this idea further to propose the notion of accumulated interactions as a key characteristic of designing interactions for body-driven energy harvesting.

The discussion in Study 04 introduced the idea of accumulated interactions in relation to immediate and delayed feedback from the electrostatic harvesting systems. Immediate feedback refers to systems where the electrostatic charges generated in each interaction are directly translated into electricity, for example, for blinking an LED. The approach of delayed feedback plays with the idea of charging something over time where the individual interactions get added up and slowly become more meaningful, for example, when there is enough energy collected to power something, or when the amount of electrostatic charges over time is used to measure everyday engagement with a certain activity.

Designing for delayed feedback or designing for collecting interactions is significantly different from the usual concern of interaction design of triggering different features in a system through interaction. Furthermore, in the case of energy harvesting, the person or people involved are engaged in a productive activity of collecting electric charge that was not there before. This marks another key shift in how we understand human computer interaction from that of manipulating electrical current already present, to generating it with and for the computational artefact. This brings two aspects of sustainability into the HCI field— one of engaging in a sustainable practice of energy harvesting, and the second of considering the sustainability of the interaction itself over time.

The idea of sustainability in HCI is not new. Sustainable HCI aims at developing interactive systems that are human and environmentally friendly.<sup>334</sup> The seminal article by

---

333. This is an aspect that relates to the objectives of the Arcintex ETN project frame of which this doctoral thesis is a part.

334. Abdulmajid Hissen Mohamed Ali et al., "Sustainability Issues In Human Computer Interaction Design," *International Journal of Technical Research and Applications*, no. Special Issue 9 (2014), <https://www.ijtra.com/special-issue-abstract.php?id=sustainability-issues-in-human-computer-interaction-design>.

Blevis<sup>335</sup> published in 2006, argued for reducing the material effects brought on by HCI in forms of use, reuse and disposal in support of sustainability. Different works within the field of HCI have addressed issues related to the environmental sustainability of computational technology. For example, Ali et al.<sup>336</sup> highlight sustainability in human computer interaction design around issues of power consumption, reducing e-waste and promoting software reusability. Energy use and awareness is also an important topic within HCI. Research projects such as Static!<sup>337</sup> have visualised energy use and included electricity as a design element to continuously inform the users of their energy-consumption behaviours. These projects operate on a premise that making the users aware of their energy practices through design can help them identify and change certain routines towards making more sustainable choices. These kinds of persuasive design approaches to change sustainability behaviours was noted to comprise about 45% of sustainability related HCI publications according to a review by DiSalvo et al.<sup>338</sup> in 2010. Some of the other genres of sustainability approaches in HCI have been identified as re-examining what users understand by sustainability, developing sensors to monitor and report on environmental data and rethinking methods for supporting reuse and reducing waste through HCI.<sup>339</sup> This body of research on sustainable HCI has contributed to raising concerns as well as presented approaches and examples of addressing issues regarding environmental sustainability in HCI design and research.

Some key critiques of the current body of sustainable HCI work have been that it needs to address larger time scales to be conclusive about its impacts on sustainable behaviour, as well as the need to address sustainability in HCI at a regional level of political policy-making that goes beyond the scale of the individual.<sup>340</sup> It has also been noted that there is a need to address the full diversity of sustainability issues and to learn from and collaborate with other disciplines to broaden the understanding of sustainability for HCI.<sup>341</sup> In addressing some of these issues, researchers such as Wakkary et al.<sup>342</sup> have proposed

---

335. Eli Blevis, "Advancing Sustainable Interaction Design: Two Perspectives on Material Effects," *Design Philosophy Papers* 4, no. 4 (December 29, 2006): 209–30, <https://doi.org/10.2752/144871306X13966268131875>.

336. Ali et al., "Sustainability Issues In Human Computer Interaction Design."

337. Mazé, "Static!: Designing for Energy Awareness."

338. Carl DiSalvo, Phoebe Sengers, and Hrönn Brynjarsdóttir, "Mapping the Landscape of Sustainable HCI," in *Proceedings of the 28th International Conference on Human Factors in Computing Systems - CHI '10* (New York, USA: ACM Press, 2010), 1975, <https://doi.org/10.1145/1753326.1753625>.

339. Ibid.

340. Ibid.; M. Six Silberman et al., "Next Steps for Sustainable HCI," *Interactions* 21, no. 5 (September 1, 2014): 66–69, <https://doi.org/10.1145/2651820>.

341. DiSalvo, Sengers, and Brynjarsdóttir, "Mapping the Landscape of Sustainable HCI" and Silberman et al. "Next Steps for Sustainable HCI."

342. Ron Wakkary and Karen Tanenbaum, "A Sustainable Identity," in *Proceedings of the 27th International Conference on Human Factors in Computing Systems - CHI 09* (New York, USA: ACM Press, 2009), 365, <https://doi.org/10.1145/1518701.1518761>.

adopting a combination of methods from practice theory and design fiction to reframe interaction design with respect to sustainability. They argue that the practice-oriented approach can help “interaction designers move away from models of individual behaviour and artefact studies towards seeing sustainable behaviours as a part of multidimensional and interrelated practices.”<sup>343</sup>

The interaction fictions introduced in this research on e-static textiles support this view of sustainability in HCI by framing it as a part of a larger network of behaviours and everyday rhythms. Interaction fictions enabled envisioning single interactions with emerging technology as part of other existing models of socio-cultural practices.

Additionally, the research proposes a new aspect of sustainability that is less explored in HCI— that of considering the sustainability of the actions themselves. The notion of accumulated interactions urges designers to discuss and address long-term use. The notion of longer time scales of interactions is considered in life-cycle studies and ergonomics to address the long-term effects on the body of assuming certain postures for an extended period of time. This is an important aspect of sustainable HCI. Additionally, accumulated interactions go beyond considering the interactions not only as repetitive but also cumulative. For example, in research studies 03 and 04, interaction fictions are used to explore and present future scenarios that do not explain the use of a product, but rather illustrate examples of how we, as a society, may interact with electrostatic energy in the everyday. In this way, computational interactions can be seen as collectively evolving and changing how we understand and relate to the world around us.<sup>344</sup> Considering interactions as accumulative can help to envision emerging social and cultural sustainability at an early stage of design and create a space for exchange and discussion.

## 9.2 Open question: Human computer collaboration

The working principle of the triboelectric circuit chosen for this research makes the human body an essential part of the energy harvesting circuit. This was chosen to bring the focus on interactions and body movements while exploring different electrostatic setups. The different electrostatic setups in the research studies thus highlight the presence of the human body in interaction and thereby focus on the electric properties of the skin that are directly utilised for energy harvesting.

In Hertzian tales,<sup>345</sup> Dunne and Raby explore the invisible landscapes of electromagnetic waves emitted by all the electronic devices that populate our everyday. Through different investigations, they illustrate and discuss not only the physical but also the emotional

---

343. Ibid.

344. This has been discussed extensively in various research fields. Example: Marshall McLuhan and Lewis H. Lapham, *Understanding Media : The Extensions of Man*, accessed December 15, 2017, <https://mitpress.mit.edu/books/understanding-media>.

345. Anthony Dunne, *Hertzian Tales: Electronic Products, Aesthetic Experience, and Critical Design* (MIT press, 2005), <http://mitpress.mit.edu/catalog/item/default.asp?tid=10771&ttype=2>.

and behavioural relationships between electronic devices and people inhabiting the same space. The boundaries are blurred when we ourselves become carriers and antennas for signals, for example, when we adjust or change our own location to get better reception on the radio or when we hold our phones up in the air trying to “catch” more bars of phone reception. The examples of electrostatic energy harvesting discussed in this thesis that utilise our body’s kinetic energy and conductive property for generating electricity further blur the boundaries between computational things and us.

Working with the context of the interior in this thesis resulted in examples such as the electrostatic cube (Study 02) that interpret an interior space as a computational object that is activated by its interaction with a person. In this immersive electrical space, the material quality of human skin is crucial to the working of the system along with that of other materials that constitute the electrostatic circuit. The body thus takes on a participative role in this computational space and converts an otherwise dormant space into an electrical object. From this perspective, people could be seen as dwelling and acting in collaboration with(in) computational spaces. Following the idea of ‘technology as second-skin’,<sup>346</sup> wearing computationally enabled clothes could also be regarded as inhabiting a computational thing. Moreover, energy harvesting technologies that can be implanted within the body take the participation of the human body to yet another level. Considering these different scales of computational interventions inside, on and around our bodies, presents a growing challenge for interaction design to address this blurring of boundaries between the user and body-driven energy harvesting systems and devices.

The above examples of human-computer interaction urge us to interpret the engagement between humans and machines as more direct and interdependent. In exploring the material properties of energy, Pierce and Paulos<sup>347</sup> describe how our expectations might change by detaching a device from its usual power source (plug points, batteries) and relying instead on human kinetic energy. They argue that de-tethering electrical artefacts from their usual power sources makes them similar to other non-electrical objects, such as a book. The person activates the electrical object using her energy in the same way as one might see opening a book as activating it. They propose that bodily engagement with electrical energy extends the design space of the HCI by expanding the electrifiable space, by presenting new ways of interacting and by exploring new relationships to electrical technology.<sup>348</sup>

The notion of collaboration also relates to the recent discussion in the field of HCI that extends the idea of interaction to the wider context of ‘integration.’<sup>349</sup> Farooq and

---

346. For example, “The Beauty of 2nd Skin | Sabine Seymour TEDx Talk | Art, Media, & Technology,” accessed July 24, 2019, <http://amt.parsons.edu/blog/the-beauty-of-2nd-skin-sabine-seymour-tedx-talk/>.

347. Pierce and Paulos, “Materializing Energy.”

348. Pierce and Paulos, “Electric Materialities and Interactive Technology.”

349. Ron Wakkary and Erik Stolterman, “Integration,” ed. Ron Wakkary and Erik Stolterman, *Interactions* 23, no. 6 (October 26, 2016): 5–5, <https://doi.org/10.1145/3005777>.

Grudin<sup>350</sup> have argued that the relationship between humans and the computer is changing from being stimulus-response based to a proactive one where the computer performs on the user's behalf even when the person is not interacting with the computer. They describe integration as a partnership between humans and computer software which aims for a symbiotic relationship where they work towards the same goals.

The results of this thesis further extend this discussion by illustrating a partnership not only at a software level but at the level of materials. This collaboration calls for an active engagement from the humans and the extent of effort and usefulness needs to be negotiated according to different contexts. Body-driven energy harvesting is an example of this kind of human computer integration that proposes a conceptual shift in how we design everyday technologies and extends the notion of use to that of collaboration. How much are we willing to do for electricity and what do we expect from our everyday technologies in return?

### 9.3 Directions for future work

This thesis aimed at developing an interaction design perspective to research body-driven energy harvesting in the context of e-textiles. The discussion in this chapter developed examples of two characteristics of body-driven energy harvesting that become relevant for interaction design— a focus on accumulated interactions and the other, building on the idea of human-computer collaboration. In chapter 8, the results and reflections positively illustrated how using electrostatic energy in the context of e-textiles was a useful case study to explore, extend and develop new insights through the design program formulated at the beginning of the thesis.

Moreover, based on the reflections and discussion presented in this chapter, I propose that long term accumulative interactions as a design goal presents a key direction for further research in the area of body-driven energy harvesting within materiality oriented interaction design. Following this proposition, the design program for future work could be refined and reformulated as:

*Explore and develop examples of accumulated interactions using e-static textile setups in the everyday, with a keen focus on the following three interpretations of accumulation:*

- *Accumulation of material expression*
- *Sustainability of interactions over time*
- *Collaborations between humans and e-static setups*

The reformulated design program focuses on aspects of accumulation of interactions in the context of energy harvesting with e-static textiles. The three focus areas within the design program build on the insights gained from the research studies of this thesis and identify areas for further research and development. The accumulation of material expressions focuses on visual and tangible expressions as a result of long-term interactions

---

350. Umer Farooq and Jonathan Grudin, "Human-Computer Integration," *Interactions* (ACM, October 26, 2016), <https://doi.org/10.1145/3001896>.

within the material itself. The sustainability of interactions emphasises designing interaction choreographies within and around e-static systems from the perspective of long-term interactions. And the third area approaches accumulative long-term interactions from the perspective of developing examples of relating with e-static setups that highlight a collaborative relationship between people and the system working towards a common goal.

### 9.3.1 Resources and tools

The design program undertaken for this thesis aimed at opening up a design space for considering electrostatic energy in textiles from the perspective of interaction design. The research studies, with the exception of Study 04, were undertaken by me and used my observations and reflections to drive the research discussion forward. These research studies were useful for opening up the topic and creating the foundational knowledge on working with static electricity and textiles. Going forward, it would be useful to share the results of the research studies outside of the dissertation in forms that are accessible and approachable for others to explore, contribute to and build on the results from this thesis. For this reason, the outcomes described in section 8.4– the online handbook for e-static textiles and the e-static textiles prototyping board– would be crucial resources for investigating the above-formulated design program and developing this work further. For example, the e-static textile prototyping board can support a prototyping-based inquiry of accumulative interactions that focuses on collection rather than single instances of input and output. Similarly, the e-static textiles handbook could be developed into a platform for sharing examples and results from electrostatic interactions observed over a long period of time.

## 10 Concluding remarks

This doctoral thesis investigated body-driven energy harvesting from the point of view of e-textile interaction design. It aimed to discuss and address the implications of involving the human body actively in powering electronic devices and explored its influences on the way we design and relate to technological artefacts.

In doing so, the research set up a systematic study of static electricity as an energy source in the context of e-textile design. Developing a working knowledge of textile-based triboelectric generators, various body-generated electricity systems of different scales were envisioned. The context of the interior formed a broad frame to situate and guide the research studies. In the process of making, discovering and exploring different textile systems, questions regarding human interactions, material behaviours and the role of electricity in the everyday were discussed.

The design program undertaken to consider static electricity as a material property for designing e-textile interactions led to extending the scope of e-textile design and development by:

- extending the definition of e-textiles as a material system that is guided by textile-specific interactions in different contexts.
- presenting examples and methods for designing with static electricity in the context of e-textiles using easily-accessible materials.
- discussing applications and future implications of engaging with electrostatic energy through interaction fictions that are based on real technological constraints and understanding.

Furthermore, the research opened a discussion in the field of human computer interaction research by presenting energy harvesting as a topic of interaction design. It identified the following two areas that become relevant for designing interactions with body-driven energy harvesting technology within materiality oriented HCI:

- Accumulated interactions as an inquiry into interaction sustainability.
- Utilising the electric properties of the body in interaction as a way of exploring the notion of human-computer collaboration

Additionally, practical outcomes of this research included:

- [www.estatictextiles.cc](http://www.estatictextiles.cc)– An online handbook for learning about and working with static electricity and e-textiles which includes tutorials and examples from the research process.
- E-static textiles prototyping board– A PCB developed for easy integration of static electricity and textiles to be used as an educational tool for designing and prototyping electrostatic energy-related interactions.

This four-year research project provided the opportunity to explore static electricity and textiles from varied perspectives and actively engage through making and observing. Although the technology of electrostatic harvesting is still developing, this thesis aimed at engaging the design community in the field of HCI and e-textiles to consider body-driven energy harvesting as an area of human computer interaction that can explore, challenge and inform the direction of technology development. Furthermore, it is hoped that this thesis has illustrated the vast potential for incorporating static electricity as a design parameter in e-textile development.





## Epilogue

This doctoral thesis was part of the ArcInTex ETN project. The Ph.D. program within the project included several summer schools, courses, workshops and research exchanges amongst the universities in the consortium. These organised teaching events along with the rich exchange amongst project supervisors and other Ph.D. students in the program contributed immensely to the development of this research. Please refer to Appendix E for a detailed overview of my participation in courses, workshops and research activities within the ArcInTex ETN project.

## References

- Acharya, Karthik. *Opening the Electrome – Redefining Home for Energy Studies through Design Practice*, 2016. <https://shop.aalto.fi/p/534-opening-the-electrome/>.
- Ali, Abdulmajid Hissen Mohamed, Fatma A. Algha, Nage E. Bazina, and Hissen A. Idress. “Sustainability Issues In Human Computer Interaction Design.” *International Journal of Technical Research and Applications*, no. Special Issue 9 (2014). <https://www.ijtra.com/special-issue-abstract.php?id=sustainability-issues-in-human-computer-interaction-design>.
- Allison, Linden K., and Trisha L. Andrew. “A Wearable All-Fabric Thermoelectric Generator.” *Advanced Materials Technologies*, January 22, 2019, 1800615. <https://doi.org/10.1002/admt.201800615>.
- AlphaLab Inc. “The TriboElectric Series.” Accessed March 28, 2017. <http://www.trifield.com/content/tribo-electric-series/>.
- Anonymous. “Adidas MiCoach Seamless Sports Bra,” 2015. <http://shop.numetrex.com/product/adidas-micoach-seamless-sports-bra/>.
- Auger, James. “Speculative Design: Crafting the Speculation.” *Digital Creativity*, 2013. <https://doi.org/10.1080/14626268.2013.767276>.
- Baird, Davis. *Thing Knowledge : A Philosophy of Scientific Instruments*. University of California Press, 2004. <https://www.ucpress.edu/book/9780520232495/thing-knowledge>.
- Bakker, Saskia, Alissa N. Antle, and Elise van den Hoven. “Embodied Metaphors in Tangible Interaction Design.” *Personal and Ubiquitous Computing* 16, no. 4 (June 12, 2011): 433–49. <https://doi.org/10.1007/s00779-011-0410-4>.
- Bandodkar, Amay J. “Review—Wearable Biofuel Cells: Past, Present and Future.” *Journal of The Electrochemical Society* 164, no. 3 (November 30, 2017): H3007–14. <https://doi.org/10.1149/2.0031703jes>.
- Bang, Anne Louise, and Mette Agger Eriksen. “Experiments All the Way - Diagrams of Dialectics between a Design Research Program and Experiments.” *Artifact* 3, no. 2 (December 3, 2014): 4. <https://doi.org/10.14434/artifact.v3i2.3976>.
- Bell, Genevieve, Mark Blythe, and Phoebe Sengers. “Making by Making Strange.” *ACM Transactions on Computer-Human Interaction* 12, no. 2 (June 2005): 149–73. <https://doi.org/10.1145/1067860.1067862>.
- Berzina, Zane, and Jackson Tan. “E-Static Shadows,” 2009. <http://www.zaneberzina.com/e-staticshadows09/Project.htm>.

- Berzowska, Joanna. "Electronic Textiles: Wearable Computers, Reactive Fashion, and Soft Computation." *Textile: The Journal of Cloth and Culture* 3, no. 1 (2005): 58–75. <https://doi.org/10.2752/147597505778052639>.
- . "Very Slowly Animating Textiles: Shimmering Flower." In *ACM SIGGRAPH 2004 Sketches*, 34---. SIGGRAPH '04. New York, USA: ACM, 2004. <https://doi.org/http://doi.acm.org/10.1145/1186223.1186266>.
- Berzowska, Joanna, and Marcelo Coelho. "Kukkia and Vilkas: Kinetic Electronic Garments." In *Ninth IEEE International Symposium on Wearable Computers*, 82–85, 2005. [http://ieeexplore.ieee.org/xpls/abs\\_all.jsp?arnumber=1550790](http://ieeexplore.ieee.org/xpls/abs_all.jsp?arnumber=1550790).
- Binder, Thomas, and Johan Redström. "Exemplary Design Research." In *Design Research Society Wonderground International Society Conference*. Lisbon, 2006. <http://redstrom.se/johan/abstracts/aexemplary.html>.
- Bishop, Durrell. "The Marble Answering Machine." *The Hand That Rocks the Cradle*, 1995. <https://www.v-must.net/biblio/marble-answering-machine>.
- Bleecker, Julian. "Design Fiction: A Short Essay on Design, Science, Fact and Fiction," 2009.
- Blevis, Eli. "Advancing Sustainable Interaction Design: Two Perspectives on Material Effects." *Design Philosophy Papers* 4, no. 4 (December 29, 2006): 209–30. <https://doi.org/10.2752/144871306X13966268131875>.
- Blythe, Mark. "Research through Design Fiction: Narrative in Real and Imaginary Abstracts." In *Proceedings of the 32nd Annual ACM Conference on Human Factors in Computing Systems - CHI '14*, 703–12. New York, USA: ACM Press, 2014. <https://doi.org/10.1145/2556288.2557098>.
- Blythe, Mark, Kristina Andersen, Rachel Clarke, and Peter Wright. "Anti-Solutionist Strategies: Seriously Silly Design Fiction Mark." In *Proceedings of the 2016 CHI Conference on Human Factors in Computing Systems - CHI '16*, 4968–78. New York, USA: ACM Press, 2016. <https://doi.org/10.1145/2858036.2858482>.
- Brandt, Eva, and Thomas Binder. "Experimental Design Research: Genealogy, Intervention, Argument." In *IASDR 07. Hongkong, 2007*. <https://adk.elsevierpure.com/en/publications/experimental-design-research-genealogy-intervention-argument>.
- Brandt, Eva, Johan Redström, Mette Agger Eriksen, and Thomas Binder. *XLAB*. Copenhagen: The Danish Design School Press, 2011.
- Buechley, Leah, Mike Eisenberg, Jaime Catchen, and Ali Crockett. "The LilyPad Arduino: Using Computational Textiles to Investigate Engagement, Aesthetics, and Diversity in Computer Science Education." In *Proceeding of the Twenty-Sixth Annual SIGCHI Conference on Human Factors in Computing Systems*, 423–32. CHI '08. New York, USA: ACM, 2008. <https://doi.org/http://doi.acm.org/10.1145/1357054.1357123>.

- Buechley, Leah, and Hannah Perner-Wilson. "Crafting Technology." *ACM Transactions on Computer-Human Interaction* 19, no. 3 (October 1, 2012): 1–21. <https://doi.org/10.1145/2362364.2362369>.
- Buur, Jacob, Mads Vedel Jensen, and Tom Djajadiningrat. "Hands-Only Scenarios and Video Action Walls." In *Proceedings of the 2004 Conference on Designing Interactive Systems Processes, Practices, Methods, and Techniques - DIS '04*, 185. New York, New York, USA: ACM Press, 2004. <https://doi.org/10.1145/1013115.1013141>.
- C., Victoria. "The History Of Solar Power | Experience." 2017. Accessed February 28, 2019. <https://www.experience.com/advice/careers/ideas/the-history-of-solar-power/>.
- Chandra, Madhup, Mark T. Jones, and Thomas L. Martin. "E-Textiles for Autonomous Location Awareness." *IEEE Transactions on Mobile Computing* 6, no. 4 (April 2007): 367–80. <https://doi.org/10.1109/TMC.2007.51>.
- Chao, Bob. "Making Low-Voltage Energy Harvesting Practical: Part 1 — The History of Energy Harvesting," 2012. [https://www.electronicproducts.com/Power\\_Products/Invertors/Making\\_low-voltage\\_energy\\_harvesting\\_practical\\_Part\\_1\\_The\\_history\\_of\\_energy\\_harvesting.aspx](https://www.electronicproducts.com/Power_Products/Invertors/Making_low-voltage_energy_harvesting_practical_Part_1_The_history_of_energy_harvesting.aspx).
- Choi, A Young, Chang Jun Lee, Jiwon Park, Dogyun Kim, and Youn Tae Kim. "Corrugated Textile Based Triboelectric Generator for Wearable Energy Harvesting." *Scientific Reports* 7, no. 1 (December 28, 2017): 45583. <https://doi.org/10.1038/srep45583>.
- Choi, Young-Man, Moon Gu Lee, Yongho Jeon, Young-Man Choi, Moon Gu Lee, and Yongho Jeon. "Wearable Biomechanical Energy Harvesting Technologies." *Energies* 10, no. 10 (September 25, 2017): 1483. <https://doi.org/10.3390/en10101483>.
- Churchill, Elizabeth, Anne Bowser, and Jennifer Preece. "Teaching and Learning Human-Computer Interaction | ACM Interactions." Accessed April 10, 2019. <http://interactions.acm.org/archive/view/march-april-2013/teaching-and-learning-human-computer-interaction>.
- Crow, Rita M. "Static Electricity: A Literature Review," 1991. <http://adsabs.harvard.edu/abs/1991selr.rept....C>.
- CUTECIRCUIT. "Twitter Dress." Accessed February 4, 2019. <http://cutecircuit.com/media/media-twitter-dress/>.
- "CUTECIRCUIT. "Haute Couture." Accessed September 12, 2018. <http://cutecircuit.com/haute-couture/>.
- Dagdeviren, Canan, Zhou Li, and Zhong Lin Wang. "Energy Harvesting from the Animal/Human Body for Self-Powered Electronics." *Annual Review of Biomedical Engineering* 19, no. 1 (June 21, 2017): 85–108. <https://doi.org/10.1146/annurev-bioeng-071516-044517>.
- Diffus Design. "Climate Dress 2009." Accessed March 14, 2019. <http://diffus.dk/work/project-climate-dress/>.

- DiSalvo, Carl, Phoebe Sengers, and Hrönn Brynjarsdóttir. "Mapping the Landscape of Sustainable HCI." In *Proceedings of the 28th International Conference on Human Factors in Computing Systems - CHI '10*, 1975. New York, USA: ACM Press, 2010. <https://doi.org/10.1145/1753326.1753625>.
- Djajadiningrat, Tom, Ben Matthews, and Marcelle Stienstra. "Easy Doesn't Do It: Skill and Expression in Tangible Aesthetics." *Personal and Ubiquitous Computing* 11, no. 8 (March 17, 2007): 657–76. <https://doi.org/10.1007/s00779-006-0137-9>.
- Djajadiningrat, Tom, Stephan Wensveen, Joep Frens, and Kees Overbeeke. "Tangible Products: Redressing the Balance between Appearance and Action." *Personal and Ubiquitous Computing* 8, no. 5 (July 31, 2004): 294–309. <https://doi.org/10.1007/s00779-004-0293-8>.
- Dongen, Pauline van. "Solar Shirt." Accessed July 15, 2019. <http://www.paulinevandongen.nl/project/wearable-solar-shirt/>.
- Dourish, Paul. "What We Talk about When We Talk about Context." *Personal and Ubiquitous Computing* 8, no. 1 (February 1, 2004): 19–30. <https://doi.org/10.1007/s00779-003-0253-8>.
- . *Where the Action Is*. The MIT Press, 2004. <http://mitpress.mit.edu/books/where-action>.
- Dumitrescu, Delia, and Anna Persson. "Exploring Heat as Interactive Expressions for Knitted Structures." *Nordes*, March 31, 2011. <http://www.nordes.org/opj/index.php/n13/article/view/123>.
- Dunne, Anthony. *Hertzian Tales: Electronic Products, Aesthetic Experience, and Critical Design*. MIT press, 2005. <http://mitpress.mit.edu/catalog/item/default.asp?tid=10771&ttype=2>.
- Dunne, Anthony, and Fiona Raby. *Design Noir: The Secret Life of Electronic Objects*. Basel: Birkhäuser, 2001.
- . *Speculative Everything : Design, Fiction, and Social Dreaming*. MIT Press, 2013.
- Dunstan, David W., Bethany Howard, Genevieve N. Healy, and Neville Owen. "Too Much Sitting – A Health Hazard." *Diabetes Research and Clinical Practice* 97, no. 3 (September 1, 2012): 368–76. <https://doi.org/10.1016/J.DIABRES.2012.05.020>.
- Eriksson, Daniel, Anders Ernevi, Lars Hallnäs, Margot Jacobs, Patricija Jaksetic, Henrik Jernström, Hanna Landin, et al. *IT+Textiles*. Edited by Redström Johan, Maria Redström, and Ramia Mazé. the Interactive Institute and the Swedish School of Textiles at the University of Borås, 2010. <https://www.tii.se/projects/ittextiles>.
- Ernevi, A., D. Eriksson, M. Jacobs, U. Löfgren, R. Mazé, J. Redström, J. Thoresson, and L. Worbin. "Tic Tac Textiles." In *Cumulus Lisbon*, 2005. <http://redstrom.se/johan/abstracts/atictac.html>.

- Evans, Helen, and Heiko Hansen. "Pixelache | Nuage Vert - Vihreä Pilvi." 2008. Accessed July 15, 2019. <https://www.pixelache.ac/pages/nuage-vert-vihrea-pilvi-e35f94a9-34ee-4523-b189-e75b918dd203>.
- Fan, Feng-Ru, Zhong-Qun Tian, and Zhong Lin Wang. "Flexible Triboelectric Generator." *Nano Energy* 1, no. 2 (March 1, 2012): 328–34. <https://doi.org/10.1016/J.NANOEN.2012.01.004>.
- Fan, Xing, Jun Chen, Jin Yang, Peng Bai, Zhaoling Li, and Zhong Lin Wang. "Ultrathin, Rollable, Paper-Based Triboelectric Nanogenerator for Acoustic Energy Harvesting and Self-Powered Sound Recording." *ACS Nano* 9, no. 4 (April 28, 2015): 4236–43. <https://doi.org/10.1021/acs.nano.5b00618>.
- Farooq, Umer, and Jonathan Grudin. "Human-Computer Integration." *Interactions*. ACM, October 26, 2016. <https://doi.org/10.1145/3001896>.
- Findeli, Alain, D. Brouillet, S. Martin, Ch. Moineau, and R. Tarrago. "Research Through Design and Transdisciplinarity: A Tentative Contribution to the Methodology of Design Research," 2008. <https://hal.archives-ouvertes.fr/hal-00995468>.
- Fitzmaurice, George W., Hiroshi Ishii, and William A. S. Buxton. "Bricks: Laying the Foundations for Graspable User Interfaces." In *Proceedings of the SIGCHI Conference on Human Factors in Computing Systems - CHI '95*, 442–49. New York, USA: ACM Press, 1995. <https://doi.org/10.1145/223904.223964>.
- Forlizzi, Jodi, Erik Stolterman, and John Zimmerman. "From Design Research to Theory : Evidence of a Maturing Field From Design Research to Theory : Evidence of a Maturing Field." In *Iasdr*, 2889–98, 2009.
- Frayling, Christopher. "Research in Art and Design." *Royal College of Art Research Papers* 1, no. 1 (1993).
- Frens, Joep. "A Rich User Interface for a Digital Camera." *Personal and Ubiquitous Computing* 10, no. 2–3 (August 26, 2005): 177–80. <https://doi.org/10.1007/s00779-005-0013-z>.
- Gauvreau, B., N. Guo, K. Schicker, K. Stoeffler, F. Boismenu, A. Aji, R. Wingfield, C. Dubois, and M. Skorobogatiy. "Color-Changing and Color-Tunable Photonic Bandgap Fiber Textiles." *Optics Express* 16, no. 20 (September 19, 2008): 15677. <https://doi.org/10.1364/OE.16.015677>.
- Gaver, William, Jacob Beaver, and Steve Benford. "Ambiguity as a Resource for Design." In *Proceedings of the Conference on Human Factors in Computing Systems - CHI '03*, 233. New York, New York, USA: ACM Press, 2003. <https://doi.org/10.1145/642651.642653>.
- Gaver, William, John Bowers, Andrew Boucher, and Sarah Pennington. "The Drift Table: Designing for Ludic Engagement." In *Proceedings of CHI 2004*. Vienna, Austria: ACM Press, 2004.

- Gowrishankar, Ramyah. "Constructing Triboelectric Textiles with Weaving." In *Proceedings of the 2017 ACM International Symposium on Wearable Computers - ISWC '17*, 170–71. New York, USA: ACM Press, 2017. <https://doi.org/10.1145/3123021.3123037>.
- . "Turn-inside-out Textile Interface." Accessed February 4, 2019. <https://narrativize.net/portfolio/turn-around-textile-interface/>.
- Gowrishankar, Ramyah, and Katharina Bredies. "Investigating Interaction Design for E-Textiles Using Case-Transfer." In *Proceedings of Ambience, Scientific Conference for Smart Textiles*. Tampere, 2014. [https://doi.org/ISSN 2342-4540](https://doi.org/ISSN%202342-4540).
- Gowrishankar, Ramyah, Katharina Bredies, and Rosan Chow. "The Music Sleeve : Fabric As An Electronic Interface Medium." In *Nordic Design Research Conferences*. North America 31 03 2011., 2011. <http://ocs.sfu.ca/nordes/index.php/nordes/2011/paper/view/400>.
- Gowrishankar, Ramyah, Katharina Bredies, and Salu Ylirisku. "A Strategy for Material-Specific e-Textile Interaction Design." In *Smart Textiles Fundamentals, Design, and Interaction*, edited by Stefan Schneegass and Oliver Amft, 233–57. Springer International Publishing, 2017. [https://doi.org/10.1007/978-3-319-50124-6\\_11](https://doi.org/10.1007/978-3-319-50124-6_11).
- Guo, Hengyu, Zhen Wen, Yunlong Zi, Min-Hsin Yeh, Jie Wang, Liping Zhu, Chenguo Hu, and Zhong Lin Wang. "A Water-Proof Triboelectric–Electromagnetic Hybrid Generator for Energy Harvesting in Harsh Environments." *Advanced Energy Materials* 6, no. 6 (March 1, 2016): 1501593. <https://doi.org/10.1002/aenm.201501593>.
- Hales, Derek. "Design Fictions an Introduction and Provisional Taxonomy." *Digital Creativity* 24, no. 1 (2013): 1–10. <https://doi.org/10.1080/14626268.2013.769453>.
- Hallnäs, Lars. "On the Foundations of Interaction Design Aesthetics: Revisiting the Notions of Form and Expression." *International Journal of Design* 5, no. 1 (2011). <http://ijdesign.org/index.php/IJDesign/article/view/689/330>.
- . "Outline of a General Artistic Design Research Program." *Borås: Smart Textiles Design Lab Research Outlet*, 2017, 30. <http://hb.diva-portal.org/smash/record.jsf?pid=diva2%3A1169474&dswid=-6131>.
- Hallnäs, Lars, and Johan Redström. "From Use to Presence: On the Expressions and Aesthetics of Everyday Computational Things." *ACM Transactions on Computer-Human Interaction* 9, no. 2 (June 1, 2002): 106–24. <https://doi.org/10.1145/513665.513668>.
- . *Interaction Design: Foundations, Experiments*. The interactive Insitute, The Swedish School of Textiles and University College of Borås, 2006. [www.hb.se/th/ctf](http://www.hb.se/th/ctf).
- . "Slow Technology – Designing for Reflection." *Personal and Ubiquitous Computing* 5, no. 3 (August 2001): 201–12. <https://doi.org/10.1007/PL00000019>.



- . “Textile Interaction Design.” *Nordic Textile Journal* 1 (2008): 104–15. <https://www.semanticscholar.org/paper/textile-interaction-design-Hallnäs-Redström/1ce8e5741a3f6bd9215baaac65bd76418fda8ad6>.
- Harrop, Peter. “Triboelectric Electricity Made Where Needed at Micro to Megawatts: IDTechEx Webinar.” *IDTechEX Triboelectric Energy Harvesting Report*, 2016. <http://www.idtechex.com/research/webinars/triboelectric-electricity-made-where-needed-at-micro-to-megawatts-00087.asp>.
- Hughes-Riley, Theodore, Tilak Dias, Colin Cork, Theodore Hughes-Riley, Tilak Dias, and Colin Cork. “A Historical Review of the Development of Electronic Textiles.” *Fibers* 6, no. 2 (May 31, 2018): 34. <https://doi.org/10.3390/fib6020034>.
- Hummels, Caroline, Kees C. J. Overbeeke, and Sietske Klooster. “Move to Get Moved: A Search for Methods, Tools and Knowledge to Design for Expressive and Rich Movement-Based Interaction.” *Personal and Ubiquitous Computing* 11, no. 8 (October 16, 2007): 677–90. <https://doi.org/10.1007/s00779-006-0135-y>.
- Hyland, Melissa, Haywood Hunter, Jie Liu, Elena Veety, and Daryoosh Vashae. “Wearable Thermoelectric Generators for Human Body Heat Harvesting (Abstract).” *Applied Energy* 182 (November 15, 2016): 518–24. <https://doi.org/10.1016/J.APENERGY.2016.08.150>.
- Ibarra, Ernesto, Angelos Antonopoulos, Elli Kartsakli, and Christos Verikoukis. “HEH-BMAC: Hybrid Polling MAC Protocol for WBANs Operated by Human Energy Harvesting.” *Telecommunication Systems* 58, no. 2 (February 4, 2015): 111–24. <https://doi.org/10.1007/s11235-014-9898-z>.
- Ishii, Hiroshi, and Brygg Ullmer. “Tangible Bits.” In *Proceedings of the SIGCHI Conference on Human Factors in Computing Systems - CHI '97*, 234–41. New York, USA: ACM Press, 1997. <https://doi.org/10.1145/258549.258715>.
- Jansen, A.J. “Human Power Empirically Explored,” 2011. <https://repository.tudelft.nl/islandora/object/uuid%3A6a8f5511-432b-45b7-8e92-23a4dfbb4237>.
- Jeerapan, Itthipon, Juliane R Sempionatto, Adriana Pavinatto, Jung-Min You, and Joseph Wang. “Stretchable Biofuel Cells as Wearable Textile-Based Self-Powered Sensors.” *Journal of Materials Chemistry. A* 4, no. 47 (December 21, 2016): 18342–53. <https://doi.org/10.1039/C6TA08358G>.
- Jensen, Mads Vedel, Jacob Buur, and Tom Djajadiningrat. “Designing the User Actions in Tangible Interaction.” In *Proceedings of the 4th Decennial Conference on Critical Computing between Sense and Sensibility - CC '05*, 9. New York, New York, USA: ACM Press, 2005. <https://doi.org/10.1145/1094562.1094565>.
- Jung, Woo-Suk, Min-Gyu Kang, Hi Gyu Moon, Seung-Hyub Baek, Seok-Jin Yoon, Zhong-Lin Wang, Sang-Woo Kim, and Chong-Yun Kang. “High Output Piezo/Triboelectric Hybrid Generator.” *Scientific Reports* 5 (March 20, 2015): 9309. <https://doi.org/10.1038/srep09309>.

- Karagozler, Mustafa Emre, Ivan Poupyrev, Gary K. Fedder, and Yuri Suzuki. "Paper Generators." In *Proceedings of the 26th Annual ACM Symposium on User Interface Software and Technology - UIST '13*, 23–30. New York, New York, USA: ACM Press, 2013. <https://doi.org/10.1145/2501988.2502054>.
- Kato, Yuto, Yudai Ogawa, Hiroyuki Kai, and Matsuhiko Nishizawa. "A Stretchable, Wearable Lactate Sensor with a Textile-Based Biofuel Cell." *Meeting Abstracts MA2016-02*, no. 44 (September 1, 2016): 3210–3210. <http://ma.ecsdl.org/content/MA2016-02/44/3210.abstract>.
- Katsarou, Stella. "Exploring Static Electricity as Design Material for Woven and Hand-Tufted Textiles." University of Borås/Swedish School of Textiles, 2014. <http://bada.hb.se/handle/2320/14080>.
- Koskinen, Ilpo, John Zimmerman, Thomas Binder, Johan Redstrom, and Stephan Wensveen. *Design Research through Practice: From the Lab, Field, and Showroom*. Elsevier, 2011. <https://www.elsevier.com/books/design-research-through-practice/koskinen/978-0-12-385502-2>.
- Kuusk, K., O. Tomico Plasencia, and G.R. Langereis. "Bedtime Stories : Weaving Traditions into Digital Technologies." In *Nordic Design Research Conference*, 2013. <http://repository.tue.nl/770918>.
- Kwon, Hyosun, Hwan Kim, and Woohun Lee. "Intangibles Wear Materiality via Material Composition." *Personal and Ubiquitous Computing* 18, no. 3 (June 4, 2013): 651–69. <https://doi.org/10.1007/s00779-013-0688-5>.
- Leonov, Vladimir. "Energy Harvesting for Self-Powered Wearable Devices." In *Wearable Monitoring Systems*, edited by Annalisa Bonfiglio and Danilo De Rossi, 1–296, 2011. <https://doi.org/10.1007/978-1-4419-7384-9>.
- Li, Xian, and Ye Sun. "WearETE: A Scalable Wearable E-Textile Triboelectric Energy Harvesting System for Human Motion Scavenging." *Sensors*, 2017. <https://doi.org/10.3390/s17112649>.
- Liu, Haiyan, Yancheng Wang, Deqing Mei, Yaoguang Shi, and Zichen Chen. "Design of a Wearable Thermoelectric Generator for Harvesting Human Body Energy," 55–66. Springer, Singapore, 2017. [https://doi.org/10.1007/978-981-10-2404-7\\_5](https://doi.org/10.1007/978-981-10-2404-7_5).
- Lossec, M., B. Multon, H. Ben Ahmed, and C. Goupil. "Thermoelectric Generator Placed on the Human Body: System Modeling and Energy Conversion Improvements." *The European Physical Journal Applied Physics* 52, no. 1 (October 17, 2010): 11103. <https://doi.org/10.1051/epjap/2010121>.
- Löwgren, Jonas, Henrik Svarrer Larsen, and Mads Hoby. "Towards Programmatic Design Research." *Designs for Learning* 6, no. 1–2 (December 1, 2013). <https://www.designs-forlearning.nu/articles/abstract/53/>.

- Lund, Anja, Karin Rundqvist, Erik Nilsson, Liyang Yu, Bengt Hagström, and Christian Müller. "Energy Harvesting Textiles for a Rainy Day: Woven Piezoelectrics Based on Melt-Spun PVDF Microfibres with a Conducting Core." *Npj Flexible Electronics* 2, no. 1 (2018): 9. <https://doi.org/10.1038/s41528-018-0022-4>.
- Lüttgens, Günter., and Norman Wilson. *Electrostatic Hazards*. Butterworth Heinemann, 1997.
- Márquez Segura, Elena, Laia Turmo Vidal, and Asreen Rostami. "Bodystorming for Movement-Based Interaction Design." *Human Technology* 12, no. 2 (November 30, 2016): 193–251. <https://doi.org/10.17011/ht/urn.201611174655>.
- Mazé, Ramia. *Static! : Designing for Energy Awareness*. Arvinus, 2010.
- McLuhan, Marshall, and Lewis H. Lapham. *Understanding Media : The Extensions of Man*. Accessed December 15, 2017. <https://mitpress.mit.edu/books/understanding-media>.
- Mikkonen, Jussi, and Emmi Pouta. "Flexible Wire-Component for Weaving Electronic Textiles." In *2016 IEEE 66th Electronic Components and Technology Conference (ECTC)*, 1656–63. IEEE, 2016. <https://doi.org/10.1109/ECTC.2016.180>.
- Moran, Dermot. *Introduction to Phenomenology*. Routledge, 2000.
- Müller, Alexander, Jochen Fuchs, and Konrad Röpke. "Skintimacy: Exploring Interpersonal Boundaries through Musical Interactions." In *Proceedings of the Fifth International Conference on Tangible, Embedded, and Embodied Interaction - TEI '11*, 403. New York, USA: ACM Press, 2011. <https://doi.org/10.1145/1935701.1935801>.
- Nova, Nicolas, Katherine Miyake, Walton Chiu, and Nancy Kwon. "Curious Rituals: Gestural Interaction in the Digital Everyday," 2012. <https://curiousrituals.wordpress.com/2012/09/03/curious-rituals-book/>.
- Pasquale, G. De, and A. Somà. "Energy Harvesting from Human Motion with Piezo Fibers for the Body Monitoring by MEMS Sensors." In *Symposium on Design, Test, Integration and Packaging of MEMS/MOEMS (DTIP)*. Barcelona: IEEE, 2013. <https://ieeexplore.ieee.org/document/6559429>.
- "Pavegen - The Next Step." Accessed April 4, 2019. <http://www.pavegen.com/>.
- Perner-Wilson, Hannah (Hannah Rosamonde). "A Kit-of-No-Parts." Massachusetts Institute of Technology, 2011. <http://dspace.mit.edu/handle/1721.1/67784>.
- Perner-Wilson, Hannah, and Mika Satomi. "How To Get What You Want." Kobakant.at. Accessed February 17, 2011. <http://www.kobakant.at/DIY/?cat=26>.
- Persson, Anna. "Knitted Circuits for Visual and Tactile Interactive Expressions," 2009.
- Persson, Anna, and Linda Worbin. "Designing Dynamic and Irreversible Textile Patterns, Using a Non-Chemical Burn-out (Ausbrenner) Technique." *The Nordic Textile Journal*, 2008, 64–87. <http://hdl.handle.net/2320/4295>.
- Pierce, James, and Eric Paulos. "Designing Everyday Technologies with Human-Power

- and Interactive Microgeneration.” In *Proceedings of the Designing Interactive Systems Conference on - DIS '12*, 602. New York, USA: ACM Press, 2012. <https://doi.org/10.1145/2317956.2318047>.
- . “Electric Materialities and Interactive Technology.” In *Proceedings of the SIGCHI Conference on Human Factors in Computing Systems - CHI '13*, 119. New York, New York, USA: ACM Press, 2013. <https://doi.org/10.1145/2470654.2470672>.
- . “Materializing Energy.” *Proceedings of the 8th ACM Conference on Designing Interactive Systems*, 2010, 113–22. <https://doi.org/10.1145/1858171.1858193>.
- Posch, Irene. “The Embroidered Computer.” Accessed February 4, 2019. <http://www.irene-posch.net/the-embroidered-computer/>.
- Post, E. R., M. Orth, P. R. Russo, and N. Gershenfeld. “E-Broidery: Design and Fabrication of Textile-Based Computing.” *IBM Systems Journal* 39, no. 3 (2000): 840–60. <https://doi.org/10.1147/sj.393.0840>.
- Post, E. Rehmi, and Kit Waal. “Electrostatic Power Harvesting for Material Computing.” *Personal and Ubiquitous Computing* 15, no. 2 (August 18, 2010): 115–21. <https://doi.org/10.1007/s00779-010-0313-9>.
- Post, E Rehmi, and Margaret Orth. “Smart Fabric, or ‘Wearable Clothing.’” In *Proceedings of the 1st IEEE International Symposium on Wearable Computers*, 167–. ISWC '97. Washington, DC, USA: IEEE Computer Society, 1997. <http://portal.acm.org/citation.cfm?id=851036.856432>.
- Probst, Laurent, Bertrand Pedersen, Dakkak, and Lauriane. “Energy Harvesting to Power the Rise of the Internet of Things - European Commission,” 2017. <https://ec.europa.eu/growth/tools-databases/dem/monitor/content/energy-harvesting-power-rise-internet-things>.
- “Project Jacquard.” Google ATAP, 2015. <https://www.google.com/atap/project-jacquard/>.
- Qu, Hang, Oleg Semenikhin, and Maksim Skorobogatiy. “Flexible Fiber Batteries for Applications in Smart Textiles.” *Smart Materials and Structures* 24, no. 2 (February 1, 2015): 025012. <https://doi.org/10.1088/0964-1726/24/2/025012>.
- Randell, Cliff. “Wearable Computing: A Review,” 2006. <http://citeseerx.ist.psu.edu/viewdoc/summary?doi=10.1.1.60.7898>.
- Redström, Johan. “Designing Everyday Computational Things.” Dept. of Informatics, Göteborg University, 2001. <http://redstrom.se/johan/thesis/index.html>.
- . *Making Design Theory*. MIT Press, 2017. <https://mitpress.mit.edu/books/making-design-theory>.
- . “On Technology as Material in Design.” *Design Philosophy Papers* 3, no. 2 (June 1, 2005): 39–54. <https://doi.org/10.2752/144871305X13966254124275>.
- . “Some Notes on Program/Experiment Dialectics.” In *Nordic Design Research*

- Conference 2011. Helsinki, 2011. <https://doi.org/10.1145/122552.122557>.
- . “Tangled Interaction.” *ACM Transactions on Computer-Human Interaction* 15, no. 4 (November 1, 2008): 1–17. <https://doi.org/10.1145/1460355.1460358>.
- Robles, Erica, and Mikael Wiberg. “Texturing the ‘Material Turn’ in Interaction Design.” In *Proceedings of the Fourth International Conference on Tangible, Embedded, and Embodied Interaction - TEI '10*, 137. New York, USA: ACM Press, 2010. <https://doi.org/10.1145/1709886.1709911>.
- Ross, P.R., and S.A.G. Wensveen. “Designing Behavior in Interaction : Using Aesthetic Experience as a Mechanism for Design.” *International Journal of Design* 4, no. 2 (2010): 3–13. <https://research.tue.nl/en/publications/designing-behavior-in-interaction-using-aesthetic-experience-as-a>.
- Rowberg, Jeff. “Keyglove,” 2011. <http://www.keyglove.net/>.
- Schoen, Donald. *The Reflective Practitioner: How Professionals Think In Action*. Basic Books, 1983. <http://cumincad.scix.net/cgi-bin/works/Show?9e1a>.
- Sengers, Phoebe, Kirsten Boehner, Shay David, and Joseph “Jofish” Kaye. “Reflective Design.” In *Proceedings of AARHUS '05*, 49–58. Aarhus, Denmark: ACM Press, 2005.
- Shahan, Zachary. “History of Wind Turbines - Renewable Energy World,” 2014. <https://www.renewableenergyworld.com/ugc/articles/2014/11/history-of-wind-turbines.html>.
- Silberman, M. Six, Lisa Nathan, Bran Knowles, Roy Bendor, Adrian Clear, Maria Håkansson, Tawanna Dillahunt, and Jennifer Mankoff. “Next Steps for Sustainable HCI.” *Interactions* 21, no. 5 (September 1, 2014): 66–69. <https://doi.org/10.1145/2651820>.
- Simon, Herbert A. (Herbert Alexander). *The Sciences of the Artificial*. [M.I.T. Press], 1969.
- Slaughter, Gymama, and Tanmay Kulkarni. “Enzymatic Glucose Biofuel Cell and Its Application.” *Journal of Biochips & Tissue Chips* 05, no. 01 (July 16, 2015). <https://doi.org/10.4172/2153-0777.1000110>.
- Soin, Navneet, Tahir H. Shah, Subhash C. Anand, Junfeng Geng, Wiwat Pornwannachai, Pranab Mandal, David Reid, et al. “Novel ‘3-D Spacer’ All Fibre Piezoelectric Textiles for Energy Harvesting Applications.” *Energy & Environmental Science* 7, no. 5 (April 17, 2014): 1670. <https://doi.org/10.1039/c3ee43987a>.
- Starner, T. “Human-Powered Wearable Computing.” *IBM Systems Journal* 35, no. 3.4 (1996): 618–29. <https://doi.org/10.1147/sj.353.0618>.
- . “The Challenges of Wearable Computing: Part 1.” *IEEE Micro* 21, no. 4 (2001): 44–52. <https://doi.org/10.1109/40.946681>.
- Starner, Thad, and Joseph A. Paradiso. “Human Generated Power for

- Mobile Electronics,” 2004. <https://www.semanticscholar.org/paper/Human-Generated-Power-for-Mobile-Electronics-Paradiso/a6164b19a636f61a018b7031b5c04210e24f5388>.
- Sterling, Bruce. *Shaping Things*. MIT Press, 2005.
- Technabob. “Wired Ralph Lauren Aero Type Ski Jacket Has iPod and Bluetooth Controls.” [technabob.com/blog](http://technabob.com/blog), 2010. <http://technabob.com/blog/2010/01/02/wired-ralph-lauren-aero-type-ski-jacket/>.
- “The Beauty of 2nd Skin | Sabine Seymour TEDx Talk | Art, Media, & Technology.” Accessed July 24, 2019. <http://amt.parsons.edu/blog/the-beauty-of-2nd-skin-sabine-seymour-tedx-talk/>.
- “Things That Think: Vision Statement.” MIT media Lab, 1995. <https://tmt.media.mit.edu/vision/vision.html>.
- Tomico, Oscar, and Danielle Wilde. “Soft, Embodied, Situated & Connected: Enriching Interactions with Soft Wearables.” *MUX: The Journal of Mobile User Experience* 5, no. 1 (December 17, 2016): 3. <https://doi.org/10.1186/s13678-016-0006-z>.
- Ullmer, Brygg, and Hiroshi Ishii. “Emerging Frameworks for Tangible User Interfaces.” *IBM Systems Journal* 39, no. 3.4 (2000): 915–31. <https://doi.org/10.1147/sj.393.0915>.
- Ünlü, Fatih, Lukas Wawrla, and Adriana Diaz. “Energy Harvesting Technologies for IoT Edge Devices,” 2018. <https://edna.iea-4e.org/library>.
- Urban, Jeffrey J. “Weaving a New World: Wearable Thermoelectric Textiles.” *Current Trends in Fashion Technology & Textile Engineering* 2, no. 2 (January 18, 2017). <https://doi.org/10.19080/CTFTTE.2018.02.555583>.
- Vagott, J, and R Parachuru. “An Overview of Recent Developments in the Field of Wearable Smart Textiles.” *Journal of Textile Science & Engineering* 08, no. 04 (August 8, 2018): 1–10. <https://doi.org/10.4172/2165-8064.1000368>.
- Vallgård, Anna. “Giving Form to Computational Things: Developing a Practice of Interaction Design.” *Personal and Ubiquitous Computing* 18, no. 3 (June 4, 2013): 577–92. <https://doi.org/10.1007/s00779-013-0685-8>.
- Vallgård, Anna, and Johan Redström. “Computational Composites.” In *Proceedings of the SIGCHI Conference on Human Factors in Computing Systems - CHI '07*, 513. New York, USA: ACM Press, 2007. <https://doi.org/10.1145/1240624.1240706>.
- Vallgård, Anna, and Tomas Sokoler. “A Material Strategy: Exploring Material Properties of Computers.” *International Journal of Design* 4, no. 3 (2010): 1–14. <http://bada.hb.se:80/handle/2320/7294>.
- Vervust, Thomas, Frederick Bossuyt, Fabrice Axisa, and Jan Vanfleteren. “Stretchable and Washable Electronics for Embedding in Textiles.” *MRS Proceedings* 1271 (January 1, 2010): 1271-JJ04-03. <https://doi.org/10.1557/PROC-1271-JJ04-03>.
- Wakkary, Ron, Doenja Oogjes, Sabrina Hauser, Henry Lin, Cheng Cao, Leo Ma, and

- Tijs Duel. "Morse Things." In *Proceedings of the 2017 Conference on Designing Interactive Systems - DIS '17*, 503–14. New York, USA: ACM Press, 2017. <https://doi.org/10.1145/3064663.3064734>.
- Wakkary, Ron, and Erik Stolterman. "Integration." Edited by Ron Wakkary and Erik Stolterman. *Interactions* 23, no. 6 (October 26, 2016): 5–5. <https://doi.org/10.1145/3005777>.
- Wakkary, Ron, and Karen Tanenbaum. "A Sustainable Identity." In *Proceedings of the 27th International Conference on Human Factors in Computing Systems - CHI 09*, 365. New York, New York, USA: ACM Press, 2009. <https://doi.org/10.1145/1518701.1518761>.
- Wang, Shuhua, Xiaojing Mu, Ya Yang, Chengliang Sun, Alex Yuandong Gu, and Zhong Lin Wang. "Flow-Driven Triboelectric Generator for Directly Powering a Wireless Sensor Node." *Advanced Materials* 27, no. 2 (January 1, 2015): 240–48. <https://doi.org/10.1002/adma.201403944>.
- Wang, Yang, Ya Yang, and Zhong Lin Wang. "Triboelectric Nanogenerators as Flexible Power Sources." *Npj Flexible Electronics* 1, no. 1 (2017): 10. <https://doi.org/10.1038/s41528-017-0007-8>.
- Wang, Zhong Lin, Jun Chen, and Long Lin. "Progress in Triboelectric Nanogenerators as a New Energy Technology and Self-Powered Sensors." *Energy & Environmental Science* 8, no. 8 (2015): 2250–82. <https://doi.org/10.1039/C5EE01532D>.
- Wensveen, Stephan, Kees Overbeeke, Tom Djajadiningrat, and Steven Kyffin. "Freedom of Fun, Freedom of Interaction." *Interactions* 11, no. 5 (September 1, 2004): 59. <https://doi.org/10.1145/1015530.1015559>.
- Wiberg, Mikael. "Methodology for Materiality: Interaction Design Research through a Material Lens." *Personal and Ubiquitous Computing* 18, no. 3 (May 29, 2013): 625–36. <https://doi.org/10.1007/s00779-013-0686-7>.
- Wiberg, Mikael, Jofish Kaye, and Peter Thomas. "PUC Theme Issue: Material Interactions." *Personal and Ubiquitous Computing* 18, no. 3 (June 9, 2013): 573–76. <https://doi.org/10.1007/s00779-013-0683-x>.
- Wiberg, Mikael, and Erica Robles. "Computational Compositions: Aesthetics, Materials, and Interaction Design." *International Journal of Design* 4, no. 2 (2010). <http://www.ijdesign.org/index.php/IJDesign/article/view/757/301>.
- Wilde, Danielle. "Swing That Thing : Moving to Move : The Poetics of Embodied Engagement." [Monash University], 2011.
- Wilde, Danielle, and Kristina Andersen. "Doing Things Backwards: The OWL Project." In *Proceedings of the 21st Annual Conference of the Australian Computer-Human Interaction Special Interest Group on Design: Open 24/7 - OZCHI '09*. New York, USA: ACM Press, 2009. <https://doi.org/10.1145/1738826.1738896>.
- Wilde, Danielle, Anna Vallgård, and Oscar Tomico. "Embodied Design Ideation Methods:

- S: Analysing the Power of Estrangement.” In *Proceedings of the 2017 CHI Conference on Human Factors in Computing Systems - CHI '17*, 5158–70. New York, USA: ACM Press, 2017. <https://doi.org/10.1145/3025453.3025873>.
- Winkler, Clemens. “Tensed Up,” 2010. <http://clemenswinkler.com/dipl/?cat=22>.
- Worbin, Linda. “Trace.” 2008. Accessed February 4, 2019. <http://smarttextiles.se/trace-exhibited-in-london/>.
- Wullur, Aoife. “Shades of Light,” 2011. <http://www.aoifewullur.com/projecten/shades-of-light/>.
- Yildiz, Faruk. “Energy Harvesting from Passive Human Power.” *Journal of Applied Science & Engineering Technology*, 2011, 5–16.
- Yuranova, T., R. Mosteo, J. Bandara, D. Laub, and J. Kiwi. “Self-Cleaning Cotton Textiles Surfaces Modified by Photoactive SiO<sub>2</sub>/TiO<sub>2</sub> Coating.” *Journal of Molecular Catalysis A: Chemical* 244, no. 1 (2006): 160–67. <http://www.sciencedirect.com/science/article/pii/S1381116905006199>.
- Zebda, A., S. Cosnier, J.-P. Alcaraz, M. Holzinger, A. Le Goff, C. Gondran, F. Boucher, et al. “Single Glucose Biofuel Cells Implanted in Rats Power Electronic Devices.” *Scientific Reports* 3, no. 1 (December 22, 2013): 1516. <https://doi.org/10.1038/srep01516>.
- Zhao, Jingjing, and Zheng You. “A Shoe-Embedded Piezoelectric Energy Harvester for Wearable Sensors.” *Sensors* 14, no. 7 (July 11, 2014): 12497–510. <https://doi.org/10.3390/s140712497>.
- Zhou, Tao, Chi Zhang, Chang Bao Han, Feng Ru Fan, Wei Tang, and Zhong Lin Wang. “Woven Structured Triboelectric Nanogenerator for Wearable Devices.” *ACS Applied Materials & Interfaces* 6, no. 16 (August 27, 2014): 14695–701. <https://doi.org/10.1021/am504110u>.
- Zimmerman, John, and Jodi Forlizzi. “Research Through Design in HCI.” In *Ways of Knowing in HCI*, 167–89. New York, Springer New York, 2014. [https://doi.org/10.1007/978-1-4939-0378-8\\_8](https://doi.org/10.1007/978-1-4939-0378-8_8).
- Zimmerman, John, Erik Stolterman, and Jodi Forlizzi. “An Analysis and Critique of Research through Design.” In *Proceedings of the 8th ACM Conference on Designing Interactive Systems - DIS '10*, 310. New York, USA: ACM Press, 2010. <https://doi.org/10.1145/1858171.1858228>.



## **APPENDICES**

APPENDIX A– Resources and tools	185
APPENDIX B– Demonstrators: e-static textile interactions	203
APPENDIX C– Woven e-static textiles: Sample book	209
APPENDIX D– Supporting files (DVD)	240
APPENDIX E– Overview of courses and research activities in ArcInTex ETN	243



## **APPENDIX A: Resources and Tools**

- A.1 Online handbook: [e-statictextiles.cc](http://e-statictextiles.cc)
- A.2 Clip-on tester
- A.3 E-static textiles prototyping board
- A.4 E-static textiles workshop kit

## A.1 Online handbook: estatictextiles.cc

The e-static textiles online handbook gives an overview of the basic knowledge and skills needed to start exploring static electricity as a material property of textiles for shaping interactions with electronic textiles.

It compiles the explorations and results from the thesis into a comprehensible handbook that can act as a reference. Furthermore, it can also become a platform for sharing and exchange amongst the e-textile design community that is interested in exploring static electricity and textiles. The image on the right presents some screenshots of the website.

estatictextiles.cc

### SITEMAP

#### HOME

##### Getting started

- What is static electricity
- Everyday electrostatic materials
  - *Collection*
- Exploring dynamic behavior
  - *Examples*
- DIY experiments
  - *Examples*

##### E-static interactions

- Triboelectric generator circuit
- E-static textile substrates
  - *Collection*
- E-static interior setups
  - *Examples*
- Long-term e-static interactions
  - *Examples*

##### Tools for prototyping

- Static electricity as energy
  - *Examples*
- E-static textiles prototyping board
  - *Introduction*
  - *Examples*
  - *Workshops*

##### All examples

##### About & contact





Prototyping interactions with  
static electricity & textiles

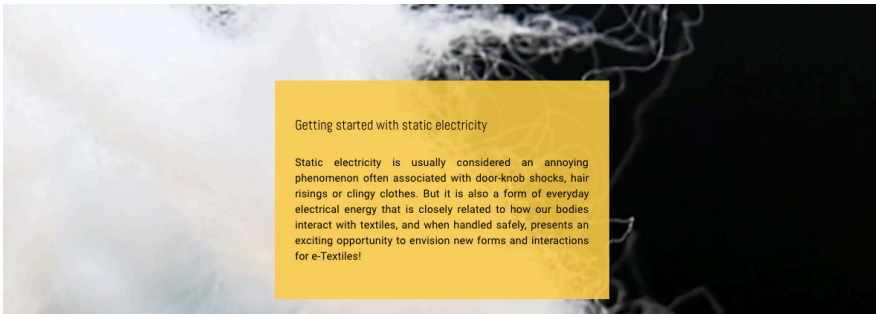

Getting started with static electricity

Static electricity is usually considered an annoying phenomenon often associated with door-knob shocks, hair raisings or clingy clothes. But it is also a form of everyday electrical energy that is closely related to how our bodies interact with textiles, and when handled safely, presents an exciting opportunity to envision new forms and interactions for e-Textiles!

What is static electricity?

electrostatic materials

dynamic behaviour

DIY-experiments

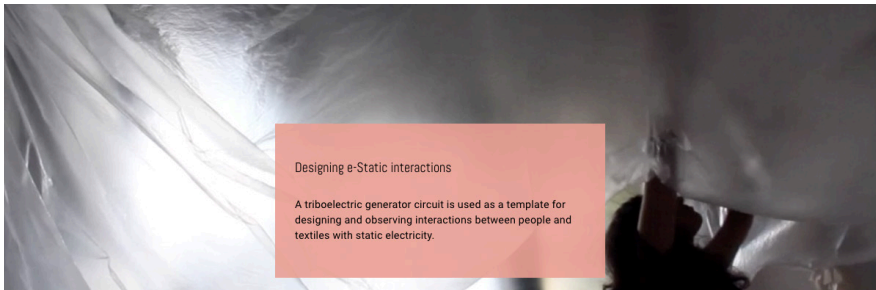

Designing e-Static interactions

A triboelectric generator circuit is used as a template for designing and observing interactions between people and textiles with static electricity.

Triboelectric circuit

e-Static textile-substrates

e-Static interior setups

longterm e-static interactions

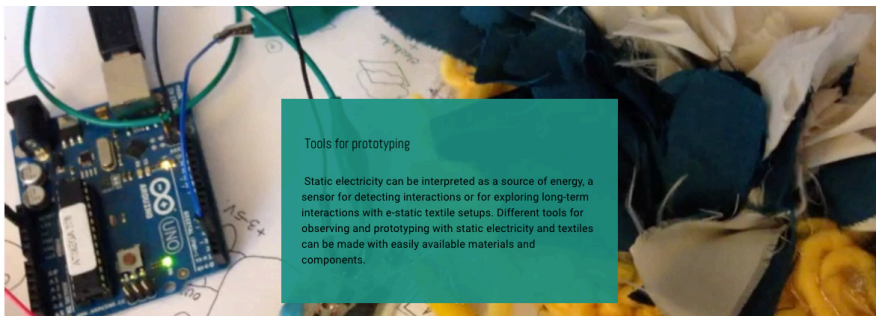

Tools for prototyping

Static electricity can be interpreted as a source of energy, a sensor for detecting interactions or for exploring long-term interactions with e-static textile setups. Different tools for observing and prototyping with static electricity and textiles can be made with easily available materials and components.

Static electricity as energy

e-textiles prototyping board

## A.2 Clip-on tester

The clip-on tester was developed during the thesis for quickly testing if interacting with certain textiles and objects generates enough electrostatic energy to light an LED. The clip is made from a crocheted cotton thread and covers a store-bought plastic clip. The triboelectric generator circuit (illustrated below) is laid out around the clip, such that one electrode is exposed on the top where the clip is held and the other electrode is placed in between the tips so that it makes a firm contact with the electrostatic surface being tested. The two electrodes are attached to a self-made LED module with a diode bridge rectifier. The tester is clipped on an electrostatic surface and held with one hand; the other hand is used to interact with the surface. When there are enough electrostatic charges, the LED flickers bright.

The clip-on tester is an example of tools built during the research process to make engaging with e-static textiles easier and more systematic. Please refer to Appendix D for a video demonstration of the clip-on tester.

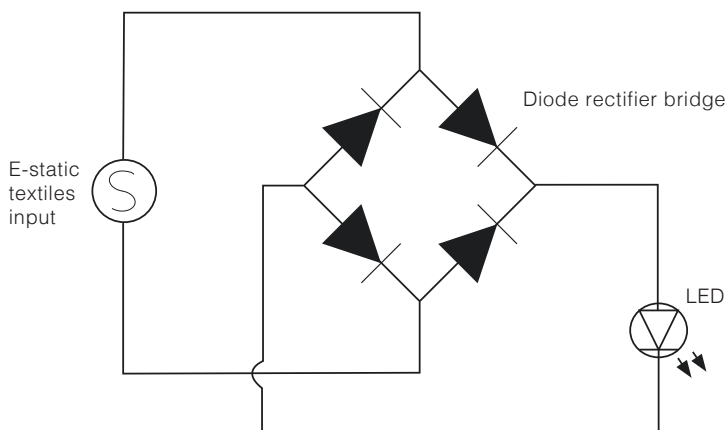



Electrode 1: Touch when clipping on the fabric

LED and diode bridge

Electrode 2: Inbetween the tips of the clip so it touches the fabric directly.

### **A.3 E-static textiles prototyping board**

The e-static textiles prototyping board is a tool developed towards the end of the thesis to support future work and development in the area of electrostatic textiles. The prototyping board makes it possible to easily incorporate high voltage inputs from electrostatic setups to visualise the generated electricity, to interpret static electricity as a sensor to trigger different functions and to create e-static interventions in the everyday for prototyping long-term interactions.

The sewable connectors on the board make it easy to incorporate in e-textile projects. The through-hole connection points allow also for connecting jumper cables and a power source directly onto the board.

Short videos demonstrating some of the features of the board can be found in the supporting files included in Appendix D.



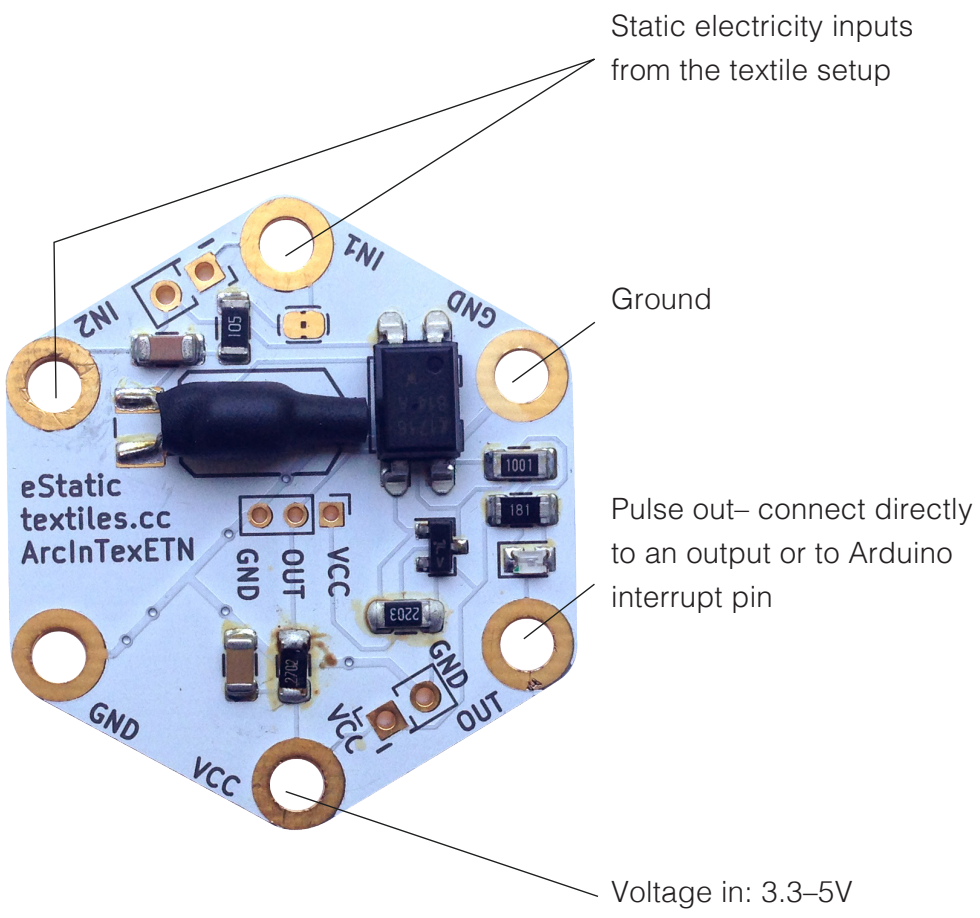

## Stages of development of the e-static prototyping board

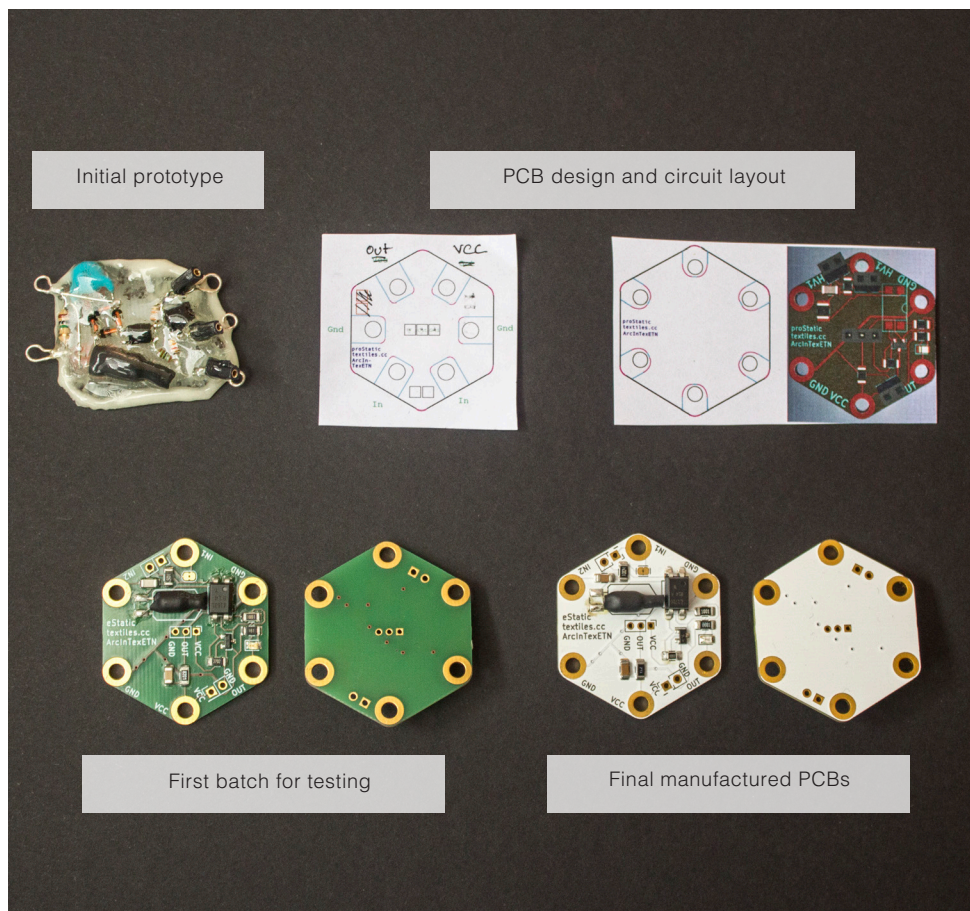

The board was developed in collaboration with a berlin-based prototyping company called August and Piela Konstruktiv GbR. It went through several stages of development, from the first initial working prototype, to collaboratively designing the shape and circuit for the printed circuit board (PCB), to a small test batch, followed by the manufacturing of the final set of prototyping board. The following pages give an overview of the circuit layout, the oscilloscope readings and notes for further development for the board.



## Oscilloscope readings of the OUT pin on the e-static textiles board

The out-pin of the e-static textiles prototyping board gives a pulse out every time a voltage higher than 90V is generated by the e-static interaction. A single interaction with a weak electrostatic setup would result in spaced out peaks. A single interaction with a highly electrostatic setup would generate denser peaks with higher amplitude. This kind of pulse input can be connected to the interrupt pin of an Arduino to easily read the values and design and prototype different kinds of electrostatic behaviours and applications.

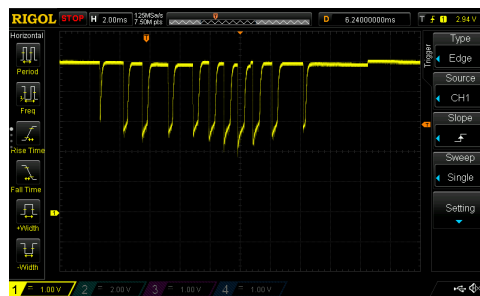

Single trigger from a low-intensity electrostatic interaction

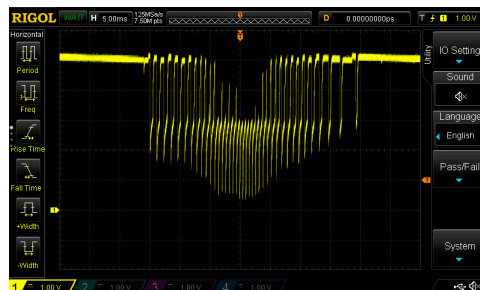

Single trigger from a high-intensity electrostatic interaction

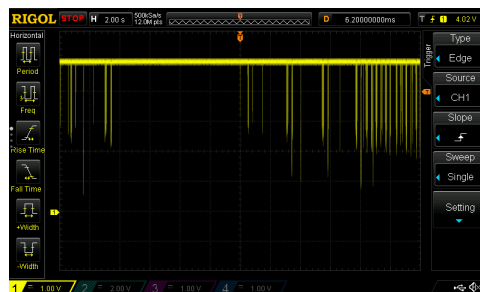

Several electrostatic interactions over a short period of time

## Notes on further development of the board

From the oscilloscope readings, it can be seen that during a high intensity electrostatic interaction, a portion of the signals do not reach back to zero. Although the e-static is still able to recognise and count electrostatic inputs to a good degree of accuracy, its performance would be improved if the pulse outputs would go back to zero every time. This issue would be addressed in further development of the board. The circuit sketch below illustrates a preliminary plan for adding an extra transistor for improving the signal output.

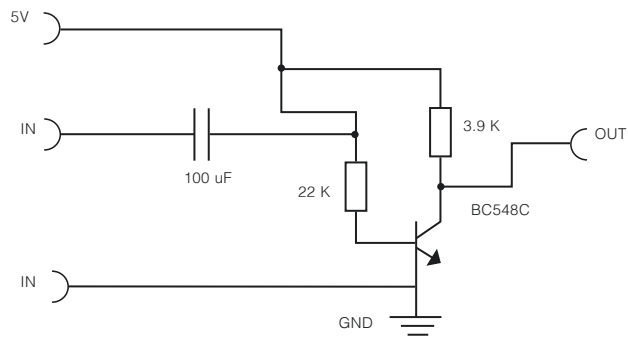

## **A.4 E-static textile workshop kit**

The e-static textiles workshop kit consists of components, materials and tools that help to give a basic introduction to working safely with static electricity and textiles in a workshop setting. The kit consists of an e-static textiles prototyping board, a module integrated with a diode-bridge and an LED, a spool of conductive yarn, an LED, and a resistor.

This kit was used to facilitate a half-day workshop for a small design team at IKEA, Sweden in June 2019. The goal of the workshop was to share my research findings, and give a hands-on workshop that would share a basic understanding of the opportunities and challenges of working with static electricity and textiles. During the workshop, the participants built their own triboelectric circuits, experimented with different electrostatic materials and interactions, tried examples of Arduino codes for prototyping interactions and also discussed their thoughts and ideas for working with this topic in their own work contexts.

It is aimed that the workshop kit would work closely with the resources included in the [estatictextiles.cc](http://estatictextiles.cc) website using it as a reference as well as an archive for documenting the results.

In the following pages, further details on the kit, the workshop handouts and some documentation pictures from the workshop at IKEA are presented.

# The Workshop kit

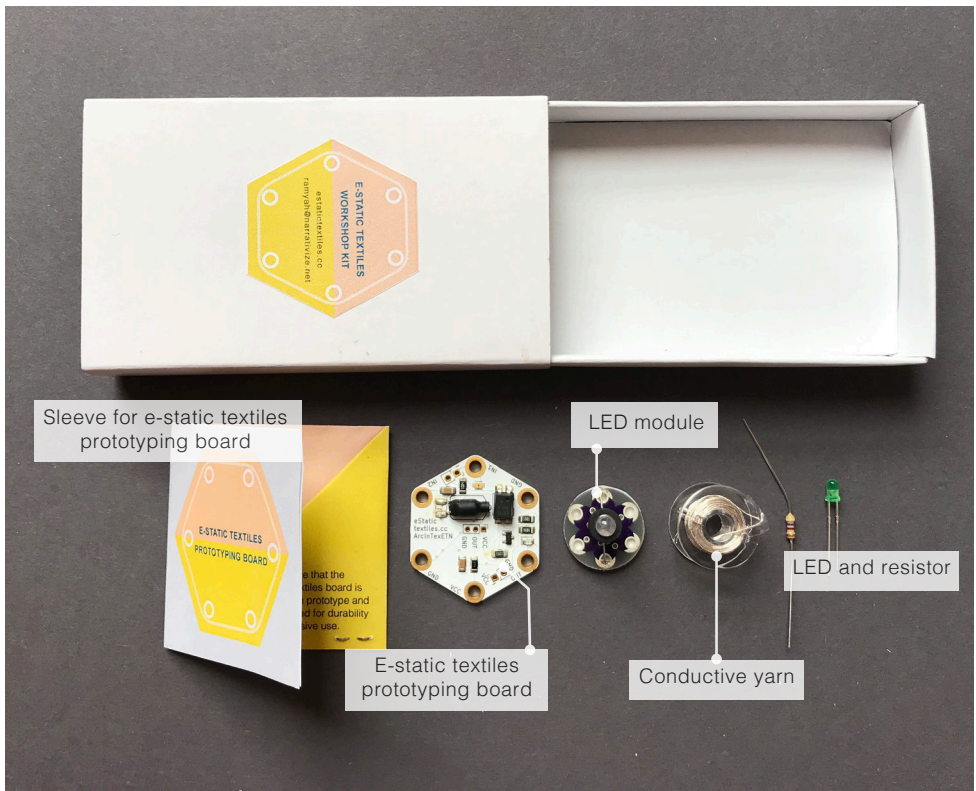

# 1 Assembling the electrostatic generator circuit

**STEP 1:**  
Connect the LED module to the two electrodes by attaching crocodile clips between pads on the module marked with a black dot, and the two conductive materials.  
Make sure the two electrodes are not touching.

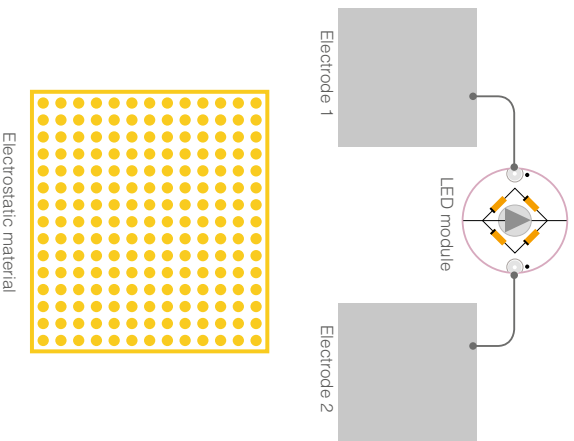

**STEP 2:**  
Place the electrostatic material on one electrode such that it completely covers it.  
Now touch the other electrode with any part of your body, while moving the electrostatic material over the first electrode.  
The electrostatic charges will flow through the circuit lighting the blue LED in short bursts.

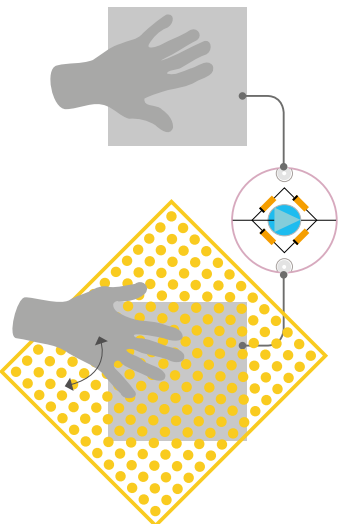

Explore different ways of moving the electrostatic material while still touching one electrode.  
Try wiping, waving, tapping – whichever interactions your electrostatic material enables.  
Observe which interactions work best for lighting the LED, which interactions are fun, which are more comfortable. How big or small are the movements you explore? What parts of the body are you using?  
Can many people interact at the same time to activate the circuit?

**STEP 3:**  
Try some other variations of the circuit, and explore different interactions for activating the circuit.

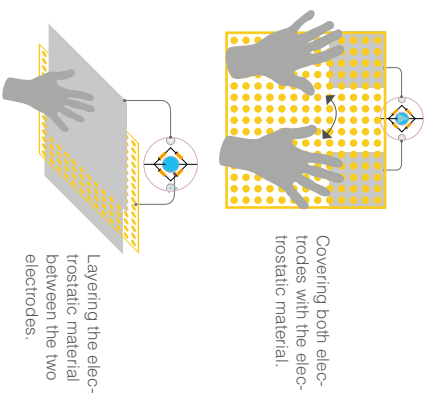



## 2 Attaching the e-static textiles prototyping board

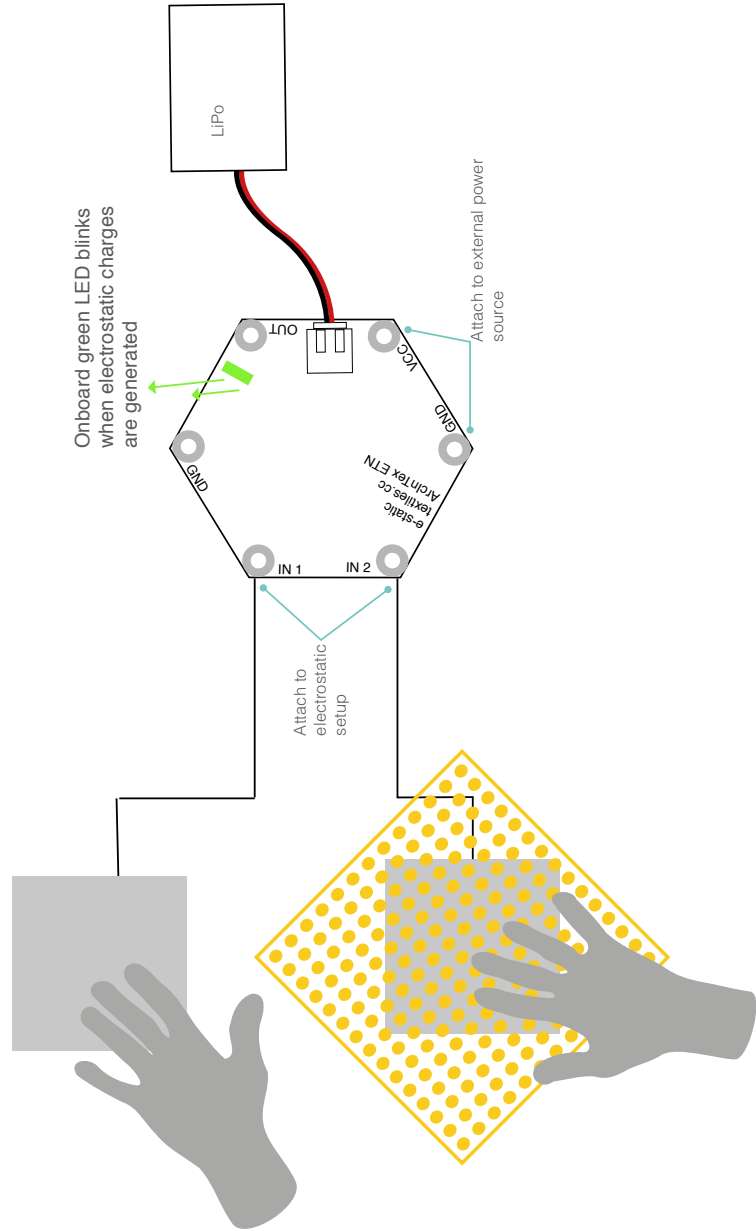

### 3 Attaching the e-static textiles prototyping board to the Arduino

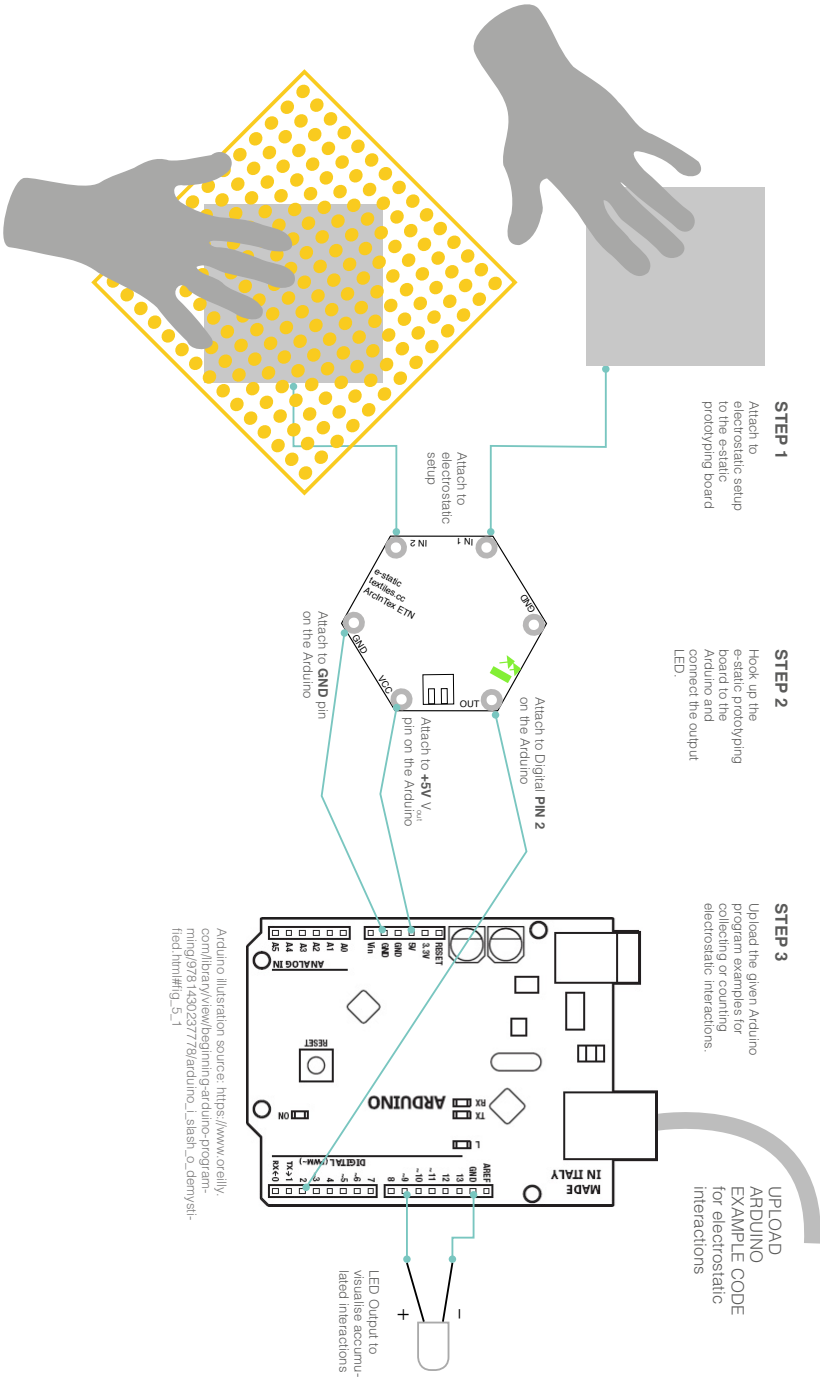

Some impressions from the workshop at IKEA, June 2019.





## **APPENDIX B: Demonstrators– e-static textile interactions**

- B.1 Energy harvesting with e-static wall
- B.2 Counting interactions with e-static seat

## **B.1 Energy harvesting with e-static wall**

This e-textile setup illustrates the experience of energy harvesting by engaging with an electrostatic wall in a home over time. The persons passing in front of the furry electrostatic surface interact by rubbing and stroking it. The electrostatic charges generated with each interaction are recorded using the e-static textiles prototyping board and an Arduino. The idea of charging a battery is simulated in software. When there are enough electrostatic charges collected, the lamp connected to the setup lights up.

When the collected charge is used up, the light starts to dim, at which point a person can add more electrostatic charges into the system by stroking the surface to make the light bright again.

The e-static wall has one electrode integrated within the textile substrate. The other electrode is placed on the floor in the form of a conductive rug. Thus, a person standing on the rug while stroking the textile becomes part of the electrostatic circuit needed to safely collect the charges.

Please refer to Appendix D for a video demonstration of this setup.

Electrostatic object/surface used: Tufted textile with plastic film yarn ( see sample 4a on page 99)

Lamp



E-static wall



Conductive rug



## **B.2 Counting interactions with an e-static seat**

This example illustrates how static electricity could be used as an interaction sensor in an electrostatic setup. The e-static seat is connected to a counter that increments when it detects electrostatic charges generated due to the person sitting and moving on the seat.

The e-static seat is made using the principle of an electrostatic generator circuit. Metal springs and conductive fabric inside the upholstered seat act as an electrode which is insulated by a thick cushion of waste plastic sheets, synthetic fabric scraps and styrofoam balls. The conductive rug on the floor acts as the second electrode. When a person sits on the seat while stepping on the conductive rug, electrostatic charges flow through the circuit. An e-static textiles prototyping board is connected to the seat which directly outputs values to the counter corresponding to the electrostatic charges generated during each interaction.

Please refer to Appendix D for a video demonstration of this setup.

Electrostatic object/surface used: Plastic sheets, polyester fabric, styrofoam balls.





E-static seat

Counter

Conductive rug



The counter increases as electrostatic charges are generated with people sitting and moving on the seat.



**APPENDIX C:  
Woven e-static textiles  
sample book**



## **Constructing Triboelectric Textiles with Weaving**

Ramyah Gowrishankar  
Berlin University of the Arts



All samples presented here were made at the textile studios at the Swedish school of textiles in Borås.



## **Looms and warp settings**

# Rakt genomgående solvning 24 skaft/ Straight threading 24 shafts

ARM 3

Vit polyester, Trevira CS Nm 40/2	Täthet/density 21 tr/ cm Sked/reed 70/10 1-3	Rakt genomgående solvning på 24 skaft Straight threading 24 shafts
--------------------------------------	----------------------------------------------------	-----------------------------------------------------------------------

Varplängd/warplength: 11,6 meter  
Skedbredd/width in reed: 40 cm  
Trådantal/Number of ends: 840 tr

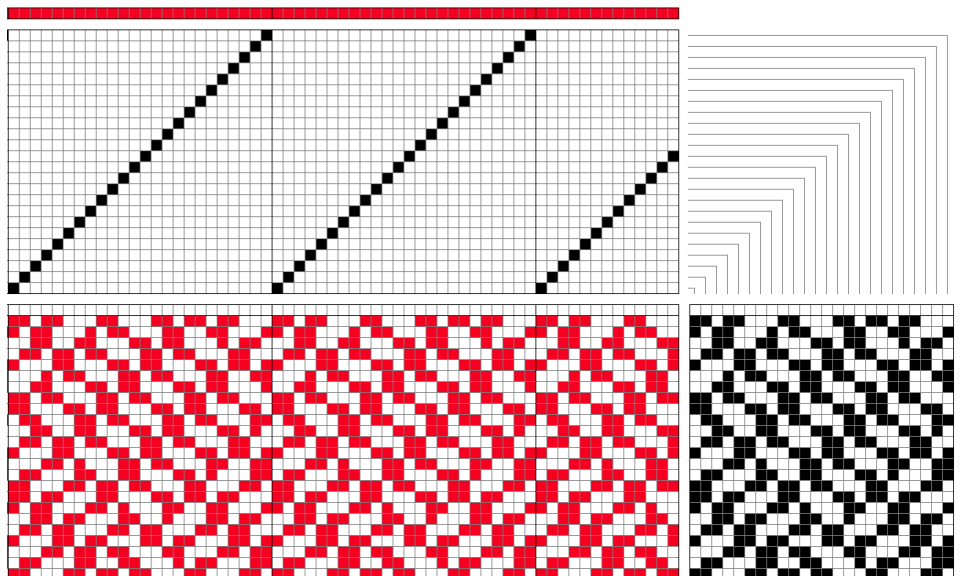



# Filtbinding/Weft faced double-faced

## ARM 4

Beige bomull Ne 20/2 (Nm 34/2) Beige cotton Väf/weft: Ull/wool Nm 6/2	Varptäthet/density 9 tr/cm Sked/reed 45/10 1-2	Rakt genomgående solvning på två partier om 4 skaft vardera Straight threading, two blocks with 4 shafts each
-----------------------------------------------------------------------------	---------------------------------------------------	------------------------------------------------------------------------------------------------------------------

Varplängd/warplength: 20 meter

Skedbredd/width in reed: 40 cm

Trådantal/Number of ends:

Kanten: 28 tr

Parti 1: 28 tr

Parti 2: 40 tr Parti 1 och 2 4 gånger=272 tr

Parti 1: 28 tr

Kanten: 32 tr

Totalt trådantal: 360

Solvning/threading 3 cm i kanterna breda partier 5 cm och smala partier 3 cm

### Partimönster/blocks

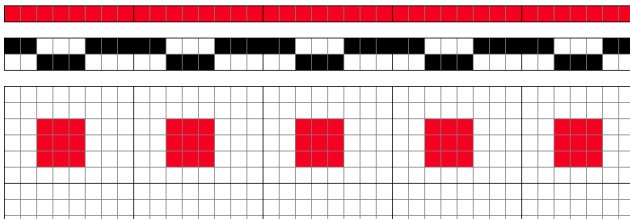

### Detaljmönster/ weave pattern

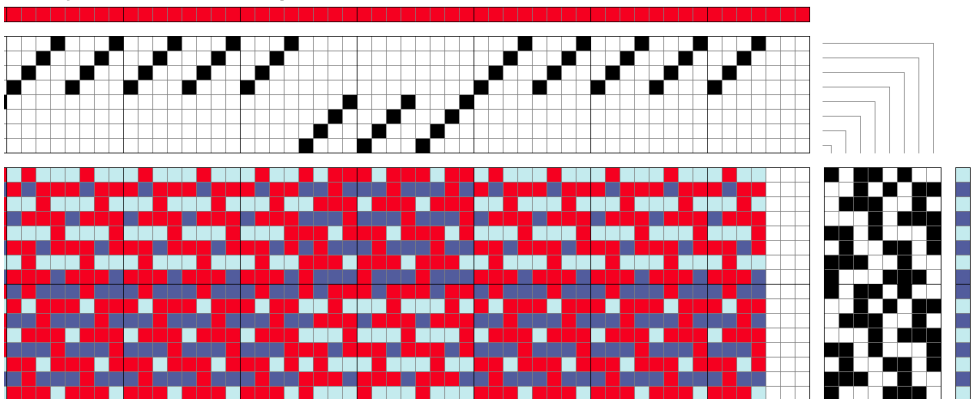

# Dubbelväv, rips/Double weave, rep weave

ARM 5

Grå/grey Bomull/cotton Ne 20/2 (Nm 34/2) Blekt/bleached Bomull/cotton Ne 20/2 Relationstal/ratio 1:1	Täthet/density 32 tr/cm Sked/reed 80/10 1-4	Rakt genomgående solvning på två partier om 8 skaft vardera Straight threading, two blocks with 8 shafts each
------------------------------------------------------------------------------------------------------------	------------------------------------------------	------------------------------------------------------------------------------------------------------------------

Skedbredd/width in reed: 30 cm  
 Trådantal/Number of ends:  
 Parti 1: 224 tr, Parti 2:224 tr  
 Parti 1:160 tr, Parti 2:160 tr  
 Parti 1: 96 tr, Parti 2: 96 tr  
 Totalt trådantal/Total number of threads: 960 tr

## Partimönster/blocks

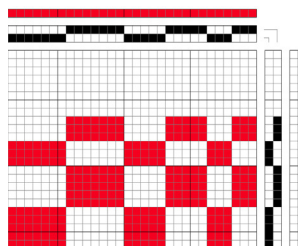

## Solvning/threading

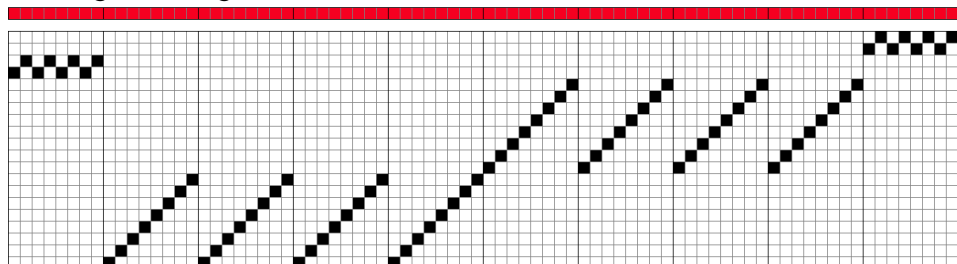

## Stadkant/selvage

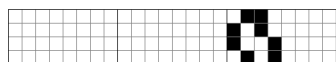

Första inslaget går från höger till vänster/ First weft goes from right to left.

## Spetssovning/Pointed threading

ARM 7

Svart/black Polyester Nm 40/2	Täthet/density 19 tr/ cm Sked/reed 95/10 1-2	Spetssovning 16 skaft Pointed threading 16 shafts
----------------------------------	----------------------------------------------------	------------------------------------------------------

Skedbredd/width in reed: 39,6 cm

Trådantal/Number of ends: Kanten/edge 4 + 4 trådar, spetsen/pointed draft 30 tr x 24,5 + 1 = 744 tr  
Solvning/threading

Solva kanten 4 tr och sedan 24,5 v:n, sluta med 4 kantrådar

### Solvning/threading

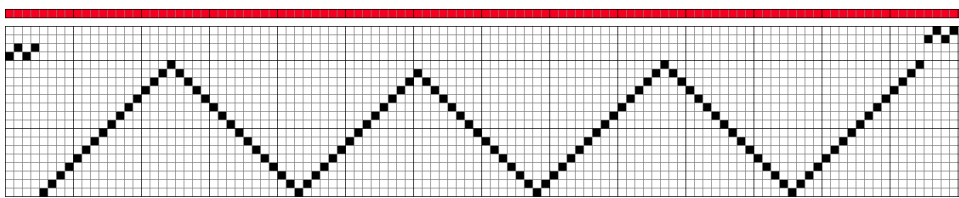

### Stadkant/selvage

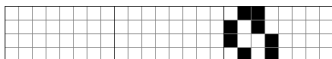

Första inslaget går från höger till vänster/ First weft goes from right to left.



## **A**

### **Single Layer Weaves**

Weaving with different electrostatic yarns /materials

A1: Samples on the hand looms

A2: Samples woven by hand using weaving frames

SAMPLE A1.1

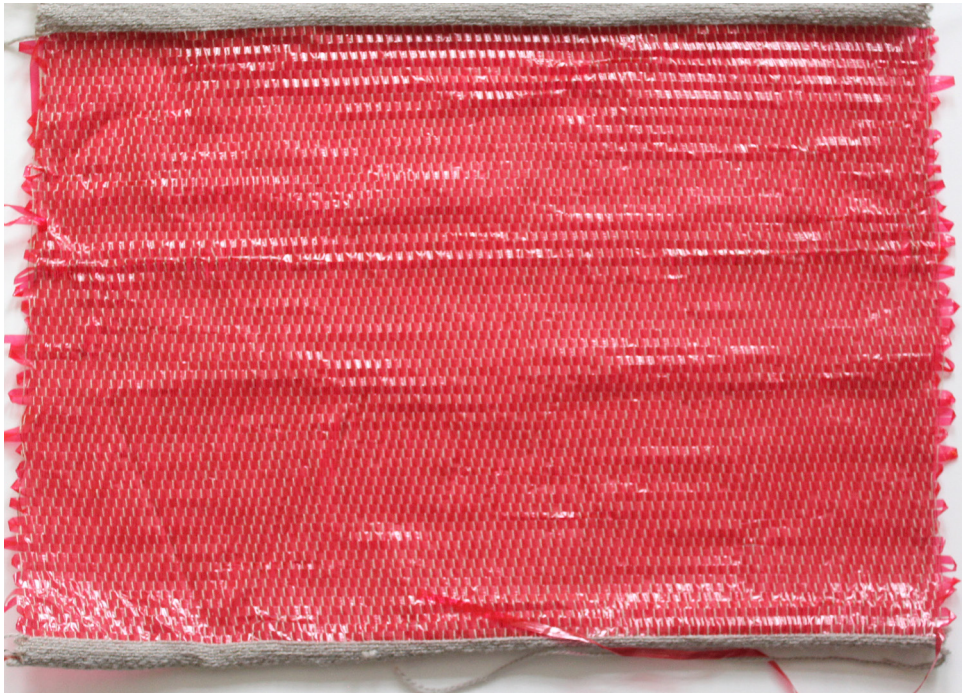

Sample dimension: 40X28 cm

Front



Back



<b>Textile technique:</b> WEAVING	<b>Construction tool:</b> ARM 4	<b>Avg (Std dev) Voltage</b> 4.6 V (1.14)
<b>Materials:</b> <u>Warp</u> : Cotton <u>Weft</u> : Plastic film yarn	<b>Method for incorporating electrode</b> External electrode	

SAMPLE A1.2



Sample dimension: 40X19 cm

Front

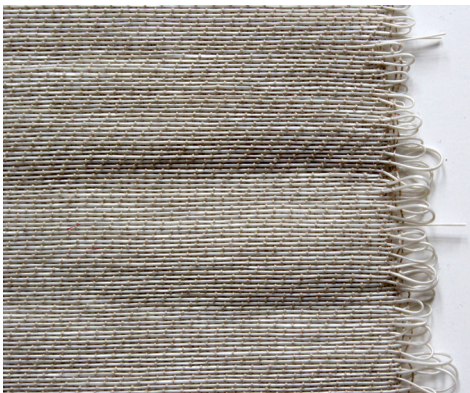

Back



<b>Textile technique:</b> WEAVING	<b>Construction tool:</b> ARM 4	<b>Avg (Std dev) Voltage</b> Not measured
<b>Materials:</b> <u>Warp:</u> Cotton <u>Weft:</u> Rubber yarn	<b>Method for incorporating electrode</b> External electrode	

SAMPLE A1.3



Sample dimension: 40X22 cm

Front



Back



<p><b>Textile technique:</b> WEAVING</p>	<p><b>Construction tool:</b> ARM 4</p>	<p><b>Avg (Std dev) Voltage</b> 3.3 V (0.79)</p>
<p><b>Materials:</b> <u>Warp:</u> Cotton <u>Weft:</u> Polyester filling yarn</p>	<p><b>Method for incorporating electrode</b> External electrode</p>	



SAMPLE A1.4



Sample dimension: 37X20 cm

Front

Back

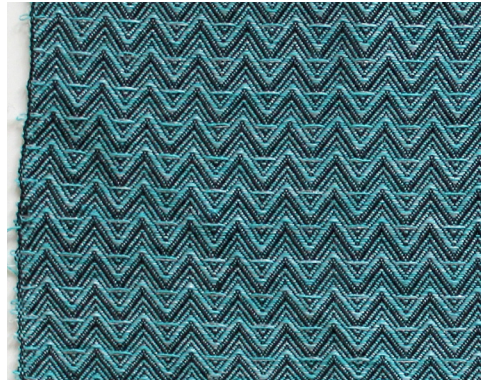
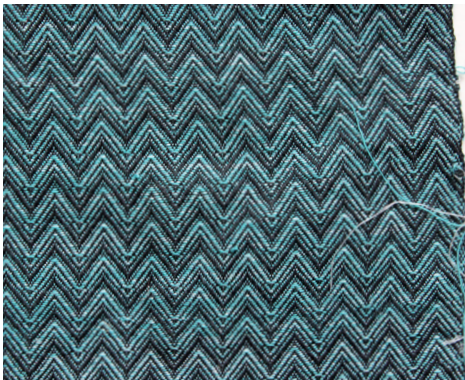

<b>Textile technique:</b> WEAVING	<b>Construction tool:</b> ARM 7	<b>Avg (Std dev) Voltage</b> 6.5 V (0.89)
<b>Materials:</b> <u>Warp:</u> Polyester <u>Weft:</u> 2 yarns: Teflon & Polyester	<b>Method for incorporating electrode</b> External electrode	

SAMPLE A1.5

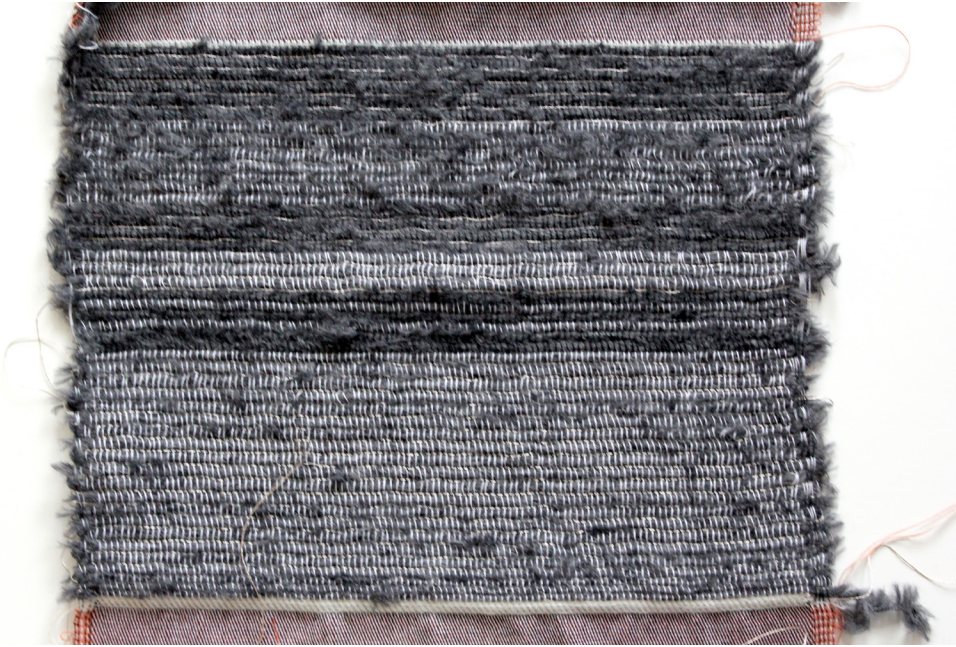

Sample dimension: 29X22 cm

Front

Back

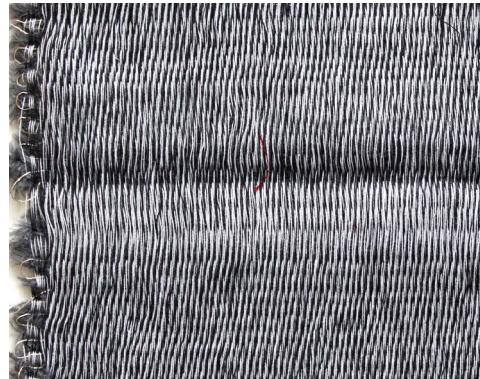

<p><b>Textile technique:</b> WEAVING</p>	<p><b>Construction tool:</b> ARM 5</p>	<p><b>Avg (Std dev) Voltage</b> Not measured</p>
<p><b>Materials:</b> <u>Warp</u>: Cotton <u>Weft</u>: Furry Polyester yarn</p>	<p><b>Method for incorporating electrode</b> External electrode <b>Note for construction:</b> Weaving with the furry yarn, and then pulling out / brushing up the pile on top. (The top half of the sample is brushed, bottom is how it looked from the loom)</p>	

SAMPLE A1.6

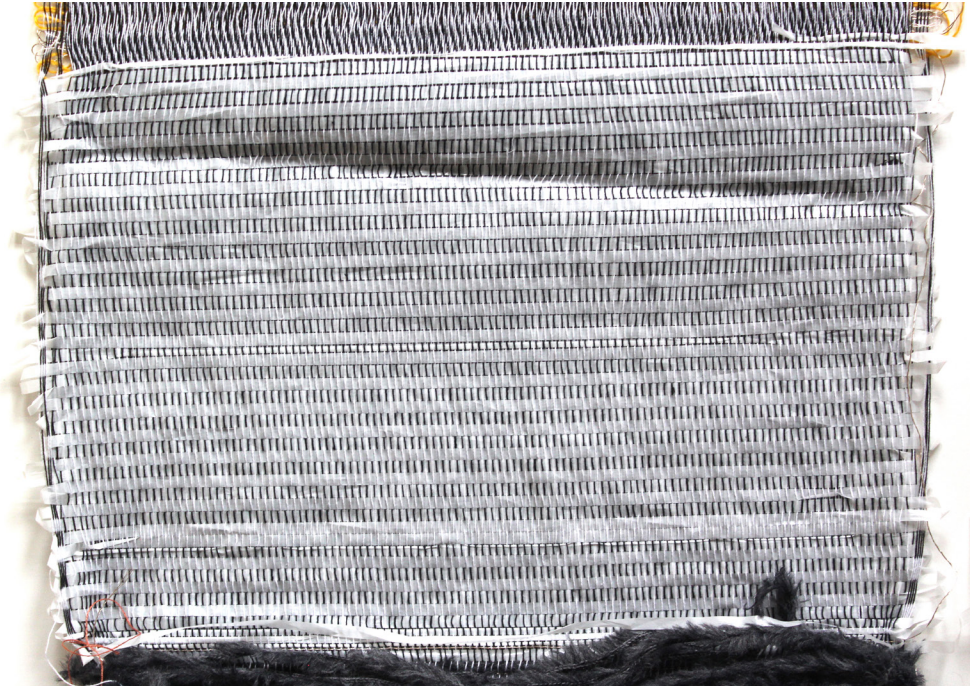

Sample dimension: 29X21 cm

Front

Back

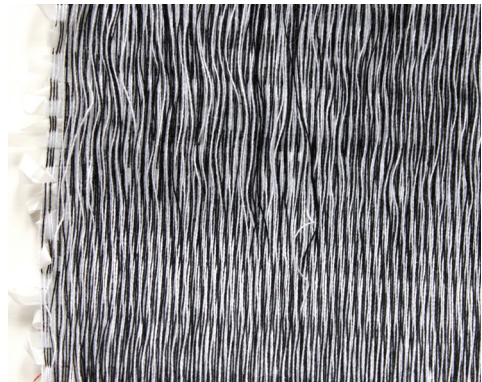
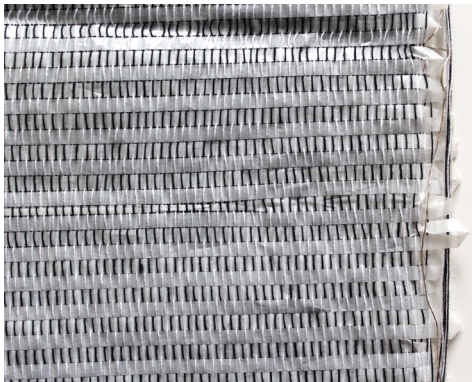

<p><b>Textile technique:</b> WEAVING</p>	<p><b>Construction tool:</b> ARM 5</p>	<p><b>Avg (Std dev) Voltage</b> Not measured</p>
<p><b>Materials:</b> <u>Warp</u>: Cotton <u>Weft</u>: Plastic film yarn</p>	<p><b>Method for incorporating electrode</b> External electrode</p>	

SAMPLE A1.7

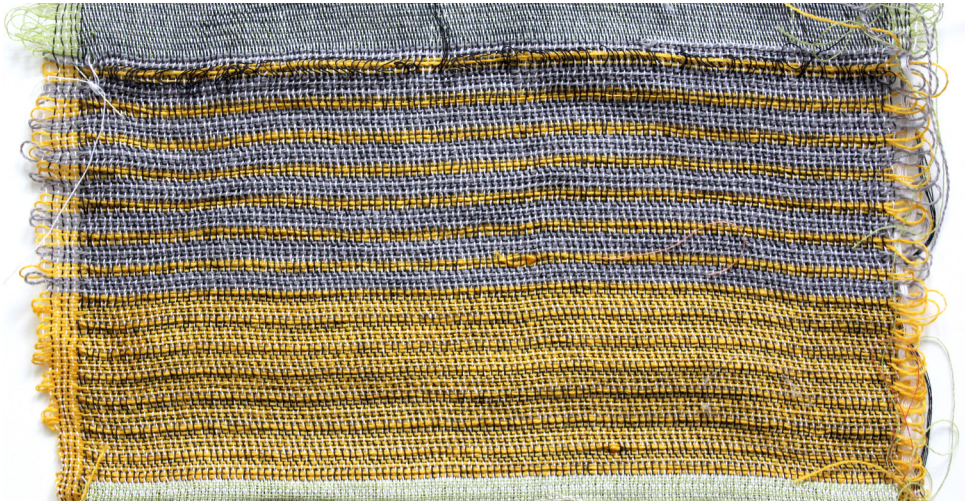

Sample dimension: 29X15 cm

Front



Back



<p><b>Textile technique:</b> WEAVING</p>	<p><b>Construction tool:</b> ARM 5</p>	<p><b>Avg (Std dev) Voltage</b> Not measured</p>
<p><b>Materials:</b> <u>Warp:</u> Cotton <u>Weft:</u> Wool</p>	<p><b>Method for incorporating electrode</b> External electrode <b>Note for construction:</b> Broken twill in 2 interconnected layers with floats inside. After weaving, the floats inside the layers can be pulled to form folds in the overall fabric.</p>	

SAMPLE A1.8



Sample dimension: 28X25 cm

Front

Back

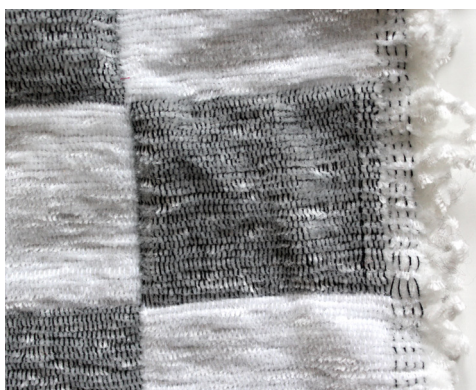

<p><b>Textile technique:</b> WEAVING</p>	<p><b>Construction tool:</b> ARM 5</p>	<p><b>Avg (Std dev) Voltage</b> Not measured</p>
<p><b>Materials:</b> <u>Warp:</u> Cotton <u>Weft:</u> Polyester chanelle yarn</p>	<p><b>Method for incorporating electrode</b> External electrode <b>Note for construction:</b> Some blocks are filled with polyester filling in attempt to amplify the electrostatic effect.</p>	

SAMPLE A2.1



Sample dimension: 23X27 cm



<b>Textile technique:</b> WEAVING	<b>Construction tool:</b> Hand woven	<b>Avg (Std dev) Voltage</b> Not measured
<b>Materials:</b> <u>Warp</u> : Cotton <u>Weft</u> : creative pipe cleaners (metal core and polyester fibres)	<b>Method for incorporating electrode</b> External electrode	

SAMPLE A2.2



Sample dimension: 16 cm diameter

Front



Back



<p><b>Textile technique:</b> WEAVING</p>	<p><b>Construction tool:</b> Hand woven on circular loom</p>	<p><b>Avg (Std dev) Voltage</b> 7.6 V (2.28)</p>
<p><b>Materials:</b> <u>Warp</u>: Conductive yarn <u>Weft</u>: Scraps of polyester fabric for piling, 100% Wool yarn and knitted tube of conductive yarn</p>	<p><b>Method for incorporating electrode</b> Conductive warp insulated by the polyester pieces knotted in the weft direction.</p> 	





## **B**

### **Double Weave**

Weaving 2-layer material combinations:

Electrostatic yarns /materials and conductive yarn

B1: Samples made with hand looms

B2: Samples woven by hand with weaving frames and

B3: Samples made with industrial looms

SAMPLE B1.1



Sample dimension: 30X14 cm

Front

Back



<p><b>Textile technique:</b> WEAVING</p>	<p><b>Construction tool:</b> ARM 5</p>	<p><b>Avg (Std dev) Voltage</b> 4.5 V (1.59)</p>
<p><b>Materials:</b> <u>Warp:</u> Cotton <u>Weft:</u> Top: Teflon Bottom: Polyester &amp; conductive yarn</p>	<p><b>Method for incorporating electrode</b> The bottom layer has rows of conductive yarn so that it is exposed to the inside of the fabric that is in contact with the top layer.</p>	

SAMPLE B1.2



Sample dimension: 30X11.5 cm

Front

Back

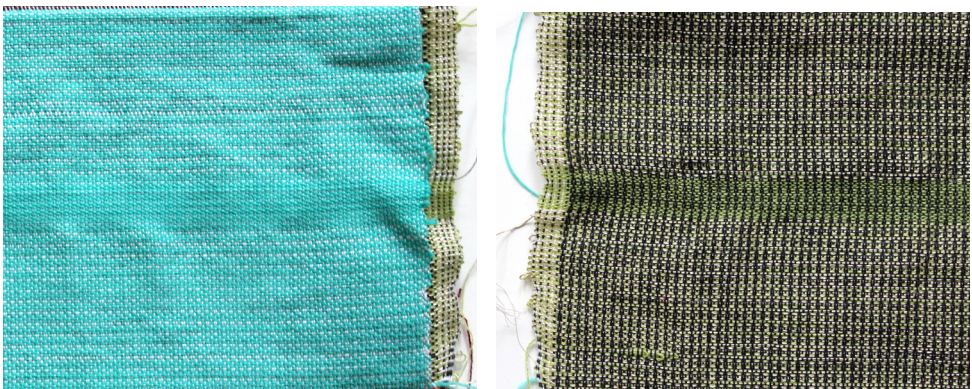

<p><b>Textile technique:</b> WEAVING</p>	<p><b>Construction tool:</b> ARM 5</p>	<p><b>Avg (Std dev) Voltage</b> 3.6 V (0.7)</p>
<p><b>Materials:</b> <u>Warp:</u> Cotton <u>Weft:</u> Top: Polyester Bottom: Wool &amp; conductive yarn</p>	<p><b>Method for incorporating electrode</b> The bottom layer has rows of conductive yarn so that it is exposed to the inside of the fabric that is in contact with the top layer.</p>	

SAMPLE B1.3

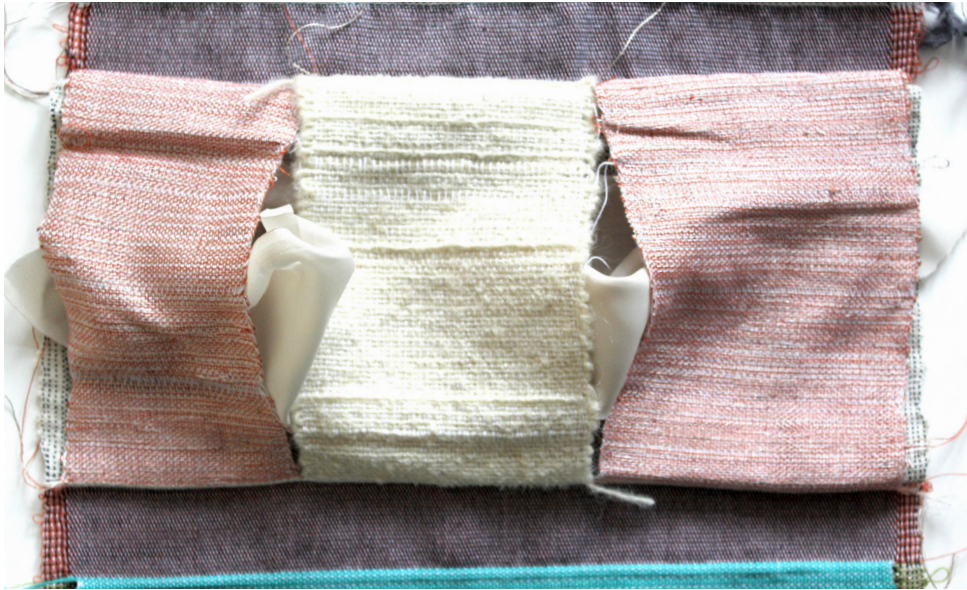

Sample dimension: 30X13 cm

Front

Back

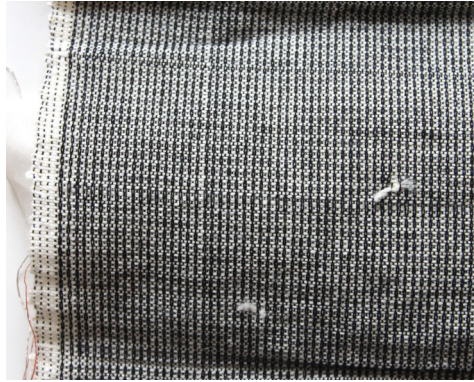

<p><b>Textile technique:</b> WEAVING</p>	<p><b>Construction tool:</b> ARM 5</p>	<p><b>Avg (Std dev) Voltage</b> Not measured</p>
<p><b>Materials:</b> <u>Warp:</u> Cotton <u>Weft:</u> Top: wool and conductive yarn, Bottom: Wool</p>	<p><b>Method for incorporating electrode</b> Weaving with three weft yarns simultaneously to make three distinct areas, two of them conductive in the front layer with gaps. A polyester fabric is inserted in between the layers that can be pulled from between the gaps of the fabric.</p>	

SAMPLE B1.4



Sample dimension: 30X38 cm

Front



Back



<p><b>Textile technique:</b> WEAVING</p>	<p><b>Construction tool:</b> ARM 5</p>	<p><b>Avg (Std dev) Voltage</b> 4.6 V (1.14)</p>
<p><b>Materials:</b> <u>Warp</u>: Cotton <u>Weft</u>: Top: Plastic foil yarn, Bottom: Conductive yarn</p>	<p><b>Method for incorporating electrode</b> The bottom layer has rows of conductive yarn so that it is exposed to the inside of the fabric that is in contact with the top layer.</p>	

SAMPLE B1.5



Sample dimension: 25x28 cm

Front



Back



<p><b>Textile technique:</b> WEAVING</p>	<p><b>Construction tool:</b> ARM 5</p>	<p><b>Avg (Std dev) Voltage</b> 5.7 V (2.49)</p>
<p><b>Materials:</b> <u>Warp</u>: Cotton <u>Weft</u>: Top: Plastic foil yarn, Bottom: Conductive yarn</p>		<p><b>Method for incorporating electrode</b> Rows of conductive yarn woven on top and bottom of the piece. The space between the woven layers is stuffed with polyester filling material during the weaving process.</p>

SAMPLE B2.1



Sample dimension: 21 cm diameter

Front



Back



<p><b>Textile technique:</b> WEAVING</p>	<p><b>Construction tool:</b> Hand woven on circular loom</p>	<p><b>Avg (Std dev) Voltage</b> 4.28 V (0.44)</p>
<p><b>Materials:</b> <u>Warp</u>: Conductive yarn <u>Weft</u>: Top: Polyester yarn, Bottom: Polyester &amp; Conductive yarn</p>	<p><b>Method for incorporating electrode</b> Conductive warp insulated by the wool and polyester wrapped in the weft direction.</p>	

SAMPLE B3.1



Sample dimension: 40X30 cm

Front

Back



<p><b>Textile technique:</b> WEAVING</p>	<p><b>Construction tool:</b> CCI Sampling Loom</p>	<p><b>Avg (Std dev) Voltage</b> 7.7 V (2.79)</p>
<p><b>Materials:</b> <u>Warp</u>: Cotton <u>Weft</u>: Top: Polyester yarn, Bottom: Polyester &amp; Conductive yarn</p>	<p><b>Method for incorporating electrode</b> The bottom layer has rows of conductive yarn so that it is exposed to the inside of the fabric that is in contact with the top layer.</p>	



LOOM SETUP FOR SAMPLE B3.1



**Loom: CCI SAMPLING**  
 16 Shafts (1-16) 40 cm width  
 12 Colours weft  
 Warp: White Polyester Nm 40/2, 30 thr/cm

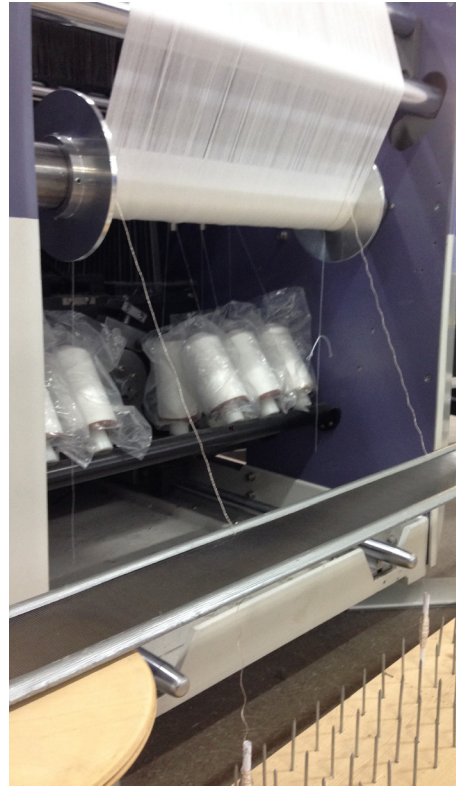

2 Warp threads at the edges changed to conductive yarn so that the row of conductive yarn would be connected to each other.

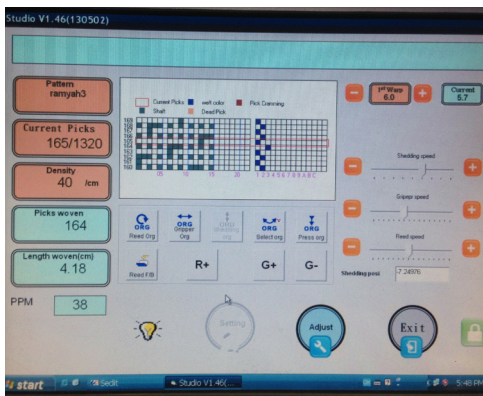

Loom settings for the broken twill area



Loom settings for the plain weave area

**APPENDIX D:  
Supporting files (DVD)**

## LIST OF SUPPORTING FILES

### **01- Electrostatic generator circuit**

- Videos demonstrating the e-static generator circuit used in this thesis

### **02- Research Studies**

- Study 01
  - Measuring e-static textile samples with an oscilloscope
  - Demonstration videos of the Clip-on tester
- Study 02
  - Electrostatic cube interaction videos
  - An analysis of the interactions in the above videos
- Study 03
  - Enacting e-static surfaces (video)
  - E-static sketches
- Study 04
  - Student videos and final works
  - Documentation materials from the workshop
- Experiment cards– An overview and analysis of different experiments undertaken.

### **03- E-static textiles prototyping board**

- Videos illustrating examples for connecting an output directly to the e-static board.
  - Connecting an LED
  - Connecting a counter
  - Connecting a piezo speaker
- Videos illustrating examples of programming interactions by using an Arduino with the e-static board.
  - Reading and displaying values from the e-static board through a serial port
  - A program that simulates slow-charging and harvesting interaction.
- Examples of Arduino programs for getting started (also available on the website)

### **04- E-static engagement demonstrators (videos of e-textile setups)**

- Energy harvesting with e-static wall
- Counting interactions with e-static seat



**APPENDIX E:  
Overview of courses and  
research activities in the  
ArcInTex ETN project**

## **Summary of participation in activities and courses within the ArcInTex ETN project**

I took part in all of the required ArcInTex research activities including common courses, workshops and training events from August 2015 to July 2018. A short summary of all the events and research activities undertaken by me within the ArcInTex ETN project is given below, followed by a more detailed account in a tabular form.

My first secondment took place at the Swedish school of textiles in Borås from September to December 2016 with the other members of work package 3. The secondment included a series of courses and workshops including ‘dynamic form workshop’, ‘textile interaction design’, ‘nomadic tent structures’, ‘academic photography’ and a research methods course. In addition to this, I took part in a month-long course on introduction to weaving techniques. This course was helpful to create several textile samples as part of my research into electrostatic textiles. During the secondment, I was able to progress in my individual work by doing an extensive material exploration and developing hands-on skills and a working method for engaging with static electricity and textiles. The work package 3 group was an important resource for discussions, collaborative brain storming and reflecting on the shared topic of the interior.

My second secondment was at the Wearable Senses Lab of the Technical University in Eindhoven (TU/e), Netherlands from September to December 2017. Being at the TU/e helped me to deepen my theoretical frame, reflect and document my experiments and extend my literature review for the dissertation.

Participation in public outreach and Marie Curie ambassadorial activities during the project included several research colloquiums and research seminars at the UdK (spring 2016, Spring 2017, Winter 2018) and Swedish school of textiles (Autumn 2016); work-in-progress exhibition at the ‘UdK Rundgang’ (Summer 2017); presenting and heading a round-table discussion around sustainability in Wear IT festival in Berlin (Summer 2017) and conducting a compact course on speculative design methods using my ongoing research work for students at UdK (Summer 2017).

Peer reviewed publications include: R. Gowrishankar, K. Bredies, and S. Ylirisku, “A Strategy for Material-Specific e-Textile Interaction Design,” in *Smart Textiles Fundamentals, Design, and Interaction*, S. Schneegass and O. Amft, Eds. Springer International Publishing, 2017, pp. 233–257.

and

R. Gowrishankar, “Constructing triboelectric textiles with weaving,” in *Proceedings of the 2017 ACM International Symposium on Wearable Computers - ISWC ’17*, 2017, pp. 170–171.

### **List of Activities**

21/9/2015–3/10/2015. Summer School 1: Research methods, artistic research, practice-based design research, University of Arts (UDK).

11/10/2015–16/10/2015. Bio plastics workshop in Vilnius Arts Academy (VAA).

15/10/2015. Mycelium workshop at the the Contemporary Art Centre in Vilnius as part of the project by Zooetics organised by artists Gediminas & Nomeda Urbonas and KTU.

22/02/2016–29/02/2016. Common Course: “Activating the surface” at the University of Arts Berlin.

11/04/2016–15/04/2016. ArcInTex Network meeting in Borås Swedish School of Textiles.

18/04/2016–20/04/2016. Workshop 1: Innovation Module at Tu/e.

15/07/2016–22/07/2016. Summer School “Research entrepreneurship in the academic and non - academic area”, Royal College of Art London.

01/9/2016 – 30/12/2016. Secondment at the Swedish school of textiles in Borås.

18/10/2016. Presentation of research at the International week at The University of Borås - along with Work package 3 team.

18/10/2016. Attended a webinar on Triboelectricity by IDTechex.

09/11/2016. Research Seminar at the Swedish School of Textiles to present ArcIntex ETN research.

5/2/2017–10/2/2017. Common Course 2 Embodied textile interactions in Vilnius Art Academy (VAA).

27/04/2016. Attended the IdTechEx Energy Harvesting and Storage summit, Berlin.

04/05/2017. Presented the ArcInTex ETN project and ongoing research at the UdK inter-departmental Doctoral colloquium

09/06/2017. Presented research and hosted a roundtable discussion as part of the sustainability track at the WearIT festival in Berlin

Summer 2017. Book Chapter “A Strategy for Material-Specific e-Textile Interaction” published in Smart Textiles: Fundamentals, Design, and Interaction.(<http://www.springer.com/de/book/9783319501239>)

7/07/2017–14/7/2017. Summer school : Research career, development and business plan. Tu/e.

31/07/2017–04/08/2017. Compact course for the students at UdK about speculative design methods using my ongoing research on Electrostatic textile energy harvesting.

11/09/2017–15/09/2017. Conference participation and poster presentation at the International Symposium for wearable computing (ISWC 2017), Hawaii, USA.

25/09/2017–31/12/2017. Secondment 2 at TU Eindhoven.

11/01/2018. Research Colloquium at Design Research Lab, UdK Berlin.

21/01/2018–26/01/2018. Workshop 2, Heriot Watt University.

During the academic year 2017/2018 my research focused on analysing the research studies, consolidating reflections, documenting my research in an online format that is usable for the e-textiles community and developing an e-static textiles prototyping board in collaboration with a Berlin-based circuit and prototyping company.

<b>1. PERSONAL DETAILS</b>		
Surname	First name	E-mail address
Gowrishankar	Ramyah	r.gowrishankar@udk-berlin.de

<b>2. GENERAL INFORMATION ABOUT DOCTORAL STUDIES</b>	
Doctoral studies subject	University/Department
Work package 3. Designing for adaptive and near-field interactions at the scale of the interior. (Textile interaction design)	UdK Berlin / Department of Design

<b>3. SUPERVISION</b>	
Principal supervisor: Prof. Dr. Gesche Joost UdK Berlin	2nd Supervisor: Prof. Dr. Berit Greinke UdK Berlin
Assistant supervisor from the project Prof. Jolanta Vasalinskiene /VAA	Assistant supervisor from the project Mr. Ian Higgins / RCA

<b>4. OVERVIEW OF COURSES, INCLUDING NETWORK TRAINING ACTIVITIES</b>			
<b>4.1 Year 1</b>			
<b>4.1.1 Summer School 1: Research methods, artistic research, practice-based design research</b>			
Examiner (for the course)	Planned(semester)	Completed(semester)	Reported(date)
Dr. Phil. Katharina Bredies	21.09–3.10.2015	3.10.2015	3.10.2015
<b>4.1.2 Common Course 1: Textile Architecture, UdK Berlin</b>			
Examiner (for the course)	Planned(semester)	Completed(semester)	Reported(date)
Prof. Dr. Norbert Palz	22-29.02.2016	29.02.2016	31.03.2016
<b>4.1.3 Workshop 1: Innovation Module, TU/e</b>			
Examiner (for the course)	Planned(semester)	Completed(semester)	Reported(date)
Ass. Prof. Oscar Tomico	18.04.2016	20.04.2016	18.05.2016



#### 4.1.4 Other research activities (lectures, seminars, workshops, etc.)

- Attended ArcInTex network meeting in Vinius, 12–15 Oct 2015. I participated in the Bio plastics workshop at the Vilnius Academy of Arts that gave an introduction to working with organic materials to create plastic substrates and small objects. In my explorations within the workshop, I experimented with combining knitted textiles and yarns with bioplastics. I also made a sample with integrating a simple LED circuit within the bioplastics that could be powered with an external battery.

- Mycelium workshop at the Contemporary Art Centre in Vilnius as part of the project by Zoetics organised by artists Gediminas & Nomedas Urbonas and KTU. This workshop gave the possibility of preparing and working with mycelium to understand the entire process of growing and developing forms with this material. Working with organic growing materials was a very interesting way to enter into the discussion of future of production and consumption of goods in our everyday lives.

- ArcInTex network seminar and workshop in Borås - April 11-15th 2016. I participated in the textile interactions workshop that explored the expression and actions of the interactions. Our group in this workshop took a simple textile object, a seating cushion, and developed different interaction ideas through body storming. My investigations revolved around exploring the idea of collaborative seating and what sort of negotiations and compromises are needed in interactions if more than one person were needed for sitting comfortably with a textile object. The explorations were captured in the form of short videos.

- IdTechEx Energy Harvesting and Storage summit, Berlin April 27th 2016. This event is an annual meeting for showcasing and sharing the state of the art in Energy harvesting and storage technologies in Europe. I visited the exhibition at the event and was able to get an interesting insight into the current developments in the field energy harvesting as well as have the opportunity to discuss with experts and share ideas for energy harvesting from a textile context.

## 4.2 Year 2

### 4.2.1 Summer School 2: Research entrepreneurship in the academic and non-academic area, RCA

Examiner (for the course)	Planned(semester)	Completed(semester)	Reported(date)
Prof. Clare Jonhston	15-22.07.2016	22.07.2016	22.08.2016

### 4.2.2 Common Course 2: Embodied Textile Interaction, VAA

Examiner (for the course)	Planned(semester)	Completed(semester)	Reported(date)
Prof Egle Ganda Bogdaniene	5–10.02.2017	10.02.2017	24.03.2017

**4.2.3 Secondments 1**

- Swedish School of Textiles, September–December 2016.

**4.2.4 Other research activities (lectures, seminars, workshops, etc.)**

- Attended a webinar on Triboelectricity by IDTechex - 18.10.2016. The webinar gave an overview on the current state of the art in triboelectric generators in the context of energy harvesting and discussed the future potentials and directions for development in the field of Engineering.

**4.3 Year 3****4.3.1 Summer School 3: Research career, development and business plan, TU/e**

Examiner (for the course)	Planned(semester)	Completed(semester)	Reported(date)
Ass. Prof. Oscar Tomico	7.07.2017	14.07.2017	30.07.2017

**4.3.2 Secondments 2**

- Eindhoven Technical University, Netherlands. September–December 2017

**4.3.3 Other research activities(lectures, seminars, workshops etc.)**

- Attended workshop 2 in HW (21-26 Jan 2018)  
 - Presented Arcintex ETN research at ISWC 2017 conference in Hawaii, USA. (sept 11-15 2017)  
 - Presented and discussed research results at the research Colloquium at UdK, Jan 2018

**4.4 Year 4****4.4.1 Other research activities (lectures, seminars, workshops etc.)**

- ArcInTex ETN research conference , 5-6 March 2019

5. SUMMARY OF COURSES AND COMPLETED RESEARCH	
YEAR 1	<p><b>Courses:</b></p> <ul style="list-style-type: none"> <li>- <u>The summer school at UdK</u>, Berlin in Autumn 2015, gave an overview of different research methods and approaches for design research and thinking which helped me to focus and develop my research questions and positioning. My research inquiry: “ What kind of novel forms and interactions can be developed for digital expression at the scale of the interior using textile interactions as a starting point?”, is positioned between the fields of electronic textiles and tangible interaction design and places an emphasis on movement and creative engagement with digital interfaces.</li> <li>- <u>The common course in Berlin “Activating the Surface”</u> at the UdK Berlin provided a theoretical introduction as well as a hands-on experience of dealing with ‘architectural-thinking’ and working with space, materials and time in a collaborative team. This course was very useful in bringing forward the challenges and opportunities of physically scaling up while considering the change in experience and perception in relation to the body.</li> <li>- <u>Workshop 1 at TU/e</u> in April 2016 introduced the idea of making a growth plan for the research which was challenging but useful for envisioning the different stages in a PhD process and identify the possible paths that the research could take and consecutively deriving the results that could be aimed for.</li> </ul>
	<p><b>Overview of research activities</b></p> <p><u>Oct 2015–Jan 2015</u></p> <ul style="list-style-type: none"> <li>- Conducted in-depth literature review in the fields of Tangible Interaction Design and e-Textiles. Through this, I further developed the theoretical framework for using textile interactions as a resource for e-Textile interaction Design. Reflecting on the ongoing empirical work and the research literature, I submitted an abstract for a chapter in a book called Handbook on smart textiles and textile electronics, to be published by Springer and edited by researchers at the university of Stuttgart.</li> <li>- This abstract was accepted, following which I worked on a full chapter, with co-authors, Katharina Bredies (UdK Berlin) and Salu Ylirisku (SDU, Denmark). Writing this 25-page research article helped to organise and collect an in-depth literature review of the related fields. I further articulated the insights and results of ongoing research work to outline and realize my research approach. This book will be published towards the end of 2016.</li> </ul>

- Along with writing the article, I also started initial explorations for investigating textiles in the context of the interiors. Having previously worked only with small scale textile prototypes, I started to address the challenge of scaling up of textile structures, materials as well as interactions. The two main activities conducted included explorations with arm knitting as a technique for using one's body for scaled up textile production. The second included open explorations with making large-scale quick prototypes with textiles.

- A collaborative project within the work package team that adopted a travelling tent as a template for collectively experimenting and exhibiting interior-scale textile explorations began to emerge. Shared online resource pools of images, texts and reflections were also set up to support collaborative work.

#### Feb–May 2016

- Following chapter writing process, through which I was able to derive a focus on movement and deformable qualities of textiles for the doctoral research, I started to look into the possibilities of energy harvesting by utilising the kinetic potential of textile interactions.

-Conducted background research on piezoelectric elements and projects developed in the recent years and started collecting research references and companies in the field. I also contacted several researchers and companies to try to get material samples to experiment with or look for collaboration opportunities. Alongside, I have been doing some low-fi piezoelectric experiments for understanding of the technology for e.g. working with ceramic piezo-elements and growing home-made piezoelectric crystals.

- I attended the exhibition at the Energy Harvesting and Storage summit at Berlin which gave me valuable insights on the current state of the art and a possibility to discuss with experts.

- Learning more about interior design and projects, I have also been working with the idea of using textile interactions for designing and interacting with spatial features. This is an ongoing exploration and the several small-scale quick models made are documented on a personal blog. Video documentation to capture the movements and interactions in the models is planned for supporting the reflection process.

- With the work package team, we have continued the explorations of considering scale, and space with respect to textile interactions through prototypes and photography. We had two group workshops so far and a third one is planned for May 2016. The first one was a writing workshop, the second one was about scaling up and using the stretchability of textiles as a structural element.

	<p><u>June–July 2016</u></p> <ul style="list-style-type: none"> <li>- The individual research took a more focused direction towards energy harvesting with textiles, especially looking at piezo and triboelectric effects. Made multiple tests and measurements of different small-scale set-ups for harvesting static electricity while using textile interactions as a focal point. Introducing movement into the explorations, a method of animating small models in photo collages was undertaken as a strategy for sketching in a bigger scale.</li> <li>- Started a research diary, where I regularly note down observations, thoughts and ideas. Also developed a more uniform template for documenting the empirical work and experiments in the form of a prototyping diary.</li> <li>- Since the energy produced with textiles is low in efficiency, I am exploring different reasons for engaging in energy harvesting and investigating what it means to produce small amounts of electric potential in a long period of time, how this relates to craft, and what kind of practices or textile interactions can be developed around energy harvesting in this way. I am currently working on scenario building and narratives as a way to further detail the research enquiry.</li> <li>- I have been also planning the collaborative project during the secondment in Borås with my work package group, as well as my own research activities with my supervisors. I am currently working on reworking my research proposal and writing a concrete plan for the secondment.</li> </ul>
<p><b>YEAR 2</b></p>	<p><b>Courses</b></p> <ul style="list-style-type: none"> <li>- <u>Summer School 2 -RCA London</u>. The summer school in London was focused on research and entrepreneurship. It provided different perspectives on the subject including research to business narratives, issues regarding funding as well as hints for improving communication and presentation skills. Persistence and flexibility in representation of the core idea were the two entrepreneurial qualities that stood out for me.</li> <li>- <u>Introduction to Electronics workshop (1-7.09.2016)</u>. This week long workshop by Erin Lewis during the Secondment covered the basics of electronic circuits and physical computing. Since I am already familiar with the basics, this was more of a revision for me. I took some time during the classes to instead experiment with components that were new to me such as working with a LED matrix and the energy harvester breakout board I got for my research project.</li> </ul>

- Dynamic form workshop (8-12.09.2016). This three-day workshop focused on exploring dynamic forms and expressions. We were given a task of exploring dynamic form by selecting 2 materials. I used this exercise to explore the potential of static electricity to create movement in materials through series of short videos. It was useful to explore alternative expression of static electricity.
- Textile Interaction Design (week 38). This course focused on writing as a tool as well as form for exploring as well as expressing interactions. I found it interesting to think about interaction through text, while it asked for specificity, it also gave freedom to open out the topic.
- Nomadic Tent structures (week 40). In this course, the work package team explored alternative ways of dwelling by camping in the Swedish forest for 2 nights. Constructing, organising, observing and adapting to a different environment gave us an opportunity to compare and critique our notions of the interior.
- Academic photography course at HB. Through different tasks of organising and communicating our research through images, this course gave a hands-on understanding of the role of images in research as not only as documentation or as a support for the text but as independent communicative elements.
- Research methods course at HB. This course by Lars Hallnas discussed Artistic research, methods and results. The discussions in class about each other's work in relation to the research results was very useful in rethinking the framing and scope of my doctoral work
- Introduction to Weaving. Learnt about basic weave structures and using the hand looms basics for programming and weaving with different machine looms. Made several woven samples through which I was able to explore different material combinations and structures for enhancing electrostatic properties.

**Overview of research activities**

August 2016

- Developed detailed research proposal
- In August 2016, I wrote a research proposal for the PhD based on the research development in the first year of the project. This included revised research questions, the literature review, empirical experiments done so far and incorporated a concrete plan for the upcoming secondment.

### September–December 2016

- The secondment in Borås started with a series of courses. I have set up a documentation blog for sharing ongoing explorations with my supervisors.

- The various courses during the secondment have been helpful to take the individual research forward. I tested different technical implementations for storing and visualising electrostatics. Discovered materials such as polyester, foil blanket to use for quick prototyping. Explored scenarios through sketches and video to further develop the future scenarios. Attended the weaving course at HB. This course gives me an opportunity to explore static electricity in textiles from a materials perspective. The patterns or structures developed during the course could inform the form-development of the intended electro-static textile interventions. Identified directions for further developing large scale electrostatic explorations through prototyping.

- Collaborative work with wp3: Several meetings with the work package to discuss collaborative work. Organised a workshop to investigate interior-scaled textile interactions in the context of electrostatic charge collection. Had several feedback sessions within the Wp3 to comment and give ideas for each other's work. Prepared group presentations for ArcInTex research work to share with students of HB and can be used for later use. Compiled the learning from previous workshops into a series of books and collaborated on setting up an exhibition for the Mid Term review meeting to present the approach and work done in the work package 3.

### Jan--April 2017

- During the beginning of the year, I focused on documenting, collecting and reflection of the work done during the secondment. The woven samples were documented in a sample book. Continued investigation with electrostatic materials and collection set-ups. Started to define methodology by analysing the work, sketches and approaches taken so far in the research.

- Submitted short paper to the ISWC 2017 conference.

- Started to write an article for the Journal of Design but was not able to finish before the deadline. The material and work done in writing the paper will be used in the final dissertation.

	<p><u>May–July 2017</u></p> <ul style="list-style-type: none"> <li>- Continued to develop research methods and design strategies for e-static harvesting using textiles. Further experiments for ways of recording and observing the voltages generated were done and an outline for technical requirements were laid out. I am currently collaborating with an expert to finalise these harvesting and observation set up to be used for analysis.</li> <li>- Started to make interior-scale interaction prototypes at the temporary work space at UdK. These interactions are documented with video and time-lapse images. The analysis of this work is in progress.</li> <li>- Prepared and submitted the Thesis exposé to the Doctoral committee of UdK and got approval for continuing with the dissertation work for pursuing the Doctor of Philosophy degree.</li> </ul>
<b>YEAR 3</b>	<p><b>Courses</b></p> <ul style="list-style-type: none"> <li>- Summer School 3 @ TU Eindhoven: The summer school 3 provided guidelines and assistance in thinking about and planning for post-PhD career development. The workshop on everyday futures was an interesting format for working with researchers from other fields and engaging in a discussion about future technologies.</li> <li>- Workshop 2 @ HW University: This workshop focused on developing visual communication skills and tips for effectively expressing research content to a wider non-expert audience.</li> </ul>
	<p><b>Overview of research activities</b></p> <p><u>July–August 2017</u></p> <ul style="list-style-type: none"> <li>- Wrapped up the interior-scale explorations started in the summer and prepared for the presentation and travel to ISWC conference.</li> <li>- Also planned and organised a week long compact course for students of UdK on Speculative Design Methods.</li> </ul> <p><u>Sept–Dec 2017</u></p> <ul style="list-style-type: none"> <li>- Participated and presented at the International Symposium for Wearable Computing and continued to Secondment 2 at TU Eindhoven.</li> <li>- The 4-month secondment at TU Eindhoven was used to reflect on the different research experiments done during the past year, starting writing and structuring thesis work, to extend the literature review and start shaping the final research frame. This also helped in identifying the next steps needed to wrap up the thesis.</li> </ul>



	<p><u>Jan–July 2018</u></p> <p>- This period was focused on continuing evaluation of the different research studies in order to develop the overall thesis arguments. During this time, I started drafting the final dissertation that needed several versions before finding the best suited structure.</p>
<b>YEAR 4</b>	<p><b>Overview of research activities</b></p> <p><u>August 2018–Feb 2019</u></p> <p>- Continued writing dissertation. In parallel, finalised the research demonstrators and started a website for documenting results in a form that is usable for e-textile community.</p> <p>- Collaborated with a circuit design and prototyping company based in Berlin to design and develop a “e-Static prototyping board” that would enable one to easily connect high voltage inputs such as static electricity and interpret it using an Arduino to design and prototype interactions with triboelectric generators.</p> <p>March 2019–Oct 2019</p> <p>- Writing and finalising thesis</p>

#### 5. LIST OF PUBLICATIONS

Name of publication	Date
<p>Book chapter: <b>A Strategy for Material-Specific e-Textile Interaction Design</b></p> <p>Gowrishankar, Ramyah, Katharina Bredies, and Salu Ylirisku. “A Strategy for Material-Specific e-Textile Interaction Design.” In Smart Textiles Fundamentals, Design, and Interaction, edited by Stefan Schneegass and Oliver Amft, 233–57. Springer International Publishing, 2017. <a href="https://doi.org/10.1007/978-3-319-50124-6_11">https://doi.org/10.1007/978-3-319-50124-6_11</a>.</p>	Spring 2017
<p>Paper/Brief: <b>Constructing triboelectric textiles with weaving</b></p> <p>Gowrishankar, Ramyah. “Constructing Triboelectric Textiles with Weaving.” In Proceedings of the 2017 ACM International Symposium on Wearable Computers - ISWC '17, 170–71. New York, USA: ACM Press, 2017. <a href="https://doi.org/10.1145/3123021.3123037">https://doi.org/10.1145/3123021.3123037</a>.</p>	Autumn 2017

6. COMPLETED MARIE SKŁODOWSKA-CURIE AMBASSADORS ACTIONS (e.g. teaching activities, workshops, lectures, seminars)		
Semester (autumn/spring and year.)	Nature of action	Date
Spring 2016	Research Colloquium at Design Research Lab, UdK Berlin	23.06.2016
Autumn 2016	Presentation of research at the International week at The University of Borås - along with Workpackage 3 team.	18 & 20.10.2016
	Research Seminar at the Swedish School of Textiles to present ArcIntex ETN research	9.11.2016
	Design seminar at the Swedish School of Textiles to present ArcIntex ETN research-along with Workpackage 3 team.	13.11.2016
Spring 2017	Presented the ArcInTex ETN project and ongoing research at the UdK inter-departmental Doctoral colloquium	4th May 2017
Spring 2017	Presented research and hosted a roundtable discussion as part of the sustainability track at the WearIT festival in Berlin	9th June 2017
Summer 2017	Work in progress exhibition at UdK Rundgang	21.07.2017– 23.07.2017
Summer 2017	Compact course for the students at UdK about speculative design methods using my ongoing research on Electrostatic textile energy harvesting.	31.07.2017– 4.08.2017
Autumn 2017	Paper publication and poster presentation at ISWC 2017 conference in Hawaii, USA.	11–15.09.2017
Jan 2018	Research Colloquium at Design Research Lab, UdK Berlin	11.01.2018



*Notes*



Ramyah Gowrishankar  
narrativize.net  
ramyah.gowrishankar@gmail.com



This work is licensed under a [Creative Commons Attribution-ShareAlike 4.0 International License](https://creativecommons.org/licenses/by-sa/4.0/).

**Photos, videos and illustrations with other statements are excluded.**