



DAAN

**Design of Ambient Assistive
Notification Systems**

Project Documentation

DAAN

Project Documentation

1—Introduction	7
2—The Finished Prototypes	15
Fiber Optic Light Shawl	17
Thermohaptic Shawl	27
The Color-Changing Shawl	35
3—Design-Driven Inquiry	41
Expanding the Original Application Scenario	46
Identifying Distinction Criteria for Electronic Textiles	47
Probing into the Context	48
Textile Input for Ambient Assisted Living	52
Textile Input Possibilities	53
The Croissant	53
The Upside Down Wearable	55
Feedback on Textile Input	57
Benchmarking: Existing Exercise Tools	59
The Tetrahedron	59
Textile Output for Ambient Assisted Living	62
Textile Output Possibilities	63
Shape Development	65
Production	65
Reflection	68
Pre-existing Constraints	69
Input	70
Output	71
Conclusion	73
4—Design Process/Prototyping	75
Process Overview	77
Light Shawl	80
Overview	82
Light Elements	85
Optical Fibers	86
Electronics	88

Knitting Patterns	92
Heat Shawl	102
Overview	104
Heat Element	105
Electronic Components	106
Heating Circuit	108
Heat Yarn Integration	110
Knitting Process	112
Thermochromic Prints	116
Connections	124
Electronics	127
Demonstrator Settings	130

5—Wearing Notifications: Exploring Meaningful Application Scenarios with Users **133**

Narrative Speculation	136
Perception of the Stimuli and Embodied Wearing	140
Ambient Attitudes	142
Public or Private	145
Personal Style	147
Perspectives	149

6—Imprint **151**

1—

Introduction

7

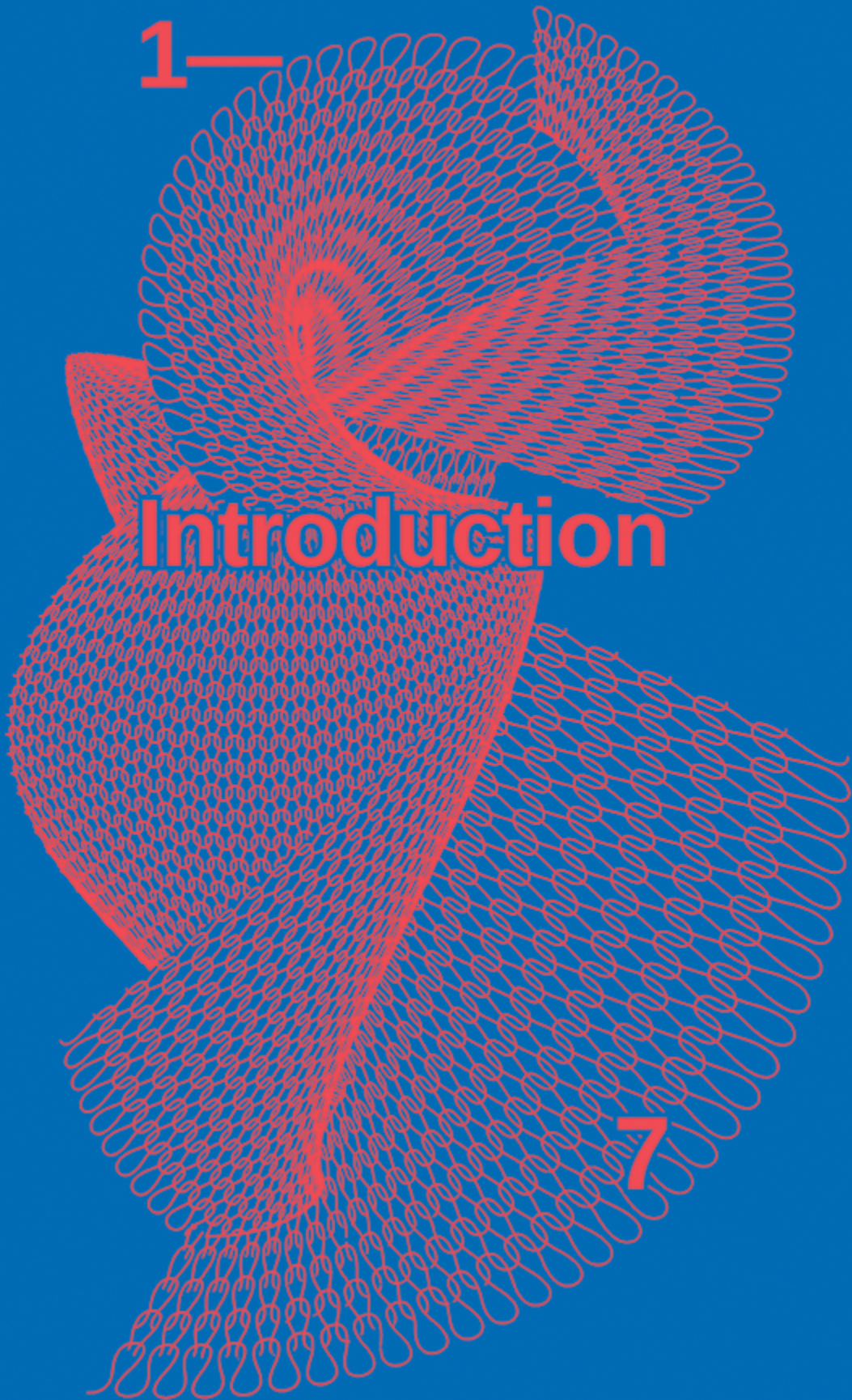

The project DAAN (Design of Assistive Ambient Notification, funded by the German Ministry for Education and Research) explored ambient notification as a part of an assistive computing system for elderly users. Within the framework of this project we investigated the potential of textiles as ambient notification devices, with a focus on knitted fabric.

Background

The term ambient notification is related to ambient computing, originally formulated by Mark Weiser in his text “The Computer for the Twenty-First Century¹” – in which he envisioned an ubiquitous computing environment where technology has become so intuitive and embedded into everyday life that it has ceased to be distracting and disturbing. Central to this vision was the thought that computers should reside in the periphery of our awareness. Building on these ideas, numerous projects within Human Computer Interaction (HCI) have since then done research on “peripheral interfaces” and “ambient information” systems, using varying modalities such as light, shadows, movement, sound, in order to display many types of data, from energy usage, weather forecasts, to the presence or absence of colleagues, to name just a few.

1

Weiser, Mark, 1999. The Computer for the 21st Century. SIGMOBILE Mob. Comput. Commun. Rev. 3, 3 (1999), 3–11.

9

Although there has been a shift moving away from Weiser's vision of "calm computing" and ubicomp in general — as it has been proven difficult and contentious to materialize — there has been a steady proliferation of computing technology in our everyday life, implying that the need for unobtrusive interfaces prevails. The concepts of "ubiquitous" or "pervasive", have largely been replaced by an "Internet of Things".

Motivation

The declared aim of the research project DAAN was to develop an assistive smart environment for elderly persons that suffer from cognitive or physical impairments, in order to enable them to live at home independently as long as possible. The underlying thought was that a context-aware computing system can potentially increase the quality of life for elderly individuals in the need of assistance, allowing them to stay in their familiar environments and ensuring their autonomy.

The environment connects devices, sensors, actuators and captures the user's habits and routines over a longer period of time, enabling them to for example manage self-care, structure their time, be unobtrusively monitored and communicate over distances. Since the type and degree of impairment differs for every user, the thought is that the system continuously adapts to their potentially changing individual needs, helping them cope with everyday tasks and activities.

The concept of ambient notification within such a system refers to the presentation of information in a non-distracting, aesthetically pleasing and, to varying degrees, tangible way. Instead of notifications that are disruptive, such as an alarm clock, an ambient display is able to show information that a person is aware of, but not necessarily focused on. Ambient notifications are unobtrusive and move between the periphery to the primary focus of a person's attention.

Pousman and Stasko² introduced a taxonomy for

2

Pousman, Z. and Stasko, J.
2006. A Taxonomy of Ambient
Information Systems: Four Pat-
terns of Design. (2006), 1–8.

10

ambient information systems, mapping out four design dimensions by which ambient displays can be categorized: Information Capacity, Notification Level, Representational Fidelity and Aesthetic Emphasis. This categorization helped us in developing our own ambient wearable prototypes.

Our role within the project

As textile designers and design researchers we were especially interested in how ambient interfaces in textile allows for experimenting with output modalities such as haptic and tangible feedback. Existing research on displays and communication devices in the field of assisted living focuses on visual feedback through displays and audio signals, and recently voice interfaces. Body-worn technologies already have an integral part of distributed intelligent systems, since they are mobile and can help systems become context-aware. Ambient body-worn technology has been explored e.g. in the form of wristbands, headbands and jewelry, but relatively few researchers have focused on ambient output modalities directly embedded into textile, and even fewer on haptic feedback.

To us, however, fabric represented a very promising material for ambient wearable notification. For once, it is a familiar interface to our skin, which makes it in many ways suitable for embedding wearable and haptic notification technologies. Since fabrics are ubiquitous in our everyday life, such technology has the potential to blend in with already existing practices and habits of use. Integrated into textile these technologies can be comfortably worn on the body as a personal, intimate interface.

Within this project we developed three wearable accessories in the shape of shawls, that all can be used as notification devices. They make use of three different output modalities – warmth, light, and color-change to notify users. What they notify of is freely configurable, depending on the needs of the individual user.

Throughout the process, we involved prospective end-users and caretakers to ensure their relevance and to find meaningful application areas from a user perspective.

A word about the user group

The targeted user group was defined already during the application phase of the project. The ideal prospective user of the assistive technology of DAAN would thus be an elderly person in the need of assistance, with a physical or cognitive impairment. Over the course of the project we decided to focus on elderly with bodily, age-related impairments. The abstract, nontextual representation of information in ambient displays and our use of novel shapes for these technologies seemed to us unfit for someone with cognitive impairments such as dementia, where clear, literal and familiar forms of communication are important.

As ageing is a very individual process, the need for assistance among elderly are extremely diverse. Nevertheless, there are some health conditions that are associated with an advanced age. Physical capability generally decreases progressively with age, due to a loss of muscle mass, and so do sensory capabilities (visual, auditive, haptic and olfactory). More serious conditions that are common in older age include arthrosis, severe loss of vision and hearing, and diabetes.

Ageing is often characterized as a process that minimizes someone's capacities, and it was important to us to understand it as it as a lived-through, embodied process that changes how you interact with the world that surrounds you. This world is not only determined by medical conditions, but it is a social, symbolic, and material world. We tried go beyond a reductionist perspective on ageing and focus on how elderly think and feel about assistive technologies as a potential part of their everyday lives.

The structure of this book

The first chapter in this book showcases the most visible and tangible results from the project, the final prototypes of the notification wearables. The second chapter recollects the research process from a methodological point of view and presents some reflections on what we call “design-driven inquiry”. The following chapter presents the design and implementation of the prototypes with all the different techniques and experiments that we explored to achieve a working solution in the end. In the last chapter, we describe the user research process and elaborate on some of the insights that we gained from engaging with the prospective user group.

Especially the chapter on the prototyping process describes a journey through the possibilities of electronic textiles as well as the challenges that one faces when trying to build them. But in general, we would like to think of our documentation as a multifaceted account of what design research is like – a constant struggle in dealing with the complexities of applied projects. We hope that revealing this struggle is to some value to our readers as well.



2

The Finished Prototypes

15

Fiber Optic Light Shawl

The fiber optic light shawl is able to send subtle light signals to its wearer by distributing the light from an LED over the knitted fabric. The optical fibers are integrated in the wool knit with a tuck-stitch pattern and run from the back to the front of the shawl. The fibers were sanded prior to knitting, and are connected to a custom made sewable circuit board in the brim of the shawl. This light shawl can be used as a comfortable, wearable notification device, for someone experiencing hearing loss.



The fiber optic light shawl.
The two areas with the knit-in
optical fibers are clearly visible
in the center.

Fiber optic light shawl



The shawl on a hanger, displaying the way that the square is folded to form a triangle.



Fiber optic light shawl



The optical fibers in an illuminated state.



In an earlier version, the optical fibers were not integrated into the knitted fabric, but held between the two layers of a Jacquard knit.

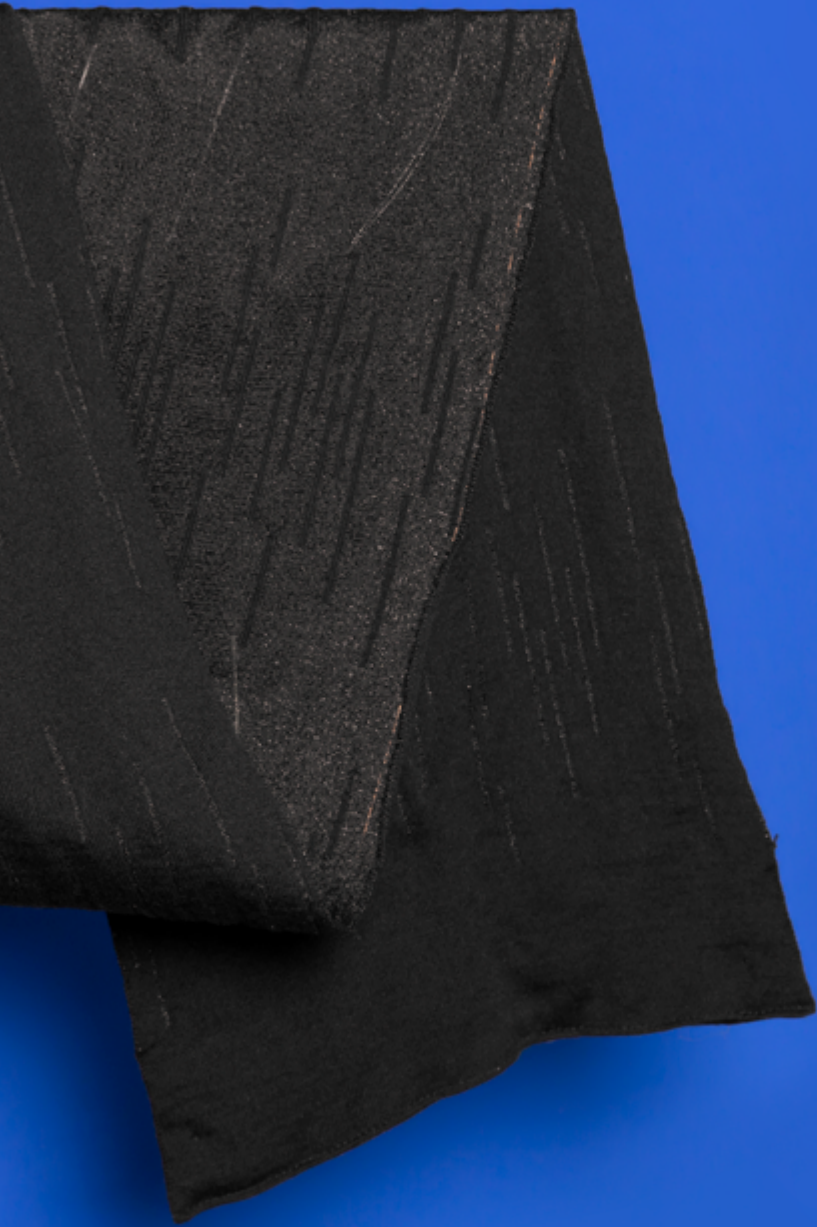



The subtle vertical stripes in the pattern connect the two faces of the shawl and hold the optical fibers in place.

Fiber optic light shawl



The optical fibers inside the shawl in an illuminated state. One can see how the fibers meander through the fabric.

Thermohaptic Shawl

The thermohaptic shawl explores warmth as an output for digital information, sending thermal signals to its wearer by resistively heating a thin steel yarn embedded in the fabric. The textile heat elements are completely soft and invisibly integrated as an in-lay in the double-face knit. The fact that the steel yarn is laid in but not knitted, makes for a more efficient heat element and also insulates the yarn, avoiding shortcuts. The surrounding fabric is knit from wool to maintain the warmth. Thermal feedback is a less explored notification method in textiles, but since it is an invisible, silent and haptic modality, it can be used as a completely private, personal notification. Warmth also has positive, affective connotations and can be used metaphorically for expressing love, sympathy, friendship.

Numerous iterations were needed to decide on the final composition of the thermohaptic shawl.



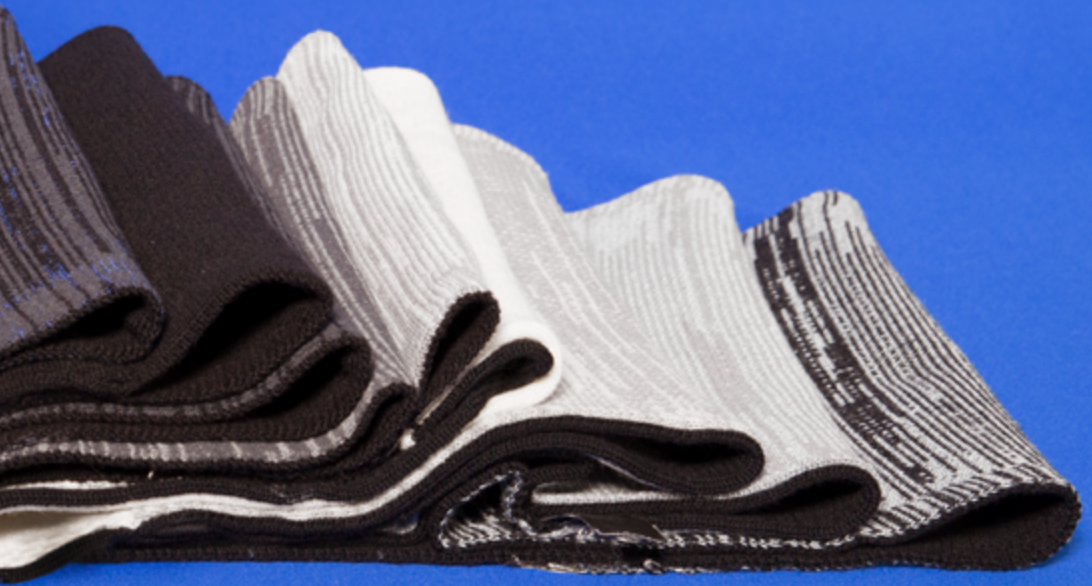

The finished prototypes

Left page: One side of the doubleface knit is entirely black, while the other side has a gradient knitted with two different yarns at once, producing a pleasant visual effect.

Right page: Closeup of the knitted structure.





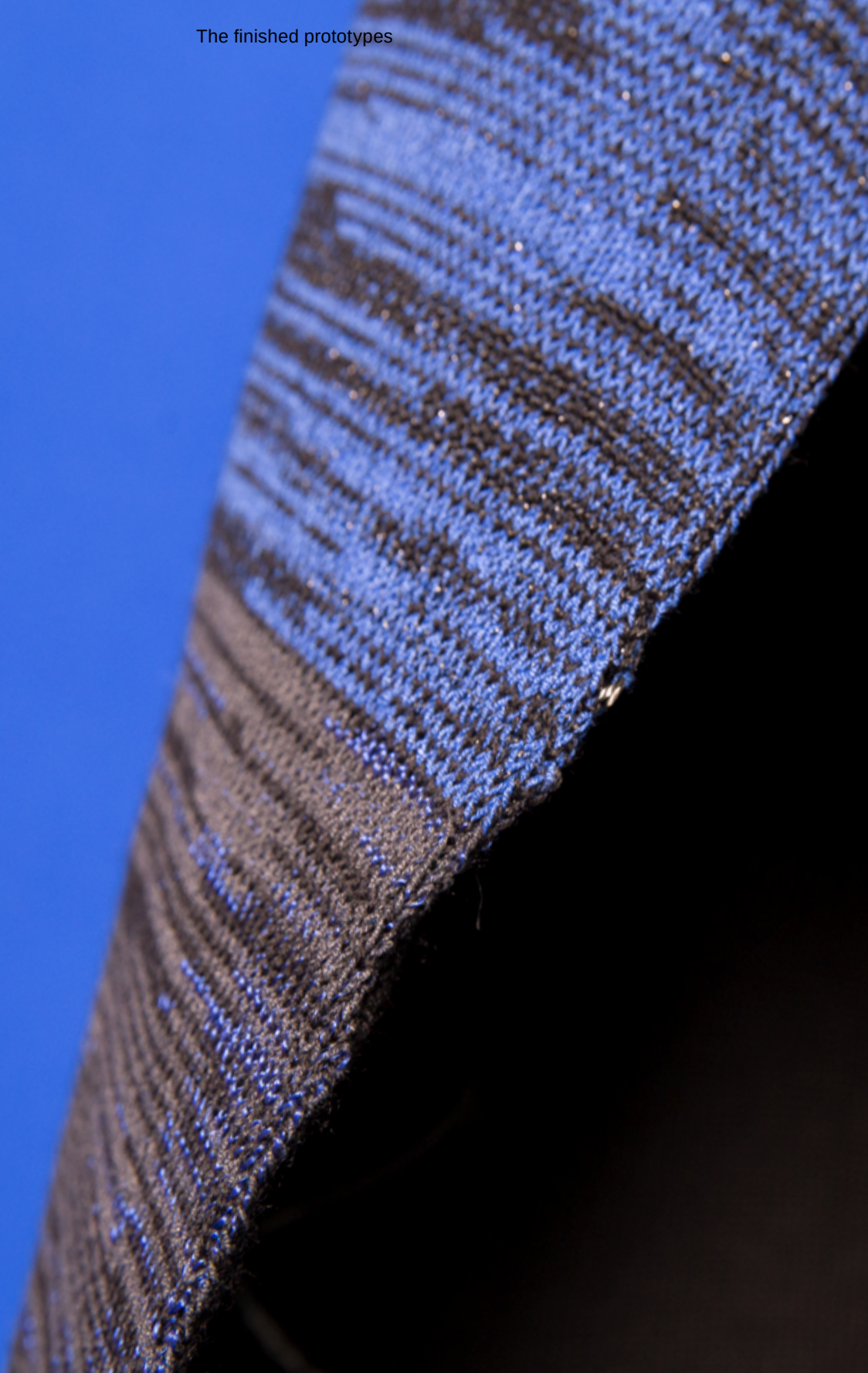

Thermohaptic shawl



Left page: Closeup of the two-colour knitted gradient with a different colour composition.

Right page: Full view of an alternative color scheme for the thermohaptic shawl.

The Color-Changing Shawl

The thermochromic shawl serves as non-emissive display that notifies through a color-change in the fabric. Displays made from thermochromics have lower resolution than standard displays and are less dynamic, with a gradual change over a few seconds. This makes them unobtrusive and inconspicuous interfaces.

When heated, the thermochromic pigments transition from color to transparent, or reverse, depending on the chosen activation temperature. Because they activate with heat, they work as a visual and tactile output at the same time.

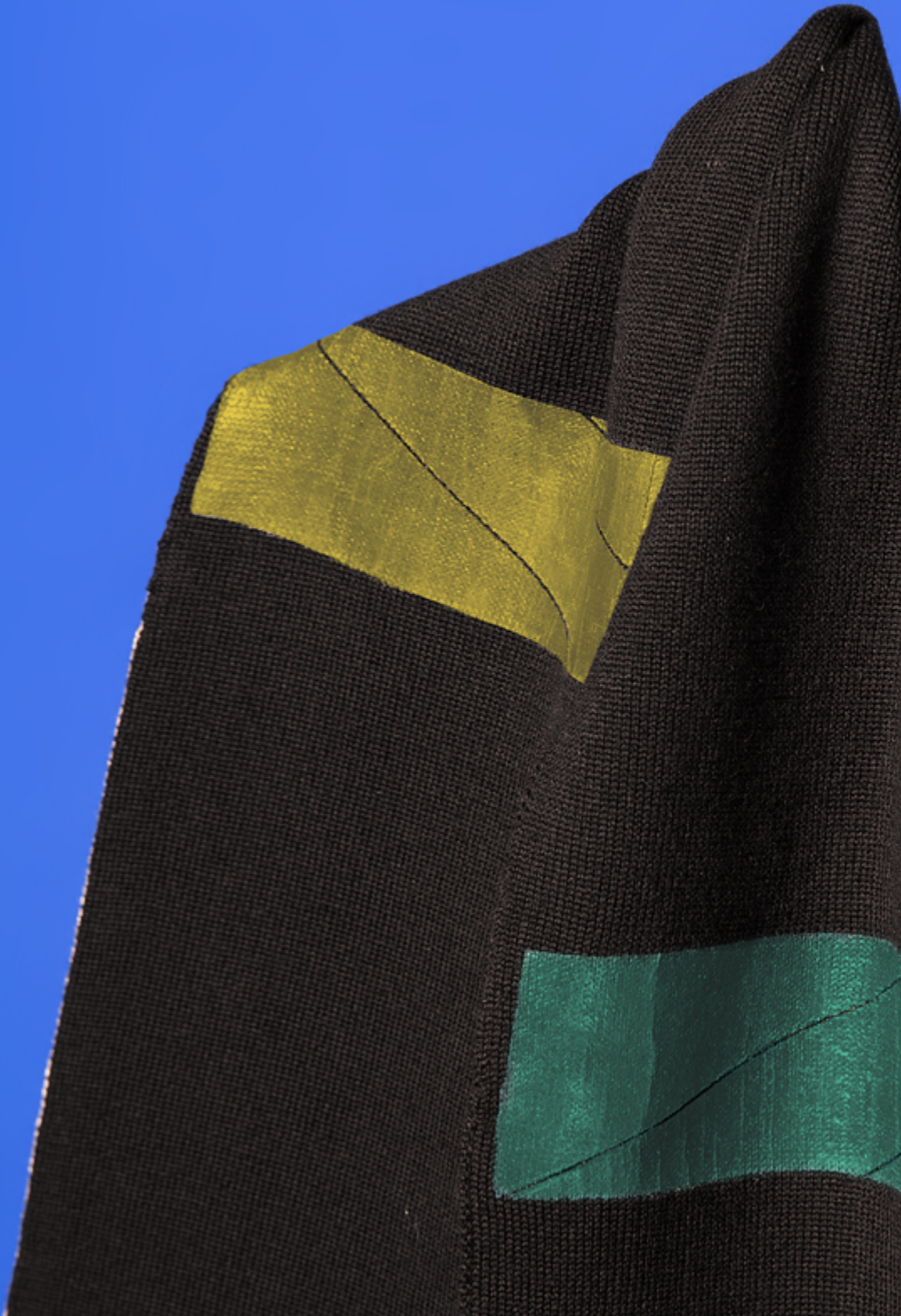





Left page: The color-changing shawl before the color change.

Right page: The four thermochromic segments of the shawl in an activated state.





2

The Finished Prototypes

15

When we started to work in the DAAN research project, our role as designers and experts in electronic textiles was only broadly defined. The project's focus was on the development of a technological system, targeting elderly users with physical or cognitive impairments. The material and technology that we wanted to work with was relatively clear, since we contributed experience in interactive and responsive textile structures to the research project. We therefore located our research activity at the interface of technology and application context: Like our engineer colleagues, we thus grounded our inquiry in the technological possibilities. But we also wanted to put those possibilities to good use, not only to make them work, but also to make them useful in an everyday life situation. For our methodological approach, this meant that we had to constantly negotiate what was possible to do with electronic textiles, and what kind of application they could be used for.

43

As unspecific as it was, the DAAN project therefore presented a good opportunity to apply a design-driven research process: that is, a methodological approach where both problem and solution are carved out of the design activity at the same time. Design is often faced with the situation to have a solution in search of a good problem. This is a common phenomenon, since

it is often only possible to evaluate a technology when it appears in a specific context – not in the abstract. Therefore it is also an established process to develop the problem and solution in parallel, shifting back and forth between the possibilities of a chosen technology and the constraints of a particular real-world problem.

This process is unlike a traditional user-oriented design process or a traditional technology-driven development as it has been practiced in engineering: In user-oriented design, the problematic situation is the source for the design constraints, and the choice of technology should ideally fit the users' problems. In technology-driven engineering, the technology is fixed but opens up for different application possibilities. Even if both processes rarely appear in real life, there are tendencies to either predefine the application context or the technology in a design project.

A broad and unspecific topic definition can therefore be considered characteristic for a design-driven approach. It allowed us to gather constraints as we went along. On the one hand, they came from practical considerations such as the choice of tools and materials that are affordable and available. On the other hand, we became more and more specific about the users and use cases. Once we could clearly define the application, this decision influenced in turn the appearance and performance of the interactive object we were going to build.

Obviously, such an approach also bears a certain risk to fail. Sometimes we could not find a match between means and ends: While it is possible to build some artifacts from electronic textiles, it is not always practical or desirable; and while some situations might be perfect for a textile interface, we might still lack the skills, materials or means of production to construct it.

In this chapter, we will therefore describe our design process from a methodological point of view. We will

explain the rationale behind the problem development, and give insights into the design process for the textile input and output devices. This is meant to make the reasoning in the process transparent, and to allow the reader to reconstruct what influenced our decision making. To conclude the chapter, we will offer some reflections on the role of the constraints from different areas, their interplay, and the challenges of the approach as such.

Expanding the Original Application Scenario

The original application scenario from the funding application represented the very first starting point from where we began to define our roles and responsibilities. This scenario provided a reasonably open-ended and flexible description of the system to be implemented. The planned system should use artificial intelligence algorithms to learn about the behavior of a smart home inhabitant. In turn it should be able to recognize if this person would deviate from his or her routine behavior. This feature should support elderly users with cognitive impairments in their everyday routines and keep them healthy and safe.

The original narrative therefore foresaw some kind of wearable device for the user that provides information on their whereabouts or their wellbeing. Sensory information in wearables are frequently used to monitor the wearer's movements and posture or their vital signs, depending on the specific application. At the same time, the scenario could accommodate additional ambient output devices, even if this application was not explicitly tied to smart textiles in the original framework. However, the existing narrative was not a fixed plan but rather a starting point, a shared story for the project partners to coordinate their work.

This meant that there was ample room for exploration beyond a wearable monitoring device. And we were indeed interested in finding other applications for two reasons: Lack of control and lack of originality.

From the very beginning, the idea of a sensing garment for an AI smart home system raised questions about delegation and control that we found hard to find a good design answer to, especially without having influence on the AI system that receives the monitoring data. There is a qualitative difference in using deliberate movements versus monitoring casual movements. Casual movements are those that a person has to

make and that she is often unaware of. Consequently, the user will most likely not be (or is not supposed to be) consciously manipulating the wearable sensors. Textile sensors are predestinated for this kind of subtle and unobtrusive monitoring. But from a user perspective, this seamless integration of sensors results in a lack of transparency and control. We were therefore reluctant to elaborate a scenario where a smart textile would be used in a monitoring device, with no obvious manipulation possibilities concerning the data input.

In addition, wearables are just one possible form for textile electronics, albeit a reasonable one; and we were interested in thinking beyond the form repertory that garments or textile accessories offer. Clothing is a well established form for textile material, and as such very much restricted by considerations of comfort, style and practicality. Garments are therefore not necessarily the most open form when it comes to experimenting with the interactive possibilities of the material. There are strong social and cultural limits to how we interact with our clothes, and what they are supposed to look like.

Apart from that, electronic textiles offer both input and output possibilities. While textile sensors are convenient inputs for body movements, e-textile output has been used a lot in professional wearables (e.g. to increase visibility in dangerous working environments) and as a new means of expression in fashion design, among other applications. We were thus interested in looking at the application potential for both e-textile input and output, either in a single object or in two separate ones.

Identifying Distinction Criteria for Electronic Textiles

By dismissing a sensing garment as a quick and convenient solution, we had to reconsider how to interpret the assistive aspects of e-textiles from scratch.

We were therefore looking for other ways to apply smart textiles as part of a smart home systems to support ambient assisted living. Since we were determined to use smart textiles, a key question in search of a better application area was: Where do textile interfaces represent an advantage over conventional electronic devices, and based on which properties? In other words, what application areas can we identify that play to the strength of interactive textiles?

To find an answer to this question, it is necessary to make oneself aware of the distinctive qualities that textile electronics have. Generally, textile materials provide a new and different look and feel to electronic devices – not only for their softness, but also because the conductive threads in a smart textiles can be combined with all sorts of non-conductive materials such as wool, cotton, hemp, linen or silk. Electronic textiles are thus able to introduce a different aesthetic to electronic appliances. This difference is based in the traditional textile production techniques and their appropriation for electronics, which indeed makes it possible to integrate sensing actuating capabilities seamlessly with the textile structure.

We can identify other differences when we look at the particularities of electronic input and output. As an input, textile materials open up for interactions that are common with soft surfaces but new in electronics, such as folding, stretching or knotting. As an output, textile production techniques are less suitable for established forms of visual output – such as a screen – than for new forms of expression such as light through optical fibers, or color change through thermochromic inks.

Probing into the Context

Even with the self-chosen restriction to work exclusively with electronic textiles, we had a large selection of materials and technologies at hand that we could apply to an ambient assisted living scenario. We therefore

needed to learn about the context first to be able to narrow down our choices, and to specify the application further that we wanted to explore. Doing so, we initially focused on the most apparent differences of seniors and other user groups and investigated the physical and cognitive impairments that often accompany ageing.

We started our inquiry with an overview of the conditions that affected elderly people, looking for cases where electronic textiles could become useful. This inquiry consisted of interviews with two caretakers (one working at a day care center and one doing home visits), with two seniors (living at home, one aged 84 and one aged 93) as well as one relative to an older person living at home. We also conducted two observation studies at a day care center in Berlin, with seniors aged 59-99. Both groups included individuals with different stages of dementia and different bodily impairments. We complemented the research with a literature review and a review on existing design projects for people with dementia.

From this initial inquiry, we learned about the characteristic health conditions that affect elderly people, and about situations where – based on these conditions – assistance might be useful. Health conditions associated with aging thus include a general decrease in physical capability, and sensory capabilities such as seeing, hearing, feeling and smelling. Common conditions include arthritis, diabetes, depression and dementia, which can occur in combination. With age, people also suffer from what is characterized as geriatric syndromes and are based on factors such as frailty, urinary incontinence, falls, delirium and pressure ulcers.

Situations where seniors with bodily impairment might need help include everyday essential tasks in the home (e.g. getting dressed, bathing, cooking, and grooming), everyday outdoor activities (e.g. shopping, taking stairs, walking long distances, handling traffic), or administrative tasks involving use of a computer or

internet (e.g. paying bills, managing doctor's appointments, booking tickets).

Beneficial activities that help elderly persons to stay healthy include physical exercise (e.g. dancing or going for a walk) and socializing activities (interaction with friends and family). At the same time, caretakers considered understimulation at home to be a problem (e.g. lack of contact and conversation), as well as long waiting times and boredom.

1

Examples are tracking devices such as an in-sole sensor by Inshoerance (<https://www.inshoerance.net/>) or „SPUR“ by Julia Danckwerth (<https://www.danckwerth.com/spur.html>) that are representative for many others of the same kind.

2

Martijn ten Bhömer's project „Tactile Dialogues“ is a positive case study of tangible interface design with e-Textiles for people with dementia. See <https://www.mtbhomer.com/portfolio/tactile-dialogues/>

The first interviews and literature review served as a baseline to gain a better understanding of prospective users. It also helped us to exclude application domains that we considered inappropriate. We learned that the activities that people with dementia enjoyed and appreciated were often individual, tied to their past. In addition, social relationships with kin and caretakers seemed more crucial and important than technological interventions. Existing wearable design projects that address people with dementia partly focus on monitoring the user's whereabouts and physical condition¹, which we did not want to do. Others apply electronic textiles to provide a non-verbal mode for communication², which appears useful but also a heavy use of technology that is not necessarily justified by the application situation.

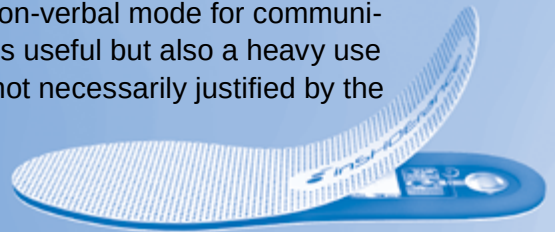

From the inquiry, we learned that designing for people with dementia is a difficult and demanding task. It also requires a strong user-oriented focus and a thorough and ongoing engagement with dementia patients, their caretakers and families. This is why we decided that it went too far off the scope of the DAAN project to focus on this user group, and that our methodology would not meet the requirements of this health condition. We focused on physical impairments instead, and, more specifically, on measuring deliberate movements, such as in rehabilitation exercises. This also left more room for exploratory design of textile interaction shapes.

We therefore started to look into health conditions that required physical exercise. One age-related impairment that we came across was arthritis and the different variations it appears in. Arthritis is inflammatory joint disorder that exists in over a hundred different forms, of which osteoarthritis is the most common form and is caused by old age. One of the symptom of this disease is constant pain in the affected joints; other symptoms are swelling and stiffness, up to the point where the affected person become unable to move their hands or walk. Secondary effects include muscle weakness and loss of flexibility. Other frequent forms are rheumatoid arthritis and finger joint arthritis.

Generally, movement and daily exercise help to relieve the pain from arthritis and to keep the sore joints flexible. Both physical and occupational therapy are used for treatment. This includes simple everyday exercises such as squeezing a rubber ball, walking, cycling or swimming. However the appropriate exercises and movements are specific to the form of arthritis that affects the patient. Another treatment is by applying warmth to the affected joint, e.g. with a heat blanket or a heat pad.

Textile Input for Ambient Assisted Living

Focusing on physical impairments and exercise, we started to develop textile shapes that invited the kind of movements that would be beneficial for patients with arthritis. In this process, we proposed shapes and then evaluated their potential to support exercise in short iterations. Our intention was to make the daily exercises more pleasant and thus to motivate the patients to perform them regularly. We therefore linked the prototypes to auditive output or to a simple game as ways to provide an enjoyable output. Regardless of the digital feedback, we also wanted to make the textile object as such aesthetically pleasing and suitable for a home environment.

We wanted to design an input object rather than a wearable for body monitoring to avoid patronizing the users. At the same time, this change in direction made it less obvious how the object would fit in with the machine learning capabilities of the DAAN system. Other than a monitoring wearable, a random input device would not provide information on the daily habits of its user. However, it would be possible to monitor the exercises, and to adjust the feedback from the device accordingly: If the user needed more exercise or needed to rest.

We initially wanted to cover three types of body movement with the objects: small movements, movements of the limbs, and whole-body movements. We constructed working prototypes for the former two but left explorations on the third on the level of concepts and sketches. During the process, we sought feedback from a hand therapist on our approach. After that, we took one more iteration to refine the small movement object but finally abandoned the approach in favor of textile output.

Textile Input Possibilities

Textile input for digital devices is usually haptic or gestural input, if a textile material is used as a sensor or a switch. One can build textile sensors with simple conductive materials by creating a structure where conductive textile surfaces touch or separate according to your movements. Capacitive sensing is another way to use conductive threads as sensors, since the conductivity of the material is sufficient to act as a capacitive antenna. In addition, all textile materials are piezo-resistive, at least to some degree; i.e. they change their resistance if pressed or pulled. There are textile materials that show a very strong piezo-resistive response due to their composition, such as yarns that blend short steel fibers with non-conductive base materials like polyester or cotton. We used all possibilities – textile sensor structures and textile sensitive materials – in our prototypes. In doing so, we did entirely without standard electronic sensors and were thus limited to inputs such as pressing, pulling, bending and stretching. This was on purpose to maintain as much of the textile feeling of the prototypes as possible. In the design, we also focused on patterns and shapes that could be knit with an industrial knitting machine, since we planned to produce the final prototypes on such a machine.

The Croissant

Our first approach to designing a textile input device was a croissant-shaped hollow object with openings on both sides to reach inside. The object was stuffed with loose filling that the user could move around with her hands. The movement was not entirely constrained by the object, but its overall shape and the shape of the

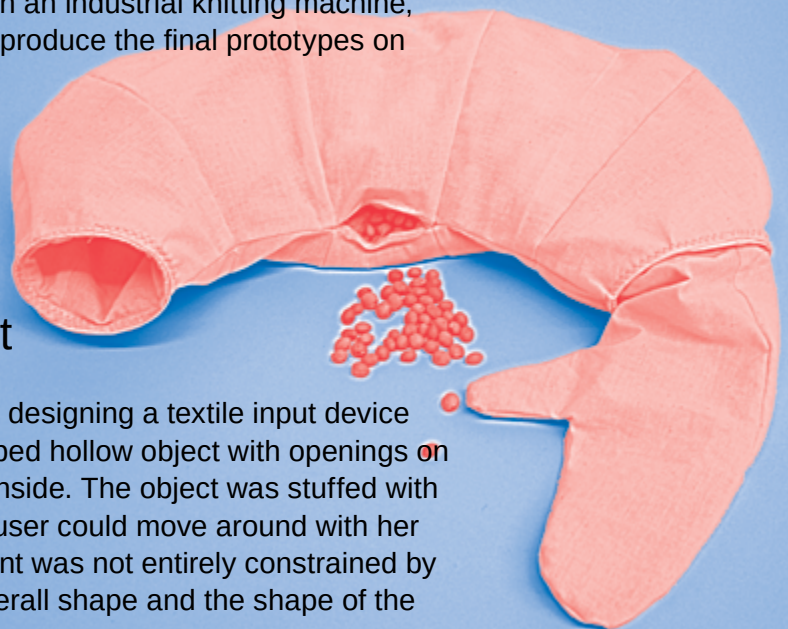

openings left enough space for the filling to dig through the filling and to squeeze it with the fingers. The object could conveniently sit on the user's lap while she placed her hands inside.

The croissant was not exclusively intended as therapy tool for arthritis, but more broadly as a comfortable and convenient interaction device to play with. From the investigation at a day center for elderly people, we learned how haptic sensing becomes more important for people with cognitive impairments, and how pleasant it can be to simply touch interesting material structures.

The shape models are therefore explorations of the size and setup of the croissant shape and the form of the openings, which were more or less glove-shaped for tight or loose fit. In designing the shape, we also considered the possibilities for shape-knitting it in one piece, and thus kept it simple and reduced. The inspiration came from the pleasant feeling of moving grains inside a grain cushion but can also be linked to therapeutic blankets.

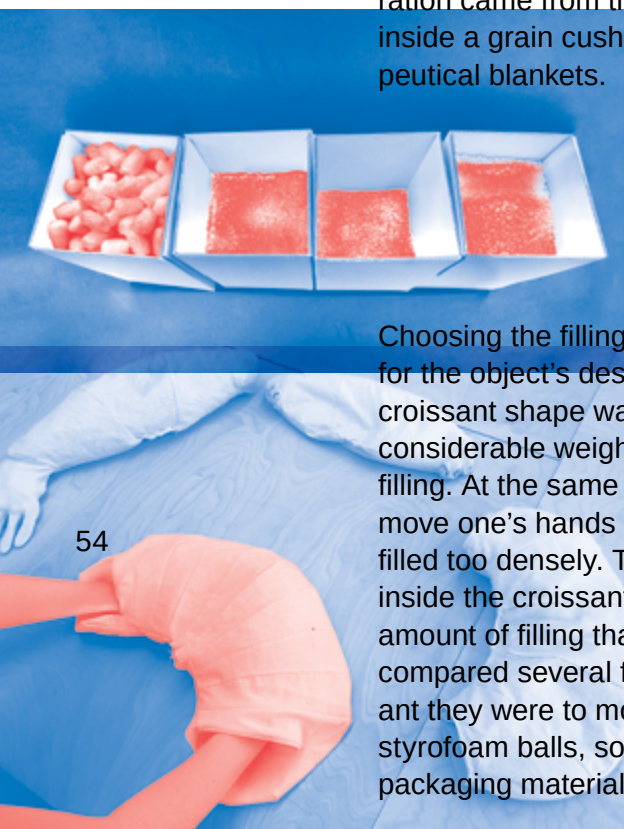

Choosing the filling turned out to be more significant for the object's design than initially expected. The croissant shape was rather big, and it would have a considerable weight if we chose a heavy and dense filling. At the same time, it should still be possible to move one's hands inside the object, so it should not be filled too densely. The experience of the ruffling motion inside the croissant thus depended on the kind and amount of filling that it was stuffed with. We therefore compared several filling materials as to how pleasant they were to move around, such as cherry cores, styrofoam balls, soft plastic granulate and puffed corn packaging material. The puffed corn and styrofoam

balls were unsuitable because of their haptic properties and electrostatic behaviour. The soft grain filling was the most pleasant to touch but also the most expensive, while the cherry cores were nice but also the heaviest filling.

To track the movements digitally, we added an embroidery pattern made from conductive yarn to the wide side of the croissant shape. The pattern consisted of two intertwining parts and could be used as capacitive sensors to indicate the average position of the hands inside the croissant. Each sensor tracked the position of one hand and sensed if the user was touching the right or left side of the croissant from the inside. We connected the shape to a simple auditive generated output to get a better idea of the sensors' performance.

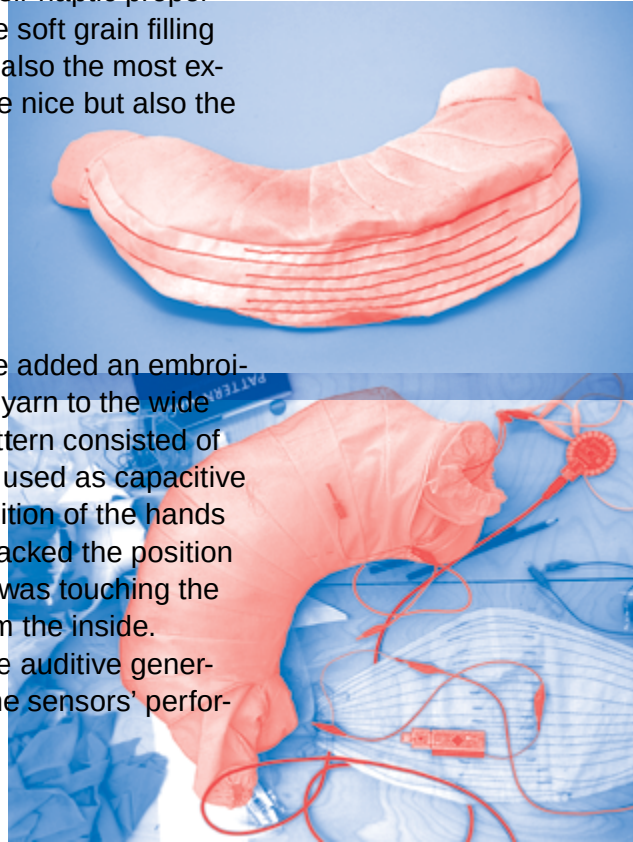

The Upside Down Wearable

The upside down wearable was inspired by the in-situ observations that we did at the day center. During our visits, we also participated in an exercise session. The exercises during these sessions were meant to maintain flexibility and stimulate the blood circulation. They included simple movements of the arms such as moving a ball around the waist, and lifting the arms laterally away from the body. The wearable is an attempt to translate some of these movements into an object, more specifically the actions of pulling down and pulling forward one's arms. Therefore it was necessary to simplify and reduce the movements from the exercise, to be able to measure them electronically.

A textile stretch sensor in the upper center of the wearable was used to measure the stretching motions. Depending on how the wearable is worn, the sensor is located either the neck or in the lower back.



The user can put her hands into the pouches at the outer edges of the wearable. If he wears the wearable with the sensor in the neck, it measures how much the user pulls down his hands.





If in turn the sensor is in the lower back, the sensor reacts if the wearer pushes his hands forwards and away from the body.

Again, the rationale was that it would be enjoyable and motivation to have a pleasant and informative visualization of the training effort. We connected the sensor input to a simple screen visualization to test the general workings of the shape.

Feedback on Textile Input

We were seeking feedback on our ideas from an experienced hand therapist to be able to decide how to develop the design further. As a basis for the interview, the therapist learned about our general interest in creating a therapeutic digital device to support hand exercise and that we wanted to apply electronic textiles. She did not see any specific designs though.

The therapist was generally skeptical about the idea of a digitized hand tool connected to a game. She considered it unnecessary to motivate patients with a high willingness to collaborate, saying that additional incentive was usually not required. But she also disliked the idea of a general tool for the variety of existing hand diseases, as well as the risk of using the therapy tool independently from professional guidance.

Another issue she pointed out is the tight cost structure in the medical system, so that health insurances will not pay for more expensive therapy tools if there is not a clear therapeutic advantage to them. This is also due to the short timespan during which these tools are used. The therapist was generally skeptical about digital technology in therapy tools since she considered it only to make handling of those tools overly complicated.

Instead, she prefers to integrate the daily exercise with everyday routines, like opening and closing a jar repeatedly. The therapist also explained a way to build a simple and cheap training tool by heating a bowl of lentils to 50°C and squeezing the lentils with the hands. However, further into the conversation, she considers visual training feedback for hand exercise tools appropriate, given that the tool is adaptable and the patient is not in risk of overdoing the training.

Being asked about applications involving heat, the therapist saw more potential in electronic textiles. Since a lot of Arthrose patients need warmth to ease their symptoms, she appreciated the idea of a heating wearable that could be placed on different parts of the body or that could adapt to the outside temperature. She also mentioned the need for compression when limbs are swollen, and cooling for rheumatoid arthritis, as useful features for electronic textiles.

Benchmarking: Existing Exercise Tools

In preparation for the next iteration of the textile input object, we made ourselves familiar with existing therapy devices. Such objects include round or egg-shaped rubber balls (e.g. Dynagrip hand squeeze ball), but also plastic modeling mass (e.g. Twin Grip) that invites pulling and pressing with the fingers. Similar objects and exercises are advertised to reduce stress. Products like the DNA stress ball connects these exercises with flashing, colourful lights, which added a playful element to the interaction.



The Tetrahedron

Based on the initial exploration with the croissant shape and the interview with the hand therapist, we took another approach to designing a textile sensor object for hand exercises. The interview made clear that we had to look at existing therapy devices more closely to ensure that the object would serve its practical function. Other than that, the design of the shape was influenced by technical considerations, such as the possibility to knit the object on an industrial knitting machine. Finally, the object should also work independently from an external power supply and run without a cable connection, which meant that all components had to be hosted inside the object. To reduce the complexity for the interaction and the technological components, we initially reduced the sensor input from the object to one stretch and pressure sensor made from conductive yarn. This sensor type is more predictable than capacitive sensing and also less complex to construct.

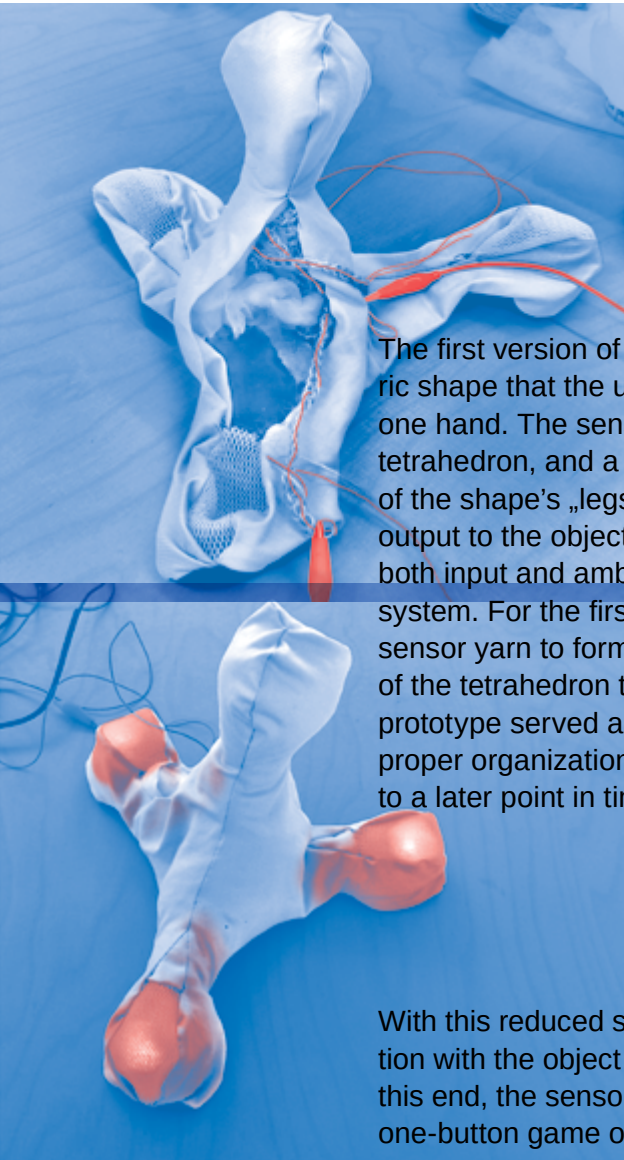

The first version of the sensor object was a tetrahedric shape that the user could conveniently grab with one hand. The sensor yarn was at the centre of the tetrahedron, and a multicolor LED was sitting on each of the shape's „legs“. We added the LEDs to add an output to the object, so that the shape could serve as both input and ambient output within the smart home system. For the first version, we simply crumpled the sensor yarn to form a ball and stuffed it into the edge of the tetrahedron that pointed upwards. Since this prototype served as a simple test, we postponed the proper organization of the electronics inside the shape to a later point in time.

With this reduced setup, we could test the interaction with the object and the sensor's performance. To this end, the sensor input was connected to a simple one-button game on a mobile device. Using the sensor as a game controller indeed revealed the lack of reliability of the sensor setup: The sensor would quickly wear out after some use and not recover to its initial value range; it would also react badly to sweaty palms. While textile sensors are usually a bit irregular, these additional sensitivities made it even more difficult to calibrate the sensor. We were thus concerned about how durable the sensor object would be in the long run. It also turned out that producing the sensor object on an industrial knitting machine was more difficult than expected. For once, we had underestimated the effort

that it took to design the tetrahedric shape as a fully-fashioned and shape-knit object. In our collaboration with the knitting company, the company's engineers ruled out this option simply because they did not see the major advantage of fully-fashioned knit versus sewing together the parts after the knitting process.

Therefore we focused on developing a suitable knitting pattern for the stretch-sensitive yarn, i.e. a pattern that would allow the material to recover well from stretching and provide more reliable sensor values. We applied a variation of a garter stitch pattern, a pattern that uses alternating plain and purl stitches. This pattern produces a knit structure that is very stretchy in horizontal direction, having a similar effect as a rib knit. In the first working session at the industrial knitting company, we had several variations produced, using the garter stitch pattern and intarsia technique in combination. These patches were intended as samples for performance tests and potentially as raw material for an actual sensor object.



Textile Output for Ambient Assisted Living

Working with textile output corresponded less to the role that was assigned to us in the DAAN project proposal, but it fitted better with the overall idea of the project to provide ambient notification in the home. Since we had trouble to find a convincing purpose for wearable textile sensing that was not intended for monitoring, we began to think of wearable output as a less intrusive and patronizing use of e-textile technology. Just like with input, we wanted to explore display technologies that were integrated into the textile structure.

Unlike other ambient notification devices planned for the DAAN system, our display was intended to be fully wearable and thus not bound to the home. We therefore revisited the initial project scenario for clues on how to relate mobile use and ambient assisted living in a single object. The starting point of our design was then a simple and reduced scenario: A wearable notification device in the shape of a shawl that reminds its owner to put it on if the weather forecast is predicting a chilly day.

From our problem development phase, we were also aware of how elderly people can be sensitive to low temperatures, especially if they suffer from arthritis. We also learned from the observations at the day center that people with cognitive impairments enjoy haptic stimuli, such as from interesting material surfaces. In designing for cognitively impaired or elderly users, haptic output has been used before³. In addition, we were looking for output modes that were highly compatible with textile materials, similar to the way we were working with haptic input modes.

We considered visual output because it is an easy and straightforward mode of notification, and it can be well implemented with electronic textiles. Apart from that, we wanted to work with haptic output other than the

3

Projects such as Vibe-Ing (<https://www.mtbhomer.com/portfolio/vibe-ing/>) and Tactile Dialogues (<https://www.mtbhomer.com/portfolio/tactile-dialogues/>) by Martijn ten Bhömer represent examples where tactile output is used in a similar context.

62

small vibration motors that were often used in wearables. Heat therefore represented an interesting and innovative alternative for ambient notification. At the same time, heat circuits represent a crucial element in thermochromic displays, which are suitable for electronic textiles.

Textile Output Possibilities

Since we were interested in output possibilities that could be integrated directly with the textile structure and thus blend in as much as possible, we focused on materials that can be processed with a textile production technique, or those that are available in a fibre-like form. This constraints the choice of output modalities to haptic output (such as warmth from heating elements), shape change (from shape-memory alloys or polymer fibers), visual output (such as optical fibers, fiber-embedded LEDs and thermochromic pigments) and auditive output (from fabric speaker coils).

Output modalities involving heating are more difficult to implement and more risky to integrate into a wearable, since they require appropriate safety measures and a sufficiently large power supply. However, display technologies such as thermochromic displays require heat elements to function properly. We therefore decided to investigate further on fibre optics and thermochromic displays in parallel. The fibre optics represented the safe approach while being less textile in nature; the thermochromic displays were more risky to build but also more textile.

Optical fibers are comparatively cheap and relatively flexible. The material is usually a transparent plastic, drawn into a thin wire. By connecting the edge of a wire to a light source, the light gets refracted inside the fibre. Sanding the fibre makes the light more visible. The wire bends well but also breaks easily if exposed to too much mechanical stress.



Thermochromic displays combine visual and haptic output. Temperature-sensitive inks change colour when they are heated above their activation temperature. This kind of display thus consists of a thermo-sensitive colour-changing dye and a heating element.

There are several thermochromic pigment types. Simple pigments become transparent when heated; they are sensitive to UV radiation and „burn out“ after some time, losing their ability to change colour. Those inks are easy to use with silkscreen printing but difficult to dye. Liquid crystals display the entire width of colours within a defined temperature range, starting from blue for the lowest activation point and ranging to red for the highest activation point before fading to black again. The crystals are expensive and sensitive to mechanical stress such as printing – ideally they are applied with an airbrush. In turn, the crystals can display the entire colour spectrum within a certain temperature range.

High-temperature thermochromic inks only react to heat from a heating element, and not to body temperature. Conventional heat elements or peltier elements are efficient and safe but also do not blend in well with fabric. There are textile heating materials such as steel thread that can be used instead but require careful handling and connection, since bad electrical connections or shortcuts can cause the surrounding fabric to overheat and burn. The heat from a heating element can act both as a thermochromic trigger and a thermo-haptic output if the element is worn close enough to the skin.

We decided to use a steel thread as a heating element, and simple heat-sensitive pigments for the colour change effects. The material was comparatively cheap and readily available while still offering a huge variety of aesthetic expressions, especially when the pigments were used in different colours and with different activation temperatures.



Shape Development

For the textile display, the overall shape was less subject to design than it was for the controller objects. After the experimentation with the controller shapes turned out to be very time-consuming, we were now looking for a simple existing object that allowed us to focus on the textile qualities. As a result, we decided to make a series of shawls. One reason for this was the application context and user group: Shawls are common and versatile accessories amongst elderly appropriated by the wearer, they fit different body sizes and genders. As an accessory, shawls are often used over longer periods of time, and do not need to be frequently washed.

Another reason was that from a textile point of view, shawls are simple textile objects, consisting of little less than a flat cloth in a rectangular or triangular shape, and using a reasonable amount of surface and material. For e-Textiles, it is useful if the object to be designed is not too small, since there are limits to how much the textile structure can be safely scaled down. After all we needed to include a wireless module, a micro controller and power supply with the output elements.

Production

We were collaborating with a small knitting factory to produce the textile input and output devices. We planned two iterations for the work with the knitting technicians: In the first iteration, we wanted to test and develop knitting patterns suitable for our purposes. The second iteration was intended for the final production of the prototypes.

65

Since we started to work more intensely on the output elements only later, the development of the pattern for the textile output elements coincided with the first visit at the knitting factory. It was then tightly coupled with the industrial production of the prototypes. The

collaboration with the knitting company then heavily influenced the development of the knitting pattern for the shawls.

Even though we tried to gain an understanding of the possibilities of industrial production prior to the visit, some parameters remained unknown. We investigated some basic techniques and made sure they were possible to knit by communicating with the company via email and phone, and by sending sample patches for evaluation. The technicians at the company considered the entire first set of samples as feasible and unproblematic. But once at the company, the communication issues with our project partner became more apparent: Since none of us was a professionally trained knitter, we would use terms that the knitting technicians considered imprecise or wrong, assuming that we had less knowledge of the production process than we actually did. It therefore took some time to establish a common understanding of what we wanted to do.

The next step was to visit the company and spend a week together with the knitting technicians to transfer the patches to the machine, and to evaluate them. On this first visit, the knitting company's owner also showed us their own sample palette and pointed out appropriate patterns that could be adapted to our purposes. We identified a suitable tuck stitch pattern for the optical fibers and experimented with different techniques to integrate the heating yarn.

The development of the tuck stitch pattern was quite straightforward, since we did not have many options to include the optical fibre into the knit without actually knitting it. Even with the industrial machine, laying in the optical fibers remained a manual process, requiring the technician to stop the machine at designated points and opening the cover. Still this process would be easier than to thread in all fibers individually.

For the heating yarn, the doubleface technique worked well to enclose the yarn between two interlocked layers

of base yarn. This prevented the heating thread from throwing loops and shortcutting inside the knitted fabric. We could also choose the outward-facing material to work well with the thermochromic print, and the heating thread would not be exposed to the outside.

For the second visit at the knitting factory and the final production, we integrated the respective patterns with the surrounding structure, leaving openings and pockets at the right spots to insert the battery and micro controller. These knitted pieces were also the basis for the final prototypes.

Reflection

Looking at how we implemented a design-driven methodology in this research project, we can observe the influence from different constraints. We can assign these constraints to the overall categories of technology, context, application and project: Technological constraints therefore describe what is possible within a specific technological field; contextual constraints are derived from engaging with prospective users or when examining the physical setting where the interaction is to take place; application constraints describe the scope of a particular design result and are often a consequence of constraints from both technology and context; and the project constraints concern the limited resources in time, money, skills and infrastructure that projects usually have available. It thus also becomes clear that some of these constraints are related to each other, such as the choice of technology and the skill to apply it to the project.

What is specific to a research project such as ours is that we did not have a specific set of constraints from neither the technology nor the context in the beginning. At this point, constraints thus come mostly from the project itself, its goal, the partners and resources involved. In the course of the project, we added contextual and technological constraints iteratively. Each constraint from one category would make us rule out some possibilities in another category. We were thus narrowing down the choices up to the point where the final working prototype was ready. Reducing complexity and contingency in the process also meant to abandon certain lines of inquiry in favor of others. At the same time, the common ground to meet all constraints becomes narrower. For example, while the decision to investigate a certain application might help to settle for a particular technological solution, it also opens up for other kinds of design interventions that do not require this technology and are therefore out of scope. The proposition that meets all contextual and technological

constraints therefore might not always be the most suitable one for a particular application.

To conclude this chapter, we will therefore look at the kind of constraints that influenced the development of the two major directions of inquiry most significantly, the input and the output prototypes. This brief analysis of the prototype development should give some insight on the kind of impact that constraints from the different categories had in our specific case.

Pre-existing Constraints

Since our research interest was to investigate possible forms for electronic textiles in a particular context, we constrained the choice of technology broadly to all materials and techniques that are related to this field. The choice of the possible target group was predefined in the project application and focused on elderly people with physical and cognitive impairments. Even if the application setting was not fully defined, it seemed most appropriate to situate the prototypes in the context of a private home, where an assistive system could be conveniently installed. Similarly, the application was also framed by the core project idea to construct such a system and illustrate its performance through the different prototypes and showcases. The project was equipped with two part-time positions for researchers and included the collaboration with the knitting company over a course of roughly two weeks time.

What becomes apparent when looking at these a priori constraints is that there is no obvious connection of the technology, the context and the application. This represented an opportunity and a challenge at the same time, because we had to actively look for such a connection without knowing that our chosen technology would be useful. It turned out that it was by far easier to find a useful application for electronic textiles as an output device than it was to construct a useful input device. A look at the interplay of the different constraints might help us to explain why that is the case.

Input

For the textile input device, we limited the choice of materials to conductive fiber, yarn and fabric. We thus depended on textile switches, capacitive sensing as well as pull and pressure sensing, using simple conductive yarns and piezo-resistive yarns.

The contextual constraints emerged from the project scope, the initial observations and literature research. We were looking into possible application scenarios involving elderly users with cognitive or physical impairments and found arthritis to be a common problem amongst this prospective user group.

The focus on this particular condition thus served as a starting point for our application constraints. Since we wanted to construct a training device for arthritis patients, we needed the device to be sufficiently accurate in recognizing the movements, and ideally to comply with existing training routines and patient-caretaker relationships. The choice of application was motivated by our desire not to construct a passive monitoring device and thus respect the users' autonomy.

It turned out that it was difficult to reconcile the project goal with the application constraints that we set for ourselves on the one hand, and to make the technological constraints fit with the contextual constraints on the other hand. The most significant constraints from the project side however turned out to be the production technique – in our case knitting – and the overall project scope of DAAN to implement a machine learning system for assistance.

The training application that we settled for imposed high requirements on the accuracy of the device. However the textile sensors are highly volatile and noisy, and the sensing capabilities were limited by the choice of materials that we settled for. At the same time, there are various artifacts that can be used as

cheap and easy training objects for arthritis, thus raising the bar concerning the additional value of a digital device.

While it would have been possible to come up with an application scenario that connects the machine learning approach of the DAAN system with the training application, it seemed a bit far fetched and overly complicated. On top of that, we were lacking the basic knowledge on arthritis as a medical condition and did not have knowledgeable partners in the project. Therefore the shape development of the input device was not thoroughly informed by experts, even if we did our best to ground it in research and observation. In general, the project goal to create an ambient assistive system was harder to reconcile with textile input than with textile output.

However, the development of the input device came to a rather sudden end because of the project constraint of knitting as a production technique. The shape and application was partly set up so that it could be easily knitted. When it turned out that the knitting company would not offer shape knitting for the input device, we prioritized the development of the output patterns. Finally we had to abandon the textile input device because the prototyping was too time-consuming, and there was no time and opportunity to refine the concept in several iterations.

Output

For the output device, the choice of technologies for textile displays was broader and more diverse than for the input. We limited ourselves to optical fibers and heat yarn with thermochromic print because these output modes were easy to integrate into a fabric structure. While both technologies were challenging to implement in a fully working prototype, we were confident that it was possible to implement them in general.

The contextual constraints concerning the users were similar to those we set for the input device. We focused on elderly users, and more specifically on physical impairments following our investigation into arthritis as a common disease at high age.

As an application constraint, ambient notification and textile output were much more open and generic than the ones for the textile input. Apart from that, the project constraints were also similar to those for the input and concerned knitting as the technique of choice for the final prototype.

It turned out that the constraints for the textile output did not conflict as much among each other than the one for the textile input. This was partly because they were much broader and generic, and therefore did not exclude each other. For example, ambient notification as an application can be achieved with different technological means (even if they are not equally suitable) and be applied in different situations by different users. The inquiry into the context even turned out to match with the choice of technology in a positive way, since warmth is a way to ease pain for patients with arthritis.

Again, the project constraint of producing the prototypes on industrial knitting machines had a major impact on our technological choices. But unlike with the textile input, we were not forced to abandon our approach or to discard our technology as entirely unsuitable; both the optical fibers and the heating yarn could be well processed with the machines. By restricting ourselves to use known wearable artifacts such as shawls, it was also much easier to achieve a good working result within the project duration, and to concentrate on the proper implementation of the prototypes.

Conclusion

One would assume that designing is easier the more freedom one has. But working with a design-driven approach in research is a challenge exactly because of the lack of constraints in the beginning. In more applied projects, designers usually do not have the luxury to define their own problem space. This liberty is what makes research projects so attractive for designers, but it also forces the design practitioner to rethink their process.

For a user-oriented design process, for example, the user's perspective serves as a baseline for the design decisions, and they inform the definition of the application as well as the choice of technology. For technology-driven design, it is key to demonstrate and fully exploit the technical possibilities at hand, without the need to situate it in a particular application context. In short: If there are pre-existing constraints in one category, the other constraints can be built around it; but if constraints in all categories have to iteratively emerge at the same time, major conflicts can occur in the process because the priorities have to be constantly renegotiated. Therefore technological research projects within a particular application context somewhat represent a middle ground, using a fictional setting as a realistic backdrop for their investigations.

Another aspect is the level of specification that constraints from each category require. The more specific the requirements from one part are, the more likely it is that a conflict with other aspects will occur. At the same time, it is easier to make design decisions with specific constraints than with general ones. The challenge here is to find a set of constraints that do not interfere with each other. And finally, the most carefully composed set of constraints from technology, application and context needs to be in line with the project constraints, which are able to override key decisions. In our case, the collaboration with external partners was a decisive point in the process that forced us to give up on some promising design ideas.



4—

**Design Process/
Prototyping**

75

Process Overview

In a research project, there is often much more knowledge generated in the process than what is immediately visible in the results. This also holds for the development of the three interactive shawls from the DAAN project. In our attempts to find wearable textile expressions for ambient notification, we had to find and successfully implement working solutions for soft display technologies such as optical fibers and thermochromic prints. We also needed to find suitable electronic components to activate our displays and to control them digitally. This was a highly exploratory and iterative process, where textile and electronic materials had to be mixed and matched until they could be assembled into a coherent whole. This chapter therefore is a summary of those different developments and a reconstruction of their interrelations at the same time. As such, it also reveals the mechanics of a design-driven research process and the reasoning behind it.

Design Process/Prototyping

06.2016

07

08

09

10

11

micro-controller

Blue Beam

Arduino mini and Bluetooth module

heat element

Lulu custom PCB

Elektrisola wiring

Bekinox wiring tests

in parallel

in series

tuck stitch

fibre optics shawl

tube

dyeing

on knits

on yarn

knitting patterns

double face

thermo-chromic shawl

intarsia

discharge print

processing thermochromic inks

printing

31°C

47°C

black 31°C on white layer

coating

paint-brush

screen-print

Design Process/Prototyping

12 01.2017 02 03 04 05

Arduino
Lilypad

ESP

heat
control
components

Strommit

Mosfet

optical fibers
tuck
stitch shawl
prototype

optical
fibers tubes
shawl
prototype

thermo-
haptic
shawl
prototype

mixed
red 31°C
and
dis-
charge

thermo-
chromic
shawl
prototype

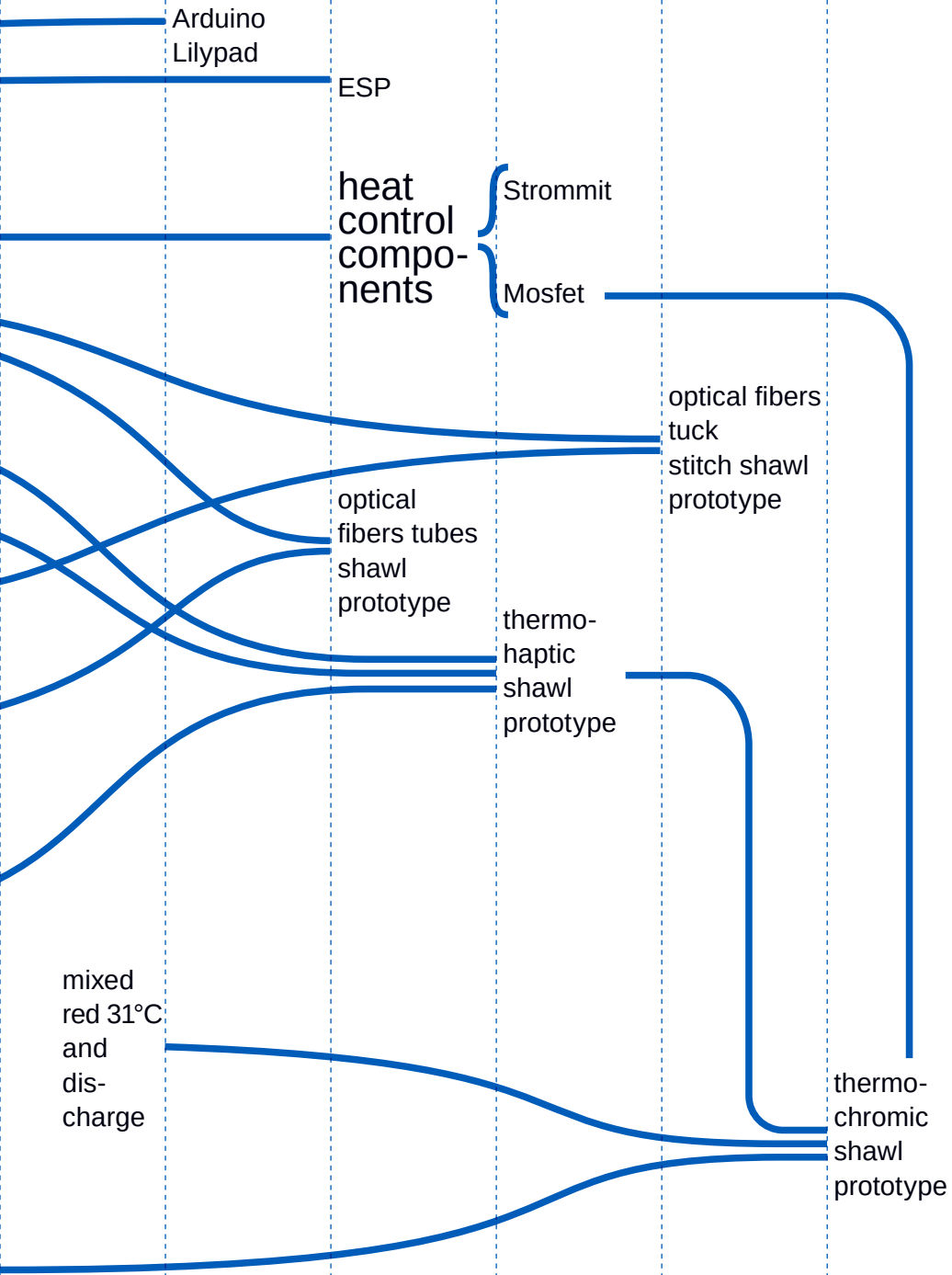

Light Shawl

Tuck Purl Side

Tuck Knit Side

Optical Fibers
Laid in Tuck Stitches

Page 86

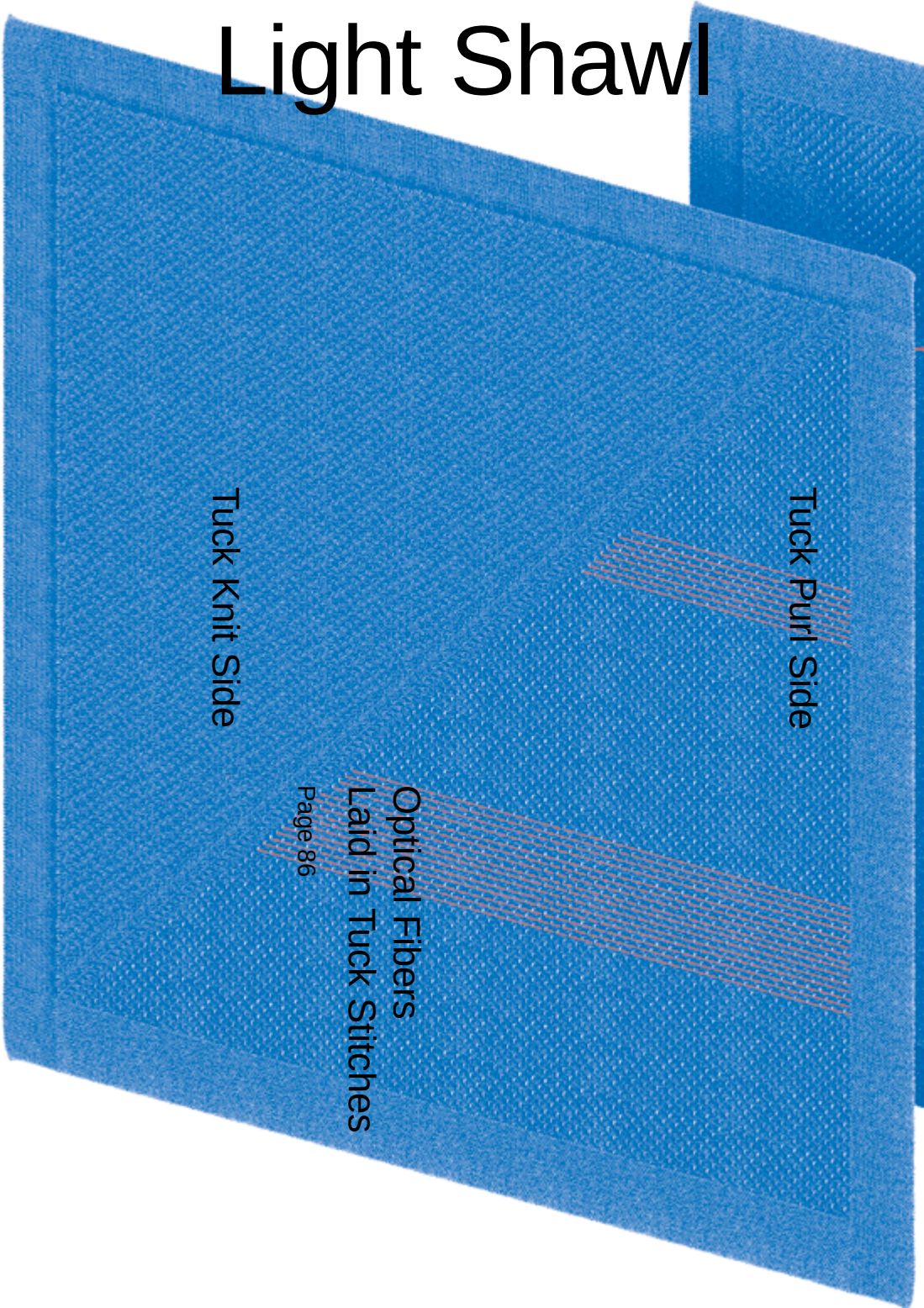



Light Elements

Page 85

Electronic Patch

Page 88



Connections

Double Length Rib Edge
to be folded afterwards to cover the LEDs

Knitting Pattern

Page 92

Rib Edges

Overview

The light shawl integrates optical fibers within the knitting pattern. Eight fibre strands diffuse the light of an SMD power LED mounted on a custom made PCB at the edges of the shawl.

The schematics illustrate the intermediary steps and iterations related to the optical fibers preparation and integration. Our aim, and main challenge, was to efficiently integrate the optical fibers with the surrounding knitting pattern, i.e. inserting the fibers during the industrial knitting process. The production infrastructure and the machines' limitations at our project partner, Peterseim Strickwaren, played a large role in developing the integration process.

For the custom-made LED PCB we benefitted from the know-how of the Parisian e-textile hackerspace Data-Palette and their facilities to produce our own set.

While the main outcome of this research is presented here, a secondary light prototype was also made, which does not address the idea of integration while knitting process. Optical fibers were integrated afterwards through an open double sided knit.

We also used the Jacquard technique (see page 99, "Vertical partial tubes") to create hollows in the textile structure. This variation of the light shawl could be used to insert optical fibre strands afterwards. The resulting prototype served as a backup in case the integrated version of the light shawl would not perform as desired.

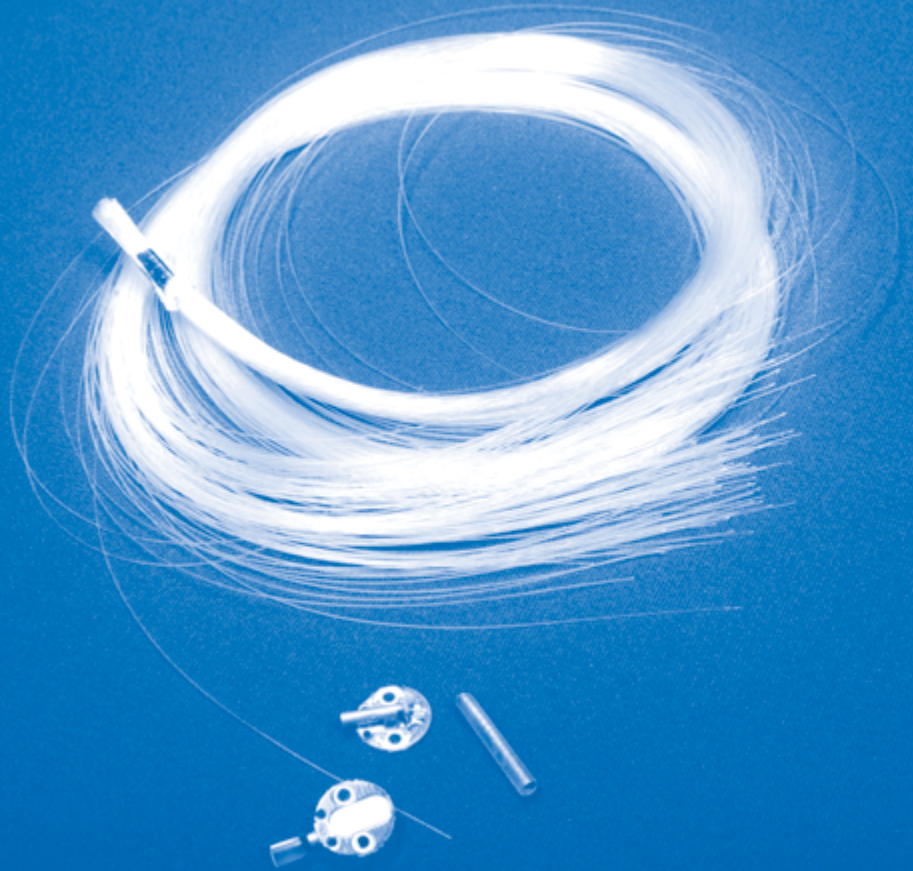

Light Elements

Optical fibers and Lulu PCB

The light element called “Lulu” is an open-source component, result of the ongoing research of Maurin Donneaud, an e-textile designer and co-creator from the Parisian hackerspace DataPaulette. The specification and assembly details are documented online¹. During a week-long residency at DataPaulette, we could use the resources to assemble a number of components for the boards, as well as access the facilities to prepare our own optical fibers for the project.

¹
http://wiki.datapaulette.org/doku.php/atelier/documentation/materiautheque/materiaux/electronique_textile/action-neurs_textiles/fibres_optiques

Optical Fibers

Optical fibers on the self-built warping tool

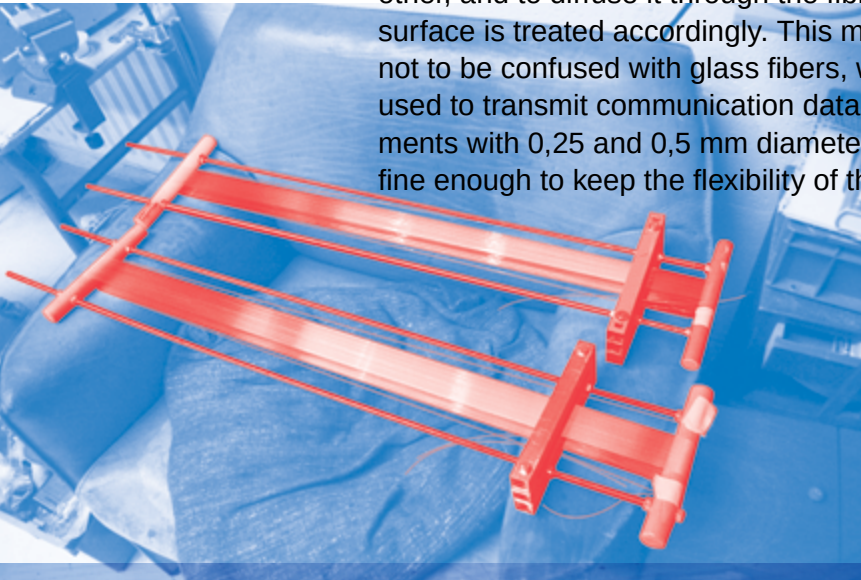

PMAA filaments, also called optical fibers, have the ability to conduct light from one end of the fibre to the other, and to diffuse it through the fibre's edges if the surface is treated accordingly. This material is however not to be confused with glass fibers, which are often used to transmit communication data. We used filaments with 0,25 and 0,5 mm diameter, since they are fine enough to keep the flexibility of the fabric.

Sanding the fibers with an air-pressured hand tool

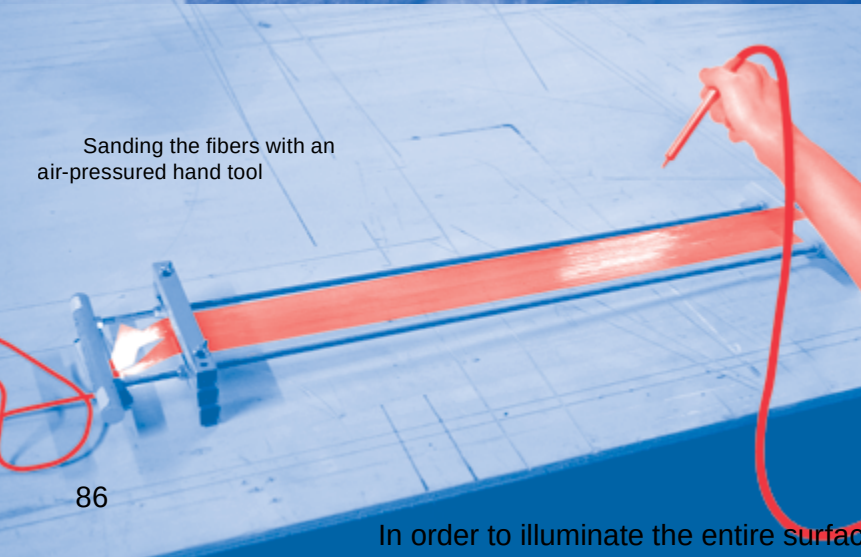

In order to illuminate the entire surface of the fibers, the fibre strands have to be carefully sanded. However, conventional large sanding machines do not provide the necessary precision for this process. We used an air-pressured hand tool with particles of 0,050 to 0,070 mm diameter that was provided at DataPaulette for this very purpose.

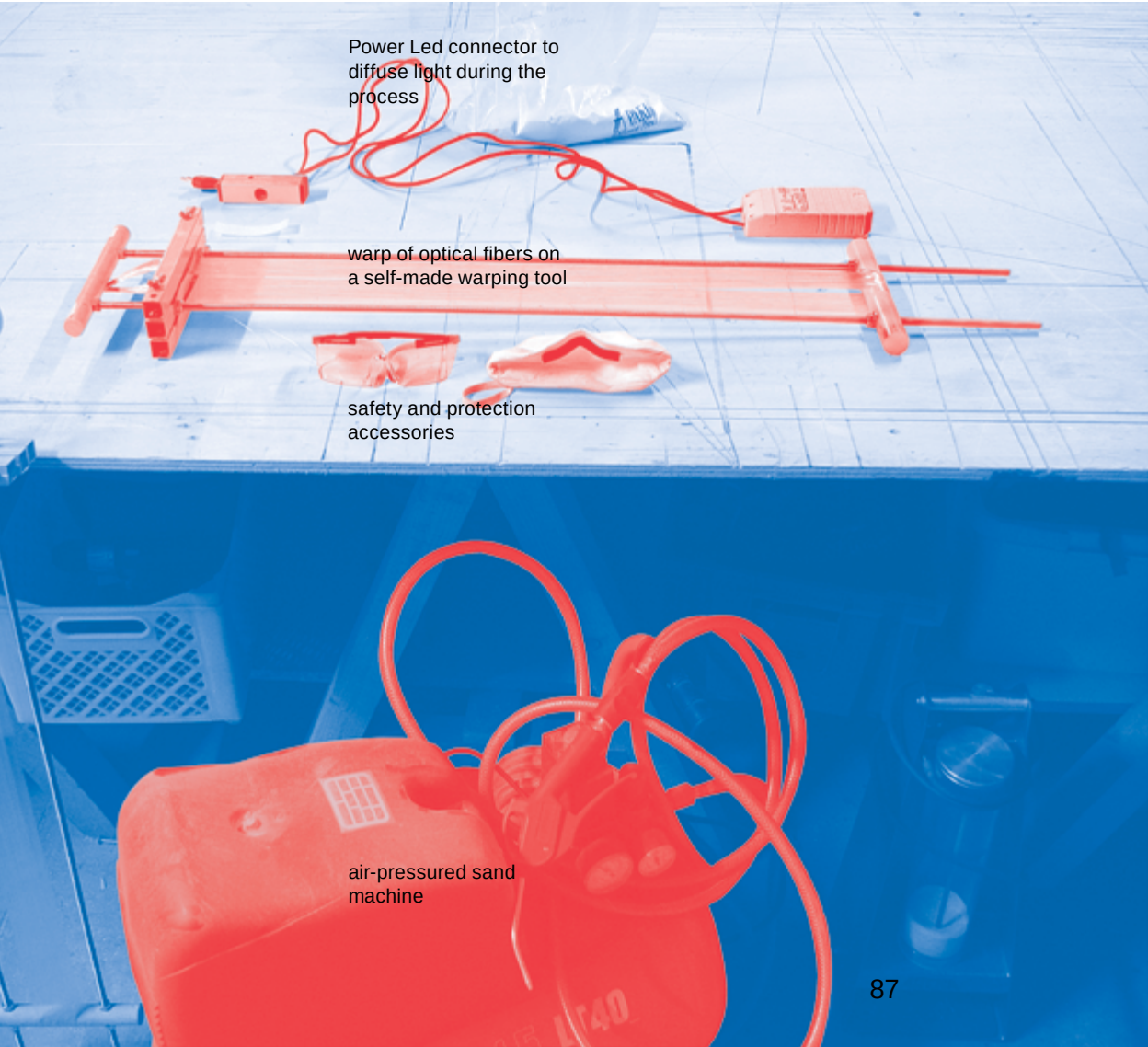

Power Led connector to diffuse light during the process

warp of optical fibers on a self-made warping tool

safety and protection accessories

air-pressured sand machine

Electronics

Lulu PCB

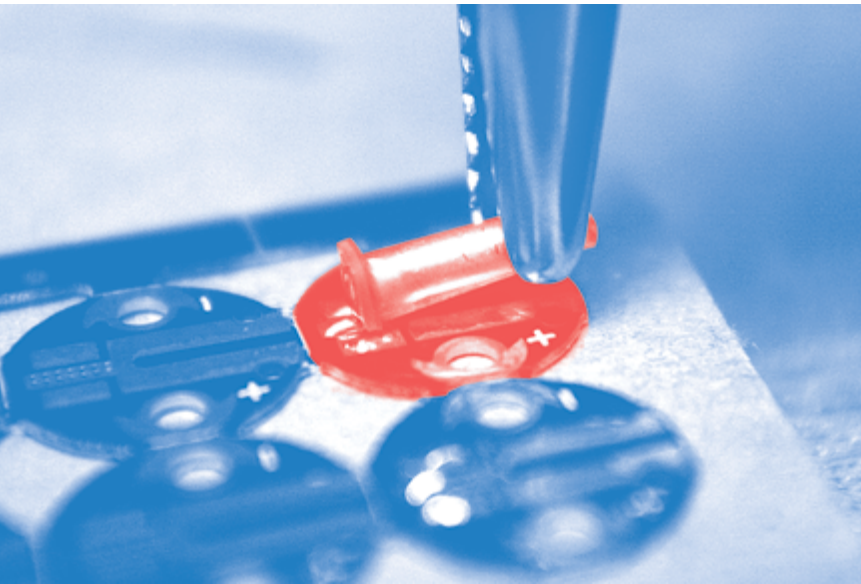

The PCB consists of a small custom-made board that hosts a high-power 1W LED soldered vertically onto the substrate, and a narrow 2mm brass tube. The tube is able to lock a bundle of eight 0,5mm optical fibers close to the light. In addition, the brass tube dissipates the heat from the LED. The fibers are inserted and glued in an end splice that fits with the brass tube. The light from the LED then feeds directly into the optical fibers. An additional rubber tube secures the fibers from slipping out and reduces mechanical stress on the joint.

We achieved an ideal luminosity when powering the Lulu with 3,2V and 200 mA.

Power resistor

With our electrical settings the LEDs were producing more heat than expected. The wool used for the shawl would keep the heat rather than dissipating it, which added to the problem of overheating.

After considering aluminium heat sinks to be too bulky and impractical for our purpose, we added a 5W ceramic power resistor of 0,33 Ohms for safety. Unfortunately, these parts add an impressive length to the otherwise tiny PCB, but they ensure safety in use and wearability while not affecting the light intensity.

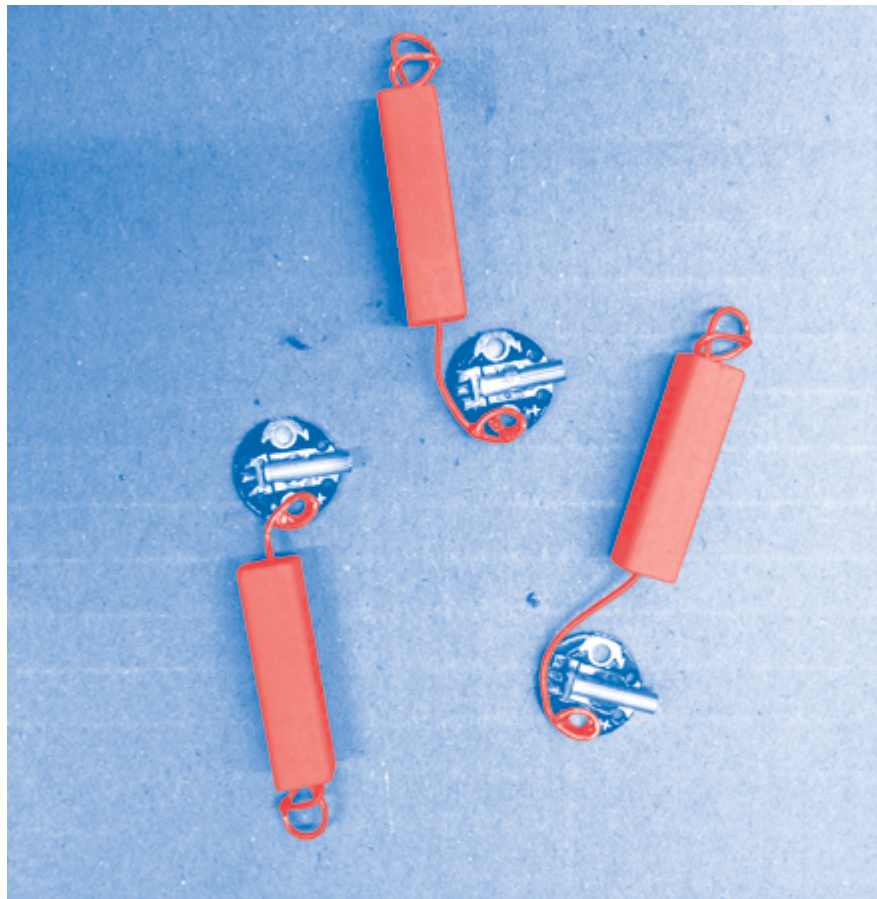

Mosfet

Mosfets are used to regulate the amount of current flowing to the LEDs.

Initially, we wanted to construct a single identical electronic patch for all shawls (heat and light). While we could not realize this idea for practical reasons, the output control elements of all shawls remained the same. The Mosfets connected to the output pins of the chosen micro controller allow for independent and adaptive control of each LED.

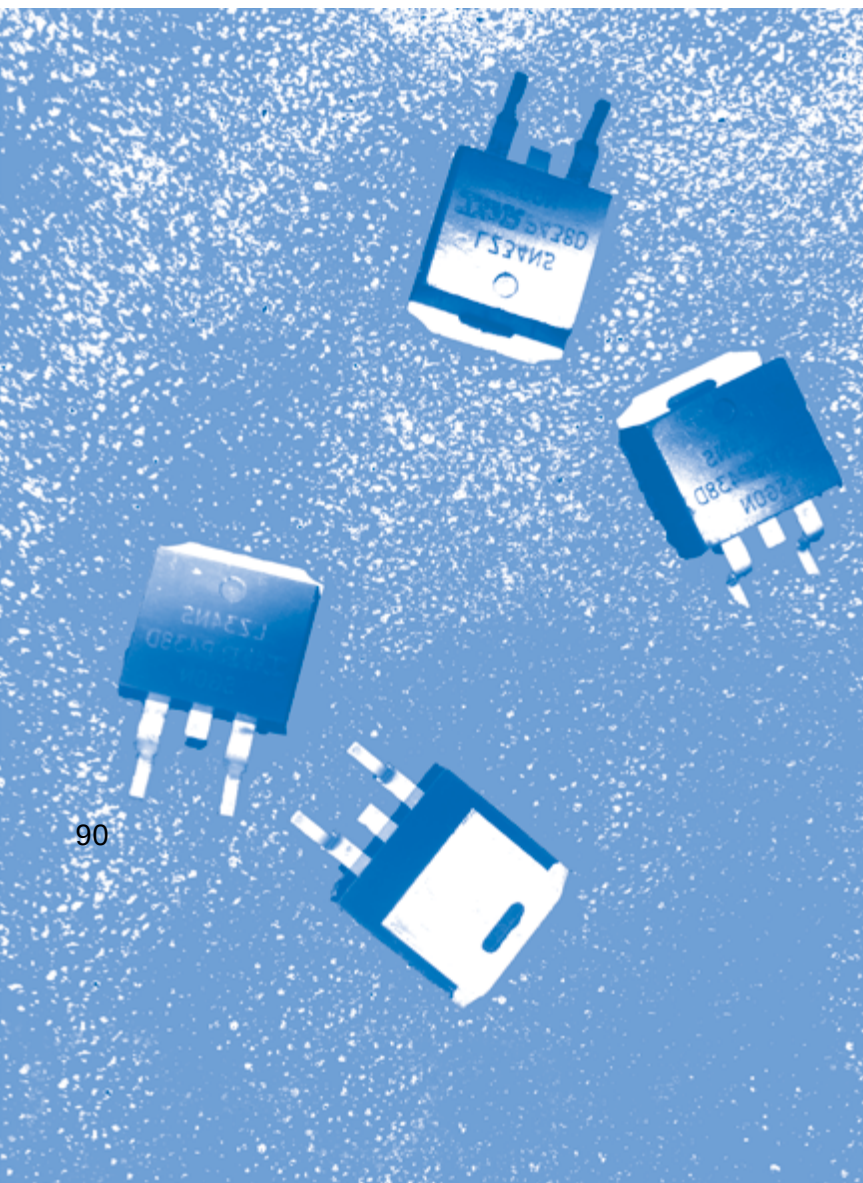

Knitting Patterns

Tuck stitches

gauge 8E; mostly on main bed, also using ribber bed for stitches on hold.

2 threads for the background Wool material, variations with Viscose were tried

For a tuck stitch to form, the yarn feeder puts a loop onto a knitting needle in the first row, which is only knitted with a regular stitch in the following row. This technique allows for the fibers to be laid in while the machine knits.

It appeared quickly that laying in one fibre of 0,5 mm was more successful than two fibers of 0,25 mm at once. In this last case, it was more complicated to not tear or break the fibers. So we decided to pursue with the 0,5 mm quality.

1. The first row in the pattern consists of a plain knit with tuck stitches in regular intervals. This is where the knitted fabric will form small holes later on.



2. In the second row, the stitches next to the tuck stitches are transferred to the front bed.

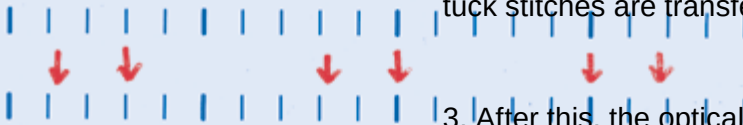

3. After this, the optical fibre strand is laid in by hand.



4. The next row is knit with plain stitches.

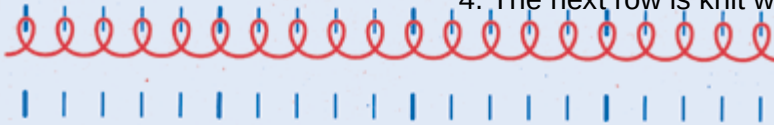

5. The stitches on the front bed are transferred back to the rear bed.

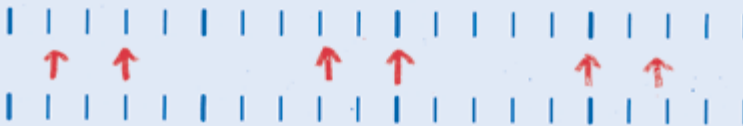

6. Another row of plain stitches follows.

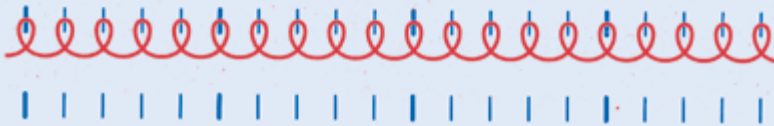

This repeat is shifted every second time so that the holes in the knit finally form a diagonal lace pattern in the end.

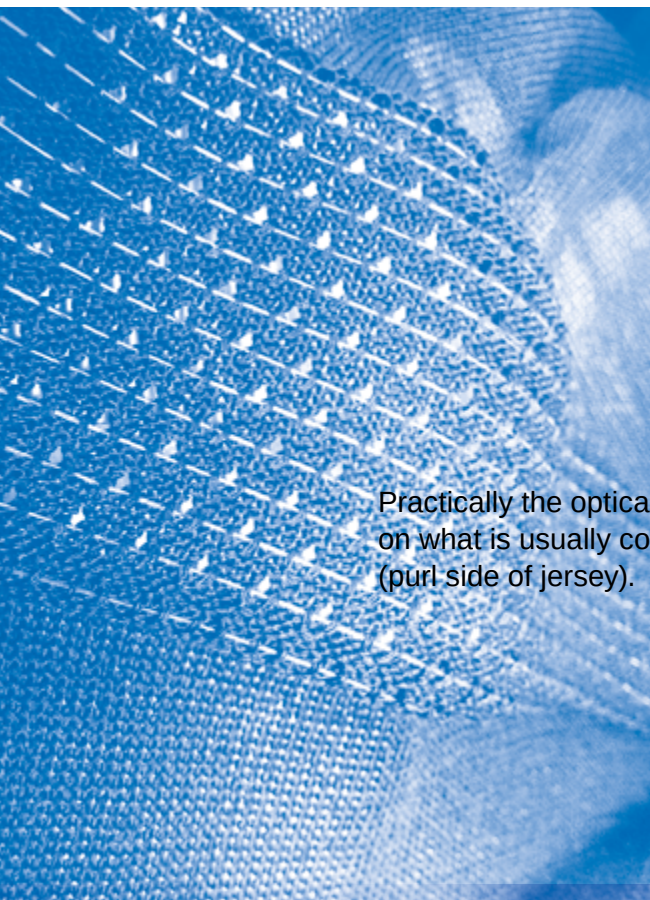

Practically the optical fibers laid in tuck stitches show on what is usually considered as the back of the knit (purl side of jersey).

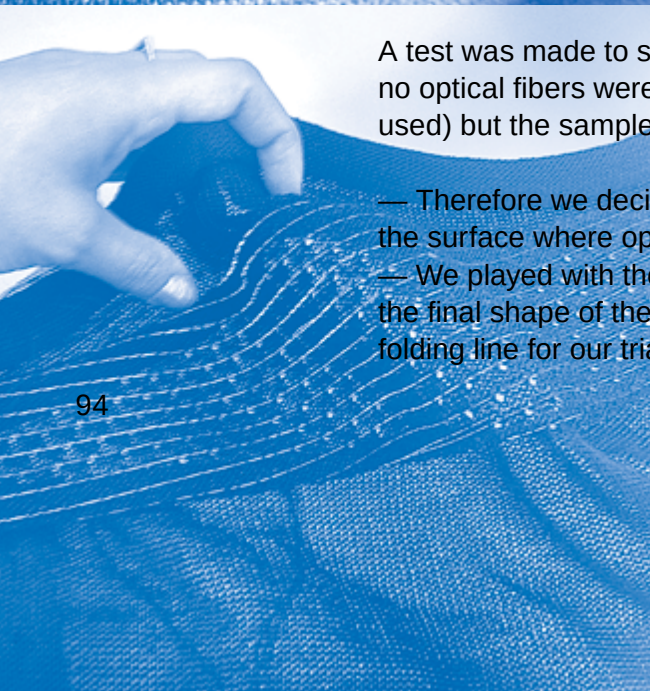

A test was made to switch purl and knit sides where no optical fibers were integrated (and no tuck stitches used) but the sample rolled up heavily.

— Therefore we decided to use tuck stitches all over the surface where optical fibers were to be integrated
— We played with the visual effect of purl and knit for the final shape of the shawl as the inversion draws the folding line for our triangle out of the square knit.

Comparison of contrast and visibility of the light when using two threads of Wool or Viscose

- Too thin and loose threads don't provide enough stability
- Woolly qualities offer a better hold and darker colours create a more contrasting background

While we are happy with the result, the process did not comply with basic security regulations in the workplace: It required the technician to interrupt the knitting process and put his hands into the machine while it was operating. For this reason, the technique cannot simply be scaled up for industrial production but only be used for small-scale prototyping.

To avoid the fibers to slip out of the knitted fabric, they are secured in pairs with crimping beads on the inner side of the shawl.

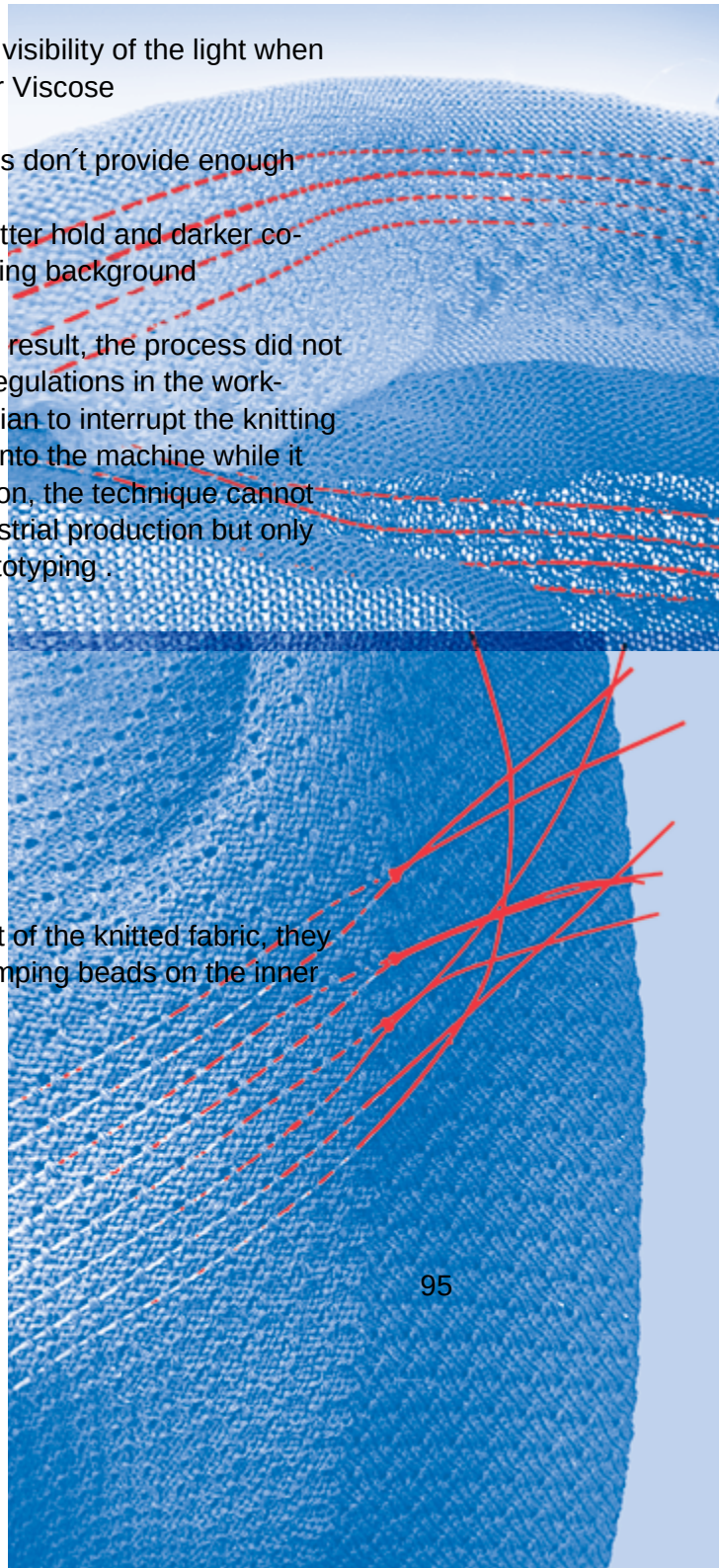

Horizontal tubes

gauge 12E with double bed,
2 threads Black Wool back, 1 thread White or Black PA
front

For this pattern, the fabric is knitted on the rear and front bed independently, so that both faces are not attached to each other. To form a tube, the faces from both beds are then knit together periodically, or the yarn alternates from the front bed to the rear bed, and vice versa.

Row one is knit as a 1-1 rib knit all over the needle bed.

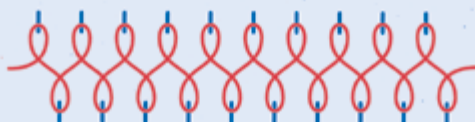

Rows two to four are knit as two separated faces that form an open tube afterwards.

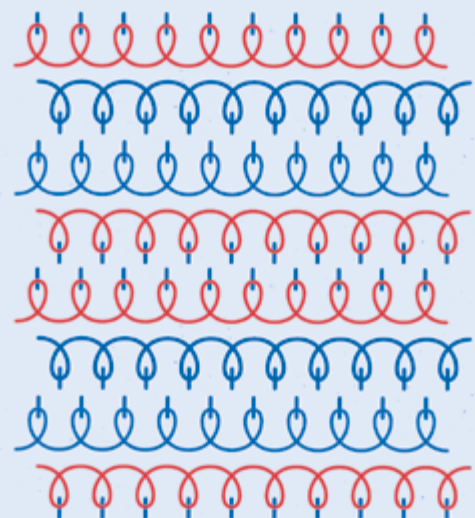

The following rows are again knit as a 1-1 rib knit to form the closing edge of the tube.

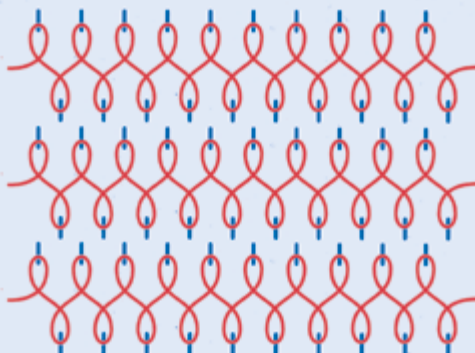

Four fibers inserted on two different tubes.
Visually the looser and larger the tube is, less light seems to be shining through.

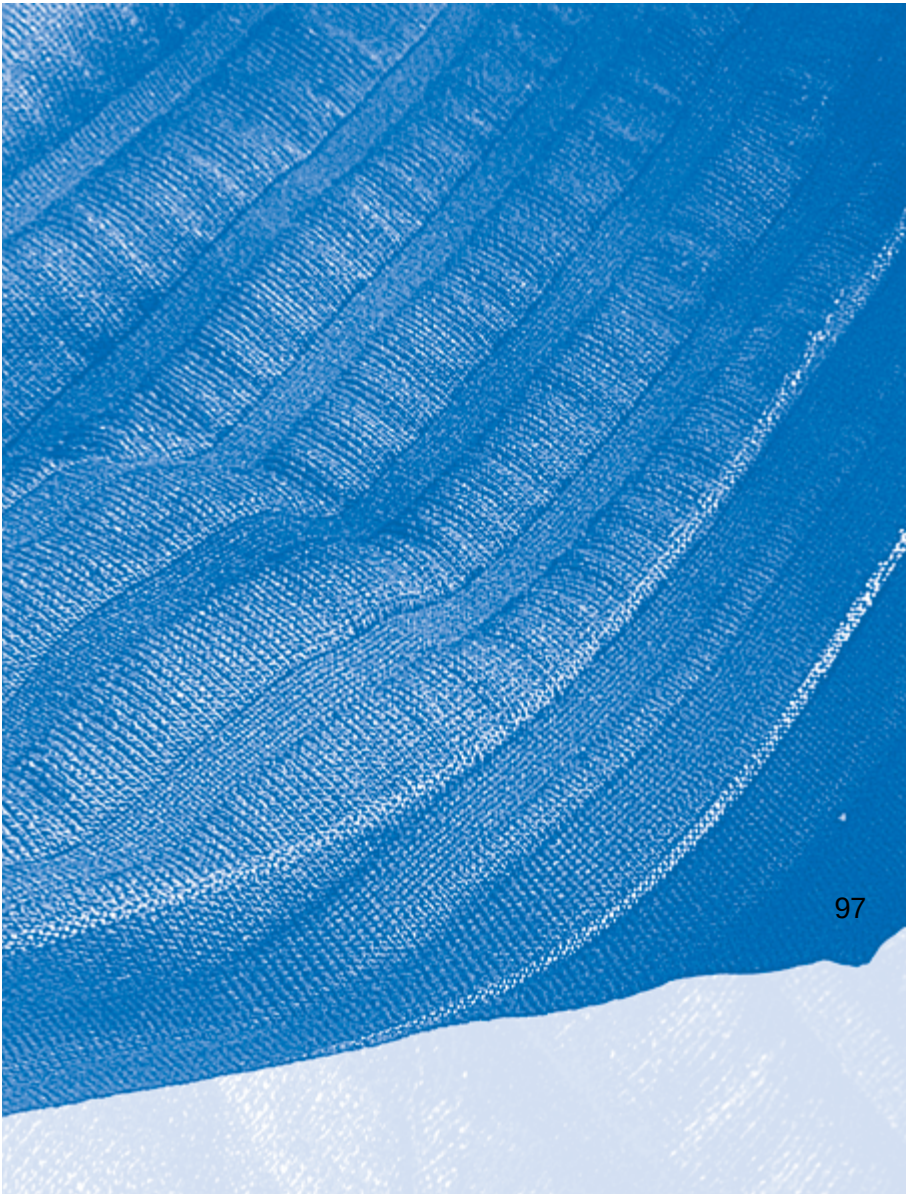

Front side knitted on every second needle.

While for narrow tubes this pattern worked relatively well, the thin thread could create some irregularities when the tubes became larger due to the difference of tension and density between both faces and materials.

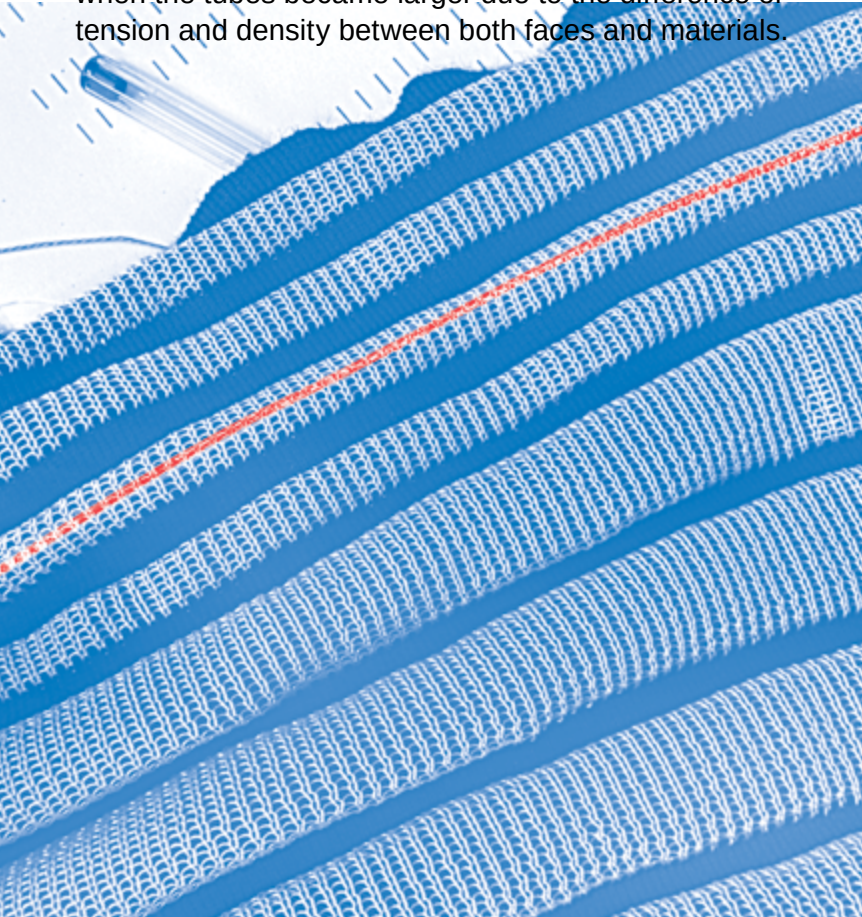

The horizontal tube samples were primarily developed for the manual integration of optical fibers. Although this approach worked as a fallback solution, we decided to abandon it in favor of the tuck stitch pattern. One reason for this was that we did not come up with a practical way to integrate electronics and electrical connections. Another reason was that visually, the pattern was not particularly pleasing, and not radically different from the tuck stitch pattern samples.

Vertical partial tubes

gauge 12E with double bed,
Black Wool back, White or Black PA front

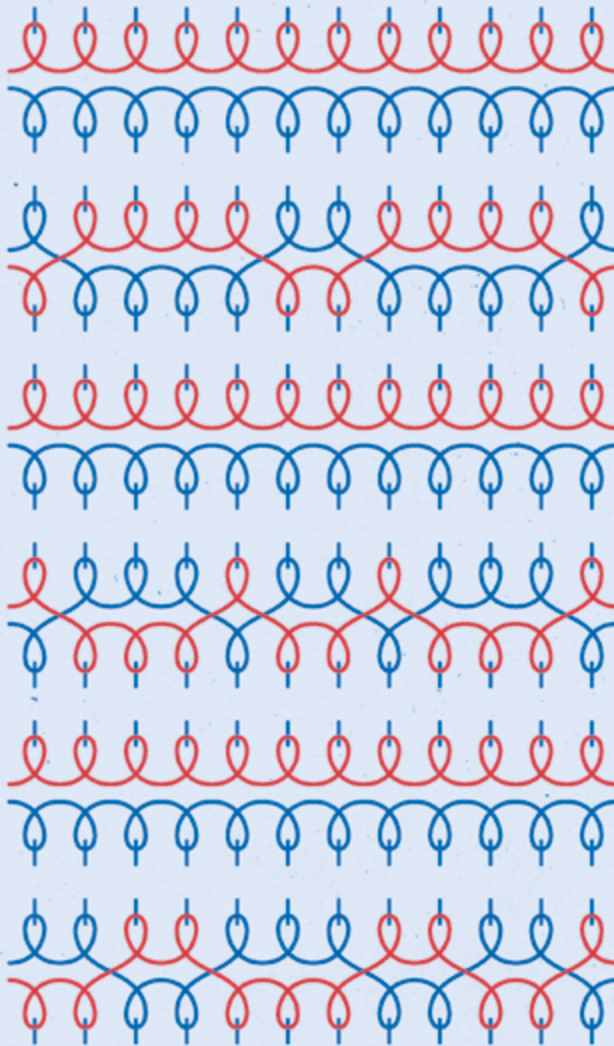

Row one is knitted with plain knit on both beds separately.

A vertical stripe Jacquard pattern is repeated over several rows.

Location of the vertical stripes changes of the course of the pattern.

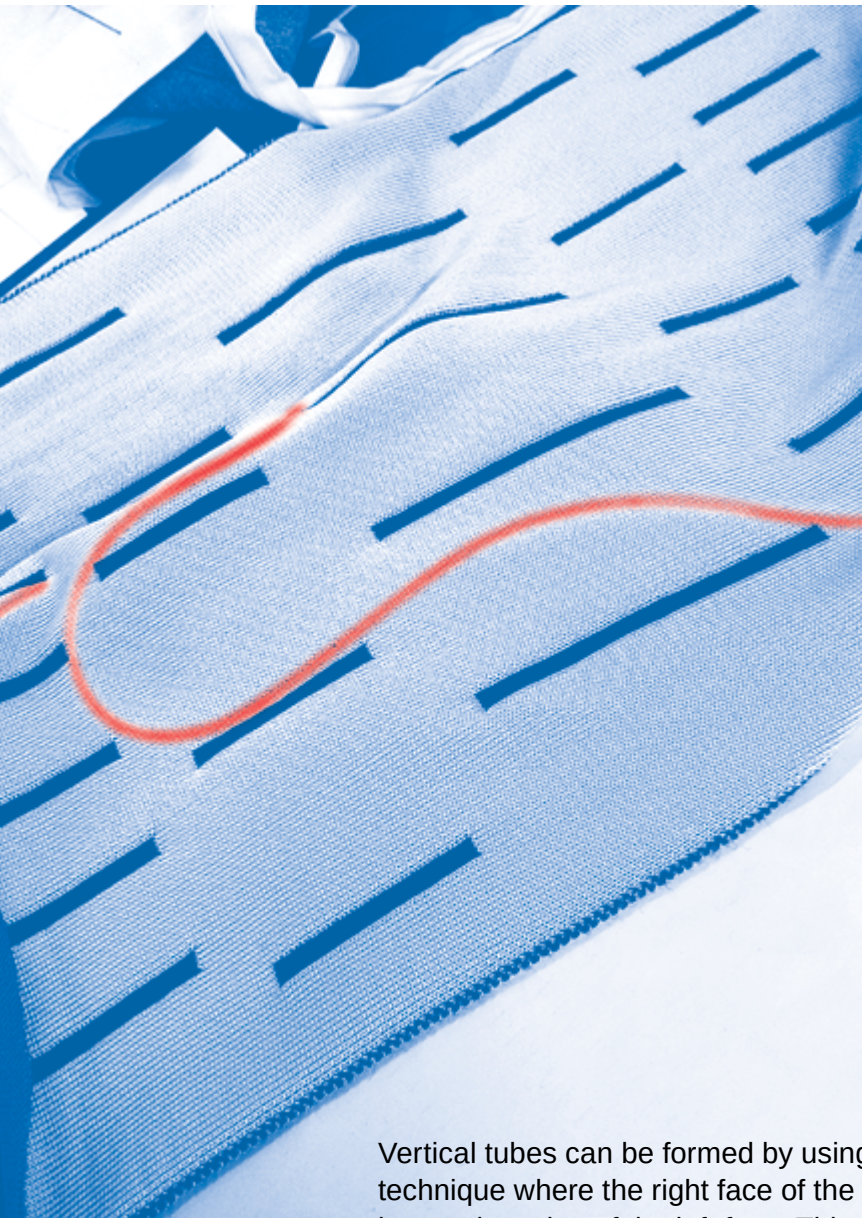

Vertical tubes can be formed by using a full Jacquard technique where the right face of the fabric is the inverted version of the left face. This can be achieved by swapping colours between the front and rear bed whenever a colour change occurs in the pattern.

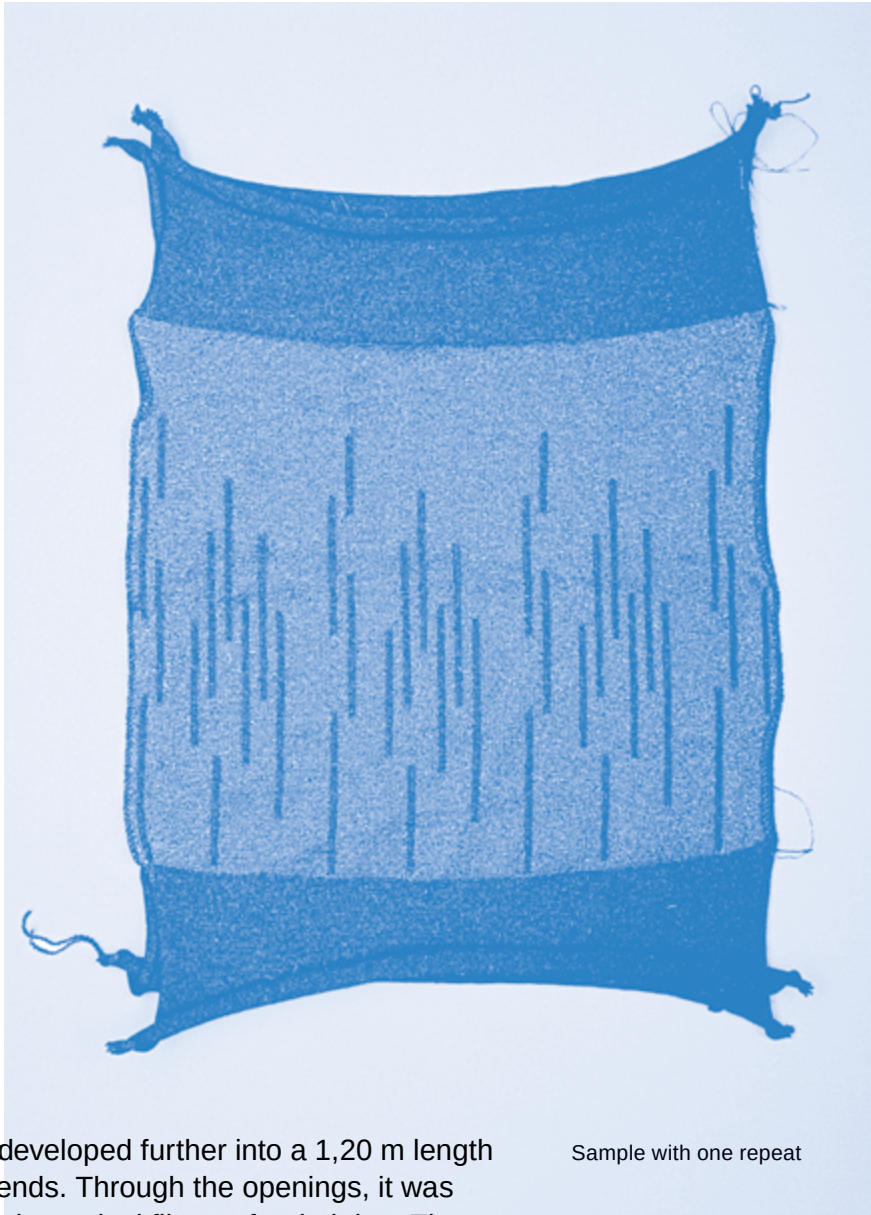

This design was developed further into a 1,20 m length shawl with open ends. Through the openings, it was possible to insert the optical fibers after knitting. The fibers have a little bit of room to move inside the in between space, making for a visually more organic appearance.

Sample with one repeat

Heat Shawl

Knitting Process
Page 112

Thermochromic Prints
Page 116

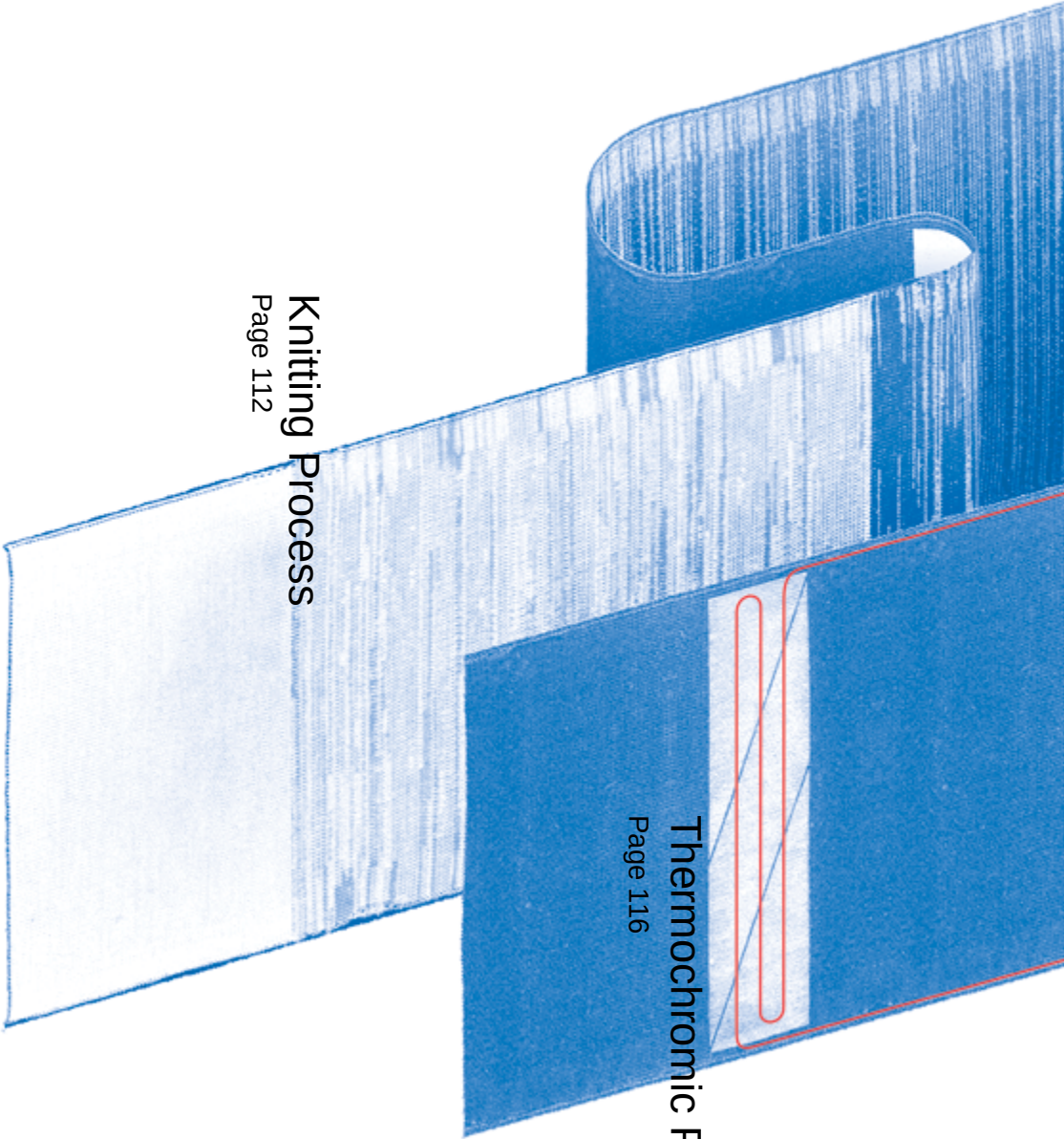

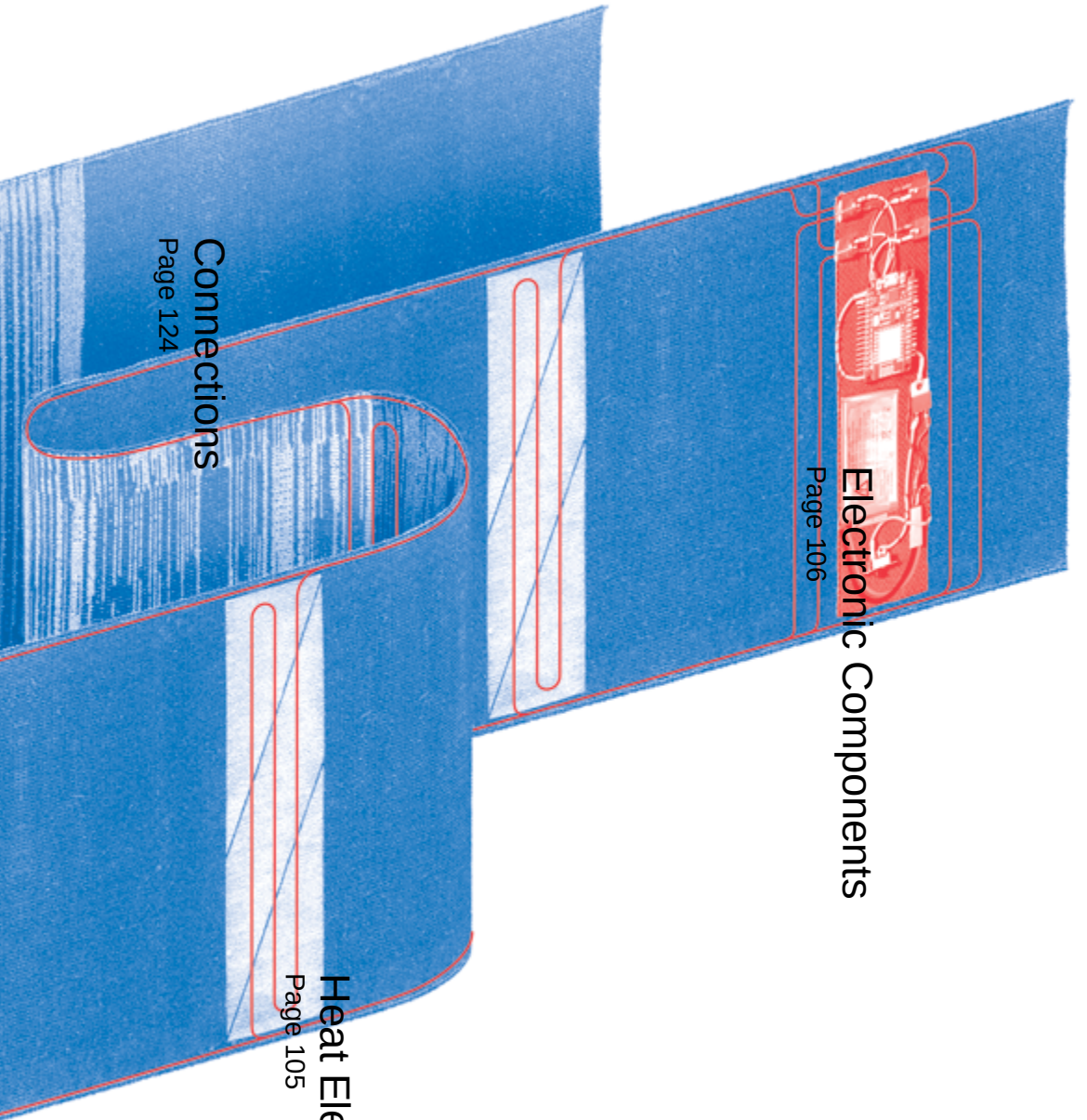

Electronic Components

Page 106

Heat Element

Page 105

Connections

Page 124

Overview

The circuit design and knitting pattern of both the heat shawl and the colour-changing shawl are identical. Each shawl hosts four heating elements made from stainless steel thread. The thread is enclosed between the double face layers of knitted fabric.

The knitting pattern was developed in collaboration with knitting technicians at Peterseim Strickwaren.

The schematics illustrate the intermediary steps and iterations related to the integration of the steel yarn which serves as a heating element. In our design we aimed at a working compromise between the resistivity of each heating element (and hence the length of the yarn), and an efficient electrical wiring process.

The final design of our shawls displays closed edges to house the cabling. Due to technical restrictions, the edges of the shawl are left open where the heating yarn is laid in. However this allowed us to connect and secure the heat elements manually at both ends.

We constructed two versions of the electronics patch with different micro controllers for different demonstration situations.

Heat Element

We chose a 100% stainless steel yarn by Bekaert with a resistivity of 1 Ohm per 10cm, to act as heating element. The fixed resistance of the material allowed us to perform reliable theoretical calculations and practical tests concerning the power consumption and heating capacity of the yarn.



Electronic Components

Although the system operates in the spectrum of extra-low voltage ($< 120\text{V DC}$), heating elements as actuators require far more current than is usually applied when using LEDs.

Within a heat control circuit, a voltage regulator acts as safe guard against over-powering a micro controller while Mosfets regulate the electrical current drained by the heating elements.

Strommit

The Strommit is a custom-made current averager component especially developed for e-textile purposes by Jussi Mikkonen in collaboration with Design Research Lab.

It consists of an ATtiny85, a Mosfet and a voltage divider integrated on a PCB. The circuit measures the length of the heat element and regulates the current accordingly. The Strommit can be controlled from an Arduino board, using an OC bus to set the desired amount of current for the project at hand.

The advantage of the component is its relatively high amount of safety for novice users, like the fact that it can be connected to heat elements of any length without prior calculations. However the integration into the relatively dense circuit of the heat shawls was not trivial, and the communication protocol turned out to be more complicated to use than expected. We therefore replaced the Strommit with less complex components in the following iterations of the patch.

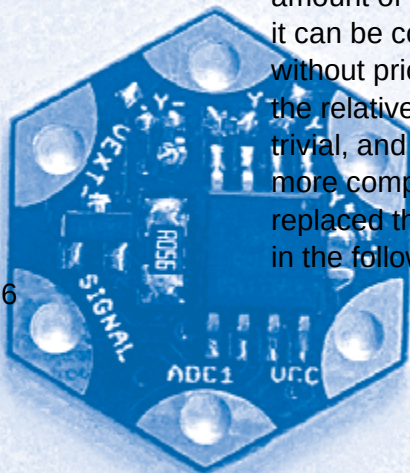

Mosfet

This is a surface mount power Mosfet capable of regulating high amounts of electrical current. We used it in place of the Strommit component to regulate the power for the heat elements directly.

Less complex than the Strommit, the Mosfet is connected to a PWM output pin of a micro controller to set the amount of current going through it.



IRLZ34NSPBF 1 HEXFET
3,8W D2PAK

Voltage regulator

Placed between the battery and Vin pin of the micro controller, it allows for the whole circuit to be powered by the same power source. This is convenient because we could use the same battery to power both the micro controller and the heat elements at once. The electronic assembly is detailed under "Electronics" p.127

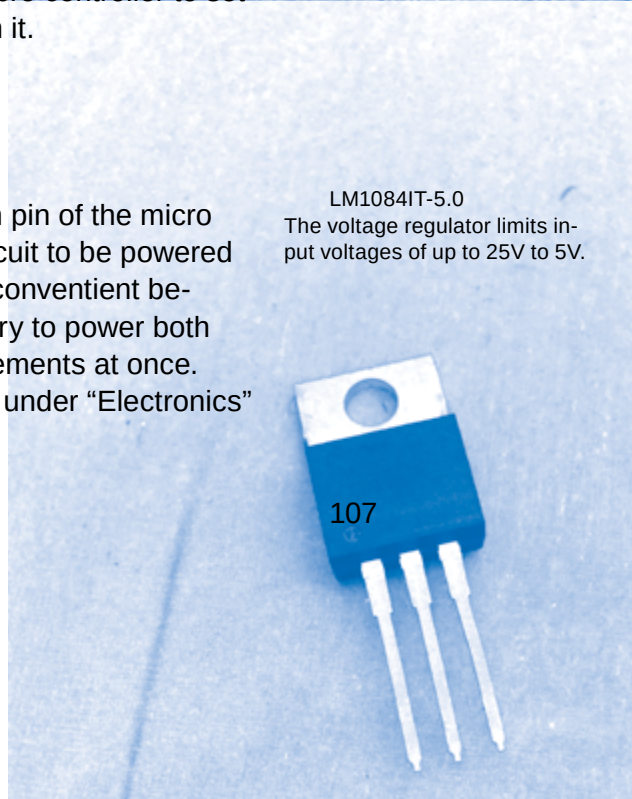

LM1084IT-5.0
The voltage regulator limits in-
put voltages of up to 25V to 5V.

Heating Circuit

We conducted quick-and-dirty user tests with the heating elements in order to evaluate energy requirements for the planned circuit. To this ends we invited some of our colleagues to touch different activated heat samples with the hand and wrist while „thinking aloud“. The heating samples were connected to an adjustable power supply that one team member controlled during the tryouts. Based on our participants' responses, we could determine the range of heat where the input is noticeable but not too hot and thus uncomfortable. We defined that for the four heating elements with a length of 75 cm each, with 750 mA current at 11V produced a comfortable heating level.

Serial and Parallel

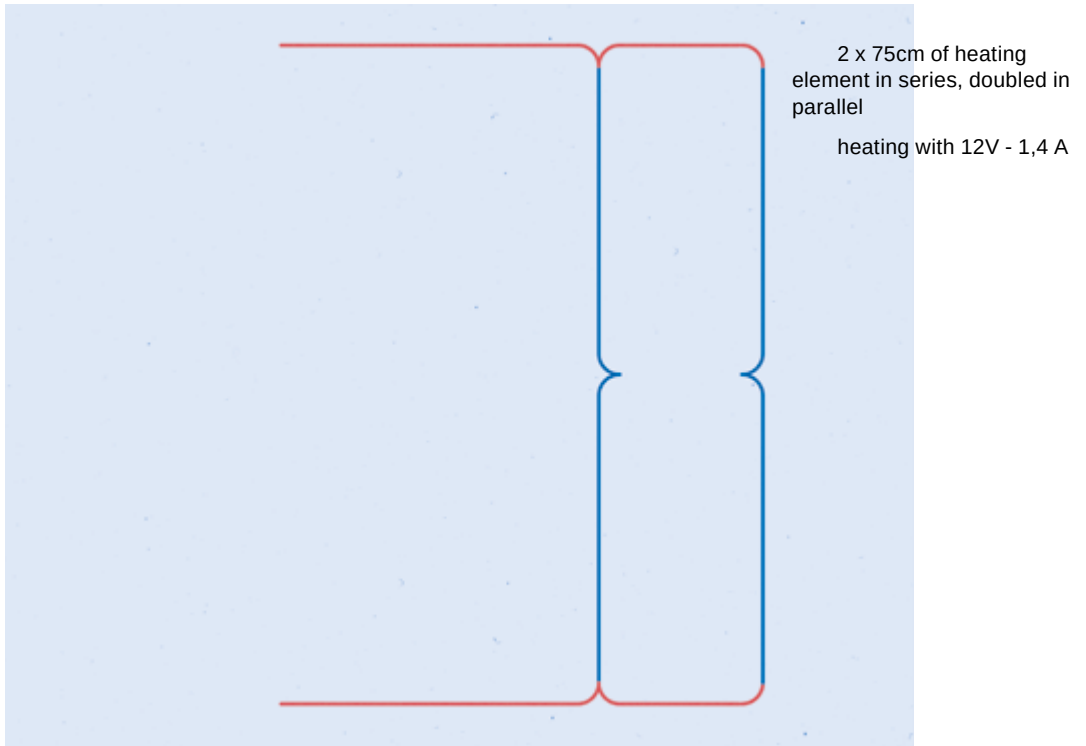

Parallel only

This circuit warms up better.

For practical reasons we decided to work with 11V later so that we could use a longer lasting battery with the final prototypes.

4x 75cm of heating element in parallel heating at 9V - 3,2 A

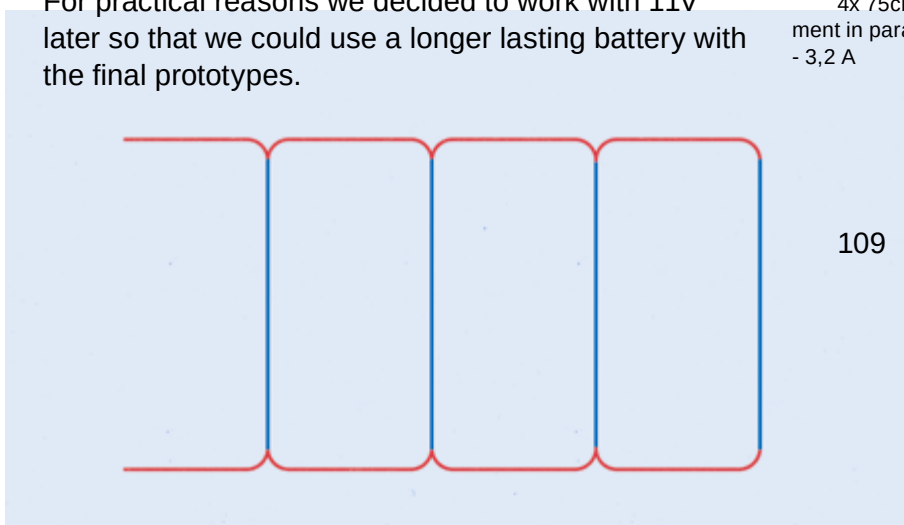

Heat Yarn Integration

As detailed in the knitting process (see p.115), we integrated the steel yarn as an inlay thread within a double-face knit. In the first iteration, we focused on insulating the heating element towards the skin to avoid undesirable electrical contacts. The second iteration was about improving the knitting pattern to avoid short cuts inside the knitted fabric. We used a final iteration to limited the length of the heating yarn in order to restrict its resistivity to a workable level with regard to energy consumption.

First test

During our heating tests with a power supply, we noticed that some areas in the knit would overheat and smolder. This was due to the fact that the knitted structure collapses significantly when taken off the needle bed, which causes the heating thread to form loops. We could easily straighten the yarn by pulling it on the edges.

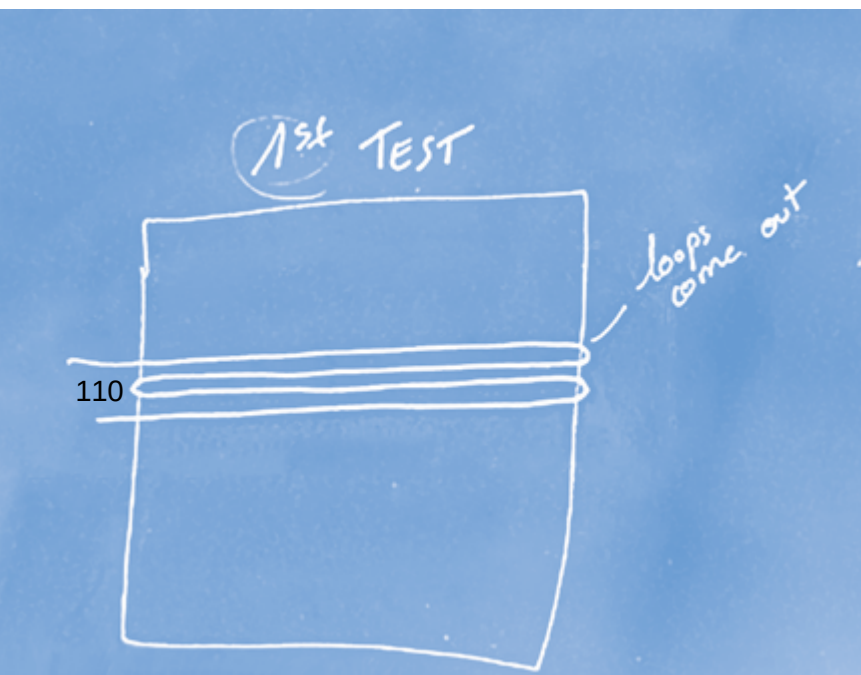

Second test

Open flaps on both sides, intended for electrical connections to be done after knitting. Therefore both ends of the heating elements are on opposite sides of the fabric, to avoid shortcutting with connections.

Where the inlay is done it is not possible to separate both faces, this will have to be dealt with in the final design.

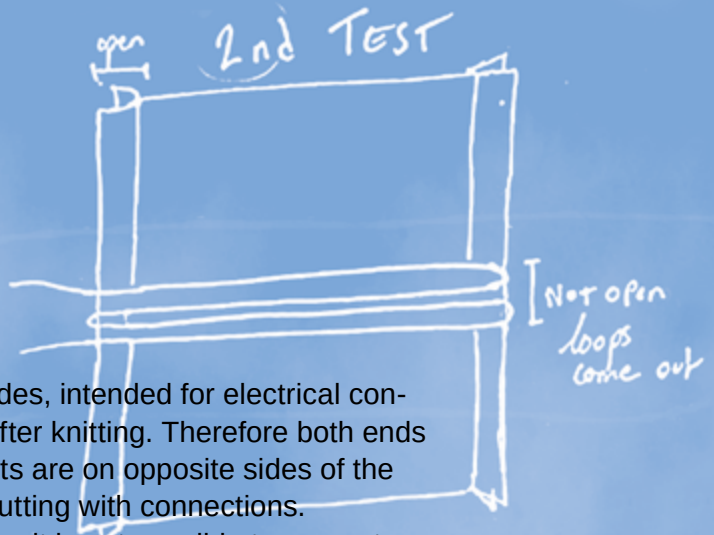

Third test

The open flaps became tubes with 5cm long openings at the level of the heating elements where we needed to access the heating threads to connect it manually. (see Connections p.124)

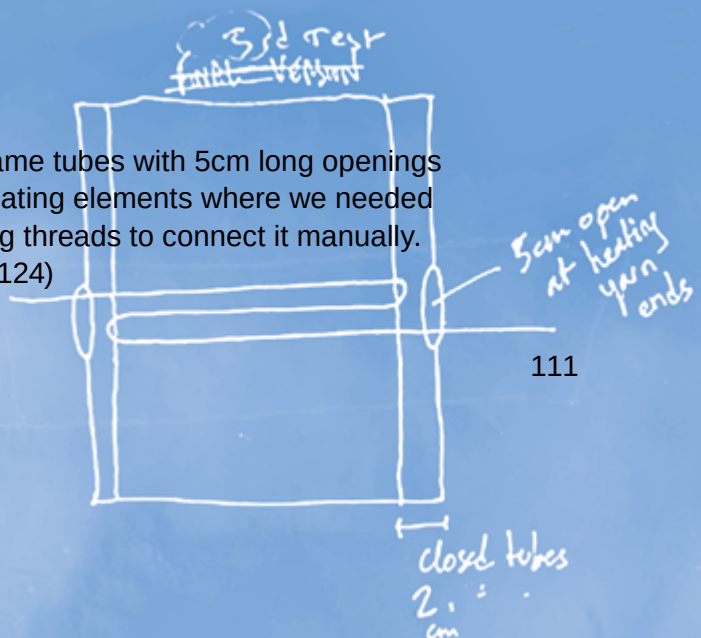

Knitting Process

All knitting patterns for the heat shawl were developed in close collaboration with the technicians at Peterseim Strickwaren GmbH. In case of the knitted heat elements, we had to try three different knitting techniques to arrive at an acceptable working result. In this case, the difference between our samples from the hand knitting machine and those from the industrial knitting machine were much larger than expected.

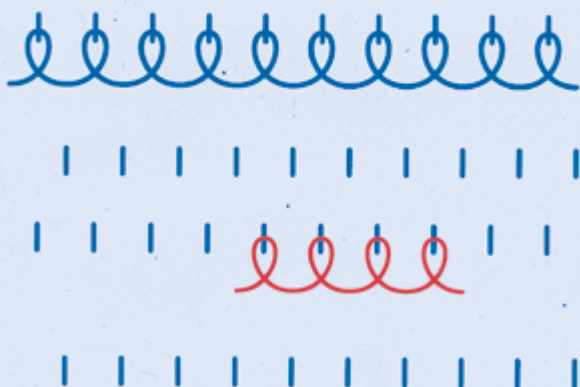

Intarsia

8E single bed, 2 threads Orange Wool, 1 thread of Bekinox

Attempt to create a heating area in the shape of a square.

The stiffness of the steel yarn deformed the fabric in an unpleasant way. It also created numerous shortcutting loops on the edges.

A great length of steel yarn was required for this technique, causing the resistivity to increase up to 70 ohm, which exceeded the values that we could work with.

During the tests with a laboratory power supply, one shortcut became so hot that the surrounding wool burnt. Therefore we discarded both pursuing with Intarsia technique as well as knitting the steel yarn itself.

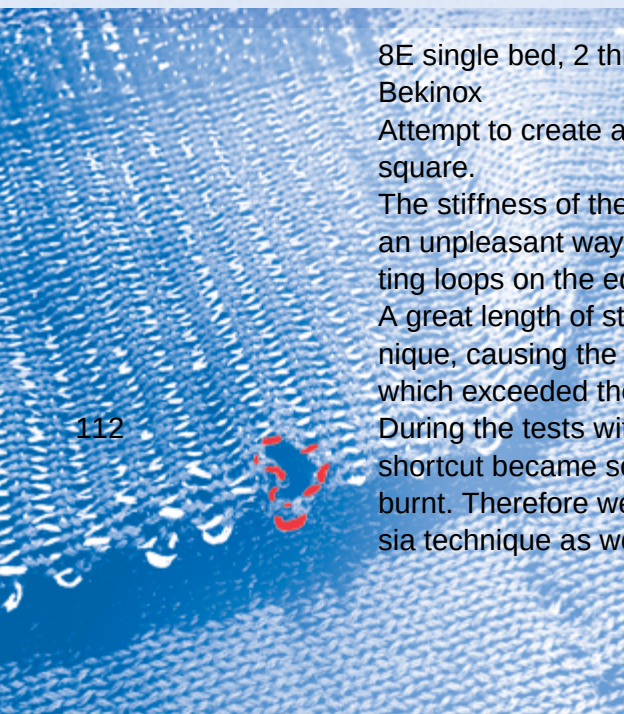

Horizontal Tubes

12E double bed, 1 thread Black Wool back, 1 thread Black PA front

These samples were primarily developed for the manual integration of optical fibers. We also tested the pattern for threading in the steel yarn. This approach worked as a fallback option but we abandoned it since the thread was not integrated during the knitting process.

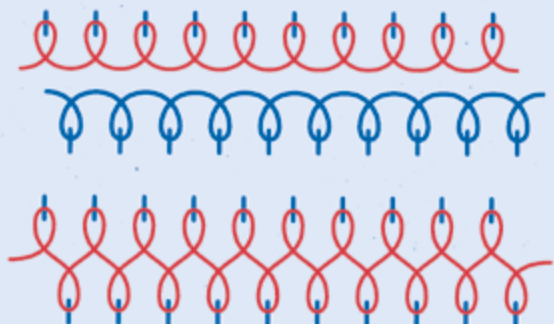
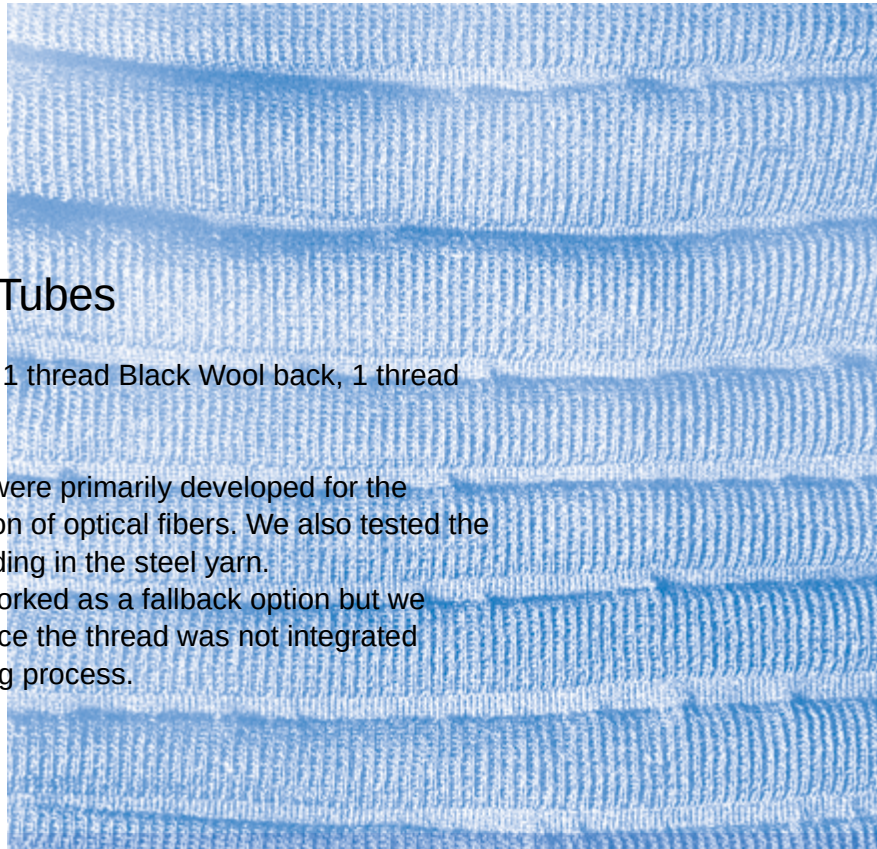

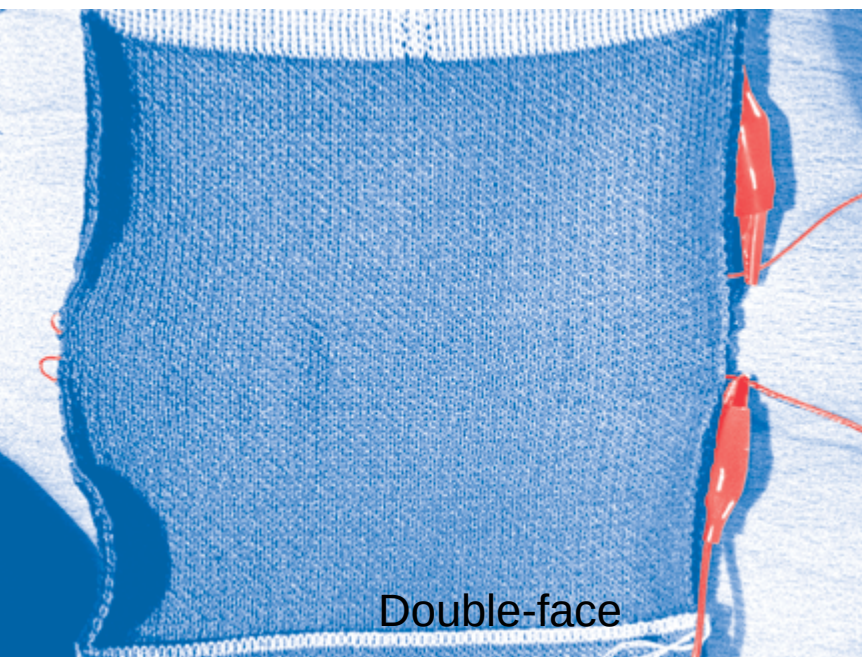

8E double bed, 2 threads for each face

A double face knit consists of two independent surfaces joined by an interlocking material (Polyamide filament Helanca).

Therefore different materials can be used for each face (e.g. Wool/Cotton, or any combination) as long as the thickness (NM) of both yarns is identical. We experienced aesthetic failure when we tried to combine a bright silk and a thicker wooly black. Inevitably the dark surface shone through the light face from the back, which did not yield a pleasing visual result.

Laying the steel thread in between front and rear layers without knitting minimizes its length and makes for a perfectly fitting heat element.

While meeting our requirements on electrical insulation, this technique also allowed for the heating thread to be integrated during the knitting process.

114

We developed further iterations in order to achieve a better integration for the final design of the shawl. (see Heat Element schematics p.103)

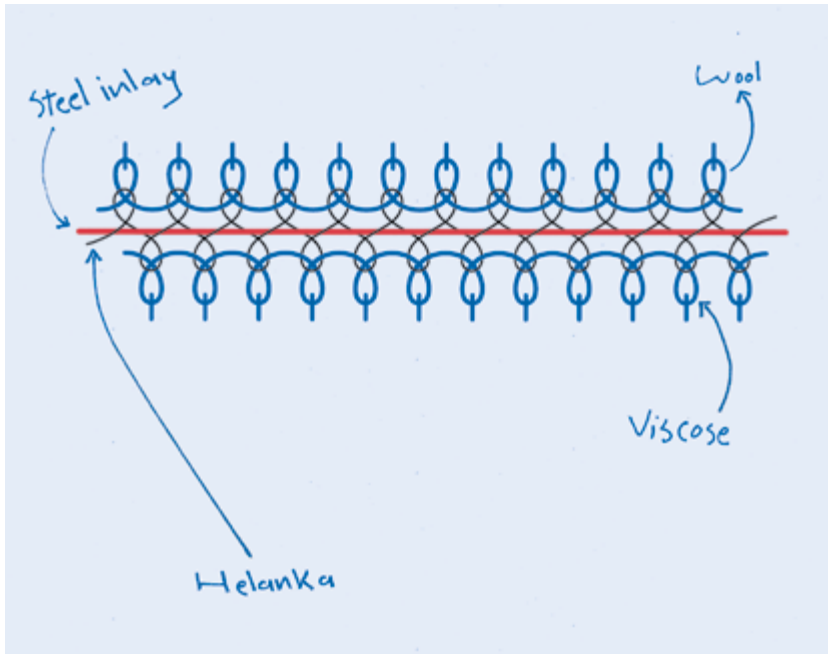

As we proceeded with the double-face technique for the final design of the shawls, we figured that its potential remained largely under-explored when knitted with only two plain colour faces. Finally combining various threads (up to 3 different qualities for one feeder) to match requirements in metric count, we achieved a variation with a gradient-like effect: in those spots where the steel yarn is laid, we blended the pattern from one colour mix to the next one, creating a slow transition from one yarn combination to another. Each shawl has four individually programmable heating areas distributed over its length, located between five mixed colour blocks forming the gradient variations.

Thermochromic Prints

Choice of a Colour-Changing Threshold

Thermochromic inks change their appearance when they are heated above their activation temperature. A common application for thermochromic inks is the magic of revealing something under a dark print by rubbing the surface with the hand. The body temperature can easily activate such pigments when they have a threshold of 29°C to 31°C.

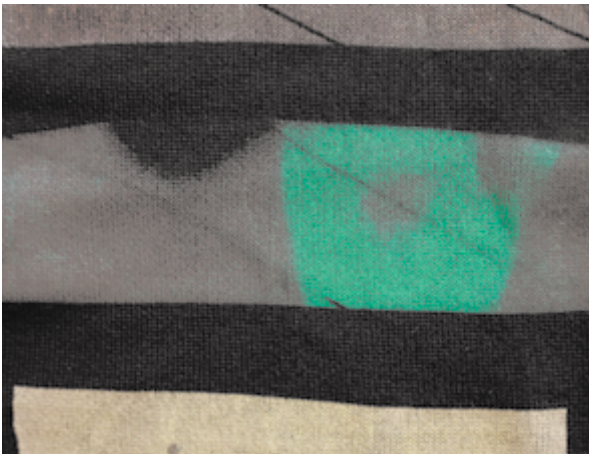

Colour changing effect activated when surface is touched with the hand.

116

As we designed a notifying shawl to be worn on the body, we needed thermochromic pigment with an activation temperature above body temperature. We started to experiment with red pigments from a previous project with an activation temperature of 47°C, which would not be activated by body heat. This pigment however proved to require excessive electrical power to turn transparent, which made it inappropriate for wearable applications.

Knowing that we were developing a wearable with restrictions in battery size and power, we had to find a compromise between spectacular visual change, battery life and weight. These requirements turned out

to become ever more complicated to meet as we gathered more knowledge from the practical experiments. Finally, we settled for a Black 43°C pigment for testing and for a Blue 38°C pigment for the final prototype.

First Test on Dark Substrate

The knitted fabric that we were going to apply the thermochromic pigment to was challenging in two aspects: firstly, it had a dark base colour, and secondly, it was relatively stretchy. The challenge represented by the fabric led us to seek for appropriate printing solutions. At first, overlaying the thermochromic colour on an opaque white base created a too thick and stiff print that was not aesthetically convincing. However, printing a black leuco-dye directly on the textile was not producing any visible effect at all.

Discharge

To be able to print on a dark substrate, we explored discharge print as another possibility. Discharge printing paste removes the colour pigment from the fibre itself by bleaching the fabric to its original colour. Printing another layer on top of a discharge print thus “replaces” the dyed colour of the fabric with the desired pigment.

Since the original dye is removed by the discharge print, the printed pigment does not produce an additional layer on the surface of the fabric. The surface therefore remains more fabric-like and keeps its softness.

In order to activate the bleaching process it is usually recommended to heat the discharge print up to 150°C / 170°C for about 120 seconds.

At first we were unsure about the stability of thermochromics pigments and thus we proceeded to a few tests cautiously to evaluate how they would react to the heat.

When a manufacturer ensured us that the pigments would not be affected by being exposed to the heat for such a short period of time, and confirmed the pigments' compatibility with discharge chemicals, we considered the technique for the final prototype as well.

Test “dark”

10g (100%) Discharge base + 10g (100%) Thermo-
chromic Black 43°C + 0,4g (4%) Discharge salt

Temperature: 100°C

Duration: 30 seconds

non heated = visually dark grey and haptic very soft

heated = no real change, possibly not enough dis-
charged in the black wool



Test “dark red”

10g (100%) Discharge base + 2g (20%) Thermo-
chromic Black 43°C + 0,5g (5%) Solid Fuchsia + 0,5g (5%)
Discharge salt

Temperature: 140°C

Duration: 15 seconds

non heated = visually dark purple red but the surface is
not homogeneous as some knit rows are contrasted

heated = brighter red/pink, irregular contrasted knit
lines appear more clearly

The visual effect may be due to a too short discharge
process, it did not replace all the initial black dye into
the fibers



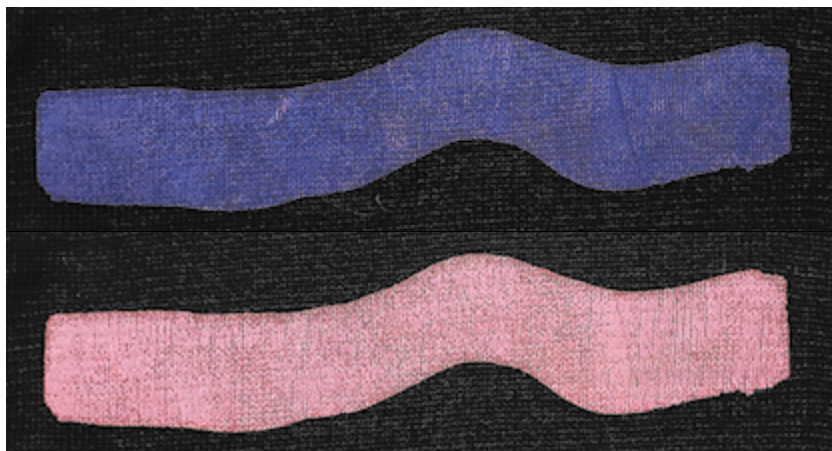

Test “blue-pink”

5g (100%) Discharge base + 5g (100%) Thermochromic Blue 38°C + 0,3g (6%) Solid Neon Red + 0,4g (8%) Discharge salt
Temperature: 160°C
Duration: 2 minutes



120

Test “blue-yellow”

5g (100%) Discharge base + 5g (100%) Thermochromic Blue 38°C + 0,2g (4%) Solid Neon Yellow + 0,4g (8%) Discharge salt
Temperature: 160°C
Duration: 2 minutes

1st print

Discharge without Thermochromics

(upper print) 10g (100%) Discharge base + 0,5g (5%)

Solid Red + (15%) Discharge salt

(lower print) 10g (100%) Discharge base + 0,5g (5%)

Solid Neon + (15%) Discharge salt

Temperature: 160°C

Duration: 1 minute



2nd print

Transparent binder + Thermochromic

Blue 38°C

Visually the effect works very well and while the blue covers optimally when non heated it fully disappears when heated up, but haptically this double layer print is stiffer and dense, not as soft as for the first tests.



Results

We ran various tests with different compositions of discharge base, discharge salt, colour pigments and heating times to gain a better understanding of how these parameters affected the printing results. In doing so, we also had to find a working recipe for the wool material that we used in the thermochromic shawls. The goal was to preserve the smooth and woolen surface as much as possible.

From those tests we decided to discharge at 160°C during 1 minute, as it proved to be working well in combination with our thermochromic inks. Although the visual effect was best with two layers print we also decided to keep the process with the mixture all in one as the haptic feel was considerably degraded by the thickness of the layered print.

Coating

While working on the discharge print recipes, we also considered coating our printed samples against UV light degradation. UV light destroys the thermochromic pigment, and a coating protects it from losing their ability to change colour. The coating layer is best applied with paint brush, but it adds stiffness to the material as well as a glossy look and a plastic feel. Aiming for a durable visual effect on the demonstrator, we decided to use it nonetheless, despite a certain loss of haptic quality.

Pattern Design

Thermochromic print opens up visual pattern design to become dynamic over time and thus offers new expressive possibilities. With different thermochromic colours and activation temperatures, one can achieve complex visual effects. In our case the colour change is reduced and simple, with a stripe pattern in a different colour for each heat area on the shawl. As a prototype, it allows for discussion on the contrasts and colour choices and preferences during user studies, while keeping the complexity of the overall object manageable.

Connections

An enameled litz wire from Elektrisola was chosen for the electrical connections on all prototypes. This is a highly conductive thin reinforced copper wire with multiple filaments which are each individually coated with a thin plastic layer. Its electrical insulation is a great advantage for connections running in parallel on the heat shawl specifically.

Step 1

Separate the synthetic fibers in the Elektrisola litz wire from the four wire strands with enameled copper and cut away about 5cm.

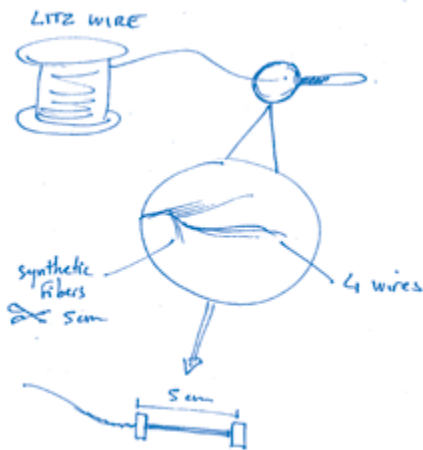

Step 2

Cover the litz wire with soldering tin with the soldering iron set to 350°C.



Step 3

Remove the excess soldering tin with copper braid with the iron set to 380°C.

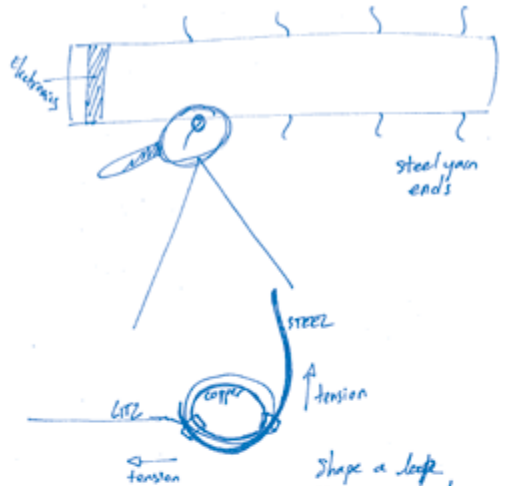

- shape a loop
- (XA) use two crimp beads
- (A) respect the tension directions
- (X) add an extra conductive thread (copper)

- (A)= reduce tension by spreading on two points
- (X)= reduce stress on fragile litz wire by adding material in the crimp beads

A = Reduce tension by spreading on 2 points

X = Reduce stress on fragile Litz wire by adding material in the crimp beads

Composed of four extra thin enamelled copper wires wrapped in polyester fibers, the challenge of using this litz wire lies in removing the enamel layer on the connecting points.

We used a soldering iron, desoldering braid and tin as shown in the illustration.

In general special care and patience is necessary in handling the wires as they become fragile at the soldered ends. While the integration of the connections are similar for all shawls, some of the processes were specific for each.

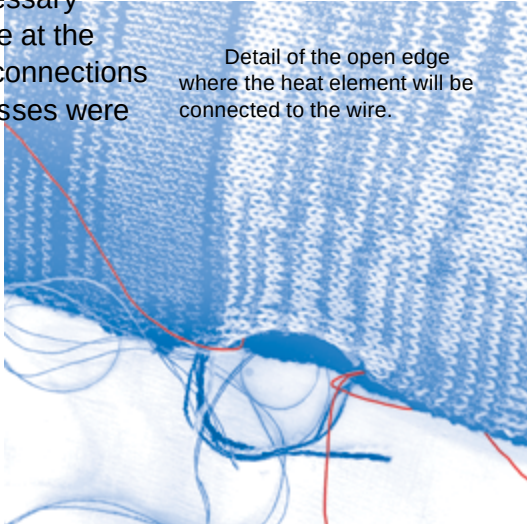

Detail of the open edge where the heat element will be connected to the wire.

Connections on the Heat Elements

When working with heat elements, heat can dramatically increase at the connection points when the resistivity of those points is higher than the surrounding material. Various tests were made with magnets and fasteners before we decided to use crimp beads as they gave the most secure connections.

To decrease the possible tension that will be applied when the heat shawl is worn the connections were made with a loop and two crimp beads. An extra few centimeters of copper thread from Karl Grimm was used in those loops in order to fill the beads and avoid the wire to break while increasing the electrical contact with the heat elements.



125

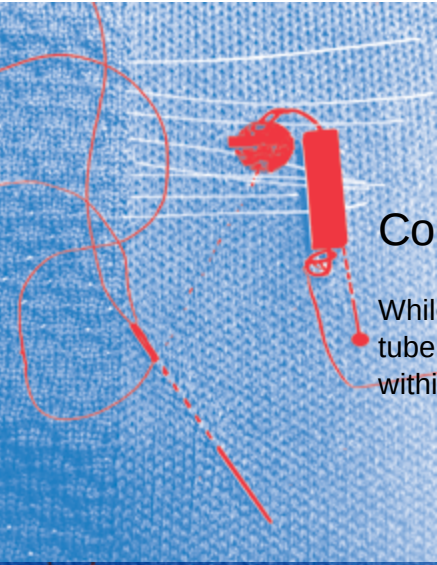

Connections through the Light Shawl

While on the heat shawls connections run through the tube edges, on the light shawl we threaded the lines within the thick fabric of the rib knit of the edges.



Connections to the Electronic Patch

On all shawls the electronic patches are removable and held in place by conductive velcro. To make sure the wires would not be pulled out when removing the patches they are stitched in zigzag in the knit on the heat shawl as well.

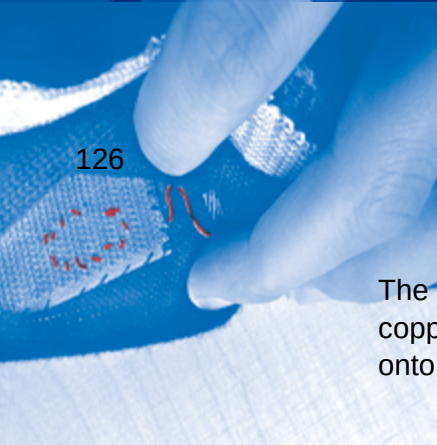

The wire end is stitched to the back of the velcro with copper thread before being attached with black thread onto the knit substrate.

Electronics

Each shawl has its own dedicated removable patch that hosts the power supply, micro controller and additional electronic components. One requirement for the final prototypes was that they should be used without any additional cable connection, neither for power supply nor for controlling the prototype's behaviour. This meant that we had to figure out a working combination of components to ensure that the prototypes worked wirelessly for a reasonable amount of time.

For wireless communication and control, we therefore firstly investigated Bluetooth Low Energy technology. To this end, we used the Light Blue Bean, a BLE-enabled micro controller which offers an Arduino compatible programming environment on computers and smartphones, similar to the Bluetooth Mate Gold breakout board.

A functional version with the BT Mate Gold plugged onto an Arduino mini was used for a demonstrator at the Dagstuhl seminar on Ambient Notifications Environments in April 2017. The Bluetooth module served as a gateway for a Serial connection to send commands from a computer to the Arduino board that was controlling the Strommit. Although in this demonstrator, not all four heating elements were individually controlled, we could exhibit different heat levels by allowing for more or less current through the circuit.

But since we experienced performance problems with both the Blue Bean and the BT Mate, we looked into more robust and flexible alternatives for wireless connections. Planning the implementation of our prototypes as part of a connected home environment in the frame of the DAAN project, we started to use an ESP Node MCU (microcontroller unit), an open source IoT platform. The hardware of this single board micro controller is based on a ESP-12 module, serving as a low-

cost Wi-Fi chip with full TCP/IP stack and MCU capability. While keeping micro controller functionalities like PWM, the Node MCU also provides web sockets. It is therefore compatible with numerous protocols already in use in different IoT and smart home environments such as the open source MQTT that was applied by our project partners.

Once we had decided for the MCU, at first we wanted to create a single patch to be used for all different shawl variations. This quickly appeared to be more work and troubles than developing bespoke patches for heat and for light functions. Therefore the patch for heat was reproduced identically for colour-change as it was exactly the same construction of the shawl, but we developed a specific patch for the light-emitting version. However only the amount of Mosfets and their placement on the patch varies, i.e four for the heat shawl, and two and three for two different versions of the light shawl.

We used the mosfets in a D2Pak surface mount package with a shorter middle leg that acts as the drain, in contrast to TO packages where all legs are of equal length. To connect the drain we shaped a loop with copper thread and held it in place with a crimp bead while the Mosfet was stitched onto the patch on the opposite side of its velcro connector. The copper thread connects both sides through the substrate fabric and proved to be a reliable solution.

Another variation of components on the patches is the use of a power switch that can deal with 3A for the heat version. This change was necessary after we burnt a lower voltage switch on our first trial.



1.
Switch

2.
Power
Supply

3.
Voltage
Regulator

4.
ESP

5.
Mosfet

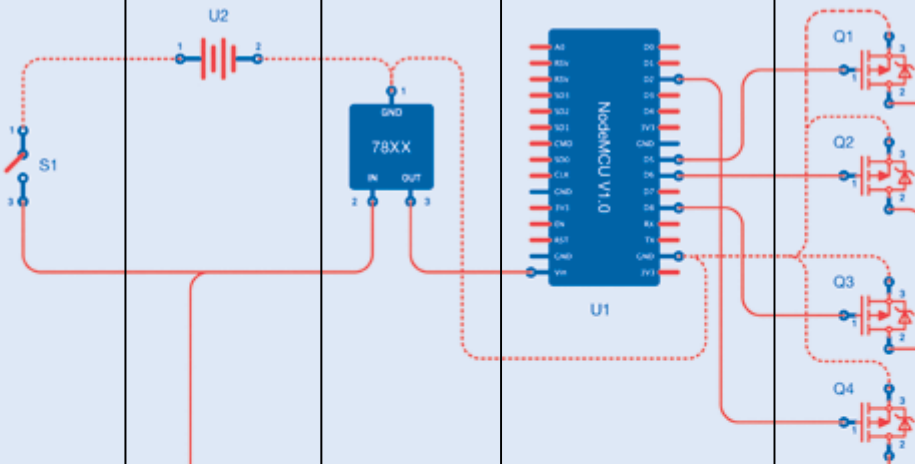
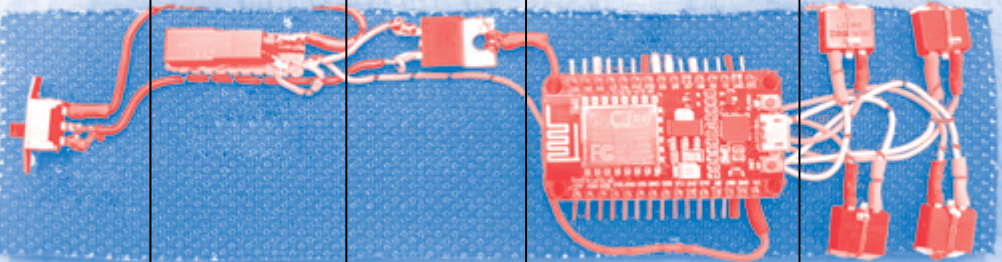

6.
Heating
Elements

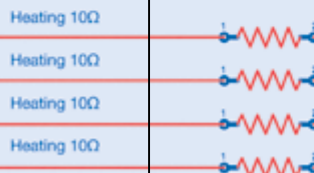

Demonstrator Settings

All the three Shawl prototypes can work in three ways:

With Arduino mini and Bluetooth Mate: (early prototype demo)

A first demonstration of the heat and the light shawls was given in April 2017 at the Dagstuhl Seminar on Ambient Notification Environments. Both the shawls were then controlled with an Arduino mini via Bluetooth and Serial commands from a computer.

As a standalone server in existing Wifi Network: (flexible, plug and play demo for everywhere)

The Node MCU is programmed to work as a web server serving http in the local wifi network. It serves a HTML website to a fixed IP address. The website provides GUI elements (like buttons) used to control the shawl. Every prototype has a different IP address and custom GUI elements tailored to its functions.

To insure a safe and reliable communication we use a Wifi extender that connects to an existing wifi (e.g our workspace wifi) and creates a local network (e.g called "daan"). When connected to it, we can call the IP address of each shawl from the browser on our phones and interact with their implemented functions via the webpage.

As a MQTT Client in an existing Wifi Network: (integration within a larger IoT environment)

MQTT (Message Queue Telemetry Transport) is a publish-subscribe-based messaging protocol for use on top of the TCP/IP protocol. Thereby a central broker is responsible for distributing messages to interested clients based on the topic of a message.

When the Node MCU is programmed as a client in an existing MQTT network it can subscribe to a specific topic, which is managed and updated by the broker. So the prototype can be easily integrated in bigger and complex IOT environments as demonstrated with the light shawl during the project's closing event at Telekom Design Gallery in Bonn.



**Wearing
Notifications:**

5 —

**Exploring Meaningful
Application Scenarios
with Users**

133

What are the social, symbolic and practical implications of implementing ambient notification in clothes worn on the body? How can textile-based notification be applied within an assistive computing environment in a meaningful way?

In order to probe these questions we conducted a series of exploratory interviews with elderly individuals. We asked them to try our prototypes and tell us how they perceived each specific stimulus. With our prototypes as a starting point, we engaged them in a general discussion about notifications, assistance, and clothes.

The interviews pointed us to the multilayered practices and individual habits of dress, and to some concrete practical implications that should be considered when embedding ambient notification into clothes. The participants' thoughts around the public and private nature of visual and haptic feedback revealed delicate dynamics around assistive technologies, clothes and self-representation. It also became clear how their current use of communication technology results in different expectations and thoughts on how ambient technologies are best applied.

Narrative Speculation

We knew from prior research that the output technologies we are working with – LEDs in combination with fiber optic light cables, thermochromic colour-change and warmth – are generally suitable to give ambient feedback in devices and objects. They are subtle, abstract, and provide a wide range in intensity, they can go from being easy to ignore to demanding attention. What happens, however, when they are worn on the body? How are ambient notification in clothes different to other devices?

1

Mankoff, J., Dey, A.K. a. K., Hsieh, G., Kientz, J., Lederer, S. and Ames, M. 2003. Heuristic Evaluation of Ambient Displays. Proceedings of the SIGCHI conference on Human factors in computing systems (2003), 169–176.

Ambient displays have the “ambitious goal of presenting information without distracting or burdening the user”¹, which goes beyond the physical perception of the stimuli. If a notification is perceived as “distracting” or “burdening” by an individual largely depends on the situational context. Early on in the project we decided to develop a notification technology, either visual or haptic, that is open to be configured to any digital information or application on the software side. The extremely low fidelity of our prototypes makes it possible to send only a few differentiated signals, which are abstractedly represented — as warmth, light pattern or a gradual colour change. Projects on ambient displays within HCI have often focused on information for a larger group of people, such as displays of the whereabouts of colleagues or energy savings in an office building. However, when the display is worn on the body and the notification is personal, questions of whether the notifications are public or private take on extra weight, and even more so when they are tied to an assistive function.

136

Based on a literature review and interviews with care takers at a day care center, we identified potential areas where elderly are commonly in the need of assistance and developed a series of application possibilities for the notifications in shawls, each represented with a narrative scenario. In these scenarios the notifi-

cations are used as a reminder for the person to take their medicine, for a person with diabetes to measure their blood sugar level, as background indications of a family member's online activity, as an indication of cold weather outside and a reminder to wear the shawl, and as a replacement for the audio signals of a mobile phone for a person hard of hearing.

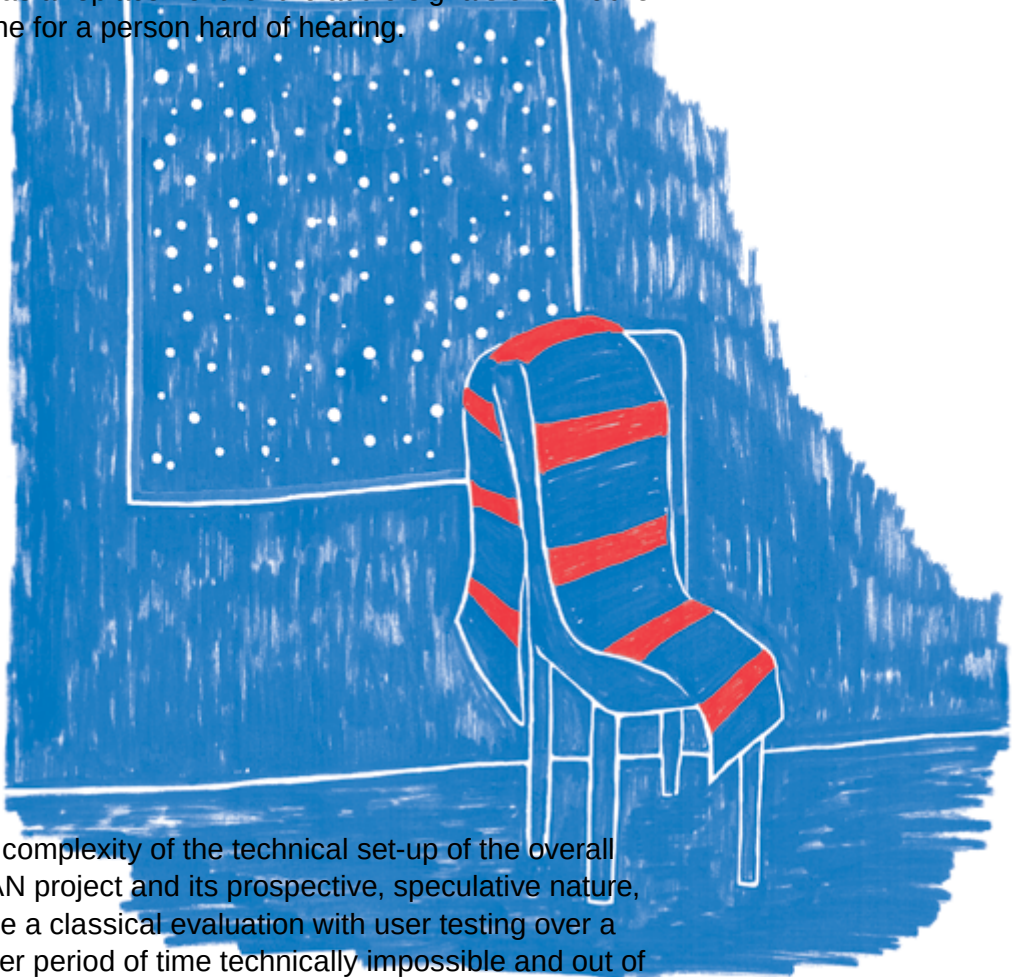

The complexity of the technical set-up of the overall DAAN project and its prospective, speculative nature, made a classical evaluation with user testing over a longer period of time technically impossible and out of scope of the project. Instead we chose an approach with a simpler test set up, where we invited participants to wear the shawl for a shorter period of time while walking around the building experiencing the stimuli, followed by a semi-structured interview. Having experienced the shawls on their own bodies enabled the participants to speculate more profoundly on application scenarios and relate them to their own everyday experiences.



In one application example for the fiber optic shawl, the light signal functions as notification for a woman who has been experiencing a gradual, age-related hearing loss. When she is outside doing her daily errands, her shawl notifies her when her phone is ringing or when she is receiving a text with a subtle light change.



The warmth of the thermochromic shawl is used not only to achieve a colour changing notification but also for physical comfort. The person in the scenario has arthritis, affecting her hands and shoulders, and the pain increases when she is cold. Her shawl is connected to the weather forecast and notifies its user when cold weather is predicted for that day, reminding her to bring it when leaving the house. While being outside the shawl is warming her in regular intervals to keep her comfortably warm. The subtle colour change makes the warmth visible. This scenario was meant to illustrate how the thermochromic shawl can both provide heat and act as a visual display at the same time.

Perception of the Stimuli and Embodied Wearing

Their first impressions of the shawls and their stimuli were overall “ambient”, described by the participants as “slow”, “gradual”, and the stimuli of the thermo-haptic shawl was regarded as “very comfortable”, “pleasant”. The light changes in the light shawl were described as “subtle”, “subdued“, „not startling“.

It quickly became apparent however, how much embodied practices alter the notification quality: how the user places the shawl on their body, how they move, their style of walking etc. directly influenced how the notification was perceived, and sometimes if at all. Most crucial was the position in the case of the visual Notifications. Depending on how it was worn and how the wearers moved, the active areas would sometimes move out of their field of vision. For one person with a stiff neck the position of the shawl made it hard for her to use it. Having to look down became unpractical, especially while walking, and she found it directly stressful: *“If you have to always keep it in mind and you have to constantly check ‘Is the light on, is the light off?’, that would interfere with my ability to pay attention to my surroundings, that can potentially make me less attentive”.*



Ambient Attitudes

“These warming capabilities, I think they're great. But to use them for information? I don't know. I can't imagine it.”

When discussing application scenarios with our interviewees, a preference for concrete use-values emerged among our participants. The notification signal was tied to critical, important information to reduce danger or support a person with a physical impairment. The use of the shawl for warming the body and the light shawl for visibility in traffic were scenarios that immediately resonated with the participants.

As notifications, they only saw a purpose if it was tied to something very important, as reminding them to take their medicine or even urgent information in emergency situations. One participant suggested to differentiate the shawl's signals further by using each stripe of the thermochromic shawl for a different piece of information: One for drinking water, another one for medication, one to do physical activity “when you've been sitting down too long, a reminder that it's time to move yourself a bit, maybe walk a few steps”.

A few participants liked the idea of the weather being indicated by the shawl. “It is good in an extended sense, because in my opinion it wouldn't only mean 'bring me as a shawl', but rather 'It's getting colder, remember to put on gloves, remember to cover your head, and make sure you're not wearing high heels, but boots. That the signal encompasses the whole outfit, saying 'Dress warm, in general' ”.

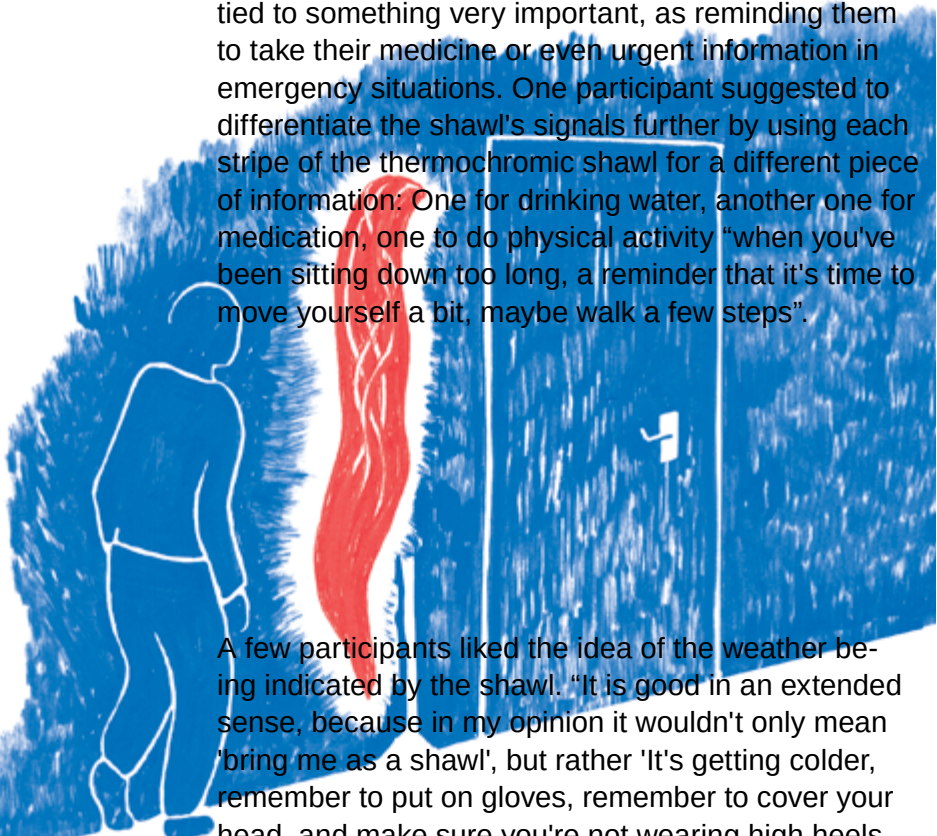

Applications like reminding the user to bring the shawl when leaving a place, they found “nice” and “cute” but ultimately unnecessary, with the technological effort too high in relation to the use value.

Our assumptions that warmth carries positive affective connotations were largely confirmed — spontaneous associations to well-being and being taken care of were common. One of the participants, living by herself, said: “The warmth gives this feeling of safety and then when you’re also reminded of something, you feel taken care of.” She continued: “I think psychologically that’s a nice feeling, the feeling that someone is looking out for you, even if in this case it’s not a person”. Another participant suggested that the stimuli of the thermohaptic shawl could be used to indicate the location of a caretaker in an assistance scenario, with the signals gradually intensifying the closer their distance.

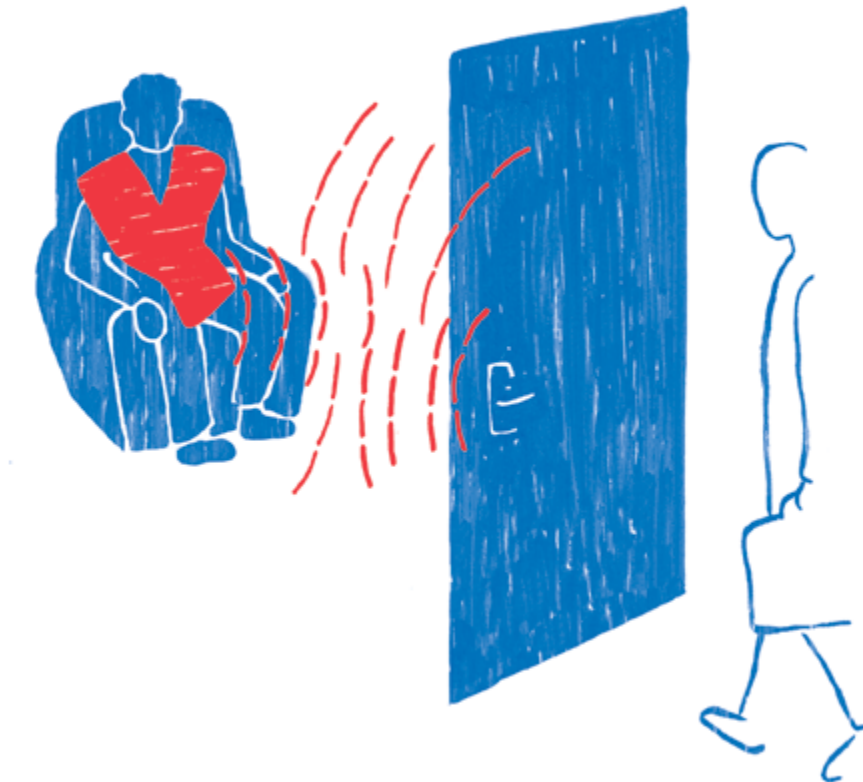

The concept of getting notifications for “background” information or non-critical events did not resonate well with them. Our participants did not relate to feelings of being overwhelmed or overstimulated by notifications or technology in general, and consequently they did not see the purpose of filtering information or presenting „background information“. „Either it is important or it’s not“, as one user put it.

One of our scenarios described a person managing a lot of information input at work, and receiving a subtle notification of other family members' online activity while at work, which stirred up feelings among the interviewees, revealing a disciplined work ethic: “When I go to work, I go to work. I don’t want anyone from home to interfere with my work mode”. “Focusing on work is more important than the family, in my opinion, but maybe times have changed”, said another. Another user elaborated: “This has to do with the way you organize your work. I would say (to my family members: 'I can be reached daily from 7:00 to 7:30 and from 12:00 to 12:15 and from 17:00 to 18:00. During this time I have my smartphone on call and will pay attention’”. Also the low representation fidelity in this case was perceived to be more confusing than ambient: One user imagined (herself as younger): “I’m in this stressful situation and I have to concentrate and then this warm push comes, and I don't know, does it mean 'My child is vomiting in kindergarten' or does it mean something less important like, my child just wants to say 'Mommy, I love you’”.

Different age cohorts have different ways of relating to technologies, which suggests that it depends on the specific use of media by the user group how meaningful ambient information is to them. Our study participants described their technology usage as pragmatic and very disciplined, checking their emails and their social media accounts on their desktops once a day at the most, and many could also go days without. None of them expressed the feeling of information overload, frustration with multitasking or the need to compulsive-

ly check their devices. Consequently, they perceived no need in filtering information, and the notion of using different output modalities to manage different types of messages did not resonate with them.

Presenting the prototypes as part of a larger assistive network raised the question of how exactly these systems are meant to work. Many voiced doubts about the technological system's ability to recognize a person's intention and paid significant attention to the way we would explain details such as how exactly the system is context-aware.

Interestingly, they were sceptical about the smart environment and technology in general, but not about the shawls themselves: to the question if they felt uncomfortable wearing a garment that is remote-controlled by another person, as in the test set up, no one voiced any negative feelings. They had no problem wearing the technology on their body and other privacy issues were not a concern, possibly suggesting that knitted shawls are a very familiar, non-intimidating interface.

Public or Private

How we dress heavily influences how people see each other and themselves, and there is a close relationship between our assessment of a social situation and what we find suitable to wear. The sociologist Erving Goffmann described the powerful dynamics that are at play around dress and self-representation. Goffman identified the main reason for wanting to manage impressions of ourselves as our desire to secure cooperation in an encounter, and ultimately to avoid shame, humiliation and embarrassment². Dress is a key factor in how we present ourselves.

The attitudes toward the fiber optic shawl were especially divided regarding to how its signal would be perceived in a social context and revealed some underlying anxieties about attracting unwanted atten-

2

Goffman, E. 1959. *The presentation of self in everyday life*. Doubleday.

145

tion: Some users expressed discomfort with the idea that passers-by would comment on the shawl. One interviewee said “I imagine sitting somewhere and my shawl starts to glow and the whole bus turns towards me.” They also mentioned that other people can notice the signal before the person and by this putting her in an embarrassing situation. “An old person is already stigmatised, by their age alone, he's standing in the way, when others are rushing to the subway, etc. If then, additionally, something starts blinking, it becomes obtrusive”. Another user said: “The attention signals to others that I'm vulnerable — no one wants that.”

Another half of the participants found the thought of wearing a light emitting shawl “fun” in general, they imagined it to be a conversation starter and appreciated its ability to attract attention from surrounding people. These participants regarded the shawl as an elegant clothing item, not made for everyday life, but rather for festive occasions like going to the opera or theatre: “Generally I don't like shiny dresses or shiny coats, but subtle strips like these, I wouldn't mind. Especially if I go out at night and wear more elegant things, this could accentuate a specific type of person”. One person said: “I would think I have something really special, people would notice me. I think it would leave a good impression on other people, it would attract positive attention”. To the question of how she felt about other people seeing the signal another participant responded; “It would be ok, since it is very subtle and the other people don't know what it signifies, they would maybe rather think that it's a special material or a special design. I wouldn't have a problem if other would people notice it.”

The attitudes toward the fiber optic shawl hinted at how tricky it is to have light in clothes when they are tied to an assistive function, as it easily runs the risk of being perceived as stigmatizing. Overall, the thermo-haptic shawl and the aspect of having a private, personal reminder, that “no one else notices” was indeed

what was most valued by our participants. One commented: “No one hears it, no one sees it. That's what's beautiful about it.”

Personal Style

Wearable devices — and electronic textiles specifically — are inherently embedded in social practices of dress and fashion. The shawls are not merely interpreted as functional objects, but as fashionable accessories and part of a person's self-expression. Perhaps more than with other digital appliances, subjective opinions on style and colour become important and influence the acceptance of a wearable, implying that the formal-aesthetic properties influence the function and purpose much more fundamentally than for other digital devices.

When asked if they would integrate the prototypes into their own wardrobe the responses naturally reflected their individual taste and personal style, which seemed to override functionality to some degree. They were positive about the haptic feel of the fabric, the warming capabilities of the thermohaptic shawl, and imagined it well for other people but only a few could imagine it for themselves. The ones who described the fiber optic shawl as “elegant” and “classy” would wear it as a fashionable accessory alone, whereas another one found the look of it “depressing”. One interviewee liked the idea of a light-emitting textile, but not as a garment: “As long as I am not inside the thing, it is somehow quite funny”.

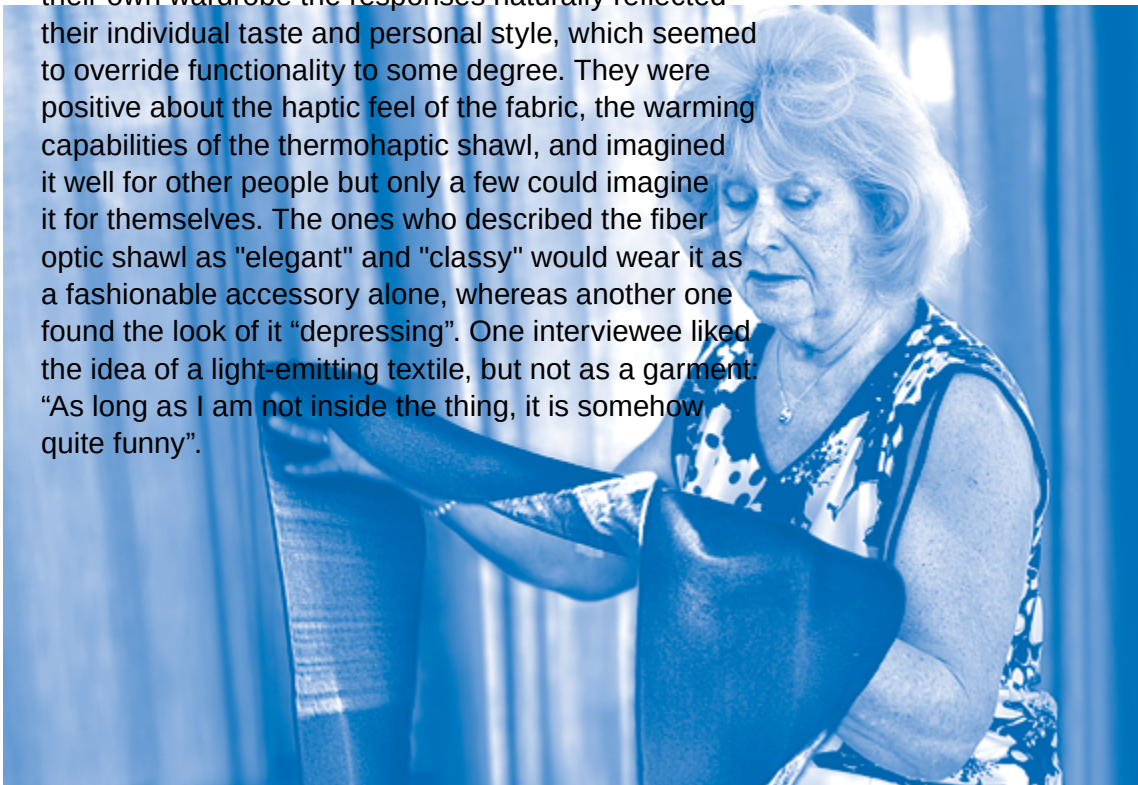

Furthermore, unlike other digital devices, we usually have a high variety of personal clothing and change them on a daily basis. We choose what we wear according to season and social situation, our clothes need to be washed and to harmonise with each other. The shape of these prototypes, shawls, have specific habits around their use. As one of our users said “It's not like one wears only one single shawl all the time. A wristband or a watch, let's say, you wear all the time. If he wears the shawl Monday, Tuesday, Wednesday but not Thursday, Friday — how will he get the reminder?” Another participant asked: “And what do you do in summer?”

Textile ambient displays need to account for the fact that users do not wear the same clothes all the time.



Perspectives

When it comes to meaningful integration into a smart assistive system and the everyday lives of the user, we could discern an appreciation for ambience in terms of unobtrusive and non-conspicuous, over ambience in terms of presenting background information. When worn on the body, thermal and thermochromic notification were preferred over light-emitting displays.

The rich quality of thermal stimuli as a notification modality for this user group became apparent. To have a discreet output modality that surrounding people do not notice was regarded as highly useful, and the reliability of the thermal signals depended less on the user's movements. Its positive, affective connotations of care and well-being seem suitable for an assistive context.

Visual feedback through light is more difficult to adapt to a personal display of information, because of its public nature and its risk of being perceived as stigmatizing, regardless of how subtle it is. For visibility at night and security in traffic the fiber optics seem very suitable, however.

Prospective users and their attitude towards technology represents a major part of the context. Their interests and knowledge shape the way they evaluate a proposed application. This is where the discrepancy between current and future potential users of wearable ambient devices becomes most apparent. Ambient displays for background information likely works better for people who experience information overload, which was not the case in among our participants. In an assistive framework ambient technologies might work better for digital natives that might be „overwhelmed“ by technology, or surrounding caregivers, that need to manage a lot of information input.

6 —



Imprint

151

GEFÖRDERT VOM



Bundesministerium
für Bildung
und Forschung

The project „DAAN“ (Design Adaptiver Ambientier Notifikationsumgebungen) was funded by Bundesministerium für Bildung und Forschung (BMBF) from 03/2015 till 05/2018.

Head of Research: Prof. Dr. Gesche Joost
Project Lead: Dr. Katharina Bredies, Dr. Berit Greinke
Research: Ebba Fransén Waldhör, Pauline Vierne
Assistance: Paul Seidler, Max Westbrock
Book Design: Masoud Morgan
Illustration: Judith Hunziker

Typeface **Arimo**, Paper **Munken Pure**, Print **Colorama Berlin**

Image on page 50 with permission from **Julia Danckwerth**,
Bauhaus Universität Weimar

Image on page 50 with permission from **Richard Feichtiger**,
Inshoerance GmbH

The text of this publication is published under the Creative Commons Attribution 4.0 International license (CC BY 4.0). You can find the complete license text under <https://creativecommons.org/licenses/by/4.0/legalcode>.

© Design Research Lab, University of the Arts Berlin





Design·Research Lab
University of the Arts Berlin