

Scheduling Maintenance Jobs in Networks^{*}

Fidaa Abed¹, Lin Chen², Yann Disser³, Martin Groß⁴, Nicole Megow⁵, Julie Meißner⁶, Alexander T. Richter⁷, and Roman Rischke⁸

¹ University of Jeddah, Jeddah, Saudi Arabia.
fabad@uj.edu.sa

² University of Houston, Texas, USA.
chenlin198662@gmail.com

³ TU Darmstadt, Darmstadt, Germany.
disser@mathematik.tu-darmstadt.de

⁴ University of Waterloo, Waterloo, Ontario, Canada.
mgrob@uwaterloo.ca

⁵ University of Bremen, Bremen, Germany.
nicole.megow@uni-bremen.de

⁶ TU Berlin, Berlin, Germany.
jmeiss@math.tu-berlin.de

⁷ TU Braunschweig, Braunschweig, Germany.
a.richter@tu-bs.de

⁸ TU München, München, Germany.
rischke@ma.tum.de

Abstract. We investigate the problem of scheduling the maintenance of edges in a network, motivated by the goal of minimizing outages in transportation or telecommunication networks. We focus on maintaining connectivity between two nodes over time; for the special case of path networks, this is related to the problem of minimizing the busy time of machines.

We show that the problem can be solved in polynomial time in arbitrary networks if preemption is allowed. If preemption is restricted to integral time points, the problem is NP-hard and in the non-preemptive case we give strong non-approximability results. Furthermore, we give tight bounds on the power of preemption, that is, the maximum ratio of the values of non-preemptive and preemptive optimal solutions.

Interestingly, the preemptive and the non-preemptive problem can be solved efficiently on paths, whereas we show that mixing both leads to a weakly NP-hard problem that allows for a simple 2-approximation.

Keywords: Scheduling, Maintenance, Connectivity, Complexity Theory, Approximation Algorithm

^{*} This work is supported by the German Research Foundation (DFG) under project ME 3825/1 and within project A07 of CRC TRR 154. It is partially funded in the framework of MATHEON supported by the Einstein Foundation Berlin and by the Alexander von Humboldt Foundation.

1 Introduction

Transportation and telecommunication networks are important backbones of modern infrastructure and have been a major focus of research in combinatorial optimization and other areas. Research on such networks usually concentrates on optimizing their usage, for example by maximizing throughput or minimizing costs. In the majority of the studied optimization models it is assumed that the network is permanently available, and our choices only consist in deciding which parts of the network to use at each point in time.

Practical transportation and telecommunication networks, however, can generally not be used non-stop. Be it due to wear-and-tear, repairs, or modernizations of the network, there are times when parts of the network are unavailable. We study how to schedule and coordinate such maintenance in different parts of the network to ensure connectivity.

While network problems and scheduling problems individually are fairly well understood, the combination of both areas that results from scheduling network maintenance has only recently received some attention [2, 4, 17, 1, 11] and is theoretically hardly understood.

Problem Definition. In this paper, we study connectivity problems which are fundamental in this context. In these problems, we aim to schedule the maintenance of edges in a network in such a way as to preserve connectivity between two designated vertices. Given a network and maintenance jobs with processing times and feasible time windows, we need to decide on the temporal allocation of the maintenance jobs. While a maintenance on an edge is performed, the edge is not available. We distinguish between **MINCONNECTIVITY**, the problem in which we minimize the total time in which the network is disconnected, and **MAXCONNECTIVITY**, the problem in which we maximize the total time in which it is connected.

In both of these problems, we are given an undirected graph $G = (V, E)$ with two distinguished vertices $s^+, s^- \in V$. We assume w.l.o.g. that the graph is simple; we can replace a parallel edge $\{u, w\}$ by a new node v and two edges $\{u, v\}, \{v, w\}$. Every edge $e \in E$ needs to undergo $p_e \in \mathbb{Z}_{\geq 0}$ time units of maintenance within the time window $[r_e, d_e]$ with $r_e, d_e \in \mathbb{Z}_{\geq 0}$, where r_e is called the release date and d_e is called the deadline of the maintenance job for edge e . An edge $e = \{u, v\} \in E$ that is maintained at time t , is not available at t in the graph G . We consider preemptive and non-preemptive maintenance jobs. If a job must be scheduled non-preemptively then, once it is started, it must run until completion without any interruption. If a job is allowed to be preempted, then its processing can be interrupted at any time and may resume at any later time without incurring extra cost.

A *schedule* S for G assigns the maintenance job of every edge $e \in E$ to a single time interval (if non-preemptive) or a set of disjoint time intervals (if preemptive) $S(e) := \{[a_1, b_1], \dots, [a_k, b_k]\}$ with

$$r_e \leq a_i \leq b_i \leq d_e, \text{ for } i \in [k] \text{ and } \sum_{[a,b] \in S(e)} (b - a) = p_e.$$

If not specified differently, we define $T := \max_{e \in E} d_e$ as our *time horizon*. We do not limit the number of simultaneously maintained edges.

For a given maintenance schedule, we say that the network G is *disconnected at time t* if there is no path from s^+ to s^- in G at time t , otherwise we call the network G *connected at time t* . The goal is to find a maintenance schedule for the network G so that the total time where G is disconnected is minimized (MINCONNECTIVITY). We also study the maximization variant of the problem, in which we want to find a schedule that maximizes the total time where G is connected (MAXCONNECTIVITY).

Our Results. For *preemptive* maintenance jobs, we show that we can solve both problems, MAXCONNECTIVITY and MINCONNECTIVITY, efficiently in arbitrary networks (Theorem 1). This result crucially requires that we are free to preempt jobs at arbitrary points in time. Under the restriction that we can *preempt* jobs only at *integral points in time*, the problem becomes NP-hard. More specifically, MAXCONNECTIVITY does not admit a $(2 - \epsilon)$ -approximation algorithm for any $\epsilon > 0$ in this case, and MINCONNECTIVITY is inapproximable (Theorem 2), unless $P = NP$. By inapproximable, we mean that it is NP-complete to decide whether the optimal objective value is zero or positive, leading to unbounded approximation factors.

This is true even for unit-size jobs. This complexity result is interesting and may be surprising, as it is in contrast to results for standard scheduling problems, without an underlying network. Here, the restriction to integral preemption typically does not increase the problem complexity when all other input parameters are integral. However, the same question remains open in a related problem concerning the busy-time in scheduling, studied in [8, 7].

For *non-preemptive* instances, we establish that there is no $(c\sqrt[3]{|E|})$ -approximation algorithm for MAXCONNECTIVITY for some constant $c > 0$ and that MINCONNECTIVITY is inapproximable even on disjoint paths between two nodes s and t , unless $P = NP$ (Theorems 3,4). On the positive side, we provide an $(\ell + 1)$ -approximation algorithm for MAXCONNECTIVITY in general graphs (Theorem 6), where ℓ is the number of distinct latest start times (deadline minus processing time) for jobs.

We use the notion *power of preemption* to capture the benefit of allowing arbitrary job preemption. The power of preemption is a commonly used measure for the impact of preemption in scheduling [6, 10, 19, 20]. Other terms used in this context include *price of non-preemption* [9], *benefit of preemption* [18] and *gain of preemption* [12]. It is defined as the maximum ratio of the objective values of an optimal non-preemptive and an optimal preemptive solution. We show that the power of preemption is $\Theta(\log |E|)$ for MINCONNECTIVITY on a path (Theorem 7) and unbounded for MAXCONNECTIVITY on a path (Theorem 8). This is in contrast to other scheduling problems, where the power of preemption is constant, e. g. [10, 19].

On paths, we show that *mixed* instances, which have both preemptive and non-preemptive jobs, are weakly NP-hard (Theorem 9). This hardness result is of particular interest, as both purely non-preemptive and purely preemptive

instances can be solved efficiently on a path (see Theorem 1 and [14]). Furthermore, we give a simple 2-approximation algorithm for mixed instances of MINCONNECTIVITY (Theorem 10).

Related Work. The concept of combining scheduling with network problems has been considered by different communities lately. However, the specific problem of only maintaining connectivity over time between two designated nodes has not been studied to our knowledge. Boland et al. [2–4] study the combination of non-preemptive arc maintenance in a transport network, motivated by annual maintenance planning for the Hunter Valley Coal Chain [5]. Their goal is to schedule maintenance such that the maximum s - t -flow over time in the network with zero transit times is maximized. They show strong NP-hardness for their problem and describe various heuristics and IP based methods to address it. Also, they show in [3] that in their non-preemptive setting, if the input is integer, there is always an optimal solution that starts all jobs at integer time points. In [2], they consider a variant of their problem, where the number of concurrently performable maintenances is bounded by a constant.

Their model generalizes ours in two ways – it has capacities and the objective is to maximize the total flow value. As a consequence of this, their IP-based methods carry over to our setting, but these methods are of course not efficient. Their hardness results do not carry over, since they rely on the capacities and the different objective. However, our hardness results – in particular our approximation hardness results – carry over to their setting, illustrating why their IP-based models are a good approach for some of these problems.

Bley, Karch and D’Andreagiovanni [1] study how to upgrade a telecommunication network to a new technology employing a bounded number of technicians. Their goal is to minimize the total service disruption caused by downtimes. A major difference to our problem is that there is a set of given paths that shall be upgraded and a path can only be used if it is either completely upgraded or not upgraded. They give ILP-based approaches for solving this problem and show strong NP-hardness for a non-constant number of paths by reduction from the linear arrangement problem.

Nurre et al. [17] consider the problem of restoring arcs in a network after a major disruption, with restoration per time step being bounded by the available work force. Such network design problems over time have also been considered by Kalinowski, Matsypura and Savelsbergh [13].

In scheduling, minimizing the busy time refers to minimizing the amount of time for which a machine is used. Such problems have applications for instance in the context of energy management [16] or fiber management in optical networks [11]. They have been studied from the complexity and approximation point of view in [7, 11, 14, 16]. The problem of minimizing the busy time is equivalent to our problem in the case of a path, because there we have connectivity at a time point when no edge in the path is maintained, i. e., no machine is busy.

Thus, the results of Khandekar et al. [14] and Chang, Khuller and Mukherjee [7] have direct implications for us. They show that minimizing busy time can

be done efficiently for purely non-preemptive and purely preemptive instances, respectively.

2 Preemptive Scheduling

In this section, we consider problem instances where all maintenance jobs can be preempted.

Theorem 1. *Both MAXCONNECTIVITY and MINCONNECTIVITY with preemptive jobs can be solved optimally in polynomial time on arbitrary graphs.*

Proof. We establish a linear program (LP) for MAXCONNECTIVITY. Let $TP = \{0\} \cup \{r_e, d_e : e \in E\} = \{t_0, t_1, \dots, t_k\}$ be the set of all *relevant time points* with $t_0 < t_1 < \dots < t_k$. We define $I_i := [t_{i-1}, t_i]$ and $w_i := |I_i|$ to be the length of interval I_i for $i = 1, \dots, k$.

In our linear program we model connectivity during interval I_i by an (s^+, s^-) -flow $x^{(i)}$, $i \in \{1, \dots, k\}$. To do so, we add for every undirected edge $e = \{u, v\}$ two directed arcs (u, v) and (v, u) . Let A be the resulting arc set. With each edge/arc we associate a capacity variable $y_e^{(i)}$, which represents the fraction of availability of edge e in interval I_i . Hence, $1 - y_e^{(i)}$ gives the relative amount of time spent on the maintenance of edge e in I_i . Additionally, the variable f_i expresses the fraction of availability for interval I_i .

$$\max \sum_{i=1}^k w_i \cdot f_i \quad (1)$$

$$\text{s.t.} \quad \sum_{u:(v,u) \in A} x_{(v,u)}^{(i)} - \sum_{u:(u,v) \in A} x_{(u,v)}^{(i)} = \begin{cases} f_i & \forall i \in [k], v = s^+, \\ 0 & \forall i \in [k], v \in V \setminus \{s^+, s^-\}, \\ -f_i & \forall i \in [k], v = s^-, \end{cases} \quad (2)$$

$$\sum_{i:I_i \subseteq [r_e, d_e]} (1 - y_e^{(i)}) w_i \geq p_e \quad \forall e \in E, \quad (3)$$

$$x_{(u,v)}^{(i)}, x_{(v,u)}^{(i)} \leq y_{\{u,v\}}^{(i)} \quad \forall i \in [k], \{u, v\} \in E, \quad (4)$$

$$f_i \leq 1 \quad \forall i \in [k], \quad (5)$$

$$x_{(u,v)}^{(i)}, x_{(v,u)}^{(i)}, y_{\{u,v\}}^{(i)} \in [0, 1] \quad \forall i \in [k], \{u, v\} \in E. \quad (6)$$

Notice that the LP is polynomial in the input size, since $k \leq 2|E|$. We show in Lemma 1 that this LP is a relaxation of preemptive MAXCONNECTIVITY on general graphs and in Lemma 2 that any optimal solution to it can be turned into a feasible schedule with the same objective function value in polynomial time, which proves the claim for MAXCONNECTIVITY. For MINCONNECTIVITY, notice that any solution that maximizes the time in which s and t are connected also minimizes the time in which s and t are disconnected – thus, we can use the above LP there as well. \square

Next, we need to prove the two lemmas that we used in the proof of Theorem 1. We begin by showing that the LP is indeed a relaxation of our problem.

Lemma 1. *The given LP is a relaxation of preemptive MAXCONNECTIVITY on general graphs.*

Proof. Given a feasible maintenance schedule, consider an arbitrary interval I_i , $i \in \{1, \dots, k\}$, and let $[a_1^i, b_1^i] \dot{\cup} \dots \dot{\cup} [a_{m_i}^i, b_{m_i}^i] \subseteq I_i$ be all intervals where s^+ and s^- are connected in interval I_i . We set $f_i = \sum_{\ell=1}^{m_i} (b_\ell^i - a_\ell^i)/w_i \leq 1$ and set $y_e^{(i)} \in [0, 1]$ to the fraction of time where edge e is not maintained in interval I_i . Note that (3) is automatically fulfilled, since we consider a feasible schedule. It is left to construct a feasible flow $x^{(i)}$ for the fixed variables f_i and $y_e^{(i)}$ for all $i = 1, \dots, k$.

Whenever the given schedule admits connectivity we can send one unit of flow from s^+ to s^- along some directed path in G . Moreover, in intervals where the set of processed edges does not change we can use the same path for sending the flow. Let $[a, b] \subseteq I_i$ be an interval where the set of processed edges does not change and in which we have connectivity. Let \mathcal{C}_i be the collection of all such intervals in I_i . Then, we send a flow $x_{[a,b]}^{(i)}$ from s^+ to s^- along any path of total value $(b-a)/w_i$ using only arcs for which the corresponding edge is not processed in $[a, b]$. The flow $x^{(i)} = \sum_{[a,b] \in \mathcal{C}_i} x_{[a,b]}^{(i)}$, which is a sum of vectors, gives the desired flow. The constructed flow $x^{(i)}$ respects the flow conservation (2) and non-negativity constraints (6), uses no arc more than the corresponding $y_e^{(i)}$, since flow $x^{(i)}$ is driven by the schedule. \square

Lemma 2. *Any feasible LP solution can be turned into a feasible maintenance schedule at no loss in the objective function value in polynomial time.*

Proof. Let (x, y, f) be a feasible solution of the given LP. Let $\mathcal{P}^i := (P_1^i, \dots, P_{\lambda_i}^i)$ be a path decomposition [15] of the (s^+, s^-) -flow $x^{(i)}$ for an arbitrary interval $I_i := [a_i, b_i]$, $i \in \{1, \dots, k\}$, after deleting all flow from possible circulations. Furthermore, let $x(P_\ell^i)$ be the value of the (s^+, s^-) -flow $x^{(i)}$ sent along the directed path P_ℓ^i . For each arc $a \in A$ we have that $\sum_{\ell \in [\lambda_i]: a \in P_\ell^i} x(P_\ell^i) = x_a^{(i)}$ by the definition of \mathcal{P}^i . Hence, we get $\sum_{\ell \in [\lambda_i]} x(P_\ell^i) = f_i \leq 1$ by using (5). We now divide the interval I_i into disjoint subintervals to allocate connectivity time for each path in our path decomposition. More precisely, we do *not* maintain any arc (u, v) (resp. edge $\{u, v\}$) contained in P_ℓ^i , $\ell = 1, \dots, \lambda_i$, in the time interval

$$\left[a_i + \sum_{m=1}^{\ell-1} w_i \cdot x(P_m^i), a_i + \sum_{m=1}^{\ell} w_i \cdot x(P_m^i) \right] \text{ of length } w_i \cdot x(P_\ell^i). \quad (7)$$

Inequality (4) and $\sum_{\ell \in [\lambda_i]: a \in P_\ell^i} x(P_\ell^i) = x_a^{(i)}$ thereby ensure that by now the total time where edge e does not undergo maintenance in interval I_i equals at most $w_i \cdot y_e^{(i)}$ time units. By Inequality (3), we can thus distribute the processing time of the job for edge e among the remaining slots of all intervals I_i , $i = 1, \dots, k$.

For instance, we could greedily process the job for edge e as early as possible in available intervals. Note that arbitrary preemption of the processing is allowed. By construction, we have connectivity on path P_ℓ^i , $\ell = 1, \dots, \lambda_i$, for at least $w_i \cdot x(P_\ell^i)$ time units in interval I_i . Thus, the constructed schedule has total connectivity time of at least $\sum_{i=1}^k w_i \sum_{\ell=1}^{\lambda_i} x(P_\ell^i) = \sum_{i=1}^k w_i \cdot f_i$. Since the path decomposition can be computed in polynomial-time and the resulting number of paths is bounded by the number of edges [15], we can obtain the feasible schedule in polynomial-time. \square

For unit-size jobs we can simplify the given LP by restricting to the first $|E|$ slots within every interval I_i . This, in turn, allows to consider intervals of unit-size, i.e., we have $w_i = 1$ for all intervals I_i , which affects constraint (3). However, one can show that the constraint matrix of this LP is generally not totally unimodular. We illustrate the behaviour of the LP with the help of the following exemplary instance in Figure 1, in which all edges have unit-size jobs associated and the label of an edge e represents (r_e, d_e) . It is easy to verify that a schedule that preempts jobs only at integral time points, has maximum connectivity time of one. However, the following schedule with arbitrary preemption has connectivity time of two. We process $\{s^+, v_2\}$ in $[0, 0.5] \cup [1, 1.5]$, $\{s^+, v_3\}$ in $[0.5, 1] \cup [1.5, 2]$, $\{v_4, s^-\}$ in $[0, 0.5] \cup [1.5, 2]$, $\{v_5, s^-\}$ in $[0.5, 1.5]$, and the other edges are fixed by their time window. This instance shows that the integrality gap of the LP is at least two.

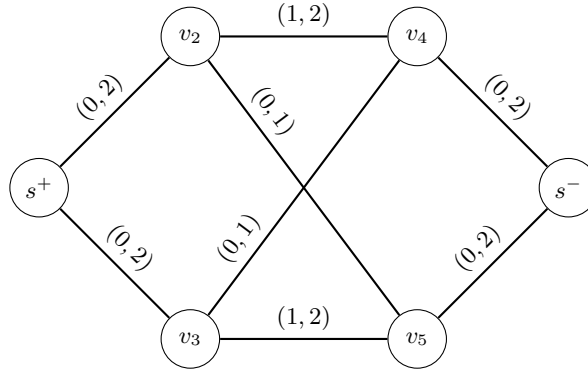

Fig. 1. Example for the difference between arbitrary preemption and preemption only at integral time points.

The statement of Theorem 1 crucially relies on the fact that we may preempt jobs arbitrarily. However, if preemption is only possible at integral time points, the problem becomes NP-hard even for unit-size jobs. This follows from the proof of Theorem 3 for $t_1 = 0$, $t_2 = 1$, and $T = 2$.

Theorem 2. MAXCONNECTIVITY with preemption only at integral time points is NP-hard and does not admit a $(2 - \epsilon)$ -approximation algorithm for any $\epsilon > 0$, unless $P = NP$. Furthermore, MINCONNECTIVITY with preemption only at integral time points is inapproximable.

3 Non-Preemptive Scheduling

We consider problem instances in which no job can be preempted. We show that there is no $(c\sqrt[3]{|E|})$ -approximation algorithm for MAXCONNECTIVITY for some $c > 0$. We also show that MINCONNECTIVITY is inapproximable, unless $P = NP$. Furthermore, we give an $(\ell + 1)$ -approximation algorithm, where $\ell := |\{d_e - p_e \mid e \in E\}|$ is the number of distinct latest start times for jobs.

To show the strong hardness of approximation for MAXCONNECTIVITY, we begin with a weaker result which provides us with a crucial gadget.

Theorem 3. Non-preemptive MAXCONNECTIVITY does not admit a $(2 - \epsilon)$ -approximation algorithm, for $\epsilon > 0$, and non-preemptive MINCONNECTIVITY is inapproximable, unless $P = NP$. This holds even for unit-size jobs.

Proof. We show that the existence of a $(2 - \epsilon)$ -approximation algorithm for non-preemptive MAXCONNECTIVITY allows to distinguish between YES- and NO-instances of 3SAT in polynomial time. Given an instance of 3SAT consisting of m clauses C_1, C_2, \dots, C_m each of exactly three variables in $X = \{x_1, x_2, \dots, x_n\}$, we construct the following instance of non-preemptive MAXCONNECTIVITY. We pick two arbitrary but distinct time points $t_1 + 1 \leq t_2$ and a polynomially bounded time horizon $T \geq t_2 + 1$. We construct our instance such that connectivity is impossible outside $[t_1, t_1 + 1]$ and $[t_2, t_2 + 1]$. For this, s^+ is followed by a path P from s^+ to a vertex s' composed of three edges that disconnect s^+ from s^- in the time intervals $[0, t_1]$, $[t_1 + 1, t_2]$, and $[t_2 + 1, T]$. These edges e have $p_e = d_e - r_e$. Furthermore, we construct the network such that the total connectivity time is greater than one if and only if the 3SAT-instance is a YES-instance. And we show that if the total connectivity time is greater than one, then there is a schedule with maximum total connectivity time of two. The high-level structure of the graph we will be creating can be found in Figure 2, with an expanded version following later in Figure 3.

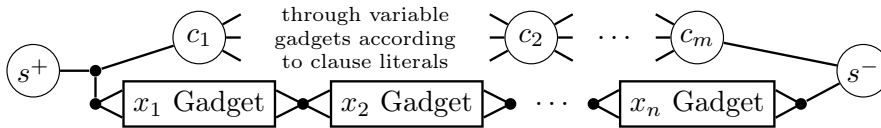

Fig. 2. High-level view of the construction for Theorem 3.

Let $Y(x_i)$ be the set of clauses containing the literal x_i and $Z(x_i)$ be the set of clauses containing the literal $\neg x_i$, and set $k_i = 2|Y(x_i)|$ and $\ell_i = 2|Z(x_i)|$. We define the following node sets

- $V_1 := \{y_i^1, \dots, y_i^{k_i} \mid i = 1, \dots, n\}$,
- $V_2 := \{z_i^1, \dots, z_i^{\ell_i} \mid i = 1, \dots, n\}$,
- $V_3 := \{c_r \mid r = 1, \dots, m+1\}$,
- $V_4 := \{v_i \mid i = 1, \dots, n+1\}$
- and set $V = \bigcup_{j=1}^4 V_j \cup \{v : v \in P\} \cup \{s^-\}$.

We introduce three edge types

- $\mathcal{E}_1 := \{e \in E : r_e = t_1, d_e = t_2 + 1, p_e = t_2 - t_1\}$,
- $\mathcal{E}_2 := \{e \in E : r_e = t_1, d_e = t_1 + 1, p_e = 1\}$,
- and $\mathcal{E}_3 := \{e \in E : r_e = t_2, d_e = t_2 + 1, p_e = 1\}$.

The graph $G = (V, E)$ consists of variable gadgets, shown in Figure 3, to which we connect the clause nodes c_r , $r = 1, \dots, m+1$. We define the following edge sets for the variable gadgets, namely,

- $E_1 := \{\{s', v_1\}, \{v_{n+1}, s^-\}\}$ of type \mathcal{E}_2 ,
- $E_2 := \{\{v_i, y_i^1\}, \{v_i, z_i^1\}, \{y_i^{k_i}, v_{i+1}\}, \{z_i^{\ell_i}, v_{i+1}\} : i = 1, \dots, n\}$ of type \mathcal{E}_2 ,
- $E_3 := \{\{y_i^q, y_i^{q+1}\} : i = 1, \dots, n; q = 1, 3, \dots, k_i - 3, k_i - 1\}$ of type \mathcal{E}_1 ,
- $E_4 := \{\{z_i^q, z_i^{q+1}\} : i = 1, \dots, n; q = 1, 3, \dots, \ell_i - 3, \ell_i - 1\}$ of type \mathcal{E}_1 ,
- $E_5 := \{\{y_i^q, y_i^{q+1}\} : i = 1, \dots, n; q = 2, 4, \dots, k_i - 4, k_i - 2\}$ of type \mathcal{E}_2 ,
- and $E_6 := \{\{z_i^q, z_i^{q+1}\} : i = 1, \dots, n; q = 2, 4, \dots, \ell_i - 4, \ell_i - 2\}$ of type \mathcal{E}_2 .

Notice that a variable x_i may only appear positive ($\ell_i = 0$) or only negative ($k_i = 0$) in our set of clauses. In this case, we also have an edge of type \mathcal{E}_2 connecting v_i and v_{i+1} besides the construction for the negative (z nodes) or positive part (y nodes). Finally, we add edges to connect the clause nodes to the graph. If some positive literal x_i appears in clause C_r and C_r is the q -th clause with positive x_i , we add the edges $\{c_r, y_i^{2q-1}\}$ and $\{y_i^{2q}, c_{r+1}\}$ both of type \mathcal{E}_3 . Conversely, if some x_i appears negated in C_r and C_r is the q -th clause with $\neg x_i$, we add the edges $\{c_r, z_i^{2q-1}\}$ and $\{z_i^{2q}, c_{r+1}\}$ both of type \mathcal{E}_3 . We also connect c_1 and c_{m+1} to the graph by adding $\{s', c_1\}$ and $\{c_{m+1}, s^-\}$ of type \mathcal{E}_3 . We define E to be the union of all introduced edges. Observe that the network G has $O(n+m)$ nodes and edges.

We call an (s^+, s^-) -path that contains no node from V_3 a *variable path* and an (s^+, s^-) -path with no node from V_4 a *clause path*. An (s^+, s^-) -path containing edges of type \mathcal{E}_2 and \mathcal{E}_3 does not connect s^+ with s^- in $[t_1, t_1+1]$ or in $[t_2, t_2+1]$. Therefore, all paths other than variable paths and relevant clause paths are irrelevant for the connectivity of s^+ with s^- .

When maintaining all edges of type \mathcal{E}_1 in $[t_1, t_2]$, we have connectivity in $[t_2, t_2+1]$ exactly on all variable paths. Conversely, maintaining all edges of type \mathcal{E}_1 in $[t_1+1, t_2+1]$ yields connectivity in $[t_1, t_1+1]$ exactly on all relevant clause paths. On the other hand, any clause path can connect s^+ with s^- only

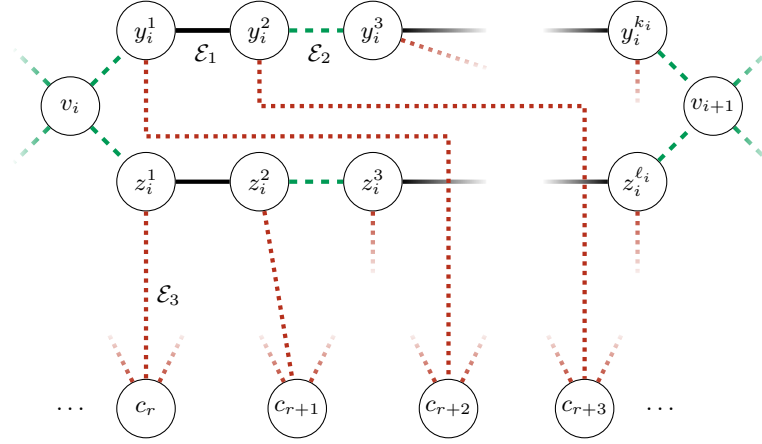

Fig. 3. Schematic representation of the gadget for variable x_i , which appears negated in clause C_r and positive in clause C_{r+2} among others.

in $[t_1, t_1 + 1]$ and any variable path only in $[t_2, t_2 + 1]$. We now claim that there is a schedule with total connectivity time greater than one if and only if the 3SAT-instance is a YES-instance.

Let S be a schedule with total connectivity time greater than one. Then there is a variable path P^v with positive connectivity time in $[t_2, t_2 + 1]$ and a clause path P^c with positive connectivity time in $[t_1, t_1 + 1]$. As the total connectivity time is greater than one, P^c cannot walk through both the positive part (y nodes) and the negative part (z nodes) of the gadget for any variable x_i . This allows to assume w.l.o.g. that P^v and P^c are disjoint between s' and s^- . Say P^v and P^c share an edge on the negative part (z nodes) of the gadget for variable x_i . Then we can redirect the variable path P^v to the positive part (y nodes) without decreasing the total connectivity time. The same works if they share an edge on the positive part.

Now set x_i to FALSE if P^v uses the nodes $y_i^1, \dots, y_i^{k_i}$, that is the upper part of the variable gadget, and to TRUE otherwise. With this setting, whenever P^c uses edges of a variable gadget, e.g. the sequence $c_r, z_i^{2q-1}, z_i^{2q}, c_{r+1}$ for some r, q , disjointness of P^v and P^c implies that clause C_r is satisfied with the truth assignment of variable x_i . Since every node pair c_r, c_{r+1} is only connected with paths passing through variable gadgets, and at least one of them belongs to P^c we conclude that every clause C_r is satisfied.

Consider a satisfying truth assignment. We define a schedule that admits a variable path P^v with connectivity in $[t_2, t_2 + 1]$. This path P^v uses the upper part (y_i -part) if x_i is set to FALSE and the lower part (z_i -part) if x_i is set to TRUE. That is, we maintain all edges of type \mathcal{E}_1 on the upper path (y_i -path) of the variable gadget for x_i in $[t_1, t_2]$ if x_i is FALSE and in $[t_1 + 1, t_2 + 1]$ if x_i is TRUE. Conversely, edges of type \mathcal{E}_1 on the lower path (z_i -path) of the variable gadget for x_i are maintained in $[t_1, t_2]$ if x_i is TRUE and in $[t_1 + 1, t_2 + 1]$ if

x_i is FALSE. This implies for the part of the gadget for x_i that is not used by P^v that the corresponding edges of type \mathcal{E}_1 are scheduled to allow connectivity during $[t_1, t_1 + 1]$. These edges can be used in a clause path to connect node c_r with c_{r+1} for some clauses C_r that is satisfied by the truth assignment of x_i . Since all clauses are satisfied by some variable x_i there exists a clause path P^c admitting connectivity in $[t_1, t_1 + 1]$. Therefore, the constructed schedule allows connectivity during both intervals $[t_1, t_1 + 1]$ and $[t_2, t_2 + 1]$.

To show the inapproximability of MINCONNECTIVITY, we reduce 3SAT to this problem. We construct an instance of MINCONNECTIVITY exactly the same way as we did above for MAXCONNECTIVITY and set $t_1 = 0$, $t_2 = 1$, and $T = 2$. By definition of the jobs, this results in a instance with only unit-sized jobs. As we discussed above, YES-instances of 3SAT result in a MAXCONNECTIVITY instance with an objective value of 2. For $T = 2$, that means we have connectivity at all time points, and therefore an objective value of 0 for MINCONNECTIVITY. NO-instances of 3SAT on the other result in MAXCONNECTIVITY instance with an objective value of 1 – for $T = 2$, this results in MINCONNECTIVITY objective value of 1 as well. Due to the gap between 1 and 0, any approximation algorithm that outputs a solution within a factor of the optimum solution needs to decide 3SAT. \square

We reuse the construction in the proof of Theorem 3 repeatedly to obtain the following improved lower bound.

Theorem 4. *Unless $P = NP$, there is no $(c\sqrt[3]{|E|})$ -approximation algorithm for non-preemptive MAXCONNECTIVITY, for some constant $c > 0$.*

Proof. We reuse the construction in the proof of Theorem 3 to construct a network that has maximum connectivity time n if the given 3SAT instance is a YES-instance and maximum connectivity time 1 otherwise. This implies that there cannot be an $(n - \epsilon)$ -approximation algorithm for non-preemptive MAXCONNECTIVITY, unless $P = NP$. Here, n is again the number of variables in the given 3SAT instance. Note that the construction in the proof of Theorem 3 has $\Theta(n)$ maintenance jobs and thus there exists a constant $c_1 > 0$ such that $|E| \leq c_1 \cdot n$. In this proof, we will introduce $\Theta(n^2)$ copies of the construction and thus $|E| \leq c_2 \cdot n^3$ for some $c_2 > 0$, which gives that $n \geq c_3 \sqrt[3]{|E|}$ for some $c_3 > 0$. This gives the statement.

For the construction, we use $n^2 - n$ copies of the 3SAT-network from the proof of Theorem 3, where each one uses different (t_1, t_2) -combinations with $t_1, t_2 \in \{0, \dots, n - 1\}$ and $t_1 \neq t_2$. We use these copies as 3SAT-gates and mutually connect them as depicted in Figure 4. Recall that for one such 3SAT-network we have the freedom of choosing the intervals $[t_1, t_1 + 1]$ and $[t_2, t_2 + 1]$, which are relevant for connectivity. This choice now differs for every 3SAT-gate.

Think of the construction as an $(n \times n)$ -matrix M with an empty diagonal. Entry (i, j) , $i, j \in \{0, \dots, n - 1\}$, in M corresponds to a 3SAT-gate in that variable paths only exist in time slot $[i, i + 1]$ and relevant clause paths exist only in $[j, j + 1]$. This is enforced by the edges of type \mathcal{E}_2 , which prevent variable paths in $[j, j + 1]$, and edges of type \mathcal{E}_3 , which prevent relevant clause paths in

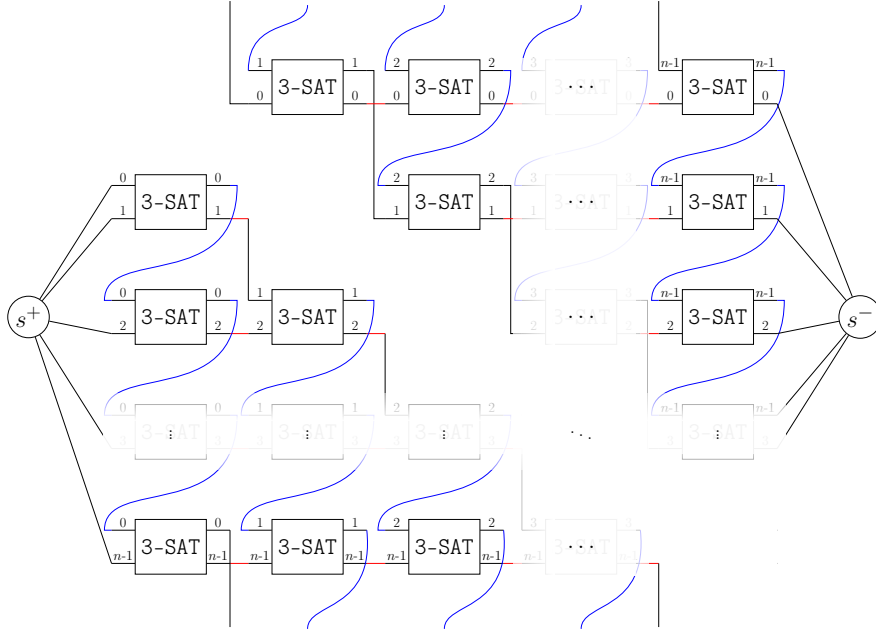

Fig. 4. Schematic representation of the network of 3SAT-gates.

$[i, i + 1]$. Edges between the s^+ -copy and s^- -copy of the 3SAT-gate(i, j) prevent connectivity outside of $[i, i + 1]$ and $[j, j + 1]$. Note that now $\mathcal{E}_1 := \{e \in E : r_e = i, d_e = j + 1, p_e = j - i\}$ if $i < j$, and $\mathcal{E}_1 := \{e \in E : r_e = j, d_e = i + 1, p_e = i - j\}$ if $i > j$.

The s^+ -copy of the 3SAT-gate(i, j) is connected to two paths, where one of them allows connectivity only during $[i, i + 1]$ and the other one only during $[j, j + 1]$. The same is done for the s^- -copy of the 3SAT-gate(i, j). In Figure 4, this is illustrated by labels on the paths. A label $i \in \{0, \dots, n - 1\}$ means, that this path allows connectivity only during $[i, i + 1]$. The upper path connected to a 3SAT-gate specifies the time slot, where variable paths may exist, and the lower path specifies the time slot, where relevant clause paths may exist. When following the path with label $k \in \{0, \dots, n - 1\}$, we pass the gadgets in column $j = 0, \dots, k - 1$ on the lower path having j on the upper path. In column k , we walk through all gadgets on the upper path and then we proceed with column $j = k + 1, \dots, n - 1$ on the lower path having j again on the upper path. Eventually, we connect the 3SAT-gate($n - 1, k$) to the vertex s^- .

Note that within 3SAT-gate(i, j) we have connectivity during $[i, i + 1]$ and $[j, j + 1]$ if and only if the corresponding 3SAT-instance is a YES-instance. Also notice that we can assume due to [3] that all jobs start at integral times, which allows us to ignore schedules with fractional job starting times and therefore fractional connectivity within a time interval $[i, i + 1]$. Now, if the 3SAT-instance is a YES-instance, there is a global schedule such that its restriction to every

$3SAT\text{-gate}(i, j)$ allows connectivity during both intervals. Thus for each label $k \in \{0, \dots, n-1\}$ there exists a path with this label that has connectivity during $[k, k+1]$. This implies that the maximum connectivity time is n .

Conversely, suppose there exists a global schedule with connectivity during $[i, i+1]$ and $[j, j+1]$ for some $i \neq j$. Then there must exist two paths P_1, P_2 from s^+ to s^- with two distinct labels i and j , each realizing connectivity during one of both intervals. By construction they walk through the $3SAT\text{-gate}(i, j)$. This implies by the proof of Theorem 3, that the global schedule restricted to this gate corresponds to a satisfying truth assignment for the $3SAT$ -instance. That is, the $3SAT$ -instance is a YES-instance. With the previous observation, it follows that an optimal schedule has maximum connectivity time of n . \square

The results above hold for general graph classes, but even for graphs as simple as disjoint paths between s and t , the problem remains strongly NP-hard.

Theorem 5. *Non-preemptive MAXCONNECTIVITY is strongly NP-hard, and non-preemptive MINCONNECTIVITY is inapproximable even if the given graph consists only of disjoint paths between s and t .*

Proof. We prove this result by reduction from the strongly NP-complete $3SAT$ problem.

$3SAT$

Input: Clauses C_1, \dots, C_m of exactly three variables in x_1, \dots, x_n .

Problem: Is there a truth assignment to the variables in x_1, \dots, x_n that satisfies all clauses?

We construct a network with $2n$ paths from s^+ to s^- , two for each variable of the $3SAT$ instance. Let P_i and \bar{P}_i denote the two paths for variable x_i . We will introduce several maintenance jobs for each path, understanding that each new job is associated with a different edge of the path. Since the ordering of these edges does not matter, we will directly associate each job with a path without explicitly specifying the respective edge of the job. The network will allow a schedule that maintains connectivity at all times if and only if the $3SAT$ instance is satisfiable.

For convenience, assume that $n \geq m$, otherwise we introduce additional dummy variables. We define a time horizon $T = 8n$ that we subdivide into five intervals $A = [0, 2n), B = [2n, 3n), C = [3n, 5n), D = [5n, 6n), E = [6n, 8n]$. We will use these intervals now when defining jobs.

Jobs representing variables. For each variable x_i , we define a job each on paths P_i and \bar{P}_i with the time window $[0, T]$ and processing time $3n$. We will ensure that neither job is scheduled to cover the time interval C entirely in any feasible schedule for the connectivity problem. This implies that a variable job either covers B or D without intersecting the other. The job on P_i (resp. \bar{P}_i) covering B will correspond to the literal x_i (resp. \bar{x}_i) being set to TRUE. We will of course ensure that not both literals can be set to TRUE simultaneously, but we will allow both to be FALSE, which simply means that the truth assignment remains satisfying, no matter how the variable is set.

Jobs needed to translate schedules into variable assignments. In the following, we introduce blocking jobs that all have a time window of unit length and unit processing time. In this way, introducing a blocking job at time t simply renders the corresponding path unusable during the time interval $[t, t+1)$. To ensure that the variable jobs for variable x_i do not cover C completely, we add a blocking job at time $t_i = 3n + 2(i - 1)$ to all paths except P_i and a blocking job at time $t'_i = 3n + 2(i - 1) + 1$ to all paths except \bar{P}_i . The first job forces the variable job for the literal x_i not to cover C completely, since otherwise connectedness is interrupted during the time interval $[t_i, t'_i)$. The second blocking job accomplishes the same for the literal \bar{x}_i . Note that the blocking jobs for each literal occupy a unique part of the time window C .

Jobs preventing variables from being 0 and 1 at the same time. In order to force at most one literal of each variable x_i to be set to TRUE, we introduce a blocking job at time $t''_i = 2n + (i - 1)$ on all paths except P_i and \bar{P}_i . These blocking jobs ensure that either path P_i or \bar{P}_i must be free during time $[t''_i, t''_i + 1)$, which means not both variable jobs may be scheduled to cover B (recall each variable job either covers B or D without intersecting the other). Again, the blocking jobs for each variable occupy a unique part of the time window B .

Jobs enforcing that at least one literal of each clause is true. For each clause C_j we introduce a blocking job at time $5n + j$ on each path except the three paths that correspond to literals in C_j . Figure 5 shows this construction for variable x_i and paths P_i, \bar{P}_i .

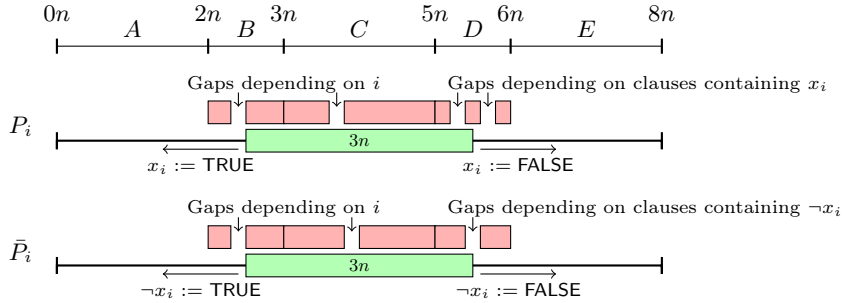

Fig. 5. The paths P_i, \bar{P}_i for variable x_i . The axis marks the times from 0 to $8n$.

These blocking jobs force that at least one of the literals of the clause has to be set to TRUE, i.e., be scheduled to overlap B instead of D , otherwise connectivity is interrupted during time $[5n + j, 5n + j + 1)$. Note again that the blocking jobs for each clause occupy a unique part of the time window D .

It is now easy to verify that each satisfying truth assignment leads to a feasible schedule without disconnectedness for the connectivity problem and vice versa.

We can use this instance construction for both MAXCONNECTIVITY and MINCONNECTIVITY. On the one hand, we have that YES-instances of 3SAT result in instances with a MAXCONNECTIVITY objective value of T and a MINCONNECTIVITY objective value of 0, and on the other hand we have that NO-instances of 3SAT result in instances with a MAXCONNECTIVITY objective value $< T$ and a MINCONNECTIVITY objective value > 0 . This gives us the strong NP-hardness for MAXCONNECTIVITY; for MINCONNECTIVITY, we get the inapproximability result since the optimal objective value is 0 here, similar to Theorem 3. \square

We give an algorithm that computes an $(\ell + 1)$ -approximation for non-preemptive MAXCONNECTIVITY, where $\ell \leq |E|$ is the number of different time points $d_e - p_e, e \in E$. The basic idea is that we consider a set of $\ell + 1$ feasible maintenance schedules, whose total time of connectivity upper bounds the maximum total connectivity time of a single schedule. Then the schedule with maximum connectivity time among our set of $\ell + 1$ schedules is an $(\ell + 1)$ -approximation.

The schedules we consider start every job either immediately at its release date, or at the latest possible time. In the latter case it finishes exactly at the deadline. More precisely, for a fixed time point t , we start the maintenance of all edges $e \in E$ with $d_e - p_e \geq t$ at their latest possible start time $d_e - p_e$. All other edges start maintenance at their release date r_e . This yields at most $\ell + 1 \leq |E| + 1$ different schedules S_t , as for increasing t , each time point where $d_e - p_e$ is passed for some edge e defines a new schedule. Algorithm 1 formally describes this procedure, where $E(t) := \{e \in E : e \text{ is not maintained at } t\}$.

Algorithm 1 Approx. Algorithm for Non-preemptive MAXCONNECTIVITY

- 1: Let $t_1 < \dots < t_\ell$ be all different time points $d_e - p_e, e \in E$, $t_0 = 0$ and $t_{\ell+1} = T$.
 - 2: Let S_i be the schedule, where all edges e with $d_e - p_e < t_i$ start maintenance at r_e and all other edges at $d_e - p_e, i = 1, \dots, \ell + 1$.
 - 3: For each S_i , initialize total connectivity time $c(t_i) \leftarrow 0, i = 1, \dots, \ell + 1$.
 - 4: **for** $i = 1$ to $\ell + 1$ **do**
 - 5: Partition the interval $[t_{i-1}, t_i]$ into subintervals such that each time point $r_e, r_e + p_e, d_e, e \in E$, in this interval defines a subinterval bound.
 - 6: **for all** subintervals $[a, b] \subseteq [t_{i-1}, t_i]$ **do**
 - 7: **if** $(V, E(1/2 \cdot (a + b)))$ contains an (s^+, s^-) -path for S_i **then**
 - 8: Increase $c(t_i)$ by $b - a$.
 - 9: **return** Schedule S_i for which $c(t_i), i = 1, \dots, \ell + 1$, is maximized.
-

Algorithm 1 considers finitely many intervals, as all (sub-)interval bounds are defined by a time point $r_e, r_e + p_e, d_e - p_e$ or d_e of some $e \in E$. As we can check the network for (s^+, s^-) -connectivity in polynomial time, and the algorithm does this for each (sub-)interval, Algorithm 1 runs in polynomial time.

Theorem 6. *Algorithm 1 is an $(\ell + 1)$ -approximation algorithm for non-preemptive MAXCONNECTIVITY on general graphs, with $\ell \leq |E|$ being the number of different time points $d_e - p_e, e \in E$.*

Proof. By construction, all schedules $S_i, i = 1, \dots, \ell + 1$, are feasible and the solution returned has a connectivity time of $\max_{i=1, \dots, \ell+1} c(t_i)$, with $c(t_i)$ being the connectivity time of schedule S_i .

The schedule $S_i, i = 1, \dots, \ell + 1$ is chosen in such a way that the connected time in the interval $[t_{i-1}, t_i]$ is maximized. To see this, we need to consider two types of jobs. First, all jobs on edges $e \in E$ with $d_e - p_e \geq t_i$ can be scheduled outside of $[t_{i-1}, t_i]$, which is definitely a correct choice in order to maximize the connectivity time in $[t_{i-1}, t_i]$. Second, for all edges $e \in E$ with $d_e - p_e < t_i$, we know due to the definition of t_{i-1} that $r_e \leq d_e - p_e \leq t_{i-1}$. Thus, scheduling these jobs at r_e guarantees the least reduction in connectivity time in $[t_{i-1}, t_i]$. More precisely, this scheduling disrupts connectivity in the interval $[t_{i-1}, r_e + p_e]$ if $t_{i-1} \leq r_e + p_e$, and otherwise not at all. However, all other feasible schedulings must also disrupt connectivity in this interval – scheduling the job earlier than r_e is not possible, and neither is scheduling the job later than $d_e - p_e \leq t_{i-1}$. Thus, schedule S_i has the maximal connectivity time in $[t_{i-1}, t_i]$.

Since the intervals $[t_{i-1}, t_i], i = 1, \dots, \ell + 1$ partition the complete time window $[0, T]$, this allows us to bound the value of the optimal solution OPT by

$$\text{OPT} \leq \sum_{i=1}^{\ell+1} c(t_i) \leq (\ell + 1) \max_{i=1, \dots, \ell+1} c(t_i) = (\ell + 1) \text{ALG} \quad (8)$$

with ALG being the value of a solution returned by Algorithm 1. This gives us an approximation guarantee of $\ell + 1$ and completes our proof. \square

4 Power of Preemption

We first focus on MINCONNECTIVITY on a path and analyze how much we can gain by allowing preemption. First, we show that there is an algorithm that computes a non-preemptive schedule whose value is bounded by $O(\log |E|)$ times the value of an optimal preemptive schedule. Second, we argue that one cannot gain more than a factor of $\Omega(\log |E|)$ by allowing preemption.

Theorem 7. *The power of preemption is $\Theta(\log |E|)$ for MINCONNECTIVITY on a path.*

Proof. Observe that if at least one edge of a path is maintained at time t , then the whole path is disconnected at t . We give an algorithm for MINCONNECTIVITY on a path that constructs a non-preemptive schedule with cost at most $O(\log |E|)$ times the cost of an optimal preemptive schedule.

We first compute an optimal preemptive schedule. This can be done in polynomial time by Theorem 1. Let x_t be a variable that is 1 if there exists a job j that is processed at time t and 0 otherwise. We shall refer to x also as the *maintenance profile*. Furthermore, let $a := \int_0^T x_t dt$ be the active time, i.e., the total time of maintenance. Then we apply the following *splitting procedure*. We compute the time point \bar{t} where half of the maintenance is done, i.e., $\int_0^{\bar{t}} x_t dt = a/2$. Let $E(t) := \{e \in E \mid r_e \leq t \wedge d_e \geq t\}$ and $p_{\max} := \max_{e \in E(t)} p_e$. We reserve the

interval $[\bar{t} - p_{\max}, \bar{t} + p_{\max}]$ for the maintenance of the jobs in $E(\bar{t})$, although we might not need the whole interval. We schedule each job in $E(\bar{t})$ around \bar{t} so that the processing time before and after \bar{t} is the same. If the release date (deadline) of a jobs does not allow this, then we start (complete) the job at its release date (deadline). Then we mark the jobs in $E(\bar{t})$ as scheduled and delete them from the preemptive schedule.

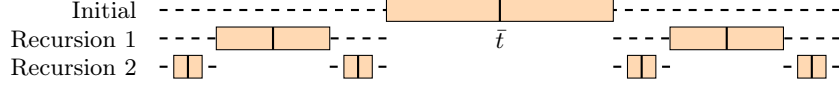

Fig. 6. A sketch of the splitting procedure and the reserved intervals.

This splitting procedure splits the whole problem into two separate instances $E_1 := \{e \in E \mid d_e < \bar{t}\}$ and $E_2 := \{e \in E \mid r_e > \bar{t}\}$. Note that in each of these sub-instances the total active time in the preemptive schedule is at most $a/2$. We apply the splitting procedure to both sub-instances and follow the recursive structure of the splitting procedure until all jobs are scheduled. \square

Lemma 3. *For MINCONNECTIVITY on a path, the given algorithm constructs a non-preemptive schedule with cost $O(\log |E|)$ times the cost of an optimal preemptive schedule.*

Proof. The progression of the algorithm can be described by a binary tree in which a node corresponds to a partial schedule generated by the splitting procedure for a subset of the job and edge set E . The root node corresponds to the partial schedule for $E(\bar{t})$ and the (possibly) two children of the root correspond to the partial schedules generated by the splitting procedure for the two subproblems with initial job sets E_1 and E_2 . We can cut a branch if the initial set of jobs is empty in the corresponding subproblem. We associate with every node v of this tree B two values (s_v, a_v) where s_v is the number of scheduled jobs in the subproblem corresponding to v and a_v is the amount of maintenance time spent for the scheduled jobs.

The binary tree B has the following properties. First, $s_v \geq 1$ holds for all $v \in B$, because the preemptive schedule processes some job at the midpoint \bar{t}_v which means that there must be a job $e \in E$ with $r_e \leq \bar{t}_v \wedge d_e \geq \bar{t}_v$. This observation implies that the tree B can have at most $|E|$ nodes and since we want to bound the worst total cost we can assume w.l.o.g. that B has exactly $|E|$ nodes. Second, $\sum_{v \in B} a_v = \int_0^T y_t dt$ where y_t is the maintenance profile of the non-preemptive solution.

The cost a_v of the root node (level-0 node) is bounded by $2p_{\max} \leq 2a$. The cost of each level-1 node is bounded by $2 \cdot a/2 = a$, so the total cost on level 1 is also at most $2a$. It is easy to verify that this is invariant, i.e., the total cost at level i is at most $2a$ for all $i \geq 0$, since the worst node cost a_v halves from level i to level $i + 1$, but the number of nodes doubles in the worst case. We obtain

the worst total cost when B is a complete balanced binary tree. This tree has at most $O(\log |E|)$ levels and therefore the worst total cost is $a \cdot O(\log |E|)$. The total cost of the preemptive schedule is a . \square

We now provide a matching lower bound for the power of preemption on a path.

Lemma 4. *The power of non-preemption is $\Omega(\log |E|)$ for MINCONNECTIVITY on a path.*

Proof. We construct a path with $|E|$ edges and divide the $|E|$ jobs into ℓ levels such that level i contains exactly i jobs for $1 \leq i \leq \ell$. Hence, we have $|E| = \ell(\ell + 1)/2$ jobs. Let P be a sufficiently large integer such that all of the following numbers are integers. Let the j th job of level i have release date $(j - 1)P/i$, deadline $(j/i)P$, and processing time P/i , where $1 \leq j \leq i$. Note that now no job has flexibility within its time window, and thus the value of the resulting schedule is P .

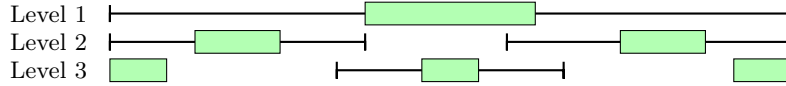

Fig. 7. A rough sketch of the instance for 3 levels.

We now modify the instance as follows. At every time point t where at least one job has a release date and another job has a deadline, we stretch the time horizon by inserting a gap of size P . This stretching at time t can be done by adding a value of P to all time points after the time point t , and also adding a value of P to all release dates at time t . The deadlines up to time t remain the same. Observe that the value of the optimal preemptive schedule is still P , because when introducing the gaps we can move the initial schedule accordingly such that we do not maintain any job within the gaps of size P . Figure 7 shows a rough sketch of this construction.

We now consider the optimal non-preemptive schedule. The cost of scheduling the only job at level 1 is P . In parallel to this job we can schedule at most one job from each other level, without having additional cost. This is guaranteed by the introduced gaps. At level 2 we can fix the remaining job with additional cost $P/2$. As before, in parallel to this fixed job, we can schedule at most one job from each level i where $3 \leq i \leq \ell$. Applying the same argument to the next levels, we notice that for each level i we introduce an additional cost of value P/i . Thus the total cost is at least $\sum_{i=1}^{\ell} P/i \in \Omega(P \log \ell)$ with $\ell \in \Theta(\sqrt{|E|})$. \square

Next, we show that for MAXCONNECTIVITY, the power of preemption can be unbounded.

Theorem 8. *For non-preemptive MAXCONNECTIVITY on a path the power of preemption is unbounded.*

Proof. Consider a path of four consecutive edges $e_1 = \{s^+, u\}$, $e_2 = \{u, w\}$, $e_3 = \{w, v\}$, $e_4 = \{v, s^-\}$, each associated with a maintenance job as depicted in Figure 8. That is, $r_1 = r_2 = 0, d_1 = r_3 = p_1 = p_4 = 1, p_2 = p_3 = 2, r_4 = d_2 = 3, d_3 = d_4 = 4$.

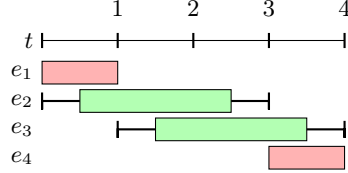

Fig. 8. Example for an unbounded power of preemption.

There is no non-preemptive schedule that allows connectivity at any point in time, as the maintenance job of edge e_i blocks edge e_i in time slot $[i - 1, i]$. On the other hand, when allowing preemptive schedules, we can process the job of edge e_2 in $[0, 2]$ and the job of edge e_3 in $[1, 2]$ and $[3, 4]$. Then no maintenance job is scheduled in the time interval $[2, 3]$ and therefore we have connectivity for one unit of time. \square

5 Mixed Scheduling

We know that both the non-preemptive and preemptive MAXCONNECTIVITY and MINCONNECTIVITY on a path are solvable in polynomial time by Theorem 1 and [14, Theorem 9], respectively. Notice that the parameter g in [14] is in our setting ∞ . Interestingly, the complexity changes when mixing the two job types – even on a simple path.

Theorem 9. MAXCONNECTIVITY and MINCONNECTIVITY with preemptive and non-preemptive maintenance jobs is weakly NP-hard, even on a path.

Proof. We reduce the NP-hard PARTITION problem to MAXCONNECTIVITY. We will show that there is a gap in the objective value between instances derived from YES- and NO-instances of PARTITION, respectively. This gap is same for MINCONNECTIVITY, since maximizing the time in which we have connectivity is the same as minimizing the time in which we do not have connectivity.

PARTITION

Input: A set of n natural numbers $A = \{a_1, \dots, a_n\} \subset \mathbb{N}$ with $\sum_{i=1}^n a_i = 2B$ for some $B \in \mathbb{N}$.

Problem: Is there a subset $S \subseteq A$ with $\sum_{a \in S} a = B$?

Given an instance of PARTITION, we create a MAXCONNECTIVITY instance based on a path consisting of $3n + 2$ edges between s^+ and s^- with preemptive

and non-preemptive maintenance jobs. We create three types of job sets denoted as J_1, J_2 and J_3 , where the first two job sets model the binary decision involved in choosing a subset of numbers to form a partition, whereas the third job set performs the summation over the numbers picked for a partition. The high-level idea is depicted in Figure 9.

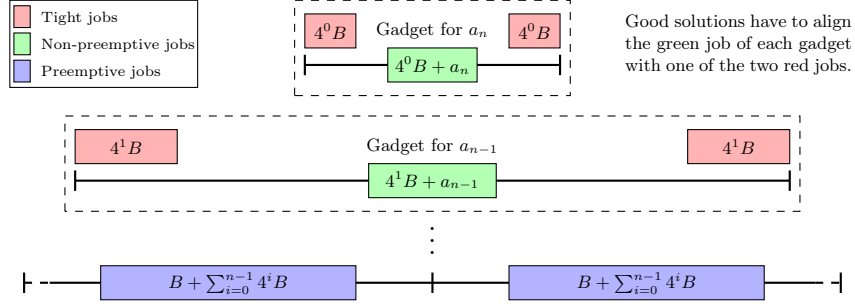

Fig. 9. Instance created from a PARTITION instance a_1, \dots, a_n, B . The number inside the blocks are the processing times of the jobs.

The job set $J_1 := \{1, 2, \dots, 2n - 1, 2n\}$ contains $2n$ *tight* jobs, i.e., $r_j + p_j = d_j$ for all $j \in J_1$. For every element $a_i \in A$ we have two tight jobs i and $2n - (i - 1)$ both having processing time $4^{n-i} B =: x_i$. The release date of a job $j \in \{2, \dots, n\} \subset J_1$ is $r_j = \sum_{k=1}^{j-1} 2x_k + a_k$ and $r_1 = 0$. Let $\tau := \sum_{k=1}^n 2x_k + a_k$. For $j \in \{n + 1, \dots, 2n\} \subset J_1$ we have $d_j = \tau + \sum_{k=n+1}^j 2x_{2n-k+1} + a_{2n-k+1}$. Note that the tight jobs in J_1 are constructed in such a way that everything is symmetric with respect to the time point τ .

The job set $J_2 := \{2n + 1, \dots, 3n\}$ contains n non-preemptive jobs. Let $j_i := 2n + i$. For every element $a_i \in A$ we introduce job j_i with processing time $p_{j_i} = x_i + a_i$, release date $r_{j_i} = r_i$, and deadline $d_{j_i} = d_{2n-(i-1)}$. Again, everything is symmetric with respect to time point τ .

Finally, the set $J_3 := \{3n + 1, 3n + 2\}$ contains two preemptive jobs, where each of them has processing time $W := B + \sum_{i=1}^n x_i$. Furthermore, we have $r_{3n+1} = 0$, $d_{3n+1} = \tau$, $r_{3n+2} = \tau$, $d_{3n+2} = 2\tau$.

We now show that there is a feasible schedule for the constructed instance that disconnects the path for at most $2W$ time units if and only if the given PARTITION instance is a YES-instance.

Suppose there is a subset $S \subseteq A$ with $\sum_{a \in S} a = B$. For each $a_i \in S$, we start the corresponding job $j_i \in J_2$ at its release date and the remaining jobs in J_2 corresponding to the elements $a_i \in A \setminus S$ are scheduled such that they complete at their deadline. This creates $B + \sum_{i=1}^n x_i$ time slots in both intervals $[0, \tau]$ and $[\tau, 2\tau]$ with no connection between s^+ and s^- . The jobs $3n + 1$ and $3n + 2$ can be preempted in $[0, \tau]$ and $[\tau, 2\tau]$, respectively, and thus if we align their processing

with the chosen maintenance slots, we get a schedule that disconnects s^+ and s^- for $2W = 2(B + \sum_{i=1}^n x_i)$ time units.

Conversely, suppose that there is a feasible schedule for the constructed instance that disconnects the path for at most $2W$ time units. By induction on i , we show that every job $j_i = 2n + i$ either starts at its release date or it completes at its deadline in such a schedule.

Consider the base case of $i = 1$. We first observe that w.l.o.g. job j_1 either starts at its release date or completes at its deadline or is scheduled somewhere in $[x_1, 2\tau - x_1]$. Suppose it starts somewhere in $(0, x_1)$ or completes somewhere in $(\tau - x_1, \tau)$. Then we do not increase the total time where the path is disconnected if we push job j_1 completely to the left or completely to the right. If we schedule job j_1 in $[x_1, 2\tau - x_1]$, then the total time where the path is disconnected is at least $3x_1 + a_1 > 2x_1 + x_1$. We will now show that $x_1 \geq 2(B + \sum_{k=2}^n x_k)$ for $n \geq 2$, which shows that the path is then disconnected for more than $2W$ time units, and thus job j_1 cannot be processed in $[x_1, 2\tau - x_1]$. The inequality is true for $n \geq 2$, since

$$\begin{aligned} 2B + 2 \sum_{k=2}^n x_k &= 2B(1 + \sum_{k=2}^n 4^{n-k}) \\ &= 2B(1 + \sum_{k=0}^{n-2} 4^k) \\ &= 2B(1 + 1/3(4^{n-1} - 1)) \\ &\leq 4^{n-1}B = x_1. \end{aligned}$$

This finishes the proof for $i = 1$.

Suppose, the statement is true for $i = 1, \dots, \ell - 1$ with $\ell \in \{2, \dots, n - 1\}$. As in the base case, we can show that job j_ℓ either starts at its release date or completes at its deadline or is scheduled somewhere in $[r_{j_\ell} + x_\ell, d_{j_\ell} - x_\ell]$. If job j_ℓ is processed in $[r_{j_\ell} + x_\ell, d_{j_\ell} - x_\ell]$, then the total time where the path is disconnected is at least

$$\sum_{k=1}^{\ell-1} (2x_k + a_k) + 3x_\ell + a_\ell > \sum_{k=1}^{\ell} 2x_k + x_\ell.$$

Again, we will show that $x_\ell \geq 2(B + \sum_{k=\ell+1}^n x_k)$ for $\ell \in \{2, \dots, n - 1\}$, which shows that the path is then disconnected for more than $2W$ time units, and thus job j_ℓ cannot be processed in $[r_{j_\ell} + x_\ell, d_{j_\ell} - x_\ell]$. The inequality is true for

$\ell \in \{2, \dots, n-1\}$, since

$$\begin{aligned}
2B + 2 \sum_{k=\ell+1}^n x_k &= 2B(1 + \sum_{k=\ell+1}^n 4^{n-k}) \\
&= 2B(1 + \sum_{k=0}^{n-\ell-1} 4^k) \\
&= 2B(1 + 1/3(4^{n-\ell} - 1)) \\
&\leq 4^{n-\ell} B = x_\ell.
\end{aligned}$$

For $i = n$, we again use the fact that j_n either starts at its release date or completes at its deadline or is scheduled somewhere in $[r_{j_n} + x_n, d_{j_n} - x_n]$. If the latter case is true, then the total time where the path is disconnected is at least

$$\begin{aligned}
\sum_{k=1}^{n-1} (2x_k + a_k) + 3x_n + a_n &= \sum_{k=1}^n (2x_k + a_k) + x_n \\
&> 2(B + \sum_{k=1}^n x_k) = 2W.
\end{aligned}$$

There is a feasible schedule for the constructed instance that disconnects the path for at most $2(B + \sum_{k=1}^n x_k)$ time units. This means that in both $[0, \tau]$ and $[\tau, 2\tau]$ the path is disconnected for exactly $B + \sum_{k=1}^n x_k$ time units. Consider the set $S := \{i : j_i \text{ starts at its release date}\}$. We conclude that

$$\sum_{k=1}^n x_k + \sum_{k \in S} a_k = \sum_{k=1}^n x_k + \sum_{k \notin S} a_k = \sum_{k=1}^n x_k + B. \quad (9)$$

□

For MINCONNECTIVITY, running the optimal preemptive and non-preemptive algorithms on the respective job sets individually gives a 2-approximation.

Theorem 10. *There is a 2-approximation algorithm for MINCONNECTIVITY on a path with preemptive and non-preemptive maintenance jobs.*

Proof. Consider an optimal schedule S^* for the mixed instance and let $|S^*|$ be the total time of disconnectivity in S^* . Furthermore, let S_{np}^* (resp. S_p^*) be the restriction of S^* to only non-preemptive (resp. preemptive) jobs. Note that the schedule S_{np}^* (resp. S_p^*) is feasible for the corresponding non-preemptive (resp. preemptive) instance. We separate the preemptive from the non-preemptive jobs and obtain two separate instances. Solving them individually in polynomial time and combining the resulting two solutions S_{np} and S_p to a schedule S gives the claimed result, because $|S| \leq |S_{np}| + |S_p| \leq |S_{np}^*| + |S_p^*| \leq 2|S^*|$. □

6 Conclusion

Combining network flows with scheduling aspects is a very recent field of research. While there are solutions using IP based methods and heuristics, exact and approximation algorithms have not been considered extensively. We provide strong hardness results for connectivity problems, which is inherent to all forms of maintenance scheduling, and give algorithms for tractable cases.

In particular, the absence of $c\sqrt[3]{|E|}$ -approximation algorithms for some $c > 0$ for general graphs indicates that heuristics and IP-based methods [2–4] are a good way of approaching this problem. An interesting open question is whether the inapproximability results carry over to series-parallel graphs, as the network motivating [2–4] is series-parallel. Our results on the power of preemption as well as the efficient algorithm for preemptive instances show that allowing preemption is very desirable. Thus, it could be interesting to study models where preemption is allowed, but comes at a cost to make it more realistic.

On a path, our results have implications for minimizing busy time, as we want to minimize the number of times where some edge on the path is maintained. Here, an interesting open question is whether the 2-approximation for the mixed case can be improved, e.g. by finding a pseudo-polynomial algorithm, a better approximation ratio, or conversely, to show an inapproximability result for it.

Acknowledgements. We thank the anonymous reviewers for their helpful comments.

References

1. Bley, A., Karch, D., D’Andreagiovanni, F.: WDM fiber replacement scheduling. *Electronic Notes in Discrete Mathematics* 41, 189–196 (2013), <http://www.sciencedirect.com/science/article/pii/S1571065313000954>
2. Boland, N., Kalinowski, T., Kaur, S.: Scheduling arc shut downs in a network to maximize flow over time with a bounded number of jobs per time period. *Journal of Combinatorial Optimization* pp. 1–21 (2015), <http://dx.doi.org/10.1007/s10878-015-9910-x>
3. Boland, N., Kalinowski, T., Kaur, S.: Scheduling network maintenance jobs with release dates and deadlines to maximize total flow over time: Bounds and solution strategies. *Computers & Operations Research* 64, 113–129 (2015), <http://www.sciencedirect.com/science/article/pii/S0305054815001288>
4. Boland, N., Kalinowski, T., Waterer, H., Zheng, L.: Scheduling arc maintenance jobs in a network to maximize total flow over time. *Discrete Applied Mathematics* 163, 34–52 (2014), <http://dx.doi.org/10.1016/j.dam.2012.05.027>
5. Boland, N.L., Savelsbergh, M.W.P.: Optimizing the hunter valley coal chain. In: Gurnani, H., Mehrotra, A., Ray, S. (eds.) *Supply Chain Disruptions: Theory and Practice of Managing Risk*. pp. 275–302. Springer, London (2012), http://dx.doi.org/10.1007/978-0-85729-778-5_10
6. Canetti, R., Irani, S.: Bounding the power of preemption in randomized scheduling. *SIAM Journal on Computing* 27(4), 993–1015 (1998), <http://dx.doi.org/10.1137/S0097539795283292>

7. Chang, J., Khuller, S., Mukherjee, K.: LP rounding and combinatorial algorithms for minimizing active and busy time. In: Blelloch, G.E., Sanders, P. (eds.) Proc. of the 26th SPAA. pp. 118–127. ACM, New York (2014), <http://doi.acm.org/10.1145/2612669.2612689>
8. Chang, J., Khuller, S., Mukherjee, K.: Active and busy time minimization. In: Proc. of the 12th MAPSP. pp. 247–249 (2015), <http://feb.kuleuven.be/mapsp2015/Proceedings%20MAPSP%202015.pdf>
9. Cohen-Addad, V., Li, Z., Mathieu, C., Milis, I.: Energy-efficient algorithms for non-preemptive speed-scaling. In: Bampis, E., Svensson, O. (eds.) Proc. of the 12th WAOA. LNCS, vol. 8952, pp. 107–118. Springer International Publishing (2015), http://dx.doi.org/10.1007/978-3-319-18263-6_10
10. Correa, J.R., Skutella, M., Verschae, J.: The power of preemption on unrelated machines and applications to scheduling orders. *Mathematics of Operations Research* 37(2), 379–398 (2012), <http://dx.doi.org/10.1287/moor.1110.0520>
11. Flammini, M., Monaco, G., Moscardelli, L., Shachnai, H., Shalom, M., Tamir, T., Zaks, S.: Minimizing total busy time in parallel scheduling with application to optical networks. *Theoretical Computer Science* 411(40–42), 3553–3562 (2010), <http://www.sciencedirect.com/science/article/pii/S0304397510002926>
12. Ha, S.: Compile-time scheduling of dataflow program graphs with dynamic constructs. Ph.D. thesis, University of California, Berkeley (1992), <http://www.eecs.berkeley.edu/Pubs/TechRpts/1992/ERL-92-43.pdf>
13. Kalinowski, T., Matsypura, D., Savelsbergh, M.W.: Incremental network design with maximum flows. *European Journal of Oper. Res.* 242(1), 51–62 (2015), <http://www.sciencedirect.com/science/article/pii/S0377221714008078>
14. Khandekar, R., Schieber, B., Shachnai, H., Tamir, T.: Real-time scheduling to minimize machine busy times. *Journal of Scheduling* 18(6), 561–573 (2015), <http://dx.doi.org/10.1007/s10951-014-0411-z>
15. Korte, B., Vygen, J.: *Combinatorial Optimization: Theory and Algorithms*. Springer Publishing Company, Incorporated, 4th edn. (2007)
16. Mertzios, G.B., Shalom, M., Voloshin, A., Wong, P.W.H., Zaks, S.: Optimizing busy time on parallel machines. In: Proc. of the 26th IPDPS. pp. 238–248. IEEE (2012), <http://ieeexplore.ieee.org/xpl/articleDetails.jsp?arnumber=6267839>
17. Nurre, S.G., Cavdaroglu, B., Mitchell, J.E., Sharkey, T.C., Wallace, W.A.: Restoring infrastructure systems: An integrated network design and scheduling (INDS) problem. *European Journal of Operational Research* 223(3), 794–806 (2012), <http://www.sciencedirect.com/science/article/pii/S0377221712005310>
18. Parsons, E.W., Sevcik, K.C.: Multiprocessor scheduling for high-variability service time distributions. In: Feitelson, D.G., Rudolph, L. (eds.) Proc. of the JSSPP. LNCS, vol. 949, pp. 127–145. Springer Berlin Heidelberg (1995), http://link.springer.com/chapter/10.1007%2F3-540-60153-8_26
19. Schulz, A.S., Skutella, M.: Scheduling unrelated machines by randomized rounding. *SIAM Journal on Discrete Mathematics* 15(4), 450–469 (2002), <http://dx.doi.org/10.1137/S0895480199357078>
20. Soper, A.J., Strusevich, V.A.: Power of preemption on uniform parallel machines. In: Proc. of the 17th APPROX. LIPIcs, vol. 28, pp. 392–402. Schloss Dagstuhl–Leibniz-Zentrum fuer Informatik, Dagstuhl, Germany (2014), <http://drops.dagstuhl.de/opus/volltexte/2014/4711>