

Long-Distance and Low-Radiation Waveguide Antennas for Wireless Communication Systems inside Tunnels

*Shotaro Ishino, Satoshi Denno, Narumi Yashiro
and Seiichi Suzuki*

Abstract

Wireless LAN usage is also increasing at construction and civil engineering sites, and the efficiency of ICT construction has increased due to the use of tablet PCs and network cameras. When constructing a wireless LAN environment, for example, a LAN cable may be laid from outside the tunnel, and a number of wireless access points (APs) may be installed. However, it is not advantageous to use a large number of APs because the system price increases significantly. We consider using a long leaky-wave antenna to provide one AP. The reason for using a leaky-wave antenna is that, since the total tunnel length is on the order of km, it is necessary to reduce the power radiated by the antenna as much as possible to provide a functional communication area over a long distance. To reduce such transmission losses, we used a waveguide. A waveguide is a low-loss line and can function as a low-loss and low-radiation leaky-wave antenna which is suitable for long-distance communications; this is accomplished by combining a waveguide with a low-radiation antenna mechanism. In this chapter, we report the development of a waveguide-type leaky-wave antenna and the development of a wireless LAN environment in a tunnel.

Keywords: wireless communication, microwave, waveguide antenna, long distance, low radiation

1. Introduction

In recent years, wireless LANs have become widespread and are indispensable for convenient Internet use. Wireless LAN usage is also increasing at construction and civil engineering sites, and the efficiency of ICT construction has increased due to the use of tablet PCs and network cameras. Remote monitoring of worksite interiors contributes greatly to more rapid construction. This means that construction of wireless environments in the field is indispensable. Tunnel construction often takes place in the mountains. An LTE (4G) line may become disconnected but it cannot connect at all to the line in the tunnel.

This is because it is difficult to transmit radio waves from outside the tunnel to the inside. Radio waves are reflected and absorbed by thick soil and concrete walls, and this means that no external radio waves can be received inside the tunnel [1]. Therefore, it is common to lay a wired line from the outside of the tunnel and to construct a telephone line or other types of communication line in the tunnel. When constructing a wireless LAN environment, for example, a LAN cable may be laid from outside the tunnel and a number of wireless access points (APs) may be installed. However, working with a wired line is complicated, and there is a high risk of disconnection due to contact with building materials and construction equipment. Therefore, a high degree of robustness with fewer system failures is also required. Also, it is not advantageous to use a large number of APs because the system price increases significantly.

Therefore, we consider using a long leaky-wave antenna to provide one AP. The reason for using a leaky-wave antenna is that, since the total tunnel length is on the order of km, it is necessary to reduce the power radiated by the antenna as much as possible to provide a functional communication area over a long distance. The use of leaky coaxial cable (LCX) as a leaky-wave antenna has been studied [2–6]. As shown in **Figure 1**, a long-range communication area can be constructed by reradiating the output of the AP from a long LCX. However, in practice, the available power is attenuated in the cable due to transmission losses (mainly dielectric losses) of the LCX, so it is difficult to communicate over long distances.

To reduce such transmission losses, we used a waveguide [7]. A waveguide is a low-loss line and can function as a low-loss and low-radiation leaky-wave antenna which is suitable for long-distance communications; this is accomplished by combining a waveguide with a low-radiation antenna mechanism. In this paper, we report the development of a waveguide-type leaky-wave antenna and the development of a wireless LAN environment in a tunnel. We evaluated the system in the W56 band (5.5–5.7 GHz), as specified by IEEE 802.11 “a”, “n” and shown in **Figure 2**.

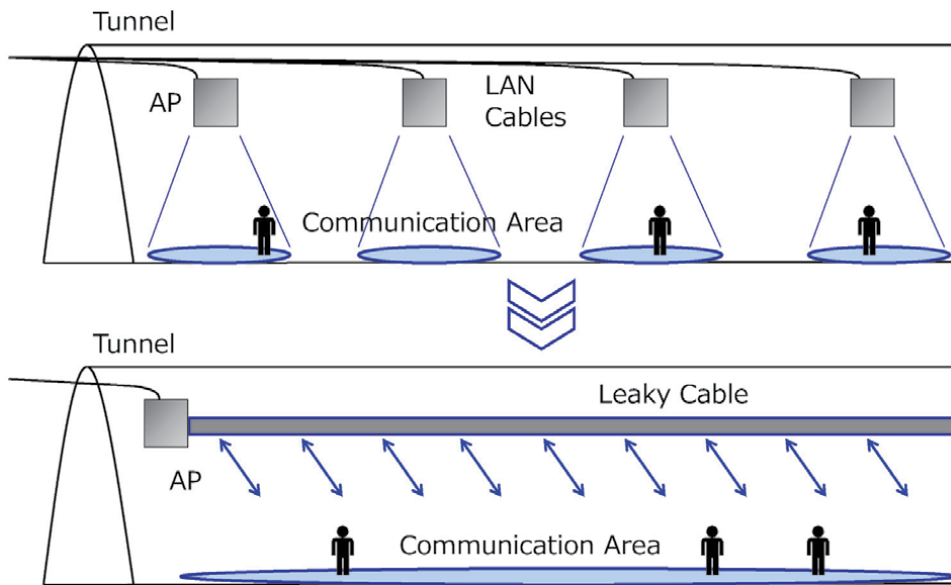

Figure 1. Wireless communication system using a leaky cable.

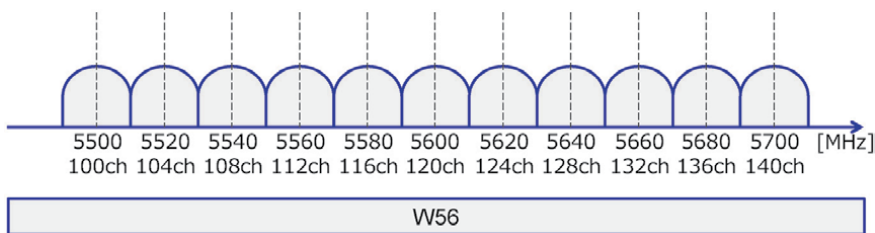

Figure 2.
 WLAN W56 band.

2. Overview of the waveguide antenna

A waveguide is a hollow metal tube and transmits radio waves using reflections within the tube. In particular, rectangular waveguides are used in various applications such as radar, microwave oven, and microwave feeds. Transmission losses are low even in a microwave band or in a millimeter-wave band, and waveguides are expected to be used as transmission lines for next-generation communications.

A waveguide has a rectangular cross section as shown in **Figure 3**, and radio waves are transmitted by reflecting between the two metal plates on both ends of the waveguide at an angle θ , as shown in **Figure 4**. **Figure 3** shows a waveguide

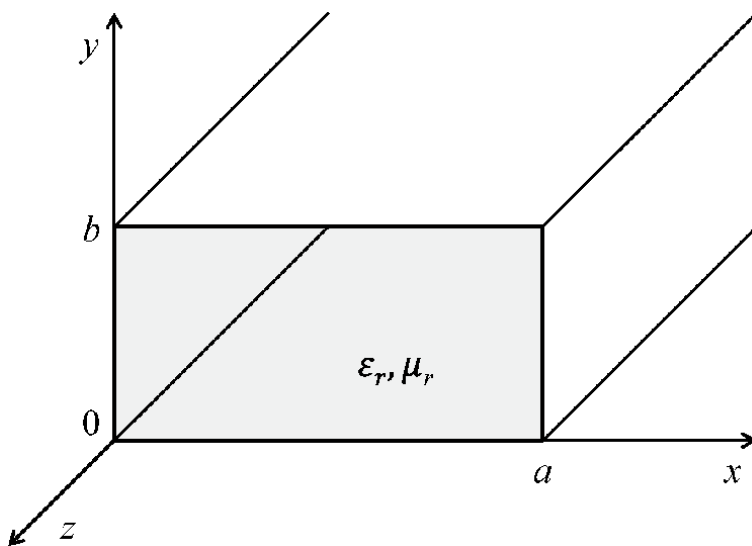

Figure 3.
 Rectangular waveguide.

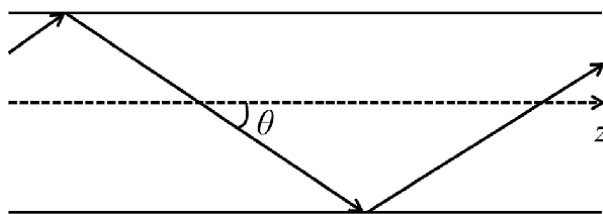

Figure 4.
 Microwaves transmitted while reflecting between two metal plates.

filled with a material and covered entirely with a conductor. The relative permittivity of the material is ϵ_r , the relative permeability is μ_r , and the cross-sectional dimension of the waveguide is $a \times b$.

Since the reflected waves at both ends are combined into one wave in the waveguide, the wave is transmitted within the waveguide at the guide wavelength λ_g . Also, as the frequency decreases, the angle θ increases, and the radio wave stops traveling back and forth between the metal plates on both ends when $\theta = 90^\circ$. The frequency at which this condition occurs is called the cutoff frequency f_c , and the free-space wavelength of f_c is called the cutoff wavelength λ_c . Eqs. 1–3 show these relationships.

$$\lambda_c = 2a \sqrt{\epsilon_r \mu_r} \quad (1)$$

$$f_c = \frac{3 \times 10^8}{\lambda_c} \quad (2)$$

$$\lambda_g = \frac{\lambda}{\cos \theta} = \frac{\lambda}{\sqrt{1 - \left(\frac{\lambda_0}{\lambda_c}\right)^2}} = \frac{\lambda}{\sqrt{1 - \left(\frac{f_c}{f}\right)^2}} \quad (3)$$

This paper deals with the TE_{10} mode, which is the most basic transmission mode. In this mode, the current and electric field shown in **Figure 5** flow through the waveguide. For this case, if a slot is provided that is orthogonal to the current direction, radiation is emitted from the slot, and a waveguide antenna is created.

A traveling-wave antenna is one that continuously emits energy by using a traveling wave; surface-wave antennas using a dielectric line and leaky-wave antennas using a waveguide or coaxial line are well known. As described above, a leaky coaxial cable (LCX) is utilized as a highly flexible traveling-wave antenna by creating a slot in the outer conductor. However, LCX is not suitable for long-distance applications due to its large dielectric losses in the 5 GHz band.

In the future, as the frequencies used shift to quasi-millimeter-wave or millimeter-wave communications, dielectric losses will increase. A waveguide is

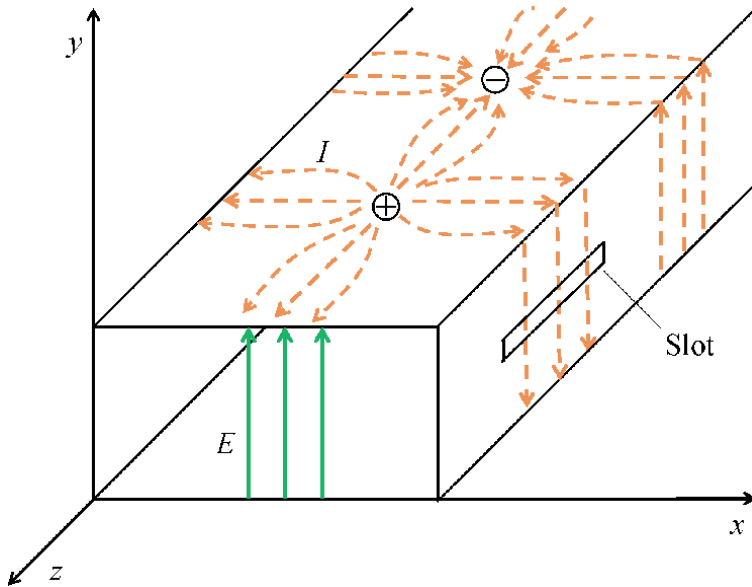

Figure 5. Current and electric field flowing in a TE_{10} mode waveguide and slot configuration.

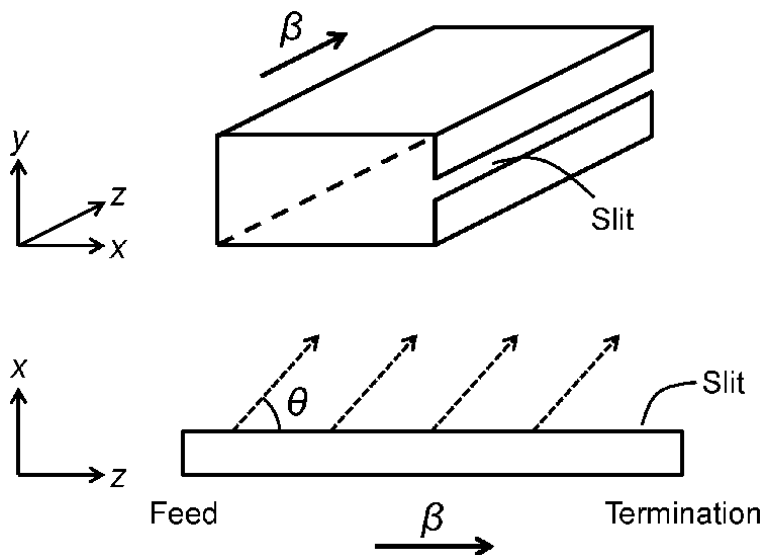

Figure 6.
 Structure of a traveling-wave leaky waveguide.

considered to be useful because it has no dielectric losses and has small overall transmission losses. **Figure 6** shows a general traveling-wave leaky waveguide (with a phase constant $\beta > 0$) [8, 9]. In the leaky waveguide, the main beam is formed and emitted in the direction θ_{rad} for which the phases are aligned (Eq. 4). Here, v_0 is the free-space propagation velocity and v_g is the pipe propagation velocity.

When a continuous slit is present, the amount of radiation power increases, and the remaining power in the waveguide decreases. To apply this method to the proposed tunnel system, it is necessary to not only reduce the transmission losses but to also reduce the radiation levels and to maintain power in the pipe over long distances.

$$\theta_{rad} \cong \tan^{-1} \left(\frac{v_g}{v_0} \right) \quad (4)$$

3. Dual-plate leaky waveguide

The traveling-wave type of leaky waveguide shown in **Figure 6** requires a slit that is continuous in the direction of tube length, and such fabrication may increase the cost. To obtain a waveguide that is significantly cheaper than LCX, we need to minimize the number of processing steps for the tube. Therefore, we consider creating a waveguide (**Figure 7**) with a slit mechanism that is constructed by combining two U-shaped plates (metal plates). Bending such metal plates does not require a mold and they are easy to manufacture [10].

In the present waveguide, a slight gap is created between the plates, and the thickness is adjusted by sandwiching a thin insulating sheet or similar material. When viewed in the cross-sectional view, the present waveguide has the structure shown in **Figure 8(a)**, which is equivalent to the structure shown in **Figure 8(b)**. As shown in **Figure 9**, the results from the analysis of the transmission characteristics, as shown in **Figure 8(a)** and **(b)**, are nearly the same.

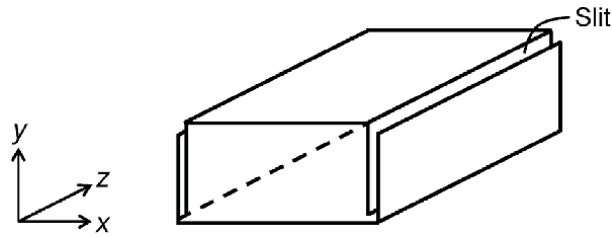

Figure 7.
Dual-plate leaky waveguide structure.

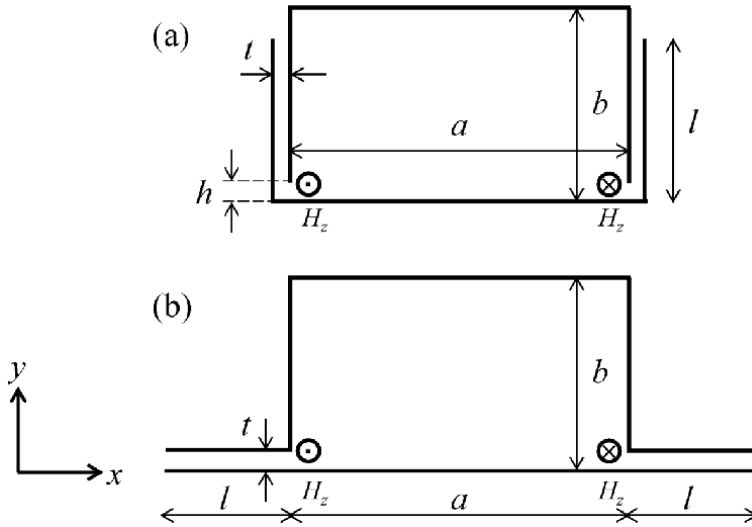

Figure 8.
(a) Cross section of leaky waveguide and (b) the equivalent cross section.

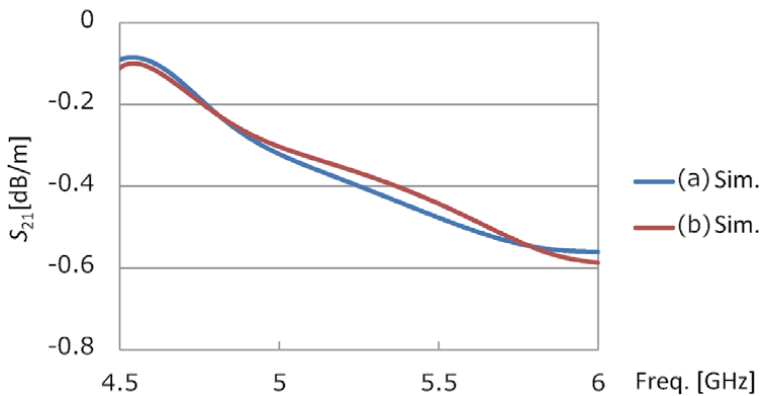

Figure 9.
(a, b) Analysis results of transmission characteristics.

Radiation is generated by the magnetic field which is generated in the opening of the waveguide. This is because the current flowing in the slit is determined by the H_z at that point where the slit entrance is short-circuited. However, since the direction of the magnetic field is reversed, the radiation level can be suppressed to a small value. When the slit length l is $\lambda/4$, the opening is short-circuited. Since the waveguide is a short-circuit boundary line, radiation theoretically does not occur.

Actually, since conductance is present in the opening, a short circuit does not occur but the radiation level is small.

When the impedance at the slit as viewed from inside the waveguide is low and when the slit height h in **Figure 8(a)** is sufficiently small, the TE_{10} mode is maintained. Since the slit satisfies the conditions of Eq. 5, only the TEM mode occurs. As t increases, the amount of radiation (and radiation resistance) increases because the magnetic current flowing to the surface when the slit entrance is short-circuited increases. **Table 1** shows the relevant design parameters.

The far-field radiation wave pattern and gain at 5.7 GHz of the designed waveguide were analyzed by simulation (Ansys HFSS). **Figures 10–12** show the results.

a	b	t	h	l	[mm]
40	20	0.05	0.05	20	

Table 1.
Design parameters.

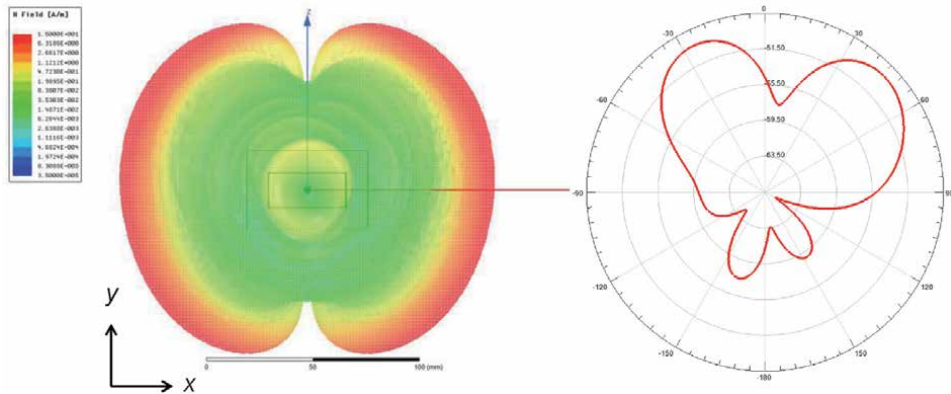

Figure 10.
Far-field radiation pattern and gain (x-y plane).

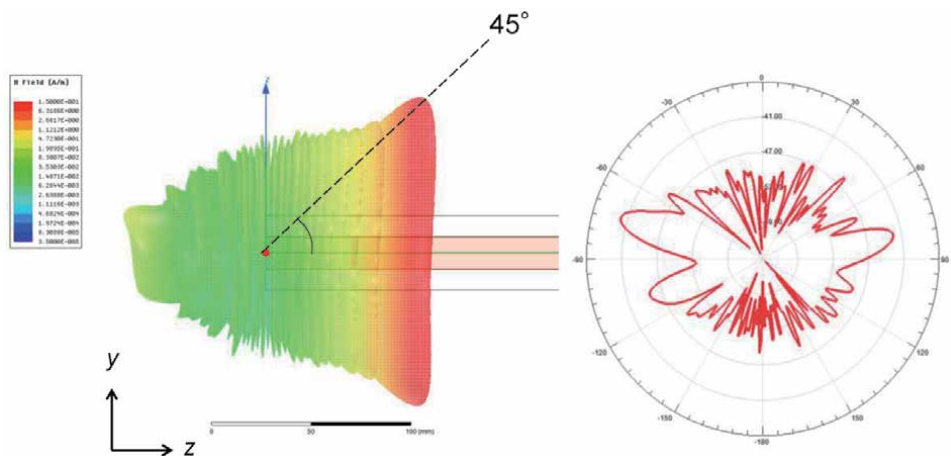

Figure 11.
Far-field radiation pattern and gain (y-z plane).

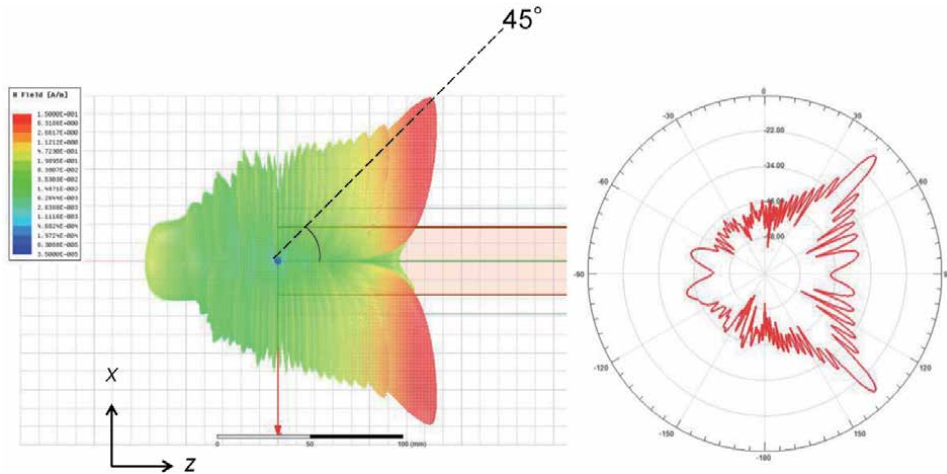

Figure 12.
Far-field radiation pattern and gain (z - x plane).

$$\frac{k}{k_c} = \frac{kt}{\pi} \ll 1 \quad (5)$$

The radiation directly above (on the y -axis) is canceled due to the phase inversion of the waves leaking from the left and right slits. It was also confirmed that the radiation was stronger at an angle of 45° with respect to the direction of propagation (e.g., z -axis direction). The maximum gain was -13.8 dBi. This is the property shown in **Figure 6**, and the radiation angle almost coincided with the calculated value. **Figure 13** shows the radiation state in the direction of propagation.

The waveguide must retain sufficient residual power over long distances. First, the conduction losses were examined. The conduction losses depend on the conductivity of the metal used for the waveguide, as shown in **Figure 14**. The waveguide discussed herein is made of aluminum, which has relatively good electrical conductivity; aluminum was used to manufacture the waveguide at a low cost. In addition, it is necessary to suppress the radiated power and reduce leakage. Therefore, whether the leakage can be reduced by adjusting the design parameters was examined. Here, it is assumed that there were no conductor losses.

First, the radiation loss when the slit height h is adjusted in the range of 0.05 – 0.5 mm is shown in **Figure 15** when t is set to 0.2 mm. In addition, to obtain the desired characteristics when the profile is decreased, the waveguide height was set to 10 mm without changing the waveguide width, and this case was evaluated. For this case, the slit length l was the same as b . It was found that h did not contribute to

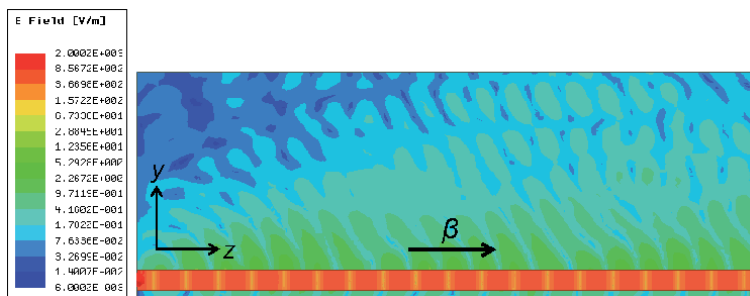

Figure 13.
Radiation in the direction of propagation (y - z plane).

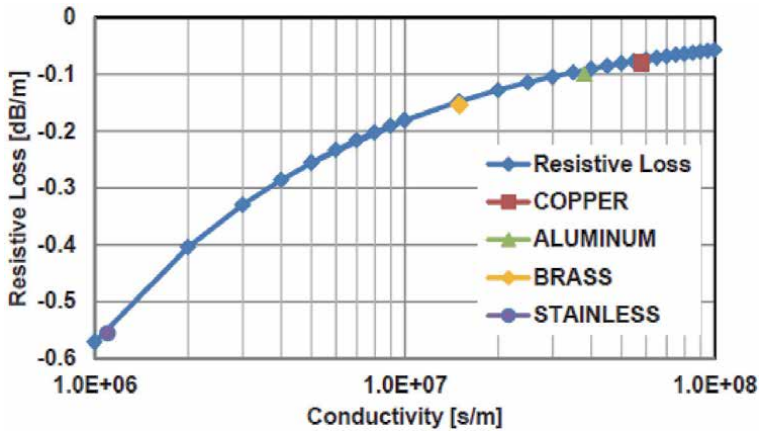

Figure 14.
 Relationship between metal types and conduction losses.

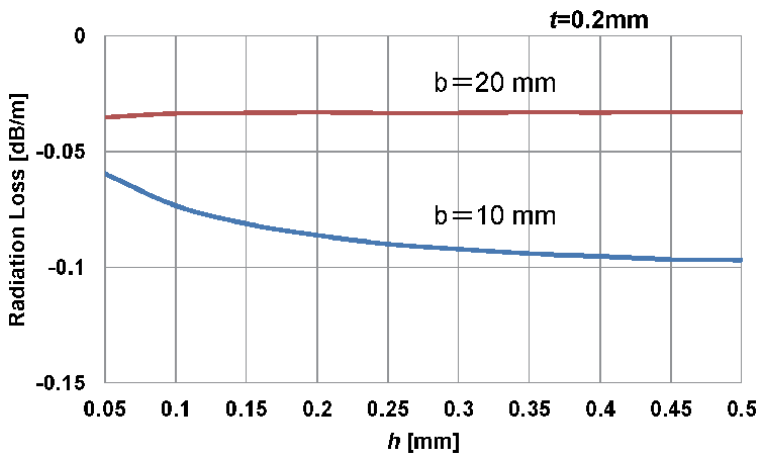

Figure 15.
 Relationship between slit height and radiation.

radiation losses in this range. If h is smaller than the height of the waveguide, it is presumed that the TE_{10} mode does not change and that the H_z in the waveguide does not change. Therefore, the current flowing through the slit does not change.

In addition, the radiation increases due to the lower attitude. This is because the current increases. Although the degree of freedom and convenience of installation are improved by decreasing the waveguide profile, it has been confirmed that there is a trade-off. Naturally, when the profile is lower, the conductor losses for the waveguide increase. In this study, we focused on the radiation characteristics, but we also need to consider conductor losses.

Next, the radiation losses when the slit width t is similarly adjusted in the range of 0.05–0.5 mm are shown in **Figure 16**, and h is set to 0.2 mm. It was determined that the radiated power increased as t increased. For the case of the low attitude, the slit length l was also set to the same value as b , but the radiation also increased.

Since the characteristic impedance at the slit varies with Δt , it is necessary to consider conductor losses.

Finally, **Figure 17** shows the radiation losses when the slit length l is adjusted in the range of 0.5–20.0 mm for the conditions shown in **Table 1**. As l increases, the radiated power decreases. However, the change is small in the region of

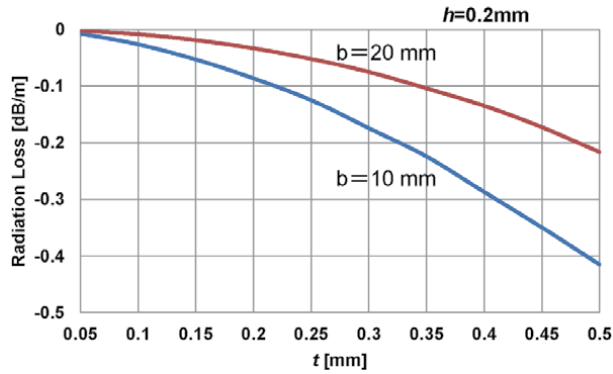

Figure 16.
Relationship between slit width and radiation.

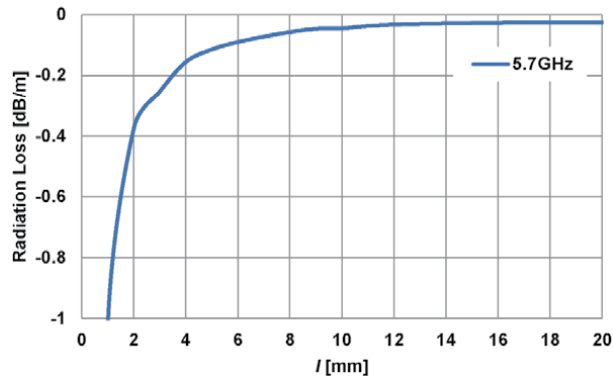

Figure 17.
Relationship between slit length and radiation.

$l > 12.0$ mm. If the open end of the slit is viewed as an ideal opening, when $l = \lambda/4$, the slit is short-circuited from inside the tube. This means that the slit can function as a leakage prevention structure.

However, t is small. It is necessary to consider that capacitance also exists between the slits. From these results, it is confirmed that, to obtain low-leakage characteristics, t should be shortened and $b \cong \lambda/4$, so it is sufficient to adjust $l \cong b$.

4. Evaluation of the communication experiment

The leaky waveguides were cascaded using joints. In this study, a non-leaky waveguide was used for the joints and the design was modified as shown in **Figure 18**. The insertion length of the leaky waveguide was 14 mm ($\cong \lambda/4$). As shown in **Figure 19**, when a 14 mm length is inserted, a short-circuit boundary is provided in the inserted portion, which means that leakage at the joint portion is reduced. In this experiment, a leaky waveguide of 1 m length was used, and the joints were placed by alternately combining them.

Figure 20 shows the configuration of the experiment. The access point (e.g., ACERA 850F, FURUNO) was connected to the leaky waveguide via a coaxial waveguide conversion connector, and the leaky wave from the waveguide was

received by the receiving antenna. At this point, the orientation of the receiving antenna from the waveguide was set as the x -axis, the antenna height direction was set as the y -axis, and the installed direction of the waveguide was set as the z -axis. The end of the waveguide was connected to a terminating resistor or to a spectrum analyzer via a connector.

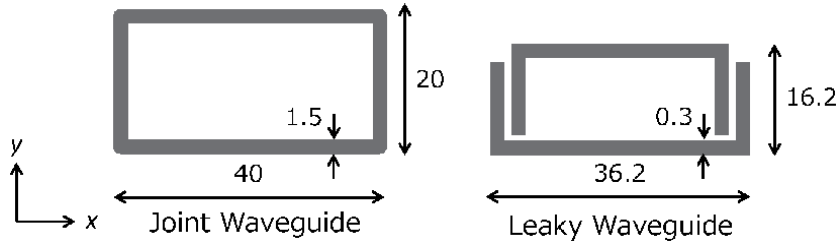

Figure 18.
 Cross-sectional dimensions of the joints and leaky waveguides.

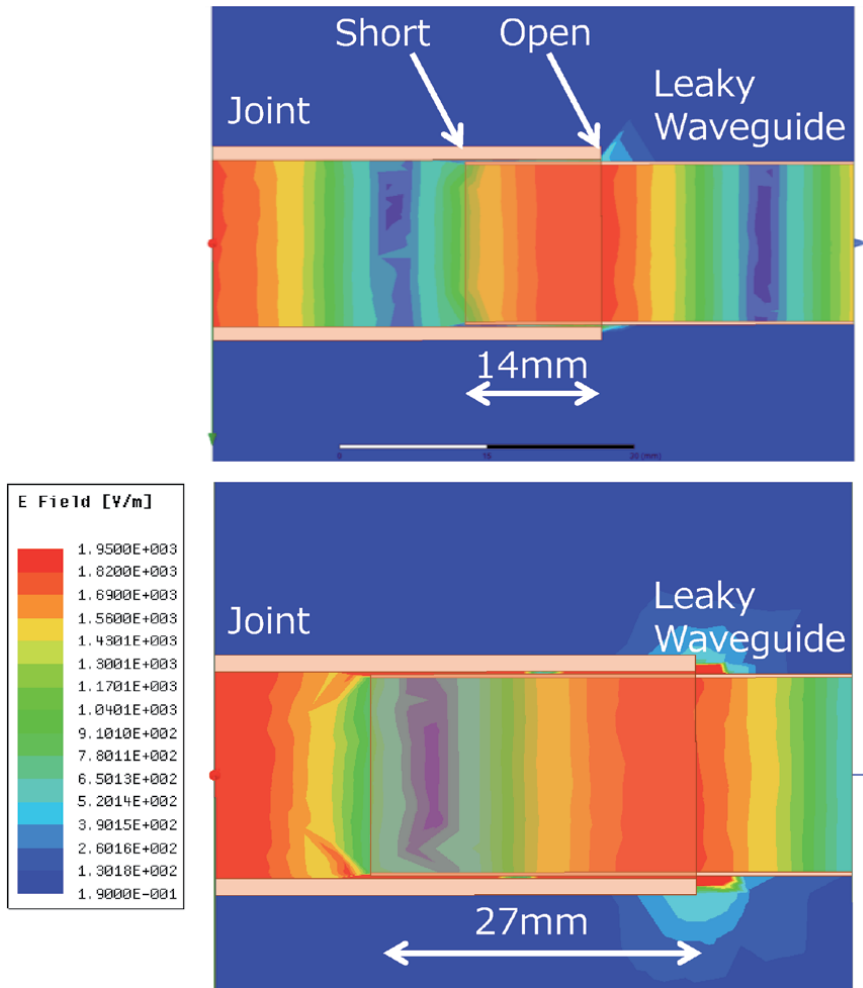

Figure 19.
 Radiation from the joint (electric field).

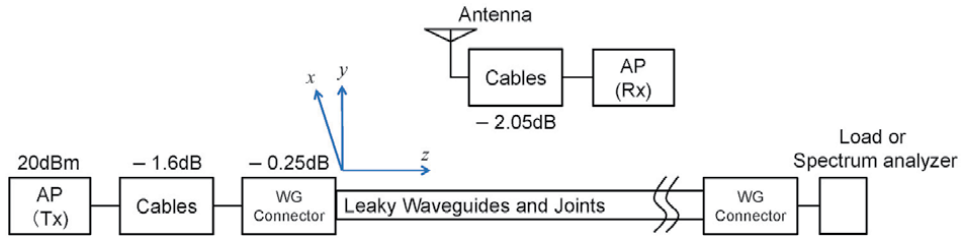

Figure 20.
Experimental configuration.

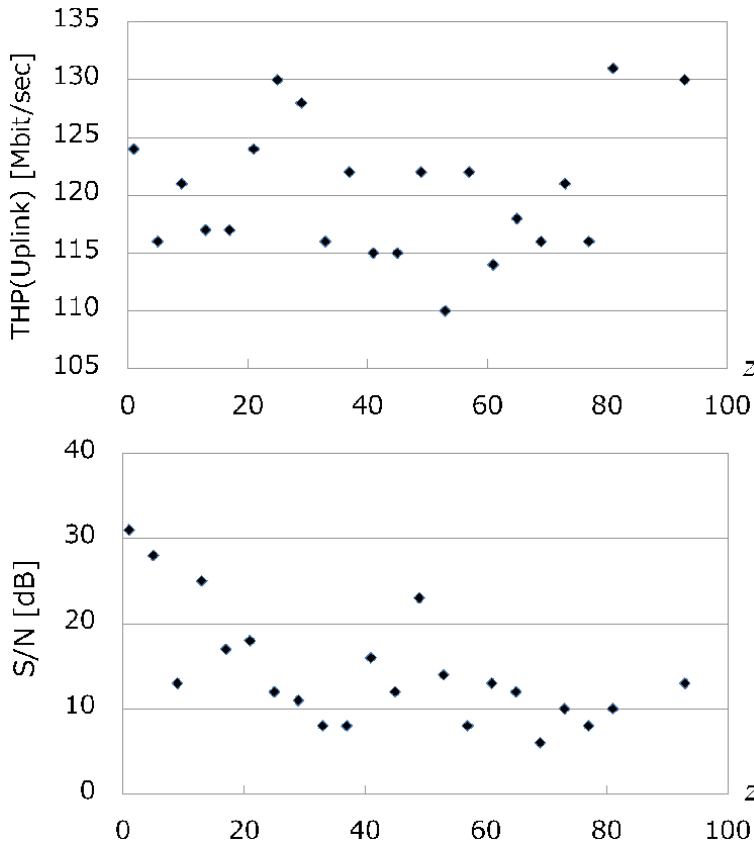

Figure 21.
Throughput and S/N evaluation results ($x = 300$ mm and $y = 400$ mm).

As a result of laying the waveguide over 120 m and measuring the power with the spectrum analyzer located at the end, it was found that the loss was 35.8 dB, i.e., approximately 0.32 dB/m. The output frequency was 5.6 GHz and the bandwidth was 40 MHz. **Figure 21** shows the evaluated throughputs and S/N ratios for the conditions $x = 300$ mm and $y = 400$ mm. In the circumference of the waveguide, good communications were possible up to 93 m. **Table 2** shows the results at $z = 21$ m and **Table 3** shows the results at $z = 81$ m. A $S/N \geq 5$ dB was the approximate index for communications, and this index provided good communications.

		S/N [dB]						THP(Uplink) [Mbit/sec]				
1000		18	22	19	20	1000		117	119	122	118	
800		15	22	21	17	800		116	117	117	120	
600		–	22	18	11	600		–	117	117	117	
400		–	26	26	23	400		–	118	122	116	
y/x		0	150	300	450	mm	y/x	0	150	300	450	mm

Table 2.
 Evaluation results at $z = 21$ m.

		S/N [dB]			
900		10	10	11	
800		14	13	14	
700		8	11	13	
600		10	12	8	
500		14	12	10	
400		12	17	7	
350		13	9	6	
y/x		0	150	300	mm

Table 3.
 Evaluation results at $z = 81$ m.

5. Conclusion

In this research, we proposed a low-leakage dual-plate waveguide and demonstrated the results of evaluating long-distance communications using this waveguide. As a result of this evaluation, under the conditions of $x = 300$ mm and $y = 400$ mm, it was shown that communication was possible at speeds of 100 Mbps or more up to a distance of 92 m. We will continue to consider using this system in tunnels.

Acknowledgements

I am grateful to Dr. Patrick Steglich of the book editor who gave me the opportunity to write this chapter. We thank Mr. Nobuyuki Watanabe and Mr. Toshifumi Sakai (FURUNO) for their help in this study. Moreover, I respect the great achievements of my predecessors whose studies I have cited.

Author details

Shotaro Ishino^{1*}, Satoshi Denno², Narumi Yashiro² and Seiichi Suzuki²

1 Furuno, Hyogo, Japan

2 Toda Corporation, Tokyo, Japan

*Address all correspondence to: shotaroh.ishino.qx@furuno.co.jp

IntechOpen

© 2020 The Author(s). Licensee IntechOpen. This chapter is distributed under the terms of the Creative Commons Attribution License (<http://creativecommons.org/licenses/by/3.0>), which permits unrestricted use, distribution, and reproduction in any medium, provided the original work is properly cited. 