



OSTBAYERISCHE  
TECHNISCHE HOCHSCHULE  
REGENSBURG

# **FMS-BERICHTE**

## **WINTERSEMESTER 2021/2022**

Hans Meier, Michael Niemetz, Thomas Fuhrmann  
und Andrea Reindl (Hrsg.)

### **Seminar zu aktuellen Themen der Elektro- und Informationstechnik**

Forschungsmethoden-Seminar, Ausgabe 3,  
Winter 2021/22

17. September 2022

# Vorwort

Dieser Bericht entstand im Rahmen der Lehrveranstaltung „Forschungsmethoden und Seminar (FMS)“ im Wintersemester 2021/22 auf Initiative der Studierenden des Masterstudiengangs „Elektro- und Informationstechnik (MEI)“.

Diese Lehrveranstaltung hat das Ziel, systematisch an das wissenschaftliche Arbeiten, speziell die Wissenschaftskommunikation, heranzuführen. Daher war geeignete Literatur zu einem individuellen Thema zu recherchieren, Veröffentlichungen auf ihre Relevanz hin zu beurteilen und letztendlich eine eigene Ausarbeitung basierend auf der Literaturrecherche zu erarbeiten und diese in einem Vortrag zu präsentieren.

Parallel dazu erfolgte im Theorieteil die entsprechende Hinführung zu den verschiedenen Elementen der Wissenschaftskommunikation:

- Bedeutung der Wissenschaftskommunikation für die Arbeit der Ingenieure in Forschung und Entwicklung
- Literaturrecherche, Suchmaschinen, Sichtung und Analyse vorhandener Publikationen, Bewertung der Qualität aufgefundener Fachliteratur, Auswahl geeigneter Materialien für die eigene Arbeit
- Aufbereitung und Darstellung der recherchierten technischer Inhalte in Form einer seitenanzahlbegrenzten wissenschaftlichen Ausarbeitung
- Einhalten formaler Randbedingungen bzgl. Strukturierung, einschl. Bildnachweise und Zitationsstile
- Peer-review-Prozess bei wertschätzender Beurteilung der Leistung anderer
- Publikumsangepasstes Aufbereiten komplexer fachlicher Inhalte mit hochschulöffentlicher Präsentation der Ergebnisse
- Führen mündlicher wissenschaftlicher Diskurse

Nachdem die Masterstudierenden in der Regel über noch keine eigene wissenschaftliche Forschungserfahrung bzw. -inhalte verfügen, lag der wählbare Schwerpunkt der Literatursuche auf der Bearbeitung von vorgegeben aktuellen technischen oder gesellschaftspolitischen Forschungsthemen.

# Inhaltsverzeichnis

<b>Vorwort</b>	<b>ii</b>
<b>Rechnerstrukturen, Sicherheit und kryptographische Verfahren</b>	<b>1</b>
1 FPGA and Microcontroller in DSP Applications: (Dis)advantages and Special Features <i>Armin Bräuer</i>	
6 Uses of One Time Pad in Hybrid Algorithms <i>Christian Zwick</i>	
<b>Wasserstofftechnologie und alternative Kraftstoffe</b>	<b>11</b>
11 Fuel Cells in Domestic Application <i>Florian Reif</i>	
16 „Grüner“ Ammoniak – eine Alternative zu Wasserstoff? <i>Andreas Kick</i>	
21 Synthetische Kraftstoffe: Gewinnung und Ökobilanz <i>Manuel Albrecht</i>	
26 Klimaneutrales Kerosin: Technologieprinzipien, Nutzen und Grenzen <i>Christoph Mayer</i>	
<b>Artificial Intelligence</b>	<b>31</b>
31 Arts and Artificial Intelligence: State of the Art <i>Mahmoud Baddour</i>	
<b>Erneuerbare und Alternative Energiegewinnung</b>	<b>36</b>
36 The Principles of Energy Harvesting using the Piezoelectric Effect <i>Lukas Stober</i>	
<b>Robotik</b>	<b>41</b>
41 Current Progress in Tactile Sensing Techniques for Industrial Grade Applications <i>Andreas Kirmeier</i>	
<b>Erfassung von Wetterdaten</b>	<b>46</b>
46 Messung von Regendaten mit Richtfunkstrecken des Mobilfunk Backhaul-Netzwerkes <i>Sebastian Griesbeck</i>	

- 51 6G Wireless Communication Systems: Applications, Requirements, Technologies and Challenges  
*Simon Reger*

# Advantages and Disadvantages of FPGA and Microcontroller Based Implementations of FFT Applications

Armin Bräuer

Faculty of Electrical Engineering and Information Technology  
Ostbayerische Technische Hochschule Regensburg  
Regensburg, Germany  
armin.braeuer@st.oth-regensburg.de

**Abstract**—Digital Signal Processing (DSP) is nowadays used in various applications. Common examples are audio, video or communication applications, which rely on this type of processing. As with all embedded applications, there are fundamentally different hardware architectures. This paper therefore aims to present the differences in terms of DSP between Field Programmable Gate Arrays (FPGAs) and microcontrollers ( $\mu$ Cs) by showing the computational costs of Fast Fourier Transformation (FFT) operations. Earlier technologies mostly used pure digital signal processors, which were suitable for a very specific task due to their structure. This resulted in problems in terms of flexibility. To counteract these, FPGAs and  $\mu$ Cs offer the right features. Their hardware is designed in a way to cover a wide range of use cases. However, there are disadvantages in both variants compared to conventional dedicated DSP cores, which are optimized for processing DSP. Due to their architecture,  $\mu$ Cs are comparatively slow. E.g. when processing challenging tasks like the calculation of FFTs. Compared to  $\mu$ Cs, FPGAs offer fast computation when used to mimic the logic structure of DSP cores. However, this possibility compromises the performance/chip area ratio, making FPGAs suitable only for less complex computations.

**Index Terms**—Digital Signal Processors, Field Programmable Gate Arrays, Microcontrollers, FFT

## I. INTRODUCTION

For years, there has been uninterrupted progress in the growth of Internet of Things (IoT). All IoT devices, regardless of their type, are connected to the Internet. Since a large part of the systems are not stationary (e.g. cars), a lot of the connections are handled via the mobile network. However, previous established technologies like 4G are reaching their limits in this use case [1, 2].

The next generation of mobile broadband communication, 5G, will enable a major step forward in this area. More clients can be active overall, the transmission rate for the respective devices increases and the latency between the subscribers decreases [2, 3].

In the field of wireless communications, DSP is a key technology and thus an enabler for 5G [4]. As applications become more complicated, the demand on DSP increases as well. For this reason, an overview of  $\mu$ C and FPGA

technologies in relation to digital signal processing is given below. Conventional digital signal processors (DSP cores) are not discussed in this paper. The advantages, disadvantages and special features of each platform are explained. As a representative for the DSP the Fast Fourier Transformation (FFT) is chosen, other areas are not discussed. First, the basics of DSP are addressed in section II, while Discrete Fourier Transformation (DFT) and FFT are explained in more detail. Then the individual systems are analyzed in section IV. Based on this section,  $\mu$ C and FPGA are compared in relation to the DSP in section V.

## II. DIGITAL SIGNAL PROCESSING

In the following, the term „Digital Signal Processing“ (DSP) and the techniques behind it are explained in more detail.

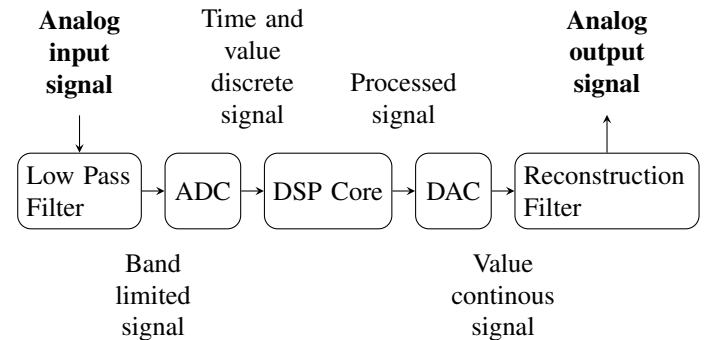

Fig. 1. Block diagram of a DSP flow. Low pass filter reduces frequency spectrum to avoid aliasing. ADC converted time and value discrete signal is processed by DSP core. Processed signal is converted back to analog and reconstructed to final output signal. Adapted from [5]

Figure 1 shows the general setup for DSP with analog input and analog output. The analog input is being limited by a low pass filter to a specific range of frequencies to avoid aliasing. Until this point all signals are time and value continuous. That band-limited signal will be processed by the following Analog-Digital-Converter (ADC), which creates a time and

value discrete digital signal out of the given analog signal. The resulting values are the input for the actual core of the digital signal processing procedure. After computing the signal, the output is being processed in the reverse direction like on the input side: the digital output of the DSP core will be converted to a value continuous but time discrete analog signal. This time discrete property is invalidated by the followings reconstruction filter, which smoothes the time discrete to a time continuous output signal. [5, 6]

The previously shown general procedure is used in various applications. There are different use cases in modern technology, which have been enabled by DSP. Some examples are:

- Digital Filtering
- Signal Frequency Analysis
- Data Compression

All of them are based on the calculation of DFTs, which will be explained in the next section. [5, 6]

### III. DFT AND FFT

In time time domain it's necessary to compute convolutions as shown in Equation 1. These are computationally costly, so they should be avoided.

$$y[n] = x[n] * h[n] \quad (1)$$

Because of the challenging task to calculate a convolution, it is common to transform to frequency domain. As shown in Figure 2, it is possible to transform every component of these calculations between time and frequency domain by performing a DFT (Equation 3) or its inverse equivalent IDFT (Equation 4). The DFT is the discrete equivalent of the ordinary continuous Fourier transform. In frequency domain the calculation of a signal modification is less complex, because it's a simple multiplication [6, 7]:

$$Y[f] = X[f] \cdot H[f] \quad (2)$$

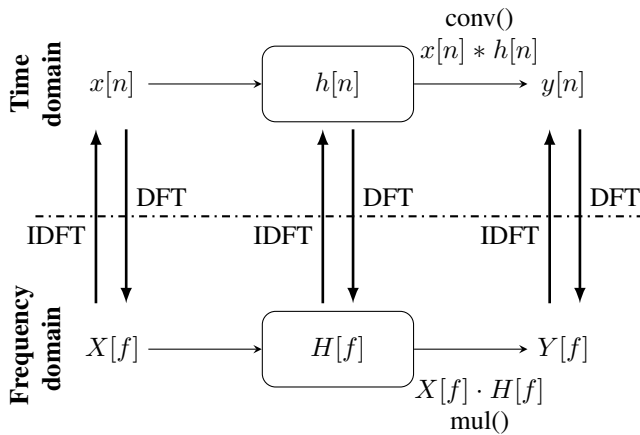

Fig. 2. Schematic block diagram for DFT and corresponding IDFT in time and frequency domain. Adapted from [6]

Those DFT and IDFT operations are quite easy to compute by only needing additions and multiplications to work:

$$X[k] = \sum_{n=0}^{N-1} x[n] \cdot e^{-\frac{2\pi i k n}{N}} \quad (3)$$

$$x[n] = \frac{1}{N} \sum_{k=0}^{N-1} X[k] \cdot e^{\frac{2\pi i k n}{N}} \quad (4)$$

with  $i$  as the imaginary unit and  $N$  the sum of time discrete inputs.

Reasonable numbers of samples start at  $N = 256$  [6]. The number of basic operations to execute a DFT is proportional to  $N^2$ . Even with ordinary numbers of samples, DFT calculations become slow due to the shown high number of complex multiplications.

FFT calculations counteract this quadratically increasing complexity [6]. The number of Radix-2 FFT operations is proportional to  $N \log_2 N$ . The logarithmic relationship to computational effort greatly reduces the number of calculations, as shown in Table I. This list only gives a rough estimation, but ignores some minor parts. However, it can be determined that the saving in calculations is large.

TABLE I  
COMPARISON OF ORDER OF COMPLEX MULTIPLICATIONS BETWEEN DFT AND FFT

N	DFT complex multiplications $O(N^2)$	FFT complex multiplications $O(N \log_2 N)$	Reduction in % FFT compared to DFT
256	65536	2048	96.88%
512	262144	4608	98.24%
1024	1048576	10240	99.02%
2048	4194304	22528	99.46%
4096	16777216	49152	99.70%

In actual applications, different variants of FFTs are used. Often the decimation in time Cooley-Tukey split radix variants are applied [6, 8–10]. In the case of a Radix-2 calculation, first the actual DFT is split into two separate DFTs of lengths  $N/2$  with even and odd sample indices, which will be added together as shown in Equation 5. The application of this simplification already reduces the number of complex calculations to  $2(\frac{N}{2})^2 + N$ , which is almost a halving for ordinary sizes of  $N$  (e.g.  $N = 2048$ ). This procedure can now be repeated until the length of each DFT equals 1. Thus, the number of complex calculations is approximately  $N \log_2 N$ .

$$X[k] = \sum_{n=0}^{\frac{N}{2}-1} x[2n] \cdot W_N^{kn} + W_N^k \cdot \sum_{n=0}^{\frac{N}{2}-1} x[2n+1] \cdot W_N^{kn} \quad (5)$$

with  $W_N^k = e^{-i\frac{2\pi k}{N}}$  and  $W_N^{kn} = e^{-i\frac{4\pi kn}{N}}$ .

### IV. DIFFERENT HARDWARE APPROACHES

In the following, two fundamentally different hardware approaches are compared. The advantages and disadvantages

of  $\mu$ Cs and FPGAs are explained. In addition, special features are presented that represent a unique selling point for each hardware structure.

#### A. Microcontroller

Due to the common use of  $\mu$ Cs with „von Neumann“ architecture, only these will be discussed in further considerations. Basically, all architectures have an Algorithmic Logic Unit (ALU) and a Central Unit (CU). The ALU is responsible for the basic arithmetic operations of addition, subtraction, multiplication and division [11].

The von Neumann structure differs essentially from its competitors in its view of memory. Programs and data are operated together on a single memory bus [11]. Thus on the one hand the production costs are lowered due to missing memory structures and buses, on the other hand also problems develop. For example, data and commands cannot be loaded at the same time, which reduces the final performance.

*1) Advantages:* A major advantage of  $\mu$ Cs is the large number of peripheral units that are already present in some  $\mu$ Cs. According to [12], there are many possibilities on an ESP32 System on a Chip (SoC) in form of integrated peripheral units to communicate with other systems. Communication options include standard embedded protocols such as SPI and I2C, but also more complex connections like WiFi and Bluetooth. These possibilities lead to a great flexibility in the use of the system, which also leads to a wide distribution or easy reusability. In addition, common peripheral units such as ADCs and DACs are already integrated in every ESP32 SoC. This eliminates the need for external peripherals, which in turn reduces complexity and development time. [12]

Another point that supports a short development time is the, compared to other systems, simple programming.  $\mu$ Cs can be programmed, for example, via the widely used programming languages C/C++ or Python, or even via simulation environments such as Matlab Simulink. One advantage of  $\mu$ Cs is that sequential programming is used as standard. This means that the execution corresponds to the sequence that was also targeted in the program code. This advantage leads to better readability, easier understanding of existing code and easier debugging. The positive points such as low cost, low design effort and still high flexibility, are also mentioned in [13]. Also, the small size of  $\mu$ Cs leads to embedded designs becoming smaller and thus less expensive. For example, an ESP32 in a QFN48 package has a size of 5x5 mm [12, 14].

*2) Disadvantages:* In addition to the positive points, however, there are also disadvantages to  $\mu$ Cs. Tessier and Burlson show in [15] that the performance of microprocessors and also microcontrollers is comparatively low. This can be justified by the fact that their use is limited to serial execution. Thus, highly parallelizable tasks can still only be executed serially. The only way to circumvent this limitation

is to use multicore controllers, but their correct programming is also more complex.

*3) Special features:* Besides the peripheral units of  $\mu$ Cs already mentioned in the previous section, there are others that can be useful in certain application areas. Among them are on the one hand connection possibilities like Ethernet or serial interfaces. These communication links can be used to establish connections to devices that are higher in the system hierarchy. On the other hand,  $\mu$ Cs often have a large number of digital I/O units.

#### B. FPGA

As with  $\mu$ Cs, look-up table (LUT)-based FPGAs have also gained acceptance in the area of programmable logic. These LUTs offer the developer the possibility to define a freely configurable relationship between input and output of this LUT. In addition, there are connection areas between the LUTs, but these can only be used to a very limited extent, which means that not any number of LUTs can be connected across the chip. Furthermore, the classical FPGA cores are extended by a RAM, which brings a more flexible use of the hardware and an extension of the application area. [15, 16]

*1) Advantages:* The structure of the FPGA enables the developer to influence the elementary components of the system. Thus, any operation can be precisely controlled in terms of time. In addition, the implementation of the functionality is possible down to the elementary operations. Also due to the free configurability of the FPGA, functionalities that allow parallelization can be implemented in parallel. In this case, the same logic is synthesized multiple times for the same parallel operations until the area of the chip is used up. Thus, a good scalability is also given for parallelizable tasks. This scalability can also be used in the opposite sense: If a design is fixed in the course of the development process, it is possible to switch to the smallest possible FPGA of the same series without having to accept performance loss. This reduction merely removes unnecessary structures from the design, which would otherwise cause useless costs. In this case, the performance remains the same due to the simple duplication of the LUTs and slices in the chip. [15–17]

*2) Disadvantages:* One of the most considerable disadvantages in the use of a FPGA is its complicated programming. The reason for this is the parallelization, whereby in languages like VHDL there is no serial execution in sequence of the program code, as it is usual with microprocessors. No problems arise for individual functions, but when synchronizing several parts. For example, access to variables from different places must be deliberately synchronized and timed, otherwise it is not clear which execution comes first.

In addition complex and large programs lead to problems with the synthesization of the hardware. This results from the fact that complex partial functions require many LUTs and

possibly slices. If at the same time still a parallelization is applicable, the appropriate parts are multiplied. By the thus high utilization of the logical units an overloading can occur fast, whereby the design is also not created successfully. Another disadvantage is the high power consumption of FPGAs, which is also due to their flexible structure [15]. An additional negative point of FPGAs is the high price for each chip.

### C. Special features

Some FPGAs offer a choice of hardware accelerators in addition to their general logic units. One of them is implementing whole units specialized for DSP tasks. These so-called slices combine functionalities that are important for typical DSP operations. Tasks are explicitly integrated into them that would cause a large area consumption in the chip in a normal implementation. This allows the utilization of the LUTs to be reduced. Thus these units become free for further program parts. Alternatively, a smaller chip can be selected. [18, 19]

Further, the use of high-level languages such as C and C++ is a recent innovation for FPGAs, it's called High Level Synthesis (HLS). Thus, the developer has the option to program in a language that is more suitable for algorithms than the parallel approaches. In addition, debugging can be done at the high-level language, which makes debugging much easier. As can be seen from Tétrault's experiments, the performance of an HLS code is comparable to that of a conventional HDL language. Only the number of used units on the FPGA chip is higher, which is why the chip area is used less effectively when using HLS. This point counteracts the major criticism of complicated and time consuming development on FPGAs. [20, 21]

## V. COMPARISON BETWEEN MICROCONTROLLER AND FPGA IN TERMS OF DIGITAL SIGNAL PROCESSING

Basically, a comparison between  $\mu\text{C}$  and FPGA only based on clock rates is not meaningful due to the strongly different architecture. In addition, a higher number of operations per time unit must be processed due to parallelization/serialization. This performance advantage is mainly dependent on the possibility of parallelization, which is clearly and strongly given in the implementation of an FFT.

According to [13] the complex multiplications are the general bottleneck of the calculation of FFTs. For this reason, they are parallelized as much as possible on a FPGA, but this is limited due to the allocation of logic units. In this case, the isolated calculations are serialized again, which is reflected badly in the performance. [22]

Also standard  $\mu\text{Cs}$  without DSP cores have a poor performance computing demanding and parallelizable FFTs.

Govil and Chowdhury show in [13] that in a codesign solution of FPGA and  $\mu\text{C}$  in a DSP application, the number of LUTs used could be greatly reduced. This also results in no overmapping, which allows maximum parallelization. This

agrees with the statement of Bergmann and Mudge in [23] that a single use of the respective systems does not provide the optimal performance.

In addition, unlike  $\mu\text{Cs}$ , FPGAs are not suitable for use in mass-produced products. While with  $\mu\text{Cs}$  the final hardware can already be used during development, development with FPGAs switches to ASICs at the state of the final hardware for cost reasons. In general, FPGAs can be used in end-user applications, but they are much more expensive than corresponding custom ASICs. The unit costs of an FPGA are also much higher compared to those of a  $\mu\text{C}$ .

Table II gives an overview of the results of the comparison between  $\mu\text{C}$  and FPGA especially in terms of computing a FFT. Positive points are stated with a + sign, negative points with a - sign.

TABLE II  
COMPARISON IN TERMS OF FFT

Attribute	Microcontroller	FPGA
Performance @ FFT	-	+
Costs	+	-
Scalability	-	+
Size	+	-
Integrated Peripherals	+	-
Programming	+	+

## VI. CONCLUSION

In summary, the digital signal processing brings special requirements with it. These will also become greater as technology advances. In addition, due to their fundamentally different architecture,  $\mu\text{C}$  and FPGA each offer their own areas for which they are well suited. Thus, neither technology individually is ideally suited for implementing a complete DSP system. Which system to use must therefore be decided depending on the project and its requirements. An optimal solution is certainly a combination of both architectures in a common embedded system. In this case, the  $\mu\text{C}$  functions as the main processor and controller of communication to the peripherals or already brings these along. The FPGA on the other hand takes over the tasks of the DSP, which are highly parallelizable like the FFT. Referring to section II this means that the tasks of the ADC and DAC are taken over by the  $\mu\text{C}$ . In addition, the tasks of communication to other systems are handled by the  $\mu\text{C}$ . The FPGA exclusively takes over the task of the DSP core. Only the actual DSP tasks like the already mentioned FFT operations are performed by the FPGA. The mentioned combined structure allows systems to be scaled and individual components like the DSP computing FPGA to be reused as a module without big changes in other projects.



## REFERENCES

- [1] S. Li, L. D. Xu, and S. Zhao, "5g internet of things: A survey," *Journal of Industrial Information Integration*, vol. 10, pp. 1–9, 6 2018. [Online]. Available: <https://linkinghub.elsevier.com/retrieve/pii/S2452414X18300037>
- [2] K. Shafique, B. A. Khawaja, F. Sabir, S. Qazi, and M. Mustaqim, "Internet of things (iot) for next-generation smart systems: A review of current challenges, future trends and prospects for emerging 5g-iot scenarios," *IEEE Access*, vol. 8, pp. 23 022–23 040, 2020. [Online]. Available: <https://ieeexplore.ieee.org/document/8972389/>
- [3] R. M. Borges, L. A. M. Pereira, H. R. D. Filgueiras, A. C. Ferreira, M. S. B. Cunha, E. R. Neto, D. H. Spadoti, L. L. Mendes, and A. S. Cerqueira, "Dsp-based flexible-waveform and multi-application 5g fiber-wireless system," *Journal of Lightwave Technology*, vol. 38, pp. 642–653, 2 2020.
- [4] B. D. Mengesha, P. Torres-Ferrera, and R. Gaudino, "Analysis of 5g new radio uplink signals on an analogue-rof system based on dsp-assisted channel aggregation," *Applied Sciences (Switzerland)*, vol. 9, 12 2018.
- [5] L. Tan, *Digital Signal Processing: Fundamentals and Applications*. Academic Press, 2007, vol. 3.
- [6] J. Alexander and C. T. Vi, *DSP Basics*. ACM, 2 2021. [Online]. Available: <https://dl.acm.org/doi/10.1145/3447404.3447412>
- [7] J. Smith, *Mathematics of the Discrete Fourier Transform (DFT): With Audio Applications*. W3K Publishing, 2007, vol. 2.
- [8] W.-C. Yeh and C.-W. Jen, "High-speed and low-power split-radix fft," *IEEE Transactions on Signal Processing*, vol. 51, pp. 864–874, 3 2003. [Online]. Available: <http://ieeexplore.ieee.org/document/1179780/>
- [9] A. Rauf, M. A. Pasha, and S. Masud, "Towards design and automation of a scalable split-radix fft processor for high throughput applications," *Microprocessors and Microsystems*, vol. 65, pp. 148–157, 3 2019.
- [10] S. Liu and D. Liu, "A high-flexible low-latency memory-based fft processor for 4g, wlan, and future 5g," *IEEE Transactions on Very Large Scale Integration (VLSI) Systems*, vol. 27, pp. 511–523, 3 2019. [Online]. Available: <https://ieeexplore.ieee.org/document/8548582/>
- [11] I. I. Arikpo, F. U. Ogban, and I. E. Eteng, "Von neumann architecture and modern computers," *Global Journal of Mathematical Sciences*, vol. 6, pp. 97–103, 2007.
- [12] A. Maier, A. Sharp, and Y. Vagapov, "Comparative analysis and practical implementation of the esp32 microcontroller module for the internet of things," in *Internet Technologies and Applications (ITA)*. IEEE, 9 2017, pp. 143–148. [Online]. Available: <http://ieeexplore.ieee.org/document/8101926/>
- [13] N. Govil and S. R. Chowdhury, "High performance and low cost implementation of fast fourier transform algorithm based on hardware software co-design," in *IEEE TENSYP 2014 - 2014 IEEE Region 10 Symposium*. Institute of Electrical and Electronics Engineers Inc., 7 2014, pp. 403–407.
- [14] Espressif, "Esp32 series datasheet," 2021. [Online]. Available: <https://www.espressif.com/en/support/download/documents>.
- [15] R. Tessier and W. Bursleson, "Reconfigurable computing for digital signal processing: A survey," *Journal of VLSI Signal Processing*, vol. 28, pp. 7–27, 2001.
- [16] M. Kubica, A. Opara, and D. Kania, *Technology Mapping for LUT-Based FPGA*. Springer Nature, 2021. [Online]. Available: <http://www.springer.com/series/7818>
- [17] W. Vanderbauwhede and K. Benkrid, Eds., *High-Performance Computing Using FPGAs*. Springer New York, 2013. [Online]. Available: <http://link.springer.com/10.1007/978-1-4614-1791-0>
- [18] Altera, "Enabling high-performance dsp applications with stratix v variable-precision dsp blocks," 2011. [Online]. Available: <https://www.intel.com/content/dam/www/programmable/us/en/pdfs/literature/wp/wp-01131-stxv-dsp-architecture.pdf>
- [19] Xilinx, "7 series dsp48e1 slice user guide (ug479)," 2011. [Online]. Available: <http://www.xilinx.com/legal.htm#tos>.
- [20] —, "Vivado design suite user guide: High-level synthesis (ug902)," 12 2018. [Online]. Available: [https://www.xilinx.com/support/documentation/sw\\_manuals/xilinx2018\\_3/ug902-vivado-high-level-synthesis.pdf](https://www.xilinx.com/support/documentation/sw_manuals/xilinx2018_3/ug902-vivado-high-level-synthesis.pdf)
- [21] M.-A. Tétrault, "Two fpga case studies comparing high level synthesis and manual hdl for hep applications," *21st IEEE NPSS Real Time Conference*, 6 2018. [Online]. Available: <http://arxiv.org/abs/1806.10672>
- [22] S. Banerjee and A. Sinha, "Performance analysis of different dsp algorithms on advanced microcontroller and fpga," in *2009 International Conference on Advances in Computational Tools for Engineering Applications*. 2009, pp. 609–613.
- [23] N. W. Bergmann and J. C. Mudge, "Comparing the performance of fpga-based custom computers with general-purpose computers for dsp applications," *Proceedings of IEEE Workshop on FPGA's for Custom Computing Machines*, pp. 164–171, 1994.

# Uses of One Time Pad in Hybrid Algorithms

Christian Zwick

Faculty of Electrical Engineering and Information Technology  
Ostbayerische Technische Hochschule Regensburg  
Regensburg, Germany  
christian.zwick@st.oth-regensburg.de

**Abstract**—Data security is very important for communication over the Internet nowadays. For this purpose, there are various encryption methods with different advantages and disadvantages. One encryption method is the One Time Pad (OTP), a fast and, if used correctly, unbreakable method. It is rarely used because of the large size of the key and the high key distribution rate due to the fact that the key must only be used once. In this paper, the OTP is analyzed and presented in combination with various encryption methods. One of the methods is the Rivest Shamir Adleman (RSA) algorithm. An OTP-RSA hybrid algorithm makes the RSA more secure while it solves the key distribution problem of the OTP. Another method is the Advanced Encryption Standard (AES) algorithm. A hybrid algorithm of AES and OTP makes the OTP even more secure while solving problems of the OTP-RSA hybrid algorithm. In all this scenarios the OTP helps providing security, while benefiting from the advantages of the other encryption methods.

**Index Terms**—Encryption, Data security, Internet, Information security, Cryptography

## I. INTRODUCTION

One of the most permanent problems is the data security in today's world. Many online services require a separate account with username and password, and each data packet must be encrypted so that no unauthorized person can read it. Therefore, encryption algorithms are used to ensure data security. There are many encryption methods that have different advantages and disadvantages. Some are slow, but the keys of the algorithms can be used several times. Others are fast, but require a new key after each use, so they do not lose their security. An example of this is the One Time Pad, which was already developed during World War I [1].

The purpose of this paper is to analyze the OTP to determine whether it can still be used in a meaningful way today and what means can be used to achieve this.

In general cryptography is used to translate plaintexts into unreadable ciphertexts and back into readable plaintexts. As Figure 1 shows, the translation into a ciphertext is known as encryption whereas the translation back from a ciphertext is called decryption. For both ways a key is needed, where a key is a number or string of characters used to encrypt the plaintext and decrypt the ciphertext. The key is important because the security of the encrypted secret depends on it. If the key is too short or openly known, the algorithm is no longer secure. [2]

There are two encryption methods:

- Secret Key Cryptography - symmetric encryption. This method uses one key for both encryption and decryption.
- Public Key Cryptography - asymmetric encryption. This method uses one key for encryption and another for decryption. [3]

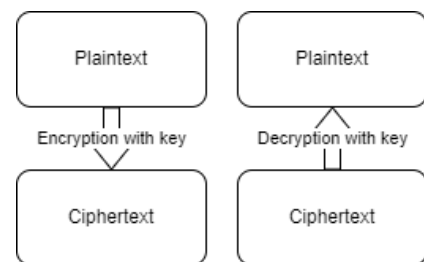

Fig. 1. The process of encryption and decryption [4]

Asymmetric encryption is slower than symmetric encryption and to get the same amount of security, asymmetric keys must be stronger than symmetric keys. [5]

An algorithm is called a hybrid algorithm if it consists of a combination of several other algorithms.

First, the OTP is presented in section II with its advantages and disadvantages. After that, the RSA algorithm is presented and it is shown how it can be combined with the OTP. Next, the AES algorithm is introduced and analyzed how it can be combined with the OTP and what advantages this combination has. In section III is a discussion about the results and in section IV a conclusion is given.

## II. ENCRYPTION METHODS

### A. One Time Pad

The One Time Pad is a symmetric encryption method that was developed by Gilbert Vernam in 1917 for use in teleprinters. Each transmitted 5-bit code was encoded with a random 5-bit code stored on a paper tape. These tapes were called one-time tapes. This invention was the basis for many pencil and paper versions. The name One-Time-Pad refers to the notepads on which the 5-bit codes had been printed. [1] The encrypted text is secure if the following rules are applied:

- The key must be at least as long as the text to be encrypted.
- Each key may only be used once.
- The key must be random. [1,6]

To encrypt a text by the OTP, a key is applied via a XOR operation. Since this key is completely random and will never be used again, the OTP cannot be cracked. [7] The reason for this is the large number of reasonable solutions for a plaintext, if the key is guessed.

TABLE I  
AN EXAMPLE OF ENCRYPTION WITH THE ONE TIME PAD

Plaintext[P]	H	E	L	L	O	W	O	R	L	D
In Numbers	8	5	12	12	15	23	15	18	12	4
Key[K]	R	Z	G	M	E	V	A	D	Q	P
In Numbers	18	26	7	13	5	22	1	4	17	16
In Numbers	26	5	19	25	20	19	16	22	1	20
Ciphertext[C]	Z	E	S	Y	T	S	P	V	A	T

In Table I the text "HELLO WORLD" is encrypted with the key "RZGMEVADQP". First, the text and the key are translated into numbers, then those numbers are added. If one number is greater than 26, 26 is subtracted and the resulting number is the ciphertext. To decrypt the text, the key is subtracted from the ciphertext. If the resulting number is lower than one, 26 is added. The resulting number is the plaintext. In mathematical terms this means  $C = P \oplus K$ . P is the plaintext to be encrypted,  $\oplus$  the XOR, K the key, and C the ciphertext. The decryption is done by following equation:  $P = C \oplus K$ . If the same key is used several times, information in the messages can be extracted by XORing the ciphertexts C1 and C2, as it can be seen in equation 4: [8,9]

$$C1 = P1 \oplus K \quad (1)$$

$$C2 = P2 \oplus K \quad (2)$$

$$C1 \oplus C2 = P1 \oplus K \oplus P2 \oplus K \quad (3)$$

$$C1 \oplus C2 = P1 \oplus P2 \quad (4)$$

One way to measure the security level of an algorithm is the so called avalanche effect. It states that a small change in plaintext or key has to lead to a significant change in the ciphertext. According to Easttom [10], the output bit should change at least with a probability of 50%, when changing one bit in key or plaintext, but the more the better. Today's random number generators for creating the key, come to an average avalanche effect of 51.67%. [11]

However, the algorithm has proven to be impractical because of the difficulty in distributing and keeping the keys secret. The problem is that a new key must be generated and sent after a new message is sent. In modern times, the OTP has been replaced by other algorithms that do not have the key distribution problem. However, the OTP is still used when unbreakable encryption is a high priority. Modern computers can create terabytes of keys which can be distributed to communication participants via hardware storages. Since hardware memories can be very large, they can store long and many keys, which are not used up so quickly. [5]

## B. RSA Algorithm

1) *RSA Algorithm itself*: The RSA algorithm was first published in 1978 by Ron Rivest, Adi Shamir and Len

Adleman. It is an asymmetric cryptography that needs two keys. The first key, known as public key, is used to encrypt a text, whereas the private key is used to decrypt the message. [12]

To generate the keys, the receiver chooses two large prime numbers, which are used to build the public and the private key. The higher the prime numbers are, the harder the algorithm is to penetrate and break. After the generation of the keys, the receiver can send the public key to the sender, who then encrypts his message and sends it to the receiver. The receiver then can decrypt and read the message. [13] If the public key ( $e$ ), private key ( $d$ ) and the modulus ( $n$ ), are already generated and  $m$  is the plaintext and  $c$  is the ciphertext, then the encryption is done with  $c = m^e \bmod n$  and the decryption is done with  $m = c^d \bmod n$ . [14]

The average avalanche effect is between 51% and 56% with a keylength of 512 bits and a blocksize of 64 bits. [15] The major advantage the RSA algorithm has, is its easy key distribution. Since only the private key can decrypt a message, it does not matter who has the public key, because he only can encrypt messages [13].

The only way of keeping RSA from being cracked is to increase the keysize, while the key size depends on number of bits in the modulus  $n$ . [16]

2) *Hybrid Algorithm*: A possible hybrid algorithm of OTP and RSA algorithm can be described as shown in Figure 2. The receiver generates the key pair and provides the public key. The sender generates an OTP key and encrypts his message with it. After receiving the public key of the RSA algorithm, he encrypts the OTP key with it. He then sends both to the recipient. The recipient can use his private key to decrypt the OTP key and read the message sent by the sender. [13]

This hybrid algorithm can be used as a registration system with increased security. The client creates an username, password and the key pair. Then it sends the public key and the username to the server. If the username does not exist, the server stores the username and the public key, otherwise the registration fails. Then the server creates a password and an OTP key, encrypts the password with the OTP key and the OTP key with the RSA public key. Then it deletes the OTP key and sends both encrypted messages to the client. The client can decrypt the OTP key with its private key and its new password with the OTP key. [14]

If someone intercepts one or both messages, he cannot decrypt them because he does not have the private key of the RSA algorithm and cannot get the OTP key without it. If he sends both messages back to the server, then nothing happens because the server can't decrypt them either. Therefore, this method is very secure. [13,14]

## C. AES Algorithm

1) *AES Algorithm itself*: The AES algorithm is an one block cipher algorithm developed by Vincent Rijmen and Joan Daemen and published by the National Institute of Standards and Technology in 2000. It belongs to the symmetric

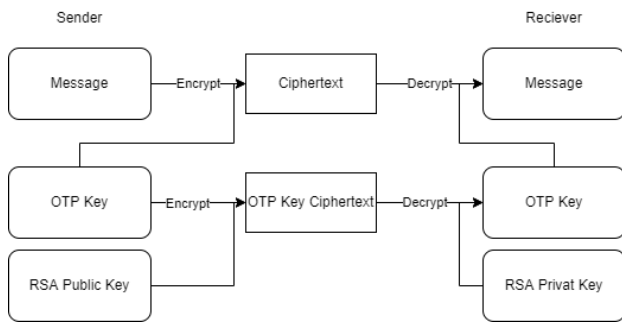

Fig. 2. Possible Hybrid of OTP and RSA [13]

encryption methods. [17]

The AES algorithm can process a plaintext block size of 16 bytes. These are divided into a 4x4 matrix and are encrypted and decrypted in a certain number of rounds. The AES can use three different key sizes (128, 192 or 256 bits). Depending on the key size, 10 rounds are used for encryption with 128 bits, 12 with 192 bits and 14 with 256 bits. [18]

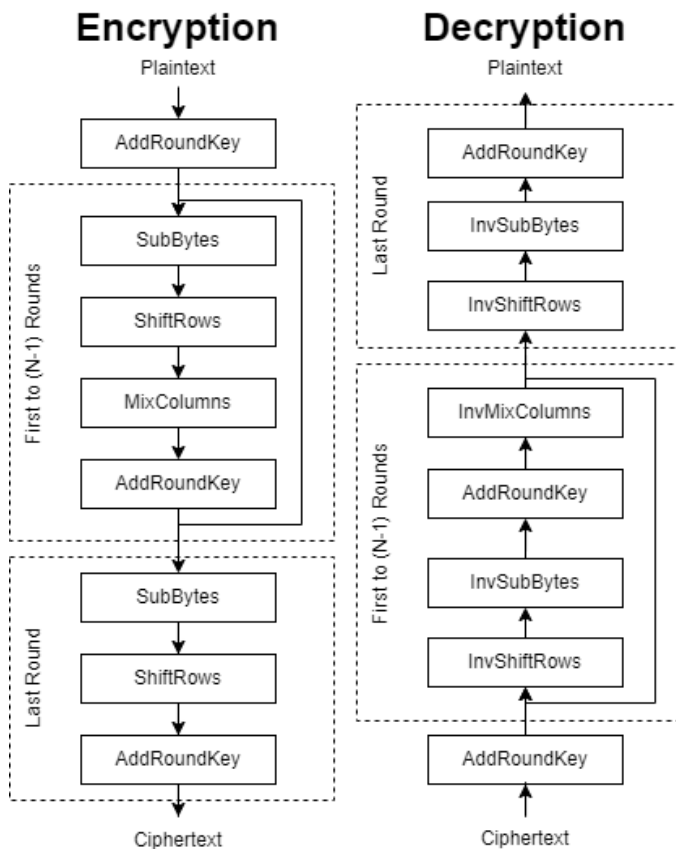

Fig. 3. AES Encryption and Decryption in Block Diagramm [19]

As shown in Figure 3, the encryption process consists of multiple steps. First Roundkey is added to the plaintext. Then several rounds are passed through. Each Round consists of the following stages:

- SubBytes Transformations - Every Byte in the matrix is changed according to a nonlinear S-box table.
- ShiftRows Transformation - Every row of the matrix except the first is shifted left according to a fixed scheme. This scheme states that the second row is shifted one byte left, the third two bytes and the fourth three bytes.
- MixColumns Transformation - Every element of the matrix is XORed with the underlying elements in the column, so the original size of the matrix is not changed.
- AddRoundKey - A 4 by 4 round key is XORed with the corresponding matrix element of the plaintext. The round key is created each round by an algorithm with the main key. [17]

These rounds are repeated according to the keysize. In the final round, the third step is excluded from the process. [18] The decryption process contains the same steps like the encryption, but other transformations have to be made in it. Instead of SubBytes, ShiftRows and MixColumns InvSubBytes, InvShiftRows and InvMixColumns will be done. [20]

The advantages of the AES is its efficiency and its low memory requirement while having a high standard of security. But since it is a symmetric encryption process, the problem of key distribution still exists. [21]

2) Hybrid Algorithms: There are several ways to create a hybrid algorithm of OTP and AES. One is the double encryption shown in Figure 4. First, the plaintext is encrypted with the OTP, then it is encrypted with the AES and an 128 bit key length. To encrypt the message, the first thing to do is to decrypt the AES and then the OTP. If the performance between OTP, AES and OTP-AES hybrid algorithm is compared, the OTP-AES hybrid is faster and performs better than the OTP and AES combined. At the same time, the OTP-AES hybrid offers higher security than the respective algorithms alone. This is indicated by the avalanche effect. The AES has an avalanche effect of 34% when one bit in the plaintext is changed, while the OTP-AES hybrid algorithm has one of 98%. For a change in the key, the AES has an avalanche effect of 96%, the OTP-AES hybrid one of 98%. So the avalanche effect values of this hybrid are better than the ones of the AES and of the OTP itself. [22]

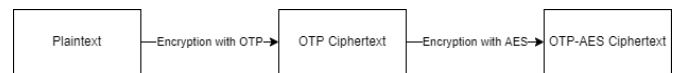

Fig. 4. OTP-AES hybrid with the first encryption done by the OTP and the second by the AES algorithm [22]

Another possible hybrid algorithm between OTP and AES can be done with an AES and up to eight characters keylength. As shown in Figure 5, the OTP is directly integrated into the encryption algorithm of the AES. First, a variable is created based on bits of plaintext, ciphertext and key and is stored in a 16 byte array. Next the plaintext is initialized, a matrix is produced with Nb, Nk, Nr, where Nb is the number bits, Nk is

the number of keys and  $N_r$  is the round number. Then and the number of rounds is determined. After that the key expansion and the cipher initialization is done. Then the RoundKey is added and the rounds are performed nine times. At the end of the rounds, the steps of SubBytes and ShiftRows are done. Now the current ciphertext is encrypted through the key via the OTP and then the last roundkey is added. To decode the text, the steps have to be gone through vice versa. The results of the testing show that the key length does not affect the processing time of the algorithm and the filesize of the encrypted file is equal to the filesize of the plaintext file. [19]

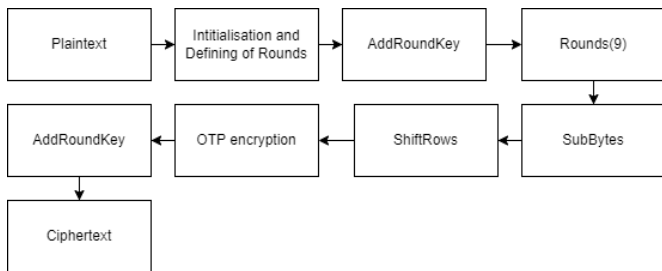

Fig. 5. OTP-AES hybrid scheme with the OTP implemented in the AES algorithm [19]

### III. DISCUSSION

The combination of OTP and the RSA algorithm is overall slower than the two algorithms individually. The advantages of this method are the increased security and the solved distribution problem of the OTP key, since the OTP cannot be cracked and its key is secured via the RSA encryption. The disadvantages of this method are the two ciphertexts that must be exchanged and the high computational load that both methods require in succession. It also cannot solve the OTP problem that the key must be at least as long as the ciphertext.

For the first combination of AES and OTP, in addition to the same problems as for the hybrid algorithm of OTP and RSA, there is also the problem that the other side must know the key of the AES algorithm. The second combination option solves some of these problems. Only one message has to be encrypted. By the direct integration of the OTP algorithm into the AES algorithm the long OTP key is not necessary, since an AddRoundKey is added every round. However, the algorithm has a high computational load and when sending a message, the other party must know the key. But the hybrid algorithm is very secure. In Table II an overview of the algorithms presented in this paper is shown. For the RSA-OTP hybrid algorithm there is no reference giving a concrete figure, so it is left blank.

### IV. CONCLUSION

This paper has explored various ways in which the OTP can be combined with other algorithms to show if the OTP can still be used effectively today. In general, it can be said that the OTP can still be used effectively today if it is combined with algorithms like the RSA algorithm and the AES algorithm.

Although it can be used alone, it is very difficult due to the condition of the long key, which can only be used once. In combination with other algorithms, the length of the key can be shortened and the exchange of the OTP key can be made easier, so that it can also be sent via a message. However, since there are many different algorithms with different advantages and disadvantages, only a very small part of possible hybrid algorithms could be presented in this paper. The benefits of hybrid algorithms depend on the application and the algorithms must be selected and adapted accordingly.

TABLE II  
OVERVIEW OF ALGORITHMS COVERED

Factors	OTP	RSA	AES	RSA- OTP	AES- OTP
Key Length	Depends on the plaintext	Depends on the number of bits in modulus $n$	128, 192 or 256 bit	see RSA and OTP	see AES and OTP
Cipher Type	Symmetric Block Cipher	Asymmetric Block Cipher	Symmetric Block Cipher	Mixed	Symmetric Block Cipher
Avalanche Effect	51.67%	51%-56%	34%-96%	–	98%

### REFERENCES

- [1] M. Borowski and M. Leśniewicz, "Modern usage of "old" one-time pad," 2012 Military Communications and Information Systems Conference (MCC), 2012, pp. 1-5
- [2] A. Sen, A. Ghosh and A. Nath, "Bit level symmetric key cryptography using genetic algorithm," 2017 7th International Conference on Communication Systems and Network Technologies (CSNT), 2017, pp. 193-199, doi: 10.1109/CSNT.2017.8418536.
- [3] E. Thambiraja, G. Ramesh and Dr. R. Umarani, "A Survey on Various Most Common Encryption Techniques", International Journal of Advanced Research in Computer Science and Software Engineering, Volume 2, Issue 7, 2012, pp. 226-233
- [4] Diaa Salama Abdul. Elminaam, Hatem Mohamed Abdul Kader and Mohie Mohamed Hadhoud, "Performance Evaluation of Symmetric Encryption Algorithms", IJCSNS International Journal of Computer Science and Network Security, VOL.8 No.12, 2008, pp. 280-286
- [5] W. Stallings, Cryptography and Network Security, Principles and Practices, 3rd Edition. Upper Saddle River, NJ: Pearson Education Asia, 2003.
- [6] G.Vernam, "Cipher Printing Telegraph Systems For Secret Wire and Radio Telegraphic Communications" in Transactions of the American Institute of Electrical Engineers, 1926-01, Vol.XLV, p.295-301
- [7] E. M. M. Manucom, B. D. Gerardo and R. P. Medina, "Analysis of Key Randomness in Improved One-Time Pad Cryptography," 2019 IEEE 13th International Conference on Anti-counterfeiting, Security, and Identification (ASID), 2019, pp. 11-16, doi: 10.1109/ICASID.2019.8925173.
- [8] A. Omolara, A. Jantan, O. Abiodun and H. Arshad, "An Enhanced Practical Difficulty of One-Time Pad Algorithm for Resolving the Key Management and Distribution Problem" in International MultiConference of Engineers and Computer Scientists(IMECS) 2018 Vol I, 2018, ISBN:978-988-14047-8-7.
- [9] M. Iavich and Z. Kevanishvili, "Modified One Time Pad" in Scientific and Practical Cyber Security Journal (SPCSJ), 2018, ISSN: 2587-4667.
- [10] C. Easttom, Modern cryptography. Applied Mathematics for Encryption and Information Security. Cham: Springer, 2016, doi: https://doi.org/10.1007/978-3-030-63115-4.

- [11] E. M. M. Manucom, B. D. Gerardo and R. P. Medina, "Security Analysis of Improved One-Time Pad Cryptography Using TRNG Key Generator", 2019 IEEE 5th International Conference on Computer and Communications (ICCC), 2019, pp. 1515-1521, doi: 10.1109/ICCC47050.2019.9064435.
- [12] Z. Alamsyah, T. Mantoro, U. Adityawarman and M. A. Ayu, "Combination RSA with One Time Pad for Enhanced Scheme of Two-Factor Authentication," 2020 6th International Conference on Computing Engineering and Design (ICCED), 2020, pp. 1-5, doi: 10.1109/ICCED51276.2020.9415850.
- [13] M. G. Ristiana, R. Marwati and S. M. Gozali, "Hybrid algorithm of RSA and one time pad cryptography substrate interface", 2018
- [14] S. Kritsanapong, "Higher Security for Login System Using RSA and One-time Pad Schemes" in Journal of Telecommunication, Electronic and Computer Engineering (JTEC), 2018, 10. Jg., Nr. 1-8, pp. 99-103, e-ISSN: 2289-8131.
- [15] R. Verma, A. K. Sharma, "Cryptography: Avalanche effect of AES and RSA" in International Journal of Scientific and Research Publications, Vol. 10, pp. 119-125, doi: 10.29322/IJSRP.10.04.2020.p10013.
- [16] L. Zhang, B. Li and X. Zhao, "Reconfigurable Hardware Implementation of AES-RSA Hybrid Encryption and Decryption," 2020 IEEE 5th International Conference on Signal and Image Processing (ICSIP), 2020, pp. 970-974, doi: 10.1109/ICSIP49896.2020.9339251.
- [17] A. Abdullah, "Advanced encryption standard (AES) algorithm to encrypt and decrypt data." in Cryptography and Network Security, Nr 16, 2017, pp. 1-11
- [18] N. Pramstaller, F. K. Gurkaynak, S. Haene, H. Kaeslin, N. Felber and W. Fichtner, "Towards an AES crypto-chip resistant to differential power analysis," Proceedings of the 30th European Solid-State Circuits Conference, 2004, pp. 307-310, doi: 10.1109/ESSCIR.2004.1356679.
- [19] I. R. Widiyari, "Combining advanced encryption standard (AES) and one time pad (OTP) encryption for data security." in International Journal of Computer Applications, Vol. 57, 2012, pp 1-8
- [20] M. M. Bachtiar, T. H. Ditanaya, S. Wasista and R. R. Kurnia Perdana, "Security Enhancement of AES Based Encryption Using Dynamic Salt Algorithm," 2018 International Conference on Applied Engineering (ICAE), 2018, pp. 1-6, doi: 10.1109/INCAE.2018.8579381.
- [21] C. Sanchez-Avila and R. Sanchez-Reillo, "The Rijndael block cipher (AES proposal) : a comparison with DES," Proceedings IEEE 35th Annual 2001 International Carnahan Conference on Security Technology (Cat. No.01CH37186), 2001, pp. 229-234, doi: 10.1109/CCST.2001.962837.
- [22] T. Tun, E. Myint and M. Aung, "Message Security using One Time Pad and AES Hybrid Cryptography" in IJCIRAS, Vol. 3, June 2020, ISSN: 2581-5334.

# Fuel Cells in Domestic Application

Florian Reif

Faculty of Electrical Engineering and Information Technology

Ostbayerische Technische Hochschule Regensburg

Regensburg, Germany

florian.reif@st.oth-regensburg.de

**Abstract**—In order to achieve the climate targets and keep global warming below 1.5 °C, Fuel Cells are coming into focus. This paper is about the Fuel Cell technologies that are applied in the domestic sector. The characteristics, efficiency, advantages and disadvantages of the technologies are discussed. This is followed by an explanation of the Fuel Cell as part of a Micro-CHP. The high overall efficiency and the higher electrical efficiency compared to a fossil fuel-fired power plant are particularly noteworthy. Subsequently, the Fuel Cell is presented as part of a potential stand-alone system. An electrolyser converts solar power into hydrogen for long time storage. The energy reversion takes place with the help of a Fuel Cell. Two systems from different manufacturers are explained. The hydrogen storing technique in a gaseous form or in a metal hydride is the greatest difference between the systems. Lastly, the paper discusses future trends. The elimination of the electrolyser by reversible Fuel Cells or special solar panels are addressed. Fuel Cells as part of a smart grid are also considered.

**Index Terms**—Fuel Cell, Domestic Application, Hydrogen, Heating, Combined Heating and Power, Residential Heating, Solar Hydrogen, PV-Hydrogen

## I. INTRODUCTION

The Climate Change is more present than ever been. Governments are trying to combat Climate Change with agreements like the Paris Climate Agreement. Countries like Germany trying to reduce their Carbon Dioxide (CO<sub>2</sub>) emissions through legislation like the 2021 Climate Protection Act [1]. To achieve these goals, science and industry are searching for alternatives which reduce the CO<sub>2</sub> emissions. A big issue is the dependence on fossil fuels. 37 billion tons of CO<sub>2</sub> were emitted in 2019 through the use of fossil fuels [2].

In the search for CO<sub>2</sub>-neutral solutions of energy generation, the Fuel Cell is increasingly coming into focus. Fuel Cells are used in a wide variety of areas. These include the automotive industry or the generation of electricity and heat. To accelerate the development, Germany started in 2020 the National Hydrogen Strategy. Part of this strategy is establishing a strong and sustainable domestic market for the production and use of hydrogen at home. [3]

The focus of this paper is to briefly describe how a Fuel Cell can be used in a domestic environment. The Fuel Cell serves as a power and heat supplier.

At the beginning, the functionality of the Fuel Cell is explained. Two types of Fuel Cells are compared, which are commonly used in domestic applications. Properties such as temperature, electrical efficiency and technology are discussed.

The third section explains Fuel Cells as part of a Micro-CHP. The structure, efficiency and costs of a Micro Combined Heating and Power (Micro-CHP) are considered. The power generation effectivity of a Micro-CHP and a fossil power plant are compared. Current projects with Micro-CHP in Japan and Europe are also showed.

The fourth section explains the concept to store excess energy of a solar power system with hydrogen. The system contains next to the solar power system an electrolyser, a hydrogen storage, an inverter and a Fuel Cell for power regeneration. Furthermore, the systems of the company Home Power Solution and LAVO are compared.

The last section contains future trends like the improvement of the electric efficiency. Replacing the electrolyser with another type of fuel cell or special solar cells is also explained. Finally, the integration of such a system into a Smart Grid is considered.

## II. FUEL CELLS

The Fuel Cell technology was invented in 1839. However, the technology was not considered at first. Around 1950 the technology was only taken up again by the military and space travel industry [4]. The basic principle of a Fuel Cell is to generate electricity from a chemical reaction between a fuel and oxygen. This reaction is also known as cold combustion. The fuel is hydrogen or a hydrogen compound like natural gas.

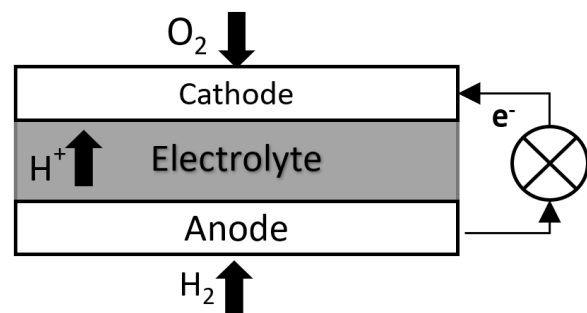
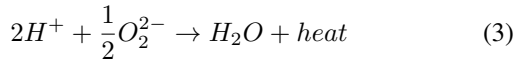

Fig. 1. Scheme of a Proton Exchange Membrane Fuel Cell

A Fuel Cell consists of an anode and cathode. Between anode and cathode is an electrolyte which is permeable only for ions. There are several types of Fuel Cells. The

functionality of a Fuel Cell will be explained by the Proton Exchange Membrane Fuel Cell (PEMFC).

The structure is shown in Figure 1. Hydrogen is added to the anode which oxidize at a catalyst. Through this reaction electrons of the hydrogen are released (1). Unlike the hydrogen ions, the electrons cannot get through the electrolyte. This creates a potential difference and the electrons are forced to flow via an external circuit to the cathode (2). In addition, the hydrogen ions flow through the electrolyte to the cathode and react with the oxygen. The reaction generates water and heat (3). [5]



A single cell generates a voltage of about 0.8-0.9 V. The Cell voltage depends on temperature, pressure and gas composition. To achieve higher performance, several Fuel Cells are interconnected in a stack. There are different types of Fuel Cells, which differ especially in the working temperature and the electrolyte. [6]

Fuel Cells are generally divided into two categories: High-temperature and low-temperature Fuel Cells. Mainly Proton Exchange Membrane Fuel Cell and Solid Oxide Fuel Cell (SOFC) are used in the domestic field. Table I shows the characteristics of the two types. [7]

TABLE I  
PROPERTIES OF DOMESTIC PEM- AND SOFC [8]

FC Technology	PEMFC	SOFC
Electrolyte	Plastic film	Oxide ceramic
Operation Temperature (°C)	80-90	550-1000
Electric power (W)	300-5000	700-2500
Thermal power (W)	700-7500	500-2000
Electrical efficiency	35-40%	45-60%
Overall efficiency	85-90%	80-95%
Fuel	hydrogen	hydrogen, methane, natural gas
Start-up phase	short	long

#### A. Polymer Electrolyte Fuel Cell

The Polymer Electrolyte Fuel Cell is a low-temperature Fuel Cell. The working temperature is 80-90 °C [5]. The electrolyte of the PEMFC is a thin plastic film which is permeable to protons. To dissolve the electrons, Platinum is used as a catalyst [9]. Platinum has a low tolerance to poisoning by carbon monoxide. So if the Fuel Cell operates with methane, the hydrogen needs to be extracted with the aid of a reformer [10]. PEMFCs offer high-power density and allow fast start-up [11]. The electrical efficiency of such a Fuel Cell is 35 to 40 % [12].

More recent developments are aimed at increasing the operating temperature and reducing the amount of platinum. Both are aimed at reducing system costs. These improved

PEMFC are called High Temperature PEMFC (HT-PEMFC) and have an operating temperature of up to 200 °C. These Fuel Cells can operate with lower fuel gas purities. [5]

#### B. Solid Oxid Fuel Cell

The Solid Oxid Fuel Cell is a high-temperature Fuel Cell with a working temperature about 550-1000 °C [13]. The electrolyte of the SOFC is an oxide ceramic [14]. This type of Fuel Cell is less sensitive to carbon monoxide. The catalyst is made of ceramic-metal. Furthermore, there are SOFC which operate directly with methane, which is why this type is also called a Direct Fuel Cell [15]. The electrical efficiency of such a Fuel Cell is 45 to 60 %. The Fuel Cell has a slow start-up behaviour because of the time it takes to get on temperature. [12]

### III. FUEL CELL AS COMBINED HEAT AND POWER UNIT

Over 17 percent of global CO<sub>2</sub> emission is produced by the energy use in buildings [16]. As mentioned in section II, heat is produced during the power generation in a Fuel Cell. Systems using both are called Combined Heat and Power. If the system has a maximum electrical output power of less than 50kW, they are called Micro-CHP [17].

#### A. System description

As shown in Figure 2, a Micro-CHP basically consists three parts. A Fuel Processor, a Power Section and a Power Conditioner. The Fuel Processor contains a reformer which extracts hydrogen from the fuel. This is passed to the Power Section, which contains the Fuel Cell Stack. The generated heat is transferred to the building's heating system via a heat exchanger. The resulting direct current is fed with the help of an inverter into the local grid or to the public power grid [18]. A normal system usually have an electrical power output of 1500 W and a heating power of 850 W [19].

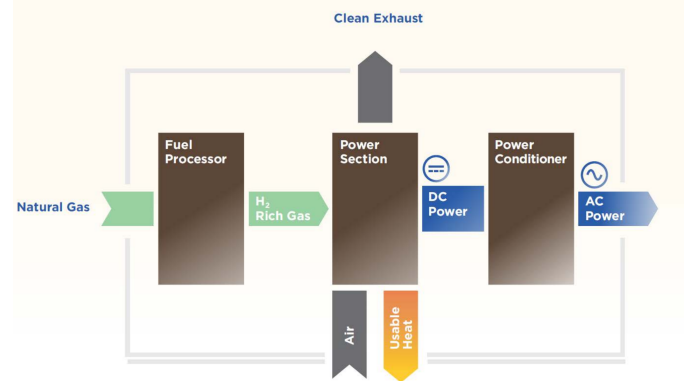

Fig. 2. Scheme of a CHP [18]

By using the heat energy, the overall efficiency of the Micro-CHP increases up to 95%. By comparison, a conventional fossil-fired power plant has an efficiency of only 44 %.



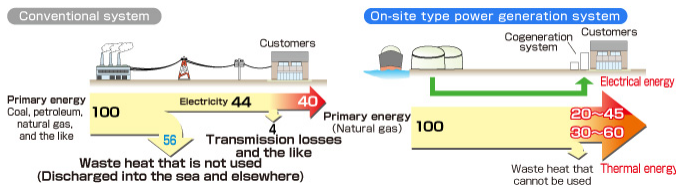

Fig. 3. Comparison of conventional and on-site power generation system [20]

56% of the energy is lost through heat. Another 4 % of the energy is lost due to line resistance. Energy generated on local site is used much more efficiently than the energy generated in a conventional power plant. In Figure 3 the losses are of both systems are shown. [20] Another benefit is that up to 50 % less CO<sub>2</sub> compared to separated heat/energy production is emitted [21]. Other advantages are, that no nitrogen oxides are produced, and less noise is generated [22]. A great disadvantage is the pricing of a Fuel Cell powered Micro-CHP. A Fuel Cell Heating cost about €30,000-35,000, which is much more expensive than €10,000-15,500 of an engine driven CHP. This price may decrease in the future through further development and mass production. Countries like Germany also offer high government subsidies to reduce investment costs. [23], [24]

### B. Application in the Domestic Field

There are projects that promote the use of a Fuel Cell as a heat and power supplier in the residential environment. The Japanese government launched the ENE-FARM program in 2017, the largest domestic Micro-CHP project to date. About 230,000 Fuel Cells are already installed in Japanese households and reduces the CO<sub>2</sub> emission by 324,000 tons. This program is part of the Japanese Hydrogen Program to be CO<sub>2</sub> neutral in 2050.

In Europe, the PACE program was launched to test Micro-CHP in the residential area. The project deploys over 2,800 Micro-CHP in 10 European country's until 2022. Companies such as Bosch, sunfire, Viessmann but also universities such as the Technical University of Denmark are involved in the program itself. [22]

## IV. FUEL CELLS IN COMBINATION WITH SOLAR POWER PANELS

Renewable energies play a crucial role in the climate turnaround. With the help of solar power plants, energy is to be generated in a CO<sub>2</sub>-neutral manner. Currently, there is the problem of storing the excess energy on very sunny days. Hydrogen is very well suited as a storage medium due to its high energy density [25]. Batteries still struggle as a long-term energy storage, cause of the costs, self-discharge and the lower energy density. The idea is, that house owners can store their own produced energy in house by using hydrogen. If necessary, the power can be generated again from the hydrogen with the help of a Fuel Cell. [26]

The concept behind it is not new. As early as 1993, the Fraunhofer Institute presented the Self-Sufficient Solar House

project. The aim of this project was to heat and supply power to a house completely self-sufficiently using only the energy of the sun. [27]

### A. System description

The individual components of such a system are shown in the Figure 4. First, the energy generated by the Photovoltaic (PV) will be sourced in a Direct-Current (DC) System. The home grid is supplied by an DC to Alternating Current (AC) inverter. Surplus energy produces Hydrogen by electrolysis of water and serves as a long-term storage medium. When needed, the hydrogen is converted back into electricity with the help of the Fuel Cell. To increase the efficiency of the system, a Micro-CHP mentioned in section III is usually used for this purpose. The battery serves as a short-term storage to supply energy during the night. When the storage is fully charged, the excess energy can be fed into the public power grid.

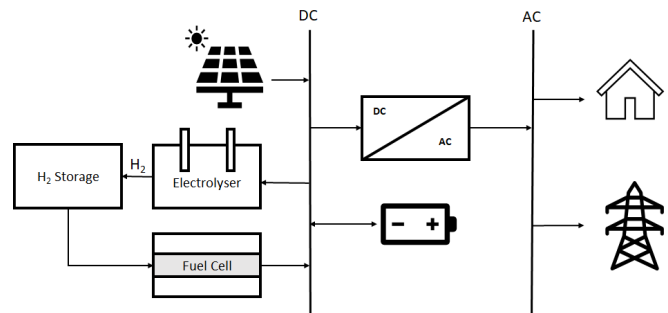

Fig. 4. Schematic of Photovoltaic integrated with Fuel Cell

### B. Application in the Domestic Field

As the first company worldwide, Home Power Solution provides a stand-alone solution for the domestic market. The system called picea includes the same components as shown in Figure 4. In this system, hydrogen is stored in gaseous form in high-pressure cylinders at 300 bar and regenerate power with a PEMFC. The picea system achieves an overall efficiency of up to 90 %. Heat generated during electrolysis and power generation is used for heating and hot water production. In addition, moist warm air can be used for humidification in winter. One disadvantage of this system is the high investment cost of approx. €70,000-100,000. In addition, the system's hydrogen storage is usually outside the home and requires additional space. The storage of 300 kWh needs 3 m<sup>2</sup> of space. [26]

A more compact system is presented by the Australian Company LAVO. The complete system needs about 1 m<sup>2</sup> of space and provides 40 kWh. According to LAVO, this amount should be able to supply two days of electricity for an Australian household. A special feature of the LAVO system is that the hydrogen is not stored in gas cylinders, but in a metal hydride. The metal hydride works like a heavy sponge, which absorbs the hydrogen. [28] Advantage of this technique

is, only a pressure of 35 bar is necessary for the storage. In addition, this type of storage is very safe and stores three times more energy than a Tesla Powerwall 2 [29] [30]. The system can be used especially in very sunny regions to bridge sunless days.

## V. FUTURE TRENDS

Even though the Fuel Cell was invented a long time ago, it still has a lot of development potential. The electrical efficiency still needs to be improved. Then the Fuel Cell would also be more profitable in areas of application that do not require a heat supply. Storing hydrogen also offers a great deal of potential. New variants, such as in the form of a paste, are developed. This paste has a ten times higher power density than a normal battery [31].

### A. Electrolyser Alternatives

The electrolyser could be completely be replaced by a reversible SOFC (rSOFC). This type of Fuel Cell not only works like a normal SOFC but can also be used reverse to generate hydrogen. This would reduce the parts to be serviced as well as the installation space. This type of Fuel Cell is actually still in the development phase. [32]

Another possibility to remove the electrolyser in the domestic area would be new invented solar panel which generate directly hydrogen. Water will be split directly into hydrogen and oxygen. The efficiency is actually about 15%, but the development is just at the beginning. Losses due electrolyses and transportation will be reduced. A panel can produce 250 liters of hydrogen per day. [33]

### B. Domestic Fuel Cells as part of a Smart Grid

A Smart Grid is a coordinated extension of generators of the current power grid. Fuel Cells are used to generate electricity for the public power grid. During peak demand, the Domestic Fuel Cells can be switched on from outside and thus stabilize the power grid. This flexibility would be an important complement to solar, wind and hydropower generation. However, this will require more Micro-CHP to be installed in households. Additionally, these must also support the connection to such a smart grid. [17]

## VI. CONCLUSION

The current state of Fuel Cells is represented by the PEMFC and SOFC. The PEMFC is more flexible due to the fast switch-on behaviour. However, SOFCs achieve a higher electrical and overall efficiency. For domestic use, a Micro-CHP is particularly useful. By utilizing the waste heat, the overall efficiency is significantly increased. Furthermore, Micro-CHP units are an alternative to normal heating systems. In addition, energy is generated much more effectively on-site with a Fuel Cell than in a fossil fuel power plant. Finally, hydrogen in combination with a Fuel Cell is a storage medium to be considered. Energy generated by a photovoltaic system can be stored for a short or long time with the help of hydrogen without large losses. Fuel Cells, storage, and

hydrogen production will be further improved in the coming years by technologies already under development.

## REFERENCES

- [1] Bundesregierung, "Klimaschutzgesetz: Klimaneutralität bis 2045," 29.11.2021. [Online]. Available: <https://www.bundesregierung.de/breg-de/themen/klimaschutz/klimaschutzgesetz-2021-1913672>
- [2] scinexx — Das Wissensmagazin, "CO<sub>2</sub>-Emissionen erreichen neue Höchstwerte - Treibhausgas-Ausstoß aus fossilen Brennstoffen steigt weiter, wenn auch langsamer," 2019. [Online]. Available: <https://www.scinexx.de/news/geowissen/co2-emissionen-erreichen-neue-hoechstwerte/>
- [3] Federal Ministry for Economic Affairs and Energy, "The national hydrogen strategy."
- [4] H. Tschöke, P. Gutzmer, and T. Pfund, *Elektrifizierung des Antriebsstrangs*. Berlin, Heidelberg: Springer Berlin Heidelberg, 2019.
- [5] S. V. M. Guaitolini, I. Yahyaoui, J. F. Fardin, L. F. Encarnacao, and F. Tadeo, "A review of fuel cell and energy cogeneration technologies," in *2018 9th International Renewable Energy Congress (IREC)*. IEEE, 2018, pp. 1–6.
- [6] P. Kurzweil, Ed., *Brennstoffzellentechnik*. Wiesbaden: Springer Fachmedien Wiesbaden, 2016.
- [7] T. Elmer, M. Worall, S. Wu, and S. B. Riffat, "Fuel cell technology for domestic built environment applications: State of-the-art review," *Renewable and Sustainable Energy Reviews*, vol. 42, pp. 913–931, 2015.
- [8] P. E. Dodds, I. Staffell, A. D. Hawkes, F. Li, P. Grünewald, W. McDowall, and P. Ekins, "Hydrogen and fuel cell technologies for heating: A review," *International Journal of Hydrogen Energy*, vol. 40, no. 5, pp. 2065–2083, 2015.
- [9] S. Ahlfs, A. Goudz, and M. Streichfuss, *Die Brennstoffzelle*. Wiesbaden: Springer Fachmedien Wiesbaden, 2020.
- [10] H.A. Khater, O. AbdelsalamE., M.Hanafy, Y.A. Abdelraouf, Ed., *Analytical Simulation of rich hydrogen gas - Air Proton Exchange Membrane Fuel Cell System fueled by natural gas: Cairo, Egypt, 17 - 20 December 2008*. Piscataway, NJ: IEEE, 2008.
- [11] S.-I. Sohn, J.-H. Oh, Y.-S. Lee, D.-H. Park, and I.-K. Oh, "Design of a fuel-cell-powered catamaran-type unmanned surface vehicle," *IEEE Journal of Oceanic Engineering*, vol. 40, no. 2, pp. 388–396, 2015.
- [12] O. GAS, "What is a fuel cell? - residential polymer electrolyte fuel cell (pefc) cogeneration system," 22.11.2021. [Online]. Available: <https://www.osakagas.co.jp/en/rd/fuelcell/pefc/fuelcell/index.html>
- [13] N. van Nguyen, R. Deja, R. Peters, and L. Blum, "Methane/steam global reforming kinetics over the ni/ysz of planar pre-reformers for sofc systems," *Chemical Engineering Journal*, vol. 292, pp. 113–122, 2016.
- [14] "SOFC-Brennstoffzelle," 20.11.2021. [Online]. Available: <https://www.erdgas.info/neue-heizung/heizungs technik/brennstoffzelle/brennstoffzellen-typen/sofc-brennstoffzelle>
- [15] P. Kurzweil, "Festoxid-brennstoffzelle (sofc)," in *Brennstoffzellentechnik*, P. Kurzweil, Ed. Wiesbaden: Springer Fachmedien Wiesbaden, 2016, pp. 195–214.
- [16] Visual Capitalist, "A global breakdown of greenhouse gas emissions by sector," 2020. [Online]. Available: <https://www.visualcapitalist.com/a-global-breakdown-of-greenhouse-gas-emissions-by-sector/>
- [17] Carsten Brorson, "Capabilities of fuel cell micro-chps in a smart grid perspective," vol. 2015.
- [18] E. R. Nielsen, C. B. Prag, "Learning points from demonstration of 1000 fuel cell based micro-chp units: Summary of analyses from the ene.field project," 2017. [Online]. Available: <http://enefield.eu/>
- [19] BlueGen, "Stromoptimierte Brennstoffzelle," 23.11.2021. [Online]. Available: <https://www.erdgas.info/neue-heizung/heizungs technik/brennstoffzelle/bluegen-von-solidpower>
- [20] OSAKA GAS, "What is a fuel cell? - residential polymer electrolyte fuel cell (pefc) cogeneration system," 26.11.2021. [Online]. Available: <https://www.osakagas.co.jp/en/rd/fuelcell/pefc/fuelcell/index.html>
- [21] Viessmann Deutschland GmbH, "Strom und Wärme aus einem Gerät: Vitolator PT2: Brennstoffzellen-Heizgerät." [Online]. Available: <https://www.viessmann.de/de/wohngebäude/kraft-waerme-kopplung/mikro-kwk-brennstoffzelle/vitolator-pt2.html>
- [22] PACE, "Home - pace," 10.09.2021. [Online]. Available: <https://pace-energy.eu/>

- [23] Thermondo, "Brennstoffzellenheizung: Kosten und Förderung," 25.11.2021. [Online]. Available: <https://www.thermondo.de/leistungen/heizsystem/brennstoffzellenheizung/kosten/>
- [24] Kesselheld, "Mikro Kraft-Wärme-Kopplung: Preise, Förderung & Technik - Kesselheld," 05.08.2021. [Online]. Available: <https://www.kesselheld.de/mikro-kwk/>
- [25] J. Bellosta von Colbe, J.-R. Ares, J. Barale, M. Baricco, C. Buckley, G. Capurso, N. Gallandat, D. M. Grant, M. N. Guzik, I. Jacob, E. H. Jensen, T. Jensen, J. Jepsen, T. Klassen, M. V. Lototskyy, K. Manickam, A. Montone, J. Puszkiel, S. Sartori, D. A. Sheppard, A. Stuart, G. Walker, C. J. Webb, H. Yang, V. Yartys, A. Züttel, and M. Dornheim, "Application of hydrides in hydrogen storage and compression: Achievements, outlook and perspectives," *International Journal of Hydrogen Energy*, vol. 44, no. 15, pp. 7780–7808, 2019.
- [26] Home Power Solutions, "Stromspeicher basierend auf wasserstoff und solarenergie," 10.11.2021. [Online]. Available: <https://www.homepowersolutions.de/produkt/>
- [27] A. Goetzberger, G. Bopp, W. Griesshaber, and W. Stahl, "The pv/hydrogen/oxygen-system of the self-sufficient solar house Freiburg," in *Conference Record of the Twenty Third IEEE Photovoltaic Specialists Conference - 1993 (Cat. No.93CH3283-9)*. IEEE, 1993, pp. 1152–1158.
- [28] Lavo, "Green energy hydrogen energy storage system by lavo™ australia," 18.11.2021. [Online]. Available: <https://lavo.com.au/#specs>
- [29] I. A. Hassan, H. S. Ramadan, M. A. Saleh, and D. Hissel, "Hydrogen storage technologies for stationary and mobile applications: Review, analysis and perspectives," *Renewable and Sustainable Energy Reviews*, vol. 149, p. 111311, 2021.
- [30] New Atlas, "World-first home hydrogen battery stores 3x the energy of a powerwall 2," 2021. [Online]. Available: <https://newatlas.com/energy/lavo-home-hydrogen-battery-storage/>
- [31] wegwerk GmbH, "Fraunhofer-Forscher entwickeln leistungsstarke Wasserstoff-Paste," 27.11.2021. [Online]. Available: <https://www.zfk.de/unternehmen/nachrichten/fraunhofer-forscher-entwickeln-leistungsstarke-wasserstoff-paste>
- [32] "Forschungszentrum Jülich - Pressemitteilungen - Reversible Brennstoffzelle bricht Wirkungsgrad-Rekord," 27.11.2021. [Online]. Available: <https://www.fz-juelich.de/SharedDocs/Pressemitteilungen/UK/DE/2018/2018-12-18-brennstoffzelle-wirkungsgrad-weltrekord.html>
- [33] M. Gallucci, "Solar panel splits water to produce hydrogen," 2019. [Online]. Available: <https://spectrum.ieee.org/solar-panel-prototype-splits-water-to-produce-hydrogen>

# ”Grüner” Ammoniak - eine Alternative zu Wasserstoff?

Andreas Kick

Fakultät Elektro- und Informationstechnik  
Ostbayerische Technische Hochschule Regensburg  
Regensburg, Deutschland  
andreas.kick@st.oth-regensburg.de

**Zusammenfassung**—Die Energiewende ist ein Prozess der kommenden Jahre. Ein wichtiger Schritt zu einer klimaneutralen Gesellschaft ist der Umstieg von fossilen Brennstoffen auf erneuerbare Energiequellen. Im Hinblick auf die Unbeständigkeit der regenerativen Energien spielt die Energiespeicherung eine entscheidende Rolle. Die Wasserstofftechnologie mit den bisher erreichten Fortschritten wird hierfür als vielversprechendste Lösung angesehen. Angesichts der weiterhin bestehenden Problematiken, wie die Lagerung und der Transport, ist es wichtig weitere alternative Ansätze zu finden.

”Grüner” Ammoniak ist aufgrund seiner Eigenschaften u.a. als Energiespeicher interessant. Es wird auf die Unterschiede zu Wasserstoff eingegangen, die aktuelle Problematik in der Produktion aufgezeigt und die Anwendungsmöglichkeiten und Herausforderungen behandelt. Ammoniak wird derzeit überwiegend in der Landwirtschaft verwendet, wodurch im Gegensatz zu Wasserstoff bereits eine weltweite Infrastruktur besteht. Aufgrund der Eigenschaften kann Ammoniak als Wasserstoffträger sowie Energieträger eingesetzt werden. Die Produktionsweise von Ammoniak weist einen erheblichen Anteil der weltweiten CO<sub>2</sub>-Emissionen auf. Diese kann schrittweise durch die Weiterentwicklung der Prozesse klimaneutral gestaltet werden. Ammoniak eignet sich für den Einsatz in verschiedensten Anwendungen. Besonders für die Schifffahrt wird die Nutzung von kohlenstofffreien Treibstoffen hinsichtlich der Reduktion der Treibhausgasemissionen untersucht. Es gilt u.a. die wirtschaftliche Tragfähigkeit von Technologien und die umweltfreundliche Produktion von ”grünem” Ammoniak zu klären. Derzeit stellt Ammoniak keine Alternative zu Wasserstoff dar, jedoch kann es bei entsprechendem Technologiestand eine sinnvolle Ergänzung im Energiesystem sein.

**Keywords**—Grüner Ammoniak, Wasserstoffträger, Energieträger, Brennstoff, Klimaneutralität

## I. EINLEITUNG

Das weltweite Wachstum der Population und Wirtschaft ist direkt proportional zur Verwendung fossiler Brennstoffe und der Zerstörung der Umwelt [1]. Um die Auswirkungen des Klimawandels reduzieren zu können und den Temperaturanstieg, wie vom Pariser Abkommen [2] beschlossen, auf 1,5 °C zu begrenzen, ist der Umstieg auf erneuerbare Energien und klimaneutrale Energieträger besonders wichtig. Die Verwendung von Wasserstoff als Brennstoff stellt eine Möglichkeit dar.

Das Hauptziel der Wasserstoff-Energiewende basiert auf ”grünem” Wasserstoff, das bedeutet die Erzeugung von Wasserstoff durch Elektrolyse von Wasser mit erneuerba-

ren Energien. Mit steigenden Produktionsanteilen sollen die ökonomischen Kosten des ”grünen” Wasserstoffs in wenigen Jahren vergleichbar mit den mittels fossiler Brennstoffe produzierten sein. Um dies zu erreichen, muss die technische Effizienz verbessert werden, die Produktionskosten für die Ausrüstung und Materialien gesenkt und die Herstellung ausgedehnt werden. [3]

Wasserstoff kann mit einem hohen Wirkungsgrad in Elektrizität umgewandelt werden, sowie mithilfe von Elektrizität produziert werden. Das Rohmaterial der Wasserstoffproduktion ist Wasser, welches in unerschöpflichen Mengen vorhanden ist. Des Weiteren kann Wasserstoff gasförmig, flüssig und fest gelagert werden und über lange Distanzen mit Pipelines, Tankern im / durch den Schienenverkehr transportiert werden. Wasserstoff ist als Energieträger umweltverträglich, da bei der Verbrennung nur geringe Mengen an NO<sub>x</sub> entstehen. [4]

Trotz vieler Vorteile, gibt es bei der Umstellung auf die Wasserstoffwirtschaft Hindernisse. Durch die niedrige Dichte von Wasserstoff ist die Lagerung ein kritischer Punkt. Des Weiteren stellen sich die hohen Produktions-, Lagerungs- und Transportkosten noch als Bürden dar. [5]

Die intensiviertere Forschung und Entwicklung alternativer Mittel zur Wasserstoffspeicherung führte zu dem Konsens, dass sich u.a. ”grüner” Ammoniak als Wasserstoff- und Energieträger eignet [6]. Ammoniak entsteht durch die Synthese von Wasserstoff mit Stickstoff [7]. Er wird aktuell überwiegend in der Landwirtschaft als Kühl- und Düngemittel verwendet [8]. Er wird somit seit über einem Jahrhundert hergestellt und weltweit transportiert (mehr als 100 Millionen Tonnen jährlich [9]).

Der Begriff ”grüner” Ammoniak bedeutet, dass bei der Produktion keine CO<sub>2</sub>-Emissionen entstehen und die benötigte Energie durch regenerative Quellen bereitgestellt wird [10].

In diesem Paper werden die Möglichkeiten, die ”grüner” Ammoniak bietet, genauer betrachtet. Zu Beginn wird auf die Eigenschaften eingegangen, die Ammoniak Vorteile u.a. als Energieträger verschaffen. Anschließend folgt eine Betrachtung der traditionellen Produktionsweise und mögliche Schritte, diese klimaneutral zu gestalten. Es werden Anwendungsmöglichkeiten, wie z.B. der Einsatz in der Schifffahrt, aufgezeigt. Abschließend werden aktuelle Hindernisse in der Verwendung von Ammoniak im Energiesystem beleuchtet.

## II. AMMONIAK ALS ENERGIE- UND WASSERSTOFFTRÄGER

Ammoniak ist als Energieträger interessant, da aufgrund der Nutzung in der Landwirtschaft eine leistungsfähige Infrastruktur besteht [11]. Er wird, vergleichbar zu Propan, bei acht bar Druck und bei Raumtemperatur im flüssigen Zustand gelagert. Der Energiegehalt pro Volumeneinheit ist übereinstimmend mit Benzin. Dies macht Ammoniak attraktiv als Treibstoff für Transportanwendungen [12]. Zusätzlich kann Ammoniak als sauberer Energieträger und -speicher fungieren, da er potenziell umweltfreundlich verbrannt werden kann und nur Wasser und Stickstoff freigesetzt werden [13]. Bei der Gegenüberstellung von Ammoniak und Wasserstoff zeigt sich, dass die Kosten pro Volumen gespeicherter Energie bei Ammoniak ein Drittel von den Kosten, die bei Wasserstoff anfallen, betragen [14]. Die Eigenschaften von Ammoniak erleichtern den Transport und die Lagerung. Wasserstoff benötigt entweder eine sehr niedrige Temperatur von  $-252.9\text{ °C}$  um verflüssigt oder einen hohen Druck von 700 bar um bei Raumtemperatur gespeichert werden zu können [6]. Miura und Tezuka [15] untersuchten Ammoniak und Wasserstoff hinsichtlich der wirtschaftlichen und ökologischen Eignung im Energiesystem in Japan anhand der drei Indikatoren Energieverbrauch,  $\text{CO}_2$ -Emissionen und Versorgungskosten. Es zeigt sich, dass in Energiesystemen, die eine relativ große Anzahl an Speichertagen erfordern, Ammoniak wettbewerbsfähig zu Wasserstoff ist und die Verwendung die Kontinuität der Energieversorgung in einer Region verbessern dürfte.

Ammoniak bietet auch als Wasserstoffträger Vorteile. Es weist neben der bestehenden Infrastruktur, eine hohe Dichte an Wasserstoffatomen und eine einfache katalytische Verbrennung auf [16]. Der Vergleich von flüssigem Wasserstoff, Methylcyclohexan und Ammoniak hinsichtlich Energieeffizienz und Wirtschaftlichkeit zeigt, dass der Transport und die Speicherung von Wasserstoff in Form von Ammoniak in Anbetracht der Energieeffizienz und Kosten gegenüber den anderen Medien vorteilhaft ist [17].

## III. PRODUKTION VON AMMONIAK

### A. Haber-Bosch Verfahren

Ammoniak wird hauptsächlich durch eine Synthesetechnik, die als Haber-Bosch-Verfahren (HB) bekannt ist, hergestellt. Es sind hohe Temperaturen im Bereich von  $400\text{ °C}$  und  $500\text{ °C}$  und ein Druck im Bereich von 100 bar bis 200 bar notwendig [7]. Beim HB-Verfahren kommt es zu folgender thermokatalytischen Reaktion [18]:

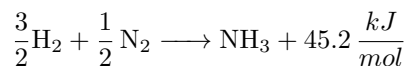

Wasserstoff und Stickstoff werden in einem Verhältnis von 3:1 kombiniert, um Ammoniak im vorher genannten Temperatur- und Druckbereich zu erzeugen. Bei der Reaktion wird Energie freigesetzt, weswegen es sich um einen exothermen Prozess handelt. Ein hoher Druck und eine niedrige Temperatur begünstigen die Ammoniaksynthese unter Gleichgewichtsbedingungen. Jedoch ist die Ammoniakbildungsrate extrem langsam und für Produktionszwecke nicht geeignet, sodass das

HB-Verfahren bei hohen Temperaturen und Drücken durchgeführt wird [19].

Heutzutage wird in herkömmlichen HB-Anlagen Ammoniak mit Erdgas (zu 50 %), Erdöl (zu 30 %) oder Kohle (zu 19 %) als Ausgangsstoff hergestellt [20]. Das methanbasierte Verfahren ist aktuell aufgrund seiner höheren Energieeffizienz und geringeren Kohlenstoffemissionen die beste verfügbare Technik. Der Herstellungsprozess kann in zwei Schritte unterteilt werden. Der erste ist die Wasserstoffproduktion aus Methan und der zweite ist die Ammoniaksynthese mittels der HB-Reaktion [21]. Die katalytische Reaktion verbraucht ca. 1 % des weltweiten Energieverbrauchs und ohne eine  $\text{CO}_2$ -Abscheidung werden 1.9 Tonnen  $\text{CO}_2$  pro Tonne Ammoniak (1.2 % der weltweiten  $\text{CO}_2$ -Emissionen) ausgestoßen. Die Verringerung des  $\text{CO}_2$ -Ausstoßes der Ammoniakproduktion durch Verwendung von kohlenstoffarmen Wasserstoff ist essentiell für die Erreichung der Netto-Null-Emissionen bis 2050 [22].

### B. Klimaneutrale Produktion

Um von dem im Abschnitt III-A vorgestellten Haber-Bosch Verfahren auf eine  $\text{CO}_2$ -neutrale Produktion umstellen zu können, muss die Produktionsweise schrittweise optimiert werden.

Die erste Möglichkeit besteht darin, mit der Verwendung von Kohlenstoffbindung oder -kompensation, die Netto-Auswirkungen der Ammoniakproduktion auf null zu bringen. Diese Produktionsart wird auch als "blauer" Ammoniak bezeichnet. Jedoch entstehen durch die Kohlenstoffseparation zusätzliche Kosten und verkomplizieren den Produktionsablauf der bisherigen HB-Technologie. [23]

Die nächste Weiterentwicklung besteht darin, Ammoniak mit dem HB-Verfahren unter der Verwendung von Wasserstoff, das nicht aus fossilen Brennstoffen stammt, zu produzieren. Dies hat den Vorteil, dass die bestehenden HB-Anlagen mit der neuen Wasserstoffversorgung weiterverwendet werden können [23]. Dieses Verfahren wird bereits in einem kleineren Umfang von Wilkinson und Kollegen bei Siemens getestet [24].

Die letzte Produktionstechnologie baut auf die Elektroreduktion von  $\text{N}_2$  zu Ammoniak auf. Das HB-Verfahren wird somit nicht mehr benötigt. Die Reaktion wird durch die elektrochemische Reduktion angetrieben und die Wasserstoffquelle beruht auf Wasser. [23]

## IV. ANWENDUNGSMÖGLICHKEITEN

Wie in Abschnitt II gezeigt, ist Ammoniak vielseitig anwendbar und eignet sich für mehrere Einsatzgebiete. Ammoniak wird als potenzielles Arbeitsmittel für thermodynamische Kreisläufe betrachtet. Diese können zum Kühlen, Heizen oder zur Stromerzeugung verwendet und mit Verbrennungsmotoren gekoppelt werden [25]. Die entstehenden Abgase können zum Antrieb von Absorptionskühlsystemen genutzt werden [26]. Zamfirescu und Dincer [27] haben die Möglichkeit untersucht, Ammoniak als Kühlmittel zu verwenden, während er als Kraftstoff für den Fahrzeugantrieb verbraucht wird. Des Weiteren ist Ammoniak auch ein Medium, das für die thermochemische Speicherung von Energie geeignet ist



Abbildung 1. Wirtschaftskreislauf von Ammoniak von der Produktion bis zur Nutzung [30].

[28]. Daher kann Ammoniak eine entscheidende Rolle u.a. in Fahrzeuganwendungen als Kraftstoff, Wasserstoffquelle, Arbeitsflüssigkeit/Kühlmittel, NO<sub>x</sub>-Reduktionsmittel oder als Energiespeichermedium einnehmen [12].

In Abbildung 1 wird der Wirtschaftskreislauf von Ammoniak von der Produktion bis zur Nutzung dargestellt. Die Wasserstoffproduktion und Luftseparation können durch verschiedene Quellen für Strom und Wärme versorgt werden. Es sind unterschiedliche Verfahren zur Erzeugung von Wasserstoff aufgelistet. Nach dem ersten Produktionsschritt folgt die Synthese. Der entstehende Ammoniak kann nun gelagert und über verschiedene Verkehrswege verteilt werden. Es lässt sich erkennen, dass sich vielfältige Anwendungen in den verschiedensten Wirtschaftsbereichen ermöglichen.

Im Folgenden wird der mögliche Einsatz von Ammoniak in der Schifffahrt betrachtet. Mit dem Ziel der internationalen Seeschifffahrtsorganisation, die Treibhausgasemissionen des internationalen Seeverkehrs bis 2050 um mindestens 50 % im Vergleich zu 2008 zu reduzieren, ist es notwendig treibhausgasfreie Kraftstoffe einzuführen. Die Verwendung von Ammoniak als Seefahrt-Kraftstoff bietet die Möglichkeit für Investitionen in Entwicklungsländer mit unerschöpflichen regenerativen Energiequellen als geeignete Produktionsstandorte. Wie in Abschnitt II erwähnt, besteht für Ammoniak aufgrund der internationalen Düngemittelindustrie ein globaler Markt und eine weltweite Produktion und Versendung. Daher gibt es schon festgelegte Normen für die sichere Handhabung, Lagerung und den Transport von Ammoniak auf Schiffen. Neben der bestehenden Infrastruktur, weist Ammoniak weitere Vorteile gegenüber anderen Seefahrtkraftstoffen auf. Im Gegensatz zu Wasserstoff wird keine kryogene Lagerung benötigt. Als

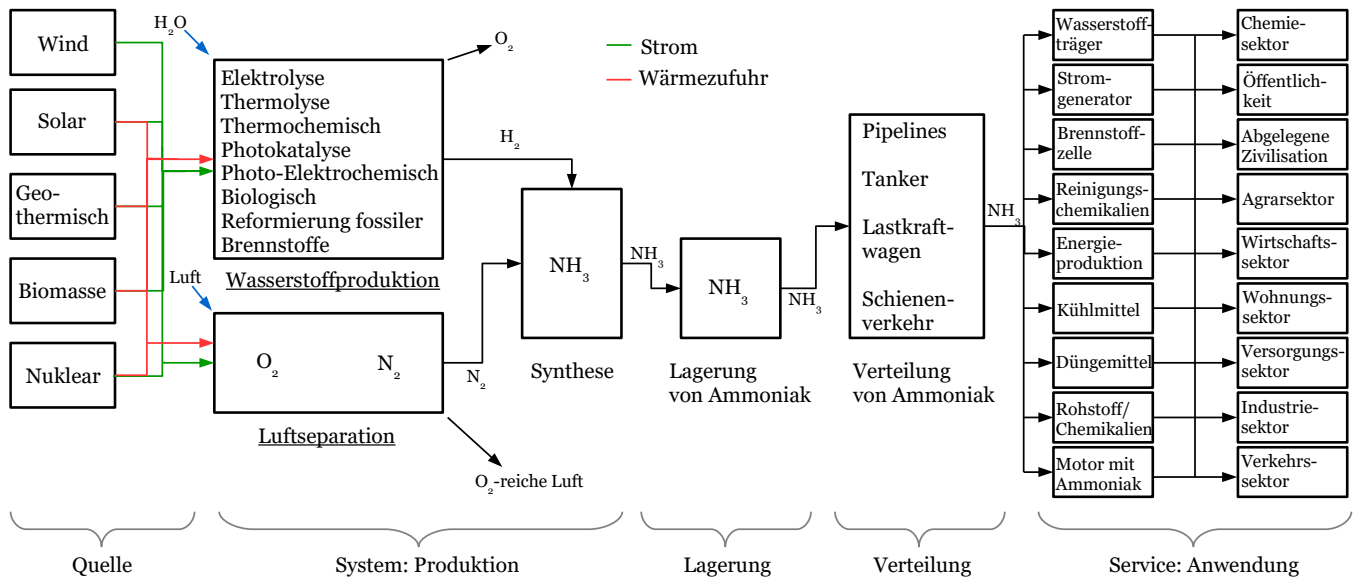
Flüssigkeit hat Ammoniak eine relativ hohe Energiedichte, die als Energiespeicher für mehrwöchige Schiffsreisen ausreicht. Dies ist wiederum mit Batterien vergleichsweise schwierig zu erreichen. Ammoniak bietet die Flexibilität ohne komplizierte Aufbereitung an Bord in Verbrennungsmotoren oder in künftigen Brennstoffzellen verwendet werden zu können. Abschließend existiert ein Risikoprofil, das mit den bestehenden Normen und Verfahren beherrscht werden kann. [29]

## V. HERAUSFORDERUNGEN

Trotz vieler Vorteile bei der Integration von Ammoniak in das Energiesystem, sind Technologieentwicklungen notwendig um die Kosten und Effizienz der Technologien zu verbessern. Bei der Ammoniakproduktion ist zuerst eine CO<sub>2</sub>-Sequestrierung notwendig, um eine nachhaltigere Produktion von Ammoniak aus Erdgas zu entwickeln. Alternative Verfahren mit Wasserstoff aus einer kohlenstofffreien Produktion sind noch zu wenig erforscht. [22]

Für die Produktion einer Tonne Ammoniak werden mindestens 1.5 Tonnen Wasser benötigt. Durch Prozessverluste und Emissionen kann sich die Menge um mindestens 20 % erhöhen, sodass dies in besonders trockenen Regionen ein wichtiges Thema ist. [23]

Die Verbrennung von Ammoniak führt einige Nebenwirkungen mit sich. Diese sind eine hohe Entzündungstemperatur, eine niedrige Flammgeschwindigkeit sowie eine langsame chemische Kinetik. Hier gilt es weitere Forschungsressourcen zu investieren, um die Auswirkungen zu minimieren und die Verbrennungsleistung zu verbessern. [30]

Die Verwendung von Ammoniak als Brennstoff wird dazu führen, dass täglich eine größere Menge im öffentlichen Raum

unterwegs ist. Die Risiken, die mit einer unbeabsichtigten Freisetzung von Ammoniak verbunden sind, müssen aufgrund der Toxizität sorgfältig bewertet und gemindert werden. Ausgehend vom Sicherheitsaspekt wird es zu gesellschaftlichen Bedenken kommen, die es zu überwinden gilt. [23]

## VI. FAZIT UND AUSBLICK

In dieser Arbeit wurde Ammoniak als kohlenstofffreier Energieträger und mögliche Alternative zu Wasserstoff genauer beleuchtet. Er bietet Vorteile hinsichtlich Transport und Lagerung und weist eine bestehende weltweite Verteilinfrastruktur auf. Außerdem ist Ammoniak geeignet als Wasserstoffträger zu fungieren. Das derzeitige Produktionsverfahren hat einen hohen Anteil des weltweiten CO<sub>2</sub>-Ausstoßes zur Folge. Dieses kann schrittweise optimiert werden bis die Produktion von "grünen" Ammoniak komplett klimaneutral ablaufen kann. Für Ammoniak bieten sich viele Anwendungsmöglichkeiten u.a. im Schiffverkehr, wo ein großes Interesse besteht, klimaneutrale Alternativen zu fossilen Brennstoffen einzuführen. Neben genannten positiven Aspekten existieren noch Herausforderungen, die eine Anwendung von Ammoniak erschweren. Es wird u.a. ein hoher Kapitalbedarf benötigt, um notwendige Technologien und Produktionsanlagen zu entwickeln und auszubauen.

Es stellt sich die Frage, ob Ammoniak als Alternative zu Wasserstoff angesehen werden kann. Die vielseitigen Anwendungsmöglichkeiten, wie der direkte Einsatz in Verbrennungsmotoren, Brennstoffzellen oder reiner Energieträger in Kombination mit der bestehenden Infrastruktur, sprechen für Ammoniak. Jedoch sind für eine klimaneutrale Produktion hohe Investitionen notwendig. Bei der Herstellung von Wasserstoff entfällt das komplette HB-Verfahren bzw. dessen klimaneutrale Alternative, das eine deutliche Einsparung darstellt. Aktuell stellt Ammoniak keine Alternative zu Wasserstoff dar, er kann jedoch bei entsprechendem Technologiestand eine gute Ergänzung im Energiesystem sein. Vor allem die Eigenschaft als Wasserstoffträger sollte genauer verfolgt werden, da hier die Schwierigkeit von Wasserstoff hinsichtlich Transport und Lagerung übergangen werden kann.

## LITERATUR

- [1] S.Z.Baykara, "Ecohealth problems and climate change I: anthropogenic climate change and ecohealth: worldwide environmental damage," in IFSSH World Congress Health Challenges of the 3rd Millenium, Istanbul, Aug. 21-26, 2005, S. 295-313.
- [2] United Nations, "Paris Agreement," 2015.
- [3] M. Wang, Z. Wang, X. Gong und Z. Guo, "The intensification technologies to water electrolysis for hydrogen production - A review," in Renewable and Sustainable Energy Reviews, Vol. 29, 2014, S. 573-588, doi: 10.1016/j.rser.2013.08.090.
- [4] S.A. Sherif, F. Barbir und T.N. Veziroglu, "Wind energy and the hydrogen economy-review of the technology," in Solar Energy, Vol. 78, 2005, S. 647-660, doi: 10.1016/j.solener.2005.01.002.
- [5] J.O. Abe, A.P.I. Popoola, E. Ajenifuja und O.M. Popoola, "Hydrogen energy, economy and storage: Review and recommendation," in International Journal of Hydrogen Energy, Vol. 44, 2019, S. 15072-15086, doi: 10.1016/j.ijhydene.2019.04.068.
- [6] H. Kobayashi, A. Hayakawa, K.D. Kunkuma, A. Somarathne und E.C. Okafor, "Science and technology of ammonia combustion," in Proceedings of the Combustion Institute, Vol. 37, 2019, S.109-133, doi: 10.1016/j.proci.2018.09.029.
- [7] J. Zheng, L. Jiang, Y. Lyu, S.P. Jian und S. Wang, "Green Synthesis of Nitrogen-to-Ammonia Fixation: Past, Present, and Future," in Energy and Environmental Materials, 2021, doi: 10.1002/eem2.12192.
- [8] C. Zamfirescu und I. Dincer, "Ammonia as a green fuel and hydrogen source for vehicular applications," in Fuel Processing Technology, Vol. 90, 2009, S.729-737, doi: 10.1016/j.fuproc.2009.02.004.
- [9] J. Nørskov und J. Cheng, "Sustainable Ammonia Synthesis Exploring the scientific challenges associated with discovering alternative, sustainable processes for ammonia production DOE Roundtable Report," 2016.
- [10] A.H. Tullo, "Is ammonia the fuel of the future? Industry sees the agricultural chemical as a convenient means to transport hydrogen," 2021. [Online]. Verfügbar: <https://cen.acs.org/business/petrochemicals/ammonia-fuel-future/99/i8>
- [11] G. Thomas und G. Parks, "Potential Roles of Ammonia in a Hydrogen Economy A Study of Issues Related to the Use Ammonia for On-Board Vehicular Hydrogen Storage," 2006.
- [12] C. Zamfirescu und I. Dincer, "Using ammonia as a sustainable fuel," in Journal of Power Sources, Vol. 185, 2008, S. 459-465, doi: 10.1016/j.jpowsour.2008.02.097.
- [13] G. Strickland, "Ammonia as a hydrogen energy storage medium," in Proc. 5th Annu. Thermal Storage Meeting, McLean, VA, USA, Oct. 10, 1980, Paper 8010555-2.
- [14] D.A. Kramer und Usgs Minerals Information Team, "Mineral Commodity Summaries 2007," 2007. [Online]. Verfügbar: <https://www.usgs.gov/centers/nmic/mineral-commodity-summaries>
- [15] D. Miura und T. Tezuka, "A comparative study of ammonia energy systems as a future energy carrier, with particular reference to vehicle use in Japan," in Energy, Vol. 68, 2014, S.428-436, doi: 10.1016/j.energy.2014.02.108.
- [16] A. Klerke, C.H. Christensen, J.K. Nørskov und T. Vegge, "Ammonia for hydrogen storage: Challenges and opportunities," in Journal of Materials Chemistry, Vol. 18, 2008, S. 2304-2310, doi: 10.1039/b720020j.
- [17] M. Aziz, T. Oda und T. Kashiwagi, "Comparison of liquid hydrogen, methylcyclohexane and ammonia on energy efficiency and economy," in Energy Procedia, Vol. 158, 2019, S.4086-4091, doi: 10.1016/j.egypro.2019.01.827.
- [18] A. Yapiçioğlu und I. Dincer, "A review on clean ammonia as a potential fuel for power generators," in Renewable and Sustainable Energy Reviews, Vol. 103, 2019, S. 96-108, doi: 10.1016/j.rser.2018.12.023.
- [19] J. Humphreys, R. Lan und S. Tao, "Development and Recent Progress on Ammonia Synthesis Catalysts for Haber-Bosch Process," in Advanced Energy and Sustainability Research, Vol. 2, 2021, doi: 10.1002/aesr.202000043.
- [20] R. Lan, J.T.S. Irvine und S. Tao, "Ammonia and related chemicals as potential indirect hydrogen storage materials," in International Journal of Hydrogen Energy, Vol. 37, 2012, S. 1482-1494, doi: 10.1016/j.ijhydene.2011.10.004.
- [21] C. Smith, A.K. Hill und L. Torrente-Murciano, "Current and future role of Haber-Bosch ammonia in a carbon-free energy landscape," in Energy and Environmental Science, Vol. 13, 2020, S. 331-344, doi: 10.1039/c9ee02873k.
- [22] N. Morlanés, S.P. Katikaneni, S.N. Paglieri, A. Harale, B. Solami, S. Mani Sarathy und J. Gascon, "A technological roadmap to the ammonia energy economy: Current state and missing technologies," in Chemical Engineering Journal, Vol. 408, 2020, doi: 10.1016/j.cej.2020.127310.
- [23] D.R. MacFarlane, P.V. Cherepanov et al., "A Roadmap to the Ammonia Economy," in Joule, Vol. 4, 2020, S. 1186-1205, doi: 10.1016/j.joule.2020.04.004.
- [24] I. Wilkinson und Siemens, "Green Ammonia – a significant contributor to a low-carbon energy system?," 2018. Verfügbar: <https://ingenuity.siemens.com/2018/05/green-ammonia-a-significant-contributor-to-a-low-carbon-energy-system/>
- [25] L. Zhu, S. Wang und J. Gu, "Performance investigation of a thermal-driven refrigeration system," in International Journal of Energy Research, Vol. 32, 2008, S. 939-949, doi: 10.1002/er.1408.
- [26] I. Hilali und M.S. Söylemez, "On the optimum sizing of exhaust gas-driven automotive absorption cooling systems," in International Journal of Energy Research, Vol. 32, 2008, S. 655-660, doi: 10.1002/er.1383.
- [27] C. Zamfirescu und I. Dincer, "Ammonia as a green fuel for transportation," 2008.

- [28] O.M. Williams und P. O'Neil Carden, "Energy storage efficiency for the ammonia/hydrogen-nitrogen thermochemical energy transfer system," in International Journal of Energy Research, Vol. 3, 1979, S. 29-40.
- [29] N. Ash und T. Scarbrough, "Sailing on Solar - Could green ammonia decarbonise international shipping?," 2019. [Online]. Verfügbar: <https://www.researchgate.net/publication/332845713>
- [30] D. Erdemir und I. Dincer, "A perspective on the use of ammonia as a clean fuel: Challenges and solutions," in International Journal of Energy Research, Vol. 45, 2021, S. 4827-4834, doi: 10.1002/er.6232.



# Synthetische Kraftstoffe: Gewinnung und Ökobilanz

Manuel Albrecht

Elektro- und Informationstechnik

Ostbayerische Technische Hochschule Regensburg, Germany

manuel.albrecht@st.oth-regensburg.de

**Zusammenfassung**—Um die gesetzten Klimaziele in Deutschland, aber auch weltweit, zu erreichen, sollen unter anderem im Verkehrssektor die CO<sub>2</sub>-Emissionen weiter reduziert werden. Neben der Elektromobilität erscheinen klimaneutrale, synthetische Kraftstoffe als vielversprechende und umweltfreundliche Alternative zu den fossilen Kraftstoffen.

In dieser Arbeit wird zunächst die aktuelle Situation in Deutschland bezüglich des Fahrzeugbestands und der eingesetzten Kraftstoffe analysiert. Anschließend wird auf die Gewinnung und die Ökobilanz einiger synthetischer Kraftstoffe, deren Markteinführung bis 2030 möglich ist, eingegangen und deren potenzieller Einsatz bewertet. Die Herstellung dieser Kraftstoffe, vom Ausgangsrohstoff bis hin zum fertigen, einsatzfähigen Kraftstoff, werden dabei unter anderem mit Hilfe von Prozessketten dargestellt und erläutert. Zudem werden die jeweiligen Ökobilanzen der Kraftstoffe anhand ihrer CO<sub>2</sub>-Emissionen und der Reduktion der Entstehung weiterer Schadstoffe, sowie ihres Umwelteinflusses, bewertet. Dabei werden vor allem Vergleiche zu fossilen Kraftstoffen gezogen.

Diese Arbeit zeigt das Potenzial verschiedener synthetischer Kraftstoffe, einen wichtigen Beitrag zur zeitnahen Reduktion der CO<sub>2</sub>-Emissionen im Verkehrssektor zu leisten. Sowie ergänzend zur Elektromobilität in Zukunft als Alternative zu den fossilen Kraftstoffen in Deutschland aber auch weltweit zum Einsatz zu kommen.

**Keywords**—Synthetische Kraftstoffe, Biokraftstoffe, E-Fuels, Sunlight-to-Liquid Kraftstoffe, Ökobilanzen

## I. EINLEITUNG

Für das Erreichen der beim Pariser Klimaabkommen beschlossenen Ziele hinsichtlich der CO<sub>2</sub>-Emissionen konnten in Deutschland in den letzten Jahren in fast allen Bereichen Fortschritte erzielt werden. Jedoch liegt man immer noch hinter den gesetzten Einsparungszielen, die aus dem Klimaschutzplan der Bundesregierung hervorgehen. [1], [2]

Die Daten des aktuellen Klimaschutzberichts der Bundesregierung belegen, dass die Emissionen im Verkehrssektor, bis auf den pandemiebedingten Rückgang im Jahr 2020, seit 1990 nahezu konstant geblieben sind, wodurch hier weiterhin großes Einsparungspotenzial besteht [3]. Neben der Elektromobilität sind synthetische Kraftstoffe eine vielversprechende Alternative, um CO<sub>2</sub>-Emissionen zu reduzieren. Diese zeichnen sich durch eine chemische Umwandlung während der Produktion aus, bei der die chemische Struktur der Ausgangsrohstoffe entscheidend verändert wird. [2], [4], [5]

Die Daten des Kraftfahrt-Bundesamtes (KBA) zu den Pkw-Neuzulassungen im Jahr 2020 zeigen ein steigendes Interesse an Elektrofahrzeugen. Trotzdem ist die Anzahl der neuzugelassenen Pkw mit herkömmlichen Verbrennungsmotoren deutlich höher. Die Zahlen zum aktuellen Fahrzeugbestand in Deutschland bestätigen den derzeitigen, geringen Anteil der

Elektroautos (Abbildung 1). [6]

Daraus ist zu folgern, dass in den kommenden Jahren die CO<sub>2</sub>-Emissionen im Verkehrssektor, nur durch den Umstieg auf Elektroautos, nicht so stark wie geplant reduziert werden können. Um die mittel- und langfristigen Klimaschutzziele



Abbildung 1 Zugelassene Fahrzeuge in Deutschland (Juli 2021) [6]

aus [1] zu erreichen, hat, ergänzend zur Elektromobilität, die Verwendung synthetischer Kraftstoffe aus Biomasse, Power-to-Liquid (PtL) bzw. Sunlight-to-Liquid (StL) Verfahren das höchste Potenzial [5].

Synthetische Kraftstoffe, die die fossilen Kraftstoffe direkt ersetzen, können speziell wegen der Weiternutzung der vorhandenen Fahrzeuge und der bestehenden Tankstellenvertriebsstruktur, zur zeitnahen Reduktion der CO<sub>2</sub>-Emissionen im Verkehrssektor beitragen. Andere synthetische Kraftstoffe, wie z. B. Methanol oder Methan, haben ebenso das Potenzial eine klimafreundliche Alternative zu fossilen Brennstoffen zu werden. Jedoch sind dafür, ebenso wie bei der Elektromobilität, große Investitionen der Regierung und der Verbraucher in neue Fahrzeuge bzw. in Infrastruktur notwendig. [2], [4]

Die in [7] angegebene Aufteilung des Kraftstoffverbrauchs in Deutschland zeigt, dass die Gewinnung synthetischer Kraftstoffe noch nicht großtechnisch umgesetzt ist. Sie befinden sich noch in der Entwicklungs- bzw. Marktvorlaufphase. [2] Im Folgenden wird die Gewinnung verschiedener synthetischer Kraftstoffe aufgezeigt und deren Ökobilanz anhand ihres CO<sub>2</sub>-Fußabdruckes und der Reduktion der Entstehung weiterer Schadstoffe, im Vergleich zu fossilen Kraftstoffen, diskutiert. Dazu wurde eine Literaturrecherche durchgeführt.

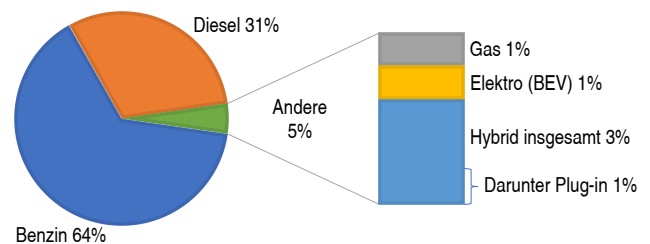
## II. SYNTHETISCHE BIOKRAFTSTOFFE

Im Gegensatz zur mechanisch-physikalischen Gewinnung der Biokraftstoffe der 1. Generation, wie z. B. Biodiesel und Pflanzenöle, werden synthetische Biokraftstoffe durch thermo-chemischen Prozesse gewonnen. Für die ökologische Produktion dieser Kraftstoffe werden Pflanzenreststoffe, die nicht in Konkurrenz zur Nahrungs- und Futtermittelproduktion

stehen, eingesetzt. Somit gehören sie zu den Biokraftstoffen der 2. Generation. Die verwendeten Rohstoffe haben nur einen geringen Einfluss auf die Qualität und die Art des resultierenden Kraftstoffes, da diese vor allem vom durchgeführten Syntheseschritt abhängig sind. [2], [4]

#### A. Gewinnung

Die Gewinnung synthetischer Biokraftstoffe (Biomass-to-Liquid; BtL) erfolgt durch einen mehrstufigen Umwandlungsprozess, der folgende Stufen enthält: Rohstoffaufbereitung, Vergasung, Gasaufbereitung und Synthese (Abbildung 2). Diese Prozesse werden im Folgenden erläutert. [4]



Abbildung 2 Prozesskette zur Herstellung synthetischer Kraftstoffe aus Biomasse [4]

1) *Rohstoffaufbereitung*: Für eine effiziente und problemlose Vergasung von Pflanzenreststoffen, wie z. B. Bio- und Grünabfälle [8], müssen diese aufbereitet werden. Zur Verbesserung des Wirkungsgrades wird dabei, durch thermische Verfahren, der Wasseranteil der Rohstoffe verringert. Dabei soll das Optimum aus Effizienzverbesserung und den damit verbundenen Kosten, in Abhängigkeit des Rohstoffs, des Vergasungsverfahrens und des Syntheseverfahrens, erreicht werden. Neben der Trocknung (bis 200 °C) werden, speziell für den Transport und die Lagerung der aufbereiteten Rohstoffe, weiterführenden thermischen Verfahren, wie die Torrefaktion (ca. 200 - 300 °C) und die Pyrolyse (ca. 400 - 600 °C) eingesetzt. Dadurch liegt das Ausgangsmaterial in komprimierter Form mit sehr hoher Energiedichte vor. [4], [9]

2) *Vergasung*: Bei der Vergasung wird die aufbereitete Biomasse bei Temperaturen von 800 - 1100 °C unter Zuführung eines Oxidationsmittels in Synthesegas, bestehend aus CO und H<sub>2</sub>, umgewandelt. Als Nebenprodukte der Umwandlung entstehen Kohlendioxid, Methan, Wasserdampf und weitere feste Rückstände wie Koks und Teer. [4]

3) *Gasaufbereitung*: Bei der Gasaufbereitung werden vor allem die bei der Vergasung entstandenen Nebenprodukte entfernt. Zudem wird das Synthesegas auf die Zusammensetzung des für das Syntheseverfahren benötigten H<sub>2</sub>/CO-Verhältnis optimiert und das notwendige Temperatur- und Druckniveau eingestellt (Tabelle 1). Das H<sub>2</sub>/CO-Verhältnis wird dabei meist über die, in beide Richtungen umsetzbare, (rückwärtige) Wassergas-Shift-Reaktion (WGS bzw. RWGS) eingestellt (Gleichung 1). [4]

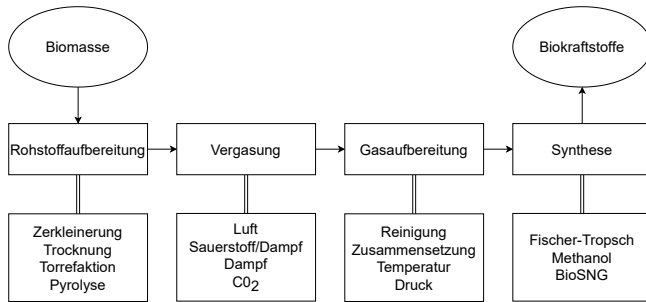

Tabelle 1 Betriebsparameter Syntheseverfahren [4]

Synthese	H <sub>2</sub> /CO	Katalysator	Druck in bar	Temperatur in °C
Fischer-Tropsch	1,5 - 2	Fe, Co	20 - 30	200 - 250
Methanol	2	Zn/Cr, Cu/Zn	50 - 100	220 - 300
Methanisierung	3	Ni/Mg	2 - 10	250 - 400

4) *Synthese*: Für die Herstellung synthetischer Biokraftstoffe werden vor allem die in Abbildung 3 dargestellten Syntheseverfahren eingesetzt. Diese Verfahren werden auch bei der Gewinnung der E-Fuels (Abschnitt III) und der StL-Kraftstoffe (Abschnitt IV) verwendet.

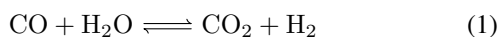

Abbildung 3 Syntheseverfahren zur Herstellung synthetischer Kraftstoffe [4], [10]–[12]

Die **Fischer-Tropsch-Synthese (FTS)** ist ein Verfahren zur "Kohleverflüssigung", sie wurde in der Vergangenheit vor allem für die Kraftstoffherstellung aus Kohle (Coal to Liquid; CtL) und Erdgas (Gas to Liquid; GtL) verwendet [11], [13]. Mit Kraftstoffen aus der FTS können fossile Kraftstoffe ersetzt werden (Abbildung 3). Dabei wird das Synthesegas mittels eines Katalysators (Tabelle 1) in einer stark exothermen Reaktion in Kohlenwasserstoffe mit unterschiedlichen Kettenlängen umgewandelt (Gleichung 2). Damit kann das gesamte Produktspektrum von kurzkettigen, gasförmigen Produkten (C<sub>1</sub> - C<sub>4</sub>), über flüssige Produkte (Zielfraktion für Kraftstoffe: C<sub>5</sub> - C<sub>20</sub>) bis hin zu Wachsen (> C<sub>20</sub>) gewonnen werden. Durch das Aufspalten der langkettigen Wachsfraktion mittels Wasserstoff, dem sogenannten Hydrocracken, kann die Menge der flüssigen Produkte erhöht werden. [4], [14], [15]

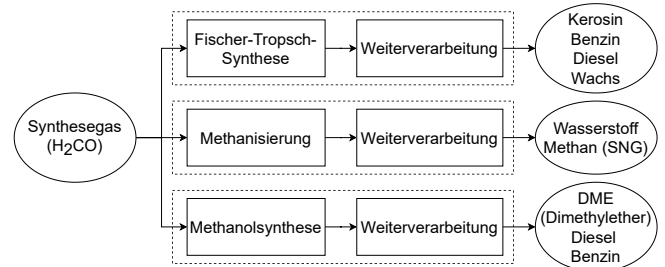
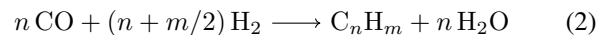

Diese flüssigen Produkte entsprechen noch nicht den derzeit geltenden Kraftstoffnormen. Sie müssen deshalb noch weiterverarbeitet werden. Dies kann z. B. durch die Isomerisierung oder Destillation erfolgen. Dabei werden in die linearen Kohlenwasserstoffketten zusätzliche Verzweigungen eingebracht, dadurch erhöht sich die Klopfestigkeit und somit die Oktanzahl der Kraftstoffe. Die drei Weiterverarbeitungsschritte (Hydrocracken, Isomerisierung und Destillation) werden auch bei der Herstellung fossiler Kraftstoffe aus Rohöl durchgeführt. Somit können die FTS-Produkte in herkömmlichen Raffinerien zu einsatzfähigen Kraftstoffen weiterverarbeitet werden. [2], [4], [11], [14], [16]

Die **Methanolsynthese** wird für die Gewinnung von Methanol unter den in Tabelle 1 angegebenen Bedingungen verwendet. Dabei wird das Synthesegas bei einer stark exothermen Reaktion in Methanol umgewandelt (Gleichung 3). Durch

Kondensation bzw. Rektifikation werden Nebenprodukte und Wasser vom Rohmethanol getrennt. Dadurch steigt die Qualität des Methanols. [2], [4]

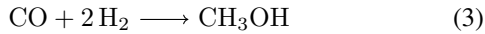

Durch die Weiterverarbeitung von Methanol können klassische Kraftstoffe, z. B. mittels Methanol-to-Gasoline-Verfahren, Oxymethylenether (OME), sowie DME gewonnen werden. [10], [16], [17]

Die Verarbeitung zu Diesel und Benzin ist laut [18] kein Standard, da dafür zusätzliche, verlustbehaftete Transformationsprozesse notwendig sind. DME und OME besitzen andere physikalisch-chemische Eigenschaften als herkömmliche Kraftstoffe, deshalb ist für ihren Einsatz eine Umrüstung der entsprechenden Motoren notwendig. [2], [19]

Bei der **Methanisierung** läuft die stark exotherme Umwandlung des Synthesegases in Methan (Gleichung 4), unter den in Tabelle 1 angegebenen Bedingungen ab. [4]

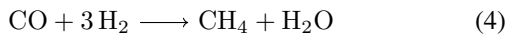

Nebenprodukte wie Wasserdampf und  $\text{CO}_2$ , sowie geringe Anteile Wasserstoff müssen vor der Weiternutzung als Kraftstoff, z. B. in Erdgasfahrzeugen, bzw. vor der Einspeisung in das Erdgasnetz entfernt werden. Bei der Verwendung regenerativer Energiequellen für die Herstellung des Synthesegases kann die Methanisierung zur Reduktion von  $\text{CO}_2$  beitragen. Besonders die Weiternutzung der vorhandenen Infrastruktur, durch die Nutzung des Erdgasnetzes und der Tankstellenvertriebsstruktur, ermöglichen einen schnellen Einstieg. Dabei kann neben dem Verkehrssektor auch der Energiesektor profitieren. [4], [17]

### B. Ökobilanz

Durch den Einsatz von Pflanzenreststoffen als Rohstoffe für die Weiterverarbeitung zu synthetischen Kraftstoffen können die  $\text{CO}_2$ -Emissionen im Vergleich zu herkömmlichen fossilen Energieträgern um ca. 70 - 77 % reduziert werden [2]. Da die Kraftstoffe durch die einzelnen Prozessschritte nahezu keine Verunreinigungen enthalten, verbrennen sie mit einem geringeren Schadstoffausstoß ( $\text{NO}_x$ , Schwefel, Ruß) und einer höheren Effizienz als fossile Brennstoffe. [5], [15]

Zudem besteht keine Konkurrenz zur Nahrungs- und Futtermittelproduktion, da die eingesetzten Rohstoffe nicht extra angebaut werden müssen. Dadurch werden Monokulturen, die einen Qualitätsverlust der Böden zur Folge haben, vermieden. Dies wirkt sich ebenfalls positiv auf die Ökobilanz synthetischer Biokraftstoffe aus. [2]

## III. STROMBASIERTE SYNTHETISCHE KRAFTSTOFFE

Strombasierte synthetische Kraftstoffe, die durch PtL oder PtG (Power to Gas) Verfahren gewonnen werden, stellen eine weitere vielversprechende Alternative zu den bisherigen Kraftstoffen dar. Sie werden auch als E-Fuels bezeichnet.

### A. Gewinnung

Wie in Abbildung 4 dargestellt, werden E-Fuels aus Wasser, Strom und  $\text{CO}_2$  hergestellt. Dabei wird Wasserstoff mittels Elektrolyse aus Strom und Wasser gewonnen. Durch die RWGS (Gleichung 1) wird  $\text{CO}_2$  in CO umgewandelt, um das für die Weiterverarbeitung notwendige Synthesegas zu erzeugen. Die Herstellung der E-Fuels erfolgt dann mit den in Abschnitt II aufgezeigten Syntheseverfahren (Abbildung 3). [15], [18], [20], [21]



Abbildung 4 Prozesskette zur Herstellung von E-Fuel [18], [20]

1) *Elektrolyse*: Wasserstoff wird durch die Elektrolyse von Wasser mit Strom gewonnen (Gleichung 5). Dabei wird zwischen der Niedrigtemperaturelektrolyse (NT-Elektrolyse) bei 50 - 80 °C und der Hochtemperatur-Elektrolyse (HT-Elektrolyse) bei 700 - 1000 °C unterschieden. Bei der NT-Elektrolyse werden vor allem die alkalische Elektrolyse und die Protonen-Austausch-Membran-Elektrolyse (PEM-Elektrolyse) eingesetzt. Der Wirkungsgrad liegt bei ca. 65 %. [18]

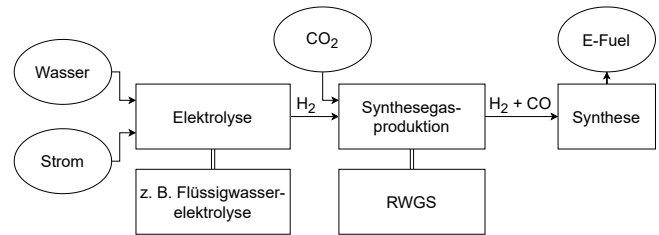
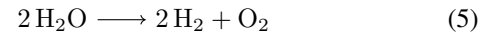

Bei der HT-Elektrolyse wird überhitzter Wasserdampf in Wasserstoff und Sauerstoff umgewandelt, der Bedarf an elektrischer Energie für die Spaltung ist dabei geringer als bei NT-Elektrolyseverfahren. Besonders bei integrierten Anlagen, mit E-Fuel-Produktion durch exotherme Syntheseverfahren, können höhere Wirkungsgrade von ca. 80 % erreicht werden. Die für die HT-Elektrolyse benötigte Verfahrenstemperatur kann dabei teilweise aus dem Syntheseprozess zurückgeführt werden. [18]

Durch die Weiterentwicklung und das Optimieren der beiden Elektrolyseverfahren werden künftig um bis zu 10 % höhere Wirkungsgrade erwartet. [18], [20]

2) *CO<sub>2</sub>-Bereitstellung*: Das für den Prozess (Abbildung 4) notwendige  $\text{CO}_2$  kann aus herkömmlichen Industrieprozessen, aus biogenen Quellen (z. B. aus Biogasanlagen) oder direkt aus der Luft stammen. Die Abscheidung aus der Luft befindet sich in der Entwicklungsphase. Die großtechnische Umsetzung ist für die kommenden Jahre geplant und ist mit einem zusätzlichen Energieaufwand verbunden. [14], [18], [22], [23]

3) *Synthesegasproduktion*: Für die Synthesegasproduktion werden Verfahren wie die RWGS (Gleichung 1) eingesetzt. Dabei wird das  $\text{H}_2/\text{CO}$ -Verhältnis für das Syntheseverfahren eingestellt (Tabelle 1). Zusätzlich können Verunreinigungen entfernt bzw. minimiert werden. [20]

## B. Ökobilanz

Die Ökobilanz von E-Fuels ist vor allem von der Art der Stromerzeugung und der CO<sub>2</sub>-Bereitstellung abhängig. Nach der aktuellen Gesetzeslage wirkt sich die Nutzung von CO<sub>2</sub>-Emissionen aus Industrieprozessen, die nicht klimaneutral sind, negativ auf die Ökobilanz der daraus produzierten Kraftstoffe aus. Daher muss für die klimaneutrale Gewinnung synthetischer Kraftstoffe Strom aus erneuerbaren Energiequellen und klimaneutrales CO<sub>2</sub> verwendet werden. Nur dann wird das Maximum (ca. 70 %) an CO<sub>2</sub>-Emissionen im Vergleich zu fossilen Brennstoffen eingespart [2]. Um den Energiesektor der entsprechenden Regionen zu entlasten, sollten für die E-Fuel Produktion nur zusätzlich errichtete regenerative Energiequellen verwendet werden. Zudem hat der hohe Wasserbedarf bei der Produktion der E-Fuels, besonders bei Anlagen in trockenen Regionen, einen großen Einfluss auf die lokalen Ressourcen. In Küstennähe sollte deshalb z. B. die Aufbereitung von Meerwasser in Entsalzungsanlagen eingesetzt werden. [18]

Wie bei den synthetischen Biokraftstoffen entstehen auch bei der Verbrennung der E-Fuels weniger Schadstoffe als bei fossilen Brennstoffen. [18], [24]

## IV. SUNLIGHT TO LIQUID VERFAHREN (StL)

Beim StL Verfahren werden die Rohstoffe direkt mit der Sonnenenergie in Synthesegas umgesetzt. Es wird bislang vor allem in kleinen Demonstrationsanlagen angewendet. [2], [22]

### A. Gewinnung

Beim StL-Verfahren wird das Synthesegas aus Wasser und CO<sub>2</sub> in einem thermo-chemischen Prozess gewonnen. Das Sonnenlicht wird dabei durch Spiegel auf den Reaktor konzentriert und erhitzt diesen auf 1500 °C. Darin wird das Synthesegas an einer Oxidationsschicht erzeugt. Dieses Gas kann dann mit den bereits bekannten Syntheseverfahren (Abbildung 3) zu verschiedenen synthetischen Kraftstoffen weiterverarbeitet werden. Wasser und CO<sub>2</sub> müssen dabei, wie bei den E-Fuels, klimaneutral bereitgestellt werden. In [22] wird vor allem die direkte Abscheidung aus der Luft behandelt. [2], [25]

### B. Ökobilanz

Die Ökobilanz der StL Kraftstoffe ist mit der von E-Fuels (Abschnitt III) vergleichbar. Ihr Wirkungsgrad ist aufgrund der direkten Nutzung des Sonnenlichtes etwas höher. Somit können bei StL-Verfahren die CO<sub>2</sub>-Emissionen im Vergleich zu fossilen Kraftstoffen um ca. 80 % reduziert werden. [2]

## V. BEWERTUNG DER SYNTHETISCHEN KRAFTSTOFFE

Einige der vorgestellten synthetischen Kraftstoffe haben aufgrund der chemischen und physikalischen Ähnlichkeit zu den konventionellen Kraftstoffen den Vorteil, dass sie die fossilen Kraftstoffe direkt ersetzen können. Der Wirkungsgrad des Herstellungsprozesses von Biokraftstoffen liegt je nach Zustand des Ausgangsrohstoffes und der anschließenden Weiterverarbeitung bei ca. 30 - 45 % [26]. Die Herstellung der E-Fuels, sowie der StL-Kraftstoffe erfolgt mit einem Wirkungsgrad von ca. 30 - 50 % [17], [22]. Im Vergleich dazu,

ist der Wirkungsgrad von Rohöl mit ca. 95 % deutlich höher [26]. Die Produktionskosten der synthetischen Kraftstoffe sind vor allem von den Kosten für die Rohstoffe, aber auch von der Effizienz der Anlagen abhängig. Aus der Literatur geht hervor, dass die Kosten mittel- bis langfristig auf 0,6 - 1,3 €/l gesenkt werden können. Sie liegen somit tendenziell höher als bei den fossilen Kraftstoffen (ca. 0,5 - 0,6 €/l). [4], [27]

Der Kraftstoffpreis für den Verbraucher könnte durch das Nutzen der Nebenprodukte, z. B. Wachs in der Kosmetikindustrie, oder durch niedrigere Strompreise bei der E-Fuel Produktion weiter gesenkt werden. [2]

Wegen dem zusätzlichen, niedrigen Wirkungsgrad von Verbrennungsmotoren (ca. 30 % [17]) können synthetische Kraftstoffe nicht mit der Effizienz von Elektroautos (Gesamtwirkungsgrad: ca. 86 % [17]) mithalten.

## VI. FAZIT UND AUSBLICK

In dieser Arbeit konnte gezeigt werden, dass synthetische Kraftstoffe, als Ergänzung zur Elektromobilität, einen wichtigen Beitrag zur Reduktion der CO<sub>2</sub>-Emissionen im Verkehrssektor leisten können. Besonders die schnelle Markteinführung als Ersatz für die herkömmlichen fossilen Kraftstoffe, durch die Weiternutzung der bestehenden Fahrzeuge und der vorhandenen Tankstellenvertriebsstruktur, zeigen ihr großes Potenzial. Um den schnellen Einstieg in den Markt möglich zu machen, sind kurzfristig sehr große Investitionen in die Entwicklung großer, effizienter Anlagen notwendig. Aufgrund des steigenden Strombedarfs sind zudem Investitionen in regenerative Energiequellen notwendig. Außerdem muss der Einstieg synthetischer Kraftstoffe in den Markt vom Staat, z. B. durch Steuersenkungen, Subventionierungen, sowie durch Anpassung der Kraftstoffnormen oder durch Festlegung von Quoten, erleichtert werden.

Langfristig ist der Einsatz der Kraftstoffe im Flug-, Schiffs- und Schwerlastverkehr, in denen aufgrund des großen Energiebedarfs flüssige Kraftstoffe benötigt werden, denkbar. [2] Die Gewinnung klimaneutraler synthetischer Kraftstoffe ist an die regionale Verfügbarkeit regenerativer Energiequellen gebunden. Da diese Ressourcen in Deutschland begrenzt sind, hat der Technologieexport in Regionen mit besseren Gegebenheiten, wie z. B. Norwegen (Wind- und Wasserkraft), Island (Geothermie/Wasserkraft), oder südliche Regionen (Sonnenergie), großes Potenzial. [28]

Dies zeigen aktuelle Pilotprojekte in Chile, Marokko, Norwegen und Spanien. [18], [29], [30]

Der Wirkungsgrad der Produktion synthetischer Kraftstoffe ist niedriger als bei fossilen Kraftstoffen, zudem können sie nicht mit der Effizienz der direkten Stromnutzung in der Elektromobilität mithalten. Trotzdem sollte künftig auf synthetische Kraftstoffe gesetzt werden, da kurzfristig eine schnelle Defossilisierung des Verkehrssektors möglich ist und langfristig vor allem der Transportsektor von der Nutzung synthetischer Kraftstoffe profitieren kann. Auch die anderen synthetischen Kraftstoffe, wie Methanol und Methan, haben das Potenzial künftig eine Alternative zu den aktuellen Kraftstoffen zu werden.

## LITERATUR

- [1] Bundesministerium für Umwelt, Naturschutz und nukleare Sicherheit, "Der Klimaschutzplan 2050 - Die deutsche Klimaschutzlangfriststrategie," <https://www.bmu.de/themen/klimaschutz-anpassung/klimaschutz/nationale-klimapolitik/klimaschutzplan-2050>, 2016, [Online; aufgerufen am 28.11.2021].
- [2] T. Bierkandt, M. Severin, S. Ehrenberger, and M. Köhler, "Kurzstudie: Klimaneutrale synthetische Kraftstoffe im Verkehr," Deutsches Zentrum für Luft- und Raumfahrt e. V. (DLR), 2018.
- [3] Bundesministerium für Umwelt, Naturschutz und nukleare Sicherheit, "Infografiken zur Klimabilanz," [https://www.bmu.de/media?tx\\_bmubmedia\\_media%5Bmedia%5D=1485&cHash=f11efe757b1efcafe45ac4dd5fab6afb](https://www.bmu.de/media?tx_bmubmedia_media%5Bmedia%5D=1485&cHash=f11efe757b1efcafe45ac4dd5fab6afb), 2021, [Online; aufgerufen am 28.11.2021].
- [4] S. Fürnsinn and H. Hofbauer, "Synthetische Kraftstoffe aus Biomasse: Technik, Entwicklungen, Perspektiven," *Chemie Ingenieur Technik*, vol. 79, no. 5, pp. 579–590, 2007.
- [5] M. Severin, T. Bierkandt, M. Köhler, M. Zwanzig, K. Simhandl, and M. Aigner, "Positionspapier: Forschen für saubere Kraftstoffe - Mit synthetischen Kraftstoffen die Klimasziele im Verkehrssektor erreichen," Deutsches Zentrum für Luft- und Raumfahrt e. V. (DLR), 2019.
- [6] Kraftfahrtbundesamt, "Bestand an Kraftfahrzeugen und Kraftfahrzeuganhängern nach Bundesländern, Fahrzeugklassen und ausgewählten Merkmalen," [https://www.kba.de/DE/Statistik/Fahrzeuge/Bestand/Vierteljaehrlicher\\_Bestand/vierteljahrlicher\\_bestand\\_node.html](https://www.kba.de/DE/Statistik/Fahrzeuge/Bestand/Vierteljaehrlicher_Bestand/vierteljahrlicher_bestand_node.html), pp. FZ 27.1 – 27.2, [Online; aufgerufen am 28.11.2021].
- [7] Fachagentur Nachwachsende Rohstoffe e. V., "Aktuelle Marktsituation - Kraftstoffabsatz in Deutschland," <https://biokraftstoffe.fnr.de/kraftstoffe/aktuelle-marktsituation>, 2021, [Online; aufgerufen am 28.11.2021].
- [8] L. Leible, A. Arlt, S. Kälber, E. Nieke, D. Winzer, and B. Fürnsinn, "Energie aus biogenen Reststoffen und Abfällen—Stand und Perspektiven in Deutschland," *Bio und Restabfallbehandlung IX. Biologisch-mechanisch-thermisch. Witzenhausen-Institut, Witzenhausen*, pp. 390–413, 2003.
- [9] M. Kaltschmitt and W. Streicher, "Energie aus Biomasse," in *Regenerative Energien in Österreich*. Springer, 2009.
- [10] N. Dahmen and E. Dinjus, "Synthetische Chemieprodukte und Kraftstoffe aus Biomasse," *Chemie Ingenieur Technik*, vol. 82, no. 8, pp. 1147–1152, 2010.
- [11] R. Güttel, U. Kunz, and T. Turek, "Reaktoren für die Fischer-Tropsch-Synthese," *Chemie Ingenieur Technik*, vol. 79, no. 5, pp. 531–543, 2007.
- [12] S. Fendt, M. Gaderer, and H. Spliethoff, "SYNTHETIC NATURAL GAS (SNG)-STATE-OF-THE-ART TECHNOLOGY AND APPLICATION REVIEW," in *19th European Biomass Conference and Exhibition*, 2011.
- [13] M. Lehner, "Carbon capture and utilization (ccu)," Climate Change Center AUSTRIA (CCCA), 2021.
- [14] M. Klumpp, T. Böltken, A. Gräfenhahn, M. Riedinger, P. Pfeifer, and R. Dittmeyer, "CO<sub>2</sub>-neutrale Kraftstoffe aus dezentralen Syntheseanlagen—Ansatz, Status Quo und der Blick nach vorne," *Journal für Mobilität und Verkehr*, no. 3, pp. 1–10, 2019.
- [15] H. Kirsch, "Dezentrale Synthese strombasierter flüssiger Kraftstoffe über die Fischer-Tropsch Route," Ph.D. dissertation, Karlsruhe Institute of Technology (KIT), 2021.
- [16] M. Bertau, M. Kraft, L. Plass, and H.-J. Wernicke, "Methanol-der Kraftstoff, der uns morgen antreibt," in *Zukünftige Kraftstoffe*. Springer, 2019, pp. 480–531.
- [17] K. Wagemann and F. Ausfelder, "E-Fuels-mehr als eine Option," DE-CHEMA Gesellschaft für Chemische Technik und Biotechnologie e.V., 2017.
- [18] P. Kasten, "E-Fuels im Verkehrssektor," Öko-Institut e.V., 2020.
- [19] A. Tremel, "Strombasierte Kraft- und Brennstoffe als Verknüpfung von weltweiten Energiesystemen," in *Zukünftige Kraftstoffe*. Springer, 2019, pp. 251–283.
- [20] A. Meurer and J. Kern, "Fischer-Tropsch synthesis as the key for decentralized sustainable kerosene production," *Energies*, vol. 14, no. 7, 2021.
- [21] F. Rudolph, "Der Beitrag von synthetischen Kraftstoffen zur Verkehrswende: Optionen und Prioritäten," Greenpeace e.V., 2019.
- [22] R. Schäppi, D. Rutz, F. Dähler, A. Muroyama, P. Haueter, J. Lilliestam, A. Patt, P. Furler, and A. Steinfeld, "Drop-in Fuels from Sunlight and Air," *Nature*, pp. 1–7, 2021.
- [23] D. Heß, M. Klumpp, and R. Dittmeyer, "Nutzung von CO<sub>2</sub> aus Luft als Rohstoff für synthetische Kraftstoffe und Chemikalien," Karlsruhe Institute of Technology (KIT), 2020.
- [24] S. Kigle, S. Pichlmaier, J. Huber, and A. Regett, "Ökobilanzen strombasierter synthetischer Kraftstoffe: Worauf es ankommt," Forschungsstelle für Energiewirtschaft e.V., 2019.
- [25] C. Falter, "Efficiency Potential of Solar Thermochemical Reactor Concepts with Ecological and Economical Performance Analysis of Solar Fuel Production," Ph.D. dissertation, RWTH Aachen, 2017.
- [26] G. Schaub and A. Vetter, "Biokraftstoffe—Eine Übersicht," *Chemie Ingenieur Technik*, vol. 79, no. 5, pp. 569–578, 2007.
- [27] C. von Olshausen and K. Hauptmeier, "Sunfire—Erneuerbare Moleküle aus CO<sub>2</sub> und H<sub>2</sub>O zur Substitution von Erdöl und Erdgas," in *Zukünftige Kraftstoffe*. Springer, 2019, pp. 410–432.
- [28] J. Perner, M. Unteutsch, and A. Loevenich, "Die zukünftigen Kosten strombasierter synthetischer Brennstoffe," *Agora Energiewende, Agora Energiewende und Frontier Economics*, 2018.
- [29] O. Machhammer, "Renewable electricity from Germany or e-fuels from Chile: What should future mobility be based on?" *Chemie Ingenieur Technik*, vol. 93, no. 4, pp. 641–654, 2021.
- [30] F. Urbansky, "Potenziale synthetischer Kraftstoffe," *MTZ-Motortechnische Zeitschrift*, vol. 81, no. 1, pp. 8–13, 2020.

# Klimaneutrales Kerosin: Technologieprinzipien, Nutzen und Grenzen

Christoph Mayer  
Elektro- und Informationstechnik  
Ostbayerische Technische Hochschule  
Regensburg, Deutschland  
christoph1.mayer@st.oth-regensburg.de

**Zusammenfassung** - Die Nutzung von fossilen Energieträgern führt zu einer erhöhten Konzentration von Treibhausgasen (u.a. Kohlenstoffdioxid, Methan, Stickstoffdioxid) in der Atmosphäre und damit zu einer Veränderung des Klimas. 2018 wurden 2,8 % des weltweit ausgestoßenen Kohlenstoffdioxids durch die Verwendung von erdölbasierendem Kerosin im Luftverkehr verursacht. Die zunehmenden Auswirkungen des anthropogenen Klimawandels sowie die umweltbezogenen Nachteile und die geforderte Unabhängigkeit von erdölbasierendem Kerosin sind Motivationsfaktoren für die Entwicklung und den Einsatz von alternativem, klimaneutralem Kerosin.

Im Rahmen dieser Arbeit werden auf Basis aktueller Veröffentlichungen Technologien zur Herstellung von klimaneutralem Kerosin aufgezeigt sowie miteinander verglichen. Hierbei wird zwischen den Technologieprinzipien Power to Liquid (PtL), Biomass to Liquid (BtL), Hydroprocessed Esters and Fatty Acids (HEFA) und Alcohol to Jet (AtJ) unterschieden. Neben den prozessspezifischen Eigenschaften (Ausgangsmaterial, Treibhausgas-Emission, Wasserbedarf) der jeweiligen Verfahren werden deren Vor- und Nachteile aufgeführt. Zudem wird auf die Grenzen zur Eindämmung des anthropogenen Klimawandels durch die Verwendung von klimaneutralem Kerosin eingegangen. Für die aufgeführten Verfahren werden außerdem moralische und ethische Aspekte hinsichtlich der eingesetzten Ressourcen erläutert.

Die Arbeit zeigt auf, dass die Verwendung von klimaneutralem Kerosin die Treibhausgas-Emissionen reduzieren kann. Das Potential der Verfahren ist stark vom verwendeten Ausgangsmaterial abhängig. Dabei weist das PtL-Verfahren i. Vgl. zu den anderen Verfahren die größte Nachhaltigkeit auf. Die Eindämmung des Klimawandels durch klimaneutrales Kerosin ist aber beschränkt, da die Verbrennung von Kerosin neben Treibhausgas-Emission noch weitere Klimawirkungen zeigt.

**Keywords** - Kerosin, klimaneutral, erneuerbar, Luftverkehr, Power to Liquid, Biomass to Liquid, Hydroprocessed Esters and Fatty Acids, Alcohol to Jet

## I. EINFÜHRUNG

Der Luftverkehr ist eine wichtige Voraussetzung für eine globalisierte Welt. Er befähigt dazu, weltweit soziale Kontakte und geschäftliche Beziehungen unterhalten zu können. Die Verwendung von erdölbasierendem Kerosin im Luftverkehr führt zu einer Emission von Treibhausgasen (THG) und somit zu einer negativen Beeinflussung des Weltklimas. [1] 2018 verursachte der weltweite Luftverkehr 2,8 % des insgesamt vom Menschen emittierten Kohlenstoffdioxids (CO<sub>2</sub>) [2]. Laut Prognosen wird sich die Passagierzahl im Luftverkehr in den nächsten 20 Jahren verdoppeln. Dies führt dazu, dass der Verbrauch von Kerosin zunehmen wird. [3] Wird dieser Verbrauch von Kerosin weiterhin durch herkömmliches Kerosin abgedeckt, so wird die THG-Emission durch den

Luftverkehr weiter zunehmen. Eine Abhilfe zur Reduktion der THG-Emissionen durch den Luftverkehr bietet klimaneutrales Kerosin, welches aus erneuerbaren Rohstoffen erzeugt wird. Klimaneutral bedeutet im Rahmen dieser Arbeit, dass das bei der Kerosin-Verbrennung freiwerdende CO<sub>2</sub> dem bei der Kerosin-Erzeugung gebundenem CO<sub>2</sub> entspricht. Berücksichtigt man aber CO<sub>2</sub>-Emissionen während des Herstellungsprozesses aufgrund von z.B. Rohstofftransport oder Düngemittelproduktion, so ist diese Klimaneutralität u.U. nicht mehr gegeben.



Abb. 1. Übersicht der Technologieprinzipien zur Herstellung von klimaneutralem Kerosin. (angelehnt an [4])

Im Rahmen dieser Arbeit werden vier Verfahren zur Herstellung von klimaneutralem Kerosin aufgezeigt. Die Verfahren sind in Abb. 1 schematisch dargestellt. Die behandelten Verfahren erzeugen Kerosin, welches keine Modifikation der bisherigen Antriebstechnik benötigt und somit direkt in bisherigen Antriebstechniken eingesetzt werden kann [4]. Aus den Technologieprinzipien der Verfahren werden deren Vor- und Nachteile abgeleitet. Zudem werden die Ökobilanzen (THG-Emission, Wasserbedarf) der Verfahren miteinander verglichen.

Abschnitt II zeigt vier Technologieprinzipien zur Herstellung von klimaneutralem Kerosin und deren Eigenschaften sowie einen Vergleich der Verfahren untereinander auf. In Abschnitt III werden die Grenzen von klimaneutralem Kerosin hinsichtlich der Eindämmung des anthropogenen Klimawandels aufgezeigt. Abschnitt IV nimmt eine moralische und ethische Einordnung von klimaneutralem Kerosin vor. In Abschnitt V werden die wichtigsten Punkte zusammengefasst und ein Ausblick gegeben.

## II. HERSTELLUNG VON KLIMANEUTRALEM KEROSIN

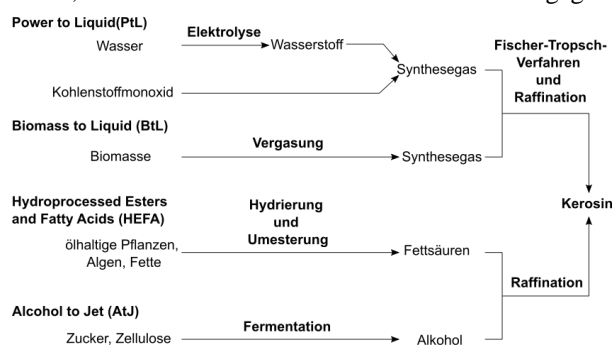
### A. Power to Liquid (PtL)

Wie in Abb. 1 ersichtlich ist, lässt sich das PtL-Verfahren grob in drei Prozessstufen gliedern. Die erste Stufe umfasst die Gewinnung des Synthesegas, welches eine Mischung aus Wasserstoff (H<sub>2</sub>) und Kohlenstoffmonoxid (CO) ist. H<sub>2</sub>

wird mittels Elektrolyse unter Einsatz von elektrischem Strom aus Wasser ( $H_2O$ ) erzeugt. [5, 6]  $CO$  wird aus  $CO_2$  mittels Wassergas-Shift-Reaktion gewonnen (siehe [7]). Um eine Reduktion der THG-Emissionen zu erzielen, muss die eingesetzte elektrische Energie klimaneutral bzw. mit geringen THG-Emissionen erzeugt werden. Möglichkeiten dafür sind z.B. Windenergie, Photovoltaik (PV), Wasserkraft und Geothermie. Zudem muss das eingesetzte  $CO_2$  durch Extraktion aus der Luft oder durch Umwandlung von erneuerbarer, organischer Biomasse gewonnen werden. Eine  $CO_2$ -Gewinnung aus dem Prozessgas von z.B. der Zementindustrie ist nicht nachhaltig, da durch die kaskadierte Nutzung des  $CO_2$  die  $CO_2$ -Konzentration in der Atmosphäre trotzdem weiter ansteigt. Das eingesetzte Wasser sollte aus nachhaltigen und nicht aus fossilen Quellen stammen, um den Prozess ökologisch zu gestalten. [8] Die zweite Stufe bildet das Fischer-Tropsch-Verfahren (FT). Dabei wird das Synthesegas katalytisch in flüssige Kohlenwasserstoffketten umgewandelt. Die Länge der erzeugten Kohlenwasserstoffketten ist u.a. von verwendetem Katalysator, Druck und Temperatur während des Umwandlungsprozesses abhängig. [1, 6] Die dritte Stufe bildet die Raffination der erhaltenen Kohlenwasserstoffketten. Das aus dem FT-Verfahren erhaltene Produkt weist Kohlenwasserstoffe mit unterschiedlichen Kettenlängen auf. Durch Hydrierung, Hydrocracken und Isomerisierung werden kurze, verzweigte Kohlenwasserstoffe gebildet. Mithilfe der Fraktionierung werden die unterschiedlichen Kohlenwasserstoffe separiert und somit u.a. Kerosin gewonnen. [6, 8]

Die Vorteile von Kerosin aus dem PtL-Verfahren sind:

- Hohe Energiedichte des erzeugten Kerosins
- Für den Prozess nötige elektrische Energie kann in landwirtschaftlich nicht nutzbaren Gebieten erzeugt werden (z.B. PV-, Windanlagen in der Wüste)
- Bei Verwendung von aus der Luft extrahiertem  $CO_2$  wird keine Biomasse benötigt, wodurch keine Konkurrenz zwischen Kerosin- und Lebensmittelproduktion besteht

Den größten Nachteil von PtL-Kerosin stellen die momentan noch hohen Produktionsgesamtkosten dar. [9]

## B. Biomass to Liquid (BtL)

Ausgangsmaterial für das BtL-Verfahren ist Biomasse. Biomasse ist eine erneuerbare Energiequelle, die Kohlenstoff enthält und  $CO_2$  direkt aus der Luft binden kann [3]. Dabei bietet sich ein breites Spektrum an möglichen Ausgangsmaterialien wie z.B. Zellulose, Holz, Algen, landwirtschaftliche und kommunale Abfälle [1].



Abb. 2. Technologieprinzip des BtL-Verfahrens mithilfe Fischer-Tropsch-Synthese. (angelehnt an [3, 10])

Abb. 2 zeigt die Prozessschritte des BtL-Verfahrens. Die Biomasse wird getrocknet, um Feuchtigkeit zu entziehen, und gemahlen, um die Partikelgröße zu reduzieren. Dann erfolgt

die Vergasung der Biomasse bei  $1300^\circ C$  unter Druck und Einsatz von reinem Sauerstoff ( $O_2$ ), um das Synthesegas ( $H_2$  und  $CO$ ) zu erzeugen. Anschließend wird das Synthesegas gereinigt, um u.a. saure Gase wie  $CO_2$ , Schwefelwasserstoff ( $H_2S$ ) und Schwefel ( $S$ ) zu entfernen. Mittels FT-Verfahren wird das Synthesegas in flüssige Kohlenwasserstoffe mit unterschiedlichen Kettenlängen umgewandelt. Durch Hydrierung, Hydrocracken und Isomerisierung werden kurze, verzweigte Kohlenwasserstoffe gebildet, aus denen mittels Fraktionierung das Kerosin separiert wird. [3, 10, 11, 12, 13]

Die Vorteile von Kerosin aus dem BtL-Verfahren sind:

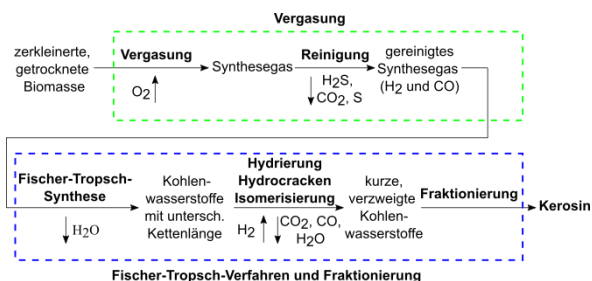
- Breites Spektrum möglicher Ausgangsmaterialien
- Biomasse ist weit verbreitet und wird in großem Maß produziert
- Kerosin aus FT-Verfahren ist durch American Society for Testing and Materials (ASTM) bereits zertifiziert und kann für kommerzielle Flüge eingesetzt werden

[3, 11] Ein weiterer Vorteil des FT-Verfahrens, welches Synthesegas aus Biomasse nutzt, ist die größere Energieeffizienz (77 %) i. Vgl. zum FT-Verfahren, welches Synthesegas aus Kohle (64 %) bzw. Erdgas (68 %) verwendet [10].

Nachteile von Kerosin aus dem BtL-Verfahren sind der höhere Preis i. Vgl. zu herkömmlichem Kerosin [1] und eine geringe Energiedichte [14]. Ein weiterer Nachteil ergibt sich durch die global begrenzte Verfügbarkeit von fruchtbarer Anbaufläche. Kerosin, welches auf Biomasse basiert, konkurriert durch die nötige Erzeugung von Energiepflanzen mit der Lebensmittelproduktion. Eine Abholzung, um Anbauflächen zu schaffen, und der Anbau von Monokulturen verringern zudem die Biodiversität, wodurch die Nachhaltigkeit von BtL-Kerosin sinkt. [8] Eine Abhilfe für diese Problematik bieten Algen oder Salzpflanzen als Ausgangsmaterial. Die Kultivierung von Algen weist einen geringen Landverbrauch auf und ist ohne Trinkwasser möglich. Der Anbau von Salzpflanzen ist in Salzwasser möglich. Folglich würde keine Konkurrenz mit der Lebensmittelproduktion bestehen. [1]

## C. Hydroprocessed Esters and Fatty Acids (HEFA)

Ausgangsmaterial für das HEFA-Verfahren sind ölhaltige Stoffe wie z.B. pflanzliche Öle (Jatropha, Leindotter), Algenöl, tierische Fette oder Altfett [1, 10].



Abb. 3. Technologieprinzip des HEFA-Verfahrens. (angelehnt an [3, 10])

In Abb. 3 sind die Prozessschritte des HEFA-Verfahrens gezeigt. Die ölhaltigen Stoffe als Ausgangsmaterial beinhalten Triglyceride sowie gesättigte und ungesättigte Fettsäuren. Um ausschließlich gesättigte Fettsäuren zu erhalten, wird eine Hydrierung mit  $H_2$  durchgeführt. Anschließend werden durch Hydrodeoxygenierung mit  $H_2$  und Decarboxylierung unter Druck (bis zu 100 bar) und bei hoher Temperatur (bis zu  $400^\circ C$ ) lange, geradkettige Kohlenwasserstoffe gebildet. Dabei wird  $O_2$  in Form der entstehenden Nebenprodukte ( $CO_2$ ,

CO, H<sub>2</sub>O, Propan (C<sub>3</sub>H<sub>8</sub>) entzogen. Die langen, geradkettigen Kohlenwasserstoffe werden dann mittels Hydrocracken und Isomerisierung in kurze, verzweigte Kohlenwasserstoffe umgewandelt. Abschließend wird durch Fraktionierung das Kerosin separiert. [3, 10, 11, 14, 15]

Vorteile von Kerosin aus dem HEFA-Verfahren sind:

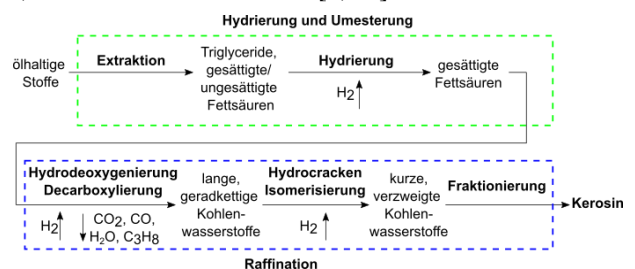
- Breites Spektrum möglicher Ausgangsmaterialien
- HEFA-Verfahren ist ausgereift
- Kerosin aus HEFA-Verfahren hat eine hohe Energiedichte und ist durch ASTM bereits zertifiziert und kann für kommerzielle Flüge eingesetzt werden
- Durch Verkauf der entstehenden Prozessnebenprodukte kann die Wirtschaftlichkeit erhöht werden

[3, 11, 14, 16]

Für das HEFA-Verfahren ergibt sich derselbe Nachteil wie für das BtL-Verfahren, wenn für die Produktion des Ausgangsmaterials landwirtschaftlich nutzbare Fläche notwendig ist (siehe Unterkapitel B).

#### D. Alcohol to Jet (AtJ)

Für das AtJ-Verfahren sind u.a. stärke- bzw. zuckerhaltige Stoffe und Zellulose als Ausgangsmaterial geeignet. Handelt es sich bei dem verwendeten Ausgangsmaterial um keinen reinen Zucker, muss zuerst durch Hydrolyse der Zucker gewonnen werden. Anschließend wird der Zucker mittels Fermentation durch Mikroorganismen oder Hefe in Alkohol umgewandelt. [1, 10, 14]



Abb. 4. Technologieprinzip des AtJ-Verfahrens. (angelehnt an [3, 10, 17])

In Abb. 4 sind die weiteren Prozessschritte des AtJ-Verfahrens dargestellt. Aus dem Alkohol wird O<sub>2</sub> in Form von H<sub>2</sub>O durch Dehydrierung entfernt, wodurch kurzkettige Alkene (ungesättigte Kohlenwasserstoffe) entstehen. Diese werden anschließend durch Oligomerisierung in langkettige Alkene umgewandelt. Für die Erzeugung von Kerosin sind Alkane (gesättigte Kohlenwasserstoffe) nötig. Folglich werden durch Hydrierung mit H<sub>2</sub> die Alkene in Alkane umgewandelt. Abschließend wird durch Fraktionierung das Kerosin separiert. [14, 17, 18, 19]

Vorteile von Kerosin aus dem AtJ-Verfahren sind:

- Breites Spektrum möglicher Ausgangsmaterialien
- Kerosin aus AtJ-Verfahren ist durch ASTM bereits zertifiziert

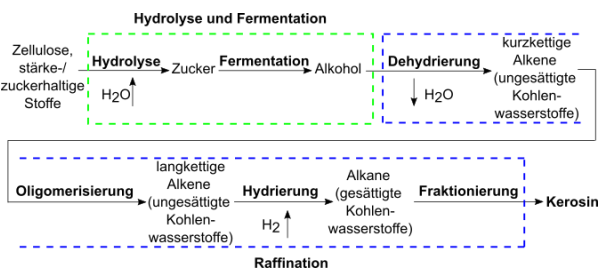
[1, 20]

Für das AtJ-Verfahren ergibt sich derselbe Nachteil wie für das BtL-Verfahren, wenn für die Produktion des Ausgangsmaterials landwirtschaftlich nutzbare Fläche notwendig ist (siehe Unterkapitel B).

Das Verfahren Direct Sugar to Hydrocarbon (DSHC) ähnelt dem AtJ-Verfahren. DSHC verwendet aber nicht das Zwischenprodukt Alkohol. [1] Im Gegensatz zu Kerosin aus dem BtL-, HEFA-, und AtJ-Verfahren, welches nach ASTM bis zu einer Mischung von 50 Vol.-% mit herkömmlichem Kerosin

zertifiziert ist, ist Kerosin aus dem DSHC-Verfahren nur bis zu einer Mischung von 10 Vol.-% zertifiziert [20].

#### E. Vergleich der Verfahren

Die Prozesse zur Herstellung von klimaneutralem Kerosin sind i. Vgl. zur Herstellung von herkömmlichem Kerosin komplexer und aufwändiger. Erdöl besteht aus sauerstoffarmen Kohlenwasserstoffen, Biomasse ist sauerstoffreich. Ableitungen aus Erdöl können beinahe direkt für die Herstellung von Kerosin verwendet werden, es ist keine grundlegende chemische Umwandlung nötig. Die Umwandlung beschränkt sich v.a. auf die Fraktionierung. Die Produktion von Kerosin aus Biomasse erfordert eine tiefgreifende chemische Umwandlung (Entfernung von O<sub>2</sub>, Einstellung von Molekülge- wicht und -struktur). [15]

Tab. 1

Vergleich von Kerosin aus PtL-, BtL-, HEFA-, AtJ-Verfahren und Kerosin aus Erdöl

Kriterien	Erdöl	PtL	BtL	HEFA	AtJ
TRL <sup>1</sup>	/	5-8 [9]	5-9 [9]	4-9 [9]	5-9 [9]
Verkaufspreis <sup>2</sup>	2,21 [21]	n.a.	6,23-7,57 [3]	1,63-31,98 [3]	3,65-10,91 [3]
THG-Emiss. <sup>3</sup>	90 [3]	1 [9]	-1,6-18,2 [3]	3,06-53,1 [3]	-27-117,5 [3]
Wasserbedarf <sup>4</sup>	n.a.	1,38 [9]	3892 [9]	5204-19914 [9]	1422-3539 [9]

<sup>1</sup> Technology Readiness Level

<sup>2</sup> minimaler Verkaufspreis in USD/gal

<sup>3</sup> THG-Emission in gCO<sub>2</sub>-equivalent/MJ

<sup>4</sup> Wasserbedarf in lH<sub>2</sub>O/lKerosin

Tab. 1 zeigt einen Vergleich von PtL-, BtL-, HEFA- und AtJ-Verfahren untereinander und mit herkömmlichem Kerosin. Der Kennwert Technology Readiness Level (TRL) gibt den Entwicklungsstand der einzelnen Verfahren an. Der erzielte TRL hängt vom verwendeten Ausgangsmaterial und damit vom darauf abgestimmten Prozess ab. PtL erzielt einen TRL von 6, falls das CO<sub>2</sub> aus der Luft extrahiert wird. HEFA erzielt einen TRL von 9, falls Palm- oder Rapsöl verwendet wird und einen TRL von 4-5 bei Algen. [9] Der Entwicklungsstand von BtL-, HEFA- und AtJ-Verfahren ermöglicht eine kommerzielle Nutzung [3]. Der Produktionsstart von PtL-Kerosin im Oktober 2021 in Niedersachsen zeigt, dass dessen kommerzielle Nutzung unmittelbar bevorsteht [22].

Die erzielbaren minimalen Verkaufspreise des mittels der Verfahren erzeugten Kerosins sind momentan noch höher als für herkömmliches Kerosin. Beim PtL-Verfahren sind ein Grund hierfür die momentan noch hohen Produktionsgesamtkosten [9]. Beim BtL-Verfahren haben die Kosten für das Ausgangsmaterial und die hohen Kosten für das FT-Verfahren einen großen Einfluss auf die Gesamtkosten. Beim HEFA-Verfahren dominieren v.a. die Kosten für das Ausgangsmaterial die Gesamtkosten. Der minimale Verkaufspreis beträgt bei Verwendung von Leindotter 1,63-4,62 USD/gal, bei Algen 31,98 USD/gal. Auch beim AtJ-Verfahren werden die Kosten v.a. durch die Kosten für das Ausgangsmaterial verursacht. Die Verwendung von Rohrzucker ergibt einen minimalen Verkaufspreis von 3,65-8,08 USD/gal, die Verwendung von Lignocellulose 4,32-10,91 USD/gal. Der Preisunterschied



ist bedingt durch den Einsatz von teuren Enzymen bei der Umwandlung der Lignocellulose. [3] Auf der anderen Seite steigt der Preis für herkömmliches Kerosin tendenziell an und unterliegt starken Schwankungen, wodurch sich finanzielle Risiken für die Fluggesellschaften ergeben [23, 24].

Das Ziel von klimafreundlichem Kerosin ist die Reduktion von THG-Emissionen. Dabei müssen alle Schritte (Kultivierung, Ernte, Transport, Raffination, etc.) im gesamten Herstellungsprozess bis einschließlich zur Verbrennung des Kerosins berücksichtigt werden. Jeder Schritt produziert direkt oder indirekt THG-Emissionen. [3] Wird beim PtL-Verfahren erneuerbare Elektrizität und aus der Luft extrahiertes CO<sub>2</sub> verwendet, kann annähernd Klimaneutralität erzielt werden [9]. Beim BtL-, HEFA- und AtJ-Verfahren hängen die THG-Emissionen v.a. vom Ausgangsmaterial ab. Unterschiedliche Ausgangsmaterialien bedingen u.a. unterschiedlichen Düngemiteleinsetz und unterschiedliche Veränderung der Landfläche. Die Verwendung von Leindotter beim HEFA-Verfahren bedingt THG-Emissionen von 3,06-53,1 g<sub>CO<sub>2</sub>-equivalent</sub>/MJ, die Verwendung von tierischem Fett 16,8-21,4 g<sub>CO<sub>2</sub>-equivalent</sub>/MJ. Beim AtJ-Verfahren zeigt die Verwendung von Rohrzucker die geringsten THG-Emissionen (-27-19,7 g<sub>CO<sub>2</sub>-equivalent</sub>/MJ), die Verwendung von Mais die höchsten (47,5-117,5 g<sub>CO<sub>2</sub>-equivalent</sub>/MJ). Eine negative THG-Emission kann nur erzielt werden, wenn eine CO<sub>2</sub>-Abscheidung und -Speicherung während des Umwandlungsprozesses verwendet wird. Mit den Verfahren können aber reduzierte THG-Emissionen ggü. herkömmlichem Kerosin (90 g<sub>CO<sub>2</sub>-equivalent</sub>/MJ) erreicht werden. [3]

Der Wasserbedarf der Verfahren ist stark vom Wasserbedarf für die Kultivierung des Ausgangsmaterials abhängig. Wird beim BtL-Verfahren als Ausgangsmaterial Pappelholz verwendet, beträgt der Wasserbedarf 3892 I<sub>H<sub>2</sub>O</sub>/I<sub>Kerosin</sub>. Beim HEFA-Verfahren liegt der Wasserbedarf zwischen 5204 I<sub>H<sub>2</sub>O</sub>/I<sub>Kerosin</sub> (Palmöl) und 19914 I<sub>H<sub>2</sub>O</sub>/I<sub>Kerosin</sub> (Jatropha). Wird beim AtJ-Verfahren der Alkohol aus Zuckerrüben gewonnen, beträgt der Wasserbedarf 1422 I<sub>H<sub>2</sub>O</sub>/I<sub>Kerosin</sub>, bei Gewinnung aus Mais 3539 I<sub>H<sub>2</sub>O</sub>/I<sub>Kerosin</sub>. Bei CO<sub>2</sub>-Gewinnung aus der Luft weist das PtL-Verfahren den geringsten Wasserverbrauch auf. [9]

### III. GRENZEN VON KLIMANEUTRALEM KEROSIN

In diesem Kapitel werden die Grenzen von klimaneutralem Kerosin zur Eindämmung des anthropogenen Klimawandels aufgezeigt.

Das mit den aufgezeigten Verfahren hergestellte Kerosin erreicht keine vollständige Klimaneutralität, solange nicht jeder einzelne Prozessschritt klimaneutral ist. Dies würde Klimaneutralität bei z.B. Anbau/Ernte des Ausgangsmaterials, Düngemittelproduktion, Energieerzeugung für Umwandlungsprozesse und Transport erfordern.

Die transportierten Passagiere und Güter im Luftverkehr werden weiter ansteigen. Laut Prognosen werden sich bis 2050 der Kerosinverbrauch verdoppeln und die CO<sub>2</sub>-Emissionen um den Faktor 6 zunehmen. [15] Falls das Wachstum des Anteils von klimaneutralem Kerosin dem Wachstum des Luftverkehrs nicht nachkommt, resultiert dies in einer Zunahme anstatt einer Reduktion der THG-Emissionen [9].

Die Verbrennung von Kerosin erzeugt durch die emittierten THG direkt eine negative Wirkung auf das Klima. Zudem führt die Kerosin-Verbrennung in großer Höhenlage zu weiteren negativen Beeinflussungen des Klimas. Die dabei entstehenden Stickoxide führen zur Bildung von Ozon. Der gebil-

dete Wasserdampf und die Aerosole beeinflussen die Sonneneinstrahlung. [25, 26, 27] Um die Klimawirkung von Kerosin zu verringern, darf sich folglich nicht nur auf die Reduktion der THG-Emissionen beschränkt werden.

### IV. MORALISCHE UND ETHISCHE EINORDNUNG

Bei den aufgezeigten Verfahren können potenzielle Lebensmittel (z.B. Weizen, Mais) als Ausgangsmaterial eingesetzt werden [3]. Gleichzeitig leiden weltweit über 800 Mio. Menschen an Hunger [28]. Folglich sollten bei den aufgezeigten Verfahren moralische und ethische Aspekte berücksichtigt werden. Zwar können bei den Verfahren auch nicht-essbare Produkte wie z.B. Leindotter, Salzpflanzen oder Holz eingesetzt werden [1], aber die Anbauflächen hierfür können mit den Anbauflächen für die Lebensmittelproduktion konkurrieren. Um die Lebensmittelproduktion nicht zu beeinträchtigen und maximale Nachhaltigkeit der Verfahren zu erreichen, muss der Anbau der eingesetzten Biomasse ohne Abholzung, mit geringem Land- und Wasserverbrauch sowie geringem Nährstoffbedarf erfolgen. [3] Es wäre sinnvoll, das Ausgangsmaterial in Gebieten anzubauen, die für die Lebensmittelproduktion ungeeignet sind [29]. Vor dem Hintergrund, dass weltweit jährlich ca. 1,3 Mrd. Tonnen Lebensmittel weggeworfen werden [28], sollte auch eine Weiterverwendung dieser Lebensmittel in Betracht gezogen werden.

### V. SCHLUSSFOLGERUNG UND AUSBLICK

Der Luftverkehr trägt zum anthropogenen Klimawandel bei. Um die Klimawirkung des Luftverkehrs zu reduzieren, kann klimaneutrales Kerosin verwendet werden. Es wurde deutlich, dass die aufgezeigten Verfahren zur Herstellung von klimaneutralem Kerosin unterschiedliche, komplexe Prozesse erfordern. Zudem bieten die unterschiedlichen Verfahren ein breites Spektrum an möglichen Ausgangsmaterialien.

Klimaneutrales Kerosin ist momentan noch teurer als herkömmliches Kerosin. Die Kosten hängen v.a. von den Kosten für das Ausgangsmaterial ab. Um die Attraktivität des klimaneutralen Kerosins für die Fluggesellschaften zu vergrößern, ist es nötig, die Herstellungsprozesse weiter zu optimieren, und so den Preisunterschied überwinden sowie die Marktprospektive verbessern zu können.

Die aufgezeigten Verfahren haben das Potential die THG-Emissionen durch den Luftverkehr zu reduzieren. Dabei hängt die erzielte THG-Reduktion ggü. herkömmlichem Kerosin stark vom verwendeten Ausgangsmaterial ab. Wird erneuerbare Energie und CO<sub>2</sub> aus der Luft eingesetzt, bietet das PtL-Verfahren i. Vgl. zu den anderen Verfahren das größte Potential zur THG-Reduktion. Zudem weist das PtL-Verfahren bei CO<sub>2</sub>-Gewinnung aus der Luft ggü. den anderen Verfahren den geringsten Wasserverbrauch auf, wodurch die Nachhaltigkeit steigt. Wird das CO<sub>2</sub> aus der Luft extrahiert, konkurriert das PtL-Verfahren nicht mit der Lebensmittelproduktion. Um eine Konkurrenz zwischen der Produktion der Ausgangsmaterialien und der Lebensmittelproduktion zu verhindern, bietet sich bei den anderen Verfahren die Verwendung von Algen an. Die Klimawirkung des Kerosins beschränkt sich aber nicht nur auf die THG-Emissionen. Weitere Wirkungsfaktoren wie z.B. Kondensstreifen sind zu berücksichtigen. Um den Einfluss des Luftverkehrs auf das Klima zu reduzieren, sollte also der Kerosinverbrauch und das Flugaufkommen reduziert werden. Dazu sollte ein grundsätzliches Umdenken zu weniger Luftverkehr erfolgen.

- [1] T. K. Hari, H. Z. Yaakob und N. N. Binitha, „Aviation biofuel from renewable resources: Routes, opportunities and challenges“, *Renewable and Sustainable Energy Reviews*, Vol. 42, Feb. 2015, S. 1234-1244, doi: 10.1016/j.rser.2014.10.095.
- [2] Bundesministerium für Umwelt, Naturschutz und nukleare Sicherheit (BMU), Bundesministerium für Verkehr und digitale Infrastruktur (BMVI), Bundesministerium für Wirtschaft und Energie (BMWi), Bundesministerium für wirtschaftliche Zusammenarbeit und Entwicklung (BMZ) und Bundesverband der Deutschen Luftverkehrswirtschaft (BDL). „PtL-Roadmap: Nachhaltige strombasierte Kraftstoffe für den Luftverkehr in Deutschland.“ [https://www.bmvi.de/SharedDocs/DE/Anlage/LF/ptl-roadmap.pdf?\\_\\_blob=publicationFile](https://www.bmvi.de/SharedDocs/DE/Anlage/LF/ptl-roadmap.pdf?__blob=publicationFile) (aufgerufen am 26.11.2021).
- [3] H. Wei, W. Liu, X. Chen, Q. Yang, J. Li und H. Chen, „Renewable bio-jet fuel production for aviation: A review“, *Fuel*, Vol. 254, Okt. 2019, S. 1-16, doi: 10.1016/j.fuel.2019.06.007.
- [4] Bundesverband der Deutschen Luftverkehrswirtschaft. „Kerosin bleibt Kerosin, unabhängig von der Herstellungsart.“ <https://www.klimaschutz-portal.aero/klimaneutral-fliegen/alternative-kraftstoffe/kerosin-herstellen/> (aufgerufen am 26.11.2021).
- [5] P. Schmidt, V. Batteiger, A. Roth, W. Weindorf und T. Raksha, „Power-to-Liquids as Renewable Fuel Option for Aviation: A review“, *Chemie Ingenieur Technik*, Vol. 90, Jan. 2018, S. 127-140, doi: 10.1002/cite.201700129.
- [6] V. Dietrich, A. Buttler, A. Hanel, H. Spliethoff und S. Fendt, „Power-to-liquid via synthesis of methanol, DME or Fischer-Tropsch-fuels: a review“, *Energy Environ. Sci.*, Vol. 13, Aug. 2020, S. 3207-3252, doi: 10.1039/D0EE01187H.
- [7] M. D. Porosoff, B. Yan und J. G. Chen, „Catalytic reduction of CO<sub>2</sub> by H<sub>2</sub> for synthesis of CO, methanol and hydrocarbons: challenges and opportunities“, *Energy Environ. Sci.*, Vol. 1, Jan. 2016, S. 62-73, doi: 10.1039/C5EE02657A.
- [8] S. Drünert, U. Neuling, T. Zitscher und M. Kaltschmitt, „Power-to-Liquids Fuels for aviation – Processes, resources and supply potential under German conditions“, *Applied Energy*, Vol. 277, Nov. 2020, S. 1-15, doi: 10.1016/j.apenergy.2020.115578.
- [9] P. Schmidt, W. Weindorf, A. Roth, V. Batteiger und F. Riegel, „Power-to-Liquids: Potentials and Perspectives for the Future Supply of Renewable Aviation Fuel“, German Environment Agency, Dessau-Roßlau, Sep. 2016, S. 1-32.
- [10] C. Gutiérrez-Antonio, F. I. Gómez-Castro, J. A. de Lira-Flores und S. Hernández, „A review on the production processes of renewable jet fuel“, *Renewable and Sustainable Energy Reviews*, Vol. 79, Nov. 2017, S. 709-729, doi: 10.1016/j.rser.2017.05.108.
- [11] W.-C. Wang und L. Tao, „Bio-jet fuel conversion technologies“, *Renewable and Sustainable Energy Reviews*, Vol. 53, Jan. 2016, S. 801-822, doi: 10.1016/j.rser.2015.09.016.
- [12] M. Hillestad, M. Ostadi, G. d. A. Serrano, E. Rytter, B. Austbo, J. G. Pharoah und O. S. Burheim, „Improving carbon efficiency and profitability of the biomass to liquid process with hydrogen from renewable power“, *Fuel*, Vol. 234, Dez. 2018, S. 1431-1451, doi: 10.1016/j.fuel.2018.08.004.
- [13] R. C. Neves, B. C. Klein, R. J. da Silva, M. C. A. F. Rezende, A. Funke, E. Olivarez-Gómez, A. Bonomi und R. Maciel-Filho, „A vision on biomass-to-liquids (BTL) thermochemical routes in integrated sugarcane biorefineries for biojet fuel production“, *Renewable and Sustainable Energy Review*, Vol. 119, Mär. 2020, S. 1-16, doi: 10.1016/j.rser.2019.109607.
- [14] A. R. K. Gollakota, A. K. Thandlam und C.-M. Shu, „Biomass to Bio Jet Fuels: A Take Off to the Aviation Industry“, in *Liquid Biofuels*, K.P. Shadangi, Beverly, MA, USA: Wiley, 2021, S. 183-213, doi: 10.1002/9781119793038.ch6.
- [15] M. A. Díaz-Pérez und J. C. Serrano-Ruiz, „Catalytic Production of Jet Fuels from Biomass“, *Molecules*, Vol. 25, Feb. 2020, S. 1-18, doi: 10.3390/molecules25040802.
- [16] R. Mawhood, E. Gazis, S. de Jong, R. Hoefnagels und R. Slade, „Production pathways for renewable jet fuel: a review of commercialization status and future prospects“, *Biofuels, Bioproducts and Biorefining*, Vol. 10, Aug. 2016, S. 462-484, doi: 10.1002/bbb.1644.
- [17] S. Geleynse, K. Brandt, M. Garcia-Perez, M. Walcott und X. Zhang, „The Alcohol-to-Jet Conversion Pathway for Drop-in Biofuels: Techno-Economic Evaluation“, *ChemSusChem*, Vol. 11, Sep. 2018, S. 3728-3741, doi: 10.1002/cssc.201801690.
- [18] M. Kaltschmitt und U. Neuling, *Biokerosene*. Berlin: Springer, 2018, doi: 10.1007/978-3-662-53065-8.
- [19] U. Neuling und M. Kaltschmitt, „Techno-economic environmental analysis of aviation biofuels“, *Fuel Processing Technology*, Vol. 171, Mär. 2018, S. 54-69, doi: 10.1016/j.fuproc.2017.09.022.
- [20] J. Yang, Z. Xin, Q. He, K. Corscadden und H. Niu, „An overview on performance characteristics of bio-jet fuels“, *Fuel*, Vol. 237, Feb. 2019, S. 916-936, doi: 10.1016/j.fuel.2018.10.079.
- [21] IndexMundi. „Kerosin Tagespreis.“ [indexmundi.com. https://www.indexmundi.com/de/rohstoffpreise/?ware=kerosin](https://www.indexmundi.com/de/rohstoffpreise/?ware=kerosin) (aufgerufen am 26.11.2021).
- [22] PM atmosfair. „atmosfair: Erste Anlage zur Produktion von CO<sub>2</sub>-neutralem synthetischen Kerosin in Emsland.“, [airportzentrale.de. https://www.airportzentrale.de/atmosfair-erste-anlage-zur-produktion-von-co2-neutralem-synthetischen-kerosin-im-emsland/72650/](https://www.airportzentrale.de/atmosfair-erste-anlage-zur-produktion-von-co2-neutralem-synthetischen-kerosin-im-emsland/72650/) (aufgerufen am 26.11.2021).
- [23] K. P. Brooks, L. J. Snowden-Swan, S. B. Jones, M. G. Butcher, G.-S. J. Lee, D. M. Anderson, J. G. Frye, J. E. Holladay, J. Owen, L. Harmon, F. Burton, I. Palou-Rivera, J. Plaza, R. Handler und D. Shonnard, „Low-Carbon Aviation Fuel Through the Alcohol to Jet Pathway“, in *Biofuels for Aviation*, C. J. Chuck, Bath, United Kingdom: Academic Press, 2016, S. 109-150, doi: 10.1016/B978-0-12-804568-8.00006-8.
- [24] B. Atems, „The response of the U.S. aviation industry to demand and supply shocks in the oil and jet fuel markets“, *Transportation Research Interdisciplinary Perspectives*, Vol. 11, Sep. 2021, S. 1-12, doi: 10.1016/j.trip.2021.100452.
- [25] N. Jungbluth und C. Meili, „Recommendations for calculation of the global warming potential of aviation including the radiative forcing index“, *The International Journal of Life Cycle Assessment*, Vol. 24, 2019, S. 404-411, doi: 10.1007/s11367-018-1556-3.
- [26] Deutsches Zentrum für Luft- und Raumfahrt. „Klimawirkungen des Luftverkehrs.“ [elib.dlr.de. https://elib.dlr.de/51462/1/Klimawirkungen\\_des\\_Luftverkehrs\\_DLR\\_0907\\_DE.pdf](https://elib.dlr.de/51462/1/Klimawirkungen_des_Luftverkehrs_DLR_0907_DE.pdf) (aufgerufen am 26.11.2021).
- [27] D. S. Lee, D. W. Fahey, A. Skowron, M. R. Allen, U. Burkhardt, Q. Chen, S. J. Doherty, S. Freeman, P. M. Forster, J. Fuglestedt, A. Gettelman, R. R. De León, L. L. Lim, M. T. Lund, R. J. Millar, B. Owen, J. E. Penner, G. Pitari, M. J. Prather, R. Sausen und L. J. Wilcox, „The contribution of global aviation to anthropogenic climate forcing for 2000 to 2018“, *Atmospheric Environment*, Vol. 244, Jan. 2021, S. 1-60, doi: 10.1016/j.atmosenv.2020.117834.
- [28] L. Haller. „Lebensmittelverschwendung | Ursachen & Fakten.“ [www.welthungerhilfe.de/lebensmittelverschwendung/?wc=DGGRAN1000&gclid=EAIAIQobChMIq\\_vyoYGG9AIViNOyCh0uggaWEAAYAyAAEgJUQfD\\_BwE](https://www.welthungerhilfe.de/lebensmittelverschwendung/?wc=DGGRAN1000&gclid=EAIAIQobChMIq_vyoYGG9AIViNOyCh0uggaWEAAYAyAAEgJUQfD_BwE) (aufgerufen am 26.11.2021).
- [29] M. Bräuninger und L. Leschus. „Pro und Contra Biokraftstoffe.“ [hwwi.org. https://www.hwwi.org/publikationen/hwwi-insights/hwwi-insights-ausgabe-03-2011/pro-und-kontra-biokraftstoffe.html](https://www.hwwi.org/publikationen/hwwi-insights/hwwi-insights-ausgabe-03-2011/pro-und-kontra-biokraftstoffe.html) (aufgerufen am 26.11.2021).

# Arts and Artificial Intelligence: State of the Art

Mahmoud Baddour

Faculty of Electrical Engineering and Information Technology  
Ostbayerische Technische Hochschule Regensburg

Regensburg, Germany

Mahmoud.baddour@st.oth-regensburg.de

**Abstract**—With the development of artificial intelligence, it is difficult not only for ordinary people but also for artists to define art. For some people, the art produced by artificial intelligence, is a kind of human art.

There is no longer any need for an artist to paint a picture or a musician to produce a piece of music. It is possible to create it using software. There are numerous of these artificial intelligence-based software applications that are used to create art. Some of these apps generate music, while others create painting or design. These artificial intelligence methods will be discussed here. How do they create new arts? Obviously, with the aid of a large number of styles or a large data bank.

Creating artistic paintings or composing music tracks are one of the defining characteristics of humans. but AI has demonstrated rapid improvement in this traditional art. This paper mainly shows how, with the advancement of science and technology, the use of artificial intelligence in the field of art design might lead to a more intelligent and individualized growth path for future art. Artificial intelligence not only encourages the integration of science and art, but it also allows today's artists to think more deeply about how to build future art. Art's efficiency is improved by combining artificial intelligence and art.

**Index Terms**—artificial intelligence, art, image generation, music generation

## I. INTRODUCTION

Artificial intelligence (AI) is no longer a science fiction concept; instead, it is a reality that we experience every day through personal assistants like Siri, Google searches, and self-driving automobiles.

Artificial intelligence (AI) is a hot issue of debate in light of its growing importance, with some individuals seeing recent trends as positive and others seeing them as negative. Some people believe AI will make human existence safer and more prosperous, while others believe AI will grow uncontrollable and end up posing a threat to human societies.

Another area where AI appears to be ready to beat humans is in creative efforts. For example, Google Deepmind's AlphaGo, a Go-playing computer program, mastered the famously difficult game in 2016 [1].

The computing power of AI Prior to 2012 doubles every two year, and Post-2012 compute has been doubling every 3.4 months [2]. As processing power improves, AI will be able to create increasingly human-like artworks on a constant basis. As a result, improvements in AI artwork inevitably confound current perceptions of creativity and aesthetic beauty in art. At the beginning, the fundamental principles of artificial

intelligence, as well as their history, are discussed in order to comprehend how to apply these concepts to build one's own art. It will be compared to artistic conceptions created by humans. The relationship between art and artificial intelligence is examined. The third section discusses AI tools and how they are used by the AI to create art. Between these tools and traditional art tools, a comparison will be made. The fourth section shows how artificial intelligence may be used to the arts. Some artificial intelligence methods will be explored and examples will be provided to explain these methods. Finally, this study forecasts the impact of artificial intelligence on new human arts in the future. It also shows how artificial intelligence decreases the time it takes to create art and increases its efficiency.

## II. ARTIFICIAL INTELLIGENCE AND ART

### A. What is artificial intelligence?

Artificial intelligence, abbreviated as AI is “the theory and development of computer systems able to perform tasks normally requiring human intelligence, such as visual perception, speech recognition, decision-making, and translation between languages” [3]. Artificial intelligence is a branch of computer science that aims to discover the nature of intelligence and develop intelligent machines that replicate human intelligence, therefore expanding and boosting human ability and efficiency. It's used in robotics, control systems, power management, and simulation systems.

Dartmouth College hosted the inaugural artificial intelligence conference in 1956, dubbed the “birthplace of AI” since it was the first to put forward the concept of artificial intelligence AI [4].

### B. The concept of art

Art is a term that refers to a variety of human activities or products that require creative imagination and a desire for proficiency, beauty, emotional power, or ideas [5].

From the standpoint of human history, people have communicated their demands and innovations through the arts, and the results of art invariably reflect the culture's progress, development, and expectations.

Art can be used to observe and describe how culture appears. Art can be used to understand a period, a country, or an area by using it as a window and indicator. Art's progression can

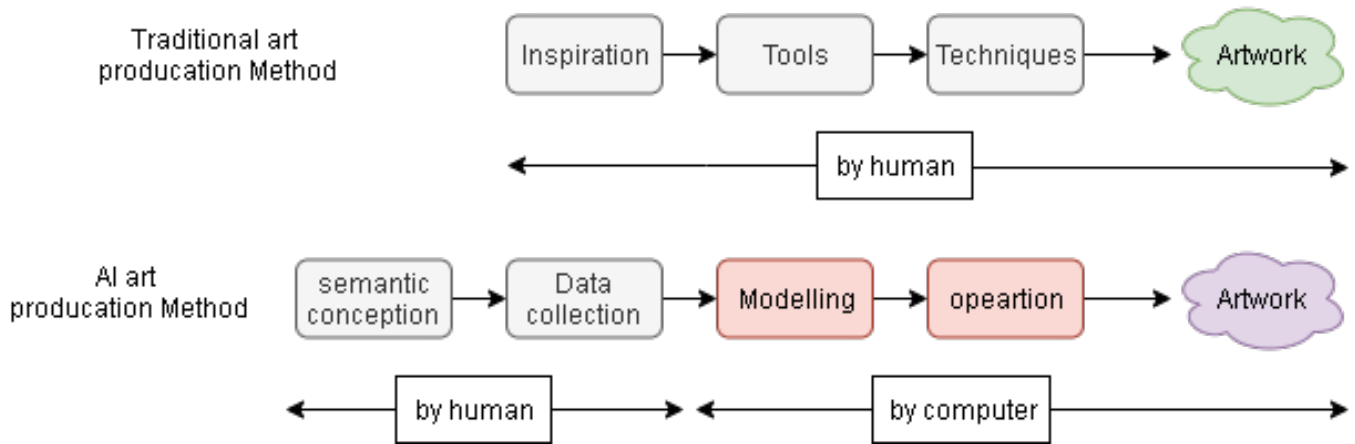

Fig. 1. The difference between traditional art production and AI-based art production, according to [10]

symbolize not only the current culture, but also the trend and substance of a civilization's development. With the passage of time, an increasing trend of cross-fertilization between natural sciences, humanities, and social sciences, as well as the interaction of art and science and technology, has emerged. Many people all over the world are exploring new AI-based arts thanks to the advancement of computer technology in the age of AI. Some may argue that AI's creative products are essentially imitations of human work.

There are works on developing artificial intelligence to compose music and poetry, for example [6]. However, AI cannot create this art without the assistance of human artworks.

### C. Artificial Intelligence and Art: What's the Connection?

Specialists can see from the concept of art that art is a vital component of people's lives. It brings together multi-level information, such as a succession of logical thinking in philosophical ideas and aesthetic thinking. If there are objective criteria for defining art, AI can readily be programmed to generate items that meet those criteria.

However, if a product's ability to be classified as "art" is based on a subjective opinion, then anything, including AI-generated items, has a potential to be classified as art. As a result, it's important to distinguish between the questions "Can AI create art?" and "Can AI create art that is good and worthy?" [7]. AI's ability to understand and recognize objects has gradually improved with the development of "deep learning." It can swiftly and accurately comprehend semantics and extract all data. AI can also be used to provide inspiration for art design works, as seen in Figure 1.

Nonhumans' role in creative processes is becoming increasingly important in the world of art [8]. At the moment, one of the issues that the art world is debating is the rise of artificial intelligence. Artificial intelligence can assist art designers in streamlining their workflow, increasing productivity, and reducing design time. The artists' sense of enjoyment and acquisition is substantially improved as a result of this [9].

### III. ARTIFICIAL INTELLIGENCE ART TOOLS

Artificial intelligence has a long history that dates back to the mid-twentieth century. Artificial intelligence has advanced significantly in the twenty-first century. With the fast advancement of artificial intelligence in recent years, new application cases have emerged in an infinite stream. The advancement of artificial intelligence has created a good bridge in the field of art design.

Art tools have evolved from conventional singularity to diversity, standardization, specialization, and matching, as well as from traditional items to virtual art tools. The development of these art tools not only decreases a variety of material consumption, but it also has an impact on artists' thoughts throughout the creative process.

Most traditional art tools are comprised of pen and ink, and may be used to make artwork. However, as computer application technology matures and artificial intelligence develops, art tools are increasingly shifting from traditional to multimedia tools.

Traditional creative tools need more resources and a larger number of creators. As a result of the advancement of modern big data and computer application technology, artists may now actualize their inspiration using a wide range of software and application materials. This simplicity of art tools can also help artists enhance their creative efficiency, reduce the design cycle, increase production efficiency, and overcome the constraints of traditional art tools [11].

### IV. APPLICATION OF ARTIFICIAL INTELLIGENCE IN ART

#### A. AI based music composition

Western music composition is an algorithmic process with specific rules and structures that must be followed. There are now various methods for automatically executing compositions. There are hybrid systems that employ a combination of AI approaches or use more than one type of AI technology. In order to create a taxonomy and classify those hybrid systems. Beginners, seasoned composers, students, and hobbyists alike

would benefit from the application of these generative models to music creation.

The taxonomy of the AI methods for algorithmic music composition is summarized in Table I. [12]

TABLE I  
TAXONOMY OF MUSIC COMPOSITION AI BASED METHODS, ACCORDING TO [12]

AI based music composition	
Area	SubAreas
Soft computing based music composition methods	Heuristic Composition Methods
	Deep Learning Composition Methods
	Stochastic Composition Methods
Symbolic AI based music composition methods	Agent Composition Methods
	Declarative Programming Composition Methods
	Grammar Composition Methods

It would be difficult to cover all of these techniques in one paper. There will only be two methods discussed.

1) *Deep Learning Composition Methods-Deep Belief Network*: Bickerman et al. [13] sent a dataset of four bar jazz tunes with chord progressions in a single key to a Deep Belief Network (DBN). Hand-transcribed jazz solos were used to create the dataset. The training of the DBN was analogous to a windowing of a procedure of four slots by clamping chords and melody. Then, by shifting forward the window slot, it makes room for the next beat. The machine creates one beat at a time, but it influences note selections by using constricted beats and chords from previous generations.

2) *Declarative Programming Composition Methods*: Eppe et al. [14] suggest conceptual blending as a way for mixing jazz chords. In the search space, several cadence rules have been combined from prior idioms or keys. Guided with diatonical rules, dissonances in chords are controlled. The approach begins by combining the combination of chord parameters with a gradual generalization procedure that eliminates notes. These notes produce inconsistency, thus the blending is reviewed and the search space is reduced with priority in notes.

### B. AI based painting

There are several methods, and some of them will be explored.

1) *Creative Adversarial Networks (CANs)*: Ahmed Elgammal et al. present Creative Adversarial Networks (CANs), which may duplicate an artwork in the artist's style as technology advances.

The Figure 2 show the process. The generator in the proposed

Creative Adversarial Network (CAN) is set up to receive two signals from the discriminator. Two adversarial networks, a discriminator, and a generator, are included in the proposed network. The discriminator has access to a wide collection of art connected with style labels (Renaissance, Baroque, Impressionism, Expressionism, and so on), which it uses to learn the difference between them. There is no art available to the generator. It creates artwork based on a random input. For any work it creates, it receives two signals from the discriminator. The discriminator's categorization of "art or not art" is the first signal. The discriminator's ability to categorize the created art into known styles is the second signal the generator gets. If the generator creates pictures that the discriminator believes are art and that the discriminator can readily classify into one of the known styles, the discriminator will believe the generator created true art that falls inside established styles. As a result, the combination of these two signals should encourage the generator to explore parts of the creative space that are close to the distribution of art, while also increasing the ambiguity of the generated art in terms of how it fits into the realm of standard art styles. The CAN-generated paintings are the subject of this work of art [15]. The paintings in Figure 3 are samples of CAN network output [15].

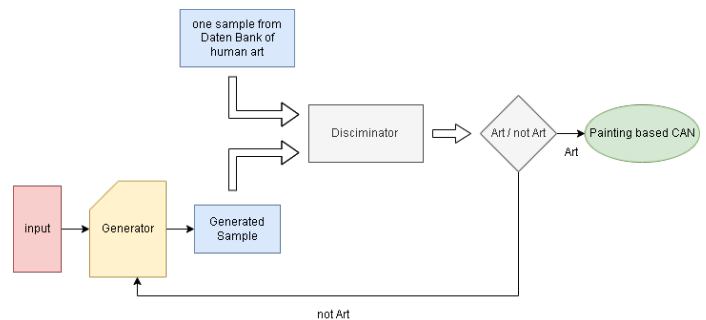

Fig. 2. overview of the Creative Adversarial Networks method, according to [15]



Fig. 3. CAN-generated paintings

2) *Stylized Painting*: There are three technical modules in the method:

- a neural renderer that has been taught to produce strokes using vectorized stroke parameters.
- a differentiable stroke blender that mixes rendering strokes.

- a similarity measuring module that follows the supplied image's reconstruction. [16]

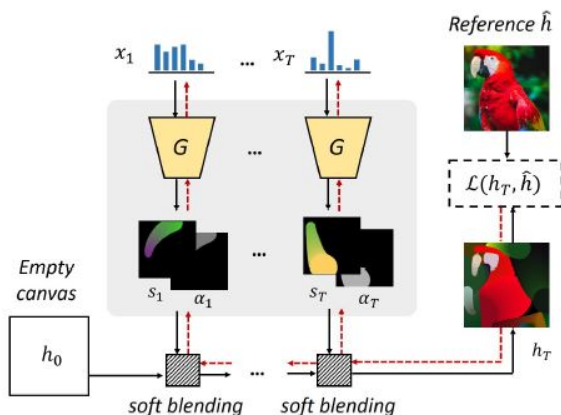

Fig. 4. overview of the stylized painting method according to [16]

Figure 4 shows an overview of the stylized painting method, began with a blank canvas and then rendered stroke by stroke with soft blending. Gradient descent is used to determine a set of "optimal" stroke parameters that reduce the loss  $\mathcal{L}$ . Forward propagation of the gradient is represented by black arrowlines, whereas back propagation is represented by red arrowlines. [16]



Fig. 5. Stylized paintings generated by stylized painting method

Figure 4 shows a group of stylized paintings generated by stylized painting method with different stroke types [17].

## V. FUTURE OF ART BASED ON AI

Artificial intelligence has achieved significant advances in a variety of disciplines as a result of its ongoing development. In the fields of painting, music composition, and fashion style choosing, artificial intelligence has made significant progress. The use of computer, software, and 3D technologies has drastically reduced the time it takes to create a product. It

increases manufacturing efficiency while also adding significant humanistic and economic value. The competition between man and machine has intensified. Artificial intelligence has the potential to replace a greater number of jobs in society. People must consider that certain human roles may be replaced by robots in this circumstance. However, in order to finish optimal design, we still want skilled designers who can understand logical design thinking via leading technical training. Users' demands and expectations for product design have shifted dramatically in recent years. From the traditional emphasis on form to a greater emphasis on the product's usage experience. With the advancement of artificial intelligence, it will be able to make judgments based on the analysis and collection of data, as well as include the user's behavior requirements into product design. as a result of which the final product will provide additional economic and societal advantages [18].

## VI. CONCLUSION

At this time, the deep integration of AI with art is still in many stages and forms. Combining artificial intelligence with art improves the efficiency of art. Artificial intelligence not only promotes the merging of science and art, but it also helps today's artists to reflect more thoroughly on how to create future art. As AI research improves, there will likely be more study into the technical aspects of AI art production. It is necessary that such study be informed not only by technical but also by humanistic considerations.

Despite its strong technical capability, AI art has failed to pass the "Turing Test" for art, in which people consistently assessed human-created art as better in a number of categories, despite their superficial similarity [19].

## REFERENCES

- [1] M. McFarland, "What AlphaGo's sly move says about machine creativity; Google's machine is leaving the smartest humans in the dust", The Washington Post, <https://www.washingtonpost.com/news/innovations/wp/2016/03/15/what-alphagos-sly-move-says-about-machine-creativity/>, 2016, Accessed: November 2021.
- [2] R. Perrault, Y. Shoham, E. Brynjolfsson, J. Clark, J. Etchemendy, B. Grosz, T. Lyons, J. Manyika, J. C. Niebles, and S. Mishra, "artificail intelligence index, 2019 annual report", pp.65, 2019.
- [3] Oxford languages and google - english, Artificial intelligence definition, <https://languages.oup.com/google-dictionary-en/>, May 2020. Accessed: November 2021.
- [4] A. Toosi, A. Bottino, B. Saboury, E. Siegel, and A. Rahmim, "A BRIEF HISTORY OF AI: HOW TO PREVENT ANOTHER WINTER, (A CRITICAL REVIEW)", 2021.
- [5] Dictionary Lexico powered by Oxford - english : Art definition, <https://www.lexico.com/definition/art/>, Accessed: November 2021.
- [6] S. Gibbs, "Google AI project writes poetry which could make a Vagon proud", The Guardian, <https://www.theguardian.com/technology/2016/may/17/googles-ai-write-poetry-stark-dramatic-vogons>, 2016.
- [7] G. Kasparov, "Deep Thinking, Where Artificial Intelligence Ends and Human Creativity Begins", pp.36-41, 2018.
- [8] M. Cypher, "Unpacking collaboration: non-human agency in the ebb and flow of practice-based visual art research", 2016.
- [9] Q. J. Chen, "Future Design and Artificial Intelligence Peer", Art Observation, vol. 10, pp. 20-21, 2017.
- [10] Z. Han, "Combined Development of Artificial Intelligence and Art Design", 2021.

- [11] F. Y. Tang, "The Impact of Artificial Intelligence on Future Industrial Design art education", vol. 9, pp. 132, 2013.
- [12] O. Lopez-Rincon, O. Starostenko and G. A. Martín, "Algorithmic music composition based on artificial intelligence: A survey", 2018.
- [13] G. Bickerman, S. Bosley, P. Swire, and R. M. Keller, "Learning to Create Jazz Melodies Using Deep Belief Nets", 2010.
- [14] M. Eppe, R. Confalonieri, E. Maclean, M. Kaliakatsos, E. Cam-bouropoulos, M. Schorlemmer, M. Codescu, and K. U. Kuhnberger, "Computational Invention of Cadences and Chord Progressions by Conceptual Chord-Blending", 2015.
- [15] A. Elgammal, B. Liu, M. Elhoseiny and M. Mazzone, "CAN: Creative Adversarial Networks Generating "Art" by Learning About Styles and Deviating from Style Norms", 2017.
- [16] Z. Zou, T. Shi, S. Oiu, Y. Yuan, and Z. Shi, "Stylized Neural Painting", 2021.
- [17] Z. Zou, "Stylized Neural Painting", Youtube, [https://www.youtube.com/watch?v=oerb-nwrXhk&ab\\_channel=ZhengxiaZou](https://www.youtube.com/watch?v=oerb-nwrXhk&ab_channel=ZhengxiaZou), 2020, Accessed: November 2021.
- [18] Y. Deng, "Application of Artificial Intelligence in Art Design", 2021.
- [19] J. Hong, N. M. CURRAN, "Artificial Intelligence, Artists, and Art: Attitudes Toward Artwork Produced by Humans vs. Artificial Intelligence", 2019.

# The Principles of Energy Harvesting Using the Piezoelectric Effect

Lukas Stober

*Department of Electrical Engineering and Information Technology*  
*Ostbayerische Technische Hochschule Regensburg*  
Regensburg, Germany  
lukas.stober@st.oth-regensburg.de

**Abstract**—The importance of energy harvesting has experienced considerable growth in the recent years because of the increasing number of portable and wireless electronic devices. Due to the fact that batteries have a limited lifespan and in some applications their replacement or charging with a regular power source is not practical, there is a need to gain energy from other sources e.g. solar power, wind energy, thermal energy and kinetic energy etc. Converting this energy to electrical energy is called energy harvesting. The collected energy is then used to power an electronic device.

In this paper the principle of energy harvesting from kinetic energy using the piezoelectric effect is described. The process is based on the piezoelectric material's property to generate an electrical field when a mechanical force is applied due to a deformation of the material and a macroscopic change of the electric polarization. This phenomenon is known as the direct piezoelectric effect.

In order to get the best efficiency for energy harvesting with a piezoelectric sensor, a geometry suitable to the application must be chosen. Two common used geometries are the cantilever beam and the cymbal geometry. Additionally the frequency of the ambient vibration must match the resonance frequency of the piezoelectric sensor.

A difficulty when using a piezoelectric sensor for energy harvesting is that it generates AC power. This paper presents the four most popular circuits used for piezoelectric energy harvesting for rectification and conversion. These are the AC-DC and two stage piezoelectric energy harvesting circuit and the SSHI and SECE technique.

**Index Terms**—Energy harvesting, Piezoelectric effect, Modeling, Power conversion

## I. INTRODUCTION

In recent decades, advances in wireless technology and microelectronics have led to a large progress for wearable devices. Its power supply is either through batteries or energy harvesting techniques [1]. In addition to these technologies, the concept of the Internet of Things (IoT), which uses wireless sensor networks, is becoming more important [2]. In some applications it is not appropriate to use batteries, because charging or replacing them is difficult [3]. To power the electronic devices in such applications energy must be gained from the environment. This process is called energy harvesting.

When dealing with this topic, one has to distinguish between different scales of harvested energy. Covaci and Gontean [3] divide energy harvesting systems into small and large scale

systems. Large scale systems are for example systems based on solar, wind, tidal or geothermal. On the other hand small scale systems can for example be based on electromagnetic radiation, mechanical energy or heat. A subfield of mechanical energy harvesting is the energy generation by means of the piezoelectric effect, which is the subject of discussion in this work. [3]

Typically, a system for energy harvesting consists of three subareas [4]:

- The energy source: the form of energy from which electrical energy is obtained.
- The harvesting mechanism: the structure or the effect which converts the ambient energy to electrical energy.
- The load: an electrical device which consumes or stores the energy.

For a piezoelectric energy harvesting system the energy source is mechanical (vibration) energy, using the piezoelectric effect. The load depends on the application. [3]

When using the piezoelectric effect as the harvesting mechanism, it consists of two basic elements: The mechanical component generates electrical energy and the electrical circuit is needed to rectify, convert and store the generated energy. The output of the sensor is an alternating voltage, which needs to be rectified to a constant voltage. To optimize the effectiveness of the energy harvesting system not only the harvesting mechanism must be considered. The electrical circuit also must be optimized. [5]

This paper presents the principle of energy harvesting with a piezoelectric sensor converting mechanical energy to electrical energy. The piezoelectric effect is described in section II. An overview for piezoelectric materials is given. To achieve a high efficiency for the energy harvesting application knowledge for various geometries is needed and provided in the section III. After that it is described that it is also important that the ambient vibration frequency matches the resonance frequency of the piezoelectric sensor. In section IV various electronic circuits for energy harvesting are presented.

## II. PIEZOELECTRICITY

In this section an overview of the physical effect of piezoelectricity is provided. The term "piezoelectricity" originates from the Greek word "squeeze or press" [6]. This refers to the



piezoelectric material's property to generate an electric field when a mechanical force is applied [3]. It was discovered by Pierre and Jacques Curie in 1880 in a micro scale device, which uses the effect in a sensor and a microgenerator [6].

When considering the piezoelectric effect, it must be divided into two categories: The direct piezoelectric effect and the inverse piezoelectric effect (also named as reverse or converse piezoelectric effect) [7]. The direct piezoelectric effect is the development of an electric polarization under mechanical deformation. The inverse piezoelectric effect is a mechanical deformation when the material is subjected to an electric polarization [8].

### A. Deformation of piezoelectric materials

To enable an understanding of the piezoelectric effect, the effect of the deformation of a piezoelectric material must be considered at the molecular level. In Figure 1 this is shown for the simplified internal structure of the quartz crystal  $\text{SiO}_2$ . The above figures show the quartz crystal, the lower ones the charge centers.  $P$  is the electric polarization pointing from the center of the negative charge  $C_{Q-}$  to the center of the positive charges  $C_{Q+}$ . (a) is the original state of the crystal without any external mechanical force, (b) and (c) shows the deformation resulting from an external mechanical force  $F$ . The deformation of the crystal leads to a shift of the center of the negative and positive charges resulting to a macroscopic change of the electric polarization. The greater the geometric distance between the center of positive and negative charges is, the higher will be the polarization. With electrodes covering the material a electric voltage or electric charges can be measured. The voltage or charges is directly related to the mechanical deformation. [7]

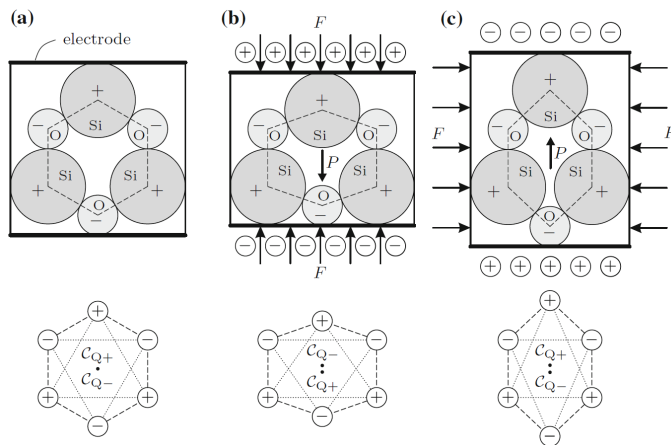

Fig. 1. Simplified inner structure of quartz crystal  $\text{SiO}_2$  with electrodes at the top and bottom; bottom drawing illustrates the center of positive and negative charge [7]

### B. Piezoelectric materials

Figure 2 shows a classification of piezoelectric materials in the crystal class.

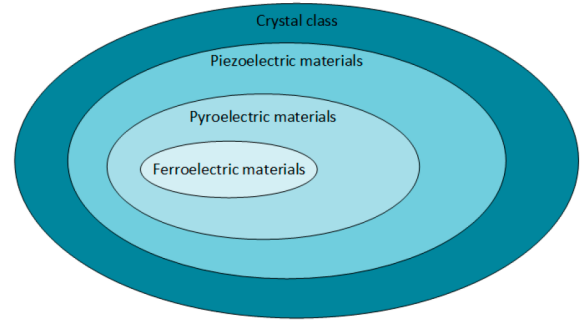

Fig. 2. The relationship between piezo-, pyro-, and ferroelectric materials in the crystal class [3]

There are 32 classes of crystals (one class contains several materials), of which 20 have direct piezoelectricity. Of these 20, there are 10 classes of pyroelectric material. They are polar crystals, exhibiting spontaneous polarization in the absence of mechanical stress. They show pyroelectricity, which is the generation of charge under an oscillating thermal gradient. Additionally the material is ferroelectric, if the dipole moment is reversible under the application of a sufficiently large electric field. Consequently, ferroelectric materials are also piezoelectric, but they exhibit semiconductor properties. [3], [9]

The type of piezoelectric material selected for a power harvesting application can have a major influence on the harvester's functionality and performance [10]. For energy harvesting there are around 200 piezoelectric materials used [11].

The most common used type for power harvesting applications is lead zirconate titanate, a piezoelectric ceramic, or piezoceramic, known as PZT [10]. PZT is toxic [8] and it has a brittle nature which causes limitations in the strain that it can safely absorb without being damaged [10]. Its popularity results from its efficiency and its cheap pricing [12].

Another common piezoelectric material is poly(vinylidene fluoride) (PVDF). PVDF is a piezoelectric polymer that exhibits considerable flexibility when compared to PZT. [10]

## III. PIEZOELECTRIC SENSORS FOR ENERGY HARVESTING APPLICATIONS

### A. Piezoelectric geometries

For energy harvesting with piezoelectric sensors there are different sensors with different shapes. In the following two geometries are presented, which are suitable for energy harvesting applications. Further geometries can be found for example in [3] or in [10].

In Figure 3 the cantilever beam structure is shown. It consist of a non-piezoelectric layer, which is usually a conductive metallic layer. This layer is fixed at one end to achieve a structure operating in its flexural mode. Above and below the non-piezoelectric layer is a thin piezoelectric layer. If there is a lower and an upper layer, the structure is called "bimorph". If only one of the layers is present, the structure is called

“unimorph”. The bimorph arrangement has the advantage over the unimorph arrangement that it provides twice as much energy without a large increase in volume. [3] [13]

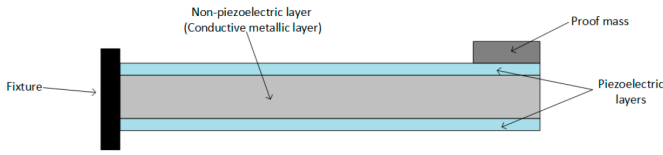

Fig. 3. Bimorph cantilever beam geometry for piezoelectric sensors for energy harvesting applications [3]

The cantilever beam structure is the most investigated piezoelectric structure for vibration energy harvesting [14]. The advantages of this geometry is that it is a simple structure and has a low manufacturing costs. In addition, it has a low resonance frequency and the power output is proportional to the proof mass. The structure has a high mechanical quality factor. However, the inability to withstand a high impact force is negative. [3]

Figure 4 shows the cymbal geometry. This consists of a piezoelectric layer between two metal end caps on both sides. There is a cavity between the metal end caps and the piezoelectric layer. When an axial load is applied to the metal end caps, the stress is amplified and converted into radial stress. This causes increased charge generation for the piezoelectric energy harvester. [3], [15]

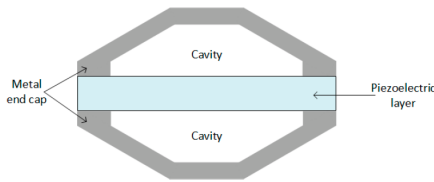

Fig. 4. Cymbal geometry for piezoelectric sensors for energy harvesting applications [3]

Cymbal transducers can provide a higher energy output than cantilever energy harvesters because the cymbal structure withstands a higher impact than the cantilever beam [15]. However, its range of use is limited to applications with high-magnitude vibration sources [3].

### B. Frequency Response

Another point that must be considered to increase the efficiency of piezoelectric energy harvesters is the frequency of the ambient vibration. To achieve the highest possible efficiency, the resonant frequency of the sensor must be matched to the frequency of the ambient vibration [10] [16]. Therefore a suitable geometry must be chosen. A mismatch in the harvester’s resonant frequency to the frequency of the ambient vibration frequency can generate a significant reduction in voltage and power output [13].

To further increase the efficiency, Roundy and Zhang [17] developed the idea of matching the resonant frequency of the

piezoelectric sensor to the frequency of the ambient vibration. By the concept of active self-tuning it is possible to achieve the adaptation of the resonant frequency. This can be achieved by altering the stiffness or the mass of the system. Energy must be continuously supplied to the system to achieve the adaptation. With passive self-tuning, only an initial energy input is needed to adjust the resonant frequency. The new resonant frequency is then maintained. [10], [17]

## IV. ELECTRONIC CIRCUITS FOR PIEZOELECTRIC ENERGY HARVESTING

As already known from the previous chapters, a piezoelectric sensor generates an electric field when an external mechanical force is applied on it. The voltage or charge generated is directly related to the mechanical deformation [7]. The energy generated varies as a function of the speed and magnitude of the applied force. Without further circuitry, a piezoelectric sensor can only be used to measure the input force. For energy harvesting applications, the output of the sensor is rectified in order to reuse the generated energy [3] [9]. It must be considered that the harvested energy in most designs is usually very low [18].

### A. Electrical model

Figure 5 shows the standard electrical model of a piezoelectric sensor. The piezoelectric element is modeled by a sinusoidal current source  $I_p(t)$  in parallel with its internal capacitance  $C_p$ . The amplitude and frequency of the polling current depends on the spectral properties of vibration [19]. The model is completed by a resistance  $R_p$ , which symbolizes the losses in the piezoelectric material. [18]

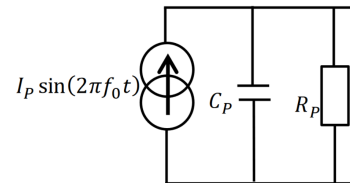

Fig. 5. Electrical model of a piezoelectric sensor [18]

### B. Rectification circuits

To rectify the output of the piezoelectric sensor, there are several approaches. The most popular circuits are: [3]

- AC-DC piezoelectric energy harvesting circuit,
- two-stage piezoelectric energy harvesting circuit,
- SSHI technique and
- SECE technique.

Figure 6 shows the AC-DC piezoelectric energy harvesting circuit. It shows the model of the piezoelectric sensor. The output of the sensor is connected to a full bridge rectifier. It converts the output voltage of both polarities to a single polarity. This circuit charges the capacitor  $C_L$  to a required voltage. When the switch is closed, the capacitor is connected to the load  $R_L$ . [3], [9], [12]

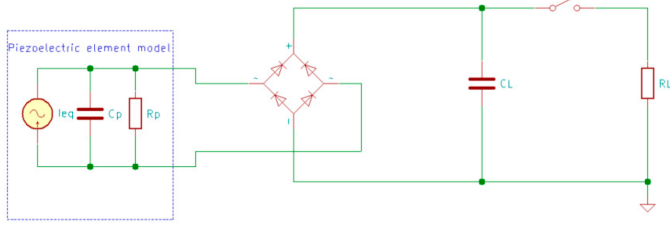

Fig. 6. Standard AC-DC energy harvesting circuit with electric piezoelectric model, full bridge rectifier and load [3]

The two stage piezoelectric energy harvesting circuit is shown in Figure 7. The output of the piezoelectric sensor gets rectified through an AC-DC converter. Since the excitation force level is not constant, the rectified voltage level is not constant either. Therefore, a DC-DC converter can be used after the rectifier to maximize the power transferred to the storage device [20].  $C_0$  is a temporary storage capacitor.

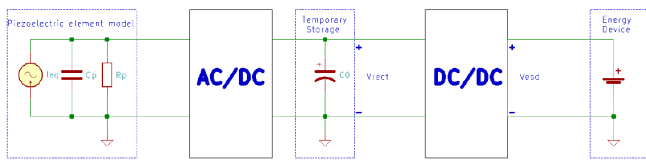

Fig. 7. Generalized two-stage piezoelectric energy harvesting circuit consisting of the sensor, the AC-DC converter, an intermediate capacitor, the DC-DC converter and the load [3]

The Synchronized Switch Harvesting on Inductor (SSHI) circuit uses a nonlinear technique to increase the output power. The technique is based on the resonant circuit created by the internal capacitor of the piezoelectric sensor and an external inductor which flips the capacitor voltage instantly to nullify the effect of the capacitive term. The energy that would be needed to conduct the diode bridge, which would have been wasted, is now harvested. [3], [21]

Figure 8 shows the SSHI circuit in parallel configuration. A switch  $S_1$  and an inductor  $L_1$  is added in comparison to the standard AC-DC energy harvesting circuit. As shown in Figure 8 the path for the inductor and the switch is connected in parallel to the sensor output. It can also be connected in series to the sensors output. [12]

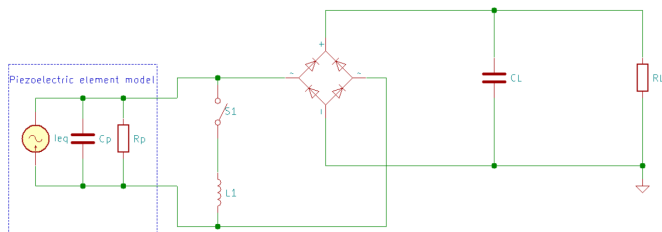

Fig. 8. Parallel-Synchronized Switch Harvesting on Inductor (SSHI) energy harvesting circuit [3]

In comparison to the other circuits the Synchronous Electrical Charge Extraction (SECE) circuit has the advantage that it does not depend on the load. The efficiency of the circuit is not affected by the load. The disadvantage is that a complex controller is needed for this circuit. [21]

The circuit is shown in Figure 9. After the AC-DC converter, there is a DC-DC power converter using a flyback switching mode converter [3]. The Gate of the transistor  $T$  is determined by a control circuit measuring the rectified voltage  $V_{rect}$  [22]. Further explanations of this circuit can be found in [3] and [22].

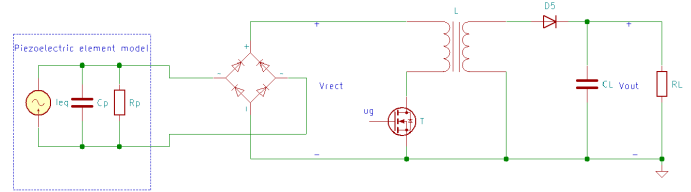

Fig. 9. Synchronous Electrical Charge Extraction (SECE) energy harvesting circuit [3]

## V. CONCLUSION

The development in wireless technology and the concept of Internet of Things has led to the need for self-powered systems due to the inaccessibility of batteries for charging. One possibility to supply such systems with energy is by means of energy harvesting. The direct piezoelectric effect can be used for this purpose. If a piezoelectric material is deformed, it generates an electric field due to a molecular shift in the center of negative and positive charges.

Piezoelectric materials are part of the crystal class and there are 20 classes which show direct piezoelectricity. The most common used material for a piezoelectric sensor is PZT, which is the most efficient and cost-acceptable material. When selecting a piezoelectric sensor for an energy harvesting application there are various geometries to chose from. To achieve high efficiency it also must be considered to chose a piezoelectric sensor which has a similar resonant frequency like the frequency of the ambient vibration.

Depending on the application an electronic circuit is needed to rectify the output of the piezoelectric sensor. Therefore a piezoelectric energy harvester contains a AC-DC converter, a two-stage conversion circuit or uses non-linear techniques like SSHI oder SECE.

## REFERENCES

- [1] A. Rjafallah, A. Hajjaji, D. Guyomar, K. Kandoussi, F. Belhora, Y. Boughaleb, "Modeling of polyurethane/lead zirconate titanate composites for vibration energy harvesting," *Journal of Composite Materials*, vol. 53, no. 5, pp. 613-623, July 2018.
- [2] H. Landaluce, L. Arjona, A. Perillos, F. Falcone, I. Angulo, F. Muralter, "A Review of IoT Sensing Applications and Challenges Using RFID and Wireless Sensor Networks," *Sensors*, vol. 20, no. 9, p. 2495, Apr 2020.
- [3] C. Covaci and A. Gontean, "Piezoelectric Energy Harvesting Solutions: A Review," *Sensors*, vol. 20, no. 12, p. 3512, Jun 2020.

- [4] S. Sudevalayam and P. Kulkarni, "Energy Harvesting Sensor Nodes: Survey and Implications," *IEEE Communications Surveys & Tutorials*, vol. 13, no. 3, pp. 443-461, Third Quarter 2011.
- [5] S. Gareh, B. C. Kok, M.H. Yee, A. A. Borhana, S. K. Alswed, "Optimization of the Compression-Based Piezoelectric Traffic Model (CPTM) for Road Energy Harvesting Application," *International Journal of Renewable Energy Research*, vol. 9, no. 3, pp. 1272-1282, Sept 2019.
- [6] E. Maghsoudi Nia, N. A. Wan Abdullah Zawawi and B. S. Mahinder Singh, "Design of a pavement using piezoelectric materials," *Materials Science & Engineering Technology*, vol. 50, no. 3, pp.320-328, Mar 2019.
- [7] S. J. Rupitsch, "Piezoelectricity" in *Piezoelectric Sensors and Actuators: Fundamentals and Applications*, Berlin, Heidelberg: Springer Berlin Heidelberg, 2019, pp. 43-45.
- [8] A. Erturk and D. J. Inman, *Piezoelectric Energy Harvesting*, Hoboken, NJ, USA: John Wiley & Sons, 2011.
- [9] J. Briscoe, S. Dunn, "Piezoelectricity and Ferroelectricity" In *Nanostructured Piezoelectric Energy Harvesters*, Berlin/Heidelberg, Germany: Springer International Publishing, 2014, pp. 3-17.
- [10] S. R. Anton and H. A. Sodano, "A review of power harvesting using piezoelectric materials (2003–2006)", *Smart Materials and Structures*, vol. 16, no. 3, May 2007.
- [11] S. Priya, H.-C. Song, Y. Zhou, R. Varghese, A. Chopra, S.-G. Kim, R.G. Polcawich, "A Review on Piezoelectric Energy Harvesting: Materials, Methods, and Circuits", *Energy Harvesting and Systems*, vol. 4, no. 1, pp. 3-39, 2017.
- [12] H. Liu, R. Hua, Y. Lu, Y. Wang, E. Salman, J. Liang, "Boosting the efficiency of a footstep piezoelectric-stack energy harvester using the synchronized switch technology," *Journal of Intelligent Material Systems and Structures*, vol. 30, no. 6, pp. 813-822, Feb 2019.
- [13] S. Mishra, L. Unnikrishnan, S.K. Nayak, S. Mohanty, "Advances in Piezoelectric Polymer Composites for Energy Harvesting Applications: A Systematic Review," *Macromolecular Materials and Engineering*, vol. 304, no. 1, Nov 2018.
- [14] G. Piliposian, A. Hasanyan, D. Piliposyan, "The effect of the location of piezoelectric patches on the sensing, actuating and energy harvesting properties of a composite plate," *Journal of Physics D: Applied Physics*, vol. 52, no. 44, p. 445501, Aug 2019.
- [15] H. Li, C. Tian, Z.D. Deng, "Energy harvesting from low frequency applications using piezoelectric materials," *Applied Physics Reviews*, vol. 1, no. 4, p. 041301, Aug 2014.
- [16] M. He, S. Wang, X. Zhong, M. Guan, "Study of a Piezoelectric Energy Harvesting Floor Structure with Force Amplification Mechanism," *energies*, vol. 12, no. 18, p. 3516, Aug 2019
- [17] S. Roundy and Y. Zhang, "Toward self-tuning adaptive vibration-based microgenerators," in *Smart Materials, Nano-, and Micro-Smart Systems*, Sydney, Australia, 2005.
- [18] A. Mouapi, N. Hakem, "Electrical Optimization of Piezoelectric Energy Harvesting System in Vehicles," in *International Conference on Energy, Environment and Economics*, Edinburgh, UK, 2016.
- [19] S. Roundy, P. K. Wright, "A piezoelectric vibration based generator for wireless electronics," *Smart Materials and Structures*, vol. 13, no. 5, p. 1131, Aug 2004.
- [20] G. K. Ottman, H. F. Hofmann, A. C. Bhatt and G. A. Lesieutre, "Adaptive piezoelectric energy harvesting circuit for wireless remote power supply," *IEEE Transactions on Power Electronics*, vol. 17, no. 5, pp. 669-676, Sept. 2002.
- [21] L. Wu, X. Do, S. Lee and D. S. Ha, "A Self-Powered and Optimal SSHI Circuit Integrated With an Active Rectifier for Piezoelectric Energy Harvesting," *IEEE Transactions on Circuits and Systems I: Regular Papers*, vol. 64, no. 3, pp. 537-549, March 2017.
- [22] E. Lefeuvre, A. Badel, C. Richard, D. Guyomar, "Piezoelectric Energy Harvesting Device Optimization by Synchronous Electric Charge Extraction," *Journal of Intelligent Material Systems and Structures*, vol. 16, no. 10, pp. 865–876, Oct 2005.

# Current progress in tactile sensing techniques for industrial grade applications

Andreas Kirmeier

*Faculty of Electrical Engineering and Information Technology*

*Ostbayerische Technische Hochschule Regensburg*

Regensburg, Germany

andreas.kirmeier@st.oth-regensburg.de

**Abstract**—Robotic devices are getting smarter everyday and researchers work eagerly to further improve them. One goal is to enable the robots to have as much of an impression of their environment as humans have. The sense of touch, which humans can use even before the sense of sight, plays a particularly important role. This sense is implemented by means of so-called tactile sensors.

This paper starts by reviewing the current state-of-the-art tactile sensing technology in development and then goes on to discuss the advantages and disadvantages of the different approaches. Since there is a huge variety of sensing techniques, this paper will focus on the most recent ones starting from 2017. With the help of these insights, the reason why tactile sensors have not yet found their way into commercial use will be given. Furthermore, it will be discussed, which areas of development need to be improved in order to create an industrial-grade sensor. Finally, an outlook will be given on the fields in which tactile sensors can be used and what major improvements they could offer to the industrial production sector.

**Index Terms**—tactile sensor, tactile sensing, robotics

## I. INTRODUCTION

Humans use their sense organs to perceive the stimuli of the environment on them. The five known human senses are taste, sight, smell, hearing and touch. With the help of these senses we can react to and interact with our environment. By combining different senses, we get a more complex picture and are able to perform difficult tasks. Inspired by the human senses, researchers are trying to transfer this ability to machines. They are trying to create a robot that performs work with human or even superhuman precision and perception. In this way, the robot could relieve or support humans of dangerous or non-ergonomic work. Particularly in Industry 4.0, much emphasis is placed on safe interaction between humans and machines [1]. To ensure this safety, robots need not only adequate vision but also the ability to perceive people and objects through touch [2]. This sense of touch is implemented by so-called tactile sensors.

Tactile sensors enable robots to tactilely perceive their environment by converting external forces acting on them into electrical signals and transmitting them to a computing unit (CPU) [2]. The software in the CPU processes these signals via an algorithm and, if necessary, sends the appropriate signals to the actuators to adjust the current movement.

In recent years, there has been much research into tactile

sensors, which has resulted in a wide variety of implementations [3]–[6]. Despite the immense promise of research, more complex tactile sensors have not yet been adapted by the industry. This paper examines the reasons for the industry’s rejection of current tactile sensors. It will also give suggestions on how tactile sensors could enter regular industrial use in the future. First, the most current tactile sensors in research will be introduced and their advantages and disadvantages will be presented followed by their comparison. Second, the results will help explain why the current tactile sensors are not suitable for more complex industrial use. Third, suggestions for improvement are given, which could make it possible to introduce tactile sensors in larger scale in industrial use.

## II. CURRENT TACTILE SENSOR TECHNIQUES

There is a high amount of research regarding tactile sensor techniques. In this section, only the newest techniques, starting from 2017, are looked at.

### A. Core Principle

The basic principle of an active (tactile) sensor is relatively simple and consists of measuring a certain physical quantity and converting it into an electrical signal. In the case of the tactile sensor, the physical quantity is an external force which is converted into an electrical signal by a transmission method [4]. Since one sensor alone cannot provide precise information about the touched object, the general design relies on an array of tactile sensors. Analogous to the pixel of the image array, the smallest component of such a tactile sensor array is also called taxel, tactel, texel or sensel [3]. From now on, only the term taxel will be used in this paper. Tactile sensing can be divided into static and dynamic sensing. In the former, a contact is localised and its magnitude is determined. In the latter, vibration, slippage, surfaces and even objects can be detected.

In the research field of tactile sensors, the following transmission principles are mainly used: resistive, capacitive, magnetic and optical.

### B. Sensors

1) *Resistive based sensors*: A change in electrical resistance is one of the earlier transduction methods in which a lot of research has been done in recent years. The basic

principle of a resistance-based sensor is the change in electrical resistance of a conductive material when pressure is applied to it [7]. In the development of resistance-based sensors, piezo-resistive materials placed between electrodes and Complementary Metal-Oxide Semiconductor (CMOS) technology have been emphasised in recent years. They gained popularity due to their simple design, readout electronics and robustness. However, it should be mentioned that piezo-resistive materials also suffer from temperature dependency [8]. In [9], the authors used a piezo-resistive tactile sensor based on a hierarchical pressure-peak effect. By using their method, they achieve a high sensitivity from  $11.60 \text{ kPa}^{-1}$  to  $1108.75 \text{ kPa}^{-1}$  while also operating in broad detection range starting from  $0.04 \text{ kPa}$  to  $600 \text{ kPa}$ .

Another promising approach utilizing piezo-resistive sensing and CMOS-MEMS (microelectromechanical systems) technology was presented in [10]. They used a two sensor approach, where a spiral coil acted as a proximity sensor and the piezo-resistor as an actual tactile sensor. They are vertically integrated by using CMOS-MEMS technology. This technique saves a lot of space and a higher sensor density can be achieved. One cell consists of four piezo-resistors which are embedded in cantilevers (Fig.1). Electrically, they are connected to build a Wheatstone bridge. When an external force is pushing against the sensor, the cantilevers and thus the piezo-resistors act as a strain gauge. Bending leads to a change of resistance which alters the measured voltage within the Wheatstone bridge.

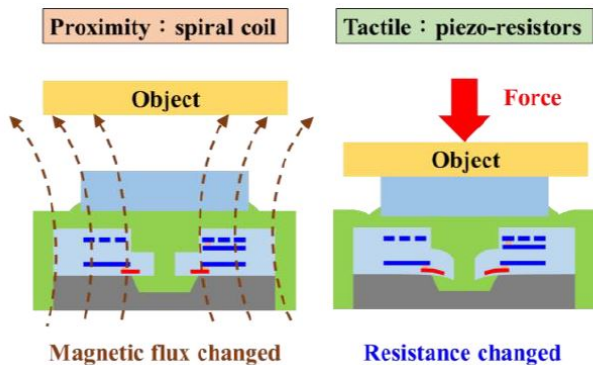

Fig. 1. Sensing principle of proximity and piezo-resistive tactile sensor taken from [10]

2) *Capacitive based sensors*: Capacitive tactile sensors are also a very popular method. The basic principle is to measure the change in capacitance of two overlapping electrodes separated by a dielectric. The dielectric in many cases consists of an elastomer such as polydimethylsiloxane (PDMS) [11]. The capacitive transduction method has a high sensitivity, high spatial resolution, large dynamic range and is temperature independent. The disadvantages are problems with stray capacitance, cross-talk, high susceptibility to noise and hysteresis [6]. Moreover, researcher often struggle with the trade-off between bulky design and small measurement ranges, due to the sensor going into saturation when the

dielectric is compressed to a minimum.

With the aim of developing the most comprehensive sensor possible, many researchers have used a very complex approach for their tactile capacitive sensor. In addition, they are also very time-consuming to develop. Therefore, in [12] the authors developed a highly sensitive, multimodal capacitive sensor that is easy to replicate and relies on relatively simple methods in implementation. They achieved a compact sensor design by using the same layer for static and dynamic sensing. For the dielectric they used polyurethane and they managed to achieve a high sensitivity, without mixing in high permittivity fillers into the dielectric, by shaping one half of the dielectric into frusto-conical shapes via  $\text{CO}_2$  laser cutting (Fig.2). This allows the dielectric to easily deform even on lower pressure levels.

A more complex approach was taken in [13]. The authors

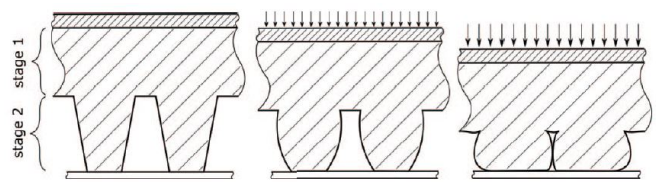

Fig. 2. Three phases of the deformation of a microstructured dielectric taken from [12]

developed a bending-insensitive, transparent nano-force tactile sensor with an enhanced percolation effect. By applying pressure to the material, the volume fraction of nanoparticles between the electrodes increases. This in turn increases the capacity. The authors developed a special nano-grating structure and thereby increased the stress concentration between the indentations, which lead to an increase in the volume fraction of the nanoparticles. In this way, they achieved an increased sensitivity. Due to the thin design of the sensor, it showed a high robustness and flexibility which was also tested by different durability tests. First they pressed the sensor with a pressure of  $100 \text{ kPa}$  up to 100000 times. Second, they tested the performance steadiness by bending the sensor to a curve with a radius of  $4 \text{ mm}$  about 10000 times. Finally, they were able to measure human pulse by curving the sensor around a human subject's wrist. Due to its flexibility and durability, the authors presented a promising sensor for industrial usage.

3) *Magnetic based sensors*: Magnetic, also called inductive transduction mechanisms, enjoy a high status among researchers. In addition to a linear, high-power output, they have a high sensitivity. The drawback is that they require a lot of energy due to the required magnetisation. In addition, in many approaches they suffer from cross-talk between the individual taxels.

In [14] the authors present a digital 3-axis soft silicone tactile sensor with permanent magnets and MLX90393 [19] sensor chips. They placed 16 MLX90393 in  $4 \times 4$  grid on a printed

circuit board (PCB). On top of the PCB layer, they used a silicone rubber material called AR-GIL. AR-GIL has a stiff structure, while being still deformable to provide a good force measurement range. The structure was printed so that on top of every sensor remains a small air gap, creating a bump like shape. The permanent magnets were glued into a gap within the bump shapes. The out most layer is a simple fabric.

In order to calculate the 3-axis force out of the raw sensor outputs, they used a calibration methods based on a linear regression model. The training data was prepared by sampling the raw sensor data and simultaneously gathering the output data of reference force sensor. The calibration parameters were found by fitting the raw data to the force sensor data by using linear regression with a Huber robust option. By using such a simple regression model, overfitting of the model was prevented.

This sensor used a simple calibration method, is durable up to 50 N and has reduced cross talk between the sensors. However, there were no specific numbers given on the force magnitude resolution or the localization accuracy. Moreover, their sensor suffers from a high hysteresis when the force is unloading due to the soft material needing some time to get back to its original shape.

The authors in [15] have developed a magnetically based tactile sensor that eliminates the latter issue. The sensor they developed, inspired by human skin, uses a Hall sensor to measure the change in magnetic flux that occurs when an external force is applied to the outer magnetised layer. The outer layer consists of a flexible magnetic layer that has a sinusoidal magnetisation profile. The middle layer consists of a soft silicone elastomer. Underneath is the Hall sensor which measures the magnetic flux. By measuring the magnetic flux and the location of the contact, they use a pre-calibrated look-up table to determine the force magnitude.

With this method, the authors managed to measure both normal and shear forces in a decoupled manner. They achieved a force magnitude measurement root-mean-square-error of  $0.01 N$ . They presented two localization modes. If there is no prior knowledge of the object being gripped, they used the "coarse localization" in which they achieve a localization accuracy of  $3 mm$ . If they know which object they are trying to grip, the authors introduce the "fine localization" method in which they used a pre-trained deep neural network to achieve a localization accuracy of  $0.1 mm$ .

The authors tested their gripper in two experiments. In the first, a regular chicken egg was gripped and the shear force was increased by a researcher dragging the egg downwards. The gripper then increases its normal force on the egg to prevent it from losing its grip. In the second experiment, an empty water bottle, held by the gripper, was filled with water and the gripper was able to keep the water bottle stable with a filling quantity of up to  $60 ml$  using a feedback loop provided with information by the tactile sensor. Without the feedback loop, the bottle already started to slip after  $30 ml$  water was put into it. However, the authors only carried out tests with very little weight, which would not be sufficient

for most industrial applications.

4) *Optical based sensors*: Optical-based sensors offer another good way to give a robot a sense of touch. They benefit from the rapid development of Convolutional Neural Networks (CNN), as they are based on image recognition. They have a great advantage when it comes to surface recognition of an object. In addition, the rigid electronic hardware can be separated from the soft touch surface and is thus better protected from external forces and the sensor can be designed more flexibly.

A very interesting approach was taken by [16] with their sensor called GelSight. Instead of measuring contact force, they measured geometry with very high spatial resolution. The sensor consists of a transparent elastomer that is encased in a reflective coating membrane. The elastomer is applied to a transparent plate and a small camera and suitable illumination is placed behind it. When an external force is applied to the surface, the elastomer deforms and the imprint of the object can be detected by the camera (Fig.3). By using LEDs with different colors and angles pointed to the elastomer, the authors obtain multiple color channels which help improve the calibration of the sensor. A computer vision algorithm

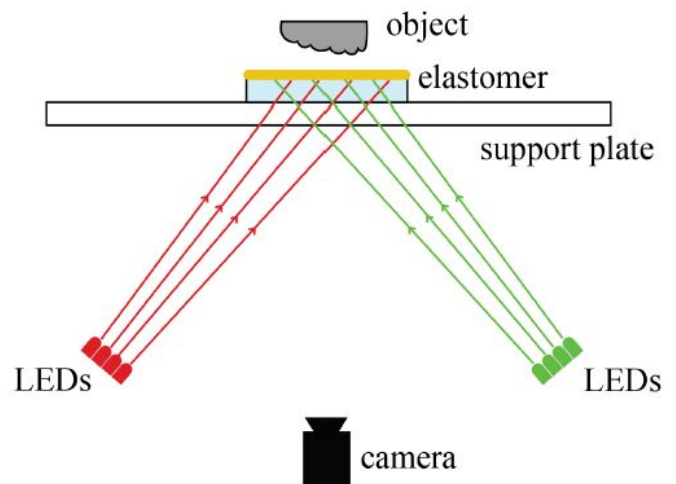

Fig. 3. Basic principle of GelSight sensor taken from [16]

can then be used to determine the exact 3D shape of the surface. The researchers have taken this a step further by printing small black dots on the surface to act as markers. If a force now presses on the surface, its movement can be used to determine the strength and type of force pressing on the object with the help of a pre-trained Convolutional Neural Network (CNN). With this method, they achieved a coefficient of determination above 0.9 for the force measurement. However, the CNN they trained was not well generalized and biased towards certain contact geometry. In order to improve the model, the authors should expand their training data and takes more measurements against overfitting. All in all, the GelSight tactile sensor offers a wide range of measurement methods. It

is able to measure geometry, normal force, shear force and slip. By gaining all this information, it could enable robots to fulfil more challenging tasks like in-hand manipulation.

In [17] a similar approach was taken. Instead of using an elastic pad, an elastic membrane was suspended between two robotic fingers. When an object is pushing against the membrane, a depth camera, placed behind the structure, can measure the deformation of the membrane. By expanding or narrowing the two robotic fingers the stiffness of the membrane can be modulated. This enables the gripper to broaden the range of objects it can sense, without deforming the object or going into quick saturation.

Another very well-known sensor is the TacTip family from SoftRobotics [18]. TacTip solves the previously undiscussed problem of sensor accessibility. They offer their basic version as an open resource for further research, adaptation and modularisation. The continuous development of their sensor has been driven by adaptation to a wide variety of applications. The basic principle has remained the same. On the inside of the soft touch surface are so-called image pins, which are captured by the camera inside. With the TacTip, a low-cost, easy-to-use, open-source device has been developed that can greatly advance research in this field.

TABLE I  
STATE-OF-THE-ART TACTILE SENSORS

year	authors	sensing principle
2019	Congyi Wu et al. [9]	resistive
2019	Jia-Horng Lee et al. [10]	resistive
2017	Thuy-Hong-Loan Le et al. [12]	capacitive
2018	Jaе-Young Yoo et al. [13]F	capacitive
2018	Tito Pradhono Tomo et al. [14]	magnetic
2021	Youcan Yan et al. [15]	magnetic
2017	Wenzhen Yuan et al. [16]	optical
2021	Carolyn Matl et al. [17]	optical
2018	Benjamin Ward-Cherrier et al. [18]	optical

### C. Comparison of the different sensors

A brief summary of the tactile sensor techniques presented is described in Table I. The specific advantages and disadvantages of the individual sensors have already been addressed in the description.

Resistive sensors or rather piezo-resistive sensor are mostly low cost productions with a simple construction which would be good fit for industrial-grade applications. However, they suffer from hysteresis and a lack of reproducibility as the material produces its output through deformation and over time wear distorts the output variable.

Capacitive sensor offer a high sensitivity, are temperature independent and can even be used in static and dynamic sensing as seen in [12]. However, they are very susceptible to noise and cross-talk and also suffer from hysteresis. Magnetic sensors have a linear output, high sensitivity, good dynamic range and can even be used as a proximity sensor. Unfortunately, they have a high power consumption and suffer from hysteresis.

Optical sensors offer a good repeatability, high spatial resolution, wide sensing range and can detect the geometry of

objects. However, they often suffer from a bulky design and are susceptible to small deviation in the construction.

In summary, the sensor techniques almost always have to deal with a trade-off. For example, if you want high sensitivity, you need expensive materials, complicated software. Also the applications in which it can be used, are often very limited and specialised. A cheaper sensor often suffers from bulky design, low sensitivity and pressure range. A multimodal approach, where different sensing principles are combined, could be beneficial to overcome these issues.

### III. DISCUSSION

Up to this day, a tremendous amount of research regarding tactile sensing has been conducted. Researchers developed novel techniques and used various new materials to improve tactile sensing systems. Some are even transcending human sensing capabilities to some point [6].

Nevertheless, there is still a lack of interest on the part of industry to incorporate the new technologies into their production processes. This is largely due to the fact that the sensors are hardly tested for durability, resistance and robustness. Many of the sensors are used in special conditions where there are no temperature fluctuations, low humidity and no unexpected collisions. This is not the case in the vast majority of production halls. In addition, sensors in high-frequency production halls must withstand hundreds to thousands of measurements every day without wearing out quickly. For this, accelerated lifetime tests would have to be carried out by the researchers. Furthermore, the sensors are calibrated before regular use, assuming the optimal condition of the sensor. If, for example, the elastomer, which many presented techniques use, is worn out after some time and the formability changes, the original calibration is no longer correct. Regular recalibration would have to be carried out, which would increase costs. Researchers are already on a good way and some modular designs like [18] are paving the way to industrial-grade usage. Still, in the future they will have to invest more time in the robustness and longevity of the tactile sensors.

### IV. CONCLUSION

This paper presented the latest research results in the field of tactile sensors. It was focused on the four transmission methods resistive, capacitive, magnetic and optical. In addition, the respective advantages and disadvantages of the tactile sensors were explained. With the different methods, researchers usually have to deal with a trade-off in the design. It was also explained why tactile sensors have still not arrived in the industry. The reasons are the inconsistency, vulnerability and the low number of lifetime tests. If researchers put more emphasis on these points in the future, tactile sensors could change industrial production significantly. An industry-approved sensor may even one day become useful to robots in home applications.



## REFERENCES

- [1] H. Liu, T. Fang, T. Zhou and L. Wang, "Towards Robust Human-Robot Collaborative Manufacturing: Multimodal Fusion" in *IEEE Access*, vol. 6, pp. 74762-74771, 2018
- [2] B. Gates, "A Robot In Every Home" in *Scientific American*, vol. 296, no. 1, pp. 58-65, 2007
- [3] P. Girao, P. Ramos, O. Postolache and J. Miguel Dias Pereira, "Tactile sensors for robotic applications" in *Measurement: Journal of the International Measurement Confederation*, vol. 46, pp. 1257-1271, 2013
- [4] H. Yousef, M. Boukallel and K. Althoefer, "Tactile sensing for dexterous in-hand manipulation in robotics - A review" in *Sensors and Actuators, A: Physical*, vol. 167, pp. 171-187, 2011
- [5] Z. Kappasov, J. Corrales and V. Perdereau, "Tactile sensing in dexterous robot hands - Review" in *Robotics and Autonomous Systems*, vol. 74, pp. 195-220, 2015
- [6] C. Chi, X. Sun, N. Xue, T. Li and C. Liu, "Recent progress in technologies for tactile sensors" in *Sensors (Switzerland)*, vol. 18, 2018
- [7] K. Weiß, H. Worn, "The working principle of resistive tactile sensor cells" in *IEEE International Conference on Mechatronics and Automation, ICMA 2005*, pp. 471-476, 2005
- [8] N. D. Arora, J. R. Hauser and D. J. Roulston, "Electron and hole mobilities in silicon as a function of concentration and temperature" in *IEEE Trans. Electron Devices*, vol. 29, no. 2, pp. 292-295, Feb. 1982.
- [9] C. Wu, T. Zhang, J. Zhang, J. Huang, X. Tang, T. Zhou et al., "A new approach for an ultrasensitive tactile sensor covering an ultrawide pressure range based on the hierarchical pressure-peak effect" in *Nanoscale Horizons*, vol. 5, no. 3, pp.541-552, 2020
- [10] J. Lee, S. Yeh and W. Fang, "CMOS-MEMS Tri-Axial Piezo-Resistive Tactile Sensor with Monolithically/Vertically Integrated Inductive Proximity Sensor", 2019 20th International Conference on Solid-State Sensors, Actuators and Microsystems & Eurosensors XXXIII (TRANSDUCERS & EUROSENSORS XXXIII), pp. 1835-1838, 2019
- [11] G. Liang, D. Mei, Y. Wang, Z. Chen, "Modeling and analysis of a flexible capacitive tactile sensor array for normal force measurement" in *IEEE Sens.*, vol. 14, pp. 4095-4103, 2014
- [12] T. Le, A. Maslyczyk, J. Roberge and V. Duchaine, "A highly sensitive multimodal capacitive tactile sensor", 2017 IEEE International Conference on Robotics and Automation (ICRA), pp. 407-412, 2017
- [13] J. Yoo, M. Seo, J. Lee, K. Choi, M. Jo and J. Yoon, "Industrial Grade, Bending-Insensitive, Transparent Nanoforce Touch Sensor via Enhanced Percolation Effect in a Hierarchical Nanocomposite Film" in *Advanced Functional Materials*, vol. 28, no. 42, 2018
- [14] T. P. Tomo et al., "A New Silicone Structure for uSkin—A Soft, Distributed, Digital 3-Axis Skin Sensor and Its Integration on the Humanoid Robot iCub", in *IEEE Robotics and Automation Letters*, vol. 3, no. 3, pp. 2584-2591, July 2018
- [15] Y. Yan et al., "Soft magnetic skin for super-resolution tactile sensing with force self-decoupling" in *Sci. Rob.* 2021, vol. 6, 2021
- [16] W. Yuan, S. Dong and E. Adelson, "GelSight: High-resolution robot tactile sensors for estimating geometry and force" in *Sensors (Switzerland)*, vol. 17, no. 12, 2017
- [17] C. Matl, J. Koe and R. Bajcsy, "StRETcH: a Soft to Resistive Elastic Tactile Hand", 2021
- [18] B. Ward-Cherrier et al., "The TacTip Family: Soft Optical Tactile Sensors with 3D-Printed Biomimetic Morphologies" in *Soft Robotics*, vol. 5, no. 2, pp. 216-227, 2018
- [19] Melexis, "MLX90393 Triaxis Magnetic Node", Nov. 2014 [Revised Jan. 2021]

# Messung von Regendaten mit Richtfunkstrecken des Mobilfunk Backhaul-Netzwerkes

Sebastian Griesbeck  
Fakultät Elektro- und Informationstechnik  
Ostbayerische Technische Hochschule Regensburg  
Regensburg, Deutschland  
sebastian.griesbeck@st.oth-regensburg.de

**Zusammenfassung**—Aktuellste Ereignisse zeigen, dass Extremwetterlagen zunehmen und punktuell schnell auftreten können, was zu großem Schaden führen kann. Aus diesem Grund ist es notwendig, ein engmaschiges Monitoring des Niederschlages durchzuführen. Aktuell werden zur Erfassung von Regendaten meist Regenradare und Kippwaagen eingesetzt. Diese haben oft eine schlechte zeitliche Auflösung, geben nur einen groben Richtwert oder sind fehleranfällig. Auch kann es zu Problemen in schwierigen geografischen Lagen wie Bergtälern kommen, in denen es sehr schwierig und aufwendig ist, den Niederschlag zu erfassen.

In dieser Arbeit wird das Potenzial der Erfassung von Regendaten mit Mikrowellenverbindungen des Mobilfunknetzes auf Basis aktueller Veröffentlichungen und Literatur aufgezeigt. Dazu wird auf die grundsätzliche Möglichkeit zur Messung von Niederschlag mit kommerziell betriebenen Mobilfunk Richtfunkstrecken eingegangen. Die Bestimmung des Niederschlages wird durch Erfassung der Streckendämpfung und durch Anwendung verschiedener Algorithmen durchgeführt.

Kommerzielle Mikrowellenverbindungen eignen sich durch ihre hohe Dichte mit einem europäischen Schnitt von 0,3 Verbindungen pro km<sup>2</sup>, als auch durch geringe Betriebskosten zur Erfassung von Regendaten als Nebeneffekt zur Datenübertragung. Eine große Chance zur Optimierung bieten zudem neue und zukünftige Mobilfunkstandards wie 5G. Neue Generationen von Mobilfunk verfügen über deutlich mehr Basisstationen, die an das Backhaul-Netzwerk angebunden werden müssen, wodurch sich eine höhere geografische Auflösung zur Erfassung der Regendaten ergibt. Aufgrund der Engmaschigkeit ergeben sich auch neue Problemstellungen, wodurch herkömmliche Algorithmen größere Fehlerraten verursachen. Es zeigt sich, dass sich für diese kürzere Distanz von Backhaulverbindungen RNNs und CNNs besser zur Niederschlagsermittlung eignen und geringere Fehlerraten erzielen können.

**Keywords**—Regen, Machine Learning, Mikrowellenverbindung, Backhaul-Verbindungen, 5G, Niederschlag

## I. EINFÜHRUNG

In Hinblick auf zukünftige Extremwetterlagen aufgrund des voranschreitenden Klimawandels, ist eine genaue Analyse des Wasserkreislaufes nötig. Somit können durch Steuerung von Talsperren und beispielsweise Ablassen von Dämmen, der Wasserfluss besser gesteuert und auf den Niederschlag angepasst werden. Da es sehr aufwendig und kostenintensiv ist, flächendeckende Regenmesser zu installieren, wird seit langer Zeit an Alternativen geforscht [1]. Herkömmliche Methoden

wie Regenradare oder Kippwaagen sind meist in geografisch anspruchsvollen Gebieten, wie in Gebirgen und abgelegenen Orten, nicht sinnvoll einsetzbar. Auch ist die Verfügbarkeit von Regenradaren und Regenmessern in vielen Teilen der Welt begrenzt. Eine vielversprechende Möglichkeit ist die Messung des Niederschlages mithilfe von Mikrowellenverbindungen [2]. Gemessen wird die Dämpfung des Mikrowellensignals einer Richtfunkstrecke [3]. Da Mikrowellenverbindungen in der Praxis häufig für den Mobilfunk eingesetzt werden, liegt die Idee nahe, diese zusätzlich für das Regenmonitoring zu verwenden. Ziel dieser Arbeit ist es, die Möglichkeiten zur Regenerfassung mithilfe des Mobilfunknetzes auf Basis aktueller Veröffentlichungen und Literatur aufzuzeigen. Aktuell sind laut Bundesnetzagentur knapp 230 000 dieser kommerziellen Verbindungen in Betrieb [4]. Früh wurden hierzu erste Ansätze verfolgt, kommerzielle Richtfunkstrecken (sogennante Backhails), die Mobilfunkmasten an das Core-Netzwerk anbinden, auszuwerten [5]. Üblicherweise eignet sich der Frequenzbereich über 10 GHz für solche Vorhaben, da ab dieser Größenordnung Regentropfen in Form von Absorption und Streuung erheblich zu den Übertragungsverlusten beitragen [6], [7]. Zur Messung der Regendaten wird die Dämpfung der Richtfunkstrecke gemessen und ausgewertet. Da es physikalisch bedingt auch während Trockenzeiten zu hohen Dämpfungen in der Richtfunkstrecke kommen kann, reicht eine einfache Entscheiderschwelle nicht aus. Es müssen verschiedene Techniken eingesetzt werden, um beispielsweise trockene und feuchte Phasen zu unterscheiden. Hierzu wird in Abschnitt II-A auf den weit verbreiteten Algorithmus [8] zur Klassifikation der Regen- und Trockenphasen eingegangen. Auch soll die grundsätzliche Methodik zur Niederschlagsschätzung aufgezeigt werden. Eine wichtige Rolle spielen auch zukünftige Mobilfunkgenerationen. Aufgrund der Tatsache, dass neue Mobilfunkgenerationen über deutlich mehr Basisstationen verfügen werden, kommen dann auch mehr (und kürzere) Richtfunkstrecken zum Einsatz. Bei geringeren Distanzen der Mikrowellenverbindungen kommen dann weitere Effekte hinzu, die in Abschnitt II-B beschrieben werden. In Kapitel III sollen neue Möglichkeiten zur Kategorisierung mithilfe von Machine Learning aufgezeigt und in Abschnitt IV ein Vergleich zu der üblich angewandten Methodik gezogen werden. Abschnitt V gibt einen Ausblick und zeigt einen konkreten Anwendungsfall in der Praxis.

## II. GRUNDLAGEN

In diesem Kapitel soll auf die Grundlagen der Niederschlags erfassung mit Mikrowellenverbindungen eingegangen und deren Probleme bei kurzen Distanzen aufgezeigt werden.

### A. Niederschlagsmessung mit kommerziellen Mikrowellenverbindungen

Vor über einem Jahrzehnt entstanden Veröffentlichungen zur Niederschlagsmessung durch kommerzielle Richtfunkstrecken [9]. Der Ansatz verfolgt dabei die vom Regen verursachte Dämpfungsr ate  $A$  über folgende Gleichung [10]:

$$A = aR^b \quad (1)$$

Wobei  $R$  die Regenrate abbildet und die Konstanten  $a$  und  $b$  von der Frequenz, der Temperatur, der Größenverteilung der Regentropfen und der Polarisation abhängen [9]. Die konstanten  $a$  und  $b$  lassen sich aus [11] entnehmen.

Durch die Linearität in Gleichung 1 lässt sich die pfadgemittelte Regenrate  $\bar{R}$  durch folgende Gleichung berechnen [10]:

$$A = \int_0^L aR(l)^b \stackrel{b \approx 1}{\approx} a\bar{R}^b L \quad (2)$$

Mit der Pfadlänge  $L$  zwischen Sender und Empfänger in km. Die konkrete Datengewinnung der Streckendämpfung (TRSL) erfolgt durch Subtraktion des empfangenen Signalpegels (RSL) vom übertragenen Signalpegel (TSL). Die alleinige Auswertung der Signaldämpfung führt nicht zur Regenrate. Die Schwierigkeit liegt darin, dass sich die Dämpfungsbasislinie im Laufe der Zeit aufgrund von Temperaturschwankungen, Luftfeuchtigkeit, starke Sonneneinstrahlung und Mehrwegeausbreitung auch bei Trockenphasen ändert [2], [12]. Ebenfalls kann es durch nasse Antennen zu zusätzlichen Dämpfungen kommen [13]. So müssen Möglichkeiten gefunden werden, um trockene und feuchte Phasen zu klassifizieren und die Daten weiterzuverarbeiten. Abbildung 1 zeigt einen typischen Workflow, um die Daten zu verarbeiten. Zuerst stehen die Daten aus den einzelnen Messstellen zur Verfügung. Im zweiten Schritt, muss das Signal gefiltert und Regenphasen in den verrauschten Daten identifiziert werden. Danach muss eine Basislinienbestimmung durchgeführt werden. Durch die nasse Antenne und der darauffolgenden zusätzlichen Dämpfung in Regenphasen wird eine sogenannte wet antenna attenuation-Korrektur durchgeführt [13]. Sobald die Daten "aufbereitet" wurden, kann die Regenrate über die Dämpfung bestimmt werden.

Eine oft eingesetzte Methode zur Kategorisierung in Trocken- und Feuchtperioden wird in [8] beschrieben.  $A(t)$  ist die gesamte Dämpfung der Strecke.  $A_B(t)$  beschreibt die Dämpfung der zuvor genannten Effekte, die durch die Umgebung und Verluste durch Länge der Strecke bei trockenen Perioden auftreten.  $A_R(t)$  ist die zusätzliche Dämpfung, die durch den Niederschlag verursacht wird. Das lässt sich so darstellen:

$$A(t) = \begin{cases} A_B(t) & \text{für trockene Perioden} \\ A_B(t) + A_R(t) & \text{für nasse Perioden} \end{cases} \quad (3)$$



Abbildung 1. Visualisierung des typischen Ablaufs, um aus den Dämpfungsdaten die Regenrate zu ermitteln. (CML = Commercial Microwave Link, Mikrowellenverbindung von kommerziellen Mobilfunkbetreibern) [10]

Für ein gleitendes Zeitfenster  $W_t = [t-w, t]$  der Dauer  $w > 0$  wird die folgende Teststatistik für die lokale Variabilität des Verbindungssignals definiert:

$$S_{W_t} = \left[ \frac{1}{N_{W_t}} \sum_{k \in W_t} (A(k) - \bar{A}_{W_t})^2 \right]^{\frac{1}{2}} \quad (4)$$

mit dem lokalen Mittelwert:

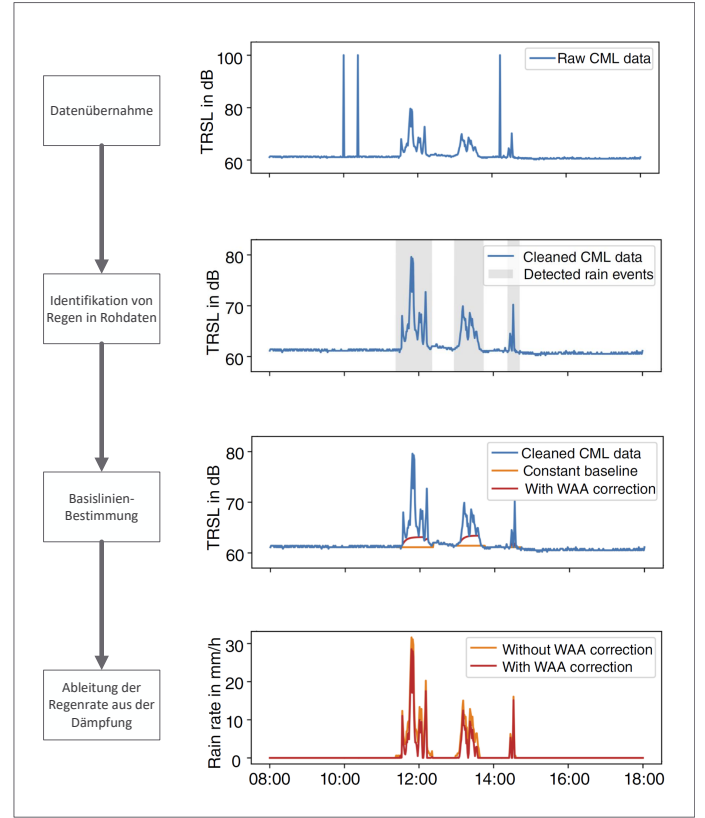
$$\bar{A}_{W_t} = \frac{1}{N_{W_t}} \sum_{k \in W_t} A(k) \quad (5)$$

$N_{W_t}$  stellt die Anzahl an Beobachtungen in  $W_t$  dar. Um die Klassifizierung vorzunehmen wird angenommen, dass  $S_{W_t}$  in Trockenperioden klein und in Regenperioden groß ist und  $P$  die Wahrscheinlichkeit angibt:

$$P[S_{W_t} \leq \sigma | \text{trocken}] \geq P[S_{W_t} \leq \sigma | \text{feucht}] \quad (6)$$

Wobei  $\sigma$  die lokale Standardabweichung ist. Die Entscheidung wird durch folgende Klassifikation getroffen:

$$\text{Entscheidungsschwelle} \begin{cases} \text{Regen:} & S_{W_t} > \sigma_0 \\ \text{trocken:} & S_{W_t} \leq \sigma_0 \end{cases} \quad (7)$$

Für die Schwelle  $\sigma_0$ , deren Bestimmungsmethode in [8] beschrieben wird.

### B. Herausforderung bei neuen Mobilfunkgenerationen

Neue Mobilfunkgenerationen zeichnen sich dadurch aus, dass die Basisstationen deutlich engmaschiger geografisch verteilt sind. Die Strecken der Richtfunkverbindungen werden folglich kürzer und mehr. In [14] wird ein Datensatz ausgewertet, der unterschiedliche Frequenzen und Längen besitzt und mit Regenschmessern in der Umgebung einen Schätzfehler berechnet. Der Fehler wird als Wurzel der mittleren Fehlerquadratsumme (RMSE) angegeben:

$$RMSE = \sqrt{\frac{1}{N} \sum_i (x_i - \hat{x}_i)^2} \quad (8)$$

Wobei  $x$  der Referenzvektor aus den Regenschmessern ist,  $\hat{x}$  die berechnete Regenrate und  $N$  die Anzahl der Samples. Die Berechnung basiert auf Gleichung 2 mit den Parametern aus [11]. Zur Berechnung der Basislinie wird die in Kapitel II-A beschriebene statische Möglichkeit aus [8] (als "State of the Art" angesehene Methode) und die dynamische Methode aus [15] benutzt.



Abbildung 2. Wurzel der mittleren Fehlerquadratsumme bei Berechnung des Niederschlages, verglichen mit Regenschmessern in der Umgebung, in Abhängigkeit von der Linklänge. [14]

Abbildung 2 veranschaulicht ein Problem bei kurzen Richtfunkstrecken. Die Berechnung des Niederschlages wurde mit der statischen und dynamischen Baseline Anpassung durchgeführt. Die Daten stammen aus einem schwedischen Datensatz von Messungen in kommerziellen Ericsson Richtfunkstrecken [16]. Es wird deutlich, dass die bei zukünftigen Mobilfunkgenerationen kurzen eingesetzten Richtfunkstrecken bei den Methoden zur Basislinienbestimmung einen größeren Fehler verursachen. In [14] wird zusätzlich beschrieben, dass mit steigender Frequenz der Links die Fehlerrate steigt. Diese Beobachtungen hängen insofern zusammen, dass kurze Links mit höheren Frequenzen arbeiten.

### III. MACHINE LEARNING ZUR KLASSIFIKATION DER DATEN

Abschnitt II-B hat gezeigt, dass die herkömmlichen Methoden zur Trocken-/Feuchtphasenbestimmung bzw. der Basisli-

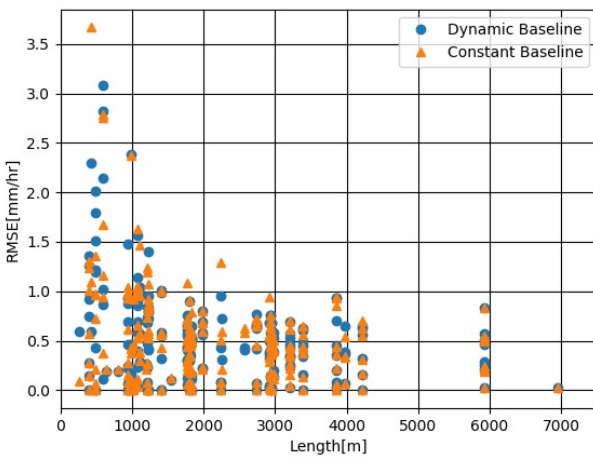
nie gerade bei den in Zukunft wichtigen kurzen Mikrowellenlinks zu Problemen bzw. Fehlern führen können.

#### A. Entscheidung mit Convolutional Neural Network

Eine vielversprechende Möglichkeit ist die Entscheidung durch Convolutional Neural Networks (CNNs). Wie in [17] beschrieben, soll ein geeignetes Netzwerk aufgezeigt werden. Dazu wird ein 1-Dimensionales CNN mit abwechselnden Faltungs- und Poolingschichten, gefolgt von Fully Connected Schichten eingesetzt. Der Faltungsteil besteht aus vier Blöcken mit zwei Faltungsschichten, einer darauffolgenden Max-Pooling Schicht und einer Faltungsschicht mit einem Average-Pooling Layer. Darauf folgt ein Fully Connected Layer mit zwei Schichten zu je 64 Neuronen. Die Ausgangsschicht hat die Aufgabe die Perioden zu klassifizieren. Abbildung 3 zeigt graphisch den Aufbau des Neuronalen Netzwerks. Das Netzwerk wird mit einem supervised Trainingsalgorithmus trainiert [18].



Abbildung 3. Grafische Darstellung des verwendeten CNNs zur Klassifizierung der Phasen. [17]

#### B. Recurrent Neuronal Network

Eine andere Methode des Machine Learnings zur Klassifikation der Trocken/Regenphasen ist der Einsatz von Recurrent Neuronal Networks (RNNs). In [19] wird ein RNN beschrieben. Dieses besteht aus zwei Schichten Gated recurrent Units (GRU) zu dem Parallel ein Fully Connected Layer (FC) liegt. Das FC entspricht dem, wie in [20] beschrieben. Die beiden Pfade werden in ein FC zusammengeführt, das in einem Klassifikator für trocken/feucht endet, bzw. in einem anderen FC, in dem die Regenrate berechnet wird. Das beschriebene RNN wird in [19] als "Two Step Network" bezeichnet. Abbildung 4 zeigt den schematischen Aufbau des RNNs.

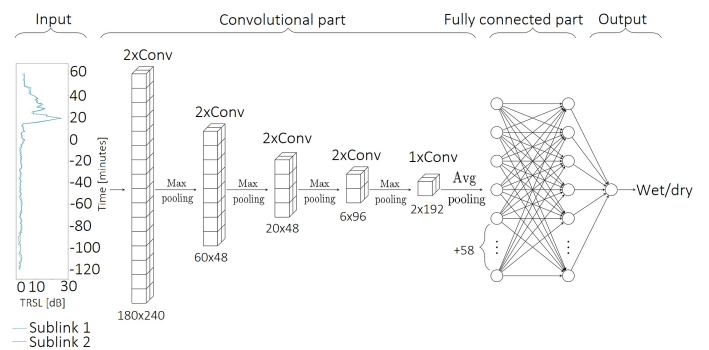

Abbildung 4. Aufbau des Two Step Recurrent Neuronal Network [14]



Abbildung 5. Vergleich der Klassifikation der Trocken- und Feuchtphasen mit der auf [8] basierenden Referenzmethode (oben) und der Klassifikation durch ein Convolutional Neuronal Network (unten). [17]

#### IV. VERGLEICH DER MACHINE LEARNING KLASSIFIKATION ZU HERKÖMMLICHEN METHODEN

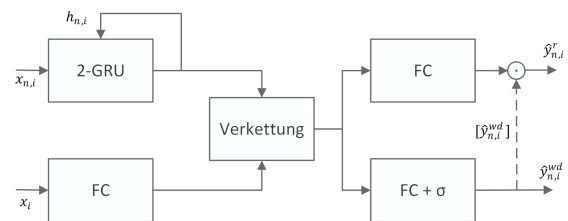
Ein Vergleich zwischen dem Convolutional Neuronal Network aus Kapitel III-A und der in [17] gezeigten Referenzmethode zur Klassifizierung, die auf [8] (siehe Abschnitt II-A) basiert zeigt, dass das CNN zuverlässiger Nass-/Trockenphasen klassifiziert als die Referenzmethode. Die Regenrate wird nach den zuvor genannten unterschiedlichen Klassifikationen in beiden Fällen durch die Pfaddämpfung in der jeweilig erkannten Regenphase geschätzt (Dabei wurde auch eine Korrektur der nassen Antenne durchgeführt [13]). Vor allem der Kompromiss zwischen falschen und verpassten Nässevorhersagen konnte mit dem CNN minimiert werden. Die Referenzmethode muss dabei auch für die verschiedenen Monate angepasst werden, um optimale Ergebnisse zu liefern, während das CNN stabile Ergebnisse auch für Zeiträume liefert, für die es nicht trainiert wurde. In Abbildung 5 ist diese deutliche Verbesserung der Klassifizierung grafisch veranschaulicht. [17]

Vergleicht man die in II-A beschriebene Methode mit der Auswertung durch das RNN, zeigt sich, dass das RNN bei kurzen Links eine deutlich genauere Abschätzung der Regenrate gibt und somit die Fehlerrate sinkt [14]. Abbildung 6 zeigt dieselben Links wie in Abbildung 2, nur dass die Daten mit dem RNN ausgewertet wurden. Eine wichtige Erkenntnis ist auch, dass RNNs, die mit Trainingsdaten aus einer bestimmten Klimaregion trainiert und mit Daten aus einer anderen klimatischen Region validiert werden, eine schlechtere Performance erzielen. So wird beispielsweise das RNN mit Daten aus Israel trainiert und mit schwedischen Daten validiert, was zu einer Trainings-Trefferquote von 97,4% und einer Validierungs-Trefferquote von 56,3% führt. Während das Training und die Validierung mit Daten jeweils aus Israel zu einer Trainings-Trefferquote von 97,4% und einer Validierungs-Trefferquote von 95,7% führten. Wobei ein Training mit Daten aus beiden Regionen und eine Validation mit beispielsweise Daten aus Schweden zu einer Validierungs-Trefferquote von 95,7% führen [21].

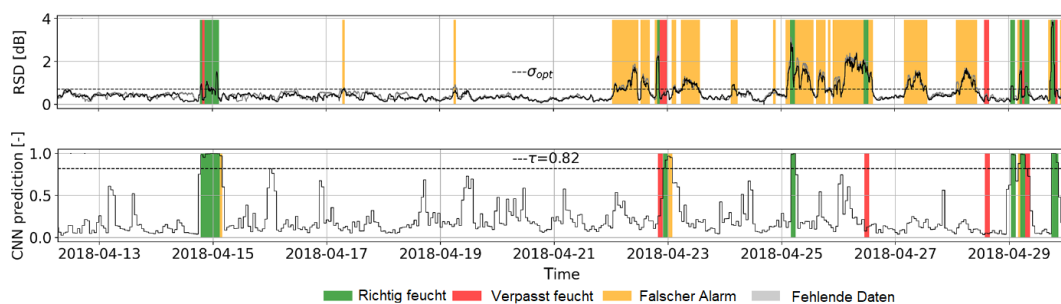
#### V. FAZIT UND AUSBLICK

Zusammenfassend ist zu sagen, dass die Grundidee von 2006 [9] zur Regenmessung mittels Mobilfunk Richtfunkstrecken geblieben ist. Um die richtige Regenrate zu schätzen, ist



Abbildung 6. Wurzel der mittleren Fehlerquadratsumme bei Berechnung des Niederschlages verglichen mit Regenmessern in der Umgebung in Abhängigkeit von der Linklänge. Die Berechnung des Niederschlages wurde mit RNNs durchgeführt, die in [19] beschrieben sind. [14]

es bedeutsam, Trocken- von Regenphasen zu unterscheiden. Dazu wird als "State of the Art" die Methode von [8] als Grundform benutzt und liefert im Normalfall gute, aber nicht optimale Ergebnisse. Auch in Hinblick auf kürzere Links, die bei neueren Mobilfunkgenerationen auftreten, kann die Fehlerrate bei der Methode aus [8] deutlich ansteigen. Aus diesem Grund bieten sich mit Blick auf die in Zukunft stark steigenden zu verarbeitenden Datenmengen, Methoden wie das Machine Learning an. Die zwei unterschiedlichen CNN und RNN Netze haben gezeigt, dass sie deutliche Vorteile bei der Klassifizierung der Trocken-/Nassphasen besitzen. In [22] wird gezeigt, dass ein flächendeckender Betrieb zur Regenauswertung mit kommerziellen Richtfunkstrecken schon möglich ist. Es werden 3904 Links ausgewertet und daraus eine Regenkarte erstellt. Der Vergleich mit dem RADOLAN-RW (Analysen radarbasierter stündlicher Niederschlagshöhen [23]) des Deutschen Wetterdienstes zeigt sehr gute Ergebnisse. In Zukunft wird diese Möglichkeit noch mehr an Bedeutung gewinnen, aufgrund der Notwendigkeit der genau aufgelösten Niederschlagserfassung und der zusätzlichen feinmaschigeren Links in künftigen Mobilfunkgenerationen.

## LITERATUR

- [1] D. Atlas und C. W. Ulbrich, "Path- and Area-Integrated Rainfall Measurement by Microwave Attenuation in the 1–3 cm Band," in *Journal of Applied Meteorology*, Vol. 16, S. 1322-1331, 1977.
- [2] A. Holt, G. Kuznetsov und A. Rahimi, "Comparison of the use of dual-frequency and single-frequency attenuation for the Measurement of path-averaged Rainfall along a microwave link," in *IEE Proceedings - Microwaves, Antennas and Propagation*, Vol. 150, S. 1322-1331, 2003.
- [3] G. Upton, A. Holt, R. Cummings, A. Rahimi und J. Goddard, "Microwave links: The future for urban Rainfall Measurement?," in *Atmospheric Research*, Vol. 77, S. 1322-1331, 2005.
- [4] Bundesnetzagentur (Zugriff 30.11.2021). "Tätigkeitsbericht Telekommunikation 2018/2019". [https://www.bundesnetzagentur.de/SharedDocs/Mediathek/Taetigkeitsberichte/2019/TK\\_20182019.pdf?\\_\\_blob=publicationFile&v=9](https://www.bundesnetzagentur.de/SharedDocs/Mediathek/Taetigkeitsberichte/2019/TK_20182019.pdf?__blob=publicationFile&v=9)
- [5] H. Leijnse, R. Uijlenhoet und J. N. M. Stricker, "Hydrometeorological Application of a microwave link: 2. Precipitation," in *Water Resources Research*, Vol. 43, S. 1322-1331, 2007.
- [6] John D. Kanellopoulos et. al., "Rain Attenuation Problems affecting the Performance of Microwave Communication Systems," in *Water Resources Research*, Vol. 43, S. 1322-1331, 1990.
- [7] R. K. Crane, "Prediction of Attenuation by Rain," in *IEEE Transaction On Communication*, Vol. 43, S. 1322-1331, 1980.
- [8] M. Schleiss und A. Berne, "Identification of dry and rainy Periods using telecommunication Microwave Links," in *IEEE Geoscience and Remote Sensing Letters*, Vol. 7, S. 611-615, 2010.
- [9] H. Messer, A. Zinevich und P. Alpert, "Environmental Monitoring by Wireless Communication Networks," in *Science*, Vol. 312, S. 611-615, 2006.
- [10] C. Chwala und H. Kunstmann, "Commercial Microwave Link Networks for rainfall observation: Assessment of the current status and future challenges," in *WIREs Water*, Vol. 6, S. 611-615, 2019.
- [11] ITU: ITU-R: Specific attenuation model for rain for use in prediction methods, Tech. Rep. (Recommendation P.838-3), ITU, Geneva, Switzerland, available at: <https://www.itu.int/rec/R-REC-P.838-3-200503-I/en> (Zugriff 30.11.2021), 2005.
- [12] H. Leijnse, R. Uijlenhoet und J. N. M. Stricker, "Rainfall measurement using radio links from cellular Communication Networks," in *Water Resources Research*, Vol. 43, S. 611-615, 2007.
- [13] H. Leijnse, R. Uijlenhoet und J. Stricker, "Microwave link rainfall estimation: Effects of link length and Frequency, temporal sampling, Power Resolution, and wet Antenna Attenuation," in *Advances in Water Resources*, Vol. 31, S. 24-33, 2008.
- [14] H. V. Habi und H. Messer, "Uncertainties in Short Commercial Microwave Links Fading Due to Rain," in *ICASSP 2020 IEEE International Conference on Acoustics, Speech and Signal Processing (ICASSP)*, Vol. 6, S. 611-615, 2020.
- [15] J. Ostrometzky und H. Messer, "Dynamic determination of the Baseline Level in microwave links for rain monitoring from minimum Attenuation values," in *IEEE Journal of Selected Topics in Applied Earth Observations and Remote Sensing*, Vol. 11, S. 24-33, 2018.
- [16] Lei Bao et. al., "A brief description on measurement data from an operational microwave network in Gothenburg, Sweden," in *15th International Conference on Environmental Science and Technology*, Rhodes, Greece, 2017, vol. 31.
- [17] J. Polz, C. Chwala, M. Graf und H. Kunstmann, "Rain event detection in commercial microwave link attenuation data using convolutional neural networks," in *Atmospheric Measurement Techniques*, Vol. 13, S. 24-33, 2020.
- [18] I. Goodfellow, Y. Bengio und A. Courville, *Deep Learning*, Berlin, Heidelberg: MIT Press, 2016.
- [19] Hai Victor Habi, "Rain detection and estimation using recurrent neural network and commercial microwavelinks," M.Sc. Thesis, Tel Aviv University, 2019.
- [20] C. M. Bishop, *Pattern Recognition and Machine Learning* - , Berlin, Heidelberg: Springer, 2006.
- [21] H. V. Habi und H. Messer, "RNN Models for Rain Detection," in *2019 IEEE International Workshop on Signal Processing Systems (SiPS)*, Vol. 31, S. 24-33, 2019.
- [22] M. Graf, C. Chwala, J. Polz und H. Kunstmann, "Rainfall Estimation from a German-wide commercial Microwave Link Network: Optimized processing and validation for 1 year of data," in *Hydrology and Earth System Sciences*, Vol. 24, S. 2931-2950, 2020.
- [23] Deutscher Wetterdienst (Zugriff 02.01.2022). "RADOLAN (Radar-Online-Aneichung)". [https://www.dwd.de/DE/leistungen/radolan/radolan\\_alt.html](https://www.dwd.de/DE/leistungen/radolan/radolan_alt.html)

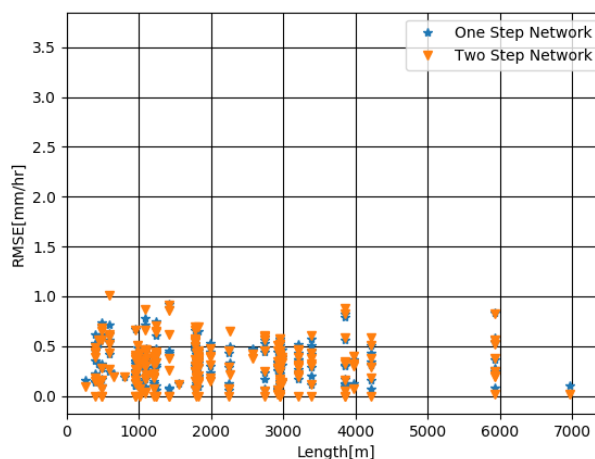
# 6G Wireless Communication Systems: Applications, Requirements, Technologies and Challenges

Simon Reger

*Faculty of Electrical Engineering and Information Technology  
Ostbayerische Technische Hochschule Regensburg  
Regensburg, Germany  
simon.reger@st.oth-regensburg.de*

**Abstract**—Although the opportunities of the fifth-generation (5G) wireless communication systems are far from being fully exploitable, it is already becoming apparent that 5G also has limits. Therefore, there is an early interest in a new generation of wireless communication systems. These new sixth-generation (6G) systems are discussed in this paper.

As with previous generations, 6G development is largely driven by applications relevant to a future digital society. This paper presents applications from the fields of communication, mobility and transportation, industry and healthcare.

As a result, requirements can be defined for enabling these 6G applications. Besides efficiency, traffic capacity, connectivity and mobility the decisive factor here is a combination of high data rates, high reliability and low latency times.

Considering these requirements, the paper elaborates some main technologies that will be part of the new 6G networks. For many problems, the intelligentization of the communication systems, i.e. the use of Artificial Intelligence (AI), is of high benefit. As well as, solutions are outlined to enable spectrum above 100 GHz, increase energy efficiency and achieve 3D network coverage.

Since many of these technologies are only in the initial development or deployment phase, numerous challenges are derived that must be mastered before 6G can be established.

**Index Terms**—6G, beyond 5G, mobile communication, massive connectivity, Internet of Everything, intelligentization, terahertz (THz)

## I. INTRODUCTION

Looking back at the last 30 years of communication systems, an enormous development can be observed. Combined with the almost exponentially increasing number of innovative mobile applications, this is leading us to a fully-connected and automated society.

A good indication of this is the strong growth in mobile traffic. While the value for traffic volume in 2010 was still 256 PB/Month<sup>1</sup>, a value of 91 EB/Month<sup>2</sup> is estimated for 2021. In 2030, it is assumed that this will reach 4394 EB/Month. [1]

A major contributor to this progress has been the introduction of a new generation of wireless communication systems approximately every 10 years. The result of each new generation has been more technologies and ways to improve people's lifestyles and work. As an example, the two current generations can be considered. 4G/Long-Term Evolution (LTE) systems significantly improved the mobile

broadband communications of the third-generation (3G). It allows users to exchange voice (Voice over IP), data and streamed multimedia, especially high definition video streams or online gaming, almost everywhere and at any time [2]. 5G also aims to further advance the aspects described for 4G. But beyond that the fields of application should be expanded. 5G was promised as a key enabler for the transformation of digital technologies in various sectors. Examples are Industry 4.0, mobility and transportation or the energy industry [3]. This is achieved through capabilities and technologies that were not possible with 4G.

It will be similar for 5G and the next generation, the sixth-generation (6G) of wireless communication systems. Even there is still a big step possible with 5G, also the performance of 5G has limitations. As with previous generations, processes are becoming increasingly data-intensive. In addition, there is an extreme growth in automated processes. Even the capabilities of 5G in terms of data rates, latency times and connectivity density are no longer sufficient for this purpose [4]. Another aspect is the development of Internet of Things (IoT) to the Internet of Everything (IoE). Wireless communication systems have to deal with a massive number of heterogeneous devices. From a certain point this will be already a challenge for 5G. Moreover, these devices allow no trade-off between rate, reliability and latency. Providing these services simultaneously 5G also reaches limits [5].

Therefore, 6G is needed with extended requirements and new or enhanced technologies for the decade from 2030. Initial research activities on 6G started in 2017 and the first relevant literature works are published in 2018 [6], [7]. Since then, activities on 6G have been significantly expanded.

This paper describes the current status of 6G. First, some relevant applications are described that will be enabled with the new generation of wireless systems. Based on these, the paper gives an overview of requirements for 6G. Then, main technologies that can be used to meet the requirements are presented. Finally, challenges are discussed that still need to be overcome in the development of 6G.

## II. APPLICATIONS

Every development of a new generation wireless communication systems is driven by certain important applications. For the last two generations, 4G and 5G, the main driver for

<sup>1</sup>PB = Petabyte (10<sup>15</sup>)

<sup>2</sup>EB = Exabyte (10<sup>18</sup>)

the development was the smartphone. Even though 5G already integrates other services.

The development of 6G is also driven by innovative applications. These are revolutionary new applications on one hand and devices and services that are created by enhancements and improvements to 5G standard applications on the other hand. The smartphone still plays a subordinate role at most. Looking ahead to 2030, there is already talk of a post-smartphone era [5].

The following applications are possible drivers for 6G.

#### A. Extended Reality and Holographic Telepresence

Extended Reality (XR) includes representative forms such as augmented reality (AR), mixed reality (MR) and virtual reality (VR). Basic XR services are already a key factor in 5G, but this technology is being significantly expanded to capturing all sensory inputs. [5]

Even more sophisticated than XR is holographic telepresence which is expected to be the next step in multimedia experience. This will make it possible to transport 3D-images from one location to another in real time.

For enabling the enhanced XR and the holographic telepresence the network has to provide a combination of very high data rates and ultra-low latency. Furthermore, to detect holograms, such as from different angles, many different sensors are needed. 6G systems consequently have to transmit different streams in a synchronized way. [8]

#### B. Connected Autonomous Systems

6G plays a major role in the development of fully autonomous systems. Examples are autonomous vehicles such as self-driving cars or unmanned aerial vehicles (UAVs). These vehicles require an extremely high reliability and low latency. The vehicles only function safely with a massive sensing and therefore an increasing number of sensors. Hence, very high data rates are also required here, as with XR and holographic telepresence. Especially considering the significantly growing number of these vehicles, the capabilities will go beyond those of 5G. [9]

It is worth to mention that UAVs can also support 6G systems, such as energy efficiency or network coverage [10].

#### C. Industry and Manufacturing

As described in Section I more and more processes become automated. In industry it is already underway that cyber physical systems and IoT services digitalize the manufacturing for an automatic control between devices and cyber computational systems. This is also well-known as Industry 4.0. 6G systems will fully realize this industry revolution. They need to provide highly reliable and secure communications with error-free data transfer. [4], [11]

#### D. Healthcare

Especially due to the aging population, healthcare will play a major role in a post-2030 society and thus also in the development of 6G which should enhance the availability and quality of care. Even there is already a great progress expected

with 5G, 6G will make it possible to establish a reliable remote monitoring system and remote operations. [4], [11]

Another aspect in the field of healthcare is screening and prevention. Helpful here is the Internet of Bodies and the Internet of Bio-Nano-Things that will be possible with 6G. By several small wearable devices and in-body sensors human physiological signals can be monitored in real-time. These helps to gain information about users' health for e.g. clinical diagnostics. Here, too, it can be seen that a large number of sensors are used. In addition, the sensors are characterized by the fact that they have a low power consumption and are battery-less. So they have to get their power by energy harvesting from the received 6G signal. [12]

### III. REQUIREMENTS

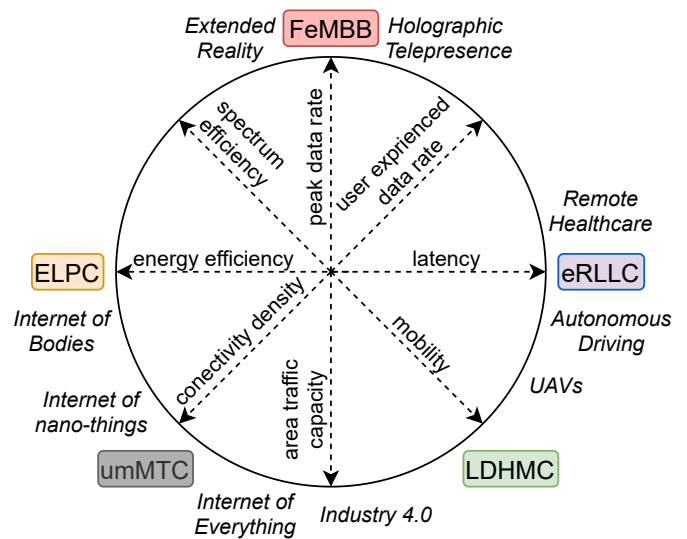

Fig. 1. Driving Applications, corresponding Requirements and Services for 6G

Considering the applications that are described in Section II, it is possible to define requirements that 6G must meet. 5G described its core requirements in three service classes: Enhanced mobile broadband (eMBB), ultra-reliable low latency communications (URLLC), and massive machine type communications (mMTC).

It can be determined that these core requirements of 5G are still important even for 6G. However, they need to be significantly increased. Reference [13] defines these services as it is shown in Figure 1: Further enhanced mobile broadband (FeMBB), extremely reliable and low-latency communications (eRLLC), ultra-massive machine-type communications (umMTC). Moreover, 6G has to provide extremely or ultra-low power communications (ELPC) and long-distance and high-mobility communications (LDHMC).

It should be noticed that these service classes are defined differently in the literature. In [14], for example, it is taken into account that low-latency and high mobile broadband can no longer be considered separately. Therefore, these classes are called ubiquitous mobile ultrabroadband (uMUB),



TABLE I  
COMPARISON OF 6G AND 5G REQUIREMENTS [11]

issue	5G	6G
peak data rates	10 Gbps	1 Tbps
radio latency	1 ms	0.1 ms
mobility	500 km/h	1000 km/h
area traffic capacity	1x	10000x
connectivity density	$10^6$ devices/km <sup>2</sup>	$10^7$ devices/km <sup>2</sup>
energy efficiency	1x	10x
spectrum efficiency	30 bps/Hz	100 bps/Hz

ultrahighspeed-with-low-latency communications (uHSLLC) and ultrahigh data density (uHDD).

In concrete terms, all these services mean that 6G should meet the requirements as shown in Table I compared to those of 5G.

#### IV. TECHNOLOGIES

As can be seen from the requirements in Section III, the respective capabilities of 6G are expected to be approximately 10-100 times greater than 5G. This is comparable to the steps between every new generation of wireless communication systems. In order to achieve this increase in requirements, new technologies must be developed every time. This section presents an overview of some main technologies for 6G.

##### A. Intelligentization

The integration of Artificial Intelligence (AI) will be the main characteristic technology of 6G with a wide variety of uses. A key technology of 5G is that the networks are software-based virtual networks by using cognitive, software-defined radios. In 6G these radios become intelligent radios. As already noted, 6G has a wide range of applications and the communicating devices are becoming more and more heterogeneous. With the intelligent networks it is possible to find an individual tuning for each device, depending on what services it needs. Required data rates, latency times or even power requirements for wireless power transfer can be tailored to the respective device. [15]

On the other hand, intelligentization also helps to reduce the load on the network and increase efficiency. Until now, redundant resources have mostly been available to cover a short-term large demand for connectivity density, spectrum and area traffic capacity, for example at large events or in emergency situations. With AI networks these redundant resources are not necessary. They release the corresponding services at the required time and place. The networks analyzing each job they have to do and then simplifying it. [16], [17]

Another aspect are the benefits of machine learning for the networks' hardware components. Also these become very heterogeneous. So there are, for example significantly more different access points and mobile terminals in 6G. Machine Learning transfers the design of one architecture to others. [15]

##### B. Hyperspectral and Full-spectral Systems

Especially for the demand of the very high data rates and the ubiquitous connectivity the conventional spectrum is not enough. It has to be revised and expanded. The 5G spectrum includes frequency bands below 6 GHz and the mmWaves between 24-100 GHz. 6G systems will use additionally bands above 100 GHz up to Terahertz (THz) and Visible Light Communication. [4]

- *higher mmWaves and THz communications* deal with frequency bands between 0.1 THz and 10 THz. For cellular solutions THz bands can be already restricted to the range from 275 GHz to 3 THz. This frequency range has not yet been allocated for specific active services worldwide. This technology enables massive resources of bandwidth and therefore high data rates above hundreds of Gbps. [18]
- The use of *Visible Light Communication (VLC)* supports mainly the cellular coverage and could improve the systems' capacity. Especially indoor LEDs can switch different light intensities very fast to modulate a signal that is received by a suitable receiver. [19]

##### C. Massive MIMO and Intelligent Surfaces

A fundamental technique, to enable higher frequencies and to increase energy and spectrum efficiency, are multiple-input multiple-output (MIMO) antennas. This is already a main technology of 5G which is further developed for 6G. One development are reconfigurable intelligent surfaces (RISs). RISs are electronically-controlled surfaces of electromagnetic material. This includes e.g. conventional reflect-arrays, liquid crystal surfaces or software-defined meta-surfaces. RISs can adjust phase, amplitude, frequency or polarization of incident signals by a very effective way and without any radio frequency processing steps. [20]

##### D. 3D Network Architecture

Unlike previous networks that provide connectivity primarily to devices on the ground, 6G networks provide 3D coverage. The network is extended in vertical direction. For this purpose, non-terrestrials networks, e.g. satellites or UAVs (see Section II), are integrated into the terrestrial networks. [21]

##### E. Energy Transfer and Harvesting

6G systems can also take an advantage of studies and developments in the field of energy harvesting and energy management which emerged in recent years. As communication paths become shorter with 6G, there are opportunities for the network to provide power to battery-free, low-power devices [22]. To increase energy efficiency, technologies such as energy harvesting and backscatter devices are used [23].

#### V. CHALLENGES

The technologies outlined in Section IV are largely innovative ideas. However, numerous challenges still need to be overcome before these can be implemented and used for wireless communication systems.

### A. THz communications

Many challenges still arise with THz communications. The wavelengths are extremely small due to these high frequencies. As a result, there are high absorption and scattering losses, which also depend on changing climatic conditions. 6G systems have to compensate these. Especially in the case of data transmission over relatively long distances, practicable solutions are still needed here. [18]

In addition, all network components, such as transceivers, antennas or amplifiers, need a redesign to operate with THz frequencies. Even with MIMO systems, new methods for successful beamforming are required due to the difficult propagation characteristics [24]. Moreover, health and safety aspects must be considered regarding the THz communications.

### B. Network Security

Another important aspect in 6G development is security. Secrecy and privacy must be maintained, especially for human users of communication systems. Due to the emergence of increasingly powerful technologies such as AI and Big Data, existing methods, including those of 5G, are no longer sufficient for this purpose. A new physical-layer security needs to be designed. [17]

### C. 3D Networking

Many open research questions remain about the goal of 6G having a 3D network architecture, as it is described in Section IV. It has already been shown that the network planning of a 3D architecture differs significantly from the conventional, previous network planning. The new propagation environment must be remodeled and measured. This also involves fundamental issues, such as the positions of base stations. Additionally new techniques for resource management, mobility management and routing are necessary. [5]

### D. High Backhaul Capacity and Connectivity

Particularly VLC and THz communications increase the number of access networks. The amount of data that the backhaul networks must exchange between these access networks and the core network is extremely large. Therefore 6G backhaul networks need a very high capacity and high connectivity. Previous technologies like fiber-optics can probably continue to be a solution. However, there must still be significant progress in development. [11]

### E. Spectrum Management

As already shown, 6G systems operate in various frequency bands, some of which differ greatly from one another. 6G continues to use the frequency bands of previous generations of wireless communication systems, plus the THz spectrum. Therefore an efficient spectrum management is absolutely necessary.

With 5G, there are different spectrum management approaches. These include the allocation of nationwide spectrum licenses, local licenses or unlicensed access. 6G will be able

to build on this, but the even greater variety of spectrum bands means that there are still many challenges ahead.

For regulators, the goal must be to maximize spectrum efficiency and strike a balance between the various competing stakeholders who want to build their wireless networks. Indispensable here is spectrum sharing. In this context the development of new strategies for spectrum sharing and interference management are indispensable. [25]

## VI. CONCLUSION

This paper provided an overview of the current status of the development of the new, the sixth-generation wireless communication systems. Various applications have been identified that will become relevant by 2030 and beyond.

As with past generations, the trend is for 6G to penetrate virtually all areas of human life and transform society. This is happening even more strongly than with 5G. XR and holographic telepresence will change the way of communication. Above all, 6G revolutionize the mobility and transport sector. Furthermore, the possibilities of 6G are leading to a greatly changed world of work and a new, significantly improved healthcare system.

To make all this possible requires a huge increase in capabilities compared to those of 5G systems. For this purpose, various services could be defined that 6G must provide. Probably the most important requirements for 6G remain high data rates, high reliability and low latencies. In addition to these the focus is also on high network efficiency.

This is to be solved by the development of new technologies. Above all, the use of AI offers 6G many possible solutions. For almost all technologies there are still challenges that need to be solved, for example in the fields of THz communication or 3D network architecture.

In addition, there are still questions to be answered, such as network security or spectrum management, and a massive number of other questions that are beyond the scope of this paper. Researchers and engineers around the world are solving these problems to enable a new generation of wireless communication systems in about 10 years.

## REFERENCES

- [1] Int. Telecommun., "Int traffic estimates for the years 2020 to 2030," 2015.
- [2] P. Datta and S. Kaushal, "Exploration and comparison of different 4g technologies implementations: A survey," in *2014 Recent Advances in Engineering and Computational Sciences (RAECS)*. IEEE, 2014, pp. 1–6.
- [3] J. Navarro-Ortiz, P. Romero-Diaz, S. Sendra, P. Ameigeiras, J. J. Ramos-Munoz, and J. M. Lopez-Soler, "A survey on 5g usage scenarios and traffic models," *IEEE Communications Surveys & Tutorials*, vol. 22, no. 2, pp. 905–929, 2020.
- [4] M. Giordani, M. Polese, M. Mezzavilla, S. Rangan, and M. Zorzi, "Towards 6g networks: Use cases and technologies." [Online]. Available: <http://arxiv.org/pdf/1903.12216v2>
- [5] W. Saad, M. Bennis, and M. Chen, "A vision of 6g wireless systems: Applications, trends, technologies, and open research problems," *IEEE Network*, vol. 34, no. 3, pp. 134–142, 2020.
- [6] K. David and H. Berndt, "6g vision and requirements: Is there any need for beyond 5g?" *IEEE Vehicular Technology Magazine*, vol. 13, no. 3, pp. 72–80, 2018.

- [7] M. Katz, M. Matinmikko-Blue, and M. Latva-Aho, "6genesis flagship program: Building the bridges towards 6g-enabled wireless smart society and ecosystem," in *2018 IEEE 10th Latin-American Conference on Communications (LATINCOM)*, 2018, pp. 1–9.
- [8] A. Clemm, M. T. Vega, H. K. Ravuri, T. Wauters, and F. de Turck, "Toward truly immersive holographic-type communication: Challenges and solutions," *IEEE Communications Magazine*, vol. 58, no. 1, pp. 93–99, 2020.
- [9] J. Choi, V. Va, N. Gonzalez-Prelcic, R. Daniels, C. R. Bhat, and R. W. Heath, "Millimeter-wave vehicular communication to support massive automotive sensing," *IEEE Communications Magazine*, vol. 54, no. 12, pp. 160–167, 2016.
- [10] B. Li, Z. Fei, and Y. Zhang, "Uav communications for 5g and beyond: Recent advances and future trends," *IEEE Internet of Things Journal*, vol. 6, no. 2, pp. 2241–2263, 2019.
- [11] M. Z. Chowdhury, M. Shahjalal, S. Ahmed, and Y. M. Jang, "6g wireless communication systems: Applications, requirements, technologies, challenges, and research directions," *IEEE Open Journal of the Communications Society*, vol. 1, pp. 957–975, 2020.
- [12] L. Mucchi, S. Jayousi, S. Caputo, E. Paoletti, P. Zoppi, S. Geli, and P. Dioniso, "How 6g technology can change the future wireless healthcare," in *2020 2nd 6G Wireless Summit (6G SUMMIT)*, 2020, pp. 1–6.
- [13] Z. Zhang, Y. Xiao, Z. Ma, M. Xiao, Z. Ding, X. Lei, G. K. Karagiannidis, and P. Fan, "6g wireless networks: Vision, requirements, architecture, and key technologies," *IEEE Vehicular Technology Magazine*, vol. 14, no. 3, pp. 28–41, 2019.
- [14] B. Zong, C. Fan, X. Wang, X. Duan, B. Wang, and J. Wang, "6g technologies: Key drivers, core requirements, system architectures, and enabling technologies," *IEEE Vehicular Technology Magazine*, vol. 14, no. 3, pp. 18–27, 2019.
- [15] K. B. Letaief, W. Chen, Y. Shi, J. Zhang, and Y.-J. A. Zhang, "The roadmap to 6g: Ai empowered wireless networks," *IEEE Communications Magazine*, vol. 57, no. 8, pp. 84–90, 2019.
- [16] M. Wang, Y. Cui, X. Wang, S. Xiao, and J. Jiang, "Machine learning for networking: Workflow, advances and opportunities," *IEEE Network*, vol. 32, no. 2, pp. 92–99, 2018.
- [17] F. Tang, Y. Kawamoto, N. Kato, and J. Liu, "Future intelligent and secure vehicular network toward 6g: Machine-learning approaches," *Proceedings of the IEEE*, vol. 108, no. 2, pp. 292–307, 2020.
- [18] K. Tekbilyk, A. R. Ekti, G. K. Kurt, and A. Görçin, "Terahertz band communication systems: Challenges, novelties and standardization efforts," *Physical Communication*, vol. 35, p. 100700, 2019.
- [19] P. H. Pathak, X. Feng, P. Hu, and P. Mohapatra, "Visible light communication, networking, and sensing: A survey, potential and challenges," *IEEE Communications Surveys & Tutorials*, vol. 17, no. 4, pp. 2047–2077, 2015.
- [20] E. Basar, M. Di Renzo, J. de Rosny, M. Debbah, M.-S. Alouini, and R. Zhang, "Wireless communications through reconfigurable intelligent surfaces," *IEEE Access*, vol. 7, pp. 116 753–116 773, 2019.
- [21] K. M. S. Huq, J. Rodriguez, and I. E. Otung, "3d network modeling for thz-enabled ultra-fast dense networks: A 6g perspective," *IEEE Communications Standards Magazine*, vol. 5, no. 2, pp. 84–90, 2021.
- [22] R. Lin, H.-J. Kim, S. Achavananthadith, S. A. Kurt, S. C. C. Tan, H. Yao, B. C. K. Tee, J. K. W. Lee, and J. S. Ho, "Wireless battery-free body sensor networks using near-field-enabled clothing," *Nature communications*, vol. 11, no. 1, p. 444, 2020.
- [23] T. Huang, W. Yang, J. Wu, J. Ma, X. Zhang, and D. Zhang, "A survey on green 6g network: Architecture and technologies," *IEEE Access*, vol. 7, pp. 175 758–175 768, 2019.
- [24] I. F. Akyildiz, J. M. Jornet, and C. Han, "Terahertz band: Next frontier for wireless communications," *Physical Communication*, vol. 12, pp. 16–32, 2014.
- [25] M. Matinmikko-Blue, S. Yrjölä, and P. Ahokangas, "Spectrum management in the 6g era: The role of regulation and spectrum sharing," in *2020 2nd 6G Wireless Summit (6G SUMMIT)*, 2020, pp. 1–5.

# Impressum

**Hans Meier, Michael Niemetz, Thomas Fuhrmann, Andrea Reindl**

Ostbayerische Technische Hochschule Regensburg

Fakultät Elektro- und Informationstechnik

Seybothstraße 2

93053 Regensburg