



Hochschule
Kempten

University of Applied Sciences



Fakultät
Maschinenbau

Die Rolle von Batteriespeichern im Kontext eines künftigen Energiesystems

Smart Energy Systems

Prof. Dr. Holger Hesse

18. April 2023



Kurzvorstellung: Prof. Dr. Holger Hesse



Elektromobilität (Quelle: BMW AG)



Stationäre Batteriespeicher (Quelle: TUM)

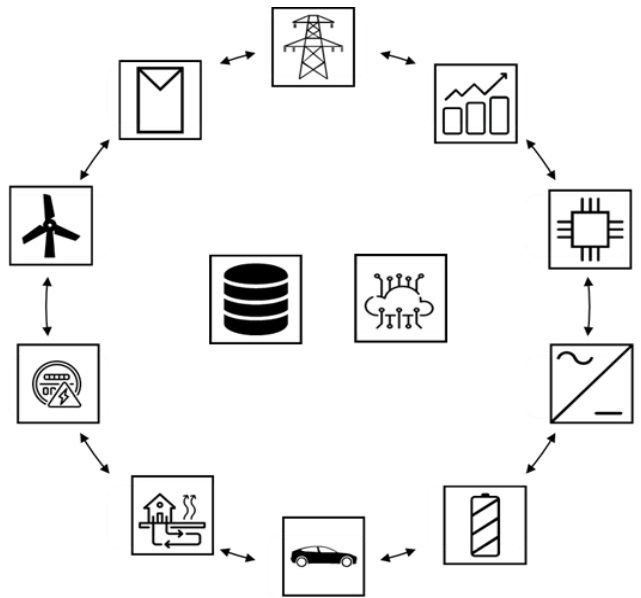

Forschungsprofessur
Smarte Energiesysteme

Agenda

- 1. Motivation – wozu Speicher?**
- 2. Lithium-Ionen Batterien**
- 3. Anwendungsfelder Batteriespeicher**
- 4. Forschung Smart Energy Systems**

1. Motivation – Wozu Speicher... ?

Energieversorgung heute und in Zukunft

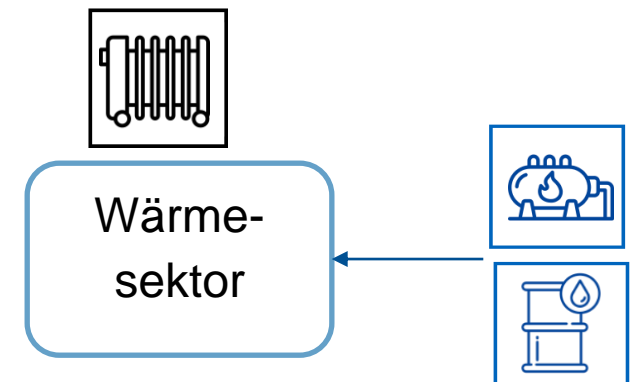
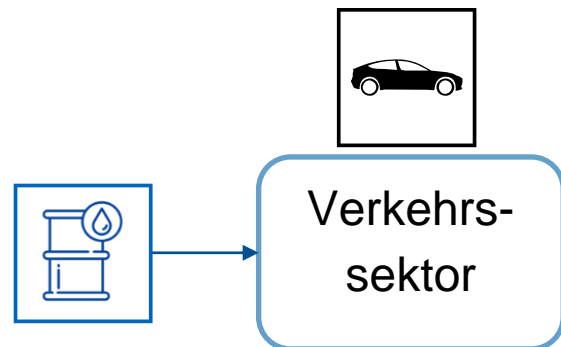
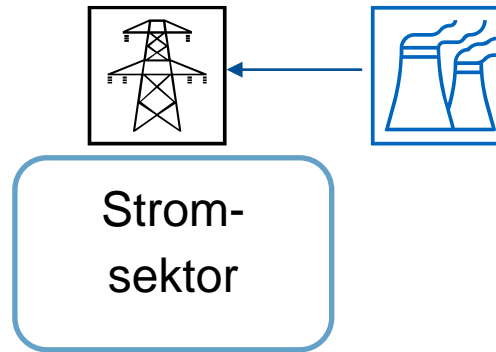

1. Motivation – Wozu Speicher... ?

Energieversorgung heute und in Zukunft

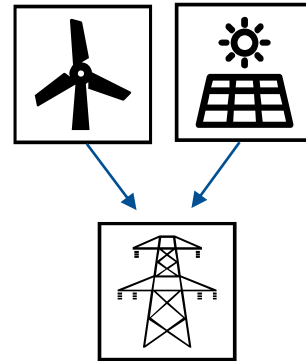

Strom-
sektor

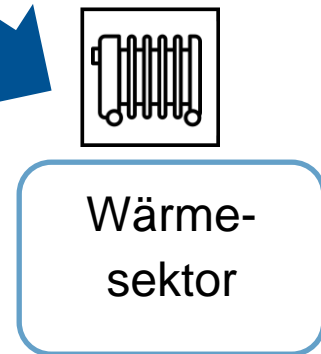
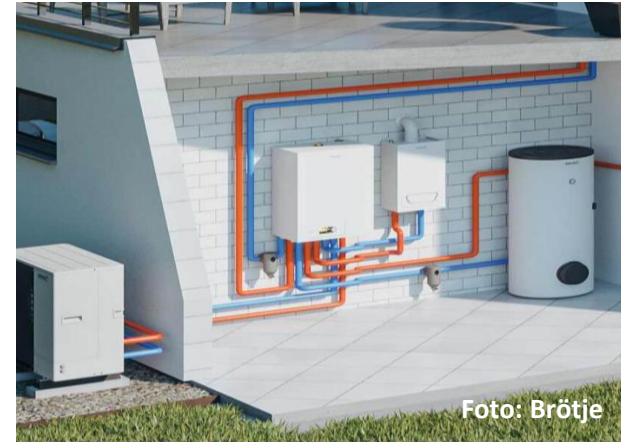

P2H = Power-to-Heat, P2G = Power to Gas, EV = Electric Vehicle

1. Motivation – Wozu Speicher... ?

Energieversorgung heute und in Zukunft

Ziel:
100% EE
in 2045

Quelle: Umweltbundesamt auf Basis Arbeitsgruppe Erneuerbare Energien-Statistik (AGEE-Stat) Datenstand: 10/2021

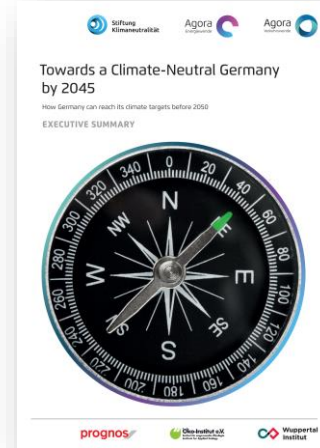
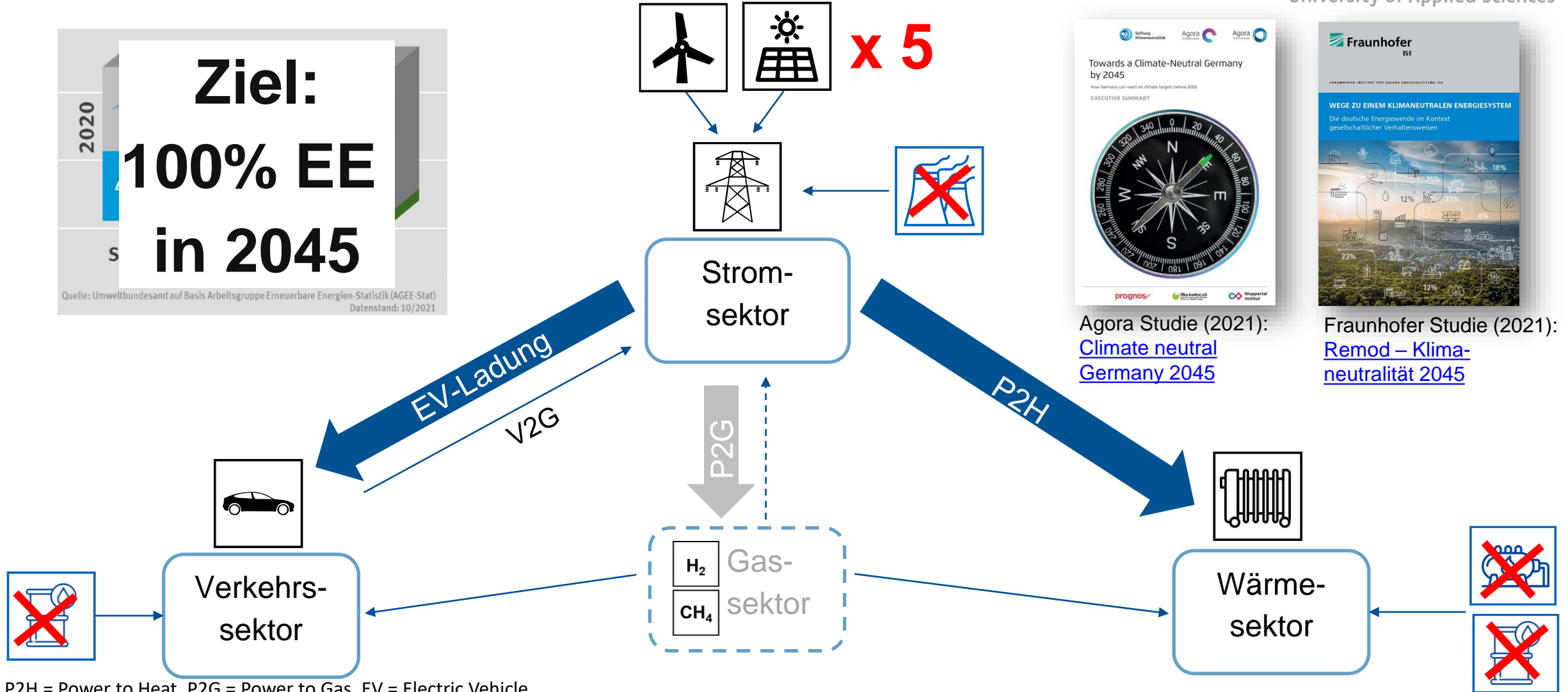

Agora Studie (2021): [Climate neutral Germany 2045](#)

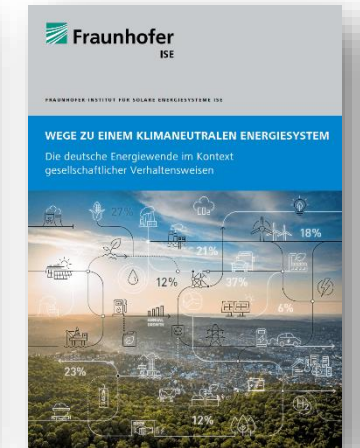

Fraunhofer Studie (2021): [Remod – Klima-neutralität 2045](#)

P2H = Power to Heat, P2G = Power to Gas, EV = Electric Vehicle

1. Motivation – Wozu Speicher... ?

Flexibilisierung des Energiesystems

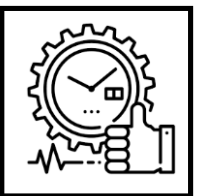
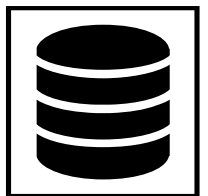
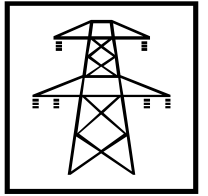
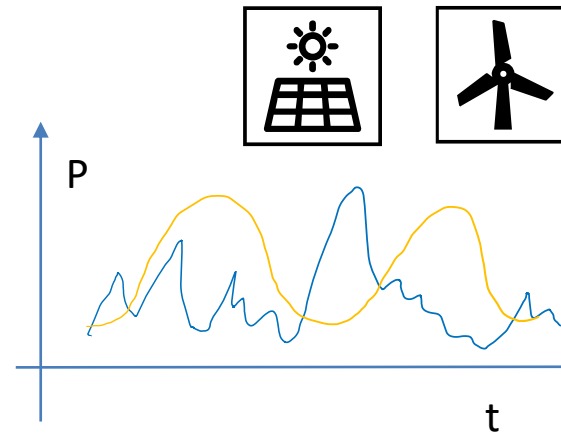
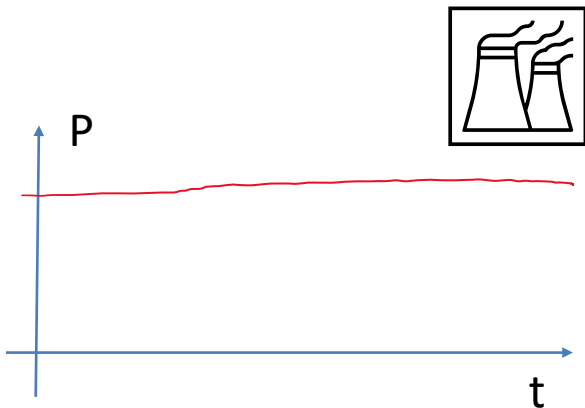
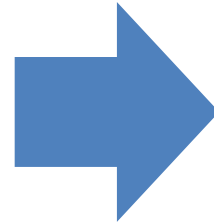

1. Motivation – Wozu Speicher... ?

Vision einer 100% Erneuerbaren Stromversorgung

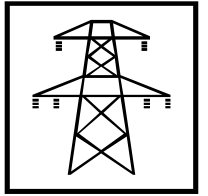
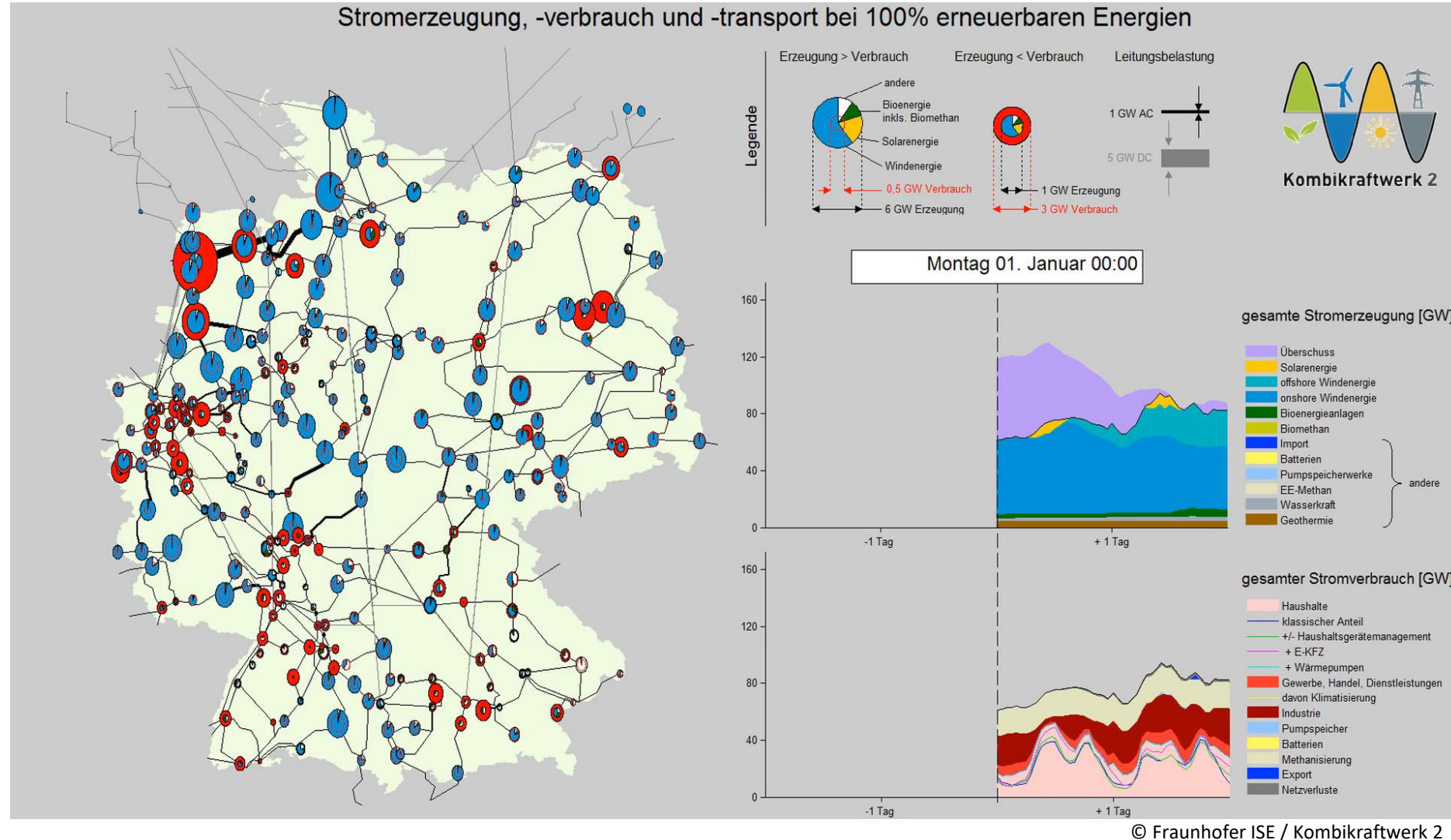

Netz



Speicher



Steuerung

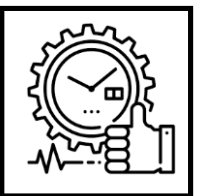

Effizienz

1. Motivation – Wozu Speicher... ?

Vision einer 100% Erneuerbaren Stromversorgung

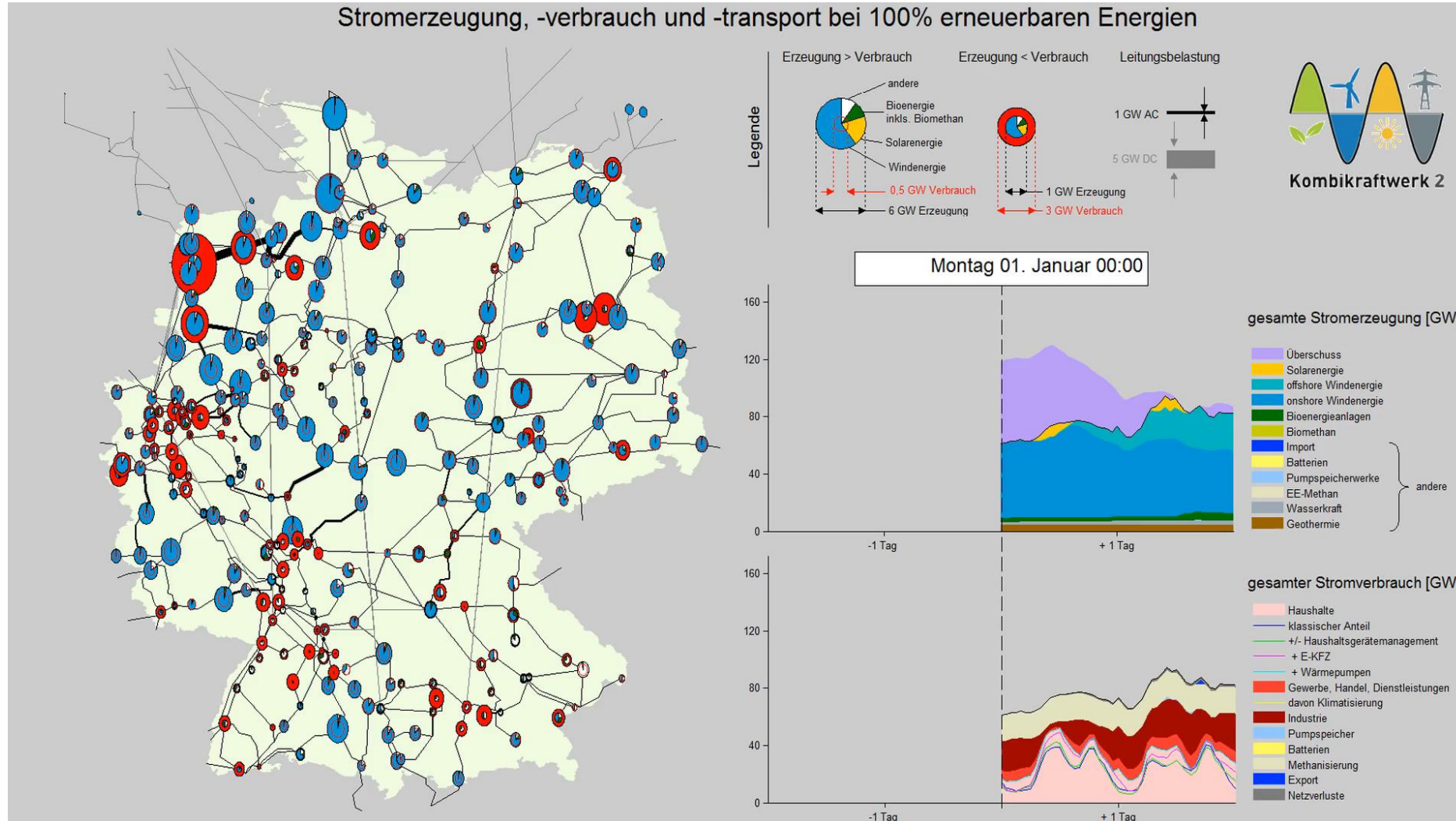

© Fraunhofer ISE / Kombikraftwerk 2

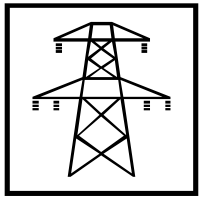

Netz



Speicher



Steuerung

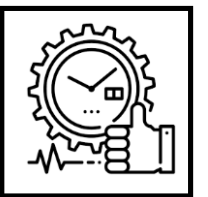

Effizienz

1. Motivation – Wozu Speicher... ?

Speicherzubau für ein Erneuerbares Energiesystem



Source: goldithal.net



Source: younicos



Source: Tesla (Model S)



Speicher

Energiequellen	Umwandlung und Speicherung	Verbrauch
regenerativ	Energieumwandlung	Verbrauchs-sektoren
Wind	Windturbine	Kfz
Sonne	Laufwasser-KW	Verkehr
Wasser	Photovoltaik	Elektrozit
Umweltwärme	Geothermie	Prozesswärme
Biomasse	Solarthermie	Gebäudewärme
Importe	Elektrolyse	Gas
Strom	Blickkraftstoff	Flüssige Brennstoffe
Synthetische Kraftstoffe	Power-to-liquid	Wasserstoff
Fossil & Uran	Konventionelle KW	Ström
Kohle & Öl	KWK	Kohle
Erddgas	Brennstoffzelle	
Uran	Atomkraftwerk	
	Methanisierung	
	Wärmespeicher	
	Speicher	
	Kfz-Batterie	
	Stationäre Batterie	
	Pumpspeicherkraftwerk	
	Gas	
	Wasserstoff	
	Biomasse	
	Wärmespeicher	

Fraunhofer ISE Studie (2021)
"Remod – Klimaneutralität in 2045"

installierte Speicherkapazität / Leistung

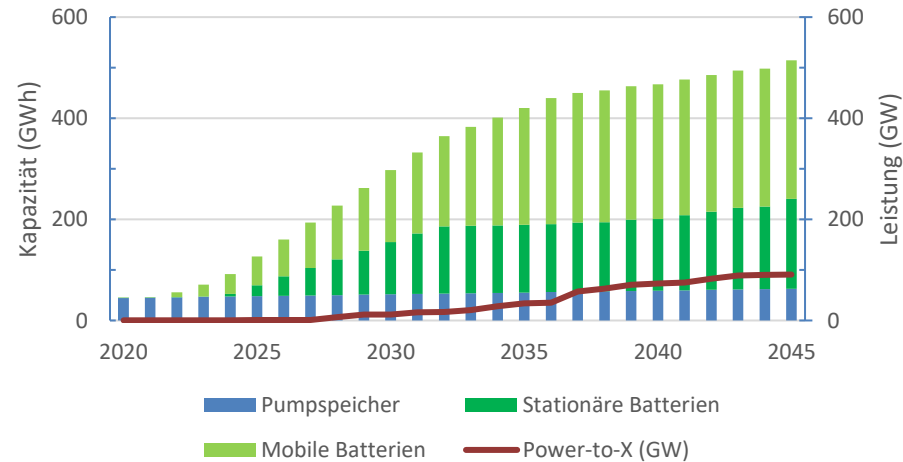

Source: H-Tec Systems

1. Motivation – Wozu Speicher... ?

Welche Speicher werden wann gebraucht / gebaut... ?

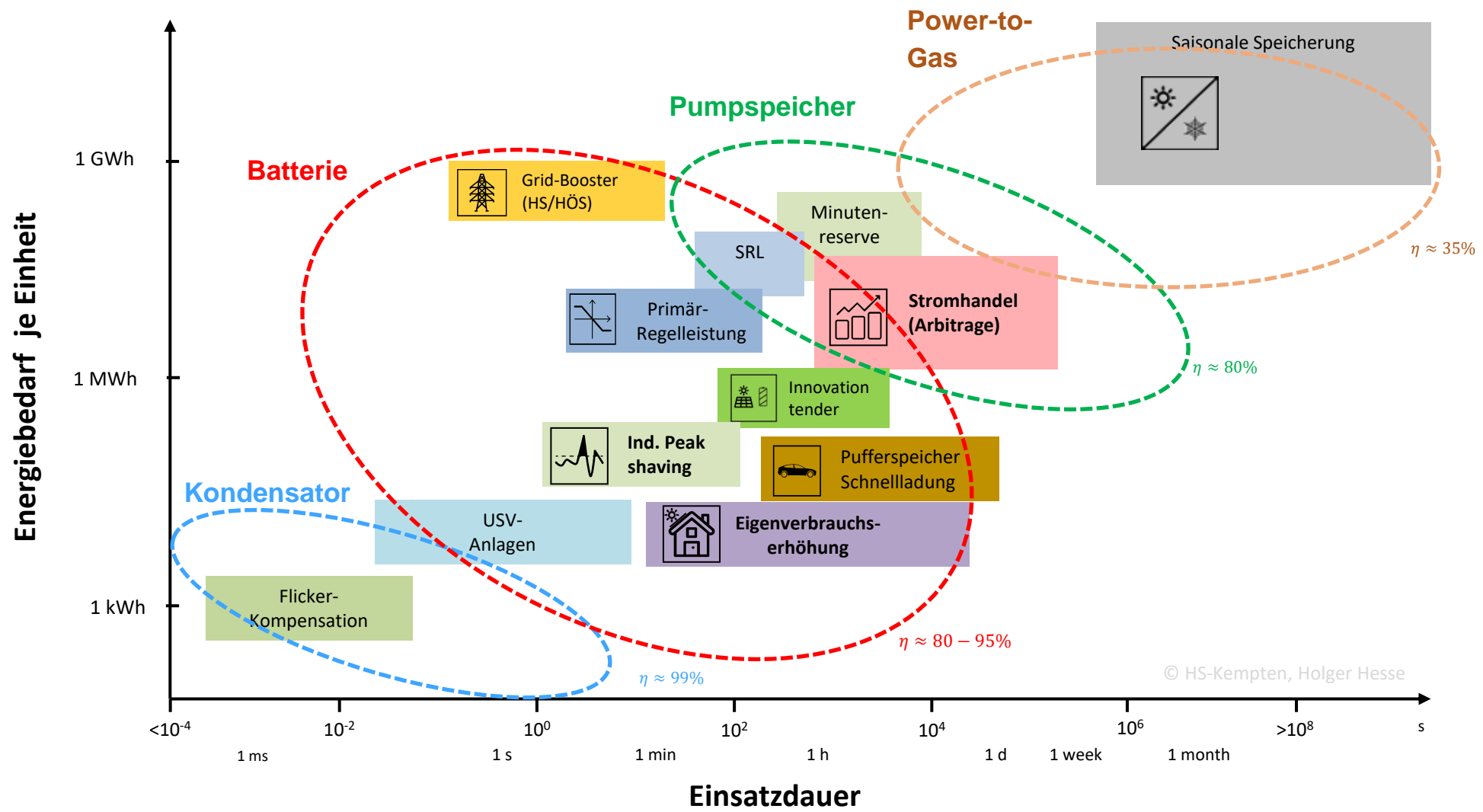

© HS-Kempten, Holger Hesse

2. Lithium-Ionen Batterien

Consumer, Automotive & Stationary LIB Storage Markets

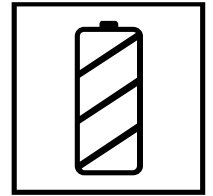
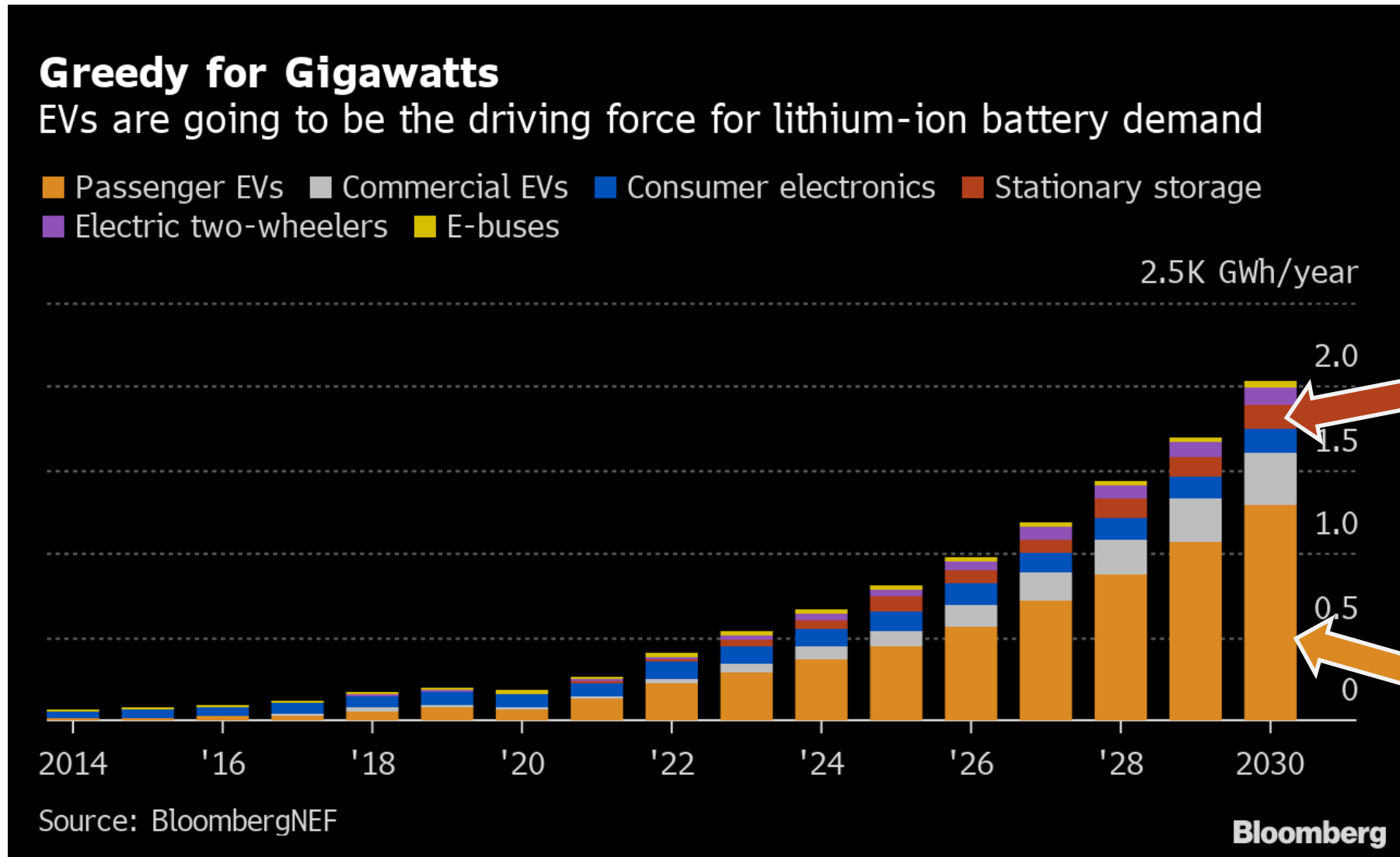

Batterien



2. Lithium-Ionen Batterien

Massenmarkt EV – Preisdegression stationär

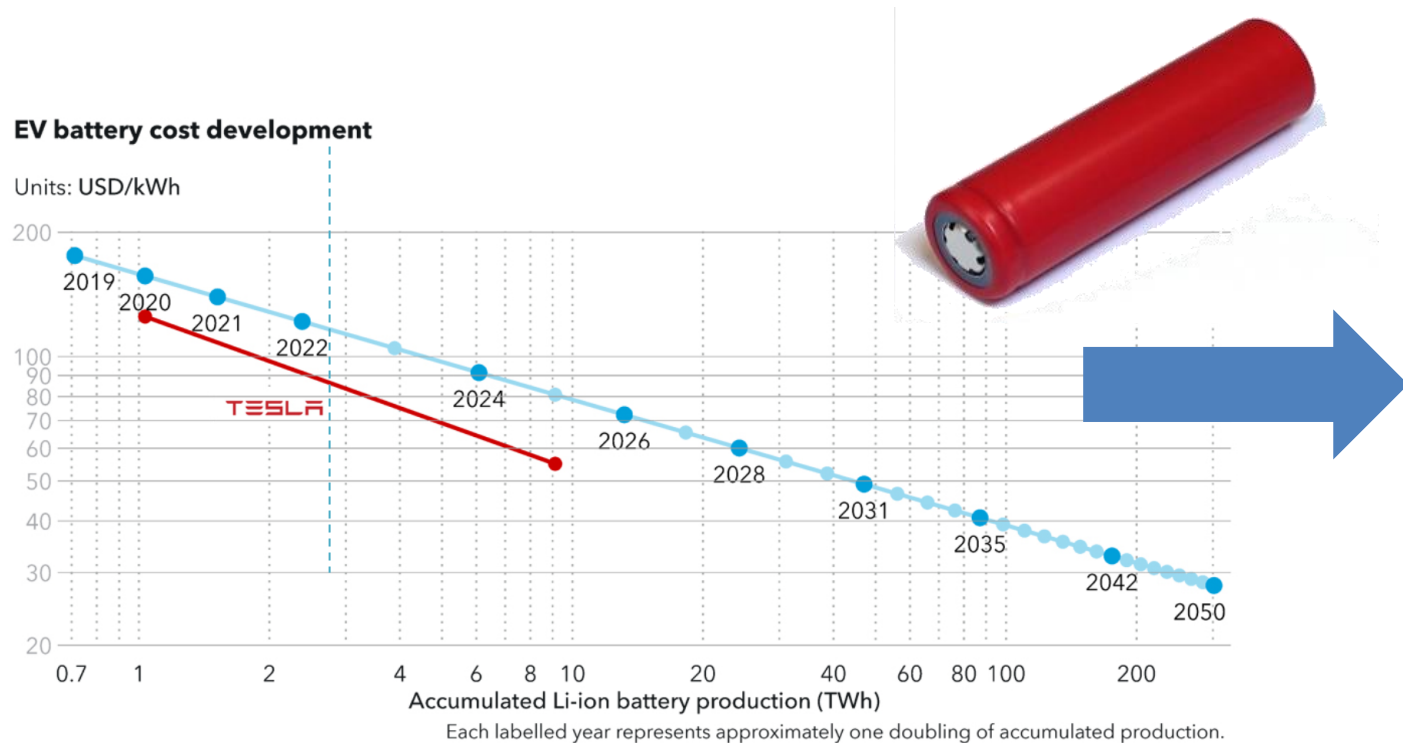
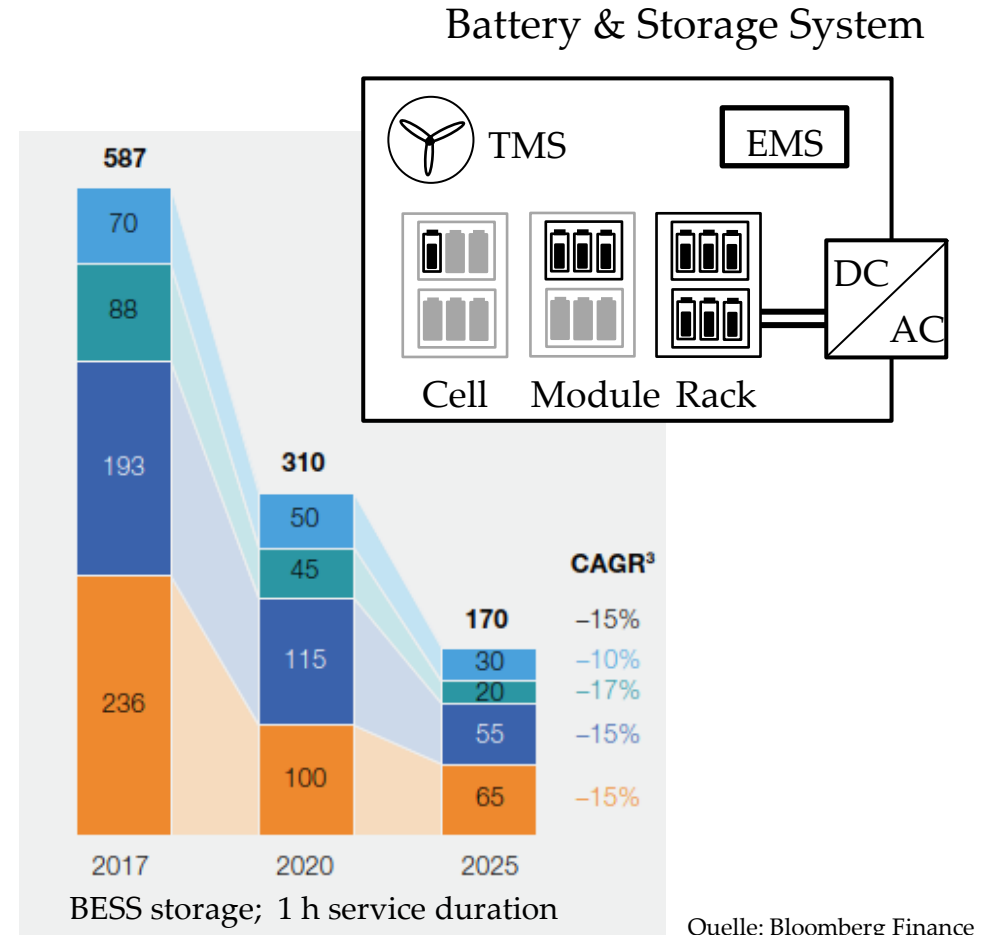

Figure 1: EV battery cost development

Quelle: Tesla, Inc, DNV-GL



Quelle: Bloomberg Finance

Motivation: Speichersysteme

Batteriespeicher in versch. Größenskalen



STEAG, Lessy, 1MW, 1MWh



2014 Younicos, 5MW, 5 MWh
Schwerin



2018 Eneco, DE, 50MW, 50MWh

Größte Batterie weltweit
300 MW / 1.200 MWh, Moss Landing



Vistra Energy
Moss Landing, CA USA
+ 300 MW / 1.200 MWh
+ Batterieracks im Gebäude (ehemaliges Gaskraftwerk)
+ 82 Container mit Umrichter & Trafo
+ CAPEX: ca. 500-600 Mio. \$US
+ Inbetriebnahme Ende 2020
+ Netzanbindung 500 kV-Netz

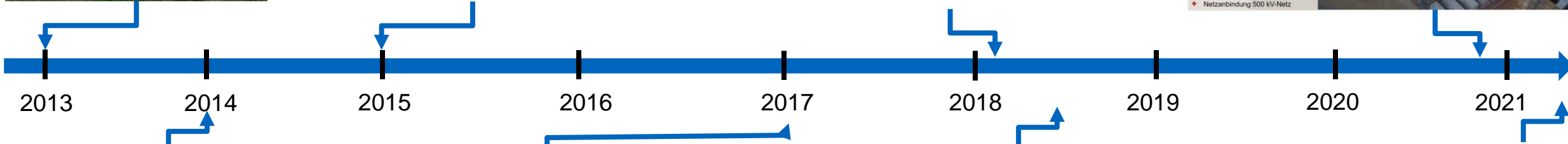

2013

2014

2015

2016

2017

2018

2019

2020

2021



2014 RES, Ohio, 4MW, 2MWh



2017 STEAG, 6 x 15MW, 130MWh



2018 Tesla, Australien, 100MW, 129MWh

Bald größte Batterie der Welt - möglicherweise



Moss Landing 3-5, CA USA
+ 600 MW / 2.400 MWh
+ 3 Lagerhäuser 85m x 100m x 12m
+ CAPEX: ca. 500-600 Mio. \$US (210-250 \$US/kWh)

Source: Trianel

Quellen: <https://www.steag.com/de/lessy>, https://www.german-energy-solutions.de/GES/Redaktion/DE/Publikationen/Praesentationen/2015/2015-11-18-iv-usa-speicher-06-res-deutschland.pdf?__blob=publicationFile&v=8, <https://encrypted-tbn0.gstatic.com/images?q=tbn%3AAND9GcSb1kCqRMfETc3bLQCTrZWpOGXsKcYTW2ToA&usqp=CAU>, <https://www.pv-magazine.de/2018/05/31/48-megawatt-grossspeicher-von-eneco-in-schleswig-holstein-geht-ans-netz/>, <https://electrek.co/2018/12/06/tesla-battery-report/>
Konzeption / Idee: M. Leuthold, Trianel

2. Lithium-Ionen Batterien

Zellformate Lithium-Ionen Batterie

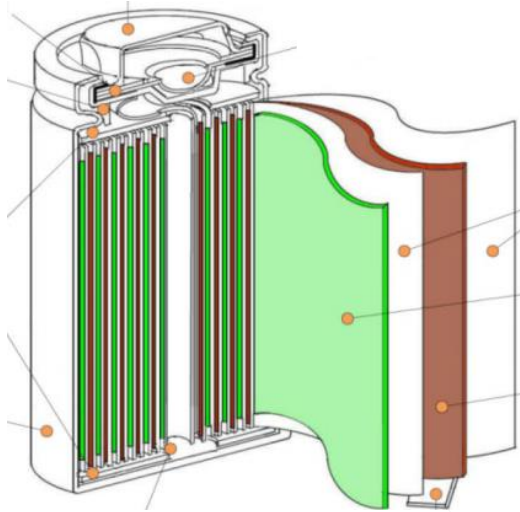

„Rund“



„Prismatisch“



TUM-EES; Schult et al (2011)

„Pouch“

2. Lithium-Ionen Batterien

Li-Ionen Batterie (LIB): Zellaufbau & Grundfunktion

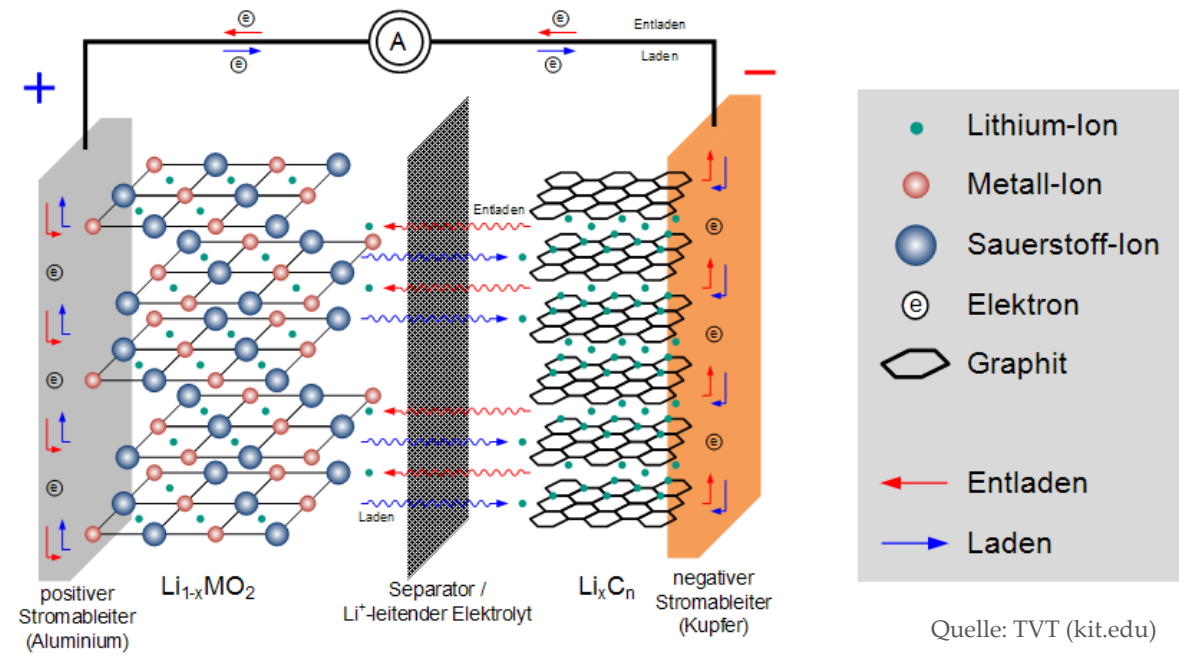

- Elektrolyt & Lösungsmittel
 - Flüssig: Organische LSM
 - Gel, fest
- Separator (PP, PE)
- Elektroden-Ableiter (Al, Cu)
- Kathode:
 - Metalloxide mit spez. Kristallstruktur
- Anode:
 - Graphit (+Si)
 - LTO

Kathode:

Anode:

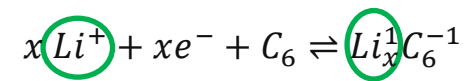
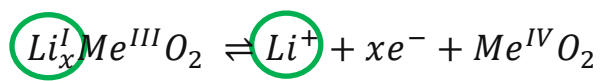

$Li^+ \Rightarrow$ *Interkalation*

2. Lithium-Ionen Batterien

Li-Ionen Batterie (LIB): Variation Materialien (1)

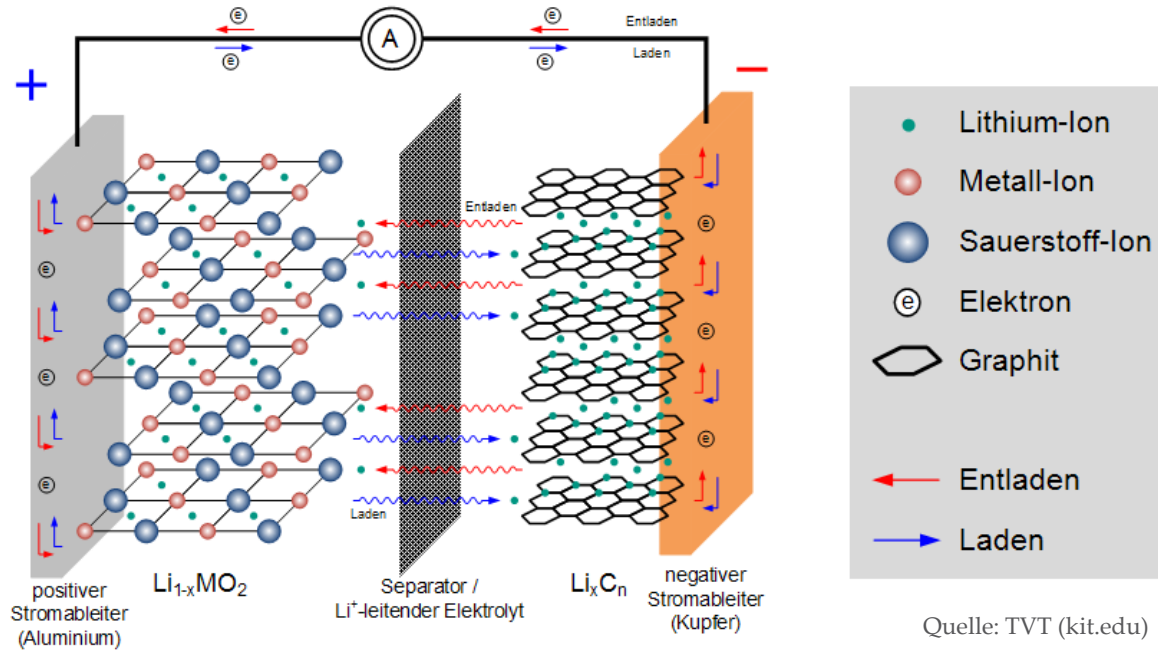

Quelle: TVT (kit.edu)

- Elektrolyt & Lösungsmittel
 - Flüssig: Organische LSM
 - Gel, fest
- Separator: (PP, PE)
- Elektroden-Ableiter (Al, Cu)
- Kathode:
 - Metalloxide mit spez. Kristallstruktur
- Anode:
 - Graphit (+Si)
 - LTO

Kathode:

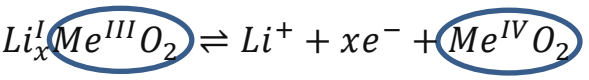

Anode:

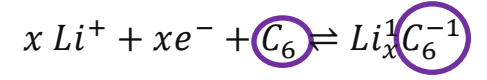

- LCO NCA
- NMC LFP
- LMO

- LTO
- Graphit (C)
- C:Si

2. Lithium-Ionen Batterien

Li-Ionen Batterie (LIB): Variation Materialien (2)

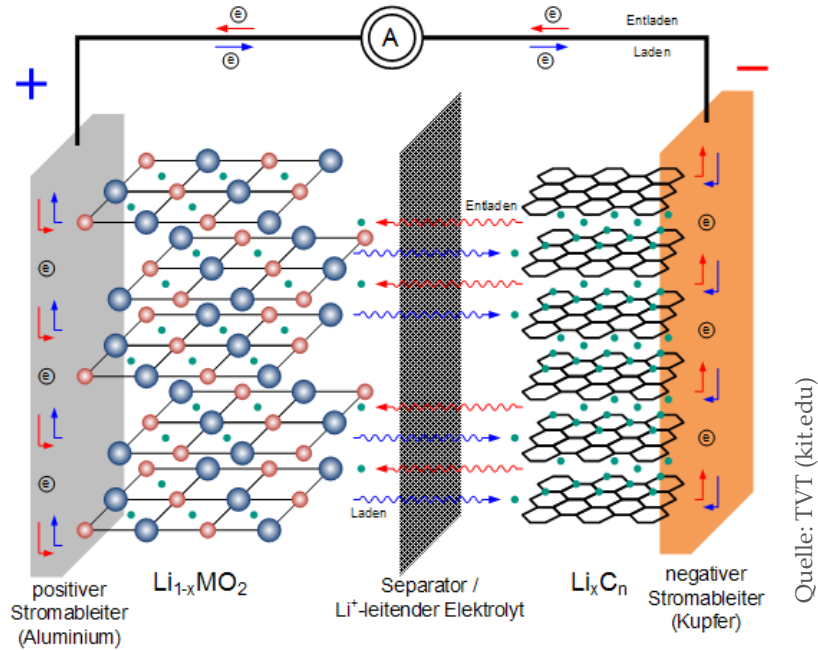

Quelle: TVT (kit.edu)

NMC - C

- Starke Synergie zu Automotive Entwicklungen
- Kobalt treibt Kosten, Sicherheit z.T. kritisch

NCA - C

- Sehr hohe Energiedichte realisiert
- Sicherheit besonders herausfordernd

LFP - C

- Hervorragende Alterungseigenschaften
- Komplizierte SOC Erkennung (Flache Kennlinie)



Kathode:

Anode:

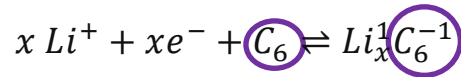
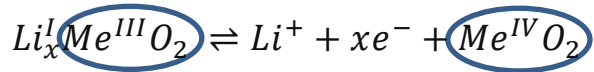

LCO NCA

NMC LFP

LMO

LTO

Graphit (C)

C:Si

Lithium Nickel-Kobalt-Aluminium (NCA-C)

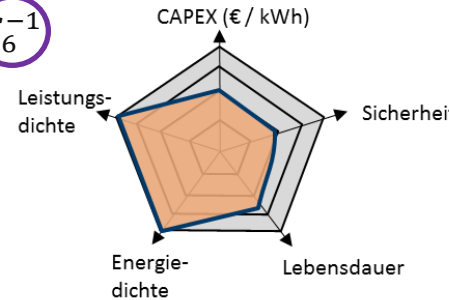

Lithium-Nickel-Magnesium-Cobalt (NMC-C)

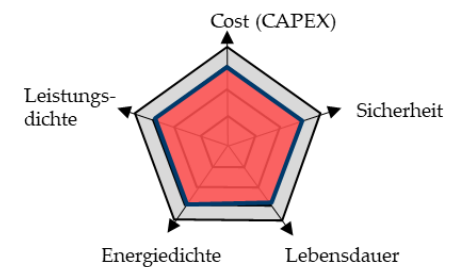

Lithium-Eisen-Phosphat (LFP-C)

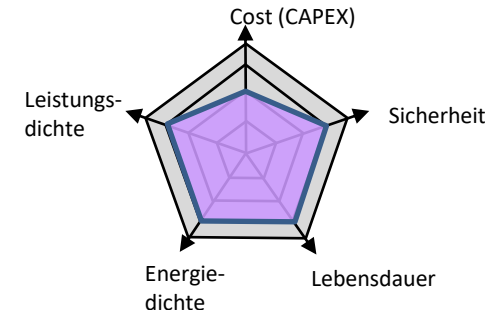

2. Lithium-Ionen Batterien

Ressourcen

Co



Minenbetrieb allg.; WWF

Kobalt

- Gewinnung u.a. im Kongo
- Kritisch: Menschenrechte und Umweltbedingungen

Ni



Minenbetrieb allg.; WWF

Nickel

- Minengewinnung in sensibler Natur
- Kritisch u.a. Bodenverschmutzung

Li



Salar de Atacama

Lithium

- Gewinnung u.a. in Atacama Wüste
- Kritisch: u.a. Wasserverbrauch

2. Lithium-Ionen Batterien

Alterung & Lebensdauer LIB



Hochschule Kempten
University of Applied Sciences

Zyklische Alterung

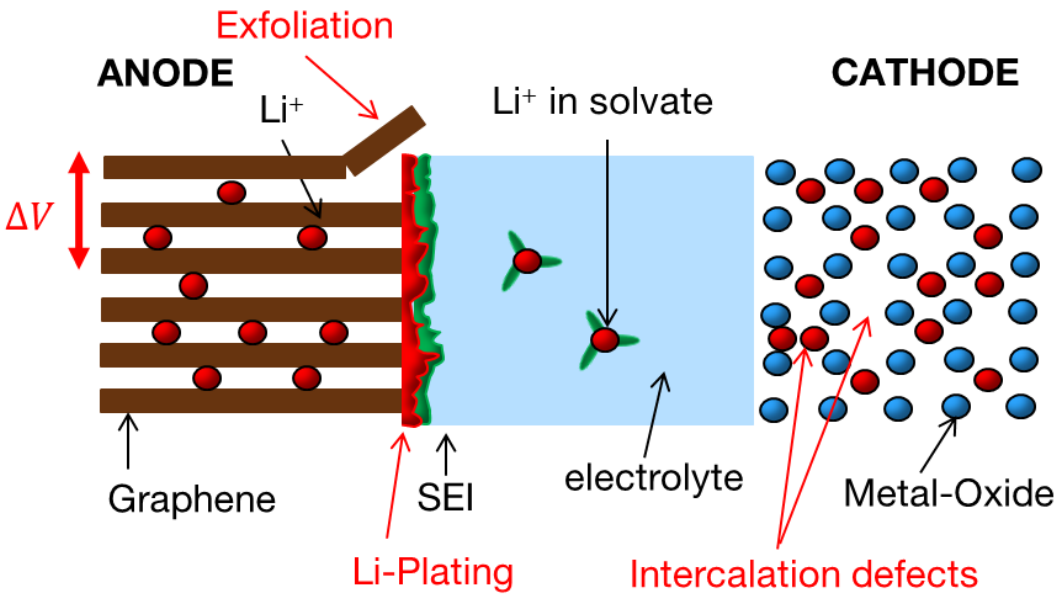

-
+

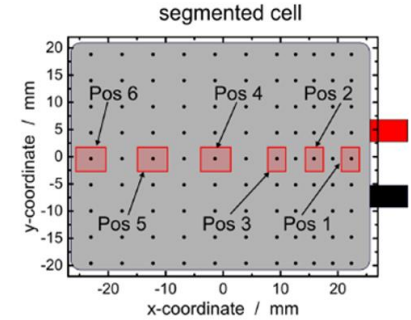

- **Zyklisierung**
- **Laderate**
- **Temperatur (niedrig)**

B. Rieger, C. von Lüders, S.F. Schuster, S.V. Erhard, A. Jossen, Multi-directional laser scanning as innovative method to detect local cell damage during fast charging, Journal of Energy Storage 8 (2016): 1-5.

2. Lithium-Ionen Batterien

Alterung & Lebensdauer LIB

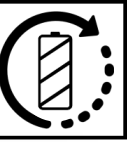

Kalendarische Alterung

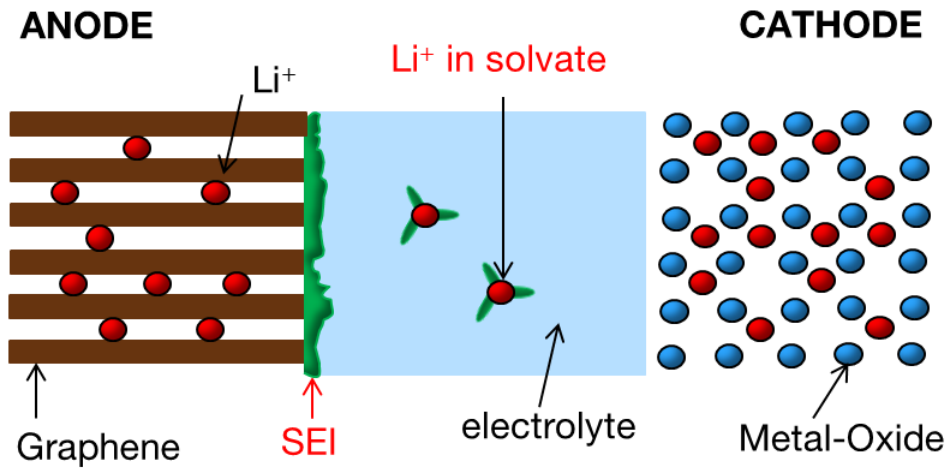

- **Temperatur (hoch)**
- **Ladezustand**
- **Komposit, Elektrolyt und Additive**

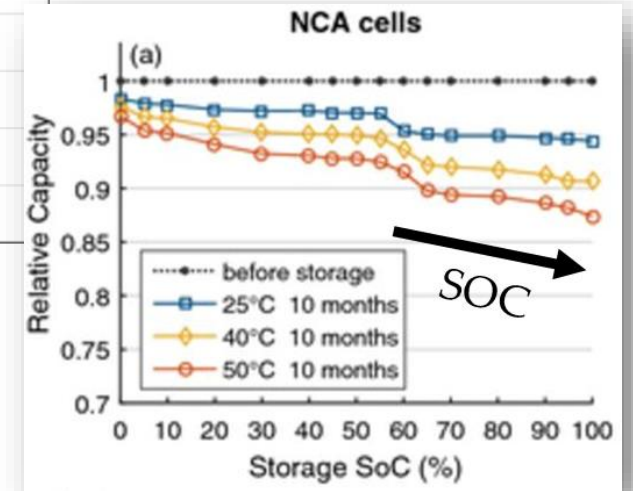
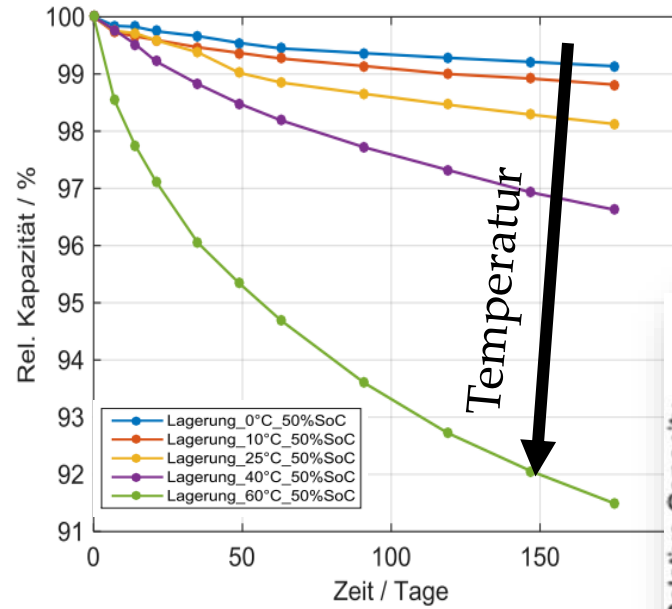

Arrhenius-Charakteristik

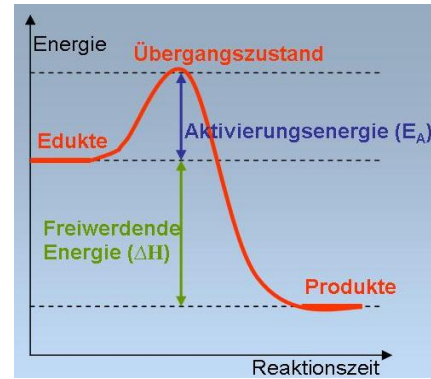

- k Reaktionsgeschwindigkeit
- k_0 Präexponentieller Faktor
- E_A Aktivierungsenergie
- R Univ. Gaskonstante
- T Temperatur in Kelvin

$$k = k_0 \cdot e^{-\frac{E_A}{R \cdot T}}$$

M. Naumann, M. Schimpe, P. Keil, H.C. Hesse, A. Jossen. Analysis and modeling of calendar aging of a commercial LiFePO₄/graphite cell, Journal of Energy Storage (2020)

Keil, Peter, et al. "Calendar aging of lithium-ion batteries." Journal of The Electrochemical Society 163.9 (2016): A1872.

3. Anwendungsfelder Batteriespeicher

Eigenverbrauchserhöhung

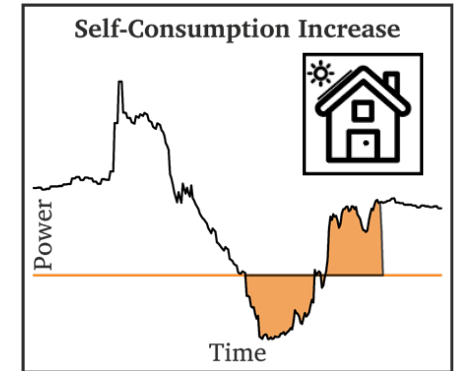
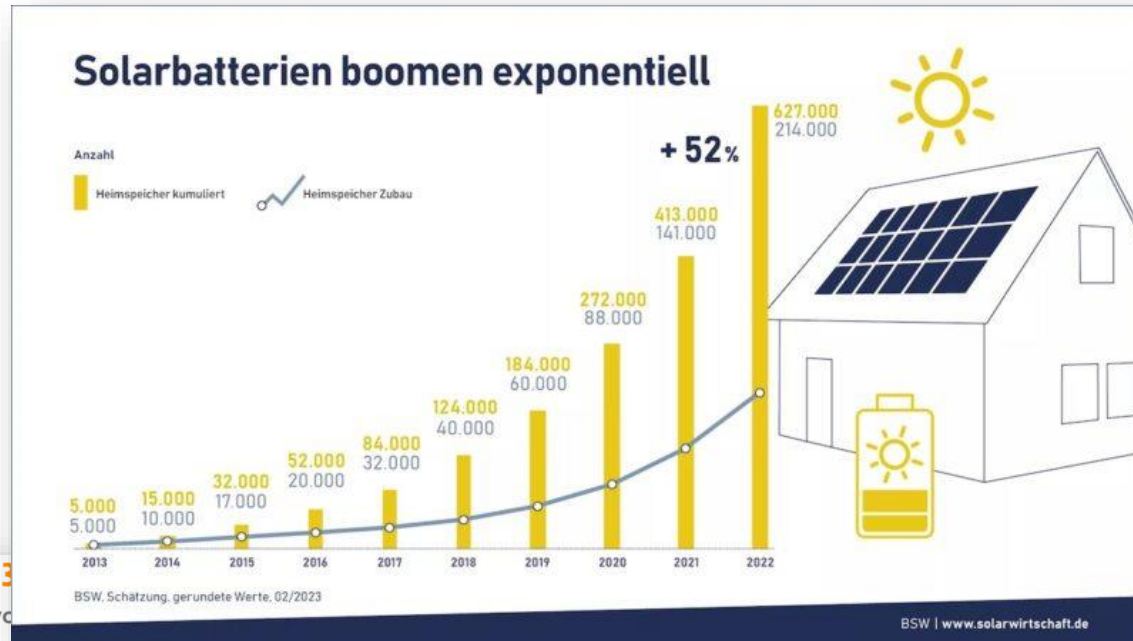

Strompreisentwicklung 2013 – 2023

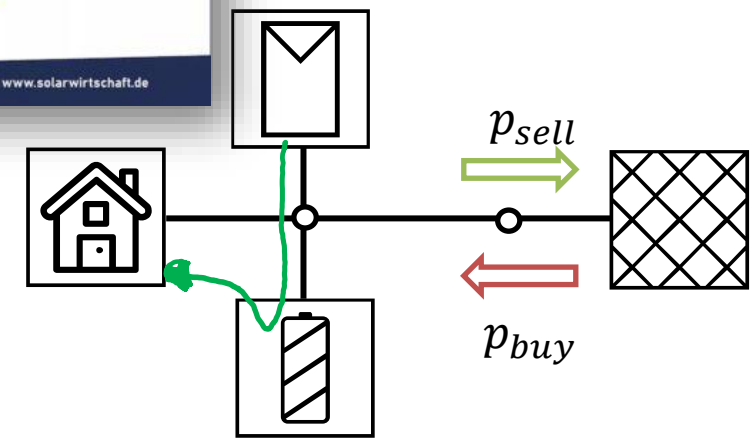
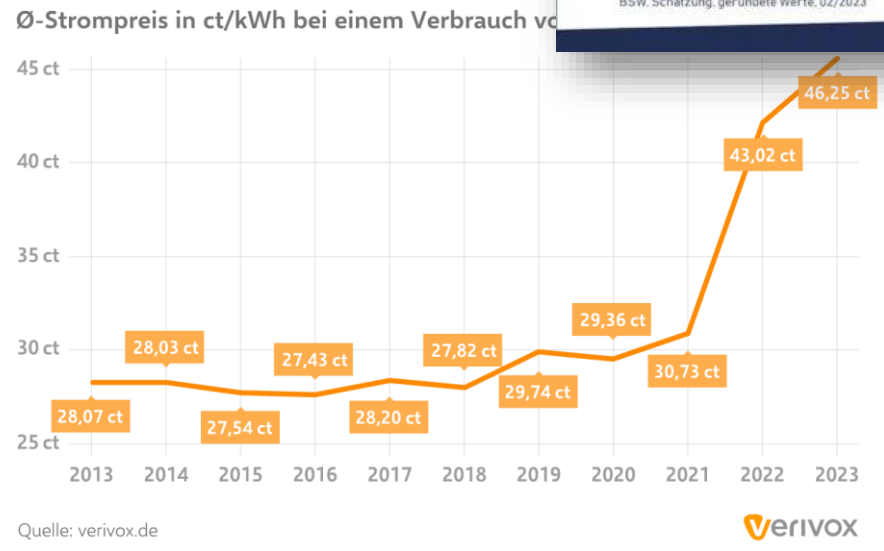

$$C_{HH}^{el} = E_{buy} * p_{buy} - E_{sell} * p_{sell}$$

Quelle: BSW Solar, Verivox, Tesla

3. Anwendungsfelder Batteriespeicher

Eigenverbrauchserhöhung

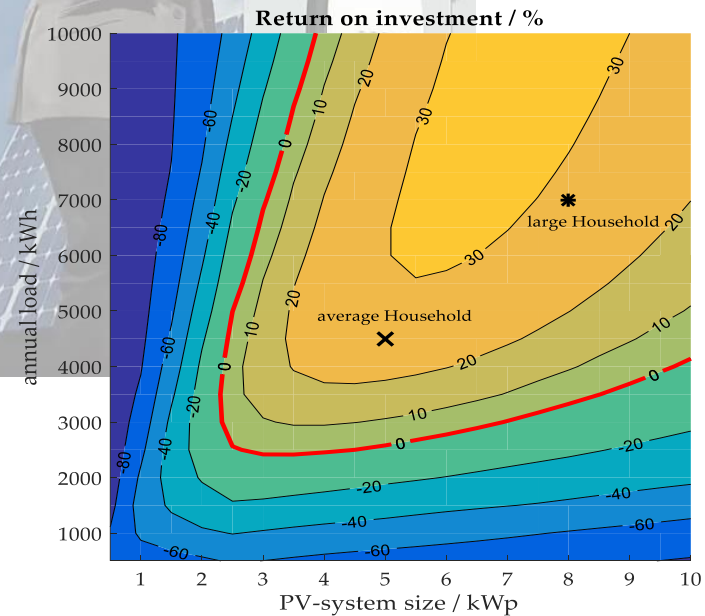
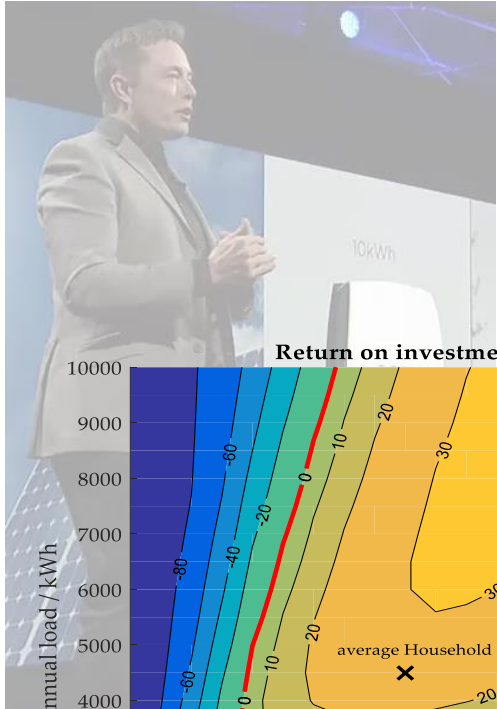

Scenario: Rising electricity price (4,55 p.a.)

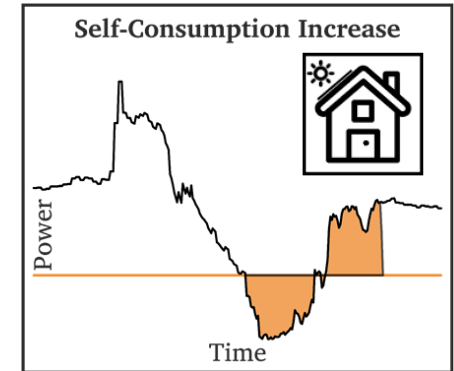
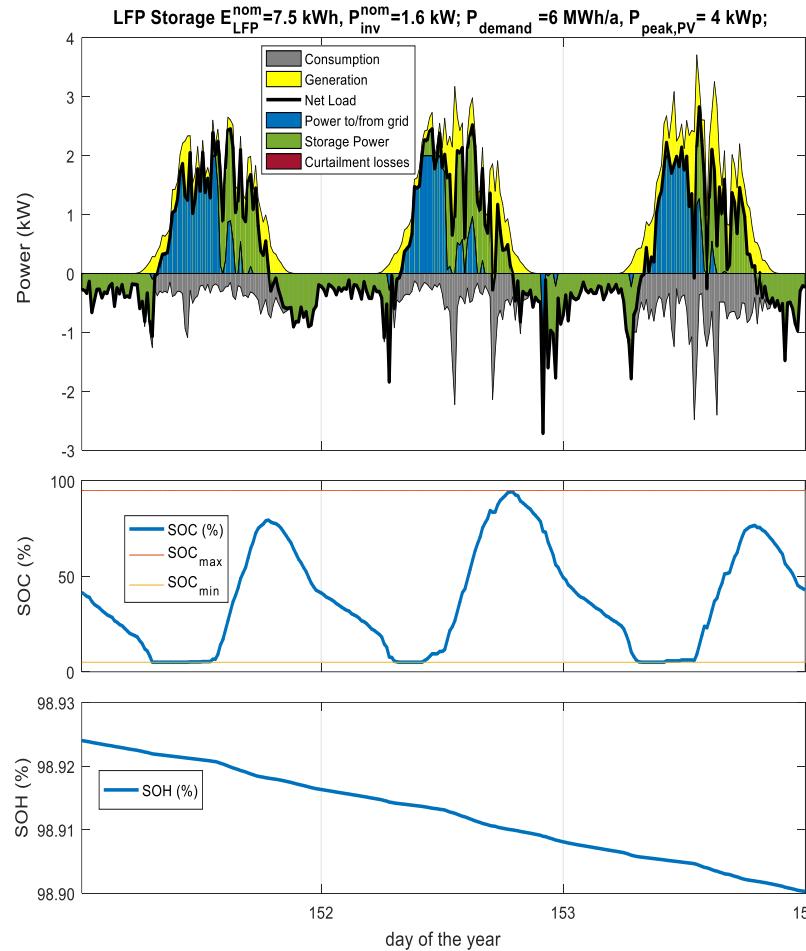

[1] S. Englberger et al., EV MultiUse

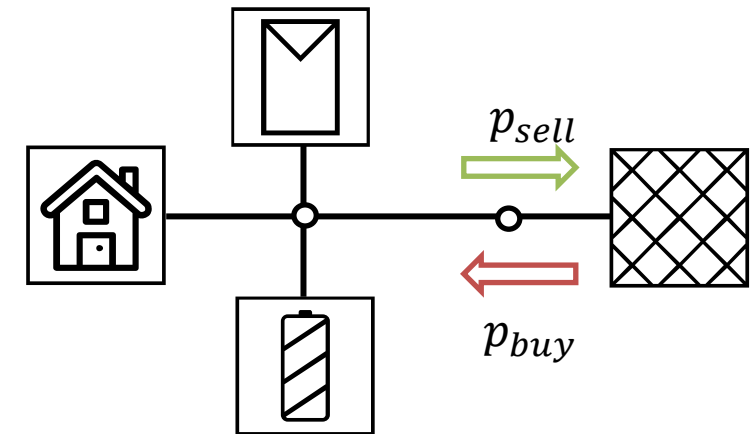

$$C_{HH}^{el} = E_{buy} * p_{buy} - E_{sell} * p_{sell}$$

3. Anwendungsfelder Batteriespeicher

Lastspitzenkappung



Bild: Donaueschingen.de

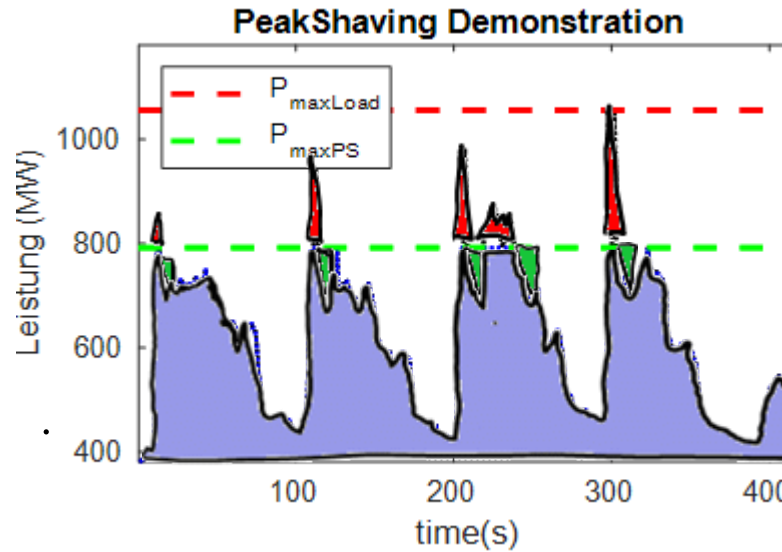

ΔP_{Peak}

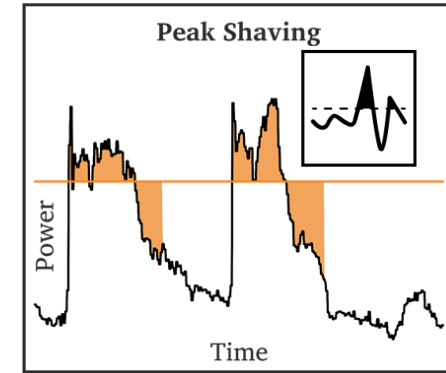

[1] S. Englberger et al., EV MultiUse

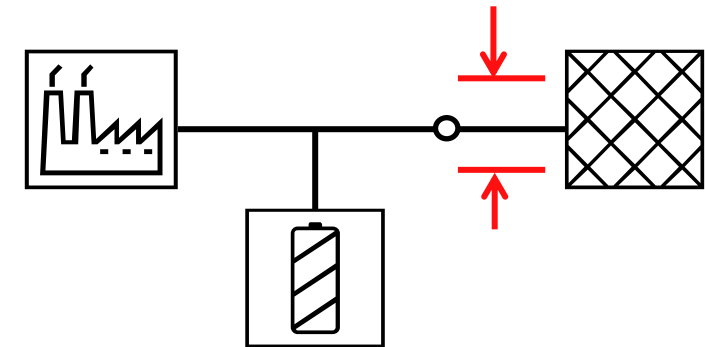
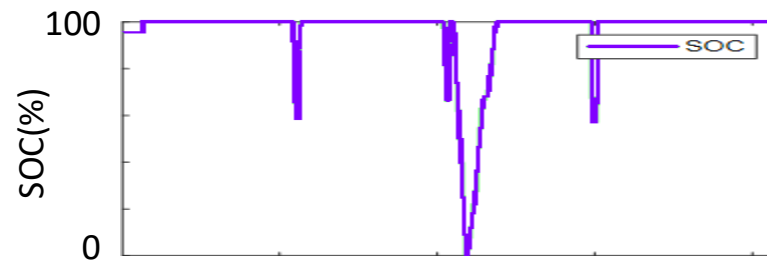
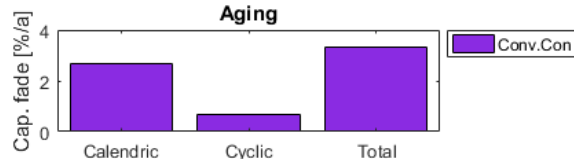
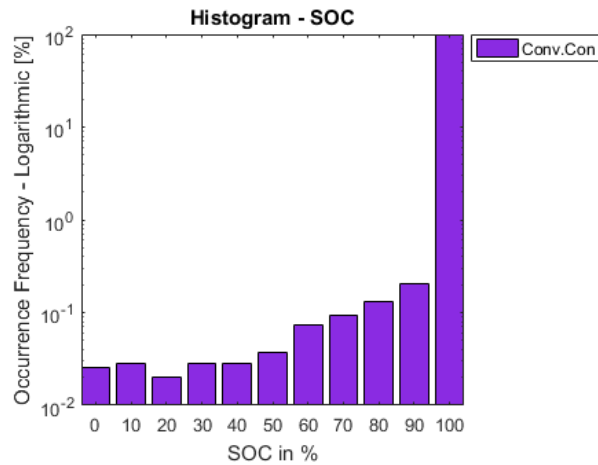

$$C_{Ind}^{el} = E_{Load} * C_{AP} + P_{peak} * C_{LP}$$

3. Anwendungsfelder Batteriespeicher

Lastspitzenkappung



Bild: Donaueschingen.de

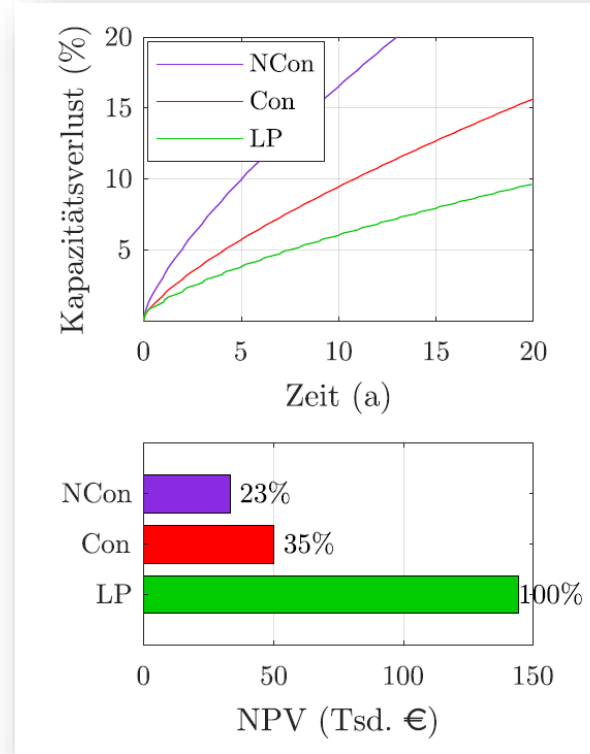
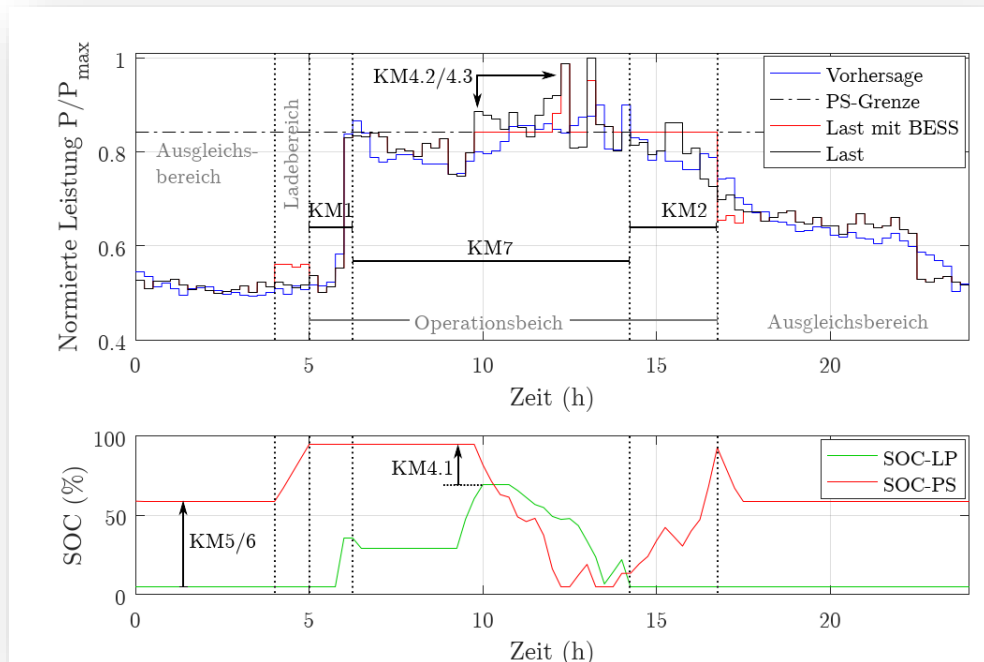

MA T. Vorbuchner (TUM)

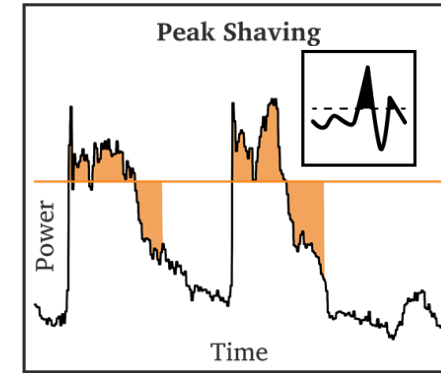

[1] S. Engberger et al., EV MultiUse

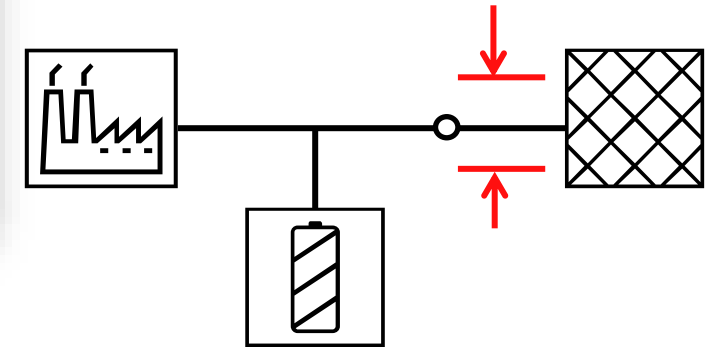

$$C_{Ind}^{el} = P_{peak} * C_{LP} + E_{Load} * C_{AP}$$

3. Anwendungsfelder Batteriespeicher

Lastspitzenkappung



<https://numbat.energy>

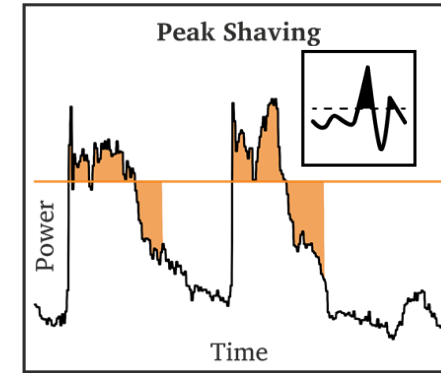

[1] S. Englberger et al., EV MultiUse

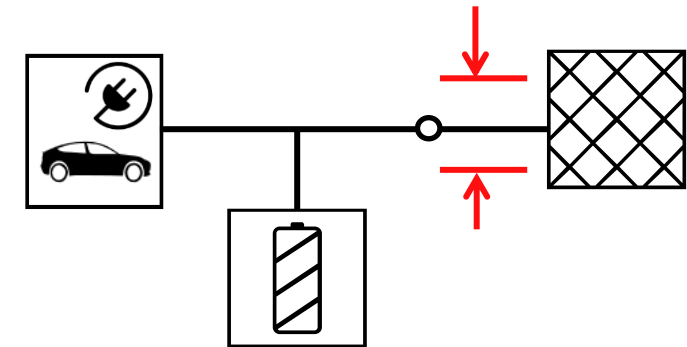

$$C_{Ind}^{el} = P_{peak} * C_{LP} + E_{Load} * C_{AP}$$

3. Anwendungsfelder Batteriespeicher

Stromhandel (Arbitrage)

Stromproduktion und Börsenstrompreise in Deutschland in Woche 12 2023

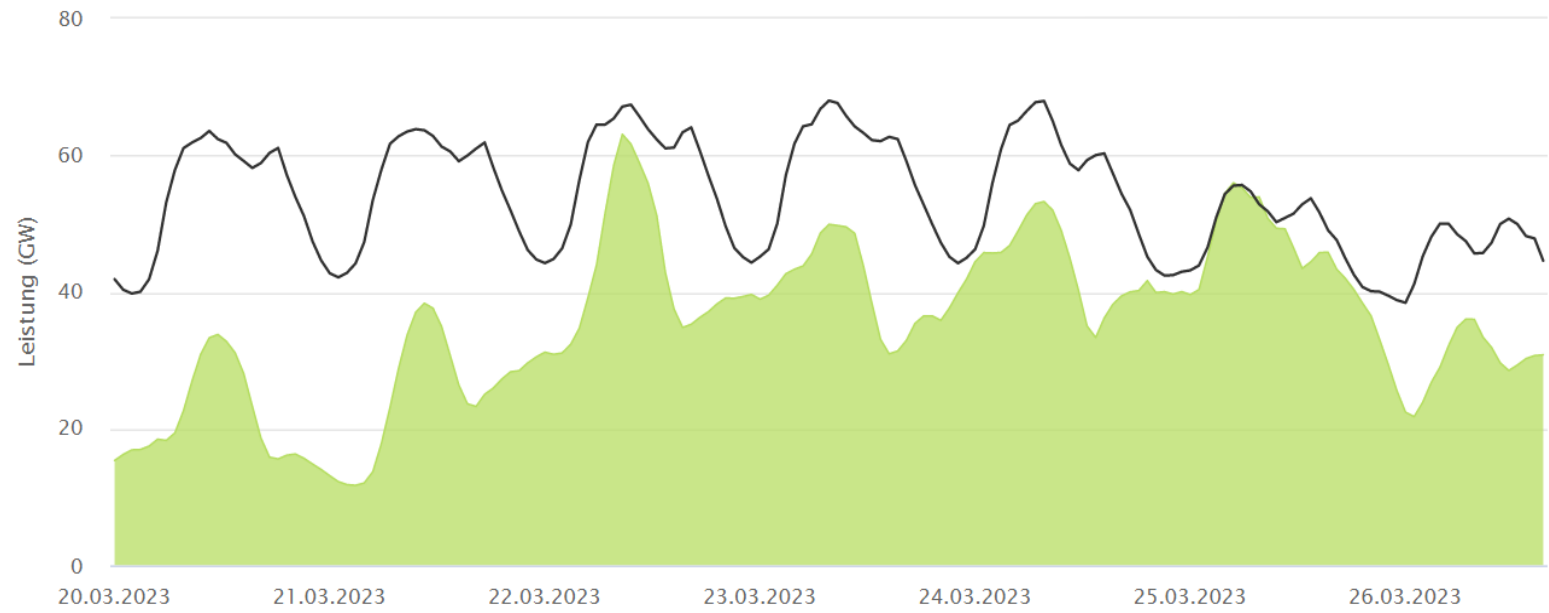

Quelle: Energy-charts.info

- Import Saldo
- Erneuerbar
- Nicht Erneuerbar
- Last

$$E_{Load}(t) - E_{EE}(t)$$

3. Anwendungsfelder Batteriespeicher

Stromhandel (Arbitrage)

Stromproduktion und Börsenstrompreise in Deutschland in Woche 12 2023

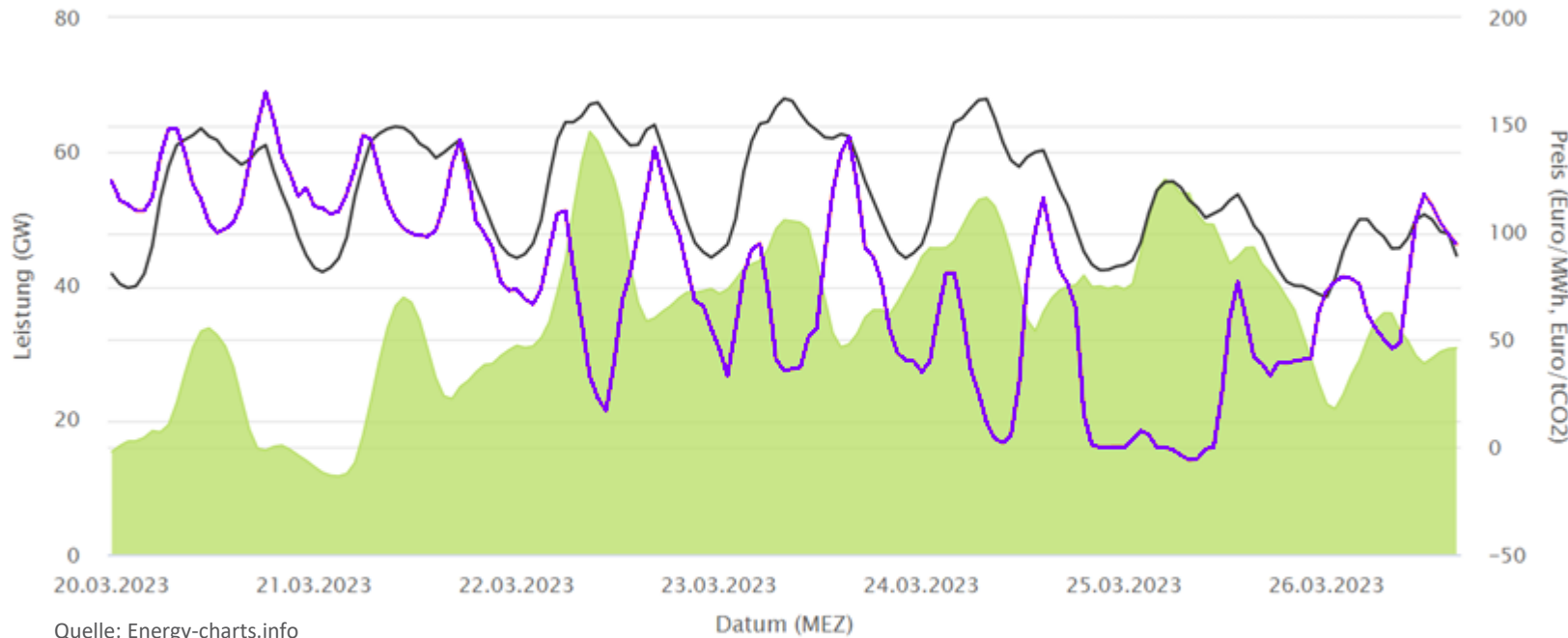

Quelle: Energy-charts.info

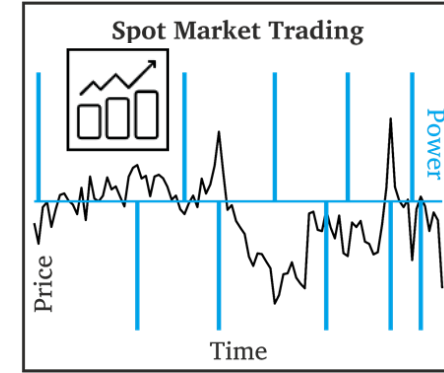

[1] S. Englberger et al., EV MultiUse

$$c_{EEX}(t) \Leftarrow E_{Load}(t) - E_{EE}(t)$$

3. Anwendungsfelder Batteriespeicher

Stromhandel (Arbitrage)

Stromproduktion und Börsenstrompreise in Deutschland in Woche 12 2023

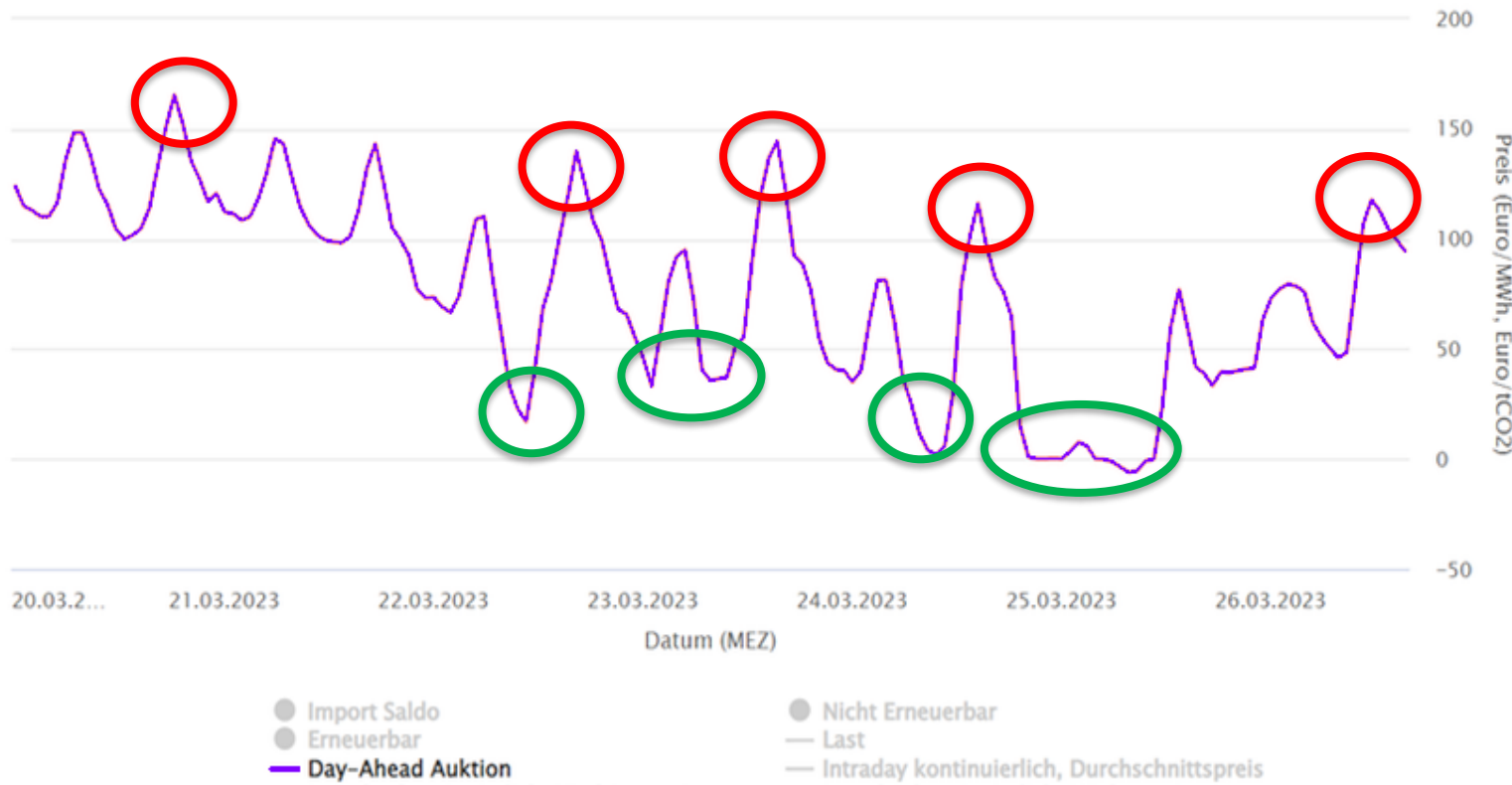

Energy-charts.info, Eigene Darstellung nach Sterner (2014)

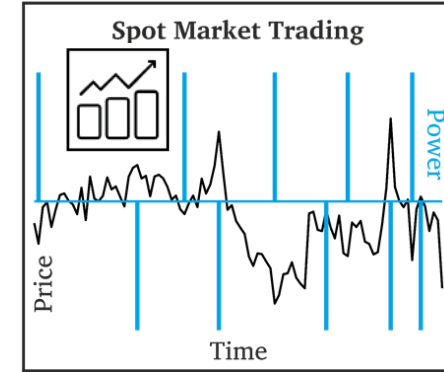

[1] S. Englberger et al., EV MultiUse

$$c_{EEX}(t) \Leftarrow E_{Load}(t) - E_{EE}(t)$$

$$Profit = \Delta(p_{DCH} - p_{CH}) - c_{ageing}$$



3. Anwendungsfelder Batteriespeicher

Stromhandel (Arbitrage)

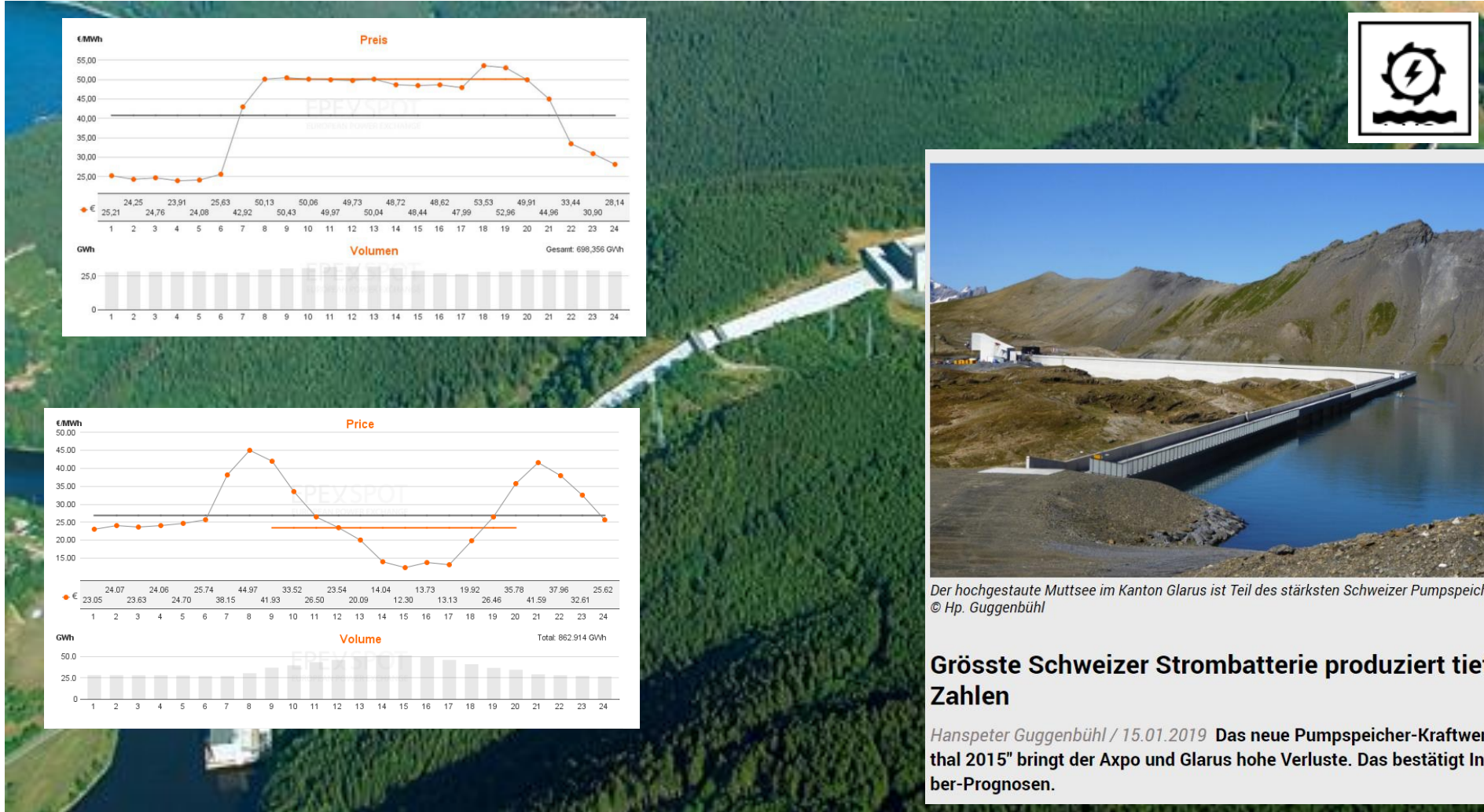

Der hochgestaute Muttssee im Kanton Glarus ist Teil des stärksten Schweizer Pumpspeicherwerks © Hp. Guggenbühl

Grösste Schweizer Strombatterie produziert tiefrote Zahlen

Hanspeter Guggenbühl / 15.01.2019 Das neue Pumpspeicher-Kraftwerk "Linthal 2015" bringt der Axpo und Glarus hohe Verluste. Das bestätigt Infosperber-Prognosen.

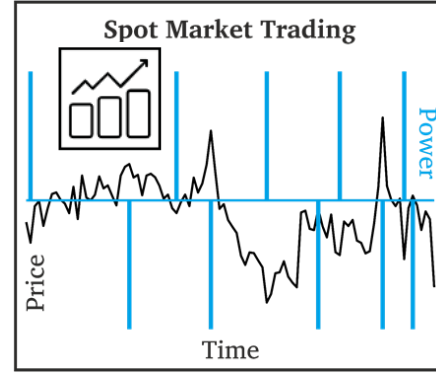

[1] S. Englberger et al., EV MultiUse

3. Anwendungsfelder Batteriespeicher

Stromhandel (Arbitrage)

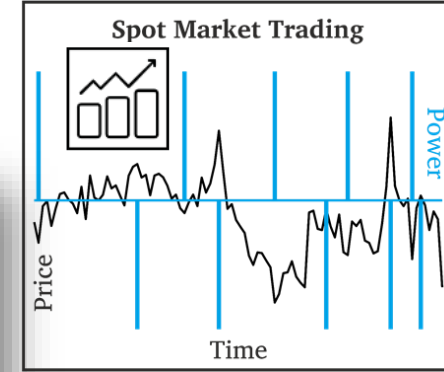
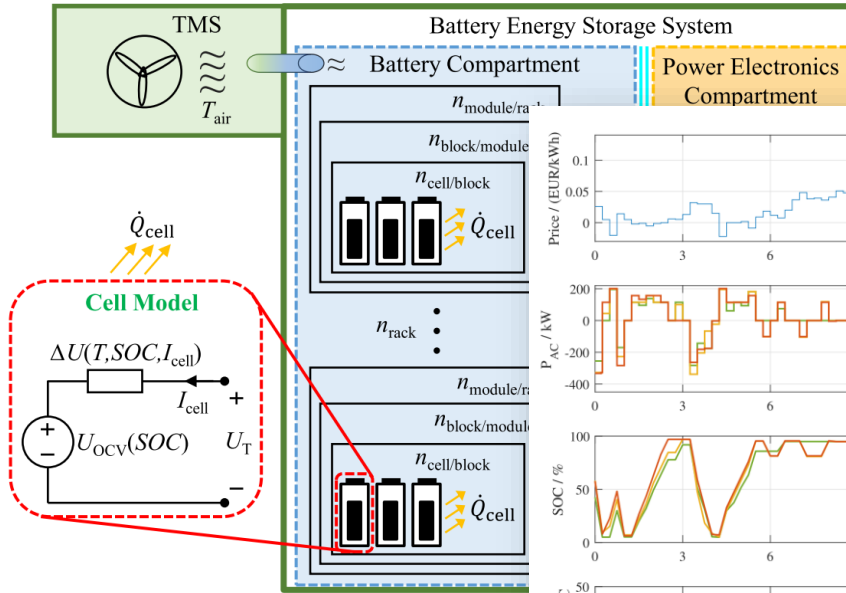

[1] S. Englberger et al., EV MultiUse

System Thermal Model

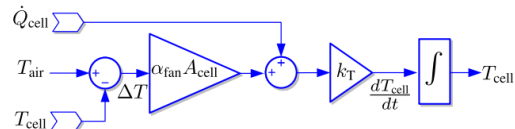
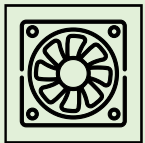
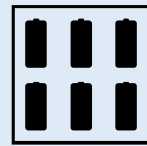

FIGURE 3. Block diagram of the BESS thermal dynamics.

System Performance



$$P_{cell}(n) = \frac{P_b(n)}{n_{cell/block} \cdot n_{block/module} \cdot n_{module/rack} \cdot n_{rack}}$$

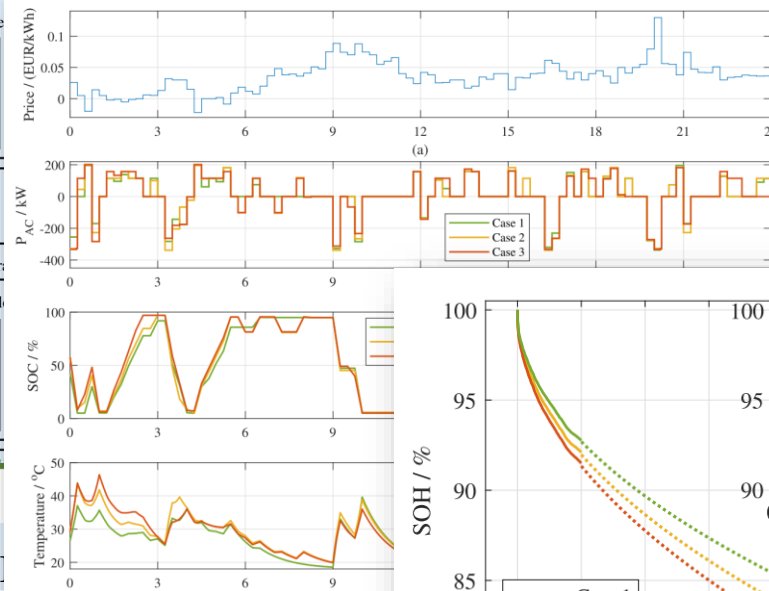
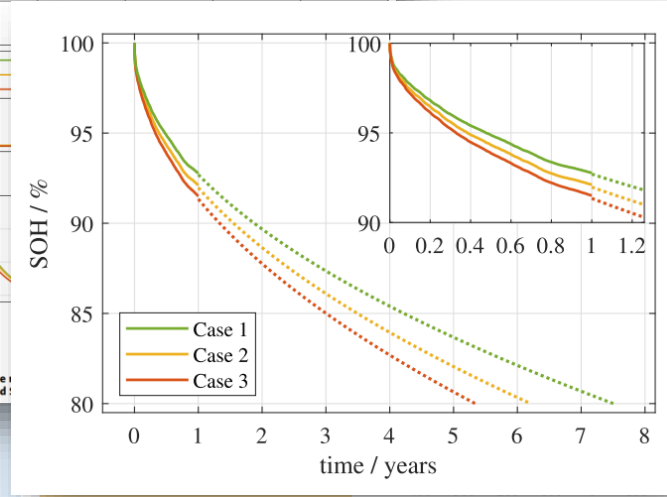

FIGURE 8. Time series plot of the day with the price variance closest to the case 2: only SOC aware 2D optimization, case 3: 1D optimization with fixed...



3. Anwendungsfelder Batteriespeicher

Zusammenfassung Anwendungsfälle

Eigenverbrauchserhöhung

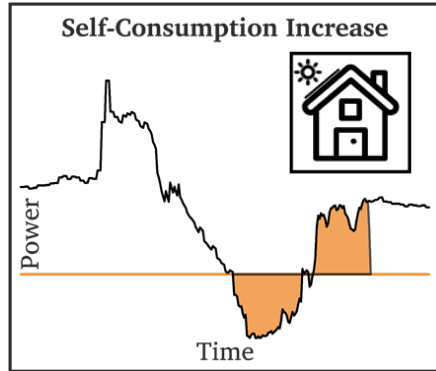

Heimspeicher



"5 - 30 kWh"

Source: sonnen.de

Lastspitzenkappung

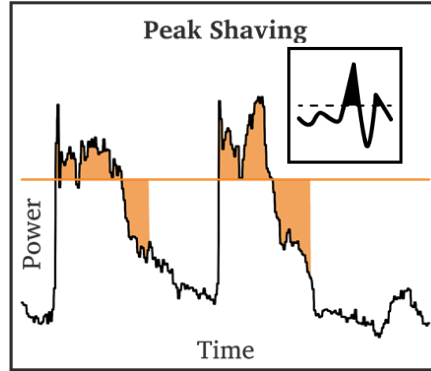

Gewerbespeicher



"30 kWh - 1 MWh"

Source: NEC.de

Stromhandel (Arbitrage)

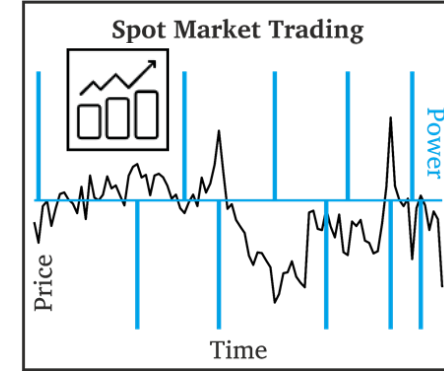

Großspeicher



"1 MWh+"

Source: tesla.com

4. Forschung Smart Energy Systems

Forschungsprojekt „StorageMultiApp“

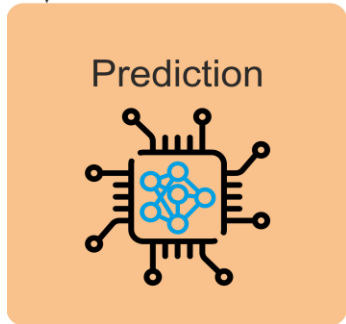
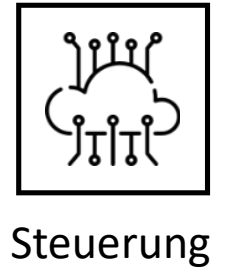
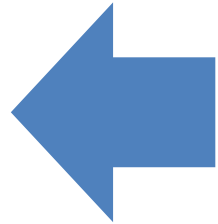
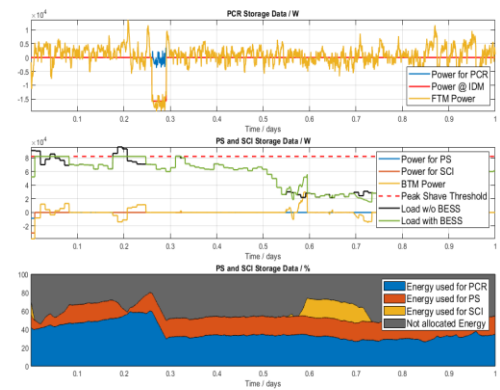
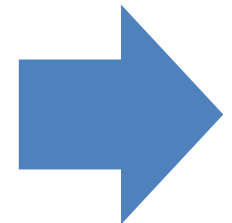
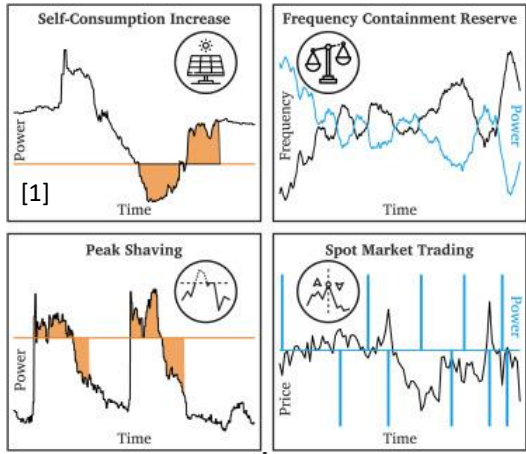

Predicted data



Operation strategy



System feedback

A collection of logos and text for the Storage MultiApp project. At the top is the 'Storage MultiApp' logo. Below it are logos for VARTA (VARTA Storage GmbH), Hochschule Kempten (University of Applied Sciences), TWICE TECHNOLOGIES, SIEMENS (Ingenuity for Life), and TWT. At the bottom, it says 'Gefördert durch:' followed by logos for Technische Universität München (TUM) and the Bundesministerium für Wirtschaft und Klimaschutz (German Federal Ministry for Economic Affairs and Climate Protection), with the note 'aufgrund eines Beschlusses des Deutschen Bundestages'.

4. Forschung Smart Energy Systems

Forschungsprojekt „KI-M-Bat“

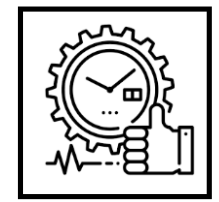
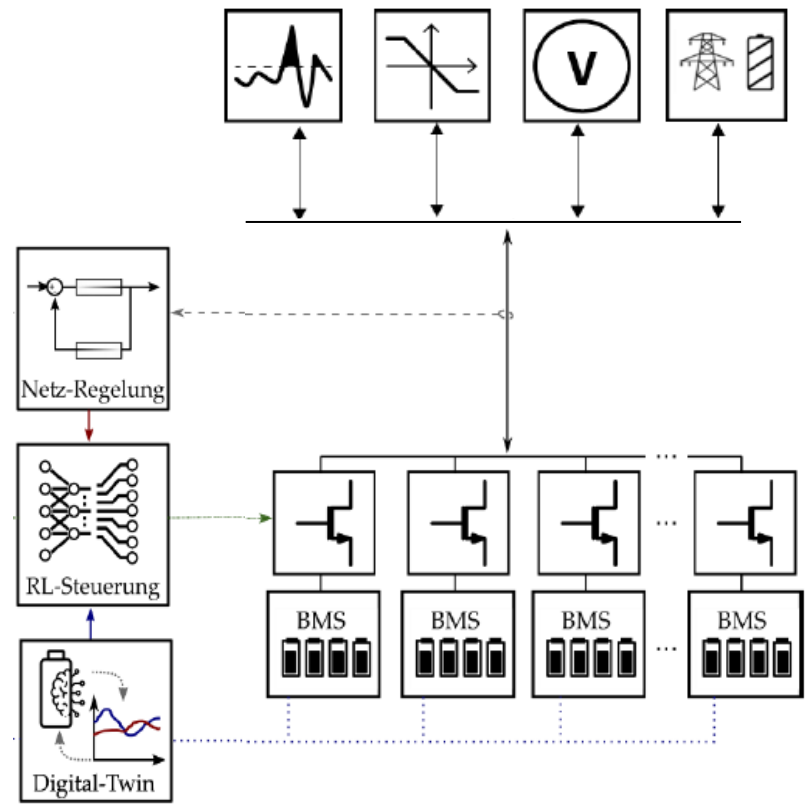

Effizienz

Projekt KI-M-Bat

STABL Hochschule Kempten
University of Applied Sciences

fenecon Technische Universität München **TUM**

Bayerische Forschungsstiftung

M. Schimpe, Piesch, C., Hesse, H. C., Paß, J., Ritter, S., & Jossen, A "Power Flow Distribution Strategy for Improved Power Electronics Energy Efficiency...", *Energies* 2018 11(3)

4. Forschung Smart Energy Systems

Alterungsprädiktion und Second-Life

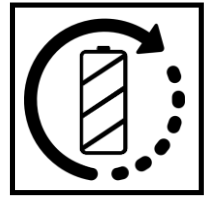
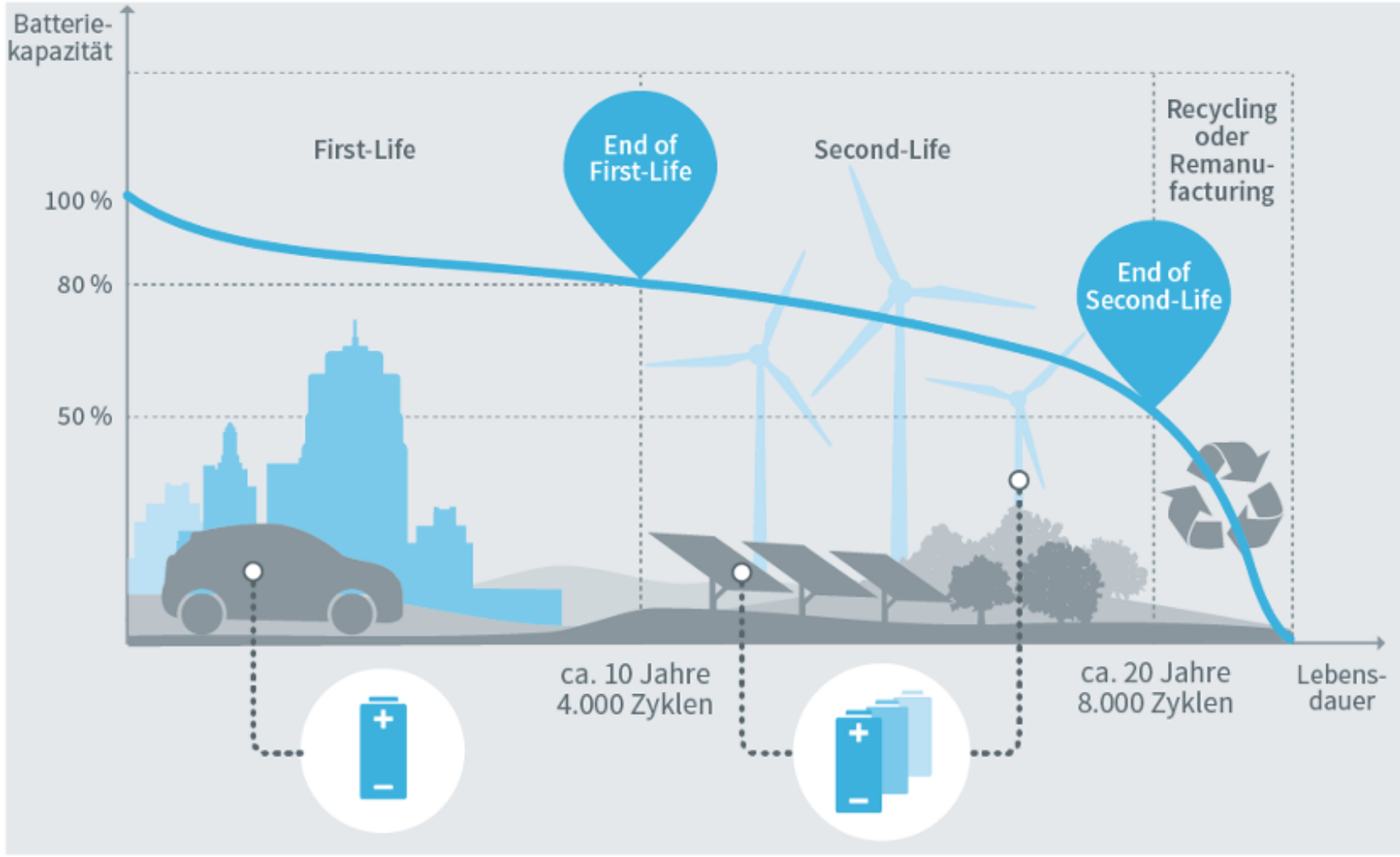

Alterung

- Belastung 1st Life: „automotive“
- Belastung 2nd Life „Stationär“
- Alterungsprädiktion und Unsicherheit

Forschungsstelle für Energiewirtschaft e.V. FFE

TUM EES – Lehrstuhl für Elektrische Energiespeichertechnik

Second-Life-Konzepte für Lithium-Ionen-Batterien aus Elektrofahrzeugen, Sebastian Fischhaber, Anika Regett, Simon F. Schuster, Dr. Holger Hesse

Zusammenfassung: Speicher für die Energiewende?

Speicher im Kontext der Energiewende („Kosten-Sicht“)

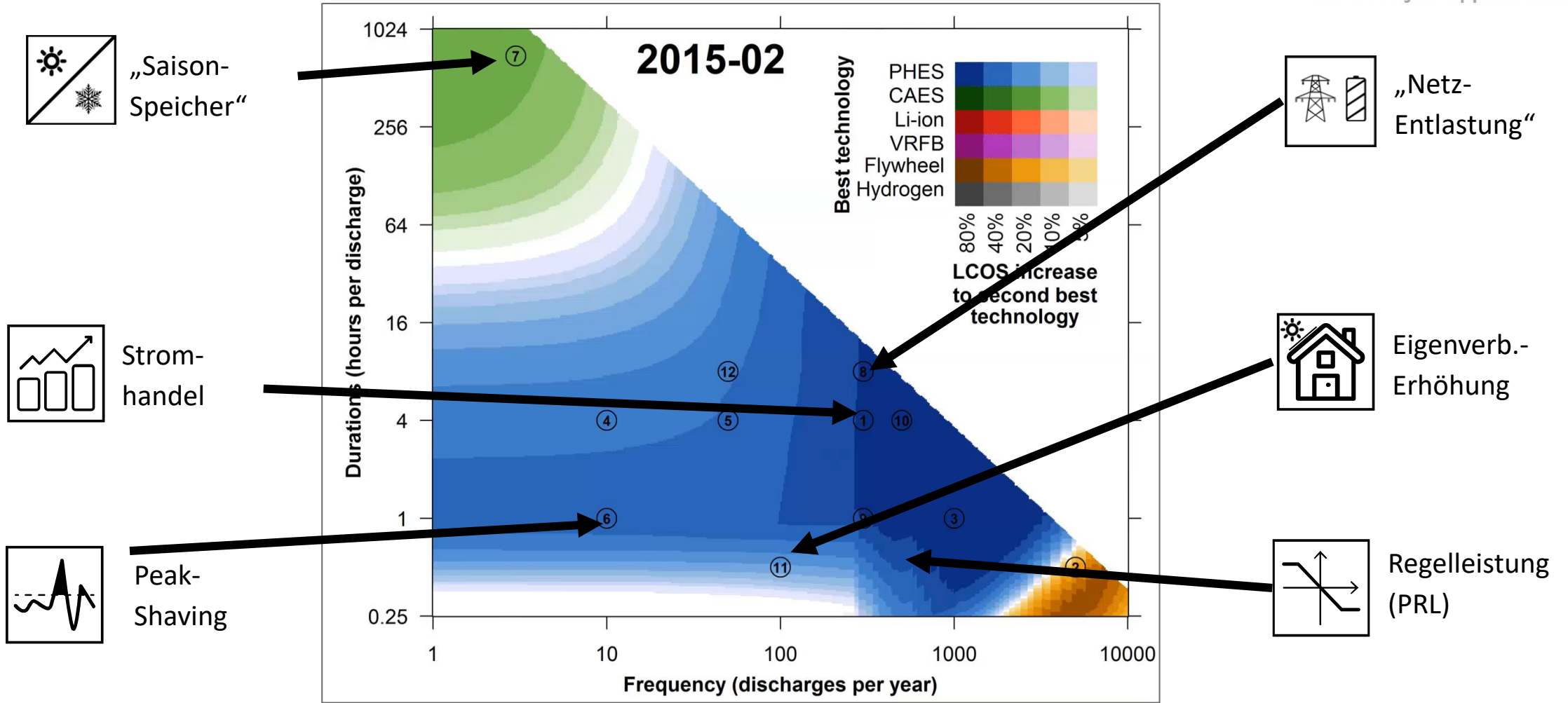

Vielen Dank!

Team Smart Energy Systems



Melina Graner

Battery Second Life and Remanufacturing



Vivek Tanjavoru

Smart Grid Integration of Battery storage through multilevel converters



Sheng Yin

Optimal control of Multi-Usecase Battery storage through AI

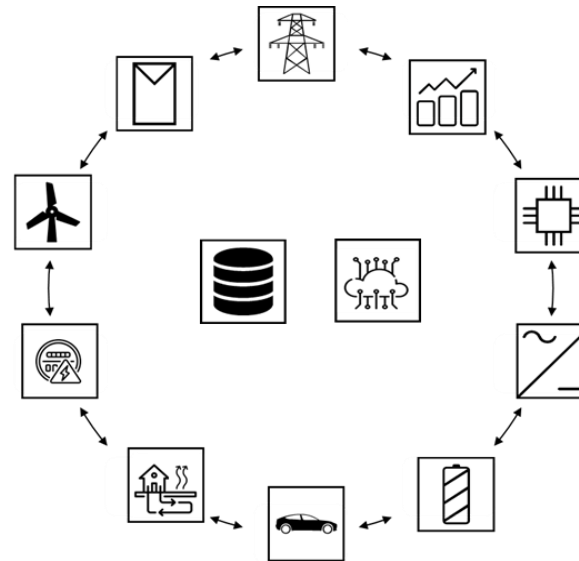

Benedikt Tepe (@TUM)

Vehicle integration and smart energy systems (TUM)



Anupam Parlikar (@TUM)

Ecologic impact minimization through battery storage (TUM)



Holger Hesse

Grid integration of energy storage systems

4. Forschung Smart Energy Systems

Vehicle-to-grid

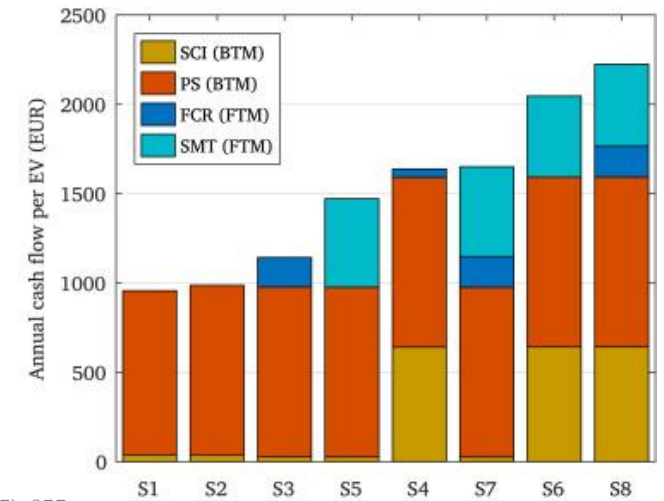
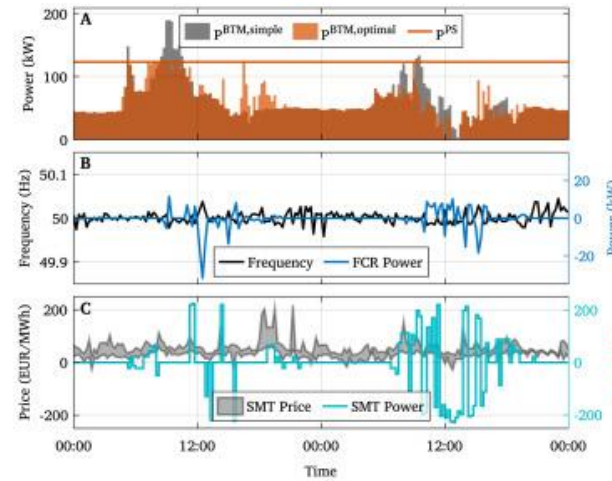
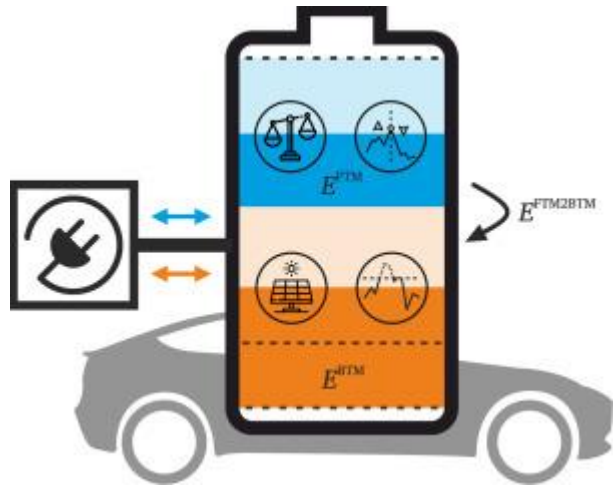
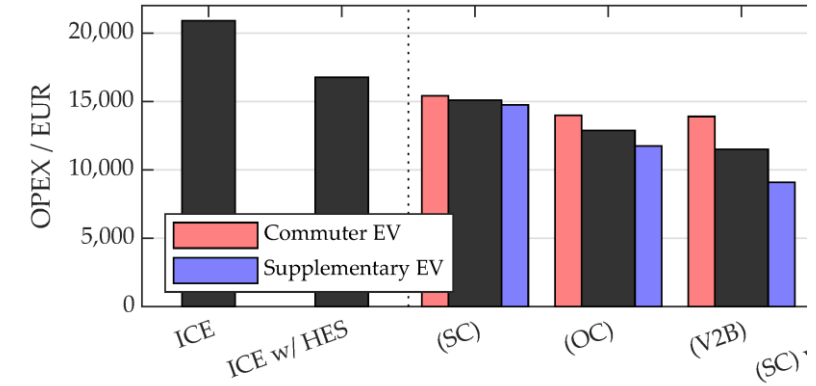
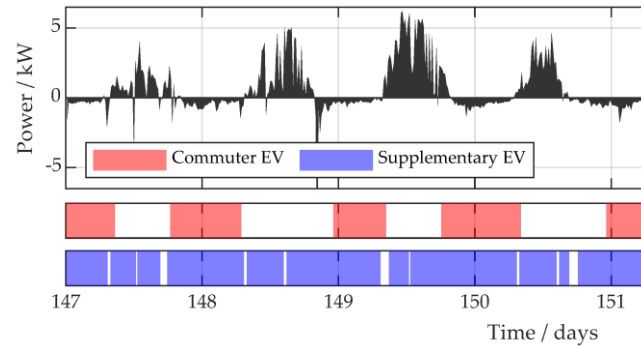
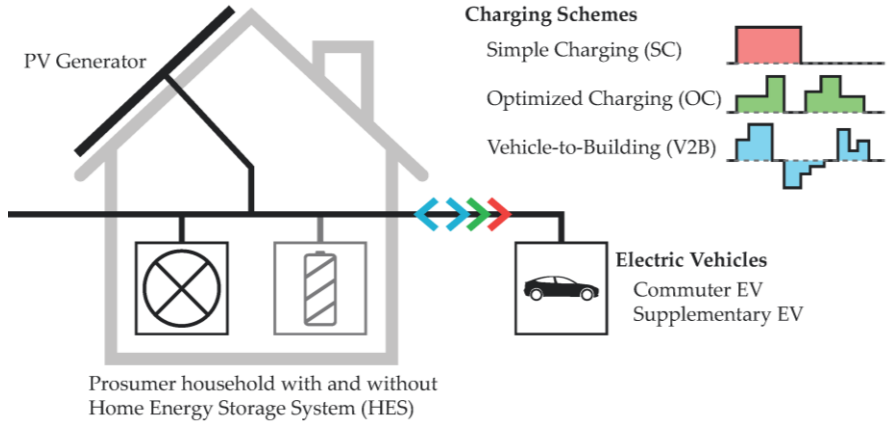

Englberger, S., Hesse, H., Kucevic, D., & Jossen, A. (2019). A techno-economic analysis of vehicle-to-building: Battery degradation and efficiency analysis... *Energies*, 12(5), 955.

Englberger, S., Gamra, K. A., Tepe, B., Schreiber, M., Jossen, A., & Hesse, H. (2021). Electric vehicle multi-use: ... *Applied energy*, 304, 117862.