

The Efficiency and Profitability of the Modular Multilevel Battery for Frequency Containment Reserve

Markus Förstl

Institute for Electrical Energy Storage Technology
Technical University of Munich
Munich, Germany
markus.foerstl@tum.de

Nam Truong

STABL Energy GmbH Institute for Electrical Energy Storage Technology
Munich, Germany

Marc Möller

Technical University of Munich
Munich, Germany
marc.moeller@tum.de

Holger Hesse

Institute for Electrical Energy Storage Technology
Technical University of Munich
Munich, Germany
holger.hesse@tum.de

Arthur Singer

STABL Energy GmbH
Munich, Germany

Thomas Weyh

Institut für Elektrische Energieversorgung
Universität der Bundeswehr München
Munich, Germany
thomas.weyh@unibw.de

Andreas Jossen

Institute for Electrical Energy Storage Technology
Technical University of Munich
Munich, Germany
andreas.jossen@tum.de

Abstract—The modular multilevel battery (M2B) is a novel approach to integrate battery storage into the electricity grid. This paper obtains the efficiency and financial benefits of a working prototype system, compared to conventional systems for frequency containment reserve (FCR). The efficiency is determined with a low-level simulation that models the conduction losses on the circuit, the MOSFETs' switching and conduction losses, and the system consumption. The simulation model shows, that the efficiency is superior to conventional inverters over the entire operating range. The operation for FCR shows a cost-reduction of 50 % for transactions on the intraday market, resulting in a 72.9 % higher net-profit after 10 years.

Keywords—inverter, power electronics, efficiency analysis, frequency control reserve

I. INTRODUCTION

A. Motivation and research objective

Conventional stationary battery energy storage systems (BESSs) usually consist of two major hardware parts: a high-voltage battery pack and a centralized converter. The battery pack consists of several modules that can be connected in a series-parallel configuration to achieve desired capacity and output voltage, depending on the project or customer specifications. The centralized converter is usually a two-level voltage source inverter operated with pulse width modulation [1–3].

While this configuration is simple and established, it has a few disadvantages. The failure of one module leads to the failure of the whole pack. Furthermore, conventional converters have maximum one-way efficiencies of around 98 % [4] that drop rapidly in partial-load operation. Since many applications of stationary BESSs, such as grid ancillary services, operate

in partial load, power electronics can be responsible for up to 50 % of the total losses [5]. Furthermore, the large switching voltage of conventional two-level inverters introduces large total harmonic distortions that need to be filtered to comply with grid codes and standards, which is cost-intensive and decreases efficiency [2].

The modular multilevel battery (M2B) is a novel approach of integrating batteries into the grid with the promise of higher efficiency [6]. Its functionality is based on the concept of cascaded H-bridge converters. Previous work describes the functionality of the M2B in detail [6, 7]. This work calculates the efficiency based on a semiconductor-level simulation model. With the obtained efficiency, we estimate the impact on the operation for a BESS providing frequency containment reserve (FCR) on the German market.

B. System topology of the modular multilevel battery

The investigated system topology differs from commercially available systems. The battery modules are not hard-wired to form a high-voltage battery pack that is connected to a central converter. Instead, the battery modules are connected to the M2B circuit. The battery modules are dynamically connected in series to generate a stepped output voltage to emulate the sine form of the grid voltage. Fig. 1 illustrates how the output voltage of the inverter is generated.

Switching losses are proportional to both the switching frequency and the squared switching voltage [8]:

$$P_{\text{switch}} \propto f_{\text{switch}} \cdot V_{\text{switch}}^2 \quad (1)$$

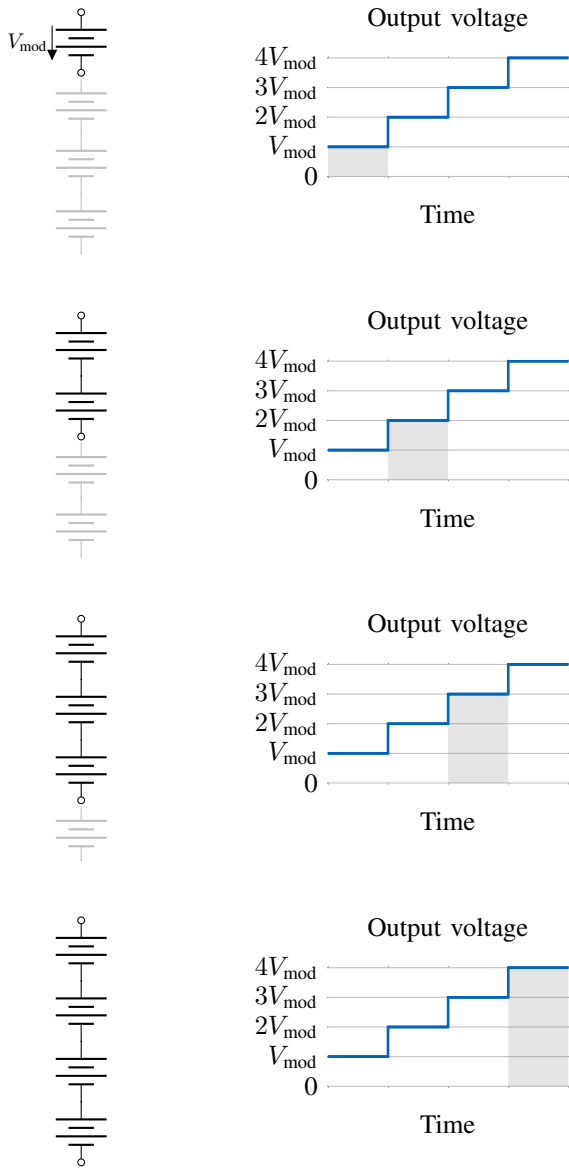

Figure 1: Illustration of operating principle of the dynamic series connection for four battery modules. Gray modules are bypassed. Black modules are active and supply the output voltage.

These are expected to be significantly reduced. The novel conversion method requires the MOSFETs to only switch with a frequency of 200 Hz, instead of 8 to 12 kHz switching frequency of the IGBTs in conventional inverters. In addition, the switching voltage is the voltage of a single battery module, which is usually below 60 V, compared to the switching of about 800 V in today's systems.

Each M2B circuit attached to a battery module attains several states. The three relevant states for the standard operation are to bypass the battery, connect the battery module with a positive voltage, and to connect the battery module with a negative voltage. The output of the module is then 0 V, $+V_{mod}$,

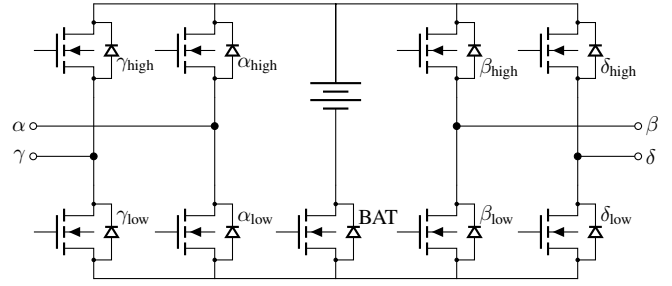

Figure 2: Topology of the M2B circuit

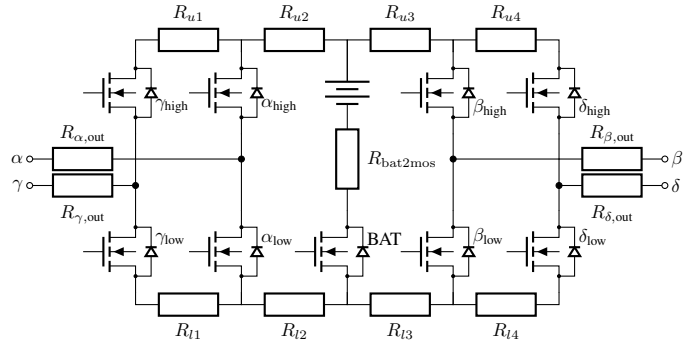

Figure 3: Implementation of one M2B circuit for the simulation model. The 13 resistors represent the resistances of the circuit board [11], which also contribute to the power losses.

and $-V_{mod}$, respectively. Fig. 2 shows the schematic of the M2B circuit. The connection of modules to one inverter leg and a BESS is described in [6].

II. SYSTEM EFFICIENCY

A. Simulation model

A simulation model is built with the “Plecs Blockset Toolbox” for MATLAB’s Simulink software to obtain the losses of the system and calculate the efficiency of the inverter system. The model includes the conduction losses of the printed circuit board and the conduction and switching losses of the MOSFETs.

The MOSFET losses are modeled using a look-up table approach [9], using datasheet values obtained from the MOSFET’s datasheet [10]. Conduction losses of the circuit board are modeled as resistances, which have of the current paths on the printed circuit board have been measured directly with a high-precision measurement [11]. Fig. 3 shows the resulting implementation of one M2B module.

The simulated BESS is a eight-module M2B connected to the grid, modeled as a AC voltage source with an impedance. Between the BESS and the grid is a line filter. Table I gives an overview of the parameters for the simulation model.

The simulation does not include the self-consumption of the electronics. As this is more dependent on the specific design of the hardware, the consumption has been measured on the actual hardware. We measured the consumption of the master

Table I: Parameters of the low-level simulation model

Parameter	Value	Unit
Simulation model		
Simulation time	1	s
Sample time	40	μs
Number of modules	8	
Grid and grid connection components		
Grid frequency	50	Hz
Grid voltage (RMS)	230	V
Line filter inductance	3	mH
Battery module		
Open-circuit voltage	47.5	V
Internal resistance	24	mΩ
MOSFET		
Maximum drain-to-source voltage	100	V
Maximum drain current	300	A
Reverse-recovery charge (body diode)	316	nC
Circuit board resistances		
R_{u1} and R_{u4}	0.74	mΩ
R_{u2} and R_{u3}	0.55	mΩ
R_{l1} and R_{l4}	0.49	mΩ
R_{l2} and R_{l3}	0.59	mΩ
$R_{\alpha,out}$	0.18	mΩ
$R_{\beta,out}$	0.25	mΩ
$R_{\gamma,out}$	0.18	mΩ
$R_{\delta,out}$	0.26	mΩ
$R_{bat2mos}$	0.15	mΩ

Table II: Power consumption of system components

Component	Power consumption
Master controller	2.595 W
Current sensor	1.215 W
Control board	1.491 W

controller, the current sensors, and the control boards of one M2B module. Hence, the system consumption of an M2B system with m modules (in total) and designed for a n -phase operation can be calculated by

$$P_{System,m,n} = m \cdot P_{Control\ board} + n \cdot P_{Current\ sensor} + P_{Master\ Controller}. \quad (2)$$

B. Results and discussion

Fig. 4 shows the resulting efficiency curve over the normalized output power of the M2B (blue) compared to the reference inverter efficiency (green) [12].

The simulation results confirm the hypothesis that the switching losses are significantly reduced. While the system consumption, conduction losses of the MOSFETs, and the conduction losses on the printed circuit boards are in the same magnitude, the switching losses are negligible in comparison. They are lower than 1% of the overall losses in all operation points. Fig. 5 shows the proportional shares of the loss mechanisms in relation to the overall losses.

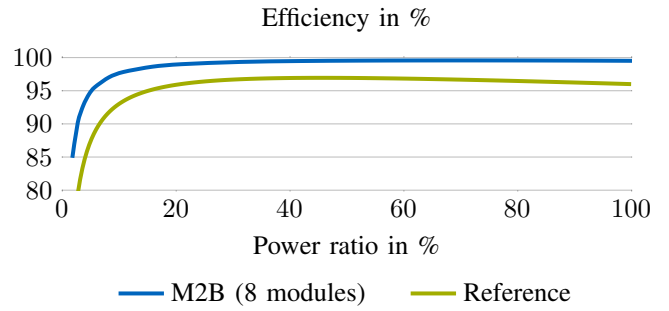

Figure 4: Simulated efficiency of the M2B system with eight modules compared to the reference system [12]. For the whole operating range, the M2B shows higher efficiencies.

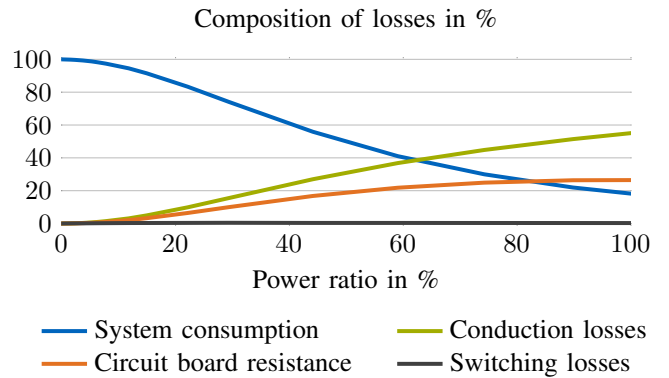

Figure 5: Composition of losses depending on power ratio.

III. CASE STUDY: FREQUENCY CONTAINMENT RESERVE

A. Assumptions

FCR is one of the two most popular applications for BESSs in Germany [13]. FCR is a grid-service for any grid participant to reduce or increase the net power output based on the grid frequency. The grid frequency serves as value to determine the balance between load and generation that needs to be maintained to keep the power system stable. BESSs already provide the major share of FCR, resulting in a larger supply than demand. Increasing renewable energy generation, however, also increases the demand.

The measurement of the ENTSO-E grid’s frequency of 2014 [14] is used to determine the necessary output power of the BESS. The utilized degrees of freedom for SOC management of the BESS are use of the frequency deadband, over fulfillment of the power request, and the participation in the German intraday market (IDM), where the BESS operator purchases or sells energy to set the SOC to stay within a valid operating range. The IDM market prices of 2018, obtained from the European Power Exchange [15] are used for the simulation. For the reserved FCR, the corresponding average capacity price retrieved by the German TSOs for 2018 was used [16]. Furthermore, we assume that the BESS participates at all tenders in the year.

Table III: Parameters for the FCR case study.

Parameter	Value	Unit	Ref.
Simulation parameters			
Simulation time	1	year	
Sample time	1	s	
Technical parameters			
Nominal energy capacity	1.5	MWh	[17]
Nominal power	1.8	MW	[17]
Prequalified power	1	MW	[17]
Maximum power for IDM	0.5	MW	
Grid frequency	50	Hz	
Dead band	±10	mHz	
Economic parameters			
Fixed battery costs	1 723	EUR	[3]
Variable battery costs	752	EUR/kWh	[3]
Total investment costs (C_{inv})	1 129 723	EUR	
Maintenance costs	$0.02 \cdot C_{inv}$	EUR/year	[17]
Operational costs	4 000	EUR/year	[17]
Depreciation period	20	years	
Inflation rate	2	%	[18]
Nominal interest rate	4	%	[18]

Technical and economic parameters for the case study are shown in Table III.

B. Simulation model

The simulation tool SimSES [19] is used to compute the BESS in the application of FCR. It calculates the BESS operation on a technical level: the respective output power of the BESS depending on the frequency every second. The system losses and energy consumption are considered, as well as the SOC of the BESS. The battery cell losses are modeled with an equivalent circuit model that includes the open-cell voltage (OCV) and the inner resistance, which resembles a state-of-the-art lithium ion battery with LFP cathode chemistry [20]. More dynamic components, such as RC-elements are not necessary because the simulation's sample time of 1 second does not capture more dynamic battery behavior.

SimSES allows for calculation of technological and economic key performance indicators, such as round-trip efficiency, state of health (SOH), and net present value (NPV) of costs and revenue.

Two parameter sets are compared: a conventional BESS and a BESS equipped with the M2B inverter and its respective efficiency curve.

The reference converter is modeled via an efficiency curve described by Notton et al. [12] and is calculated by

$$\eta_{ref} = \frac{p}{p + p_0 + kp^2}, \quad (3)$$

where p is the power ratio and p_0 and k are constants calculated by

$$p_0 = \frac{1}{99} \left(\frac{10}{\eta_{10}} - \frac{1}{\eta_{100}} - 9 \right) \text{ and} \quad (4)$$

$$k = \frac{1}{\eta_{100}} - p_0 - 1, \quad (5)$$

Table IV: Parameters of the converter models for the FCR simulations.

Parameter	Reference [12]		M2B		
	p_0	k	k_0	k_1	k_2
Value	0.0072	0.0345	0.003189	-0.007566	0.009991

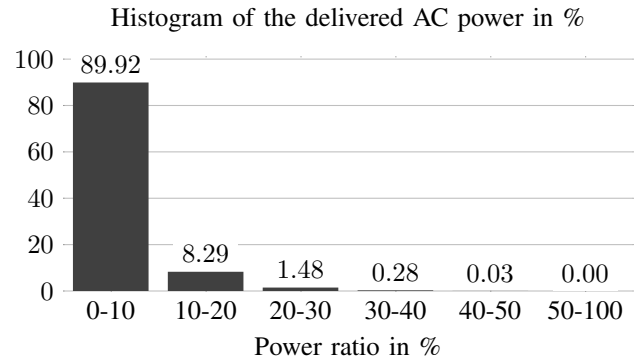

Figure 6: Frequency distribution of the delivered AC power of the storage systems.

where η_{10} and η_{100} are the efficiencies at 10% and 100% of the maximum power. [12]

The M2B efficiency is also fitted mathematically, but with a different equation

$$\eta_{M2B} = \frac{p}{p + k_0 + k_1p + k_2p^2}, \quad (6)$$

according to [21], which yields a more precise fit. Again, p is the power ratio; k_0 , k_1 , and k_2 are mathematical coefficients, which were determined by a non-linear least squares approach.

Table IV shows the parameters for both converter models.

C. Technical results of the case study

With M2B's efficiency, the BESS achieves a round-trip efficiency of 90.7% compared to the reference system's 79.6%. Looking at the power distribution of the delivered AC power for both systems in Figure 6, it becomes clear that FCR operates below 30% of the nominal power for more than 99% of the time.

Together with the relative conversion efficiency difference of the M2B and the reference, shown in Figure 7, we can explain the high difference of the round-trip efficiency. Almost 90% of the delivered AC power lie within the range of 0 to 10%, where, on average, M2B efficiency is 13.5% higher than the reference's.

D. Economic results of the case study

Fig. 8 shows all cash flows for the simulated year. The expenditure of M2B through IDM transactions is 53.9% lower than those of the reference. Revenue through FCR is the same for both systems as they can reserve their prequalified power for the whole time. The cost savings on the IDM yield an annual cash flow of 99 669 EUR for the M2B, which is 15.8% higher than the reference.

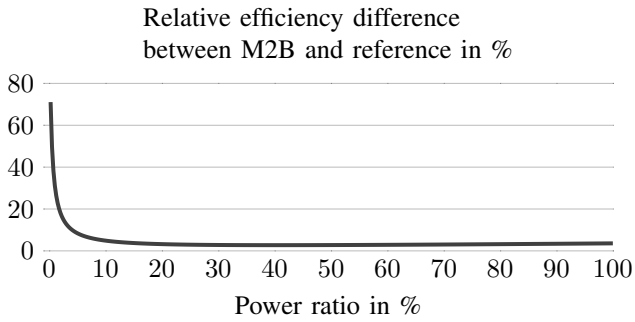

Figure 7: Relative efficiency difference between M2B and the reference system.

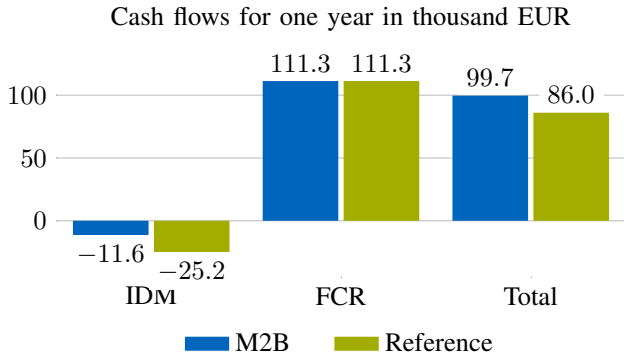

Figure 8: Cash flows for the M2B and reference converter topology for one year. With M2B’s efficiency, the BESS saves more than 53.9% on IDM transactions. Revenue for FCR is the same for both systems; they can reserve their prequalified power for the whole time. The IDM savings for M2B yield an increase in cash flow of 15.8%.

The reason for the cost savings is the higher efficiency of the M2B system, whereby differences in partial load operation especially come into play. Due to the higher efficiency, less energy is lost during charge and discharge. Hence, less energy needs to be purchased through IDM transactions to stay within the valid operating range. This leads to reduced costs and in turn to a higher annual cash flow.

We discount the cash flow for 20 years assuming that each year’s revenue is the same and use the NPV method to determine the time it takes for the project to become profitable. After ten years, the NPV is -284 909 EUR and -436 807 EUR for M2B and the reference, respectively.

Fig. 9 shows the NPV for every other year of operation. After 20 years, the reference accomplishes an NPV of 461 606 EUR. The M2B’s NPV is 797 957 EUR, which marks a relative increase of 72.9%.

IV. CONCLUSION

This paper quantifies the efficiency of the M2B topology and compares it to conventional converters, based on references from academic literature.

A low-level component simulation model is used to obtain the efficiency curve of the converter. The results reveal a higher efficiency compared to conventional converters, especially in partial-load operation. The high efficiency can be attributed to low switching frequency and using low-resistance MOSFETs as switches. Furthermore, the modularity of the M2B leads to a smaller switching voltage. Therefore, switching losses do not play a significant role. Conduction and circuit path resistances are the primary loss mechanisms for high powers, while system consumption is dominant for low powers.

Based on the obtained efficiency curve, we performed a case study for estimating the performance on a system level. For this, we simulated a BESS providing FCR and performing IDM transactions for one year two times: with the M2B inverter efficiency and with a reference efficiency representing an inverter with low load-independent and load-dependent losses. M2B’s efficiency yielded in better performance both technically and economically. The round-trip efficiency of the BESS with M2B efficiency was 90.7%, which is more than ten percentage points higher than the round-trip efficiency of the reference (79.6%). The M2B saves more than 50% on IDM transactions, which yielded in a cash flow increase of over 15% compared to the reference.

The simulations reveal that the M2B has a higher efficiency compared to conventional battery inverters. Especially the high partial-load efficiency can be attributed to the economic savings of the M2B for the FCR scenario.

V. OUTLOOK

Further work will focus on verifying the high efficiency with system measurements. Additionally, a comparison with state-of-the-art commercial converters is necessary. Statements about the impact on battery health of the M2B were not made within the scope of this work. Therefore, future work will also investigate longer simulation periods and impact on battery health. The economic performance for other applications such as peak shaving would also be an interesting topic. Lastly, future work can estimate the possible reductions of carbon emissions on a global scale.

ACKNOWLEDGMENT

The authors thank the Federal Ministry for Economic Affairs and Energy for their financial support via the EffSkalBatt project (FKZ: 03ET6148). The responsibility for the content of this publication lies with the authors.

Development of NPV over 20 years in thousand EUR

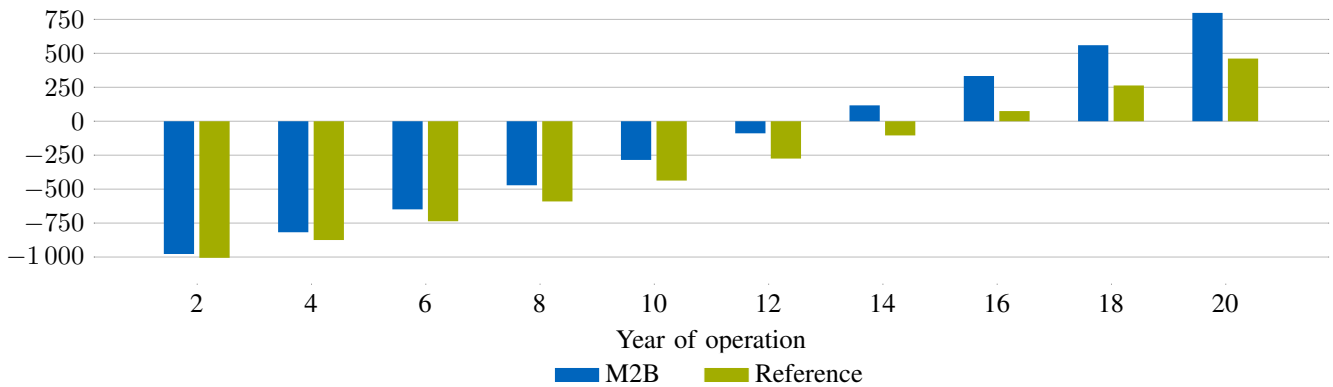

Figure 9: NPV for both inverter topologies for every other year of operation.

REFERENCES

[1] T. Soong and P. W. Lehn. "Evaluation of Emerging Modular Multilevel Converters for BESS Applications". In: *IEEE Transactions on Power Delivery* 29.5 (Oct. 2014), pp. 2086–2094. ISSN: 0885-8977. DOI: 10.1109/TPWRD.2014.2341181.

[2] G. Wang et al. "A Review of Power Electronics for Grid Connection of Utility-Scale Battery Energy Storage Systems". In: *IEEE Transactions on Sustainable Energy* 7.4 (Oct. 2016), pp. 1778–1790. ISSN: 1949-3029. DOI: 10.1109/TSTE.2016.2586941.

[3] Holger C. Hesse et al. "Lithium-Ion Battery Storage for the Grid—A Review of Stationary Battery Storage System Design Tailored for Applications in Modern Power Grids". In: *Energies* 10.12 (2017). ISSN: 1996-1073. DOI: 10.3390/en10122107.

[4] Silke Allebrod, Roman Hamerski, and Rainer Marquardt. "New transformerless, scalable Modular Multilevel Converters for HVDC-transmission". In: *2008 IEEE Power Electronics Specialists Conference*. IEEE, June 2008. DOI: 10.1109/pesc.2008.4591920.

[5] Michael Schimpe et al. "Energy efficiency evaluation of a stationary lithium-ion battery container storage system via electro-thermal modeling and detailed component analysis". In: *Applied Energy* 210 (Jan. 2018), pp. 211–229. DOI: 10.1016/j.apenergy.2017.10.129.

[6] Florian Helling et al. "The AC battery – A novel approach for integrating batteries into AC systems". In: *International Journal of Electrical Power & Energy Systems* 104 (2019), pp. 150–158. ISSN: 0142-0615. DOI: <https://doi.org/10.1016/j.ijepes.2018.06.047>.

[7] Arthur Singer et al. "A Novel, Scalable, Low-Cost and High-Efficiency Battery Storage System Topology". In: *The 13th International Renewable Energy Storage Conference 2019 (IRES 2019)*. Atlantis Press, 2019/11. ISBN: 978-94-6252-836-9. URL: <https://www.atlantis-press.com/article/125923334>.

[8] T. Okabe et al. "Characterization and Improvement of Power MOSFET Switching Loss". In: *INTELEC '83 - Fifth International Telecommunications Energy Conference*. Oct. 1983, pp. 508–513.

[9] A. Kersten, E. Grunditz, and T. Thiringer. "Efficiency of Active Three-Level and Five-Level NPC Inverters Compared to a Two-Level Inverter in a Vehicle". In: *2018 20th European Conference on Power Electronics and Applications (EPE'18 ECCE Europe)*. Sept. 2018, P.1–P.9.

[10] *MOSFET OptiMOS 5 Power-Transistor, 100 V. Data sheet*. Infineon Technologies AG, 2017, pp. 1–12. URL: <https://www.infineon.com/dgdl/Infineon-IPT015N10N5-DS-v02%7B%5C%7D01-EN.pdf?fileId=5546d4624a75e5f1014ac94680661aff> (visited on Jan. 22, 2020).

[11] Arthur Singer. "Evaluierung einer modularen Umrichtertopologie zur Kombination von Batteriesystemen, Balancing-Systemen, Umrichtern und Ladeschaltungen". German. Dissertation. München: Bundeswehr University Munich, 2019.

[12] G. Notton, V. Lazarov, and L. Stoyanov. "Optimal sizing of a grid-connected PV system for various PV module technologies and inclinations, inverter efficiency characteristics and locations". In: *Renewable Energy* 35.2 (Feb. 2010), pp. 541–554. DOI: 10.1016/j.renene.2009.07.013.

[13] Peter Stenzel, Wilfried Hennings, and Jochen Linssen. "Energiespeicher 2016". German. In: *BWK Energie* (May 1, 2016). URL: <https://www.ingenieur.de/fachmedien/bwk/energiespeicher/energiespeicher-2/>.

[14] Transnet BW. *Regelenergie Bedarf + Abruf*. 2020. URL: <https://www.transnetbw.de/de/strommarkt/systemdienstleistungen/regelenergie-bedarf-und-abruf#netz2014> (visited on Feb. 12, 2020).

[15] European Power Exchange SE. 2020. URL: <http://www.epexspot.com/en>.

[16] Deutsche Übertragungsnetzbetreiber. *regelleistung.net. Internetplattform zur Vergabe von Regelleistung*. 2020. URL: <https://www.regelleistung.net/ext/> (visited on Feb. 12, 2020).

[17] Johannes Fleer et al. "Price development and bidding strategies for battery energy storage systems on the primary control reserve market". In: *Energy Procedia* 135 (Oct. 2017), pp. 143–157. DOI: 10.1016/j.egypro.2017.09.497.

[18] Markus Förstl et al. "Assessment of residential battery storage systems and operation strategies considering battery aging". In: *International Journal of Energy Research* 44.2 (Nov. 2019), pp. 718–731. DOI: 10.1002/er.4770.

[19] Maik Naumann et al. "SimSES: Software for techno-economic Simulation of Stationary Energy Storage System". In: *Batterieforum Deutschland 2017*. Berlin: Unpublished, 2017. DOI: 10.13140/RG.2.2.13008.61449.

[20] Maik Naumann et al. "Analysis and modeling of calendar aging of a commercial LiFePO4/graphite cell". In: *Journal of Energy Storage* 17 (June 2018), pp. 153–169. DOI: 10.1016/j.est.2018.01.019.

[21] G.A. Rampinelli, A. Krenzinger, and F. Chenlo Romero. "Mathematical models for efficiency of inverters used in grid connected photovoltaic systems". In: *Renewable and Sustainable Energy Reviews* 34 (June 2014), pp. 578–587. DOI: 10.1016/j.rser.2014.03.047.