

Hochschule Geisenheim University

and

Justus Liebig University Giessen

Faculty 08 - Biology and Chemistry

**“Characterization, regulation and genetic
modification of the synthesis of aroma compounds
in non-conventional wine yeasts“**

Presented by

Jennifer Badura, M.Sc.

Born 1st July 1991

in Nastätten, Germany

Submitted in fulfilment of the requirements

for the degree of

Doktorin der Naturwissenschaften

(Doctor rerum naturalium, Dr. rer. nat.)

April 2023

Chair of the Examination Board: Prof. Dr. rer. hort. Heiko Mibus-Schoppe

1st Reviewer: Dr. rer. nat. Christian von Wallbrunn

2nd Reviewer: Prof. Dr. rer. nat. Martin Rühl

3rd Reviewer: Prof. Dipl.-Ing. Dr. nat. techn. Diethard Mattanovich

1st Examiner: Prof. Dr. agr. Doris Rauhut

2nd Examiner: Prof. Dr. rer. nat. Kai Thormann

Submitted: 5th April 2023

Date of defense 18th January 2024

The thesis was accepted on 18th January 2024 as a dissertation in fulfilment of the requirements for the degree Doktorin der Naturwissenschaften (Doctor rerum naturalium, Dr. rer. nat.) by Hochschule Geisenheim University and Faculty 08 - Biology and Chemistry, Justus-Liebig-University Giessen.

Parts of this thesis have been published in peer-reviewed journals as:

Badura, J.; van Wyk, N.; Brezina, S.; Pretorius, I. S.; Rauhut, D.; Wendland, J.; von Wallbrunn, C. (2021): Development of genetic modification tools for *Hanseniaspora uvarum*. In *Int. J. Mol. Sci.* 22 (4), 1943. DOI: 10.3390/ijms22041943.

Badura, J.; Medić, M.; van Wyk, N.; Krause, B.; Semmler, H.; Brezina, S. et al. (2023): Synthesis of aroma compounds as a function of different nitrogen sources in fermentations using non-*Saccharomyces* wine yeasts. In *Microorganisms* 11 (1), 14. DOI: 10.3390/microorganisms11010014.

Badura, J.; Kiene, F.; Brezina, S.; Fritsch, S.; Semmler, H.; Rauhut, D.; Pretorius, I. S.; von Wallbrunn, C.; van Wyk, N. (2023): Aroma profiles of *Vitis vinifera* L. cv. Gewürztraminer must fermented with co-cultures of *Saccharomyces cerevisiae* and seven *Hanseniaspora* spp. In *Fermentation* 9 (2), 109. DOI: 10.3390/fermentation9020109

van Wyk, N.; Badura, J.; von Wallbrunn, C.; Pretorius, I. S. (2023): Exploring future applications of the apiculate yeast *Hanseniaspora*. In *Crit. Rev. Biotechnol.* DOI: 10.1080/07388551.2022.2136565.

Parts of this thesis have been submitted to peer-reviewed journals as:

Badura, J.; van Wyk, N.; Zimmer, K.; Pretorius, I. S.; von Wallbrunn, C.; Wendland, J.: PCR-based gene targeting in *Hanseniaspora uvarum*. In *FEMS Yeast Research*.

Table of contents

Statutory declaration	1
Acknowledgments	2
Summary	6
Zusammenfassung	8
List of publications and awards	11
Introduction.....	14
Winemaking.....	14
Nitrogen in winemaking	16
Wine flavour	17
Flavour formation through fermentation	17
Ehrlich Pathway.....	19
Esters	20
Volatile fatty acids	21
Influence of nitrogen sources on wine flavour	22
Influence of non-conventional yeasts on wine flavour	23
The importance of <i>Hanseniaspora uvarum</i> in winemaking	24
The use of transcriptomics during wine fermentations	26
Possibilities of genetic modification	27
Structure and aims of the thesis.....	29
Characterization	31
Chapter 1 - Exploring future applications of the apiculate yeast <i>Hanseniaspora</i>	32
Chapter 2 - Aroma profiles of <i>Vitis vinifera</i> L. cv. Gewürztraminer must fermented with co-cultures of <i>Saccharomyces cerevisiae</i> and seven <i>Hanseniaspora</i> spp.	53
Chapter 3 - Synthesis of aroma compounds as a function of different nitrogen sources in fermentations using non- <i>Saccharomyces</i> wine yeasts	66
Regulation and genetic modification	94
Chapter 4 - Regulated gene expression of flavour relevant genes in <i>Hanseniaspora uvarum</i>	95

Chapter 5 - Development of genetic modification tools for <i>Hanseniaspora uvarum</i>	156
Chapter 6 - PCR-based gene targeting in <i>Hanseniaspora uvarum</i>	178
General conclusion.....	205
References	210

Statutory declaration

I declare that this thesis has been composed solely by myself, without the unpermitted aid of others, except where explicitly stated in the text. All text passages taken in letter or in spirit from published writings and all information based on oral statements are clearly referenced as such. I have adhered to the principles of good scientific practice as laid down in the Statutes of Hochschule Geisenheim University and Justus Liebig University Giessen to ensure good scientific practice in the studies I have carried out and which are referred to as such in the doctoral thesis.

Geisenheim, April 2023

Jennifer Badura

Acknowledgments

I would like to thank Dr. Christian von Wallbrunn for the opportunity being part of the AromaPlus project, for funding my research, his trust in me and for giving me the freedom to design and manage my project and my research! Thank you, Prof. Dr. Martin Rühl, for being my second supervisor! Thank you for our discussions and all your support! Thanks also to Prof. Dr. Diethard Mattanovich for preparing the third review for my thesis and for trying to save me from an unpleasant situation in Vancouver through a nice conversation!

A huge thank you also goes to Prof. Dr. Jürgen Wendland for his support and know-how in the implementation of the genetic engineering work, for proofreading my work and the countless discussions! Special thanks to Prof. Dr. Sakkie Pretorius for all his support, countless proofreading of various manuscripts over the years and for his translation into Afrikaans.

I would like to thank everyone involved in the AromaPlus project for the great discussions, support and encouragement! Thank you to all those involved from Justus Liebig University Giessen Holger Zorn, Martin Rühl, Svenja, Nadine, Julia, Marko and Carolin. My thanks also go to the project partners of Dechema Forschungsinstitut Frankfurt Markus Buchhaupt, Jens Schrader, Felix, Dascha, Parab and Laura! My special thanks go to my fellow HGU members, first of all Christine, Niël, Florian K., Florian M., Lisa, Angelika, Frauke, Tina, Otmar, Erika, Doris Rauhut and Christian von Wallbrunn.

My heartfelt thanks go to all the dear colleagues in our institute, including Heike, Kerstin, Stefano, Anja, Silvia, Beata, Stefanie, Hildegard, Judith, Katrin, Devarani, Carmen and Davies. Special thanks to my peers and friends Mareike and Beatrice for the long and intensive conversations, the motivating and comforting words and all the support! I would also like to thank the former staff members of our institute Steffen, Madina, Khavar, Georgia and Karolina, and especially my students Kathi L., Marko, Carla and Kathi B.

A very special thank you to my mentor Dr. Tatjana Wolf for our eye-to-eye conversations and all your support! It meant a lot to me and I grew mentally during this time and gained strength and self-confidence! I would also like to thank Dr. Arndt Griebel! Thank you for taking the time to talk to me, for helping me sort out my thoughts and for keeping my husband in check!

My diepste dankbaarheid betuig ek graag teenoor my werksteunpilaar, Dr Niël van Wyk, sonder wiese ondersteuning ek nie so ver sou kon vorder nie. Dankie dat jy altyd na my as persoon en na my navorsingprojek met soveel sorg omgesien het. Dankie dat ons saam oplossings kon vind wanneer ons voor skynbaar onoorkomentlike uitdagings te staan gekom

het, dat ons saam aan werkbare alternatiewe strategieë kon beplan, en dat jy my deurgaans bemoedig het en my in moeilike tye bygestaan en opgehef het. Jy het begrip vir my omstandighede gehad en my situasie met deernis verstaan; jy het my frustrasies gedeel en my daarvan weerhou om soms in 'n diep gat van moedeloosheid te verval. Ek sal altyd goeie herinneringe van ons koffie- en roomspouses hê, en van ons harde geswoeg in die laboratorium in die aande and oor naweke, ons gesprekke en besprekings in ons eie Duits/Engels/Afrikaans/Switserse werkstaal, en die ontelbare ure wat ons saam spandeer het om met probleemoplossings vorendag te kom. Uit die diepte van my hart sê ek dankie vir jou hulp, aanmoediging and ons produntiewe samewerking. Jy is een van die beste dinge wat met my tydens my PhD-studie kon gebeur het; jy is die rede hoekom ek nie van lotjie getik geraak het nie, maar aangehou het nie.

Ich möchte mich herzlich bei all meinen Freunden bedanken, die mich in den letzten Jahren kaum zu Gesicht bekommen haben und immer voller Verständnis und Unterstützung hinter mir standen! Danke an Johannes und Lena und deren Familien! Ich danke euch, dass ihr mir in den letzten Jahren immer Asyl gewährt habt und immer für mich da seid! Danke an Beate, Pia, Chrissy, Eva, Laura, Shelby & Mac, Mom, Dad, Karo und mein Patenkind Leo! Ich kann immer auf euch zählen und ihr seid für mich da, auch wenn uns hunderte oder tausende von Kilometern trennen.

Ich bin meiner Familie unendlich dankbar, für all die Unterstützung und das Verständnis! Danke, dass ihr an mich geglaubt habt! Mama, ich danke dir für die Weitergabe deiner kreativen Ader an mich und für deine tatkräftige Unterstützung in all meinen Plänen und Projekten in den letzten Jahren! Ich danke meinem Papa, meinem Vorbild, der mir eine unglaubliche intrinsische Motivation und Willenskraft vererbt hat. Durch dich habe ich gelernt, dass es selbstverständlich ist, gute Arbeit zu leisten und ein Scheitern gar nicht in Frage kommt. Ich möchte mich auch herzlich bei meiner lieben Schwiegermama Inge bedanken. Danke, dass du mich so lieb aufgenommen hast und ich immer auf dich zählen kann! Ich danke meinem Zwillingbruder Björn und seiner Frau Evelyn, die mir mit Matteo das größte Geschenk gemacht haben. Björn, wir sind typische Zwillinge, manchmal sind wir spinnefeind, aber wenn es darauf ankommt, halten wir zusammen! Evelyn, du bist die Schwester, die ich nie hatte! Du schaust mir nur in die Augen und weißt genau was los ist, wenn ich mal wieder zum Knuddeln und Spielen vorbeikomme. Ein ganz besonderer Dank gilt dem Kleinsten, Matteo! Ich danke dir für deine pure Liebe und Freude mir gegenüber und dass deine leuchtenden Augen mich immer auffangen! Ich möchte mich auch bei dem Rest meiner buckeligen Verwandtschaft für deren Unterstützung in all den Jahren bedanken, allen voran meinen Paten Alex, Nicole und Jürgen, sowie deren Familien!

Danke Opa! ♥

Der größte Dank gilt meinem Ehemann Andy! Ich danke dir von ganzem Herzen für deine bedingungslose Unterstützung, deine Liebe, dein Verständnis, deine Fähigkeit mich immer aufzumuntern, mich zum Lachen zu bringen, dass du immer mitgefiebert hast, meinen Schmerz geteilt hast und immer eine Lösung parat hattest! Danke, dass du mir den Weg ins Labor gewiesen hast und meinen Backup Plan somit zunichte gemacht hast! Ich liebe es! Danke, dass du auf mich achtest, mich zu meiner Freizeit zwingst und mich mit Essen und Getränken versorgst, wenn ich so in meine Arbeit versunken bin! Ich weiß, keiner hat gesagt, dass es schön wird, aber denk dran, du liebst mich! Ich danke dir für den persönlichen Weckdienst mit einem Kaffee jeden Morgen um 6 Uhr in den letzten Monaten des Schreibens. Danke, dass du mich am Leben gehalten hast!

Ich möchte mich von ganzem Herzen bei allen bedanken, die zum Gelingen meiner Arbeit beigetragen haben, auf die unterschiedlichsten Weisen. Ich weiß es sehr zu schätzen und bin euch unendlich dankbar!

I would like to say thank you from the bottom of my heart to everyone who has contributed to the success of my work, in many different ways. I appreciate it very much and I am infinitely grateful!

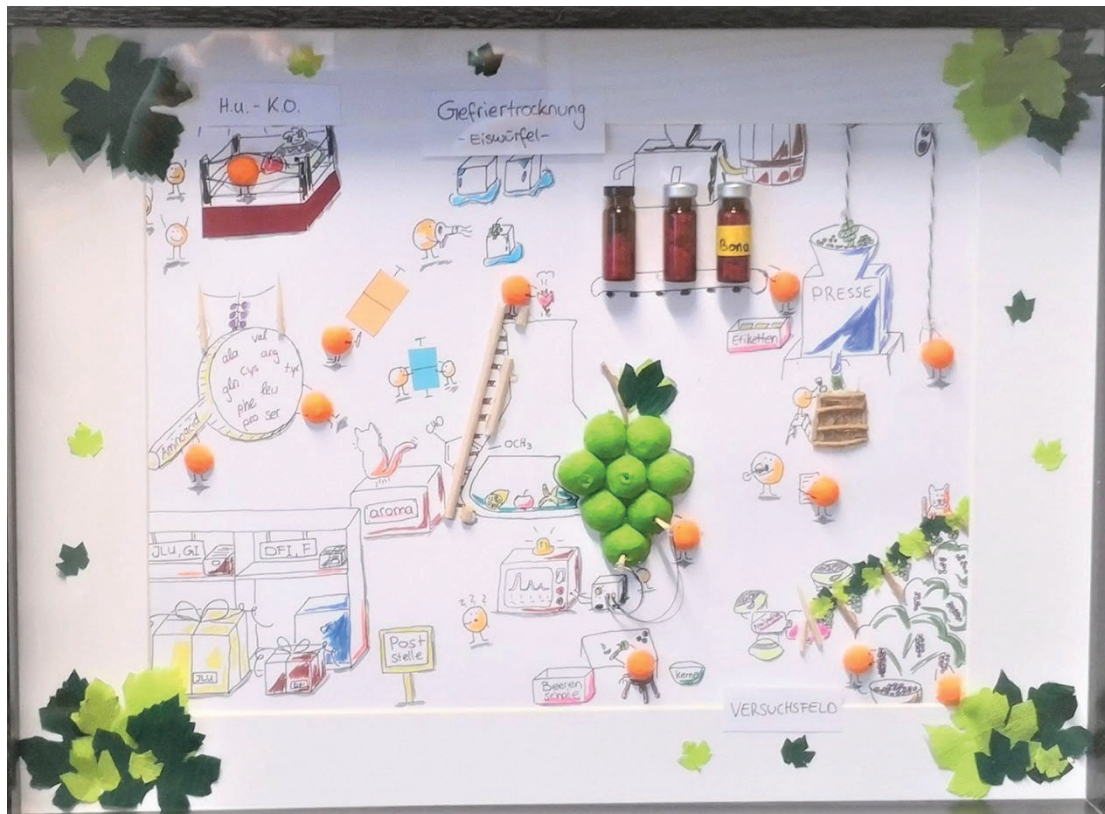

~ AromaPlus Project 2018-2022 ~

Summary

Yeasts belonging to the genus of *Hanseniaspora* are widespread in nature and are generally part of the microbiome of ripe fruits, such as apples, pears and grapes. *Hanseniaspora* spp. form 50-75% of the microorganisms found at the onset of grape must fermentations, *H. uvarum* often being the most abundant. *H. uvarum* is also a common isolate from other fruits, such as oranges, pineapples, mangoes, apples and pears. Since *H. uvarum*, known for producing high amounts of acetic acid and ethyl acetate, dominates the onset of spontaneous grape must fermentations, it greatly influences the aroma profile of wines. Besides its important role in fermentations, more biotechnological research has been reported in recent years, highlighting the universal value of *H. uvarum* beyond the beverage industry.

In this thesis, I characterized the aroma-production profile of seven different *Hanseniaspora* spp. in simultaneous co-fermentations with *Saccharomyces cerevisiae*. Significant differences could be detected between fermentations using *Hanseniaspora* spp. belonging to the fast-evolving lineage (FEL) and the slow-evolving lineage (SEL). Fermentations with yeasts of FEL showed increased amounts of ethyl acetate, whereas yeasts belonging to SEL revealed no meaningful difference compared to the pure *S. cerevisiae* fermentation. Furthermore, co-fermentations resulted in lactic acid depletion (*H. osmophila*), extremely high isoamyl acetate levels (*H. guilliermondii*), reduction in glycerol (*H. occidentalis*), increased terpenols (*H. opuntiae*) as well as esterified terpenes (*H. guilliermondii* and *H. uvarum*). This is the first study to investigate the use of *H. nectarophila* and *H. meyerii* in relation to wine, of which fermentations using *H. nectarophila* revealed high levels of acetate esters.

Nitrogen sources in form of amino acids have a major impact on the resulting aroma-production profile of yeasts as they serve as backbones for several volatile organic compounds. I explored amino acid uptake preferences of *Hanseniaspora* spp. of both lineages (*H. uvarum* = FEL; *H. osmophila* = SEL), *S. cerevisiae* (all glucophilic), as well as the fructophilic yeasts *Starmerella bacillaris* and *Zygosaccharomyces rouxii* in synthetic must, spiked with single amino acids. Among yeasts investigated, *H. uvarum* showed the most rapid amino acid uptake. Additional research on yeast fermentations with synthetic must supplemented with an amino acid mix resulted in amino acid-dependent synthesis of specific aroma compounds by the respective yeast. This study reveals similarities in both preferences in amino acid uptake and nitrogen source depending aroma compound synthesis of *H. osmophila* and *S. cerevisiae*.

I investigated the transcriptomic profile of *H. uvarum* and *S. cerevisiae* to gain insight into the different regulation mechanisms involved in the synthesis of aroma compounds. Furthermore, I explored the impact of different levels of nitrogen (nitrogen deficiency/ diammonium hydrogen

phosphate (DAHP) supplemented must) within the grape must on the gene expression profile and therefore on the resulting aroma profile. Even though the different nitrogen regimes did not significantly affect transcriptional levels, a major impact on both fermentation kinetics and the aroma profile could be monitored. *H. uvarum* unravelled possessing additional genes including alcohol acetyltransferase activity leading to a rapid esterification of higher alcohols to acetate esters. In addition, the lack of genes involved in the synthesis of higher alcohols and ethyl esters, as well as an up-regulation of genes responsible for the synthesis of acetyl-coA and acetate esters favour the high acetate ester production.

In this study, I developed the first genetic modification tool for *H. uvarum* by constructing a synthetic marker gene encoding the hygromycin marker under the control of a *H. uvarum* promoter, flanked by ~1 000 bp homology region to the target locus, enabling the knock-out of one copy of the alcohol acetyltransferase 1 (*ATF1*) gene. By increasing the concentration of the antibiotic during selection, I could identify a knock-out of both *ATF1* alleles in the diploid yeast, generating a homozygotic *atf1* mutant. Fermentations resulted in a significant reduction of the acetate ester synthesis, proving the function of *ATF1* as an important gene involved in the ester synthesis in *H. uvarum*.

Genetic modification of *H. uvarum* was optimized by establishing a rapid PCR-based gene targeting approach for one-step gene replacement. Generation of two novel synthetic antibiotic resistance genes (pFA-*hygXL* and pFA-*clnXL*) provided resistance against hygromycin and nourseothricin, respectively. Short flanking-homology regions of 56-80 bp added to these selection markers via PCR enabled gene targeting and the deletion of both the *H. uvarum* *LEU2* and *LYS2* genes via two rounds of consecutive transformations, generating a leucine auxotrophic *leu2//leu2* mutant and a lysine auxotrophic *lys2//lys2* mutant, respectively. The genetic modification approach of *H. uvarum* using PCR-based gene targeting was further validated by targeted complementation of the auxotrophic *leu2//leu2* strain.

Zusammenfassung

Hefen der Gattung *Hanseniaspora* sind in der Natur weit verbreitet und gehören im Allgemeinen zum Mikrobiom von reifen Früchten wie Äpfeln, Birnen und Trauben. *Hanseniaspora* spp. machen 50-75% der Mikroorganismen aus, die zu Beginn der Gärung von Traubenmost gefunden werden, wobei *H. uvarum* oft am häufigsten vorkommt. *H. uvarum* ist auch ein häufiges Isolat aus anderen Früchten, wie Orangen, Ananas, Mangos, Äpfeln und Birnen. Da *H. uvarum*, bekannt für die Herstellung großer Mengen an Essigsäure und Ethylacetat, den Beginn der spontanen Gärung von Traubenmost dominiert, haben sie großen Einfluss auf das Aromaprofil von Weinen. Neben ihrer wichtigen Rolle bei der Gärung wurde in den letzten Jahren auch über weitere biotechnologische Forschungen berichtet, die den universellen Wert von *H. uvarum* über die Getränkeindustrie hinaus unterstreichen.

In dieser Arbeit habe ich das Profil der Aromaproduktion von sieben verschiedenen *Hanseniaspora* spp. in simultanen Co-Fermentationen mit *Saccharomyces cerevisiae* charakterisiert. Es konnten signifikante Unterschiede zwischen Gärungen mit *Hanseniaspora* spp. der sich schnell entwickelnden Linie (FEL) und der sich langsam entwickelnden Linie (SEL) festgestellt werden. Gärungen mit Hefen der FEL zeigten erhöhte Mengen an Ethylacetat, während Hefen der SEL keinen signifikanten Unterschied im Vergleich zur reinen *S. cerevisiae*-Fermentation aufwiesen. Darüber hinaus führten Co-Fermentationen zu einem Abbau von Milchsäure (*H. osmophila*), zu extrem hohen Isoamylacetatwerten (*H. guilliermondii*), zu einer Verringerung des Glycerins (*H. occidentalis*), zu erhöhten Konzentration von Terpenolen (*H. opuntiae*) sowie zu veresterten Terpenen (*H. guilliermondii* und *H. uvarum*). Dies ist die erste Studie, in der die Verwendung von *H. nectarophila* und *H. meyerii* im Zusammenhang mit Wein untersucht wird, wobei bei der Gärung mit *H. nectarophila* ein hoher Gehalt an Acetatestern festgestellt wurde.

Stickstoffquellen in Form von Aminosäuren haben einen großen Einfluss auf das resultierende Aromaprofil von Hefen, da sie als Grundgerüst für mehrere flüchtige organische Verbindungen dienen. Ich untersuchte die Aminosäureaufnahmepräferenzen von *Hanseniaspora* spp. beider Linien (*H. uvarum* = FEL; *H. osmophila* = SEL), *S. cerevisiae* (alle glucophil) sowie der fructophilen Hefen *Starmerella bacillaris* und *Zygosaccharomyces rouxii* in synthetischem Most, der mit einzelnen Aminosäuren versetzt war. Von den untersuchten Hefen nahm *H. uvarum* die Aminosäuren am schnellsten auf. Weitere Untersuchungen von Hefegärungen mit synthetischem Most, dem ein Aminosäuremix zugesetzt wurde, ergaben eine aminosäureabhängige Synthese von spezifischen Aromastoffen durch die jeweilige Hefe. Diese Studie zeigt Ähnlichkeiten sowohl in den Präferenzen bei der Aminosäureaufnahme als

auch bei der von der Stickstoffquelle abhängigen Synthese von Aromastoffen bei *H. osmophila* und *S. cerevisiae*.

Ich untersuchte das Transkriptionsprofil von *H. uvarum* und *S. cerevisiae*, um Einblicke in die unterschiedlichen Regulierungsmechanismen bei der Synthese von Aromastoffen zu gewinnen. Darüber hinaus untersuchte ich die Auswirkungen unterschiedlicher Stickstoffgehalte (Stickstoffmangel/ mit Diammoniumhydrogenphosphat (DAHP) angereicherter Most) im Traubenmost auf das Genexpressionsprofil und damit auf das resultierende Aromaprofil. Obwohl die verschiedenen Stickstoffregime keinen signifikanten Einfluss auf die Transkriptionslevel hatten, konnte ein wesentlicher Einfluss sowohl auf die Fermentationskinetik als auch auf das Aromaprofil beobachtet werden. *H. uvarum* erwies sich als Träger zusätzlicher Gene, die eine Alkohol-Acetyltransferase-Aktivität aufweisen, welche eine schnelle Veresterung höherer Alkohole zu Acetatestern ermöglicht. Darüber hinaus begünstigt das Fehlen von Genen, die an der Synthese höherer Alkohole und Ethylester beteiligt sind, sowie eine Hochregulierung von Genen, die für die Synthese von Acetyl-CoA und Acetatestern verantwortlich sind, die hohe Acetatester-Produktion.

In dieser Studie habe ich das erste Werkzeug zur genetischen Veränderung von *H. uvarum* entwickelt, indem ich ein synthetisches Marker Gen konstruiert habe, welches für den Hygromycin-Marker unter der Kontrolle eines *H. uvarum*-Promotors kodiert, der von einer ~1000 bp großen Homologie Region zum Ziellokus flankiert wird und den Knock-out einer Kopie des Alkohol Acetyltransferase 1 (*ATF1*)-Gens ermöglicht. Durch die Erhöhung der Antibiotikakonzentration während der Selektion konnte ich einen Knock-out beider *ATF1*-Allele in der diploiden Hefe identifizieren, wodurch eine homozygote *atf1*-Mutante entstand. Die Fermentationen führten zu einer deutlichen Verringerung der Acetatester-Synthese, was die Funktion von *ATF1* als wichtiges Gen für die Ester-Synthese in *H. uvarum* beweist.

Die genetische Veränderung von *H. uvarum* wurde durch die Einführung eines schnellen PCR-basierten Gen-Targeting-Ansatzes für den Genaustausch in einem Schritt optimiert. Die Generierung von zwei neuen synthetischen Antibiotikaresistenzgenen (pFA-*hygXL* und pFA-*clnXL*) ermöglichte die Resistenz gegen Hygromycin bzw. Nourseothricin. Kurze flankierende Homologie Regionen von 56-80 bp, die mittels PCR an diese Selektionsmarker angefügt wurden, ermöglichten das Gen-Targeting und die Deletion der beiden *H. uvarum*-Gene *LEU2* und *LYS2* durch zwei aufeinanderfolgende Transformationen, wodurch eine Leucin- bzw. Lysin-auxotrophe Mutante entstand. Der Ansatz zur genetischen Veränderung von *H. uvarum* mittels PCR-basiertem Gen-Targeting wurde durch gezielte Komplementierung des auxotrophen *leu2/leu2*-Stammes validiert.

“The most beautiful thing we can experience is the mysterious.”

~ *Albert Einstein* ~

List of publications and awards

Peer-reviewed publications:

- (1) Development of genetic modification tools for *Hanseniaspora uvarum*
J. Badura, N. van Wyk, S. Brezina, I. S. Pretorius, D. Rauhut, J. Wendland, C. von Wallbrunn
Int. J. Mol. Sci. 2021, 22 (4), 1943
DOI: 10.3390/ijms22041943.
- (2) Synthesis of aroma compounds as a function of different nitrogen sources in fermentations using non-Saccharomyces wine yeasts
J. Badura, M. Medić, N. van Wyk, B. Krause, H. Semmler, S. Brezina, I. S. Pretorius, D. Rauhut, C. von Wallbrunn
Microorganisms 2023, 11 (1), 14
DOI: 10.3390/microorganisms11010014.
- (3) Aroma profiles of *Vitis vinifera* L. cv. Gewürztraminer must fermented with co-cultures of *Saccharomyces cerevisiae* and seven *Hanseniaspora* spp.
J. Badura, F. Kiene, S. Brezina, S. Fritsch, H. Semmler, D. Rauhut, I. S. Pretorius, C. von Wallbrunn, N. van Wyk
Fermentation 2023, 9 (2), 109
DOI: 10.3390/fermentation9020109
- (4) N. van Wyk, J. Badura, C. von Wallbrunn, I. S. Pretorius
Exploring future applications of the apiculate yeast *Hanseniaspora*
Crit. Rev. Biotechnol. 2023, pp. 1-20
DOI: 10.1080/07388551.2022.2136565.

Conference contributions:

Presentations:

- (1) Transcriptional regulation of the synthesis of aroma compounds in non-conventional wine yeasts
J. Badura
Young Scientists Conference Food Biotechnology, DECHEMA, Summer School in Hohenheim 2019
- (2) Development of Genetic Modification Tools for *Hanseniaspora uvarum*
J. Badura, N. van Wyk, I. S. Pretorius, J. Wendland, C. von Wallbrunn
ICY 15 meets 30 ICYGMB (International Congress on Yeasts meets International Conference on Yeast Genetics and Molecular Biology) 2021
- (3) Transcriptional regulation of the synthesis of aroma compounds in non-conventional wine yeasts

J. Badura, N. van Wyk, S. Brezina, I. S. Pretorius, D. Rauhut, J. Wendland, C. von Wallbrunn

2nd Wine Graduates Forum - 64. International DWV-Congress 2022

- (4) *Hanseniaspora* in wine-making: Their genetic modification and potential role in acid modulation

N. van Wyk, J. Badura, S. Scansani, I. S. Pretorius, D. Rauhut, C. von Wallbrunn

In Vino Analytica Scientia – Neustadt 2022 – Analytical Chemistry for Wine, Brandy and Spirits

Posters:

- (1) Transcriptional regulation of the synthesis of aroma compounds in non-conventional wine yeasts

J. Badura, C. von Wallbrunn

Young Scientists Conference Food Biotechnology, DECHEMA, Summer School 2019

- (2) Transcriptional regulation of the synthesis of aroma compounds in non-conventional wine yeasts

J. Badura, N. van Wyk, S. Brezina, I. S. Pretorius, D. Rauhut, J. Wendland, C. von Wallbrunn

2. Geisenheimer Forschungsforum der Hochschule Geisenheim University 2021

- (3) Synthesis of aroma compounds as a function of different nitrogen sources in fermentations of non-Saccharomyces yeasts

J. Badura, M. Medić, S. Brezina, D. Rauhut, C. von Wallbrunn

ISSY 36 (36th International Specialised Symposium on Yeasts: Yeast in the genomics era) 2022

- (4) Synthesis of aroma compounds as a function of different nitrogen sources in fermentations of non-Saccharomyces yeasts

J. Badura, M. Medić, S. Brezina, D. Rauhut, C. von Wallbrunn

Bioflavour 2022: Biotechnology of Flavours, Fragrances and Functional Ingredients, DECHEMA, Frankfurt 2022

Awards:

- (1) Transcriptional regulation of the synthesis of aroma compounds in non-conventional wine yeasts

J. Badura, C. von Wallbrunn

Poster award for the best scientific poster at the Young Scientists Conference Food Biotechnology, DECHEMA, Summer School 2019

“The greatest reward for our efforts is not what we get for them, but what we become because of them.”

~ *John Ruskin* ~

Introduction

Winemaking

Fermentation has been used in the preparation of food and beverages for thousands of years. Originally, fermentation was used to prepare or preserve food. Archaeological discoveries in China indicate the fermentative production of alcoholic beverages from fruits around 7 000 BC (McGovern et al. 2004). Wine is one of the earliest fermented products and remains popular among consumers to this day. Excavation sites from Egypt evidence the everyday production and use of wine around 4 000 BC. At that time, the cultivation of grapes as well as winemaking seemed to have been advanced and an important part of the culture (Poo 2013).

Alcoholic beverages such as beer and wine have always been very popular. In the Middle Ages, for instance, between the 6th and 15th centuries, beer and wine were more popular for hygienic reasons, as they were considered cleaner than the water available (Unger 2004; Woolgar 2010). The widespread popularity of wine and beer prompted a more detailed research of the yeasts responsible for alcoholic fermentation in the 19th and 20th centuries. In 1873, Louis Pasteur elucidated the bioconversion of grape must into wine, leading to extensive research of this complex process and the yeasts involved (Pasteur 1873). In the early 19th century, the genus name *Saccharomyces* appeared for the first time, describing fermentation yeasts (Meyen 1839). In 1879, Louis Pasteur developed methods for keeping beer free from contaminating moulds and bacteria (Pasteur 1876; Pasteur and Faulkner 1879). Emil Christian Hansen, working at the Carlsberg Laboratory in Copenhagen, developed methods to cultivate single colonies and isolated the first pure culture yeast, known as *S. carlsbergensis* (Hansen 1883, 1896), while Øjvind Winge, who also worked at Carlsberg Laboratory in Copenhagen, elucidated the sexual cycle of *S. cerevisiae* (Winge 1935). Inspired by the work of Hansen, Julius Wortmann, founder of the 'Hefereinzuchtstation', 1894 in Geisenheim, Germany (nowadays called 'Geisenheim Yeast Breeding Center'), promoted the use of pure yeasts in winemaking in the early 1890s (Wortmann 1895). The first two active dried wine yeasts (ADWY) were commercially produced in 1965 (Degré 1993).

The production of wine is a complex process, where the grapes are harvested, destemmed and crushed prior to fermentation. A distinction is made between white wine and red wine production. In white wine production, the crushed berries are then macerated, pressed mechanically and the clarified must is fermented by microorganisms, more precisely by *S. cerevisiae* (Pretorius 2000). In general, yeasts convert the sugar present in the grape must into ethanol and carbon dioxide in a process called alcoholic fermentation (Racker 1974). At

the end of fermentation, the yeast cells flocculate and settle on the bottom, forming a sediment called lees. The fermentation supernatant is then decanted, clarified, matured, stabilised and finally filtered and bottled. Red wine is made in a similar way, but here the alcoholic fermentation already occurs after crushing and thus before pressing (Pretorius 2000). After pressing, a malolactic fermentation can take place if desired, where excess malic acid is converted to lactic acid primarily through the action of lactic acid bacteria. With the knowledge that yeasts are responsible for alcoholic fermentation, it is possible for winemakers to control the winemaking process from vineyard to bottling. Traditional winemaking is based on the use of the microflora of the grapes, the vineyard and the winery, so-called spontaneous fermentations. For larger, industrial production, however, it is essential to achieve consistent quality of the wine. For this, a basic understanding of the biology of yeasts and their fermentation process is of great importance. Spontaneous fermentations complicate the production of good quality wines. Therefore, yeasts with improved properties were selected and added to fermentations by Hermann Müller-Thurgau around 1890 as pure yeast cultures, enabling the production of predictable and reliable wines and improving both the quality (smell and taste of wine) and quantity (allowing industrial production scales of wine in large quantities) in winemaking (Pretorius 2000; Pretorius et al. 2003). Selection criteria for yeasts were the ability to quickly and completely convert sugars to ethanol and carbon dioxide, preventing stuck or sluggish fermentations, and sensory important metabolites without the appearance of off-flavours (Pretorius 2000). This refers primarily to *Saccharomyces cerevisiae*, the so-called wine yeast, as it is a very strong fermenter and known to produce high amounts of ethanol (Rainieri and Pretorius 2000). Furthermore, sulphur dioxide (SO₂) was added to the fermentations, since non-*Saccharomyces* yeasts are known to have a low tolerance to SO₂, unlike *S. cerevisiae* (Jolly et al. 2014). In addition to *Saccharomyces* strains, some non-conventional starter cultures have become commercially available in recent years (Roudil et al. 2020; van Wyk et al. 2021). In 2004, the first starter cultures including both *S. cerevisiae* and non-*Saccharomyces* yeast strains, i.e. *Kluyveromyces thermotolerans* or *Torulaspota delbrueckii*, provided by Chr. Hansen Holding A/S, came to the market (Roudil et al. 2020). These starter cultures with different yeast combinations are offered for both white and red wine, resulting in a more complex, fruity wine aroma. Between 2007 and 2018, several companies released pure non-*Saccharomyces* starter cultures, containing non-*Saccharomyces* yeast genera belonging to *Candida* spp., *Schizosaccharomyces* spp., *Pichia* spp., *Wickerhamomyces* spp., *Metschnikowia* spp., *Lachancea* spp., *Kluyveromyces* spp. and *Torulaspota* spp. (Roudil et al. 2020). Recently, a starter culture of *Hanseniaspora vineae* has become commercially available under the name Fermivin VINEAE supplied by Oenobrand (van Wyk et al. 2021; Carrau and Henschke 2021).

Nitrogen in winemaking

The nitrogen status of the vine can be influenced by various factors, such as the cultivar and/or rootstock, site – climate and soil, season, cultural practices, trellis system, canopy shading, canopy temperature, and nitrogen fertilization, timing and rate of application, as well as by infections, such as *Botrytis* infection (Bell and Henschke 2005). The total nitrogen concentration of grape berries increases during maturing, can plateau after initial increase and may decline towards the end of ripening (Bell and Henschke 2005). The nitrogen content in grape berries plays a major role in winemaking, since its management prevents stuck or sluggish fermentations (Bisson 1999). It is not only essential for the growth of yeasts to complete the alcoholic fermentation, but also provides the basic backbone for the production of many important aroma-relevant compounds (Mas et al. 2014). The yeast assimilable nitrogen (YAN) describes the nitrogen within grape must utilized by microbiota. YAN consists of ammonium ions (NH_4^+), and free amino nitrogen (FAN) derived from individual amino acids, as well as, to a lesser extent, small peptides, excluding the abundant amino acid L-proline as the yeasts are unable to assimilate these under anaerobic conditions. In general, the total amino acid concentration increases from veraison to harvest, but in some cases, it reaches a peak prior to harvest, and stabilizes or declines until harvest, whereas the ammonium concentration declines during maturing (Bell and Henschke 2005). YAN is taken up by the yeasts at the beginning of fermentation to meet the demand for amino acids necessary for growth and protein synthesis, while excess amounts of YAN are stored in the cell vacuole (Henschke and Jiranek 1993). YAN levels below 140 mg/L are considered insufficient for successful completion of the fermentation (Bell and Henschke 2005). A lack of assimilable nitrogen leads to lower yields of biomass resulting in slower fermentation rates (Varela et al. 2004), which in turn bears the risk of stuck or sluggish fermentations (Alexandre and Charpentier 1998). The addition of inorganic nitrogen, such as diammonium phosphate (DAP), to the grape must can prevent nitrogen deficiency and the associated risk of stuck fermentations. Furthermore, the supplementation with inorganic nitrogen may have a positive impact on the reduced formation of undesirable volatile sulphur compounds (Jiranek et al. 1995; Bell and Henschke 2005). Excessive YAN levels, however, can lead to an increase in biomass yield as well as higher fermentation vigour related heat output, microbial instability, increased haze formation, increased biogenic amine levels, increased synthesis of ethyl acetate and volatile acidity, and could also favour atypical aging properties (Bell and Henschke 2005).

It is known that climate change has a great influence on the chemical composition of grape musts due to warmer climates and the associated longer maturing periods. In addition to the associated increase in sugar content (van Leeuwen and Destrac-Irvine 2017), higher

temperatures and limited irrigation also lead to reduced production of amino acid levels in the grape berries (Gutiérrez-Gamboa et al. 2018; Gutiérrez-Gamboa et al. 2020).

Wine flavour

The flavour of the wine is a key element in contributing towards the quality of wine. Wine flavour is very complex due to the interaction of chemical compounds with the consumers' sense of taste and smell. Volatile compounds create the odour while non-volatiles are responsible for the taste impression, such as sweetness or sourness. Hundreds of different compounds form the flavour of wine with concentrations ranging from 10^{-1} to 10^{-10} g/kg (Rapp and Mandery 1986).

The flavour is shaped by four main factors: the grape's own varietal aromas, the so-called primary aroma; pre-fermentative flavours, as they arise from the extraction and processing of the must; fermentative flavours caused by yeasts and lactic acid bacteria during alcoholic and malolactic fermentation (secondary aromas) and post-fermentative flavours (tertiary aromas or bouquet). The latter can result from maturation in vessels made of wood, primarily oak, concrete or stainless steel, for instance, with changes in the wine's composition depending on the maturing time. However, the post-fermentative flavours of the wine are affected by enzymatic or physiochemical processes that occur on contact with wood during ageing, leading to a typical woody note (Lambrechts and Pretorius 2000). Moreover, these post-fermentative flavours can be influenced by exposure to light, oxygen and high storage temperatures (Garde-Cerdán and Ancín-Azpilicueta 2006).

Flavour formation through fermentation

The volatile substances that are formed by yeasts during fermentation represent the largest proportion of volatile compounds in wine. Besides ethanol, carbon dioxide and glycerol, the major volatiles produced by yeasts, the "fermentation bouquet" is mainly contributed by organic acids, higher alcohols, esters as well as aldehydes (Figure 1; Figure 2; Rapp and Versini 1995; Sumbly et al. 2010).

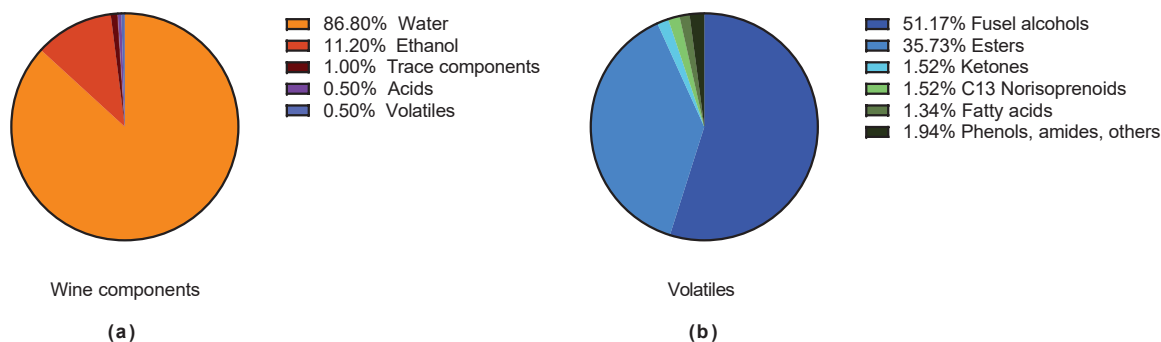

Figure 1. Chemical composition and average quantities of major components in (a) wine and (b) volatile compounds of wine. The values vary between the wine type and the extraction technique. All components are represented as weight per volume (w/v), with ethanol being equivalent to 14% (v/v). Tannins would be present at 0.4% in red wine (modified from Sumbly et al. (2010)).

Esters are of particular relevance due to their low aroma threshold (Swiegers and Pretorius 2005). However, if individual substances of this fermentation bouquet occur in too high concentrations, they are quickly considered as undesirable and are called off-flavours. These include acetic acid, ethyl acetate, higher alcohols, aldehydes, diacetyl and especially sulphur-containing compounds (Lambrechts and Pretorius 2000). The aroma profile of the wine is mainly affected by the yeast strain used for fermentation, e.g. wines produced with yeast strains demanding greater nitrogen, show higher concentrations of esters, while those demanding less nitrogen, show increased levels of higher alcohols (Pérez-Coello et al. 1999; Torrea et al. 2003). Besides the wine yeast *S. cerevisiae*, however, non-*Saccharomyces* yeasts, the so-called non-conventional yeasts, add to the diversity of aroma compounds and to a complex aroma profile of wines (Figure 2; Domizio et al. 2011). These non-conventional yeasts dominate the microflora on grapes in vineyards and are thus also the predominant yeast species found at the beginning of spontaneous grape must fermentations, such as *Hanseniaspora*, *Metschnikowia* and *Candida* (Heard and Fleet 1985; Lema et al. 1996; Combina et al. 2005). Since the first days of fermentation are crucial for the formation of volatile compounds, the non-conventional yeasts have a great influence on the aroma of the wine. In order to control the fermentation process and thus also the formation of aroma components in winemaking, pure culture yeasts are often added at the beginning of fermentation. These starter cultures, as well as adding SO₂, inhibit the growth of non-conventional yeasts and thus prevent the occurrence of off-flavours.

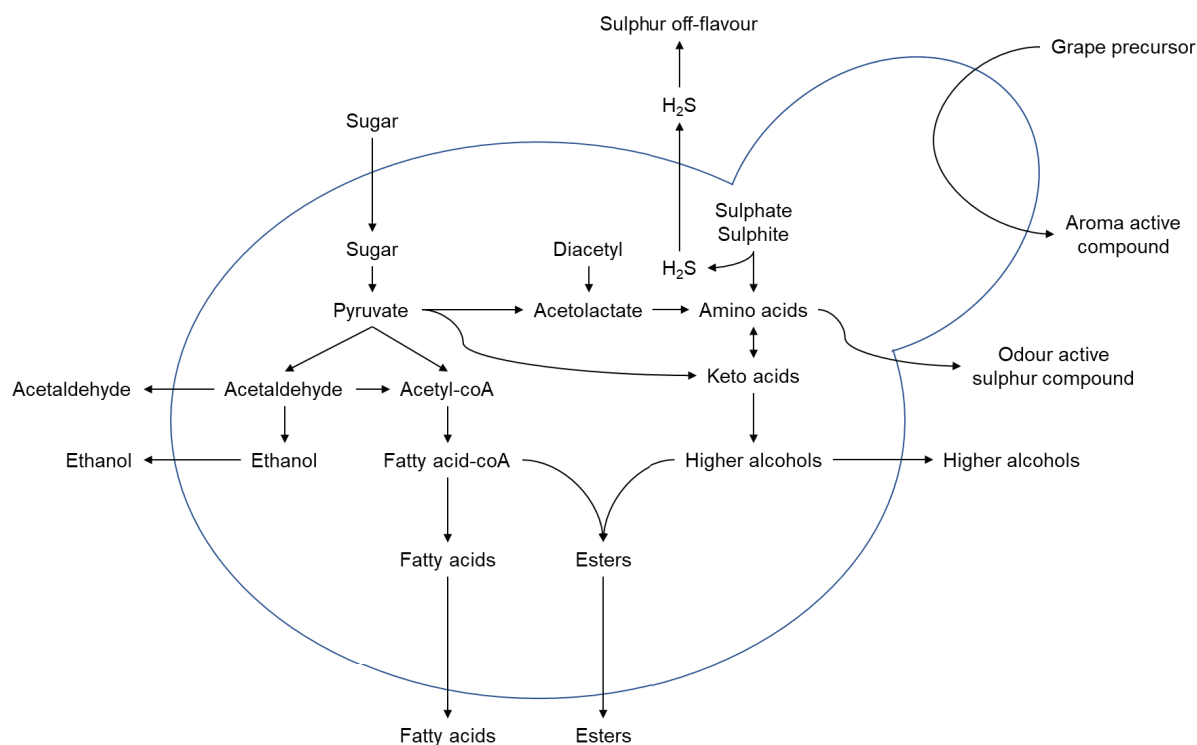

Figure 2. Scheme of the synthesis of aromatic compounds by yeasts contributing to the aroma profile of wines (modified from Lambrechts and Pretorius (2000)).

Ehrlich Pathway

Higher alcohols, containing a backbone with more than two C-atoms, form the largest component of volatile compounds. They are produced via two synthesis pathways during alcoholic fermentation in the yeast cells. In the catabolic Ehrlich pathway, named after the biochemist Felix Ehrlich (Ehrlich 1907), amino acids are broken down to higher alcohols via three successive reactions, a transamination of the amino acid to an α -keto acid, decarboxylation into aldehydes and finally reduction to higher alcohols (Figure 3, Dzialo et al. 2017). Anabolically, higher alcohols can be generated from the α -keto acid pyruvate, which is produced from glucose through glycolysis. Research showed that the process of both the catabolic and anabolic pathways are depending on the YAN level in form of amino acids available during fermentations (Äyräpää 1971; Schulthess and Ettliger 1978). Low amino acid levels lead to the synthesis of higher alcohols through the anabolic pathway, while higher amino acid levels favour the process of the catabolic pathway. Higher alcohols are categorised into two groups, namely aliphatic alcohols, including e.g. propanol, isoamyl alcohol, isobutanol and 2-methylbutanol, and aromatic alcohols, such as 2-phenyl ethanol and tyrosol (Lambrechts and Pretorius 2000). Concentrations of higher alcohols below 300 mg/L have a positive impact on the aroma and complexity of the wine, whereas contents exceeding 400 mg/L negatively affect the aroma profile (Rapp and Mandery 1986). Besides the nitrogen source, also the temperature affects the synthesis of higher alcohols. Fermentations with *S.*

cerevisiae performed at 15 °C show a higher production of isobutanol, isoamyl alcohol and 2-methyl butanol, whereas higher amounts of 2-phenyl ethanol were detected in fermentations conducted at 28 °C (Molina et al. 2007). Besides higher alcohols, fusel acids, so-called volatile organic acids, can be derived from aldehydes through the Ehrlich pathway. This oxidative reaction is catabolized by aldehyde dehydrogenases. While higher alcohols simply diffuse into the medium, the acids are released from the cell via active transporters (Hazelwood et al. 2008). Hereby, the redox status of the cell determines whether higher alcohols or volatile organic acids are formed. In the case of anaerobic fermentative conditions, as found in grape must fermentations, the production of higher alcohols is favoured (Vuralhan et al. 2003).

Esterification of higher alcohols enables the formation of the respective acetate esters by condensation of the higher alcohol and a coenzyme-A activated acid (acetyl-CoA), catalysed by an alcohol acetyltransferase (Verstrepen et al. 2003; Sumbly et al. 2010). Besides the higher alcohols, also branch-chain acids can be formed through Ehrlich Pathway by oxidation of the aldehydes (Dickinson et al. 1997). Acyltransferases are involved in the synthesis of ethyl esters using acyl-CoA and ethanol (Saerens et al. 2008).

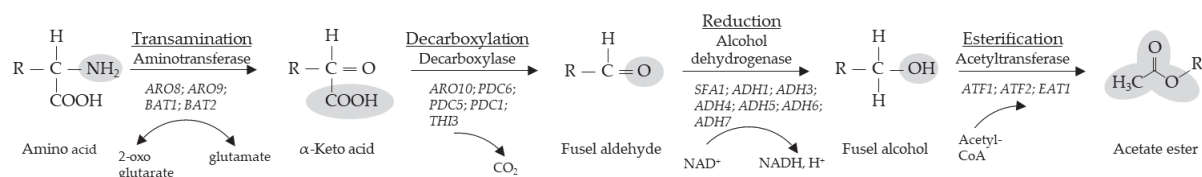

Figure 3. Synthesis of aroma compounds via Ehrlich Pathway including additional esterification. Conversion of amino acids into fusel aldehydes, fusel alcohols and acetate esters. Enzymes and encoding genes known in *S. cerevisiae* to catalyze the reactions are indicated. Specific molecular groups are highlighted (modified from Badura et al. (2023b)).

Esters

Grape musts already contain small amounts of esters. During alcoholic fermentation, however, the concentrations of ethyl esters and acetate esters increase in parallel with the ethanol concentration (Rapp and Mandery 1986). Even if esters remain below a concentration of 100 mg/L in general, they form the next largest group of volatiles present in wines, after ethanol, organic acids and higher alcohols (Etiévant 1991; Sumbly et al. 2010), forming the primary source of fruity aroma compounds (Gürbüz et al. 2006). Therefore, they significantly contribute to the character of young wines. Many of the esters derived from higher alcohols contribute a fruity note to the aroma profile of the wine, such as isoamyl acetate or hexyl acetate (Ebeler 2001; Gürbüz et al. 2006). Others are known to quickly develop a strong solvent-like odour in higher concentrations and tend to spoil the wine. Besides a fruity aroma, in lower concentrations, ethyl acetate, which is the main ester formed by yeasts, is characterised by this solvent-like odour occurring particularly in excess concentrations. Production of esters, not

only depends on the different yeast species, but is also influenced by the temperature of fermentation. Low fermenting temperatures are known for their positive effect on the ester production, in form of isoamyl acetate, isobutyl acetate, ethyl butyrate or hexyl acetate, regarding its quantity and thus contributing to the typical fruity and soapy aroma of esters (Killian and Ough 1979; Molina et al. 2007). In contrast, higher fermentation temperatures lead to the increased production of more aromatic, “heady” esters, such as ethyl octanoate, 2-phenylethyl acetate or ethyl decanoate (Killian and Ough 1979).

Since the concentrations of esters have an enormous influence on the quality of the wine, it is particularly important to understand the synthesis of the esters. Esters are obtained from the reaction of functional groups of alcohol and carboxylic acid under the elimination of a water molecule. Esterification occurs mainly via alcohol-O-acetyltransferases, encoded by *ATF1*, *ATF2* and *EAT1* (Figure 3) or acyltransferases, catalysed by *EHT1* and *EEB1* in *S. cerevisiae*, resulting in acetate and ethyl esters, respectively. While acetate esters, such as ethyl acetate and isoamyl acetate, are comprised of an acid group (acetate) and an alcohol group (ethanol or higher alcohol), ethyl esters, such as ethyl hexanoate, ethyl octanoate and ethyl decanoate, are solely derived from ethanol and medium-chain fatty acids (Saerens et al. 2008). It is assumed, that acetate esters of higher alcohols, ethyl esters of organic esters (C₄-C₁₀ ethyl esters) as well as ethyl esters derived from fatty acids (mainly straight chain fatty acids, branched-chain fatty acids to a lesser extent) are the main compounds responsible for the fruity aroma of wine (Ebeler 2001).

In addition to the amount of esters already developed in grapes, esters are formed both enzymatically during fermentation and chemically through esterification during the ageing process of bottled wine (Margalit 2012). In addition to acetyltransferases and acyltransferases, esters can also be catalysed enzymatically by esterases and lipases (Sumbly et al. 2010). Among the esters produced enzymatically, ethyl acetate occurs in the highest concentrations (Margalit 2012). In low concentrations with an odour threshold value of 7.5 mg/L, ethyl acetate has a fruity character (at ≤100 mg/L; Swiegers and Pretorius 2005; Sumbly et al. 2010). However, if the concentration exceeds 100 mg/L, the fruity note quickly changes to a penetrating, solvent/nail varnish-like odour (Swiegers and Pretorius 2005).

Volatile fatty acids

Besides volatile organic acids derived through the Ehrlich pathway, yeasts also produce volatile fatty acids contributing to the aroma profile of wines. While short-chain fatty acids, such as acetic acid, propanoic acid and butanoic acid, are by-products of fermentation, long-chain fatty acids (C₁₆ and C₁₈) serve as precursors, essentially for the synthesis of many lipid components within yeasts. Long-chain fatty acids are usually found as esters, e.g. of glycerol

or sterols (Paltauf et al. 1992), with unsaturated long-chain fatty acids being an integral part of the yeast plasma membrane. Therefore, these fatty acids are normally not appearing as yeast derived products in wine (Lambrechts and Pretorius 2000). Medium-chain fatty acids, such as hexanoic acid, octanoic acid or decanoic acid, however, which are intermediate products of the biosynthesis of long-chain fatty acids, as well as their ethyl esters, occur naturally in alcoholic beverages. The amount of medium-chain fatty acids released to the fermentation supernatant varies depending on the yeast strain, the mediums' composition as well as fermentation conditions, such as pH, temperature and aeration (Lambrechts and Pretorius 2000).

Fatty acid synthesis in yeasts proceeds through several successive enzyme-catalysed steps. First, acetyl-coA is oxidatively decarboxylated from pyruvate and then converted into malonyl-coA by acetyl-coA carboxylase. In the fatty acid synthase complex, saturated fatty acids are then formed by repetitive condensation of enzyme-bound acetyl-CoA and malonyl-CoA (Paltauf et al. 1992). Acetyl-coA is replaced by propionyl-coA in the production of odd numbered fatty acids. Double bonds are introduced into saturated fatty acids in an oxidative desaturation step catalysed by a fatty acid desaturase, forming long-chain, mono-unsaturated fatty acids. Under oxygen limiting conditions, as found in wine fermentations, yeasts are dependent on the uptake of essential exogenous unsaturated fatty acids or ergosterol (Lambrechts and Pretorius 2000).

Influence of nitrogen sources on wine flavour

YAN is not only affecting yeast growth and fermentation kinetics, but it can also influence the regulation of other yeast metabolisms, such as those involved in the synthesis of volatile and non-volatile metabolites contributing to the wine flavour (Garde-Cerdán and Ancín-Azpilicueta 2008; Badura et al. 2023b). Both the amount of nitrogen and the type of nitrogen source have a significant influence on the aroma profile of the wine (Albers et al. 1996). The synthesis of branched-chain fatty acids and esters in *S. cerevisiae* is favoured by lower nitrogen concentrations, whereas higher nitrogen concentrations lead to the formation of medium-chain fatty acids and acetic acid, depending on the type of nitrogen source present (Mas et al. 2014; Torrea et al. 2011). Furthermore, a correlation between the synthesis of higher alcohols and the YAN level is observed. Higher alcohols such as tyrosol, isoamyl alcohol and 2-phenyl ethanol are produced proportionally to the initial amount of YAN in the must, while propanol and isobutanol are produced in an inverse proportion (Garde-Cerdán and Ancín-Azpilicueta 2008). Among the different aroma-relevant compounds synthesized during alcoholic fermentation, volatiles such as acetate and ethyl esters, higher alcohols, medium-chain fatty acids as well as branched-chain acids are the ones the most affected by the nitrogen source

present within the grape must. Since various amino acids serve as backbones for the volatile aroma compounds formed, the aroma profile of the wine strongly depends on the amino acid composition of the grape must. However, the supplementation of inorganic nitrogen, such as DAP, leads to a higher production of esters like ethyl propionate, isoamyl acetate or ethyl acetate in grape must fermentations (Miller et al. 2007; Unterfrauner et al. 2009; Bell and Henschke 2005). The presence of moderate ammonium levels favours the inhibition of hydrogen sulphide (H₂S) production during alcoholic fermentation (Jiranek et al. 1995). The addition of amino acids to double its initial concentration in grape must fermentations, reduces the levels of 2-phenyl ethanol, methionol and isoamyl alcohol, whereas it leads to an increasing level of propionic acid, γ -butyrolactone and isobutanol (Hernández-Orte et al. 2005). The nitrogen dependent production of aroma compounds is especially reflected in the sensory aroma profile of the wines. Low nitrogen wines show less floral/ fruity aroma, moderate nitrogen wines are well balanced in desirable and less desirable aromas, and high nitrogen wines are either related to an acetic/ solvent character or high floral/ fruity attributes (Torrea et al. 2011).

Influence of non-conventional yeasts on wine flavour

For a long time, non-conventional yeasts were considered to be spoilage yeasts whose metabolites had a negative impact on the taste and quality of the wine (Jolly et al. 2014). Therefore, in the past, the growth of non-conventional yeasts, and thus, their influence in winemaking was inhibited by the addition of pure culture yeasts (Andorrà et al. 2010) and the supplementation of SO₂ (Jolly et al. 2014). In recent years, non-conventional wine yeasts have increasingly become the focus of research because of the benefits they contribute to the quality of wine (Gil et al. 1996; Jolly et al. 2003a; Wang et al. 2016). The metabolites produced by these yeasts in mixed fermentations with *S. cerevisiae* contribute to the complexity of the wine (Domizio et al. 2011; van Wyk et al. 2019). Also the amount of aroma compounds produced differs between the yeast species (Herraiz et al. 1990; Sponholz and Dittrich 1974).

Wine yeasts are not only found in the vineyard soil or on the surface of ripe, intact grape berries but are also part of the natural flora of wine cellars, having an oenological impact on wine fermentations, especially at the onset of fermentations as well as in spontaneous fermentations (Martini 1993). In addition to *S. cerevisiae*, which only represents a small proportion, the microflora of grape berries mainly includes non-*Saccharomyces* yeasts such as the largely aerobic yeasts belonging to *Pichia* spp., *Debaryomyces* spp., *Rhodotorula* spp., and *Candida* spp. or yeasts with fermentative metabolism, such as *Kluyveromyces marxianus*, *Torulasporea delbrueckii*, *Metschnikowia pulcherrima*, and *Zygosaccharomyces bailii* as well as the apiculate yeasts with low fermentative activity *Hanseniaspora uvarum*, *H. guilliermondii*, and *H. occidentalis* (Jolly et al. 2014). Yeasts of the genus *Hanseniaspora* (asexual anamorph

Kloeckera) are likely to have a major influence in spontaneous fermentations. They are the most common yeasts found at the onset of grape must fermentations representing more than half of the yeast flora on grape berries (Pretorius et al. 2017) and up to 75% of the yeast population in the early stages of spontaneous grape must fermentations (Jolly et al. 2003a; Romano et al. 2006). Therefore, as the predominant yeast species in grape must, *Hanseniaspora* spp. are expected to have a major impact on subsequent wine fermentations and the resulting wine quality (Jolly et al. 2003b). At the beginning of fermentations, mainly spontaneous fermentations, where the initial concentration of *S. cerevisiae* is very low, the non-*Saccharomyces* yeasts dominate. In the progress of the fermentation, however, *S. cerevisiae* takes over and finishes the fermentation (Di Maro et al. 2007; Moreira et al. 2008). The dominance at the beginning of wine fermentations allows non-conventional yeasts to influence the quality of the wine (Romano et al. 1997; Rojas et al. 2001). The use of non-*Saccharomyces* yeasts in winemaking can result, for instance, in the reduction of acetic acid (Bely et al. 2008) or malic acid (Snow and Gallander 1979), the increase of glycerol (Ciani and Ferraro 1996), mannoproteins (Domizio et al. 2014), pleasant acetate esters (Moreira et al. 2008; Viana et al. 2009) and varietal thiols (Anfang et al. 2009).

Nevertheless, research has shown that it is possible for non-conventional yeasts to persist to the end of a fermentation despite the dominance of *S. cerevisiae* (Jolly et al. 2003a). It is assumed that non-conventional yeasts are inhibited in their tendency to spoilage by modification through metabolites produced by *S. cerevisiae* (Ciani and Comitini 2011). Excessive ethanol contents can mask the aroma of wine (Guth and Sies 2002). It is assumed that non-conventional yeasts can influence the ethanol content, which could be an alternative to expensive physical processes such as reverse osmosis, adsorption, distillation, extraction and others, involving the risk of loss or modification of aroma compounds (Longo et al. 2017; Liguori et al. 2019; Sam et al. 2021). Lower alcohol wines are becoming more popular with consumers and their demand on the market is increasing, leading to growing interest in the development of wine yeasts for the production of low alcohol wines by the wine industry (de Barros Lopes et al. 2003).

The importance of *Hanseniaspora uvarum* in winemaking

Hanseniaspora uvarum is a lemon-shaped apiculate yeast, closely related to the genera of *Nadsonia* and *Saccharomycodes* (Martin et al. 2018). Yeasts of the species *Hanseniaspora* are distributed widely. *H. uvarum* are mainly found on ripe fruit. They are among the most commonly-isolated yeasts from grapes (Drumonde-Neves et al. 2021). Accordingly, in addition to grapes, *H. uvarum* also belongs to the microflora of oranges (Arias et al. 2002), pineapples (Dellacassa et al. 2017), mangoes (Ramírez-Castrillón et al. 2019), apples and pears (Pelliccia

et al. 2011). They are also found in fermentations of beer, tequila and coffee beans, where they contribute positively to the aroma (van Wyk et al. 2023). In recent years, an increasing number of biotechnological applications of *H. uvarum* have been reported, including its use as a biocontrol agent (Long et al. 2007), for the removal of nitrogen from waste water systems (Zhang et al. 2018) or for the development of fly traps (Bueno et al. 2020).

H. uvarum is considered to be a slow-fermenting yeast, which often gets dominated by *Saccharomyces* yeasts. But it has been reported that the inoculation of *Saccharomyces* yeast not necessarily led to an inhibition of the growth of *H. uvarum* (Heard and Fleet 1985; Lema et al. 1996). They are able to grow both aerobically and anaerobically and have been detected throughout the fermentation process (Zott et al. 2008) and can even persist until the end of the fermentation (Lema et al. 1996). In that case, they compete with *Saccharomyces* yeasts for nutrients, thus leading to an inhibited fermentation activity, and continue to produce aroma-relevant compounds, such as higher alcohols and esters. The growth of non-conventional yeasts is often inhibited by increasing ethanol concentrations. *H. uvarum*, in contrast, shows increased ethanol tolerance in low temperature fermentations (10-15 °C; Heard and Fleet 1988). Furthermore, *H. uvarum* is capable of producing up to ~10% ethanol itself, so the impact of high ethanol concentrations in the must on its growth is unclear (Grangeteau et al. 2015; Akan et al. 2020; Feng et al. 2021).

H. uvarum is known for its high synthesis of ethyl acetate (Ciani et al. 2006), acetic acid as well as acetaldehyde (Romano et al. 2003). Concentrations of higher alcohols, serving as precursors for esterification, remain low in pure *H. uvarum* fermentations (Moreira et al. 2008). *H. uvarum* may also contribute to the aroma profile of wines, due to increased production of isoamyl acetate (Moreira et al. 2008), polyphenols (Testa et al. 2021), 2-phenylethyl acetate and terpineol (López et al. 2016), as well as decreased production of ethanol (Mestre et al. 2019) and volatile acidity (Tristezza et al. 2016). Furthermore, *H. uvarum* shows high potential in reducing biogenic amines, such as putrescine, in wines (Han et al. 2022).

Yeasts belonging to the genus *Hanseniaspora* are divided into two main lineages: the fast-evolving lineage (FEL), the so-called 'fruit clade' and the slow-evolving lineage (SEL), the so-called 'fermentation clade' (Steenwyk et al. 2019). Members of FEL, such as *H. uvarum* and *H. nectarophila*, are mostly adapted to fruit niches, while members of SEL, such as *H. vineae* or *H. osmophila*, are known for their fermentation capabilities. Yeasts belonging to *Hanseniaspora*, especially belonging to the FEL, are lacking genes involved in the DNA repair pathways, such as genes responsible for cell-cycle-checkpoints (Steenwyk et al. 2019). The loss of cell-cycle checkpoint genes could indicate a rapid growth advantage over competitors. A possible link to the lack of sporulation as described for *H. uvarum*, remains unestablished (Albertin et al. 2015). Recently published studies show similarities in metabolism between

yeasts of the SEL and *S. cerevisiae* (Lleixà et al. 2018; Valera et al. 2020; Badura et al. 2023b). However, yeasts belonging to FEL seem to behave differently in their metabolism than *S. cerevisiae* (Valera et al. 2020). The activity of pyruvate kinase, a key enzyme within glycolysis, shows to be ~10-fold lower in *H. uvarum* than in *S. cerevisiae*, for instance, suggesting that this may be a reason for its low fermentative capacity (Langenberg et al. 2017).

The use of transcriptomics during wine fermentations

Metabolic pathways as well as the genes involved are very well studied in *Saccharomyces* yeasts. In non-conventional yeasts, however, this knowledge is limited (Carrau et al. 2015; Masneuf-Pomarede et al. 2015). Since the latter ones are known for their great potential in aroma synthesis during winemaking, elucidating the genes involved in these metabolic pathways are of particular value. The impact of non-conventional yeasts on the complexity of the aroma profile of wines can be analysed by multidisciplinary studies, consisting of genetic studies, metabolomic studies and transcriptomic studies. In recent years, genomes of *Hanseniaspora* spp. relevant to wine have been sequenced via next generation sequencing (Giorello et al. 2014; Sternes et al. 2016; Seixas et al. 2019). Genomic studies along with functional gene analysis are an important fundamental for clarifying gene functions. Combining genetic studies with transcriptomics allows drawing precise conclusions about the individual functions of genes and their role in metabolism (Giorello et al. 2019). Transcriptomics technologies enable the research of the transcriptome, the expression profile of genes, more precisely the sum of all ribonucleic acid (RNA) transcripts within an organism. Research on transcriptomics can provide fundamental information about the activity of cellular processes, their regulation and reveals information about the function of unknown genes. The most commonly used transcriptomic technologies include the quantification of predetermined sequences, the so-called microarrays (Nelson 2001), and RNA-Seq, in which all transcripts are recorded by means of high-throughput screening (McGettigan 2013).

Such multidisciplinary studies performed with *H. vineae* revealed the identification of six novel proteins with alcohol acetyltransferase (AATase) domains, as well as the absence of a branched-chain amino acid transaminase (*BAT2*) and an acyl-CoA/ ethanol O-acyltransferase (*EEB1*) gene, which is in accordance with its extremely high levels of acetate esters and the decreased synthesis of branched-chain higher alcohols, fatty acids, and ethyl esters, respectively (Giorello et al. 2019). Besides the high relevance for the elucidation of aroma-relevant metabolic pathways, these multidisciplinary studies also provide insights into other important processes in winemaking. Just recently, a study has been published showing the high potential of *H. uvarum* as a promising strategy to reduce biogenic amines in wines (Han et al. 2022).

Possibilities of genetic modification

Genetic modification is essential for gene-to-function analyses. This involves, for instance, the insertional inactivation or complete deletion of genes, their regulated expression or overexpression, localization of gene products via GFP-fusion or the study of mutations in genes or alleles. For each yeast species, a genetic modification toolkit is required in order to carry out these studies.

Since metabolic pathways of non-conventional yeasts have not been extensively studied, knowledge on their role in wine related fermentations is still rudimentary. Genetic modification of candidate genes, putatively involved in important metabolic pathways such as glycolysis or aroma synthesis, can elucidate their function and their contribution to wine fermentations.

Overexpression of a gene occurs through the change of the transcriptional regulation of the gene expression. This is often achieved by placing the gene of interest under the transcriptional control of a promoter known to be strongly expressed. The overexpression is usually done in combination with the insertion of a selection marker. This can be an auxotrophic selection marker or a dominant selection marker, e.g. an antibiotic resistance, for selecting genetically modified strains. The deletion of a gene, the so-called knock-out, is also achieved by using selection markers. For each deleted gene, a selection marker is needed replacing the gene of interest. Usually, only one gene can be deleted per transformation step. The higher the ploidy of the yeast strain, *i.e.* the more alleles there are, the more different selection markers are required. When using removable selection markers, flanked by repeat sequences, the selection marker integrated into the genome can be recycled by homologous recombination-based “loop out” (Walker et al. 2003). In general, two main transformation methods for genetic modification of yeasts are established. One option is the transformation of chemically competent yeast cells for introducing exogenous DNA. Chemical transformation is done using lithium acetate/single-strand DNA/polyethylene glycol 4000 (Gietz and Schiestl 2007). Another approach is the transformation of electrocompetent yeast cells by electroporation (Thompson et al. 1998). In both cases, the cell wall of the yeast cells is permeabilised so that exogenous DNA can be introduced into the cell. The DNA used for transformation can either be a plasmid containing an autonomous replication sequence allowing propagation or a linear DNA sequence flanked by homology regions to the target locus, which is integrated into the genome via homologous recombination (Bergkessel and Guthrie 2013).

These genetic modification tools are well established in *S. cerevisiae*. There are libraries of all the viable deletion strains available to e.g. determine genes with wine relevant functions, such as genes involved in the aroma synthesis or ethanol production. The latter is especially important for *S. cerevisiae* since it is known for its strong fermentative capacity producing high amounts of ethanol. Genetic modification of *Saccharomyces* wine yeasts has been attempted

in a number of ways (Schuller and Casal 2005; Cebollero et al. 2007), with two genetically modified wine yeast strains having been approved for use in the winemaking industry by the Food and Drug Administration (FDA) in the United States of America (van Wyk et al. 2021). The genetically modified yeast ML01 is able to transport malate and convert it to lactate due to the insertion of two heterologous genes: a malolactic conversion gene from *Oenococcus oeni* and a malate transport gene from *Schizosaccharomyces pombe* (Volschenk et al. 1997; Husnik et al. 2006). This was the first time that *S. cerevisiae* could be used for a meaningful malolactic fermentation, eliminating the need for lactic acid bacteria (Husnik et al. 2006). Apart from being approved for commercial winemaking in the USA in 2003 and in Canada in 2006, Moldova is the only country in Europe to allow its use. ECMo01, the second authorized yeast strain, is a self-cloned strain containing an extra copy of the urea amidolyase gene *DUR1,2*, which catalyses the hydrolysis of urea, enabling this strain to degrade urea consistently (Coulon et al. 2006). ECMo01 has been approved for use in the USA and Canada since 2006.

Several genetic modification methods have been developed for non-conventional yeast, such as *Debaryomyces* spp. (Minhas et al. 2009), *Metschnikowia* spp. (Moreno-Beltrán et al. 2021), *Torulaspota* spp. (Hernandez-Lopez et al. 2003), *Kluyveromyces* spp. (Spencer et al. 2002; van Ooyen et al. 2006), *Pichia* spp. (Peña et al. 2018), *Candida* spp. (Gola et al. 2003) or *Ashbya gossypii* (Wendland et al. 2000). However, genetic modification tools are not well established for most non-conventional yeasts commonly found in winemaking, including *Lachancea* spp., *Starmarella* spp., and *Hanseniaspora* spp. The development of genetic modification tools for *Hanseniaspora* spp. helps elucidating similarities in the metabolism of *Hanseniaspora* spp. belonging to SEL and *S. cerevisiae*, as well as determining differences between FEL and *S. cerevisiae*. Initial studies on the genetic modification of *H. uvarum* have been carried out, using plasmids containing autonomous replicating sequences from the species (Bink 2010). Nevertheless, until the beginning of this thesis, no reliable transformation system has been developed for yeasts belonging to the genus of *Hanseniaspora*.

Structure and aims of the thesis

In the past, the demand on yeasts for wine fermentation was to completely convert the grape sugar into ethanol and carbon dioxide, without producing off-flavours. All these properties have been found in the so-called wine yeast *Saccharomyces cerevisiae*, which is why there have been many studies to elucidate the various metabolic pathways of this species. In recent decades, more and more studies have been published on the use of non-*Saccharomyces* yeasts, the non-conventional yeasts, in co-fermentations with *S. cerevisiae* in winemaking. They are known for contributing to a more complex aroma profile of wines due to their abilities in increasing volatile organic compound levels and lowering ethanol concentrations. Yeasts belonging to the genus of *Hanseniaspora* have been considered spoilage yeasts for a long time, especially *H. uvarum*, which is the most abundant found at the beginning of spontaneous grape must fermentations. *H. uvarum* is well-known for the synthesis of high levels of acetaldehyde, acetic acid and ethyl acetate, exceeding the odour threshold of these compounds, leading to a penetrant, solvent-like smell and taste of the wine. More promising research on biotechnological uses of *H. uvarum* have been published in the past few years, demonstrating the universal potential of this yeast species and highlighting the importance of the scientific investigation of metabolic pathways, as well as their regulation and genetic modification.

One aim of this thesis was the characterization of the synthesis of aroma compounds in non-conventional wine yeasts, focussing on yeast species belonging to the genus of *Hanseniaspora*. Characterizing the aroma synthesis of non-conventional yeasts is an important basis for further research into the individual metabolic pathways and the elucidation of their regulatory mechanisms. **Chapter 1**, “Exploring future applications of the apiculate yeast *Hanseniaspora*”, provides a comprehensive overview about the use of *Hanseniaspora* spp. in winemaking, its impact on co-fermentations with *S. cerevisiae* in terms of aroma formation, and its role in other biotechnological applications. In **Chapter 2**, the impact of seven *Hanseniaspora* spp. on the aroma profiles of wines derived from co-fermentations with *S. cerevisiae* was investigated. The resulting aroma profiles allow a precise characterization of the respective *Hanseniaspora* spp. revealing information about their influence on the amount of volatile compounds in the wine, such as acids, higher alcohols, esters or terpenes. The amount of yeast assimilable nitrogen as well as the type of nitrogen source has a significant influence on the aroma synthesis during the fermentation of the grape must by the yeasts. Rising temperatures due to climate change as well as lacking irrigation not only influence the sugar content of the berries, but also the nitrogen levels in the grapes. Consequently, in

addition to the amount of ethanol produced during fermentation, the variety and amount of aroma compounds in the final wine product is also affected. In **Chapter 3**, “Synthesis of aroma compounds as a function of different nitrogen sources in fermentations using non-*Saccharomyces* wine yeasts”, fundamental insight into the preferences of amino acid uptake of *S. cerevisiae* and various non-conventional yeasts (glucophilic yeasts: *H. uvarum* and *H. osmophila*, fructophilic yeasts: *Starmerella bacillaris* and *Zygosaccharomyces rouxii*), respectively, by synthetic must fermentations supplemented with an amino acid mix is provided. Furthermore, synthetic must fermentations spiked with single amino acids using *H. uvarum*, *H. osmophila* and *Z. rouxii*, enabled a characterization of the amino acid-dependent synthesis of aroma compounds by these yeasts. By using members of different lineages found within the *Hanseniaspora* spp., as well as both *Saccharomyces* yeasts and fructophilic non-conventional yeasts, differences and similarities could be elaborated allowing a classification of *Hanseniaspora* yeast strains.

The aroma profiles of wines produced by *S. cerevisiae* strains differ significantly from those made with non-conventional yeast strains. Research on the transcriptional profile of aroma relevant metabolisms in yeasts is essential for understanding their regulatory mechanisms during grape must fermentations. In **Chapter 4**, multidisciplinary studies containing genomics, metabolomics and transcriptomics unravel the time point of aroma formation during grape must fermentations with *H. uvarum* and *S. cerevisiae*, as well as differences in the expression levels, and thus, the regulation of genes involved in the synthesis of aroma compounds. In addition, fermentations using grape must containing different ammonia concentrations revealed potential variations in both the gene expression levels and the resulting aroma profile.

While gene functions as well as their role in various metabolisms are well studied within the *Saccharomyces* yeast strains, most of this information is still lacking in non-conventional wine yeasts, such as *H. uvarum*. In **Chapter 5**, the development of genetic modification tools for *H. uvarum*, based on the use of a selection marker, encoding for an antibiotic resistance gene, flanked with long homology regions, is reported. Thus, enabling the identification of genes essential for the synthesis of aroma compounds, as well as their impact on the phenotype in terms of winemaking. A PCR-based approach on the genetic modification of *H. uvarum*, as described in **Chapter 6**, “PCR-based gene targeting in *Hanseniaspora uvarum*”, simplifies the time-consuming generation of selection markers. The inability of *H. uvarum* to form viable spores complicates both the identification of gene-to-function and yeast breeding. Therefore, the establishment of a second selection marker is essential for genetically modifying diploid yeast strains, such as *H. uvarum*.

Characterization

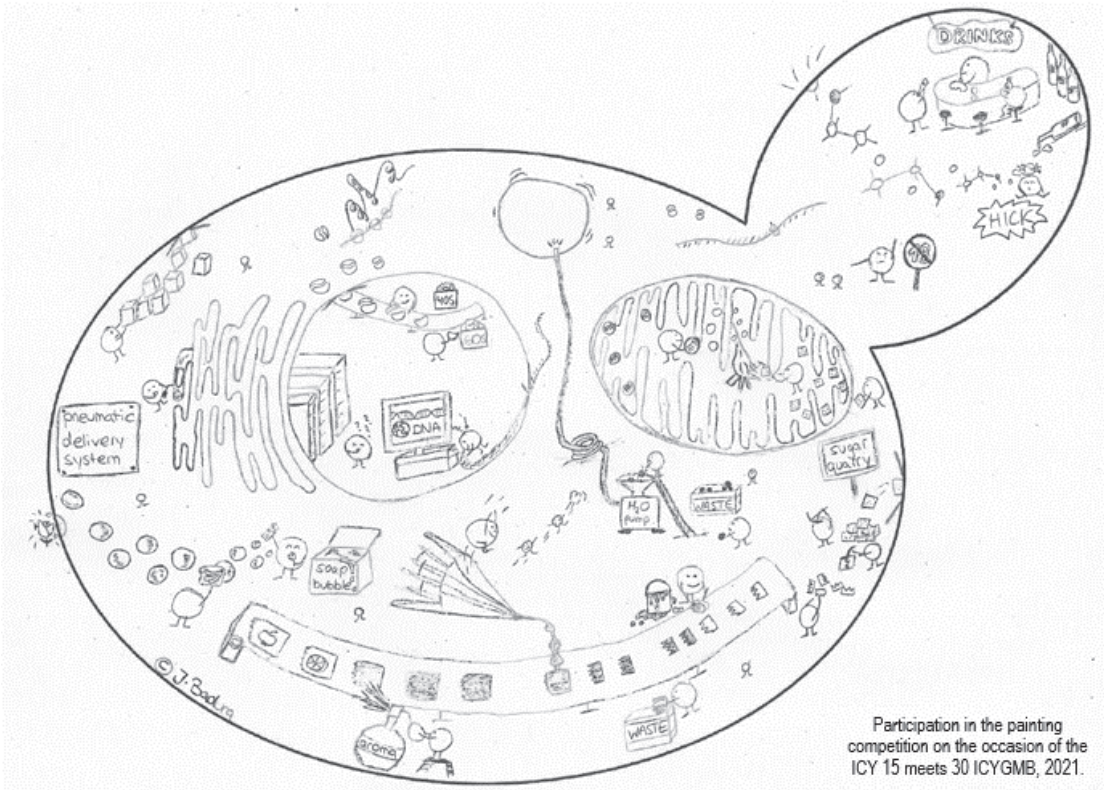

~ Characterizing the synthesis of aroma compounds in non-conventional wine yeasts ~

Chapter 1 - Exploring future applications of the apiculate yeast *Hanseniaspora*

Chapter 1 is based on the following peer-reviewed publication:

van Wyk, N.; Badura, J.; von Wallbrunn, C.; Pretorius, I. S. (2023): Exploring future applications of the apiculate yeast *Hanseniaspora*. In *Crit. Rev. Biotechnol.*, pp. 1-20. DOI: 10.1080/07388551.2022.2136565.

Author contributions:

Conceptualization: NvW, ISP

Funding acquisition: ISP

Visualization: **JB**, ISP



Supervision: ISP, CvW

Writing – original draft: NvW

Writing – review & editing: **JB**, NvW, CvW, ISP

All authors have read and agreed to the accepted version of the manuscript.

Exploring future applications of the apiculate yeast *Hanseniaspora*

Niël van Wyk^{a,b} , Jennifer Badura^a , Christian von Wallbrunn^a , and Isak S. Pretorius^b 

^aDepartment of Microbiology and Biochemistry, Hochschule Geisenheim University, Geisenheim, Germany; ^bARC Centre of Excellence in Synthetic Biology, Macquarie University, Sydney, Australia

ABSTRACT

As a metaphor, lemons get a bad rap; however the proverb ‘if life gives you lemons, make lemonade’ is often used in a motivational context. The same could be said of *Hanseniaspora* in wine-making. Despite its predominance in vineyards and grape must, this lemon-shaped yeast is underappreciated in terms of its contribution to the overall sensory profile of fine wine. Species belonging to this apiculate yeast are known for being common isolates not just on grape berries, but on many other fruits. They play a critical role in the early stages of a fermentation and can influence the quality of the final product. Their deliberate addition within mixed-culture fermentations shows promise in adding to the complexity of a wine and thus provide sensorial benefits. *Hanseniaspora* species are also key participants in the fermentations of a variety of other food-stuffs ranging from chocolate to apple cider. Outside of their role in fermentation, *Hanseniaspora* species have attractive biotechnological possibilities as revealed through studies on biocontrol potential, use as a whole-cell biocatalyst and important interactions with *Drosophila* flies. The growing amount of ‘omics data on *Hanseniaspora* is revealing interesting features of the genus that sets it apart from the other Ascomycetes. This review collates the fields of research conducted on this apiculate yeast genus.

ARTICLE HISTORY

Received 24 July 2022
Revised 16 September 2022
Accepted 24 September 2022

KEYWORDS

Hanseniaspora; fermentation; wine; biocontrol; whole-cell biocatalyst; aroma; *Drosophila*

Introduction

In Pasteur’s sketches and notes on the early stages of a grape must fermentation he observed small, lemon-shaped yeast cells that he named *Saccharomyces apiculatus*, which disappeared as fermentation progressed and were replaced with bigger, round-shaped yeast cells [1]. The term ‘lemon-shaped’ is not often used to describe ‘wine yeast’ (i.e., members of the *Saccharomyces* genus) and it is evident that Pasteur observed what we now call *Hanseniaspora* (Figure 1). The lemon-shape denotes the bipolar budding that is a distinctive feature of the apiculate yeast which, besides *Hanseniaspora*, also include the related genera of *Nadsonia*, *Saccharomycodes* and *Wickerhamia*. *Hanseniaspora* yeasts are widely known for their prevalence on ripe fruits, following a comprehensive survey cataloguing yeast isolation campaigns from several continents and vinicultural settings and spanning decades [2]. Although the majority of isolation studies were conducted in wine milieu, *Hanseniaspora* spp. are also commonly isolated from apple and pear cider [3–6], as well as from a variety of other fruits [7–10]. Not just

their prevalence, but their general abundance is quite noteworthy, as at least 50–75% of the general yeast population at the onset of a grape must fermentation can be comprised of members of the *Hanseniaspora* genus [11,12]. One species in particular is that of *H. uvarum*, which is generally considered to be the most commonly-isolated yeast from grapes [2]. In general, *Hanseniaspora* spp. are not good fermenters and are often dominated by fermenting yeast belonging to the *Saccharomyces* genus. Assessing the influence that *Hanseniaspora* can have on a fermentation is complex and dependent on many variables.

There is a stark contrast in the trajectories of scientific interest in *Hanseniaspora* and *Saccharomyces*, the most common and the most important yeast genera found in must, respectively. *Saccharomyces* is by far the best-studied yeast. Not only because it is the main player in beer, wine and bread production, along with myriad other biotechnological applications, but these studies laid the groundwork for our fundamental understanding of how a eukaryotic cell operates [13]. With *Hanseniaspora*, research has been focused on its

CONTACT Isak S. Pretorius  sakkie.pretorius@mq.edu.au

© 2023 The Author(s). Published by Informa UK Limited, trading as Taylor & Francis Group.
This is an Open Access article distributed under the terms of the Creative Commons Attribution-NonCommercial-NoDerivatives License (<http://creativecommons.org/licenses/by-nc-nd/4.0/>), which permits non-commercial re-use, distribution, and reproduction in any medium, provided the original work is properly cited, and is not altered, transformed, or built upon in any way.

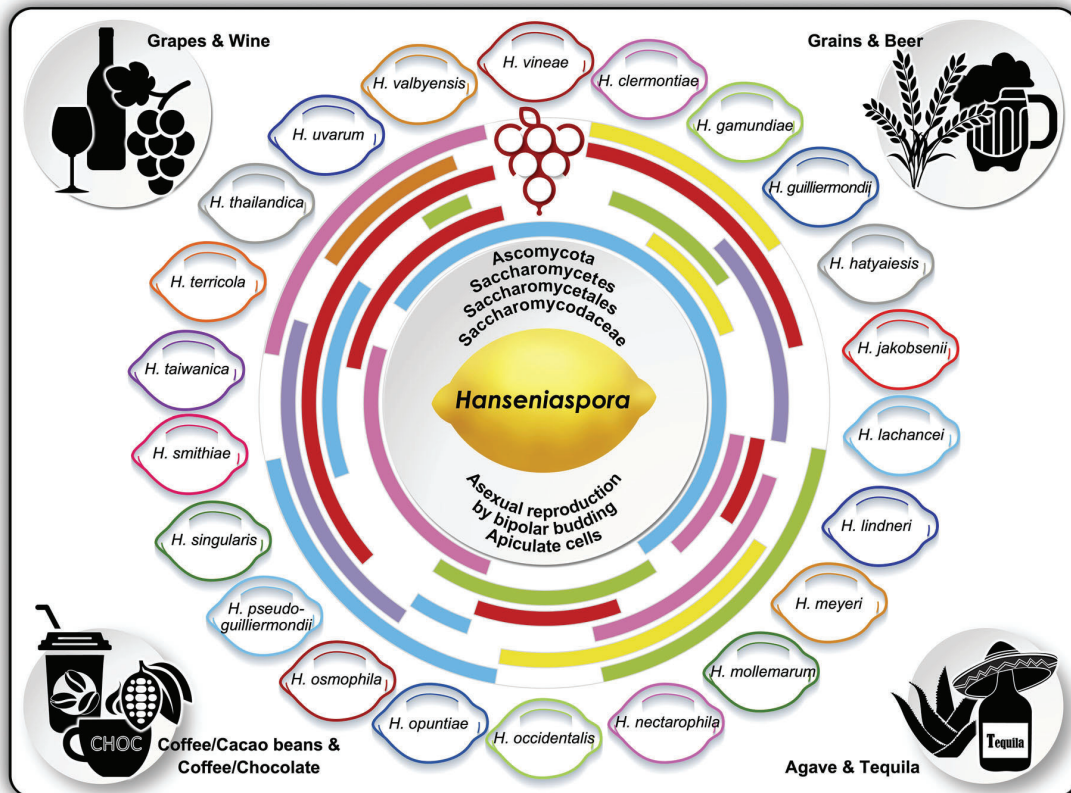

Figure 1. Species belonging to the genus *Hanseniaspora*. These lemon-shaped yeasts are prevalent on ripe fruits and have been isolated from a diverse range of environments. Some of these apiculate species are associated with grapes and wine; grains and beer; agave plants and tequila; and cacao and coffee beans; as well as apple and pear cider.

role in fermentation beverages and as a possible copartner with *Saccharomyces cerevisiae* [14], along with possible application in biocontrol trials as well as other biotechnological ventures. Despite a blooming interest in applications for *Hanseniaspora* there is still a big gap in understanding its biology. Recent genomic analyses have unveiled interesting features of this genus that will provide insights into its lifestyle, which we will discuss.

Members of the genus

The name *Hanseniaspora* was first coined in 1912 to describe the apiculate yeasts commonly found in fermenting fruit juices [15]. Cells tend not to be uniform but often display a distinct lemon-shape morphology in routine culturing media. Cells can also be ovoid, long-ovoid or elongate and sometimes form pseudohyphae. The use of standard molecular techniques for the classification of yeast species resolved the issue of its inconsistent ability to form ascospores and allowed for the merging with the anamorphic genus *Kloeckera*. At the

time of writing (2022), 22 species have been recognized including four new species described during the past four years [16–19]. Phylogenetic analyses further divide the genus into two major clades: the ‘fermentation clade’ and the ‘fruit clade’ (Figure 2). The ‘fermentation clade’, which has fewer members, includes *H. vineae* and *H. osmophila* for their stronger fermentative capabilities, whereas the ‘fruit clade’ contains members mostly adapted to fruit niches [20].

Role in fermentations

Impact on wine

By far the most studied aspect of *Hanseniaspora* is its role within a grape must fermentation as discussed in previous reviews [14,21,22]. Due to their sheer numbers at the onset of a fermentation, *Hanseniaspora* could have an impactful role in the early development of a wine. It should be noted that although trends exist regarding the general role of *Hanseniaspora* within fermentation settings, their contribution is shrouded with

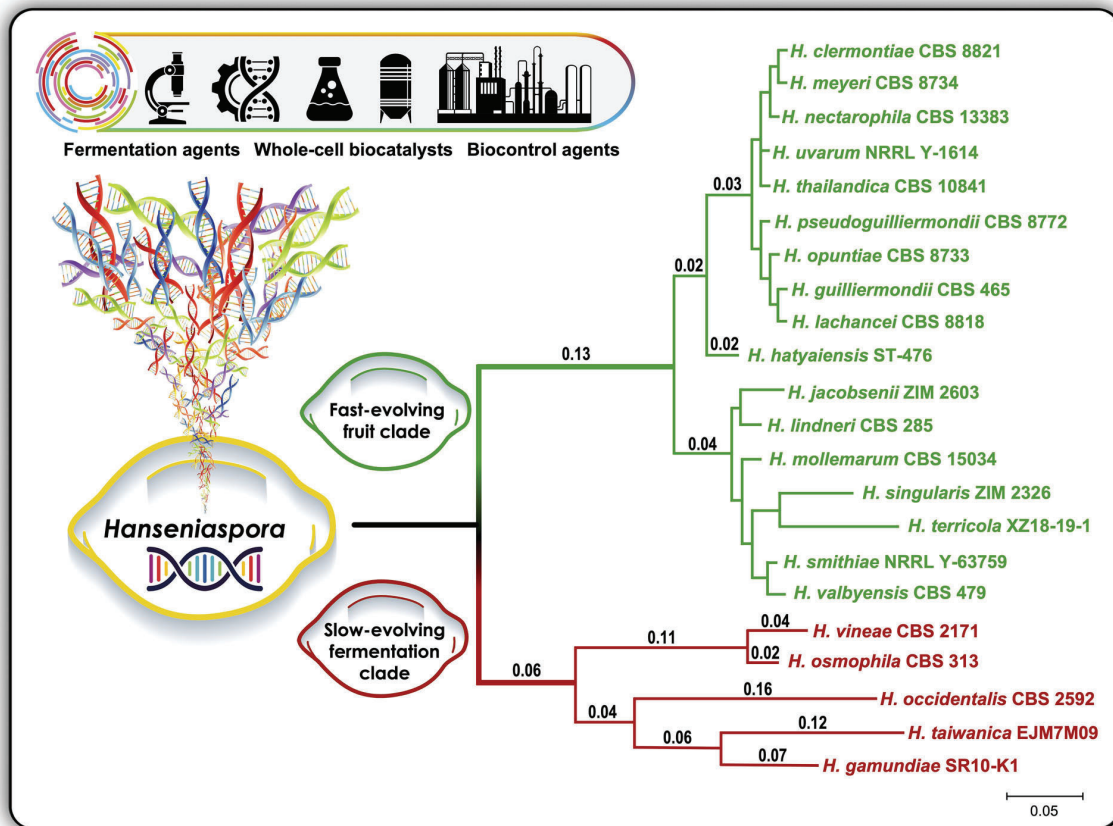

Figure 2. A phylogenetic tree of members of the genus *Hanseniaspora*. Using maximum-likelihood analysis of the internal transcribed sequences of one representative of each *Hanseniaspora* species divides the genus into two large clades, a fast-evolving fruit clade and a slow-evolving fermentation clade. MEGA 11 software was used to draw the tree [218].

contradictions. *Hanseniaspora* has been labeled a 'spoilage yeast' as it can produce compounds like acetic acid, acetaldehyde and ethyl acetate in excess amounts that could cause wine faults [23,24]. *Hanseniaspora* species are known to consume sufficient amounts of thiamin or other nutrients early in a fermentation leading to a stuck or sluggish fermentation [25,26]. Conversely, different *Hanseniaspora* species have been successfully implemented as a copartner with a *Saccharomyces* starter culture in a mixed-culture fermentation, with many reports showing a positive impact on the final wine product. Figure 3 shows some of the beneficial attributes of using *Hanseniaspora* spp. as a starter culture for winemaking.

When inoculated alone, *Hanseniaspora* spp. tend to display a glucophilic nature and do not completely consume the sugars in grape must [27]. There are, however, members of the 'fermentation clade', particularly *H. osmophila*, which is able to 'finish' fermentation, and can produce a significant amount of ethanol of over 11% [28]. *Hanseniaspora's* production of the

compounds acetic acid, acetoin, acetaldehyde, ethyl acetate and glycerol is often significantly higher than the amounts produced by any wine strain of *S. cerevisiae*, yet the interspecies and inter-strain variation is striking [29–36].

An important consideration is their interaction with *Saccharomyces* spp. within a fermentation. In spontaneous fermentations, i.e., where no starter culture is added, a dramatic shift in the populations of *Hanseniaspora* (as well as other non-*Saccharomyces* yeast or NSY) and *Saccharomyces* is often observed. As *Hanseniaspora* cell numbers decline rapidly in the first couple of days of fermentation, those of *Saccharomyces* increase [37–41]. This is, of course, exacerbated when a *Saccharomyces* starter culture is added [42,43]. Most wine strains of *Saccharomyces* produce a wide array of so-called 'killer factors' that limit the viability of other members of the wine microbiota [44]. These factors include antimicrobial peptides encoded on RNA virus-like particles [45–47]. Killer activity requires cell-to-cell contact as a membrane separation between

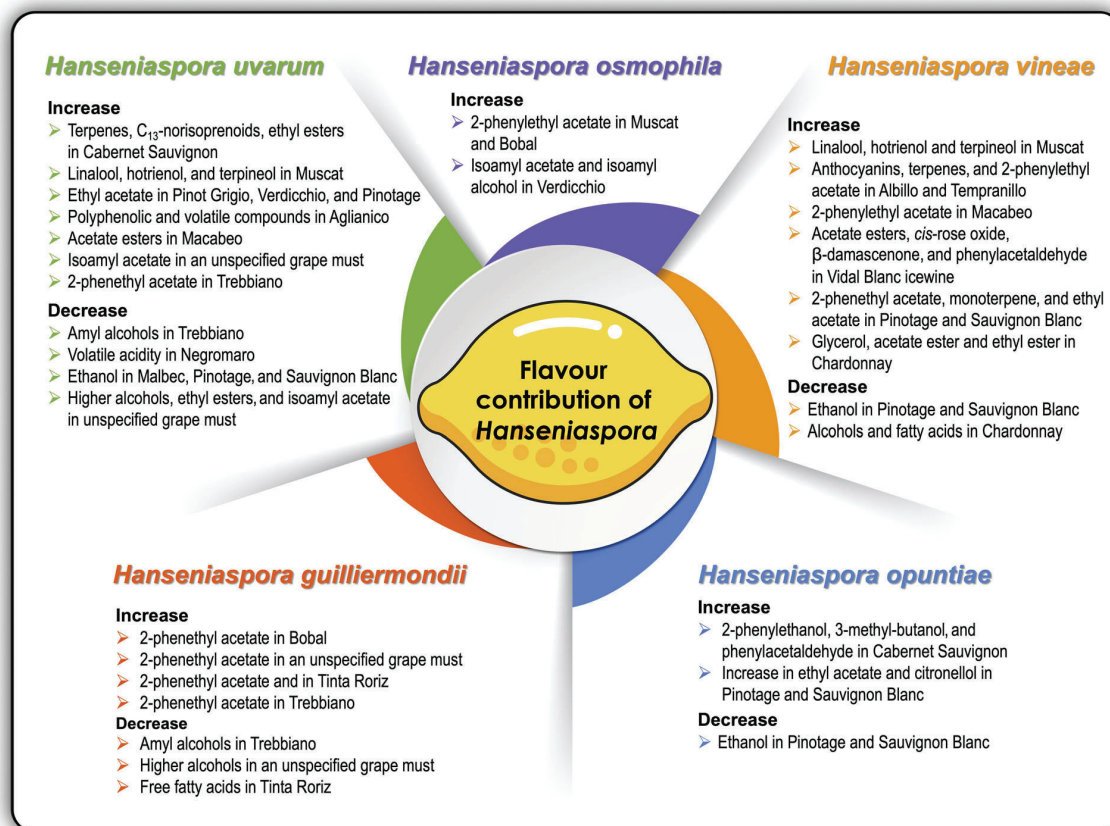

Figure 3. Effect of *Hanseniaspora*-initiated cultures in mixed-culture wine fermentations. Increases and decreases in metabolite concentrations are shown relative to the levels of those metabolites produced in fermentations conducted with a pure culture of *Saccharomyces cerevisiae*. References for *Hanseniaspora uvarum* [67,76,85,104,219–224], *Hanseniaspora guilliermondii* [31,220,221,225], *Hanseniaspora vineae* [68,69,75,79,85,105,226] and other *Hanseniaspora* species [75,223,227–229].

Saccharomyces and non-*Saccharomyces* strains within a fermentation vessel curbs cell death of the non-*Saccharomyces* yeast cells [48–51]. Although ethanol production by *Saccharomyces* can also be considered as a ‘zymostatic agent’, *Hanseniaspora* strains can often withstand ethanol levels of ~10%, and it is thus unclear to what extent ethanol affects *Hanseniaspora* viability [52–56]. Standard SO₂ additions at the onset of a fermentation have a negative impact on the viability of most non-*Saccharomyces* yeasts, yet studies on how it specifically affects *Hanseniaspora* spp. have shown contradictory results [28,57–62]. Killer ability, particularly RNA viruses, have also been identified in *H. uvarum* strains. These killer *H. uvarum* cultures inhibit a number of yeasts *in vitro*, including *S. cerevisiae*, yet its role in a fermentation setting remains unexplored [63–66].

Strains from three *Hanseniaspora* species have been extensively explored in a mixed-culture fermentation namely *H. guilliermondii*, *H. uvarum* and *H. vineae*

(Figure 3). Although many trials have been conducted in which the performance of these *Hanseniaspora* species have been studied and tested on a pilot-scale [67–71], at the time of writing, no *Hanseniaspora* strain has been commercially sold as a starter culture [72,73]. There are many beneficial aspects attributed to the addition of *Hanseniaspora* starter cultures, ranging from lowering the ethanol levels [74–76], modulating the acid composition [77] to an increase in anthocyanin content [78,79], but arguably their biggest contribution is toward the aroma profile. Although every aroma component has been modulated by the addition of *Hanseniaspora* starter cultures, the majority of mixed-culture fermentations highlight a meaningful increase in the acetate ester content (Figure 4). Acetate ester synthesis is largely catalyzed by alcohol acetyltransferases (AAFs or ATFs), which condenses primary alcohols with the carboxylic group from acetyl-coenzyme A. Three of the five main acetate esters found in wine:

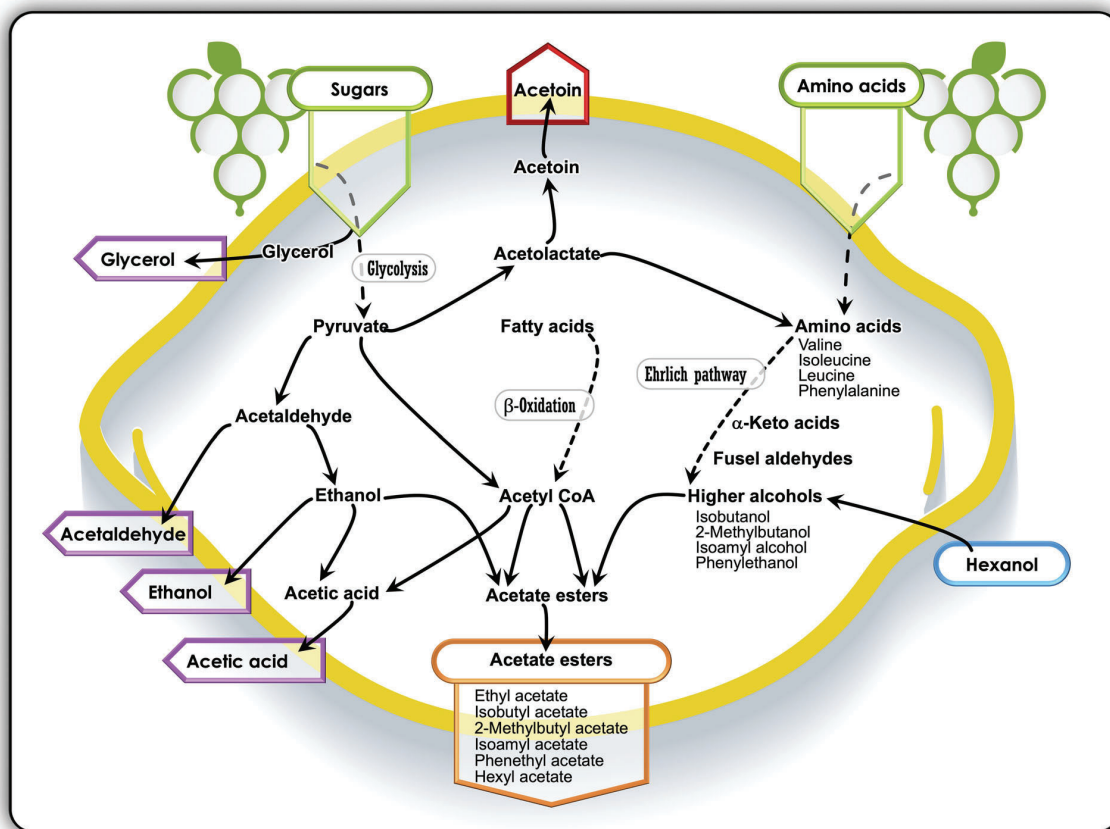

Figure 4. Biosynthesis pathways of fermentation-derived aroma compounds produced by grape-related *Hanseniaspora* species during winemaking [14,80].

2-methyl butyl acetate, isoamyl acetate (both imparting a fruity, banana-like aroma) and 2-phenethyl acetate (honey, flower-like aroma) obtain their alcohol part from the breakdown of the corresponding amino acids *via* the Ehrlich pathway [80]. Hexyl acetate (apple-like aroma) obtains its alcohol from hexanol, which is found in grape must and the most common acetate ester in wine, ethyl acetate, is largely synthesized *via* the condensation of ethanol and acetyl-coenzyme A. This ester lends pleasant fruity aromas at concentrations below 50 mg/L, but above this concentration can mask other aromas and is considered a sensory defect at concentrations above 150 mg/L, imparting a solvent-like, nail polish aroma [81]. These levels are often exceeded with *Hanseniaspora* additions. Alcohol acetyltransferases can also catalyze the esterification of other wine alcohols, most notably varietal thiols like 3-sulfanylhexasan-1-ol or terpene alcohols like geraniol, leading to their corresponding acetate esters [82,83].

All *Hanseniaspora* species are capable of growing in media containing cellobiose as the sole carbohydrate source, implying that they possess β -glucosidase activity

[15,84]. β -Glucosidases are useful enzymes in winemaking as they can release certain aroma compounds from bound sugar moieties like terpenes [85–88]. β -Glucosidases from some *Hanseniaspora* release important, but non-aromatic, compounds from glycosylated precursors like the polyphenol resveratrol [89,90] and anthocyanins [78]. Strong β -xylosidase, polygalacturonase and protease activities have been identified in *Hanseniaspora* strains which could also enhance the flavor profile of wines [90–93]. In addition, the protease activity could be useful in the reduction of haze formation [94].

The deliberate use of non-*Saccharomyces* yeast strains as starter cultures have enjoyed a large appeal in winemaking and are a key force in the current elaboration of wine profiles [95–97]. The *Hanseniaspora* species with arguably the most potential in winemaking is that of *H. vineae*, as has been discussed in several reviews [98–100]. Even though the general acetate ester production of *H. vineae* strains are still pronounced, high levels of desirable benzenoids, including 2-phenethyl ethanol and 2-phenethyl acetate, have often been stated [69,101,102].

The mode of inoculation, i.e., whether the *Hanseniaspora* starter culture is added at the same time as *Saccharomyces* or prior (normally three days before *Saccharomyces* addition), has a dramatic influence on the final wine composition [102–105]. The addition of oxygen also plays an important role, particularly due to most *Hanseniaspora* spp. showing limited fermentative capabilities [106]. Thus, fine-tuning the culturing conditions, along with strain and/or species selection, are key determinants in order to reliably display beneficial wine attributes in mixed-culture fermentations.

Impact on other fermentations

Like with grape berries, members of the *Hanseniaspora* genus are also frequently isolated on a wide variety of ripe fruit and would be present at the onset of the respective fruit wine fermentation. These include the fruit or resulting juices from agave [107], apple [10,108–111], mango [112], orange [7,113,114], pineapple [113,115,116] and plum [10,117] – by no means an exhaustive list. Their role in these different fruit juice matrices are not as extensively studied as in wine, but, in general, their populations decline as the fermentation progresses, as seen in grape must [5,118].

Researchers have also explored the effect of the deliberate addition of *Hanseniaspora* spp. to the start of a fermentation in order to augment the aromatic content of the resulting fruit wine. Figure 5 gives examples of outcomes of different *Hanseniaspora* starter cultures when added to a given non-grape starting material. As observed in wine, every aroma compound can be affected when compared to the pure inoculation of the fermenting *Saccharomyces* strain, but what stands out is the consistent increase in acetate ester content [4,108,119].

Populations of *Hanseniaspora* spp. (particularly *H. guilliermondii*, *H. opuntiae* and *H. uvarum*) are also frequently isolated from beans of coffee and cocoa, as has been discussed in previous reviews [120–125]. Yeasts are critical for the successful fermentation of these beans, as suppressing their growth *via* the addition of an antizymotic agent led to a much lower quality bean prior to roasting [126,127]. The complex role of yeasts within bean fermentation includes ethanol production; acid modulation; and the production of volatile components, proteases and pectinases. Although both bean fermentations are still largely driven by actions of the natural microbiota, starter cultures have been added to accelerate the fermentation or to direct the flavor profile into a certain direction, including *Hanseniaspora* cultures which are also mentioned in Figure 5.

Hanseniaspora spp. lack the ability to utilize maltose and lactose and only a few members (belonging to the ‘fermentation clade’) can utilize sucrose [15]. Thus, they do not normally form part of the natural yeast microbiota of fermentations that are grain- or dairy-based, or fermentations where sucrose or molasses are added. Recently though, *Hanseniaspora* spp. have been added to beer fermentations owing to its ester-producing abilities, yet they were unable to utilize the maltose within the fermentation (Figure 5). This forms part of the growing trend in beer brewing where low or non-alcohol beers are preferred among consumers [128,129].

Hanseniaspora as a biocontrol agent

Fruits and vegetables farmed on a large-scale and in monoculture are particularly susceptible to the colonization by undesired microbiota or phytopathogens of fungal origin, which negatively impact the quality and yield of the harvest and their subsequent storage [130]. Current practices to mitigate the growth of these microbiota consist mainly of chemical interventions or fungicides. Despite success in controlling disease, their negative long-term impact on the environment [131], resistance being developed by fungi [132], as well as growing consumer pressure to reduce their usage [133], prompted investigations into alternative solutions [134]. Yeast associated with fruit and that show antagonistic action against the growth of these fungal phytopathogens have long been considered as potential biocontrol agents [135]. As common isolates from these niches, *Hanseniaspora* strains have been extensively employed in biocontrol trials to prevent fungal disease on a variety of fruit. Table 1 lists examples where *Hanseniaspora* yeast cultures were successfully implemented in a range of biocontrol experiments to prevent fungal disease, especially caused by *Penicillium* spp., *Aspergillus* spp. and *Botrytis* spp.

Although the majority of these reports was primarily concerned in the outcome, i.e., whether a meaningful reduction in phytopathology was observed, some reports have attempted to explain the mode of inhibition caused by *Hanseniaspora*. The killer activity identified in *Hanseniaspora* has been attributed to its biocontrol ability [136]. Interestingly, multiple reports have attributed the biocontrol to the production of volatiles, particularly phenylethanol [137,138]. Another volatile, trans-cinnamaldehyde, produced by a *H. uvarum* strain, was shown to be the main volatile responsible for inhibiting fungal growth [139]. Moreover, the inoculation of *Hanseniaspora* induced the expression of defence-related genes in table grapes, strawberries,

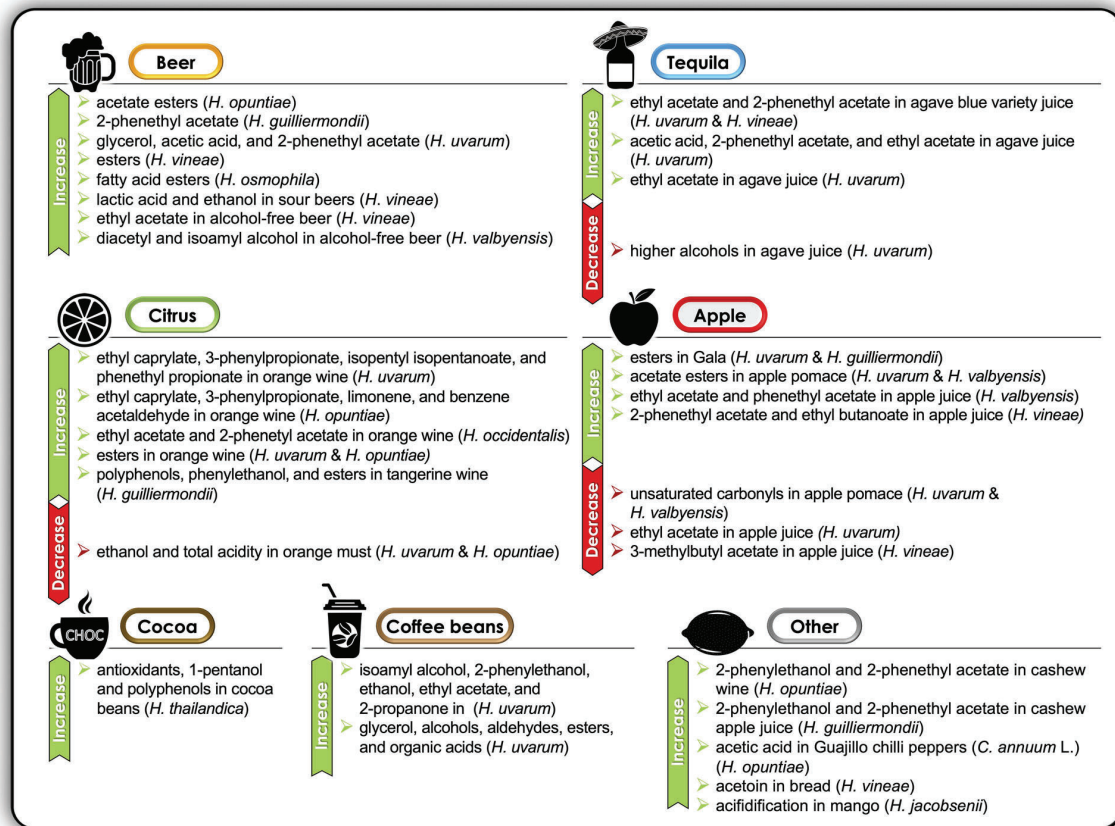

Figure 5. Effect of the deliberate addition of *Hanseniaspora* starter cultures on a diverse set of foodstuffs. References for beer [4,128,129,230–232], cocoa [233–235], coffee [236,237], citrus [238–240], apple [241–245], tequila [118,246,247], other [248–252].

oranges and *Arabidopsis thaliana* [140–143]. The inhibition effect was enhanced with the addition of other compounds like β -aminobutyric acid [144], phosphatidylcholine [145], ammonium molybdate [146], trehalose [140,147], salicylic acid and sodium bicarbonate [148]. Interestingly, with the combination of an acetic acid bacteria, *Gluconobacter cerinus*, *H. osmophila* showed an increased biocontrol effect leading to a bio-product patent [149]. *Hanseniaspora* cultures also have been shown to degrade mycotoxins, which are important carcinogenic compounds produced by infections caused by strains belonging to *Aspergillus* [150–153].

Despite the promise of using *Hanseniaspora* or any other yeast antagonist in the biocontrol of fungal growth, it should be noted that strain-specific variability do exist, because *Hanseniaspora* cultures can also display no meaningful fungal inhibition [154,155]. Most of the reports, especially on post-harvest applications on fruit, appear to show a clear path forward in this research field, yet it would be interesting to see how effective and realistic it would be for large-scale

implementations of spraying *Hanseniaspora* yeast cultures in a field.

Associations with *Drosophila*

Members of the fruit-fly genus *Drosophila* co-inhabit the same ephemeral fruit niches as yeast [156]. Moreover, yeast cells are an important food source for both larva and adult drosophila and greatly influence its development time, body weight, egg-laying behavior (or oviposition) and survival [157–159]. Two noteworthy members of this genus include the vinegar fly (*D. melanogaster*)—a well-studied commensal fruit fly that swarms vineyards and orchards as fruit ripens and lays their eggs in rotten fruit—and the spotted wing fruit-fly (*D. suzukii*). The latter is a major insect pest capable of ovipositing in healthy ripe fruit. This causes major damage to the harvest of a wide range of fruit crops, including grapes, where it contributes to sour rot disease [160–162].

Table 1. Summary of biocontrol trials where *Hanseniaspora* strains were employed.

Species	Effect	Reference
<i>H. clermontiae</i>	Strong protease activity along with inhibitory action against <i>B. cinerea</i> and <i>P. expansum</i> growth on lab media	[135]
<i>H. guilliermondii</i>	Inhibits mycelial growth of <i>Aspergillus</i> spp.-infected grapes	[136]
<i>H. guilliermondii</i>	Inhibits the growth of the pineapple pathogen <i>F. guttiforme</i>	[253]
<i>H. guilliermondii</i>	Reduces incidence of disease caused by <i>P. digitatum</i> on various citrus fruits	[254]
<i>H. guilliermondii</i>	Displays <i>in vitro</i> antifungal activity against <i>F. graminearum</i>	[255]
<i>H. opuntiae</i>	Releases compounds inhibiting <i>B. cinerea</i> and <i>C. cassiicola</i> growth on <i>Arabidopsis thaliana</i> and <i>Glycine max</i>	[143]
<i>H. opuntiae</i>	Inhibits growth and mycotoxin production of <i>A. flavus</i> attributed to its volatile organic compounds	[151]
<i>H. opuntiae</i>	Inhibits the growth of <i>A. flavus</i> which is enhanced when co-cultured with lactic acid bacteria	[256]
<i>H. opuntiae</i>	Produces volatiles inhibiting mycelial growth of <i>P. italicum</i> and <i>B. cinerea</i>	[257]
<i>H. opuntiae</i>	Reduces radial growth of fig pathogens <i>P. expansum</i> , <i>C. cladosporoides</i> , <i>B. cinerea</i> , and <i>M. laxa</i> on lab media	[258]
<i>H. opuntiae</i>	Displays <i>in vitro</i> antifungal activity against <i>B. cinerea</i>	[259]
<i>H. osmophila</i>	Produces an array of diffusible compounds capable of inhibiting the growth of several fungal pathogens of table grapes	[260]
<i>H. osmophila</i>	Together with <i>G. cerinus</i> inhibits <i>in vitro</i> mycelial growth of <i>Botrytis</i> , <i>Aspergillus</i> , <i>Penicillium</i> , and <i>Rhizopus</i>	[261]
<i>H. uvarum</i>	Exhibits strong inhibitory action against <i>A. carbonarius</i> , <i>B. cinerea</i> , and <i>P. expansum</i> growth on lab media	[135]
<i>H. uvarum</i>	Inhibits growth of <i>P. digitatum</i> and <i>P. italicum</i> attributed to its phenyl ethanol production promoting adhesion	[137]
<i>H. uvarum</i>	Inhibits <i>P. digitatum</i> and <i>P. italicum</i> growth attributed to its 2-phenylethanol production	[138]
<i>H. uvarum</i>	Produces trans-cinnamaldehyde which were shown to inhibit <i>B. cinerea</i> -infection in cherry tomatoes	[139]
<i>H. uvarum</i>	Supplemented with trehalose induces defence-related enzyme activities in table grapes combatting <i>A. tubingensis</i>	[140]
<i>H. uvarum</i>	Produces volatile organics and induce defence-related enzyme production in strawberries	[141]
<i>H. uvarum</i>	With β -aminobutyric acid shows inhibition against the growth of <i>B. cinerea</i> and <i>A. alternata</i> in kiwifruit	[144]
<i>H. uvarum</i>	Together with phosphatidylcholine inhibits spore germination and mycelial growth of <i>P. digitatum</i> in oranges	[145]
<i>H. uvarum</i>	With the addition of ammonium molybdenum reduces grey mold caused by <i>B. cinerea</i> in grapes	[146]
<i>H. uvarum</i>	With the addition of trehalose reduces grape rot caused by <i>A. tubingensis</i> and <i>P. commune</i>	[147]
<i>H. uvarum</i>	Along with salicylic acid or sodium bicarbonate shows decreased disease incidence of grape berries infected with <i>B. cinerea</i>	[148]
<i>H. uvarum</i>	Certain strains reduce ochratoxin levels within a grape must fermentation	[150]
<i>H. uvarum</i>	Inhibits growth and mycotoxin production of <i>A. flavus</i> attributed to its volatile organic compounds	[151]
<i>H. uvarum</i>	Inhibits the growth of mycotoxigenic fungi and detoxify the major mycotoxins aflatoxin B ₁ and ochratoxin in grape berries	[152]
<i>H. uvarum</i>	Reduces incidence of disease caused by <i>P. digitatum</i> on various citrus fruits	[254]
<i>H. uvarum</i>	Displays <i>in vitro</i> antifungal activity against <i>B. cinerea</i>	[259]
<i>H. uvarum</i>	Reduces postharvest mold decay in strawberries	[262]
<i>H. uvarum</i>	Reduces natural decay development caused by <i>B. cinerea</i> on grape berries	[263]
<i>H. uvarum</i>	Limits blue mold decay caused by <i>P. italicum</i> on navel orange fruit	[264]
<i>H. uvarum</i>	Produces volatile compounds capable of inhibiting growth of <i>A. ochraceus</i> in coffee beans	[265]
<i>H. uvarum</i>	Provides effective control against rot caused by <i>Rhizopus</i> of postharvest stone fruits	[266]
<i>H. uvarum</i>	Reduces decay caused by the green and blue molds caused by <i>P. digitatum</i> and <i>P. italicum</i> on a commercial scale	[267]
<i>H. uvarum</i>	Reduces postharvest decay of grapes and peach caused by <i>R. stolonifera</i> and grey mold by <i>B. cinerea</i>	[268]
<i>H. uvarum</i>	Controls brown rot in postharvest plum caused by <i>M. fructicola</i> attributing to chitinase activity and volatile organic compounds	[269]
<i>H. uvarum</i>	Reduces disease caused by <i>P. expansum</i> , <i>M. fructicola</i> and <i>B. cinerea</i> in peaches and nectarines	[270]
<i>H. uvarum</i>	Reduces the incidence of decay, caused by <i>B. cinerea</i> in strawberries	[271]
<i>H. uvarum</i>	Shows inhibition of <i>B. cinerea</i> -infections on grape, apples, and peaches	[272]
<i>H. uvarum</i>	Shows reduction in chili fruit rot caused by <i>C. capsici</i>	[273]
Full species names of fungal pathogens	<i>Colletotrichum</i>	<i>Penicillium</i>
<i>Aspergillus</i>	<i>C. capsici</i>	<i>P. commune</i>
<i>A. alternata</i>	<i>Corynespora</i>	<i>P. digitatum</i>
<i>A. carbonarius</i>	<i>C. cassiicola</i>	<i>P. expansum</i>
<i>A. flavus</i>	<i>Fusarium</i>	<i>P. italicum</i>
<i>A. ochraceus</i>	<i>F. graminearum</i>	<i>Rhizopus</i>
<i>A. tubingensis</i>	<i>F. guttiforme</i>	<i>R. stolonifera</i>
<i>Botrytis</i>	<i>Monilinia</i>	
<i>B. cinerea</i>	<i>M. fructicola</i>	
<i>Cladosporium</i>	<i>M. laxa</i>	
<i>C. cladosporoides</i>		

As one of the more common yeasts found on fruit, it is not a surprise that members of the *Hanseniaspora* genus are also often isolated from *Drosophila* fruit-flies with *H. uvarum* reported as being the most common isolate [156,163–166]. Although not conclusively proven, it is conceivable that *Drosophila* fruit-flies are an important vector for the dispersal of the non-motile *Hanseniaspora* cells within their environment, which could explain their relative abundance on ripe fruit. Some members, such as *H. occidentalis*, survive the alimentary tract of *Drosophila* adults [167]. Several studies

have looked at the effect of single-yeast diets on life traits of *Drosophila* fruit-flies including that of *H. uvarum*. A *H. uvarum*-rich diet shortened the 'egg-to-pupa' period [168], increased larva survival [159], and promoted fecundity [169], yet has also shown poor larval development despite *H. uvarum* being the most attractive [170]. These results underscore the pivotal role this yeast has on the life quality of *Drosophila*.

It is well-established that *Drosophila* fruit-flies are significantly more attracted to partially-fermented juices than sterile or unfermented juices [158,171–173]

suggestive of the important role that volatile organic compounds, produced by yeast, can have on the olfactory attraction of *Drosophila*. As a pure culture, *H. uvarum*-initiated fermentations significantly attract *Drosophila* fruit-flies [169,171,174,175].

The infestation of *Drosophila* peaks at fruit maturity, thus just prior to harvest, making chemical management undesirable, and leading to many investigations to develop microbial-based traps or lures [176–178]. Exploiting the attraction that *Drosophila* fruit-flies have for *Hanseniaspora*-inoculated substrates, various studies have shown the successful implementation of attract-and-kill strategies using *Hanseniaspora*-cultures as ‘bait’ in both laboratory and field experiments [172,179–183]. These findings show formulations using *Hanseniaspora* cultures as a promising and cost-effective ‘attracticide’ and can dramatically lower the use of insecticides to control *D. suzukii*-infestations [184]. Research still needs to be done to improve selectivity as current formulations attract all species of *Drosophila*.

Whole-cell biotransformation of chemical compounds

Using intact cells to act as so-called whole-cell biocatalysts has been useful in providing alternatives for the chemical synthesis or conversion of many compounds [185]. This method provides many benefits, as it can be highly selective, catalytically efficient and conducted in milder conditions. In addition, whole-cell catalysts can conduct multi-step reactions within ‘one pot’ and is also preferred for its environmentally-friendly approaches. *Hanseniaspora* cells (particularly *H. guilliermondii*) are often candidates to be screened for the bio-conversion of many different chemicals [186]. *H. guilliermondii* has been used for the reduction of the flavor molecules (4R)-(–)-carvone and (1R)-(–)-myrtenal, presumably by the catalytic action of ene-reductases and/or carbonyl reductases [187–189]. *H. guilliermondii* cells reduce the C=C bonds of some chalcones [190]. In one study, a *H. guilliermondii* strain was shown to possess high levels of phytase activity and was able to effectively break down phytate in a cereal-based gruel [191]. In another study, it was reported that a yeast consortium consisting of, amongst others, a *H. valbyensis* and/or a *H. opuntiae* strain degraded the 5- and 6-ring structures of perylene and benzo[ghi]perylene often found at oil spills [192,193]. Interestingly, a *H. uvarum* strain was found to possess exceptional denitrification capabilities and could be used in the removal of nitrogen from wastewater systems [194].

‘Omics-based research

As with all biological research, large-scale genomic sequencing of *Hanseniaspora* strains, coupled with transcriptomic, proteomic, and biochemical data, have greatly contributed to our understanding of this genus and made studies on this yeast far more intriguing due to some surprising discoveries.

The mitochondrial genome sequence of a *H. uvarum* strain was first published in 2005 [195] and showed a strikingly compact linear molecule, which is the smallest among sequenced Ascomycetes with only 5.1% of non-coding regions [196]. In 2014, the first whole-genome sequence of a *H. vineae* strain was published [197] followed by many other well-known *Hanseniaspora* members in subsequent years: *H. guilliermondii*, *H. opuntiae*, *H. osmophila*, *H. uvarum* and *H. valbyensis* [198–201]. Most of the accepted species within *Hanseniaspora* have at least one represented genome sequenced.

Perhaps the most instructive genomic work on *Hanseniaspora* was done by Steenwyk and colleagues [202]. Their phylogenomic analyses divided *Hanseniaspora* into two main lineages: the faster-evolving lineage (FEL), which encompasses the ‘fruit clade’, and a slower-evolving lineage (SEL), which corresponds to the ‘fermentation clade’. Closer inspection on the genomic content of *Hanseniaspora* indicated that many genes associated with DNA repair pathways and maintenance, i.e., genes involved in cell cycle-checkpoints, were absent from the genomes – especially from members belonging to the FEL. It was already shown with comparative genome-scale analyses of members within the subphylum *Saccharomycotina* that species within *Hanseniaspora* are characterized by very long branches [203,204]. This feature resembles the long branches of fungal hypermutator strains belonging to cryptococci [205,206]. *Hanseniaspora* spp. also possess a low guanine-cytosine content, small genome sizes as well as lower gene numbers compared to other members of *Saccharomycotina* [203,204]. These features are quite remarkable and could explain the lifestyle of these yeasts, as they are abundant on ripe fruits or flowers where simple sugars are available as a food source for one period in a year [16]. A loss of cell-cycle checkpoint genes has also been suggested to give *Hanseniaspora* spp. a rapid growth advantage over competitors. There could also be a link to the lack of sporulation that has been reported for *H. uvarum* strains, yet this remains unestablished [207]. Interestingly, *H. vineae* strains have been shown to undergo arrest at G2 cell cycle during the stationary phase, an extremely uncommon phenomenon among eukaryotes in general [208].

In one study it was shown that multigene comparisons of different strains belonging to the same species displayed a sizable level of intraspecific nucleotide diversity [209]. Flow cytometry analysis has also shown a fairly dynamic ploidy architecture within the genus with allodiploids, allotriploids and allotetraploids being identified. Even interspecies hybridization between *H. opuntiae* and *H. pseudoguilliermondii* has been reported. Upon comparison among eight genomes of *H. uvarum* strains, genes involved in flocculation as well as oligopeptide transport were found to be missing in some strains, which could predict their fermentation performance, but reaffirmed the remarkable genomic variation found within one species [210].

In another study, it was demonstrated that in *H. uvarum*, the enzymatic function of a key enzyme within glycolysis—pyruvate kinase—is ~10-fold lower than its counterpart in *S. cerevisiae*, which could explain its low fermentative capacity [198]. This was further substantiated with a study that showed that differences in pyruvate kinases could be the reason for *H. vineae*'s limited fermentative capability [20]. Yet, interestingly, members of the SEL have enzymes involved in the glycolytic pathway that are more closely related to *S. cerevisiae* than members belonging to the FEL. Transcriptome analysis on *H. vineae* also showed a marked upregulation of the aroma-related genes [211]. This, combined with genome data, which showed duplications of the *ARO8* and *ARO9* genes, which encodes amino acid aminotransferases, and the *ARO10* gene phenylpyruvate decarboxylase, along with multiple *ATF*-like genes, could explain *H. vineae*'s capability of producing meaningful amounts of phenyl ethanol and phenethyl acetate. Within the genome of *H. guilliermondii*, four putative *ATF*-like genes have been identified which could explain the high acetate ester content often associated with *H. guilliermondii*-initiated cultures [200]. Owing to its strong ester-forming capabilities, the ethyl acetate transferase gene of *H. uvarum* was overexpressed in *S. cerevisiae* in order to improve its ethyl acetate production capability [212].

Transcriptomic data of a *H. uvarum* strain used in biocontrol studies have identified genes involved in ABC transport and ribosome biosynthesis to be upregulated when cultivated at a low temperature. The data also identified genes involved in the synthesis of the amino acids arginine, phenylalanine and lysine to be upregulated when co-incubated with *P. digitatum* [213]. Transcriptomic data of *H. vineae* strains revealed that the genes upregulated upon amino acid and ammonium consumption are similar to what is known from

S. cerevisiae under similar conditions, suggesting a shared nitrogen catabolism mechanism [214].

Using *H. vineae* as model organism, an alternative pathway for the synthesis of benzenoid-derived compounds was discovered via the mandelate pathway [215]. This could account for the lack of phenylalanine ammonia lyase and tyrosine ammonia lyase pathways in ascomycetes yet they are capable of synthesizing benzenoids.

Attempts have been made to genetically modify *H. uvarum* by constructing plasmids containing autonomous replicating sequences from the species [216]. Recently, the first tools to knock out the genes of *H. uvarum* have been developed [217]. The two copies of the *ATF*-encoding gene (*HuATF*) were genetically removed, which led to a strain with much lower acetate ester production. This paves the way for further gene function studies in the *Hanseniaspora* genus.

Conclusions

A surge in applied research exploiting the interesting qualities of *Hanseniaspora* has occurred over the past decade – not just in fermentation settings, but also in the biocontrol of fungal and insect phytopathogens and as a whole-cell biocatalyst. This underlines the tremendous biotechnological potential of this genus that is still poorly understood regarding its ecological function, interstrain and intraspecies variation. The emergence of 'omics-based data has already shown fascinating aspects of this genus and will continue to help elucidate this apiculate yeast.

Acknowledgements

The authors thank Geisenheim University and Macquarie University for co-funding of the research fellowship of N.V.W. I.S.P. is a team member of the Macquarie-led national Centre of Excellence in Synthetic Biology funded by the Australian Government through its agency, the Australian Research Council. The authors thank the Hessen State Ministry of Higher Education, Research and the Arts for the financial support within the Hessen initiative for scientific and economic excellence (LOEWE) in the framework of AROMAplus (<https://www.hs-geisenheim.de/aromaplus/>).

Disclosure statement

No potential conflict of interest was reported by the author(s).

Funding

This work was jointly funded by Geisenheim University and Macquarie University.

ORCID

Niël van Wyk  <http://orcid.org/0000-0003-3031-8821>

Jennifer Badura  <http://orcid.org/0000-0003-0615-9250>

Christian von Wallbrunn  <http://orcid.org/0000-0002-0520-9351>

Isak S. Pretorius  <http://orcid.org/0000-0001-9127-3175>

References

- [1] Barnett JA. A history of research on yeasts 2: Louis Pasteur and his contemporaries, 1850-1880. *Yeast*. 2000;16(8):755–771.
- [2] Drumonde-Neves J, Fernandes T, Lima T, et al. Learning from 80 years of studies: a comprehensive catalogue of non-*Saccharomyces* yeasts associated with viticulture and winemaking. *FEMS Yeast Res*. 2021;21:foab017.
- [3] Pelliccia C, Antonielli L, Corte L, et al. Preliminary prospection of the yeast biodiversity on apple and pear surfaces from Northern Italy orchards. *Ann Microbiol*. 2011;61(4):965–972.
- [4] Madrera RR, Bedriñana RP, Valles, BS. Evaluation of indigenous non-*Saccharomyces* cider yeasts for use in brewing. *Eur Food Res Technol*. 2021;247(4):819–828.
- [5] Valles BS, Bedriñana RP, Tascón, F et al. Yeast species associated with the spontaneous fermentation of cider. *Food Microbiol*. 2007;24(1):25–31.
- [6] Bedriñana RP, Simón AQ, Valles, BS. Genetic and phenotypic diversity of autochthonous cider yeasts in a cellar from Asturias. *Food Microbiol*. 2010;27(4):503–508.
- [7] Arias CR, Burns JK, Friedrich LM, et al. Yeast species associated with orange juice: evaluation of different identification methods. *Appl Environ Microbiol*. 2002;68(4):1955–1961.
- [8] Dellacassa E, Trenchs O, Fariña L, et al. Pineapple (*Ananas comosus* L. Merr.) wine production in Angola: characterisation of volatile aroma compounds and yeast native flora. *Int J Food Microbiol*. 2017;241:161–167.
- [9] Ramírez-Castrillón M, Usman LM, Silva-Bedoya LM, et al. Dominant yeasts associated to mango (*Mangifera indica*) and rose apple (*Syzygium malaccense*) fruit pulps investigated by culture-based methods. *An Acad Bras Cienc*. 2019;91(4):e20190052.
- [10] Vadkertiová R, Molnárová J, Vránová D, et al. Yeasts and yeast-like organisms associated with fruits and blossoms of different fruit trees. *Can J Microbiol*. 2012;58(12):1344–1352.
- [11] Fleet GH, Heard GM. Yeast-growth during fermentation. In: Fleet GH, editor. *Wine, microbiol biotechnol*. Lausanne: Harwood Academic; 1993. p. 27–54.
- [12] de Celis M, Ruiz J, Vicente J, et al. Expectable diversity patterns in wine yeast communities. *FEMS Yeast Res*. 2022;22:foac034.
- [13] Duina AA, Miller ME, Keeney JB. Budding yeast for budding geneticists: a primer on the *Saccharomyces cerevisiae* model system. *Genetics*. 2014;197(1):33–48.
- [14] Martín V, Valera M, Medina K, et al. Oenological impact of the *Hanseniaspora/Kloeckera* yeast genus on wines—a review. *Fermentation*. 2018;4(3):76. <http://www.mdpi.com/2311-5637/4/3/76>.
- [15] Čadež N, Smith MT. *Hanseniaspora Zikes* (1912). In: *The yeasts*. Amsterdam: Elsevier B.V.; 2011.
- [16] Čadež N, Bellora N, Ulloa R, et al. *Hanseniaspora smithiae* sp. nov., a novel apiculate yeast species from patagonian forests that lacks the typical genomic domestication signatures for fermentative environments. *Front Microbiol*. 2021;12:679894.
- [17] Groenewald M, Lombard L, de Vries M, et al. Diversity of yeast species from dutch garden soil and the description of six novel ascomycetes. *FEMS Yeast Res*. 2018;18:foy076.
- [18] Čadež N, Bellora N, Ulloa R, et al. Genomic content of a novel yeast species *Hanseniaspora gamundiae* sp. nov. from fungal stromata (cyttaria) associated with a unique fermented beverage in andean patagonia, Argentina. *PLoS One*. 2019;14(1):e0210792.
- [19] Liu Z, Wang M-M, Wang G-S, et al. *Hanseniaspora terricola* sp. nov., an ascomycetous yeast isolated from tibet. *Int J Syst Evol Microbiol*. 2021;71:004741.
- [20] Valera MJ, Boido E, Dellacassa E, et al. Comparison of the glycolytic and alcoholic fermentation pathways of *Hanseniaspora vineae* with *Saccharomyces cerevisiae* wine yeasts. *Fermentation*. 2020;6(3):78.
- [21] Díaz-Montaño DM, de Jesús Ramírez Córdoba J. The fermentative and aromatic ability of *Kloeckera* and *Hanseniaspora* yeasts. In: Satyanarayana T, Kunze G, editors. *Yeast Biotechnol divers appl*. Dordrecht, Netherlands: Springer; 2009. p. 282–301.
- [22] Varela C, Borneman AR. Yeasts found in vineyards and wineries. *Yeast*. 2017;34(3):111–128.
- [23] Malfeito-Ferreira M. Yeasts and wine off-flavours: a technological perspective. *Ann Microbiol*. 2011;61(1):95–102.
- [24] Escott C, Loira I, Morata A, et al. Wine spoilage yeasts: control strategy. In: Morata A, Loira I, editors. *Yeast—industrial appl*. London: intechOpen; 2017. p. 89–116.
- [25] Bataillon M, Rico A, Sablayrolles JM, et al. Early thiamin assimilation by yeasts under enological conditions: impact on alcoholic fermentation kinetics. *J Ferment Bioeng*. 1996;82(2):145–150.
- [26] Bisson LF. Stuck and sluggish fermentations. *Am J Enol Vitic*. 1999;50(1):107–119.
- [27] Ciani M, Fatichenti F. Selective sugar consumption by apiculate yeasts. *Lett Appl Microbiol*. 1999;28(3):203–206.
- [28] Granchi L, Ganucci D, Messini A, et al. Oenological properties of *Hanseniaspora osmophila* and *Kloeckera corticis* from wines produced by spontaneous fermentations of normal and dried grapes. *FEMS Yeast Res*. 2002;2(3):403–407.
- [29] Romano P, Suzzi G. Origin and production of acetoin during wine yeast fermentation. *Appl Environ Microbiol*. 1996;62(2):309–315.
- [30] Plata C, Millán C, Mauricio JC, et al. Formation of ethyl acetate and isoamyl acetate by various species of wine yeasts. *Food Microbiol*. 2003;20(2):217–224.
- [31] Rojas V, Gil JV, Piñaga F, et al. Acetate ester formation in wine by mixed cultures in laboratory fermentations. *Int J Food Microbiol*. 2003;86(1-2):181–188.

- [32] Romano P, Fiore C, Paraggio M, et al. Function of yeast species and strains in wine flavour. *Int J Food Microbiol.* 2003;86(1-2):169–180.
- [33] Romano P, Suzzi G, Comi G, et al. Glycerol and other fermentation products of apiculate wine yeasts. *J Appl Microbiol.* 1997;82(5):615–618.
- [34] Ciani M, Maccarelli F. Oenological properties of non-*Saccharomyces* yeasts associated with wine-making. *World J Microbiol Biotechnol.* 1998;14(2):199–203.
- [35] Mendoza LM, Vega-Lopez GA, Fernández de Ullivarri M, et al. Population and oenological characteristics of non-*Saccharomyces* yeasts associated with grapes of northwestern Argentina. *Arch Microbiol.* 2019; 201(2):235–244.
- [36] Benedictis D, Bleve M, Tristezza G, et al. An optimized procedure for the enological selection of non-*Saccharomyces* starter cultures. *Antonie van Leeuwenhoek, Int J Gen Mol Microbiol.* 2011;99(2): 189–200.
- [37] Di Maro E, Ercolini D, Coppola S. Yeast dynamics during spontaneous wine fermentation of the catalanesca grape. *Int J Food Microbiol.* 2007;117(2):201–210.
- [38] Cioch-Skoneczny M, Satora P, Skotniczny M, et al. Quantitative and qualitative composition of yeast microbiota in spontaneously fermented grape musts obtained from cool climate grape varieties 'rondo' and 'regent'. *FEMS Yeast Res.* 2018;18:foy089.
- [39] Sun H, Ma H, Hao M, et al. Identification of yeast population dynamics of spontaneous fermentation in Beijing wine region, China. *Ann. Microbiol.* 2009; 59(1):69–76.
- [40] Andorrà I, Landi S, Mas A, et al. Effect of oenological practices on microbial populations using culture-independent techniques. *Food Microbiol.* 2008;25(7): 849–856.
- [41] Mendoza LM, De Nadra MCM, Fariás ME. Kinetics and metabolic behavior of a composite culture of *Kloeckera apiculata* and *Saccharomyces cerevisiae* wine related strains. *Biotechnol Lett.* 2007;29(7): 1057–1063.
- [42] Egli CM, Edinger WD, Mittrakul CM, et al. Dynamics of indigenous and inoculated yeast populations and their effect on the sensory character of riesling and chardonnay wines. *J Appl Microbiol.* 1998;85(5):779–789.
- [43] Lu Y, Sun F, Wang W, et al. Effects of spontaneous fermentation on the microorganisms diversity and volatile compounds during 'marselan' from grape to wine. *LWT - Food Sci Technol* [Internet. 2020;134: 110193.
- [44] van Vuuren HJJ, Jacobs CJ. Killer yeasts in the wine industry: a review. *Am J Enol Vitic.* 1992;43:119–128.
- [45] Albergaria H, Francisco D, Gori K, et al. *Saccharomyces cerevisiae* CCM1 885 secretes peptides that inhibit the growth of some non-*Saccharomyces* wine-related strains. *Appl Microbiol Biotechnol.* 2010; 86(3):965–972.
- [46] Branco P, Francisco D, Chambon C, et al. Identification of novel GAPDH-derived antimicrobial peptides secreted by *Saccharomyces cerevisiae* and involved in wine microbial interactions. *Appl Microbiol Biotechnol.* 2014;98(2):843–853.
- [47] Rodríguez-Cousiño N, Maqueda M, Ambrona J, et al. A new wine *Saccharomyces cerevisiae* killer toxin (klus), encoded by a double-stranded RNA virus, with broad antifungal activity is evolutionarily related to a chromosomal host gene. *Appl Environ Microbiol.* 2011;77(5):1822–1832.
- [48] Renault PE, Albertin W, Bely M. An innovative tool reveals interaction mechanisms among yeast populations under oenological conditions. *Appl Microbiol Biotechnol.* 2013;97(9):4105–4119.
- [49] Wang C, Esteve-Zarzoso B, Cocolin L, et al. Viable and culturable populations of *Saccharomyces cerevisiae*, *Hanseniaspora uvarum* and *Starmerella bacillaris* (synonym *Candida zemplinina*) during barbera must fermentation. *Food Res Int.* 2015;78:195–200.
- [50] Pietrafesa A, Capece A, Pietrafesa R, et al. *Saccharomyces cerevisiae* and *Hanseniaspora uvarum* mixed starter cultures: influence of microbial/physical interactions on wine characteristics. *Yeast.* 2020; 37(11):609–621.
- [51] Luyt NA, Beaufort S, Divol B, et al. Phenotypic characterization of cell-to-cell interactions between two yeast species during alcoholic fermentation. *World J Microbiol Biotechnol.* 2021;37(11):186.
- [52] Feng CT, Du X, Wee J. Microbial and chemical analysis of non-*Saccharomyces* yeasts from chambourcin hybrid grapes for potential use in winemaking. *Fermentation.* 2021;7(1):15.
- [53] Alberico G, Capece A, Mauriello G, et al. Influence of microencapsulation on fermentative behavior of *Hanseniaspora osmophila* in wine mixed starter fermentation. *Fermentation.* 2021;7(3):112.
- [54] Pina C, António J, Hogg T. Inferring ethanol tolerance of *Saccharomyces* and non-*Saccharomyces* yeasts by progressive inactivation. *Biotechnol Lett.* 2004;26(19): 1521–1527.
- [55] Grangeteau C, Gerhards D, Rousseaux S, et al. Diversity of yeast strains of the genus *Hanseniaspora* in the winery environment: what is their involvement in grape must fermentation? *Food Microbiol.* 2015; 50:70–77.
- [56] Pina C, Santos C, Couto JA, et al. Ethanol tolerance of five non-*Saccharomyces* wine yeasts in comparison with a strain of *Saccharomyces cerevisiae* - Influence of different culture conditions. *Food Microbiol.* 2004; 21(4):439–447.
- [57] Cureau N, Threlfall R, Carbonero F, et al. Fungal diversity and dynamics during grape wine fermentations with different sulfite levels and yeast inoculations. *Am J Enol Vitic.* 2021;72(3):240–256.
- [58] Pateraki C, Paramithiotis S, Doulgeraki AI, et al. Effect of sulfur dioxide addition in wild yeast population dynamics and polyphenolic composition during spontaneous red wine fermentation from *Vitis vinifera* cultivar agjorgitiko. *Eur Food Res Technol.* 2014; 239(6):1067–1075.
- [59] Grangeteau C, Gerhards D, von Wallbrunn C, et al. Persistence of two non-*Saccharomyces* yeasts (*Hanseniaspora* and *Starmerella*) in the cellar. *Front Microbiol.* 2016;7:268.

- [60] Cuijvers K, van den Heuvel S, Varela C, et al. Alterations in yeast species composition of uninoculated wine ferments by the addition of sulphur dioxide. *Fermentation*. 2020;6(2):62.
- [61] Windholtz S, Vinsonneau E, Farris L, et al. Yeast and filamentous fungi microbial communities in organic red grape juice: effect of vintage, maturity stage, SO₂, and bioprotection. *Front Microbiol*. 2021;12:748416.
- [62] Windholtz S, Redon P, Lacampagne S, et al. Non-*Saccharomyces* yeasts as bioprotection in the composition of red wine and in the reduction of sulfur dioxide. *LWT - Food Sci Technol*. 2021;149:111781.
- [63] Zorg J, Kilian S, Radler F. Killer toxin producing strains of the yeasts *Hanseniaspora uvarum* and *Pichia kluyveri*. *Arch. Microbiol*. 1988;149(3):261–267.
- [64] Schmitt MJ, Neuhausen F. Killer toxin-secreting double-stranded RNA mycoviruses in the yeasts *Hanseniaspora uvarum* and *Zygosaccharomyces bailii*. *J Virol*. 1994;68(3):1765–1772.
- [65] Radler F, Schmitt MJ, Meyer B. Killer toxin of *Hanseniaspora uvarum*. *Arch Microbiol*. 1990;154(2):175–178.
- [66] Hameed AR, Al-Qaysi SAS, Hameed ST. Killer activity of *Hanseniaspora uvarum* isolated from dates vinegar: partially purification and characterization of killer toxin. *Baghdad Sci J*. 2019;16:141–150.
- [67] Tristezza M, Tufariello M, Capozzi V, et al. The oenological potential of *Hanseniaspora uvarum* in simultaneous and sequential co-fermentation with *Saccharomyces cerevisiae* for industrial wine production. *Front Microbiol*. 2016;7:670.
- [68] Medina K, Boido E, Fariña L, et al. Increased flavour diversity of chardonnay wines by spontaneous fermentation and co-fermentation with *Hanseniaspora vineae*. *Food Chem*. 2013;141(3):2513–2521.
- [69] Lleixà J, Martín V, Portillo MC, et al. Comparison of fermentation and wines produced by inoculation of *Hanseniaspora vineae* and *Saccharomyces cerevisiae*. *Front Microbiol*. 2016;7:338.
- [70] Lombardi SJ, Pannella G, Iorizzo M, et al. Sequential inoculum of *Hanseniaspora guilliermondii* and *Saccharomyces cerevisiae* for winemaking campanino on an industrial scale. *World J Microbiol Biotechnol*. 2018;34(11):161.
- [71] Rompkovksi C, Agustini BC, Deffert F, et al. Microbial dynamics in industrial-scale wine fermentation employing *Hanseniaspora uvarum* β -glucosidase-producer strain. *J Food Sci Technol*. 2022;59(4):1570–1576.
- [72] Roudil L, Russo P, Berbegal C, et al. Non-*Saccharomyces* commercial starter cultures: scientific trends, recent patents and innovation in the wine sector. *Recent Pat Food Nutr Agric*. 2020;11(1):27–39.
- [73] van Wyk N, von Wallbrunn C, Swiegers JH, et al. Biotechnology of wine yeasts. *Encycl mycol*. Amsterdam: Elsevier; 2020. p. 34–44.
- [74] Adriana PCS, Regina V, Bruna ASM, et al. Improving production of aromatic compounds by indigenous yeasts in chenin blanc grape must. *Afr J Agric Res*. 2016;11(28):2433–2442.
- [75] Rossouw D, Bauer FF. Exploring the phenotypic space of non-*Saccharomyces* wine yeast biodiversity. *Food Microbiol*. 2016;55:32–46.
- [76] Mestre MV, Maturano YP, Gallardo C, et al. Impact on sensory and aromatic profile of low ethanol malbec wines fermented by sequential culture of *Hanseniaspora uvarum* and *Saccharomyces cerevisiae* native yeasts. *Fermentation*. 2019;5(3):65.
- [77] van Wyk N, Scansani S, Beisert B, et al. The use of *Hanseniaspora occidentalis* in a sequential must inoculation to reduce the malic acid content of wine. *Appl Sci*. 2022;12(14):6919.
- [78] Manzanares P, Rojas V, Genovés S, et al. A preliminary search for anthocyanin- β -D-glucosidase activity in non-*Saccharomyces* wine yeasts. *Int J Food Sci Technol*. 2000;35(1):95–103.
- [79] del Fresno JM, Loira I, Escott C, et al. Application of *Hanseniaspora vineae* yeast in the production of rosé wines from a blend of tempranillo and albillo grapes. *Fermentation*. 2021;7(3):141.
- [80] Dzialo MC, Park R, Steensels J, et al. Physiology, ecology and industrial applications of aroma formation in yeast. *FEMS Microbiol Rev*. 2017;41(Supp_1):S95–S128. http://academic.oup.com/femsre/article/41/Supp_1/S95/4084365/Physiology-ecology-and-industrial-applications-of.
- [81] Jackson RS. Sensory perception and wine assessment. In: *Wine Science, Principles and Applications*. 3rd ed. San Diego: Academic Press; 2008. p. 641–685. <https://www.sciencedirect.com/science/article/pii/B9780123736468500147>
- [82] Kiene F, Pretorius IS, Rauhut D, et al. Construction and analysis of a yeast for the simultaneous release and esterification of the varietal thiol 3-sulfanylhexan-1-ol. *J Agric Food Chem*. 2021;69(40):11919–11925.
- [83] Rojas V, Gil JV, Piñaga F, et al. Studies on acetate ester production by non-*Saccharomyces* wine yeasts. *Int J Food Microbiol*. 2001;70(3):283–289.
- [84] Vasserot Y, Chemardin P, Arnaud A, et al. Evidence for the beta-glucosidase activity and cellobiose fermentation by various kloeckera strains. *Acta Biotechnol*. 1990;10:451–457.
- [85] López S, Mateo JJ, Maicas S. Characterisation of *Hanseniaspora* isolates with potential aroma-enhancing properties in Muscat wines. *South African J Enol Vitic*. 2014;35:292–303.
- [86] Vasserot Y, Christiaens H, Chemardin P, et al. Purification and properties of a beta-glucosidase of *Hanseniaspora vineae* van der Walt and tscheuschner with the view to its utilization in fruit aroma liberation. *J Appl Bacteriol*. 1989;66:211–219.
- [87] Swangkeaw J, Vichitphan S, Butzke CE, et al. Characterization of β -glucosidases from *Hanseniaspora* sp. and *Pichia anomala* with potentially aroma-enhancing capabilities in juice and wine. *World J Microbiol Biotechnol*. 2011;27:423–430.
- [88] Zhang P, Zhang R, Sirisena S, et al. Beta-glucosidase activity of wine yeasts and its impacts on wine volatiles and phenolics: a mini-review. *Food Microbiol*. 2021;100:103859.

- [89] Gaensly F, Carla B, Almeida G, et al. Autochthonous yeasts with β -glucosidase activity increase resveratrol concentration during the alcoholic fermentation of *Vitis labrusca* grape must. *J Funct Foods*. 2015;19:288–295.
- [90] López S, Mateo JJ, Maicas S. Screening of *Hanseniaspora* strains for the production of enzymes with potential interest for winemaking. *Fermentation*. 2015;2:1.
- [91] Manzanares P, Ramón D, Querol A. Screening of non-*Saccharomyces* wine yeasts for the production of β -D-xylosidase activity. *Int J Food Microbiol*. 1999;46(2):105–112.
- [92] Mateo JJ, Maicas S, Thie C. Biotechnological characterisation of exocellular proteases produced by enological *Hanseniaspora* isolates. *Int J Food Sci Technol*. 2015;50:218–225.
- [93] Belda I, Ruiz J, Alastruey-Izquierdo A, et al. Unraveling the enzymatic basis of wine “flavorome”: a phylo-functional study of wine related yeast species. *Front Microbiol*. 2016;7:1–13.
- [94] Dizy M, Bisson LF. Proteolytic activity of yeast strains during grape juice fermentation. *Am J Enol Vitic*. 2000;51:155–167.
- [95] Jolly NP, Varela C, Pretorius IS. Not your ordinary yeast: non-*Saccharomyces* yeasts in wine production uncovered. *FEMS Yeast Res*. 2014;14(2):215–237.
- [96] van Wyk N, Grossmann M, Wendland J, et al. The whiff of wine yeast innovation: strategies for enhancing aroma production by yeast during wine fermentation. *J Agric Food Chem*. 2019;67(49):13496–13505.
- [97] Ciani M, Comitini F, Mannazzu I, et al. Controlled mixed culture fermentation: a new perspective on the use of non-*Saccharomyces* yeasts in winemaking. *FEMS Yeast Res*. 2010;10(2):123–133.
- [98] Martin V, Farina L, Medina K, et al. Oenological attributes of the yeast *Hanseniaspora vineae* and its application for white and red winemaking. *BIO Web Conf*. 2019;12:02010.
- [99] Carrau F, Henschke PA. *Hanseniaspora vineae* and the concept of friendly yeasts to increase autochthonous wine flavor diversity. *Front Microbiol*. 2021;12:702093.
- [100] Martin V, Valera MJ, Medina K, et al. Application of *Hanseniaspora vineae* to improve white wine quality. In Morata A, editor. *White wine technology*. London: Academic Press; 2022. p. 99–115.
- [101] Zhang B, Xu D, Duan C, et al. Synergistic effect enhances 2-phenylethyl acetate production in the mixed fermentation of *Hanseniaspora vineae* and *Saccharomyces cerevisiae*. *Process Biochem*. 2020;90:44–49.
- [102] Viana F, Belloch C, Vallés S, et al. Monitoring a mixed starter of *Hanseniaspora vineae*-*Saccharomyces cerevisiae* in natural must: impact on 2-phenylethyl acetate production. *Int J Food Microbiol*. 2011;151(2):235–240.
- [103] Herriaz T, Reglero G, Herriaz M, et al. The influence of the yeast and type of culture on the volatile composition of wines fermented without sulfur dioxide. *Am J Enol Vitic*. 1990;41:313–318.
- [104] Hu K, Jin GJ, Xu YH, et al. Wine aroma response to different participation of selected *Hanseniaspora uvarum* in mixed fermentation with *Saccharomyces cerevisiae*. *Food Res Int*. 2018;108:119–127.
- [105] Zhang B, Shen JY, Duan CQ, et al. Use of indigenous *Hanseniaspora vineae* and *Metschnikowia pulcherrima* co-fermentation with *Saccharomyces cerevisiae* to improve the aroma diversity of vidal blanc icewine. *Front Microbiol*. 2018;9:2303.
- [106] Yan G, Zhang B, Joseph L, et al. Effects of initial oxygenation on chemical and aromatic composition of wine in mixed starters of *Hanseniaspora vineae* and *Saccharomyces cerevisiae*. *J Food Microbiol*. 2020;90:103460.
- [107] Lachance MA. Yeast communities in a natural tequila fermentation. *Antonie van Leeuwenhoek*. 1995;68:151–160.
- [108] Lorenzini M, Simonato B, Slaghenau D, et al. Assessment of yeasts for apple juice fermentation and production of cider volatile compounds. *LWT Food Sci Technol*. 2019;99:224–230.
- [109] Graça A, Santo D, Esteves E, et al. Evaluation of microbial quality and yeast diversity in fresh-cut apple. *Food Microbiol*. 2015;51:179–185.
- [110] Morrissey WF, Davenport B, Querol A, et al. The role of indigenous yeasts in traditional irish cider fermentations. *J Appl Microbiol*. 2004;97(3):647–655.
- [111] Lorenzini M, Simonato B, Zapparoli G. Yeast species diversity in apple juice for cider production evidenced by culture-based method. *Folia Microbiol*. 2018;63(6):677–684.
- [112] Suresh ER, Onkarayya H, Ethiraj S. A note on the yeast flora associated with fermentation of mango. *J Appl Bacteriol*. 1982;52:1–4.
- [113] Deak T, Beuchat LR. Yeasts associated with fruit juice concentrates. *J Food Prot*. 1993;56(9):777–782.
- [114] Mingorance-Cazorla L, Clemente-Jiménez JM, Martínez-Rodríguez S, et al. Contribution of different natural yeasts to the aroma of two alcoholic beverages. *World J Microbiol Biotechnol*. 2003;19:297–304.
- [115] Chanprasartsuk OO, Prakitchaiwattana C, Sanguandeeikul R, et al. Autochthonous yeasts associated with mature pineapple fruits, freshly crushed juice and their ferments; and the chemical changes during natural fermentation. *Bioresour Technol*. 2010;101(19):7500–7509.
- [116] Chanprasartsuk O, Prakitchaiwattana C, Sanguandeeikul R. Comparison of methods for identification of yeasts isolated during spontaneous fermentation of freshly crushed pineapple juices. *J Agric Sci Technol [Internet]*. 2013;15:1779–1790. <https://jast.modares.ac.ir/article-23-5776-en.html>.
- [117] Satora P, Tuszyński T. Biodiversity of yeasts during plum wegierka zwykła spontaneous fermentation. *Food Technol Biotechnol*. 2005;43:277–282.
- [118] González-Robles IW, Estarrón-Espinosa M, Díaz-Montaño DM. Fermentative capabilities and volatile compounds produced by *Kloeckera/Hanseniaspora* and *Saccharomyces* yeast strains in pure and mixed cultures during agave tequilana juice fermentation. *Antonie van Leeuwenhoek*. 2015;108(3):525–536.

- [119] Wei J, Zhang Y, Wang Y, et al. Assessment of chemical composition and sensorial properties of ciders fermented with different non-*Saccharomyces* yeasts in pure and mixed fermentations. *Int J Food Microbiol.* 2020;318:108471.
- [120] Figueroa-Hernández C, Mota-Gutierrez J, Ferrocino I, et al. The challenges and perspectives of the selection of starter cultures for fermented cocoa beans. *Int J Food Microbiol.* 2019;301:41–50.
- [121] Schwan RF, Wheals AE. The microbiology of cocoa fermentation and its role in chocolate quality. *Crit Rev Food Sci Nutr.* 2004;44(4):205–221.
- [122] Sarbu I, Csutak O. The microbiology of cocoa fermentation. In: Grumezescu A, Holban AM, editors. *Caffeinated cocoa based beverages sci beverages.* Sawston: Woodhead Publishing; 2019. p. 423–446.
- [123] Huch M, Franz CMAP. Coffee: fermentation and microbiota. In: *Advances in fermented foods and beverages, improving quality, technologies and health benefits.* Heidelberg, Germany: Elsevier Ltd; 2014. p. 501–513.
- [124] Pereira Gv de M, Soccol VT, Soccol CR. Current state of research on cocoa and coffee fermentations. *Curr Opin Food Sci.* 2016;7:50–57.
- [125] Ruta LL, Farcasanu IC. Coffee and yeasts: from flavor to biotechnology. *Fermentation.* 2021;7:9.
- [126] Elhalis H, Cox J, Frank D, et al. The crucial role of yeasts in the wet fermentation of coffee beans and quality. *Int J Food Microbiol.* 2020;333:108796.
- [127] Ho VTT, Zhao J, Fleet G. Yeasts are essential for cocoa bean fermentation. *Int J Food Microbiol.* 2014; 174:72–87.
- [128] Matraxia M, Alfonzo A, Prestianni R, et al. Non-conventional yeasts from fermented honey by-products: focus on *Hanseniaspora uvarum* strains for craft beer production. *Food Microbiol.* 2021;99:103806.
- [129] Bourbon-Melo N, Palma M, Rocha MP, et al. Use of *Hanseniaspora guilliermondii* and *Hanseniaspora opuntiae* to enhance the aromatic profile of beer in mixed-culture fermentation with *Saccharomyces cerevisiae*. *Food Microbiol.* 2021;95:103678.
- [130] Spadaro D, Droby S. Development of biocontrol products for postharvest diseases of fruit: the importance of elucidating the mechanisms of action of yeast antagonists. *Trends Food Sci Technol.* 2016;47: 39–49.
- [131] Aktar W, Sengupta D, Chowdhury A. Impact of pesticides use in agriculture: their benefits and hazards. *Interdiscip Toxicol.* 2009;2(1):1–12.
- [132] Hahn M. The rising threat of fungicide resistance in plant pathogenic fungi: botrytis as a case study. *J Chem Biol.* 2014;7(4):133–141.
- [133] Saleh R, Bearth A, Siegrist M. How chemophobia affects public acceptance of pesticide use and biotechnology in agriculture. *Food Qual prefer.* 2021. 91:104197.
- [134] Romanazzi G, Lichter A, Gabler FM, et al. Recent advances on the use of natural and safe alternatives to conventional methods to control postharvest gray mold of table grapes. *Postharvest Biol Technol.* 2012; 63:141–147.
- [135] Cordero-Bueso G, Mangieri N, Maghradze D, et al. Wild grape-associated yeasts as promising biocontrol agents against *Vitis vinifera* fungal pathogens. *Front Microbiol.* 2017;8:2025.
- [136] Nandhini M, Harish S, Aiyathan KEA, et al. Glycerol-based liquid formulation of the epiphytic yeast *Hanseniaspora guilliermondii* isolate YBB3 with multiple modes of action controls postharvest *Aspergillus* rot in grapes. *J Plant Pathol.* 2021;103: 1253–1264.
- [137] Pu L, Jingfan F, Kai C, et al. Phenylethanol promotes adhesion and biofilm formation of the antagonistic yeast *Kloeckera apiculata* for the control of blue mold on citrus. *FEMS Yeast Res.* 2014;14(4):536–546.
- [138] Liu P, Cheng Y, Yang M, et al. Mechanisms of action for 2-phenylethanol isolated from *Kloeckera apiculata* in control of penicillium molds of citrus fruits. *BMC Microbiol.* 2014;14:12–18.
- [139] Guo H, Qin X, Wu Y, et al. Biocontrol of gray mold of cherry tomatoes with the volatile organic monomer from *Hanseniaspora uvarum*, *trans-cinnamaldehyde*. *Food Bioprocess Technol.* 2019;12:1809–1820.
- [140] Apaliya MT, Zhang H, Yang Q, et al. *Hanseniaspora uvarum* enhanced with trehalose induced defense-related enzyme activities and relative genes expression levels against *Aspergillus tubingensis* in table grapes. *Postharvest Biol Technol.* 2017;132:162–170.
- [141] Wang L, Dou G, Guo H, et al. Volatile organic compounds of *Hanseniaspora uvarum* increase strawberry fruit flavor and defense during cold storage. *Food Sci Nutr.* 2019;7(8):2625–2635.
- [142] Wang C, Wu C, Qiu S. Yeast diversity investigation of *vitis davidii* fœx during spontaneous fermentations using culture-dependent and high-throughput sequencing approaches. *Food Res Int.* 2019;126: 108582.
- [143] Ferreira-Saab M, Formey D, Torres M, et al. Compounds released by the biocontrol yeast *Hanseniaspora opuntiae* protect plants against *corynespora cassicola* and *Botrytis cinerea*. *Front Microbiol.* 2018;9:1596.
- [144] Cheng L, Nie X, Jiang C, et al. The combined use of the antagonistic yeast *Hanseniaspora uvarum* with β -aminobutyric acid for the management of postharvest diseases of kiwifruit. *Biol Control.* 2019;137: 104019.
- [145] Li W, Zhang H, Li P, et al. Biocontrol of postharvest green mold of oranges by *Hanseniaspora uvarum* Y3 in combination with phosphatidylcholine. *Biol Control.* 2016;103:30–38.
- [146] Liu HM, Guo JH, Luo L, et al. Improvement of *Hanseniaspora uvarum* biocontrol activity against gray mold by the addition of ammonium molybdate and the possible mechanisms involved. *Crop Prot.* 2010;29:277–282.
- [147] Apaliya MT, Zhang H, Zheng X, et al. Exogenous trehalose enhanced the biocontrol efficacy of *Hanseniaspora uvarum* against grape berry rots caused by *Aspergillus tubingensis* and *penicillium commune*. *J Sci Food Agric.* 2018;98(12):4665–4672.
- [148] Qin X, Xiao H, Xue C, et al. Biocontrol of gray mold in grapes with the yeast *Hanseniaspora uvarum* alone and in combination with salicylic acid or sodium

- bicarbonate. Postharvest Biol Technol [Internet]. 2015;100:160–167.
- [149] Canales XAB, Morales FFC, Varas ES. Gluconobacter cerinus plus *Hanseniaspora osmophila* for controlling fungal infections in plants and fruits. US 10,993,444. 2017.
- [150] Angioni A, Caboni P, Garau A, et al. In vitro interaction between ochratoxin a and different strains of *Saccharomyces cerevisiae* and *Kloeckera apiculata*. J Agric Food Chem. 2007;55(5):2043–2048.
- [151] Tejero P, Martín A, Rodríguez A, et al. In vitro biological control of *Aspergillus flavus* by *Hanseniaspora opuntiae* I479 and *Hanseniaspora uvarum* I793, producers of antifungal volatile organic compounds. Toxins (Basel). 2021;13:663.
- [152] Gómez-Albarrán C, Melguizo C, Patiño B, et al. Diversity of mycobiota in spanish grape berries and selection of *Hanseniaspora uvarum* U1 to prevent mycotoxin contamination. Toxins (Basel). 2021;13:649.
- [153] Ben Taheur F, Mansour C, Ben Jeddou K, et al. Aflatoxin B1 degradation by microorganisms isolated from kombucha culture. Toxicon. 2020;179:76–83.
- [154] Prendes LP, Merín MG, Zchetti VGL, et al. Impact of antagonistic yeasts from wine grapes on growth and mycotoxin production by *Alternaria alternata*. J Appl Microbiol. 2021;131(2):833–843.
- [155] Prendes LP, Merín MG, Fontana AR, et al. Isolation, identification and selection of antagonistic yeast against *Alternaria alternata* infection and tenuazonic acid production in wine grapes from Argentina. Int J Food Microbiol. 2018;266:14–20.
- [156] Lam SSTH, Howell KS. *Drosophila*-associated yeast species in vineyard ecosystems. FEMS Microbiol Lett. 2015;362:fnv170.
- [157] Anagnostou C, Dorsch M, Rohlf M. Influence of dietary yeasts on *Drosophila melanogaster* life-history traits. Entomol Exp Appl. 2010;136:1–11.
- [158] Becher PG, Flick G, Rozpedowska E, et al. Yeast, not fruit volatiles mediate *Drosophila melanogaster* attraction, oviposition and development. Funct Ecol. 2012;26:822–828.
- [159] Bellutti N, Gallmetzer A, Innerebner G, et al. Dietary yeast affects preference and performance in *Drosophila suzukii*. J Pest Sci (2004). 2018;91(2):651–660.
- [160] Lee JC, Dreves AJ, Cave AM, et al. Infestation of wild and ornamental noncrop fruits by *Drosophila suzukii* (diptera: drosophilidae). Ann Entomol Soc Am. 2015;108:117–129.
- [161] Rombaut A, Guillhot R, Xuéreb A, et al. Invasive *Drosophila suzukii* facilitates *Drosophila melanogaster* infestation and sour rot outbreaks in the vineyards. R Soc Open Sci. 2017;4(3):170117.
- [162] Entling W, Hoffmann C. Single and combined effects of *Drosophila suzukii* and *Drosophila melanogaster* on sour rot development in viticulture. J Appl Entomol. 2020;144:153–160.
- [163] Morais PB, Martins MB, Klaczko LB, et al. Yeast succession in the amazon fruit parahancornia Amapa as resource partitioning among *drosophila* spp. Appl Environ Microbiol. 1995;61(12):4251–4257.
- [164] Hamby KA, Hernández A, Boundy-Mills K, et al. Associations of yeasts with spotted-wing drosophila (*Drosophila suzukii*; diptera: drosophilidae) in cherries and raspberries. Appl Environ Microbiol. 2012;78(14):4869–4873.
- [165] Chandler JA, Eisen JA, Kopp A. Yeast communities of diverse drosophila species: comparison of two symbiont groups in the same hosts. Appl Environ Microbiol. 2012;78(20):7327–7336.
- [166] Lachance M-A, Gilbert DG, Starmer WT. Yeast communities associated with drosophila species and related flies in an Eastern oak-pine Forest: a comparison with Western communities. J Ind Microbiol. 1995;14(6):484–494.
- [167] Hoang D, Kopp A, Chandler JA. Interactions between drosophila and its natural yeast symbionts- is *Saccharomyces cerevisiae* a good model for studying the fly-yeast relationship? PeerJ. 2015;3:e1116.
- [168] Murgier J, Everaerts C, Farine J, et al. Live yeast in juvenile diet induces species-specific effects on drosophila adult behaviour and fitness. Sci Rep. 2019;9(1):8873.
- [169] Spitaler U, Bianchi F, Eisenstecken D, et al. Yeast species affects feeding and fitness of *Drosophila suzukii* adults. J Pest Sci. 2020;93:1295–1309.
- [170] Lewis MT, Hamby KA. Differential impacts of yeasts on feeding behavior and development in larval *Drosophila suzukii* (diptera: drosophilidae). Sci Rep. 2019;9(1):13370.
- [171] Palanca L, Gaskett AC, Günther CS, et al. Quantifying variation in the ability of yeasts to attract *Drosophila melanogaster*. PLoS One. 2013;8(9):e75332.
- [172] Jones R, Fountain MT, Günther CS, et al. Separate and combined *Hanseniaspora uvarum* and *Metschnikowia pulcherrima* metabolic volatiles are attractive to *Drosophila suzukii* in the laboratory and field. Sci Rep. 2021;11(1):1201.
- [173] Becher PG, Hagman A, Verschut V, et al. Chemical signaling and insect attraction is a conserved trait in yeasts. Ecol Evol. 2018;8(5):2962–2974.
- [174] Lasa R, Navarro-de-la-Fuente L, Gschaedler-Mathis AC, et al. Yeast species, strains, and growth media mediate attraction of *Drosophila suzukii* (diptera: drosophilidae). Insects. 2019;10:228.
- [175] Scheidler NH, Liu C, Hamby KA, et al. Volatile codes: correlation of olfactory signals and reception in drosophila-yeast chemical communication. Sci Rep. 2015;5:14059.
- [176] Toledo-Hernandez R, Lasa R, Montoya P, et al. Efficacy of food-based attractants for monitoring *Drosophila suzukii* (diptera: drosophilidae) in berry crops. Crop Prot. 2021;150:105797.
- [177] Khan MS, Ullah F, Badshah H, et al. Bait attractants based on artificial fruit-essence for trapping and monitoring *Drosophila suzukii* (diptera: drosophilidae) females in Peshawar-Pakistan. Phytoparasitica. 2019;47:179–184.
- [178] Huang J, Gut L, Grieshop M. Behavior evaluation of food-based attractants for *Drosophila suzukii* (diptera : Drosophilidae). Environ Entomol. 2017;46(4):878–884.
- [179] Noble R, Dobrovin-Pennington A, Phillips A, et al. Improved insecticidal control of spotted wing

- drosophila (*Drosophila suzukii*) using yeast and fermented strawberry juice baits. *Crop Prot* [Internet]. 2019;125:104902.
- [180] Bianchi F, Spitaler U, Castellan I, et al. Persistence of a yeast-based (*Hanseniaspora uvarum*) attract-and-kill formulation against *Drosophila suzukii* on grape leaves. *Insects*. 2020;11:810.
- [181] Reherrmann G, Spitaler U, Sahle K, et al. Behavioral manipulation of *Drosophila suzukii* for pest control: high attraction to yeast enhances insecticide efficacy when applied on leaves. *Pest Manag Sci*. 2022;78(3):896–904.
- [182] Mori BA, Whitener AB, Leinweber Y, et al. Enhanced yeast feeding following mating facilitates control of the invasive fruit pest *Drosophila suzukii*. *J Appl Ecol*. 2017;54:170–177.
- [183] Batista MRD, Uno F, Chaves RD, et al. Differential attraction of drosophilids to banana baits inoculated with *Saccharomyces cerevisiae* and *Hanseniaspora uvarum* within a neotropical Forest remnant. *PeerJ*. 2017;5:e3063.
- [184] Noble R, Walker A, Whitfield C, et al. Minimizing insecticides for control of spotted wing drosophila (*Drosophila suzukii*) in soft fruit using bait sprays. *J Appl Entomol*. 2021;00:1–9.
- [185] Lin B, Tao Y. Whole-cell biocatalysts by design. *Microb Cell Fact*. 2017;16(1):106.
- [186] Goretti M, Ponzoni C, Caselli E, et al. Bioreduction of α,β -unsaturated ketones and aldehydes by non-conventional yeast (NCY) whole-cells. *Bioresour Technol*. 2011;102(5):3993–3998.
- [187] Goretti M, Turchetti B, Cramarossa MR, et al. Production of flavours and fragrances via bioreduction of (4R)-(-)-carvone and (1R)-(-)-myrtenal by non-conventional yeast whole-cells. *Molecules*. 2013;18:5736–5748.
- [188] Van Dyk MS, Van Rensburg E, Rensburg IPB, et al. Biotransformation of monoterpene ketones by yeasts and yeast-like fungi. *J Mol Catal - B Enzym*. 1998;5:149–154.
- [189] Goretti M, Ponzoni C, Caselli E, et al. Biotransformation of electron-poor alkenes by yeasts: asymmetric reduction of (4S)-(+)-carvone by yeast enoate reductases. *Enzyme Microb Technol*. 2009;45:463–468.
- [190] Filippucci S, Tasselli G, Kenza Labbani FZ, et al. Non-conventional yeasts as sources of ene-reductases for the bioreduction of chalcones. *Fermentation*. 2020;6:29.
- [191] Hellström AM, Almgren A, Carlsson N, et al. Degradation of phytate by *pichia kudriavzevii* TY13 and *Hanseniaspora guilliermondii* TY14 in Tanzanian togwa. *Int J Food Microbiol*. 2012;153(1-2):73–77.
- [192] Mandal SK, Ojha N, Das N. Process optimization of benzo[ghi]perylene biodegradation by yeast consortium in presence of ZnO nanoparticles and produced biosurfactant using Box-Behnken design. *Front Biol*. 2018;13:418–424.
- [193] Mandal SK, Das N. Biodegradation of perylene and benzo[ghi]perylene (5-6 rings) using yeast consortium: kinetic study, enzyme analysis and degradation pathway. *J Environ Biol*. 2018;39:5–15.
- [194] Zhang H, Zhao Z, Kang P, et al. Biological nitrogen removal and metabolic characteristics of a novel aerobic denitrifying fungus *Hanseniaspora uvarum* strain KPL108. *Bioresour Technol*. 2018;267:569–577.
- [195] Pramateftaki PV, Kouvelis VN, Lanaridis P, et al. The mitochondrial genome of the wine yeast *Hanseniaspora uvarum*: a unique genome organization among yeast/fungal counterparts. *FEMS Yeast Res*. 2006;6(1):77–90.
- [196] Freel KC, Friedrich A, Schacherer J. Mitochondrial genome evolution in yeasts: an all-encompassing view. *FEMS Yeast Res*. 2015;15(4):fov023. fov023.
- [197] Giorello FM, Berná L, Greif G, et al. Genome sequence of the native apiculate wine yeast *Hanseniaspora vineae* T02/19AF. *Genome Announc*. 2014;2:19–20.
- [198] Langenberg A, Bink FJ, Wolff L, et al. Glycolytic functions are conserved in the genome of the wine yeast *Hanseniaspora uvarum*, and pyruvate kinase limits its capacity for alcoholic fermentation. *Appl Environ Microbiol*. 2017;83:e01580-17.
- [199] Sternes PR, Lee D, Kutyna DR, et al. Genome sequences of three species of *Hanseniaspora* isolated from spontaneous wine fermentations. *Genome Announc*. 2016;4:e01287-16.
- [200] Seixas I, Barbosa C, Mendes-Faia A, et al. Genome sequence of the non-conventional wine yeast *Hanseniaspora guilliermondii* UTAD222 unveils relevant traits of this species and of the *Hanseniaspora* genus in the context of wine fermentation. *DNA Res*. 2019;26(1):67–83.
- [201] Riley R, Haridas S, Wolfe KH, et al. Comparative genomics of biotechnologically important yeasts. *Proc Natl Acad Sci U S A*. 2016;113(35):9882–9887.
- [202] Steenwyk JL, Opulente DA, Kominek J, et al. Extensive loss of cell-cycle and DNA repair genes in an ancient lineage of bipolar budding yeasts. *Plos Bio*. 2019;1:e3000255.
- [203] Shen XX, Opulente DA, Kominek J, et al. Tempo and mode of genome evolution in the budding yeast subphylum. *Cell*. 2018;175(6):1533–1545.e20.
- [204] Shen XX, Zhou X, Kominek J, et al. Reconstructing the backbone of the saccharomycotina yeast phylogeny using genome-scale data. *G3 Genes, Genomes, Genet*. 2016;6:3927–3939.
- [205] Boyce KJ, Wang Y, Verma S, et al. Mismatch repair of DNA replication errors contributes to microevolution in the pathogenic fungus *Cryptococcus*. *MBio*. 2017;8:e00595-17.
- [206] Billmyre RB, Clancey SA, Heitman J. Natural mismatch repair mutations mediate phenotypic diversity and drug resistance in *Cryptococcus deuterogattii*. *Elife*. 2017;6:e28802.
- [207] Albertin W, Setati ME, Miot-Sertier C, et al. *Hanseniaspora uvarum* from winemaking environments show spatial and temporal genetic clustering. *Front Microbiol*. 2015;6:1569.
- [208] Schwarz LV, Valera MJ, Delamare APL, et al. A peculiar cell cycle arrest at g2/m stage during the stationary phase of growth in the wine yeast *Hanseniaspora vineae*. *Curr Res Microb Sci*. 2022;3:100129.

- [209] Saubin M, Devillers H, Proust L, et al. Investigation of genetic relationships between *Hanseniaspora* species found in grape musts revealed interspecific hybrids with dynamic genome structures. *Front Microbiol.* 2019;10:2960.
- [210] Guaragnella N, Chiara M, Capece A, et al. Genome sequencing and comparative analysis of three *Hanseniaspora uvarum* indigenous wine strains reveal remarkable biotechnological potential. *Front Microbiol.* 2019;10:3133.
- [211] Giorello F, Valera MJ, Martin V, et al. Genomic and transcriptomic basis of *Hanseniaspora vineae*'s impact on flavor diversity and wine quality. *Appl Environ Microbiol.* 2019;85:e01959–18.
- [212] Shi W, Li J, Chen Y, et al. Metabolic engineering of *Saccharomyces cerevisiae* for ethyl acetate biosynthesis. *ACS Synth Biol.* 2021;10(3):495–504.
- [213] Tian Z, Du Y, Yang F, et al. Chromosome genome sequencing and comparative transcriptome-based analyses of *Kloeckera apiculata* 34-9 unveil the potential biocontrol mechanisms against citrus green mold. *Front Microbiol.* 2021;12:752529.
- [214] Lleixà J, Martín V, Giorello F, et al. Analysis of the NCR mechanisms in *Hanseniaspora vineae* and *Saccharomyces cerevisiae* during winemaking. *Front Genet.* 2019;10:00747.
- [215] Valera MJ, Boido E, Ramos JC, et al. The mandelate pathway, an alternative to the phenylalanine ammonia lyase pathway for the synthesis of benzenoids in ascomycete yeasts. *Appl Environ Microbiol.* 2020;86:e00701–20.
- [216] Bink FJ. Molekulargenetische und physiologische untersuchungen an der weinhefe *Kloeckera apiculata* (*Hanseniaspora uvarum*). diss zur erlangung des doktorgrades der naturwissenschaften; University of Osnabrück. Fachbereich Biol Abteilung Genet. 2010;: 129.
- [217] Badura J, van Wyk N, Brezina S, et al. Development of genetic modification tools for *Hanseniaspora uvarum*. *Int J Mol Sci.* 2021;22:1–17.
- [218] Tamura K, Stecher G, Kumar S. MEGA11: molecular evolutionary genetics analysis version 11. *Mol Biol Evol.* 2021;38(7):3022–3027.
- [219] Andorrà I, Berradre M, Rozès N, et al. Effect of pure and mixed cultures of the main wine yeast species on grape must fermentations. *Eur Food Res Technol.* 2010;231:215–224.
- [220] Zironi R, Romano P, Suzzi G, et al. Volatile metabolites produced in wine by mixed and sequential cultures of *Hanseniaspora guilliermondii* or *Kloeckera apiculata* and *Saccharomyces cerevisiae*. *Biotechnol Lett.* 1993;15:235–238.
- [221] Moreira N, Mendes F, Guedes de Pinho P, et al. Heavy sulphur compounds, higher alcohols and esters production profile of *Hanseniaspora uvarum* and *Hanseniaspora guilliermondii* grown as pure and mixed cultures in grape must. *Int J Food Microbiol.* 2008;124(3):231–238.
- [222] Testa B, Coppola F, Lombardi SJ, et al. Influence of *Hanseniaspora uvarum* AS27 on chemical and sensorial characteristics of aglianico wine. *Processes.* 2021; 9:326.
- [223] Canonico L, Comitini F, Oro L, et al. Sequential fermentation with selected immobilized non-*Saccharomyces* yeast for reduction of ethanol content in wine. *Front Microbiol.* 2016;7:278.
- [224] Ciani M, Beco L, Comitini F. Fermentation behaviour and metabolic interactions of multistarter wine yeast fermentations. *Int J Food Microbiol.* 2006;108(2):239–245.
- [225] Moreira N, Pina C, Mendes F, et al. Volatile compounds contribution of *Hanseniaspora guilliermondii* and *Hanseniaspora uvarum* during red wine vinifications. *Food Control.* 2011;22:662–667.
- [226] Morata A, Loira I, González C, et al. Non-*Saccharomyces* as biotools to control the production of off-flavors in wines. *Molecules.* 2021;26:4571.
- [227] Luan Y, Zhang BQ, Duan CQ, et al. Effects of different pre-fermentation cold maceration time on aroma compounds of *Saccharomyces cerevisiae* co-fermentation with *Hanseniaspora opuntiae* or *Pichia kudriavzevii*. *LWT Food Sci Technol.* 2018;92:177–186.
- [228] Viana F, Gil JV, Genovés S, et al. Rational selection of non-*Saccharomyces* wine yeasts for mixed starters based on ester formation and enological traits. *Food Microbiol.* 2008;25(6):778–785.
- [229] Viana F, Gil JV, Vallés S, et al. Increasing the levels of 2-phenylethyl acetate in wine through the use of a mixed culture of *Hanseniaspora osmophila* and *Saccharomyces cerevisiae*. *Int J Food Microbiol.* 2009; 135(1):68–74.
- [230] Osburn K, Amaral J, Metcalf SR, et al. Primary souring: a novel bacteria-free method for sour beer production. *Food Microbiol.* 2018;70:76–84.
- [231] Bellut K, Michel M, Zarnkow M, et al. Application of non-*Saccharomyces* yeasts isolated from kombucha in the production of alcohol-free beer. *Fermentation.* 2018;4:66.
- [232] Larroque MN, Carrau F, Fariña L, et al. Effect of *saccharomyces* and non-*Saccharomyces* native yeasts on beer aroma compounds. *Int J Food Microbiol.* 2021; 337:108953.
- [233] Ooi TS, Ting ASY, Siow LF. Volatile organic compounds and sensory profile of dark chocolates made with cocoa beans fermented with *pichia kudriavzevii* and *Hanseniaspora thailandica*. *J Food Sci Technol [Internet].* 2020;122:108977.
- [234] Ooi TS, Ting ASY, Siow LF. Influence of selected native yeast starter cultures on the antioxidant activities, fermentation index and total soluble solids of Malaysia cocoa beans : a simulation study. *LWT Food Sci Technol.* 2020;122:108977.
- [235] Ooi TS, Ting ASY, Siow LF. Physicochemical properties, antioxidant content, volatile organic compounds and sensory profile of cocoa beans fermented with yeast starter cultures. *J Food Process Preserv.* 2021; 45:e15893.
- [236] Elhalis H, Cox J, Frank D, et al. Microbiological and chemical characteristics of wet coffee fermentation inoculated with *Hansinaspora uvarum* and *Pichia kudriavzevii* and their impact on coffee sensory quality. *Front Microbiol.* 2021;12:713969.
- [237] Elhalis H, Cox J, Frank D, et al. Microbiological and biochemical performances of six yeast species as

- potential starter cultures for wet fermentation of coffee beans. *LWT - Food Sci Technol.* 2021;137:110430.
- [238] Hu L, Wang J, Ji X, et al. Selection of non-*Saccharomyces* yeasts for orange wine fermentation based on their enological traits and volatile compounds formation. *J Food Sci Technol.* 2018;55(10):4001–4012.
- [239] Xu A, Xiao Y, He Z, et al. Use of non-*Saccharomyces* yeast co-fermentation with *Saccharomyces cerevisiae* to improve the polyphenol and volatile aroma compound contents in Nanfeng tangerine wines. *J Fungi.* 2022;8:128.
- [240] Bourdichon F, Casaregola S, Farrokh C, et al. Food fermentations: microorganisms with technological beneficial use. *Int J Food Microbiol.* 2012;154(3):87–97.
- [241] Wei J, Wang S, Zhang Y, et al. Characterization and screening of non-*Saccharomyces* yeasts used to produce fragrant cider. *LWT - Food Sci Technol.* 2019;107:191–198.
- [242] Wei J, Zhang Y, Qiu Y, et al. Chemical composition, sensorial properties, and aroma-active compounds of ciders fermented with *Hanseniaspora osmophila* and *torulaspora quercuum* in co- and sequential fermentations. *Food Chem.* 2020;306:125623.
- [243] Bilbao A, Irastorza A, Dueñas M, et al. The effect of temperature on the growth of strains of *Kloeckera apiculata* and *Saccharomyces cerevisiae* in apple juice fermentation. *Lett Appl Microbiol.* 1997;24(1):37–39.
- [244] Madrera RR, Bedriñana RP, Hevia, G, et al. Production of spirits from dry apple pomace and selected yeasts. *Food Bioprod Process.* 2013;91:623–631.
- [245] Xu Y, Zhao GA, Wang LP. Controlled formation of volatile components in cider making using a combination of *Saccharomyces cerevisiae* and *Hanseniaspora valbyensis* yeast species. *J Ind Microbiol Biotechnol.* 2006;33(3):192–196.
- [246] Diaz-Montano DM, Delia M-L, Estarron-Espinosa M, et al. Fermentative capability and aroma compound production by yeast strains isolated from agave tequilana weber juice. *Enzyme Microb Technol.* 2008;42:608–616.
- [247] Arellano M, Pelayo C, Ramirez J, et al. Characterization of kinetic parameters and the formation of volatile compounds during the tequila fermentation by wild yeasts isolated from agave juice. *J Ind Microbiol Biotechnol.* 2008;35(8):835–841.
- [248] Seixas E, Rêgo B, Augusto C, et al. Cashew wine and volatile compounds produced during fermentation by non-*Saccharomyces* and *Saccharomyces* yeast. *LWT Food Sci Technol.* 2020;126:109291.
- [249] Gamero A, Ren X, Lamboni Y, et al. Development of a low-alcoholic fermented beverage employing cashew apple juice and non-conventional yeasts. *Fermentation.* 2019;5:71.
- [250] Lara-Hidalgo C, Belloch C, Dorantes-Alvarez L, et al. Contribution of autochthonous yeasts with probiotic potential to the aroma profile of fermented guajillo pepper sauce. *J Sci Food Agric.* 2020;100:4940–4949.
- [251] Coulibaly WH, Bouatenin KJ-PM, Kouamé AK, et al. Use of non-*Saccharomyces* yeast strains as starter cultures to enhance fermented mango juice production. *Sci African.* 2020;7:e00226.
- [252] Takaya M, Ohwada T, Oda Y. Characterization of the yeast *Hanseniaspora vineae* isolated from the wine grape 'yamasachi' and its use for bread making. *Food Sci Technol Res.* 2019;25:835–842.
- [253] Korres AMN, Buss DS, Ventura JA, et al. *Candida krusei* and *Kloeckera apis* inhibit the causal agent of pineapple fusariosis, *Fusarium guttiforme*. *Fungal Biol.* 2011;115(12):1251–1258.
- [254] Taqarort N, Echairi A, Chaussod R, et al. Screening and identification of epiphytic yeasts with potential for biological control of green mold of citrus fruits. *World J Microbiol Biotechnol.* 2008;24:3031–3038.
- [255] Fernández-Pacheco P, García-Béjar B, Castillo MJ, et al. Potential probiotic and food protection role of wild yeasts isolated from pistachio fruits (*Pistacia vera*). *J Sci Food Agric.* 2021;101(6):2201–2209.
- [256] Romanens E, Leischfeld F, Volland S, et al. Screening of lactic acid bacteria and yeast strains to select adapted anti-fungal co-cultures for cocoa bean fermentation. *Int J Food Microbiol.* 2019;290:262–272.
- [257] Thomé RM, de Oliveira LVB, Sumida CH, et al. In vitro control of *Botrytis cinerea* and *Penicillium italicum* by antagonistic yeasts. *Semin Agrar.* 2020;41:2411–2418.
- [258] Ruiz-Moyano S, Martín A, Villalobos MC, et al. Yeasts isolated from figs (*Ficus carica* L.) as biocontrol agents of postharvest fruit diseases. *Food Microbiol.* 2016;57:45–53.
- [259] Sabaghian S, Braschi G, Vannini L, et al. Isolation and identification of wild yeast from malaysian grapevine and evaluation of their potential antimicrobial activity against grapevine fungal pathogens. *Microorganisms.* 2021;9:2582.
- [260] Olivera M, Delgado N, Cádiz F, et al. Diffusible compounds produced by *Hanseniaspora osmophila* and *Gluconobacter cerinus* help to control the causal agents of gray rot and summer bunch rot of table grapes. *Antibiotics.* 2021;10:664.
- [261] Delgado N, Fabiola C, Bravo G. Volatile organic compounds (VOCs) produced by *Gluconobacter cerinus* and *Hanseniaspora osmophila* displaying control effect against table grape-rot pathogens. *Antibiotics.* 2021;10:663.
- [262] Cai Z, Yang R, Xiao H, et al. Effect of preharvest application of *Hanseniaspora uvarum* on postharvest diseases in strawberries. *Postharvest Biol Technol.* 2015;100:52–58.
- [263] Liu HM, Guo JH, Cheng YJ, et al. Control of gray mold of grape by *Hanseniaspora uvarum* and its effects on postharvest quality parameters. *Ann Microbiol.* 2010;60:31–35.
- [264] Liu P, Luo L, An LC. Characterization of competition for nutrients in the biocontrol of *Penicillium italicum* by *Kloeckera apiculata*. *Biol Control [Internet].* 2013;67:157–162.
- [265] Masoud W, Poll L, Jakobsen M. Influence of volatile compounds produced by yeasts predominant during processing of *Coffea arabica* in east Africa on growth and ochratoxin A (OTA) production by *Aspergillus ochraceus*. *Yeast.* 2005;22(14):1133–1142.

- [266] Fan Q, Tian S, Jiang A, et al. Isolation and screening of biocontrol antagonists of diseases of postharvest fruits. *Zhongguo Huanjing Kexue/China Environ Sci.* 2001;21:313–316.
- [267] Long CA, Deng BX, Deng XX. Commercial testing of *Kloeckera apiculata*, isolate 34-9, for biological control of postharvest diseases of citrus fruit. *Ann Microbiol.* 2007;57:203–207.
- [268] Mclaughlin RJ, Wilson CL, Droby S, et al. Biological control of postharvest diseases of grape, peach, and apple with the yeasts *Kloeckera apiculata* and *Candida guilliermondii*. *Plant Dis.* 1992;76:470–473.
- [269] Zhang J, Xie J, Zhou Y, et al. Inhibitory effect of *Pichia membranaefaciens* and *Kloeckera apiculata* against *Monilinia fructicola* and their biocontrol ability of brown rot in postharvest plum. *Biol Control.* 2017;114:51–58.
- [270] Karabulut OA, Baykal N. Biological control of post-harvest diseases of peaches and nectarines by yeasts. *J Phytopathol.* 2003;151:130–134.
- [271] Long CA, Yuan G. *Kloeckera apiculata* strain (34-9) to control *Botrytis cinerea* during the pre- and postharvest handling of strawberries. *Ann Microbiol.* 2009;59:77–81.
- [272] Rabosto X, Carrau M, Paz A, et al. Grapes and vineyard soils as sources of microorganisms for biological control of *Botrytis cinerea*. *Am J Enol Vitic.* 2006;57:332–338.
- [273] Basha H, Ramanujam B. Growth promotion effect of *Pichia guilliermondii* in chilli and biocontrol potential of *Hanseniaspora uvarum* against *Colletotrichum capsici* causing fruit rot. *Biocontrol Sci Technol.* 2015;25:185–206.

Chapter 2 - Aroma profiles of *Vitis vinifera* L. cv. Gewürztraminer must fermented with co-cultures of *Saccharomyces cerevisiae* and seven *Hanseniaspora* spp.

Chapter 2 is based on the following peer-reviewed publication:

Badura, J.; Kiene, F.; Brezina, S.; Fritsch, S.; Semmler, H.; Rauhut, D.; Pretorius, I. S.; von Wallbrunn, C.; van Wyk, N. (2023): Aroma profiles of *Vitis vinifera* L. cv. Gewürztraminer must fermented with co-cultures of *Saccharomyces cerevisiae* and seven *Hanseniaspora* spp. In *Fermentation* 9 (2), 109. DOI: 10.3390/fermentation9020109.

Author contributions:

Conceptualization: **JB**, NvW

Funding acquisition: CvW

Methodology: **JB**, NvW

Investigation: **JB**, NvW

Validation: **JB**

Data curation: **JB**

Formal analysis: HS, SB, SF

Visualization: **JB**, FK

Project administration: CvW

Resources: CvW

Supervision: DR, ISP, CvW

Writing – original draft: NvW

Writing – review & editing: **JB**, FK, ISP, NvW

All authors have read and agreed to the published version of the manuscript.



Article

Aroma Profiles of *Vitis vinifera* L. cv. Gewürztraminer Must Fermented with Co-Cultures of *Saccharomyces cerevisiae* and Seven *Hanseniaspora* spp.

Jennifer Badura ¹, Florian Kiene ¹, Silvia Brezina ¹, Stefanie Fritsch ¹, Heike Semmler ¹, Doris Rauhut ¹, Isak S. Pretorius ², Christian von Wallbrunn ¹ and Niël van Wyk ^{1,2,*}

¹ Department of Microbiology and Biochemistry, Hochschule Geisenheim University, Von-Lade-Strasse 1, 65366 Geisenheim, Germany

² ARC Centre of Excellence in Synthetic Biology, Department of Molecular Sciences, Macquarie University, Sydney, NSW 2113, Australia

* Correspondence: niel.wyk@hs-gm.de

Abstract: In this study, the aroma-production profiles of seven different *Hanseniaspora* strains, namely *H. guilliermondii*, *H. meyeri*, *H. nectarophila*, *H. occidentalis*, *H. opuntiae*, *H. osmophila* and *H. uvarum* were determined in a simultaneous co-inoculation with the wine yeast *Saccharomyces cerevisiae* Champagne Epernay Geisenheim (Uvaferm CEG). All co-inoculated fermentations with *Hanseniaspora* showed a dramatic increase in ethyl acetate levels except the two (*H. occidentalis* and *H. osmophila*) that belong to the so-called slow-evolving clade, which had no meaningful difference, compared to the *S. cerevisiae* control. Other striking observations were the almost complete depletion of lactic acid in mixed-culture fermentations with *H. osmophila*, the more than 3.7 mg/L production of isoamyl acetate with *H. guilliermondii*, the significantly lower levels of glycerol with *H. occidentalis* and the increase in certain terpenols, such as citronellol with *H. opuntiae*. This work allows for the direct comparison of wines made with different *Hanseniaspora* spp. showcasing their oenological potential, including two (*H. meyeri* and *H. nectarophila*) previously unexplored in winemaking experiments.

Keywords: *Hanseniaspora*; mixed-starter culture fermentation; wine; aroma



Citation: Badura, J.; Kiene, F.; Brezina, S.; Fritsch, S.; Semmler, H.; Rauhut, D.; Pretorius, I.S.; von Wallbrunn, C.; van Wyk, N. Aroma Profiles of *Vitis vinifera* L. cv. Gewürztraminer Must Fermented with Co-Cultures of *Saccharomyces cerevisiae* and Seven *Hanseniaspora* spp. *Fermentation* **2023**, *9*, 109. <https://doi.org/10.3390/fermentation9020109>

Academic Editor: Amparo Gamero

Received: 9 December 2022

Revised: 12 January 2023

Accepted: 18 January 2023

Published: 24 January 2023



Copyright: © 2023 by the authors. Licensee MDPI, Basel, Switzerland. This article is an open access article distributed under the terms and conditions of the Creative Commons Attribution (CC BY) license (<https://creativecommons.org/licenses/by/4.0/>).

1. Introduction

Yeasts belonging to the genus *Hanseniaspora* are among the most commonly isolated in vitivicultural settings, and their role within grape must fermentations has been the topic of investigation among wine microbiologists for many years [1–3]. They are also common isolates on other fruits and have an influential role on the outcomes of fermentations, ranging from apple cider to coffee and chocolate [4–6]. During grape must fermentations, in general, the population of *Hanseniaspora* spp. drops significantly within the first couple of days due to a number of factors, including the accumulative exposure to an anaerobic environment and, intriguingly, the killer ability of fermenting yeast, such as *S. cerevisiae* [7–9]. Nevertheless, their impact on the final wine product can be meaningful as they compete for nutrients needed for fermenting yeasts to complete the fermentation, and most importantly, are capable of producing a large array of important aroma-active compounds. *Hanseniaspora* spp. are well-known for their production of high-levels of acetate esters, particularly ethyl acetate, which would often exceed concentrations deemed to be pleasant (~150 mg/L) and imparting a solvent or nail polish remover aroma [10]. Although *Hanseniaspora* has often been cited as being a spoilage yeast within winemaking [11,12], researchers are re-evaluating the overall impact that some species of *Hanseniaspora* can have as co-partners with *S. cerevisiae* in mixed-culture fermentations, with many reporting on the beneficial effects in adding to the aroma complexity of a wine [2]. *Hanseniaspora*-initiated fermentations have also been shown to reduce final ethanol levels [13], increase overall

glycerol concentration [14], modulate acid composition [15], as well as causing a change in anthocyanin content and therefore the colour of the wine [16,17]. One species in particular, namely *H. vineae*, has shown repeatedly to provide several oenological benefits, which led to the development of a commercially available starter culture by the name of Fermivin VINEAE supplied by Oenobrandts [18].

In mixed-culture fermentations, the most popular inoculation modality is a so-called sequential inoculation where the non-*Saccharomyces* yeast (NSY) starter culture is inoculated at the onset, allowing for NSY to exert an effect without the influence of *S. cerevisiae* [19].

One to three days later or once the sugar consumption has reached a certain level, the *Saccharomyces* culture is normally added. Alternatively, both starter cultures can be added simultaneously at the onset of fermentations. Studies where both modalities were conducted show the dramatic difference in the final outcome of the wine, which emphasizes the complexity and unpredictability of the interaction between the different yeasts [20–23].

The recent influx of whole-genome sequencing of representatives of each species within the *Hanseniaspora* genus, along with accompanying comparative studies, have revealed interesting data regarding the genomic make-up of this genus. Phylogenetic analyses have separated *Hanseniaspora* into two major clades, namely the fast-evolving lineage (FEL) and the slow-evolving lineage (SEL) [24,25]. Genes involved with cell cycle and genome integrity, thought to be conserved within ascomycetes, are not present within the genus. These genomic features of *Hanseniaspora* could assist in explaining the biology of the genus that becomes rapidly abundant as the sugar content in fruits increases during ripening [26]. Moreover, *H. vineae* was recently shown to undergo a rapid loss in cell viability during the stationary phase warranting more in-depth research in this genus, in particular how the two different lineages differ from each other [27].

In this study, we report on the co-fermentation of seven different *Hanseniaspora* spp. (two belonging to the SEL and five to the FEL) and how the respective species affected the aroma profile of a Gewürztraminer wine.

2. Materials and Methods

2.1. Yeast Strains Used in the Study

The *Hanseniaspora* strains *H. guilliermondii* NRRL-Y 1625, *H. meyeri* NRRL-Y 27,513 and *H. osmophila* NRRL Y-1613 were obtained from the Agriculture Resource Service Culture Collection (NRRL) (Peoria, IL, USA). The strain *H. uvarum* DSM2768 was a gift from Professor Jürgen Heinisch (University Osnabrück). The strains *H. nectarophila* GYBC-283, *H. occidentalis* GYBC-211 and *H. opuntiae* GYBC-284 were obtained from the Geisenheim yeast breeding culture collection. The *S. cerevisiae* strain Uvaferm CEG (Eaton, Nettersheim, Germany) was used as the fermenting yeast.

2.2. Microvinification

Pasteurised Gewürztraminer (GT) grape must (harvested from the vineyards belonging to the Geisenheim University in the Rheingau wine region of Germany) were used in the study. The GT must had a total sugar concentration of 247.8 g/L (123.3 g/L glucose and 124.5 g/L fructose). The main wine acids, tartaric and malic acid, were measured to be 3.7 g/L and 2.1 g/L, respectively. The must also had a citric acid content of 0.18 g/L. Its yeast available nitrogen was calculated as 65 mg/L by determining the primary free amino acid content using the spectrophotometrically-based nitrogen by the *o*-phthaldialdehyde method [28] and the free ammonium content using the rapid ammonium kit (Megazyme, Bray, Ireland). Opti-MUM White™ (Lallemand, Montreal, QC, Canada), at a concentration of 20 g/hL, was added as a supplement. Fermentations were conducted in 250 mL Schott Duran flasks filled with 150 mL of GT must. All yeasts were precultured in YPD medium (20 g/L glucose, 20 g/L peptone, 10 g/L yeast extract) and washed once with phosphate-buffered saline. The *Hanseniaspora* cultures were inoculated at a concentration of $\sim 1 \times 10^7$ cells/mL, as determined by haemocytometer, whereas the *S. cerevisiae* strain was inoculated at a concentration of 1×10^6 cells/mL. Airlocks were added to the flasks filled

with approximately 3 mL of water. Fermentations were conducted at 22 °C and flasks were weighed daily until no further mass-loss was recorded. Samples were then centrifuged and subsequently prepared for high-performance liquid chromatography (HPLC) and gas-chromatography mass-spectrometry (GC-MS) analyses.

A one-day fermentation was also conducted where 1 µL of citronellol (Thermo Fisher Scientific, Geel, Belgium) was added to pure inoculations of *H. guilliermondii* and *H. uvarum*.

2.3. Analysis of the Must and Wines

Standard operating procedures, as established by the analysis team at the Institute of Microbiology and Biochemistry at Hochschule Geisenheim University, were followed to analyse the grape must and final wines produced in the study.

2.3.1. HPLC

For the quantification of the major organic acids, sugars, ethanol and glycerol of the wines and must, HPLC was implemented with a method previously described [29]. An HPLC Agilent Technologies Series 1100 (Agilent Technologies, Steinheim, Germany) was used built-in with an autosampler, a multi-wavelength (MWD) and refractive index (RID) detector and a binary pump. An HPLC column, 250 mm in length (Allure Organic Acids Column, Restek, Bad Homburg v. d. Höhe, Germany), with an inside diameter of 4.6 mm and a particle size of 5 µm was used for the separation of the different analytes. The MWD was set at a wavelength of 210 nm for the detection of organic acids and the RID was used to detect the sugars, organic acids, glycerol and ethanol. The isocratic eluent was comprised of deionized water with 0.5% ethanol and acidified with 0.0139% concentrated sulphuric acid (95–97%). The flow rate was 0.6 mL/min and column temperatures were 29 °C and 46 °C. Chemstation software (Agilent, Steinheim, Germany) was used to analyse, integrate and determine the concentrations of each analyte.

2.3.2. GC-MS

Aroma Bouquet Analysis

To detect and quantify the so-called aroma bouquet of the final wines comprising of expected higher alcohols; medium-chain fatty acids; and acetate and ethyl esters, a targeted headspace solid-phase micro-extraction gas-chromatography mass spectrometry analysis (HS-SPME-GC-MS) was employed using a protocol, as previously outlined [30]. Sample preparation entailed pipetting 5 mL of wine samples along with adding 1.7 g NaCl to a 20 mL headspace vial. Two internal standards, 1-octanol (600 mg/L) and cumene (52 mg/L), were also added. The GC-MS used was a GC 7890 A, equipped with an MS 5975 B (both Agilent, Santa Clara, CA, USA), an MPS robotic autosampler and a CIS 4 (both Gerstel, Mülheim an der Ruhr, Germany). A 65 µm fibre coated with polydimethylsiloxane crosslinked with divinylbenzene (Supelco, Merck, Darmstadt, Germany) was used to carry out the solid-phase microextraction. Separation of the volatiles was performed with a 60 m × 0.25 mm × 1 µm gas chromatography column (Rxi[®]-5Si1 MS w/5 m Integra-Guard, Restek, Bad Homburg v. d. Höhe, Germany) with helium as a carrier gas. Split mode injection was employed (1:10, initial temperature 30 °C, rate 12 °C/s to 240 °C, hold for 4 min). The initial temperature of the GC run was 40 °C for 4 min, and then increased to 210 °C at 5 °C/min and raised again to 240 °C at 20 °C/min and held for 10.5 min. Mass spectral data were acquired in a range of mass-to-charge ratio (m/z) of 35 to 250 and used to determine the concentration values. A 5-point calibration curve was used for each volatile compound within a wine model solution of 12% ethanol with 3% tartaric acid at pH 3.

Terpenes

Free terpenes and C₁₃-norisoprenoids expected in wines were also measured by means of HS-SPME-GC-MS, as detailed previously [29,31]. A GC 6890 and a 5973 N quadrupole MS (Agilent Technologies, Palo Alto, CA, USA) equipped with a Gerstel MPS2 autosampler

(Gerstel, Mülheim an der Ruhr, Germany) was used. Similar to the aroma bouquet sample preparation, 5 mL of wine samples with 1.7 g of NaCl were added to a 20 mL headspace amber vial, along with 10 µL of the internal standard, which contained 30 µg/L 3-octanol, 30 µg/L linalool-d3, 40 µg/L α-terpineol-d3, 10 µg/L β-damascenone-d4, 16 µg/L β-ionone-d3 and 12.5 µg/L of naphthalene-d8 in ethanol solution (Sigma-Aldrich, Merck KGaA, Darmstadt, Germany).

A 100 µm polydimethylsiloxane fibre (Supelco, Merck, Darmstadt, Germany) was used to carry out the headspace solid-phase microextraction. Separation of the volatiles was performed with a 30 m × 0.25 mm × 0.5 µm gas chromatography column (DB-Wax, J & W Scientific, Agilent Technologies, Palo Alto, CA, USA) with helium as a carrier gas. Splitless mode injection was employed (injector temperature: 240 °C). The initial temperature of the GC run was 40 °C for 4 min, and then increased to 190 °C at 5 °C/min and raised again to 240 °C at 10 °C/min and held for 15 min. Mass spectral data were acquired in SIM mode with characteristic ions for each analyte and used to determine the concentration values. Calibration was performed by means of the standard addition in Riesling wine. For both the aroma bouquet and terpene analysis, Masshunter workstation software version B.09.00 (Agilent Technologies, Palo Alto, CA, USA) was used to calculate the concentrations of the aroma compounds.

2.4. Statistical Analysis

All fermentations were conducted in triplicate. Results from the fermentation analyses that are shown in the Tables are the average value of the triplicates followed by the standard deviation of the mean (±). All statistical analyses were performed using Graphpad Prism version 9.4.1 (GraphPad Software, San Diego, CA, USA). The control experiment in all cases was the fermentation inoculated with only *S. cerevisiae*. Principal component analyses were performed on the fermentation data using RStudio (version 2022.07.0) along with the packages factextra (version 1.0.7), ggbiplot (version 0.55) and ggplot2 (version 3.3.6).

3. Results and Discussion

3.1. Fermentation Curves

Co-fermentations using *Hanseniaspora* strains with *S. cerevisiae* were carried out at 22 °C using 10:1 ratios of starting cultures. The progression of these fermentations was followed by daily measurements of CO₂ mass-loss (Figure 1). All fermentations were completed by 13 days, which was also confirmed by the HPLC analysis indicating that all fermentations reached dryness (Table 1). There were some deviations in the mass-loss patterns, with some co-fermentations (*H. occidentalis*, *H. osmophila* and *H. nectarophila*) exhibiting slightly less mass-loss throughout the fermentation, yet no notable fermentation burden was observed with any of the co-inoculations. This is in concurrence with previous *Hanseniaspora*-initiated fermentations, where no meaningful influence on the fermentation rate of *S. cerevisiae* was observed [32]. CEG is known for its slow fermentation performance. This was also the reason why we decided to use this *Saccharomyces* yeast.

3.2. Organic Acids

Organic acids, such as tartaric acid, malic acid, lactic acid, acetic acid and citric acid, play a major role in the aroma profile and the mouthfeel of the wine. Table 1 shows the content of the major organic acids of the final GT wines, as determined via HPLC. All fermentations, including the pure *S. cerevisiae* inoculation, led to a reduction in malic acid, yet in some cases (with *H. occidentalis* and *H. opuntiae*) the malic acid content was indeed higher than the control. This observation, especially with *H. occidentalis*, was surprising as it was recently shown that *H. occidentalis* can consume malic acid within grape must [15]. In that study, *H. occidentalis* consumed malic acid in a sequential-type of inoculation modality without an airlock, suggestive of the importance of oxygen in the consumption of malic acid.

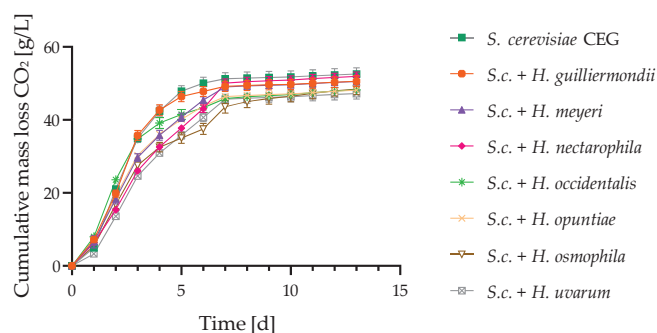

Figure 1. The mass-loss curves (g/L) of the co-fermentations of *Hanseniaspora* spp. conducted in GT must.

Table 1. The major organic acids, ethanol, glycerol and total sugar levels (all g/L) of the GT wines co-fermented with different *Hanseniaspora* spp., as determined with HPLC. Values are the means of three replicate fermentations followed by its standard deviations (\pm). Two-tailed unpaired *t*-tests with Welch's correction were conducted to compare values to the pure *S. cerevisiae* inoculum control. \uparrow indicates significantly more than the control ($p < 0.05$), \downarrow indicates significantly less than the control ($p < 0.05$). nd: not detected.

	<i>S. cerevisiae</i>	<i>H. guilliermondii</i>	<i>H. meyeri</i>	<i>H. nectarophila</i>	<i>H. occidentalis</i>	<i>H. opuntiae</i>	<i>H. osmophila</i>	<i>H. uvarum</i>
Total sugars	nd	nd	nd	nd	nd	nd	nd	nd
Tartaric acid	2.60 \pm 0.12	2.40 \pm 0.09	2.53 \pm 0.03	2.59 \pm 0.01	2.52 \pm 0.07	2.45 \pm 0.09	2.75 \pm 0.02	2.56 \pm 0.05
Malic acid	1.48 \pm 0.06	1.35 \pm 0.02	1.48 \pm 0.02	1.57 \pm 0.01	1.71 \pm 0.05 \uparrow	1.65 \pm 0.03 \uparrow	1.56 \pm 0.02	1.55 \pm 0.01
Lactic acid	0.25 \pm 0.02	0.23 \pm 0.01	0.23 \pm 0.01	0.20 \pm 0.01 \downarrow	0.22 \pm 0.00	0.22 \pm 0.02	0.04 \pm 0.00 \downarrow	0.22 \pm 0.01
Acetic acid	0.84 \pm 0.04	0.75 \pm 0.01	0.75 \pm 0.03 \downarrow	1.10 \pm 0.01 \uparrow	0.56 \pm 0.01 \downarrow	0.94 \pm 0.02 \uparrow	1.23 \pm 0.01 \uparrow	0.68 \pm 0.02 \downarrow
Citric acid	0.14 \pm 0.01	0.12 \pm 0.00 \downarrow	0.12 \pm 0.00 \downarrow	0.13 \pm 0.01	0.14 \pm 0.00	0.11 \pm 0.01 \downarrow	0.14 \pm 0.00	0.10 \pm 0.01 \downarrow
Ethanol	117.10 \pm 3.20	114.67 \pm 1.39	115.75 \pm 0.91	117.35 \pm 1.34	116.65 \pm 2.74	116.37 \pm 1.62	118.56 \pm 0.59	116.31 \pm 0.61
Glycerol	9.39 \pm 0.35	9.28 \pm 0.15	10.17 \pm 0.05	10.05 \pm 0.08	7.80 \pm 0.12 \downarrow	10.10 \pm 0.22 \uparrow	8.25 \pm 0.08 \downarrow	9.98 \pm 0.02

Regarding acetic acid, *Hanseniaspora*-inoculated fermentations resulted in both a reduction and an increase, depending on the species: for *H. nectarophila*, *H. opuntiae* and *H. osmophila*, co-fermentations led to a significant increase, whereas co-fermentations with *H. occidentalis* and *H. uvarum* led to a reduction. Acetic acid is the main contributor of volatile acidity in wine and along with its activated thioester acetyl-coenzyme (acetyl-CoA) are key participants within the central metabolism of cells. They directly take part in acetate ester formation as acetyl-CoA condenses with ethanol and other higher alcohols, which could explain the reduction in acetic acid in *H. uvarum* co-fermentations, which made the highest levels of ethyl acetate (Table 2). The divergent acetic acid levels with different *Hanseniaspora* spp. additions are consistent with the literature where no clear pattern emerges to what effect it has on the volatile acidity in wine [15,33].

Strikingly, lactic acid (the minor acid) was almost completely consumed within the co-fermentation with *H. osmophila*. It is unclear why this occurred as this has, to our knowledge, not been reported before.

3.3. Ethanol and Glycerol

A microbially-facilitated strategy to reduce ethanol levels in wine is by implementing NSY in co-culturing set-ups [34]. The strategy is based on the idea that the NSY would consume a portion of the initial sugars leaving less sugars to be fermented to ethanol by *Saccharomyces*. With the experimental set-up presented here, no significant reduction of ethanol was observed in any of the *Hanseniaspora* co-inoculums. Even though there have been reports of a reduction in ethanol in final wines with *Hanseniaspora* additions [13,20,35,36], fermentations, especially with simultaneous inoculation modalities did not observe ethanol reductions [37,38].

Table 2. Major wine aroma components of the GT wines, as determined with HS-SPME-GC-MS. Values are means of three replicate fermentations followed by the standard deviations (\pm). Two-tailed unpaired *t*-test with Welch's correction was conducted to compare values with the pure *S. cerevisiae* inoculum control. \uparrow indicates significantly more than the control ($p < 0.05$), \downarrow indicates significantly less than the control ($p < 0.05$). nq: not quantifiable.

	<i>S. cerevisiae</i>	<i>H. guilliermondii</i>	<i>H. meyeri</i>	<i>H. nectarophila</i>	<i>H. occidentalis</i>	<i>H. opuntiae</i>	<i>H. osmophila</i>	<i>H. uvarum</i>
Acetate esters ($\mu\text{g/L}$, except for ethyl acetate (mg/L))								
Ethyl acetate	115.80 \pm 6.73	318.93 \pm 28.10 \uparrow	332.86 \pm 97.78	312.98 \pm 55.29 \uparrow	108.19 \pm 12.18	291.07 \pm 21.83 \uparrow	151.60 \pm 34.74	558.07 \pm 52.66 \uparrow
Isoamyl acetate	1089 \pm 104	3788 \pm 614 \uparrow	2731 \pm 803	2120 \pm 351 \uparrow	646 \pm 19 \downarrow	723 \pm 51 \downarrow	640 \pm 197 \downarrow	2523 \pm 383 \uparrow
2-Phenylethyl acetate	203 \pm 16	1185 \pm 24 \uparrow	488 \pm 59 \uparrow	269 \pm 22 \uparrow	225 \pm 2	683 \pm 45 \uparrow	1236 \pm 48 \uparrow	466 \pm 13 \uparrow
2-Methylbutyl acetate	108 \pm 16	416 \pm 63 \uparrow	390 \pm 134	336 \pm 127	62 \pm 17 \downarrow	147 \pm 16 \uparrow	63 \pm 10 \downarrow	339 \pm 118
Hexyl acetate	3 \pm 2	24 \pm 5 \uparrow	9 \pm 5	13 \pm 4 \uparrow	nq	nq	3 \pm 1	15 \pm 2 \uparrow
Ethyl esters ($\mu\text{g/L}$)								
Ethyl propionate	217 \pm 17	238 \pm 24	274 \pm 70	253 \pm 53	482 \pm 34 \uparrow	265 \pm 19 \uparrow	122 \pm 29 \downarrow	425 \pm 67 \uparrow
Ethyl butyrate	222 \pm 21	312 \pm 37 \uparrow	248 \pm 55	241 \pm 39	182 \pm 7	177 \pm 14 \downarrow	227 \pm 46	272 \pm 30
Ethyl hexanoate	76 \pm 21	92 \pm 40	51 \pm 59	66 \pm 47	nq	nq	35 \pm 32	77 \pm 11
Ethyl octanoate	494 \pm 99	459 \pm 184	266 \pm 268	541 \pm 305	nq	nq	317 \pm 140	473 \pm 33
Ethyl decanoate	468 \pm 44	525 \pm 85	425 \pm 88	666 \pm 318	172 \pm 48 \downarrow	106 \pm 44 \downarrow	462 \pm 138	576 \pm 205
Medium-chain fatty acids (mg/L)								
Hexanoic acid	5.63 \pm 0.06	5.56 \pm 0.04	5.44 \pm 0.05 \downarrow	5.53 \pm 0.05	5.37 \pm 0.02 \downarrow	5.30 \pm 0.01 \downarrow	5.47 \pm 0.02 \downarrow	5.57 \pm 0.01
Octanoic acid	3.17 \pm 0.07	3.09 \pm 0.04	2.97 \pm 0.03 \downarrow	3.02 \pm 0.03 \downarrow	2.88 \pm 0.00 \downarrow	2.86 \pm 0.01 \downarrow	2.98 \pm 0.03 \downarrow	3.02 \pm 0.00
Higher alcohols (mg/L)								
Isobutanol	141.80 \pm 12.75	149.54 \pm 18.24	161.05 \pm 41.06	150.83 \pm 26.32	121.33 \pm 16.12	190.04 \pm 23.72	116.23 \pm 13.69	140.45 \pm 0.83
Isoamyl alcohol	668.82 \pm 40.95	539.02 \pm 54.58 \downarrow	581.12 \pm 112.97	493.20 \pm 92.87	510.68 \pm 64.69 \downarrow	544.60 \pm 66.44	429.67 \pm 37.26 \downarrow	540.64 \pm 7.27 \downarrow
2-Methyl butanol	125.16 \pm 3.01	97.85 \pm 8.83 \downarrow	101.78 \pm 21.19	104.83 \pm 19.05	53.08 \pm 6.59 \downarrow	105.55 \pm 9.04	99.63 \pm 2.63 \downarrow	102.37 \pm 1.21 \downarrow
1-Hexanol	1411.90 \pm 71.14	1099.56 \pm 46.86 \downarrow	1348.98 \pm 34.27	1257.44 \pm 161.69	1029.03 \pm 40.98 \downarrow	1431.11 \pm 46.72	1312.47 \pm 25.20	1168.21 \pm 26.82 \downarrow
2-Phenylethanol	44.34 \pm 0.43	28.34 \pm 0.45 \downarrow	41.82 \pm 5.42	27.75 \pm 4.54 \downarrow	59.40 \pm 4.51 \uparrow	48.52 \pm 2.11	36.31 \pm 2.32 \downarrow	37.70 \pm 1.17 \downarrow

As with acetic acid, the co-fermentations produced both significantly more (*H. opuntiae*) or less glycerol (the two members of the SEL, *H. occidentalis* and *H. osmophila*) than the control. Glycerol levels are often elevated with NSY additions [39] and often coincide with an increase in acetic acid [40]. This is often explained within the context of cofactor maintenance, as the enzymes directly responsible for glycerol and acetic acid production, glycerol-3-phosphate dehydrogenase and acetaldehyde dehydrogenase, respectively, require and produce NADH. Curiously, in this experiment, the co-fermentation with *H. occidentalis* led to an unexpected reduction in both acetic acid and glycerol, a finding which was not observed when the same yeast was co-fermented in a sequential-type inoculation [15].

3.4. Aroma Analysis

Since *Hanseniaspora* is known for acetate ester formation and produces large amounts of ethyl acetate, a solvent-like odour, too much of which can quickly spoil the wine, the volatile aroma compounds (VOC) were measured. Table 2 shows the concentrations of many of the expected esters, medium-chain fatty acids, and higher alcohols in the final wines co-cultured with *Hanseniaspora* spp. With regards to the ethyl esters and medium-chain fatty acids, little modulation was observed with the *Hanseniaspora* co-cultured fermentations, when compared to the *S. cerevisiae* control, apart from the concentration of ethyl propionate (an aroma compound imparting a pineapple-like odour). The ethyl propionate concentrations in wines fermented with *H. occidentalis* and *H. uvarum* were measured to be more than double than that of the control.

As expected, a large level of variability was measured looking at acetate esters. For all of the five acetate esters, the concentrations were significantly more in *H. guilliermondii* co-fermentations, whereas four of the five acetate esters were higher with *H. nectarophila* and *H. uvarum*. An increase in all of these esters within a wine will generally be considered as an oenological benefit as they contribute to a fruity or flowery aroma, except for ethyl acetate. Ethyl acetate measured in the five FEL members were approximately three times more than the control with *H. uvarum* co-fermentations achieving levels of more than 500 mg/L. All of these levels far exceed what is considered to be pleasant (<100 mg/L). With the ethyl acetate levels obtained from the two members of the SEL, no significant difference with the control was observed. Yet for *H. osmophila*, more than six times more 2-phenethyl acetate, a key rose-like aroma component, was recorded. Furthermore, of note are the quantitatively high levels of the beneficial acetate esters produced by *H. guilliermondii*.

The majority of the higher alcohols were either unchanged or comparatively lower than the control. This is directly connected with their conversion to their corresponding acetate esters. Only co-fermentations with *H. occidentalis*, however, showed to have higher amounts of one of the higher alcohol than the controls, namely 2-phenyl ethanol.

3.5. Terpenes

Typical of GT must is that it has a high terpene potential. Terpenes are often bound to sugar moieties in grape must and require deglycosylation for their release, in order to be perceived. This release can be facilitated enzymatically via the action of β -glucosidases or non-specific β -glucanases and it has been shown that NSY, including *Hanseniaspora* spp., have superior terpene-releasing abilities than *Saccharomyces* [38,41–43]. The conversion of terpenes can also occur, which can be catalyzed by several enzymes, including dehydrogenases, oxygenases and reductases [44]. Table 3 shows the terpene content of the GT wines co-fermented with the different *Hanseniaspora* spp. We observed in certain cases significant modulation of the terpenes within the co-fermentations. With *H. opuntiae*, in particular, many of the terpenes were significantly affected like citronellol and β -myrcene, which is suggestive of the release of terpenes from sugar moieties. Curiously, with some co-fermentations (*H. guilliermondii*, *H. nectarophila* and *H. uvarum*) citronellol levels were significantly lower than those of the control. A short fermentation of must spiked with higher levels of citronellol in wines co-fermented with *H. guilliermondii* and *H. uvarum*

was conducted to see if other peaks related to citronellol could be observed. A peak corresponding to the acetate ester of citronellol (i.e., citronellyl acetate) was detected in the GC-MS chromatograms (Figure 2). This strongly suggests that these *Hanseniaspora* strains converted citronellol (which is a terpenol with a primary alcohol functional group) to its acetate ester, presumably via the same action as the esterification of other alcohols.

3.6. PCA

To analyse the overall outcome of VOC production in the different co-fermentations, a principal component analysis was conducted, including aroma compounds, organic acids, ethanol and glycerol (Figure 3). Large variations, especially in the ethyl ester content, of co-fermentations with *H. nectarophila* and *H. meyeri* replicates caused the overlaps of the data points with other groups. The PCA indicated that the two members of the SEL separated from the other groups regarding their wine profiles. It is also noteworthy that the bulk of the acetate esters production was associated with members of the FEL, such as *H. guilliermondii* and *H. uvarum*. The PCA also shows the noteworthy acid modulation displayed by the fermentation with *H. osmophila* with its high production of acetic acid coinciding with the possible consumption of lactic acid.

Table 3. Terpene and norisoprenoid content (all $\mu\text{g/L}$) of the GT wines, as measured with HS-SPME-GC-MS. Values are the means of three replicate fermentations followed by the standard deviations (\pm). Unpaired *t*-test with Welch's correction was conducted to compare values with the pure *S. cerevisiae* inoculum control. \uparrow indicates significantly more (<0.05) than the control (*S. cerevisiae*) \downarrow indicates significantly less (<0.05) than the control (*S. cerevisiae*).

	<i>S. cerevisiae</i>	<i>H. guilliermondii</i>	<i>H. meyeri</i>	<i>H. nectarophila</i>	<i>H. occidentalis</i>	<i>H. opuntiae</i>	<i>H. osmophila</i>	<i>H. uvarum</i>
β -myrcene	6.71 \pm 0.31	9.82 \pm 1.26 \uparrow	7.87 \pm 1.05	9.37 \pm 0.58 \uparrow	7.95 \pm 1.74	9.13 \pm 0.17 \uparrow	8.87 \pm 0.67 \uparrow	9.06 \pm 0.24 \uparrow
limonene	0.96 \pm 0.01	0.99 \pm 0.02	0.97 \pm 0.02	0.99 \pm 0.01 \uparrow	0.96 \pm 0.03	1.01 \pm 0.01 \uparrow	0.98 \pm 0.01	1.02 \pm 0.01 \uparrow
cis-rose oxide	0.42 \pm 0.03	0.24 \pm 0.03 \downarrow	0.35 \pm 0.07	0.38 \pm 0.04	0.19 \pm 0.07 \downarrow	0.36 \pm 0.03 \downarrow	0.24 \pm 0.04 \downarrow	0.45 \pm 0.02
trans-rose oxide	0.15 \pm 0.01	0.09 \pm 0.01 \downarrow	0.14 \pm 0.02	0.15 \pm 0.01	0.09 \pm 0.02 \downarrow	0.13 \pm 0.01 \downarrow	0.11 \pm 0.01 \downarrow	0.17 \pm 0.01
cis-linalool oxide	19.74 \pm 1.03	19.68 \pm 0.13	19.11 \pm 0.19	18.37 \pm 0.24	18.13 \pm 0.54	18.84 \pm 1.43	18.54 \pm 0.65	19.12 \pm 0.68
nerol oxide	1.29 \pm 0.04	1.35 \pm 0.07	1.27 \pm 0.11	1.32 \pm 0.09	1.25 \pm 0.18	1.45 \pm 0.05 \uparrow	1.29 \pm 0.16	1.38 \pm 0.07
trans-linalool oxide	6.20 \pm 0.67	5.75 \pm 0.18	5.43 \pm 0.34	5.77 \pm 0.21	5.45 \pm 0.20	5.72 \pm 0.25	5.63 \pm 0.52	5.52 \pm 0.03
vitispirane	0.56 \pm 0.01	0.54 \pm 0.00 \downarrow	0.55 \pm 0.01	0.54 \pm 0.01 \downarrow	0.54 \pm 0.01 \downarrow	0.55 \pm 0.01	0.52 \pm 0.01 \downarrow	0.57 \pm 0.00
linalool	72.43 \pm 3.71	72.93 \pm 1.80	71.43 \pm 0.69	72.13 \pm 3.01	71.18 \pm 2.51	73.91 \pm 3.70	72.04 \pm 5.49	72.50 \pm 0.45
hotrienol	36.61 \pm 6.24	29.52 \pm 1.85	31.48 \pm 4.25	28.38 \pm 3.47	39.98 \pm 3.95	43.04 \pm 3.24	35.04 \pm 0.35	31.78 \pm 1.97
α -terpineol	55.46 \pm 9.81	47.13 \pm 2.74	50.75 \pm 6.32	46.91 \pm 5.59	68.66 \pm 7.75	72.42 \pm 4.46	69.19 \pm 2.49	49.01 \pm 3.90
citronellol	26.97 \pm 4.40	9.52 \pm 0.56 \downarrow	18.96 \pm 4.08	13.83 \pm 1.22 \downarrow	27.37 \pm 4.97	38.08 \pm 1.52 \uparrow	20.31 \pm 2.57	13.85 \pm 1.88 \downarrow
β -damascenone	0.46 \pm 0.01	0.56 \pm 0.04	0.53 \pm 0.05	0.61 \pm 0.04 \uparrow	0.64 \pm 0.14	0.69 \pm 0.03 \uparrow	0.70 \pm 0.10	0.55 \pm 0.06

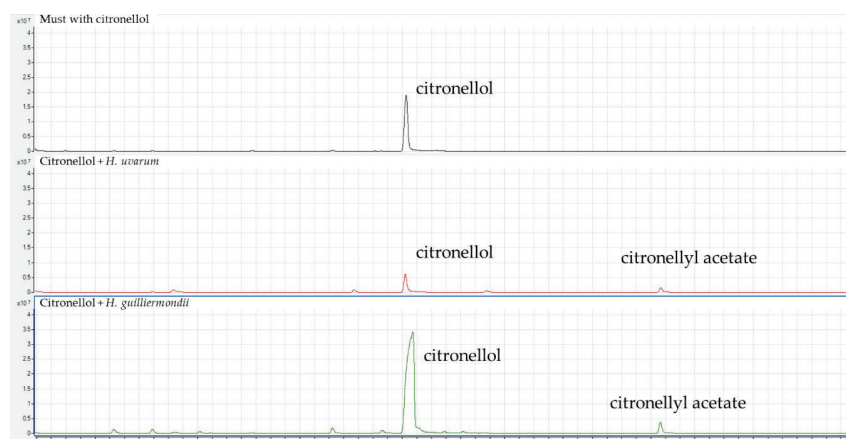

Figure 2. GC-MS chromatograms of the one-day must fermentations with *H. guilliermondii* and *H. uvarum* supplemented with higher levels of citronellol.

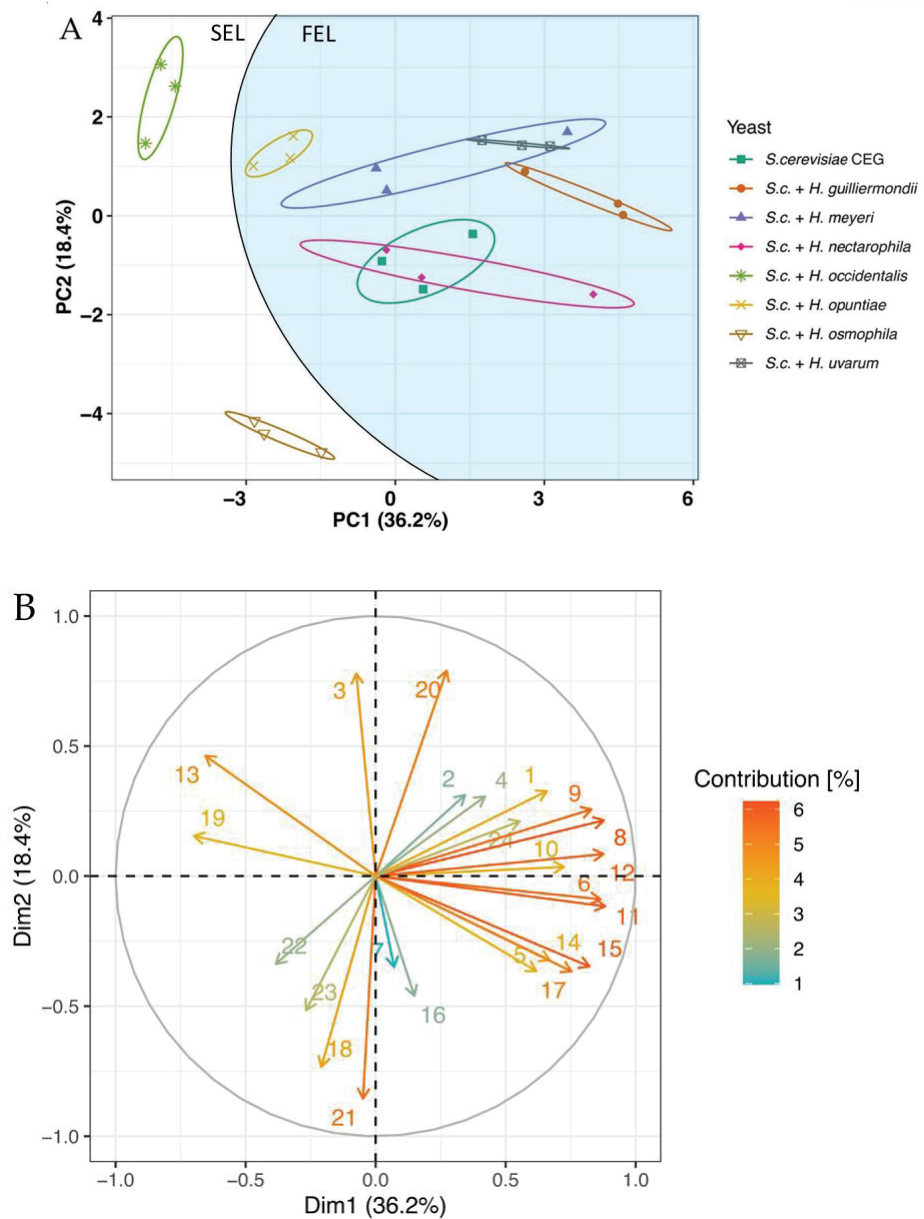

Figure 3. PCA of the final wines co-fermented with *Hanseniaspora* spp. All of the measured wine parameters, excluding the terpene data, were used to compose the PCA. Score plot (A) in the first two PCs: fermentation replicates are shown with the same shape and colour. The blue-and-white separation indicates the division of the two lineages (FEL and SEL). (B) Corresponding loading map. Each arrow relates to the tip of a vector starting from the origin. The closer the variable is to the circle, the better it is explained by the components. Contribution values (%) are shown in a gradient scale of colours with corresponding values. Numbers in the loading map correspond to: (1) ethyl acetate, (2) isobutanol, (3) ethyl propionate, (4) isoamyl alcohol, (5) 2-methyl-1-butanol, (6) ethyl butanoate, (7) hexan-1-ol, (8) isoamyl acetate, (9) 2-methyl-1-butyl acetate, (10) hexanoic acid, (11) ethyl hexanoate, (12) hexyl acetate, (13) 2-phenylethanol, (14) octanoic acid, (15) ethyl octanoate, (16) 2-phenylethyl acetate, (17) ethyl decanoate, (18) tartaric acid, (19) malic acid, (20) lactic acid, (21) acetic acid, (22) citric acid, (23) ethanol, (24) glycerol.

4. Conclusions

Even though non-*Saccharomyces* yeasts are increasingly used in wine fermentations, reproducibility is a concern. This is not only evident in our study, but also emerges from the literature on mixed-culture fermentations. The interaction of different yeast species is complex and strongly dependent on the initial conditions in the must. In conclusion, the different *Hanseniaspora* species contributed in various ways to the aroma profile of the wine. The SEL yeasts (*H. occidentalis* and *H. osmophila*) showed little change in ethyl acetate formation, which is typical for *Hanseniaspora*, in contrast to the control fermentation with *S. cerevisiae*. In addition, some of the *Hanseniaspora* spp. contributed significantly to the complex aroma profile through the depletion of lactic acid, an increase in acetate esters or terpenols, or through the conversion of citronellol to citronellyl acetate. Finally, this study shows for the first time the use of *H. nectarophila* and *H. meyerii* in winemaking and the characterization of the resulting wine. In particular, the wines fermented with *H. nectarophila* showed increased amounts of acetate esters, compared to the control wine.

Author Contributions: Conceptualization, J.B. and N.v.W.; methodology, J.B. and N.v.W.; validation, J.B.; formal analysis, H.S., S.B. and S.F.; investigation, J.B. and N.v.W.; resources, C.v.W.; data curation, J.B.; writing—original draft preparation, N.v.W.; visualization, J.B. and F.K., supervision, D.R., I.S.P. and C.v.W.; project administration, C.v.W.; funding acquisition, C.v.W. All authors have read and agreed to the published version of the manuscript.

Funding: The authors would like to thank the Hessen State Ministry of Higher Education, Research and the Arts for the financial support within the Hessen initiative for scientific and economic excellence (LOEWE) in the framework of AROMAplus (<https://www.hs-geisenheim.de/aromaplus/>, (accessed on 25 October 2022)). The authors thank Geisenheim University and Macquarie University for the co-funding of this project and the research fellowship of N.v.W. I.S.P. is a team member of the Macquarie-led national Centre of Excellence in Synthetic Biology funded by the Australian Government through its agency, the Australian Research Council.

Acknowledgments: I.S.P. is a team member of the Macquarie-led national Centre of Excellence in Synthetic Biology funded by the Australian Government through its agency, the Australian Research Council. The authors would like to thank the Hessen State Ministry of Higher Education, Research and the Arts for the financial support within the Hessen initiative for scientific and economic excellence (LOEWE) in the framework of AROMAplus (<https://www.hs-geisenheim.de/aromaplus/>, (accessed on 25 October 2022)). Jürgen Heinisch is thanked for providing the yeast strain DSM2768. Florian Michling is thanked for providing the yeast strain NRRL Y-1613, NRRL-Y 1625, and NRRL-Y 27513. Georgia Tylaki and Kerstin Zimmer are thanked for technical assistance.

Conflicts of Interest: The authors declare no conflict of interest.

References

1. Van Wyk, N.; Badura, J.; Von Wallbrunn, C.; Pretorius, I.S. Exploring future applications of the apiculate yeast *Hanseniaspora*. *Crit. Rev. Biotechnol.* **2023**, *in press*. [CrossRef]
2. Martin, V.; Valera, M.; Medina, K.; Boido, E.; Carrau, F. Oenological impact of the *Hanseniaspora*/*Kloeckera* yeast genus on wines—A review. *Fermentation* **2018**, *4*, 76. [CrossRef]
3. Díaz-Montaña, D.M.; de Jesús Ramírez Córdova, J. The fermentative and aromatic ability of *Kloeckera* and *Hanseniaspora* yeasts. In *Yeast Biotechnology: Diversity and Applications*; Satyanarayana, T., Kunze, G., Eds.; Springer: Dordrecht, The Netherlands, 2009; pp. 282–301, ISBN 9781402082917.
4. Wei, J.; Zhang, Y.; Qiu, Y.; Guo, H.; Ju, H.; Wang, Y.; Yuan, Y.; Yue, T. Chemical composition, sensorial properties, and aroma-active compounds of ciders fermented with *Hanseniaspora osmophila* and *Torulaspora quercuum* in co- and sequential fermentations. *Food Chem.* **2020**, *306*, 125623. [CrossRef] [PubMed]
5. Elhalis, H.; Cox, J.; Frank, D.; Zhao, J. The crucial role of yeasts in the wet fermentation of coffee beans and quality. *Int. J. Food Microbiol.* **2020**, *333*, 108796. [CrossRef]
6. Ho, V.T.T.; Zhao, J.; Fleet, G. Yeasts are essential for cocoa bean fermentation. *Int. J. Food Microbiol.* **2014**, *174*, 72–87. [CrossRef] [PubMed]
7. Wang, C.; Mas, A.; Esteve-Zarzoso, B. Interaction between *Hanseniaspora uvarum* and *Saccharomyces cerevisiae* during alcoholic fermentation. *Int. J. Food Microbiol.* **2015**, *206*, 67–74. [CrossRef] [PubMed]
8. Hierro, N.; Esteve-Zarzoso, B.; Mas, A.; Guillamón, J.M. Monitoring of *Saccharomyces* and *Hanseniaspora* populations during alcoholic fermentation by real-time quantitative PCR. *FEMS Yeast Res.* **2007**, *7*, 1340–1349. [CrossRef] [PubMed]

9. Moreira, N.; Mendes, F.; Guedes de Pinho, P.; Hogg, T.; Vasconcelos, I. Heavy sulphur compounds, higher alcohols and esters production profile of *Hanseniaspora uvarum* and *Hanseniaspora guilliermondii* grown as pure and mixed cultures in grape must. *Int. J. Food Microbiol.* **2008**, *124*, 231–238. [CrossRef]
10. Rojas, V.; Gil, J.V.; Piñaga, F.; Manzanares, P. Acetate ester formation in wine by mixed cultures in laboratory fermentations. *Int. J. Food Microbiol.* **2003**, *86*, 181–188. [CrossRef]
11. Loureiro, V.; Malfeito-Ferreira, M. Spoilage yeasts in the wine industry. *Int. J. Food Microbiol.* **2003**, *86*, 23–50. [CrossRef]
12. Malfeito-Ferreira, M. Yeasts and wine off-flavours: A technological perspective. *Ann. Microbiol.* **2011**, *61*, 95–102. [CrossRef]
13. Rossouw, D.; Bauer, F.F. Exploring the phenotypic space of non-Saccharomyces wine yeast biodiversity. *Food Microbiol.* **2016**, *55*, 32–46. [CrossRef] [PubMed]
14. Medina, K.; Boido, E.; Fariña, L.; Gioia, O.; Gomez, M.E.; Barquet, M.; Gaggero, C.; Dellacassa, E.; Carrau, F. Increased flavour diversity of Chardonnay wines by spontaneous fermentation and co-fermentation with *Hanseniaspora vineae*. *Food Chem.* **2013**, *141*, 2513–2521. [CrossRef]
15. Van Wyk, N.; Scansani, S.; Beisert, B.; Brezina, S.; Fritsch, S.; Semmler, H.; Pretorius, I.S.; Rauhut, D.; von Wallbrunn, C. The use of *Hanseniaspora occidentalis* in a sequential must inoculation to reduce the malic acid content of wine. *Appl. Sci.* **2022**, *12*, 6919. [CrossRef]
16. Manzanares, P.; Rojas, V.; Genovés, S.; Vallés, S. A preliminary search for anthocyanin- β -D-glucosidase activity in non-Saccharomyces wine yeasts. *Int. J. Food Sci. Technol.* **2000**, *35*, 95–103. [CrossRef]
17. Manuel, J.; Escott, C.; Carrau, F.; Herbert-Pucheta, J.E.; Vaquero, C.; Gonz, C.; Morata, A. Improving aroma complexity with *Hanseniaspora* spp.: Terpenes, acetate esters, and safranal. *Fermentation* **2022**, *8*, 654. [CrossRef]
18. Carrau, F.; Henschke, P.A. *Hanseniaspora vineae* and the concept of friendly yeasts to increase autochthonous wine flavor diversity. *Front. Microbiol.* **2021**, *12*, 702093. [CrossRef]
19. Van Wyk, N.; Grossmann, M.; Wendland, J.; von Wallbrunn, C.; Pretorius, I.S. The whiff of wine yeast innovation: Strategies for enhancing aroma production by yeast during wine fermentation. *J. Agric. Food Chem.* **2019**, *67*, 13496–13505. [CrossRef]
20. Tristezza, M.; Tufariello, M.; Capozzi, V.; Spano, G.; Mita, G.; Grieco, F. The oenological potential of *Hanseniaspora uvarum* in simultaneous and sequential co-fermentation with *Saccharomyces cerevisiae* for industrial wine production. *Front. Microbiol.* **2016**, *7*, 670. [CrossRef]
21. Chen, L.; Li, D. Effects of simultaneous and sequential cofermentation of *Wickerhamomyces anomalus* and *Saccharomyces cerevisiae* on physicochemical and flavor properties of rice wine. *Food Sci. Nutr.* **2021**, *9*, 71–86. [CrossRef] [PubMed]
22. Gobbi, M.; Comitini, F.; Domizio, P.; Romani, C.; Lencioni, L.; Mannazzu, I.; Ciani, M. *Lachancea thermotolerans* and *Saccharomyces cerevisiae* in simultaneous and sequential co-fermentation: A strategy to enhance acidity and improve the overall quality of wine. *Food Microbiol.* **2013**, *33*, 271–281. [CrossRef] [PubMed]
23. Viana, F.; Belloch, C.; Vallés, S.; Manzanares, P. Monitoring a mixed starter of *Hanseniaspora vineae*-*Saccharomyces cerevisiae* in natural must: Impact on 2-phenylethyl acetate production. *Int. J. Food Microbiol.* **2011**, *151*, 235–240. [CrossRef]
24. Steenwyk, J.L.; Oplente, D.A.; Kominek, J.; Shen, X.; Zhou, X.; Labella, A.L.; Bradley, N.P.; Eichman, B.F.; Libkind, D.; Devirgilio, J.; et al. Extensive loss of cell-cycle and DNA repair genes in an ancient lineage of bipolar budding yeasts. *PLoS Biol.* **2019**, *17*, e3000255. [CrossRef] [PubMed]
25. Phillips, M.A.; Steenwyk, J.L.; Shen, X.-X.; Rokas, A. Examination of gene loss in the DNA mismatch repair pathway and its mutational consequences in a fungal phylum. *Genome Biol. Evol.* **2021**, *13*, evab219. [CrossRef] [PubMed]
26. Čadež, N.; Bellora, N.; Ulloa, R.; Tome, M.; Petković, H.; Groenewald, M.; Hittinger, C.T.; Libkind, D. *Hanseniaspora smithiae* sp. nov., a novel apiculate yeast species from Patagonian forests that lacks the typical genomic domestication signatures for fermentative environments. *Front. Microbiol.* **2021**, *12*, 679894. [CrossRef]
27. Schwarz, L.V.; Valera, M.J.; Delamare, A.P.L.; Carrau, F.; Echeverrigaray, S. A peculiar cell cycle arrest at g2/m stage during the stationary phase of growth in the wine yeast *Hanseniaspora vineae*. *Curr. Res. Microb. Sci.* **2022**, *3*, 100129. [CrossRef]
28. Dukes, B.C.; Butzke, C.E. Rapid determination of primary amino acids in grape juice using an o-phthalaldehyde/N-acetyl-L-cysteine spectrophotometric assay. *Am. J. Enol. Vitic.* **1998**, *49*, 125–134. [CrossRef]
29. Scansani, S.; van Wyk, N.; Nader, K.B.; Beisert, B.; Brezina, S.; Fritsch, S.; Semmler, H.; Pasch, L.; Pretorius, I.S.; von Wallbrunn, C.; et al. The film-forming *Pichia* spp. in a winemaker's toolbox: A simple isolation procedure and their performance in a mixed-culture fermentation of *Vitis vinifera* L. cv. Gewürztraminer must. *Int. J. Food Microbiol.* **2022**, *365*, 109549. [CrossRef]
30. Jung, R.; Kumar, K.; Patz, C.; Rauhut, D.; Tarasov, A.; Schuessler, C. Influence of transport temperature profiles on wine quality. *Food Packag. Shelf Life* **2021**, *29*, 100706. [CrossRef]
31. Brandt, M. The Influence of Abiotic Factors on the Composition of Berries, Juice and Wine in *Vitis vinifera* L. cv. Riesling. Ph.D. Thesis, Hochschule Geisenheim University, Geisenheim, Germany, 2021.
32. González-Robles, I.W.; Estarrón-Espinosa, M.; Díaz-Montaña, D.M. Fermentative capabilities and volatile compounds produced by *Kloeckera/Hanseniaspora* and *Saccharomyces* yeast strains in pure and mixed cultures during Agave tequilana juice fermentation. *Antonie Van Leeuwenhoek* **2015**, *108*, 525–536. [CrossRef]
33. Del Fresno, J.M.; Loira, I.; Escott, C.; Carrau, F.; Gonz, C.; Cuerda, R.; Morata, A. Application of *Hanseniaspora vineae* yeast in the production of Rosé wines from a blend of Tempranillo and Albillo grapes. *Fermentation* **2021**, *7*, 141. [CrossRef]
34. Contreras, A.; Hidalgo, C.; Henschke, P.A.; Chambers, P.J.; Curtin, C.; Varela, C. Evaluation of non-Saccharomyces yeasts for the reduction of alcohol content in wine. *Appl. Environ. Microbiol.* **2014**, *80*, 1670–1678. [CrossRef] [PubMed]

35. Mestre, M.V.; Maturano, Y.P.; Gallardo, C.; Combina, M.; Mercado, L.; Toro, M.E.; Carrau, F.; Vazquez, F.; Dellacassa, E. Impact on sensory and aromatic profile of low ethanol Malbec wines fermented by sequential culture of *Hanseniaspora uvarum* and *Saccharomyces cerevisiae* native yeasts. *Fermentation* **2019**, *5*, 65. [CrossRef]
36. Zhang, B.; Shen, J.Y.; Duan, C.Q.; Yan, G.L. Use of indigenous *Hanseniaspora vineae* and *Metschnikowia pulcherrima* co-fermentation with *Saccharomyces cerevisiae* to improve the aroma diversity of Vidal blanc icewine. *Front. Microbiol.* **2018**, *9*, 2303. [CrossRef]
37. Capozzi, V.; Berbegal, C.; Tufariello, M.; Grieco, F.; Spano, G.; Grieco, F. Impact of co-inoculation of *Saccharomyces cerevisiae*, *Hanseniaspora uvarum* and *Oenococcus oeni* autochthonous strains in controlled multi starter grape must fermentations. *LWT Food Sci. Technol.* **2019**, *109*, 241–249. [CrossRef]
38. Hu, K.; Jin, G.J.; Xu, Y.H.; Tao, Y.S. Wine aroma response to different participation of selected *Hanseniaspora uvarum* in mixed fermentation with *Saccharomyces cerevisiae*. *Food Res. Int.* **2018**, *108*, 119–127. [CrossRef] [PubMed]
39. Goold, H.D.; Kroukamp, H.; Williams, T.C.; Paulsen, I.T.; Varela, C.; Pretorius, I.S. Yeast's balancing act between ethanol and glycerol production in low-alcohol wines. *Microb. Biotechnol.* **2017**, *10*, 264–278. [CrossRef]
40. van Wyk, N.; Kroukamp, H.; Espinosa, M.I.; von Wallbrunn, C.; Wendland, J.; Pretorius, I.S. Blending wine yeast phenotypes with the aid of CRISPR DNA editing technologies. *Int. J. Food Microbiol.* **2020**, *324*, 108615. [CrossRef]
41. van Wyk, N.; Pretorius, I.S.; von Wallbrunn, C. Assessing the oenological potential of *Nakazawaea ishiwadae*, *Candida railenensis* and *Debaryomyces hansenii* strains in mixed-culture grape must fermentation with *Saccharomyces cerevisiae*. *Fermentation* **2020**, *6*, 49. [CrossRef]
42. Garcia, A.; Carcel, C.; Dulau, L.; Samson, A.; Aguera, E.; Agosin, E.; Günata, Z. Influence of a mixed culture with *Debaryomyces vanriji* and *Saccharomyces cerevisiae* on the volatiles of a Muscat wine. *J. Food Sci.* **2002**, *67*, 1138–1143. [CrossRef]
43. Fernández-González, M.; Di Stefano, R.; Briones, A. Hydrolysis and transformation of terpene glycosides from muscat must by different yeast species. *Food Microbiol.* **2003**, *20*, 35–41. [CrossRef]
44. Vaudano, E.; Moruno, E.G.; Di Stefano, R. Modulation of geraniol metabolism during alcohol fermentation. *J. Inst. Brew.* **2004**, *110*, 213–219. [CrossRef]

Disclaimer/Publisher's Note: The statements, opinions and data contained in all publications are solely those of the individual author(s) and contributor(s) and not of MDPI and/or the editor(s). MDPI and/or the editor(s) disclaim responsibility for any injury to people or property resulting from any ideas, methods, instructions or products referred to in the content.

Chapter 3 - Synthesis of aroma compounds as a function of different nitrogen sources in fermentations using non-*Saccharomyces* wine yeasts

Chapter 3 is based on the following peer-reviewed publication:

Badura, J.; Medić, M.; van Wyk, N.; Krause, B.; Semmler, H.; Brezina, S.; Pretorius, I. S.; Rauhut, D.; von Wallbrunn, C. (2023): Synthesis of aroma compounds as a function of different nitrogen sources in fermentations using non-*Saccharomyces* wine yeasts. In *Microorganisms* 11 (1), 14. DOI: 10.3390/microorganisms11010014.

Author contributions:

Conceptualization: CvW

Funding acquisition: CvW

Methodology: CvW, **JB**

Investigation: MM, **JB**

Validation: **JB**, NvW

Data curation: **JB**

Formal analysis: **JB**, BK, HS, SB, DR

Visualization: **JB**

Project administration: CvW

Resources: CvW

Supervision: **JB**, CvW

Writing – original draft: **JB**, NvW

Writing – review & editing: **JB**, NvW, ISP, CvW

All authors have read and agreed to the published version of the manuscript.



Article

Synthesis of Aroma Compounds as a Function of Different Nitrogen Sources in Fermentations Using Non-*Saccharomyces* Wine Yeasts

Jennifer Badura ¹, Marko Medic ¹, Niël van Wyk ^{1,2}, Birgit Krause ³, Heike Semmler ¹, Silvia Brezina ¹, Isak S. Pretorius ², Doris Rauhut ¹ and Christian von Wallbrunn ^{1,*}

¹ Department of Microbiology and Biochemistry, Hochschule Geisenheim University, Von-Lade-Strasse 1, 65366 Geisenheim, Germany

² ARC Centre of Excellence in Synthetic Biology, Department of Molecular Sciences, Macquarie University, Sydney, NSW 2113, Australia

³ Department of Soil Science and Plant Nutrition, Hochschule Geisenheim University, Von-Lade-Strasse 1, 65366 Geisenheim, Germany

* Correspondence: christian.wallbrunn@hs-gm.de

Abstract: Non-*Saccharomyces* yeasts are prevalent at the onset of grape must fermentations and can have a significant influence on the final wine product. In contrast to *Saccharomyces cerevisiae*, the biosynthetic pathways leading to aroma compound formation in these non-conventional yeasts, in particular those that are derived from amino acid metabolism, remains largely unexplored. Within a synthetic must environment, we investigated the amino acid utilization of four species (*Hanseniaspora uvarum*, *Hanseniaspora osmophila*, *Zygosaccharomyces rouxii*, *Starmerella bacillaris*) and *S. cerevisiae*. We report on the differential uptake preferences for amino acids with *H. uvarum* displaying the most rapid uptake of most amino acids. To investigate the fate of amino acids and their direct contribution to aroma synthesis in *H. uvarum*, *H. osmophila* and *Z. rouxii*, musts were supplemented with single amino acids. Aroma profiling undertaken after three days showed the synthesis of specific aroma compounds by the respective yeast was dependent on the specific amino acid supplementation. *H. osmophila* showed similarities to *S. cerevisiae* in both amino acid uptake and the synthesis of aroma compounds depending on the nitrogen sources. This study shows how the uptake of specific amino acids contributes to the synthesis of aroma compounds in wine fermentations using different non-*Saccharomyces* yeasts.

Keywords: fermentation; amino acids; nitrogen consumption; aroma profile; *Hanseniaspora*; *Zygosaccharomyces*; *Starmerella*



Citation: Badura, J.; Medic, M.; Wyk, N.v.; Krause, B.; Semmler, H.; Brezina, S.; Pretorius, I.S.; Rauhut, D.; Wallbrunn, C.v. Synthesis of Aroma Compounds as a Function of Different Nitrogen Sources in Fermentations Using Non-*Saccharomyces* Wine Yeasts. *Microorganisms* **2023**, *11*, 14. <https://doi.org/10.3390/microorganisms11010014>

Academic Editor: Matthias Sipiczki

Received: 23 November 2022

Revised: 14 December 2022

Accepted: 16 December 2022

Published: 21 December 2022



Copyright: © 2022 by the authors. Licensee MDPI, Basel, Switzerland. This article is an open access article distributed under the terms and conditions of the Creative Commons Attribution (CC BY) license (<https://creativecommons.org/licenses/by/4.0/>).

1. Introduction

Managing the nitrogen content in grape must is essential to prevent stuck or sluggish fermentations [1]. The forms of nitrogen utilized by the microbiota within grape must are collectively known as the yeast assimilable nitrogen (YAN) and consist of ammonium ions (NH₄⁺) and free amino nitrogen (FAN). FAN is a combination of individual amino acids and small peptides and most notably excludes the abundant amino acid L-proline as it cannot be utilized by yeast under anaerobic conditions. Insufficient starting levels of YAN (below 100 mg/L for red wines and 150 mg/L for white wines) can be remedied by the addition of inorganic forms of nitrogen like diammonium phosphate (DAP) or even more complex protein supplementations. Increased levels of YAN in must directly contribute to greater fermentation vigour, yet often lead to increased microbial instability, increased haze formation, increased biogenic amine levels, and could also contribute to atypical aging properties [2]. It is thus pivotal to provide the optimal amount of YAN to ensure a successful fermentation without causing any type of wine faults.

Most of our understanding of how nitrogen is consumed during wine fermentation is obtained from studies conducted with *S. cerevisiae*, which is mainly responsible for the

alcoholic fermentation. Nitrogen utilization is a highly regulated process and at least four different regulatory mechanisms have been described: the Ssy1-Ptr3-Ssy5 system (SPS), the nitrogen catabolic repression (NCR), the retrograde signalling pathway (RTG) and the general amino acids control (GAAC) [3]. All the above-mentioned mechanisms are in turn governed by the target of rapamycin (TORC1) signalling pathway. Several allelic variants in key genes involved in the TORC1 signalling pathway have been identified to explain possible adaptations of wine strains of *S. cerevisiae* and their consumption preference for specific amino acids during wine fermentation [4]. Nitrogen, both form and quantity, also has a major impact on the aroma profile and thus the sensorial characteristics of the final wine product [5,6]. The breakdown of amino acids via the Ehrlich pathway results in the production of higher alcohols like isoamyl alcohol and 2-phenylethyl alcohol which are some of the key aroma determinants in wine along with their corresponding acetate esters (Figure 1, Table 1) [7]. With regards to wine aroma, insufficient YAN has also been implicated in excessive H₂S production, yet excessive YAN has been shown to lead to increased volatile acidity and increased ethyl acetate production [8,9].

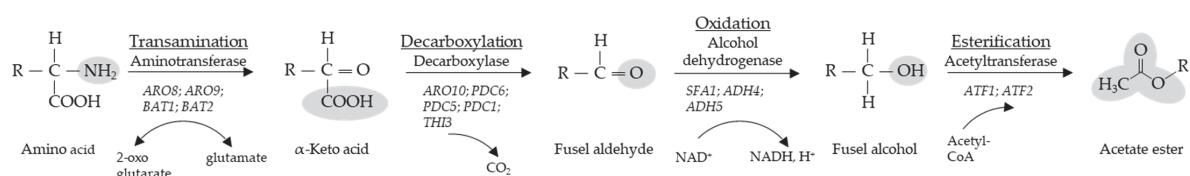

Figure 1. The Ehrlich pathway. Conversion of amino acids into fusel aldehydes, fusel alcohols and acetate esters. Enzymes and encoding genes known in *S. cerevisiae* to catalyze the reactions are indicated. Specific molecular groups are highlighted. Modified from Hazelwood et al. [10].

At the onset of a grape must fermentation, the microbial population structure is particularly heterogeneous consisting of numerous yeast genera. It is often the case that only a small proportion of the population is comprised of *Saccharomyces* spp. [11]. This is why commercial winemaking largely employs starter cultures of *S. cerevisiae*, as this ensures early onset of fermentation, successful conversion of the grape must sugars, and reproducible fermentation results. With spontaneous fermentations, when no starter culture is added, the *S. cerevisiae* population tends to not just increase, but manages to suppress the non-*Saccharomyces* yeast (NSY) populations. Yet, spontaneous fermentations are at a far greater risk of becoming stuck due to the initial competition for nutrients among the different yeast species. Nevertheless, many of the NSY have enjoyed increasing popularity in recent years as co-partners with *S. cerevisiae* wine yeasts in so-called mixed-culture fermentations [12]. Their deliberate additions provide many beneficial attributes ranging from lower alcohol levels to more complex aroma profiles [13] and currently several different NSY starter cultures have become commercially available, e.g., *Torulaspora delbrueckii* and *Pichia kluyveri* [14].

It is important not to study *S. cerevisiae* in isolation but to consider the NSY populations and their roles in nitrogen consumption during winemaking. A major uptick in studies on this topic has occurred over the past couple of years, where the nitrogen metabolism of key NSYs has been investigated. Studies ranged from the nitrogen preference of NSYs under winemaking conditions to comparing their nitrogen regulation mechanisms to that of *S. cerevisiae* [15–17]. The amino acid preferences can vary significantly depending on many environmental parameters [18]. For *S. cerevisiae*, diverse amino acid preferences have been reported in fermentations of grape must and beer wort [19,20]. For example, it was found that, in grape must fermentations, Lys was the most preferred amino acid to be utilized, followed by early consumption of Asp, Thr, Glu, Leu, His, Met, Ile, Ser, Gln, and Phe [19]. The amino acids Val, Arg, Ala, Trp, and Tyr were consumed slower. In beer wort, the most preferred amino acids that were the first to disappear in the medium were Glu, Asp, Asn, Gln, Ser, Thr, Lys and Arg, followed by the branched-chain amino acids Ile, Leu and Val as

well as Met and His [20]. The amino acids Gly, Ala and the aromatic amino acids Phe, Tyr and Trp were detected longer in the fermentation supernatant and disappeared before the amino acid Pro.

Table 1. Ehrlich pathway intermediates and derivatives of branched-chain amino acids (Leu, Val, Ile), aromatic amino acids (Phe, Tyr, Trp), the sulfur-containing amino acids (Met, Cys) and the polar-uncharged amino acid (Thr) as well as the odor descriptors of their acetate esters. Modified from Dzialo et al. [7], Valera et al. [21] and Vermeulen et al. [22].

Amino Acid	α -Keto Acid	Fusel Aldehyde	Fusel Alcohol	Acetate Ester	Odor Descriptor of Acetate Ester
Leu	α -Keto-isocaproate	3-Methylbutanal	Isoamyl alcohol	Isoamyl acetate	Banana, sweet, fruity
Val	α -Keto-isovalerate	2-Methylpropanal	Isobutanol	Isobutyl acetate	Sweet, fruity, tropical
Ile	α -Keto-3-methylvalerate	2-Methylbutanal	2-Methylbutanol	2-Methylbutyl acetate	Fruity, tropical, overripe fruit
Phe	Phenylpyruvate	2-Phenylethanal	2-Phenylethanol	2-Phenylethyl acetate	Floral, rose, honey
Tyr	4-Hydroxyphenylpyruvate	2-(4-Hydroxyphenyl)ethanal	Tyrosol	Tyrosol acetate	Fruity, flowery
Trp	Indol-3-pyruvate	2-(Indol-3-yl)ethanal	Tryptophol	Tryptophol acetate	Fruity, flowery
Met	2-Keto-4-methylthio-2-oxobutyrate	3-(Methylthio)propanal	Methionol	Methionyl acetate	Cabbage, potato, mushroom
Thr	α -Keto-butyrate	Butanal	Butanol	Butyl acetate	Solvent, fruity, banana
Cys	3-Mercaptopyruvate	Mercaptoacetaldehyde	2-Mercaptoethanol	2-Mercaptoethyl acetate	Roasted

In this study, we determined amino acid consumption profiles for one *S. cerevisiae* commercial wine strain (Geisenheim/Uvaferm GHM) and the non-*Saccharomyces* yeast species *Hanseniaspora uvarum*, *H. osmophila*, *Zygosaccharomyces rouxii* and two strains of *Starmerella bacillaris*, that can be found at the onset of grape must fermentation. Subsequently, we carried out fermentations with three of the non-*Saccharomyces* yeast strains (*H. uvarum*, *H. osmophila* and *Z. rouxii*) in synthetic musts that were spiked with one amino acid as an additional nitrogen source in order to determine the amino acid-dependent production of aroma compounds.

2. Materials and Methods

2.1. Yeast Strains and Media

The following yeast strains were used: the commercial *S. cerevisiae* wine yeast strain Geisenheim/Uvaferm GHM (Lallemand, Montreal, Canada), *H. uvarum* DSM2768, *H. osmophila* NRRL Y-1613^T, *S. bacillaris* GYBC-240 and GYBC-241 as well as the *Z. rouxii* GYBC-242. The latter three strains were obtained from the Geisenheim Yeast Breeding Center culture collection.

Yeasts were routinely cultured in YPD medium (20 g/L glucose, 20 g/L bacto peptone and 10 g/L yeast extract). For the preparation as preculture for fermentation experiments, yeast strains were grown in synthetically defined (SD) media (20 g/L glucose, 0.17 g/L yeast nitrogen base and 0.23 g/L ammonium chloride [16]) and washed in a sterilized 9 g/L NaCl solution.

The synthetic grape must (SM) medium was prepared according to Bely et al. [23], with adjustments from Su et al. [24] and Seguinot et al. [25]. The composition of the synthetic grape must, without the addition of the amino acids (AA), can be found in Table 2.

Table 2. Composition of the synthetic must base without the added amino acids. All chemicals were obtained from Merck (Darmstadt, Germany).

Component	Concentration
Sugars	[g/L]
Glucose	100
Fructose	100
Acids	[g/L]
DL-Malic acid	5
Citric Acid	0.5
L-(+)-Tartaric acid	3
Minerals	[mg/L]
KH ₂ PO ₄	750
K ₂ SO ₄	500
MgSO ₄	250
CaCl ₂	160
NaCl	200
Trace elements	[mg/L]
MnSO ₄	4
ZnSO ₄	4
CuSO ₄	1
KI	1
CoCl ₂	0.4
H ₃ BO ₃	1
(NH ₄) ₆ Mo ₇ O ₂₄	1
Vitamins	[mg/L]
Myo-inositol	20
Calcium pantothenate	1.5
Nicotinic acid	2
Thiamine hydrochloride	0.25
Pyridoxine hydrochloride	0.25
Biotin	0.003
Phytosterol solution for 100 L of SM	
β-Sitosterol	500 mg
Tween 80	16.7 mL
Ethanol pure	16.7 mL

The pH of the SM medium was adjusted to pH 3.3 using 5N NaOH. The nitrogen content was 140 mg/L of YAN. For experiments using an amino acid mixture (SM-mix), amounts of amino acids resembling the natural composition found in grapes were added, with 70% of the nitrogen coming from amino acids and 30% from ammonium chloride. For experiments with single amino acid fermentations (SM-AA), amino acids were added in amounts derived from their molecular mass and number of assimilable nitrogen atoms in the molecule. The concentrations of amino acids used were taken from Su et al. [16]. The concentrations of the added amino acids for the fermentations with the amino acid mixture and the addition of individual amino acids are listed in Table 3. All amino acids used were purchased either from Merck (Darmstadt, Germany) or Carl Roth (Karlsruhe, Germany).

Table 3. Amino acid and ammonium concentrations of the synthetic must with amino acid mix (SM-mix) and when used individually in the single amino acid fermentations (SM-AA).

Amino Acid	SM-mix [mg/L] *	SM-AA [mg/L] *
L-alanine	48	891
L-arginine	123	581
L-asparagine	0	661
L-aspartic acid	15	1331
L-cysteine	4	1212
L-glutamine	40	1471
L-glutamic acid	166	731
Glycine	6	751
L-histidine	11	1552
L-isoleucine	11	1312
L-leucine	16	1312
L-lysine	6	731
L-methionine	10	1492
L-phenylalanine	13	1652
L-proline	202	1151
L-serine	26	1051
L-threonine	25	1191
L-tryptophan	59	2042
L-tyrosine	6	1812
L-valine	15	1172
NH ₄ Cl	151	535

* The respective concentrations were taken from Su et al. [16].

2.2. Fermentation Experiments

We followed three experimental lines in our fermentation experiments. On the one hand, fermentation kinetics of all individual yeast strains in SM-mix were determined using the ANKOM Rf Gas Production system (ANKOM Gesellschaft für Analysetechnik – HLS, Salzwedel, Germany) as described previously [26]. Therefore, 150 mL of SM-mix were transferred into a modified 250 mL borosilicate bottle sealed with a lid containing the Rf sensor module of the ANKOM Rf Gas Production system and inoculated with 1×10^6 cells/mL. The bottles were equipped with appropriate magnetic stirrer bars before placing on magnetic stirrer pads, enabling constant stirring. The interval for measuring the prevailing pressure was set to 30 min. The pressure was measured for 237.5 h (~10 days).

Secondly, the rate at which each amino acid was consumed within a mixture of amino acids was evaluated. All six yeast strains were used to ferment the 150 mL SM-mix (in 300 mL Erlenmeyer flasks) with the nitrogen content as described in Tables 2 and 3. The yeast pitching rate was 1×10^6 cells/mL. Appropriate dilutions of starting cultures were prepared according to cell numbers determined by haemocytometer cell counts. Flasks were covered with aluminium foil. Fermentations were conducted in a temperature-controlled shaking incubator at 25 °C and shaken at 120 min^{-1} . Samples (2 mL) were removed every 8 h for the first 32 h, pelleted by centrifugation at 13.000 min^{-1} for 1 min and stored at -80 °C for later analysis of the amino acid composition via ion exchange chromatography (IEC). After 72 h, samples were also prepared for aroma compound analysis via gas chromatography/mass spectrometry (GC/MS) and quantification of organic acids, ethanol, and sugar concentrations via high-performance liquid chromatography (HPLC).

The last line of experiments evaluated the aroma compound formation of must fermentations that were enriched with individual amino acids. The strains *H. uvarum* DSM2768, *H. osmophila* NRRL Y-1613^T and *Z. rouxii* GYBC-242 were used in this experiment. High-throughput fermentations were carried out at 25 °C in 35 mL of SM-AA (see Table 3) in 50 mL conical fermentation tubes fitted in tube racks to allow stirring at 120 min^{-1} . The nitrogen content of SM-AA totalled 140 mg/L of YAN. Tubes were sealed with aluminium foil. Fermentations were carried out for 72 h. Samples were analysed via GC/MS and HPLC.

2.3. Analysis of Amino Acid Uptake with Ion Exchange Chromatography (IEC)

Concentrations of amino acids were undertaken on an ARACUS Amino Acid Analyzer Advanced (membraPure GmbH, Hennigsdorf, Germany). The analyser uses post-column derivatisation with ninhydrin and cation exchange chromatography [27]. Samples were prepared by mixing 600 μL of sample buffer (lithium-citrate solution 0.12 M, pH 2.2, 26.23 $\mu\text{g}/\text{mL}$ norleucine as internal standard; Sykam, Eresing, Germany) with 600 μL of the sample. Samples were passed through a nylon filter (syringe filter, nylon, 0.45 μm , MS Scientific, Berlin, Germany) into glass vials to analyse free amino acids. Prior to photometric detection of primary and secondary amino acids via UV/VIS-detector at 570 nm and 440 nm, respectively, automatic post-column ninhydrin derivatisation at 130 $^{\circ}\text{C}$, leading to a colourisation of the amino acids, was performed for quantification according to Krause and Löhnertz [28]. This treatment dyes primary amino acids blue-violet and secondary amino acids (i.e., Pro) yellow. Samples up to and including the 32 h timepoint were analysed for each strain.

Since cysteine is not stable in solution and oxidizes to form cystine, cysteine could not be detected in the fermentation supernatant. Due to the deamination of glutamine to glutamic acid and asparagine to aspartic acid, neither glutamine nor asparagine could be measured in the fermentation supernatants. Accordingly, the glutamic acid values contain the sum of glutamine and glutamic acid at the respective time of sampling. The same applies to the values of aspartic acid and asparagine.

2.4. High-Performance Liquid Chromatography (HPLC) Analysis

Sugars (glucose and fructose), organic acids (tartaric acid, malic acid, lactic acid, acetic acid and citric acid) and ethanol were measured by HPLC using a method as described previously [29,30]. An Agilent Series 1100 (Agilent Technologies Inc., Santa Clara, CA, USA) HPLC with UV/VIS (at 210 nm) and Refractive Index (35 $^{\circ}\text{C}$) detectors and an Allure Organic Acids 5 μm particle size (length 250 mm, diameter 4.6 mm; Restek GmbH, Bad Homburg vor der Höhe, Germany) column was used. As eluent, a 0.5% ethanol/ 0.0139% H_2SO_4 solution was used at a flowrate of 0.5 mL/min at 46 $^{\circ}\text{C}$. Quantification was aided by the use of external standards. For sample preparation, thawed samples were centrifuged at 13,000 min^{-1} for 10 min and the supernatant subsequently diluted fourfold with ultrapure water along with the addition of 55 μL of 10% ethanol.

2.5. Analysis of VOCs with Head-Space Solid Phase Microextraction Gas Chromatography (HS-SPME-GC-MS)

The concentrations of volatile aroma compounds were measured by head-space (HS) solid phase microextraction (SPME) GC/MS (HS-SPME-GC-MS) as previously described [31,32]. A 7890 A gas chromatograph with a 5975-B mass spectrometer (both Agilent Technologies Inc., USA) was utilised. SPME was undertaken with a 1 cm length and 65 μm particle size polydimethylsiloxane and divinylbenzol fiber (Merck, Germany) at 40 $^{\circ}\text{C}$ and 10 min incubation time. Extraction was performed at 500 min^{-1} for 20 min. For the GC a Rxi[®]-5Si1 MS (Restek GmbH, Germany) column of 60 m length, 0.25 mm diameter and 1 μm particle size was used with helium as the carrier gas. Sample injection was performed 1:10 split mode and heating from 30 $^{\circ}\text{C}$ to 240 $^{\circ}\text{C}$ with a 12 $^{\circ}\text{C}/\text{s}$ raise and a 4 min hold. The GC run started with an initial 4 min hold at 40 $^{\circ}\text{C}$ after which the temperature was raised to 210 $^{\circ}\text{C}$ at a 5 $^{\circ}\text{C}/\text{min}$ rate and to 240 $^{\circ}\text{C}$ with 20 $^{\circ}\text{C}/\text{min}$ and a final 10.5 min hold. Data from the mass spectrometer used for the concentration values were in the range of 35 to 250 of the m/z masses to charge ratio. For the calibration of each measured compound a 5-point curve was made with a 3%, 6%, 9% or 12% ethanol, respectively, and 3% tartaric acid solution at pH 3, depending on the ethanol content of the samples. Samples were prepared by adding 1.7 g NaCl to 5 mL of sample in a 20 mL brown head-space glass vials. Two internal standard solutions (10 μL) were also added, namely 600 mg/L 1-octanol and 52 mg/L cumene.

2.6. Statistical Evaluation and Software

All fermentation experiments were performed in triplicates. For the statistical evaluation two-tailed unpaired *t*-test with Welch's correction was used to analyse the data in GraphPad PRISM software (Version 9.4.1) and significance was set at $p < 0.05$ to the control (GraphPad Software, San Diego, CA, USA). HPLC data were analysed using the software ChemStation for LC systems from Agilent (Agilent, Santa Clara, CA, USA). Agilent's MassHunter software (Agilent, Santa Clara, CA, USA) was used for analysing the HS-SPME-GC-MS data. IEC data were analysed by Clarity chromatography software (DataApex, Prague, Czech Republic).

3. Results

3.1. Fermentation Kinetics

Fermentations of all individual yeast strains in SM-mix were performed to analyze the fermentation kinetics and evaluate their fermentation performance within this must (Figure 2). The cumulative pressure of fermentations using *H. osmophila* reached a plateau phase after ~180 h (~7.5 days) indicating the end of fermentation. Fermentations with the other yeast strains showed slightly increasing pressure until the end of the experiment, with *S. cerevisiae* having a steadier increase reaching the highest value of cumulative pressure measured. In contrast, the fermentations with *H. uvarum* yielded the lowest value of cumulative pressure, which was about half of the pressure achieved by *S. cerevisiae*. Fermentations using both *Z. rouxii* and the *S. bacillaris* strains showed similar patterns in fermentation performance, slightly resembling in appearance to that of *H. osmophila*. Among all yeasts, *S. cerevisiae* was the first one reaching a cumulative pressure of one bar (~18.75 h) in the SM-mix fermentations, followed by *S. bacillaris* GYBC-240 (~20.67 h) and *H. uvarum* (~21 h). *Z. rouxii* and *S. bacillaris* GYBC-241 (both ~23.67) were found to exceed this value even before *H. osmophila* (~29.67 h).

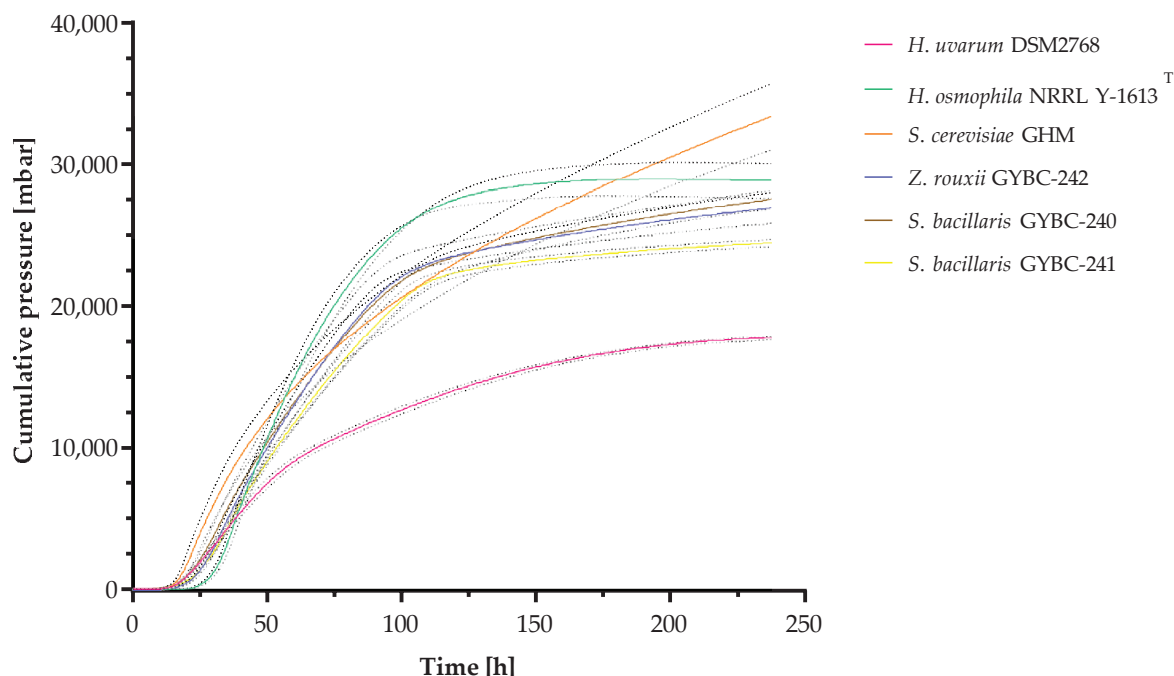

Figure 2. Fermentation kinetics of fermentations with SM-mix. Cumulative pressure was measured using ANKOM Rf Gas Production system. Data are the mean of three independent experiments \pm SEM. Dashed lines indicate the standard deviation.

3.2. Evaluation of Amino Acid Consumption Rate

To evaluate the consumption rate of 17 amino acids (Cys, Asn and Gln could not be measured), we generated a synthetic must supplemented with defined amounts of these amino acids (Table 2). Fermentations of these musts by *H. uvarum*, *H. osmophila*, *Z. rouxii* GYBC-242 and *S. bacillaris* GYBC-240 & GYBC-241 were carried out over a duration of 32 h (Figure 3, Figure S1) and the amino acid concentrations in the supernatants of these fermentations were quantified in eight-hour intervals. The results of the amino acid uptake of the yeasts at the individual time points compared to the initial values are described below.

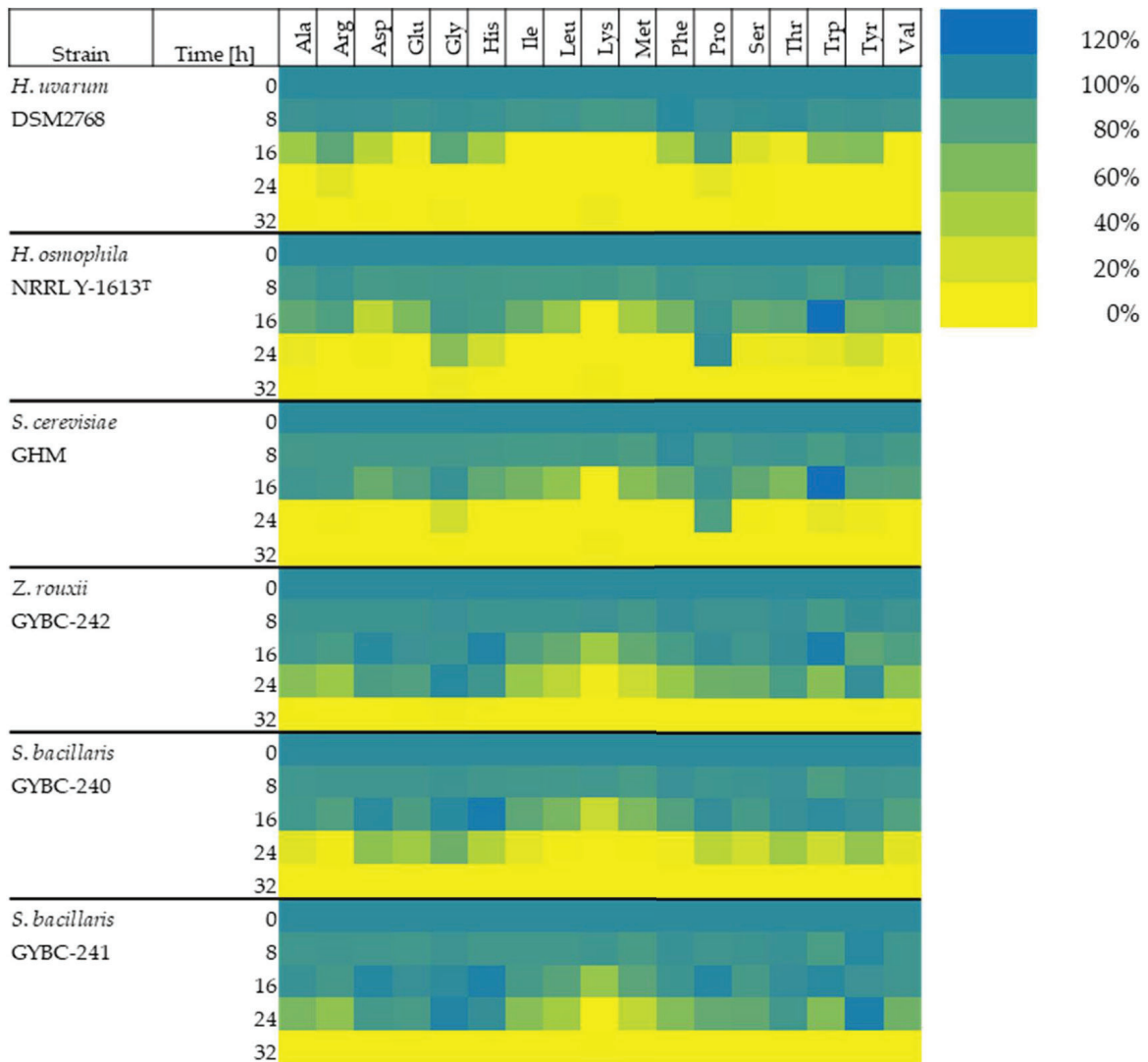

Figure 3. Amino acid concentration (%) present in the medium at different time points of the alcoholic fermentation in SM-mix. The initial concentration of each amino acid is expressed as 100%. It should be noted that the values of Glu also contained Gln and Asp also contained Asn. Cys could not be measured.

Eight hours after inoculation, the concentrations of the individual amino acids in the fermentation supernatant ranged from 83% to 100% for all yeast cultures. In the fermentations with *H. uvarum*, Lys (87%) and Met (88%) were present in the lowest concentrations. In both the fermentations with *H. osmophila* and *S. cerevisiae*, the lowest concentrations of amino acids were Met (*H. osmophila*: 83%, *S. cerevisiae*: 84%), followed by Trp (both 85%). The concentration of Trp had decreased the most after eight hours in the fermentations with *Z. rouxii* (87%) and both *S. bacillaris* strains (GYBC-240: 83%, GYBC-241: 85%), followed by Met (*Z. rouxii* GYBC-242: 89%, *S. bacillaris* GYBC-240 & GYBC-241: 86%).

Sixteen hours after inoculation, the branched-chain amino acids (Ile, Leu and Val) as well as Lys and Met were completely depleted in the fermentations with *H. uvarum*, while the concentrations of Glu and Thr were below 6%. Additionally, the concentrations of Ala, Asp, His, Phe and Ser diminished to 15–50%. Arg, Gly, Pro, Trp and Tyr were still present at more than 50%. In the fermentations with the other yeasts, however, the amino acids were present in much higher concentrations at 16 h. Only Lys was completely utilized in the fermentations with *H. osmophila* and also *S. cerevisiae* after 16 h. The concentrations of the other amino acids in these cultures ranged from 30% to 95%. An exception was Trp, which was present in both cultures at higher concentrations than the initial concentration at this time (120%). In the fermentations with both *Z. rouxii* and the two *S. bacillaris* strains, it was also Lys that was present in the lowest concentration 16 h after the start of fermentation (*Z. rouxii* GYBC-242: 46%, *S. bacillaris* GYBC-240: 25%, *S. bacillaris* GYBC-241: 50%). The concentrations of the other amino acids in these cultures ranged from 60% to 100%. Histidine was present in all three cultures at slightly higher than initial concentrations at that time (105–111%). The concentration of Trp was also increased in the cultures with *Z. rouxii* (110%), as with the cultures of *H. osmophila* and *S. cerevisiae*. Twenty-four hours after inoculation, almost all amino acids were consumed in the cultures with *H. uvarum*. Only 12% of Arg and 10% of Pro were still present. In the fermentations with *H. osmophila* and *S. cerevisiae*, on the other hand, a Pro concentration of 97% and 83%, respectively, was still measured after 24 h. Furthermore, the following amino acids were detected at this time in *H. osmophila*: Ala, Gly, His, Ser, Thr, Trp and Tyr (see also Figure S1). Glycine, Trp and Tyr were also measured in fermentations with *S. cerevisiae* 24 h after inoculation. The concentrations of the measured amino acids in the fermentations with *Z. rouxii* and the two *S. bacillaris* strains at the 24 h time point, ranged from completely depleted to unconsumed. After 24 h, the concentration of Lys was below 2% in all three cultures. In the fermentations with *S. bacillaris* GYBC-240, only very low amounts of Arg, Leu, Met and Phe were detected (1–3%). Thirty-two hours after the start of fermentation, all amino acids were used up in all yeast cultures.

3.3. Analysis of Sugar Content

To evaluate the sugar consumption of the six different yeast strains, the sugar concentrations were determined via HPLC analysis and are listed in Table 4. In the SM-mix fermentations with 200 g/L starting sugar concentration, those with *H. osmophila* and *S. cerevisiae* showed a residual sugar concentration below 100 g/L, while *H. uvarum*, *Z. rouxii* and the two *S. bacillaris* strains contained sugar levels above 100 g/L. As glucose and fructose were initially present in equal amounts, the rate of assimilation of these sugars is of interest. Comparing glucose to fructose, the glucose concentrations in the fermentation supernatants of *S. cerevisiae* and both *Hanseniaspora* species were lower than the fructose concentrations. In contrast, glucose was barely utilized in the fermentation supernatant in the fermentations with *Z. rouxii* and both *S. bacillaris* strains. Looking at the ratio of glucose to fructose, apart from the original must (SM), it was most balanced in the *H. uvarum* fermentations.

Ethanol production and formation of acetic acid during fermentation with individually supplemented amino acids are given in Figure 3.

Table 4. Analysis of glucose, fructose and total sugar in yeast fermentations with SM-mix ^{a, b}.

Strain	Glucose [g/L]	Fructose [g/L]	Total Sugar [g/L]	Glucose * [%]	Fructose * [%]
<i>H. uvarum</i> DSM2768	52.46 ± 0.74	62.67 ± 1.70	115.13 ± 2.45	45.57	54.43
<i>H. osmophila</i> NRRL Y-1613 ^T	33.29 ± 0.79	55.79 ± 0.71	89.08 ± 1.36	37.37	62.63
<i>S. cerevisiae</i> GHM	30.70 ± 0.80	68.83 ± 0.90	99.54 ± 1.70	30.84	69.15
<i>Z. rouxii</i> GYBC-242	98.18 ± 1.31	20.09 ± 0.86	118.26 ± 2.17	83.02	16.99
<i>S. bacillaris</i> GYBC-240	95.06 ± 0.84	19.84 ± 0.68	114.90 ± 0.17	82.73	17.27
<i>S. bacillaris</i> GYBC-241	97.18 ± 0.94	22.46 ± 1.00	119.65 ± 0.49	81.22	18.77
SM ^c	101.24 ± 2.17	102.06 ± 2.20	203.30 ± 4.36	49.80	50.20

^a Samples were analysed via HPLC three days after inoculation. ^b Data are the mean of three independent experiments ± SD. ^c Synthetic must (SM) was analysed to measure the initial concentration of sugars. * The percentage of each sugar remaining in the supernatant.

3.4. Volatile Organic Compounds Produced during Single Amino Acid Fermentations

Fermentations using *H. uvarum*, *H. osmophila* and *Z. rouxii* in SM were spiked with single amino acids (SM-AA) to analyse their impact on volatile aroma compound synthesis. A fermentation with the respective yeast with the addition of an amino acid mix served as a control (Ctrl.). Figure 4 shows the amounts of ethanol and acetic acid formed. SM-mix fermentations with yeasts achieved the highest concentration of ethanol. Except for SM-AA fermentations with *H. osmophila* with Ala and Gln, significantly less ethanol was measured in the SM-AA fermentations with all three yeast strains. *H. uvarum* produced the least ethanol when Cys (~7 g/L), Ile (~5 g/L) or Thr (~5 g/L) were added and the most when Arg or Gln (both ~30 g/L) were added [Figure 4a]. The lowest ethanol concentrations were also found in fermentations using *Z. rouxii* when Cys (~3 g/L), Ile (~4 g/L) or Thr (~4 g/L) were added. The highest ethanol concentration was measured when Gln (~21 g/L) was added [Figure 4c]. Fermentations with *H. osmophila* showed the lowest ethanol concentrations when Cys (~1 g/L), Gly (~3 g/L), His (~1 g/L), Lys (~4 g/L) and Thr (~5 g/L) were added and the highest when only Ala (~37 g/L) was added [Figure 4b]. Figure 4d shows that in all SM-AA fermentations using *H. uvarum* acetic acid was detected. Besides the control, the highest acetic acid values occurred in Arg and Gln (both ~0.5 g/L) fermentations. Apart from the SM-AA Trp fermentations, which showed the highest acetic acid concentrations (~0.2 g/L), lower amounts of acetic acid were detected in all other SM-AA fermentations with *H. osmophila* than in the corresponding fermentations using *H. uvarum* [Figure 4e]. *H. osmophila* did not produce acetic acid in the SM-AA fermentations with Cys. *Z. rouxii* produced the highest amount of acetic acid when Phe was added (~0.2 g/L), even significantly exceeding the amount of acetic acid formed in the control (~0.17 g/L; Figure 4f).

Ethyl acetate, 2-phenylethyl acetate and isoamyl acetate are among the most aroma-relevant acetate esters produced during wine fermentation. In Figure 5a it can be seen that ethyl acetate was detected in all fermentations using *H. uvarum*. Besides the control (~1163 mg/L), the highest values were measured with the addition of Arg (~470 mg/L) or Glu (~478 mg/L). However, when only Ile or Ser was added, relatively small amounts of ethyl acetate were formed (Ile: ~11 mg/L; Ser: ~4 mg/L).

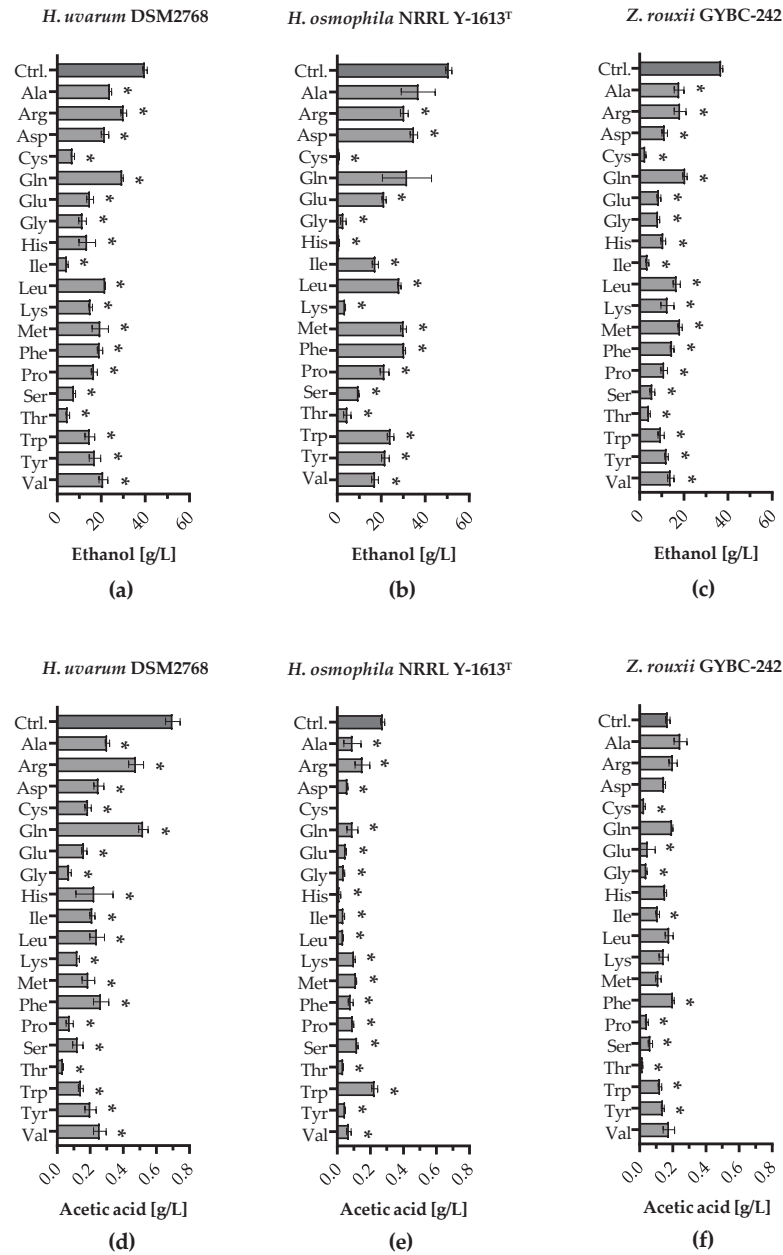

Figure 4. Ethanol production and formation of acetic acid during fermentation with individually supplemented amino acids. Ethanol production [g/L] in fermentations using (a) *H. uvarum* DSM2768, (b) *H. osmophila* NRRL Y-1613^T and (c) *Z. rouxii* GYBC-242. Formation of acetic acid [g/L] in fermentations using (d) *H. uvarum* DSM2768, (e) *H. osmophila* NRRL Y-1613^T and (f) *Z. rouxii* GYBC-242. Fermentations using the respective yeast with SM-mix served as control (Ctrl.). Ethanol and acetic acid concentrations were measured via high performance liquid chromatography (HPLC) analysis. Data are the mean of three independent experiments \pm SEM, two-tailed unpaired *t* test with Welch's correction, * $p < 0.05$ as compared to the control. Error bars indicate the standard deviation.

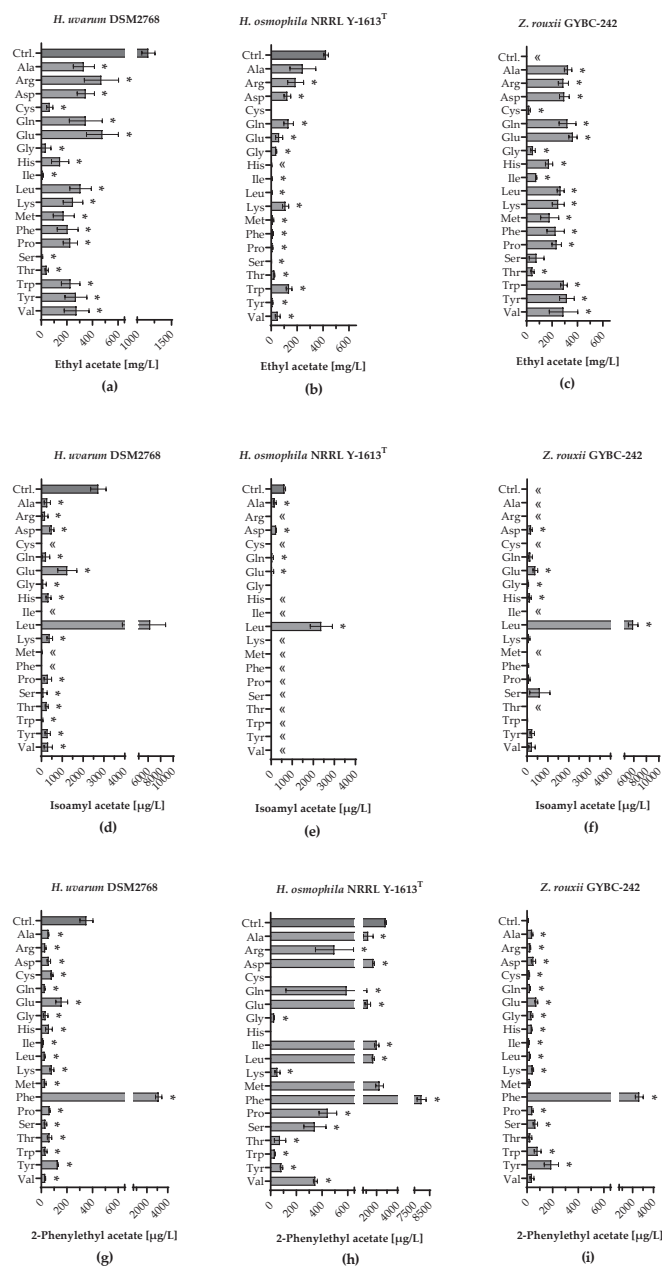

Figure 5. Production of acetate esters during fermentation with individually supplemented amino acids. Ethyl acetate production [mg/L] in fermentations using (a) *H. uvarum* DSM2768, (b) *H. osmophila* NRRL Y-1613T and (c) *Z. rouxii* GYBC-242. Isoamyl acetate production [µg/L] in fermentations using (d) *H. uvarum* DSM2768, (e) *H. osmophila* NRRL Y-1613T and (f) *Z. rouxii* GYBC-242. 2-Phenylethyl acetate production [µg/L] in fermentations using (g) *H. uvarum* DSM2768, (h) *H. osmophila* NRRL Y-1613T and (i) *Z. rouxii* GYBC-242. Fermentations using the respective yeast with SM-mix served as control (Ctrl.). Acetate esters were measured via HS-SPME-GC-MS analysis. Data are the mean of three independent experiments \pm SEM, two-tailed unpaired *t* test with Welch's correction, * $p < 0.05$ as compared to the control. Error bars indicate the standard deviation; \ll : not quantifiable.

Z. rouxii was also able to produce ethyl acetate in all SM-AA fermentations [Figure 5c]. In contrast to *H. uvarum*, however, no ethyl acetate was quantifiable in the control. The highest amount of ethyl acetate was formed when Glu was added (~365 mg/L) and the lowest when Cys was added (~22 mg/L). Many of the SM-AA fermentations using *H. osmophila* resulted in low ethyl acetate levels [below 10 mg/L; Figure 5b]. The addition of Ala yielded the highest amount of ethyl acetate (~245 mg/L). In all three yeast strains, the highest concentration of isoamyl acetate was obtained in fermentations with the addition of Leu [Figure 5d-f]. Compared to the other two yeast strains, *H. uvarum* was able to use almost all amino acids for the production of isoamyl acetate, apart from four amino acids, which were not quantifiable. Figure 5g-i shows that the addition of Phe resulted in the highest production of 2-phenylethyl acetate in all three yeast strains. Except for the SM-AA fermentations using *H. osmophila* with Cys and His and the control fermentation using *Z. rouxii*, 2-phenylethyl acetate was detected in all fermentations with the three yeast strains. In addition to the control, fermentations with *H. osmophila* with the addition of eight single amino acids, respectively, showed 2-phenylethyl acetate levels higher than 500 µg/L. In contrast, only the addition of Phe in the fermentations using *H. uvarum* and *Z. rouxii* resulted in 2-phenylethyl acetate amounts of this quantity.

Besides the acetate esters, the higher alcohols also play a major role in the aroma profile during wine fermentation. All three yeast strains showed the highest isobutanol amounts when Val was added [>700 mg/L; Figure 6a,e,i]. *H. osmophila* did not produce isobutanol when Cys or His was added. Apart from this, isobutanol was detected in all fermentations with the different yeasts. In the fermentations with the addition of Leu, *H. uvarum*, *H. osmophila* and *Z. rouxii* produced large amounts of isoamyl alcohol [<700 mg/L; Figure 6b,f,j)]. Besides Leu, the addition of Asp in fermentations using *H. osmophila* also showed significantly higher levels of isoamyl alcohol than the control. When Cys, Ile or Thr were added, isoamyl alcohol was not quantifiable in any fermentation using the various yeast strains. In Figure 6c,g,k) it can be seen that an addition of Ile led to a higher increase of 2-methyl butanol in all three yeast strains. Among the yeast strains tested, *Z. rouxii* produced significantly less 2-methyl butanol (~66 mg/L), in contrast to *H. uvarum* (~166 mg/L) and *H. osmophila* (~484 mg/L). In addition, the fermentations with *Z. rouxii* and Ala also produced significantly more 2-methyl butanol (~42 mg/L) than the control (~26 mg/L). Additional Phe led to significantly increased 2-phenyl ethanol production in all yeast strains [Figure 6d,h,l)]. A higher concentration of 2-phenyl ethanol than in the control (~46 mg/L) was also found in the single amino acid fermentations using *H. osmophila* with Leu (~67 mg/L).

The measured ethyl esters ethyl propionate and ethyl isobutyrate, as well as the acetate ester 2-methylbutyl acetate of the SM-AA fermentations are shown in Figure S2. It shows that SM-AA fermentations with Val resulted in significantly higher levels of ethyl propionate and ethyl isobutyrate in all yeast strains studied. In addition, elevated ethyl propionate levels were measured in the SM-AA Thr fermentations using all yeasts. When Ile was added, ethyl propionate was not found in fermentations using either *H. uvarum* or *Z. rouxii*. In comparison, less ethyl propionate was produced in SM-AA fermentations with *H. osmophila* with the respective nitrogen source. Besides Val, a significant increase in ethyl isobutyrate was also observed in fermentations using *H. osmophila* when Ala was added. In the SM-AA Cys fermentations, ethyl isobutyrate was not detected for any of the yeasts. The addition of Ile yielded higher concentrations of 2-methylbutyl acetate. Higher concentrations of 2-methylbutyl acetate were measured in the SM-AA fermentations with *H. uvarum* in the case of most nitrogen sources than in the respective fermentations using the other two yeasts.

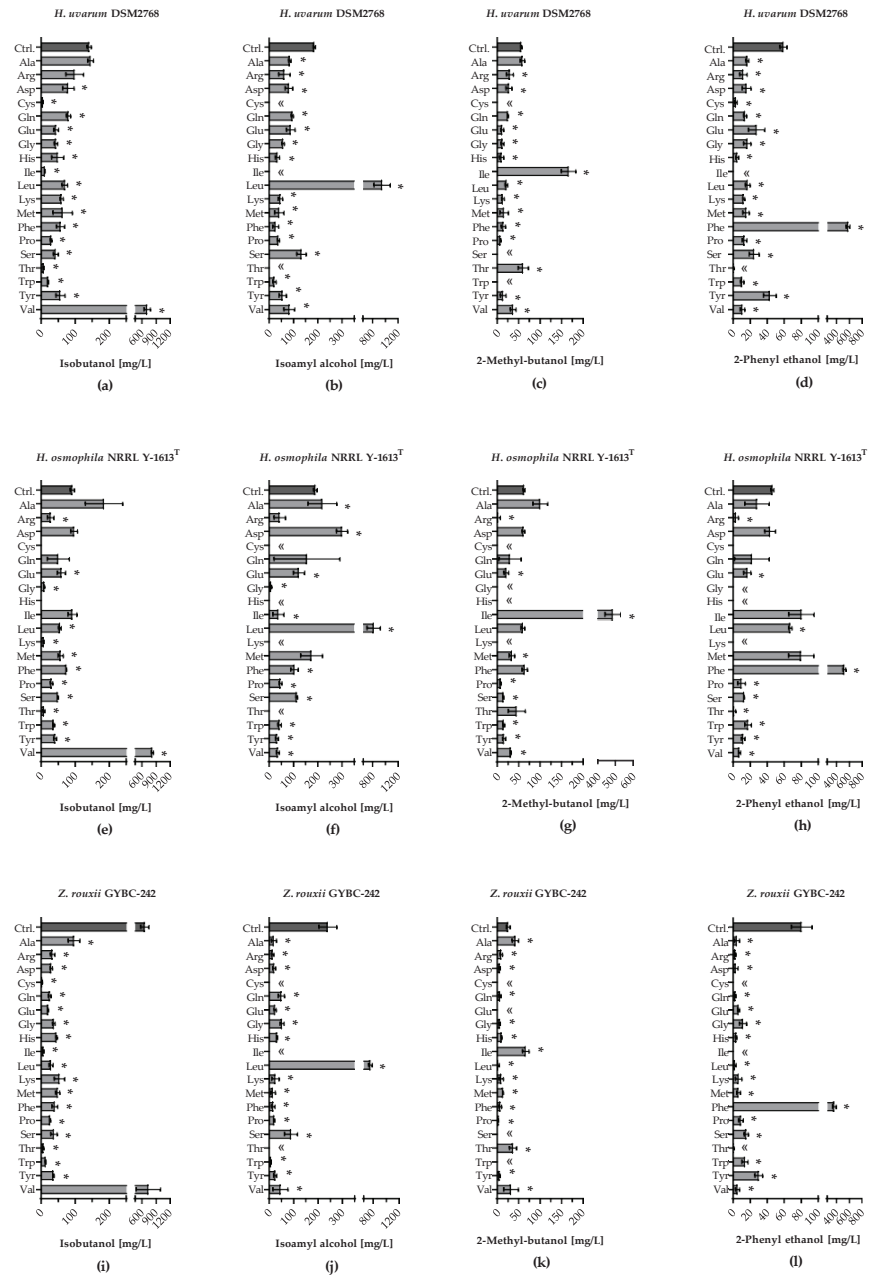
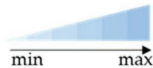

Figure 6. Formation of higher alcohols during fermentation with individually supplemented amino acids. Formation of isobutanol [mg/L] in fermentations using (a) *H. uvarum* DSM2768, (e) *H. osmophila* NRRL Y-1613^T and (i) *Z. rouxii* GYBC-242. Formation of isoamyl alcohol [mg/L] in fermentations using (b) *H. uvarum* DSM2768, (f) *H. osmophila* NRRL Y-1613^T and (j) *Z. rouxii* GYBC-242. Formation of 2-methyl butanol [mg/L] in fermentations using (c) *H. uvarum* DSM2768, (g) *H. osmophila* NRRL Y-1613^T and (k) *Z. rouxii* GYBC-242. Formation of 2-phenyl ethanol [mg/L] in fermentations using (d) *H. uvarum* DSM2768, (h) *H. osmophila* NRRL Y-1613^T and (l) *Z. rouxii* GYBC-242. Fermentations using the respective yeast with SM-mix served as control (Ctrl.). Higher alcohols were measured via HS-SPME-GC-MS analysis. Data are the mean of three independent experiments \pm SEM, two-tailed unpaired *t* test with Welch's correction, * $p < 0.05$ as compared to the control. Error bars indicate the standard deviation; «: not quantifiable.

Malic acid and isovaleric acid were also measured (Figure S3). Isovaleric acid could only be detected in the SM-AA Leu fermentations with all yeast strains [Figure S3d-f]. Isovaleric acid was not quantifiable in any of the SM-mix fermentations (Ctrl.). Malic acid was found in each of the culture supernatants [Figure S3a-c]. When Pro was added as the only nitrogen source, significantly less malic acid was found in fermentations of all three yeast strains. When Thr was added, however, higher malic acid values than in the SM-mix fermentations were measured in all different yeast fermentations.

The calculation of total alcohols, total acetate esters and total ethyl esters provides information about their synthesis depending on the SM-AA fermentations using the various yeast strains. Table 5 shows the total alcohols and total acetate esters, produced through the Ehrlich pathway (see also Table 1), and total ethyl esters formed in the SM-mix fermentations (Ctrl.) and SM-AA fermentations using the individual yeast strains. In the SM-mix fermentations, *Z. rouxii* formed more total alcohols than *H. uvarum* and *H. osmophila*. The latter produced the highest amounts of total acetate esters, while *H. uvarum* produced the most total ethyl esters.

Table 5. Overview of the production of total alcohols, total acetate esters and total ethyl esters in SM-mix (Ctrl.) and SM-AA fermentations using *H. uvarum* DSM2768 (*H.u.*), *H. osmophila* NRRL Y-1613^T (*H.o.*) and *Z. rouxii* GYBC-242 (*Z.r.*). Darker colours indicate higher concentrations within the total alcohols, total acetate esters and total ethyl esters, lighter colours indicate lower concentrations within the respective group.



	Total Alcohols ^a [g/L]			Total Acetate Esters ^b [mg/L]			Total Ethyl Esters ^c [mg/L]		
	<i>H.u.</i>	<i>H.o.</i>	<i>Z.r.</i>	<i>H.u.</i>	<i>H.o.</i>	<i>Z.r.</i>	<i>H.u.</i>	<i>H.o.</i>	<i>Z.r.</i>
Ctrl.	0.44	0.39	1.01	3.47	3.58	0.01	1.88	0.78	0.28
Ala	0.31	0.53	0.16	0.43	1.45	0.10	0.50	0.26	0.43
Arg	0.20	0.08	0.06	0.26	0.50	0.04	0.36	0.07	0.34
Asp	0.20	0.50	0.06	0.62	1.96	0.26	0.44	0.25	0.40
Cys	0.01	0.00	0.00	0.08	0.00	0.02	0.08	0.00	0.03
Gln	0.22	0.26	0.08	0.27	0.66	0.19	0.45	0.15	0.46
Glu	0.17	0.22	0.05	1.47	1.21	0.49	0.45	0.03	0.37
Gly	0.13	0.02	0.11	0.13	0.03	0.09	0.06	0.00	0.09
His	0.10	0.00	0.09	0.41	0.00	0.20	0.17	0.00	0.25
Ile	0.18	0.69	0.07	0.23	2.57	0.17	0.00	0.01	0.00
Leu	1.06	1.00	0.79	6.40	4.08	5.92	0.38	0.03	0.34
Lys	0.13	0.01	0.09	0.51	0.05	0.15	0.22	0.04	0.24
Met	0.14	0.35	0.08	0.06	2.30	0.03	0.14	0.05	0.28
Phe	0.68	0.76	0.43	3.15	7.99	2.68	0.18	0.08	0.24
Pro	0.09	0.09	0.06	0.41	0.44	0.15	0.26	0.00	0.34
Ser	0.20	0.19	0.14	0.13	0.35	0.68	0.00	0.00	0.06
Thr	0.07	0.05	0.04	0.40	0.12	0.11	0.52	0.49	0.77
Trp	0.05	0.11	0.03	0.06	0.04	0.10	0.19	0.07	0.28
Tyr	0.17	0.10	0.10	0.47	0.09	0.47	0.26	0.00	0.40
Val	0.84	0.90	0.82	0.41	0.36	0.34	5.25	3.30	13.68

^a Total alcohol produced through Ehrlich pathway including isobutanol, isoamyl alcohol, 2-methyl butanol and 2-phenyl ethanol. ^b Total acetate esters produced through Ehrlich pathway including isoamyl acetate, 2-methylbutyl acetate and 2-phenylethyl acetate. ^c Total ethyl esters including ethyl propionate and ethyl isobutyrate.

Comparing the SM-AA fermentations using all three strains, *H. uvarum* formed the highest amounts of total alcohols (1.06 g/L) when Leu was added. All three strains formed high amounts of total alcohols when Leu, Phe or Val were added. In fermentations with Cys, on the other hand, only very low or no alcohols were formed. In 53% of the nitrogen sources tested in the SM-AA fermentations, *H. osmophila* produced more total alcohols than the other two yeast strains, followed by *H. uvarum* with 47%.

The highest amount of total acetate esters formed was detected in the SM-AA Phe fermentations using *H. osmophila* at 7.99 mg/L. The highest total acetate esters were measured in fermentations with Phe and Leu in all three yeast strains. Whereas the lowest concentrations were found in the fermentations with Cys. *H. uvarum* formed higher amounts of total acetate esters in 45% of the nitrogen sources tested and *H. osmophila* in 42%. *Z. rouxii* was found to be the highest total acetate ester producer in 13% of the nitrogen sources tested. *Z. rouxii* showed poorly measurable total acetate esters in the SM-mix fermentations (0.01 mg/L), whereas high amounts were formed in the SM-AA fermentations with Leu (5.92 mg/L) and Phe (2.68 mg/L).

When Val was added, all three yeast strains showed the highest total ethyl ester values, with *Z. rouxii* producing significantly more than *H. uvarum* and *H. osmophila*. The lowest amounts of measured ethyl esters were formed when Ile was added. *H. osmophila* produced more total ethyl esters in 5% of the nitrogen sources tested and *H. uvarum* in 32%. *Z. rouxii* formed more total ethyl esters than *H. uvarum* and *H. osmophila* in 63% of the SM-AA fermentations.

4. Discussion

From a winemaking perspective, nitrogen has a dual role, by being essential for yeast growth to complete the alcoholic fermentation and by providing the backbone structures for many important wine aroma compounds [33]. The alarming world-wide trend in increased weather temperatures directly affects the development of the grape berry leading to earlier harvest times and higher sugar content [34]. Apart from eventually leading to increased alcohol levels in the final wines, this also leads to a bigger imbalance in the sugar to nitrogen levels in the must. Also, higher temperatures and limited irrigation water are associated with lower amino acid levels in grape berries [35,36]. Furthermore, the nitrogen content can also influence the formation of volatile and non-volatile components. Lower nitrogen levels are associated with the synthesis of branched-chain fatty acids and esters in *S. cerevisiae*, while high nitrogen levels lead to the formation of medium-chain fatty esters and acetic acid, depending on the nitrogen source added [33,37]. In order to prevent the associated fermentation problems, it is important to gain more insight in the exact nitrogen requirements of the common non-*Saccharomyces* yeasts that are present in the must.

In order to investigate the fermentation performance of the different yeast strains, fermentations were carried out in SM-mix, measuring the cumulative pressure over a period of ten days. Among all yeasts tested, only *H. osmophila* was able to finish the fermentation although *S. cerevisiae* showed the steadiest pressure increase thus reaching the highest value of cumulative pressure. The fructophilic yeasts (*Z. rouxii* and *S. bacillaris*) showed similar fermentation behaviour, with a slightly lower cumulative pressure formation than in the fermentations with *H. osmophila*. However, in the SM-mix fermentations, *H. uvarum* showed by far the lowest fermentation performance. The results are in accordance to previous studies. *S. bacillaris* as well as *H. uvarum* are known to be slow fermenting yeasts, with *H. uvarum* showing even lower fermenting performances in synthetic must fermentations [38]. Whereas *H. osmophila* proved to be a good fermenter in synthetic must fermentations [39].

From our second experiment, we observed that the *H. uvarum* DSM strain, an apiculate yeast, often cited as the most abundant yeast at the onset of a fermentation, consumed the amino acids the quickest of all the yeasts in this study. Similarly, Roca-Mesa et al. [15] observed that *H. uvarum* and *S. bacillaris* utilized amino acids faster in the absence of ammonium and behave similarly in terms of amino acid uptake in anaerobic fermentations. In contrast to *H. uvarum*, *H. osmophila* had a similar amino acid utilization profile than

S. cerevisiae, *H. uvarum* and *H. osmophila* belong to different lineages within the *Hanseniaspora* genus, namely the fast-evolving lineage (FEL) and the slow-evolving lineage (SEL), respectively and it has been shown, at least within the genes involved in the glycolytic pathway that members of SEL are closer in enzyme identity to *S. cerevisiae* [40]. Moreover, transcriptome data of *H. vineae* (another member of SEL) showed a similar gene upregulation pattern regarding their nitrogen utilization than that of *S. cerevisiae* which suggest these latter two yeast species share a similar nitrogen catabolism mechanism [17]. Contrary to the findings of Roca Mesa et al. [15], the two *S. bacillaris* strains and *Z. rouxii* performed similarly in terms of amino acid utilization and were significantly slower in degradation performance than *S. cerevisiae* and *H. osmophila*. Lysine was preferentially consumed by all yeast strains. This finding is consistent with previously published data [19]. Barraón-Simancas et al. [41], however, demonstrated that different *S. cerevisiae* strains all preferred cysteine and tyrosine, but also glycine and alanine. Thirty-two hours after inoculation of the media with different yeast strains, amino acids were not detected in the fermentation supernatant, including proline, which was one of the last amino acids still to be found in the fermentation medium. Gobert et al. [42] reported that *S. bacillaris* did not consume histidine, methionine, threonine or tyrosine. Our study shows that although these amino acids were depleted after 32 h, they were among the last amino acids to be assimilated. The intermediate increase of tryptophan in the medium in fermentations with fructophilic yeasts and especially *H. osmophila* and *S. cerevisiae* was remarkable. It is known that yeasts release amino acids into the medium especially towards the end of fermentation or also in the presence of higher salt concentrations in the medium [41,43,44].

Generalising for all yeast strains investigated, lysine was most strongly preferred by all yeasts, as already described by Crépin et al. [19]. Next was a strong preference of all yeasts for Ile, Leu and Met. Besides Phe, Ser, Thr, Glu and Asp, also Ala and Val were among the preferred amino acids. Gly, Arg, His, Pro, Trp and Tyr, on the other hand, were taken up more slowly. *H. uvarum* stood out particularly in amino acid uptake. It was interesting that *H. uvarum* had already completely consumed seven of the amino acids examined within 16 h after inoculation. Most of the remaining amino acids in the fermentation supernatant were also found in significantly lower concentrations than in the fermentations with the other yeasts.

S. cerevisiae strains are known for their strong glucophilic properties [45]. The results of this study also show the preference for glucose by *H. uvarum* and especially *H. osmophila*. Among these three glucophilic yeasts, *S. cerevisiae* showed the strongest glucophilic properties, followed by *H. osmophila*. *H. uvarum*, showing to be moderately glucophilic, absorbed proportionally more fructose compared to the other two yeast strains. In contrast, both *Z. rouxii* and the two *S. bacillaris* strains displayed a strong fructophilic phenotype [46,47]. Of the three, *Z. rouxii* consumed proportionally more fructose than glucose.

For further analyses of the single amino acid fermentations and the synthesis of aroma relevant compounds, we selected *H. uvarum*, *H. osmophila* and *Z. rouxii*. *H. uvarum* plays a major role in spontaneous fermentations as it is abundant in the grape microbiome. Moreover, *H. uvarum* stood out in amino acid uptake and sugar degradation. Due to the similarities to *S. cerevisiae* in terms of sugar degradation and amino acid degradation, we decided to investigate amino acid metabolism and the resulting alcohols and esters in fermentations with *H. osmophila* in more detail. *H. uvarum* and *H. osmophila* are two different yeasts of one yeast genus, which also correspond to different lineages (FEL and SEL), that can be compared with each other. Since all fructophilic yeast strains tested, showed a similar behaviour regarding both the amino acid uptake and the sugar degradation, *Z. rouxii* was chosen for further experiments as *Z. rouxii* revealed slightly stronger fructophilic properties.

The Ehrlich pathway-mediated catabolism of the branched chain amino acids (Val, Leu and Ile), the aromatic amino acids (Phe, Tyr and Trp) and the sulphur-containing amino acid Met produces compounds that are the main yeast-derived aroma contributors in wine and other alcoholic beverages [10,48,49]. As expected, feeding leucine led to an increase

in isoamyl alcohol and isoamyl acetate in all three yeast strains studied. Isoleucine was converted to 2-methyl butanol and 2-methylbutyl acetate as predicted. Valine is converted to isobutanol and isobutyl acetate in the Ehrlich pathway leading to a pineapple and banana-like aroma. The SM-AA fermentations using the various yeast strains with valine addition showed the increased production of isobutanol, ethyl isobutyrate as well as ethyl propionate. α -Keto isovalerate, which is formed from valine in a transaminase reaction, can not only be converted to isobutanol or isobutyrate via 2-methylpropanal, but can also be converted into α -keto-isocaproate and then introduced into the leucine catabolism [7]. There, it is converted into isoamyl alcohol or isoamyl acetate. Thus, in the SM-AA Val fermentations using the three yeast strains, significant amounts of isoamyl alcohol and, in the case of *H. uvarum*, isoamyl acetate were also detected. Compared to the other two yeasts, *H. uvarum* was able to form isoamyl acetate from almost all amino acids tested in the SM-AA fermentations. This was also observed previously for *S. cerevisiae* [50]. In contrast to our studies, in addition to leucine, it was also isoleucine that led to a higher production of isoamyl acetate and isoamyl alcohol in fermentations using *S. cerevisiae*. Threonine is first converted to α -ketobutyrate and then further to either 1-propanol or 1-butanol. α -ketobutyrate can also be converted to alpha-keto-3-methylvalerate, which is then introduced into the isoleucine catabolism and further converted to 2-methyl-butanol [7]. This can be seen in this experiment from the amount of 2-methyl butanol formed in the SM-AA Thr fermentations using the three yeast strains. Of the three strains, *H. uvarum* produced the largest amounts of both 2-methyl butanol in the SM-AA Thr and isoamyl alcohol in the SM-AA Val fermentations. The aromatic amino acid phenylalanine also led to the production of large amounts of 2-phenyl ethanol and 2-phenylethyl acetate, which are known for producing the typical rose-like aroma. Even though methionine is known to be converted into methionol and 3-(methylthio) propanoate, within the Ehrlich pathway, it also had a general influence on the formation of alcohols and esters. This is particularly seen in fermentations inoculated with *H. osmophila*. In addition to phenylalanine, methionine as well as isoleucine appeared to have a particularly strong influence on the formation of 2-phenylethyl acetate and the corresponding alcohol. This is in contrast to previously published studies on fermentations with *S. cerevisiae* [50]. Fairbairn et al. [50] showed that only the addition of phenylalanine led to the production of 2-phenylethyl acetate.

The SM-AA fermentations with leucine led not only to the strong production of isoamyl alcohol in *H. osmophila*, but also to the formation of 2-methyl butanol and 2-phenyl ethanol. This discovery was also made by Espinosa Vidal et al. [51] in fermentations using *S. cerevisiae* with an oversupply of leucine, as the only nitrogen and carbon source. They proposed that these substances are biosynthesised *de novo* as outflows of valine, isoleucine and phenylalanine in *S. cerevisiae*. We did not observe this in the SM-AA Leu fermentations using *H. uvarum* and *Z. rouxii*. This finding supports our assumption that *H. osmophila* and *S. cerevisiae* have a similar amino acid metabolism, as both yeasts show a similar amino acid degradation profile in the SM-mix fermentations. *H. osmophila* showed no fermenting activity in the SM-AA fermentations with only lysine or histidine as amino acid source, conforming to its reported similarities with *S. cerevisiae* [52].

It is noticeable that *Z. rouxii* formed only a few (quantifiable) acetate- and ethyl esters under the fermentation conditions of the SM-mix fermentations. In the SM-AA fermentations, on the other hand, compared to the other yeast strains, it produced more total ethyl esters in most of the nitrogen sources tested. *H. uvarum* formed the highest amounts of total ethyl esters in the SM-mix fermentations. Interestingly, *Z. rouxii* was able to form high amounts of total acetate esters in the SM-AA fermentations, especially with leucine and phenylalanine, although this was not observed in the SM-mix fermentations. This suggests that there is some kind of inhibition of acetate ester production in the presence of all amino acids. Even though *H. osmophila* formed the highest amounts of total acetate esters in the SM-mix fermentations and also in SM-AA fermentations (with Phe added), *H. uvarum* formed more acetate esters in the fermentations in most of the nitrogen sources tested.

As a typical feature of *H. uvarum*, it produced the highest level of ethyl acetate, which is by far the most abundant ester found in alcoholic fermentations. In contrast to *H. osmophila*, which displayed relatively weak ester formation, ethyl acetate was detected in every SM-AA fermentation using *H. uvarum* and *Z. rouxii*. The amino acids Ala, Arg, Asp, Gln and Glu, which are not primarily associated with the production of aromatic acetate esters in the Ehrlich pathway, appear to have an important role not only in the formation of ethyl acetate, but also in total acetate ester formation. Even though *H. osmophila* is rather weak in terms of total ester production, in addition to SM-AA Phe fermentations, SM-AA fermentations with seven other amino acids reached 2-phenylethyl acetate values of over 1000 µg/L. While *H. osmophila* uses many amino acids for a strong 2-phenylethyl acetate formation, no 2-phenylethyl acetate was detected in the SM-AA fermentations with cysteine and histidine.

Regarding the SM-mix fermentations, *Z. rouxii* showed an increased formation of total alcohols. In the SM-AA fermentations, however, they always produced fewer total alcohols than the *Hanseniaspora* strains. Although the highest level of total alcohol was detected in the SM-AA fermentations with *H. uvarum* (with the addition of leucine), *H. osmophila* produced the highest levels of total alcohols in most fermentations with different nitrogen sources. In addition to the amino acids known to be relevant for the Ehrlich pathway, arginine and aspartic acid also appeared to have an influence on total alcohol production, especially by *H. osmophila*.

Our data show that leucine and phenylalanine have a significant influence on total alcohol and total acetate ester production in all yeast strains tested. Valine leads to an increase in total alcohol and total ethyl ester synthesis. Comparing the SM-AA fermentations with each other, it is noticeable that cysteine leads to a low yield of total alcohols, total acetate esters and total ethyl esters in all yeast strains. This could be explained by the inhibited growth of yeasts in SM-AA fermentations spiked with cysteine, as already reported by Su et al. [16]. In the SM-AA fermentations with *H. osmophila*, histidine also leads to inhibited growth and the absence of total alcohols and total esters in the fermentation supernatant. Su et al. [16] showed that the growth of *S. cerevisiae* was also inhibited by the addition of histidine as the sole nitrogen source. Due to the similarity in amino acid uptake and similar behaviour in amino acid-related aroma synthesis of *H. osmophila* and *S. cerevisiae*, this is according to the observations of Su et al. [16].

H. uvarum produced the highest amounts of acetic acid in both the SM-mix and SM-AA fermentations. In contrast to *H. osmophila* and *Z. rouxii*, acetic acid levels in *H. uvarum* were only very low (<0.1 g/L) in the SM-AA fermentations with glycine and threonine. Interestingly, SM-AA fermentations with proline, which led to significant amounts of ethanol in all yeast strains, resulted in a very low amount of acetic acid in fermentations using the various yeast strains. The presence of oxygen enables its degradation and makes it "yeast-available" [53]. This is also evident in the results of this study. In the fermentations with proline, the yeasts studied showed an increased production of total esters.

In a comparison of all amino acids as the only nitrogen source of the yeasts tested, leucine and phenylalanine are the most desirable in conferring general benefits to wine fermentations. Not only are they particularly strong in the production of aromatic components and contribute to the quality of the aroma profile of alcoholic end products, but they also enable the yeasts to run a strong fermentation when they are the only source of nitrogen. Isoleucine is also important in terms of flavour diversity, but leads to a weaker fermentation progress if no other nitrogen sources are available.

5. Conclusions

In conclusion, nitrogen requirements of non-*Saccharomyces* yeasts, as well as their utilization, are species dependent. Even yeasts belonging to the same genus may have different nitrogen uptake and utilization profiles. Also, glucophilic and fructophilic yeasts can produce similar aroma profiles as a function of different nitrogen sources. This work

highlights information about the amino acid preferences of selected NSY and how it influences the production of aroma compounds relevant in a winemaking context.

Supplementary Materials: The following supporting information can be downloaded at: <https://www.mdpi.com/article/10.3390/microorganisms11010014/s1>, Figure S1: Amino acid concentration (%) present in the medium at different time points of the alcoholic fermentation in SM-mix. The initial concentration of each amino acid is expressed as 100%. It should be noted that the values of Glu also contained Gln and Asp also contained Asn. Cys could not be measured.; Figure S2: Formation of ethyl- and acetate esters during fermentation with individually supplemented amino acids. Formation of ethyl propionate [$\mu\text{g/L}$] in fermentations using (a) *H. uvarum* DSM2768, (b) *H. osmophila* NRRL Y-1613T and (c) *Z. rouxii* GYBC-242. Formation of ethyl isobutyrate [$\mu\text{g/L}$] in fermentations using (d) *H. uvarum* DSM2768, (e) *H. osmophila* NRRL Y-1613T and (f) *Z. rouxii* GYBC-242. Formation of 2-methylbutyl acetate [$\mu\text{g/L}$] in fermentations using (g) *H. uvarum* DSM2768, (h) *H. osmophila* NRRL Y-1613T and (i) *Z. rouxii* GYBC-242. Fermentations using the respective yeast with SM-mix served as control (Ctrl.). Higher alcohols were measured via HS-SPME-GC-MS analysis. Data are the mean of three independent experiments \pm SEM, two-tailed unpaired t test with Welch's correction, * $p < 0.05$ as compared to the control. Error bars indicate the standard deviation; «: not quantifiable.; Figure S3: Acid production during fermentation with individually supplemented amino acids. Malic acid production [g/L] in fermentations using (a) *H. uvarum* DSM2768, (b) *H. osmophila* NRRL Y-1613T and (c) *Z. rouxii* GYBC-242. Isovaleric acid production [$\mu\text{g/L}$] in fermentations using (d) *H. uvarum* DSM2768, (e) *H. osmophila* NRRL Y-1613T and (f) *Z. rouxii* GYBC-242. Fermentations using the respective yeast with SM-mix served as control (Ctrl.). Higher alcohols were measured via HS-SPME-GC-MS analysis. Data are the mean of three independent experiments \pm SEM, two-tailed unpaired t test with Welch's correction, * $p < 0.05$ as compared to the control. Error bars indicate the standard deviation; «: not quantifiable.

Author Contributions: Conceptualization, C.v.W.; methodology, C.v.W. and J.B.; validation, J.B. and N.v.W.; formal analysis, J.B., B.K., H.S., S.B. and D.R.; investigation, M.M. and J.B.; resources, AROMAplus (LOEWE) and Department of Microbiology and Biochemistry of Hochschule Geisenheim University; data curation, J.B.; writing—original draft preparation, J.B. and N.v.W.; writing—review and editing, J.B., N.v.W., I.S.P. and C.v.W.; visualization, J.B.; supervision, J.B. and C.v.W.; project administration, C.v.W.; funding acquisition, C.v.W. All authors have read and agreed to the published version of the manuscript.

Funding: The authors would like to thank the Hessen State Ministry of Higher Education, Research and the Arts for the financial support within the Hessen initiative for scientific and economic excellence (LOEWE) in the framework of AROMAplus (<https://www.hs-geisenheim.de/aromaplus/>, (accessed on 25 October 2022)). The authors thank Geisenheim University and Macquarie University for co-funding of this project and the research fellowship of N.V.W., I.S.P. is a team member of the Macquarie-led national Centre of Excellence in Synthetic Biology funded by the Australian Government through its agency, the Australian Research Council.

Informed Consent Statement: Not applicable.

Data Availability Statement: Not applicable.

Acknowledgments: I.S.P. is a team member of the Macquarie-led national Centre of Excellence in Synthetic Biology funded by the Australian Government through its agency, the Australian Research Council. The authors would like to thank the Hessen State Ministry of Higher Education, Research and the Arts for the financial support within the Hessen initiative for scientific and economic excellence (LOEWE) in the framework of AROMAplus (<https://www.hs-geisenheim.de/aromaplus/>, (accessed on 25 October 2022)). Jürgen Heinisch is thanked for providing the yeast strain DSM2768. Florian Michling is thanked for providing the yeast strain NRRL Y-1613^T.

Conflicts of Interest: The authors declare no conflict of interest. The funders had no role in the design of the study; in the collection, analyses, or interpretation of data; in the writing of the manuscript; or in the decision to publish the results.

References

1. Bisson, L.F. Stuck and sluggish fermentations. *Am. J. Enol. Vitic.* **1999**, *50*, 107. [CrossRef]
2. Bell, S.-J.; Henschke, P.A. Implications of nitrogen nutrition for grapes, fermentation and wine. *Aust. J. Grape Wine Res.* **2005**, *11*, 242–295. [CrossRef]
3. Kessi-Pérez, E.I.; Molinet, J.; Martínez, C. Disentangling the genetic bases of *Saccharomyces cerevisiae* nitrogen consumption and adaptation to low nitrogen environments in wine fermentation. *Biol. Res.* **2020**, *53*, 2. [CrossRef] [PubMed]
4. Molinet, J.; Cubillos, F.A.; Salinas, F.; Liti, G.; Martínez, C. Genetic variants of TORC1 signaling pathway affect nitrogen consumption in *Saccharomyces cerevisiae* during alcoholic fermentation. *PLoS ONE* **2019**, *14*, e0220515. [CrossRef] [PubMed]
5. Rapp, A.; Versini, G. Influence of nitrogen compounds in grapes on aroma compounds of wines. In *Food Flavors: Generation, Analysis and Process Influence, Proceedings of the 8th International Flavor Conference, Cos, Greece, 6–8 July 1995*; Elsevier: Amsterdam, The Netherlands, 1995; pp. 1659–1694. ISBN 9780444820136.
6. Hernández-Orte, P.; Cacho, J.F.; Ferreira, V. Relationship between varietal amino acid profile of grapes and wine aromatic composition. Experiments with model solutions and chemometric study. *J. Agric. Food Chem.* **2002**, *50*, 2891–2899. [CrossRef]
7. Dzialo, M.C.; Park, R.; Steensels, J.; Lievens, B.; Verstrepen, K.J. Physiology, ecology and industrial applications of aroma formation in yeast. *FEMS Microbiol. Rev.* **2017**, *41*, S95–S128. [CrossRef]
8. Burin, V.M.; Gomes, T.M.; Caliari, V.; Rosier, J.P.; Bordignon Luiz, M.T. Establishment of influence the nitrogen content in musts and volatile profile of white wines associated to chemometric tools. *Microchem. J.* **2015**, *122*, 20–28. [CrossRef]
9. Jiranek, V.; Langridge, P.; Henschke, P.A. Regulation of hydrogen sulfide liberation in wine-producing *Saccharomyces cerevisiae* strains by assimilable nitrogen. *Appl. Environ. Microbiol.* **1995**, *61*, 461–467. [CrossRef]
10. Hazelwood, L.A.; Daran, J.-M.; van Maris, A.J.A.; Pronk, J.T.; Dickinson, J.R. The Ehrlich pathway for fusel alcohol production: A century of research on *Saccharomyces cerevisiae* metabolism. *Appl. Environ. Microbiol.* **2008**, *74*, 2259–2266. [CrossRef]
11. Drumonde-Neves, J.; Fernandes, T.; Lima, T.; Pais, C.; Franco-Duarte, R. Learning from 80 years of studies: A comprehensive catalogue of non-*Saccharomyces* yeasts associated with viticulture and winemaking. *FEMS Yeast Res.* **2021**, *21*, foab017. [CrossRef]
12. Van Wyk, N.; Grossmann, M.; Wendland, J.; von Wallbrunn, C.; Pretorius, I.S. The whiff of wine yeast innovation: Strategies for enhancing aroma production by yeast during wine fermentation. *J. Agric. Food Chem.* **2019**, *67*, 13496–13505. [CrossRef]
13. Domizio, P.; Romani, C.; Lencioni, L.; Comitini, F.; Gobbi, M.; Mannazzu, I.; Ciani, M. Outlining a future for non-*Saccharomyces* yeasts: Selection of putative spoilage wine strains to be used in association with *Saccharomyces cerevisiae* for grape juice fermentation. *Int. J. Food Microbiol.* **2011**, *147*, 170–180. [CrossRef]
14. Van Wyk, N.; von Wallbrunn, C.; Swiegers, J.H.; Pretorius, I.S. Biotechnology of Wine Yeasts. In *Encyclopedia of Mycology*; Elsevier: Amsterdam, The Netherlands, 2021; pp. 428–446. ISBN 9780323851800.
15. Roca-Mesa, H.; Sendra, S.; Mas, A.; Beltran, G.; Torija, M.-J. Nitrogen preferences during alcoholic fermentation of different non-*Saccharomyces* yeasts of oenological interest. *Microorganisms* **2020**, *8*, 157. [CrossRef]
16. Su, Y.; Seguinot, P.; Sanchez, I.; Ortiz-Julien, A.; Heras, J.M.; Querol, A.; Camarasa, C.; Guillamón, J.M. Nitrogen sources preferences of non-*Saccharomyces* yeasts to sustain growth and fermentation under winemaking conditions. *Food Microbiol.* **2020**, *85*, 103287. [CrossRef]
17. Lleixà, J.; Martín, V.; Giorello, F.; Portillo, M.C.; Carrau, F.; Beltran, G.; Mas, A. Analysis of the NCR mechanisms in *Hanseniaspora vineae* and *Saccharomyces cerevisiae* during winemaking. *Front. Genet.* **2018**, *9*, 747. [CrossRef]
18. Gobert, A.; Tourdot-Maréchal, R.; Sparrow, C.; Morge, C.; Alexandre, H. Influence of nitrogen status in wine alcoholic fermentation. *Food Microbiol.* **2019**, *83*, 71–85. [CrossRef]
19. Crépin, L.; Nidelet, T.; Sanchez, I.; Dequin, S.; Camarasa, C. Sequential use of nitrogen compounds by *Saccharomyces cerevisiae* during wine fermentation: A model based on kinetic and regulation characteristics of nitrogen permeases. *Appl. Environ. Microbiol.* **2012**, *78*, 8102–8111. [CrossRef]
20. Jones, M.; Pierce, J.S. Absorption of amino acids from wort by yeasts. *J. Inst. Brew.* **1964**, *70*, 307–315. [CrossRef]
21. Valera, M.J.; Olivera, V.; Boido, E.; Dellacassa, E.; Carrau, F. Wine aroma characterization of the two main fermentation yeast species of the apiculate genus *Hanseniaspora*. *Fermentation* **2021**, *7*, 162. [CrossRef]
22. Vermeulen, C.; Lejeune, I.; Tran, T.T.H.; Collin, S. Occurrence of polyfunctional thiols in fresh lager beers. *J. Agric. Food Chem.* **2006**, *54*, 5061–5068. [CrossRef]
23. Bely, M.; Sablayrolles, J.-M.; Barre, P. Automatic detection of assimilable nitrogen deficiencies during alcoholic fermentation in oenological conditions. *J. Ferm. Bioeng.* **1990**, *70*, 246–252. [CrossRef]
24. Su, Y.; Origone, A.C.; Rodríguez, M.E.; Querol, A.; Guillamón, J.M.; Lopes, C.A. Fermentative behaviour and competition capacity of cryotolerant *Saccharomyces* species in different nitrogen conditions. *Int. J. Food Microbiol.* **2019**, *291*, 111–120. [CrossRef] [PubMed]
25. Seguinot, P.; Bloem, A.; Brial, P.; Meudec, E.; Ortiz-Julien, A.; Camarasa, C. Analysing the impact of the nature of the nitrogen source on the formation of volatile compounds to unravel the aroma metabolism of two non-*Saccharomyces* strains. *Int. J. Food Microbiol.* **2020**, *316*, 108441. [CrossRef] [PubMed]
26. Van Wyk, N.; Michling, F.; Bergamo, D.; Brezina, S.; Pretorius, I.S.; von Wallbrunn, C.; Wendland, J. Effect of isomixing on grape must fermentations of ATF1-overexpressing wine yeast strains. *Foods* **2020**, *9*, 717. [CrossRef] [PubMed]
27. Csapó, J.; Lóki, K.; Csapóné Kiss, Z.; Albert, C. Separation and determination of the amino acids by ion exchange column chromatography applying postcolumn derivatization. *Acta Univ. Sapientiae Aliment.* **2008**, *1*, 5–29.

28. Krause, B.; Löhnertz, O. Saccharopin und Pipecolinsäure: Diagnostische Biomarker in der klassischen Aminosäureanalytik. *MTA-Dialog* **2017**, *18*, 316–321. [CrossRef]
29. Badura, J.; van Wyk, N.; Brezina, S.; Pretorius, I.S.; Rauhut, D.; Wendland, J.; von Wallbrunn, C. Development of genetic modification tools for *Hanseniaspora uvarum*. *Int. J. Mol. Sci.* **2021**, *22*, 1943. [CrossRef]
30. Scansani, S.; van Wyk, N.; Nader, K.B.; Beisert, B.; Brezina, S.; Fritsch, S.; Semmler, H.; Pasch, L.; Pretorius, I.S.; von Wallbrunn, C.; et al. The film-forming *Pichia* spp. in a winemaker's toolbox: A simple isolation procedure and their performance in a mixed-culture fermentation of *Vitis vinifera* L. cv. Gewürztraminer must. *Int. J. Food Microbiol.* **2022**, *365*, 109549. [CrossRef]
31. Tarasov, A.; Garzelli, F.; Schuessler, C.; Fritsch, S.; Loisel, C.; Pons, A.; Patz, C.-D.; Rauhut, D.; Jung, R. Wine storage at cellar vs. room conditions: Changes in the aroma composition of Riesling wine. *Molecules* **2021**, *26*, 6256. [CrossRef]
32. Jung, R.; Kumar, K.; Patz, C.; Rauhut, D.; Tarasov, A.; Schüßler, C. Influence of transport temperature profiles on wine quality. *Food Packag. Shelf Life* **2021**, *29*, 100706. [CrossRef]
33. Mas, A.; Guillamon, J.M.; Torija, M.J.; Beltran, G.; Cerezo, A.B.; Troncoso, A.M.; Garcia-Parrilla, M.C. Bioactive compounds derived from the yeast metabolism of aromatic amino acids during alcoholic fermentation. *Biomed Res. Int.* **2014**, *2014*, 898045. [CrossRef]
34. Van Leeuwen, C.; Destrac-Irvine, A. Modified grape composition under climate change conditions requires adaptations in the vineyard. *OENO One* **2017**, *51*, 147. [CrossRef]
35. Gutiérrez-Gamboa, G.; Carrasco-Quiroz, M.; Martínez-Gil, A.M.; Pérez-Álvarez, E.P.; Garde-Cerdán, T.; Moreno-Simunovic, Y. Grape and wine amino acid composition from Carignan noir grapevines growing under rainfed conditions in the Maule Valley, Chile: Effects of location and rootstock. *Food Res. Int.* **2018**, *105*, 344–352. [CrossRef]
36. Gutiérrez-Gamboa, G.; Garde-Cerdán, T.; Rubio-Bretón, P.; Pérez-Álvarez, E.P. Study of must and wine amino acids composition after seaweed applications to Tempranillo blanco grapevines. *Food Chem.* **2020**, *308*, 125605. [CrossRef]
37. Torrea, D.; Varela, C.; Ugliano, M.; Ancin-Azpilicueta, C.; Francis, I.L.; Henschke, P.A. Comparison of inorganic and organic nitrogen supplementation of grape juice—Effect on volatile composition and aroma profile of a Chardonnay wine fermented with *Saccharomyces cerevisiae* yeast. *Food Chem.* **2011**, *127*, 1072–1083. [CrossRef]
38. Du Plessis, H.W.; Du Toit, M.; Hoff, J.W.; Hart, R.S.; Ndimba, B.K.; Jolly, N.P. Characterisation of non-*Saccharomyces* yeasts using different methodologies and evaluation of their compatibility with malolactic fermentation. *S. Afr. J. Enol. Vitic.* **2017**, *38*, 46–63. [CrossRef]
39. Domizio, P.; Liu, Y.; Bisson, L.F.; Barile, D. Use of non-*Saccharomyces* wine yeasts as novel sources of mannoproteins in wine. *Food Microbiol.* **2014**, *43*, 5–15. [CrossRef]
40. Steenwyk, J.L.; Opulente, D.A.; Kominek, J.; Shen, X.-X.; Zhou, X.; Labella, A.L.; Bradley, N.P.; Eichman, B.F.; Čadež, N.; Libkind, D.; et al. Extensive loss of cell-cycle and DNA repair genes in an ancient lineage of bipolar budding yeasts. *PLoS Biol.* **2019**, *17*, e3000255. [CrossRef]
41. Barrajón-Simancas, N.; Giese, E.; Arévalo-Villena, M.; Ubeda, J.; Briones, A. Amino acid uptake by wild and commercial yeasts in single fermentations and co-fermentations. *Food Chem.* **2011**, *127*, 441–446. [CrossRef]
42. Gobert, A.; Tourdot-Maréchal, R.; Morge, C.; Sparrow, C.; Liu, Y.; Quintanilla-Casas, B.; Vichi, S.; Alexandre, H. Non-*Saccharomyces* yeasts nitrogen source preferences: Impact on sequential fermentation and wine volatile compounds profile. *Front. Microbiol.* **2017**, *8*, 2175. [CrossRef]
43. Žulj, M.M.; Tomaz, I.; Bandić, L.M.; Puhelek, I.; Korenika, A.J.; Jeromel, A. Influence of different yeast strains on metabolism of tryptophan and indole-3-acetic acid during fermentation. *S. Afr. J. Enol. Vitic.* **2016**, *36*, 44–49. [CrossRef]
44. Malaney, G.W.; Tanner, R.D.; Rodrigues, A.M. The production of extracellular and intracellular free amino acids during aerated fermentation of glucose by baker's yeast (*Saccharomyces cerevisiae*). *Folia Microbiol.* **1991**, *36*, 468–477. [CrossRef] [PubMed]
45. Magyar, I.; Tóth, T. Comparative evaluation of some oenological properties in wine strains of *Candida stellata*, *Candida zemplinina*, *Saccharomyces uvarum* and *Saccharomyces cerevisiae*. *Food Microbiol.* **2011**, *28*, 94–100. [CrossRef] [PubMed]
46. Leandro, M.J.; Cabral, S.; Prista, C.; Loureiro-Dias, M.C.; Sychrová, H. The high-capacity specific fructose facilitator ZrFfz1 is essential for the fructophilic behavior of *Zygosaccharomyces rouxii* CBS 732T. *Eukaryot. Cell* **2014**, *13*, 1371–1379. [CrossRef] [PubMed]
47. Rantsiou, K.; Englezos, V.; Torchio, F.; Risse, P.-A.; Cravero, F.; Gerbi, V.; Rolle, L.; Cocolin, L. Modeling of the fermentation behavior of *Starmerella bacillarum*. *Am. J. Enol. Vitic.* **2017**, *68*, 378–385. [CrossRef]
48. Ehrlich, F. Über die Bedingungen der Fuselölbildung und über ihren Zusammenhang mit dem Eiweißaufbau der Hefe. *Ber. Dtsch. Chem. Ges.* **1907**, *40*, 1027–1047. [CrossRef]
49. Neubauer, O.; Fromherz, K. Über den Abbau der Aminosäuren bei der Hefegärung. *Hoppe-Seyler's Z. Physiol. Chem.* **1910**, *70*, 326–350. [CrossRef]
50. Fairbairn, S.; McKinnon, A.; Musarurwa, H.T.; Ferreira, A.C.; Bauer, F.F. The impact of single amino acids on growth and volatile aroma production by *Saccharomyces cerevisiae* strains. *Front. Microbiol.* **2017**, *8*, 2554. [CrossRef]
51. Espinosa Vidal, E.; de Morais, M.A.; François, J.M.; de Billerbeck, G.M. Biosynthesis of higher alcohol flavour compounds by the yeast *Saccharomyces cerevisiae*: Impact of oxygen availability and responses to glucose pulse in minimal growth medium with leucine as sole nitrogen source. *Yeast* **2015**, *32*, 47–56. [CrossRef]

52. Martin, V.; Valera, M.; Medina, K.; Boido, E.; Carrau, F. Oenological impact of the *Hanseniaspora/Kloeckera* yeast genus on wines – A Review. *Fermentation* **2018**, *4*, 76. [CrossRef]
53. Ingledew, W.M.; Magnus, C.A.; Sosulski, F.W. Influence of oxygen on proline utilization during the wine fermentation. *Am. J. Enol. Vitic.* **1987**, *38*, 246–248.

Disclaimer/Publisher's Note: The statements, opinions and data contained in all publications are solely those of the individual author(s) and contributor(s) and not of MDPI and/or the editor(s). MDPI and/or the editor(s) disclaim responsibility for any injury to people or property resulting from any ideas, methods, instructions or products referred to in the content.

Synthesis of aroma compounds as a function of different nitrogen sources in fermentations using non-*Saccharomyces* wine yeasts

Badura, J.; Medić, M.; van Wyk, N.; Krause, B.; Semmler, H.; Brezina, S.; Pretorius, I. S.; Rauhut, D.; von Wallbrunn, C.

Microorganisms (2023) 11 (1), 14.

DOI: 10.3390/microorganisms11010014

Supporting Information



Supplementary Materials:

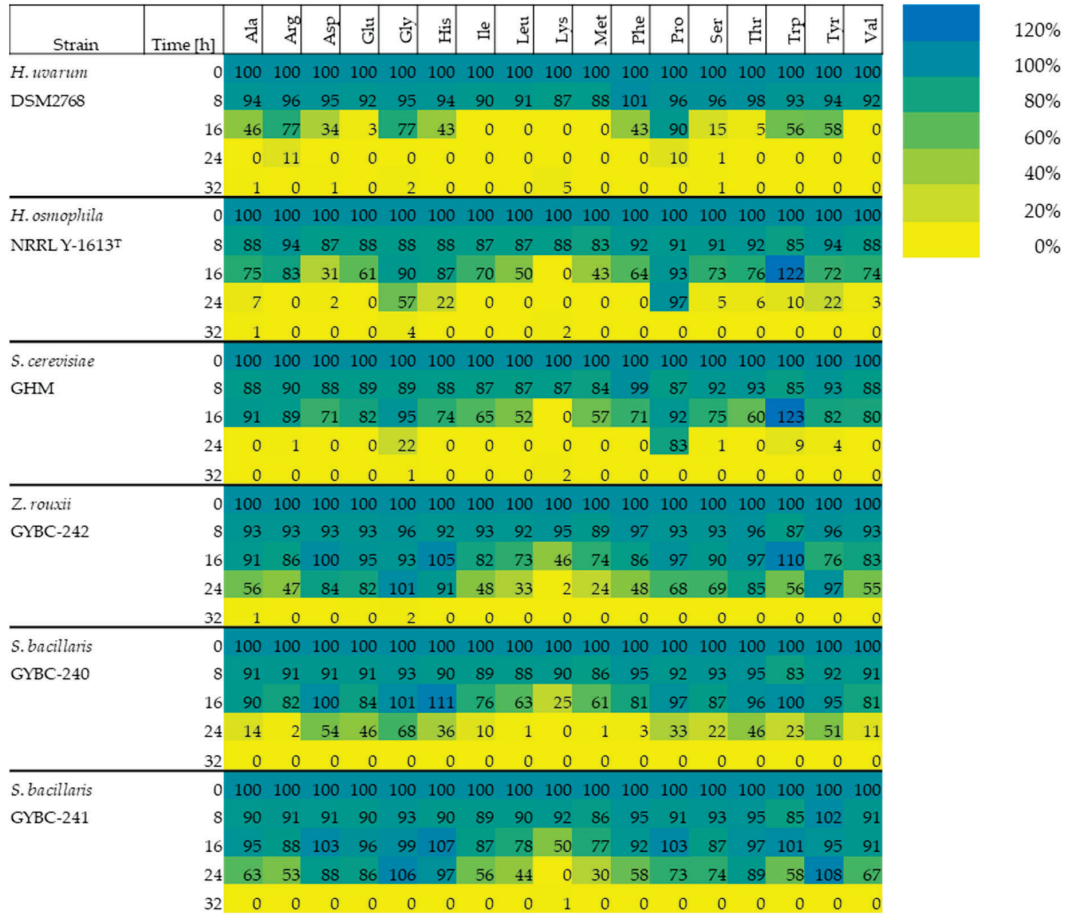

Figure S1. Amino acid concentration (%) present in the medium at different time points of the alcoholic fermentation in SM-mix. The initial concentration of each amino acid is expressed as 100%. It should be noted that the values of Glu also contained Gln and Asp also contained Asn. Cys could not be measured.

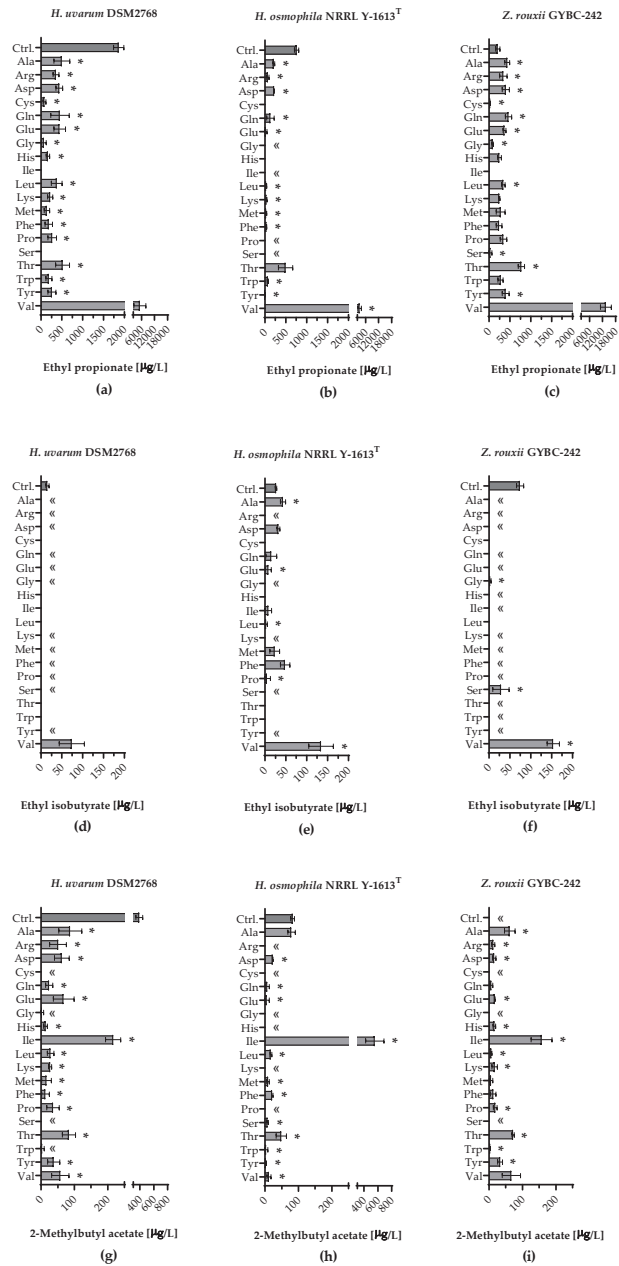

Figure S2. Formation of ethyl- and acetate esters during fermentation with individually supplemented amino acids. Formation of ethyl propionate [$\mu\text{g/L}$] in fermentations using (a) *H. uvarum* DSM2768, (b) *H. osmophila* NRRL Y-1613^T and (c) *Z. rouxii* GYBC-242. Formation of ethyl isobutyrate [$\mu\text{g/L}$] in fermentations using (d) *H. uvarum* DSM2768, (e) *H. osmophila* NRRL Y-1613^T and (f) *Z. rouxii* GYBC-242. Formation of 2-methylbutyl acetate [$\mu\text{g/L}$] in fermentations using (g) *H. uvarum* DSM2768, (h) *H. osmophila* NRRL Y-1613^T and (i) *Z. rouxii* GYBC-242. Fermentations using the respective yeast with SM-mix served as control (Ctrl.). Higher alcohols were measured via HS-SPME-GC-MS analysis. Data are the mean of three independent experiments \pm SEM, two-tailed unpaired t test with Welch's correction, * $p < 0.05$ as compared to the control. Error bars indicate the standard deviation; \ll : not quantifiable.

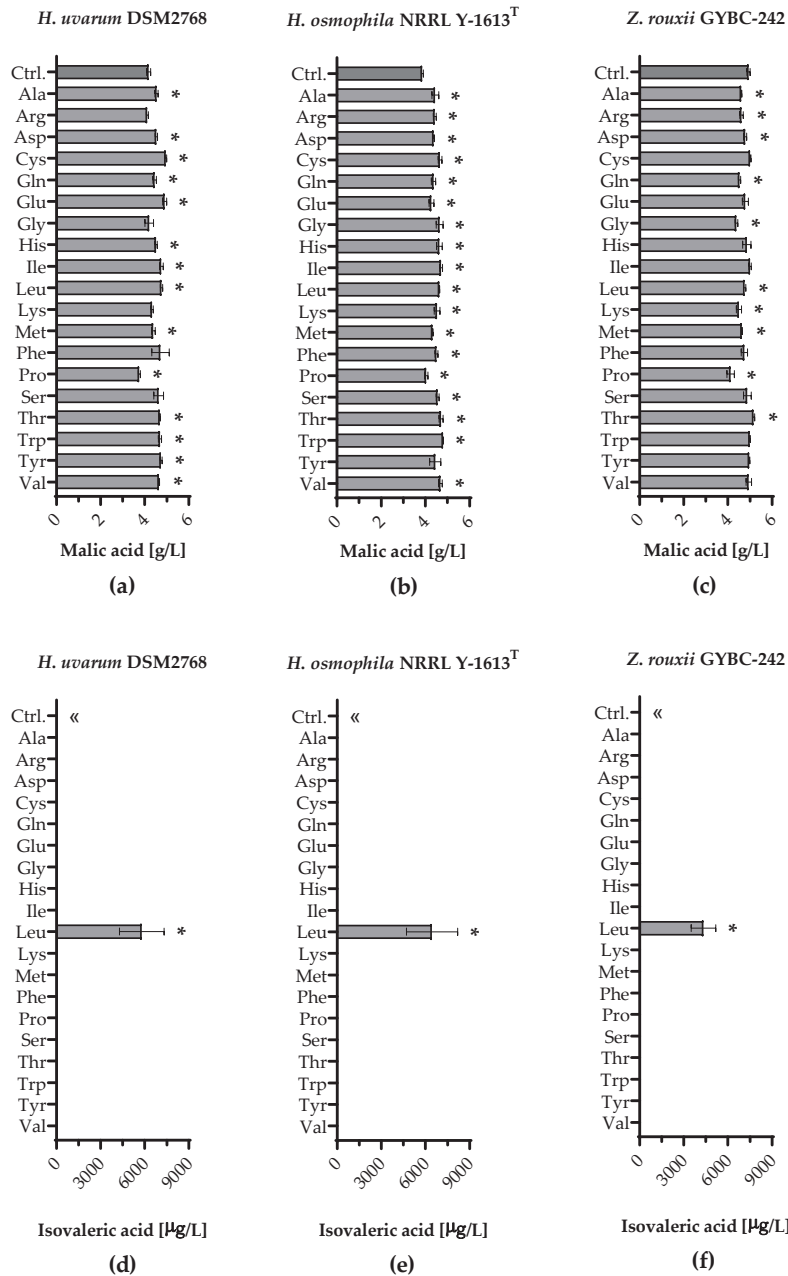

Figure S3. Acid production during fermentation with individually supplemented amino acids. Malic acid production [g/L] in fermentations using (a) *H. uvarum* DSM2768, (b) *H. osmophila* NRRL Y-1613^T and (c) *Z. rouxii* GYBC-242. Isovaleric acid production [µg/L] in fermentations using (d) *H. uvarum* DSM2768, (e) *H. osmophila* NRRL Y-1613^T and (f) *Z. rouxii* GYBC-242. Fermentations using the respective yeast with SM-mix served as control (Ctrl.). Higher alcohols were measured via HS-SPME-GC-MS analysis. Data are the mean of three independent experiments ± SEM, two-tailed unpaired t test with Welch's correction, * p < 0.05 as compared to the control. Error bars indicate the standard deviation; «: not quantifiable.

Regulation and genetic modification

Wine making
by Dr. Badura

Panel 1: Grapes everywhere... Boring!! Uva, look what I produced!

Panel 2: Let's spread it everywhere, Hans! Smells interesting! Invisible!

Panel 3: It's getting kinda stinky..

Panel 4: I don't feel good. Where is Uva? I'm loosing RNA. Alert! Delete the gene!

Panel 5: I can't find Hans! Watch out, Uva!

Panel 6: The one step transformation is carried out by electroporation using the triple antibiotic concentration for the selection.

Panel 7: Poor Uva! OHNO, it hit you twice!

Panel 8: Uva, you look great! Beautiful smell!

Panel 9: Such a lovely wine! So fruity!

Microorganisms are responsible for a longer shelf life of food, the colouring and, above all, the synthesis of aromas by means of fermentation.

Saccharomyces uvarum produces high amounts of ethyl acetate, a solvent like smell reminding of nail polish.

The odour threshold of 7.5 mg/L [1] is quickly exceeded and causes unpleasant odours, which is why *S. uvarum* was long considered a spoilage yeast.

Transcriptome analyses are used to identify the exact metabolic pathways and identify the genes involved in flavour synthesis.

The identified candidate genes are knocked-out by transformation using a selection marker under the control of an *S. uvarum* promoter.

A double knock-out is necessary for the complete deletion of a gene, since *S. uvarum* is diploid.

Fermentation shows a dramatic reduction in ethyl acetate production (~40%) in *S. uvarum* double knock-out strains [2].

Literature:
[1] Swiegers and Pretorius, *Adv. Appl. Microbiol.* 2005, 57, pp. 131-175.
[2] Badura et al. *Int. J. Mol. Sci.* 2021, 22(4), 1943.

~ Regulation and genetic modification of the synthesis of aroma compounds in non-conventional wine yeasts ~

Chapter 4 - Regulated gene expression of flavour relevant genes in *Hanseniaspora uvarum*

Chapter 4 is in preparation for submission.

Badura, J.; Michling, F.; Semmler, H.; Brezina, S.; Rauhut, D.; Rühl, M.; von Wallbrunn, C.:
Regulated gene expression of flavour relevant genes in *Hanseniaspora uvarum*.

Author contributions:

Conceptualization: CvW, **JB**, FM

Funding acquisition: CvW

Methodology: CvW, **JB**, FM

Investigation: **JB**, FM

Validation: **JB**, FM

Data curation: **JB**

Formal analysis: **JB**, FM, HS, SB, DR

Visualization: **JB**, FM

Project administration: CvW

Resources: CvW

Supervision: CvW, MR

Writing – original draft: **JB**, FM

Writing – review & editing: **JB**, FM, CvW

Regulated Gene Expression of Flavour Relevant Genes in *Hanseniaspora uvarum*

Abstract

Non-*Saccharomyces* wine yeasts contribute to a more complex aroma profile of wines, but their metabolic pathways as well as the regulation of the genes involved in the synthesis of aroma compounds still remain unclear. In this study, multidisciplinary studies elucidate the expression levels of genes and their regulation within Müller-Thurgau grape must fermentations conducted with different nitrogen regimes to investigate differences in aroma relevant metabolic pathways of *S. cerevisiae* and *Hanseniaspora uvarum*. Nitrogen regimes had an impact on both fermentation kinetics and the aroma profiles. However, differences in gene expression levels were not observed. In contrast to *S. cerevisiae*, *H. uvarum* has a different ester profile, producing 62.2-77.5-fold increased acetate ester levels, depending on nitrogen availability. In addition to *ATF1* and the up-regulated *EAT1*, *H. uvarum* possesses four other genes with putative alcohol acetyltransferase activity, which, combined with lacking certain genes involved in the production of higher alcohols and ethyl esters and an up-regulated acetyl-coA synthesis, lead to rapid esterification of higher alcohols to acetate esters.

Keywords: non-*Saccharomyces*, *Hanseniaspora uvarum*, transcriptomics, aroma compound synthesis, flavour, differential gene expression, Ehrlich pathway, fermentation, nitrogen

Introduction

Yeast of the genus *Hanseniaspora* are widespread in the environment and are present on many different fruits. *Hanseniaspora uvarum* is one of the most abundant yeast species found on grapes in vineyards (Drumonde-Neves et al. 2021). Accordingly, this species often dominates the onset of spontaneous grape must fermentations but is displaced by *Saccharomyces cerevisiae* during later stages of fermentation (Di Maro et al. 2007). *H. uvarum*, which is known to be a slow fermenting yeast, has been monitored throughout all stages of fermentation (Zott et al. 2008). Therefore, *H. uvarum* can greatly influence wine fermentations and contribute to the aroma profile of the final product. In particular, *H. uvarum* is known for the production of large amounts of ethyl acetate (Ciani et al. 2006), which imparts a solvent-like odour, which is unpleasant when present in wine in excessive concentrations. In addition, grape must fermentations with *H. uvarum* contained increased levels of acetic acid and acetaldehyde (Romano et al. 2003). Hence, *H. uvarum* was considered a spoilage yeast for a long time, and its appearance in fermentations was suppressed by the addition of both sulphur dioxide (SO₂) and *S. cerevisiae* starter cultures (Pretorius 2000). In recent years, the use of so-called co-fermentations with *Saccharomyces* wine strains and non-*Saccharomyces*

yeasts, also called non-conventional yeasts, has gained in popularity (Jolly et al. 2014; Mas et al. 2016; Comitini et al. 2017). Wines produced by co-fermentations benefit from a more complex aroma profile due to a higher variety of aroma compounds added by non-conventional yeasts (Masneuf-Pomarede et al. 2015; Lleixà et al. 2016).

Yeast assimilable nitrogen present in grape must is a major determinant of the production of aroma compounds during alcoholic fermentation by yeasts. Yeast assimilable nitrogen consists of ammonium ions (NH_4^+), free amino nitrogen (FAN) derived from individual amino acids, and small, low molecular peptides. FAN, serving as basis for proteins and various cellular functions, can either be directly derived from the medium or the essential amino acids can be synthesised by the yeast cells from NH_4^+ (Henschke and Jiranek 1993). Amino acids serve as backbones for the synthesis of several volatiles, such as 2-phenyl ethanol, isoamyl alcohol or 2-methyl butanol, as well as their respective esters (Dzialo et al. 2017), thus the higher the concentration of the initial amino acids (precursors), the more precursor-derived volatiles can be synthesized (Schulthess and Ettlinger 1978). Increasing temperatures and decreasing irrigation lead to a reduction of nitrogen levels in the form of amino acids in grape berries (Gutiérrez-Gamboa et al. 2018; Gutiérrez-Gamboa et al. 2020), resulting in enhanced biosynthesis of amino acids by yeasts. A lack of YAN bears the risk of lower biomass yields, slower fermentation rates (Varela et al. 2004) and stuck or sluggish fermentations (Alexandre and Charpentier 1998). The addition of inorganic nitrogen, such as diammonium phosphate (DAP), is a common practice in winemaking to prevent associated fermentation problems. However, excessive YAN levels not only lead to rising biomass yield, but also favour the increase of microbial instability, fermentation vigour related heat output, haze formation, biogenic amine levels, as well as an increased synthesis of volatiles and formation of atypical aging properties (Bell and Henschke 2005).

Several multidisciplinary studies elucidating metabolic pathways involved in the synthesis of aroma compounds by *S. cerevisiae* have been published. A study of the impact of genes responsible for ester production unravelled a shift in the expression of 1 124 genes implicated in nitrogen and lipid metabolism, as well as chromatin organization and histone acetylation, in a $\Delta atf1/\Delta atf2/\Delta eeb1/\Delta eht1$ *S. cerevisiae* strain that lacks genes encoding alcohol acetyltransferases as well as ethanol acyltransferases responsible for ester synthesis, suggesting regulatory effects in the genome expression through ester metabolism (Marullo et al. 2021). Mendes et al. (2017) revealed an up-regulation of the genes *ADH6*, *ADH7* and *AAD6*, encoding alcohol dehydrogenases and an aryl-alcohol dehydrogenase, respectively, leading to an increased synthesis of higher alcohols in *S. cerevisiae*.

In recent years, more and more studies on transcriptome analyses of *Hanseniaspora* spp., including *H. uvarum*, have been published (Giorello et al. 2019; Valera et al. 2020; Han et al.

2022). Giorello et al. (2019) reported on high expression of duplicated genes (*ARO8* and *ARO9*, encoding aromatic aminotransferases I and II; *ARO10*, encoding a phenylpyruvate decarboxylase) in *H. vineae*, when reaching the plateau phase, coupled to an increased production of their related compounds, such as higher alcohols and esters derived from the degradation of branched-chain amino acids and aromatic amino acids (e.g. isoamyl acetate or 2-phenylethyl acetate). In addition, increased levels of acetate esters and decreased levels of branched chain higher alcohols, fatty acids, and ethyl esters, are consistent with six novel proteins containing alcohol acetyltransferase (AATase) domains and the absence of *BAT1* and *EEB1*, respectively (Giorello et al. 2019). Valera et al. (2020) suggest a differentiation of *H. uvarum* from *H. osmophila* and *H. vineae* due to the similarity in fermentation enzyme sequences of the latter two species to *S. cerevisiae*. Furthermore, the potential of *H. uvarum* to reduce biogenic amines in wine was demonstrated by the overexpression of copper amine oxidase 1 (CuAO1) in *H. uvarum* following the addition of putrescine, an amine with toxicological risk to consumer health that can occur in wine (Han et al. 2022).

Aroma profiles of wines resulting from fermentations using *S. cerevisiae* differ from those fermented with non-conventional yeasts. The mechanisms involved in the aroma formation by *S. cerevisiae* are well-studied. However, transcriptome studies in non-conventional yeast, such as *H. uvarum*, providing information on the metabolic pathways for the synthesis of aroma compounds, the expression levels of genes involved as well as their regulation, during wine fermentation are still lacking. In this study, multidisciplinary studies, comprising genome, metabolome and transcriptome analyses, were performed investigating the relative contributions of fermentation progress and nitrogen availability to gene expression, as well as their regulation, in *H. uvarum* DSM2768 and *S. cerevisiae* EC1118. Different nitrogen regimes were analysed to investigate its impact on gene expression relevant for synthesis of aroma compounds during early, middle and late stages of wine fermentations.

Materials and Methods

Yeast strains and media

Strains used in this study were a derivate of *Hanseniaspora uvarum* DSM2768 (Langenberg et al. 2017) and the *Saccharomyces cerevisiae* wine yeast strain Lalvin EC-1118™ (Lallemand, Montreal, QC, Canada). Yeasts were cultivated routinely in YPD medium (20 g/L glucose, 20 g/L Bacto peptone and 10 g/L yeast extract).

Fermentation experiments were carried out using pasteurised Müller-Thurgau (MT) grape must (harvested from the vineyards of Hochschule Geisenheim University in the Rheingau wine region of Germany in 2019; pH 3.1). The grape must was autoclaved at 110 °C for 20 min prior

to the experiments. The sugar concentration of the must is shown in Table 1. The experiments were carried out with nitrogen-deficient pure must (Ctrl) and must supplemented with 667 mg/L diammonium hydrogen phosphate (DAHP). Yeast assimilable nitrogen (YAN) levels of the MT must, containing the free amino nitrogen (FAN), ammonium ions (NH_4^+) and the total YAN are listed in Table 1. FAN was measured by the spectrophotometrically-based method using o-phthaldialdehyde/N-acetyl-L-cysteine (OPA/NAC) reagent for derivatization of primary amino groups (Dukes and Butzke 1998), while the NH_4^+ content was determined using the rapid ammonium kit (Megazyme, Bray, Ireland). The FAN content is listed in Table S1.

Table 1. Concentration of initial sugar (glucose, fructose, total sugars; all g/L) and initial YAN (free amino nitrogen (FAN), ammonium ions (NH_4^+), total YAN; all mg/L) in Müller-Thurgau (MT) must.

	MT (110 °C) ^a	MT (110 °C, DAHP) ^b
Glucose	87.60 ± 0.42	88.64 ± 1.25
Fructose	92.64 ± 1.43	93.63 ± 1.76
Total sugars	180.24 ± 1.81	182.27 ± 2.80
FAN	44.38 ± 1.78	46.16 ± 1.52
NH_4^+	16.10 ± 2.30	57.91 ± 2.69
Total YAN	60.48 ± 3.86	104.07 ± 3.02

^a MT must, autoclaved at 110 °C for 20 min

^b MT must, autoclaved at 110 °C for 20 min, supplemented with 667 mg/L DAHP

Fermentation experiments

Fermentations were conducted in 500 mL Erlenmeyer flasks containing 300 mL of the autoclaved MT must. Precultures were centrifuged and the pellet was washed twice with sterile distilled water. The main cultures were inoculated to yield 1×10^6 cells/mL. Appropriate dilutions of the main cultures were prepared according to the cell numbers determined by haemocytometer cell counts. The fermenting flasks were sealed with aluminium foil and incubated in a temperature-controlled shaking incubator at 17 °C and 120 min⁻¹. Samples were removed for high-performance liquid chromatography (HPLC; 1 mL; daily), YAN analysis (1 mL; daily), cell counting (1 mL; RNA-Seq sampling days), gas chromatography/ mass spectrometry (GC/MS; 12 mL; daily) and RNA-Seq (3x 1 mL; RNA-Seq days).

Sampling for RNA-Seq

Samples for RNA-Seq were taken during the lag phase (early), the logarithmic phase (mid) and at the beginning of the plateau phase (late; Figure 1), representing the different transcriptome sampling time points (TSTP). Daily measurements of the CO₂ mass-loss enabled the determination of the stages of fermentation process. Thus, the sample day was determined individually for each fermentation, which leads to possible variations in the fermentation days of the sampling. Sampling days of fermentation are shown in Table S2.

These samples were centrifuged immediately, frozen in liquid nitrogen and stored at -80 °C until they were shipped for RNA isolation and transcriptome analyses.

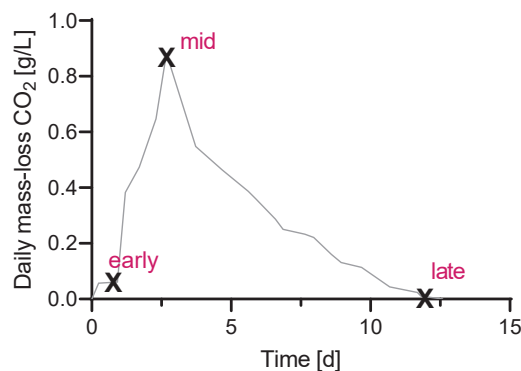

Figure 1. RNA-Seq sampling days according to daily mass-loss CO₂ [g/L] illustrated by a model fermentation. Sample “early” was taken during the lag phase, “mid” at the highest peak of daily mass-loss CO₂ and “late” when reaching the plateau phase (0 g/L daily mass-loss CO₂).

Genome sequencing and annotation of *H. uvarum* DSM2768

A draft genome sequence was assembled for the derivative of the yeast strain *Hanseniaspora uvarum* DSM2768 (Langenberg et al. 2017) using 2x150 nucleotides (nt) paired-end reads by Illumina NextSeq 2000 sequencing system. Pre-processing of raw reads was conducted using tools from the BMAP bioinformatics suite version 38.84 (Bushnell et al. 2017); 24 651 256 reads with an insert size interdecile range of 108 nt to 246 nt were used for genome assembly with SPAdes version 3.14.1 (Nurk et al. 2013). SPAdes ran in only-assembler mode and using all kmer lengths ranging from 37 to 127 increasing by increments of 10. Contigs were ordered by whole-genome-alignment to *H. uvarum* AWRI3580 genome assembly (GCA_001747055.1; ASM174705v1) using Mauve Contig Mover (Darling et al. 2004).

Open reading frames (ORFs) were annotated using the Find ORFs tool of Geneious Prime 2022 (Biomatters Ltd., Auckland, New Zealand). Model-based gene prediction was performed using BRAKER version 2.1.6 (Hoff et al. 2019) in ES mode (ab initio prediction, Ter-Hovhannisyan et al. 2008) and in EP mode (gene-model training based on protein sequences, Brůna et al. 2020); training data for EP mode comprised 36 951 protein sequences from *Saccharomycodaceae* (The UniProt Consortium 2023; 36 951 sequences). Additional training of gene models using our RNA-Seq read alignments (BRAKER ET mode) repeatedly failed to complete successfully for *H. uvarum* DSM2768. We therefore annotated split genes and introns manually based on splice junctions detected during mapping of our RNA-Seq reads (see below). Intron boundaries were confirmed by visual inspection of RNA-Seq read depth at the implicated loci and additionally, when deemed necessary, DNA sequence alignment to *Saccharomyces cerevisiae* S288C R64-3-1 homologous genes. Gene identity was established by comparison to *S. cerevisiae* S288C R64-3-1 genome annotation using blastp version 2.9.0

(Camacho et al. 2009) and by protein profile search using HMMER version 3.3.2 (Eddy 2011). Gene set completeness was estimated via Benchmarking Universal Single-Copy Orthologs (BUSCO) version 5.4.2 (Simão et al. 2015) against OrthoDB (Kuznetsov et al. 2023) version 10 *Saccharomyces* database comprising 2 317 BUSCOs.

Transcriptome sequencing

Transcriptome sequencing comprised 2x 150 nt paired-end read sequencing on an Illumina HiSeq sequencing system with an estimated yield of 15-20 Mio reads per transcriptome. RNA extraction from frozen cells, library preparation with polyA selection and sequencing were conducted by GENEWIZ Germany GmbH (Leipzig, Germany).

RNA-Seq reads were error-corrected using Rcorrector (Song and Florea 2015). Additional pre-processing, such as adapter clipping, PhiX removal, quality trimming and read decontamination were conducted using tools from the BBMap bioinformatics suite version 38.84 (Bushnell et al. 2017). Pre-processed reads were mapped onto corresponding reference genomes and fragments-per gene were counted using STAR version 2.7.8a in 2-pass mode (Dobin et al. 2013). Reference genomes were our *H. uvarum* DSM2768 draft genome and annotation, and GenBank Assembly accession GCA_000218975.1 for *S. cerevisiae* EC1118, respectively.

Differential gene expression analysis

We conducted differential gene expression analysis for both yeast strains using package DESeq2 version 1.30.1 (Love et al. 2014) with independent hypothesis weighing (Ignatiadis et al. 2016). Gene expressions with log2fold changes > 1 and a corresponding p-value $p < 0.01$ were considered differentially expressed genes. Analyses were performed in R version 4.0.3 (R Core Team R version 4.0.3 2020). Comparisons among conditions (e.g. TSTP) were performed using DE2Seq's median of ratios (MoR; Anders and Huber 2010).

Multivariate analysis of raw fragment counts

Information on performing multivariate analysis of raw read counts can be found in the Supplementary Material (see Supplementary material on the multivariate analysis of raw fragment counts).

High-Performance Liquid Chromatography (HPLC) Analysis

Ethanol, sugars (glucose and fructose) and organic acids (tartaric acid, malic acid, lactic acid, acetic acid and citric acid) were measured by HPLC. The method applied was previously described (Badura et al. 2021). For analysis, an Agilent Series 1 100 (Agilent Technologies

Inc., USA) HPLC with UV/VIS (at 210 nm) and Refractive Index (35 °C) detectors and an Allure Organic Acids 5 µm particle size (length 250 mm, diameter 4.6 mm; Restek GmbH, Germany) column was applied. An Ethanol (0.5%)/H₂SO₄ (0.0139%) solution was used as eluent at a flowrate of 0.5 mL/min at 46 °C. For quantification, external standards were utilized. Samples were centrifuged at 13000 min⁻¹ for 10 min. The supernatant was diluted fourfold with ultrapure water and 55 µL of 10% ethanol were added.

Analysis of VOCs with Head-Space Solid Phase Microextraction Gas Chromatography (HS-SPME-GC-MS)

Volatile aroma compounds were measured by head-space (HS) solid phase microextraction (SPME) GC/MS (HS-SPME-GC-MS) as described previously (Badura et al. 2023a) using a 7890 A gas chromatograph equipped with a 5975-B mass spectrometer (both Agilent Technologies Inc., USA). SPME was performed with a polydimethylsiloxane and divinylbenzol fibre (length: 1 cm; particle size: 65 µm; Merck, Germany) for 10 min at 40 °C. Extraction was conducted at 500 min⁻¹ for 20 min. A Rxi®-5Si1 MS (Restek GmbH, Germany) column (length: 60 m; diameter: 0.25 mm; particle size: 1 µm) with helium as carrier gas was used for the GC. Samples were injected using 1:10 split mode and heating from 30 °C to 240 °C and raised by 12 °C/s with 4 min hold. The GC run was started by a 4 min hold at 40 °C prior to raising temperature up to 210 °C at a 5 °C/min rate and to 240 °C with 20 °C/min, ending with a 10.5 min hold. Mass spectrometer data ranging from 35 to 250 of the m/z masses to charge ratio was used for the concentration values. Each compound was calibrated using a 5-point curve made with a 3%, 6%, 9% or 12% ethanol, respectively, and 3% tartaric acid solution at pH 3, regarding to the ethanol content of each sample. For sample preparation, 1.7 g NaCl to 5 mL of sample were transferred into a 20 mL brown head-space glass vial, added with two internal standard solutions (10 µL), namely 600 mg/L 1-octanol and 52 mg/L cumene.

Analysis of Amino Acid Uptake with Ion Exchange Chromatography (IEC)

The amino acid content of the MT grape must (Ctrl and DAHP) was analysed after autoclaving using a method described previously (Badura et al. 2023b). Amino acid analysis was performed by the use of ARACUS Amino Acid Analyzer Advanced (membraPure GmbH, Hennigsdorf, Germany). The method applied comprises post-column derivatisation with ninhydrin and cation exchange chromatography (Csapó et al. 2008). For sample preparation 600 µL of sample buffer (lithium-citrate solution 0.12 M, pH 2.2, 26.23 µg/mL norleucine as internal standard; Sykam, Eresing, Germany) were mixed with 600 µL of the sample. Samples were filtered using a nylon filter (syringe filter, nylon, 0.45 µm, MS Scientific, Berlin, Germany), and filled into glass vials to analyse free amino acids. Colourization of the amino acids was achieved by automatic post-column ninhydrin derivatisation at 130 °C, prior to photometric

detection of the primary and secondary amino acids using a UV/VIS-detector at 570 nm and 440 nm, respectively (Krause and Löhnertz 2017). With this method, primary amino acids are coloured in blue-violet and secondary amino acids (*i.e.*, Pro) in yellow.

Statistical evaluation and Software

All fermentation experiments were performed in triplicates, in three separate batches. For the statistical evaluation of mass-loss, HPLC and HS-SPME-GC-MS analysis, two-tailed unpaired *t*-tests with Welch's correction were applied to analyse the data in GraphPad PRISM software (version 9.5.0) and significance was set at $p < 0.05$, $p < 0.01$, $p < 0.001$ or $p < 0.0001$, respectively, to the control (GraphPad Software, San Diego, CA, USA). HPLC data were evaluated by the software ChemStation for LC systems from Agilent (Agilent, Santa Clara, CA, USA), whereas HS-SPME-GC-MS data were analysed using Agilent's MassHunter software (Agilent, Santa Clara, CA, USA). By using Clarity chromatography software (DataApex, Prague, Czech Republic) IEC data were assessed. Bioinformatic analyses were performed using Geneious prime (version 2023.0.1; Biomatters Ltd., Auckland, New Zealand) and R version 4.0.3 (R Core Team R version 4.0.3 2020). GO-enrichment analysis (Carbon and Mungall 2018) was performed using PANTHER 17.0 (released 20221013) provided by GeneOntology (The Gene Ontology Consortium et al. 2000, 2021; Carbon et al. 2009; Mi et al. 2019).

Results

Fermentation kinetics

The fermentation kinetics were analysed daily to determine the time point of the lag phase, logarithmic phase and the beginning of the plateau phase of each fermentation culture for RNA-Seq sampling (Figure 2, see also Figure S1). The fermentations of both nitrogen regimes (Ctrl and DAHP) with *H. uvarum* reached the plateau phase at about the same time (9-11 days after inoculation). The DAHP fermentation curve of *H. uvarum* shows an almost sigmoidal pattern, while that of the control is more compressed. In contrast, DAHP fermentations with *S. cerevisiae* reached the plateau phase after 7 days of fermentation, whereas the fermentations of the ones conducted with the nitrogen deficient must (Ctrl) were finished 20 days after the beginning of fermentation. Here, the DAHP fermentation curves show a steady, linear increase, whereby the control fermentations are flattened.

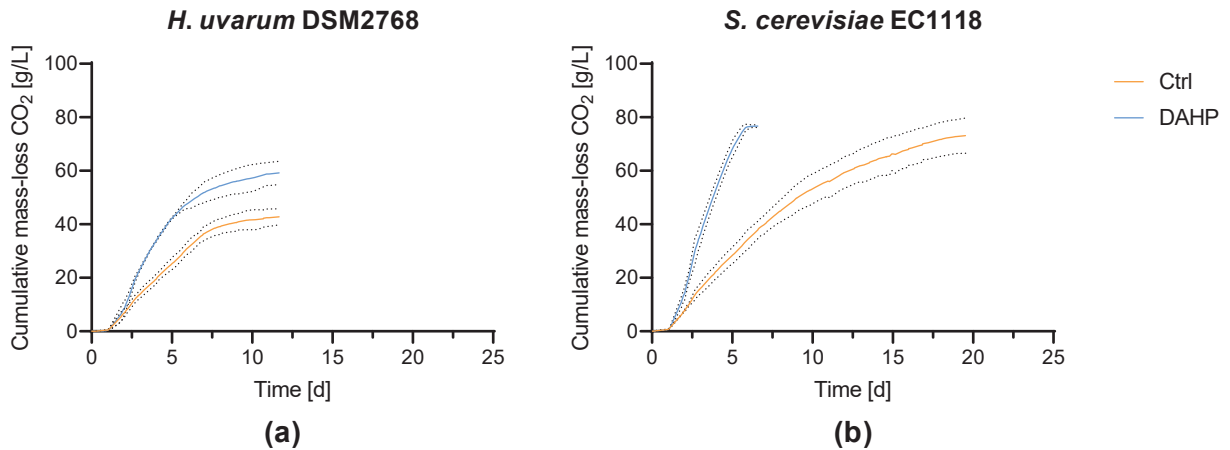

Figure 2. Fermentation kinetics (cumulative mass-loss CO₂ [g/L]) of fermentations with (a) *H. uvarum* DSM2768 and (b) *S. cerevisiae* EC1118 using MT must (Ctrl) and MT must supplemented with DAHP (DAHP). Data are the mean of three independent experiments \pm SEM. Dashed lines indicate the standard deviation.

DAHP supplementation resulted in an increase of fermentation vigour (Figure 2). The effect was statistically significant for both yeast strains: 50% of total observed mass-loss was achieved after 3.86 days of fermentation in fermentations with *H. uvarum* DSM2768 supplemented with DAHP, one day in advance of control fermentations: $t(38059) = 75577$, $p = 0.002$ (two-sided, unpaired *t*-test with Welch correction); for *S. cerevisiae* EC1118 50 % of total observed mass-loss in supplemented fermentations was achieved after 3.86 days, 2.9 days ahead of control fermentations: $t(38634) = 23205$, $p < 0.001$ (two-sided, unpaired *t*-test with Welch correction).

Genome sequence and annotation of *H. uvarum* DSM2768

To facilitate the evaluation of the transcriptome analyses, the genome of the *H. uvarum* was sequenced and annotated. The *H. uvarum* DSM2768 draft genome comprised 141 contigs > 299 nt adding to a total assembly size of 8 776 415 nt. Contig N50 and L50 were 8 and 371 197 kb, respectively. The longest Contig comprised 993 972 nt and 96% (8 436 531 nt) of the genome was represented in contigs > 50 kb (31 contigs). The GC content was 31.95%. The genome annotation comprised 4 322 genes, of which 58 genes were split genes comprising 1 (56 genes) or 2 introns (2 genes). For 3 651 genes (84.5%) a match to *Saccharomyces cerevisiae* was achieved by blastp search (e-value < $1e^{-3}$); 3 403 (78.7%) genes returned credible matches in protein profile search (domain independent e-value < $1e^{-3}$). The results are summarized in supplementary table (see *H. uvarum*_feature_table_MASTER in the supplemental materials).

BUSCO analysis recovered 1 764 complete BUSCOs for *H. uvarum* DSM2768: 1 763 complete and single copy BUSCOs (82.5%); 1 complete and duplicated BUSCO and 17 fragmented BUSCOs (0.8%). 356 BUSCOs (16.7%) of a total of 2 317 BUSCOs (OrthoDB 10:

Saccharomyces) were missing. *H. uvarum* gene content may be substantially higher than reported previously (63.79% completeness reported in Steenwyk et al. 2019): Our genome annotation in conjunction with version 10 of OrthoDB resulted in an increase of gene set completeness of more than 18%.

Transcriptome sequencing

The numbers of mapped reads are given in Table S3. The results show a strong drop-off in on-feature, *i.e.* on-gene, RNA-Seq reads in late stage fermentations.

Multivariate analysis of raw fragment counts

The results of the multivariate analysis of the raw fragment counts can be seen in the Supplementary Material (see Supplementary material on the multivariate analysis of raw fragment counts, Figure S15).

Differential gene expression

Differential gene expression describes the expression of genes from the genotype to the phenotype. First, genes are transcribed into RNA by enzymes and these are then translated into proteins. Since each gene is essential for executing a specific function within the organism, there are no situations in which all the genes of a cell are active at the same time. Differential gene expression provides an overview of the gene activity and their regulation at a specific point in time.

The differentially expressed genes (DEGs) in MT fermentations with and without DAHP supplementation using *H. uvarum* and *S. cerevisiae* comparing different stages of grape must fermentation are shown in Table 2. In fermentations with *H. uvarum* with and without DAHP addition, more genes are up-regulated than down-regulated in the comparison of mid to early and also late to mid. When comparing the time points of the fermentations of both nitrogen regimes, more genes are up-regulated in the logarithmic phase of the fermentation than in the lag phase. Likewise, more genes are up-regulated in the plateau phase than in the logarithmic phase. In addition, in fermentations with *S. cerevisiae* with and without DAHP supplementation, more genes are up-regulated in the logarithmic phase than in the lag phase. In the comparison of the time points late to mid, also more genes are up-regulated in the fermentations without DAHP addition, *i.e.* more active at the late time point (plateau phase). Whereas in the fermentations supplemented with DAHP, more genes are down-regulated at the late time point, *i.e.* they are more inactive compared to the logarithmic phase (l/m, DAHP: ▲ 122, ▼ 137). It is noticeable that, when comparing the DEGs of the control and DAHP fermentations of *H. uvarum* at the respective time points, more DEGs are up-regulated in the DAHP fermentations

(m/e: ▲ 130 (DAHP), ▲ 114 (Ctrl); l/m: ▲ 168 (DAHP), ▲ 88 (Ctrl)). The same applies to the time point m/e for the fermentations with *S. cerevisiae* (▲ 513 (DAHP), ▲ 484 (Ctrl)), but not for the time point l/m (▲ 122 (DAHP), ▲ 412 (Ctrl)). During the fermentations with both nitrogen regimes using *S. cerevisiae* as well as the control fermentations with *H. uvarum*, the number of up-regulated DEGs decreases as the fermentation progresses. In the *H. uvarum* fermentations with additional DAHP, however, the number of up-regulated DEGs increases as the fermentation proceeds (DAHP: ▲ 130 (m/e), ▲ 168 (l/m)). The number of down-regulated DEGs decreases over time in all fermentations using both yeast strains.

Table 2. Number of differentially expressed genes (DEGs) in fermentations with *H. uvarum* DSM2768 and *S. cerevisiae* EC1118 using Müller-Thurgau (MT) must comparing different stages of grape must fermentations. A DEG scored an adjusted *p*-value < 0.001 when testing if absolute log2 fold change was > 1.

Contrast	<i>H. uvarum</i> DSM2768	<i>H. uvarum</i> DSM2768	<i>S. cerevisiae</i> EC1118	<i>S. cerevisiae</i> EC1118
	Ctrl ^a	DAHP ^b	Ctrl ^a	DAHP ^b
mid fermentation/ early fermentation ^c	up ▲: 114 down ▼: 40	up ▲: 130 down ▼: 24	up ▲: 484 down ▼: 338	up ▲: 513 down ▼: 469
late fermentation/ mid fermentation ^d	up ▲: 88 down ▼: 6	up ▲: 168 down ▼: 18	up ▲: 412 down ▼: 311	up ▲: 122 down ▼: 137
	total: 4.322 genes	total: 4.322 genes	total: 6.045 genes	total: 6.045 genes

^a MT must fermentations without diammonium hydrogen sulphate (DAHP) supplementation (Ctrl)

^b MT must fermentations supplemented with DAHP

^c Comparison between time points mid (logarithmic phase) and early (lag phase) of fermentation

^d Comparison between time points late (plateau phase) and mid (logarithmic phase) of fermentation

Besides the comparison at different time points, a comparison of the DEGs between the different nitrogen regimes of the MT fermentations with *H. uvarum* and *S. cerevisiae* is also of interest (Table 3). While there are no DEGs in the lag phase as well as in the logarithmic phase of the *H. uvarum* fermentations when comparing DAHP to control fermentations, 13 genes are up-regulated in the stationary phase in the DAHP fermentations, *i.e.* more active than in the control fermentations. In contrast, in fermentations with *S. cerevisiae*, more genes are down-regulated at all different time points in DAHP fermentations compared to the control fermentations (early: ▼2; mid: ▼7; late: ▲111, ▼153), thus showing lower gene activity in the DAHP fermentations than in the control fermentations.

Table 3. Numbers of differentially expressed genes (DEGs) between different stages during grape must fermentations with *H. uvarum* DSM2768 and *S. cerevisiae* EC1118 using Müller-Thurgau (MT) must with different total nitrogen supply. A DEG scored an adjusted *p*-value < 0.001 when testing if absolute log₂ fold change was > 1.

Contrast	<i>H. uvarum</i> DSM2768	<i>S. cerevisiae</i> EC1118
	DAHP/ Ctrl ^a	DAHP/ Ctrl ^a
early fermentation	up ▲: 0 down ▼: 0	up ▲: 0 down ▼: 2
mid fermentation	up ▲: 0 down ▼: 0	up ▲: 0 down ▼: 7
late fermentation	up ▲: 13 down ▼: 0	up ▲: 111 down ▼: 153
	total: 4.322 genes	total: 6.045 genes

^a Comparison between fermentations using MT must supplemented with diammonium hydrogen sulphate (DAHP) and without DAHP supplementation (Ctrl)

DEGs can either be shared when comparing different conditions or unique for one of the conditions analysed (Figure 3; see also Figure S6). We intersected DEGs observed between sampling times under different nitrogen regimes to identify those shared or unique. In fermentations with both yeast strains, identical genes are up- and down-regulated in both the control and DAHP fermentations as the fermentations proceed. In addition, genes are uniquely up- or down-regulated in fermentations only conducted with MT must with or without additional DAHP. Table S6 shows the original number of regulated genes and the number of genes identified. The difference is due to the fact that not all DSM2768 genes could be homologised with EC1118.

When comparing the early and middle stage of fermentations with both yeast strains, more DEGs are being shared between both nitrogen regimes (*H. uvarum*: 62%, *S. cerevisiae*: 58%), than being uniquely regulated in the control (*H. uvarum*: 19%, *S. cerevisiae*: 14%) or DAHP (*H. uvarum*: 19%, *S. cerevisiae*: 28%) fermentations. However, in the comparison of the middle and late stage of fermentations, the highest amount of DEGs are found in DAHP fermentations with *H. uvarum* (58%) or the control fermentations with *S. cerevisiae* (71%), respectively.

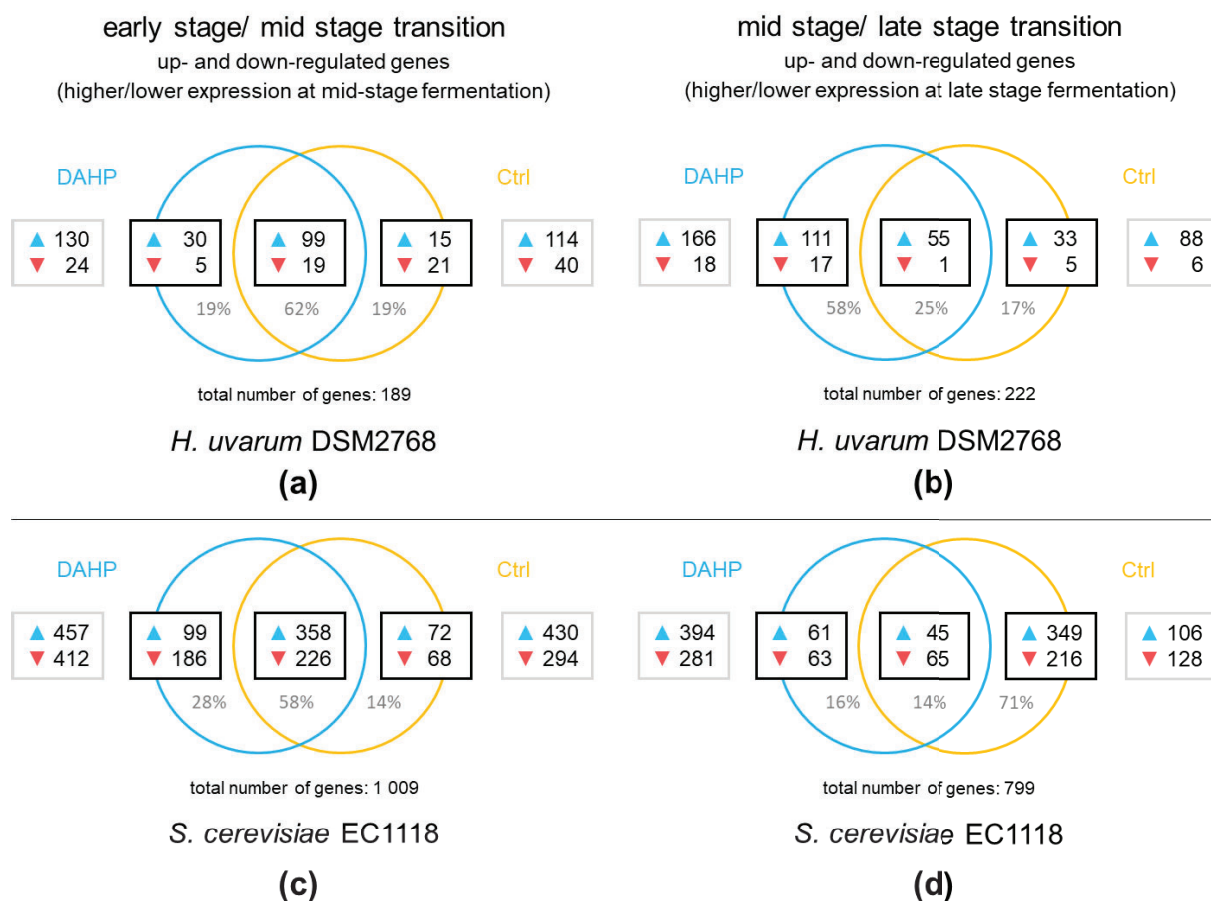

Figure 3. Venn diagrams of differentially up- and down regulated genes in fermentations with *H. uvarum* DSM2768 and *S. cerevisiae* EC1118. Differentially expressed genes (DEGs) shared between and unique to nitrogen regimes (supplemented with diammonium hydrogen phosphate (DAHP) and without DAHP (Ctrl)) in fermentations with (a-b) *H. uvarum* and (c-d) *S. cerevisiae* between different fermentation points: (a, c) early/ mid-stage transition or (b, d) mid/ late stage transition. ▲ numbers of up-regulated genes, ▼ numbers of down-regulated genes. Percentages indicate the proportion of DEGs in that fraction.

GO-enrichment analysis revealed, that shared up-regulated genes of *H. uvarum* at early to mid-stage transition (Figure 3a) are involved in carbohydrate metabolic processes, nitrogen compound metabolic processes and gene expression, whereas genes found to be down-regulated in both the control and DAHP fermentations of *H. uvarum* are involved in the lysine biosynthetic process. Among the DEGs, that are jointly up-regulated in *H. uvarum* (DAHP and Ctrl fermentations; early to mid-stage transition) is *EAT1*, an ethanol acetyltransferase, which is putatively involved in the esterification of higher alcohols into acetate esters (Kruis et al. 2017; Kruis et al. 2018), while *ARO8* is one of the commonly down-regulated genes in *H. uvarum* (DAHP and Ctrl fermentations). *ARO8* encodes an aromatic aminotransferase, responsible for the degradation of aromatic amino acids into α -keto acids. DEGs down-regulated in *H. uvarum* (Ctrl fermentation) are involved in biosynthetic processes of lysine, serine and sulphur compounds. These down-regulated genes include *MET17*, *HOM3* and *ILV5*, catalysing reactions of the biosynthesis of methionine, isoleucine and valine. Genes uniquely up- or down-regulated in DAHP fermentations and up-regulated in control

fermentations with *H. uvarum* at early to mid-stage transition unravelled no results in the GO-enrichment analysis. *HOM6* (homoserine dehydrogenase) is one of the five down-regulated genes found in *H. uvarum* (DAHP fermentations), which is involved in the biosynthesis of methionine and threonine. GO-enrichment analysis did not reveal GO-terms for unique and joined genes differentially up- or down-regulated in *H. uvarum* (DAHP and Ctrl) at the mid to late stage transition (Figure 3b, see also GO_enrichment_analysis in the supplemental materials).

Genes, which are down-regulated in *S. cerevisiae* with both DAHP and control fermentations during the logarithmic phase, compared to the lag phase (Figure 3c), are involved in biological processes such as lysine/ serine/ nucleotide biosynthesis, rRNA export from nucleus, ribosomal small/ large subunit assembly, cytoplasmic translation, regulation of transcription, tRNA aminoacylation for protein translation, protein modification processes and protein transport. Examples for shared down-regulated genes are *LEU9*, *ARO8*, *ILV5*, *CYS3*, *HOM2*, involved in the biosynthesis or degradation of amino acids, and *ALD5*, encoding an aldehyde dehydrogenase, converting acetaldehyde to acetic acid. Commonly up-regulated genes of *S. cerevisiae* in fermentations with both nitrogen regimes at the early to mid-stage transition are involved in biological processes, such as aldehyde catabolic processes, glycogen biosynthetic processes, sugar metabolic processes, regulation of metabolic processes, DNA repair, translation and transcription. *ALD2*, *ALD3*, *ALD4*, responsible for the oxidation of acetaldehyde into acetic acid, and *EEB1*, encoding an ethanol O-acyltransferase, catalysing the formation of ethyl esters, are found to be up-regulation in *S. cerevisiae*, for instance. GO-enrichment analysis revealed that uniquely down-regulated genes in *S. cerevisiae* (Ctrl fermentations) are involved in mitotic cell cycle processes, while genes that are found to be down-regulated in DAHP fermentations are involved in biological processes, such as cytoplasmic translation, DNA repair, signal transduction, modification/ localization/ transport of proteins and translation.

Up-regulated genes in *S. cerevisiae* shared between DAHP and control fermentations when entering the plateau phase (Figure 3d) unravelled contribution in biosynthetic processes of cysteine, methionine, serine and aspartate, whereas shared down-regulated genes are responsible for carbohydrate metabolic processes, alcohol metabolic processes, biological regulation and the generation of precursor metabolites and energy. While genes, found to be uniquely down-regulated in *S. cerevisiae* (Ctrl fermentations), are part of biological processes, such as ergosterol biosynthesis, cytoplasmic translation and positive regulation of transcription, genes catalysing sulphate assimilation, iron-sulphur cluster assembly, proteasome-mediated ubiquitin-dependent protein catabolic processes and phosphate-containing compound metabolic processes are up-regulated. In DAHP fermentations, however, genes involved in glycolytic processes, gluconeogenesis, Ehrlich pathway,

fermentation, and regulation of primary metabolic processes are found to be down-regulated in *S. cerevisiae* at the late stage of fermentation, while genes responsible for ornithine metabolic processes, arginine biosynthetic processes and tricarboxylic acid cycle are up-regulated.

In addition to the comparison of commonly and uniquely up- and down-regulated genes in one yeast species, performed in fermentations of both nitrogen regimes, jointly or individually up- and down-regulated genes can also be identified within both yeast species (Figure 4). *H. uvarum* and *S. cerevisiae* share two up-regulated genes in both the control and DAHP fermentations at early to mid-stage transition, respectively (Figure 4a). The two genes shared between the control fermentations are a putative protein of unknown function (YDL218W) and *PIB1* (a RING-type ubiquitin ligase), whereas *HSP104* (heat shock protein) and *NCA3* (nuclear control of ATPase) are found to be up-regulated in the DAHP fermentations. *H. uvarum* and *S. cerevisiae* do not share down-regulated genes in either their control or DAHP fermentations (Figure 4b).

Four genes are commonly up-regulated in *H. uvarum* and *S. cerevisiae* control fermentations at the mid to late stage transition (Figure 4c). Besides the alcohol dehydrogenase *ADH7*, also *FLO11* (involved in flocculation), *TRA1* (subunit of SAGA and NuA4 histone acetyltransferase complex; involved in DNA repair) and *HBN1* (protein of unknown function; enables oxidoreductase activity) are up-regulated in yeasts cells of the control fermentations. DAHP fermentations with both yeast strains share two up-regulated genes when entering the plateau phase: *CAT8* (catabolite repression; sequence-specific DNA binding transcription factor) and *SDH2* (succinate dehydrogenase; involved in cellular respiration and tricarboxylic acid cycle). While *H. uvarum* and *S. cerevisiae* do not have down-regulated genes in common in the control fermentations at the mid to late stage transition (Figure 4d), both yeasts reveal a down-regulation of *ENO1* encoding a phosphopyruvate hydratase catalysing the hydrolysis of 2-phosphoglycerate to phosphoenolpyruvate during glycolysis in the DAHP fermentations at that stage.

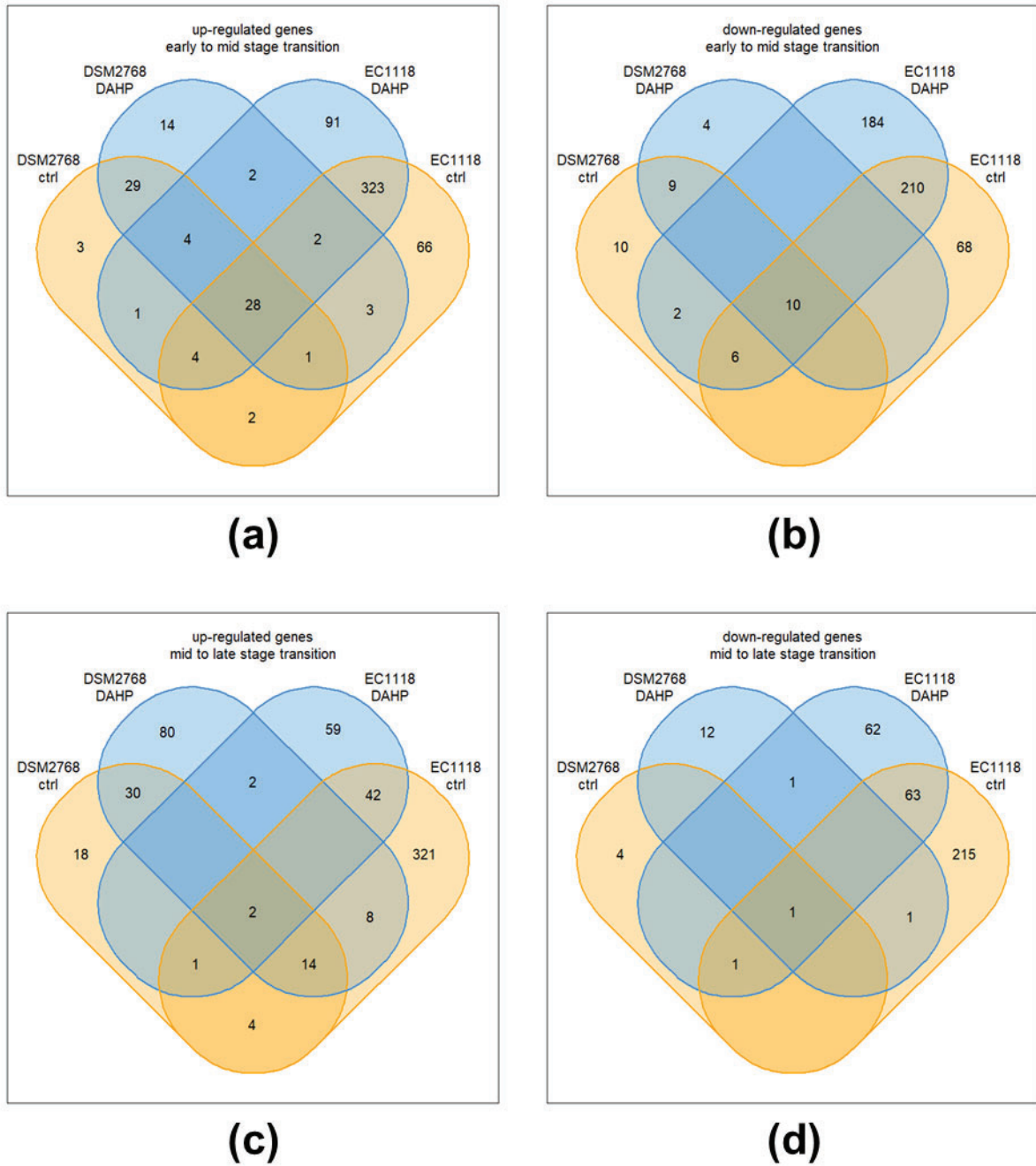

Figure 4. Venn diagrams showing joined differentially expressed genes (DEGs) in *H. uvarum* DSM2768 and *S. cerevisiae* EC1118. Jointly (a, c) up-regulated and (b, d) down-regulated genes in fermentations with both yeast strains during (a-b) early to mid-stage transition and (c-d) mid to late stage transition.

Each gene is responsible for fulfilling certain functions within a cell and thus within an organism. Regarding the synthesis of compounds during alcoholic fermentation by yeasts, affecting the taste and mouthfeel of the wine, the conversion of pyruvate to acetyl-coA, ethanol and acetic acid, respectively, plays an important role (Table 4, Figure 5a).

Table 4. Genes involved in the conversion of pyruvate to acetyl-coA and acetaldehyde, and the reduction of acetaldehyde to ethanol, as well as its oxidation to acetic acid. Differentially expressed genes are labelled (bold, pink).

Pathway	Reaction	Genes involved
Pyruvate → Acetyl-coA	Oxidative decarboxylation	<i>PDB1</i> , <i>PDA1</i> , <i>LAT1</i> , <i>LPD1</i>
Pyruvate → Acetaldehyde	Decarboxylation	<i>PDC1</i> , 5 , 6
Acetaldehyde ↔ Ethanol	Reduction	<i>ADH1</i> , 2 , 3 , 5
Acetaldehyde → Acetic acid	Oxidation	<i>ALD2</i> , 3 , 4 , 5 , 6

DAHP fermentations with *H. uvarum* resulted in up-regulated DEGs when comparing the late and mid time point (*PDA1*, *LAT1*; Figure 5b). Both genes encode pyruvate dehydrogenases, involved in the oxidative decarboxylation of pyruvate, which is derived from the glycolysis out of sugar, to acetyl-coA. When reaching the plateau phase, genes responsible for the formation of acetyl-coA are more active in *H. uvarum* using DAHP supplemented MT must for fermentations.

Fermentations using *H. uvarum* show high expression levels of genes encoding the decarboxylation of pyruvate to acetaldehyde throughout all stages of fermentation, while the expression levels of the genes involved, namely *PDC1* and *PDC6*, decrease in the plateau phase of fermentations with *S. cerevisiae* (Figure S2b). *PDC1* is down-regulated at the late stage of DAHP fermentations, whereas *PDC6* is found to be up-regulated at logarithmic phase (m/e) within both nitrogen regimes, revealing its highest activity at that time point, since *PDC6* is down-regulated at the late stage of both fermentations (Figure 5b).

The same applies to *ALD3*, catalysing the oxidation from acetaldehyde to acetic acid. Additionally, the aldehyde dehydrogenases *ALD2* and *ALD4* are also up-regulated at the mid-stage of the fermentations (Ctrl and DAHP) using *S. cerevisiae*, whereas *ALD5* is down-regulated. Analyses unravel high expression levels of individual genes, encoding for aldehyde dehydrogenases, at a certain stage of the fermentation process (early: *ALD5*, or mid: *ALD3*) in *S. cerevisiae*. In contrast to the control fermentations with *S. cerevisiae*, *ALD3* is down-regulated in the DAHP fermentations during logarithmic phase.

With regard to the activity of alcohol dehydrogenases, which are responsible for the conversion of acetaldehyde to ethanol, it is remarkable that the responsible genes show high activity during the entire fermentation process, particularly evident by the expression levels of *ADH1* found in both yeast strains in fermentations with both nitrogen regimes (Figure S2b).

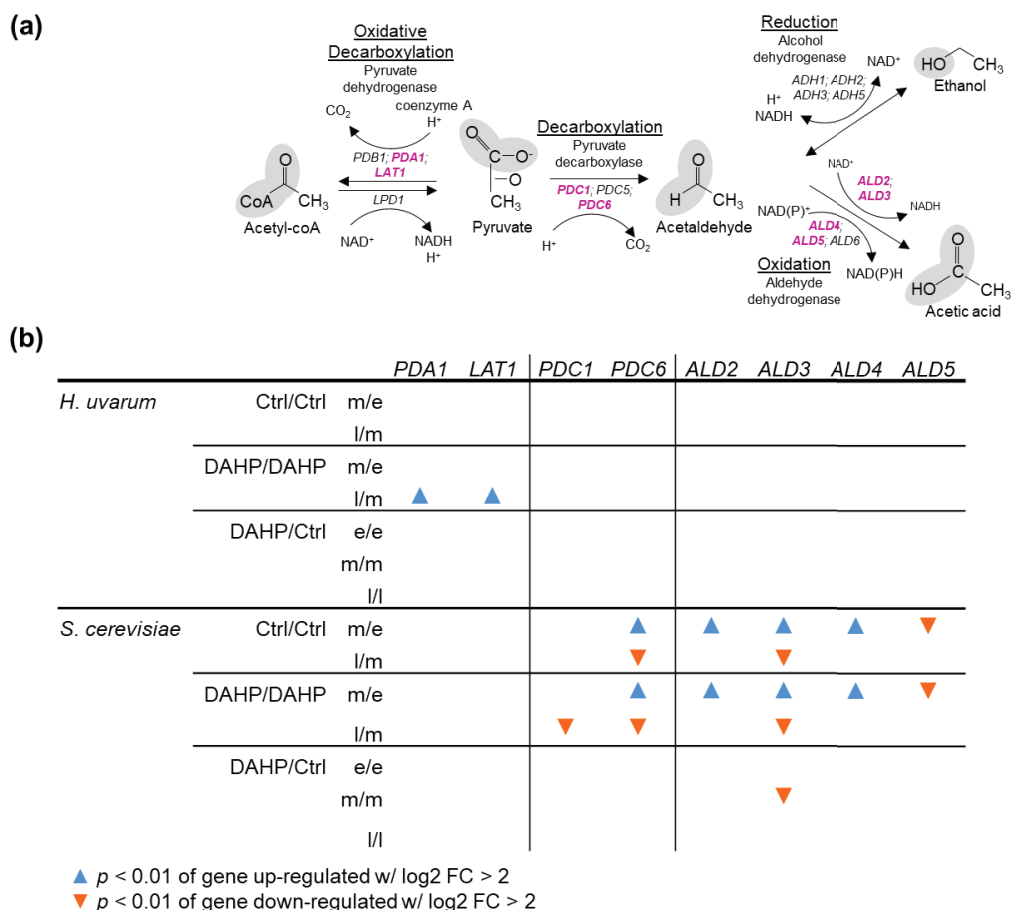

Figure 5. Conversion of pyruvate to acetyl-coA, ethanol and acetic acid, respectively, including genes involved as well as their differential expression (DE). (a) Conversion of pyruvate to acetyl-coA, ethanol and acetic acid, labelled with enzymes and encoding genes known to catalyse the reactions in *S. cerevisiae*. Specific molecular groups are highlighted (modified from Dzialo et al. (2017) and Heit et al. (2018)). Differentially expressed genes (DEGs) are marked (bold, pink). (b) DEGs (\log_2 fold change) involved in the conversion of pyruvate to acetyl-coA, ethanol and acetic acid in fermentations using Müller-Thurgau must with (DAHP) and without (Ctrl) diammonium hydrogen phosphate supplementation with *H. uvarum* DSM2768 and *S. cerevisiae* EC1118. m/e: DEGs at logarithmic phase (mid; m) compared to lag phase (early; e). l/m: DEGs at plateau phase (late; l) compared to logarithmic phase (mid; m). e/e: DEGs at DAHP early compared to Ctrl early. m/m: DEGs at DAHP mid compared to Ctrl mid. l/l: DEGs at DAHP late compared to Ctrl late. ▲ $p < 0.01$ of gene up-regulated w/ \log_2 FC > 2 , ▼ $p < 0.01$ of gene down-regulated w/ \log_2 FC > 2 .

Higher alcohols form the largest group of volatile aroma compounds in wine, followed by esters. The latter, especially acetate esters, have a particular influence on the aroma profile of wine due to their low odour threshold. Higher alcohols can be synthesized from amino acids via the Ehrlich pathway (Table 5, Figure 6a). First, amino acids are transaminated to α -keto acids, following a decarboxylation to aldehydes, before being reduced to higher alcohols. Subsequent esterification then leads to the formation of acetate esters.

Table 5. Genes involved in Ehrlich pathway, as well as in the esterification of higher alcohols. Differentially expressed genes are labelled (bold, pink).

Pathway	Reaction	Genes involved
Amino acid → α -Keto acid	Transamination	ARO8,9, BAT1,2
α -Keto acid → Fusel aldehyde	Decarboxylation	ARO10, PDC1,5,6, THI3
Fusel aldehyde → Fusel alcohol	Reduction	SFA1, ADH1,3,4,5,6,7
Fusel alcohol → Acetate ester	Esterification	ATF1,2, EAT1
Fusel alcohol → Ethyl ester	Esterification	EHT1, EEB1
Putative <i>H.u.</i> pathways		
Fusel alcohol → Acetate ester	Esterification	ATF, PBI1, EAT2, IMO32

Looking at the gene expression, again only minor differences can be seen between the fermentations of the two nitrogen regimes (Figure S3, Figure 6). Genes, encoding aminotransferases, such as *ARO8* and *BAT1*, catalysing the transamination of amino acids to α -keto acids, reveal to be highly expressed during the lag phase in both control and DAHP fermentations with *S. cerevisiae*, and are down-regulated at the logarithmic phase (Figure 6b). In fermentations using *H. uvarum*, however, these genes show similar expression levels throughout the entire fermentation (Figure S3b). When comparing control to DAHP fermentations, *ARO9* is down-regulated at the late stage of DAHP fermentations with *S. cerevisiae* (Figure 6b). Gene duplications of *ARO8* and *ARO9* could be identified in *H. uvarum* and their expression levels as well as their DE is shown in Figure S4. One of the *ARO8* duplications is down-regulated in its expression during the logarithmic phase in fermentations with both nitrogen regimes, revealing its highest activity during the lag phase, similar to the DE of *ARO8* found in *S. cerevisiae* (Figure 6).

Genes involved in the conversion of α -keto acids to aldehydes show to be expressed during all stages of fermentations with *H. uvarum* using both MT must with and without DAHP addition (Figure S3b). In fermentations with *S. cerevisiae*, in contrast, there is a decline in expression levels in the plateau phase, especially in the DAHP fermentations. *PDC1* and *PDC6* are down-regulated when reaching the plateau phase in DAHP fermentations, while only the latter reveals to be down-regulated in the control fermentations at that stage (Figure 6b). Furthermore, DE analysis unravels an up-regulation of *PDC6* at the mid-stage of fermentations (Ctrl and DAHP) with *S. cerevisiae*.

Genes encoding for alcohol dehydrogenases enabling the reduction of aldehydes to higher alcohols are expressed at high levels throughout the entire fermentation process of fermentations using both yeast strains with and without DAHP supplemented, with a few genes, such as *ADH1* and *ADH4*, showing a decrease in their expression towards the late time point of *S. cerevisiae* fermentations (Figure 6b, Figure S3b). Interestingly, *ADH7* shows to be

very low expressed in fermentations with *S. cerevisiae* using both MT must control and DAHP addition at all stages of fermentation, except for up-regulated expression levels at the late stage of the control fermentation. In addition, *SFA1* also shows to be up-regulated at the late stage of control fermentations with *S. cerevisiae* (Figure 6b). Following, *SFA1* and *ADH7* reveal to be down-regulated at the late stage of DAHP fermentations, compared to the control fermentations with *S. cerevisiae*, while *ADH5* shows to be up-regulated in its expression levels in DAHP fermentations. Remarkably, *ADH7* is found to be up-regulated at the late stage of fermentations with both nitrogen regimes using *H. uvarum* (Figure 6b).

Aryl-alcohol dehydrogenases are putatively involved in the reduction of aldehyde to higher alcohols. No annotated genes encoding this enzyme were found in the genome of *H. uvarum*. In *S. cerevisiae*, however, *AAD* genes are up-regulated in their expression in control fermentations (mid: *AAD10*; late: *AAD3*, *AAD4*, *AAD14*) and in DAHP fermentations (late: *AAD4*; Figure S5). Comparing DAHP and control fermentations, *AAD3*, *AAD4* and *AAD14* are found to be down-regulated at the late stage of DAHP fermentations.

Acetyltransferases are responsible for the esterification of higher alcohols to acetate esters. In general, expression levels reveal very low acetyltransferase activity in fermentations with *S. cerevisiae* (Figure S3b), with an up-regulation of *ATF1* during the logarithmic phase when using MT must supplemented with DAHP (Figure 6b). However, the fermentations with *H. uvarum* show high expression of *EAT1* in the logarithmic phase and plateau phase, being highly increased when entering the logarithmic phase in fermentations with both nitrogen regimes. Besides the genes involved in esterification known in *S. cerevisiae*, more genes could be identified in *H. uvarum*, revealing acetyltransferase activity. Genes labelled with AATase and *PBI1*, were identified by Seixas et al. (2019) as probable alcohol acetyltransferases in *Hanseniaspora* spp. (AWRI3580_g3168 = K68_g3477 (AATase); AWRI3580_g2249 = K68_g1493 (*PBI1*)). The genes named *EAT1* (AWRI3580_g1230 = K68_g2129), *EAT2* (AWRI3580_g2626 = K68_g2090) and *IMO32* (AWRI3580_g3433 = K68_g2510) were identified in *H. uvarum* using the protein sequences of *EAT1* and its homologs described in Kruis et al. (2017). Gene alignments can be seen in Figure S6. While AATase, *PBI1*, *EAT2* and *IMO32* show to be similar expressed during all stages of fermentations using *H. uvarum*, fermentations with *S. cerevisiae* unravel up-regulated expression of *PBI1* at the mid-stage of both the control and DAHP fermentations (Figure 6b).

In addition to acetate esters, ethyl esters can also be derived from higher alcohols, catalysed by acyltransferases encoded by *EHT1* and *EEB1*. *EHT1* is similarly expressed at all stages of fermentations using *S. cerevisiae* (Figure S3c), whereas *EEB1* shows to be up-regulated at the mid-stage of fermentations (Ctrl and DAHP), with down-regulated expression found at the late stage of DAHP fermentations (Figure 6b). However, in fermentations using *H. uvarum*,

expression levels reveal similar activity of *EEB1* throughout fermentations with both nitrogen regimes.

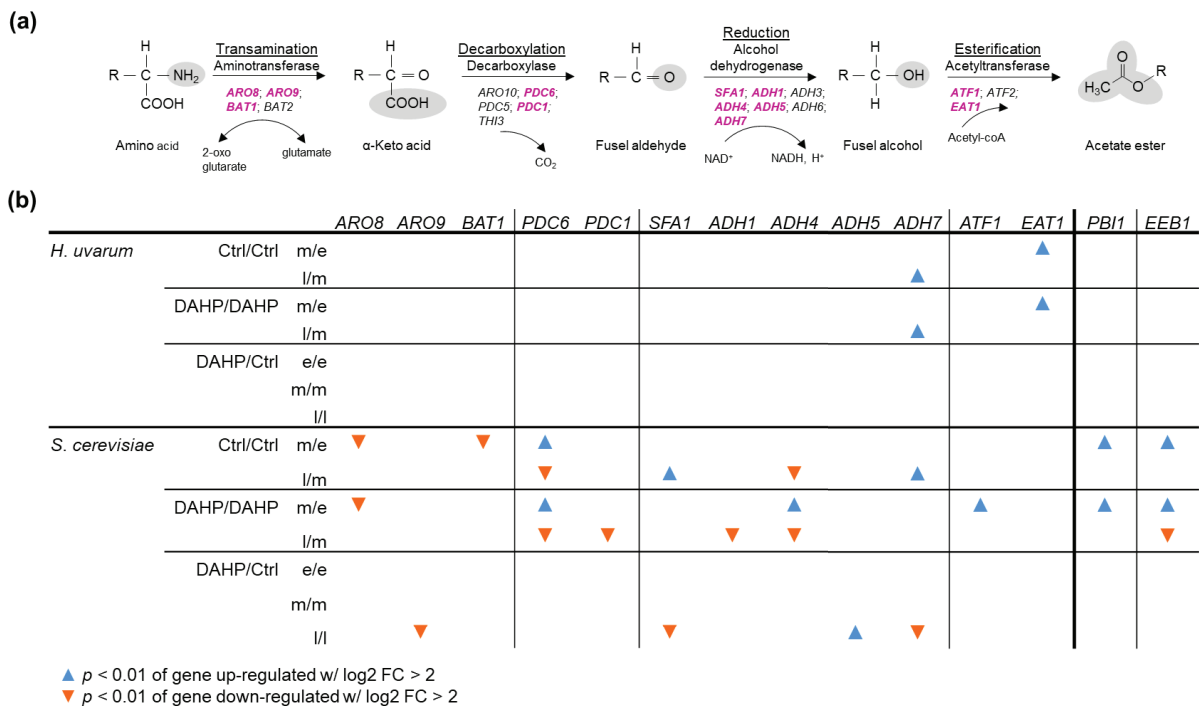

Figure 6. The Ehrlich Pathway with subsequent esterification and the genes involved as well as their differential expression (DE). (a) Conversion of amino acids into fusel aldehydes, fusel alcohols and acetate esters, indicated with enzymes and encoding genes known in *S. cerevisiae* to catalyse the reactions. Specific molecular groups are highlighted (modified from Badura et al. (2023b)). Differentially expressed genes (DEGs) are marked (bold, pink). (b) DEGs (\log_2 fold change) involved in the Ehrlich pathway and subsequent esterification in fermentations using Müller-Thurgau must with (DAHP) and without (Ctrl) diammonium hydrogen phosphate supplementation with *H. uvarum* DSM2768 and *S. cerevisiae* EC1118. m/e: DEGs at logarithmic phase (mid; m) compared to lag phase (early; e). l/m: DEGs at plateau phase (late; l) compared to logarithmic phase (mid; m). e/e: DEGs at DAHP early compared to Ctrl early. m/m: DEGs at DAHP mid compared to Ctrl mid. l/l: DEGs at DAHP late compared to Ctrl late. ▲ $p < 0.01$ of gene up-regulated w/ $\log_2 FC > 2$, ▼ $p < 0.01$ of gene down-regulated w/ $\log_2 FC > 2$.

Since *H. uvarum* is known for its high acetate ester production in wine fermentations, analysing genes involved in the biosynthesis or degradation of aroma-relevant amino acids is of particular interest. Amino acids, such as the branched-chain amino acids Ile, Val and Leu, the aromatic amino acids Phe, Trp and Tyr, as well as the sulphur containing amino acid Met and the polar uncharged amino acid Thr play a major role in the synthesis of aroma compounds, serving as backbones. Genes known to be responsible for the biosynthesis or degradation of these amino acids, investigated in this study, are listed in Table 6.

Looking at the expression levels of these aroma-relevant genes, contributing to the biosynthesis and/ or degradation of amino acids, the generally low activity of *ARO9*, *ARO10* and *PHA2* in fermentations of *S. cerevisiae* is remarkable, as well as the low expression levels of *MET7*, *MEU1* and *TYR1* in *H. uvarum* fermentations (Figure S7). Again, data reveal only slight differences in expressions of genes in fermentations with MT must with and without DAHP supplementation. Control fermentations using *H. uvarum* reveal a down-regulation at

the logarithmic phase of genes, involved in biosynthesis pathways of Ile, Val, Trp, Met and Thr, while the biosynthesis activity of Met and Thr is also decreased at the mid-stage of DAHP fermentations (Figure 7, Table 6).

Table 6. Genes involved in the biosynthesis and degradation of branched-chain amino acids (Ile, Val, Leu), aromatic amino acids (Phe, Trp, Tyr), the sulphur containing amino acid Met and the polar uncharged amino acid Thr. Differentially expressed genes (DEGs) are marked (bold, pink).

Amino acid	Pathway	Genes involved
Branched-chain amino acids		
Ile	L-Ile biosynthesis I (from Thr)	<i>ILV1,2,3,5,6; BAT1,2</i>
	Ile degradation	<i>BAT1,2; ARO10; SFA1; PDC1,5,6; THI3; ADH1,2,3,4,5</i>
Val	L-Val biosynthesis	<i>ILV2,3,5,6; BAT1,2</i>
	Val degradation	<i>BAT1,2; ARO10; SFA1; PDC1,5,6; ADH1,2,3,4,5</i>
Leu	L-Leu biosynthesis	<i>LEU1,2,4,9; BAT1,2</i>
	Leu degradation	<i>BAT1,2; ARO10; SFA1; THI3; ADH1,2,3,4,5</i>
Aromatic amino acids		
Phe	Phe biosynthesis	<i>PHA2; ARO7,8,9</i>
	Phe degradation	<i>ARO8,9; HIS5; ARO10; PDC1,5,6; SFA1; ADH1,2,3,4,5</i>
Trp	L-Trp biosynthesis	<i>TRP1,2,3,4,5</i>
	Trp degradation	<i>ARO8,9,10; PDC1,5,6; SFA1; ADH1,2,3,4,5</i>
Tyr	Tyr biosynthesis	<i>ARO7,8,9; TYR1</i>
	L-Tyr degradation III	<i>ARO8,9; PDC1,5,6; ADH1,2,3,4,5</i>
Sulfur containing amino acid		
Met	L-Met biosynthesis	<i>MET6,7</i>
	superpathway L-Met biosynthesis	<i>HOM2,3,6; MET2,6,7,17</i>
	Met salvage pathway	<i>MEU1; MRI1; MDE1; UTR4; ADI1; BAT1,2; ARO8,9</i>
Polar uncharged amino acid		
Thr	L-Thr biosynthesis	<i>THR1,4</i>
	Thr degradation	<i>CHA1; CYS3</i>
	superpathway L-Thr biosynthesis	<i>AAT1,2; HOM2,3,6; THR1,4</i>
	superpathway Thr biosynthesis	<i>PYC1,2; AAT1,2; HOM2,3,6; THR1,4</i>

During the progress of *S. cerevisiae* fermentations, down-regulations of genes involved in several pathways, such as the biosynthesis and degradation of branched-chain amino acids, aromatic amino acids and Thr, as well as the biosynthesis of Met, are observed in both the control and DAHP fermentations (Figure 7). However, up-regulations of some of these genes can also be observed in fermentations with *S. cerevisiae*. At the late stage of fermentations, genes involved in the degradation of Thr (Ctrl) and branched chain amino acids (Ctrl), as well as the biosynthesis of Met (Ctrl and DAHP) are up-regulated in their expression levels (Figure 7). DEGs catalysing the degradation of both branched-chain and aromatic amino acids, unravel to be up-regulated during the logarithmic phase in control and DAHP fermentations with *S. cerevisiae*. When comparing DAHP and control fermentations, differences in the regulation of genes can be seen at the late stage of *S. cerevisiae* fermentations (Figure 7).

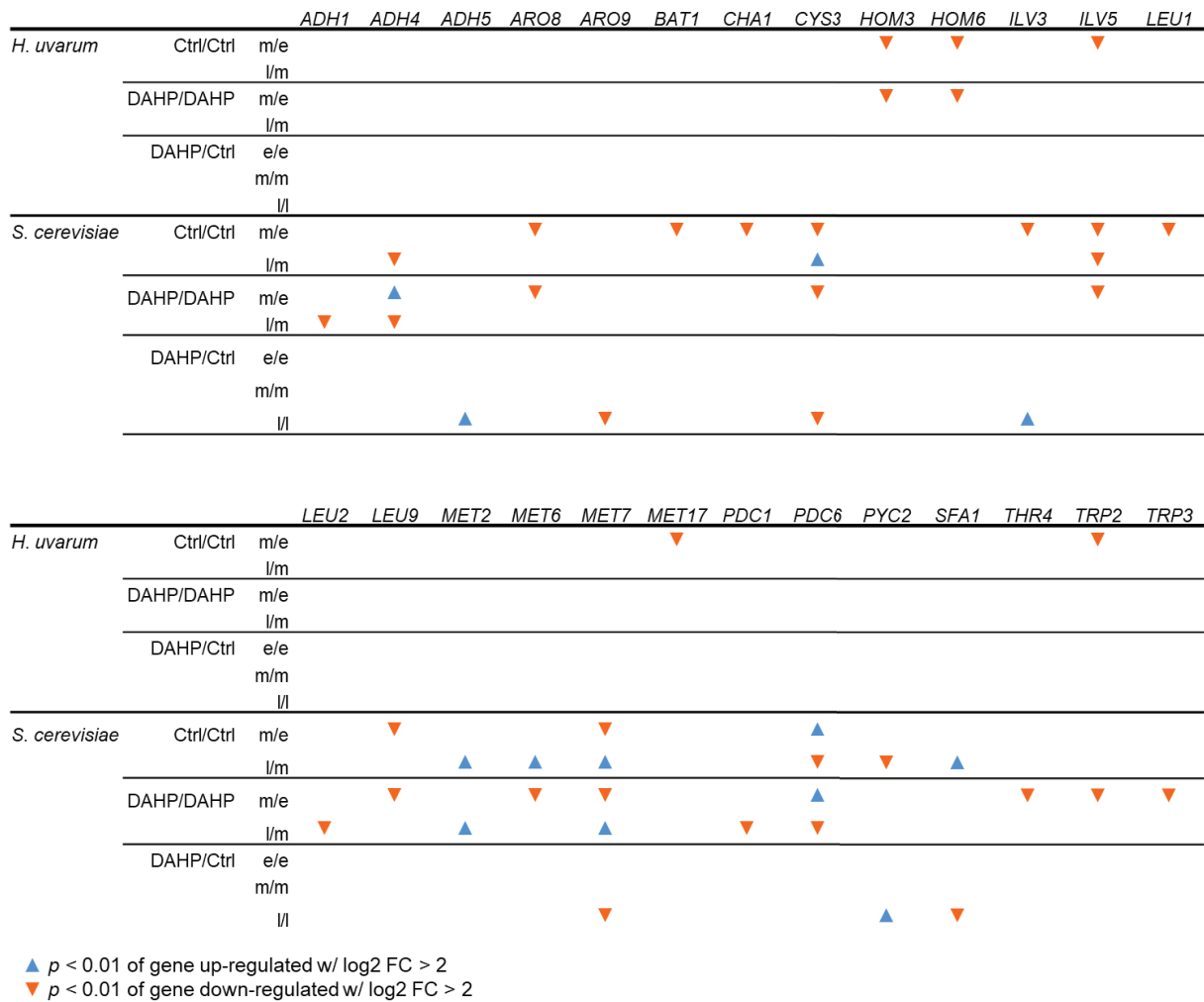

Figure 7. Differentially expressed genes (DEGs; \log_2 fold change) involved in the biosynthesis and degradation of aroma-relevant amino acids in fermentations using Müller-Thurgau must with (DAHP) and without (Ctrl) diammonium hydrogen phosphate supplementation at different stages of fermentation (lag phase = early, logarithmic phase = mid, plateau phase = late) with *H. uvarum* DSM2768 and *S. cerevisiae* EC1118. m/e: differential expression of genes at logarithmic phase (mid; m) compared to lag phase (early; e). l/m: differential expression of genes at plateau phase (late; l) compared to logarithmic phase (mid; m). e/e: DEGs at DAHP early compared to Ctrl early. m/m: DEGs at DAHP mid compared to Ctrl mid. l/l: DEGs at DAHP late compared to Ctrl late. ▲ $p < 0.01$ of gene up-regulated w/ \log_2 FC > 2 , ▼ $p < 0.01$ of gene down-regulated w/ \log_2 FC > 2 .

Nitrogen analysis

Since YAN plays a major role in the experimental set-up, concentrations of FAN and NH_4^+ were determined in the fermentation supernatant at the respective times of transcriptome sampling. As expected, total YAN content as well as NH_4^+ content varied in fermentations with and without DAHP addition, being higher in fermentations using DAHP supplemented MT must (Figure 8). At the early stage of control fermentations with *H. uvarum*, the NH_4^+ concentration was found to be ~13 mg/L, whereas it was already depleted in fermentations with *S. cerevisiae* (see also Table S7). FAN concentration was relatively high in fermentations with both yeast strains in the lag phase, while it was almost depleted in the logarithmic phase. At the plateau phase, however, FAN levels have slightly increased again (see also Figure 9).

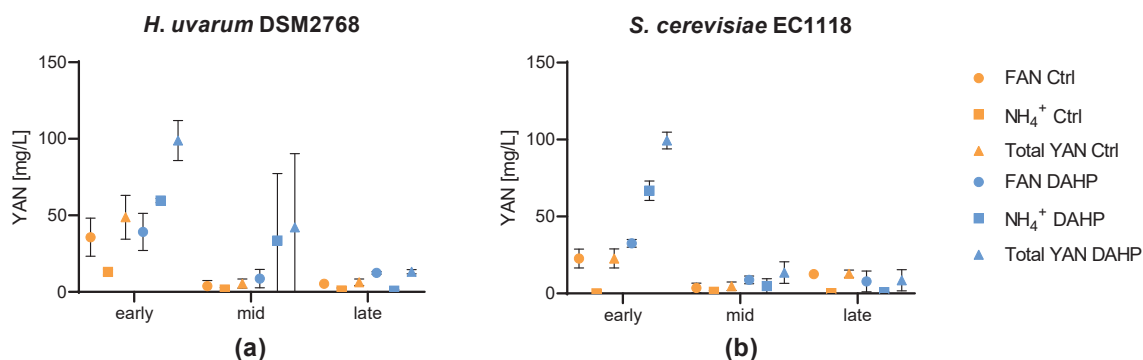

Figure 8. Yeast assimilable nitrogen (YAN) in fermentations using Müller-Thurgau must with (DAHP) and without (Ctrl) diammonium hydrogen phosphate supplementation at different stages of fermentation (lag phase = early, logarithm phase = mid, plateau phase = late) with (a) *H. uvarum* DSM2768 and (b) *S. cerevisiae* EC1118. Free amino nitrogen (FAN), ammonium ions (NH_4^+) and total YAN (Total YAN) containing the sum of FAN and NH_4^+ . FAN and NH_4^+ were measured using a spectrophotometrically-based method. Data are the mean of three independent experiments \pm SEM. Error bars indicate the standard deviation.

The FAN contents were not significantly different in most fermentations of both yeast strains at the respective time points, when comparing the two nitrogen regimes (Figure 9). The fermentations with *H. uvarum* at the late stage of fermentation showed to be an exception. Here, the concentration of FAN was significantly higher in the fermentations using the MT must supplemented with DAHP than in the control fermentations.

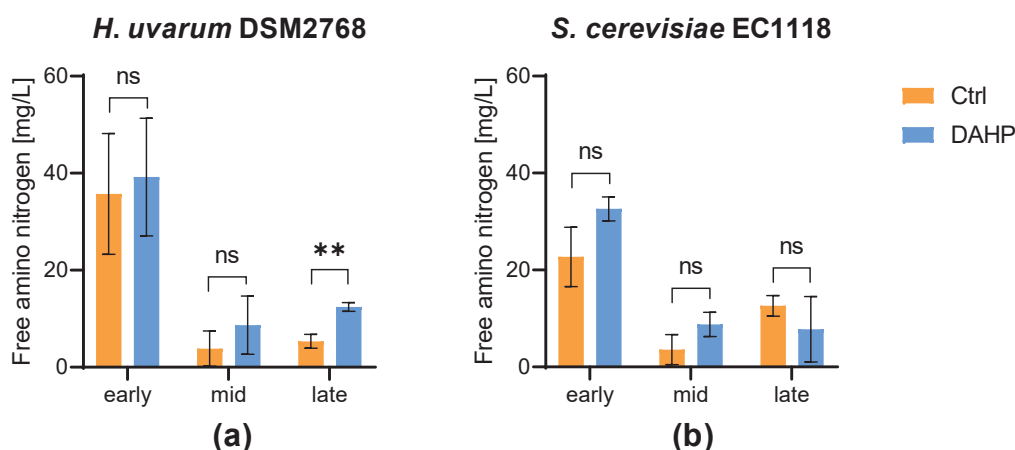

Figure 9. Free amino nitrogen (FAN) in fermentations using Müller-Thurgau must with (DAHP) and without (Ctrl) diammonium hydrogen phosphate supplementation at different stages of fermentation (lag phase = early, logarithm phase = mid, plateau phase = late) with (a) *H. uvarum* DSM2768 and (b) *S. cerevisiae* EC1118. FAN was measured using a spectrophotometrically-based method. Data are the mean of three independent experiments \pm SEM, two-tailed unpaired *t*-test with Welch's correction, ** $p < 0.01$, ns – not significant. Error bars indicate the standard deviation.

Synthesis of aroma-relevant compounds

Volatile compounds synthesized during alcoholic fermentation by yeasts essentially contribute to the aroma profile of wines, shaping its smell, taste and mouthfeel. During grape must

fermentation, sugar is being consumed by yeasts and converted into ethanol and carbon dioxide.

At the end of the fermentations with *S. cerevisiae*, the sugar was completely consumed (Figure 10f). In contrast, the fermentations with *H. uvarum* still contained residual sugar when reaching the plateau phase, whereby the amount differed significantly between the fermentations of the different nitrogen regimes (Figure 10c). Ethanol was detected early in all fermentations and increased as the fermentation proceeded, reaching its highest level at the end of fermentation with significant higher concentrations in fermentations supplemented with DAHP (Figure 10b, e). While fermentations (Ctrl and DAHP) with *S. cerevisiae* showed ethanol levels of ~10%, fermentations with *H. uvarum* resulted in ~6% (Ctrl) and ~8% (DAHP), respectively (Figure S8a, c). Acetic acid was also measured in all fermentations at an early stage (Figure 10a, d). Surprisingly, significant higher concentrations of acetic acid were detected at the late stage of the control fermentations with *S. cerevisiae*, compared to the DAHP ones, reaching concentrations of ~0.8 g/L. Malic acid was found to decrease during the progress of fermentation, resulting in significant variations in concentration in DAHP and control fermentations at the late stage of fermentations, with higher concentrations in the control fermentations with *H. uvarum* and higher concentrations in the DAHP fermentations with *S. cerevisiae*, respectively (Figure S8b, d).

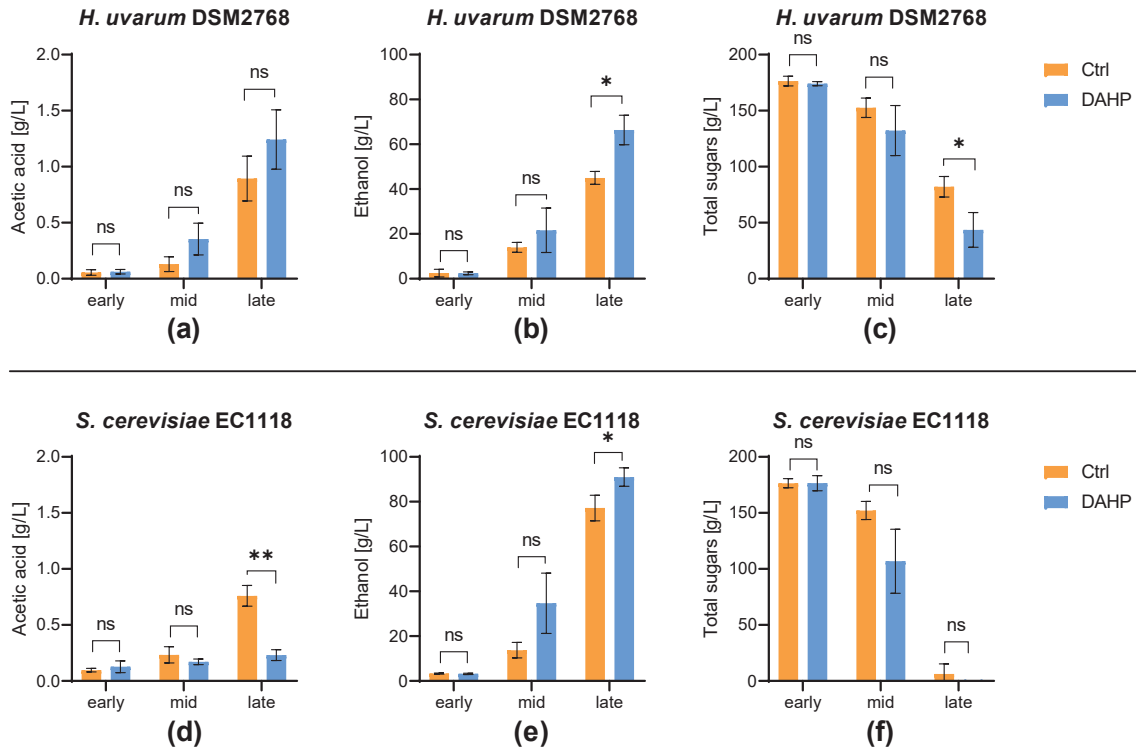

Figure 10. Concentration of acetic acid, ethanol and total sugars in fermentations using Müller-Thurgau must with (DAHP) and without (Ctrl) diammonium hydrogen phosphate supplementation at different stages of fermentation (lag phase = early, logarithm phase = mid, plateau phase = late) with (a-c) *H. uvarum* DSM2768 and (d-f) *S. cerevisiae* EC1118. Compounds were measured via HPLC analysis. Data are the mean of three independent experiments \pm SEM, two-tailed unpaired *t*-test with Welch's correction, * $p < 0.05$, ** $p < 0.01$, ns – not significant. Error bars indicate the standard deviation.

Higher alcohols provide the largest group of volatile compounds in wine, thus having an essential impact on the sensory perception of the consumer.

Figure S9 reveals the detection of the higher alcohols during fermentation and thus the time of their synthesis, whereas Figure 11 illustrates the levels of higher alcohols at the RNA-Seq sampling days, respectively. While 1-hexanol and isobutanol were already detected at the beginning of the fermentations with *H. uvarum*, higher alcohols such as isoamyl alcohol, 2-methyl butanol and 2-phenyl ethanol were first being monitored in the logarithmic phase. There were no significant differences in the higher alcohol content observed in fermentations with *H. uvarum* in both the control and DAHP fermentations. Similar to the fermentations with *H. uvarum*, concentrations of 1-hexanol and isobutanol were already measured in the lag phase, while 2-methyl butanol was first being detected during logarithmic phase of fermentation. Although isoamyl alcohol and 2-phenyl ethanol were first measured in the logarithmic phase of the control fermentations, small amounts of these substances were already detected in the lag phase of the DAHP fermentations. In contrast to fermentations with *H. uvarum*, the control fermentations with *S. cerevisiae* resulted in significantly higher detection of isoamyl alcohol, isobutanol and 2-methyl butanol at the late stage of fermentations compared to the DAHP

fermentations. Concentrations of higher alcohols increased during fermentations with both yeast strains, except for 1-hexanol, which decreased towards the end of fermentation.

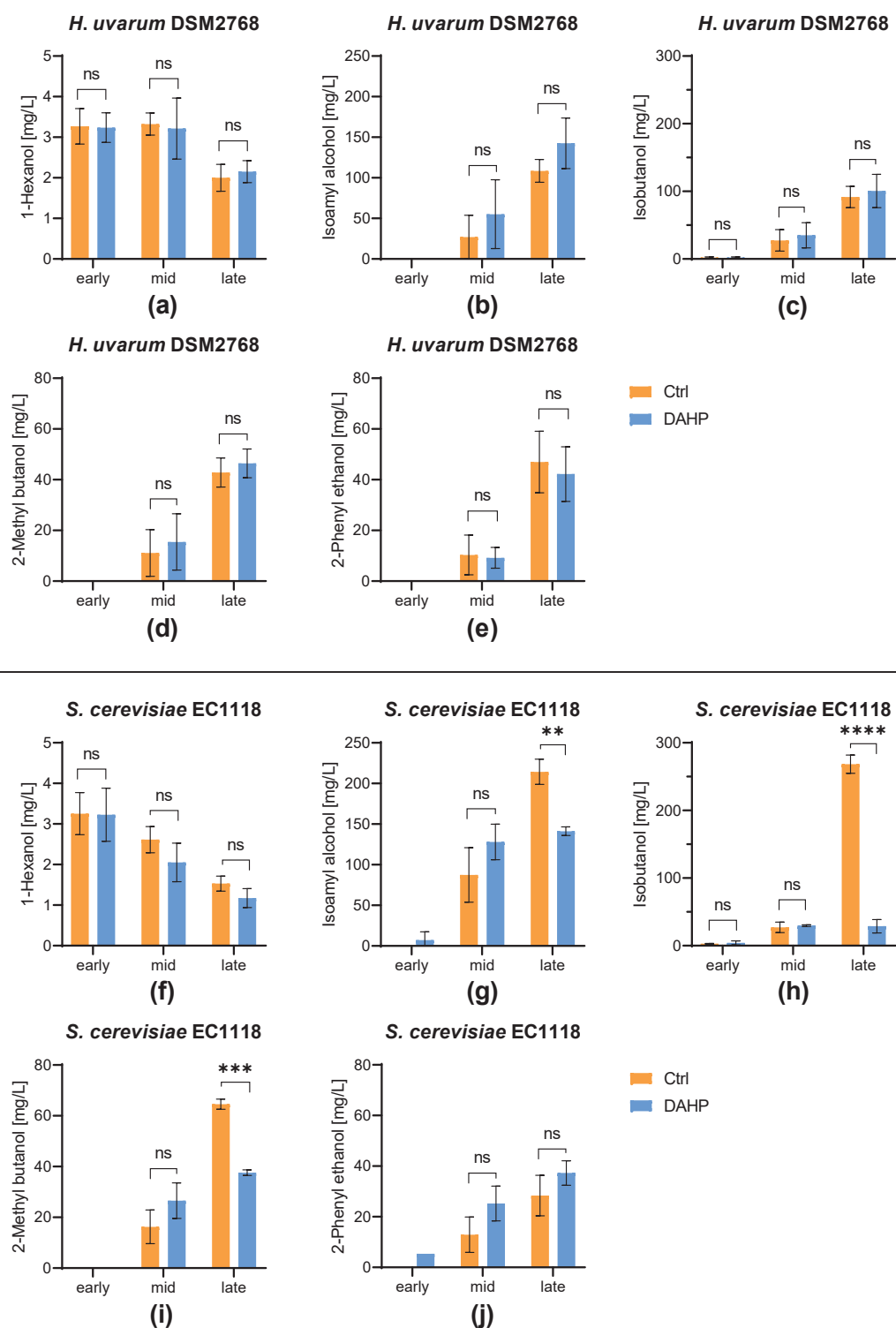

Figure 11. Higher alcohols synthesized in fermentations using Müller-Thurgau must with (DAHP) and without (Ctrl) diammonium hydrogen phosphate supplementation at different stages of fermentation (lag phase = early, logarithm phase = mid, plateau phase = late) with (a-e) *H. uvarum* DSM2768 and (f-j) *S. cerevisiae* EC1118. Higher alcohols were measured via HS-SPME-GC-MS analysis. Data are the mean of three independent experiments \pm SEM, two-tailed unpaired *t*-test with Welch's correction, ** $p < 0.01$; *** $p < 0.001$; **** $p < 0.0001$, ns – not significant. Error bars indicate the standard deviation.

H. uvarum is known for producing high amounts of acetate esters, especially ethyl acetate. Due to the very low odour threshold of esters, excessive concentrations of acetate esters easily lead to the spoilage of wines. Therefore, they decisively affect the aroma profile of the wine.

Except for the control fermentation with *H. uvarum*, where no isoamyl alcohol was detected during the lag phase, all acetate esters analysed were monitored at the early stage of *H. uvarum* fermentations (Ctrl and DAHP; Figure 12; see also Figure S10). Apart from hexyl acetate, which decreased, concentrations of all acetate esters increased during the progress of fermentations. Interestingly, significantly higher contents of isoamyl acetate, 2-methylbutyl acetate and 2-phenylethyl acetate were detected in the control fermentations at the late stage of fermentation compared to the DAHP fermentations. In contrast to the fermentations with *H. uvarum*, most of the acetate esters were first being detected at the late stage of fermentations using *S. cerevisiae*, namely ethyl acetate (Ctrl fermentations), hexyl acetate, isoamyl acetate (both DAHP fermentations) and 2-methylbutyl acetate (Ctrl and DAHP fermentations). Hexyl acetate and isoamyl acetate could not be monitored in the control fermentations. Ethyl acetate was recorded during the logarithmic phase (DAHP fermentation), whereas 2-phenylethyl acetate was already measured at early stage of fermentation (Ctrl and DAHP fermentation). Significantly higher amounts of 2-phenylethyl acetate were detected at the late stage of fermentations in DAHP fermentations than in the control fermentations with *S. cerevisiae*.

Besides acetate esters, ethyl esters also influence the aroma profile of wines. These are usually produced in smaller quantities by *H. uvarum* than acetate ester. The contents of ethyl esters are shown in Figure S11 (see also Figure S12). Fermentations with *H. uvarum* revealed no detection of ethyl decanoate, ethyl hexanoate and ethyl octanoate and ethyl butyrate only being measured at the late stage of DAHP fermentations. Ethyl isobutyrate was first being monitored in the logarithmic phase of fermentations, whereas ethyl propionate was already detected at early stages (all Ctrl and DAHP), reaching concentrations varying between ~2-3 mg/L. In comparison to the fermentations with *H. uvarum*, the ethyl esters already mentioned were detected in all *S. cerevisiae* fermentations, with most of them appearing during the logarithmic phase of fermentations. Ethyl isobutyrate was only monitored in the plateau phase, while quantities of ethyl octanoate were already measured during the early stage of DAHP fermentations. In the plateau phase, significantly higher levels of ethyl butyrate and ethyl hexanoate were detected in DAHP fermentations, while the amount of ethyl isobutyrate was significantly increased in the control fermentations.

Fermentations using *H. uvarum* showed no detection of decanoic acid and isovaleric acid, whereas hexanoic acid and octanoic acid were measured at early stage or during logarithmic phase, respectively (Figure S13; see also Figure S14). In contrast, all of these fatty acids were already monitored during the lag phase of the *S. cerevisiae* fermentations, resulting in

significant increase in the concentrations of decanoic acid and octanoic acid in DAHP fermentations, compared to the control fermentations.

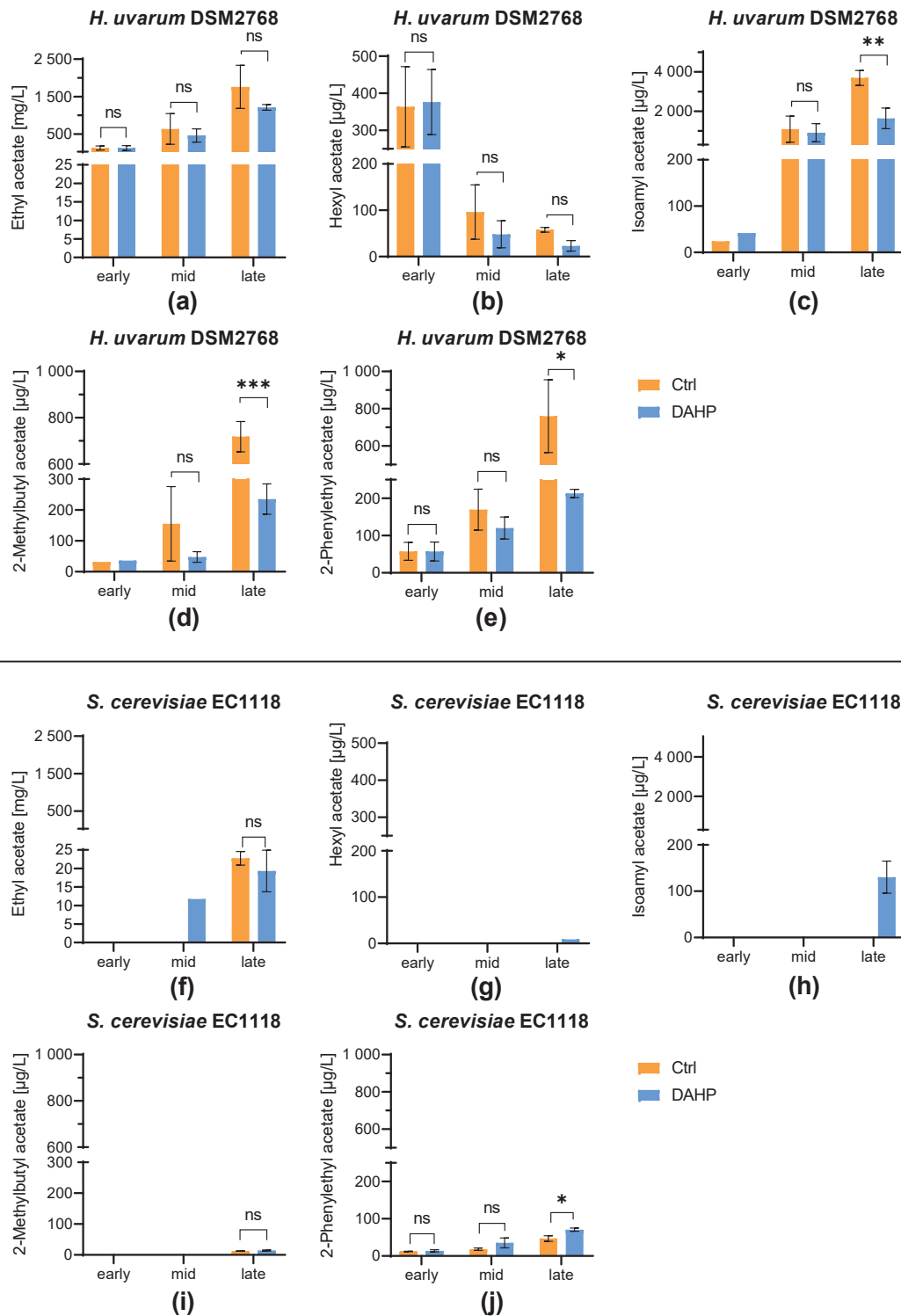

Figure 12. Acetate esters synthesized in fermentations using Müller-Thurgau must with (DAHP) and without (Ctrl) diammonium hydrogen phosphate supplementation at different stages of fermentation (lag phase = early, logarithm phase = mid, plateau phase = late) with (a-e) *H. uvarum* DSM2768 and (f-j) *S. cerevisiae* EC1118. Acetate esters were measured via HS-SPME-GC-MS analysis. Data are the mean of three independent experiments \pm SEM, two-tailed unpaired *t*-test with Welch's correction, * $p < 0.05$; ** $p < 0.01$; *** $p < 0.001$, ns – not significant. Error bars indicate the standard deviation.

Discussion

During alcoholic fermentation, hundreds of aroma compounds are being produced by yeasts (Rapp and Mandery 1986), forming the aroma profile of wines. The pathways relevant for the synthesis of these compounds, such as the Ehrlich Pathway, as well as the genes involved are well-studied within the model organism *S. cerevisiae*. Using non-*Saccharomyces* wine yeasts, so-called non-conventional yeasts, for winemaking is considered to positively contribute to the complexity of wines by enhancing the contents of volatile acidity, higher alcohols and esters, for instance (van Wyk et al. 2023). Although some non-*Saccharomyces* yeasts share similarities in metabolism to *Saccharomyces* yeasts, there are many non-conventional yeasts that appear to differ drastically in metabolism to *Saccharomyces* yeasts. In addition to the yeast strains used, also the nitrogen composition in the grape must influences the formation of aroma compounds during fermentation.

To investigate the metabolic pathways responsible for aroma synthesis in fermentations with *H. uvarum*, as well as the genes involved, fermentations using autoclaved Müller-Thurgau must (with and without DAHP supplementation) were performed in three independent experimental blocks, by shaking flasks sealed with aluminium foil. Daily sampling enabled constant oxygen exchange. This experimental set up was chosen to stimulate the metabolism of the yeasts and thus the expression of aroma-relevant genes due to constant oxygen exchange, since *H. uvarum* is known to be a slow fermenting yeast. In parallel, fermentations using the model organism *S. cerevisiae* were carried out for comparison.

Fermentation kinetics show that fermentations with *H. uvarum* carried out with both nitrogen regimes got stuck after ~10 days, reaching the plateau phase. The fermenting capacity of *H. uvarum* using the nitrogen deficient grape must was significantly lower, resulting in lower ethanol levels and higher residual total sugars in the fermentation supernatant. Even though the fermentations with *S. cerevisiae* reached the stationary phase with a time difference of 13 days, the yeast strain was able to utilise all the sugars in both the low-nitrogen and the nitrogen-enriched must, indicating high fermentation capacity to finish fermentations.

The multivariate analysis of the raw fragment counts resulted in a clear clustering of the different sampling points analysed, confirming the choice of experimental set up and indicating a good experimental design. However, the supplementation of DAHP to the grape must fermentations only showed to have a visible effect at the late stage of fermentations. The clustering of transcriptomes was very dense, especially at the early sampling time, but lost density in the course of fermentation. At the late stage, there was a greater dispersion of the individual experimental blocks. Furthermore, the number of mapped reads revealed a strong drop-off in on-feature RNA-Seq reads observed in the late stage of fermentations, indicating

low transcriptional activity in the plateau phase and subsequently a higher level of DNA contamination in the RNA libraries.

The sugar consumption was similar at the early stage of all fermentations using both yeast strains conducted with both nitrogen regimes. When reaching the plateau phase, the sugar levels were completely depleted in fermentations using *S. cerevisiae*, while fermentations with *H. uvarum* still showed to have high amounts of total sugars left in the fermentation supernatant, indicating a higher fermentation capacity by *S. cerevisiae*. This goes along with low ethanol levels detected in all fermentations at the early stage and higher concentrations found at the late stage of *S. cerevisiae* fermentations. Interestingly, both DAHP fermentations using *H. uvarum* and *S. cerevisiae* resulted in higher ethanol levels detected at the end of fermentation than the control fermentations. However, when comparing the total residual sugar levels at the late stage of fermentation, those with *S. cerevisiae* were depleted, whereas those with *H. uvarum* carried out with both nitrogen regimes showed significant variations with a higher total sugar level in the control fermentations.

At the early stage of control fermentation, YAN levels were lower in fermentations using *S. cerevisiae* than in the ones with *H. uvarum*. *S. cerevisiae* already consumed all of the NH_4^+ at that stage and also showed lower residual FAN levels. While the YAN levels were almost depleted in *S. cerevisiae* fermentations at the mid-stage of fermentation, total YAN, mainly containing NH_4^+ , was still monitored in the DAHP fermentations using *H. uvarum*. In contrast to *H. uvarum*, fermentations using *S. cerevisiae* revealed lower FAN levels at the early stage of fermentation, but about the same FAN levels were measured during the logarithmic phase of fermentations with yeast strains. Thus, *H. uvarum* seems to have taken up more FAN than *S. cerevisiae* during the period between the early and the mid sampling. During the plateau phase, FAN levels were elevated compared to the logarithmic phase in fermentations using both yeast strains. This suggests the biosynthesis or release of amino acids that were taken up by the yeast cells at the beginning of fermentation to meet their amino acid requirements and stored as excess FAN in the vacuoles (Henschke and Jiranek 1993). While FAN levels in fermentations with *S. cerevisiae* showed no differences between nitrogen regimes, fermentations with *H. uvarum* resulted in significantly higher FAN levels in DAHP fermentations at this stage. Gene expression analysis revealed the ability of both yeast strains to produce amino acids relevant for aroma compound synthesis via biosynthesis not only at the early or mid-stage of fermentation, but also when reaching the plateau phase, due to elevated expression levels of the genes involved. This is found in most cases for both nitrogen regimes. Only genes important for the biosynthesis of tyrosine and phenylalanine are expressed at a higher level at the late time point only in the DAHP fermentations with *H. uvarum*. The same applies to the genes involved in the biosynthesis of phenylalanine in *S. cerevisiae*.

Furthermore, high gene expression levels of genes involved in the amino acid degradation metabolism at the late stage of fermentation indicate the ability of both *H. uvarum* and *S. cerevisiae* in consuming amino acids also when reaching the plateau phase. The increased biosynthesis of amino acids during the plateau phase is in accordance with Bisson and Karpel (2010), who suggested that initial amino acids as well as other preferred nitrogen sources are catabolized early on, leading to the assumption that enhanced amino acid turnover during the plateau phase resulted from newly synthesized amino acids.

The nitrogen content in grape must influences the aroma compounds produced by yeasts during fermentation. Lower nitrogen concentrations, for instance, lead to the synthesis of branched-chain amino acids and esters in fermentations using *S. cerevisiae*, whereas higher nitrogen concentrations favour the production of medium-chain fatty acids and acetic acid, depending on the nitrogen source present in the must (Mas et al. 2014; Torrea et al. 2011). This is only to some extent consistent with our discoveries. We detected higher concentrations of esters, such as isoamyl acetate, 2-methylbutyl acetate and 2-phenylethyl acetate at the late stage of the *H. uvarum* fermentations as well as increased levels of ethyl isobutyrate in *S. cerevisiae* fermentations, both using nitrogen deficient must. While hexyl acetate and isoamyl acetate were only found in DAHP fermentations with *S. cerevisiae*, both control and DAHP fermentations using *S. cerevisiae* yielded amounts of 2-phenylethyl acetate, ethyl butyrate and ethyl hexanoate. The high production of isoamyl acetate in DAHP fermentations with *S. cerevisiae*, however, agrees with the findings of Miller et al. (2007). In addition, the branched-chain fatty acid isovaleric acid was not detected in fermentations with *H. uvarum* and not found in significantly higher concentrations in control fermentations with *S. cerevisiae*. DAHP fermentations using both yeast strains did not show elevated acetic acid levels. On the contrary, the control fermentations with *S. cerevisiae* showed a clearly increased acetic acid production. Moreover, fermentations supplemented with DAHP yielded higher concentrations of the medium-chain fatty acids decanoic acid and octanoic acid.

In general, higher concentrations of higher alcohols or acetate esters, derived from the branched-chain amino acids (isoleucine, valine, leucine), the aromatic amino acid phenylalanine as well as the polar uncharged amino acid threonine, have been detected in the fermentations with *S. cerevisiae* or *H. uvarum*, respectively, using the nitrogen deficient grape must. An explanation for that could be the preference for NH_4^+ uptake by yeasts, leading to the increased processing of NH_4^+ by the yeasts in the must supplemented with DAHP. This results in a lower production of amino acid-derived aroma compounds and promotes the synthesis of other volatile substances derived from glycolysis, such as ethanol. This is also evident from the ethanol measurements of both yeast strains fermented with additional DAHP, as well as the higher consumption of total sugars in DAHP fermentations using *H. uvarum*.

Some correlations between the formation of the aroma compounds and gene expressions are also observed.

Aldehyde dehydrogenases catalyse the oxidation of acetic acid from acetaldehyde. In *H. uvarum*, higher expression levels of aldehyde dehydrogenases are recorded than in *S. cerevisiae*, which can be confirmed by higher amounts of acetic acid produced by *H. uvarum* according to metabolomics. While the expression levels of the genes coding for aldehyde dehydrogenases did not differ in the fermentations of different nitrogen regimes with *H. uvarum*, higher expression levels of *ALD3* and *ALD4* were measured in the control fermentations with *S. cerevisiae* corresponding to the high formation of acetic acid in these fermentations.

Unlike *H. vineae*, a member of the slow-evolving lineage (SEL), showing high expression levels of *ARO8-10* and their duplications when reaching the plateau phase (Giorello et al. 2019), *H. uvarum*, belonging to the fast-evolving lineage (FEL), showed similar expression levels of these genes and their duplications, except for the down-regulation of an *ARO8* duplicate during the logarithmic phase.

Similar to what Mendes et al. (2017) described, genes directly involved in the synthesis of higher alcohols were found to be up-regulated in *S. cerevisiae*, such as *SFA1*, *ADH7*, *AAD3*, *AAD4*, *AAD10* and *AAD14* (all up-regulated at the late stage of fermentation, except for *AAD10*, which is up-regulated during the logarithmic phase). This is in accordance to the elevated levels of higher alcohols in the fermentations of *S. cerevisiae* with the nitrogen deficient grape must. In fermentations of grape must supplemented with DAHP, however, only *ADH4* (mid-stage of fermentation) and *AAD4* (late stage of fermentation) revealed to be up-regulated in their expression levels, explaining the lower amounts of higher alcohols that were produced in DAHP fermentations using *S. cerevisiae*. In contrast, *H. uvarum* shows an up-regulation of *ADH7* in both the control and the DAHP fermentations, resulting in similar concentrations of higher alcohols synthesized.

At the mid-stage of *S. cerevisiae* fermentations, a high increase in concentrations of ethyl butyrate and ethyl hexanoate as well as an increase in isoamyl alcohol in DAHP fermentations, is observed. Isoamyl alcohol is produced from the amino acid leucine and can also be synthesised by intermediates formed during the degradation of valine. In addition to the genes involved in the degradation of these amino acids, which are highly expressed at both the early and mid-stage of fermentation, *ADH4* and *ADH5* as well as *PDC6* are found to be highly expressed during the logarithmic phase, suggesting to favour a fast increase in synthesis of volatiles derived from these amino acids. The consistently high expression of *EHT1* and the additional high expression of *EEB1* setting in at the middle time point explain the drastic increase in ethyl esters detected at that time point.

The genes *CHA1* and *CYS3* are in charge of the degradation of the polar uncharged amino acid threonine, whose degradation product, α -ketobutyrate, can also be fed into the catabolism of isoleucine leading to the synthesis of 2-methyl butanol in addition to being further metabolised to 1-propanol and 1-butanol. Both genes show high expression levels at the early stage of *S. cerevisiae* control fermentations, whereas only *CYS3* is higher expressed at that stage in the DAHP fermentations. Additionally, *CYS3* is highly expressed in *S. cerevisiae* control fermentations reaching the plateau phase. The higher activity of both genes in the control fermentations with *S. cerevisiae* could be an explanation for the higher amounts of 2-methyl butanol found at the late stage of *S. cerevisiae* fermentations using nitrogen deficient must.

The expression levels of *PDA1* and *LAT1*, which are encoding pyruvate dehydrogenases, involved in the oxidative decarboxylation of pyruvate to acetyl-coA, show to be up-regulated in *H. uvarum* when being fermented using the DAHP supplemented grape must at the late stage of fermentation, indicating an enhanced formation of acetyl-coA via this metabolic pathway in *H. uvarum*, which in turn is required for the formation of acetate esters.

When comparing the gene expression levels between *S. cerevisiae* and *H. uvarum*, the higher activity of *ARO8-10*, *PHA2*, *PYC2*, *THR4*, *TRP2-3* as well as *TRP5* in *H. uvarum* is particularly striking. All of these genes are in charge of metabolic processes regarding the biosynthesis and/ or degradation of the branched-chain amino acids, aromatic amino acids, the polar uncharged amino acid threonine and the sulphur-containing amino acid methionine, suggesting higher capacities in amino acid utilisation and thus a concomitant enhanced ability to produce amino acid-derived volatiles by *H. uvarum*.

Alcohol acetyltransferases, such as *ATF1*, *ATF2* and *EAT1* are known to be responsible for esterification of higher alcohols to acetate esters in *S. cerevisiae* (Kruis et al. 2018). Badura et al. (2021) showed a reduced ethyl acetate synthesis of about ~40% in an *H. uvarum atf1* mutant strain, suggesting more genes to be involved in the production of ethyl acetate. Seixas et al. (2019) identified two more *H. uvarum* genes probably having alcohol acetyltransferase activity. Furthermore, with the aid of protein sequences described in Kruis et al. (2017) we could identify three more genes putatively involved in esterification in the *H. uvarum* yeast strain we used for experiments. Looking at the expression levels of these putative alcohol acetyltransferase genes, their strong expression in *H. uvarum* in contrast to the weaker expression in *S. cerevisiae* is remarkable. In the fermentations with *S. cerevisiae*, these genes are only very weakly expressed at the early time point and the expression levels increase at the middle and late time point. Since the fermentations with *S. cerevisiae* resulted in late detection of most of the acetate esters investigated, these results agree with the metabolomics. *H. uvarum*, however, shows high expression levels of putative genes encoding alcohol

acetyltransferases at all stages of fermentation investigated. Compared to *S. cerevisiae*, *H. uvarum* was able to produce large amounts of acetate esters, which can be explained by the highly expressed alcohol acetyltransferases as well as the multiple homologs showing acetyltransferase activity found in *H. uvarum*. Furthermore, the absence of *EHT1* inhibits the synthesis of ethyl esters and therefore, favours the esterification of the higher alcohols into acetate esters, similar to the findings of Giorello et al. (2019). Also, *H. uvarum* is lacking genes involved in the transamination, decarboxylation and reduction reactions of the Ehrlich pathway, leading to a lower synthesis of higher alcohols, which are immediately converted to acetate esters due to the high amount of genes encoding for alcohol acetyltransferases.

Although, performing grape must fermentations with different nitrogen regimes did not reveal major differences in the transcriptomic profile of the yeast strains investigated, an effect of the nitrogen supplementation could be seen in both the fermentation kinetics and the aroma profile. In conclusion, *H. uvarum* reveals a different acetate ester profile than *S. cerevisiae*. On the one hand, *H. uvarum* shows to have less genes responsible for the synthesis of higher alcohols, and on the other, *H. uvarum* unravelled to have more genes containing alcohol acetyltransferase activity, resulting in increased acetate ester production. An up-regulation of genes involved in the production of acetyl-coA, higher alcohols as well as acetate esters additionally favours the synthesis of acetate esters.

Acknowledgements: We would like to thank Frauke Dormann for analysing the amino acid concentration of the Müller-Thurgau grape must as part of the AromaPlus project.

References

- Alexandre, H.; Charpentier, C. (1998): Biochemical aspects of stuck and sluggish fermentation in grape must. In *J. Ind. Microbiol. Biotechnol.* 20 (1), pp. 20–27. DOI: 10.1038/sj.jim.2900442.
- Anders, S.; Huber, W. (2010): Differential expression analysis for sequence count data. In *Genome Biol.* 11 (10), R106. DOI: 10.1186/gb-2010-11-10-r106.
- Badura, J.; Kiene, F.; Brezina, S.; Fritsch, S.; Semmler, H.; Rauhut, D. et al. (2023a): Aroma profiles of *Vitis vinifera* L. cv. Gewürztraminer must fermented with co-cultures of *Saccharomyces cerevisiae* and seven *Hanseniaspora* spp. In *Fermentation* 9 (2), 109. DOI: 10.3390/fermentation9020109.
- Badura, J.; Medić, M.; van Wyk, N.; Krause, B.; Semmler, H.; Brezina, S. et al. (2023b): Synthesis of aroma compounds as a function of different nitrogen sources in fermentations using non-*Saccharomyces* wine yeasts. In *Microorganisms* 11 (1), 14. DOI: 10.3390/microorganisms11010014.
- Badura, J.; van Wyk, N.; Brezina, S.; Pretorius, I. S.; Rauhut, D.; Wendland, J.; von Wallbrunn, C. (2021): Development of genetic modification tools for *Hanseniaspora uvarum*. In *Int. J. Mol. Sci.* 22 (4), 1943. DOI: 10.3390/ijms22041943.
- Bell, S.-J.; Henschke, P. A. (2005): Implications of nitrogen nutrition for grapes, fermentation and wine. In *Aust J Grape Wine Res* 11 (3), pp. 242–295. DOI: 10.1111/j.1755-0238.2005.tb00028.x.
- Bisson, L. F.; Karpel, J. E. (2010): Genetics of yeast impacting wine quality. In *Annu Rev Food Sci Technol* 1 (1), pp. 139–162. DOI: 10.1146/annurev.food.080708.100734.
- Brůna, T.; Lomsadze, A.; Borodovsky, M. (2020): GeneMark-EP+: Eukaryotic gene prediction with self-training in the space of genes and proteins. In *NAR genom. bioinform.* 2 (2), lqaa026. DOI: 10.1093/nargab/lqaa026.
- Bushnell, B.; Rood, J.; Singer, E. (2017): BBMerge - Accurate paired shotgun read merging via overlap. <https://www.sourceforge.net/projects/bbmap/>. In *PLOS ONE* 12 (10), e0185056. DOI: 10.1371/journal.pone.0185056.
- Camacho, C.; Coulouris, G.; Avagyan, V.; Ma, N.; Papadopoulos, J.; Bealer, K.; Madden, T. L. (2009): BLAST+: Architecture and applications. In *BMC Bioinform.* 10, p. 421. DOI: 10.1186/1471-2105-10-421.
- Carbon, S.; Ireland, A.; Mungall, C. J.; Shu, S.Q.; Marshall, B.; Lewis, S. (2009): AmiGO: Online access to ontology and annotation data. In *Bioinformatics (Oxford, England)* 25 (2), pp. 288–289. DOI: 10.1093/bioinformatics/btn615.
- Carbon, S.; Mungall, C. (2018): Gene ontology data archive.
- Ciani, M.; Beco, L.; Comitini, F. (2006): Fermentation behaviour and metabolic interactions of multistarter wine yeast fermentations. In *Int. J. Food Microbiol.* 108 (2), pp. 239–245. DOI: 10.1016/j.ijfoodmicro.2005.11.012.
- Comitini, F.; Capece, A.; Ciani, M.; Romano, P. (2017): New insights on the use of wine yeasts. In *Current Opinion in Food Science* 13, pp. 44–49. DOI: 10.1016/j.cofs.2017.02.005.

- Csapó, J.; Lóki, K.; Csapóné Kiss, Z.; Albert, C. (2008): Separation and determination of the amino acids by ion exchange column chromatography applying postcolumn derivatization. In *Acta Univ. Sapientiae Aliment.* (1), pp. 5–29. Available online at https://dea.lib.unideb.hu/dea/bitstream/handle/2437/248858/file_up_0_csap%c3%b3aminosavioncser_ekormatogr%c3%a1fia.pdf?sequence=1.
- Darling, A. C. E.; Mau, B.; Blattner, F. R.; Perna, N. T. (2004): Mauve: Multiple alignment of conserved genomic sequence with rearrangements. In *Genome Res.* 14 (7), pp. 1394–1403. DOI: 10.1101/gr.2289704.
- Di Maro, E.; Ercolini, D.; Coppola, S. (2007): Yeast dynamics during spontaneous wine fermentation of the Catalanesca grape. In *Int. J. Food Microbiol.* 117 (2), pp. 201–210. DOI: 10.1016/j.ijfoodmicro.2007.04.007.
- Dobin, A.; Davis, C. A.; Schlesinger, F.; Drenkow, J.; Zaleski, C.; Jha, S. et al. (2013): STAR: Ultrafast universal RNA-seq aligner. In *Bioinformatics* 29 (1), pp. 15–21. DOI: 10.1093/bioinformatics/bts635.
- Drumonde-Neves, J.; Fernandes, T.; Lima, T.; Pais, C.; Franco-Duarte, R. (2021): Learning from 80 years of studies: A comprehensive catalogue of non-*Saccharomyces* yeasts associated with viticulture and winemaking. In *FEMS yeast Res.* 21 (3). DOI: 10.1093/femsyr/foab017.
- Dukes, B. C.; Butzke, C. E. (1998): Rapid determination of primary amino acids in grape juice using an o-phthaldialdehyde/N-acetyl-L-cysteine spectrophotometric assay. In *Am. J. Enol. Vitic.* 49 (2), pp. 125–134. DOI: 10.5344/ajev.1998.49.2.125.
- Dzialo, M. C.; Park, R.; Steensels, J.; Lievens, B.; Verstrepen, K. J. (2017): Physiology, ecology and industrial applications of aroma formation in yeast. In *FEMS Microbiol. Rev.* 41 (Supp_1), S95-S128. DOI: 10.1093/femsre/fux031.
- Eddy, S. R. (2011): Accelerated profile HMM searches. In *PLoS Comput. Biol.* 7 (10), e1002195. DOI: 10.1371/journal.pcbi.1002195.
- Giorello, F.; Valera, M. Jose; Martin, V.; Parada, A.; Salzman, V.; Camesasca, L. et al. (2019): Genomic and transcriptomic basis of *Hanseniaspora vineae*'s impact on flavor diversity and wine quality. In *Applied and environmental microbiology* 85 (1). DOI: 10.1128/AEM.01959-18.
- Gutiérrez-Gamboa, G.; Carrasco-Quiroz, M.; Martínez-Gil, A. M.; Pérez-Álvarez, E. P.; Garde-Cerdán, T.; Moreno-Simunovic, Y. (2018): Grape and wine amino acid composition from Carignan noir grapevines growing under rainfed conditions in the Maule Valley, Chile: Effects of location and rootstock. In *Food Res. Int.* 105, pp. 344–352. DOI: 10.1016/j.foodres.2017.11.021.
- Gutiérrez-Gamboa, G.; Garde-Cerdán, T.; Rubio-Bretón, P.; Pérez-Álvarez, E. P. (2020): Study of must and wine amino acids composition after seaweed applications to Tempranillo blanco grapevines. In *Food Chem.* 308, p. 125605. DOI: 10.1016/j.foodchem.2019.125605.
- Han, B.; Gao, J.; Han, X.; Deng, H.; Wu, T.; Li, C. et al. (2022): *Hanseniaspora uvarum* FS35 degrade putrescine in wine through the direct oxidative deamination pathway of copper amine oxidase 1. In *Food Research International* 162, p. 111923. DOI: 10.1016/j.foodres.2022.111923.

Heit, C.; Martin, S. J.; Yang, F.; Inglis, D. L. (2018): Osmoadaptation of wine yeast (*Saccharomyces cerevisiae*) during Icewine fermentation leads to high levels of acetic acid. In *J. Appl. Microbiol.* 124 (6), pp. 1506–1520. DOI: 10.1111/jam.13733.

Henschke, P. A.; Jiranek, V. (1993): Yeast - Metabolism of nitrogen compounds. In G. H. Fleet (Ed.): *Wine microbiology and biotechnology*. London: Taylor & Francis, pp. 77–164.

Hoff, K. J.; Lomsadze, A.; Borodovsky, M.; Stanke, M. (2019): Whole-genome annotation with BRAKER. In *Methods Mol. Biol.* 1962, pp. 65–95. DOI: 10.1007/978-1-4939-9173-0_5.

Ignatiadis, N.; Klaus, B.; Zaugg, J. B.; Huber, W. (2016): Data-driven hypothesis weighting increases detection power in genome-scale multiple testing. In *Nat. Methods* 13 (7), pp. 577–580. DOI: 10.1038/nmeth.3885.

Jolly, N. P.; Varela, C.; Pretorius, I. S. (2014): Not your ordinary yeast: Non-*Saccharomyces* yeasts in wine production uncovered. In *FEMS yeast research* 14 (2), pp. 215–237. DOI: 10.1111/1567-1364.12111.

Krause, B.; Löhnertz, O. (2017): Saccharopin und Pipecolinsäure: Diagnostische Biomarker in der klassischen Aminosäureanalytik. In *MTA-Dialog* (18), pp. 316–321.

Kruis, A. J.; Gallone, B.; Jonker, T.; Mars, A. E.; van Rijswijck, I. M. H.; Wolkers-Rooijackers, J. C. M. et al. (2018): Contribution of *Eat1* and other alcohol acyltransferases to ester production in *Saccharomyces cerevisiae*. In *Front. Microbiol.* 9, p. 3202. DOI: 10.3389/fmicb.2018.03202.

Kruis, A. J.; Levisson, M.; Mars, A. E.; van der Ploeg, M.; Garcés Daza, F.; Ellena, V. et al. (2017): Ethyl acetate production by the elusive alcohol acetyltransferase from yeast. In *Metab. Eng.* 41, pp. 92–101. DOI: 10.1016/j.ymben.2017.03.004.

Kuznetsov, D.; Tegenfeldt, F.; Manni, M.; Seppey, M.; Berkeley, M.; Kriventseva, E. V.; Zdobnov, E. M. (2023): OrthoDB v11: Annotation of orthologs in the widest sampling of organismal diversity. <https://www.orthodb.org/>. In *Nucleic acids research* 51 (D1), D445-D451. DOI: 10.1093/nar/gkac998.

Langenberg, A.-K.; Bink, F. J.; Wolff, L.; Walter, S.; von Wallbrunn, C.; Grossmann, M. et al. (2017): Glycolytic functions are conserved in the genome of the wine yeast *Hanseniaspora uvarum*, and pyruvate kinase limits its capacity for alcoholic fermentation. In *Appl. Environ. Microbiol.* 83 (22). DOI: 10.1128/AEM.01580-17.

Lleixà, J.; Manzano, M.; Mas, A.; Del Portillo, M. C. (2016): *Saccharomyces* and non-*Saccharomyces* competition during microvinification under different sugar and nitrogen conditions. In *Front. Microbiol.* 7, p. 1959. DOI: 10.3389/fmicb.2016.01959.

Love, M. I.; Huber, W.; Anders, S. (2014): Moderated estimation of fold change and dispersion for RNA-seq data with DESeq2. In *Genome Biol.* 15 (12), p. 550. DOI: 10.1186/s13059-014-0550-8.

Marullo, P.; Trujillo, M.; Viannais, R.; Hercman, L.; Guillaumie, S.; Colonna-Ceccaldi, B. et al. (2021): Metabolic, organoleptic and transcriptomic impact of *Saccharomyces cerevisiae* genes involved in the biosynthesis of linear and substituted esters. In *Int. J. Mol. Sci.* 22 (8). DOI: 10.3390/ijms22084026.

- Mas, A.; Guillamon, J. M.; Torija, M. J.; Beltran, G.; Cerezo, A. B.; Troncoso, A. M.; Garcia-Parrilla, M. C. (2014): Bioactive compounds derived from the yeast metabolism of aromatic amino acids during alcoholic fermentation. In *BioMed Res. Int.* 2014, p. 898045. DOI: 10.1155/2014/898045.
- Mas, A.; Guillamón, J. M.; Beltran, G. (2016): Editorial: Non-conventional yeast in the wine industry. In *Front. Microbiol.* 7, p. 1494. DOI: 10.3389/fmicb.2016.01494.
- Masneuf-Pomarede, I.; Bely, M.; Marullo, P.; Albertin, W. (2015): The genetics of non-conventional wine yeasts: Current knowledge and future challenges. In *Front. Microbiol.* 6, p. 1563. DOI: 10.3389/fmicb.2015.01563.
- Mendes, I.; Sanchez, I.; Franco-Duarte, R.; Camarasa, C.; Schuller, D.; Dequin, S.; Sousa, M. J. (2017): Integrating transcriptomics and metabolomics for the analysis of the aroma profiles of *Saccharomyces cerevisiae* strains from diverse origins. In *BMC genomics* 18 (1), p. 455. DOI: 10.1186/s12864-017-3816-1.
- Mi, H.; Muruganujan, A.; Ebert, D.; Huang, X.; Thomas, P. D. (2019): PANTHER version 14: more genomes, a new PANTHER GO-slim and improvements in enrichment analysis tools. In *Nucleic Acids Res.* 47 (D1), D419-D426. DOI: 10.1093/nar/gky1038.
- Miller, A. C.; Wolff, S. R.; Bisson, L. F.; Ebeler, S. E. (2007): Yeast strain and nitrogen supplementation: Dynamics of volatile ester production in Chardonnay juice fermentations. In *Am J Enol Vitic.* 58 (4), pp. 470–483. DOI: 10.5344/ajev.2007.58.4.470.
- Nurk, S.; Bankevich, A.; Antipov, D.; Gurevich, A.; Korobeynikov, A.; Lapidus, A. et al. (2013): Assembling genomes and mini-metagenomes from highly chimeric reads. In M. Deng, R. Jiang, F. Sun, X. Zhang (Eds.): *Research in Computational Molecular Biology. RECOMB: Springer, Berlin, Heidelberg (Lecture Notes in Computer Sciences, 7821)*, pp. 158–170. Available online at https://link.springer.com/chapter/10.1007/978-3-642-37195-0_13.
- Pretorius, I. S. (2000): Tailoring wine yeast for the new millennium: Novel approaches to the ancient art of winemaking. In *Yeast* 16 (8), pp. 675–729. DOI: 10.1002/1097-0061(20000615)16:8<675::AID-YEA585>3.0.CO;2-B.
- R Core Team (R version 4.0.3 2020): R: A language and environment for statistical computing. R Foundation for Statistical Computing. Vienna, Austria. Available online at <https://www.R-project.org/>.
- Rapp, A.; Mandery, H. (1986): Wine aroma. In *Experientia* 42 (8), pp. 873–884. DOI: 10.1007/BF01941764.
- Romano, P.; Fiore, C.; Paraggio, M.; Caruso, M.; Capece, A. (2003): Function of yeast species and strains in wine flavour. In *Int. J. Food Microbiol.* 86 (1-2), pp. 169–180. DOI: 10.1016/s0168-1605(03)00290-3.
- Schulthess, D.; Ettlinger, L. (1978): Influence of the concentration of branched chain amino acids on the formation of fusel alcohols. In *J. Inst. Brew.* 84 (4), pp. 240–243. DOI: 10.1002/j.2050-0416.1978.tb03881.x.

- Seixas, I.; Barbosa, C.; Mendes-Faia, A.; Güldener, U.; Tenreiro, R.; Mendes-Ferreira, A.; Mira, N. P. (2019): Genome sequence of the non-conventional wine yeast *Hanseniaspora guilliermondii* UTAD222 unveils relevant traits of this species and of the *Hanseniaspora* genus in the context of wine fermentation. In *DNA Res.* 26 (1), pp. 67–83. DOI: 10.1093/dnares/dsy039.
- Simão, F. A.; Waterhouse, R. M.; Ioannidis, P.; Kriventseva, E. V.; Zdobnov, E. M. (2015): BUSCO: Assessing genome assembly and annotation completeness with single-copy orthologs. In *Bioinformatics* 31 (19), pp. 3210–3212. DOI: 10.1093/bioinformatics/btv351.
- Song, L.; Florea, L. (2015): Rcorrector: Efficient and accurate error correction for Illumina RNA-seq reads. In *GigaScience* 4 (1), p. 48. DOI: 10.1186/s13742-015-0089-y.
- Steenwyk, J. L.; Opulente, D. A.; Kominek, J.; Shen, X.-X.; Zhou, X.; Labella, A. L. et al. (2019): Extensive loss of cell-cycle and DNA repair genes in an ancient lineage of bipolar budding yeasts. In *PLoS Biol.* 17 (5), e3000255. DOI: 10.1371/journal.pbio.3000255.
- Ter-Hovhannisyanyan, V.; Lomsadze, A.; Chernoff, Y. O.; Borodovsky, M. (2008): Gene prediction in novel fungal genomes using an ab initio algorithm with unsupervised training. In *Genome Res.* 18 (12), pp. 1979–1990. DOI: 10.1101/gr.081612.108.
- The Gene Ontology Consortium; Ashburner, M.; Ball, C. A.; Blake, J. A.; Botstein, D.; Butler, H. et al. (2000): Gene ontology: Tool for the unification of biology. In *Nat. Genet.* 25 (1), pp. 25–29. DOI: 10.1038/75556.
- The Gene Ontology Consortium; Ashburner, M.; Ball, C. A.; Blake, J. A.; Botstein, D.; Butler, H. et al. (2021): The Gene Ontology resource: Enriching a GOld mine. In *Nucleic Acids Res.* 49 (D1), D325–D334. DOI: 10.1093/nar/gkaa1113.
- The UniProt Consortium (2023): UniProt: The universal protein knowledgebase in 2023. <https://www.uniprot.org/>. In *Nucleic acids research* 51 (D1), D523–D531. DOI: 10.1093/nar/gkac1052.
- Torrea, D.; Varela, C.; Ugliano, M.; Ancin-Azpilicueta, C.; Leigh Francis, I.; Henschke, P. A. (2011): Comparison of inorganic and organic nitrogen supplementation of grape juice - Effect on volatile composition and aroma profile of a Chardonnay wine fermented with *Saccharomyces cerevisiae* yeast. In *Food Chem.* 127 (3), pp. 1072–1083. DOI: 10.1016/j.foodchem.2011.01.092.
- Valera, M. J.; Boido, E.; Dellacassa, E.; Carrau, F. (2020): Comparison of the glycolytic and alcoholic fermentation pathways of *Hanseniaspora vineae* with *Saccharomyces cerevisiae* wine yeasts. In *Fermentation* 6 (3), p. 78. DOI: 10.3390/fermentation6030078.
- van Wyk, N.; Badura, J.; von Wallbrunn, C.; Pretorius, I. S. (2023): Exploring future applications of the apiculate yeast *Hanseniaspora*. In *Crit. Rev. Biotechnol.*, pp. 1–20. DOI: 10.1080/07388551.2022.2136565.
- Varela, C.; Pizarro, F.; Agosin, E. (2004): Biomass content governs fermentation rate in nitrogen-deficient wine musts. In *Appl. Environ. Microbiol.* 70 (6), pp. 3392–3400. DOI: 10.1128/AEM.70.6.3392-3400.2004.

Zott, K.; Miot-Sertier, C.; Claisse, O.; Lonvaud-Funel, A.; Masneuf-Pomarede, I. (2008): Dynamics and diversity of non-*Saccharomyces* yeasts during the early stages in winemaking. In *Int. J. Food Microbiol.* 125 (2), pp. 197–203. DOI: 10.1016/j.ijfoodmicro.2008.04.001.

Regulated gene expression of flavour relevant genes in
Hanseniaspora uvarum

Badura, J.; Michling, F.; Semmler, H.; Brezina, S.; Rauhut, D.; Rühl, M.; von Wallbrunn, C.

Supporting Information

Supplementary Material

Supplementary Figures:

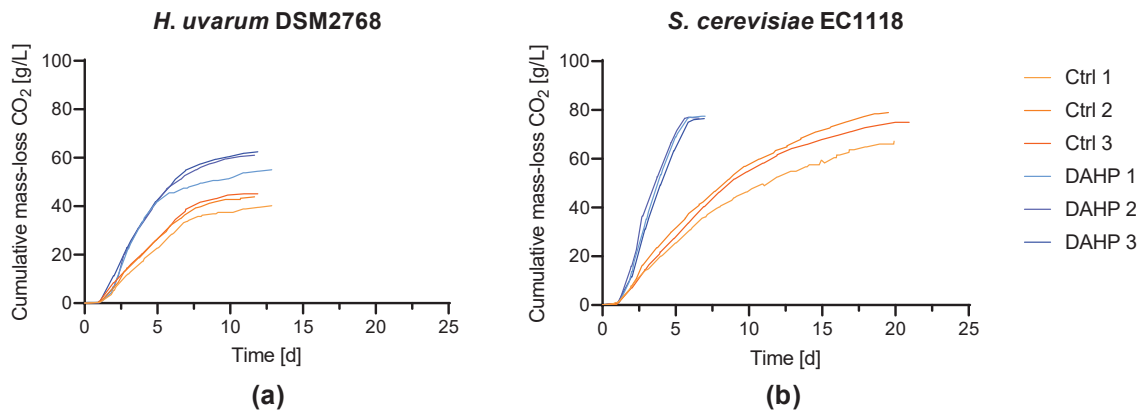

Figure S 1. Fermentation kinetics (cumulative mass-loss CO₂ [g/L]) of fermentations with (a) *H. uvarum* DSM2768 and (b) *S. cerevisiae* EC1118 using Müller-Thurgau (MT) must (Ctrl) and MT must supplemented with diammonium hydrogen phosphate (DAHP). Fermentations were performed in three independent experiments (1-3).

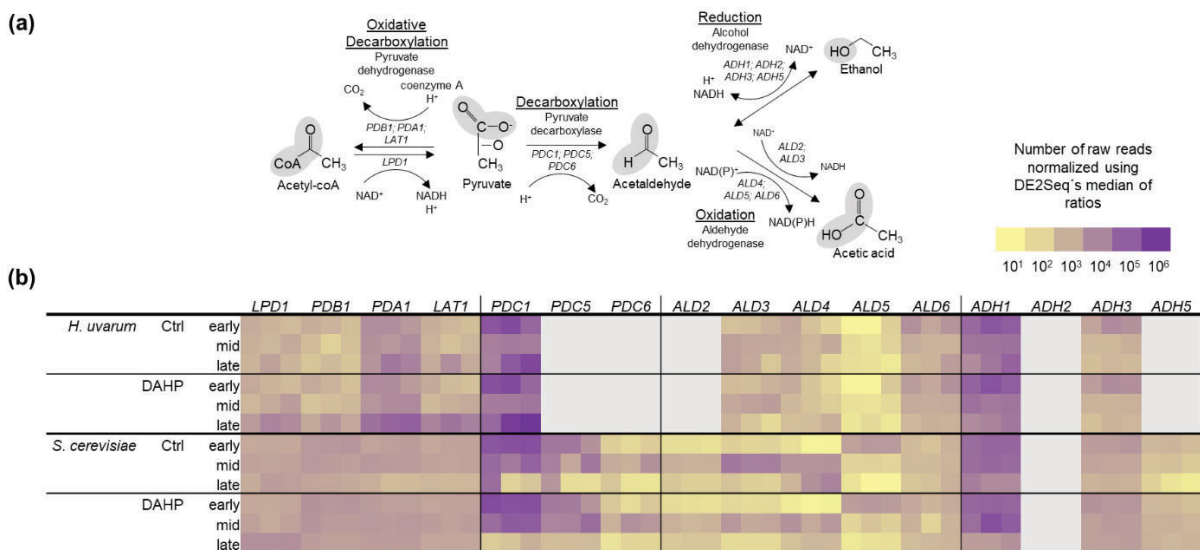

Figure S 2. Conversion of pyruvate to acetyl-coA, ethanol and acetic acid, respectively, including genes involved as well as their expression levels. (a) Conversion of pyruvate to acetyl-coA, ethanol and acetic acid, labelled with enzymes and encoding genes known to catalyse the reactions in *S. cerevisiae*. Specific molecular groups are highlighted (modified from Dzialo et al. (2017) and Heit et al. (2018)). (b) Logarithm (log₁₀) of the raw reads normalized by DE2Seq's median of ratios (MoR) showing the expression levels of genes involved in the conversion of pyruvate to acetyl-coA, ethanol and acetic acid in fermentations using Müller-Thurgau must with (DAHP) and without (Ctrl) diammonium hydrogen phosphate supplementation at different stages of fermentation (lag phase = early, logarithmic phase = mid, plateau phase = late) with *H. uvarum* DSM2768 (*H.u.*) and *S. cerevisiae* EC1118 (*S.c.*). The legend shows the number of normalized raw reads using DE2Seq's MoR, with lighter colours indicating lower expression levels, whereas darker colours indicate higher expression levels. Genes with no annotation found are marked in grey.

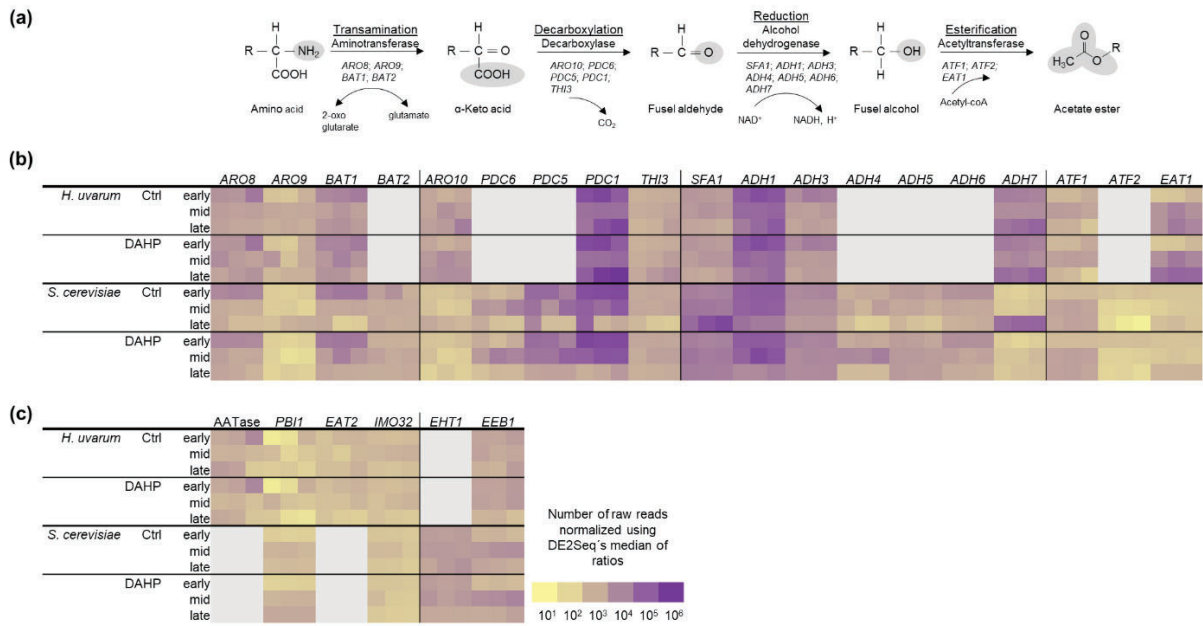

Figure S 3. The Ehrlich Pathway with subsequent esterification and the genes involved as well as their expression. (a) Conversion of amino acids into fusel aldehydes, fusel alcohols and acetate esters, indicated with enzymes and encoding genes known in *S. cerevisiae* to catalyse the reactions. Specific molecular groups are highlighted (modified from Badura et al. (2023)). (b) Logarithm (\log_{10}) of the raw reads normalized by DE2Seq's median of ratios (MoR) showing the expression levels of genes involved in the Ehrlich pathway in fermentations using Müller-Thurgau must with (DAHP) and without (Ctrl) diammonium hydrogen phosphate supplementation at different stages of fermentation (lag phase = early, logarithmic phase = mid, plateau phase = late) with *H. uvarum* DSM2768 (*H.u.*) and *S. cerevisiae* EC1118 (*S.c.*). (c) Log₁₀ of the raw reads normalized by DE2Seq's MoR showing the expression levels of genes showing AATase activity (AATase, *PBI1*), homologs of *EAT1* (*EAT2*, *IMO32*) as well as genes involved in ethyl ester synthesis (*EHT1*, *EEB1*) in DAHP and Ctrl fermentations using Müller-Thurgau at different stages of fermentation (lag phase = early, logarithmic phase = mid, plateau phase = late) with *H. uvarum* DSM2768 (*H.u.*) and *S. cerevisiae* EC1118 (*S.c.*). The legend shows the number of normalized raw reads using DE2Seq's MoR, with lighter colours indicating lower expression levels, whereas darker colours indicate higher expression levels. Genes with no annotation found are marked in grey.

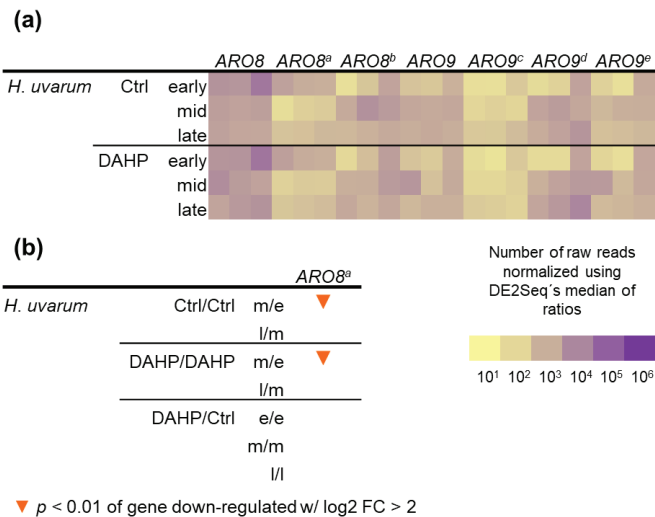

Figure S 4. Expression of *ARO8/ ARO9* duplications. **(a)** Logarithm (\log_{10}) of the raw reads normalized by DE2Seq's median of ratios (MoR) showing the expression levels and **(b)** differentially expressed genes (\log_2 fold change; ▼ $p < 0.01$ of gene down-regulated w/ $\log_2 FC > 2$) of *ARO8* and *ARO9* and their duplicates, respectively, in fermentations using Müller-Thurgau must with (DAHP) and without (Ctrl) diammonium hydrogen phosphate supplementation at different stages of fermentation (lag phase = early, e; logarithmic phase = mid, m; plateau phase = late, l) with *H. uvarum* DSM2768. The legend shows the number of normalized raw reads using DE2Seq's MoR, with lighter colours indicating lower expression levels, whereas darker colours indicate higher expression levels. ^a K68_g0787, ^b K68_g2390, ^c K68_g0017, ^d K68_g1017, ^e K68_g1897.

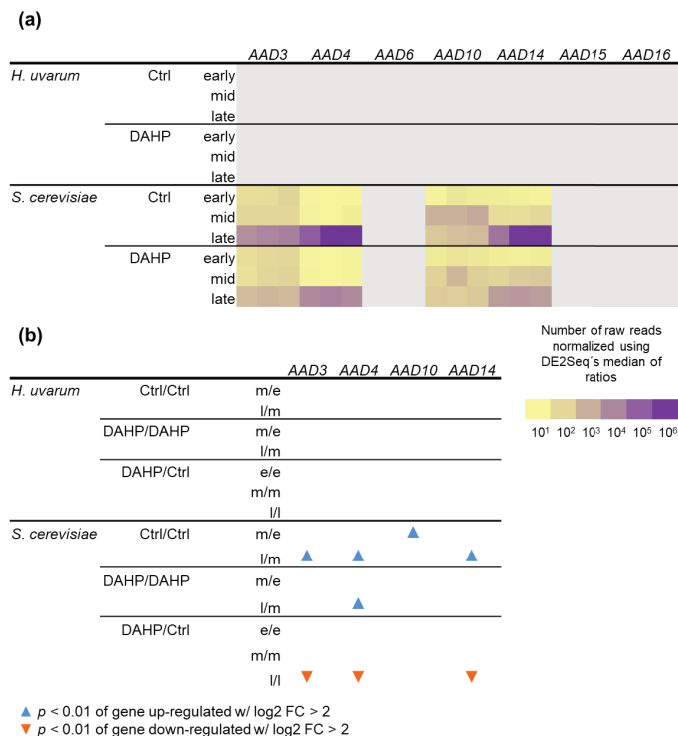

Figure S 5. Expression of aryl-alcohol dehydrogenases. **(a)** Logarithm (\log_{10}) of the raw reads normalized by DE2Seq's median of ratios (MoR) showing the expression levels and **(b)** differentially expressed genes (\log_2 fold change; ▲ $p < 0.01$ of gene up-regulated w/ $\log_2 FC > 2$; ▼ $p < 0.01$ of gene down-regulated w/ $\log_2 FC > 2$) of aryl-alcohol dehydrogenases, respectively, in fermentations using Müller-Thurgau must with (DAHP) and without (Ctrl) diammonium hydrogen phosphate supplementation at different stages of fermentation (lag phase = early, e; logarithmic phase = mid, m; plateau phase = late, l) with *H. uvarum* DSM2768 and *S. cerevisiae* EC1118. The legend shows the number of normalized raw reads using DE2Seq's MoR, with lighter colours indicating lower expression levels, whereas darker colours indicate higher expression levels.

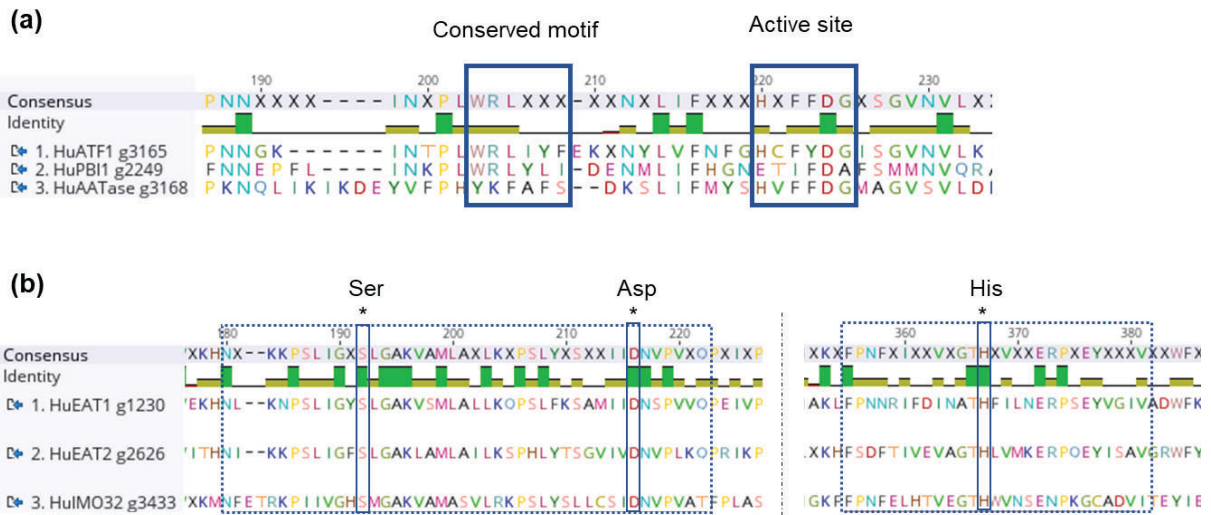

Figure S 6. Alignment of genes encoding for putative acetyltransferases. **(a)** Alignment of *HuATF1* identified previously (Badura et al. 2021) with genes putatively containing O-acetyltransferase activity showing the conserved motif and active site. **(b)** Alignment of putative *HuEAT1* gene and its potential homologs. The conserved Ser-Asp-His triad is labelled by asterisks.

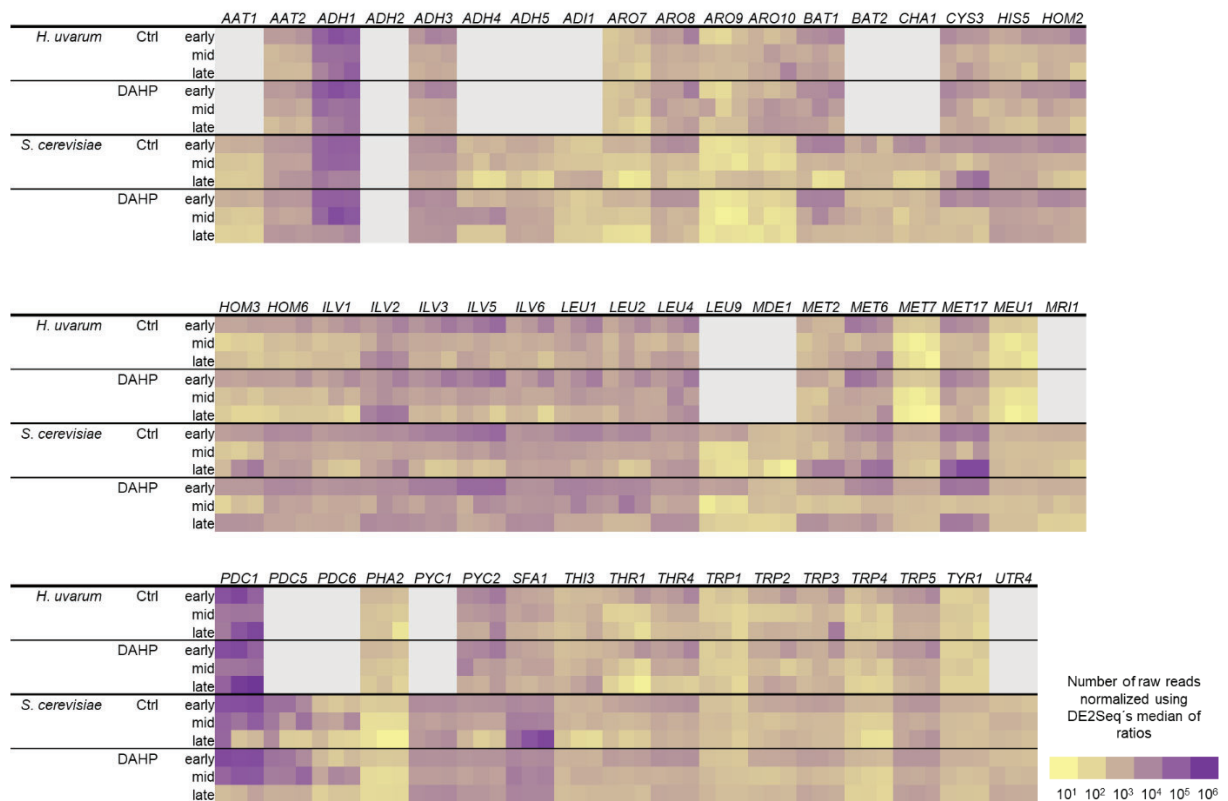

Figure S 7. Logarithm (log₁₀) of the raw reads normalized by DE2Seq's median of ratios (MoR) showing the expression levels of genes involved in the biosynthesis and degradation of aroma-relevant amino acids in fermentations using Müller-Thurgau must with (DAHP) and without (Ctrl.) diammonium hydrogen phosphate supplementation at different stages of fermentation (lag phase = early, logarithm phase = mid, plateau phase = late) with *H. uvarum* DSM2768 (*H.u.*) and *S. cerevisiae* EC1118 (*S.c.*). The legend shows the number of normalized raw reads using DE2Seq's MoR, with lighter colours indicating lower expression levels, whereas darker colours indicate higher expression levels. Genes with no annotation found are marked in grey.

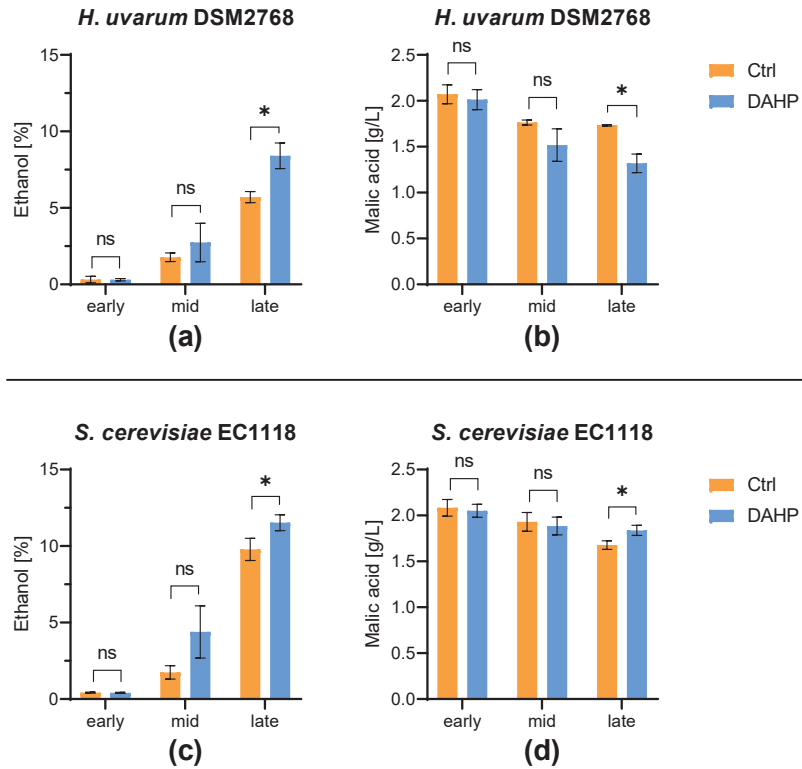

Figure S 8. Concentration of ethanol and malic acid in fermentations using Müller-Thurgau must with (DAHP) and without (Ctrl) diammonium hydrogen phosphate supplementation at different stages of fermentation (lag phase = early, logarithmic phase = mid, plateau phase = late) with **(a-b)** *H. uvarum* DSM2768 and **(c-d)** *S. cerevisiae* EC1118. Ethanol and malic acid were measured via HPLC analysis. Data are the mean of three independent experiments \pm SEM, two-tailed unpaired *t*-test with Welch's correction, * $p < 0.05$, ns – not significant. Error bars indicate the standard deviation.

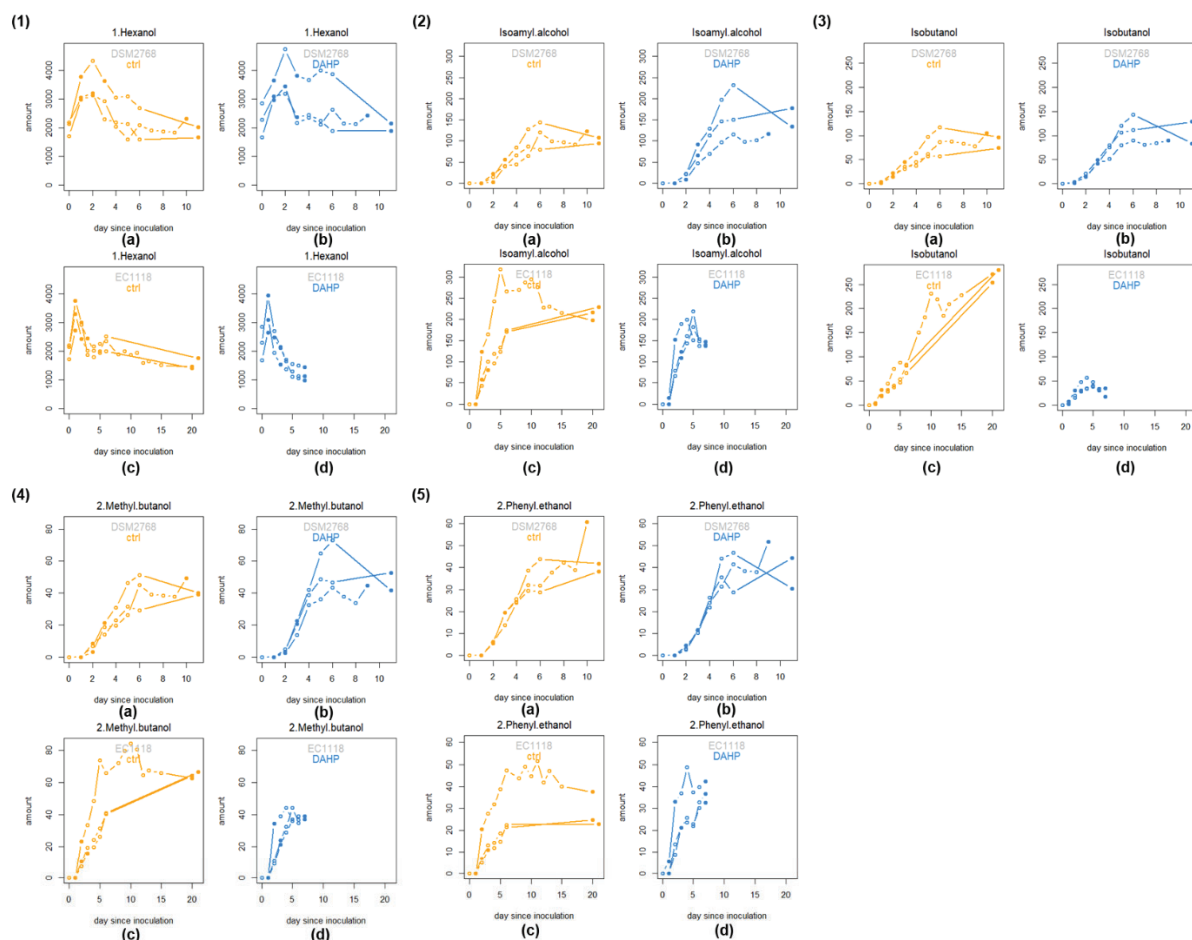

Figure S 9. Higher alcohols synthesized in fermentations using Müller-Thurgau must (**b,d**) with (DAHP) and (**a,c**) without (Ctrl) diammonium hydrogen phosphate supplementation during all stages of fermentation with (**a-b**) *H. uvarum* DSM2768 and (**c-d**) *S. cerevisiae* EC1118. Higher alcohols were measured via HS-SPME-GC-MS analysis. Data show three independent experiments. (1) 1-hexanol, (2) isoamyl alcohol, (3) isobutanol, (4) 2-methyl butanol, (5) 2-phenyl ethanol.

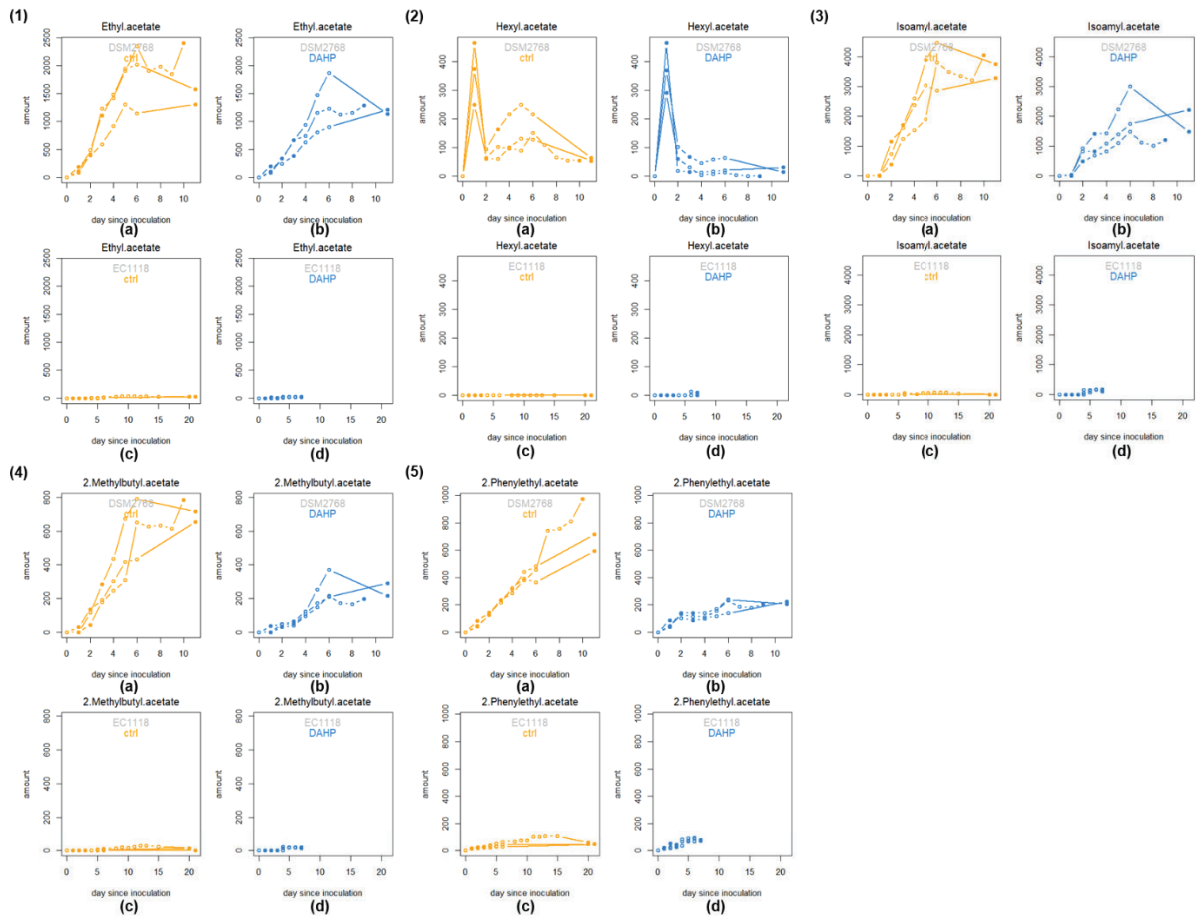

Figure S 10. Acetate esters synthesized in fermentations using Müller-Thurgau must (**b,d**) with (DAHP) and (**a,c**) without (Ctrl) diammonium hydrogen phosphate supplementation at all stages of fermentation with (**a-b**) *H. uvarum* DSM2768 and (**c-d**) *S. cerevisiae* EC1118. Acetate esters were measured via HS-SPME-GC-MS analysis. Data show three independent experiments. (1) ethyl acetate, (2) hexyl acetate, (3) isoamyl acetate, (4) 2-methylbutyl acetate, (5) 2-phenylethyl acetate.

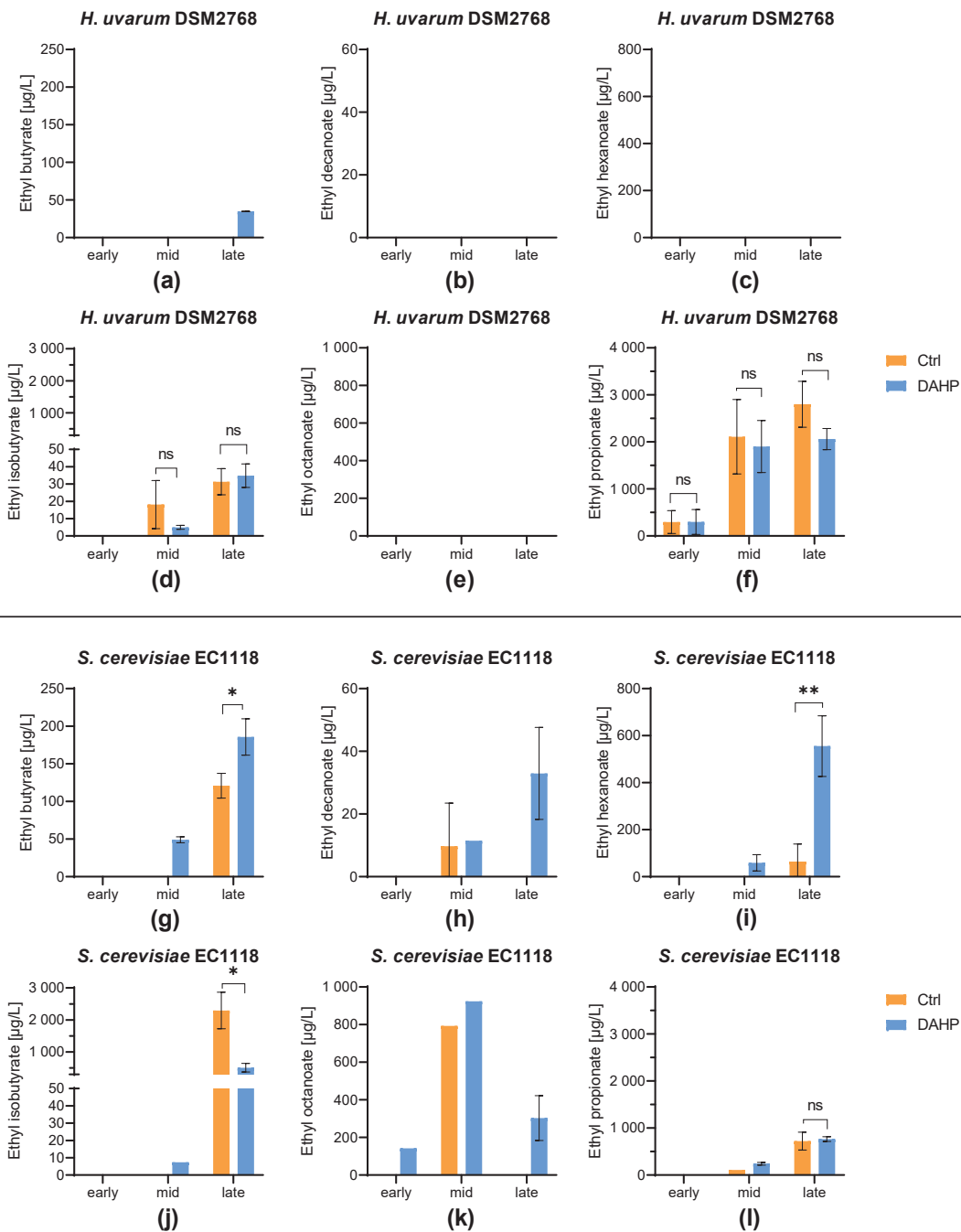

Figure S 11. Ethyl acetates synthesized in fermentations using Müller-Thurgau must with (DAHP) and without (Ctrl) diammonium hydrogen phosphate supplementation at different stages of fermentation (lag phase = early, logarithmic phase = mid, plateau phase = late) with (a-f) *H. uvarum* DSM2768 and (g-l) *S. cerevisiae* EC1118. Ethyl esters were measured via HS-SPME-GC-MS analysis. Data are the mean of three independent experiments \pm SEM, two-tailed unpaired *t*-test with Welch's correction, * $p < 0.05$, ** $p < 0.01$, ns – not significant. Error bars indicate the standard deviation.

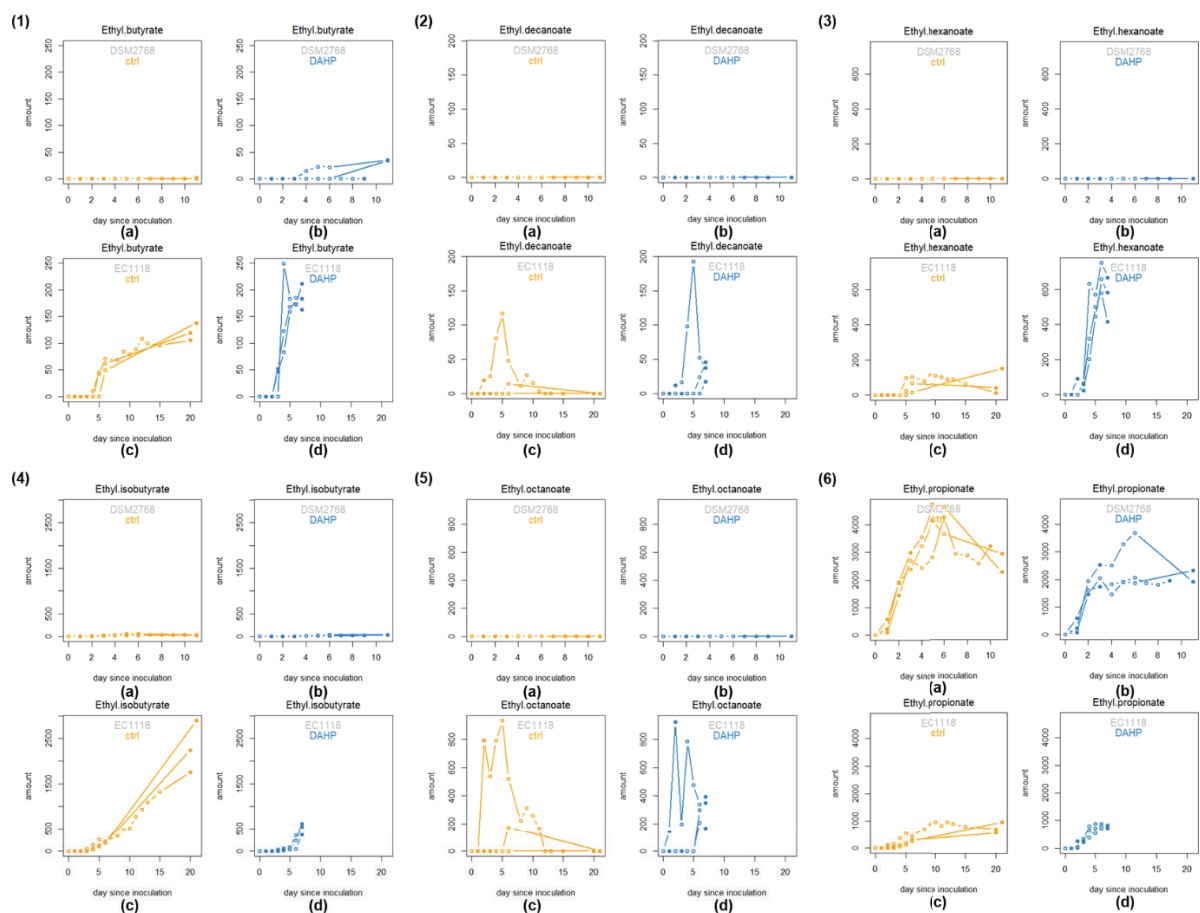

Figure S 12. Ethyl acetates synthesized in fermentations using Müller-Thurgau must (**b,d**) with (DAHP) and (**a,c**) without (Ctrl) diammonium hydrogen phosphate supplementation at all stages of fermentation with (**a-b**) *H. uvarum* DSM2768 and (**c-d**) *S. cerevisiae* EC1118. Ethyl esters were measured via HS-SPME-GC-MS analysis. Data show three independent experiments. (1) ethyl butyrate, (2) ethyl decanoate, (3) ethyl hexanoate, (4) ethyl isobutyrate, (5) ethyl octanoate, (6) ethyl propionate.

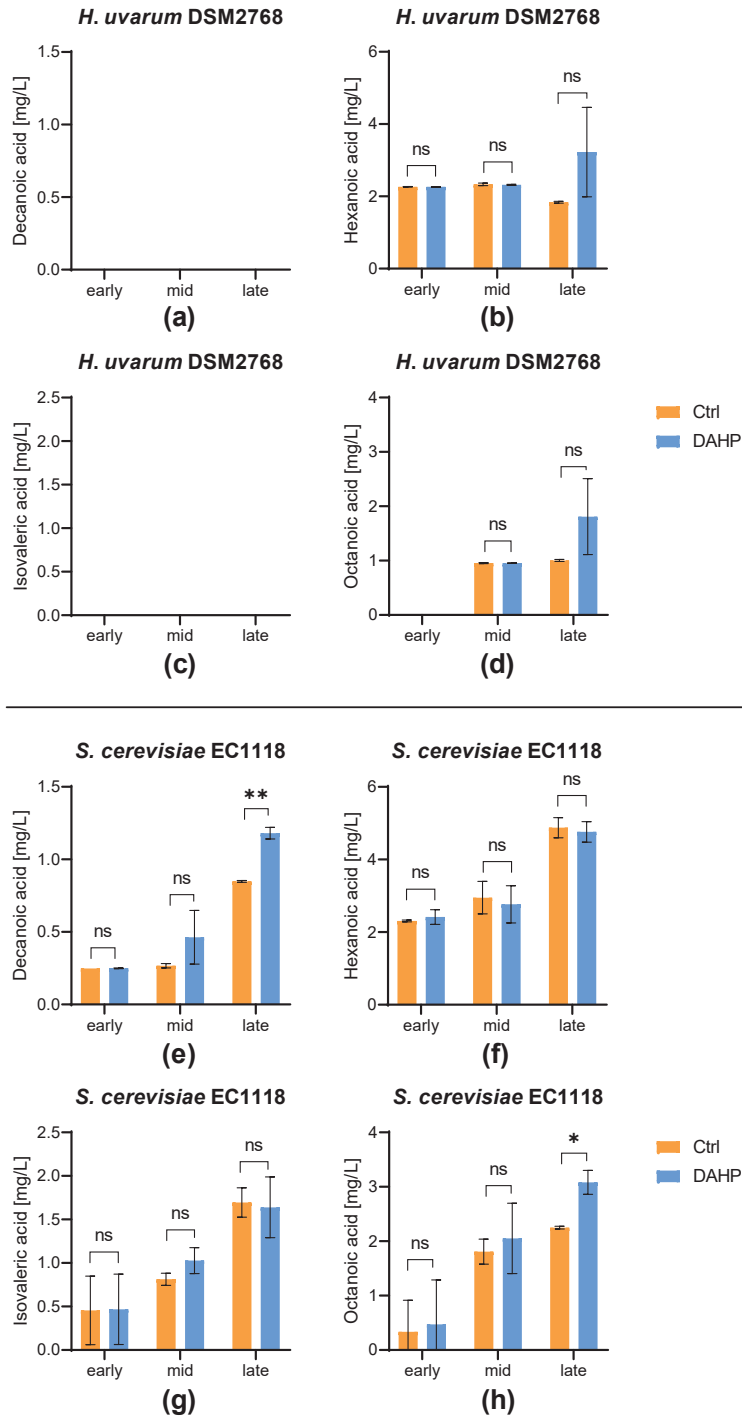

Figure S 13. Fatty acids synthesized in fermentations using Müller-Thurgau must with (DAHP) and without (Ctrl) diammonium hydrogen phosphate supplementation at different stages of fermentation (lag phase = early, logarithmic phase = mid, plateau phase = late) with (a-d) *H. uvarum* DSM2768 and (e-h) *S. cerevisiae* EC1118. Fatty acids were measured via HS-SPME-GC-MS analysis. Data are the mean of three independent experiments \pm SEM, two-tailed unpaired *t*-test with Welch's correction, * $p < 0.05$, ** $p < 0.01$, ns – not significant. Error bars indicate the standard deviation.

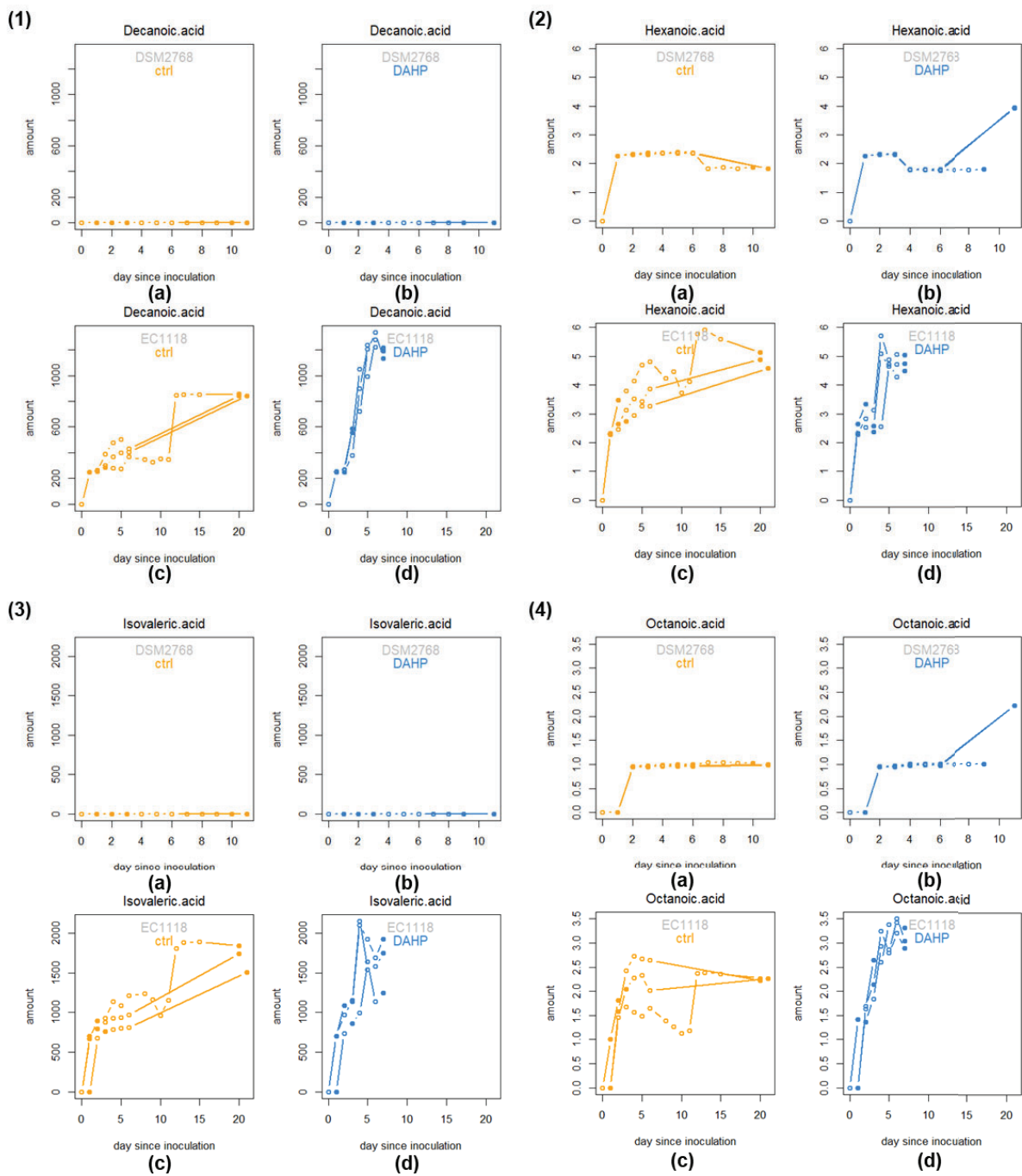

Figure S 14. Fatty acids synthesized in fermentations using Müller-Thurgau must (b,d) with (DAHP) and (a,c) without (Ctrl) diammonium hydrogen phosphate supplementation at all stages of fermentation with (a-b) *H. uvarum* DSM2768 and (c-d) *S. cerevisiae* EC1118. Fatty acids were measured via HS-SPME-GC-MS analysis. Data show three independent experiments. (1) decanoic acid, (2) hexanoic acid, (3) isovaleric acid, (4) octanoic acid.

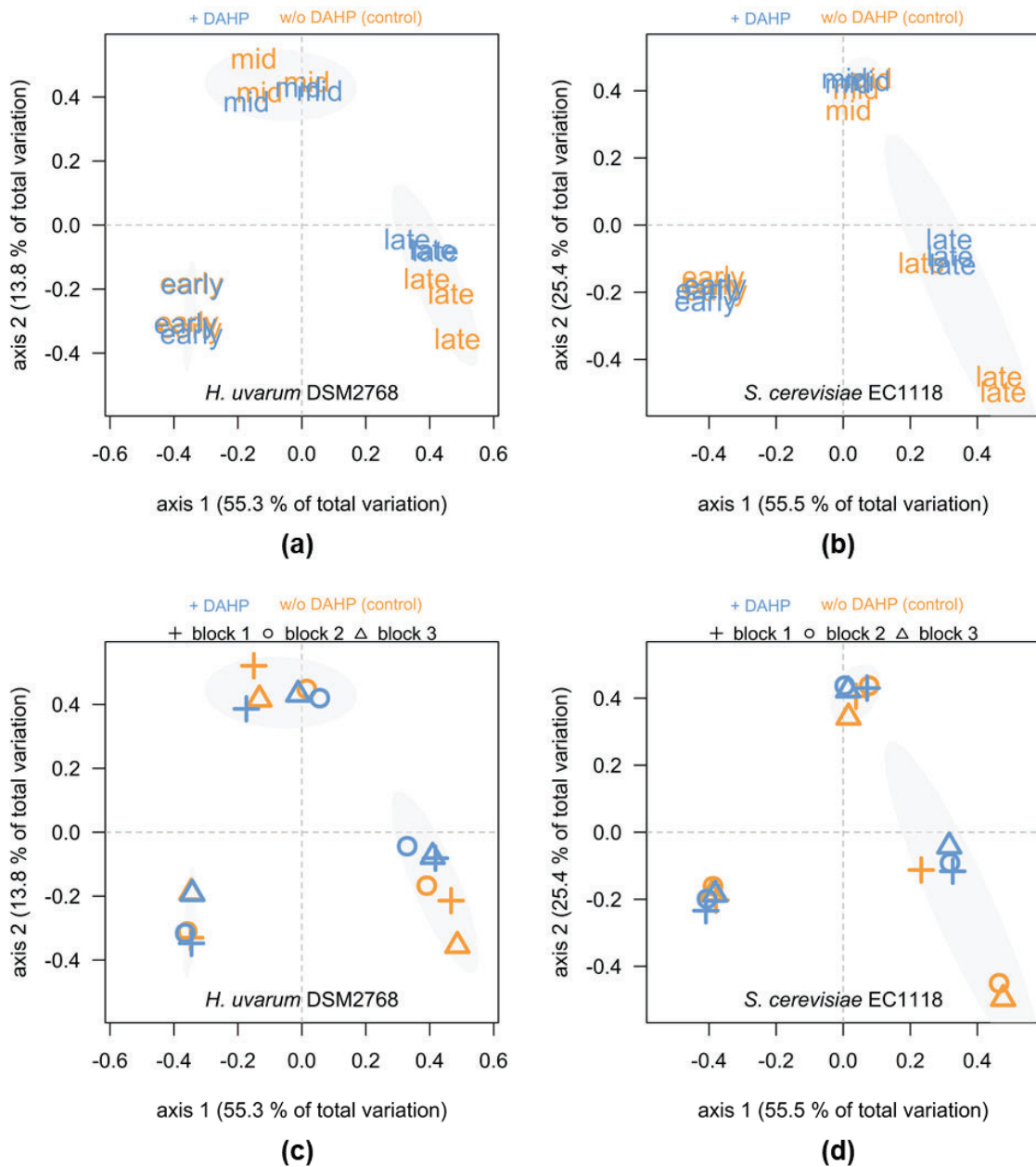

Figure S 15. Transcriptome ordination based on Hellinger transformed fragment counts. **(a, b)** transcriptomes were text-coded to indicate transcriptome sampling time point (early, mid or late). **(c-d)** symbol colour and symbol shape code for nitrogen supplementation and experimental block, respectively. Transcriptomes clustered according to transcriptome sampling time point, *i.e.* early, mid or late stage fermentation for both strains, *H. uvarum* DSM2768 and *S. cerevisiae* EC1118. An effect of nitrogen supplementation by diammonium hydrogen phosphate (DAHP) was noticeable only in late stage fermentations **(a-b)**; batch effects from experimental blocks were most apparent in late stage fermentations as well. Ellipses are 95% confidence ellipses based on group standard deviation for transcriptome sampling time points.

Supplementary Tables:

Table S 1. Free amino nitrogen content in autoclaved Müller-Thurgau (MT) must with and without DAHP supplementation (all mg/L).

Compound		MT (110 °C)	MT (110 °C, DAHP)
aspartic acid	Asp	32.27	32.22
threonine	Thr	40.92	40.81
serine	Ser	25.99	26.38
asparagine	Asn	1.00	0.97
glutamic acid	Glu	48.45	48.56
glutamine	Gln	0.60	0.56
glycine	Gly	1.62	1.64
alanine	Ala	24.76	24.67
citruiline	Cit	0.45	0.58
a-aminobutyric acid	Abut	0.00	0.00
valine	Val	12.04	11.75
cystine	Cys	0.00	0.00
methionine	Met	0.46	0.33
isoleucine	Ile	4.35	4.32
leucine	Leu	5.36	5.38
tyrosine	Tyr	2.28	2.31
phenylalanine	Phe	8.30	8.23
b-alanine	Bala	2.68	2.65
aminoisobutyric acid	Baib	0.00	0.00
g-aminobutyric acid	Gaba	44.35	46.12
histidine	His	5.08	5.13
tryptophan	Trp	1.39	1.35
ornithine	Orn	0.68	0.69
lysine	Lys	1.50	1.44
arginine	Arg	95.46	94.82
proline	Pro	153.58	151.72
Total		513.57	512.66

Table S 2. Sampling days of fermentations with *H. uvarum* DSM2768 and *S. cerevisiae* EC1118 in nitrogen deficient must (Ctrl) and DAHP supplemented must (DAHP) in batches 1-3 for RNA-Seq.

	Ctrl 1	Ctrl 2	Ctrl 3	DAHP 1	DAHP 2	DAHP 3
<i>H. uvarum</i> DSM2768						
early ^a	Day 1	Day 1	Day 1	Day 1	Day 1	Day 1
mid ^b	Day 2	Day 3	Day 2	Day 2	Day 3	Day 3
late ^c	Day 10	Day 11	Day 11	Day 9	Day 11	Day 11
<i>S. cerevisiae</i> EC1118						
early ^a	Day 1	Day 1	Day 1	Day 1	Day 1	Day 1
mid ^b	Day 2	Day 2	Day 3	Day 2	Day 3	Day 3
late ^c	Day 20	Day 20	Day 21	Day 7	Day 7	Day 7

^a Early time point of RNA-Seq sampling (lag phase)

^b Middle time point of RNA-Seq sampling (log phase)

^c Late time point of RNA-Seq sampling (plateau phase)

Table S 3. Average number^a of RNA-seq reads mapped-on-feature (gene) and mapped, but not-on-an-a-feature.

Strain	Nitrogen regime		early	mid	late
<i>H.u.</i> ¹	DAHP ^b	on feature	20 017 586 ± 9.3%	19 402 163 ± 12.7%	10 885 157 ± 22.0%
	Ctrl ^c		18 592 694 ± 9.2%	22 299 530 ± 23.0%	8 189 842 ± 60.2%
<i>S.c.</i> ²	DAHP ^b		16 095 605 ± 6.9%	16 781 348 ± 4.3%	16 736 214 ± 11.2%
	Ctrl ^c		15 932 931 ± 7.3%	17 109 503 ± 5.7%	13 045 311 ± 12.2%
<i>H.u.</i> ¹	DAHP ^b	not-on-feature	861 540 ± 2.3%	1 022 188 ± 6.2%	7 777 424 ± 41.9%
	Ctrl ^c		896 202 ± 5.6%	1 287 454 ± 16.1%	14 097 453 ± 57.8%
<i>S.c.</i> ²	DAHP ^b		1 055 279 ± 15.7%	1 438 131 ± 9.5%	1 905 377 ± 11.2%
	Ctrl ^c		1 034 872 ± 3.5%	1 393 118 ± 12.0%	1 569 274 ± 9.6%

^a Percentages are coefficient of variation (sample standard deviation * 1 / sample mean)

^b Müller-Thurgau (MT) must fermentations supplemented with diammonium hydrogen phosphate

^c MT must fermentations without DAHP supplementation

¹ *H. uvarum* DSM2768

² *S. cerevisiae* EC1118

Table S 4. Multivariate dispersions of Hellinger transformed Read Counts.

Yeast	Explanatory variable	Df ^a	Sum of squares (model, residual)	Mean squares (model, residual)	F	Pr(>F) ^b
<i>H.u.</i> ¹	ExBl ^c	2.15	0.00672, 0.44304	0.00336, 0.02954	0.1137	0.90
	TSTP ^d	2.15	0.081678, 0.134347	0.04084, 0.00896	4.5597	0.02
	DAHP ^e	1.16	0.003475, 0.309363	0.00347, 0.01934	0.1797	0.66
<i>S.c.</i> ²	ExBl ^c	2.15	0.00747, 0.22382	0.00373, 0.01492	0.2503	0.79
	TSTP ^d	2.15	0.096716, 0.167541	0.04836, 0.01117	4.3295	0.03
	DAHP ^e	1.16	0.00133, 0.21518	0.00133, 0.01345	0.0989	0.76

^a Degree(s) of freedom: among group degrees of freedom, residual degrees of freedom

^b Proportion of random permutations (N=999), which resulted in a larger F, *i.e.* explaining more variation than the true configuration

^c Experimental block

^d Transcriptome sampling time point

^e Müller-Thurgau (MT) must fermentations supplemented with diammonium hydrogen phosphate

¹ *H. uvarum* DSM2768

² *S. cerevisiae* EC1118

Table S 5. Between groups multivariate dispersion (Turkey's Honors Significant Differences).

Strain	Factor	Pair	Difference	CI ^a Lower	CI ^a Upper	p-Value ^b
<i>H.u.</i> ¹	ExBI ^c	2-1	-0.039	-0.297	0.219	0.919
		3-1	0.004	-0.254	0.261	0.999
		3-2	0.043	-0.215	0.300	0.904
	TSTP ^d	mid-early	0.066	-0.076	0.208	0.463
		late-early	0.164	0.022	0.306	0.023
		late-mid	0.098	-0.044	0.240	0.207
	DAHP ^e	2-1	0.028	-0.111	0.167	0.677
<i>S.c.</i> ²	ExBI ^c	2-1	0.049	-0.134	0.232	0.771
		3-1	0.033	-0.15	0.216	0.887
		3-2	-0.016	-0.199	0.167	0.973
	TSTP ^d	mid-early	0.074	-0.085	0.232	0.468
		late-early	0.179	0.020	0.337	0.027
		late-mid	0.105	-0.053	0.264	0.229
	DAHP ^e	Ctrl. ^f -DAHP ^e	0.017	-0.099	0.133	0.757

^a Confidence Intervals (95% Cis)^b p-Values are adjusted for multiple comparisons (number of pairs per factor)^c Experimental block^d Transcriptome sampling time point^e Müller-Thurgau (MT) must fermentations supplemented with diammonium hydrogen phosphate^f MT must fermentations without DAHP supplementation¹ *H. uvarum* DSM2768² *S. cerevisiae* EC1118**Table S 6.** Amount of unique, comparable differentially expressed genes (DEGs) between *H. uvarum* DSM2768 and *S. cerevisiae* EC1118.

			▲ up-regulated genes		▼ down-regulated genes	
			unique comparable	initial number	unique comparable	initial number
<i>H. uvarum</i>	DAHP	early/mid	84 (65.1%)	129	37 (92.5%)	40
	Ctrl		73 (63.1%)	114	23 (95.6%)	24
<i>S. cerevisiae</i>	DAHP		429 (99.7%)	430	412 (100.0%)	412
	Ctrl		455 (99.6%)	457	294 (100.0%)	294
<i>H. uvarum</i>	DAHP	mid/late	69 (78.4%)	88	6 (100.0%)	6
	Ctrl		136 (82.0%)	166	15 (83.3%)	18
<i>S. cerevisiae</i>	DAHP		106 (100.0%)	106	128 (100.0%)	128
	Ctrl		392 (99.5%)	394	281 (100.0%)	281

Table S 7. Yan content (free amino nitrogen (FAN), ammonium ions (NH₄⁺), total YAN (Total)) in fermentations of *H. uvarum* DSM2768 and *S. cerevisiae* EC1118 using nitrogen deficient must (Ctrl) and DAHP supplemented must (DAHP). Data are the mean of three independent experiments \pm SD.

	FAN	Ctrl NH ₄ ⁺	Total	FAN	DAHP NH ₄ ⁺	Total
<i>H. uvarum</i> DSM2768						
early	35.73 \pm 12.44	13.03 \pm 1.94	48.76 \pm 14.32	39.20 \pm 12.11	59.71 \pm 1.40	98.91 \pm 13.05
mid	3.84 \pm 3.62	1.62 \pm 1.45	5.46 \pm 3.04	8.66 \pm 6.00	33.52 \pm 43.83	42.18 \pm 48.14
late	5.34 \pm 1.42	0.95 \pm 1.65	6.29 \pm 2.13	12.43 \pm 0.89	0.81 \pm 0.77	13.24 \pm 1.38
<i>S. cerevisiae</i> EC1118						
early	22.71 \pm 6.13	0.02 \pm 0.03	22.73 \pm 6.16	32.60 \pm 2.50	66.78 \pm 6.29	99.38 \pm 5.40
mid	3.57 \pm 3.10	1.11 \pm 0.97	4.68 \pm 2.71	8.76 \pm 2.50	4.78 \pm 4.79	13.53 \pm 6.99
late	12.61 \pm 2.13	0.19 \pm 0.29	12.80 \pm 2.35	7.78 \pm 6.74	0.76 \pm 0.40	8.54 \pm 6.86

Supplementary material on the multivariate analysis of raw fragment counts:

Materials and Methods:

We performed multivariate analysis of RNA-Seq fragment counts to obtain transcriptome ordination and estimates of total variation explained by either TSTP (sampling during early, mid or late fermentation), DAHP supplementation (DAHP, grape must with or without DAHP supplementation) and covariate experimental block (ExBI, blocks 1 to 3). RNA-Seq fragment counts were Hellinger transformed prior to analysis (Legendre and Gallagher 2001) and homogeneity of multivariate dispersions among groups were tested (Anderson 2006). Ordination was obtained by Principal Components Analysis (PCA) and variation partitioning was performed with (sets of) explanatory variables which were maintained after forward model selection using adjusted R^2 as stop criterion for variable inclusion. Statistical significance and magnitude of individual fractions of explained variation were calculated by Partial Redundancy Analysis (pRDA; Borcard et al. 1992). Analyses followed guidelines outlined in Borcard et al. (2011) and Legendre and Legendre (2012). We started variation partitioning with three sets of explanatory variables (i) TSTP, (ii) DAHP and (iii) ExBI representing (i) grape must fermentation progression, (ii) nitrogen availability and (iii) experimental design, respectively. Factor levels were coded as reverse Helmert contrasts. After model selection, for each strain, only two sets remained: TSTP and ExBI for *H. uvarum* DSM2768 and TSTP and DAHP for *S. cerevisiae* EC1118. Analyses were performed in R version 4.0.3 (R Core Team R version 4.0.3 2020) using functions from package vegan version 2.5-7 (Oksanen et al. 2020).

Results:

For both *H. uvarum* and *S. cerevisiae*, the homogeneity of dispersions among groups was maintained for factors DAHP and ExBI, but rejected for TSTP (Figure S15). For the latter, rejection resulted from differences of dispersion between early and late stage fermentation transcriptomes, with later stages showing larger dispersion (Tukey's Honest Significant Differences, Table S4 and Table S5). We decided on proceeding with variation partitioning nonetheless, since ordination of transcriptomes showed a strong difference in location with no overlap among TSTP for both *H. uvarum* and *S. cerevisiae*.

Difference in gene expression was at its highest when comparing transcriptomes sampled at different time points. For both yeast strains, TSTP by itself explained the largest fraction of read count variation, at 62.6% for *H. uvarum* and 74.2% *S. cerevisiae* (Figure S15) and the number of differentially expressed (DE) genes was large (Table 2). Only for *S. cerevisiae*, we observed a minor effect from DAHP supplementation, accounting for 3.6% of total variation ($p = 0.017$), fraction [b]. Accordingly, the number of DE genes was smaller when comparing between DAHP supplementation levels at the same time point (Table 3).

In pRDA, we observed an increase in adjusted R^2 for TSTP in both strains due to the negative adjusted R^2 obtained for fractions of shared variation [c]; small negative values for adjusted R^2 indicate no correlation of variation with the corresponding explanatory variable (Peres-Neto et al. 2006).

For *H. uvarum* there was also a minor batch effect introduced by experimental block 3, fraction [b]; the magnitude was small: 2.8%, but statistically significant ($p = 0.018$, while controlling for the effect of TSTP in rRDA). This effect is also observable in Figure S15.

References:

- Anderson, M. J. (2006): Distance-based tests for homogeneity of multivariate dispersions. In *Biometrics* 62 (1), pp. 245–253. DOI: 10.1111/j.1541-0420.2005.00440.x.
- Borcard, D.; Gillet, F.; Legendre, P. (2011): Numerical ecology with R. 1st ed. New York, NY: Springer (2).
- Borcard, D.; Legendre, P.; Drapeau, P. (1992): Partialling out the spatial component of ecological variation. In *Ecology* 73 (3), pp. 1045–1055. DOI: 10.2307/1940179.
- Legendre, P.; Gallagher, E. D. (2001): Ecologically meaningful transformations for ordination of species data. In *Oecologia* 129 (2), pp. 271–280. DOI: 10.1007/s004420100716.
- Legendre, P.; Legendre, Loic F. J. (2012): Numerical ecology. 3rd ed. Amsterdam, the Netherlands: Elsevier Science.

Oksanen, J.; Guillaume Blanchet, F.; Friendly, M.; Kindt, R.; Legendre, P.; McGlinn, D. et al. (2020):
Vegan: Community ecology package.

Peres-Neto, P. R.; Legendre, P.; Dray, S.; Borcard, D. (2006): Variation partitioning of species data
matrices: Estimation and comparison of fractions. In *Ecology* 87 (10), pp. 2614–2625. DOI:
10.1890/0012-9658(2006)87[2614:VPOSDM]2.0.CO;2.

R Core Team (R version 4.0.3 2020): R: A language and environment for statistical computing. R
Foundation for Statistical Computing. Vienna, Austria. Available online at <https://www.R-project.org/>.

Chapter 5 - Development of genetic modification tools for *Hanseniaspora uvarum*

Chapter 5 is based on the following peer-reviewed publication:

Badura, J.; van Wyk, N.; Brezina, S.; Pretorius, I. S.; Rauhut, D.; Wendland, J.; von Wallbrunn, C. (2021): Development of genetic modification tools for *Hanseniaspora uvarum*. In *Int. J. Mol. Sci.* 22 (4), 1943. DOI: 10.3390/ijms22041943.

Author contributions:

Conceptualization: CvW, JW, NvW, **JB**

Funding acquisition: CvW

Methodology: **JB**, NvW, JW

Investigation: **JB**, NvW

Validation: **JB**, NvW

Data curation: **JB**, NvW

Formal analysis: SB

Visualization: **JB**

Project administration: CvW

Resources: CvW

Supervision: CvW

Writing – original draft: **JB**, NvW

Writing – review & editing: **JB**, NvW, ISP, DR, JW, CvW

All authors have read and agreed to the published version of the manuscript.



Article

Development of Genetic Modification Tools for *Hanseniaspora uvarum*

Jennifer Badura ¹, Niël van Wyk ^{1,2}, Silvia Brezina ¹, Isak S. Pretorius ², Doris Rauhut ¹, Jürgen Wendland ¹ and Christian von Wallbrunn ^{1,*}

¹ Department of Microbiology and Biochemistry, Hochschule Geisenheim University, Von-Lade-Strasse 1, 65366 Geisenheim, Germany; jennifer.badura@hs-gm.de (J.B.); niel.wyk@hs-gm.de (N.v.W.); silvia.brezina@hs-gm.de (S.B.); doris.rauhut@hs-gm.de (D.R.); juergen.wendland@hs-gm.de (J.W.)

² ARC Centre of Excellence in Synthetic Biology, Department of Molecular Sciences, Macquarie University, Sydney, NSW 2113, Australia; sakkie.pretorius@mq.edu.au

* Correspondence: christian.wallbrunn@hs-gm.de

Abstract: Apiculate yeasts belonging to the genus *Hanseniaspora* are commonly isolated from viticultural settings and often dominate the initial stages of grape must fermentations. Although considered spoilage yeasts, they are now increasingly becoming the focus of research, with several whole-genome sequencing studies published in recent years. However, tools for their molecular genetic manipulation are still lacking. Here, we report the development of a tool for the genetic modification of *Hanseniaspora uvarum*. This was employed for the disruption of the *HuATF1* gene, which encodes a putative alcohol acetyltransferase involved in acetate ester formation. We generated a synthetic marker gene consisting of the *HuTEF1* promoter controlling a hygromycin resistance open reading frame (ORF). This new marker gene was used in disruption cassettes containing long-flanking (1000 bp) homology regions to the target locus. By increasing the antibiotic concentration, transformants were obtained in which both alleles of the putative *HuATF1* gene were deleted in a diploid *H. uvarum* strain. Phenotypic characterisation including fermentation in Müller-Thurgau must showed that the null mutant produced significantly less acetate ester, particularly ethyl acetate. This study marks the first steps in the development of gene modification tools and paves the road for functional gene analyses of this yeast.

Keywords: *Hanseniaspora uvarum*; transformation; genetic modification; *ATF1*; ethyl acetate; fermentation

Citation: Badura, J.; van Wyk, N.; Brezina, S.; Pretorius, I.S.; Rauhut, D.; Wendland, J.; von Wallbrunn, C. Development of Genetic Modification Tools for *Hanseniaspora uvarum*. *Int. J. Mol. Sci.* **2021**, *22*, 1943. <https://doi.org/10.3390/ijms22041943>

Academic Editor: Maurizio Ciani
Received: 20 January 2021
Accepted: 11 February 2021
Published: 16 February 2021

Publisher's Note: MDPI stays neutral with regard to jurisdictional claims in published maps and institutional affiliations.



Copyright: © 2021 by the authors. Licensee MDPI, Basel, Switzerland. This article is an open access article distributed under the terms and conditions of the Creative Commons Attribution (CC BY) license (<http://creativecommons.org/licenses/by/4.0/>).

1. Introduction

The term apiculate yeast signifies a distinctive lemon-shaped cell structure of yeast species belonging to the genus *Hanseniaspora* and closely-related genera, such as *Saccharomyces* and *Nadsonia* [1]. The genus *Hanseniaspora* has a cosmopolitan distribution and has often been reported to be the most abundant genus on mature and intact grape berries, and thus contributes the largest yeast population to the initial stages of a grape must fermentation [2,3]. Since *Hanseniaspora* is prevalent on grapes in almost all vineyards worldwide [4–8], it plays a crucial role in affecting the sensory profile of wine, especially regarding the complexity of wine [9–11]. In general, *Hanseniaspora* populations decrease significantly during wine fermentation as these yeasts are usually outcompeted by the main wine yeast, *Saccharomyces cerevisiae*. It was initially thought that the gradual increase in ethanol concentration was primarily responsible for the decline in the *Hanseniaspora* population, but there is growing scientific evidence suggesting that a variety of metabolites secreted by *S. cerevisiae* significantly impacts the viability of *Hanseniaspora* within a grape must fermentation [12]. Moreover, *Hanseniaspora* strains have been shown to withstand ethanol concentrations of more than 10% and are able to produce a considerable

amount of ethanol themselves [12–14]. In the past, *Hanseniaspora* populations have been regarded to be spoilage yeasts when a significant proportion of these apiculate yeasts persists within a fermentation, as some strains are capable of producing significant amounts of acetaldehyde, acetic acid, and ethyl acetate. Winemaking practices, such as the addition of SO₂ or even the utilisation of yeasts, which produce killer toxins that have antimicrobial activity against apiculate yeasts [15], are used to limit the proliferation of *Hanseniaspora* yeasts. This hypothesis of *Hanseniaspora* as purely a spoilage yeast has been challenged and re-evaluated in recent years as wine researchers are reporting many beneficial oenological contributions that *Hanseniaspora* strains can provide when co-cultured with *S. cerevisiae* in a mixed-culture type of must fermentation. The oenological benefits of *Hanseniaspora* wine strains include lower final ethanol levels as well as increased acetate and ethyl ester concentrations [16–18]. Although selected *Hanseniaspora* strains have been used in mixed starter cultures with *S. cerevisiae* in wine fermentations, no *Hanseniaspora* strain is commercially available yet for use as an oenological starter culture [19]. Moreover, its ester production capability is particularly striking.

By sheer numbers found in fermentations, one of the most prolific species is that of *Hanseniaspora uvarum*, which, in the earlier literature, was also referred to as *Kloeckera apiculata*. Apart from its predominance and importance in winemaking, *H. uvarum* strains have also been isolated from many other fermented beverages, such as cider [20] or tequila [21], as well as from various food-related niches such as the processing of coffee beans [22] and cocoa fermentations [23] and from fresh-squeezed orange juice [24]. In addition to its presence in foods and beverages, *H. uvarum* has also been isolated from soil [25], plants [26], insects [27], birds [28], molluscs [29], shrimps [30] and snails [14]. Due to its antagonistic properties against mould development, *H. uvarum*'s potential as a biocontrol agent has also been investigated [31–33].

In spite of the increasing importance of *Hanseniaspora* in wine fermentations, only in the past couple of years, has large-scale genome sequencing provided information on *Hanseniaspora* species [34–37]; this wealth of information provides a basic framework for analysing the biology of *Hanseniaspora*. Recent research has shown that the low specific activity of pyruvate kinase, catalysing one of the rate limiting steps in the glycolytic pathway, could explain the reduced capacity of *Hanseniaspora* to form ethanol [38]. Analyses of different *Hanseniaspora* genomes have provided insight into an extensive loss of genes involved in cell cycle regulation and the maintenance of genome integrity [39]. Comparisons among different species and strains have revealed that *Hanseniaspora* isolates possess particular dynamic genome structures with various variations in ploidy [40].

A central element of gene-function analyses is the ability to generate deletion strains. However, there is still a lack of protocols for targeted gene deletions in *H. uvarum* based on DNA-mediated transformation to achieve homologous gene replacements with disruption cassettes. In this study, we developed a basic tool for the initiation of molecular characterisation of *H. uvarum* genes. To this end, we targeted the *H. uvarum* *ATF1* homolog encoding an alcohol acetyltransferase, successfully deleted both alleles in this diploid yeast, and compared the fermentation performance and flavour production of the mutant with the wild type.

2. Results

2.1. Plasmid Design and Construction

2.1.1. Design and Testing of Promoters

We originally attempted to transform *Hanseniaspora* using geneticin (*kanMX*) and hygromycin (*hygMX*) resistance cassettes already tailored for *S. cerevisiae* genetic modification. These cassettes are under the transcriptional control of the *TEF1* promoter of *Ashbya gossypii*. Despite numerous attempts to optimise transformation procedures, we were unable to obtain transformants and opted to clone promoters of *H. uvarum* to drive the expression of the respective antibiotic markers. To this end, we PCR-amplified three regions

upstream of the open reading frames (ORFs) of *H. uvarum* genes whose *S. cerevisiae* homologs are known to be strongly expressed. These genes encode translation elongation factor EF-1 α (*TEF1*), 3-phosphoglycerate kinase 1 (*PGK1*) and fructose-1,6-bisphosphate aldolase 1 (*FBA1*). We cloned these three *H. uvarum* promoters upstream of the *LacZ* reporter gene to test their heterologous function in *S. cerevisiae*. By transforming *S. cerevisiae* with these synthetic constructs, expression of beta-galactosidase can be monitored by its conversion of X-Gal into a blue strain. *S. cerevisiae* transformed with *HuFBA1* and *HuPGK1* constructs did not result in blue-stained *S. cerevisiae* colonies, suggesting that these promoters are non-functional in *S. cerevisiae*. However, use of the *HuTEF1* promoter yielded beta-galactosidase activity in *S. cerevisiae* (Figure 1). Next, we fused the *HuTEF1* promoter to ORFs of antibiotic resistance genes to generate new marker genes for *Hanseniaspora* and to drive transcription of these resistance markers in *Hanseniaspora* transformants.

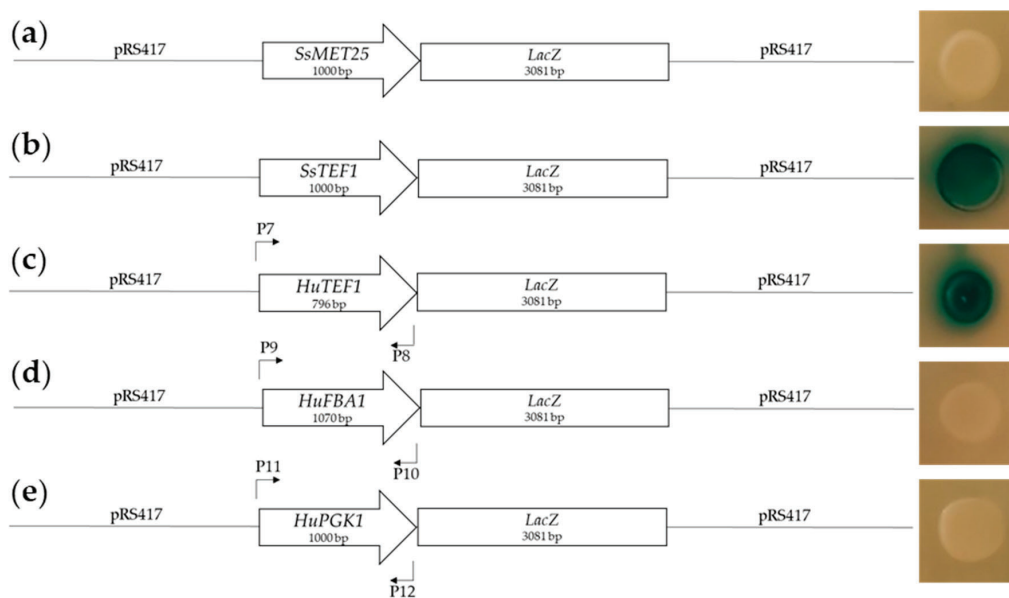

Figure 1. Plasmid constructs and testing of the functionality of three putative *Hanseniaspora uvarum* promoters, *HuTEF1*, *HuFBA1*, and *HuPGK1*, in *Saccharomyces cerevisiae* using *Streptococcus thermophilus LacZ* as reporter gene (picture on the right, blue colonies indicate the conversion of X-gal by beta-galactosidase). (a) pRS417-SsMET25-LacZ [41] (negative control); (b) pRS417-SsTEF1-LacZ [41] (positive control); (c) pRS417-HuTEF1-LacZ construct, generated as described in 4.2. using primer set 7/8 (for primers see description in 4.2.); (d) pRS417-HuFBA1-LacZ, built using primer set 9/10; (e) pRS417-HuPGK1-LacZ built using primer set 11/12. *SsMET25* and *SsTEF1* are promoter sequences from *Saccharomyces cerevisiae* [41].

2.1.2. Choice of Candidate Gene and Design of the Knock-Out Cassette

We selected the *ATF1* alcohol acetyltransferase I gene from *H. uvarum* as the candidate gene to knock out, as *ATF1* and *ATF2* in *S. cerevisiae* are known to be the main catalysts for ethyl acetate production in wine. The generation of an *HuATF1* disruption cassette is described in the Material and Methods. The HuAtf1 protein shows only 22% homology to ScAtf1 and 25% ScAtf2, respectively. HuAtf1 contains both the active site HXXXDG [42] and the conserved WRLICLP motif of acetyltransferases (Figure 2a). The complete HuAtf1, ScAtf2, and ScAtf1 alignment can be seen in supplementary (Figure S1).

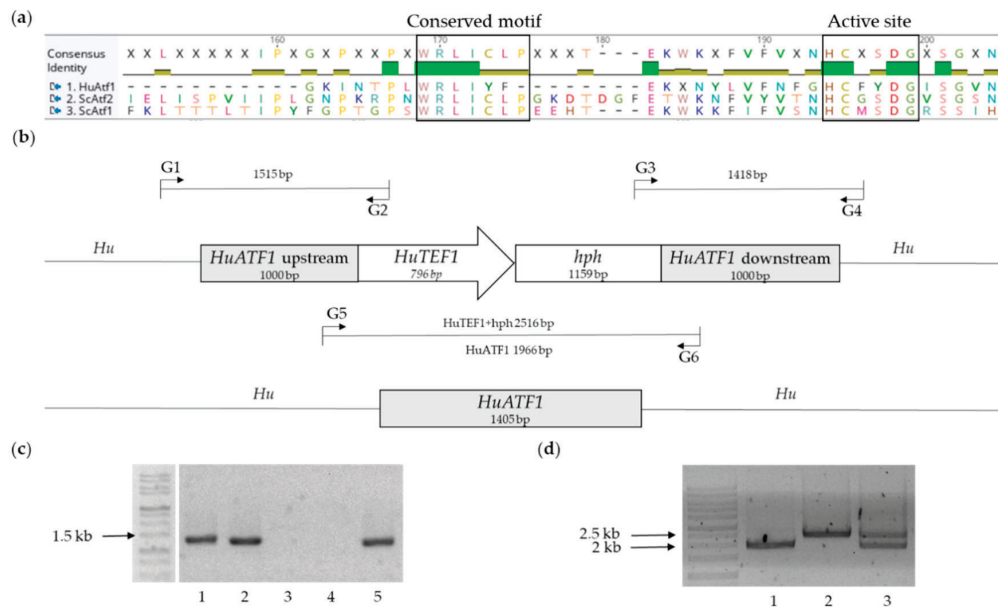

Figure 2. (a) Alignment of the amino acid sequence of the *Hanseniaspora uvarum* HuAtf1 with the two *S. cerevisiae* Atf proteins. The conserved WRRLICLP motif as well as the HXXXDG active site [42] are shown in boxes; (b) Replacement of the *HuATEF1* ORF by *HuTEF1_hph*. *HuATEF1* was replaced by the *HuTEF1* promoter in front of the selection marker *hph* with 1000 bp of flanking regions that are upstream and downstream of the *HuATEF1* ORF. The G1/G2, G3/G4, and G5/G6 diagnostic primer sets were used to verify correct integration of the marker cassette and deletion of *HuATEF1*. The G5/G6 primer set was used to determine the absence of *HuATEF1*, and thus a double knock-out due to the different nucleotide size of *HuATEF1* and *HuTEF1-hph*; (c) GelRed stained agarose gel showing PCR amplification of *HuATEF1* using primer set 39/40. (1) DSM2768 Ctrl, (2) DSM2768 #34 (WT/ Δ), (3) DSM2768 #40 (Δ/Δ), (4) DSM2768 #46 (Δ/Δ), (5) DSM2768 #97 (WT/ Δ). Resulting bands with size of ~1.4 kb; (d) GelRed stained agarose gel showing PCR amplification of wild type, single, or double knock-out of *HuATEF1* using primer set 41/42 (G5/G6). (1) DSM2768 Ctrl, (2) DSM2768 #40 (Δ/Δ), (3) DSM2768 #34 (WT/ Δ). Resulting bands with size of 2 kb and 2.5 kb.

2.2. Generation of Strains and Verification of Transformants

We applied the two main *Saccharomyces* transformation procedures based on chemical or electro competence in order to transform *H. uvarum*. Although both methods yielded transformants, electroporation yielded more transformants. The specific electroporation protocol used, involved a sensitising step with lithium acetate [43]. We constructed selection cassettes containing the resistance markers for hygromycin (*hph*), geneticin (*neoR*), nourseothricin (*clonNAT*, *natI*), and zeocin (*Sh Ble*), commonly used for yeasts. The transformation of *H. uvarum* with the hygromycin-resistance selection cassette in the form of a linearised plasmid, containing *HuTEF1* and *hph*, each flanked by 1000 bp upstream and downstream homology regions of the ORF of *HuATEF1*, yielded many transformants, without background colonies. In total, more than 100 colonies were re-streaked on selection plates, incubated overnight, and genomic DNA was isolated. Subsequently, PCR with diagnostic primers (G1/G2 and G3/G4, Figure 2b) was used to verify the correct intended integration of the selection cassette. In 99% of the colonies, the targeted insertion of the selection cassette could be detected via PCR. Integration of the cassette was also confirmed by sequencing of both the G1-G2 PCR product and G3-G4 PCR product. In addition, a second *HuATEF1* allele was amplified by PCR suggesting a diploid state of *H. uvarum*.

Unfortunately, we were unable to obtain *H. uvarum* transformants using geneticin, nourseothricin, or zeocin in selection media. We found *H. uvarum* to be extremely resistant to these antibiotics even when we increased the concentration to two to three times more

than what is recommended for the selection of *S. cerevisiae* transformants. This left us without a second dominant selection marker.

Since hygromycin proved to be the only antibiotic with which we were able to obtain *H. uvarum* transformants, we decided to transform it and plate the cells out on selective agar plates containing a three-fold higher concentration of hygromycin. From two out of 100 transformants that we obtained, we could not amplify an internal *HuATF1* band even after several PCR attempts, which suggested that both alleles of *ATF1* had been removed (Figure 2c). Primers were designed that bind outside the selection marker to the genomic DNA upstream and downstream of *HuATF1* (G5/G6, Figure 2b) and were used to amplify this sequence via PCR. GelRed stained agarose gel can be found in Figure 2d. While Samples 1 (DSM2768 Ctrl) and 2 (DSM2768 #40) show only one band each, with sizes of 2 kb (Sample 1) and 2.5 kb (Sample 2), two bands of both sizes are visible in Sample 3 (DSM2768 #34). In *H. uvarum* DSM2768, only the *HuATF1* band is visible. DSM2768 #34 showed two bands (*HuATF1* and the selection cassette) indicative of a heterozygous state (single knock-out).

The transformant DSM2768 #40 (Sample 2) showed only one band corresponding to the size of the selection cassette, indicating an integration via homologous recombination. Sanger sequencing using primers G5 and G6 confirmed that only the *HuTEF1-hph* marker could be amplified from transformant DSM2768 #40. Accordingly, this is indicative of a homozygous deletion (double knock-out). Two independent homozygous deletion mutants were obtained (DSM2768 #40 and DSM2768 #46). The transformation efficiency of receiving double knock-out transformants obtained using the higher concentration of antibiotic was 2%.

2.3. Fermentations and Phenotypical Characterisation

In order to determine the phenotype of the transformants, fermentations with Müller-Thurgau must were performed. The phenotypical characterisation is shown in Figure 3. The most noteworthy difference between the double knock-out transformants (DSM2768 #40 and DSM2768 #46) and the control was the acetate ester content (Figure 3a). The most abundant acetate ester, ethyl acetate, had a concentration of 600–800 mg/L less in the Δ/Δ strains than the control (Supplementary Figure S2a). The four other acetate esters measured isoamyl acetate, 2-methylbutyl acetate, hexyl acetate, and 2-phenylethyl acetate also had significantly reduced amounts. In general, the alcohols of the respective esters showed an increase in the Δ/Δ strains, which also includes ethanol (Figures 3c and 4b and Supplementary Figure S3). The Δ/Δ strains had an ~10% increase in ethanol. Interestingly, the Δ/Δ strain produced no detectable acetic acid and slightly increased levels of certain ethyl esters (ethyl propionate and ethyl butyrate) were found (Supplementary Figure S2f–h). The sugar consumption of all the strains was comparable over the period of three days (Figure 4a). The strain in which only one allele of *HuATF1* was removed performed similarly to the control strain apart from isoamyl acetate, 2-methylbutyl acetate, isobutanol, and 2-phenyl ethanol, which increased slightly in production as compared with the control (Supplementary Figures S2 and S3). On the basis of the observation that the putative double knock-out yeast strains metabolised the same amounts of sugars as the control strain, it was concluded that the transformants were a physiological fit.

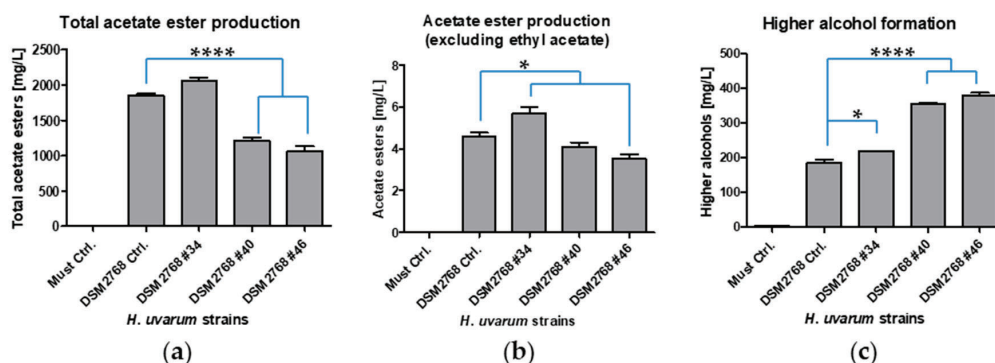

Figure 3. Acetate ester production and formation of higher alcohols during fermentation. (a) Total acetate ester production (mg/L) including ethyl acetate, isoamyl acetate, 2-methylbutyl acetate, hexyl acetate, and 2-phenylethyl acetate; (b) Acetate ester production (mg/L) excluding ethyl acetate; (c) The formation of respective higher alcohols (mg/L) including isoamyl alcohol, 2-methyl-1-butanol, hexanol, and 2-phenyl ethanol after three days of fermentation of Müller-Thurgau must with *H. uvarum* DSM2768 for comparison (DSM2768 Ctrl), DSM2768 #34 (WT/ Δ), DSM2768 #40 (Δ/Δ), and DSM2768 #46 (Δ/Δ). Pure must without the addition of yeasts served as a negative control (Must Ctrl). Total ester production was measured via HS-SPME-GC-MS analysis while acetic acid production was measured via high performance liquid chromatography (HPLC) analysis. Data are the mean of three independent experiments \pm SEM, 1-way ANOVA, Bonferroni's multiple comparison test, * $p < 0.05$ and *** $p < 0.0001$. Error bars indicate the standard deviation.

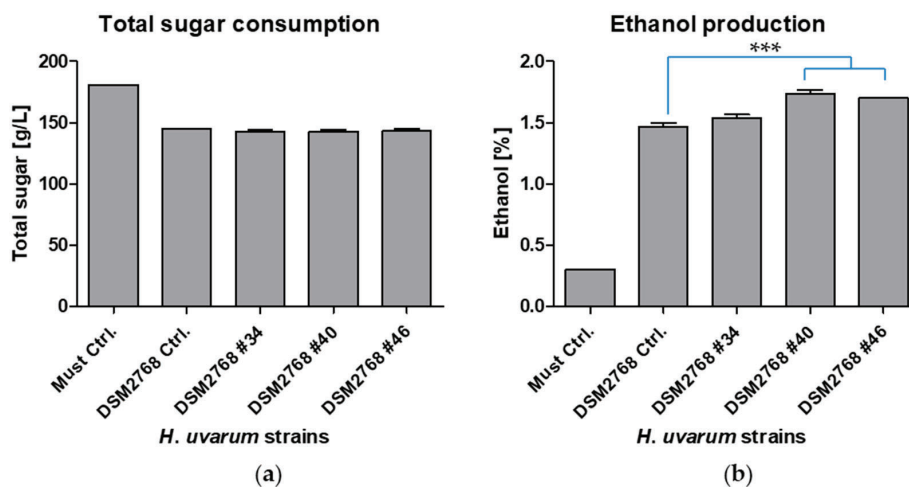

Figure 4. (a) Total sugar consumption (g/L); (b) Ethanol production (%) after three days of fermentation of Müller-Thurgau must with *H. uvarum* DSM2768 for comparison (DSM2768 Ctrl), DSM2768 #34 (WT/ Δ), DSM2768 #40 (Δ/Δ), and DSM2768 #46 (Δ/Δ). Pure must without the addition of yeasts served as a negative control (Must Ctrl). The amount of total sugar and ethanol produced was measured via high performance liquid chromatography (HPLC) analysis. Data are the mean of three independent experiments \pm SEM, 1-way ANOVA, Bonferroni's multiple comparison test, *** $p < 0.001$. Error bars indicate the standard deviation.

3. Discussion

Hanseniaspora uvarum is an important yeast in the beverage industry, in particular for wine. In recent years, researchers have shown particular interest in this yeast, and reports on its beneficial impact on winemaking as well as several genome sequences have been published [34–37]. Despite the growing interest, to date, there are no genetic modification tools available for *H. uvarum*.

Our study attempts to fill this gap and describes a successful genetic modification experiment in *H. uvarum*. A common antibiotic used in eukaryotic transformations, hygromycin, proved to be effective for selection purposes. Furthermore, *H. uvarum* was found not to be sensitive against other standard antibiotics which complicated our attempts to generate a double knock-out of the *HuATF1* gene. However, by increasing the hygromycin concentration, we were able to obtain colonies in which both alleles of *HuATF1* were successfully deleted. The transformation of *H. uvarum* DSM2768 with the linearised DNA containing the hygromycin selection cassette resulted in a highly efficient deletion of *HuATF1*. Previous reports have suggested that the phenotype of antibiotic resistance is dose dependent and that transformation efficiency correlates with the copy number in the yeast cell [44–46]. Hashida-Okado et al. [47] succeeded in generating a null mutant of a diploid *S. cerevisiae* strain by transforming with only one selection marker. These authors have shown that it is possible to disrupt both gene copies of homologous chromosomes of diploid cells in only one transformation step using one selection marker. After increasing the concentration of the antibiotic in the selective agar medium, transformants (such as DSM2768 #40) lacking *HuATF1* were obtained, and integration of the selection cassette could be verified. On the basis of these results, it was concluded that DSM2768 #40 (as well as DSM2768 #46) is a null mutant.

We showed that it was also possible to generate a double knock-out of *ATF1* in *H. uvarum* in such a fashion using only one selection cassette. This was done by tripling the antibiotic concentration in the selective plates. Here, the transformation efficiency of a single knock-out was 98% and that of a double knock-out was 2%.

The double knock-out strains showed a dramatic reduction in ethyl acetate production (~40%). *HuATF1* deletion did not completely abolish ethyl acetate production, suggesting other transferase enzymes to be involved in its production besides *HuATF1*. This is similar to *S. cerevisiae*, as up to half of the ethyl acetate is still present when the major *ATF* genes (*ATF1* and *ATF2*) are deleted, which are also known to be associated with ethyl acetate production [48,49].

The reduction in ethyl acetate was accompanied by an increase in the formation of ethanol. This can be explained by the function of *ATF1* to esterify ethanol to ethyl acetate. In the case of a deletion of *HuATF1*, this esterification of ethanol to ethyl acetate is restricted, resulting in an accumulation of ethanol during fermentation. The same applies to the other acetate esters and their respective alcohols. In addition to ethyl acetate, other acetate esters were also produced in smaller quantities by the null mutant strain. In contrast, the production of the corresponding alcohols increased significantly. Contrary to what we expected, significantly lower levels of acetic acid were produced by the double knock-out strains. This is in contrast to a previous study in *S. cerevisiae*, where no significant differences in acetic acid levels were detected in an *ATF1* knock-out strain as compared with the wild type [50]. Overexpression of *ATF1* in *S. cerevisiae* led to a decrease in acetic acid production [48,51], presumably as more of the available pool of acetyl coenzyme A (acetyl-CoA) is needed for the acetate ester synthesis. As a major catalyst for acetate ester production was removed in *H. uvarum*, we were not expecting a dramatic drop in acetic acid levels. This astonishing finding warrants further investigation.

The knock-out of *HuATF1* did not lead to any apparent reduction in the vitality of *H. uvarum*. The null mutant strain metabolised the same amounts of total sugars as the control strain.

The development of suitable transformation tools for the widespread wine yeast *H. uvarum* enables more detailed investigations of the individual metabolic pathways for the formation of aroma compounds and the genes involved. In *S. cerevisiae*, these methods are common practice, and thus the individual gene functions and metabolic pathways are well characterised. Up to now, a detailed investigation of *H. uvarum* has not been possible. The next steps are the development of additional selection markers and the knock out or overexpression of other genes involved in the metabolism of the aroma compounds in *H. uvarum*.

4. Materials and Methods

4.1. Strains and Culture Conditions

The yeast strains used and generated in this study (see Table 1) were routinely cultivated in YPD (1% yeast extract, 2% glucose, and 2% peptone) at either 25 °C (*H. uvarum*) or 30 °C (*S. cerevisiae*). Solid YPD plates were prepared by adding 2% agar and for transformation, two different concentrations of hygromycin b (200 and 600 µg/mL) were used. Plasmids were propagated in *Escherichia coli* DH5alpha in 2xYT (1.6% tryptone, 1% yeast extract, and 0.5% NaCl) supplemented with 100 µg/mL ampicillin.

Table 1. Strains used and generated in this study.

Strain	Feature/Genotype	Source
BY4741	<i>Saccharomyces cerevisiae</i> MATa <i>his3Δ1, leu2Δ0, met15Δ0, ura3Δ0</i>	Euroscarf, Oberursel, Germany
DSM2768	<i>Hanseniaspora uvarum</i> ATF1/ATF1	[38]
DSM2768 (WT/Δ)	<i>Hanseniaspora uvarum</i> ATF1/ <i>atf1:HuTEF1-hph</i>	This study
DSM2768 (Δ/Δ)	<i>Hanseniaspora uvarum atf1:HuTEF1-hph/atf1:HuTEF1-hph</i>	This study

4.2. Plasmid Design and Construction

Plasmids used in this study are listed in Table 2. Primers required for plasmid constructions are listed in Table 3. Plasmid constructions were assembled in *S. cerevisiae* BY4741 by yeast assembly. Plasmid DNAs were amplified in *E. coli* and prepared using a Plasmid Midi Purification Kit (Genaxxon, Ulm, Germany). For sequencing verification, PCR fragments were cloned either into pJET (Thermo Fisher Scientific, Waltham, MA, USA) or pGEM (Promega, Madison, WI, USA). DNA sequences of *H. uvarum* were obtained from the publicly available genomes of both DSM2768 (Accession: SAMN01885404) and AWRI3580 (Accession: SAMN04331434). By using corresponding *S. cerevisiae* homologs as queries, putative regions of interest, including the *ATF1* locus (*HuATF1*) and the promoter regions of *TEF1*, *FBA1*, and *PGK1* were identified using the BLAST function on NCBI. The *TEF1*, *FBA1*, and *PGK1* promoter were amplified from *H. uvarum* DSM2768 genomic DNA using primers 1/2 (*TEF1*), 3/4 (*FBA1*), and 5/6 (*PGK1*). To test for promoter activity, the *LacZ* ORF was placed under the control of *H. uvarum* promoters using primers 7/8 (*HuTEF1*-promoter), 9/10 (*HuFBA1*-promoter), and 11/12 (*HuPGK1*-promoter), which added 40 bp of flanking homology region to *pLacZ* (Figure 1). The upstream region of the *LacZ* ORF [41] was removed by restriction digestion of *pLacZ* with *KpnI* and *XhoI*. The linearised vector and *H. uvarum* promoters (*HuTEF1*, *HuFBA1*, and *HuPGK1*) were transformed into yeast and fused to *LacZ* by *in vivo* recombination. Transformed cells were plated out on YPD plates +200 µg/mL geneticin. After two days of incubation, X-Gal was pipetted onto plates, and then plates were incubated to visualise beta-glucosidase activity. All restriction enzymes were purchased from Thermo Fisher Scientific (Waltham, MA, USA) and all primers were purchased from Sigma-Aldrich (Steinheim, Germany). The analyses of all PCR and restriction digestion products were performed by gel electrophoresis separation on 1% agarose gels, stained with GelRed (Genaxxon Bioscience, Ulm, Germany). Sequencing was conducted by Starseq, Mainz, Germany.

Table 2. Plasmids used and generated in this study.

Strain	Feature/Genotype	Source
pRS415	<i>bla</i> , <i>LEU2</i>	[52]
pGEM	<i>bla</i>	Promega, Madison, WI, USA
pJET	<i>bla</i>	Thermo Fisher Scientific, Waltham, MA, USA
pRS417-SsTEF-lacZ	<i>bla</i> , <i>GEN3</i> , <i>lacZ</i> driven by <i>S. schoenii</i> <i>TEF1</i> promoter	[41]
pRS417-SsMET25-lacZ	<i>bla</i> , <i>GEN3</i> , <i>lacZ</i> driven by <i>S. schoenii</i> <i>MET25</i> promoter	[41]
pRS417-HuTEF-lacZ	<i>bla</i> , <i>GEN3</i> , <i>lacZ</i> driven by <i>H. uvarum</i> <i>TEF1</i> promoter	This study
pRS417-HuFBA-lacZ	<i>bla</i> , <i>GEN3</i> , <i>lacZ</i> driven by <i>H. uvarum</i> <i>FBA1</i> promoter	This study
pRS417-HuPGK-lacZ	<i>bla</i> , <i>GEN3</i> , <i>lacZ</i> driven by <i>H. uvarum</i> <i>PGK1</i> promoter	This study
pRS40H	<i>HygMX</i>	[53]
pTEF	pJET- <i>HuTEF1</i>	This study
pJB1-HuTEF-hph	pRS415- <i>HuTEF1-hph</i>	This study
pJB2-HuTEF-hph-ATF1up/down	pRS415- <i>HuTEF1-hph</i> -1000 bp <i>HuATF1</i> upstream/downstream	This study
pFA-KanMX6	<i>KanMX6</i>	[54]
pJB3-HuTEF-neoR	pRS415- <i>HuTEF1-neoR</i>	This study
pFA-NatMX3	<i>NatMX3</i>	[55]
pJB4-HuTEF-natI	pRS415- <i>HuTEF1-natI</i>	This study
pZeo ^R	<i>BleMX6</i>	[56]
pJB5-HuTEF-Sh Ble	pRS415- <i>HuTEF1-Sh Ble</i>	This study
pJB6-HuTEF-Sh Ble-ATF1up/down	pRS415- <i>HuTEF1-Sh Ble</i> -1000 bp <i>HuATF1</i> upstream/downstream	This study

Table 3. Primers used in this study.

Primer Number	Primer Name	Sequence 5' → 3'
Hu-Promoter Test		
1	TEF_L	TTGATGGATAACTTGAAGGC
2	TEF_R	TCTATATACTGTATACCTTAG
3	FBA_L	GAAGATATACTAAATTTGTCCC
4	FBA_R	AATGTATGTATTTGTATAATTGATATTATTATGG
5	PGK_L	TGATTATGACTCTGATAGCAAC
6	PGK_R	TTTTAAGATTTGTAGTAATTTAATTGTTTATATG
7	TEF forw. LacZ	CGCCAGGGTTTTCCAGTCACGACGTTGTAACCG ACGCCAGTGTGATGGATAACTTGAAGGC
8	TEF rev. LacZ	CAATCTTTGGATCGTTTAAATAAGTTTGAATTTT TCAGTCATGTTTCTATATACTGTATACCTTAG
9	FBA forw. LacZ	CGCCAGGGTTTTCCAGTCACGACGTTGTAACCG ACGCCAGTGGAAAGATATACTAAATTTGTCCC
10	FBA rev. LacZ	CAATCTTTGGATCGTTTAAATAAGTTT- GAATTTTTTCAGTCA TGTTAATGTATGATTTT- GTATAATIGATAT TATTATGG

11	PGK forw. LacZ	CGCCAGGGTTTTCCAGTCACGACGTTGTAAAAC GACGGCCAGTGTGATTATGACTCTGATAGCAAC CAATCTTTGGATCGTTTTAAATAAGTTT-
12	PGK rev. LacZ	GAATTTTTTCAGTC ATGTTTTTAAGATTTGTAG- TAATTTAATTGTTTATATG
Construction Knock-Out Cassette <i>hph</i>		
13	pRS415 (ov) + TEF_L	ATTGGGTACCGGGCCCCCCTCGAGGTCGACGGTA TCGATTTGATGGATAAAGTTGAAGGC
14	TEF_R+hyg (ov)	TTTTTCAACAGAAGTAGCAGTCAATTCTGGTTTTT TCATTCTATATACTGTATACCTTAG
15	TEF (ov) + hyg_L	AGCGGTATAACCATAGAAAATAAGGTATACAGTAT ATAGAATGAAAAAACCAGAATTGAC
16	hyg_R + pRS415 (ov)	GCTGGAGCTCCACCGCGGTGGCGGCCGCTCTAGAA CTAGTAGGACCACCTTTGATTGTAA
17	pRS415 (ov) + ATFup_L	ATTGGGTACCGGGCCCCCCTCGAGGTCGACGGTA TCGATGTACATCTGTTTTTAATGCT
18	ATFup_R + TEF (ov)	AGTATGGCCATTGTTATGATGCCTTCAAGTTATCC ATCAACTCCGAGGTAATGTTTTTGA
19	Hyg (ov) + ATFdown_L NEW	AGGGTGGTAATTACTATTTACAATCAAAGGTG GTCCTTCAAATATTGATTTTTCTT
20	ATFdown_R + pRS415 (ov) NEW	CTGGAGCTCCACCGCGGTGGCGGCCGCTCTAGAAC TAGTGTATCCCAACAAAAGATAGAA
21	ATFup (ov) + TEF_L	TTAACCCAGCAGGAATACATCAAAAACATTACCT CGGAGTTGATGGATAAAGTTGAAGGC
22	Hyg_R + ATFdown (ov) NEW	TAAAAAGAATAAAAACCTTGAAAAGAAAATACAATAT TTTGAAGGACCACCTTTGATTGTAA
Construction Knock-Out Cassette <i>neoR, natI, Sh Ble</i>		
23	TEF_R + kanMX (ov)	CGTATAAATCAGCATCCATTCTATATACTGTATACC TTAGTTTCTATGGTTATACCGCTA
24	TEF (ov) + kanMX_L	AGCGGTATAACCATAGAAAATAAGGTATACAGTAT ATAGAATGGATGCTGATTATACGG
25	kanMX_R + pRS415 (ov)	GCTGGAGCTCCACCGCGGTGGCGGCCGCTCTAGAA CTAGTTAATAAATTATTTTTATTGT
26	kanMX_R + ATFdown (ov)	GGATCGTAAAGTCTATTAAAAACCTTTAAAGTAATT GAACCTAATAAATTATTTTTATTGT
27	kanMX (ov) + AT- Fdown_L	TTCTTGCTTTTATAAATAACAATAAAAAATAATTT ATTAAGTTCAATTACTTTAAAAAGT
28	TEF_R + clo (ov)	CCAATGTTTCAGCAACTTGTTCAGGAATAACAGAAA TTTTTCTATATACTGTATACCTTA
29	clo_L + TEF (ov)	AGCGGTATAACCATAGAAAATAAGGTATACAGTAT ATAGAAAAATTTCTGTATTCTCGA
30	TEF_R + Zeo (ov)	GAGCAGTCAGGACTGGAACAGCAGAGGTGAGTTTA GCCATTCTATATACTGTATACCTTA
31	Zeo_L + TEF (ov)	AGCGGTATAACCATAGAAAATAAGGTATACAGTAT ATAGAATGGCTAAACTCACCTCTGC
32	ATFdown_L + Zeo (ov)	GTTTTATTATCTATTTATGCCCTTATATTCTGTAAC TCTCAAAAATATTGATTTTTCTT
33	Zeo_R + ATFdown (ov)	TAAAAAGAATAAAAACCTTGAAAAGAAAATACAATAT TTTGAGATAGTTACAGAATATAAGG
34	Zeo_R + pRS415 (ov)	CTGGAGCTCCACCGCGGTGGCGGCCGCTCTAGAACT AGTGGATAGTTACAGAATATAAGG
Verification of Gene Deletion in <i>H. uvarum</i> (see Error! Reference source not found.)		
35	G1 ATF1 F	ATTCTGCGCAGTCTTAAGCTT
36	G2 R	CAAATCGCTGAAATGGGTGCT
37	G3 F	CAGGTGCTGGTACTGTTGGT
38	G4 ATF1 R NEW	AGAATCTTTGACCGAGCATGA

39	ATF1_L	TTAATTAAATGCTTACGCTTTCGGATGTC
40	HuATF1 R	AAAGGCGCGCCTACAATATTTTGACTAAATGTTAT
41	G5 ATFup-TEF_L	CAAAAGGCAACCATTCCCCC
42	G6 ATFdown-Hyg_R	CTGCCATGGCCAATATCCA

The transformation cassette for creating a null mutant of the *ATF1* gene within the genome of *H. uvarum* is shown in Figure 2b. For selection of transformants, the hygromycin-resistance gene ORF was placed under control of *HuTEF1* promoter. The pRS415 vector was linearised using *Bam*HI and *Hind*III. Flanking adaptor regions to control *in vivo* recombination were added to *HuTEF1* and *hph* marker fragments using the primer set 13/14 and 15/16. Next, BY4741 was transformed with the two PCR products and the cut vector. In addition, 1000 bp homology region upstream and downstream of *HuATF1* gene was amplified from *H. uvarum* DSM2768 genomic DNA using primers 17/18 and 19/20, containing 40 bp flanking homology region to pRS415 and either *HuTEF1* or *hph*. Flanking homology regions to guide *in vivo* recombination were added to pJB1-HuTEF-hph using primers 21/22. Then, BY4741 was transformed with the three PCR products and the linearised vector. Further knock-out cassettes with resistance genes against geneticin (*neoR*), nourseothricin (*natI*), and zeocin (*Sh Ble*) under the control of the *HuTEF1* promoter were designed similar to the hygromycin knock-out cassette. Primers 23–34 are additional primers that were specifically used to assemble the knock-out cassettes with these three antibiotic resistances.

To transform *H. uvarum* DSM2768, the constructed plasmid (pJB2-HuTEF-hph-ATF1up/down) was linearised using *Xho*I and *Xba*I. The cut plasmid was purified using GeneJET Gel Extraction Kit (Thermo Fisher Scientific, Waltham, MA, USA).

4.3. Yeast Transformation

The transformation of *S. cerevisiae* was done according to the lithium acetate/single strand DNA/polyethylene glycol 4000 protocol described by Gietz and Schiestl [57]. For transformation of *H. uvarum* DSM2768, an adaption of the protocols described by Thompson et al. [58] and Bernardi et al. [43] was used. *H. uvarum* DSM2768 was grown overnight in 5 mL YPD at 30 °C. Then, the culture was transferred into 50 mL YPD and incubated at 25 °C for 5 h. After centrifuging and washing with sterile double-distilled water, the culture was resuspended in 25 mL ice-cold 0.1 M lithium acetate/10 mM dithiothreitol/10 mM TE solution and incubated at room temperature for 1 h. The pellet was washed in 25 mL ice-cold sterile double-distilled water first, and then washed with 10 mL of ice-cold 1 M sorbitol. After centrifugation at 4 °C, the cells were resuspended in 100 µL of ice-cold 1 M sorbitol. For transformation, 100 µL of cell suspension were used per sample. An aliquot of 15 µL of transforming DNA or sterile distilled water as negative control, respectively, was mixed with the cell suspension and incubated on ice for 5 min before electroporation with 1.8 kV in 0.2 cm cuvettes. Cells were resuspended in 1 mL of ice-cold 1 M sorbitol and 300 µL YPD and transferred into a 1.5 mL reaction tube for a 3 h incubation at 30 °C. Shortly before the cells were plated out on selective plates (concentration of antibiotics: hygromycin 200–600 µg/mL, geneticin 200 µg/mL, nourseothricin 100–200 µg/mL, and zeocin 50–700 µg/mL) which did not contain sorbitol, they were centrifuged, and the cell pellet resuspended in 1 mL of YPD.

4.4. Verification of Yeast Transformants

Yeast transformants were picked, re-streaked on selection plates, and inoculated in 5 mL YPD including 200 µg/mL hygromycin. Genomic DNA was isolated from these cells by suspending a colony in a 100 µL solution of 200 mM lithium acetate and 1% sodium dodecyl sulphate and incubating in a 70 °C heat block, for three minutes. Thereafter, 300 µL of cooled 100% ethanol was added and centrifuged for 3 min at 13,000 min⁻¹. The supernatant was discarded, then, 400 µL of cooled 70% ethanol was added and centrifuged again with the same settings. The supernatant was discarded, and the pellet was left to

dry. Afterwards, the pellet was resuspended in 50 μL of TE buffer. For verification of transformation, G-primers were constructed (Figure 2b), targeting ~20 bp located within the transformation cassette (primers 36/37) and ~20 bp located within the genome of *H. uvarum* DSM2768 (primers 35/38). The resulting PCR product included either the 1000 bp *HuATF1* upstream or downstream region, respectively (primer sets used, 35/36 and 37/38).

4.5. Fermentations

In this study, pasteurised Müller-Thurgau grape must, harvested in 2019 from a vineyard of the Hochschule Geisenheim University in the Rheingau wine region of Germany, was used. The total sugar content was 180.9 g/L, of which 87.0 g/L was glucose and 93.3 g/L was fructose. The primary amino acid content of the must was analysed using the NOPA (nitrogen by o-phthaldialdehyde) assay and it amounted to 19.73 mg/L. The free ammonium level was 8.17 mg/L, as determined using a Rapid Ammonium kit from Megazyme (Bray, Ireland).

Fermentations with pasteurised Müller-Thurgau grape must using *H. uvarum* DSM2768, as well as the transformants *H. uvarum* DSM2768 (WT/ Δ)/(Δ / Δ) generated within this study, were performed. Precultures of all yeast strains were prepared in shake flasks with YPD and incubated overnight at 30 °C. The next day, the must was inoculated with approximately 1×10^6 cells/mL (as determined via hemocytometer). Fermentations were carried out in triplicate, utilising 250 mL fermentation flasks closed with aluminium foil. The fermentation temperature was 17 °C and flasks were shaken at 120 min^{-1} and fermentation was stopped after 3 days. Samples for high performance liquid chromatography (HPLC) analysis and volatile compound analysis (VCA) were taken and directly measured analytically. In addition, the bio-dry mass was determined.

4.6. High Performance Liquid Chromatography (HPLC) Analysis

The final concentrations of the major organic acids, sugars, and ethanol were determined by HPLC, using a method according to Schneider et al. [59] and modified as described in [60]. An HPLC Agilent Technologies Series 1100, equipped with a binary pump, an autosampler, a multi-wavelength detector (MWD), and a refractive index detector (RID, Agilent Technologies, Steinheim, Germany) was employed. A column with a length of 250 mm, an inside diameter of 4.6 mm, and a particle size of 5 μm was used for the measurements (Allure Organic Acids Column, Restek, Bad Homburg v. d. Höhe, Germany). The MWD was set at a wavelength of 210 nm for the detection of organic acids and the RID was used for the detection of carbohydrates, organic acids, and ethanol. The eluent used was double distilled water with 0.5% ethanol and 0.0139% concentrated sulfuric acid. The flow rate was 0.6 mL/min at a temperature of 46 °C.

4.7. Volatile Compound Analysis

To analyse volatile compounds, headspace-solid phase microextraction gas chromatography mass spectrometry (HS-SPME-GC-MS) analysis was applied according to Câmara et al. [61]. An amount of 5 mL of each sample was needed to measure the quantity of different aroma compounds. A GC 7890 A, equipped with a MS 5975 B (both Agilent, Santa Clara, CA, USA), and MPS robotic autosampler and CIS 4 (both Gerstel, Mülheim an der Ruhr, Germany), was used. Before the addition of 5 mL of wine sample and 10 μL of internal standard each (concentration of stock solution standards, 600 mg/L 1-octanol and 52 mg/L cumene), 1.7 g NaCl were weighed into a 20 mL headspace vial. Solid phase microextraction was carried out using a 65 μm polydimethylsiloxane and divinylbenzol fiber (Supelco, Merck, Darmstadt, Germany). Aroma compound separation was performed with a 60 m \times 0.25 mm \times 1 μm gas chromatography column (Rxi[®]-5Si1 MS w/5m Integra-guard, Restek, Bad Homburg v. d. Höhe, Germany) with helium as carrier gas. The sample was injected in split mode (1:10, initial temperature 30 °C, rate 12 °C/s to 240 °C, hold for 4 min). The gas chromatography (GC) run started with an initial temperature

of 40 °C for 4 min, raised to 210 °C (5 °C/min), and then raised to 240 °C (20 °C/min) and held for 10.5 min. Mass spectral data were acquired in a range of mass to charge ratio (m/z) of 35 to 250 and used to derive concentration values. A 5-point calibration curve was used for each volatile compound within a wine model solution of 10% ethanol with 3% tartaric acid pH 3, as described previously [62].

4.8. Data Analysis

The HPLC data were analysed using the software ChemStation for LC systems from Agilent (Agilent, Santa Clara, CA, USA). The HS-SPME-GC-MS data analyses were carried out using Agilent's MassHunter software (Agilent, Santa Clara, CA, USA).

The graphics were created with GraphPad Prism 5 (Graph Pad Software, La Jolla, CA, USA) and statistical analyses were employed in the form of a one-way analysis of variance (ANOVA) in combination with Bonferroni's multiple comparison test. For statistical analysis, all fermentations were done in triplicate and the values for the metabolites are the means of these triplicates.

Supplementary Materials: The following are available online at www.mdpi.com/1422-0067/22/4/1943/s1, Figure S1: Alignment of the amino acid sequence HuAtf1 with the two Atfs of *Saccharomyces cerevisiae*. The conserved WRLICLP motif as well as the HXXXDG active site are shown in boxes, Figure S2: Acetate esters, ethyl esters, and acetic acid produced after three days of fermentation of Müller-Thurgau must with *Hanseniaspora uvarum* DSM2768 for comparison (DSM2768 Ctrl), DSM2768 #34 (WT/ Δ), DSM2768 #40 (Δ/Δ), and DSM2768 #46 (Δ/Δ). Pure must without the addition of yeasts served as a negative control (Must Ctrl). The measured acetate esters are: (a) ethyl acetate [mg/L]; (b) isoamyl acetate [μ g/L]; (c) 2-methylbutyl acetate [μ g/L]; (d) hexyl acetate [μ g/L]; (e) 2-phenylethyl acetate [μ g/L]; (f) ethyl propionate [μ g/L], (g) ethyl butyrate [μ g/L] and (h) acetic acid [g/L]. Acetate ester production was measured via HS-SPME-GC-MS analysis. Data are the mean of three independent experiments \pm SEM, 1-way ANOVA, Bonferroni's multiple comparison test, * $p < 0.05$, ** $p < 0.01$, *** $p < 0.001$, **** $p < 0.0001$. Error bars indicate the standard deviation, Figure S3: Amounts of fatty acid and alcohols detected after three days of fermentation of Müller-Thurgau must with *Hanseniaspora uvarum*, DSM2768 for comparison (DSM2768 Ctrl), DSM2768 #34 (WT/ Δ), DSM2768 #40 (Δ/Δ), and DSM2768 #46 (Δ/Δ). Pure must without the addition of yeasts served as a negative control (Must Ctrl). The measured fatty acid and alcohols are: (a) hexanoic acid [mg/L]; (b) isobutanol [mg/L]; (c) isoamyl alcohol [mg/L]; (d) 2-methyl-1-butanol [mg/L]; (e) hexanol [μ g/L] and (f) 2-phenyl ethanol [mg/L]. The amounts of fatty acid and alcohols were measured via HS-SPME-GC-MS analysis. Data are the mean of three independent experiments \pm SEM, 1-way ANOVA, Bonferroni's multiple comparison test, * $p < 0.05$, ** $p < 0.01$, **** $p < 0.0001$. Error bars indicate the standard deviation.

Author Contributions: Conceptualisation, C.v.W., J.W., N.v.W., and J.B.; methodology, J.B., N.v.W., and J.W.; strain generation, J.B.; fermentations, J.B. and N.v.W.; analyses, S.B., validation, J.B. and N.v.W.; investigation, J.B. and N.v.W., data curation, J.B. and N.v.W.; visualisation, J.B.; writing—original draft preparation, J.B. and N.v.W.; writing—review and editing, J.B., N.v.W., I.S.P., D.R., J.W., and C.v.W. All authors have read and agreed to the published version of the manuscript.

Funding: The authors would like to thank the Hessen State Ministry of Higher Education, Research and the Arts for the financial support within the Hessen initiative for scientific and economic excellence (LOEWE) in the framework of AROMAplus (<https://www.hs-geisenheim.de/aromaplus/>). The authors thank Geisenheim University and Macquarie University for co-funding of this project and the research fellowship of N.V.W. I.S.P. is a team member of the Macquarie-led national Centre of Excellence in Synthetic Biology funded by the Australian Government through its agency, the Australian Research Council. J.W. is supported by the European Union Marie Skłodowska-Curie Actions Innovative Training Network Aromagenesis (764364) (<https://www.aromagenesis.eu/>).

Institutional Review Board Statement: Not applicable.

Informed Consent Statement: Not applicable.

Data Availability Statement: Not applicable.

Acknowledgments: I.S.P. is a team member of the Macquarie-led national Centre of Excellence in Synthetic Biology funded by the Australian Government through its agency, the Australian Research Council. The authors would like to thank the Hessen State Ministry of Higher Education, Research and the Arts for the financial support within the Hessen initiative for scientific and economic excellence (LOEWE) in the framework of AROMAplus (<https://www.hs-geisenheim.de/aromaplus/>). J.W. is supported by the European Union Marie Skłodowska-Curie Actions Innovative Training Network Aromagenesis (764364) (<https://www.aromagenesis.eu/>). Heike Semmler and Beatrice Bernardi are thanked for their technical assistance. Christine Schlering is thanked for providing the Müller-Thurgau must. Jürgen Heinisch is thanked for providing the yeast strain DSM2768.

Conflicts of Interest: The authors declare no conflict of interest.

Abbreviations

MDPI	Multidisciplinary Digital Publishing Institute
ATF1	Alcohol acetyltransferase I
TEF1	Translational elongation factor EF-1 α
bp	Base pair
DNA	Deoxyribonucleic acid
SO ₂	Sulphur dioxide
<i>kanMX</i>	Geneticin resistance marker
<i>hygMX</i>	Hygromycin resistance marker
ORF	Open reading frame
PCR	Polymerase chain reaction
<i>PGK1</i>	3-Phosphoglycerate kinase 1
<i>FBA1</i>	Fructose-1,6-bisphosphate aldolase 1
<i>ATF2</i>	Alcohol acetyltransferase II
<i>Hph</i>	Hygromycin b phosphotransferase
<i>neoR</i>	Neomycin-geneticin resistance gene
<i>natI</i>	Nourseothricin N-acetyltransferase
<i>Sh Ble</i>	Bleomycin resistance protein
acetyl-CoA	Acetyl coenzyme A
YPD	Yeast extract peptone dextrose media
ANOVA	Analysis of variance
TE	Tris-ethylenediaminetetraacetic acid
HCl	Hydrogen chloride
EDTA	Ethylenediaminetetraacetic acid
HPLC	High performance liquid chromatography
VCA	Volatile compound analysis
MWD	Multi-wavelength detector
RID	Refractive index detector
HS-SPME-GC-MS	Headspace-solid phase microextraction gas chromatography mass Spectrometry
GC	Gas chromatography
MS	Mass spectrometry
MPS	Multipurpose sampler
CIS	Cooled injection system
NaCl	Sodium chloride

References

1. Martin, V.; Valera, M.; Medina, K.; Boido, E.; Carrau, F. Oenological impact of the *Hanseniaspora/Kloeckera* yeast genus on wines—A review. *Fermentation* **2018**, *4*, 76, doi:10.3390/fermentation4030076.
2. Heard, G.M.; Fleet, G.H. Evaluation of selective media for enumeration of yeasts during wine fermentation. *J. Appl. Bacteriol.* **1986**, *60*, 477–481, doi:10.1111/j.1365-2672.1986.tb01086.x.
3. Fleet, G. Yeast interactions and wine flavour. *Int. J. Food Microbiol.* **2003**, *86*, 11–22, doi:10.1016/S0168-1605(03)00245-9.

4. Heard, G.M.; Fleet, G.H. Growth of natural yeast flora during the fermentation of inoculated wines. *Appl. Environ. Microbiol.* **1985**, *50*, 727–728.
5. Holloway, P.; Subden, R.E.; Lachance, M.-A. The yeasts in a Riesling must from the Niagara grape-growing region of Ontario. *Can. Inst. Food Sci. Technol. J.* **1990**, *23*, 212–216, doi:10.1016/S0315-5463(90)70245-3.
6. Comi, G.; Romano, P.; Cocolin, L.; Fiore, C. Characterization of *Kloeckera apiculata* strains from the Friuli region in Northern Italy. *World J. Microbiol. Biotechnol.* **2001**, *17*, 391–394, doi:10.1023/A:1016731420425.
7. Jolly, N.P.; Augustyn, O.; Pretorius, I.S. The occurrence of non-*Saccharomyces cerevisiae* yeast species over three vintages in four vineyards and grape musts from four production regions of the Western Cape, South Africa. *S. Afr. J. Enol. Vitic.* **2003**, *24*, doi:10.21548/24-2-2640.
8. Li, S.-S.; Cheng, C.; Li, Z.; Chen, J.-Y.; Yan, B.; Han, B.-Z.; Reeves, M. Yeast species associated with wine grapes in China. *Int. J. Food Microbiol.* **2010**, *138*, 85–90, doi:10.1016/j.ijfoodmicro.2010.01.009.
9. Belda, I.; Ruiz, J.; Alastruey-Izquierdo, A.; Navascués, E.; Marquina, D.; Santos, A. Unraveling the enzymatic basis of wine “flavorome”: A phylo-functional study of wine related yeast species. *Front. Microbiol.* **2016**, *7*, 12, doi:10.3389/fmicb.2016.00012.
10. Tofalo, R.; Patrignani, F.; Lanciotti, R.; Perpetuini, G.; Schirone, M.; Di Gianvito, P.; Pizzoni, D.; Arfelli, G.; Suzzi, G. Aroma profile of Montepulciano d’Abruzzo wine fermented by single and co-culture starters of autochthonous *Saccharomyces* and non-*Saccharomyces* yeasts. *Front. Microbiol.* **2016**, *7*, 610, doi:10.3389/fmicb.2016.00610.
11. Jolly, N.P.; Varela, C.; Pretorius, I.S. Not your ordinary yeast: Non-*Saccharomyces* yeasts in wine production uncovered. *FEMS Yeast Res.* **2014**, *14*, 215–237, doi:10.1111/1567-1364.12111.
12. Wang, C.; Mas, A.; Esteve-Zarzoso, B. Interaction between *Hanseniaspora uvarum* and *Saccharomyces cerevisiae* during alcoholic fermentation. *Int. J. Food Microbiol.* **2015**, *206*, 67–74, doi:10.1016/j.ijfoodmicro.2015.04.022.
13. Pina, C.; Santos, C.; Couto, J.A.; Hogg, T. Ethanol tolerance of five non-*Saccharomyces* wine yeasts in comparison with a strain of *Saccharomyces cerevisiae*—Influence of different culture conditions. *Food Microbiol.* **2004**, *21*, 439–447, doi:10.1016/j.fm.2003.10.009.
14. Akan, M.; Michling, F.; Matti, K.; Krause, S.; Muno-Bender, J.; Wendland, J. Snails as taxis for a large yeast biodiversity. *Fermentation* **2020**, *6*, 90, doi:10.3390/fermentation6030090.
15. Comitini, F.; Ciani, M. The zymocidal activity of *Tetrapisispora phaffii* in the control of *Hanseniaspora uvarum* during the early stages of winemaking. *Lett. Appl. Microbiol.* **2010**, *50*, 50–56, doi:10.1111/j.1472-765X.2009.02754.x.
16. Tristezza, M.; Tufariello, M.; Capozzi, V.; Spano, G.; Mita, G.; Grieco, F. The oenological potential of *Hanseniaspora uvarum* in simultaneous and sequential co-fermentation with *Saccharomyces cerevisiae* for industrial wine production. *Front. Microbiol.* **2016**, *7*, 670, doi:10.3389/fmicb.2016.00670.
17. Petrucci, L.; Capozzi, V.; Berbegal, C.; Corbo, M.R.; Bevilacqua, A.; Spano, G.; Sinigaglia, M. Microbial resources and enological significance: Opportunities and benefits. *Front. Microbiol.* **2017**, *8*, 995, doi:10.3389/fmicb.2017.00995.
18. Roudil, L.; Russo, P.; Berbegal, C.; Albertin, W.; Spano, G.; Capozzi, V. Non-*Saccharomyces* commercial starter cultures: Scientific trends, recent patents and innovation in the wine sector. *Recent Pat. Food Nutr. Agric.* **2020**, *11*, 27–39, doi:10.2174/2212798410666190131103713.
19. van Wyk, N.; von Wallbrunn, C.; Swiegers, J.H.; Pretorius, I.S. Biotechnology of wine yeasts. In *Encyclopedia of Mycology*; Elsevier: Amsterdam, The Netherlands, 2020; ISBN 9780128096338.
20. Valles, B.S.; Bedriñana, R.P.; Tascón, N.F.; Simón, A.Q.; Madrera, R.R. Yeast species associated with the spontaneous fermentation of cider. *Food Microbiol.* **2007**, *24*, 25–31, doi:10.1016/j.fm.2006.04.001.
21. Lachance, M.A. Yeast communities in a natural tequila fermentation. *Antonie van Leeuwenhoek* **1995**, *68*, 151–160, doi:10.1007/BF00873100.
22. Masoud, W.; Cesar, L.B.; Jespersen, L.; Jakobsen, M. Yeast involved in fermentation of *Coffea arabica* in East Africa determined by genotyping and by direct denaturing gradient gel electrophoresis. *Yeast* **2004**, *21*, 549–556, doi:10.1002/yea.1124.
23. Batista, N.N.; Ramos, C.L.; Ribeiro, D.D.; Pinheiro, A.C.M.; Schwan, R.F. Dynamic behavior of *Saccharomyces cerevisiae*, *Pichia kluyveri* and *Hanseniaspora uvarum* during spontaneous and inoculated cocoa fermentations and their effect on sensory characteristics of chocolate. *LWT—Food Sci. Technol.* **2015**, *63*, 221–227, doi:10.1016/j.lwt.2015.03.051.
24. Arias, C.R.; Burns, J.K.; Friedrich, L.M.; Goodrich, R.M.; Parish, M.E. Yeast species associated with orange juice: Evaluation of different identification methods. *Appl. Environ. Microbiol.* **2002**, *68*, 1955–1961, doi:10.1128/AEM.68.4.1955-1961.2002.
25. Vadkertiová, R.; Dudášová, H.; Stratilová, E.; Balaščíková, M. Diversity of yeasts in the soil adjacent to fruit trees of the Rosaceae family. *Yeast* **2019**, *36*, 617–631, doi:10.1002/yea.3430.
26. Sláviková, E.; Vadkertiová, R.; Vránová, D. Yeasts colonizing the leaves of fruit trees. *Ann. Microbiol.* **2009**, *59*, 419–424, doi:10.1007/BF03175125.
27. Nguyen, N.H.; Suh, S.-O.; Blackwell, M. Five novel *Candida* species in insect-associated yeast clades isolated from *Neuroptera* and other insects. *Mycologia* **2007**, *99*, 842–858, doi:10.3852/mycologia.99.6.842.
28. Kocan, R.M.; Hasenclever, H.F. Normal yeast flora of the upper digestive tract of some wild columbids. *J. Wildl. Dis.* **1972**, *8*, 365–368, doi:10.7589/0090-3558-8.4.365.
29. de Araujo, F.V.; Soares, C.A.; Hagler, A.N.; Mendonça-Hagler, L.C. Ascomycetous yeast communities of marine invertebrates in a southeast Brazilian mangrove ecosystem. *Antonie van Leeuwenhoek* **1995**, *68*, 91–99, doi:10.1007/BF00873096.
30. Pagnocca, F.G.; Mendonça-Hagler, L.C.; Hagler, A.N. Yeasts associated with the white shrimp *Penaeus schmitti*, sediment, and water of Sepetiba Bay, Rio de Janeiro, Brasil. *Yeast* **1989**, *5*, 479–483.

31. Long, C.; Wu, Z.; Deng, B.-X. Biological control of *Penicillium italicum* of citrus and *Botrytis cinerea* of grape by strain 34–9 of *Kloeckera apiculata*. *Eur. Food Res. Technol.* **2005**, *221*, 197–201, doi:10.1007/s00217-005-1199-z.
32. Basha, H.; Ramanujam, B. Growth promotion effect of *Pichia guilliermondii* in chilli and biocontrol potential of *Hanseniaspora uvarum* against *Colletotrichum capsici* causing fruit rot. *Biocontrol Sci. Technol.* **2015**, *25*, 185–206, doi:10.1080/09583157.2014.968092.
33. Liu, H.M.; Guo, J.H.; Cheng, Y.J.; Li Luo; Liu, P.; Wang, B.Q.; Deng, B.X.; Long, C.A. Control of gray mold of grape by *Hanseniaspora uvarum* and its effects on postharvest quality parameters. *Ann. Microbiol.* **2010**, *60*, 31–35, doi:10.1007/s13213-010-0018-3.
34. Sternes, P.R.; Lee, D.; Kutyna, D.R.; Borneman, A.R. Genome sequences of three species of *Hanseniaspora* isolated from spontaneous wine fermentations. *Genome Announc.* **2016**, *4*, doi:10.1128/genomeA.01287-16.
35. Seixas, I.; Barbosa, C.; Mendes-Faia, A.; Güldener, U.; Tenreiro, R.; Mendes-Ferreira, A.; Mira, N.P. Genome sequence of the non-conventional wine yeast *Hanseniaspora guilliermondii* UTAD222 unveils relevant traits of this species and of the *Hanseniaspora* genus in the context of wine fermentation. *DNA Res.* **2019**, *26*, 67–83, doi:10.1093/dnares/dsy039.
36. Guaragnella, N.; Chiara, M.; Capece, A.; Romano, P.; Pietrafesa, R.; Siesto, G.; Manzari, C.; Pesole, G. Genome sequencing and comparative analysis of three *Hanseniaspora uvarum* indigenous wine strains reveal remarkable biotechnological potential. *Front. Microbiol.* **2019**, *10*, 3133, doi:10.3389/fmicb.2019.03133.
37. Chen, K.; Yang, X.; Zheng, F.; Long, C. Genome sequencing and analysis of *Kloeckera apiculata* strain 34-9, a biocontrol agent against postharvest pathogens in citrus. *Genes Genom.* **2017**, *39*, 87–99, doi:10.1007/s13258-016-0475-6.
38. Langenberg, A.-K.; Bink, F.J.; Wolff, L.; Walter, S.; von Wallbrunn, C.; Grossmann, M.; Heinisch, J.J.; Schmitz, H.-P. Glycolytic functions are conserved in the genome of the wine yeast *Hanseniaspora uvarum*, and pyruvate kinase limits its capacity for alcoholic fermentation. *Appl. Environ. Microbiol.* **2017**, *83*, doi:10.1128/AEM.01580-17.
39. Steenwyk, J.L.; Oplente, D.A.; Kominek, J.; Shen, X.-X.; Zhou, X.; Labella, A.L.; Bradley, N.P.; Eichman, B.F.; Čadež, N.; Libkind, D. et al. Extensive loss of cell-cycle and DNA repair genes in an ancient lineage of bipolar budding yeasts. *PLoS Biol.* **2019**, *17*, e3000255, doi:10.1371/journal.pbio.3000255.
40. Saubin, M.; Devillers, H.; Proust, L.; Brier, C.; Grondin, C.; Pradal, M.; Legras, J.-L.; Neuvéglise, C. Investigation of genetic relationships between *Hanseniaspora* species found in grape musts revealed interspecific hybrids with dynamic genome structures. *Front. Microbiol.* **2019**, *10*, 2960, doi:10.3389/fmicb.2019.02960.
41. Kayacan, Y.; Griffiths, A.; Wendland, J. A script for initiating molecular biology studies with non-conventional yeasts based on *Saccharomyces schoenii*. *Microbiol. Res.* **2019**, *229*, 126342, doi:10.1016/j.micres.2019.126342.
42. Nancolas, B.; Bull, I.D.; Stenner, R.; Dufour, V.; Curnow, P. *Saccharomyces cerevisiae Atf1p* is an alcohol acetyltransferase and a thioesterase in vitro. *Yeast* **2017**, *34*, 239–251, doi:10.1002/yea.3229.
43. Bernardi, B.; Kayacan, Y.; Akan, M.; Wendland, J. Overexpression of *RAD51* enables PCR-based gene targeting in lager yeast. *Microorganisms* **2019**, *7*, doi:10.3390/microorganisms7070192.
44. Sakai, K.; Yamamoto, M. Transformation of the yeast, *Saccharomyces carlsbergensis*, using an antibiotic resistance marker. *Agric. Biol. Chem.* **1986**, *50*, 1177–1182, doi:10.1080/00021369.1986.10867557.
45. Nakazawa, N.; Hashimoto, H.; Harashima, S.; Oshima, Y. Use of the *PDR4* gene as a dominant selective marker in combination with cerulenin for prototrophic strains in *Saccharomyces cerevisiae*. *J. Ferment. Bioeng.* **1993**, *76*, 60–63, doi:10.1016/0922-338X(93)90054-C.
46. Kondo, K.; Saito, T.; Kajiwara, S.; Takagi, M.; Misawa, N. A transformation system for the yeast *Candida utilis*: Use of a modified endogenous ribosomal protein gene as a drug-resistant marker and ribosomal DNA as an integration target for vector DNA. *J. Bacteriol.* **1995**, *177*, 7171–7177, doi:10.1128/jb.177.24.7171-7177.1995.
47. Hashida-Okado, T.; Ogawa, A.; Kato, I.; Takesako, K. Transformation system for prototrophic industrial yeasts using the *AUR1* gene as a dominant selection marker. *FEBS Lett.* **1998**, *425*, 117–122, doi:10.1016/S0014-5793(98)00211-7.
48. Lilly, M.; Bauer, F.F.; Lambrechts, M.G.; Swiegers, J.H.; Cozzolino, D.; Pretorius, I.S. The effect of increased yeast alcohol acetyltransferase and esterase activity on the flavour profiles of wine and distillates. *Yeast* **2006**, *23*, 641–659, doi:10.1002/yea.1382.
49. Verstrepen, K.J.; van Laere, S.D.M.; Vanderhaegen, B.M.P.; Derdelinckx, G.; Dufour, J.-P.; Pretorius, I.S.; Winderickx, J.; Thevelein, J.M.; Delvaux, F.R. Expression levels of the yeast alcohol acetyltransferase genes *ATF1*, *Lg-ATF1*, and *ATF2* control the formation of a broad range of volatile esters. *Appl. Environ. Microbiol.* **2003**, *69*, 5228–5237, doi:10.1128/AEM.69.9.5228-5237.2003.
50. Christiaens, J.F.; Franco, L.M.; Cools, T.L.; Meester, L. de; Michiels, J.; Wenseleers, T.; Hassan, B.A.; Yaksi, E.; Verstrepen, K.J. The fungal aroma gene *ATF1* promotes dispersal of yeast cells through insect vectors. *Cell Rep.* **2014**, *9*, 425–432, doi:10.1016/j.celrep.2014.09.009.
51. van Wyk, N.; Kroukamp, H.; Espinosa, M.I.; von Wallbrunn, C.; Wendland, J.; Pretorius, I.S. Blending wine yeast phenotypes with the aid of CRISPR DNA editing technologies. *Int. J. Food Microbiol.* **2020**, *324*, 108615, doi:10.1016/j.ijfoodmicro.2020.108615.
52. Sikorski, R.S.; Hieter, P. A System of shuttle vectors and yeast host strains designed for efficient manipulation of DNA in *Saccharomyces cerevisiae*. *Genetics* **1989**, *122*, 19–27.
53. Chee, M.K.; Haase, S.B. New and redesigned pRS plasmid shuttle vectors for genetic manipulation of *Saccharomyces cerevisiae*. *G3 Genes | Genomes | Genetics* **2012**, *2*, 515–526, doi:10.1534/g3.111.001917.
54. Wach, A.; Brachat, A.; Pöhlmann, R.; Philippsen, P. New heterologous modules for classical or PCR-based gene disruptions in *Saccharomyces cerevisiae*. *Yeast* **1994**, *10*, 1793–1808, doi:10.1002/yea.320101310.

55. Schaub, Y.; Dünkler, A.; Walther, A.; Wendland, J. New pFA-cassettes for PCR-based gene manipulation in *Candida albicans*. *J. Basic Microbiol.* **2006**, *46*, 416–429, doi:10.1002/jobm.200510133.
56. Gatignol, A.; Dassain, M.; Tiraby, G. Cloning of *Saccharomyces cerevisiae* promoters using a probe vector based on phleomycin resistance. *Gene* **1990**, *91*, 35–41, doi:10.1016/0378-1119(90)90159-O.
57. Gietz, R.D.; Schiestl, R.H. High-efficiency yeast transformation using the LiAc/SS carrier DNA/PEG method. *Nat. Protoc.* **2007**, *2*, 31–34, doi:10.1038/nprot.2007.13.
58. Thompson, J.R.; Register, E.; Curotto, J.; Kurtz, M.; Kelly, R. An improved protocol for the preparation of yeast cells for transformation by electroporation. *Yeast* **1998**, *14*, 565–571, doi:10.1002/(SICI)1097-0061(19980430)14:6<565:AID-YEA251>3.0.CO;2-B.
59. Schneider, A.; Gerbi, V.; Redoglia, M. A rapid HPLC method for separation and determination of major organic acids in grape musts and wines. *Am. J. Enol. Vitic.* **1987**, *38*, 151.
60. Mecca, D.; Benito, S.; Beisert, B.; Brezina, S.; Fritsch, S.; Semmler, H.; Rauhut, D. Influence of nutrient supplementation on *Torulaspota Delbrueckii* wine fermentation aroma. *Fermentation* **2020**, *6*, 35, doi:10.3390/fermentation6010035.
61. Câmara, J.S.; Alves, M.A.; Marques, J.C. Development of headspace solid-phase microextraction-gas chromatography–mass spectrometry methodology for analysis of terpenoids in Madeira wines. *Anal. Chim. Acta* **2006**, *555*, 191–200, doi:10.1016/j.aca.2005.09.001.
62. Dutraive, O.; Benito, S.; Fritsch, S.; Beisert, B.; Patz, C.-D.; Rauhut, D. Effect of sequential inoculation with non-*Saccharomyces* and *Saccharomyces* yeasts on Riesling wine chemical composition. *Fermentation* **2019**, *5*, 79, doi:10.3390/fermentation5030079.

Development of genetic modification tools for *Hanseniaspora uvarum*

Badura, J.; van Wyk, N.; Brezina, S.; Pretorius, I. S.; Rauhut, D.; Wendland, J.; von Wallbrunn, C.

Int. J. Mol. Sci. (2021) 22 (4), 1943.

DOI: 10.3390/ijms22041943

Supporting Information

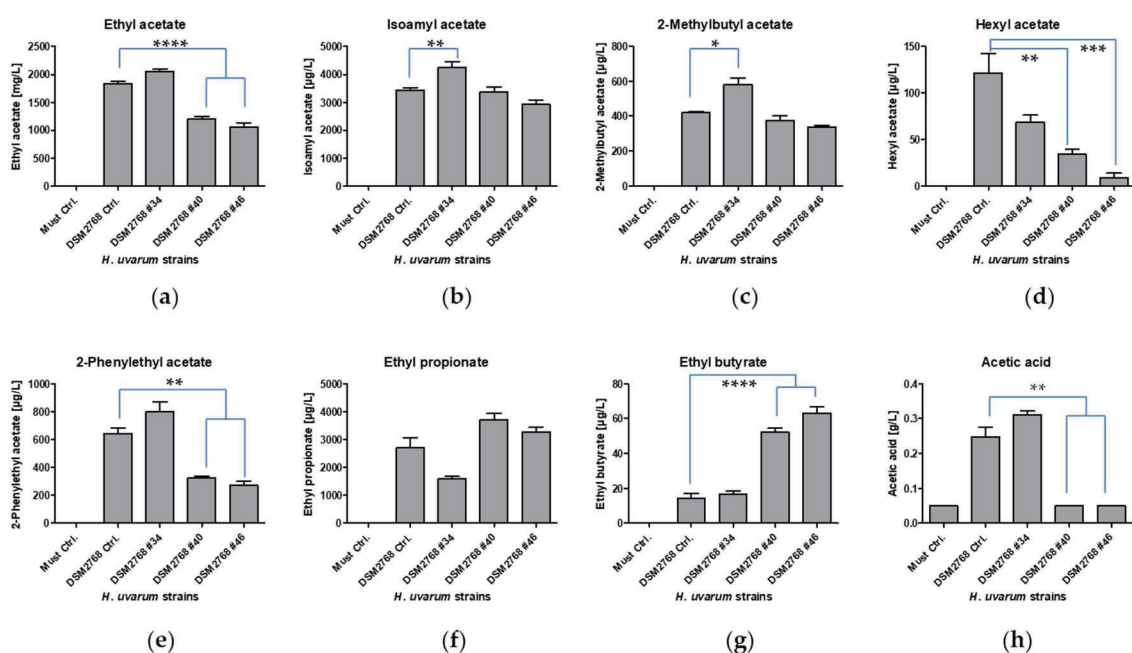

Figure S2. Acetate esters, ethyl esters and acetic acid produced after three days of fermentation of Müller-Thurgau must with *Hanseniaspora uvarum* DSM2768 for comparison (DSM2768 Ctrl.); DSM2768 #34 (WT/ Δ); DSM2768 #40 (Δ/Δ) and DSM2768 #46 (Δ/Δ). Pure must without the addition of yeasts served as a negative control (Must Ctrl.). The measured acetate esters are: (a) ethyl acetate [mg/L]; (b) isoamyl acetate [$\mu\text{g/L}$]; (c) 2-methylbutyl acetate [$\mu\text{g/L}$]; (d) hexyl acetate [$\mu\text{g/L}$]; (e) 2-phenylethyl acetate [$\mu\text{g/L}$]; (f) ethyl propionate [$\mu\text{g/L}$], (g) ethyl butyrate [$\mu\text{g/L}$] and (h) acetic acid [g/L]. Acetate ester production was measured via HS-SPME-GC-MS analysis. Data are the mean of three independent experiments \pm SEM, 1-way ANOVA, Bonferroni's multiple comparison test, * $p < 0.05$, ** $p < 0.01$, *** $p < 0.001$, **** $p < 0.0001$. Error bar indicate the standard deviation.

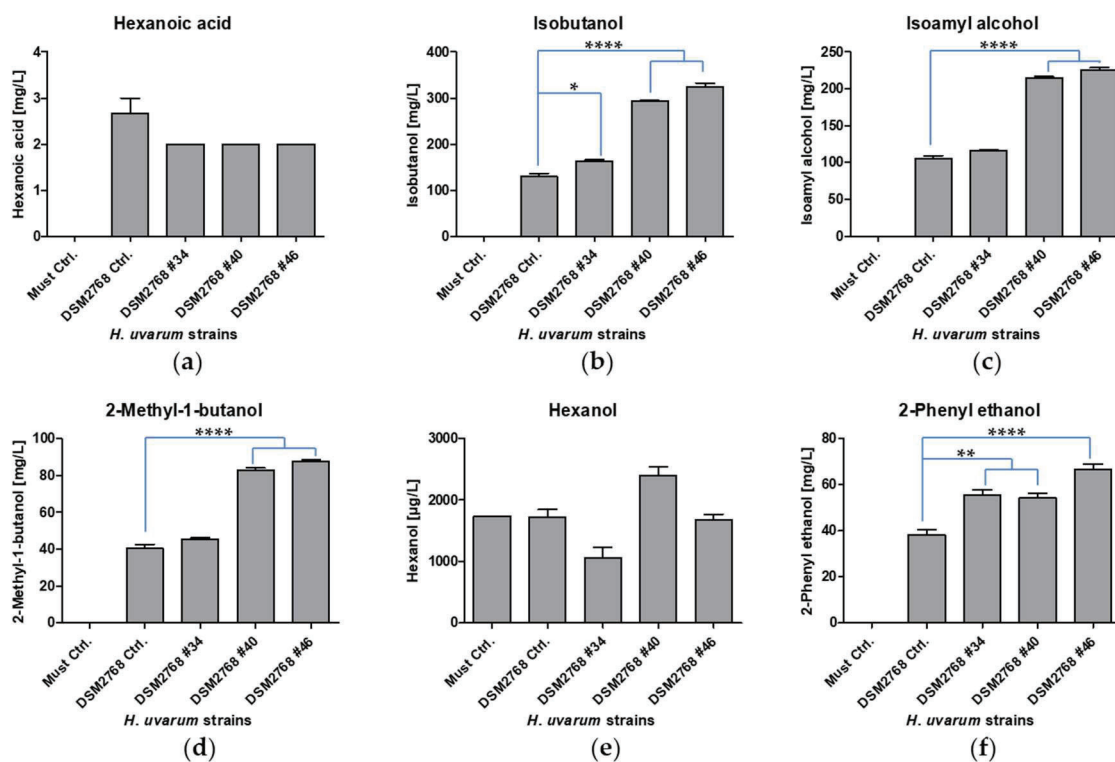

Figure S3. Amounts of fatty acid and alcohols detected after three days of fermentation of Müller-Thurgau must with *Hanseniaspora uvarum* DSM2768 for comparison (DSM2768 Ctrl.); DSM2768 #34 (WT/ Δ); DSM2768 #40 (Δ/Δ) and DSM2768 #46 (Δ/Δ). Pure must without the addition of yeasts served as a negative control (Must Ctrl.). The measured fatty acid and alcohols are: (a) hexanoic acid [mg/L]; (b) isobutanol [mg/L]; (c) isoamyl alcohol [mg/L]; (d) 2-methyl-1-butanol [mg/L]; (e) hexanol [μ g/L] and (f) 2-phenyl ethanol [mg/L]. The amounts of fatty acid and alcohols were measured via HS-SPME-GC-MS analysis. Data are the mean of three independent experiments \pm SEM, 1-way ANOVA, Bonferroni's multiple comparison test, * $p < 0.05$, ** $p < 0.01$, **** $p < 0.0001$. Error bar indicate the standard deviation.

Chapter 6 - PCR-based gene targeting in *Hanseniaspora uvarum*

Chapter 6 is submitted for publication.

Badura, J.; van Wyk, N.; Zimmer, K.; Pretorius, I. S.; von Wallbrunn, C.; Wendland, J.: PCR-based gene targeting in *Hanseniaspora uvarum*

Author contributions:

Conceptualization: JW, **JB**

Funding acquisition: CvW

Methodology: JW, **JB**

Investigation: **JB**, KZ

Validation: **JB**

Data curation: **JB**

Formal analysis: **JB**

Visualization: **JB**

Project administration: CvW

Resources: CvW

Supervision: JW, CvW

Writing – original draft: **JB**, JW

Writing – review & editing: **JB**, JW, NvW, ISP, CvW

All authors have read and agreed to the submitted version of the manuscript.

RESEARCH ARTICLE

PCR-based gene targeting in *Hanseniaspora uvarum*

Jennifer Badura¹, Niël van Wyk^{1,2}, Kerstin Zimmer¹, Isak S. Pretorius², Christian von Wallbrunn¹ and Jürgen Wendland^{1,*}

¹ Department of Microbiology and Biochemistry, Hochschule Geisenheim University, Von-Lade-Strasse 1, 65366 Geisenheim, Germany; jennifer.badura@hs-gm.de (J.B.); niel.wyk@hs-gm.de (N.V.W.); kerstin.zimmer@hs-gm.de (K.Z.); christian.wallbrunn@hs-gm.de (C.V.W.)

² ARC Centre of Excellence in Synthetic Biology, Macquarie University, Sydney, NSW 2109, Australia
sakkie.pretorius@mq.edu.au (I.S.P)

*Corresponding author: Prof Jürgen Wendland, Department of Microbiology and Biochemistry, Hochschule Geisenheim University, Von-Lade-Strasse 1, 65366 Geisenheim, Germany.
juergen.wendland@hs-gm.de (J.W.)

One sentence summary: This article describes a PCR-based gene targeting approach with two marker genes as tools for directed gene manipulations in the apiculate yeast *Hanseniaspora uvarum*.

ABSTRACT

Lack of gene-function analyses tools limits studying the biology of *Hanseniaspora uvarum*, one of the most abundant yeasts on grapes and in must. We investigated a rapid PCR-based gene targeting approach for one-step gene replacement in this diploid yeast. To this end, we generated and validated two novel synthetic antibiotic resistance genes, pFA-*hygXL* and pFA-*clnXL*, providing resistance against hygromycin and nourseothricin, respectively, for use with *H. uvarum*. Addition of short flanking-homology regions of 56–80 bp to these selection markers via PCR was sufficient to promote gene targeting. We report here the deletion of the *H. uvarum* *LEU2* and *LYS2* genes with these novel marker genes via two rounds of consecutive transformations, each resulting in the generation of auxotrophic strains (*leu2/leu2*; *lys2/lys2*). The hereby constructed leucine auxotrophic *leu2/leu2* strain was subsequently complemented in a targeted manner, thereby further validating this approach. PCR-based gene targeting in *H. uvarum* was less efficient than in *Saccharomyces cerevisiae*. However, this approach combined with the availability of two marker genes, provides essential tools for directed gene manipulations in *H. uvarum*.

Keywords: functional analysis, gene replacement, *LEU2*, *LYS2*, *Hanseniaspora uvarum*, homologous recombination, short-flanking homology region, yeast

Introduction

Hanseniaspora uvarum is an apiculate yeast that is frequently found on ripe fruits (Drumonde-Neves et al. 2021; Fleet 2003). It is also one of the most abundant yeast species present at the onset of grape must fermentations. Therefore, it has an influential role in shaping the final wine product as it prevails in the early stages of fermentation, competes for nutrients with

Saccharomyces wine yeasts, and produces several aroma-active compounds, especially acetate esters (van Wyk et al. 2023). The population of *Hanseniaspora* declines during a fermentation due to a number of factors including being sensitive to the killer factor of *Saccharomyces* (Wang et al. 2015). *H. uvarum* is known for its production of high amounts of acetic acid and ethyl acetate and was therefore considered a spoilage yeast for a long time. However, the deliberate use of *H. uvarum* in mixed-culture fermentations has shown to provide several benefits to the final fermented beverages, not just in grape-derived wines (Tristezza et al. 2016), but also in tequila (González-Robles et al. 2015), orange (Hu et al. 2018) and apple fermentations (Rodríguez Madrera et al. 2013). Moreover, *H. uvarum*-based biotechnological applications are increasing, e.g. its use in the development of fly traps (Bueno et al. 2020), for the removal of nitrogen from wastewater systems (Zhang et al. 2018) and as a biocontrol agent against fungal phytopathogens (Long et al. 2007).

In-depth genomic analysis of members of the genus *Hanseniaspora* have revealed interesting features on its genomic composition, most noteworthy are the absence of several genes involved in the cell cycle and genome integrity, especially within the so-called 'fast-evolving clade' of which *H. uvarum* is a member (Steenwyk et al. 2019).

Recently, genome modifying tools have been developed for *H. uvarum* whereby a synthetic marker based on the hygromycin resistance gene transcriptionally driven by a native *H. uvarum* promoter was used to disrupt a putative alcohol acetyltransferase (*ATF*) gene in *H. uvarum*. The resulting strain produced significantly lower levels of acetate esters indicating that this enzyme provided the major transferase activity. Homologous recombination was achieved by flanking the marker gene with ~1 000 bp of target homology regions (Badura et al. 2021). However, due to *H. uvarum* being a diploid yeast without a known sexual cycle, further development of tools for gene-function analyses are required (Saubin et al. 2020).

In several ascomycetous yeasts and filamentous fungi PCR-based gene targeting methods have been developed (Baudin et al. 1993; Wach et al. 1994; Bähler et al. 1998; Wendland et al. 2000). The advantage of such methods is the rapid generation of specific disruption cassettes by PCR. To these cassettes short-flanking homology regions are introduced via PCR-primers instead of cloning or synthesizing cassettes bearing long-flanks (Walther and Wendland 2008). The size of the flanking homology regions is species dependent and varies between species. For example, while 35-40 bp flanks are sufficient for PCR-based gene targeting of *S. cerevisiae*, 100 bp flanks are required for *Candida albicans* (Gola et al. 2003; Wendland 2003). Particularly, in the diploid human fungal pathogen *C. albicans*, the generation of marker modules that allowed the amplification of different markers with the same set of primers allows the targeting of both alleles in sequential rounds of transformations (Gerami-Nejad et al. 2004; Schaub et al. 2006).

Here, we present evidence that short-flanking homology regions introduced by PCR to the hygromycin resistance gene, pFA-*hygXL*, were sufficient to achieve gene-targeting in *H. uvarum*. To promote gene-function studies in this diploid yeast, we established a second marker gene, pFA-*clnXL*, providing resistance to the antibiotic nourseothricin. PCR-based gene targeting was validated by deletion of both the *H. uvarum* *LEU2* and *LYS2* genes, generating a leucine auxotrophic *leu2/leu2* mutant and a lysine auxotrophic *lys2/lys2* mutant, respectively. Furthermore, we complemented the *leu2/leu2* mutant by reintegration of the *HuLEU2* ORF at the *LEU2* locus replacing either of the selectable marker gene ORFs in a targeted manner.

Materials and Methods:

Yeast Strains and Culture Conditions

Yeasts strains used and generated in this study (Table 1) were cultured in YPD (10 g/L yeast extract, 20 g/L Bacto peptone and 20 g/L glucose) at 25 °C (*H. uvarum*) or 30 °C (*S. cerevisiae*), respectively. 2x-CSM-Leu (5 g/L ammonium sulphate, 3.4 g/L yeast nitrogen base, 1.38 g/L single drop-out-Leu and 20 g/L glucose) was used for selection of complemented *leu2* strains and for the identification of leucine auxotrophic strains. 2x-CSM-Lys medium (5 g/L ammonium sulphate, 3.4 g/L yeast nitrogen base, 3.9 g/L single drop-out-Lys and 20 g/L glucose) was used for the identification of lysine auxotrophic strains.

Table 1. Yeast strains used and generated in this study.

Strain	Feature/Genotype	Source
BY4741	<i>Saccharomyces cerevisiae</i> MAT α <i>his3</i> Δ 1, <i>leu2</i> Δ 0, <i>met15</i> Δ 0, <i>ura3</i> Δ 0	Euroscarf, Oberursel, Germany
DSM2768	<i>Hanseniaspora uvarum</i> wildtype	(Langenberg et al. 2017)
G373	<i>Hanseniaspora uvarum</i> <i>LEU2/leu2::hygXL</i>	This study, derivative of DSM2768
G374/G375	<i>Hanseniaspora uvarum</i> <i>leu2::clnXL/leu2::hygXL</i>	This study, derivative of G373
G376	<i>Hanseniaspora uvarum</i> <i>leu2::clnXL/leu2::hygXL, LEU2</i>	This study, derivative of G375
G377	<i>Hanseniaspora uvarum</i> <i>LEU2/leu2::clnXL</i>	This study, derivative of G375
G378	<i>Hanseniaspora uvarum</i> <i>HuTEF1p-LEU2/leu2::hygXL</i>	This study, derivative of G375
G379	<i>Hanseniaspora uvarum</i> <i>HuTEF1p-LEU2/leu2::clnXL</i>	This study, derivative of G375
G422	<i>Hanseniaspora uvarum</i> <i>LYS2/lys2::hygXL</i>	This study, derivative of DSM2768
G423/G424/G425	<i>Hanseniaspora uvarum</i> <i>lys2::clnXL/lys2::hygXL</i>	This study, derivative of G422

By adding 20 g/L agar, solid media plates were prepared. YPD plates, were supplemented with antibiotics (200 μ g/mL hygromycin B or 50 μ g/mL nourseothricin/clonNat) for selection of

transformants. *Escherichia coli* DH5 α , cultured in 2xYT (16 g/L tryptone, 10 g/L yeast extract and 5 g/L NaCl) supplemented with 100 μ g/mL ampicillin, was used for plasmid propagation.

Plasmid and primer design

Plasmids used and generated in this study are shown in Table 2. Primers used for plasmid constructions and PCR-based gene targeting are listed in Table 3. Plasmids were assembled in *S. cerevisiae* BY4741 using yeast assembly (Kuijpers et al. 2013). Plasmid DNA amplification was carried out in *E. coli* and was obtained by Plasmid Midi Purification Kit (Promega, Madison, WI, USA). *H. uvarum* DNA sequences were retrieved from the genomes of AWRI3580 (Accession: SAMN04331434) and DSM2768 (Accession: SAMN01885404), which are both publicly available. *S. cerevisiae* homologs, e.g. *LEU2* encoding the β -isopropylmalate dehydrogenase (IMDH), *LYS2*, which encodes the α -aminoadipate reductase and the promoter region of *TEF1* encoding the *translation elongation factor EF-1 α* , were identified in *H. uvarum* by using BLAST functions at NCBI. An error in a previously designed, yet functional, transformation cassette providing resistance of *H. uvarum* transformants to hygromycin was corrected in this study by exchanging the inadvertently used *HuELF1* promoter with the correct *HuTEF1* promoter. Therefore, we named the new selection marker containing the *hph* ORF under control of the *HuTEF1* promoter *hygXL*. The *hygXL* selection marker (Figure 1A) was inserted into the pRS415 vector (cut with *Bam*HI and *Hind*III) via yeast assembly using primers 1-4 (primer sets 1/2 (S1-pRS415-*HuTEF1*1/3'-*HuTEF1*-*hph*), 3/4 (5'-*hph*-*HuTEF1*/S2-pRS415-*hph*), Table 3), generating PCR products of the *HuTEF1* promoter and the hygromycin ORF with primer overhangs homologous to the vector and the second PCR product, respectively.

Table 2. Plasmids utilized and generated in this study.

Plasmid	Feature/Genotype	Source
pRS415	<i>bla</i> , <i>LEU2</i>	(Sikorski and Hieter 1989)
pGEM-T	pGEM-T Easy Vector System	Promega (Madison, WI, USA)
pRS415-YES2	pRS415-YES2	(Chee and Haase 2012; Kayacan et al. 2019)
pRS415-YES3	pRS415-YES3	(Schaub et al. 2006; Kayacan et al. 2019)
pFA- <i>hygXL</i>	pRS415, <i>hygXL</i>	This study
pGEM-T-pFA- <i>hygXL</i>	<i>hygXL</i>	This study
pFA- <i>clnXL</i>	pRS415, <i>clnXL</i>	This study

Table 3. Primers utilized for complete *HuLYS2* ORF and *HuLEU2* ORF deletion and complementation of *HuLEU2* ORF.

Primer Number	Primer Name	5' → 3' Sequence ^a
Plasmid design and construction		
1	S1-pRS415- <i>HuTEF1</i>	ttgggtaccgggccccccctcgaggctcgacggtatcgataCAACCAGGCGCTATAGCACG
2	3'- <i>HuTEF1</i> - <i>hph</i>	attttcaacagaagtagcagctcaattctggtttttcatTTTTTTATAATTATTGTTAA
3	5'- <i>hph</i> - <i>HuTEF1</i>	gaataagtaaaaaccagtcattaacaataattataaaaaaATGAAAAAACAGAATTGAC
4	S2-pRS415- <i>hph</i>	ctggagctccaccgcggtggcggccgctctagaactagtgAGGACCACCTTTGATTGTAA
5	5'- <i>hygXL</i>	gaagcttcgtacgctgcaggctcTCTAGATTA AAAACACTTACATGC
6	3'- <i>hygXL</i>	ctcgagctgatcatcgatgaattcgagctcGACCACCTTTGATTGTAAATAG
7	S1-pRS415- <i>HuTEF1</i>	tgtaaaacgacggccagtgagcgcgtaatacagctcactataggaagcttcgtacgct gcaggctcTCTAGATTA AAAACACTTACATGCAG
8	S2- <i>HuTEF1</i> - <i>natI</i>	aacaagacaaaagtcagataacaagtgaactgctccaagcagtaatacataccatTTT TTTATAATTATTGTTAATGACTGG
Gene deletion and complementation		
9	S1- <i>HuLEU2</i>	cacttaataaaatagataatgaaatggaataacaccatacactatattaataatata tacaataaaaaGAAGCTTCGTACGCTGCAGGTC
10	S2- <i>HuLEU2</i>	caatgaagtgtttatatagctacccatttttttttattcttaacaaatattaagt ccatcacataaagcatagagTCTGATATCATCGATGAATTCGAG
11	S1- <i>HuLYS2</i>	aaatattaataaggaagaagatagaaatacaataatagtaacaaaacaataaccag taacaaaacaattagatacaGAAGCTTCGTACGCTGCAGGTC
12	S2- <i>HuLYS2</i>	tattcatttaaaaaataataataaaagctatataatgcactcaaatgaacaattat ttattaatttttttaattTCTGATATCATCGATGAATTCGAG
13	S1- <i>HuLEU2</i> - <i>HuTEF1</i> p	gaattatatttgattactaaagaataagtaaaaaccagtcattaacaataattataaa aaaATGTCTACTACAAAGAAAATAAC
14	S2- <i>HuLEU2</i> - <i>CaURA3t</i>	cttattttttttattatacatatatacaaatctaataaagtgaaaatctccccTTAT AAGTACTTTTTGACTG
Verification		
15	I1- <i>HuLEU2</i>	GGTGCTGCTATTGATGCCACC
16	I2- <i>HuLEU2</i>	CTTGAGCAACACCACTACC
17	G1- <i>HuLEU2</i>	GTCTCCTGTATCGGCGAACTTC
18	G4- <i>HuLEU2</i>	ACTTCTGCCTCCTTGAACC
19	5'- <i>HuLEU2</i>	ATGTCTACTACAAAGAAAATAAC
20	3'- <i>HuLEU2</i>	TTATAAGTACTTTTTGACTGC

21	G1- <i>HuLYS2</i>	GAACTCTCGCCTATTTTCGCCG
22	G4- <i>HuLYS2</i>	GCACAAAAAGATGGTGGACG
23	G2- <i>HuTEF1p</i>	CAGCTGTCATTTCTCTGACCG
24	G3- <i>hph</i>	CCATCTACTAGACCAAGAGC
25	G3- <i>natI</i>	GGTGGTATTGATTTGTTTAC
26	I1- <i>HuLYS2</i>	GTGCCACCTCCAAGATTCCA
27	I2- <i>HuLYS2</i>	AGTCAATGCTGTCCCAGTGG

^a Primer sequences with homology to a target locus are written in lower case.

Flanking S1-/S2-annealing regions were added using primer set 5/6 (5'-*hygXL*/3'-*hygXL*) and the PCR product was ligated in pGEM-T Easy (Promega, Madison, WI, USA). The pFA-*clnXL* selection marker was generated by exchange of the *Saccharomyces schoenii* *TEF1* promoter of pRS415-YES3 with the promoter of the *HuTEF1* gene. To this end, pRS415-YES3 was linearized with *Pst*I to release the *S. schoenii* *TEF1* promoter. The *HuTEF1* promoter was amplified from genomic DNA with primer set 7/8 (S1-pRS415-*HuTEF1*/S2-*HuTEF1-natI*) and assembled upstream of the nourseothricin resistance gene ORF via GAP-repair, generating pFA-*clnXL*. All primers were purchased from Sigma-Aldrich (Steinheim, Germany) and restriction enzymes were purchased from Thermo Fisher Scientific (Waltham, MA, USA). All restriction digests and PCR products were analysed by gel electrophoretic separation on 1% agarose gels stained with GelRed (Genaxxon Bioscience, Ulm, Germany). The size of PCR products was determined by comparing samples along with GenLadder 1 kb (ready-to-use) DNA marker (Genaxxon, Ulm, Germany). Sequencing of newly created plasmids or of verification PCR-products was done by Starseq (Mainz, Germany).

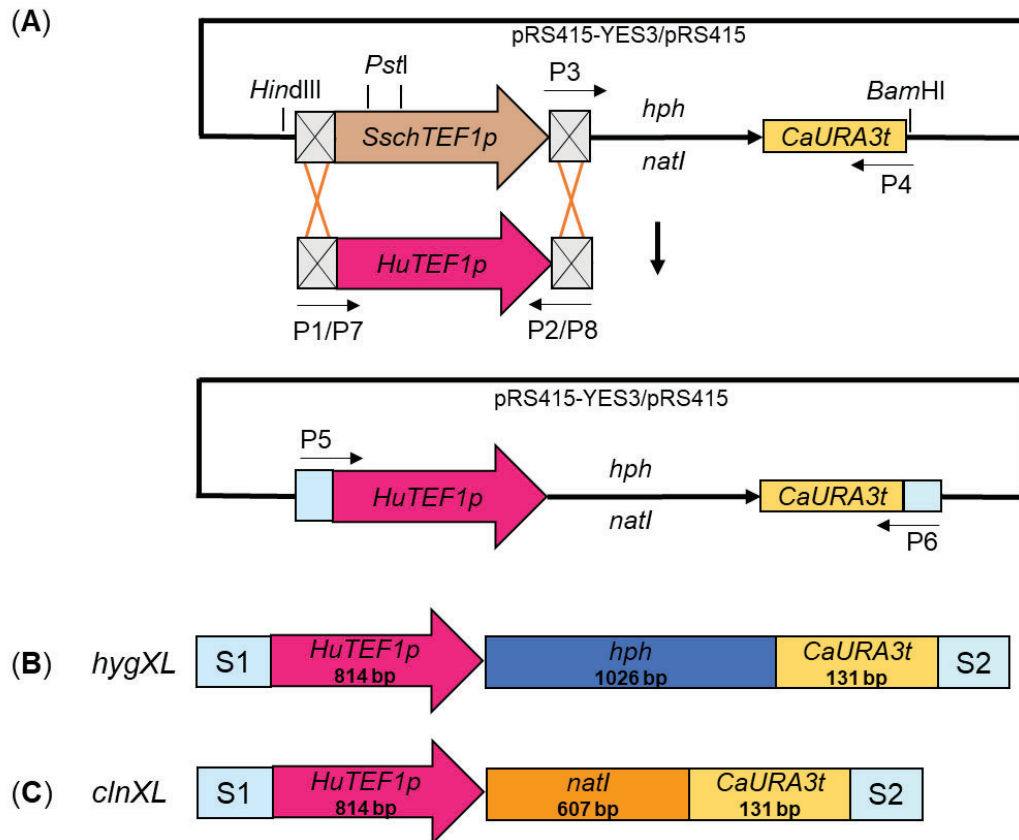

Figure 1. Design and assembly of the selection markers *hygXL* and *clnXL*. **(A)** Plasmids pRS415 or pRS415-YES3 were linearized with *Bam*HI and *Hind*III or *Pst*I, respectively. Linearized pRS415-YES3 was co-transformed with a PCR-product of the *HuTEF1* promoter that carried terminal homology regions of 67 or 57 bp to the vector as indicated (primer set 7/8 (S1-pRS415-*HuTEF1*/S2-*HuTEF1*-*natI*)), generating a promoter exchange of *Saccharomyces schoenii* *TEF1* promoter with the *HuTEF1* promoter. Linearized pRS415 was co-transformed with PCR-products of the *HuTEF1* promoter and *hph*-*CaURA3* terminator carrying terminal homology regions of 40 bp to the vector and to each other (primer sets 1/2 (S1-pRS415-*HuTEF1*/3'-*HuTEF1*-*hph*) and 3/4 (5'-*hph*-*HuTEF1*/S2-pRS415-*hph*)). **(B)** Then, *hygXL* was amplified with primers adding the S1 and S2 primer annealing regions (primer set 5/6 (5'-*hygXL*/3'-*hygXL*)) and ligated into pGEM-T Easy. **(B,C)** This generated functional analysis plasmids pFA-*hygXL* and pFA-*clnXL*.

Cassette amplification for transformation experiments

Specific disruption cassettes of *hygXL* and *clnXL* used in sequential transformations of *H. uvarum* to delete both alleles of its *LEU2* gene were generated by PCR with primer set 9/10 (S1-*HuLEU2*/S2-*HuLEU2*), while primer set 11/12 (S1-*HuLYS2*/S2-*HuLYS2*) was used to generate *LYS2* deletion cassettes in a similar manner. For transformation of *H. uvarum* 120 μ L of PCR products were generated, precipitated and resuspended in 30 μ L of H₂O, with a DNA concentration of \sim 350 ng/ μ L, and used to transform 100 μ L of a yeast cell suspension. *H. uvarum* *LEU2* fragments used for complementation were amplified directly from genomic DNA of *H. uvarum*. For complementation of a *H. uvarum* *leu2/leu2* strain two different PCR products were generated. One contained the *HuLEU2* ORF flanked by 239 bp and 376 bp of direct upstream and downstream homology regions, respectively, derived from the endogenous *LEU2* promoter and terminator (primer set 17/18, G1-*HuLEU2*/G4-*HuLEU2*, Figure 5A). The other consisted of the *HuLEU2* ORF amplified with primer set 13/14 (S1-

HuLEU2-HuTEF1p/S2-HuLEU2-CaURA3t). This PCR-product allowed targeting of the *HuLEU2* ORF into either *hygXL* or *clnXL* at the *LEU2* locus thereby replacing either one of the resistance gene ORFs (Figure 5B).

Yeast transformation and verification

S. cerevisiae was transformed using the lithium acetate/single strand DNA/polyethylene glycol 4000 protocol according to Gietz and Schiestl (2007). *H. uvarum* was transformed by electroporation as described previously (Badura et al. 2021). For transformation, a culture with an O.D. value of 0.7 (diluted culture 1:10) was used for the preparation of electrocompetent cells, from which $\sim 1 \times 10^{12}$ cells per sample were used for electroporation. Electroporation was performed using Eporator® (4309FH901694) from Eppendorf SE (Hamburg, Germany) set at 1.8 kV with an actual discharge time ranging between 5.4-5.9 ms using 0.2 cm cuvettes. When selecting transformants for antibiotic resistance cells were incubated at 30 °C for 3 h after transformation to allow for the expression of the resistance gene prior to plating on selective media. For complementation of *leu2*, this adaptation step was not required. After two - four days of incubation, yeast transformants were picked, re-streaked on selection plates and inoculated in 5 mL liquid selective media. DNA was isolated from these transformants and used for diagnostic PCR using appropriate primer sets (*LEU2* deletion: 15/16 (I1-*HuLEU2*/I2-*HuLEU2*), 17/18 (G1-*HuLEU2*/G4-*HuLEU2*), 19/20 (5'-*HuLEU2*/3'-*HuLEU2*), 9/20 (S1-*HuLEU2*/3'-*HuLEU2*) and 19/10 (5'-*HuLEU2*/S2-*HuLEU2*); *LYS2* deletion: 21/23 (G1-*HuLYS2*/G2-*HuTEF1p*), 24/22 (G3-*hph*/G4-*HuLYS2*), 25/22 (G3-*natI*/G4-*HuLYS2*) and 26/27 (I1-*HuLYS2*/I2-*HuLYS2*)). Relevant PCR products as well as newly generated plasmid constructs were verified by sequencing. Diagnostic PCRs with a PCR product size of less than 600 bp were obtained by colony PCR. To this end, a small amount of cell material was picked from a transformant colony, dissolved in 50 μ L of distilled water and 5 μ L thereof were used in 50 μ L PCR reactions. Purified genomic DNA from transformants was used as a template in diagnostic PCRs to obtain verification bands larger than 600 bp. For DNA isolation, 1.5 mL of the culture were pelleted and resuspended in 700 μ L of STE buffer (1 M sorbitol; 50 mM Tris pH 7-8; 100 mM EDTA; 50 μ g/mL RNase) with the addition of 50 μ L of zymolase (10 mg/mL), vortexed and incubated at 37 °C for 45 min. Then, 50 μ L of 10% SDS was added for cell lysis and after mixing and incubation at room temperature for 5 min, 300 μ L of neutralization buffer (294.42 g/L potassium acetate, 11.5% glacial acetic acid) was added. The samples were incubated on ice for 5 min and then centrifuged for 10 min at 13 000 min^{-1} . DNA was precipitated by adding 1 ml of isopropanol to the supernatant and centrifugation for 25 min at 13 000 min^{-1} . The DNA pellet was washed with 70% ethanol, dried and resuspended in 100 μ L H₂O. Pico™ Microcentrifuge 17 (75002410) from Thermo Fisher Scientific (Waltham, MA, USA) was used for centrifugation steps.

Results:

Design and Testing of Selection Markers

Use of PCR-based gene targeting techniques for diploid yeasts requires sequential transformation and the use of two selection markers. To be able to target two alleles of a single gene with only one primer set we generated marker gene modules consisting of the *HuTEF1* promoter and the *C. albicans URA3* terminator controlling the expression of the selection marker gene open reading frames mediating resistance to the antibiotics hygromycin and nourseothricin (Figure 1). Due to the heterologous function of *HuTEF1* promoter in *S. cerevisiae* we could directly verify the functionality of pFA-*hygXL* and pFA-*clnXL* by selecting *S. cerevisiae* transformants that had correctly assembled these marker genes.

We had previously established protocols for using hygromycin selection in *H. uvarum* (Badura et al. 2021). However, at that time our attempts to engage clonNAT as an antibiotic against *H. uvarum* failed. Upon re-evaluation of our selection scheme we found that *H. uvarum* is sensitive to clonNAT at concentrations of $\geq 50 \mu\text{g/mL}$. This promoted the construction of *clnXL*, a new selection marker providing resistance against clonNAT in *H. uvarum*. Previously, we achieved gene targeting in *H. uvarum* with flanking homology regions of ~ 1000 bp. Here, we wanted to determine whether shorter homology regions were also sufficient for gene targeting. We chose the *H. uvarum LEU2* and *LYS2* genes as targets to investigate PCR-based gene targeting approaches. Homozygous deletion of *LEU2* and *LYS2* will yield auxotrophic strains requiring either leucine or lysine for growth, respectively, which can be easily detected using minimal media.

Disruption of *HuLEU2* and *HuLYS2* by PCR-based gene targeting

Two rounds of transformations were used to delete both alleles of the target genes as shown in Figure 2. For transformation we conducted a lithium acetate sensitizing step prior to electroporation as described previously (Badura et al. 2021). The disruption cassettes generated by PCR carried 5'- and 3'-flanking homology regions of 72 bp and 80 bp, respectively. These were derived from promoter and terminator regions directly upstream and downstream of either the *LEU2*-ORF or the *LYS2*-ORF to result in complete ORF deletions at the target loci. The first rounds of transformation of *H. uvarum* were performed with the *hygXL* marker and the second rounds with the *clnXL* marker.

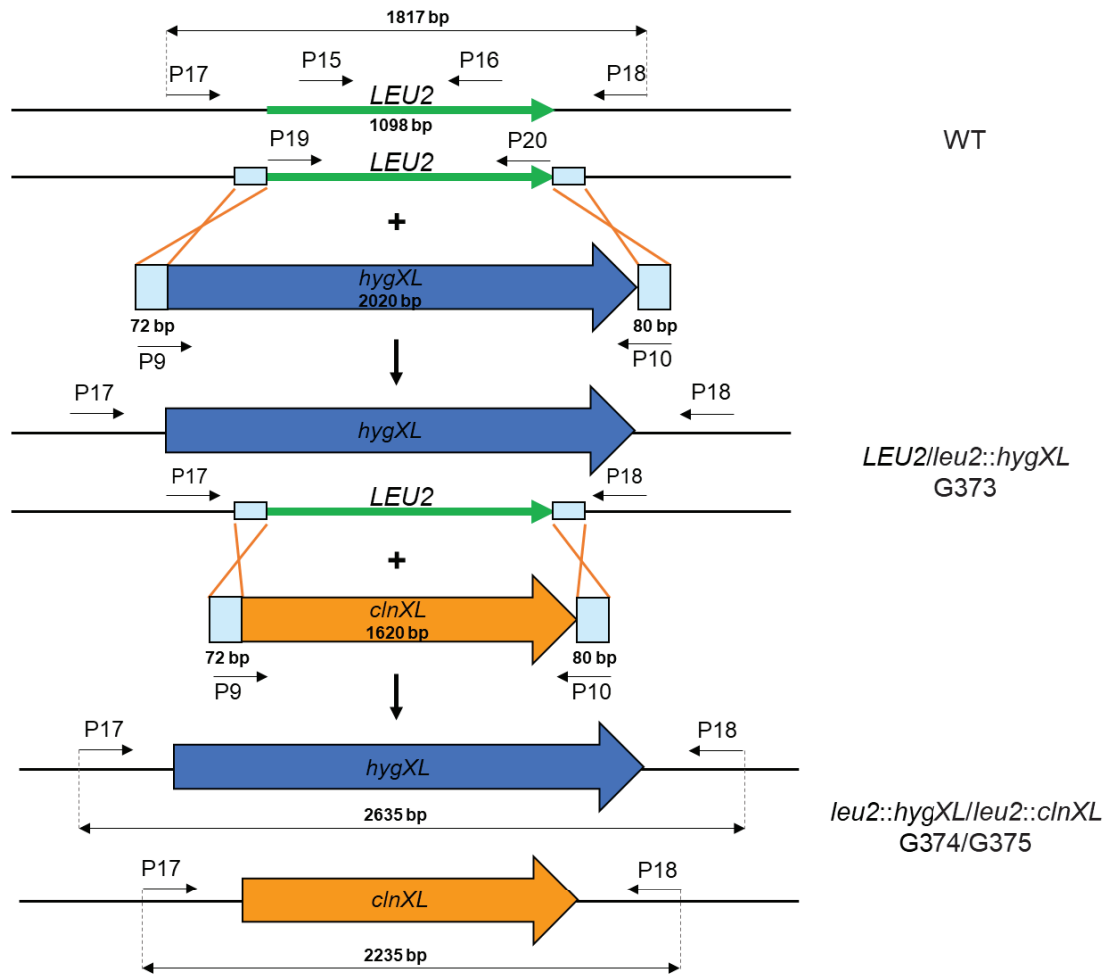

Figure 2. Schematic drawing of the sequential disruption of *HuLEU2* by PCR-based gene targeting. *H. uvarum* wildtype (WT) was transformed with disruption cassettes amplified from pFA-*hygXL* and pFA-*clnXL* with primers S1-*HuLEU2* and S2-*HuLEU2* (9/10, Table 3). Homologous recombination resulted in the integration of the disruption cassettes and replacement of the *LEU2* ORF. After the first round of transformation this generated strain G373 (*LEU2/leu2::hygXL*). In the second round of transformation, strains G374 and G375 (*leu2::hygXL/leu2::clnXL*) were generated.

Upon transformation of *H. uvarum* to delete *LEU2*, 108 primary transformants were re-streaked on new selection plates of which eight strains failed to grow. Genomic DNA was isolated from 24 randomly picked colonies grown in liquid selective medium and correct integration at the *LEU2* locus was investigated by diagnostic PCR (G1-*HuLEU2*/G4-*HuLEU2*, primer set 17/18, see Figure 2). All of these 24 transformants generated G1-G4 verification bands indicative of the presence of a wildtype *LEU2* locus (1.8 kb band lane 1 in Figure 3) as can be expected for (at best) heterozygous mutants. Surprisingly, all of these transformants also showed the successful integration of *hygXL* at a *LEU2* locus (diagnostic band of 2.6 kb band; compare lanes 1 and 2 in Figure 3). Sequence analysis of the PCR-product of the upper (2.6 kb) band indicated correct integration of *hygXL* at *LEU2* (not shown).

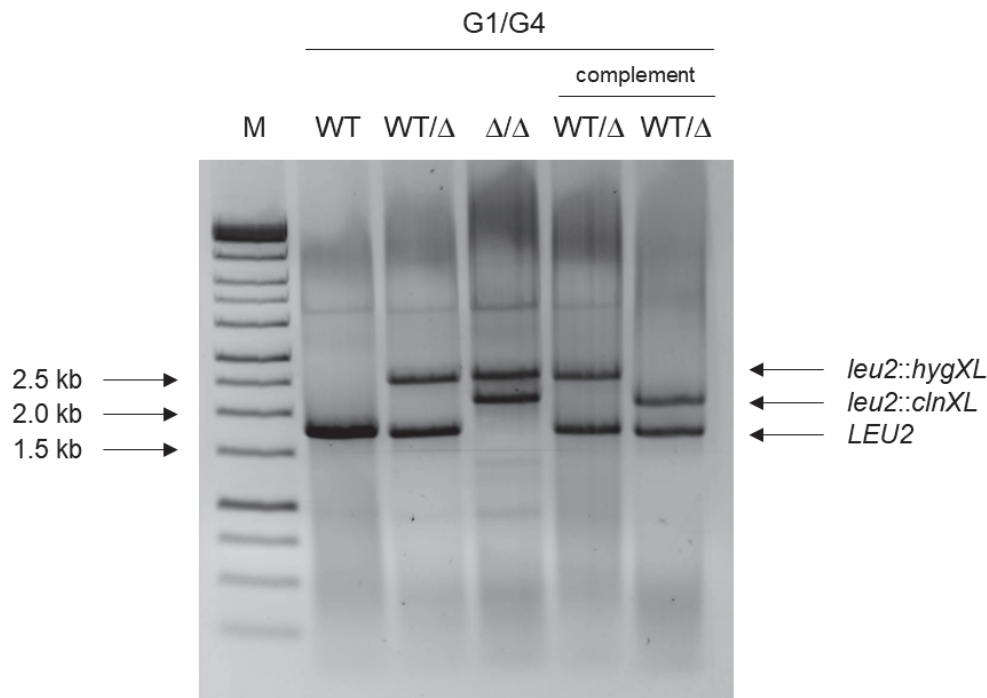

Figure 3. Verification of Transformants via PCR amplification with primer set 17/18 (G1-*HuLEU2*/G4-*HuLEU2*). Agarose gel, stained with GelRed, showing PCR amplification of wildtype (WT), single knock-out (*LEU2/leu2::hygXL*; WT/ Δ), double knock-out (*leu2::clnXL/leu2::hygXL*; Δ/Δ), *LEU2* complementation by reintegration at the *clnXL* locus using PCR amplified G1/G4 *HuLEU2* (*LEU2/leu2::hygXL*; WT/ Δ) and *LEU2* complementation by reintegration at the *hygXL* locus using PCR amplified G1/G4 *HuLEU2* (*LEU2/leu2::clnXL*; WT/ Δ). Resulting bands showed to be the size of ~1.8 kb (*LEU2*), ~2.2 kb (*leu2::clnXL*) and ~2.6 kb (*leu2::hygXL*). M indicates the GenLadder 1kb (ready-to-use) DNA marker.

In the next step, one of these heterozygous *LEU2/leu2* deletion mutants was selected for the second-round transformation with the PCR-amplified *clnXL* marker. This transformation was carried out in the same manner as before; however, transformants were selected on double-selective medium, *i.e.* on plates containing both hygromycin and nourseothricin. Three-hundred primary transformants were obtained, all of which grew upon re-streaking onto double-selective plates. Two of these strains showed no growth on minimal medium plates lacking leucine. Diagnostic-PCR verified correct integration of the second marker, presence of both markers and deletion of the *LEU2* gene. In these transformants the *LEU2* wildtype band of 1.8 kb had disappeared and next to the 2.6 kb band for the *hygXL* integration a 2.2 kb band appeared instead that was indicative of *clnXL* integration at *LEU2* (Figure 3).

Growth phenotypes of these strains demonstrated that the *leu2/leu2* genotype verified by PCR indeed also resulted in leucine auxotrophy as expected (Figure 4).

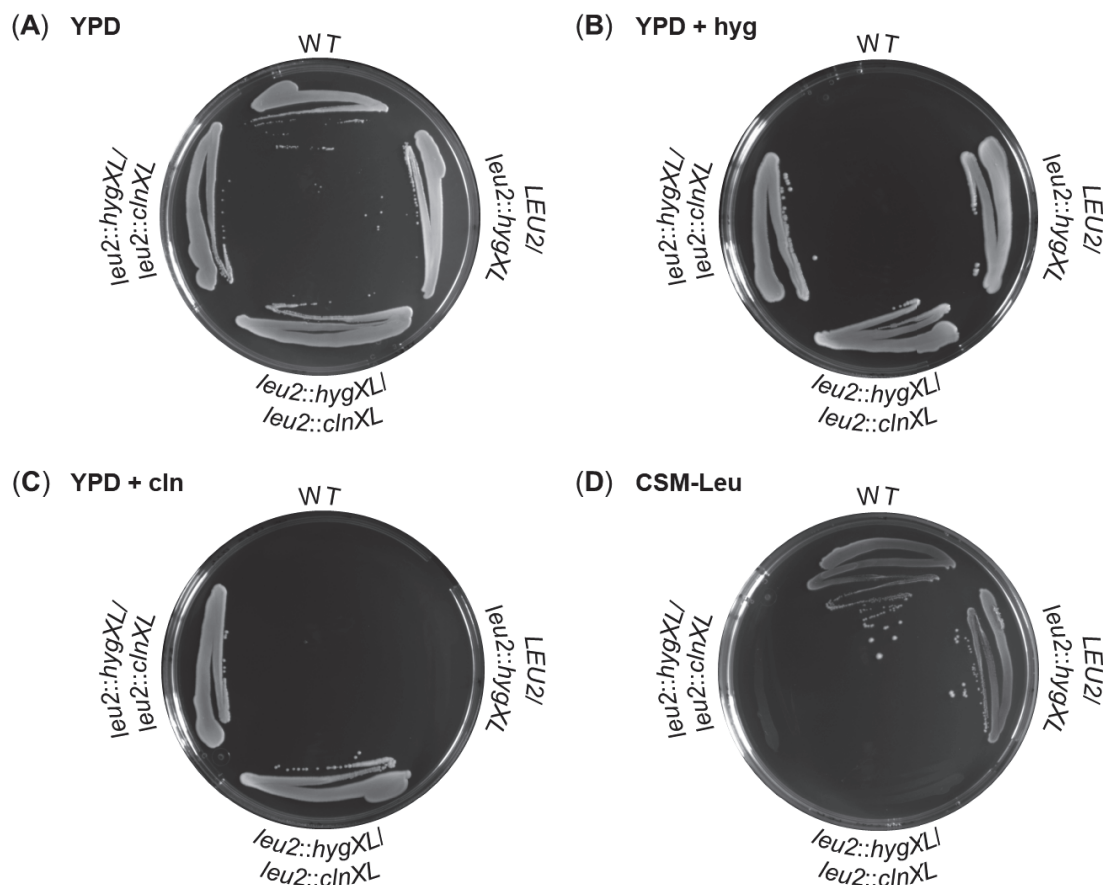

Figure 4. Complete *LEU2* ORF deletion by PCR-based gene targeting in *H. uvarum*. *H. uvarum* WT, WT/ Δ (*LEU2*/*leu2::hygXL*; G373) and two Δ/Δ strains (*leu2::hygXL*/*leu2::clnXL*; G374 and G375) were streaked out on plates containing (A) YPD, (B) YPD supplemented with 200 μ g/mL of hygromycin, (C) YPD supplemented with 50 μ g/mL of nourseothricin and (D) CSM-Leu medium.

Deletion of the *LYS2* gene was performed in an analogous manner (see Figure S1). Disruption cassettes were generated by PCR with primers adding 80 bp of flanking homology region to the target gene. First, *H. uvarum* was transformed using the *hygXL* marker and 38 primary transformants were obtained. These were tested by colony PCR using primer sets 21/23 (G1-*HuLYS2*/G2-*HuTEF1p*) and 24/22 (G3-*hph*/G4-*HuLYS2*). Eight of these transformants showed successful integration of *hygXL* into one of the *LYS2* alleles by amplifying a G1/G2 band of 393 bp and a G3/G4 band of 466 bp indicating correct targeting (see Figure S2 for one of those). One of these *LYS2*/*lys2* heterozygous mutants (G422) was selected for transformation with the *clnXL* marker. This generated 112 primary transformants, which were tested for insertion of *clnXL* into the second *LYS2* allele. Out of these, six transformants showed disruption of the second *LYS2* allele and lysine auxotrophy (see Figure S3).

Complementation of the *Hanseniaspora uvarum leu2* mutant strain

We next set out to use the *H. uvarum leu2* mutant in complementation experiments. The simplest approach was to transform the mutant strain with a DNA-fragment containing the complete *LEU2* gene. Integration of *LEU2* in any non-essential position in the genome and

expression of the gene will revert the mutant phenotype back to wildtype. This can conveniently be achieved due to the high percentage of ectopic integration in *H. uvarum*. To test this, we amplified a *LEU2* fragment from *H. uvarum* genomic DNA using the G1-*HuLEU2*/G4-*HuLEU2* primer pair (primer set 17/18). Here, the *LEU2*-ORF was flanked by 239 bp upstream and 376 bp downstream sequences. From this experiment we expected three potential outcomes (Figure 5A): (i) ectopic integration outside of the *LEU2* loci; (ii) homologous recombination resulting in the removal of the *hygXL* marker or (iii) homologous recombination and marker exchange of the *clnXL* marker.

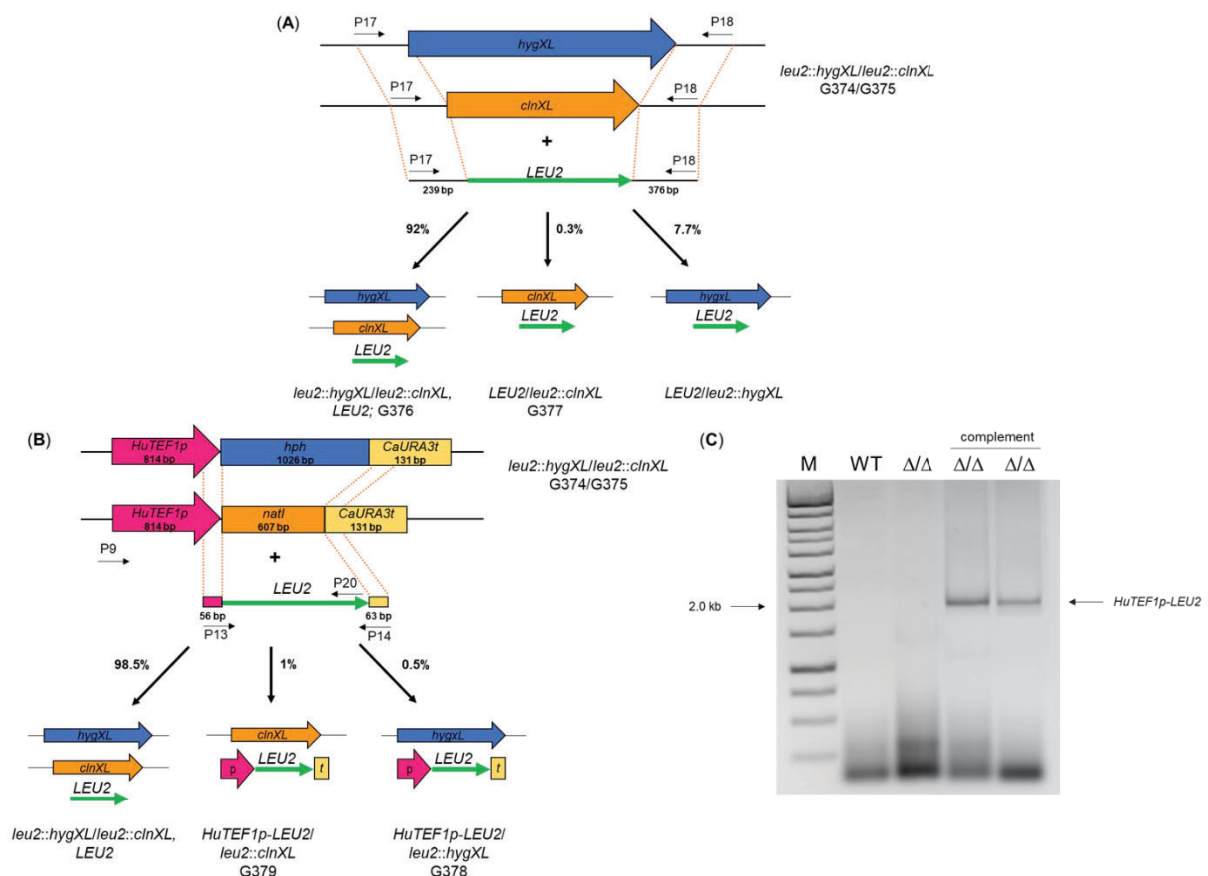

Figure 5. Schematic drawing of the complementation of *H. uvarum leu2* mutant via PCR-based gene targeting and diagnostic verification of *HuTEFp-LEU2*. (A) Complementation of the *leu2* mutant using PCR products generated with G1-*HuLEU2*/G4-*HuLEU2* primers (primer set 17/18) resulting either in ectopic integration of the PCR product (generating strain *leu2::hygXL/leu2::clnXL, LEU2; G376*) or targeted integration and removal of *hygXL* (generating strain *LEU2/leu2::clnXL; G377*) or *clnXL* (generating strain *LEU2/leu2::hygXL; G373*), respectively. (B) Complementation of the *leu2* mutant using PCR products of the *HuLEU2* ORF with short-flanking homology regions to the selection markers (primer set 13/14 (S1-*HuLEU2*-*HuTEF1p*/S2-*HuLEU2*-*CaURA3t*)) resulting either in ectopic integration (generating strain *leu2::hygXL/leu2::clnXL, LEU2*) or targeted integration and exchange of the *hph* ORF (generating strain *HuTEF1p-LEU2/leu2::clnXL; G379*) or *natI* ORF (generating strain *HuTEF1p-LEU2/leu2::hygXL; G378*). (C) Agarose gel, stained with GelRed, showing PCR amplification products using primer set 9/20 (S1-*HuLEU2*/3'-*HuLEU2*) on DNA of the wildtype (WT), G375 (*leu2::clnXL/leu2::hygXL; Δ/Δ*), G379 (*HuTEF1p-LEU2/leu2::clnXL; Δ/Δ*) and G378 (*HuTEF1p-LEU2/leu2::hygXL; Δ/Δ*). Resulting bands showed to be the size of ~2.0 kb (*HuTEF1p-LEU2*). M indicates the GenLadder 1kb (ready-to-use) DNA marker.

During this experiment we observed poor growth of *H. uvarum* on minimal medium plates. As the minimal medium mixtures are optimized for growth of *S. cerevisiae* some of the nutrients could be present in insufficient quantities for *H. uvarum* and thus yield only poor growth of this

yeast. We, therefore, increased the minimal medium mixture by doubling both the amounts of YNB and CSM-Leu to provide additional nutrients (except leucine). With this alteration, *H. uvarum* transformants showed good growth after two days of incubation at 25 °C.

Transformation with the longer flanking homology regions of this PCR-product did not result in increased gene targeting efficiencies. Out of 300 Leu⁺ transformants, 276 showed ectopic integration and only 24 transformants had integrated the transforming DNA at the endogenous *LEU2* locus. Ectopic integration was evident as these strains still contained both antibiotic resistance marker genes (our unpublished results). In contrast, correct gene targeting led to the replacement of one of the two selection markers. Thus, such transformants had lost either the *hygXL* or the *clnXL* gene (see lanes 4 and 5 in Figure 3 and Figure 5A). In these transformants complementation reconstituted one *LEU2* locus back to wildtype. Transformants G377 (*LEU2/leu2::clnXL*) and G373 (*LEU2/leu2::hygXL*) are examples for this and, in fact, represent heterozygous deletion strains. However, it should be noted that we had not previously generated the *LEU2/leu2::clnXL* strain as our initial heterozygous mutants were obtained with the *hygXL* marker.

To demonstrate complementation in a more targeted manner, we chose to amplify the *LEU2*-ORF with primers (primer set 13/14, S1-*HuLEU2-HuTEF1p*/S2-*HuLEU2-CaURA3t*) adding very short flanking homology regions of 56 bp upstream and 63 bp downstream of the start and stop codon, respectively. These homology regions were designed to target the *LEU2*-ORF directly to the *hygXL* or *clnXL* marker genes and generate an ORF replacement. In this way, the *LEU2* ORF was to be brought under the control of the *HuTEF1* promoter used for these antibiotic resistance marker genes.

From this experiment we expected an increased amount of correct gene targeting as the 56 bp homology region to the *TEF1* promoter was thought to be insufficient to activate *LEU2* transcription. However, still a large number of transformants apparently harboured all three selection markers (*hygXL*, *clnXL* and *LEU2*). Nevertheless, replica-plating identified strains that had lost either hygromycin or clonNAT resistance via *hygXL*- or *clnXL*-ORF replacement (see lanes 3 and 4 in Figure 5C). These strains generated also a novel gene consisting of the *HuTEF1* promoter, the *HuLEU2* ORF and the *C. albicans URA3* terminator, which was verified by PCR as a 2 kb band (Figure 5B). A phenotypic growth comparison of the complemented strains compared to the *leu2/leu2* mutant strain is shown in Figure 6. Taken together, our results verify correct *LEU2* target gene deletion and complementation of the resulting auxotrophy.

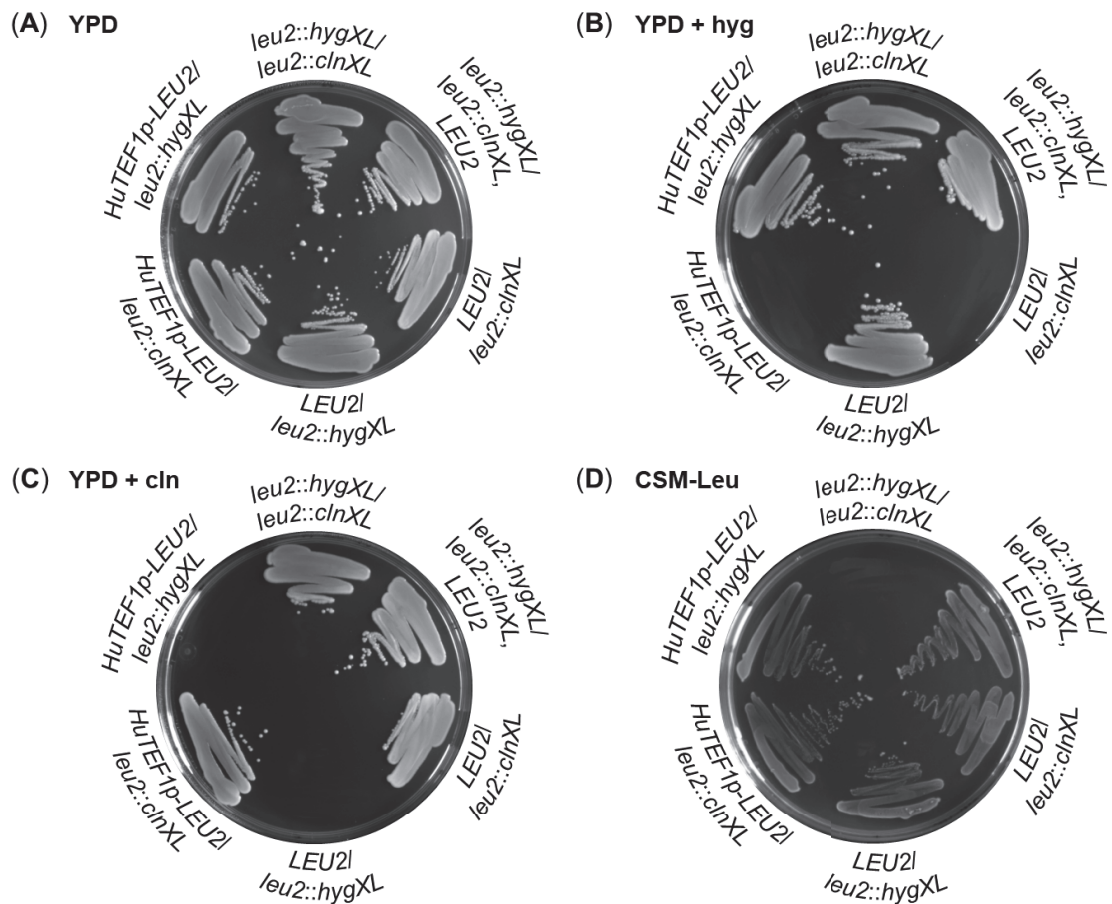

Figure 6. Complementation of the *leu2* mutant by PCR-based gene targeting. *H. uvarum* Δ/Δ (*leu2::clnXL/leu2::hygXL*; G375), Δ/Δ (*leu2::clnXL/leu2::hygXL*, *LEU2*; G376), *WT/\Delta* (*LEU2/leu2::clnXL*; G377), *WT/\Delta* (*LEU2/leu2::hygXL*), Δ/Δ (*HuTEF1p-LEU2/leu2::clnXL*; G379) and Δ/Δ (*HuTEF1p-LEU2/leu2::hygXL*; G378) were streaked out on plates containing (A) YPD, (B) YPD supplemented with 200 $\mu\text{g}/\text{mL}$ of hygromycin, (C) YPD supplemented with 50 $\mu\text{g}/\text{mL}$ of nourseothricin and (D) CSM-Leu medium.

Transformation Efficiency

PCR-based gene targeting is highly efficient in some species, e.g. *S. cerevisiae* and *Ashbya gossypii* (Wach et al. 1994; Wendland et al. 2000). In *H. uvarum*, the targeting success was found to be variable (Table 4). First round transformation to obtain a *LEU2* deletion was surprisingly successful, however the second round with the *clnXL* marker was drastically less efficient. This was also observed in the *LYS2* deletion experiment. However, transformants could be screened in a higher throughput way by using colony PCR for diagnostics. This can bypass the need for genomic DNA preparation (see Discussion).

Table 4. Efficiency of PCR-based gene targeting as a function of the length of homologous regions to the target locus.

Transformation step	Homology region [bp]	Correct integration [%]	Ectopic integration [%]
Generation of complete <i>LEU2</i> ORF deletion strains in two successive transformations			
1. <i>hygXL</i>	72, 80	~100	~0
2. <i>clnXL</i>	72, 80	~0.6	~99.4
Generation of complete <i>LYS2</i> ORF deletion strains in two successive transformations			
1. <i>hygXL</i>	80	~21	~79
2. <i>clnXL</i>	80	~5.4	~94.6
Complementation of <i>LEU2</i> in two single transformations (using two different templates)			
1. G1/G4 <i>LEU2</i>	239, 376	~8	~92
2. <i>HuLEU2</i> ORF	56, 63	~1.5	~98.5

Discussion

H. uvarum has a major impact on the wine industry, due to its abundance on berries and in grape must. Thus, this yeast will impact early stages of wine fermentations all over the world. Due to its overwhelming ethyl acetate production, this yeast has been considered a spoilage yeast for a long time. In recent years, however, *H. uvarum* has raised considerable interest as a non-conventional yeast that could add complexity to wine flavour (Albertin et al. 2015; Tristezza et al. 2016; Guaragnella et al. 2019; Pietrafesa et al. 2020; Fan et al. 2022). These studies have demonstrated both challenges and opportunities of the use of apiculate yeasts in winemaking (van Wyk et al. 2023). This interest in using *H. uvarum* in co-fermentations with *S. cerevisiae* also promoted genomics studies and attempts to make these data accessible for molecular genetic analyses (Chen et al. 2017; Steenwyk et al. 2019; Akan et al. 2020).

For *H. uvarum* both diploid and triploid isolates have been described (Albertin et al. 2015; Saubin et al. 2020). Sporulation is absent on standard sporulation media, which up to now prohibited both classical genetic and molecular genetic studies. Classical studies indicated, however, that *H. uvarum* may produce asci with single spores (Kreger-van Rij 1977). Other non-conventional yeasts, e.g. *Kluyveromyces lactis*, *Pichia pastoris*/ *Komagataella phaffii* or *Yarrowia lipolytica* are haploid and their studies are currently more advanced so that these yeasts have already been utilized as cell factories (Wagner and Alper 2016; Rebello et al. 2018).

First steps in molecular characterization of *H. uvarum* showed that gene targeting can be accomplished with long flanking homology regions of 1 000 bp (Badura et al. 2021). However, lack of a second selection marker and the tedious construction of transformation cassettes containing a selection marker flanked with homologous regions to the target locus posed considerable drawbacks.

This study advanced the modular toolbox so that there are now three marker genes based on *HuTEF1* promoter and *CaURA3* terminator control: two dominant antibiotic resistance

markers, pFA-*hygXL* and pFA-*clnXL*, as well as an auxotrophic marker gene, *LEU2*. With these markers several new options are available: (i) the establishment of a Cre-loxP site-specific recombinase system for gene editing and marker recycling (Krappmann 2014; van Duyne 2015); (ii) the development of freely replicating plasmids similar to those available for other systems (Vernis et al. 1997; Schade et al. 2003); (iii) the implementation of CRISPR mediated genome editing tools using multiple selection markers (Cai et al. 2019). Recent advances in CRISPR-Cas gene manipulations in several non-conventional yeasts may help in advancing molecular genetic studies also in *Hanseniaspora* (Raschmanová et al. 2018).

Traditional gene deletion experiments in diploid yeasts require iterative integration of disruption cassettes. This can be hindered by dominant NHEJ-pathways (non-homologous end-joining) as it requires homologous recombination (HR) for the integration of selection markers. To test the efficiency of HR in *H. uvarum*, we targeted both the *LEU2* and the *LYS2* genes. Surprisingly, homology regions of 72 – 80 bp allowed the recovery of targeted deletion mutants, even though HR in *H. uvarum* is apparently not as efficient as in *S. cerevisiae*. However, utilizing the HR machinery of *H. uvarum* in combination with CRISPR/Cas9 site specific double-strand break formation and suitable repair templates harbouring short-flanking homology regions may rapidly advance molecular genetic studies in this yeast.

The optimal length of flanking homology regions for use in *H. uvarum* has not been determined. In a previous study, the use of 1 000 bp of homology regions resulted in nearly complete correct gene targeting (Badura et al. 2021). Our results showed that very short flanks of 56 – 63 bp resulted only in a low amount of correct targeting (<1%). This was, however, sufficient in our case to retrieve complemented strains based on a growth assays, even though it will not be convenient for other gene function studies. Hence, we recommend flanking homology regions of 80 – 100 bp for *H. uvarum* as has proven useful also in *C. albicans* (Gola et al. 2003).

Conclusion

Our study showed that PCR-based gene targeting approaches work successfully in *H. uvarum*, which opens up new research roads with this genus that has a strong impact in alcoholic beverage fermentations world-wide. Other PCR-based tools as well as more advanced genome-editing tools can now be deployed that will promote molecular characterization of *H. uvarum* genes and help in elucidating the biology of apiculate yeasts in the future.

Note added in proof

A recent communication established the use of a geneticin/G418 resistance gene in *H. uvarum* and also demonstrated the use of the Cre-recombinase for marker gene recycling (Heinisch et al. 2023).

Author Contributions: Conceptualization, J.W. and J.B.; methodology, J.W. and J.B.; validation, J.B.; formal analysis, J.B.; investigation, J.B. and K.Z.; resources, AROMAplus (LOEWE) and Department of Microbiology and Biochemistry of Hochschule Geisenheim University; data curation, J.B.; writing—original draft preparation, J.B. and J.W.; writing—review and editing, J.B., J.W., N.V.W., I.S.P. and C.V.W.; visualization, J.B.; supervision, J.W. and C.V.W.; project administration, C.V.W.; funding acquisition, C.V.W. All authors have read and agreed to the published version of the manuscript.

Funding: The authors would like to thank the Hessen State Ministry of Higher Education, Research and the Arts for the financial support within the Hessen initiative for scientific and economic excellence (LOEWE) in the framework of AROMAplus (<https://www.hs-geisenheim.de/aromaplus/>, [accessed on 25 October 2022]). The authors thank Geisenheim University and Macquarie University for co-funding of this project and the research fellowship of N.V.W., I.S.P. is a team member of the Macquarie-led national Centre of Excellence in Synthetic Biology funded by the Australian Government through its agency, the Australian Research Council.

Acknowledgments: I.S.P. is a team member of the Macquarie-led national Centre of Excellence in Synthetic Biology funded by the Australian Government through its agency, the Australian Research Council. The authors would like to thank the Hessen State Ministry of Higher Education, Research and the Arts for the financial support within the Hessen initiative for scientific and economic excellence (LOEWE) in the framework of AROMAplus (<https://www.hs-geisenheim.de/aromaplus/>, (accessed on 25 October 2022)). Jürgen Heinisch is thanked for providing the yeast strain DSM2768.

Conflicts of Interest: The authors declare no conflict of interest. The funders had no role in the design of the study; in the collection, analyses, or interpretation of data; in the writing of the manuscript; or in the decision to publish the results.

References

- Akan, M.; Michling, F.; Matti, K.; Krause, S.; Muno-Bender, J.; Wendland, J. (2020): Snails as taxis for a large yeast biodiversity. In *Fermentation* 6 (3), p. 90. DOI: 10.3390/fermentation6030090.
- Albertin, Warren; Setati, Mathabatha E.; Miot-Sertier, Cécile; Mostert, Talitha T.; Colonna-Ceccaldi, Benoit; Coulon, Joana et al. (2015): *Hanseniaspora uvarum* from winemaking environments show spatial and temporal genetic clustering. In *Front. Microbiol.* 6, p. 1569. DOI: 10.3389/fmicb.2015.01569.
- Badura, Jennifer; van Wyk, Niël; Brezina, Silvia; Pretorius, Isak S.; Rauhut, Doris; Wendland, Jürgen; von Wallbrunn, Christian (2021): Development of genetic modification tools for *Hanseniaspora uvarum*. In *Int. J. Mol. Sci.* 22 (4), 1943. DOI: 10.3390/ijms22041943.
- Bähler, Jürg; Wu, Jian-Qiu; Longtine, Mark S.; Shah, Nirav G.; Mckenzie III, Amos; Steever, Alexander B. et al. (1998): Heterologous modules for efficient and versatile PCR-based gene targeting in *Schizosaccharomyces pombe*. In *Yeast* 14 (10), pp. 943–951. DOI: 10.1002/(SICI)1097-0061(199807)14:10<943::AID-YEA292>3.0.CO;2-Y.

- Baudin, A.; Ozier-Kalogeropoulos, O.; Denouel, A.; Lacroute, F.; Cullin, C. (1993): A simple and efficient method for direct gene deletion in *Saccharomyces cerevisiae*. In *Nucleic Acids Res.* 21 (14), pp. 3329–3330.
- Bueno, Eduardo; Martin, Kyle R.; Raguso, Robert A.; McMullen, John G.; Hesler, Stephen P.; Loeb, Greg M.; Douglas, Angela E. (2020): Response of wild spotted wing Drosophila (*Drosophila suzukii*) to microbial volatiles. In *J. Chem. Ecol.* 46 (8), pp. 688–698. DOI: 10.1007/s10886-019-01139-4.
- Cai, Peng; Gao, Jiaoqi; Zhou, Yongjin (2019): CRISPR-mediated genome editing in non-conventional yeasts for biotechnological applications. In *Microb. Cell Factories* 18 (1), p. 63. DOI: 10.1186/s12934-019-1112-2.
- Chee, M. K.; Haase, S. B. (2012): New and redesigned pRS plasmid shuttle vectors for genetic manipulation of *Saccharomyces cerevisiae*. In *G3: Genes|Genomes|Genetics* 2 (5), pp. 515–526. DOI: 10.1534/g3.111.001917.
- Chen, Kai; Yang, Xiaoping; Zheng, Feng; Long, Chao-an (2017): Genome sequencing and analysis of *Kloeckera apiculata* strain 34-9, a biocontrol agent against postharvest pathogens in citrus. In *Genes Genom.* 39 (1), pp. 87–99. DOI: 10.1007/s13258-016-0475-6.
- Drumonde-Neves, João; Fernandes, Ticiana; Lima, Teresa; Pais, Célia; Franco-Duarte, Ricardo (2021): Learning from 80 years of studies: a comprehensive catalogue of non-*Saccharomyces* yeasts associated with viticulture and winemaking. In *FEMS Yeast Res* 21 (3), foab017. DOI: 10.1093/femsyr/foab017.
- Fan, Tongtong; Jing, Siyu; Zhang, Hongyan; Yang, Xiaobing; Jin, Guojie; Tao, Yongsheng (2022): Localization, purification, and characterization of a novel β -glucosidase from *Hanseniaspora uvarum* Yun268. In *J. Food Sci.* 87 (3), pp. 886–894. DOI: 10.1111/1750-3841.16068.
- Fleet, G. (2003): Interactions and wine flavour. In *Int. J. Food Microbiol.* 86, pp. 11–22. DOI: 10.1016/S0168-1605(03)00245-9.
- Gerami-Nejad, Maryam; Hausauer, Danielle; McClellan, Mark; Berman, Judith; Gale, Cheryl (2004): Cassettes for the PCR-mediated construction of regulatable alleles in *Candida albicans*. In *Yeast* 21 (5), pp. 429–436. DOI: 10.1002/yea.1080.
- Gietz, R. Daniel; Schiestl, Robert H. (2007): High-efficiency yeast transformation using the LiAc/SS carrier DNA/PEG method. In *Nat. Protoc.* 2 (1), pp. 31–34. DOI: 10.1038/nprot.2007.13.
- Gola, Susanne; Martin, Ronny; Walther, Andrea; Dünkler, Alexander; Wendland, Jürgen (2003): New modules for PCR-based gene targeting in *Candida albicans*: rapid and efficient gene targeting using 100 bp of flanking homology region. In *Yeast* 20 (16), pp. 1339–1347. DOI: 10.1002/yea.1044.
- González-Robles, Ivonne Wendolyne; Estarrón-Espinosa, Mirna; Díaz-Montaño, Dulce María (2015): Fermentative capabilities and volatile compounds produced by *Kloeckera/Hanseniaspora* and *Saccharomyces* yeast strains in pure and mixed cultures during Agave tequilana juice fermentation. In *Antonie van Leeuwenhoek* 108 (3), pp. 525–536. DOI: 10.1007/s10482-015-0506-3.

- Guaragnella, Nicoletta; Chiara, Matteo; Capece, Angela; Romano, Patrizia; Pietrafesa, Rocchina; Siesto, Gabriella et al. (2019): Genome sequencing and comparative analysis of three *Hanseniaspora uvarum* indigenous wine strains reveal remarkable biotechnological potential. In *Front. Microbiol.* 10, p. 3133. DOI: 10.3389/fmicb.2019.03133.
- Heinisch, J. J.; Murra, A.; Jürgens, K.; Schmitz, H.-P. (2023): A versatile toolset for genetic manipulation of the wine yeast *Hanseniaspora uvarum*. In *International Journal of Molecular Sciences* 24 (3). DOI: 10.3390/ijms24031859.
- Hu, Lanlan; Wang, Jia; Ji, Xueao; Liu, Rui; Chen, Fusheng; Zhang, Xiuyan (2018): Selection of non-*Saccharomyces* yeasts for orange wine fermentation based on their enological traits and volatile compounds formation. In *Journal of food science and technology* 55 (10), pp. 4001–4012. DOI: 10.1007/s13197-018-3325-5.
- Kayacan, Yeseren; Griffiths, Adam; Wendland, Jürgen (2019): A script for initiating molecular biology studies with non-conventional yeasts based on *Saccharomycopsis schoenii*. In *Microbiol. Res.* 229, p. 126342. DOI: 10.1016/j.micres.2019.126342.
- Krappmann, Sven (2014): Genetic surgery in fungi: employing site-specific recombinases for genome manipulation. In *Appl. Microbiol. Biotechnol.* 98 (5), pp. 1971–1982. DOI: 10.1007/s00253-013-5480-y.
- Kreger-van Rij, N. J. (1977): Ultrastructure of *Hanseniaspora* ascospores. In *Antonie van Leeuwenhoek* 43 (2), pp. 225–232. DOI: 10.1007/BF00395677.
- Kuijpers, Niels G. A.; Solis-Escalante, Daniel; Bosman, Lizanne; van den Broek, Marcel; Pronk, Jack T.; Daran, Jean-Marc; Daran-Lapujade, Pascale (2013): A versatile, efficient strategy for assembly of multi-fragment expression vectors in *Saccharomyces cerevisiae* using 60 bp synthetic recombination sequences. In *Microb. Cell Factories* 12 (1), p. 47. DOI: 10.1186/1475-2859-12-47.
- Langenberg, Anne-Kathrin; Bink, Frauke J.; Wolff, Lena; Walter, Stefan; Wallbrunn, Christian von; Grossmann, Manfred et al. (2017): Glycolytic functions are conserved in the genome of the wine yeast *Hanseniaspora uvarum*, and pyruvate kinase limits its capacity for alcoholic fermentation. In *Appl. Environ. Microbiol.* 83 (22). DOI: 10.1128/AEM.01580-17.
- Long, Chao-an; Deng, Bo-Xun; Deng, Xiu-Xin (2007): Commercial testing of *Kloeckera apiculata*, isolate 34-9, for biological control of postharvest diseases of citrus fruit. In *Ann. Microbiol.* 57 (2), pp. 203–207. DOI: 10.1007/BF03175208.
- Pietrafesa, Angela; Capece, Angela; Pietrafesa, Rocchina; Bely, Marina; Romano, Patrizia (2020): *Saccharomyces cerevisiae* and *Hanseniaspora uvarum* mixed starter cultures: Influence of microbial/physical interactions on wine characteristics. In *Yeast* 37 (11), pp. 609–621. DOI: 10.1002/yea.3506.
- Raschmanová, Hana; Weninger, Astrid; Glieder, Anton; Kovar, Karin; Vogl, Thomas (2018): Implementing CRISPR-Cas technologies in conventional and non-conventional yeasts: Current state and future prospects. In *Biotechnol. Adv.* 36 (3), pp. 641–665. DOI: 10.1016/j.biotechadv.2018.01.006.

- Rebello, Sharrel; Abraham, Amith; Madhavan, Aravind; Sindhu, Raveendran; Binod, Parameswaran; Karthika Bahuleyan, Arun et al. (2018): Non-conventional yeast cell factories for sustainable bioprocesses. In *FEMS Microbiol. Lett.* 365 (21). DOI: 10.1093/femsle/fny222.
- Rodríguez Madrera, Roberto; Pando Bedriñana, Rosa; García Hevia, Ana; Arce, Marcos Bueno; Suárez Valles, Belén (2013): Production of spirits from dry apple pomace and selected yeasts. In *Food and Bioproducts Processing* 91 (4), pp. 623–631. DOI: 10.1016/j.fbp.2013.04.005.
- Saubin, Méline; Devillers, Hugo; Proust, Lucas; Brier, Cathy; Grondin, Cécile; Pradal, Martine et al. (2020): Investigation of genetic relationships between *Hanseniaspora* species found in grape musts revealed interspecific hybrids with dynamic genome structures. In *Front. Microbiol.* 10, p. 2960. DOI: 10.3389/fmicb.2019.02960.
- Schade, D.; Walther, A.; Wendland, J. (2003): The development of a transformation system for the dimorphic plant pathogen *Holleya sinecauda* based on *Ashbya gossypii* DNA elements. In *Fungal Genet. Biol.* 40 (1), pp. 65–71. DOI: 10.1016/s1087-1845(03)00064-1.
- Schaub, Y.; Dünkler, A.; Walther, A.; Wendland, J. (2006): New pFA-cassettes for PCR-based gene manipulation in *Candida albicans*. In *J. Basic Microbiol.* 46 (5), pp. 416–429. DOI: 10.1002/jobm.200510133.
- Sikorski, R. S.; Hieter, P. (1989): A system of shuttle vectors and yeast host strains designed for efficient manipulation of DNA in *Saccharomyces cerevisiae*. In *Genetics* 122 (1), pp. 19–27. DOI: 10.1093/genetics/122.1.19.
- Steenwyk, Jacob L.; Opulente, Dana A.; Kominek, Jacek; Shen, Xing-Xing; Zhou, Xiaofan; Labella, Abigail L. et al. (2019): Extensive loss of cell-cycle and DNA repair genes in an ancient lineage of bipolar budding yeasts. In *PLOS Biol.* 17 (5), e3000255. DOI: 10.1371/journal.pbio.3000255.
- Tristezza, Mariana; Tufariello, Maria; Capozzi, Vittorio; Spano, Giuseppe; Mita, Giovanni; Grieco, Francesco (2016): The oenological potential of *Hanseniaspora uvarum* in simultaneous and sequential co-fermentation with *Saccharomyces cerevisiae* for industrial wine production. In *Front. Microbiol.* 7, p. 670. DOI: 10.3389/fmicb.2016.00670.
- van Duyne, Gregory D. (2015): Cre Recombinase. In *Microbiol. Spectr.* 3 (1), MDNA3-0014-2014. DOI: 10.1128/microbiolspec.MDNA3-0014-2014.
- van Wyk, N.; Badura, J.; von Wallbrunn, C.; Pretorius, I. S. (2023): Exploring future applications of the apiculate yeast *Hanseniaspora*. In *Crit. Rev. Biotechnol.*, pp. 1–20. DOI: 10.1080/07388551.2022.2136565.
- Vernis, L.; Abbas, A.; Chasles, M.; Gaillardin, C. M.; Brun, C.; Huberman, J. A.; Fournier, P. (1997): An origin of replication and a centromere are both needed to establish a replicative plasmid in the yeast *Yarrowia lipolytica*. In *Mol. Cell. Biol.* 17 (4), pp. 1995–2004. DOI: 10.1128/MCB.17.4.1995.
- Wach, A.; Brachat, A.; Pöhlmann, R.; Philippsen, P. (1994): New heterologous modules for classical or PCR-based gene disruptions in *Saccharomyces cerevisiae*. In *Yeast* 10 (13), pp. 1793–1808. DOI: 10.1002/yea.320101310.

- Wagner, James M.; Alper, Hal S. (2016): Synthetic biology and molecular genetics in non-conventional yeasts: Current tools and future advances. In *Fungal Genet. Biol.* 89, pp. 126–136. DOI: 10.1016/j.fgb.2015.12.001.
- Walther, Andrea; Wendland, Jürgen (2008): PCR-based gene targeting in *Candida albicans*. In *Nat. Protoc.* 3 (9), pp. 1414–1421. DOI: 10.1038/nprot.2008.137.
- Wang, C.; Mas, A.; Esteve-Zarzoso, B. (2015): Interaction between *Saccharomyces cerevisiae* and *Hanseniaspora uvarum* during alcoholic fermentation. In *Int. J. Food Microbiol.* 206, pp. 67–74. DOI: 10.1016/j.ijfoodmicro.2015.04.022.
- Wendland, J.; Ayad-Durieux, Y.; Knechtle, P.; Rebischung, C.; Philippsen, P. (2000): PCR-based gene targeting in the filamentous fungus *Ashbya gossypii*. In *Gene* 242 (1-2), pp. 381–391. DOI: 10.1016/S0378-1119(99)00509-0.
- Wendland, Jürgen (2003): PCR-based methods facilitate targeted gene manipulations and cloning procedures. In *Curr. Genet.* 44 (3), pp. 115–123. DOI: 10.1007/s00294-003-0436-x.
- Zhang, Haihan; Zhao, Zhenfang; Kang, Pengliang; Wang, Yue; Feng, Ji; Jia, Jingyu; Zhang, Zhonghui (2018): Biological nitrogen removal and metabolic characteristics of a novel aerobic denitrifying fungus *Hanseniaspora uvarum* strain KPL108. In *Bioresource technology* 267, pp. 569–577. DOI: 10.1016/j.biortech.2018.07.073.

PCR-based gene targeting in *Hanseniaspora uvarum*

Badura, J.; van Wyk, N.; Zimmer, K.; Pretorius, I. S.; von Wallbrunn, C.; Wendland, J.

Supporting Information

SUPPLEMENTAL MATERIAL

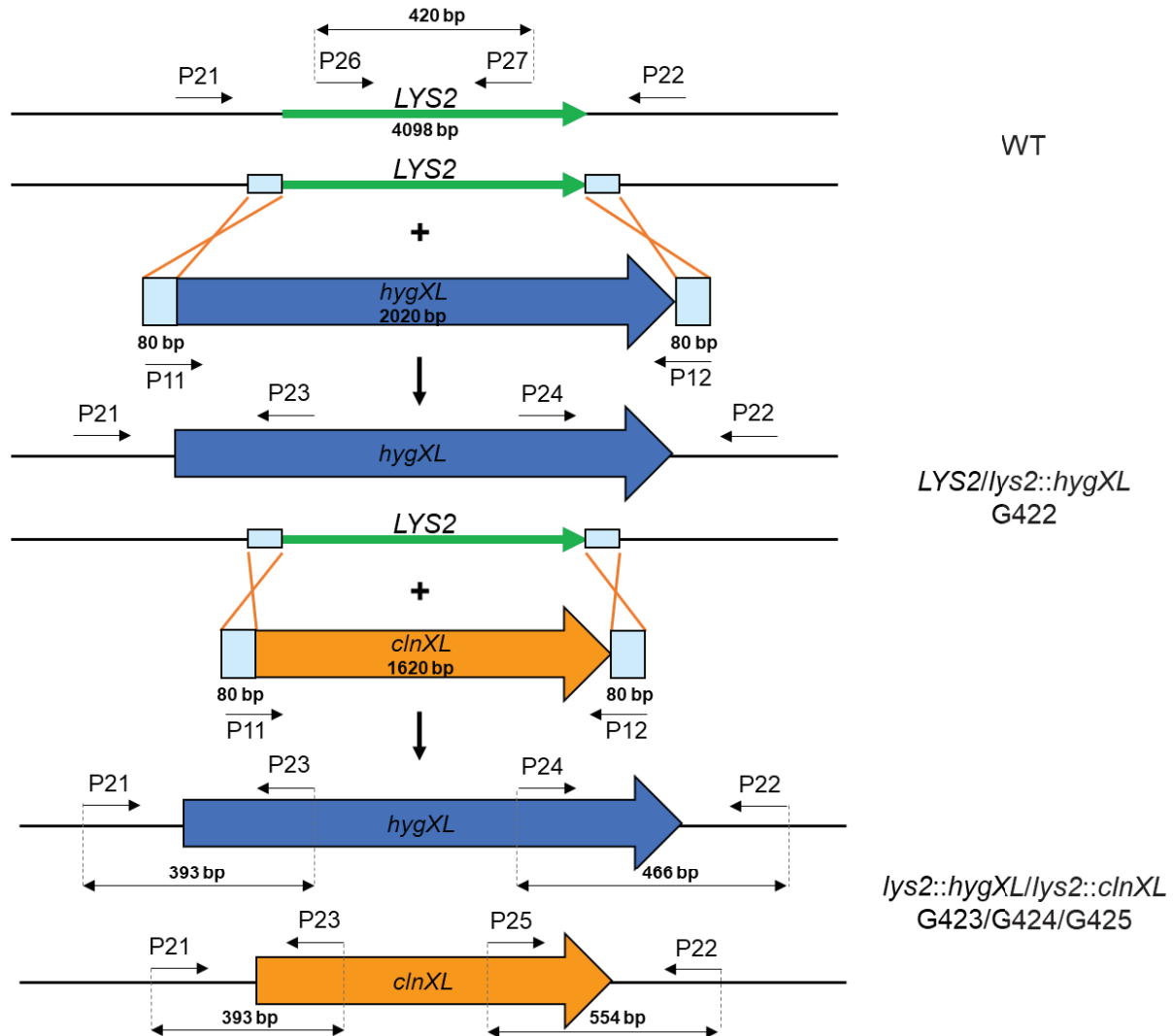

Figure S 1. Schematic drawing of the sequential disruption of *HuLYS2* by PCR-based gene targeting. *H. uvarum* wildtype (WT) was transformed with disruption cassettes amplified from pFA-*hygXL* and pFA-*cInXL* with primers S1-*HuLYS2* and S2-*HuLYS2* (11/12, Table 3). Homologous recombination resulted in the integration of the disruption cassettes and replacement of the *LYS2* ORF. After the first round of transformation this generated strain G422 (*LYS2/lys2::hygXL*). In the second round of transformation, strains G423, G424 and G425 (*lys2::hygXL/lys2::cInXL*) were generated.

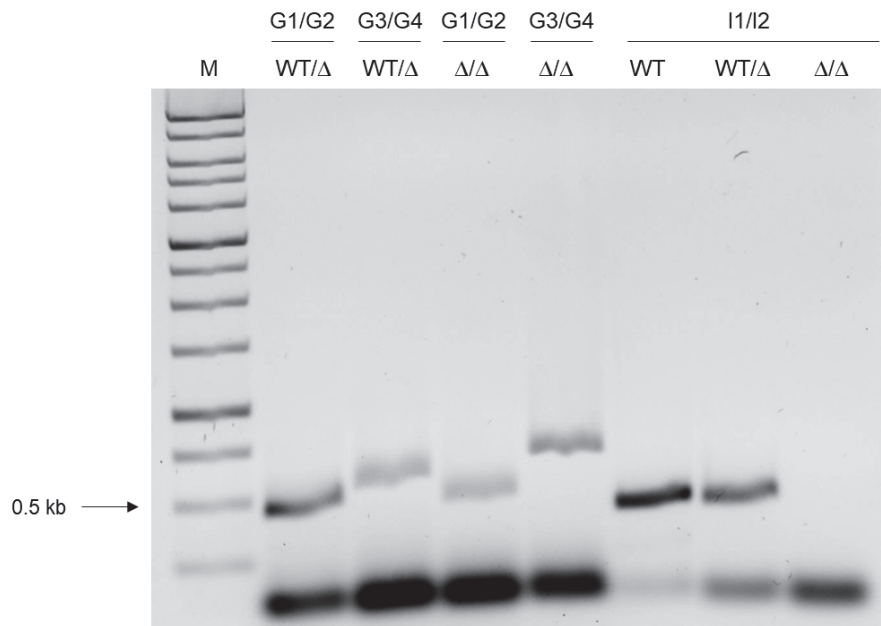

Figure S 2. Verification of Transformants via PCR amplification with primer set 21/23 (G1-*HuLYS2*/G2-*HuTEF1p*), 24/22 (G3-*hph*/G4-*HuLYS2*), 25/22 (G3-*natI*/G4-*HuLYS2*) and 26/27 (I1-*HuLYS2*/I2-*HuLYS2*). Agarose gel, stained with GelRed, showing PCR amplification of wildtype (WT), single knock-out (*LYS2*/*lys2::hygXL*; WT/ Δ) and double knock-out (*lys2::cInXL*/*lys2::hygXL*; Δ/Δ). Resulting bands showed to be the size of ~0.4 kb (G1/G2), ~0.5 kb (G3/G4, WT/ Δ), ~0.6 kb (G3/G4, Δ/Δ) and ~0.4 kb (I1/I2). M indicates the GenLadder 1kb (ready-to-use) DNA marker.

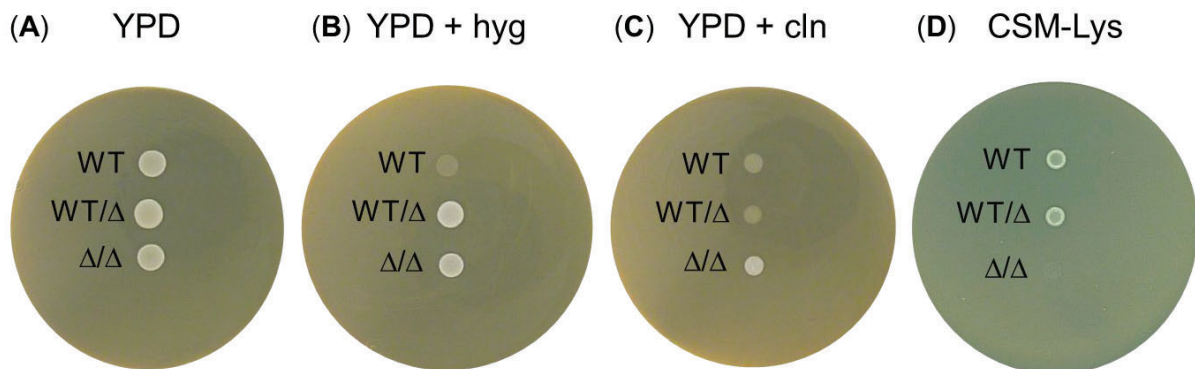

Figure S 2. Complete *LYS2* ORF deletion by PCR-based gene targeting in *H. uvarum*. *H. uvarum* wildtype (WT), the *H. uvarum* heterozygous *LYS2*/*lys2::hygXL* strain G422 (WT/ Δ) and the homozygous deletion mutant *lys2::hygXL*/*lys2::cInXL* strain G423 (Δ/Δ) were spotted on plates containing (A) YPD, (B) YPD supplemented with 200 μ g/mL of hygromycin, (C) YPD supplemented with 50 μ g/mL of nourseothricin and (D) 2x-CSM-Lys medium.

“I was taught that the path of progress is neither quick nor easy.”

~ *Marie Curie* ~

General conclusion

Traditionally, grape berries were mashed and left for fermentation using microorganisms found on the surface of the berries, called spontaneous fermentations. Since the yeasts conducting the grape must fermentations could not be controlled in spontaneous fermentations, the quality of the resulting wines was unpredictable. Wine production was revolutionized by Emil Christian Hansen's discovery of selecting and picking single brewer's yeast colonies in 1883 (Hansen 1883, 1896), and their transfer of use in winemaking by Julius Wortmann in 1895 (Wortmann 1895). *Saccharomyces cerevisiae* showed to be able to convert all grape sugar into ethanol and carbon dioxide without producing off-flavours (Rainieri and Pretorius 2000). By adding *S. cerevisiae*, also called the 'wine yeast', to the onset of grape must fermentations, as well as SO₂, the growth of undesired, non-conventional yeasts could be inhibited, thus enabling a controlled fermentation process for the first time (Pretorius 2000).

Over the course of time, consumers' demands on wine changed. Nowadays, for instance, the trend is towards wines with more complex aromas and lower alcohol levels. Based on research into microorganisms found in spoiled wines produced by spontaneous fermentations, it is known that non-conventional yeasts are involved in the massive production of volatiles which, in excessive concentrations, lead to wine spoilage. In recent decades, more studies on non-conventional yeasts, such as co-fermentations with *S. cerevisiae*, revealed new insights into the aroma profile of wines and how it is influenced by non-conventional wine yeasts. Characterization of the aroma profiles of wines produced using non-conventional yeasts shows the diversity of volatile organic compounds synthesized by different non-*Saccharomyces* yeast strains belonging to the same genus. *Hanseniaspora* spp., for instance, appearing on various ripe fruits (van Wyk et al. 2023), often are associated with the synthesis of excessive amounts of acetic acid and ethyl acetate, probably due to its most abundant member *H. uvarum* (Romano et al. 2003; Ciani et al. 2006). However, research has proven that the different members belonging to the genus of *Hanseniaspora* spp. are versatile in the synthesis of aroma compounds (van Wyk et al. 2023; Badura et al. 2023a). Steenwyk et al. (2019) reported on different lineages found within this species, clustering yeasts regarding their fermentation capabilities. While *Hanseniaspora* spp. belonging to SEL show similarities in metabolism to *S. cerevisiae* with high fermentation capabilities (Lleixà et al. 2018; Valera et al. 2020), members of FEL seem to behave differently in terms of metabolism (Valera et al. 2020), revealing both lower ethanol production and higher synthesis of volatiles, such as acetate esters (Badura et al. 2023b).

The aroma profile of wines can not only be influenced by the yeast used for fermentation, but also by the composition of the grape berries, such as the type and quantity of sugars, nitrogen as well as precursors for the production of terpenes. Among those, nitrogen plays a dual role in grape must fermentations by influencing both the growth rate of yeasts, and thus, preventing or favouring stuck fermentations, and the aroma compounds produced by yeasts. In addition to amino acids serving as backbone for the synthesis of certain volatile organic compounds generated through the Ehrlich pathway, also the amount of yeast assimilable nitrogen affects the type and quantity of volatiles being synthesized. Especially in times of climate change with constantly rising temperatures, the composition of grape berries regarding sugar and nitrogen levels is changing significantly. Increasing temperatures lead to earlier harvest times, and thus, higher sugar concentrations of the berries (van Leeuwen and Destrac-Irvine 2017), whereas decreasing amino acid levels in grape berries are associated in combination with increasing temperatures and limited irrigation water (Gutiérrez-Gamboa et al. 2018; Gutiérrez-Gamboa et al. 2020). Therefore, the addition of both inorganic and complex nitrogen sources to the grape must is common practice during winemaking. The impact on the aroma profile by the different nitrogen sources available for yeasts to ferment, is well-studied for *Saccharomyces* 'wine yeast' strains (Gobert et al. 2019), while this information is lacking for most of the non-conventional yeasts. Elucidating the impact of nitrogen supplementation, varying in type and quantity, in terms of the resulting aroma profile produced by non-*Saccharomyces* yeasts, may enable conducting controlled grape must fermentations using non-conventional wine yeasts. This is promising in that customers' demands for low alcohol wines, or even non-alcoholic wines, with more complex aromas, can be addressed. In recent years, the product range of starter cultures for winemaking has already been expanded by several non-conventional yeasts (van Wyk et al. 2021), including *H. vineae*, the first commercially available starter culture belonging to *Hanseniaspora* spp. (Carrau and Henschke 2021). Research on wine fermentations using *H. uvarum*, the most abundant yeast species found on grape berries (Drumonde-Neves et al. 2021), unravelled its high potential on contributing to pleasant aroma profiles of the wines (van Wyk et al. 2023), making it an interesting candidate for starter cultures. Using multidisciplinary studies provides more insight into the metabolic pathways involved in the synthesis of aroma compounds by yeasts. In this way, for instance, the exact time of aroma synthesis can be determined, the expression levels of the genes involved can be studied as well as the influence of different conditions, such as different nitrogen contents in the grape must, on aroma synthesis by the yeasts can be investigated. Thus, aroma compounds could be synthesized in a controlled fermentation process, which is highly profitable for the flavour industry.

In addition, several studies on biotechnological applications of *H. uvarum* have been published in the past few years, highlighting its value beyond winemaking (Long et al. 2007; Zhang et al.

2018; Bueno et al. 2020). On the one hand, *H. uvarum* is known for producing off-flavours during grape must fermentation, but on the other hand, there is great potential in taking advantage of its ability in producing high amounts of volatiles, such as acetic acid or ethyl acetate. One example is *H. uvarum*'s high potential in attracting insects, *i.e.* drosophila, by producing high ethyl acetate levels, thus serving as bait. Furthermore, ethyl acetate is an important component used in various industrial applications, such as serving as a solvent, cleaning agent, for extraction and chromatographic recovery of pharmaceuticals, in the production of coating formulations, adhesives, paints, herbicide formulations as well as resins (Löser et al. 2014). This diversity of applications makes ethyl acetate one of the most important carboxylate esters, with annual global production estimated at around three million tons (Šulgan et al. 2020). Currently, ethyl acetate is generated by energy-intensive petrochemical processes, based on natural gas and crude oil, thus using microorganisms for producing ethyl acetate becomes more attractive (Löser et al. 2014). Wildtype yeast strains, such as *Kluyveromyces marxianus*, showed to be able producing high amounts of ethyl acetate providing economic benefits (Löser et al. 2014; Hoffmann et al. 2021). Multidisciplinary studies on genetically engineered ethyl acetate pathways in *S. cerevisiae* have been published, increasing ethyl acetate production, reaching levels around 700 mg/L (Dong et al. 2019). Constantly aerated, shaking fermentations with *H. uvarum* show noticeably higher amounts of ethyl acetate, significantly exceeding values of 1 g/L (Ciani et al. 2006). Therefore, the use of *H. uvarum* could be a good possibility for an alternative production of ethyl acetate.

Multidisciplinary research, including genomics, metabolomics and transcriptomics, provides fundamental knowledge elucidating the potential of non-conventional yeasts as well as their benefits in winemaking, as well as other biotechnological applications. The loss of cell-cycle-checkpoint genes, such as the cell-cycle regulator WHiskey 5, found within the genome of *Hanseniaspora* spp., especially within members of FEL, *i.e.* *H. uvarum* (Steenwyk et al. 2019), could indicate a rapid growth advantage over competitors. Furthermore, the lack of DNA repair genes in *Hanseniaspora* spp. provides a promising basis for its use in other biotechnological research, such as serving as a model organism in cancer research.

Findings from such multidisciplinary research also serve as a basis for further elucidation of the functions of previously unknown genes. While gene-to-function is well-studied in *Saccharomyces* strains, the transcriptomic profile of *H. uvarum* unravelled 671 genes of unknown function, all being candidates for genetic modification to investigate both their function and impact on the phenotype regarding winemaking. This could be achieved by overexpression or knock-out of an unknown gene, using selection markers based on antibiotic resistance, and subsequent metabolomic studies to investigate its effect on the phenotype. Depending on the ploidy of the yeasts, several selection markers containing different antibiotic

resistance genes for selection, are necessary to genetically modify each allele of the genome. Targeted manipulation of the genome is time-consuming, especially when generating selection markers flanked with long homology regions to each target gene. PCR-based gene targeting approaches adding short homology regions via primer overhangs simplify the construction of selection markers, making them reusable for other target genes. So far, no viable spores of *H. uvarum* have been obtained (Albertin et al. 2015), which has a major impact on yeast breeding, e.g. classical approaches such as sexual hybridisation. Therefore, the establishment of genetic modification tools for *H. uvarum* using metabolic engineering or selection markers for enhancing the synthesis of desired aroma compounds and inhibiting the expression of genes involved in the off-flavour synthesis may contribute to the generation of a *H. uvarum* starter culture strain. The use of genetically modified organisms in the development of food cultures is critical and rejected by current consumers. Nevertheless, in recent years, the advantages of biotechnological applications have led to a different mindset about genetic engineering (Lucht 2015; Shew et al. 2018). The synthetic biology tool CRISPR enables designing and modification of genes without introducing DNA from other microorganisms (Sajid et al. 2021) and regulations differentiating genetically modified organisms from DNA edited using CRISPR-Cas9 already exist in some countries, e.g. Germany, Sweden and Argentina (Jagtap et al. 2017). The first synthetic *S. cerevisiae* yeast strain Sourvisiae® provided by the company Lallemand is commercially available in the USA, genetically modified by the insertion of a lactate dehydrogenase gene allowing the production of lactic acid (Alperstein et al. 2020; Lallemand Sourvisiae Technical Data Sheet). So far, the use of genetically modified organisms is not allowed in the EU. However, especially in the production of fermented foods to increase fragrance and flavour, the use of genetic engineering should be considered since no genetically modified material is present in the end product (Morrissey et al. 2015). A similar application is the production of ingredients, such as vitamins or enzymes, derived from genetically modified organisms, which are separated and purified prior to use in food and supplements, for instance (van Wyk et al. 2018; Shukla 2019).

In conclusion, the non-conventional wine yeast *H. uvarum* is the most abundant yeast species found on grape berries and thus, at the onset of spontaneous fermentations. *H. uvarum* is known for producing high amounts of acetate esters, especially ethyl acetate, easily exceeding their odour threshold, leading to spoilage of wines. Since *H. uvarum* has also been detected at the end of fermentations, withstanding increased ethanol levels, being able to control fermentations influencing its synthesis of aroma compounds is of high interest. Research has shown the great potential and value of *H. uvarum* not only in winemaking. This thesis provides fundamental knowledge on the characterization, regulation and genetic modification of the synthesis of aroma compounds in the non-conventional wine yeast *H. uvarum* paving the way for future research.

“The pessimist complains about the wind; the optimist expects it to change; the realist adjusts the sails.”

~ *William Arthur Ward* ~

References

- Akan, M.; Michling, F.; Matti, K.; Krause, S.; Muno-Bender, J.; Wendland, J. (2020): Snails as taxis for a large yeast biodiversity. In *Fermentation* 6 (3), p. 90. DOI: 10.3390/fermentation6030090.
- Albers, E.; Larsson, C.; Lidén, G.; Niklasson, C.; Gustafsson, L. (1996): Influence of the nitrogen source on *Saccharomyces cerevisiae* anaerobic growth and product formation. In *Appl. Environ. Microbiol.* 62 (9), pp. 3187–3195. DOI: 10.1128/aem.62.9.3187-3195.1996.
- Albertin, W.; Setati, M. E.; Miot-Sertier, C.; Mostert, T. T.; Colonna-Ceccaldi, B.; Coulon, J. et al. (2015): *Hanseniaspora uvarum* from winemaking environments show spatial and temporal genetic clustering. In *Front. Microbiol.* 6, p. 1569. DOI: 10.3389/fmicb.2015.01569.
- Alexandre, H.; Charpentier, C. (1998): Biochemical aspects of stuck and sluggish fermentation in grape must. In *J. Ind. Microbiol. Biotechnol.* 20 (1), pp. 20–27. DOI: 10.1038/sj.jim.2900442.
- Alperstein, L.; Gardner, J. M.; Sundstrom, J. F.; Sumby, K. M.; Jiranek, V. (2020): Yeast bioprospecting versus synthetic biology-which is better for innovative beverage fermentation? In *Appl. Microbiol. Biotechnol.* 104 (5), pp. 1939–1953. DOI: 10.1007/s00253-020-10364-x.
- Andorrà, I.; Berradre, M.; Rozès, N.; Mas, A.; Guillamón, J. M.; Esteve-Zarzoso, B. (2010): Effect of pure and mixed cultures of the main wine yeast species on grape must fermentations. In *Eur. Food Res. Technol.* 231 (2), pp. 215–224. DOI: 10.1007/s00217-010-1272-0.
- Anfang, N.; Brajkovich, M.; Goddard, M. R. (2009): Co-fermentation with *Pichia kluyveri* increases varietal thiol concentrations in Sauvignon Blanc. In *Aust. J. Grape Wine Res.* 15 (1), pp. 1–8. DOI: 10.1111/j.1755-0238.2008.00031.x.
- Arias, C. R.; Burns, J. K.; Friedrich, L. M.; Goodrich, R. M.; Parish, M. E. (2002): Yeast species associated with orange juice: evaluation of different identification methods. In *Appl. Environ. Microbiol.* 68 (4), pp. 1955–1961. DOI: 10.1128/AEM.68.4.1955-1961.2002.
- Äyräpää, T. (1971): Biosynthetic formation of higher alcohols by yeast. Dependence on the nitrogenous nutrient level of the medium. In *J. Inst. Brew.* 77 (3), pp. 266–276. DOI: 10.1002/j.2050-0416.1971.tb06945.x.
- Badura, J.; Kiene, F.; Brezina, S.; Fritsch, S.; Semmler, H.; Rauhut, D. et al. (2023a): Aroma profiles of *Vitis vinifera* L. cv. Gewürztraminer must fermented with co-cultures of *Saccharomyces cerevisiae* and seven *Hanseniaspora* spp. In *Fermentation* 9 (2), 109. DOI: 10.3390/fermentation9020109.
- Badura, J.; Medić, M.; van Wyk, N.; Krause, B.; Semmler, H.; Brezina, S. et al. (2023b): Synthesis of aroma compounds as a function of different nitrogen sources in fermentations using non-*Saccharomyces* wine yeasts. In *Microorganisms* 11 (1), 14. DOI: 10.3390/microorganisms11010014.

- Bell, S.-J.; Henschke, P. A. (2005): Implications of nitrogen nutrition for grapes, fermentation and wine. In *Australian Journal of Grape and Wine Research* 11 (3), pp. 242–295. DOI: 10.1111/j.1755-0238.2005.tb00028.x.
- Bely, M.; Stoeckle, P.; Masneuf-Pomarède, I.; Dubourdieu, D. (2008): Impact of mixed *Torulasporea delbrueckii-Saccharomyces cerevisiae* culture on high-sugar fermentation. In *Int. J. Food Microbiol.* 122 (3), pp. 312–320. DOI: 10.1016/j.ijfoodmicro.2007.12.023.
- Bergkessel, M.; Guthrie, C. (2013): Chemical transformation of yeast. In J. Lorsch (Ed.): *Methods in Enzymology*: Elsevier, pp. 311–320.
- Bink, F. J. (2010): Molekulargenetische und physiologische Untersuchungen an der Weinhefe *Kloeckera apiculata* (*Hanseniaspora uvarum*). Available online at https://osnadocs.ub.uni-osnabrueck.de/bitstream/urn:nbn:de:gbv:700-201008246468/1/thesis_bink.pdf.
- Bisson, L. F. (1999): Stuck and sluggish fermentations. In *Am J Enol Vitic* 50 (1), pp. 107–119. DOI: 10.5344/ajev.1999.50.1.107.
- Bueno, E.; Martin, K. R.; Raguso, R. A.; McMullen, J. G.; Hesler, S. P.; Loeb, G. M.; Douglas, A. E. (2020): Response of wild spotted wing Drosophila (*Drosophila suzukii*) to microbial volatiles. In *J. Chem. Ecol.* 46 (8), pp. 688–698. DOI: 10.1007/s10886-019-01139-4.
- Carrau, F.; Gaggero, C.; Aguilar, P. S. (2015): Yeast diversity and native vigor for flavor phenotypes. In *Trends Biotechnol.* 33 (3), pp. 148–154. DOI: 10.1016/j.tibtech.2014.12.009.
- Carrau, F.; Henschke, P. A. (2021): *Hanseniaspora vineae* and the concept of friendly yeasts to increase autochthonous wine flavor diversity. In *Front. Microbiol.* 12, p. 702093. DOI: 10.3389/fmicb.2021.702093.
- Cebollero, E.; Gonzalez-Ramos, D.; Tabera, L.; Gonzalez, R. (2007): Transgenic wine yeast technology comes of age: is it time for transgenic wine? In *Biotechnol. Lett.* 29 (2), pp. 191–200. DOI: 10.1007/s10529-006-9236-y.
- Ciani, M.; Beco, L.; Comitini, F. (2006): Fermentation behaviour and metabolic interactions of multistarter wine yeast fermentations. In *Int. J. Food Microbiol.* 108 (2), pp. 239–245. DOI: 10.1016/j.ijfoodmicro.2005.11.012.
- Ciani, M.; Comitini, F. (2011): Non-*Saccharomyces* wine yeasts have a promising role in biotechnological approaches to winemaking. In *Ann. Microbiol.* 61 (1), pp. 25–32. DOI: 10.1007/s13213-010-0069-5.
- Ciani, M.; Ferraro, L. (1996): Enhanced glycerol content in wines made with immobilized *Candida stellata* cells. In *Appl. Environ. Microbiol.* 62 (1), pp. 128–132. DOI: 10.1128/aem.62.1.128-132.1996.
- Combina, M.; Elía, A.; Mercado, L.; Catania, C.; Ganga, A.; Martinez, C. (2005): Dynamics of indigenous yeast populations during spontaneous fermentation of wines from Mendoza, Argentina. In *Int. J. Food Microbiol.* 99 (3), pp. 237–243. DOI: 10.1016/j.ijfoodmicro.2004.08.017.

- Coulon, J.; Husnik, J. I.; Inglis, D. L.; van der Merwe, G. K.; Lonvaud, A.; Erasmus, D. J.; van Vuuren, H. J.J. (2006): Metabolic engineering of *Saccharomyces cerevisiae* to minimize the production of ethyl carbamate in wine. In *Am J Enol Vitic* 57 (2), pp. 113–124. DOI: 10.5344/ajev.2006.57.2.113.
- de Barros Lopes, M.; Eglinton, J.; Henschke, P.; Høj, P.; Pretorius, I. S. (2003): The connection between yeast and alcohol reduction in wine: managing the double-edged sword of bottled sunshine. In *Australian and New Zealand wine industry journal* 18 (4), pp. 17–22. Available online at <https://researchers.mq.edu.au/en/publications/the-connection-between-yeast-and-alcohol-reduction-in-wine-managi>.
- Degré, R. (1993): Selection and commercial cultivation of wine yeast and bacteria. In *Wine Microbiology and Biotechnology*, pp. 421–448. Available online at <https://ci.nii.ac.jp/naid/20001671577/>.
- Dellacassa, E.; Trenchs, O.; Fariña, L.; Debernardis, F.; Perez, G.; Boido, E.; Carrau, F. (2017): Pineapple (*Ananas comosus* L. Merr.) wine production in Angola: Characterisation of volatile aroma compounds and yeast native flora. In *Int. J. Food Microbiol.* 241, pp. 161–167. DOI: 10.1016/j.ijfoodmicro.2016.10.014.
- Di Maro, E.; Ercolini, D.; Coppola, S. (2007): Yeast dynamics during spontaneous wine fermentation of the Catalanesca grape. In *Int. J. Food Microbiol.* 117 (2), pp. 201–210. DOI: 10.1016/j.ijfoodmicro.2007.04.007.
- Dickinson, J. R.; Lanterman, M. M.; Danner, D. J.; Pearson, B. M.; Sanz, P.; Harrison, S. J.; Hewlins, M. J. (1997): A ¹³C nuclear magnetic resonance investigation of the metabolism of leucine to isoamyl alcohol in *Saccharomyces cerevisiae*. In *J. Biol. Chem.* 272 (43), pp. 26871–26878. DOI: 10.1074/jbc.272.43.26871.
- Domizio, P.; Liu, Y.; Bisson, L. F.; Barile, D. (2014): Use of non-*Saccharomyces* wine yeasts as novel sources of mannoproteins in wine. In *Food Microbiol.* 43, pp. 5–15. DOI: 10.1016/j.fm.2014.04.005.
- Domizio, P.; Romani, C.; Lencioni, L.; Comitini, F.; Gobbi, M.; Mannazzu, I.; Ciani, M. (2011): Outlining a future for non-*Saccharomyces* yeasts: selection of putative spoilage wine strains to be used in association with *Saccharomyces cerevisiae* for grape juice fermentation. In *Int. J. Food Microbiol.* 147 (3), pp. 170–180. DOI: 10.1016/j.ijfoodmicro.2011.03.020.
- Dong, J.; Wang, P.; Fu, X.; Dong, S.; Li, X.; Xiao, D. (2019): Increase ethyl acetate production in *Saccharomyces cerevisiae* by genetic engineering of ethyl acetate metabolic pathway. In *J. Ind. Microbiol. Biotechnol.* 46 (6), pp. 801–808. DOI: 10.1007/s10295-019-02142-0.
- Drumonde-Neves, J.; Fernandes, T.; Lima, T.; Pais, C.; Franco-Duarte, R. (2021): Learning from 80 years of studies: a comprehensive catalogue of non-*Saccharomyces* yeasts associated with viticulture and winemaking. In *FEMS yeast Res.* 21 (3). DOI: 10.1093/femsyr/foab017.
- Dzialo, M. C.; Park, R.; Steensels, J.; Lievens, B.; Verstrepen, K. J. (2017): Physiology, ecology and industrial applications of aroma formation in yeast. In *FEMS Microbiol. Rev.* 41 (Supp_1), S95-S128. DOI: 10.1093/femsre/fux031.

- Ebeler, S. E. (2001): Analytical chemistry: unlocking the secrets of wine flavor. In *Food Rev. Int.* 17 (1), pp. 45–64. DOI: 10.1081/FRI-100000517.
- Ehrlich, F. (1907): Über die Bedingungen der Fuselölbildung und über ihren Zusammenhang mit dem Eiweißaufbau der Hefe. In *Ber. Dtsch. Chem. Ges.* 40 (1), pp. 1027–1047. DOI: 10.1002/cber.190704001156.
- Etiévant, P. X. (1991): Wine. In H. Maarse (Ed.): Volatile compounds in foods beverages. New York u.a.: Dekker (Food science and technology, 44), pp. 483–546.
- Feng, C.; Du, X.; Wee, J. (2021): Microbial and chemical analysis of non-*Saccharomyces* yeasts from chambourcin hybrid grapes for potential use in winemaking. In *Fermentation* 7 (1), p. 15. DOI: 10.3390/fermentation7010015.
- Garde-Cerdán, T.; Ancín-Azpilicueta, C. (2006): Review of quality factors on wine ageing in oak barrels. In *Trends Food Sci Technol.* 17 (8), pp. 438–447. DOI: 10.1016/j.tifs.2006.01.008.
- Garde-Cerdán, T.; Ancín-Azpilicueta, C. (2008): Effect of the addition of different quantities of amino acids to nitrogen-deficient must on the formation of esters, alcohols, and acids during wine alcoholic fermentation. In *LWT* 41 (3), pp. 501–510. DOI: 10.1016/j.lwt.2007.03.018.
- Gietz, R. D.; Schiestl, R. H. (2007): High-efficiency yeast transformation using the LiAc/SS carrier DNA/PEG method. In *Nat. Protoc.* 2 (1), pp. 31–34. DOI: 10.1038/nprot.2007.13.
- Gil, J. V.; Mateo, J. J.; Jiménez, M.; Pastor, A.; Huerta, T. (1996): Aroma compounds in wine as influenced by apiculate yeasts. In *J. Food Sci.* 61 (6), pp. 1247–1250. DOI: 10.1111/j.1365-2621.1996.tb10971.x.
- Giorello, F.; Valera, M. Jose; Martin, V.; Parada, A.; Salzman, V.; Camesasca, L. et al. (2019): Genomic and transcriptomic basis of *Hanseniaspora vineae*'s impact on flavor diversity and wine quality. In *Appl. Environ. Microbiol.* 85 (1). DOI: 10.1128/AEM.01959-18.
- Giorello, F. M.; Berná, L.; Greif, G.; Camesasca, L.; Salzman, V.; Medina, K. et al. (2014): Genome sequence of the native apiculate wine yeast *Hanseniaspora vineae* T02/19AF. In *Genome Announc.* 2 (3). DOI: 10.1128/genomeA.00530-14.
- Gobert, A.; Tourdot-Maréchal, R.; Sparrow, C.; Morge, C.; Alexandre, H. (2019): Influence of nitrogen status in wine alcoholic fermentation. In *Food Microbiol.* 83, pp. 71–85. DOI: 10.1016/j.fm.2019.04.008.
- Gola, S.; Martin, R.; Walther, A.; Dünkler, A.; Wendland, J. (2003): New modules for PCR-based gene targeting in *Candida albicans*: rapid and efficient gene targeting using 100 bp of flanking homology region. In *Yeast* 20 (16), pp. 1339–1347. DOI: 10.1002/yea.1044.
- Grangeteau, C.; Gerhards, D.; Rousseaux, S.; von Wallbrunn, C.; Alexandre, H.; Guilloux-Benatier, M. (2015): Diversity of yeast strains of the genus *Hanseniaspora* in the winery environment: What is their involvement in grape must fermentation? In *Food Microbiol.* 50, pp. 70–77. DOI: 10.1016/j.fm.2015.03.009.

- Gürbüz, O.; Rouseff, J. M.; Rouseff, R. L. (2006): Comparison of aroma volatiles in commercial Merlot and Cabernet Sauvignon wines using gas chromatography-olfactometry and gas chromatography-mass spectrometry. In *J. Agric. Food Chem.* 54 (11), pp. 3990–3996. DOI: 10.1021/jf053278p.
- Guth, H.; Sies, A. (2002): Flavour of wines: Towards an understanding by reconstitution experiments and an analysis of ethanol's effect on odour activity of key compounds. In R.J. Blair, P.J. Williams, P.B. Høj (Eds.): Proceedings of the 11th Australian Wine Industry Technical Conference, Adelaide, Australia., pp. 128–139.
- Gutiérrez-Gamboa, G.; Carrasco-Quiroz, M.; Martínez-Gil, A. M.; Pérez-Álvarez, E. P.; Garde-Cerdán, T.; Moreno-Simunovic, Y. (2018): Grape and wine amino acid composition from Carignan noir grapevines growing under rainfed conditions in the Maule Valley, Chile: Effects of location and rootstock. In *Food Res. Int.* 105, pp. 344–352. DOI: 10.1016/j.foodres.2017.11.021.
- Gutiérrez-Gamboa, G.; Garde-Cerdán, T.; Rubio-Bretón, P.; Pérez-Álvarez, E. P. (2020): Study of must and wine amino acids composition after seaweed applications to Tempranillo blanco grapevines. In *Food Chem.* 308, p. 125605. DOI: 10.1016/j.foodchem.2019.125605.
- Han, B.; Gao, J.; Han, X.; Deng, H.; Wu, T.; Li, C. et al. (2022): *Hanseniaspora uvarum* FS35 degrade putrescine in wine through the direct oxidative deamination pathway of copper amine oxidase 1. In *Food Res. Int.* 162 (Pt A), p. 111923. DOI: 10.1016/j.foodres.2022.111923.
- Hansen, E. C. (1883): Recherches sur la physiologie et la morphologie des ferments alcooliques. V. Methodes pour obtenir des cultures pures de *Saccharomyces* et de microorganismes analogues. In *Compt. Rend. Trav. Lab. Carlsberg.* 2, pp. 92–105. Available online at <https://ci.nii.ac.jp/naid/10005413667/>.
- Hansen, E. C. (1896): Practical studies in fermentation. Being contributions to the life history of microorganisms: E. & F.N. Spon.
- Hazelwood, L. A.; Daran, J.-M.; van Maris, A. J. A.; Pronk, J. T.; Dickinson, J. R. (2008): The Ehrlich pathway for fusel alcohol production: a century of research on *Saccharomyces cerevisiae* metabolism. In *Appl. Environ. Microbiol.* 74 (8), pp. 2259–2266. DOI: 10.1128/AEM.02625-07.
- Heard, G. M.; Fleet, G. H. (1985): Growth of natural yeast flora during the fermentation of inoculated wines. In *Appl. Environ. Microbiol.* 50 (3), pp. 727–728. DOI: 10.1128/aem.50.3.727-728.1985.
- Heard, G. M.; Fleet, G. H. (1988): The effects of temperature and pH on the growth of yeast species during the fermentation of grape juice. In *J. Appl. Bacteriol.* 65 (1), pp. 23–28. DOI: 10.1111/j.1365-2672.1988.tb04312.x.
- Henschke, P. A.; Jiranek, V. (1993): Yeast - Metabolism of nitrogen compounds. In G. H. Fleet (Ed.): Wine microbiology and biotechnology. London: Taylor & Francis, pp. 77–164.
- Hernandez-Lopez, M. J.; Blasco, A.; Prieto, J. A.; Randez-Gil, F. (2003): Ura^r host strains for genetic manipulation and heterologous expression of *Torulasporea delbrueckii*. In *Int. J. Food Microbiol.* 86 (1-2), pp. 79–86. DOI: 10.1016/S0168-1605(03)00249-6.

Hernández-Orte, P.; Ibarz, M.J.; Cacho, J.; Ferreira, V. (2005): Effect of the addition of ammonium and amino acids to musts of Airen variety on aromatic composition and sensory properties of the obtained wine. In *Food Chem.* 89 (2), pp. 163–174. DOI: 10.1016/j.foodchem.2004.02.021.

Herraiz, T.; Reglero, G.; Herraiz, M.; Martín-Alvarez, P. J.; Cabezudo, M. D. (1990): The influence of the yeast and type of culture on the volatile composition of wines fermented without sulfur dioxide. In *Am J Enol Vitic* 41 (4), pp. 313–318. Available online at <https://www.ajevonline.org/content/ajev/41/4/313.full-text.pdf>.

Hoffmann, A.; Kupsch, C.; Walther, T.; Löser, C. (2021): Synthesis of ethyl acetate from glucose by *Kluyveromyces marxianus*, *Cyberlindnera jadinii* and *Wickerhamomyces anomalus* depending on the induction mode. In *Eng. Life Sci.* 21 (3-4), pp. 154–168. DOI: 10.1002/elsc.202000048.

Husnik, J. I.; Volschenk, H.; Bauer, J.; Colavizza, D.; Luo, Z.; van Vuuren, H. J. J. (2006): Metabolic engineering of malolactic wine yeast. In *Metab. Eng.* 8 (4), pp. 315–323. DOI: 10.1016/j.ymben.2006.02.003.

Jagtap, U. B.; Jadhav, J. P.; Bapat, V. A.; Pretorius, I. S. (2017): Synthetic biology stretching the realms of possibility in wine yeast research. In *Int. J. Food Microbiol.* 252, pp. 24–34. DOI: 10.1016/j.ijfoodmicro.2017.04.006.

Jiranek, V.; Langridge, P.; Henschke, P. A. (1995): Regulation of hydrogen sulfide liberation in wine-producing *Saccharomyces cerevisiae* strains by assimilable nitrogen. In *Appl. Environ. Microbiol.* 61 (2), pp. 461–467. DOI: 10.1128/aem.61.2.461-467.1995.

Jolly, N. P.; Augustyn, O.P.H.; Pretorius, I. S. (2003a): The effect of non-*Saccharomyces* yeasts on fermentation and wine quality. In *South African Journal of Enology & Viticulture* 24 (2). DOI: 10.21548/24-2-2638.

Jolly, N. P.; Augustyn, O.P.H.; Pretorius, I. S. (2003b): The occurrence of non-*Saccharomyces cerevisiae* yeast species over three vintages in four vineyards and grape musts from four production regions of the Western Cape, South Africa. In *South African Journal of Enology & Viticulture* 24 (2), pp. 35–42. DOI: 10.21548/24-2-2640.

Jolly, N. P.; Varela, C.; Pretorius, I. S. (2014): Not your ordinary yeast: non-*Saccharomyces* yeasts in wine production uncovered. In *FEMS yeast Res.* 14 (2), pp. 215–237. DOI: 10.1111/1567-1364.12111.

Killian, E.; Ough, C. S. (1979): Fermentation esters — formation and retention as affected by fermentation temperature. In *Am J Enol Vitic* 30 (4), pp. 301–305.

Lallemand Sourvisiae Technical Data Sheet. Available online at <https://www.lallemandbrewing.com/wp-content/uploads/2019/09/LAL-TDS-Mascoma-Sourvisiae-Final-1.pdf>, checked on 1/23/2023.

Lambrechts, M. G.; Pretorius, I. S. (2000): Yeast and its importance to wine aroma - A Review. In *South African Journal of Enology & Viticulture* 21 (1). DOI: 10.21548/21-1-3560.

Langenberg, A.-K.; Bink, F. J.; Wolff, L.; Walter, S.; von Wallbrunn, C.; Grossmann, M. et al. (2017): Glycolytic functions are conserved in the genome of the wine yeast *Hanseniaspora uvarum*, and

pyruvate kinase limits its capacity for alcoholic fermentation. In *Appl. Environ. Microbiol.* 83 (22). DOI: 10.1128/AEM.01580-17.

Lema, C.; Garcia-Jares, C.; Orriols, I.; Angulo, L. (1996): Contribution of *Saccharomyces* and non-*Saccharomyces* populations to the production of some components of Albarino wine aroma. In *Am J Enol Vitic* 47 (2). Available online at https://www.ajevonline.org/content/ajev/47/2/206.full-text.pdf?casa_token=pwph6vgs82caaaaa:cidj4et4y3tpboo2pao4a-wgxbihgchmrpsof-ipgox6_basvcep1v6pi3rlykiorjm5gegtzew8.

Liguori, L.; Albanese, D.; Crescitelli, A.; Di Matteo, M.; Russo, P. (2019): Impact of dealcoholization on quality properties in white wine at various alcohol content levels. In *J. Food Sci. Technol.* 56 (8), pp. 3707–3720. DOI: 10.1007/s13197-019-03839-x.

Lleixà, J.; Martín, V.; Giorello, F.; Portillo, M. C.; Carrau, F.; Beltran, G.; Mas, A. (2018): Analysis of the NCR Mechanisms in *Hanseniaspora vineae* and *Saccharomyces cerevisiae* During Winemaking. In *Frontiers in genetics* 9, p. 747. DOI: 10.3389/fgene.2018.00747.

Long, C.-A.; Deng, B.-X.; Deng, X.-X. (2007): Commercial testing of *Kloeckera apiculata*, isolate 34-9, for biological control of postharvest diseases of citrus fruit. In *Ann. Microbiol.* 57 (2), pp. 203–207. DOI: 10.1007/BF03175208.

Longo, R.; Blackman, J. W.; Torley, P. J.; Rogiers, S. Y.; Schmidtke, L. M. (2017): Changes in volatile composition and sensory attributes of wines during alcohol content reduction. In *J. Sci. Food Agric.* 97 (1), pp. 8–16. DOI: 10.1002/jsfa.7757.

López, S.; Mateo, J. J.; Maicas, S. Maicas (2016): Characterisation of *Hanseniaspora* isolates with potential aroma-enhancing properties in Muscat wines. In *South African Journal of Enology & Viticulture* 35 (2). DOI: 10.21548/35-2-1018.

Löser, C.; Urit, T.; Bley, T. (2014): Perspectives for the biotechnological production of ethyl acetate by yeasts. In *Appl. Microbiol. Biotechnol.* 98 (12), pp. 5397–5415. DOI: 10.1007/s00253-014-5765-9.

Lucht, J. M. (2015): Public Acceptance of Plant Biotechnology and GM Crops. In *Viruses* 7 (8), pp. 4254–4281. DOI: 10.3390/v7082819.

Margalit, Y. (2012): Concepts in wine chemistry. 3rd ed. San Francisco, CA: Wine Appreciation Guild.

Martin, V.; Valera, M.; Medina, K.; Boido, E.; Carrau, F. (2018): Oenological impact of the *Hanseniaspora/Kloeckera* yeast genus on wines—A Review. In *Fermentation* 4 (3), p. 76. DOI: 10.3390/fermentation4030076.

Martini, A. (1993): Origin and domestication of the wine yeast *Saccharomyces cerevisiae*. In *J Wine Res* 4 (3), pp. 165–176. DOI: 10.1080/09571269308717966.

Mas, A.; Guillamon, J. M.; Torija, M. J.; Beltran, G.; Cerezo, A. B.; Troncoso, A. M.; Garcia-Parrilla, M. C. (2014): Bioactive compounds derived from the yeast metabolism of aromatic amino acids during alcoholic fermentation. In *BioMed Res. Int.* 2014, p. 898045. DOI: 10.1155/2014/898045.

- Masneuf-Pomarede, I.; Bely, M.; Marullo, P.; Albertin, W. (2015): The genetics of non-conventional wine yeasts: Current knowledge and future challenges. In *Front. Microbiol.* 6, p. 1563. DOI: 10.3389/fmicb.2015.01563.
- McGettigan, P. A. (2013): Transcriptomics in the RNA-seq era. In *Curr Opin Chem Biol* 17 (1), pp. 4–11. DOI: 10.1016/j.cbpa.2012.12.008.
- McGovern, P. E.; Zhang, J.; Tang, J.; Zhang, Z.; Hall, G. R.; Moreau, R. A. et al. (2004): Fermented beverages of pre- and proto-historic China. In *Proc. Natl. Acad. Sci. U.S.A.* 101 (51), pp. 17593–17598. DOI: 10.1073/pnas.0407921102.
- Mestre, M. V.; Maturano, Y. P.; Gallardo, C.; Combina, M.; Mercado, L.; Toro, M. E. et al. (2019): Impact on sensory and aromatic profile of low ethanol Malbec wines fermented by sequential culture of *Hanseniaspora uvarum* and *Saccharomyces cerevisiae* native yeasts. In *Fermentation* 5 (3), p. 65. DOI: 10.3390/fermentation5030065.
- Meyen, F. J. F. (1839): A report on the progress of vegetable physiology during the year 1837: Taylor.
- Miller, A. C.; Wolff, S. R.; Bisson, L. F.; Ebeler, S. E. (2007): Yeast strain and nitrogen supplementation: Dynamics of volatile ester production in Chardonnay juice fermentations. In *Am J Enol Vitic* 58 (4), pp. 470–483. DOI: 10.5344/ajev.2007.58.4.470.
- Minhas, A.; Biswas, D.; Mondal, A. K. (2009): Development of host and vector for high-efficiency transformation and gene disruption in *Debaryomyces hansenii*. In *FEMS yeast Res.* 9 (1), pp. 95–102. DOI: 10.1111/j.1567-1364.2008.00457.x.
- Molina, A. M.; Swiegers, J. H.; Varela, C.; Pretorius, I. S.; Agosin, E. (2007): Influence of wine fermentation temperature on the synthesis of yeast-derived volatile aroma compounds. In *Appl. Microbiol. Biotechnol.* 77 (3), pp. 675–687. DOI: 10.1007/s00253-007-1194-3.
- Moreira, N.; Mendes, F.; Guedes de Pinho, P.; Hogg, T.; Vasconcelos, I. (2008): Heavy sulphur compounds, higher alcohols and esters production profile of *Hanseniaspora uvarum* and *Hanseniaspora guilliermondii* grown as pure and mixed cultures in grape must. In *Int. J. Food Microbiol.* 124 (3), pp. 231–238. DOI: 10.1016/j.ijfoodmicro.2008.03.025.
- Moreno-Beltrán, M.; Gore-Lloyd, D.; Chuck, C.; Henk, D. (2021): Variation among *Metschnikowia pulcherrima* isolates for genetic modification and homologous recombination. In *Microorganisms* 9 (2). DOI: 10.3390/microorganisms9020290.
- Morrissey, J. P.; Etschmann, M. M. W.; Schrader, J.; de Billerbeck, G. M. (2015): Cell factory applications of the yeast *Kluyveromyces marxianus* for the biotechnological production of natural flavour and fragrance molecules. In *Yeast* 32 (1), pp. 3–16. DOI: 10.1002/yea.3054.
- Nelson, N. J. (2001): Microarrays have arrived: gene expression tool matures. In *J. Natl. Cancer Inst.* 93 (7), pp. 492–494. DOI: 10.1093/jnci/93.7.492.
- Paltauf, F.; Kohlwein, S. P.; Henry, S. A. (1992): Regulation and compartmentalization of lipid synthesis in yeast. In E. W. Jones, J. R. Pringle, J. R. Broach (Eds.): *Molecular and Cellular Biology of the Yeast*

Saccharomyces: Gene Expression: Cold Spring Harbor Laboratory Press (2), pp. 415–500. Available online at <https://cir.nii.ac.jp/crid/1574231874216293248>.

Pasteur, L. (1873): Études sur le vin. Ses maladies, causes qui les provoquent, procédés nouveaux pour le conserver et pour le vieillir: Simon Raçou et Comp.

Pasteur, L. (1876): Études sur la bière. Ses maladies, causes qui les provoquent, procédé pour la rendre inaltérable; avec une théorie nouvelle de la fermentation: Gauthier-Villars.

Pasteur, L.; Faulkner, F. (1879): Studies on fermentation. The diseases of beer, their causes, and the means of preventing them: Kraus Reprint.

Pelliccia, C.; Antonielli, L.; Corte, L.; Bagnetti, A.; Fatichenti, F.; Cardinali, G. (2011): Preliminary prospection of the yeast biodiversity on apple and pear surfaces from Northern Italy orchards. In *Ann. Microbiol.* 61 (4), pp. 965–972. DOI: 10.1007/s13213-011-0220-y.

Peña, D. A.; Gasser, B.; Zanghellini, J.; Steiger, M. G.; Mattanovich, D. (2018): Metabolic engineering of *Pichia pastoris*. In *Metab. Eng.* 50, pp. 2–15. DOI: 10.1016/j.ymben.2018.04.017.

Pérez-Coello, M. S.; Briones Pérez, A. I.; Ubeda Iranzo, J. F.; Martín Álvarez, P. J. (1999): Characteristics of wines fermented with different *Saccharomyces cerevisiae* strains isolated from the La Mancha region. In *Food Microbiol.* 16 (6), pp. 563–573. DOI: 10.1006/fmic.1999.0272.

Poo, M.-c. (2013): Wine & wine offering in the religion of ancient egypt. Hoboken: Routledge.

Pretorius, I. S. (2000): Tailoring wine yeast for the new millennium: Novel approaches to the ancient art of winemaking. In *Yeast* 16 (8), pp. 675–729. DOI: 10.1002/1097-0061(20000615)16:8<675::AID-YEA585>3.0.CO;2-B.

Pretorius, I. S.; Du Toit, M.; van Rensburg, P. (2003): Designer yeasts for the fermentation industry of the 21st century. In *Food Technol. Biotechnol.* 41 (1), pp. 3–10. Available online at <https://hrcak.srce.hr/clanak/163447>.

Pretorius, I. S.; van der Westhuizen, T. J.; Augustyn, O.P.H. (2017): Yeast biodiversity in vineyards and wineries and its importance to the South African wine Industry. A Review. In *South African Journal of Enology & Viticulture* 20 (2). DOI: 10.21548/20-2-2234.

Racker, E. (1974): History of the Pasteur effect and its pathobiology. In *Molecular and cellular biochemistry* 5 (1-2), pp. 17–23. DOI: 10.1007/BF01874168.

Rainieri, S.; Pretorius, I.S. (2000): Selection and improvement of wine yeast. In *Ann. Microbiol.* 50 (1). Available online at https://www.researchgate.net/profile/sandra-rainieri-2/publication/237429676_selection_and_improvement_of_wine_yeast.

Ramírez-Castrillón, M.; Usman, L. M.; Silva-Bedoya, L. M.; Osorio-Cadavid, E. (2019): Dominant yeasts associated to mango (*Mangifera indica*) and rose apple (*Syzygium malaccense*) fruit pulps investigated by culture-based methods. In *Anais da Academia Brasileira de Ciências* 91 (4), e20190052. DOI: 10.1590/0001-3765201920190052.

- Rapp, A.; Mandery, H. (1986): Wine aroma. In *Experientia* 42 (8), pp. 873–884. DOI: 10.1007/BF01941764.
- Rapp, A.; Versini, G. (1995): Influence of nitrogen compounds in grapes on aroma compounds of wines. In : Food Flavors: Generation, Analysis and Process Influence. Proceedings of the 8th International Flavor Conference, vol. 37. 37 volumes: Elsevier (Developments in Food Science), pp. 1659–1694.
- Rojas, V.; Gil, J. V.; Piñaga, F.; Manzanera, P. (2001): Studies on acetate ester production by non-*Saccharomyces* wine yeasts. In *Int. J. Food Microbiol.* 70 (3), pp. 283–289. DOI: 10.1016/s0168-1605(01)00552-9.
- Romano, P.; Capece, A.; Jespersen, L. (2006): Taxonomic and ecological diversity of food and beverage yeasts. In G. H. Fleet, A. Querol (Eds.): *Yeasts in food and beverages*. Berlin: Springer (The yeasts handbook, 2), pp. 13–53.
- Romano, P.; Fiore, C.; Paraggio, M.; Caruso, M.; Capece, A. (2003): Function of yeast species and strains in wine flavour. In *Int. J. Food Microbiol.* 86 (1-2), pp. 169–180. DOI: 10.1016/s0168-1605(03)00290-3.
- Romano, P.; Suzzi, G.; Domizio, P.; Fatichenti, F. (1997): Secondary products formation as a tool for discriminating non-*Saccharomyces* wine strains. Strain diversity in non-*Saccharomyces* wine yeasts. In *Antonie Van Leeuwenhoek* 71 (3), pp. 239–242. DOI: 10.1023/A:1000102006018.
- Roudil, L.; Russo, P.; Berbegal, C.; Albertin, W.; Spano, G.; Capozzi, V. (2020): Non-*Saccharomyces* commercial starter cultures: Scientific trends, recent patents and innovation in the wine sector: Bentham Science Publishers (11). Available online at <https://www.ingentaconnect.com/content/ben/pfna/2020/00000011/00000001/art00006>.
- Saerens, S. M. G.; Delvaux, F.; Verstrepen, K. J.; van Dijck, P.; Thevelein, J. M.; Delvaux, F. R. (2008): Parameters affecting ethyl ester production by *Saccharomyces cerevisiae* during fermentation. In *Appl. Environ. Microbiol.* 74 (2), pp. 454–461. DOI: 10.1128/AEM.01616-07.
- Sajid, M.; Stone, S. R.; Kaur, P. (2021): Transforming traditional nutrition paradigms with synthetic biology driven microbial production platforms. In *Curr. Res. Biotechnol.* 3, pp. 260–268. DOI: 10.1016/j.crbiot.2021.07.002.
- Sam, F. E.; Ma, T.-Z.; Salifu, R.; Wang, J.; Jiang, Y.-M.; Zhang, B.; Han, S.-Y. (2021): Techniques for dealcoholization of wines: Their impact on wine phenolic composition, volatile composition, and sensory characteristics. In *Foods* 10 (10), p. 2498. DOI: 10.3390/foods10102498.
- Schuller, D.; Casal, M. (2005): The use of genetically modified *Saccharomyces cerevisiae* strains in the wine industry. In *Appl. Microbiol. Biotechnol.* 68 (3), pp. 292–304. DOI: 10.1007/s00253-005-1994-2.
- Schulthess, D.; Ettlinger, L. (1978): Influence of the concentration of branched chain amino acids on the formation of fusel alcohols. In *J. Inst. Brew.* 84 (4), pp. 240–243. DOI: 10.1002/j.2050-0416.1978.tb03881.x.
- Seixas, I.; Barbosa, C.; Mendes-Faia, A.; Güldener, U.; Tenreiro, R.; Mendes-Ferreira, A.; Mira, N. P. (2019): Genome sequence of the non-conventional wine yeast *Hanseniaspora guilliermondii* UTAD222

unveils relevant traits of this species and of the *Hanseniaspora* genus in the context of wine fermentation. In *DNA Res.* 26 (1), pp. 67–83. DOI: 10.1093/dnares/dsy039.

Shew, A. M.; Nalley, L. L.; Snell, H. A.; Nayga, R. M.; Dixon, B. L. (2018): CRISPR versus GMOs: Public acceptance and valuation. In *Glob. Food Sec.* 19, pp. 71–80. DOI: 10.1016/j.gfs.2018.10.005.

Shukla, P. (2019): Synthetic biology perspectives of microbial enzymes and their innovative applications. In *Indian J. Microbiol.* 59 (4), pp. 401–409. DOI: 10.1007/s12088-019-00819-9.

Snow, P. G.; Gallander, J. F. (1979): Deacidification of white table wines through partial fermentation with *Schizosaccharomyces Pombe*. In *Am J Enol Vitic* 30 (1), pp. 45–48. DOI: 10.5344/ajev.1979.30.1.45.

Spencer, J. F. T.; Ragout de Spencer, A. L.; Laluce, C. (2002): Non-conventional yeasts. In *Appl. Microbiol. Biotechnol.* 58 (2), pp. 147–156. DOI: 10.1007/s00253-001-0834-2.

Sponholz, W. R.; Dittrich, H. H. (1974): Die Bildung von SO₂-bindenden Gärungs-Nebenprodukten, Höheren Alkoholen und Estern bei einigen Reinzuchthefestämmen und bei einigen fuer die Weinbereitung wichtigen wilden Hefen. In *Die Wein-Wissenschaft* 29 (6), pp. 301–314. Available online at <https://pascal-francis.inist.fr/vibad/index.php?action=getrecorddetail&idt=pascal7534006779>.

Steenwyk, J. L.; Oplente, D. A.; Kominek, J.; Shen, X.-X.; Zhou, X.; Labella, A. L. et al. (2019): Extensive loss of cell-cycle and DNA repair genes in an ancient lineage of bipolar budding yeasts. In *PLOS Biol.* 17 (5), e3000255. DOI: 10.1371/journal.pbio.3000255.

Sternes, P. R.; Lee, D.; Kutyna, D. R.; Borneman, A. R. (2016): Genome sequences of three species of *Hanseniaspora* isolated from spontaneous wine fermentations. In *Genome Announc.* 4 (6). DOI: 10.1128/genomeA.01287-16.

Šulgan, B.; Labovský, J.; Labovská, Z. (2020): Multi-aspect comparison of ethyl acetate production pathways: Reactive distillation process integration and intensification via mechanical and chemical approach. In *Processes* 8 (12), p. 1618. DOI: 10.3390/pr8121618.

Sumby, K. M.; Grbin, P. R.; Jiranek, V. (2010): Microbial modulation of aromatic esters in wine: Current knowledge and future prospects. In *Food Chem.* 121 (1), pp. 1–16. DOI: 10.1016/j.foodchem.2009.12.004.

Swiegers, J. H.; Pretorius, I. S. (2005): Yeast modulation of wine flavor. In *Adv. Appl. Microbiol.* 57, pp. 131–175. DOI: 10.1016/S0065-2164(05)57005-9.

Testa, B.; Coppola, F.; Lombardi, S. J.; Iorizzo, M.; Letizia, F.; Di Renzo, M. et al. (2021): Influence of *Hanseniaspora uvarum* AS27 on chemical and sensorial characteristics of Aglianico wine. In *Processes* 9 (2), p. 326. DOI: 10.3390/pr9020326.

Thompson, J. R.; Register, E.; Curotto, J.; Kurtz, M.; Kelly, R. (1998): An improved protocol for the preparation of yeast cells for transformation by electroporation. In *Yeast* 14 (6), pp. 565–571. DOI: 10.1002/(SICI)1097-0061(19980430)14:6<565::AID-YEA251>3.0.CO;2-B.

- Torrea, D.; Fraile, P.; Garde, T.; Ancín Azpilicueta, C. (2003): Production of volatile compounds in the fermentation of chardonnay musts inoculated with two strains of *Saccharomyces cerevisiae* with different nitrogen demands. In *Food Control* 14 (8), pp. 565–571. DOI: 10.1016/S0956-7135(02)00146-9.
- Torrea, D.; Varela, C.; Ugliano, M.; Ancin-Azpilicueta, C.; Francis, I. L.; Henschke, P. A. (2011): Comparison of inorganic and organic nitrogen supplementation of grape juice - Effect on volatile composition and aroma profile of a Chardonnay wine fermented with *Saccharomyces cerevisiae* yeast. In *Food Chem.* 127 (3), pp. 1072–1083. DOI: 10.1016/j.foodchem.2011.01.092.
- Tristezza, M.; Tufariello, M.; Capozzi, V.; Spano, G.; Mita, G.; Grieco, F. (2016): The oenological potential of *Hanseniaspora uvarum* in simultaneous and sequential co-fermentation with *Saccharomyces cerevisiae* for industrial wine production. In *Front. Microbiol.* 7, p. 670. DOI: 10.3389/fmicb.2016.00670.
- Unger, R. W. (2004): Beer in the middle ages and the renaissance. Philadelphia: University of Pennsylvania Press.
- Unterfrauner, M.; Kobler, A.; Rauhut, D. (2009): Einfluss unterschiedlich hoher Gär Salzdosierungen auf Südtiroler Weißweine; Auswirkungen auf Sensorik und Aromastoffe. In *Mitteilungen Klosterneuburg* 59, pp. 106–114. Available online at <https://www.weinobst.at/dam/jcr:aecd5ea1-e4b5-4613-a784-4f6cf417dfd1/106-2009.pdf>.
- Valera, M. J.; Boido, E.; Dellacassa, E.; Carrau, F. (2020): Comparison of the glycolytic and alcoholic fermentation pathways of *Hanseniaspora vineae* with *Saccharomyces cerevisiae* wine yeasts. In *Fermentation* 6 (3), p. 78. DOI: 10.3390/fermentation6030078.
- van Leeuwen, C.; Destrac-Irvine, A. (2017): Modified grape composition under climate change conditions requires adaptations in the vineyard. In *OENO One* 51 (2), p. 147. DOI: 10.20870/oeno-one.2016.0.0.1647.
- van Ooyen, A. J. J.; Dekker, P.; Huang, M.; Olsthoorn, M. M. A.; Jacobs, D. I.; Colussi, P. A.; Taron, C. H. (2006): Heterologous protein production in the yeast *Kluyveromyces lactis*. In *FEMS yeast Res.* 6 (3), pp. 381–392. DOI: 10.1111/j.1567-1364.2006.00049.x.
- van Wyk, N.; Badura, J.; von Wallbrunn, C.; Pretorius, I. S. (2023): Exploring future applications of the apiculate yeast *Hanseniaspora*. In *Crit. Rev. Biotechnol.*, pp. 1–20. DOI: 10.1080/07388551.2022.2136565.
- van Wyk, N.; Grossmann, M.; Wendland, J.; von Wallbrunn, C.; Pretorius, I. S. (2019): The whiff of wine yeast innovation: Strategies for enhancing aroma production by yeast during wine fermentation. In *J. Agric. Food Chem.* 67 (49), pp. 13496–13505. DOI: 10.1021/acs.jafc.9b06191.
- van Wyk, N.; Kroukamp, H.; Pretorius, I. S. (2018): The smell of synthetic biology: Engineering strategies for aroma compound production in yeast. In *Fermentation* 4 (3), p. 54. DOI: 10.3390/fermentation4030054.

van Wyk, N.; von Wallbrunn, C.; Swiegers, J. H.; Pretorius, I. S. (2021): Biotechnology of wine yeasts. In *Encyclopedia of mycology*, pp. 428–446. DOI: 10.1016/B978-0-12-819990-9.00007-X.

Varela, C.; Pizarro, F.; Agosin, E. (2004): Biomass content governs fermentation rate in nitrogen-deficient wine musts. In *Appl. Environ. Microbiol.* 70 (6), pp. 3392–3400. DOI: 10.1128/AEM.70.6.3392-3400.2004.

Verstrepen, K. J.; van Laere, S. D. M.; Vanderhaegen, B. M. P.; Derdelinckx, G.; Dufour, J.-P.; Pretorius, I. S. et al. (2003): Expression levels of the yeast alcohol acetyltransferase genes *ATF1*, *Lg-ATF1*, and *ATF2* control the formation of a broad range of volatile esters. In *Appl. Environ. Microbiol.* 69 (9), pp. 5228–5237. DOI: 10.1128/AEM.69.9.5228-5237.2003.

Viana, F.; Gil, J. V.; Vallés, S.; Manzanares, P. (2009): Increasing the levels of 2-phenylethyl acetate in wine through the use of a mixed culture of *Hanseniaspora osmophila* and *Saccharomyces cerevisiae*. In *Int. J. Food Microbiol.* 135 (1), pp. 68–74. DOI: 10.1016/j.ijfoodmicro.2009.07.025.

Volschenk, H.; Viljoen, M.; Grobler, J.; Petzold, B.; Bauer, F.; Subden, R. E. et al. (1997): Engineering pathways for malate degradation in *Saccharomyces cerevisiae*. In *Nat. Biotechnol.* 15 (3), pp. 253–257. DOI: 10.1038/nbt0397-253.

Vuralhan, Z.; Morais, M. A.; Tai, S.-L.; Piper, M. D. W.; Pronk, J. T. (2003): Identification and characterization of phenylpyruvate decarboxylase genes in *Saccharomyces cerevisiae*. In *Appl. Environ. Microbiol.* 69 (8), pp. 4534–4541. DOI: 10.1128/AEM.69.8.4534-4541.2003.

Walker, M. E.; Gardner, J. M.; Vystavelova, A.; McBryde, C.; de Barros Lopes, M.; Jiranek, V. (2003): Application of the re-useable, KanMX selectable marker to industrial yeast: construction and evaluation of heterothallic wine strains of *Saccharomyces cerevisiae*, possessing minimal foreign DNA sequences. In *FEMS yeast Res.* 4 (3), pp. 339–347. DOI: 10.1016/S1567-1356(03)00161-2.

Wang, C.; Mas, A.; Esteve-Zarzoso, B. (2016): The interaction between *Saccharomyces cerevisiae* and non-*Saccharomyces* yeast during alcoholic fermentation is species and strain specific. In *Front. Microbiol.* 7, p. 502. DOI: 10.3389/fmicb.2016.00502.

Wendland, J.; Ayad-Durieux, Y.; Knechtle, P.; Rebischung, C.; Philippsen, P. (2000): PCR-based gene targeting in the filamentous fungus *Ashbya gossypii*. In *Gene* 242 (1-2), pp. 381–391. DOI: 10.1016/S0378-1119(99)00509-0.

Winge, Ø. (1935): On haplophase and diplophase in some *Saccharomycetes*. In *C. R. Trav. Lab. Carlsberg* 21, pp. 77–111.

Woolgar, C. M. (2010): Food and the middle ages. In *Journal of Medieval History* 36 (1), pp. 1–19. DOI: 10.1016/j.jmedhist.2009.12.001.

Wortmann, J. (1895): Anwendung und Wirkung reiner Hefen in der Weinbereitung: Parey.

Zhang, H.; Zhao, Z.; Kang, P.; Wang, Y.; Feng, J.; Jia, J.; Zhang, Z. (2018): Biological nitrogen removal and metabolic characteristics of a novel aerobic denitrifying fungus *Hanseniaspora uvarum* strain KPL108. In *Bioresource technology* 267, pp. 569–577. DOI: 10.1016/j.biortech.2018.07.073.

Zott, K.; Miot-Sertier, C.; Claisse, O.; Lonvaud-Funel, A.; Masneuf-Pomarede, I. (2008): Dynamics and diversity of non-*Saccharomyces* yeasts during the early stages in winemaking. In *Int. J. Food Microbiol.* 125 (2), pp. 197–203. DOI: 10.1016/j.ijfoodmicro.2008.04.001.