

Workshop “Effiziente elektrische Antriebe”

Labor für mechatronische und regenerative Energiesysteme
Prof. Dr.-Ing. Christoph Hackl

Herzlich Willkommen!

17.05.2019

Hochschule München



Workshop “Effiziente elektrische Antriebe”

Freitag, 17.05.2019 von 10-17 Uhr in Raum E0117

Labor für mechatronische und regenerative Energiesysteme
Prof. Dr.-Ing. Christoph Hackl

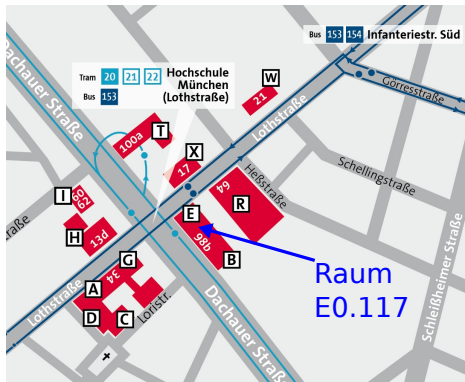

Uhrzeit	Agenda
10:00-10:15	Begrüßung
10:15-11:00	1. Vortrag: „Analytische Berechnung der optimalen Sollströme für beliebige Synchronmaschinen zur Minimierung der Kupfer- & Eisenverluste in allen Betriebsbereichen“, Christoph Hackl (HM)
11:00-11:15	Kaffeepause
11:15-12:00	2. Vortrag: „Optimale Betriebsführung unter Berücksichtigung von Eisenverlusten mit kontinuierlichem Übergang zwischen alle Betriebsstrategien“, Niklas Monzen (Volkswagen)
12:00-12:15	Kaffeepause
12:15-13:00	3. Vortrag: „Generische Maschinenidentifikation und effizienzoptimierte Momentensteuerung für Asynchronmaschinen“, Julian Kullick (HM)
13:00-14:30	Mittagspause (zur freien Verfügung)
14:30-15:15	4. Vortrag: „Optimierte Pulsmuster zur Ansteuerung eines 2-Level Wechselrichters für Permanentmagnet-Synchronmaschinen mit starker magnetischer Anisotropie“, Athina Birda (BMW Group)
15:15-15:30	Kaffeepause
15:30-16:15	5. Vortrag: „Analytische Berechnung von Schaltzeitpunkten von Hochleistungs-DC/DC-Wandlern in Auslegung und Betrieb mit dem Ziel der Effizienzsteigerung“, Daniel Goldmann (HM)
16:15-17:00	Abschließende Diskussion und Verabschiedung

Analytische Berechnung der optimalen Sollströme für beliebige Synchronmaschinen zur Minimierung der Kupfer- & Eisenverluste in allen Betriebsbereichen

Eine umfassende Theorie zur Minimierung der Maschinenverluste

Christoph Hackl

17.05.2019

Hochschule München

Outline

- 1 Generic loss minimization in synchronous machines

Outline

1 Generic loss minimization in synchronous machines

- Motivation
- Problem statement and proposed solution
- Optimal operation strategies
- Analytical solution
- Implementation
- Conclusion

Motivation

Synchronous machines: Widely-used, compact and efficient actuators



www.bmw.de



www.farmwood.co.uk

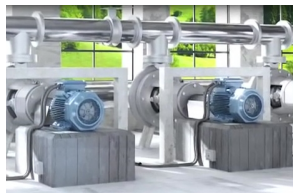

www.abb.com (from video)

- traction drives (e.g. electric vehicles or trains)
- air conditioning/fans
- pumps
- conventional power plants (e.g. hydro power plants)
- renewable energy systems (e.g. direct-drive wind turbine systems)

Motivation

Examples of anisotropic synchronous machines [1] with “saliency ratio” $L_s^d/L_s^q \neq 1$

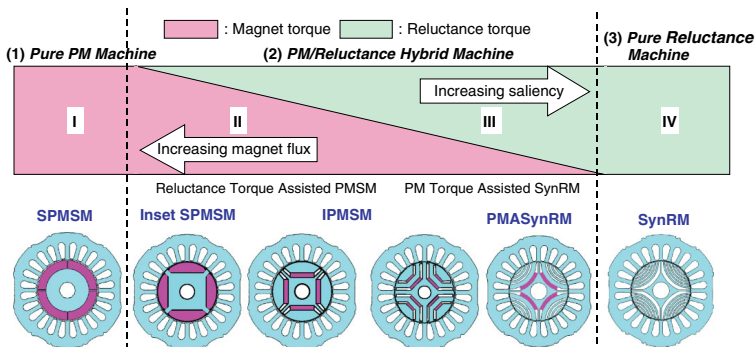

$$m_m(i_s^d, i_s^q) = \frac{3}{2} n_p \left[\underbrace{\psi_{pm} i_s^q}_{\text{magnetic torque}} + \underbrace{(L_s^d - L_s^q) i_s^d i_s^q}_{\text{reluctance torque}} + \underbrace{L_m ((i_s^q)^2 - (i_s^d)^2)}_{\text{cross-coupling torque}} \right]$$

Motivation

Optimal feedforward torque control problem: **Isotropic machine**

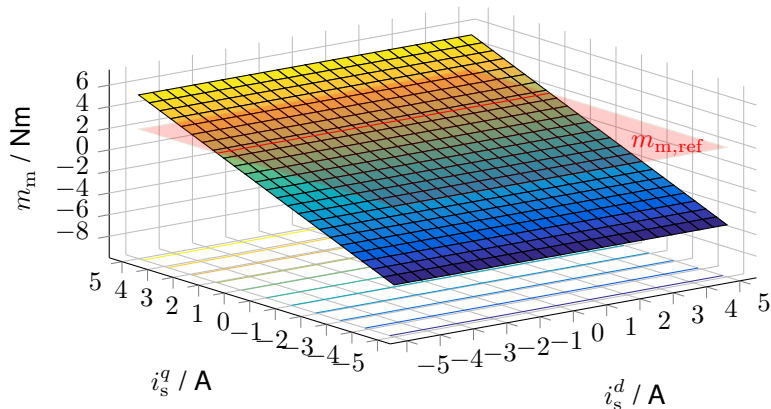

$$m_{m,ref} \stackrel{!}{=} m_m(i_s^d, i_s^q) = \frac{3}{2} n_p \psi_{pm} i_s^q \quad (\implies i_{s,ref}^q = \frac{2 m_{m,ref}}{3 n_p \psi_{pm}})$$

Motivation

Optimal feedforward torque control problem: **Anisotropic machine** (with cross-coupling)

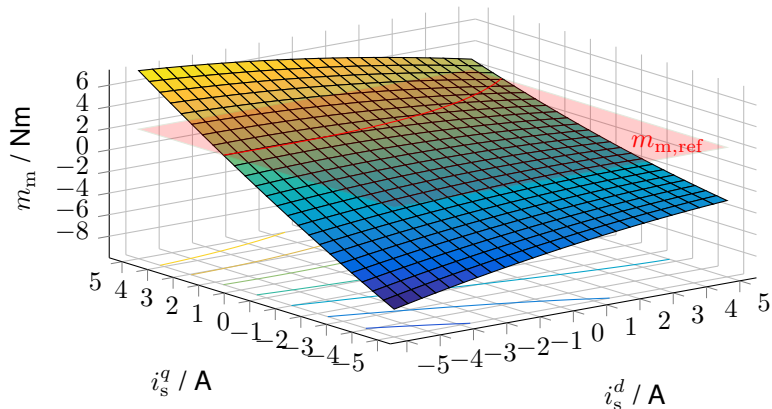

$$m_{m,ref} \stackrel{!}{=} m_m(i_s^d, i_s^q) = \frac{3}{2} n_p \left[\underbrace{\psi_{pm} i_s^q}_{\text{magnetic torque}} + \underbrace{(L_s^d - L_s^q) i_s^d i_s^q}_{\text{reluctance torque}} + \underbrace{L_m ((i_s^q)^2 - (i_s^d)^2)}_{\text{cross-coupling torque}} \right]$$

Problem statement and proposed solution

Optimal feedforward torque control problem: Optimal reference current generation

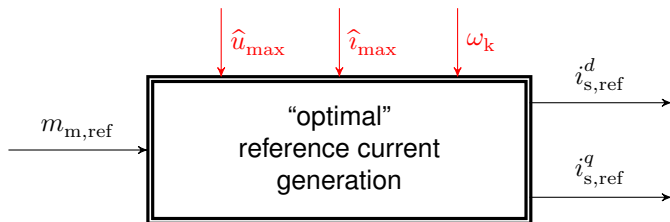

$$\dot{i}_{s,ref}^k(m_{m,ref}, \hat{u}_{max}, \hat{i}_{max}, \omega_k) = \begin{pmatrix} i_{s,ref}^d(m_{m,ref}, \hat{u}_{max}, \hat{i}_{max}, \omega_k) \\ i_{s,ref}^q(m_{m,ref}, \hat{u}_{max}, \hat{i}_{max}, \omega_k) \end{pmatrix}$$

- ✓ Numerical solutions and/or look-up tables
(but: limited storage, accuracy, real-time applicability)
- ? Analytical solutions (some do exist but impose simplifying assumptions
such as ~~$R_s = 0$, $R_{Fe} = 0$ and/or $L_m = 0$~~)

Problem statement and proposed solution

Considered anisotropic synchronous machines with iron losses [2]: Electrical circuit

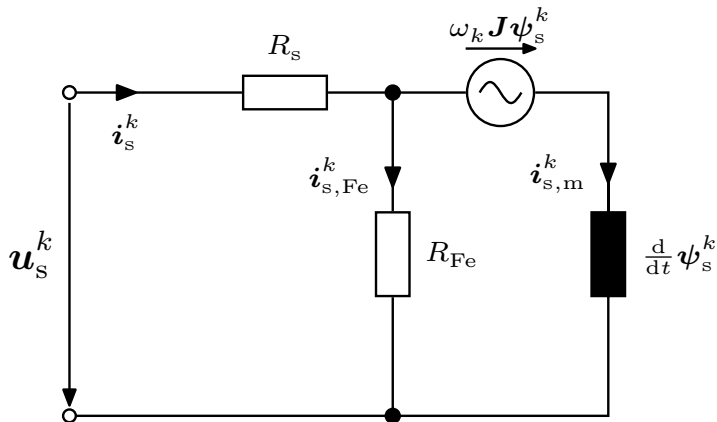

Problem statement and proposed solution

Considered anisotropic synchronous machines with iron losses [2]: Modeling

$$\underbrace{\begin{pmatrix} u_s^d \\ u_s^q \end{pmatrix}}_{=: \mathbf{u}_s^k} = R_s(\vartheta) \underbrace{\begin{pmatrix} i_s^d \\ i_s^q \end{pmatrix}}_{=: \mathbf{i}_s^k} + \omega_k \underbrace{\begin{bmatrix} 0 & -1 \\ 1 & 0 \end{bmatrix}}_{=: \mathbf{J}} \underbrace{\begin{pmatrix} \psi_s^d(\mathbf{i}_{s,m}^k) \\ \psi_s^q(\mathbf{i}_{s,m}^k) \end{pmatrix}}_{=: \boldsymbol{\psi}_s^k(\mathbf{i}_{s,m}^k)} + \cancel{\frac{d}{dt} \boldsymbol{\psi}_s^k(\mathbf{i}_{s,m}^k)}$$

$$\mathbf{i}_s^k = \mathbf{i}_{s,m}^k + \mathbf{i}_{s,Fe}^k = \mathbf{i}_{s,m}^k + \frac{\omega_k \mathbf{J} \boldsymbol{\psi}_s^k(\mathbf{i}_{s,m}^k) + \cancel{\frac{d}{dt} \boldsymbol{\psi}_s^k(\mathbf{i}_{s,m}^k)}}{R_{Fe}(\omega_k)}$$

$$p_{\text{loss}} = p_{\text{Cu}}(\mathbf{i}_s^k) + p_{\text{Fe}}(\boldsymbol{\psi}_s^k, \omega_k) = \frac{3}{2} R_s \|\mathbf{i}_s^k\|^2 + \frac{3}{2} \frac{\|\omega_k \mathbf{J} \boldsymbol{\psi}_s^k(\mathbf{i}_{s,m}^k) + \cancel{\frac{d}{dt} \boldsymbol{\psi}_s^k(\mathbf{i}_{s,m}^k)}\|^2}{R_{Fe}(\omega_k)}$$

$$m_m(\mathbf{i}_{s,m}^k) = \frac{3}{2} n_p (\mathbf{i}_{s,m}^k)^\top \mathbf{J} \boldsymbol{\psi}_s^k(\mathbf{i}_{s,m}^k)$$

Assumption (Affine flux linkage (at least locally))

$$\boldsymbol{\psi}_s^k(\mathbf{i}_{s,m}^k) \approx \underbrace{\begin{bmatrix} L_s^d & L_m \\ L_m & L_s^q \end{bmatrix}}_{=: \mathbf{L}_s^k \in \mathbb{R}^{2 \times 2}} \mathbf{i}_{s,m}^k + \underbrace{\begin{pmatrix} \psi_{\text{pm}} \\ 0 \end{pmatrix}}_{=: \boldsymbol{\psi}_{\text{pm}}^k} \quad \text{with } \mathbf{L}_s^k = (\mathbf{L}_s^k)^\top > 0$$

Problem statement and proposed solution

Optimal reference current generation: Optimization problem(s) with multiple constraints

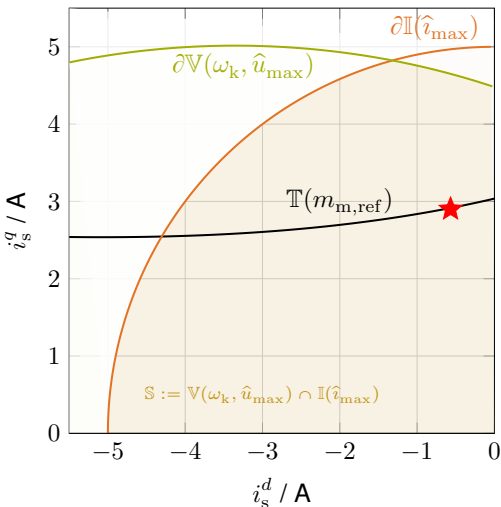

$$\max_{\mathbf{i}_s^k \in \mathbb{S}} -f(\mathbf{i}_s^k) \quad \text{subject to}$$

$$\left\{ \begin{array}{l} \|\mathbf{i}_s^k\|^2 \leq \hat{i}_{\max}^2, \\ \text{(current circular area)} \\ \|\mathbf{u}_s^k(\mathbf{i}_s^k, \omega_k)\|^2 \leq \hat{u}_{\max}^2, \\ \text{(voltage elliptical area)} \\ |m_m(\mathbf{i}_s^k)| \leq |m_{m,\text{ref}}|, \text{ and} \\ \text{sign}(m_{m,\text{ref}}) = \\ \text{sign}(m_m(\mathbf{i}_s^k)). \end{array} \right.$$

e.g. $-f(\mathbf{i}_s^k) = -\|\mathbf{i}_s^k\|^2$ (minimize copper losses) $\implies \mathbf{i}_{s,\text{ref}}^k$ at ★

Problem statement and proposed solution

Proposed solution: Implicit formulation (quadratics), optimization and intersection points

Step 1: Derivation of quadratics $Q_A(\mathbf{i}_s^k) := (\mathbf{i}_s^k)^\top \mathbf{A} \mathbf{i}_s^k + 2\mathbf{a}^\top \mathbf{i}_s^k + \alpha:$

- Current circular area: $(i_s^d)^2 + (i_s^q)^2 \leq \hat{i}_{\max}^2 \iff \|\mathbf{i}_s^k\|^2 = (\mathbf{i}_s^k)^\top \mathbf{I}_2 \mathbf{i}_s^k \leq \hat{i}_{\max}^2$

$$\implies \mathbb{I}(\hat{i}_{\max}) := \{ \mathbf{i}_s^k \in \mathbb{R}^2 \mid (\mathbf{i}_s^k)^\top \mathbf{I}_2 \mathbf{i}_s^k - \hat{i}_{\max}^2 \leq 0 \}$$

- Voltage elliptical area: $(u_s^d)^2 + (u_s^q)^2 \leq \hat{u}_{\max}^2 \iff \|\mathbf{u}_s^k(\mathbf{i}_s^k, \omega_k)\|^2 = \dots \leq \hat{u}_{\max}^2$

$$\implies \mathbb{V}(\omega_k, \hat{u}_{\max}) := \{ \mathbf{i}_s^k \in \mathbb{R}^2 \mid (\mathbf{i}_s^k)^\top \mathbf{V}(\omega_k) \mathbf{i}_s^k + 2\mathbf{v}(\omega_k)^\top \mathbf{i}_s^k + \nu(\omega_k, \hat{u}_{\max}) \leq 0 \}$$

- Reference torque hyperbola:

$$m_m(\mathbf{i}_{s,m}^k) = \frac{3}{2} n_p (\mathbf{i}_{s,m}^k)^\top \mathbf{J} \boldsymbol{\psi}_s^k(\mathbf{i}_{s,m}^k) \stackrel{!}{=} m_{m,\text{ref}} \iff \dots$$

$$\implies \mathbb{T}(m_{m,\text{ref}}) := \{ \mathbf{i}_s^k \in \mathbb{R}^2 \mid (\mathbf{i}_s^k)^\top \mathbf{T} \mathbf{i}_s^k + 2\mathbf{t}^\top \mathbf{i}_s^k - m_{m,\text{ref}} = 0 \}$$

- ...

Problem statement and proposed solution

Proposed solution: Implicit formulation (quadrics), optimization and intersection points

Step 2: Optimization problem with equality constraint

$$\max_{\mathbf{i}_s^k} - \left(\underbrace{(\mathbf{i}_s^k)^\top \mathbf{A} \mathbf{i}_s^k + 2\mathbf{a}^\top \mathbf{i}_s^k + \alpha}_{=: Q_A(\mathbf{i}_s^k)} \right) \text{ s.t. } \underbrace{(\mathbf{i}_s^k)^\top \mathbf{B} \mathbf{i}_s^k + 2\mathbf{b}^\top \mathbf{i}_s^k + \beta}_{=: Q_B(\mathbf{i}_s^k)} = 0$$

\implies Hyperbolas for e.g. MTPC, MTPL or MTPV (with $R_s, R_{Fe} \neq 0$ & $L_m \neq 0$)

Step 3: Intersection of two quadrics (e.g. voltage ellipse and current circle)

$$\mathbf{i}_{s,\text{ref}}^k := \arg \min_{\|\mathbf{i}_s^k\|} \left\{ \mathbf{i}_s^k \in \mathbb{R}^2 \mid Q_A(\mathbf{i}_s^k) = 0 \wedge Q_B(\mathbf{i}_s^k) = 0 \right\}$$

\implies Optimal operation point \star (reference current)

Both lead to subproblem of solving a fourth-order (quartic) polynomial

$$\chi(\lambda) := c_4 \lambda^4 + c_3 \lambda^3 + c_2 \lambda^2 + c_1 \lambda + c_0 \stackrel{!}{=} 0$$

\implies Analytical solutions exist (e.g. Euler's solution, see [3])

Optimal operation strategies

Maximum Torque per Current (**MTPC** @ $0 \cdot \omega_{m,\text{rat}}$): Reference torque feasible

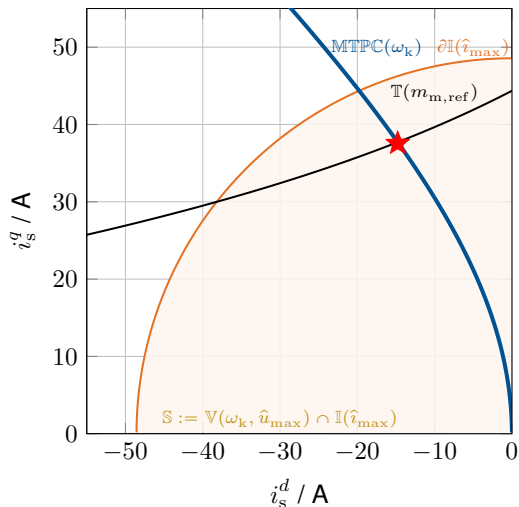

Optimization problem

$$\begin{aligned} \max_{\mathbf{i}_s^k \in \mathcal{S}} -p_{\text{Cu}}(\mathbf{i}_s^k) \quad \text{s.t.} \\ \underbrace{(\mathbf{i}_s^k)^\top \mathbf{T} \mathbf{i}_s^k + 2 \mathbf{t}^\top \mathbf{i}_s^k}_{= m_m(\mathbf{i}_s^k)} - m_{m,\text{ref}} = 0 \end{aligned}$$

Solution set

$$\begin{aligned} \text{MTPC}(\omega_k) := \{ \mathbf{i}_s^k \in \mathbb{R}^2 \mid \\ (\mathbf{i}_s^k)^\top \mathbf{M}_C \mathbf{i}_s^k + 2 \mathbf{m}_C^\top \mathbf{i}_s^k = 0 \} \end{aligned}$$

Optimal reference currents (★)

$$\mathbf{i}_{s,\text{ref}}^k = \text{MTPC} \cap \mathbf{T}(m_{m,\text{ref}})$$

Optimal operation strategies

Maximum Torque per Losses (**MTPL** @ $1 \cdot \omega_{m, \text{rat}}$): Reference torque feasible

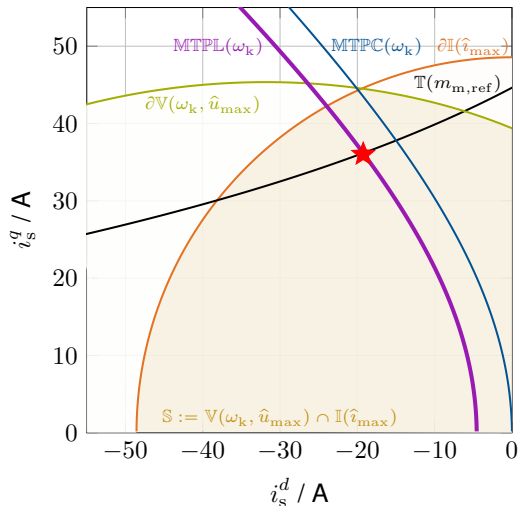

Optimization problem

$$\begin{aligned} \max_{\mathbf{i}_s^k \in \mathcal{S}} \quad & -p_{\text{Cu}}(\mathbf{i}_s^k) - p_{\text{Fe}}(\mathbf{i}_s^k) \quad \text{s.t.} \\ & \underbrace{(\mathbf{i}_s^k)^\top \mathbf{T} \mathbf{i}_s^k + 2 \mathbf{t}^\top \mathbf{i}_s^k}_{= m_m(\mathbf{i}_s^k)} - m_{m, \text{ref}} = 0 \end{aligned}$$

Solution set

$$\begin{aligned} \text{MTPL}(\omega_k) := \{ & \mathbf{i}_s^k \in \mathbb{R}^2 \mid \\ & (\mathbf{i}_s^k)^\top \mathbf{M}_L \mathbf{i}_s^k + 2 \mathbf{m}_L^\top \mathbf{i}_s^k + \mu_L = 0 \} \end{aligned}$$

Optimal reference currents (★)

$$\mathbf{i}_{s, \text{ref}}^k = \text{MTPL} \cap \text{T}(m_{m, \text{ref}})$$

Optimal operation strategies

Field Weakening (FW @ $1.40 \cdot \omega_{m, \text{rat}}$): Reference torque feasible

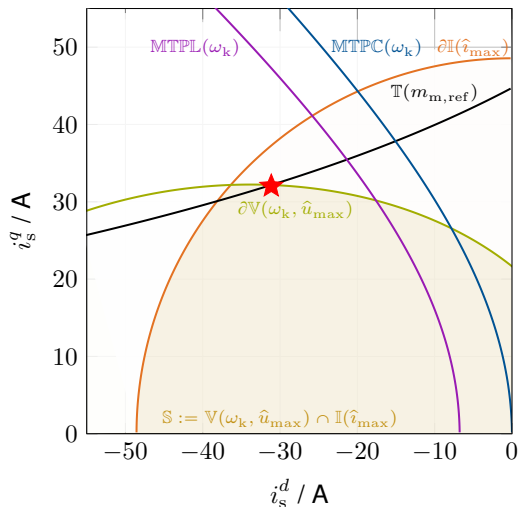

Optimization problem

$$\begin{aligned} \max_{\mathbf{i}_s^k \in \mathcal{S}} & -p_{\text{Cu}}(\mathbf{i}_s^k) - p_{\text{Fe}}(\mathbf{i}_s^k) \quad \text{s.t.} \\ & \underbrace{(\mathbf{i}_s^k)^\top \mathbf{T} \mathbf{i}_s^k + 2 \mathbf{t}^\top \mathbf{i}_s^k - m_{m, \text{ref}}}_{= m_m(\mathbf{i}_s^k)} = 0 \end{aligned}$$

Feasible set

$$\text{FW}(m_{m, \text{ref}}, \omega_k, \hat{u}_{\text{max}}) := \mathcal{S}(\omega_k, \hat{u}_{\text{max}}, \hat{i}_{\text{max}}) \cap \mathbb{T}(m_{m, \text{ref}})$$

Optimal reference currents (★)

$$\mathbf{i}_{s, \text{ref}}^k = \partial \mathcal{V}(\omega_k, \hat{u}_{\text{max}}) \cap \mathbb{T}(m_{m, \text{ref}})$$

Optimal operation strategies

Maximum Current (**MC** @ $1.75 \cdot \omega_{m, \text{rat}}$): Reference torque **not** feasible

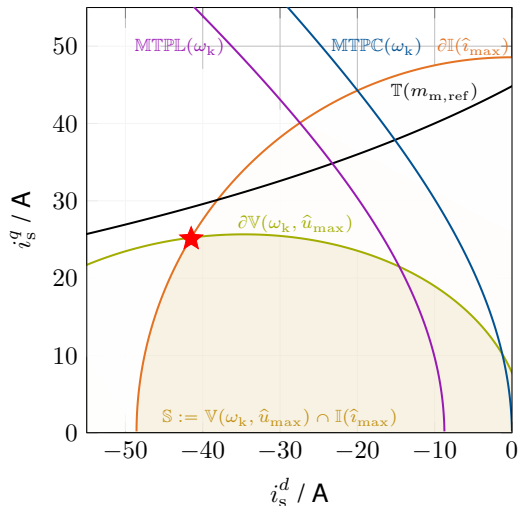

Optimization problem

$$\max_{\dot{\mathbf{i}}_s^k \in \mathcal{S}} m_m(\dot{\mathbf{i}}_s^k)$$

Feasible set

$$\text{MC}(\omega_k, \hat{u}_{\max}, \hat{i}_{\max}) := \mathcal{V}(\omega_k, \hat{u}_{\max}) \cap \partial \mathbb{I}(\hat{i}_{\max})$$

Optimal current reference (★)

$$\dot{\mathbf{i}}_{s, \text{ref}}^k = \partial \mathcal{V}(\omega_k, \hat{u}_{\max}) \cap \partial \mathbb{I}(\hat{i}_{\max})$$

Optimal operation strategies

Maximum Torque per Voltage (MTPV @ $2.50 \cdot \omega_{m, \text{rat}}$): Reference torque **not** feasible

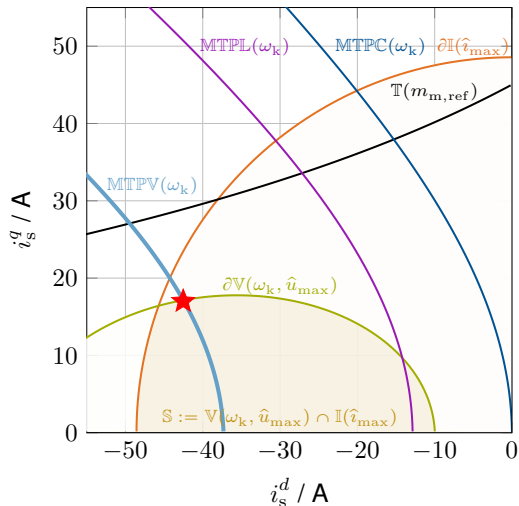

Optimization problem

$$\begin{aligned} \max_{\mathbf{i}_s^k \in \mathcal{S}} & -\|\mathbf{u}_s^k(\mathbf{i}_s^k)\|^2 \quad \text{s.t.} \\ & \underbrace{(\mathbf{i}_s^k)^\top \mathbf{T} \mathbf{i}_s^k + 2 \mathbf{t}^\top \mathbf{i}_s^k}_{= m_m(\mathbf{i}_s^k)} - m_{m, \text{ref}} = 0 \end{aligned}$$

Solution set

$$\text{MTPV}(\omega_k) := \left\{ \mathbf{i}_s^k \in \mathbb{R}^2 \mid (\mathbf{i}_s^k)^\top \mathbf{M}_V \mathbf{i}_s^k + 2 \mathbf{m}_V^\top \mathbf{i}_s^k + \mu_V = 0 \right\}$$

Optimal reference currents (★)

$$\mathbf{i}_{s, \text{ref}}^k = \text{MTPV}(\omega_k) \cap \partial \mathcal{V}(\omega_k, \hat{u}_{\text{max}})$$

Optimal operation strategies

Field Weakening (FW @ $1.40 \cdot \omega_{m, \text{rat}}$): Illustration of the effect of neglecting R_s , R_{Fe} and/or L_m

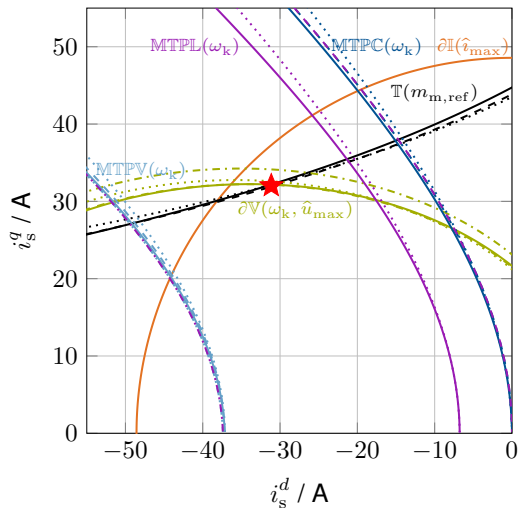

- $R_s = 0$
- $L_m = 0$
- - - - $R_{Fe} = \infty$

⇒ **Reduced efficiency!**
(and wrong torque and/or possibly wrong operation strategy)

Analytical solution

Example: Analytical solution for intersection points of two quadrics

Problem

$$\mathbb{X} := \left\{ \mathbf{x} \in \mathbb{R}^2 \mid \underbrace{\mathbf{x}^\top \mathbf{A} \mathbf{x} + 2\mathbf{a}^\top \mathbf{x} + \alpha}_{=: Q_A(\mathbf{x})} = 0 \wedge \underbrace{\mathbf{x}^\top \mathbf{B} \mathbf{x} + 2\mathbf{b}^\top \mathbf{x} + \beta}_{=: Q_B(\mathbf{x})} = 0 \right\}$$

Solution: Relate both (e.g., if $\alpha \neq 0$ and $\beta \neq 0$)

$$Q_D(\mathbf{x}) := \frac{Q_A(\mathbf{x})}{\alpha} - \frac{Q_B(\mathbf{x})}{\beta} = \mathbf{x}^\top \underbrace{\left(\frac{\mathbf{A}}{\alpha} - \frac{\mathbf{B}}{\beta} \right)}_{=: \mathbf{D}} \mathbf{x} + 2 \underbrace{\left(\frac{\mathbf{a}}{\alpha} - \frac{\mathbf{b}}{\beta} \right)^\top}_{=: \mathbf{d}^\top} \mathbf{x} + \underbrace{\left(\frac{\alpha}{\alpha} - \frac{\beta}{\beta} \right)}_{=0} = 0$$

and note that

$$Q_D(\mathbf{x}) := \mathbf{x}^\top \left(\underbrace{\mathbf{D} \mathbf{x} + 2\mathbf{d}}_{\stackrel{!}{=} \lambda \mathbf{J} \mathbf{x}} \right) \stackrel{!}{=} 0 \iff \mathbf{x}^\star(\lambda) = -2(\mathbf{D} - \lambda \mathbf{J})^{-1} \mathbf{d}$$

Analytical solution

Example: Analytical solution for intersection points of two quadrics (cont'd)

then insert $\mathbf{x}^*(\lambda)$ in $Q_A(\mathbf{x})$ (or $Q_B(\mathbf{x})$), i.e.

$$Q_A(\mathbf{x}^*(\lambda)) = 4\mathbf{d}^\top (\mathbf{D} - \lambda \mathbf{J})^{-\top} \mathbf{A} (\mathbf{D} - \lambda \mathbf{J})^{-1} \mathbf{d} - 4\mathbf{a}^\top (\mathbf{D} - \lambda \mathbf{J})^{-1} \mathbf{d} + \alpha = 0 \quad \left| \cdot \underbrace{[\det(\mathbf{D} - \lambda \mathbf{J})]^2}_{\propto \lambda^2} \right.$$

$$\implies \boxed{\chi(\lambda) := c_4 \lambda^4 + c_3 \lambda^3 + c_2 \lambda^2 + c_1 \lambda + c_0 \stackrel{!}{=} 0}$$

\implies Analytical (real) solutions $\lambda^* \in \{\lambda_1, \dots, \lambda_4\}$ can be computed [3]:

$$\implies \boxed{\mathbf{x}^*(\lambda^*) = -2(\mathbf{D} - \lambda^* \mathbf{J})^{-1} \mathbf{d}}$$

Implementation results

Laboratory setup

Reluctance SM (RSM) and Permanent-magnet SM

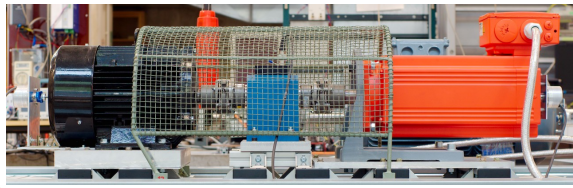

Host PC (rapid prototyping)

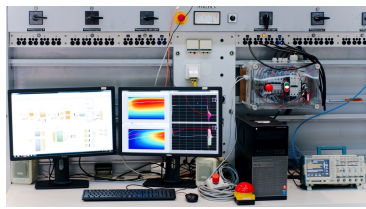

Real-time system and VSIs

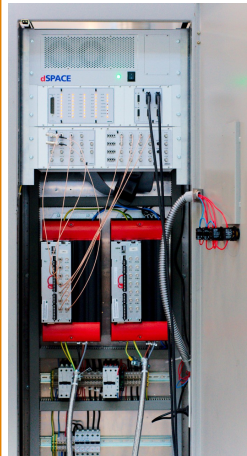

Implementation results

RSM: Nonlinear flux linkages and differential inductances

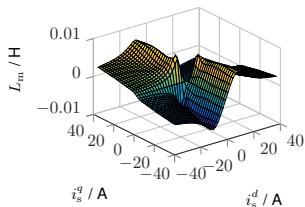
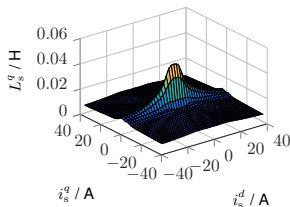
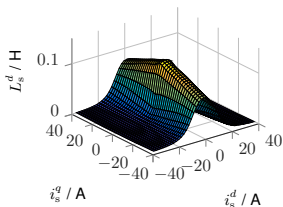
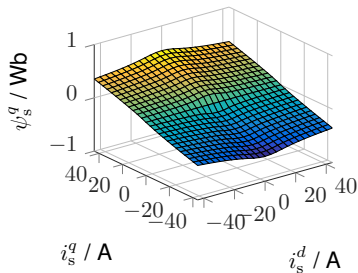
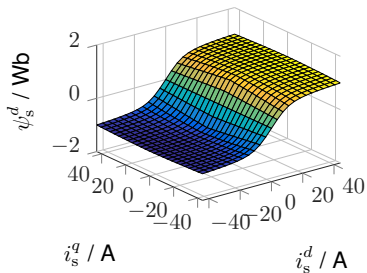

Implementation results

RSM: Comparison of numerical and analytical solutions for MTPC

 m_m — numerical — analytical

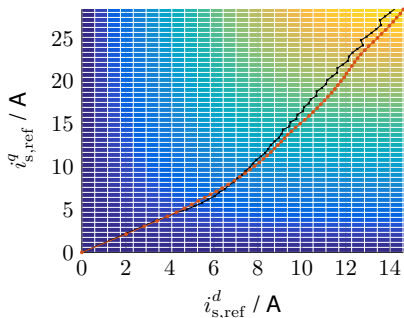

Cartesian coordinates

 m_m — numerical — analytical

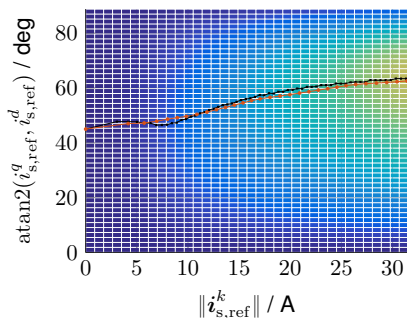

polar coordinates

Implementation results

RSM: Comparison of computational load

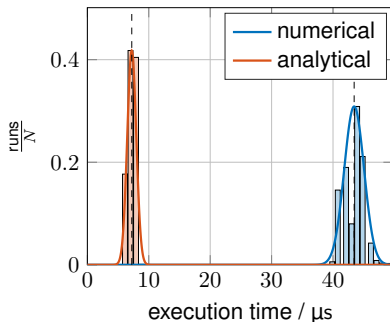
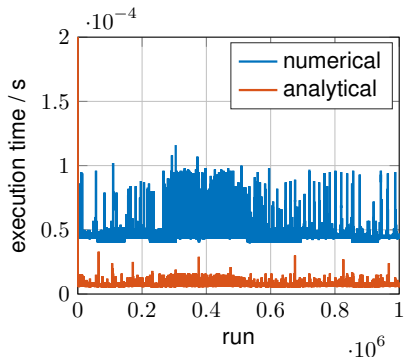

- Execution times for $N = 10^6$ runs (downsampled by factor 100)
- Standard deviations $\sigma_n = 1,61 \cdot 10^{-6}$ s and $\sigma_a = 0,73 \cdot 10^{-6}$ s
- Average execution times $\mu_n = 43,4 \cdot 10^{-6}$ s and $\mu_a = 7,23 \cdot 10^{-6}$ s (>**6x faster**)

Implementation results

PME-RSM: Implementation by colleagues ($p_{m, \text{rat}} = 4,5 \text{ kW}$ & $L_s^d/L_s^q = 1.43$) [4]

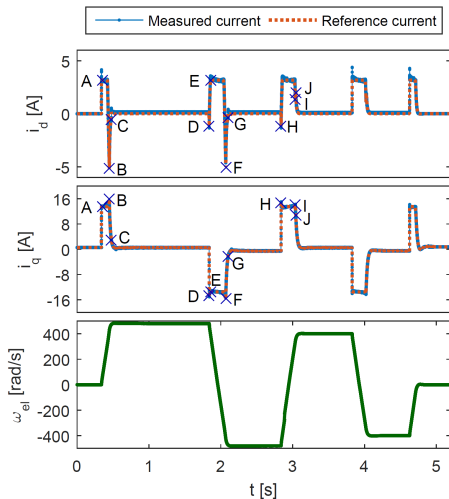
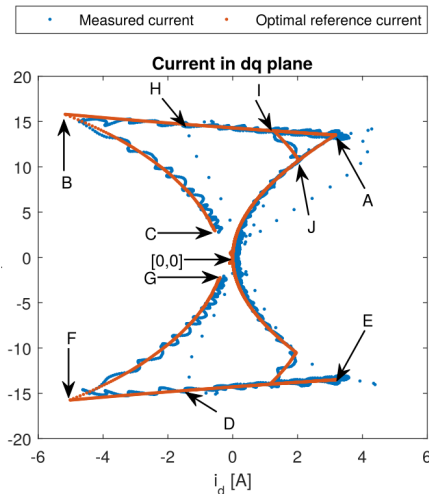

Implementation results

IPMSM (generator mode): Efficiency enhancements considering iron losses [5]

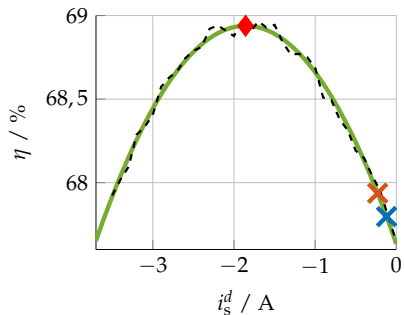
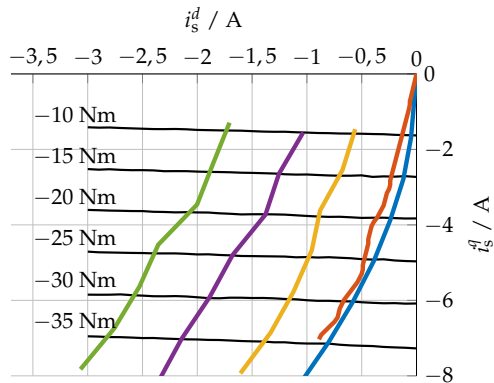

Conclusion

Summary and future work

To take home

- **unified** theory for MTPC, **MTPL**, FW, MC and MTPV based on [6]
 - **quadrics** (implicit formulation),
 - **optimization problems** with **equality constraint**, and
 - **intersection** of two quadrics
- **analytical** solution for reference currents (& transition points)
- $R_s \neq 0$, $R_{Fe} \neq 0$ and $L_m \neq 0$ (can all be considered **simultaneously**)
- **fast(er)** and **more accurate** computation
- **applicable** in real-world (e.g. nonlinear RSM, PME-RSM or IPMSM; also IMs)

Future work

- convergence (mathematical proof for nonlinear flux linkages)
- more extensive experimental validation
- impact of (parameter) uncertainties
- consideration of *rotor* iron losses (e.g. for induction machines)
- combination with minimization of *conduction and switching losses*

References

Journal article (published 2017)

INTERNATIONAL JOURNAL OF CONTROL, 2017
<https://doi.org/10.1080/00207179.2017.1338359>



Taylor & Francis
Taylor & Francis Group

OPEN ACCESS

Check for updates

A unified theory for optimal feedforward torque control of anisotropic synchronous machines

Hisham Eldeeb^a, Christoph M. Hackl^{a,*}, Lorenz Horlbeck^b and Julian Kullick^a

^aResearch Group 'Control of Renewable Energy Systems (CRES)', Munich School of Engineering (MSE), Technical University of Munich (TUM), Munich, Germany; ^bInstitute of Automotive Technology (FTM), Technical University of Munich (TUM), Munich, Germany

ABSTRACT

A unified theory for optimal feedforward torque control of anisotropic synchronous machines with *non-negligible stator resistance and mutual inductance* is presented which allows to *analytically* compute (1) the optimal direct and quadrature reference currents for all operating strategies, such as maximum torque per current (MTPC), maximum current, field weakening, maximum torque per voltage (MTPV) or maximum torque per flux (MTPF), and (2) the transition points indicating when to switch between the operating strategies due to speed, voltage or current constraints. The analytical solutions allow for an (almost) instantaneous selection and computation of actual operation strategy and corresponding reference currents. Numerical methods (approximating these solutions only) are *no longer* required. The unified theory is based on one simple idea: all optimisation problems, their respective constraints and the computation of the intersection point(s) of voltage ellipse, current circle or torque, MTPC, MTPV, MTPF hyperbolas are reformulated implicitly as *quadratics* which allows to invoke the Lagrangian formalism and to find the roots of fourth-order polynomials analytically. The proposed theory is suitable for any anisotropic synchronous machine. Implementation and measurement results illustrate effectiveness and applicability of the theoretical findings in real world.

ARTICLE HISTORY

Received 18 March 2017
Accepted 31 May 2017

KEYWORDS

Maximum torque per ampere (MTPA); maximum torque per current (MTPC); maximum torque per voltage (MTPV); maximum torque per flux (MTPF); maximum current (MC); field weakening (FW); analytical solution; optimal feedforward torque control; efficiency; copper losses; anisotropy; synchronous machine; interior

References

Monograph (published May 2017)



References I

- [1] Shigeo Morimoto. Trend of permanent magnet synchronous machines. *IEEJ Transactions on Electrical and Electronic Engineering*, 2(2):101–108, mar 2007.
- [2] L. Xu and J. Yao. A compensated vector control scheme of a synchronous reluctance motor including saturation and iron losses. *IEEE Transactions on Industry Applications*, 28(6):1330–1338, 1992.
- [3] R.W.D Nickalls. The quartic equation: Invariants and Euler's solution revealed. *Mathematical Gazette*, 93(526):66–75, 2009.
- [4] Antonín Glac, Václav Šmídl, and Zdenek Peroutka. Optimal feedforward torque control of synchronous machines with time-varying parameters. In *Proceedings of the 44th Annual Conference of the IEEE Industrial Electronics Society (IECON)*, pages 613–618, 2018.
- [5] Simon Krüner and Christoph M. Hackl. Experimental identification of the optimal current vectors for a permanent-magnet synchronous machine in wave energy converters. *Energies*, 12(862), 2019.
- [6] Hisham Eldeeb, Christoph M. Hackl, Lorenz Horlbeck, and Julian Kullick. A unified theory for optimal feedforward torque control of anisotropic synchronous machines. *International Journal of Control*, 2017.



Smooth transition between optimal operation strategies considering iron losses

17. Mai 2019, Effiziente elektrische Antriebe, Hochschule München

Outline

1. Generation of motor model based on FEM calculations considering nonlinear flux linkage and iron losses
2. Optimal operation strategies
3. Smooth transition between optimal operation strategies

Model of PMSM

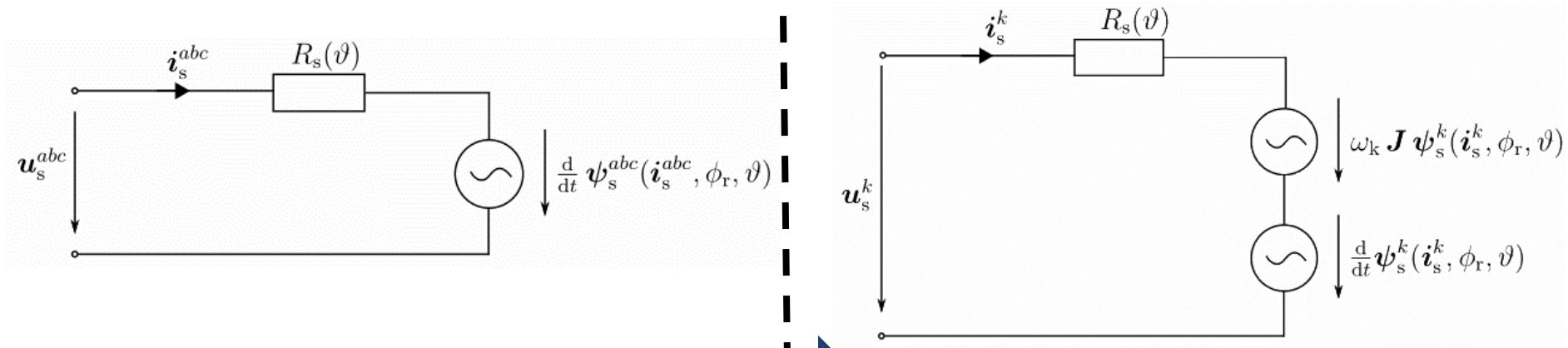

Clarke- and Park-
transformation

$$u_s^{abc} = R_s(\vartheta) i_s^{abc} + \frac{d}{dt} \psi_s^{abc}(i_s^{abc}, \phi_r, \vartheta)$$

$$u_s^k = R_s(\vartheta) i_s^k + \omega_k \mathbf{J} \psi_s^k(i_s^k, \phi_r, \vartheta) + \frac{d}{dt} \psi_s^k(i_s^k, \phi_r, \vartheta)$$

Model of PMSM

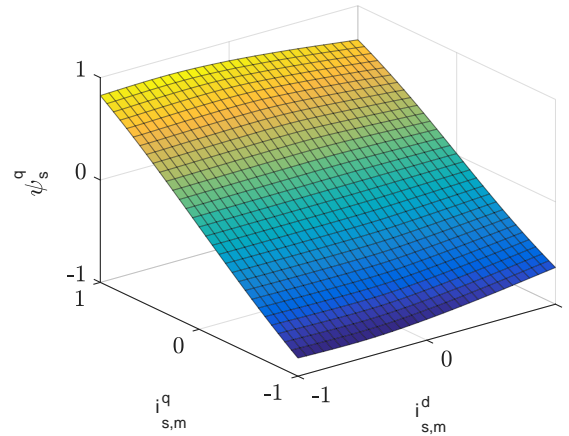
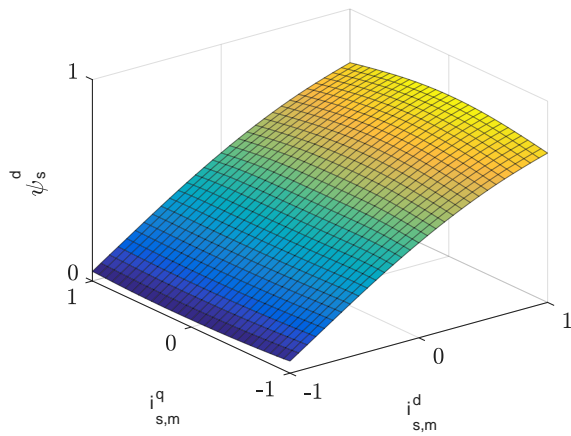
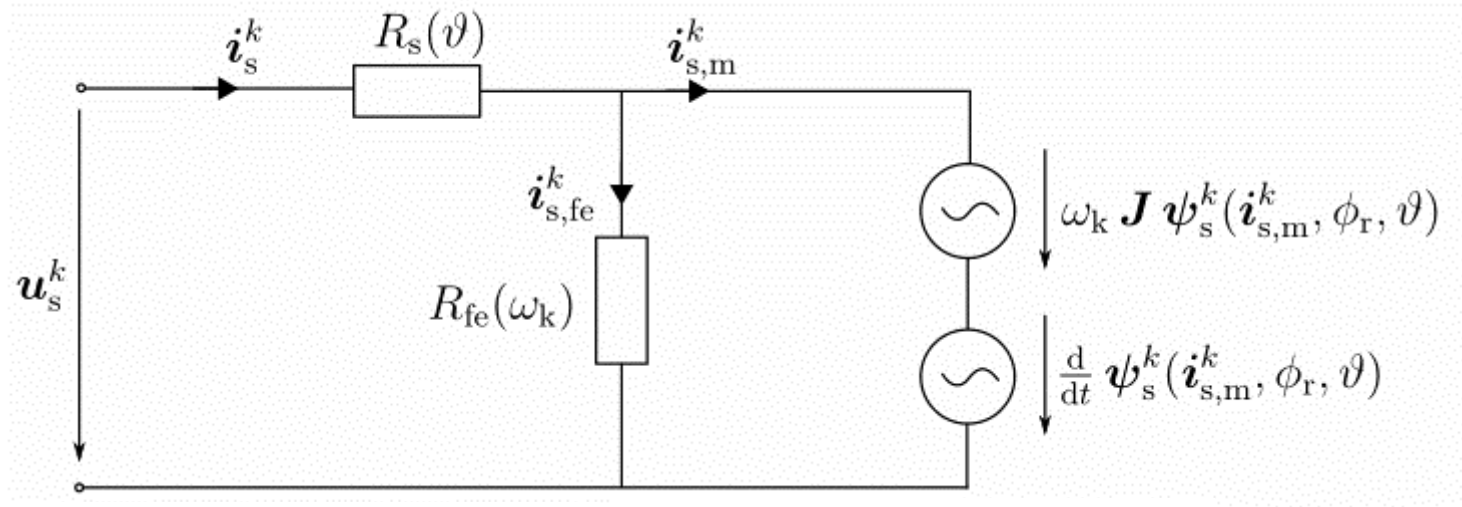

Tool chain

Python – femagtools – FEMAG

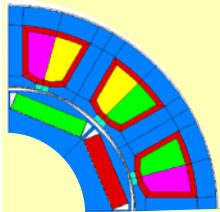

- several calculation simultaneously
- variation of Id-Iq
- variation of rotational speed

FEM calculations

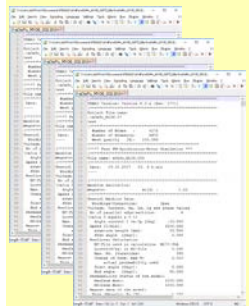

$$\psi_s^{abc}(i_{s,m}^d, i_{s,m}^q, \varphi_r)$$

$$P_{vu}(\omega_r)$$

$$R_s$$

$$J$$

post-processing

- identify angle of noload flux
- transformation of flux linkage
- calculation of R_{Fe}

$$\psi_s^k(i_{s,m}^d, i_{s,m}^q, \varphi_r),$$

$$R_{Fe}(\omega_r), R_s, J$$

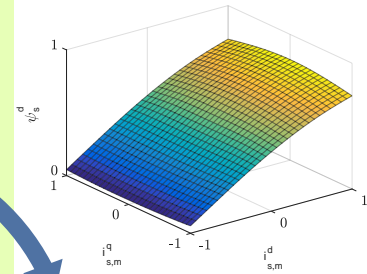

- calculation of d-q currents with respect to d-q flux linkage (e. g. RBF- or inverse bilinear interpolation)

look-up tables

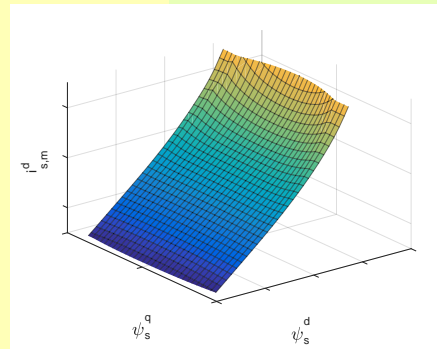

$$i_{s,m}^k(\psi_{s,m}^d, \psi_{s,m}^q, \varphi_r)$$

$$R_{Fe}(\omega_r), R_s, J$$

Matlab – Simulink

simulation model

- flux based fundamental model
- considering rotor's angle
- considering iron losses

> U_1 [V]	I_a [A]
> U_2 [V]	I_b [A]
> U_3 [V]	I_c [A]
> M_Load [Nm]	torque [Nm]
> phi_el [rad]	phi_el [rad]
> n [1/min]	n [1/min]

Model of PMSM

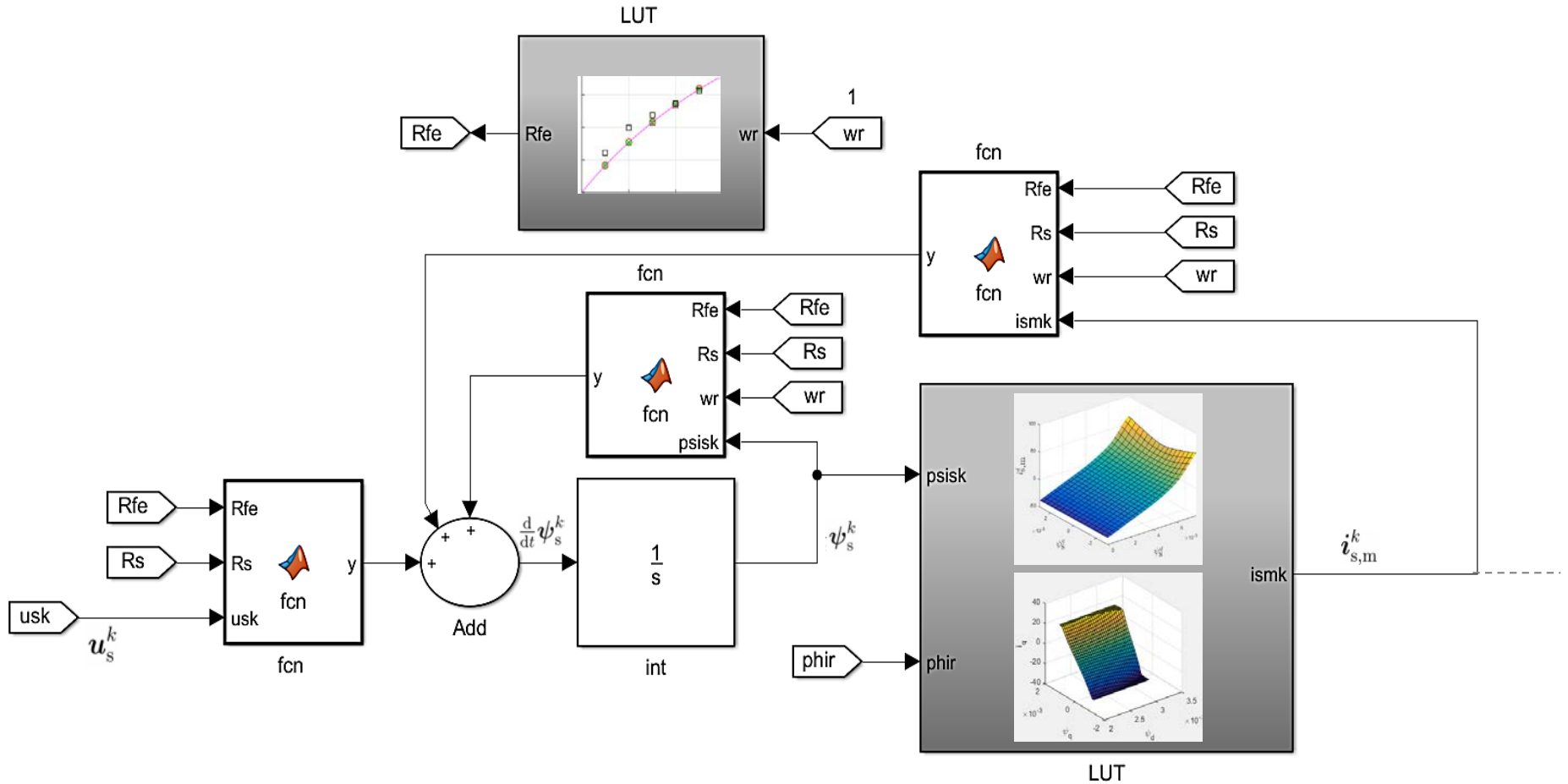

Simulation

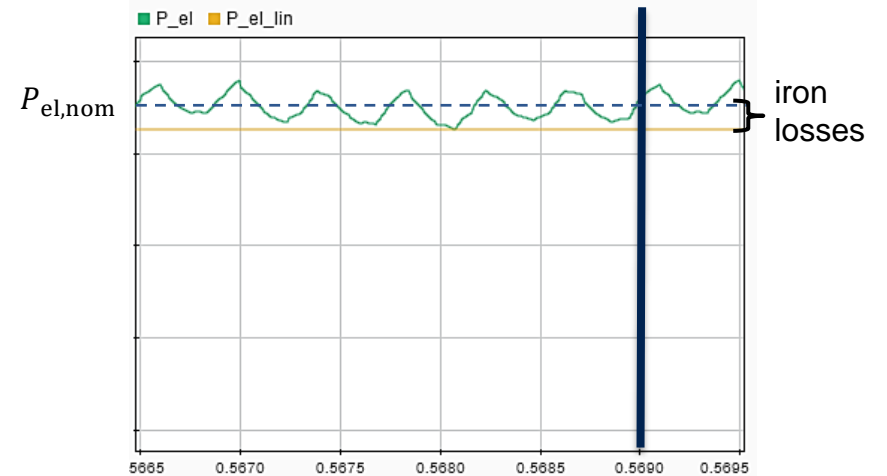
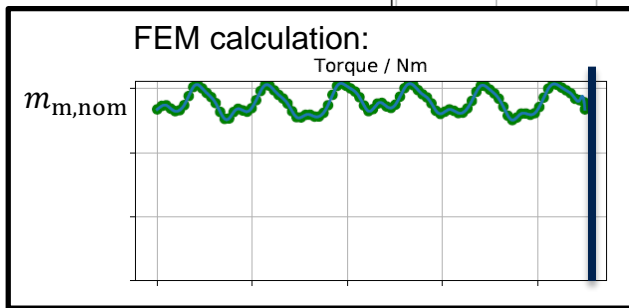
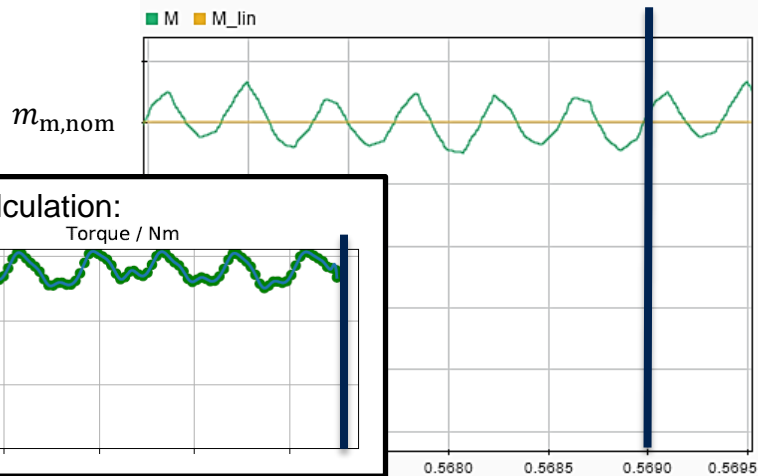
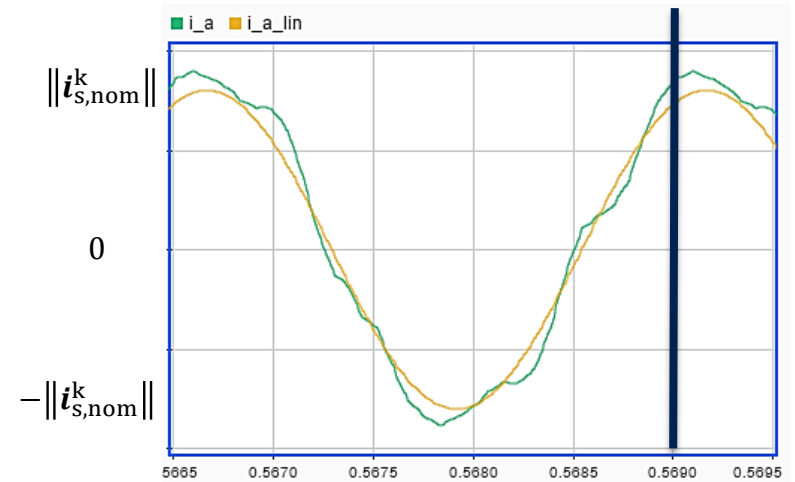
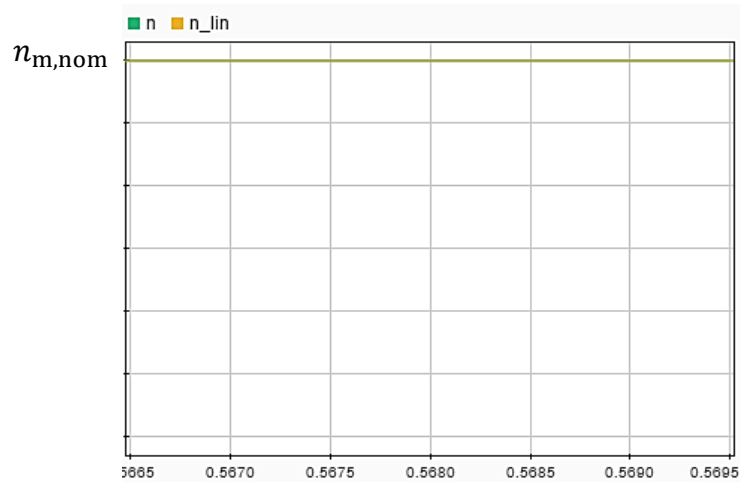

Optimal operation strategies

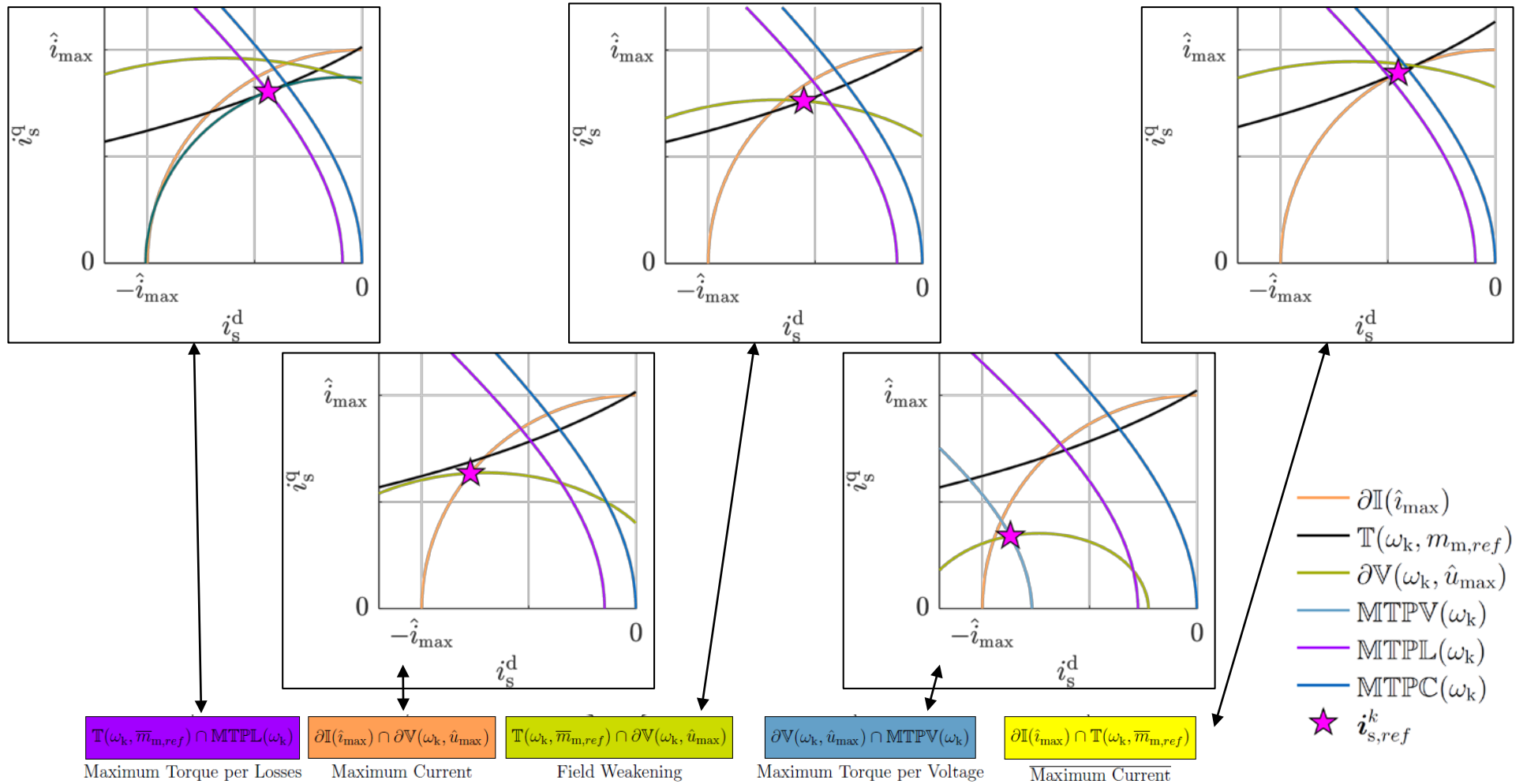

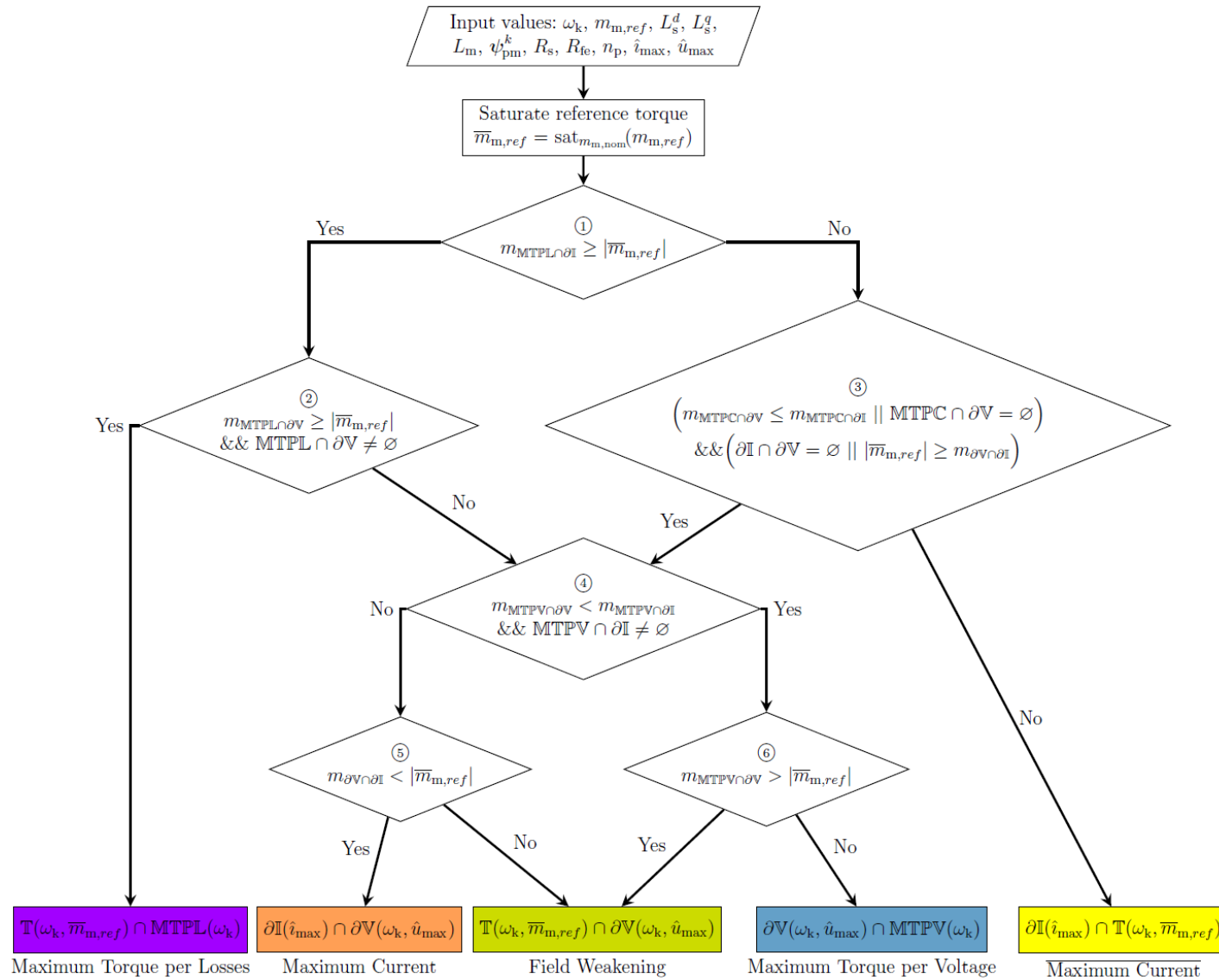

Optimal operation strategies

- decision of optimal operation strategy based on finding and comparing of torque values
- torque values are given by the torque quadric $m_m = (\mathbf{i}_s^k)^T \mathbf{T} \mathbf{i}_s^k + 2\mathbf{t}^T \mathbf{i}_s^k + \tau$
- if quadrics' intersection exist, \mathbf{i}_s^k can be calculated analytically

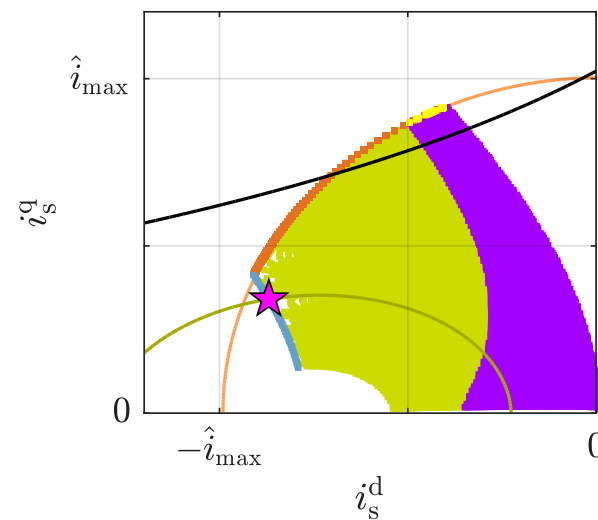
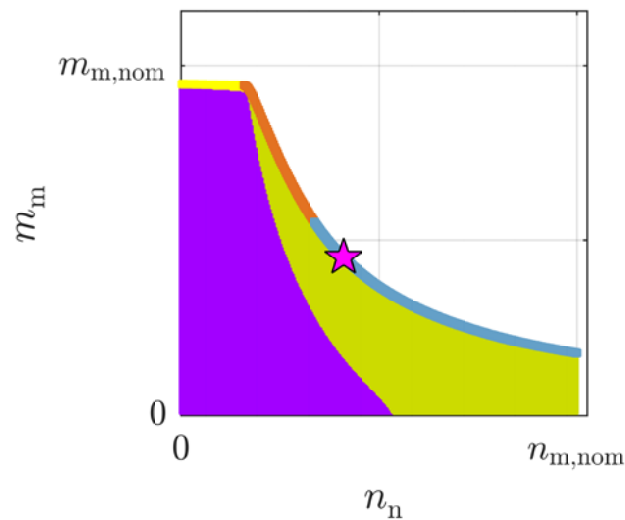

$\mathbb{T}(\omega_k, \bar{m}_{m,ref}) \cap \text{MTPL}(\omega_k)$
Maximum Torque per Losses

$\partial\mathbb{I}(i_{max}) \cap \partial\mathbb{V}(\omega_k, \hat{u}_{max})$
Maximum Current

$\mathbb{T}(\omega_k, \bar{m}_{m,ref}) \cap \partial\mathbb{V}(\omega_k, \hat{u}_{max})$
Field Weakening

$\partial\mathbb{V}(\omega_k, \hat{u}_{max}) \cap \text{MTPV}(\omega_k)$
Maximum Torque per Voltage

$\partial\mathbb{I}(i_{max}) \cap \mathbb{T}(\omega_k, \bar{m}_{m,ref})$
Maximum Current

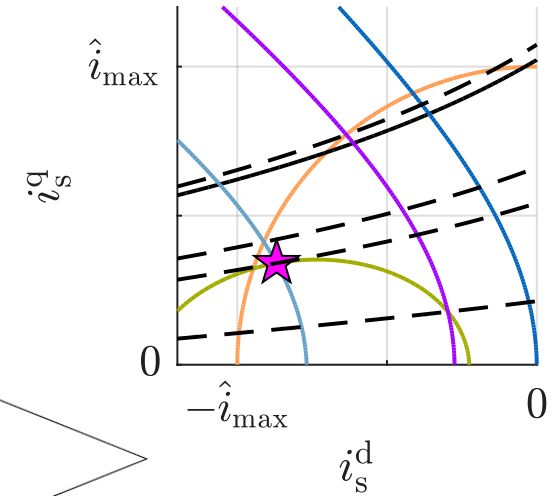
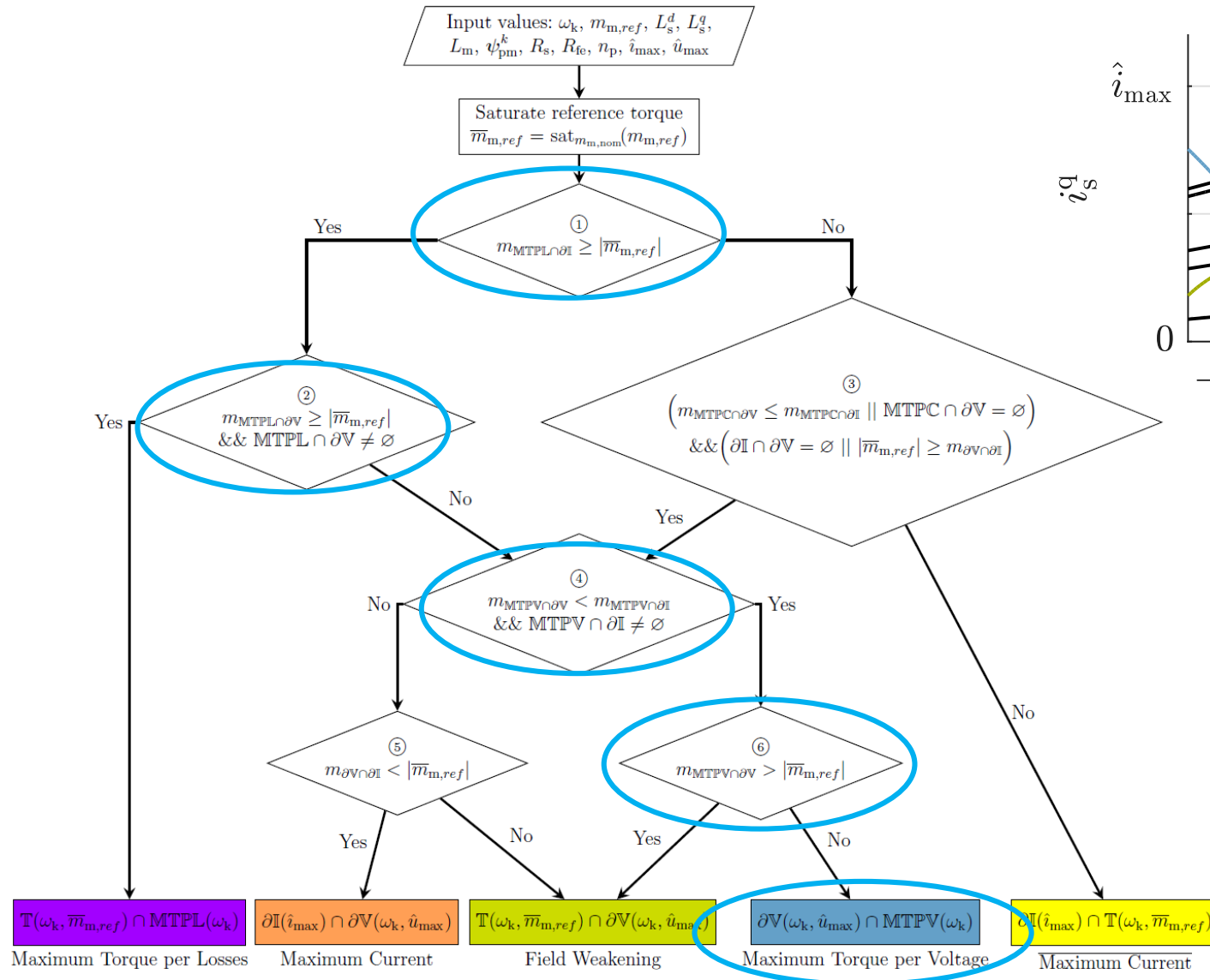

Simulation

Different operation strategies

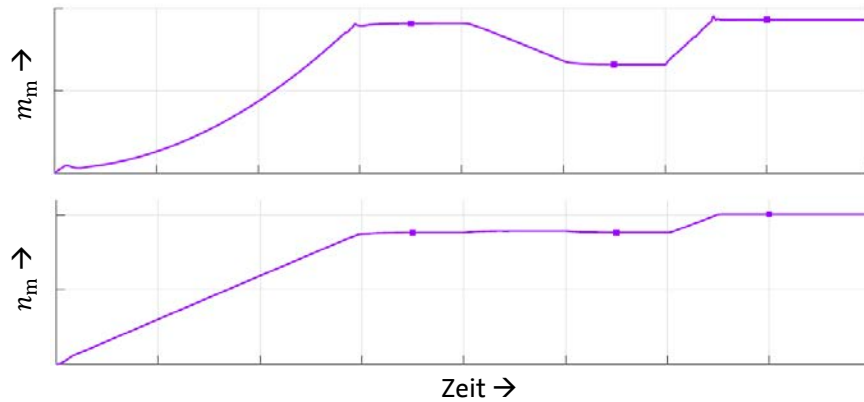
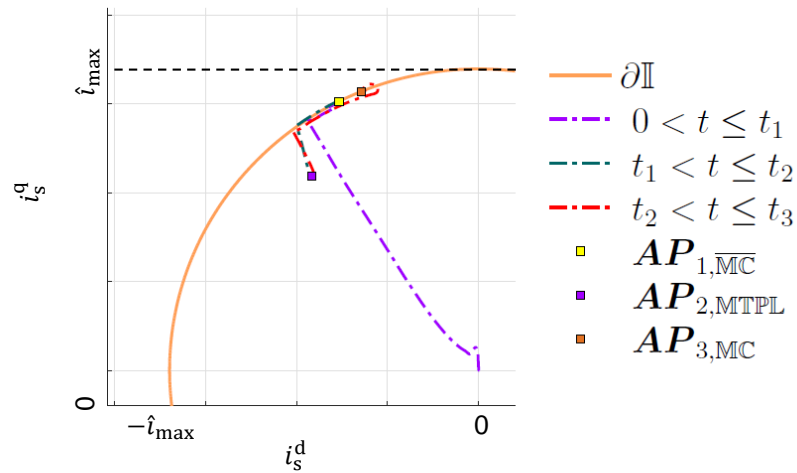

Efficiency improvement

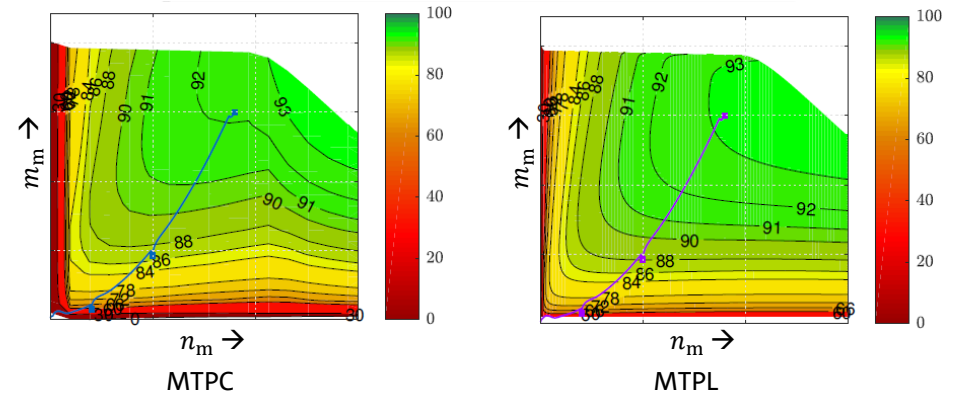
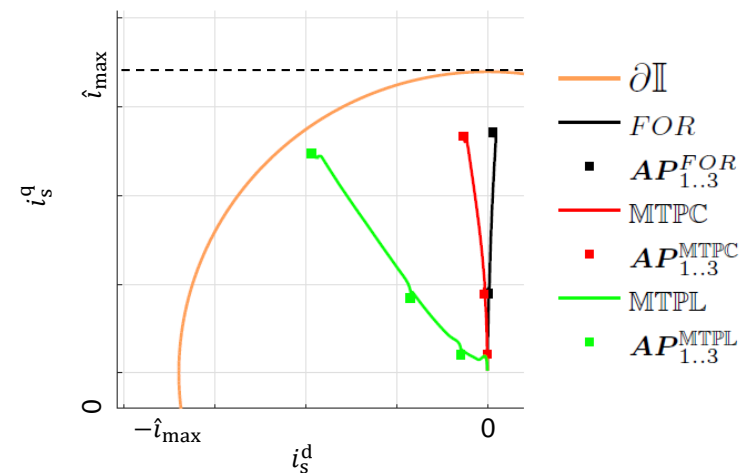

Conclusion

To take home

- simulation model (e.g. generated from FEM) considers
 - nonlinear flux linkage
 - rotor's angle
 - iron losses
- analytical solution for finding optimal operation strategy

Future work

- experimental validation of simulation model (measuring of flux linkage and iron loss resistance)
- further analysis on modeling iron losses: $R_{Fe}^d(\omega_r, \mathbf{i}_s^k) \neq R_{Fe}^q(\omega_r, \mathbf{i}_s^k)$
- impact of dynamic operation

Generische Maschinenidentifikation und effizienzoptimierte Momentensteuerung für Asynchronmaschinen

Julian Kullick

Hochschule München
Fakultät für Elektrotechnik und Informationstechnik (FK04)
<http://lmres.ee.hm.edu/>

17.05.2019

München

Introduction

Problem formulation

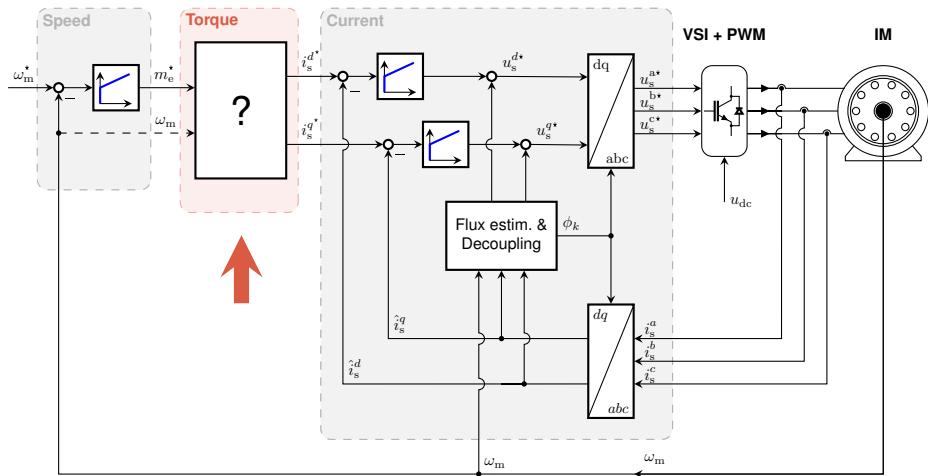

Introduction

Proposed solution

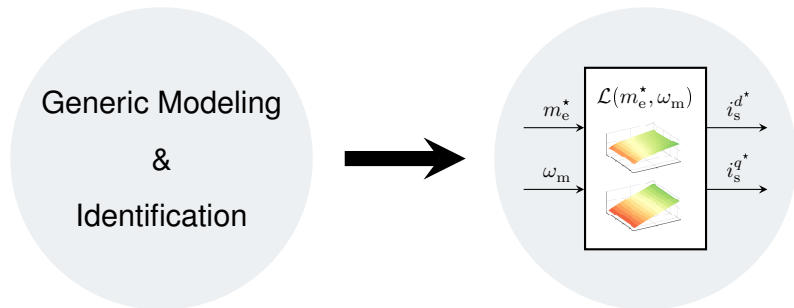

Generic? Accept that flux linkage is a *nonlinear* function!

Outline I

- 1 Generic model in arbitrary rotating coordinates system
- 2 Field-oriented current control system
- 3 Machine identification
- 4 Optimized feedforward torque control
- 5 Results
- 6 Conclusion & Outlook



Generic model in rotating reference frame

Voltage equations without inductance terms

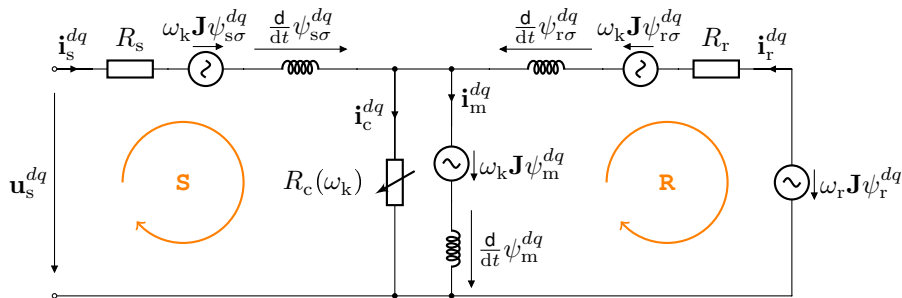

$$\text{Stator (S):} \quad \mathbf{u}_s^{dq} = R_s \mathbf{i}_s^{dq} + \frac{d}{dt} \underbrace{(\psi_m^{dq} + \psi_{s\sigma}^{dq})}_{=\psi_s^{dq}} + \omega_k \mathbf{J} (\psi_m^{dq} + \psi_{s\sigma}^{dq})$$

$$\text{Rotor (R):} \quad \mathbf{0}_2 = R_r \mathbf{i}_r^{dq} + \frac{d}{dt} \underbrace{(\psi_m^{dq} + \psi_{r\sigma}^{dq})}_{=\psi_r^{dq}} + (\omega_k - \omega_r) \mathbf{J} (\psi_m^{dq} + \psi_{r\sigma}^{dq})$$

Field-oriented current control

Overview

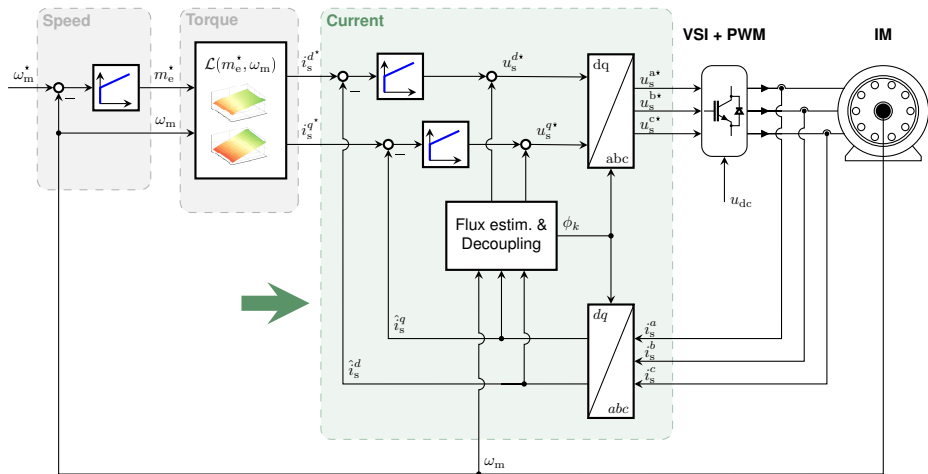

Indirect field-oriented current control

Rotor-flux estimation ($\psi_r^q = 0$)

- Assumption of magnetic linearity

$$\psi_r^{dq} = L_m \mathbf{i}_s^{dq} + L_r \mathbf{i}_r^{dq} \quad \Longrightarrow \quad \mathbf{i}_r^{dq} = \frac{1}{L_r} (\psi_r^{dq} - L_m \mathbf{i}_s^{dq})$$

- Rotor voltage equation:

$$\frac{d}{dt} \psi_r^{dq} = \frac{L_m}{L_r} R_r \mathbf{i}_s^{dq} - \left(\frac{R_r}{L_r} \mathbf{I}_2 + (\omega_k - \omega_r) \mathbf{J} \right) \psi_r^{dq}$$

- Require q-Flux component to be zero ($\psi_r^q \stackrel{!}{=} 0$) ...

- ... open-loop observer

$$\frac{d}{dt} \hat{\psi}_r^d = \frac{L_m}{L_r} R_r i_s^d - \frac{R_r}{L_r} \hat{\psi}_r^d$$

- ... flux orientation

$$\omega_k \stackrel{!}{=} \omega_r + \frac{L_m}{L_r} R_r \frac{i_s^q}{\hat{\psi}_r^d} \quad \Longrightarrow \quad \phi_k = \int \omega_k dt$$

Indirect field-oriented current control

Rotor flux orientation

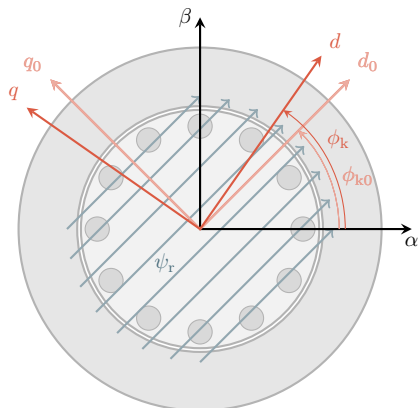

Perfect alignment is *not* essential, but: **Reproducibility** and **Uniqueness**!

Machine identification

Idea

- Use FOC current control and prime mover to **achieve steady-state**
- Stator currents and speed define **unique and reproducible operating points**
- Use generic equations to **determine flux terms, efficiency, ...**
- Use maps to create torque control **Look-up tables $\mathcal{L}(\cdot)$**

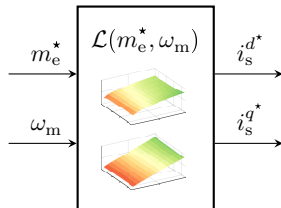
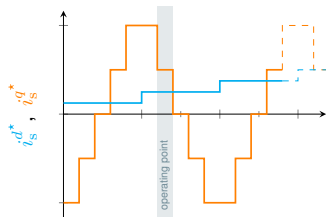

Machine identification

Lab setup

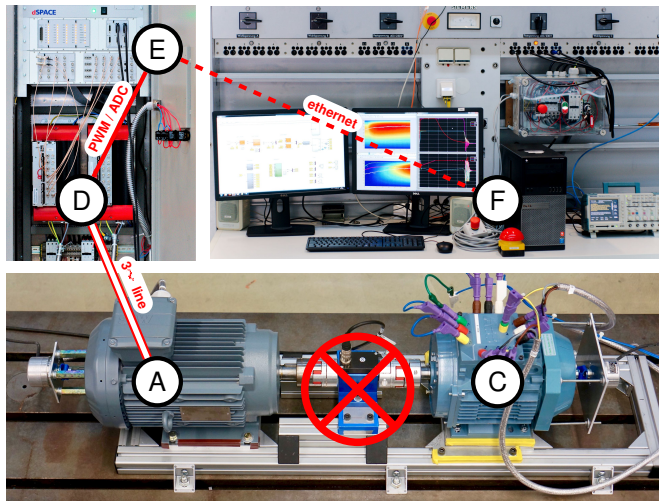

Machine identification

Steady-state voltage equations $\rightarrow \frac{d}{dt}(\cdot) = 0$

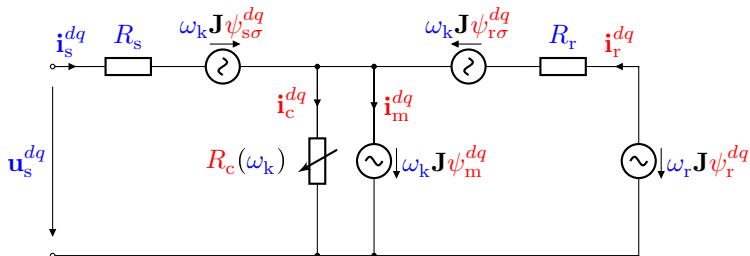

$$\text{Stator : } \mathbf{u}_s^{dq} = R_s \mathbf{i}_s^{dq} + \omega_k \mathbf{J} \psi_s^{dq} \Rightarrow \text{Solve for } \psi_s^{dq} !$$

$$\text{Rotor : } \mathbf{0}_2 = R_r \mathbf{i}_r^{dq} + (\omega_k - \omega_r) \mathbf{J} \psi_r^{dq} \Rightarrow ??$$

Which variables *do* we know?
Which variables *do* we *not* know?

Machine identification

Stator flux linkage maps (from steady-state voltage equation)

$$\psi_s^{dq} = -\frac{1}{\omega_k} \mathbf{J}(\mathbf{u}_s^{dq} - R_s \mathbf{i}_s^{dq})$$

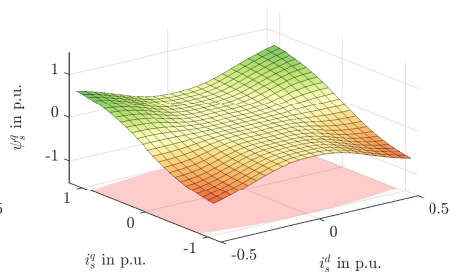
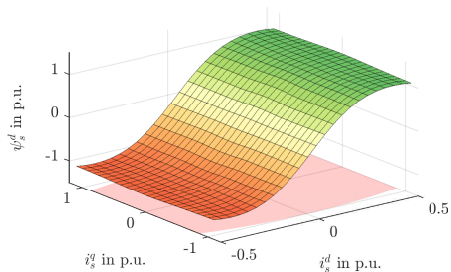

(measured @ $\omega_m = 0.5$ p.u.)

Machine identification

Torque map

- ... on *stator* (can be calculated):

$$\hat{m}_e = \frac{3}{2} n_p (\mathbf{i}_s^{dq})^\top \mathbf{J} \psi_s^{dq}$$

- ... on *rotor* (measurable):

$$m_e = -\frac{3}{2} n_p (\mathbf{i}_r^{dq})^\top \mathbf{J} \psi_r^{dq}$$

- Actio = Reactio? ...

$$\hat{m}_e = -m_e?$$

- ... No! Due to losses!

$$\hat{m}_e = -m_e + \Delta m_e$$

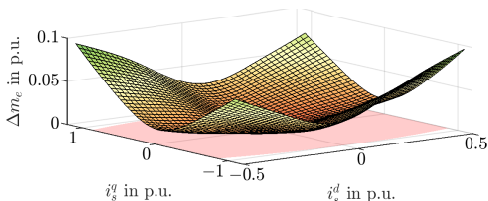
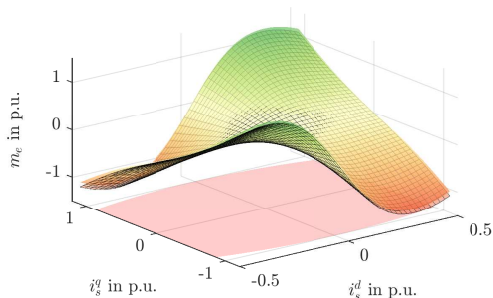

Machine identification

Rotor flux linkage map (from steady-state voltage equation)

$$\|\psi_r^{dq}\| = \sqrt{\frac{R_r}{\omega_k - \omega_r} \frac{2}{3n_p} m_e}$$

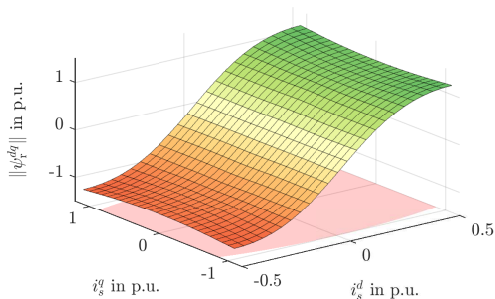

(measured @ $\omega_m = 0.5$ p.u.)

Optimized feedforward torque control

Overview

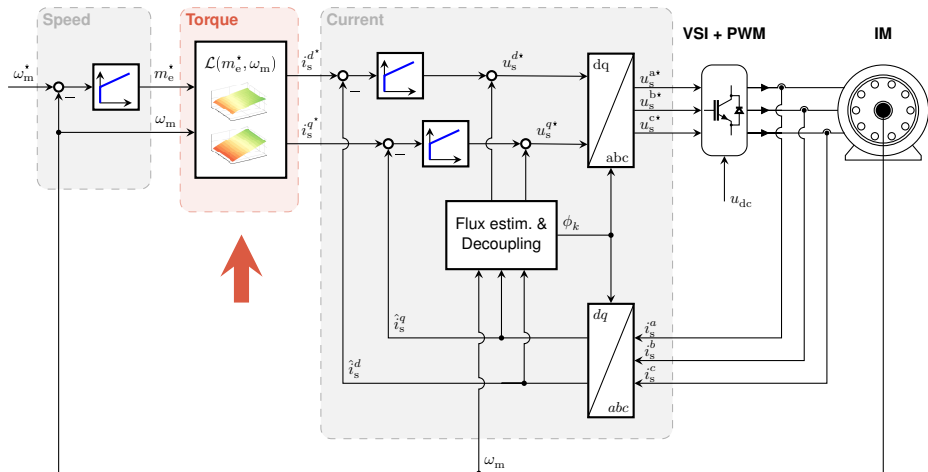

Optimized feedforward torque control

Torque control strategies

1. Constant Voltage over Frequency (\mathbf{U}/f):

$$\xi := \frac{\|\mathbf{u}_s^{dq}\|}{\omega_k}, \quad \xi = \text{const.} \quad \text{s.t.} \quad m_e = m_e^*$$

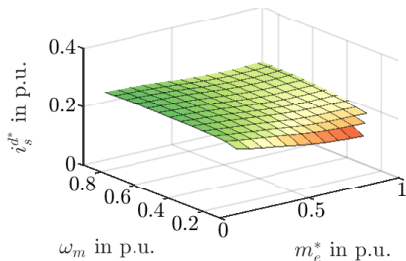

(a) $\mathcal{L}_{i_s^d}^{U/f}(m_e^*, \omega_m)$

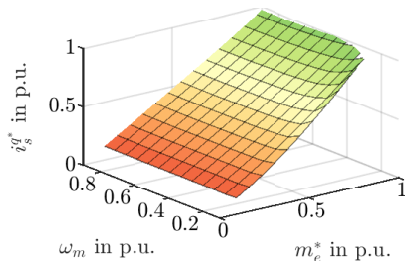

(b) $\mathcal{L}_{i_s^q}^{U/f}(m_e^*, \omega_m)$

Optimized feedforward torque control

Torque control strategies

2. Constant Flux (CF):

$$i_s^{d*} = \text{const.} \quad \text{s.t.} \quad m_e = m_e^*$$

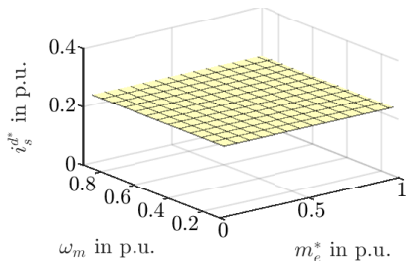

(c) $\mathcal{L}_{i_s^{d*}}^{\text{CF}}(m_e^*, \omega_m)$

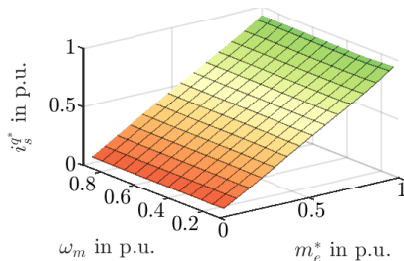

(d) $\mathcal{L}_{i_s^{q*}}^{\text{CF}}(m_e^*, \omega_m)$

Optimized feedforward torque control

Torque control strategies

3. Maximum Torque per Ampere/Current (**MTPA / MTPC**):

$$\min \|\mathbf{i}_s^{dq}\| \quad \text{s.t.} \quad m_e = m_e^*$$

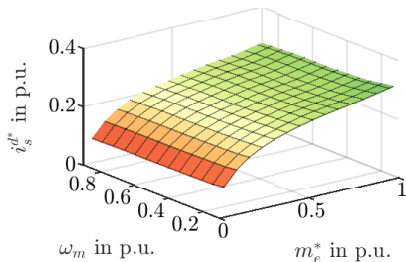

(e) $\mathcal{L}_{i_s^{d^*}}^{\text{MTPC}}(m_e^*, \omega_m)$

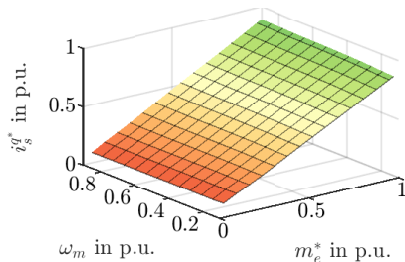

(f) $\mathcal{L}_{i_s^{q^*}}^{\text{MTPC}}(m_e^*, \omega_m)$

Optimized feedforward torque control

Torque control strategies

4. Maximum Efficiency per Torque (**MEPT**):

$$\eta := \frac{P_{\text{out}}}{P_{\text{in}}}, \quad \max \eta \quad \text{s.t.} \quad m_e = m_e^*$$

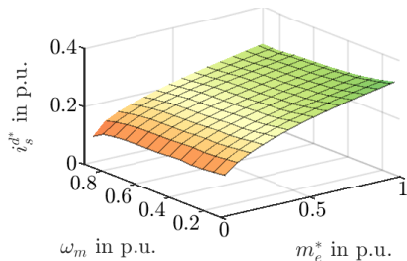

$$(g) \mathcal{L}_{i_s^{d^*}}^{\text{MEPT}}(m_e^*, \omega_m)$$

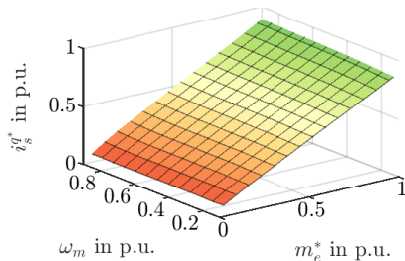

$$(h) \mathcal{L}_{i_s^{q^*}}^{\text{MEPT}}(m_e^*, \omega_m)$$

Optimized feedforward torque control

Torque map with trajectories

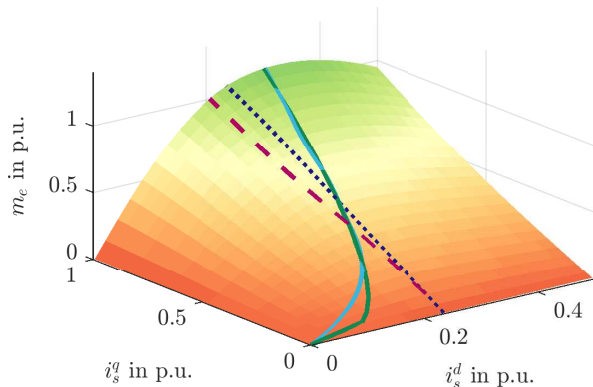
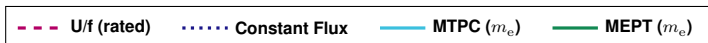

First quadrant torque map @ $\omega_m = 0.5$ p.u.

Optimized feedforward torque control

Efficiency map with trajectories

--- U/f (rated) Constant Flux — MTPC (m_e) — MEPT (m_e)

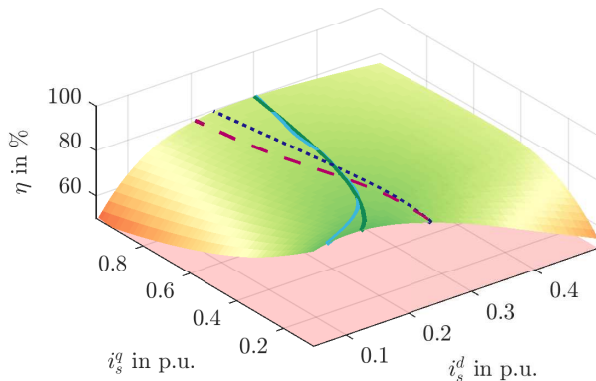

First quadrant efficiency map (motor mode) @ $\omega_m = 0.5$ p.u.

Results

Performance of different torque strategies

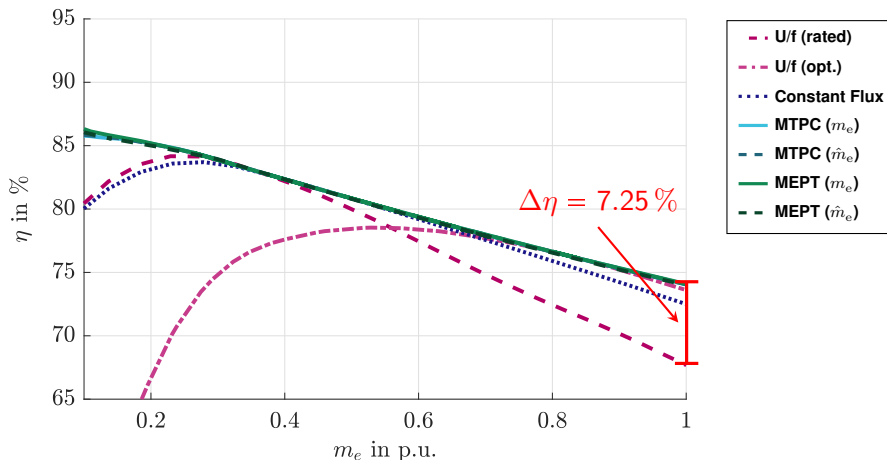

Efficiency over machine torque @ $\omega_m = 0.3$ p.u.

Results

Performance of different torque strategies

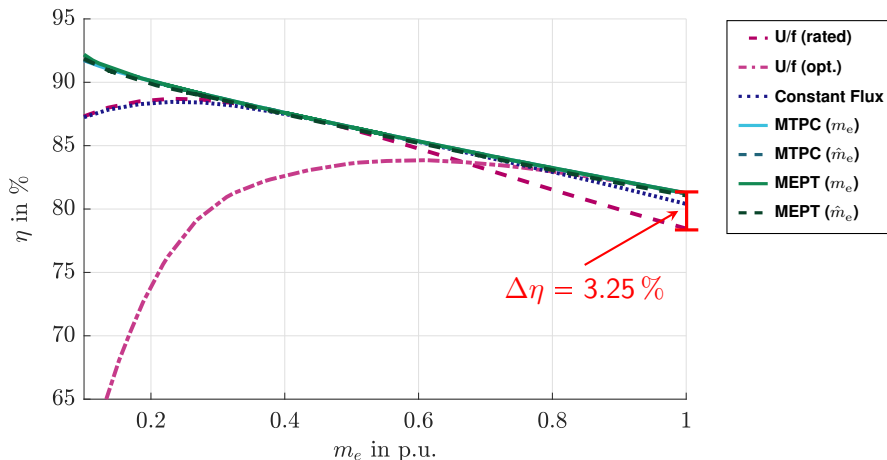

Efficiency over machine torque @ $\omega_m = 0.5$ p.u.

Results

Performance of different torque strategies

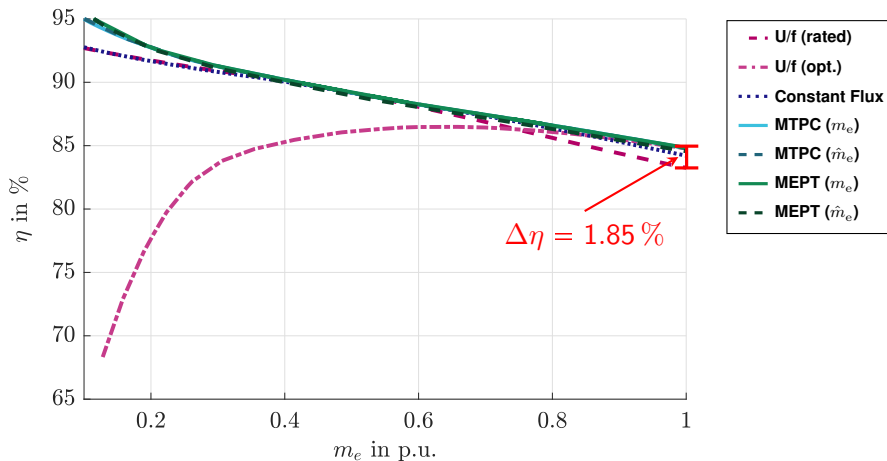

Efficiency over machine torque @ $\omega_m = 0.7$ p.u.

Results

Performance of different torque strategies

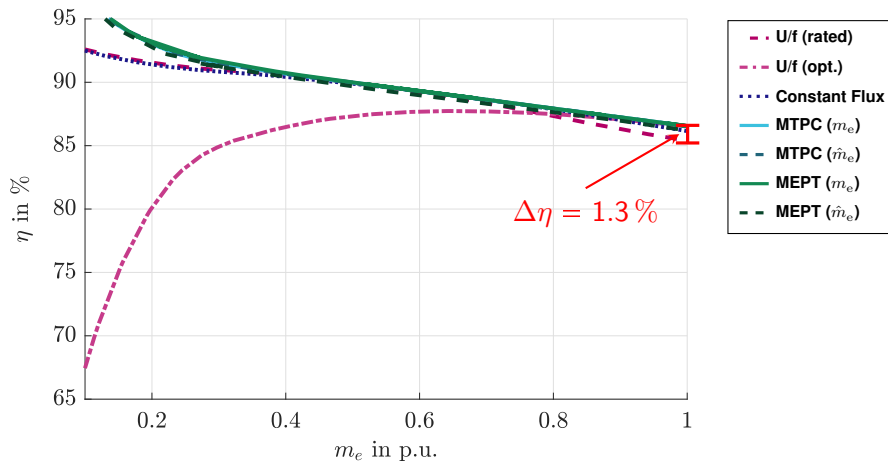

Efficiency over machine torque @ $\omega_m = 0.9$ p.u.

Results

Performance of different torque strategies

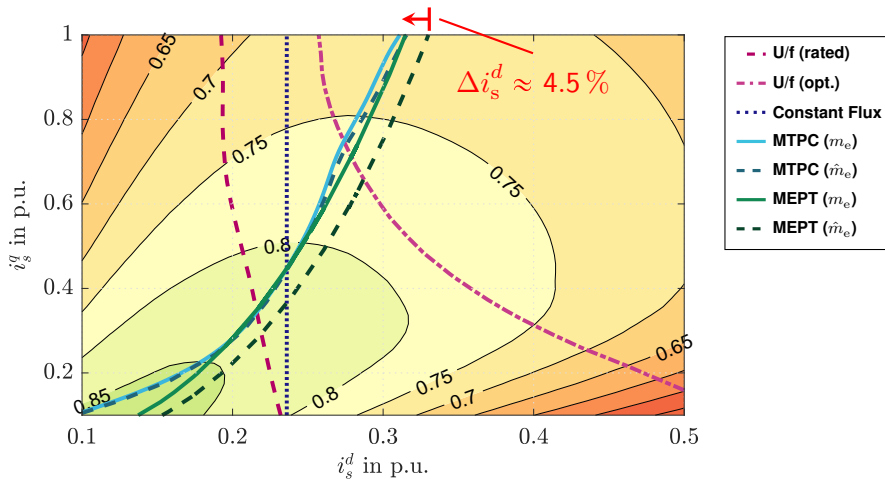

Efficiency over machine torque @ $\omega_m = 0.3$ p.u.

Results

Performance of different torque strategies

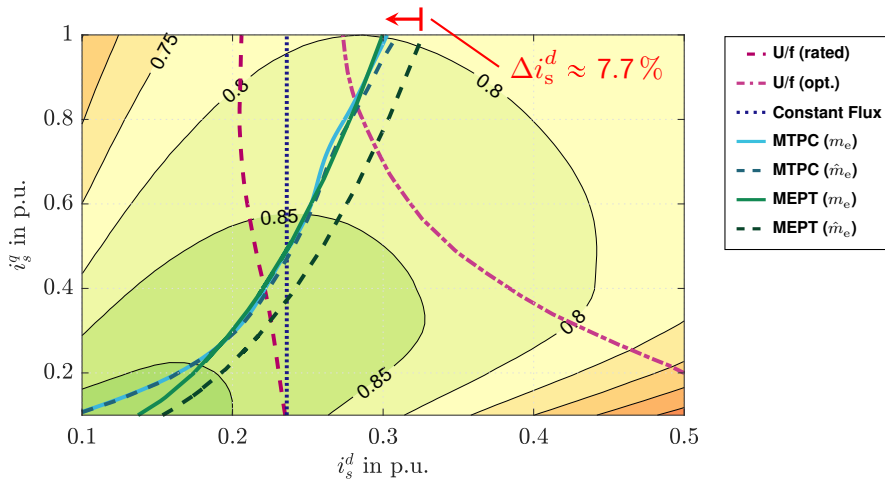

Efficiency over machine torque @ $\omega_m = 0.5$ p.u.

Results

Performance of different torque strategies

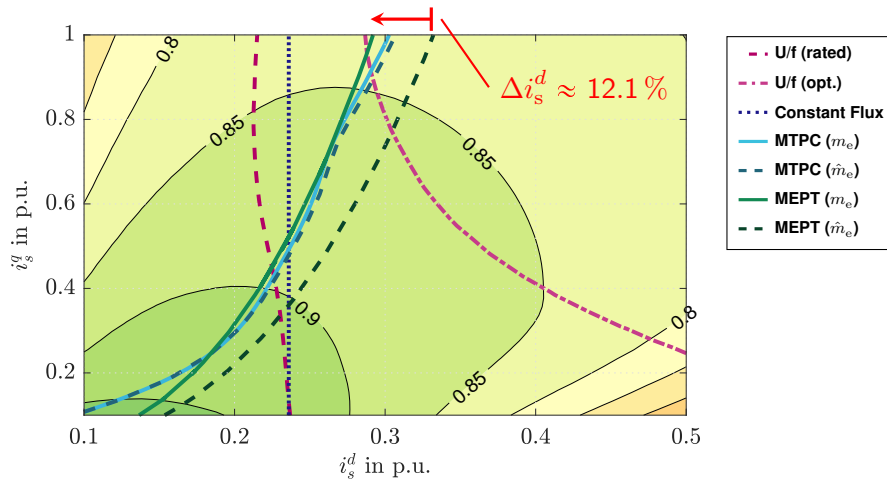

Efficiency over machine torque @ $\omega_m = 0.7$ p.u.

Results

Performance of different torque strategies

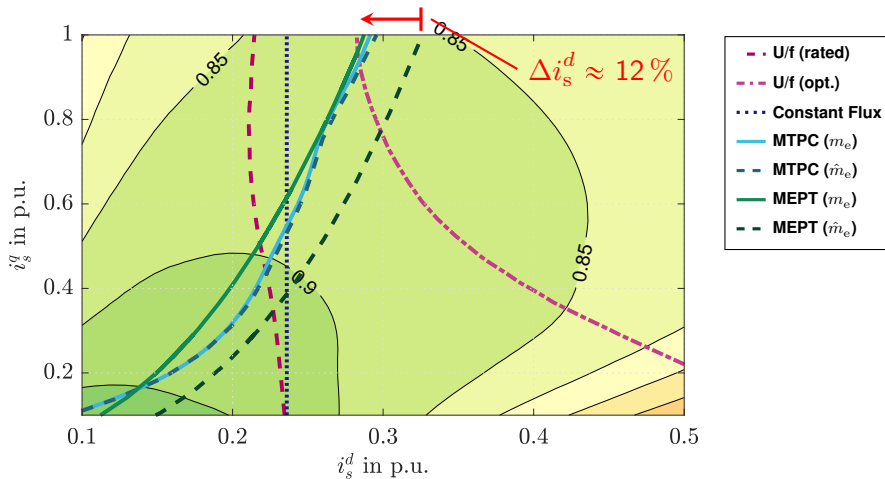

Efficiency over machine torque @ $\omega_m = 0.9$ p.u.

Conclusion & Outlook

What to take home (see also [?]):

- Linear flux assumption is *wrong* (i.e. inductances are not constant)
- MEPT operation can be approximated even *without torque sensor*
- Perfect flux orientation is not essential, but reproducible results are!
- *FOC beats U/f*, especially in part load (we knew, but now we have numbers)

Open questions:

- Variation of stator and rotor resistance due to temperature?
- High-speed operation (field-weakening) with increased iron losses?



References I

- [1] Julian Kullick and Christoph M. Hackl. Generic machine identification and maximum efficiency operation of induction machines. *arXiv e-prints*, page arXiv:1812.02431, Dec 2018.





**OPTIMIZED PULSE PATTERNS FOR THE CONTROL OF A 2-LEVEL VSI
FEEDING A PMSM WITH HIGH MAGNETIC ANISOTROPY.**

Athina Birda

May 2019

**BMW
GROUP**



AGENDA

- INTRODUCTION.
- OPTIMIZED PULSE PATTERNS (OPP) VS. SPACE VECTOR MODULATION (SVM).
- OPTIMIZATION PROBLEM.
- EXPERIMENTAL RESULTS.
- CONCLUSION.

INTRODUCTION

CONTROL OF AN ELECTRICAL DRIVE SYSTEM.

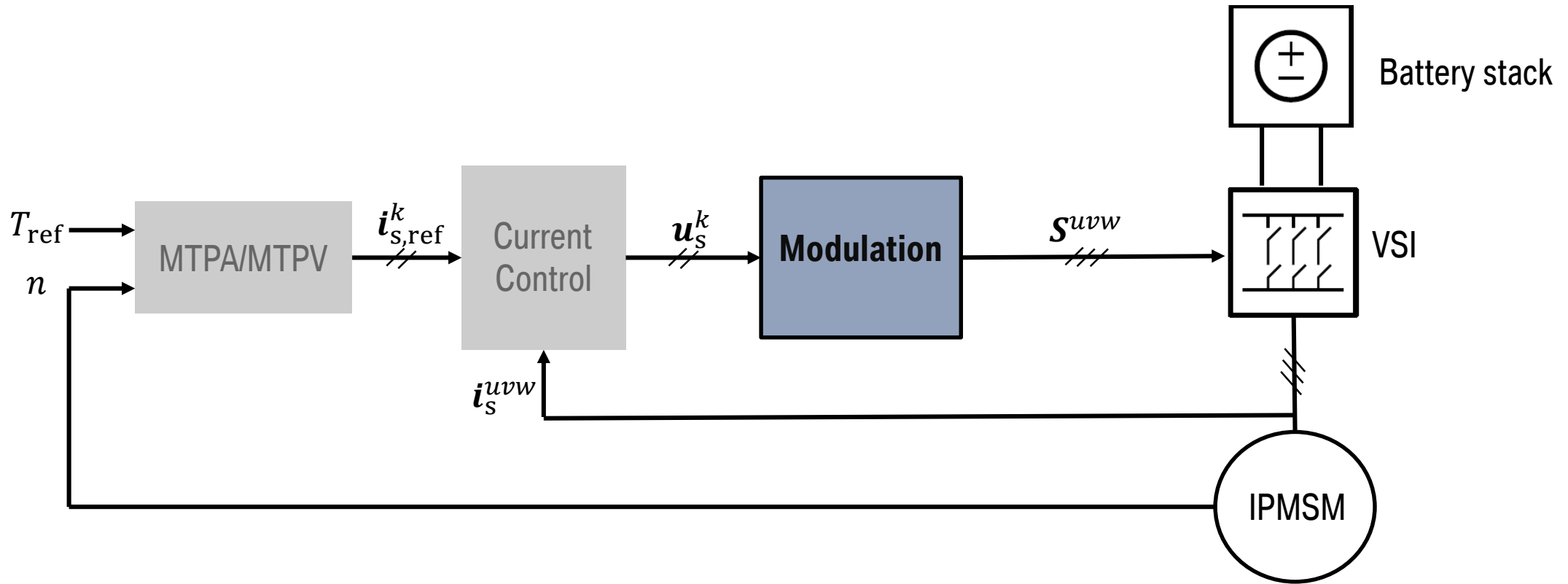

CONTROL OF AN ELECTRICAL DRIVE SYSTEM.

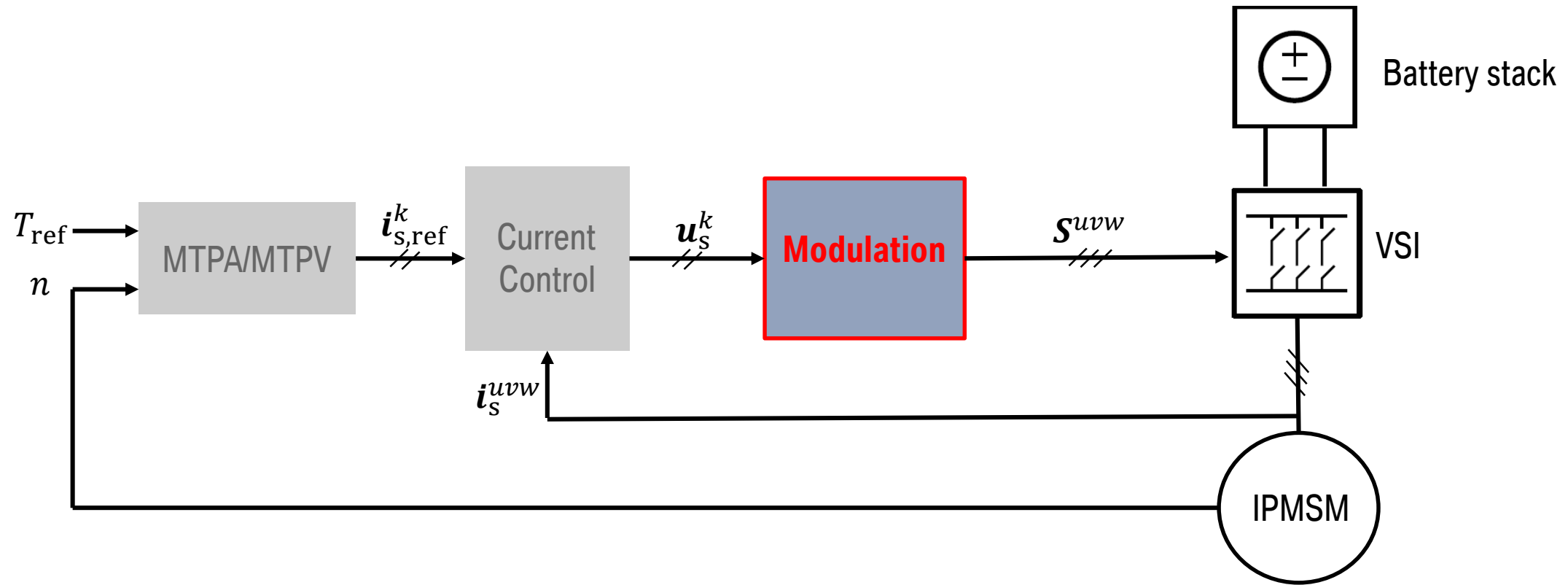

MODULATION OBJECTIVES

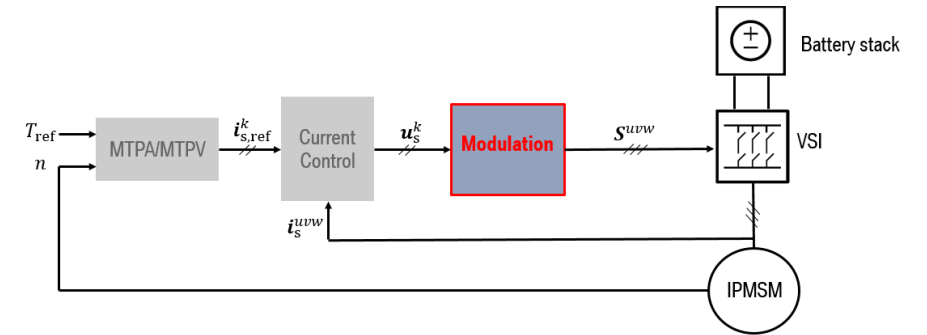

1

Max. dc-link voltage utilization: Modulation index $m \rightarrow max$

2

Efficiency enhancement: Minimization of the inverter- AND motor-losses.

OPTIMIZED PULSE PATTERNS (OPP) VS. SPACE VECTOR MODULATION (SVM).

1 Better dc-link voltage utilization with OPP.

OPP	$m_{max} = 1.273$
SVM	$m_{max} = 1.155$

2 Optimization of the electrical drive power losses with OPP. → **HOW?**

SVM

- ✓ Asynchronous modulation :
- ✓ On-Line modulation:

Constant switching frequency ($f_{s,SVM} = 10kHz$).
The inverter switching times are determined online.

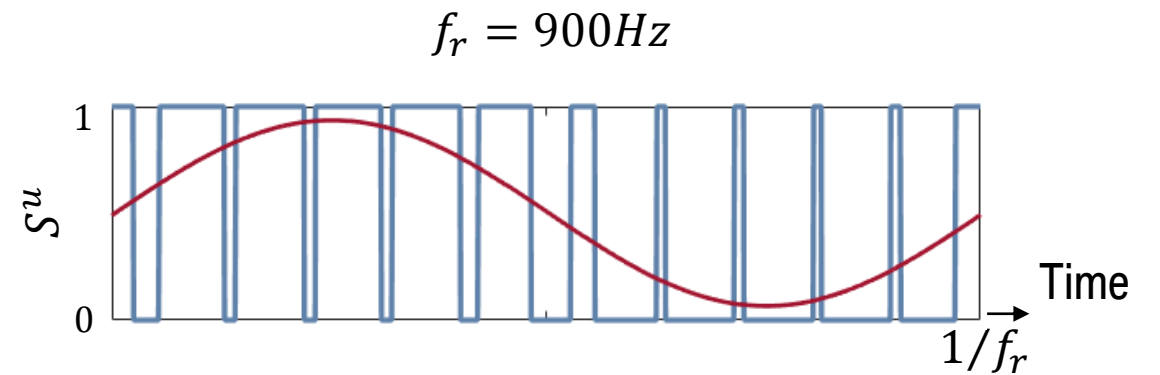
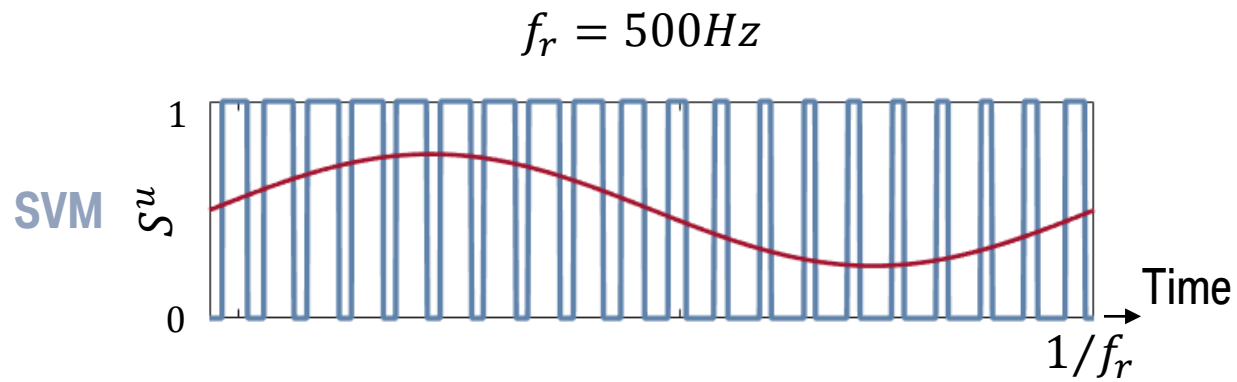

SVM

- ✓ Asynchronous modulation :
- ✓ On-Line modulation:

Constant switching frequency ($f_{s,SVM} = 10kHz$).
The inverter switching times are determined online.

OPP

- ✓ Synchronous modulation :
- ✓ Off-Line modulation :

The switching frequency depends on the electrical frequency ($f_{s,OPP} = qf_r$, $q = \text{Pulse number}$)
An optimization problem is used, which offline determines the optimized inverter switching angles (α). These are then stored in LUTs.

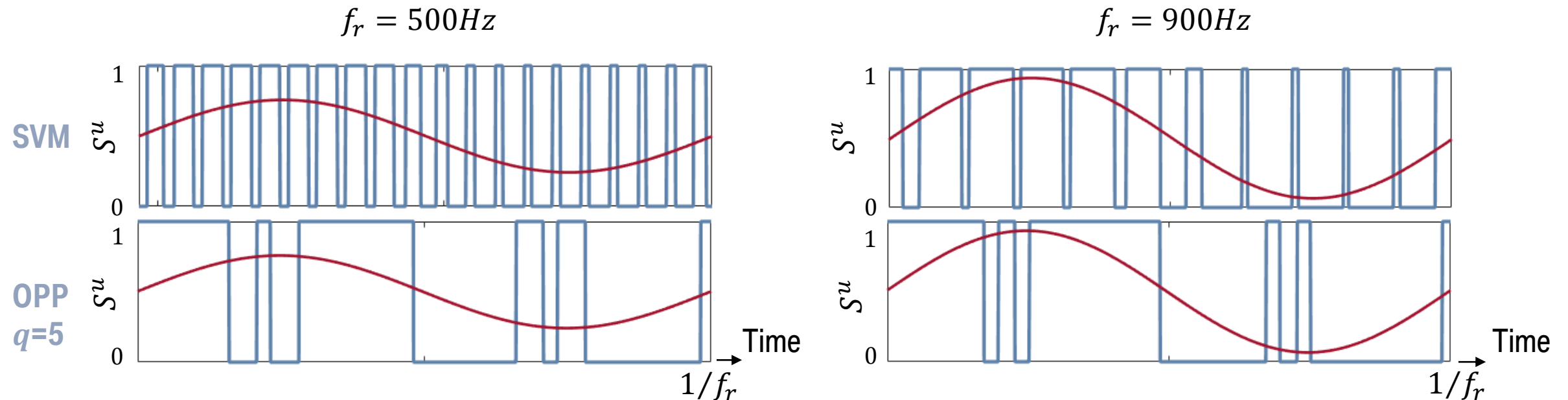

OPTIMIZATION PROBLEM

OPTIMIZATION PROBLEM

- ✓ A small pulse number is chosen ($q = 5,9$).
- ✓ The switching angles are determined by minimizing the current THD.

→ reduced switching losses.

→ reduced copper and conduction losses ($R_D I_{rms}^2$).

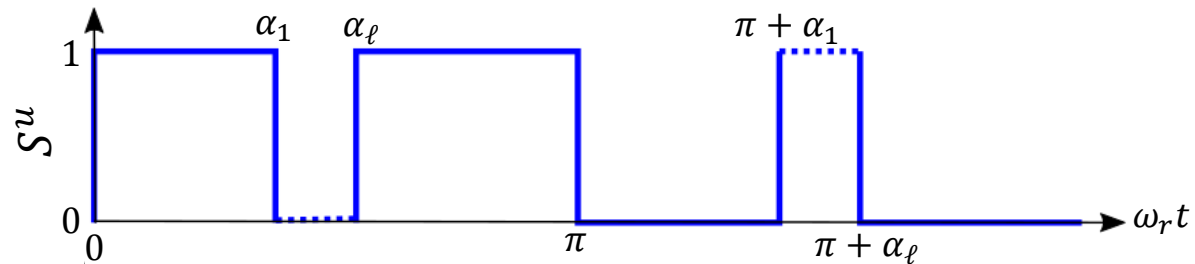

Number of optimized angles

$$l = q - 1$$

OPTIMIZATION PROBLEM

- ✓ A small pulse number is chosen ($q = 5,9$).
- ✓ The switching angles are determined by minimizing the current THD.

→ reduced switching losses.

→ reduced copper and conduction losses ($R_D I_{rms}^2$).

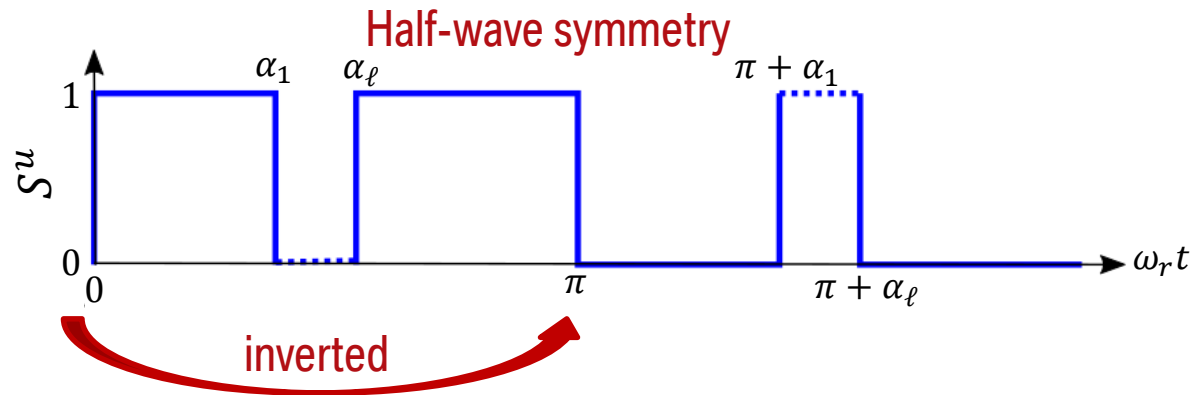

Number of optimized angles
 $\ell = q - 1$

OPTIMIZATION PROBLEM

- ✓ A small pulse number is chosen ($q = 5, 9$).
- ✓ The switching angles are determined by minimizing the current THD.

→ reduced switching losses.

→ reduced copper and conduction losses ($R_D I_{rms}^2$).

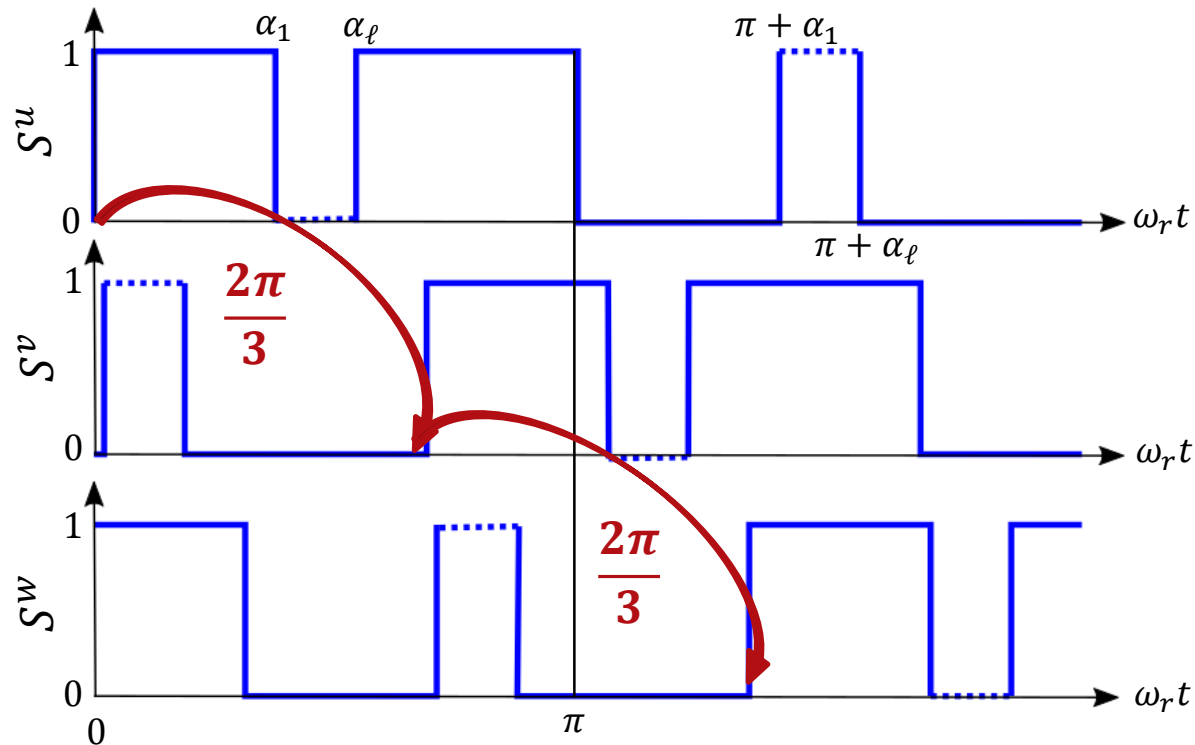

OBJECTIVE FUNCTION FORMULATION [1]

Formulation of the harmonic motor phase current

$$i_{s,h}^u(t, \alpha)$$

with respect to the inverter switching angles

$$\alpha,$$

considering also the **anisotropic properties** of the PMSM, i.e. the **anisotropic factor**

$$\lambda$$

OBJECTIVE FUNCTION FORMULATION [1]

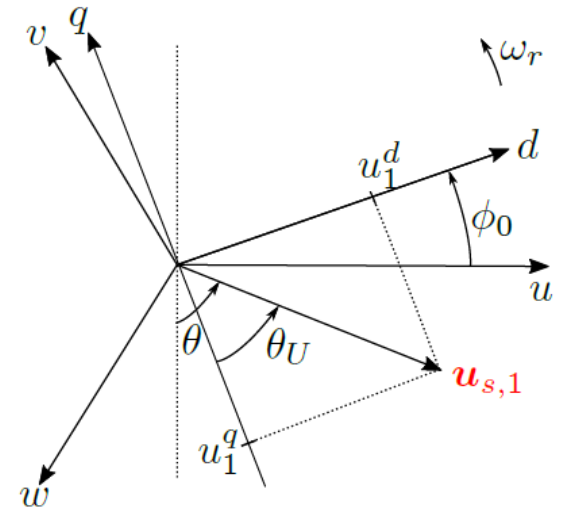

θ_U : phase angle of the voltage vector $u_{s,1}(\alpha)$

ϕ_0 : initial rotor position

OBJECTIVE FUNCTION FORMULATION [1]

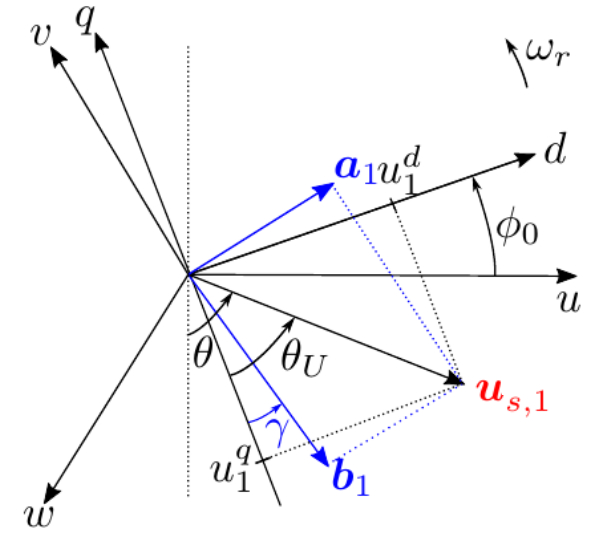

$$a_v(\alpha) = \frac{2U_{dc}}{v\pi} \sum_{k=1}^{\ell} (-1)^{k+1} \sin(v\alpha_k)$$

$$b_v(\alpha) = \frac{2U_{dc}}{v\pi} \left[1 + \sum_{k=1}^{\ell} (-1)^k \cos(v\alpha_k) \right]$$

$$\gamma(\alpha) = \arctan \left[\frac{a_1(\alpha) - b_1(\alpha) \tan \theta_U}{-a_1(\alpha) \tan \theta_U - b_1(\alpha)} \right]$$

$a(\alpha), b(\alpha)$: Fourier vectors

$\gamma(\alpha)$: phase angle of $a_1(\alpha), b_1(\alpha)$

θ_U : phase angle of the voltage vector $u_{s,1}(\alpha)$

ϕ_o : initial rotor position

OBJECTIVE FUNCTION FORMULATION [1]

Phase voltage in time domain:

$$\mathbf{u}_s^{uvw}(t, \boldsymbol{\alpha}) = \sum_{v \in \mathcal{H}} \begin{bmatrix} a_v(\boldsymbol{\alpha}) \cos(v(\omega_r t + \phi_o + \gamma(\boldsymbol{\alpha}))) + b_v(\boldsymbol{\alpha}) \sin(v(\omega_r t + \phi_o + \gamma(\boldsymbol{\alpha}))) \\ a_v(\boldsymbol{\alpha}) \cos\left(v\left(\omega_r t + \phi_o + \gamma(\boldsymbol{\alpha}) - \frac{2\pi}{3}\right)\right) + b_v(\boldsymbol{\alpha}) \sin\left(v\left(\omega_r t + \phi_o + \gamma(\boldsymbol{\alpha}) - \frac{2\pi}{3}\right)\right) \\ a_v(\boldsymbol{\alpha}) \cos\left(v\left(\omega_r t + \phi_o + \gamma(\boldsymbol{\alpha}) - \frac{4\pi}{3}\right)\right) + b_v(\boldsymbol{\alpha}) \sin\left(v\left(\omega_r t + \phi_o + \gamma(\boldsymbol{\alpha}) - \frac{4\pi}{3}\right)\right) \end{bmatrix}$$

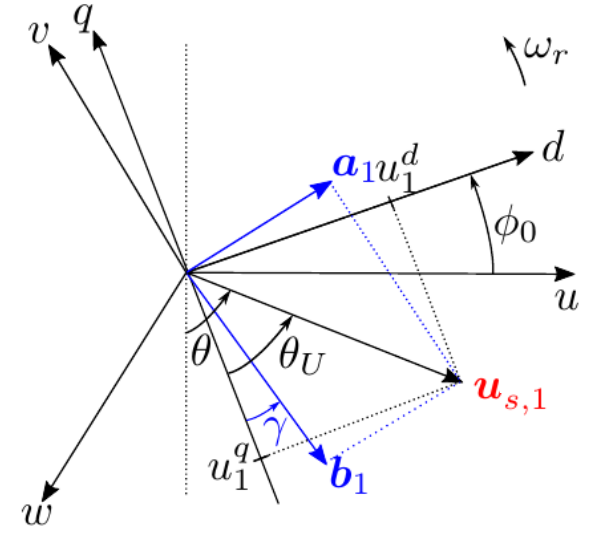

where:

$$\mathcal{H} = \{1, 5, 7, 11, 13, \dots\}$$

$$a_v(\boldsymbol{\alpha}) = \frac{2U_{dc}}{v\pi} \sum_{k=1}^{\ell} (-1)^{k+1} \sin(v\alpha_k)$$

$$b_v(\boldsymbol{\alpha}) = \frac{2U_{dc}}{v\pi} \left[1 + \sum_{k=1}^{\ell} (-1)^k \cos(v\alpha_k) \right]$$

$$\gamma(\boldsymbol{\alpha}) = \arctan \left[\frac{a_1(\boldsymbol{\alpha}) - b_1(\boldsymbol{\alpha}) \tan \theta_U}{-a_1(\boldsymbol{\alpha}) \tan \theta_U - b_1(\boldsymbol{\alpha})} \right]$$

$a(\boldsymbol{\alpha}), b(\boldsymbol{\alpha})$: Fourier vectors

$\gamma(\boldsymbol{\alpha})$: phase angle of $a_1(\boldsymbol{\alpha}), b_1(\boldsymbol{\alpha})$

θ_U : phase angle of the voltage vector $u_{s,1}(\boldsymbol{\alpha})$

ϕ_o : initial rotor position

OBJECTIVE FUNCTION FORMULATION [1]

Phase voltage in time domain:

$$\mathbf{u}_s^{uvw}(t, \boldsymbol{\alpha}) = \sum_{v=\mathcal{H}}^{\infty} \begin{bmatrix} a_v(\boldsymbol{\alpha}) \cos(v(\omega_r t + \phi_o + \gamma(\boldsymbol{\alpha}))) + b_v(\boldsymbol{\alpha}) \sin(v(\omega_r t + \phi_o + \gamma(\boldsymbol{\alpha}))) \\ a_v(\boldsymbol{\alpha}) \cos\left(v\left(\omega_r t + \phi_o + \gamma(\boldsymbol{\alpha}) - \frac{2\pi}{3}\right)\right) + b_v(\boldsymbol{\alpha}) \sin\left(v\left(\omega_r t + \phi_o + \gamma(\boldsymbol{\alpha}) - \frac{2\pi}{3}\right)\right) \\ a_v(\boldsymbol{\alpha}) \cos\left(v\left(\omega_r t + \phi_o + \gamma(\boldsymbol{\alpha}) - \frac{4\pi}{3}\right)\right) + b_v(\boldsymbol{\alpha}) \sin\left(v\left(\omega_r t + \phi_o + \gamma(\boldsymbol{\alpha}) - \frac{4\pi}{3}\right)\right) \end{bmatrix}$$

Clarke-Park Transformation

$$\mathbf{u}_s^k(t, \boldsymbol{\alpha}) = \begin{bmatrix} R_s & -\omega_r L_s^q \\ \omega_r L_s^d & R_s \end{bmatrix} \mathbf{i}_s^k(t, \boldsymbol{\alpha}) + \begin{bmatrix} L_s^d & 0 \\ 0 & L_s^q \end{bmatrix} \frac{d}{dt} \mathbf{i}_s^k(t, \boldsymbol{\alpha}) + \begin{pmatrix} 0 \\ \omega_r \psi_{PM} \end{pmatrix} \rightarrow \mathbf{i}_s^k(t, \boldsymbol{\alpha}) = \dots$$

Inverse Clarke-Park Transformation

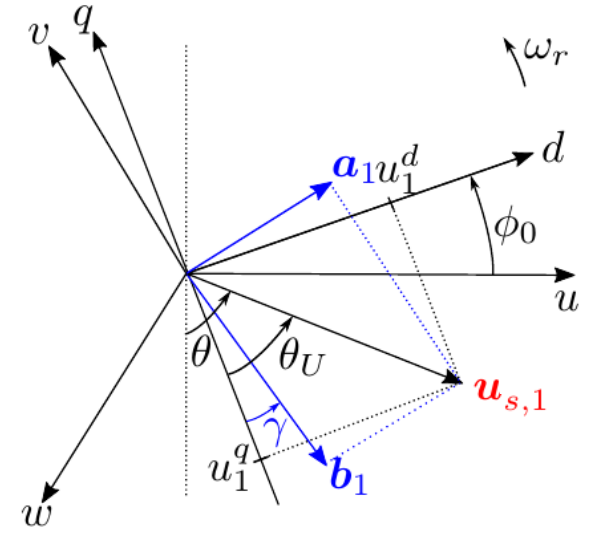

L_s^d, L_s^q : d- and q-axis inductances

R_s : stator resistance

ψ_{PM} : PM flux linkage

OBJECTIVE FUNCTION FORMULATION

Harmonic phase current in time domain:

$$i_{s,h}^u(t, \alpha) = \frac{1}{2\omega_r L_s^q} \sum_{v=6i}^{\infty} \left[\frac{a_{v-1}(\alpha)}{v-1} (\lambda + 1) \cos \left((v-1)(\omega_r t + \phi_o) + (v-1)\gamma(\alpha) - \frac{\pi}{2} \right) \right. \\ + \frac{a_{v+1}(\alpha)}{v+1} (\lambda - 1) \cos \left((v-1)(\omega_r t + \phi_o) + (v+1)\gamma(\alpha) - \frac{\pi}{2} \right) \\ - \frac{b_{v-1}(\alpha)}{v-1} (\lambda + 1) \cos \left((v-1)(\omega_r t + \phi_o) + (v-1)\gamma(\alpha) \right) \\ - \frac{b_{v+1}(\alpha)}{v+1} (\lambda - 1) \cos \left((v-1)(\omega_r t + \phi_o) + (v+1)\gamma(\alpha) \right) \\ + \frac{a_{v-1}(\alpha)}{v-1} (\lambda - 1) \cos \left((v+1)(\omega_r t + \phi_o) + (v-1)\gamma(\alpha) - \frac{\pi}{2} \right) \\ + \frac{a_{v+1}(\alpha)}{v+1} (\lambda + 1) \cos \left((v+1)(\omega_r t + \phi_o) + (v+1)\gamma(\alpha) - \frac{\pi}{2} \right) \\ - \frac{b_{v-1}(\alpha)}{v-1} (\lambda - 1) \cos \left((v+1)(\omega_r t + \phi_o) + (v-1)\gamma(\alpha) \right) \\ \left. - \frac{b_{v+1}(\alpha)}{v+1} (\lambda + 1) \cos \left((v+1)(\omega_r t + \phi_o) + (v+1)\gamma(\alpha) \right) \right]$$

λ : anisotropic factor

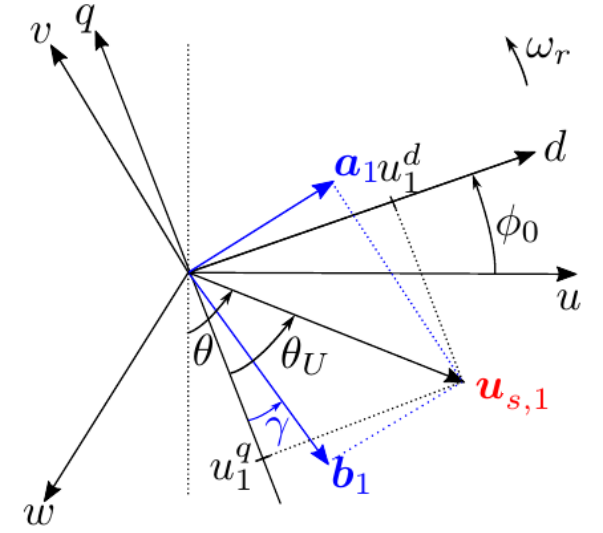

where:

$$i = \{1, 2, \dots\}$$

$$a_v(\alpha) = \frac{2U_{dc}}{v\pi} \sum_{k=1}^{\ell} (-1)^{k+1} \sin(v\alpha_k)$$

$$b_v(\alpha) = \frac{2U_{dc}}{v\pi} \left[1 + \sum_{k=1}^{\ell} (-1)^k \cos(v\alpha_k) \right]$$

$$\gamma(\alpha) = \arctan \left[\frac{a_1(\alpha) - b_1(\alpha) \tan \theta_U}{-a_1(\alpha) \tan \theta_U - b_1(\alpha)} \right]$$

$$\lambda = \frac{L_s^q}{L_s^d}$$

OBJECTIVE FUNCTION FORMULATION

RMS value of the harmonic phase current:

$$I_{s,h,RMS}(\alpha) = \frac{1}{\omega_r L_s^q} \left[\sum_{v=6i}^{\infty} \left[\left(\left(\frac{a_{v-1}(\alpha)}{v-1} \right)^2 + \left(\frac{a_{v+1}(\alpha)}{v+1} \right)^2 + \left(\frac{b_{v-1}(\alpha)}{v-1} \right)^2 + \left(\frac{b_{v+1}(\alpha)}{v+1} \right)^2 \right) \left(\frac{\lambda^2 + 1}{4} \right) \right. \right. \\ \left. \left. + 2 \left(\frac{a_{v-1}(\alpha) a_{v+1}(\alpha)}{v-1} + \frac{b_{v-1}(\alpha) b_{v+1}(\alpha)}{v-1} \right) \left(\frac{\lambda^2 - 1}{4} \right) \cos(2\gamma(\alpha)) \right. \right. \\ \left. \left. + 2 \left(\frac{a_{v-1}(\alpha) b_{v+1}(\alpha)}{v-1} - \frac{a_{v+1}(\alpha) b_{v-1}(\alpha)}{v+1} \right) \left(\frac{\lambda^2 - 1}{4} \right) \sin(2\gamma(\alpha)) \right] \right]^{\frac{1}{2}}$$

OBJECTIVE FUNCTION FORMULATION

RMS value of the harmonic phase current:

$$\sigma_{aniso}(\alpha) \Big|_{\lambda, \theta_U}$$

$$I_{s,h,RMS}(\alpha) = \frac{1}{\omega_r L_s^q} \left[\sum_{v=6i}^{\infty} \left[\left(\left(\frac{a_{v-1}(\alpha)}{v-1} \right)^2 + \left(\frac{a_{v+1}(\alpha)}{v+1} \right)^2 + \left(\frac{b_{v-1}(\alpha)}{v-1} \right)^2 + \left(\frac{b_{v+1}(\alpha)}{v+1} \right)^2 \right) \left(\frac{\lambda^2 + 1}{4} \right) \right. \right. \\ \left. \left. + 2 \left(\frac{a_{v-1}(\alpha) a_{v+1}(\alpha)}{v-1} + \frac{b_{v-1}(\alpha) b_{v+1}(\alpha)}{v-1} \right) \left(\frac{\lambda^2 - 1}{4} \right) \cos(2\gamma(\alpha)) \right. \right. \\ \left. \left. + 2 \left(\frac{a_{v-1}(\alpha) b_{v+1}(\alpha)}{v-1} - \frac{a_{v+1}(\alpha) b_{v-1}(\alpha)}{v+1} \right) \left(\frac{\lambda^2 - 1}{4} \right) \sin(2\gamma(\alpha)) \right] \right]^{\frac{1}{2}}$$

ANISOTROPIC PMSM

Objective function for an **anisotropic** PMSM:

$$\begin{aligned} \sigma_{aniso}(\boldsymbol{\alpha}) \Big|_{\lambda, \theta_U} = & \left[\sum_{\nu=6i}^{\infty} \left[\left(\left(\frac{a_{\nu-1}(\boldsymbol{\alpha})}{\nu-1} \right)^2 + \left(\frac{a_{\nu+1}(\boldsymbol{\alpha})}{\nu+1} \right)^2 + \left(\frac{b_{\nu-1}(\boldsymbol{\alpha})}{\nu-1} \right)^2 + \left(\frac{b_{\nu+1}(\boldsymbol{\alpha})}{\nu+1} \right)^2 \right) \left(\frac{\lambda^2 + 1}{4} \right) \right. \right. \\ & + 2 \left(\frac{a_{\nu-1}(\boldsymbol{\alpha}) a_{\nu+1}(\boldsymbol{\alpha})}{\nu-1 \nu+1} + \frac{b_{\nu-1}(\boldsymbol{\alpha}) b_{\nu+1}(\boldsymbol{\alpha})}{\nu-1 \nu+1} \right) \left(\frac{\lambda^2 - 1}{4} \right) \cos(2\gamma(\boldsymbol{\alpha})) \\ & \left. \left. + 2 \left(\frac{a_{\nu-1}(\boldsymbol{\alpha}) b_{\nu+1}(\boldsymbol{\alpha})}{\nu-1 \nu+1} - \frac{a_{\nu+1}(\boldsymbol{\alpha}) b_{\nu-1}(\boldsymbol{\alpha})}{\nu+1 \nu-1} \right) \left(\frac{\lambda^2 - 1}{4} \right) \sin(2\gamma(\boldsymbol{\alpha})) \right) \right]^{\frac{1}{2}} \end{aligned}$$

Optimization problem

$$\min_{\boldsymbol{\alpha} \in [0, \pi]} \sigma_{aniso}(\boldsymbol{\alpha}) \Big|_{\lambda, \theta_U}$$

$$\text{s.t. } u_{s,1} = m \frac{U_{dc}}{2}$$

$$0 \leq \alpha_1 \leq \dots \leq \alpha_\ell \leq \pi$$

The optimized angles for an anisotropic PMSM depend not only on m but also on the load angle θ_U and anisotropic factor λ .

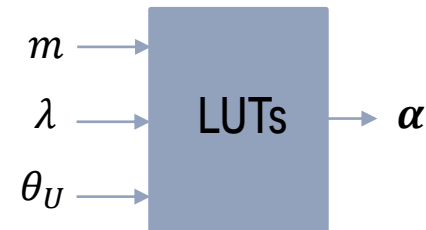

ISOTROPIC PMSM

Objective function for an **isotropic** PMSM:

$$\sigma_{iso}(\boldsymbol{\alpha}) = \sigma_{aniso}(\boldsymbol{\alpha})|_{\lambda=1} = \sqrt{\frac{1}{2} \sum_{v=6i \pm 1}^{\infty} \frac{a_v^2(\boldsymbol{\alpha}) + b_v^2(\boldsymbol{\alpha})}{v^2}}$$

Optimization problem

$$\begin{aligned} \min_{\boldsymbol{\alpha} \in [0, \pi]} \quad & \sigma_{iso}(\boldsymbol{\alpha}) \\ \text{s.t.} \quad & u_{s,1} = m \frac{U_{dc}}{2} \\ & 0 \leq \alpha_1 \leq \dots \leq \alpha_\ell \leq \pi \end{aligned}$$

The optimized angles for an isotropic PMSM depend solely on the modulation index m .

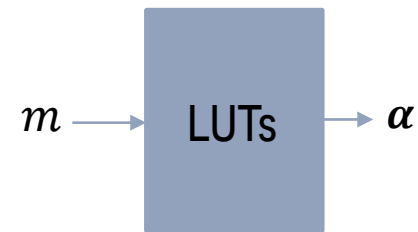

OPTIMIZATION RESULTS FOR α_7 ($m = 0.9, q = 9$)

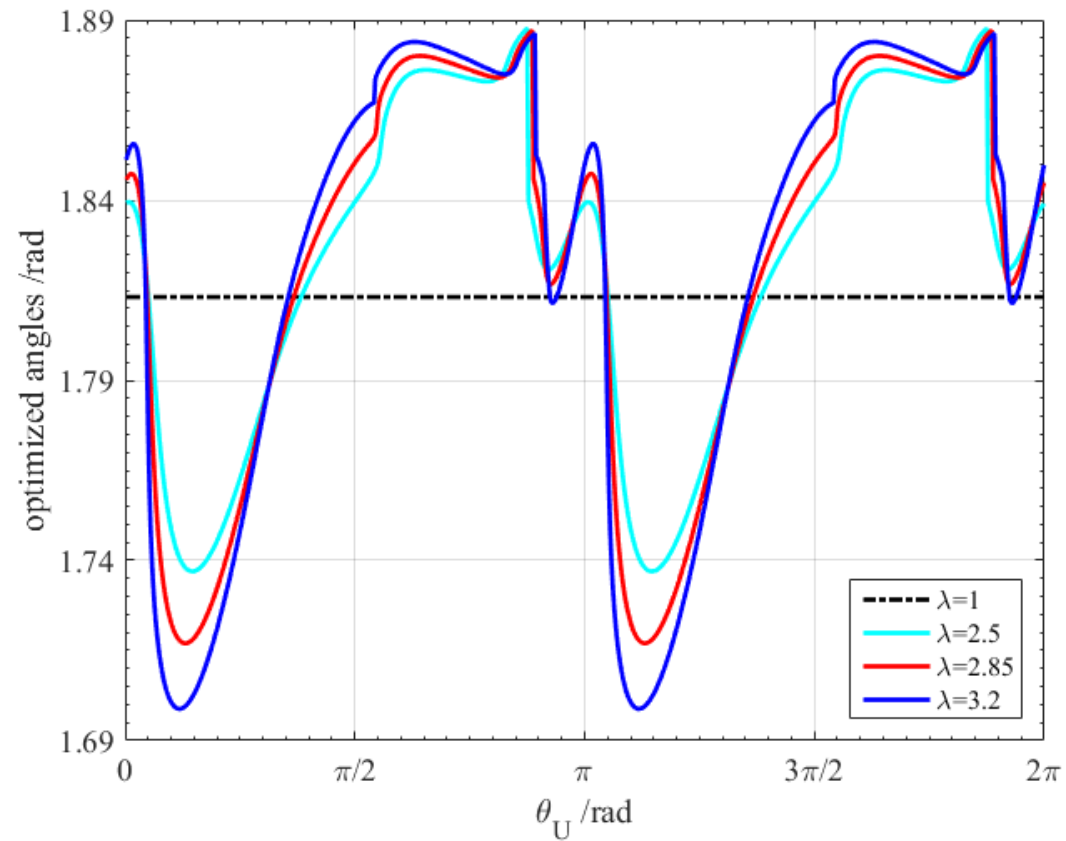

EXPERIMENTAL RESULTS

ELECTRICAL DRIVE SYSTEM

DC-link	
Dc-link voltage	$U_{dc} = 400 \text{ V}$
Dc-link capacitor	$C = 320 \mu\text{F}$

PMSM	
Max. power	$P_{\max} = 125\text{kW}$
Max. torque	$T_{\max} = 250\text{Nm}$
Max. Speed	$n_{\max} = 11400\text{rpm}$
Pole pairs	$p = 6$
Anisotropic factor	$\lambda = 2.5 - 3.2$

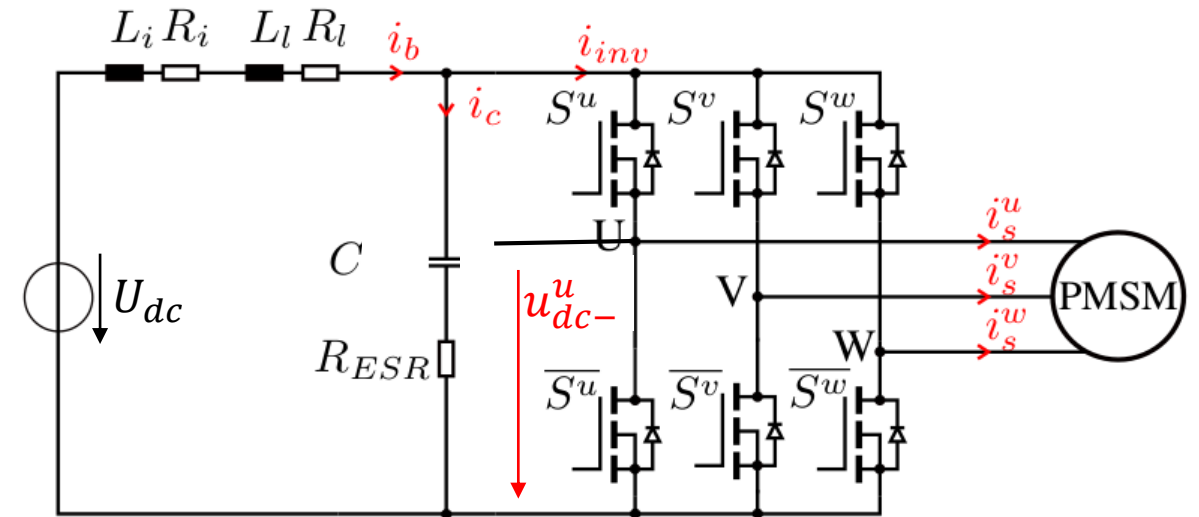

2-Level VSI	
Rated power	$P_N = 361\text{kW}$
Rated voltage	$U_N = 550\text{V}$
Rated current	$I_N = 379\text{A rms}$

EXPERIMENTAL RESULTS

„Isotropic angles“:

inverter switching angles optimized for an isotropic PMSM.

„Anisotropic angles“:

inverter switching angles optimized for an anisotropic PMSM.

Operating Point

$$T_{\text{ref}} = 20 \text{ Nm}$$

$$n_{\text{ref}} = 8500 \text{ rpm}$$

$$m = 0.9$$

$$\theta_U = 1.94 \text{ rad}$$

$$\lambda = 3.146$$

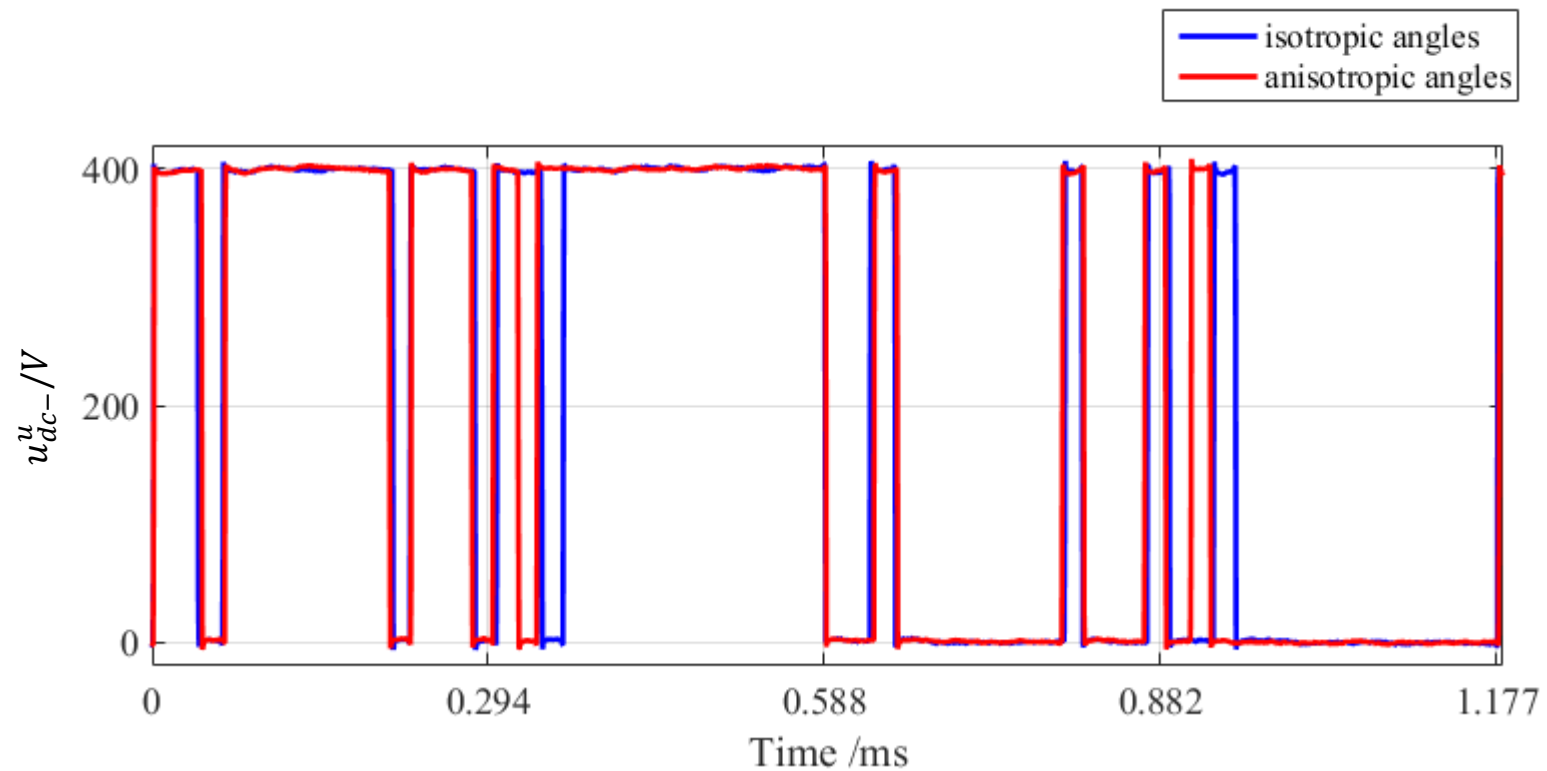

EXPERIMENTAL RESULTS

OPP ANISOTROPIC ANGLES

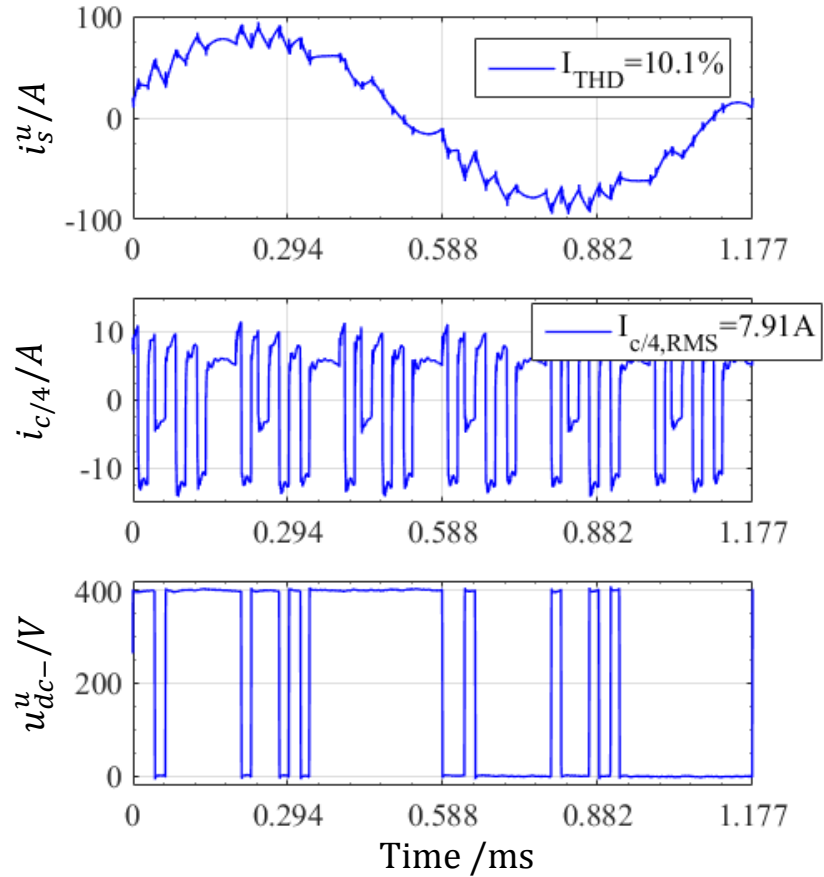

OPP ISOTROPIC ANGLES

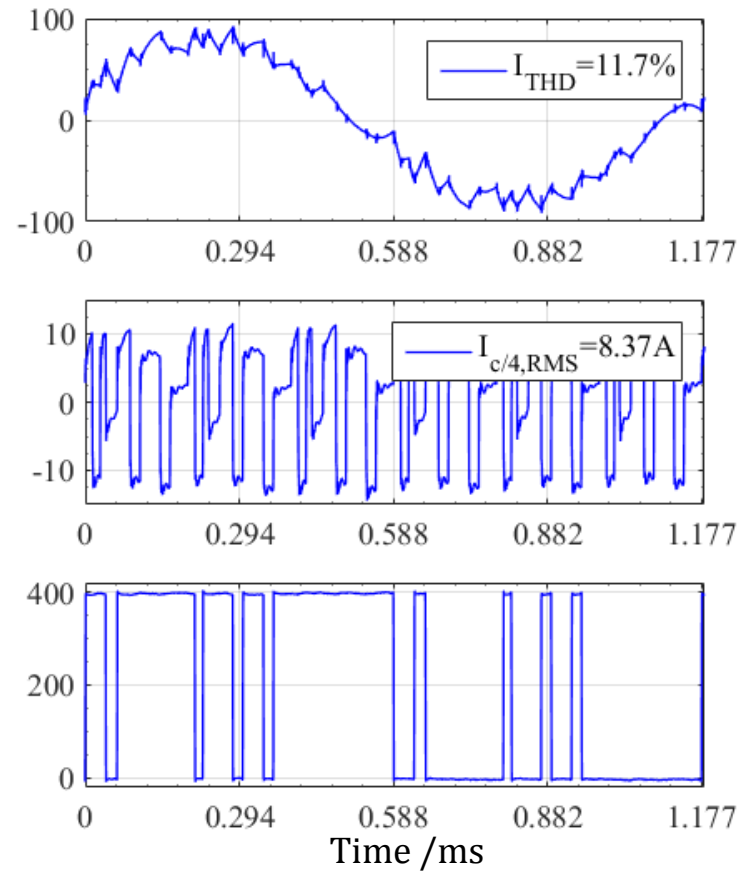

EXPERIMENTAL RESULTS

OPP ANISOTROPIC ANGLES

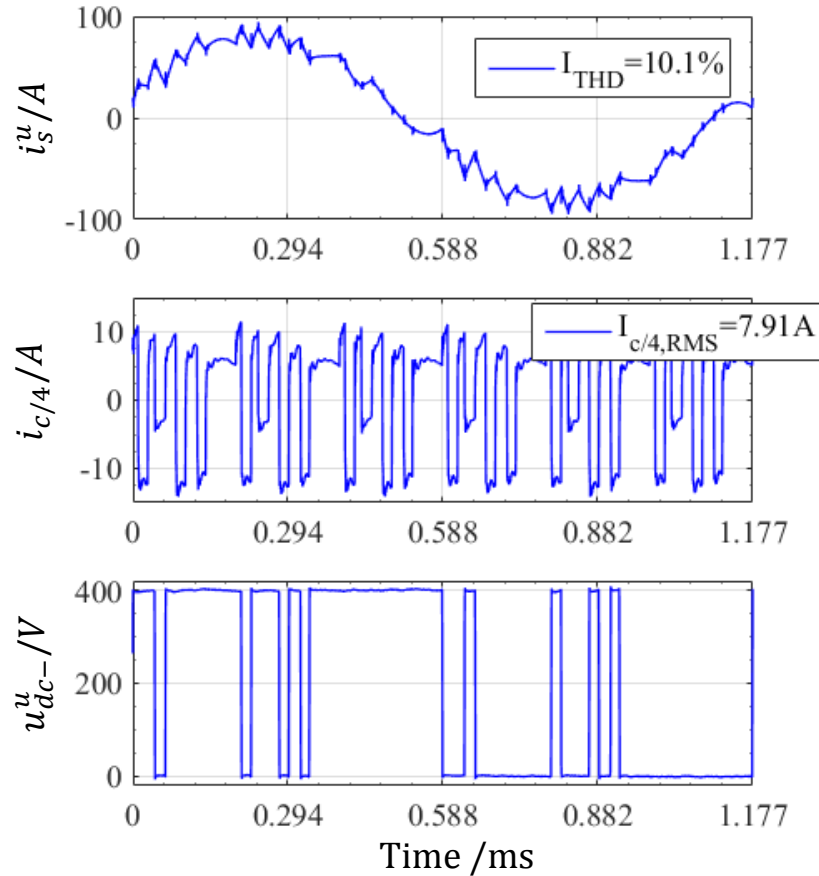

OPP ISOTROPIC ANGLES

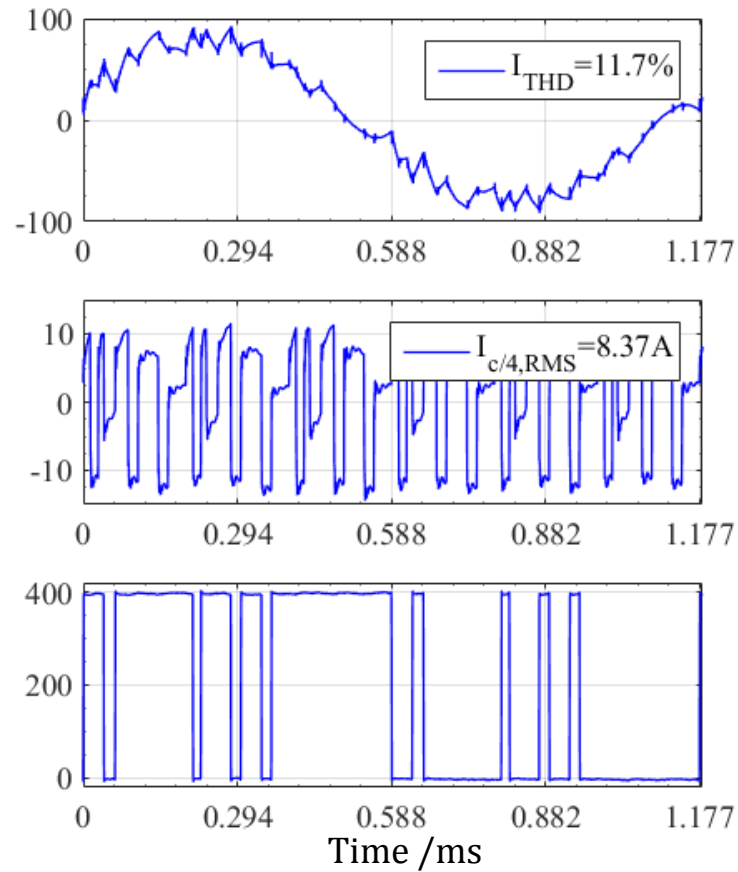

1.6% reduction in the current harmonic distortion with the optimized switching angles for an anisotropic PMSM.

The same switching frequency is used ($q = 9$).

$$f_{s,OPP} = qf_r = 7.65kHz$$

EXPERIMENTAL RESULTS

OPP ANISOTROPIC ANGLES

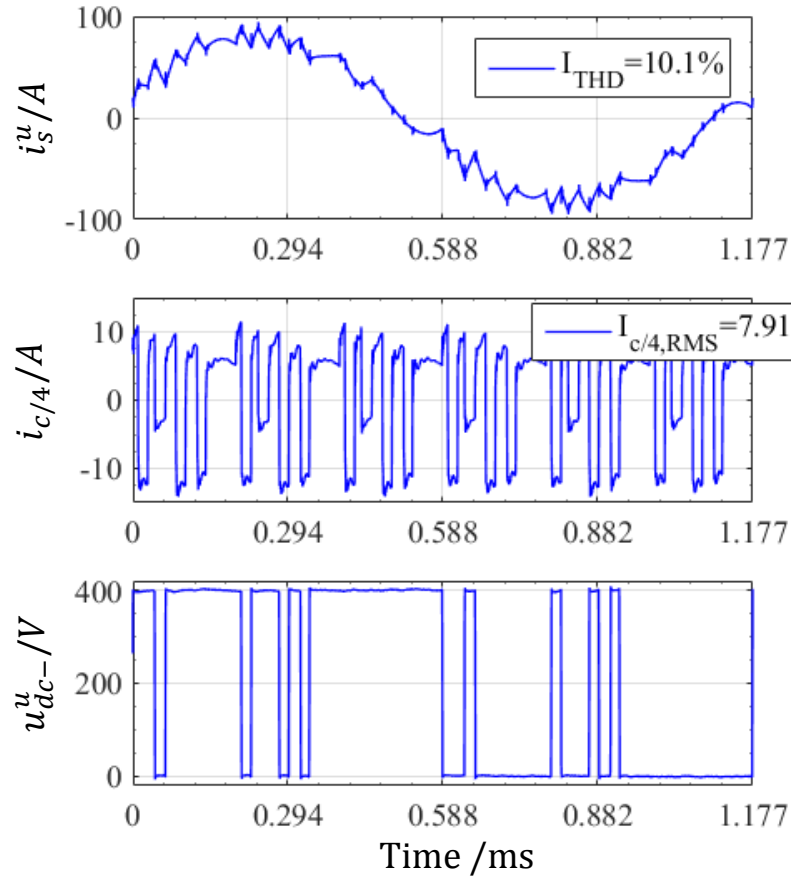

$$f_{s,OPP} = qf_r = 7.65kHz$$

OPP ISOTROPIC ANGLES

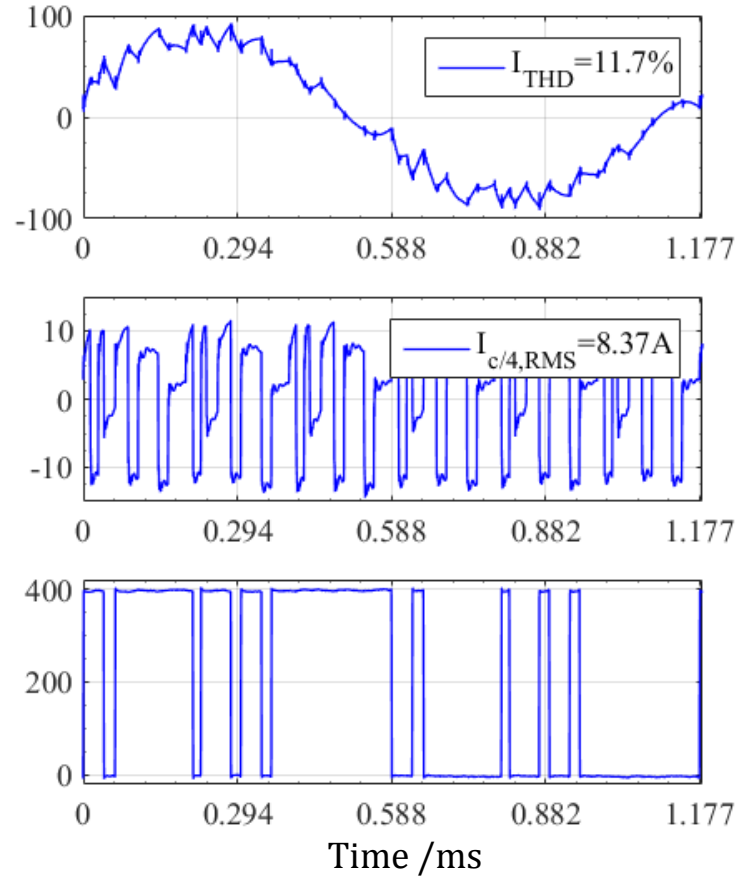

SVM

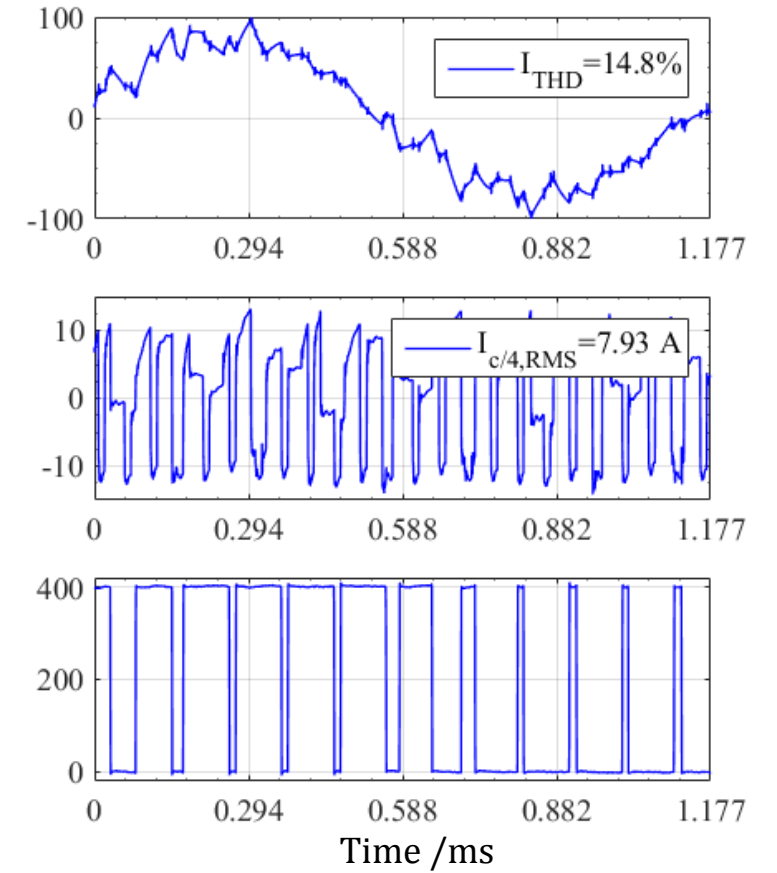

$$f_{s,SVM} = 10kHz$$

EXPERIMENTAL RESULTS

OPP ANISOTROPIC ANGLES

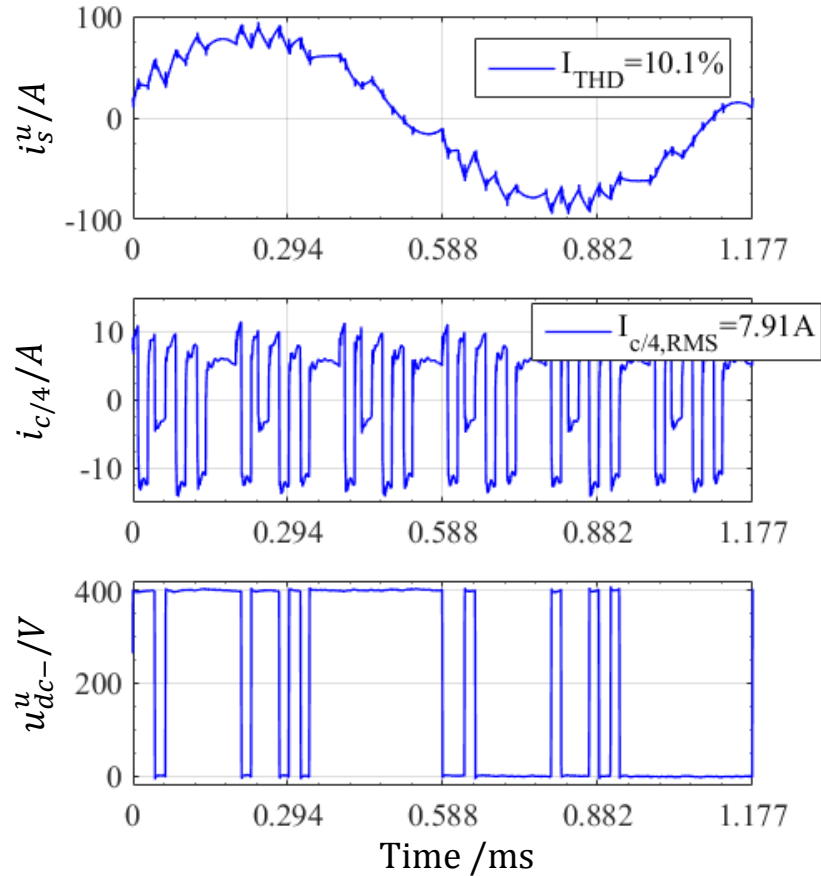

$$f_{s,OPP} = qf_r = 7.65kHz$$

OPP ISOTROPIC ANGLES

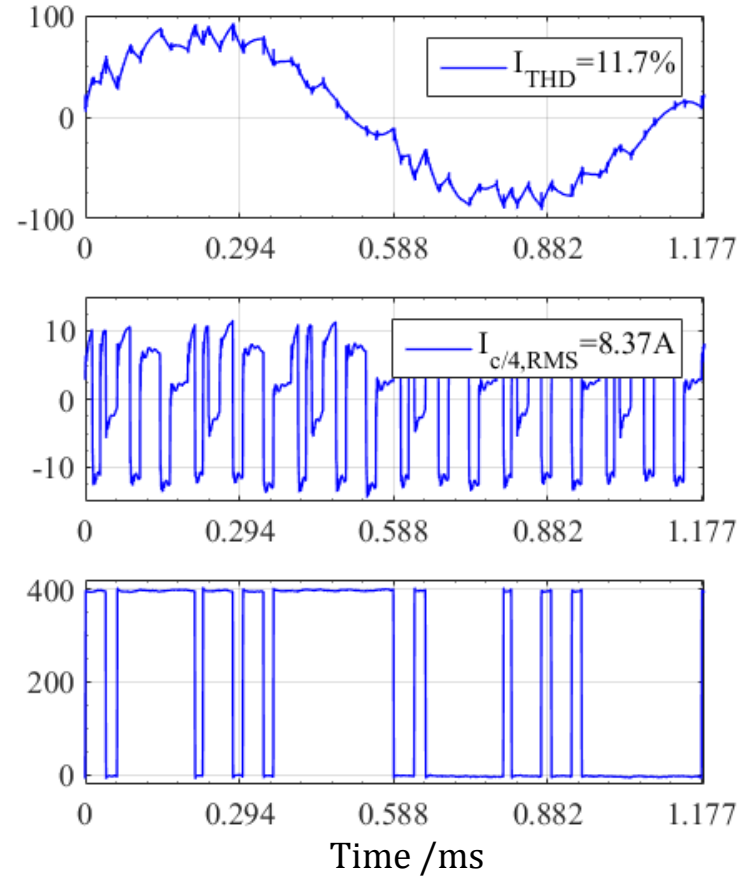

SVM

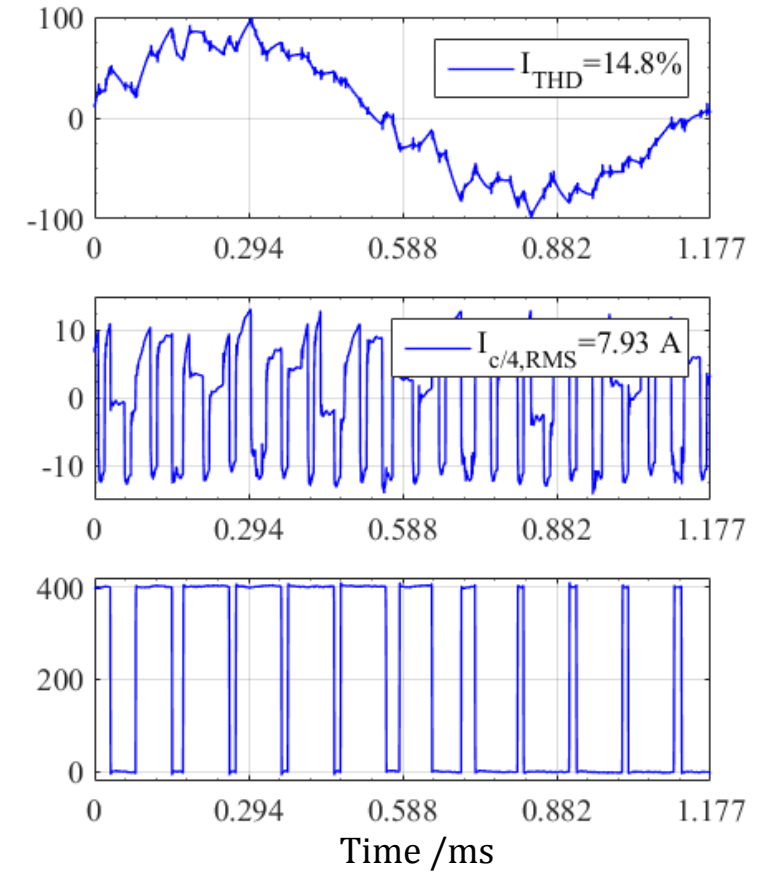

$$f_{s,SVM} = 10kHz$$

Reduced current harmonic distortion with reduced inverter switching frequency with OPP → Efficiency enhancement is expected.

VALIDATION OF THE EQUATIONS

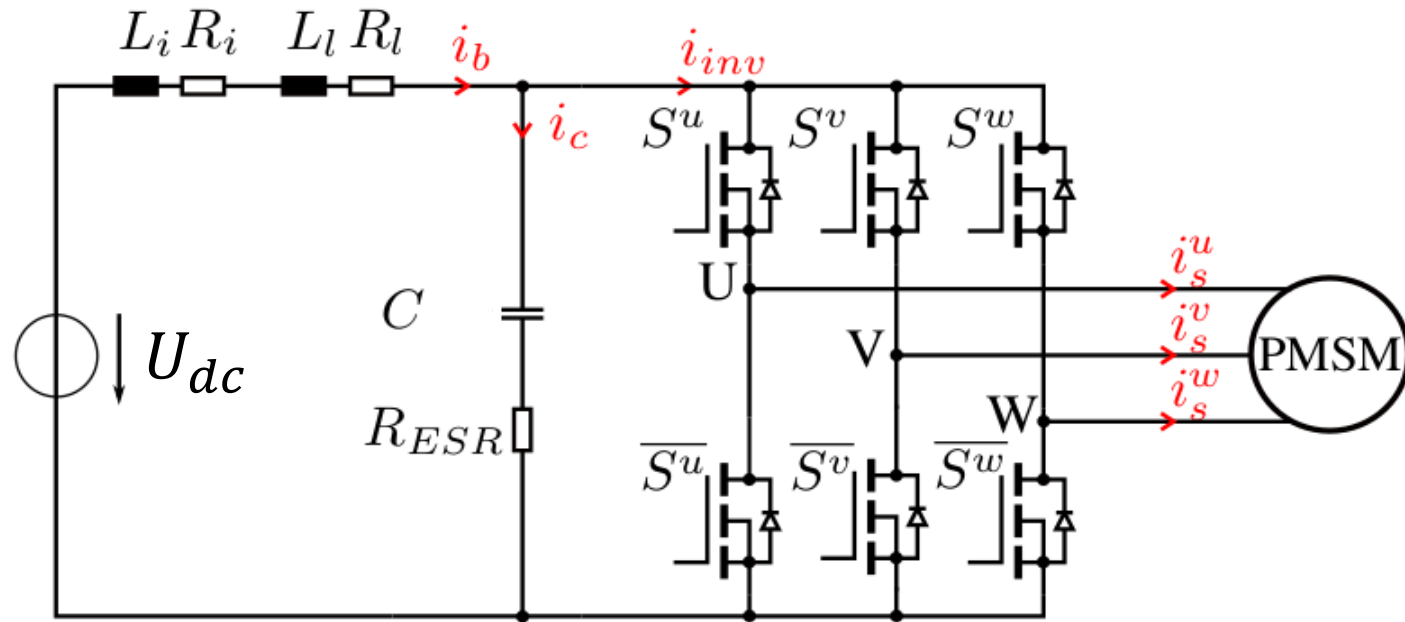

Derivation of the analytical equations in the time domain of:

- $i_s^{uvw}(\alpha, t), i_s^{dq}(\alpha, t)$
- $u_s^{uvw}(\alpha, t), u_s^{dq}(\alpha, t)$
- $S^{uvw}(\alpha, t)$
- $i_b(\alpha, t), i_c(\alpha, t), i_{inv}(\alpha, t)$

VALIDATION OF THE EQUATIONS (MOTOR PHASE CURRENT)

ANISOTROPIC ANGLES

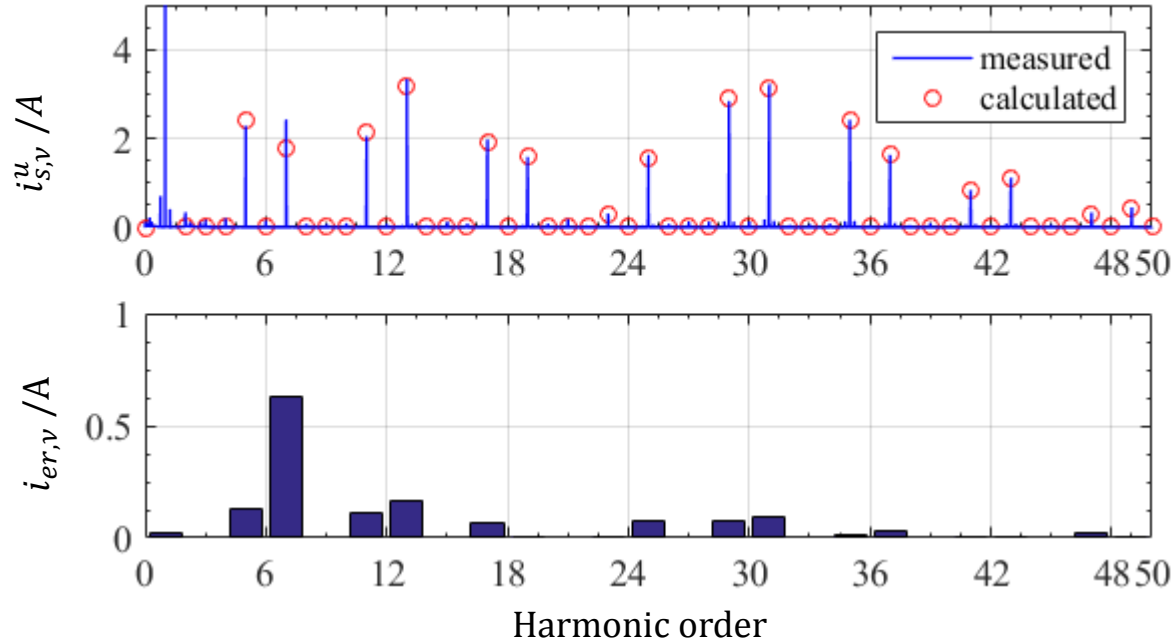

ISOTROPIC ANGLES

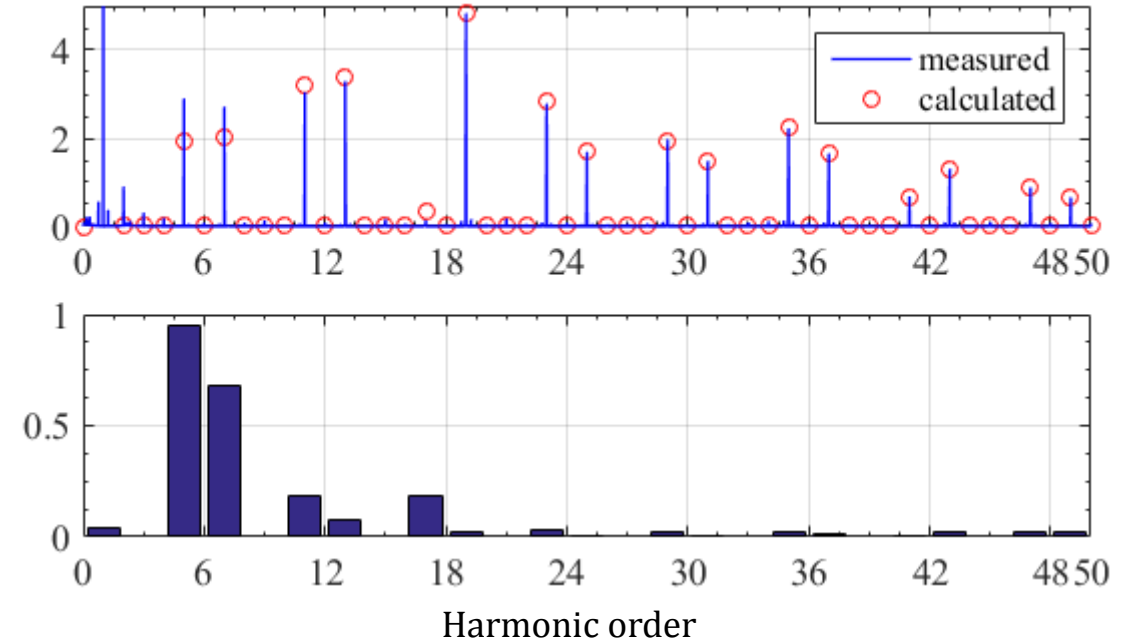

$I_{THD}/\%$	Anisotropic angles	Isotropic angles
Measured	10.1	11.7
Calculated	9.96	11.39

$$i_{er,v} = \text{abs} \left(i_{s,v}^u \Big|_{\text{meas}} - i_{s,v}^u \Big|_{\text{calc}} \right)$$

VALIDATION OF THE EQUATIONS (CAPACITOR CURRENT)

ANISOTROPIC ANGLES

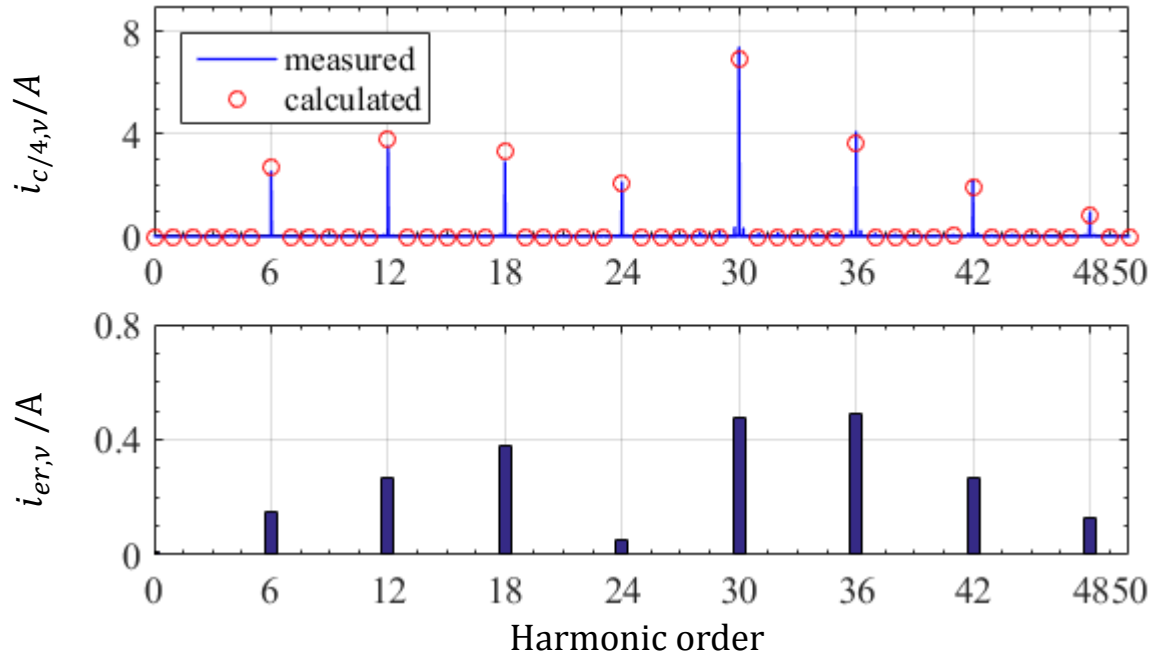

ISOTROPIC ANGLES

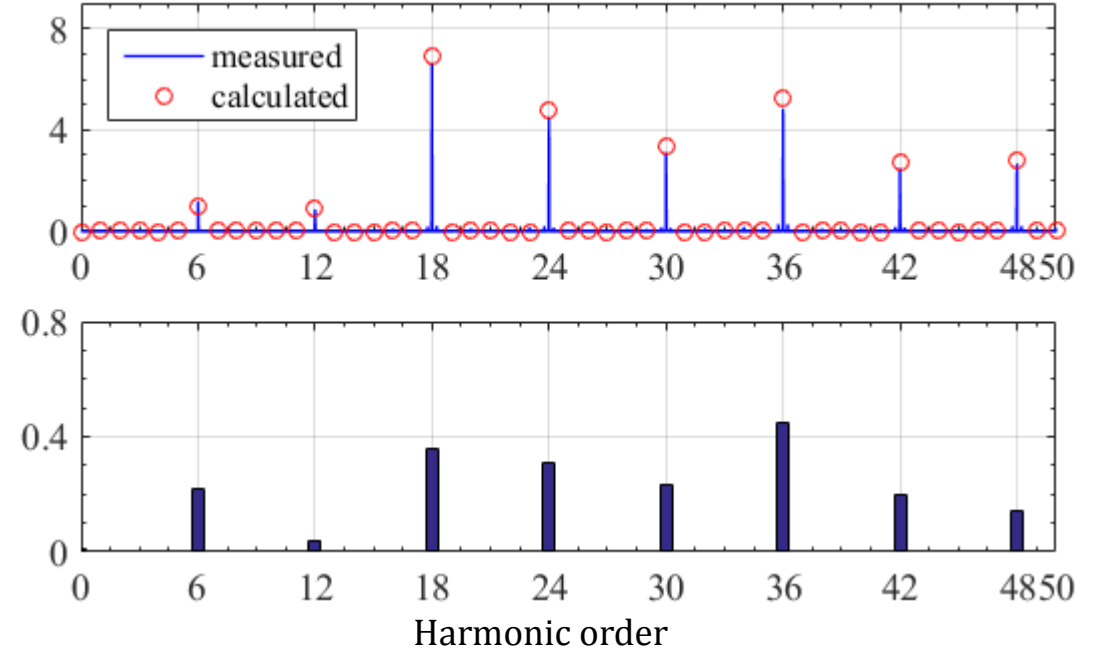

$I_{c/4,RMS}/A$	Anisotropic angles	Isotropic angles
Measured	7.91	8.37
Calculated	7.86	8.7

$$i_{er,v} = \text{abs} \left(i_{c/4,v} \Big|_{\text{meas}} - i_{c/4,v} \Big|_{\text{calc}} \right)$$

CONCLUSION

OPP for an anisotropic PMSM:

- The anisotropic properties of the PMSM influence the optimized inverter switching angles.
- Increased memory requirements for the controller when the optimized angles for an anisotropic PMSM are used (three-dimensional LUTs)

OPP vs. asynchronous SVM:

- Better dc-link voltage utilization with OPP.
- The inverter switching frequency can be reduced with OPP, without compromising on the motor current quality.
- An efficiency enhancement is expected.



THANK YOU FOR YOUR ATTENTION

BMW
GROUP

THE NEXT
100 YEARS 



REFERENCES

1. A. Birda, J. Reuss, and C. Hackl, “Synchronous optimal pulse-width modulation with differently modulated waveform symmetry properties for feeding synchronous motor with high magnetic anisotropy,” EPE ECCE Europe, DOI 10.23919/EPE17ECCEurope.2017.8098963, pp. P.1 – P.10, Sep. 2017.

Open Loop Control with Analytic Equations for High Power DC-DC Converters in Design and Operation

Daniel Goldmann
LMRES Workshop 17.05.2019

Agenda

- Project UnABESA
- Dual Active Bridge DC-DC Converter
- Open Loop Control with Analytic Equations
 - Deriving Equations for Triangular Buck Mode
 - Considering Additional Parasitic Effects
 - Comparing Traditional to Extended Equations

UnABESA Research Project

UnABESA Research Project

Automotive-Battery



Plug & Play

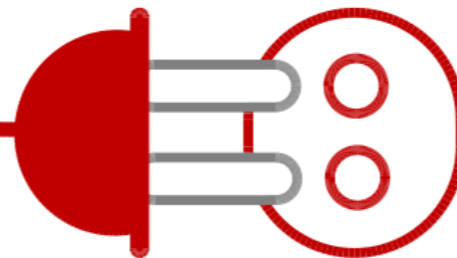

Grid

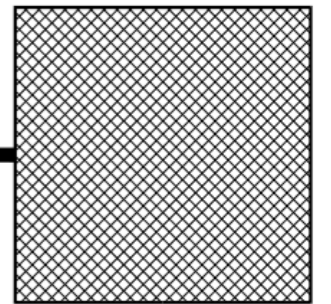

400V \pm 10% / 50Hz

UnABESA Research Project

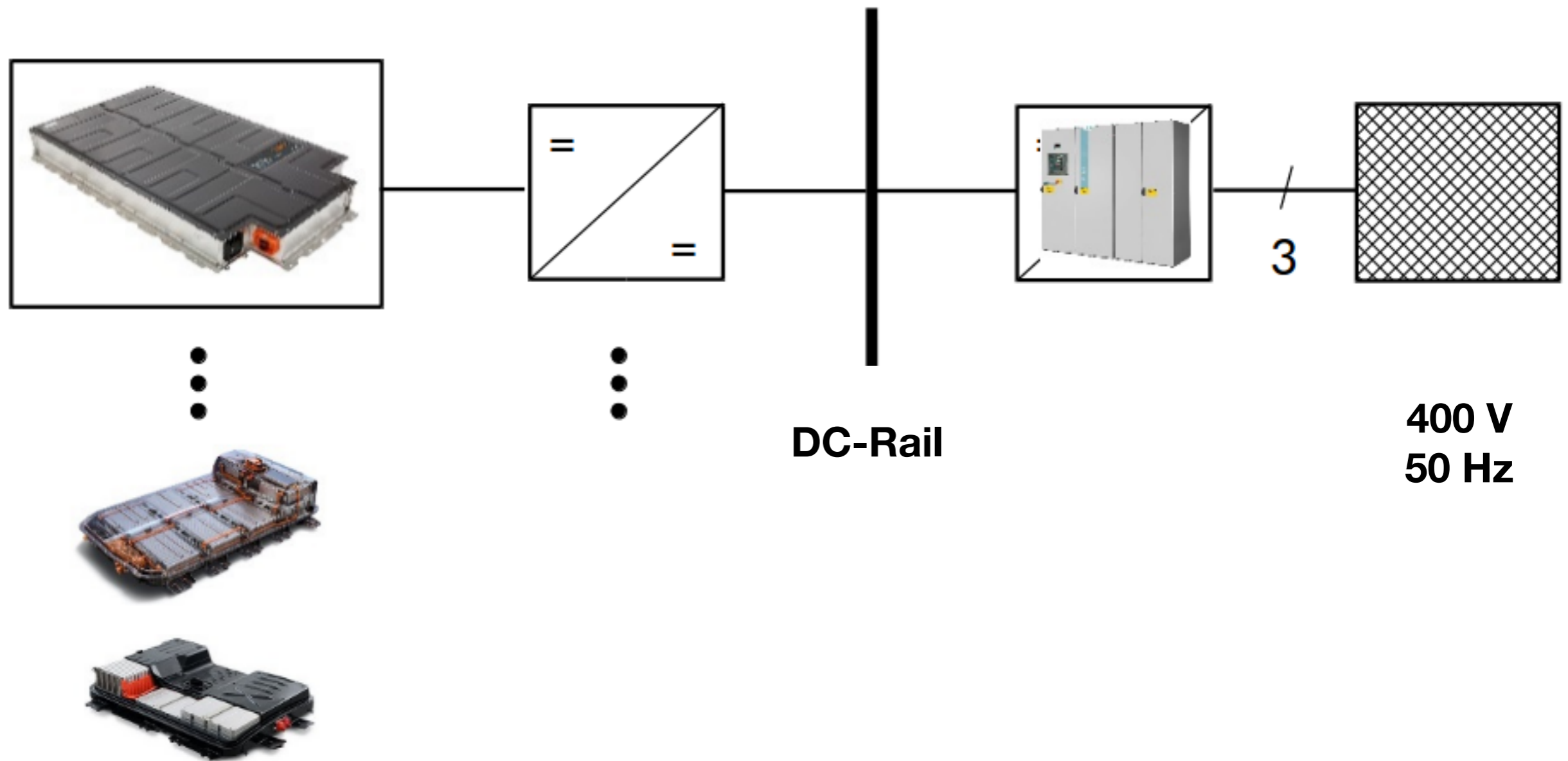

UnABESA - Converter

The UnABESA converter has to be:

- Galvanically isolated
- Bi-directional
- Efficient

Dual Active Bridge Converter

Dual Active Bridge

Principle of operation:

- High frequency AC modulated with h-bridges
- Current limited by stray inductance of transformer

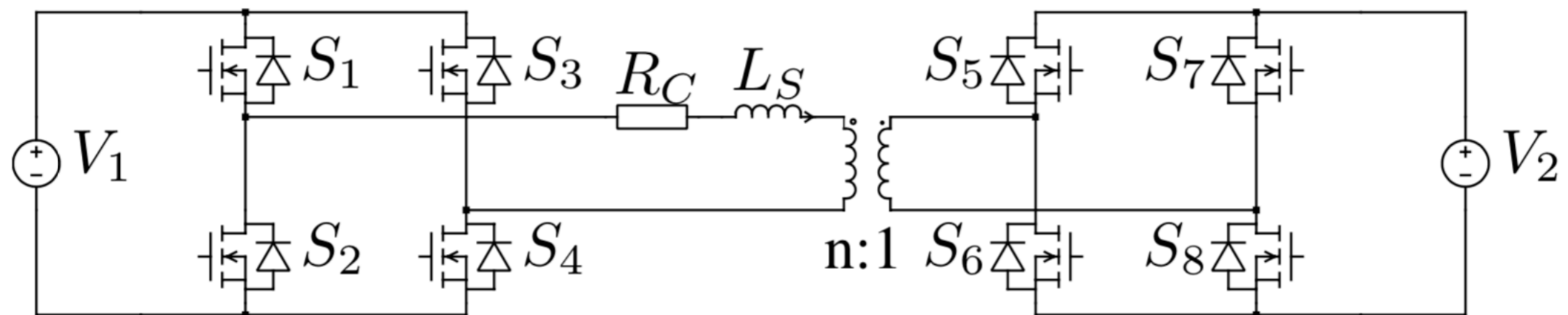

UnABESA DAB Design

Parameter	Value
Input Voltage	700V
Output Voltage Range	300V - 450V
Nominal Power	20kW
Switching Frequency	60kHz
Leakage Inductance	23 μ H
Transformer Ratio	2
Equivalent Resistance	441m Ω

Dual Active Bridge

Principle of operation:

- High frequency AC modulated with h-bridges
- Current limited by stray inductance of transformer

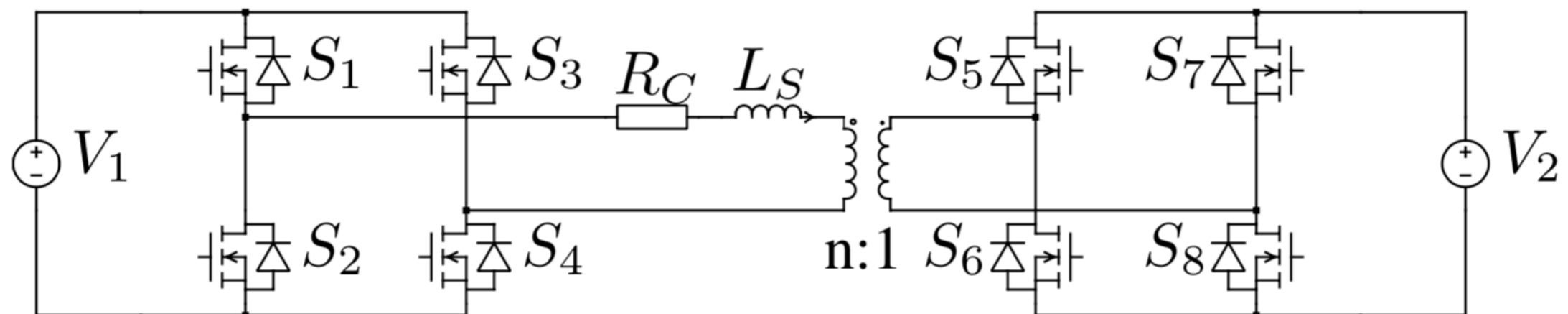

DAB Simplified

Simplified DAB model:

- Voltage sources are dependent on h-bridge state
- Resistances and inductances are combined and referenced to primary side

State	S1	S2	S3	S4
1	On	Off	Off	On
0	On	Off	On	Off
0	Off	On	Off	On
-1	Off	On	On	Off

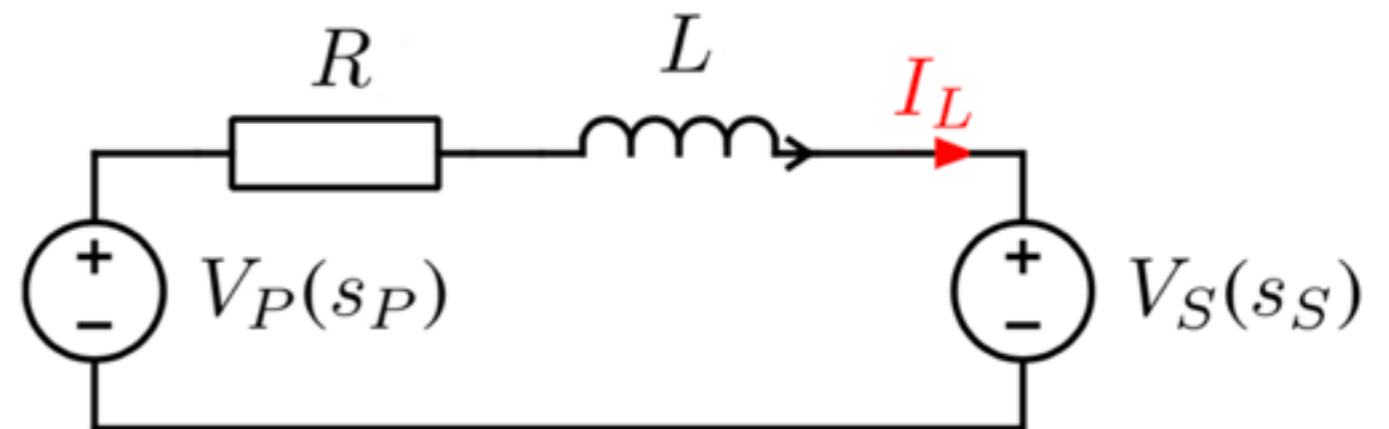

DAB Simplified

$$V_P(s_P) = \begin{cases} +V_1 & \forall s_P = +1 \\ 0 & \forall s_P = 0 \\ -V_1 & \forall s_P = -1 \end{cases}$$

$$V_S(s_S) = \begin{cases} +V_2 n & \forall s_S = +1 \\ 0 & \forall s_S = 0 \\ -V_2 n & \forall s_S = -1 \end{cases}$$

$$V_L(s_P, s_S) = V_P(s_P) - V_S(s_S) - V_R$$

$$I_L(s_P, s_S, t) = I_0 + \frac{V_L(s_P, s_S)}{L} t$$

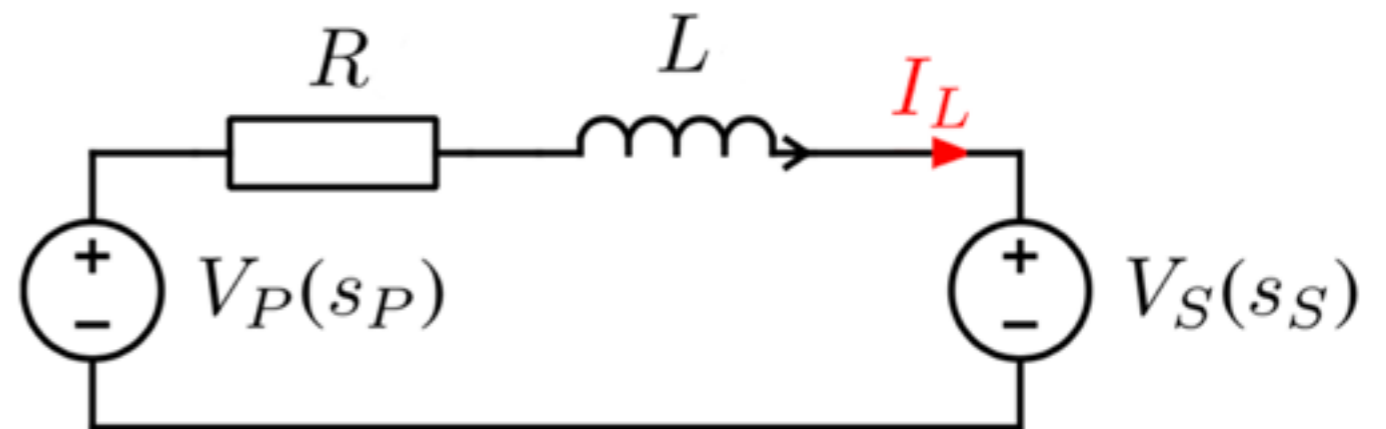

Open Loop Control with Analytic Equations

Operating Range

- Trapezoidal and triangular modulation are used
- The borders are different for varying power flow directions
- Different borders due to voltage drop over resistor

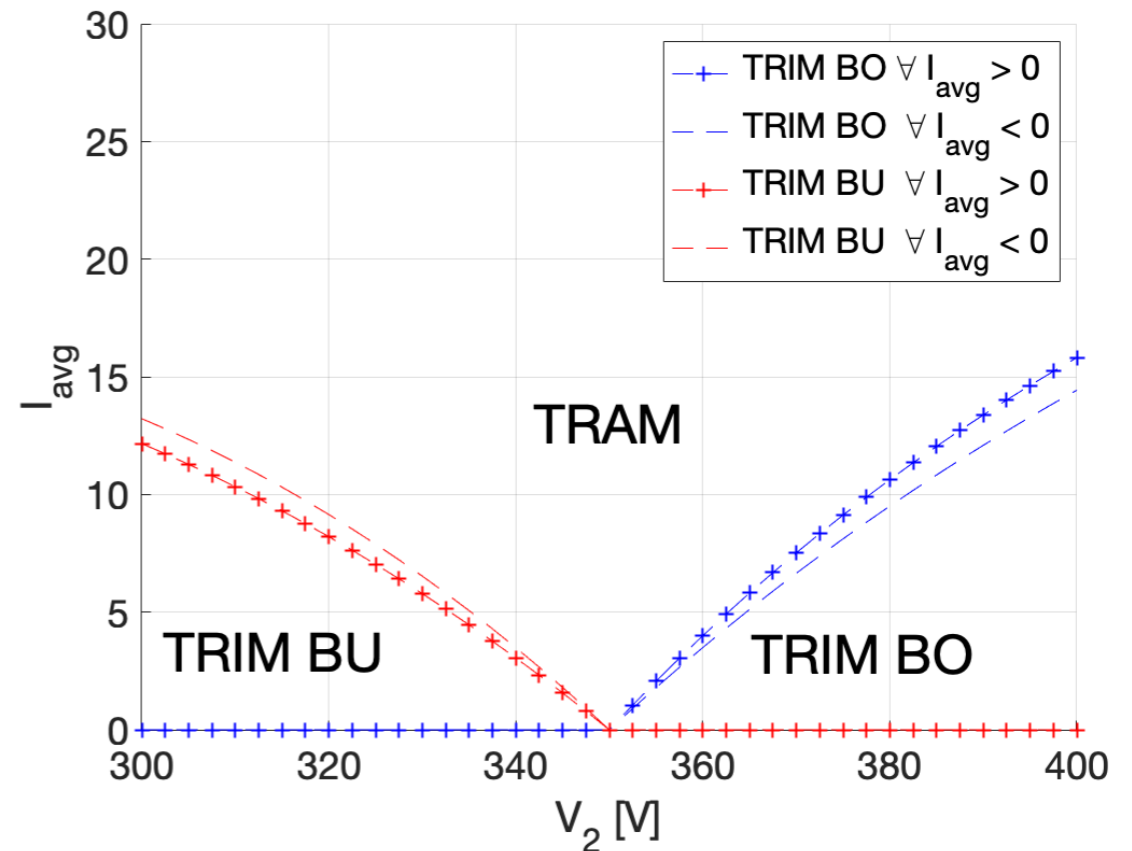

TRIM BU

- Triangular Modulation in Buck Mode
- Discontinuous mode of TRAM
- Useable for low output voltages and partial load

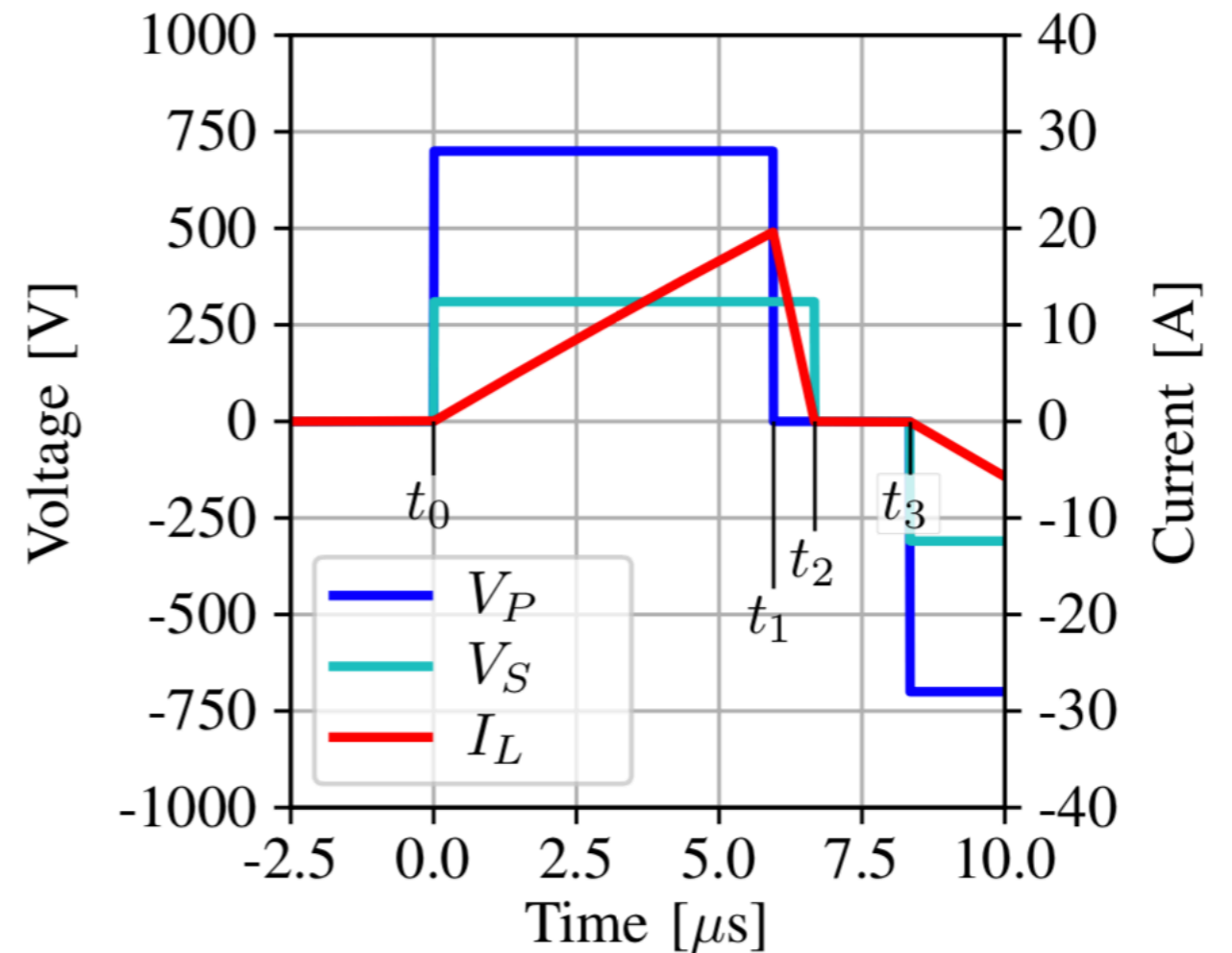

TRIM BU

$$I_L(t) = \begin{cases} \frac{V_1 - V_2 n - V_R}{L} t & \forall t = 0 \dots t_1 \\ \frac{V_1 - V_2 n - V_R}{L} t_1 + \frac{-V_2 n - V_R}{L} (t - t_1) & \forall t = t_1 \dots t_2 \\ 0 & \forall t = t_2 \dots t_3 \end{cases}$$

$$V_R = \frac{t_3}{t_1} I_{avg} R$$

$$t_3 = \frac{1}{2f_s}$$

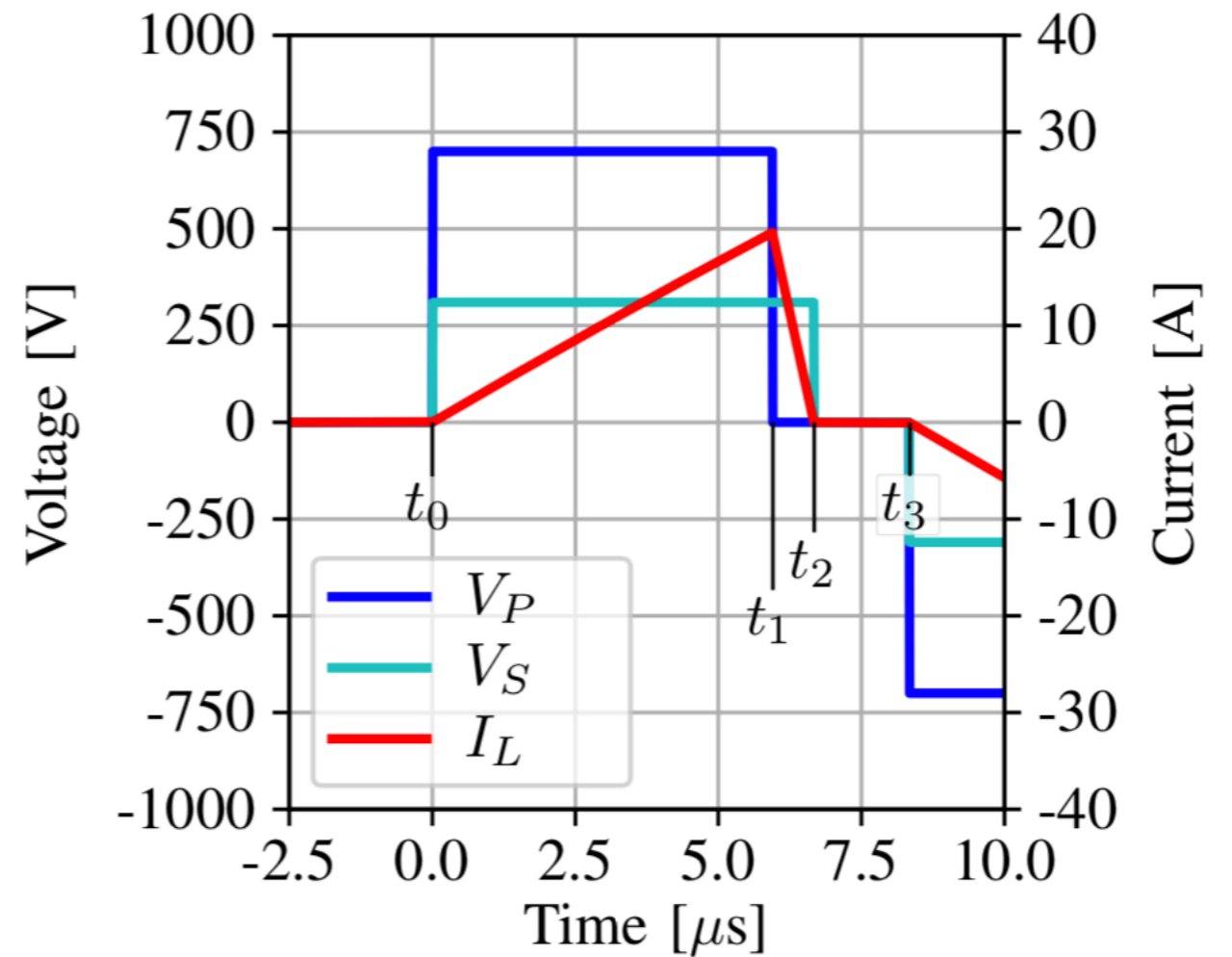

TRIM BU

$$I_{avg} = \frac{1}{t_3} \int_0^{t_1} \frac{V_1 - V_2 n - V_R}{L} t dt$$

$$t_1 = \frac{I_{ave} R \pm \sqrt{(I_{ave} R^2 + 16 L f_s (V_1 - V_2 n)) I_{ave}}}{4 f_s (V_1 - V_2 n)}$$

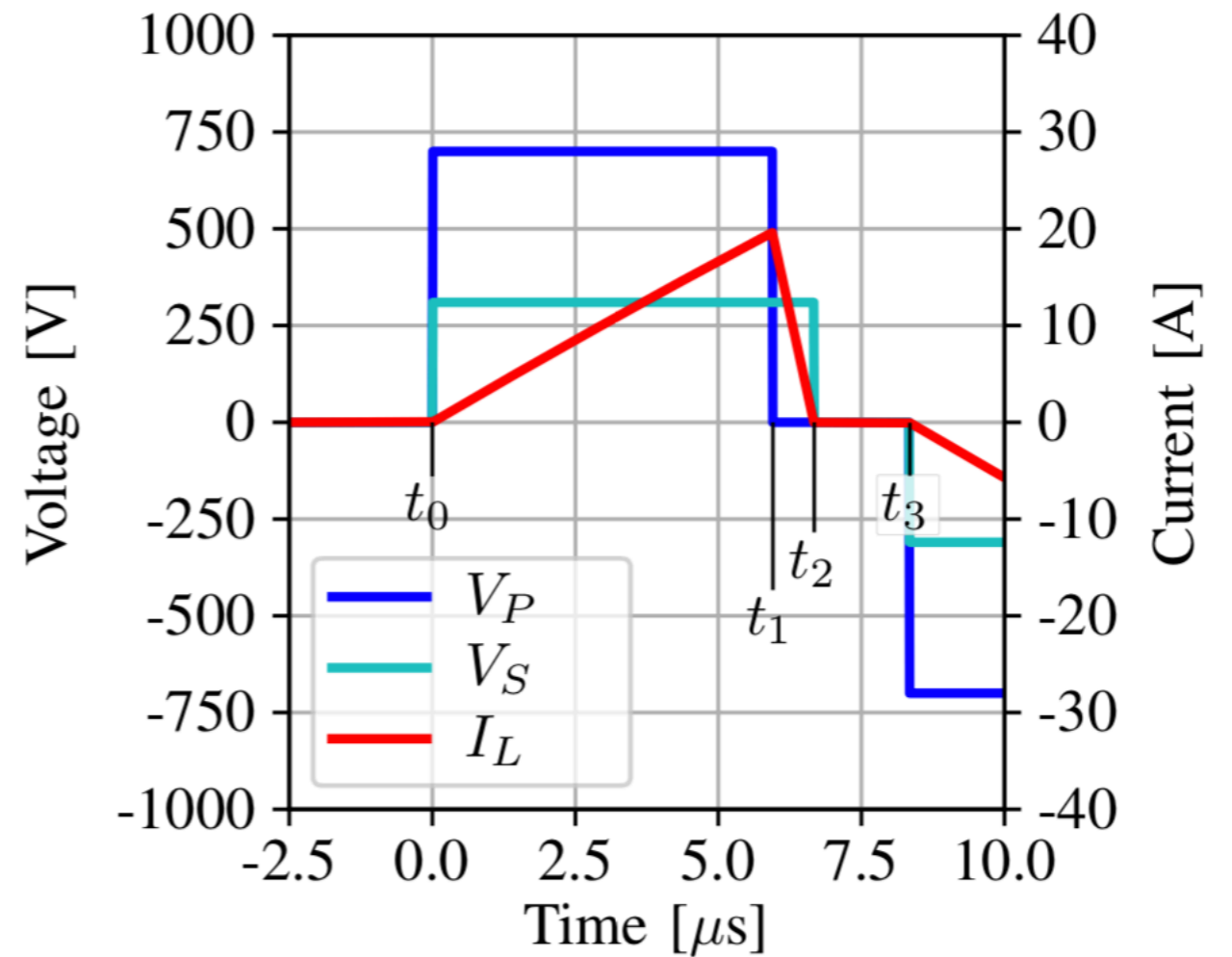

TRIM BU

$$\int_0^{t_2} V_L(s_P, s_S) dt = 0$$

$$0 = \int_0^{t_1} (V_1 - V_2 n - V_R) dt + \int_{t_1}^{t_2} (-V_2 n - V_R) dt$$

$$t_2 = \frac{2 \cdot V_1 \cdot f_s \cdot t_1^2}{2 \cdot V_2 n \cdot t_1 \cdot f_s + I_{avg} \cdot R}$$

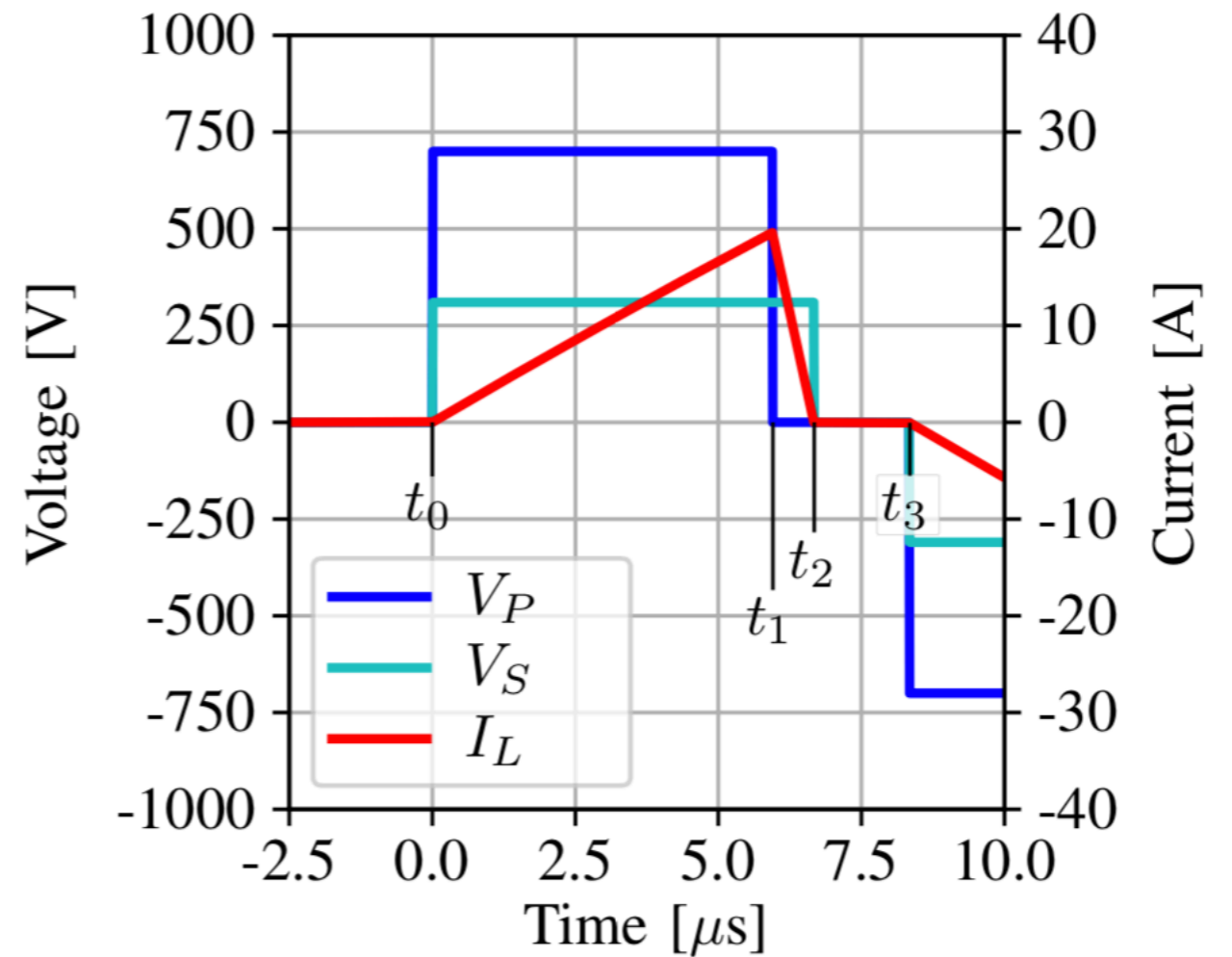

Commutation Time

- Limited dv/dt over semiconductors for ZVS
- Voltage slope dependent on inductor current I_L
- Correcting of the times dependent on the switching event is necessary

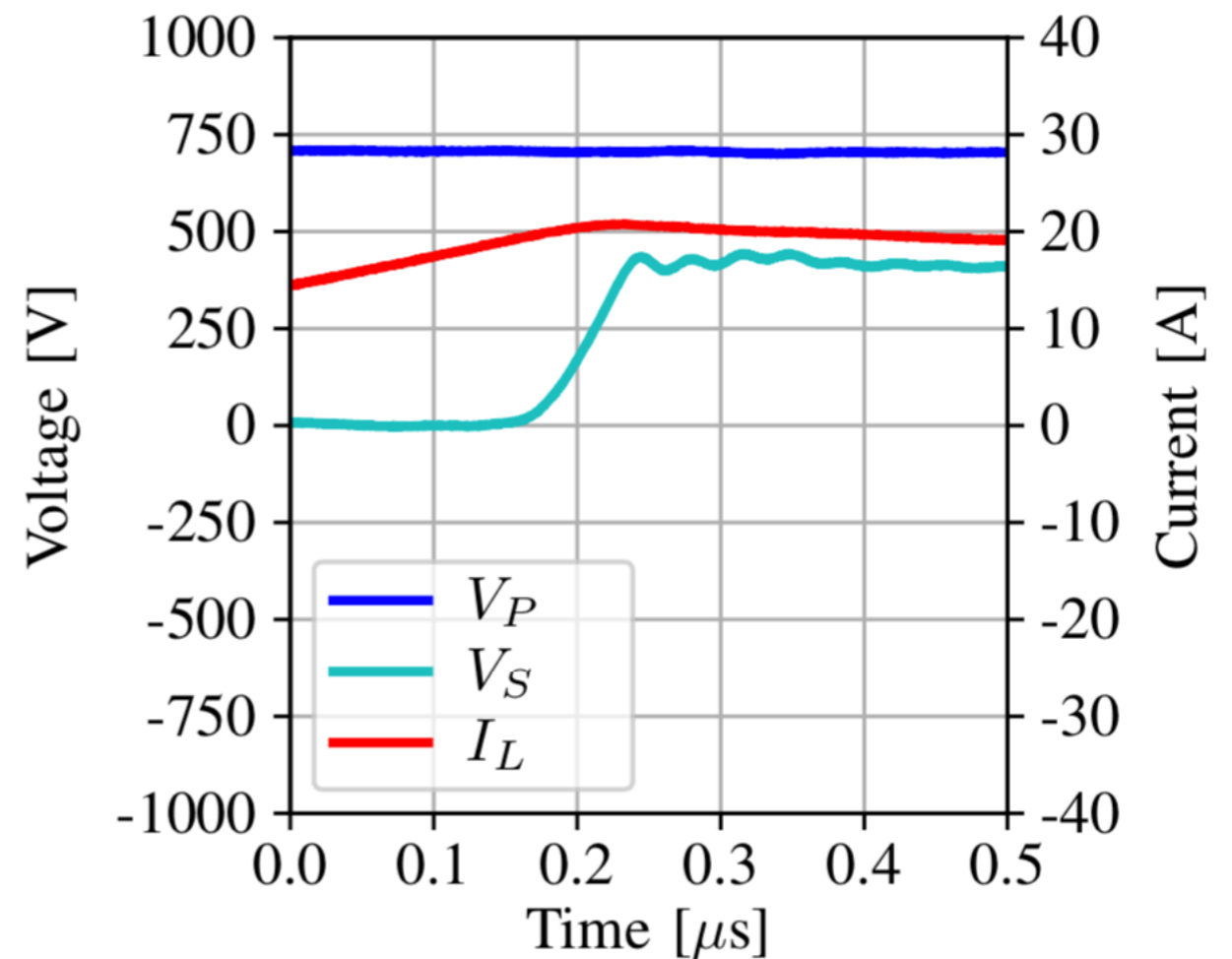

Commutation Time

- Slow commutation for ZCS
- No current flowing to discharge the parasitic capacitances
- Correcting of the times dependent on the switching event is necessary

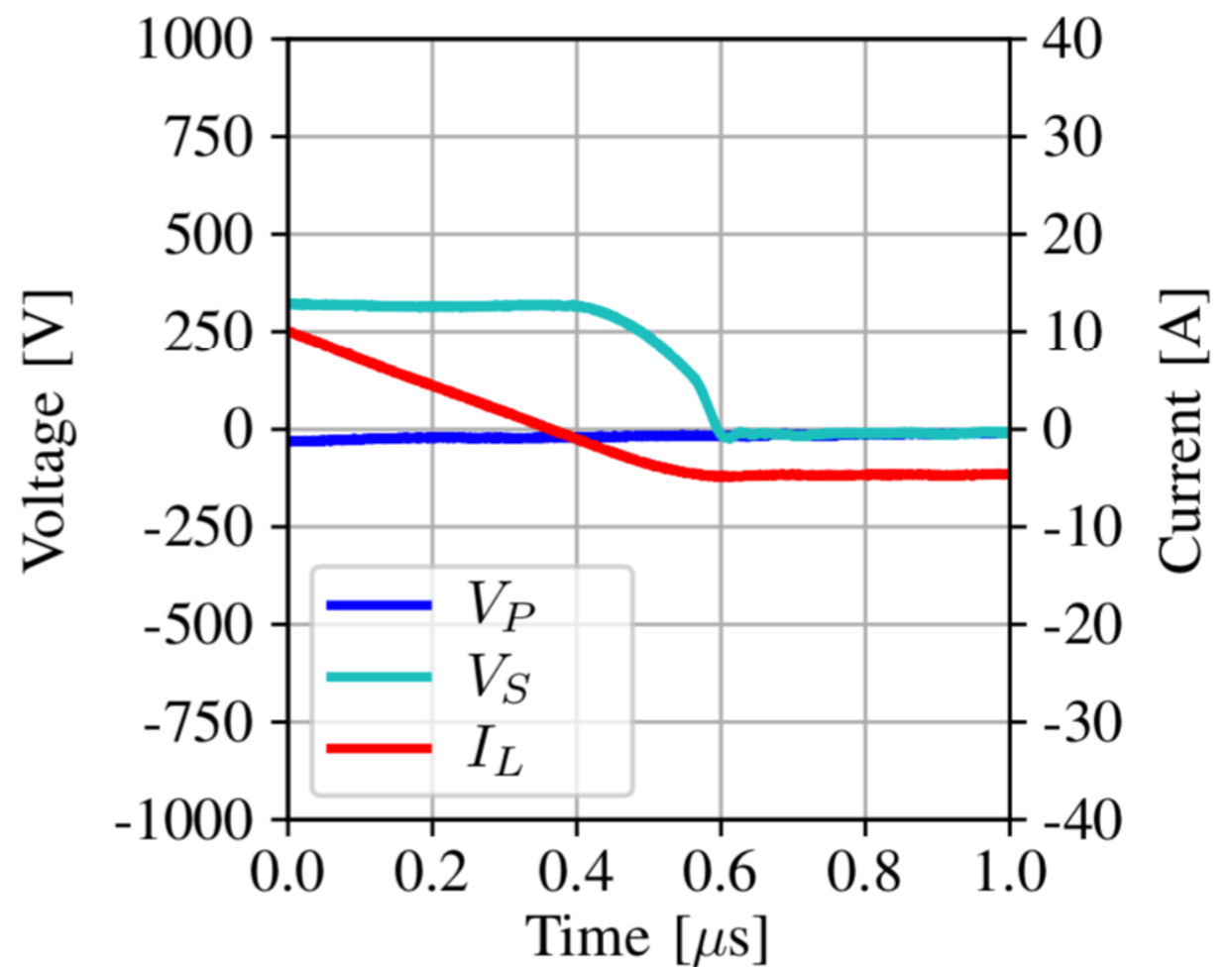

Conventional Equations

Conventional Equations

- The voltage drop over the resistor is not considered
- Zero current switching is not achieved
- The desired current is not transmitted

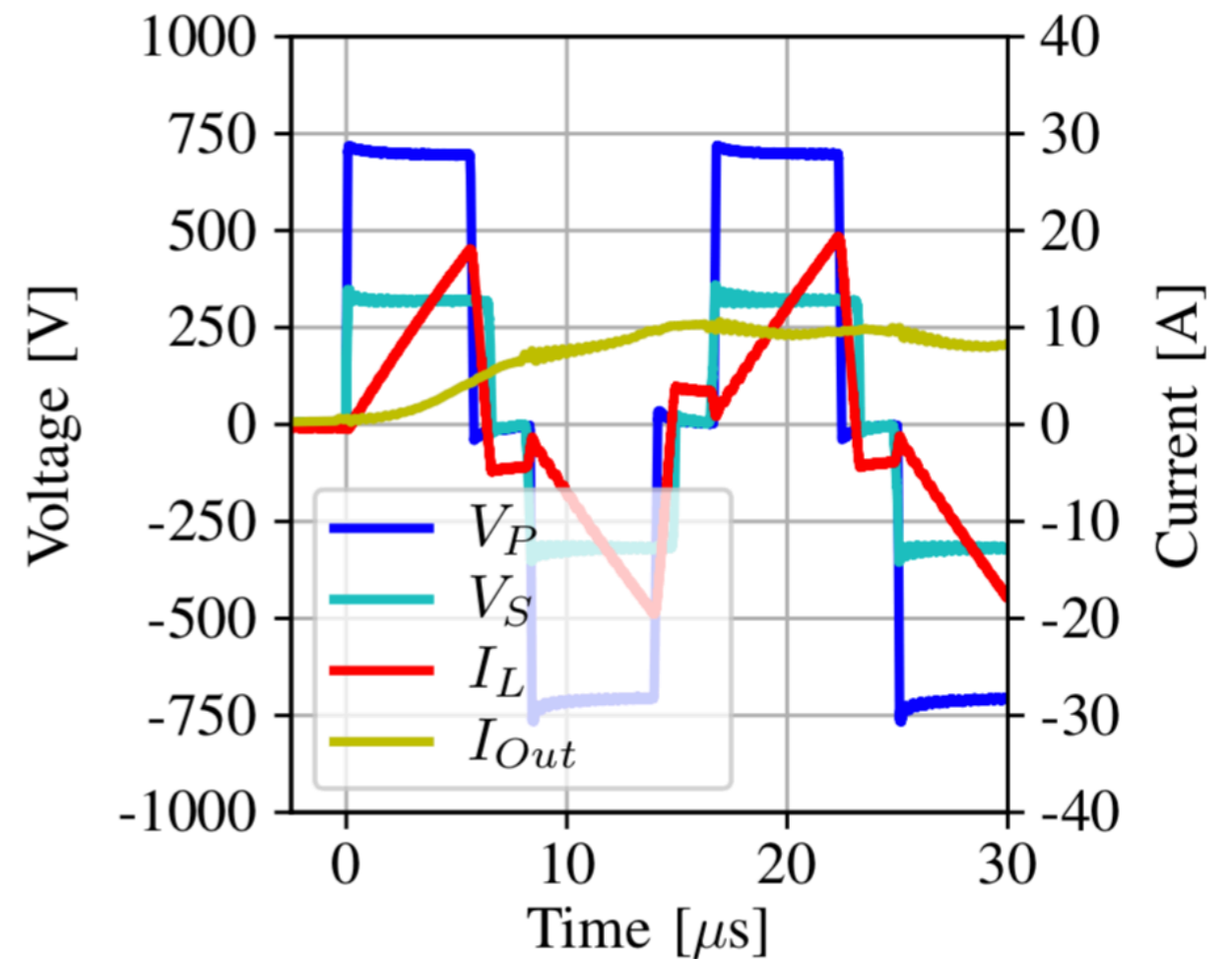

Conventional Equations

New Equations

- Current during zero current phases reduced
- The desired current is transmitted

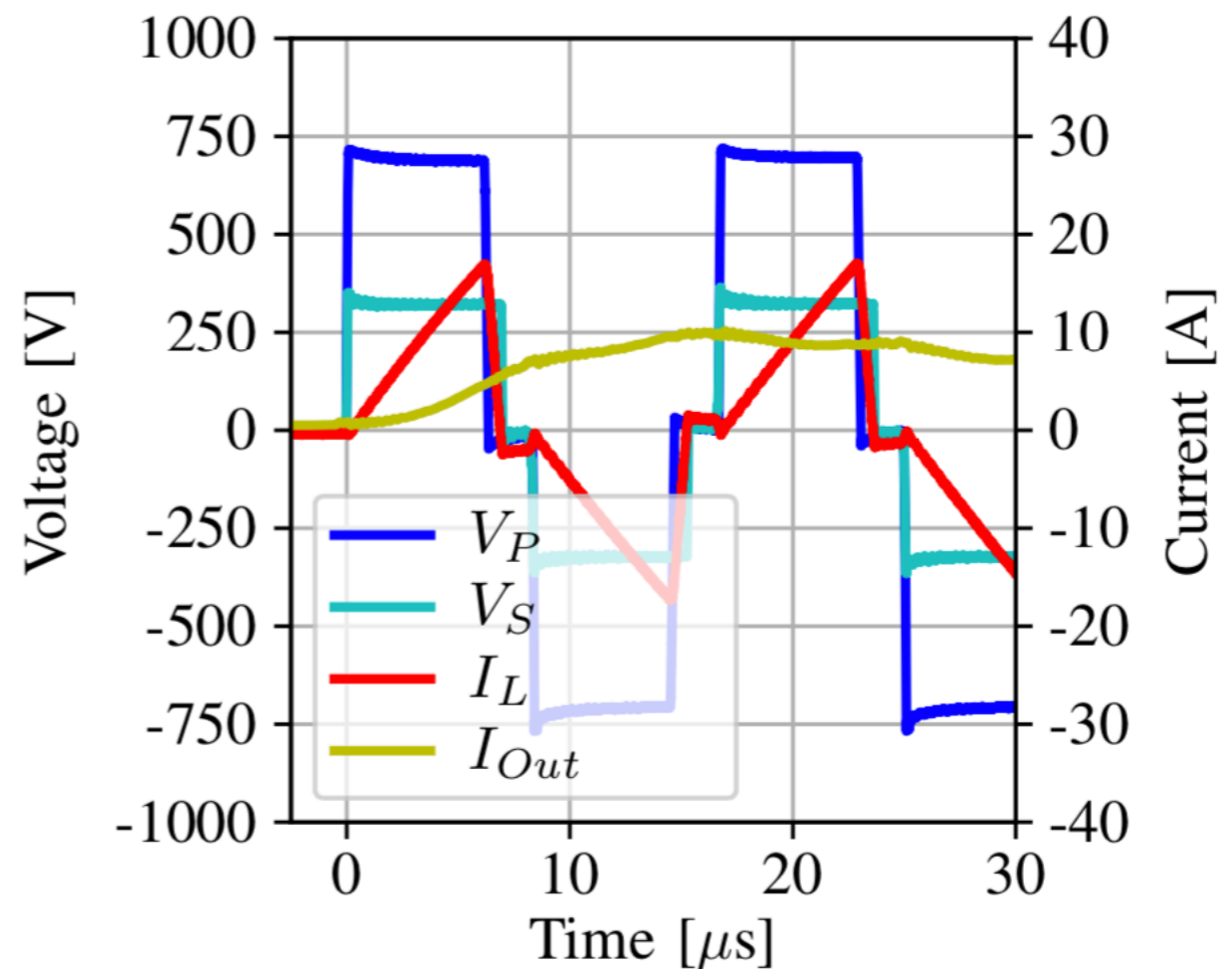

TRAM

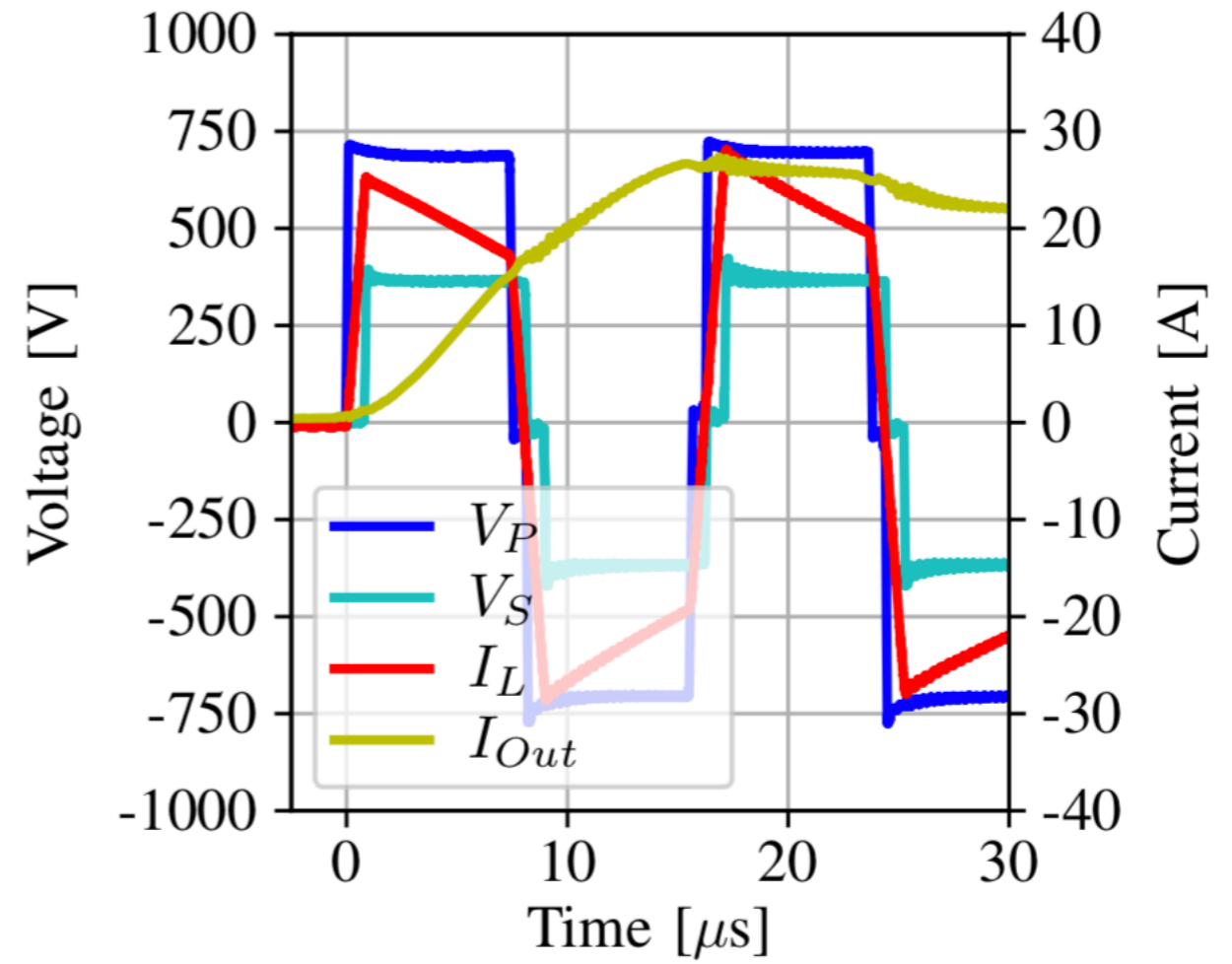
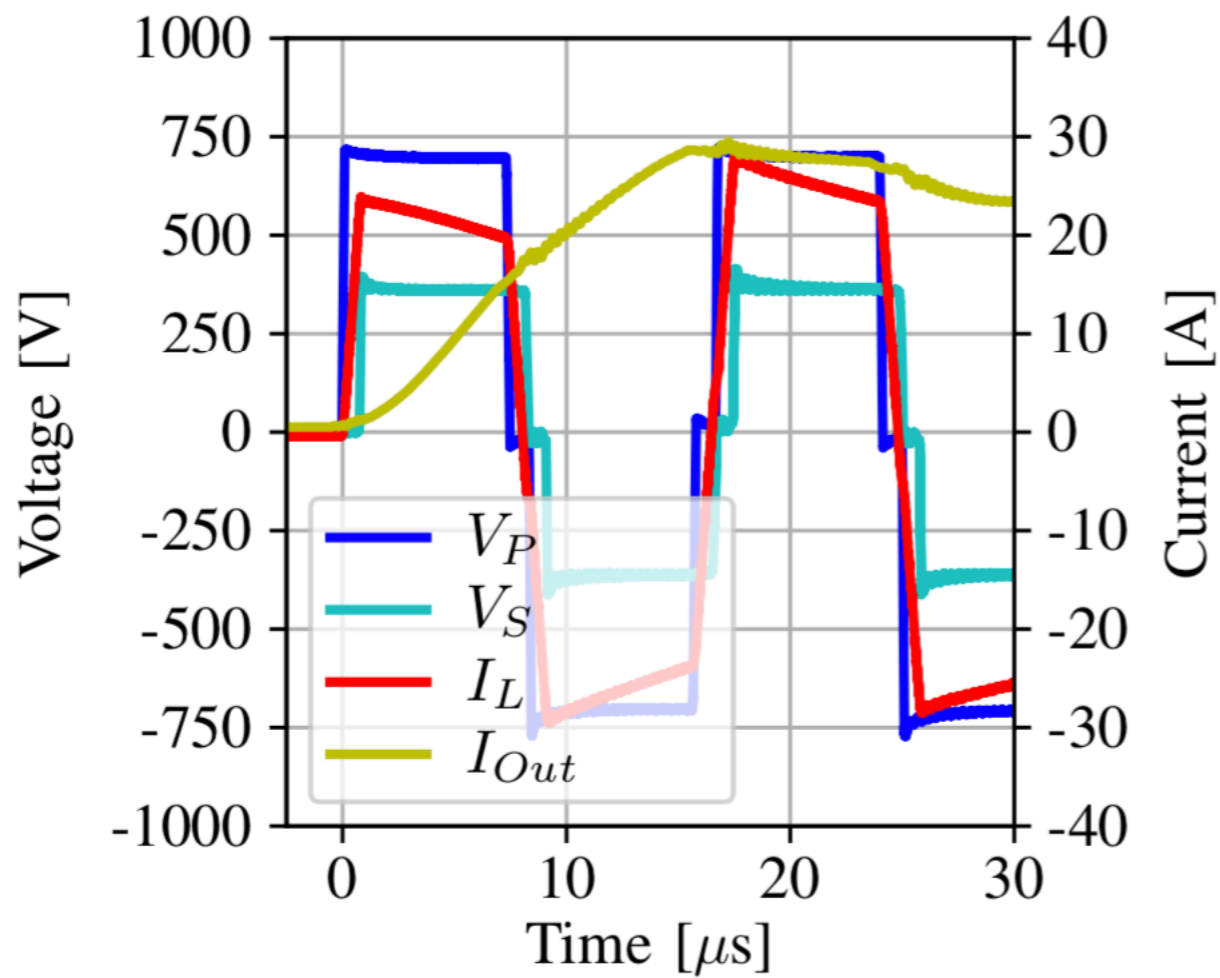

TRAM

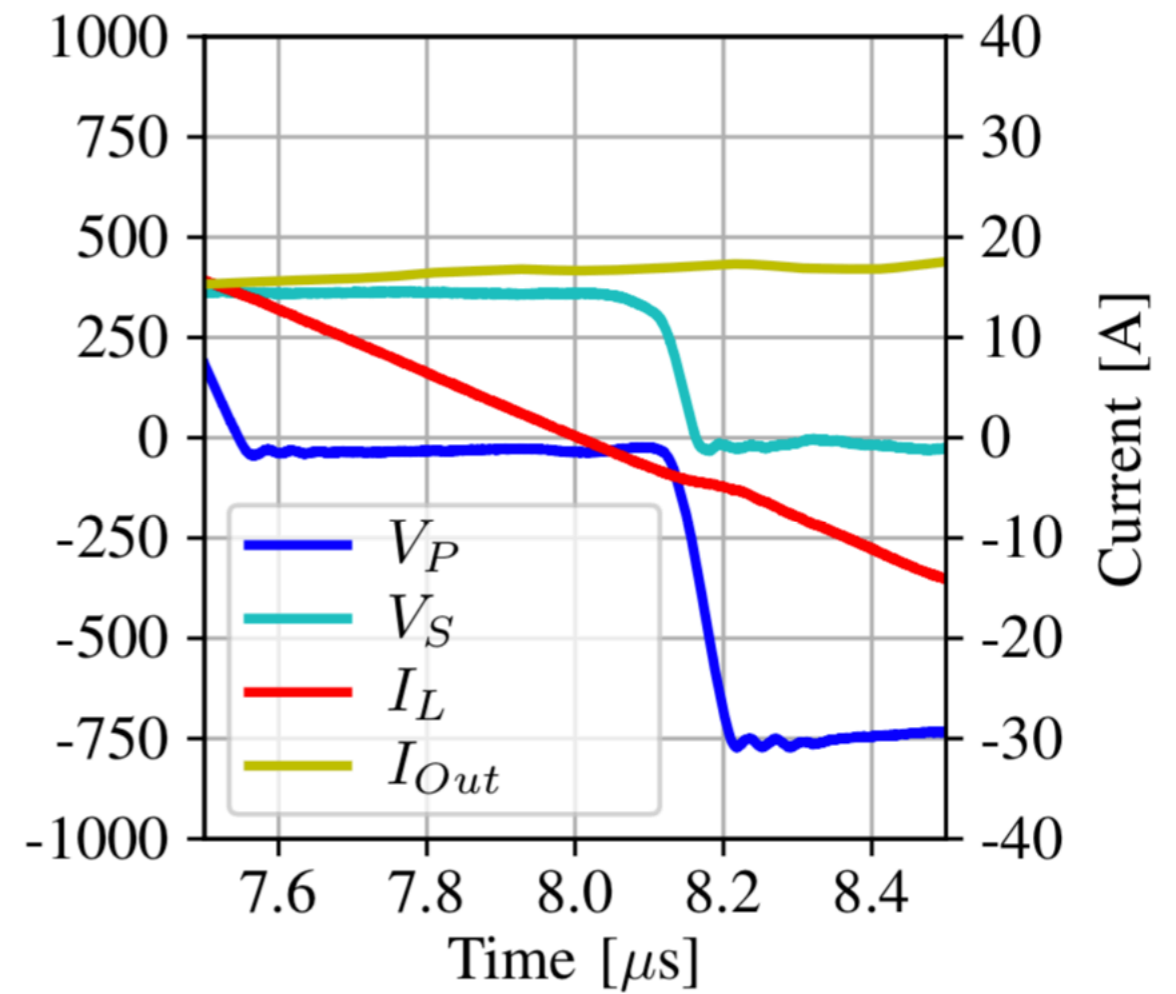
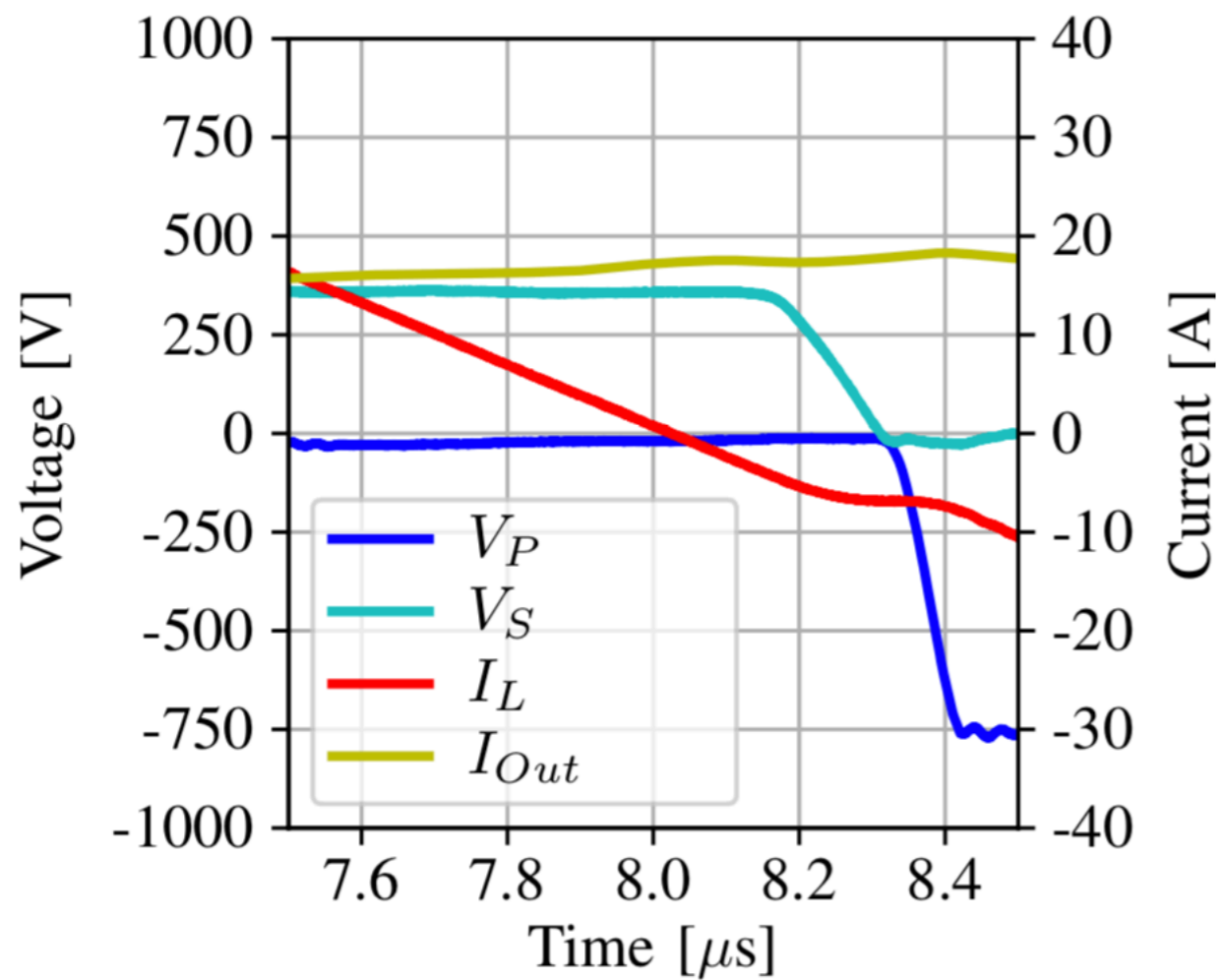

Conclusion

Conclusion

- Conventional equations for predictive open loop control have been improved by taking additional effects into account
 - Voltage drop over equivalent resistor
 - Limited commutation time
 - Dead Time
- Improved Performance has been measured with a prototype
- A very fast step response has been measured

Questions