

**Proceedings of the**

**PhD-Symposium for Applied Sciences 2011**

**"Innovation in Engineering, Economics and Social Sciences"**

**September 26 – 27, 2011**

**University of Applied Sciences Munich**









	<u>Page</u>
<b>Foreword</b>	<b>3</b>
<b><u>Papers</u></b>	
<b>Chlupsa, Christian</b> <i>The Impact of Implicit Motives on the Decision-Making Process: A Hypothesis for the Business to Business Sector</i>	<b>5</b>
<b>Dickow, Andreas, Waber, Tobias, Graf, Klemens &amp; Gregor Feiertag</b> <i>A High Speed Tempering System for MEMS Calibration and Test</i>	<b>17</b>
<b>Ehmann, Markus</b> <i>Testing Mixed Reality for an Application in Order Picking</i>	<b>23</b>
<b>Maszczyńska, Magda H.</b> <i>Transnational Organized Crime. Analysis of Gang's Structures and Networks</i>	<b>31</b>
<b>Schamberger, Florian, Ziegler, A. &amp; Gerhard Franz</b> <i>Influence of Film Thickness and CVD Deposition Rate on Surface Quality of Polyparylene Coatings</i>	<b>39</b>
<b>Steinheber, Jürgen &amp; Wolfgang Döhl</b> <i>Crossing the chasm with technologies not contributing to a proper technology mix</i>	<b>45</b>
<b>Vogt, Roland M.</b> <i>RESPONSIBLE MANAGEMENT AND MARKETING OF CAR FLEETS: How sustainable management is lived in Germany by car fleet managing companies</i>	<b>53</b>
<b>Zellner, Michael</b> <i>Hybrid strategies and firm specific individualization: Theoretically linking generic concepts, activities and resources</i>	<b>59</b>
<b>Appendix</b> <i>Call for papers</i> <i>Agenda</i>	<b>77</b>



## Foreword

■ This proceedings provide an overview of the 2rd International PhD-Symposium at the University of Applied Sciences Munich, September 26-27, 2011. The papers reflect ongoing research from PhD-Students enrolled at University of Plymouth as well as PhD Students enrolled at University of Applied Sciences in Munich.

The goal of the PhD-Symposium is to provide PhD students with an opportunity to present their work to a group of mentors and peers from a diverse set of academic and industrial institutions, to receive feedback on their doctoral research plan and progress, and to build a cohort of young researchers interested in finding new and helpful answers for current challenges.

Many thanks all those who provided their manuscripts for publication in these proceedings.

**Prof. Dr. Jürgen Spitznagel, Director of PhD-Node Munich**

**University of Applied Sciences Munich**

■ Undertaking a PhD is a life changing decision and requires courage and a passion to do research, to push the limits of understanding of yourself and the subject area. It is not a trivial choice but one that is going to take you through a whole series of emotions from elation to despair and it is only when you make it through that you appreciate what it all means. The opportunity to do a PhD is also restricted in many parts of the world to a small elite group of young, bright students based at an Ivory Tower of an Institution. This is not the case at Plymouth University where we are proud of our mission to take the opportunity for PhD study to more and more people wherever they are based. We have developed a model of approval of “nodes of Plymouth” which has developed from a single node in 2004 to ten nodes in 2012 and includes partnerships with institutions in Germany, Italy, the UK, Switzerland, the USA and Kephallonia and potential future nodes in China and Canada. Around 100 students are engaged through these nodes and they are mostly employed and holding a demanding career job, yet are motivated to become involved in a research nexus and pursue their own challenges driven by an internal curiosity. I was personally excited and proud to be involved in the establishment of the Munich node which itself grew from an existing Bachelors and Masters partnership between Munich and Plymouth Business School. Munich staff and students demonstrated such commitment to these collaborations that I was convinced that the Munich node was going to be a success and I have not been disappointed. As the European Commission wakes up to the need for PhD students to be networked with business and industry, Plymouth through both its nodes and its home based students will already be well integrated through an alumni that valued both the opportunity to study whilst remaining employed.

Remember if something is worth having, it is worth working hard for and the harder you work the luckier you get!

**Mick Fuller BSc, PhD, Head of Graduate School**

**Plymouth University**





# The Impact of Implicit Motives on the Decision-Making Process: A Hypothesis for the Business to Business Sector

Christian Chlupsa

<sup>1</sup>School of Management, University of Plymouth, Plymouth, United Kingdom

<sup>2</sup>School of Psychology, University of Plymouth, Plymouth, United Kingdom  
(christian.chlupsa@plymouth.ac.uk)

**Abstract** –This paper proposes interplay between the economic decision-making process in the field of business to business against the background of implicit motives. This theory sheds new light on the business to business decision-making process beyond the regimentation of the existing models in business and management. The article is drawn from an economical and psychological perspective and shows the missing link in the models of the business to business decision-making process. The research strategy for this paper is based on an experiment. The key idea of this hypothesis is that every decision-making process is influenced by implicit motives. These motives are stored in a non-verbal format and so our conscious mind is not involved in all decisions. Based on the results of the experiment it can be postulated with a high degree of certainty that a rational choice in B2B based on facts can be nearly ruled out. It seems that there is clear interplay between implicit motives and the choice of products.

*Keywords* –B2B, Decision Making, Implicit Motives

## I. INTRODUCTION

Decision-making forms the basis of our daily lives and this is what marketing is derived from. There are different tracks in marketing. Consumer marketing is called Business to Consumer (B2C) and industrial marketing is called Business to Business (B2B). Ultimately, all B2C and B2B marketing activities are concentrated on influencing the process of decision-making (Döhl, 2011).

The more emotions are regarded and accepted as the most powerful force in decisions made by consumers, the more and the harder companies try to keep them out of the decision-making process in business. Consumer decisions might be emotional, business decisions need to be rational. The most sophisticated approach to eliminating emotion or personal motivation from decision-making in a company is the buying-centred approach frequently applied in modern organisations (Pepels, 2004).

However, there is no way to eliminate emotion and individual motivation from decision-making in business life as there are implicit motives acting as powerful but hidden drivers. This paper will substantiate the impact of implicit motives in the business to business decision-making process.

Drawing on the recent advances in the research of implicit motives and decision-making it seems worthwhile to define the different tracks in marketing and

discuss the differences. Based on these findings, concrete models existing in the B2B decision-making process will be verified. Before such gains can be realised, it is important to understand the boundary conditions based on the hypothesis and to show the gap in the existing literature. To this end, the findings will be synthesised across a range of theories and a set of objectives will be constructed. Considering the factors determining the decision-making process, the paper will arrive at a main hypothesis. Linked to the methodology, an experiment will show first results for a broader assessment that is aimed at identifying systematic approaches.

## II. DISCUSSION

*Economical Decision-Making:* Economy is based on choices and choice means decision. This is the classical idea in the science of business and management (Zerfaß, 2010). This area of corporate management deals with the decision-making process in the company. Due to different constellations of personal and group decisions, owner and director decisions show that the operational decision-making process is a central problem in business and management (Gutenberg, 1958). There is a long tradition in science dealing with the decision-making process.

The concept of the homo oeconomicus who decides and acts based on rational principles is part of this tradition. The idea is that a defined outcome has to be achieved with a minimum of resources. Or conversely, a certain input has to obtain the best possible result. The model of the rational decision supposes that one or more defined aims should be fulfilled. Every decision-making process is characterised by a restricted number of alternatives that can be followed at the same time. The idea of the concept is that for every option, the customer gets a prognosis of the estimated consequences. The homo oeconomicus has to evaluate the future outcomes of his choice without complete and reliable information. As the future is uncertain, the homo oeconomicus has to make a decision under uncertainty. The results of his decision are uncertain (Heinen, 1986).

The complexity of economy and the economic principle are based on the general principle of rationality as well. Yet even pioneers in business and management science actually stress that the economic principle is just a formal principle without even mentioning motives and

objectives of the economic actors (Wöhe, 1971). To get a deeper insight into the different types of decision making, it seems appropriate to distinguish between the generic types of decision-making.

#### *A. Consumer Decision-Making:*

A characteristic situation of a consumer decision-making process is the weekly shopping trip to the supermarket. The customer is faced with thousands of products and brands to choose from.

##### *1) Definition of B to C Decision-Making:*

The customer decision-making process is defined as a process by which consumers identify their needs, collect information, evaluate alternatives and make a purchase decision. These actions are determined by psychological and economic factors and are influenced by environmental factors such as cultural environment, peer group and social values. In a Business to Consumer market, the offer is provided by a corporation to a customer. The term B2C is used to separate this type of market from other markets in order to identify special parameters of decision-making (Kollmann, 2011).

##### *2) The Objective Nature of B to C Decision-Making:*

The nature of the consumer decision-making is in general that the customer makes his decision for himself. The everyday decision-making process of the consumer is low-structured and does not follow defined procedures or have to face problems with limited financial budgets or critical time schedules. In contrast to the exception of limited financial resources, the customer is completely free to make a decision (Döhl, 2011).

#### *B. Business to Business Decision-Making:*

Scholars and marketing managers have focused increased attention on buyer-seller relationships in business to business markets (Cannon & William, 1999). The characteristic situation of the business to business decision-making process is the purchasing process in a company. Corporations are usually looking for specific solutions. In general the decision-making process is well-structured, subject to defined processes and supervision by hierarchical levels. The dominant perspective of the organisational buying behaviour suggests that buyers tend to rely on objective criteria when making product choice decisions (Brown, Zablah, Bellenger, & Wesley, 2011).

##### *1) Definition of B2B Decision-Making:*

Due to the theory of marginal benefit, an enterprise invests if the benefit is increased by the investment (Döhl, 2011). The decision-making process in companies is standardised. It is a step-by-step method in which hard and quantitative data is obtained by observation.

Mathematical or statistical analysis tools are used for making decisions. Generally in the Business to Business market, an offer is provided by one corporation to another. The term Business to Business is helpful to identify the specific variables of decision-making in this constellation (Kirchgeorg, 2011).

##### *2) The Objective Nature of B to B Decision-Making:*

The nature of organisational decision-making is that, in general, decisions are made against the background of many limitations such as financial budgets or timescales (Döhl, 2011). In organisations, investments and high expenditures are subject to strict limitations based on internal procedures. B2B decision-making processes are often attended by consultants such as architects, lawyers and financial advisers (San Diego State University, 2011).

#### *C. Business to Business versus Business to Customer*

As a matter of fact there are many differences between the B2B and the B2C markets. Companies operating in industrial markets are purchasing goods and services to be used in the production of other products or services which are sold to other companies (Kotler & Pfoertsch, 2006). Consumers use products for themselves. In business markets, the point of sale is company to company. In consumer markets, the point of sale is company to private individuals. B2B business faces the challenge of superior solutions for a specific problem in order to increase production figures, reduce costs or to improve services. Consumer decisions fulfil needs, are rather volatile and are based on emotion. Business decisions are based on rationality, teamwork, rules and hierarchy. They are fact-based, time-critical, face a limited budget and are focused on deficit situations.

#### *D. Existing Models of B to B Decision-Making*

Several models exist in the business to business decision-making process. Furthermore there are different classifications for the different models. In general we have to distinguish between partial and total models.

##### *1) Integrated Models:*

Total models try to analyse all influencing variables of the decision-making process (Pepels, 2004). The approach of Webster and Wind using environment, organisation of the corporation, interpersonal factors and intrapersonal factors as variables is a typical total model. The variables in the Howard and Sheth approach differ a lot: *Price, quality and information, perceptual constructs* such as involvement and awareness; *learning constructs* such as purchase intention and brand value lead to *output variables* such as attention, brand awareness, preferences, buying intention and purchase decision (Stigler, 2011).

## 2) *Partial Models:*

By contrast, partial models focus on selected aspects of the decision-making and ignore the rest. The partial models can be divided into concepts using vertical factors such as the interaction between just one participant and suppliers or customers and concepts using horizontal factors such as the interaction between both suppliers and customers (Pepels, 2004). The promoter concept, the reaction concept and the information concept are typical examples of partial models. Obviously the buying centre approach is the most prominent partial model today. Following Webster and Wind, a buying centre is a team within an organisation in which the team members have different roles: buyer, user, influencer, decision maker and gate keeper (Stigler, 2011). The idea of the buying centre approach is to assure rational decision-making, but doubts are expressed with regard to practical work (Pepels, 2004).

## 3) *The gap in the existing literature:*

Based on the B2B literature, decision-making seems to be a central problem in business and management (Gutenberg, 1958). The idea of the homo oeconomicus described in the past (Heinen, 1986) as an institution for decision-making appears to be an obsolete model. The complexity of economy and the economics just based on the general principle of rationality does not appear to be tenable (Dane & Pratt, 2007). Even pioneers in business and management stress that the economic principle is just a formal principle without mentioning motives (Wöhe, 1971). Controversial discussions about the impact of emotions draw a clear picture of the organisational buying procedure (Haehnel, 2010).

In psychology, emotions are defined as: joy, inclination, fear, unrest, sorrow, anger, aversion, condemnation, shame and excitement (Schmidt-Atzert, 2008). Inseparably, emotion goes hand in hand with motivation. No motivation without emotion and no emotion without motivation (Brandstätter, 2009). Motivation is a construct of many variables, a mix of cognitive, affective and physiological processes. From this point of view, motivation is just a hypothetical construct. The result of motivation is based on the genuine model of the classical motivation, the coincidence of a potential stimulus and personal motives depending on a specific situation (Rheinberg, 2009).

Yet no fundamental useful solution for the B2B decision-making process would be presented.

As the first objective, it should be possible to reveal a typical structure of implicit motives and to make some assumptions about the diversification of these for the people making B2B decisions in companies. Based on the structure and hierarchies of the organisation there is probably some correlation between the different formal groups of decision makers. Ideally it should be possible to attribute the same implicit motive structure to a target group within the organisation. For example, most top

managers may have the same mix in their implicit motives and a lot of management assistants will show another structure. An additional approach is the difference of the structure in implicit motives in relation to the gender factor.

The second objective is the interplay between motives and the decision-making process. Due to the fact that people have different needs based on their implicit motives, the classification of the people who make the decisions in the firms is an interesting aspect. What is the correlation between the chosen products and how does this fit with their motives?

- (i) Objective 1 – Typical structure of implicit motives
- (ii) Objective 2 – Interplay between motives and decision-making

## III. DEVELOPMENT OF HYPOTHESES

### *A. Rational Decision in Business to Business*

Against the background of various economic and psychological theories and based on the expressed doubts of the pioneers of business management, pure rational-based decision-making seems to be fairly unlikely. There is no B2B decision maker whose actions are just based on facts (Becker & Daschmann, 2010). Even in the B2B decision-making process, emotion seems to be a driving force. As mentioned before, there is no emotion without motivation.

Motivation itself is based on motives. The universal motive of the economic actors is to maximise their own benefit based on rationality, defined as rules of logic (Etzioni, 1988). This is just an idealistic approach, not suitable in every decision-making process in business. Generally it is expected that we need as much information as possible and a high performance computer to make a reliable forecast. A complex situation needs a complex solution. Actually in difficult situations the opposite is true (Gigerenzer, 2007).

Economic decisions are usually rational within certain limitations due to limited cognitive resources, convenience or lack of time. They are notably driven by the objective to maximise the benefit but also by individual motives (Kirchler, Holler, & Hartner, 2009). This is why it is worthwhile to have a closer look at motives and their impact on the decision-making process in B2B business.

## B. Impact of Motives

A motive is a driving force selecting direct cognition and indirect behaviour; it is orientating and energising (McClelland, 1987). A lot of research shows that self-assessment is incongruent with the implicit results. Explicit and implicit motives are independent constructs (Scheffer, 2009). Against this background it seems advisable to analyse the two types of motives separately.

### 1) *Explicit Motives:*

Explicit motives are connected to the speech-based self-concept of an individual. They are located in the younger parts of the brain. Explicit motives provide conscious and focused attention (Scheffer, 2009).

### 2) *Implicit Motives:*

By contrast, implicit motives are neither speech-based nor connected to the self-concepts of an individual. They are located in the older parts of the brain and have an affective core (McClelland, 1987, Scheffer, 2009). The nature of implicit motives is that they work beyond the level of consciousness (Langes, 2009).

## C. Generating Main Hypotheses

It is not easy to find out what makes a man tick: behaviour, energy or tenacity. The reason why the analysis is difficult is that the most important motives are implicit. These motives are stored in a non-verbal format (Scheffer, 2005). Our conscious mind is not involved in all decisions (Storch, 2006). The reason is that our emotional memory is much older than our conscious memory. For every decision we have two systems of responding to a stimulus: the rational system and the emotional system.

The explicit memory works slowly and processes as many details as possible. We can realise and formulate all information in our explicit memory, also known as episodic memory. The explicit memory is characterised by a conscious recollection of the event and the reflection about the event (Lee, 2002).

The implicit memory works in a fast and diffuse manner. It is more difficult to articulate the information we receive from our implicit memory. The implicit memory is the emotional part of our brain. It delivers the feelings we have when we try to make a good decision.

If we want to make a rational decision we need time to evaluate every possibility. The implicit memory gives the feedback for a decision in 200 milliseconds, in every situation, even if we are exhausted (Storch, 2006). Whereas the explicit memory is characterised by the conscious recollection of an event, the implicit memory performs better at the task of having an experienced event (Lee, 2002). The emotional memory conserves knowledge as emotions and feelings, and is the storage of all our life experience. If we have to make a

decision, our brain produces imaginary pictures of future scenarios. We look into the future like a shortmovie trailer (Storch, 2006). That is the moment we try to find the best solution, based on the stored emotion.

Research has clearly detected four cases where implicit processes have an important role (Frieze, Hofmann, & Wänke, 2009).

#### (i). Low involvement:

The interest e.g. in advertisement is low. There is no motivation to think explicitly about the message or the product itself.

#### (ii). Pressure of time:

If we have no time to think explicitly, implicit processes dominate and we make good decisions.

#### (iii). Overload:

If we get so much information about the product or advertising messages that our cognitive resources are swamped, then we cannot think explicitly about the information.

#### (iiii). High complexity:

Complex decisions like buying a car or a washing machine can benefit from the implicit system because, due to its large capacity, it can process all the relevant details needed.

To sum up, current research proves that the implicit system dominates decisions with low involvement, pressure of time, information overload or confusion based on a high scale of complexity. By contrast, the explicit system plays an important role in decisions with high involvement with a low scale of reflexion and a lot of time (Frieze, Hofmann, & Wänke, 2009). If we compare this to the classical idea of decision-making of the rational Homo oeconomicus we get a completely new picture. Every offer has a package of rational information but it seems that the package of implicit information is even bigger. What does this mean for the daily decision-making process in the business to business sector? What are the hidden factors having an impact on the decision-making process? This leads to two main hypotheses:

H1: Business people have a typical structure of implicit motives

H2: There is interplay between the implicit motives and B2B decision-making

#### IV. METHODOLOGY

##### 1) *Philosophical Position of Ontology and Critical Realism:*

The paper is written on the philosophical position of realism, with the essence that what our senses show us is real and true. Objects have an existence independent of the human mind. The paper is written in the assumption of ontology with the aspect of subjectivism. The idea is to interpret the results through social conditioning. The type of realism is critical realism. "Critical realists point out how often our senses deceive us" (Saunders, Philip, & Thornhill, 2009). The very idea is to show the effects of deceiving of your senses in the decision-making process, especially in the business to business sector. What we see in reality are often sensations which are mere illusions of what is real (Saunders, Philip, & Thornhill, 2009).

These sensations are important factors of our daily life and our decision-making process as well. Thus, the critical realist's position is that our knowledge of reality is a result of social conditioning and cannot be understood independently of the social actors involved in the knowledge derivation process (Dobson, 2002).

##### 2) *Deductive Research Approach:*

The research approach of the thesis is based on a deductive approach. "This is whether your research should use the deductive approach, in which you develop a theory a hypothesis (or hypotheses) and design a research strategy to test the hypothesis..." (Saunders, Philip, & Thornhill, 2009). The theory is that implicit motives based in the human brain influence the business to business decision-making process. In the first step, there is the search to explain causal relationships between variables (Saunders, Philip, & Thornhill, 2009). Variables are implicit motives themselves: the age of the people, the gender of the people and the position within the hierarchy of the organisation. The aim of the deduction is to come to a level of generalisation.

##### 3) *Research Design:*

The paper shows the direct connection between implicit motives based in every human brain and the right coding of communication. The unique approach of this paper is that all research in the area is based on consumer products. The theoretical justification of the thesis is close to the impact of emotions in the B2B (Haehnel, 2010). Yet the focus of interest is not on the level of emotion. It penetrates deeper into the area of implicit motives which are regarded as important drivers in the decision-making process. This paper tries to examine if implicit motives are an important factor in the B2B decision-making process.

The research strategy of the whole thesis is based on an experiment, a survey and interviews.

An experiment should give a first indication for the decision-making process. If the decision-making process were completely rational, the experiment will bring no variations in the decision. The tested persons should always make the same economic decision. Due to the relationship between benefit and performance, just one of the products could be the best. To get a clear result it will be important to detect the right stimulus for the manipulation of a business to business decision focused on implicit motives. In literature there is the hint to implement an experimental group and a control group. Finally there is no possibility of creating a placebo effect without triggering implicit motives themselves. The reason is that both sides of the experiment are manipulated by the unconscious mind which is the basis for interpreting the communication.

A survey combined with the experiment should help to detect the particular relationship between the variables used and the official data. Answering the research questions within the dimensions of who, what, where, how much and how many is a popular, frequently used and common strategy in business and management science (Saunders, Philip, & Thornhill, 2009).

The results will be discussed with experts from different industries to reveal the impact for business to business marketing.

##### 4) *Research Method Mixed Methods Approach:*

Data collection and data analysis are based on multiple methods. Based on a cross-sectional analysis it is a mixed methods approach. The focus is on the non-numeric data such as words but the statistical work will prove the correlation between the statements and the reactions of the test subjects. The qualitative data will be quantified and converted into numerical codes to allow a statistical analysis (Saunders, Philip, & Thornhill, 2009). The reason for the mixed methods approach is to move from the individual level to a general level. This will allow a solid analysis and clear statements to be made regarding the correlation of variables and results.

##### 5) *Data Collection:*

The basic structure of the thesis is based on international secondary literature. Secondary literature involves books and journals. The detailed content is based on primary literature. Primary literature involves sources such as reports, white papers and planning documents. The terms are reviewed in the tertiary literature. Tertiary literature involves media such as encyclopaedias and dictionaries (Saunders, Philip, & Thornhill, 2009).

## V. EXPERIMENT

*Description of the Pilot Test:* The idea behind the experiment is to show the direct interplay between implicit motives and the business to business decision-making process. If the decision-making process were completely rational, people should make the same economic decision twice. The test subjects had to come up with a standard buying scenario in the field of investment goods. They have to buy two investment products: a car and office equipment. Masters and Diploma students of the University of Applied Sciences in Munich were used as the test subjects.

The experiment has three dimensions and different stages:

- (i) Test of the implicit motives of the test subjects.
- (ii) Buying process for personal use (car and office equipment)
- (iii) Buying process for three colleagues (car and office equipment)

In the first stage, the test subject had to buy a company car and office equipment for himself. In the second stage they had to buy company cars and office equipment for three colleagues. The idea behind the experiment is that the implicit category of the test subject will match with the implicit codes of the product and the implicit code of communication. If the test subjects choose a product for a colleague, the implicit category should match the implicit type of the colleagues. If our test subjects are the so-called Homo oeconomicus, the choice must be the same product each time. In this case it is not important if they buy a car or other investment good for their colleagues or themselves. The decision should be based only on the facts and features of the product.

For the OMT test, the social demographic data and the answering form of the experiment, mechanical numbered envelopes were used.

### 1) The Phases of the Experiment

The bright boxes show the basic experiment for the test subject's own use. The dark box show the phase of manipulation. In this phase of the experiment, the test subject is given an imaginary colleague. The task involves, after choosing a car and office equipment for himself, choosing a car and office equipment for three different, imaginary colleagues. The typology of the three different colleagues is optimised for the implicit motive structures.

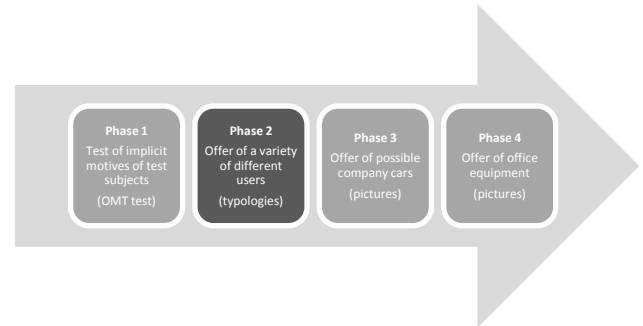

Figure 1: Phases of the experiment

*Phase 1 of the Experiment - The Mind Set:* The first stage of the experiment is to check the implicit mind set of the test subject. For this stage, the Operant Multimotive Test (OMT) will be used. It is similar to the Thematic Apperception Test (TAT). The test subjects are given ambiguous pictures. Based on their former experiences, the test subjects come to a personal interpretation of the picture. The aim of the test is to show the structure of the implicit motives.

*Phase 2 of the Experiment - The Manipulation:* The second stage is the manipulation phase. In the first step of the experiment, the test subject must buy a product for himself. In the second version of the experiment, the test subject must buy a business to business product for three colleagues. These colleagues are not real. The typology of the colleagues is based on the implicit motives. The idea is to trigger the mirror neurons which are the base for social understanding. So the test subject should decode the implicit motives of the fictive colleague and choose the right product.

*Phase 3 of the Experiment - The Company Car:* In the third stage, the test subjects are given a selection of cars. The budget for the cars is nearly the same but the cars are different. First we have cars which reflect the needs of persons with different implicit characteristics. For the pilot test, the choice of cars was a grey Volvo for the implicit motive affiliation, a black Chrysler for the implicit motive power and a red Alfa Romeo for the implicit motive achievement. The backgrounds of the pictures and the colours of the cars were adapted to the areas of association based on the implicit motives.

*Phase 4 of the Experiment - The Business Product:* The fourth stage in the experiment is the same procedure as for the car experiment. The choice will have the same structure for the test subjects. Phase four is to make sure that the choice of the test subject has the quality of a similar decision based on the implicit motives.

21 participants take part in the experiment. The result of 21 participants is again 21 possible answers in diverse dimensions. So it seems useful to use a professional statistic tool, SPSS.

2) The implicit motives via the OMT test

Implicit Motive				
	Frequency	Percent	Valid Percent	Cumulative Percent
Affiliation	8	38.1	38.1	38.1
Achievement	3	14.3	14.3	52.4
Power	10	47.6	47.6	100.0
Total	21	100.0	100.0	

Figure 2: Frequency of implicit motives

At 47.6 percent, the implicit motive power is the clearly dominant motive. It is an impressive dimension but it differs a lot from the initial assumption.

H1a: Structure of implicit motives is connected to the hierarchy

H1a<sup>1</sup>: High potentials have a power motive

The theory dictates that they should have the classic implicit profile of the High Performers (Häusel, 2005). In 2007, 55 percent of the population in the United Kingdom and 34 percent of the population in Germany began tertiary education. Just 38.7 percent of the UK and just 23.4 percent of the German population graduated at a tertiary education level. (OECD 2010). So it can be assumed that the tested students are willing and want to perform. They are a society's high potentials. People who are successful in their job and are highly motivated are known as High Performer(Häusel, 2005).

The second most frequent implicit motive with 38.1 percent in the tested group was affiliation.

H1b: Implicit motives are connected to the gender

H1b<sup>1</sup>: Women and old people are affiliation-motivated

This is actually surprising because the implicit motive affiliation is usually more often found in the peer group of women and older people (Branding Code, 2011). So it seems to be useful to have a narrow view on the gender factor.

The quota of 28.6 percent of female participants could not be the reason for the disproportionate cumulative percentage of the implicit motive affiliation. So it seems useful to examine the coherence between gender and the implicit motive structure

Gender				
	Frequency	Percent	Valid Percent	Cumulative Percent
Female	6	28.6	28.6	28.6
Male	15	71.4	71.4	100.0
Total	21	100.0	100.0	

Figure 3: Evaluation of frequency of gender

The bar chart visualises the result of the cross tabulation of the implicit motives and shows that the implicit motive power is dominated by the male students participating in the test

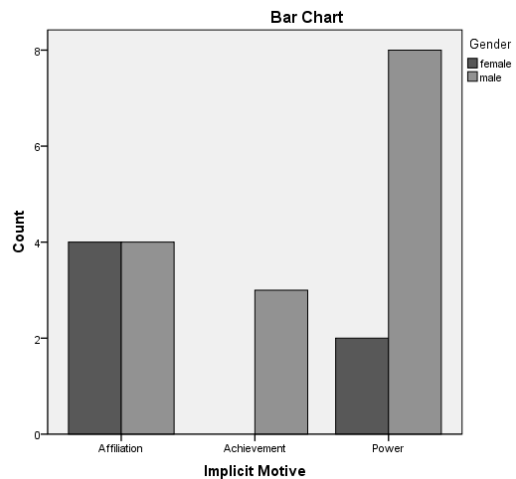

Figure 4: Implicit motives of the test subjects

With a Cramer's contingency coefficient V of 0.4, a statistical relationship between the implicit motives and the gender of the tested students is verifiable. The Cramer's contingency coefficient is always between 0 and 1, regardless of the volume of data. In social science, a correlation is valid if the Cramer's contingency coefficient V is more than 0.3. So the correlation between the motives and gender is not significant but numerically provable.

The third implicit motive with 14.3 percent was achievement. This is actually surprising given the young student peer group.

*The Company Car:* Most of the test subjects choose the car with the seemingly implicit coding of power, although they are categorised in the typology of the implicit motive affiliation. Two possible reasons are that the used car has more implicit coding in the dimension of affiliation. The Chrysler is a big car with a robust style and so maybe the wrong associations would be triggered. The second possibility is that the evaluation of the

implicit motives of the OMT test has a bigger deficit than expected.

The analysis of the cross-tabs shows no clear correlations at first glance between the implicit motives and the chosen car. Yet the Cramer's contingency coefficient V shows a relatively clear correlation between the two dimensions. With a Cramer's V of 0.616 it seems that there is a statistical correlation between the implicit motives and the car chosen by the test subjects.

Symmetric measures			
		Value	Approx. Sig.
Nominal by	Phi	.871	.003
Nominal	Cramer's V	.616	.003
	contingency coefficient	.657	.003
N of valid vases		21	

Figure 5: Contingency coefficient motives vs. personal choice of car

Most people with the implicit motive affiliation take the power-coded car. People with the implicit motive achievement more often choose the car with the affiliation coding as the achievement-coded car. Most of the power-coded people choose the achievement-coded, then the affiliation-coded and lastly the power-coded car. The coding process of the implicit codes of product and communication goes awry. In addition, a deficit in the interpretation of the implicit motives goes awry.

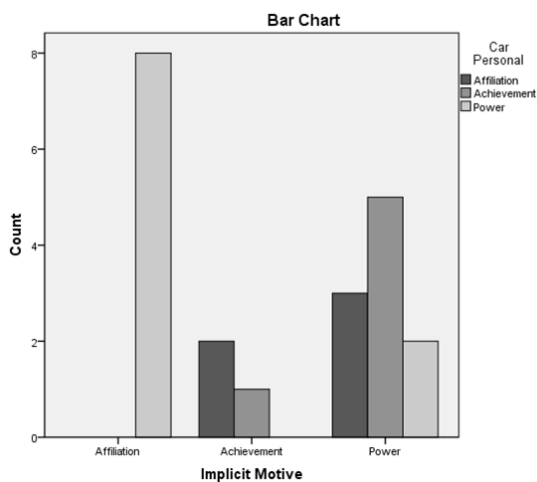

Figure 6: Implicit motives versus personal car

*The Business Product:* In the analysis of the connection between the test subjects' implicit motives and the implicit coding of the office equipment, more people with the implicit motive affiliation choose the affiliation-coded product and more people with the implicit motive power choose the power-coded product.

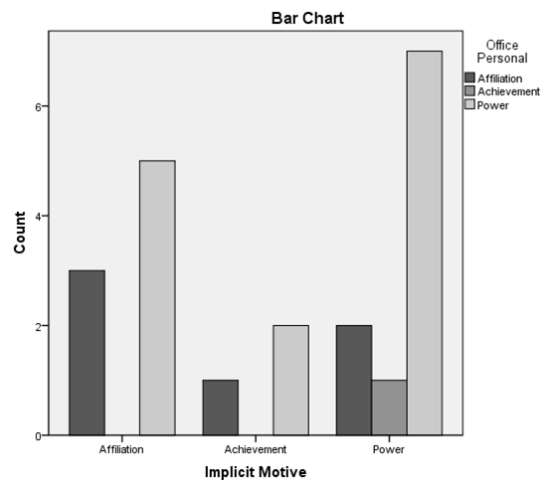

Figure 7: Implicit motives vs. office personal choice

It seems that the bar chart clearly visualises the connection between the implicit motives and the implicit product coding. In the field of achievement, the result was not positive. Yet in the area of affiliation and power, more people chose the expected products.

*Colleague Manipulation - Affiliation:* The cross-check with the connection between the imaginary implicit motive affiliation and the product choice for the controller colleague shows a relatively clear picture. Most test subjects choose the suitable product for the imaginary controller colleague.

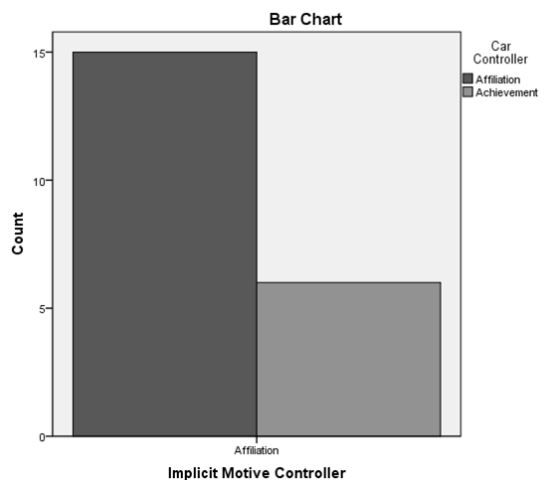

Figure 8: Choice car controller



A classical statistical contingency coefficient such as Cramer's V is not possible because the variable implicit motive affiliation for the controller colleague is constant but the bar charts show the extreme correlation.

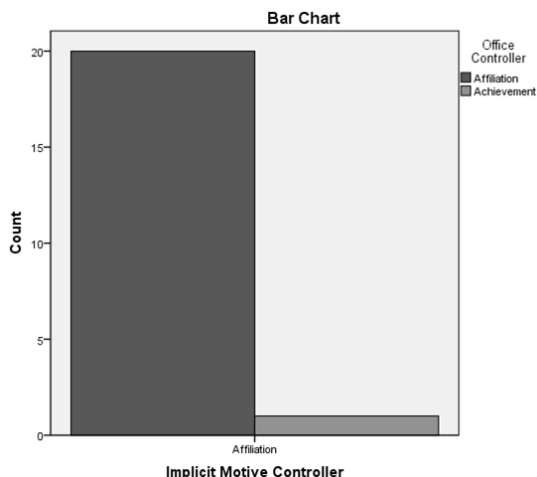

Figure 9: Choice Office Controller

*The Colleague Manipulation Power:* The cross-tabs with the connection between the imaginary implicit motive power and the product choice for the management colleague show a relatively clear picture in the case of car choice, however the office choice is wrong. Most test subjects choose the suitable product for the imaginary controller colleague

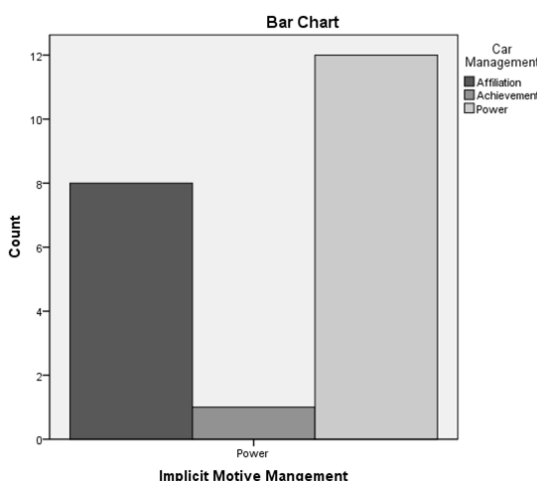

Figure 10: Choice car management

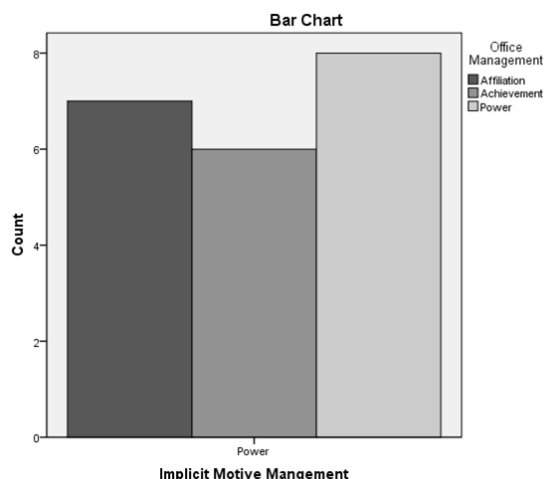

Figure 11: Choice office management

A classical statistical contingency coefficient such as Cramer's V is not possible because the variable implicit motive power for the management colleague is constant but the bar charts show the extreme correlation

*Colleague Manipulation- Achievement:* The cross-check with the connection between the imaginary implicit motive achievement and the product choice for the event colleague shows a relatively clear picture. Most test subjects choose the suitable product for the imaginary event colleague.

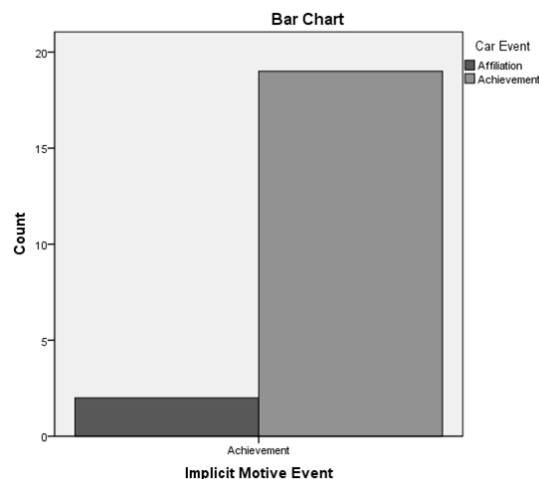

Figure 12: Choice car event

A classical statistical contingency coefficient such as Cramer's V is not possible because the variable implicit motive achievement for the event colleague is constant but the bar charts show the extreme correlation.

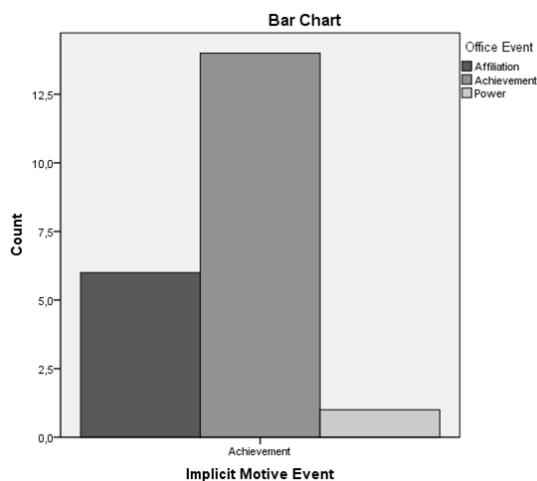

Figure 13: Choice office event

## VI. RESULT

This small pilot study as part of a complete research work of a PhD thesis has some inherent limitations in connection with the laboratory situation, the peer group and the volume of the experiment.

Yet, based on the data of the pilot test, we get the expected feedback based on the research that women are more affiliation-orientated than men. The primary assumption of an extreme dominance of the power motive in the peer group cannot be verified.

The experiment discovered that B2B decision-making seems to be far from a rational decision. Therefore the assumption that the so-called Homo oeconomicus is an obsolete model in the economic field can be committed with a highly probable forecast.

The experiment revealed that it seems more likely that people in a B2B decision-making situation are controlled by hidden drivers.

## VII. CONCLUSION

In conclusion, it is important to suggest that further research on the implicit motive in connection to the business decision-making process is important not only for building theory on this particular construct but also for increasing the field more generally.

In this study, the researcher posited that the implicit motives are an important factor in the B2B decision-making process. On the one hand, it seems important to make rational decisions. On the other hand, the nature of decision-making in B2B seems to be examined in completely new light. The theoretical justification of the thesis is close to Haehnle (Haehnel, 2010).

Yet, the focus of interest is not on the level of emotion. It penetrates deeper into the area of implicit motives which are regarded as important drivers in the decision-making process.

This theoretical concept analyses the interaction between the business to business decision-making process and the implicit motives embedded in every human being. Finally the whole research project will highlight the impact on the business to business marketing process.

Summarising, it can be postulated that a rational choice based on facts with a high degree of certainty can be ruled out. It seems that there is a clear connection between the implicit motives and the choice of products.

## ACKNOWLEDGMENTS

This paper is dedicated to my grandfather Josephus Cornelis Cornelissen, who died unexpectedly during the work on this article.

## REFERENCES

- European Communities. (2009). *European Business Facts and Figures*. Luxembourg: Office for Official Publications of the European Communities.
- San Diego State University. (2011, July 29.). Retrieved December 03., 2011, from Rohan Academic Computing: <http://www-rohan.sdsu.edu/~renglish/370/notes/chapt06/index.htm>
- Bechara, A., & Damasio, A. R. (2004). *The Somatic Marker hypothesis: A neural theory of a economic decision*. Iowa City: Elsevier.
- Becker, R. (2011, February 10). Kopf oder Bauch. (R. Otto, Interviewer)
- Becker, R., & Daschmann, G. (2010, 02 01). Noch immer entschieden der Instinkt. *B2B*, pp. 27-32.
- Branding Code. (2011, August 08). *www.branding-code.com*. Retrieved August 08, 2011, from Branding Code: <http://www.branding-code.com/en/branding-code-system.php>
- Brandstätter, V. (2009). *Handbuch der Allgemeinen Psychologie - Motivation und Emotion*. Göttingen: Hogrefe Verlag GmbH & Co.KG.
- Brown, B. P., Zablah, A. R., Bellenger, D. N., & Wesley, J. J. (2011). *When Do B2B Brands Influence the Decision Making of Organizational Buyers?* Virginia: VCU Scholl of Business.
- Cannon, J. P., & William, P. D. (1999, Novemeber). Buyer-Seller Relationship in Business Markets. *Journal of Marketing Research*, pp. 439-460.
- Damasio, A. (1994). *Descartes' Error: Emotion, Reason, and the Human Brain*. New York: Grosset/Putnam.
- Dane, E., & Pratt, M. G. (2007, Vol. 32). Exploring Intuition and its Role in Managerial Decision Making. *Academy of Management Review*, pp. 33-54.

- Deutsche Post World Net. (2007, December 12). *Wirtschaftsauskünfte & Unternehmensprofile. Möglichkeiten und Grenzen*. Bonn, Nordrhein-Westfalen, Germany: Market Research Service Center Deutsche Post World Net/Market Research und Innovation GmbH.
- Dobson, P. J. (2002, 01 02). *Information Research*. Retrieved 04 18, 2011, from an international electronic journal: <http://informationr.net/ir/7-2/paper124.html>
- Döhl, W. (1983). *Akzeptanz innovativer Technologien in Büro und Verwaltung*. Göttingen: Vandenhoeck & Ruprecht.
- Döhl, W. (2011, October 01.). *Basics of Marketing. Technical Marketing*. Munich, Bavaria, Germany: Munich University of Applied Sciences.
- Döhl, W. (2011, October 01.). *Competitive Analysis. Technical Marketing*. Munich, Bavaria, Germany: Munich University of Applied Sciences.
- Döhl, W. (2011, October 01.). *Integrated Product Life Cycle. Technical Marketing*. Munich, Bavaria, Germany: Munich University of Applied Sciences.
- Döhl, W. (2011, October 01.). *Introduction. Technical Marketing*. Munich, Bavaria, Germany: Munich University of Applied Sciences.
- Döhl, W. (2011, October 01.). *Segmentation. Technical Marketing*. Munich, Bavaria, Germany: Munich University of Applied Sciences.
- Döhl, W. (2011, October 01.). *Technology Management. Technical Marketing*. Munich, Bavaria, Germany: Munich University of Applied Sciences.
- Etzioni, A. (1988). *The moral dimension. Toward a new economics*. New York: Free Press.
- Friese, M., Hofmann, W., & Wänke, M. (2009). The impulsive consumer Predicting consumer behavior with implicit reaction time measures. In: *Wänke, Michaela (Ed.), Social psychology of consumer behavior*, pp. 335-364.
- Gigerenzer, G. (2007). *Gut Feelings - Bauchentscheidung - Die Intelligenz des Unbewussten und die Macht der Intuition*. München: Bertelsmann.
- Glimcher, P. W., Camerer, C. F., Fehr, E., & Poldrack, R. A. (2009). *Neuroeconomics*. London: Elsevier.
- Gutenberg, E. (1958). *Einführung in die Betriebswirtschaftslehre*. Wiesbaden: Betriebswirtschaftlicher Verlag Dr. Th. Gabler GmbH.
- Haehnel, C. (2010). *Emotionen bei Buying-Center-Entscheidungen*. Wiesbaden: Gabler Verlag.
- Hanoch, Y. (2008). *Can consumers have too much choice?* London: Expert-Reviews Ltd.
- Häusel, H.-G. (2005). *Think Limbic*. Planegg: Haufe Verlag.
- Häusel, H.-G. (2007). *Neuromarketing*. Planegg: Haufe Verlag.
- Heinen, E. (1986). *Einführung in die Betriebswirtschaft*. Wiesbaden: Betriebswirtschaftlicher Verlag Dr. Th. Gabler GmbH.
- Jaakkola, E. (2009). *Purchase decision-making within professional consumer services - Organizationla or consumer buying behaviour?* Turku: Sage Publications.
- Jung, H., & von Matt, J.-R. (2002). *Momentum*. Berlin: Lardon Media AG.
- Kirchgeorg, M. (2011, July 25). *Gabler Wirtschaftslexikons*. Retrieved July 25, 2011, from Gabler Wirtschaftslexikons: <http://wirtschaftslexikon.gabler.de/Archiv/57569/business-to-business-markt-v6.html>
- Kirchler, E., Holler, M., & Hartner, M. (2009). Motivationspsychologische Konzepte in der Ökonomie. In V. Brandstätter, *Handbuch der Allgemeinen Psychologie - Motivation und Emotion* (pp. 369-376). Göttingen: Hogrefe.
- Kollmann, T. (2011, July 25). *Gabler Wirtschaftslexikons*. Retrieved July 25, 2011, from Gabler Wirtschaftslexikons: <http://wirtschaftslexikon.gabler.de/Archiv/57568/business-to-consumer-markt-v6.html>
- Kotler, P., & Pfoertsch, W. (2006). *B2B Brand Management*. Berlin: Springer.
- Kuhl, J. (2001). *Motivation und Persönlichkeit - Interaktion psychischer Systeme*. Göttingen: Hogrefe.
- Kuhl, J. (2011, 03 23). *Operant Multi-Motive Test (OMT)*. (C. Chlupsa, Interviewer)
- Langes, T. A. (2009). *Leistung - Achievement*. In V. Brandstätter, *Handbuch der Allgemeinen Psychologie - Motivation und Emotion* (pp. 217-224). Göttingen: Hogrefe.
- Lee, A. Y. (2002, November). Effects of Implicit Memory on Memory-Based Versus Stimulus-Based Brand Choice. *Journal of Marketing Research*, pp. 440-454.
- Lieberman, M. D., & Satpute, A. B. (2006, February 20 ). Integrating automatic and controlled processes into. *Brain Research*, pp. 86-97.
- Lindstrom, M. (2008). *buy-ology*. New York: Random House Inc.
- McClelland, D. (1987). *Human motivation*. Cambridge: Cambridge University Press.
- Niedeggen, M. (2010, December 02). *stern TV*. Retrieved December 02, 2010, from Verrückte Experimente: Getäuschter Geschmackssinn: <http://www.stern.de/tv/sterntv/verruueckte-experimente-getaeuschter-geschmackssinn-und-falsche-verkaeufer-1629564.html>
- OECD 2010. (2010). *OECD Factbook 2010 Education: Key tables from OECD - ISSN 2075-5120*. Paris: OECD.
- Otto, R. (2011, February 10). *Kopf oder Bauch. INDUKOM*, pp. 36-41.
- Pepels, W. (2004). *Marketing*. München: Oldenbourg Verlag.
- Ranganath, K., Smith, C., & Nosek, B. (2008). Distinguishing automatic and controlled components of attitudes from direct and indirect measurement methods. *Journal of Experimental Social Psychology*, pp. 44, 386-396.

- Rheinberg, F. (2009). Motivation. In V. Brandstätter, *Handbuch der Allgemeinen Psychologie - Motivation und Emotion* (pp. 668-674). Göttinger: Hogrefe.
- Sachs, L. (2000). *Angewandte Statistik*. Berlin: Springer Verlag.
- Saunders, M., Philip, L., & Thornhill, A. (2009). *Research methods for business students*. Essex: Pearson Education Limited.
- Scheffer, D. (2005). *Implizite Motive*. Göttingen: Hogrefe.
- Scheffer, D. (2009). Implizite und explizite Motive. In V. Brandstätter, *Handbuch der Allgemeinen Psychologie - Motivation und Emotion* (pp. 29-36). Göttingen: Hogrefe.
- Scheier, C., & Scarabis, M. (2009). *Das Implizite in der Marketing-Forschung Was funktioniert in der Praxis*. Hamburg: decode Marketingberatung GmbH.
- Schmidt-Atzert, L. (2008). Klassifikation von Emotionen. In W. Janke, G. Debus, & M. Schmidt-Daffy, *Experimentelle Emotionspsychologie* (pp. 181-193). Lengerich: Pabst.
- Stern TV. (2010, December 01). SternTV. *Report*. Cologne, Germany: RTL Television.
- Stigler, P. (2011). *Der Einfluss von Emotionalität auf das organisationale Beschaffungsverhalten*. München: Munich University of Applied Sciences.
- Storch, M. (2006, April). Welcher Entscheidertyp sind Sie. *Harvard Business Manager Magazin*, pp. 2-7.
- Thaler, R. H., & Sunstein, C. R. (2009). *nudge*. London: Penguin Books Ltd.
- Wöhe, G. (1971). *Einführung in die Allgemeine Betriebswirtschaftslehre*. Berlin: Verlag Franz Vahlen GmbH.
- Zerfaß, A. (2010). *Unternehmensführung und Öffentlichkeitsarbeit*. Wiesbaden: Springer Medien.

# A High Speed Tempering System for MEMS Calibration and Test

A. Dickow, T. Waber, K. Graf, G. Feiertag

Department of Electrical Engineering, Munich University of Applied Sciences, Germany  
(dickow@hm.edu, waber@hm.edu, klemens.graf@ee.hm.edu, gregor.feiertag@hm.edu)

*Abstract - Performance over a wide range of temperatures is one of the main design objectives for Micro-Electro-Mechanical-System (MEMS) sensors. As customers desire high quality standards, the temperature performance of every chip has to be adjusted and tested in the calibration phase before chip delivery. To increase manufacturing capacities, a tempering-system with short time characteristics was developed, using the Peltier-effect. The system uses the feed-forward control technique to achieve a fast and accurate tempering process. The paper presents the system behavior of the proposed tempering system and an experimental comparison with a state-of-the-art tempering system. Results show a time saving of five times, compared to the state-of-the-art system.*

**Keywords - feed forward control, MEMS, tempering system**

## I. INTRODUCTION

MEMS sensors can be used as barometers, as thermometers, as load cells, as acceleration sensors, and as microphones. The widespread field of application comes along with a great market potential according to [1]. MEMS sensors combine high accuracy with fast reaction time and very small size, which makes them applicable for use in mobile technology.

Capacity or resistance changes can be used to calculate temperature, pressure, humidity, or sound. The better the characteristic of a chip is known, the more accurate the sensor can measure. Dependent on the application area, the sensors have to be calibrated for use in several temperatures and pressures.

In MEMS sensor production the calibration and stress-test is part of the back-end-assembly. In the calibration phase [2, 3], the frequency response, the temperature- and the pressure-behavior of the sensor are determined, analyzed and written on the chips *Application-Specific-Integrated-Circuit* (ASIC). To accomplish this process, a probe card, a system for pressure test, and a tempering device are required.

State-of-the-art test- and calibration-systems make use of large heating circuits with inertial time characteristics based on compressor-techniques, as it can be found in [4, 5]. It takes several hours to fulfill a temperature-performance-test for a single chip, due to the inherent thermal mass of the tempering device. An improvement in tempering time can be achieved by using a hybrid tempering system. These systems use a combination of the compressor technique with the Peltier-effect technique. The resulting advantages are a wide

temperature range and high speed in temperature adjustment. Hybrid systems approaches can be found in the patents [6–8].

The vast majority of present tempering systems uses PID- or cascade PID-control for precise temperature adjustment (see [9] p. 1). This is an easy to use control technique, not requiring knowledge about the system dynamics. Adaptive PID-controllers ([10] p. 90) are capable to online identify the plant controlled system and adapt their control parameters for time-optimized performance. Unfortunately these kind of controllers perform poor in handling systems with highly nonlinear dynamics. For this reason a system was developed, which linearizes system dynamics, enabling high speed tempering. The concept of feed-forward control (see [11] p.126 ff.) is used for linearizing the nonlinear system dynamics. In literature the concept is used to control electric drives [11], but no application in tempering devices was found. For this reason an experiment was performed to test the feed-forward control performance in a Peltier-technique tempering device. Application of feed-forward control in hybrid tempering systems is proposed as subject for further research.

The paper is structured as follows: the proposed system tempering method, the feed-forward control strategy, and the basics about system identification and stability are presented in Sec. 2. The experimental setup to identify the system dynamics and compare the tempering performance with a state-of-the-art system is detailed in Sec. 3. The results of the experiment are discussed in Sec. 4. The paper closes with a summary and outlook to future research.

## II. METHODOLOGY

In this section the proposed Peltier-effect based tempering system is introduced from a theoretical background.

### A. Peltier-Based Tempering

The Peltier-effect generates a local thermal gradient using an electrical current [12]. By applying an electrical current  $I$ , the system temperature  $T_0$  starts to locally spread up to a  $T_{upper}$  and a  $T_{lower}$ . The realized temperature-spread  $\Delta T = T_{upper} - T_{lower}$  depends on the applied current and material parameters of

thesurrounding medium. The influence of the Peltier-effecton the local temperature is illustrated in Fig. 1. The electrical current includes a load, consisting of a PN junction, and a DC-current source, creating a current  $I$ .  $\Delta T$  depends on the level of  $I$ . By changing theflow-direction of  $I$ , the hot and the cold side switchpositions. The coordinates  $x_0$  and  $x_1$  symbolize thepossible contact points of the Peltier-effect actuatorand the tempering good. The contact point temperatures  $TC_0$  and  $TC_1$  indicate the maximum temperatureof the tempering good surface.

A Peltier-effect actuator is called Peltier-element.In physical meanings a Peltier-element is an electro-thermaltransducer making use of the Peltier-effect.It can be used as heat-pump to adjust temperatureswithin a short range of time. In sequel the term *Peltier-technology* is used to emphasize the Peltier-element astechnological feature of the tempering system.

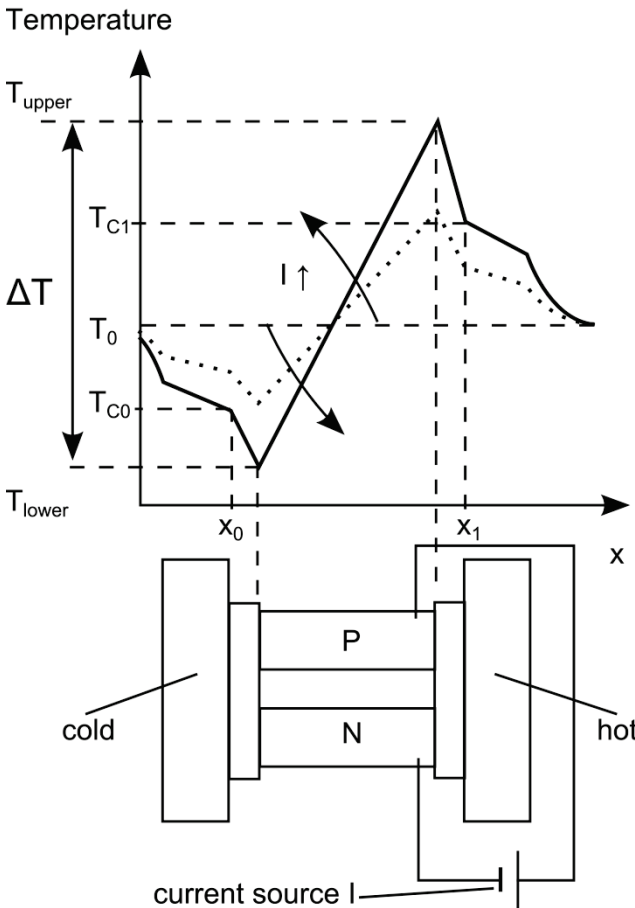

Fig. 1. Local temperature distribution, caused by the Peltier-effect.

### B. Temperature Control

In tempering systems temperature is locally distributed. Failures in temperature-measurement are minimized by sensors attached to the tempering

goodsurface. The temperature controller adjusts the temperatureat the single point where the sensor is placed. Temperature control can be achieved by a variety of methods, having a strong influence on the temperingsystems accuracy and adjustment speed. The proposedsystem is based on a feed-forward-method used in [11]for control of electric drives combined with a proportionalcontroller. The function-principle of feed-forward-control is shown in Fig. 2. The inverse systemdynamics are added to the failure signal  $K_p e(t)$ . In an ideal case, the inverse system dynamics are equalto the system dynamics, so  $e(t) = 0 \forall t \geq 0$ .

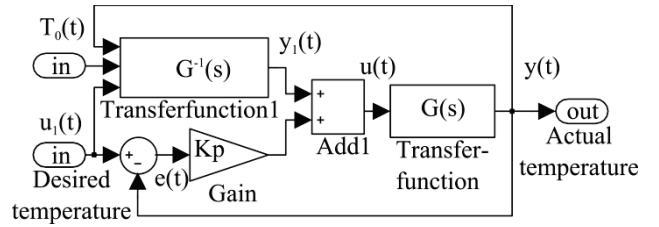

Fig. 2. Feed-forward control of system temperature.

Consider the general nonlinear system

$$\dot{x} = f(x, t, u, t), \quad (1a)$$

$$y = g(x, t, u, t), \quad (1b)$$

where  $x(t)$  is the system state vector,  $u(t)$  is the control signal,  $y(t)$  is the actual measured signal, and  $t$  is the systems time index. The dynamics of  $x(t)$  are unknown, nonlinear, and depend on material and geometric parameters. For system identification a simple linear PT1-transfer-function was fitted on the step-response of the systems transfer function  $G(s)$ .

The open loop system dynamics were approximated as a PT1-system with an additional nonlinear transfer-function. A differential equation

$$A \frac{\partial}{\partial t} y(t) + y(t) = B u_1(t) \quad (2)$$

was used to identify the PT1 part of the system, where  $y(t)$  is the system output,  $u_1(t)$  is the desired temperature signal, and the constant factors  $A, B$  are parameters to describe the system dynamics. An additional nonlinear term

$$y_f(u_2, t) = g(u_2, t) \quad (3)$$

was added to the PT1 system to equalize the nonlinear system behavior, where  $y_f(u_2)$  is the system output and  $u_2 = u_1 - T_0$ . For calculating the signal  $u_2$  the atmospheric temperature  $T_0$  has to be measured (shown in Fig. 2 as additional system input port).

As shown in Fig. 2, the control signal

$$u(t) = y_f(u_1, t, u_2, t) + K_p e(t) \quad (4)$$

uses a combination of feed-forward and feedback control. This combination is necessary, because the ideal controlled transfer-behavior

$$Y(s) = G^{-1}(s) G(s) X(s) = X(s) \quad (5)$$

cannot be exactly realized due to limited knowledge about the systems transfer behavior and to equalized disturbances. In general, the case described in Eq. 5 does not represent the systems transient behavior. The systems inherent transfer-function leads to a delayed output. For a input signal  $u_1(t) = u_1 = \text{const.}$  the closed-loop system output

$$y(t+x) = u_1 = \text{const.} \quad (6)$$

where the argument  $t+x$  stands for a point in time where  $y$  already is stationary. For the approximation of  $G^{-1}(s)$  a combination of linear and nonlinear transfer-function is used. The linear part of the feed-forward function is described as the inverse of a approximated PT1-plant-transferfunction

$$G_s(s) = \frac{K_s}{1+T_s s} \quad (7)$$

where  $K_s$  is the plant gain and  $T_s$  the plant-time-constant. The resulting inverse function

$$G_s^{-1}(s) = \frac{1}{K_s} + \frac{T_s}{K_s} s \quad (8)$$

cannot be realized due to the derivative part  $s$ . The derivative is approximated as difference  $u_1[t] - u_1[t-1]$ . It is assumed that the time for building the derivative  $T_d$  is much smaller than the plant-time-constant  $T_s$ , resulting in

$$\frac{G_s^{-1}(s)}{G_s(s)} = \frac{1+T_s s}{K_s(1+T_s s)} \approx 1 \quad (9)$$

The shape of the nonlinear part is identified in two steps. First the open loop step-responses of several applied step sizes  $u(t)$  are used to identify the linear system part described in Eq. 7. The time constant  $T_s$  is assumed as invariant for all step-sizes. The plant gain  $K_p$  is influenced by the system nonlinearity. It is determined as average value of all step sizes for a single step direction. In a second step, the closed loop using linear-feed-forward part and the proportional controllers shown in Fig. 2 tries to regulate the system for a set of desired temperatures. The resulting permanent error is calculated back to a actuator output  $u(t)$ . The values of  $u(t)$  are interpolated in a discontinuous form, dependent on the sign of  $u(t)$ . For both directions a function

$$y_f u_2 = \begin{cases} -\sin C_1 u_2, & u_2 > 0 \\ -\sin C_2 u_2, & u_2 \leq 0 \end{cases} \quad (10)$$

is used to fit measurement data. As combination of the linear with the nonlinear feed-forward function, a

$$G_s^{-1}(s) = \frac{y_f u_2}{u_2} G_s(s) \quad (11)$$

results, with

$$G_s^{-1}(s) \approx G^{-1}(s) \quad (12)$$

To create a robust system an additional controller is needed to equalize disturbances and imprecise linearization according to Eq. 12. The controller used in Fig. 2, multiplies the tempering failure with a constant gain  $K_p$ . This proportional controller is characterized by a short reaction time. The resulting control-signal shown in Eq. 4 combines the feed-forward-signal for linearization and the controller signal for disturbance equalization.

The identification of the system dynamics was accomplished as a first part of the experiment, described in the following section.

### III. EXPERIMENT

An experiment was performed to investigate the proposed systems tempering performance and compare it to a state-of-the-art tempering system. The experimental setup is shown in Fig. 3. A Peltier-element is placed under a FR4-plate. System temperature is recorded at two measurement sites. A thermocouple of type K (see [13]) was placed on the plate-surface to measure the tempering good temperature and another thermocouple of type K is placed at the heat sink to measure the reference temperature. The combination of the two temperature sensors allows the temperature controller to normalize the temperature signal to the atmospheric temperature.



Fig. 3. Experimental setup for Peltier-technique tempering.

Temperature data is recorded by a Keithley 2700© data acquisition unit and sent to a Lab-PC via GPIB-bus. The Lab-PC processes the data in real time with a sample rate of 220 ms using LabView© and sends out the control signal to the actuator power supply, also via GPIB-bus.

The Peltier-elements power supply is a *Keithley 2601* source-meter, enabling a maximum applied current of  $\pm 3$  A at a maximum applied power of  $\pm 20$  W. A *Marlow Industries-RC6-6-01LS* Peltier-element was used as actuator. A heat-sink with heat pipes and a fan with a air flow rate of  $60 \text{ m}^3/\text{h}$  was used to cool the Peltier-elements backside.

#### A. Parameter identification

As first part of the experiment, the Peltier-element system was calibrated. According to section II, the parameters of the system plant can be identified through step responses and the closed loop permanent error. These responses were recorded for applied actuator currents of  $\{-3.0 \text{ A}; -2.5 \text{ A}; -2.0 \text{ A}; -1.5 \text{ A}; -1.0 \text{ A}; 0.5 \text{ A}; 1.0 \text{ A}; 1.5 \text{ A}; 2.0 \text{ A}; 2.5 \text{ A}; 3.0 \text{ A}\}$ . The closed loop temperature failure was recorded and fitted with a sinus function shown in Eq. 10.

#### B. Tempering Performance

As second part of the experiment the tempering performance was tested in comparison to a state-of-the-art system. As state-of-the-art system, a *Julabo FP51* compressor-thermostat was used, in combination with a state-of-the-art thermo chuck (comparable to [4, 5]). The compressor system uses an online-auto-tuning PID controller for temperature adjustment. Although the system possesses a second temperature sensor for cascaded temperature control, the single sensor configuration was used. The controller for cascaded configuration was not capable to online-auto-tune, so the single sensor configuration performed better. The compressor-system is controlled by a *National Instruments PXI* system. Measurement data is transferred via a RS232-port and processed and logged in *Lab-View*. The *LabView* software also calculates and sends out the desired temperature signal to the *Julabo FP51* compressor-thermostat temperature controller.

The experiment proposes temperature steps of  $-5 \text{ }^\circ\text{C}$ . The transition condition is a temperature failure of less than  $0.1 \text{ }^\circ\text{C}$  for at least 10 s. In Fig. 4 the experiment cycle is described as automaton. Every time the temperature transition condition is fulfilled,  $\delta T_{10s}$  switches from logical zero to logical one, affecting the desired temperature  $u_1$  to decrease by  $5 \text{ }^\circ\text{C}$ . The desired temperature is initialized with  $40 \text{ }^\circ\text{C}$ . After six transitions, the desired temperature reached  $10 \text{ }^\circ\text{C}$  and the experiment stops.

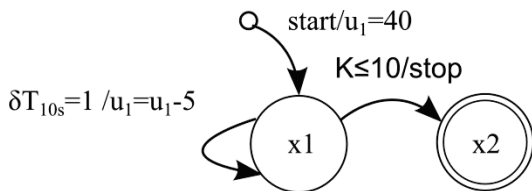

Fig. 4. Experiment cycle as automaton.

## IV. RESULTS

In this section the results of the experiment are presented.

The parameters  $A, B$  of Eq. 2 were identified as  $A = 21.2279$  and  $B = 0.1193$ . The resulting differential equation

$$\begin{aligned} 21.2279 \frac{\partial}{\partial t} y + y &= \\ 1.193 \cdot 10^{-3} u_1 t, e t + y_f(u_2) &\geq 0 \\ 3.579 \cdot 10^{-3} u_1 t, e t + y_f u_2 &< 0 \end{aligned} \quad (13)$$

describes the linear part of the system dynamics. The system's nonlinearity was identified by recording the open loop step responses of different step amplitudes shown in Fig. 5. To equalize the nonlinear dynamics, Eq. 3 was identified as

$$y_f u_2 = \begin{cases} -\frac{\pi}{400} \sin u_2, & u_2 > 0 \\ -\frac{\pi}{5.681} \sin u_2, & u_2 \leq 0 \end{cases} \quad (14)$$

based on the interpretation of the step responses shown in Fig. 5. A unsteady sinus like function was used to fit the nonlinear system dynamics.

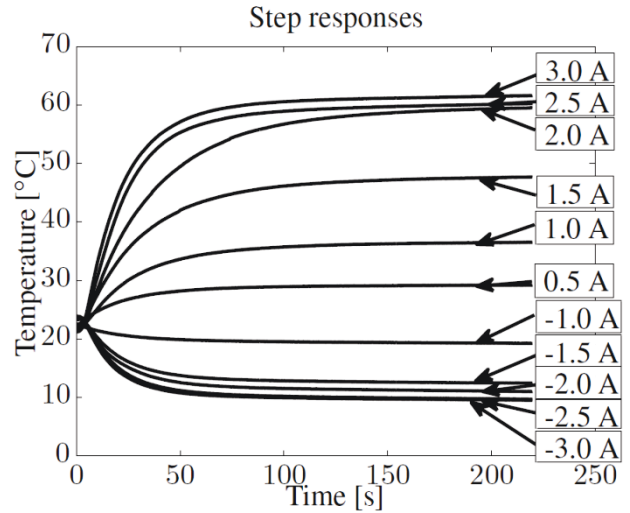

Fig. 5. Step responses of the Peltier-tempering system.

The output amplitude shows a nonlinear saturation. The increase in amplitude is not proportional to the increase in applied current. Heating is three times more effective than cooling. This coherence was taken into account in Eq. 13. The results in Eq. 14 and in Eq. 13 were used for the feed-forward part of the closed-loop system. The controller gain  $K_p$  was optimized heuristically. The optimal  $K_p = 0.4$ . Using these parameters for system control, the Peltier-tempering system was compared to a state-of-the-art compressor-tempering system using an online-auto-adjusting PID-controller. The experimental results are shown in Fig. 6. The desired accuracy of  $0.1 \text{ }^\circ\text{C}$



is reached much faster by the proposed system. This is due to a difference in reaction time of a factor ten between both systems. The reaction time leads to instability and elongates the transient time.

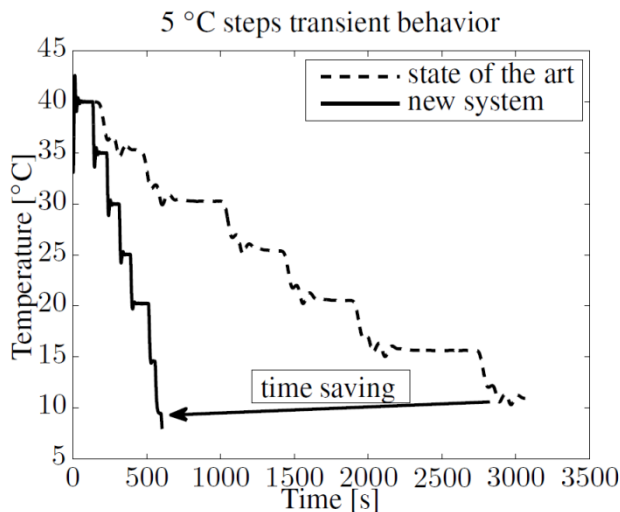

Fig. 6. Comparison of Peltier- and compressor based tempering.

The proposed tempering device can be used within an range of 10 to 70 °C, based on an atmospheric temperature of 25 °C. This range can be further optimized by lowering the thermal resistance between Peltier-element and tempering good, but it will not reach the tempering spectrum of a state-of-the-art compressor thermostat, which can create temperatures from -30 °C to 200 °C, as Peltier-elements can only create a temperature spread of approximately 70 °C. Despite this fact, the results in figure 6 show a fast tempering procedure for an accuracy condition of less than 0.1 °C temperature failure.

In the field of MEMS sensors, time performance has to be weighed against tempering range. Large production lots demand high time performance and special operation conditions, such as military application, require a wide range of working temperatures.

## V. CONCLUSION

In this paper, a tempering system based on the Peltier-effect was presented. Unlike present tempering system, the new system uses feed-forward control for temperature adjustment. The results show a very fast transient response in comparison to state-of-the-art systems.

In further research a hybrid tempering system will be developed, combining the advantages of Peltier- and compressor systems. The compressor-system is proposed to adjust the back-side temperature of the Peltier-element and the Peltier-system is used to adjust temperature fast and precise. It is expected, that this

combination will lead to a high-speed tempering system with extended tempering range.

For future work it is planned to replace the feed-forward algorithm by nonlinear feedback (see [14] p. 60 ff.) for linearization. This method is expected to linearize the plant dynamics better in areas near to the actuator saturation.

## ACKNOWLEDGMENT

This work is supported by the Bavarian ministry of economic affairs within the research-project "MEMSBaro".

## REFERENCES

- [1] Yole Developpement, "MEMS market overview," in *MEMS Executive Congress 2010*.
- [2] O. Köster, J. Slotkowski, and D. Brögger, "Kalibrierung von integrierten Drucksensoren im Waferverbund," *Technisches Messen*, vol. 70, pp. 265–269, 2003.
- [3] G. T. Kober, S. Sindlinger, and R. Werthschützky, "Analyse des Übertragungsverhaltens von Differenzdrucksensoren durch dynamische Druckkalibrierung," *Technisches Messen*, vol. 77, pp. 83–88, 2010.
- [4] M. Eibl, "Method and device for tempering a substrate," Patent US 2008/0 302 513 A1, 2008.
- [5] L. DiBattista, M. Malinoski, and T. Shitara, "Apparatus and method for temperature control of IC device during test," U.S. Patent US 6,549,026 B1, 2003.
- [6] K. Emoto, "Temperature adjustment apparatus, exposure apparatus having the temperature adjustment apparatus, and semiconductor device manufacturing method," U.S. Patent US 2006/0 187 438 A1, 2006.
- [7] M. Eibl, "Hybrid chuck," U.S. Patent US 2009/0 250 202 A1, 2009.
- [8] D. Hudson, D. Butcher, R. Gates, and J. Pelrin, "Workpiece chuck with temperature control assembly having spacers between layers providing clearance for thermoelectric modules," U.S. Patent US 6,886,347 B2, 2005.
- [9] A. Visioli, *Practical PID Control*, 1st ed., ser. Advances in Industrial Control. London: Springer, 2006.
- [10] V. Bobal, J. Böhöhm, J. Fessl, and J. Machacek, *Digital Self-tuning Controllers: Algorithms, Implementation and Applications*, ser. Advanced Textbooks in Control and Signal Processing. London: Springer, 2005.
- [11] D. Schröder, *Elektrische Antriebe: Regelung von Antriebsystemen*, 3rd ed. Berlin Heidelberg: Springer, 2009.
- [12] V. A. Drebuschak, "The peltier effect," *Journal of Thermal Analysis and Calorimetry*, no. 91, pp. 311–315, 2008.
- [13] F. Bernhard, *Technische Temperaturmessung*. Springer VDI, 2004.
- [14] Q. Lu, Y. Sun, and S. Mei, *Nonlinear Control Systems and Power System Dynamics*, ser. The International Series on Asian Studies in Computer and Information Science. Dordrecht: Kluwer Academic Publishers, 2001.



# Testing Mixed Reality for an Application in Order Picking

Markus Ehmann

PhD Research Student, University of Plymouth Business School  
School of Management

E-mail: markus.ehmann@plymouth.ac.uk

*Abstract* - Innovation counts as the economic foundation for the progression of modern industrial society. Competition is often determined by the fast and efficient implementation of new technologies.

These progresses often seem to be of strategic importance, yet the implementation of the new technologies is still missing. For example, the RFID 1-technology created hype in the 1990's though there still are not many economic applications for it today.

One of the reasons is the lack of a useful concept for the identification and analysis of the optimal implementation of new technologies in the beginning when the influence on the development is still high.

The question is how this gap can be filled. Which approach has to be used in order to graze the potential for optimization methodically and effectively in the early stages of a technological implementation, so as to make the most of the still high influence on the further development?

One field for the proper evaluation of such a methodical approach for the implementation of new technologies is the process of order picking. Apart from a classical procedure using paper, several systems to enhance order collating have been developed.

Mixed Reality<sup>2</sup> is the new technology to be applied to order picking by enhancing the optical sense with computer generated information in real time (Azuma, 1997, S. 355f). Several universities (Günthner, Blomeyer, Reif, & Schedlbauer, 2009, S. 212ff) and institutes (Tümler, Grubert, & Mecke, 2009, S. 74f)(Ehmann, 2008, S. 2ff) are already on the point of launching their prototypes and developing successors.

Their methodical approach in coping with the effective implementation serves as a practical example and the pending development of a similar system at the Munich University of Applied Sciences can serve as an evaluation of the derived methodology. Keeping this in mind, the first step is the evaluation of the technology MR in its first, prototypal status in a field experiment to draw conclusions of its suitability for any further implementation.

*Keywords* –Diffusion of Innovations, Augmented Reality, Mixed Reality, Order Picking

## I. THEORETICAL BACKGROUND

This chapter is giving a short overview over the three main topics of the research field. These are MR as the technology in question for the implementation, logistics, especially warehousing as the area of implementation, and are innovations management, bringing them together in an industrial application.

### 1.1 Mixed Reality

One technology offering promising features is MR as it has already been tested in several production processes. MR is the enhancement of the optical sense with computer generated information in real time (Azuma, 1997, S. 355f). It is a blend of the real environment and virtual objects projected to the user as can be seen in the following figure:

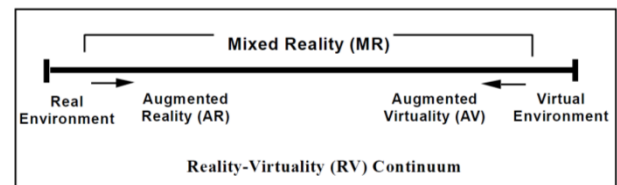

Fig. 1: Simplified representation of a RV Continuum according to Milgram (Milgram & Colquhoun, 1994, S. 283)

It can be seen in figure one, that the often referred to Augmented Reality is much more focused on the direction to the real environment. As there is no conclusion now, to what intensity virtually enhanced reality is applicable best, the much broader definition of MR is used in this paper.

Adapted to the area of logistics for the application, the worker gets special glasses with displays that provide him with context related and helpful information. This allows him to focus on the main work, picking and packaging.

The following figure two shows a possible example with a visualised pick list:

<sup>1</sup>Radio Frequency Identification

<sup>2</sup>Mixed Reality is a blend of the real environment and virtual objects projected to the user; abbreviated as MR in the following

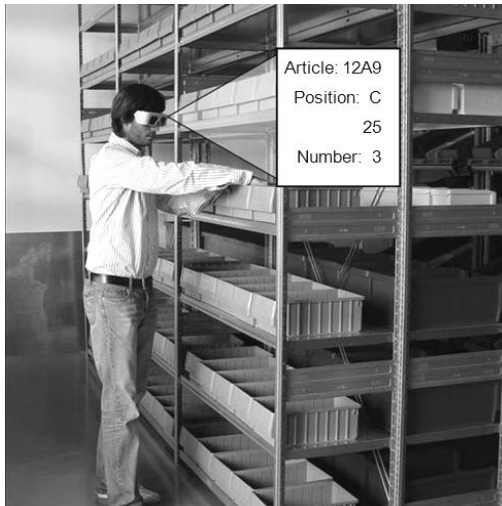

Fig. 2: Scheme of a worker with visualised pick list

It is the aim to implement the system at low costs in order to provide an efficient and affordable solution.

#### 1.1.1 Current State of Research

There are already prototypal applications for MR-technology in many areas, e.g. medicine (Lievin & Keeve, 2001, S. 10f), military (Tappert, et al., 2001, S. 625ff), architecture (Tamura, Yamamoto, & Katayama, 1999, S. 62f) and production (Azuma, Bailiot, Behringer, Feiner, Julier, & MacIntyre, 2001, S. 35f)(Mizell, 2001, S. 447ff), just to name a few.

In any case, four main questions have to be discussed for the implementation of MR for order picking:

- display unit
- tracking system
- information representation
- procedural influence (Alt, 2003, S. 21)

#### 1.1.2 Display Unit

There are basically four methods of displaying mixed reality images, classified by two characteristics. First it offers the possibility of looking around, i.e. the viewer is not connected to the display, or looking through, i.e. the display is attached to the user and his field of vision.

Secondly the question of whether the field of vision is enhanced by virtual insertions (OST3) or whether the real and virtual images are premixed and displayed as one picture (VST4) arises.

Figure three shows the four different types of visual overlays.

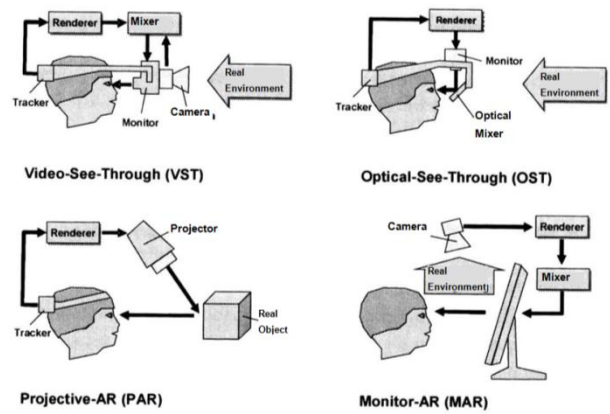

Fig. 3: Different methods of visual overlays(Patron, 2004, S. 24)

#### 1.1.3 Tracking System

In order to provide context-based visualisation, the position and direction of the user have to be identified and tracked. The assessment of the tracking system includes degrees of freedom, accuracy, latency, robustness, room of measuring and price (Alt, 2003, S. 74ff).

Excluding the Global Positioning System (GPS), as it is simply not working indoors, there are the following possibilities:

Using mechanical tracking, the user's display device is attached to arms and joints equipped with sensors which gauge the movement/alteration (Müller, 2001, S. 498f). This method is very accurate but involves high costs and limited mobility.

Another possible way is to use an electro-magnetic field. The user wears a sensor that measures the field intensity and determines the position. Its advantages are its small size, little latency and low cost. However, the diverting influence that metallic objects have on the magnetic field, limits the operational possibilities within industrial environments (Ascension Technology Corp., 2008, S. www.ascension-tech.com/products/index.php).

The optical tracking, using cameras, offers two solutions. Either outside-in, where the cameras are installed in the room (Livingston, 1998) and tracking markers are fixed to the user, or inside-out where the user is wearing the camera and tracking different markers to locate his position (Kato & Billinghurst, 1999, S. 86ff). Fair accuracy is confronted with high costs for commercial solutions.

Inertial tracking measures acceleration of gyroscopes and by single (velocity) or double (position) integration provides the necessary information (Müller, 2001, S. 499). This system is small and shielded from environmental influences but relatively inaccurate.

Other outsider tracking systems make use of acoustics, laser or a mini-indoor-GPS (Müller, 2001, S. 499).

<sup>3</sup> i.e. Optical See Through

<sup>4</sup> i.e. Video See Through

### 1.1.4 Information Representation

The form of visualised information in MR systems is open to any style the operator chooses. They may consist of static or dynamic insertions, text, pictures or 3D-models. Different kinds were already tested in past applications:

- ID-Nr.
- position oriented text
- animation: blinking
- animation: frame
- animation: colour (Alt, 2003, S. 62f)

Depending on the individual case, the visualisation may be context-sensitive and congruent (Alt, 2003, S. 48).

In order to provide a spatial perception, monoscopic techniques like the constancy of size or the overlapping of objects as well as the parallax of movement can be employed (Frisby, 1997). Even better results can be yielded with a real stereoscopic view. In order to create the effect, the images for the right and left eye have a slight offset depending on their virtual distance. The closer the object the bigger is the offset. But as every eye only perceives its own image, the displacement is recorded as depth. This natural awareness of stereoscopy is represents a much lesser strain for the users mind of the user (Klein, 2008, S. www.stereoscopy.com/faq/computer-stereo.html).

### 1.1.5 Procedural Influence

In order to evaluate the effect of MR enhanced processes, quality and time have to be measured.

In one recorded test, the needed time for the assembly of plane parts could be halved (Mizell, 2001). In another test the time for an experimental automotive assembly step could be reduced from 24s to 11s, the recall ratio rose from 94% to 98% (Alt, 2003, S. 88f). The study further identified the dependence of effective MR systems on the complexity of an application.

Only after a specific bound of complexity, the use of MR is of help to the operator and therefore contributes to the reduction of necessary time for the process as can be seen in figure four:

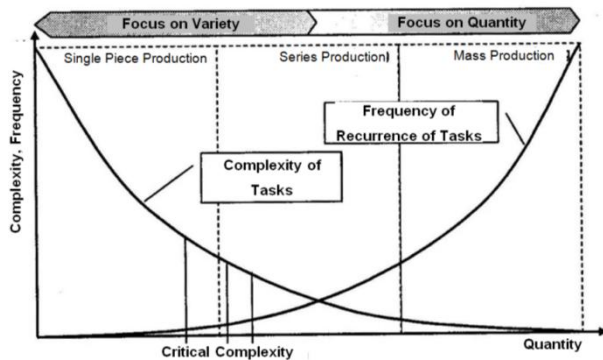

Fig. 4: Critical complexity for the use of MR technology(Alt, 2003, S. 100)

### 1.2 Logistics, Warehousing, Order Picking

Conditions in the field of logistics have changed rapidly over the last years. Customers are demanding more individualised products in even shorter delivery time. Production Systems and the logistics material and information flow, as well as the workers within these systems, have to become more flexible, faster and of course more efficient (Reif & Walch, 2008, S. 987). One of the most important processes in logistics is order picking. Order picking is the gathering of goods out of a prepared range of items following some customer orders (Gudehus & Kotzab, Logistics. A Handbook: Principles, Strategies, Operations, 2007). As it is no value-added process costs arising from this handling of goods are especially in focus to be reduced (Ehmann & Kaiser, Auswahl von Kommissionierverfahren (Choosing Consignment Systems), 2009, S. 19). Due to the high variety of goods in order picking applications, machines cannot usually replace the human-being with his flexibility and fine motor skills (Gudehus & Kotzab, Logistics. A Handbook: Principles, Strategies, Operations, 2007).

Being part of the supply chain, the process of order collating is still dominated by manual operation. As this concerns more or less C-parts with a low value, the need to reduce costs is of great importance and therefore the process has to be kept as brief as possible. This is even more important against the background of a demand for an increasing number of individual orders.

Beside the classic pick list, several systems to enhance order collating already exist, each with its pros and cons:

System	Pro	Contra
<i>Barcode-Scanner</i>	flexible additional tasks possible	hand occupation time-consuming navigation
<i>Pick by Light</i>	fast easy to learn hands free	serial order handling expensive installation limited to sections
<i>Pick by Voice</i>	flexible hands free	slow difficult communication

Table 1: Comparison of different consignment systems(Vogt, 1997, S. 81ff)(Gudehus, 2002, S. C2-71)

It is now the intention, to implement a new consignment system that functions without these disadvantages and at the same time enhances the process in several ways.

### 1.3 Innovations Management

Implementing new ideas is often difficult, even if they have obvious advantages. This process often requires a lengthy period of time. How to speed up this rate of diffusion is the main focus of Rogers' "Diffusion of Innovations" (Rogers, 2003, S. 1).

The process of diffusion can be compared to the product life cycle concerning the penetration of the market (see figure five).

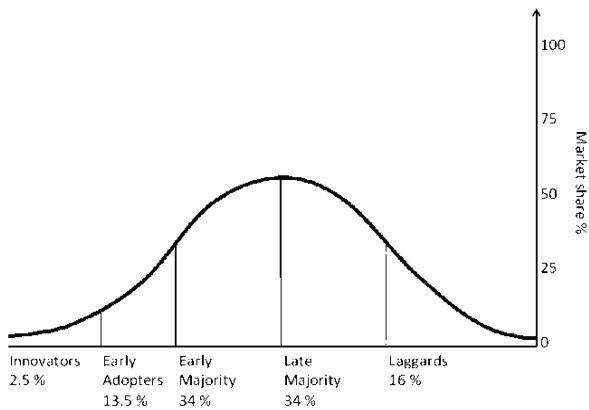

Fig. 5: The innovativeness dimension (Rogers, 2003, S. 281)

Rogers is stating that new innovations and products undergo a rise in market share from their introduction to the first buyers (which means users of a technology in this case). This is followed by a saturation of the market when the majority is making use of the technology and only rounded off by the laggards. Mixed Reality in Order Picking is still in the innovators phase without a measurable market share.

It is mainly focusing on the temporal sequence of innovation acceptance (Rogers, 2003, S. XV):

- **Knowledge** of the technology
- **Persuasion** of the client/customer to make first use if the technology
- **Decision** after the first use whether the technology and its benefits are accepted or rejected
- **Implementation** of the technology in the applicable environment
- And finally **confirmation**, which may lead to further diffusion inside and outside the company.

Since there are now industrial applications of MR in the logistics area up to this date (further than prototypal experiments) the innovation in this case should be somewhere between stage one to three of the

acceptance process. The actual stage has to be verified in the upcoming approach in order to measure to what extent influence can still be made.

This model therefore may be applied in order to determine the status of acceptance of a technology.

Defining the phase and stage of a technology's status in the innovations lifecycle, prepares for the afterwards following methodological approach in influencing the abilities of MR in applications in order picking.

One similar problem was discussed by Resch in relation to the implementation of RFID-tags. This technology created hype in the 1990's due to its promoted possibilities in assisting the information flow in supply chains. Nevertheless, there are still not many implementations in the companies.

Resch described this as the research gap as can be seen in figure six (Resch, 2006, S. 5).

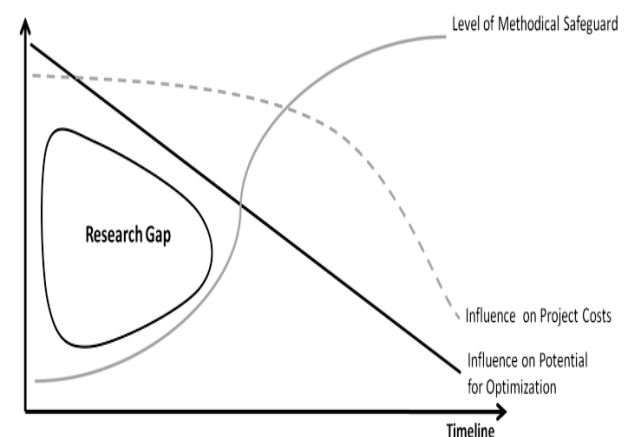

Fig. 6: The Research Gap (Resch, 2006, S. 5)

The figure states, that most of the future project costs for the implementation of a technology are set in the beginning. Also the decisions made at the start influence greatly what and how much of the potential of the innovation is going to be realised.

On the other hand, there's no methodical safeguard to graze the full potential and understand the technology's best way of application right from the beginning.

Evaluation of the triggering criteria of a technology's possibilities has to have two perspectives: Firstly, what can the technology provide? Meaning, what are the advantages of it compared to the existing and already used older techniques. This was related to in chapter 2.1.

Secondly, what do the users and decision makers for the implementation want to get by risking to implement this new technology.

One theoretical model, assisting the second point of view, is discussed in the following.

Scientists in the area of management information systems often rely on theories from social and psychological sciences. Thereby the theoretical basics were applied to specific situations of a computer based use of information systems (Resch, 2006, S. 132). For the first time, Davis described it as Technology Acceptance Model 5 in his report “Perceived Usefulness, Perceived Ease of Use and User Acceptance of Information Technology” in 1989 (Davis, 1989).

In contrast to the diffusion of innovations model, the TAM is focusing on the causal parameters for decision making and not the timeline of the decision process. Nevertheless it has experienced several adjustments and derivations as well.

An adaptation of the TAM for complex technologies can be seen in figure seven.

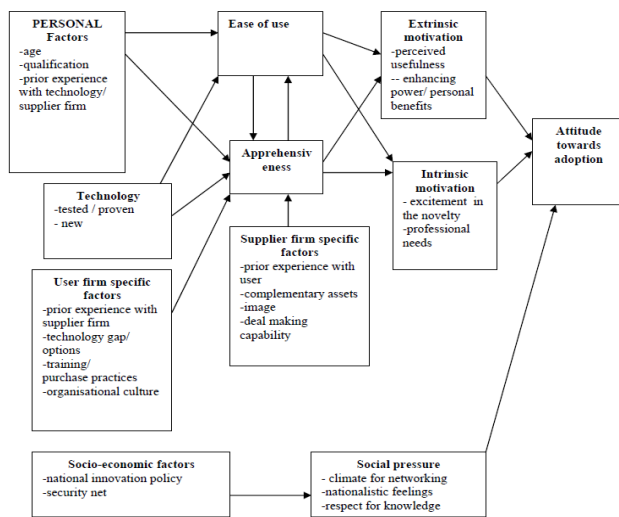

Fig. 7: Adaptation of the TAM for complex technologies (Rao, 2004, S. 8)

It mentions different aspects of a technology as triggers for the decision of an individual of accepting or rejecting it. According to Rao, the four main influencing parameters are apprehensiveness, ease of use of the technology and extrinsic and intrinsic motivation.

Which parameters are relevant in this particular case, has to be elaborated, once MR has proved to be a competitive technology to the existing techniques in order picking.

## II. DERIVATIONS AND FIRST TEST IN ORDER PICKING

With the background from the three areas innovations management, MR and warehousing a first

field experiment was prepared and as well performance characteristics as personal feedback was gathered.

The goal of the field test was to see, whether MR is even applicable for order picking or not. This should show if the users can work ergonomically with the equipment needed for the prototype, if they are accepting a new, innovative technology and are the decision makers willing to get to know this possibility.

To gather firsthand experience and evaluate the first reactions caused by the implementation of an mixed reality system in a logistic environment, a very basic prototype for order picking was assembled and tested with an industrial partner.

The prototype consists of a pocket computer connected to the warehouse management system of the partners warehouse, a head mounted display for the visualisation of the order data and a key-pad for basic interaction. The prototype can be seen in the following figure eight:



Fig. 8: Prototypal order picking with a head mounted display

Three workers of different age used the prototype for several weeks. During that time the performance was measured (see table two). The decline in concentration was measured before and after work. The workers were furthermore requested to fill in a feedback form, partly guided and partly with open sections.

<sup>5</sup> abbreviated as TAM in the following

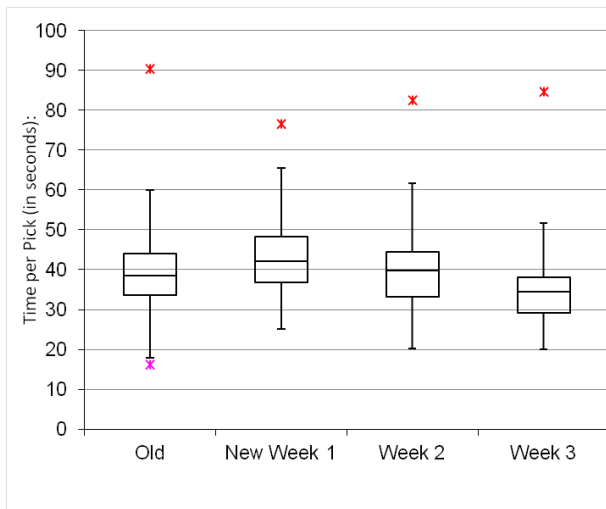

Table 2: Distribution of the picking time as output of the field test

Week zero displays the distribution before the implementation of the prototype. Weeks one to three state the progression after the implementation. . Using a box and whisker chart makes it possible to evaluate the progression as well as the distribution of the measured picking time on the timeline. As can be seen the median is declining and the spread of the distribution is being reduced. The decreasing median is showing, that the picking is processed quicker, being already ten percent faster than the old method in week three. The worker seems to get used to the tool and understand its advantages for his task. Implementations of other pick assisting technologies show, that a saturation of this learning curve is to expected two to three months after introduction.

The distribution of the pick times is reduced as well. This may be due to the stabilization of the process. Lesser outliers may result from more routine for the worker during his task and therefore less unexpected problems while working.

The field experiment provided two main outcomes. Firstly mixed reality can make a difference in performance. To what extent and under what circumstance remains undetected.

Secondly there is a great influence from both, the user of the technology and the decision maker for the implementation. The influencing factors and their proper adjustment remain unclear so far as well.

### III. CONCLUSION

Driven by competition, companies try to implement new technological innovations in industrial applications in order to gain advantages over their competitors. These three fields are back upped theoretically and on the applied side filled with MR (innovation),

logistics/warehousing (application) and the visual guided order picking system as junction.

As there are already technical but not economic applications in this area, the further research focuses on the evaluation of key parameters for the successful implementation of this innovation and the relevant characteristics of its application.

A first field test was prepared and executed to gather first reactions from the users and evaluate the applicability of MR in order picking. The outcome was positive. Any further field experiments should be prepared with the triggers and factors to be evaluated in mind.

These aspects have to be elaborated and discussed with the decision makers of such applications with guidance from existing models for innovations management.

### REFERENCES

- Alt, T. (2003). *Augmented Reality in der Produktion (Augmented Reality for Production)*. Munich: Herbert Utz.
- Ascension Technology Corp. (3. 11 2008). *Tracking 3D Worlds*. [www.ascension-tech.com](http://www.ascension-tech.com).
- Azuma, R. (1997). A Survey of Augmented Reality. *Teleoperators and Virtual Environments*, 6, S. 355-385.
- Azuma, R., Baillot, Y., Behringer, R., Feiner, S., Julier, S., & MacIntyre, B. (2001). Recent Advances in Augmented Reality. *Computer Graphics and Applications*, 21, S. 34-47.
- Davis, F. D. (September 1989). Perceived Usefulness, Perceived Ease of Use and User Acceptance of Information Technology. *MIS Quarterly* , S. 319-340.
- Ehmann, M. (2008). *Pick by Vision: Development if an Order Picking System Based on Augmented Reality*. Munich: Munich University of Applied Sciences.
- Ehmann, M., & Kaiser, T. (2009). Auswahl von Kommissionierverfahren (Choosing Consignment Systems). *IPL Magazine*, 16-20.
- Frisby, J. (1997). *Sehen: Optische Täuschungen, Gehirnfunktionen, Bildgedächtnis (Seeing: Optical Illusions, Brain Functions, Photographic Memory)*. Heins Moos.
- Gudehus, T. (2002). *Kommissioniersystem (Consignment Systems)*. In D. Arnold, H. Isermann, A. Kuhn, & H. Tempelmeier, *Handbuch Logistik (Handbook Logistics)*. Berlin: Springer.
- Gudehus, T., & Kotzab, H. (2007). *Logistics. A Handbook: Principles, Strategies, Operations*. Berlin: Springer.
- Günthner, W., Blomeyer, N., Reif, R., & Schedlbauer, M. (2009). *Pick by Vision - Augmented Reality unterstützte Kommissionierung (Pick by Vision - an Augmented Reality Based Consignment System)*.



- Munich: Technical University of Munich - Chair for Conveyor Systems, Materials Flow and Logistics.
- Kato, H., & Billinghamurst, M. (1999). Marker Tracking and HMD Calibration for a Video-Based Augmented Reality Conferencing System. Second International Workshop on Augmented Reality, (S. 85-94). San Francisco.
- Klein, A. (6 2008). How to Make 3D Pictures by Computer. [www.stereoscopy.com](http://www.stereoscopy.com).
- Lievin, M., & Keeve, E. (2001). Stereoscopic Augmented Reality System for Computer Assisted Surgery. Computer Assisted Radiology and Surgery. Berlin.
- Livingston, M. (1998). Vision-Based Tracking with Dynamic Structured Light for Video See Through Augmented Reality. Chapel Hill: University of North Carolina at Chapel Hill.
- Milgram, P., & Colquhoun, H. (1994). Augmented Reality: A class of displays on the reality-virtuality continuum. *Telemanipulator and Telepresence Technologies*, 2351, S. 282-292.
- Mizell, D. (2001). Boeing's Wire Bundle Assembly Project. In W. Barfield, & T. Claudell, *Fundamentals of Wearable Computers and Augmented Reality* (S. 447-467). Mahwah: Lawrence Earlbaum Associates.
- Müller, S. (2001). Augmented Reality: Monteure mit Durchblick (AR: Assembly Employees Look Through). *wt-Werkstatttechnik (Workshop Technologies)*, 498-499.
- Patron, C. (2004). Konzept für den Einsatz von Augmented Reality in der Montageplanung (Concept for the Implementation of AR for Assembly Planning). Munich: Herbert Utz.
- Rao, A. S. (2004). *Technology Acceptance Model for Complex Technologies in a Period of Rapid Catching-Up*. New Delhi.
- Reif, R., & Walch, D. (2008). Augmented & Virtual Reality Applications in the Field of Logistics. *Vis Comput*, 987-994.
- Resch, F. (2006). Entwicklung eines prozess- und erfahrungsbasierenden Anaylsemodells zur systematischen Identifikation und Bewertung von RFID Einsatzpotentialen (Development of a Process and Experience Related Analysis for Systematic Identification and Evaluation of RFID). Rostock: University of Rostock.
- Rogers, E. M. (2003). *Diffusion of Innovations* (5th Ausg.). New York: Free Press.
- Tamura, H., Yamamoto, H., & Katayama, A. (1999). Steps Toward Seamless Mixed Reality. In Y. Ohta, & H. Tamura, *Mixed Reality: Merging Real and Virtual Worlds* (S. 59-84). Berlin: Springer.
- Tappert, C., Ruocco, A., Langdorf, K., Mabry, F., Heinemann, K., Brick, T., et al. (2001). Military Applications of Wearable Computers and Augmented Reality. In W. Barfield, & T. Caudell, *Fundamentals of Wearable Computers and Augmented Reality* (S. 625-647). Mahwah: Lawrence Earlbaum Associates.
- Tümler, J., Grubert, J., & Mecke, R. (2009). Nutzerbezogene Entwicklung und Untersuchung mobiler AR-basierter Werkerassistenzsysteme (Customer Related Development and Analysis of Mobile and AR-based Assistance). *Fraunhofer IFF Jahresbericht (Annual Report) 2008*, 74-75.
- Vogt, G. (1997). *Das neue Kommissionierhandbuch (The New Order Picking Hand Book)*. Landsberg: Moderne Industrie.



# Transnational Organized Crime. Analysis of Gang's Structures and Networks.

M. H. Maszczynska

School of Law, Plymouth Business School, Plymouth, UK

**Abstract** - Transnational Organized Crime (TOC) due to its uncertain and changing arrays is not yet well understood by the international community. Their patterns of networking and their 'methodologies' are confusing (due to lack of knowledge and poor flow of information within this area). In this article the author reviews the development of ideas about working Transnational Organized Crime. This paper explains the current working patterns of TOC, recognize and classify their structures and networks. Through the in-depth analysis of existing structures and international criminal networks the author aims to answer the question whether structures can determine networking.

**Keywords** – transnational organized crime, gangs, organized criminal groups, structures, international criminal networks

## I. INTRODUCTION

Globalization impacts on all aspects of our lives. Whilst there are some benefits, for example free flow of goods, people, improvements in international trade and market economy growth, one area of concern is the globalization of crime. Accordingly, not all of the goods transported and distributed are legal. Due to the problems with clarity of the international policies and its implications, it is possible for criminals to circumvent rules and find a way through borders and customs searches in order to fulfill their illegal goals. Transnational Organized Crime (TOC) presents a serious problem to national and international spheres in terms of its ability to disrupt communities and undermine the rule of law. However, aspects of TOC can equally provide a stimulus for local economic activity. The nature of TOC presents a challenge to law enforcement agencies which have to deal with cross border phenomena; social and economic policy makers who need to provide alternative resources and academics who are challenged with making sense of TOC in analytical terms. Whilst international policy makers and law enforcement agencies are trying to develop policies which will help to tackle and punish organized crime, due to the lack of knowledge and competencies the delivery of motivational as well as operational aspects of those laws do not seem to work. Some may argue with that point, however monitoring the world's situation for last 10 years, as well as undertaking research around this topic shows that we do have

insufficient knowledge, which leads to reduced legal capacity and its management, in order to stop Transnational Organized Crime (Felson, 2002, Wright, 2006, Decker et al. 2008 Aas, 2010). As it could be said, this phenomenon is rather invisible, due to its illegality, therefore it is very difficult to filter information, the line between subjective and objective sometimes seems very thin. Thus, it is vital for international legal community to conduct more in-depth research to understand structures and networking of the organized crime syndicates.

## II. METHODOLOGY

The main aim of the research is to focus on the Transnational Organized Crime (TOC) phenomenon with greater emphasis on related organized crime groups, their structures and networks. Data collection and evaluation process include the following: review of previous research, introduction of the problem and purpose of the study, the hypothesis, the methods of data collection, results and discussion, conclusion and recommendations and lastly; references (Miller and Salkind, 2002).

The main challenge of this research is to establish if there is any possible connection between structure and networking in relation to mutual trust and business. In other words this research will try to answer the question: Can structures determine networking? This research is focused on studying behavior of organized criminal groups.

Research objectives are:

1. To increase familiarity with the phenomenon and to attain new insight into it (exploratory research)
2. To produce an accurate account of the characteristic of a particular phenomenon, situation, and a group (descriptive research)
3. To determine the frequency and strength with which the phenomenon occurs or with which it is associated with something else (diagnostic research)

Data gathering will include the following: primary data collection (interviews) and secondary data collection (books, journals, news articles, police reports, conferences papers)

The main focus of this inquiry is not measuring opinion, but the phenomenon itself. Furthermore, taking under the consideration the ‘dangerousness’ of the subject it is particularly difficult to remain a/ safe, b/unbiased, c/not influenced by political situation, d/ not corrupted.

Nowadays there are a sufficient number of accessible secondary sources. As underpinned by Frankfort-Nachmias and Nachmias (1996) there should be no limitations on the selection of units to be analyzed in a research project. However, in reality, driven by the selection of units of research and its topic itself, I had to adjust the research procedures, mainly the scope and level of generalization and theorizing; in order for the research to be reliable.

The process involved:

1. Analysis and interpretation
2. Relating data to the research question
3. Drawing conclusions and recommendations
4. Assessing the limitations of the study

### III. CURRENT HEURISTIC DEVICE

Until the creation of a common heuristic device all cross-border crime will be seen as ‘TOC’. Some of the heuristic devices have already been developed by international organizations such as the UN, the EU, and Interpol. However, their heuristic approach varies according to their methodology, and the reason behind their policies and actions. For example the United Nation Office on Drugs and Crime (UNODC) produced the Convention Against Transnational Organized Crime (2000); the main principle of this protocol is:

“The international community demonstrated the political will to answer a global challenge with a global response. If crime crosses borders, so must law enforcement. If the rule of law is undermined not only in one country, but in many, then those who defend it cannot limit themselves to purely national means. If the enemies of progress and human rights seek to exploit the openness and opportunities of globalization for their purposes, then we must exploit those very same factors to defend human rights and defeat the forces of crime, corruption and trafficking in human beings.” (United Nation Office on Drugs and Crime produced the Convention Against Transnational Organized Crime, 2000).

The convention may be view as a tool or a framework, which we could use in order to understand TOC. However, the methodology used by more of a practical, rather than theoretical organization, which is Interpol, is described as:

*“[...] to facilitate cooperation among our member countries and stimulate the exchange of information between all national and international enforcement bodies concerned with countering these problems” (Interpol, 2011).*

Consecutively, the heuristic device used in this paper, involves models derived from existing empirical research. The assistive tool has been created in order for better understanding of the phenomenon itself, its structures and its networking. The original principles for the creation of the working definition were:

- The hypothesis that there is an existing and operating phenomenon known here as Transnational Organized Crime.
- A recognition that the term TOC is complex, as it consists of multiple groups, with multiple cultures, in multiple countries.
- TOC itself is a concept or heuristic device to describe a series of actions and patterns of behaviour rather than a tangible measurable thing
- TOC have existed since long time ago (pirates would be proud of naming their activities this way), there has been few waves of TOC’s development and activities on the international arena, however the modern TOC as we know now, emerged in 1990s. Organized cross boarder crime has a long history.
- TOC consists of many groups cooperating with each other. In order for clear understanding and a common working definition it is vital to distinguish between an organized group, international organized group, transnational organized group, criminal syndicate and the Big Six International Criminal Organizations.
- Structures of the TOC groups are compared and contrasted with legal business structures which are already known. However it has to be remembered, that illegal activities, its criminalization and its incognitivism (from word incognito), may be a reason for structures undertaking different shapes and/or dynamics. This is very difficult to detect without being biased, and relying on the subjective opinions of interviewees, police, authors
- The existence of networks (few are already know very well, so the organized criminal groups are in search for new routes of trafficking), and reasons behind them.
- Some other issues around the topic may suggest that it may be just an opportunistic crime (Densley, 2011), or maybe it is just profit based (thousands Mexican mothers smuggling drugs through the US-Mexican border (Vulliamy, 2011)), or the cooperation can be derived from a long term opportunity? (for example: drug smuggling in Rotterdam (Zaith 2002)).
- And the grand finale, which still remains unknown, will be to answer the question: Can structures determine networking (or if there is a possibility of it; technical and/or theoretical. It may also be a case of an invisible causation)

Therefore; my heuristic device which will be used as a form of preliminary analysis will be:

*Transnational Organized Crime is an international phenomenon which involves transnational cooperation within illegal organized crime groups from different countries in order to gain profits.*

The empirical meaning of the concept: Transnational Organized Crime implies two words worth explanation: transnational (has to cross as least two borders, whereas term international is acceptable for describing activities between only two countries), and organized– which introduces the broad concept and practice of an identifiable and measurable set of structures and practices of gangs, organized criminal groups, criminal syndicates. The other phenomenal issue surrounding the problem is its globalization. As an international society, we had missed the moment when organized crime became as organized as its legal businesses counterparts. If TOC would be as known as legal international businesses, we would have more chances to follow it, understand it and tackle it, however, as all crime, it seem to remain undercover (Edwards and Levi 2008, Levi, 2008, and Varese, 2009).

#### IV. FINDINGS

Andre Bossard said that the constitutive elements of transnational crime are twofold: first: the crossing of a boarder by people (criminals), object (for example: firearms), and the international recognition of a crime, through international conventions, extradition treaties and national laws concordats (Bossard, 1990). That last point is important – it has to be a crime that is recognised by a number of countries. My working definition of an organized crime group (and a gang) is:

*“Any group having some manner of a formalized structure and whose primary objective is to obtain money through illegal activities. Such groups maintain their position through the use of actual or threatened violence, corrupt public officials, graft, or extortion, and generally have significant impact on the people in their locales, region, or the country od a whole” (FBI, 2011).*

As mentioned earlier, the concept of Transnational Organized Crime is recognized as relatively new term on the international arena (firstly recognized in the beginning of the 20th century in the USA, but its high- speed development could be seen mostly since late 1980’s). During the past decade in the EU there has been a growing stress posed by governments and police upon the term ‘organized crime’.

However the nature of this phenomenon has remained elusive Despite of the constant attention towards term ‘organized crime’ in the media, political and legal sectors around the world, the great consensus in the criminological literature and among contemporary police

agencies, is that networks are very important and more sophisticated then the term ‘organized crime; as a dynamic picture of how criminals operate (Edwards and Levi, 2008).

#### V. GANGS’ ORGANIZATION

Gang organization is one of the least understood concepts in the literature on gangs, as it has been described by Decker et al. (2008). – a ‘black box’. There are those who argue that gangs are organized, and some who think they are not: “The organized crime fallacy is the tendency to attribute much greater organization to crime conspiracies than they usually have. There’s no point being a criminal if you have to go to long meetings” (Felson, 2002: 10).

Some consider gangs as formal- rational organizations, hierarchical, dealing with specially arranged profitable illegal activities, which were possible due to group work (Kemp, 2008, Garcia, 2008 and Densley, 2011). Another approach suggests that gangs are very organized, motivated by opposition to rival gangs. Diego Gambetta suggested that they also use ‘conventional and other symbolic signals’; for example: colors and hand gestures (Gambetta, 2009).

In some cases gang members are too young, and too new to the subject of creation of strong and plausible structure, their efforts are focused mainly on violence, robberies and drugs. Sometimes they could even be seen as ‘freelance’ drug dealers (Hagedorn, 1994). As argued by Densley; many gangs in Britain would like to be like those gangs presented in media, however, their characteristics, activities and recognition is different. This symbolic organization of gangs, in turn, becomes sometimes a necessary component of their actual physical organization. The evolution of gangs in greater London is straight forward; most of them started as recreational groups; influenced by media, occasionally boredom, and will of undertaking more profitable activities. The group provided activities and social life. Sometimes they were criminal activities, but if so, they were rather opportunistic (Densley, 2011).

“But then as we got older we just started getting more organized, just working on money, like dealing drugs and stuff, just, we just wanted to make money that was it” (Interviewee 1, cited in Densley, 2011:49).

With the evoution and subsequent growth of the overall organization, gangs start to rely less on personal attachments and more on established rules and regulations. There is less emphasis on personal orientation and more on goal orientation, decision- making process becomes more calculated rather than spontaneous (Densley, 2011). In short, the gang’s organization reflects gang’s business.

At this point, when private goals are overridden by a possibility of earning more money via group work, it

changes the whole structure of the gang. The gang stops being just a 'gang' any more, it becomes an organized group, where common goals are the priority. At this stage the scope of activities and businesses speeds into different sectors (for example they are dealing not only with drugs, but also with racketeering, extortion, cybercrime and weapon smuggling). Also, they are seeking more activities which bring profits, however are less opportunistic. Now, the group realizes their potential (knowing their size, number of 'real members', number of 'experts', their territory and range of activities, connections with 'legal world' and the direction where threat may come from), in short: they have learnt from experience, and evolved into more sophisticated group. From psychology of behavior, cognition and group dynamics, in most cases in order to organized people - the leader also has to appear and lead the meetings, actions and people. By that time, members also know each other well, and know what to expect from each other as a group, and what are the capabilities of each member, also their skills, involvement and trust (trust as one can trust his group and their actions, as well as trust between member themselves, and trust in leader). Sometimes, the group may not be aware of this change at its first stages, however, later when they realize in what ways they evolved, they feel proud and stronger.

Next stage happens when one organized group is deciding to start cooperation with someone else, an individual, another group or a legal syndicate. The activity which involves all of above is for example stealing cars in Germany by Polish specialists from organized group, bribing border agency officers or policemen in order to let them go if stopped, and handing over the car in Poland to the Russian or Ukrainian organized group member (Kowalewski et al. 2004). This pathway is also happening within one country; however this research is interested in Transnational Organized Crime. When the group is strong enough to be willing to cooperate with another transnational organized criminal group, they do it only because they want to maximize their profits. Although, it is a risky move, the benefits from this cooperation seem too good to not get involved.

## VI. COOPERATION AND NETWORKING

When the cooperation flourishes (internal as well as with other gangs), the group is looking for more opportunities within their domestic environment, as well as abroad. When the group becomes successful in the transnational cooperation it can be named properly: a Transnational Organized Crime Group. There are 6 giant (in comparison with other) groups like this. For example: Italian Mafia, Chinese Triads and Columbian Cartels, Russian Mafiya, Japanese Yakuza and Mexican Organized Crime Groups. Transnational Organized Crime can be seen as an informal institution/organization with permanent, but dynamic and invisible constitutions. The rules have been created by the boss(es), and are reflecting the current

situation in the organized group. Sometimes, those rules have not changed since the gang was created, however, sometimes, as noted above; rules are dynamic, the same as the whole organization, which indicates that rules can change together with business. It is very important to remember, that organized crime is one of the fastest growing industry in the world (UN Office of Drugs and Crime, 2000) It is developing in a sense of adaptation to new laws and the international climate, but also becoming flexible in the trading of materials and maintaining of its own place within the criminal world. However, what is most remarkable about this concept is the fact that they have the ability and knowledge to avoid the authorities and to be invisible to the laws and international conventions. "The plain fact is that we struggle to catch burglars and car thieves" (Barton, 2011), without even mentioning tackling TOC. Since 1920's, when our knowledge and understanding has developed, we aim to have more sophisticated awareness of organized crime.

## VII. LAW ENFORCEMENT

Transnational Organized Crime is an international phenomenon which has to be dealt with on an international level, by international laws. In the modern world it is very important for law enforcement organizations and international police to understand the complexity and flexibility of Organized Crime. The scaling theory, deep knowledge about structure and network is necessary. Transnational Organized Crime is constantly developing and changing. When the Mafia goes through moments of crisis, it hides- *si ingrotta*, as they say in Palermo, and waits for better times to come. Therefore, one should not misinterpret the Mafia's silence as its defeat.

Although Organized Crime operates subversively, outcomes are noticeable, and from time to time we read in the newspaper that bad bandito was caught, or that Mexican cartels kill another person ('Mexican journalist's throat slit', 27th July 2011, the guardian.com). It is crucial for us to have greater understanding of those cooperate activities. This empirical approach would be very valuable when explaining and analyzing transnational cooperation between organized crime groups. One of the main issues with our comprehension of organized crime groups arise from the fact that this area has been vastly under-researched due to its exclusivity and secrecy are the structures of organized crime groups.

## VIII. STRUCTURES AND VARIABILITY

The structure of a group creates useful tool for further understanding of a gang, its internal movement, decision pathways, and outcomes. There is recognition of different types of structures within TOC groups. Those structures were defined by national police, people like Roberto Saviano (2008), who went inside the structure of a

criminal organization and police informants. In some cases a structure can be predicted by the way the gang behaves. A widely recognized structure is the pyramidal structure; made famous by La Cosa Nostra and also by the film the Godfather. The structure strikes with its simplicity and power dependence. At the top of the structure there is the boss, who receives help and advice from his consigliere, below the boss is underboss, who commands his caporegimes (captains) of their legions, which are consisted of soldiers. Nowadays, in most know cases, soldiers do not know who is their main boss, this element is there for protection of the main personnel in the gang in case of a riot in the bottom of the pyramid. The evidence suggests that this certain structure was not created for the purposes of maximizing profits or financial power efficiency.

The organization was determined by cultural aspects such as respect for people, who were already maintaining some social and financial status. This family associated, geometrically simple structure, which reflects the culture of Sicily, does not find its correspondents in the rest of Italy.

In contrast, the structure of Camorra is totally different. Camorra represents more of a horizontal structure. As a result individual clans act independently of each other, this makes Camorra more resistant when top bosses are arrested or killed. Camorra developed structures that are not easy to tackle. Even the Columbian Cartel members in Rotterdam who are involved in cocaine business in Netherlands; they do not form a homogenous structure or a cultural group, they can be seen as a group with members that have certain level of trust, accordingly to their roles within the group (Fig.1).



Fig. 1. REFERENCE: Zaith, 2002

Although other European states share the same geo-political features such as long coast line, good roads, fast and convenient transport, Rotterdam is situated between West and East extremes and also is one of the biggest ports in Europe and that means a volume of traffic through it is almost impossible to police. According to Damian Zaith's research (2002) the distance does not

play a big role for cocaine traffickers. Transportations costs are very small in compare to potential benefits. The Columbian kingpins put a certain degree of trust which they placed in oversees businesses. Cocaine entrepreneurs devote time and efforts in trying to reduce the risk of a dirty play (being stolen, ripped-off, injured or killed). But, many operators are shaped around 'trusted' individuals: "The sent to Switzerland because they knew that woman there" (Zaith, 2002:9). As we can see on the pyramid (Fig.1) on the top there are the capitalized exporters, who live in Columbia, further down, non-capitalized exporters, importers and distributors who collect the packages, and distribute them around the high-risk employers, who are selling the drug, they make the lowest group on the pyramid. It has to be remembered that structure differs accordingly to the type of organized group, place and businesses available. Due to rather coherent work of British Police, Boarder Agency and welfare state of United Kingdom, organized crime in Britain is less developed, and the focus of illegal business is local, rather than global.

## IX. DISCUSSION

Current world illicit trafficking network is vast, and requires cooperation within multicultural societies. The question is, does fundamental differences in culture and perception of business shapes or rather makes it more difficult for transnational cooperation/trafficking? What makes gangs trust each other? In order to answer this question, it is crucial the understanding of the cost-benefit decision making process.

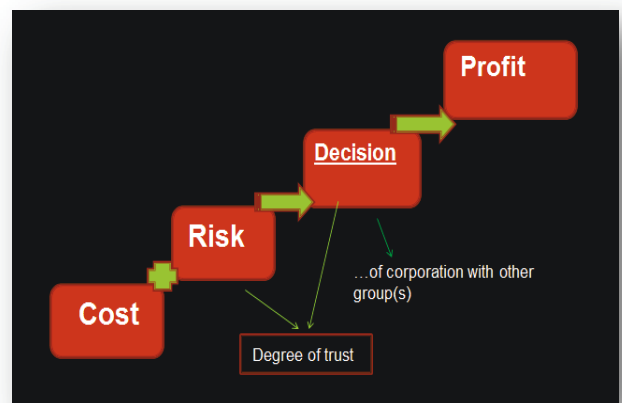

Fig.2. REFERENCE: Maszczynska, 2011

Decision on cooperation with other entities comes after the analysis of costs of a product, transportation etc. plus risk involved in the criminal activity. The degree of trust is being created after mitigations, and evaluation of partnership. This whole mechanism results in pursuit of financial profit. For example; shipment of radioactive waste from Italy (Camorra) to China (Triads) requires a

vast degree of trust and professionalism from both criminal groups. Subsequently, the radioactive waste is manufactured into plastic toys and shipped back to Europe via Naples. The financial profit from this illegal production is very rewarding; the risk of getting caught is minimized to minimum, due to the professionalism of people involved and corruption of relevant individuals who may extinguish the whole operation. There is a mutual trust between Camorra and Chinese organized crime syndicate. While those illegal operations seem to continue, it can be assumed that multicultural differences do not play a major role, neither do the threat of being tackled. The possibility of financial gratification as well as history of positive cooperation ‘helps’ with decision making within organized crime groups (Fig.2).

The issue of functionalism and business-to-business networking is represented as follows: some groups tend to represent rather post-hoc rationalization rather than actual reasons in a decision making process. Moreover, as it is recognizable now: cultural diversity, boundaries and other barriers do not matter greatly when it is coming to big money (it only extends the process).

“It’s about time law enforcement got as organized as organized crime” (Rudolph W. Giuliani)

## X. CONCLUSION

In the current international climate problems such as: imbalance within laws and policies, differences in approaches to TOC, political and social phenomenology, and diverse political doctrines are the cause of unequal understanding of the TOC by the multicultural international society. Until all of those obstacles will be recognized and analyzed implemented we will not have sufficient knowledge and understanding of what Transnational Organized Crime actually represents. There are certain legal definitions present, however they are not equivalent to each other, and they represent different stands.

It would be beneficial for international law enforcement organizations to create one definition which would cover all aspects of TOC, as well as common understanding of what it is, that they are fighting against.

In the modern world it is very important for law enforcement organizations and international police to understand the complexity and flexibility of Organized Crime. At this stage, the information which we possess are not enough to give a valid statement that structures can determine networking. There is an evidence of cooperation between similarly structured groups; however there are also indications about networking between diverse structures gangs. Further research is being undertaken in order for further exploration of this fascinating phenomenon.

## REFERENCES

- Aas, K.F. (2010) *Globalization and Crime. Key Approaches to Criminology*. London: SAGE Publications
- Barton,A. (2011) *Casual conversation*. November, 2011. Plymouth.
- Bossard, A. (1990) *Transnational Crime and Criminal Law*. Chicago: Office of International Criminal Justice
- Decker, S. and Pyrooz, D. (forthcoming) ‘Gangs: Another Form of Organized Crime?’, in *Oxford Handbook of Organized Crime* (ed. Letizia Paoli) New York: Oxford University Press
- Decker, S., Katz, C. and Webb, V. (2008) ‘Understanding the Back Box of Gang Organization: Implications for Involvement in Violent Crime, Drug Sales, and Violent Victimization’. *Crime and Delinquency* 54(2008): 153-72.
- Densley, J.A. (2011) ‘The Organisation of London’s street gangs’. *Global Crime* 1 (2011): 1-23.
- Edwards, A. and Levi, M. (2008) ‘Researching the Organization of Serious Crimes’, *Criminology and Criminal Justice*, 8, pp. 363
- Felson, M. (2002) *Crime and Everyday Life*. 3rd edition. Thousand Oaks: SAGE Publications
- Frankfort- Nachmias, C. and Nachmias D. (1996) *Research methods in the Social Sciences*. London: Arnold
- Gambetta, D. (2009) *Codes of the Underworld. How Criminals Communicate*. Princeton: Princeton University Press
- Garcia, J. (2008) *Making Jack Falcone. An Undercover FBI Agent Takes Down a Mafia Family*. Krakow: Znak.
- Hagedorn, J. (1994) ‘Homeboys, Dope Friends, Legits, and New Jacks’, *Criminology* 32(1994): 197-219
- Kemp, R. (2008) *Gangs*. London: Penguin Books
- Kowalewski, A., Kazen, L. and Spiechowicz, K. (2004) *Alfabet Mafii*. Warszawa: TVN
- Levi, M. (2008) ‘Organized fraud and organized frauds: Unpacking research on networks and organizations’, *Criminology and Criminal Justice* Vol. 8 pp.389
- Miller, D.C. and Salkind, N.J. (2002) *Handbook of Research Design and Social Measurement*. Thousand Oaks: SAGE Publications
- Saviano, R. (2008) *Gomorra: A Personal Journey Into the Violent International Empire of Naples’ Organised Crime System*. New York: Farrar
- Varese, F. (2009) ‘The Camorra closely observed’ *Global Crime*, 10: 3, pp.262-266
- Vulliamy, E. (2011) *Amexica. War along the Borderline*. London: Vintage Books
- Wright, A. (2006) *Organised Crime*. Culompton: Willan Publishing
- Zaitch, D. (2002) *Trafficking Cocaine: Colombian Drug Entrepreneurs in the Netherlands*. Hague: Kulwer Law International.



Websites:

Federal Bureau of Investigation, 2011 ([www.fbi.gov](http://www.fbi.gov))

Interpol , 2011 ([http://www.interpol.int/Crime-areas/Organized-crime/Organized crime](http://www.interpol.int/Crime-areas/Organized-crime/Organized%20crime)).

The United Nation Office on Drugs and Crime produced the Convention Against Transnational Organized Crime (2000)

(<http://www.unodoc.org/documents/treaties/UNTOC/Publications/TOC%20Convention/TOCebook-e.pdf>),

UN Office on Drugs and Crime (2000) ([www.unodc.org](http://www.unodc.org))

Unknown author, 'Mexican journalist's throat slit', 27th July 2011, [the guardian.com](http://the-guardian.com) <accessed on the 2 January 2012>



# Influence of Film Thickness and CVD Deposition Rate on Surface Quality of Polyparylene Coatings

F. Schamberger\*, A. Ziegler, G. Franz  
Munich University of Applied Sciences  
Munich D-80335, Bavaria, Germany  
\*Email: f.schamberger@hm.edu

**Abstract**—Polyparylene is a polymer with outstanding properties when compared to other synthetics. Therefore, CVD deposition of polyparylene is making inroads in several technical fields. Even applications demanding tight requirements on coating quality, like gate dielectrics for semiconductor industry and semi-permeable layers for drug eluting implants in medical science, are coming within its purview. In this paper, the impact of film thickness and deposition rate of the polyparylene CVD process on surface parameters like roughness and pinhole density is investigated. Surface roughness and pinhole density was monitored by atomic force microscopy (AFM) measurement. Furthermore, the influence of the pinhole density on tunnelling current and breakdown voltage of the deposited layers is also investigated. The results obtained are used to establish an easy method to estimate the pinhole density by electrical measurement rather than the AFM method, which is not only time consuming but also limited to small flat areas. To deposit very thin layers below a thickness of 1  $\mu\text{m}$ , conventional coating techniques for polyparylene has been replaced by a completely new method that employs a steep slew rate for the deposition rate. In comparison to the well known Gorham method, the new coating method has the major advantage that it permits control of the deposition rate that is independent of evaporator temperature.

## I. INTRODUCTION

The established CVD process for parylene deposition consists of three main steps using the set-up in Fig. 2. First, the dimeric precursor is converted from the solid state into the gaseous phase. This is typically conducted at a reduced pressure of a few pascals and at a temperature between 100 °C to 150 °C. Under these conditions the dimeric precursor is sublimated. The furnace for sublimation is a steel barrel powered by an electrically heated jacket. The di-parylene is kept in a brass boat within the furnace. In the second step the gaseous di-parylene is made to go through a pyrolysis process of approximately 700 °C, wherein it cracks into its two monomeric constituents. The cracker unit consists of a steel tube which is approximately 40 cm in length. It is heated electrically and is thermally insulated from the ambient. The output of the cracker unit is connected to the vacuum chamber by a electrically heated allocator, which is maintained at a temperature of approximately 140 °C. At this temperature the deposition rate of parylene is almost zero. In the third and last step the monomeric parylene is guided into a vacuum chamber at room temperature, where the molecules react to form long polymeric chains which deposit themselves as homogeneous films. Any part in the recipient will be coated with a homogeneous film of polymeric parylene. The properties of

the deposited layers can be influenced by varying the process pressure, vaporisation temperature and pyrolysis temperature. Furthermore, by doping the recipient atmosphere with different process gases, the deposition rate and the film properties can be modified. On molecular basis the three described processes happen as shown in Fig. 1. The above described method is extensively described in literature *e.g.* [1],[2] as the Gorham method. It must be noted that in addition to the basic set-

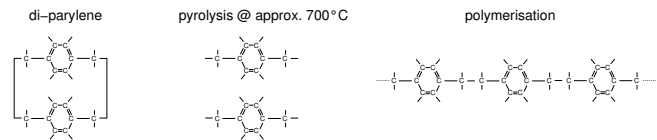

Fig. 1. Parylene pyrolysis and polymerisation

up as shown in Fig. 2, there are several supporting systems like vacuum gauges for pressure measurement, rotary vane pumps for vacuum generation, a cooling trap and a gas inlet control system as well as a microwave generator system to ignite a low pressure plasma in the vacuum recipient. The plasma capability also adds some additional degree of freedom to modify the deposited films. All these supporting systems are controlled by a industrial process controller, which can be modified accordingly to fit the needs.

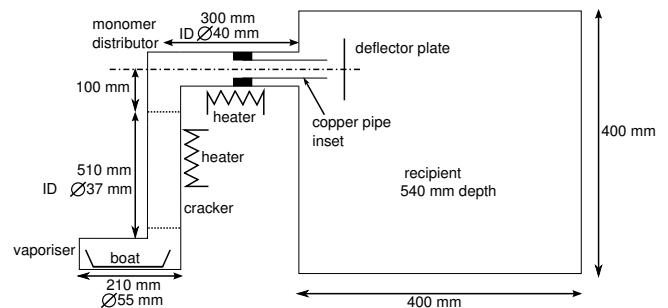

Fig. 2. Diagram and dimensions of CVD machine

## II. METHODOLOGY

### A. Film deposition

The Gorham method has limitations in depositing thin layers below 1  $\mu\text{m}$ . The main obstacle in producing thin layers in this

process is the thermal lag of the vaporiser unit which shows a retardation of approx. 40 minutes until it stabilises at the target temperature. During this heat up phase the deposition rate will rise in an uncontrolled manner from zero to its final value. To eliminate this unstable process step the recipient is kept under increased supporting gas pressure of 40 Pa of argon gas which inhibits the evaporation of di-parylene. As the vaporiser reaches its target temperature, the supporting gas pressure is abruptly reduced to its target value *e.g.* 5 Pa, and the coating process begins immediately with a constant deposition rate. We determined the deposition rate DepR for various coating runs as shown in column 5 of Tab. I. With the above modification of the Gorham method it is now possible to change the deposition rate with a steep slew rate. Moreover, due to the supporting gas pressure, the deposition rates can be reduced to values which allow the growth of reproducible film thicknesses even below 1  $\mu\text{m}$ . This method was applied to process all samples used for this paper.

### B. Mass flow

The flow into the reactor can be evaluated as difference between the mass in the boat at the beginning and end of the process. It must be noted that the flow into the reactor itself is diminished by a certain amount, because of recrystallisation of di-parylene at the colder door. The surface of the boat covers approx. 60  $\text{cm}^2$ . The surface change due to mass reduction in the boat is negligible. We now calculate the flow into the reactor. Using Eq. 1 for the ideal gas law, Eq. 2 for the amount of substance and Eq. 3 for the molecular mass, Eq. 4 for the volume of the flow is derived.

$$V = \frac{n \cdot R \cdot T}{p} \quad (1)$$

$$n = \frac{m}{N_A \cdot m_M} \quad (2)$$

$$m_M = \frac{M}{N_A} \quad (3)$$

$$V = \frac{\frac{m}{N_A \cdot m_M} \cdot R \cdot T}{p} \quad (4)$$

Simplification of the upper equation leads to Eq. 5. In the flow column in Tab. I, the volume  $V$  is converted from  $\text{m}^3$  to  $\text{cm}^3$  and is divided by the process time in minutes

$$V = \frac{\frac{m}{M} \cdot R \cdot T}{p} \quad (5)$$

To estimate the cracker velocity  $v$  in Tab. I we use Amontons and Gay-Lussac law

$$\frac{p_1 V_1}{T_1} = \frac{p_2 V_2}{T_2}, \quad (6)$$

to solve for  $V_1$  in Eq. 7. Process relevant parameters are used for  $T_1$  and  $p_1$ . For  $p_1$  is the measured pressure listed under column  $p$  in Tab. I. For  $T_1$ , the exact values are not available, however we know that  $T_1$  is at least above the vaporiser temperature but below the cracker temperature. This means

TABLE I  
PRESSURE DEPENDENT MASS FLOW OF PARYLENE N AT  $T_{\text{vap}} 130^\circ\text{C}$  AND  $T_{\text{cracker}} 700^\circ\text{C}$

time	$p$	VapR	DepR	yield	flow	$v$	cracker residence
in min	in Pa	$\frac{\text{mg}}{\text{cm}^2 \cdot \text{min}}$	in $\frac{\text{nm}}{\text{min}}$	in $\frac{\text{nm}}{\text{mg}}$	in $\frac{\text{sccm}}{\text{min}}$	in $\frac{\text{m}}{\text{s}}$	in s
60	$\approx 0.8$	0.86	17.7	0.34	5.57	10.8	0.047
90	$\approx 0.8$	0.83	18.7	0.37	5.39	10.4	0.049
90	$\approx 0.8$	0.89	18.3	0.34	5.75	11.2	0.045
240	5	0.43	5.5	0.21	2.78	0.86	0.59
240	5	0.53	7.5	0.24	3.41	1.05	0.49
240	10	0.24	1.8	0.13	1.53	0.24	2.13
680	15	0.14	0.4	0.05	0.92	0.09	5.67

that  $T_1$  is a function of the location within the vaporiser-cracker unit. To calculate the values in Tab. I it is assumed that  $T_1$  equals the vaporiser temperature

$$V_1 = \frac{p_2 \cdot V_2 \cdot T_1}{T_2 \cdot p_1}. \quad (7)$$

The gas velocity inside the cracker can be determined using Eq. 8, where  $A$  is the cross section area of the cracker unit (for dimensions refer Fig. 2).

$$v = \frac{V_1}{A \cdot t}. \quad (8)$$

### C. AFM investigation of surface topography

To record the surface topography of the deposited poly-parylene layers a AFM from JPK with a maximum scan area of 130  $\mu\text{m}$  x 130  $\mu\text{m}$  was used. As a scanning tip, an OMCL-RC Olympus micro cantilever was employed. The data obtained was subsequently processed and analysed by the open source software Gwyddion [3]. By this procedure, the surface is evaluated with respect to hole density and their depth referred to layer thickness. As substrate for the poly-parylene coatings, microscope glass slides were found to be suitable enough, as their roughness is approx. 1 nm.

1) *AFM investigation of film roughness:* To investigate the influence of the deposition rate on to the height profile of the films, three types of samples were processed. Different films are deposited with basic pressure (0.8 Pa), 5 Pa and 10 Pa with argon as the diluting gas. The results of the scanned samples are depicted in Fig. 3. The height index of the three height

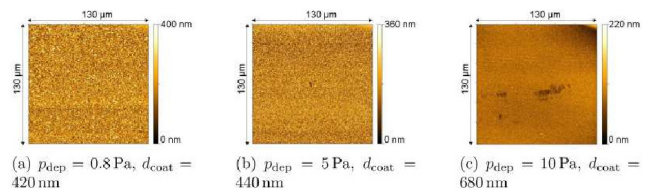

Fig. 3. Height map of poly-parylene N coating

maps in Fig. 3 on the right hand side of the diagrams indicates the decrease of roughness with higher supporting gas pressure. Beside this the grain size is also reduced with higher pressure.

To further investigate the influence of the deposition rate on the surface quality of the coated films, the average roughness  $R_a$  was computed according to Eq. 9 for the scanned area of the samples. In this equation,  $y_i$  represents the vertical distance of the  $i^{th}$  data point from the mean plane of the surface.

$$R_a = \frac{1}{n} \cdot \sum_{i=1}^n |y_i| \quad (9)$$

The results of the calculated roughness  $R_a$  for deposited poly-parylene N at various process pressures and film thickness are depicted in Fig. 4.

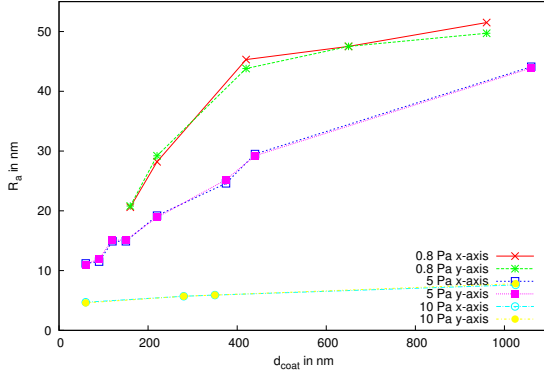
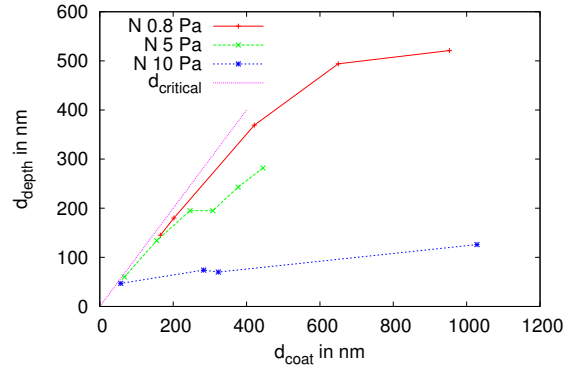

Fig. 4. Average roughness  $R_a$  of poly-parylene N coating

2) *AFM investigation of pinholes*: The AFM data of the investigated samples were also evaluated for pinhole depth and pinhole diameter. Fig. 5(a) shows the results for the pinhole depth. The  $d_{critical}$  line in Fig. 5(a) indicates where pinhole depth equals film thickness, which implies persistent holes. In Fig. 5(b) all data points are plotted where the scan depth of the AFM tip reaches 90% of the maximum hole depth found in that scan run. The 90% scan depth reflects two important aspects of the coating quality *viz.* the deepest holes inside the film thickness and the transition boundary from persistent to non-persistent holes with increasing film thickness.

#### D. Electrical Impedance Spectroscopy

Electrical impedance spectroscopy (EIS) is a common technique to judge the quality of coatings or paints. In this analysis method, the coating or paint acts as a dielectric between two electrodes. In this case too, the same type of glass slides as used for the AFM investigation were first vapour coated on the front side with copper and then made to undergo the parylene deposition process. In doing so, a copper electrode with parylene as the dielectric is formed. As a second electrode a piece of copper with the same size as the glass slide is used. The whole system consisting of the coated glass slide and the copper electrode is dipped into a low ohmic aqueous  $1 \frac{mol}{l}$  NaOH solution. As the thickness of the glass slide is  $1000 \mu m$ , the parasitic backside capacitance can be neglected. The calculated error is below 1% in respect to the parylene film formed capacitor. To measure the impedance of the system the electrodes are connected to a HP 4192A



(a) Absolute pinhole depth of poly-parylene N

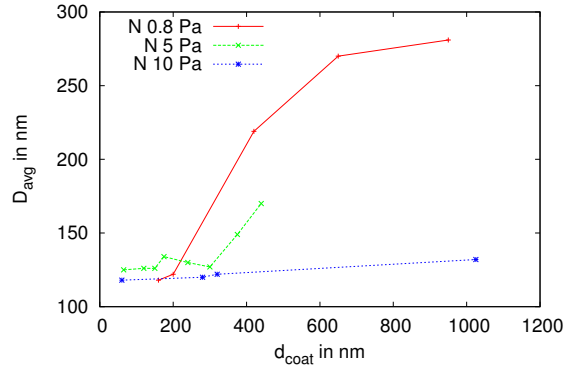

(b) Average pinhole diameter of poly-parylene N at 90 % scan depth of AFM

Fig. 5. AFM results of poly-propylene N at 0.8, 5 and 10 Pa supporting gas pressure

Impedance Analyzer which measures the impedance  $Z$  and the phase angle  $\varphi$  between test voltage and resulting current. The set-up is depicted in Fig. 6(a). The HP 4192A Impedance Analyzer is able to sweep the frequency from a fraction of a hertz up to 12 MHz. The measurement results are shown as Nyquist plots in Fig. 7 for a sample with 2240 nm of poly-parylene N coated at 0.8 Pa process pressure in Fig. 7(a) and 1650 nm N deposited at 5 Pa in Fig. 7(b). According to a simple equivalent circuit as shown in Fig. 6(b) the intersection of the graph with the real axis close to the origin is caused by the serial ohmic resistance  $R_S$  of the NaOH solution. The semi-circle trajectory is caused by the capacitance  $C_{dl}$  of the NaOH-parylene-copper layer, system which transits for lower measurement frequencies into a line. This linear slope is caused by the so called Warburg  $Z_W$  impedance. Ions diffuse into the poly-parylene film where they have to travel a certain distance during one measurement period. The Warburg impedance increases with lower frequencies as the ions can diffuse farther. To represent the additional resistance,  $R_F$  is in series with  $Z_W$ . Without the influence of  $Z_W$ , the half-circle would hit the abscissa for low frequencies, means direct current, at  $R_F + R_S$ .  $R_F$  represents the degree of insulating capability of the coating. The local minimum at  $\Re(Z) = 3250 \Omega$  translates to a measurement frequency of 100 Hz. Therefore,

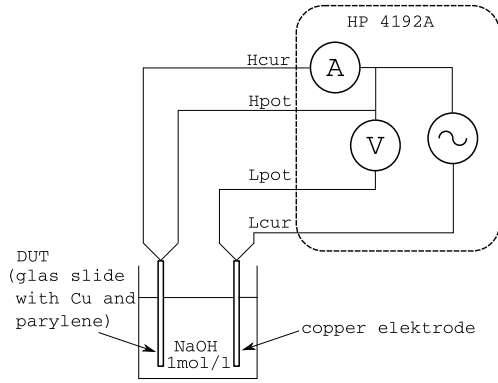

(a) Electro impedance spectrum measurement set-up

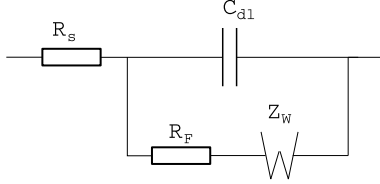

(b) Simple equivalent circuit for mixed kinetic diffusion

Fig. 6. Electro impedance spectrum analysis

all capacitance measurements of the parylene layer have to be performed well above 100 Hz to avoid a mixture of  $C_{dl}$  and  $Z_W$  parts. To investigate the dynamics of the soaking of the coated layers, the measurements were taken every 5 minutes.

### E. Electrical measurement of $C$ and $\varepsilon$

With the same measurement set-up as in Fig. 6(a), the capacitance of the sample was investigated. The measurement frequency was 1 MHz to minimise the influence of the Warburg capacitance. As the dimensions of the glas slide are known (area, film thickness), the permittivity  $\varepsilon$  was calculated according to Eq. 10. The results for the capacitance  $C$  and the calculated permittivity  $\varepsilon$  are shown in Fig. 8(a).

$$C = \varepsilon_0 \cdot \varepsilon \cdot \frac{A}{d_{coat}} \quad (10)$$

### F. Measurement of electrical breakdown field strength

The test method for determining the dielectric breakdown voltage is defined by ASTM<sup>1</sup> D149. This test method uses two contact electrodes on each side of the dielectric under test. The test is performed under arid conditions, where the voltage across the electrodes is ramped with a distinct slope. We modified this method to a wet measurement as we wanted to access the pinholes for worst case breakdown field strength values. We used for the measurement of the electrical breakdown field strength a glass-copper-poly-parylene sandwich, as used for the EIS experiments. In this set-up the counter electrode is formed by a polished metal slug with an area of  $150 \text{ mm}^2$ . The average roughness  $R_a$  of the polished contact surface was

<sup>1</sup>American Society for Testing and Materials

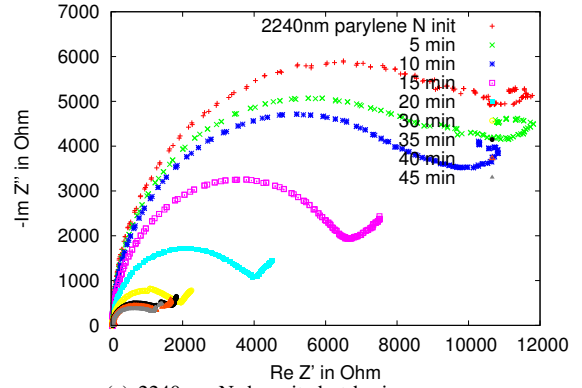

(a) 2240 nm N deposited at basic pressure

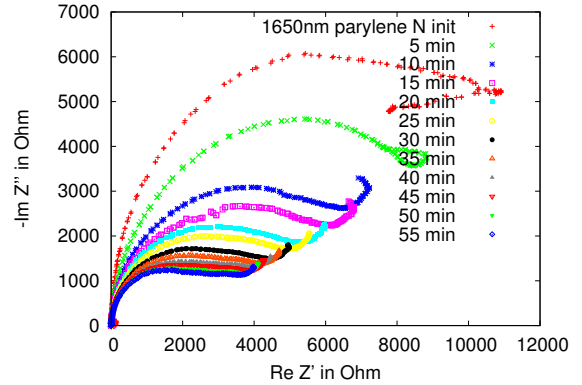

(b) 1650 nm N deposited at 5 Pa

Fig. 7. Dynamic impedance spectrum of poly-parylene N

determined to 6.7 nm, which is well below the  $R_a$  values of the deposited films. This minimises additional scratches caused by the electrode. To facilitate good electrical connectivity right down to the bottom of the pinholes, a drop of  $KNO_3$  was dispensed between electrode and poly-parylene surface. Moreover, to ensure constant and reproducible measurement conditions, the pressure of the polished contact electrode is adjusted with a micrometer screw and controlled by an electronic balance. Finally a Keithley Series 2600 source meter was used to control the voltage over the electrodes and to measure the transition from tunnel current branch to the breakthrough point. The results obtained are shown in Fig. 8(b).

## III. RESULTS AND DISCUSSION

### A. Relation between cracker residence time and deposition rate

The mass flow was checked with two sources of precursors. One was poly-crystalline di-parylene N which was obtained from sublimation and the other, di-parylene powder as supplied. Within error tolerance, exactly the same result is obtained, although the di-parylene powder was stuffed and hence its surface should be larger than the poly-crystalline sample. One reason may be that the powder sintered to a cake during annealing. This densifies the surface even further. From

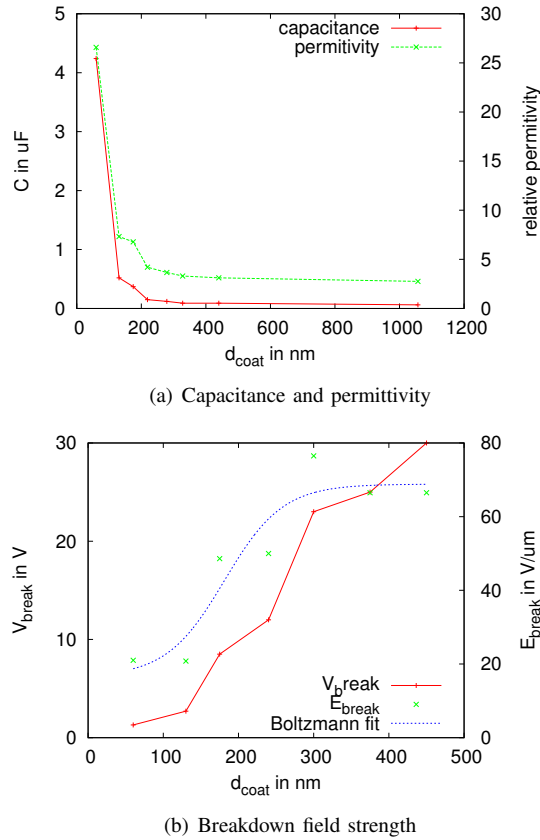

Fig. 8. Electrical parameters of poly-parylene N

this data, the flow for di-parylene N is 5.5 sccm at 130 °C and a basic pressure of approximately 0.8 Pa, cf. Tab. I. For higher pressures of the supporting gas, the flow drops to 0.09 sccm at 15 Pa. In contrast to [4], with our method, the deposition rate increases with decreasing pressure. This can be explained by the fact that more parylene is evaporated. The deposition method described by [4] differs to ours with respect to the method of pressure control. In [4] the pressure control is supposedly accomplished by controlling the upstream of the precursors whereas in our case, pressure is adjusted by an inert supporting gas. Investigation of the deposited film thickness per mg parylene in Tab. I shows a drop in yield with rising pressure. This can be explained by the longer residence time of the parylene in the cracker unit wherein the monomeric molecules are capable of acquiring more thermal energy. As colder surfaces show higher deposition rates as observed in [4], this may also be valid for cooler monomer molecules.

### B. Relation between deposition rate and surface quality

From the AFM measurements it becomes obvious that lower deposition rates reduce the roughness  $R_a$  of the coated films as shown in Fig. 3 and Fig. 4. For coatings with 10 Pa Ar supporting gas, which translates to approx.  $1.9 \frac{nm}{min}$  the roughness  $R_a$  remains saturated around 5 nm for all film thicknesses. With lower Ar pressure and therefore increased deposition rate,  $R_a$  also increases. For the 5 Pa and 0.8 Pa coatings the

increase of roughness  $R_a$  for films over 1  $\mu m$  levels slowly out. For a film-thickness of 1000 nm the roughness is four times higher compared to the 5 Pa coating and five times higher for a basic pressure coating compared to that with 10 Pa. Similar findings are observed with the absolute pinhole depth as shown in Fig. 5(a). The pinhole depth is significantly reduced with lower deposition rates. Of interest is the slope  $d_{critical}$  in Fig. 5(a) which represents the boundary where the absolute pinhole depth equals the film-thickness. This indicates persistent holes. The 10 Pa coating is free of persistent holes for film thickness well below 100 nm, whereas the 5 Pa coating lacks such pinholes only above 200 nm. For coatings at basic pressure the graph of the absolute pinhole depth creeps close the  $d_{critical}$  line and shows a sufficient distance to the critical depth only above 300 nm of film-thickness. Investigating the average diameter of the pinholes as shown in Fig. 5(b) the picture is somewhat similar. The average diameter  $D_{avg}$ , for the 10 Pa coating is approx. constant at 125 nm. The basic pressure coating shows an increase of  $D_{avg}$  from 125 nm at 200 nm film thickness up to 275 nm for a 1000 nm film. With film-thicknesses above 1000 nm the  $D_{avg}$  saturates around an average pinhole diameter of 275 nm. The 5 Pa coating run is as expected between the characteristics of the 10 Pa and the basic pressure coating. For coatings below 200 nm in all three pressure regimes show the same  $D_{avg}$  of 125 nm within the measurement uncertainty. A reason for this is that the 5 Pa and basic pressure coating show persistent holes below 200 nm film-thickness. The surface quality with respect to roughness, pinhole depth and pinhole diameter shows an obvious relation to the deposition rate. Lower deposition rates result in better film-quality. With our proposed deposition process, lower deposition rate implies a longer resident time of the monomer species in the cracker unit. During this time the molecule can acquire more thermal energy, hence reaching the surface as a hotter gas where it polymerises. This additional energy may allow a kind of “in-situ” thermal annealing leading to tighter crystallites within the polymer.

### C. Relation between surface quality and electrical data

The evaluation of the EIS data in Fig. 6 shows that the poly-parylene layer coated with 5 Pa, as shown in Fig. 7(b), settles after 55 min. of soaking in NaOH at a  $R_F$  of approx. 3000  $\Omega$ . Compared with the  $R_F$  of approx. 1000  $\Omega$  after 45 min. for the coating at basic pressure, this is three times more although the coating at basic pressure is 135% thicker than the 5 Pa coating and soak time was reduced by 10 minutes. This data support the findings of the AFM investigation, that coatings with lower deposition rates result in less pinholes with lower diameter. The measurement of the capacitance in Fig. 8(a) shows a steep increase below 200 nm film thickness, which can be explained by persistent or almost persistent pinholes. These pinholes add additional capacitance due to their remaining dielectric which are very thin. With films above 200 nm the capacitance becomes a function of the thickness. In this range, the calculated permittivity  $\epsilon$  settles to a value of 2.75 which is close to the 2.65 found in literature [5]. The results of

the breakdown experiment in Fig. 8(b) indicates that the breakdown field strength, above a film-thickness of 300 nm settles to approx.  $70 \frac{V}{\mu m}$ . This is below the  $276 \frac{V}{\mu m}$  known from literature [5]. As the data in Fig. 8(b) was obtained by wet measurement, which stresses the deepest pinhole the most, a lower value is expected. In contrast, the method used to obtain the value in literature is based on dry measurement. Dry measurement cause lower stress as it does not access the bottom of the pinhole.

#### IV. CONCLUSION

In this paper, the influence of film thickness and CVD deposition rate on surface quality of polyparylene coatings is investigated using a new method. The main topics of improvement are that the coating process can be started and stopped in a digital-like manner by the supporting gas pressure. Furthermore, it gives an additional degree of freedom by controlling the deposition rate by adjusting the pressure of the supporting gas. This is a difference to the Gorham method, where the di-parylene mass flow can only be controlled over the slow temperature control path of the vaporiser and as a result of it, the deposition rate. Films with different deposition rates and thicknesses were coated. The quality of the films has been investigated in respect to roughness, pinhole depth and pinhole diameter which showed that slower deposition rate results in higher film quality. A dependency of the quality and the hotter monomer gas temperature was discussed. To investigate this topic more in detail a X-ray diffraction or a differential scanning calorimeter measurement should be performed. The electrical characterisation of the deposited layers support the previous findings that above 200 nm the films become free of persistent pinholes.

#### ACKNOWLEDGMENT

Financial support of Germanys federal secretary of education and research under # 1715X04 and # 753X08 is gratefully acknowledged.

#### REFERENCES

- [1] W. F. Gorham, *J. Polym. Sci.*, Part [A-1] 4, 1966, p. 3027 - 3039,
- [2] J. B. Fortin & T. M. Lu, *Chemical Vapor Deposition Polymerization The Growth and Properties of Parylene Thin Films*, Kluwer Academic Publishers, 2004, p. 4
- [3] Gwyddion: *Gwyddion*, Access 25.08.2011  
**URL:** <http://gwyddion.net/>
- [4] S. Ganguli, H. Agrawal, B. Wang, J. F. McDonald, T. M. Lu, G. R. Yang, & W. N. Gill, *Improved growth and thermal stability of Parylene films*, *Journal of Vacuum Science & Technology A: Vacuum, Surfaces and Films* 15(6), 1997, pp. 3138
- [5] SCS: *Parylene Conformal Coating Specifications & Properties*, Access 19.06.2009  
**URL:** <http://www.scscookson.com/parylene/properties.cfm>



# Crossing the chasm with technologies not contributing to a proper technology mix

Jürgen Steinheber, MBA&Eng, PMP  
School of Management, University of Plymouth, Plymouth, United Kingdom  
(juergen.steinheber@plymouth.ac.uk)

Prof.Dr. Wolfgang Döhl  
School of Industrial Engineering, Munich University of Applied Science, Munich, Germany  
(wolfgang.doehl@hm.edu)

*Abstract* –This paper is based on the investigations of Moore (1991), who adapted Rogers' diffusions of innovations model (1962). They contain suggestions, how to cross a critical period of time in sales (the Chasm) before the early majority starts to gain interest in the technologically new product. Once a product crossed the chasm it has to face a make or break time period where mainstream customers determine whether the product is going to be successful or not.

Technical products do not exist just out of a single piece of technology but incorporate different components forming a mix of different technologies. Unfortunately, the technologies of all components do not progress at the same speed concerning their performance.

There are limits for combining components representing different technologies because some of them just do not fit. Devices with a misfit in the technology-mix bring up products with a limited customer benefit. Nevertheless, Innovators sometimes do not bother about problems with incomplete products. They want to be at the leading edge of technology. But once the chasm is crossed customer needs are different. In the mainstream, technology does not count, functionality is taken for granted.

We outline that a proper technology-mix strongly influences and correlates with the market success of a product for mainstream customers.

*Keywords*– Technology Mix, Diffusion of Innovation, S-curve, Technology Substitution

## I. INTRODUCTION

Investigations of Geoffrey A. Moore (1991) were focusing on the specifics of marketing high tech products, adapting the diffusions of innovations model of Rogers (1962). The investigations contain suggestions, how to cross a critical period of time in sales (the Chasm) before the early majority starts to gain interest in the technologically new product. Moore provides additional guidelines for moving a product into the lucrative mainstream market. Once a product crossed the chasm according to Moore (1999) it has to face with a potential "tornado" in sales and marketing, a make or break time period where mainstream customers determine whether the product is going to be successful or not.

Moore explains different appearances between innovators and early adopters and the mainstream market. Thus, various ideas may help to cross a chasm of different perceptions. Such an idea can be the identification of a

"point of attack" (Moore, 1991) as specific segment or technology to focus on.

Since Moore's initial theories focus on companies in the High-Tech industry of the late Nineties, it is important to describe an innovative technical product in a generic way to question how to successfully cross the chasm. One important aspect for industrial goods and b2b marketing is the product's ability to be perceived as a complete product. Its importance was underlined by Kalb (1995) and lately has been focused on in case study researches of Penttinen and Palmer (2007). It is not only solving the customer's problem by the product core, but also creates the basis of a long-term customer relationship by additional services and additionally ensures an emotional commitment of the customer to the supplier.

As more and more electronics is embedded in consumer long-durables the concept of a complete product has become an important contribution in achieving competitive advantage. The understanding of the importance of the idea of a complete product is strongly called for by many product managers, as for example by Athol Foden (2011) in his job role. Nevertheless, this paper is focusing on the core of an innovative product only, since the core has to be in place with various well-combined technologies.

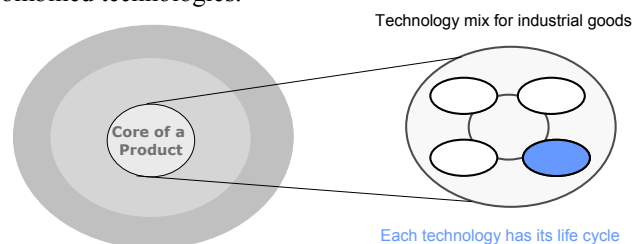

**Figure 1.** Product core consisting of a technology mix

Since most technical products do not exist only of one kind of technology as their product core, but consist of different components or devices representing different technologies, literature refers to as technology mix. A technology mix can form the core of a product with its interaction but can also describe a whole system, as R. Pagell (1991) researched.

## II. REVIEW OF BASIC CONCEPTS

The decision for a proper set of technologies as technology mix at the right time is a big challenge in marketing, as Capon and Glazer (1987) line out. Each embedded technology of a system or device is subject to the course of technical progress. Unfortunately, the technologies of all components neither are progressing at the same speed nor are they at the top-level of its physical performance at the same time.

Since technologies play a very important part regarding their performance and availability, it is essential to describe its existence by a basic concept. The concept of the product life cycle has been introduced both empirically and theoretically in literature by Brockhoff (1967), Day (1981), Midgley (1981), Easingwood (1988) and Bass (1995). Focusing on technology, Kim (2003) explains a concept for the product life cycle to technological innovation leading to the concept of the technology life cycle, as the investigations of Godoe (2000) and Winter et al. (2000) show. Researches like their results, show, that a technology life cycle as well consists of phases of market entry, growing, maturing and declining.

The life cycle of a technology represents an aggregation of specific technology application life cycles in various fields of application and markets, as Döhl (2006) points out. Technologies are initially used in extreme applications and in markets of marginal size, where only a limited number of suppliers are able to master it. After being tested and proved the new technology leaks into applications and markets, regarded as „high-tech“, being in the vanguard of the technology. The number of applications is increasing, more suppliers are able to master the technology and customers are re-designing their existing product lines to incorporate the technology. On its way to a mass market application, a technology might be considered to be incorporated into a product via a sub-component.

Generally, technologies are applied in different products, markets and industries each with different levels of maturity. This can mean, that a technology that still has some potential in a specific application may already have reached its limit of performance in other applications, which indicates a potential transition to a superior technology. For some components technological performance may increase dramatically or technology can be substituted, while there seems no progress at all with others. (Twiss and Goodridge, 1989).

In analyzing the development of the performance of a technology Milling and Maier (1996) regard the S-curve concept as very suitable for explaining the development and transition of a new technology. Performance of a technology, which can be speed, dimension, weight etc, follows an S-shaped pattern over time. At some point in time (at the end of the s-curve) it is getting difficult to improve the performance, since it gets more and more expensive and the degree of improvement gets smaller.

The curve of the S-curve approximates to a limit in performance.

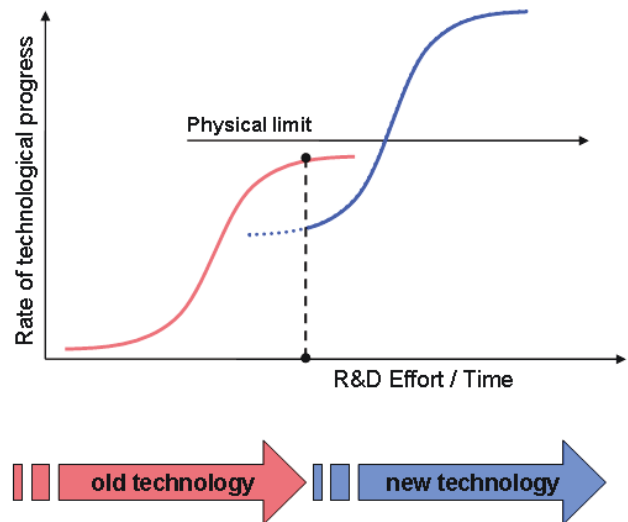

Figure 2. Technology substitution and s-curves

Approaching the S-point, alternate and superior technologies might be explored. With the development course of a new technology the increase in performance over time is very high in the adolescent stage of a technology leading to discontinuity of applying a technology. The latter as consequence is the basis for the displacement of products by new generations of products each outpacing its previous generation, if the incorporated technology is mainly dominating a product's performance. If the technology plays a minor role for complex products, products will not be necessarily displaced.

Since most industrial goods and innovative products consist of different incorporated technologies, we talk about a technology-mix. Therefore, there are limits of combining components representing different technologies because some of them just do not fit. If there is a follow-up product, the entire technology mix has to be redesigned. Replacing just a specific module or part without redesigning the entire device can result in a misfit regarding the technology-mix. Devices with a misfit in the technology-mix bring up products with a limited benefit for the customer.

Since Moore (1991) describes the challenge of crossing the chasm, there is a need of lining out on the one hand different factors for the success of an innovation and on the other hand aspects to prevent, which make the innovations fail.

It is interesting how diverse aspects for successful innovations are described in literature both before and after Moore's approach for crossing the chasm. Pfeiffer et al (1990) did tailor a list of empirical researches of determinants of successful innovation mostly from the 40s onwards until its publication in the 90s concerning different dimensions. Among their introduced dimensions, one is outlining a methodological dimension

incorporating both successful innovations and flops compared in pairs, whereas another is identifying determinants for successful technological innovations.

In contrast to that, MacVaugh&Schiavone (2010) have researched concentrating on the limits of diffusion of innovation mostly consisting of researches of innovation in the 90s. The majority of the research assumes being in line with Rogers (1962) that for utility maximizing consumers new technology replaces old technology. Among others, one part is focusing on the effect of conditions relating to technology and takes into account several researches focusing on the areas of utility, complexity and complementarity.

In the following this paper is questioning and explaining the correlation of the introduced idea of a proper technology mix and factors, which are limiting an innovation focusing on technology-related aspects according to McVaugh&n Schiavone (2010).

### III. DISCUSSION

#### A. Perception of a technology mix' utility:

Zeithmal (1988) as well as Davis (1989) and Moreau et al (2001) explain in diverse approaches that if the utility of a new technology is perceived to be less than the old technology by a social group of users, the technology would fail. Focusing on the utility of a product consisting of a technology mix, the outcome of their researches is even more important since the utility perceived has to be researched on the level of the complete product. Although a technology of one component might be perceived as utile, but the combination of various product technologies might be perceived as less utile than the previous product generation.

With a theoretical approach Zeithmal (1988) focused on the perception of quality and value relating to price which gave the possibility of modifying the model of diffusion of innovation. Here it has to be taken into account, that price paid is as well on a product level consisting of several technologies. Focusing on IT, Davis outlines empirically, that the successful adoption of a technology can be correlated with the perceived ease of use.

The role of knowledge concerning the aspect of quickly learning to apply a new technology was subject to the empirical research of Moreau et al. (2001) relating to the consumer perception and the tendency of preferring discontinuous innovation. The research attempts to discover new but critical product features regarding successful adoption. The adoption of such a new technology within a technology mix is much easier if the basic application hasn't changed in principal. Therefore, customer's tendency of preferring discontinuous innovation on a product level is about having a familiar application of a product with new technologies as discontinuous innovation in its mix.

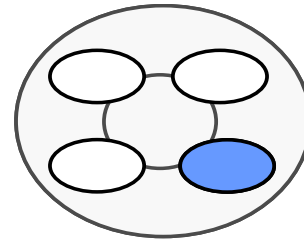

Figure 3. Innovative technology within a technology mix

Changing the perspective from the perception of individuals and social groups to the perception of a whole market or industry, it has to be said, that research outcomes could be very different. For example Roure&Keeley (1990) line out, that there is no ways of driving an innovative technology to success, if within a market or industry the new technology does not exceed the specifications of the older technology. This aspect is bottom-line message regarding a proper technology mix. If a technology within a technology is innovative and of a high performance, the technology mix may still be regarded as misfit, if the aggregated product performance is not of a higher performance than the competitor's product or the product's predecessor. A technology within a misfit of a technology mix would fail to cross the chasm.

#### B. A product's technology within a network industry:

Focusing on network industries, like in telecommunication or broadcasting, it is essential to mention the aspect of complementary market situations for innovations, known as "technology lock-in" markets (Shapiro and Varian, 1999). A broadcast network consisting of several transmitters stations and mediums, a diversity of test and measurement equipment as well as very different kinds of receivers for example provides a tough technological condition concerning the adoption and diffusion of an innovation for both, the individual and on industry level.

This is why very often governmental institutions and laws are involved in the technological way-forward by establishing a regional standard. According to the empirical research of network industries, Shy (2001) points out that once a standardization is achieved, diffusion of innovation is affected positively due to the adoption decisions of big social groups of users. If no new standard can be achieved in geographically or politically wide area, old technology may be longer present in those markets.

Representing network industries, the broadcasting market can be characterized by a strong dependence on aspects of complementarity, compatibility and standardization. Although Shy (2001) refers to this technology lock-in it has also to be mentioned that those markets have a big potential for scale-effects. Shy explains that diffusion of innovation is only possible if

technological infrastructures, e.g. digital radio receivers are complementary with the same transmission standards.

In those industries, this kind of situation is often referred to as chicken-egg problem. Referring to the example of broadcasting, broadcasters might decide against a standard, since they argue that there are no receivers in the market. On the other hand, receiver manufacturers might not proceed with a business plan, when the actual transmission standard is not used for broadcasting.

Concerning the technology-mix in network industries, there should be a focus on a technological innovation, which is used in all complementary devices, e.g. a transmission standard. Two concrete examples can be introduced talking about DAB+ as a new standard for sound broadcasting. The standard itself provides the possibility of broadcasting slideshows in addition to the actual sound. If a receiver's technology mix is not consisting of a display to show images, there is a misfit in its technology mix due to its lack of complementarity. On the other hand a receiver built for the classic FM standard but providing a color-display does not provide additional value for the listeners.

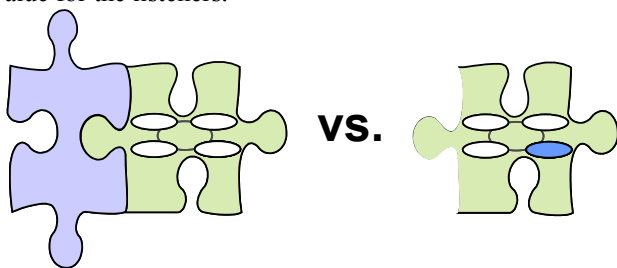

**Figure 4.** Innovation in a non-complementary product

Focusing on the whole market or industry, further aspects in network industries are the costs and learning efforts for switching to another standard that a potential adopter of a new technology has in order to use its new features. For instance, a typical advantage of first movers in network industries is a dominant design, which might quickly enter a market. Once it got adopted, it is very hard for followers to gain market share with alternative technologies. According to the empirical research of Abernathy and Utterback (1978) about patterns of industrial innovations, a dominant design is a product widely adopted within the industry. Innovations of potential competing followers do have difficulties concerning technological innovation due to its dominant design, even if improvements to products or processes are incremental. The reason of a first mover becoming an industry standard can be explained by a small discourse in IT history. The software industry mainly was dominated by Microsoft with its computing system Windows and the Microsoft office. Today they are still the standards in offices all over the world. (Doehl, 2006)

Nevertheless, if a dominant design is not complying to the need of complementarity technology-wise, it would get very difficult concerning the adoption of the

technology. Having a dominant design, the product's technology mix may include a new innovative technology. If this technology is of complementary significance, the only strategy of boosting the adoption process would be to provide other products being complementary to this product. If there is not complementary technology in the market, the product would fail no matter if it was consisting of a proper technology mix or not.

### C. The success of complex mixes of technology:

Industrial goods barely consist of one single technology. Some technology mixes consist of one dominating technology, where as the other technologies are more peripheral. If an industrial good is very complex in functionality, there is a good chance, that the technology-mix would also be very complex. Moreau et al. (2001) focused in their research as well on the aspect, that a new technological product can also be more complex compared to the preliminary technology. Nevertheless, if the marketing approach is focusing on the overall effectiveness and not the very new and modern functionalities or features this fails as well to cross the chasm concerning Maidique&Zirger (1984) since according groups of users would not be convinced. The researchers empirically identified success factors for product innovation explaining special challenges high-tech products have to face during their development and market introduction.

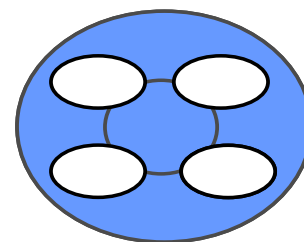

**Figure 5.** Perception of a complex technology mix

Focusing on the big picture of an industry and distinguishing between sustaining and disruptive innovations (Christensen, 1997) and continuous and discontinuous innovations (Anderson and Tushman, 1990; Moore, 1991), the empirical research of Song & Montoya-Weiss (1998) points out that success factors vary depending on the level of innovativeness of a product. Disruptive innovations, being able to create completely new markets, require more effort and time for its success and lack in its predictability. If the focus is on discontinuous but sustaining innovation, it has to be taken into consideration that markets would not adapt those kinds of innovations very often within a short period in time.

Transferring the outcome to complex technology mixes, this would mean, that changing a lot of technologies

within a technology mix tends to need more effort in marketing to let the product be successful. If the grade of innovativeness is more a disruptive one, there is the need of not only explaining the new application of a product but also the different technologies of the technology mix for the types of customers considered as innovators or early adopters. Is the grade of innovativeness more on sustaining innovation, or even continuous, the effort would not be that high.

A complex product of a disruptive innovative application consisting of various very new technologies therefore needs a lot of effort in marketing and sales. If the application of the product is not new, considered as a continuous innovation concerning its application, it can be easier to communicate one or more new technologies to convince innovators or early adopters. Mentioning different kinds of potential customers, it is very important to distinguish the effort for marketing depending on different phases of a product life cycle correlating with the mentioned technology life cycle. During the course of the various life cycle of each technology and the product life cycle itself, the significance of a proper technology mix varies, as the following paragraph will point out.

#### D. Course of significance of a technology mix:

As already described, a technology is used in various types of applications. The existence of a technology can also be sketched as technology life cycle familiar to a product life cycle. The main difference is, that there barely is an end of the life cycle, since a technology would be used in nostalgic product. At different stages in the life cycle of a technology different aspects are to be distinguished in its importance. In extreme applications functionality dominates as well as in the high-tech applications. There, function is by far the most important aspect that motivates customers to try this as a new technology. Often technologies used in extreme and high-tech applications need a long time to diffuse into mass applications. Sometimes they never succeed and end technology-wise in a chasm. Crossing the „chasm“ between high-tech and mass applications is a critical point in the life cycle of technologies. But often once the chasm is crossed, the „tornado“ starts i.e. the new technology avalanches the markets displacing the status quo technology.

Turning the focus on technological products incorporating different technologies as a technology mix, the importance of a well-fitted technology-mix can be pointed out. The following graphic illustrates the importance of technology for potential customers and how differently has to be communicated and focused from a marketing point-of-view, illustrated by the arrow. It is a modification of a Normann's (1998) figure with the life cycle of a technology illustrating the different types of adopters of a new technology first described by E.M. Rogers (1962). They are useful to explain the mystery about the chasm focusing both on technology and

products incorporating the technology in its technology mix.

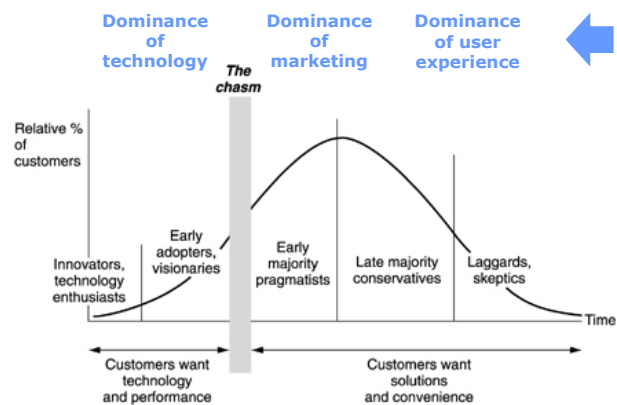

Figure 6. Dominances in the life cycle of technology

Some ideas for the difficulty in distinguishing in different customer needs and the consequence for marketing to achieve a successful diffusion of innovation relating on the life cycle of technology are described by Norman (1998). He did distinguish the initial focus on technology and a motivation for a higher performance and the later interest of customers for well-working solutions.

Due to its performance in „high-tech“ applications and markets a new technology becomes known in public as „innovative“ technology. Products incorporating this specific technology are regarded as lead or premium products. The types of customer groups initially interested in these lead products are referred to as innovators and early adopters. They drive the market and the applications for the new technology in the early phase of the technology life cycle. Even if the technology is part of a product's technology mix, this type of potential customer is interested in the technology and its performance. Even if the technology mix doesn't fit perfectly, they would accept this inconvenience and even help the manufacturer to correct errors after their trials. Since the market growth is high and driven by an increasing number of applications also in other types of products and industries, marketing has to focus on communicating the technology itself to innovators and early adopters.

After more market segments or even industries have been penetrated, the technology is well known and regarded as „state-of-the-art“ and mature by users referred to as early and late majority. They differ considerably from the innovators and visionaries, since they are not interested in technology at all. This type of customer wants to have its problems solved and expects a specific relationship between its costs and values of a complete product, where a specific technology might only be a single part of a technology mix.

When a product with its technology mix is considered as old-fashioned, nostalgic or even out of date by some types of potential customers, laggards do appreciate, that the product is convenient and that all initial bugs are gone

and everybody could explain how the product with this kind of technology can be used.

Passing the different life cycle phases of a technology, the risk of buying products of a technology decreases. Since the risks of applying the technology are compensated and potential doubts are gone, the marketing effort for explaining the specific technology and its interaction within the technology mix can be reduced. The phase of having to face a potential chasm is walked through and products basing their technology mix on this specific technology are regarded as state-of-the-art and well-tested.

#### IV. CONCLUSION

Although there is a potential chasm, new technologies and products with new technologies in their mix have to face, marketing can focus on changing the way of communicating its technology mix.

Due to Norman (1998), Rogers' (1962) customer types of innovators and visionaries do not bother about a certain inconvenience, problems and incomplete products. They are motivated to be at the leading edge of technology although there are still problems of a brand new product. Problems are probable to occur due to a technology misfit, where the focus is on launching a product with one specific and brand new technology not being in line with the other technologies of the technology mix. But innovators do not bother about it that much, since they are pulling for the new technology. They would cope with potential problems of a new product, since it gives them a feeling of being differently innovative.

But once the chasm is reached and products with a potential misfit in its technology-mix got sold, customer needs are different and products have to be marketed differently as well. In the mainstream, a great technology as part of a technology mix does not count any more, overall functionality is taken for granted. The product core has to consist of a proper technology-mix and the product itself as an overall perception has to be easy to use. Price is a dominating and important aspect and additional services and a good company image add up for a product to be perceived as a complete one. If a great technology remains to be part of a technology mix misfit, it would most probably fail to cross the chasm, Moore (1991) is referring to.

#### REFERENCES

- [1] Moore GA. (1991). Crossing the Chasm: Marketing and Selling High-Tech Products to Mainstream Customers. 1st ed. USA: Harper Collins.
- [2] Moore GA (1999). Inside the Tornado: Marketing Strategies from Silicon Valley's Cutting Edge. 1st ed. USA: Harper Collins.
- [3] Rogers EM. (1962). Diffusion of Innovations. 1st ed. New York: Free Press.
- [4] Pfeiffer, W., Weiss, E. (1990). Technologie-Management: Philosophie – Methodik - Erfahrungen. Göttingen, Germany: Vandenhoeck&Ruprecht.
- [5] Shapiro, C. and Varian, H.R. (1999), Information Rules: A Strategic Guide to the Network Economy, Harvard Business School Press, Boston, MA.
- [6] Zeithmal, V. (1988), "Consumer perceptions of price, quality, and value: a means-end model and synthesis of evidence", *Journal of Marketing*, Vol. 52, July, pp. 2-22.
- [7] Davis, F. (1989), "Perceived usefulness, perceived ease of use, and user acceptance of information technology", *MIS Quarterly*, September, pp. 319-40.
- [8] Moore, G. and Benbasat, I. (1991), "Development of an instrument to measure the perceptions of adopting an information technology innovation", *Information Systems Research*, Vol. 2No. 3, pp. 192-222.
- [9] Pfeiffer, W., Weiss, E. (1990), Technologie-Management: Philosophie – Methodik - Erfahrungen. Göttingen, Germany: Vandenhoeck&Ruprecht.
- [10] Maidique, M. and Zirger, B. (1984), "A study of success and failure in product innovation: the case of the US electronic industry", *Harvard Business Review*, Vol. 61, May/June, pp. 192-203.
- [11] Moreau, C., Lehmann, D. and Markman, A. (2001), "Entrenched knowledge structures and consumer response to new products", *Journal of Marketing Research*, Vol. 8, February, pp. 14-29.
- [12] Shy, O. (2001), *The Economics of Network Industries*, Cambridge University Press, Cambridge.
- [13] Song, M. and Montoya-Weiss, M. (1998), "Critical development activities for really new versus incremental products", *Journal of Product Innovation Management*, Vol. 15, pp. 124-35.
- [14] Abernathy, W. and Utterback, J. (1978), "Patterns of industrial innovation", *Technology Review*, Vol. 50, pp. 41-7.
- [15] Norman D.A. (1998) „The life cycle of a technology: Why it is so difficult for large companies to innovate.“ [Online] Nielsen Norman Group Report. Retrieved May 3<sup>rd</sup> 2011. Available from [http://www.nngroup.com/reports/life\\_cycle\\_of\\_tech.html](http://www.nngroup.com/reports/life_cycle_of_tech.html)
- [16] Penttinen, E.; Palmer, J. Improving firm positioning through enhanced offerings and buyer-seller relationships. *Industrial Marketing Management*, Vol. 36, No. 5, July 2007, Pages 552-564.
- [17] Kalb, I.S. (1995). *Nuts & bolts marketing*, 2nd ed. K&A Press.
- [18] Foden, A. (2011), A complete product, [Online], Retrieved June 5<sup>th</sup> 2011, Available from: <http://brighter.s466.sureserver.com/?p=3>
- [19] Döhl, W. (2006), *Technologie Management*, lecture notes distributed in faculty of industrial engineering, Technisches Marketing, Munich University of Applied Science, Munich in October 2006.
- [20] Capon, N; Glazer, R. Marketing and Technology: A Strategic Coalignment. *The Journal of Marketing*, Vol. 51, No. 3, July 1987, pp. 1-14.
- [21] Milling P and Maier F. (1996) *Invention, innovation and Diffusion models*, Berlin: Duncker und Humbolt.
- [22] Brockhoff, K. (1967) A test for the product life cycle. *Econometrica*, Vol. 35 (1967), pp. 472-484.
- [23] Day G. (1981) *The Product Life Cycle: Analysis and Application Issues*. *Journal of Marketing*. 45 (4), pp. 60-67.

- [24] Midgley, D.F. (1981). Toward a theory of the product life cycle: explaining diversity. *Journal of Marketing*, Vol. 45 (1981), pp. 109-115.
- [25] Easingwood, C.J. (1988). Product life cycle patterns for new industrial goods. *R&D Management*, Vol. 18 (1988), pp. 23-32.
- [26] Bass, F.M. (1995). Empirical generalizations and marketing science: a personal view. *Marketing Science*, Vol. 14 (1995), pp. G6-G19.
- [27] Kim, B. (2003). Managing the transition of technology life cycle. *Technovation*, Vol. 23, No. 5, pp. 371-381.
- [28] Godoe, H. (2000). Innovation regime, R&D and radical innovations in telecommunications. *Research Policy*, Vol. 29 (2000), pp. 1033-1046.
- [29] Winter, S.G.; Kaniovski, Y.M.; Dosi, G. (2000). Modeling industrial dynamics with innovative entrants. *Structural Change and Economic Dynamics*, Vol. 11 (2000), pp. 255-293.
- [30] Pagell, R. (1991). Planning your technology mix: decision factors that meet user needs. *The Electronic Library*, Vol. 9, No. 6, pp.316-324
- [31] Anderson, P and Tushman, M. (1990). Technological discontinuities and dominant designs: a cyclical model of technological change. *Administrative Science Quarterly*. Vol. 35, No. 1, 604-633.
- [32] Christensen, C.M. (1997). *The innovator's dilemma: when new technologies cause great firms to fail*, Boston: Harvard Business School Press.
- [33] Twiss B, Goodridge, M. (1989) *Managing Technology for Competitive Advantage*. London.





# RESPONSIBLE MANAGEMENT AND MARKETING OF CAR FLEETS

## How sustainable management is lived in Germany by car fleet managing companies

Roland. M. Vogt,  
Plymouth Business School, University of Plymouth, Plymouth, UK  
Faculty of Business and Engineering, University of Applied Sciences, Munich, Germany

*Abstract-* Firms conduct car fleet management in a variety of kinds and objectives. Many of them are engaged in sustainable measures for different reasons.

This study examines empirical evidence about the factors deemed necessary for successful responsible operating car fleets. During April and May 2011 an online survey had been addressed therefore via online newsletter and e-mail to more than 30,000 car fleet managing companies in Germany. The response rate has been in sum 305 participating different companies until end of August 2011. The first objective of this survey was to find out the current situation in German fleet management operations regarding responsible and sustainable management of car fleets. It also examines how these activities are accompanied by marketing measures. Other findings of this paper are connections and causal relationships between several facts and results of the survey. The analysis of these relationships leads to several propositions and hypotheses.

*Key words* - Fleet management, sustainability, CSR, marketing

### I THEORETICAL BACKGROUND

To prepare the survey there are investigated four general approaches regarding corporate responsibility at all. This is helpful regarding the following empirical research strategies, which are executed in the market of German car fleet managing companies. The approaches are evaluated regarding their relevance to research question and research objectives. Starting with the philanthropic approach (Ulrich, 2008), which constitutes, that to be “good” has to keep in focus the review goes over to profit maximisation approach (Friedman, M., 1970) what sets economic success into preference. However, the approach of incentive compatibility stands well to the fore (Homann & Suchanek, 2005) (Homann, 2002) (Suchanek, 2007). The results of this theories lead to stakeholder approach (Freeman, 1984) (Freeman, Harrison, & Wicks, 2007), which is recognized as the most objective compatible approach as a basis for the empirical survey.

### II EMPIRICAL RESEARCH

#### II.1 Survey to Car Feet Managing Companies

##### *II.1.1 Description of objectives*

The objectives of the survey is first to find out what the current situation in the German fleet management operations shows regarding responsible and sustainable management of car fleets and second to prepare the multiple embedded case study for in depth analysis of car fleet managing behaviour.

For that, the survey looks for questions of “what?” and “how?” (Saunders, Lewis, & Thornhill, Research methods for business students 5th ed., 2009). Another objective is to find out connections and causal relationships between several facts. The analysis of these relationships leads to several propositions, theses, and to open questions. These remaining gaps can be filled out during the step two of the empirical part of this research – the multiple embedded case studies. So, one objective of the survey in this paper is to prepare the case study.

##### *II.2.2 Method and design of the survey*

The survey’s method uses a link to an online survey. In this case it was very helpful to use the online method because in many questions there are multiple answers possible. This made it impossible to use the telephone interview method in an economic way. The disadvantage of this method is that the response quote is not very high.

April and May 2011 a survey has been addressed to car fleet managing companies. It has been sent out in two ways. First of all it was promoted as one topic within an electronic specialist fleet newsletter sent out by “Dataforce” April 18th 2011 to about 25,000 addresses of car fleet operating companies in Germany. The response rate of this way was very small. So additional to that the same survey was addressed via direct e-mail to approximately 5,200 car fleet responsible persons in Germany. The response rate has been in sum 305 participating different companies until end of August 2011. Because of access mainly to business car operating companies this study is representative for this type of car fleet managing companies. The design of the survey is portioned in four main parts.

- 1) The first part takes a close look to the operations of car fleet management. Questions are designed about the structure, objective, and function of the fleet and reflect the relevance of ecological aspects in fleet management.
- 2) The second part pays attention to the stakeholders and interest groups of participating enterprises.
- 3) The third part occupies with car policy themes regarding issues, measures and objectives.
- 4) The main approach of the fourth part is to get in detail with behaviour of fleet responsible people regarding marketing and communications.

### *II.1.3 First Results of the survey*

The results are shown and explained in the next figures. Therefore first the data are explained and mirrored with existing experiences of car fleet managing business. Second the results are examined for connections and causal relationships.

Question: In what area are you in?

This paragraph tells about the functions of responding persons in their companies. These functions are independent from car fleet responsibility. The main group of respondents is responsible for fleet management followed by the management of the company. This fact goes well with the common responsibilities regarding fleet management.

Question: Is the operation of vehicles, the core business of your company? (E.g. transport companies, freight forwarding, passenger transport, package delivery)

This information shows that the main part of participating companies use their car fleet not as core business. The main part of participants uses the fleet for reasons of accompanying functions. A check of the addressed sectors shows also a predominance of this part. So there is no rule derivable out of this fact.

The results of this survey reflect on the typical business car fleet and fleets with additional functions. Fleets with the function as core business are underrepresented.

So - all conclusions are just valid for this main type of fleet managing companies.

Question: How many vehicles include your fleet?

This result differs from the real existing partitioning in Germany. The whole responded picture shows a much larger part of midsize or large fleets. Larger fleets have also a disproportionately high number of participants in comparison with midsize fleets. Since the survey was

directed to all sizes of fleets in a manner of real share of sizes, the reasons of less response can be seen in less interest of green fleet themes in small fleets but also in the smaller relevance of fleet management at all in small fleets. This leads to the first proposition.

**Proposition 1:** Responsible behaviour in fleet management is that more likely to happen in organizations, the larger the size of fleet is.

Question: What types of use are in your fleet? (Multiple answers possible % value)

This question shows the main emphasis in field service and vehicles for executives. This shows as already mentioned that this study is mainly representative for the sector of personally assigned company car fleets. Within this sector is partitioned in a typical way as it is usual in Germany. The parts "Functional vehicles for executives", "Field service fleets", "Gross deferred compensation for employees" are usually completely personally assigned company cars.

The part "Service fleet" is usually partly personally assigned while the part "Delivery vehicles" usually are not personally assigned. Because of this large amount of personal assigned cars the questions about car policy are of great significance. Further down it will be shown, whether there is a causal relationship between types of fleet and other aspects.

Question: What particular importance has "Ecological fleet" currently in your company?

This important question is mainly incorporated into the questionnaire to get causal connections to other questions. First of all it shows a usual picture of importance of a responsible managing car fleets. More participants feel the importance higher than middle. This can be influenced in a greater likelihood in answering questionnaires like this by "engaged" persons responsible for car fleets. This phenomenon was moderated through a combination of answering this questionnaire and a raffle to win a prize. In this case participants had the ability to win an "Eco-training".

Question: Who is mainly responsible for "Ecological fleet"?

The responsibility question and its answers tell, that the responsibility themes have a great focus at the management of a company even if it is a special theme as fleet management. Just 22% of the responsible people come from fleet management while at nearly 50% of participants the management is responsible for this theme.

While the responsibility in "Ecological fleet" lies by 1 %, it shows 5 to 7 % of the persons who answered this questionnaire.

Another significant difference is the small part of responsible persons for fleet management in answering vs. responsibility for ecological fleet.

It can be assumed that the persons who answered the questionnaire are most responsible persons for the car fleet. This leads to the second proposition:

**2. Proposition:** In companies the responsibilities for ecological fleet management is more likely at the management of a company than at the fleet management.

Question: Which stakeholders / interest groups might be interested in your opinion for the type of operation of your fleet? (Multiple answers possible)

This question aims to the assumption of participating companies, which stakeholder they think are affected about their kind of fleet management. Number one in this ranking are the customers partitioned in business and consumer customers. It will be one of the tasks of the multi embedded case studies to figure out what the drivers in whole for the importance of this stakeholder group are.

Number two in this ranking is the 'employees'. This is a typical result because the main part of participating fleet volume is personally assigned company cars.

On the other hand is company's bond and attractiveness to employees one of the main drivers of running a car fleet. Some measures of car policies affect the employees in a direct way so it is important for the company in many points of view to take the needs of the stakeholder group employees in consideration. Very interesting is the low number of "Investors" and "NGOs". Asking about the relationship to all different stakeholder groups will be one of the most important parts of the multiple embedded case studies.

Question: What environmental issues you can find in your car policy? (multiple answers are possible)

The main environmental issues are driven by ideas of car model policy. In the centre of attention thereby is the restrictive selection in vehicle models followed by restrictive selection for CO<sub>2</sub> consumption. It is remarkable that these two measures are far above all other measures. They are accompanied by measures of engine size, fuel consumption, and bonus scheme.

The reason for that can be found in the easy possibilities of implementation of these rules because the model range and selection are usually variable in car policies so that these measures can be adapted easily. Another reason is the great leverage effect to the follow-up costs. The model policy is one of the most important cost drivers in a company fleet. The size of the car in common and of the engine in special for example decides about the amount of financing costs, maintenance costs, fuel costs, insurance costs, and so of indirect accident costs. That means with a smaller engine you can realize a lower CO<sub>2</sub> emission on the one hand and a lot of cost reduction on the other hand. This fact combined with the relatively easy implementation possibilities leads to a big resonance in the survey. Other reasons and drivers will be figured out by answering the "why" questions within the multiple embedded case study.

The measure "bonus scheme" supports the named measures by giving an incentive for choosing a model which fulfils the demands of the other measures within the car policy. Mostly it is designed as a bonus penalty scheme, which is oriented in a certain reference rate of a certain status group in a firm. If there is for example defined a reference rate for the third leadership level (e.g. 470 € finance leasing rate) it could be the rule, that the employee can choose a car within this rate without added payment. Every single € above that number has to be paid from employee's income. This reference rate could be linked to a certain CO<sub>2</sub> data (e.g. 160 g/km). The bonus scheme could say that every chosen step of 10 g/km under the reference date (e.g. 150 g/km) leads to a larger amount of finance rate (e.g. 490 €) without extra payment. So there is an incentive to choose a reasonable model out of the policy.

Two other conspicuous findings are „Training for Economical Driving“ and “Incentives for Employees to go by Bicycle to Work”. Both are designed to influence the employees' behaviour.

Question: What environmental issues are planned? (Multiple answers are possible)

This question asks for measures, which are already not installed but planned to be introduced. Remarkable in this figure is that just four participants plan not any activity in this case. For these the survey ends at this question. This small number is another sign that a whole part of the participants are fundamentally interested in CSR measures. The companies which answered in the question before that they had no or nearly no environmental issues, started at this question mainly with car policy measures as restrictive model choice. Other companies who had already implemented such a model policy expand their activities now in the direction of measures to enhance the drivers' behaviour.

So a third proposition can be stated:

**3. Proposition:** Companies usually start with car policy measures which are easily to implement. It is likely that these measures are followed by more lavish measures as employee training and motivating incentive systems.

Question: Have the measures been evaluated? (If so - what?)

Interesting at this question is that just a third doesn't evaluate their measures. The most used measurement was regarding cost reduction. This is followed far away by stakeholders like environment (CO<sub>2</sub> reduction), customers (Increasing sales thereby), and employees (Employee turnover). This result supports the assumption, that an important precondition for companies being engaged in CSR is incentive compatibility (Suchanek, 2007).

**4. Proposition:** If there are economic advantages for the company, it is much more likely that the management is justified to invest in CSR measures.

Question: Are the measures part of an integrated company-wide Corporate Responsibility (CR) concept?

The question reflects on integration of sustainable car fleet measures into corporate CR concept. Only 15% of the participating firms see their measures as a part of a corporate CR concept. A part of 23 % (no, in addition to corporate-wide conception) doesn't even have such a concept implemented. This part of answering participants did develop their measures independent on their own initiative. This is the usual behaviour of engaged car fleet responsible people.

Very interesting is the second part of 21% which are not integrated in an existing corporate responsibility concept with those measures. This is a signal for car fleet management not being perceived as an important part of the whole CR concept. Reasons for that will be figured out through the multiple embedded case studies.

Question: What are the objectives in your company with an ecological car policy? (Multiple answers are possible)

The question confirms again that incentive compatibility is one of the greatest motivators in starting corporate responsibility activities. Cost reduction is with a number of nearly 180 by far the most named objective regarding ecological car policy. Ecological motivation (Energy saving and CO<sub>2</sub> reduction) is with around a number of 100 mentions the second important class of objectives narrow followed by the stakeholder employees (Securing and recruiting qualified employees), the corporate reputation stake and the stakeholder customer. The objectives "Employers' Safety", "Economic Value Added (EVA)" and "Innovation" are at the end of the range. Because of expecting EVA in a more prominent position the reason for this could be low knowledge about the term "EVA" which is one aspect to be examined in multi embedded case studies.

Question: What targets have been achieved already with an ecological car policy? (Multiple answers are possible)

The answers to this question show nearly the same picture as the mentions about the objectives with little smaller numbers. The reason for this can be derived out feeling reaching the aims. As to be seen in a previous question there have less measures been verified than mentioned in these answers. The reason for that can be seen in "harboring illusions" in a way of fulfilling prophecies. This phenomenon will also be a topic for the multiple embedded case studies. In this case it is also an objective to figure out measurability of softer objectives as company's reputation and meeting the needs of employees.

Question: Do you have published the use of your fleet or results and achievements? (If so - how?)

The main kind of communicating results and success of measures is by far mostly mentioned through

stakeholder dialog. The kinds of stakeholder dialog can be read in the next question. Besides this the most important kinds of publishing can be found in public relation measures as magazines which are published internal (company-owned magazines) and external (trade press) and joining awards which can also be seen as PR-measure because of the great public attention through reporting.

Question: If communication through stakeholder dialogue, which stakeholders / interest groups?

The media can also be found in the answers of this question. By far more important is the stakeholder "Employees" with their representatives followed by the "Customers". Here it will be interesting, how the stakeholder dialogues are arranged. This will be figured out through the multiple embedded case studies.

Not expected in this question was the great amount of stakeholder dialog to suppliers, because in a previous question the stakeholder supplier has been mentioned in a very low range asked after expected interest to companies' behavior with the fleet. A possible reason could be other interests of the participants with suppliers not direct driven by CR measures for example the need for a CSR minded supplier which fits into the own CSR strategy.

The stakeholder "Public" concentrates on local publicity what fits to the great number of participants with small and midsize fleets. There is a direct relation between this public answer and the size of the fleet. From there it can be assumed, that the aimed public connects usually with the market of the firm. This thesis has to be verified through the multiple embedded case studies.

The usually very important stakeholder group "Investors" seems to be completely irrelevant. On the one hand the reason for this unexpected result could lie in the focus on economic success of the company. On the other hand some important CSR measures regarding fleet management lead to cost savings and thus support economic success. So this phenomenon is another question which will be examined through the multiple embedded case studies.

Question: Did you achieve feedback from stakeholders (interest groups)?

Here again employees and their representatives take the main part of response. The obvious reason for that is the narrow contact between car fleet responsible persons and the employees.

The relative big amount of naming suppliers is rather as expected because of interdependence between company and customer.

In the middle of the range you can find customers as feedback giving stakeholder. As it is one of the largest objectives of companies to impress their customers it is one of the questions of the multiple embedded case studies to find out, what sort of measure and what sort of communication leads to this important success at the

customer. Also the sort of feedback is very interesting. Especially whether it is positive or negative may give starting points to develop the right strategy to enhance the customer relationship.

Question: These comments are recorded systematically?

This last question shows that nearly no participant handles the stakeholder approach in car fleet management in an entirety way. One of the answers to be figured out through the multiple embedded case studies will be the relationship of company's behaviour in managing CSR measures, results, and communication in all company themes in relationship with car fleet managing aspects.

### III CONCLUSION

The survey led to four propositions and several open questions to be answered in follow up multiple embedded case studies.

#### Propositions

1. Proposition: Responsible behaviour in fleet management is that more likely to happen in organizations, the larger the size of fleet is.
2. Proposition: In companies the responsibilities for ecological fleet management is more likely at the management of a company than at the fleet management.
3. Proposition: Companies usually start with car policy measures which are easily to implement. It is likely that these measures are followed by more lavish measures as employee training and motivating incentive systems.
4. Proposition: If there are economic advantages for the company, it is much more likely that the management is justified to invest in CSR measures.

#### NOTES

The author gratefully acknowledges the support of "Dataforce GmbH" which gave the access via business newsletter to about 25,000 car fleet responsible persons.

#### REFERENCES

- Freeman, E. R. (1984). *Strategic Management, A Stakeholder Approach*. Boston: Cambridge University Press.
- Freeman, E. R., Harrison, J. S., & Wicks, A. C. (2007). *Managing for Stakeholders: Survival, Reputation and Success*. New Haven & London: Yale University Press.
- Friedman, M.; (13. 09 1970). The social responsibility of business is to increase its profits. *The New York Times Magazine*, S. 32-33.
- Homan, K., & Blome-Drees, F. (1992). *Wirtschafts- und Unternehmensethik*. Göttingen.
- Homann, K. (2002). Ökonomik: Fortsetzung der Ethik mit anderen Mitteln. In A. Folani, & S. Nacke (Eds.), *Wirtschaftsethik im Diskurs. Eine kritische Auseinandersetzung mit Karl Homann* (pp. 19-50). Münster.
- Homann, K., & Suchanek, A. (2005). *Ökonomik Eine Einführung*. Tübingen: Mohr Siebeck.
- Lin-Hi, N. (2009). *Dissertation Handelshochschule Leipzig: Eine Theorie der Unternehmensverantwortung Die Verknüpfung von Gewinnerzielung und gesellschaftlichen Interessen*. Berlin: Erich Schmidt Verlag GmbH & Co.
- Saunders, M., Lewis, P., & Thornhill, A. (2009). *Research methods for business students 5th ed*. Essex: Prentice Hall FT.
- Suchanek, A. (1999). Institutionenökonomik und Verantwortungsteilung. *Jenseits von Privatisierung und "schlankem" Staat: Verantwortungsteilung als Schlüsselbegriff eines sich verändernden Verhältnisses von öffentlichem und privatem Sektor*, pp. 273-298.
- Suchanek, A. (2007). *Ökonomische Ethik*. Tübingen: Mohr Siebeck.
- Suchanek, A. (2008). *Business Ethics and the Golden Rule Discussion Paper Nr. 2008-3*. Lutherstadt Wittenberg: Wittenberg-Zentrum für Globale Ethik e.V.
- Ulrich, P. (2000, 11). Integrative Wirtschaftsethik: Grundlagenreflexion der ökonomischen Vernunft. *Ethik und Sozialwissenschaften Heft 4*, pp. 553-567.
- Ulrich, P. (2008). *Integrative Economic Ethics*. Cambridge: Cambridge University Press.



# Hybrid strategies and firm specific individualization: Theoretically linking generic concepts, activities and resources

Michael Zellner

School of Management, University of Plymouth Business School

Michael.Zellner@plymouth.ac.uk

*Abstract* - The purpose of this conceptual paper is to review the relevant literature and to explore a consistent concept of hybrid competitive strategies. It is argued that the current body of theoretical and empirical research on this topic largely ignored the link of generic concepts with a firm's activity system and its resources. The research on hybrid strategies is extended by integrating the resource based view of the firm with an activity systems perspective. Based on a variety based sequential hybrid strategy type the link between its underlying generic concept, activity drivers, activities, and its stock of resources and capabilities is described. Methodologically a general foundation of hybrid strategies is developed. Based on that, the mechanisms of sequential hybrid strategies are explained and detailed. Finally, a sequential hybrid strategy's underlying activity system and its underlying resources are conceptualized. On a collective level, hybrid generic concepts embed the required knowledge of activity drivers and activities defining the space of alternative positioning. Based on that, the activity system is individualised on firm level. As in strategic management research on organizational ambidexterity the prevailing role of management is stressed. However, the importance of management is not seen in managing 'tensions' within a firm's activity system directed to seemingly contradictory competitive advantages. Rather it is argued, that success of hybrid strategies is build on consistently applied concepts avoiding tensions within the activity system. The gap between generic concepts and a firm's individual stock of resources is closed by the activity based view. Two sources of management capability are essential in achieving sequential hybrid strategies: First, the capability to identify generic concepts applicable to the company and its corresponding context and second, to acquire or create, as well as to arrange and apply its stock of resources and capabilities within the activity system. The theoretically derived concepts demonstrate that explaining success of hybrid strategies requires consistently applied generic concepts on an activity systems level.

*Keywords* - Hybrid strategies, competitive advantage, activity based view

## I. INTRODUCTION

Hybrid competitive strategies are compelling as they allow generating higher rents by combining several competitive advantages simultaneously. Also they are less vulnerability to changes compared to pure or no

emphasis strategies as they better address customer needs, are more difficult to imitate, and generates a more flexible and wider view (Pertusa-Ortega, Molina-Azurin, & Claver-Cortés, 2009). The current body of research on what is termed 'combination', 'simultaneous', 'mixed', 'ambidextrous', or 'hybrid' strategies is comprehensive (Fleck, 1994; Mahr, 2010; Parnell, 1997), however theoretically and empirically far from conclusive and at least partly contradictory. This is especially disappointing as hybrid strategies are potentially fruitful in volatile and dynamic environments, most companies facing today (Proff, 2000).

Lines of reasoning for this ambiguity are threefold. The first line focuses on covering the full scope of strategic variety, the second regards varying measures of strategic success, and the third highlights operationalisation issues.

Many existing strategy typologies cover the scope of strategy variety incompletely or partially. One example is Porter's typology, which is still among the top mentioned schemes in empirical and theoretical research on strategic management (Allen & Helms, 2006, p. 2). Despite making clear recommendations on which competitive advantages to focus at (either cost or differentiation) and which, namely combinations, to avoid, his classification does not include a successful combination type. Rather Porter taxonomically includes an unsuccessful 'stuck-in-the-middle strategy', lacking a necessary distinction between successful and unsuccessful combination strategies. This might lead empirical researchers applying his scheme to confuse and mix underperforming 'stuck-in-the-middle strategies' with outperforming 'hybrid strategies' (Dess & Rasheed, 1992; Wright, Kroll, Tu, & Helms, 1991). In consequence, research on hybrid strategies based on Porter's scheme, may produce inconsistent and incomparable results (Chrisman, Hofer, & Boulton, 1988).

Further, strategic targets vary among strategy schools and thus, may bias comparability of empirical research. Examples for different targets are Porter's generic strategies based on company performance, Buzzel et al.'s market share, or Abell's scope and differentiation targets (Porter, 1991; Buzzel, Gale, & Sultan, 1975; Abell, 1980). Correspondingly, empirical

results on hybrid strategies range on a continuum from 'prove of vitality' to 'below average performance'. In addition to different performance measures, studies also vary according to different comparison groups. Examples are studies measuring against all companies within an industry sample or comparing only individual strategy groups with one another (Mahr, 2010). Beyond that, some research on hybrid strategy assesses strategic orientations by subjective assessments of bundles or indicators of a company's resources and capabilities. These approaches, besides suffering the frequent shortcomings of subjective measurement approaches, are potentially biased as it remains unclear whether intended or measurable, emergent strategy patterns are observed (Mintzberg, Ahlstrand, & Lampel, 1999).

Last but not least, the few research examining operational concepts, activity systems, and resources and capabilities of hybrid strategies remains limited and fractional. Currently no theoretical or empirical research is available on linking generic concepts with individual levels of resources and capabilities in the context of hybrid strategies.

This paper aims at extending the research on hybrid strategies by integrating the resource based view of the firm with an activity systems perspective. Based on a variety oriented sequential hybrid strategy type the link between its underlying generic concept, activity drivers and activities, as well as its stock of resources and capabilities is described.

The paper is structured the following. First, sources of competitive advantage are explained. Second, a theory of consistent and sustainable hybrid strategies is developed and one specific variety based type explained. Third, for sequential hybrid strategy a generic concept is developed, its underlying drivers revealed, and the activity system and corresponding consequences for a firm's resource and capability stock disclosed. Finally, results and limitations are discussed and future research opportunities outlined.

## II. ROLE OF ACTIVITY SYSTEMS IN ACHIEVING COMPETITIVE ADVANTAGE

### A. Sources of competitive advantage

While the notion of competitive advantage is one of the common themes in strategic management research, its origins are disputed.

According to one major school, the industrial organization's (IO) view, competition is mainly focused on achieving a favourable industry position (Mason, 1939; Bain, 1956; Bain, 1968). In this view competitive advantage is primarily determined by an industry's structural characteristics such as concentration, entry barriers, intensity of rivalry, or demand elasticity (Bain, 1956;). Specifically entry barriers are identified as serving as mechanisms for protecting abnormal profits and thus determine competitive advantage. While

originally elaborated on industry level, in the theory's preceding the concept of entry barriers was also applied as mobility barriers on intra-industrial groupings. Thus the view advanced to considering heterogeneity, however restricting it to the level of intra-industrial groupings, what remains its main critique.

Another view on competitive advantage is the resource based view of the firm (RBV) focusing on unique resources and capabilities as drivers of superior performance (Barney, 1991). In this notion, competitive advantage results from firm heterogeneity and barriers to imitation (Mahoney & Pandian, 1992, p. 371). Hence, the possibilities of a firm are not a function of what opportunities it confronts; rather a function of what resources an organization controls (Teece, Pisano, & Shuen, 1997). Consequently, competitive advantages are located 'upstream' of product markets (Teece, Pisano, & Shuen, 1997, p. 513). In this sense, strategic resources and capabilities are scarce, firm-specific, valuable and difficult to imitate. Thereby, a resource refers to a tangible or intangible firm asset or input to production owned, controlled, or accessed on a semi-permanent basis (Helfat & Peteraf, 2003). Contrary capabilities are special types of firm-specific resources enhancing the productivity of a firm's other resources by coordinating a set of tasks and utilizing resources (Makadok, 2001). Typically firms consist of and use a combination of resources and capabilities. Often resources are 'co-specialized' and value derives only from certain combinations (Teece D. J., 2009). In addition, past investment decisions often lead to path dependencies (Mahoney & Pandian, 1992). 'Distinctive competences', 'core resources' or 'core competences' are frequently used synonymously for capabilities (Selznick, 1957; Peteraf, 1993; Barney, 1986; Wernerfelt, 1984; Hamel, 1994).

Despite the different views on competitive advantage provided by IO and the RBV, both complement each other rather than providing alternative explanations of the origins of competitive advantage.

### B. Competitive advantage and a firm's activity system

Recent developments in strategic research acknowledge the role of firm activities, routines, and business processes in achieving competitive advantage (Sheehan & Foss, 2007). The focus of the activity based view (ABV) is on activities, which are seen as the engagement of assets, resources and capabilities to serve a specific purpose toward fulfilling an objective. Correspondingly, activity systems are sets of interdependent activities within and across a firm's boundaries (Zott & Amit, 2010, p. 217). In this notion, previous research found certain combinations of activities to be more effective than others, what leads to the importance of configuring the activity system (Sheehan & Foss, 2007; Allen & Helms, 2006, p. 452). Activities can be considered on different levels such as top-level activities of planning, sourcing, manufacturing



or delivering or at the level of sub-activities (Davenport, 2005). This allows a distinction between strategic implementations, which are factually inconsistent and those, which seem to be conflicting on high level, but are consistent on lower activity levels (Sheehan & Foss, 2007, p. 219). From an activity based view, competitive advantage results from “mechanisms through which resources and capabilities get exposed to market processes where their ultimate value and ability to generate competitive advantage are realized” (Ray, Barney, & Muhanna, 2004, p. 35). In this notion resources are stocks which have no value per se and can even destroy value if storing the resource, such as unemployed labour, generates cost. Converting the resource into capabilities determines, what can be done with the stock. Finally elaborating the capability in an activity generates value. For instance, underemployed labour is a cost-generating stock which is potentially value-creating if employed to produce something the market values and demands. Finally it needs to be stated that none of the above mentioned steps in isolation is sufficient to generate competitive advantage.

This notion is similar to Porter’s value chain, which decomposes a firm’s activity system into functions and activities from which competitive advantages result (Porter, 1985). However Porter adds another level of analysis to the ABV, the activity driver. Activity drivers represent “the underlying source of competitive advantage” (Pearce & Robinson, 2005, p. 104) and explain, why a firm’s set of activities is generating more value than a competitor’s (Sheehan & Foss, 2007, p. 453). Drivers can be used to manipulate the value chain either in terms of cost and differentiation or in order to improve fit within a firm’s activity system (Sheehan & Foss, 2007; Ghemawat, 2006). They are generic and structural in nature, what requires a firm’s management to adapt drivers firm specifically. This way, drivers make competitive advantage operational (Pearce & Robinson, 2005). Competitive advantage then results from the sum of cost and value generated by each firm activity and can only be determined relative to a firm’s competition (Sheehan & Foss, 2007).

Drivers are distinct from resources, as drivers need to be made controllable by the firm, while resources need to be organized and developed according to the logic inherent in a firm’s activity system (Sheehan & Foss, 2007, p. 458). Also, drivers are generic, while an activity system is a concrete manifestation of how a firm does business. The manifestation occurs on two levels: the individual activity and the collective, overall activity system orchestrating all activities within a firm’s internal and external value chain (Allen & Helms, 2006). Despite the unilateral relationship of drivers on collective level, on individual level single activity drivers operationally influence multiple activities and vice versa. This multi-lateral operational relationship leads to decoupling of activity drivers from an activity system and its constituent activities.

In summary, contrary to RBV thinking, ABV considers the availability of bundles of heterogeneous assets, resources and capabilities a necessary but not sufficient prerequisite for achieving competitive advantages. Rather it emphasizes the importance of transforming resources into competitive weapons through activities, routines and business processes (Porter, 1991; Stalk, Evans, & Shulman, 1992; Chrisman, Hofer, & Bouldon, 1988). Competitive advantage rests on a firm’s activity system, the performed activities and activity drivers. However, RBV and ABV are compatible (Sheehan & Foss, 2007, p. 452) and complement each other. While RBV is focusing on managing a firm’s portfolio of resources, ABV is concerned about elaborating a firm’s resource portfolio in the competitive process (Dierickx & Cool, 1989; Black & Boal, 1995). In this sense RBV is more static in nature and describes what pool of resources and capabilities is available to the firm. ABV is complementing this view by explaining how a firm’s resource pool is applied and dynamically developed further.

### III. A THEORY OF HYBRID STRATEGIES

#### A. Constructing a theoretical fundament of hybrid competitive strategies

Two common key characteristics exist in most strategy typologies, founding the basis for outperforming competitors: internal consistency and external sustainability. Some dispute exists on other construction characteristics, such as the principles of concentration and dimensionality.

##### 1. Consistency

The system based consistency principle, widely applied in strategic management, follows the motive that strategies need to be constructed and implemented avoiding system immanent conflicts (Acquaah & Yasai-Ardekani, 2008, p. 353).

However, in discussing strategic contradictions and their emergence, the unit of analysis is crucial (Gupta, Smith, & Shalley, 2006, p. 694). Potential units of analysis are organizations as a whole, a firm’s activity system and its decomposed parts, as well as the individual level of resources and capabilities. Depending on the unit of analysis, conflicts can either be accepted and trade-offs made, conflicts can be resolved by balancing tensions or completely avoided through concepts allowing coherent implementations within a firm’s value chain (Simsek, Heavey, Veiga, & Souder, 2009, p. 868; Fleck, 1994; Porter, 1980).

Research on March’s exploration and exploitation strategies exemplifies parts of this development. Early research often claimed that combining different competitive advantages is impossible. That way, a firm’s activity system can either be consistently aligned

to exploration (cost advantage) or exploitation (differentiation advantage). The level of analysis is, despite mentioning a firm's activity system, the organization as a whole. Recent research on 'organizational ambidexterity' (OA), however turned to the thinking of balancing tensions of seemingly contradictory advantages. This led to a rich body of research identifying a firm's combinative properties and capabilities, such as context, culture or management skills (Gibson & Birkinshaw, 2006). Thus the original organizational focus shifted to an activity systems level and even to the level of (groups of) individual resources. However OA, still assumes immanent tensions and a necessity of trade-offs (Simsek, Heavey, Veiga, & Souder, 2009). Raisch and Birkinshaw make explicit this assumption by stating that "... managing two *inconsistentalignments* within an organization simultaneously is far more complex than managing one consistent strategy after the other or externalizing one of these activities" (Raisch & Birkinshaw, 2008). This 'inconsistency assumption' narrows the research spectrum of OA on hybrid strategies mainly on a firm's capability to manage unavoidable conflicts.

In contrast, comparably few researchers analyzed the existence and constitutional characteristics of hybrid strategies combining multiple competitive advantages consistently. (Pertusa-Ortega, Molina-Azurin, & Claver-Cortés, 2009; Claver-Cortés, Pertusa-Ortega, & Molina-Azorin, 2011; Morschetta, Swobodab, & Schramm-Klein, 2006; Acquaah & Yasai-Ardekani, 2008). Despite first mentioning the term hybrid strategies in 1995 by Fleck and in 1997 by Proff and Proff strategic combinations were identified earlier. Empirical researchers already recognized vital combinations of competitive advantages in 1980 (Hall, 1980). Shortly after this also theoretical concepts were developed explaining vital concepts of hybrid strategies (Karnani, 1984; Gilbert & Strebel, 1985). In Greek the word 'hybrid' means 'composed of incongruous kinds' or 'derived from heterogeneous sources' (Proff&Proff, 1997). Especially the last explains the word's application in strategic management as combining seemingly contradictory competitive advantages. Frequently, however, hybrid combinations generate incongruous and thus temporal instable states. Therefore one key criterion of vital hybrid strategies is consistent combinations of competitive advantages. On a more specific level, consistent hybrid strategies need to implement activities impacting concurrently on for example exploitation drivers through some parts of a firm's activity system and exploration drivers through other parts. According to this consistency requirement of hybrid strategic concepts, two distinct hybrid strategy types can be differentiated. First, concepts that assume inevitable tensions within a firm's activity system require a firm's management to balance tensions. Such *management based* hybrid strategies conflict, however, with the consistency principle. The second distinct type regards concepts that coherently align a firm's activity

system on multiple competitive advantages. Tensions do not occur as the implementation of activities favouring one competitive advantage simultaneously forward the achievement of another (Jiao, Ma, & Tseng, 2003, p. 809; Chrisman, Hofer, & Boulton, 1988; Fleck, 1994). Such *simultaneous* hybrid strategies are compliant with the consistency principle.

## 2. Sustainability

In order to sustain a competitive advantage a strategy has to be inimitable, unique and stable in nature (Barney, 1991). For this, collective design and market exposure of a firm's activity system and its underlying resource and capability portfolio is vital. The corresponding implications can be differentiated on organizational and individual level.

The fundamental question answered on organizational level is 'How resources are transformed by a firm's activity system into services and how (bundles of) resources are integrated?' One starting point for answering this question are generic competitive concepts available to all firms within an industry or even across industries (Sheehan & Foss, 2007). Such widely diffused generic concepts are sources of sustainable competitive advantage by influencing a management's decision making and thus impacting an organization as a whole as managers "...make selective strategic choices about accumulation and acquisition of firm resources, and these decisions, in turn, affect the potential for firm heterogeneity and sustainable advantage" (Bharadwaj, Varadarajan, & Fahy, 1993, p. 701). Besides managers decision behavior in implementing strategies, collective know-how is also comprised in structures, business processes or social norms fosters firm heterogeneity (Spender, 1994). While some scholars determine collective know-how as the aggregation of individual knowledge, meaning all learning within organizations is individual, others treat organizations similar to individuals in a way that organizations remember through its routines, procedures and by institutionalizing individuals' beliefs (Simon, 1991; March, 1991). In this paper a collective view is applied: Collective knowledge is embedded in collective ways of acting and thinking and manifests for example in a firm's culture or social norms and is emergent in nature (Spender, 1994). Only this view allows identifying also core resources and capabilities on collective level

In conclusion, sustainability results from a management's capability to adopt generic concepts, to configure a firm's activity system and to develop a firm's resource portfolio in a firm's specific context altogether making a firm's strategy inimitable and unique. Further, the degree of conceptual adaptation necessary and/or the extent of collective firm specification required provide barriers to imitation. As changing collective firm attributes such as activity systems or collective knowledge is rather long-term,

competitive advantage might be easier protected over time. This especially holds for hybrid strategies, which are more complex than singular or no emphasis strategies. In addition another sustainability driven benefit is provided from hybrid strategies complexity: adaptability due to the possible elaboration of several competitive weapons in unpredictable, dynamic and volatile environments.

For the above mentioned mechanisms to work, certain resources and capabilities need to be available or developed on *individual* level. While obviously, resources and capabilities are logically prior to firm activities, resources can also be a product of a firm's unique set of activities (Spender, 1994, p. 359). However, regardless of what resources and capabilities a firm possesses, 'it is never the resources themselves that are the inputs to the production process, only the services that the resources can render' (Penrose, 1959, p. 25). This points to the important difference between a resources latent market potential and the realized market potential achieved through actions. Chrisman et al. coin this 'competitive weapons', and explain them as "the primary ways the organization applies its skills and resources to meet environmental needs and create enduring competitive advantages" (Chrisman, Hofer, & Boulton, 1988, p. 415). Consequently a firm's competitive advantage is less dependent on resources and capabilities a firm owns per se, but rather on its way of exposing them in the market place. Analysing origins of sustainable competitive advantage on individual level must therefore start with identifying a firm's applied competitive weapons and based on that deducting the underlying resources and capabilities. Accordingly, a hybrid strategy's sustainability rests primarily on the complexity of combining multiple competitive weapons within the same activity system and only secondarily on (co-specialized) individual assets, resources and capabilities.

In total, a hybrid strategy's sustainability depends on identifying generic strategic concepts, analysing their applicability on a firm's specific context and environment, and, fit assumed, adopting and applying the firm's activity system accordingly. Thus, sustainable hybrid strategies necessitate fit and integration across all implementation layers. Ergo, it is not enough having the intention to be hybrid, rather it is compulsory to have the necessary resource potential and the ability to transfer them into market perceived and valued actions. Therefore, the above mentioned construct is focused on realized strategies in the sense of observable patterns in a stream of actions reflected in resource deployment (Mintzberg, 1978, p. 935; Spanos, Zaralis, & Spyros, 2004).

Besides this two, commonly shared characteristics, others are more debated. The most important among them is Porter's concentration principle and its counterpart dimensionality (Porter, 1980; Campbell-Hunt, 2000).

The concentration principle postulates that firms need to concentrate on either one of Porter's two generic competitive advantages of cost or differentiation. Concentration, however, is not an objective of its own for developing and implementing strategies. Rather it is the consequence of assuming that competitive advantages are opposing each other and cannot be combined successfully. This contrasts to the principle of dimensionality, which is based on the assumption, that competitive advantages are independent and combinations are principally feasible. Both principles are either assuming consistency or inconsistency in combining competitive advantage. As already explained consistency depends on the level of analysis and thus cannot be generalized. The attempt, however, to find a principally applicable consistency principle across collective and individual level might be one reason for the widespread theoretical and empirical ambiguity on this principle.

## B. Developing a theory of hybrid strategies

Constituent characteristic of hybrid strategies is the pursuit of multiple competitive weapons in the market place combining several competitive advantages simultaneously (Proff&Proff, 1997). From an activity perspective, these multiple competitive advantages arise from the application of generic concepts, its firm specific and consistent adaptation within a firm's activity system and its underlying activities.

In the strategic management literature three types of hybrid strategies are differentiated: Management based, sequential and concurrent hybrid strategies.

Management based types assume insolvable tensions resulting from ambidextrous strategic directions. Grounded on organizational theory their emphasis lies on management capabilities and organizational design. Based on the underlying assumption of managing inevitable tensions, however, the consistency principle is neglected. In addition sustainability mainly rests on a firm's unique organizational design and its distinctive management, however concepts and their corresponding implementations are suppressed.

In comparison sequential and concurrent hybrid strategies are based on the assumption of consistently applying concepts achieving multiple competitive advantages simultaneously. However they differ in the way of achieving these combinations. While sequential hybrid strategies imply enhancing competitive advantages synergistically one after the other, concurrent types achieve those combinations coinstantaneous. Furthermore, the underlying theoretical foundations vary between the sequential and concurrent types. While sequential hybrid strategies are based on systems theory, concurrent hybrid strategies are rooted in microeconomic theory applying concepts of variety, quality or innovation positively affecting multiple competitive advantages simultaneously. For an

overview on the various hybrid strategy types compare figure 1.

For practical reasons of limiting the scope of this paper and as the paper's focus is to discover the link between hybrid strategy's generic concepts and resources and not to describe the full range of hybrid strategies the further discussion is restricted on sequential hybrid strategies.

#### IV. THEORETICAL FOUNDATION AND GENERIC CONCEPT OF SEQUENTIAL HYBRID STRATEGIES

##### A. Theoretical foundation of sequential hybrid strategies

Sequential hybrid strategies (SQHS) or 'outpacing strategies' combine competitive advantages by extending strategic focus over time (Gilbert & Strebel, 1985). This type is based on a dynamic strategy concept, matching or aligning organizational resources with environmental opportunities and threats (Venkatraman & Camillus, 1984). The major part of research on SQHS is empirical and based on the relationship between a firm's adaptability and its achieved performance (McKee, Varadarajan, & Pride, 1989; Snow & Hrebiniak, 1980). In essence, the key notion of sequential hybrid strategies is, that "... success results not from the single-minded pursuit of either strategy but from the ability to add one to the other at certain stages in the evolution of the market ...." (Gilbert & Strebel, 1985, p. 29).

However, key to success of SQHS is to identify the requirement, time and degree of strategic enhancements. All are mainly determined by the limits of pure strategies. March considers general limitations of exploitation by too much focus to the exclusion of exploration, which leads to competency traps, inertia, and finally obsolescence. Contrary, too much exploration to the exclusion of exploitation leads to failure traps, leaving firm's not gaining returns on their knowledge (March, 1991, p. 71; Simsek, Heavey, Veiga, & Souder, 2009). More specifically, strategic limitations can either originate from internal or external factors of a firm. External limitations on, for example, Porter's pure differentiation strategy are a lack of customer perception on increased product quality, or missing consumer price acceptance on incremental innovations (Knyphausen & Ringlstetter, 1991, p. 553). Both of these examples lead to a marginalization of differentiation efforts at potentially higher cost of production or transaction. Internal limitations on Porter's cost leadership are, for example, marginal benefits arising from additional investments in mature technologies, or too low initial investments generating economies of scale only insufficiently (Kloock & Sabel, 1993). Accordingly, Booth and Philip empirically find "... the emphasis was more on mix and match

combinations of cost, differentiation, and other incentives, rather than on any one generic posture".

Successively extending competitive advantages can only be explained relative to changes in a firm's organizational and environmental factors, as they determine the degree of adaptation necessary. Zajac and Shortell develop a model of dynamic fit based on two dimensions: Change required and change implemented (Zajac & Shortell, 1989, p. 431). They distinguish two 'dynamic fit' types, 'beneficial change' and 'beneficial inertia', from two 'dynamic misfit' types, 'excessive change' and 'insufficient change' and conclude that change is only one way successfully handling contingencies, while another is inertia. This is true on organizational as well as on individual level. Companies use flexibility on organizational level for improving their competitive position and their adaptability in volatile markets, while simultaneously using stability to reduce uncertainty. Similarly individuals seek predictable relationships and stability in behavior while simultaneously looking for variety and stimulation in organizational life (Leana & Barry, 2000). This indicates complementary relationships on organizational and individual level and considers both dynamic fit types as concurrent forces affecting organizational actions (Connor, 1999). This in turn specifies the activity system as the adequate unit of analysis for SQHS. Due to the sequential achievement of multiple competitive advantages, effectively attaining one, say differentiation, provides the basis for successfully utilizing another. In detail, achieving differentiation through fulfilling customers demand for an innovative product, production capacity could be raised and thus economies of scale increased (Parnell, 1998, p. 30). Therefore, a consistent and sustainable model of SQHS has to simultaneously pursue beneficial change and inertia on an activity system's level, with the premise that beneficial change compensates all associated costs and risks from changing. Only if the sum of all effects is positive SQHS is outperforming singular and no-emphasis strategies. Otherwise it will be stuck-in-the-middle.

##### B. A generic conceptualization of sequential hybrid strategies

Sequential strategic expansions are driven by internal and external change. Following Ashby's 'law of requisite variety', systems efficiency depends on the degree of fit between a system's internal and external complexity (Ashby, 1956). As individual firms have only marginal impact on external factors, sequential hybrid strategy's success depends on the adaptation of a firm's activity system, activities, resources and capabilities to its external environment.

System theory provides two important insights for adapting activity systems sequentially: First, adaptation efforts should principally kept small and second, should be limited to as few as possible and independent system

parts. While the first depends on the required fit and is, as already mentioned before, mainly externally determined, the second focus on a systems' architecture. System architectures are defined by the Institute of Electrical and Electronics Engineers Standards Association (IEEE-SA) as the fundamental organization of a system embodied in its components, their relationships to each other, and to the environment, and the principles guiding its design and evolution (IEEE Standard 1471). Accordingly systems architectures can be differentiated according to the intensity of coupling its subsystems and components. While adapting tightly coupled subsystems can even lead to the necessity of a complete systems redesign, loosely coupled systems allow adapting certain subsystems, without compromising the overall architecture (Orton & Weick, 1990). Accordingly, system theoretically conceptualizing a SQHS combining beneficial change with beneficial inertia requires loosely coupled, modular system designs (Sanchez, 1995) and is applicable to any complex system such as products, processes, organizational structures, knowledge systems, or even customers' utility systems (Baldwin & Clark, 2000; Sanchez & Mahoney, 1996).

On an aggregated level generic cornerstones of SQHS are modular product design and modular organization design. Modular product design supports SQHS by increasing product variety and adaptability through mixing and matching of components within existing product architectures. In addition modular designs increase production volume of individual components reused across product variants, families and generations. Similarly, reuse of existing product architectures, interfaces and components foster efficiencies in a firm's value chain beyond manufacturing. Moreover, the reuse of existing architectural designs, interfaces and components create efficiencies through emphasizing architectural level and core components critical to overall product performance and customer perception.

Modular organization design fosters SQHS by substituting overt managerial authority through embedding coordination in standard interfaces between decentralized units (Worren, Moore, & Cardona, 2002; Henderson & Clark, 1990; Schilling, 2000; Sanchez, 1995). This generates adaptability through reconfiguring a firm's activity system, activities and its underlying portfolio of resources and capabilities by flexibly 'mixing and matching' organizational units. Modular organizational designs also increase learning through reusing and transferring knowledge between decentralized organizational units.

## V. LINKING ACTIVITY DRIVERS AND ACTIVITIES OF SEQUENTIAL HYBRID STRATEGIES

For analysing the competitive success resulting from the above outlined SQHS concept activity drivers need to be determined and linked to a firm's activity system and activities.

Activity drivers are generic and structural. They are structural 'in the sense that they represent abstract, relative or relational properties of activities, both in the context of the firm and in the context of the business value system the firm operates in (Sheehan & Foss, 2007, p. 453). Scale for example as a potential driver needs to be determined relative to the total product market volume and has to be considered in relation to the scale of other activities performed in the firm. In this way drivers determine the space of alternative positioning. They are abstract as they need to be instantiated firm specifically. For scale a firm specific decision is required in terms of the amount of output produced. Drivers impact the activity system in two ways: First, they can improve an activity system's efficiency and effectiveness and second, improve the fit between activities within a firm's activity system. Typically multiple drivers need to be balanced and made operational within several activities of the value chain. Quality for example has its requirements in product development, inbound logistics and material, manufacturing, or outbound logistics. However the same functions are also affected by another driver as for example scale or flexibility.

Links between activity drivers and activities are mutual and manifold. Variety as a driver spans the space of alternative positioning for example for marketing by determining how many product variants are offered to certain customers or segments. Based on that, firm management decides on what position a firm wants to occupy within the space of alternative positioning. For example firms following a SQHS carry out variety supporting activities such as rapidly developing prototypes for real time market research based on modular product design. However, as seen in the example, variety impacts not only marketing but also other activities such as operations, firm infrastructure or technology. Conversely the activity, decoupling product design from technology on architectural level for example increases differentiation by fostering variety and simultaneously improves efficiency by lessening research cost per variant. In consequence, drivers and activities are not tightly bonded but form systems which need to be aligned with each other. Therefore, the identification of (groups of) activities impacting multiple drivers concurrently is the key prerequisite of hybrid strategies in general and SQHS in particular. According to Porter's value chain framework activities are differentiated in primary activities, directly influencing value generating activity, and support activities, only indirectly impacting drivers

by affecting the performance of primary activities (Porter, 1985). Primary activities consist of inbound logistics, operations, outbound logistics, marketing, sales and services. Secondary activities consist of firm infrastructure, human resources, procurement and technology management. Porter's value chain is central as a framework for the analysis of a firm's strength and weaknesses as it allows evaluating each value chain function and activities (Stabell&Fjeldstad, 1998). Less frequently, however, it is applied to first- or second-order analyses (Hax&Majluf, 1992; Stabell&Fjeldstad, 1998). First-order analyses are used to assess the most important activities in terms of cost and value. Second-order analyses are more detailed and used to uncover structural activity drivers behind activities. For this research a two-tiered second-order analysis is applied on activity drivers and core activities, which sufficiently satisfies a strategic and management perspective (Stabell&Fjeldstad, 1998, p. 413). While, however Porter unnecessarily limits value chain analyses to the activity level as the smallest possible entity, in this paper resources and capabilities as the ammunition of activity based weapons are added as elementary units of analyses.

In the following, first, differentiation and cost drivers of SQHS' are discussed before, secondly, core activities and their interdependencies will be identified. An overview on SQHS' generic concept and key activity drivers is provided in figure 1

#### A. Activity drivers of sequential hybrid strategies

##### 1. Differentiation drivers

Major differentiation drivers of modularity are increasing variety and flexibility.

*Product variety* increases the diversity of product function, characteristics, and performance specifications (Dickson & Ginter, 1987; Sanchez & Mahoney, 1996). Variety improves positioning to heterogeneous customer preferences compared to integrated product designs and allows serving many more market segments than competitors not capable of designing modular products (Dickson & Ginter, 1987; Sanchez & Sudharshan, 1993). Furthermore, modularly adapted and updated products reduce the time to market of modified or new products. Besides this primary differentiation aspect, modular product architectures reduce test, change and adaptation costs for customers by requiring only certain components to be replaced if products advance (Nobeoka & Cusumano, 1997; Baldwin & Clark, 2000; Sanderson & Uzumeri, 1995; Schilling, 2000, p. 321). By this customers are enabled to participate in component based technology innovations, while only carrying the cost of adapting its current product configuration. This also founds the basis for continuous improvements (Sanchez, 1996, p. 128; Sanchez & Sudharshan, 1993). Last but not least, modular product design provides the basis for real time learning by leveraging product variants for market

research and product adaptation according to customer needs (Sanchez & Sudharshan, 1993, p. 130).

*Flexibility* can be differentiated in mix, changeover and modification flexibility (Gerwin, 1993). Mix flexibility results from composing products from a modular set of components (Sanderson & Uzumeri, 1995). Changeover flexibility is achieved by applying existing product designs as development platforms for new product families and models or reusing components across product families and generations (Gerwin, 1993). Modification flexibility is based on altering certain components, while obtaining the overall product architecture and unmodified components (Wheelwright & Sasser, 1989).

##### 2. Cost drivers

Before discussing cost drivers, economies of substitution as a central cost element of modularity need to be described. They occur if "(...) the cost of designing a higher-performance system through the partial retention of existing components is lower than the cost of designing the system afresh" (Garud & Kumaraswamy, 1995, p. 96). Substitution economies differ from economies of scope in terms of its origins. While economies of scope result from using capacities of 'quasi-public' goods, which otherwise would remain unexploited (Kloock & Sabel, 1993), economies of substitution are based on fully separable, autonomous inputs, which are designed to provide variable output capacities. Thus, economies of scope use 'variations of alternative input capacities' for alternative applications, while economies of substitution use 'variations of standardized output capacities' for alternative applications (Kloock & Sabel, 1993). In consequence, scope economies are factor input oriented while substitution economies are factor output oriented. Based on this, positive and negative cost effects as well as risks of modularity are discussed.

For a concept to be 'hybrid', it is obligatory to combine differentiation with positive cost effects. While differentiation is mainly driven by product and service characteristics, costs are impacted by product and organization design. *Product oriented cost drivers* of modularity are scale and capacity utilization as well as substitution and make or buy decisions.

For manufacturers modular product designs generate economies of substitution in product development, testing and quality assurance per product variant (Sanchez, 1995; Garud & Kumaraswamy, 1995, p. 96). Additionally, combinational learning leads to incremental product innovations and improvements as well as reductions in development, test and quality costs (Kloock & Sabel, 1993). Furthermore, set-up costs are reduced or even avoided for all sustained components (Garud & Kumaraswamy, 1995, p. 96). Continued architectures, interfaces and components lead to a component based increase of economies of scale in production and purchasing (Sanchez, 1996, p. 129).

Thus available capacities in manufacturing as well as in marketing and sales can be better utilized. Beyond that, 'delayed differentiation', through adding differentiation relevant components late in the delivery process generate cost advantages in inventory and assembly (Zangwill, 1993; Lee & Billington, 1993; Hau & Tang, 1997). Also modularity's emphasize on architectural level and core components, which are critical to overall product performance and customer perception, generate value chain efficiencies through supporting decisions on make or buy. (Sanchez & Mahoney, 1996, p. 72) Finally, market and competitor imitation risks are reduced by increasing product flexibility and adaptation to customer preferences as well as shorter product development cycles (Sanchez, 1996, p. 129; Baldwin & Clark, 2000).

*Organizational cost drivers* are often determined by a company's product design choice meaning that modular product manufacturer often structure their organization modularly as well (Sanchez & Mahoney, 1996, p. 131; Worren, Moore, & Cardona, 2002, p. 1126). The major modular organization cost drivers are substitution, strategic adaptability and learning.

By decoupling relatively autonomous units and linking them through pre-specified, standardized interfaces modular organizations use 'embedded coordination' and substitute overt, managerial authority (Orton & Weick, 1990). Consequently less management capacities are required and coordination and transaction costs decline (Sanchez, 1995, p. 146). The product oriented principle of 'mixing and matching of components' applies also to a modular organization's independent and reusable units. Thus, recombining and reconfiguring independent organizational units generates organizational flexibility and economies of substitution, if change can be located on the level of groups or individual units (Teece, Pisano, & Shuen, 1997, p. 520; Sanchez, 1995, p. 154). Moreover, economies of substitution result from knowledge sharing, compared to knowledge 'hoarding' in traditional hierarchical structures of knowledge (Garud & Kumaraswamy, 1995, p. 98).

Despite the above mentioned positive impacts on cost drivers, modularity produces also *negative cost effects*, compared to traditional designs. Costs are negatively driven through costs of increased complexity and diseconomies of substitution on both, product and organizational level. Modularity's higher level of variety and complexity increases coordination costs. Lateral integration of 'in-house' produced components and vertical integration of externally supplied components raise management coordination efforts. Additional coordination costs also occur as management's cognitive complexity expands through allocating scarce resources on partly competing activities (Teece D. , 1980). Diseconomies of substitution primarily result from increased development and coordination efforts. Development

costs rise because of increased design requirements (Garud & Kumaraswamy, 1995, p. 100). In addition specifying and aligning interfaces between autonomous units and components as well as developing modular architectures including degrees of freedom for future opportunities is relatively costly compared to traditional, integrated designs. Moreover cumulative search and test costs are higher as the total amount of product components and variety rises. (Banker, Datar, & Kemerer, 1993).

Summarizing, modular product and organization design is a necessary, but not sufficient prerequisite for SQHS *per se*. Rather the net result of the corresponding production and transaction costs of all product lines and variants determine the success of SQHS. This directs the discussion onto a firm's activity system as a concrete manifestation of SQHS' generic concept and activity drivers.

#### B. Determining a SQHS' core activities and core resources

Contrary to the relationship of drivers and activities shaped by alignment, activities and resources are bonded by the nature of activities engaging resources for achieving a firm's objectives. Moreover, activities do not simply employ resources; they also can shape existing ones or create new ones. Principally, many activities and resources are similar in traditional and modular design. However some core activities and resources differ, which therefore are emphasized in the following discussion (Hamel, 1994).

SQHS's core primary activities are mainly located in purchasing, operations, outbound logistics and marketing.

In purchasing hybrid core activities relate to make or buy decisions and are based on the capability of identifying core components within product architectures or core units within organizational structures (Garud&Kumaraswamy, 1995, p. 97). This in turn is determined by capabilities in marketing, product design and operations. In marketing the capability rests on real-time market research and competitor and market analysis, while product design provides the basis for modularity and thus variety, and operations capable of providing rapid prototypes (Wheelright& Clark, 1992). With this knowledge firm's identify non-core components or units, evaluate competitors' and suppliers' corresponding performance and decide whether to externally supply or internally produce the components or services. In consequence, the selection of capable partners is one core purchasing activity for SQHS.

In operations core activities are integrating and managing outsourced component and service provision, design product architectures decoupling architecture and technology development, rapidly designing and reusing modular architectures for products and

organizations, as well as reusing architectures, interfaces and components. While in purchasing potential partners are evaluated and selected, in operations external partners are operationally integrated and managed in order to meet pre-specified requirements and service levels. Moreover, designing modular product architectures is an essential activity of SQHS. Such architectures contain a complete information structure defining 'required outputs of component development processes before beginning development of components' (Sanchez & Mahoney, 1996, p. 70). While basic knowledge on technology is necessary for designing architectures, technology development typically manifests on component level. Therefore architectural design and basic technology capabilities are a prerequisite of hybrid strategies based on modularity. Similarly strong competencies in technology development on core component level are required. Rapid prototyping as another core activity in R&D forms the basis for real-time market research. Furthermore testing and developing modular architectures and components are core activities in research and development. This requires sufficient upfront investments in complex modular product architectures with costly interface definitions and degrees of freedom for future opportunities. Correspondingly capabilities are required in modular and experimental product design, interface specification and alignment, experimental product design, as well as in search and reuse of knowledge and existing modular product architectures, components or interfaces as well as adaptable organizational units. Similarly to R&D in manufacturing capital investments in production facilities are required to provide the basis for generating sufficient scale economies (Kloock&Sabel, 1993). This is necessary as the volume increasing effect of differentiation generate the potential of realizing economies of scale if production facilities are sufficiently dimensioned (Kloock&Sabel, 1993). Furthermore, modularity in products and organizations are a necessary but not sufficient prerequisite for generating economies of substitution. Rather substitution effects occur only if components are actually reused in operations (Cusumano, 1991; Banker, Datar, & Kemerer, 1993). Thus the corresponding core activity is stimulating modularity conform employee behavior through applying core resources such as a focused incentive system and IT and communications infrastructure supporting search and coordination activities (Graham, 1994).

The core activity in outbound logistics is delayed differentiation, what is achieved by adding value delivering customer perceived components at late stages of the delivery process (Hau& Tang, 1997). As delayed differentiation components are frequently assembled in warehouses, decentralized assembly capabilities are required.

In marketing and sales core activities are real-time market research and identifying core components

determining customer perceived value. Real time market research depends on customer feedback generated on rapid and efficient prototyping based on modular designs. This feedback in turn is used to identify core components by analysing the differential effects of product variants on customers' value perceptions. Accordingly 'threshold, central or plus-only' product attributes can be differentiated with special attention on threshold components (Bogner& Thomas, 1996). In addition, this requires specific analytical capabilities, which are often located in decentralized sales and marketing units generating customer data on product variants from field trials in for example antenna or test shops (Sanchez, 1996, p. 130).

SQHS's core support activities are located in firm infrastructure, HR management and technology.

Core activities within firm infrastructure are constructing organization structures modularly, orchestrating independent, self-managing units, and dynamically reconfiguring and transforming the value chain. Developing loosely coupled organizational subsystems or 'self managing teams' is an essential activity for dynamically adapting the value chain (Worren, Moore, & Cardona, 2002, p. 1126). This requires high degrees of standardization and formalization capabilities for defining interfaces as the basis for embedded coordination (Zander &Kogut, 1995; Zenger &Hesterly, 1997). Also the capabilities of identifying core components and units, partitioning the overall system and coordinating internal and external product and service provision are essential (Garud&Kumaraswamy, 1995; Worren, Moore, & Cardona, 2002, p. 1126). As coordination and partitioning are required repeatedly knowledge sharing and codification are also essential capabilities. Moreover, the decomposition of the value chain requires strong collaboration capabilities in order to coordinate individual units by means of standard input and output definitions (Jarvenpaa& Ives, 1991). Last but not least, deconstructing the value chain in its individual parts and reconfiguring it by using external resources can foster 'resource leverage' as external resources can be used while resources' costs need only partially be carried by the firm (Sanchez, 1995, p. 151; Garud&Kumaraswamy, 1995, p. 102). Thereby SQHS' compensate own resource deficits, facilitate knowledge exchange, or align definitions of interfaces beyond company borders (Prahalad& Hamel, 1990). However for achieving this, firm's need to have a distinct combinative capability allowing effective and efficient integration of internal and external resources (Zander &Kogut, 1995). Additionally, sequential strategic enhancement require the management capability of identifying internal or external change requirements, determining the degree of internal change necessary and adapting the value chain accordingly. Especially the last core capability requires the dynamic capability of reconfiguring and transforming a firm's current set of activities and resources. In consequence the focus of



strategic management shifts to a ,higher-order' process of redesigning the firm as a system for rapidly reconfiguring and redeploying a changing array of assets and capabilities (Sanchez, 1996, p. 126).

In HR management core activities of SQHS are reuse and transfer of knowledge, architectures and components as well as employee rotation and development. Next to operative learning through 'real-time market research', knowledge transfer is among the most important activities for developing or improving a firm's reconfiguration and transformation capabilities and achieving economies of substitution (Garud&Kumaraswamy, 1995, p. 98). Knowledge in traditionally structured firms is typically not characterize by change and adaptation; rather it is stable in nature and coined by 'knowledge hoarding' (Garud&Kumaraswamy, 1995, p. 98; Henderson & Clark, 1990, p. 20). Contrary, SQHS are sharing, reusing and developing knowledge by means of employee rotation and development, knowledge documentation and incentives (Garud&Nayyar, 1994). This is mainly based on the capabilities of standardization and formalization and is congruent with Worren et al.'s findings that if 'all teams and departments follow the same basic process architecture, the company achieved more rapid knowledge transfer and rotation of personnel across organizational boundaries' (Worren, Moore, & Cardona, 2002, p. 1127; Garud&Kumaraswamy, 1995). This is additionally supported by the core activity of offering incentives to employees for sharing and documenting knowledge. Therefore, management has to be capable of developing a clear understanding of employees' intrinsic and extrinsic motivation and transferring that knowledge into the firm's incentive system (Cusumano, 1991). Another resource supporting knowledge sharing and reuse is a company's culture fostering collaboration and exchange (Worren, Moore, & Cardona, 2002, p. 1128). In addition a SQHS' culture advances employee orientation and thus emphasizes the importance of employees for other capabilities such as reconfiguration and learning (Worren, Moore, & Cardona, 2002, p. 1129; Garud&Kumaraswamy, 1995, p. 99). Also fundamental change willingness needs culturally be embedded reflecting the continuous search for new solutions by using existing and new knowledge (Henderson & Clark, 1990, p. 6). Finally a SQHS' core operational and management activities are reflected in a firm's culture by encouraging strong customer, competitor, innovation and technology orientation.

Core activities in technology management are centered on information and communication technology (ITC) supporting learning, reuse and coordination. This is mainly driven by the increased information and communication requirements resulting from SQHS' modular variety and its distinct capabilities of standardization, formalization and coordination. Therefore "... information and telecommunications technologies are playing an important new role in

linking widely dispersed product creation activities. Establishing effective electronic mediation of processes for developing, manufacturing, distributing, and marketing products requires establishing shared communications interfaces and standardizing descriptions of products, components, parts, and processes" (Sanchez, 1996, p. 132). Consequently hybrid sequential firms have to be capable of evaluating ITC technology in terms of its firm specific applicability and benefit as well as successfully implementing the technology to benefit from it.

In summary, a SQHS' core primary activities can be located in operations, explicitly research and development, and on marketing and service. For combining competitive advantages successfully, however, an adequate structure of support activities and corresponding resources and capabilities is required. While principally only few core resources are primary, such as capital requirements, combining competitive advantages rests mainly on a firm's managerial capability of orchestrating operational capabilities in areas such as real-time market research, modular and experimental product development, rapid prototyping, or interface specification. Correspondingly core capabilities are focused on coordination and integration, learning, and reconfiguration and transformation. An overview of a SQHS' core activities and capabilities is shown in figure 1.

## VI. DISCUSSION AND IMPLICATIONS

### A. Summary and conclusion

In this paper it is argued that the gap between generic concepts and a firm's individual resources and capabilities can be closed by activity drivers and activities. At organizational or collective level hybrid generic concepts embed the required knowledge of activity drivers and activities defining the space of alternative positioning. Based on that, the activity system is individualized on firm level. As in research on organizational ambidexterity the prevailing role of management is stressed. However, the importance of management is not seen in managing 'tensions' within a firm's activity system as in management based hybrid strategies. Rather it is argued that success of hybrid strategies is build on consistently applied and implemented concepts principally avoiding tensions within the activity system. Combining competitive advantages consistently can be either achieved sequentially or concurrently. On that basis, the link between generic concepts and resources provided by the activity based view was theoretically outlined and further detailed for sequential hybrid strategies. Conclusions are drawn from both levels starting with findings from linking concepts, activities and resources and ending with more specific results derived from modularity based sequential hybrid strategies.

Theoretically linking concepts and resources highlighted a general prerequisite of deploying resources through activities as competitive weapons in the market place. This shifts analysis emphasis from a resource to an activity systems level orchestrating resource engagements. Then a firm's stock of resources is a necessary but not sufficient condition for combining competitive advantages. Rather it is crucial to determine how a firm engages its resources from an activity based perspective. Furthermore the activity based view bridges the gap between concepts and resources by cascading activity drivers from generic concepts and then composing activity systems orchestrating the engagement of (groups of) resources through activities. In consequence it is concluded that there is not such a thing as hybrid resources, but activities elaborating resources and thus impacting several activity drivers influencing multiple competitive advantages concurrently. The hybrid effect of activities occurs on an individual activity as well as on an activity systems level. This means on individual level a single activity impacts multiple drivers, while on collective level the sum of all activities develops hybrid effects. In both cases, however, the hybrid effect requires a firm's activity system to be consistently aligned avoiding contradictions potentially offsetting each other.

For hybrid strategies two types are identified satisfying this consistency prerequisite: Sequential and concurrent hybrid strategies. For practical reasons of limiting the scope of this paper only sequential hybrid strategies were further detailed. System theoretically derived modularity principles provide the foundation for sequential hybrid strategies. As exemplified with SQHS, activities and resources of generic and hybrid strategies differ only in a few core operational functions. However, firm's applying hybrid strategies need to excel in these, while potentially externalize non-core activities and components. In addition, operational core activities and resources are not sufficient to perform hybrid. Rather a firm's support activities and resources, especially its infrastructure, management capabilities, technology base and culture are essential in consistently aligning operational activities for achieving hybrid competitive advantages. In this sense, management's core tasks are identifying generic concepts applicable to the firm and its specific context and acquiring or creating, as well as arranging and applying its stock of resources within the activity system.

In summary, two major pillars of academic discussions on hybrid strategies need to be revised. Both related to operationalisation. First, success of hybrid strategies can neither be determined on generic concept nor on resource level. Generic concepts represent industry wide available knowledge and are often used as the starting point for developing a strategy. However, similarly to Mintzberg's distinction of intended and emergent strategy patterns, generic concepts are valuable only if they 'emerge' within a

firm's activity system (Mintzberg, 1978). This means in turn, that despite the key role of management in implementing hybrid concepts it is crucial to consider the level of strategic realization on operational level. Otherwise researchers risk analysing management's strategic intentions without testing its realization within a firm's activity system. Second, operationalising the link between concepts and resources requires three layers. First, generic and structural activity drivers define the space of alternative positioning and thus determine the underlying logic of competitive advantages. The second layer, the activity system, is mainly responsible for consistently orchestrating the overall set of activities on multiple competitive advantages. Individual activities as the last layer engage resources and capabilities in order to positively affect competitive advantages. In consequence, lacking one or more of the above operationalisation layers can distort research results on hybrid strategies by leaving a blind spot on implementation effectiveness.

## B. Limitations and future research

The focus of this paper was on strengthening the theoretical foundation of hybrid strategies by reviewing the literature and constructing a consistent concept of hybrid strategies. Based on market based, activity based and resource based views a consistent concept of hybrid strategies was developed and the corresponding strategic implications, structures, activities and resources provided. Accordingly, the next stage is to apply these findings in an empirical study testing the above made hypotheses. For this, a triangulated pattern matching case based approach comparing theory with empirical results seems most appropriate.

Additionally future research should investigate the influence of intended versus realized strategy patterns implemented within an activity system. This could illuminate the importance of a firm's management as well as its implementation effectiveness and efficiency. Furthermore, theoretical and empirical investigations are required determining SQHS' capabilities necessary for identifying the requirements, time and degree of strategic enhancements. In this respect especially the hypothesized key role of management needs to be tested. Operational fit between hybrid concepts and activity drivers on the one side and hybrid activities and resources on the other side depends on a variety of factors such as differences in firm specific context, diversity in resources and capabilities, discrepancy between a management's perception of a firm's current activities and resources and its transformation capability. Additional research on this is necessary to clarify the relationship, direction and intensity of those factors' on implementing hybrid strategies. Furthermore the relationship between generic concepts, activity drivers and activities as well as resources and capabilities is fruitful for further investigation. While in this paper activity based insights were applied to

strategy operationalisation it also could be applied to topics such as strategy formulation and implementation. Last but not least, the focus of this paper is limited to exemplify sequential hybrid strategies. Concurrent hybrid strategies provide further potential for future theoretical and empirical research. This is of particular importance as the theoretical fundament differs between both consistent hybrid strategies and consequently SHQS's basis cannot simply be transferred to concurrent hybrid strategies.

Hybrid strategy type	Variants	Description	Theoretical grounding	Evaluation	
				Consistency	Sustainability
<b>Management based hybrid strategy</b>	Management based	Inevitable tensions between activities directed to multiple competitive advantages need to be balanced	Organizations theory	Inconsistent, as strategic conflicts to be managed	Emphasis on management capabilities and organizational design
<b>Sequential hybrid strategy</b>	Sequential	Sequentially enhance competitive advantages	System design	Consistent, no strategic conflicts occur through modular structures	Emphasis on operational and management capabilities required to implement strategic change
<b>Concurrent hybrid strategy</b>	Variety Quality Innovation	Concurrently achieve multiple competitive advantages	Microeconomic principles	Consistent, applying concepts avoiding strategic conflicts	Emphasis on operational and management capabilities required to implement microeconomic concepts

Fig. 1 Overview on hybrid strategy types

		Generic concept	Drivers	Systems and activities	Core resources and capabilities
POSITIVE COST EFFECTS	Modular product and service design	1. Increase customer perceived product variety and adaptability through mixing and matching of components within existing architectures	<ul style="list-style-type: none"> <li>- Variety</li> <li>- Flexibility</li> <li>- Timing</li> <li>- Innovation</li> </ul>	<p><b>I.1. Firm infrastructure</b></p> <ul style="list-style-type: none"> <li>- Dynamically reconfiguring and transforming the value chain</li> <li>- Constructing processes and structures modularly</li> <li>- Flat hierarchies and self-managed, independent units coordinated by embedded coordination</li> <li>- Market driven, dynamic partner network management</li> </ul> <p><b>I.2. HR management</b></p> <ul style="list-style-type: none"> <li>- Incentive based reuse and transfer of knowledge, architecture and components</li> <li>- Employee rotation and development</li> </ul> <p><b>I.3. Technology</b></p> <ul style="list-style-type: none"> <li>- Learning, reuse and coordination supporting technology infrastructure</li> </ul> <p><b>I.4. Purchasing</b></p> <ul style="list-style-type: none"> <li>- Vendor selection for non-core components and services</li> </ul> <p><b>II.1. Inbound logistics</b></p> <ul style="list-style-type: none"> <li>-</li> </ul> <p><b>II.2. Operations</b></p> <ul style="list-style-type: none"> <li>- Designing modular product architecture</li> <li>- Technology development coupled on component and decoupled on architecture level</li> <li>- Reusing product architectures, interfaces, components and structural units</li> <li>- Selective outsourcing of non-core business</li> </ul> <p><b>II.3. Outbound logistics</b></p> <ul style="list-style-type: none"> <li>- Decentralised, late assembly of core components</li> </ul> <p><b>II.4. Marketing and sales</b></p> <ul style="list-style-type: none"> <li>- Real time market research through customer feedback on basis of rapid prototyping</li> <li>- Identification of customer perceived, core components</li> </ul> <p><b>II.5 Service</b></p> <ul style="list-style-type: none"> <li>-</li> </ul>	<p><b>Operational resources and capabilities</b></p> <ul style="list-style-type: none"> <li>- Sufficient investments in manufacturing hardware</li> <li>- Upfront investment in modular architecture</li> <li>- Modular design capability</li> <li>- Research capability on customers, competitors and suppliers</li> <li>- Experimental product development capabilities</li> <li>- Component oriented customer value analytic capability</li> <li>- Product interface specification and alignment capability</li> <li>- Organizational and individual learning by using, doing and experimenting</li> </ul> <p><b>Management capabilities</b></p> <ul style="list-style-type: none"> <li>- Management capability of identifying change requirements and required strategy adaptation as well as firm specific adaption of generic concepts</li> <li>- Business architectural (re-)configuration and transformation capability</li> <li>- Standardization, formalization and codification capability</li> <li>- Capability of decomposing processes and functions</li> <li>- Structural interface specification and alignment capability</li> <li>- Partner evaluation, selection, integration and management capability</li> <li>- Capability to manage network oriented structures combining and assimilating internal and external resources</li> <li>- Evaluation and implementation capability of ITC technology</li> <li>- Understanding employee motivators and transfer to incentive system</li> </ul> <p><b>Company culture</b></p> <ul style="list-style-type: none"> <li>- Culture fostering collaboration and exchange</li> <li>- Culture of employee orientation and change willingness</li> </ul>
		2. Value chain efficiency through reusing components across product variants, families and generations	<ul style="list-style-type: none"> <li>- Scale</li> <li>- Capacity utilization</li> </ul>		
		3. Manufacturing efficiencies through leveraging existing architectures, interfaces and components across product variants, families and generations	<ul style="list-style-type: none"> <li>- Substitution</li> </ul>		
		4. Value chain efficiency through emphasizing architectural level and core components, critical to overall product performance and customer perception	<ul style="list-style-type: none"> <li>- Make or buy</li> </ul>		
	Modular organization design	5. Substitution of overt managerial authority through embedding coordination in standard interfaces between decentralized units	<ul style="list-style-type: none"> <li>- Substitution</li> </ul>		
		6. Organizational adaptability through reconfiguring the activity system, activities and underlying portfolio of resources and capabilities	<ul style="list-style-type: none"> <li>- Substitution</li> </ul>		
		7. Improve learning through reuse and transfer of knowledge across, divisions, functions and processes	<ul style="list-style-type: none"> <li>- Learning</li> </ul>		

Fig. 2 Generic concept, activity drivers, activities and resources

## REFERENCES

- Abell, D. F. (1980). Defining the business: The starting point of strategic planning. Englewood Cliffs.
- Acquaah, M., & Yasai-Ardekani, M. (2008). Does the implementation of a combination competitive strategy yield incremental performance benefits? A new perspective from a transition economy in Sub-Saharan Africa. *Journal of Business Research* Vol. 61 , 346–354.
- Adner, R., & Zemsky, P. A. (2006). A demand-based perspective on sustainable competitive advantage. *Strategic Management Journal*, Vol. 27 , 215-239.
- Allen, R. p., & Helms, M. M. (2006). Linking strategic practices and organizational performance to Porter's generic strategies. *Business Process Management* , 433-454.
- Ashby, W. R. (1956). *An Introduction to Cybernetics*. New York.
- Bain, J. (1956). *Barriers to New Competition*. Cambridge .
- Bain, J. (1968). *Industrial Organisation (2nd edition)*. New York.
- Baldwin, C. Y., & Clark, K. B. (2000). *Design Rules: The power of modularity*. Boston, MA.
- Banker, R. D., Datar, p. M., & Kemerer, C. F. (1993). Software complexity and maintenance costs. *Communications of the ACM* , 81-94.
- Barney, J. B. (1991). Firm Resources and Sustained Competitive Advantage. *Journal of Marketing*, Vol. 1 , 99-120.
- Barney, J. B. (1986). Strategic Factor Markets: Expectations, Luck and Business Strategy. *Management Science*, Vol. 32, No. 10 , 1231-1241.
- Barney, J. B. (1986). Types of Competition and the Theory of Strategy: Toward an Integrative Framework. *Academy of Management Review* , 791-800.
- Bharadwaj, p. G., Varadarajan, P. R., & Fahy, J. (1993). Sustainable competitive advantage in service industries: A conceptual model and research proposition. *Journal of Marketing*, Vol. 57 , 83-99.
- Black, J. A., & Boal, K. ... (1995). Strategic resources: Traits, configurations and paths to sustainable competitive advantage. *Strategic Management Journal*, Vol. 15 , 131-148.
- Bock, W. J. (1973). Philosophical foundations of classical evolutionary classification. *Systematic Zoology* , 375-392.
- Bohn, A. (1993). *Differenzierungsstrategien – Kritische Würdigung eines zentralen Konzeptes der strategischen Unternehmensführung*. München.
- Bongartz, U. (1997). Strategische Ressourcen und erhaltbare Wettbewerbsvorteile. *Zeitschrift für Betriebswirtschaft, Ergänzungsheft 1/97* , 21-43.
- Booth, M. E., & Philip, G. (1998). Technology, competencies, and competitiveness: The case for reconfigurable and flexible strategies. *Journal of Business Research*, Vol. 41 , 29-40.
- Bresnahan, T. F. (1989). Empirical Studies of Industries with Market Power. In R. Schmalensee, & R. D. Willig, *Handbook of Industrial Organization, Volume 2* (pp. 1011-1057). Amsterdam.
- Bühner, R. (1977). Messung des Erfolgs von Organisationen unter Berücksichtigung situativer Einflußfaktoren. *Management International Review*, Vol. 17, No. 3 , 51-59.
- Buzzel, R., Gale, B. T., & Sultan, R. (1975). Market Share: A Key to Profitability. *Harvard Business Reviews*, Vol. 53, No.1 .
- Campbell-Hunt, C. (2000). What Have We Learned About Generic Competitive Strategy? A Meta-Analysis. *Strategic Management Journal*, No. 21 , 127-154.
- Chamberlin, E. (1933). *The Theory of Monopolistic Competition*. Cambridge.
- Chrisman, J. J., Hofer, C. W., & Boulton, W. R. (1988). Toward a System for Classifying Business Strategies. *Toward a System for Classifying Business Strategies, in: Academy of Management Review* , 413-428.
- Claver-Cortés, E., Pertusa-Ortega, E. M., & Molina-Azorín, J. F. (2011). Characteristics of organizational structure relating to hybrid competitive strategy: Implications for performance. *Journal of Business Research* , doi:10.1016/j.jbusres.2011.04.012.
- Connor, T. (1999). Customer-led and market-oriented: a matter of balance. *Strategic Management Journal* 20 , 1157-1163.
- Cusumano, M. (1991). *Japan's software factories: A challenge to US management*. New York.
- Davenport, T. (2005). The coming commoditization of processes. *Harvard Business Review*, Vol. 74 , 100-108.
- Dess, G. G., & Rasheed, A. M. (1992). Commentary: Generic strategies: classification, combination and context (D. Miller). *Advances in Strategic Management* , 409-416.
- Dess, G. G., & Robinson, R. (1984). Measuring Organizational Performance in the Absence of Objective Measures: The Case of the Privately-held Firma and Conglomerate Business Unit. *Strategic Management Journal*, Vol.5 , 265-273.
- Dickson, P. R., & Ginter, J. L. (1987). Market Segmentation, Product Differentiation, and Marketing Strategy. *Journal of Management*, Vol. 4 , 1-10.
- Dierickx, I., & Cool, K. (1989). Asset Stock Accumulation and Sustainability of Competitive Advantage. *Management Science* , 1504-1511.
- Dunst, K. H. (1983). *Portfolio-Management – Konzeption für die strategische Unternehmensplanung, 2. Auflage*. Berlin.
- Einav, L., & Levin, J. (2010). Empirical Industrial Organization: A Progress Report. *Journal of Economic Perspectives*, Vol. 24, No. 2 , 145-162.
- Einav, L., & Levin, J. (2009). *Industrial Organization: A Progress Report*.
- Etzioni, A. (1964). *Modern Organizations*. New Jersey.
- Fleck, A. (1994). *Hybride Wettbewerbsstrategien: Zur Synthese von Kosten- und Differenzierungsvorteilen*. Wiesbaden.
- Gaitanides, M. (1995). Führungsorganisation. In H. Corsten, & M. Reiss, *Handbuch Unternehmensführung* (pp. 419-431). Wiesbaden.
- Garud, R., & Kumaraswamy, A. (1995). Technological and organizational designs for realizing economies of substitution. *Strategic Management Journal* , 93-109.
- Gerwin, D. (1993). Manufacturing Flexibility: A Strategic Perspective. *Management Science*, Vol. 39 , 395-410.
- Ghemawat, P. (2006). *Strategy and the Business Landscape*. Upper Saddle River, NJ.
- Gibson, B. C., & Birkinshaw, J. (2006). The antecedents, consequences, and mediating role of organizational ambidexterity. *Academy of Management Journal*, Vol. 47 , 209-226.
- Gilbert, X., & Strebel, P. (1985). Outpacing Strategies. *IMEDE – Perspectives for Managers*, No. 2 .
- Ginsberg, A. (1994). Minding the competition: From mapping to mastery. *Strategic Management Journal*, Vol. 15 , 153-174.
- Gupta, A. K., Smith, K. G., & Shalley, C. E. (2006). The interplay between exploration and exploitation. *Academy of Management Journal*, Vol. 49, No. 4 , 693-706.
- Haedrich, G., Gussek, F., & Tomczak, T. (1989). Differenzierte Marktbearbeitung und Markterfolg im Reiseveranstaltermarkt der Bundesrepublik Deutschland. *Marketing ZFP, No.1, 1989* , 11-19.
- Hall, R. H. (1982). *Organizations, Structure and Process*. Englewood Cliffs.
- Hall, K.H. (1980). Survival strategies in a hostile environment, in: *Harvard Business Manager*, No. 5, 1980, S.75-85
- Hambrick, D. C., & Lei, D. (1984). Towards an Empirical Prioritization of Contingency Variables for Business Strategy. *Academy of Management Journal*, Vol. 10 , 687-707.
- Hamel, G. (1994). The Concept of Core Competence. In G. Hamel, & A. Heenev, *Competence Based Competition* (pp. 11-33). Chichester.
- Henderson, K. R. (1979). *Henderson on Corporate Strategy*. New York.
- Henderson, R. M., & Clark, K. B. (1990). Architectural innovation: The reconfiguration of existing product technologies and the failure of established firms. *Administrative Science Quarterly*, Vol. 35 , 9-30.
- Hinterhuber, H. M. (1980). *Strategische Unternehmensführung, 2. Auflage*. Berlin, New York.
- Hofer, C. W., & Schendel, D. (1978). *Strategy Formulation: Analytical Concept*. St. Paul: MN: West.
- Hunt, M. (1972). *Competition in the Major Home Appliance Industry*. Cambridge.
- Jenner, T. (1999). *Determinanten des Unternehmenserfolges*. Stuttgart.
- Jiao, J., Ma, Q., & Tseng, M. M. (2003). Towards high value-added products and services: mass customization and beyond. *Technovation*, Vol. 23 , 809–821.

- Kirsch, W., & Obring, K. (1991). *Beiträge zum Management strategischer Programme, Rahmenkonzepte und Programme*. München.
- Karnani, A. (1984). Generic Competitive Strategies – An Analytical Approach, in: *Strategic Management Journal*, No. 5, 1984, S. 367-380
- Kloock, J., & Sabel, H. (1993). Economies und Savings als grundlegende Konzepte der Erfahrung – Was bringt mehr? *Zeitschrift für Betriebswirtschaft*, 63. Jg., 209-233.
- Knyphausen, D. z., & Ringlstetter, M. (1991). Wettbewerbsumfeld, Hybride Strategien und Econoies of Scope. In W. Kirsch, *Beiträge zum Management strategischer Programme* (pp. 539-557). Herrsching.
- Kotha, p., & Orne, D. (1989). Generic Manufacturing Strategies: A Conceptual Synthesis. *Strategic Management Journal* 1989, 211-231.
- Leana, C. R., & Barry, B. (2000). Stability and change as simultaneous experiences in organizational life. *The Academy of Management Review*, Vol. 25, 753-759.
- Lee, H. L., & Billington, C. (1993). Material management in decentralized supply chains. *Operations Research*, 835-847.
- Link, J. (1985). *Organisation der strategischen Planung*. Heidelberg/Wien.
- Mahoney, J. T., & Pandian, J. R. (1992). The Resource-Based View Within the Conversation of Strategic Management. *Strategic Management Journal*, Vol. 13, 363-380.
- Mahr, F. (2010). *Hybrid Strategy and Firm Performance: The moderating role of Individual and Technological Ambidexterity*. Munich.
- Makadok, R. (2001). "Toward a synthesis of the resource-based and dynamic-capability views of rent creation". *Strategic Management Journal*, Vol. 22 No. 5.
- Mansfield, R. (1986). *Company Strategy and Organizational Change*. London.
- March, J. G. (1991). Exploration and exploitation in organizational learning. *Organization Science*, Vol. 2, 71-87.
- Mason, E. (1939). Price and production policies of large scale enterprise. *American Economic Review*, No. 29, 61-74.
- McKee, D. O., Varadarajan, P. R., & Pride, W. M. (1989). Strategic adaptability and firm performance: a market-contingent perspective. *Journal of Marketing*, Vol. 53, 21-35.
- Miles, R. E., & Snow, C. C. (1978). *Organizational Strategy, Structure, and Process*. New York: McGraw-Hill.
- Miles, R. H. (1980). *Macro Organizational Behavior*. Genview.
- Miller, A., & Dess, G. G. (1993). Assessing Porter's (1980) Model in terms of its generalizability, accuracy and simplicity. *Journal of Management Studies*, Vol. 30, No. 4, 553-586.
- Mintzberg, H. (1978). Patterns in strategy formation. *Management Science*, Vol. 24, 934-949.
- Mintzberg, H., Ahlstrand, B., & Lampel, J. (1999). *Strategy Safari: A Guided Tour Through the Wilds of Strategic Management*. Vienna.
- Morschetta, D., Swobodab, B., & Schramm-Klein, H. (2006). Competitive strategies in retailing—an investigation of the applicability of Porter's framework for food retailers. *Journal of Retailing and Consumer Services*, Vol. 13, 275-287.
- Nobeoka, K., & Cusumano, M. A. (1997). Multiproject strategy and sales growth: the benefits of rapid design transfer in new product development: The benefits of rapid design transfer in new product development. *Strategic Management Journal*, 169-186.
- Orton, J. D., & Weick, K. E. (1990). Loosely Coupled Systems: A Reconceptualization. *Academy of Management Journal*, 203-223.
- Parnell, J. (1997). New Evidence in the Generic Strategy and Business Performance Debate: A Research Note. *British Journal of Management*, Vol. 8, 175-181.
- Parnell, J. (1998). Performance's influence on strategic change: A longitudinal assessment. *Scandinavian Journal of Management*, Vol. 14, 19-36.
- Pearce, J. A., & Robinson, R. B. (2005). *Formulation, Implementation, and Control of Competitive Strategy*. Boston, MA.
- Penrose, E. T. (1959). *The theory of the growth of the firm*. New York.
- Pertusa-Ortega, E. M., Molina-Azurin, J. F., & Claver-Cortés, E. (2009). Competitive Strategies and Firm a Comparative Analysis of Pure, Hybrid and 'Stuck-in-the-middle' Strategies in Spanish Firms. *British Journal of Management*, Vol. 20, No. 4, 508-523.
- Peteraf, M. (1993). The Cornerstones of Competitive Advantage: A Resource-Based View. *Strategic Management Journal*, Vol. 14, 179-191.
- Porter, M. E. (1980). *Competitive Strategy*. New York.
- Porter, M. E. (1985). How Information Gives You Competitive Advantage. *Harvard Business Manager*, July-August.
- Porter, M. E. (1981). The Contributions of Industrial Organization to Strategic Management. *Academy of Management Review*, Vol. 6, No.4, 609-620.
- Porter, M. E. (1979). The Structure within Industries and Companies' Performance. *Review of Economics and Statistics*, Vol. 61, 214-227.
- Porter, M. E. (1991). Towards a Dynamic Theory of Strategy. *Strategic Management Journal*, Vol. 12, 95-117.
- Prahalad, C. K., & Hamel, G. (1990). The Core Competence of the Corporation. *Harvard Business Review*, No. 3, 79-91.
- Proff, H. (2000). Hybrid strategies as a strategic challenge — the case of the German automotive industry. *Omega*, Vol. 28, No. 5, 541-553.
- Proff, H., & Proff, H. V. (1997). Möglichkeiten und Grenzen hybrider Strategien. *Die Betriebswirtschaft*, No. 6, 796-809.
- Raisch, p., & Birkinshaw, J. (2008). Organizational ambidexterity: Antecedents, outcomes, and moderators. *Journal of Management*, Vol. 34, No. 3, 375-409.
- Ray, G., Barney, J., & Muhanna, W. (2004). Capabilities, business processes, and competitive advantage: choosing the dependent variable in empirical tests of the resource-based view. *Strategic Management Journal*, Vol. 25 No. 1, 23-38.
- Rumelt, R. P., Schendel, D., & Teece, D. J. (1991). Strategic Management and Economics. *Strategic Management Journal*, Vol. 12, 5-29.
- Sanchez, R. (1995). Strategic flexibility in product competition. *Strategic Management Journal*, Vol. 16, 135-159.
- Sanchez, R. (1996). Strategic product creation: Managing new interactions of technology, markets, and organizations. *European Management Journal*, Vol. 14, 121-138.
- Sanchez, R., & Mahoney, J. (1996). Modularity, flexibility, and knowledge management in product and organization desig. *Strategic Management Journal*, Vol. 17, 63-76.
- Sanchez, R., & Sudharshan, D. (1993). Real-time market research. *Marketing Intelligence & Planning*, 29-38.
- Sanderson, p., & Uzumeri, M. (1995). Managing product families: The case of the Sony Walkman. *Research Policy*, 761-782.
- Saunders, M., Philip, L., & Thornhill, A. (2009). *Research methods for business students*. Essex: Pearson Education Limited.
- Schanz, G. (1982). *Organisationsgestaltung: Struktur und Verhalten*. München.
- Schertler, W. (1995). *Unternehmensorganisation, 6. durchgesehene Auflage*. München.
- Schilling, M. A. (2000). Toward a general modular systems theory and its application to interfirm product modularity. *The Academy of Management Journal*, 312-334.
- Schmalensee, R. (1989). Inter Industry Studies of Structure and Performance. In R. I. Schmalensee, & R. D. Willig, *In Handbook of Industrial Organization*, vol. 2 (pp. 951-1010). Amsterdam: North Holland.
- Seashore, p. E. (1983). A Framework for an Integrated Model of Organizational Effectiveness, Organizational Effectiveness: A Comparison of Multiple Models. In K. p. Cameron, & D. A. Whetten. New York.
- Selznick, P. (1957). *Leadership in Administration*. New York.
- Sheehan, N., & Foss, N. (2007). Enhancing the prescriptiveness of the resource-based view through Porterian activity analysis. *Management Decision* Vol. 45, No. 3, 450-461.
- Simon, H. A. (1991). Bounded rationality and organizational learning. *Organization Science*, Vol. 2, 125-134.
- Simsek, Z., Heavey, C., Veiga, J. F., & Souder, D. (2009). A typology for aligning organizational ambidexterity's conceptualizations, antecedents, and outcomes. *Journal of Management Studies*, Vol. 46, No. 5, 864-894.

- Snow, C. C., & Hrebiniak, L. G. (1980). Strategy, distinctive competence, and organizational performance. *Administrative Science Quarterly*, Vol. 25 , 317-336.
- Spanos, Y. E., Zaralis, G., & Spyros, L. (2004). Strategy and industry effects on profitability: Evidence from Greece. *Strategic Management Journal*, Vol. 25 , 139-165.
- Spender, J. C. (1994). Organizational knowledge, collective practice, and Penrose rents. *International Business Review*, Vol. 3 , 353-367.
- Stahle, W. H., & Grabatin, G. (1979). Effizienz von Organisationen. *Die Betriebswirtschaft*, 39. Jg., No 1b , 89-102.
- Stalk, G. E., & Shulman, L. (1992). Competing on capabilities: the new rules of corporate strategy. *Harvard Business Review*, Vol. 70, No.2 , 57-69.
- Stalk, G., Evans, P., & Shulman, L. (1992). Competing on capabilities: the new rules of corporate strategy. *Harvard Business Review*, Vol. 70, No.2 , 57-69.
- Teece, D. (1980). Economies of Scope and the Cope of the Enterprise. *Journal of Economic Behavior and Organization*, Vol. 1 , 223-247.
- Teece, D. J. (2009). *Dynamic Capabilities and Strategic Management: Organizing for Innovation and Growth*. Oxford.
- Teece, D., Pisano, G., & Shuen, A. (1997). Dynamic Capabilities and Strategic Management. *Strategic Management Journal*, Vol. 18, No. 7 , 509-533.
- Venkatraman, N., & Camillus, J. (1984). Exploring the concept of fit in strategic management. *Academy of Management Review*, No. 9 , 513-525.
- Wernerfelt, B. (1984). A Resource-Based View of the Firm: Ten Years After. *Strategic Management Journal*, Vol. 16, No.2 , 171-180.
- Wheelwright, P. C., & Sasser, W. E. (1989). New product development map. *Harvard Business Review* , 112-125.
- Withney, J. O. (1996). Strategic Renewal for Business Units. *Harvard Business Manager*, July-August , 84-89.
- Worren, N., Moore, K., & Cardona, P. (2002). Modularity, strategic flexibility, and firm performance: A study of the home appliance industry. *Strategic Management Journal* , 123-1140.
- Wright, P., Kroll, M., Pringle, C., & Johnson, J. (1990). Organization Types, Conduct, Profitability and Risk in the Semiconductor Industry. *Journal of Management Systems* 2(2) , 33-48.
- Wright, P., Kroll, M., Tu, H., & Helms, M. (1991). Generic Strategies and Business Performance: An Empirical Study of the Screw Machine Products Industry. *British Journal of Management* , 57-65.
- Zajac, E. J., & Shortell, P. M. (1989). Changing Generic Strategies: Likelihood, Direction, and Performance Implications. *Strategic Management Journal*, Vol.10 , 413-430.
- Zangwill, W. I. (1993). *Lightning Strategies for Innovation*. Lexington.
- Zott, C., & Amit, R. (2010). Business Modell Design: An activity system perspective. *Long Range Planning*, Vol. 43 , 216-22



## Appendix

Page

**Call for papers**

**77**

**Agenda**

**83**



**MunichUniversity of Applied Sciences**



**CALL FOR PAPERS**

**"Innovation in Engineering, Economics and Social Sciences"**

**PhD-Symposium for Applied Sciences 2011**

July 2011

Munich, Germany

## **Introduction**

The 2<sup>nd</sup> PhD-Symposium for Applied Sciences will bring together international PhD researchers of the PhD-Node Munich –Plymouth and further PhD candidates from both universities (U Plymouth and UAS Munich) who work on different aspects of motivation.

The symposium is open for multiple disciplines and all kind of PhD research and includes, but is not limited, to the following topics:

- Logistics
- Virtual and Augmented Reality
- Product Life Cycle
- Patents and Copyright
- Corporate Social Responsibility
- Intangible Assets
- Business to Business Decision Making

All participants are invited to present the latest state of progress of their PhD work by a short presentation and discuss their work with the peer group. The Symposium will feature presentations and discussions and individual review for all node members.

The Symposium is organised by the PhD-Node Munich-Plymouth and the Research Office of Munich University of Applied Sciences.

It will take place from September 26 to 27, 2011, at Munich University of Applied Sciences.

Conference proceedings including abstracts and papers will be published end of the year 2011.

## **General Guidelines**

### ***Deadlines***

Please confirm your **participation** and your working title **by 14-08-2011**.

Please submit your **abstract** including the final title **by 04-09-2011**.

Please submit your **final paper** for the conference proceedings **by 13-11-2011**.

**All notifications and papers should be send per email (pdf format or word document) to Dr. Stephanie Kastner(skastner@hm.edu).**

### ***Schedule***

25-09-2011	Individual arrival
26-09-2011	Symposium: Day 1
	Opening
	Presentations and discussion
27-09-2011	Symposium Day 2
	Individual meetings of PhD-node students with supervisors
28-09-2011	Individual departure

### ***Eligibility***

This conference welcomes PhD research students to submit full papers and extended abstracts. Papers should clearly demonstrate the research and practical contributions.

## **Travel information**

### ***Flight and Accommodation***

Travel to Munich and accommodation should be organised by participants.

**Please be aware that during the Symposium the “Oktoberfest” takes place in Munich.**

Therefore, there will likely be a shortage of affordable hotel rooms in Munich. It is recommended to book hotel rooms as soon as possible.

Please find a selection of hotel rooms: [www.hrs.de](http://www.hrs.de)

### ***Contact information***

#### Postal Address

Munich University of Applied Sciences

Lothstrasse 34

80335 Munich

Germany

#### Email for further information

Dr. Stephanie Kastner – Research Coordinator

[skastner@hm.edu](mailto:skastner@hm.edu)

#### Website

[www.hm.edu](http://www.hm.edu)

<http://www.wi.hm.edu/phd/index.de.html>

map of the area

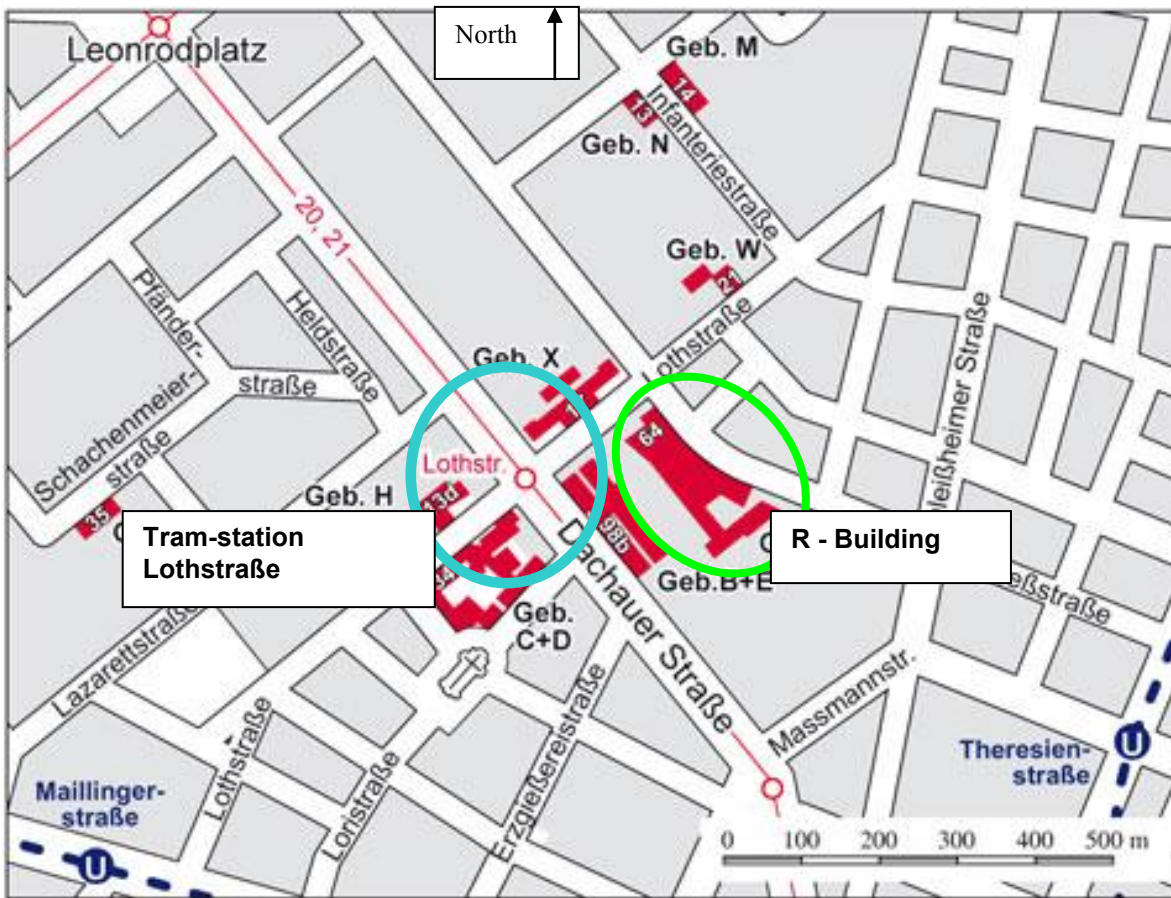

main station / city center



Main entrance, Lothstraße 64 (building with red cube)

please, follow labelling to meeting room R 2.086

(pictures by UAS Munich, [www.hm.edu](http://www.hm.edu))







## **AGENDA**

### **PhD-Symposium for Applied Sciences 2011**

**September 26 – 27, 2011**

### **"Innovation in Engineering, Economics and Social Sciences"**

**room R 2.086, R – Building, Lothstraße 64, 80335 Munich**

#### **Agenda Monday 26<sup>th</sup> September 2011**

*8:30 registration open*

9:00 – 10:00 welcome

*10:00 – 10:20 coffee break*

10:20 – 12:00 session 1

*12:00 – 13:20 lunch break – joint lunch at UAS Munich Campus*

13:20 – 14:40 session 2

*14:40 – 15:00 coffee break*

15:00 – 16:00 session 3

*16:00 – 16:20 coffee break*

16:20 – 17:20 session 4

*17:20 – 17:40 coffee break*

17:40 – 18:20 session 5

*ca. 18:30 end*

**evening event – guide Munich tour and get together for those who are interested**

## **Session 1 Innovation Management**

10:20 Florian Huber – UAS Munich, StrascwegCenter for Entrepreneurship

Exploring Entrepreneurial Personality within the Greater Munich Area - A Quantitative Study Utilising the Big Five Personality Traits and Selected Facets

10:40 Roland Vogt – UAS Munich

The interplay of corporate social responsibility, marketing activities and corporate reputation - a concept for sustainable management in case of car fleet management

11:00 Thomas Holzmann - UAS Munich, StrascwegCenter for Entrepreneurship

Collaborative Innovation between established companies and young entrepreneurial firms

11:20 Christina Weber - UAS Munich, StrascwegCenter for Entrepreneurship

Innovation networks in crises management

11:40 Volker Dietz – UAS Munich

New possibilities for using patent based instruments on the analysis of inventors' remuneration for companies' corporate patent and trademark activities

## **Session 2 Technical Innovation**

13:20 Tobias Waber – UAS Munich

Optimized Calibration of Miniaturized Barometric Pressure Sensors

13:40 Andreas Dickow – UAS Munich

Development of a High Speed Tempering System for Lead Time Reduction in Microsensor Production

14:00 Matthias Domke – UAS Munich

Time- and space resolved investigations on thin film solar cell ablation by ultra-short pulse lasers

14:20 Regina Moser – UAS Munich

Patterning of a nanometer thin aluminium layers on a polyester film with ultra short laser – pulses

### **Session 3 Technical Innovation to World Economy**

15:00 Florian Schamberger – UAS Munich

Properties of Monomeric-, Dimeric- and Polymeric- Parylene

15:20 Martina Hanuskova – University of Plymouth

CO2 reduction in distribution of finished product

15:40 Jürgen Steinheber – UAS Munich

Crossing the chasm with technologies not contributing to a proper technology mix

### **Session 4 Marketing Innovations**

16:20 Christian Chlupsa – UAS Munich

The Impact of the Implicit Motives on the Business to Business Decision Making Process

16:40 Michael Zellner – UAS Munich

Hybrid generic concepts and firm specific individualization: Theoretically linking competitive strategies with strategic concepts, activities and resources

17:00 Markus Ehmann – UAS Munich

Methodical Approach for the Identification and Application of New Technological Potentialities - Based on the Example of Augmented Reality in Order Picking

### **Session 5 Marketing Innovations and Politics**

17:40 Rebecca Tidy - University of Plymouth

Political Marketing Segmentation within English Local Elections

18:00 Magda Maszczyńska - University of Plymouth

Transnational Organized Crime - Analysis of gang's structures and networks

## **Agenda Tuesday 27<sup>th</sup> September 2011**

Individual talks on PhD-projects for **PhD-node participants**

### **Module 1**

Supervisor Prof. Wolfgang Döhl and Prof. Jonathan Lean

9:00 Roland Voigt

10:30 Christian Chlupsa

*lunch break*

12:30 Volker Dietz

14:00 Jürgen Steinheber

others on individual agreement with their supervisors

### **16:00 evening event “Oktoberfest” with all participants**

meeting point: R 2.086

reserved tables for PhD-node

Munich, 16.09.2011

for further questions please contact: Dr. Stephanie Kastner ([skastner@hm.edu](mailto:skastner@hm.edu))







# Credits

## **Responsible for the purpose of press law**

Prof. Dr. Christiane Fritze

Vice President

## **Editors**

Dr. Stephanie Kastner

Markus Ehmann

## **Munich University of Applied Sciences**

**Lothstraße 34**

**80335 München**

**[www.hm.edu](http://www.hm.edu)**