

Technische Hochschule Ingolstadt

Faculty of Mechanical Engineering Master of Science in Renewable Energy Systems

Master's Thesis

**Subject: Integrating Renewable Energies into a District Heating
Network in a Residential Area in Dachau**

Name and Surname	Bahareh Asadollahi Esfahani
Matriculation Number	000089579
Issued on	8 th July 2020
Submitted on	8 th January 2021
First examiner	Prof.Dr.Ing.Tobias Schrag
Second examiner	Prof.Dr.Ing.Daniel Navarro Gevers

Declaration

I hereby declare that this thesis is my own work, that I have not presented it elsewhere for examination purposes and that I have not used any sources or aids other than those stated. I have marked verbatim and indirect quotations as such.

Ingolstadt, _____

(Date)

Bahareh Asadollahi Esfahani

(Signature)

Acknowledgment

I would first like to express my appreciation and gratitude to my Colleagues in the DME Consult GmbH for the professional and initial support and the openness regarding company data, which were of great value for this work.

I would also wholeheartedly like to thank my professor and supervisor at Technische Hochschule Ingolstadt, Prof.Dr.Ing. Tobias Schrag, who has supported this work with valuable suggestions. I am gratefully indebted for showing patience, motivation, enthusiasm, and immense knowledge throughout my thesis work, taking time off his busy schedule, acknowledging my requests, and replying to every email I wrote to him. Special thanks to Prof.Dr.Ing. Daniel Navarro Gevers for accepting the position of the second examiner for my work.

Thanks a lot to my friends in Germany, who have been only supportive and tried to be my family far from home. Lastly, I would like to show my gratitude for my family members, who, despite the distance, stayed with me in my difficult times and believed in me for all these years of my study.

Abstract

District heating network distributes the heat generated from central heating systems through organized insulated piping system (buried underground level) for residential and commercial buildings. District heating utilizes boilers fueled by fossil fuels or renewable fuels such as gas, wood chips, pellet, oil, etc. also, other additional systems (CHP and renewable sources such as solar plants, heat pumps, etc.) produce hot water. Heat accumulators or Buffer storage collects the extra heat produced. Today, industry owners and researchers aim at lowering the grid temperature to reduce costs and energy. The project includes designing a low-temperature district heating network center with a flow and return temperature of 45 °C/20 °C in a modern residential area with 50 buildings with 37,000 square meters located in Dachau, Bavaria and consists of two scenarios. In the first scenario, in energy generation, the focus was on the natural gas supply. The fossil fuel system design was initially done with a simulator available in the company. In the simulator, by default, an electric heater inside the buffer provides 10% of the network heat energy. Due to the high cost of electricity, systems were simulated in a new Excel-tool by eliminating electricity share. By keeping the generators' output constant, and a small change in the buffer volume, the share of natural gas in energy production becomes one hundred percent. At this stage, the use of CHP units with outputs 113 kW and 94 kW, a buffer storage with a volume of 22 m³, and a peak-load gas boiler with 508 kW in energy generation, as well as the use of heat pumps in substations, was an essential step to increase energy efficiency and to achieve the federal government's energy targets. And in the scenario 2 the region's renewable potential was integrated and replaced with fossil fuels. The pellet boiler with 230 kW output and 472 m² solar heat collector system has been replaced at this phase as the main generators, and the buffer volume was increased to 29 m³. By comparing the two systems, although the investment costs of System 2 were more, it is more cost-effective in financial accounting, considering the government's financial support for renewable energy projects and more maintenance and fuel costs of the first system. According to the present factors and CO₂ emissions, the renewable system was much better in environmentally-friendly terms.

Keywords: Renewable energies, low-temperature district heating network, fossil fuels, residential area

Table of Contents

Declaration.....	I
Acknowledgment.....	II
Abstract.....	III
Table of Contents.....	IV
List of Figures.....	VII
List of Tables.....	IX
List of Appendix.....	XI
Abbreviations and symbols.....	XII
Chapter 1	
Introduction	1
1.1 Focus on district heating system	1
1.2 Approach to this research	2
1.3 Contribution to the present work.....	4
1.4 Research question	4
1.5 Methodology	4
Chapter2	
Literature Review	6
2.1 What is a District Heating Network?.....	6
2.2 Review of studies in low temperature and Ultra low temperature DHN.....	10
Chapter3	
Project Requirement Specification.....	15
3.1 Location metrological details	15
3.1.1 Evaluation of site.....	15
3.1.2 Potential of renewable energies in region.....	17
3.2 Subsidies	25
3.2.1 KFW.....	25

3.2.2	BAFA	26
3.2.3	TFZ	27
3.3	Technical details of the project	28
3.3.1	Available details from Stadtwerke-Dachau	28
3.3.2	Determined details from Dme-Consult company	29
3.3.3	Low-temperature DHN with CHP and gas considering boiler	33
Chapter 4		
	Optimization	40
4.1	Volume of buffer	40
4.2	Area of solar collectors	41
Chapter 5		
	Designing a new plant with integrating renewable energies	43
5.1	Simulation	43
5.1.1	Methodology and data sources used for designing of the energy Centre	44
5.1.2	The new results of the non-RE system's simulation (Scenario1-Variant2)	44
5.1.3	The results of the RE system's simulation (Scenario 2)	45
5.2	Technical details of new heating plant	46
5.2.1	Solar thermal system	46
5.2.2	Solid biomass boiler	46
5.2.3	Biogas peak load boiler	46
5.2.4	Thermal storage	47
5.3	Layout of heating Centre with renewable energies	47
Chapter 6		
	Financial part	50
6.1	Subsides	50
6.2	Costs	50
6.2.1	Fuel Costs	50
6.2.2	Investment costs	51

6.2.3	Maintenance and operation costs.....	51
6.2.4	Electricity costs	52
6.2.5	CO2 prices.....	53
6.2.6	The district heating price	55
6.3	Low interest loans	56
6.3.1	Loan amount.....	56
6.3.2	Duration and fixed interest rates.....	56
6.3.3	Loan Payment Calculations.....	56
6.4	Financial results	58
Chapter 7		
	Discussion.....	60
Chapter 8		
	Conclusion and future works	66
8.1	Conclusion	66
8.2	Future Works	66
	References.....	68
	Appendix.....	73

List of Figures

Figure 1 Section of the development plan	2
Figure 2 Layout of the main heating generation system	3
Figure 3 Thesis Process.....	5
Figure 4 Schematic of a DHN including substations in every property.....	6
Figure 5 Sketch of a twin-pipe and a triple-pipe with a triangular arrangement	7
Figure 6 Principles of common DH substation-coupling methods	8
Figure 7 Diagram of the two substation types employed	9
Figure 8 Diagram of five substation types with supplementary heating devices	10
Figure 9 Scheme of the energy supply concept of a system with PV+CHP+HPs	11
Figure 10 Four system design cases of LTDH and ULTDH	12
Figure 11 Structure of primary energy consumption in Bavaria and Germany	16
Figure 12 Development of primary energy consumption in Bavaria	17
Figure 13 Structure of the share of RE in final energy consumption in Bavaria 2018..	17
Figure 14 Monthly solar irradiations	18
Figure 15 Hourly solar irradiation in winter time.....	19
Figure 16 Hourly solar irradiation in summer time	19
Figure 17 Tilt and azimuth angles change in one year.....	21
Figure 18 Tilt and azimuth angle in relation to the Equator.....	21
Figure 19 price development of Wood chips, pellet, Oil and Natural gas	23
Figure 20 The designated location for the heating center	29
Figure 21 Methodology and data sources used to estimate heat demand	30
Figure 22 Heating Demand per hours during a year.....	32
Figure 23 Hot water demand per hours during a year.....	32
Figure 24 Total heat demand annually	32
Figure 25 Heat Load.....	32
Figure 26 PI diagram of heat transfer station.....	34
Figure 27 Schematic of a system with solar collector, boiler and thermal storage tank	38
Figure 28 Relationship between volume of buffer, E_{tot} and SF	40
Figure 29 Total investment costs of the system (Area of solar collector is 470m ²).....	41
Figure 30 Relationship between area of collectors, SF and E_{tot}	41
Figure 31 Total investment costs of the system (The volume of buffer 29m ³).....	41
Figure 32 Methodology and data sources used to design of the energy centre	44

Figure 33 The layout of desired heating plant with RE.....	48
Figure 34 The layout of desired DH Grid	49
Figure 35 Cash flow diagram of the project with integrating RE.....	58
Figure 36 Cash flow diagram of the project without integrating RE.....	58
Figure 37 The contribution of each device in energy production	61

List of Tables

Table 1 The comparison of District heating network Generations	1
Table 2 Research methods of thesis	5
Table 3 Practical information on the five measured substations in ULTDH	9
Table 4 information of site	15
Table 5 Primary energy consumption from 1970 to 2018	16
Table 6 Technical details of solar thermal collector	20
Table 7 price data of pellet in August 2020.....	23
Table 8 Price data of wood chips in August 2020.....	23
Table 9 Data details of Pellet and Wood chips	24
Table 10 Basic details of project.....	29
Table 11 Energy demand profile of site	31
Table 12 Annual heat demand	31
Table 13 The simulation results of heat plant in DHN in Dachau	33
Table 14 Final generators design	33
Table 15 Technical information of heat pumps	34
Table 16 CHP units details	35
Table 17 Gas considering boiler details.....	36
Table 18 Technical details of Buffer storage	39
Table 19 The results of the non-RE system's simulation in the new tool.....	45
Table 20 Simulation results of system with solar and biomass energy	45
Table 21 Final simulation results of RE system	45
Table 22 Data sheet of Pellet boiler.....	46
Table 23 Comparison of biogas and natural gas ,	47
Table 24 Subsidies calculation results	50
Table 25 Fuel costs of both systems per year	51
Table 26 Investment costs.....	51
Table 27 M&O costs.....	52
Table 28 Electricity details.....	52
Table 29 The price of electricity output and fed into grid from CHP units.....	53
Table 30 Electricity price details from Stadtwerke-Dachau	53
Table 31 CO2-Pricing.....	54
Table 32 District heating prices (connection load is greater than 16 kW).....	55
Table 33 Financial results of the projects in a standard energy price.....	58

Table 34 Financial results (energy price=7.71 cent/kWh)	59
Table 35 Financial results (energy price= 9 cent/kWh)	59
Table 36 Comparison of two project scenarios	62
Table 37 Comparison of several Low/Ultra-low temperature DHN	63

List of Appendix

Appendix 1 Energy configurations developed for the case study of Jansen.....	73
Appendix 2 Hydraulic connection possibilities of CS500.....	74
Appendix 3 Overview of subsidies for solar thermal from BAFA.....	75
Appendix 4 Overview of subsidies of BAFA for biomass	76
Appendix 5 Excel sheet with the necessary parameters from Stadtwerke-Dachau o. .	77
Appendix 6 Excel sheet with heat demand profile for each property.....	78
Appendix 7 Piping draft of DHN in Dachau.....	79
Appendix 8 Excel sheet of piping specifications	80
Appendix 9 The detail of energy consumption of heat pumps.....	81
Appendix 10 Datasheet of YADO/EG-60.....	82
Appendix 11 Module diagram of YADO/EG-60.....	83
Appendix 12 Datasheet of YADO/EG-70.....	84
Appendix 13 Module diagram of YADO/EG-70.....	85
Appendix 14 Module diagram of VITOCROSSAL 300/ Type CT3B	86
Appendix 15 Datasheet of VITOCROSSAL 300/ Type CT3B	87
Appendix 16 The hydraulic scheme of thermal storage	88
Appendix 17 module components of pellet boiler(PT4e).....	89
Appendix 18 Subsidies details of both systems.....	90
Appendix 19 Financial project balance of RE system	91
Appendix 20 Financial project balance of non-RE system	92

Abbreviations and symbols

€	Euro
°C	Celsius Degrees
A	The solar collector's area
APR	Annual Percentage Rate
BAFA	Federal Office of Economics and Export Control
BP	Base price
CARMEN	Central Agricultural Raw Material Marketing and Energy Network
CHP	Combined Heat and Power
CO ₂	Carbon dioxide
COP	Coefficient Of Performance
C _p	The specific heat
DHN	District Heating Network
DHW	Domestic Hot Water
EnEV	The Energy Saving Ordinance
EP	Energy Price
E _{tot}	Total energy
G _G	Global irradiation
GHG	Greenhous Gas
GWHP	Groundwater Heat Pump
h	Hour
HP	Heat Pump
HT	High Temperature
HTF	Heat Transfer Fluid

HX	Heat exchanger
IRR	Internal Rate of Return
K	Kelvin
KfW	Reconstruction Credit Institute
kg	Kilogram
kW	Kilowatt
kWh	Kilowatt-hour
LTDH	Low Temperature District Heating network
m	Meter
m ²	Square meter
m ³	Cubic metre, Qubic meter
MP	Measurement Price
MW	Megawatt
MWh	Megawatt-hour
n	Number of modules
PE	Primary Energy
PV	PhotoVoltaic
PVT	Photovoltaic Thermal collectors
Q _{gain}	Total energy colleted per squared meter
RES	Renewable Energy Systems
ROI	Return On Investment
SF	Solar Fraction
SH	Space Heating
SHS	Sensible heat storage
STES	Seasonal thermal energy storage
t	Tone

TES	Thermal Energy Storage
T_{flow}	Flow temperature
TFZ	The Institution of the Bavarian State Ministry for Food, Agriculture and Forests
T_{ret}	Return temperature
TSSE	Twin-Screw Steam Expander
ULTDH	Ultra_Low Temperature District Heating network
η	Collector efficiency

Chapter 1

Introduction

1.1 Focus on district heating system

The amount of GHG (greenhouse gas) emission, CO₂ emissions, and transmission into the environment, which is the primary factor of climate change and global warming, are increasing. One of the most significant reasons for releasing GHG in the climate is, increasing heating demand in residential and business sectors and supplying this amount of energy. Although it is expected with proper planning, innovative measures, and solutions, this trend is decreasing till 2030 significantly and plays an essential role in growing energy efficiency in buildings and system improvement. One of these solutions is a district heating network(Tian et al. 2019; Pakere et al. 2018).

The heating network research shows that with some solutions and measures, such as minimizing the network losses by lowering flow and return temperatures, integrating renewable energy sources, pumping optimization by increasing the pipe insulation thickness, the use of twin or triple pipes, and optimization the piping routes, can achieve to sustainable energy technologies and improvement of efficiency (Lund and Mohammadi 2016; Volkova et al. 2018; Jones et al. 2019; Best et al. 2018).

The following table shows the trend of improvement of the district heating system by reducing the flow and return temperatures.

Table 1 The comparison of District heating network Generations (Lund et al. 2018b)

Generation	Period	Heating Medium	DH flow Temperature	DH return temperature
1 st Generation	1800 - 1930	-Steam system -Steam pipes	< 200 °C	<80 °C
2 nd Generation	1930 – 1980	-High Temp. -Pressurized hot-water system -Heavy equipment -Large “build on site” station	> 100 °C	< 70 °C
3 rd Generation	1980 – 2020	-High Temp. -Pressurized hot-water system -Pre-insulated pipes -Industrialized compact	< 100 °C	< 45 °C
4 th Generation	2020- 2050	-Low and Ultra- Low Temp. - insulated pipes -Optimum interaction of energy sources	< 50°C	~25°C

With low and ultra-low temperature and the integration of renewable energy, the district heating network would be one of the most important solutions for the sustainable development of the heating system.

Some of the benefits of low and ultra-low temperature DH include the following:

- Cost-effectiveness
- Improving overall efficiency
- More efficient use of renewable energy resources
- More environmentally- friendly

(Lund et al. 2018a; Averfalk and Werner 2020; Pakere et al. 2018)

1.2 Approach to this research

Stadtwerke Dachau is planning to construct a large residential area in Augustenfelder street with 50 properties and buildings with a total of up to 37,000 m². Figure 1 shows the boundaries of the project. Sections that are highlighted with yellow are related to this current project.



Figure 1 Section of the development plan

The focus is on low-temperature district heating networks (45 °C/20 °C) when it comes to energy generation. Besides, the use of CHP units as the main generators, gas boiler covers the peak loads, and heat pumps integrated into the sub heat transfer station.

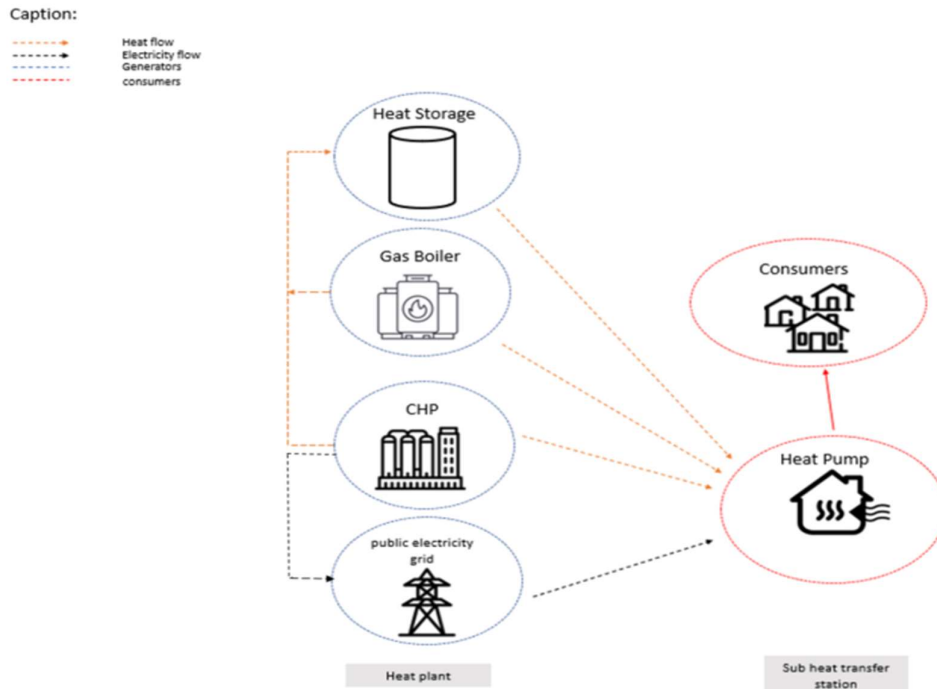

Figure 2 Layout of the main heating generation system

The use of CHP units combined with heat pumps would be an essential and vital step towards "increasing energy efficiency in Dachau." Besides, the energy targets set by the federal government can be achieved with the assessed systems.

The first draft contains the following points:

- Energy center which is consisting of CHP unit and buffer storage,
- Gas boiler as a reserve in peak load and stopping time

The result shows:

- Determination of heating demand (Heating and DHW),
- Determination of generators output and buffer volume

The general starting point, motivation, and background for creating this system are:

- Climate-friendly urban development
- Increasing energy efficiency in buildings and sustainability and minimizing CO2 emission

At present, the sizing of heat plant with combination CHP, gas boiler, and buffer storage, with data of Stadtwerke and the available tools in the company, has been done. According to the environmental and energy efficiency aspects, the German government's policy is to encourage companies and the public to use more renewable fuels, heating, and cooling systems of the residential and industrial areas, with low-

interest and long-term loans. This thesis's core work is based on the optimization of designing a new heating system by integrating renewable energies and comparing it with the main structure in terms of cost-effectiveness and environmental compatibility. The results are presented as a tool that might be used in a similar project.

1.3 Contribution to the present work

This work has been done in collaboration with Company DME-Consult in Rosenheim to continue the project " low-temperature district heating system in a residential area" from Stadtwerke-Dachau. The given information by Stadtwerke-Dachau and some calculations performed in the company have been used as the project's initial data. In this regard, other existing and valid databases and applications on the internet were used to advance the project.

The present work has also used scientific articles, authors' views, books and dissertations in the theoretical section related to district heating systems, and some basic calculations in the system designing section.

1.4 Research question

The following are the research questions that would be answered in this thesis.

1. What potential renewable energies in Dachau-region are feasible to integrate into District Heating System?
2. How to design a new system, with integrating renewable energies, more optimized?
3. What are the advantages of a new system in comparison to the main system?

1.5 Methodology

This work would be divided into two steps. The first step is designing and simulation a new heating system with available potential renewable energies in the region and the next step is comparing with the main designed plant according to cost-effectiveness and CO2 emission factors.

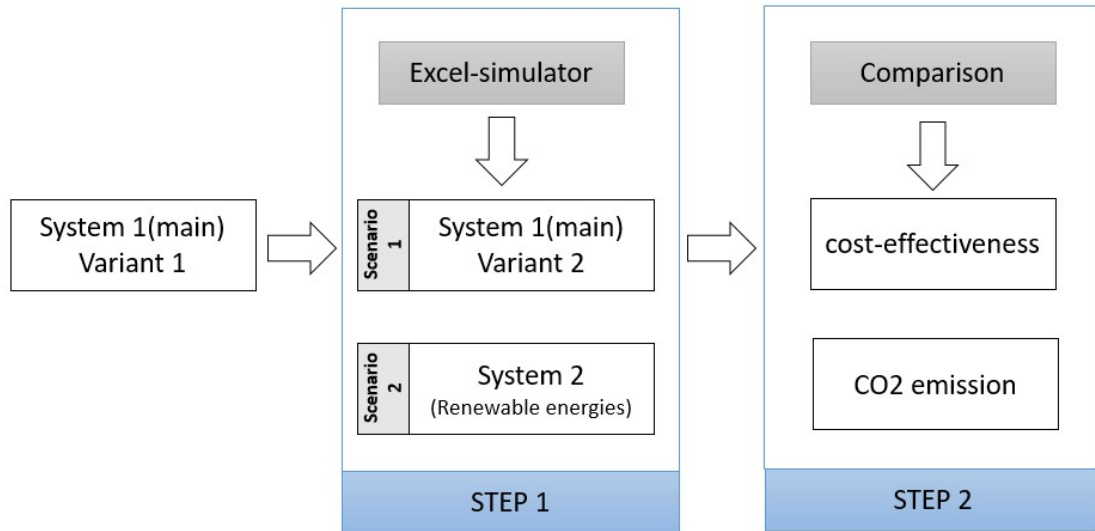

Figure 3 Thesis Process

The research methods for this thesis are listed as follow,

Table 2 Research methods of thesis

NO.	Methods	Description
1.	Literature studies and document analysis	<ul style="list-style-type: none"> • District heating network with different temperatures • How to design a heating plant? • Analysis of available data and document from Stadtwerke-Dachau • Analysis of the available financial sponsorships for using renewable energies in the heating system • Analysis of available potential of renewable energies in the region for integrating into the system • Analysis of designed system with CHP and Gas boiler data
2.	Simulation a new heating plant	<ul style="list-style-type: none"> • Designing and sizing new plant with integrating renewable energies in excel
3.	Financial assessment	<ul style="list-style-type: none"> • Investment costs • Maintenance and repair costs • CO2 costs • Fuel costs • Subsidies
4.	Evaluation	<ul style="list-style-type: none"> • Assessment of district heating system after getting renewable energies

Chapter2 Literature Review

This section includes literature extracted from other scientific articles and publications to describe the layout of a district heating grid and its components, and other proposed solutions for heating a building complex. Also, existing studies in the field of LTDH and ULTDH are reviewed. The results of similar studies in the field of small low-temperature DHN can be compared with the results obtained from this work.

2.1 What is a District Heating Network?

District heating network (also known as heating networks or district heating) is a system for distributing the heat generated in a central location via a system of insulated pipes for residential and commercial heating requirements such as space heating and hot water generation.

DHNs Present a variety of technologies but generally have two main components (see figure 4):

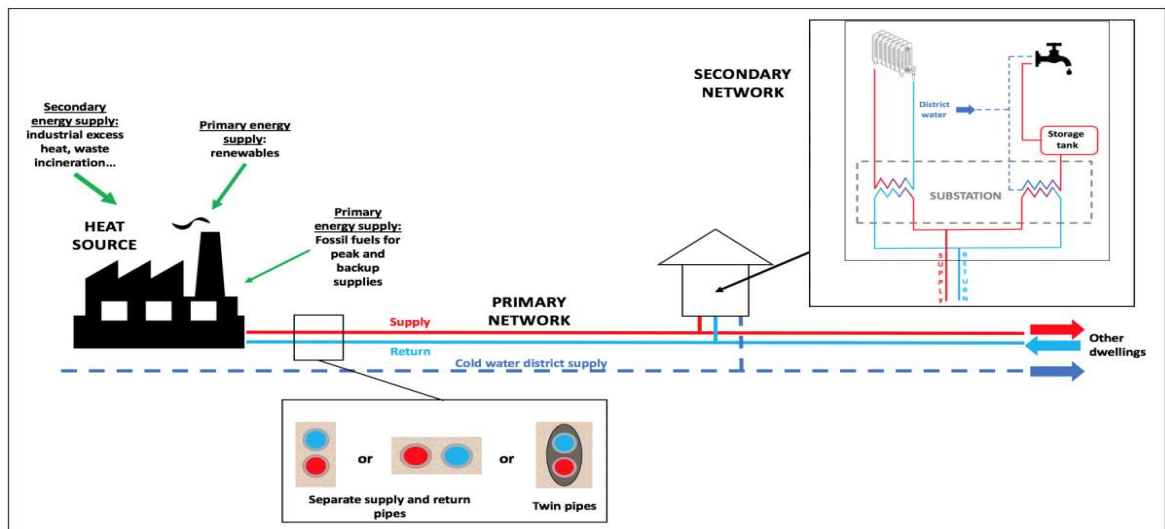

Figure 4 Schematic of a district heating network including substations in every property (Delangle 2016)

- A heating center, which comprises one or more heat generators, balances the heat demand with production, storage, and backup supply.
- The heat transmission and distribution network includes:
 - The main network that supplies hot water from the heating plant to customers

- Substations that connect the primary and secondary networks
- A secondary network that transmits hot water to the end-user (radiators, tap water) and is often located in apartments. (Delangle 2016)

In particular, there is a distinction between primary and secondary heat sources in the energy center (Frederiksen and Werner 2014; Delangle 2016):

- Primary energy (PE) is a naturally occurring type of energy that has not been subjected to any human technical conversion process. This energy is contained in raw fuels and other forms of energy that go into the system as inputs. Primary energies can be renewable heat (solar, geothermal, biomass, etc.) or nonrenewable (fossil fuels).
- The secondary heat supply refers to the excess heat that can be fed into the network (CHP, waste incineration, etc.).

The primary network that transmits and distributes hot water from the heating center to the secondary structure plays a crucial role in this system. Precise design minimizes heat loss in the grid and energy production. Its main components are:

- Pipes: Piping consists of supply pipes and return pipe and are usually buried underground. Twin pipes, both housed in the same cover, have better thermal properties and take up less space, are more popular than other configurations. In the new proposals, designs with more than two pipes have been examined, and comparisons have shown that the triple type's energy saving is more. Figure 5 illustrates the structure of a triple tube with a triangular arrangement of pipes inside the cover. The smallest pipe is the second flow pipe (hot water flow pipe), the middle pipe is the main flow pipe (mostly for space heating), and the most massive pipe is the return pipe. Besides, heat losses can be reduced partly by insulating pipes and using polyethylene foams. (Shakerin 2016; Nilsson 2016; Delangle 2016; Alsagri et al. 2019)

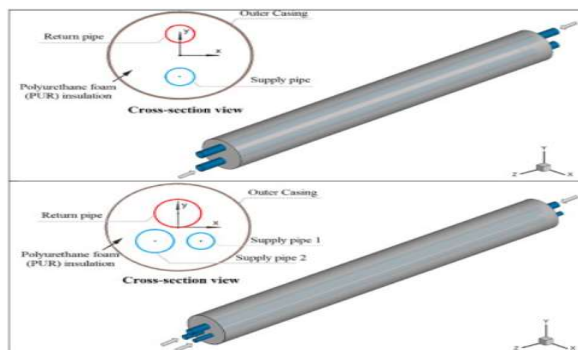

Figure 5 Sketch of a twin-pipe (up), and a triple-pipe with a triangular arrangement (down). (Alsagri et al. 2019)

- Distribution pumps distribute the heat over the network. These pumps are typically controlled by variable speed drives for varying flow rates.
- Pressurization pumps are used to control the small amount of water in the system by controlling the pressure. They are also used to prevent water from boiling. They are often connected to expansion tanks that can be used to remove excess water from the system.
- Valves are used to regulate flow or separation.
- The most robust welded Joints

There are several ways to connect a customer to distribution systems. The space heating system can be connected directly (Figure 6b, 6d) or with a set of heat exchangers (Figure 6a, 6c), each with their own advantages. The DHW system can be connected directly to the DH water supply system, where the system is open, and nothing returns to the system (Figs. 6d, 6c). But substations usually use a set of heat exchangers to heat drinking water (Figs. 6a, 6b). (Gustafsson and Sandin 2016)

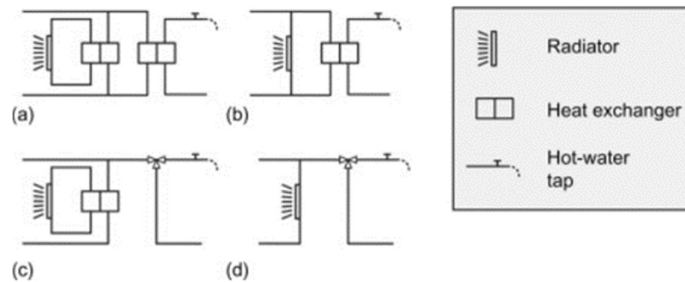

Figure 6 Principles of common DH substation-coupling methods. (a) Indirect/closed. (b) Direct/closed. (c) Indirect/open. (d) Direct/open (Gustafsson and Sandin 2016)

In a study of low-temperature systems, Ibrahim Tol illustrated two configurations. Substations are equipped with/without a storage tank to supply domestic hot water. In the first solution (see Fig.7a), hot water is stored in the tank during charging, and when the user consumes the water, the stored water flows for circulation by the heat exchanger of the DHW grid. The results show that this configuration has a significant reduction in heat load compared to the other. (Ibrahim Tol 2015)

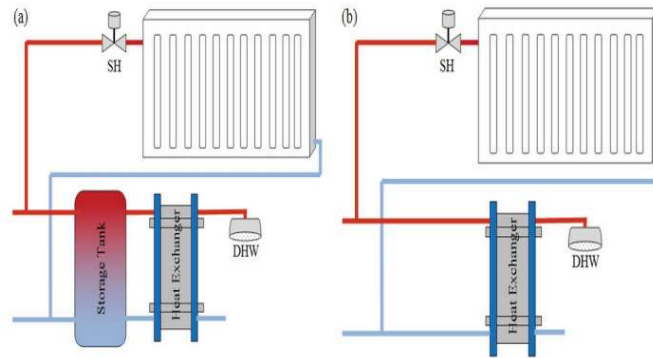

Figure 7 Diagram of the two substation types employed: (a) with a storage tank and (b) without a storage tank (Ibrahim Tol 2015)

In one study, Yang et al. evaluated five substation types in a ULTDH. All five stations have additional heating devices, which are summarized in the table below. According to the measurements, the combination of DHN and different heating devices can meet comfort and hygienic drinking water needs. Comparing the measurements and results illustrated, posts d and e with separate electric heaters are more energy-efficient and economical than the others. (Yang et al. 2016)

Electric heater without a tank for DHW has both pros and cons points. High safety and efficiency are probably the best options for small, single-family apartments with low heat demand. However, in large and huge buildings consisting of several apartments, by replacing separate electric heaters with a mini HP and buffer, electricity costs are significantly reduced. Even in the event of a power outage, hot water is always available.

Table 3 Practical information on the five measured substations in ULTDH (Yang et al. 2016)

House	Elements in the substation					Operation information	
	Storage tank	Heater		Heat exchanger for DHW	Separate electric heater		Micro heat pump
	Stored fluid	Size					
a	DHW	160 L	3 kW electric heater	Coil in the tank	–	–	The DHW is stored in the tank. The immersion heater can heat up the DHW to 50 °C.
b	DH water	160 L	3 kW electric heater	Plate heat exchanger between the tank and DHW system	–	–	The DH water is heated up to 55 °C in the tank, and DHW was heated instantaneously by the separate heat exchanger.
c	DH water	160 L	–	Plate heat exchanger between the tank and DHW system	–	Design COP 4.5 Max power 250 W	Charging temperature of the tank is 55 °C
d	–	–	–	Plate heat exchanger between the DH supply and DHW system	11 kW in-line heater only for kitchen use	–	Set-point temperature of the in-line heater is 55 °C
e	–	–	–	Plate heat exchanger between the DH supply and DHW system	18 kW in-line heater for all DHW use	–	Set-point temperature of the in-line heater is 55 °C

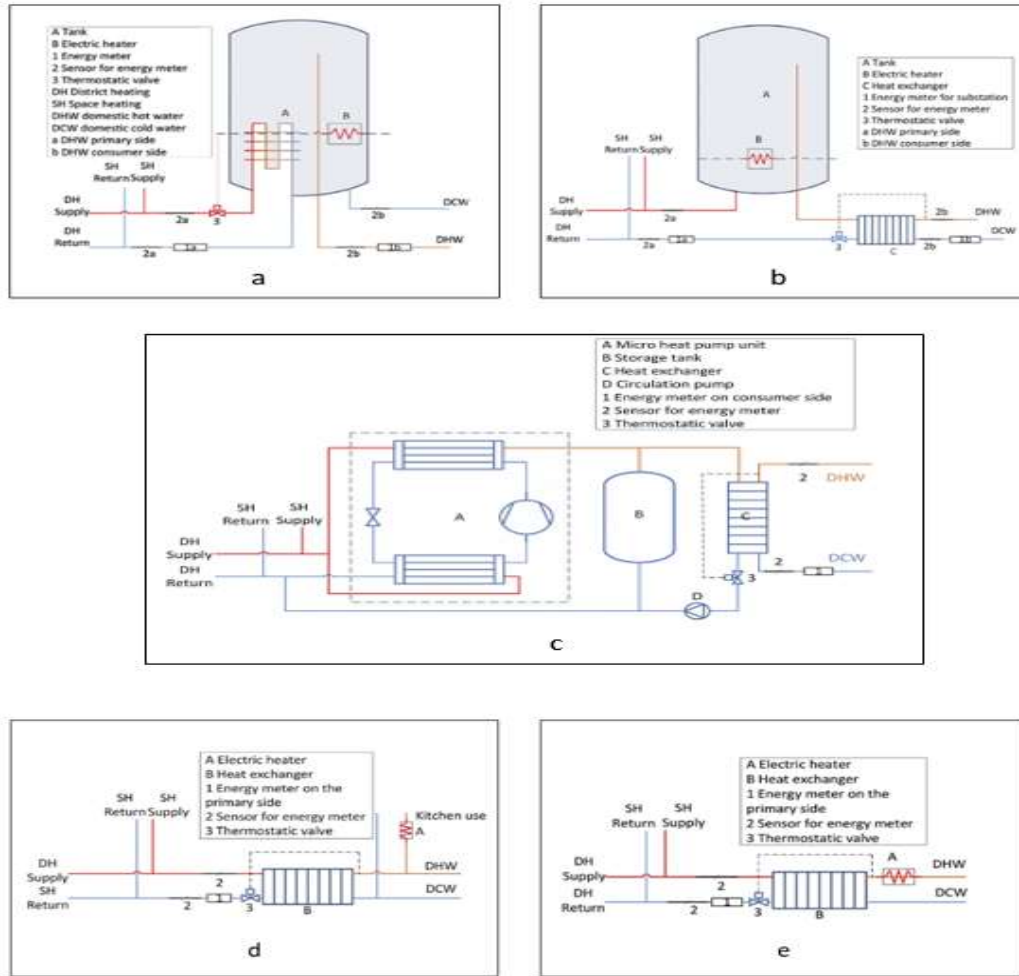

Figure 8 Diagram of five substation types with supplementary heating devices installed (Yang et al. 2016)

2.2 Review of studies in low temperature and Ultra low temperature DHN

Many studies and researches have been done in the field of district heating networks and solutions for optimizing these systems and how to equip them to have an efficient heating network, some of which can be summarized in the following examples and scenarios for small and medium-size:

- Aste et al. have technically investigated a zero-energy low-temperature heating network in Milan, Italy. The proposed energy concept is based on a combination of low-energy buildings and high-efficiency technical systems that reduce final energy consumption. In this project, fossil fuels are eliminated and fed with renewable energy. The thermal power plant consists of a biomass CHP that integrates with a groundwater heat pump (GWHP) and solar photovoltaic(PV) systems. This small CHP unit with a twin-screw steam expander (TSSE) provides part of the space

heating(SH) and the need for domestic hot water(DHW) in winter, and with the rest of the winter heat needs and all summer, heat demand is provided by GWHP along with PV. This area is designed with sustainability concepts in mind and is technically and innovatively interesting, although no information is available economically. The electricity demand for heat pumps and electrical devices in office buildings is covered by the CHP's electrical output (during operation), by photovoltaic systems installed on the ceilings, and by the power grid. The concept of energy supply is shown in the following figure. (Aste et al. 2020)

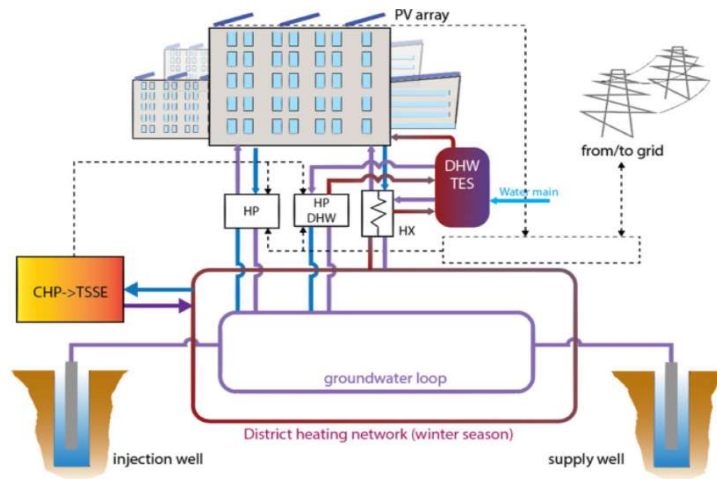

Figure 9 Scheme of the energy supply concept of a system with PV+CHP+HPs strategy (Aste et al. 2020)

- The next study is the economic feasibility of an ultra-low-temperature district heating system (ULTDH) in a newly built building area in Denmark, which is supplied with renewable energies and heat pumps. Meesenburg et al. have compared three different designs of the ULTDH system (with water-to-water booster HP at building level, with air-to-water HP at building level (the evaporator and compressor unit is usually placed outdoors, but was drawn inside for simplicity), and with water-to-water booster HP at apartment level) with the performance of a LTDH system (with indirect DH substation at building level) including direct preheating of the freshwater (see Fig. 10). It was illustrated that in most cases, Low-temperature district heating is economically preferred. But at high thermal densities, if the investment cost of a central heating unit can be significantly reduced, ULTDH will be possible and even more efficient.

At a temperature of 60°C, it is possible to heat the space and drinking water (DHW) directly, but at a temperature of 40°C, to provide hot water, decentralized heating units

are necessary to increase the temperature of the network, which can be named as follows:

- Use of heat pumps and thermal storage in substations.
- Use electricity to reduce heat loss (Meeseburg et al. 2020)

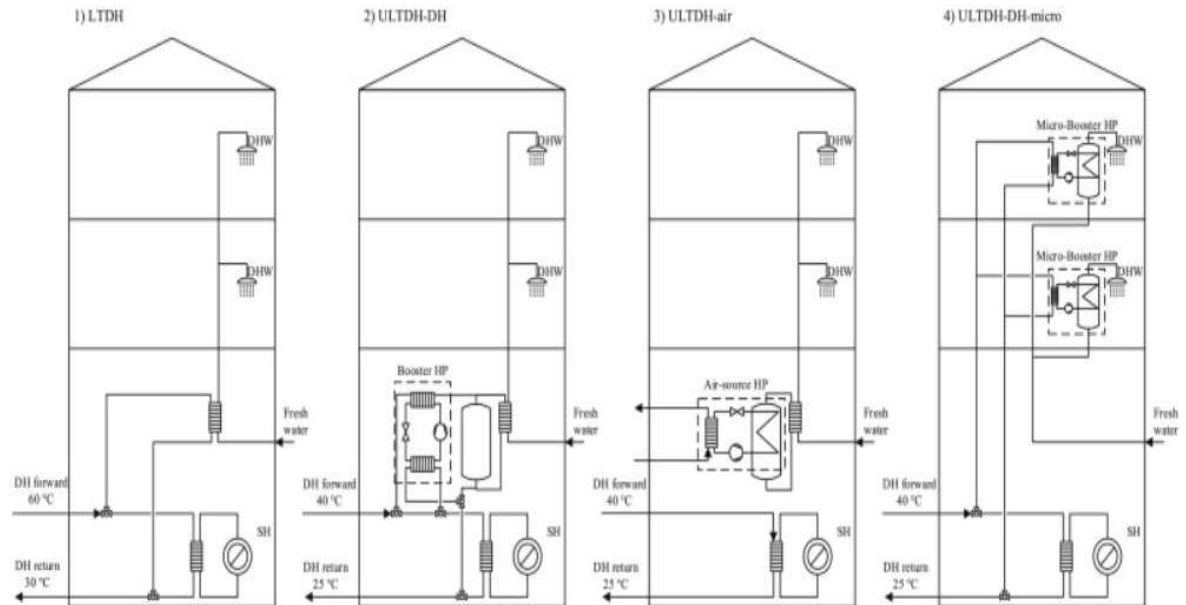

Figure 10 Four system design cases of LTDH and ULTDH (Meeseburg et al. 2020)

Due to the lack of booster HPs and substations expensive systems in LTDHN (flow temperature= 55 - 60°C), this system is more economical than ULTDH. Assuming that the Heat demand and heat density increase as a result of adding customers to the network or turning the one-family house or small apartments into complex apartments, it is evident that fuel consumption will increase. In this case, installing the booster HPs in substations, lowering the flow temperature, and replacing new and cheaper devices as generators with HPs will make the network more economical.

- Due to the thermal specifications of new buildings and low and Ultra low-temperature district heating networks, DHW has emerged as one of the primary energy factors in buildings, and its share is continuously increasing because energy consumption in other sectors are continually decreasing. Therefore, one of the goals of energy optimization is to reduce losses related to the DHW system. Pomianowski et al. suggested a paper that various solutions are proposed in the early stages of development, but some are more promising:
 - Electric heater without a storage tank. For the reasons already mentioned, an electric heater is not recommended for this project.

- Optimization of heat pump performance in DHW supply
 - o New control method to increase COP
 - o Better usage of temperature stratification in storage tanks
 - o the decrease in temperature lift between evaporator and condenser
- Solar-based water production can reduce carbon dioxide emissions. Although a solar water heater is a suitable method, the investment costs are high, and the payback time is extended. In general, the use of renewable energy is still a costly challenge. (Pomianowski et al. 2020)
- In another article, Behzadi described a district heating network in Esbjerg-Denmark with available PVT of a smart building system that provides the building electricity demand and the annual hot water needs. The proposed approach is just a heat storage tank to create an intelligent balance between the building and the district heating and electricity network. Due to not using the battery, there is a significant reduction in investment costs. Annual energy costs are offset by selling surplus hot water to the local LTDH network. The power output for supplying domestic hot water is used in heat storage tanks and pumps, and the rest is used to meet the house's electricity demand. (Behzadi et al. 2020)
- This suggestion is significant, but it should be noted that the buffers inside the building cannot store hot water for several days. Therefore, in unfavorable weather conditions, such as cloudy skies for several consecutive days, this system is not practical, and is better to have a suitable alternative.
- The next case study is the heating-energy sector's design using the existing energy potentials in a residential neighborhood in the Netherlands with a relatively cold climate, which means that heat demand is predominant. In the design, four options were compared with the desired KPIs (option1: Individual air source heat pump, option2: Ultra-low temperature (ULT) heat grid with individual heat pumps and PVT, Option 3: Low/medium temperature heat grid with booster heat pumps at the dwelling level, option4: High Temperature (HT) heat grid with a collective HT heat pump), which are described in Appendix 1.

The most optimized option is an Ultra-low temperature district heating grid with decentralized heat generation from individual PVT collectors on each ceiling of each house that connected to underground storage. This approach, called a decentralized solar feed-in heat grid, can lead to an innovative local energy system and be a good model for other similar neighborhoods. A new application of single PVT panels and heat pumps in combination with a ULTDH network. The power output of the panels is sufficient for the heating net and heat pumps. Excess heat generated in the summer season is exported to the storage network in a seasonal storage system. Jansen

emphasizes that this approach has greater energy efficiency and potential for sustainability than individual solutions. (Jansen et al. 2021)

Unlike the previous case study, this system uses a seasonal storage tank to make the system more functional. But studies and results show that seasonal heat storage systems are expensive. Therefore, it is not recommended for projects where investment and maintenance costs are essential.

- The results of an economic and energy efficiency assessment of LTDHN in three European geographical regions (Spain, France, and Denmark) showed that grid-integrated solar heating systems' performance increases compared to isolated ST. And the return on investment (ROI) is faster. (Lumbreras and Garay 2020)
- By researching seasonal thermal energy storage (STES) efficiency in DHNs, McKenna et al. have illustrated that achieving 100% renewable energy capacity requires a significant amount of storage volume with a final cost of 14% higher than the reference cost. But with some measures, such as improving insulation, 60 to 80 percent of the absorbed solar energy can be used to provide heat to the network under study, at the cost of only 1 percent more than the reference cost. It can be estimated that this technology is not affordable at the moment. (McKenna et al. 2019)
- The use of biomass CHPs in low-temperature district heating networks is increasing in line with decarbonization policies in Germany and the approval of renewable energies budgets. In an article, Koch et al. evaluate the performance of a DHN consisting of a CHP, a peak load boiler, and thermal heat storage technically and economically. In the simulation model, two cases (natural gas and wood-chip gasifier CHP) are compared, which highlights the technical and economic superiority of fossil CHP over the biomass system. On the other hand, despite the CO₂- tax for natural gas as a fuel, which is currently being debated in Germany, it could increase the competition for biomass burners. (Koch et al. 2020)

Chapter3

Project Requirement Specification

The project requirements include the technical and environmental details required for the project. The parameters used for the dissertation are as follows, which can provide a clear idea by justifying the necessary data such as location, heat demand, solar radiation, piping length, etc., to design a heating system.

3.1 Location metrological details

3.1.1 Evaluation of site

Dachau is a town in the Upper Bavaria district of Bavaria, a state in Germany's southern part. It is a significant district town of the administrative region of Upper Bavaria, about 20 kilometers (12 miles) north-west of Munich. It is now a popular residential area for people working in Munich, with roughly 45,000 inhabitants. The formerly most essential pillars of the Dachau economy, brick production, and paper production (closure of the MD paper factory on July 1, 2007), decline. Today, larger employers within the city of Dachau are the Dachau municipal utilities and municipal companies, the spare parts warehouse. Several medium-sized industrial, service, and handicraft businesses are concentrated in the east of Dachau. Table 4 shows the site's technical details, including the exact location and latitude, longitude, and solar irradiation. The technical parameters of the location are taken from the PVSol-online software.

Table 4 information of site (PVSol 2020)

Information of location	
Country	Germany
Location	Dachau/Bavaria
Latitude	48.2557456 °
Longitude	11.4370778 °
Annual global irradiation	1,294 kWh/m ²
Average temperature	8 °

Bavarian energy policy's primary goal is a sustainable, secure, and affordable energy supply for citizens, municipalities, and companies that is widely accepted and

encourages people to participate. According to the latest report of the Ministry of economic affairs, regional development and energy in February 2020 in comparing primary energy consumption in Bavaria and all of Germany (Figure 11), the development of primary energy consumption from 1970 to 2018, especially the share of renewable energy (Figure 12) as well as total primary energy consumption (table 5), reflects Bayern's good progress in achieving this goal. (Bavarian Ministry of Economic Affairs 2020b)

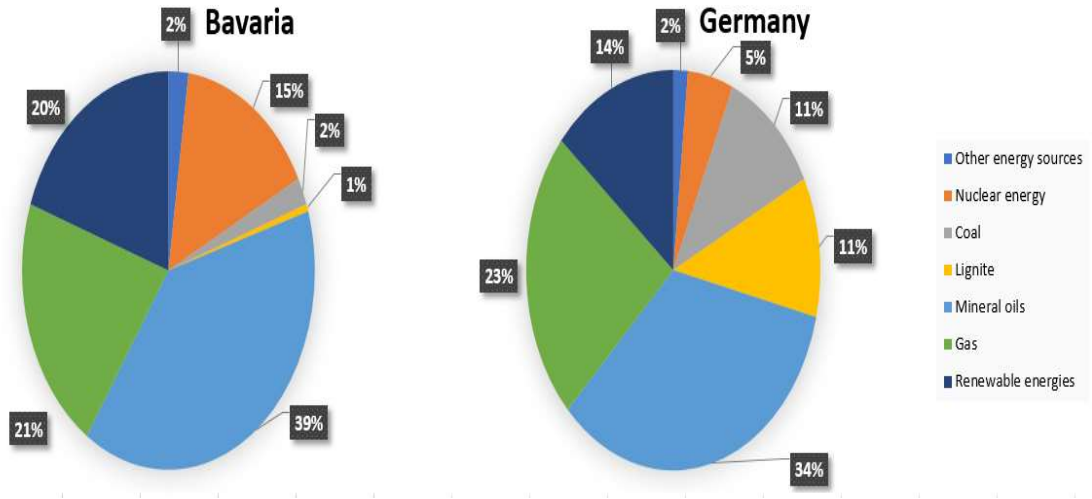

Figure 11 Structure of primary energy consumption in Bavaria and Germany (Bavarian Ministry of Economic Affairs 2020a)

Table 5 Primary energy consumption from 1970 to 2018

Total primary energy consumption	
1970	1176 PJ
1980	1509 PJ
1990	1784 PJ
2000	2037 PJ
2010	2081 PJ
2017	1946PJ
2018	1824 PJ

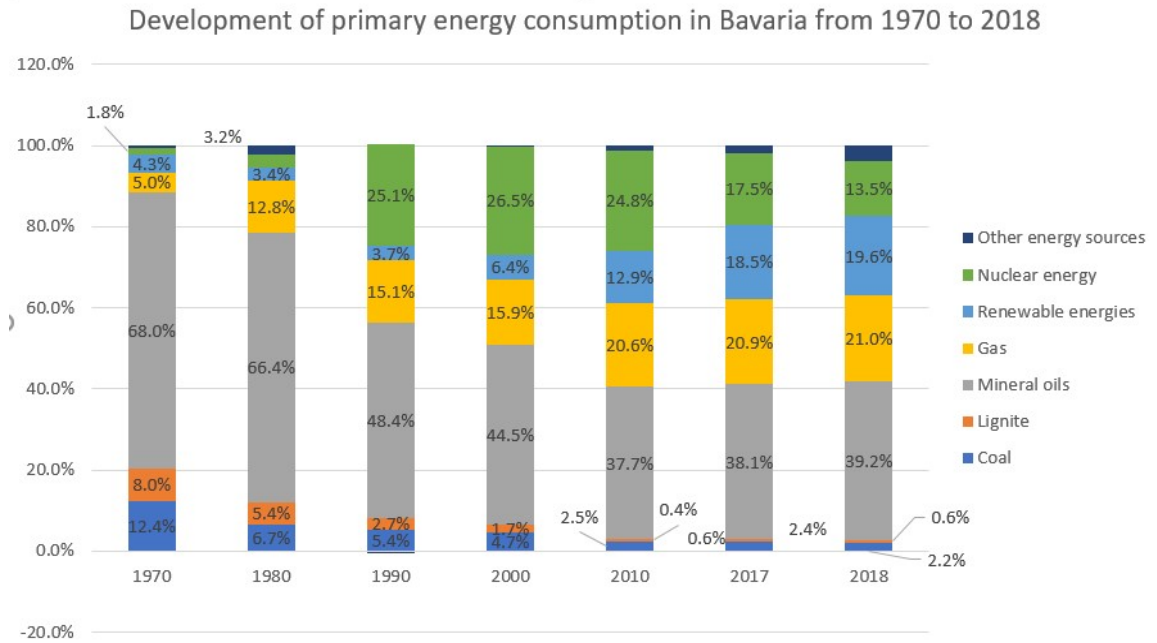

Figure 12 Development of primary energy consumption in Bavaria (in percentage) (Bavarian Ministry of Economic Affairs 2020a)

3.1.2 Potential of renewable energies in region

With the high number of hours of sunshine per year and many solar collectors and photovoltaic systems, Bavaria is the leader in the use of solar energy in Germany. Bavaria is also a leader in Germany when it comes to using hydropower and geothermal energy. When it comes to power generation from bioenergy, Bavaria ranks second among the federal states. The share of renewable energy sources is shown in figure 13 which are taken from the publication of the Bavarian Ministry of Economic Affairs and Energy: Current figures on energy supply in Bavaria - forecast up to 2018.

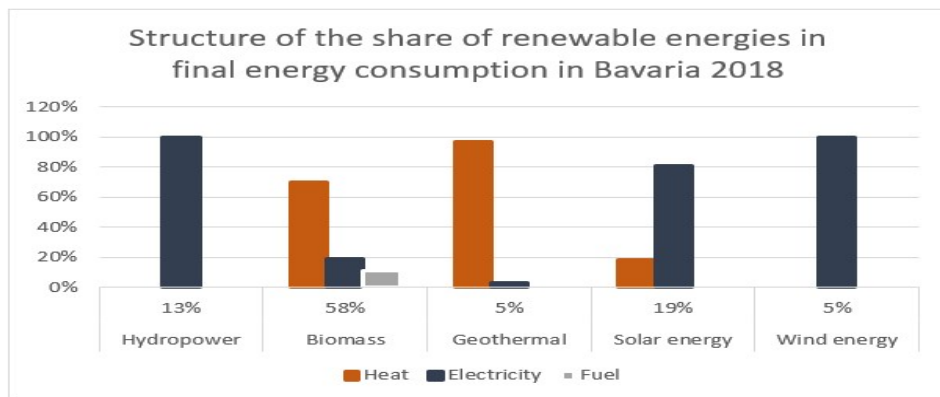

Figure 13 Structure of the share of renewable energies in final energy consumption in Bavaria 2018 (Bavarian Ministry of Economic Affairs 2019)

As shown from the figure, solar, geothermal, and biomass contribute to the heating sector with 20%, 97%, and 70% shares, respectively.

3.1.2.1 Solar thermal energy

In a Germany-wide comparison, Bavaria has very favorable conditions for using solar energy. Dachau is located in the south-east of Bavaria, and the highest value of the sunshine duration up to 1,800 hours was measured.

Solar thermal systems are a conversion of solar radiation into heat that takes place. This heat is then used in process technology. The following definitions are used in this technology: (Pelda et al. 2020)

- The solar fraction is defined as the percentage of total thermal charge supplied by solar energy and is calculated using equation1.

$$SF(\%) = \frac{\text{thermal energy supplied by solar energy } (Q_{req})}{\text{total therm supplied energy } (Q_{sup})} \times 100 \quad (1)$$

- The global solar radiation is the radiation of sunlight to the earth's surface. Radiation consists of direct and diffuse solar radiation.

The amounts of annual global radiation sums of up to 1,294 kWh / m² are obtained. The solar details are taken with the help of the PV-Sol calculator and Soda-pro service. The monthly irradiancies in Dachau are shown in figure 14 and the hourly irradiancies are shown in figure 15 and 16. In fact, the last two photos compare the amount of radiation in winter and summer.

(CAMS 2020; Bavarian Energy Atlas 2020c; PVSol 2020)

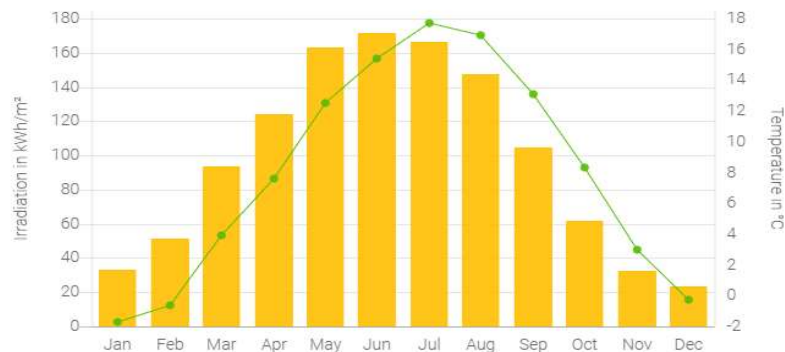

Figure 14 Monthly solar irradiancies (PVSol 2020)

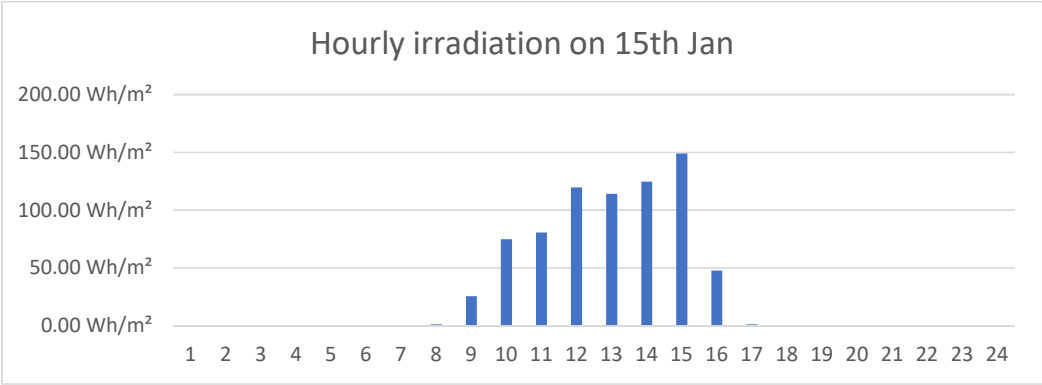

Figure 15 Hourly solar irradiation in winter time

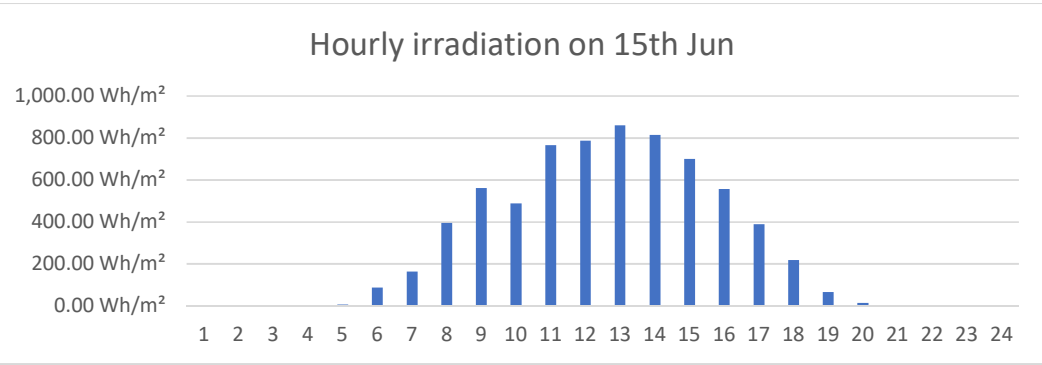

Figure 16 Hourly solar irradiation in summer time

- The collector efficiency is expressed as the collector output ratio divided by the total usable radiation. A solar collector, also a thermal solar collector, converts solar radiation into heat energy. The heat can be used for heating, cooling, water disinfection, desalination, etc. Solar collectors are part of a solar thermal system.
- Flat-plate collectors are probably the most basic and most studied technology for solar water heating systems. The general idea of this technology is straightforward. The sun heats a dark surface that collects as much energy as possible and then transfers the energy to water, air, or other liquids for further use. In most of the company's existing projects, Citirin Solar GmbH thermal collectors are used. The technical details from the manufacturer are given in table 6; also, the schematics are shown in appendix 2.

Table 6 Technical details of solar thermal collector (Citrin Solar 2020a)

Details	
Manufacturer	Citrin Solar
Model	CS 500
Type	Flat-plate
Absorber surface	2.36 m ²
Efficiency	67.12%
Maximum number of parallel connections	15

- The solar gain is the total energy collected per m² per year. It is the product of the global irradiation and the collector efficiency and depends on the location and the type of solar system (see Eq. (2)) (Pelda et al. 2020).

$$Q_{gain} = G_G \times \eta \quad (2)$$

- The area of the collectors is equal to the ratio of required solar energy and the amount of solar gain (Eq. (3)) and also the total area of the solar system is estimated with an approximate factor of 2.5 in the area of the collectors (Eq. (4)) (Pelda et al. 2020).

$$A = \frac{Q_{req}}{Q_{gain}} \quad (3)$$

$$A_{sys} = A \times fac \quad (4)$$

- The number of modules required is equal to the total area of the solar collector system divided by the area of a module.

$$n = \frac{A}{A_{Module}} \quad (5)$$

Tilt and Azimuth angles

The tilt angle describes the vertical angle of the solar panels, and the azimuth angle is their horizontal facing relative to the equator. Solar panels should be exposed to direct sunlight to optimize their output, in which case they will perform best. However, it is a complicated fact that the sun changes angle during the day and seasons. Since it is rarely cost-effective to purchase technology to track the angle of the sun and change panels automatically, it is recommended that the elevation angles of the panels be changed at the end of each month, as shown in the chart below. Moreover, according to

diagram17 and figure18, since the azimuth angle (0°) is facing north, installing the panels facing south better. Data are calculated by Keisan online calculator. (Keisan online calculator 2020)



Figure 17 Tilt and azimuth angles change in one year

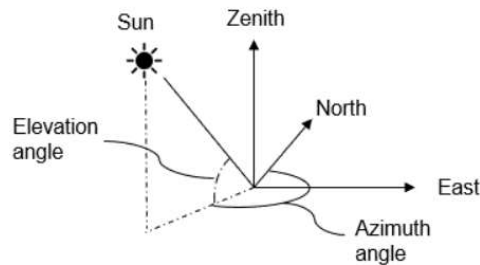

azimuth angle: north=0, east=90, south=180, west=270 degree

Figure 18 Tilt and azimuth angle in relation to the Equator. (Keisan online calculator 2020)

3.1.2.2 Biomass

Biomass is used as a solid, liquid, or gaseous energy source. The highest efficiency in its use is achieved in the heating sector, especially in heating systems based on logs, wood chips, or pellets, and in the electricity sector in CHP plants and biogas from liquid manure residual materials. Besides, bioenergy can be stored and used in the form of fuel in the transportation system. Energy from biomass has a long tradition. In Bavaria, due to numerous forests, farms, and pastures, biomass was used 12,000 years ago in the form of wood or animal dung for heating, cooking, and lighting purposes and today is the most important renewable energy source. Bioenergy is experiencing remarkable success. Over 70 percent of the heat generated from renewable energies and around 25 percent of the electricity generated from renewable energies are obtained from biomass. The aim of the Bavarian ministry of economic Affairs and energy is to increase further the share of solid biomass in the heat energy market and thus to make a

contribution to climate and environmental protection as well as to a stable and secure heat energy supply, with the newly launched BioKlima funding program for wood-fired thermal plant. (TFZ 2020; Bavarian Ministry of Economic Affairs 2020c; Bavarian Energy Atlas 2020a)

Some of other advantages of this type of sources include the following:

- Heating with wood is just as convenient as heating with oil or gas. Pellet and wood chips boilers are fully automatic heating systems that work similarly to oil or gas heating. The fuel is automatically transported from a storage room to the boiler. Depending on the control, it is also possible to connect solar systems, secondary boilers, and other components. Unit heaters also offer a high level of operating convenience, for example, when equipped with automatic ignition.
- Another essential factor when choosing a fuel is, of course, the fuel cost. The raw material wood ensures independence from the global development of fossil energy prices on international markets. Since domestic wood is generally used for both logs and wood chips, prices have been stable for years, while oil and gas prices continue to rise sharply.
- Besides, the regionally renewable raw material is available in sufficient quantities. Studies confirm that, as a rule, more trees are afforested than cut down and that in no case so much wood is removed from the forest to damage it. Due to the high security of supplies and crises, more and more oil heating owners are considering switching to biomass heating.
- Trees absorb carbon dioxide (CO₂) from the air as they grow. When wood is burned, this amount of CO₂ is released back into the environment. The amount of CO₂ released during combustion corresponds to that which is released during normal rotting in the forest. Heating with biomass fuels such as wood, therefore, means heating in the balance of nature.

Pellet and wood chips

To decide on the main boiler's choice, pellets and wood chips can be compared in some aspects. The diagrams and tables below are taken from the last reports of CARMEN (Central Agricultural Raw Material Marketing and Energy Network) and compare the two fuels economically and contents. (CARMEN 2020; BAFA 2020a)

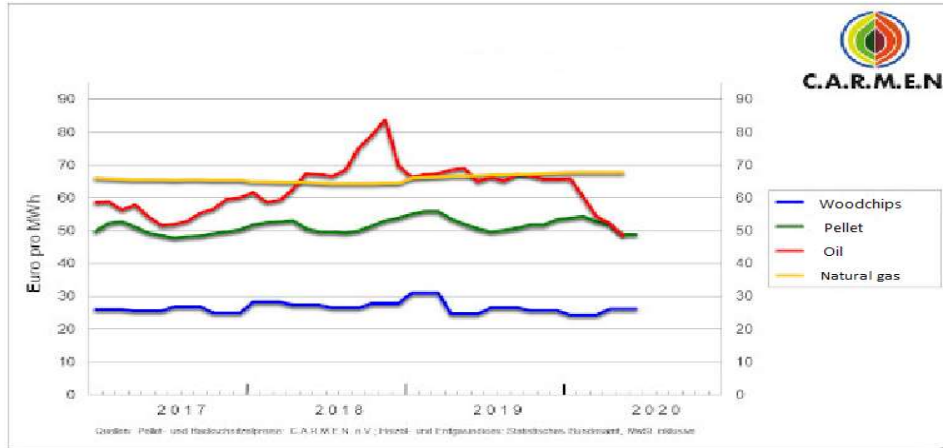

Figure 19 price development of Wood chips with 35% water content, pellet, Oil and Natural gas

Table 7 price data of pellet in August 2020

Delivery packages	€/t	€/MWh
1 tons	295.26	60.33
2 tons	270.26	55.23
5 tons	232.32	47.41
10 tons	222.85	45.48
20 tons	215.55	43.99

The price of 10-ton packages should be considered.

Table 8 Price data of wood chips in August 2020

Delivery packages	€/t	€/MWh
water content of 35%	80.95	26.29
water content of 20%	121.51	30.8

Although the amount of carbon dioxide emitted by burning wood chips is slightly higher than wood pellets but Compared to wood chips, wood pellets are more expensive, but they require less storage space and lead to lower maintenance costs. This advantage speaks in favor of pellets because the storage space can be four times smaller than that of wood chips for the same calorific value. Withdrawal technology and the boiler are almost the same in both cases regarding technology and acquisition costs. This makes the construction costs for the pellet heating cheaper.

Table 9 Data details of Pellet and Wood chips

parameters		Pellet	Wood chips
Water content	%	max.10	max.35
Bulk weight	kg/m ³	650	210-250
Energy content	kWh/kg	4.9	3.5
CO ₂ -Factor	tCO ₂ /MWh	0.023	0.029

3.1.2.3 Geothermal

A distinction is made between near-surface (up to approx. 400 m depth) and deep geothermal energy (up to approx. 7,000 m depth). Geothermal energy is available regardless of the weather and time of day. In Bavaria, using geothermal energy from near-surface and deep areas is favorable in many places. The geothermal potential, previously developed at depths of 800 m to 5,000 m via deep boreholes in Bavaria, is currently used around 380 MW for heat and around 36 MW for electricity generation.(Bavarian Energy Atlas 2020b)

Although geothermal energy has great potential in the heating sector, but regarding the average grid size and the initial thumb account, exploiting this energy requires much investment and is probably not cost-effective.

3.1.2.4 Industrial heat waste

Different industries and many mechanical or thermal processes generate heat that is dissipated into the environment. This waste heat should be used. That saves energy and costs. Because the site is located far from the Dachau Industrial Zone and the two major industries in the city are declining, it is impossible to use this resource as a supplier of thermal energy.

3.1.2.5 The desired combination of RE for this project

Considering the conditions and potentials of various types of renewable energies, the best combination for implementing the new heating system is biomass, solar and heating storage.

3.2 Subsidies

There are a large number of different funding programs, each with different requirements. The most important sponsor is the federally owned development bank (KfW). Moreover, the Federal Office of Economics and Export Control (BAFA) promotes the district heating networks' optimization.

3.2.1 KfW

The KfW Renewable Energies "Premium" program particularly supports larger systems for using renewable energies in the heating market with low-interest loans from KfW and repayment grants financed by the Federal Ministry for Economic Affairs and Energy. The KfW program is an initiative of the Federal Ministry of Economics and Energy and the KfW for future-proof and sustainable energy supply and environmental and climate protection. The following measures of new installation are funded (KfW 2020a)

3.2.1.1 Solar collector systems

The funding of solar collector systems can be applied via this mechanism.

The annual collectors' heat yield multiplied by 0.45 euros.

3.2.1.2 Biomass systems for heating purpose

Up to 20 euros per kW of installed nominal heat output (basic subsidy) for eligible biomass plants for thermal use, but no more than 50,000 euros per individual plant. In addition, the following bonuses can be used for biomass systems:

- Bonus for low particle emissions: Up to 20 euros per kilowatt of nominal heat output.
- Bonus for the installation of a buffer storage tank: The basic subsidy increases by up to 10 euros per kilowatt nominal heat output, provided that a buffer storage tank with a minimum storage volume of 30 liters per kilowatt nominal heat output is installed for the boiler

The maximum repayment subsidy with bonus utilization is 100,000 euros per system.

3.2.1.3 Heating networks that are fed from renewable energies

60 euros per newly constructed piping meter, up to a maximum of 1 million euros (maximum subsidy amount) under these conditions:

- a. The distributed heat with minimum proportions comes from the following heat sources:

- At least is provided 20 % from solar heat, otherwise almost exclusively heat from highly efficient combined heat and power plants, from heat pumps or industrial or commercial waste heat.
 - At least 50%, in the case of heating networks of new buildings 60%, heat from renewable energies. Or,
 - At least 50%, in the case of heating networks of new buildings 60%, heat from heat pumps. Or,
 - At least 50%, in the case of heating networks of new buildings 60%, heat from waste heat.
- b. The heating network has an average minimum heat output of 500 kilowatt-hours per year and 500 meters of route over the entire network.

3.2.1.4 Large heat storage

Two hundred fifty euros per cubic meter of storage volume for eligible large heat storage units with more than ten cubic meters of water volume. The maximum repayment subsidy per heat storage tank is 1 million euros.

3.2.1.5 Biogas pipes

For eligible biogas pipelines for biogas up to 30% of the eligible net investment costs.

3.2.1.6 House heat transfer stations

In addition to the heating network subsidy per meter of the route, each house transfer station of existing buildings can be subsidized up to 1,800 euros.

3.2.2 BAFA

BAFA program support these installations under follow conditions:
(BAFA 2020b)

3.2.2.1 Solar thermal collector systems

The subsidy is given to systems with solar collector's area to 100 m², the details of which are shown in the appendix 3.

3.2.2.2 Biomass systems for heating purpose

The subsidy is given to systems with a heat output of 5 to 100 kW, the details of which are shown in the appendix 4.

3.2.2.3 Heating network

100 € per meter of piping will be awarded to the project if the following conditions are met: 60% of the heat is fed in from CHP plants or industrial waste heat and heat from renewable energies, as long as the heat share from CHP plants in the heating network is at least 25%.

3.2.2.4 Heat storage

The requirements for this funding involve:

- More than 50% of the heat must come from CHP systems
- Using industrial waste heat
- Average heat losses of max. 15 watts/ m²

The amount of funding is 250 € per m³ storage volume and a maximum of 30% of the applicable investment costs for storage tanks over 50 m³. The maximum repayment subsidy per heat storage tank is 1 million euros.

3.2.3 TFZ

Strengthening the heat supply with renewable energies is an essential part of the energy turnaround and climate protection. If domestic bioenergy is used, supply security and regional value creation cycles can be strengthened. The State of Bavaria is therefore promoting investments in new, environmentally friendly biomass heating plants for the efficient, energetic use of solid biomass, investments in energy efficiency measures, and the use of solar heat and waste heat in conjunction with the new investment in biomass heating plants in accordance with the regulations.

The purpose of the funding is to construct biomass heating plants to contribute to the implementation of the Bavarian Energy Program and climate protection. The funded projects are expected to save up to 5 000 tons of carbon dioxide per year.

This subsidy includes investment in new environmentally-friendly biomass heating systems with a nominal heat output of at least 60 kW. In addition to biomass, solar energy or waste heat is also fed to it in this system. The share of waste heat or solar heat in the annual heating energy requirement should be at least ten percent. (TFZ 2020)

3.2.3.1 Type of funding

Funding takes the form of non-repayable grants (project funding) as partial financing. It includes two parts of subsidies: primary funding and economizer.

3.2.3.2 System specification

- The heating system must be newly installed.
- Existence of storage buffer with a volume of more than 30 liters.
- Existence of solar heating or/and waste heat which are fed in to system.
- The biomass boilers must achieve a utilization of at least 2,500 full operating hours per year.
- Nominal heat output of boiler should be at least 60kW.

3.2.3.3 Subsidy rates

- Basic funding is the maximum financial support for investments in new environmentally-friendly biomass heating plants and that is thirty percent of the eligible costs.
- The economizer budget includes 10% of the base budget if the share of solar energy is 20% of the energy requirement, otherwise, it will be 5%. (TFZ 2020)

It should be noted that each project other than the heating network mode can receive subsidies from several organizations in combination, provided that it does not exceed a specific limit. Nevertheless, in the heating network, subsidies are given to the project only by one organization.

3.3 Technical details of the project

3.3.1 Available details from Stadtwerke-Dachau

As mentioned in the project description, the main project is based on the use of CHP and gas boilers, in which both generators are supplied by natural gas. One of the fundamental reasons for using these components in the network is that Stadtwerke_Dachau is the natural gas provider in Dachau. The project includes new buildings that meet KFW55 standards. The use of heat pumps in each heat transfer station is required below one parameter, which can be used to reduce the required temperature to 45°C. Table 10 summarizes the project details; also, in appendix 5, the buildings' area is listed individually.

Table 10 Basic details of project

Basic details from Stadterke_Dachau	
Number of buildings	50
The year of constructions	2020
The standards of construction	KFW55
Total area	37000 m ²
Buffer storage	Yes
Generators	CHP, Gas boiler
Sub heat transfer stations	Yes
Flow/Return Temperature	45 °C/20 °C

3.3.2 Determined details from Dme-Consult company

3.3.2.1 The location of heating center

After a meeting at the company, the best place to set up a heating plant close to the project was selected, the area of which is shown in red in Figure 20.



Figure 20 The designated location for the heating center

3.3.2.2 Determination of the annual heat load

A precise estimate of the heat demand is the key to measuring the energy center's heat capacity. Therefore, an incorrect estimate of the heat demand can lead to over-installation and additional investment (Delangle 2016). The annual heat consumption of customers has been calculated by Using the available data. The tool available in the

company determines the hourly heat demand of residential areas. The following method is created to create connection scenarios for the simulator:

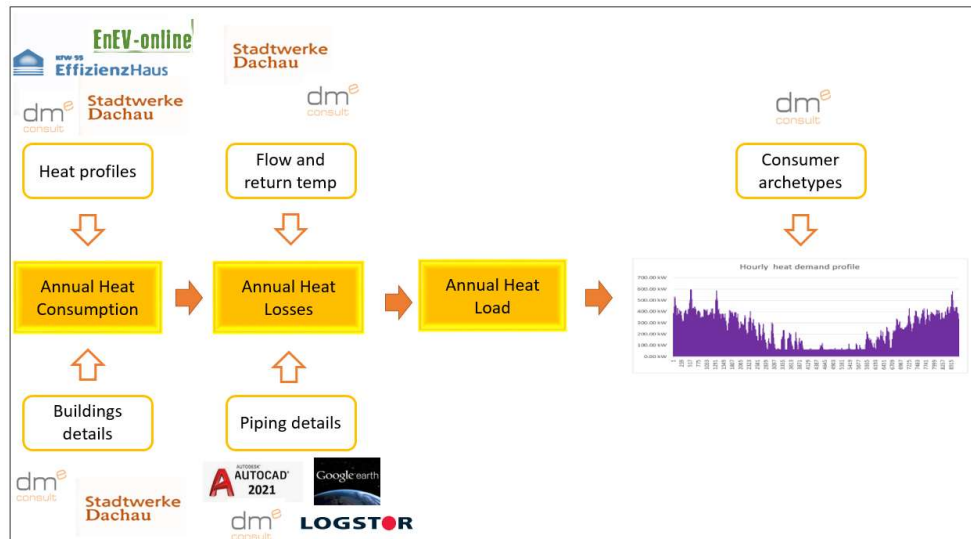

Figure 21 Methodology and data sources used to estimate heat demand

- The KfW Efficiency House Standard is a benchmark for energy-saving buildings. The smaller the number, the greater the energy efficiency and the higher the house's value. Energy efficiency in new buildings is an important part of the energy transition and is subsidized by the state. The KfW Efficiency House Standard is made up of 2 criteria:
 - Total energy required by the property
 - Quality of building thermal insulation

That becomes with the values of primary energy demand and transmission heat loss specified. A KfW Efficiency House 100, which complies with the requirements of the Energy Saving Ordinance (EnEV), serves as a reference. Compared to the EnEV reference building, the efficiency house 55 only requires 55% of the primary energy. (KfW 2020c)

The EnEV is part of the German economic, administrative law. Thereby, the legislator prescribes the requirements of the building standard for efficient energy demand. Based on that, a legal permit is issued for the construction projects of residential and office buildings. (EnEV 2014)

Regarding the company's decisions and practical experiences, the specifications of new buildings' energy demand according to the requirements of EnEV rules are given in the following table. It should also be noted that hot water demand is always constant and

calculated according to the table, but space heat demand varies with the change of KfW standards.

Table 11 Energy demand profile of site

Energy demand profile			
Parameters	EnEV Energy demand profile	KfW55 Energy demand profile	
Heating demand	45 kWh/m ² a	45 *55%= 25 kWh/ m ² a	13.75~14 W/m ² a
Hot water demand	11,5 kWh/m ² a	11,5 kWh/m ² a	6.38~6 W/m ² a
Full hour of usage	1800 h	1800 h	1800 h

Based on primary data from Stadtwerke- Dachau, including the size of buildings, heating and heat water demand (respectively, 14 W/m²a and 6 W/m²a), and other calculations and measurements such as the length of piping provided by AutoCAD, customer map, and Google earth, and the calculation of heat and pressure losses (the results can be found in Appendixes 6,7 and 8). These losses are estimated by the pressure loss tool developed in DME and Log Stor calculator. As heat demand fluctuates throughout the day and year, the building's annual heat demand data shows nothing about its heat consumption pattern. For this reason, the heat demand profiles were created using existing consumer archetypes. The model developed by Dme-Consult was chosen for this purpose. This model was used to create the hourly characteristics of heat demand consumption during the year. The model inputs were adjusted according to the average annual heating requirement and depending on the type of building, area, and use of the building. The Summary of calculations and load curves are shown as follow:

Table 12 Annual heat demand

Annual heat demand	
Annual heat demand	1,316,765 kWh
Annual heat losses	118,370 kWh
Average annual output	1,435,149 kWh

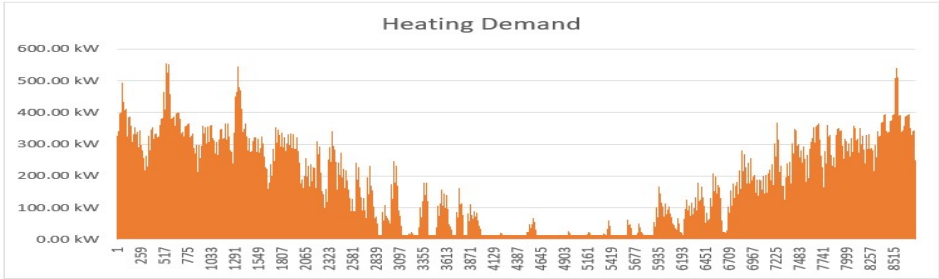

Figure 22 Heating Demand per hours during a year

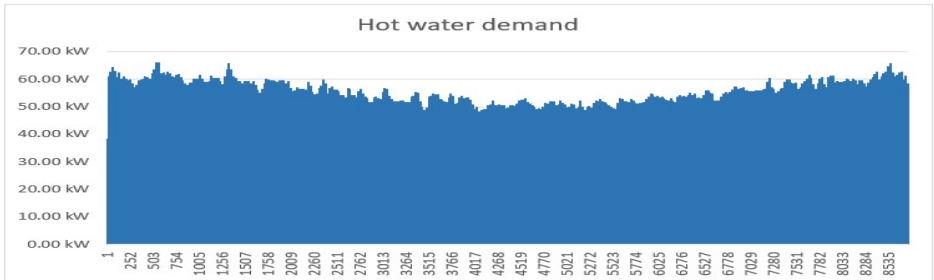

Figure 23 Hot water demand per hours during a year

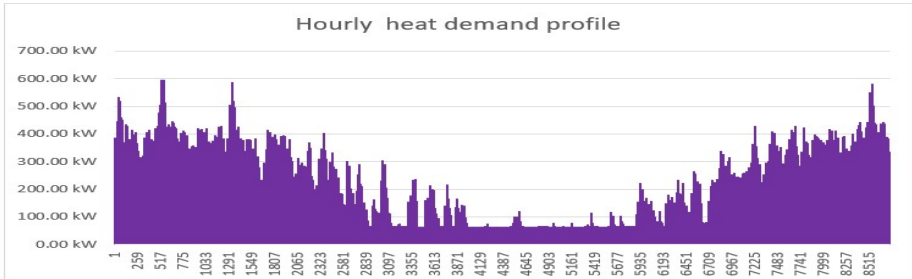

Figure 24 Total heat demand annually

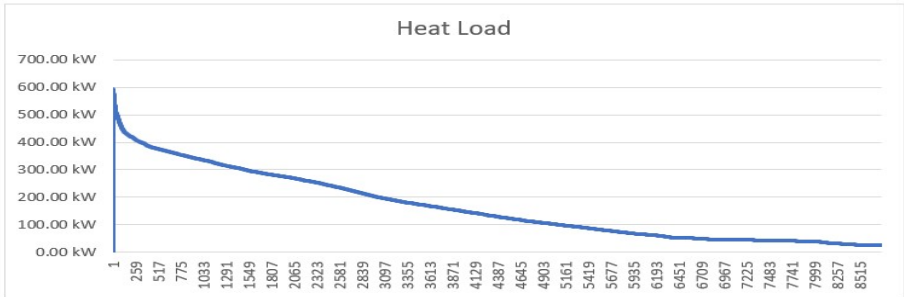

Figure 25 Heat Load

3.3.3 Low-temperature DHN with CHP and gas considering boiler

3.3.3.1 The simulation results of the heating center with CHP and gas considering boiler provided by the company (Scenario1- Variant1)

According to calculated data, this system's peak load is 595 kW, and the simulation has been done based on this value.

After the simulation, two configures were the best, which the results came in table 13. As one CHP unit has an awful part load behavior and 2 CHP units in the system are recommendable for maintenance periods, the configure 1 has been selected.

Table 13 The simulation results of heat plant in DHN in Dachau

	Buffer storage	CHP1					CHP2					Boiler				Heating Element		annual generated heating by generators (KWh/a)	annual generated electricity by generators (kWh/a)
		Volume [m³]	th. Output [kW]	el. Output [kW]	[h/a]	Annual generated heating (KWh/a)	Annual generated electricity (kWh/a)	th. Output [kW]	el. Output [kW]	[h/a]	Annual generated heating (KWh/a)	Annual generated electricity (kWh/a)	Output [kW]	[h/a]	Annual generated heating (kWh/a)	Annual fuel consumption (kWh)	Annual generated heating (KWh/a)		
Configure1	23	113	70	6,092	688,379	426,429	94	64	3,658	343,814	234,086	250	1,027	256,625	261,862	146,336	146,336	1,435,155	660,516
Configure2	23	207	142	4,915	1,017,488	697,987				0	0	250	1,085	271,325	276,862	146,336	146,336	1,435,149	697,987



In the simulations carried out, the operation was based on a partial load operation. In principle and simplified form, it can be said that the gas boiler simulated here does not operate at full load - i.e., 100% of its possible output (Gas boiler output =508 kW). The planned gas boiler should run at full load if necessary (upcoming maintenance work or malfunctions on the CHP unit side). The remaining time should run under partial load. so, the final generators' design would be as follow:

Table 14 Final generators design

	Buffer storage	CHP1					CHP2					Boiler				Heating Element		annual generated heating by generators (KWh/a)	annual generated electricity by generators (kWh/a)
		Volume [m³]	th. Output [kW]	el. Output [kW]	[h/a]	Annual generated heating (KWh/a)	Annual generated electricity (kWh/a)	th. Output [kW]	el. Output [kW]	[h/a]	Annual generated heating (KWh/a)	Annual generated electricity (kWh/a)	Output [kW]	[h/a]	Annual generated heating (kWh/a)	Annual fuel consumption (kWh)	Annual generated heating (KWh/a)		
Configure1	23	113	70	6,092	688,379	426,429	94	64	3,658	343,814	234,086	508	505	256,625	261,862	146,336	146,336	1,435,155	660,516

3.3.3.2 Sub heat transfer stations

Figure 26 is intended to illustrate better the function and concept of the heat transfer station in conjunction with the integrated heat pump and the generator on the heating center's side. Heat transfer station systems obtain their source temperature from the

temperature level of the network. This possibility is a stable and well-thought-out basis connected with a planned district heating network in the new building area. Also, houses could use this system to increase their domestic hot water temperature levels. However, there should be supply via this system.

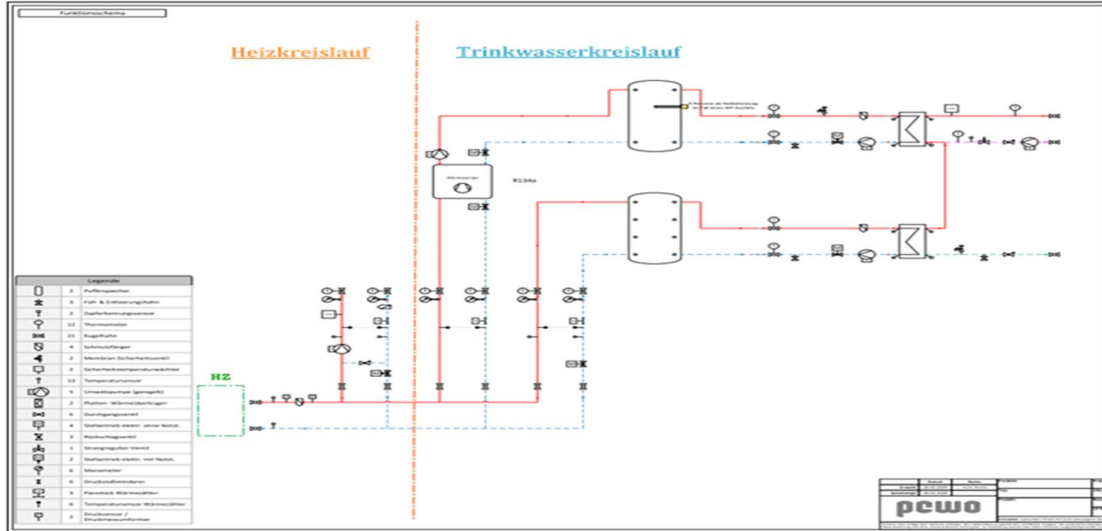

Figure 26 PI diagram of heat transfer station

- Every building has its own undersupply, which is connected to the heating center via the pipes.
- The district heating network is operated with low flow temperatures in order to keep the heat loss within the network as low as possible.
- The heating circuits (underfloor heating) and the preheating stage of the hot water preparation are supplied directly.
- The integrated heat pump uses the DHN as a source and increases temperature for the stage of the hot water preparation.

The technical information of heat pumps provided by PEWO company is given in Table 15:

Table 15 Technical information of heat pumps

Type of heat pump	Data	Quelle:55/35°C Heizung:65/50°C
SW05 HT	COP	4.8
	Heating output(kW)	10.5
SW07 HT	COP	5.4
	Heating output(kW)	17.2
SW12 HT	COP	5.3
	Heating output(kW)	27.3

Annual electricity consumption for running the heat pumps is 79,670 kWh/a, which has been brought in appendix 9 in detail.

3.3.3.3 CHP units

Even though generated electricity of CHP is not used in DHN at this stage of the project, the project manager has chosen CHPs as the main generators for several reasons:

- CHP fuel is natural gas which is supplied by Stadtwerke-Dachau itself.
- In case of an increase in heat demand and customers are added to the heating network, CHP heat losses can be used as the heat source of an air-to-water heat pump.
- the generated electricity by CHP is injected into the local electricity network and make revenue through it.

The technical specification of the selected units is mentioned in table 16, and module diagrams, and datasheets are shown in appendixes 10 to 13. (YADOS 2020)

Table 16 CHP units details

Parameters	Unit 1	Unit 2
Manufacturer	YADOS	YADOS
Model	EG-70	EG-60
Type	Natural gas type	Natural gas type
Electricity Capacity	70 kW	64 kW
Electrical efficiency	34.4 %	36.1%
Thermal Capacity	113 kW	94 kW
Thermal efficiency	55.4 %	53.1 %
Fuel consumption	204 kW	177 kW
Required Electricity	0.30 kW	0.30 kW

3.3.3.4 Gas considering boiler

A condensing boiler is a boiler for hot water heating that uses almost all of the fuel use d's energy (calorific value). With condensing boilers, the flue gas is cooled down as far

as possible, and the condensation heat (= latent heat) of the water vapor in the flue gas is used to provide heat. Different substances are produced during combustion depending on the type of fuel, combustion temperature, oxygen content, and other factors. If the exhaust gas is cooled below the dew point, its condensable substances begin to condense.

The gas boiler covers the peak load. All projects of the company are equipped with the Viessmann GmbH gas boilers. These products can be running with all types of gases. The primary data from the manufacturer is given in table 17; also datasheet is in appendix 14. (VIESSMANN 2020)

A Gas boiler consists of the following parameters.

- Efficiency = Boiler efficiency is a measure of how effectively chemical energy in fuel is converted into heat energy (GoldsWorthy et al. 2013)
- Nominal heat output = It is defined as the maximum output heat of a boiler
- Required Electricity = The amount of electrical energy required to operate the boiler per hour.
- Flow temperature (T_{flow})/ Return temperature (T_{ret}) = The temperature of the water which is flowing from the boiler and reaches the consumers through the pipes and delivers heat to them, so it returns to the boiler at a lower temperature.

Table 17 Gas considering boiler details

Parameters	
Manufacturer	Viessmann
Model	Vitocrossal 300
Type	CT3B
Thermal Capacity	508 kW
Required Electricity	3 kW
$T_{\text{flow}}/T_{\text{ret}}$	50°C/30°C
Efficiency	98 %

3.3.3.5 Thermal storage

Thermal energy storage includes the temporary storage of high or low-temperature thermal energy for later use. For example, storage of excess solar energy in summer and use in winter called seasonal storage or heat storage outside of peak hours for use

during peak demand hours. TES is an excellent option to compensate for the mismatch of demand and access to heating energy and optimize the heat supply system. The benefits of using TES in an energy system include increased overall efficiency and better reliability, leading to better economies, reduced investment and running costs, and less pollution to the environment, i.e., less carbon dioxide emissions. (Dincer and Rosen 2013; Dinçer and Rosen 2010)

There are three methods for TES at temperature -40°C to over 400°C which is depended on the nature of the process:

Sensible heat for water heating system or in the system with air heating collectors, latent heat associated with phase change materials (PCMs) can also be used in the system with air heating collectors, and chemical heat storage associated with chemical reactions that provide storage for photovoltaic or photochemical processes. (A Comprehensive Review of Thermal Energy Storage 2018)

Sensible heat storage (SHS) is the simplest method of storing thermal energy by heating or cooling a liquid or solid storage medium in which water appears to be the cheapest option with high specific heat. It is also the most popular and commercial storage of heat, which has several residential and industrial applications (a cheap alternative without the risks associated with the use of toxic substances). (Guelpa and Verda 2019)

Water tank storage as short-term storage and underground storage as seasonal storage are two different types of SHS that can be used in DHN with solar thermal collectors. According to the advantages given in paper of Elisa Guelpa and the limited possibility of using seasonal thermal energy storage (STES), which is summarized below, in this project, short-term storage is examined. (Guelpa and Verda 2019)

- The most widely used TES in DH for short-term applications are water-filled tanks.
- Heat exchangers are not required because water is both a storage medium and a heat transfer fluid (HTF).
- Technology and design of this technology is simple and well known.
- The project's size is not so big, and the water tank storage can manage the system's thermal energy supply.
- One of the project goals is to minimize the area involved in the central heating plant.
- Due to the high investment cost in installing this type of storage and the amount of heat demand, its installation is not economical.

The figure 27 shows a heating system which is optimized with a buffer storage.

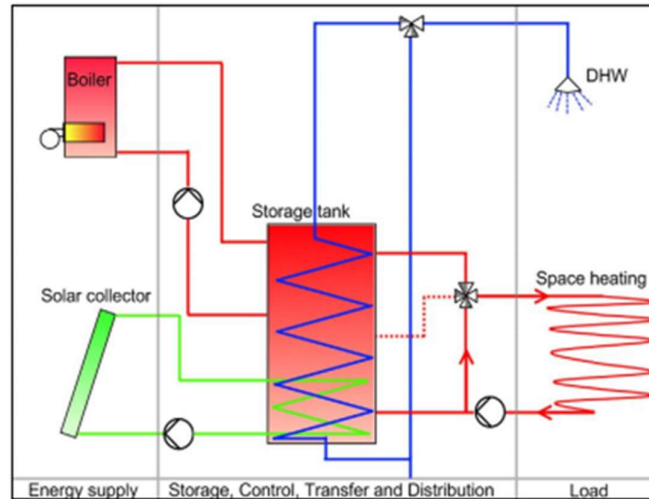

Figure 27 Schematic of a system with solar collector, boiler(gas, oil, wood, CHP etc.) and thermal storage tank (A Comprehensive Review of Thermal Energy Storage 2018)

The SHS system utilizes the storage medium's heat capacity and temperature change during the charging and discharging process. The amount of heat stored depends on the specific heat temperature, the temperature change, and the amount of storage material.

$$Q_s = \int_{t_i}^{t_f} mc_p(t_f - t_i) \quad (6)$$

Where: (A Comprehensive Review of Thermal Energy Storage 2018)

Q_s : The quantity of heat stored in Joules or 0.000000277777778 kWh

m : The mass of heat storage medium in kg

c_p : The specific heat in J/(kg.K)

t_i : The initial temperature or t_{flow} in °C

t_f : The final temperature or t_{ret} in °C

Water has a particularly high heat capacity (about $4180 \text{ kJ}\cdot\text{m}^{-3}\cdot\text{K}^{-1}$) and The mass of each cubic meter of water is equal to 1000 kg.

For the current project, Citirin solar GmbH thermal storage, which is located in Bavaria state and is a useful option to reduce shipping cost, is selected. The technical details from the manufacturer are given in table 18, also the hydraulic scheme is shown in appendix 16.

Table 18 Technical details of Buffer storage (Citrin Solar 2020b)

Details	
Manufacturer	Citrin Solar
Model	PS
Type	energy storage for the use of Solid fuel, pellet, gas, oil boilers and CHP and solar thermal
Max. Temperature	95°C
Material	Steel S 235 JRG 2, raw inside, primed outside
Insulation	120 mm
Capacity	23000 liters
Environmentally friendly	100% recyclable fiber fleece insulation

Chapter 4

Optimization

The overall goal of optimizing a district heating system is to minimize GHG emissions and operation and investment costs. In this case, the higher share of the SF means a lower share of fuel energy and electricity consumed in pumps and auxiliary heating devices (E_{tot}) and also, leads to reduce GHG emission. Therefore, the optimization of the volume of buffer storage, the total area of thermal collectors, and SF are presented in the following. (Fu and Li 2018)

4.1 Volume of buffer

Comparison of the SF in different volumes of a buffer should be made in a common collector area. According to Equations 1 to 3, to have an SF of 20%, the collector area is calculated to be about 300 square meters. In the simulator, to reach the actual size, the required area starts from 300m² and reaches a minimum of 470m² with increasing the area of the collectors. This gap between theoretical size and the actual size is since the sun's supply of energy seldom corresponds to the times required for heat. As shown in Figure 28, to achieve SF of 20 %, the minimum buffer volume required is 29 cubic meters. Also, with a massive increase in buffer volume, the SF rises by only 3%. On the other hand, The E_{tot} trend is slightly decreasing. Due to the initial investment trend (Fig.29) of the system with different buffer volumes, 29 cubic meters seems to be the most optimal choice.

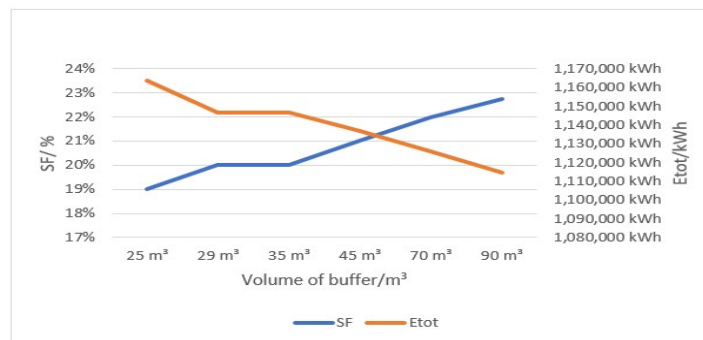

Figure 28 Relationship between volume of buffer, E_{tot} and SF. (Area of solar collectors is 470 m²)

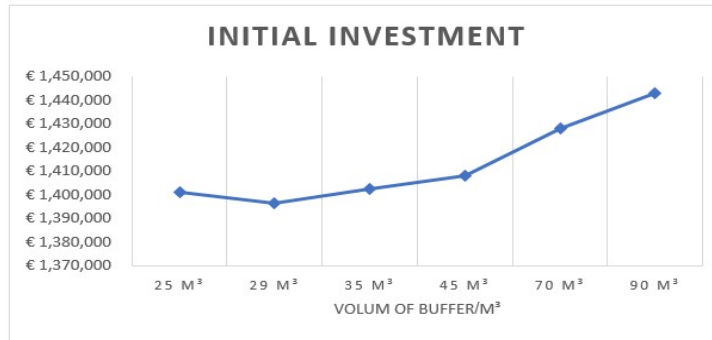

Figure 29 Total investment costs of the system (Area of solar collector is 470m²)

4.2 Area of solar collectors

Raising the solar collector's area from 470 m² to 770 m², at a constant buffer volume of 29 m³, leads to an increase of only SF of 5% and a slight decrease in the E_{tot} (see Fig.30). with considering the sharp increase in the investment chart (see Fig.31), it seems that the minimum solar collector's area is applicable for an optimal system.

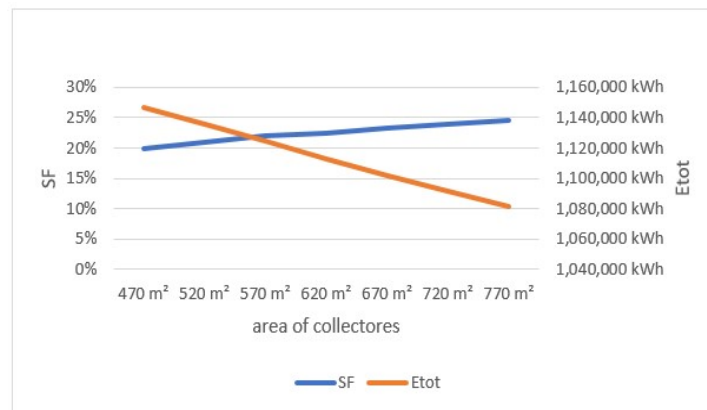

Figure 30 Relationship between area of collectors , SF and E_{tot}

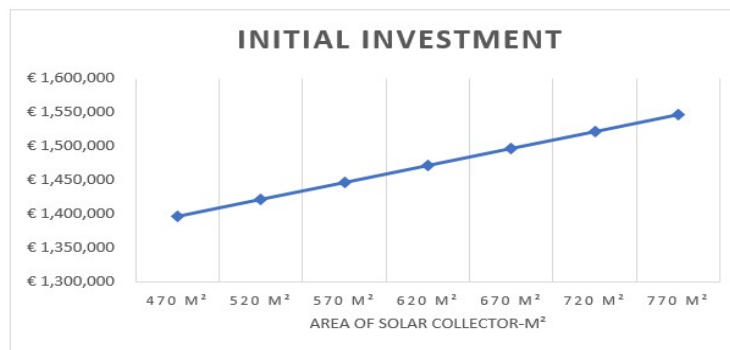

Figure 31 Total investment costs of the system (The volume of buffer 29m³)

After adjusting the optimal values obtained, the proportion of solar energy used in the system with 289,147 kWh/a and the amount of solar energy absorbed by the collectors in the correct position and angle with 409,963 kWh/a, is 0.705. This means that the storage tank in the most optimal system saves only 70.5% of solar energy.

Chapter 5

Designing a new plant with integrating renewable energies

As described in Section 3.1.2.5, and since power generation is not currently important in the project, the ideal combination for an integrated heating system with renewable energies, solar thermal collectors, gas boilers, biomass boilers, and heat storage. It is necessary to re-stimulate with new components to design a new heating network by combining renewable energies, solar energy, and biomass.

5.1 Simulation

Two different simulators perform the results of two-phase simulation of the project. The main project was done with an internal simulator, and then for the following reasons, it has been decided that another tool with some modifications would be designed and used.

- Disclosure and use of company tools outside the company are not possible.
- This tool is difficult to work with, and if no response is received or information is entered incorrectly, the user will have to restart the simulator. It is very effortless to work with the new tool designed in Excel, and in case of wrong feedback, you can change the values and compare the results.
- The calculated value of the buffer volume is not an exact value, and in practice, a smaller volume can be used for this purpose and to cover heat losses.
- The collectors' solar output is not accurate due to the lack of accurate information about regional radiation, and the calculated area is much larger than the actual area. This is the highest tool defect due to the high cost of investing in solar heating and boilers systems. Annual solar irradiation information of region per hour is added to the new tool.
- In the company simulator, 10% of the required heat energy is supplied by electrical heating elements in buffer storage. Considering the best efficiency (100%) for converting all the consumed electricity into heat, it is not cost-effective at all in high amounts of heating energy demand due to the high cost of electricity. In the new tool, the heating elements are removed.

5.1.1 Methodology and data sources used for designing of the energy Centre

To provide the required heat, designing an optimal heat center is the primary goal of this system. As described in the previous section, one of the most optimal layouts is to reduce fuel energy by increasing the share of solar energy in energy production at the lowest possible investment cost (ie, the lowest number and area of the collector). On the other hand, according to the company's practical, an optimistic estimate of the buffer volume, which is the balance between heat production and demand during peak and off-peak hours, would increase the nominal generator output to 80% of the maximum heat load. Also, in a solar heating system, the SF increases with decreasing generator operating hours. In both cases, there is a reduction in fuel consumption and GHG emissions. The following methodology shows the simulation method used in the project:

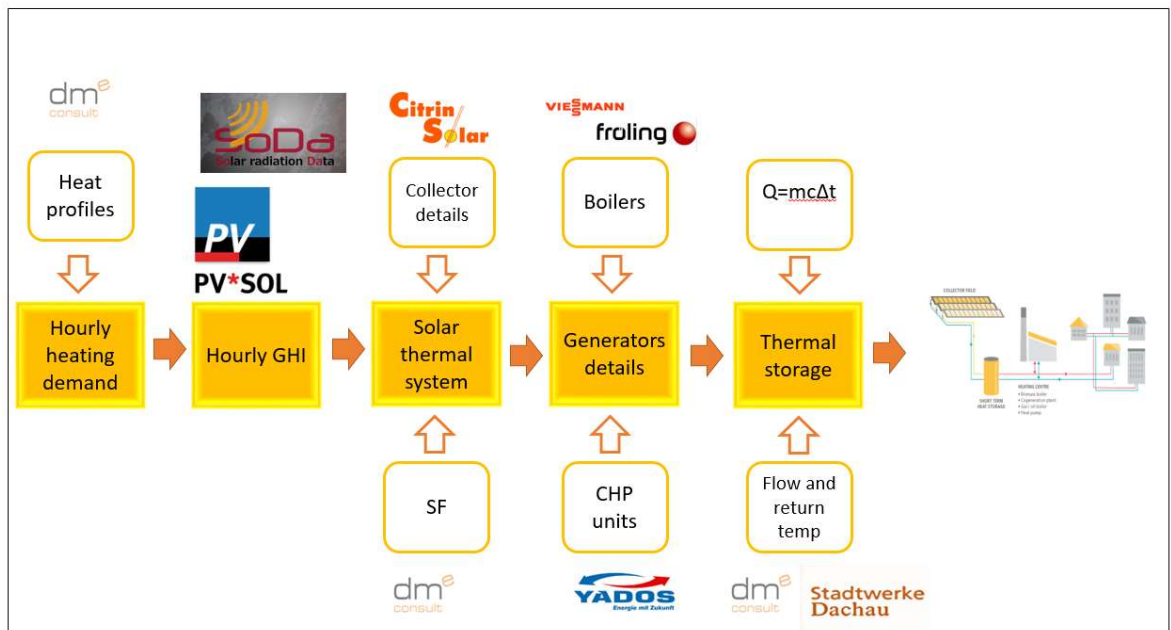

Figure 32 Methodology and data sources used to design of the energy centre

5.1.2 The new results of the non-RE system's simulation (Scenario1-Variant2)

Since the goal is to compare the two systems, it is better to evaluate the system consisting of CHP units and gas boiler with the same components in the new simulator, the result of which is presented below.

Table 19 The results of the non-RE system's simulation in the new tool

New-simulation	Buffer storage	CHP1						CHP2						Boiler			annual generated heating by generators (kWh/a)	annual generated electricity by generators (kWh/a)		
	Volume [m ³]	th. Output [kW]	el. Output [kW]	Fuel consumption [kWh/a]	Annual generated heating [kWh/a]	Annual fuel consumption [kWh]	Annual generated electricity [kWh/a]	th. Output [kW]	el. Output [kW]	Fuel consumption [kWh/a]	Annual generated heating [kWh/a]	Annual fuel consumption [kWh]	Annual generated electricity [kWh/a]	Output [kW]	Annual generated heating [kWh/a]	Annual fuel consumption [kWh]				
	22	113	70	204	6,790	767,321	1,385,251	475,331	94	64	177	3,850	361,866	681,386	246,377	508			602	305,963

5.1.3 The results of the RE system's simulation (Scenario 2)

The simulation results are shown in following table which is included two different configures. One of them with less buffer volume and more solar surface and another variant vice versa.

Table 20 Simulation results of system with solar and biomass energy

	Buffer storage	Biomass boiler				Gas boiler				Solar			annual generated heating by generators (kWh/a)
	Volume [m ³]	Output [kW]	[h/a]	Annual generated heating (kWh/a)	Annual fuel consumption (kWh)	Output [kW]	[h/a]	Annual generated heating (kWh/a)	Annual fuel consumption (kWh)	Output at 1000 W/m2, 20°C [kW]	[h/a]	Annual generated heating (kWh/a)	
Configure1	29	230	4,187	962,936	982,588	508	361	183,446	187,190	470	614	288,767	1,435,149
Configure2	20	230	4,117	946,811	966,133	508	351	178,095	181,730	570	544	310,243	1,435,149

Here, as in the previous system, the output capacity of the gas boiler must be sufficient to meet the energy demand during maintenance and shutdown of the main boiler and regarding to the optimization results in last section, the first option seems more economical. Also, by calculating the number of modules (see Eq.5) and after rounding their number, 200 are estimated. Therefore, the final area of the solar system is 472 square meters. Therefore, the results change according to the table below.

Table 21 Final simulation results of RE system

	Buffer storage	Biomass boiler				Gas boiler				Solar			annual generated heating by generators (kWh/a)
	Volume [m ³]	Output [kW]	[h/a]	Annual generated heating (kWh/a)	Annual fuel consumption (kWh)	Output [kW]	[h/a]	Annual generated heating (kWh/a)	Annual fuel consumption (kWh)	Output at 1000 W/m2, 20°C [kW]	[h/a]	Annual generated heating (kWh/a)	
Configure1	29	230	4,185	962,664	982,310	508	361	183,338	187,079	472	613	289,148	1,435,149

5.2 Technical details of new heating plant

5.2.1 Solar thermal system

The desired solar system includes 200 Citrin-solar collectors (see table .6) with a total area of 472 square meters.

5.2.2 Solid biomass boiler

As mentioned in Section 3.1.2.2, wood derivatives are good options for a district heating project due to the financial backing of investment costs. Moreover, considering the advantages of pellets, this type of boiler is suitable for this project.

Pellet boiler

This heating plant could be equipped with a pellet boiler of Froeling products which is detailed in the following table. The components of boiler are shown in appendix 17.

Table 22 Data sheet of Pellet boiler

Details	
Manufacturer	Froeling
Model	PT4e
Type	Pellet boiler
Thermal Capacity	230 kW
Efficiency	98%
Required Electricity	146 W/h
Max. Temperature	90°C
Pellet storage	24 m ³

5.2.3 Biogas peak load boiler

In a district heating network with a central gas boiler and only for heating purposes, a maximum share of 10% of biogas can be used. Changing the contract from natural gas to biogas is free. Despite the biogas contract, consumers continue to take natural gas from the pipeline. The provider feeds the biogas into the gas network elsewhere and it

works without technical upgrading. To do this, the newly installed heating system must correspond to the current state of the art, e.g. with a condensing boiler. (EWärmeG 2020) Based on the simulation result and since Viessmann gas condensing boilers are capable of refueling from biogas, the same gas boiler of the main system with detailed specifications of table 17 is selected.

A comparison of natural gas and biogas tariffs shows that natural gas has a higher cost and, in addition, the amount of CO₂ emission from biogas fuel is lower than natural gas. (BAFA 2020a; Logo Energie 2020)

Table 23 Comparison of biogas and natural gas

Parameters		Natural gas	Biogas
Energy price	Cent/kWh	5.03	3.45
Base price	€/Year	595	408
Provider		Stadtweke-Dachau	Logo Energie
CO ₂ -Factor	tCO ₂ /MWh	0.202	0.148

But it should be noted that the estimated cost of biogas is for this area. In other parts of Germany, due to the high cost of transportation or the shortage of biogas plants nearby, prices may rise, and biogas injection will not have a positive effect.

5.2.4 Thermal storage

According to section 3.3.2.7, for this system, the Citrine solar storage tank is selected with the same details as Table 18 but in a different volume (29 cubic meters and depending on the simulation results).

5.3 Layout of heating Centre with renewable energies

Network heating center includes 472 m² of solar thermal collectors and pellet boiler as the principal generators, a gas boiler that supports the system during peak hours, and a 29 m³ heat storage which balances the heat generated during off-peak hours and consumption during peak hours.

To bring the supply heat temperature to 45 degrees, solar energy is a priority. If more heating is needed, for example, in cold seasons, cloudy times, nights, etc., the pellet boiler is set. Besides, during peak hours, if these two generators and the buffer volume do not meet the heat demand, the gas boiler compensates for the lack of energy.

Due to the lack of need for space heating, solar energy provides a large part of the heat demand in summer. A large portion of it is stored in the buffer during the day and used

at night. The network uses underground twin pipes for piping to substations. This technology has a high share of energy savings and efficiency and dramatically reduces heat loss.

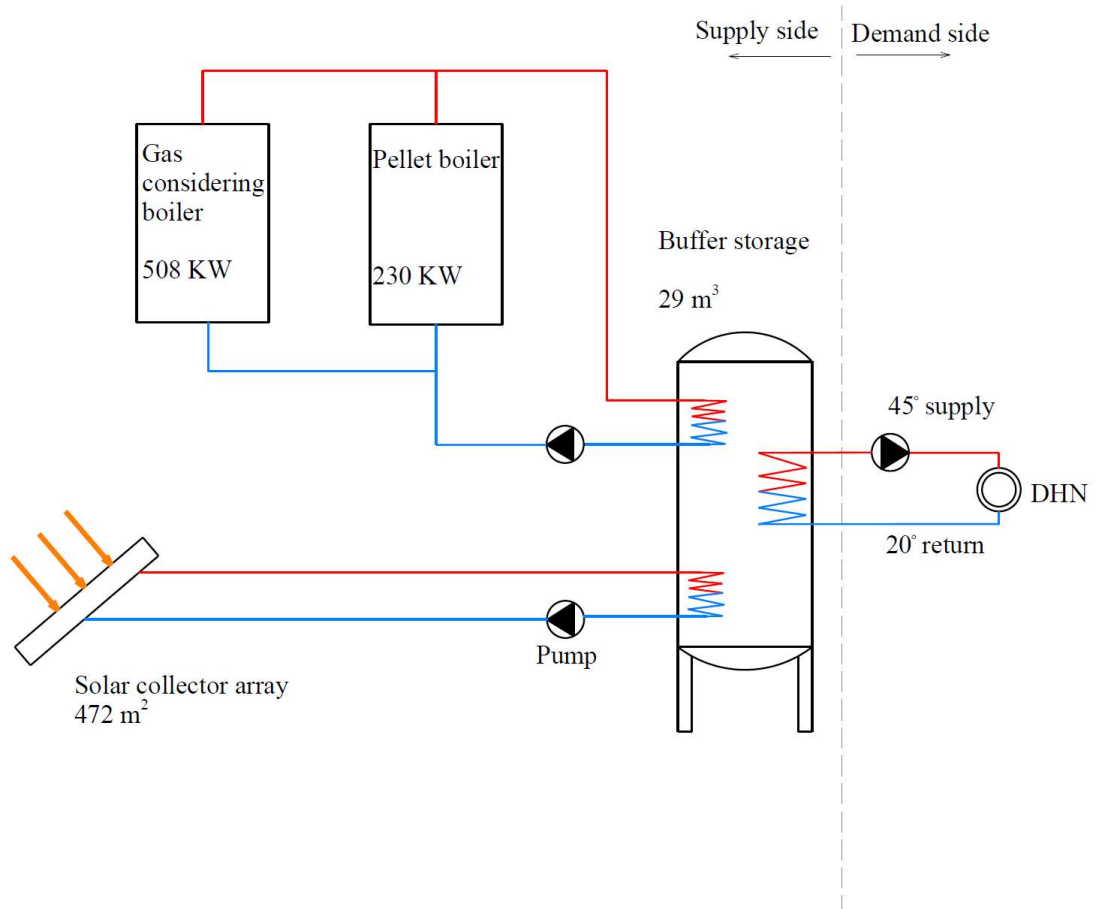

Figure 33 The layout of desired heating plant with RE

Due to several apartments in each building, this type of substation is selected, with two buffers and a mini heat pump. The heating of the building space is from 20 to 30, so the water supply of 45°C by a HX with return water has reached the desired temperature and, in a way, is used directly. But to have hot Drinkwater of 60°C to 65°C, a mini HP is

used. Hot water is stored in buffers to minimize electricity consumption for running HP.

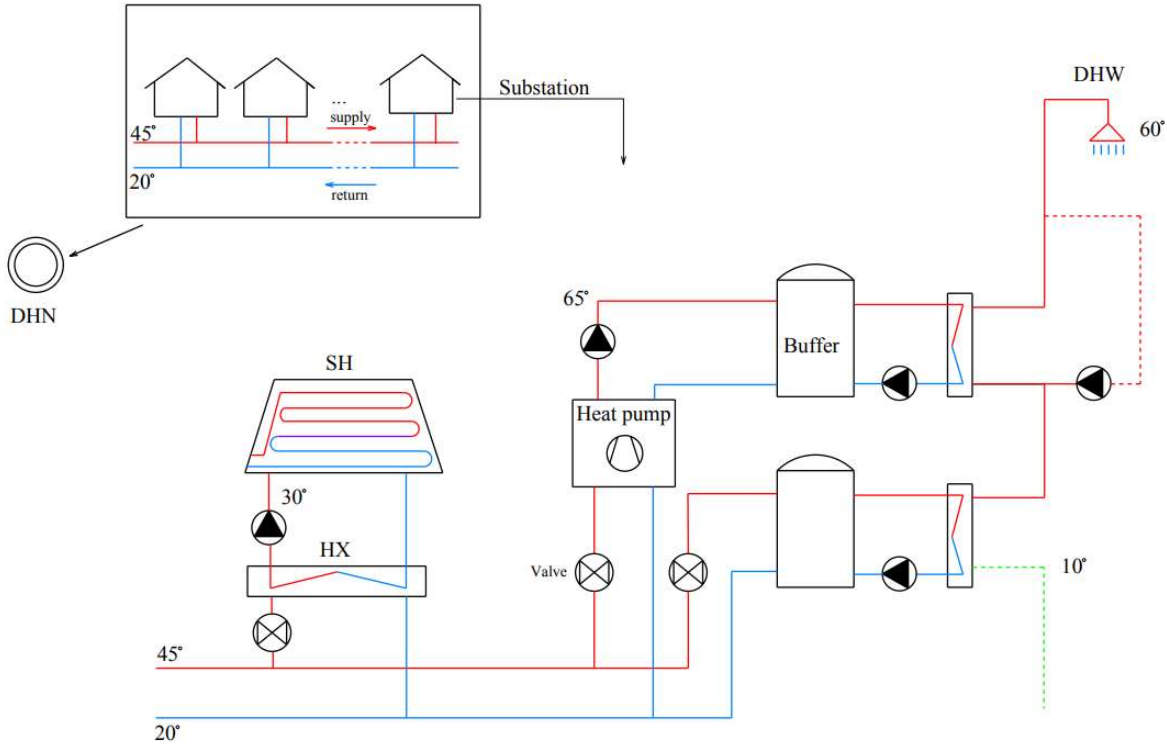

Figure 34 The layout of desired DH Grid

Chapter 6

Financial part

For the financial evaluation of the selected with /without RES, the incomes, expenses, subsidies, and the systems' initial investment is defined. In the incomes, the cash flow inputs come from the revenue of supplying district heating to customers and feeding electricity by CHP units into the grid per year. Therefore, the payback time will be determined by the incomes generated by the outcome of DHN. On the other hand, the yearly expenses are generated by the Operation and Maintenance (O&M) costs.

6.1 Subsidies

According to the explanation of how to calculate subsidies in Section 3.2, the results are summarized in Table 24 and its details are given in appendix 18.

Table 24 Subsidies calculation results

Subsidies		
Subside program	RE-system	Non-RE system
KFW	361,818 €	5,500 €
BAFA	0 €	202,920 €
TFZ	23,100 €	0 €
Total	384,918 €	208,420 €

6.2 Costs

6.2.1 Fuel Costs

The first system consists of CHP units and a gas boiler, which consume natural gas, and the second system is supplied by wood pellets and biogas. Details of all three types of fuel are given in the previous sections. The cost of natural gas and biogas is calculated according to Equations 7 and 8.

$$EP(\text{€}) = \text{Annual} \frac{\text{Fuel}}{\text{Electricity}} \text{consumption (kWh)} \times \frac{\text{the price of EP per kWh (Cent)}}{100} \left(\frac{\text{Cent}}{\text{kWh}} \right) \quad (7)$$

$$\text{Annual Fuel/Electricity cost (€)} = EP (\text{€}) + BP (\text{€}) \quad (8)$$

The price of pellets can be calculated in two ways and with information on the amount of fuel in kilograms or kilowatt-hours.

$$\text{Pellet cost (€)} = \text{Annual Pellet consumption (kWh)} \times \text{pellet cost per kWh (€/kWh)} \quad (9)$$

$$\text{Pellet cost (€)} = \frac{\text{Annual pellet consumption (kWh)}}{\text{Energy content of the pellet } \left(\frac{\text{kWh}}{\text{Kg}}\right)} \times \text{pellet cost per Kg (€/Kg)} \quad (10)$$

Table 25 Fuel costs of both systems per year

Fuel-types	RE system	Non-RE system
Natural gas	0 €	120,251 €
Biogas	6,862 €	0 €
Pellet	44,675 €	0 €
Total	51,537 €	120,251€

6.2.2 Investment costs

For the selected systems, each part's costs were provided directly by the manufacturer and with a rule of thumb from the company. The investment cost for both systems are summarized in the following table:

Table 26 Investment costs

			Investment costs	
	Quantity	Euro per unit	RE System	Non-RE System
1	Building and technical equipments		1,217,916 €	1,099,356 €
	Gas system	1 15,000 €	15,000 €	15,000 €
	CHP1 (YADO/EG-70)	1 94,000 €	- €	94,000 €
	CHP2 (YADO/EG-60)	1 86,000 €	- €	86,000 €
	Gas boiler (VITOCROSSAL300/CT3B)	1 36,000 €	36,000 €	36,000 €
	Pellet boiler (PT4e)	1 70,000 €	70,000 €	- €
	Solar thermal	472 m ² 480 €	226,560 €	- €
	Buffer storage	29(RE),22(NRE) m ³ 1,000 €	29,000 €	22,000 €
	Heat transfer station	50 8,000 €	400,000 €	400,000 €
	Distributor	1 4,000 €	4,000 €	4,000 €
	Pipelines	1,974 m 180 €	355,356 €	355,356 €
	Chimney	2(RE), 3(NRE) 5,000 €	10,000 €	15,000 €
	Equipment per 400000kWh/a	3.6 15,000 €	54,000 €	54,000 €
	Other	1 18,000 €	18,000 €	18,000 €
2	Electrical systems		20,000 €	20,000 €
3	Building automation		20,000 €	20,000 €
4	Heating building		200,000 €	200,000 €
5	Additional building costs		314,479 €	284,839 €
	Planning	25%* technical equipments costs	304,479 €	274,839 €
	General construction costs	1 5,000 €	5,000 €	5,000 €
	Other construction costs	1 5,000 €	5,000 €	5,000 €
Sum			1,782,168 €	1,633,968 €

6.2.3 Maintenance and operation costs

These costs include three categories: heating components, building automation, and building electrical systems. The calculation of this cost is equivalent to a percentage of the investment costs, which in all cases except the CHP unit and solar thermal system (with 6% and 1.5% respectively) is equal to 2.5%. The costs of both systems are listed in the table below.

Table 27 M&O costs

		Maintenance and operation costs	
		RE System	Non-RE System
1	Components	21,772 €	27,249 €
	CHP1 (YADO/EG-70)	- €	5,640 €
	CHP2 (YADO/EG-60)	- €	5,160 €
	Gas boiler (VITOCROSSAL300/CT3B)	900 €	900 €
	Pellet boiler (PT4e)	1,750 €	- €
	Solar thermal	3,398 €	- €
	Buffer storage	725 €	550 €
	Heat transfer station	10,000 €	10,000 €
	Distributor	100 €	100 €
	Pipelines	3,554 €	3,554 €
	Equipment	1,345 €	1,345 €
2	Electrical systems	500 €	500 €
3	Building automation	500 €	500 €
	Sum	22,772 €	28,249 €

6.2.4 Electricity costs

This cost is divided into two electricity consumption costs of heating network components and the amount of electricity produced by CHP units and sold to the electricity network. The required electricity calculation components include boilers and CHP units, which are approximate but close to the actual value. Besides, the cost of consuming heat pumps at each heat transfer station is paid by customers and is not included in the system's recurring costs. The simulation results of both systems are shown in the table below.

Table 28 Electricity details

Components	Electricity consumption (kWh/a)		Electricity output (kWh/a)	
	RE System	Non-RE system	RE System	Non-RE system
Boilers	1,694	1,807	0	0
CHP units	0	1,691	0	721,708
Heating elements	0	0	0	0
Total	1,694	3,498	0	721,708
Heat pumps	79,670	79,670	0	0

6.2.4.1 The outcome of CHP units

According to the BHKW-consult, there are two feed-in tariffs.

- The specific subsidy rate - i.e., the cents per kWh that a CHP system receives in the first ten years or the first 30,000 operating hours regardless of whether the electricity is used by the customer or fed into the power grid.
- The feed subsidy rates refer to the cents per kilowatt-hour that a CHP system fed into the power grid.

(BHKW-Consult 2020)

Table 29 The price of electricity output and fed into grid from CHP units

	net prices 2020		outcome of CHP units
The specific subsidy rate (€)	4.53	Cent/kWh	32,686
The feed subsidy rates (€)	6.07	Cent/kWh	43,799
Total price per year (€)	The first ten years		76,501
	After the 10 th year		43,808

6.2.4.2 Electricity consumption cost

Stadtwerke-Dachau supplies the electricity required for the area, the price of which is calculated according to the table prepared from Stadtwerke-Dachau and equations 7 and 8.

Table 30 Electricity price details from Stadtwerke-Dachau

	net prices 2020		RE System	Non-RE system
Energy price (€)	0.3094	€/kWh	524.25	1,082
Base price (€)	74.74	€/Year	74.74	74.74
Total price per year (€)			599	1,157

6.2.5 CO2 prices

The federal government will invest the income from CO2 pricing in the climate protection program measures - for example, for climate-friendly transport and energy-efficient

buildings. Currently, the price of carbon dioxide is 10 euros per ton. With the federal and state governments' agreement in the mediation committee, it will change the price of CO2 from January 2021 at 25 euros per ton. After that, the price will gradually increase to 55 euros in 2025. By 2026, the price range should be at a minimum of 55 and a maximum of 65 euros. (The federal government 2020)

In this project, the average price of carbon dioxide for the years between 2021 and 2025 is 40 euros, and from 2025 onwards, 60 euros. The CO2 factors are taken from BAFA. As stated in the carbon dioxide emission guidelines, the district heating factor is 0.28 and a relative value that should increase or decrease depending on fuel type. This fee is one of the parameters in the customer invoice and is paid by them. The table below compares the CO2-pricing of both systems with fossil fuels and renewable energies. (BAFA 2020a)

The CO2 price is calculated via the following equation:

$$CO_2 - \text{prices (€)} = CO_2 - \text{factor (t/MWh)} \times (\text{amount of Fuel})/1000 (\text{MWh}) \times CO_2 - \text{price (€/t)} \quad (11)$$

As can be seen, although the actual emission cost in a renewable energy system is much lower than the cost of emitting a district heating system, according to government policies, the emission cost is considered the same for both systems.

Table 31 CO2-Pricing

Co2- pricing							
CO2-Price							
	Untill 2021			10.0 €/t			
	2021-2025			40.0 €/t			
	from 2025			60.0 €/t			
Fuel/heat generator	Scenario	CO2- Factor (t/MWh)	Fuel (kWh)	CO2 amount (t)	CO2- pricing till 2021	CO2- pricing from 2021 to 2025	CO2- pricing from 2025
Biogas	Scenario 2	0.148	187,079	27.69	277 €	1,107.51 €	1,661.26 €
Pellet	Scenario 2	0.023	982,310	22.59	226 €	903.73 €	1,355.59 €
Light heating oil		0.266		0.00	- €	- €	- €
Heavy fuel oil		0.294		0.00	- €	- €	- €
Natural gas	Scenario 1	0.202	2,378,844	480.53	4,805 €	19,221.06 €	28,831.59 €
Coal		0.337		0.00	- €	- €	- €
Lignites		0.381		0.00	- €	- €	- €
District heating	both	0.28	1,435,149	401.84	4,018 €	16,073.67 €	24,110.51 €
Woodchips		0.029	0	0.00	- €	- €	- €
Scenario 1				480.5 t/MWh	€ 4,805.27	€ 19,221.06	€ 28,831.59
Scenario 2				50.3 t/MWh	€ 502.81	€ 2,011.23	€ 3,016.85
DHN				401.8 t/MWh	4,018.42 €	16,073.67 €	24,110.51 €

6.2.6 The district heating price

The district heating price (DHP) consists of a part that depends on consumption and a part that is independent of consumption. (neu-Stadtwerke 2020)

- Base price (BP) refers to all fixed components of the costs - the costs incurred regardless of actual consumption - are in district heating basic price included. The fixed costs mainly consist of the capital costs for generating plants, transport lines, transfer stations, and the personnel costs for operation, maintenance, and repair.
- Energy price (EP) is covering the fixed costs of the district heating price. This is consumption-dependent, and it is directly related to the amount of heat you use. The energy price covers the cost of using fuel to generate district heating.
- Measurement price (MP) is also independent of consumption. It includes the district heating counter (heat quantity calculator) and the costs for metering and billing.

With 1,435,149 kWh Annual consumption and 732 kW connected load, the price of district heating that will be received from customers on an annual basis is calculated according to the following formulas and results are shown in the following table.

$$EP = \text{Annual heat consumption (kWh)} \times \text{net price of EP (€/kWh)} \quad (12)$$

$$BP = \text{Connected load (kW)} \times \text{net price of BP (€/kW)} \quad (13)$$

$$MP = \text{Net price of MP} \times 12 \quad (14)$$

$$DHP = EP + BP + MP \quad (15)$$

Table 32 District heating prices (connection load is greater than 16 kW)

	net prices 2020		District heating prices per year
Energy price	0.0608	€/kWh	87,257 €
Base price	37.85	€/kW	27,706 €
Measurement price	33.23	€/Month	399 €
Total price			115,362 €

6.3 Low interest loans

To advance both projects and since the buildings are built according to KFW standards, the existing KFW program and its defined loans can be used.

6.3.1 Loan amount

- a maximum of 25 million euros per project
- Up to 100% of the eligible costs are financed.

(It is assumed that 90% -100% of the project investment cost will be covered by the loan).

6.3.2 Duration and fixed interest rates

- Up to 5 years with a maximum of 1 grace year and a fixed interest rate for the entire term of the loan
- Up to 10 years with a maximum of 2 grace periods and a fixed interest rate for the entire term of the loan
- Up to 20 years with a maximum of 3 grace years for investment projects with a technical and economic life of more than 10 years.

According to the KFW risk-based interest system Instruction sheet, this project can be financed under the best price range and with a 1.76% annual interest rate. (KFW 2020b)

6.3.3 Loan Payment Calculations

The loan repayments consist of two parts: the part that reduces the balance to repay the loan and the part that covers the interest on the loan. There are some essential factors to calculate the amount of repayment of a loan.

- Loan term refers to the loan repayment period is until settlement. Shorter loan terms generally mean higher repayments but less interest in the long run, while more extended repayments reduce annual repayments but have higher interest rates over the loan's life.
- The grace years means the specified deadline after the due date can be paid without penalty.
- The interest rate is the amount that the lender sets as a percentage of the loan principal. Interest rates are usually recorded annually, known as the annual percentage rate (APR).

$$\text{Annually repayment} = \frac{a}{n} \quad (16)$$

Where:

a: The amount of the loan

n: Loan term – grace years

After the calculation for the initial investment, annual incomes and expenses, the annual project cash flow and the overall project balance (for N years) must be determined using the following formulas:

$$\text{Cash flow} = I_{\text{heating and electricity}} - \text{Expenses} - \text{Cash flow from bank loan} \quad (17)$$

$$\text{Project Balance} = \text{Initial Investment} + \sum_{i=1}^N \text{Cash flow} \quad (18)$$

$$\text{Cash flow from bank loan} = \text{Interest on bank loan} + \text{repayment} \quad (19)$$

$$\text{Interest on bank loan} = \text{Interest rate} \times \text{residual debt} \quad (20)$$

$$\text{residual debt} = \text{residual debt of last year} - \text{repayment} \quad (21)$$

Where:

$I_{\text{heating and electricity}}$: Income from generated heating and electricity and emission price.

Expenses: Payments for annual electricity consumption, fuel costs, and R&O expenses

The projects' duration is 20 years; therefore, the project's cash flow and the project's balances are determined for this period, and the results are summarized in the appendix. For both projects, there is no return on investment in the 20 years until the bank installments are completed, and if we assume that there is no fixed equipment and reinvestment, the return on investment is possible after the twentieth year. Besides, the internal rate of return (IRR) of the project alignment was calculated using an Excel tool. The final financial results of the projects are shown in the following graphs:

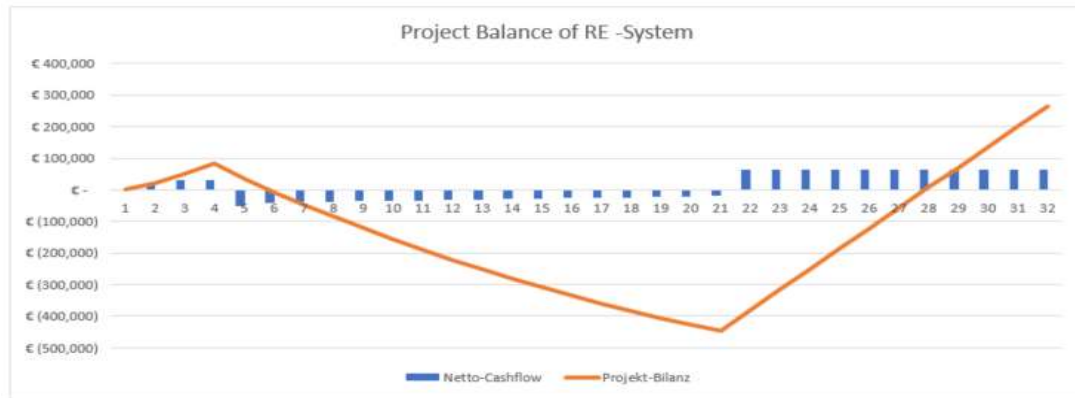

Figure 35 Cash flow diagram of the project with integrating RE

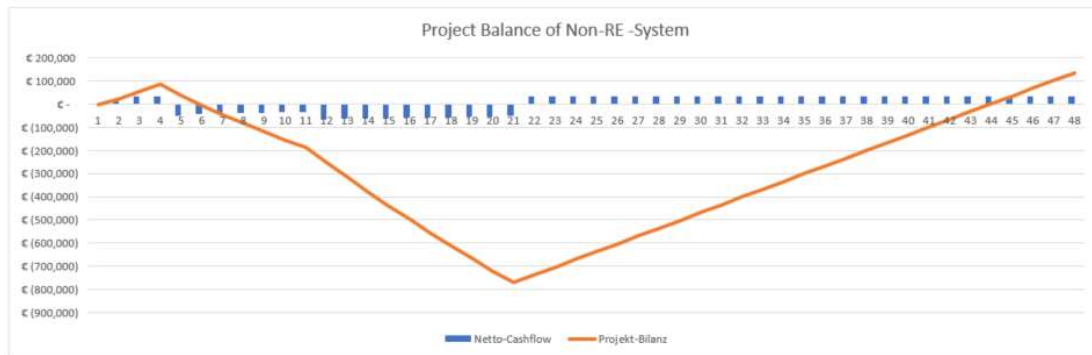

Figure 36 Cash flow diagram of the project without integrating RE

6.4 Financial results

Finally, a summary table with the financial results of the projects is presented:

Table 33 Financial results of the projects in a standard energy price

Description	Value	
	RE system	Non-RE system
Internal Rate of return (%)	36%	37%
Payback time (years)	28	44
Final project balance (Euro)	€ -44 ,278	€ -771,427
Duration of the project (years)	20	20

Although both systems do not seem to be economically viable, the renewable energy system is a priority due to lower payback time.

On the other hand, with proper pricing for district heating costs, the system can be made more valuable for investment. The results of the applied price change as well as considering the 95% loan are given in the following tables.

Table 34 Financial results (energy price=7.71 cent/kWh)

Description	Value	
	RE system	Non-RE system
Internal Rate of return (%)	40%	28%
Payback time (years)	2.5	26

Table 35 Financial results (energy price= 9 cent/kWh)

Description	Value	
	RE system	Non-RE system
Internal Rate of return (%)	83%	82%
Payback time (years)	2	2

As it turns out, with a slight increase in the price of energy, a heating system integrated with renewable energy is a cost-effective system to invest in.

Chapter 7

Discussion

This master's thesis has been done in collaboration with DME-Consult. This company provides heating concepts and heating facilities individually or connected to the district heating network using renewable or fossil fuels.

While electricity is more important in energy transmission, heat generation, distribution, and consumption are of secondary importance. Even if the demand for thermal energy in Germany is about 25% of the total energy required, the building sector's share is even 70%. This energy demand can be met by a large amount of technology and heat sources. While the amount of heat has been significant for many years, project leaders should focus on increasing the efficient use of heat and heat distribution due to current policies, fuel price changes, and environmental taxes.

One of the methods of supplying heat to the building is the district heating network, which has provided many solutions and measures to minimize network heat loss, energy consumption, and CO₂ and GHG emissions. Including:

- Construction and renovation of buildings with the lowest energy demand. In this regard, there are standards such as KFW55, KFW70, etc. These standards guide the implementing companies in applying the type and manner of insulation and construction.
- District heating systems with low and Ultra-low temperature and minimizing the network's flow and return temperature.
- Using more renewable energies and using clean energy potentials in the local region.

This project's subject is the design of a Low or Ultra low-temperature DHN in a newly built residential area in Dachau and southern Germany. A district heating network consists of a heating center consisting of heat generators that balance heat demand with production, storage, and backup.

This project includes two scenarios. In the first scenario, the grid is fed with natural gas, and in the second scenario, renewable energies replace fossil fuels. Finally, the two projects are compared in terms of efficiency, environmentally friendly, and economically. It is worth noting that the first scenario was simulated with the tools available in the company, assuming that 10% of the primary energies is supplied by heating element

and electricity. Due to the high cost of electricity, in the next step, with the help of a new simulator, the share of electricity in the energy supply is eliminated and other fuels are replaced.

The required heating of the region reaches all the houses from the DHN. Moreover, electricity is used only in the running of heating devices and heat pumps inside the houses. This amount of electricity is supplied only from the local electricity network, and also the electricity taken out of the CHP units is injected only into the local electricity grid. The specifications related to the required electricity and the generated electricity are given in Table 29.

Heat transmission and production network included:

- The main network of hot water suppliers
- Substations
- Secondary network that transmits hot water to the user.

The pie charts below show the share of energy generated by each generator in two scenarios.

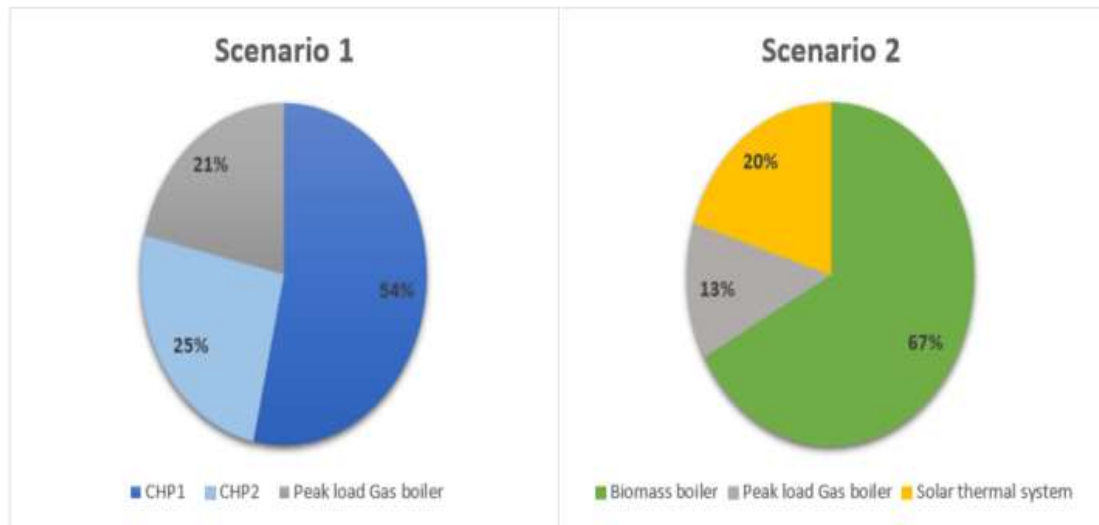

Figure 37 The contribution of each device in energy production

Considering the base price of the district heating network for customers at 7.71 cents per kilowatt-hour, both scenarios are summarized and compared in the table 36.

Table 36 Comparison of two project scenarios

			Scenario 1	Scenario 2	
The main components of DHN of current project	Heating Center	Generators/Storage	CHP units peak load gas boiler buffer storage	Solar thermal system Pellet boiler peak load gas boiler buffer storage	
		Primary energies	Natural gas	Solar energy biomass(pellet) biogas	
	Heat transmission	Main network pipes	Twin Pipe $T_{flow}/T_{ret}=45/20^{\circ}\text{C}$	Twin Pipe $T_{flow}/T_{ret}=45/20^{\circ}\text{C}$	
		Substation type	Direct supplied for SH and Micro and booster HP+ HX+ heat storage for DHW	Direct supplied for SH and Micro and booster HP+ HX+ heat storage for DHW	
		Secondary network	Water tabs, radiators, underfloor	Water tabs, radiators, underfloor	
	CO ₂ emission			480.5 t/MWh/year	50.4 t/MWh/year
Financial analysis	IRR			28%	40%
	Payback time			26 years	2.5 years

Cases of low and Ultra low-temperature district heating networks have been studied extensively, some of which are listed in Section two. The proposed solutions can be summarized in table 37.

The results show that although in the district heating network, the usage of renewable energies, underground and air-water heat pumps is preferred as the primary energy sources, especially in the environmental field, the results of economic evaluations in some cases indicate that fossil fuels, especially natural gas, are more economical. Nevertheless, in Germany, as the results of this project and other studies show, biomass and solar can be entered into the competitive market due to greenhouse gas emission taxes, bonuses, numerous financial support from the government, and low-interest loans. It even places the optimality of the renewable system at a great distance from the fossil system.

Heat storage tanks play a critical role in optimizing the system, and also seasonal storage is a useful solution in benefiting from 90% to 100% of the absorbed solar renewable energy. However, according to financial calculations, STES are not cost-effective.

Among the available solutions for DHW supply, direct plumbing from the bathroom network, and the use of an electric heater for the kitchen, is an interesting proposal and solution in optimizing the supply of the domestic hot water system. But in case of power outages and network problems, electric heater without a storage tank has some drawbacks. On the other hand, many have suggested booster and mini HP and their connection to the buffer storage that this technology has been used in this project. Besides, it is useful for using two buffer storages per substation to reduce electricity consumption to set up mini heat pumps in buildings.

Table 37 Comparison of several Low/Ultra-low temperature DHN

	system specification	Results
Case 1	Comparison of different pipes in terms of efficiency in heating networks.	Insulation of pipes using polyethylene foam greatly reduces heat loss. Also, the main energy savings in triple pipes are more than in twin-pipes.
Case 2	Equipping the substations for hot water supply with several different technologies, including: <ul style="list-style-type: none"> - With the storage tank - Electric heater stored inside the tank - Electric heater only for the hot water supply of the kitchen - Electric heater for domestic hot water - With booster/ micro heat pumps and ST 	Since the system temperature is sufficient to heat the home environment and the bathroom's hot water, the use of electric heaters in the kitchen is the most optimal, economical, and practical case in ideal conditions. Electric heater without a tank for DHW has both pros and cons points. High safety and efficiency are probably the best options for small, single-family apartments with low heat demand. However, in large and huge buildings consisting of several apartments, by replacing separate electric heaters with a mini HP and buffer, electricity costs are significantly reduced. Even in the event of a power outage, hot water is always available.
Case 3	A system consisting of CHP biomass, GWHP, and a photovoltaic system in which substations are equipped with TES, HX, and HP.	Electricity demand for heat pumps is met by PV and CHP outputs. No financial evaluation information was provided in this study. But empirically, the integration of GWHP into the network requires high investment and requires a large space for the construction. Therefore, it is not recommended for small and medium systems.

<p>Case 4</p>	<p>It consists of two scenarios. Both of which are supplied with renewable energies. In the first scenario, a LTDHN provides DHW and SH directly. In the second scenario, hot water reaches the customer with micro heat pumps from ULTDHN.</p>	<p>It was illustrated that in most cases, Low-temperature district heating is economically preferred. But at high thermal densities, if the investment cost of a central heating unit can be significantly reduced, ULTDH will be possible and even more efficient. Also, the energy efficiency of ULTDH increases compared to LTDH if it is supplied by HP.</p> <p>Due to the lack of booster HPs and substations' expensive systems in LTDHN, this system is more economical than ULTDH. Assuming that the Heat demand and heat density increase as a result of adding customers to the network or turning the one-family house or small apartments into complex apartments, it is evident that fuel consumption will increase. In this case, installing the booster HPs in substations, lowering the flow temperature, and replacing new and cheaper devices as generators with HPs or improving the COP of system, will make the network more economical.</p> <p>The thermal density of the current project is high, and it includes a large set of apartments. Therefore, designing a network with a flow temperature of 45°C and using biomass boiler, gas boiler, and mini HP in substations puts it in a favorable position.</p>
<p>Case 5</p>	<p>It offers three solutions for ULTDH's DHW supply.</p> <ul style="list-style-type: none"> - Electric heater without a storage tank. - Optimization of heat pump performance in DHW supply - Solar-based water production can reduce carbon dioxide emissions. 	<ul style="list-style-type: none"> - For the reasons already mentioned, an electric heater is not recommended for this project. - Although a solar water heater is a suitable method, the investment costs are high, and the payback time is extended. <p>In this project, PEWO's substations systems are used. In multi-family and large buildings, two buffers are used to store DHW. This way, hot water is always available, and less electricity is used to run the mini heat pumps.</p>

Case 6	In this project, separate PVT systems and solar thermal storage available in each building are used to supply DHW.	The PVT system also supplies the building with the electricity it needs, which reduces investment costs due to the lack of the use of the battery. This suggestion is significant, but it should be noted that the buffers inside the building are not able to store hot water for several days. Therefore, in the case of unfavorable weather conditions, such as cloudy skies for several consecutive days, this system is not practical and it is better to have a suitable alternative
---------------	--	--

Chapter 8

Conclusion and future works

8.1 Conclusion

A comparison of the two scenarios of low-temperature district heating networks shows that the scenario with integrating the renewable energies potentials of biomass and solar in the production of thermal energy, due to the German government's policies on financial support for renewable and efficient heating systems and the existence of significant subsidies, on the other hand, the additional costs of maintenance and operation, and fuel in the scenario which is fed with natural gas, is more economical. Besides, the network with renewable primary energies is much less harmful to the environment and more sustainable than the other system.

Despite the choice technology of mini heat pump and buffer for substations, which was a new proposal from the manufacturer in terms of economic and health benefits, but in future studies, other technologies can be evaluated with different factors. In addition, the use of storage tanks is the best option for increasing the system's optimization because although with the help of seasonal storage, solar energy can be fully utilized, studies show that this type of technology has not yet reached the stage of being economical and it raises costs.

8.2 Future Works

The project's main goal is to design a heating plant for a low-temperature DHN in Dachau, located in Germany, and to compare the system with two types of primary energies, renewable and fossil. However, in future works and projects, other interesting aspects of the project, which have been omitted due to lack of time or lack of prominence, can be done in the same area or other areas with similar regional details with the help of available data. The following can be mentioned:

- Grid review and optimization by modeling and benchmarking new technologies under the latest generation DHN specifications.
- Study different electricity-generating methods to supply the electricity required to set up energy plants and the whole region.
- Study various methods of optimal generation of power and heat simultaneously to supply the required energy for setting up the heating plant and the whole region.
- Study of other possible renewable potentials and their application in energy production and systems' comparison in various parameters.

- Study how to optimize the transmission components of low-temperature DHN (pipes and substations) and reduce energy waste.
- Study how to integrate more energy into the area as the area expands and customers are added to the grid.

References

1. A Comprehensive Review of Thermal Energy Storage (2018). In *Sustainability* 10 (2), p. 191.
2. Alsagri, Ali Sulaiman; Arabkoohsar, Ahmad; Khosravi, Milad; Alrobaian, Abdulrahman A. (2019): Efficient and cost-effective district heating system with decentralized heat storage units, and triple-pipes. In *Energy* 188, p. 116035. DOI: 10.1016/j.energy.2019.116035.
3. Aste, Niccolò; Caputo, Paola; Del Pero, Claudio; Ferla, Giulio; Huerto-Cardenas, Harold Enrique; Leonforte, Fabrizio; Miglioli, Alessandro (2020): A renewable energy scenario for a new low carbon settlement in northern Italy: Biomass district heating coupled with heat pump and solar photovoltaic system. In *Energy* 206, p. 118091. DOI: 10.1016/j.energy.2020.118091.
4. Averfalk, Helge; Werner, Sven (2020): Economic benefits of fourth generation district heating. In *Energy* 193, p. 116727. DOI: 10.1016/j.energy.2019.116727.
5. BAFA (2020a): CO2 Factors.
6. BAFA (2020b): Overview of renewable energies funding. PDF.
7. Bavarian Energy Atlas (2020a): Biomass. Bavarian Energy Atlas. Available online at https://www.energieatlas.bayern.de/thema_biomasse.html, updated on 2020.
8. Bavarian Energy Atlas (2020b): Geothermal. Bavarian Energy Atlas. Available online at https://www.energieatlas.bayern.de/thema_geothermie.html, updated on 2020.
9. Bavarian Energy Atlas (2020c): Solar thermal. Potential. Available online at https://www.energieatlas.bayern.de/thema_sonne/solarthermie/potenzial.html, checked on 2020.
10. Bavarian Ministry of Economic Affairs (2019): Current figures on energy supply in Bavaria. PDF.
11. Bavarian Ministry of Economic Affairs (2020a): Bavarian energy data.
12. Bavarian Ministry of Economic Affairs (2020b): Energy and natural resources. Renewable energies. Munich. Available online at <https://www.stmwi.bayern.de/energie-rohstoffe/>.
13. Bavarian Ministry of Economic Affairs (2020c): Renewable energies. Bioenergy. Available online at <https://www.stmwi.bayern.de/energie-rohstoffe/erneuerbare-energien/bioenergie/>.

14. Behzadi, Amirmohammad; Arabkoohsar, Ahmad; Yang, Yongheng (2020): Optimization and dynamic techno-economic analysis of a novel PVT-based smart building energy system. In *Applied Thermal Engineering* 181, p. 115926. DOI: 10.1016/j.applthermaleng.2020.115926.
15. Best, Isabelle; Orozaliyev, Janybek; Vajen, Klaus (2018): Impact of Different Design Guidelines on the Total Distribution Costs of 4th Generation District Heating Networks. In *Energy Procedia* 149, pp. 151–160. DOI: 10.1016/j.egypro.2018.08.179.
16. BHKW-Consult (2020): CHP calculation. BHKW-Consult. Available online at <http://www.bhkw-consult.de/kwk-zuschlag-berechnung-nach-dem-kwk-gesetz/>.
17. CAMS (2020): Radiation service. Copernicus Atmosphere Monitoring Service. France. Available online at <http://www.soda-pro.com/web-services/radiation/cams-radiation-service>, checked on 2020.
18. CARMEN (2020): Price development for wood pellets and woodchips. CARMEN. Straubing. Available online at <https://www.carmen-ev.de/infothek/preisindizes/holzpellets>.
19. Citrin Solar (2020a): data sheet of solar thermal collector. datasheet.
20. Citrin Solar (2020b): datasheet of buffer storage.
21. Delangle, Axelle Catherine Christel (2016): Modelling and Optimisation of a District Heating Network's Marginal Extension. Master's dissertation. Imperial College London, London.
22. Dincer, Ibrahim; Rosen, Marc A. (2013): Exergy Analysis of Thermal Energy Storage Systems. In : Exergy: Elsevier, pp. 133–166.
23. Dinçer, İbrahim; Rosen, Marc A. (2010): Thermal Energy Storage: Wiley.
24. EnEV (2014): EnEV2009. Available online at <http://www.enev-online.org/>.
25. EWärmeG (2020): Biogas Instructions. EWärmeG. Available online at <https://www.erneuerbare-waerme-gesetz.de/erfuellungsoptionen>.
26. Frederiksen, Svend; Werner, Sven (2014): District heating and cooling. Lund: Studentlitteratur.
27. Fu, F. F.; Li, F. (2018): Optimal sizing of a solar thermal system in building based on simulation results of Polysun. In *IOP Conf. Ser.: Earth Environ. Sci.* 188, p. 12006. DOI: 10.1088/1755-1315/188/1/012006.
28. GoldsWorthy, P.; Eyre, D. J.; On, E. (2013): Value-in-use (VIU) assessment for thermal and metallurgical coal. In : The Coal Handbook: Towards Cleaner Production: Elsevier, pp. 455–496.



29. Guelpa, Elisa; Verda, Vittorio (2019): Thermal energy storage in district heating and cooling systems: A review. In *Applied Energy* 252, p. 113474. DOI: 10.1016/j.apenergy.2019.113474.
30. Gustafsson, J.; Sandin, F. (2016): District heating monitoring and control systems. In : *Advanced District Heating and Cooling (DHC) Systems*: Elsevier, pp. 241–258.
31. Ibrahim Tol, Hakan (2015): District Heating in Areas with Low Energy Houses. Detailed Analysis of District Heating Systems based on Low Temperature Operation and Use of Renewable Energy. PhD Thesis. DTU, Denmark. Technical University of Denmark.
32. Jansen, Sabine; Mohammadi, Saleh; Bokel, Regina (2021): Developing a locally balanced energy system for an existing neighbourhood, using the ‘Smart Urban Isle’ approach. In *Sustainable Cities and Society* 64, p. 102496. DOI: 10.1016/j.scs.2020.102496.
33. Jones, Sean Rhys; Gillott, Mark; Boukhanouf, Rabah; Walker, Gavin; Tunzi, Michele; Tetlow, David et al. (2019): A System Design for Distributed Energy Generation in Low-Temperature District Heating (LTDH) Networks. In *Future Cities and Environment* 5 (1), p. 39. DOI: 10.5334/fce.44.
34. Keisan online calculator (2020): Solar elevation angle (for a year) Calculator. CASIO COMPUTER CO. Japan. Available online at <https://keisan.casio.com/exec/system/1224682331>.
35. KfW (2020a): Renewable energies - premium/The promotional loan with a repayment allowance for heat. PDF.
36. KfW (2020b): Risk-adjusted interest system. KfW. Available online at <https://translate.google.com/?hl=de#view=home&op=translate&sl=de&tl=en&text=Risikogerechtes%20Zinssystem>.
37. KfW (2020c): The KfW efficiency house standard for a new building. Benchmark for energy efficiency. KfW. Frankfurt am Main. Available online at <https://www.kfw.de/inlandsfoerderung/Privatpersonen/Neubau/Das-KfW-Effizienzhaus/>, updated on 2020.
38. Koch, Katharina; Höfner, Peter; Gaderer, Matthias (2020): Techno-economic system comparison of a wood gas and a natural gas CHP plant in flexible district heating with a dynamic simulation model. In *Energy* 202, p. 117710. DOI: 10.1016/j.energy.2020.117710.
39. Logo Energie (2020): Biogas pricing. Logo Energie. Available online at <https://www.logoenergie.de/>.

40. Lumbreras, Mikel; Garay, Roberto (2020): Energy & economic assessment of façade-integrated solar thermal systems combined with ultra-low temperature district-heating. In *Renewable Energy* 159, pp. 1000–1014. DOI: 10.1016/j.renene.2020.06.019.
41. Lund, Henrik; Østergaard, Poul Alberg; Chang, Miguel; Werner, Sven; Svendsen, Svend; Sorknæs, Peter et al. (2018a): The status of 4th generation district heating. Research and results. In *Energy* 164, pp. 147–159. DOI: 10.1016/j.energy.2018.08.206.
42. Lund, Henrik; Østergaard, Poul Alberg; Chang, Miguel; Werner, Sven; Svendsen, Svend; Sorknæs, Peter et al. (2018b): The status of 4th generation district heating: Research and results. In *Energy* 164, pp. 147–159. DOI: 10.1016/j.energy.2018.08.206.
43. Lund, Rasmus; Mohammadi, Soma (2016): Choice of insulation standard for pipe networks in 4 th generation district heating systems. In *Applied Thermal Engineering* 98, pp. 256–264. DOI: 10.1016/j.applthermaleng.2015.12.015.
44. McKenna, R.; Fehrenbach, D.; Merkel, E. (2019): The role of seasonal thermal energy storage in increasing renewable heating shares: A techno-economic analysis for a typical residential district. In *Energy and Buildings* 187, pp. 38–49. DOI: 10.1016/j.enbuild.2019.01.044.
45. Meesenburg, Wiebke; Ommen, Torben; Thorsen, Jan Eric; Elmegaard, Brian (2020): Economic feasibility of ultra-low temperature district heating systems in newly built areas supplied by renewable energy. In *Energy* 191, p. 116496. DOI: 10.1016/j.energy.2019.116496.
46. neu-Stadtwerke (2020): District heating. neu SW. Available online at <https://www.neu-sw.de/fernwaerme/haeufige-fragen>.
47. Nilsson, S. F. (2016): New developments in pipes and related network components for district heating. In : *Advanced District Heating and Cooling (DHC) Systems*: Elsevier, pp. 191–214.
48. Pakere, Ieva; Romagnoli, Francesco; Blumberga, Dagnija (2018): Introduction of small-scale 4th generation district heating system. Methodology approach. In *Energy Procedia* 149, pp. 549–554. DOI: 10.1016/j.egypro.2018.08.219.
49. Pelda, Johannes; Stelter, Friederike; Holler, Stefan (2020): Potential of integrating industrial waste heat and solar thermal energy into district heating networks in Germany. In *Energy* 203, p. 117812. DOI: 10.1016/j.energy.2020.117812.
50. Pomianowski, M. Z.; Johra, H.; Marszal-Pomianowska, A.; Zhang, C. (2020): Sustainable and energy-efficient domestic hot water systems: A review. In

- Renewable and Sustainable Energy Reviews* 128, p. 109900. DOI: 10.1016/j.rser.2020.109900.
51. PVSol (2020): free tool for the calculation of PV system. Valentin Software GmbH. Available online at <http://pvsol-online.valentin-software.com/#/>.
52. Shakerin, Mohammad (2016): Analysis of district heating systems integrating distributed sources. M.Sc. NTNU, Norway.
53. TFZ (2020): Funding of wood chip and pellet heating systems. The technology and support center in the Competence Center for Renewable Raw Materials (TFZ). Straubing. Available online at <https://www.tfz.bayern.de/foerderung/biomasseheizwerke/index.php>.
54. The federal government (2020): Climate protection. Available online at <https://www.bundesregierung.de/breg-de/themen/klimaschutz>.
55. Tian, Chuan; Feng, Guohui; Li, Shuai; Xu, Fuqiang (2019): Scenario Analysis on Energy Consumption and CO₂ Emissions Reduction Potential in Building Heating Sector at Community Level. In *Sustainability* 11 (19), p. 5392. DOI: 10.3390/su11195392.
56. VIESSMANN (2020): Datasheet of Vitocrossal 300.
57. Volkova, Anna; Mašatin, Vladislav; Siirde, Andres (2018): Methodology for evaluating the transition process dynamics towards 4th generation district heating networks. In *Energy* 150, pp. 253–261. DOI: 10.1016/j.energy.2018.02.123.
58. YADOS (2020): Technical data of YADO/KWK EG. Datasheet.
59. Yang, Xiaochen; Li, Hongwei; Svendsen, Svend (2016): Evaluations of different domestic hot water preparing methods with ultra-low-temperature district heating. In *Energy* 109, pp. 248–259. DOI: 10.1016/j.energy.2016.04.109.

Appendix

Appendix 1 Energy configurations developed for the case study of Jansen , matching the demand with the available sources.

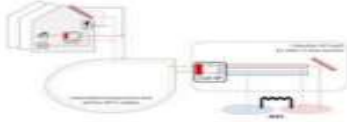
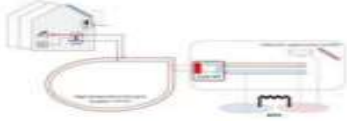
<p>Option 1) Individual air source heat pump</p>		<p>Each building has an individual heat pump using the outdoor air as a heat source. As not all dwellings are suitable for individual ground source or solar thermal heat pumps, the air source heat pump option is selected for the comparison.</p>
<p>Option 2) Ultra-low temperature (ULT) heat grid with individual heat pumps and PVT</p>		<p>The ULT heat grid is connected to Aquifer thermal storage (ATES). In winter, the heat grid functions as a source of the heat pump; in spring and autumn, the thermal output of PVT is used by the heat pump; in summer, the overproduction of the PVT is used to regenerate the ATES, which would otherwise not in annual thermal balance.</p>
<p>Option 3) Low/medium temperature heat grid with booster heat pumps at the dwelling level.</p>		<p>The LT/MT heat grid is connected to an provided by a collective heat pump which is connected to an ATES. Space heating is directly supplied by the grid; hot water is produced with a booster heat pump. As in option 2, individual PVT can be used to regenerate the ATES system, but as the output of PVT is lower for higher temperatures (see Fig. 7), more collective regeneration must be accounted for in option 3 than in option 2.</p>
<p>Option 4) High Temperature (HT) heat grid with a collective HT heat pump</p>		<p>A collective HT heat pump is used to feed a HT heat grid, which is directly able to supply both space heating and domestic hot water. This option uses PV on the dwellings instead of PVT, since the low-temperature output of the PVT cannot be utilized in this concept. This means the generation of the ATES needs to be provided with other sources near the ATES wells. In this case, drycoolers are considered.</p>

CS 500

Bei wechselseitigem Anschluss können maximal 15 Kollektoren in Reihe verschaltet werden.

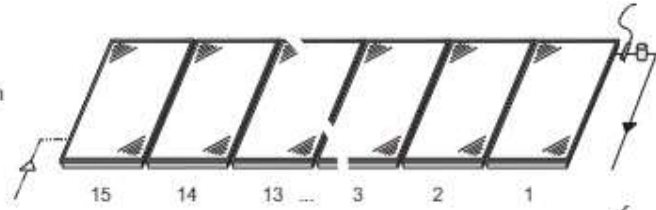

Bei einseitigem Anschluss können maximal 6 Kollektoren verschaltet werden.

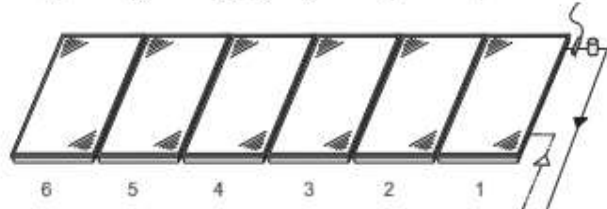

Bei mehr Kollektoren müssen gleich große Kollektorfelder nach Tichelmann verschaltet werden.

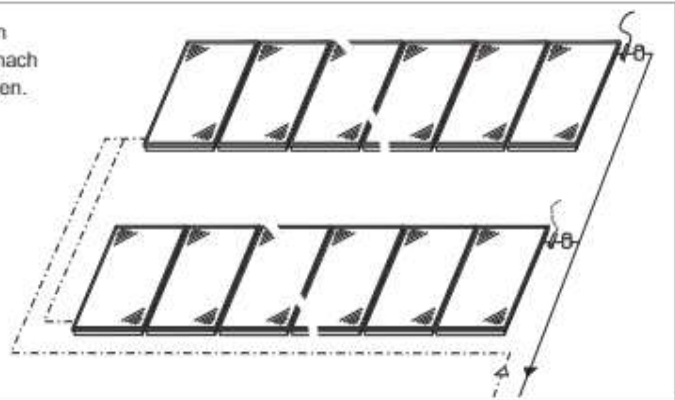

Beispiele für Verschaltungsmöglichkeiten

Bei 2-reihiger Montage von max. 15 Kollektoren müssen die beiden Reihen doppelt verbunden werden.

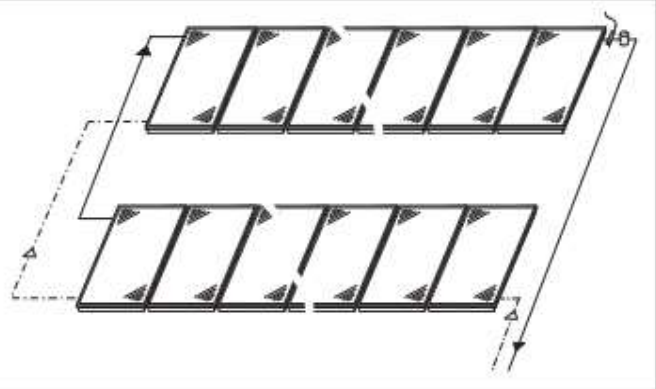

Vorlauf



Rücklauf



Position für Temperaturfühler



Alternative Position Temperaturfühler



Entlüftungstopf

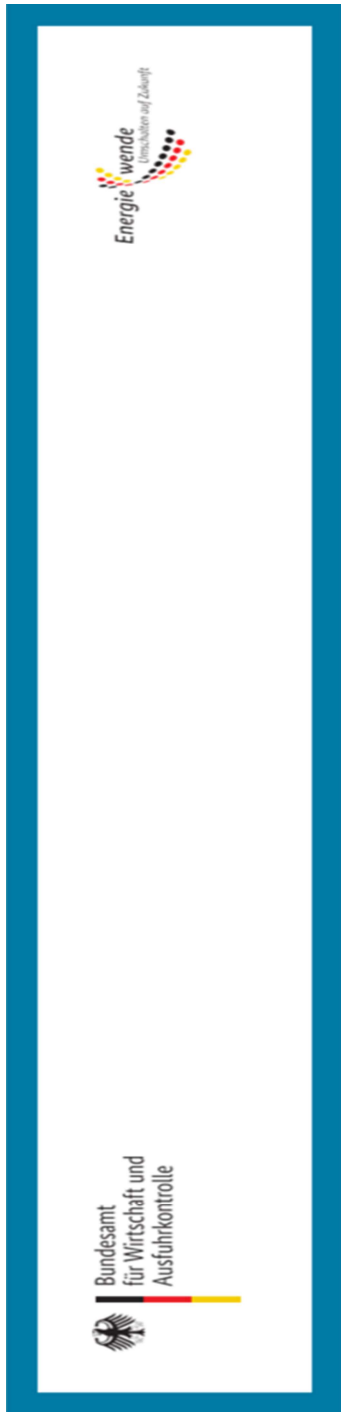

Overview of subsidies for Solar thermal (basic, innovation, and additional funding)

Measure	Basic funding	Support for innovation		Additional support			Optimization measure	
		Existing buildings	Existing buildings	New buildings	Biomass plant, heat pump plant	Heating network		Boiler
Construction of a solar collector system for ...	Existing buildings							
3 to 10 m ² collector area	500 €							
11 to 40 m ² collector area	50 €/m ² collector area	-	-	-				
20 to 100 m ² collector area	-	100 €/m ² collector area	75 €/m ² collector area					
... Exclusive hot water preparation								
to 14 m ² collector area	2.000 € ¹							
15 m ² to 40 m ² collector area	140 €/m ² Bruttokollektorfläche							
20 to 100 m ² collector area	-	200 €/m ² collector area	150 €/m ² collector area					
... combined hot water supply and heating support, solar cooling or heat network supply								
20 to 100 m ² collector area	-				500 €	500 €	additional 0.5 x basic or innovation support	With construction: 10 % of the net investment costs
... Heat or cold generation (alternative)								
20 to 100 m ² collector area	-	0,45€ x Annual collector yield x number of collectors						
Extension of an existing solar collector system	50 €/m ² additional collector area							



Bundesamt
für Wirtschaft und
Ausfuhrkontrolle



Energie wende
Investition auf Zukunft

Overview of subsidies for biomass (basic, innovation, and additional funding)

measure	Basic funding		Support for Innovation						Additional support		
	Existing buildings	New buildings	condensing technology		particle separation		Upgrading	Combination bonus		Building efficiency bonus	Optimization measure
			Existing buildings	New buildings	Existing buildings	New Buildings		Solar collector system, heat pump system	Heating network		
Systems from 5 to max. 100.0 kW nominal heat output	Existing buildings	2.000 €	-	-	3.000 € ^{3.1}	2.000 €					
	25.1kW to max. 100kW	80 €/kW	-	-	3.000 € ^{3.1}	2.000 €					
Pellet heater with water tank	Existing buildings	3000 €	4.500 € ^{3.1}	3.000 €	4.500 € ^{3.1}	3.000 €					
	25.1kW to max. 100kW	80 €/kW	4.500 € ^{3.1}	3.000 €	4.500 € ^{3.1}	3.000 €					
Pellet boiler	Existing buildings	3500 €	5.250 € ^{3.1}	3.500 €	5.250 € ^{3.1}	3.500 €					
	5 kW to 43.7 kW	80 €/kW	5.250 € ^{3.1}	3.500 €	5.250 € ^{3.1}	3.500 €					
Pellet boiler with a buffer storage (newly built) of at least 30 l/kW	Existing buildings	3500 €	5.250 € ⁷	3.500 € ⁷	5.250 €	3.500 €	750 €				
	43.8kW to max. 100kW	80 €/kW	5.250 € ⁷	3.500 € ⁷	5.250 €	3.500 €	750 €				
Wood chip boiler with a buffer tank of at least 30 l/kW	Existing buildings	3500 € per plant	4.500 € ⁸	3.000 € ⁸	4.500 € ⁸	3.000 € ⁸					
	25.1kW to max. 100kW	80 €/kW	4.500 € ⁸	3.000 € ⁸	4.500 € ⁸	3.000 € ⁸					
Combination boiler automatically fed pellet or wood chip boiler with a manually fed log wood gasification boiler	Existing buildings	mind. 5.000 €	mind. 7.500 €	3.000 €/3.500 €	mind. 6.500 €	3.000 €/3.500 €					
	25.1kW to max. 100kW	mind. 5.000 €	mind. 7.500 €	3.000 €/3.500 €	mind. 6.500 €	3.000 €/3.500 €					
Firewood gasification boiler with a buffer storage of at least 55 l/kW	Existing buildings	2000 € per plant	5.250 € ⁷	3.500 € ⁷	3.000 € ⁸	3.000 € ⁸					
	25.1kW to max. 100kW	2000 € per plant	5.250 € ⁷	3.500 € ⁷	3.000 € ⁸	3.000 € ⁸					

Appendix

Appendix 5 Excel sheet with the necessary parameters from Stadtwerke-Dachau on which calculations are performed.

Nr.	Buildings	Usable area(m²)	Year of construction
1	1.1	1,024	KFW 55
2	1.2	456	KFW 55
3	1.3	785	KFW 55
4	1.4	1,024	KFW 55
5	1.5	456	KFW 55
6	1.6	785	KFW 55
7	1.7	1,072	KFW 55
8	1.8	456	KFW 55
9	1.9	1,024	KFW 55
10	1.10	456	KFW 55
11	1.11	785	KFW 55
12	1.12	785	KFW 55
13	1.13	785	KFW 55
14	1.14	785	KFW 55
15	1.15	785	KFW 55
16	1.16	1,024	KFW 55
17	2.1	1,224	KFW 55
18	2.2	378	KFW 55
19	2.3	378	KFW 55
20	3.1	790	KFW 55
21	3.2	294	KFW 55
22	3.3	440	KFW 55
23	3.4	294	KFW 55
24	3.5	158	KFW 55
25	3.6	158	KFW 55
26	3.7	158	KFW 55
27	4.1	136	KFW 55
28	5.1	290	KFW 55
29	5.2	290	KFW 55
30	5.3	290	KFW 55
31	5.4	290	KFW 55
32	5.5	290	KFW 55
33	5.6	305	KFW 55
34	5.7	305	KFW 55
35	5.8	266	KFW 55
36	6.1	266	KFW 55
37	6.2	266	KFW 55
38	6.3	275	KFW 55
39	6.4	304	KFW 55
40	6.5	304	KFW 55
41	6.6	304	KFW 55
42	7.1	348	KFW 55
43	7.2	348	KFW 55
44	8.1	2,939	KFW 55
45	9.1	2,558	KFW 55
46	10.1	2,400	KFW 55
47	11.1	3,600	KFW 55
48	12.1	1,032	KFW 55
49	12.2	1,708	KFW 55
50	12.3	702	KFW 55
Sum		36,577	

Appendix

Appendix 6 Excel sheet with heat demand profile for each property

Nr.	Buildings	Heating demand			Hot water demand			total Load		
		Load(W/m ²)	demand (KW)	Heating consumption (kWh/a)	Load(W/m ²)	demand (KW)	Hot water consumption (kWh/a)	Load(W/m ²)	total demand (KW)	Consumption (kWh/a)
1	1.1	14	14	25,805	6	6	11,059	20	20	36,864
2	1.2	14	6	11,491	6	3	4,925	20	9	16,416
3	1.3	14	11	19,777	6	5	8,476	20	16	28,253
4	1.4	14	14	25,805	6	6	11,059	20	20	36,864
5	1.5	14	6	11,491	6	3	4,925	20	9	16,416
6	1.6	14	11	19,777	6	5	8,476	20	16	28,253
7	1.7	14	15	27,014	6	6	11,578	20	21	38,592
8	1.8	14	6	11,491	6	3	4,925	20	9	16,416
9	1.9	14	14	25,805	6	6	11,059	20	20	36,864
10	1.10	14	6	11,491	6	3	4,925	20	9	16,416
11	1.11	14	11	19,777	6	5	8,476	20	16	28,253
12	1.12	14	11	19,777	6	5	8,476	20	16	28,253
13	1.13	14	11	19,777	6	5	8,476	20	16	28,253
14	1.14	14	11	19,777	6	5	8,476	20	16	28,253
15	1.15	14	11	19,777	6	5	8,476	20	16	28,253
16	1.16	14	14	25,805	6	6	11,059	20	20	36,864
17	2.1	14	17	30,845	6	7	13,219	20	24	44,064
18	2.2	14	5	9,536	6	2	4,087	20	8	13,622
19	2.3	14	5	9,536	6	2	4,087	20	8	13,622
20	3.1	14	11	19,898	6	5	8,528	20	16	28,426
21	3.2	14	4	7,419	6	2	3,180	20	6	10,598
22	3.3	14	6	11,088	6	3	4,752	20	9	15,840
23	3.4	14	4	7,419	6	2	3,180	20	6	10,598
24	3.5	14	2	3,992	6	1	1,711	20	3	5,702
25	3.6	14	2	3,992	6	1	1,711	20	3	5,702
26	3.7	14	2	3,992	6	1	1,711	20	3	5,702
27	4.1	14	2	3,427	6	1	1,469	20	3	4,896
28	5.1	14	4	7,318	6	2	3,136	20	6	10,454
29	5.2	14	4	7,318	6	2	3,136	20	6	10,454
30	5.3	14	4	7,318	6	2	3,136	20	6	10,454
31	5.4	14	4	7,318	6	2	3,136	20	6	10,454
32	5.5	14	4	7,318	6	2	3,136	20	6	10,454
33	5.6	14	4	7,681	6	2	3,292	20	6	10,973
34	5.7	14	4	7,681	6	2	3,292	20	6	10,973
35	5.8	14	4	6,693	6	2	2,868	20	5	9,562
36	6.1	14	4	6,693	6	2	2,868	20	5	9,562
37	6.2	14	4	6,693	6	2	2,868	20	5	9,562
38	6.3	14	4	6,935	6	2	2,972	20	6	9,907
39	6.4	14	4	7,661	6	2	3,283	20	6	10,944
40	6.5	14	4	7,661	6	2	3,283	20	6	10,944
41	6.6	14	4	7,661	6	2	3,283	20	6	10,944
42	7.1	14	5	8,770	6	2	3,758	20	7	12,528
43	7.2	14	5	8,770	6	2	3,758	20	7	12,528
44	8.1	14	41	74,068	6	18	31,743	20	59	105,811
45	9.1	14	36	64,452	6	15	27,622	20	51	92,074
46	10.1	14	34	60,480	6	14	25,920	20	48	86,400
47	11.1	14	50	90,720	6	22	38,880	20	72	129,600
48	12.1	14	14	26,006	6	6	11,146	20	21	37,152
49	12.2	14	24	43,042	6	10	18,446	20	34	61,488
50	12.3	14	10	17,700	6	4	7,586	20	14	25,286
Sum		700	512	921,735	300	219	395,029	1,000	732	1,316,765

101_Dachau_Entwurfsplanung_.dwg

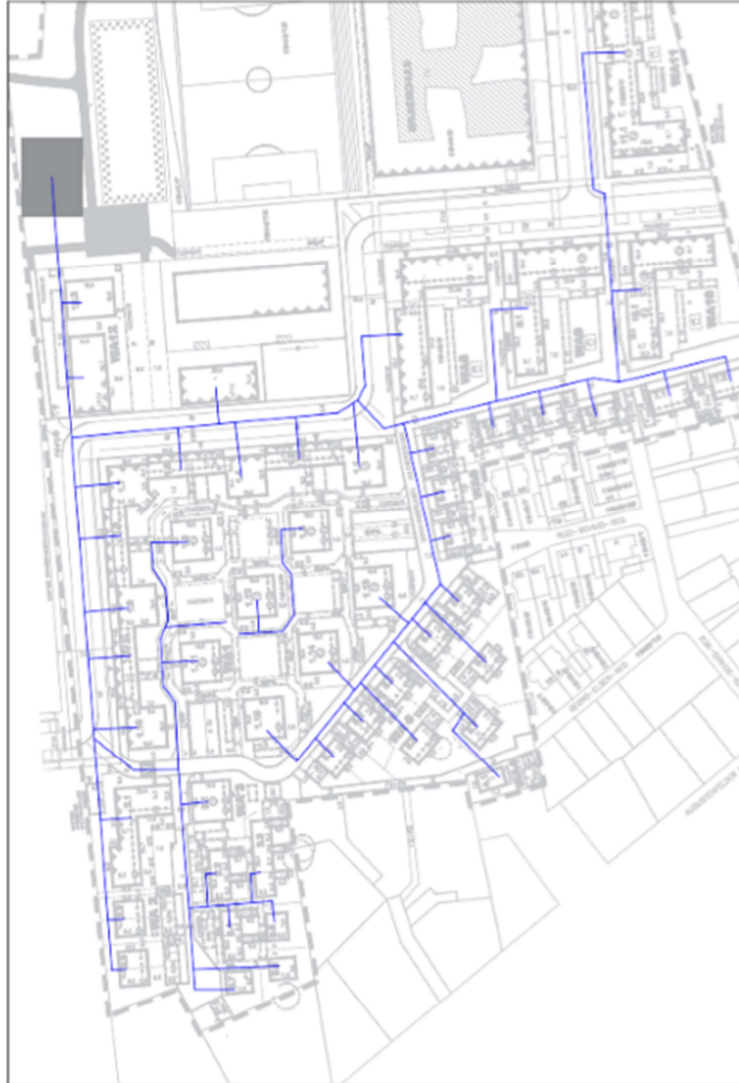

Appendix

Appendix 8 Excel sheet of piping specifications

Buildings	Piping		
	Piping	Pressure Loss	Nominal width (DN)
1.1	24.5 m	192.1 pa/m	20
1.2	15.5 m	195.5 pa/m	15
1.3	155.3 m	120.6 pa/m	20
1.4	20.8 m	192.1 pa/m	20
1.5	15.9 m	195.5 pa/m	15
1.6	45.0 m	120.6 pa/m	20
1.7	17.1 m	208.2 pa/m	20
1.8	16.2 m	195.5 pa/m	15
1.9	17.3 m	192.1 pa/m	20
1.10	16.4 m	195.5 pa/m	15
1.11	13.6 m	120.6 pa/m	20
1.12	12.2 m	120.6 pa/m	20
1.13	15.0 m	120.6 pa/m	20
1.14	14.6 m	120.6 pa/m	20
1.15	166.6 m	120.6 pa/m	20
1.16	16.8 m	192.1 pa/m	20
2.1	12.0 m	262.6 pa/m	20
2.2	6.4 m	141.1 pa/m	15
2.3	307.6 m	141.1 pa/m	15
3.1	10.1 m	121.9 pa/m	20
3.2	17.0 m	99.0 pa/m	20
3.3	14.0 m	201.0 pa/m	20
3.4	8.4 m	153.0 pa/m	20
3.5	41.0 m	155.0 pa/m	15
3.6	33.3 m	155.0 pa/m	15
3.7	132.1 m	155.0 pa/m	15
4.1	33.0 m	123.0 pa/m	15
5.1	10.0 m	99.0 pa/m	20
5.2	10.1 m	99.0 pa/m	20
5.3	10.0 m	99.0 pa/m	20
5.4	10.0 m	229.7 pa/m	15
5.5	9.7 m	217.8 pa/m	15
5.6	31.0 m	132.2 pa/m	15
5.7	46.0 m	263.7 pa/m	15
5.8	32.7 m	144.7 pa/m	15
6.1	8.0 m	155.5 pa/m	15
6.2	9.6 m	213.9 pa/m	15
6.3	9.2 m	196.7 pa/m	15
6.4	8.9 m	187.4 pa/m	15
6.5	9.1 m	195.2 pa/m	15
6.6	14.3 m	104.2 pa/m	15
7.1	9.3 m	132.1 pa/m	15
7.2	53.0 m	132.1 pa/m	15
8.1	41.0 m	107.9 pa/m	32
9.1	49.0 m	377.3 pa/m	25
10.1	11.4 m	284.1 pa/m	25
11.1	366.1 m	153.9 pa/m	32
12.1	6.5 m	194.8 pa/m	20
12.2	7.7 m	156.7 pa/m	25
12.3	14.0 m	99.3 pa/m	20

Appendix

Appendix 9 The detail of energy consumption of heat pumps

Buildings	Hot water consumption(kWh/a)	COP	Electricity consumption per year(kWh/a)
1.1	11,059	4.8	2,304
1.2	4,925	4.8	1,026
1.3	8,476	4.8	1,766
1.4	11,059	4.8	2,304
1.5	4,925	4.8	1,026
1.6	8,476	4.8	1,766
1.7	11,578	4.8	2,412
1.8	4,925	4.8	1,026
1.9	11,059	4.8	2,304
1.10	4,925	4.8	1,026
1.11	8,476	4.8	1,766
1.12	8,476	4.8	1,766
1.13	8,476	4.8	1,766
1.14	8,476	4.8	1,766
1.15	8,476	4.8	1,766
1.16	11,059	4.8	2,304
2.1	13,219	4.8	2,754
2.2	4,087	4.8	851
2.3	4,087	4.8	851
3.1	8,528	4.8	1,777
3.2	3,180	4.8	662
3.3	4,752	4.8	990
3.4	3,180	4.8	662
3.5	1,711	4.8	356
3.6	1,711	4.8	356
3.7	1,711	4.8	356
4.1	1,469	4.8	306
5.1	3,136	4.8	653
5.2	3,136	4.8	653
5.3	3,136	4.8	653
5.4	3,136	4.8	653
5.5	3,136	4.8	653
5.6	3,292	4.8	686
5.7	3,292	4.8	686
5.8	2,868	4.8	598
6.1	2,868	4.8	598
6.2	2,868	4.8	598
6.3	2,972	4.8	619
6.4	3,283	4.8	684
6.5	3,283	4.8	684
6.6	3,283	4.8	684
7.1	3,758	4.8	783
7.2	3,758	4.8	783
8.1	31,743	5.3	5,989
9.1	27,622	5.4	5,115
10.1	25,920	5.4	4,800
11.1	38,880	5.3	7,336
12.1	11,146	4.8	2,322
12.2	18,446	4.8	3,843
12.3	7,586	4.8	1,580
		sum	79,670 kWh/a

Erdgas-Blockheizkraftwerk YADO|KWK EG

EG-60

KWK-Betriebsdaten¹⁾

Laast	%	100	80	60
Elektrische Leistung (+/-1%) ¹⁾	KW	64	50	37
Thermische Leistung (+/-5%)	KW	94	80	65
Brennstoffleistung (+/-5%)	KW	177	147	115
Elektrischer Wirkungsgrad HI	%	36,1	34,1	32,1
Thermischer Wirkungsgrad HI	%	53,1	54,2	56,6
Gesamtwirkungsgrad HI	%	89,2	88,3	88,7
Emission Abgas	mg/Nm ³	CO < 300 / NO _x < 500 / HCHO < 30 (bei 5% O ₂)		
Stromkennzahl		0,68		

Motor ²⁾

Hersteller	MAN	
Typ		E0834 E302
ISO-Standard-Leistung	kW	68
Nenn Drehzahl	min ⁻¹	1500
Brennstoff		Erdgas
Zylinder		4
Hubraum	dm ³	4,58
Bohrung/Hub	mm	108/125
Mittl. effektiver Druck	bar	11,90
Mittl. Kolbengeschwindigkeit	mis	6,30
Verdichtungsverhältnis		11 : 1
Schmierölverbrauch (max.)	kg/h	0,050
Füllmenge Motoröl (min./max.)	dm ³	17/25
Gemischkühlung auf	°C	50
Luftverhältnis Lambda	λ	1,62
Zündzeitpunkt (ZZP) vor OT		16°
Gewicht, trocken	kg	495

Wärmeauskopplung ³⁾

Plattenwärmetauscher

Motor-Kühlwasserwärme	kW	54
Material Heizflächen		1.4401 oder 1.4404
Gemischwärme - HT (80°C)	kW	7
Gemischwärme - NT (50°C)	kW	2

Rohrbündelwärmetauscher

Motor-Abgaswärme bis 120°C	kW	33
Material Heizflächen		1.4571 oder 1.4404

Anschlussdaten ³⁾

Heizwasser (Modulaustritt)

Temperatur Vorlauf	°C	90
Temperatur Rücklauf	°C	70
Volumenstrom, Standard	m ³ /h	4,2

Abgas

Maximaltemperatur TS	°C	650
Abgastemperatur Modul	°C	120
Abgasstrom, feucht	kg/h	361
Abgasstrom, trocken (273 K, 1013 hPa)	Nm ³ /h	288
Gegendruck max. Modulaustritt	kPa	1,5

Zuluft und Abluft

Zulufttemperatur	°C	10-30
Zuluftmenge	m ³ /h	3936
Verdorennungsluft	m ³ /h	294
Ablufttemperatur	°C	50
Abluftmenge	m ³ /h	3642
Strahlungswärme, max.	kW	20,9

Schalldruckpegel ⁴⁾ (-> dB(A))

Modulgeräusch in 1m	dB (A)	68
Abgas Restgeräusch in 10m		
- mit Kombischalldämpfer	dB (A)	70
- mit Modulschalldämpfer	dB (A)	-
- und Tiefionschalldämpfer (optional)	dB (A)	45

Anschlüsse

Wärmeauskopplung	DN/PN	32/6
Gemischkühnkreis	DN/PN	25/6
Abgas	DN/PN	100/6
Brennstoff	R/PN	20/2,5
Elektro	V/Hz	400/50
Luftkanal Zuluft / Abluft	mm	451/451

3~ Generator ³⁾

Hersteller	Marell	
Typ		MXB 225 MB4
Art		synchro
Nennleistung	KVA	78
Drehzahl	min ⁻¹	1500
Wirkungsgrad - cos φ 1,0	%	95,3
Spannung	V	400
Strom	A	112,6
Frequenz	Hz	50
Schutzart	IP	23
Isolationsklasse		H
Erwärmungsklasse		F
Gewicht	kg	401

Abmessungen und Gewicht (ca. Maße)

inkl. Schaltschrank, mit Schalldämmverkleidung	
Breite	mm 980
Höhe	mm 1985
Tiefe	mm 3760
Gewicht ohne Befüllung	kg 2550
Gewicht mit Befüllung	kg 2700

1) Elektrische Leistung am Generator bei cos φ 0,95 / 0,95 über-/untererregt.
2) Alle Daten gelten bei Vollastbetrieb des Moduls und vorbehaltlich technischer Weiterentwicklungen. Die BHKW-Daten sind bezogen auf Erdgas mit einem Heizwert (HI) von 36,0 MJ/Nm³ (10,0 kWh/Nm³) und einer Methanzahl größer 80. Leistungsangaben unter Normbezugsbedingungen: Aufstellhöhe 115 m, Ansaugtemperatur 25°C, relative Feuchte 30%. Die eingesetzten Motoren sind für den dauerhaften Betrieb bei 100% Nennleistung ausgelegt. Hinweise für den Teillastbetrieb entnehmen Sie bitte der Betriebsanleitung/Projekterstellungshinweise.

16
Technische Änderungen vorbehalten | Ausgabe 03-2020

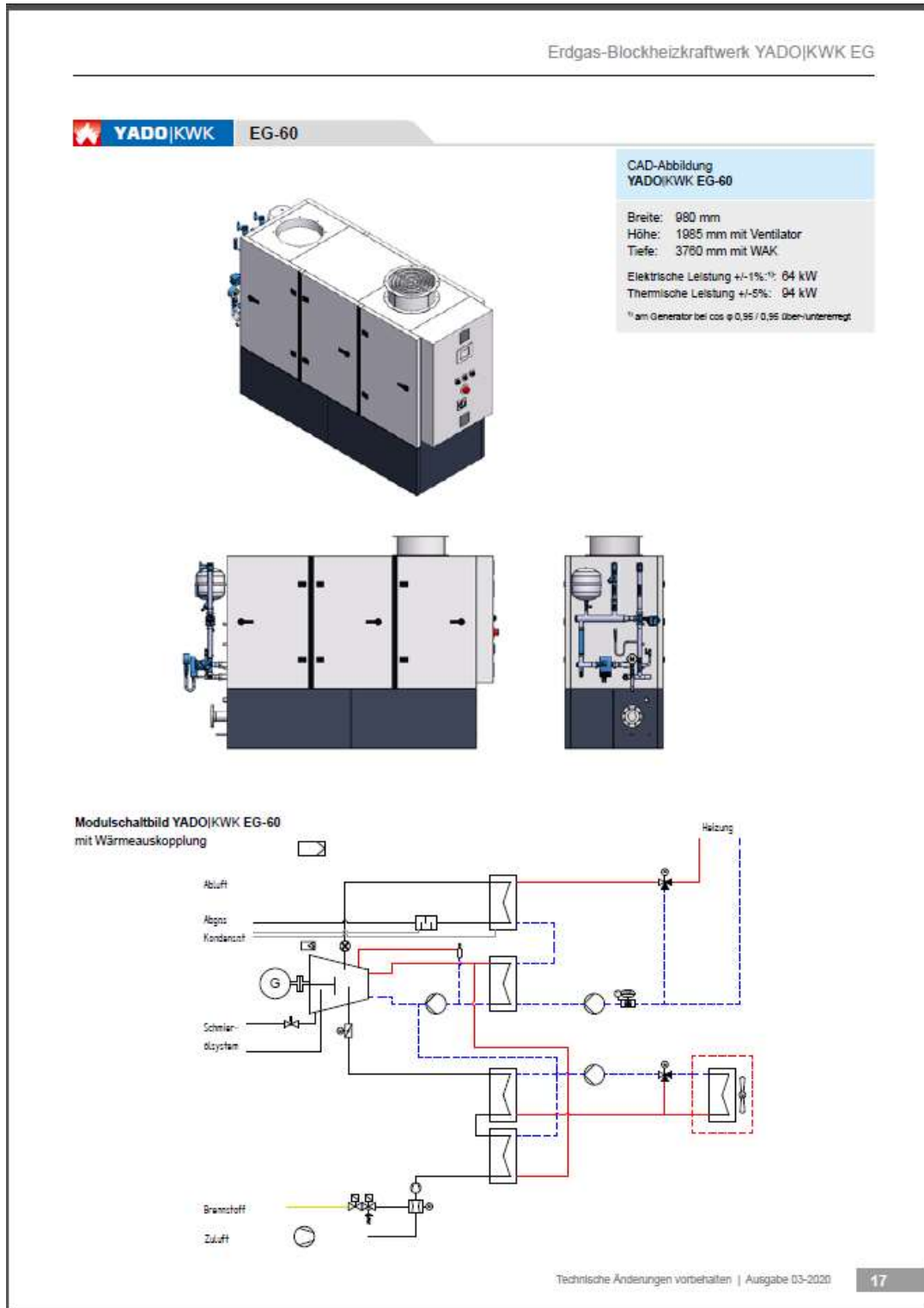

Erdgas-Blockheizkraftwerk YADO|KWK EG

EG-70
KWK-Betriebsdaten¹⁾

Last	%	100	80	60
Elektrische Leistung (+/-1%) ¹⁾	kW	70	55	41
Thermische Leistung (+/-5%)	kW	113	90	73
Brennstoffleistung (+/-5%)	kW	204	167	136
Elektrischer Wirkungsgrad HI	%	34,4	32,9	30,2
Thermischer Wirkungsgrad HI	%	55,4	53,7	53,4
Gesamtwirkungsgrad HI	%	89,7	86,6	83,6
Emission Abgas	mg/Nm ³	CO < 300 / NO _x < 250 / HCHO < 20 (bei 5% O ₂)		
Stromkennzahl		0,62		

Motor²⁾

Hersteller	MAN
Typ	E0836 E302
ISO-Standard-Leistung	kW 75
Nennrehzahl	min ⁻¹ 1500
Brennstoff	Erdgas
Zylinder	6
Hubraum	dm ³ 6,87
Bohrung/Hub	mm 108/125
Mittl. effektiver Druck	bar 8,73
Mittl. Kolbengeschwindigkeit	m/s 6,30
Verdichtungsverhältnis	13 : 1
Schmierölverbrauch (max.)	kg/h 0,060
Füllmenge Motordi (min./max.)	dm ³ 24/34
Gemischkühlung auf	°C -
Luftverhältnis Lambda	λ 1,00
Zündzeitpunkt (ZZP) vor OT	16°
Gewicht, trocken	kg 520

3- Generator²⁾

Hersteller	Marzili
Typ	MXB 225 LA4
Art	synchron
Nennleistung	kVA 88
Drehzahl	min ⁻¹ 1500
Wirkungsgrad - cos φ 1,0	% 95,4
Spannung	V 400
Strom	A 127
Frequenz	Hz 50
Schutzart	IP 23
Isolationsklasse	H
Erwärmungskategorie	F
Gewicht	kg 451

Abmessungen und Gewicht (ca. Maße)

inkl. Schaltschrank, mit Schalldämmverkleidung	
Breite	mm 980
Höhe	mm 1985
Tiefe	mm 3760
Gewicht ohne Befüllung	kg 2600
Gewicht mit Befüllung	kg 2750

Wärmeauskopplung²⁾

Plattenwärmetauscher	
Motor-Kühlwasserwärme	kW 65
Material Heizflächen	1.4401 oder 1.4404
Gemischwärme - HT (80°C)	kW -
Gemischwärme - NT (50°C)	kW -
Rohrbündelwärmetauscher	
Motor-Abgaswärme bis 120°C	kW 48
Material Heizflächen	1.4571 oder 1.4404

Anschlussdaten²⁾

Heizwasser (Modulaustritt)	
Temperatur Vorlauf	°C 90
Temperatur Rücklauf	°C 70
Volumenstrom, Standard	m ³ /h 5,0
Abgas	
Maximaltemperatur TS	°C 650
Abgastemperatur Modul	°C 120
Abgasstrom, feucht	kg/h 272
Abgasstrom, trocken (273 K, 1013 hPa)	Nm ³ /h 221
Gegendruck max. Modulaustritt	kPa 1,5
Zuluft und Abluft	
Zulufttemperatur	°C 10-30
Zuluftmenge	m ³ /h 4458
Verbrennungsluft	m ³ /h 217
Ablufttemperatur	°C 50
Abluftmenge	m ³ /h 4241
Strahlungswärme, max.	kW 23
Schalldruckpegel +/-3 dB(A)	
Modulgeräusch in 1m	dB (A) 68
Abgas Restgeräusch in 10m	
- mit Kombischalldämpfer	dB (A) -
- mit Modulschalldämpfer	dB (A) 70
- und Tiefenschalldämpfer (optional)	dB (A) 45
Anschlüsse	
Wärmeauskopplung	DN/PN 40/6
Gemischkühlkreis	DN/PN
Abgas	DN/PN 100/6
Brennstoff	R/PN 25/2,5
Elektro	V/Hz 400/50
Luftkanal Zuluft / Abluft	mm 503/503

1) Elektrische Leistung am Generator bei cos φ 0,96 / 0,95 über-luntererregt.

2) Alle Daten gelten bei Vollastbetrieb des Moduls und vorbehaltlich technischer Weiterentwicklungen. Die BHKW-Daten sind bezogen auf Erdgas mit einem Heizwert (HI) von 36,0 MJ/Nm³ (10,0 kWh/Nm³) und einer Methanzahl grösser 80. Leistungsangaben unter Normbezugsbedingungen: Aufstellhöhe 115 m, Ansaugtemperatur 25°C, relative Feuchte 30%.

Die eingesetzten Motoren sind für den dauerhaften Betrieb bei 100% Nennleistung ausgelegt. Hinweise für den Teillastbetrieb entnehmen Sie bitte der Betriebsanleitung/Projektierungshinweise.

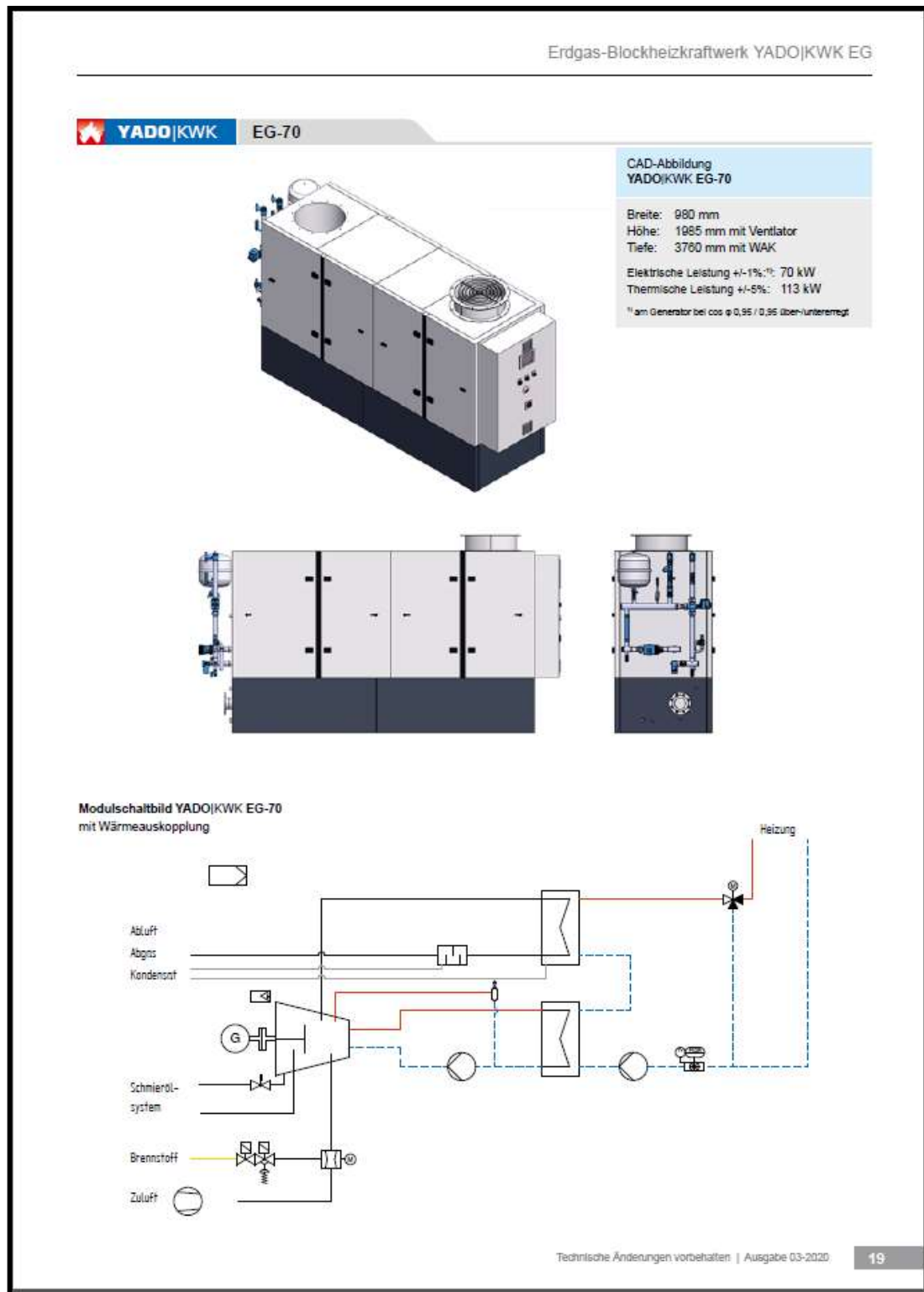

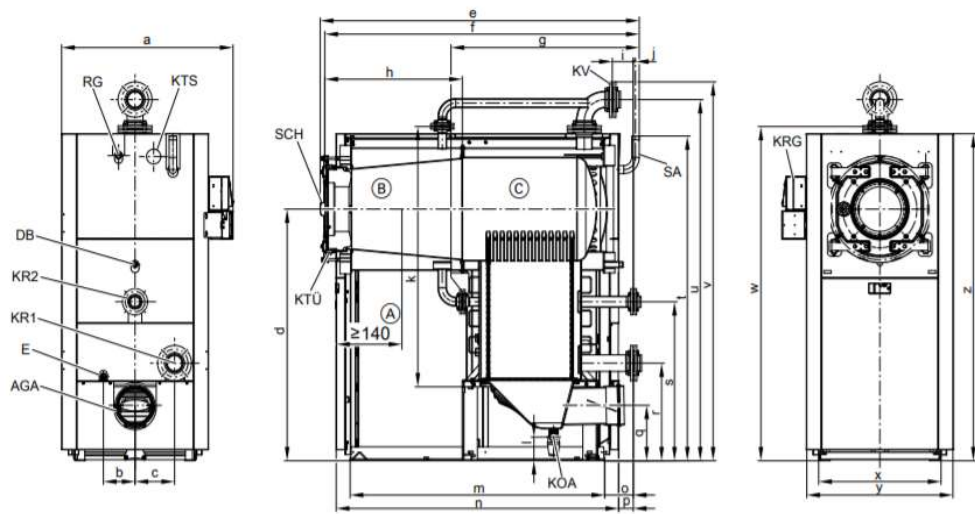

- | | |
|---|---|
| (A) Zur einwandfreien Funktion sollte die geforderte Mindest-Brennerrohrlänge eingehalten werden. | KR 2 Kesselrücklauf 2 |
| (B) Flammrohrmodul | KTS Kesseltemperatursensor |
| (C) Wärmetauschermodul | KTÜ Kesseltür mit Brenneranschlussflansch |
| AGA Abgasabzug | KRG Vitotronic Regelung |
| DB Muffe R ½ für Druckbegrenzungseinrichtung | KV Kesselvorlauf |
| E Entleerung | RG Muffe R ¼ (Außengewinde) für zusätzliche Regeleinrichtungen |
| KOA Kondenswasserablauf | SA Sicherheitsanschluss (Sicherheitsventil) |
| KR 1 Kesselrücklauf 1 | SCH Schauöffnung (Heizkessel mit 187 bis 314 kW; um 90° versetzt) |

Technische Angaben Heizkessel

Technische Daten

Nenn-Wärmeleistung							
$T_v/T_R = 50/30 \text{ °C}$	kW	187	248	314	408	508	635
$T_v/T_R = 80/60 \text{ °C}$	kW	170	225	285	370	460	575
Nenn-Wärmebelastung							
	kW	1,77	234,5	297	385,5	479	599
Produkt-ID-Nummer							
		CE-0085AQ0257					
Zul. Betriebstemperatur							
	°C	100	100	100	100	100	100
Zul. Vorlauftemperatur							
	°C	110	110	110	110	110	110
(= Absicherungstemperatur)							
Zul. Betriebsdruck max.							
	bar	4	4	4	5,5	5,5	5,5
	MPa	0,4	0,4	0,4	0,55	0,55	0,55
Zul. Betriebsdruck min.^{†1}							
	bar	0,5	0,5	0,5	0,5	0,5	0,5
	kPa	50	50	50	50	50	50
Heizgasseitiger Widerstand							
	Pa	100	140	160	200	220	270
	mbar	1,0	1,4	1,6	2,0	2,2	2,7
Abmessungen Kesselkörper (Einbringmaße)							
– Länge f	mm	1600	1678	1756	1850	1928	2084
– Breite x	mm	684	684	684	800	800	800
– Höhe w (mit Stützen)	mm	1745	1794	1794	2012	2012	2012
Gesamtabmessungen							
– Länge e (ohne Brenner)	mm	1628	1708	1792	1875	1955	2112
– Breite a (mit Regelung)	mm	958	958	958	1104	1104	1104
– Breite y (ohne Regelung)	mm	821	821	821	937	937	937
– Höhe v	mm	1959	2009	2032	2290	2290	2290
Fundament							
– Länge	mm	1350	1450	1500	1600	1650	1800
– Breite	mm	800	800	800	900	900	900
– Höhe	mm	100	100	100	100	100	100
Gewicht							
– Kesselkörper	kg	445	490	510	740	780	890
– Abnehmbare Brennkammer ohne Kesselstür	kg	96	96	96	124	124	124
Gesamtgewicht							
Heizkessel mit Wärmedämmung und Kesselkreisregelung							
Inhalt Kesselwasser	l	240	265	300	460	500	540
Anschlüsse Heizkessel							
Kesselvorlauf	PN 8 DN	65	65	80	100	100	100
Kesselrücklauf 1 ^{†2}	PN 8 DN	65	65	80	100	100	100
Kesselrücklauf 2 ^{†2}	PN 8 DN	50	50	50	80	80	80
Sicherheitsanschluss (Sicherheitsventil) (Außengewinde)	R	1½	1½	1½	1½	1½	1½
Entleerung (Außengewinde)	R	1	1	1	1	1	1
Kondenswasserablauf (Außengewinde)	R	½	½	½	½	½	½
Abgaskennwerte^{†3}							
Temperatur (bei Rücklauftemperatur von 30 °C)							
– bei Nenn-Wärmeleistung	°C	45	45	45	45	45	45
– bei Teillast	°C	40	40	40	40	40	40
Temperatur (bei Rücklauftemperatur von 60 °C)							
– bei Nenn-Wärmeleistung	°C	75	75	75	75	75	75
Massenstrom (bei Erdgas)							
– bei Nenn-Wärmeleistung	kg/h	269	357	452	588	727	909
– bei Teillast	kg/h	81	107	136	176	218	272
Verfügbare Förderdruck am Abgassutzen	Pa	70	70	70	70	70	70
	mbar	0,7	0,7	0,7	0,7	0,7	0,7
Abgasanschluss	∅ mm	200	200	200	250	250	250
Norm-Nutzungsgrad							
bei Heizsystemtemp. 50/30 °C	%	bis 98 (H _v)					
bei Heizsystemtemp. 75/60 °C	%	bis 95 (H _v)					
Bereitschaftsverlust $q_{br,70}$	%	0,40	0,30	0,30	0,30	0,28	0,25

^{†1} Für den sicheren Betrieb ist ein Mindest-Betriebsdruck von 0,5 bar erforderlich. Dafür kann ein Minimaldruckwächter eingesetzt werden.

^{†2} Beim Anschluss von 2 Heizkreisen den Heizkreis mit dem niedrigsten Temperaturiveau an den Kesselrücklauf 1 anschließen.

^{†3} Rechenwerte zur Auslegung der Abgasanlage nach EN 13384 bezogen auf 10 % CO₂ bei Erdgas

Abgastemperaturen als gemessene Bruttowerte bei 20 °C Verbrennungslufttemperatur.

Die Angaben für die Teillast beziehen sich auf eine Leistung von 30 % der Nenn-Wärmeleistung. Bei abweichender Teillast (abhängig von der Betriebsweise des Brenners) ist der Abgasmassenstrom entsprechend zu errechnen.

5796298

VITOCROSSAL 300

VICMANN 3

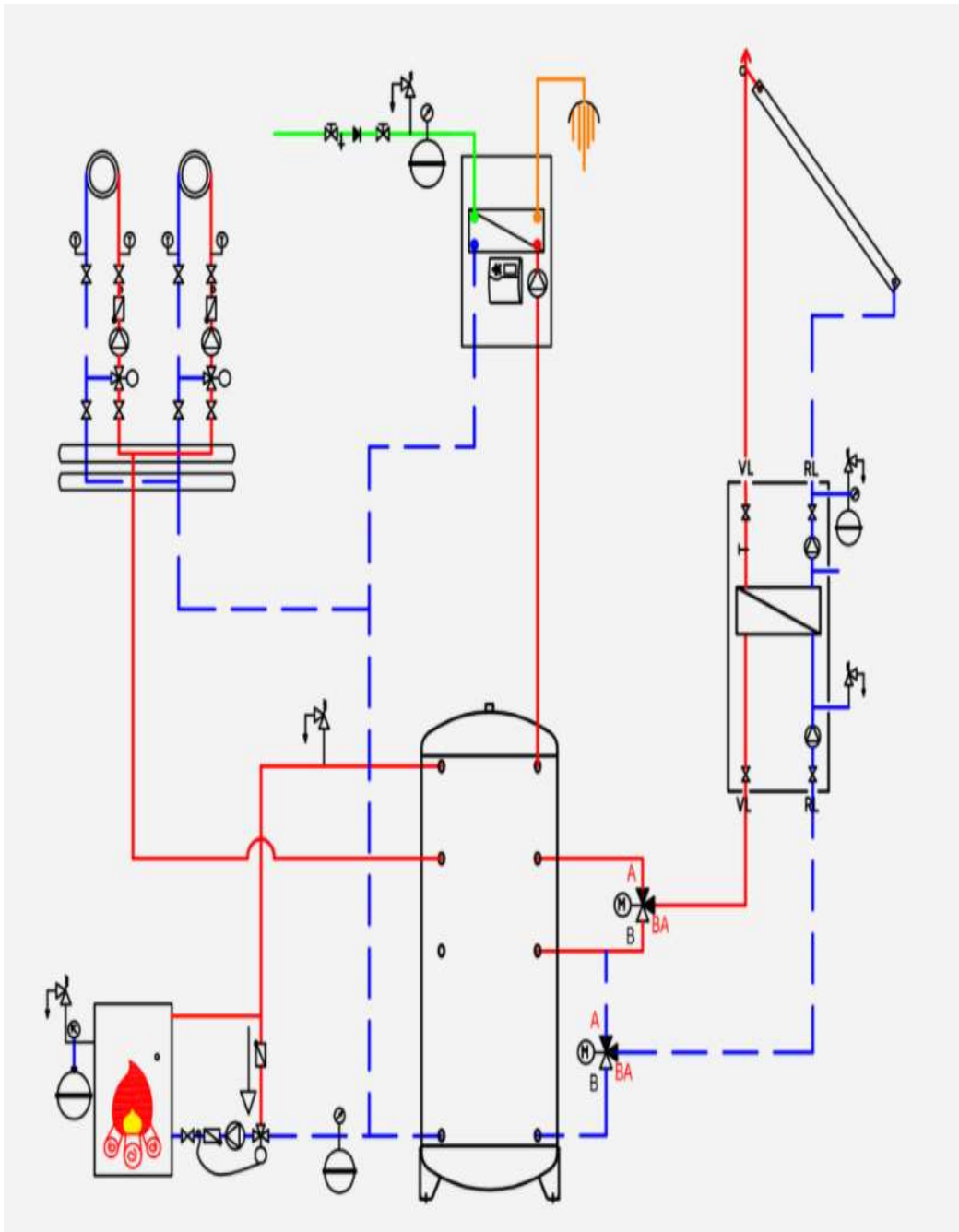

Appendix 17 module components of pellet boiler(PT4e)

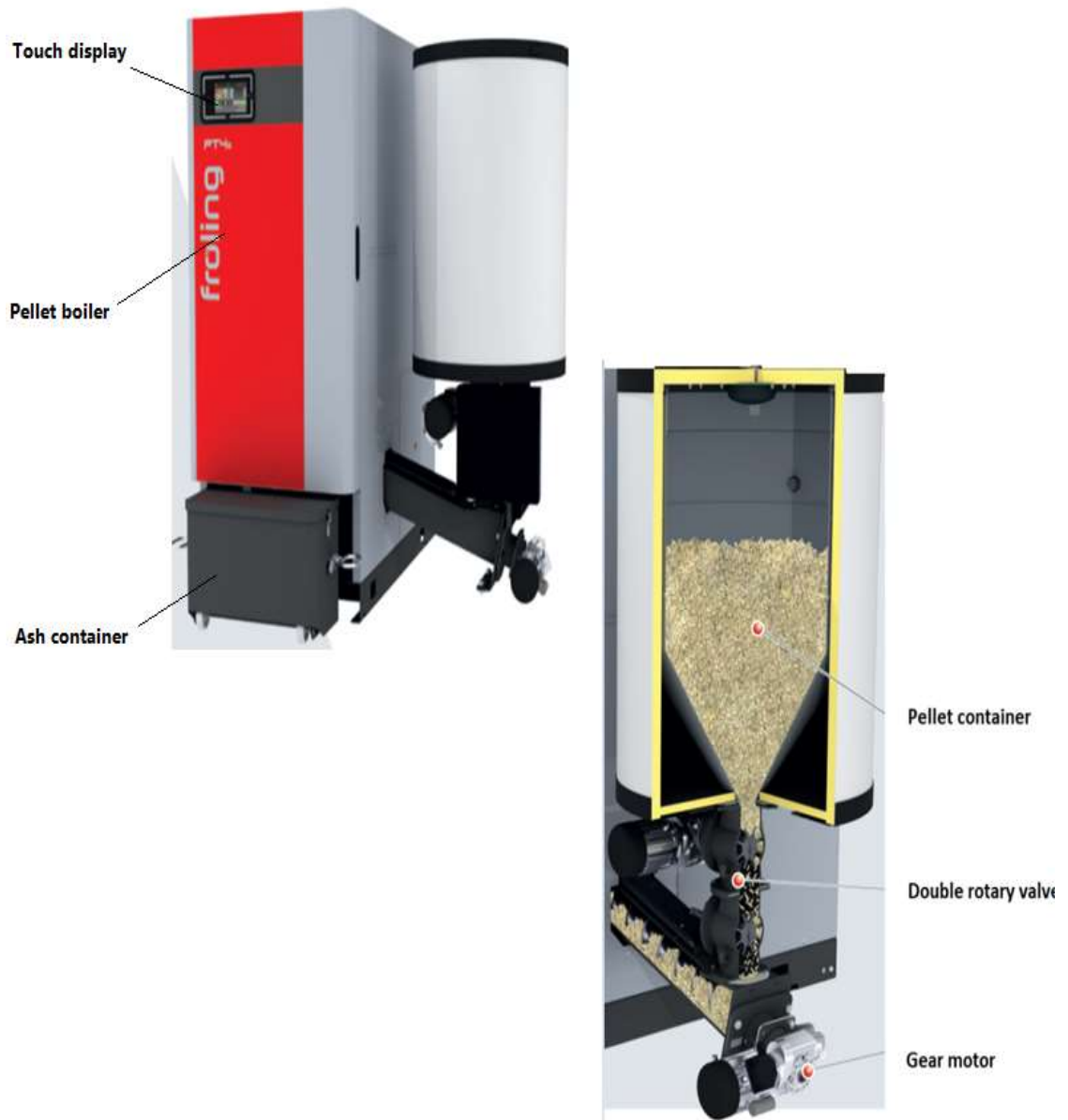

Appendix 18 Subsidies details of both systems

None RE-System	KfW		Tilgungszuschuss	Bonus	APEE	SUMME
		1 Solarkollektoranlagen	0 €	0 €	0 €	0 €
		2 Biomasseanlagen	0 €	0 €	0 €	0 €
		3 Wärmenetze	0 €	0 €	0 €	0 €
		4 Wüst	0 €	0 €	0 €	0 €
		5 Wärmespeicher	5,750 €	0 €	0 €	5,750 €
		6 Biogasleitungen	0 €	0 €	0 €	0 €
Summe				5,750 €		

BAFA		Basis	Innovations	Zusatz	SUMME
	1 Solarkollektoranlagen	0 €	0 €	0 €	0 €
	2 Biomasseanlagen	0 €	0 €	0 €	0 €
	3 Wärmenetze	0 €	197,420 €	0 €	197,420 €
	4 BHKW	0 €	0 €	0 €	0 €
	5 Wärmespeicher	5,750 €	0 €	0 €	5,750 €
	Summe				203,170 €

TFZ		Grundförderung	Economiser	SUMME
	1 Biomasseanlagen	0 €	0 €	0 €

RE-System	KfW		Tilgungszuschuss	Bonus	APEE	SUMME
		1 Solarkollektoranlagen	129,945 €	0 €	0 €	129,945 €
		2 Biomasseanlagen	4,600 €	6,900 €	0 €	11,500 €
		3 Wärmenetze	118,452 €	0 €	0 €	118,452 €
		4 Wüst	90,000 €	0 €	0 €	90,000 €
		5 Wärmespeicher	7,250 €	0 €	0 €	7,250 €
		6 Biogasleitungen	4,500 €	0 €	0 €	4,500 €
Summe				361,647 €		

BAFA		Basis	Innovations	Zusatz	SUMME
	1 Solarkollektoranlagen	0 €	0 €	0 €	0 €
	2 Biomasseanlagen	0 €	0 €	0 €	0 €
	3 Wärmenetze	0 €	0 €	0 €	0 €
	4 BHKW	0 €	0 €	0 €	0 €
	5 Wärmespeicher	0 €	0 €	0 €	0 €
	Summe				0 €

TFZ		Grundförderung	Economiser	SUMME
	1 Biomasseanlagen	21,000 €	2,100 €	23,100 €

Year	Income	Expenses	Cash flow from bank loan	Cash flow	Project Balance
0	€ -	€ -	€ -	€ -	€ -
1	€ 119,380	€ 74,909	€ 24,592	€ 19,887	€ 19,880
2	€ 131,436	€ 74,909	€ 24,592	€ 31,942	€ 51,315
3	€ 131,436	€ 74,909	€ 24,592	€ 31,942	€ 83,750
4	€ 131,436	€ 74,909	€ 106,783	€ -50,249	€ 33,494
5	€ 139,473	€ 74,909	€ 105,336	€ -40,765	€ -7,278
6	€ 139,473	€ 74,909	€ 103,890	€ -39,319	€ -46,604
7	€ 139,473	€ 74,909	€ 102,443	€ -37,872	€ -84,483
8	€ 139,473	€ 74,909	€ 100,996	€ -36,425	€ -120,916
9	€ 139,473	€ 74,909	€ 99,550	€ -34,979	€ -155,902
10	€ 139,473	€ 74,909	€ 98,103	€ -33,532	€ -189,442
11	€ 139,473	€ 74,909	€ 96,567	€ -32,086	€ -221,535
12	€ 139,473	€ 74,909	€ 95,210	€ -30,639	€ -252,182
13	€ 139,473	€ 74,909	€ 93,764	€ -29,193	€ -281,382
14	€ 139,473	€ 74,909	€ 92,317	€ -27,746	€ -309,135
15	€ 139,473	€ 74,909	€ 90,871	€ -26,300	€ -335,442
16	€ 139,473	€ 74,909	€ 89,424	€ -24,853	€ -360,302
17	€ 139,473	€ 74,909	€ 87,977	€ -23,406	€ -383,716
18	€ 139,473	€ 74,909	€ 86,531	€ -21,960	€ -405,693
19	€ 139,473	€ 74,909	€ 85,084	€ -20,513	€ -426,204
20	€ 139,473	€ 74,909	€ 83,638	€ -19,067	€ -445,278
TOTAL PROJECT BALANCE					€ -445,278

Year	Income	Expenses	Cash flow from bank loan	Cash flow	Project Balance
0	€ -	€ -	€ -	€ -	€ -
1	€ 195,882	€ 149,657	€ 25,090	€ 21,135	€ 21,135
2	€ 207,937	€ 149,657	€ 25,090	€ 33,190	€ 54,325
3	€ 207,937	€ 149,657	€ 25,090	€ 33,190	€ 87,515
4	€ 207,937	€ 149,657	€ 108,945	€ -50,666	€ 36,850
5	€ 215,974	€ 149,657	€ 107,470	€ -41,153	€ -4,303
6	€ 215,974	€ 149,657	€ 105,994	€ -39,677	€ -43,980
7	€ 215,974	€ 149,657	€ 104,518	€ -38,201	€ -82,181
8	€ 215,974	€ 149,657	€ 103,042	€ -36,725	€ -118,907
9	€ 215,974	€ 149,657	€ 101,566	€ -35,249	€ -154,156
10	€ 215,974	€ 149,657	€ 100,090	€ -33,773	€ -187,930
11	€ 183,280	€ 149,657	€ 98,614	€ -64,991	€ -252,921
12	€ 183,280	€ 149,657	€ 97,138	€ -63,516	€ -316,436
13	€ 183,280	€ 149,657	€ 95,663	€ -62,040	€ -378,475
14	€ 183,280	€ 149,657	€ 94,187	€ -60,564	€ -439,038
15	€ 183,280	€ 149,657	€ 92,711	€ -59,088	€ -498,126
16	€ 183,280	€ 149,657	€ 91,235	€ -57,612	€ -555,738
17	€ 183,280	€ 149,657	€ 89,759	€ -56,137	€ -611,874
18	€ 183,280	€ 149,657	€ 88,283	€ -54,661	€ -666,534
19	€ 183,280	€ 149,657	€ 86,807	€ -53,185	€ -719,719
20	€ 183,280	€ 149,657	€ 85,332	€ -51,708	€ -771,427
TOTAL PROJECT BALANCE					€ -771,427