

Faculty of Engineering and management
Master of Engineering in Automotive Production Engineering

Master's thesis

Fuel cell system layout development for heavy duty road
application - a concept study for a Balance-of-Plant layout

Author: Jaber Amini
Matriculation Number: 00119960
Lead Supervisor: Prof. Dr. Ing. Roland Meyer
Assistant Supervisor: Prof. Dr. Ing. Bernhard Axmann
External Supervisors: Dr. Stephan Johannes Schnorpfeil
Arne Kotowski
Issued on: 13.12.2023
Submitted on: 14.05.2024

Ingolstadt, 14.05.2024

Abstract

This thesis examines a concept study in developing a 100 Kw PEM fuel cell, focusing on the balance of plant development and system packaging. In response to the need for the desired packaging, market analysis was conducted to acquire relevant data for modelling the balance of plant components.

The project is divided into two interconnected sections. The first section involves realizing the system, understanding its components, and identifying parameters that affect machine operation. Market analysis was conducted to gather data for these components, which are presented in several tables. This information was gathered from academic research, handbooks, supplier fact sheets, and discussions with experts in the field.

The second section of the thesis involves practical activities, specifically designing the system by modelling the components using CATIA V5 software. The dimensions of the components and definition of the package size acquired through market analysis and related fuel cell standard are incorporated, and the system is assembled with optimal space utilization for packaging purposes.

Additionally, the energy consumption of the components in the balance of plant is considered, and a suitable energy distribution study is conducted to determine the required energy to operate the system. Moreover, a SWOT analysis is conducted to identify the project's opportunities and challenges. Furthermore, suggestions for further improvement are provided, each of which could serve as a valuable topic for future study.

Overall, this thesis offers valuable insights into PEM fuel cell realization, all components, affecting parameters which are essential in developing this product. Additionally, recommendations for enhancing the project are offered, with each suggestion presenting an opportunity for valuable future research.

Statement of authorship

I hereby declare that I am the sole author of this master thesis and that I have not used any sources other than those listed in the bibliography and identified as references. This master thesis is based on internal confidential information of Segula Technologies GmbH, any further usage of the data should be with the knowledge and consent of the company. Furthermore, I further declare that I have not submitted this thesis at any other institution in order to obtain a degree.

Ingolstadt, 14.05.2024
(Place, Date)

Jaber Amini
(Name, Signature)

A handwritten signature in black ink, appearing to be "Jaber Amini", written over a faint horizontal line.

Task Description Master Thesis

Mr. Jaber Amini

Matr. No. 00119960

Gabelsberger Pl. 2, 65428 Rüsselsheim am Main

Title

Fuel cell system layout development for heavy duty road application - a concept study for a Balance-of-Plant layout

Initial Situation

Segula Technologies offers engineering services for various purposes. As contribution to their clean energy solutions for road vehicles, this master thesis is a part of a project in the company for developing a fuel cell system.

Problem description

The main challenge in developing an applicable fuel cell for this project is accurately positioning the right components to ensure integration with other compartments, fulfill packaging criteria regarding technical and functional requirements, and achieving the desired power.

Target and approach

Target of this thesis is a Balance-of-Plant layout concept for possible mobile fuel cell drive applications with focus on components to be integrated in terms of system energy efficiency. The necessary steps in this work to achieve are:

1. Application and technical requirements of the fuel cell system.
2. Research on system components and characteristics of operation and design.
3. Research on suppliers and market availability of components.
4. System assembly layout and packaging of the components.
5. Concept assessment and premises for future system development.

Supervisors of the Segula technologies company

Stephan Johannes Schnorpfeil

- Stephanjohannes.schnorpfeil@segulagr.de
- +4961421731228

Arne Kotowski

- Arne.kotowski@segulagr.de
- +4961421731223

Jaber Amini



Rüsselsheim

31.10.2023

Table of content

LIST OF FIGURES	II
LIST OF DIAGRAMS	III
LIST OF TABLES	IV
LIST OF ABBREVIATION	V
1. INTRODUCTION	1
2. STATE OF KNOWLEDGE.....	4
2.1 FUEL CELL STACK	4
2.2 OPERATION OF FUEL CELL	5
2.3 AFFECTING PARAMETERS IN FUEL CELL OPERATION	6
2.3.1 <i>Temperature parameter</i>	6
2.3.2 <i>Pressure parameter</i>	7
2.3.3 <i>Humidity parameter</i>	8
2.4 BASIC OF HYDROGEN AND TYPES OF FUEL CELLS	9
2.5 APPLICATION OF FUEL CELL.....	13
2.6 INTEGRATION OF FUEL CELL INTO E-DRIVETRAIN.....	18
3. METHODOLOGY	20
3.1 BALANCE OF PLANT DEFINITION.....	20
3.2 ANODE SYSTEM	21
3.2.1 <i>Isolation valve</i>	21
3.2.2 <i>Pressure regulator valve</i>	23
3.2.3 <i>Check valve</i>	24
3.2.4 <i>Recirculation pump</i>	26
3.2.5 <i>Water separator</i>	29
3.3 CATHODE SYSTEM	31
3.3.1 <i>Air filter</i>	31
3.3.2 <i>Air compressor</i>	32
3.3.3 <i>Humidifier</i>	35
3.4 THERMAL MANAGEMENT.....	38
3.5 ELECTRICAL MANAGEMENT	43
3.6 PACKAGING	46
3.6.1 <i>Fundamental of packaging</i>	46
3.6.2 <i>Fuel cell module standard size</i>	48
3.6.3 <i>Initial draft for packaging</i>	50
3.6.4 <i>Components development and market analysis</i>	51
4. ENERGY DISTRIBUTION.....	57
5. PRODUCT MODEL AND SPECIFICATION	58
6. SWOT ANALYSIS	60
7. SUGGESTIONS AND CONCLUSION.....	61
8. REFERENCES	63

List of figures

Figure 1. Hydrogen fuel cell system	1
Figure 2. Fuel cell stack [100].....	4
Figure 3. Fuel cell construction.....	6
Figure 4. Fuel cell temperature vs. power [2].....	6
Figure 5. Effect of fuel pressure on fuel cell performance [5].....	7
Figure 6. Membrane resistance vs. water content [9].....	9
Figure 7. Fuel cell application areas	14
Figure 8. Integration structure of fuel cell with battery to transport power into e-drive train [21]	18
Figure 9. Balance of plant definition	20
Figure 10. Isolation valve.....	22
Figure 11. Pressure regulator valve.....	24
Figure 12. Check valve mechanism.....	25
Figure 13. a) Hydrogen recirculation pumps types b) structure of injector [39]	28
Figure 14. Water separator position, in-line liquid gas separator [42].....	30
Figure 15. Air filters	32
Figure 16. Types of compressors.....	33
Figure 17. Positive displacement and dynamic compressor comparison [50]	34
Figure 18. Water formation and movements in PEM fuel cell [52].....	36
Figure 19. Cooling strategies of PEMFC	39
Figure 20. Water cooling system in PEMFC	42
Figure 21. Function of a DC/DC convertor [77].....	44
Figure 22. Bleeder resistor function in fuel cell system [79].....	45
Figure 23. Full vehicle packaging concept development [92,94]	47
Figure 24. Fuel cell modules HH_{ABC}	50
Figure 25. Initial concept of fuel cell module packaging	51
Figure 26. Market analysis for fuel cell stack module dimension.....	53
Figure 27. Sankey diagram - energy distribution.....	57
Figure 28. Product model and interfaces	58
Figure 29. Product breakdown	59
Figure 30. Fuel cell development- SWOT analysis	60

List of diagrams

Diagram 1. PEM fuel cell piping and instrumentation	21
---	----

List of tables

Table 1. Types of fuel cells	13
Table 2. Benefit and challenges of fuel cell technology.....	17
Table 3. Types of Shut-off valve.....	22
Table 4. Hydrogen supply configuration.....	26
Table 5. Cooling methods in PEM fuel cell	43
Table 6. Dimensions of fuel cell module HH _{ABC} tolerance +0 / -100 mm	49
Table 7. Market analysis fuel cell stack module	52
Table 8. Market analysis hydrogen pump.....	53
Table 9. Market analysis air compressor	54
Table 10. Market analysis humidifier	55
Table 11. Heat exchanger market analysis	56
Table 12. Product description	59

List of abbreviation

BOP	Balance Of Plant
MEA	Membrane electrode assembly
PEMFC	proton exchange membrane fuel cells
GDL	gas diffusion layer
CHP	combined heat and power
FCV	Fuel cell vehicle
BEV	battery electric vehicle
PCM	phase change material
P&ID	Piping and instrumentation diagram
TCO	total cost of ownership

1. Introduction

Climate change stands as a paramount challenge in the 21st century. The effects of global warming, coupled with related occurrences of extreme weather and natural disasters, are progressively more apparent. The primary force behind climate warming is carbon dioxide (CO₂). Although CO₂ possesses a lower greenhouse potential compared to other gases, its significant concentration and extended stay in the Earth's atmosphere establish it as the foremost contributor to climate change [1]. In 2020, carbon dioxide accounted for 66% of the greenhouse effect, with methane at 16%, nitrous oxide at 6%, and other greenhouse gases at 11% [1]. The prolonged use of fossil fuels in previous decades and centuries has led to a gradual increase in the Earth's atmosphere of carbon dioxide and other greenhouse gases. Combustion engines in traditional vehicles emit a variety of pollutants, including carbon monoxide, nitrogen oxides, particulate matter, and volatile organic compounds. The release of greenhouse gases, such as carbon dioxide, from the burning of fossil fuels in vehicles is a major driver of climate change.

Fuel cell vehicles use fuel cell technology to provide the necessary drive power required for autos. Compared to conventional internal combustion engine vehicles, fuel cells emit zero emissions to the environment, which is one of the main reasons for selecting this technology as a substitute for ICE vehicles. Figure 1. illustrates an overview of a fuel cell system powering an electric motor.

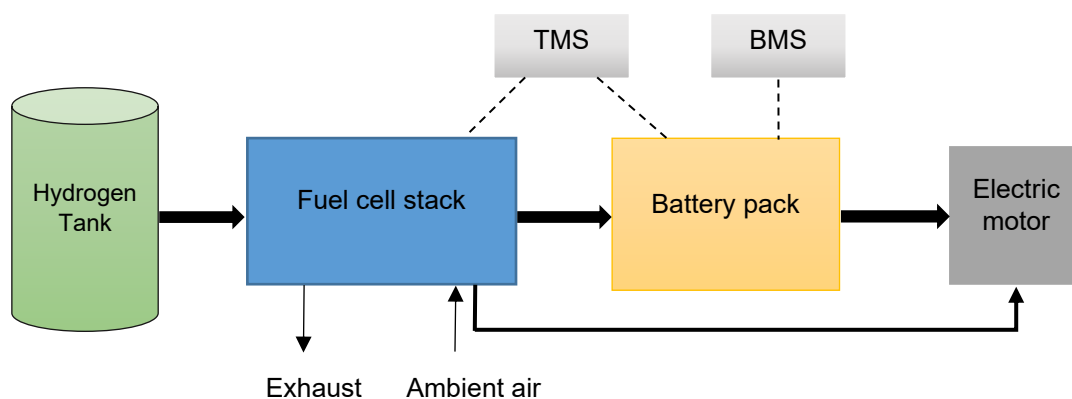

Figure 1. Hydrogen fuel cell system

As shown in Fig. 1, the hydrogen tank supplies the required fuel to the fuel cell stack, while oxygen is delivered to the system from the surrounding area. The electricity generated is delivered to the electric motor. Since the process produces heat, it needs

to be dissipated from the system. Moreover, electrical energy must be controlled to be used optimally. Therefore, the thermal management system (TMS) and battery management system (BMS) cooperate in the fuel cell unit.

- **Project motivation**

The motivation behind this project originates from the necessity to address the demand for clean energy solutions applicable in road vehicles. In recent years, climate change has emerged as a significant global challenge. Examples of this problem include global warming and severe weather conditions. Carbon dioxide (CO₂) serves as the primary driver of climate warming, with one of its sources being internal combustion engine vehicles (ICE). Since the vast majority of trips are conducted by automobile, these engines significantly pollute the environment. This project aims to contribute to the introduction of clean energy solutions by developing a system that utilizes hydrogen and oxygen as fuel to power vehicles, meeting their energy requirements. By understanding these underlying motivations, stakeholders can align their efforts towards achieving meaningful outcomes.

- **Project objective**

The primary objective of this project is to conduct a concept study for a 100 kW PEM fuel cell balance of plant packaging, which is part of an internal project at Segula Technologies aimed at introducing a system suitable for road vehicle applications. Through system realization and market analysis, this thesis intends to suggest a fuel cell package with optimum utilization of space for positioning the balance of plant components. This objective is essential as it provides a clear direction for the project's activities and ensures that resources are utilized effectively. Achieving these objectives will not only provide a clear concept for the product applicable to desired road vehicles but also contribute to Segula Technologies' portfolio of engineering services.

- **Project approach**

The approach adopted for this project involves fuel cell system realization, market research study and modelling the package with CATIA V5. By conducting market analysis, data for these components, which are illustrated in various tables, was gathered. This data was acquired from academic research, manuals, supplier fact sheets, and consultations with industry experts, moreover, in addition, the system is created by modelling its components using CATIA V5 software. The dimensions of the

components and the package size are determined through market analysis and relevant fuel cell standards. Subsequently, the system is assembled to optimize space usage for packaging needs. Furthermore, the energy consumption of the components in the balance of plant is taken into account, and a relevant energy distribution study is undertaken to ascertain the necessary energy for system operation. Additionally, a SWOT analysis is performed to clarify the project's strengths, weaknesses, opportunities, and threats. Finally, recommendations for additional enhancements are proposed, which addresses for future study.

2. State of knowledge

In this chapter, the basics of fuel cells and current developments in fuel cell technology are discussed. Furthermore, the applications of fuel cells are presented.

2.1 Fuel cell stack

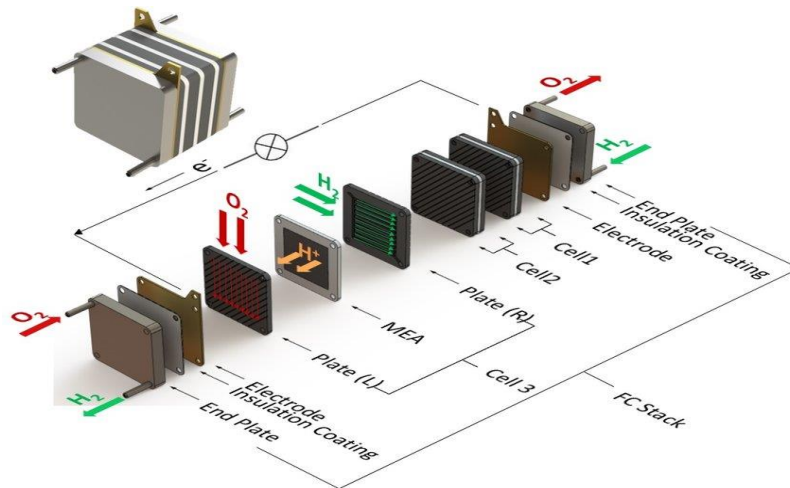

Figure 2. Fuel cell stack [100]

A fuel cell is an electrochemical technology that converts chemical energy into electrical energy. It is a promising clean energy source considered to be a substitute for fossil fuels, which pollute the environment and have countless side effects [2,3]. At the heart of the fuel cell is a simple but unique process: the conversion of chemical energy directly into electricity. Unlike traditional combustion engines, which burn fossil fuels, fuel cells rely on a reaction between hydrogen and oxygen to produce electricity, with water as the only by-product.

This makes them an environmentally friendly energy source, emitting no harmful pollutants or greenhouse gases. A fuel cell stack comprises at least one cell, where chemical reactions occur inside the cells figure 2 is representation for fuel cell stack. When several cells are combined, it is called a stack. The purpose of stacking is to enhance the voltage and current from the cells. Each cell is comprised of a pair of electrodes: one anode and one cathode. The fundamental parts of a fuel cell include an ion-conducting electrolyte, cathode, and anode. These three components are frequently known as the membrane-electrode assembly (MEA) or can be referred to simply as a single-cell fuel cell when considered together. Basically, hydrogen is introduced into the anode compartment, and an oxidant, typically oxygen, is introduced into the cathode system. There exists an inherent chemical driving force for the oxygen

and hydrogen to undergo a reaction resulting in the formation of water. Direct chemical combustion is impeded by the presence of the electrolyte, which serves as a barrier that separates the fuel (H₂) from the oxidant (O₂) [4,10]. The current produced must be collected, and there are two plates which have high potential of conductivity. The bipolar plate plays a vital role in numerous fuel cell varieties, notably in proton exchange membrane fuel cells (PEMFCs) and various other electrochemical cell types. Its primary purpose is to facilitate the efficient operation of the fuel cell by serving as both an electrical conductor and a separator between individual cells within the fuel cell stack. Some of the specifications of fuel cells will be discussed in other chapters.

2.2 Operation of fuel cell

The working principle of the fuel cell is simple: it involves a reaction between oxygen and hydrogen elements. Hydrogen is ionized to form hydrogen molecules and electrons, which are the charged elements carrying energy. Oxygen is also ionized, which reacts with the hydrogen to produce water as a by-product of this process. From this combination, heat and water are produced, which are also usable in the fuel cell system for cooling and humidification purposes, as discussed in later chapters. The equation for the ionization of hydrogen and oxygen is described below

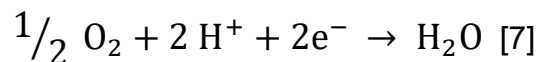
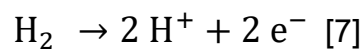

The overall equation in a fuel cell to produce water is:

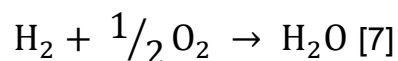

In a fuel cell, the reaction takes place between electrodes. Oxygen (O₂) from the air is supplied into the cathode. Oxygen molecules adsorb to the surface of the cathode catalyst, and they are separated into oxygen atoms (2 atoms). Protons (H⁺) migrate through the electrolyte from the anode to the cathode side of the fuel cell. The process works continuously, and the electrical current flows through the circuit, delivering power. Figure 3. provides the working principle and construction of a fuel cell.

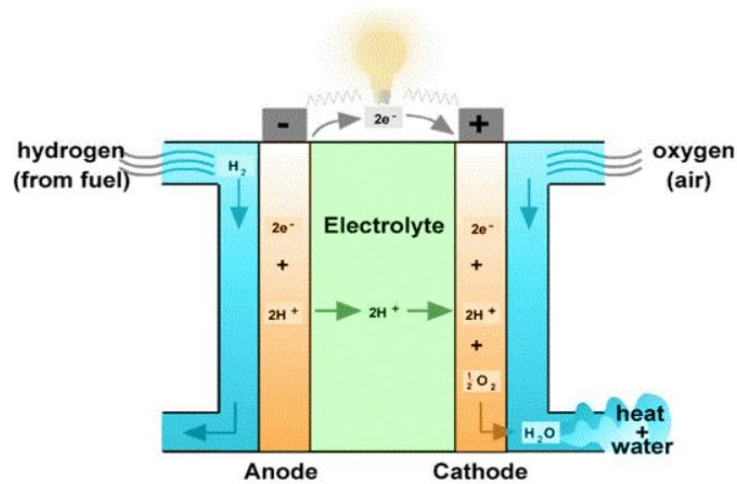

Figure 3. Fuel cell construction

2.3 Affecting parameters in fuel cell operation

2.3.1 Temperature parameter

The performance of the fuel cell depends on several parameters; moreover, a balance between them is crucial to achieve the optimal performance of the fuel cell. Temperature, pressure, and humidity are pivotal measures that directly affect the output power. The reaction of oxygen and hydrogen ends with electricity, water, and heat. High temperatures exist in the area of cells, which can lead to the evaporation of water and dry out the electrodes, consequently affecting the performance of the system. In an experimental survey [2], the effect of various temperatures on the power of the system (a 10-watt fuel cell) was characterized. Figure 4. represents the power dependency on the increased temperature.

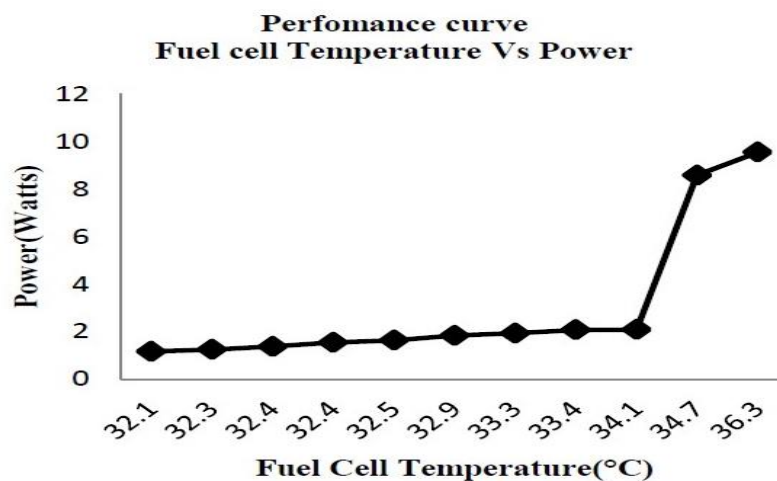

Figure 4. Fuel cell temperature vs. power [2]

2.3.2 Pressure parameter

Another process parameter is pressure, which refers to the pressure of the hydrogen and oxygen supplied to the cell. It plays a crucial role in determining the efficiency and power output of the fuel cell. In the anode side of the fuel cell, hydrogen is injected from a high-pressure vessel. The high pressure of the tank is due to the compressed fuel element. Higher pressure results in the feed of more hydrogen to the electrode. Since hydrogen releases electrons in the circuit, a greater amount of current is produced in the cell. Several studies have examined the role of pressure on the polarization curve in fuel cells. Fig. 5 illustrates that as the operating pressure is increased from 1 atm to 5 atm, the fuel cell performance also increases.

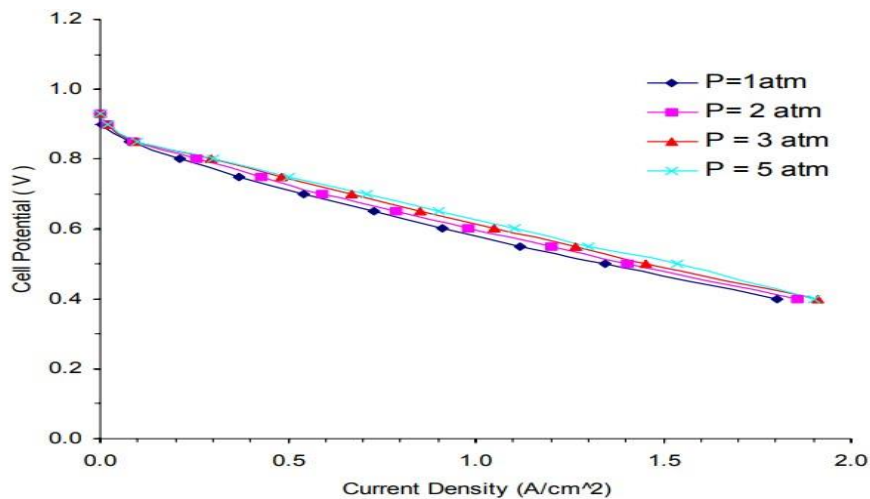

Figure 5. Effect of fuel pressure on fuel cell performance [5]

Oxygen pressure plays a crucial role in determining the performance of fuel cells, particularly proton exchange membrane fuel cells (PEMFCs). The availability of oxygen at the cathode of a fuel cell is vital for the electrochemical reactions that occur during power generation. When the oxygen pressure is too low, it can lead to insufficient oxygen supply to the cathode catalyst layer, resulting in reduced reaction rates and decreased fuel cell performance. This limitation can manifest as lower power output, decreased efficiency, and sluggish response to changes in load.

Conversely, higher oxygen pressure levels can enhance fuel cell performance. Elevated oxygen pressure increases the driving force for oxygen diffusion through the gas diffusion layer (GDL) and into the catalyst layer, promoting faster reaction kinetics [6,7]. This can lead to improved power density and overall fuel cell efficiency. However, it is essential to strike a balance, as excessive high oxygen pressure may cause

mechanical stresses on the fuel cell components and lead to increased parasitic losses associated with air compression. Therefore, optimizing the oxygen pressure within the design and operational parameters of a fuel cell system is crucial to achieving the best performance and efficiency while ensuring the longevity of the cell. The impact of humidity on fuel cell performance is a subject of critical importance, particularly in proton exchange membrane fuel cells (PEMFCs). The hydration level within these fuel cells significantly influences their electrochemical processes and consequently their efficiency. Insufficient hydration can lead to a dearth of water within the polymer electrolyte membrane (PEM) and catalyst layers, resulting in decreased proton conductivity and sluggish electrochemical reactions. This, in turn, translates to reduced power density and overall diminished performance. Conversely, excessive humidity can oversaturate the fuel cell, leading to water flooding, which impedes gas diffusion and disrupts reactant transport, ultimately compromising performance and efficiency. Thus, precise and controlled hydration management is indispensable in fuel cell operation to optimize water distribution, thereby maximizing performance and ensuring the prolonged operation of these electrochemical devices. Ongoing research endeavors continue to investigate advanced materials and strategies for achieving precise humidity regulation within fuel cells, aiming to enhance their reliability and overall performance in diverse applications. In [8], the study investigated the effect of hydrogen and air humidity as well as their flow rate in a finite element model. As a result of this study, as the water produced at the cathode side increases, the membrane becomes more hydrated, and its conductivity increases. In conclusion, to achieve maximum power, a major challenge is water management. The fuel cell must be operated such that the membrane is adequately hydrated to reduce the ohmic losses. Additionally, the water generated at the cathode must be removed quickly to avoid electrode flooding.

2.3.3 Humidity parameter

The membrane water content (represented as λ) is an essential parameter in the fuel cell system. It has a direct impact on the membrane's resistance, specifically its proton conductivity. Dehydration reduces the performance of the fuel cell system by increasing the membrane resistance and, in some cases, can lead to permanent degradation of the membrane [9].

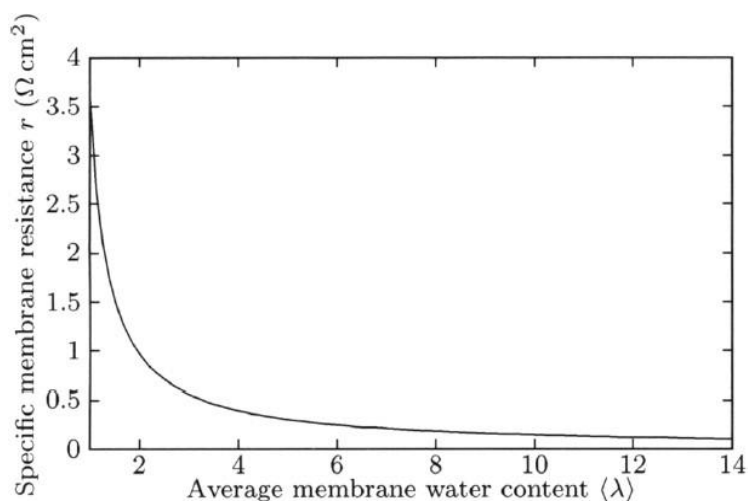

Figure 6. Membrane resistance vs. water content [9]

2.4 Basic of hydrogen and types of fuel cells

Hydrogen is the lightest gaseous element known in the environment. Due to its high reactivity, it cannot be found as a single molecule and forms compounds immediately upon exposure. Despite its lightweight nature, hydrogen disperses into the air quickly. This non-toxic, odorless gas is considered an energy-rich fuel, with an energy density of 33 kWh/kg [80], making it a competitor for battery technology. Hydrogen finds applications across various sectors, with industry, transportation, and energy being two well-known examples. In the realm of mobility, fuel cell electric vehicles (FCEVs) emerge as leading competitors for battery electric vehicles (BEVs). FCEVs offer advantages such as shorter filling times, less performance degradation under cold conditions, and longer travel ranges compared to BEVs. In the energy industry, hydrogen can be stored and utilized during peak energy demand periods to produce electricity. The fuel cell stack comprises layers where electrochemical reactions between oxygen and hydrogen occur. Fuel cells are classified based on the electrolyte used, which is responsible for carrying electrical charge particles from the anode to the cathode. This classification determines the electrolyte type, temperature range of the fuel cell, required catalysts, and other factors. Fuel cells are categorized based on their electrolyte as follows: polymer electrolyte membrane fuel cell (PEMFC), direct methanol fuel cell (DMFC), alkaline fuel cell (AFC), phosphoric acid fuel cell (PAFC), molten carbonate fuel cell (MCFC), and solid oxide fuel cell (SOFC). A PEM fuel cell, also known as a proton exchange membrane or solid polymer fuel cell, operates by combining oxygen and hydrogen to produce electricity. As a chemical reaction, heat and water are by-products of this process. Unlike some other fuel cell types, PEMFCs

do not require a warm-up period, allowing them to start quickly and operate at low temperatures. The operational temperature range for PEMFCs typically falls between 60 to 80 degrees Celsius [81]. Catalysts are utilized in PEMFCs to enhance the reaction between the electrodes, with platinum commonly employed to facilitate this process. However, the use of platinum contributes to an increase in production costs due to its expensive nature.

- Direct methanol fuel cell (DMFC)

A direct methanol fuel cell (DMFC) is a power generator that directly converts the chemical energy of methanol into electricity. It is considered one of the best candidates for micro fuel cell applications such as mobile devices, laptops, and electrical gadgets. In this type of fuel cell, methanol and oxygen react with each other to produce electricity. Similar to other fuel cell systems, heat and water are by-products of the reaction. Additionally, a small quantity of carbon monoxide may also be produced in this process. Like PEMFCs, DMFCs consist of two electrodes—an anode and a cathode—separated by an electrolyte. Compared to hydrogen, methanol can be stored more easily as it does not require low temperatures or high pressures. Furthermore, methanol is in liquid form, which facilitates transportation. All by-products of the DMFC process, except for carbon dioxide (CO₂), can be utilized. The heat generated can be used for space heating. Since DMFCs do not have any moving parts, they operate silently and experience minimal friction and wear.

- Alkaline fuel cell (AFC)

An alkaline fuel cell (AFC) is a type of power-generating system that utilizes hydrogen as fuel. In this system, the electrolyte is typically liquid, and the operating temperature ranges from room temperature up to 230°C [82]. Alkaline solutions such as sodium hydroxide (NaOH) or potassium hydroxide (KOH) are commonly used as the electrolyte. Nickel serves as a catalyst in AFCs, which can be substituted for platinum, contributing to cost reduction [83]. AFCs boast high electrical efficiency and are easy to handle, making them suitable for both small-scale systems and larger power plant installations. The stack design in AFCs differs from that of PEMFCs and solid oxide fuel cells. However, AFCs are sensitive to carbon monoxide (CO). Even small amounts of CO can solidify the electrolyte, leading to detrimental effects on the system's performance as the electrolyte circulates. Therefore, it is crucial to ensure that only pure hydrogen and oxygen are fed to the fuel cell to avoid this issue.

- Phosphoric acid fuel cell

Phosphoric acid fuel cells (PAFCs) utilize liquid acid as the electrolyte, with hydrogen and oxygen injected into the anode and cathode, respectively. Similar to proton exchange membrane fuel cells (PEMFCs), PAFCs also employ platinum as a catalyst. In this type of fuel cell, liquid phosphoric acid is surrounded by Teflon silicon carbide and porous carbon electrodes containing platinum [84]. The temperature range for PAFCs is typically between 150 to 210°C, resulting in higher-quality thermal energy compared to PEMFCs [85]. PAFCs exhibit greater tolerance to impurities, making them suitable for stationary power generation applications due to their large volume and heavy weight. Some PAFCs are also used in large city buses. When used in cogeneration systems that utilize both heat and electricity, PAFCs can achieve an efficiency of around 85%. In applications focused solely on electricity production, the efficiency ranges from 37% to 42% [86]. However, the higher load of platinum used in PAFCs contributes to their higher cost. Despite their expense, PAFCs are well-suited for applications requiring long operational life and constant power supply, as they are reliable and durable.

- Molten carbonate fuel cell (MCFC)

Molten carbonate fuel cells (MCFCs), known as high-temperature fuel cells, utilize a molten carbonate salt mixture as an electrolyte. The basic structure of this type of fuel cell consists of a ceramic matrix containing the electrolyte, surrounded by hydrogen and oxygen. MCFCs operate at temperatures of about 650°C and pressures ranging from 1 to 10 atm [87]. One of the key advantages of MCFCs is their improved efficiency, as their high operating temperature allows for better utilization of heat energy. The overall efficiency of MCFCs, when both heat and electricity are utilized, can reach around 70% [88]. Additionally, MCFCs have the versatility to use a wide range of hydrogen-based fuels such as natural gas and coal gases. When fuel reforming occurs inside the fuel cell, the need for an external reformer is eliminated, reducing power generation costs. However, the high operating temperature of MCFCs also presents some challenges. These include fast degradation of cell structure, corrosion leading to a low operational lifecycle, constant loss of electrolyte, slowly start up time to reach operational temperature, and the possibility of short circuits due to cathode dissolution inside the electrolyte [89]. Due to their high temperature operation, MCFCs are primarily suitable for large-scale stationary power generation applications. They are

not applicable for portable mobile applications due to their high temperature requirements.

- Solid oxide fuel cell (SOFC)

Solid oxide fuel cells (SOFCs) are another type of high-temperature fuel cell primarily developed for stationary applications. They operate within a temperature range of 800 to 1000°C [89], allowing for the use of various hydrogen-based fuels such as coal gases, biogases, and others. The high operating temperature of SOFCs facilitates internal fuel reforming, leading to cost reduction. In longer performance durations, SOFCs demonstrate acceptable efficiency, around 60%. Additionally, due to the high quality of waste heat produced, when combined with a gas turbine-based system, the overall efficiency can be enhanced to 80% [90]. The structure of SOFCs is similar to other fuel cell types, with an electrolyte layer sandwiched between anode and cathode layers. The electrolyte is typically composed of thin solid ceramic material, usually yttrium-doped zirconium oxide (YSZ) [91]. SOFCs offer several advantages, including high electrical and thermal efficiency, low noise production, the ability to use a wide range of hydrocarbon fuels, and the simplicity of their structure, which simplifies production. However, longer starting times are considered a drawback of SOFCs, as they involve various components with different thermal values that must be carefully coupled, leading to thermo-mechanical challenges. Additionally, their poor capability for thermal cycling limits their suitability for portable applications, making them primarily suitable for stationary applications [89]. An overview of these different types of fuel cells, along with their specifications, is presented in Table 1.

Fuel cell type	Electrolyte	Operating temperature	Stack power range	applications	advantages	disadvantages
Polymer electrolyte membrane (PEM)	Sulfonic acid	<120 C°	<1 KW-100Kw	<ul style="list-style-type: none"> • Backup power • Portable • transportation 	<ul style="list-style-type: none"> • low temperature • quick start time 	<ul style="list-style-type: none"> • expensive catalysts • sensitive to impurities
Phosphoric acid (PAFC)	Phosphoric acid soaked in a porous matrix	150-200 C°	400 KW (liquid), < 100 KW (polymer)	<ul style="list-style-type: none"> • distributed generation 	<ul style="list-style-type: none"> • increased tolerance to fuel impurity 	<ul style="list-style-type: none"> • expensive catalysts • long running time
Alkaline (AFC)	Aqueous potassium hydroxide soaked in a porous matrix	<100 C°	1-100KW	<ul style="list-style-type: none"> • military • space • transportation 	<ul style="list-style-type: none"> • low cost components • low temperature • quick start up 	<ul style="list-style-type: none"> • sensitive to CO₂ • electrolyte management
Molten carbonate (MCFC)	Molten lithium, sodium, potassium, carbonates soaked in a porous matrix	600-700 C°	300KW-3MW	<ul style="list-style-type: none"> • distributed generation • electric utility 	<ul style="list-style-type: none"> • high efficiency • fuel flexibility • hybrid turbine cycle 	<ul style="list-style-type: none"> • breakdown of components due to high temperature • low start up time • low power density
Solid oxide (SOFC)	Ytria stabilized zirconia	500-1000 C°	1KW-2MW	<ul style="list-style-type: none"> • electric utility • distributed generation • auxiliary power 	<ul style="list-style-type: none"> • high efficiency • solid electrolyte • hybrid gas turbine cycle 	<ul style="list-style-type: none"> • breakdown of components due to high temperature • low start up time • low power density • limited number of shutdowns

Table 1. Types of fuel cells

2.5 Application of fuel cell

Fuel cells have found diverse and promising applications across various industries, primarily due to their high energy efficiency, low emissions, and versatility. Examples of fuel cell applications include the automotive industry, aerospace, maritime, material handling, backup power, and residential and commercial power. In other words, wherever electricity is required, this technology can be helpful. Fuel cells are classified based on the types of electrolytes used, each with their unique specifications and working conditions, which will be discussed in detail in subsequent chapters. Generally, there are six types of fuel cells [11].

- 1) Alkaline fuel cell (AFC)
- 2) Proton exchange membrane (PEMFC)
- 3) Molten carbonate fuel cells (MCFC)
- 4) Phosphoric acid fuel cell (PAFC)
- 5) Solid oxide fuel cell (SOFC)
- 6) Direct methanol fuel cell (DMFC)

While various fuel cell types have been developed, PEMFCs are particularly suitable for a range of diverse uses [11]. This technology can be applied in various applications, with power ranging from a few watts to megawatts. Fuel cell applications can be

classified as either mobile or stationary. Stationary areas include residential, combined heat and power (CHP) systems, and distributed power generation, while mobile applications encompass transportation, portable fuel cells, and space applications. Based on the desired application, required power, and other factors, the appropriate fuel cell system can be chosen.

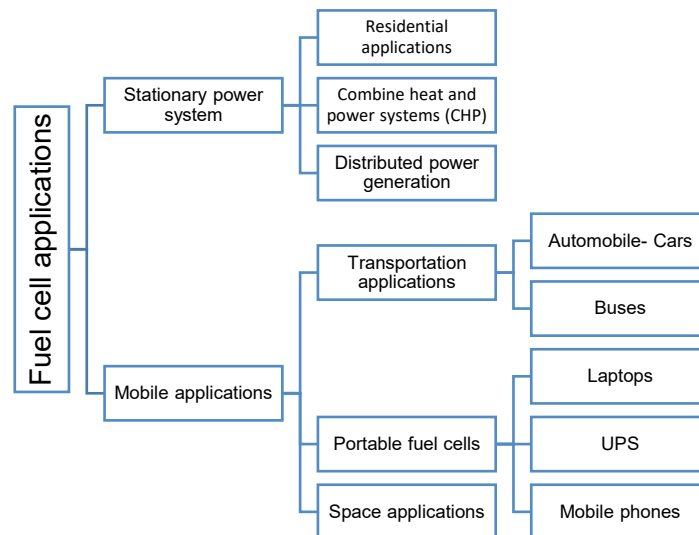

Figure 7. Fuel cell application areas

- Stationary power systems

Stationary power products encompass a wide power range, from 1 kilowatt to several megawatts, and find utility in various settings where electricity is required, such as homes, businesses, schools, hospitals, and more. These markets are conventionally supplied by centralized power generation [11, 12]. Residential fuel cells support homes by providing electricity either independently or in conjunction with the power grid. The space they require for the related facilities can be as small as an ordinary refrigerator and provide quiet, reliable power. According to [11], these systems have the capability of producing about 5 kW of power or 120 kWh of energy per day.

Combined heat and power (CHP) systems often utilize fuel cells to achieve energy efficiency and provide both electricity and heat for various applications. Fuel cells produce electricity, and the by-product heat can be used for various purposes. Fuel cell and CHP integration is an example of combining two different energy technologies that complement each other. By integrating these two methods, the overall energy output is maximized, waste is reduced, and system efficiency is amplified.

Distributed power generation, also called decentralized power generation, involves producing electricity near the point of use rather than at distant power plants. This approach to providing electricity to end-users involves smaller-scale power generation using renewable energy sources such as solar panels, wind turbines, fuel cells, and other technologies. Distributed Generation (DG) systems offer several significant advantages. One key benefit is the reduction of energy losses associated with long transmission and distribution lines. This enhances overall system efficiency and sustainability by minimizing wasted energy during electricity transport. DG systems are also cost-effective to install, leading to lower initial investments, which can be particularly beneficial for smaller-scale energy projects. Furthermore, DG systems enable localized voltage regulation, ensuring a stable and reliable power supply for end-users. In summary, this system provides flexibility in responding to peak load conditions by allowing the addition of smaller units, rather than relying solely on larger, centralized power plants. This approach can lead to better load management and improved grid resilience [11].

- Mobile applications

The rapid growth in population and the increasing demand for transportation, especially in developed countries, have had significant impacts on energy consumption and the environment. Therefore, the need for acquiring reliable, sustainable, and clean energy for transportation means is essential and warrants investigation. Fuel cell systems have revolutionized mobility by offering longer runtime, faster refuelling, and reduced greenhouse gas emissions compared to other traditional power sources. As the reaction process inside fuel cells is chemical and the by-product has zero emissions to the environment, they are considered one of the most reliable sources of energy for transportation vehicles.

Public transportation plays a vital role in urban mobility, especially in densely populated major cities. The average number of trips taken per person each year in countries with urban populations exceeding 30 million varies, ranging from around 40 (in the United States) to approximately 250 (in Japan). In the EU, bus transportation is popular due to its cost efficiency and flexibility, accounting for about 56% of all public transport journeys. Therefore, in some EU countries, targets and measures have been set to shift from fossil fuel transport technology to those with less or zero carbon emissions. For instance, cities like Paris, Madrid, Athens, and Copenhagen have committed to

removing all diesel vehicles from their cities by 2025. Presently, some improvements have been made to reach Euro VI diesel engines, although there is a large expectation to achieve zero-emission buses, such as battery electric buses (BEB) and fuel cell buses (FCB) [13].

Portable fuel cells are compact, efficient power sources that have gained popularity for their versatility in various applications. Their small size and lightweight design make them ideal for use in situations where electricity is required, such as camping, outdoor adventures, or emergency situations. Unlike lithium-ion batteries commonly used in laptops and mobile phones, which have limited operating times and can be restricted by application, fuel cell energy sources can continuously produce electricity with a constant fuel supply, making them long-lasting for portable devices.

These devices can generate electricity from hydrogen or other fuels, providing a clean and eco-friendly source of energy. With the ability to charge electronic devices, run small appliances, or serve as backup power sources, portable fuel cells are revolutionizing the way we think about mobile power [14]. Their zero emissions and sustainable energy production make them an excellent choice for off-grid and remote power requirements.

Fuel cells have played a pivotal role in advancing space exploration by providing a reliable and efficient power source for spacecraft. The extreme conditions of space, including the absence of oxygen, make conventional combustion-based power generation methods impractical. Fuel cell technology not only offers a high energy-to-weight ratio but also excels in space where weight constraints are critical. NASA and other space agencies have extensively utilized fuel cells in various missions, including the Apollo program, the Space Shuttle program, and the International Space Station. These fuel cells ensure continuous power generation for life support systems, equipment, and scientific instruments during extended missions [15,16,17]. In summary, as fuel cell applications expand and enhancements in fuel storage techniques and management are introduced, cost reductions in the future are expected. These advancements are likely to lead to a substantial decrease in the expenses associated with fuel cell systems.

In every study, it is worth mentioning the difficulties and opportunities of the subject. In this chapter, the challenges and opportunities faced by fuel cells are presented. High

initial cost, safety concerns, and lack of infrastructure are the threats facing this system. However, the range of usage, clean energy, and high efficiency are some of its potentials.

Benefit	Challenges
High Efficiency	High initial cost
range of usage	safety concern
Environmentally beneficial	Lack of infrastructure
Noise	Barriers to access

Table 2. Benefit and challenges of fuel cell technology

Fuel cells offer a multitude of benefits that position them as cutting-edge technology in various applications. High efficiency is one of the significant advantages of this technology, as fuel cells can produce electricity from chemical reactions with minimal waste. Cogeneration, also known as Combined Heat and Power (CHP), is a highly efficient energy production process wherein electricity and useful heat are simultaneously produced from a single device, maximizing fuel utilization and minimizing energy waste. Depending on the type of fuel cell, its productivity is typically around 50%. When integrated into hybrid systems, efficiency levels can increase to a range of 60 to 70% [18]. Solid Oxide Fuel Cell (SOFC) is one example of a fuel cell suitable for cogeneration, given its high operating temperature. Companies like Siemens Westinghouse have developed SOFC cogeneration power plants, such as those incorporating SOFC and micro gas turbines. These plants can achieve an electric plant efficiency of 53% and generate significant power, such as 220 kW [18, 19]. Fuel cells are highly efficient energy conversion devices capable of converting various fuels into electricity with minimal waste, often surpassing traditional combustion-based power generation methods. One of the main differentiating parameters between fuel cells and internal combustion engines (ICE) is the level of noise production. ICE engines work by harnessing the energy from the explosion of fuel, such as gasoline or benzene, which is then converted into mechanical power to drive the machine. This process involves several mechanical components that produce noise. In contrast, fuel cells generate electricity through a chemical reaction, resulting in silent operation. While some components of the Balance of Plant (BOP) in fuel cells, such as compressors, valves, exhaust systems, and cooling systems, may produce noise, the fuel cell stack itself is silent compared to ICE engines. Efforts to mitigate noise in fuel cell systems typically involve the use of sound-absorbing materials,

vibration dampeners, and the design of components for reduced noise production. Several experiments are underway to address this issue.

2.6 Integration of fuel cell into e-drivetrain

Zero-emission vehicles, such as Battery Electric Vehicles (BEVs) and Fuel Cell Electric Vehicles (FCEVs), produce no tailpipe emissions. In BEVs, electricity is generated by the battery traction, while in FCEVs, it is produced by the fuel cell stack. Combining battery technologies with fuel cell technology introduces a new category of emission-free cars known as Fuel Cell Hybrid Electric Vehicles (FCHEVs). FCHEVs utilize a combination of battery, ultra-capacitor storage technology, and fuel cell to extend the range and power of the vehicle [20]. It's important to note that the fuel cell consumes hydrogen to generate electricity. In Figure 8, the integration of fuel cell and battery technologies into the electric motor to transport power to the gearbox is illustrated.

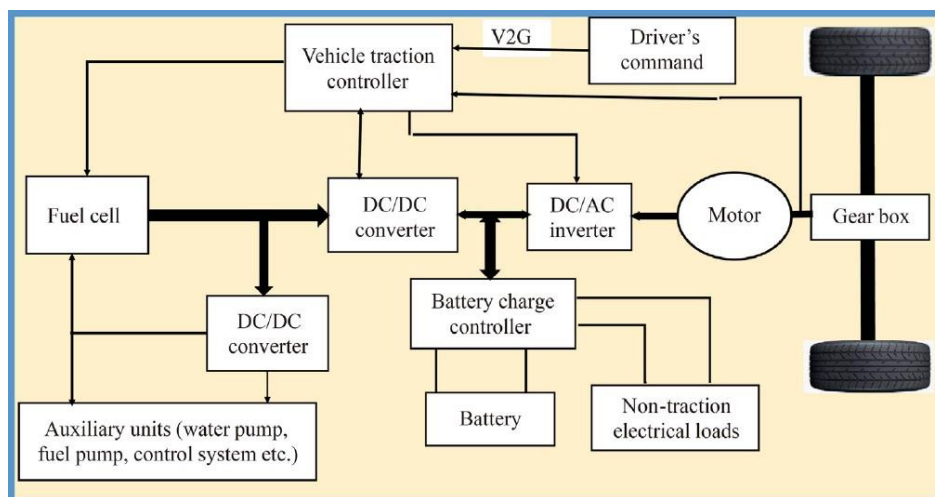

Figure 8. Integration structure of fuel cell with battery to transport power into e-drive train [21]

To develop a hybrid system suitable for powering hybrid electric vehicles, fuel cells are combined with various additional energy sources such as batteries, flywheels, and ultra-capacitors [22]. DC/DC converters are used to convert the low voltage produced by the fuel cell into a suitable voltage level for the electric motor. Initially, the battery serves as a power supply to start the fuel cell. Once the fuel cell is operational, the battery allocation is cut off, and the system is then run solely by the fuel cell. In a hybrid car, power transfer occurs in two stages: from DC to DC and from DC to AC. After being transformed from low voltage DC power to high voltage DC, the elevated voltage DC is then inverted to become AC [21]. Integrating a fuel cell into an electric drivetrain

involves the cooperation of fuel cell systems alongside electric drivetrain components to create a hybrid powertrain.

3. Methodology

This section presents the methodology of the project, which involves studying the fuel cell module consisting of the fuel cell stack and balance of plant (BOP). A market analysis is conducted to acquire suitable parts, and the positioning of the BOP for the desired system is implemented. Figure 9. illustrates the fuel cell module with its corresponding BOP.

3.1 Balance of plant definition

In this project, it is possible to include or exclude some components from and into the BOP package based on the size of the system. This decision is made in agreement with the fuel cell team to develop the system in an optimum size. Due to limitations in package size for the current project, some components in the BOP are decided to be located outside of the package. Examples include the radiator and hydrogen storage, where their dimensions and quantity are factors to consider placing them outside the package. For the current project, the definition of the fuel cell module development and its related BOP include the fuel cell stack, anode (hydrogen) subsystem, cathode (oxygen) subsystem, thermal management, and power management. Any components outside this module are excluded from this project.

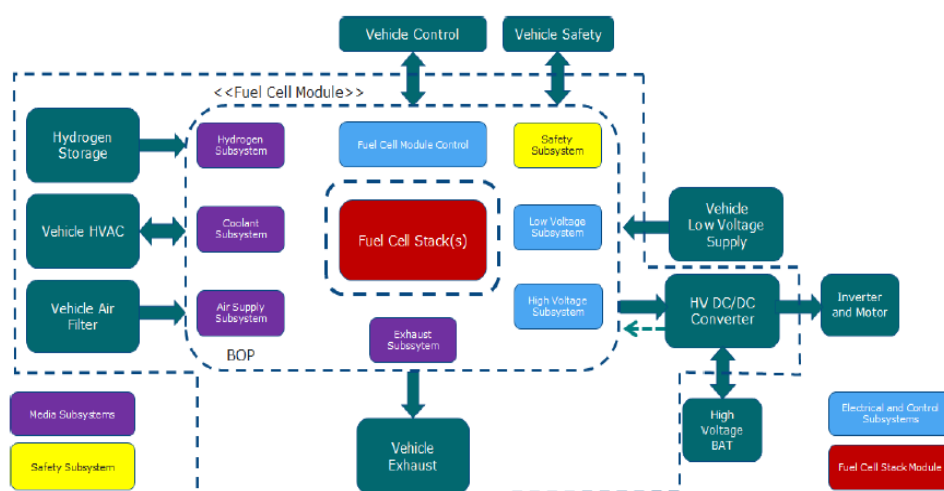

Figure 9. Balance of plant definition

A detailed piping and instrumentation diagram (P&ID) is necessary for this PEM fuel cell system as a blueprint to describe the precise arrangement of pipes, valves, instruments, and control loops essential for its efficient functioning. Diagram 1. offers a comprehensive visualization of the flow paths of reactants, anode, cathode, electrical management, and thermal management subsystems.

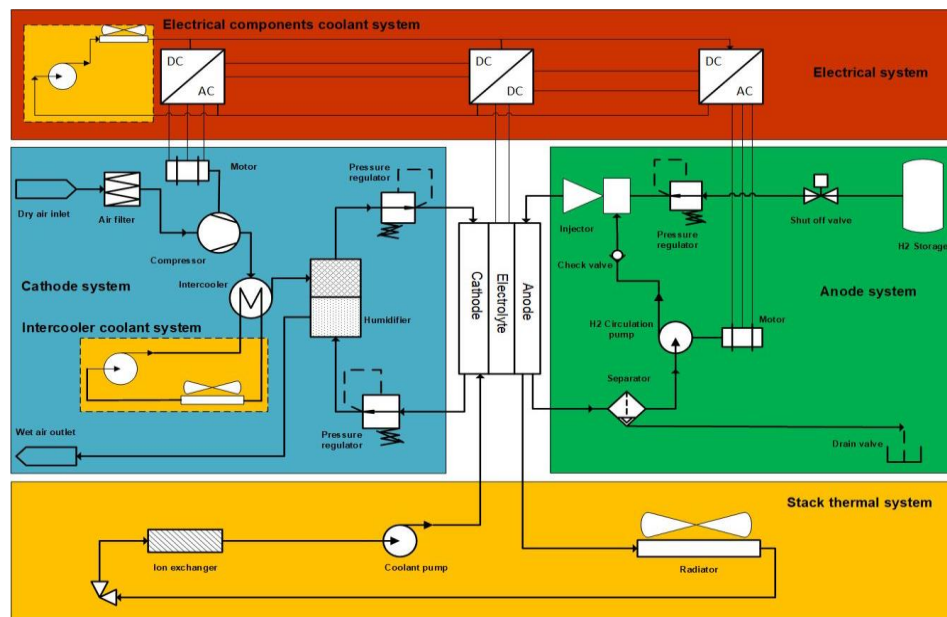

Diagram 1. PEM fuel cell piping and instrumentation

3.2 Anode system

3.2.1 Isolation valve

In pneumatic systems, safety is a paramount consideration due to the potential risks associated with the high-pressure flow of media within the system. Uncontrolled flow under high pressure can lead to hazardous conditions that must be mitigated to protect the system and its components. In fuel cell systems, isolation valves, also known as shut-off valves, are employed to enhance safety. These valves serve to block the flow of gases into the system during repair and maintenance activities. Additionally, in emergency situations, such as leaks or malfunctions, isolation valves isolate the entrance of hydrogen or oxygen to prevent damage and ensure the safety of the system. Isolation valves play a crucial role in ensuring the efficient and safe operation of pneumatic systems. They are typically categorized based on their method of operation, which can include mechanical or hand-operated valves, solenoid-operated valves, and air-operated valves. Solenoid valves, for instance, are controlled by electrical pulses that command the valve to either close or open the path of hydrogen flow. The schematic of an isolation valve is depicted below, along with its corresponding pneumatic symbol. This symbol represents the valve's function and operation within the pneumatic system.

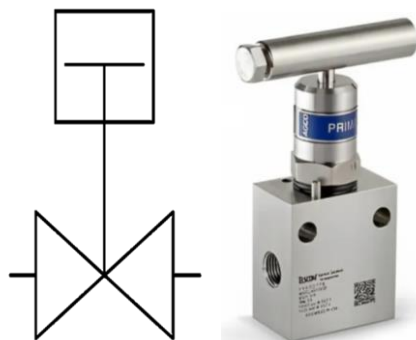

Figure 10. Isolation valve

Different types of shut-off valve offer degrees of precision, flow capacity, and suitability for specific operating conditions. Some common isolation valves with their application is listed in the table below [23].

Shut-off valve type	Feature	Application
Ball Valve	General-purpose of in compressed air systems	Wide range of application in pneumatic systems
Needle Valve	These valve provide precise control over air flow	<ul style="list-style-type: none"> • Laboratory • precision equipment
Plug Valve	Plug valves are used in pneumatic systems that require simple, reliable, and low-maintenance on/off control	<ul style="list-style-type: none"> • bulk material handling • mining
Diaphragm Valve	Diaphragm valves are suitable for applications where cleanliness and contamination control are essential	<ul style="list-style-type: none"> • Pharmaceuticals • food processing • semiconductor manufacturing

Table 3. Types of Shut-off valve

Choosing a suitable valve is important to reach high level of safety in the system, to achieve this mean there are some factors to be considered as below:

- Valve type: The choice of valve type depends on the specific application. Common types include ball valves, gate valves, globe valves, butterfly valves, and plug valves. Each has its own advantages and limitations in terms of flow control, sealing, and pressure drop.
- Pressure Rating: For safety reasons, the maximum pressure of the system must be considered in the pressure range of the valve in order to prevent leakage or failure under high pressure.

- **Temperature Rating:** The temperature of the fluid passing through the valve is important for choosing the right valve. Some materials are brittle and prone to failure in extreme temperatures.
- **Material Construction:** The material of the valve must be compatible with the fluid passing through it; there must not be any incompatibility. The chemical reaction between the valve and fluid is important for selecting the valve.

Selecting the appropriate shut-off valve is a critical decision that directly impacts the safety and efficiency of fluid control systems. In addition to the mentioned specifications of the valve, industry standards and regulations, maintenance requirements, and cost considerations are some of the other factors that must be examined in the selection process. By considering these factors, we can achieve the desired performance and reliability in fluid control systems.

3.2.2 Pressure regulator valve

Pressure regulators, also known as reducing valves, are used to reduce the pressure in pneumatic circuits. Most pneumatic power systems are designed to operate within a defined pressure range. When this pressure is not controlled, components and expensive equipment are at risk of damage. The role of the pressure regulator is to control the upstream pressure and prevent hazards. The primary purpose of pressure regulators is to control pressure with close tolerances to ensure that compressed air in a pneumatic system is not wasted. Pressure-regulating valves accomplish this by maintaining constant output pressure under various input pressures and output flows. Pressure relief valves are categorized into two subcategories: direct and pilot-operated. Direct and pilot-operated air pressure regulators are two common types of regulators used to control and maintain the pressure of compressed air or gases in pneumatic systems. They work differently and are suited to various applications based on their operational principle.

- **Direct air pressure regulator:**

Compressed air or gas enters the regulator through the inlet port and exits through the outlet port. Inside the regulator, there is a flexible diaphragm and a spring. The diaphragm separates the high-pressure inlet from the low-pressure outlet, with the spring applying force to keep it in a closed or partially closed position.

The regulator is equipped with an adjustment mechanism, typically a screw or knob, allowing the operator to set the desired outlet pressure. This adjustment mechanism

alters the tension on the spring. The downstream pressure, or outlet pressure, is sensed through a connection on the diaphragm.

When the downstream pressure deviates from the set point, the diaphragm flexes in response. This flexing action affects the opening of the valve inside the regulator. As the diaphragm flexes, it either opens or closes the valve to control the flow of air or gas. If the downstream pressure is too high, the diaphragm flexes to close the valve partially or completely, thereby reducing the flow and regulating the pressure. Conversely, if the downstream pressure is too low, the diaphragm allows the valve to open wider, increasing the flow and pressure.

- Pilot-Operated Air Pressure Regulator:

Pilot-operated air pressure regulators use an additional control mechanism, known as a pilot, to regulate the main regulator's operation.

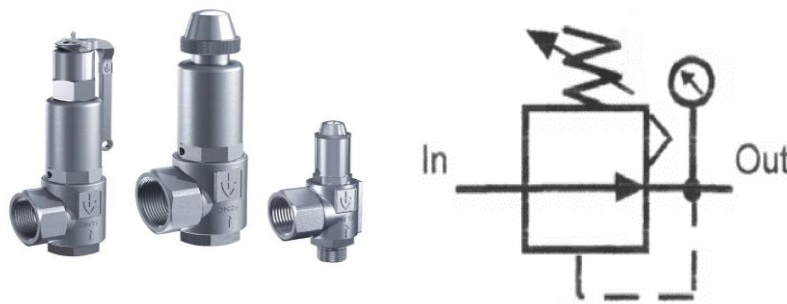

Figure 11. Pressure regulator valve

When choosing an air pressure regulator, it is essential to consider some important technical specifications [24]:

- The required pressure (P1, P2)
- Port (thread size): There are many options for port sizes for a pressure regulator. Generally, port size will be dictated by the flow requirements in a particular application. The two main thread types are NPT (National Pipe Thread) and BSP (British Standard Pipe).
- Range of working temperature
- Material, compatibility with medium

3.2.3 Check valve

A check valve, also known as a one-way valve or non-return valve, is a device used in hydraulic and pneumatic systems to allow the flow of medium in one direction only,

preventing gas or liquid from returning into the downstream system or flowing in the opposite direction. Check valves operate based on the pressure difference between the inlet and outlet ports. There is a specific pressure, known as the cracking pressure, at which the valve starts to operate and allows the medium to flow in the desired direction [25,27]. When the pressure difference between the inlet and outlet is greater than the cracking pressure, the valve begins to allow the medium to flow.

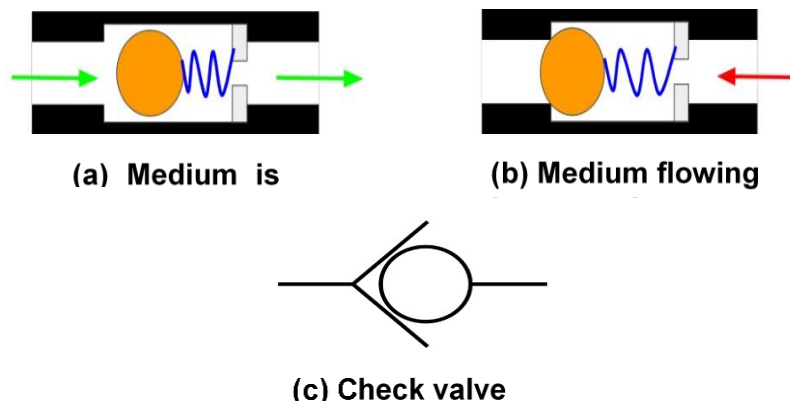

Figure 12. Check valve mechanism

There are various types of check valves available, each chosen based on the specific application requirements. These types include swing check valves, lift check valves, ball check valves, diaphragm check valves, dual plate check valves, stop-check valves, spring-loaded check valves, and others [26]. While the specific design and features may vary, the general mechanism of all check valves is similar: there is a feature that closes the passage of the medium, and there is a pressure required to overcome the force of this feature. In figure 12, a schematic of the ball check valve, one of the simplest types of check valves, is presented along with its symbol.

In the first picture (a), the pressure of the spring causes the ball to open, allowing gas or liquid to flow through the valve. Additionally, the pressure of the medium is not sufficient to overcome the force of the spring and close the outlet. In the second state (b), the medium flows back and pushes against the spherical object, causing it to seal against the structure of the valve. As a result, the passage is closed, preventing the gas or liquid from moving in the opposite direction.

Check valves play a critical role in various industries, including biology, chemical engineering, microfluidics, heat pipes, plumbing networks, and many others. They are designed with consideration for factors such as pressure, structural design, cost, and more, all aimed at increasing system safety and enhancing efficiency.

3.2.4 Recirculation pump

PEM fuel cell systems have revolutionized energy supply in various applications, specifically in the automotive industry. Due to the high potential of hydrogen energy in recent decades, fuel cell technology has made meaningful progress in commercialization [28]. Although the output power of fuel cell systems has increased to the range of 60-100 kW, cost and durability remain considerable challenges [29]. Much research has been conducted to enhance the performance and durability of the stacks. Additionally, developing efficient balance of plant (BOP) subsystems can increase the operational life of fuel cell systems. BOP subsystems include cathode air supply, anode fuel supply, and thermal and electrical management. With the increase in output power, the operational pressure for fuel cell systems has increased to 200-300 kPa [30]. Therefore, hydrogen consumption in subsystems has also increased. It is noticeable that when hydrogen flows to the anode to react with oxygen, not all transferred hydrogen is consumed. Consequently, some portion of it remains unused and is delivered out from the stack outlet. To manage this hydrogen, there are two options. One is to purge it, combined with the water produced in the stack. However, since hydrogen gas in the fuel cell system is valuable and directly affects the output power and efficiency of the overall system [31], it is favourable to recover it, enabling anode gas utilization rates of up to 99% [32]. As explained, hydrogen recovery is a profitable alternative in utilizing this gas, which can be achieved by a recirculation pump. Generally, there are three types of hydrogen supply configurations [30], which are mentioned in the table below.

Hydrogen supply configuration	Features
Dead end design	Simple and compact configuration
Flow through structure	Continuous flow, balancing
Hydrogen recirculation	High power density, low hydrogen consumption, robust reliability

Table 4. Hydrogen supply configuration

In a dead-end design, fuel and air are injected into the system in a one-way path without any recirculating system to recover the unreacted hydrogen. Consequently, distribution is uneven, and utilization is low. Due to the lack of recirculation, this method's configuration is simple. The flow-through structure is another configuration for reusing hydrogen. However, this operation mode must overcome the viscous forces

of water droplets, leading to high fuel losses [33]. The last method involves recirculating hydrogen to the system using a hydrogen pump. In this method, unreacted hydrogen produced during the electrochemical reactions is typically captured and recirculated to the hydrogen inlet to maximize hydrogen utilization and improve efficiency. The hydrogen pump is a critical component in fuel cell systems, as the performance of this element impacts the efficiency of the system. Performance maps of these devices provide valuable information for designing a fuel cell system, helping designers implement control strategies during system operation. The performance map varies for different pumps. To classify hydrogen pumps, there are three different types:

- Electrochemical pump [30,34]

An electrochemical pump, often referred to as an electrochemical pump cell or pump cell, is a device that utilizes electrochemical reactions to move liquids or gases. This device operates based on principles of electrochemistry. Electrochemical pumps can be employed as alternatives to mechanical compressors or ejectors in closed-loop fuel supply systems. Compared to mechanical compressors, electrochemical pumps have much lower power consumption and higher efficiency, particularly in low-power applications such as anodic recirculation systems of PEMFCs. Additionally, the flexibility of electrochemical pumps across various ranges of PEMFC operating conditions, reduced noise, and lifetime reliability are other advantages of this device.

- Ejector [30]

The pressure difference between the hydrogen tank and the fuel cell stack serves as the driving force for ejectors. The efficiency of ejectors is high due to their low parasitic power. Consequently, advantages of these pumps include the absence of moving parts, low maintenance costs, and high efficiency.

- Mechanical pump [30]

In a mechanical pump, the pressure of the hydrogen is increased at the outlet of the stack for recirculation to the system, and the power for this pump is supplied by an electric motor. From an efficiency standpoint, mechanical pumps generally exhibit lower efficiency compared to ejectors, which is a disadvantage. However, mechanical pumps offer advantages such as multi-phase delivery, controllability, and unique characteristics in off-design conditions, making them widely used in fuel cell systems. While "mechanical pump" is a general term, based on the structure and key

components of this pump, it can be divided into several types. In the figure below, an overview of the circulation pump is presented, and the mechanical pump is further discussed.

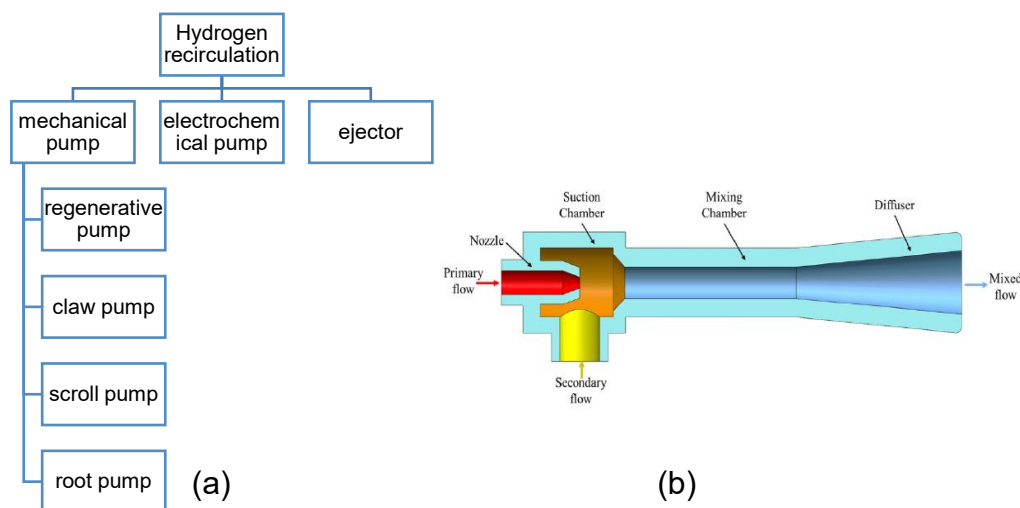

Figure 13. a) Hydrogen recirculation pumps types b) structure of injector [39]

Regenerative pumps are considered alternatives to volumetric pumps in certain applications, particularly for low-flow, high-pressure tasks like hydrogen recirculation. They offer compactness, high performance, reduced cost, low vibration, and the ability to operate without lubrication. However, their compression efficiency tends to be low, typically below 45% [35]. Despite this drawback, regenerative pumps find numerous applications in various industries, including automotive and aerospace fuel pumping, booster systems, water supply, shipping, mining, and chemical and food processing.

Claw pumps, a type of positive displacement pump, are utilized for generating vacuum for gases, including air and various industrial gases. Their distinctive claw-shaped rotors or lobes contribute to their efficiency in discharging pressure compared to root vacuum pumps [36]. Claw pumps are favoured for their simple construction, compactness, and oil-free operation, making them suitable for applications requiring clean and efficient vacuum generation.

Scroll pumps, also known as spiral compressors/pumps, employ two twisted spiral-shaped scrolls to pack gases [37]. They are renowned for their efficiency, reliability, oil-free operation, and ability to provide consistent and pulse-free gas compression. Due to these characteristics, scroll-type hydrogen pumps are promising for hydrogen recirculation in fuel-cell systems, offering high efficiency, low noise and vibration, reliable operation, and adjustable flow.

Root pumps, or Root blowers, utilize counter-rotating, high-speed rotors with lobes to move gas. They are valued for providing constant and pulse-free airflow, making them suitable for various industrial and environmental applications. While root pumps lack built-in compression, their efficiency is not significantly compromised for hydrogen fuel cell recirculation applications, as the required pressure difference is relatively small. Root pumps are preferred in fuel cell vehicles for their high reliability, low cost, and compatibility with reversible rotation for example Toyota in one of its products, Mirai, used this type of pump [38]. The size of root pumps depends on factors such as rotation speed and volume rate, which must be considered in system design.

The overall efficiency of a fuel cell system depends on the performance of its individual components. The selection of suitable components, including pumps, is crucial for optimizing system performance and efficiency. Parameters such as power consumption, pressure drop, and technical specifications must be carefully evaluated when choosing pumps for fuel cell systems. Technical information provided by vendors, such as fact sheets, aids in selecting appropriate components for the system.

3.2.5 Water separator

In a PEM fuel cell, hydrogen inserted into the anode side reacts with oxygen to produce water and electricity. Although not all the hydrogen is consumed, the unused proportion of it can be utilized in the cycle to conserve hydrogen, thereby increasing efficiency [40]. Several studies have investigated methods for separating water from the reactant gas, including centrifugal force for water-gas separation and voltage drop for opening the valve for separation [40, 41]. If moisture is not effectively separated from the anode side, it can return with the hydrogen gas to the anode inlet, significantly impacting the performance and durability of the PEM fuel cell. Excess moisture in the anode can lead to flooding, where the gas diffusion channels become blocked by liquid water, impeding the supply of hydrogen to the catalyst and inhibiting the electrochemical reactions. Flooding can result in reduced fuel cell power output and potential damage to the catalyst and membrane. Effective water management, including moisture separation at the anode, is essential to maintain optimal PEMFC performance. Therefore, strategies for managing water as a by-product in the anode are crucial.

- **Water channel**

In anode structure design, there are channels designed to facilitate the removal of water from the cell, aiming to prevent flooding and remove excess water. When water

droplets form on the walls of the anode plate and are not effectively removed, the consequences are more significant compared to the cathode. One reason for this is that the hydrogen gas trapped in the produced water is not utilized, leading to a reduction in its flow rate within the cycle. Consequently, this reduction in efficiency results in decreased electricity production [43].

- **External Water Separators**

Another component used to separate water is separators. With the help of this device, unreacted hydrogen is filtered from the water exiting from the anode. From one outlet, the hydrogen is transferred to the system for recovery, while from the other outlet, water is exhausted out of the fuel cell. A vapor-liquid separator is a device used to separate the mixture of liquid and gas into its constituents and isolate contaminants from them. It is placed in the path of the anode outlet, where the water produced and excess hydrogen flow through it. The hydrogen is separated and recycled back into the system.

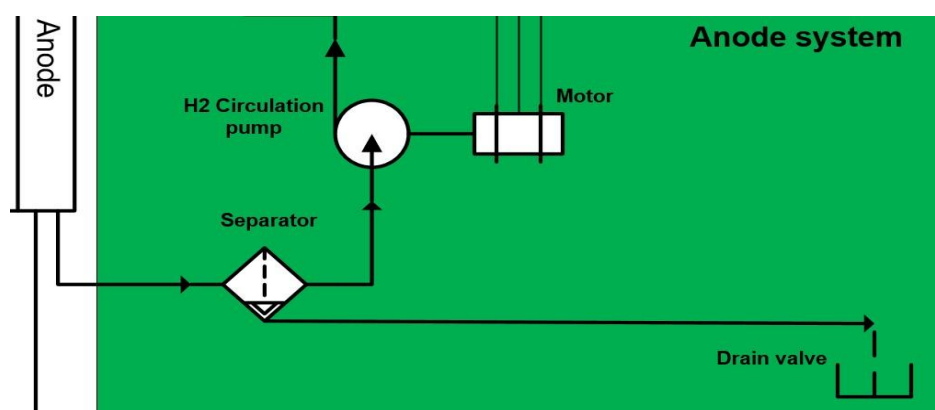

Figure 14. Water separator position, in-line liquid gas separator [42]

There are several factors to consider when selecting a water separator for a fuel cell system. The primary function of a water separator is to efficiently remove moisture from a gas stream. Therefore, the separator should have high separation efficiency to ensure that the gas leaving the separator is adequately dry for the intended application. Separation efficiency is typically expressed as a percentage of moisture removed. Additionally, the separator should be able to handle the required flow without causing excessive pressure drop or reduced separation efficiency. Matching the separator's flow capacity to the application is crucial. The temperature range of the separator must also be considered, as the water from the anode may have a high temperature. Particle removal capability is another important factor when choosing a separator, as it must

be able to effectively separate moisture and contaminants. Effective anode water management is essential for maintaining the performance and durability of PEMFCs. This involves achieving a proper balance of hydration for proton conduction while preventing flooding. Continued research and development efforts focus on optimizing anode water management strategies to enhance the overall efficiency and reliability of fuel cells.

3.3 Cathode system

3.3.1 Air filter

In PEM fuel cells, the chemical reaction between the reactant gases, hydrogen and oxygen, generates electricity. On the cathode side of the fuel cell system, oxygen is supplied at a certain flow and pressure to facilitate the reaction. The performance and durability of the fuel cell are closely linked to the purity of the oxygen supplied. Since the required oxygen is sourced from the air, which contains various particles not all necessary for the stack, filtration alternatives are necessary to separate unwanted particles. The chemical reaction in the cathode is enhanced by a platinum catalyst. Due to the complexity of the reaction and the double reduction of oxygen compared to hydrogen, twice as much platinum is required on the cathode side, typically 0.1 mg cm^{-2} compared to 0.05 mg cm^{-2} on the anode side [44,45]. Contaminants in the air can lead to degradation in the optimum performance of the fuel cell, thereby affecting the overall efficiency of the system. Air primarily consists of 78.09% nitrogen, 20.95% oxygen, 0.93% argon, 0.04% carbon dioxide, and other gases. Several studies have investigated the effects of pollutants on fuel cells [46]. For example, sulphur dioxide (SO_2) [47] and nitrogen dioxide (NO_2) concentrations have been shown to reduce fuel cell performance [46, 47]. In a more precise example, even small concentrations of carbon monoxide (e.g. 20 ppm) can cause a temporary 4% reduction in fuel cell output. Other contaminants, such as sulfur compounds like hydrogen sulfide (H_2S) and SO_2 , can have permanent effects, reducing performance to as low as 30% of the original output [48]. To mitigate airborne contaminants, three strategies can be employed to decrease the level of impurities from the air, thereby protecting the expensive and sensitive platinum catalysts. One method involves the use of tolerant electro catalysts, which are materials with a high tolerance to various conditions [49]. Another approach is ozone injection into the cathode line as a recovery method to increase the removal of contamination. The third method is applying an air filter before captured air passes

through the fuel cell, which is a more cost-effective alternative compared to the last two. However, when selecting a filter for air filtration, durability, adsorption capacity, and pressure drop are the most critical parameters to consider. Figure 14 presents some examples of air filters.



Figure 15. Air filters

When selecting an air filter, the design, shape, size of particle adsorption, and pressure drop must be carefully considered. When air with pressure P_1 reaches the filter, there is resistance which causes the pressure to drop to P_2 at the outlet. This P_1 pressure serves as the inlet for the compressor, as the pressure and flow of oxygen need to be maintained at specific values for the fuel cell. Therefore, a compressor is required to compensate for the pressure drop, increasing the outlet pressure ($P_{\text{Compressor}}$). As the ratio of $P_{\text{Compressor}} / P_2$ increases, higher power is required from the compressor, which affects the overall efficiency of the system. This example underscores the importance of selecting an appropriate air filter. In summary, achieving higher performance and optimal efficiency in PEM fuel cells requires careful consideration of the air filter in the cathode line.

3.3.2 Air compressor

The chemical reaction in a PEM fuel cell involves the combination of hydrogen from the anode and the reduction of oxygen from the cathode, resulting in the generation of electricity at a certain voltage and current. The amount of electricity produced depends on the consumption rates of hydrogen and oxygen by the cells, as well as various parameters affecting the overall performance of the fuel cell, particularly from the perspective of the air supply route. The air supply system consists of several components designed to deliver oxygen to the cell. These include pressure valves, transducers, temperature and pressure sensors, all of which are part of the Balance of Plant (BOP) components on the cathode side of the fuel cell. Additionally, the

compressor plays a critical role as one of the main functional elements in this operation. In low-pressure fuel cells, a blower is used, while in high-pressure fuel cells, a compressor is employed to ensure sufficient oxygen flow to the system [50]. However, it's important to note that compressors are energy-consuming machines that require electricity to operate within a system. Therefore, it is crucial to consider certain parameters of the compressor during the design or selection process for the fuel cell. In the following sections, various types of compressors will be introduced and compared based on Key Performance Indicators (KPIs).

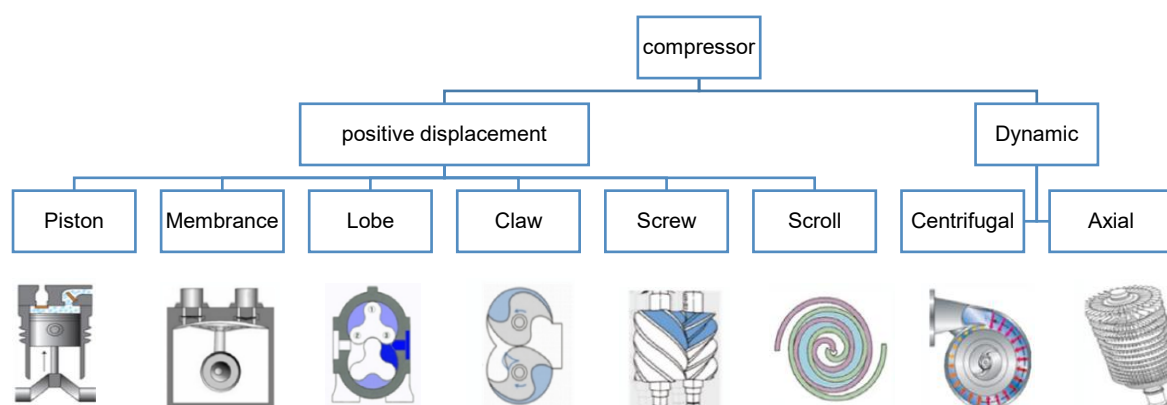

Figure 16. Types of compressors

The above figure depicts a representation of a compressor, specifically a positive displacement compressor. In this type of compressor, a certain amount of air is compressed in one or more chambers, causing the volume to decrease. Once the pressure reaches the desired value, a port is opened to allow the compressed gas to flow out of the compressor. On the other hand, dynamic compressors increase the pressure of the gas by supplying the medium through a rotating element, with the impeller being the main component of these compressors. Unlike positive displacement compressors, which trap and compress a fixed volume of air, dynamic compressors work on the principle of continuous flow. They typically provide a continuous flow of compressed air at high speeds, resulting in periodic variation. In terms of pressure, dynamic compressors are better suited for high-pressure ratio applications, while positive displacement compressors are more suitable for low-pressure applications. Moreover, dynamic compressors tend to have higher efficiency in certain operating ranges, especially at higher flow rates, while positive displacement compressors may have higher efficiency at lower flow rates and higher pressure ratios. One advantage of dynamic compressors is their reliability, as they do not have

reciprocating components subject to cyclic stress during operation. Generally selecting centrifugal compressor has proved benefits as below

- Extensive operation ranges [51].
- More reliable than positive displacement compressor [51].
- Run at optimal efficiency [51].
- Possibility of integration with turbine [51].

In the study [50], these compressors are compared to each other based on five comparison factors. The results are presented in a radar diagram, which indicates the more compatible compressor based on these Key Performance Indicators (KPIs).

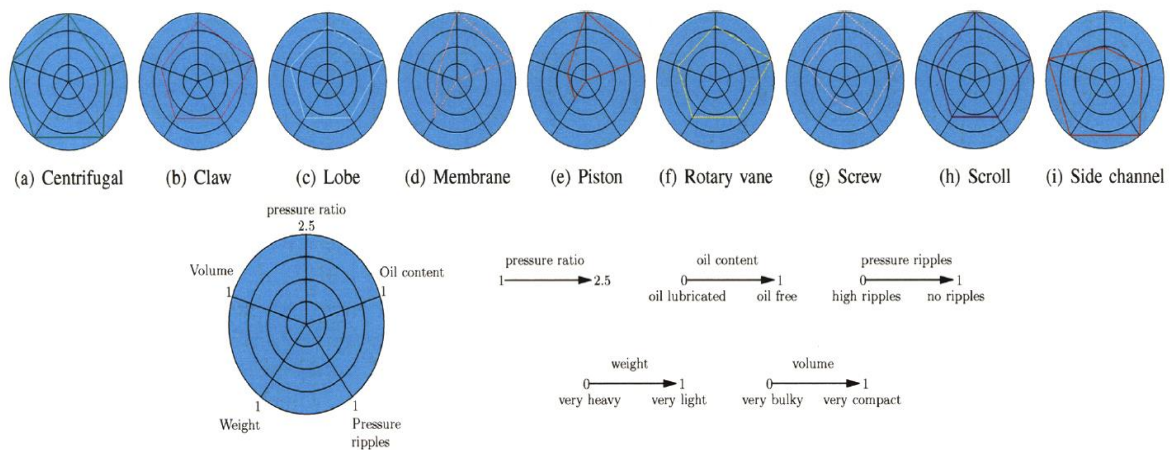

Figure 17. Positive displacement and dynamic compressor comparison [50]

In the comparison between dynamic and positive displacement compressors, the study investigates five factors: pressure ratio, oil content, pressure drop, weight of the compressor, and size.

- Pressure ratio: depending the stack design the pressure ratio must be in the range of 1.5-3 bar [50].
- Oil content: any contaminants in oil can be damaging for the fuel cell membrane [50].
- Pressure drop: pressure ripple greater than 100-200 mbar is not allowed as it might damage the membrane [50].
- Size: size should be as small as possible [50].
- Weight: weight should be as small as possible [50].

In the comparison between dynamic and positive displacement compressors, various factors such as pressure ratio, oil content, pressure drop, weight, and size have been

considered. The radar diagram illustrates that the Scroll compressor stands out as a more adaptable candidate for fuel cell applications. It achieves a pressure ratio of 2.5, operates oil-free, exhibits average pressure drop, and although it is relatively heavy, it has a compact size compared to piston compressors. On the other hand, piston and membrane compressors demonstrate weaker performance across most KPIs, making them less suitable for fuel cell purposes. Among them, the centrifugal compressor performs better across the requirements. However, when selecting a compatible compressor for our design, additional factors such as efficiency, price, noise level, and reliability must also be considered. The air compressor plays a critical role in fuel cell systems, providing the necessary oxygen for the electrochemical reactions. Its design ensures optimal compression of oxygen, directly impacting the efficiency of the system. As an electrical consuming device, the compressor utilizes a portion of the produced electricity for its operation. In summary, the air compressor is an indispensable component of fuel cell technology, enabling the reliable and efficient conversion of chemical energy into electrical power for various applications.

3.3.3 Humidifier

The conductivity of a fuel cell is intricately linked to the amount of water present in the electrolyte. However, this water content should not be excessive to the extent that it floods the electrolyte or blocks the pores of the gas diffusion layer. Therefore, a delicate balance is required in the presence of water on the cathode side, as water formation primarily occurs in PEM fuel cells. Ideally, this water would provide a hydration level suitable for the entire electrolyte. Since the electrolyte is a thin layer, this water is transferred to the anode side as well. However, achieving this optimal situation requires well-engineered design and precise control conditions. Figure 18. introduces the formation and movement of water in a PEM fuel cell.

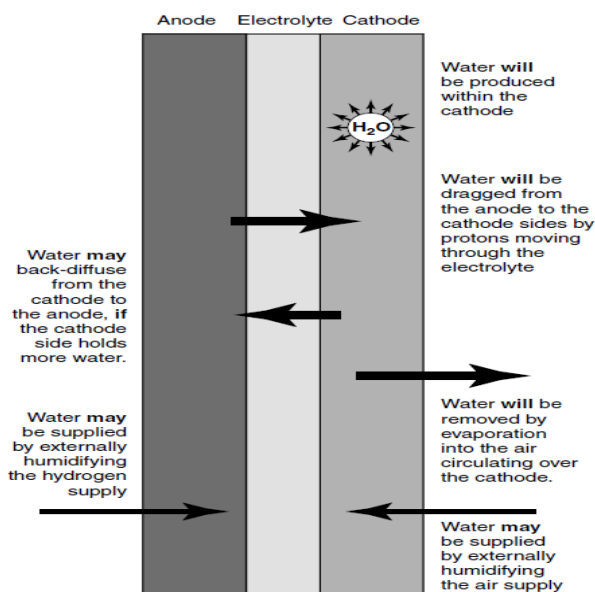

Figure 18. Water formation and movements in PEM fuel cell [52]

The production of water in a PEM fuel cell results in humidity in the cathode region. It is possible for hydrogen ions moving from the anode to the cathode to pull water molecules along with them, a phenomenon known as electro-osmotic drag [53]. Consequently, at higher current densities, dehydration becomes predictable. In fuel cells with a greater number of cells, as current density increases, the temperature of the cells also rises. Studies have shown that at temperatures exceeding 60°C, the electrolyte dries out faster than water is produced [52], which adversely affects fuel cell performance. Humidification of both reactant gases, including oxygen, presents a practical alternative to combat this unfavourable issue.

In PEMFC systems, two different humidification systems are commonly used: internal (self-humidification) and external. Both of these methods are designed to support the electrolyte in achieving a level of humidity and enhance conductivity within the cell. However, it's crucial to consider the disadvantages of each method when choosing a humidification approach. The drawbacks of the external options are

- Parasitic power loss [54]
- System complexity [54]
- High cost [54]
- Bulky volume [54]

Parasitic power losses occur when a portion of the energy produced by the fuel cell is consumed in the humidification process itself, thereby reducing overall system efficiency. Furthermore, this approach increases system complexity, as it requires

additional components and controls, making it heavier to implement and maintain. High costs are another concern, as the equipment required for effective external humidification can be expensive. Additionally, the bulky volume required can be a limiting factor, especially in applications with space constraints. Below, some examples of external humidification methods are mentioned.

- The bubbler and steam injector are two different methods of external humidification that precisely control hydration levels. However, they are primarily used for experimental purposes due to their large equipment volume, high energy consumption, significant weight, and high pressure loss [54].
- The membrane humidifier is a heat and mass exchanger method in which gas and water vapor are simultaneously transferred through a hydrophilic membrane from the exiting gas outlet to the oxygen inlet port. This technique is widely used in fuel cells due to its simplicity. However, disadvantages include high pressure drop and costly components [54].
- Enthalpy wheels are utilized in PEMFCs as an external humidifier. They consist of a rotating drum made of ceramics or metal sheets that transfer water vapor and gas from the outlet of the stack to the incoming gas. Advantages of this approach include low cost, minimal pressure drop, reliability, and long lifetime. However, due to the presence of moving parts, it consumes electrical energy and may experience gas leakage during supply [54,55].
- In the spray humidifier method, water is sprayed into the dry gas. The temperature and flow rate of the spray water are crucial factors for effective humidification. Additionally, a water separator is required to separate any unevaporated large droplets from the gas stream [56].

Internal humidification is another approach for controlling the humidity level within fuel cells to prevent drying out and improve electrolyte conductivity. Several studies have investigated this method to address humidity concerns. It has been found that fuel cells operating under stable conditions, such as a temperature of 60°C and appropriate stoichiometry ratios, can function without external humidification. However, their performance is 20-40% lower compared to fully humidified reactants [57]. Another study showed that using less hydrophobic gas diffusion layers (GDL) reduced performance by 17% compared to fully humidified fuel cells. While this reduced parasitic power loss by 46%, it may pose serious problems in larger fuel cells [58].

Porous fiber wicks have been developed within the membrane to directly supply water to the anode reactant gas, reducing electrode polarization [59]. Additionally, incorporating Pt and hygroscopic materials such as SiO₂ and TiO₂ is another approach to internal humidification [60]. These internal humidification methods can mitigate drawbacks of external methods such as parasitic power loss and space restrictions of external subsystems. However, they require changes in stack design and manufacturing, leading to increased production costs. Water management in PEM fuel cells is critical as it directly impacts system performance. Optimal operation of reactant gases, particularly in the cathode side, occurs under humidified conditions, enhancing electrolyte conductivity. Water produced in larger fuel cells with higher current densities can dry out due to elevated internal temperatures, leading to decreased efficiency. Humidifying the gas is a practical solution to alleviate this effect. Parameters such as flow rate, temperature range, and material compatibility must be carefully considered when selecting humidification.

3.4 Thermal management

Heat is one of the by-products of a PEM fuel cell, as the reaction of hydrogen and oxygen releases heat due to the negative enthalpy change. Along with heat, water and electricity are also results of this process. Inside the fuel cell, the temperature rises due to several sources, including electrochemical reaction of reactants, ohmic resistance, and mass transport. Despite PEM fuel cells being considered highly efficient devices, the heat produced accounts for around 50% of the total energy by electrochemical reaction [61] under load conditions, the temperature increases due to higher gas flow and reaction rates. Surprisingly, it has been observed that the power of the fuel cell increases with the rise in temperature [62]. However, if the temperature of the fuel cell remains extremely high for an extended period, saturation vapor increases and water content around the electrolyte decreases, leading to an increase in internal resistance of the membrane, destruction of the catalyst, and gas diffusion layer (GDL), consequently degrading fuel cell performance [63]. On the other hand, when the temperature is too low, the water produced in the cathode increases and flooding may occur, negatively affecting the overall output of the fuel cell. Studies have revealed that temperature can have both positive and negative effects on fuel cell performance; therefore, managing temperature is of paramount importance in PEM fuel cells. Figure 19 illustrates different types of cooling strategies in PEMFCs.

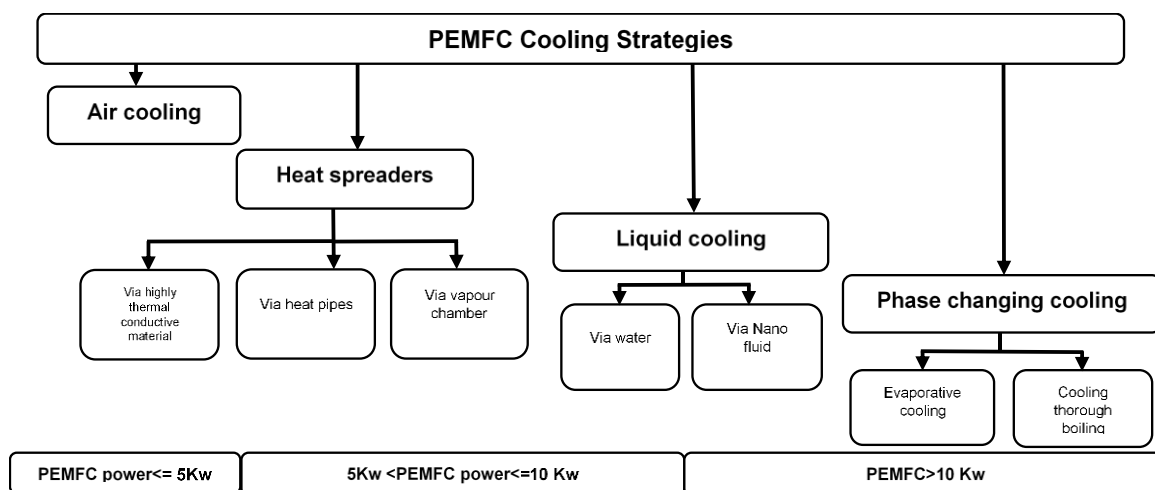

Figure 19. Cooling strategies of PEMFC

The heat produced in a fuel cell is transferred through different modes: convective heat transfer occurs between the surfaces of the cell and the flowing reactant, while conductive heat transfer takes place in the solid and porous material components such as the electrolyte, electrodes, and interconnected layers [64]. Thermal management involves dissipating the heat produced in the fuel cell to maintain a suitable operating temperature. To achieve this, an adaptable strategy based on the fuel cell power and application must be selected. There are two approaches for cooling fuel cells: passive and active methods.

In passive cooling, heat is dissipated through different modes such as convection, conduction, or radiation without the use of external devices for support. This approach can be implemented using heat spreaders or heat pipes. The advantages of passive cooling include simplicity, low cost, ease of handling, low noise, and higher energy efficiency. However, its disadvantages include lower cooling capacity and unsuitability for heavy PEMFC applications [65].

Active cooling involves the use of external devices, such as blowers and fans, to transfer heat from the fuel cell. These devices improve heat transfer and enable higher dissipation. In this approach, heat is transferred to a fluid passing through the high-temperature stack, absorbed by the fluid, and then dissipated from the cooling liquid as it passes through a radiator before being recycled back into the system. Factors such as the flow rate of the cooling liquid and the inlet temperature of the coolant are important and need to be monitored [66].

Thermal management is achieved through one of these four cooling strategies shown in figure 19, considering the power range of the fuel cell, the material of the coolant,

and compatibility with fuel cell components. These approaches are described as follows:

- Air cooling

In this strategy, air cooling and heat dissipation are achieved by passing air through the cathode or cooling plates [66]. Due to the simplicity of this method and the integratability of cooling channels with the cathode, weight and cost are reduced. However, this approach is most suitable for small fuel cells with low power. Parameters such as inlet temperature, mass flow rate of air, and configuration of the flow field are important considerations in air-cooling thermal management, directly impacting the achievement of uniform temperature within the fuel cell [67].

Several studies have investigated the effect of cooling configuration on fuel cell performance. For instance, in [68] it was found that the size of the air channel influences the cooling performance of the fuel cell. The study suggested that a more uniform temperature distribution can be achieved with larger air channels.

- Heat separator

The heat spreader is a method used for dissipating heat from the fuel cell. It offers several advantages including a simple design, low parasitic losses, and the absence of a need for coolant circulation, making it an effective passive cooling approach. This technique can be implemented in three different forms:

1. Highly thermally conductive material

In this method, heat is transferred into the air through convection by utilizing special materials designed to absorb heat from the center of the fuel cell. Heat separators are often made of highly conductive materials, with copper and aluminum being commonly used in this cooling method. Due to the lightweight nature of aluminum, it is predominantly used in lightweight fuel cell stacks [66]. The technology of pyrolytic graphite sheet (PGS) for heat separators in single-cell and small to medium-sized fuel cells was investigated, revealing that using PGS can enhance cell performance at high cathode flow rates while also achieving more uniform temperature distribution [69].

2. Heat-pipe based heat spreader

Heat pipes, with their high thermal conductivity ranging from 2100 to 5000 W/mK, are highly efficient for dissipating heat and are successfully used as cooling elements. Various heat pipe methods suitable for cooling PEM fuel cells include loop heat pipes (LHP), plastic heat pipes (PHP), and micro heat pipes (μ HP) [66]. These pipes are typically integrated into the bipolar plate to efficiently dissipate heat from the fuel cell.

3. Vapour chamber

The vapor chamber (VC) represents another passive method for the cooling management of fuel cells. While similar to heat pipes in working concept, vapor chambers differ in shape, process, and heat transfer mechanisms. Studies have demonstrated that vapor chambers exhibit excellent cooling characteristics, quick thermal response, and higher thermal conductivity. As a result, vapor chambers are particularly suitable for low-power PEM fuel cells [66].

- Phase change cooling

In this technique, phase change material (PCM) is used as a coolant material. PCMs absorb heat and undergo a change in their properties, primarily due to heat absorption, aiding in dissipating heat from the system. This approach is more appealing than water cooling due to its ability to enhance heat removal rates, reduce coolant flow rates, decrease power losses, and provide a more uniform temperature distribution [66]. Phase change cooling techniques can be either evaporative or two-phase cooling. In evaporative cooling, instead of circulating liquid water, the technique involves injecting liquid water with reactant to achieve cooling. During this process, injected water evaporates, removing heat and humidifying the cells. The removed water is then directed to a condenser to be cooled down and converted back to liquid water. However, the high cost and complexity of controlling evaporation are two factors that differentiate this method from other passive cooling methods.

- Liquid cooling

The heat required to raise the temperature of water is four times greater than that of air, making it a better coolant choice and reducing the size of heat exchange components. For fuel cells with loads higher than 5 kW, such as fuel cell electric vehicles (FCEVs), water cooling is preferable. Deionized water is commonly used as the cooling liquid medium due to its ability to minimize corrosion, enhance heat transfer, avoid contaminants, and prevent leakage current. Figure 20 illustrates the water cooling system in PEM fuel cells.

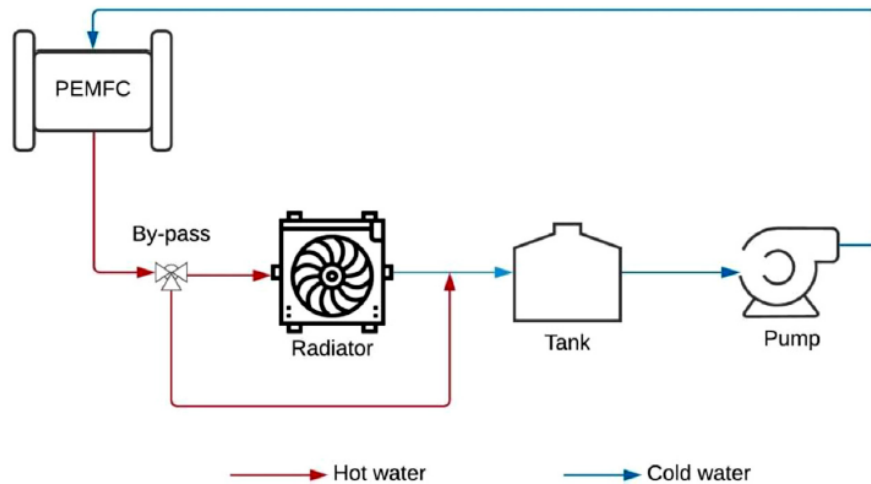

Figure 20. Water cooling system in PEMFC

As depicted in the figure above, the water passes through the fuel cell to absorb heat and then flows through the radiator to dissipate heat. The cooled water is then pumped back into the system, constituting the overall operation of water cooling in PEMFCs. Utilizing cooling plates helps distribute uniform temperatures, mitigating local hot spots that could lead to dehydration and degradation of the fuel cell. This uniform temperature distribution allows for better fuel cell performance and efficiency [70].

The configuration of coolant passages is a critical factor affecting cooling performance, directly impacting heat removal from the fuel cell. For example, a study in [71] examined the effects of serpentine and parallel flow field types on parameters such as the Index of Uniform Temperature (IUT) and pressure drop (ΔP). It was found that the parallel flow type exhibited lower pressure drop, indicating it requires less power to transmit the cooling medium. However, the serpentine passage showed better performance in terms of IUT.

Water cooling in PEM fuel cells helps maintain a stable operating temperature, essential for optimal performance and efficiency. Table 5 summarizes these cooling methods along with their corresponding advantages and disadvantages.

PEMFC cooling method	advantages	disadvantages
Phase change cooling	<ul style="list-style-type: none"> • Simple, compact size 	<ul style="list-style-type: none"> • Expensive than other method
Air cooling	<ul style="list-style-type: none"> • Low cost • Less maintenance • High reliability 	<ul style="list-style-type: none"> • Low cooling performance for heavy load fc
Liquid cooling	<ul style="list-style-type: none"> • High performance 	<ul style="list-style-type: none"> • Parasitic losses • Low energy efficiency
Heat spreader	<ul style="list-style-type: none"> • Simple design • No need for coolant circulation 	<ul style="list-style-type: none"> • Suitable for fc with low power loss

Table 5. Cooling methods in PEM fuel cell

3.5 Electrical management

In this section, power and electrical management are discussed. A detailed explanation of all the electrical components is beyond the scope of this study. To deliver power from the fuel cell to the user, various systems and subsystems need to be utilized. These systems are not only used for delivery but also sometimes for modifying the output electricity to be suitable for consumers. Parameters such as current, voltage, and power quality can be altered to the desired level to make them applicable for the user's needs.

- DC/DC convertor

In a PEM fuel cell, the current-voltage relationship represents the fuel cell performance. The consumption of reactant gases, hydrogen and oxygen, directly correlates with the output power of the fuel cell. Degradation in fuel cell voltage results from hydrogen utilization and voltage drop [72], making fuel cell voltage a crucial specification for performance assessment. As the trend in electrical supply applications leans towards higher power and longer durability, enhancing fuel cell voltage becomes imperative. At times, the desired output voltage exceeds that produced by the current voltage. Heavy-duty electric vehicles (EVs) exemplify this scenario, where power output surpasses that of the fuel cell. Mitigating this difference between energy supply and demand requires alternatives. One such solution involves adding more fuel cell stacks, though this necessitates increased hydrogen consumption. However, opting for a more robust balance of plant (BOP) is often impractical. Therefore, auxiliary elements can support and boost the voltage difference. Voltage regulators, DC/DC converters, and DC/AC converters are examples of such devices. Depending on system performance, these

elements can be selected appropriately. Figure 21 illustrates a simplified function of a DC/DC converter.

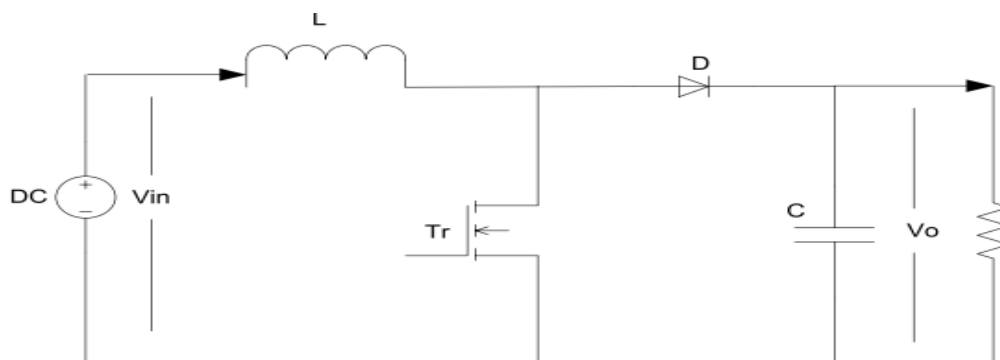

Figure 21. Function of a DC/DC convertor [77]

A DC-DC converter is an electronic device used to transform a direct current (DC) voltage from one level to a target point. Different components require varying voltages to operate, making DC-DC converters essential in applications such as electric vehicles (EVs) where higher or lower voltage is necessary. These converters play a crucial role in maintaining stable power supplies. In the diagram above, the lower voltage is shifted up to a higher voltage using capacitors, an inductor, an on-off switch, and a diode. When the switch is closed, current passes through the inductor and returns to the low voltage supply. The inductor functions by creating a magnetic field when current passes through it, storing energy. Upon opening the switch, the stored energy in the inductor boosts the current flow as it passes through the diode and enters the second capacitor. The frequency of the switch or transistor's open and close cycle affects the energy storage of the inductor and the output voltage. The diode's role is to manage the current flow during the transistor's off-time, ensuring proper function of the boost conversion by preventing reverse current flow. In industrial applications, the output voltage of a fuel cell can be increased using DC/DC converters. Different types of boost converters include full bridge converters, resonant boost converters, interleaved converters, and more [72,73,74]. In conclusion, the DC/DC converter is a fundamental element in electrical systems for regulating and improving electrical energy for specific devices. This process is facilitated by various electrical components to step up or reduce the input voltage to a level suitable for the application. The management of electricity produced by a fuel cell can be handled by this system.

- Battery

Another complementary element used in electrical management in fuel cells is the battery. They are employed in cooperation with fuel cells and are known as a hybrid system. Since the power produced from fuel cells can be costly, and in certain applications, the required power needs to be higher, batteries are employed to compensate for the low-level power to achieve the desired higher level of power [75]. In a hybrid system, batteries are integrated with fuel cells for the following reasons:

- Response time: When there is a sudden increase in electrical load, the battery can provide a faster response to the power demand compared to the fuel cell. It can quickly support the system until the fuel cell can adjust to the demand [76].
- Power support: In cases where the fuel cell is unable to support the demanded power, the battery serves as assistance during periods of high power demand [76]
- Bleeder resistor

A bleeding resistor is a resistor commonly employed in electrical circuits, especially in electronic devices powered by batteries or capacitors. Its primary function is to slowly discharge any excess voltage stored in capacitors when the device is turned off or disconnected from its power source [78,79].

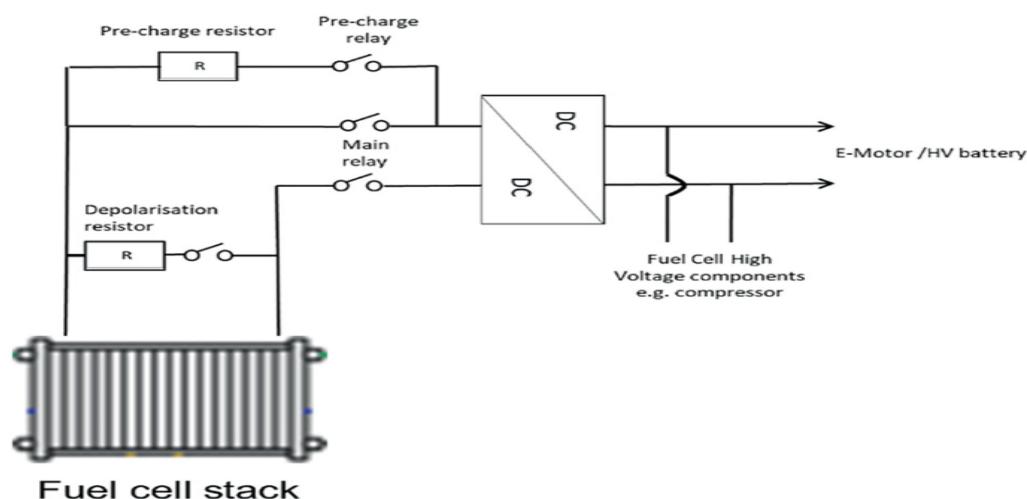

Figure 22. Bleeder resistor function in fuel cell system [79]

In circuits with capacitors, residual charge can remain even after the power is turned off, posing a risk if accidentally touched. A bleeding resistor provides a safe path for this charge to dissipate slowly, reducing the risk of electric shock and ensuring that the

capacitors are fully discharged before maintenance or servicing [79]. Selecting the appropriate electrical management devices is paramount, as these components regulate output power and manage the required voltage for the desired load. Additionally, their weight and size are crucial for packaging purposes, particularly in the automotive industry where space constraints are common. Excessive dimensions and volume can affect both the appearance and performance of the system.

3.6 Packaging

In this section, the packaging of the fuel cell, which is the primary focus of this study, is investigated. Before delving into the definition of packaging, it is important to note that based on surveys conducted among various sources on the internet and discussions with experts in the field of packaging and layout design, it has been observed that there is limited academic research directly addressing packaging in the context of fuel cells. This is largely due to the experimental nature of packaging activities, which can vary significantly from company to company. Additionally, the perspectives of engineers on this topic may differ. However, through an examination of papers related to ergonomic design, structural design, product design, packaging, and layout design, a variety of sources have been identified that serve as a valuable starting point for understanding and implementing packaging strategies for fuel cells.

3.6.1 Fundamental of packaging

In the process of product development, once the components are selected, determining their positions becomes crucial. This process, known as packaging, involves ensuring that certain requirements are met. Factors such as the dimensions of the components, availability of alternative components, and their respective functionalities need to be considered in the layouting process. An example can help elucidate this concept. Consider a bedroom that needs to be furnished with various pieces of equipment. The overall dimensions and space of the room are fixed. The available components include a bed, drawer, desk, chair, lamp, curtain, and carpet. Each of these elements serves a specific function and has particular dimensions. Therefore, the main goal is to utilize the space efficiently by arranging these components accordingly. For instance, the bed must be placed on the ground and not upside down, and it should not obstruct the entrance. Similar logic applies to all other components. Selecting the right products to furnish the room requires thorough market analysis. If the most suitable element is not available commercially, manufacturing may

be considered to meet the requirements. Styling and primary packaging to fulfill space and ergonomic requirements, along with geometrical integration of the elements, are fundamental aspects in the initial phase of product development [92]. Virtual methods are increasingly preferred in this area due to several reasons, such as reducing prototyping costs. By modelling the product in related software, the realization of components becomes achievable, and various packaging configurations can be tested without material waste. This contrasts with traditional approaches, where building a complete rough structure consumes time and capital. In modern product development processes, 3D-CAD models serve as the basis for packaging layout, containing all geometrical data and relevant interfaces. Therefore, virtual representation has become an indispensable part of the packaging process [93]. Below, a vehicle packaging concept is presented to illustrate these principles.

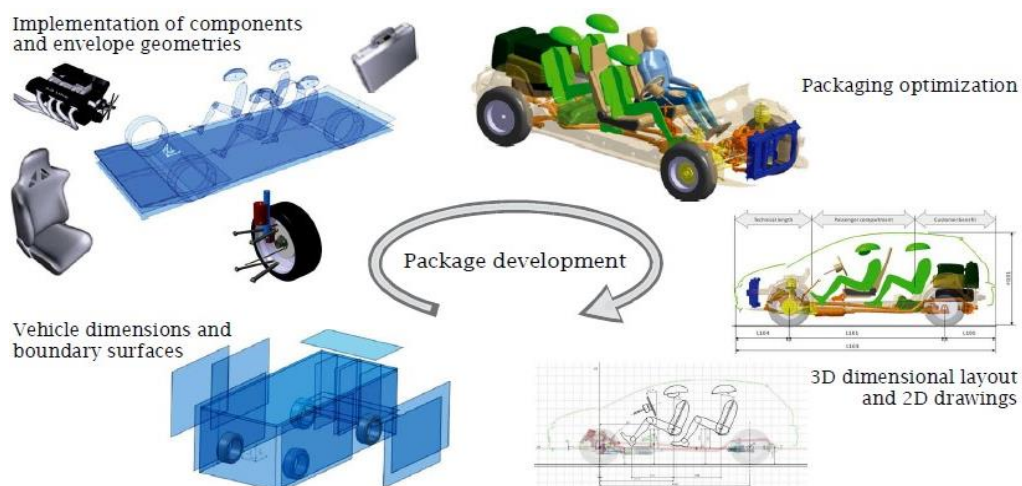

Figure 23. Full vehicle packaging concept development [92,94]

In product development, the position of components within the defined overall space is determined, and an initial rough 3D packaging is implemented. Corresponding drawings can then be prepared, and the outer surfaces' boundaries are created based on the concept's further development. This iterative process continues, with any changes to components requiring modifications to their locations while also optimizing previous designs [95]. Each component model may undergo remodelling during the packaging and product development process. However, any changes to the model sketches consume time, particularly if the entire model needs remodelling. To minimize reworking time, parametric design is employed, allowing for flexible and dynamic geometry definition in CAD contexts. Virtual design plays a crucial role in the packaging process, introducing new methods to the design industry. CAD applications within

packaging shorten design cycles and improve quality. In product development and design, VR is termed virtual design, aiming not only to simulate and visualize but also to predict, evaluate, and optimize products [96]. There are several categories of virtual design, including:

- Virtual prototype: a software-based engineering tool to model a system and visualize its behaviour under real operating conditions.
- Immersive virtual environments: technology that fully immerses the user in a generated environment modelled in corresponding software.
- Virtual assembly: in traditional design methods, errors may not be discovered until final assembly. However, virtual prototyping enables early detection of clashes during the design process.
- Virtual ergonomic design: based on virtual prototype systems, designers can accurately study ergonomic factors and find suitable component positions in case of modifications.

3.6.2 Fuel cell module standard size

In this section, the process of selecting a standard for the outer size of a fuel cell module is investigated, with a focus on the STASHH initiative. STASHH, or Standard Sized FC Module for Heavy Duty applications, is an EU-funded project coordinated in Norway. It involves collaboration between 11 fuel cell module suppliers, 9 OEMs, and 5 research institutes, aiming to define, test, and develop the first European standard for fuel cell modules in heavy-duty applications. The goal of STASHH is to standardize physical dimensions, flow and digital interfaces, as well as testing protocols and safety requirements for fuel cell modules. These standardized modules can then be stacked and integrated into heavy-duty applications such as forklifts, buses, trucks, trains, ships, and construction equipment. STASHH provides an open standard for heavy-duty fuel cell module applications, encompassing size, interface, control, and testing protocols [97]. While hydrogen applications in mobility have been increasing, the cost of fuel cell production remains high compared to consumer demand. One of the main aims of standardization efforts like STASHH is to reduce the total cost of ownership (TCO). Moreover, the standardization provided by STASHH can facilitate the scaling up of fuel cell modules to the megawatt scale. A significant cost aspect in fuel cell development is research and development (R&D), which often involves adapting OEM platforms to supplier technologies. By establishing a standard like STASHH, a well-

defined interface for power, flow, and cooling is presented, helping to reduce additional costs associated with customization. The core idea of STASHH is the realization of a standard for fuel cell modules, which encompasses three key references: size definition, interface definition, and API definition. Adhering to these standards enables the following characterizations to be achieved:

- FC stack, the air supply system, the hydrogen system (storage excluded) and cooling system (excluding radiators and coolers).
- Module which delivers 30 to 100 kW net.
- scalable to at least 1 MW by integrating multiple units.
- applicable in different heavy-duty applications.

Based on the roadmap, three different sizes of fuel cell boxes have been defined, denoted as Box A, Box B, and Box C. Table 6 provides a representation of these standard boxes, considering a tolerance range of +0 / -100 mm for all proposed shapes. Figure 24 illustrates these boxes along with their related dimensions.

StasHH	Length mm	Width mm	Height mm	Expected PEM KW
HH _A	1020	700	340	50
HH _{AA}	1020	700	680	110
HH _B	1360	700	340	70
HH _{BB}	1360	700	680	145
HH _{BBB}	1360	700	1020	220
HH _C	1700	700	340	90

Table 6. Dimensions of fuel cell module HH_{ABC} tolerance +0 / -100 mm

The dimensions mentioned above pertain to the proposals for various boxes of fuel cell modules, each with a different range of power generation. The volumes of these boxes are defined below, either in cubic meters (m³) or in liters.

- HH_A external volume is max. 0.243 m³
HH_{AA} external volume is max. 0.486 m³
- HH_B external volume is max. 0.324 m³
HH_{BB} external volume is max. 0.647 m³
HH_{BBB} external volume is max. 0.971 m³
- HH_C external volume is max. 0.405 m³

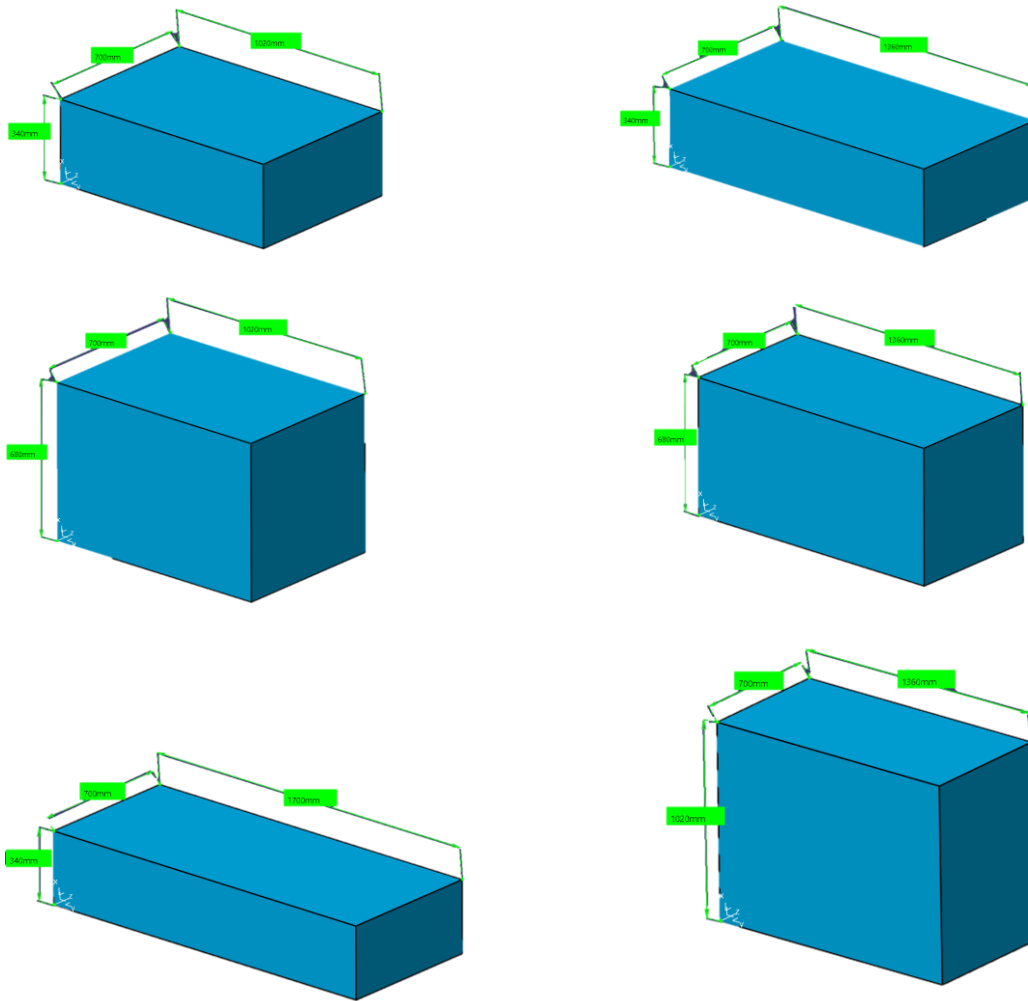

Figure 24. Fuel cell modules HH_{ABC}

For the packaging purpose of this project, the HH_{AA} configuration has been selected based on its power output of 100 kW. According to StasHH recommendations, the HH_A and HH_{AA} configurations can be oriented on their sides for special applications.

3.6.3 Initial draft for packaging

The initial proposal for packaging the 100-kW fuel cell balance of plant (BOP) is depicted in Figure 25. In accordance with the HH_{AA} box recommended by StasHH, the components are positioned in a rough model to ensure suitable placement inside the box. Initially, the dimensions of the elements fall within the range provided from market analysis. The main objective of this initial draft is to achieve a general view of the component locations within the box and determine whether any adjustments need to be made for optimal packaging. After discussions with experts, it has been suggested to eliminate the radiator from the BOP package due to size limitations. A fuel cell with this power volume requires a large radiator to dissipate heat, and the dimensions of

the radiator exceed those of the designated box. Therefore, it has been decided not to include it directly in the BOP.

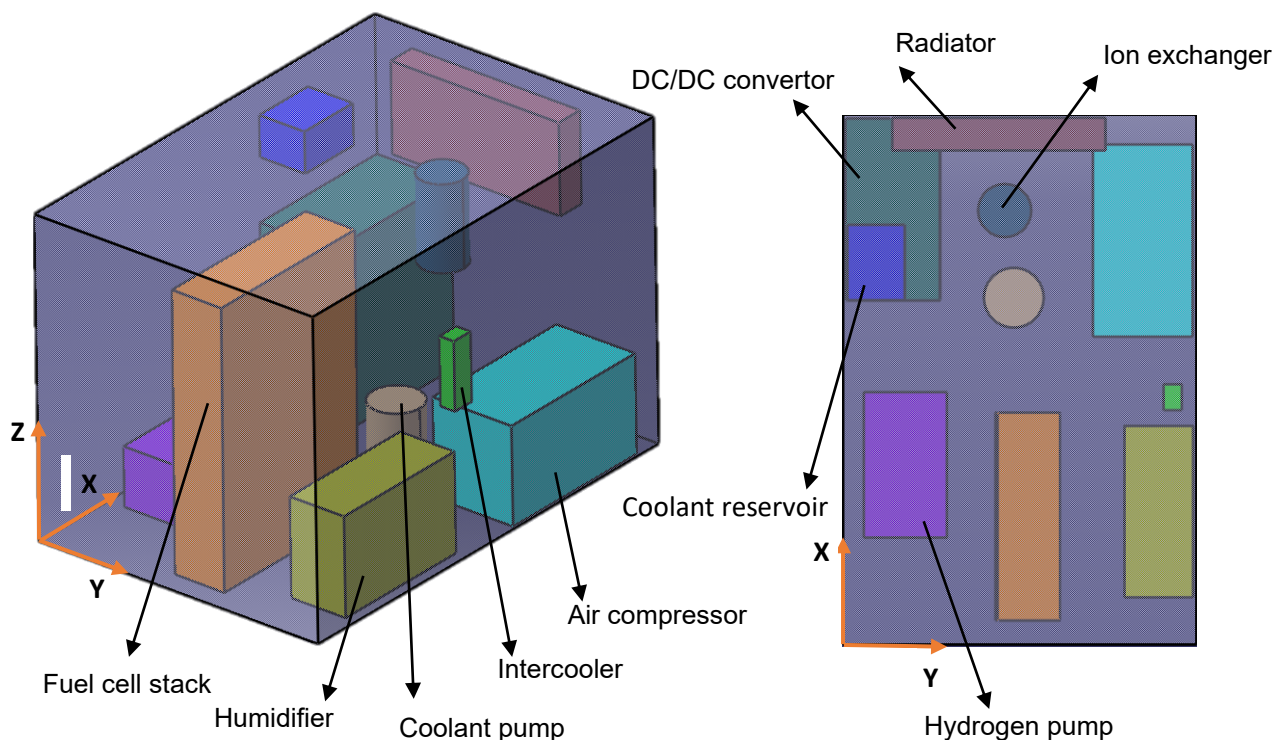

Figure 25. Initial concept of fuel cell module packaging

Another proposal for optimizing the outer size of the fuel cell module suggested for the 100-kW power range involves changing the orientation of components. For instance, the fuel cell stack position could be adjusted horizontally or vertically. This adjustment would allow for better utilization of space, enabling the inclusion of additional components such as compressors and hydrogen pumps. With this idea in mind, another draft has been investigated to serve as a package that can be positioned within a vehicle space. This approach aims to maximize efficiency and functionality within the given constraints.

3.6.4 Components development and market analysis

- Fuel cell stack module

Table 7 provides information on various fuel cell stack module suppliers, along with some relevant parameters for packaging purposes across a range of power outputs. For instance, by stacking up five 20 kW fuel cell stack modules, an ultimate output of 100 kW can be achieved. This flexibility in module configuration is valuable for alternative design approaches. Due to importance of dimensions in packaging, a market analysis for the sizes of the stacks corresponding to different power ranges is

suggested in figure 25 and table 7. This analysis aids in realization the available alternatives and decision making during the packaging process.

FC stack module provider	Model	Power range KW	Dimension (mm) L x W x H	Weight Kg	Cell count
Ballard	FCgen-HPS	Up to 140	484 x 555 x 195	55	309
	FCgen-LCS	93	131-601 x 443 x 110	10.2-26.7	Max 311
	FCvelocity-9SSL	21.2	302 x 760 x 60	16.6	-
Axane		20	302 x 275 x 235	-	56
		102	684 x 275 x 235	42	300
		120	1104 x 275 x 235	-	331
EH group	EH-81	100	610 x 120 x 400	96	-
	EH-81	20	400 x 120 x 260	32	-
POWERCELL	S3	98	444 x 156 x 420	34	335
Ekpo	NM12 single	123	700 x 287 x 402	-	359

Table 7. Market analysis fuel cell stack module

The market analysis aimed to provide an overview of available fuel cell sizes by collecting data from the websites of various fuel cell stack module providers, along with relevant accessible fact sheets. Figure 26 offers a graphical representation of the length and width of the mentioned fuel cell stack modules, with the X and Y axes representing these dimensions, respectively. Dimensions include the whole features of stack module and interfaces not only the sheets, this visualization aids in comparing the sizes of different fuel cell modules available in the market, assisting in the decision-making process for packaging purposes.

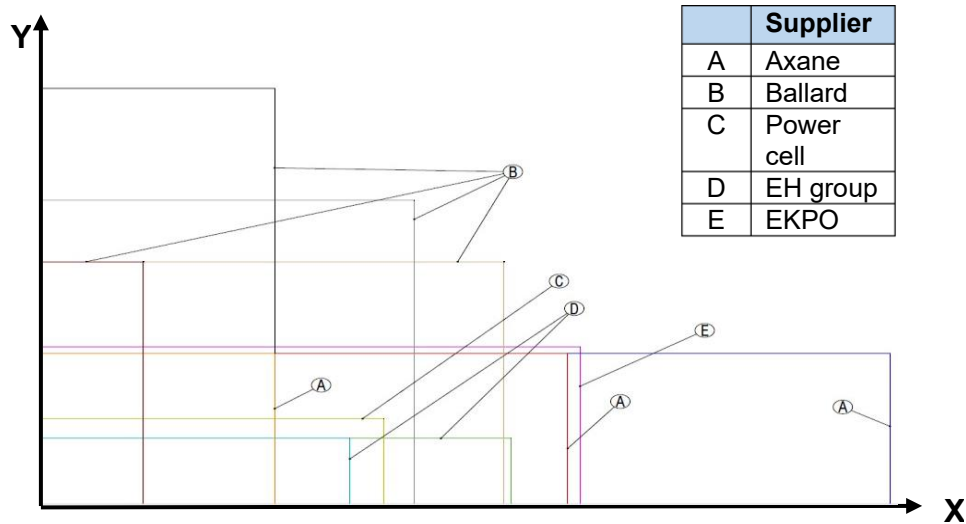

Figure 26. Market analysis for fuel cell stack module dimension

- Hydrogen circulation pump development

Table 8 displays information gathered from market research regarding hydrogen recirculation pumps, which are crucial components in fuel cell systems for recirculating unreacted hydrogen from the outlet of the anode section. These pumps play a vital role in maximizing hydrogen utilization efficiency within the fuel cell stack. The table provides details about various suppliers offering hydrogen recirculation pumps, including key specifications and features relevant for selection purposes.

Pump supplier	model	Power consumption W	Temp. range C°	Flow rate L/min Nm ³ /h	Max Rpm	Dimension mm	Weight kg
Dongde industry	DQ47	700	-40 to 85	417.5 L/min	6500	189 x 156 x 147	-
	DQ60	2000	-40 to 85	1002 L/min	8000	280 x 160 x 129	-
	DQ30	1000	-40 to 85	417.5 L/min	8000	218 x 161 x 129	-
Barber nicols	BNHP-35	-	-	100-600 L/min	40000	156 x 290	4.5
WOBO group	WQ60	2000	-	60 Nm ³ /h	8000	256 x 161 x 121	-

Table 8. Market analysis hydrogen pump

Flow rate is one of the crucial parameters which indicates flow rate of media into the system, flow rate of pump must be greater than the amount of hydrogen at the outlet of the fuel cell stack. Formula 1 calculates mass flow rate of hydrogen at the outlet of the stack [99].

$$m_{H_2, cycle} = m_{H_2, out} = (\lambda_{H_2} - 1) \frac{M_{H_2}}{2F} I_{n cell} \quad (1)$$

Where λ_{H_2} denotes the hydrogen stoichiometry ratio which for this project it is 1.8, M_{H_2} denotes the hydrogen molecular weight which is $2.02 \frac{g}{mol}$, F is faraday constant $96485.3321 \frac{SA}{mol}$, $I_{n\ cell}$ donates current flow of n cell ($I = \frac{P}{V}$), 0.65 volt is the voltage of each cell.

The hydrogen pumps are more efficient than mechanical compressors due to the isothermal conditions under which they operate. Another alternative for circulating hydrogen in the fuel cell system is to apply an injector to the anode cycle. In any system, with respect to the system criteria, either a hydrogen pump or an injector, or a combination of the two, is possible to be used. When a pump is used, it is called active hydrogen recovery, and when an injector is used, it is called passive hydrogen recovery.

- Air compressor development

The use of a compressor is a common method to increase the power density of a fuel cell, as the cell voltage generated by the fuel cell is dependent on the cathode air supplied to the system. In PEM fuel cells, a continuous flow of oxygen to the cathode side of the fuel cell module is crucial for the smooth performance of the system. Pressurized air must be within the specified conditions recommended by manufacturers; too low or too high air pressure leads to inefficient oxygen supply and decreased fuel cell efficiency. Selecting a suitable compressor requires consideration of some important factors unique to the compressor. Moreover, the compressor is an electrical energy consumption device that directly affects the desired power of the fuel cell system; therefore, its performance parameters need to be investigated. In Table 9, an investigation of compressors among some of the suppliers based on important parameters is presented.

Compressor supplier	model	Power consumption KW	Mass flow g/s	Max RPM	Dimension mm	Weight kg
Celeroton	CT-3000	19	155	130,000	370 x 192 x 215	18.5
Rotrex	Ek40	40	100-300	120,000	450 x 250 x 220	30
Fischer	EMTCT-120K GEN4	22.5	150	120,000	Ø213 x 370	11
Aeristech	AeC808L-9	25	135	-	-	-

Table 9. Market analysis air compressor

Mass flow rate of air compressor is one of the main parameters which need to be considered when designing a compressor, with formula 2 this value is calculated [98,99].

$$m_{comp,out} = \frac{\lambda_{O_2} M_{air}}{y_{O_2} 4F} I_{n\ cell} \quad (2)$$

The calculated value is in kg/s, which needs to be converted to g/s. λ_{O_2} denotes the hydrogen stoichiometry ratio of the cathode, derived from the fuel cell stack fact sheet and considered to be 2.5, M_{air} denotes air molar mass which is $28.98 \times 10^{-3} \frac{Kg}{mol}$, y_{O_2} is oxygen molar fraction in air which is 0.21, F is faraday constant and $I_{n\ cell}$ donates current flow of n cell. By substituting these values into the formula, an air mass flow rate range of 137 g/s is achieved.

- Humidifier development

To enhance the efficiency of the fuel cell system, oxygen needs to be humidified. The oxygen coming from the compressor has low humidity. High heat in the stack module causes evaporation of the water inside the fuel cell, leading to a decrease in the performance of the system. Therefore, a humidifier is required on the cathode side before the oxygen flow enters the fuel cell cathode to increase the humidity of the oxygen. The inlet water to the humidifier can be supplied from either the intercooler or the stack module. Table 10 presents variants of humidifiers available in the market.

Humidifier supplier	Model	Pressure bar Kpa	Temperature C°	Weight Kg	Dimension mm
Fumatech	H100N	Max. 3	-30 to 90	6.2	180 x 315 x 286
Perma	FC600-7000-7PP	Max. 35Kpa	1 to 80	-	Ø 223 x 347
Freudenberg	FC HU-MG2-X	Max. 3	80	7	330 x 217 x 132

Table 10. Market analysis humidifier

It can be considered that a humidifier acts as a resistance in the stream of oxygen, which leads to a drop in pressure in the medium at the outlet before entering the stack. Therefore, one of the important parameters that must be checked in selecting and designing the humidifier is the pressure drop, which directly affects the flow of the oxygen. Upon investigation of the product data for the mentioned humidifiers, the pressure drop values are designated as 8 kPa on the dry side and 12 kPa on the wet side for Fumatech, and 8.1 kPa on the dry side and 6.1 kPa on the wet side for Prema humidifiers, respectively. The term 'dry side' describes the air that passes through the

humidifier without humidification, and the pressure drop on the wet side describes the fluctuation of the air when it is humidified.

- Heat exchanger development

In the cathode side, compressing the oxygen leads to an increase in its temperature. If this heat is not controlled, it affects the operational parameters. A high temperature of the cathode accelerates the evaporation of water inside the fuel cell; since humidity is essential to improve the conductivity of the membrane, evaporation leads to degradation of the efficiency of the system. The heat exchanger in the fuel cell system plays a crucial role in heat management. Air-air or liquid-air are two alternatives used in heat exchanger components. On one side, a hot air stream flows into the intercooler, and from the other inlet, a cooled medium is introduced. Heat transfers from the hot medium to the cooled liquid, and from the outlet of the system, the cooled-down oxygen follows to the next component of the fuel cell system. Because of condensation, a drain outlet can be designed in the heat exchanger to remove water droplets. With a market analysis between different suppliers, Table 11 is created with important parameters required for selecting and designing a heat exchanger.

Heat exchanger supplier	model	Volume of channel Liter	Dimension mm	Weight kg
Alpha Lava	GL 50	Oxygen 0.094 Liquid 0.194	281 x 126 x A*	2.36
Kelvion	GBE 200	0.030	231x90x(12.50+2.24xN*)	0.50+0.060xN*
	GBE 400	0.065	335x124x(12.50+2.25xN*)	0.80+0.120xN*
	GNS 700L	0.230	532x271x(13.20+2.34xN*)	9.80+0.530xN*

*A dimension varies with number of plate-refer to the fact sheet - *N number of sheet

Table 11. Heat exchanger market analysis

The heat exchanger is made from a combination of laminated sheet metal in which the route of the medium is designed to transfer heat. Stainless steel is mostly used for the plate material, and copper is selected for brazing. Durability of the heat exchanger with pressure is an important factor for designing the system. Through market investigation, the pressure ranges from 16 bar up to over 100 bar is identified. With respect to the oxygen pressure for this concept study, which is maximum 3-4 bar, a maximum pressure of 16 bar is dedicated for this type of heat exchanger.

4. Energy distribution

A Sankey energy distribution diagram for a Proton Exchange Membrane (PEM) fuel cell provides an insightful visualization of the energy flow within the system. The fuel cell operates with the collaboration of components, each of which consumes energy to start. The required energy can be supplied from the produced energy of the system. Moreover, it is proven that almost 50% of the total energy is dissipated as heat. The efficiency of the fuel cell depends on several factors; however, in general, the PEM fuel cell has a 60-68% efficiency. With regard to technical data acquired from suppliers of corresponding components, the amount of required hydrogen and dissipated energy out of the system is illustrated in figure 27 as a Sankey energy diagram.

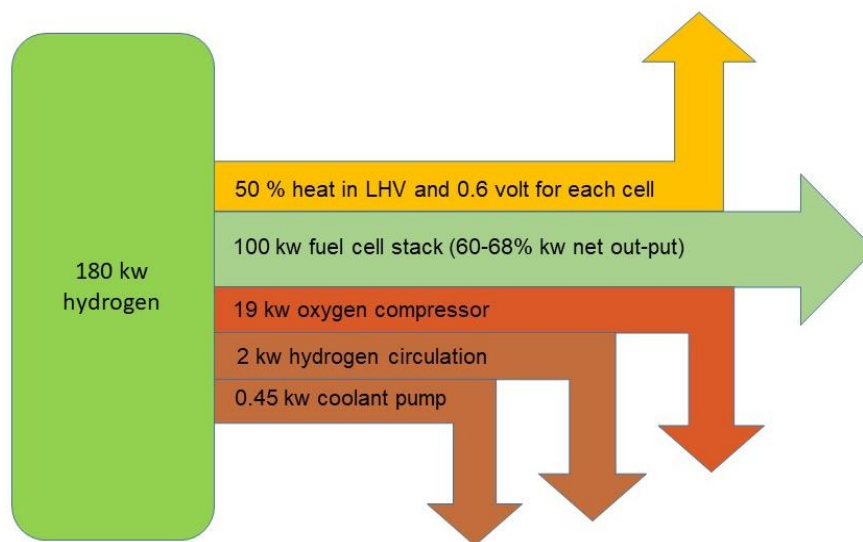

Figure 27. Sankey diagram - energy distribution

5. Product model and specification

In this section, the finalized CAD model of the product is presented, along with illustrations of the interfaces depicted in the figures below. The cover case of the fuel cell is modeled with the company logo and a honeycomb pattern. These two features serve dual purposes: enhancing aesthetics and aiding in heat dissipation. Given the presence of electrical components, heat accumulates inside the package. However, with the incorporation of these two features, the heat can effectively dissipate out of the system. Moreover, the top cover is made of polycarbonate to remain visible inside the package, with a monitor placed on it to control parameters.

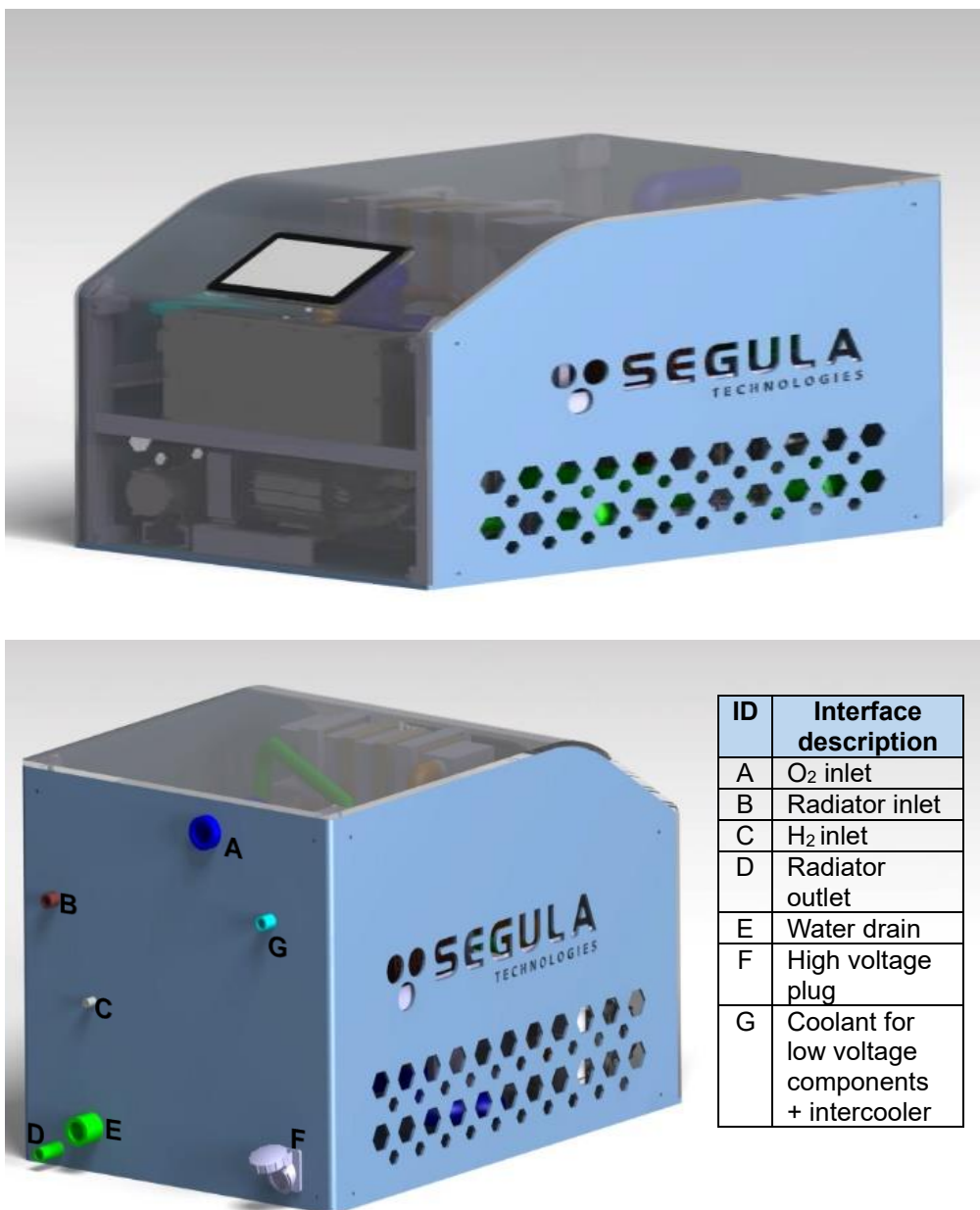

Figure 28. Product model and interfaces

The breakdown and specifications of this fuel cell system are presented in the figure and table below. The mentioned components are critical Balance of Plant (BOP) components for the system.

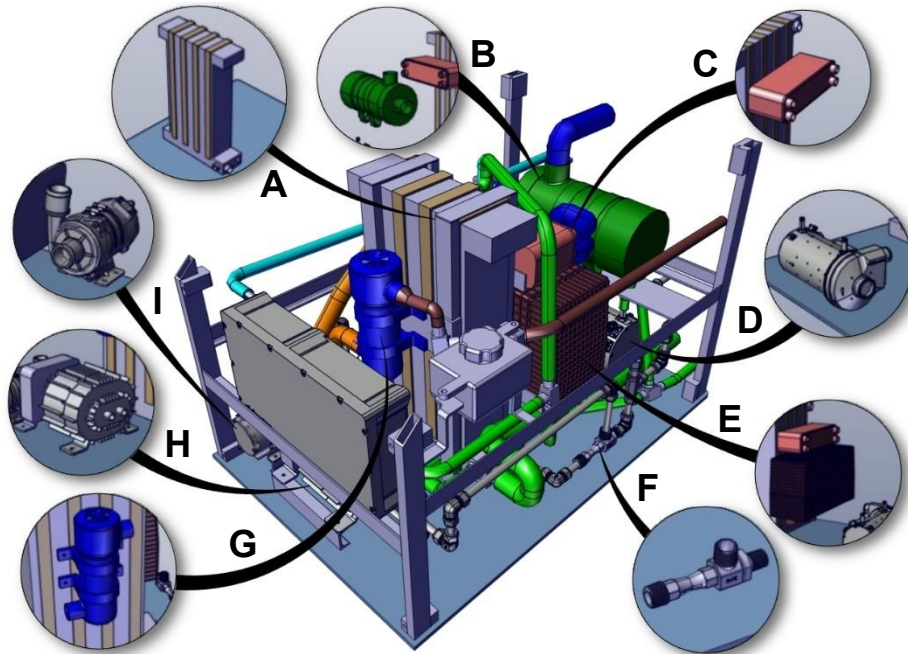

Figure 29. Product breakdown

ID	Product name	Description
A	Fuel cell stack module	100 Kw power, 231-462 voltage, 0-450 amper
		O ₂ Stoichiometry 1.5-2.5, O ₂ pressure level < 1.5 bar
		H ₂ Stoichiometry 1.2-1.8, H ₂ pressure level < 1.5 bar
B	Air filter	-
C	Intercooler	-
D	Air compressor	-
E	Humidifier	-
F	Jet pump- injector	-
G	Ion exchanger	-
H	H ₂ circulation pump	-
I	Coolant pump	-

Table 12. Product description

6. SWOT analysis

Similar to every project, there are challenges and potentials encountered during the development of this project. By identifying these points, there are opportunities to improve the system. To accomplish this, SWOT technique is employed, which is a framework for evaluating the strengths, weaknesses, opportunities, and threats of the project. figure 30 represents the SWOT analysis.

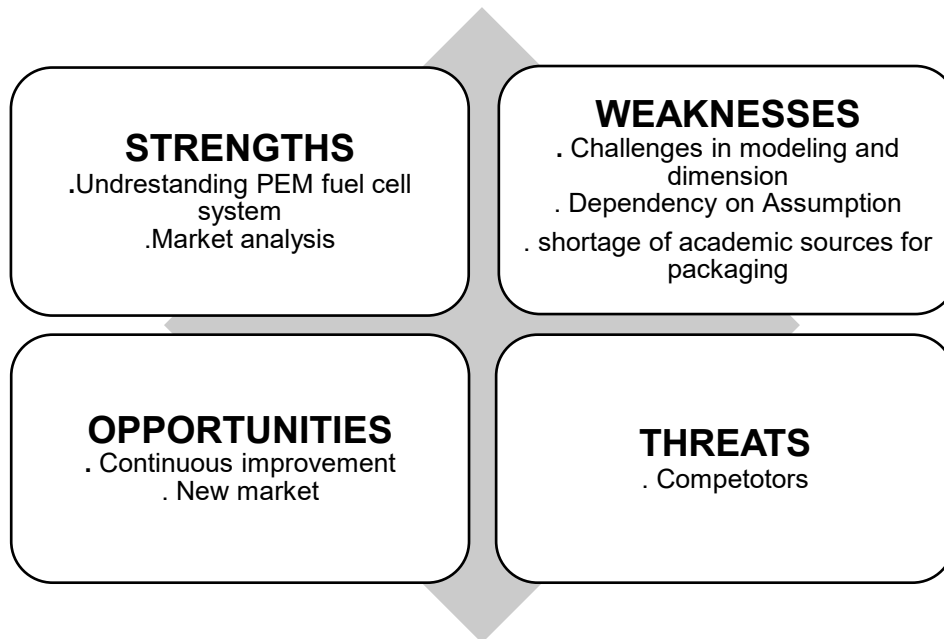

Figure 30. Fuel cell development- SWOT analysis

In the development of PEM fuel cells, a comprehensive understanding of the system, coupled with identifying market trends, showcases researchers' expertise in this subject. Moreover, due to innovative technology, constant improvement in exploring new materials, enhancing efficiency, and integrating the technology into different applications are the potentials behind this project. Since the dimensions of the parts are crucial for packaging purposes, acquiring the correct dimensions could be challenging if not provided by suppliers. To mitigate this issue, intensive collaboration with suppliers was undertaken, and in some cases, assumptions based on similar components were the only solution. Packaging, an activity for which academic sources are not sufficiently available, could benefit from several interviews with experts in this area to improve related realization and fill gaps in research. Fuel cell technology is relatively new, with several studies being conducted on it, and in the market, other companies are also focusing on it, leading to competition. Therefore, strategic decisions and continuous improvement are required to stay competitive in the market.

7. Suggestions and conclusion

Future studies could be implemented to improve the present research in developing fuel cell systems. As a suggestion, below are some areas for improvement open to investigation:

- Since this project focuses on packaging the components, space utilization is of utmost importance for optimization. It is suggested to investigate alternative orientations of critical components in the BOP.
- Piping throughout the system directly affects the pressure of the fuels and the weight of the package. Further research could be conducted to analyse the effect of routes on hydrogen and oxygen pressure and to identify optimum piping.
- The water produced inside the stack is drained out of the system into the environment. While it has no side effects, in colder areas, this might lead to ice formation on roadways and increase the risk of icy roads. To mitigate this problem, an on-board system can be designed to collect this water and drain it regularly.

The objective of this project was to develop packaging for the balance of plant (BOP) for a 100 kW PEM fuel cell suitable for heavy-duty road applications. This goal was pursued through two distinct sections.

In the first section, the realization of the system, along with all critical components, was investigated through an intensive search of academic papers and technical handbooks. Furthermore, a standard reference, STASHH, was consulted to define the package dimensions and related interfaces. The definition of the BOP and Piping and Instrumentation Diagrams (P&ID) was another crucial step in this project, achieved through collaboration and consultation with experts in the fuel cell team.

The second section involved the development of BOP components. Intensive market analysis was conducted to gather critical information on these components, which is presented in various tables within the project. Subsequently, the components were modeled using Catia V5 and assembled to create the package. Moreover, an initial concept of the package in defined dimensions provided by STASHH was used as the starting concept for packaging. A finalized CAD model, showcasing different views along with product specifications, was provided as the primary objective of this project.

To conclude the study, a SWOT analysis was presented to highlight the challenges and conditions for success in developing this system. Additionally, several suggestions were made to enhance this project for future activities.

8. References

- [1] M. Endres, *Entwicklung einer operando Einzelzellen-Brennstoffzellen-Aufnahmeeinheit*, Hochschule RheinMain, 2021.
 - [2] D. G.D, M. Sabeena, C. Shankar and V. Kirbakaran , "Effect of cell Temperature on the power output of a PEM fuel cell in a test bed condition," in *2016 International Conference on Energy Efficient Technologies for Sustainability (ICEETS)*, 2016, April.
 - [3] C. Bao, M. Ouyang and B. Yi, "Analysis of water management in proton exchange membrane fuel cells," *Tsinghua Science and Technology*, vol. 11, no. 1, pp. 54-64, 2006.
 - [4] J. Larminie, A. Dicks and M. McDonald, *Fuel cell systems explained*, vol. 2, J. Wiley, pp. 207-225.
 - [5] P. Nguyen, "A Three-Dimensional Computational Model of PEM Fuel Cell with Serpentine Gas Channels," 2003.
 - [6] M. Butori, B. Eriksson, N. Nikolić, C. Lagergren, G. Lindbergh and R. Wreland Lindström, *The Effect of Oxygen Partial Pressure and Humidification in Proton Exchange Membrane Fuel Cells at Intermediate Temperature*.
 - [7] A. Abd El Monem, A. Azmy and S. Mahmoud, "Effect of process parameters on the dynamic behavior of polymer electrolyte membrane fuel cells for electric vehicle applications," *Ain Shams Engineering Journal*, vol. 5, no. 1, pp. 75-84, 2014.
 - [8] G. Guvelioglu and H. Stenger, "Flow rate and humidification effects on a PEM fuel cell performance and operation," *Journal of Power Sources*, vol. 163, no. 2, pp. 882-891, 2007.
 - [9] B. Blunier and A. Miraoui, "Air management in PEM fuel cells: State-of-the-art and perspectives," in *2007 International Aegean Conference on Electrical Machines and Power Electronics, IEEE*, 2007.
 - [10] S. Haile, "Fuel cell materials and components," *Acta Materialia*, vol. 51, no. 19, pp. 5981-6000, 2003.
 - [11] Z. Bayrak and M. Gencoglu, "Application areas of fuel cells," *2013 International Conference on Renewable Energy Research and Applications (ICRERA), IEEE*, pp. 452-457, 2013.
 - [12] F. Shahrokhi, A. Nasab and R. Guarnaccia, "Innovative applications of hydrogen fuel cells," *Second International Hydrogen Energy Congress and Exhibition (IHEC)*, 2007.
 - [13] A. Ajanovic, A. Glatt and R. Haas, "Prospects and impediments for hydrogen fuel cell buses," *Energy*, vol. 235, p. 121340, 2021.
 - [14] O. Erdinc and M. Uzunoglu, "Recent trends in PEM fuel cell-powered hybrid systems: Investigation of application areas, design architectures and energy management
-

- approaches," *Renewable and Sustainable Energy Reviews*, vol. 14, no. 9, pp. 2874-2884, 2010.
- [15] Z. Bayrak and M. Gencoglu, "Application areas of fuel cells," in *2013 International Conference on Renewable Energy Research and Applications (ICRERA), IEEE, P.452-457*, 2013.
- [16] Y. Sone, M. Ueno and S. Kuwajima, "Fuel cell development for space applications: fuel cell system in a closed environmen," *Journal of Power Sources*, vol. 137, no. 2, pp. 269-276, 2004.
- [17] W. Simon and D. Nored, "Manned spacecraft electrical power systems," *Proceedings of the IEEE*, vol. 75, no. 3, pp. 277-307, 1987.
- [18] S. Guaitolini, I. Yahyaoui, J. Fardin, L. Encarnaç o and F. Tadeo, "A review of fuel cell and energy cogeneration technologies," in *2018 9th International Renewable Energy Congress (IREC), IEEE, P.1-6*, 2018.
- [19] S. de Melo, I. Yahyaoui, J. Fardin, L. Encarnaç o and F. Tadeo, "Study of combined cycle of solid oxide fuel cell with micro gas turbines," in *2017 8th International Renewable Energy Congress (IREC), IEEE, P. 1-5*, 2017.
- [20] H. Fathabadi, "Fuel cell hybrid electric vehicle (FCHEV): Novel fuel cell/SC hybrid power generation system," *Energy Conversion and Management*, vol. 156, pp. 192-201, 2018.
- [21] M. Waseem, M. Amir, G. Lakshmi, S. Harivardhagini and M. Ahmad, "Fuel cell-based hybrid electric vehicles: An integrated review of current status, key challenges, recommended policies, and future prospects," *Green Energy and Intelligent Transportation*, p. 100121, 2023.
- [22] M. Iqbal, M. Becherif, H. Ramadan and A. Badji, "Dual-layer approach for systematic sizing and online energy management of fuel cell hybrid vehicles," *Applied Energy*, vol. 300, p. 117345, 2021.
- [23] J. Frenck, *Valve Selection Handbook*, vol. 108 (1), 2001, p. 10.
- [24] "shoptransmitter," [Online]. Available: <https://shoptransmitter.com/blog/air-pressure-regulators-basics-purpose-working-principle-and-more-faq/#:~:text=Air%20pressure%20regulators%20reduce%20the,same%20as%20the%20set%20pressure..> [Accessed 05 09 2023].
- [25] J. Wang, K. Toyoda, K. Uesugi and K. Morishima, "A simple micro check valve using a photo-patterned hydrogel valve core," *Sensors and Actuators A: Physical*, vol. 304, p. 111878, 2020.
- [26] "smlease," [Online]. Available: <https://www.smlease.com/entries/automation/types-of-check-valves-and-their-applications/>. [Accessed 28 10 2023].
- [27] J. Dolan, "Check valve problems," *LC GC EUROPE*, vol. 19, no. 3, p. 140, 2006.
-

- [28] T. Wilberforce, A. Alaswad, A. Palumbo, M. Dassisti and A. Olabi, "Advances in stationary and portable fuel cell applications," *International Journal of Hydrogen Energy*, vol. 41, no. 37, pp. 16509-16522, 2006.
- [29] L. Dubau, L. Castanheira, F. Maillard, M. Chatenet, O. Lottin, G. Maranzana, J. Dillet, A. Lamibrac, J. Perrin, E. Moukheiber and A. Elkaddouri, "A review of PEM fuel cell durability: materials degradation, local heterogeneities of aging and possible mitigation strategies," *Wiley Interdisciplinary Reviews: Energy and Environment*, vol. 3, no. 6, pp. 540-560, 2014.
- [30] L. Xing, J. Feng, W. Chen, Z. Xing and X. Peng, "Development and testing of a roots pump for hydrogen recirculation in fuel cell system," *Applied Sciences*, vol. 10, no. 22, p. 8091, 2020.
- [31] P. Koski, L. Pérez and J. Ihonen, "Comparing anode gas recirculation with hydrogen purge and bleed in a novel PEMFC laboratory test cell configuration," *Fuel Cells*, vol. 15, no. 3, pp. 494-504, 2015.
- [32] K. Nikiforow, H. Karimäki, T. Karimäki and J. Ihonen, "Optimization study of purge cycle in proton exchange membrane fuel cell system," *Journal of Power Sources*, vol. 238, pp. 336-344, 2013.
- [33] K. Shen, S. Park and Y.B., "Hydrogen utilization enhancement of proton exchange membrane fuel cell with anode recirculation system through a purge strategy," *International Journal of Hydrogen Energy*, vol. 45, no. 33, pp. 16773-16786, 2020.
- [34] S. Toghyani, E. Afshari and E. Baniasadi, "A parametric comparison of three fuel recirculation system in the closed loop fuel supply system of PEM fuel cell," *International Journal of Hydrogen Energy*, vol. 44, no. 14, pp. 7518-7530, 2019.
- [35] M. Badami and M. Mura, "Leakage effects on the performance characteristics of a regenerative blower for the hydrogen recirculation of a PEM fuel cell," *Energy Conversion and Management*, vol. 55, pp. 20-25, 2012.
- [36] J. Wang, X. Jiang and Y. Cai, "Investigation of a novel circular arc claw rotor profile for claw vacuum pumps and its performance analysis," *Vacuum*, vol. 111, pp. 102-109, 2015.
- [37] Q. Zhang, J. Feng, J. Wen and X. Peng, "3D transient CFD modelling of a scroll-type hydrogen pump used in FCVs," *International Journal of Hydrogen Energy*, vol. 43, no. 41, pp. 19231-19241, 2018.
- [38] N. Konno, S. Mizuno, H. Nakaji and Y. Ishikawa, "Development of compact and high-performance fuel cell stack," *SAE International Journal of Alternative Powertrains*, vol. 4, no. 1, pp. 123-129, 2015.
- [39] C. Zhang, L. Chen, L. Lu, Y. Li, D. Hao, C. Chin and Y. Qiao, "The experiment and the control of hydrogen circulation of fuel cell based on of fuel ejector: A review," *International Journal of Hydrogen Energy*, 2023.
- [40] S. Goebel, S. Falta and J. Owejan, "Anode water separator for a fuel cell system". GM Global Technology Operations LLC Patent U.S. Patent 8,277,988, 2012.
-

- [41] A. Shojaei, S. Rahgoshay, M. Rahimi Esboee, A. Pahnabi and K. Mohammadi, "Experimental Investigation of Water Level Control System of Liquid-Gas Separator in the Fuel Cell," *Amirkabir Journal of Mechanical Engineering*, vol. 53, no. 1, pp. 589-596, 2021.
- [42] Y. Bai and Q. Bai, *Subsea Engineering Handbook*, Gulf Professional Publishing, 2018.
- [43] Z. Chen, D. Ingham, M. Ismail, L. Ma, K. Hughes and M. Pourkashanian, "Dynamics of liquid water in the anode flow channels of PEM fuel cells: A numerical parametric study," *Journal of the Energy Institute*, vol. 92, no. 6, pp. 1956-1967, 2019.
- [44] P. Costamagna and S. Srinivasan, "Quantum jumps in the PEMFC science and technology from the 1960s to the year 2000: Part II. Engineering, technology development and application aspects," *Journal of Power Sources*, vol. 102, no. 1-2, pp. 253-269, 2001.
- [45] D. Kennedy, D. Cahela, W. Zhu, K. Westrom, R. Nelms and B. Tatarchuk, "Fuel cell cathode air filters: Methodologies for design and optimization," *Journal of Power Sources*, vol. 168, no. 2, pp. 391-399, 2007.
- [46] B. Kakati, A. Unnikrishnan, N. Rajalakshmi, R. Jafri, K. Dhathathreyan and A. Kucernak, "Recovery of Polymer Electrolyte Fuel Cell exposed to sulphur dioxide," *International Journal of Hydrogen Energy*, vol. 41, no. 12, pp. 5598-5604, 2016.
- [47] A. Talke, U. Misz, G. Konrad and H. Heinzl, "Influence of nitrogen compounds on PEMFC: a comparative study," *Journal of The Electrochemical Society*, vol. 165, no. 6, p. F3111, 2018.
- [48] R. Mohtadi, W. Lee and J. Van Zee, "Assessing durability of cathodes exposed to common air impurities," *Journal of Power Sources*, vol. 138, no. 1-2, pp. 216-225, 2004.
- [49] H. Lv, Y. Shen, X. Xu, W. Zhou, D. Yang and C. Zhang, "Structure simulation design of a cathode air filter for SO₂ contamination on a 7 kW fuel cell sightseeing vehicle," *International Journal of Hydrogen Energy*, vol. 47, no. 8, pp. 5521-5530, 2022.
- [50] B. Blunier and A. Miraoui, "Air management in PEM fuel cells: State-of-the-art and perspectives," in *2007 International Aegean Conference on Electrical Machines and Power Electronics*, P. 245-254, IEEE, September 2007.
- [51] M. Stewart, *Surface Production Operations-Dynamic compressors*, Gulf Professional Publishing, 2019, pp. 527-653.
- [52] J. Larminie, A. Dicks and M. McDonald, *Fuel Cell Systems Explained*, vol. 2, Chichester, UK: J. Wiley, 2003, pp. 207-225.
- [53] R. Lin, C. Cao, MaJ., E. Gülzow and K. Friedrich, "Optimizing the relative humidity to improve the stability of a proton exchange membrane by segmented fuel cell technology," *International Journal of Hydrogen Energy*, vol. 37, no. 4, pp. 3373-3381, 2012.
-

- [54] B. Kim and M. Kim, "Studies on the cathode humidification by exhaust gas recirculation for PEM fuel cell," *International Journal of Hydrogen Energy*, vol. 37, no. 5, pp. 4290-4299, 2012.
- [55] A. Casalegno, S. De Antonellis, L. Colombo and F. Rinaldi, "Design of an innovative enthalpy wheel based humidification system for polymer electrolyte fuel cell," *International Journal of Hydrogen Energy*, vol. 36, no. 8, pp. 5000-5009, 2011.
- [56] S. Jung, S. Kim, M. Kim, Y. Park and T. Lim, "Experimental study of gas humidification with injectors for automotive PEM fuel cell systems," *Journal of Power Sources*, vol. 170, no. 2, pp. 324-333, 2007.
- [57] F. Büchi and S. Srinivasan, "Operating proton exchange membrane fuel cells without external humidification of the reactant gases: Fundamental aspects," *Journal of the Electrochemical Society*, vol. 144, no. 8, p. 2767, 1997.
- [58] M. Williams, H. Kunz and J. Fenton, "Operation of Nafion®-based PEM fuel cells with no external humidification: influence of operating conditions and gas diffusion layers," *Journal of Power Sources*, vol. 135, no. 1-2, pp. 122-134, 2004.
- [59] M. Watanabe, Y. Satoh and C. Shimura, "Management of the water content in polymer electrolyte membranes with porous fiber wicks," *Journal of the Electrochemical Society*, vol. 140, no. 11, p. 3190, 1993.
- [60] H. Su, L. Xu, H. Zhu, Y. Wu, L. Yang, S. Liao, H. Song, Z. Liang and V. Birss, "Self-humidification of a PEM fuel cell using a novel Pt/SiO₂/C anode catalyst," *International Journal of Hydrogen Energy*, vol. 35, no. 15, pp. 7874-7880, 2010.
- [61] W. Daud, R. Rosli, E. Majlan, S. Hamid, R. Mohamed and T. Husaini, "PEM fuel cell system control: A review," *Renewable Energy*, vol. 113, pp. 620-638, 2017.
- [62] G. Devi, M. Sabeena, C. Shankar and V. Kirbakaran, "Effect of cell Temperature on the power output of a PEM fuel cell in a test bed condition," in *2016 International Conference on Energy Efficient Technologies for Sustainability (ICEETS)*, April 2016.
- [63] Y. Chang, Y. Qin, Y. Yin, J. Zhang and X. Li, "Humidification strategy for polymer electrolyte membrane fuel cells—A review," *Applied Energy*, vol. 230, pp. 643-662, 2018.
- [64] M. Yuan, B. Faghri and Sund_en, *Transport Phenomena Fuel Cells, On heat and mass transfer phenomena in PEMFC and SOFC and modeling approaches*, 133-174, pp. 133-174.
- [65] M. Hossain and B. Shabani, "Metal foams application to enhance cooling of open cathode polymer electrolyte membrane fuel cells," *ournal of Power Sources*, vol. 295, pp. 275-291, 2015.
- [66] A. Baroutaji, A. Arjunan, M. Ramadan, J. Robinson, A. Alaswad, M. Abdelkareem and A. Olabi, "Advancements and prospects of thermal management and waste heat recovery of PEMFC," *International Journal of Thermofluids*, vol. 9, p. 100064, 2021.
-

- [67] M. Ramezanizadeh, M. Nazari, M. Ahmadi and L. Chen, "A review on the approaches applied for cooling fuel cells," *International Journal of Heat and Mass Transfer*, vol. 138, pp. 517-525, 2019.
- [68] M. Matian, A. Marquis and N. Brandon, "Model based design and test of cooling plates for an air-cooled polymer electrolyte fuel cell stack," *International Journal of Hydrogen Energy*, vol. 36, no. 10, p. 6051–6066, 2011.
- [69] C. Wen and G. Huang, "Application of a thermally conductive pyrolytic graphite sheet to thermal management of a PEM fuel cell," *Journal of Power Sources*, vol. 178, no. 1, pp. 132-140, 2008.
- [70] S. Baek, S. Yu, J. Nam and C. Kim, "A numerical study on uniform cooling of large-scale PEMFCs with different coolant flow field designs," *Applied Thermal Engineering*, vol. 31, no. 8-9, pp. 1427-1434, 2001.
- [71] S. Yu, S. Sohn, J. Nam and C. Kim, "Numerical study to examine the performance of multi-pass serpentine flow-fields for cooling plates in polymer electrolyte membrane fuel cells," *Journal of Power Sources*, vol. 194, no. 2, pp. 697-703, 2009.
- [72] S. Kart, F. Demir, i. Kocaarslan and N. Genc, "Increasing PEM fuel cell performance via fuzzy-logic controlled cascaded DC-DC boost converter," *International Journal of Hydrogen Energy*, 2023.
- [73] N. Genc and I. Iskender, "Steady-state analysis of a novel ZVT interleaved boost converter," *International Journal of Circuit Theory and Applications*, vol. 39, no. 10, pp. 1007-1021, 2011.
- [74] N. Genc, M. Celik and H. Uzmus, "Experimental verification of interleaved hybrid DC/DC boost converter," *Journal of Power Electronics*, vol. 22, no. 10, pp. 1665-1675, 2022.
- [75] J. Larminie, "Fuel Cell Systems Explained," *John Wiley & Sons*, vol. 2, pp. 9-14, 2003.
- [76] S. Ma, M. Lin, T. Lin, T. Lan, X. Liao, F. Maréchal, Y. Yang, C. Dong and L. Wang, "Fuel cell-battery hybrid systems for mobility and off-grid applications: A review," *Renewable and Sustainable Energy Reviews*, vol. 135, p. 110119, 2021.
- [77] I. Anshory, J. Jamaaluddin, A. Wisaksono, I. Sulistiyowati, B. Rintyarna, A. Fudholi, Y. Rahman and K. Sopian, "Optimization DC-DC boost converter of BLDC motor drive by solar panel using PID and firefly algorithm," *Results in Engineering*, vol. 21, p. 101727, 2024.
- [78] S. Schnorpfeil, A. Kotowski, H. Sötje and G. Hartmann, "Fuel Cell System Development for Heavy Duty Application," in *International MTZ Conference on Heavy-Duty Engines*, Wiesbaden, November 2022.
- [79] C. Liu, F. Deng, J. Zhang, X. Cai, Z. Chen and F. Blaabjerg, "Power loss reduction control for modular multilevel converters based on resistor controllable submodule," *IEEE Transactions on Power Electronics*, vol. 37, no. 8, pp. 9767-9776, 2022.
- [80] A. Züttel, "Hydrogen storage methods," *Naturwissenschaften*, vol. 91, pp. 157-172, 2004.
-

- [81] J. Renau, V. García, L. Domenech, P. Verdejo, A. Real, A. Giménez, F. Sánchez, A. Lozano and F. Barreras, "Novel use of green hydrogen fuel cell-based combined heat and power," 2021.
- [82] E. Gülzow and M. Schulze, *Materials for fuel cells, Alkaline fuel cells*, Woodhead Publishing, 2008, pp. 64-100.
- [83] O. Burheim, *Engineering Energy Storage*, Academic Press, 2017.
- [84] N. Sammes, R. Bove and K. Stahl, "Phosphoric acid fuel cells: Fundamentals and applications," *Current Opinion in Solid State and Materials Science*, vol. 8, no. 5, pp. 372-378, 2004.
- [85] S. Sadeghi and I. Baniasad Askari, "Performance and economic investigation of a combined phosphoric acid fuel cell/organic Rankine cycle/electrolyzer system for sulfuric acid production; Energy-based organic fluid selection," *International Journal of Energy Research*, vol. 44, no. 4, pp. 2704-2725, 2020.
- [86] H. Wang, C. Chang, Y. Huang, Y. Su and F. Tseng, "A high-yield and ultra-low-temperature methanol reformer integratable with phosphoric acid fuel cell (PAFC)," *Energy*, vol. 133, pp. 1142-1152, 2017.
- [87] E. Antolini, "The stability of molten carbonate fuel cell electrodes: A review of recent improvements," *Applied Energy*, vol. 88, no. 12, pp. 4274-4293, 2011.
- [88] R. Rashidi, P. Berg and I. Dincer, "Performance investigation of a combined MCFC system," *International Journal of Hydrogen Energy*, vol. 34, no. 10, pp. 4395-4405, 2009.
- [89] L. Giorgi and F. Leccese, "Fuel cells: Technologies and applications," *The Open Fuel Cells Journal*, vol. 6, no. 1, 2013.
- [90] S. Singhal, "Advances in solid oxide fuel cell technology," *Solid State Ionics*, vol. 135, no. 1-4, pp. 305-313, 2000.
- [91] N. Minh, "Solid oxide fuel cell technology—features and applications," *Solid State Ionics*, vol. 174, no. 1-4, pp. 271-277, 2004.
- [92] S. Stadler, M. Hirz, K. Thum and P. Rossbacher, "Conceptual full-vehicle development supported by integrated computer-aided design methods," *Computer-Aided Design and Applications*, vol. 10, no. 1, pp. 159-172, 2013.
- [93] G. Standard, *Global Cars Manufacturers Information Exchange Group. Model Year*, 2008.
- [94] W. Dietrich, M. Hirz and P. Rossbacher, "Integration von geometrischen und funktionalen Aspekten in die parametrisch assoziative Modellgestaltung in der konzeptionellen Automobilentwicklung," in *3rd Grazer Symposium Virtuelles Fahrzeug*, 2010.
- [95] F. Furini and N. Silva, *FRAMEWORK FOR ADVANCED DESIGN VEHICLE PROCESS DEVELOPMENT*, João Ferreira, ISEL,(Portugal) jferreira@deetc.isel.ipl.pt..
-

-
- [96] Q. Yun and C. Leng, "Using VR technology combined with CAD software development to optimize packaging design," *Computer-Aided Design and Applications*, vol. 18, no. S1, pp. 97-108, 2020.
- [97] "cordis.europa," [Online]. Available: <https://cordis.europa.eu/project/id/101005934>. [Accessed 05 08 2023].
- [98] J. Larminie, "Fuel Cell Systems Explained," pp. 61-69 , 3rd edition, 2003.
- [99] J. Lu, B. Sun, D. Huang, T. Gu, P. Wang and W. Li, "Parameter Design of Core Components of Proton Exchange Membrane Fuel Cell (PEMFC) for Commercial Vehicles," *IAENG International Journal of Applied Mathematics*, vol. 53, no. 1, 2023.
- [100] T. Sutharssan, D. Montalvao, Y. Chen, W. Wang, C. Pisac and H. Elemara, "A review on prognostics and health monitoring of proton exchange membrane fuel cell," *Renewable and Sustainable Energy Reviews*, vol. 75, pp. 440-450, 2017.
-