



Technische Hochschule Ingolstadt

Master Thesis

Determining the Optimal Size of Agri-PV and Battery Systems in Rural Areas: A Case Study of Morocco and Algeria

**Faculty of Mechanical Engineering
Study program „Renewable Energy Systems“**

Submitted by

Amirmahdi Ghorreshi

First examiner	Prof. Dr.-Ing. Wilfried Zörner
Second examiner	Prof. Dr.-Ing. Daniel Navarro Gevers
Issue date	05.05.2024
Submission date	14.05.2024

Affidavit

I hereby declare the following § 18 Para. 4 Nr. 7 APO THI by my signature, that this thesis is my work, that I have not presented it elsewhere for examination purposes, and that I have not used any sources or aids other than those stated.

Ingolstadt, Date: 14. May 2024

A handwritten signature in black ink, consisting of a stylized initial 'A' followed by a long horizontal stroke.

Amirmahdi Ghorreshi

Signature

First name, Surname

Abstract

The global population is anticipated to experience a significant surge by 2050, posing profound challenges in ensuring food and energy security. Concurrently, the prevalence of hunger, exacerbated by pandemics, climate shocks, and conflicts, underscores the urgency to enhance agricultural productivity and energy efficiency. Agriculture currently accounts for 70% of freshwater consumption and 30% of global energy usage, requiring innovative solutions to meet increasing demands. In this context, Agri-Photovoltaic (Agri-PV) systems emerge as a promising approach, integrating agricultural practices with solar technology to enhance food production and energy generation simultaneously. These systems not only address the pressing need for sustainable food and energy sources but also offer benefits such as resilience against extreme weather events and income diversification for farmers.

This study investigates the potential of Agri-PV systems to address power outages in rural areas of Kissane in Morocco, as well as Bouda in Algeria. These areas are characterized by weak grid networks. After developing the load profiles of farms and households in the case study areas based on real data and literature, the PV-SOL software is utilized to estimate the size of the photovoltaic system. After simulation in the software and considering the type of Agri-PV substructure, three different scenarios for sizing the system are taken into account. The first scenario aims to cover all energy demands for both farms and households, the second focuses solely on farms, and the third focuses only on household energy requirements.

The results reveal that with six hours of power outage in a day, Kissane requires a 39 kWp Agri-PV system with an 85.31 kWh battery to fulfill its total energy demands. For farms alone, a 38 kWp system with an 82.04 kWh battery is necessary, while households, due to cooperative arrangements and few houses, need only a 1 kWp system with a 3.27 kWh battery. In Bouda, facing six power outages in a day, a 46 kWp system with a 144.34 kWh battery is required for total energy, 41 kWp with a 125.78 kWh battery for farms, and 5 kWp with an 18.56 kWh battery for households. Economic analysis favors Morocco due to higher electricity prices, yielding Kissane a positive 8.69% internal rate of return (IRR) and a competitive 10.95 cent/kWh levelized cost of electricity (LCOE). In contrast, Bouda faces economic challenges with a -2.93% IRR and a 13.77 cent/kWh LCOE, necessitating financial incentives for viability.

Keywords: Agri-Photovoltaic (Agri-PV), power outage, load profile, grid network, rural energy security, Morocco, Algeria

Table of Content

Affidavit.....	ii
Abstract.....	iii
1. Introduction	1
1.1 Agri-PV	1
1.2 Morocco.....	2
1.2.1 Background.....	2
1.2.2 Region Population & Socio-Economic Activities	2
1.2.3 Climate Condition.....	3
1.2.4 Energy Sector	3
1.2.5 Grid State	5
1.2.6 Power Losses and Outages	6
1.2.7 Energy Policy.....	6
1.3 Algeria	8
1.3.1 Background.....	8
1.3.2 Region Population & Socio-Economic Activities	8
1.3.3 Climate Condition.....	9
1.3.4 Energy Sector	9
1.3.5 Grid State	12
1.3.6 Power Losses and Outages	13
1.3.7 Energy Policy.....	14
1.4 Advantages of Agri-PV in Rural Areas of Morocco and Algeria.....	15
1.5 Load Patterns	17
1.5.1 Household Load Profiles in Rural Areas.....	17
1.5.2 Agricultural Load Profiles	23
1.6 Research Motivation	26
1.7 Research Challenges	27

2.	Research Design & Methodology.....	27
2.1	Questions and Objectives.....	27
2.2	Methodology.....	28
3.	Case Study Area: Kissane and Bouda.....	29
4.	Energy Demand Analysis	30
4.1	Households	31
4.2	Farm.....	33
4.2.1	Non-livestock Farms	33
4.2.2	Livestock Farm	36
5.	Result and Discussion.....	39
5.1	Kissane - PV and Battery Sizing	39
5.1.1	Scenario 1: Sizing Battery for Farms and Households	39
5.1.2	Scenario 2: Sizing Battery for Farms.....	40
5.1.3	Scenario 3: Sizing Battery for Households	40
5.2	Bouda - PV and Battery Sizing	40
5.2.1	Scenario 1: Sizing Battery for Farms and Households	41
5.2.2	Scenario 2: Sizing Battery for Farms.....	41
5.2.3	Scenario 3: Sizing Battery for Households	42
5.3	System Components	42
5.3.1	PV Module	42
5.3.2	Inverter	42
5.3.3	Battery	42
5.3.4	Construction of Substructure.....	43
6.	Economical Assessment	44
6.1	Kissane.....	45
6.2	Bouda.....	48
7.	Conclusion	50

8. Publication bibliography.....	52
9. Appendices	57
Appendix A: Hourly household consumption in Bouda	57
Appendix B: Hourly household consumption in Kissane	58
Appendix C: Monthly Average Load Profile: Algerian Livestock Farm	59
Appendix D: PV-SOL Report for Bouda-Algeria	60
Appendix E: PV-SOL Report for Kissane-Morocco	64
Appendix F: Data Analysis of Agri-PV Projects, Fraunhofer ISE.....	68
Appendix G: PV and Inverter Data sheets	69
Appendix H: Battery Storage	73

List of Figures

Figure 1.1 Agri-PV system (Suness, 2024)	2
Figure 1.2 Map of Morocco (Morccomap360, 2024).....	3
Figure 1.3 Morocco's primary energy demand in Millions TEP (Meliani et al., 2022)	4
Figure 1.4 Morocco's renewable energy perspective, 2015-34%, 2020-42%, 2030-52% (Boulakhbar et al., 2020).....	4
Figure 1.5 The topologies of the Moroccan network (Sahbani et al., 2016)	5
Figure 1.6 Power losses and outages in Morocco (Passero et al., 2021)	6
Figure 1.7 Map of Algeria (Encyclopedia Britannica, 2024b)	9
Figure 1.8 Algeria's population & energy consumption profile (Zahraoui et al., 2021).....	10
Figure 1.9 Energy production in Algeria (0,35% from RES) (Zahraoui et al., 2021).....	11
Figure 1.10 Achievement of MEM program in Algeria (Trade.gov, 2023)	11
Figure 1.11 Algerian 400 kV power transmission grid (Belkhiri et al., 2022)	12
Figure 1.12 Power losses and outages in Algeria.....	13
Figure 1.13 Blackout experiences in rural areas in Algeria (ABVII, 2022).....	13
Figure 1.14 PV potential in Algeria and Morocco (Solargis, 2024a).....	16
Figure 1.15 Rate of photosynthesis against intensity of sunlight (ISE, 2022).....	16
Figure 1.16 Average household load profile in urban and rural areas in India (Gaur et al., 2016)	17
Figure 1.17 Household demand profiles in rural areas in India, (a) Small villages with 5–6 small households; (b) Medium households with, a range of appliances; (c) Small standalone households; and (d) Small standalone off-grid rural households (Verma et al., 2015)	18
Figure 1.18 Measure rural load profiles for households in (a) Zimbabwe and (b) Uganda (Prinsloo et al., 2016).....	18
Figure 1.19 Energy load profiles in rural settings across different countries: (a) Ban Pang, Praratchatan, Thailand; (b) Rural Western Australia; (c) Alaminos, Rural Philippines; (d) San Juanico, Rural Mexico; (e) Rural Lao household, PDR; and (f) Puerto Plata, Dom (Prinsloo et al., 2016)	19
Figure 1.20 Average week-day load profiles in Omorate and Tum (Wassie et al., 2024).....	20
Figure 1.21 Mean monthly electricity consumption per household customer for Tum and Omorate based on Ethiopia Electricity Supplier (EEU) (Wassie et al., 2024)	21
Figure 1.22 Average household energy consumption in India (GWh/year) (Verma et al., 2015).....	22
Figure 1.23 A livestock farm appliance (Maammeur et al., 2017)	23

Figure 1.24 Daily load profile of a family farm in north Algeria in a year (Maammeur et al., 2017)	24
Figure 1.25 Electrical load profile of a farm in Mitidja in the north of Algeria, (a) spring/summer and (b) autumn/winter (Nacer et al., 2016)	24
Figure 1.26 Load profile of a livestock farm in Sebdou in the north of Algeria, (a) 1. July, (b) 1. January	25
Figure 2.1 Methodology flowchart	28
Figure 3.1 Jbel Kissanee, Morocco (Mapcarta, 2024b)	30
Figure 3.2 Bouda, Algeria (Mapcarta, 2024a)	30
Figure 4.1 Household load Profile for Bouda	32
Figure 4.2 Household load Profile in Kissane	33
Figure 4.3 Harvesting potatoes in large farms	34
Figure 4.4 Load profile for a potato farm	35
Figure 4.5 Annual consumption in a non-livestock farm based on Irrigation and non-irrigation Periods	35
Figure 4.6 Energy taken from the grid in 1. January, Non-irrigation Period (left), Energy taken from the grid in 1. July, Irrigation Period (right)	36
Figure 4.7 Load Profile of a livestock farm	37
Figure 4.8 Annual consumption in a livestock farm	38
Figure 4.9 Energy taken from the grid in a livestock farm during a year	38
Figure 5.1 Solar PV configuration: single-axis horizontal tracking (A) and vertical mounted bifacial (B) (Niazi et al., 2023)	43
Figure 5.2 Solar PV: static with optimal tilt (Niazi et al., 2023)	44
Figure 6.1 Kissane, scenario 1: from operation	46
Figure 6.2 Kissane, scenario 1: from bank	46
Figure 6.3 Kissane, Scenario 1: From bank, financial project balance	47
Figure 6.4 Bouda, scenario 1: from operation	48
Figure 6.5 Bouda, scenario 1: financial cash flow	49
Figure 6.6 Bouda, scenario 1: From bank, financial project balance	49
Figure 9.1 Capacity Retention in relation to Hot Temperatures (Albright et al., 2012)	73

List of Tables

Table 1.1 Photovoltaic project in development in Morocco (IEA, 2019)	5
Table 1.2 Solar energy potential in Algeria (Stambouli et al., 2012)	10
Table 1.3 Feed-in tariff for solar installation in Algeria (IEA, 2014a)	15
Table 1.4 The link between electrical asset ownership and poverty in Tanzania (Scott et al., 2021)	21
Table 1.5 Mean daily energy consumption categorized by age group in Tanzania (Scott et al., 2021)	22
Table 1.6 Annual energy consumption (Kythreotou et al., 2012)	25
Table 3.1 Kissane and Bouda overview	29
Table 4.1 Energy demand classifications in isolated rural communities (Renné et al., 2021)	31
Table 4.2 Main household appliances of a village house (Draftlogic, 2024; Narayan et al., 2018)	32
Table 4.3 Required appliances for small non-livestock farms	34
Table 4.4 Livestock-farm appliances (Maammeur et al., 2017)	36
Table 5.1 PV system sizing in Kissane	39
Table 5.2 Battery sizing for total consumption in Kissane	40
Table 5.3 Battery sizing for farms in Kissane	40
Table 5.4 Battery size for households in Kissane	40
Table 5.5 PV system sizing in Bouda	41
Table 5.6 Battery sizing for total consumption in Bouda	41
Table 5.7 Battery sizing for farms in Bouda	41
Table 5.8 Battery sizing for households in Bouda	42
Table 6.1 System and battery sizing scenarios in Kissane	45
Table 6.2 Kissane, scenario 1: LCOE	47
Table 6.3 Kissane, scenario 2: LCOE	47
Table 6.4 Kissane, scenario 3: LCOE	47
Table 6.5 System and battery sizing scenarios in Bouda	48
Table 6.6 Bouda, scenario 1: LCOE	49
Table 6.7 Bouda, scenario 2, LCOE	50
Table 6.8 Bouda, scenario 3, LCOE	50

List of Abbreviations

PV	Photovoltaic
Agri-PV / AGPV / APV	Agri-Photovoltaic
AV	Agrivoltaic
IEA	International Energy Agency
km	Kilometer
Mtoe	Million tons of Oil Equivalent
kW	Kilowatt
kWp	Kilowatt peak
kWh	Kilowatt-hour
ONEE	National Office of Electricity and Drinking Water
SAIDI	System Average Interruption Duration Index
SAIFI	System Average Interruption Frequency Index
MASEN	Moroccan Agency for Solar Energy
ANRE	National Authority for Electricity Regulation
GDP	Gross Domestic Product
FDE	The Energy Development Fund
SIE	Energy Investment Company
APRUE	National Agency for Energy Management
ICEM	Intersectoral Council for Energy Management
NFEM	National Fund for Energy Management
NPV	Net Present Value
PP	Payback Period
IRR	Internal Rate of Return on Capital
LCOE	Levelized Cost of Energy

1. Introduction

According to a recent United Nations report, the current world population is expected to increase from 7.6 billion to 8.6 billion by 2030, and then to 9.8 billion by 2050 (UN et al., 2023). Between 691 and 783 million people faced hunger in 2022. Based on the Food and Agriculture Organization report, about 122 million more people worldwide have faced hunger since 2019 due to pandemics and repeated climate shocks and conflicts, like the war in Ukraine (FAO et al., 2023). Considering the population growth rate, one of the challenges that humanity is currently facing is providing food and energy for this growing population. Therefore, the role of agriculture has become more important than before. Currently, 70% of freshwater consumption is due to agriculture as a large share. Moreover, 30% of the world's total energy belongs to food production and its supply chain. To meet human food needs, food production must increase by 60% by 2050 (FAO et al., 2017). In addition, the forecast of a 50% increase in global energy consumption by 2035 led to various proposals to supply these two related sectors. Knowing that agricultural land is limited and valuable, Agri-PV is not only a suitable idea for producing food and energy at the same time but also has a positive effect on the efficiency of agricultural land and can be used as a source of income for farmers, therefore contributing to the development of rural areas (ISE, 2023). Since many villages do not have access good grid infrastructures, irregular power outages are one of the issues that severely lower the quality of life in those areas. Therefore, the use of a renewable source such as solar energy, in addition to reducing fossil fuel consumption, makes it possible for farmers to become independent and self-producers. In this research, the design of the Agri-PV system with batteries for two end-of-line communities in Morocco and Algeria, two countries with high potential for installing solar systems is focused on, and the effect of the Agri-PV system in compensating for grid power cuts, the supply of agricultural and household needs is also examined.

1.1 Agri-PV

Agri-Photovoltaic (Agri-PV / AGPV / APV), also referred to as Agrivoltaic (AV) as shown in Figure 1.1 represents a sustainable system integrating agricultural farming activities with photovoltaic technology, which can play a significant role in developing rural areas (Efremov et al., 2022). According to the International Energy Agency (IEA) by 2050, solar will cover one-fifth of global energy generation, and the capacity of solar PV will grow 20 times (IEA, 2021), Agri-PV can play a role in this trend. In addition, studies show that increasing Agri-PV on only 1% of global cropland can help support substantial portions of global energy demand (Adeh et al., 2019). Beyond energy production, these systems provide additional advantages, such as protection

against extreme weather events like hail, frost, and drought. Furthermore, Agri-PV creates opportunities for farmers to diversify their incomes.



Figure 1.1 Agri-PV system (Suness, 2024)

1.2 Morocco

1.2.1 Background

As shown in Figure 1.2, Morocco, is in northwestern Africa with access to the Atlantic and the Mediterranean, spans 446,550 km² and has a coastline of 1,835 kilometers. In terms of area, the country ranks 58th globally and is the 25th largest in Africa. Over 65% of the population lives in urban areas. With an average elevation of 909 meters above sea level, Morocco is relatively high, featuring its highest peak, Toubkal, at 4,165 meters. It includes around 10 islands and shares direct borders with Algeria, Western Sahara, and Spain (Worlddata, 2024).

1.2.2 Region Population & Socio-Economic Activities

The population of Morocco is above 38 million (Worldometer, 2024). In economic terms, agriculture plays a crucial role, contributing an average of 11% to the nation's GDP (Statista, 2024b). After a decrease in GDP growth from 8% to 1.2% in 2022 due to drought, war in Ukraine, pandemic, and a decrease in the average global economy, Morocco's agricultural exports had an important role in reducing economy-pressures and increased the growth rate to 3% in 2023 (World Bank, 2023b). Additionally, tourism and mining, especially in phosphates, are vital for Morocco's economy. The country holds about 77% of the world's phosphate reserves and leads in global phosphate exports (Oxford Business Group, 2016). Nevertheless, the 9% poverty rate (Ahmed, 2020, p. 4), the lack of purchasing power, the low quality of education, and the 10.49% unemployment rate (Statista, 2022c) are some of the challenges that this country is dealing with.



Figure 1.2 Map of Morocco (Morccomap360, 2024)

1.2.3 Climate Condition

Morocco has a diverse climate that varies by season and region. Generally tropical, with temperatures ranging from 5°C to 35°C in the Sahara, the country has warm Mediterranean coastal areas and hotter, drier inland regions. Southern areas are very hot and dry, with significant nighttime temperature drops in December and January. Coastal regions receive rain from November to March, while the overall climate is mostly dry with high summer temperatures and cooler mountainous areas (Encyclopedia Britannica, 2024c).

1.2.4 Energy Sector

In recent years, total energy demand in Morocco has grown annually by about 5% since 2004 (Trade, 2024). As shown in Figure 1.3, the future demand for primary energy can reach 43 Mtoe (Million tons of Oil Equivalent) by 2030. Under the Paris Agreement, Morocco has committed to decrease greenhouse gas emissions by around 17% until 2030, with a secondary reduction of 25% conditional on international support. Additionally, Morocco has set a goal to reach 52% of installed power capacity from renewable sources by 2030 (Boulakhbar et al., 2020).

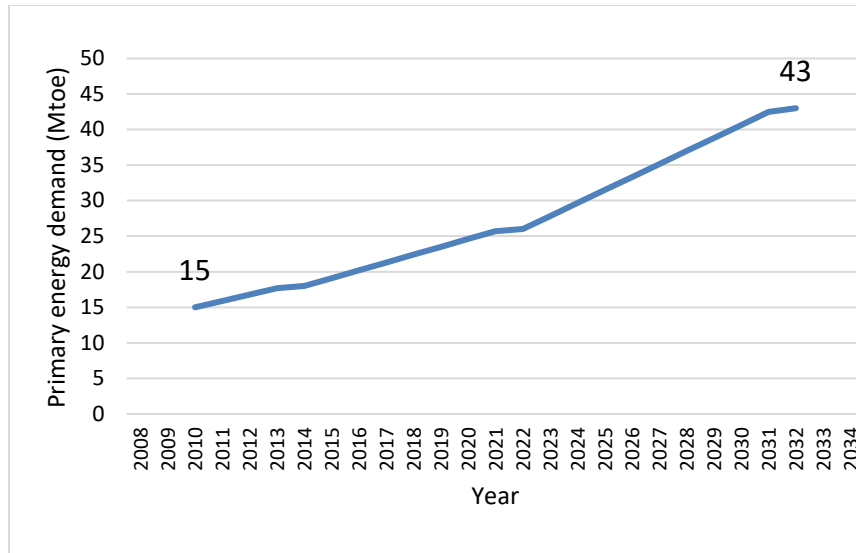

Figure 1.3 Morocco's primary energy demand in Millions TEP (Meliani et al., 2022)

However, as of 2021, fossil fuels still have 62.51% of Morocco's energy production, while hydropower contributed 16.14%, wind power 13.67%, and solar energy around 7.68% of the total energy (Trade, 2024).

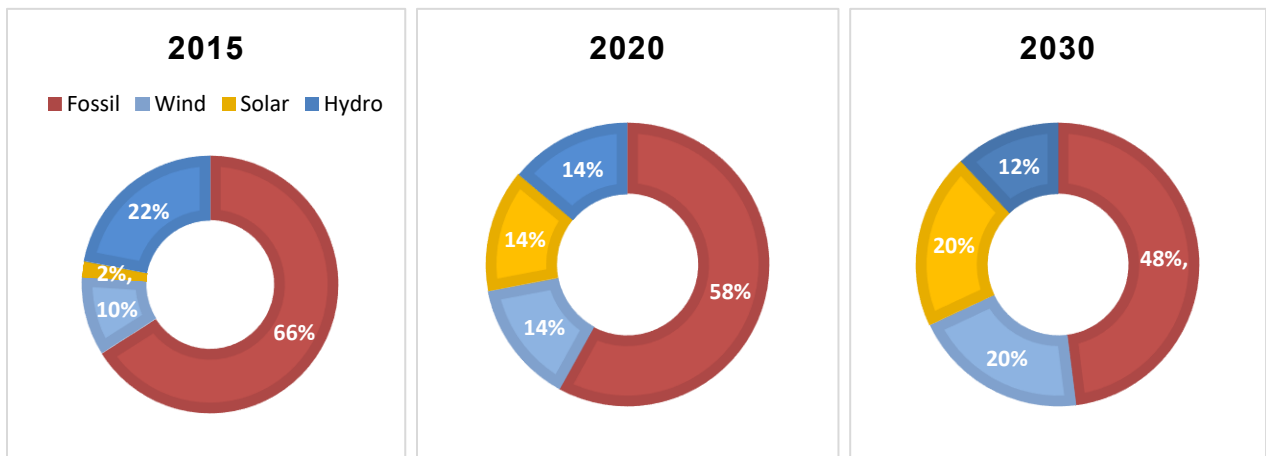

Figure 1.4 Morocco's renewable energy perspective, 2015-34%, 2020-42%, 2030-52% (Boulakhbar et al., 2020)

As a developing country, whose 41% of total energy consumption has been allocated to the industrial sector (Boris Schinke et al., 2016) and also to achieve its goals in the solar power sector, Morocco has started the Noor project as shown in Table 1.1.

Table 1.1 Photovoltaic project in development in Morocco (IEA, 2019)

Site/Plant	Power in MW	Commissioning
NOOR MIDELT	Up to 800	2021
NOOR TATA	More than 500	2020
NOOR Laayoune I	80	2018
NOOR Boujdour I	20	2018
NOOR PV II (total at several sites)	800	2020
NOOR Tafilalet	100	2019
NOOR Atlas	200	2020
NOOR Argena	200	2021

1.2.5 Grid State

The grid system in Morocco is a vast grid network, including transmission lines with approximately 3,000 km of 400 kV, around 9,000 km of 225 kV, 147 km of 150 kV, and 11,780 km of 60 kV lines, as shown in Figure 1.5. However, this grid was established 50 years ago and consists of a mix of outdated and modern technology. Most of the grid components are antiquated and continue to deteriorate due to environmental stresses such as extreme temperatures, vibrations, water infiltration, and civil works damages. Consequently, the current power system necessitates urgent upgrades to the electrical grid infrastructure.

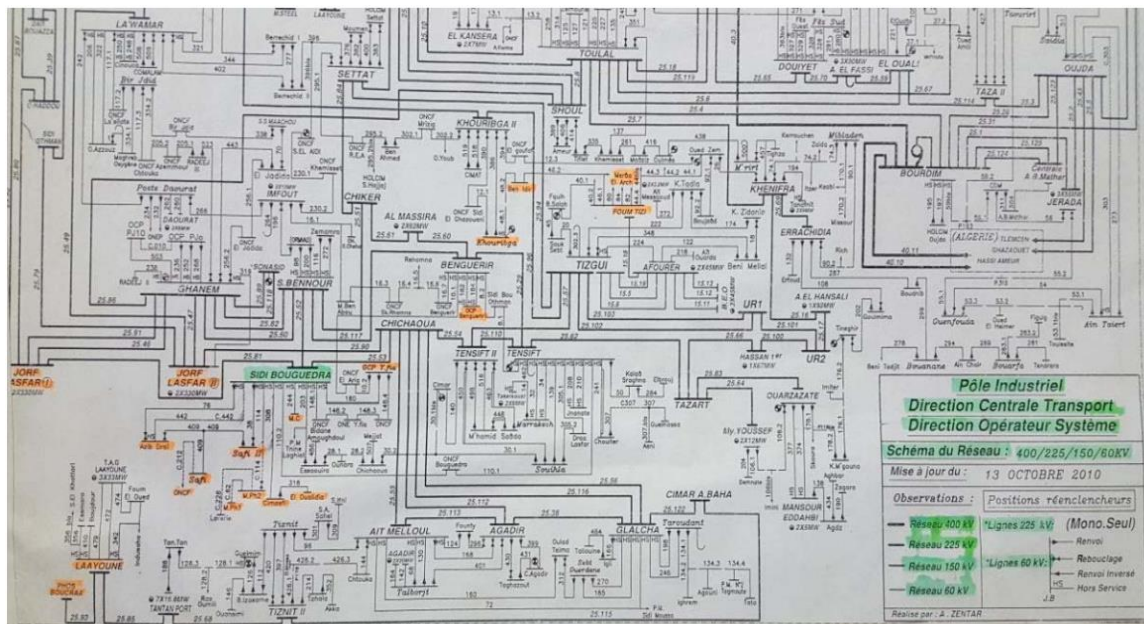

Figure 1.5 The topologies of the Moroccan network (Sahbani et al., 2016)

The primary role of power grid systems is to facilitate the transmission of electricity from large-scale generation plants to end-users. The transmission system carries electricity from power

plants using high-voltage transmission lines (>60 kV) to distribution substations. At these substations, the voltage is converted to medium voltage and distributed to the feeders through transmission networks. These feeders are typically located near customers and further reduce the voltage to the appropriate level for end-users. It is important to note that this power flow within the grid is predominantly one-way (Sahbani et al., 2016).

1.2.6 Power Losses and Outages

Morocco's grid challenges, as discussed in the previous sub-chapter lead to power outages, losses, and inefficiencies. As shown in Figure 1.6, transmission losses, and distribution losses which include technical and commercial account for 22% of power output. The average frequency and duration of power outages in Morocco, as measured by the System Average Interruption Duration Index (SAIDI) and the System Average Interruption Frequency Index (SAIFI), respectively, present contrasting values. SAIDI reflects figures reported by the government, while SAIFI provides measurements that are considered to be more closely aligned with the actual situation (Passero et al., 2021).

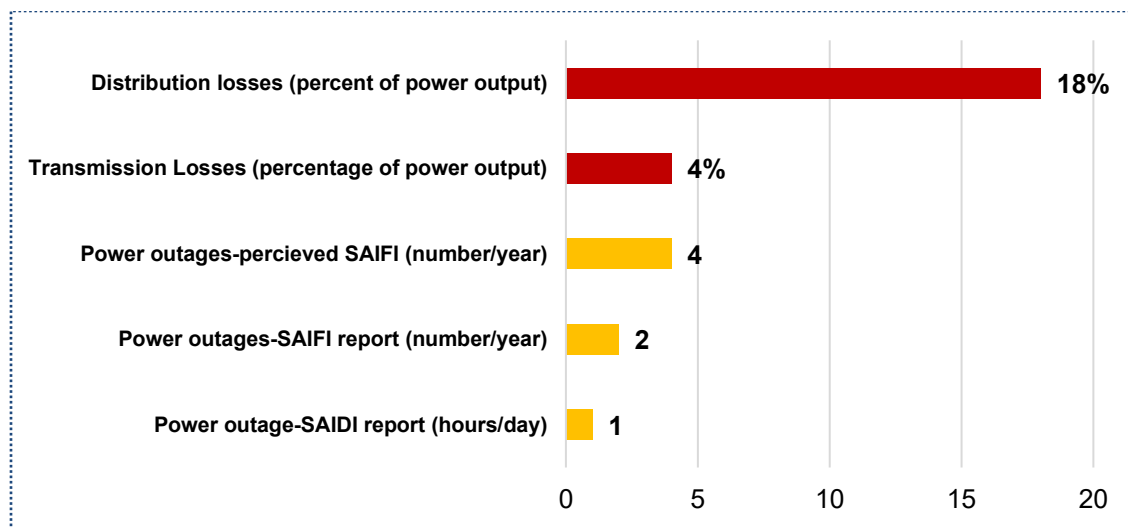

Figure 1.6 Power losses and outages in Morocco (Passero et al., 2021)

1.2.7 Energy Policy

Agri-PV, as an innovative approach, requires supportive policies for implementation and advancement. Therefore, it is necessary to consider the policies of the country where the system is intended to be installed. In the past 20 years, Morocco's electricity sector changed policies in favor of renewable energy and market liberalization. In 1994, the government empowered the National Office of Electricity and Drinking Water (ONEE) to make agreements with Independent

Power Producers (IPPs) up to 10 MW, increasing competition (Amegroud et al., 2015). In 2006, Law 54-05 allowed private entities to manage public services, including electricity (Andriani et al., 2013). These steps show a push for market liberalization and private sector involvement. Later laws increased the private production limit to 50 MW and removed limitations for solar and wind projects to connect to grids (Schinke et al., 2016).

The Moroccan government, guided by the mentioned laws, acted by establishing new institutes to manage the transition, among which is the Ministry of Mines, Energy, Water, and Environment (MEMEE). MEMEE is responsible for implementing government policies on energy, mines, and geology. It manages companies and public institutes in these areas and controls energy and mining resources, diversifies energy sources, develops renewable energy projects, and ensures sufficient energy supply. The ministry plays a key role in crafting and coordinating the country's new energy strategy (IEA, 2014b). Other relevant agencies involved in implementing energy policies include ONEE, Moroccan Agency for Solar Energy (MASEN), and National Agency for Renewable Energy and Energy Efficiency (ADEREE). ADEREE was established in 2010. Its focus is on the development of renewable energy projects and energy efficiency initiatives at national, regional, and sectoral levels. Beyond project development, ADEREE also is an advisor to other agencies, particularly in the selection of project sites. The agency has plans for collaboration with the French Environment and Energy Management Agency (ADEME) to promote renewable energy and energy efficiency projects, leveraging European experiences. Notably, ADEREE has a greater emphasis on investing in renewable energy projects compared to energy efficiency projects (IEA, 2014a).

MASEN was established in 2015 through orders from King Mohamed VI. As a state-owned agency, it oversees the implementation of the Moroccan renewable energy program in collaboration with ONEE. MASEN has three main responsibilities: developing solar and renewable energy projects, improving the workforce and expertise, and recommending solar and renewable energy technologies on different scales. It is important to highlight that MASEN played a key role in planning the 580 MW solar complex "Noor" and actively engages in attracting both local and foreign investors for renewable energy projects, along with the development of feasibility studies.

the National Authority for Electricity Regulation (ANRE), is an independent regulatory agency formed to define tariffs and conditions for network and connection access for all participants involved in the electricity market. These organizations play crucial roles in securing and managing funds for national energy projects in Morocco. The Energy Development Fund (FDE), initiated in 2009 by King Mohamed VI, holds a substantial 1 billion USD, contributed by Saudi Arabia, the

United Arab Emirates, and the Hassan II Fund. Its purpose is to support the Moroccan national energy strategy. Additionally, the Energy Investment Company (SIE), also established in 2009, manages 1 billion Moroccan Dirham from the FDE. SIE allocates these funds, with a portion dedicated to Energy Efficiency projects and the remainder to renewable energy projects. Its primary function is to facilitate projects within the energy sector by engaging investors and the private industry. Another important initiative is the Morocco Sustainable Energy Financing Facility (MorSEFF), launched in 2015 with a capital of 80 million EUR from various international sources. MorSEFF's objective is to support private-sector renewable energy projects in Morocco. It achieves this by providing credit to companies or parties involved in sustainable energy projects, after a thorough review process. Local banks such as BMCE Bank and Credit Agricole are also actively involved in MorSEFF, contributing to the promotion of sustainable energy practices in the country (Schinke et al., 2016).

In conclusion, Morocco grapples with energy sector challenges while navigating a diverse economy, ambitious renewable goals, and an aging grid system. However, the country's commitment to renewable energy and strategic collaborations signals a determined effort for a resilient and sustainable future.

1.3 Algeria

1.3.1 Background

Democratic Republic of Algeria is in the northern part of Africa. This country is the largest in Africa and the 10th largest nation in the world. Algeria has a population of 46,11 million and approximately 2,382 million square kilometers area (Encyclopedia Britannica, 2024a). Algeria has many bays along its coast and its rivers are small and mostly only flow at certain times. In the north, there are high mountains called the Atlas Mountains. The highest of them is Mount Chelia, which is 2328 meters high. In the central and southern parts of Algeria, there is a large part of the northern Sahara desert (Trade.gov, 2023).

1.3.2 Region Population & Socio-Economic Activities

As the fourth oil and gas exporter in the world, Algeria makes more than 93% of its export revenues, 60% of budget revenues, and 19% of gross domestic product (GDP) from hydrocarbon resources (World Bank, 2023a). However, due to the reduction of resources and the endangerment of the economic future of this country, Algeria has recently focused on agriculture, tourism, and increasing the production of renewable energy. In addition, the agricultural sector plays an important role in the economy of this country with 41.36 million hectares of agricultural

land and an 11.38% share of GDP (Statista, 2024a). However, due to global inflation, the average consumer price inflation in Algeria increased from 4.8% to 9.5% in 2022. In addition, the 11.55% unemployment rate, the lack of quality education and health system as well as poverty are the challenges that stand in the way of progress in this country (Algeria Economy, 2019).



Figure 1.7 Map of Algeria (Encyclopedia Britannica, 2024b)

1.3.3 Climate Condition

Algeria has two main climates: a mild Mediterranean climate in the north with wet winters and hot summers, and a desert climate covering most of the country where winters range from 15 °C to 28 °C and summers reach 40 °C to 45 °C. The northern region gets rain from autumn to spring due to sea winds, while the Sahara Desert experiences dry conditions. Historical climate trends show an increase in temperature and a drop in precipitation rate since the 1900s. The climate is also influenced by the Sirocco winds, which bring hot and humid conditions to the Mediterranean Sea (Word Bank, 2024).

1.3.4 Energy Sector

As shown in Figure 1.8, between 2009 and 2021, Algeria's population increased by around 1.8% each year, while energy consumption grew at a faster rate of 7.9% per year. This highlights that energy demand is rising quicker than the population. The analysis predicts energy demand will be around 150 TWh by 2030 (Zahraoui et al., 2021). This is a challenge for the country, and it is a reason to change the way the country produces energy, moving away from relying solely on

natural gas.

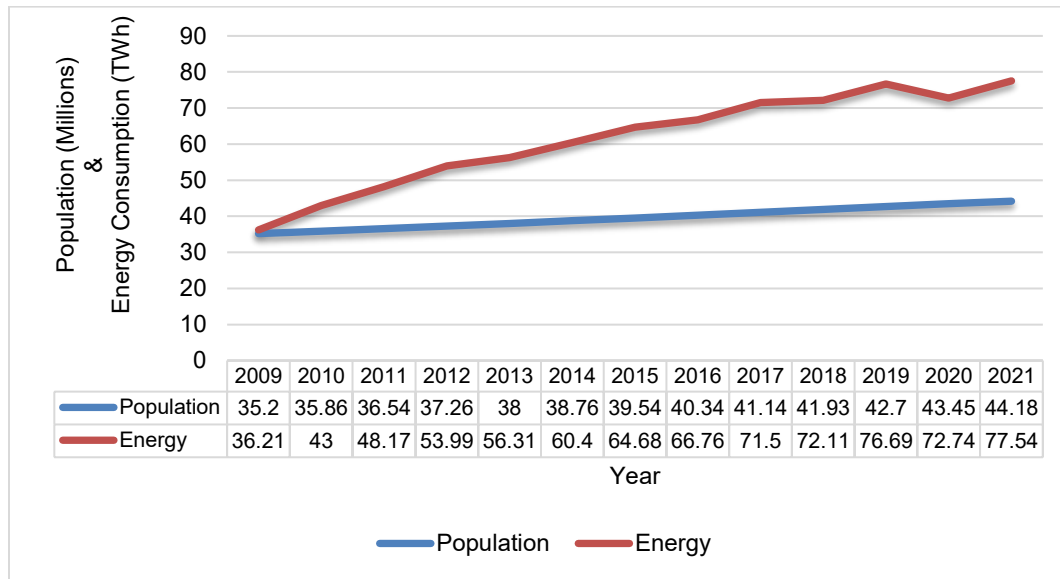

Figure 1.8 Algeria's population & energy consumption profile (Zahraoui et al., 2021)

However, Algeria not only has significant hydrocarbon resources but also great potential in the renewable energy sector. Table 1.2 illustrates the high potential areas for solar energy in Algeria, categorizing them into coastal, high plain, and desert areas. It also indicates that more than 16,555 TWh can be produced by solar power in this country (Stambouli et al., 2012).

Table 1.2 Solar energy potential in Algeria (Stambouli et al., 2012)

Areas	Surface Available	Average Daily Sunshine (Hours)	Potential Daily Energy (TWh)
Coastal	4%	7.26	443.96
High Plains	10%	8.22	1240.89
Desert	86%	9.59	14870.63

As mentioned, the main source of energy supply in Algeria is hydrocarbons. Considering the cheap price of electricity in this country at around 0.040 cents/kWh (GPP, 2023) and the lack of policies related to sustainable energy, Algeria's share in the production of renewable energy is about 0.35% (c.f. Figure 1.9) (Zahraoui et al., 2021), of which 88% is related to solar energy (IRENA, 2023). However, due to the downward trend in oil and gas resources and sustainability to cover the energy sector in 50-70 years (Stambouli et al., 2012), a growing population, increased energy consumption, reducing CO₂ emissions by 7-22% by 2030 (IEA, 2023) and also being on the path of development, this country decided to have a plan to increase renewable sources. In February 2011, the government introduced a program called Renewable Energy Development

and Energy Efficiency (PENREE) to include more renewable energy in Algeria's energy sources. Initially aiming for 40% of total energy consumption from renewables, the program was later modified in February 2015 by the Ministry of Energy and Mining (MEM), with a new goal to install 22 gigawatts of renewable energy by 2030 (Trade.gov, 2023). Figure 1.10 shows the progress of the MEM renewable energy program.

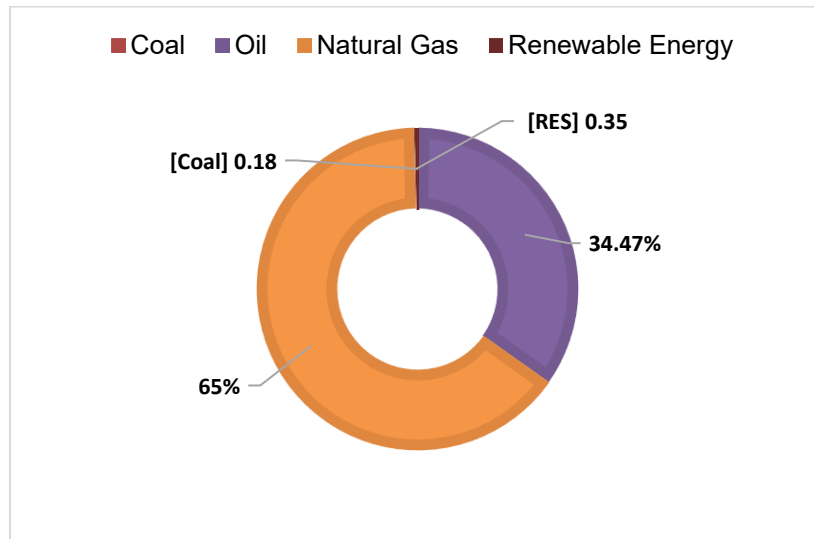

Figure 1.9 Energy production in Algeria (0,35% from RES) (Zahraoui et al., 2021)

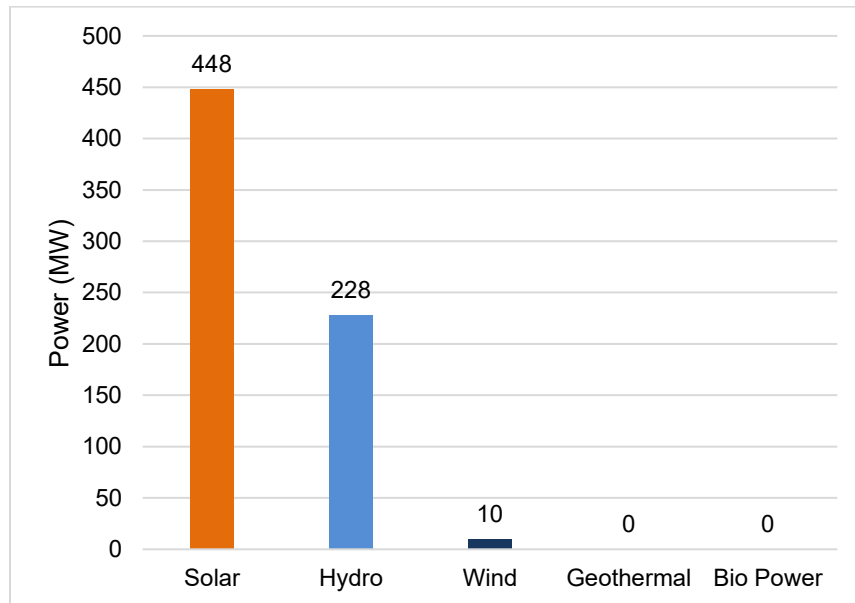

Figure 1.10 Achievement of MEM program in Algeria (Trade.gov, 2023)

1.3.5 Grid State

The Algerian electricity grid has three main subsystems:

- National Interconnected Network (RIN)
- Southern pole of In-Salah, Adrar, Timimoune (PIAT)
- Isolated southern network (RIS)

The National Interconnected Network (RIN) covers the North, including cities such as Bechar, Hassi Massoud, Hassi Ramel, and Ghardaya. It connects 40 power plants using 200 kV and 400 kV high voltage lines. The Antarctic Grid (PIAT) uses gas turbines for locations such as In-Salah, Adrar, and Timimoune, with electricity delivered via 220 kV lines. The Southern Isolated Network (RIS) supplies 26 remote sites with small diesel and gas turbine power plants (Amrouche et al., 2017). The Algerian national power transmission grid currently extends more than 30,000 km as shown in Figure 1.11, and based on the Development Plan for the year 2030, the addition of 20,000 km of new transmission lines in ten years is predicted (Belkhiri et al., 2022). For international connections, the Algerian grid links to Tunisia and Morocco through two high-voltage lines at 400 kV. Tunisia, involves two 90 kV lines, one 220 kV line, one 150 kV line, and one 400 kV line. The connection with Morocco has two 220 kV lines and one 400 kV line. These connections help neighboring countries share electrical energy and improve cooperation (Amrouche et al., 2017).

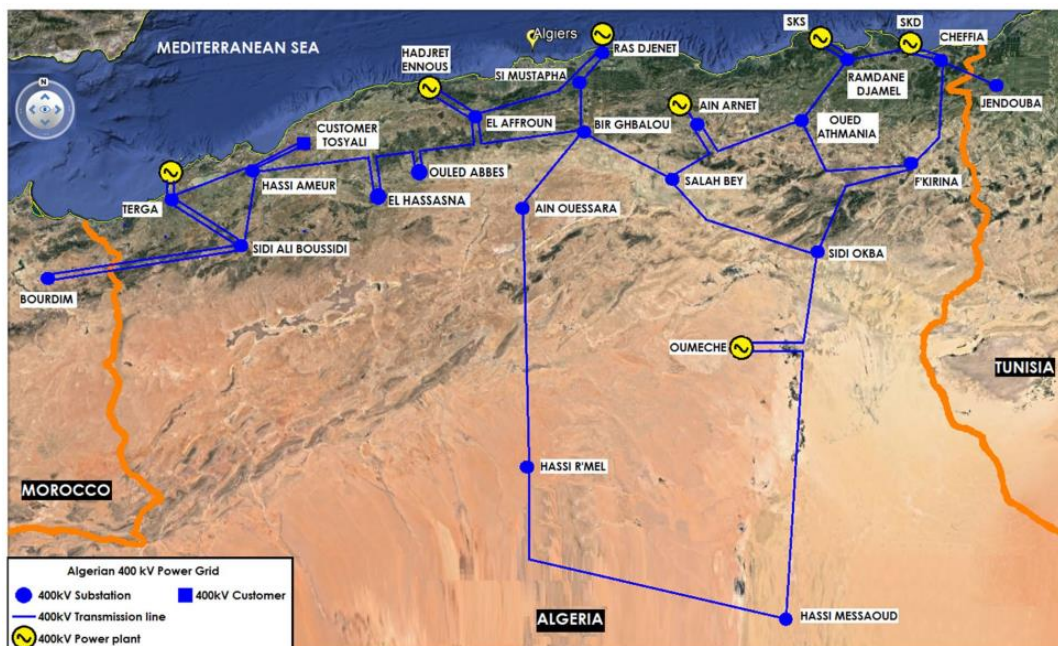

Figure 1.11 Algerian 400 kV power transmission grid (Belkhiri et al., 2022)

1.3.6 Power Losses and Outages

As mentioned by SAIDI and SAIFI, shown in Figure 1.12, Algeria faces power outages throughout the year. The SAIFI number is based on real situations, not just reported outages, making it a trustworthy measure. Additionally, a significant issue for Algeria's grid is losing power during transmission and distribution due to the long distance to rural areas and old infrastructure (Passero et al., 2021, p. 12).

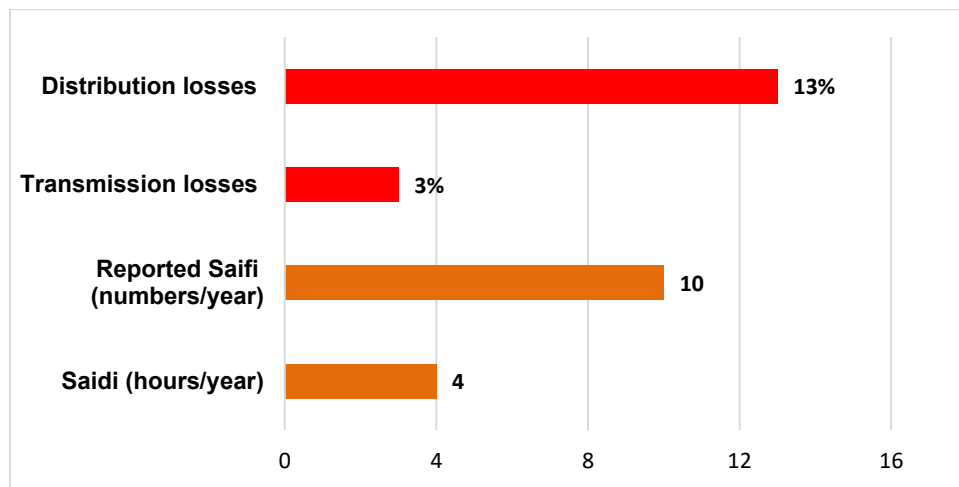

Figure 1.12 Power losses and outages in Algeria

Power outages tend to be more frequent in rural areas compared to urban regions (SRA, 2021). Consequently, the average numbers reported in official documents are often lower than the actual occurrences in these rural areas. To gain insight into the extent of electricity outages, residents in rural areas of Algeria were surveyed. Figure 1.13 illustrates the experiences of individuals regarding outages throughout different times of the year.

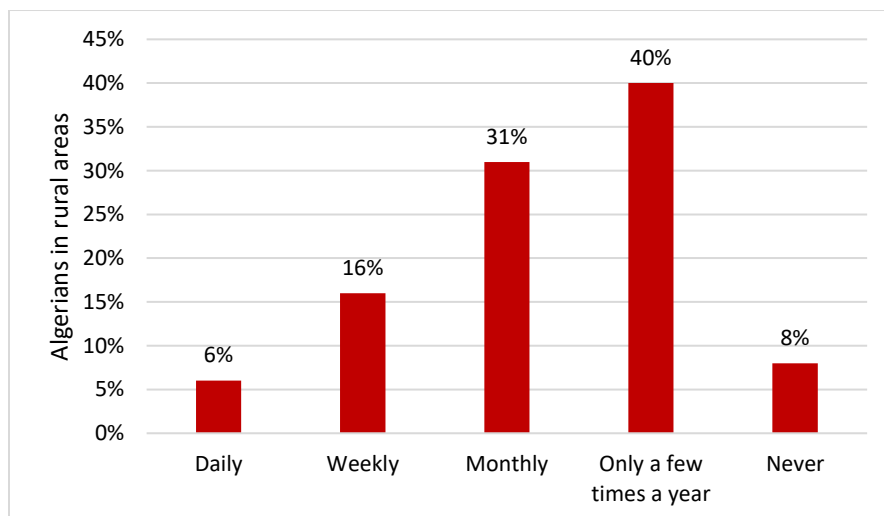

Figure 1.13 Blackout experiences in rural areas in Algeria (ABVII, 2022)

1.3.7 Energy Policy

Algeria's approach to sustainable development through its national energy strategy is outlined in the 1999 Law on Energy Management (99-09). This law sets the stage for a comprehensive national energy policy, focusing on three key aspects: the efficient use of energy, the development of renewable energy sources, and the protection of the environment from the negative impacts of the energy system. To implement this law, key institutional structures were established, including the National Agency for Energy Management (APRUE), the Intersectoral Council for Energy Management (ICEM), and the National Fund for Energy Management (NFEM).

The main goal of the law is to guide energy demand toward a more efficient consumption model. The NFEM plays a crucial role by providing financial support for actions and programs under the National Program of Energy Management (NPEM). This includes funding for renewable energy projects, with Article 33 offering tax and customs benefits to initiatives promoting renewable energy. The APRUE oversees the animation and coordination of the NPEM, with other agencies offering technical coordination at the sectoral level. Specific measures under the NPEM focus on renewable energy projects in residential and tertiary sectors, such as the installation of solar water heaters (Ghezloun et al., 2011).

Algeria's legal framework also addresses electricity and gas distribution through the Law on Electricity and Gas Distribution by Pipeline (N° 02-01 of 5 February 2002). This law considers environmental protection and encourages the integration of renewable energies into the country's energy mix. Article 95 emphasizes support for the additional costs of transporting and distributing electricity from renewable sources, with tax benefits outlined in a decree from March 25, 2004.

Furthermore, the Law on the Promotion of Renewable Energies in the Context of Sustainable Development (N° 04-09 of August 14, 2004) makes Algeria's commitment more robust to environmental sustainability. This law aims to protect the environment by promoting clean energy sources, contributing to the global fight against climate change, preserving fossil fuels, and aligning with national policy planning by promoting the widespread use of renewable energy. Financial incentives, detailed in the finance law, support research, development, and utilization of renewable energy (Ghezloun et al., 2011).

Furthermore, to enhance the renewable energy sector and meet power goals, a policy was implemented to establish feed-in tariffs for solar projects with a capacity of 1 MW or greater. This policy as shown in Table 1.3, was executed in two distinct phases, aiming to further optimize the transformation of the power landscape compared to previous efforts.

Table 1.3 Feed-in tariff for solar installation in Algeria (IEA, 2014a)

Phase	Hours of annual operation	Feed in tariff levels in DZD/kWh per plant size	
		1 MW – 5 MW	> 5 MW
Phase I	-	15.94/kWh (\$202/MWh)	12.75/kWh (\$ 162/MWh)
Phase II	1275-1349	20.08/kWh (\$255/MWh)	16.06/kWh (\$204/MWh)
	1350-1424	18.83/kWh (\$239/MWh)	15.06/kWh (\$191/MWh)
	1425-1499	17.45/kWh (\$222/MWh)	13.96/kWh (\$177/MWh)
	1500-1574	15.94/kWh (\$202/MWh)	12.75/kWh (\$162/MWh)
	1575-1649	14.43/kWh (\$183/MWh)	11.54/kWh (\$147/MWh)
	1575-1649	13.06/kWh (\$166/MWh)	10.44/kWh (\$133/MWh)
	≥1725	11.80/kWh (\$150/MWh)	9.44/kWh (\$120/MWh)

1.4 Advantages of Agri-PV in Rural Areas of Morocco and Algeria

Rural population

The percentage of people living in rural areas is significant for both countries. In Morocco, it is more than 37% or 13.7 million people (Statista, 2022c), and in Algeria, it is about 25% or 11.04 million people (Statista, 2022a). Regarding the discussed power outages, Agri-PV can be a solution to cover outages and provide access to sustainable and clean energy.

High potential for solar energy

Morocco has an average of 3146 hours of sunshine and Algeria has 2847 hours of sunshine per year (Climate top, 2024). The energy production potential per kilowatt hour in Algeria is 1909.3 kWh/kW in Morocco is 1952.7 kWh/kW (Solargis, 2024b). Figure 1.14 indicates photovoltaic power potential in both areas.

The importance of the agricultural sector

Agriculture is one of the key sectors of both countries, which has a direct impact on the economy of both countries. The existence of 30.38 million hectares of agricultural land in Morocco and a 13% share of GDP and 41.36 million hectares in Algeria and an 11.38% share of GDP indicate this issue. In addition, both countries are facing various challenges in reaching their goals in solar power (Statista, 2022b). Agri-PV can be a solution for the further development of both countries in the field of renewable energy.

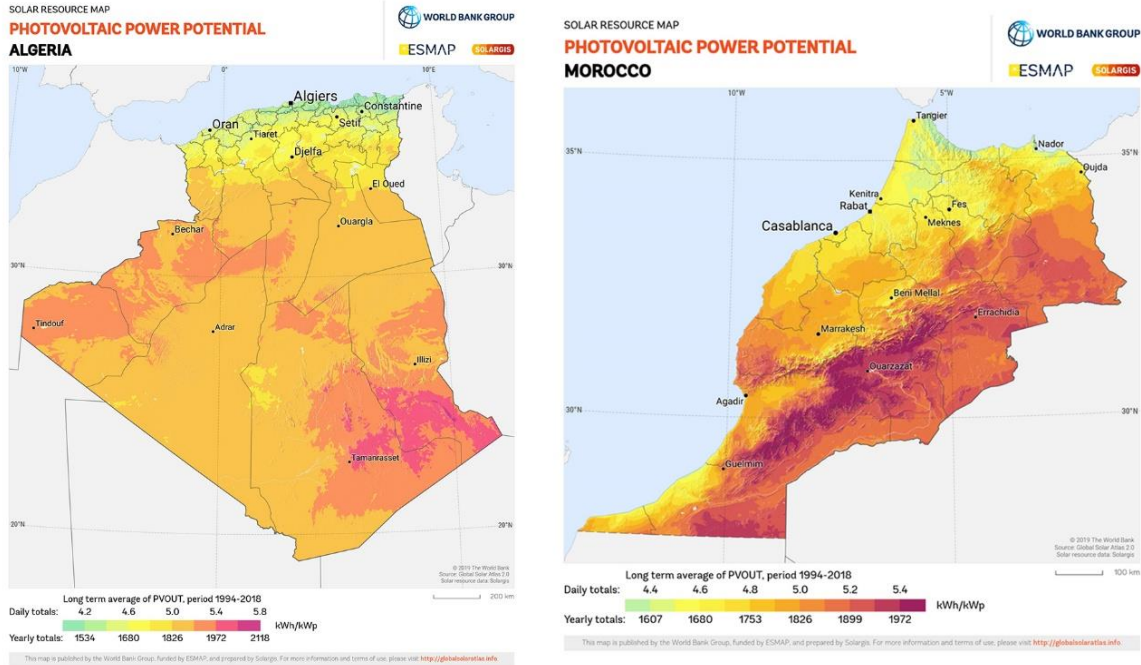

Figure 1.14 PV potential in Algeria and Morocco (Solargis, 2024a)

Moreover, another advantage of Agri-PV is to become a protector against direct sunlight. As shown in the Figure 1.15 photosynthesis occurs in crops up to a certain point of light saturation, and after that, sunlight does not affect crops to convert light into photosynthesis anymore, on the contrary, it can lead to the evaporation of soil moisture and a negative impact on agriculture. Also, weather changes such as hail, storms, etc. can threaten products, with the presence of Agri-PV, the possibility of their damage is reduced (ISE, 2022).

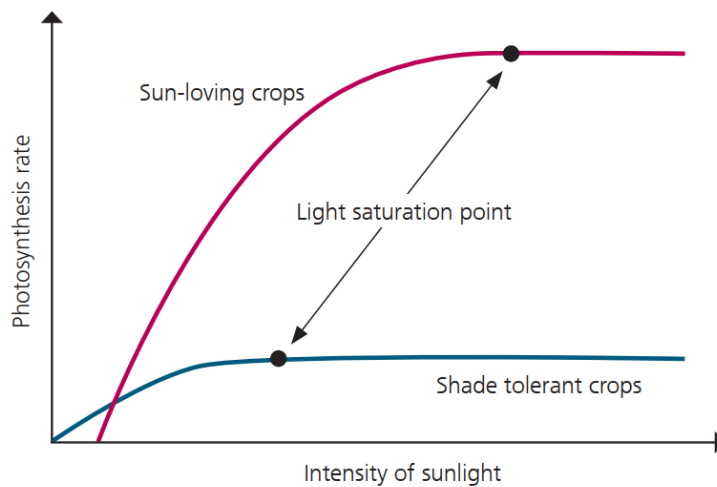

Figure 1.15 Rate of photosynthesis against intensity of sunlight (ISE, 2022)

1.5 Load Patterns

1.5.1 Household Load Profiles in Rural Areas

Appliance ownership and income levels significantly impact electricity consumption. Additionally, common appliances and weather conditions act as indicators that facilitate the recognition of similarities in consumption patterns across different regions and offer valuable insights into overall load patterns (Wassie et al., 2024). Building upon this concept, Figure 1.16 shows the average household consumption pattern in urban and rural areas in India, which has similarities with Northern Africa and experiences two consumption peaks in the morning and evening. During summer, electricity demand typically increases in the morning hours until noon, remaining relatively steady for the rest of the day. It starts to decrease in the early evening until 6 PM, and then sharply rising due to increased space cooling, reaching its peak between 9-10 PM and remaining high until midnight. In contrast, on a winter day, electricity demand rises early in the morning, reaching its peak between 9-10 AM, and then declines until sunset. It increases again with the rise in loads until 19:00-19:30, gradually decreasing to a minimum in the late night hours. The majority of annual domestic consumption in this country is devoted to space cooling which is more than 50% (Gaur et al., 2016). Certainly, the average consumption in rural areas is lower than in urban and semi-urban areas due to the lack of high-consumption space cooling systems such as air conditioners, and this causes the peak consumption in the morning and evening to experience relative changes in terms of energy and time. Figure 1.17 depicts distinct household load profiles in rural Indian communities. Load profiles (a) and (b) indicate a normal consumption connected to the grid, in comparison to (c) and (d), being standalone systems with no access to the grid, have completely different lifestyles. Particularly in the morning and afternoon, they show constant demand, while in the evening and night, there is a higher energy consumption.

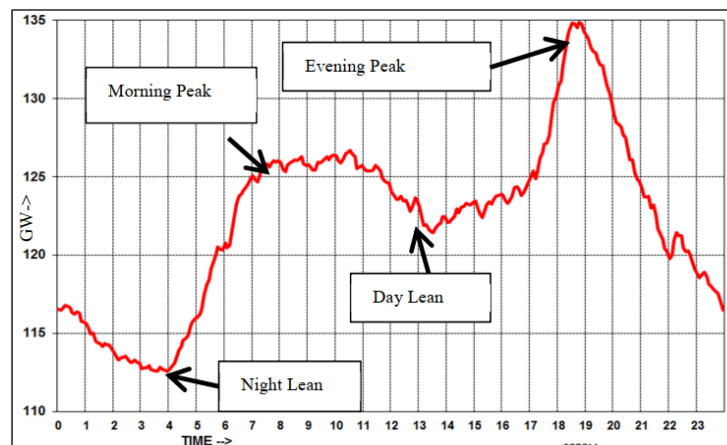

Figure 1.16 Average household load profile in urban and rural areas in India (Gaur et al., 2016)

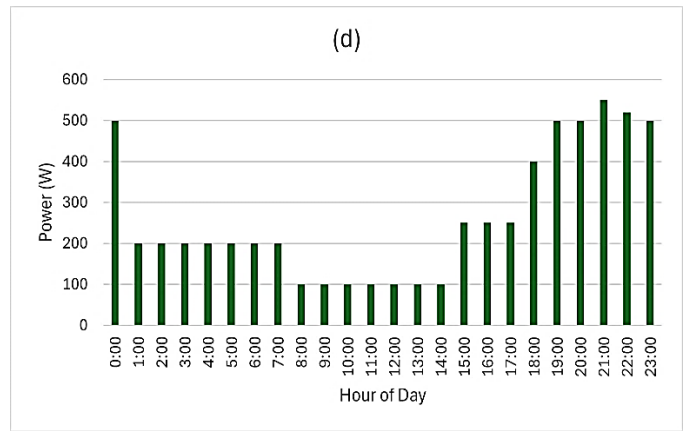
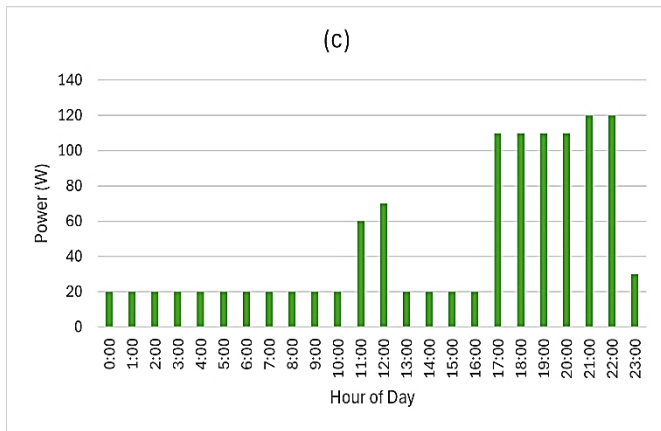
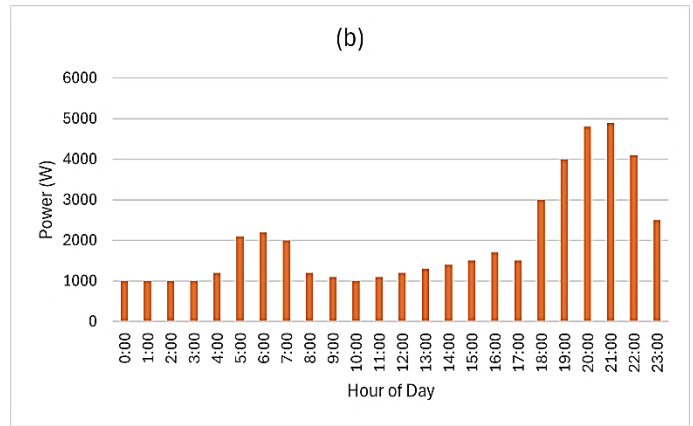
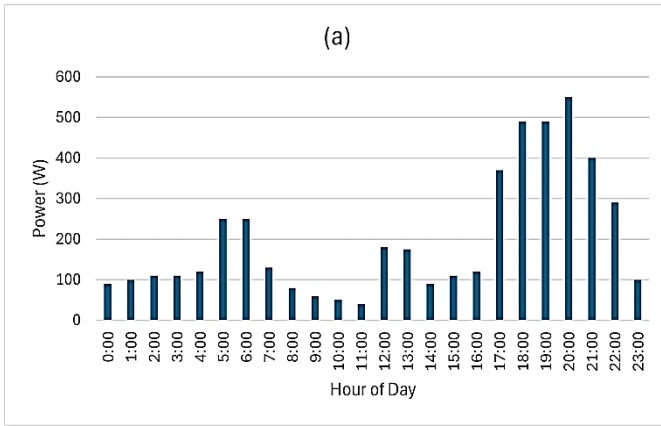

Figure 1.17 Household demand profiles in rural areas in India, (a) Small villages with 5–6 small households; (b) Medium households with a range of appliances; (c) Small standalone households; and (d) Small standalone off-grid rural households (Verma et al., 2015)

Rural houses in Africa Figure 1.18 illustrate the measured data from two homes (Prinsloo et al., 2016). Farmers and family members utilize the most electricity in the morning and evening when they are at home.

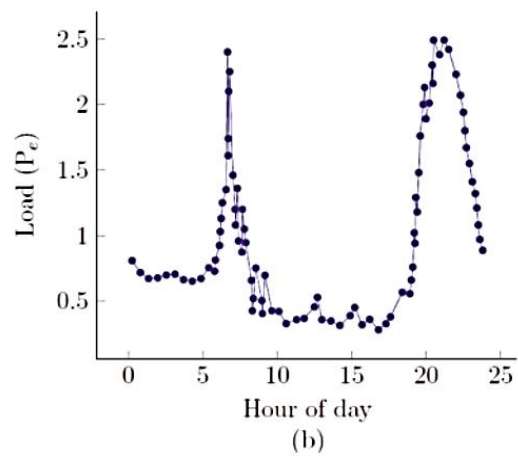
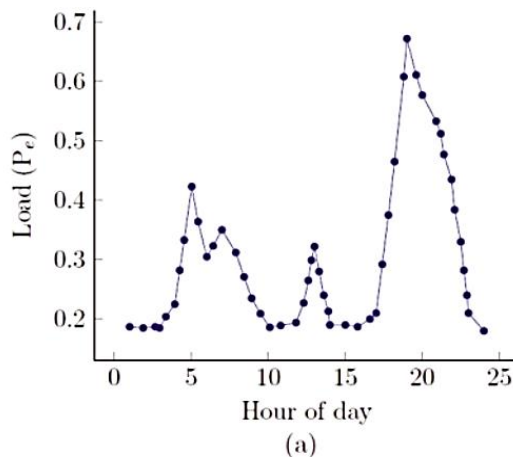

Figure 1.18 Measure rural load profiles for households in (a) Zimbabwe and (b) Uganda (Prinsloo et al., 2016)

The variation in the load profiles is linked to the midday period. In the load profile of the house in Zimbabwe, the consumption peak is higher than in the load profile of Uganda. This is because, in the second profile, some farmers haven't come home for lunch, leading to a change in the consumption pattern (Prinsloo et al., 2016). Figure 1.19 Indicates that the daily energy pattern observed in rural Africa is comparable to that in households and small villages in other rural parts of the world. Therefore, the pattern can be a valuable reference for areas challenged by the lack of data.

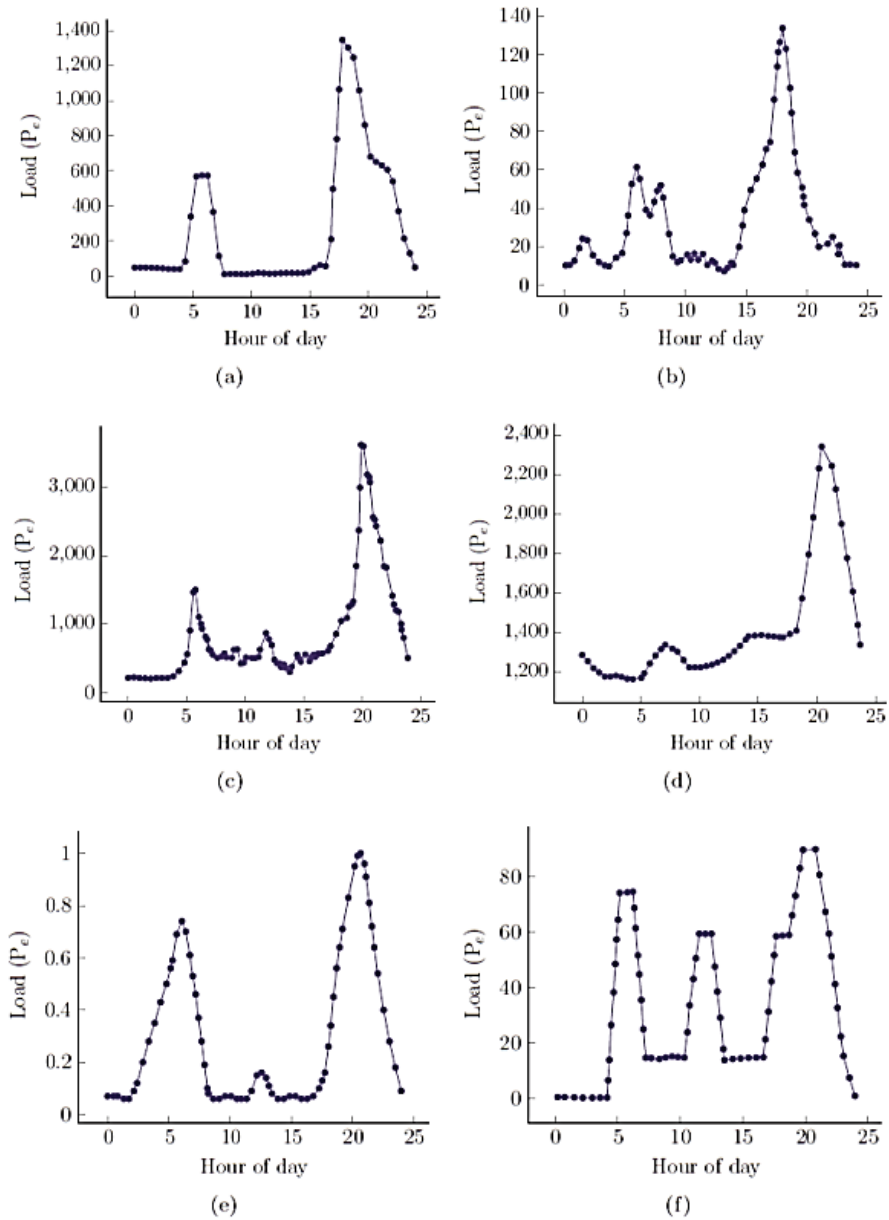

Figure 1.19 Energy load profiles in rural settings across different countries: (a) Ban Pang, Praratchatan, Thailand; (b) Rural Western Australia; (c) Alaminos, Rural Philippines; (d) San Juanico, Rural Mexico; (e) Rural Lao household, PDR; and (f) Puerto Plata, Dom (Prinsloo et al., 2016)

Due to the lack of information, activities such as interviews, surveys, and inquiries are conducted to predict energy patterns in rural areas. As shown in Figure 1.20, the daily load profiles of Omorate and Tum in southwestern Ethiopia through a survey of 238 customers and metered data. In Omorate, characterized by continuous power cuts due to high consumption, households average 1.49 kWh per day. Between 18:00 and 19:00, and after 22:00 there is no load due to load shedding. Another result of consecutive power outages is the similarity in household consumption patterns as well as small businesses in Omorate. This implies that they were compelled to adjust their consumption during the times when they had access to electricity. In contrast, Tum exhibits a more stable pattern with an average daily consumption of 0.8 kWh per household (Wassie et al., 2024). Comparing the two villages, about 50% in Omorate use less than 50 kWh per month, while 70% of households in Tum use less than 20 kWh per month (Wassie et al., 2024).

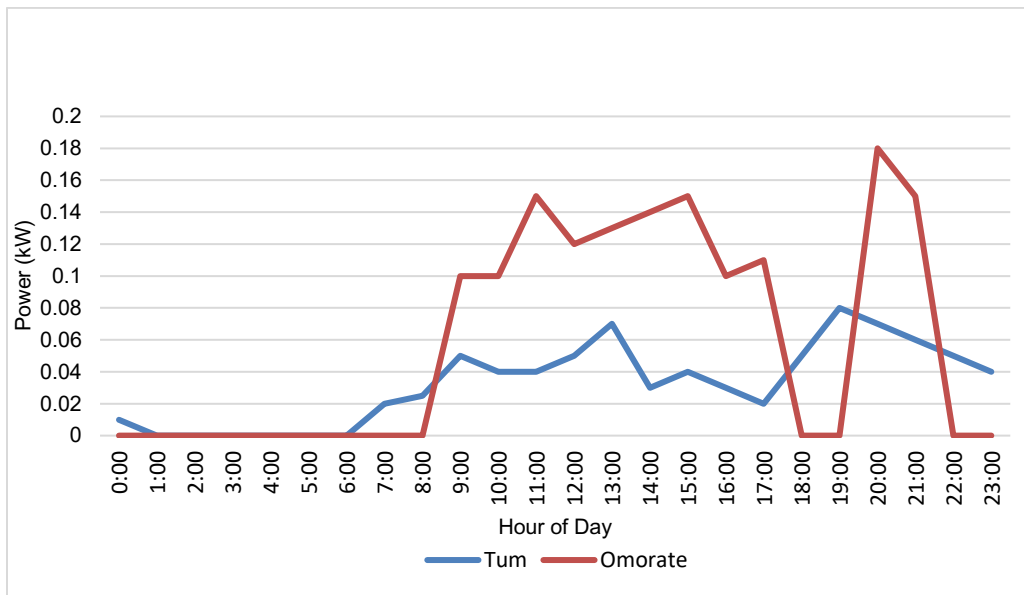

Figure 1.20 Average week-day load profiles in Omorate and Tum (Wassie et al., 2024)

In addition, the average consumption per household customer over 20 months is depicted in Figure 1.21. The data indicates that in Omorate, the number of customers connected to the microgrid is decreasing due to high-volume loads and successive outages. The microgrid network is unable to provide access and connection to new customers, resulting in a decrease in the number of connected houses from about 100 to less than 50 families. In contrast, in Tum, the consumption graph is on the rise, with the count of microgrid customers increasing from 25 to nearly 150 people (Wassie et al., 2024).

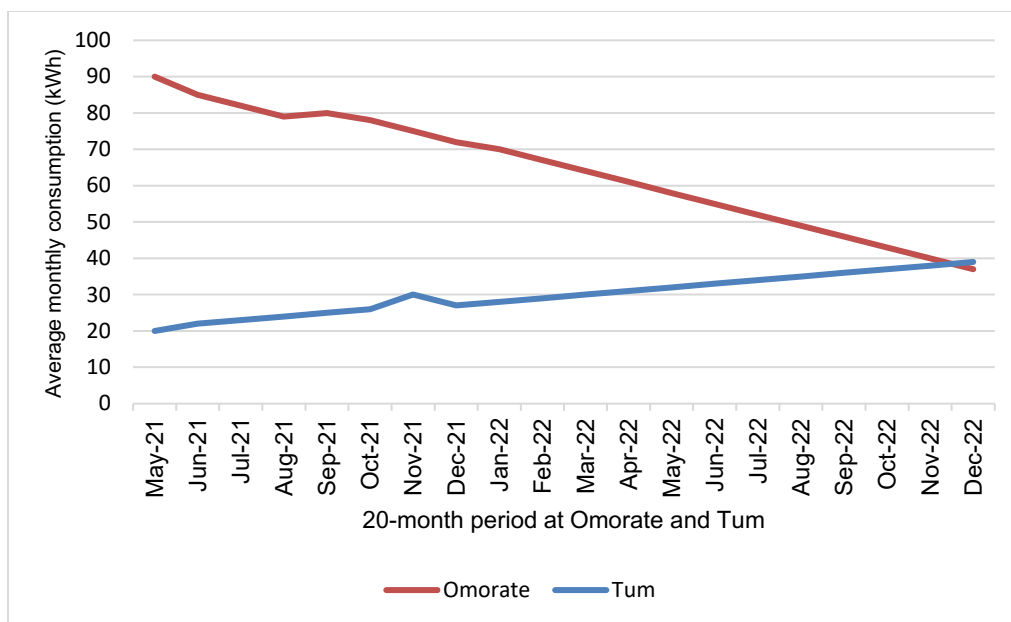

Figure 1.21 Mean monthly electricity consumption per household customer for Tum and Omorate based on Ethiopia Electricity Supplier (EEU) (Wassie et al., 2024)

As mentioned, poverty and ownership have a direct influence on each other. Regarding this, a survey was conducted with 35 families in a small community in Tanzania, East Africa. The analysis presented Table 1.4 shows that there is a link between poverty and ownership.

Table 1.4 The link between electrical asset ownership and poverty in Tanzania (Scott et al., 2021)

Electrical Asset	Ownership (A Binary Indicator of Ownership y/n)			
	Yes		No	
	number	Probability of Poverty	number	Probability of Poverty
Mobile	32	4.8%	3	9.1%
Radio	19	3.9%	16	6.7%
TV	21	2.4%	14	9.4%
Battery Torch	7	3.6%	28	5.6%
Fixed Lighting	12	3.8%	23	5.9%

Another significant aspect to consider is the age group. As highlighted in Table 1.5, in this area, energy consumption decreases, as the age group gets older. It shows that following poverty, the lifestyle of older people involves accessing basic appliances and tends to be more conservative.

Table 1.5 Mean daily energy consumption categorized by age group in Tanzania (Scott et al., 2021)

Age Group	Number of Household	Mean Daily Consumption (kWh/day/household)
< 30	5	0.170
30-39	19	0.112
40+	11	0.082
Total	35	0.111

Moreover, the statistics (Figure 1.22) show that household energy consumption, on average, mainly includes kitchen appliances. In developing rural areas, for which modern household appliances are going to be used, the solution that can decrease the cost of energy and increase self-consumption is photovoltaic, reducing the cost of cooking electricity by up to 70%.

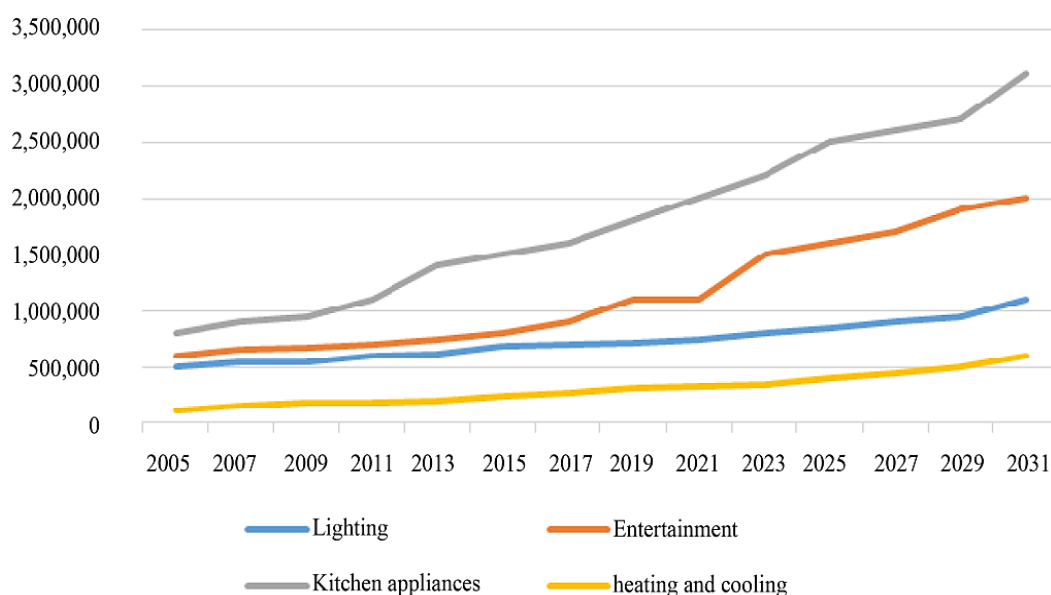

Figure 1.22 Average household energy consumption in India (GWh/year) (Verma et al., 2015)

Consequently, understanding the complex interplay between poverty, ownership, and age demographics is essential for addressing energy access challenges in rural areas. Efforts to deploy renewable energy solutions, such as photovoltaic systems, hold promise for mitigating energy costs and enhancing self-sufficiency, thereby contributing to sustainable development and improved livelihoods in these communities.

1.5.2 Agricultural Load Profiles

In analyzing agricultural load profiles, it is crucial to consider two key factors: the 'type of farm' and the 'type of appliances'. Given the variety in land sizes and diverse agricultural activities and functions, farmlands are here divided into two groups: livestock and non-livestock farms. Regarding livestock farms, as shown Figure 1.23 various load appliances are considered.



Figure 1.23 A livestock farm appliance (Maammeur et al., 2017)

The appliances mentioned are associated with a family farm in Chettia municipality, located in the Chlef district of Algeria. The farm comprises a breeding building with fifteen cows and six calves, a fodder storage facility, seven cold rooms for agricultural products, an irrigation well, a water basin, and a twenty-acre orange grove. The electrical energy consumption varies across three periods: low in January, February, March, October, November, and December (first period); average in April, May, and September (second period); and very high in June, July, and August (third period). During the first period, consumption reached 9.38 MWh, in the second period 21.9 MWh, and in the third period 60 MWh. Annual consumption of this family farm is below 95 MWh/yr (Maammeur et al., 2017). It illustrates how monthly consumption patterns change. From April to September, irrigation activities take place on the farm between 5:00 and 20:00. The load observed from 01:00 to 5:00 and 20:00 to 00:00 is associated with milking and milk cooling. Additionally, due to agricultural product storage, a small base load exists in all months of the year. Estimate the annual consumption in this family farm ranges between 15 and 650 kWh/day.

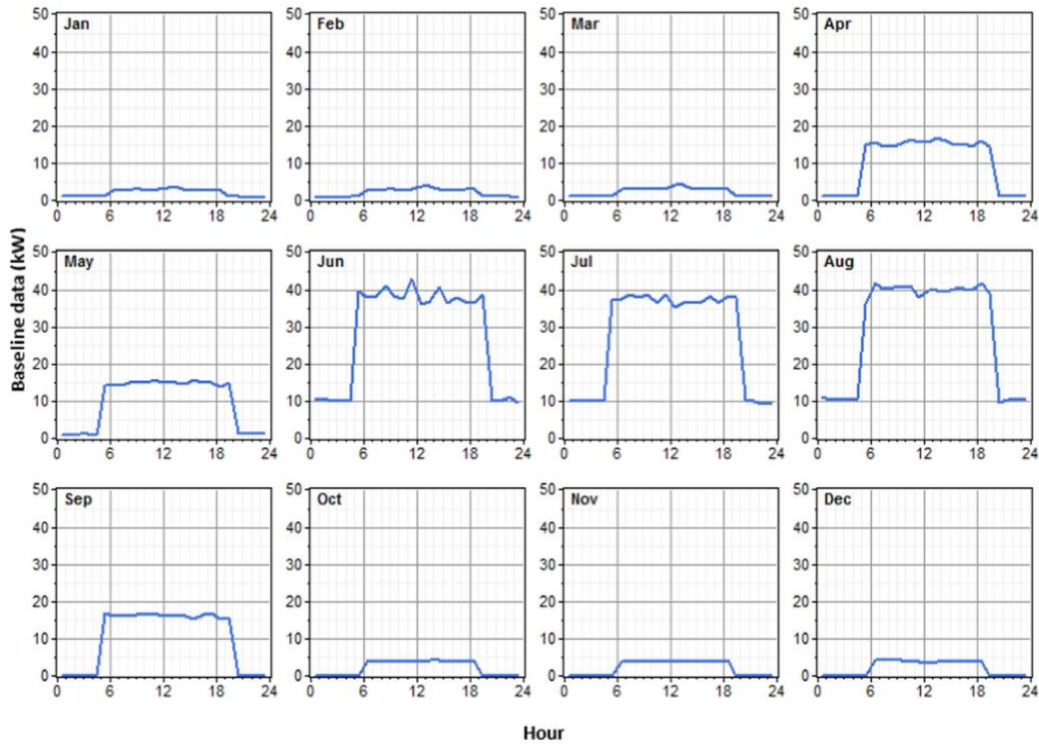

Figure 1.24 Daily load profile of a family farm in north Algeria in a year (Maammour et al., 2017)

Following the analysis of livestock farms, one of the most important aspects to consider is the total number of cows, as milking and milk cooling account for the highest share of energy consumption on such farms. Supporting this claim Figure 1.25 illustrates the load profile of a livestock farm in Mitidja, situated in the north of Algeria and encompassing the four cities of Algiers, Blida, Tipaza, and Boumerdes. The farm has an annual energy consumption of approximately 8.6 MWh, averaging 23.6 kWh/day, resulting in a relatively low Energy Use Intensity (EUI) of 330 kWh/cow/year compared to the international average.

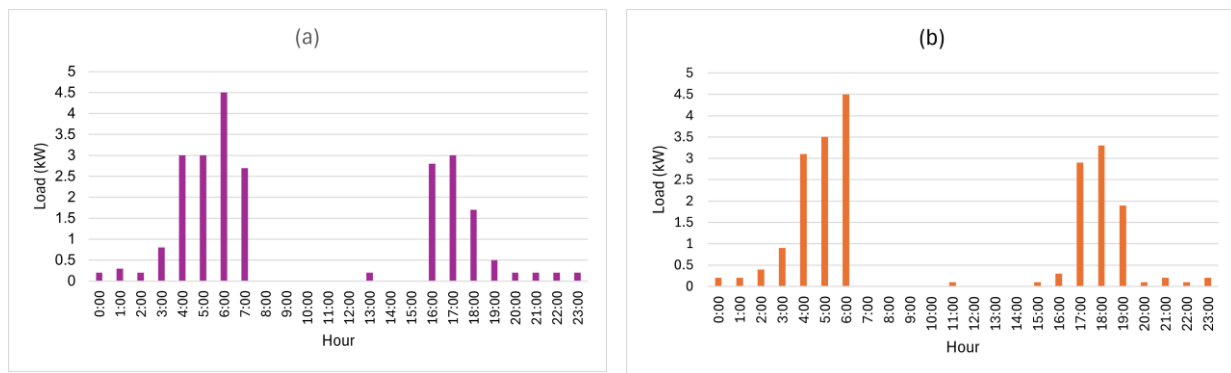

Figure 1.25 Electrical load profile of a farm in Mitidja in the north of Algeria, (a) spring/summer and (b) autumn/winter (Nacer et al., 2016)

(Kythreotou et al., 2012) reveals that over 60% of the energy consumption is attributed to milking and milk cooling operations, underscoring the significance of understanding the total cow population. The remaining energy is allocated to various tasks, including lighting (21%), fodder preparation (15%), and miscellaneous activities such as farm cleaning and manure handling (4%) (Nacer et al., 2016). Certainly, in various livestock farms, it is possible to have different types of animals, and energy consumption can vary for each one. Table 1.6 illustrates the differences in energy consumption for dairy cattle, pigs, and chickens.

Table 1.6 Annual energy consumption (Kythreotou et al., 2012)

Animal Specie	Energy Consumption/animal	Average
Dairy Cattle	178 - 908 kWh/cow	565 kWh/cow
Pigs	18 - 1742 kWh/sow	537 kWh/sow
Chicken	0.067 - 2.954 kWh/chicken	0.677 kWh/chicken

Comparing different farms reveals similarities in consumption patterns, providing valuable insights for better estimation and compensating for lacking data. Figure 1.26 illustrates the consumption patterns for a family farm in the Sebdou region, northwest Algeria, during two different months. It highlights the maximum daily consumption in June, reaching 123 kWh/day, when the water pump, cooling tank, and refrigerator are in operation. In contrast, another day in January records a lower consumption of 38 kWh/day when only the normal cooling and ventilation system is utilized, with other appliances remaining inactive (Bey et al., 2016).

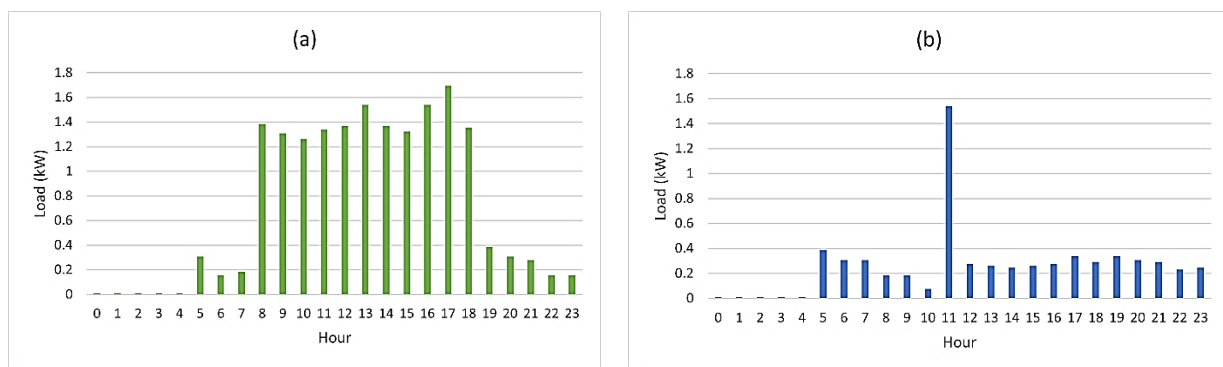

Figure 1.26 Load profile of a livestock farm in Sebdou in the north of Algeria, (a) 1. July, (b) 1. January

1.6 Research Motivation

Ensuring widespread access to electricity is crucial for the prosperity of communities, particularly in rural and end-of-line communities. Despite the lower energy demand in these remote regions, the prevalence of rural settlements results in a substantial market share. Unfortunately, these areas often lack reliable energy solutions and face limited investments due to unfavorable conditions for both public and private energy stakeholders. The disparity in electrification rates between urban and rural regions in Morocco and Algeria highlights the need for innovative and cost-effective approaches to address the challenges posed by high investment costs and infrastructural barriers.

This study focuses on introducing Agri-PV systems in rural communities of Morocco and Algeria, offering an alternative and sustainable solution to the prevalent electricity challenges. By implementing solar panels optimized for agricultural settings and complementing them with appropriately sized batteries, this approach aims to bring about a transformative change in addressing power outages in rural electrification. The integration of Agri-PV technology not only provides affordable and reliable energy but also serves as a strategic tool to mitigate disruptions in power supply. This research delves into the feasibility and potential impact of Agri-PV systems, exploring their capacity to contribute to sustainable rural development while addressing the pressing need for enhanced energy access.

In the context of Morocco and Algeria, where centralized electricity generation and grid extensions face limitations, Agri-PV emerges as a promising avenue to empower rural communities. By progressing energy independence and resilience through innovative solutions, this research seeks to contribute to a more inclusive and sustainable energy landscape in these North African countries. The optimized size of battery storage alongside Agri-PV systems serves as a practical strategy to control interruptions in power supply, promoting a reliable and efficient energy supply for the end-of-community rural areas in the region.

Due to the substantial investment required, Agri-PV is not yet widely adopted globally, and projects are being tested and analyzed in various locations. This study aims to analyze Agri-PV and battery systems for two small villages, seeking to present different scenarios with optimal results.

1.7 Research Challenges

The primary challenge encountered during this thesis was the insufficient availability of data to estimate energy consumption accurately and to track the frequency of power outages throughout the year. Consequently, alternative sources and methodologies were employed to develop load profiles. For instance, the load profile for a rural dwelling in Algeria was modeled using data from a similar setting in Brazil. Subsequently, comparisons were made with various village consumption patterns to refine the design. Similarly, agricultural energy usage was categorized initially, followed by the utilization of load profiles from two Algerian farms to finalize the process. Consequently, the design of photovoltaic (PV) and battery systems for these villages prioritized addressing maximum potential power interruptions, with optimization efforts focused on providing continuous coverage throughout the day. Access to specific location data and daily energy consumption records across different months and seasons could significantly enhance system sizing and economic viability.

2. Research Design & Methodology

2.1 Questions and Objectives

In this thesis, the feasibility of a renewable system is studied as a supporting source for the grid in two end-of-line communities. Although Morocco is more developed than Algeria in terms of renewable energy, both countries are facing challenges in the power grid system such as grid reliability, grid resilience, modernization, and transmission and distribution losses. For this reason, rural areas do not have access to a stable system.

On the other hand, the unachieved targets of both countries in the field of renewable energy, according to the published statistics, show that the efforts in this field were not enough and did not achieve the expected results. This increases the importance of research to find an innovative solution. The question of this study becomes important in this context:

- What is the potential of Agri-PV in end-of-line communities to optimally compensate for grid deficiencies?

Therefore, this thesis aims to assess the feasibility of integrating Agri-PV and battery storage as a backup source for power outages to meet agricultural and household needs in rural areas of Morocco and Algeria. To address this question, two case studies are analyzed, both of which are connected to the grid but experience low-quality access to electricity. The following chapter

outlines the methodology of the thesis, detailing how the research question will be addressed.

2.2 Methodology

This thesis focuses on developing the energy sector based on specific demands. To supply the required energy, it is important to first analyze the settlement part, identify appliances, and understand consumption patterns. These are subtopics of "Demand Segment". The next step is designing an appropriate renewable energy system, which is referred to as the "Supply Segment". This segment includes assessing grid functionality and, in the final step, sizing, designing, and integration.

To optimize the supply method, which is one of the key purposes of this research, different scenarios with varying system sizes are considered. This involves assessing the economic aspect and selecting the most optimum and efficient scenario. Figure 2.1 illustrates the methodology used in the thesis.

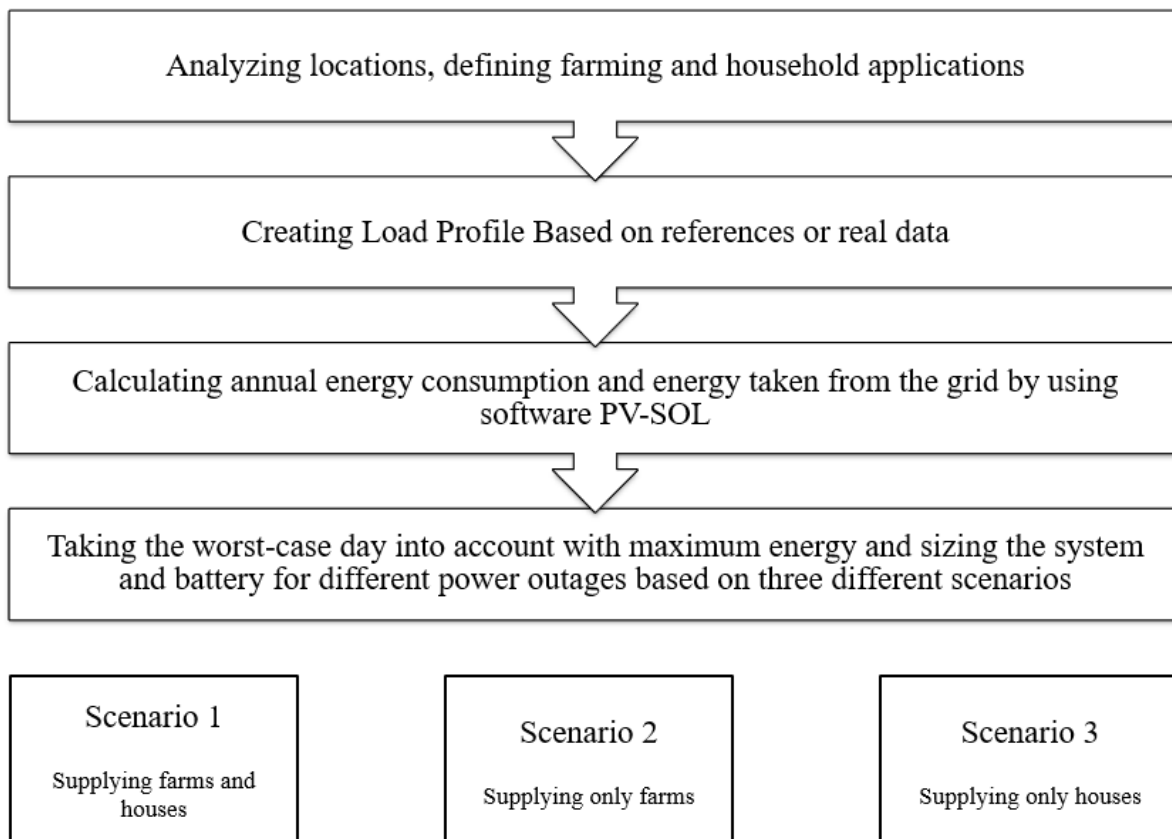

Figure 2.1 Methodology flowchart

In the first step, the location and type of farms are categorized into two models: non-livestock

farms or crop farms like potato, olive, onion, wheat, and similar crops, and livestock farms which include crops and livestock. This categorization helps to determine appliances, and following that, create load profile models. However, due to the lack of data meters in rural areas, to estimate annual consumption, comparisons and the utilization of available data from existing literature are taken into account to create the desired consumption model. Afterward, utilizing the software "PV-SOL" provides the possibility to calculate crucial parameters, including system performance, annual energy production, injected energy into the network, and losses (PV SOL, 2021b). Additionally, it provides a daily production forecast, aligns the PV production graph with the load profile, and forecasts the amount of energy taken from the grid. This information will be given in the final PV-SOL report. After designing the system, optimal battery sizes are suggested based on different outage hours and prioritization in terms of energy stability and economic evaluation for farms and households (scenario 1), only farms (scenario 2), and only households (scenario 3).

3. Case Study Area: Kissane and Bouda

As shown in the Table 3.1, both villages face the challenge of dealing with an unstable network. Studying the differences in energy consumption, agricultural and livestock products, irrigation methods, and household usage patterns in the two villages enables a more accurate assessment of the feasibility of Agri-PV in these communities.

Table 3.1 Kissane and Bouda overview

	Kissane (Morocco)	Bouda (Algeria)
Condition of terrain	Mountainous terrain	Oasis in the Sahara Desert
Challenges with Electricity Supply	End-of-line communities suffering from power outages	End-of-line communities suffering from power outages
Main Indicator for Economy	Agricultural cooperatives in addition and artisanal activities and ecotourism	Agricultural community

Mount Kissane stands in the southeastern part of Morocco, situated within the Drâa-Tafilalet region. This prominent mountain is positioned in the Anti-Atlas range, running alongside the Draa River valley. Its coordinates are approximately 30.70439° N latitude and -6.28733° W longitude, with an elevation reaching 1,410 meters (Mapcarta, 2024b).



Figure 3.1 Jbel Kissanee, Morocco (Mapcarta, 2024b)

Furthermore, Bouda, located in the Adrar district of the Adrar province in south-central Algeria, is a commune with a population that saw an increase from 8,668 in 1998 to 9,938 in 2008, marking an annual growth rate of 1.4%, as per the census data. The geographical coordinates of Bouda are approximately 28.01° N latitude and -0.4268° W longitude, with an elevation standing at 227 meters (Mapcarta, 2024a).



Figure 3.2 Bouda, Algeria (Mapcarta, 2024a)

4. Energy Demand Analysis

Energy demand in a region reflects its social status, economic growth, geographical variations, and population demographics (Gaur et al., 2016). Regarding rural areas, the absence of crucial facilities, like smart meters, causes a lack of enough data to analyze demands (Prinsloo et al.,

2016). Analyzing how much electricity consumers use is crucial for designing power systems. If a system size is larger than the demand, it causes financial loss and less income than expected, if it is underestimated, it does not meet the demand and poses poor satisfaction. Methods of measuring and simulating accurate consumption patterns in rural areas, are still being investigated (Scott et al., 2021). By categorizing rural needs into three different sectors, as shown in Table 4.1 the process of designing a load profile is initiated.

Table 4.1 Energy demand classifications in isolated rural communities (Renné et al., 2021)

Energy for Community Services	Energy for households	Energy for productive uses
Water supply, Education, Healthcare, Street lighting Mobile network, TV/Radio broadcasting Public institutions (e.g. Community centre)	Lighting Electrical appliances Space cooling and heating Cooking and water heating	Irrigation, Agriculture, Crop processing Micro market, Snack bar, Barbershop, Tourism

Considering villages in Morocco and Algeria, the consumer groups in both regions are divided into household and agricultural sectors..

4.1 Households

Table 4.2 presents a variety of household appliances commonly used in a village house, along with their respective active power consumption, and priority level.

Following this, the load profile for Bouda, as shown in Figure 4.1, corresponding to usage patterns as compiled in Appendix A is depicted. Due to lacking data about household loads in Bouda, It is assumed that the household consists of a family with two children, and their usage follows the pattern taken from a village house in San Antonio, Brazil (Polepally et al., 2023). There are two peak load periods: one in the morning at 09:00 with a power usage of 0.21 kW, when the family wakes up, and another at 20:00 with a power peak of 0.25 kW, upon returning from farming activities. During this time, they engage in cooking, watching TV, washing clothes, and other activities. The total consumption, in this case, is 1.54 kWh/day. Following that, monthly and annual consumption is 46.29 and 555.48 kWh respectively. Given the similarity in appliance types, lifestyle, low economic status, and comparable weather conditions between Bouda and Kissane, the load profile can be similar to each other. But the difference in Kissane is the type of village, in

which people live together as a cooperative. Based on an interview with one of the people in Kissane, the population is about 21 persons and available appliances are 10 LED lamps, 10 fluorescent, 1 radio, 1 laptop, and 4 Mobile chargers. Moreover, 1 fan, 1 mini-refrigerator, and 1 blender for cooking were considered supplementary loads. By identifying appliances, their active power, and their usage duration, a table as indicated in Appendix B is compiled. Subsequently, based on that, the daily household load profile in Kissane, illustrated in Figure 4.2, is established.

Table 4.2 Main household appliances of a village house (Draftlogic, 2024; Narayan et al., 2018)

Appliance	Need	Typical Rating (W)
LED lights	a	10
Fluorescent	a	35
Mobile charging	b	7
Television	b	40
Mini-Refrigerator	c	40
Washing Machine	C	80
Fans	f	80
Laptops	b	50
Internet Router	b	10
DVD	b	45
Blender	c	100

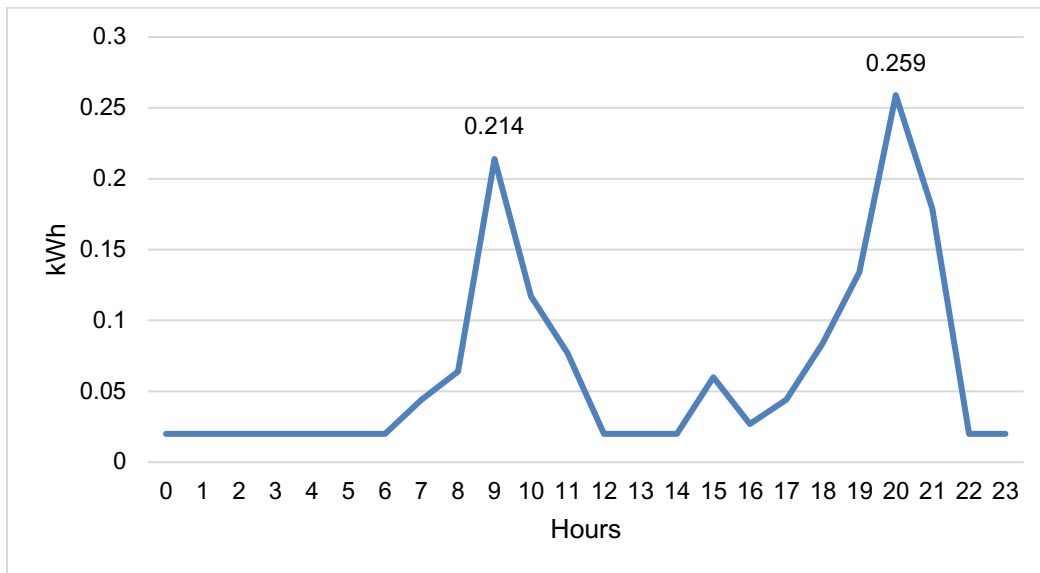

Figure 4.1 Household load Profile for Bouda

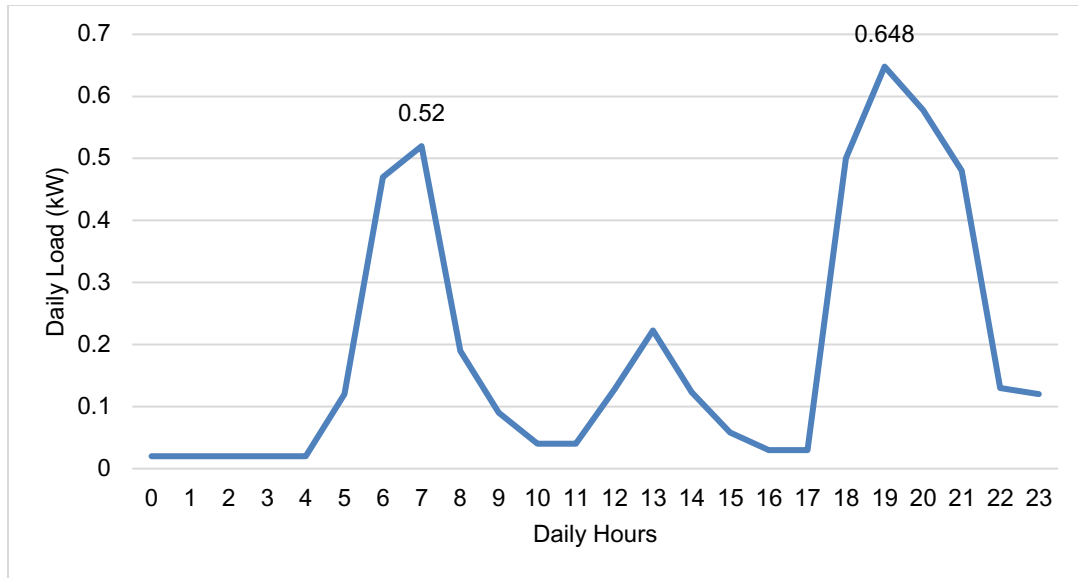

Figure 4.2 Household load Profile in Kissane

Based on this load pattern, there are two peak loads: first, in the morning at 07:00 with a peak power of 0.52 kW, and second, at 20:00 with a peak load of 0.64 kW. It is important to note that the baseload is about 20 W and is for a mini-refrigerator. Additionally, a blender for cooking and a fan for cooling the area during summer are appliances that have been considered to create this load profile.

4.2 Farm

Since each farm can have different appliances, the approach here is to first categorize farms into two groups: non-livestock farms and livestock farms. As it's clear, non-livestock farms concentrate on crops like potatoes, onions, olives, etc., where the important aspect is the method and timing of irrigation. Alternatively, livestock farms can have dual functions, meaning the appliances are not only for crop agriculture but also for their livestock. With this approach, both load profile types are shown.

4.2.1 Non-livestock Farms

Regarding non-livestock farms, big potato farms, as shown in Figure 4.3 require specific equipment such as tractors and machinery planters, cooling systems, potato harvesters, potato washers and irrigation pumps (Demin, 2021). Conversely, in small farms, more manual labor should be considered to protect the crops and ensure their growth. This involves techniques such as hand planting, where seed potatoes are manually placed in the soil at the correct spacing and depth, and manual cultivation, utilizing smaller-scale tools like hand hoes or animal-drawn implements for soil preparation and weed control. Additionally, weeding can be managed

manually or through mulching, particularly feasible on smaller plots. Harvesting potatoes on such farms involves manual methods, such as digging them up with shovels or pulling up plants by hand, typically when plants have died back.



Figure 4.3 Harvesting potatoes in large farms

Transporting harvested potatoes also relies on manual labor, with farmers gathering them by hand and placing them in baskets or sacks for transportation (Suness, 2024; Sustainable Farming, 2020). Table 4.3 displays the required appliances for small potato farms along with their active power range during Irrigation times. After identifying these appliances, it is crucial to establish the timing of irrigation, which is the primary task in non-livestock farms. Figure 4.4 illustrates two distinct load profiles, one for non-irrigation periods and another for irrigation times. After utilizing consumption patterns from (Bey et al., 2016), load profiles have been rescaled by a factor of 6.6.

Table 4.3 Required appliances for small non-livestock farms

Small non-livestock farm appliances	Power Range (kW)	Hours	Energy in Irrigation times (kWh)	Reference
Water Pumping	1.5	10	15	(Nature's Generator 2024)
Cooling System	0.2	5	1	(Draftlogic, 2024)
Lighting	0.2	5	1	(Draftlogic, 2024)
Energy			17	

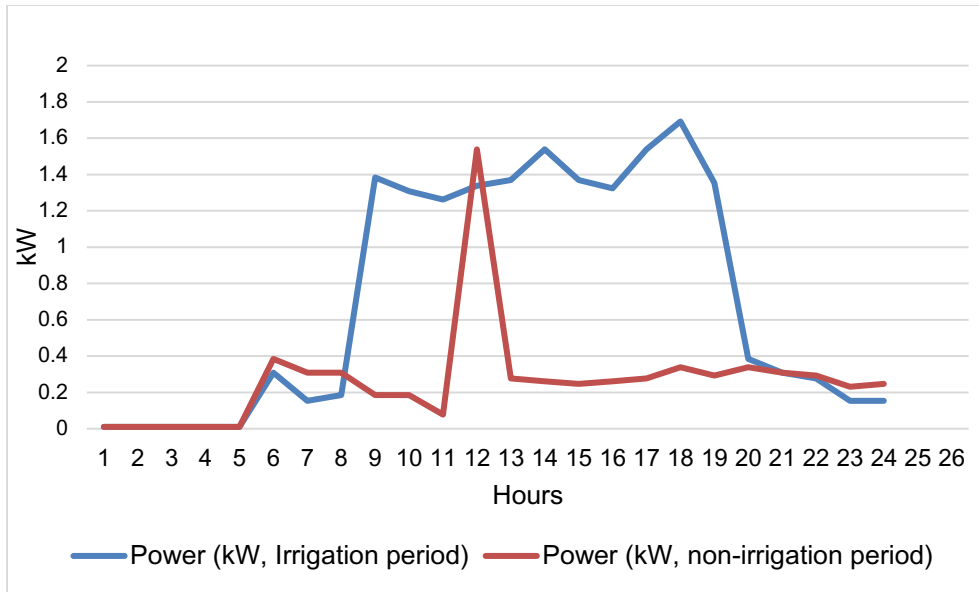

Figure 4.4 Load profile for a potato farm

Irrigation time, as shown by the blue graph, starts at 08:00 and continues until 18:00. This is in contrast to non-irrigation periods, where the only load peak occurs at noon for storage and cooling systems. Due to weather conditions, from April to September, the farm is irrigated and the total daily energy is 17 kWh, whereas during milder weather when there is no irrigation, the total daily energy is 5.7 kWh. By gathering monthly data for both irrigated and non-irrigated periods, the annual electricity consumption for the non-livestock farm, as depicted in Figure 4.5, is illustrated. From this data, it is determined that January, February, March, October, November, and December are months without irrigation.

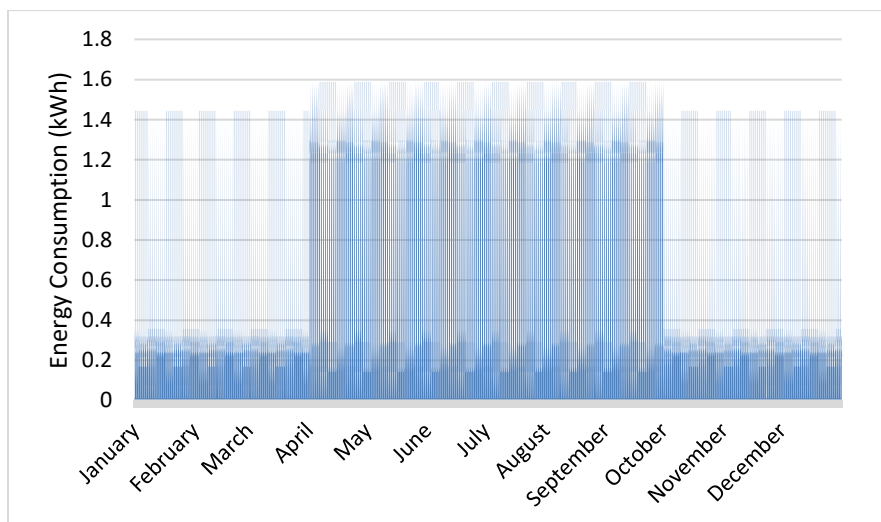

Figure 4.5 Annual consumption in a non-livestock farm based on Irrigation and non-irrigation Periods

Using this annual load profile data in PV SOL, apart from providing energy during sunny hours, the energy taken from the grid for a non-livestock farm in Kissane or Bouda as shown in Figure 4.6, is in non-irrigation 2.14 kWh/day and irrigation period 1.48 kWh/day.

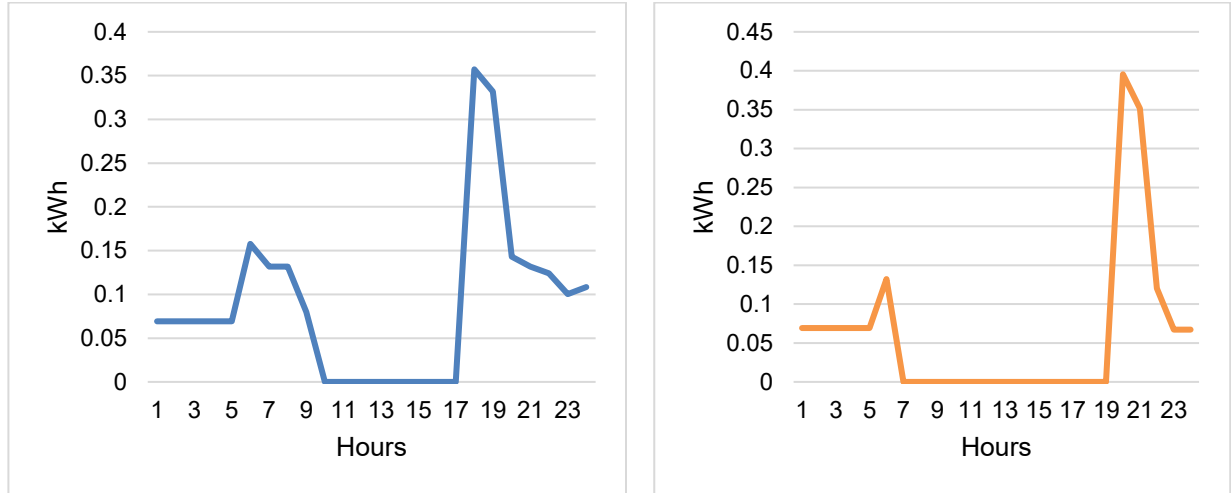

Figure 4.6 Energy taken from the grid in 1. January, Non-irrigation Period (left), Energy taken from the grid in 1. July, Irrigation Period (right)

Consequently, non-livestock farms, apart from the type of crops, are mostly dependent on the irrigation system. The method and times of irrigation determine the average consumption in a non-livestock farm. Following this, load profiles of a livestock farm are shown, and based on them, the process of system and battery sizing goes one step further

4.2.2 Livestock Farm

Table 4.4 depicts the types of appliances used on a farm for crop cultivation and milking purposes with specific brands. Drawing from data sourced from an Algerian livestock farm (Maammeur et al., 2017), consumption patterns have been studied.

Table 4.4 Livestock-farm appliances (Maammeur et al., 2017)

Appliances	Model	Power Range (W)	Reference
Lighting	Philips	5 - 15	(Philips-lighting, 2018)
Mechanical Ventilation Big	Munters	100 – 500	(Munters, 2022)
Milk Cooling	Mueller	500 - 2000	(Mueller, 2014)
Agricultural product storage	CoolBot	500 - 1500	(Coolbot, 2022)
Water pumping	Grundfos	500 - 2000	(Grundfos, 2013)
Milking	DeLaval	500 - 3000	(DeLaval, 2022)

Figure 4.7 shows four different monthly load profiles in the year. Irrigation occurs from January until April from 05:00 until 20:00. Milking and milk cooling typically occur from 20:00 until 05:00 the following day. In June, July, and August milking and milk cooling are based on a stable baseload of about 10 kW. In January, February, and March this milking process is done on a smaller scale as the baseload is about 1 kW. However, in the last three months of the year, consumption is more dependent on the cooling and storage systems.

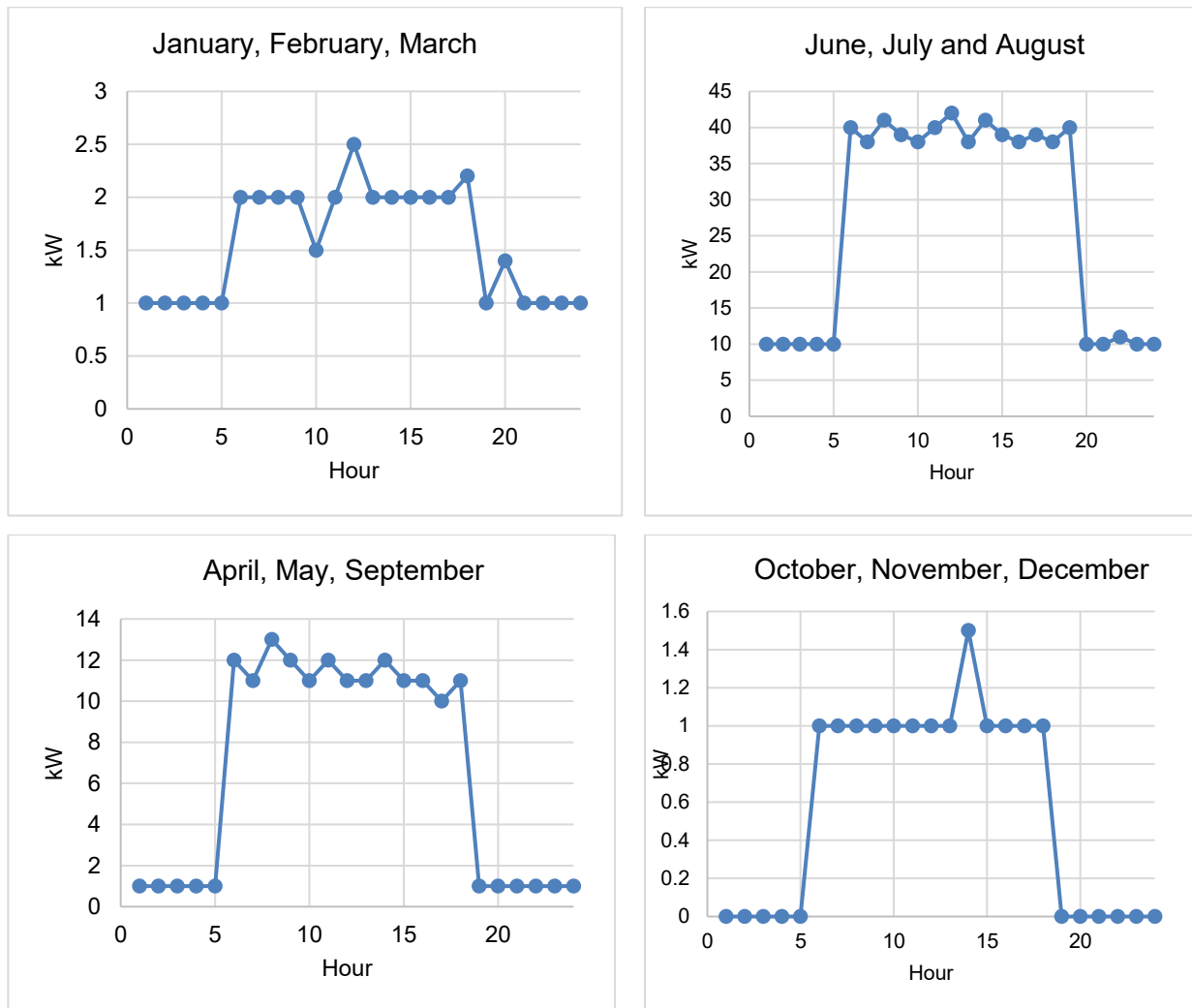

Figure 4.7 Load Profile of a livestock farm

Due to the lack of real data in Bouda and Kissane, the data in Appendix C has been rescaled by a factor of 17 to be compatible with small villages. Following this adjustment, the daily loads for January, February, and March are approximately 2.2 kWh/day. For April and May, the demand increases to 9.4 kWh/day. In June, July, and August, consumption rises significantly to 38.4 kWh/day. Finally, in the last three months of the year, the consumption decreases to 0.8 kWh/day.

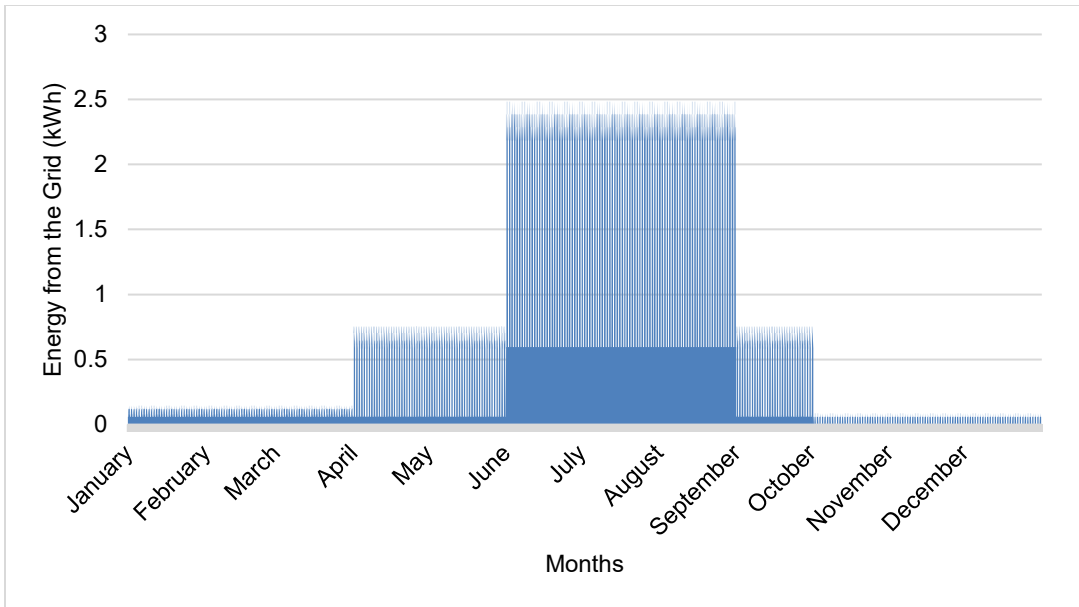

Figure 4.8 Annual consumption in a livestock farm

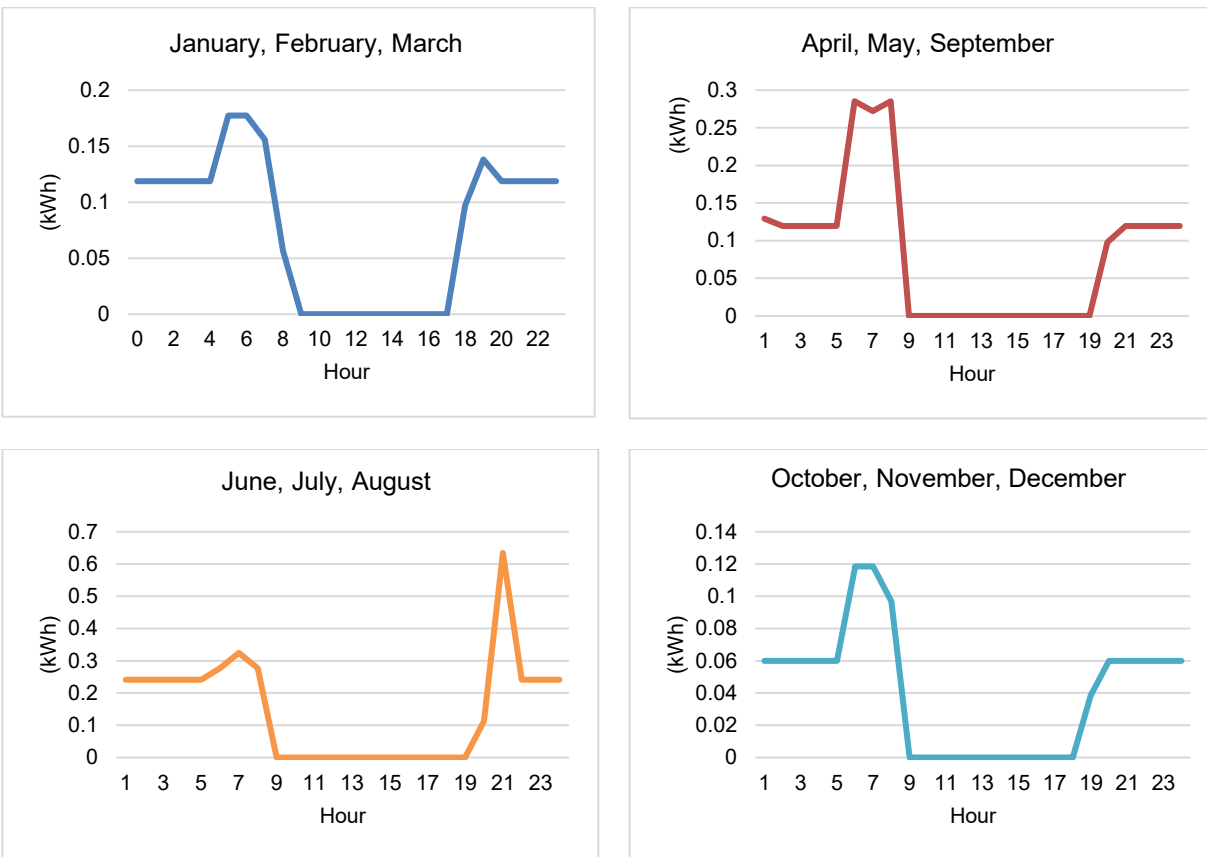

Figure 4.9 Energy taken from the grid in a livestock farm during a year

Figure 4.8 depicts the annual consumption of livestock in Kissane or Bouda. Regarding this, apart from providing energy during sunny hours, the energy taken from the grid in four different periods of the year varies. After simulation in PV-SOL, as shown in Figure 4.9 , it resulted that in January, February, and March, the consumption is about 1.87 kWh/day. In April, May, and September, it is 2.02 kWh/day. In June, July, and August, it is 3.55 kWh/day, and in October, November, and December, it is 0.97 kWh/day (PV SOL, 2021a).

5. Result and Discussion

5.1 Kissane - PV and Battery Sizing

In Kissane, it's assumed that the main type of farm is non-livestock which is about 20 and just 1 livestock farm is there. Following an interview with one of the people, the number of people in this place, as a cooperative community where families live together and work as farmers, is about 21 people in one house. Based on consumptions and global horizontal irradiation of 2275.33 kWh/m² (PV SOL, 2021b), PV system sizing for households, livestock, and non-livestock farms as shown in Table 5.1 is calculated. As it is clear, total PV sizing, and PV sizing for farms and houses are 39 kWp, 38 kWp, and 1 kWp respectively.

Table 5.1 PV system sizing in Kissane

Type	Consumption	SI Unit	Number
Non-Livestock Farm	4090.51	kWh/a	20
Livestock Farm	4570.06	kWh/a	1
Household	1685.57	kWh/a	1
Total	88065.79	kWh/a	
Annual Yield	2275.33	kWh/m ²	
PV Size (Based on Total Consumption)	39	kWp	
PV Size (Based on Total Farms)	38	kWp	
PV Size (Based on Total Houses)	1	kWp	

Regarding reducing and controlling power outages with batteries, each scenario with different power outages is examined.

5.1.1 Scenario 1: Sizing Battery for Farms and Households

In this scenario, as shown in Table 5.2 to address power outages from 17:00 to 23:00, a period during which most families rely on essential loads, the size of the battery with a 0.75 depth of discharge (DoD) has been considered. Following that maximum size of the battery is 85.31 kWh and the minimum size is 38.31 kWh.

5.1.2 Scenario 2: Sizing Battery for Farms

In this case, sizing battery for farms, means 20 non-livestock and 1 livestock farm have been calculated. Table 5.3 shows the result.

Table 5.2 Battery sizing for total consumption in Kissane

Power outage time (Hours/day)	Consumption (kWh/day)	Battery (kWh)
6	63.99	85.31
5	57.39	76.53
4	50.79	67.73
3	44.37	59.16
2	37.32	49.77
1	28.74	38.31

Table 5.3 Battery sizing for farms in Kissane

Power outage time (hours/day)	Consumption (kWh/day)	Battery (kWh)
6	61.53	82.04
5	55.45	73.93
4	48.59	64.78
3	42.65	56.86
2	36.18	48.24
1	28.24	37.65

5.1.3 Scenario 3: Sizing Battery for Households

In this scenario, focusing on household consumption, battery storage as shown in Table 5.4 is determined. Certainly, due to the lower consumption of households, the battery size is smaller.

Table 5.4 Battery size for households in Kissane

Power outage time (hours/day)	Consumption (kWh/day)	Battery (kWh)
6	2.46	3.27
5	2.34	3.11
4	1.76	2.34
3	1.18	1.57
2	1.15	1.53
1	0.50	0.67

5.2 Bouda - PV and Battery Sizing

Regarding Bouda, it's assumed that there are more livestock farms and households compared to Kissane. With 5 non-livestock farms, 15 livestock farms, and approximately 80 people or 20 four-member families, this case requires additional PV sizing with 2168.61 kWh/kWp annual yield (PV SOL, 2021b), as shown in Table 5.5.

Table 5.5 PV system sizing in Bouda

Type	Consumption	SI Unit	Number
Small Potato Farm Consumption	4090.51	kWh/a	5
Livestock Farm Consumption	4570.06	kWh/a	15
House Consumption	563.195	kWh/a	20
Total Consumption	100267.3	kWh/a	
Annual Yield	2168.61	kWh/kWp	
PV Size (Based on Total Consumption)	46	kWp	
PV Size (Based on Total Farms)	41	kWp	
PV Size (Based on Total Houses)	5	kWp	

5.2.1 Scenario 1: Sizing Battery for Farms and Households

In this case, PV power is 46 kWp. To cover power outages during the evening, different sizes of batteries with 0.75 DoD as indicated in Table 5.6 have been determined. In this case, the maximum size of a battery for a six-hour power outage is 144.34 kWh, and the minimum size of a battery with a one-hour power outage is 57.93 kWh.

Table 5.6 Battery sizing for total consumption in Bouda

Power outage time (Hours/day)	Consumption (kWh/day)	Battery (kWh)
6	101.30	144.34
5	90.80	130.09
4	80.31	115.83
3	67.49	96.35
2	54.61	75.72
1	42.60	57.93

5.2.2 Scenario 2: Sizing Battery for Farms

In this case, the size of the PV system for farms is 41 kWp. As shown in Table 5.7, the battery size for covering six hours is 125.78 kWh, and for one hour, it is 55.69 kWh.

Table 5.7 Battery sizing for farms in Bouda

Power outage time (Hours/day)	Consumption (kWh/day)	Battery (kWh)
6	94.34	125.78
5	87.93	117.24
4	73.75	98.33
3	62.72	83.63
2	52.43	69.90
1	41.76	55.69

5.2.3 Scenario 3: Sizing Battery for Households

Regarding 80 people or 20 families in Bouda, Table 5.8 illustrated that with a 5 kWp PV system, 9.28 kWh of battery storage is essential to cover six hours of a power outage and 1.12 kWh is required for a one-hour power outage.

Table 5.8 Battery sizing for households in Bouda

Power outage time (Hours/day)	Consumption (kWh/day)	Battery (kWh)
6	6.96	9.28
5	6.76	9.01
4	5.21	6.95
3	2.62	3.49
2	2.18	2.91
1	0.84	1.12

It is important to note that due to variations in load patterns, as mentioned in the load profile section, different households will certainly have different peak loads. However, for the purpose of this study, an average load pattern has been considered. Now, with the sizes of the PV and battery systems determined in both cases, the types of equipment and the economic aspects will be considered.

5.3 System Components

5.3.1 PV Module

All types of PV modules can in principle be used for Agri-PV (ISE, 2022). One of the important aspects of selecting solar panels is paying attention to hot weather conditions in both areas. Therefore, a module with a lower temperature coefficient should be chosen. In this regard, the Trina Solar 440, which has already been used in the 120 MW Noor projects (Trina Solar, 2018), is selected for this project. The price range of this type of module is 0.22-0.27 cents per watt (MGSolar, 2024).

5.3.2 Inverter

The selected inverter model for this project is the Sungrow SG25CX-P2. This model has three MPP trackers, and its operating temperature ranges from -25°C to +60°C. Additionally, this type of model has distributors in both Algeria and Morocco, which is why delivery is convenient (Sungrowpower, 2024).

5.3.3 Battery

Appendix H displays technical data for the selected Li-ion battery model, Sungrow SBR, including its capacity. Each module has a capacity that can be increased in units of up to 8 modules. While

there are other battery models available in the market at lower prices, it is generally recommended to use the same type of inverter and battery for enhanced compatibility and to minimize potential functionality issues.

5.3.4 Construction of Substructure

The construction of substructures and foundations for agrivoltaic systems involves critical decisions regarding clearance height and solar tracking mechanisms to optimize energy yield and crop growth. Clearance height, typically set at a minimum of five meters, impacts land trafficability and light distribution under PV modules. Higher clearance offers advantages but comes with increased capital expenditure, while lower clearance reduces costs but may weaken light distribution. Solar tracking systems, particularly single and dual-axis mechanisms, offer enhanced efficiency but come with higher initial investment and maintenance costs (ISE, 2022).

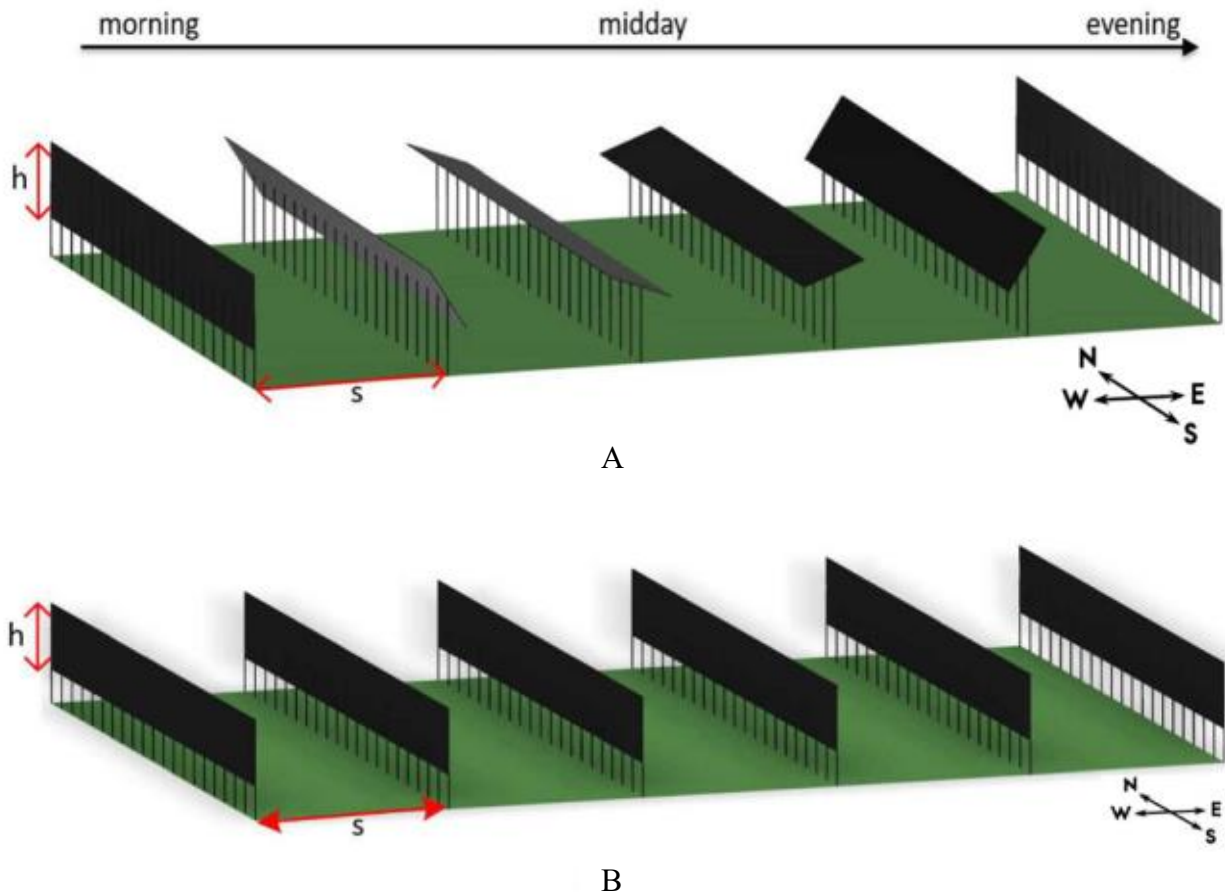

Figure 5.1 Solar PV configuration: single-axis horizontal tracking (A) and vertical mounted bifacial (B)
(Niazi et al., 2023)

In considering agrivoltaic integration for villages in Morocco and Algeria, cost-effectiveness emerges as a primary concern. Given the emphasis on affordability, static substructures with optimum angle as shown in Figure 5.2 stand out as a favorable choice due to their balance

between efficiency and affordability.

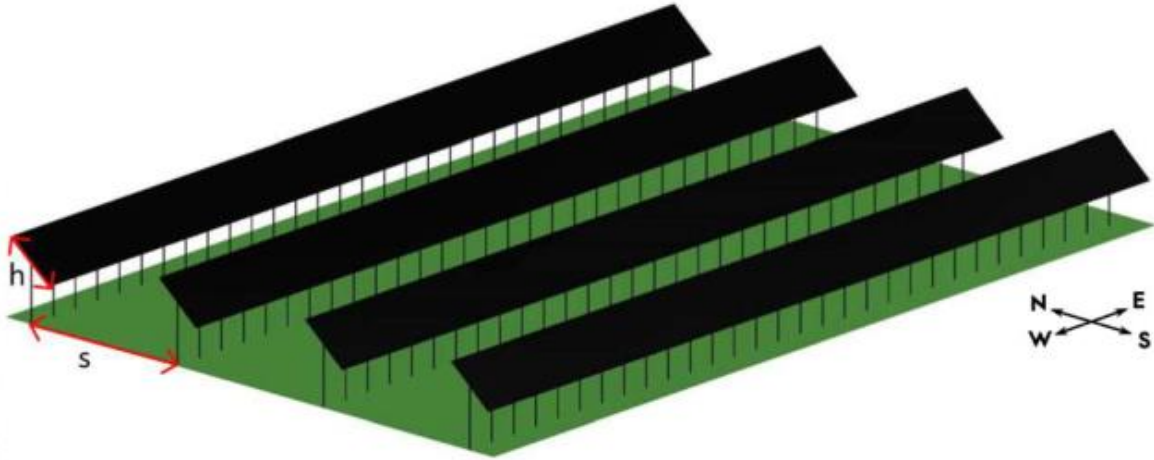

Figure 5.2 Solar PV: static with optimal tilt (Niazi et al., 2023)

The optimal tilt angle can be determined by taking into account the latitudes of Kissane at 34.80°N and Bouda at 28.01°N . Given that both countries are in the Northern Hemisphere, orienting the panels towards the south would maximize solar exposure.

Regarding the price of Agri-PV substructures, as per Fraunhofer ISE, the cost for agrivoltaics with arable farming is 372 €/kWp, while for agrivoltaics with horticulture, it ranges from 243 to 306 €/kWp, while the substructure for ground-mounted systems is 75 €/kWp (Agri-PV economy, 2022).

6. Economical Assessment

In this section, economic parameters are studied to compare different scenarios. The economic parameter is one of the most important parts that influence the choice of the desired system. There are various methods for evaluating photovoltaic projects that are used in different studies depending on the conditions. Among the most important and widely used theories in photovoltaic and energy systems introduce parameters such as the Internal Rate of Return on capital (IRR), Payback Period (PP), Net Present Value (NPV), and Levelized Cost of Energy (LCOE). Each of these parameters represents important information that can be used depending on different investment motives (Haramaini et al., 2019).

IRR is an important parameter for evaluating the amount of investment attractiveness. This is the interest rate at which the NPV of positive and negative cash flows for the systems are equal to zero (Talavera et al., 2019).

PP is the time that the cost of the initial investment is equal to the project's revenue. The timing

of this event after the start of a project is one of the most important economic parameters. The most important advantage of knowing this time is to understand the relationship between fixed and variable costs with sales price and the amount of production in the business (Talavera et al., 2019).

NPV is the difference between the present value of the cash inflows and the present value of the cash outflows. NPV is used to budget capital to calculate the probability of success in investing. The positive NPV indicates that the calculated revenue from the project or investment exceeds the expectancy costs. Investments with positive NPVs are generally beneficial and negative NPVs will result in losses (Haramaini et al., 2019).

LCOE is a metric that is widely used to evaluate the overall cost of generating electricity from a particular power plant or technology over its lifetime. LCOE considers both the installation and operating costs of the power plant and divides it by the total amount of electricity generated over the same period. This enables a more accurate assessment of the lifetime cost of generating electricity and allows for a comparison of different power plant technologies (Aldersey et al., 2019).

The examined economic parameters have their strengths and weaknesses. For this reason, several parameters are usually used in projects to enable a more accurate economic analysis.

6.1 Kissane

Regarding 11 cent/kWh electricity price in Morocco, with an assumed supportive policy offering a feed-in-tariff of 11 cents/kWh, along with 75.7% self-consumption of with a battery and 2290.76 kWh/kWp annual yield (PV SOL, 2021a), the economic parameters are calculated for two different cases: 1) from operation, and 2) after financing.

Table 6.1 System and battery sizing scenarios in Kissane

Kissane – System Sizing for Different Scenarios						
	PV Size (kW)	Battery Size for 6 hours outage (kWh)	Installation Cost + Substructure (euro/kWp)	Battery Cost (euro/kWh)	Feed-In-Tariff (cent/kWh)	Bank Investment (% of Capex)
Scenario 1	39	85.31				
Scenario 2	38	82.04	1300	1000	11	80
Scenario 3	1	3.27				

Collecting economic data as shown in Table 6.1, three scenarios are calculated. Figure 6.1 shows the cash flow of the project from operation for scenario 1. The Return of Investment (ROI) of the

project is 9.35 years, compared to the calculation after financing.

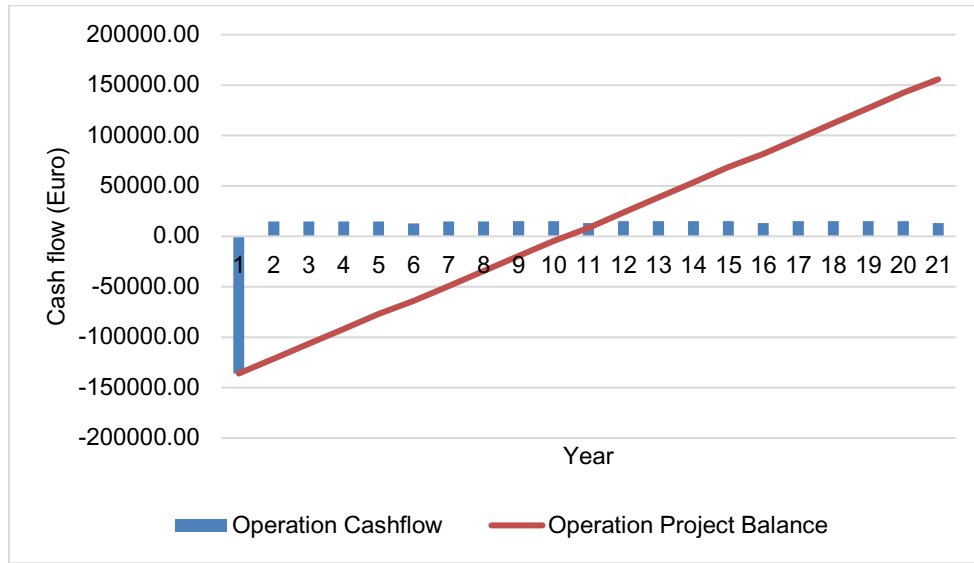

Figure 6.1 Kissane, scenario 1: from operation

For the second case, It is assumed that the project is supported up to 80% through a bank or financial institution. Figure 6.2 and Figure 6.3 show the residual debt and financial project balance after financing. The project yields more benefits, with ROI in 6.35 years. By calculating the financing method and taking load 80% of capital as a loan from a bank, IRR, ROI, project balance, and LCOE are calculated. After analyzing scenarios 2 and 3 with different sizes of PV and Battery, all these parameters are shown in Table 6.2, Table 6.3 and Table 6.4.

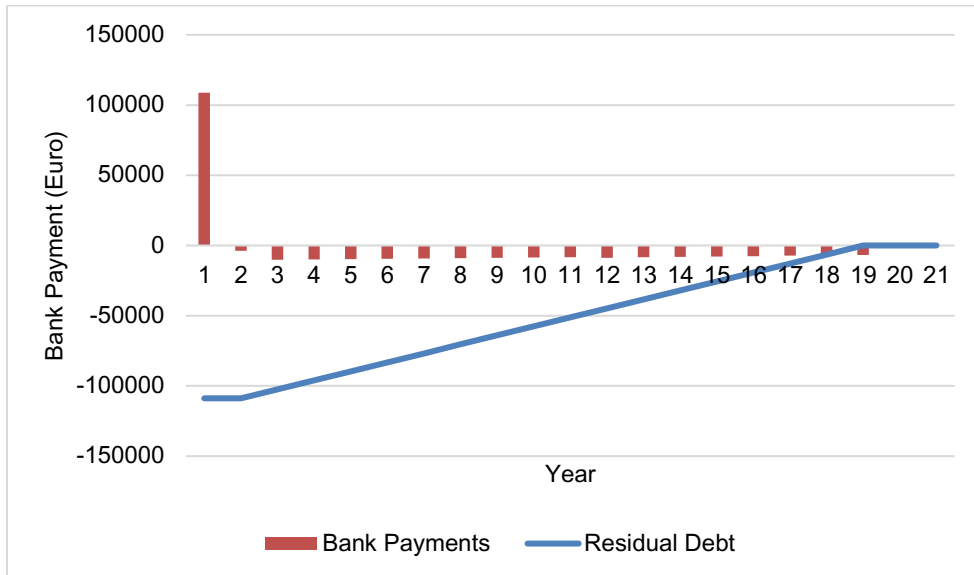

Figure 6.2 Kissane, scenario 1: from bank

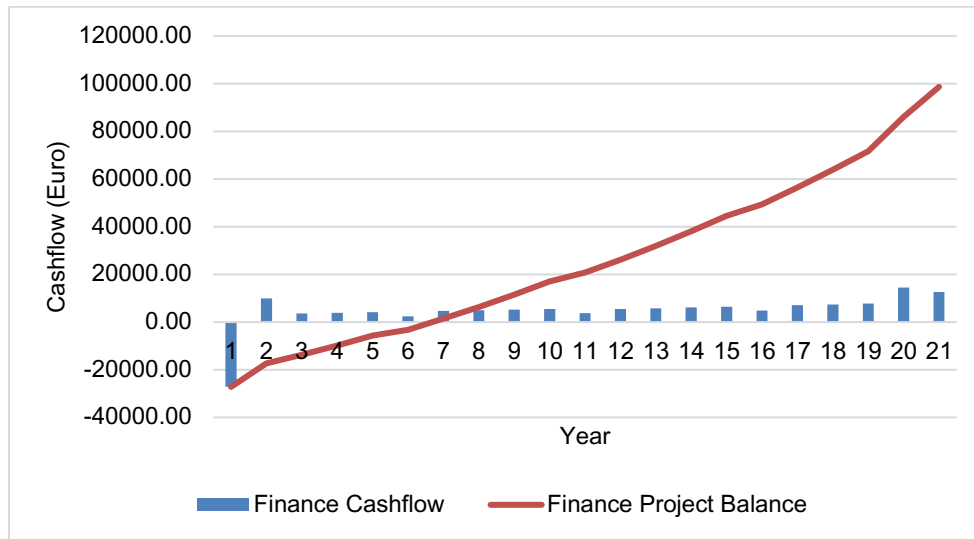

Figure 6.3 Kissane, Scenario 1: From bank, financial project balance

Table 6.2 Kissane, scenario 1: LCOE

Results	IRR (%)	ROI (Yrs.)	Balance (€)	LCOE (cent/kWh)
Operation	8.69%	9.35	155683.65	10.95
Finance	22.84%	4.58	115296.68	11.04

Table 6.3 Kissane, scenario 2: LCOE

Results	IRR (%)	ROI (Yrs.)	Balance (€)	LCOE (cent/kWh)
Operation	8.81%	9.26	152774.33	10.88
Finance	23.32%	4.43	113744.38	10.97

Table 6.4 Kissane, scenario 3: LCOE

Results	IRR (%)	ROI (Yrs.)	Balance (€)	LCOE (cent/kWh)
Operation	5.23%	12.25	2909.32	13.61
Finance	9.26%	11.60	1552.30	16.35

As seen above, by reducing the size of the project, LCOE increases, indicating the influence of a high feed-in tariff in the project.

6.2 Bouda

In the case of Bouda, a clear change is related to the low grid tariff, which is in the range of 0.04 cents/kWh (GPP, 2023). Here, with an annual yield of 2168.61 kWh/m² in Algeria, 52.1% self-consumption of the system with battery (PV SOL, 2021a), and an assumed supportive policy of 11 cents/kWh as well as Kissane, the economic calculation is done.

Table 6.5 System and battery sizing scenarios in Bouda

Bouda – System Sizing for Different Scenarios						
	PV Size (kW)	Battery Size for 6 hours outage (kWh)	Installation Cost + Substructure (euro/kWp)	Battery Cost (euro/kWh)	Feed-In-Tariff (cent/kWh)	Bank Investment (% of Capex)
Scenario 1	46	144.34				
Scenario 2	41	125.78	1300	1000	11	80
Scenario 3	5	18.56				

As Figure 6.4, Figure 6.5 and Figure 6.6 shown, investment from the operation, after financing and financial cashflow results in negative IRR and zero ROI during twenty years, and the balance of the project as shown in Table 6.6, Table 6.7, and Table 6.8 for three scenarios of Bouda is negative.

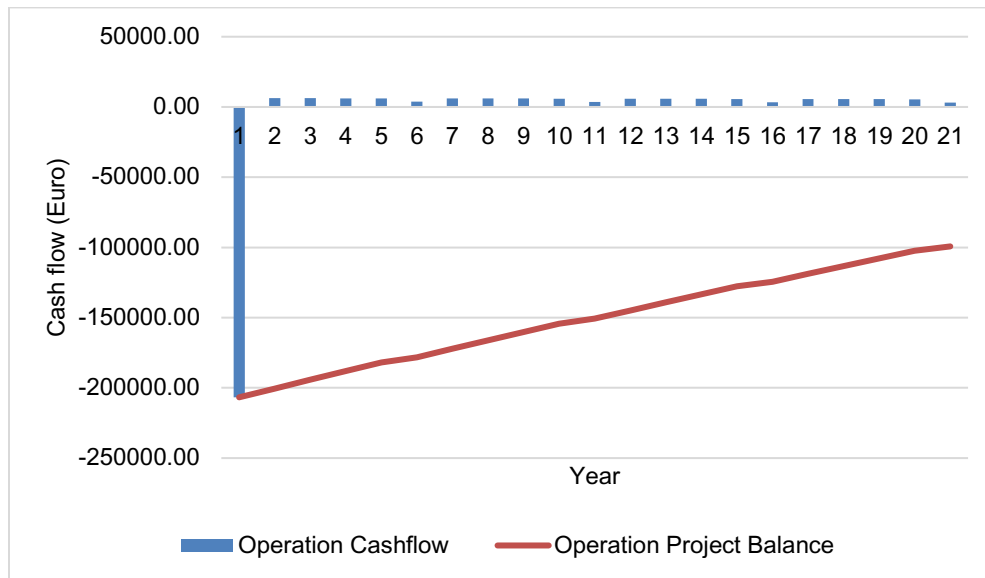

Figure 6.4 Bouda, scenario 1: from operation

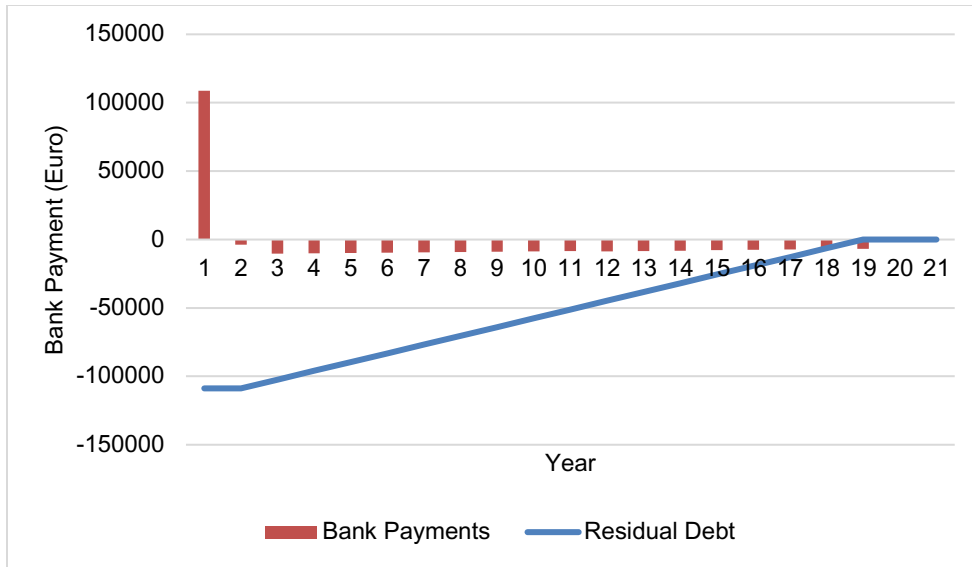

Figure 6.5 Bouda, scenario 1: financial cash flow

Table 6.6 Bouda, scenario 1: LCOE

Results	IRR (%)	ROI (Yrs.)	Balance (€)	LCOE (cent/kWh)
Operation	-2.93%	0.00	-55812.72	13.77
Finance	-	0.00	-114893.03	13.69

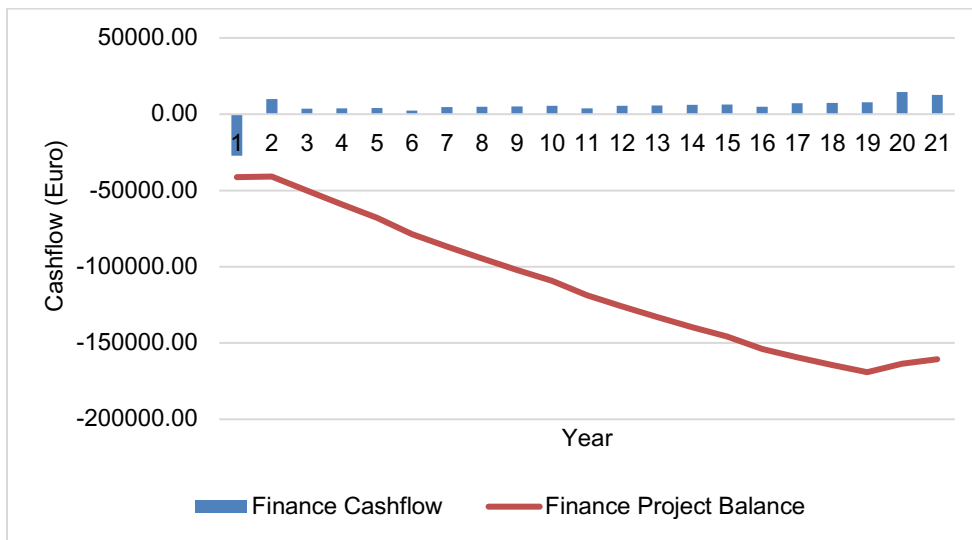

Figure 6.6 Bouda, scenario 1: From bank, financial project balance

Table 6.7 Bouda, scenario 2, LCOE

Results	IRR (%)	ROI (Yrs.)	Balance (€)	LCOE (cent/kWh)
Operation	-2.61%	0.00	-44405.55	13.40
Finance	-	0.00	-98353.83	13.49

Table 6.8 Bouda, scenario 3, LCOE

Results	IRR (%)	ROI (Yrs.)	Balance (€)	LCOE (cent/kWh)
Operation	-4.05%	0.00	-9037.85	15.40
Finance	-	0.00	-16461.38	16.00

In terms of the economy, installing Agri-PV in Morocco is a better choice than in Algeria. However, establishing a new power plant or other renewable energy systems in Algeria incurs significant costs and time, potentially more than PV systems. Therefore, if a comparison is made between these options in end-of-line community areas, Agri-PV remains a viable choice that can also be considered in Bouda.

7. Conclusion

The growing global population and the increasing danger of hunger until 2050 emphasize the critical importance of both the energy sector and food production. One innovative solution that addresses both these concerns is Agri-Photovoltaic (Agri-PV) systems. This concept allows for the dual usage of farmlands, offering not only agricultural productivity but also serving as a source of renewable energy generation. Supported by government policies, Agri-PV presents an opportunity for additional income generation for farmers. To explore the feasibility and benefits of Agri-PV, this study focuses on two case studies in rural areas, namely Kissane in Morocco and Bouda in Algeria. These areas experience power outages due to weak grid networks, necessitating alternative energy solutions. By conducting interviews with locals in Kissane and gathering relevant data from literature sources, load profiles for farms and households were determined. Utilizing PV-SOL, the energy consumption patterns were analyzed to assess the extent of self-consumption and grid dependency. Three scenarios were considered to cover total energy requirements: solely from farms, solely from households, and a combined approach. The

results indicate that Kissane requires a 39 kWp Agri-PV system with a static substructure and an 85.31 kWh battery capacity to meet its total energy demands, 38 kWp system and 82.04 kWh storage for only farms, and 1 kWp system and 3.27 kWh Battery for households because of cooperative area and having just one house, while Bouda necessitates a 46 kWp system with a 144.34 kWh storage capacity for total energy, 41 kWp and 125.78 kWh battery for only farms, and 5 kWp system and 18.56 kWh battery for households. It should be noted that the optimization is based on the capacity to cover a six-hour power outage during the day at peak load. Economic analysis reveals the favorable investment environment in Morocco, driven by higher electricity prices and supportive policies like feed-in-tariffs. Kissane demonstrates a positive internal rate of return (IRR) of 8.69% and competitive levelized cost of electricity (LCOE) with 10.95 Cent/kWh, indicating the feasibility and profitability of Agri-PV implementation. Conversely, Bouda faces economic challenges with a negative -2.93% IRR and 13.77 cent/kWh LCOE, underscoring the need for financial incentives to enhance project viability. Overall, the technical specifications and economic considerations highlight the transformative potential of Agri-PV in promoting sustainable energy and agricultural development in rural areas.

8. Publication bibliography

ABVII (2022): ABVII_Algeria_Report-EN.

Adeh, Elnaz H.; Good, Stephen P.; Calaf, M.; Higgins, Chad W. (2019): Solar PV Power Potential is Greatest Over Croplands. In *Scientific reports* 9 (1), p. 11442. DOI: 10.1038/s41598-019-47803-3.

Agri-PV economy (2022): Agrivoltaics: a fad or the future? - Milk the Sun Blog. Available online at <https://en.blog.milkthesun.com/agrivoltaics/>, updated on 8/17/2022, checked on 3/24/2024.

Ahmed, Gihan (2020): Arab Development Challenges Report.

Albright et al. (2012): Lead-acid-white-paper.

Aldersey et al. (2019): Levelised cost of energy – A theoretical justification and critical assessment. In *Energy Policy* 124, pp. 169–179. DOI: 10.1016/j.enpol.2018.10.004.

Algeria Economy (2019): Algeria Economic Outlook. Available online at <https://www.afdb.org/en/countries-north-africa-algeria/algeria-economic-outlook>, updated on 6/7/2023, checked on 1/19/2024.

Amegroud et al. (2015): Morocco's power sector transition. Achievements and potential. Roma: Istituto Affari Internazionali (IAI Working Papers, 15/05). Available online at <http://www.iai.it/sites/default/files/iaiw1505.pdf>.

Amrouche, Said Ould; Saidj, Sabah Hana; Boumechta, Samer; Arab, Amar Hadj; Abdeladim, Kamel; Bouchakour, Salim; Yassaa, Noureddine (2017): Distributed photovoltaic systems in Algeria and control of DC-DC converters for grid integration - an overview. In *Energy Procedia* 136, pp. 356–361. DOI: 10.1016/j.egypro.2017.10.289.

Andriani et al. (2013): Lighting up the kingdom of Morocco.

Belkhiri et al. (2022): Assessment of magnetic field induced by overhead power transmission lines in Algerian National Grid. In *Electr Eng* 104 (2), pp. 969–978. DOI: 10.1007/s00202-021-01298-2.

Bey et al. (2016): Viability study of the use of grid connected photovoltaic system in agriculture: Case of Algerian dairy farms. In *Renewable and Sustainable Energy Reviews* 63, pp. 333–345. DOI: 10.1016/j.rser.2016.05.066.

Boris Schinke et al. (2016): Summary: Country Fact Sheet Morocco. Energy and Development at a glance 2016.

Boulakhbar, M.; Lebrouhi, B.; Kousksou, T.; Smouh, S.; Jamil, A.; Maaroufi, M.; Zazi, M. (2020): Towards a large-scale integration of renewable energies in Morocco. In *Journal of energy storage* 32, p. 101806. DOI: 10.1016/j.est.2020.101806.

Climate top (2024): Sunshine & Daylight Hours in Algiers, Algeria Sunlight, Cloud & Day length. Available online at <https://www.climate.top/algeria/algiers/sunlight/>, updated on 1/23/2024, checked on 1/23/2024.

Coolbot (2022): 14-0000-8-75.

DeLaval (2022): flow-responsive-milking-brochure-eng.

Demin, Alexey (2021): How To Grow Potatoes Using Minimal Tillage – POTATOES NEWS. In *Potatoes News*, 2021. Available online at <https://potatoes.news/how-to-grow-potatoes-using-minimal-tillage/Daily-News>, checked on 3/16/2024.

Draftlogic (2024): Power Consumption of Typical Household Appliances. Available online at <https://www.daftlogic.com/information-appliance-power-consumption.htm>, updated on 3/16/2024, checked on 3/16/2024.

Efremov, Cristina; Sanduleac, Mihai; Braga, Dumitru (2022): Challenges and Opportunities of Agri-PV systems in a Clean Energy Transition for Rural Areas. In : 2022 International

- Conference and Exposition on Electrical And Power Engineering (EPE). 2022 International Conference and Exposition on Electrical And Power Engineering (EPE). Iasi, Romania, 10/20/2022 - 10/22/2022: IEEE, pp. 556–561.
- Encyclopedia Britannica (2024a): Africa | History, People, Countries, Regions, Map, & Facts. Available online at <https://www.britannica.com/place/Africa>, updated on 1/19/2024, checked on 1/19/2024.
- Encyclopedia Britannica (2024b): Algeria | Flag, Capital, Population, Map, & Language. Available online at <https://www.britannica.com/place/Algeria>, updated on 1/19/2024, checked on 1/19/2024.
- Encyclopedia Britannica (2024c): Morocco - Mediterranean, Arid, Temperate. Available online at <https://www.britannica.com/place/Morocco/Climate>, updated on 1/14/2024, checked on 1/14/2024.
- FAO; IFAD; UNICEF; WFP and WHO (2023): The State of Food Security and Nutrition in the World 2023: FAO; IFAD; UNICEF; WFP; WHO.
- FAO et al. (2017): Water for Sustainable Food and Agriculture.
- Gaur et al. (2016): Analysing the Electricity Demand Pattern.
- Ghezloun, A.; Chergui, S.; Oucher, N. (2011): Algerian energy strategy in the context of sustainable development (Legal framework). In *Energy Procedia* 6, pp. 319–324. DOI: 10.1016/j.egypro.2011.05.036.
- GPP (2023): Algeria electricity prices, June 2023 | GlobalPetrolPrices.com. Available online at https://www.globalpetrolprices.com/Algeria/electricity_prices/, updated on 1/19/2024, checked on 1/19/2024.
- Grundfos (2013): PowerPoint Presentation.
- Haramaini et al. (2019): Economic Analysis of PV Distributed Generation Investment Based on Optimum Capacity for Power Losses Reducing. In *Energy Procedia* 156, pp. 122–127. DOI: 10.1016/j.egypro.2018.11.115.
- IEA (2014a): Feed-in tariff for solar PV installations – Policies - IEA. Available online at <https://www.iea.org/policies/5661-feed-in-tariff-for-solar-pv-installations>, updated on 1/22/2024, checked on 1/22/2024.
- IEA (2014b): World Energy Outlook 2014.
- IEA (2019): Energy Policies Beyond IEA Countries: Morocco 2019 Review.
- IEA (2021): Net Zero by 2050 - A Roadmap for the Global Energy Sector.
- IEA (2023): First National Determined Contribution (NDC) – Policies - IEA. Available online at <https://www.iea.org/policies/15813-first-national-determined-contribution-ndc>, updated on 1/19/2024, checked on 1/19/2024.
- IRENA (2023): Algeria_Africa_RE_SP.
- ISE, Fraunhofer (2022): Agrivoltaics: Opportunities for Agriculture and the Energy Transition.
- ISE, Fraunhofer (2023): Dual Use of Land with Agrivoltaics.
- Kythreotou et al. (2012): A proposed methodology for the calculation of direct consumption of fossil fuels and electricity for livestock breeding, and its application to Cyprus. In *Energy* 40 (1), pp. 226–235. DOI: 10.1016/j.energy.2012.01.077.
- Maammeur et al. (2017): Performance investigation of grid-connected PV systems for family farms: case study of North-West of Algeria. In *Renewable and Sustainable Energy Reviews* 78, pp. 1208–1220. DOI: 10.1016/j.rser.2017.05.004.
- Mapcarta (2024a): Bouda. Available online at <https://mapcarta.com/17352312>, updated on 1/25/2024, checked on 1/25/2024.

- Mapcarta (2024b): Jbel Kissane. Available online at <https://mapcarta.com/34192346>, updated on 1/25/2024, checked on 1/25/2024.
- Meliani, Meryem; El Barkany, Abdellah; El Abbassi, Ikram; Mahmoudi, Morad (2022): Smart Grid Challenges in Morocco and an Energy Demand Forecasting with Time Series. In *JERA* 61, pp. 195–215. DOI: 10.4028/p-2gufv6.
- MGSolar (2024): Trina Solar Vertex S+ 440 Wp Glas-Glas Solarmodul TSM-NEG9R.28. Available online at <https://www.mg-solar-shop.de/Trina-Solar-Vertex-S-440-Wp-Glas-Glas-Solarmodul-TSM-NEG9R.28>, updated on 3/20/2024, checked on 3/20/2024.
- Morccomap360 (2024): Karte der Flughäfen in Marokko: Flughafenposition und internationale Flughäfen von Marokko. In *morccomap360.com*,, 2024. Available online at <https://de.morccomap360.com/marokko-flugh%C3%A4fen-karte>, checked on 1/14/2024.
- Mueller (2014): EN - Model P 01-2014 blad 1.
- Munters (2022): EN - Model P 01-2014 blad 1.
- Nacer et al. (2016): A comprehensive method to assess the feasibility of renewable energy on Algerian dairy farms. In *Journal of Cleaner Production* 112, pp. 3631–3642. DOI: 10.1016/j.jclepro.2015.06.101.
- Narayan et al. (2018): Scoping exercise to determine load profile archetype reference shapes for solar co-generation models in isolated off-grid rural African villages.
- Nature's Generator (2024): How Many Watts Does a Well Pump Use., 2023. Available online at <https://naturesgenerator.com/blogs/news/how-many-watts-does-a-well-pump-use>, updated on 3/30/2024, checked on 3/30/2024.
- Niazi et al. (2023): Comparative analysis of photovoltaic configurations for agrivoltaic systems in Europe. In *Progress in Photovoltaics* 31 (11), pp. 1101–1113. DOI: 10.1002/pip.3727.
- Oxford Business Group (2016): Mining sector in Morocco diversifies away from phosphates - Africa 2016 - Oxford Business Group. Available online at <https://oxfordbusinessgroup.com/reports/morocco/2016-report/economy/new-tricks-having-traditionally-relied-on-the-phosphates-industry-the-mining-sector-is-diversifying>, updated on 11/16/2022, checked on 1/14/2024.
- Passero et al. (2021): Private Sector Participation in African Grid Development. Philips-lighting (2018).
- Polepally et al. (2023): Off-Grid Project, THI.
- Prinsloo et al. (2016): Scoping exercise to determine load profile archetype reference shapes for solar co-generation models in isolated off-grid rural African villages.
- PV SOL (2021a): Project report, created with PV*SOL premium 2021 (R8).
- PV SOL (2021b): Project report, created with PV*SOL premium 2021 (R8).
- Renné et al. (Ed.) (2021): Proceedings of the ISES Solar World Congress 2021. ISES Solar World Congress 2021. Virtual. Freiburg, Germany: International Solar Energy Society.
- Sahbani et al. (2016): Development Prospect of Smart Grid in Morocco. In *Procedia Computer Science* 83, pp. 1313–1320. DOI: 10.1016/j.procs.2016.04.274.
- Schinke et al. (2016): Background Paper: Country Fact Sheet Morocco. Energy and Development at a glance 2016.
- Scott et al. (2021): Understanding Load Profiles of Mini-Grid Customers in Tanzania. In *Energies* 14 (14), p. 4207. DOI: 10.3390/en14144207.
- Solargis (2024a): Solar resource maps and GIS data for 200+ countries | Solargis. Available online at <https://solargis.com/maps-and-gis-data/download/algeria>, updated on 1/22/2024, checked on 1/23/2024.

- Solargis (2024b): Solargis Prospect. Available online at <https://apps.solargis.com/prospect/map?show-registration=1&c=28.926547,-9.121632,6&s=31.172821,-7.336248&m=solargis-dni&l=true>, updated on 1/17/2024, checked on 1/23/2024.
- SRA (2021): After the big storm: how to supply emergency power to residents of rural and suburban communities during multi-day outages. Available online at <https://www.preventionweb.net/news/after-big-storm-how-supply-emergency-power-residents-rural-and-suburban-communities-during>, updated on 4/18/2024, checked on 4/18/2024.
- Stambouli, A. Boudghene; Khiat, Z.; Flazi, S.; Kitamura, Y. (2012): A review on the renewable energy development in Algeria: Current perspective, energy scenario and sustainability issues. In *Renewable and Sustainable Energy Reviews* 16 (7), pp. 4445–4460. DOI: 10.1016/j.rser.2012.04.031.
- Statista (2022a): Algeria - urbanization 2022 | Statista. Available online at <https://www.statista.com/statistics/455775/urbanization-in-algeria/>, updated on 1/23/2024, checked on 1/23/2024.
- Statista (2022b): Morocco - GDP distribution across economic sectors 2012-2022 | Statista. Available online at <https://www.statista.com/statistics/502771/morocco-gdp-distribution-across-economic-sectors/>, updated on 1/23/2024, checked on 1/23/2024.
- Statista (2022c): Morocco - unemployment rate 2003-2022 | Statista. Available online at <https://www.statista.com/statistics/502794/unemployment-rate-in-morocco/>, updated on 1/14/2024, checked on 1/14/2024.
- Statista (2024a): Algeria: agriculture value added to GDP 2017-2022 | Statista. Available online at <https://www.statista.com/statistics/1184013/gdp-contribution-of-agriculture-and-fisheries-in-algeria/>, updated on 1/19/2024, checked on 1/19/2024.
- Statista (2024b): Morocco: agriculture as share of GDP | Statista. Available online at <https://www.statista.com/statistics/1176594/share-of-value-added-by-agriculture-to-gdp-in-morocco/>, updated on 1/14/2024, checked on 1/14/2024.
- Suness (2024): Suness. Available online at <https://www.suness.com/agricultural-photovoltaic-solution/>, updated on 1/19/2024, checked on 2/11/2024.
- Sungrowpower (2024). Available online at <https://uk.sungrowpower.com/distributorsresidential>, updated on 3/22/2024, checked on 3/22/2024.
- Sustainable Farming (2020): Harvesting potatoes. Available online at <https://www.sustainablemarketfarming.com/2020/07/14/harvesting-potatoes/>, updated on 7/14/2020, checked on 3/16/2024.
- Talavera et al. (2019): Assessment of cost-competitiveness and profitability of fixed and tracking photovoltaic systems: The case of five specific sites. In *Renewable Energy* 134, pp. 902–913. DOI: 10.1016/j.renene.2018.11.091.
- Trade (2024): Morocco - Energy. Available online at <https://www.trade.gov/country-commercial-guides/morocco-energy>, updated on 1/12/2024, checked on 1/12/2024.
- Trade.gov (2023): Algeria - Market Overview. Available online at <https://www.trade.gov/country-commercial-guides/algeria-market-overview>.
- Trina Solar (2018): Trina Solar: Continued Growth Worldwide in 2018. Available online at <https://www.trinasolar.com/us/resources/blog/trina-solar-continued-growth-worldwide-2018>, updated on 7/18/2018, checked on 3/20/2024.

- UN et al. (2023): Sustainable development report. In *UN Department of Public Information*. Available online at https://www.un.org/en/development/desa/population/events/pdf/other/21/21June_FINAL%20PRESS%20RELEASE_WPP17.pdf.
- Verma et al. (2015): Techno-Financial Analysis of Energy Access through Hybrid System with Solar PV under the Various Rural Community Models for State of Uttarakhand, India. In *SGRE* 06 (04), pp. 75–94. DOI: 10.4236/sgre.2015.64008.
- Wassie et al. (2024): Understanding the load profiles and electricity consumption patterns of PV mini-grid customers in rural off-grid east africa: A data-driven study. In *Energy Policy* 185, p. 113969. DOI: 10.1016/j.enpol.2023.113969.
- Wittke, Maximilian (2023): Masterthesis Max Wittke.
- World Bank (2024): World Bank Climate Change Knowledge Portal. Available online at <https://climateknowledgeportal.worldbank.org/country/algeria/climate-data-historical>, updated on 1/18/2024, checked on 1/19/2024.
- World Bank (2023a): Overview. Available online at <https://www.worldbank.org/en/country/algeria/overview>, updated on 1/18/2024, checked on 1/19/2024.
- World Bank (2023b): Overview. Available online at <https://www.worldbank.org/en/country/morocco/overview>, updated on 1/13/2024, checked on 1/14/2024.
- Worlddata (2024): Morocco: country data and statistics. Available online at <https://www.worlddata.info/africa/morocco/index.php>, updated on 1/14/2024, checked on 1/14/2024.
- Worldometer (2024): Morocco Population (2024) - Worldometer. Available online at <https://www.worldometers.info/world-population/morocco-population/>, updated on 1/14/2024, checked on 1/14/2024.
- Zahraoui, Younes; Khan, Mohammed Reyasudin Basir; AlHamrouni, Ibrahim; Mekhilef, Saad; Ahmed, Mahrous (2021): Current Status, Scenario, and Prospective of Renewable Energy in Algeria: A Review. In *Energies* 14 (9), p. 2354. DOI: 10.3390/en14092354.

9. Appendices

Appendix A: Hourly household consumption in Bouda

Hours	LED	Fluore TV	Internet	Fan	Blender	DVD	Refrig	Was	Mobile Fan	Drilling Machine	Computer
0							0				
1							1				
2							0				
3							1				
4							0				
5							1				
6	1	1					0				
7	1	1					1				
8	1	1					0				
9	1	1			1		1		1		
10	1	1					0				
11					1		1				1
12					1		0				1
13					1		1				1
14							0		1		
15					1		1		1		
16					1		0				
17	1	1					1				
18	1	1					0				1
19	1	1					1				1
20	1	1					0				1
21	1	1				1	1		1		1
22	1	1				1	0				
23							1				

Appendix B: Hourly household consumption in Kissane

Daily	LED	Fluoresc	Internet	Fan	Blender	Mini-	Mini-	Mobile	Laptop
0	0	0	0	0	0	0	1	0	0
1	0	0	0	0	0	0	1	0	0
2	0	0	0	0	0	0	1	0	0
3	0	0	0	0	0	0	1	0	0
4	0	0	0	0	0	0	1	0	0
5	1	0	0	0	0	0	1	0	0
6	1	1	0	0	0	0	1	0	0
7	1	1	0	0	0	0	1	0	1
8	1	0	0	0	0	1	0	0	1
9	0	0	0	0	0	1	0	0	1
10	0	0	0	0	0	1	0	0	0
11	0	0	0	0	0	1	0	0	0
12	0	0	1	0	1	0	1	1	0
13	1	0	1	1	0	0	1	1	0
14	0	0	1	1	0	0	1	1	0
15	0	0	1	0	0	0	1	1	0
16	0	0	1	0	0	0	1	0	0
17	0	0	1	0	0	0	1	0	0
18	1	1	1	0	0	1	0	0	0
19	1	1	1	0	1	1	0	1	1
20	1	1	1	0	0	1	0	1	1
21	1	1	1	0	0	0	1	0	0
22	1	0	1	0	0	0	1	0	0
23	1	0	0	0	0	0	1	0	0

Appendix C: Monthly Average Load Profile: Algerian Livestock Farm

(Maammeur et al., 2017)

Daily Hours	January	February	March	April	May	Jun	July	August	Septemb	October	Novembre	Decem
0	1	1	1	1	1	10	10	10	1	0	0	0
1	1	1	1	1	1	10	10	10	1	0	0	0
2	1	1	1	1	1	10	10	10	1	0	0	0
3	1	1	1	1	1	10	10	10	1	0	0	0
4	1	1	1	1	1	10	10	10	1	0	0	0
5	2	2	2	12	13	40	39	40	13	1	1	1
6	2	2	2	11	12	38	37	38	12	1	1	1
7	2	2	2	13	11	41	40	41	13	1	1	1
8	2	1.5	2	12	11.5	39	38	39	12	1	0.8	1.1
9	1.5	2.5	1.5	11	11	38	37	38	11	1	1	1
10	2	2	2	12	12	40	41	40	12	1	1	1
11	2.5	1.5	2.5	11	11	42	41.5	42	11	1	1	0.8
12	2	2	2	11	11	38	37	38	11	1	1	1
13	2	2	2	12	12	41	40	41	12	1.5	1	1
14	2	2	2	11	11	39	38	39	11	1	1	1
15	2	2	2	11	11	38	37	38	11	1	1	1
16	2	1.8	2	10	10	39	38	39	10	1	1	1
17	2.2	2.2	2.2	11	12	38	37	38	11	1	1	1
18	1	1.2	1	1	1	40	41	40	1	0	0	0
19	1.4	0.9	1.2	1	1	10	10	10	1	0	0	0
20	1	1	1	1	1	10	10	10	1	0	0	0
21	1	1	1	1	1	11	11	11	1	0	0	0
22	1	1	1	1	1	10	10	10	1	0	0	0
23	1	1	1	1	1	10	10	10	1	0	0	0

Appendix D: PV-SOL Report for Bouda-Algeria

Agri-PV: Bouda, Algeria

Project Overview

PV System

Grid-connected PV System with Electrical Appliances and Battery Systems

Climate Data	Adrar, DZA (1991 - 2010)
PV Generator Output	49.28 kWp
PV Generator Surface	223.8 m ²
Number of PV Modules	112
Number of Inverters	2
No. of battery systems	7

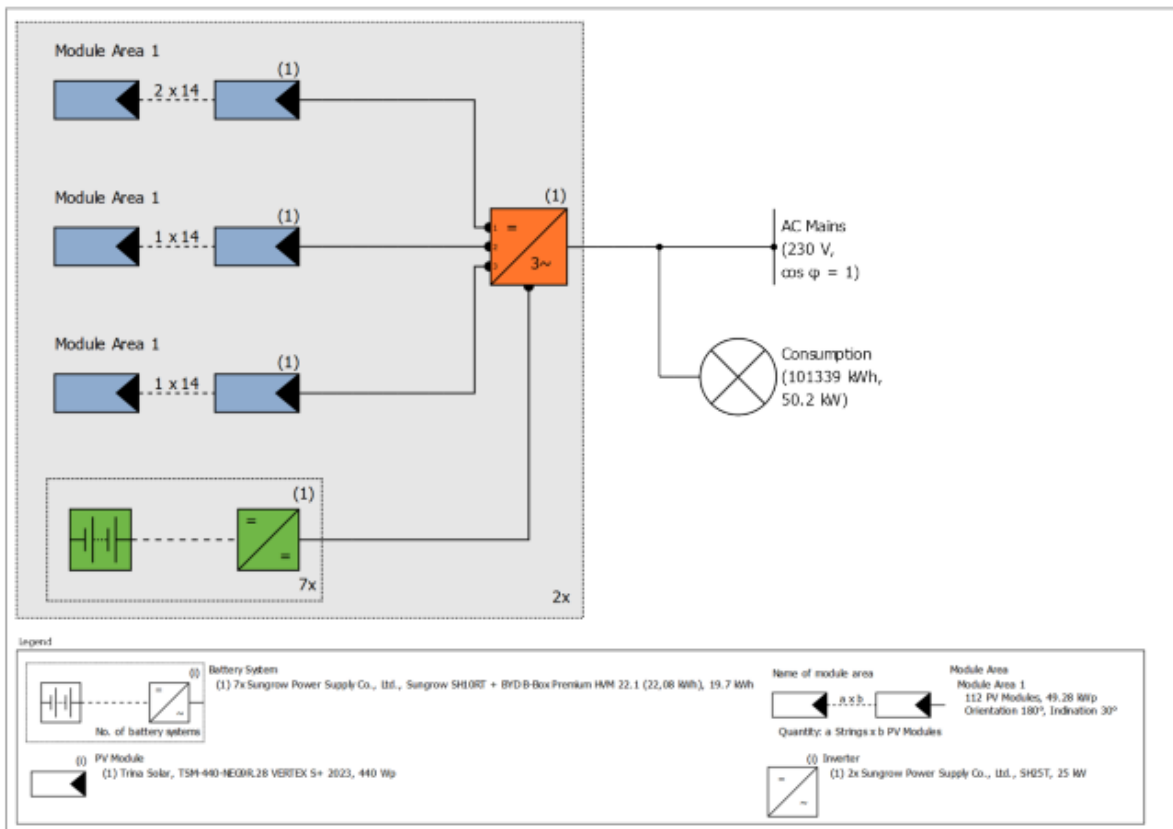

Figure: Schematic diagram

Simulation Results

Results Total System

PV System

PV Generator Output	49.3 kWp
Spec. Annual Yield	2,168.61 kWh/kWp
Performance Ratio (PR)	88.6 %
PV Generator Energy (AC grid) with battery	105,600 kWh/Year
Own Consumption	55,015 kWh/Year
Down-regulation at Feed-in Point	0 kWh/Year
Grid Feed-in	50,585 kWh/Year
Own Power Consumption	52.1 %
CO ₂ Emissions avoided	48,906 kg / year

PV Generator Energy (AC grid) with battery

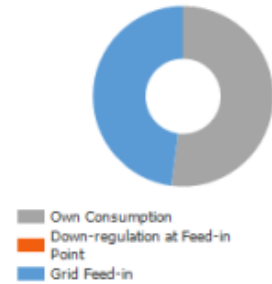

Appliances

Appliances	101,339 kWh/Year
Standby Consumption (Inverter)	68 kWh/Year
Total Consumption	101,407 kWh/Year
covered by PV power with battery	55,015 kWh/Year
covered by grid	46,392 kWh/Year
Solar Fraction	54.3 %

Total Consumption

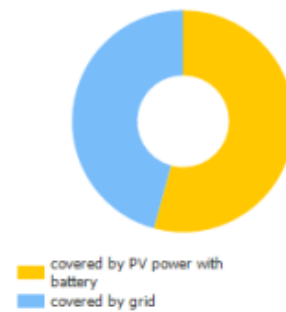

Battery System

Charge at beginning	138 kWh
Battery Charge (PV System)	12,244 kWh/Year
Battery Energy for the Covering of Consumption	10,906 kWh/Year
Losses due to charging/discharging	1,181 kWh/Year
Losses in Battery	295 kWh/Year
Cycle Load	1.3 %
Service Life	>20 Years

Level of Self-sufficiency

Total Consumption	101,407 kWh/Year
covered by grid	46,392 kWh/Year
Level of Self-sufficiency	54.3 %

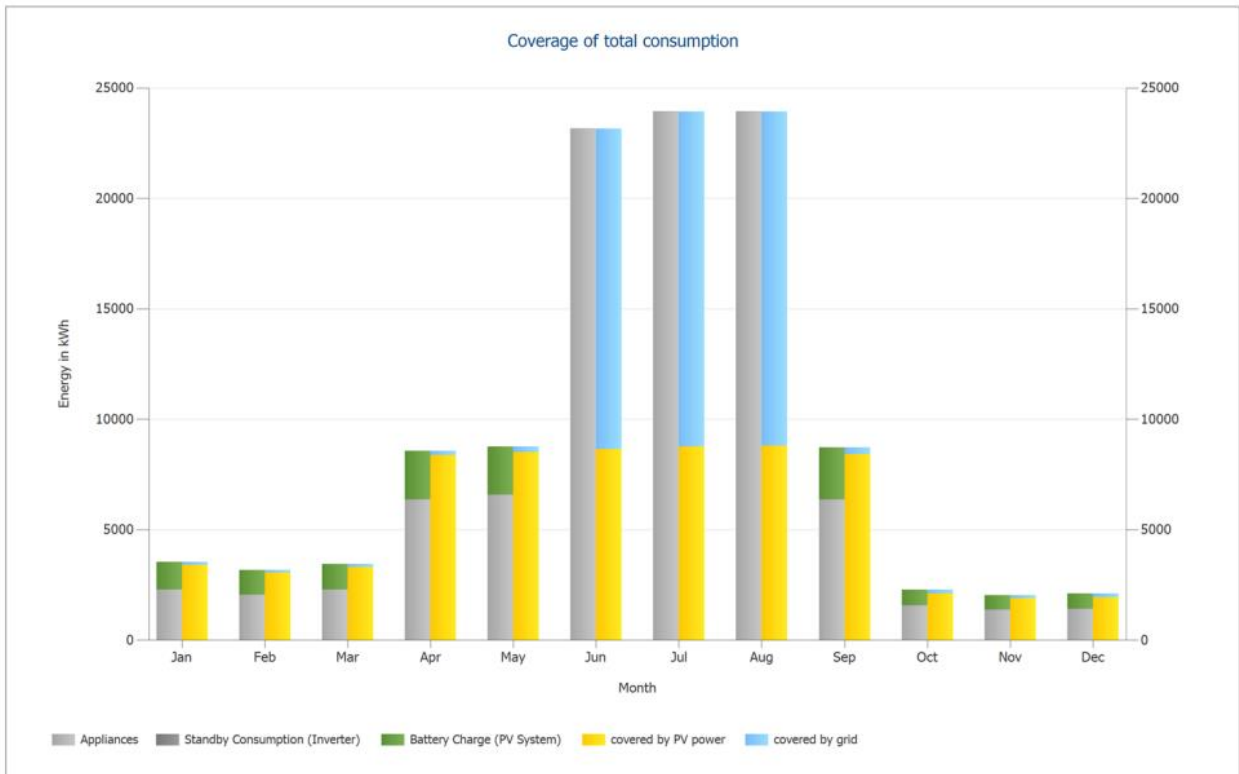
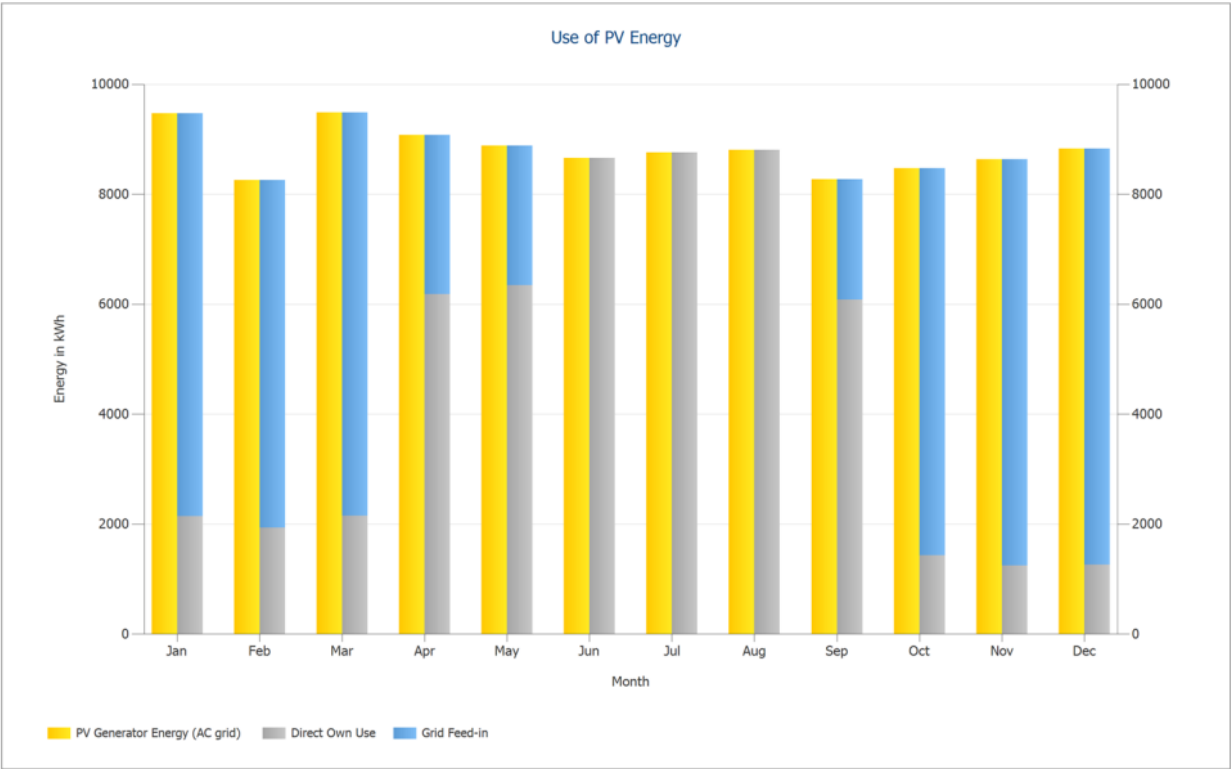

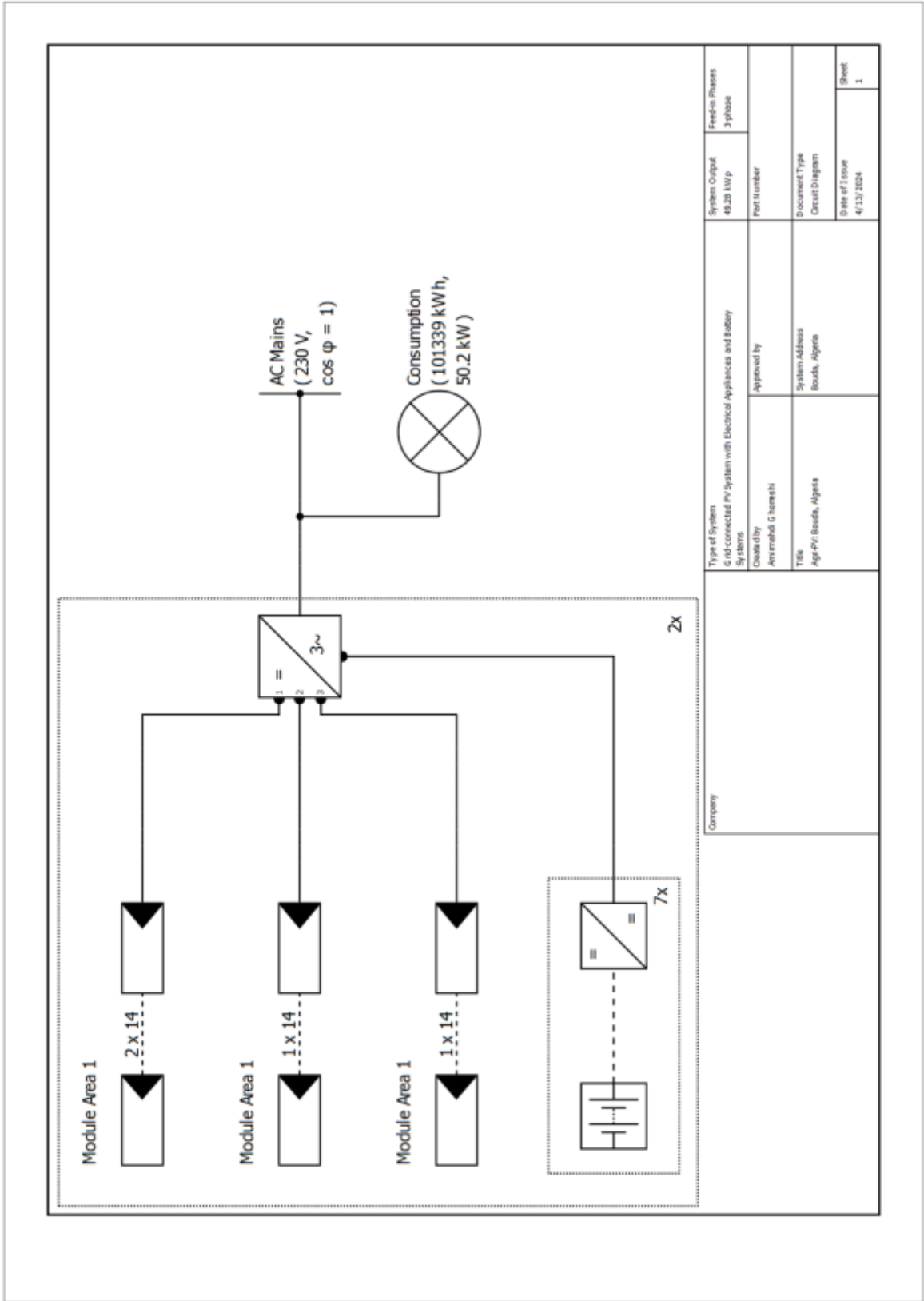

Type of System Grid-connected PV System with Electrical Appliances and Safety Systems	System Output 49.28 kWp	Free-Is Phases 3-phase
Checked by Ahmed El Gharah	Approved by	Plot Number
Title Agr PV: Becha, Algata	System Address Becha, Algata	Document Type Circuit Diagram
Company	Date of Issue 4/13/2024	Sheet 1

Figure: Circuit Diagram

Appendix E: PV-SOL Report for Kissane-Morocco

Project Overview

PV System

Grid-connected PV System with Electrical Appliances and Battery Systems

Climate Data	Ouarzazate, MAR (1991 - 2010)
PV Generator Output	39.6 kWp
PV Generator Surface	179.8 m ²
Number of PV Modules	90
Number of Inverters	2
No. of battery systems	3

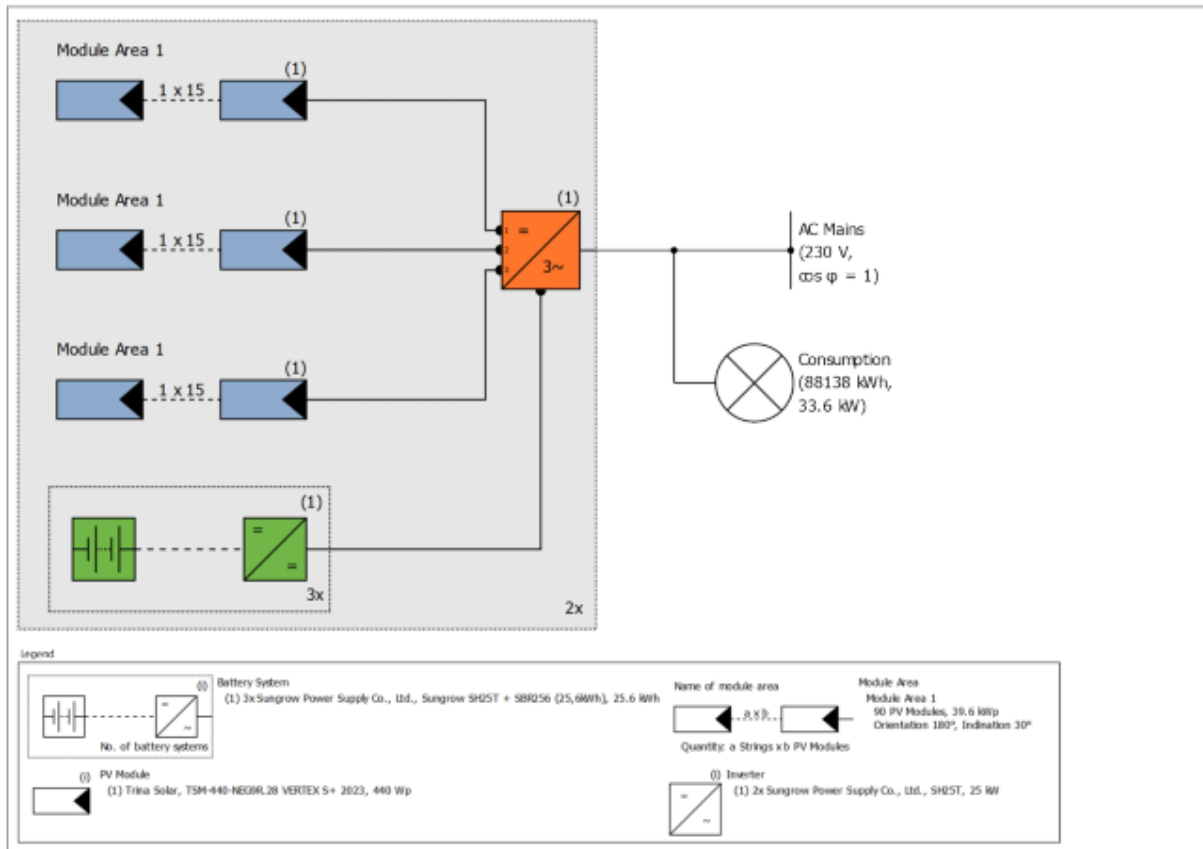

Figure: Schematic diagram

Simulation Results

Results Total System

PV System

PV Generator Output	39.6 kWp
Spec. Annual Yield	2,290.76 kWh/kWp
Performance Ratio (PR)	90.3 %
PV Generator Energy (AC grid) with battery	89,195 kWh/Year
Down-regulation at Feed-in Point	0 kWh/Year
CO ₂ Emissions avoided	41,058 kg / year

Total Consumption



■ covered by PV power with battery
■ covered by grid

Appliances

Appliances	88,138 kWh/Year
Standby Consumption (Inverter)	120 kWh/Year
Total Consumption	88,258 kWh/Year
covered by PV power with battery	67,553 kWh/Year
covered by grid	20,705 kWh/Year

Battery System

Charge at beginning	77 kWh
Battery Charge (PV System)	15,571 kWh/Year
Battery Energy for the Covering of Consumption	13,932 kWh/Year
Losses due to charging/discharging	1,565 kWh/Year
Losses in Battery	152 kWh/Year
Cycle Load	5.1 %
Service Life	19 Years

Level of Self-sufficiency

Total Consumption	88,258 kWh/Year
covered by grid	20,705 kWh/Year
Level of Self-sufficiency	76.5 %

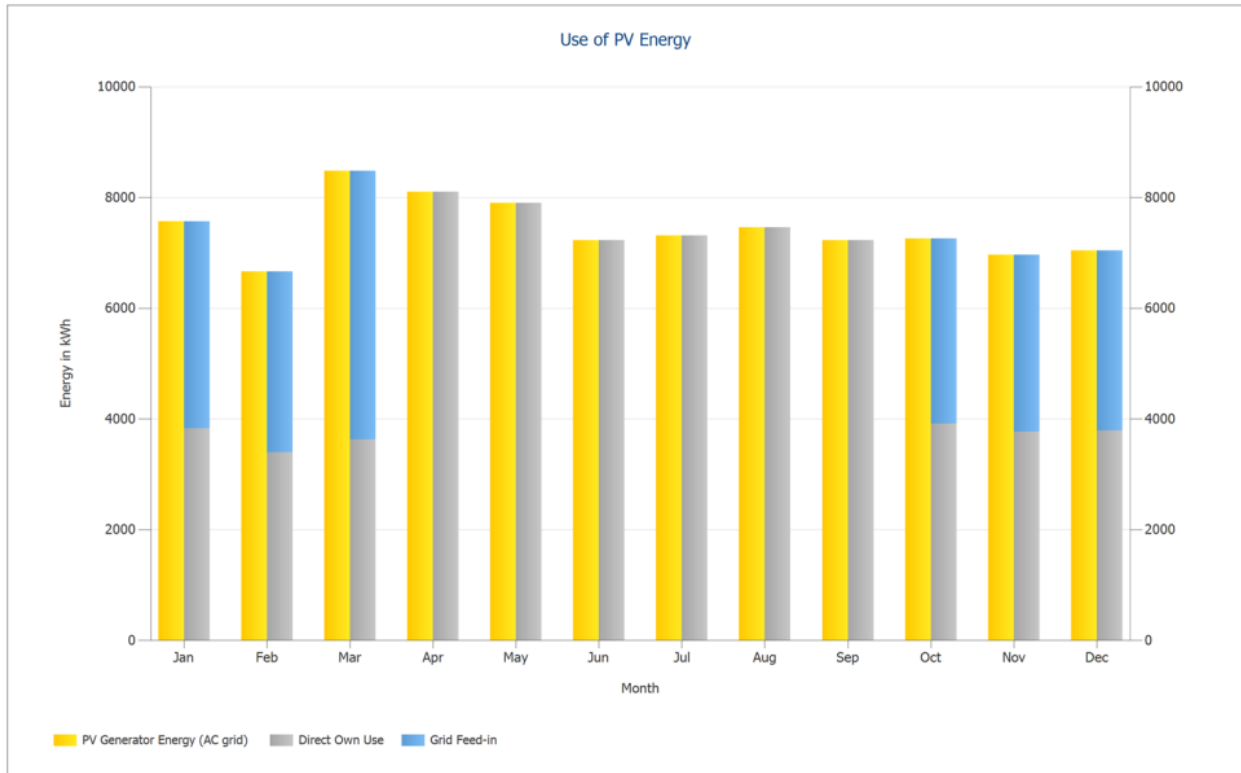

Figure: Use of PV Energy

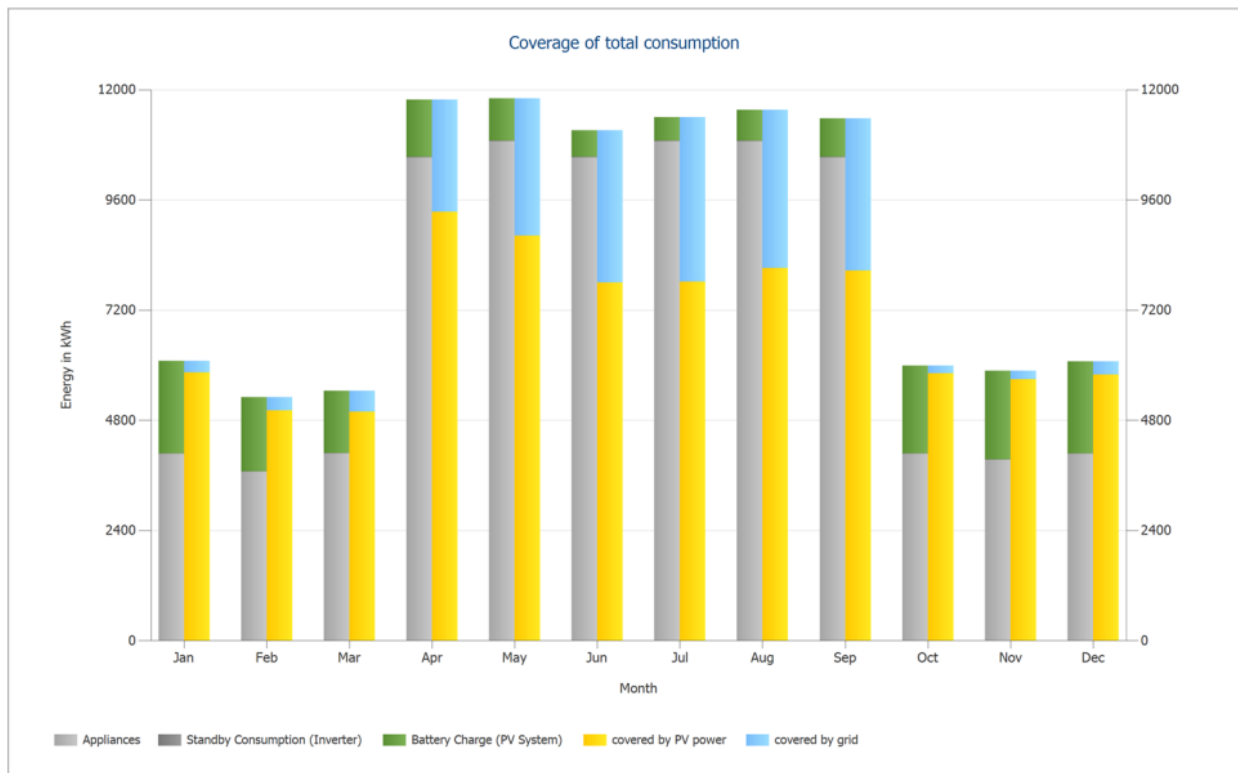

Figure: Coverage of total consumption

Circuit Diagram

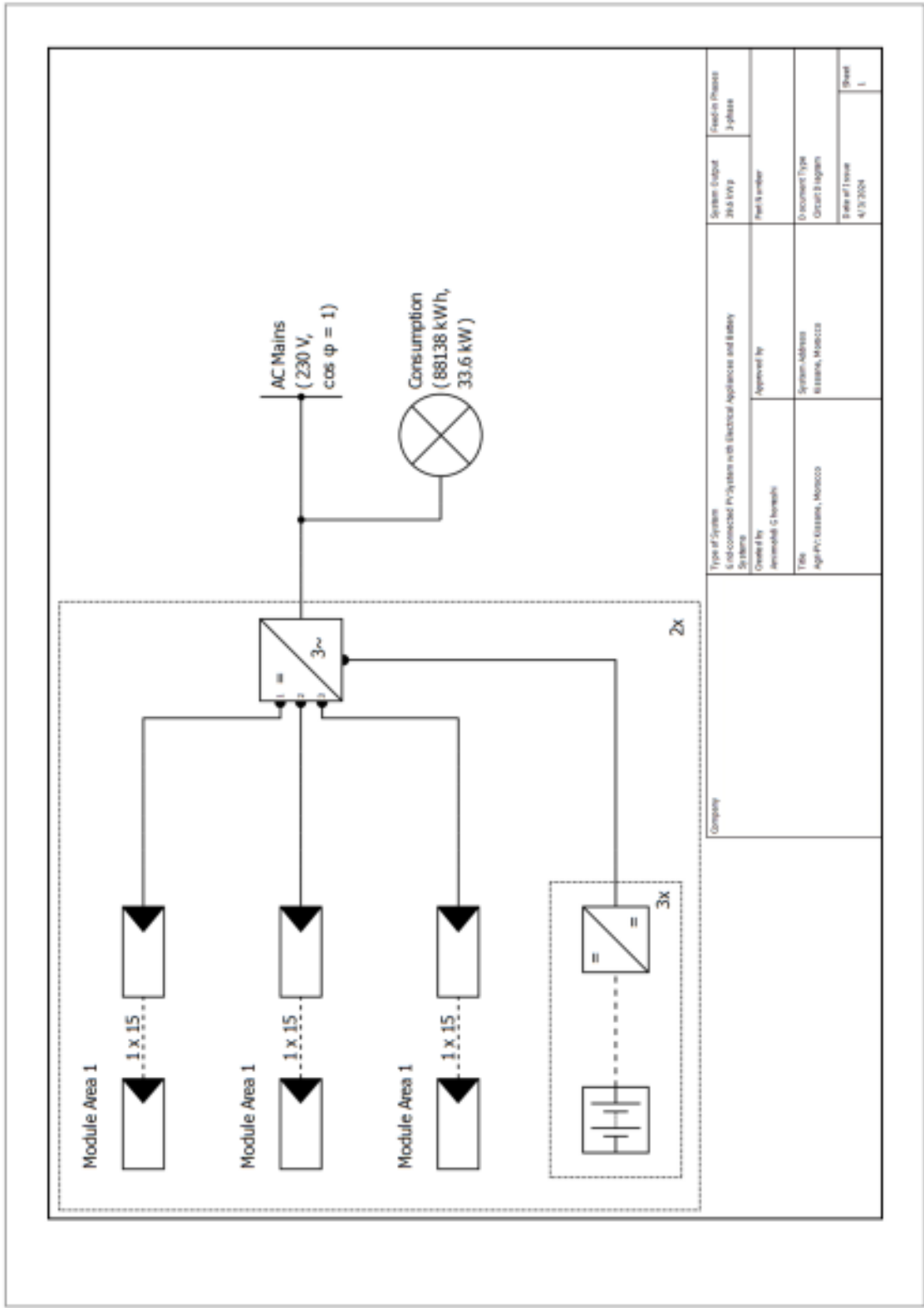

Figure: Circuit Diagram

Appendix F: Data Analysis of Agri-PV Projects, Fraunhofer ISE

Nr.:	Input-Datennanalyse											E66					
	Source	Erhebungs- /Veröff.jahr	Category	Size (ha)	D13	D51	kWh/ha	CAPEX (€/kWp)	D19	D20	D21		D22	D23	D34	D40	D40
1	Heggebach	2018	Arable land	0,5		389	3.986	700	42	3.244	1.491	608	1.146			607	21
2	Krinner	2020	Arable land	0,6		504	977	307	58	612	396	283	123			93	52
3	Schindele	2020	Arable land	2		519	1.294	290	60	944	535	405	330			79	16
4	Fraunhofer ISE	2021	Arable land	2		600	1.146	313	36	798	472	372	274			52	15
5	Jäger	2022	Arable land	2		600	1.518	360	80	1.078	653	400	360			65	17
6	Industry	2023	Arable land	30		290	857	460	40	357	209	198	143			5	11
7	Krinner	2020	Arable land	0,6		504	1.088	307	58	723	507	394	123			93	57
8	Agostini	2021	Arable land	2		500	1.455	310	80	520	-	-	500			45	17
9	Industry	2023	Arable land	30		290	934	460	40	434	286	275	143			5	12
10	Geldorf	2022	Horticulture	0,3		700	2.024	405	40	1.579	1.149	832	22			408	30
11	Kressbronn	2022	Horticulture	0,4		598	1.910	768	362	780	677	426	-			103	28
12	KOB	2022	Horticulture	0,6		378	1.798	504	47	1.247	716	544	471			60	26
13	Chalghayeva	2022	Horticulture	2		519	1.344	340	36	607	375	275	180			52	19
14	Fraunhofer ISE	2021	Horticulture	2		700	983	540	80	1.015	595	343	354			65	14,5
15	Jäger	2022	Horticulture	2		700	1.635	1.024	323	1.916	1.682	1.257	120			114	
16	Industry	2023	Viticulture	0,13		670	3.263	767	47	1.812	1.584	733	130			98	
17	Industry	2023	Horticulture	15		803	2.626	460	40	516	233	229	169			114	15
18	Jung Salmon (calculated)	2022	Horticulture	20		785	1.016	287	96	615	48	137	287			143	16
19	Industry	2023	Horticulture	15		900	1.106	460	40	606	323	319	169			114	16
20	Jung & Salmon	2022	Horticulture	20		550	1.051	287	96	669	48	191	287			143	17
21	Industry	2023	Arable land	1,5		697	702	215	48	439	352	85	59			28	14
22	Leitfaden ISE	2021	Grassland	2		300	800	326	36	439	248	132	139			52	15
23	Industry	2023	Grassland	12		837	550	246	65	239	116	60	69			54	11
24	Industry	2023	Grassland	35		493	631	280	49	302	155	96	143			4	13
25	Industry	2023	Horticulture	36,11		1.357	643	250	68	325	216	160	59			50	13
26	Industry	2023	Arable land	1,5		697	769	215	48	506	419	152	59			28	15
27	Industry	2023	Grassland	12		837	596	246	65	285	162	106	54			54	12
28	Industry	2023	Graa	35		493	706	280	49	377	230	171	143			4	14
29	Jäger	2022	Grassland	2		346	935	252	80	604	467	191	71			65	16
30	Industry	2023	Grassland	2,7		370	848	268	23	557	362	170	145			50	16
31	Industry	2023	Grünland	13,5		370	645	264	22	359	243	142	96			20	14
32	Industry	2023	Grünland	14		300	580	278	29	273	168	70	83			22	13
33	Industry	2023	Grünland	27		370	616	264	22	330	231	136	10			10	13
34	Industry	2023	Grünland	54		370	595	263	22	310	219	133	86			5	12

(Wittke, 2023)

Appendix G: PV and Inverter Data sheets

Mono Multi Solutions



DUAL GLASS MONOCRYSTALLINE MODULE

PRODUCT: TSM-XXXNEG9R.28

PRODUCT RANGE: 420-440W

440W

MAXIMUM POWER OUTPUT

0~+5W

BINNING TOLERANCE

22.0%

MAXIMUM EFFICIENCY

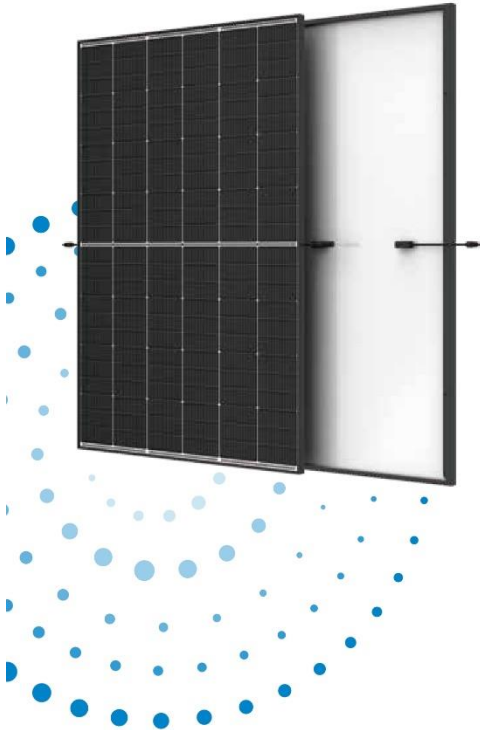

Small in size, bigger on power

- Up to 440W, 22.0% module efficiency with high density interconnect technology
- Multi-busbar technology for better light trapping, lower series resistance, improved current collection and enhanced reliability
- Reduce installation cost with higher power bin and efficiency
- Boost performance in warm weather with low temperature coefficient and operating temperature



Dual-glass Design, more secure and sustainable

- Upgraded dual glass of Vertex S, less prone to micro-cracks and scratches on the back during installation
- Double-glass + innovative non-destructive cutting for improved mechanical resistance and strength
- Fire class rating C, salt spray, sand dust, ammonia performance which is fully applicable in coastal, high temperature, humidity area and harsh environment



Ultra-low Degradation, longer warranty, higher output

- First-year degradation 1% and annual degradation at 0.4%
- 25 years product warranty and 30 years power warranty



Universal solution for residential and C&I rooftops

- Easy for integration, designed for compatibility with existing mainstream inverters and diverse mounting systems
- Perfect size and low weight for handling and installation
- Most valuable solution on low load capacity rooftops (weight similar to backsheet version)
- Mechanical performance up to 5400 Pa positive load and 4000 Pa negative load

Trina Solar's Dual Glass Performance Warranty

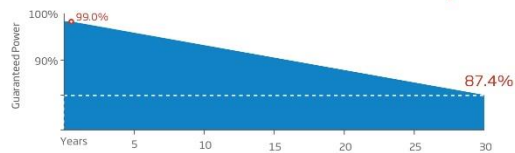

Comprehensive Products and System Certificates



ISO 9001: Quality Management System
 ISO 14001: Environmental Management System
 ISO14064: Greenhouse Gases Emissions Verification
 ISO45001: Occupational Health and Safety Management System



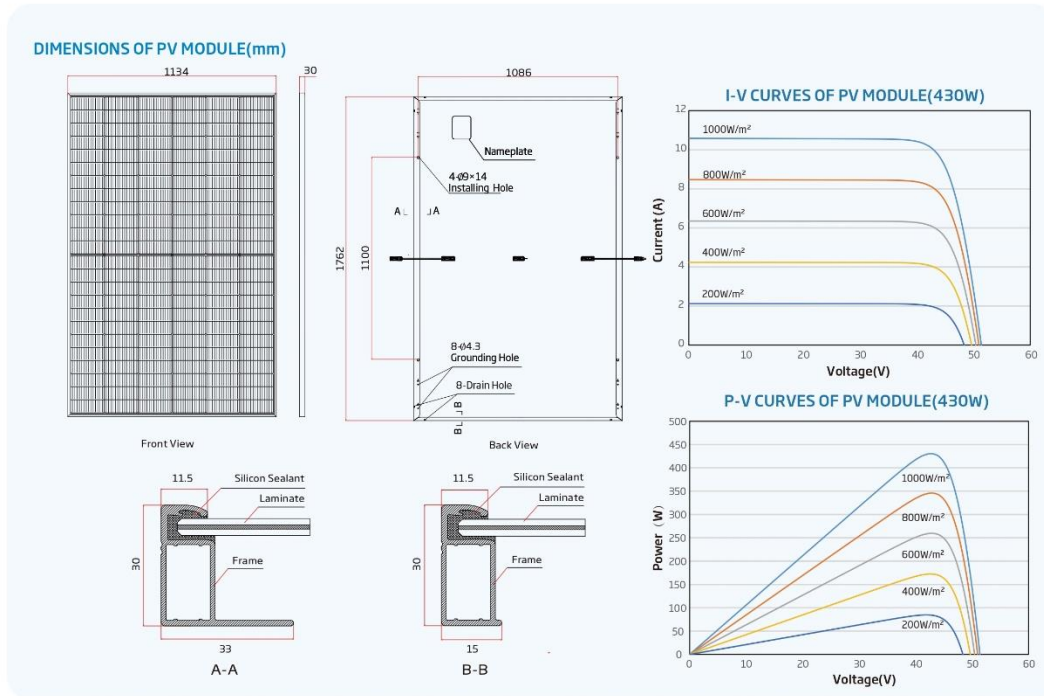

ELECTRICAL DATA (STC) TSM-XXXNEG9R.28(XXX=420-440)

	420	425	430	435	440
Peak Power Watts- P_{MAX} (Wp)*	420	425	430	435	440
Binning Tolerance- P_{MAX} (W)	0 ~ +5				
Maximum Power Voltage- V_{MPP} (V)	42.5	42.9	43.2	43.6	44.0
Maximum Power Current- I_{MPP} (A)	9.89	9.92	9.96	9.99	10.01
Open Circuit Voltage- V_{OC} (V)	50.5	50.9	51.4	51.8	52.2
Short Circuit Current- I_{SC} (A)	10.53	10.56	10.59	10.64	10.67
Module Efficiency η_m (%)	21.0	21.3	21.5	21.8	22.0

STC: Irradiance 1000W/m², Cell Temperature 25°C, Air Mass AM1.5. *Measuring tolerance: ±3%

ELECTRICAL DATA (NOCT)

	320	324	328	332	335
Maximum Power- P_{MAX} (Wp)	320	324	328	332	335
Maximum Power Voltage- V_{MPP} (V)	39.7	40.0	40.4	40.7	41.0
Maximum Power Current- I_{MPP} (A)	8.07	8.09	8.11	8.15	8.17
Open Circuit Voltage- V_{OC} (V)	47.8	48.2	48.7	49.1	49.4
Short Circuit Current- I_{SC} (A)	8.49	8.51	8.53	8.57	8.60

NOCT: Irradiance at 800W/m², Ambient Temperature 20°C, Wind Speed 1m/s.

MECHANICAL DATA

Solar Cells	N type
No. of cells	144 cells
Module Dimensions	1762×1134×30 mm (69.06×43.15×1.18 inches)
Weight	21.1kg (46.5 lb)
Front Glass	1.6 mm (0.06 inches), High Transmission, AR Coated Heat Strengthened Glass
Encapsulant material	EVA/POE
Back Glass	1.6mm(0.06 inches), Heat Strengthened Glass
Frame	30mm (0.06 inches) Anodized Aluminium Alloy, Black
J-Box	IP 68 rated
Cables	Photovoltaic Technology Cable 4.0mm ² (0.006 inches ²), Portrait: 350/280 mm(13.78/11.02 inches) Length can be customized
Connector	Stabul MC4 EVO2 / Trina Solar TS4

TEMPERATURE RATINGS	MAXIMUM RATINGS
NOCT(Nominal Operating Cell Temperature)	43°C (±2°C)
Temperature Coefficient of P_{MAX}	-0.30%/°C
Temperature Coefficient of V_{OC}	-0.24%/°C
Temperature Coefficient of I_{SC}	0.04%/°C
Operational Temperature	-40 ~ +85°C
Maximum System Voltage	1500V DC (IEC)
Max Series Fuse Rating	25A

WARRANTY	PACKAGING CONFIGURATION
25 year Product Workmanship Warranty**	Modules per box: 36 pieces
30 year Power Warranty	Modules per 40' container: 936 pieces
1% first year degradation	
0.4% Annual Power Attenuation	

(**Please refer to Limited Warranty Supplement that applies to the TSM-XXXNEG9R.28, TSM-XXXNEG9R.27, Products supplied after 1st Jan 2023 and installed within Australia & New Zealand residential rooftop market.)

SG25/30/36/40CX-P2

Multi-MPPT String Inverter for 1000 Vdc System



☀️ HIGH YIELD

- DC 15A current input, compatible with over 500Wh+ PV module
- Dynamic shading optimization mode
- Built-in PID recovery function

💡 SMART O&M

- Key component diagnosis and protection
- Smart IV Curve Diagnosis
- Grid fault record function, easy for remote O&M

🛠️ LOWER INVESTMENT

- Easy to handle thanks to 34% weight reduced
- Plug and Play with Buckle Design

🛡️ PROVEN SAFETY

- IP66 protection and C5 Anti-corrosion
- DC Type I+II SPD, AC Type II SPD
- Support AFCI 2.0 function

CIRCUIT DIAGRAM

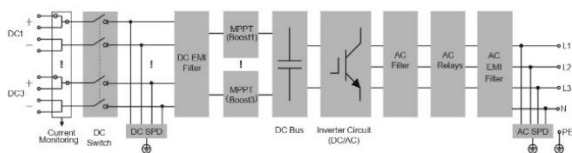

EFFICIENCY CURVE (SG33CX-P2)

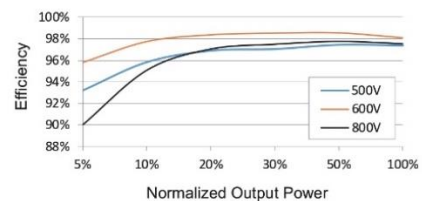

Type designation	SG25CX-P2*	SG30CX-P2*	SG36CX-P2*	SG40CX-P2*
Input (DC)				
Recommended max. PV input power	35 kWp	42 kWp	50.4 kWp	56 kWp
Max. PV input voltage	1100 V			
Min. PV input voltage / Startup input voltage	160 V / 200 V			
Rated PV input voltage	600 V			
MPP voltage range	160 V - 1000 V			
No. of independent MPP inputs	3	3	4	4
No. of PV strings per MPPT	2	2	2	2
Max. PV input current	90 A (30 A * 3)	90 A (30 A * 3)	120 A (30 A * 4)	120 A (30 A * 4)
Max. DC short-circuit current	120 A (40 A * 3)	120 A (40 A * 3)	160 A (40 A * 4)	160 A (40 A * 4)
Max. current for DC connector	20A			
Output (AC)				
Rated AC output power	25 kVA	30 kVA	36 kVA	40 kVA
Max. AC output apparent power	27.5 kVA	33 kVA *	40 kVA	44 kVA
Max. AC output current	41.8 A	50.2 A	60.2 A	66.9 A
Rated AC output current(at 230V)	36.2 A	43.5 A	52.17 A	58 A
Rated AC voltage	3 / N / PE, 220 / 380 V, 230 / 400 V			
AC voltage range	312 - 480 V			
Rated grid frequency	50 Hz / 60 Hz			
Grid frequency range	45 - 55 Hz / 55 - 65 Hz			
Harmonic (THD)	< 3 % (at rated power)			
Power factor at rated power / Adjustable power factor	> 0.99 / 0.8 leading - 0.8 lagging			
Feed-in phases / connection phases	3 / 3-N-PE			
Efficiency				
Max. efficiency / European efficiency	98.4% / 98.2%	98.5% / 98.3%	98.5% / 98.3%	98.5% / 98.3%
Protection				
Grid monitoring	Yes			
DC reverse connection protection	Yes			
AC short-circuit protection	Yes			
Leakage current protection	Yes			
Surge protection	DC Type I+II / AC Type II			
Ground fault monitoring	Yes			
DC switch	Yes			
PV String current monitoring	Yes			
Arc fault circuit interrupter (AFCI)	Yes			
PID recovery function	Yes			
General Data				
Dimensions (W*H*D)	645*575*245 mm			
Mounting Method	Wall-mounting bracket			
Weight	38 kg	38 kg	40 kg	40 kg
Topology	Transformerless			
Degree of protection	IP66			
Corrosion	C5			
Night power consumption	< 5W			
Operating ambient temperature range	-30 to 60 °C			
Allowable relative humidity range (non-condensing)	0 - 100 %			
Cooling method	Smart forced air cooling			
Max. operating altitude	4000 m			
Display	LED, Bluetooth+APP			
Communication	RS485 / Optional: WLAN, Ethernet			
DC connection type	EVO2 (Max. 6 mm ²)			
AC connection type	OT terminal (16~35 mm ²)			
AC Cable specification	Outside diameter 18~38mm			
Grid Compliance	IEC 62109, IEC 61727, IEC 62116, VDE-AR-N 4105:2018, IEC 61000-6-3, EN 50549-1, CEI 0-21 2019, CEI0-16 2019, VDE 0126-1-1/A1 VFR 2019, UTE C15-712-1:2013, UNE 206007-1/RD 1699, UNE 217002, G99			
Grid Support	Q at night function, LVVRT, HVVRT, active & reactive power control and power ramp rate control			

*Product subjected to minimum quantity order, reach out Sungrow Sales office for more information

Appendix H: Battery Storage

Among the different types of batteries, both Lead Acid and Lithium-ion (Li-ion) are viable choices for projects. Lead-acid batteries are available in two variations: Flooded Lead Acid (FLA) and Sealed Lead Acid (SLA). FLA batteries, being less expensive than SLA batteries, boast a longer discharge cycle, rendering them suitable for reserve power appliances. However, FLA batteries necessitate regular maintenance, and proper ventilation, and are susceptible to extreme climates. Similarly, SLA batteries, while also more economical than Li-ion batteries, feature a longer discharge cycle and are leak-proof. Despite being referred to as maintenance-free, SLA batteries still require some upkeep and ventilation, albeit less than FLA batteries. In contrast, Li-ion batteries present numerous advantages over Lead-Acid batteries. They are leak-proof, maintenance-free, and boast a lifespan of up to 10 years. Li-ion batteries also lack hydrogen gas emissions and offer superior efficiency, energy density, and power density. Their ability to operate within a wider temperature range makes them better suited for diverse climates. Given the high temperatures experienced in both Morocco and Algeria, the selection of the Li-ion battery, as depicted in Figure below, ensures enhanced safety and longevity (Albright et al., 2012).

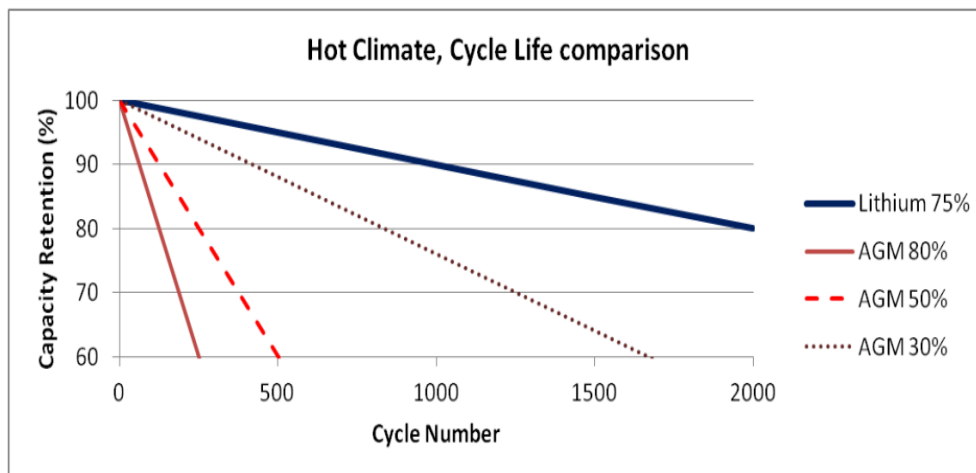

Figure 9.1 Capacity Retention in relation to Hot Temperatures (Albright et al., 2012)

SBR096/128/160/192/ 224/256

Hochspannungs-LFP-Batterie



HOHE LEISTUNG

- Bis zu 30 A Dauerlade- und -entladestrom mit hohem Wirkungsgrad
- Bis zu 100 % nutzbare Energie



SICHERHEIT

- Lithium-Eisenphosphat-Batterie
- Mehrstufiges Schutzkonzept und umfassende Sicherheitszertifizierung



FLEXIBILITÄT

- Erweiterungsfähig während der Lebensdauer
- Unterstützung von 3-8 Modulen pro Einheit, max. 4 Einheiten parallel, 9-100 kWh Leistungsspanne









EINFACHE INSTALLATION

- Kompakt und leicht, Installation durch eine einzige Person
- Plug & Play, keine Verkabelung zwischen den einzelnen Batteriemodulen erforderlich



© 2022 Sungrow Power Supply Co., Ltd. Alle Rechte vorbehalten. Änderungen ohne Vorankündigung vorbehalten. Version 13

Typenbezeichnung	SBR096	SBR128	SBR160	SBR192	SBR224	SBR256
Technische Eigenschaften	 3 Module	 4 Module	 5 Module	 6 Module	 7 Module	 8 Module
Systemdaten						
Batterietyp	LiFePO4 prismatische Zelle					
Batteriemodul	3,2 kWh, 33 kg					
Energie (nutzbar) ¹	9,6 kWh	12,8 kWh	16 kWh	19,2 kWh	22,4 kWh	25,6 kWh
Nennspannung	192 V	256 V	320 V	384 V	448 V	512 V
DC-Nennleistung	5,76 kW	7,68 kW	9,60 kW	11,52 kW	13,44 kW	15,36 kW
Betriebsspannung	150 - 219 V	200 - 292 V	250 - 365 V	300 - 438 V	350 - 511 V	400 - 584 V
Maximaler Lade-/Entladestrom: Dauerbetrieb	30 A					
Entladungstiefe	Max. 100 % DOD (einstellbar)					
Kurzschlussstrom	3500 A					
Anzeige	SOC-Anzeige, Statusanzeige					
Kommunikationsschnittstelle	CAN					
Schutz						
Über-/Unterspannungsschutz	Ja					
Überstromschutz	Ja					
Schutz vor Über-/Untertemperatur	Ja					
DC-Unterbrecher	Ja					
Allgemeine Daten						
Abmessungen (B*H*T)	625 x 545 x 330 mm	625 x 675 x 330 mm	625 x 805 x 330 mm	625 x 935 x 330 mm	625 x 1065 x 330 mm	625 x 1195 x 330 mm
Gewicht	114 kg	147 kg	180 kg	213 kg	246 kg	279 kg
Standort	Innenbereich/Außenbereich					
Befestigung	Bodenständer					
Umgebungstemperatur zum Betrieb	Ladung: 0 bis 50 °C Entladung: -20 bis 50 °C					
Schutzart	IP55					
Zulässige relative Luftfeuchtigkeit	0 % bis 95 % nicht kondensierend					
Max. Betriebshöhe	Max. 4000 m					
Kühlverfahren	Natürliche Konvektion					
Zertifizierungen	CE, CEC, IEC 62619, IEC 62040, UN38.3, VDE 2510-50					
Gewährleistung ²	10 Jahre					

1: Testbedingungen: 25°C, 100 % Entladungstiefe (DOD), 0,2C Laden und Entladen

2: Siehe Batterie-Garantieerklärung für bedingte Anwendung.