

**TECHNISCHE HOCHSCHULE INGOLSTADT**

**FACULTY OF MECHANICAL ENGINEERING**

**MSc. RENEWABLE ENERGY SYSTEMS**

**MASTER'S THESIS**

**A business case study of green hydrogen production  
using photovoltaics in Germany**

**Submitted by**

**Vaibhav Armal**

**Issued on: 30.05.2022**

**Submitted on: 13.07.2022**

**First Examiner: Prof. Dr.-Ing Daniel Navarro Gevers**

**Second Examiner: Prof. Dr.-Ing. Sergej Diel**



## Declaration (§ 18 Para. 4 Nr. 7 APO THI)

I hereby declare that this thesis is my own work, that I have not presented it elsewhere for examination purposes and that I have not used any sources or aids other than those stated. I have marked verbatim and indirect quotations as such.

Ingolstadt, (13.07.2022)

A handwritten signature in black ink, appearing to read 'V. Armal', is written over a horizontal line.

Vaibhav Armal

# Acknowledgement

It was my immense pleasure to study and work at Technische Hochschule Ingolstadt. First of all, I would like to thank the university for giving me this opportunity to be a part of the prestigious organisation and working under the guidance of such well-qualified tutors.

Next, I would like to thank my supervisor Prof. Dr.-Ing. Daniel Navarro Gevers for his well-planned assistance and guidance throughout the whole process. Working under his supervision was a great learning experience.

Lastly, I would like to thank all my family, friends, and colleagues for believing in me and supporting and motivating me during the process.

# Abstract

The world is moving forward, and its energy need is also increasing daily. Currently, a significant amount of this energy comes from a finite resource called fossil fuels. The biggest problem with this resource is the high amount of carbon emissions, which has an adverse impact on the environment in the form of global warming, greenhouse gases, ozone layer depletion, etc. This in turn could lead to dangerous consequences for the planet and the ecosystems. Governments across the globe are getting serious and taking big resolutions toward green energy, but the set targets are big and still far away. High motivation and strong will among the top leaders are necessary to achieve the target of using green energy for most of the world's energy demands. This must be met with prompt actions and a decisive approach. Hydrogen, the resource available abundantly in the atmosphere, can be the biggest hope towards this target. Studies have shown that hydrogen can take the green energy revolution a long way if produced on a large scale.

A renewed and widespread hydrogen momentum is growing in the energy market. The last years have witnessed a substantial increase in demand for hydrogen, including several countries introducing and developing new hydrogen national strategies and many private companies leaning toward investing in hydrogen-related projects. Green hydrogen's environment-friendly and versatility will lead the world toward a hydrogen economy [1].

Though there are increased investments in the technological advancement in green hydrogen, there exist many unresolved issues related to technical and infrastructural challenges. Nevertheless, a clean and renewable hydrogen economy will not only fight climate change but also offers a comprehensive infrastructure for new opportunities in terms of jobs and employment. Hydrogen may play a crucial role in restructuring the international alliances and conflicts regarding global transformation and decarbonisation of the energy market. As mentioned in [1], by 2050, hydrogen can supply up to 24% of the world's energy needs

This paper is inclined towards a quantitative assessment of the hybrid (with and without battery storage) green hydrogen production system in terms of working and financial feasibility.

# Table of Contents

Declaration (§ 18 Para. 4 Nr. 7 APO THI)	i
Acknowledgement	ii
Abstract	iii
List of Tables	vi
List of Figures	vii
List of Abbreviations	ix
1. Introduction	1
2. Hydrogen as an atom	2
2.1. Importance and usage	2
2.2. Methods of production and different shades	3
3. Electrolyzers and their types	4
3.1. Functioning	4
3.2. Technology	5
3.2.1. Alkaline electrolyzers	5
3.2.2. Solid polymer (polymeric membrane) electrolyzers	5
3.2.3. High-temperature electrolyzers	5
4. Fuel cells and their types	6
4.1. Functioning	7
4.2. Types of fuel cells	8
4.2.1. Proton exchange membrane fuel cells (PEMFC) or polymer electrolyte fuel cells (PEFC)	10
4.2.2. Alkaline fuel cells (AFC)	10
4.2.3. Phosphoric acid fuel cells (PAFC)	10
4.2.4. Solid oxide fuel cells (SOFC)	10
4.2.5. Molten carbonate fuel cells (MCFC)	11
4.2.6. Direct methanol fuel cells (DMFC)	11
4.2.7. Reversible fuel cells	11
5. Green hydrogen	12
6. Business case study	13
6.1. Aim	13
6.2. Available data	15
6.3. Sizing guidelines	17
6.3.1. Photovoltaic system	17
6.3.2. Battery system	18
6.3.3. Electrolyzer system	20
6.3.4. Fuel cell system	21
6.3.5. Heat pump	22

6.4.	Calculation process.....	24
6.5.	Simulations.....	29
6.6.	Results.....	43
6.7.	Calculating the cost of energy.....	57
7.	Storage.....	58
8.	Transportation.....	60
8.1.	Advantages and disadvantages of hydrogen as a transport fuel.....	62
9.	Future scope.....	63
10.	Conclusion.....	65
11.	References.....	A
12.	Appendix.....	D
12.1.	Battery Datasheet.....	D
12.2.	UPS Datasheet.....	E
12.3.	Electrolyzer Datasheet.....	I
12.4.	Fuel Cell Datasheet.....	K
12.5.	Heat Pump Datasheet.....	M
12.6.	Solar Module Datasheet.....	O
12.7.	Helioscope Simulation Results.....	Q
12.8.	Hydrogen Storage Tank Datasheet.....	T

## List of Tables

Table 1: Shades of hydrogen and production methods [11].....	3
Table 2: Principle operation characteristics of some fuel cells [17] .....	9
Table 3: Physical properties of some fuel cells [17] .....	9
Table 4: Energy requirement of the office building.....	16
Table 5: Total energy requirement of the office building .....	16
Table 6: Final energy consumption of the office building .....	23
Table 7: Four different load profiles for simulation .....	25
Table 8: HOMER Result 1 .....	36
Table 9: HOMER Result 2 .....	37
Table 10: Costs of the system components used in HOMER simulation.....	38
Table 11: Costs of the system components used in developed excel tool simulation...39	
Table 12: The characteristics of hydrogen gas transmission technologies [43].....	61



# List of Figures

Figure 1: PEM Fuel Cell .....	8
Figure 2: Flow of electricity from the PV system .....	14
Figure 3: Office building .....	15
Figure 4: PV plant overview.....	18
Figure 5: Single Battery Module.....	19
Figure 6: Battery Life Cycle.....	20
Figure 7: Electrolyzer Single Module.....	21
Figure 8: Fuel Cell Single Module.....	22
Figure 9: Heat Pump .....	24
Figure 10: Battery Bank Supply .....	26
Figure 11: PV Energy flow into Electrolyzer.....	27
Figure 12: Fuel Cell Energy Flow.....	28
Figure 13: Case 1 Result .....	31
Figure 14: Case 1.2.....	33
Figure 15: Case 1.3.....	34
Figure 16: Homer Result 1 Summary.....	37
Figure 17: Homer Result 2 Summary.....	38
Figure 18: Excel Tool Result 1 Summary.....	40
Figure 19: Excel Tool Result 2 Summary.....	41
Figure 20: Electrolyzer Size Variation Result 1.1 .....	44
Figure 21: Electrolyzer Size Variation Result 1.2.....	46
Figure 22: Electrolyzer Size Variation Result 1.3.....	48
Figure 23: Electrolyzer Size Variation Result 1.4.....	49
Figure 24: Electrolyzer Size Variation Result 1.5.....	50
Figure 25: Electrolyzer Size Variation Result 1.6.....	51
Figure 26: Hydrogen Tank Size Variation Result 1.7.....	53
Figure 27: Hydrogen Tank Size Variation Result 1.8.....	54
Figure 28: Battery Unit Size Variation Result 1.9.....	56
Figure 29: Hydrogen storage applications [41].....	59
Figure 30: COE Comparison .....	65
Figure 31: Battery datasheet .....	D
Figure 32: UPS datasheet.....	E
Figure 33: Electrolyzer datasheet.....	I
Figure 34: Fuel cell datasheet.....	K

Figure 35: Solar module datasheet .....	O
Figure 36: Helioscope simulation results.....	Q
Figure 37: Hydrogen tank datasheet.....	T

## List of Abbreviations

CO <sub>2</sub>	Carbon dioxide
LPG	Liquefied petroleum gas
FT synthesis	Fischer–Tropsch synthesis
GTL synthesis	Gas to liquid synthesis
IC engine	Internal combustion engine
DME	Dimethyl ether
NaOH	Sodium hydroxide
HCL	Hydrochloric acid
NaCl	Sodium chloride
KOH	Potassium hydroxide
SPE	Solid polymer electrolyzer
PME	Polymer Membrane electrolyzer
HTE	High-temperature electrolysis
PEM	Polymer Electrolyte Membrane
SOFC	Solid-oxide fuel cells
PEFC	Polymer electrolyte fuel cells
AFC	Alkaline fuel cells
PAFC	Phosphoric acid fuel cells
MCFC	Molten carbonate fuel cells
DMFC	Direct methanol fuel cells
PV system	Photovoltaic system
LCE	Levelized cost of energy
NPC	Net present cost
ACS	Annualized cost of the system
IRR	Internal rate of return

PBP	Payback period
COP	Coefficient of performance
HDD	Heating degree days
COE	Cost of energy
HOMER	Hybrid Optimization of Multiple Energy Resources
DOD	Depth of discharge

# 1. Introduction

The world has recently faced huge energy crises because of resource reduction and environmental problems. The increased use of fossil fuels across the newly developed energy infrastructure is said to be the largest source of CO<sub>2</sub> emissions, which is known to be responsible for global warming and climate change. In addition, the fall in crude oil supplies, political instability in the parts of the world with ample oil reserves, and strict regulations against emissions are generating a need for alternative energy resources or, as it can be said, the 'New fuel'. This new fuel must be technically feasible, readily available, environmentally acceptable, and economically competitive. Many such fuels have been proposed in the past years, e.g., biodiesel, natural gas, boron, LPG, methanol, and hydrogen.

One of these suggestions, hydrogen's specific energy content is the highest of all conventional fuels and is present in abundant amounts in the universe. Considering this, hydrogen could be the key contributor to sustainable development in future, as it can be produced in almost unlimited quantities using renewable energy. The biggest challenge to achieving this feat would be the future hydrogen cost, advancements in the technologies producing hydrogen from renewable energy sources, prices of competing energy systems, and the implication of stricter restrictions on greenhouse gases.

Hydrogen, a carbon-less fuel, holds the potential of being a dream fuel of the future, bringing many environmental, economic, and social benefits. It has the credibility of reducing foreign oil dependency and lowering the transportation sector's carbon emissions. Hydrogen has a high calorific value of 122 kJ/g, which is 2.75 times more than other hydrocarbon fuels. This paper studies hydrogen production in Germany using photovoltaic energy and its economic aspects. This study will try to evaluate the future potential and economic feasibility of hydrogen production using photovoltaic energy. [2]

The paper emphasizes the alternate ways of renewable electricity storage and its comparison with battery storage. It is now well known that battery storage is costly and cannot be used on a large scale. Also, it is impossible to store energy for a long time with battery storage technology. On the other hand, using excess electricity from renewable sources for hydrogen production and storing that hydrogen for long periods is possible. This stored hydrogen can be used anytime for electricity production using Fuel Cells. This study aims to evaluate the feasibility of this technology while comparing it with battery storage. In the following chapters, let's understand the processes and components involved in this technology.

## **2. Hydrogen as an atom**

According to the energy crisis and environmental concerns for power generation and high-valued chemical products, hydrogen has been said to be one of the most promising alternative energy carriers. Efficient technologies are necessary for hydrogen production to meet the requirements of global energy demands, which are continuously increasing every year [3].

Hydrogen has been widely used in many industrial processes such as petrochemical, steel, petroleum, and food. These days, hydrogen, also considered as a clean fuel, has recently been used as an alternative to fossil fuel usage, resulting in a dramatic increase in hydrogen demand, leading to less hydrogen supply because of restricted hydrogen sources. Conventionally, hydrogen is produced by steam reforming of natural gas or (LPG) liquified petroleum gas, which emits a high amount of gaseous carbon in the atmosphere causing environmental problems [3]. This resulted in the immediate requirement of alternative hydrogen resources, which must be environment friendly and available in abundant amounts. Green hydrogen made this possible while providing clean and pure hydrogen in large quantities without any carbon emissions.

### **2.1. Importance and usage**

Hydrogen has many potential applications in the real world. To list a few, hydrogen is used in ammonia synthesis and other nitrogenated fertilizer synthesis, hydrogenation of hazardous wastes (dioxins, PCBs), alternative fuels synthesis by Fischer–Tropsch (FT) synthesis, refining and desulphurization (hydrogenation reactions, hydrodesulfurization), gas to liquid (GTL) synthesis technology, chemical plants, food preparation, IC engine fuel, rocket fuel, synthesis of methanol, ethanol, dimethyl ether (DME), and high-temperature industrial furnaces fuel [4]. Ammonia (fertilizer) production itself consumes half of the total hydrogen produced today and is the primary chemical industry use of hydrogen. Table 1 shows the hydrogen consumption in the world by different usage [5].

Hydrogen is also being noticed and getting much attention as a fuel for transportation and stationary application as a technical and policy issue [6]. Hydrogen gas is also tested for use in IC engines and fuel cell electric vehicles. Fuel cells are in the process of being commercialized and can use hydrogen more efficiently. Many big car manufacturers in the world have already presented fuel cell vehicles and have even started to lease a small number of vehicles to selected customers. A hydrogen fuel cell vehicle is said to

be more advantageous over hydrogen-fueled IC engines or fuel cells powered by other fuels [7]. Hydrogen used in fuel cells can achieve high electric efficiency and even go above 90% if the heat generated from the electricity production process is used for heating purposes [8]. As explained in this paper, hydrogen and fuel cells are often considered the future key technology for sustainable energy supply.

## 2.2. *Methods of production and different shades*

Today the biggest resource for hydrogen production is natural gas [9]. Though there are many different technologies for hydrogen production, a wise way of hydrogen production should be selected which is economical and efficient to sustain the current market scenario and increasing demand. Most importantly, it should not have any carbon emissions [3].

That is why this paper emphasizes on electrolysis process, which is powered by electricity produced from the solar power plant. The electrolysis process has null direct carbon emissions. Hydrogen is named with different shades depending on its method of production. Some essential shades are Grey hydrogen, Blue hydrogen, Turquoise hydrogen, and Green hydrogen [10]. Similar to these shades, there are two more shades named as Pink hydrogen and Yellow hydrogen [11]. The following table shows the differentiation of these shades and the production methods.

*Table 1: Shades of hydrogen and production methods [11]*

<b>SHADES</b>	<b>METHOD</b>	<b>RESOURCE</b>
<b>GREY</b>	Steam methane reforming or gasification	Methane or coal
<b>BLUE</b>	Steam methane reforming or gasification with carbon capture (85-95%)	Methane or coal
<b>GREEN</b>	Electrolysis	Renewable Energy
<b>PINK</b>	Electrolysis	Nuclear Energy
<b>YELLOW</b>	Electrolysis	Solar Energy
<b>TURQUOISE</b>	Pyrolysis	Methane

### **3. Electrolyzers and their types**

It is well known that hydrogen is one of the most abundantly found elements in the universe, but it rarely exists as an independent molecule. Mostly, it is bound with other elements or molecules to form a compound like carbohydrates, water, nucleic acids and hydrocarbons. It is not easy to break the bonds connecting hydrogen and other elements and requires a certain amount of energy [15]. One fundamental process to split these particles is water electrolysis, which splits water into hydrogen and oxygen using electricity.

The process of separating hydrogen and oxygen from water using electricity is known as water electrolysis. This is the process of converting electric energy into chemical energy. The water electrolysis process, in particular, is important industrially as it produces a pure quality of hydrogen and oxygen. [12] [9] [13]

#### **3.1. Functioning**

An electrolytic cell is a device where oxidation-reduction reactions, also known as redox reactions, occur to decompose chemical compounds with the help of electric energy. An electrolyte in the cell, which is present in the form of a base (a hydroxide like NaOH), an acid (like HCL), or a salt (like NaCl), reacts with the solvent, which is usually water and splits into different ions as positive and negative ( $H^+$ ,  $Na^+$ ,  $OH^-$ , or  $Cl^-$ ). The process induces an electron flow through the external circuit by connecting two electrodes immersed in the electrolytic cell with the outer electric circuit, which is applied by an electromotive force and corresponded by an ion flow in the cell's internal electrolyte solution [14]. The electrons enter the cell through the cathode electrode, where the reduction half-reaction occurs, while the electrons exit the cell through the anode electrode, where the other oxidation half-reaction happens.

Industrial electrolyzers usually contain more electrolytic cells. To increase the productivity and distribute the voltage drop evenly, these electrolyzers are built with multiple cells connected in series and the metallic separator in between two cells works as a bipolar plate. It functions as the anode on one side and the cathode on the other.

The efficiency of electrolyzers is calculated as the ratio between the chemical energy contained in the produced hydrogen to the electrical power required for the process [15].



## **3.2. Technology**

### **3.2.1. Alkaline electrolyzers**

This type of electrolyzer occupies a large portion of the commercial electrolyzer market. They are constructed with the material resistant to the potassium hydroxide (KOH) attack and designed to prevent electrolyte leakage. The anode and cathode are made of nickel and nickel coated with platinum. They operate at around 70-85 °C, and the electric current density on electrodes is about 6-10 kA/m<sup>2</sup> and has an efficiency of about 75%-85%.

The alkaline electrolyzer comprises an electrolytic cell in which two electrodes are dipped in a water solution of (KOH) potassium hydroxide. The OH<sup>-</sup> ions move towards the anode to be oxidized (where it loses electrons) and release water, oxygen molecules and electrons, which enter the external circuit as per the following reaction [15]:



### **3.2.2. Solid polymer (polymeric membrane) electrolyzers**

In Solid polymer electrolyzer (SPE), or Polymer Membrane electrolyzer (PME), the electrolyte consists of solid polymer, which helps make construction and maintenance easier and more convenient. When it is saturated with water, the polymer becomes acid and permeable to ions. The cells are made with very thin electrolytes and the toughness of the membrane helps cells to function at a pressure up to 4 Mpa and temperatures between 80-150 °C.

The SPE gives good efficiency and high current density as they are made of rare and expensive materials (the cathode is built with porous carbon and the anode is built with porous titanium) [15] [14].

### **3.2.3. High-temperature electrolyzers**

High-temperature electrolysis (HTE) process, as its name says, requires high-temperature heat (around 1000°C) and a very costly production process, but it guarantees good results with a solid and non-corrosive electrolyte (which is based on yttrium and zirconium oxides) capable of conducting oxygen ions. The cathode is made of nickel, and the anode can be made of lanthanum, nickel oxides and nickel. The current density at the electrodes is estimated to be around 3-5 kA/m<sup>2</sup> and has a cell voltage in the range of 1-1.6 V, giving a hypothetically reachable efficiency of about 95% [15].

## 4. Fuel cells and their types

Fuel cells are the devices that convert chemical free energy in gaseous or liquid reactants electrochemically into electrical energy [13]. Because of the electrochemical process instead of the thermal process, fuel cells are the most energy-efficient devices to extract power from fuels. They can be used for extracting energy from a variety of fuels such as hydrogen, biogas, and natural gas. Fuel cells can provide clean power for various applications ranging from less than a watt to multiple megawatts.

As fuel cells work on open flow systems, they scale well for longer- and larger-scale operation, unlike batteries. This helps them to be explored and commercialized in large-scale energy conversion and electricity production, materials handling equipment, automotive and truck applications, and Auxiliary power units, to mention some of the applications [13].

Fuel cells can play an important part in the future by providing an alternative to petroleum, which is currently used in cars and trucks with cleaner and lower-emission fuels like hydrogen or natural gas [16]. Stationary fuel cells can be used for a backup power (even at remote locations), cogeneration (where the excess released heat in the electricity generation process is used for other applications), and distributed power generation. They can be very advantageous in reducing greenhouse gas emissions by using inexpensive natural gas and low-carbon fuels like biogas rather than combustion-based power generators. Fuel cells can be used for almost every portable application, which typically uses batteries, from hand-held devices to portable generators.

Though fuel cells are used with multiple fuel sources, this paper focuses on hydrogen fuel cell usage. Hydrogen is abundantly found in many forms on Earth. Though it is not readily found in its molecular form of  $H_2$ , it can be extracted or reformed from hydrocarbon fuels, biological and fossil, or water by using the "electrolysis" process, which works on the principle of water splitting [13].

Fuel cells convert the chemical energy in the hydrogen directly into electricity. The byproducts of the process are pure water and heat. This released heat can be used for heating purposes as well. Hydrogen-powered fuel cells are pollution-free and have more than two times the efficiency of traditional combustion technologies. The typical generation efficiency of a conventional combustion-based power plant is 33-35%, whereas fuel cell systems can have a generation efficiency of up to 60% or higher with cogeneration [16].

## **4.1. Functioning**

A single fuel cell is an electrolyte sandwiched between 2 electrodes, a cathode and an anode. The bipolar plates on both sides of the cell help distribute gases and serve as current collectors. In a Polymer Electrolyte Membrane (PEM) fuel cell, considered the most promising for light-duty transportation, hydrogen gas flows through channels towards the anode, where hydrogen molecules separate into protons and electrons due to catalyst. Here the membrane allows only protons to pass through it. When the protons pass through the membrane to the cell's other side, the negatively charged electrons travel along the external circuit to the cathode. This flow of electrons is called electricity, which can be used for various purposes.

Air reaches the cathode through the channels on the other side of the cell. When electrons return after completing the external circuit, they react with oxygen in the air and the protons at the cathode, resulting in water formation. This is the exothermic reaction which generates heat that can be used outside of the fuel cell.

The power output of the fuel cell depends on various factors like fuel cell type, size, operating temperature, and the pressure at which gases are supplied [16]. The output of a single fuel cell is in the range of 0.5 to 1 volt, which is hardly enough voltage for even the smallest application. This voltage can be increased by connecting multiple fuel cells in series and forming a stack. Usually, the term fuel cell is used for the whole stack. The stack size of the fuel cell depends on the application. It can range from a few cells to hundreds of cells connected together.

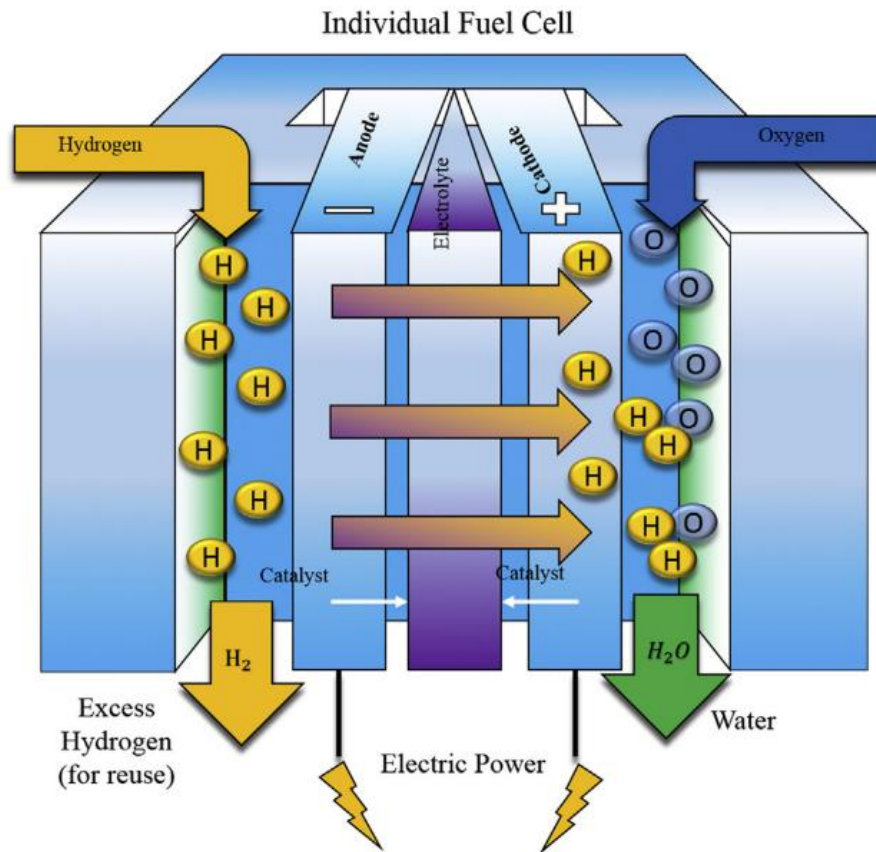

Figure 1: PEM Fuel Cell

(Source: [17])

## 4.2. Types of fuel cells

Classification of fuel cells is done based on their electrolyte, which is greatly correlated to the operating temperature. Solid-oxide fuel cells (SOFCs) operate at a higher temperature scale. They operate on various gaseous, liquid fuels at around  $700^\circ\text{C}$  and above with ceramic materials and oxygen anion conducting species. Molten carbonate (carbonate anions) works at a little lower temperature and then the proton-conducting cells, including phosphoric acid cells, work at even lower temperatures. Finally, the polymer electrolyte fuel cells which operate at  $100^\circ\text{C}$  or lower temperatures. These cells typically operate on hydrogen because of this temperature requirement. However, they may work with denser carriers such as methanol [13].

The below tables shows the principle operation characteristics and physical properties of some of the fuel cells.

Table 2: Principle operation characteristics of some fuel cells [17]

FUEL CELL TYPE	MOBILE ION	OPERATING TEMPERATURE °C	APPLICATIONS
PROTON EXCHANGE MEMBRANE, PEMFC, PEFC	H <sup>+</sup>	30 - 100	Vehicles, mobile equipment, low-power CHP systems
DIRECT METHANOL, DMFC	H <sup>+</sup>	20 - 90	Portable electronic systems with low power, long operating times
PHOSPHORIC ACID (PAFC)	H <sup>+</sup>	~ 200	Large numbers of 200 kW CHP systems
ALKALINE, AFC	OH <sup>-</sup>	50 - 200	Space vehicles
MOLTEN CARBONATE, MCFC	CO <sub>3</sub> <sup>2-</sup>	~ 650	Medium to large-scale CHP systems
SOLID OXIDE, SOFC	O <sup>2-</sup>	500 - 1000	All sizes of CHP systems

Table 3: Physical properties of some fuel cells [17]

FUEL CELL TYPE	MATERIAL AND CATALYST	OPERATING TEMPERATURE °C	ELECTROLYTE	EFFICIENCY
PROTON EXCHANGE MEMBRANE, PEMFC, PEFC	Carbon and Platinum	30 - 100	Solid membrane, e.g., Nafion	40 - 50
DIRECT METHANOL, DMFC	Platinum and Ruthenium	20 - 90	Solid membrane	20 - 50
PHOSPHORIC ACID (PAFC)	H <sup>+</sup>	~ 200	Phosphoric acid	40 - 50
ALKALINE, AFC	Carbon and Nickel	50 - 200	Potassium hydroxide	50 - 60
MOLTEN CARBONATE, MCFC	Stainless steel and Nickel	~ 650	Carbonated metal	> 60
SOLID OXIDE, SOFC	Ceramic and Perovskites	500 - 1000	Ceramics, e.g., YSZ	50 - 60

#### **4.2.1. Proton exchange membrane fuel cells (PEMFC) or polymer electrolyte fuel cells (PEFC)**

PEM fuel cell operates at relatively low temperatures, around 80°C. Their efficiency (conversion of hydrogen into electricity) is about 50-60%. In this type of fuel cell, the electrolyte is a solid polymer through which protons can penetrate. This type of fuel cell is being well promoted and is introduced as the power source for ground vehicles. These are small and compact in size and have good start-up behaviour.

PEM fuel cells are also considered as the power source for mobile and big stationary power plants. Their advantage is the solid phase electrolyte in the form of a thin polymer membrane. The surrounding catalyst used is of platinum. This cell is susceptible to the purity of the hydrogen provided. PEM fuel cells were also used on the first human-crewed spacecraft [17]. Though the platinum catalyst is costly, the discovery of the nickel-tin catalyst has helped boost its usage. As a result, these fuel cells can be used as an alternative for batteries in spacecraft.

#### **4.2.2. Alkaline fuel cells (AFC)**

This type of fuel cell is used in space vehicles for electricity generation and drinkable water production for astronauts. It has an energy efficiency of about 70% and operates at a temperature of 150-200°C. Its electrolyte mainly consists of potassium hydroxide (KOH). Its significant advantage is that it does not depend upon platinum as the catalyst. The input fuels used are generally pure hydrogen and oxygen; if the air is used (instead of oxygen), it must be free from CO<sub>2</sub> [17]. This fuel cell type was used in Apollo and Shuttle Orbiter craft.

#### **4.2.3. Phosphoric acid fuel cells (PAFC)**

Phosphoric acid fuel cells have been commercially in operation for a while now. It is used in hospitals, offices, schools, hotels, and airports. It has a conversion efficiency of 40-50%, which is slightly lower than other fuel cells. It operates in the temperature range of 150-200°C. Here the electrolyte is phosphoric acid [17]. These fuel cells are usually big in size and heavy, but the technology used is considered as mature.

#### **4.2.4. Solid oxide fuel cells (SOFC)**

The electrolyte which is used in solid oxide fuel cells (SOFC) is zirconia compounds. It conducts oxygen ions formed at the positive electrode [18]. This fuel cell type is considered a good choice for big units, even in remote locations. Its operating temperature is on a higher scale which is around 1000°C. Because of the high-

temperature range, high reaction rates can be attained without using expensive catalysts. Also, due to these high temperatures, gases, e.g., natural gas can be used directly or can be internally reformed without any separate reformer unit. It has an efficiency of up to 60% and can also be integrated with steam turbines to generate extra electricity.

#### **4.2.5. Molten carbonate fuel cells (MCFC)**

Fuel cell types, such as PEMFC (proton exchange membrane fuel cell), PAFC (phosphoric acid fuel cell), and AFC (alkaline fuel cell), operate on  $H^+$  and  $OH^-$  movements in the electrolyte. On the contrary, the SOFC (solid oxide fuel cell) and MCFCs (molten carbonate fuel cells) operate with carbonate ions  $CO_3^{2-}$  and oxide ions  $O^{2-}$ . [13]

Molten carbonate fuel cells need molten carbonates at around  $600^\circ C$ , and the efforts to manage and control molten carbonates in fuel cell heating appliances are also very tough, but the process is technically feasible [19]. The electrolyte used in this fuel cell consists of carbonates of lithium, potassium, and sodium. It has a working efficiency of about 60% and requires carbon dioxide in the air to function. Like SOFC, it can also be integrated with steam turbines to produce extra electricity.

#### **4.2.6. Direct methanol fuel cells (DMFC)**

The direct methanol fuel cell (DMFC) is similar to the PEMFC, but instead of hydrogen, methanol is used as a fuel [13]. It has a working efficiency of 30-40% and operates in the temperature range of 50-100C. DMFC can be used in portable devices such as mobiles, computers, etc. [17]. The advantage of these fuel cells is their fuel. Methanol is readily available in cartridges which can be easily connected without particular skill or training, unlike compressed gas cylinders [19].

#### **4.2.7. Reversible fuel cells**

A cell that can be used for both purposes, hydrogen generation by electrolysis and electricity production as a fuel cell is known as a reversible fuel cell [17]. Whenever there is extra electricity from solar or wind, the cell can operate as an electrolyzer and produce hydrogen by electrolysis process on water. In fuel cell mode, it will work reverse to produce electricity.

## 5. Green hydrogen

The idea of CO<sub>2</sub> emissions and global warming is not new; it was already said by Arrhenius a century ago that CO<sub>2</sub> released from fossil fuel combustion could cause the temperature to rise on earth, making it warm as the infrared opacity of earth's atmosphere will continue to increase [14]. To maintain the earth's temperature and avoid excessive CO<sub>2</sub> emissions, there is no alternative to using a clean and abundant energy source.

As per energy crisis and environmental concerns, hydrogen is one of the most favourable alternative energy carriers for power generation and expensive chemical products. [3] Hydrogen production is possible in many renewables and non-renewable ways, which vary in their greenhouse gas emissions. For hydrogen to be the future low-carbon energy system, it is necessary to accept and scale hydrogen production with environment-friendly methods, such as water electrolysis with the use of electricity produced from solar or wind generation systems. The hydrogen produced with this method is called "Green Hydrogen" [20].

Europe, particularly Germany, is one of the largest energy consumers. Its dependence on Russian gas is well known. Germany is focusing more on increasing its renewable energy generation capacity to become more energy independent. Though it is said that green hydrogen could be the best alternative for current fuel and greenhouse gas problems, it is also necessary to evaluate the actual potential of green hydrogen plants.

This paper focuses on designing and evaluating a small green hydrogen production and storage system, which could be used for electricity production in the winter months when the actual electricity generation from the solar system is shallow. The study aims to design a self-sustainable building using green hydrogen, battery bank, electrolyzer, and fuel cell system. The following chapters will focus on system design, operation, financial compatibility of the system compared to orthodox energy production and storage methods, and future scope and challenges for the system.



## 6. Business case study

Hydrogen and renewable energy sources share a strong synergy [21]. On one side, the benefits of hydrogen as a clean, efficient, and versatile fuel can only be realized if it is produced from renewable energy sources. On the other side, the energy produced from renewable sources needs storage. Hydrogen can be stored easily and for a long duration and hence could be a great source of energy storage for later use as a fuel for electricity production or transportation [22].

The business case to be studied here is one such effort to test the overall performance and feasibility of green hydrogen production and storage system with the help of electricity produced from an oversized photovoltaic system, an electrolyzer, fuel cell, and battery storage system as a backup.

The system will further be compared with the combination of only photovoltaic and battery storage systems to find out which could be the best-optimized system both financially and performance-wise.

### 6.1. Aim

Hydrogen is one of the most abundant and simplest elements found on Earth. It can store and deliver useful energy effectively, but it does not exist in its true form in nature. It has to be produced or extracted from the compounds containing it, which requires diverse and domestic resources. Currently, a large portion of total hydrogen is produced from fossil fuels, especially natural gas. One more way to produce hydrogen includes electrolysis using electricity from the grid or renewable sources. The hydrogen produced from the electrolysis method using electricity from solar or wind is the cleanest form of hydrogen, and with the current technological advancement, this technology is becoming cheaper and cheaper [23].

Germany has ideally two seasons, summer and winter. Each season occupies six months approximately. This paper aims to evaluate the financial feasibility of green hydrogen production in summer to use for winter electricity production. In the summer season, when the electricity generated from the photovoltaic system is much higher than the actual energy requirement of the building, the extra electricity generated can be used for hydrogen production with the help of the electrolysis method and this hydrogen can be stored to use in the winter season for electricity production with the help of fuel cells.

An excel tool is created for the evaluation of the system. The results from the excel tool are later compared with the simulation results from "HOMER" software for the exact configuration of the system. Further, the system will be divided into two parts, i.e., with and without battery storage system, to compare and find the best solution.

Before going further in the topic, it is very important to understand the energy flow in the system. There are more than four components in the system, and it is often very confusing to understand the exact flow of energy. The first and primary energy source in the system is the photovoltaic system. The electricity produced from the photovoltaic system travels throughout the system. The order of electricity flow is as shown below; going forward if it remains extra after every stage,

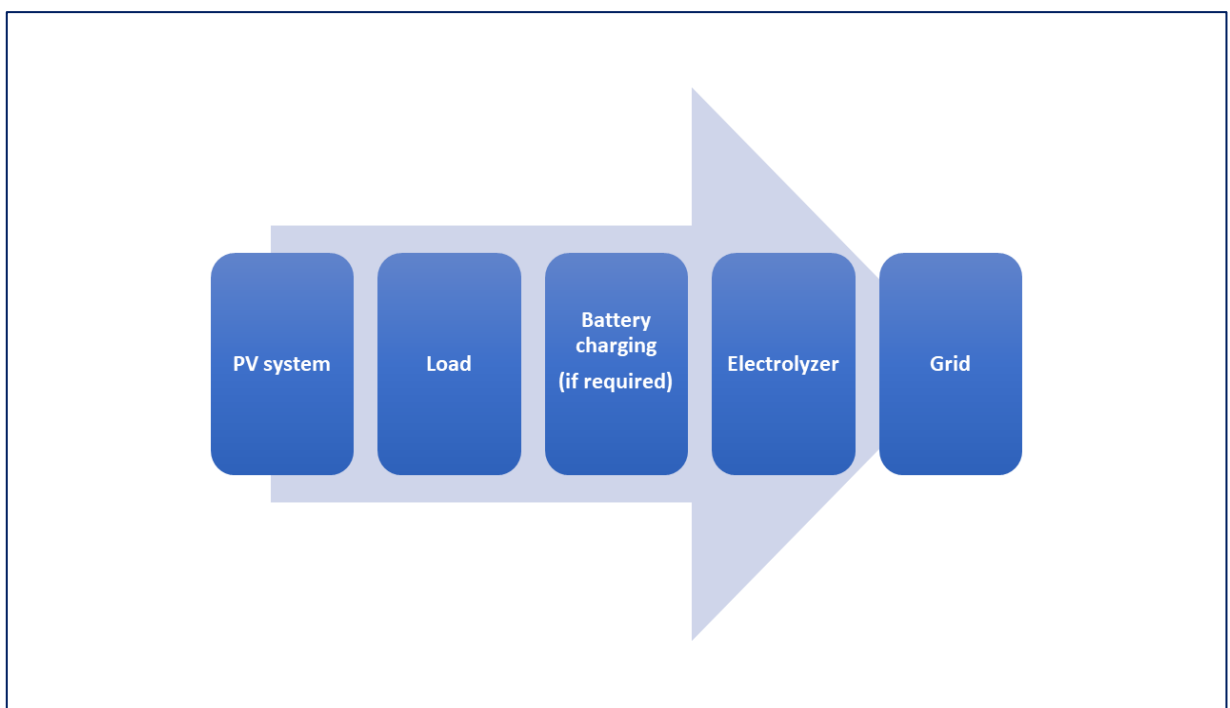

*Figure 2: Flow of electricity from the PV system*

The load first consumes the electricity from the photovoltaic system. If the electricity produced at that time is more than what loads require, it will be used for battery system charging. It will then be used for the electrolysis process in the electrolyzer if more energy is available after the battery charging stage. Lastly, the remaining electricity will be fed to the grid if it is still left. In the whole process, there is a certain amount of energy loss at every stage of energy conversion, e.g., the energy is converted from electric form to chemical while charging the batteries, or it is converted to gaseous form from electric in the electrolyzer. Every component has its efficiency, which cannot be changed. This energy loss must be considered when deciding the size of other components. The following chapters will explain the sizing method and its calculations for all the components in the system.

## 6.2. Available data

The system is planned for a commercial building of approximately 2100 m<sup>2</sup> area including warehouses and around 1120 m<sup>2</sup> office area located in Neuss, a city in North-Rhine Westphalia in Germany. The building has two parts, one is a pitched roof facing northeast and southwest, and the other part is a flat roof, as seen in the image below. The photovoltaic system is installed on a pitched roof parallel to the roof. The system is sized much bigger than the actual energy requirement of the building. It is because of the cost-effectiveness of solar energy and the provision of extra electricity for the electrolysis process.

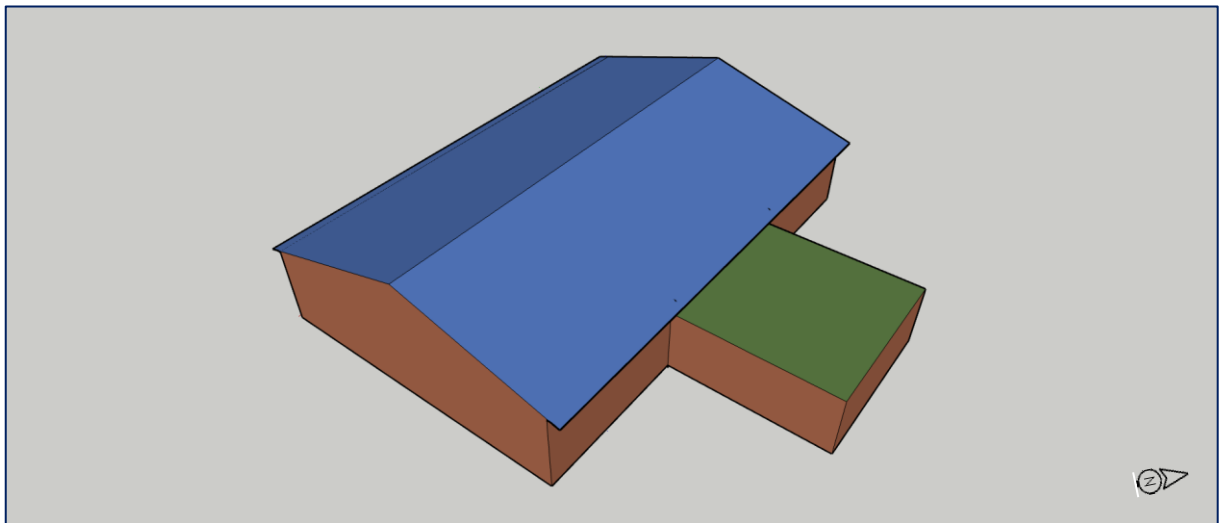

Figure 3: Office building

The energy requirements are given by the respective authorities of the building, and the values are given for a year. The requirement is as follows,

Table 4: Energy requirement of the office building

<b>Annual final energy demand for heating</b>	= 37.4 kWh/m <sup>2</sup> x 1,120m <sup>2</sup>	= 41,888 kWh
<b>Annual final energy demand for ventilation and cooling</b>	= 9.4 kWh/m <sup>2</sup> x 1,120m <sup>2</sup>	= 10,528 kWh
<b>Annual final energy demand for lighting and auxiliary power</b>	= 22.9 kWh/m <sup>2</sup> x 1,120m <sup>2</sup>	= 25,648 kWh
<b>Warehouse (lighting/production)</b>		= 15,000 kWh (estimated)
<b>Electromobility</b>		= 100,000 kWh (estimated)

The system needs to be sized according to the energy needs of the building so that energy generation should not be very less or very high than the requirement. Summarizing all the energy demands together, the final energy requirement of the building is as shown in the below table,

Table 5: Total energy requirement of the office building

<b>Living area [m<sup>2</sup>]</b>	1,120.00
<b>Number of persons in the building</b>	25.00
<b>Electricity consumption [kWh / a]</b>	51,199.05
<b>Heating requirements [kWh / a]</b>	41,888.00
<b>Electromobility [kWh / a]</b>	100,000.00
<b>Total energy consumption in KWh / a</b>	<b>193,087.05</b>

### **6.3. Sizing guidelines**

The renewable energy sources such as wind and solar are totally dependent on the weather and often fluctuate in power output. Storage systems are broadly accepted as the potential solution to filter these fluctuations. It offers advantages like continuous power delivery, fast response capability, and geographical independence [24]. But the most important thing during the implementation of storage systems is to determine the optimum sizing. It is crucial as it determines the balancing between technical improvements brought by the storage system and overall extra cost.

It is also necessary to optimize the other system components like storage systems. Proper sizing of the system not only increases system efficiency but also results in a low overall cost of energy. The following chapters will discuss some important principles to be considered while sizing different system components.

#### **6.3.1. Photovoltaic system**

A photovoltaic system is mainly installed in 4 different ways, first is to use the generated electricity for self-consumption and feed the remaining electricity to the grid; the second is to feed all the generated electricity to the grid; the third is self-consumption but in off-grid mode, where the extra generated electricity will be stored in storage systems instead of feeding it into the grid; and the fourth is the hybrid mode, where in addition to the photovoltaic system, other renewable sources, e.g., wind or biomass are also connected.

Every way of PV system installation has different sizing requirements to make it more beneficial, e.g., in the self-consumption system, if sized higher than the actual requirement, most of the produced electricity will go to the grid, which turns out to be non-profitable as the cost of energy per unit paid by the grid is often significantly less than the actual cost of electricity. Whereas, when the system is sized purely for feeding the grid, the higher sizing of the system will be beneficial.

The PV plant used in this system is sized higher than the actual energy requirement. It is because the energy produced from the PV plant is not only self-consumed but also used for storage and hydrogen production purposes. In the first phase of the calculation, the PV plant size is determined by the available space on the rooftop. As PV is the primary energy source in this system, it is necessary to first decide its sizing as per the space availability, and later with the help of the designed tool, the optimized size of the PV plant can be found.

The below image shows the planned installation of the PV plant.

The system is planned with Suntech STP405S-C54/Umh solar module. The module has a power output of 405W. Its dimensions are 1724x1134cx30 mm with a total weight of 22.1 kg. All the other properties of the module can be seen in the appendix section in the attached datasheet. The total system size is 388.8 kWp with 1360 modules (480 facing south-west and 480 facing north-east).

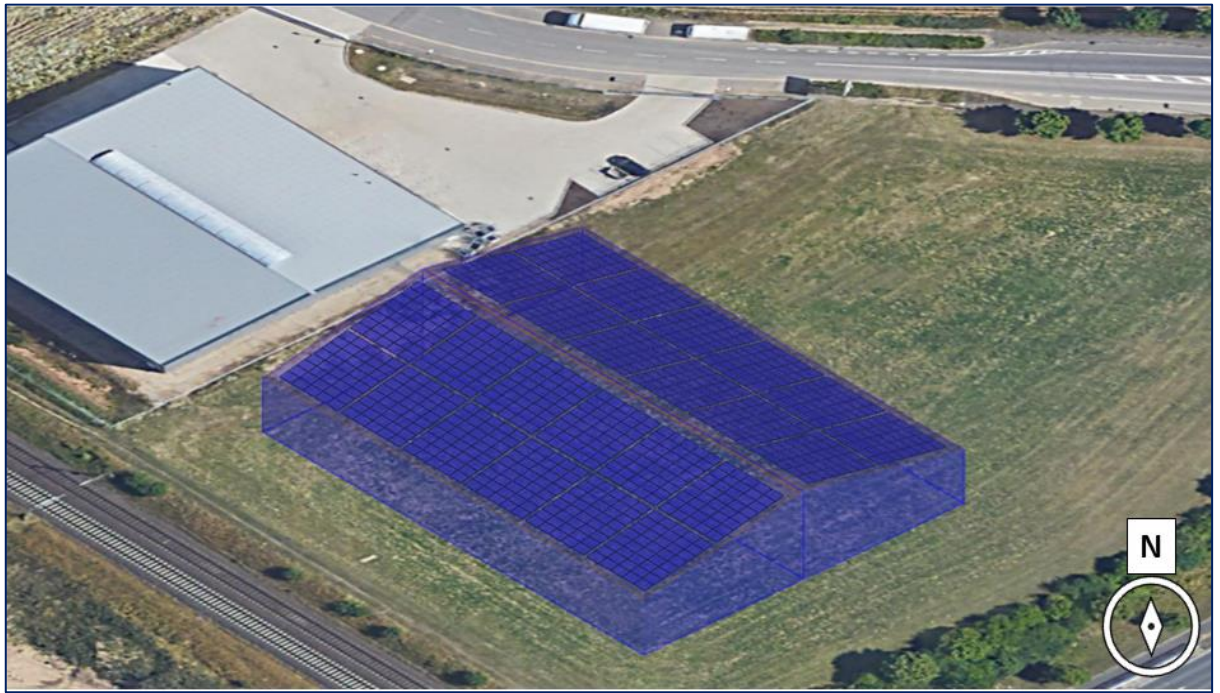

Figure 4: PV plant overview

### 6.3.2. Battery system

The energy storage system has been in use since the beginning itself. Germany used many local energy storages (batteries) in 1930 to stabilize and support the power system, specifically during nighttime. The energy storage system was a necessary part of the power system at that time as well. It was used for the continuous power supply at night, especially to overcome the problems of limited power supply from generators. The energy storage at that time comprised about 2% of total installed power (7GW) [25].

Energy storage systems are generally used to maintain power stability in case of power demand variations due to fluctuations of power flows produced from renewable energy sources and the dynamics of the necessary load profiles. [26] Cell voltage and impedance are the main factors determining the battery's power capability. The impedance of the battery can vary depending upon the current, time of charge/discharge, state of charge, and temperature. So it is essential to know the operating temperature, operating voltage range, and the duration of usage while sizing the battery system [27].

For sizing the storage system, it is also necessary to evaluate the system on economics and power reliability factors [28]. In economic criteria, parameters such as levelized cost of energy (LCE), net present cost (NPC), the annualized cost of the system (ACS), internal rate of return (IRR), payback period (PBP), etc. are to be considered. Also, as the solar and wind systems are highly intermittent, it is important to evaluate the system's reliability as well. System reliability assessment will give helpful information about energy generation, such as whether it can balance the load demand or not for a given amount of time.

There are many studies available to calculate the sizing of the battery bank. A Chauhan in [28] points out many approaches and methodologies reported in the literature. Also, L A Wong in [29] depicts some interesting techniques for sizing the optimum battery storage systems. One more attractive and easy way of sizing a battery system can be seen in [30] by Á A Bayod-Rújula.

The actual and optimal sizing of the battery system used for the current system will be found out later with the help of a comparison between the results from the developed excel tool and a simulation software 'Homer'. The battery used in this system is a 48V nominal voltage, 3552 Wh capacity lithium-ion battery from BatterX (seen in the below image). The different life cycles proposed by the company can also be seen in the below graph. The detailed datasheet can be seen in the appendix.



Figure 5: Single Battery Module

(Source: [https://www.batterx.io/wp-content/uploads/2018/11/batterX\\_Batterie-Lifepo-DE.pdf](https://www.batterx.io/wp-content/uploads/2018/11/batterX_Batterie-Lifepo-DE.pdf))

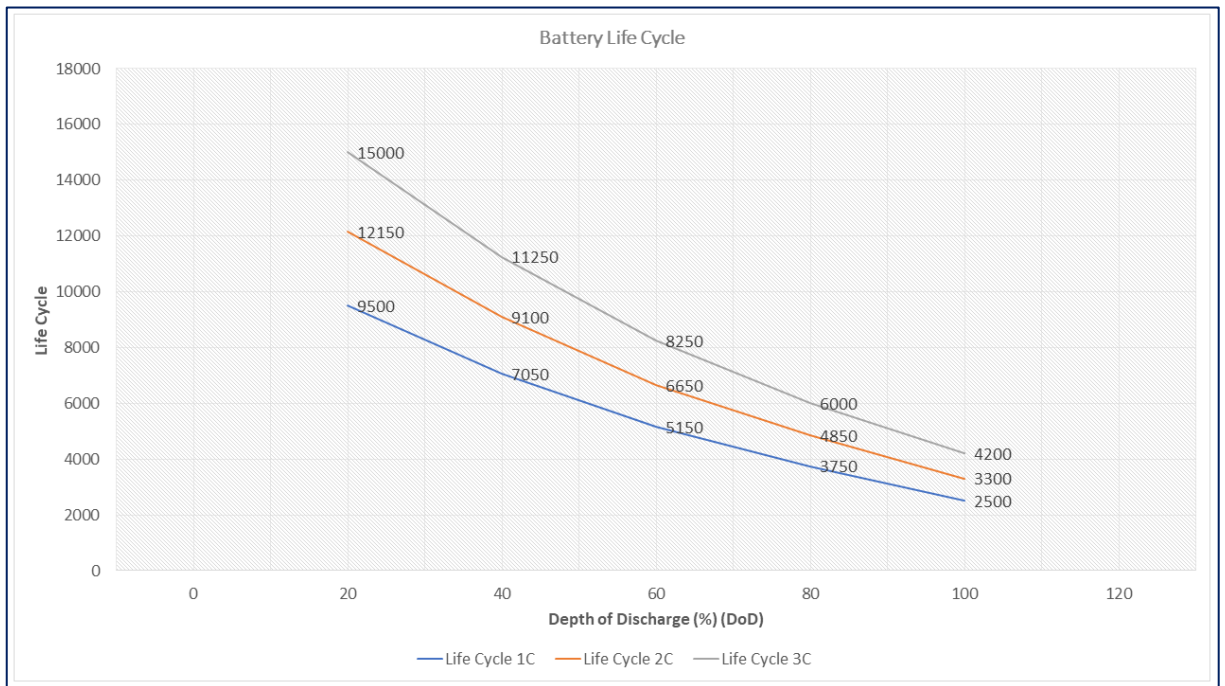

Figure 6: Battery Life Cycle

(Source: [https://www.batterx.io/wp-content/uploads/2018/11/batterX\\_Batterie-Lifepo-DE.pdf](https://www.batterx.io/wp-content/uploads/2018/11/batterX_Batterie-Lifepo-DE.pdf))

### 6.3.3. Electrolyzer system

O Atlam in [22] gives an electrolyzer sizing methodology depending on the relationship of MPP characteristic of a PV module and the I-V curve of the single PEM electrolyzer. T Maeda in [31] studies to find the best relationship between the control technique and the number of cells on the photovoltaic panel to attain the 0.48 Nm<sup>3</sup>/h hydrogen production rate with a power consumption of 2.25 kWe. J J Caparrós Mancera in [32] gives an overview of various studies carried out in the past for design and usage of PEM electrolyzers considering the balance of plants.

The current project is designed with the AEM 2.1 electrolyzer from Enapter (seen in the image below). It has a production rate of approx. 0.5Nm<sup>3</sup>/h, and it consumes 4.8kWh of electricity per Nm<sup>3</sup> hydrogen produced. Further parameters can be seen in the appendix. The total number of stacks required for the system will be find out at the end after comparing the results from the Homer simulation and excel tool.



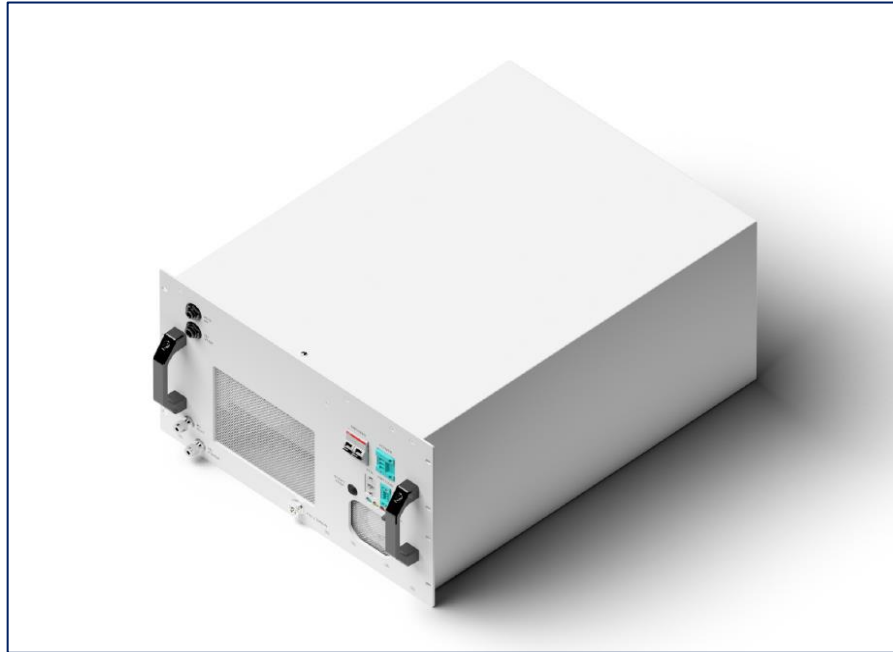

Figure 7: Electrolyzer Single Module

(Source: [https://handbook.enapter.com/electrolyser/el40/downloads/Enapter\\_Datasheet\\_EL40\\_EN.pdf](https://handbook.enapter.com/electrolyser/el40/downloads/Enapter_Datasheet_EL40_EN.pdf))

#### **6.3.4. Fuel cell system**

The power produced from the fuel cells should be distributed between the energy units in such a way that the fuel cell will supply constant average power (which will help in increasing the optimum efficiency of the fuel cell) and the storage system will provide the necessary peak power and continue to get recharged by fuel cells during the off-peak periods [33]. The combination of fuel cells with other storage types comes with many advantages. It helps in reducing the required battery power, resulting in longer battery life [34].

Using the fuel cell as the energy generator, batteries can act as an energy buffer, reducing the burden from every component in supplying power demands. This is mainly for the applications where load changes (peak power requirement) occur only at certain times. In such cases, this approach permits the components of the system to be downsized, reducing the overall system cost, and longer operating life cycles, low maintenance, and lower physical size, will result in higher system efficiency.

The fuel cell to be used in this system is PM 400-48 stack module produced by Proton Motors (seen in the image below). The module used has an output power range of 2.1-14.2 kW with an efficiency of about 50%. Further details are available in the appendix.

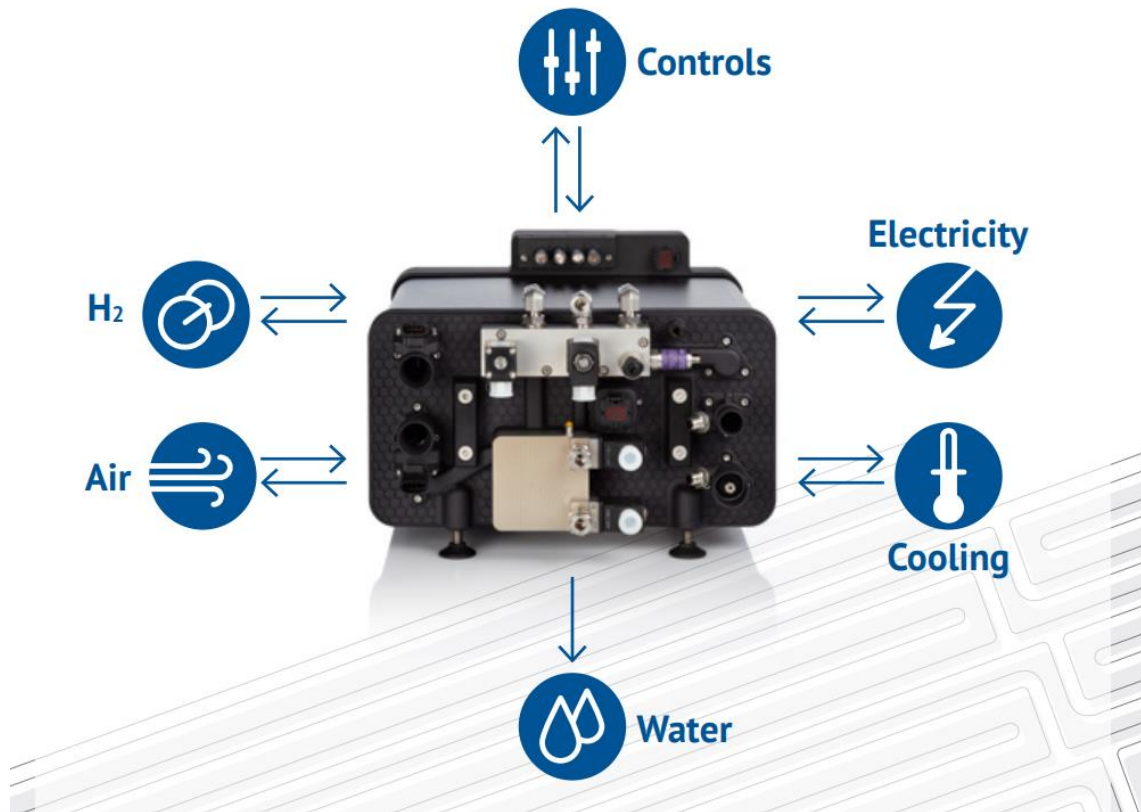

Figure 8: Fuel Cell Single Module

(Source: [https://www.batterx.io/wp-content/uploads/2018/11/batterX\\_Batterie-Lifepo-DE.pdf](https://www.batterx.io/wp-content/uploads/2018/11/batterX_Batterie-Lifepo-DE.pdf))

### 6.3.5. Heat pump

The required heating energy, though mentioned as 41,888 kWh/yr, is the energy in terms of heat. The system designed in this paper comprises an electric heat pump which will consume energy in terms of electricity and give output in the form of heat. Heat pumps usually have an efficiency of more than 300%, e.g., the heat pump used in this system can convert 1 kWh electricity into up to 5-6 kWh of heat energy. This conversion factor is known as the coefficient of performance (COP).

The heat pump has to be chosen according to the hourly average heat requirement of the building, which in this case is an unknown factor. The only known factor is the total heat requirement for one year. A heating degree days (HDD) method is opted to convert an initial value into hourly usage. Though the final hourly values are not the exact ones, it gives the basic idea about the average hourly heating requirement over the whole year and will be used as a basis for heat pump selection.

The heating degree day is a term used to calibrate the weather component in the user's heating load. In simple words, it is commonly used to evaluate the related energy consumption of the buildings for heating. Heating degree day is defined as a product of how much in degrees and the duration in days where the temperature outside the

building was below a certain level. The certain level mentioned here is known as 'Base Temperature', which is the outside temperature below which the building needs heating. For example, if the base temperature is considered to be 15.5°C, and the average outside temperature on a particular day is 13°C, then the heating degree day of that particular day is [35],

$$= (15.5 - 13) \text{ degree} \times 1 \text{ day}$$

$$= 2 \text{ degree day}$$

The base temperature considered here as 15.5°C is taken from the [36].

The values used for the heating degree days are calculated with a tool developed by 'degreedays.net'. The total heating degree days for the given location were calculated to be 1983.1 for the year 2021. The daily HDD values can be seen in the developed tool. These daily HDD values were later divided into 24 equal parts to get the hourly values. Though the final hourly value will not be the exact value, it can be used as an average reference value to choose the heat pump. After all the calculations, the average hourly heating load was found to be 4.78 kW, and the maximum hourly heating load was found to be 19.63 kW.

After much research, the 'SmartHeat Classic 016 WWi (W10/W35)' (seen in the image below) heat pump was finalized for calculation purposes. It offers a COP in the range of 5.93-6.52 for different ranges of power output between 3.36-16.62 kW. Further details are available in the datasheet attached in the appendix.

The final electric energy required for heating was calculated to be 7448.75 kWh. So, the final energy requirement of the building will be,

*Table 6: Final energy consumption of the office building*

<b>Electricity requirements in KWh per year</b>	51,199.05
<b>Heating requirements (in the form of electricity) [kWh / a]</b>	7448.75
<b>Electromobility [kWh / a]</b>	100,000.00
<b>Total energy consumption in KWh / a</b>	<b>158,647.8</b>



Figure 9: Heat Pump

(Source: [https://www.smartheat.de/fileadmin/media/downloads/SmartHeat\\_classic\\_2017\\_Auszug.pdf](https://www.smartheat.de/fileadmin/media/downloads/SmartHeat_classic_2017_Auszug.pdf))

## 6.4. Calculation process

To evaluate the total system performance, it is important to observe the individual performances of all the components in the system. It can be very easy if a tool could calculate and present the final outcomes of the system and all component's performances. This paper also explains the factors necessary while designing such a tool. This will help in the final comparison of the green hydrogen system when used with or without a battery storage system. It would be very easy and interesting to evaluate and compare with the help of actual numbers instead of mere approximations.

While designing any tool, it is essential to have the reference sizing for every component of the system. This helps in going further with the calculations; to be more precise, it helps in framing the conditional sets for inserting actual operating parameters of the component in the tool. For example, while writing the conditions for the electrolyzer system, the electrolyzer must operate only if there is extra electricity from the PV system after supplying primary load and battery charging. Having reference values of primary load and battery system helps determine the quantity and occurrence of the remaining energy. For that purpose, all the components seen in the previous chapters were sized on a reference basis (except the PV system), and the optimum sizing will be found at the end with the help of the designed tool. The results from the tool will then be compared with simulation results from Homer to examine the correctness.

The following chapters will explain the designing process of the tool, which incurs multiple steps as follows.

### **Step 1: Distribution and classification of load**

As mentioned in previous chapters, the total primary load is divided into three categories: electricity demand for complete lighting, heating demand in terms of electricity, and electromobility demand for charging electric vehicles. Four types of primary load profiles have been created to test the system's optimization with every kind of primary load. The first load profile has loads only from the lighting section. The load is distributed on an hourly basis over one year. This load profile is obtained from the facility authorities for the year 2021. The second load profile is the combination of the first load profile and heating demand. The third load profile is the combination of the first load profile and electromobility demand, and the fourth load profile is the combination of all the three categories. The total load requirement of all the load profiles is as shown in below table,

*Table 7: Four different load profiles for simulation*

<b>LOAD PROFILES</b>		
<b>ONLY LIGHTING (KWH)</b>	51.20	MWh
<b>LIGHTING AND ELECTROMOBILITY (KWH)</b>	151.199	MWh
<b>LIGHTING AND HEATING (KWH)</b>	58.65	MWh
<b>LIGHTING, ELECTROMOBILITY AND HEATING (KWH)</b>	158.65	MWh

It is important to know here that the electromobility load is an estimation based on the number of vehicles and their consumption. Also, this load, in particular, is distributed only on the working days (as there will be no charging on holidays) in the year from 8 A.M. to 6 P.M. On the other hand, the heating demand is not distributed only on working days. Instead, it is calculated for all the days, as the heater will not be switched ON and OFF on a daily basis.

This distribution of loads makes it easier to find the remaining amount of primary energy coming from the PV system, which will be used for the following stages. In the next step, the extra energy from the primary source will be used for battery charging (if needed) and then supplied to the electrolyzer for hydrogen production.

## Step 2: Battery system creation

Designing a battery system is the most critical phase of tool creation. The battery is the section which acts as a mediator between all the components in the system. Multiple conditions need to be considered for the battery system.

Condition 1: batteries will always prefer the PV energy in case of the charging phase. If it is not available, or not enough, in that case only it will use the energy from fuel cells.

Condition 2: in case of discharging, energy from the batteries will only be used for supplying the primary load. It can never be used as a supply for electrolyzer.

Condition 3: The battery should supply primary load only if the energy from the PV and fuel cell system is insufficient.

Condition 4: if the PV energy is more than what is needed for battery charging, the remaining energy should go to the electrolyzer.

Condition 5: for every charge/discharge cycle, the fluctuations in the battery state of charge should be visible.

Condition 6: there should be a counter to count the energy supplied and consumed by the battery system.

Condition 7: there should be a counter to count the number of battery cycles.

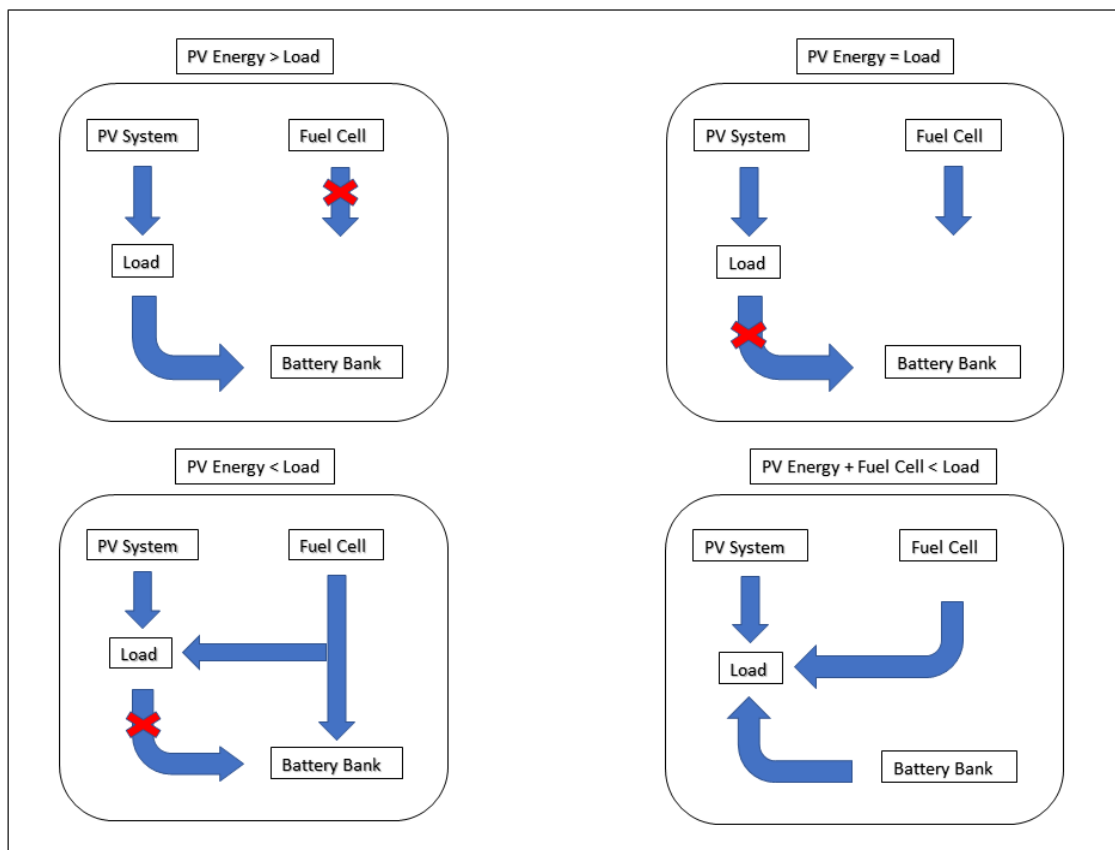

Figure 10: Battery Bank Supply

### Step 3: Electrolyzer system

The electrolyzer keeps the system alive and serves the purpose by producing emission-free hydrogen, and that too only when there is extra electricity generation from the PV plant. While designing an electrolyzer system, it is essential to track PV energy usage. The electricity remaining after the primary load supply and battery charging (if necessary) should be used for the electrolysis process. The steps included in designing are as follows,

1. keeping track of remaining PV electricity every hour after primary load supply and battery charging
2. usage of extra electricity for electrolysis purpose as per electrolyzer parameters
3. counting the amount of hydrogen produced every hour
4. counting the amount of extra electricity going to the grid after electrolysis.

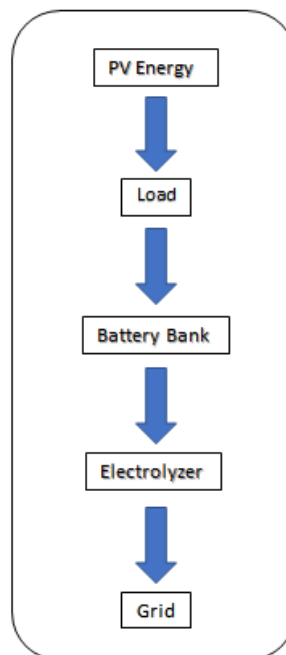

Figure 11: PV Energy flow into Electrolyzer

### Step 4: Fuel cell system

Fuel cell working technology is based on the principle of converting the chemical energy of hydrogen into electrical energy. As mentioned in previous chapters, it is better for the fuel cell system to run without interruption. Therefore, there should be enough supply of hydrogen to keep the fuel cell running for the given period. There comes the optimum sizing of electrolyzer, hydrogen storage cylinders and fuel cell. Every component

depends on each other. If the electrolyzer is sized big without enough hydrogen storage cylinders, the system efficiency will reduce drastically, resulting in high overall system costs. With the help of this excel tool, it will be easy to find out the optimum sizing of every component just by comparing different size combinations and choosing the best combination by looking in the results tab, where it shows the overall system efficiency and Levelized cost of energy.

The fuel cell system is planned to operate in the winter season when the PV production is comparatively less than in the summer season and requires additional support for primary load supply. For the first year (it is considered that the system is already installed and starts its operation on the first day of the year), the fuel cell will switch ON two times. The first phase will be from January to April, and the second phase will be from October to December. Overall, the fuel cell system will run for seven months in the year.

The fuel cell system is responsible for supporting the PV system in winter times for primary load supply. The fuel cells can operate in different output ranges as per their technical specifications, e.g., a fuel cell model PM400-48 can operate in the output range of 2.1 kW to 14.2 kW (data sheet attached in the appendix). It means it can generate the power output in the range of 2.1-14.2 kW as per the load requirements. So, whenever there is no power requirement from the fuel cell, it will continue to operate on the lowest possible output. As soon as PV energy is insufficient to supply the load, fuel cells will increase their production maximum until its specified capacity. In case of extra potential, i.e., if the power requirement from the primary load is less than the fuel cell's maximum power output range, it can operate at full load with the remaining amount of power for battery charging. The flow of energy is as follows,

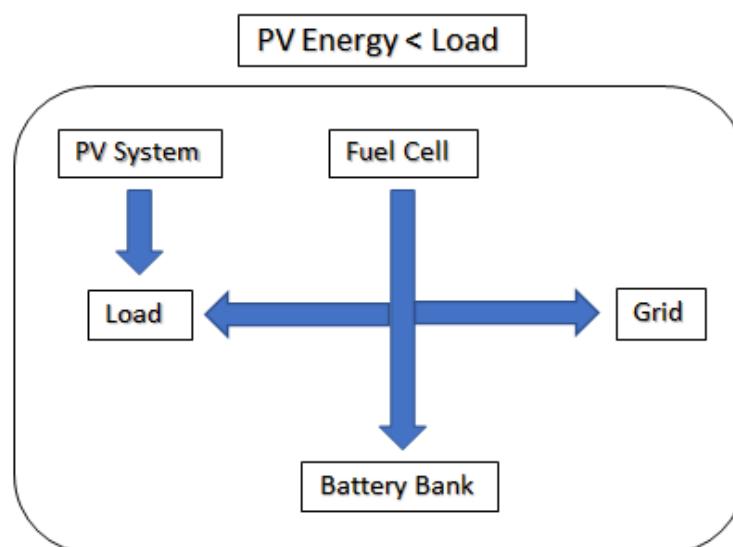

Figure 12: Fuel Cell Energy Flow



The conditions to consider while designing a fuel cell system in the tool can be,

Condition 1: it should operate only in the specified time period

Condition 2: the hydrogen consumption per hour should not exceed the given range of quantity for a particular fuel cell

Condition 3: there should be an indicator which shows the point at which hydrogen supply to the fuel cell system is stopped

Condition 4: fuel cell system should operate as per the load requirement and that too within the technical specifications given by the manufacturer

Condition 5: if there is no load on the fuel cell, it should continue to run at its lowest limit, and the energy generated will be supplied to the grid

Condition 6: there should be a counter to count the exact amount of energy generated by the fuel cell and the amount of energy supplied to the primary load, battery system and grid

Condition 7: there should be a counter to count the amount of hydrogen consumed.

## **6.5. Simulations**

After considering all the conditions mentioned in the previous chapter, an excel program is designed to make all the calculations after inserting the component sizes in the input fields. The most important thing while designing the final product is that there should be a display where the performance of all the system components can be easily seen in one pane, making it easier for the user to understand. The simulation results can be seen in the following steps.

Final simulations of the system are performed in the developed excel tool with combinations of different system components' sizing. Some combination results are compared with the simulation results from "HOMER". Homer being a paid software, has limited access and could be used for some iterations.

### **Case 1:**

The system is designed to generate the maximum power from the PV source. In the first case, the PV system is sized at its maximum possible value, that is 388.8 kWp. The PV system is designed and simulated with the "Helioscope" software, which gives the annual energy production forecast. The software also provides the annual hourly

production forecast, which is used for the excel tool calculations. The sizing for all the components to be considered for case 1 are as follows,

PV System: 388.8 kWp

Electrolyzer System: 48 kW

Fuel Cell System: 14.2 kWp

Battery Storage System: 520 kWh

Hydrogen Storage Tank: 1000 kg

The result of the above combination of component sizing is as shown below,



As seen in the fig. 12, the final cost of energy (COE) (COE is calculated for the period of 25 years. It is the ratio of the total expenditure of 25 years to the total electricity produced) with this combination of components sizes comes as 0.23 €/kWh. Though the COE looks pretty tempting for such a hybrid system, there are many factors to consider before coming to a conclusion. The first thing to note is the amount of hydrogen remaining at the year-end. The amount is very small, and the fuel cell system needs to run for four more months. The second thing is an error in the Fuel cell unit. The cell marked red in the fuel cell unit is the 'number of times fuel cell starts in a year'. As the calculation phase of the system starts in Jan 2021 and ends in Dec 2021, the fuel cell system should start and shut down two times a year because the fuel cell system is designed to run only in the winter months (Oct-Apr). But it can be seen that, the fuel cell system is starting six times, which means there is a shortage of hydrogen supply at some points in the current year. To be specific, the red box at the left bottom shows that the hydrogen tank is getting empty in both the phases of fuel cell operation. To rectify this error, the system needs sizing changes.

It is natural to think that if there is a shortage of hydrogen, then there must be less hydrogen production by the electrolyzer system, and its size should be increased. The results after increasing the electrolyzer size are as shown in fig. 13.

Even after increasing the electrolyzer size, there is not much improvement in the number of fuel cell starts. Also, no significant change in the stored hydrogen quantity can be observed at the year-end, and the increase in electrolyzer size has only resulted in an increase in final COE. This is because of the system limitation for hydrogen storage. The electrolyzer will stop working even if it is supplied with the electricity if the hydrogen tanks are full. The only positive result in this case is that the first phase of the fuel cell operation has no interruptions. Also, to store more hydrogen in summer, the storage tank has to be increased.

A business case study of Green Hydrogen production using PV in Germany				PV		Fuel Cell		Unmet electricity load	
				Total PV Production	312.44	MWh	Operating hours	4889	hrs
				PV energy used directly to supply primary load	98.13	MWh	H2 consumed	2467.54	kg
				PV energy used for battery charging	14.02	MWh	Total electricity produced	39.43	MWh
				PV energy used for Electrolyser	78.38	MWh	Energy Supplied by FC to primary load	22.74	MWh
				Extra PV Electricity going to GRID	121.91	MWh	No. of Starts	4.00	
PV Plant Size	388.8	kw		<b>Battery Bank</b>		Extra FC Electricity going to GRID		1.75	MWh
Battery Bank Size	520	kWh	← Input	Energy consumed by batteries + initial capacit		29.92	MWh	<b>Total Electricity going to GRID</b>	
Electrolyser Size	72	kw		Energy supplied by batteries		29.79	MWh	<b>Direct PV usage</b>	
Fuel Cell Size	14.20	kw		No. of Battery Cycles		56.92	Cycles	<b>Cost of Energy (COE)</b>	
(Note: FC size and data need to change in FC sheet as per the details in datasheet)				<b>Electrolyser</b>		<b>Hydrogen Tank</b>		<b>0.25 €/kWh</b>	
H2 Tank Size	1000	kg	1st phase	Operating hours		1528.00	hrs	<b>PV Energy Flow</b>	
Initial amount of H2	1000	kg	8561	Electricity consumed		78.38	MWh		
				H2 produced		1467.91	kg	Total PV Energy → 312.44 MWh	
				<b>System Cost &amp; Energy Production</b>		<b>PV COE</b>		<b>0.04 €/kWh</b>	
				System cost for 1st year		1,594,661.05	€	Direct Consumption → 98.13 MWh	
				System cost for 25 years		1,942,686.25	€	Battery Charging → 14.02 MWh	
				Electricity produced in 25 years		7810.99	MWh	Electrolyser Usage → 78.38 MWh	
				Total Load		158.65	MWh	Excess Electricity to GRID → 121.91 MWh	
(Note : for different load profile, change the values in column "J", sheet "Battery")									

Figure 14: Case 1.2

Fig. 14 shows the results after increasing hydrogen storage and reducing the electrolyzer value to its previous value of 48 kW.

A business case study of Green Hydrogen production using PV in Germany				PV		Fuel Cell		Unmet electricity load		
				Total PV Production	312.44	MWh	Operating hours	5088	hrs	
				PV energy used directly to supply primary load	98.13	MWh	H2 consumed	2603.09	kg	
				PV energy used for battery charging	13.49	MWh	Total electricity produced	41.53	MWh	
				PV energy used for Electrolyser	77.16	MWh	Energy Supplied by FC to primary load	23.91	MWh	
				Extra PV Electricity going to GRID	123.65	MWh	No. of Starts	2.00		
PV Plant Size	388.8	kW	← Input	<b>Battery Bank</b>				<b>Hydrogen Tank</b>		
Battery Bank Size	520	kWh		Energy consumed by batteries + initial capacit	29.85	MWh	Initial amount of H2	1200	kg	
Electrolyser Size	48	kW		Energy supplied by batteries	29.74	MWh	Amount of H2 at year end	41.30	kg	
Fuel Cell Size	14.20	kW		No. of Battery Cycles	56.80	Cycles	Hydrogen used by FC in 1st phase	1308.17	kg	
(Note: FC size and data need to change in FC sheet as per the details in datasheet)				<b>Electrolyser</b>				Hydrogen used by FC in 2nd phase	1294.92	kg
H2 Tank Size	1200	kg	1st phase	Operating hours	1991.00	hrs	<b>PV Energy Flow</b>			
Initial amount of H2	1200	kg	8760	Electricity consumed	77.16	MWh				
				<b>System Cost &amp; Energy Production</b>				Total PV Energy	312.44	MWh
				System cost for 1st year	1,639,523.36	€	Direct Consumption	98.13	MWh	
				System cost for 25 years	1,916,243.99	€	Battery Charging	13.49	MWh	
				Electricity produced in 25 years	7810.99	MWh	Electrolyser Usage	77.16	MWh	
								Excess Electricity to GRID	123.65	MWh
(Note : for different load profile, change the values in column "J", sheet "Battery")								<b>Cost of Energy (COE)</b>		<b>0.25 €/kWh</b>
								<b>PV COE</b>		<b>0.04 €/kWh</b>
								<b>Hydrogen system efficiency</b>		<b>30.90 %</b>
								PV -> Electrolyser -> Fuel Cell -> Electricity		
								Note : for accurate efficiency, set initial amount of H2 to "0"		
								<b>Total Electricity going to GRID</b>		<b>125.44 MWh</b>
								<b>Direct PV usage</b>		<b>31.41 %</b>

Figure 15: Case 1.3

The results show a significant improvement in the fuel cell running and even resulted in a slight lift in the hydrogen quantity remaining at year-end. But this increase in hydrogen storage is still insufficient as the remaining hydrogen at the year-end is inadequate for the fuel cell to keep running for the next four months. There is no doubt that in the upcoming months, the electrolyzer will also keep generating hydrogen, but due to the winter season, there will not be much electricity supply from PV to produce enough hydrogen.

Overall, the final COE and hydrogen quantity at the year-end does not only depend upon the electrolyzer and hydrogen storage tanks; it is affected by all the other system components as well. So, trying multiple combinations is necessary to find the optimum solution. Before going further with the different iterations, it would be good to provide all the information to the simulation software HOMER and see what optimum results the software gives. These results can later be used to find the optimum solution with the developed excel tool. This procedure can help in reducing the number of iterations.

### **Case 2: HOMER results**

HOMER software is used to run simulations to find out the best possible system combination. The HOMER software is an excellent tool with plenty of options to work with. It is therefore essential to feed the necessary information at the correct place. Before using the software, it is important to know the software better and use only those parts of the software which are required for the project, e.g., for this system, the inputs needed for the HOMER will be load profile, PV plant details, battery system details, electrolyzer details, fuel cell system details, and hydrogen tank storage sizes. It would be possible to explain the usage of HOMER software in detail, but this paper focuses on the different system, and HOMER is just a small part of it, so it will not be possible to explain the software in detail here, but still, following steps will explain the overall idea. The input method for the parameters discussed is as follows,

1. Load profile: HOMER provides the option to create a new load profile itself in the tool or a readymade excel load profile can be uploaded. The current project's load profile, which includes electricity, heating, and e-mobility, is uploaded.
2. PV System creation: PV system can be created by giving all the details of the plant such as solar module manufacturer, inverter manufacturer, inclination and azimuth of the modules, location of the solar plant, etc. HOMER also provides an option to upload the simulated project from Helioscope. It automatically detects all the information from Helioscope and uses it for further calculations. A Helioscope simulation with a 388.8 kWp solar power plant is uploaded to the HOMER for this project.

3. Battery System: HOMER contains all types of battery storage units. It is therefore easy to choose the required battery system, and if the required battery system is not present in the software database, a new battery system can also be added.

4. Electrolyzer: HOMER also gives the solution to add an electrolyzer. The electrolyzer can be added with all its properties given in the datasheet by the manufacturer.

5. Fuel Cell: HOMER does not provide a special option to add a fuel cell system. It can be added as a generator operating on hydrogen as a fuel instead of fossil fuels. The properties of the fuel cell can then be added as provided by the manufacturer in the datasheet.

6. Hydrogen Storage Tank: Hydrogen storage tank option is also available and can be added.

To find the optimum solution at the end of the simulation, HOMER allows providing different sizing and pricing options for every component. It will calculate the number of iterations by considering all the possible combinations of the given size and price values. It focuses more on the final COE for the best result and provides the results with the best COE to evaluate and select. But all the other iterations performed in the background can also be accessed if required. After giving multiple sizing options for every component of the system, a couple of the best results from the software are as follows,

**Result 1:**

*Table 8: HOMER Result 1*

COMPONENT	SIZE	UNIT	COE (€)
PV SYSTEM	388.8	kWh	<b>0.30</b>
BATTERY SYSTEM	67.2	kWh	
ELECTROLYZER	24	kW	
FUEL CELL	14.2	kW	
HYDROGEN STORAGE TANK	1000	kg	



**Result 2:**

Table 9: HOMER Result 2

COMPONENT	SIZE	UNIT	COE (€)
<b>PV SYSTEM</b>	388.8	kWh	<b>0.37</b>
<b>BATTERY SYSTEM</b>	336	kWh	
<b>ELECTROLYZER</b>	24	kW	
<b>FUEL CELL</b>	14.2	kW	
<b>HYDROGEN STORAGE TANK</b>	1000	kg	

Both the results above have only one difference, and that is the battery size. But the increase in battery sizing has resulted only in the increase of system COE. The result considers the inflation rate of 2% every year. Also, the battery system used while doing the simulations in HOMER was a Tesvolt HV-70 lithium-ion battery set consisting of 14 modules, each of 4.8 kWh. The performance details of the system are shown in the image below.

<b>PV</b>		<b>Battery Bank</b>	
Total PV Production	312.43 MWh	Energy consumed by batteries + initial capacity	0.00 MWh
<b>Grid Purchase</b>		Energy supplied by batteries	0.00 MWh
Total electricity purchased from Grid	48.71 MWh	No. of Battery Cycles	0.00 Cycles
<b>Fuel Cell</b>		<b>Electrolyser</b>	
Operating hours	5088.00 hrs	Electricity consumed	63.41 MWh
H2 consumed	2173.00 kg/yr	H2 produced	1173.00 kg/yr
Total electricity produced	33.28 MWh	<b>Hydrogen Tank</b>	
No. of Starts	2.00	Initial amount of H2	1000 kg
Mean electrical efficiency	45.90 %	Amount of H2 at year end	0.00 kg

Figure 16: Homer Result 1 Summary

<b>PV</b>		<b>Battery Bank</b>	
Total PV Production	312.43	MWh	
<b>Grid Purchase</b>		<b>Electrolyser</b>	
Total electricity purchased from Grid	25.71	MWh	
<b>Fuel Cell</b>		<b>Hydrogen Tank</b>	
Operating hours	5088.00	hrs	
H2 consumed	1960.00	kg/yr	
Total electricity produced	30.02	MWh	
No. of Starts	2.00		
Mean electrical efficiency	45.90	%	
		Energy consumed by batteries	
		25.44	
		MWh	
		Energy supplied by batteries	
		25.00	
		MWh	
		Electricity consumed	
		51.90	
		MWh	
		H2 produced	
		960.00	
		kg/yr	
		Initial amount of H2	
		1000	
		kg	
		Amount of H2 at year end	
		0.00	
		kg	

Figure 17: Homer Result 2 Summary

The pricing of the system components is as shown in below table,

Table 10: Costs of the system components used in HOMER simulation

COMPONENT	INITIAL COST (€)	REPLACEMENT COST (%)
<b>PV SYSTEM</b>	330480	0
<b>BATTERY SYSTEM</b>	72000	21213.69
<b>ELECTROLYZER</b>	85000	40430
<b>FUEL CELL</b>	42600	38144.61
<b>HYDROGEN STORAGE TANK</b>	650000	0

It would be nice to check the same system configuration with the excel tool. The difference between both tools is the battery manufacturer and its cost, and the excel tool does not consider the inflation rate. The prices for all the components used in the system are,

Table 11: Costs of the system components used in developed excel tool simulation

COMPONENT	INITIAL COST (€)	REPLACEMENT COST (%)
<b>PV SYSTEM</b>	330480	0
<b>BATTERY SYSTEM</b>	40320	32256
<b>ELECTROLYZER</b>	85000	68000
<b>FUEL CELL</b>	42600	34080
<b>HYDROGEN STORAGE TANK</b>	650000	0

	INITIAL	25 YEARS
<b>MAINTENANCE COST (€)</b>	3000	75000

Fig. 17 and 18 show the results from the excel tool simulation.



A business case study of Green Hydrogen production using PV in Germany				PV		Fuel Cell		Unmet electricity load	
				Total PV Production	312.44	MWh	Operating hours	4394	hrs
				PV energy used directly to supply primary load	98.13	MWh	H2 consumed	2029.53	kg
				PV energy used for battery charging	12.39	MWh	Total electricity produced	32.80	MWh
				PV energy used for Electrolyser	54.88	MWh	Energy Supplied by FC to primary load	19.66	MWh
				Extra PV Electricity going to GRID	147.04	MWh	No. of Starts	15.00	
PV Plant Size	388.8	kW		<b>Battery Bank</b>		Extra FC Electricity going to GRID		1.81	MWh
Battery Bank Size	336	kWh	← Input	Energy consumed by batteries + initial capacit		25.18	MWh	<b>Total Electricity going to GRID</b>	
Electrolyser Size	24	kW		Energy supplied by batteries		25.06	MWh	<b>Direct PV usage</b>	
Fuel Cell Size	14.20	kW		No. of Battery Cycles		74.26	Cycles	<b>Cost of Energy (COE)</b>	
(Note: FC size and data need to change in FC sheet as per the details in datasheet)				<b>Electrolyser</b>		<b>Hydrogen Tank</b>		<b>0.20 €/kWh</b>	
H2 Tank Size	1000	kg	1st phase	Operating hours		2522.00	hrs	<b>PV Energy Flow</b>	
Initial amount of H2	1000	kg	8066	Electricity consumed		54.88	MWh		
				H2 produced		1027.78	kg	Total PV Energy → 312.44 MWh	
				<b>System Cost &amp; Energy Production</b>		<b>PV COE</b>		<b>0.04 €/kWh</b>	
				System cost for 1st year		1,315,746.41	€	Direct Consumption → 98.13 MWh	
				System cost for 25 years		1,563,420.19	€	Battery Charging → 12.39 MWh	
				Electricity produced in 25 years		7810.99	MWh	Electrolyser Usage → 54.88 MWh	
				Total Load		158.65	MWh	Excess Electricity to GRID → 147.04 MWh	
(Note : for different load profile, change the values in column "J", sheet "Battery")									

Figure 19: Excel Tool Result 2 Summary

The COE is calculated as the ratio of total system cost incurred to the amount of electricity produced from the PV system over 25 years. While looking at the results, though there is not a significant change in COE for both the combinations, it is seen that when the battery system size is increased, there is a substantial increase in the occurrences of hydrogen tank getting emptied and fuel cell switching ON and OFF, which means that according to the excel tool, the second result does not satisfy the system requirement. Even after taking a close look at HOMER results, it can be observed that the hydrogen tank is getting emptied at the year-end for both the results, which is not good according to the requirement. There must be enough hydrogen gas in the gas tank at year-end to keep the fuel cell running for the next four winter months.

The next thing to be noted in HOMER and excel tool results is the difference between COE. This difference is mainly due to variable battery system prices and inflation rates. In both the systems, whenever the battery storage is sized small, it reaches its maximum life cycle in around 15 years and needs to be replaced, but when sized big, it doesn't need replacement. For example, in the excel tool result 1, 201 battery cycles were used in a year. For a depth of discharge (DOD) of 90%, as shown in the battery data sheet, it offers approximately 3000 cycles. So, the first battery set will reach its maximum life cycle in 15 years and has to be replaced. On the other hand, for result 2, the number of cycles used were 74, which means it can last long for more than 25 years if used in the same manner as the first year.

To conclude both the results, according to the quantity of hydrogen gas remaining in the hydrogen tank, the system is insufficient for the purpose and needs a little change. It would be good to try some more combinations and find out the optimum solution. The tool can be used distinctively for finding the best results and this paper is just an introduction to the tool usage. The final results can therefore be debated. The images in the following section will show the results of some more simulations done by using different combinations and users can choose the best results at their convenience. While trying the various combinations, it is very important to remember that the storage systems are usually expensive and should be sized considering the actual requirement and its effect on overall COE.

As many combinations are possible, it would be better to see the pattern while changing the sizes of different components. The resultant factor can be set as minimum COE with a minimum amount of hydrogen remaining at the end of the first year that can be enough for next year's first winter phase (i.e., from January to April). The last best-seen result was found with result 1, where everything works well except the hydrogen amount remaining at the end of the year. Some of the best combinations can be seen in the next chapter to rectify the issue. The PV system size will be kept constant as it is the cheapest

energy source for the system. Also, the fuel cell size will be kept constant as it will continue to run once it starts till the end of the defined period even if there is no requirement for electricity; in that case, if the size of the fuel cell is bigger, high amount of hydrogen will be used unnecessarily for the electricity production which will directly go to the grid. So, it is always better to keep the fuel cell size at the lowest possible value, which is 2.1-14.2 kW in this case.

## **6.6. Results**

This chapter will evaluate some of the different combinations tried with the excel tool. The below images show the overall summary of the simulations. It is found that the first phase of the fuel cell consumes a maximum of 1255.54 kg of hydrogen in the first year. Assuming the same scenario for subsequent years, the minimum amount of hydrogen remaining in the hydrogen tank at the end of the year should be a minimum of 1255.54 kg. Also, the fuel cell size is kept constant as explained in the previous chapter. The size of other components is varied to see the final outcome.

It would be a good approach to focus on one component at a time to examine its effects on the system and determine its optimum value as per the final COE outcome. To begin with, the first component to consider can be taken as 'Electrolyzer'. Electrolyzer size can be varied to see its effect on COE.

### **Electrolyzer size variation result 1.1**

In this scenario, the electrolyzer size is changed to a minimum value of 12 kW, while all the other components were kept constant with the sizing in the previous result. The below image shows the final output of the simulation.

A business case study of Green Hydrogen production using PV in Germany				PV		Fuel Cell		Unmet electricity load	
				Total PV Production	312.44	MWh	Operating hours	3685	hrs
				PV energy used directly to supply primary load	98.13	MWh	H2 consumed	1550.79	kg
				PV energy used for battery charging	12.43	MWh	Total electricity produced	25.44	MWh
				PV energy used for Electrolyser	29.28	MWh	Energy Supplied by FC to primary load	15.19	MWh
				Extra PV Electricity going to GRID	172.59	MWh	No. of Starts	38.00	
PV Plant Size	388.8	kw		<b>Battery Bank</b>		Extra FC Electricity going to GRID		1.76	MWh
Battery Bank Size	336	kWh	← Input	Energy consumed by batteries + initial capacity		27.72	MWh	Heat produced	28.43
Electrolyser Size	12	kw		Energy supplied by batteries		27.60	MWh	Energy Supplied by FC to charge batteries	8.49
Fuel Cell Size	14.20	kw		No. of Battery Cycles		81.83	Cycles	<b>Hydrogen Tank</b>	
(Note: FC size and data need to change in FC sheet as per the details in datasheet)				<b>Electrolyser</b>		Initial amount of H2		1000	kg
H2 Tank Size	1000	kg	1st phase	Operating hours		2529.00	hrs	Amount of H2 at year end	0.12
Initial amount of H2	1000	kg	7357	Electricity consumed		29.28	MWh	Hydrogen used by FC in 1st phase	1122.65
				H2 produced		548.38	kg	Hydrogen used by FC in 2nd phase	428.14
				<b>System Cost &amp; Energy Production</b>		Hydrogen available before 2nd phase		378.14	kg
				System cost for 1st year		1,272,662.12	€	Hydrogen produced in 2nd phase	49.40
				System cost for 25 years		1,472,313.01	€	<b>PV COE</b>	
				Electricity produced in 25 years		7810.99	MWh	<b>0.04 €/kWh</b>	
				Total Load		158.65	MWh	<b>Cost of Energy (COE)</b>	
				Total Load		158.65	MWh	<b>0.19 €/kWh</b>	
				(Note: for different load profile, change the values in column "J", sheet "Battery")				<b>PV Energy Flow</b>	
								Total PV Energy	→ 312.44 MWh
								↓	
								Direct Consumption	→ 98.13 MWh
								↓	
								Battery Charging	→ 12.43 MWh
								↓	
								Electrolyser Usage	→ 29.28 MWh
								↓	
								Excess Electricity to GRID	→ 172.59 MWh

Figure 20: Electrolyzer Size Variation Result 1.1



As it can be seen in fig. 19, the considered combination does not satisfy any of the system's requirements. The storage tank status at the below left of the image goes red, showing that the hydrogen tank is getting emptied during both phases of usage. Because of this, the fuel cell restarts multiple times a year, surpassing its permissible value of 2 times for the first year. The amount of hydrogen at year-end is almost '0', which is nowhere close to the estimated minimum amount of 1255.54 kg. Overall, the electrolyzer's small size does not help the system run as per the requirements and has to be changed.

### **Electrolyzer size variation result 1.2**

For the next case, the electrolyzer size is increased with the next multiple of the previous minimum value, i.e. (12 x 2), which is equal to 24 kW.

As seen in the fig. 20, though there is a good improvement in the number of times the hydrogen tank gets empty and the number of starts for the fuel cell, the system needs an even bigger electrolyzer to match the requirements. But the amount of hydrogen at year-end still stays the same. The COE does not have a significant improvement even after increasing the electrolyzer size twice its initial value. It has increased only by 0.01 €. It would be interesting to see the result in the next step after increasing the electrolyzer size three times the initial value.

A business case study of Green Hydrogen production using PV in Germany				PV		Fuel Cell		Unmet electricity load	
				Total PV Production	312.44	MWh	Operating hours	4394	hrs
				PV energy used directly to supply primary load	98.13	MWh	H2 consumed	2029.53	kg
				PV energy used for battery charging	12.39	MWh	Total electricity produced	32.80	MWh
				PV energy used for Electrolyser	54.88	MWh	Energy Supplied by FC to primary load	19.66	MWh
				Extra PV Electricity going to GRID	147.04	MWh	No. of Starts	15.00	
PV Plant Size	388.8	kw		<b>Battery Bank</b>		Extra FC Electricity going to GRID		1.81	MWh
Battery Bank Size	336	kWh	← Input	Energy consumed by batteries + initial capacit		25.18	MWh	Heat produced	
Electrolyser Size	24	kw		Energy supplied by batteries		25.06	MWh	Energy Supplied by FC to charge batterie	
Fuel Cell Size	14.20	kw		No. of Battery Cycles		74.26	Cycles	<b>Hydrogen Tank</b>	
(Note: FC size and data need to change in FC sheet as per the details in datasheet)				<b>Electrolyser</b>		Initial amount of H2		1000	kg
H2 Tank Size	1000	kg	1st phase	Operating hours		2522.00	hrs	Amount of H2 at year end	0.00
Initial amount of H2	1000	kg	8066	Electricity consumed		54.88	MWh	Hydrogen used by FC in 1st phase	1213.41
				H2 produced		1027.78	kg	Hydrogen used by FC in 2nd phase	816.12
				<b>System Cost &amp; Energy Production</b>		Hydrogen available before 2nd phase		728.40	kg
				System cost for 1st year		1,315,746.41	€	Hydrogen produced in 2nd phase	87.21
				System cost for 25 years		1,563,420.19	€	<b>PV COE</b>	
				Electricity produced in 25 years		7810.99	MWh	0.04 €/kWh	
				Total Load		158.65	MWh	<b>Cost of Energy (COE)</b>	
				(Note : for different load profile, change the values in column "J", sheet "Battery")				0.20 €/kWh	
								<b>PV Energy Flow</b>	
								Total PV Energy	→ 312.44 MWh
								↓	
								Direct Consumption	→ 98.13 MWh
								↓	
								Battery Charging	→ 12.39 MWh
								↓	
								Electrolyser Usage	→ 54.88 MWh
								↓	
								Excess Electricity to GRID	→ 147.04 MWh

Figure 21: Electrolyzer Size Variation Result 1.2

### **Electrolyzer size variation result 1.3**

The result, in this case, has some improvements compared to the last two cases. As seen in the fig. 21, now the system has enough amount of hydrogen for the first phase and the number of fuel cell starts has reduced to 4 times which is not very far from the required value of 2 times. Though the amount of hydrogen at the year-end stays the same, it can be easily concluded that to increase the amount of stored hydrogen, it is necessary to increase the hydrogen storage tank size. The COE again has increased by 0.01, which is still a good value considering the actual cost of electricity from the grid, which is approx. 0.25€/kWh. Also, this case gives the exact amount of hydrogen required in the first phase as well. As the first phase has enough hydrogen needed to run the fuel cell continuously, the system is running smoothly, giving the maximum amount of hydrogen it can consume in the first phase, which is 1255.54 kg. The electrolyzer size should be increased as the system's second phase still does not have enough hydrogen to run the fuel cell uninterrupted.

The results obtained by trying the different sizes of electrolyzer can be seen in fig. 22, 23 and 24. As it can be seen, even after increasing the electrolyzer size by many times the initial size, the quantity of hydrogen available at the year-end is not increasing much. It can be easily observed that the amount of hydrogen produced by the electrolyzer in the second phase is not enough for the system to store the extra hydrogen. Clearly, there is not enough PV energy to supply to the electrolyzer. This means that the hydrogen needs to be stored in the summer months when there is a high amount of PV energy. For that, the storage tank size must be increased.

Different sizing options should be tried to determine the optimum sizing of the hydrogen storage tank, while the other system component sizes can be kept constant. As seen in the previous cases, the electrolyzer size can be kept constant at 36 kW.



A business case study of Green Hydrogen production using PV in Germany				PV		Fuel Cell		Unmet electricity load				
				Total PV Production	312.44	MWh	Operating hours	4922	hrs			
				PV energy used directly to supply primary load	98.13	MWh	H2 consumed	2399.91	kg			
				PV energy used for battery charging	12.23	MWh	Total electricity produced	38.50	MWh			
				PV energy used for Electrolyser	74.72	MWh	Energy Supplied by FC to primary load	22.96	MWh			
				Extra PV Electricity going to GRID	127.36	MWh	No. of Starts	4.00				
PV Plant Size	388.8	kw		<b>Battery Bank</b>		Extra FC Electricity going to GRID		1.86	MWh			
Battery Bank Size	336	kWh	← Input	Energy consumed by batteries + initial capacit	26.25	MWh	Heat produced	43.99	MWh			
Electrolyser Size	48	kw		Energy supplied by batteries	26.21	MWh	Energy Supplied by FC to charge batterie	13.68	MWh			
Fuel Cell Size	14.20	kw		No. of Battery Cycles	77.57	Cycles	<b>Hydrogen Tank</b>					
(Note: FC size and data need to change in FC sheet as per the details in datasheet)				<b>Electrolyser</b>		Initial amount of H2	1000	kg				
H2 Tank Size	1000	kg	1st phase	Operating hours	1948.00	hrs	Amount of H2 at year end	0.00	kg			
Initial amount of H2	1000	kg	8594	Electricity consumed	74.72	MWh	Hydrogen used by FC in 1st phase	1255.54	kg			
				H2 produced	1399.44	kg	Hydrogen used by FC in 2nd phase	1144.37	kg			
				<b>System Cost &amp; Energy Production</b>		Hydrogen available before 2nd phase	1000.00	kg				
				System cost for 1st year	1,400,056.02	€	Hydrogen produced in 2nd phase	143.21	kg			
				System cost for 25 years	1,699,160.60	€	<b>PV COE</b>		<b>0.04 €/kWh</b>			
				Electricity produced in 25 years	7810.99	MWh	<b>PV Energy Flow</b>					
				<b>Total Load</b>		158.65	MWh	Total PV Energy	→	312.44	MWh	
				<b>Electrolyser Usage</b>		74.72	MWh	↓	Direct Consumption	→	98.13	MWh
				<b>Excess Electricity to GRID</b>		127.36	MWh	↓	Battery Charging	→	12.23	MWh
				<b>Hydrogen system efficiency</b>		31.10	%	↓	Electrolyser Usage	→	74.72	MWh
				<b>Total Electricity going to GRID</b>		129.22	MWh	↓	Excess Electricity to GRID	→	127.36	MWh
				<b>Direct PV usage</b>		31.41	%					
				<b>Cost of Energy (COE)</b>		0.22	€/kWh					
				<b>Hydrogen system efficiency</b>		31.10	%					
				<b>Unmet electricity load</b>		11.31	MWh					
				<b>Direct PV usage</b>		31.41	%					
				<b>Cost of Energy (COE)</b>		0.22	€/kWh					
				<b>Hydrogen system efficiency</b>		31.10	%					
				<b>Unmet electricity load</b>		11.31	MWh					
				<b>Direct PV usage</b>		31.41	%					
				<b>Cost of Energy (COE)</b>		0.22	€/kWh					
				<b>Hydrogen system efficiency</b>		31.10	%					
				<b>Unmet electricity load</b>		11.31	MWh					
				<b>Direct PV usage</b>		31.41	%					
				<b>Cost of Energy (COE)</b>		0.22	€/kWh					
				<b>Hydrogen system efficiency</b>		31.10	%					
				<b>Unmet electricity load</b>		11.31	MWh					
				<b>Direct PV usage</b>		31.41	%					
				<b>Cost of Energy (COE)</b>		0.22	€/kWh					
				<b>Hydrogen system efficiency</b>		31.10	%					
				<b>Unmet electricity load</b>		11.31	MWh					
				<b>Direct PV usage</b>		31.41	%					
				<b>Cost of Energy (COE)</b>		0.22	€/kWh					
				<b>Hydrogen system efficiency</b>		31.10	%					
				<b>Unmet electricity load</b>		11.31	MWh					
				<b>Direct PV usage</b>		31.41	%					
				<b>Cost of Energy (COE)</b>		0.22	€/kWh					
				<b>Hydrogen system efficiency</b>		31.10	%					
				<b>Unmet electricity load</b>		11.31	MWh					
				<b>Direct PV usage</b>		31.41	%					
				<b>Cost of Energy (COE)</b>		0.22	€/kWh					
				<b>Hydrogen system efficiency</b>		31.10	%					
				<b>Unmet electricity load</b>		11.31	MWh					
				<b>Direct PV usage</b>		31.41	%					
				<b>Cost of Energy (COE)</b>		0.22	€/kWh					
				<b>Hydrogen system efficiency</b>		31.10	%					
				<b>Unmet electricity load</b>		11.31	MWh					
				<b>Direct PV usage</b>		31.41	%					
				<b>Cost of Energy (COE)</b>		0.22	€/kWh					
				<b>Hydrogen system efficiency</b>		31.10	%					
				<b>Unmet electricity load</b>		11.31	MWh					
				<b>Direct PV usage</b>		31.41	%					
				<b>Cost of Energy (COE)</b>		0.22	€/kWh					
				<b>Hydrogen system efficiency</b>		31.10	%					
				<b>Unmet electricity load</b>		11.31	MWh					
				<b>Direct PV usage</b>		31.41	%					
				<b>Cost of Energy (COE)</b>		0.22	€/kWh					
				<b>Hydrogen system efficiency</b>		31.10	%					
				<b>Unmet electricity load</b>		11.31	MWh					
				<b>Direct PV usage</b>		31.41	%					
				<b>Cost of Energy (COE)</b>		0.22	€/kWh					
				<b>Hydrogen system efficiency</b>		31.10	%					
				<b>Unmet electricity load</b>		11.31	MWh					
				<b>Direct PV usage</b>		31.41	%					
				<b>Cost of Energy (COE)</b>		0.22	€/kWh					
				<b>Hydrogen system efficiency</b>		31.10	%					
				<b>Unmet electricity load</b>		11.31	MWh					
				<b>Direct PV usage</b>		31.41	%					
				<b>Cost of Energy (COE)</b>		0.22	€/kWh					
				<b>Hydrogen system efficiency</b>		31.10	%					
				<b>Unmet electricity load</b>		11.31	MWh					
				<b>Direct PV usage</b>		31.41	%					
				<b>Cost of Energy (COE)</b>		0.22	€/kWh					
				<b>Hydrogen system efficiency</b>		31.10	%					
				<b>Unmet electricity load</b>		11.31	MWh					
				<b>Direct PV usage</b>		31.41	%					
				<b>Cost of Energy (COE)</b>		0.22	€/kWh					
				<b>Hydrogen system efficiency</b>		31.10	%					
				<b>Unmet electricity load</b>		11.31	MWh					
				<b>Direct PV usage</b>		31.41	%					
				<b>Cost of Energy (COE)</b>		0.22	€/kWh					
				<b>Hydrogen system efficiency</b>		31.10	%					
				<b>Unmet electricity load</b>		11.31	MWh					
				<b>Direct PV usage</b>		31.41	%					
				<b>Cost of Energy (COE)</b>		0.22	€/kWh					
				<b>Hydrogen system efficiency</b>		31.10	%					
				<b>Unmet electricity load</b>		11.31	MWh					
				<b>Direct PV usage</b>		31.41	%					
				<b>Cost of Energy (COE)</b>		0.22	€/kWh					
				<b>Hydrogen system efficiency</b>		31.10	%					
				<b>Unmet electricity load</b>		11.31	MWh					
				<b>Direct PV usage</b>		31.41	%					
				<b>Cost of Energy (COE)</b>		0.22	€/kWh					
				<b>Hydrogen system efficiency</b>		31.10	%					
				<b>Unmet electricity load</b>		11.31	MWh					
				<b>Direct PV usage</b>		31.41	%					
				<b>Cost of Energy (COE)</b>		0.22	€/kWh					
				<b>Hydrogen system efficiency</b>		31.10	%					
				<b>Unmet electricity load</b>		11.31	MWh					
				<b>Direct PV usage</b>		31.41	%					
				<b>Cost of Energy (COE)</b>		0.22	€/kWh					
				<b>Hydrogen system efficiency</b>		31.10	%					
				<b>Unmet electricity load</b>		11.31	MWh					
				<b>Direct PV usage</b>		31.41	%					
				<b>Cost of Energy (COE)</b>		0.22	€/kWh					
				<b>Hydrogen system efficiency</b>		31.10	%					
				<b>Unmet electricity load</b>		11.31	MWh					
				<b>Direct PV usage</b>		31.41	%					
				<b>Cost of Energy (COE)</b>		0.22	€/kWh					
				<b>Hydrogen system efficiency</b>		31.10	%					
				<b>Unmet electricity load</b>		11.31	MWh					
				<b>Direct PV usage</b>		31.41	%					
				<b>Cost of Energy (COE)</b>		0.22	€/kWh					
				<b>Hydrogen system efficiency</b>		31.10	%					
				<b>Unmet electricity load</b>		11.31	MWh					
				<b>Direct PV usage</b>		31.41	%					
				<b>Cost of Energy (COE)</b>		0.22	€/kWh					
				<b>Hydrogen system efficiency</b>		31.10	%					
				<b>Unmet electricity load</b>		11.31	MWh					
				<b>Direct PV usage</b>		31.41	%					
				<b>Cost of Energy (COE)</b>		0.22	€/kWh					
				<b>Hydrogen system efficiency</b>		31.10	%					
				<b>Unmet electricity load</b>		11.31	MWh					
				<b>Direct PV usage</b>		31.41	%					
				<b>Cost of Energy (COE)</b>		0.22	€/kWh					
				<b>Hydrogen system efficiency</b>		31.10	%					
				<b>Unmet electricity load</b>		11.31	MWh					
				<b>Direct PV usage</b>		31.41	%					
				<b>Cost of Energy (COE)</b>		0.22	€/kWh					
				<b>Hydrogen system efficiency</b>		31.10	%					
				<b>Unmet electricity load</b>		11.31	MWh					
				<b>Direct PV usage</b>		31.41	%					
				<b>Cost of Energy (COE)</b>		0.22	€/kWh					
				<b>Hydrogen system efficiency</b>		31.10	%					
				<b>Unmet electricity load</b>		11.31	MWh					
				<b>Direct PV usage</b>		31.41	%					
				<b>Cost of Energy (COE)</b>		0.22	€/kWh					
				<b>Hydrogen system efficiency</b>		31.10	%					
				<b>Unmet electricity load</b>		11.31	MWh					
				<b>Direct PV usage</b>		31.41	%					
				<b>Cost of Energy (COE)</b>		0.22	€/kWh					
				<b>Hydrogen system efficiency</b>		31.10	%					
				<b>Unmet electricity load</b>		11.31	MWh					
				<b>Direct PV usage</b>		31.41	%					
				<b>Cost of Energy (COE)</b>		0.22	€/kWh					
				<b>Hydrogen system efficiency</b>		31.10	%					
				<b>Unmet electricity load</b>		11.31	MWh					
				<b>Direct PV usage</b>		31.41	%					
				<b>Cost of Energy (COE)</b>		0.22	€/kWh					
				<b>Hydrogen system efficiency</b>		31.10	%					
				<b>Unmet electricity load</b>		11.31	MWh					
				<b>Direct PV usage</b>		31.41	%					
				<b>Cost of Energy (COE)</b>		0.22	€/kWh					
				<b>Hydrogen system efficiency</b>		31.10	%					
				<b>Unmet electricity load</b>		11.31	MWh					
				<b>Direct PV usage</b>		31.41	%					
				<b>Cost of Energy (COE)</b>		0.22	€/kWh					
				<b>Hydrogen system efficiency</b>		31.10	%					
				<b>Unmet electricity load</b>		11.31	MWh					
				<b>Direct PV usage</b>		31.41	%					
				<b>Cost of Energy (COE)</b>		0.22	€/kWh					
				<b>Hydrogen system efficiency</b>		31.10	%					
				<b>Unmet electricity load</b>		11.31	MWh					
				<b>Direct PV usage</b>		31.41	%					
				<b>Cost of Energy (COE)</b>		0.22	€/kWh					
				<b>Hydrogen system efficiency</b>		31.10	%					
				<b>Unmet electricity load</b>		11.31	MWh					
				<b>Direct PV usage</b>		31.41	%					
				<b>Cost of Energy (COE)</b>		0.22	€/kWh					
				<b>Hydrogen system efficiency</b>		31.10	%					
				<b>Unmet electricity load</b>		11.31	MWh					
				<b>Direct PV usage</b>		31.41	%					
				<b>Cost of Energy (COE)</b>		0.22	€/kWh					
				<b>Hydrogen system efficiency</b>		31.10	%					
				<b>Unmet electricity load</b>		11.31	MWh					
				<b>Direct PV usage</b>		31.41	%					
				<b>Cost of Energy (COE)</b>		0.22	€/kWh					
				<b>Hydrogen system efficiency</b>		31.10	%					
				<b>Unmet electricity load</b>		11.31	MWh					
				<b>Direct PV usage</b>		31.41	%					
				<b>Cost of Energy (COE)</b>		0.22	€/kWh					
				<b>Hydrogen system efficiency</b>		31.10	%					
				<b>Unmet electricity load</b>		11.31	MWh					
				<b>Direct PV usage</b>		31.41	%					
				<b>Cost of Energy (COE)</b>		0.22	€/kWh					
				<b>Hydrogen system efficiency</b>		31.10	%					
				<b>Unmet electricity load</b>		11.31	MWh					
				<b>Direct PV usage</b>		31.41	%					
				<b>Cost of Energy (COE)</b>		0.22	€/kWh					
				<b>Hydrogen system efficiency</b>		31.10	%					

A business case study of Green Hydrogen production using PV in Germany				PV		Fuel Cell		Unmet electricity load	
				Total PV Production	312.44	MWh	Operating hours	4980	hrs
				PV energy used directly to supply primary load	98.13	MWh	H2 consumed	2425.08	kg
				PV energy used for battery charging	11.88	MWh	Total electricity produced	38.91	MWh
				PV energy used for Electrolyser	76.14	MWh	Energy Supplied by FC to primary load	23.19	MWh
				Extra PV Electricity going to GRID	126.28	MWh	No. of Starts	4.00	
PV Plant Size	388.8	kw		<b>Battery Bank</b>		Extra FC Electricity going to GRID		1.88	MWh
Battery Bank Size	336	kWh	← Input	Energy consumed by batteries + initial capacity		26.30	MWh	Heat produced	
Electrolyser Size	60	kw		Energy supplied by batteries		26.26	MWh	Energy Supplied by FC to charge batteries	
Fuel Cell Size	14.20	kw		No. of Battery Cycles		77.72	Cycles	<b>Hydrogen Tank</b>	
(Note: FC size and data need to change in FC sheet as per the details in datasheet)				<b>Electrolyser</b>		Initial amount of H2		1000	kg
H2 Tank Size	1000	kg	1st phase	Operating hours		1696.00	hrs	Amount of H2 at year end	0.00
Initial amount of H2	1000	kg	8652	Electricity consumed		76.14	MWh	Hydrogen used by FC in 1st phase	1255.54
				H2 produced		1426.05	kg	Hydrogen used by FC in 2nd phase	1169.54
				<b>System Cost &amp; Energy Production</b>		Hydrogen available before 2nd phase		1000.00	kg
				System cost for 1st year		1,442,480.06	€	Hydrogen produced in 2nd phase	169.40
				System cost for 25 years		1,773,761.52	€	<b>PV COE</b>	
				Electricity produced in 25 years		7810.99	MWh	0.04 €/kWh	
				<b>Total Load</b>		158.65	MWh	<b>PV Energy Flow</b>	
				(Note: for different load profile, change the values in column "J", sheet "Battery")				Total PV Energy	→ 312.44
								↓	
								Direct Consumption	→ 98.13
								↓	
								Battery Charging	→ 11.88
								↓	
								Electrolyser Usage	→ 76.14
								↓	
								Excess Electricity to GRID	→ 126.28
								Hydrogen system efficiency	
								31.05 %	
								Total Electricity going to GRID	
								128.16 MWh	
								Direct PV usage	
								31.41 %	
								Cost of Energy (COE)	
								0.23 €/kWh	

Figure 24: Electrolyzer Size Variation Result 1.5



## Hydrogen Tank Size Variation Result 1.7

The increased size of the hydrogen tank definitely helps the system to run continuously, and it increases the hydrogen storage at year-end as well. Fig. 25 shows the improvement in the system. Compared to case 1.5, the system has now both phases running without interruption and has even started accumulating more hydrogen for next year's first phase. As can be seen in the tool, the remaining amount of hydrogen at year-end is 70.52 kg, which is 1185.02 kg less than the required amount of hydrogen.

The hydrogen storage capacity needs a huge increase which will also increase the final COE. According to the simulation results, the minimum size required for hydrogen storage is 2400 kg, which comes with the final COE of 0.323 €/kWh as shown in fig. 26.





A business case study of Green Hydrogen production using PV in Germany				PV		Fuel Cell		Unmet electricity load				
				Total PV Production	312.44	MWh	Operating hours	5088	hrs			
				PV energy used directly to supply primary load	98.13	MWh	H2 consumed	2508.98	kg			
				PV energy used for battery charging	11.88	MWh	Total electricity produced	40.20	MWh			
				PV energy used for Electrolyser	73.69	MWh	Energy Supplied by FC to primary load	23.91	MWh			
				Extra PV Electricity going to GRID	128.73	MWh	No. of Starts	2.00				
PV Plant Size	388.8	kw		<b>Battery Bank</b>		Extra FC Electricity going to GRID		1.89	MWh			
Battery Bank Size	336	kWh	← Input	Energy consumed by batteries + initial capacit		26.62	MWh	Heat produced	45.99	MWh		
Electrolyser Size	36	kw		Energy supplied by batteries		26.53	MWh	Energy Supplied by FC to charge batterie	14.40	MWh		
Fuel Cell Size	14.20	kw		No. of Battery Cycles		78.60	Cycles	<b>Hydrogen Tank</b>				
(Note: FC size and data need to change in FC sheet as per the details in datasheet)				<b>Electrolyser</b>		Initial amount of H2		2400	kg			
H2 Tank Size	2400	kg	1st phase	Operating hours		2402.00	hrs	Amount of H2 at year end	1270.52	kg		
Initial amount of H2	2400	kg	8760	Electricity consumed		73.69	MWh	Hydrogen used by FC in 1st phase	1255.54	kg		
				2nd phase		H2 produced		1380.18	kg	Hydrogen used by FC in 2nd phase	1253.44	kg
				if turns RED, tank storage has reached 0%		<b>System Cost &amp; Energy Production</b>		Hydrogen available before 2nd phase		2400.00	kg	
				Total Load		158.65	MWh	Hydrogen produced in 2nd phase		123.95	kg	
				System cost for 1st year		2,267,297.21	€	<b>PV COE</b>		0.04 €/kWh		
				System cost for 25 years		2,526,190.13	€	System cost for 25 years		7810.99	MWh	
				Electricity produced in 25 years		7810.99	MWh	Unmet electricity load		10.08	MWh	
				(Note : for different load profile, change the values in column "J", sheet "Battery")				Hydrogen system efficiency		31.14	%	
								PV -> Electrolyser -> Fuel Cell -> Electricity		Note : for accurate efficiency, set initial amount of H2 to "0"		
								Total Electricity going to GRID		130.62	MWh	
								Direct PV usage		31.41	%	
								Cost of Energy (COE)		0.32	€/kWh	
								<b>PV Energy Flow</b>				
								Total PV Energy		312.44	MWh	
								Direct Consumption		98.13	MWh	
								Battery Charging		11.88	MWh	
								Electrolyser Usage		73.69	MWh	
								Excess Electricity to GRID		128.73	MWh	

Figure 27: Hydrogen Tank Size Variation Result 1.8

## **Battery unit size variation 1.9**

Further variations could be to try changing the battery storage sizing. The battery storage consumes 11.88 MWh of PV energy to charge itself. Some amount of this energy can be used by an electrolyzer if there is no battery storage unit. As seen in the fig. 27, when the battery unit is removed (or in this case, reduced to its minimum value), there are significant changes in the system. First, the COE value reduces drastically from 0.323 €/kWh to 0.231 €/kWh. The difference is huge. Also, the hydrogen consumption of the fuel cell for the first phase has reduced to 828.14 kg, which is 427.4 kg less than in the last case, which resulted in a smaller hydrogen storage tank size. The hydrogen storage tank size required after removing battery storage is 1500 kg, which reduces overall costs. Also, the electrolyzer size can be reduced due to less hydrogen requirements.

The only negative impact of the battery unit removal on the system performance is the increase in grid energy usage. With the battery system included, the total electricity imported from the grid was 10.08 MWh; without the battery unit, it is 36.25 MWh. But the overall COE is still less because the comprehensive COE from the battery system is greater than the COE from the grid. But the usage of the battery unit is strictly optional and depends upon the critical load. The battery system should be sized as per the critical load requirement. So, the system can be designed with or without a battery unit depending on the user's requirements.

After studying all the above cases, it can be deduced that case 1.9 becomes the optimum case result if there is no critical load. In the presence of critical load, the necessary battery system should be used with the best possible combination of sizes for other system components. The tool can be used with more variations, such as changing the PV plant and fuel cell size. Also, the load profile can be changed. All the changes should be made as per the requirement, and an optimum solution should be found using the different steps used in all the cases seen before.

The final COE of 0.231 €/kWh is a great value, and one must stay informed that this value is without considering any government subsidy on such a huge renewable project. If considered, the results will be astonishing.



## 6.7. Calculating the cost of energy

To create a future hydrogen energy economy, the amount of sustainable hydrogen production needs to be increased widely, which will result in cheap hydrogen production [2]. The production costs of hydrogen by using sustainable energy will reduce only if there is a huge boost in renewable hydrogen production. The method to calculate the Levelized Cost of energy in this business case is used from the [37].

The LCE is defined as the ratio of total costs incurred for the system over its lifetime to the total energy generated by the system [37]. It can be calculated with the help of following expression,

$$LCE = TAC/E_{tot}$$

where,

LCE - levelized cost of energy

TAC - total accrued cost

$E_{tot}$  - total energy generated.

Applying this formula to case 1.9,

$$\begin{aligned} LCE &= 1801540.85/7810990 \\ &= 0.231 \text{ €/kWh} \end{aligned}$$

## 7. Storage

Hydrogen storage is one of the most discussed issues affecting the future hydrogen economy. The traditional storage systems for hydrogen, both for steady and mobile applications, are very complicated because of its low density in both forms as a gas at 0.09 kg/NAm<sup>3</sup> (kilogram per normal cubic meter) and a liquid at 70.9 kg/NAm<sup>3</sup> and the low boiling point at 20.2 K [2]. Hydrogen is the lightest, simplest and most abundant in nature. To store it physically, it is necessary to change its state conditions like temperature, pressure, phase, and it can also be stored chemically in various solid and liquid compounds such as methane, methanol, alanates, light hydrocarbons, borohydrides, carbon nanostructures, metal hydrides [38].

The hydrogen can be stored in three forms which are liquid, gaseous and solid-state. The most established storage system for hydrogen is the physical storage system which uses pressurized hydrogen gas [39]. The physical hydrogen storage methodology is primarily based on the compression and cooling or liquefaction of hydrogen and also on sorption methods which include mainly adsorption or sorption-like methods such as clathrate hydrates, and molecular inclusion of hydrogen on nanostructured carbon. The primary method compressed and liquefaction of hydrogen requires its corresponding infrastructure, such as cryogenics for liquefaction and a compressor system for pressurization [40].

The hydrogen storage system used in this study is from Wystrach GmbH. The unit comes with a 20 ft. container which can occupy 104 cylinders of 200 or 300 bar pressure which is approx. 241 or 312 kg of hydrogen respectively, and all the other components required for installation of the system, including cross fabricated side walls for the container, making it easier for transportation if necessary or even for stationary purposes. Complete assembly costs approx. 180,000 € for 200 bar variant and 200,000 € for 300 bar variant. In the calculation tool, a 300-bar variant is used.

Hydrogen storage can be differentiated in terms of its application. The two types of applications are stationary and mobile. Fixed storage methods are used generally at the point of on-site generation, storage, and use. Mobile application includes the transportation of stored hydrogen at a point of another storage or use, and in vehicles [41].

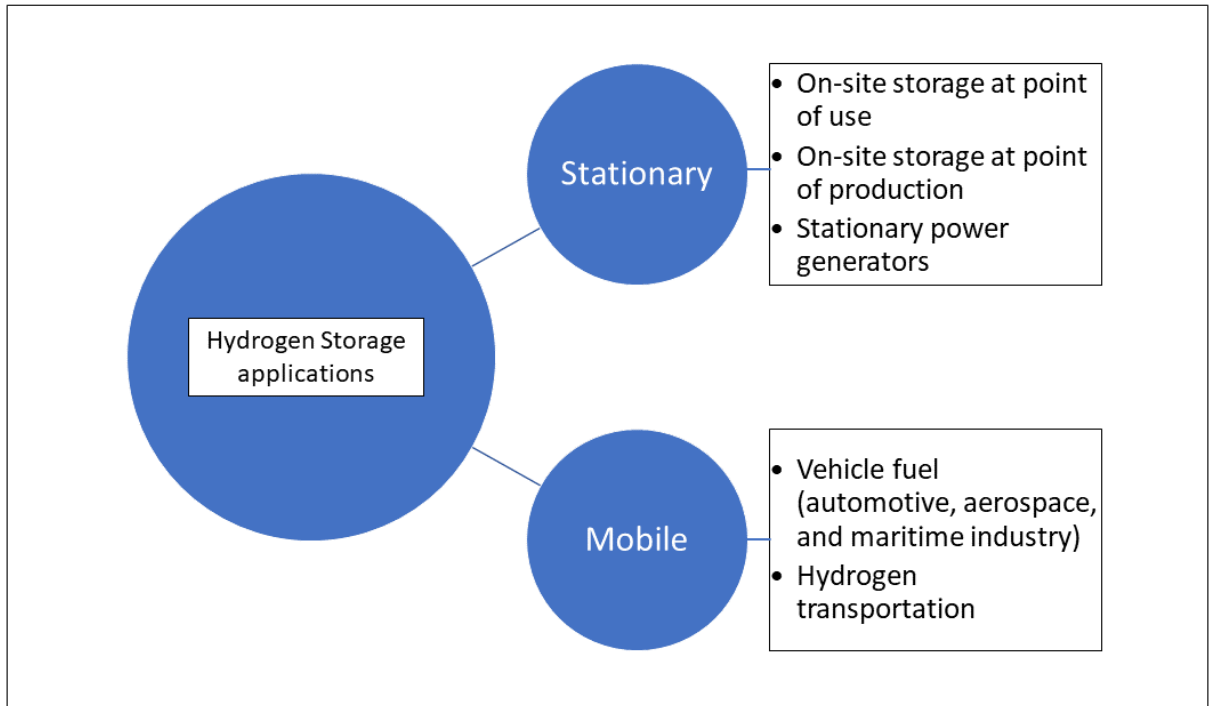

Figure 29: Hydrogen storage applications [41]

## 8. Transportation

To develop a hydrogen economy, a stable and high-quality hydrogen delivery infrastructure is required for transporting the hydrogen from its production point to the user, which can be a refuelling station or stationary power facility, etc. [2]. Hydrogen gas has low volumetric energy density at standard temperatures and pressures. If compared to gasoline, it is over three orders of magnitude lesser. That is why hydrogen needs to be stored with high volumetric energy density to make it available for practical use and transportation. This requirement makes it expensive and includes higher energy requirements for it to be used as an energy carrier. Some of the methods used to improve hydrogen's volumetric energy density are transporting it as a compressed gas, as a chemical compound, such as metal hydride, or a cryogenic liquid [42].

Usually, two types of hydrogen delivery systems are considered; the first is hydrogen transmission which can be from a central production plant to a single point of use, and the second is hydrogen distribution which is from a central production unit to a distributed network of refuelling stations with a city or a region. There are three types of delivery modes; 1. Compressed-gas trucks, 2. cryogenic liquid trucks, and 3. compressed gas pipelines [42].

The characteristics of hydrogen gas transmission technologies can be seen in the table 12 [43].

The important factors affecting the hydrogen delivery cost are,

1. Scale (flow rate of hydrogen into the city): For liquid hydrogen delivery systems, scale is very important because liquefiers have strong scale economies. The pipeline system is also scale-oriented as pipeline capital cost distribution depends strongly on the scale. The scale economies for the compressed gas trucks are mild in nature.
2. Number of stations: This is mainly related to the extent of pipeline infrastructure needed for the connections between stations (higher distances for pipelines can cause higher costs).
3. Distance: It mainly affects the compressed gas trucks and pipeline delivery system. Liquid hydrogen delivery is less affected. [44]



Table 12: The characteristics of hydrogen gas transmission technologies [43]

	<b>PIPELINE</b>	<b>LIQUID (ROAD)</b>	<b>LIQUID (SHIP)</b>	<b>GAS TRUCKS</b>
<b>ADVANTAGES</b>	<ul style="list-style-type: none"> <li>- high efficiency</li> <li>- large volumes</li> <li>- low variable cost</li> <li>- provides storage and buffering</li> </ul>	<ul style="list-style-type: none"> <li>– High efficiency</li> <li>– Higher volumes than compressed gas</li> </ul>	<ul style="list-style-type: none"> <li>– Very high volumes</li> <li>– Could allow international transport</li> </ul>	<ul style="list-style-type: none"> <li>– Can be deployed at small scales</li> </ul>
<b>DISADVANTAGES</b>	<ul style="list-style-type: none"> <li>- needs high volumes of hydrogen to validate the pipeline costs</li> <li>- capital intensive</li> <li>- required volume increase with distance</li> </ul>	<ul style="list-style-type: none"> <li>– Increases road traffic</li> <li>– Boil-off losses</li> <li>– Expense and inefficiency of the liquefaction process</li> </ul>	<ul style="list-style-type: none"> <li>– Not feasible until large supply and demand exists</li> <li>– No experience of LH2 shipment</li> <li>– Boil-off losses are more significant than road</li> </ul>	<ul style="list-style-type: none"> <li>– Energy inefficient</li> <li>– Small deliveries per truck</li> <li>– Increases traffic</li> <li>– Can't handle large capacities</li> </ul>
<b>SUITABLE FOR</b>	<ul style="list-style-type: none"> <li>– Where pipeline storage is used</li> <li>– Large and very large quantities of gas</li> </ul>	<ul style="list-style-type: none"> <li>– Where liquid storage is used</li> <li>– Large quantities of gas</li> </ul>	<ul style="list-style-type: none"> <li>– International transport</li> <li>– Very large quantities of gas</li> </ul>	<ul style="list-style-type: none"> <li>– Small distances</li> <li>– Small quantities of gas</li> </ul>
<b>CAPACITY</b>	<ul style="list-style-type: none"> <li>– Up to 100 000 kg/h (3.9 GW)</li> </ul>	<ul style="list-style-type: none"> <li>– Up to 4000 kg per truck</li> </ul>	<ul style="list-style-type: none"> <li>– Potentially 10 million kg per shipment</li> </ul>	<ul style="list-style-type: none"> <li>– Up to 400 kg (delivered) per truck</li> </ul>
<b>ENERGY REQUIRED EFFICIENCY</b>	<ul style="list-style-type: none"> <li>Pipeline compressors</li> <li>– 99.2% per 100 km</li> </ul>	<ul style="list-style-type: none"> <li>Transport fuel</li> <li>– 99% per 100 km for transport</li> <li>– 75% efficiency of liquefaction</li> </ul>	<ul style="list-style-type: none"> <li>Transport fuel</li> <li>– fuel use unknown</li> <li>– boil-off 0.3% per day</li> </ul>	<ul style="list-style-type: none"> <li>Transport fuel</li> <li>– 94% per 100 km</li> </ul>

## **8.1. Advantages and disadvantages of hydrogen as a transport fuel**

Hydrogen as a transportation fuel has both advantages as well disadvantages. Some of the key advantages and disadvantages are listed below.

Advantages:

1. Direct usage of hydrogen as a fuel in the internal combustion engine. It is almost similar to the engines used with gasoline. [45]
2. Hydrogen and ethyl alcohol can be blended together to be used as an alternative renewable fuel in a carbureted spark-ignition engine. [46]
3. Because of its unchanged state (gaseous) even in extreme winters, hydrogen engines are very easy to start in winters, even at a temperature as low as  $-253^{\circ}\text{C}$ . [47]
4. Hydrogen has a clean combustion product which contains water and a small portion of NO<sub>x</sub>. It is believed that the NO<sub>x</sub> portion can be reduced with proper measurements to the extent as low as 1/200<sup>th</sup> fraction of diesel engines. [47]

Some of the drawbacks are mentioned below.

Drawbacks:

1. The most significant disadvantage of hydrogen as a transportation fuel is its low density which causes the usage of huge on-board storage tanks necessary. [2]
2. Hydrogen needs four times of volume to store the same amount of energy as compared to gasoline. [48]

## 9. Future scope

Hydrogen is highly considered to be the next potential cost-efficient fuel for the future economy. The consideration is based on the facts that it is [39],

1. the most abundant element which can be found in the universe (almost more than 90% of the atoms contain hydrogen)
2. the lightest element with a molecular weight of 2.106 having the highest energy content compared to any other fuel
3. sustainable
4. non-toxic
5. when compared to fossil fuels such as petroleum, natural gas or coal, hydrogen is very pleasant to the environment and clean with the water as the only exhaust product while converting energy.

There needs a lot of changes before hydrogen becomes a vital part of day-to-day life, e.g., using hydrogen as a fuel source for transportation or as a new energy source. It requires more than changing to fuel cell cars. To change even the car type, it needs a vast infrastructure of hydrogen refuelling stations, enough hydrogen production plants and delivery systems for the supply of hydrogen to these refuelling stations. Also, safe hydrogen storage tanks will be needed to store the hydrogen in liquid form and the provision to convert it back into a gaseous state for refuelling [23].

There should be a considerable growth in hydrogen production using renewable energy, which will reduce the production costs and can even be used for electricity production if stored in large quantities. According to Renewable Energy Directive in the EU, the 'EU Hydrogen Strategy' emphasizes on the increased use of hydrogen and addresses on how to transform this potential into reality through regulation, investments, market creation and research and innovation.

The commission has planned the phased approach [49],

- Period: 2020 to 2024, at least 6 GW of renewable hydrogen electrolyzer systems installation will be supported, which could produce up to 1 million tonnes of renewable hydrogen
- Period: 2025 to 2030, hydrogen has to be the intrinsic part of the integrated energy system, with further improvement in renewable hydrogen electrolyzers to at least 40 GW and 10 million tonnes of green hydrogen production

- Period: 2030 to 2050, renewable hydrogen technologies should reach maturity and be used significantly across all the hard-to-decarbonize sectors.

To help deliver this strategy, the commission has launched the 'European Clean Hydrogen Alliance' with industry leaders, national and regional ministers, civil society, and European Investment Bank. The Alliance will work together to build up an investment pipeline throughout all the phases to scale up renewable hydrogen production and increase and support the demand for clean hydrogen in the EU [49].

Looking at Europe's strategic plan towards increasing renewable hydrogen production and creating a clean hydrogen economy till 2050, the hydrogen industry can itself feel the push. Acting towards these resolutions, a German firm named Fraunhofer ISE in Freiburg (south of Germany) has even built a filling station and is operating it. The hydrogen used here is produced with the PEM-electrolyzer working with the electricity produced from wind and solar power plants. The electrolyzer capacity is 13 kilograms of hydrogen per day with a purity of 99.9995%. The filling station is funded by the Federal State of Baden-Württemberg. Also, companies like Siemens (8.75 MW), Lhyfe (10 MW), HH2E in collaboration with MET Group and many more have started building the green hydrogen plants in Germany and around 30 small-scale companies in the Germany are using renewable energy to produce hydrogen.

## 10. Conclusion

As discussed in the business case in this paper, it gives excellent results when the green hydrogen plant is implied in SMEs or even industries with mid-ranged electricity consumption and enough space for such a plant to install. Though the initial investment in such cases looks enormous, it will give significant returns over a period of time. As seen in fig. 29, the COE over the period of 25 years, differs significantly when the system is used with the batteries. Inclusion of battery storage results into higher hydrogen consumption and bigger hydrogen tank and electrolyzer size, which significantly contributes to system's higher costs.

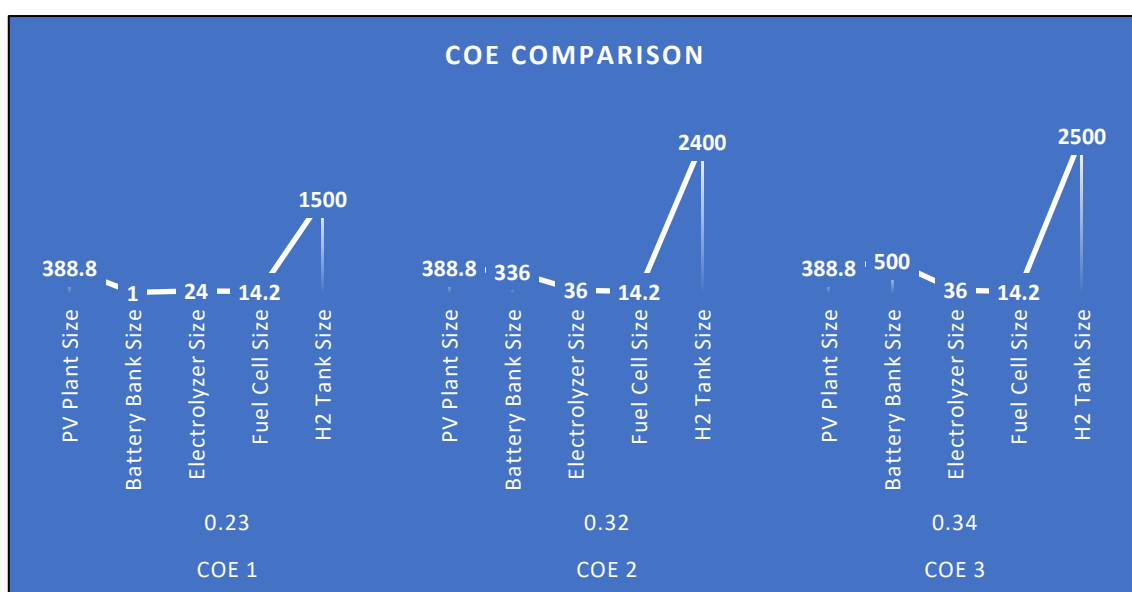

Figure 30: COE Comparison

As seen in chapter 8, hydrogen storage is the biggest question being studied right now. There are different methodologies including liquid and gaseous hydrogen storage systems which have their own advantages and disadvantages such as liquid hydrogen storage has high costs because the liquefaction process is costly and gaseous storage where on one hand offers simplicity in design and use, it also comes with the disadvantage of high pressure and big volume requirement.

The fuel cell has to be chosen with minimal capacity to utilize the hydrogen more efficiently, so that the electricity produced from hydrogen is mostly used for load supply and less energy should go back to the grid. Also, the fuel cell efficiency can be increased even more by utilizing the waste heat in the process. The waste heat can be used with the help of CHP for heat supply in the building reducing the heat pump size requirement.

The most important factor in the whole system is PV plant. As it can be seen in the tool results, the electricity generated from PV plant is the cheapest source of energy and the bigger the PV plant is, the smaller will be the COE.

Overall, the important factor in heading towards a hydrogen economy is to focus more on renewable hydrogen production and its transport and storage infrastructure. The more significant the investment and approach, the renewable hydrogen becomes cheaper, making it the preferable alternative over other fuels.

As the globe is moving towards sustainable and clean alternatives to tackle the energy crisis and reduce the impact on the environment due to carbon emissions, green hydrogen is the perfect solution to this. Green hydrogen, a carbon-neutral fuel, is a step closer to a sustainable future.

## 11. References

- [1] R. Scita, P. P. Raimondi, and M. Noussan, "Green Hydrogen: The Holy Grail of Decarbonisation? An Analysis of the Technical and Geopolitical Implications of the Future Hydrogen Economy," *SSRN Journal*, 2020, doi: 10.2139/ssrn.3709789.
- [2] M. Balat, "Potential importance of hydrogen as a future solution to environmental and transportation problems," *International Journal of Hydrogen Energy*, vol. 33, no. 15, pp. 4013–4029, 2008, doi: 10.1016/j.ijhydene.2008.05.047.
- [3] Suttichai Assabumrungrat, Suwimol Wongsakulphasatch, Pattaraporn Lohsoontorn Kim and Alírio E. Rodrigues, *Hydrogen Production Technologies*. Basel, Switzerland: MDPI - Multidisciplinary Digital Publishing Institute, 2021.
- [4] D. V., "Steam reforming of sunflower oil for hydrogen gas production," *Helvia*, vol. 30, no. 46, pp. 103–132, 2007, doi: 10.2298/HEL0746103D.
- [5] C. W. Forsberg, "Future hydrogen markets for large-scale hydrogen production systems," *International Journal of Hydrogen Energy*, vol. 32, no. 4, pp. 431–439, 2007, doi: 10.1016/j.ijhydene.2006.06.059.
- [6] R. Cherry, "A hydrogen utopia?," *International Journal of Hydrogen Energy*, vol. 29, no. 2, pp. 125–129, 2004, doi: 10.1016/S0360-3199(03)00121-6.
- [7] European Service Network, "Hydrogen energy and fuel cells: A vision of our future," vol. 20719, EUR-20719-EN.
- [8] Prof. Albert Germain, "Hydrogen as an energy carrier," 2006.
- [9] Z. Fang, R. L. Smith, and X. Qi, *Production of Hydrogen from Renewable Resources*. Dordrecht: Springer Netherlands, 2015.
- [10] International Renewable Energy Agency (IRENA), "Green hydrogen: A guide to policy making,"
- [11] Alex Haynes, *The difference between green hydrogen and blue hydrogen*. [Online]. Available: <https://www.petrofac.com/media/stories-and-opinion/the-difference-between-green-hydrogen-and-blue-hydrogen/#:~:text=What%20is%20blue%20hydrogen%3F,environmental%20impacts%20on%20the%20planet>
- [12] A. Godula-Jopek, *Hydrogen Production by Electrolysis: Materials, processes, systems and technology*. Weinheim: Wiley-VCH Verlag GmbH & Co. KGaA, 2016.
- [13] T. E. Lipman and A. Z. Weber, *Fuel Cells and Hydrogen Production*. New York, NY: Springer New York, 2019.
- [14] K. Rajeshwar, R. D. McConnell, and S. Licht, *Solar hydrogen generation: Toward a renewable energy future*. New York NY: Springer, 2008.
- [15] G. Zini and P. Tartarini, *Solar Hydrogen Energy Systems*. Milano: Springer Milan, 2012.
- [16] Energy Efficiency and Renewable Energy (U.S. Department of Energy), Ed., *Fuel Cells Fact Sheet*. [Online]. Available: [https://www.energy.gov/sites/prod/files/2015/11/f27/fcto\\_fuel\\_cells\\_fact\\_sheet.pdf](https://www.energy.gov/sites/prod/files/2015/11/f27/fcto_fuel_cells_fact_sheet.pdf)
- [17] B. Sundén, "Fuel cell types - overview," pp. 123–144, doi: 10.1016/B978-0-12-816950-6.00008-7.
- [18] B. Sørensen, *Hydrogen and fuel cells: Emerging technologies and applications*, 1st ed. Amsterdam, Boston: Elsevier Academic Press, 2005.
- [19] J. Töpler and J. Lehmann, *Hydrogen and Fuel Cell*. Berlin, Heidelberg: Springer Berlin Heidelberg, 2016.
- [20] A. Velazquez Abad and P. E. Dodds, "Green hydrogen characterisation initiatives: Definitions, standards, guarantees of origin, and challenges," *Energy Policy*, vol. 138, p. 111300, 2020, doi: 10.1016/j.enpol.2020.111300.

- [21] T. N. Veziroglu and F. Barbir, "Solar–Hydrogen Energy System: The Choice of the Future," *Envir. Conserv.*, vol. 18, no. 4, pp. 304–312, 1991, doi: 10.1017/S0376892900022554.
- [22] O. Atlam, F. Barbir, and D. Bezmalinovic, "A method for optimal sizing of an electrolyzer directly connected to a PV module," *International Journal of Hydrogen Energy*, vol. 36, no. 12, pp. 7012–7018, 2011, doi: 10.1016/j.ijhydene.2011.03.073.
- [23] B. Zohuri, *Hydrogen Energy*. Cham: Springer International Publishing, 2019.
- [24] Y. Yang, S. Bremner, C. Menictas, and M. Kay, "Battery energy storage system size determination in renewable energy systems: A review," *Renewable and Sustainable Energy Reviews*, vol. 91, pp. 109–125, 2018, doi: 10.1016/j.rser.2018.03.047.
- [25] Przemyslaw Komarnicki, Pio Lombardi, Zbigniew Styczynski, *Electric Energy Storage Systems Flexibility Options for Smart Grids (Przemyslaw Komarnicki, Pio Lombardi etc.)* (z-lib.org).
- [26] N. Bizon, *Optimization of the fuel cell renewable hybrid power systems*. Cham: Springer, 2020.
- [27] Thomas B. Reddy, *Linden's Handbook of Batteries*, 4th ed.: Mc Graw Hill, 2010.
- [28] A. Chauhan and R. P. Saini, "A review on Integrated Renewable Energy System based power generation for stand-alone applications: Configurations, storage options, sizing methodologies and control," *Renewable and Sustainable Energy Reviews*, vol. 38, pp. 99–120, 2014, doi: 10.1016/j.rser.2014.05.079.
- [29] L. A. Wong, V. K. Ramachandaramurthy, S. L. Walker, and J. B. Ekanayake, "Optimal Placement and Sizing of Battery Energy Storage System Considering the Duck Curve Phenomenon," *IEEE Access*, vol. 8, pp. 197236–197248, 2020, doi: 10.1109/ACCESS.2020.3034349.
- [30] Á. A. Bayod-Rújula, M. E. Haro-Larrode, and A. Martínez-Gracia, "Sizing criteria of hybrid photovoltaic–wind systems with battery storage and self-consumption considering interaction with the grid," *Solar Energy*, vol. 98, pp. 582–591, 2013, doi: 10.1016/j.solener.2013.10.023.
- [31] T. Maeda, H. Ito, Y. Hasegawa, Z. Zhou, and M. Ishida, "Study on control method of the stand-alone direct-coupling photovoltaic – Water electrolyzer," *International Journal of Hydrogen Energy*, vol. 37, no. 6, pp. 4819–4828, 2012, doi: 10.1016/j.ijhydene.2011.12.013.
- [32] J. J. Caparrós Mancera, F. Segura Manzano, J. M. Andújar, F. J. Vivas, and A. J. Calderón, "An Optimized Balance of Plant for a Medium-Size PEM Electrolyzer: Design, Control and Physical Implementation," *Electronics*, vol. 9, no. 5, p. 871, 2020, doi: 10.3390/electronics9050871.
- [33] Q. Cai, D. Brett, D. Browning, and N. P. Brandon, "A sizing-design methodology for hybrid fuel cell power systems and its application to an unmanned underwater vehicle," *Journal of Power Sources*, vol. 195, no. 19, pp. 6559–6569, 2010, doi: 10.1016/j.jpowsour.2010.04.078.
- [34] C. Bernay, M. Marchand, and M. Cassir, "Prospects of different fuel cell technologies for vehicle applications," *Journal of Power Sources*, vol. 108, 1-2, pp. 139–152, 2002, doi: 10.1016/S0378-7753(02)00029-0.
- [35] James E. Piper, *Facility Management: Tools and Techniques, Formulas and Tables*: BNI Publication, Inc.
- [36] Victoria Aragon, Julian David Quintero, Stephanie Gauthier, Patrick James and Abubakr Bahaj, "UNPACKING MID-SEASON HEATING DEMAND IN SOCIAL HOUSING," Sep. 2018. [Online]. Available: <https://www.ashrae.org/File%20Library/Conferences/Specialty%20Conferences/2018%20Building%20Performance%20Analysis%20Conference%20and%20SimBuild/Papers/C104.pdf>



- [37] R. Luna-Rubio, M. Trejo-Perea, D. Vargas-Vázquez, and G. J. Ríos-Moreno, "Optimal sizing of renewable hybrids energy systems: A review of methodologies," *Solar Energy*, vol. 86, no. 4, pp. 1077–1088, 2012, doi: 10.1016/j.solener.2011.10.016.
- [38] B. D. Shakya, L. Aye, and P. Musgrave, "Technical feasibility and financial analysis of hybrid wind–photovoltaic system with hydrogen storage for Cooma," *International Journal of Hydrogen Energy*, vol. 30, no. 1, pp. 9–20, 2005, doi: 10.1016/j.ijhydene.2004.03.013.
- [39] J. O. Abe, A. Popoola, E. Ajenifuja, and O. M. Popoola, "Hydrogen energy, economy and storage: Review and recommendation," *International Journal of Hydrogen Energy*, vol. 44, no. 29, pp. 15072–15086, 2019, doi: 10.1016/j.ijhydene.2019.04.068.
- [40] Patrick Preuster, Alexander Alekseev, and Peter Wasserscheid, "Hydrogen Storage Technologies for Future Energy Systems,"
- [41] R. Moradi and K. M. Groth, "Hydrogen storage and delivery: Review of the state of the art technologies and risk and reliability analysis," *International Journal of Hydrogen Energy*, vol. 44, no. 23, pp. 12254–12269, 2019, doi: 10.1016/j.ijhydene.2019.03.041.
- [42] C. YANG and J. OGDEN, "Determining the lowest-cost hydrogen delivery mode," *International Journal of Hydrogen Energy*, vol. 32, no. 2, pp. 268–286, 2007, doi: 10.1016/j.ijhydene.2006.05.009.
- [43] Sam Hawkins, "Technological characterisation of hydrogen storage and distribution technologies," 2006.
- [44] C. Yang, Michael A Nicholas, and Joan M Ogden, "Comparison of Idealized and Real-World City Station Siting Models for Hydrogen Distribution," 2006.
- [45] M. Balat, "Current Alternative Engine Fuels," *Energy Sources*, vol. 27, no. 6, pp. 569–577, 2005, doi: 10.1080/00908310490450458.
- [46] M. A.-R. S. Al-Baghdadi, "A study on the hydrogen–ethyl alcohol dual fuel spark ignition engine," *Energy Conversion and Management*, vol. 43, no. 2, pp. 199–204, 2002, doi: 10.1016/S0196-8904(01)00020-6.
- [47] J. Ma, "Simulation and prediction on the performance of a vehicle's hydrogen engine," *International Journal of Hydrogen Energy*, vol. 28, no. 1, pp. 77–83, 2003, doi: 10.1016/S0360-3199(02)00046-0.
- [48] A. Demirbaş, "Hydrogen and Boron as Recent Alternative Motor Fuels," *Energy Sources*, vol. 27, no. 8, pp. 741–748, 2005, doi: 10.1080/00908310490450836.
- [49] *Powering a climate-neutral economy: Commission sets out plans for the energy system of the future and clean hydrogen.*

# 12. Appendix

## 12.1. Battery Datasheet

(Source: [https://www.batterx.io/wp-content/uploads/2018/11/batterX\\_Batterie-Lifepo-DE.pdf](https://www.batterx.io/wp-content/uploads/2018/11/batterX_Batterie-Lifepo-DE.pdf))



### LIFEPO-BATTERIEMODUL

LFP3500



Die batterX® LFP ist eine Lithium-Eisenphosphat-Batterie in Form eines 3,5kWh-Moduls, welches mit und ohne Gehäuse installiert werden kann. Werden die Module frei aufgestellt, nutzt man Brackets, um sie mechanisch miteinander zu verbinden.

Abhängigkeit der Zyklenzahl von Entladestrom und Entladetiefe (DoD): Durch kleine Entladeströme und eine geringe Entladetiefe werden bis zu 15.000 Zyklen erreicht.

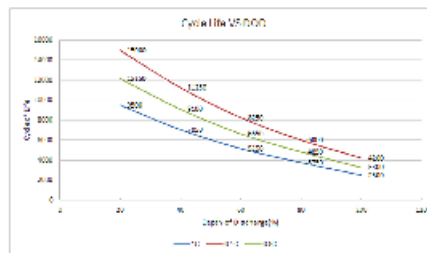

#### TECHNISCHE DATEN

Basisparameter	Batteriemodul LFP3500
Nominalspannung (V)	48
Nominalkapazität (Wh)	3552
Nutzbare Kapazität (Wh)	3200 (90% DoD)
Abmessungen (mm, BxTxH)	442'420'132
Gewicht (kg)	32
Entladespannung (V)	45 ~ 53,5
Ladespannung (V)	52,5 ~ 53,5
Standard-Lade- und Entladestrom (A)	37A
Maximaler Lade- und Entladestrom (A)	74A
Kommunikation	RS232, RS485, CAN
Betriebstemperatur	0°C ~ 50°C Ladung
Zertifikate	TÜV / CE / UN38.3
Zyklen	Bis zu 8000 Zyklen in Abhängigkeit von C-Rate und DoD

22.11.18 14:02 batterX\_Batterie-Lifepo-DE



Figure 31: Battery datasheet

## 12.2. UPS Datasheet

(Source: <http://www.batterx.io/wp-content/uploads/2019/05/batterx-Business-Series-EN.pdf>)



by Vision UPS Systems

Applications | Industry | Data center | Healthcare | Server | Home

---



eco friendly

# batterX business

## 10-650 kVA (3/3)









HYBRID

### Characteristics

- UPS with online double conversion technology
- Hybrid ready for photovoltaic use:
  - Best choice for PV off grid project
  - Best choice for energy storage
  - Compatible with any standard on grid inverter from the market
- Remote maintenance software - liveX
- Very small foot print
- Double input for AC grid and Bypass
- 2x RS232 + Relay box + SNMP + ModBus + HDMI
- Multiple "Eco Mode" settings to increase the efficiency

Working principle

Protection against...

 Blackout	 Overvoltage
 Frequency variation	 Voltage harmonic
 Undervoltage	 High-frequency transient
 Voltage imbalance	 Power surge

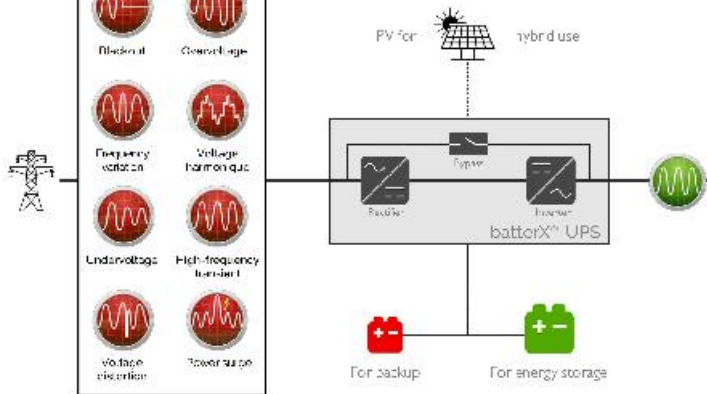





PV for hybrid use

Rectifier    Inverter

batterX<sup>®</sup> UPS

For backup    For energy storage

### Applications

- 
- 
- 
- 
- 

1

[www.visionups.com](http://www.visionups.com)

Figure 32: UPS datasheet

E | Page

batterX business	batterX Specifications														
Power (kVA)	10	15	20	30	40	60	80	100	120	160	200	250	300	400/500	
<b>— Input</b>															
Voltage	380/400/415 Vac 3phase +N,+/-20% (415 Vac +15% -25%)														
Frequency range	50/60 Hz adjustable, +/-10 Hz														
Power factor	0,99														
Harmonic distortion (THDi)	<3%														
Additional bypass input	ja														
Bypass Voltage range	380/400/415 Vac 3phase +N, +/-10%														
Solar charge controller	yes - hybrid function														
<b>— Output</b>															
Power factor	0,9														
Power (kW)	9	13,5	18	27	36	54	72	90	108	144	180	225	270	360/400	
Voltage Regulation	380/400/415 Vac 3phase +N, +/-1% (220/230/240 Vac for 10-30 kVA)														
frequency	50 Hz or 60 Hz selectable														
Frequency Regulation	line synchronized +/-2%, battery mode +/-0,1% adjustable														
Efficiency	up to 94%														
Crest factor	3:1														
Overvoltage protection	100-125% 10 min, 125-150% 60 sec														
Additional protection	short circuit, voltage and current range														
Harmonic distortion (THD)	<3% at 100% linear load														
<b>— Battery</b>															
Type	VRLA AGM/GEL or other types														
Nominal voltage	+/-360 Vdc (2x30-12 Vdc)														
Float and end of discharge DC voltage	+/- 405 Vdc, +/-300 Vdc														
<b>— General</b>															
Standard	EMC/LVD/EMI - EN62040-1/2, EN60950														
User interface	multi language graphical LCD														
LCD Information	Phase to phase voltage, phase to neutral voltage/current, power, frequency, crest factor,T°, error code														
Advanced	Auto diagnostics, different maintenance alarms and calibration through RS232														
Communication	2x RS232 ports, 4 dry contact (in option 8 dry contacts)														
Input	Generator contact and emergency power off														
Genset Kit	User programmable														
Software	liveX management software														
Alarm	200 events (time and date) / in option 500 events														
Protection	Over-temperature, over-current, over-temperature alarm														
Temperature range	0°C - 40°C														
Degree of protection	IP20														
Humidity / Altitude	90% max without condensation / < 1000 m														
Sound level at 1m distance	≤ 56 dB	≤ 61 dB	≤ 64 dB	≤ 67 dB	≤ 72 dB										
Weight (kg)	86	92	98	175	182	196	218	259	480	560	650	770			
Dimensions (mm), LxWxH	1037x398x812			1437x513x852				1797x882x763					1797x1246x763		

HYBRID





liveX	liveX-Controlling Box	GPIO-Controlling Box
Communication	HDMI, Ethernet, 4 USB	relay contacts
Programmable relay contacts	8 input (optional)	8 input / 8 output
Dimensions (LxWxH)	240x140x95 mm (wall mount)	
Software	Energy Flow Management with local & cloudbased monitoring	
Visualization	Browser / mobile Application	



Charge Controller

Hybrid Off-grid Charge Controller	HCC10	HCC20	HCC40
max output power	10 kW	20 kW	40 kW
max PV output	12,5 kWp	25 kWp	50 kWp
MPPTs / max flow rate	1 x 13 A	1 x 50 A	2 x 50 A
Input range MPPT	400-650 V	400-650 V	210-300 V
Voc max	850 V	850 V	500 V
Efficiency	>97%		
Scalable	up to 8 controllers. Different capacities can be used in the same system.		
Installation	Wall mount or rack		
Dimensions (LxWxH)	520x420x150 mm	520x420x150 mm	749x454x150 mm
Weight (kg)	20 kg	20 kg	30 kg

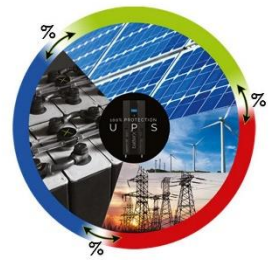

	batterX UPS	batterX UPS+ energy storage+partial feeding into the grid	batterX UPS+ energy storage+ 100% auto consumption
On-line double conversion technology with static bypass - 100% Protection	✓	✓	✓
Hybrid ready	✓	✓	✓
Green energy storage	●	✓	✓
<b>ON-GRID<sup>+</sup> MODE</b> In combination with on-grid inverter for partial auto consumption & feeding into the grid	●	✓	●
<b>FULL SELF CONSUMPTION MODE</b> Combination with batterX charge controller - 100% of PV power at power failure - No PV power restrictions - For 100% auto consumption - For off-grid installation - Calculable ROI with 15 min load profile	●	●	✓
<b>ENERGY FLOW MANAGEMENT</b>  Simultaneous mix of max 3 different energy sources  - Guaranteed load supply in case of missing AC grid power - For peak load sharing - Decentralized power supply - Choosing the lowest grid kw/h price	●		
<b>CLOUD BASED SOFTWARE liveX</b>   - Live view of grid, PV, battery, load parameter - Remote support via local or cloud access - Smart load management - Daily, weekly, monthly, yearly energy flow data	●		

✓ = Yes    -- = No    ● = Optional

# Operating modes

**UPS MODE** UPS protection



**ON-GRID<sup>+</sup> MODE** batterX + energy storage for PV ongrid systems

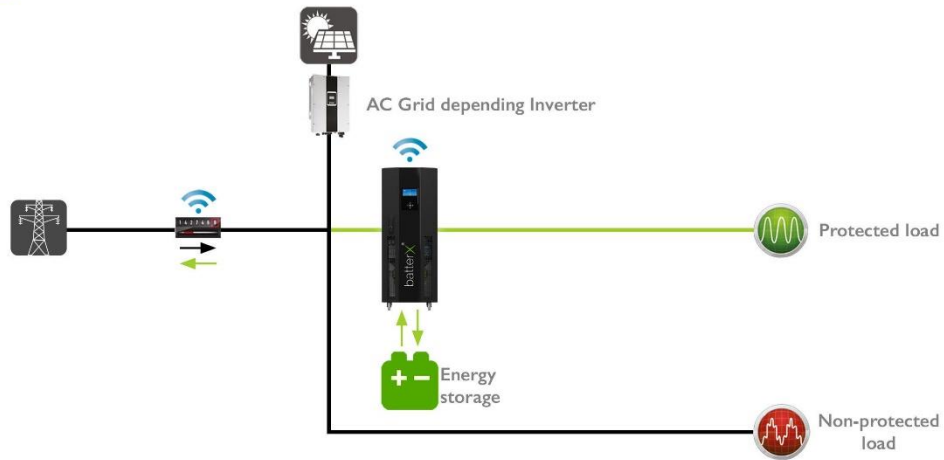

**FULL SELF CONSUMPTION MODE** batterX + energy storage for 100% auto consumption

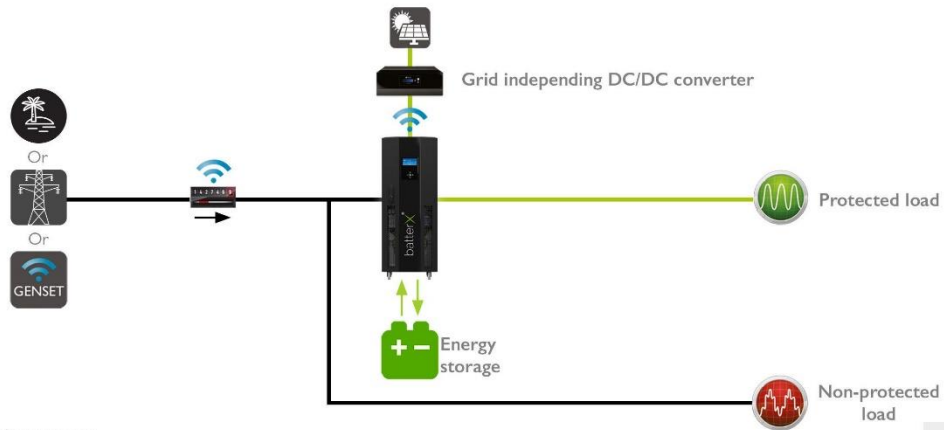

## 12.3. Electrolyzer Datasheet

(Source: [https://handbook.enapter.com/electrolyser/el40/downloads/Enapter\\_Datasheet\\_EL40\\_EN.pdf](https://handbook.enapter.com/electrolyser/el40/downloads/Enapter_Datasheet_EL40_EN.pdf))

# AEM Electrolyser EL 2.1

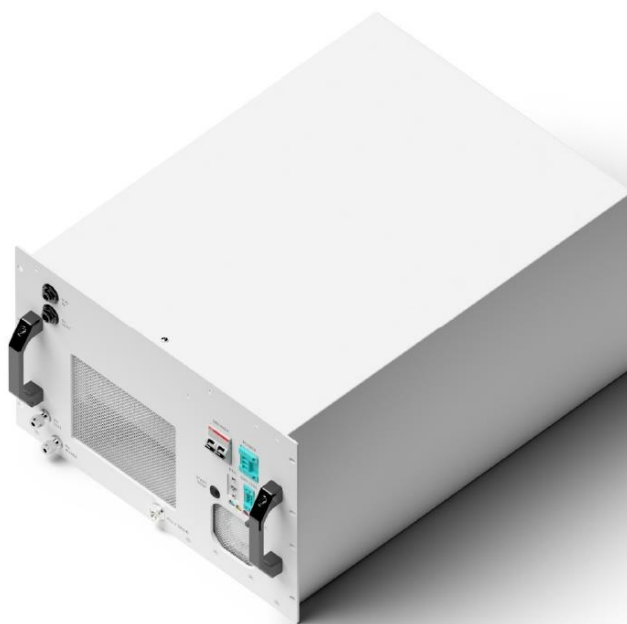

Enapter's patented anion exchange membrane (AEM) electrolyser is a standardized, stackable and flexible system to produce on-site hydrogen. The modular design – paired with advanced software integration – allows set up in minutes and remote control and management. Stack this electrolyser to achieve the required hydrogen flowrate.

### KEY FEATURES

- ≡ High efficiency
- ≡ Automated & remote operation with Enapter's Energy Management System
- ≡ Scalable and modular, add as many modules as needed
- ≡ Low maintenance requirements

ELE21-DTS-COM02

Figure 33: Electrolyzer datasheet

# Specifications

Enapter  
AEM Electrolyser EL 2.1

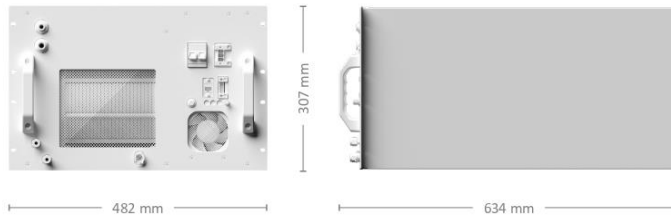

<b>Production rate</b>	500 NL/h 1.0785 kg/24h
<b>Hydrogen output purity</b>	35 bar: ~ 99.90% (Impurities: ~ 1000 ppm H <sub>2</sub> O) 8 bar: > 1500 ppm H <sub>2</sub> O
<b>Output pressure</b>	Up to 35 barg
<b>Nominal power consumption per Nm<sup>3</sup> of H<sub>2</sub> produced (beginning of life)</b>	4.8 kWh/Nm <sup>3</sup>
<b>Operative power consumption</b>	2.4 kW
<b>Stand-by power consumption</b>	15 W
<b>Power supply</b>	AC 200 - 240 V, 50/60 Hz
<b>Ambient operative temperature range</b>	5 °C - 45 °C
<b>Ambient operative humidity range</b>	Up to 95% Rh, non-condensing
<b>IP rating</b>	IP 20
<b>Control and monitoring</b>	Fully automatic with Enapter's EMS, Modbus TCP via Ethernet
<b>Water consumption</b>	~ 400 mL/h
<b>Water input conductivity</b>	< 20 µS/cm (at 25 °C)
<b>Water input pressure range</b>	1 - 4 barg
<b>Weight</b>	55 kg
<b>Dimensions</b>	W: 482 mm × D: 634 mm × H: 307 mm
<b>Space inside cabinet</b>	7 U
<b>Conformity</b>	CE certified according to the machine directive 2006/42/CEVv

ELE21-DTS-COM02





## 12.4. Fuel Cell Datasheet

(Source: [https://www.batterx.io/wp-content/uploads/2018/11/batterX\\_Batterie-Lifepo-DE.pdf](https://www.batterx.io/wp-content/uploads/2018/11/batterX_Batterie-Lifepo-DE.pdf))



**Proton Motor**  
Fuel Cell Stacks and Systems  
Cleantech Competence



DATA SHEET

### PM 400 Stack Module

Fuel Cell Stack Module for integration into fuel cell systems

Stationary

Automotive

Maritime

Rail



Grafik/Foto: High-performance stack with bi-polar plates. Unique installation horizontally and vertically possible and worldwide only available with Proton Motor.

#### Interfaces

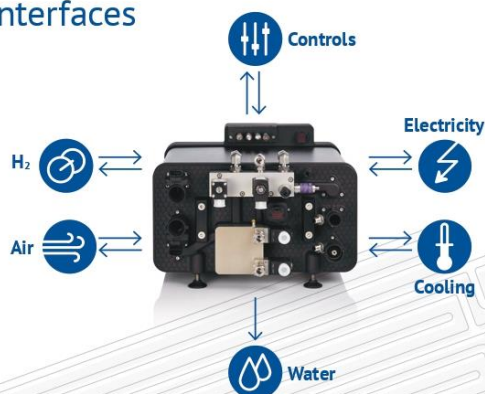

January 2021 © Proton Motor

#### Main benefits

- Freeze storage and start capable
- Long life time
- Liquid cooling (easy usability of the reaction heat)
- High reliability
- High efficiency
- Live monitoring and diagnosis
- Ideal for multiple applications
- No external humidification necessary
- Housed module
- No forced air ventilation needed
- Safe use – Stack housing explosion tested
- Most powerful stack with bi-polar plates

Figure 34: Fuel cell datasheet

Type PM 400	48	72	96	120	144	168	192	216	240
<b>Electrical Output</b>									
Power Range* [kW]	2.1-14.2	3.1-21.3	4.1-28.4	5.1-35.5	6.2-42.6	7.2-49.7	8.2-56.8	9.2-64.0	10.3-71.0
Current Range [A]	0-500								
Voltage Range [V DC]	28-55	42-83	56-110	71-137	85-165	99-193	113-220	127-248	142-275
EL System Efficiency* [%]	47-67								
<b>Hydrogen Interface</b>									
Hydrogen Quality	ISO 14687-2 / SAE J2719								
H2 Supply Pressure [bar <sub>a</sub> ]	3.0-7.0							7.0 +/-0.5	
Hydrogen Consumption (max) [kg/h]	0.93	1.39	1.85	2.32	2.78	3.25	3.71	4.18	4.64
<b>Dimensions</b>									
Width x Height** [mm x mm]	436 x 279								
Length** [mm]	486	580	673	768	860	954	1048	1141	1235
Volume [l]	59.1	70.6	81.9	93.4	104.6	116.0	127.5	138.8	150.2
Tare weight [kg]	37	46	55	64	73	82	91	100	109

\* without peripherals  
 \*\* main dimensions

## The PM 400 Fuel Cell Stack Module – the heart of PM’s technology

The PM Stack Module offers high performance and reliability. It is specially developed and manufactured by Proton Motor. Its straight forward and flexible integration makes the PM Stack Module ideal for multiple energy applications. In addition to the fuel cell stack, the stack module already includes electrical interfaces as well as communication and media connections.

### Included parts:

- Fuel cell stack
- Two main power switches to main DC/DC converter
- Pre-charging device for main DC/DC converter
- Voltage bleeding device
- Current sensor
- H2 purge valve
- H2 pressure sensor stack inlet
- H2 pressure switch stack inlet
- H2 pressure regulator stack inlet
- Main shut off valve stack inlet
- H2 filter stack inlet
- Anode water separator stack outlet
- Level switch anode water separator stack outlet
- Shut of valve anode water separator stack outlet
- Shut-off valve air outlet (back pressure)
- Temperature sensor cooling stack inlet
- Temperature sensor cooling stack outlet
- Temperature sensor air stack inlet
- Temperature sensor air stack outlet
- Cell voltage monitoring unit

### Environmental Conditions

Ambient Temperature [°C]	-35 to +45
Operating Altitude* [m]	< 2,000
Humidity ** [% r.H.]	< 95

### Others

Conformity	CE
Protection Class	IP65

\* without de-rating  
 \*\* non condensing

Specifications are subject to change without notice. Specifications and descriptions in this document were in effect at the time of publication. Proton Motor Fuel Cell GmbH reserves the right to changes at any time.

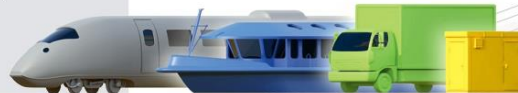

**Proton Motor Fuel Cell GmbH**  
 Benzstraße 7  
 D-82178 Puchheim  
 Germany

Phone +49 (0) 89 1276265 - 11  
 Fax +49 (0) 89 1276265 - 99  
 email [sales@proton-motor.de](mailto:sales@proton-motor.de)  
 Web [www.proton-motor.de](http://www.proton-motor.de)

Stationary  
 Automotive  
 Maritime  
 Rail

January 2021 © Proton Motor

## 12.5. Heat Pump Datasheet

(Source: [https://www.smartheat.de/fileadmin/media/downloads/SmartHeat\\_classic\\_2017\\_Auszug.pdf](https://www.smartheat.de/fileadmin/media/downloads/SmartHeat_classic_2017_Auszug.pdf))

**classic i**

### SmartHeat classic i

Sole/Wasser, Wasser/Wasser - Wärmepumpen  
Brine/Water, Water/Water heat pumps

**eco INVERTER TECHNOLOGIE**

**15 classic years**

**A+++<sup>4)</sup>**

**best selling 2016**

SmartHeat classic  
ideal für Ein- & Mehrfamilienhaus  
Ideal for detached and semidetached homes

### SERIE classic i

Wärmepumpen der Serie classic i bestehen durch ihr hohes Maß an Flexibilität: Heizen, Kühlen sowie Warmwasserbereitung (mit frei wählbarem externen Speichersystem). Im Leistungsbereich von 2 bis 33 kW bieten hocheffiziente Verdichter beste Voraussetzungen für einen ganzjährig optimalen Wärmepumpeneinsatz.

Mit modernster Inverter-Technologie in Verbindung mit einem elektronischen Expansionsventil lassen sich höchste Arbeitszahlen und geringe Verbrauchskosten realisieren und die Größe von Pufferspeichern kann deutlich reduziert werden. Zahlreiche Zusatzoptionen und Zubehörvarianten machen die SmartHeat classic i zu einer sehr flexibel einsetzbaren Wärmepumpe, die auf die Anforderungen des Projektes optimal abgestimmt werden kann. Das gilt vom energiesparenden Passivhaus bis zum energetischen Sanierungsfall von Mehrfamilienhäusern.

Typen: Sole/Wasser, Wasser/Wasser  
Leistungsbereich: 2 - 33 kW  
Leistungszahl: Bo/W35 bis 4,82 // W10/W35 bis 6,55

Ihre Vorteile auf einen Blick:

#### ➤ Ausstattung:

- » Kompakte Bauweise für extrem platzsparende Innenaufstellung
- » Maximale Vorlauftemperatur bis 60 °C
- » Multifunktionale Regelung (smic-system), siehe Seite 52
- » Anschlüsse hinten
- » Schnellaufheizstab 6 kW
- » Modernste Invertertechnologie
- » Leistungsstarke Doppel-Rollkolben- oder Scrollverdichter in Verbindung mit elektronischem Expansionsventil

- » Schallgedämmtes, pulverbeschichtetes Gehäuse
- » Mehrfach schwingungsentkoppelt
- » Vormontierte elektrische Ausstattung

#### ➤ Optionen:

- » Option R: Reversible Ausführung für Aktive Kühlung
- » Diverse Bus-Schnittstellen zur GUT-Anbindung
- » Zahlreiche Regleroptionen

#### ➤ Extras / Zubehör-Set (siehe ab Seite 21):

- » Anschluss-Set bestehend aus flexiblen Anschlussschläuchen zur Schwingungsentkopplung
- » Pumpenbaugruppe bestehend aus Hocheffizienzpumpen für Solekreis, Heizkreis und Warmwasser
- » Quellen-Set bestehend aus Mikroblasenabscheider, Schmutzfänger, zwei Multifunktionshähnen zum Befüllen und Spülen, Kleinteilen, Strömungsschalter
- » Sicherheitsbaugruppe mit Entlüfter und Manometer & Membran-Ausdehnungsgefäß
- » Wärmemengenzähler
- » Externe Pufferspeicher und Brauchwasserspeicher
- » Passive Kühleinheit
- » Druckschalter
- » Hydraulische Weiche
- » Weiteres Zubehör auf Anfrage

### Serie classic i

Heat pumps of the SmartHeat classic i series offer unrivalled flexibility and can be used for heating, cooling and hot water preparation (with or without chosen external storage system of your choice). The SmartHeat classic i units are designed for an output range from 2 to 33 kW, where high-efficiency compressors are the most effective solution for year-round operation.

Advanced inverter technology combined with an electronic expansion valve guarantees high COPs and low consumption costs. In addition, the size of the buffer storage tanks can be significantly reduced. The wide range of available extras and accessories make the SmartHeat classic i one of the most versatile heat pumps in the market, as these units can be adapted to meet virtually any project requirements. SmartHeat classic i units are therefore widely used in projects as diverse as new passive energy houses and heating system renovations.

Types: Brine/water, water/water  
Capacity range: 2 - 33 kW  
COP: Bo/W35 up to 4,82 // W10/W35 up to 6,55

Advantages at a glance:

#### ➤ Features:

- » Compact design for indoor installation
- » Max. heating flow temperature 60 °C
- » Smart multi-function control (smic) system, see page 52
- » Connections at the rear of the unit
- » 6 kW quick heat coil
- » State-of-the-art inverter technology
- » High-performance dual rotary piston or scroll compressors equipped with electronic expansion valves
- » Sound-insulated, powder-coated housing

- » Multi-stage vibration decoupling
- » All electrical components installed and fully wired

#### ➤ Options:

- » Option R: Reversible model for active cooling
- » Various bus interfaces for integration into facility management system
- » Wide range of regulating options

#### ➤ Extras / Accessories (see from page 21):

- » Connecting kits consisting of flexible tubes for vibration decoupling
- » Pump assembly, including high-efficiency pumps for brine, heating and hot water circuits
- » Source kit including micro-bubble separator, dirt trap, two multi-function taps for filling and rinsing, various small fittings and flow switch
- » Safety assembly with bleeder valve, pressure gauge and membrane expansion vessel
- » Heat meter
- » External buffer and DHW tank
- » Passive cooling unit
- » Pressure switch
- » Hydraulic shunt
- » Other accessories available on request

classic i

Bezeichnung Description	Typ Type			Verdichtertyp Compressor			Leistungsdaten Performance data 1)										Energieeffizienz energy label		Schallleistungspegel Sound power level				
	Sole/Wasser brine/water	Wasser/Wasser water/water	mit aktiver Kühlung incl. active cooling	Kältemittel Refrigerant	Inverter scroll inverter scroll	Inverter Rollenhuben inverter rotary	Betriebspunkt Operation point	Drehzahl Revolutions per second	Leistungsbereich Capacity range	Heizleistung Nominal heating capacity	Leistungsaufnahme Power input	Betriebsstrom Operating current	Leistungszahl EER	EEF // Kühlung W(B)12/W35 max rps	Max. Betriebsstrom Max. current consumption	Netzanschluss Power supply	Max. Verflüssigttemperatur Max. flow temperature	Hydraul. Anschlüsse Hydraulic connections		Abmessungen H x B x T Dimensions H x W x D 2)	ca. Gewicht approx. weight	Raumheizgeräte Space heaters 3)	Verbandanlage Package 4)
SmartHeat classic 008 BWi H055001008	x	-	-	R410a	-	x	Bo/W35	min (30rps) nominal (65rps) max (100rps)	1,89-7,84 4,24 7,84	0,43 0,93 1,79	3,7 3,9 5	4,43 4,57	-	12	230 ; 50 1 Ph	60	4 x 1"	Schrankdimension dimensions of housing 1060 x 600 x 620 mit Anschlüssen with connections 1060 x 600 x 700	135	A++	A+++	2,7	42-52
SmartHeat classic 008 BWi R H055006008	x	-	x	R410a	-	x	Bo/W35	min (30rps) nominal (65rps) max (100rps)	1,85-7,68 4,15 7,68	0,42 0,91 1,76	3,7 3,9 5	4,34 4,48	5,12 // 8,35	12	230 ; 50 1 Ph	60	4 x 1"	Schrankdimension dimensions of housing 1060 x 600 x 620 mit Anschlüssen with connections 1060 x 600 x 700	140	A++	A+++	2,7	42-52
SmartHeat classic 010 WWi H055002010	-	x	-	R410a	-	x	W10/W35	min (30rps) nominal (65rps) max (100rps)	2,53-10,33 5,72 10,33	0,42 0,91 1,77	3,6 3,8 5,8	6,11 6,3 5,84	-	12	230 ; 50 1 Ph	60	4 x 1"	Schrankdimension dimensions of housing 1060 x 600 x 620 mit Anschlüssen with connections 1060 x 600 x 700	135	A++	A+++	2,7	42-52
SmartHeat classic 010 WWi R H055007010	-	x	x	R410a	-	x	W10/W35	min (30rps) nominal (65rps) max (100rps)	2,48-10,13 5,61 10,13	0,41 0,89 1,74	3,6 3,8 5,8	5,98 6,17	5,12 // 8,35	12	230 ; 50 1 Ph	60	4 x 1"	Schrankdimension dimensions of housing 1060 x 600 x 620 mit Anschlüssen with connections 1060 x 600 x 700	140	A++	A+++	2,7	42-52

SmartHeat classic 012 BWi H055001012	x	-	-	R410a	-	x	Bo/W35	min (30rps) nominal (58rps) max (130rps)	2,47-12,27 4,9 12,27	0,54 1,05 2,86	4,5 4,7 7,1	4,56 4,69	-	16	230 ; 50 1 Ph	60	4 x 1"	Schrankdimension dimensions of housing 1060 x 600 x 620 mit Anschlüssen with connections 1060 x 600 x 700	140	A++	A+++	2,7	24-40
SmartHeat classic 012 BWi R H055006012	x	-	x	R410a	-	x	Bo/W35	min (30rps) nominal (58rps) max (130rps)	2,42-12,03 4,81 12,03	0,53 1,03 2,8	4,5 4,7 7,1	4,47 4,59	4,94 // 13,82	16	230 ; 50 1 Ph	60	4 x 1"	Schrankdimension dimensions of housing 1060 x 600 x 620 mit Anschlüssen with connections 1060 x 600 x 700	145	A++	A+++	2,7	24-40
SmartHeat classic 016 WWi H055002016	-	x	-	R410a	-	x	W10/W35	min (30rps) nominal (58rps) max (130rps)	3,36-16,62 6,68 16,62	0,53 1,03 2,8	4,4 4,4 7,7	6,34 6,52	-	16	230 ; 50 1 Ph	60	4 x 1"	Schrankdimension dimensions of housing 1060 x 600 x 620 mit Anschlüssen with connections 1060 x 600 x 700	140	A++	A+++	2,7	24-40
SmartHeat classic 016 WWi R H055007016	-	x	x	R410a	-	x	W10/W35	min (30rps) nominal (58rps) max (130rps)	3,3-16,28 6,55 16,28	0,52 1 2,74	4,4 4,4 7,7	6,21 6,39	4,94 // 13,82	16	230 ; 50 1 Ph	60	4 x 1"	Schrankdimension dimensions of housing 1060 x 600 x 620 mit Anschlüssen with connections 1060 x 600 x 700	145	A++	A+++	2,7	24-40
SmartHeat classic 024 BWi H055001024	x	-	-	R407c	x	-	Bo/W35	min (20rps) nominal (42rps) max (120rps)	3,94-23,74 8,63 23,74	0,9 1,79 6,06	10,1 10 12,2	4,37 4,82	-	24	400 ; 50 3 Ph	60	4 x 1 1/4"	Schrankdimension dimensions of housing 1060 x 600 x 620 mit Anschlüssen with connections 1060 x 600 x 700	155	A++	A+++	4,4	43-54

Aktuelle technische Daten und hydraulische Hinweise sowie Maßangaben sind den aktuellen Datenblättern und Bedienungsanleitungen zu entnehmen. Alle Hydrauliken und Darstellungsvorzeichen sind als Hinweis. Technische Änderungen und Änderungen am Design vorbehalten.  
For up-to-date technical data, hydraulic specifications and dimensions, see data sheets and operating manuals. All hydraulic schematics and other diagrams are provided for information purposes only. Subject to technical changes and changes in design without prior notice.

## 12.6. Solar Module Datasheet

(Source: [https://de.suntech-power.com/wp-content/uploads/download/product-specification/DE\\_Ultra\\_V\\_mini\\_STP410S\\_C54\\_Umh.pdf](https://de.suntech-power.com/wp-content/uploads/download/product-specification/DE_Ultra_V_mini_STP410S_C54_Umh.pdf))



# Ultra V mini

## HALBZELLIGES MONOFAZIALES MODUL

TYP: STPXXXS - C54/Umh



AUSGANGSLEISTUNG      MAX. EFFIZIENZ  
**390-410W**              **21,0%**

### Merkmale



**Hohe Ausgangsleistung**  
 Verglichen mit 166 mm basierten Halbzellenmodulen, erhöht sich die Ausgangsleistung der Module um ca. 25 - 30 Wp.



**Geringere Betriebstemperatur**  
 Der Leistung von Modulen ist stark von dessen Betriebstemperatur beeinflusst, der niedrige Temperaturkoeffizient der Zelle und der Suntech Module gewährleistet eine hohe Ausgangsleistung auch an heißen Tagen.



**Stromklassensortierung bei Suntech**  
 Bei Suntech werden die Module in die Stromklassen (I, II, III) sortiert bzw. unterschieden. Werden Module der gleichen Stromklasse in Reihe verschaltet, dann kann sich die Systemleistung um bis zu 2% erhöhen und so die Wirtschaftlichkeit der Anlage verbessern.



**Erweiterte Belastungstests**  
 Erweiterte mechanischen Belastbarkeit  
 Modul ist zertifiziert für eine hohe Belastung (bis max. 6000 Pa) auf der Vorderseite (z.B. Schneelasten) und hohe Belastung (max. 3800 Pascal) auf der Rückseite (wie z.B. Windlasten/Sog).



**Ausgezeichnete Schwachlicht-Leistung**  
 Ausgezeichnete Schwachlicht-Verhalten  
 Solarzellen und Module von Suntech sind so entwickelt, das diese bei schwachen Lichtverhältnissen wie Sonnenuntergang, Bewölkung oder Morgendämmerung noch die bestmögliche Ausgangsleistung haben.



**Standhalten in rauer Umgebung**  
 Die hohe Verarbeitungsqualität der sorgsam ausgewählten Materialien der Suntech Module resultiert in einer erhöhten Widerstandsfähigkeit und Lebensdauer in rauen Umgebungsbedingungen.\*

### Branchenführende Garantie\*\*

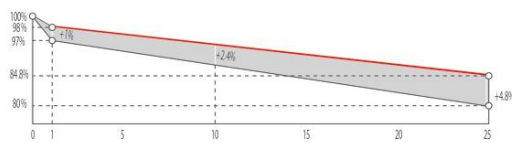

- ◆ Leistungsminderung des ersten Jahres: 2%
- ◆ Degradation: 0,55%
- ◆ Jahre Produktgarantie: 15 Jahre
- ◆ Garantie: 25 Jahre

### Zertifizierungen und Normen

CE IEC 61730 IEC 61215  
 SA 8000 Standards der sozialen Verantwortung  
 ISO 9001 Qualitätsmanagement-System  
 ISO 14001 Umweltmanagementsystem  
 ISO 45001 Arbeitsschutz und Sicherheit  
 IEC TS 62941 Leitfaden für die Qualifizierung des Moduldesigns und die Typenzulassung



Munich RE

\* Weitere Informationen finden Sie im Suntech-Installationshandbuch für Standardmodule.  
 \*\* Weitere Informationen finden Sie in der Suntech-Produktgarantie.

\*\*\* WEEE nur für den EU-Markt.  
 \*\*\*\* Suntech behält sich das Recht auf eine endgültige Auslegung der Erklärung von Munich RE vor.

Figure 35: Solar module datasheet

# Ultra V STPXXXS - C54/Umh 390-410W

## Mechanische Eigenschaften

Solarzelle	Monokristallines Silizium 182 mm
Anzahl der Zellen	108 (6 x 18)
Abmessungen	1724 x 1134 x 30 mm (67,9 x 44,6 x 1,2 Zoll)
Gewicht	22,1 kgs (48,7 lbs.)
Frontglas	3,2 mm (0,126 Zoll) voll gehärtetes Glas
Ausgangskabel	4,0 mm <sup>2</sup> symmetrische Längen (-) 1400 mm, (+) 1400 mm oder kundenspezifische Länge
Verteilerdose	Schutzklasse IP68 (3 Bypass-Dioden)
Betriebstemperatur Modul	-40 °C bis +85 °C
Maximale Systemspannung	1500 V DC (IEC)
Steckverbinder	MC4 EVO2, Cable01S, STP-XC4
Maximaler Bemessungsstrom bei Reihensicherung	25 A
Leistungstoleranz	0/+5 W

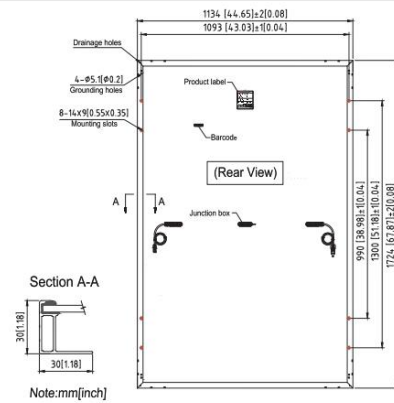

## Elektrische Eigenschaften

Modul Typ	STP410S-C54/Umh		STP405S-C54/Umh		STP400S-C54/Umh		STP395S-C54/Umh		STP390S-C54/Umh	
Testbedingungen	STB	NMOT	STB	NMOT	STB	NMOT	STB	NMOT	STB	NMOT
Maximale Leistung (Pmax/W)	410	309,6	405	306,0	400	302,3	395	298,6	390	294,9
Optimale Betriebsspannung (Vmp/V)	31,59	29,2	31,38	29,0	31,18	28,8	30,98	28,6	30,76	28,4
Optimaler Betriebsstrom (Imp/A)	12,98	10,62	12,91	10,56	12,83	10,50	12,76	10,44	12,69	10,38
Leerlaufspannung (Voc/V)	37,45	35,2	37,24	35,0	37,04	34,8	36,84	34,6	36,62	34,4
Kurzschlussstrom (Isc/A)	13,88	11,16	13,81	11,10	13,73	11,04	13,66	10,98	13,59	10,93
Modulwirkungsgrad (%)	21,0		20,7		20,5		20,2		19,9	

STB: Bestrahlungsstärke 1000 W/m<sup>2</sup>, Modultemperatur 25 °C, LM = 1,5, NMOT: Bestrahlungsstärke 800 W/m<sup>2</sup>, Umgebungstemperatur 20 °C, LM = 1,5, Windgeschwindigkeit 1 m/s; Die Toleranz von Pmax liegt bei +/- 3%.

## Temperaturmerkmale

Nenntemperatur bei Modulbetrieb (NMOT)	42 ± 2 °C
Temperaturkoeffizient von Pmax	-0,36%/°C
Temperaturkoeffizient von Voc	-0,304%/°C
Temperaturkoeffizient von Isc	0,050%/°C

## Verpackungskonfiguration

Container	40' HC
Stück pro Palette	36
Paletten pro Container	26
Stück pro Container	936
Abmessung der Palette	1755x1130x1255 mm
Gewicht der Palette	804 kg

Informationen zur Installation und Betrieb dieses Produkts finden Sie in der Installationsanleitung. Alle in diesem Datenblatt angegebenen Werte können ohne vorherige Ankündigung geändert werden. Die Spezifikationen können geringfügig abweichen. Alle Spezifikationen entsprechen der Norm EN 50380. Farbunterschiede der Module gegenüber den Abbildungen sowie Verfarbungen der Module innerhalb der Module, die ihre einwandfreie Funktion nicht beeinträchtigen, sind möglich und stellen keine Abweichung von der Spezifikation dar.

## Grafiken

Strom-Spannungs- & Leistungs-Spannungs-Kurve (410S)

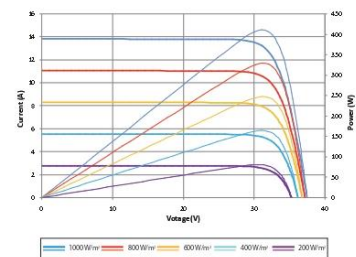

# 12.7. Helioscope Simulation Results

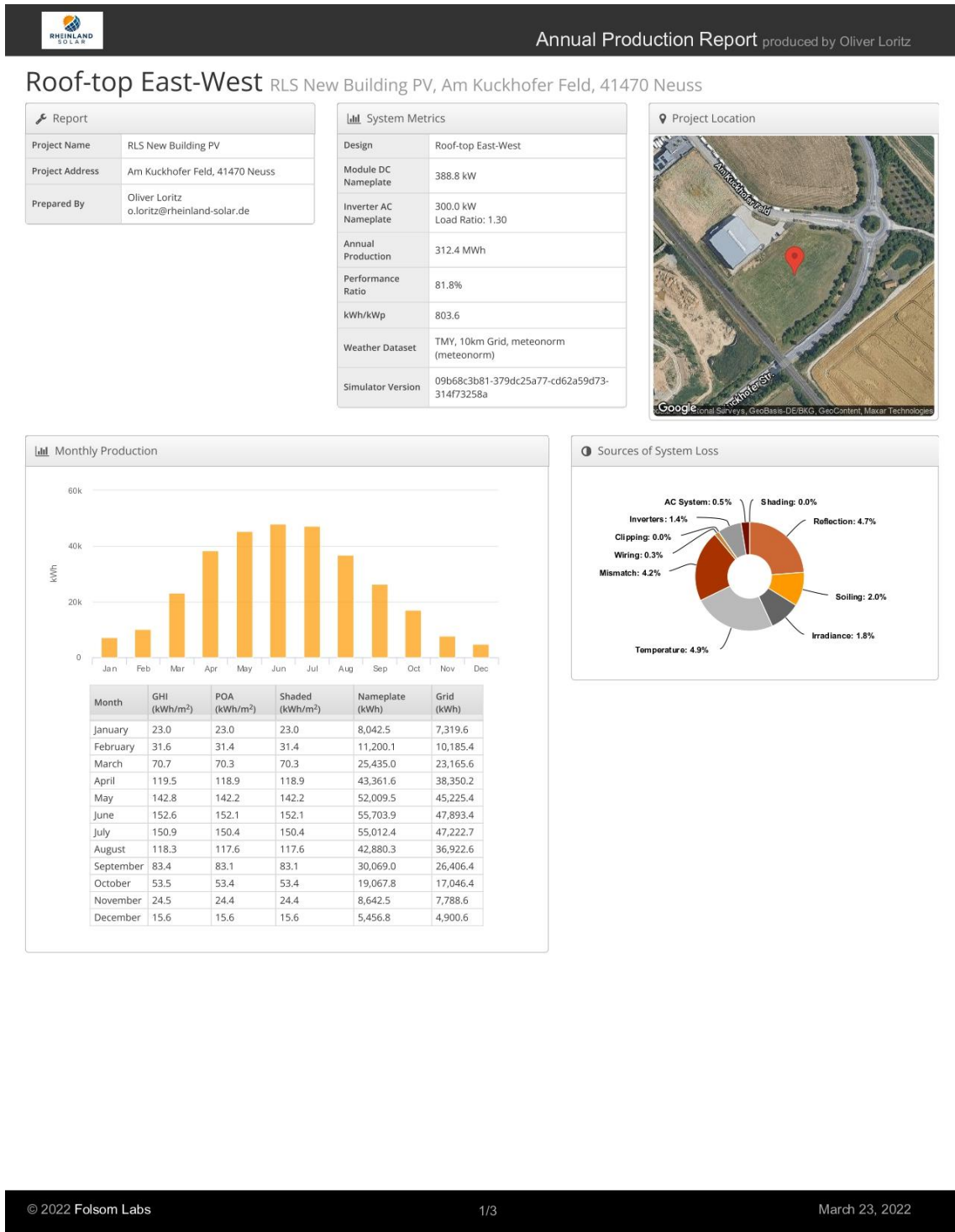

Figure 36: Helioscope simulation results

⚡ Annual Production			
	Description	Output	% Delta
Irradiance (kWh/m <sup>2</sup> )	Annual Global Horizontal Irradiance	986.4	
	POA Irradiance	982.5	-0.4%
	Shaded Irradiance	982.5	0.0%
	Irradiance after Reflection	936.4	-4.7%
	Irradiance after Soiling	917.6	-2.0%
	<b>Total Collector Irradiance</b>	<b>917.7</b>	<b>0.0%</b>
Energy (kWh)	Nameplate	356,881.5	
	Output at Irradiance Levels	350,339.4	-1.8%
	Output at Cell Temperature Derate	333,319.8	-4.9%
	Output After Mismatch	319,330.3	-4.2%
	Optimal DC Output	318,457.9	-0.3%
	Constrained DC Output	318,455.2	0.0%
	Inverter Output	313,996.8	-1.4%
<b>Energy to Grid</b>	<b>312,426.9</b>	<b>-0.5%</b>	
Temperature Metrics			
	Avg. Operating Ambient Temp	13.5 °C	
	Avg. Operating Cell Temp	23.8 °C	
Simulation Metrics			
	Operating Hours	4633	
	Solved Hours	4633	

☁ Condition Set			
Description	Condition Set 1		
Weather Dataset	TMY, 10km Grid, meteornorm (meteornorm)		
Solar Angle Location	Meteo Lat/Lng		
Transposition Model	Perez Model		
Temperature Model	Sandia Model		
Temperature Model Parameters	Rack Type	a	b
	Fixed Tilt	-3.56	-0.075
	Flush Mount	-2.81	-0.0455
Soiling (%)	Temperature Delta		
	0°C		
Soiling (%)	J	F	M
	A	M	J
Irradiation Variance	J	J	A
	S	O	N
Cell Temperature Spread	D		
	2	2	2
Module Binning Range	2	2	2
	2	2	2
AC System Derate	5%		
	4° C		
Module Characterizations	Module	Uploaded By	Characterization
	STP405S-C54/Umh (Suntech)	Folsom Labs	Spec Sheet Characterization, PAN
Component Characterizations	Device	Uploaded By	Characterization

📦 Components		
Component	Name	Count
Inverters	SUN2000-100KTL-M1 (380/400) (Huawei)	3 (300.0 kW)
Strings	10 AWG (Copper)	39 (1,479.9 m)
Module	Suntech, STP405S-C54/Umh (405W)	960 (388.8 kW)

🔌 Wiring Zones			
Description	Combiner Poles	String Size	Stringing Strategy
Wiring Zone	-	7-26	Along Racking

🏠 Field Segments									
Description	Racking	Orientation	Tilt	Azimuth	Intrarow Spacing	Frame Size	Frames	Modules	Power
South-West	Flush Mount	Landscape (Horizontal)	10°	229.372°	0.5 m	8x5	12	480	194.4 kW
North-West	Flush Mount	Landscape (Horizontal)	10°	49.371994°	0.5 m	8x5	12	480	194.4 kW



Detailed Layout



## 12.8. Hydrogen Storage Tank Datasheet

(Source: Wystrach GmbH)

product data sheet 10/2019

# WyRefueler 350/120

Wystrachli  
Worldwide art of precision.

- Die mobile Wasserstofftankstelle für 350 bar-Betankung
- Entnahmekapazität 120 kg / Tag
- fahrbar als BDF-Wechselbrückenfahrzeug

- The mobile hydrogen filling station for 350 bar refueling
- discharging capacity of 120 kg / day
- mobile as BDF swap body

Interreg North-West Europe H2-Share

Figure 37: Hydrogen tank datasheet

product data sheet 10/2019

# WyRefueler 350/120

Wystrachli  
Worldwide art of precision.

– die mobile Wasserstofftankstelle / the mobile hydrogen filling station

<ul style="list-style-type: none"> <li>✔ Stand-alone Tankanlage für 350 bar-Betankung</li> <li>✔ Entnahmekapazität 120 kg / Tag</li> <li>✔ 24/7 einsatzbereit</li> <li>✔ mit intelligenter Steuerung</li> <li>✔ für die mobile Befüllung von H<sub>2</sub>-Tankssystemen, z.B. LKW oder Bussen transportabel</li> <li>✔ 24/7-Fernwartung möglich durch Wystrach-Service</li> <li>✔ fahrbar als BDF-Wechselbrückenfahrzeug (ADR)</li> <li>✔ Anschlusswert 3x400VAC/63A</li> <li>✔ Stellfläche 21 x 6,7 m</li> </ul>	<ul style="list-style-type: none"> <li>✔ standalone tank system for 350 bar refueling</li> <li>✔ discharging capacity of 120 kg / day</li> <li>✔ available 24/7</li> <li>✔ with smart control</li> <li>✔ for mobile refueling of H<sub>2</sub> tank systems, e.g. trucks or buses</li> <li>✔ transportable</li> <li>✔ 24/7 remote maintenance possible realized by Wystrach service</li> <li>✔ mobile as BDF swap body (ADR)</li> <li>✔ power requirement 3x400VAC/63A</li> <li>✔ requested footprint 21 x 6.7 m</li> </ul>
<p>TANKCONTAINER VERFÜGT ÜBER</p> <ul style="list-style-type: none"> <li>+ 54 Typ 4-Behälter à 350 Liter, 300 bar</li> <li>+ Nutzvolumen 300 kg</li> <li>+ Steuerungseinheit</li> <li>+ Zugelassen nach ADR</li> </ul>	<p>TANKSTELLENCONTAINER VERFÜGT ÜBER</p> <ul style="list-style-type: none"> <li>+ Wasserstoffkompressor</li> <li>+ Regelungstechnik, autark funktionsfähig</li> <li>+ 100 kg-Pufferspeicher, 500 bar</li> <li>+ Automatische Drucksteuerung für optimale Betankung</li> <li>+ Zugelassen nach ADR und Druckgeräterichtlinie</li> </ul>
<p>TANK CONTAINER SPECS</p> <ul style="list-style-type: none"> <li>+ 54 type 4 containers à 350 liter, 300 bar</li> <li>+ 300 kg usable volume</li> <li>+ control unit</li> <li>+ ADR approved</li> </ul>	<p>REFUELER CONTAINER SPECS</p> <ul style="list-style-type: none"> <li>+ hydrogen compressor</li> <li>+ regulation technology, independent operation</li> <li>+ 100 kg buffer, 500 bar</li> <li>+ automatic pressure control for optimum refueling</li> <li>+ ADR and Pressure Equipment Directive approved</li> </ul>