



## OPEN ACCESS

## EDITED BY

Pourya Pourhejazy,  
UiT The Arctic University of Norway, Norway

## REVIEWED BY

Espen Johannessen,  
UiT The Arctic University of Norway, Norway  
Slawomir Wycislak,  
Jagiellonian University, Poland

## \*CORRESPONDENCE

Helena Müller  
✉ helena.mueller@h-da.de

RECEIVED 06 December 2023

ACCEPTED 19 January 2024

PUBLISHED 13 February 2024

## CITATION

Eisen C, Schenten J, Theis A,  
Rehn-Groenendijk J, Helferich M,  
Müller H and Hanss D (2024) Toward system  
innovation for more sustainable chemistry:  
insights into consumers' perceptions,  
knowledge, and behavior related to  
traceability and product design strategies  
along leather supply chains.  
*Front. Sustain.* 5:1351638.  
doi: 10.3389/frsus.2024.1351638

## COPYRIGHT

© 2024 Eisen, Schenten, Theis, Rehn-Groenendijk, Helferich, Müller and Hanss. This is an open-access article distributed under the terms of the [Creative Commons Attribution License \(CC BY\)](https://creativecommons.org/licenses/by/4.0/). The use, distribution or reproduction in other forums is permitted, provided the original author(s) and the copyright owner(s) are credited and that the original publication in this journal is cited, in accordance with accepted academic practice. No use, distribution or reproduction is permitted which does not comply with these terms.

# Toward system innovation for more sustainable chemistry: insights into consumers' perceptions, knowledge, and behavior related to traceability and product design strategies along leather supply chains

Charis Eisen<sup>1</sup>, Julian Schenten<sup>1</sup>, Anna Theis<sup>1,2</sup>,  
Jonas Rehn-Groenendijk<sup>1</sup>, Marvin Helferich<sup>1,3</sup>, Helena Müller<sup>1\*</sup>  
and Daniel Hanss<sup>1</sup>

<sup>1</sup>Darmstadt University of Applied Sciences, Department of Social Sciences, Darmstadt, Germany,

<sup>2</sup>Otto von Guericke University, Institute of Psychology, Faculty of Natural Sciences, Magdeburg,

Germany, <sup>3</sup>Fraunhofer Institute for Systems and Innovation Research, Karlsruhe, Germany

The leather industry is a complex system with multiple actors that faces a fundamental transition toward more sustainable chemistry. To support this process, this article analyzes challenges of the industry and consumers' roles as a nexus of transition-relevant developments. We present findings of an empirical study ( $N=439$ ) among consumers on their perception of leather, related knowledge, and purchasing behavior. We found that participants perceived leather as natural, robust, and of high quality. Knowledge about the manufacturing of leather products was overall limited but varied. Applying a psychological behavior theory, we found that being aware of environmental and health consequences from conventional manufacturing of leather products was positively associated with a personal norm to purchase leather products that are less harmful to environment and health. The perceived ease of buying such products was positively associated with their purchase. Our findings shed light on consumers' roles in the current leather system and their support of niche innovations toward more sustainable chemistry. Against this backdrop, we discuss implications for product design, consumer information, and needs for traceability along supply chains.

## KEYWORDS

leather, traceability, sustainable chemistry, psychology, multi-level perspective, consumer behavior

## 1 Introduction

Producing leather from animal hides requires complex tanning processes, in the course of which a large number of chemicals are used. Some of these chemicals pose serious risks to the natural environment and human health and, thus, stand in vast contrast to Sustainable Development Goal (SDG) 12 of the [United Nations \(2015\)](https://www.un.org/sustainabledevelopment/), which targets sustainable consumption

and production patterns and calls for transformations of industries and markets (Führ and Schenten, 2018). With regard to SDG target 12.4, leather chemistry would be more “sustainable,” if it enabled high levels of protection for people and the natural environment and helped reduce company risks, such as compliance violations, liability cases, and reputational damages. The leather industry has accordingly an interest in a transition toward more sustainable chemistry, and research on technical innovations to support that end has been growing in recent years (Omoloso et al., 2021). However, to achieve this transition, systemic changes are required, encompassing behaviors by different actors along the entire supply chain as well as consumers of leather products and waste managers.<sup>1</sup> Understanding the relevant characteristics of this system and identifying more specific needs to change existing behavior routines of key actors is pivotal to facilitating the transition. This article contributes to these challenges by presenting practical insights obtained from actors of transition-relevant organizations (e.g., industry representatives) as well as an empirical study to identify factors that may influence consumer support of more sustainable leather chemistry. Importantly, as the objective of this research is the facilitation of a transition toward more sustainable leather chemistry, research questions are derived from an action gap that shapes the current state of the industry. Researchers from psychology, design research, and environmental governance combine their disciplinary perspectives on the challenges with perspectives of industry representatives.

In the following part of the introduction, we describe the current systemic context and present an analysis of existing problems and strategies for system change conducted together with non-scientific actors (practitioners and experts of the leather industry). A perspective from transformative research will lead us to the conclusion that growing consumer awareness constitutes a key driver of several transition-relevant developments. Consequently, we describe theory, methodology, and findings of an empirical consumer study before discussing implications for product design and consumer information as well as underlying needs for traceability along supply chains.<sup>2</sup>

## 1.1 Background and problem statement

We proceed on the assumption that global leather supply chains constitute a socio-technical system consisting of intertwining technical

(production, transportation, communication tools, etc.) and social aspects (collaborations, working conditions), context factors (market demand, product requirements, etc.) and various actor groups within and outside the supply chains (e.g., consumers, civil society, science) (in accordance with Polita and Madureira, 2021). Global leather supply chains are therefore open, organized, and heterogenic entities of functional structures. They show high levels of contingencies and interdependencies leading to non-linear and therefore partly unpredictable developments. In this regard, they can be seen as complex systems. In fact, supply chains in general (Cheng et al., 2014) and leather supply chains in particular qualify as complex adaptive systems as proposed by several scholars (e.g., Surana et al., 2005; Chaouni et al., 2018). This refers, for instance, to their ability to adapt to changing context factors and to integrate learning experiences as well as to evolve and self-organize. Transitioning this system toward sustainable development goals requires a system innovation (Geels and Schot, 2007), enabled by the interplay of technological, social, and organizational advancements, all embedded into an institutional framework that incites behavioral change. In this context, system innovation does not refer to specific innovations within a given system but rather comprises several orchestrated or self-organized developments that eventually and collaboratively lead to system change. A prominent framework for analyzing and describing transitions of socio-technical systems toward sustainability is Geels (2002) Multi-Level Perspective (MLP). MLP differentiates three levels to characterize systems and their transitions: (a) the prevailing “socio-technical regime,” (b) “landscape developments,” such as socio-cultural or policy developments, and (c) small-scale “niches” (Geels and Schot, 2007; Grin et al., 2010). Socio-technical regimes resemble long-lasting economic, political, or scientific practices that are highly institutionalized and only reluctantly react to changes in the landscape. Niches refer to social and/or technical innovations that have the potential to disrupt the dominant regime and lead to new system configurations that gradually change the regime. Approaches, such as “strategic niche management” (Kemp et al., 1998), aim at fostering these processes to support system transitions. Aiming for more sustainable leather chemistry in the global supply chains requires a comprehensive understanding of the prevailing regime, relevant niches, and landscape characteristics. Against this backdrop, we provide a systemic overview of the global leather industry in the following subsections.

The prevailing socio-technical regime of the leather industry is highly complex. In the course of the globalization of markets and supply chains in the last third of the last century, large shares of production structures shifted from the West to locations with low production costs in the Global South. The race for the lowest prices led to devastating cuts in social standards (labor rights, social insurance, etc.), and the simplest and cheapest production methods prevailed, not least at the expense of protecting health and the environment. Steering these developments in a positive direction is a major challenge for at least three reasons: the price pressure continues, the leather sector has reduced its research and development efforts in parallel with the global relocations, and leather production in its current form represents a decisive economic factor in some countries. Efforts to address these interrelated environmental, social and economic challenges thus pertain to several, interrelated SDGs and can, in a best-case scenario, mutually benefit but may also create conflicts (Le Blanc, 2015). On the one hand, processing animal hides, which are in most cases by-products of the dairy and meat industry,

1 One may – for example, on the grounds of a deontological ethic – fundamentally oppose the exploitation of animals by dairy, meat, and leather industries. However, shifting away from these industries entirely implies an enormous transformation that is beyond the scope of this paper. Instead, we focus on the question of how a transition of the leather industry that minimizes its negative consequences – especially those of problematic chemicals – can be achieved.

2 The structure of our manuscript diverges slightly from the typical structure of other articles normally found in this journal. Our research questions are derived from and feed into system analyses as part of a transformative research process conducted together with practitioners and researchers from various disciplines. While our study contributes to literature in the field of pro-environmental behavior, consumer research, and system innovation, our main focus is to answer practical questions relating to system transition processes.

into an enduring leather product can preserve resources by avoiding the exploitation of alternative fossil-based raw materials (Dixit et al., 2015). In addition, the manufacturing of leather products not only enhances the value creation of livestock breeding but also boosts local economies by employment of unskilled workers (SDG 8) (Asian Development Bank and United Nations Conference on Trade and Development, 2015). On the other hand, the process of leather manufacturing often poses threats to human health and environment. Importantly, the conventional way to turn hides into leather involves different types of chemicals, which cause severe environmental pollution and pose health threats to people working in the manufacturing of leather products. Transforming one ton of raw hides requires an input of approximately 500 kg of process chemicals (Black et al., 2010). While the actual risks depend on the specific process conditions in every tannery, some typical hot spots of chemical challenges in conventional technologies have been identified (Febriana et al., 2012; Buljan and Král, 2019; Hansen et al., 2020): During transportation and storage, biocides, pesticides, and salts are applied to preserve raw hides or pre-tanned materials. At the pre-tanning and tanning stages, workers can be exposed to irritant substances such as sodium chloride and sodium sulfide. Effluents at these stages comprise high concentrations of salt and cause high chemical oxygen and biological oxygen demand, which can compromise water quality (Hutton and Shafahi, 2019). At the finishing stage, volatile organic solvents may harm workers and people living nearby. To make leather more robust, it often receives a coating of Per- and Polyfluorinated Compounds (PFCs, or PFAS), which are highly persistent in the environment and often toxic. Final products (e.g., leather footwear) can constitute a health risk for end consumers if their skin gets into direct contact with sensitizing substances. At a leather product's end-of-life stage, more or less environmentally friendly measures to dispose of the product may be applied (Karupiah et al., 2019).

Notably, even industry actors currently lack understanding of which specific chemicals are used during manufacturing. While in niche markets supply chains can be regional, allowing manufacturers to determine where animals were raised and slaughtered and which tanneries processed the hides into enduring leather, mass production is organized along global, intertwined, and often intransparent supply chains. Raw materials usually originate from countries with well-established farming structures such as Australia and Brazil (Jiang et al., 2018), while labor-intensive activities, including tanning and assembly of final products, typically take place in countries with comparably low labor costs, such as China, Vietnam, India, or Indonesia (Buljan and Král, 2012). In addition to price-driven sourcing strategies, resulting in globally dispersed supply, two other factors contribute to the opacity of leather supply chains: First, traders usually act in between the supply chain stages with little willingness to make their sources transparent. Second, a significant share of supply chain processes takes place in the so-called informal sector, operating beyond the hold of national authorities and controls. Together, these levels of complexity and opacity pose substantial obstacles to the transition toward more sustainable chemistry (Smit et al., 2020). In sum, the socio-technical regime is characterized by opaque supply chains and the extensive use of problematic chemicals in conventional manufacturing. However, niche innovations aim to reduce the quantity of chemicals by technical innovation and design.

## 1.2 Existing solutions and windows of opportunity for system change

Promoting steps toward more sustainable leather chemistry is only possible with elaborated product development and design, taking into account environmental, economic and social impacts along the value chains alike. Recent innovations in product development include greater efficiency in the use of chemicals, the use of environmentally friendly chemicals that do not negatively affect the quality of finished products, and dry tanning (Sathish et al., 2016; Omoloso et al., 2021). Recent research also aims at improving waste management and upcycling (e.g., Gupta et al., 2018; Gerek et al., 2019). Further, design decisions such as material coatings, techniques to connect materials as well as the selection of the specific type of leather directly affect the necessity of certain chemicals and to some extent a product's longevity and reparability. For instance, gluing instead of stitching product parts reduces overall production costs but adds chemicals and may limit possibilities to repair the product by replacing parts (De Fazio et al., 2021). Another example is the current trend to apply coatings to replace patinas with homogeneous and unchanging surfaces, which requires additional chemicals that potentially pose risks for human health or environment. In many cases, designers have to choose not only out of several different types of leather but also leather surrogates such as composite materials based on polymers, textiles, and sometimes organic substances usually referred to as "imitation leather," "artificial leather," "faux leather" or "leatherette."<sup>3</sup> Although there is an ongoing debate on the differences between leather and imitation leather with regards to chemicals and their impact on the environment, a study commissioned by the leather industry found that genuine leather usually exceeds imitation leather in terms of several physical attributes and functional performance (Meyer et al., 2021).

In addition to modified design processes, changes in regulatory frameworks as well as an increased awareness among consumers and willingness to demand and use innovative products open windows of opportunity for the transition toward more sustainable leather chemistry. Existing or planned legislation targeting chemical suppliers, leather manufacturers, brands, and retailers aims to mitigate the negative environmental and societal impacts of the leather industry. For example, larger European tanneries are already required to take into account "Best available techniques," defined by a reference document under the Industrial Emission Directive 2010/75/EU [12]. Furthermore, the EU chemicals regulation "Registration, Evaluation, Authorisation and Restriction of Chemicals" (REACH, 1907/2006/EC) aims to ensure a high level of protection of human health and environment and to this end stipulates restrictions on chemicals in products. Although chemical restrictions according to REACH generally apply to imported products, enforcing this provision is currently a challenge (European Chemicals Agency, 2020), and civil society organizations have documented cases from non-EU tanneries where misconduct (e.g., lack of protective clothing) poses severe threats to human health and environment (Chellapilla et al., 2017; Organization for Economic Cooperation and Development, 2017).

However, the "European Green Deal" launched by the European Commission (2019) and subsequent policies aim to ensure stronger

<sup>3</sup> In this paper, we use the term "imitation leather."

contributions to SDG 12. Turning manufacturing and consumption patterns into “circular economies” is a key rationale of the Green Deal. To facilitate this transformation, a legislative proposal of March 2022 for a so-called Ecodesign for Sustainable Products Regulation (ESPR) opens the scope of the ecodesign framework that so far is reserved for energy-related products (European Commission, 2022a). Indeed, in the simultaneously launched “EU Strategy for Sustainable and Circular Textiles,” which addresses a whole “textiles ecosystem” including the clothing, leather and footwear industries (European Commission, 2022b), the European Commission plans introducing mandatory ecodesign requirements aiming for, *inter alia*, higher durability, preferred material compositions as well as the presence of chemicals of concern. A “Digital Product Passport,” as mandated by the ESPR, shall for the first time provide relevant information “for example on substances of concern, on repair or on the fiber composition” for value chain actors and consumers so they can make better choices. In addition, a February 2022 legislative proposal pursues to improve due diligence by brands and retailers on the environmental and social impacts of operations along the supply chains (European Commission, 2022c). These shifts in landscape create impetus for change that does not go unnoticed by the leather industry (Cotance, 2020).

Increasing consumer awareness can be considered a landscape change that facilitates the transition toward more sustainable leather chemistry. An increasing number of people worldwide recognize the need to adapt their consumption styles and at the same time push governments and corporations to pay more attention to limited resources and the relationship between economy and environment (Cohen, 2014; Nielsen, 2018). A recent Eurobarometer survey shows that the majority of German citizens are concerned about the impact of chemicals included in consumer products, on both the natural environment (87%) and their personal health (80%) (European Commission, 2020). The Coronavirus Disease of 2019 (COVID-19) pandemic seems to have further fueled environmental awareness and the purchasing of products that are less harmful to environment and human health (Severo et al., 2021). Activated by their awareness, consumers may be motivated to support niche innovations through their purchasing decisions and usage patterns, and the leather industry and governmental policies may contribute their parts to a more sustainable leather chemistry. Indeed, a study by Wahga et al. (2018) found that consumer demands for environmentally compatible products act as a driver for sustainable industry practices.

### 1.3 Transdisciplinary approach

Against this background, a transdisciplinary transformative research project at Darmstadt University of Applied Sciences supports the leather industry in its transition to more sustainable chemistry. Conceptually, the project follows the three-stage recursive model that has emerged to guide transdisciplinary projects (Lang et al., 2012; Brandt et al., 2013; Wiek and Lang, 2016; Defila, 2019): exchange and dialog formats establish a transdisciplinary understanding of the problem, translated into a jointly formulated “research question” (stage A), in order to develop and test specific innovative solutions based on this (B), which are finally to be disseminated and rolled-out in business and society (C). A main assumption of the project is that key actors need to cooperate in order

to transform complex socio-technical systems, such as the manufacturing along global supply chains and consumption of leather. In a scenario building process using methods by Geschka et al. (2008), a transdisciplinary team, including representatives, *inter alia*, from civil society, chemical and leather industries, brands as well as research, developed future scenarios for the topic “Leather 2035.” Scenario building is an exploratory process, empirically substantiated by the inputs of the participating experts. This process first facilitated the creation of a common problem understanding among all actors (stage A). It concluded with the team agreeing on and committing to an ambitious scenario in which more sustainable leather chemistry will have emerged in 2035.<sup>4</sup> In this scenario, increased transparency about the chemicals used in the global supply chains and their effects on humans and environment as well as related knowledge among supply chain actors and the civil society are major drivers of change (*cf.* Figure 1).

Subsequently, we hosted transdisciplinary strategy workshops to identify specific short-term and long-term actions to attain the 2035 scenario. The results of these workshops were further elaborated into a Theory of Change (Belcher et al., 2019) for more sustainable leather chemistry (Schenten and Rehn, 2021), *cf.* Figure 2. ToC is a tool for designing and monitoring system innovations (Deutsch et al., 2021).

According to our ToC for the leather industry, system transition requires behavior change and innovations at different levels, in terms of MLP, including shifts in the landscape and niche solutions. Notably, the ToC illustrates the interplay between innovations in market demand and supply chain management (*cf.* Figure 1). The actors involved in the scenario building anticipated that consumers’ awareness regarding the leather industry’s negative impacts would increase, leading to more targeted demands for transparency and products with lower negative impacts on the natural environment. This demand would, in concert with additional factors (regulation, investors, Non-Governmental Organizations (NGOs), etc.), put pressure on the industry to improve processes and products by employing more sustainable chemistry solutions and to increase transparency on chemicals in products and processes along the supply chains, thereby, informing consumption decisions.

To further inform transitions as outlined by the ToC, participants of the workshops polled for the most important leverage points: leather design guidelines for sustainable development, chemical innovations and harmonization of standards, sector-wide efforts to establish IT and governance infrastructures for the traceability of chemicals used along global supply chains.<sup>5</sup> Across these leverage points that are further investigated in distinct subprojects developing innovative solutions (stage B), consumer behavior turned out to be a crucial element, influencing relevant transition processes, as outlined below.

<sup>4</sup> <https://sne.h-da.de/en/implementation-project/more-sustainable-chemistry-in-the-leather-supply-chains/system-innovation-for-a-more-sustainable-leather-chemistry>

<sup>5</sup> <https://sne.h-da.de/en/implementation-project/more-sustainable-chemistry-in-the-leather-supply-chains/subprojects-as-pathways-to-solutions>





## 2 Empirical consumer study

### 2.1 Research and action gap

With regard to global leather supply chains, understanding the interrelatedness of consumer perceptions and motives toward purchasing leather and leather products can be of crucial importance to adapt industrial routines and product development processes in favor of sustainable development while advancing valid business models. There is a growing body of literature on pro-environmental behavior (Bamberg and Möser, 2007; Cruz et al., 2016; Concari et al., 2020) as well as consumer awareness, knowledge and behavior

regarding system change in the context of consumer products in general (Gailhofer et al., 2023). However, challenges persist regarding the actual transfer of this knowledge into complex socio-technical systems such as the leather supply chains. Transdisciplinary approaches (Defila, 2019), as proposed in this paper, present a methodological framework in which disciplinary tools – such as empirical consumer studies – are part of an orchestrated co-creative process that primarily aims at informing efforts for system innovation toward sustainable development. In addition, research on these aspects with regard to the specific characteristics of leather products and related consumption patterns remains scarce. Such tailored research is needed, as leather products differ in several key features

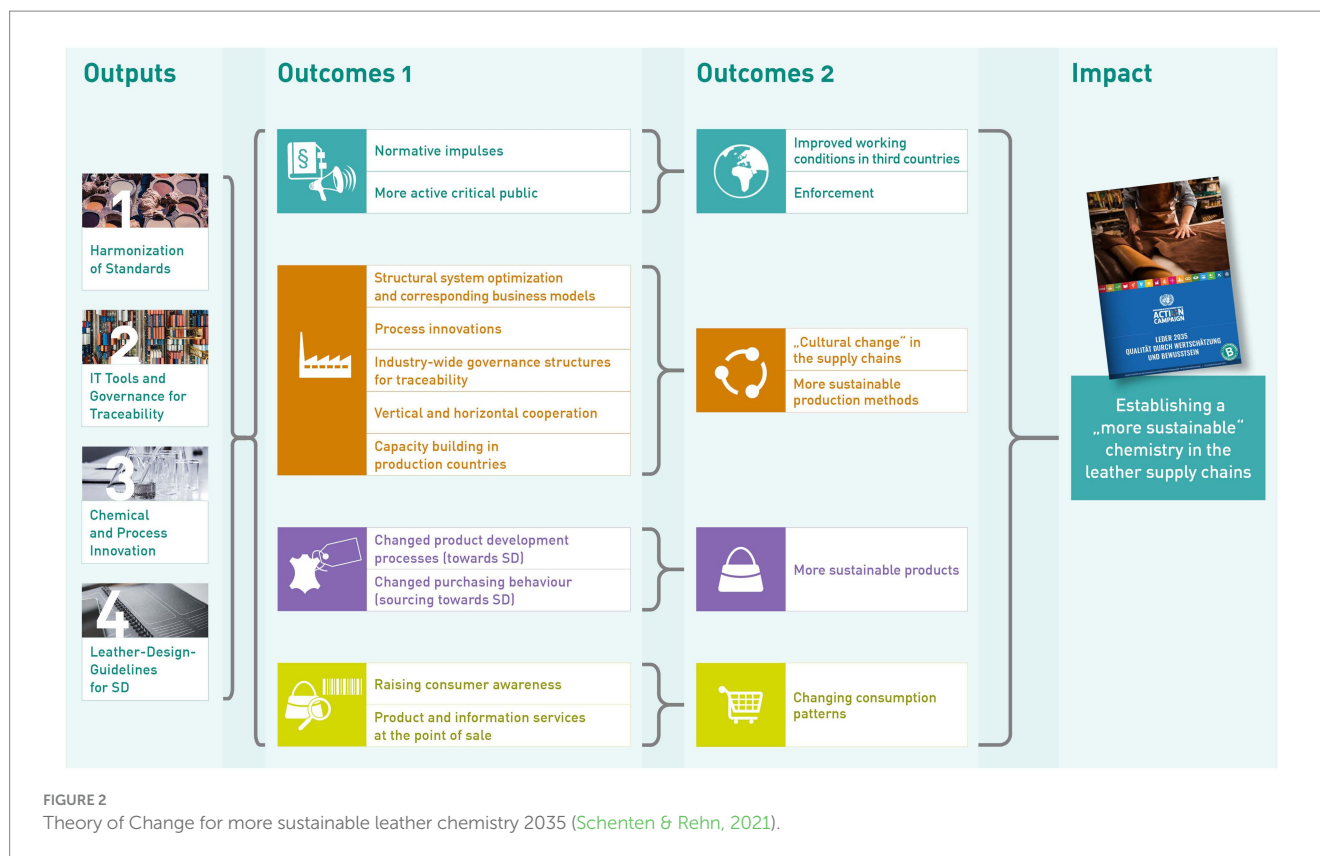

from other consumer and especially apparel products, e.g., in terms of maintenance, longevity, cultural and historical connotation (e.g., Rehn-Groenendijk et al., 2022).

## 2.2 Literature review and hypotheses

The design of leather products is often based on marketer's assumptions of what consumers expect (e.g., specific odors, robustness), considering that purchasing decisions may depend on individual perceptions of products (Kamalha et al., 2013; Lee et al., 2019). Gaining insights into characteristics of leather that are most important to consumers as well as their esthetic distinctions between leather and imitation leather can be a valuable asset to inform the development of design guidelines for more sustainable leather chemistry. Based on discussions with industry representatives,<sup>6</sup> we assume that current trends in leather fashion toward more homogeneous surfaces dissent from consumer perceptions of leather and thus pose unnecessary burdens on the environment (e.g., because additional coating layers are being used to make surfaces homogeneous although consumers do not demand these homogeneous surfaces and rather value natural surfaces). To inform industry practices, we therefore test the hypothesis that consumers perceive leather as a natural material (H1).

Additionally, a deepened understanding of consumers' appreciation of attributes of leather products can inform both

chemical process innovations and industry standards: In many leather products, additional chemical processes are applied to products to establish or increase properties such as hydrophobia, UV-resistance and more. In some cases (e.g., in the automobile industry), chemicals are applied to create a "genuine leather smell." However, we assume that from a consumers' point of view, these attributes are not the most important ones and thus could be pretermitted in favor of sustainable development. We test the hypothesis that attributes such as UV resistance, leather smell, and water resistance are less important to consumers than natural appearance and overall robustness of the material (H2). Several studies have identified factual knowledge about the manufacturing process as an antecedent of purchases based on moral and environmental considerations (Connell, 2010; Jonell et al., 2016). Identifying current levels of knowledge among consumers also allows producers to plan and adjust targeted communication strategies. Considering the vast variance of types of leather and to what extent they might be called more or less sustainable, we explore whether consumers lack information regarding the manufacturing and properties of leather and leather products necessary to making informed decisions at the point of sale as well as during and after the usage phase. When it comes to harmonization of industry standards and their communication to consumers, it is crucial to analyze the current use and clarity of eco-labels for leather products because this helps identify blind spots. Former research supports the notion that knowledge of eco-labels is often positively associated with the intention to purchase products that are less harmful to environment and health (Connell, 2010; Müller et al., 2014). However, the role of eco-labels relevant to leather products has yet hardly been investigated. We therefore explore consumers' familiarity with eco-labels for leather products.

<sup>6</sup> <https://www.leathernaturally.org/resources/fact-sheets/>

A common concern among industry actors is that implementing traceability of materials requires complex technological systems and, thus, substantial financial investments. Most likely, the leather industry would be less hesitant to invest in tracing systems, if these investments could be compensated for by retail prices. Therefore, investigating consumers' Willingness To Pay (WTP) for products whose supply chains including chemical ingredients is transparent should produce valuable insights to support transitions toward traceability. Indeed, studies have found environmentally aware consumers to have a higher WTP for apparel that is produced in environmentally less harmful ways (Ha-Brookshire and Norum, 2011; Tey et al., 2018). To test whether this finding applies to leather products as well, we test the following hypotheses in connection with an exemplary leather product: Consumers are willing to pay higher prices for leather products, if these products are manufactured in ways that are less harmful to environment and health than conventional manufacturing (H3a) and if information about the supply chain is given (H3b). While acknowledging the importance of reducing individual consumption overall (Bengtsson et al., 2018), our study focuses on contributions to sustainable development by promoting the purchasing of leather products that are less harmful to environment and human health. To gain insights into the characteristics of consumers who already purchase leather products that are less harmful to environment and health and, thereby, to understand how the purchasing of such products may be further promoted, we drew upon a psychological theory that helps identify person-level drivers and barriers of individual behavior.

Buying environmentally compatible leather products instead of conventionally manufactured alternatives enables consumers to contribute to the reduction of harm to environment and human health (of people working in manufacturing as well as consumers). Thus, it can be described not only as pro-environmental but also pro-social behavior. The Norm Activation Model (NAM) (Schwartz, 1977; Steg and de Groot, 2010) proposes a theoretical framework capturing factors that influence an individual's decision for or against pro-social behavior. The NAM has been applied to diverse environmental behaviors, including the purchasing of environmentally friendly products, demonstrating good explanatory power (Van der Werff and Steg, 2015). We therefore deemed the NAM suitable for our study purposes. Specifically, our goals were to investigate the relative importance of the NAM components for explaining the purchasing of leather products that are less harmful to environment and health, and, against this backdrop, to derive recommendations for measures to strengthen such purchasing decisions.

At the core of the model is the assumption that a person's propensity to carry out a pro-social behavior (B) is determined by the degree to which they feel morally obliged to act altruistically (Personal Norm, PN). Schwartz (1977) ties this term to morally-based self-expectations to act in a certain way in a particular situation, thereby distinguishing it from Social Norms (SN), which either describe how other people act or what they expect in terms of how one should behave. In the NAM framework, PN is in turn determined by the degree to which the individual is aware of the problematic consequences that follow from not carrying out the pro-social behavior (Awareness of Consequences, AC). According to the model, a person with a strong AC should also feel responsible for the action's consequences (Ascription of Responsibility, AR) and thereby develop

a PN for carrying out the pro-social behavior (Steg and de Groot, 2010).

Bamberg et al. (2007) found that the relation between PN and behavior was mediated by Behavioral Intention (BI) and showed an individual's BI was also determined by external barriers. These barriers are mirrored in Perceived Behavioral Control (PBC), which captures the subjectively perceived ease of carrying out a behavior (Ajzen, 2002). Another finding was that SN mediated the relation between AC and AR (Bamberg et al., 2007). In line with these findings as well as additional studies emphasizing the importance of PBC in the context of consumption decisions (Klößner and Ohms, 2009; Müller et al., 2014; Keller et al., 2021), we use an extended NAM as our analytic framework. More specifically, we added BI as a mediator between PN and behavior, PBC as a predictor of intention and behavior, and SN as a mediator between AC and AR (as shown in Figure 3).

Consequently, we hypothesize that personal norms are positively associated with purchasing intentions and behavior concerning leather products (H4a), that this personal norm is in turn positively related to feeling responsible for the purchasing decisions' consequences when people are aware of these consequences (H4b), and that perceived behavioral control is positively associated with purchasing intentions and behavior (H4c).

We investigated these hypotheses with an online questionnaire study that aimed at understanding consumers' perceptions, knowledge, WTP, and self-reported purchasing behavior relating to leather products (see Figure 4).

## 3 Materials and methods

### 3.1 Sampling

Respondents to our survey were participants of a local citizens' panel that is an integral element of the transformative research project described above. Participants of the panel are recruited through random sampling from local citizen registries as well as informational campaigns. The panel enables participating citizens to express their opinions and preferences on innovative ideas related to sustainable development through periodic participation in online surveys. In May and June 2020, we invited the (at the time) 1,208 participants of the panel to take part in our survey that was administered through Limesurvey GmbH (2017) (version 3, 2017). Five hundred seventy-seven participants answered, resulting in a response rate of 48%. After data cleaning, the data set contained data from 573 participants.<sup>7</sup> For the analyses reported below, we only used data from people who generally bought leather products ( $n = 439$ ). Among these, 51% were female and 42% were male, the remaining participants identified as diverse or did not answer. The mean age was 47.28 years ( $SD = 13.25$ ). For more detailed sample characteristics, see [Supplementary material S2](#).

<sup>7</sup> Cases were deleted because participants were younger than 18 years ( $n = 1$ ) or because they did not answer a question about their general leather consumption, which was used as a necessary condition for further analyses ( $n = 3$ ).

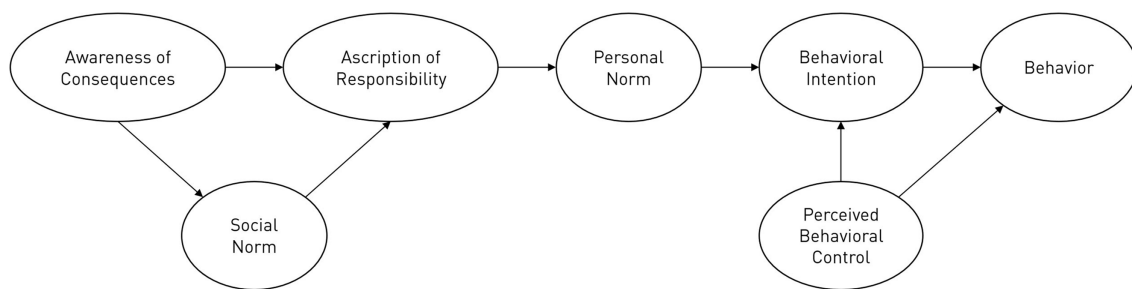

FIGURE 3  
Theoretical framework of the present study based on the Norm Activation Model (Schwartz, 1977; Bamberg, et al., 2007).

|   |   |  |
|---|---|--|
| 1 | Perception of leather & imitation leather   | Semantic differential (8 pairs of opposites)   |
| 2 | Eco-labels for textiles and shoes   | Judgement of familiarity, environmental and consumer protection (6 Labels)   |
| 3 | Knowledge about leather production  | 11 Statements (true vs. false)   |
| 4 | Attributes of leather goods   | Rating of importance of 8 attributes   |
| 5 | Willingness to pay  | Price depending on manufacturing and traceability  |
| 6 | Leather purchasing behavior<br>(based on NAM model, Schwartz 1977, Bamberg et al. 2007) | Awareness of consequences (5 items)<br>Ascription of responsibility (5 items)<br>Social norms (4 items)<br>Personal norms (4 items)<br>Perceived behavioral control (4 items)<br>Behavioral intention (3 items)<br>Relevant behavior (3 items) |

FIGURE 4  
Summary of survey contents and measures.

## 3.2 Measures

### 3.2.1 Perception of leather and imitation leather

To assess how participants perceived leather and imitation leather, we applied a semantic differential (*cf.* Osgood, 1952) with eight pairs of opposing adjectives: natural – artificial, high-priced – low-priced, high-quality – low-quality, harmless to health – harmful to health, environmentally friendly – environmentally harmful, robust – delicate, modern – conservative, and morally impeccable – morally reprehensible. Participants were asked to indicate their perceptions of leather and, separately, of imitation leather on a 5-point scale as a continuum between the respective adjective poles.

### 3.2.2 Attributes of leather products

To identify which attributes of leather products participants valued most, we presented eight attributes (i.e., robustness, natural appearance, water resistance, aging material, consistent appearance over time, authentic smell, individuality, UV-resistance). Participants had 100 points to distribute among the attributes, where assigning more points signified higher subjective importance.

### 3.2.3 Knowledge of leather manufacturing

We measured participants' factual knowledge of leather manufacturing through 11 statements (see [Supplementary material S7](#)) that were based on crucial topics emerging from discussions with actors of the leather industry and NGOs. We instructed participants to rate these statements as either true or false. Additionally, we offered a no-answer option to avoid forced choice. Five of the presented statements were true, six were false.

### 3.2.4 Familiarity with eco-labels

We presented six eco-labels that are used in connection with textile and leather products: OEKO-TEX Standard 100,<sup>8</sup> OEKO-TEX Leather Standard, Grüner Knopf,<sup>9</sup> Label of the International Association of Natural Textile Industry (IVN),<sup>10</sup> [Blauer Engel \(2021\)](#),<sup>11</sup>

8 <https://www.oeko-tex.com/de/>

9 <https://www.gruener-knopf.de/>

10 <https://naturtextil.de/>

11 <https://www.blauer-engel.de/de>



and [Global Organic Textile Standard \(GOTS\) \(2021\)](https://global-standard.org/).<sup>12</sup> The selection, chosen in collaboration with actors of the leather industry and NGOs, aimed to ensure variety with regard to the scope of labels (i.e., coverage of consumer protection and environmental aspects during manufacturing) and expected levels of familiarity. Participants were asked to indicate for each label how well they knew it, to what extent they thought it represented environment protection, and to what extent they thought it represented protection of consumers' health, each on a 5-point Likert-type scale, ranging from 1 = not at all to 5 = very well.<sup>13</sup>

### 3.2.5 Willingness to pay

To compare participants' WTP for different modes of manufacturing, we repeatedly presented the same picture of an exemplary product (i.e., leather boots, see [Supplementary material S1](#)) accompanied by three different descriptions of the leather used, namely leather from (a) conventional manufacturing (b) manufacturing that is less harmful to environment and health, and (c) manufacturing that is less harmful to environment and health and also provides information about the supply chain. For each of the three manufacturing modes, participants were asked to indicate the maximum purchasing price between 0€ and 350€ that they were willing to pay for the depicted shoes.

### 3.2.6 Psychological constructs and purchasing behavior

Based upon the extended NAM and further studies on consumer behavior ([Lee, 2009](#); [Onwezen et al., 2013](#); [Müller et al., 2014](#); [Landon et al., 2017](#); [Joanes et al., 2020](#)), we developed 29 items for the six psychological constructs and behavior (see [Supplementary material S3](#) for all items and scale internal consistencies before and after exclusion of items): AC (5 items), AR (5 items), SN (4 items), PN (4 items), PBC (4 items), BI (3 items), and B (3 items). Each item consisted of a statement, to which participants indicated how much they agreed on a 5-point Likert-type scale, ranging from 1 = not at all to 5 = entirely. Higher numbers indicate that the respective construct was more pronounced.

## 3.3 Handling of missing values

Due to higher amounts of missing values on some of the psychological variables (> 10%), we performed an analysis to identify the missing data mechanism. This analysis led to the assumption that the missing data were missing at random (cf. [Little, 1988](#)) except for our measure of SN. Therefore, we decided to exclude SN from further analyses. Items on knowledge about leather manufacturing also contained missing values (6 to 43%), which we interpreted as missing knowledge. As we assumed missing values to be missing at random, we imputed the data using an expectation-maximization algorithm within NORM ([Schafer, 1999](#); [Graham, 2009](#)).

<sup>12</sup> <https://global-standard.org/>

<sup>13</sup> Results on environment protection and protection of consumers' health are reported in the Supplementary Material 9 (SM\_9).

## 3.4 Data analysis

To investigate the assumed associations between purchasing behavior and the psychological variables, we performed a Structural Equation Model (SEM), including a Confirmatory Factor Analysis (CFA) and a path model with IBM SPSS AMOS (Version 27). The CFA tested whether our set of items validly assessed the psychological constructs of the NAM. Using the maximum likelihood method, CFA computes factor loadings of single items on latent factors and provides fit indices to judge the goodness of fit of the hypothesized model.

The CFA indicated an acceptable fit for the hypothesized model [CFI = 0.947, TLI = 0.931, RMSEA (90%CI) = 0.063 (0.054, 0.071)] after reducing the number of items to two or three items for each latent variable.<sup>14</sup> Items with factor loadings below 0.65 were excluded if this did not limit content validity. Standardized regression weights of the final selection of items as well as the covariance and correlation matrix are given in [Supplementary materials S3, S4](#). For further analyses, we applied non-parametric tests since the Shapiro-Wilk test ([Shapiro and Wilk, 1965](#)) indicated that the assumption of normality was not met for most of the variables.

## 4 Results

### 4.1 Perception of leather and imitation leather

Participants' perception of leather differed significantly from the perception of imitation leather for all eight pairs of adjectives, as indicated by the respective means and non-overlapping confidence intervals displayed in [Figure 5](#). Means, standard deviations, confidence intervals, and Wilcoxon signed rank tests on the difference in perception of leather and imitation leather can be found in the [Supplementary material S5](#). Leather was perceived as natural, high-quality and robust, providing support for H1. Imitation leather was not only perceived as more artificial, but also as lower in price and quality, more harmful to health and environment, and less robust.

### 4.2 Attributes of leather

[Figure 6](#) depicts all attributes in ascending order of importance, with UV resistance being the least important and robustness being the most important. Means, standard deviations, confidence intervals, and Wilcoxon signed rank tests on the difference between the ranked attributes can be found in the [Supplementary material S6](#). Importantly, in line with hypotheses H1 and H2, natural appearance was rated among the most important attributes of leather products, while UV resistance, leather smell, and water resistance were rated less important.

<sup>14</sup> In this study, we report the Comparative Fit Index (CFI), the Tucker-Lewis Index (TLI), and the Root Mean Square Error of Approximation (RMSEA) for the results of the CFA as well as for the whole SEM. For the CFI and the TLI, values above 0.90 indicate an acceptable model fit. The RMSEA values should be below 0.08 for an adequate fit ([Pituch and Stevens, 2016](#)).

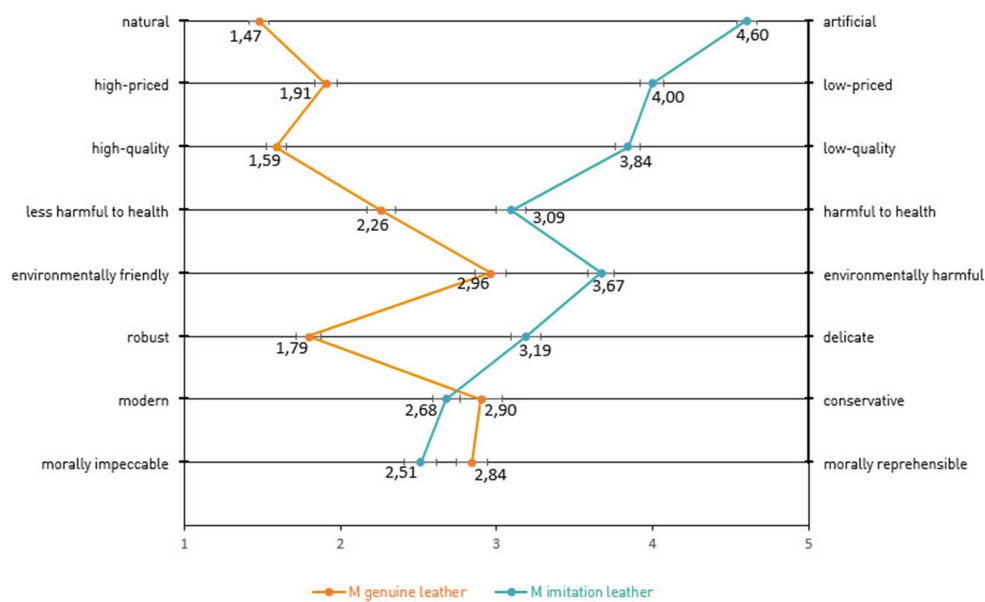

FIGURE 5 Comparison of genuine and imitation leather on the eight semantic differential scales.  $N = 439$ . Error bars represent 95% confidence intervals for mean values.

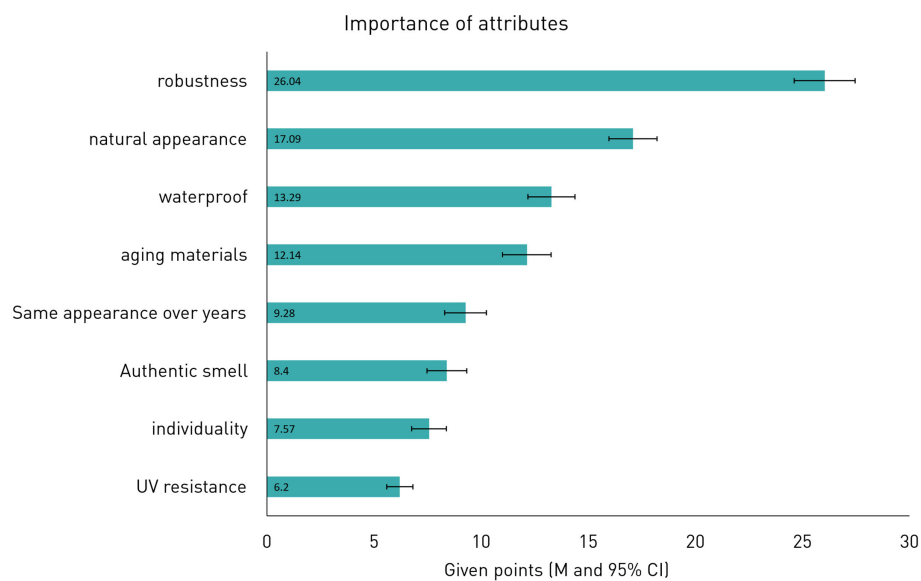

FIGURE 6 Means of points assigned to each of the leather attributes. Error bars represent 95% confidence intervals for mean values.

### 4.3 Knowledge of leather manufacturing

Factual knowledge of leather manufacturing was analyzed as a sum index representing the number of correct assignments of the given statements as true or false. On average,  $M = 5.68$  ( $SD = 2.05$ ,  $n = 428$ ) out of 11 statements were assigned correctly. Thus, participants had some knowledge about the manufacturing of leather but lacked important knowledge to judge the sustainability

performance of leather products. Most participants (94.8%) knew that the statement “the tanning process requires a lot of water” is correct, while only few participants knew that the statements “German manufacturers and retailers of leather products are legally required to know the chemicals contained in the leather” (21.9%) and “Genuine leather is always without plastic components” (26.9%) were false. [Supplementary material S7](#) shows the number of participants who answered the questions correctly per item.

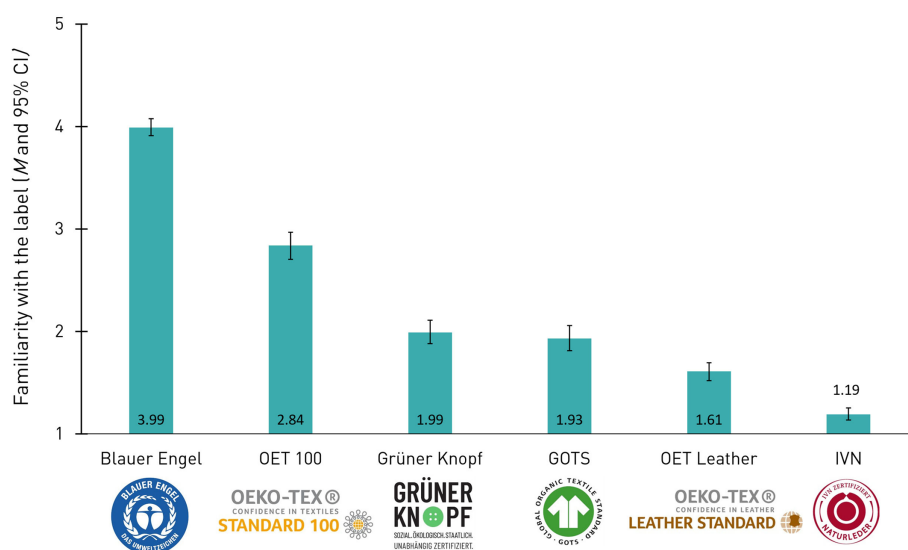

FIGURE 7

Mean familiarity with labels (Öko-Tex, BMZ, Grüner Knopf, Internationaler Verband der Naturtextilwirtschaft e.V., Blauer Engel, Global Organic Textile Standard).  $N = 439$ . Error bars are 95% confidence intervals. Tests of difference between the ranks of familiarity and effect sizes are given in the Supplementary material S8.

#### 4.4 Familiarity with eco-labels

Concerning participants' familiarity with eco-labels, we found considerable differences between the single labels. Figure 7 displays the familiarity means and confidence intervals for the labels and shows that 'Blauer Engel (2021)' was the best-known label while the 'IVN' label was the least-known one. To assess the meaning of eco-labels for the purchasing decision, we analyzed whether PBC is associated with the familiarity of the labels. The underlying rationale was that labels offer information about the sustainability performance of a product and thus, might make it easier to select those products that are more environmentally compatible. Results demonstrate moderate correlations between PBC and familiarity of the GOTS label and only weak correlations with the other labels (see Table 1).

#### 4.5 Willingness to pay

Using Friedman's Analysis of Variance (ANOVA), we tested participants' WTP in € for the three options of the exemplary leather product.

As depicted in Figure 8, participants' WTP differed between these three options,  $\chi^2 F(2) = 698.87, p < 0.001$ . Pairwise comparisons with Bonferroni correction revealed significant differences between all possible pairs: WTP was significantly lower for conventionally produced shoes ( $M = 91.58, SD = 41.37$ ) compared to shoes with leather stemming from manufacturing that is less harmful to environment and health ( $M = 127.06, SD = 43.30, T(z) = -1.00 (-14.82), p < 0.001, r = 0.50$ ), WTP was significantly lower for conventionally produced shoes than for shoes stemming from manufacturing that is less harmful to environment and health and also provides information about the supply chain ( $M = 141.36,$

$SD = 46.83, T(z) = -1.65 (-24.37), p < 0.001, r = -0.82$ ), and WTP was significantly lower for shoes stemming from manufacturing that is less harmful to environment and health without information on the supply chain than for shoes produced in that way with information on the supply chain [ $T(z) = -0.65 (-9.55), p < 0.001, r = -0.32$ ]. These results support hypotheses H3a and H3b.

#### 4.6 Understanding purchasing behavior

We used SEM for testing the hypothesized relations of variables as specified in the extended NAM introduced above (the path model is depicted in Figure 9).<sup>15, 16</sup> The total SEM had an acceptable model fit (CFI = 0.927, TLI = 0.912, RMSEA [90% CI] = 0.071 [0.063, 0.079],  $N = 439$ ). AC explained 53% of the variance in AR which in turn was significantly positively associated with PN, supporting H4b. In accordance with H4a, we found the strongest positive association between PN and BI. PBC positively predicted BI and B, supporting H4c, with the latter association being substantively stronger. Together, BI and PBC explained 80% of the variance in self-reported behavior (B).

<sup>15</sup> The distribution of NAM items was assessed within AMOS and showed violations of univariate normality for three variables and violation of multivariate normality. Due to content validity, we did not exclude these items. We originally analyzed the model using the maximum likelihood estimation but because of violations of normality, we repeated the analyses using bootstrapping. However, we did not find substantial differences within our results, so we report the maximum likelihood estimation results.

<sup>16</sup> With the exemption of SN, which we excluded from the analyses.

TABLE 1 Correlations between familiarity with labels and perceived behavioral control (PBC).

|      | Blauer Engel | OEKO-TEX standard 100 | Grüner Knopf | GOTS     | OEKO-TEX Leather Standard | IVN      |
|------|--------------|-----------------------|--------------|----------|---------------------------|----------|
| PBC2 | 0.120*       | 0.168***              | 0.195***     | 0.357*** | 0.168***                  | 0.142**  |
| PBC4 | 0.103*       | 0.107*                | 0.149**      | 0.290*** | 0.116*                    | 0.177*** |

$N=439$ . \* $p < 0.05$ , \*\* $p < 0.01$ , \*\*\* $p < 0.001$ . PBC 2 is the reversed mean value of agreement to the statement “I do not know where to buy leather products that are manufactured in a way that is less harmful to environment and health,” PBC 4 is the reversed mean value of agreement to the statement “Most of the time, I do not know whether a leather product was manufactured in a way that is less harmful to environment and health.” We report PBC2 and PBC4 as these items were also included in the SEM.

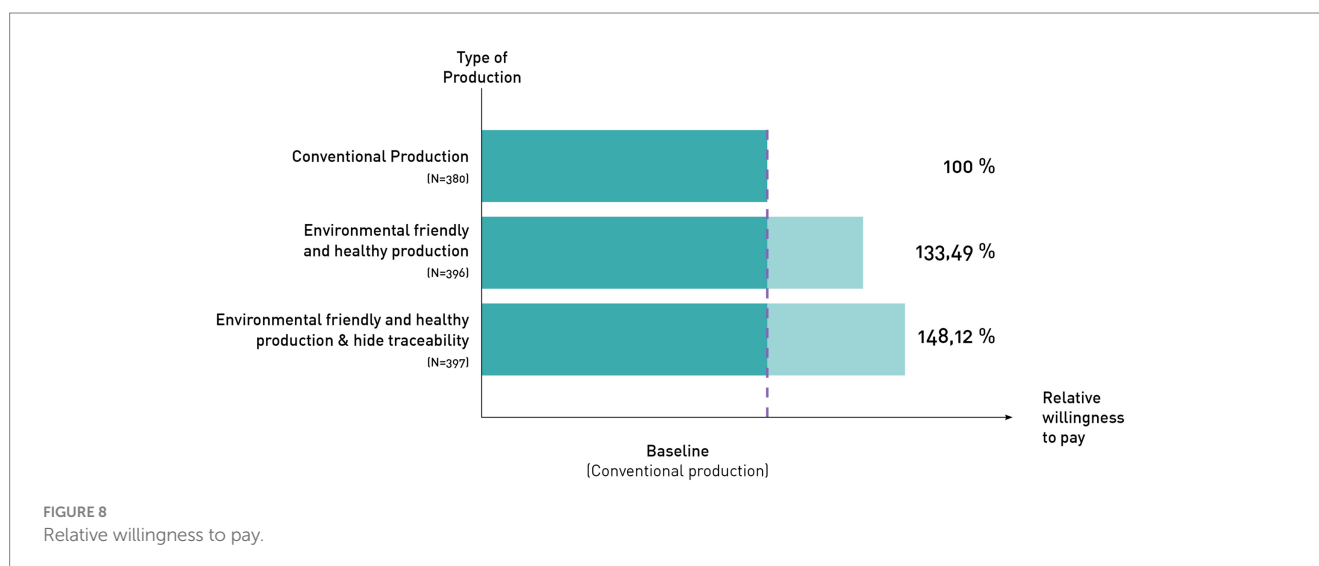

## 5 Discussion

### 5.1 Interpretation of empirical results and recommendations for stimulating more sustainable leather chemistry

#### 5.1.1 Perceptions of leather, most important material attributes, and implications for design guidelines for more sustainable chemistry

Leather is a natural material with a unique structure and aging processes through time and usage. However, in modern times, intensive application of coatings have been used to replace these patinas with homogeneous and unchanging surfaces. These coatings require additional chemicals that potentially pose risks for human health or environment. Paradoxically, while the leather industry seems to be moving toward synthetic appearances, the imitation-leather-industry is aiming at natural looking materials. These trends indicate that consumers' perceptions of these two materials may converge. However, our findings tell a different story: Imitation leather was perceived as artificial, being of lower quality, more harmful to health and environment, and less robust than leather.

In line with participants' perception of leather, participants ranked “robustness,” “natural appearance” and “aging material” among its most important attributes. As opposed to trends in the leather industry that aim at even and homogeneous surfaces, consumers seem to appreciate material properties such as natural surfaces that – when considered throughout the design process – allow for manufacturing with lower environmental impact through the reduction of chemical

additives and longer use of the product. Focusing on the notion of “robustness,” designers could aim at more durable and repairable products. These and other aspects and approaches in the context of de-sign and product development are currently subject to scrutiny in the ongoing subproject aiming for design guidelines for more sustainable leather products (for more information on design guidelines for sustainable development, see [Rehn, 2021](#)).

Our finding that leather is perceived as natural can also be used for marketing. The characteristic of an aging material that might require maintenance to remain durable and esthetically pleasing can be seen both as a material weakness or a unique selling proposition depending on the communicative framing of this phenomenon. By emphasizing the natural properties, marketers can dissociate their products from the seemingly less durable and lower quality category of imitation leather. Fostering expectations of longevity of leather products strengthens the product's overall appeal and offers new potentials for business models. Additionally, caring practices can strengthen product attachment and in turn extend product lifetime (e.g., [Gwilt et al., 2015](#)).

#### 5.1.2 Knowledge, purchasing behavior, and insights for informational campaigns

Previous research showed that knowledge can be a prerequisite for environmentally conscious behavior (e.g., [Meinhold and Malkus, 2005](#); [Roubanis, 2008](#)). The majority of our participants had limited knowledge about leather manufacturing, the currently missing transparency in the supply chains, and properties of leather products. For example, most expected “genuine leather” to be entirely free of



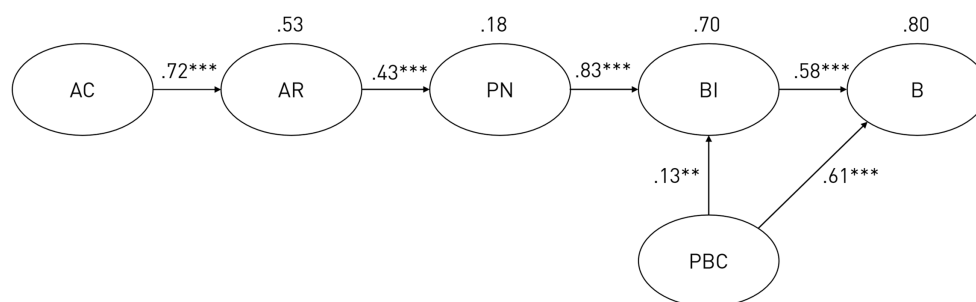

FIGURE 9

Structural model of the SEM including the various explanatory variables for behavior as specified in the extended NAM. Ellipses represent latent variables, numbers on arrows are standardized regression weights, numbers above latent variables are squared multiple correlations (i.e., the amount of variance explained by the influencing variables). AC, Awareness of Consequences, AR, Ascription of Responsibility, PN, Personal Norm, BI, Behavioral Intention, B, Behavior, PBC, Perceived Behavioral Control,  $N = 439$ , \* $p < 0.05$ , \*\* $p < 0.01$ , \*\*\* $p < 0.001$ .

plastic components (SM\_7). Many participants strongly agreed with the item “Most of the time, I do not know whether a leather product was manufactured in a way that is less harmful to environment and health.” Also, except for “Blauer Engel (2021),” the presented eco-labels were not well-known. Together, these findings illustrate the need to inform consumers about environmental and health impacts of leather and to improve product labeling. However, it is important to note that there was considerable variance in the average number of knowledge items correctly answered, thus, marketing campaigns should identify and target consumer groups with particularly low levels of knowledge.

In our empirical study, we used an extended version of the NAM to gain a better understanding of participants’ purchasing behavior of leather products. The structural model provided supporting evidence for the hypothesized relations between all variables within the NAM framework that we included in our analyses. Descriptive statistics indicated a high AC regarding conventional leather manufacturing, which corresponds to recent data on attitudes of Europeans toward chemicals in everyday products (European Commission, 2020). According to the NAM, AC leads to AR and the development of a PN for carrying out the pro-social behavior (Steg and de Groot, 2010). Indeed, our results show that the effect of AC on PN is mediated by AR, which expands former research on purchasing decisions in different product domains (Shin et al., 2018; Borusiak et al., 2020). Furthermore, as assumed by the NAM, PN was connected to BI. In addition to PN, PBC turned out to be a strong predictor of buying leather products that have been manufactured in a way that is less harmful to environment and health in our study. Based upon this finding, we propose that PBC should be looked at in closer detail, particularly, because our participants indicated that they found it rather difficult to buy leather products that were manufactured in a way that is less harmful to environment and health (i.e., relatively low PBC mean values). Moreover, a strong predictor of relevant behavior, PBC is a potential lever for interventions to promote the purchasing of leather products that are less harmful to environment and health.

Strategies to increase PBC should consider informational campaigns. Our study revealed which information is needed in general (i.e., where to buy and how to recognize leather products that are less harmful to environment and health). NGOs, retailers, and brands could help consumers by spreading exactly this information. Given that our results also show a positive association between PBC and familiarity with labels (see Table 1), it can be assumed that labels

constitute one way of offering transparency and information. They may allow consumers at the point of sale to recognize leather products that have been produced in a way that is less harmful to environment and health. However, consumers seem to be partly unaware of what product characteristics the respective labels represent: almost half of our respondents expected the STANDARD 100 by OEKO-TEX to certify actions to protect the environment (SM\_9). Yet, this label focuses on consumer protection while environmentally friendly manufacturing is out of the label’s scope (see text footnote 8, respectively). Labels that comprise environmental aspects of manufacturing, for example, the IVN Leather Standard (see text footnote 10, respectively), were the least-known in our study. This illustrates that consumers are not well-versed with labels in the leather context and therefore, in addition to labeling the products, information about the meanings of the labels should be spread.

Using insights from empirical studies that apply theories, such as the NAM, can further increase the effectiveness of informational campaigns (Michie and Johnston, 2012). They enable targeting people with specific behavioral patterns depending on their specific needs for behavior change and the development of tailored interventions, which were found to be more effective than non-tailored ones (Steg and Vlek, 2009; Klöckner, 2015). One promising strategy may be to first ask people about the obstacles (knowledge, availability, price, etc.) that prevent them from buying leather products that are less harmful to environment and health. They could then receive the specific information they need (e.g., potential environmental and health impacts, where product alternatives are sold, where to get second-hand products in good condition, how to refurbish products). Many participants of our study had already developed a PN to purchase environmentally less harmful leather products. However, as described above, one of the perceived obstacles to translating this feeling of moral obligation into action was missing information about the supply chains and the manufacturing process. This illustrates the need for manufacturers and retailers to increase transparency.

### 5.1.3 Willingness to pay, supply chain management, and traceability as a central driver for more sustainable leather chemistry

Industry perceives increased transparency and traceability as a cost driver. This is not only due to necessary investments in technology, but also due to the tendency to over-emphasize

short-term costs over long-term effects which might as well be cost-reducing or otherwise net beneficial (Barton et al., 2017). We assume that actors would be less hesitant to invest in such a tracing system if this investment could be compensated for by retail prices. Our study shows that consumers are willing to pay more for leather products that have been manufactured in a way that is less harmful to environment and health and an additional premium if information concerning the supply chain is provided. These findings indicate that some of the extra costs that may accrue for measures to promote sustainable development can be forwarded to consumers, if plausible and well-communicated. With this in mind, the leather industry is challenged to develop products and services that support and make use of enhanced exchange of information.

In order to be able to provide consumers with this information about manufacturing and the supply chain, and in particular, on chemicals involved, fundamental changes of contemporary supply chain management are necessary. To this end, industry actors along the chains, including brands and retailers, must build up the capacities to respond to emerging demands for transparency. This entails effective chemicals management underpinned by supply chain interaction, communication, and cooperation. Indeed, organizations such as Zero Discharge of Hazardous Chemicals (ZDHC, 2022), an initiative led by multi-national textile brands and retailers but also involving suppliers, already aim to support companies in disclosing their supplier networks and in implementing sound chemical management along the supply chains.<sup>17</sup> The tools provided by such organizations, for example, allow chemical suppliers to show compliance of their products with chemical restrictions. However, the tools are not sufficient to create transparency for brands and retailers about what chemicals are present in their products and processes to actively control those (Schenten et al., 2019).

Our scenario building process with representatives from the leather industry illustrated that full traceability of chemicals could be a central driver for more sustainable leather chemistry. Such traceability would be the basis for a database on which companies can build up trusted communication with consumers. Once a traceability framework is established, knowing all chemicals present in processes and products, the industry could identify opportunities and specific needs for more sustainable products and processes, thus, creating entry points for niche innovations into the regime. Besides, knowledge of chemical ingredients can be employed to proactively inform consumers of any unwanted impact. The landscape changes in European policies (“Green Deal”) already create windows of opportunity for the industry to engage and ensure the control of chemicals and their risks along supply chains and the product life cycle.

## 5.2 Practical implications

Building on a transdisciplinary approach, this research uses empirical consumer data as a facilitator in a complex process in which stakeholders from industry, retail and others need to be engaged. Leather manufacturing in modern globalized supply chains often

entails negative impacts – for a big part driven by chemicals - on human health and the natural environment. Due to opaque supply chains, controlling the chemical inputs and outputs constitutes a major challenge. Establishing more sustainable leather chemistry requires behavior change of diverse actors at various levels. For instance, the chemical industry needs to provide more data on chemical products for the evaluation of leather and leather manufacturing, tanners need to use more sustainable chemicals or non-chemical alternatives in leather manufacturing, brands need to shift their sourcing in this direction, taking into account the impact on product design while offsetting the additional costs incurred by tanners. System innovations can facilitate the transition by combining new technical solutions in chemistry, moving from the niche to mainstream, and the design of leather products with social and organizational innovations in terms of enhanced supply chain collaborations. In addition, an institutional framework stipulating the formal and informal rights and obligations of all relevant actors is needed to ensure the intended behavioral contributions.

Our main interest in the empirical study presented in this article was on consumers’ perceptions and behaviors concerning mainstream leather products and niche innovations, particularly leather that is manufactured in a way that is less harmful to environment and health. The insights gained from this study were not primarily targeted to add to the overall body of literature on pro-environmental consumer behavior but first and foremost to inform industry practices and routines related to the specific project at hand. Such research is necessary to improve our understanding of the expectations, and behavioral antecedents of consumers as change agents within transition processes, thereby explaining how members of the civil society corroborate the pre-vailing regime or participate in niche innovations. Our results show that there are consumers who support sustainable innovations for leather products through their consumption choices. Moreover, our findings point to specific strategies to support these innovations through product design, informational campaigns, and increased traceability along supply chains. Within the MLP framework (Geels, 2002), civil society represents a heterogeneous group of individuals, some of whom stick to the current regime and are unaware of inherent problems, while others support niche innovations through their consumption and usage behavior. Our empirical study emphasizes opportunities to engage consumers in the transition process, as there is environmental awareness and willingness to adapt purchasing decisions and usage behaviors to reduce negative environmental impacts. This window of opportunity can be used to facilitate the transitions toward more sustainable chemistry in leather.

By providing empirical insights for possible steps to foster more sustainable chemistry in leather, our research indirectly contributes to SDG 12. However, as mentioned in the introduction, the topic is linked to other SDGs. For example, the leather industry increases employment of unskilled workers in many countries, thereby potentially promoting sustainable economic growth and productive employment (SDG 8). More sustainable leather chemistry also contributes to the reduction of water pollution (SDG 6) (China et al., 2020). Moreover, improved municipal waste management (SDG 11) is needed to deal with leather products at their end of life. Manufacturing and consumption of leather products are also linked to diverse short-term and long-term social and ethical aspects, which need to be considered in the promotion of systemic change. To name

<sup>17</sup> <https://www.roadmaptozero.com/>

a few, change actors should elaborate on working conditions, child labor, fair trade, and the exploitation of animals. These interrelations of sustainable development-related challenges of the leather industry illustrate the high complexity of the topic and call for a systemic approach, which entails adapting the entire arrangements of manufacturing, trade, consumption, and waste including associated infrastructures, lifestyles, and governance (Bengtsson et al., 2018). Therefore, to support niche innovations in entering the regime, diverse actor groups need to align and coordinate goals as well as translate their knowledge of the system and its dynamics into strategy and interventions (Birney, 2021). To back these actors, we collaborate with practitioners in a transformative research project that provides opportunities for experimentation, particularly in the fields of chemical innovation, harmonization of standards, traceability of chemicals along supply chains, as well as more sustainable product design and business models. The approach presented in this paper can be adapted to other social-technical systems that face comparable challenges and transitions, such as the textile, energy and mobility industries.

## 6 Conclusion

The leather industry faces a highly needed transition toward more sustainable chemistry. To support this transition, this article analyzed challenges of the leather industry and consumers' roles as a nexus of transition-relevant developments. This research bridges perspectives from law, design and psychology to contribute to sustainability science. By analyzing and describing the current system and by highlighting potential levers for change, our study provides insights for transition researchers, industry representatives and policy makers to support a transition toward more sustainable chemistry in the leather industry. Based on empirical survey data on leather-related perceptions, knowledge, and purchasing behavior of consumers, we illuminate how changes in consumption styles can be supported and how consumers push on niche innovations to enter the regime. With regard to these data, our study supports the development of more sustainable leather products that at the same time meet current market demands.

Our results show that participants perceived leather as natural, robust, and of high quality. Knowledge about the manufacturing of leather products is overall limited but varied. Data obtained with regard to the psychological framework NAM hints at person-level factors that may motivate consumers to opt for more sustainable leather products. More specifically, being aware of environmental and health consequences from conventional manufacturing of leather products is positively associated with a personal norm to purchase leather products that are less harmful to environment and health. The perceived ease of buying more environmentally compatible leather products is positively associated with their purchase. These results can support informational campaigns to promote transition-relevant consumer behavior.

The survey results should be interpreted with some caution, due to possible sampling biases. Compared to the general population in Germany, the Citizens' Panel used for data collection in this study over-represents people with higher education and higher incomes. It also includes a smaller share of people with a non-German nationality. Although this is a common pattern of participants in

psychological and sustainable consumption research (e.g., Henrich et al., 2010), it could limit the generalizability of the findings, especially regarding knowledge and WTP. Further studies with larger, more balanced samples should be conducted to validate our findings. Nevertheless, people with high incomes and high education levels have stronger purchasing power, can choose from a greater variety of products, and usually have higher carbon footprints (Druckman and Jackson, 2016; Joanes et al., 2020). Thus, investigating the behavior of these people provides valuable information on possible changes in consumption styles. Another limiting aspect is the data assessment based on self-reports, as this method is prone to displaying attitudes or intentions that often differ from actual behavior (e.g., Carrington et al., 2010). As numerous studies show (e.g., Young et al., 2009; Hassan et al., 2016), participants often indicate higher intentions for behaviors that are less harmful to environment and human health compared to what they actually do in their everyday life. While self-reports offer valuable insights into subjective perception, cognition, and emotions, response biases such as social desirability (Dodou and De Winter, 2014) as well as self-serving biases should be taken into account. Since we used an online survey for our data collection, social desirability might not be as pronounced as for in-person data collection methods, such as interviews. Nevertheless, additional studies using observation measures of actual consumption behavior could enrich the given findings. Unfortunately, in our study, the psychological variable SN had a high amount of missing values, due to which we decided to exclude it from further analyses. Unlike other topics, to which the NAM framework has been applied (e.g., choice of travel mode), the purchasing of leather may not be as salient in everyday life and therefore not subject to discussions with peers and family. Consequently, participants may have found it difficult to answer our items on SN, which would explain the high number of missing data. In future studies, this issue might be addressed by asking participants to imagine what close others think about the purchasing of leather instead of asking them to state others' actual opinions on it. Finally, we only collected cross-sectional data and, therefore, cannot draw any conclusions about causality and directionality in the found associations. Further studies should use experimental or longitudinal designs to investigate how information and psychological antecedents affect purchasing decisions regarding leather products. More research is needed regarding when and how disciplinary empirical methods should be applied and how they can be communicated and implemented in transdisciplinary processes. With regard to ongoing discussions in sustainability science and (environmental) psychology on how to further intertwine methodology and theory from these two fields for mutual benefit (e.g., Upham et al., 2020; Hanss, 2021; Wullenkord and Hamann, 2021), the present research showcases that empirical insights into human agency can inform inter- and transdisciplinary system analysis and the development of measures to promote necessary system transitions.

## Data availability statement

The datasets presented in this article are not readily available because participants signed a data statement, which included that publications will only contain aggregated data. Nevertheless, upon reasonable request, we can consult our data security officer and ask for

permission to share data in specific forms and the code we used to analyze data. Requests to access the datasets should be directed to HM, [helena.mueller@h-da.de](mailto:helena.mueller@h-da.de).

## Ethics statement

Ethical approval was not required for the study involving human participants in accordance with the local legislation and institutional requirements. Written informed consent to participate in this study was not required from the participants in accordance with the national legislation and the institutional requirements.

## Author contributions

CE: Conceptualization, Formal analysis, Methodology, Software, Writing – original draft, Writing – review & editing. JS: Conceptualization, Writing – original draft, Writing – review & editing. AT: Conceptualization, Formal analysis, Methodology, Software, Writing – original draft, Writing – review & editing. JR-G: Conceptualization, Visualization, Writing – original draft, Writing – review & editing. MH: Conceptualization, Formal analysis, Methodology, Software, Writing – original draft, Writing – review & editing. HM: Conceptualization, Formal analysis, Methodology, Writing – original draft, Writing – review & editing. DH: Conceptualization, Methodology, Supervision, Writing – original draft, Writing – review & editing.

## Funding

The author(s) declare financial support was received for the research, authorship, and/or publication of this article. This project was funded by the Federal Ministry of Education and Research Germany and the Joint Science Conference within the federal-state initiative “Innovative Hochschule,” grant no. 03IHS036A. The authors

## References

- Ajzen, I. (2002). Perceived behavioral control, self-efficacy, locus of control, and the theory of planned behavior. *J. Appl. Soc. Psychol.* 32, 665–683. doi: 10.1111/j.1559-1816.2002.tb00236.x
- Asian Development Bank and United Nations Conference on Trade and Development. (2015). *Intraregional trade in leather and leather products in South Asia: identification of potential regional supply chains*, Asian Development Bank: Mandaluyong City, metro Manila, Philippines.
- Bamberg, S., Hunecke, M., and Blöbaum, A. (2007). Social context, personal norms and the use of public transportation: two field studies. *J. Environ. Psychol.* 27, 190–203. doi: 10.1016/j.jenvp.2007.04.001
- Bamberg, S., and Möser, G. (2007). Twenty years after Hines, Hungerford, and Tomera: a new meta-analysis of psycho-social determinants of pro-environmental behaviour. *J. Environ. Psychol.* 27, 14–25. doi: 10.1016/j.jenvp.2006.12.002
- Barton, D., Manyika, J., Timothy, K., Palter, R., Godsall, J., and Zoffer, J. (2017). *Measuring the economic impact of short-termism*. Available at: <https://www.mckinsey.com/~/media/mckinsey/featured%20insights/long%20term%20capitalism/where%20companies%20with%20a%20long%20term%20view%20outperform%20their%20peers/mgi-measuring-the-economic-impact-of-short-termism.ashx>.
- Belcher, B. M., Claus, R., Davel, R., and Ramirez, L. F. (2019). Linking transdisciplinary research characteristics and quality to effectiveness: a comparative analysis of five research-for-development projects. *Environ. Sci. Pol.* 101, 192–203. doi: 10.1016/j.envsci.2019.08.013

were responsible for the content of this publication. In addition, we acknowledge support by the Open Access Publication Funds of the Hochschule Darmstadt.

## Acknowledgments

We would like to thank Silke Kleihauer and Martin Führ for consultation and funding acquisition in the project *System Innovations for Sustainable Development (s:ne)* at Darmstadt University of Applied Sciences. We also would like to thank our other colleagues in this project for their support and helpful comments as well as the practitioners included in transdisciplinary initiatives of the s:ne project for sharing their expertise.

## Conflict of interest

The authors declare that the research was conducted in the absence of any commercial or financial relationships that could be construed as a potential conflict of interest.

## Publisher's note

All claims expressed in this article are solely those of the authors and do not necessarily represent those of their affiliated organizations, or those of the publisher, the editors and the reviewers. Any product that may be evaluated in this article, or claim that may be made by its manufacturer, is not guaranteed or endorsed by the publisher.

## Supplementary material

The Supplementary material for this article can be found online at: <https://www.frontiersin.org/articles/10.3389/frsus.2024.1351638/full#supplementary-material>.

- Bengtsson, M., Alfredsson, E., Cohen, M., Lorek, S., and Schroeder, P. (2018). Transforming systems of consumption and production for achieving the sustainable development goals: moving beyond efficiency. *Sustain. Sci.* 13, 1533–1547. doi: 10.1007/s11625-018-0582-1
- Birney, A. (2021). How do we know where there is potential to intervene and leverage impact in a changing system? Practitioners perspective. *Sustain. Sci.* 16, 749–765. doi: 10.1007/s11625-021-00956-5
- Black, M., Canova, M., Rydin, S., Scalet, B. M., Roudier, S., and Delgado Sancho, S. (2010). Best available techniques (BAT) reference document for the tanning of hides and skins. Available at: <https://op.europa.eu/en/publication-detail/-/publication/c9c39631-f89f-4bff-a154-fa82f8f8b569> (Accessed June 9, 2021).
- Blauer Engel. (2021). *Blauer Engel: Das Umweltzeichen*. Available at: <https://www.blauer-engel.de/de> (Accessed July 19, 2021).
- Borusiak, B., Szymkowiak, A., Horska, E., Raszka, N., and Żelichowska, E. (2020). Towards building sustainable consumption: a study of second-hand buying intentions. *Sustain. For.* 12:875. doi: 10.3390/su12030875
- Brandt, P., Ernst, A., Gralla, F., Luederitz, C., Lang, D. J., Newig, J., et al. (2013). A review of transdisciplinary research in sustainability science. *Ecol. Econ.* 92, 1–15. doi: 10.1016/j.ecolecon.2013.04.008
- Buljan, J., and Král, I. (2012). *Benchmarking in the tanning industry* Available at: [https://leatherpanel.org/sites/default/files/publications-attachments/benchmarking\\_final\\_d2012.pdf](https://leatherpanel.org/sites/default/files/publications-attachments/benchmarking_final_d2012.pdf) (Accessed June 9, 2021).



- Buljan, J., and Král, I. (2019). *The framework for sustainable leather manufacture*. Available at: [https://leatherpanel.org/sites/default/files/publications-attachments/the\\_framework\\_for\\_sustainable\\_leather\\_manufacturing\\_2nd\\_edition\\_2019\\_f.pdf](https://leatherpanel.org/sites/default/files/publications-attachments/the_framework_for_sustainable_leather_manufacturing_2nd_edition_2019_f.pdf) (Accessed June 9, 2021).
- Carrington, M. J., Neville, B. A., and Whitwell, G. J. (2010). Why ethical consumers don't walk their talk: towards a framework for understanding the gap between the ethical purchase intentions and actual buying behaviour of ethically minded consumers. *J. Bus. Ethics* 97, 139–158. doi: 10.1007/s10551-010-0501-6
- Chaouni, B. A., Bouhaddou, I., and Benghabrit, A. (2018). "Supply chain challenges with complex adaptive system perspective" in *Trends and advances in information systems and technologies*. eds. A. Rocha, H. Adeli, L. P. Reis and S. Costanzo, vol. 745 (Cham: Springer International Publishing), 1081–1093.
- Chellappilla, S. L., Jaiswal, R., Haller, S., Kernegger, L., and Ravi, P. (2017). *Zeigt her Eure Schuhe! Soziale und ökologische Auswirkungen von Gerbereien in Uttar Pradesh und Tamil Nadu in Indien*. Available at: <https://suedwind-institut.de/files/Suedwind/Publikationen/2017/2017-61%20Zeigt%20her%20Eure%20Schuhe.%20Soziale%20und%20oekologische%20Auswirkungen%20von%20Gerbereien%20in%20Uttar%20Pradesh%20und%20Tamil%20Nadu%20in%20Indien.pdf> (Accessed June 9, 2021).
- Cheng, C.-Y., Chen, T.-L., and Chen, Y.-Y. (2014). An analysis of the structural complexity of supply chain networks. *Appl. Math. Model.* 38, 2328–2344. doi: 10.1016/j.apm.2013.10.016
- China, C. R., Maguta, M. M., Nyandoro, S. S., Hilonga, A., Kanth, S. V., and Njau, K. N. (2020). Alternative tanning technologies and their suitability in curbing environmental pollution from the leather industry: a comprehensive review. *Chemosphere* 254:126804. doi: 10.1016/j.chemosphere.2020.126804
- Cohen, S. (2014). *The growing level of environmental awareness*. Available at: [https://www.huffpost.com/entry/the-growing-level-of-envi\\_b\\_6390054](https://www.huffpost.com/entry/the-growing-level-of-envi_b_6390054) (Accessed January 19, 2022).
- Concari, A., Kok, G., and Martens, P. (2020). A systematic literature review of concepts and factors related to pro-environmental consumer behaviour in relation to waste management through an interdisciplinary approach. *Sustain. For.* 12:4452. doi: 10.3390/su12114452
- Connell, K. Y. H. (2010). Internal and external barriers to eco-conscious apparel acquisition. *Int. J. Consum. Stud.* 34, 279–286. doi: 10.1111/j.1470-6431.2010.00865.x
- Cotance. (2020). *Social and environmental report 2020: the European leather industry*. Available at: <https://www.euroleather.com/doc/SER/European%20Leather%20Industry%20-%20Social%20and%20Environmental%20Report%202020%20-%20EN%20web.pdf> (Accessed June 9, 2021).
- Cruz, C. M. L., De Medeiros, J. F., Hermes, L. C. R., Marcon, A., and Marcon, É. (2016). Neuromarketing and the advances in the consumer behaviour studies: a systematic review of the literature. *Int. J. Bus. Glob.* 17:330. doi: 10.1504/IJBG.2016.078842
- Darmstadt University of Applied Sciences. (n.d.) *System innovation for a more sustainable leather chemistry*. Available at: <https://sne.h-da.de/en/implementation-project/more-sustainable-chemistry-in-the-leather-supply-chains/system-innovation-for-a-more-sustainable-leather-chemistry>
- De Fazio, F., Bakker, C., Flipsen, B., and Balkenende, R. (2021). The disassembly map: a new method to enhance design for product reparability. *J. Clean. Prod.* 320:128552. doi: 10.1016/j.jclepro.2021.128552
- Defila, E. D. (2019). *Transdisziplinär und transformativ forschen, Band 2: Eine Methodensammlung*. Wiesbaden: Springer Fachmedien Wiesbaden.
- Deutsch, L., Belcher, B., Claus, R., and Hoffmann, S. (2021). Leading inter- and transdisciplinary research: lessons from applying theories of change to a strategic research program. *Environ. Sci. Pol.* 120, 29–41. doi: 10.1016/j.envsci.2021.02.009
- Dixit, S., Yadav, A., Dwivedi, P. D., and Das, M. (2015). Toxic hazards of leather industry and technologies to combat threat: a review. *J. Clean. Prod.* 87, 39–49. doi: 10.1016/j.jclepro.2014.10.017
- Dodou, D., and De Winter, J. C. F. (2014). Social desirability is the same in offline, online, and paper surveys: a meta-analysis. *Comput. Hum. Behav.* 36, 487–495. doi: 10.1016/j.chb.2014.04.005
- Druckman, A., and Jackson, T. (2016). "Understanding households as drivers of carbon emissions" in *Taking stock of industrial ecology*. eds. R. Clift and A. Druckman (London: Springer), 181–203.
- European Chemicals Agency. (2020). *Forum pilot project on cooperation with customs in enforcement of REACH restrictions and CLP labelling – Project report*, Helsinki, Finland: European Chemicals Agency.
- European Commission. (2019). *The European green Deal*. Available at: [https://eur-lex.europa.eu/resource.html?uri=cellar:b828d165-1c22-11ea-8c1f-01aa75ed71a1.0002.02/DOC\\_1&format=PDF](https://eur-lex.europa.eu/resource.html?uri=cellar:b828d165-1c22-11ea-8c1f-01aa75ed71a1.0002.02/DOC_1&format=PDF) (Accessed June 9, 2021).
- European Commission. (2020). Attitudes of European citizens towards the environment. Available at: <https://europa.eu/eurobarometer/surveys/detail/2257> (Accessed July 13, 2021).
- European Commission. (2022a). *Proposal for a regulation on Ecodesign for sustainable products*. Brussels: European Commission.
- European Commission. (2022b). *Communication from the commission to the European Parliament, the council, the European economic and social committee and the Committee of the Regions*. Brussels: European Commission.
- European Commission. (2022c). *OECD guidelines for multinational enterprises*. Brussels: European Commission.
- Febriana, S. A., Jungbauer, F., Soebono, H., and Coenraads, P.-J. (2012). Inventory of the chemicals and the exposure of the workers' skin to these at two leather factories in Indonesia. *Int. Arch. Occup. Environ. Health* 85, 517–526. doi: 10.1007/s00420-011-0700-1
- Führ, M., and Schenten, J. (2018). "Sustainable production and consumption" in *Principles of environmental law*. eds. L. Krämer and E. Orlando (Cheltenham, Northampton, MA: Edward Elgar Publishing)
- Gailhofer, P., Heyen, D. A., Fischer, C., López, V., Kampffmeyer, N., and Brand, T. (2023). *Verbraucher\*innen als Akteure in der Lieferkettenregulierung – und Möglichkeiten ihrer Stärkung*. Berlin: Öko-Institut.
- Geels, F. W. (2002). Technological transitions as evolutionary reconfiguration processes: a multi-level perspective and a case-study. *Res. Policy* 31, 1257–1274. doi: 10.1016/S0048-7333(02)00062-8
- Geels, F. W., and Schot, J. (2007). Typology of sociotechnical transition pathways. *Res. Policy* 36, 399–417. doi: 10.1016/j.respol.2007.01.003
- Gerek, E. E., Yilmaz, S., Kopalal, A. S., and Gerek, Ö. N. (2019). Combined energy and removal efficiency of electrochemical wastewater treatment for leather industry. *J. Water Proc. Eng.* 30:100382. doi: 10.1016/j.jwpe.2017.03.007
- Geschka, H., Hahnenwald, H., and Schwarz-Geschka, M. (2008). "Szenariotechnik" in *Praxiswissen Innovationsmanagement*. eds. V. D. I. Z. Markterfolg, O. Gassmann and P. Sutter (München: Hanser), 119–138.
- Global Organic Textile Standard (GOTS). (2021). *Global organic textile standard*. Available at: <https://global-standard.org/> (Accessed 19 July 2021).
- Graham, J. W. (2009). Missing data analysis: making it work in the real world. *Annu. Rev. Psychol.* 60, 549–576. doi: 10.1146/annurev.psych.58.110405.085530
- Grin, J., Rotmans, J., and Schot, J. (2010). *Transitions to sustainable development: New directions in the study of long term transformative change, first issued in paperback*. New York, London: Routledge.
- Gupta, S., Gupta, S., Dharmija, P., and Bag, S. (2018). Sustainability strategies in the Indian leather industry: an empirical analysis. *Benchmarking* 25, 797–814. doi: 10.1108/BIJ-06-2017-0140
- Gwilt, A., Leaver, J., Fisher, M., and Young, G. (2015). "Understanding the caring practices of users" in *Product lifetimes and the environment, conference proceedings, 17–19 June, 2015 – Nottingham, UK. Nottingham Trent University. Product lifetimes and the Environment*. eds. T. Cooper, N. Braithwaite, M. Moreno and G. Salvia (Nottingham, UK: Nottingham Trent University), 17–19.
- Ha-Brookshire, J. E., and Norum, P. S. (2011). Willingness to pay for socially responsible products: case of cotton apparel. *J. Consum. Mark.* 28, 344–353. doi: 10.1108/07363761111149992
- Hansen, É., Monteiro de Aquim, P., Hansen, A. W., Cardoso, J. K., Ziulkoski, A. L., and Gutterres, M. (2020). Impact of post-tanning chemicals on the pollution load of tannery wastewater. *J. Environ. Manag.* 269:110787. doi: 10.1016/j.jenvman.2020.110787
- Hanss, D. (2021). Commentary: we need to change: integrating psychological perspectives into the multilevel perspective on socio-ecological transformations. *Front. Psychol.* 12:724768. doi: 10.3389/fpsyg.2021.724768
- Hassan, L. M., Shiu, E., and Shaw, D. (2016). Who says there is an intention-behaviour gap? Assessing the empirical evidence of an intention-behaviour gap in ethical consumption. *J. Bus. Ethics* 136, 219–236. doi: 10.1007/s10551-014-2440-0
- Henrich, J., Heine, S. J., and Norenzayan, A. (2010). The weirdest people in the world? *Behav. Brain Sci.* 33, 61–83. doi: 10.1017/S0140525X0999152X
- Hutton, M., and Shafahi, M. (2019). Water pollution caused by leather industry: a review. In proceedings of the ASME 2019 13th international conference on energy sustainability collocated with the ASME 2019 heat transfer summer conference. *ASME 2019 13th International Conference on Energy Sustainability, July 14–17, 2019, ASME*. Bellevue, Washington, DC: ASME.
- Internationaler Verband der Naturtextilwirtschaft EV. *Internationaler Verband der Naturtextilwirtschaft E.V.* Available at: <https://naturtextil.de/> (Accessed July 19, 2021).
- Jiang, Y., Jia, F., and Gong, Y. (2018). IKEA: global sourcing and the sustainable leather initiative. *Int. Food Agribus. Manage. Rev.* 21, 627–639. doi: 10.22434/IFAMR2017.0109
- Joanes, T., Gwozdz, W., and Klöckner, C. A. (2020). Reducing personal clothing consumption: a cross-cultural validation of the comprehensive action determination model. *J. Environ. Psychol.* 71:101396. doi: 10.1016/j.jenvp.2020.101396
- Jonell, M., Crona, B., Brown, K., Rönnbäck, P., and Troell, M. (2016). Eco-labeled seafood: determinants for (blue) green consumption. *Sustain. For.* 8:884. doi: 10.3390/su8090884
- Kamalha, E., Zeng, Y., Mwasiagi, J. I., and Kyatuheire, S. (2013). The comfort dimension, a review of perception in clothing. *J. Sens. Stud.* 28, 423–444. doi: 10.1111/joss.12070
- Karuppiah, K., Sankaranarayanan, B., and Saravanasankar, S. (2019). Leather waste management scenario in developed and developing nations. *Int. J. Eng. Adv. Technol.* 9, 852–857. doi: 10.35940/ijeat.A1056.1291S419
- Keller, A., Köhler, J. K., Eisen, C., Kleihauer, S., and Hanss, D. (2021). Why consumers shift from single-use to reusable drink cups: an empirical application of the stage model

- of self-regulated behavioural change. *Sustain. Prod. Consum.* 27, 1672–1687. doi: 10.1016/j.spc.2021.04.001
- Kemp, R., Schot, J., and Hoogma, R. (1998). Regime shifts to sustainability through processes of niche formation: the approach of strategic niche management. *Tech. Anal. Strat. Manag.* 10, 175–198. doi: 10.1080/09537329808524310
- Klöckner, C. A. (2015). *The psychology of pro-environmental communication: Beyond standard information strategies*, Palgrave Macmillan UK: London.
- Klöckner, C. A., and Ohms, S. (2009). The importance of personal norms for purchasing organic milk. *Br. Food J.* 111, 1173–1187. doi: 10.1108/00070700911001013
- Landon, A. C., Kyle, G. T., and Kaiser, R. A. (2017). An augmented norm activation model: the case of residential outdoor water use. *Soc. Nat. Resour.* 30, 903–918. doi: 10.1080/08941920.2016.1239294
- Lang, D. J., Wiek, A., Bergmann, M., Stauffacher, M., Martens, P., Moll, P., et al. (2012). Transdisciplinary research in sustainability science: practice, principles, and challenges. *Sustain. Sci.* 7, 25–43. doi: 10.1007/s11625-011-0149-x
- Le Blanc, D. (2015). Towards integration at last? The sustainable development goals as a network of targets. *Sustain. Dev.* 23, 176–187. doi: 10.1002/sd.1582
- Leathernaturally. (2021). *Fact sheets*. Available at: <https://www.leathernaturally.org/Education/Fact-Sheets> (Accessed September 20, 2022).
- Lee, K. (2009). Gender differences in Hong Kong adolescent consumers' green purchasing behavior. *J. Consum. Mark.* 26, 87–96. doi: 10.1108/07363760910940456
- Lee, M., Karpova, E., and Baytar, F. (2019). The effects of information on young consumers' attitudes and purchase intentions of fashion products made of fur, leather, and wool. *J. Glob. Fashion Market.* 10, 177–193. doi: 10.1080/20932685.2019.1577160
- Limesurvey GmbH. (2017). *LimeSurvey: An open source survey tool*. Available at: <http://limesurvey.org>.
- Little, R. J. A. (1988). A test of missing completely at random for multivariate data with missing values. *J. Am. Stat. Assoc.* 83, 1198–1202. doi: 10.1080/01621459.1988.10478722
- Meinhold, J. L., and Malkus, A. J. (2005). Adolescent environmental behaviors: can knowledge, attitudes, and self-efficacy make a difference? *Environ. Behav.* 37, 511–532. doi: 10.1177/0013916504269665
- Meyer, M., Dietrich, S., Schulz, H., and Mondschein, A. (2021). Comparison of the technical performance of leather, artificial leather, and trendy alternatives. *Coatings* 11:226. doi: 10.3390/coatings11020226
- Michie, S., and Johnston, M. (2012). Theories and techniques of behaviour change: developing a cumulative science of behaviour change. *Health Psychol. Rev.* 6, 1–6. doi: 10.1080/17437199.2012.654964
- Müller, T., Gwozdz, W., and Reisch, L. A. (2014). “Responsibility attribution and consumer behaviour in the light of the Bangladesh factory collapse” in *Macromarketing and the crisis of the social imagination: Proceedings of the 39th annual macromarketing conference*, eds A. Bradshaw, M. Laamanen and A. Reppel (Egham, UK: Macromarketing Society), 892–903.
- Nielsen. (2018). *Global consumers seek companies that care about environmental issues*. Available at: <https://nielseniq.com/global/en/insights/analysis/2018/global-consumers-seek-companies-that-care-about-environmental-issues/> (Accessed January 19, 2022).
- Öko-Tex. (2021). *Öko-Tex*. Available at: <https://www.oeko-tex.com/de/> (Accessed July 19, 2021).
- Omologo, O., Mortimer, K., Wise, W. R., and Jraisat, L. (2021). Sustainability research in the leather industry: a critical review of progress and opportunities for future research. *J. Clean. Prod.* 285:125441. doi: 10.1016/j.jclepro.2020.125441
- Onwezen, M. C., Antonides, G., and Bartels, J. (2013). The norm activation model: an exploration of the functions of anticipated pride and guilt in pro-environmental behaviour. *J. Econ. Psychol.* 39, 141–153. doi: 10.1016/j.joep.2013.07.005
- Organization for Economic Cooperation and Development. (2017). *OECD due diligence guidance for responsible supply chains in the garment and footwear sector*. Available at: <https://mneguidelines.oecd.org/OECD-Due-Diligence-Guidance-Garment-Footwear.pdf> (Accessed June 9, 2021).
- Osgood, C. E. (1952). The nature and measurement of meaning. *Psychol. Bull.* 49, 197–237. doi: 10.1037/h0055737
- Pituch, K. A., and Stevens, J. P. (2016). *Applied multivariate statistics for the social sciences*. London: Routledge.
- Polita, F. S., and Madureira, L. (2021). Evolution of short food supply chain innovation niches and its anchoring to the socio-technical regime: the case of direct selling through collective action in north-West Portugal. *Sustain. For.* 13:13598. doi: 10.3390/su132413598
- Rehn, J. (2021). *Leather product design canvas for sustainable development*. Darmstadt University of Applied Sciences.
- Rehn-Groenendijk, J., Lehmann, K., and Schenten, J. (2022). *Handbook of leather design for sustainable development*. Darmstadt: Hochschule Darmstadt.
- Roubanis, J. L. (2008). Comparison of environmentally responsible consumerism and voluntary simplicity lifestyle between U.S. and Japanese female college students. *Fam. Consum. Sci. Res. J.* 37, 210–218. doi: 10.1177/1077727X08327241
- Sathish, M., Madhan, B., Sreeram, K. J., Raghava Rao, J., and Nair, B. U. (2016). Alternative carrier medium for sustainable leather manufacturing – a review and perspective. *J. Clean. Prod.* 112, 49–58. doi: 10.1016/j.jclepro.2015.06.118
- Schafer, J. L. (1999). *NORM University Park: The methodology Center*: Penn State.
- Schenten, J., Führ, M., Kleihauer, S., and Schönborn, J. (2019). Traceability as driver for more sustainable chemistry in the global textile supply chains. *Curr. Opin. Green Sustain. Chem.* 19, 87–93. doi: 10.1016/j.cogsc.2019.08.003
- Schenten, J., and Rehn, J. (2021). *A theory of change (ToC) supporting the visioning of a sustainable supply chain*. Beitrag im portal “SCNAT wissen - Methoden und Werkzeuge für die Koproduktion von Wissen”. Available at: [https://naturwissenschaften.ch/co-producing-knowledge-explained/practical\\_experiences/theory\\_of\\_change](https://naturwissenschaften.ch/co-producing-knowledge-explained/practical_experiences/theory_of_change) (Accessed June 9, 2021).
- Schwartz, S. H. (1977). Normative influences on altruism. *Adv. Exp. Soc. Psychol.* 10, 221–279. doi: 10.1016/S0065-2601(08)60358-5
- Severo, E. A., Guimarães, J. C. F., and De Dellarmelin, M. L. (2021). Impact of the COVID-19 pandemic on environmental awareness, sustainable consumption and social responsibility: evidence from generations in Brazil and Portugal. *J. Clean. Prod.* 286:124947. doi: 10.1016/j.jclepro.2020.124947
- Shapiro, S. S., and Wilk, M. B. (1965). An analysis of variance test for normality (complete samples). *Biometrika* 52, 591–611. doi: 10.2307/2333709
- Shin, Y. H., Im, J., Jung, S. E., and Severt, K. (2018). The theory of planned behavior and the norm activation model approach to consumer behavior regarding organic menus. *Int. J. Hosp. Manag.* 69, 21–29. doi: 10.1016/j.ijhm.2017.10.011
- Smit, L., Bright, C., McCorquodale, R., Bauer, M., Deringer, H., Baeza-Breinbauer, D., et al. (2020). *Study on due diligence requirements through the supply chain: final report*. Available at: <https://op.europa.eu/en/publication-detail/-/publication/8ba0a8fd-4c83-11ea-b8b7-01aa75ed71a1> (Accessed June 9, 2021).
- Steg, L., and de Groot, J. (2010). Explaining prosocial intentions: testing causal relationships in the norm activation model. *Br. J. Soc. Psychol.* 49, 725–743. doi: 10.1348/014466609X477745
- Steg, L., and Vlek, C. (2009). Encouraging pro-environmental behaviour: an integrative review and research agenda. *J. Environ. Psychol.* 29, 309–317. doi: 10.1016/j.jenvp.2008.10.004
- Surana, A., Kumara, S., Greaves, M., and Raghavan, U. N. (2005). Supply-chain networks: a complex adaptive systems perspective. *Int. J. Prod. Res.* 43, 4235–4265. doi: 10.1080/00207540500142274
- Tey, Y. S., Brindal, M., and Dibba, H. (2018). Factors influencing willingness to pay for sustainable apparel: a literature review. *J. Glob. Fashion Market.* 9, 129–147. doi: 10.1080/20932685.2018.1432407
- United Nations. (2015). *Transforming our world: the 2030 agenda for sustainable development*. Available at: <https://sdgs.un.org/sites/default/files/publications/21252030%20Agenda%20for%20Sustainable%20Development%20web.pdf> (Accessed June 9, 2021).
- Upham, P., Bögel, P., and Dütschke, E. (2020). Thinking about individual actor-level perspectives in sociotechnical transitions: a comment on the transitions research agenda. *Environ. Innov. Soc. Trans.* 34, 341–343. doi: 10.1016/j.eist.2019.10.005
- Van der Werff, E., and Steg, L. (2015). One model to predict them all: predicting energy behaviours with the norm activation model. *Energy Res. Soc. Sci.* 6, 8–14. doi: 10.1016/j.erss.2014.11.002
- Wahga, A. I., Blundel, R., and Schaefer, A. (2018). Understanding the drivers of sustainable entrepreneurial practices in Pakistan's leather industry: a multi-level approach. *Int. J. Entrep. Behav. Res.* 24, 382–407. doi: 10.1108/IJEBR-11-2015-0263
- Wiek, A., and Lang, D. J. (2016). “Transformational sustainability research methodology” in *Sustainability science: An introduction*, eds H. Heinrichs, W. J. M. Martens, G. Michelsen and A. Wiek (Dordrecht: Springer), 31–41.
- Wullenkord, M. C., and Hamann, K. R. S. (2021). We need to change: integrating psychological perspectives into the multilevel perspective on socio-ecological transformations. *Front. Psychol.* 12:655352. doi: 10.3389/fpsyg.2021.655352
- Young, W., Hwang, K., McDonald, S., and Oates, C. J. (2009). Sustainable consumption: green consumer behaviour when purchasing products. *Sustain. Dev.* 18, 20–31. doi: 10.1002/sd.394
- ZDHC. (2022). *Roadmap to change*. Available at: <https://www.roadmaptozero.com/> (Accessed January 19, 2022).