

The Third
Neuroadaptive Technology Conference



NEUROADAPTIVE
TECHNOLOGY

NAT '22

CONFERENCE PROGRAMME

October 9 – October 12, 2022,
Lübbenau, Germany

The Third Neuroadaptive Technology Conference

Conference Programme

© 2022 Society for Neuroadaptive Technology



This work is licensed under the
Creative Commons Attribution-NonCommercial-NoDerivatives 4.0 International License.
To view a copy of this license, visit <http://creativecommons.org/licenses/by-nc-nd/4.0/>
or send a letter to Creative Commons, PO Box 1866, Mountain View, CA 94042, USA.

DOI: 10.26127/BTUOpen-6271

The Third
Neuroadaptive Technology Conference
is sponsored by

ZΔ zander labs

Zander Laboratories BV / GmbH, Netherlands / Germany
zanderlabs.com



Brain Products GmbH, Germany



Brandenburg University of Technology, Germany
Liverpool John Moores University, UK
Volkswagen Stiftung, Germany

General Chairs

Prof. Thorsten O. Zander
Brandenburg University of Technology, Germany

Prof. Stephen H. Fairclough
Liverpool John Moores University, UK

Organizational Support

Annett Ströer
Zander Labs GmbH, Germany

Laurens R. Krol
Brandenburg University of Technology, Germany

Juliane Pawlitzki
Brandenburg University of Technology, Germany

Pia Hofmann
Brandenburg University of Technology, Germany

Sarah M. Mehnert
Brandenburg University of Technology, Germany

Maria Fărăgău
Brandenburg University of Technology, Germany

Conference Programme	4
Keynote Lectures	5
Artificial Intelligence for passive BCI design: the good, the bad and the maybe	6
<i>Fabien Lotte</i>	
The Ethics and Philosophy of Neurotechnologies	7
<i>Marcello Ienca</i>	
Brain-Computer Interfaces for Group Decision-making.....	8
<i>Caterina Cinel</i>	
Brain-Artificial Intelligence Interfaces (BAIs).....	9
<i>Moritz Grosse-Wentrup</i>	
The Unhackable Brain – Why Brain-Computer Interfaces will become a Matter of Cybersecurity..	10
<i>Simon Vogt</i>	
Neuro-tech in Defence and Security	11
<i>Matt Richins</i>	
Session BCI & Applications	12
Exploring Human Centredness Through Neuroadaptive Technology	13
<i>Karran, Boasen, Tadson, Beauchemin, Charland, Courtemanche, Leger, Sylvain</i>	
Passive BCI for realizing human perception of robot movement	17
<i>Mahmoudi Khomami, Ahmadi, Ahmad Sharbafi</i>	
Interpersonal synchrony in electrodermal activity predicts decreased performance in a vigilance task induced by sleep deprivation.....	20
<i>Stuldreher, Van Erp, Brouwer</i>	
Towards an Awkward Silence-Adaptive Virtual Meeting System	23
<i>Seitz, Reuscher, Jacob, Maedche</i>	
Real Virtual Magic – Modifying a VR game with a BCI to enhance immersion	27
<i>Klug</i>	
An investigation of a passive BCI’s performance in different user postures and presentation modalities	29
<i>Gherman, Zander</i>	
Longitudinal Changes in Sensorimotor Functional Connectivity during Learning to Control a Brain-Computer Interface	31
<i>Kapralov, Jamshidi Idaji, Studenova, Vidaurre, Ros, Villringer, Nikulin</i>	
Acoustic stimulation during deep sleep using a mobile EEG system at home.....	34
<i>Kramer, Da Silva Souto, Bartels, Debener, Doclo, Winneke</i>	
Large-Scale Assessment of a Biofeedback Breathing Guide	37
<i>Frey, Labrosse, Pariente, Lagorce, Lhomme, Nicolas, Micoulaud-Franchi</i>	
Session Ethics & Perspectives	40
Symbiotic technology and the self	41
<i>Mecacci, Haselager, Van Elteren</i>	
Technologically Enhancing Our Moral Identity	44
<i>Titz</i>	

Is speaking one's mind the same as moving one's arm? Extended cognition, bodily movement, and the differences between BCI-mediated speech and BCI-mediated action	46
<i>Buller</i>	
Modeling subject perception and behaviour during neurofeedback training	48
<i>Annicchiarico, Lotte, Mattout</i>	
A taxonomy of neurotechnologies enabling the notion of a hybrid mind	51
<i>Colucci, Vermehren, Buthut, Finkbeiner, Soekadar</i>	
BCIs for education: future steps for wider use.....	52
<i>Armani, Daly, Vernitski, Gillmeister, Scherer</i>	
EEG Brain Mapping with Interpretable Deep Learning	55
<i>Kapitonova, Ball</i>	
Towards Privacy-preserving Deep Transfer Learning for Heterogenous EEG Data Sets.....	57
<i>Wej, Faisal</i>	
Weight perception in exoskeleton-supported teleoperation	59
<i>Förster, Kim, Maurus, Kumar, Lenggenhager, Kirchner</i>	
Session AI & Machine Learning	62
Interactive Machine Learning for Neuroadaptive Technology	63
<i>Fairclough, Karran</i>	
BCI-based Deep Reinforcement Learning for Robot Training	65
<i>Vukelić, Bui, Lingelbach</i>	
Improving fNIRS-based BCIs with Convex Optimization for Generalized Classification and Semi-Supervised Learning	68
<i>Harvey, Wang, Vu, Jacob</i>	
Versatile neuroadaptive feedback platform using reinforcement learning.....	71
<i>Dinov, Asai, Kaytati, Leech</i>	
Classifier Visualisation Reveals Saliency, Valence, and Serial Dependency in a Modified Implicit Cursor Control Paradigm	73
<i>Krol, Pawlitzki, Gramann, Zander</i>	
Interpretable Deep Neural Networks for EEG-based Auditory Attention Detection with Layer-Wise Relevance Propagation.....	76
<i>Ivucic, Putze, Cai, Li, Schultz</i>	
Simple Probabilistic Data-driven Model for Adaptive BCI Feedback	78
<i>Mladenović, Lotte, Mattout, Frey</i>	
Creating adaptive state-representation in neurophysiological systems using Gaussian state-space model.....	81
<i>Wannawas, Faisal</i>	
Signal Alignment for Cross-dataset Transfer Learning in P300 Brain-Computer Interfaces	83
<i>Song, Gwon, Won, Jun, Ahn</i>	
Poster Session.....	86
Using Granger Analyses to Measure Functional Connectivity in Response to Demand and Experimental Pain.....	87
<i>Fairclough, Stamp, Dobbins</i>	

Neurophysiological constraints on human-robot interfacing for augmentation.....	89
<i>Mio, Faisal</i>	
Modelling the effects of sleep deprivation – from physiological to biochemical analyses	91
<i>Özsezen, Verschuren, Bottenheft, Stuldreher, Kleemann, Van Erp, Brouwer</i>	
Comparative Analysis of Public Dataset of Motor Imagery to Infer Compatibility	93
<i>Gwon, Won, Song, Nam, Jun, Ahn</i>	
Loving Videos: A New Paradigm to Elicit Strong Positive Emotions.....	97
<i>Sprengel, Velut, Stuldreher, Van Engen, Brouwer</i>	
Cross-lingual Voice Activity Detection for Human-Robot Interaction.....	100
<i>Höfling, Kim, Kirchner</i>	
Passive BCI for gait assistance	104
<i>Ahmad Sharbafi</i>	
Studying mechanisms of brain-computer interface induced plasticity after stroke: A preliminary outlook	108
<i>Grigoryan, Masri, Wagner, Nikulin, Villringer, Sehm</i>	
Neurophysiological constraints on human-robot interfacing for augmentation.....	110
<i>Mio, Faisal</i>	
Task-Independent Workload Classification using Non-Binary Output and Task Scaling	112
<i>Krol, Müller, Boyanova, Kübler, Zander</i>	
Neural and Social-Psychological Correlates of Immersion in a Virtual Reality Safety Training	115
<i>Alkhasli, Hoffmann</i>	
Detecting threat identification from event-related brain potentials.....	118
<i>Du Bois, Hudson, Coyle</i>	

Conference Programme

Sunday, the 9th of October

20:00 Hotel garden reception

Monday, the 10th of October

08:00 - 08:30 Registration

08:30 - 09:00 Welcome

09:00 - 09:40 **Keynote: Fabien Lotte**

09:40 - 11:00 **Session:** BCI & Applications I

11:00 - 11:20 Coffee break

11:20 - 13:00 **Session:** BCI & Applications II

13:00 - 14:00 Lunch

14:00 - 14:40 **Keynote: Marcello Ienca**

14:40 - 16:00 **Session:** Ethics & Perspectives I

16:00 - 16:20 Coffee break

16:20 - 18:00 **Session:** Ethics & Perspectives II

18:00 - 18:40 **Keynote: Caterina Cini**

20:00 Dinner & cocktails; music by **Cile**

Tuesday, the 11th of October

08:00 - 09:00 Registration & coffee

09:00 - 09:40 **Keynote: Mortiz Grosse-Wentrup**

09:40 - 11:00 **Session:** AI & Machine Learning I

11:00 - 12:20 **Session:** Posters & coffee

12:20 - 14:00 **Session:** AI & Machine Learning II

14:00 - 15:00 Lunch

15:00 - 15:40 **Panel:** Business

15:40 - 16:20 **Keynote: Simon Vogt**

16:20 - 16:40 Coffee break

16:40 - 17:20 **Keynote: Matthew Richins**

17:20 - 18:00 **Panel:** Cybersecurity

18:00 - 19:00 Goodbye session

19:00 Open discussions

Wednesday, the 12th of October

First Meeting of the BCI Network Germany

Sponsors: Cyberagentur, Brandenburg University of Technology

Open to attendees:

09:00 - 12:00 Overview of BCI research landscape in France, UK, and Germany

12:00 - 13:00 Lunch

By invitation only:

13:00 Workshop of the BCI Network

Keynote Lectures

Fabien Lotte

Artificial Intelligence for passive BCI design: the good, the bad and the maybe

Monday, October 10th
09:00 – 09:40

Passive Brain-Computer Interfaces (pBCIs) hold great promises for Human-Computer Interaction (HCI), notably to monitor users' sensory, cognitive, affective or conative states during interaction, and adapt this interaction accordingly. Artificial Intelligence (AI) methods, notably machine learning classifiers, have always played a key role in pBCI designs. This role is currently increasing even further by now encompassing methods not only to classify brain signals but also to model the users' behaviour, intentions and needs as well as to design intelligent adaptations, based on such models. While numerous publications on AI methods for (p)BCIs are released every month, such publication landscape may sometimes appear like the "far west", with a lack of research rules and standards, and an apparent difficulty in identifying solid works from the rest. Therefore, in this talk, I will discuss on the pros and promises of various recent AI algorithms for pBCI designs (the good), but also on the flaws and common pitfalls of AI use for (p)BCIs (the bad), as well as related perspectives for the future of the pBCI field (the maybe). More precisely, I will first start by the bright side (the good), by presenting recent and promising advances in Riemannian geometry and deep learning classifiers for mental state monitoring, and discuss of their respective merits when compared with each other. I will then move to more concerning issues (the bad), by identifying various pitfalls in AI studies for (p)BCIs, including lack of reproducibility, biased evaluations and comparisons, ignorance of common confounding factors or lack of usability in practice, among others. Finally, I will end on a more optimistic note, by presenting some perspectives on AI for pBCIs (the maybe). I will notably cover future promising applications of AI for pBCIs, such as pBCI-based personalized and adaptive medical rehabilitation or artistic experience, as well as open challenges such as the need for models of variability in (p)BCIs and for considering pBCI users in all stages of their design, including in AI algorithms.



Fabien Lotte obtained a M.Sc., a M.Eng. (2005), and a PhD (2008) from INSA Rennes, and a Habilitation (HDR, 2016) from Univ. Bordeaux, all in computer science. His research focuses on the design, study and application of Brain-Computer Interfaces (BCI). In 2009 and 2010, Fabien Lotte was a research fellow at the Institute for Infocomm Research in Singapore. From 2011 to 2019, he was a Research Scientist at Inria Bordeaux Sud-Ouest, France. Between October 2016 and January 2018, he was a visiting scientist at the RIKEN Brain Science Institute, Japan, and then in 2019 a visiting associate professor at the Tokyo University of Agriculture and Technologies (TUAT), still in Japan. Since October 2019, he is a

Research Director (DR2) at Inria Bordeaux Sud-Ouest. He is on the editorial boards of the journals Brain-Computer Interfaces (since 2016), Journal of Neural Engineering (since 2016) and IEEE Transactions on Biomedical Engineering (since 2021). He is also "co-specialty chief editor" of the section "Neurotechnologies and System Neuroergonomics" of the journal "Frontiers in Neuroergonomics". He co-edited the books "Brain-Computer Interfaces 1: foundations and methods" and "Brain-Computer Interfaces 2: technology and applications" (2016) and the "Brain-Computer Interfaces Handbook: Technological and Theoretical Advance" (2018). In 2016, he was the recipient of an ERC Starting Grant to develop his research on BCI.

Marcello Ienca

The Ethics and Philosophy of Neurotechnologies

Monday, October 10th
14:00 – 14:40

In recent years, the debate on the ethical implications of advances in neuroscience and neurotechnology has resonated widely not only in academia but also at the political level of governmental and intergovernmental organizations. Various governance proposals have been made in order to ensure the responsible development of neurotechnologies, promote fair access to them and prevent their misuse. Among these approaches, the most foundational one is that of the so-called ‘neurorights’, i.e. the fundamental human rights linked to the sphere of the human brain and mind. From the perspective of neurorights, the human brain and the cognitive and affective processes it enables, represents a domain of fundamental ethical-normative salience. Therefore, it must be protected through regulatory reforms concerning either the evolutionary reinterpretation of existing rights or the introduction of new rights. Among the rights that have been proposed are the right to cognitive liberty, mental privacy, mental integrity and psychological continuity. The neurorights approach serves to identify certain unauthorized forms of intrusion into a person’s brain function (especially if they result in damage to the cognitive, affective or behavioral sphere) and banish or limit them as violations of the aforementioned rights. International organizations such as the UN, UNESCO, the Council of Europe, the OECD as well as national parliaments such as that of Chile are working on the advancement of neurorights through various forms of regulatory instruments. This presentation will provide an overview of the ethics and policy challenges of neurotechnologies from a neurorights perspective, inform the audience about ongoing regulatory efforts by governmental and intergovernmental agencies, and propose a novel interdisciplinary approach to the assessment of ethical considerations in neuroscience called “experimental neuroethics”.



Dr. Marcello Ienca is a Principal Investigator at the College of Humanities at EPFL where he leads the ERA-NET funded Intelligent Systems Ethics research unit. He is also an affiliate member of the Health Ethics and Policy unit, Department of Health Sciences and Technology, and an ordinary member of the Competence for Rehabilitation Engineering & Science at ETH Zurich, Switzerland.

Dr. Ienca's scholarship focuses on the ethical, legal, social and policy implications of emerging technologies. In particular, he investigates the broader implications of new (and often converging) sociotechnical trends such as Artificial Intelligence (AI), big data, digital epidemiology, robotics, assisted living, digital health, social media, dual use, and neurotechnology. He and his team use both theoretical and empirical methods to explore the requirements for responsible innovation, ethically-aligned technology design, user-centred design, and human-centered technology assessment.

Caterina Cinel

Brain-Computer Interfaces for Group Decision-making

Monday, October 10th
18:00 – 18:40

Making decisions—either individually or in group—is an important aspect at all levels of everyday life. Decisions (for example made by government, military or hospital management) can be highly critical in nature, with mistakes possibly resulting in extremely adverse outcomes, including loss of lives. Often, decisions must be made with limited amounts of information, or indeed too much information for any single person to process in a meaningful manner, hence involving a high degree of uncertainty. In such difficult conditions, groups usually make better decisions than individuals, who tend to make suboptimal decisions. Groups have inherent error correction capabilities, but, unfortunately, they also suffer from many biases and flaws, such as difficulties in coordination and interaction between group members, reduced member effort within a group, strong leadership, group judgement biases, and so on.

Brain-Computer Interfaces (BCIs) have traditionally been used as assistive devices for restoring capabilities in people with disabilities. However, an important and exciting line of research has turned them into tools for augmenting cognitive functions in healthy people.

For nearly a decade, this has been a major strand of research within the Essex BCI-NE lab, where we pioneered the idea of combining brain signals (and other physiological and behavioural data) across multiple people to achieve a form of emergent group augmentation particularly for decision-making.

Over this period, with significant support from the UK Ministry of Defence, we have developed a collaborative BCI (cBCI) technology that has delivered significant improvements over the group performance achieved by more traditional methods of integrating individual decisions, for progressively more and more realistic environments.

In this presentation, I will give an overview of the work done in our lab with cBCIs, from their precursors to the range of techniques and results obtained in nearly a decade, in decision tasks, including: identification of visual targets in cluttered environments, comprehension of military radio communication, face recognition, military simulations of outposts and strategic decision making in a pandemic. I will touch upon our recent results with decision making systems where BCI-assisted humans make decisions together with AI agents treated as peers.



Caterina Cinel is a Lecturer at the University of Essex (UK) and a co-founder of the Essex BCI-NE lab. Her background is in cognitive psychology and neuroscience and has expertise in multisensory perception, attention, decision-making and memory, BCIs and cognitive augmentation. Her research is highly interdisciplinary, and has gradually focussed on BCIs for cognitive augmentation, including hybrid collaborative BCIs for group decision-making. The majority her work in that area has been funded by UK MoD: two past projects as co-I, and currently a US DoD/UK MoD funded Bilateral Academic Research Initiative (BARI). She has co-authored 50+ peer-reviewed publications, has a Google Scholar h-index 22, is an editor for

Brain Sciences, and an Associate Editor for the Frontiers in Neuroergonomics and Frontiers in Human Neurosciences.

Moritz Grosse-Wentrup

Brain-Artificial Intelligence Interfaces (BAIs)

Tuesday, October 11th

09:00 – 09:40

Brain-Computer Interfaces (BCIs) provide alternative communication channels to users with impaired peripheral nervous systems. They are of limited utility, however, if users lack the cognitive abilities to operate a BCI. For instance, a BCI that decodes intended movements of vocal tract muscles to synthesize speech would be of limited use to a stroke patient with Broca's aphasia. To overcome this limitation and expand the group of people that could benefit from neural interfaces, I introduce a new class of systems, which I term Brain-Artificial Intelligence (BAI) interfaces. BAIs aim to connect the brain with an AI system that replaces a lost cognitive function. Speech BAIs, for instance, would decode high-level cognitive states that enable a conversational AI to generate sentences congruent with their users' communication intents. I review recent advances in AI that render BAIs feasible, discuss how to adapt our decoding pipelines from BCIs to BAIs, and outline the challenges that we need to address to turn BAIs from a vision into a reality.



Moritz Grosse-Wentrup is full professor and head of the Research Group Neuroinformatics at the University of Vienna, Austria. He develops machine learning algorithms that provide insights into how large-scale neural activity gives rise to (disorders of) cognition, and applies these algorithms in the domain of cognitive neural engineering, e.g., to build brain-computer interfaces for communication with severely paralyzed patients, design closed-loop neural interfaces for stroke rehabilitation, and develop personalized brain stimulation paradigms. He has received numerous awards for his work, including the 2011 Annual Brain-Computer Interface Research Award, the 2014 Teaching Award of the Graduate School of Neural Information Processing at the University of Tübingen, and the 2016 IEEE Brain Initiative Best Paper Award.

Simon Vogt

The Unhackable Brain – Why Brain-Computer Interfaces will become a Matter of Cybersecurity

Tuesday, October 11th
15:40 – 16:20

Brain-Computer Interfaces (BCI) are undergoing a rapidly accelerating pace of research and development. Today, emerging applications and use-cases outside of controlled laboratories are still at an early technological stage. Nevertheless, it is clear to see that the future applications of BCI span new domains, especially in the context of consumer products for interaction with robots, autonomous vehicles, computer games or metaverse/Web 3 scenarios. In parallel to those new communication channels between machines on the one side and the human brain on the other side, privacy and security concerns must be taken into account as early as possible.

The Cyberagentur as a federal German organization has the mission to find and foster breakthrough research in technology fields that are relevant to the security of every citizen, company, authority or the infrastructure with a scope of 10-15 years into the future. For us, BCI are a focal topic of interest. We aim to escort and guide technology development in this domain based on a privacy and security by design approach and have thus commissioned the development of a “Framework for Preserving Privacy and Cybersecurity in Brain-Computer Interfacing Applications” that has just been finished and will be presented during this conference.

For us, the human brain represents the highest resort for privacy and security of information – and we aim to make sure that this will never change.



Dr. Simon Vogt leads Cyberagentur's research activities in the domains of human-machine interaction. After having served as Navy Officer for almost 15 years and a PhD in information systems research, he joined the German Forces Cyber Innovation Hub, aiming to connect startups and innovative ideas and methods with the needs of the troops. He then became the founding head of IBM's Garage for Defense - an industry approach to fostering agile methodology within large-scale research and development projects. After Cyberagentur was founded in 2020, Simon Vogt joined a few months later as one of the first employees.

His first projects examine the future applications of neurotechnology and brain-computer interfaces (BCI) within human-machine interaction, focusing on how to ensure and maintain security, privacy, and integrity for brain data.

Matt Richins

Neuro-tech in Defence and Security

Tuesday, October 11th

16:40 – 1:20



Matthew Richins is a Psychologist in the Human and Social Sciences group at Defence, Science, and Technology Laboratory. Matt's current work involves understanding, assessing, and improving the cognitive components in complex socio-technical systems and optimising physical function, health, protection and performance of personnel across the Defence and Security workforce.

Session BCI & Applications

Monday, October 10th

09:40 – 13:00

Exploring Human Centredness Through Neuroadaptive Technology

Karran A.J¹, Boasen J¹, Tadson B¹, Beauchemin N¹, Charland P², Courtemanche F¹, Leger P-M¹, Senecal Sylvain¹

1) HEC Montréal

2) Université du Québec à Montréal

Keywords: BCI, AI, HCAI, Machine Learning, Classification, Education, E-Commerce

Abstract

Neuroadaptive technology has become a tool to overcome physical impairments, augment specific cognitive capacities and a method for providing improved time to insight for user experience testing. Rapid improvements in the size and sensitivity of sensor technologies and methods of classifying brain activity into specific states have shown brain-computer interfaces (BCI) to be both a useful assistive technology and a general interfacing technology for human-machine systems (Zander & Kothe, 2011). BCI technology has been defined as "a device that reads voluntary changes in brain activity, then translates these signals into a message or command in real-time" (Guger et al., 2021). As such, BCI's are a core component of systems that utilise the user's neurophysiological data as input to a computer system, which then performs actions to adapt, assist or provide feedback to the operator. A common application of BCI technology is to measure and classify operators' mental workload (MW) under various conditions. Studies have found (Grimes et al., 2008) correlations between MW and variance in brainwaves expressed as increases or decreases in α (8-12hz) and θ (4-8hz) in pre-frontal brain regions.

We will discuss a program of research and development that will be completed in two phases. The research aims to investigate the use of a brain-computer interface to monitor and classify operator mental workload in real-time to drive interface adaptations to aid the operator make better decisions in an e-commerce context or improve learning outcomes in an education context. In phase one, two studies will utilise relatively simple methods to monitor and classify operators' mental workload.

Study One - BCI for Education

The development and integration of technologies into teaching practices have begun a trend toward transitioning from the more traditional classroom pedagogical models to online models (Alharthi, 2020; Bergdahl et al., 2020). Research has shown that the use of technological tools in learning helps promote engagement and motivation as predictors of success (Bergdahl et al., 2020; Firat et al., 2018). While technological tools in education have been designed with user cognitive load as a design consideration (Gerjets et al., 2014; Sweller, 2020) very few of these technologies adapt in real-time, potentially making learning less personalised (Kalyuga & Liu, 2015).

By posing the following research question, "*To what extent does utilising a real-time BCI that adapts the speed of information provision and response times based on cognitive load improve learning outcomes over a task involving learning astronomical constellations?*", this study explores two interface adaptations (speed of information presentation and response time) with the aim of demonstrating that these adaptations can improve learning outcomes.

Study Two - BCI For E-Commerce

With the growth of e-commerce, consumers face choice difficulties due to the many products available online (Donkers et al., 2020; Schulz et al., 2019; Wertenbroch et al., 2020). This paradox of choice (Schwartz & Schwartz, 2004) leads to increased cognitive load, resulting in hindered decision-making and a reduced likelihood of selecting rational and objective options (Besedeš et al., 2015; Deck & Jahedi, 2015; Zhang et al., 2014). Thus, predictive recommendation algorithms are deployed within e-commerce to facilitate decision-making (Smith et al., 2005). However, these algorithms are essentially blind to the user's cognitive load and do not dynamically update recommendations.

To investigate how dynamic recommendations triggered by operator cognitive load may facilitate improved decision making, we formulated the following research question: "Can a BCI which measures and classifies cognitive workload to adapt information presentation, reduce the cognitive workload of online shoppers and facilitate optimal decision-making?". Thus, this study will compare recommendations embedded in product comparison matrices, dependent on whether these recommendations appear perpetually or activated using a BCI and a classification of high cognitive load.

Methods

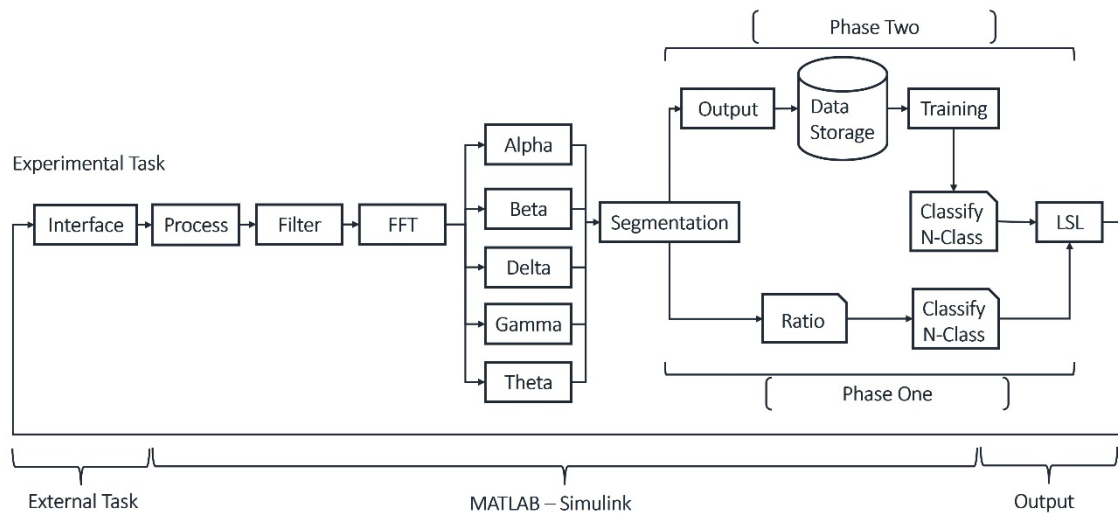

Figure 1. The BCI Process and Classification Pipeline

Utilising EEG technology from g.tec (Guger, 2017) and a custom BCI framework developed in MATLAB Simulink (MATLAB, 2010), the process flow (Figure 1.) will be used for both phases of the research program, starting with data streaming from the experimental task, which is processed, filtered, subject to Fast Fourier Transform. These data are then segmented before being sent to data storage for later use and in parallel to calculate the index of cognitive engagement (Pope et al., 1995) to provide a real-time assessment of cognitive load coupled with a computational classifier (Demazure et al., 2021; Karran et al., 2019) which outputs classification via lab streaming layer to drive the interface adaptations required for studies one and two.

In phase two, we will utilise the data from storage to train a variety of more advanced techniques for classifying mental workload, such as machine learning using support vector machine(s) and end-to-end deep learning. An end-to-end process in the context of deep learning for mental workload estimation describes a process that takes raw EEG signal data, processes these data, derives discriminant features, and then provides a classification of the target state as a complete functional solution requiring *no manual* feature engineering, studies one and two will be repeated using these new classification techniques.

We look forward to discussing our approach with an emphasis on end-to-end deep learning for EEG classification, study progress and interim results.

References

- Alharthi, M. (2020). Students' Attitudes toward the Use of Technology in Online Courses. *International Journal of Technology in Education*, 3(1), 14-23.
- Bergdahl, N., Nouri, J., & Fors, U. (2020). Disengagement, engagement and digital skills in technology-enhanced learning. *Education and information technologies*, 25(2), 957-983.
- Besedeš, T., Deck, C., Sarangi, S., & Shor, M. (2015). Reducing choice overload without reducing choices. *Review of Economics and Statistics*, 97(4), 793-802.
- Deck, C., & Jahedi, S. (2015). The effect of cognitive load on economic decision making: A survey and new experiments. *European Economic Review*, 78, 97-119.
- Demazure, T., Karran, A. J., Boasen, J., Léger, P.-M., & Sénécal, S. (2021). Distributed Remote EEG Data Collection for NeuroIS Research: A Methodological Framework. In D. D. Schmorow & C. M. Fidopiastis, *Augmented Cognition* Cham.
- Donkers, B., Dellaert, B. G., Waisman, R. M., & Häubl, G. (2020). Preference dynamics in sequential consumer choice with defaults. *Journal of Marketing Research*, 57(6), 1096-1112.
- Firat, M., Kiliç, H., & Yüzer, T. V. (2018). Level of intrinsic motivation of distance education students in e-learning environments. *Journal of Computer Assisted Learning*, 34(1), 63-70.
- Gerjets, P., Walter, C., Rosenstiel, W., Bogdan, M., & Zander, T. O. (2014). Cognitive state monitoring and the design of adaptive instruction in digital environments: lessons learned from cognitive workload assessment using a passive brain-computer interface approach. *Frontiers in neuroscience*, 8, 385.
- Grimes, D., Tan, D. S., Hudson, S. E., Shenoy, P., & Rao, R. P. (2008). Feasibility and pragmatics of classifying working memory load with an electroencephalograph. Proceedings of the SIGCHI Conference on Human Factors in Computing Systems,
- Guger, C. (2017). g. tec medical engineering GmbH. In: Austria.
- Guger, C., Allison, B. Z., & Gunduz, A. (2021). Brain-computer interface research: a state-of-the-art summary 10. In *Brain-Computer Interface Research* (pp. 1-11). Springer.
- Kalyuga, S., & Liu, T.-C. (2015). Guest editorial: Managing cognitive load in technology-based learning environments. *Journal of Educational Technology & Society*, 18(4), 1-8.
- Karran, A. J., Demazure, T., Leger, P.-M., Labonte-LeMoyné, E., Senecal, S., Fredette, M., & Babin, G. (2019). Toward a hybrid passive bci for the modulation of sustained attention using EEG and fNIRS. *Frontiers in Human Neuroscience*, 13, 393.
- MATLAB. (2010). *Version 9.10 (R2021a)*. The MathWorks Inc.
- Pope, A. T., Bogart, E. H., & Bartolome, D. S. (1995). Biocybernetic system evaluates indices of operator engagement in automated task. *Biological psychology*, 40(1-2), 187-195.
- Schulz, E., Bhui, R., Love, B. C., Brier, B., Todd, M. T., & Gershman, S. J. (2019). Structured, uncertainty-driven exploration in real-world consumer choice. *Proceedings of the National Academy of Sciences*, 116(28), 13903-13908.
- Schwartz, B., & Schwartz, B. (2004). The paradox of choice: Why more is less.
- Smith, D., Menon, S., & Sivakumar, K. (2005). Online peer and editorial recommendations, trust, and choice in virtual markets. *Journal of interactive marketing*, 19(3), 15-37.
- Sweller, J. (2020). Cognitive load theory and educational technology. *Educational Technology Research and Development*, 68(1), 1-16.
- Wertenbroch, K., Schrift, R. Y., Alba, J. W., Barasch, A., Bhattacharjee, A., Giesler, M., Knobe, J., Lehmann, D. R., Matz, S., & Nave, G. (2020). Autonomy in consumer choice. *Marketing Letters*, 31(4), 429-439.
- Zander, T. O., & Kothe, C. (2011). Towards passive brain-computer interfaces: applying brain-computer interface technology to human-machine systems in general. *Journal of neural engineering*, 8(2), 025005.

Zhang, H., Lu, Y., Gao, P., & Chen, Z. (2014). Social shopping communities as an emerging business model of youth entrepreneurship: exploring the effects of website characteristics. *International Journal of Technology Management*, 66(4), 319-345.

Passive BCI for realizing human perception of robot movement

Asghar Mahmoudi Khomami¹, Arjang Ahmadi¹, Maziar Ahmad Sharbafi¹

1) Laulabor Locomotion Laboratory, Centre for Cognitive Science, Technical University of Darmstadt, Germany

Keywords: Passive BCI, Human-robot-Interaction, legged locomotion

Introduction

This study is the first step for investigating the possibility of utilizing the passive brain-computer interface (pBCI) concept in the interaction between humans and assistive wearable robots. Neuroadaptive systems can automatically adapt to specific aspects of their operator's mindset [1]. This capability has great potential to be used in the interaction between assistive wearable robots (e.g., exosuits) and users. By widening the communication bottleneck between the robot and the user, robot's assistance could be both enhanced in quality and evaluated more accurately. At this first step, we aimed to examine the feasibility of using neuroadaptive technology for this use case.

Identifying brain activities using EEG measurement devices during locomotion, which occurs in assistive scenarios, is a complex and challenging task. Depending on the quality of the measurement device, the EEG signals measured during tasks such as walking are heavily contaminated with movement artifacts. Although various methods have been proposed to remove the movement artifacts from the EEG signals [2], it remains an open research topic. Consequently, to avoid dealing with this challenge at this initial step of research, we designed a simple experiment to evaluate the idea of using neuroadaptive technology (NAT) [1] to assess human perception of locomotion. This experiment is designed to validate the possibility of using NAT for human-robot interaction in legged robots which can later be extended to assistive devices.

The robot model uses EPA actuation technology [3] composed of electric motors and Pneumatic Artificial Muscles (PAM). Changing the air pressure of each PAM is considered as the adjustable mechanical parameter when the controller is fixed. The same idea will be later used for gait assistance while different stiffness of an exosuit will be evaluated by the user in the locomotion task.

Methods

A preliminary experiment was conducted as proof of concept. The goal of this experiment was to investigate changes in brain signals in the face of different behaviors shown in a video of a simulated hopping robot. The robot consists of a single leg that hops in place. Changing the air pressure of each PAM would result in a different hopping behavior in terms of the maximum height reached by the robot, the frequency of hopping, and the energy consumption of the robot. By varying PAM pressure of two actuators of the robot (mimicking human soleus and gastrocnemius muscles), different hopping conditions were simulated and used to create the video for this experiment.

We conducted three different experiments by giving combinations of sensory information (e.g., visual feedback, feeling PAM pressures) to three different subjects. Here, we present the simplest experimental scenario. One healthy subject (male, 28) participated in this preliminary experiment. The subject was asked to sit in front of a screen and watch a 21-minute-long video of a hopping robot, while his brain activity was measured. A wireless Emotiv EPOC X with 14 active dry electrodes was used

as the measurement device with a sampling rate of 256 Hz. The experiment was first explained to the subject, and he was asked to focus on the robot throughout the video. No further instruction was given to the participant.

The video consisted of an animation of the hopping robot. The only information given to the participant in the video was the maximum hopping height of the robot, which was demonstrated by a solid black line on a color bar next to the robot. Figure 1.a illustrates a representative picture of this video. Three conditions (HIGH: 55 cm, MEDIUM: 34 cm, LOW: 22 cm) were simulated with different hopping heights by changing the PAM pressures of the model. Each condition is shown for 6.5 minutes in the following order: HIGH, LOW, MEDIUM.

The power spectrum of the three conditions is used for comparison. Processing of the data includes band-pass filtering the EEG signals (1-100 Hz), performing Artifact Subspace Reconstruction (ASR) and ICA to remove artifacts from the data. All data processing was conducted using EEGLAB v2021.1.

Results

After data processing, the power spectrums of all 14 channels were calculated and compared for the three conditions. Comparing the power spectrum of electrodes in the region of the anterior cingulate cortex (F3, F4, F7, F8, FC5, and FC6) shows a clear difference between the three conditions. More specifically, condition 1 with the highest hopping height has lower power in high frequencies, whereas the other two conditions (MEDIUM, LOW) show similar patterns. This can be explained by the fact that the difference between the highest hopping height and the other two conditions is more noticeable than the difference between the hopping heights of conditions LOW and MEDIUM. Figure 1.b shows the power spectrum for channels F3 and F4.

Conclusion

This preliminary experiment shows a clear difference between different scenarios which could support the general idea of using pBCI for identifying human perception of locomotion performance. Further investigations are required to find a correlation between movement performance measures and EEG-based measures. Additional experiments with more subjects are planned. Adding PAMs to the subject's leg during the experiment and presenting more information to the subject (e.g., energy consumption) are the next steps. We hypothesize that the human cost function for assessing locomotion could be identified using more advanced analyses of NAT, e.g., event-based analysis.

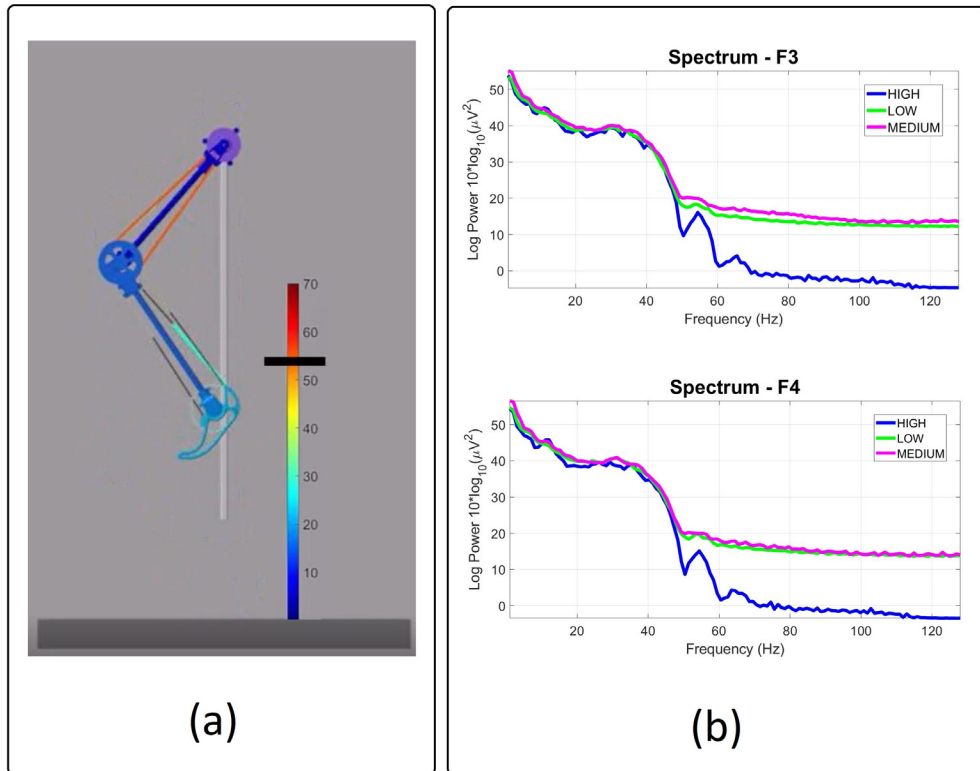

Figure 1 - (a) screenshot of the video shown to the subject during the experiment, (b) power spectrum of the two channels located at F3 and F4 for the three conditions

Acknowledgement

This work received support by the German Research Foundation DFG within RTG 2761 LokoAssist (Grant no. 450821862).

References

- [1] Zander, Thorsten O., et al. "Neuroadaptive technology enables implicit cursor control based on medial prefrontal cortex activity." *Proceedings of the National Academy of Sciences* 113.52 (2016): 14898-14903.
- [2] Gorjan, Dasa, et al. "Removal of movement-induced EEG artifacts: current state of the art and guidelines." *Journal of neural engineering* (2022).
- [3] Ahmad Sharbafi, Maziar, et al. "Electric-pneumatic actuator: A new muscle for locomotion." *Actuators*. Vol. 6. No. 4. MDPI, 2017.

Interpersonal synchrony in electrodermal activity predicts decreased performance in a vigilance task induced by sleep deprivation

Ivo Stuldreher^{1,2}, Jan van Erp^{1,2}, Anne-Marie Brouwer¹

1) Human Factors, TNO, Soesterberg, The Netherlands

2) Human Media Interaction, University of Twente, Enschede, The Netherlands

Keywords: Physiological synchrony, inter-subject correlations, sleep deprivation, electrodermal activity, heart rate

Introduction

Safety and security tasks often rely on operators' vigilant attention, the ability to focus for a prolonged period of time while performing a monotonous cognitive task. Sleep deprivation (SD) impairs vigilant attention (Hudson et al., 2020). At the same time, SD is unavoidable in certain professions and under certain circumstances. Continuous information about vigilant attention of sleep deprived individuals would be helpful to monitor whether they are at risk of lapsing and consequently making mistakes. Physiological synchrony may be used for this purpose. Physiological synchrony refers to the degree to which physiological measures such as heart rate (HR) or electrodermal activity (EDA) uniformly change across individuals. When individuals attend to the same events in the world for a few minutes or more, they show physiological synchrony (Stuldreher et al., 2020). The degree of physiological synchrony reflects the amount of attentional engagement, i.e., the more engaged an individual is with the presented event, the higher the physiological synchrony with other individuals. We here investigate whether physiological synchrony as measure of attentional engagement can predict decreased performance in a vigilant attention task during SD.

Methods

This study was approved by the METC Brabant (approval no. NL74961.028.20). 54 Dutch-speaking volunteers (29 female) between 18 to 55 years old ($M = 29.4$, $SD = 11.9$) participated.

Throughout the experiment, participants' HR and EDA were recorded with a Tickr chest-strap (Wahoo Fitness, Atlanta, GA, USA) and EdaMove 4 (Movisens GmbH, Karlsruhe, Germany), respectively. As Figure 1a depicts, over the course of a night, participants were presented with a 10-minute video every hour from 22:00 to 07:00. The movie clips were selected from the Dutch YouTube channels NPO3 and KORT! and featured short, moderately emotionally engaging stories. After each movie clip, participants performed a 10-minute psychomotor vigilance task (PVT), a vigilant attention task in which the participant has to respond as fast as possible to an irregularly occurring stimulus (Hudson et al., 2020). Then they filled out the Stanford sleepiness scale (SSS).

We assessed physiological synchrony across participants during each movie by computing inter-subject correlations (ISC) in HR and EDA following earlier work (Stuldreher et al., 2020; Pérez et al., 2021; Madsen et al., 2022). We also computed the lapse probability performance measure for each

PVT, following (Hudson et al., 2020). We then used hierarchical linear models to investigate whether ISC is predictive of PVT lapse probability.

Results

Figure 1b shows traces of PVT lapse probability, and ISC in HR and EDA over the course of the night. The PVT lapse probability shows a clear pattern over the course of the night, with an increase of the lapse probability up to 04:00 AM, followed by a strong decrease in the early morning. ISC in HR and EDA do not show the reverse pattern. Our hierarchical linear models indeed indicated that ISC in HR did not significantly contribute to the prediction of PVT lapse probability. However, ISC in EDA significantly contributed to the prediction of PVT lapse probability. Follow-up analyses suggest that this is mainly due to the association of very high lapse probability with low ISC. Figure 1c gives an overview of self-reported sleepiness, HR and EDA over the night.

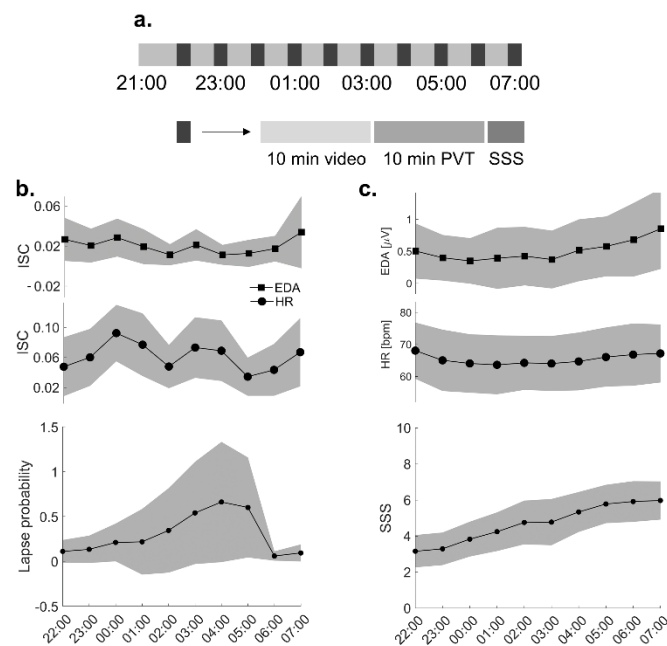

Figure 1. a. The experimental paradigm consisted of a block with a 10 minute video, a 10 minute PVT and the filling out the SSS. b. Traces of PVT lapse probability, and ISC in HR and EDA over the course of the night. c. Traces of SSS, and HR and phasic EDA over the course of the night.

Discussion

We here aimed to predict performance in a vigilant attention task over the course of a sleep deprived night with the use of physiological synchrony. ISC in HR was not predictive of the PVT lapse probability, our metric of vigilant attention performance, but ISC in EDA has a modest predictive value. Note that our movies were not a monotonous cognitive task that require vigilant attention, but were complex stimuli evoking attentional engagement. Participants reported to feel more awake during the movie after which they would feel more tired again during the PVT. For future work, we therefore suggest not to use engaging movies, but continuous background audio such as a radio show. We expect higher predictive value of ISC in such a case. Furthermore, our results showed an increase in EDA over the course of a sleep-deprived night, which as far as we are aware, has not been shown or examined before. The finding that self-reported sleepiness consistently increased over the night while performance showed a profound improvement after 5:00 underscore the notion that self-reports are not always reflective of objective performance.

References

- Hudson, A. N., Van Dongen, H., & Honn, K. A. (2020). Sleep deprivation, vigilant attention, and brain function: a review. *Neuropsychopharmacology*, *45*(1), 21-30.
- Madsen, J., & Parra, L. C. (2022). Cognitive processing of a common stimulus synchronizes brains, hearts, and eyes. *PNAS Nexus*, *1*(1), pgac020.
- Pérez, P., Madsen, J., Banellis, L., Türker, B., Raimondo, F., Perlberg, V., ... & Sitt, J. D. (2021). Conscious processing of narrative stimuli synchronizes heart rate between individuals. *Cell Reports*, *36*(11), 109692.
- Stuldreher, I. V., Thammasan, N., van Erp, J. B., & Brouwer, A. M. (2020). Physiological synchrony in EEG, electrodermal activity and heart rate reflects shared selective auditory attention. *Journal of Neural Engineering*, *17*(4), 046028.

Towards an Awkward Silence-Adaptive Virtual Meeting System

Julia Seitz¹, Tom Frank Reuscher², Saskia Jacob³, Alexander Maedche¹

¹ Karlsruhe Institute of Technology (KIT), Institute of Information Systems and Marketing (IISM), Research Group Information Systems I, Kaiserstr. 89, 76133 Karlsruhe, Germany

² Karlsruhe Institute of Technology (KIT), Institute of Management (IBU), Chair of Human Resource Management, Kaiserstr. 89, 76133 Karlsruhe, Germany

³ Karlsruhe Institute of Technology (KIT), Institute of Information Systems and Marketing (IISM), Research Group Marketing and Sales, Zirkel 2, 76133 Karlsruhe, Germany

{julia.seitz, tom.reuscher, saskia.jacob, alexander.maedche}@kit.edu

Keywords: Virtual meetings, Awkward Silence, Adaptation

Abstract

In times of worldwide confinements and global crisis, virtual meetings are increasingly an alternative to in-person meetings. Within virtual meetings, moments of silence can occur due to several reasons like connection issues, several persons starting to speak or none starts to speak (see e.g. [1]). As participants in meetings follow the obligation to avoid interaction gaps, silent moments might cause a state of anxiety referred to “awkward silence” and lead to unconscious behavior such as laughing or being embarrassed [2]–[6]. This so-called state anxiety differs from anxiety disorders and is a short-term emotional state [7]. According to [8], people tend to feel awkward after a certain duration of silence. However, this does not necessarily mean that everyone feels awkward at the same time as individual and contextual factors play an important role. Existing approaches to encounter this awkward silence have created conversational agents or topic proposals that aim to break the silence (see e.g. [9]–[12]). However, recent literature suggests that silence itself is not necessarily bad as it helps to increase creative solutions and can ultimately lead to better meeting outcomes [13]. To incorporate the idea of embracing the silence, we aim to build an adaptive system that can detect and respond to moments of awkward silence by reducing the feeling of state anxiety. In this work-in-progress paper, we report on a first design prototype and a pre-tested experimental design to create silent moments while collecting and analyzing participants’ physiological data.

For our proposed neuroadaptive system, three stages exist based on the biocybernetics loop: Collection of data, state recognition and system adaptation [14]. In stage 1, we continuously monitor the user’s electrocardiogram (ECG) and electrodermal activity (EDA) data. These signals were chosen, because symptoms associated with state anxiety such as alterations in heart rate (HR), HR variability (HRV), as well as sweating and skin conductance response (SCR) can be detected with this data (see e.g. [15], [16]). Further, the meetings audio output is collected. In stage 2, we aim to recognize silence and state anxiety. The detection of silence, defined as none of the meeting participants is speaking, is done via the audio output of the virtual meeting. To recognize state anxiety, the collected ECG and EDA signals are filtered, windowed and features for HR and HRV as well as SCR are calculated based on similar approaches that aim to detect changes in ultra-short time windows (see e.g. [17], [18]). We aim to train a two-class classifier (state anxiety/no state anxiety) on the derived EDA and ECG features similar to existing classifiers detecting arousal by using algorithms such as random forest, decision

trees, LDA or k-nearest neighbors (see e.g. area of arousal/stress detection [19], [20]). Stage 3 covers the adaptation logic and visualization. The designed mechanism works as follows: When the state of silence is recognized, the classifier is consulted to identify if state anxiety exists. If so, an adaptation is triggered. To retrieve different initial proposals for the adaptation visualization, we followed an iterative design approach including two workshops with participants from different disciplinary backgrounds. Based on the first workshop, we decided to implement a deep breathing support and reviewed existing applications in literature and practice. Deep breathing exercises supporting a slow breathe in, hold breath and breathe out rhythm, can embrace the silence in meetings and at the same time mitigate state anxiety and anxious feelings (see e.g. [21]). We identified the application “headspace” [22] as an inspiration for our deep breathing animation and created different visualizations and placement options in a group of three researchers. After the two workshops, we voted and chose the design shown in Figure 1.

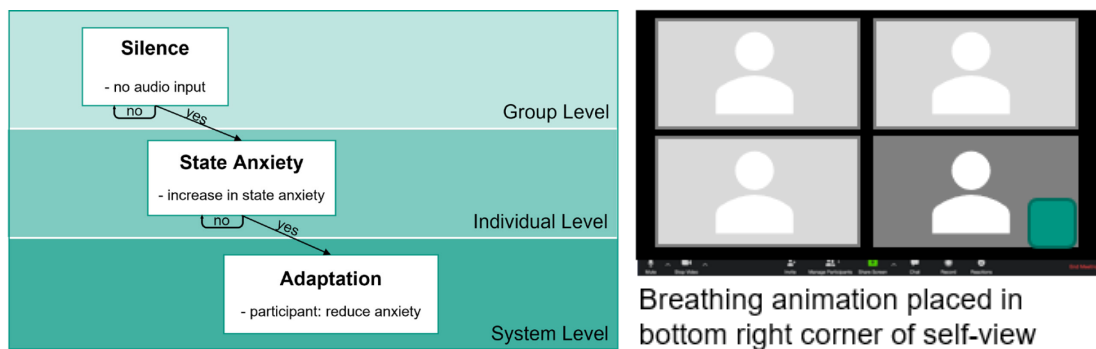

Figure 1. Adaptive system logic and design prototype

To ensure that the recognition will be successful, we need to collect data to better understand the relationship between silence and the occurrence of state anxiety. We designed an experiment that artificially creates silent moments while collecting participants ECG and EDA data using Plux devices in a virtual meeting [23], [24]. During the experiment, a trained experimenter asks randomized questions taken from the International English Testing System [25] for participants to discuss. The participants are instructed to contribute an answer to the questions or comment on other participant’s contributions. If no participant contributes to the discussion for more than 20 seconds, the experimenter moves on to the next question. Thus, besides natural silence between contributions of individual participants, we expect moments of awkward silence to occur. To distinguish between these two types of silence, participants are asked to self-report moments of awkward silence during the experiment by writing down the time and rating the intensity on a five-point scale (none to severe).

Results from a first pre-test with six persons (one experimenter, five participants) showed differences in the individual reported intensity of awkwardness for each silent pause which provides first evidence for our stated difference in individual perceptions of silence. We collected ECG data from three participants and EDA data from four participants and are currently analyzing the data. First results hint to differences between awkward silence moments and the collected baseline. Still, the collected data needs to be further analyzed to ensure that the patterns are actually due to silence-induced state anxiety. After having collected enough data, the proposed classifiers will be trained and evaluated.

In this project, we present work-in-progress on a proposed awkward-silence adaptive virtual meeting system. As the evaluation of adaptive systems is manifold [26], several next steps are planned: First, targeting the recognition stage, the proposed experiment needs to be conducted on a larger scale and a more fine-grained analysis of the collected ECG and EDA data is needed. Second, the proposed classifiers need to be trained and evaluated. Finally, targeting the adaptation stage, the selected

classifier will be integrated in the prototype to evaluate the users' perception of the proposed adaptive system. We plan to evaluate the system against a baseline non-adaptive system and an alternative rule-based adaptation mechanism using the duration of silence as a threshold to trigger the adaptation when it is longer than the mean duration to perceive silence as awkward (see e.g. [8]). We aim to contribute with design knowledge for system that supports more pleasurable experiences in virtual meetings in silent pauses. Besides, we may provide further insights into the design of adaptive video meeting systems that support users in emotional situations, for example, when experiencing nervousness due to public speaking anxiety.

References

- [1] Z. Huang, B. Sat, and B. W. Wah, "Automated learning of playout scheduling algorithms for improving perceptual conversational quality in multi-party VoIP," *2008 IEEE Int. Conf. Multimed. Expo, ICME 2008 - Proc.*, pp. 493–496, 2008, doi: 10.1109/ICME.2008.4607479.
- [2] K. DIndia and K. Dindia, "Antecedents and Consequences of Awkward Silence A Replication Using Revised Lag Sequential Analysis," *Hum. Commun. Res.*, vol. 13, no. 1, pp. 108–125, Sep. 1986, doi: 10.1111/J.1468-2958.1986.TB00097.X.
- [3] T. J. Bruneau, "Communicative Silences: Forms and Functions," *J. Commun.*, vol. 23, no. 1, pp. 17–46, Mar. 1973, doi: 10.1111/J.1460-2466.1973.TB00929.X.
- [4] D. Kurzon, "Discourse of Silence," vol. 49, Mar. 1998, doi: 10.1075/PBNS.49.
- [5] M. L. McLAUGHLIN and M. J. CODY, "AWKWARD SILENCES: BEHAVIORAL ANTECEDENTS AND CONSEQUENCES OF THE CONVERSATIONAL LAPSE," *Hum. Commun. Res.*, vol. 8, no. 4, pp. 299–316, 1982, doi: 10.1111/J.1468-2958.1982.TB00669.X/CITEDBY.
- [6] N. Koudenburg, T. Postmes, and E. H. Gordijn, "Disrupting the flow: How brief silences in group conversations affect social needs," *J. Exp. Soc. Psychol.*, vol. 47, no. 2, pp. 512–515, Mar. 2011, doi: 10.1016/J.JESP.2010.12.006.
- [7] C. D. Spielberger, "The effects of anxiety on complex learning and academic achievement," *Anxiety Behav.*, 1966.
- [8] J. King and A. Aono, "Talk, silence and anxiety during one-to-one tutorials: A cross-cultural comparative study of Japan and UK undergraduates' tolerance of silence," *Asia Pacific Educ. Rev.*, vol. 18, no. 4, pp. 489–499, Dec. 2017, doi: 10.1007/S12564-017-9503-8/TABLES/1.
- [9] V. Kan, K. Fujii, J. Amores, C. L. Z. Jin, P. Maes, and H. Ishii, "Social Textiles: Social affordances and icebreaking interactions through wearable social messaging," *TEI 2015 - Proc. 9th Int. Conf. Tangible, Embed. Embodied Interact.*, pp. 619–624, Jan. 2015, doi: 10.1145/2677199.2688816.
- [10] H. Ogawa and P. Maes, "Smartwatch-based topic suggestions to enrich casual conversations in awkward encounters," *Proc. - Int. Symp. Wearable Comput. ISWC*, pp. 68–72, Sep. 2020, doi: 10.1145/3410531.3414310.
- [11] N. Ohshima, K. Kimijima, J. Yamato, and N. Mukawa, "A conversational robot with vocal and bodily fillers for recovering from awkward silence at turn-takings," *Proc. - IEEE Int. Work. Robot Hum. Interact. Commun.*, vol. 2015-November, pp. 325–330, Nov. 2015, doi: 10.1109/ROMAN.2015.7333677.
- [12] N. Ohshima, R. Fujimori, H. Tokunaga, H. Kaneko, and N. Mukawa, "Neut: Design and evaluation of speaker designation behaviors for communication support robot to encourage conversations," *RO-MAN 2017 - 26th IEEE Int. Symp. Robot Hum. Interact. Commun.*, vol. 2017-January, pp. 1387–1393, Dec. 2017, doi: 10.1109/ROMAN.2017.8172485.

- [13] "Why Brilliant Minds Embrace the Rule of Awkward Silence | Inc.com." <https://www.inc.com/justin-bariso/why-brilliant-minds-embrace-rule-of-awkward-silence.html> (accessed Jul. 13, 2022).
- [14] A. T. Pope, E. H. Bogart, and D. S. Bartolome, "Biocybernetic system evaluates indices of operator engagement in automated task," *Biol. Psychol.*, vol. 40, no. 1–2, pp. 187–195, May 1995, doi: 10.1016/0301-0511(95)05116-3.
- [15] H. Senaratne Levin Kuhlmann Kirsten Ellis, A. Glenn Melvin, and A. Sharon Oviatt, "A Multimodal Dataset and Evaluation for Feature Estimators of Temporal Phases of Anxiety; A Multimodal Dataset and Evaluation for Feature Estimators of Temporal Phases of Anxiety," *Proc. 2021 Int. Conf. Multimodal Interact.*, vol. 21, 2021, doi: 10.1145/3462244.
- [16] M. Chollet, T. Massachi, and S. Scherer, "Racing heart and sweaty palms: What influences users' self-assessments and physiological signals when interacting with virtual audiences?," *Lect. Notes Comput. Sci. (including Subser. Lect. Notes Artif. Intell. Lect. Notes Bioinformatics)*, vol. 10498 LNAI, pp. 83–86, 2017, doi: 10.1007/978-3-319-67401-8_9/COVER/.
- [17] H. W. Guo, Y. S. Huang, J. C. Chien, K. Haraikawa, and J. S. Shieh, "Short-term analysis of heart rate variability for emotion recognition via a wearable ECG device," *ICIIBMS 2015 - Int. Conf. Intell. Informatics Biomed. Sci.*, pp. 262–265, Mar. 2016, doi: 10.1109/ICIIBMS.2015.7439542.
- [18] M. L. Munoz *et al.*, "Validity of (Ultra-)Short Recordings for Heart Rate Variability Measurements," *PLoS One*, vol. 10, no. 9, p. e0138921, Sep. 2015, doi: 10.1371/JOURNAL.PONE.0138921.
- [19] K. Tzevelekakis, Z. Stefanidi, and G. Margetis, "Real-Time Stress Level Feedback from Raw Ecg Signals for Personalised, Context-Aware Applications Using Lightweight Convolutional Neural Network Architectures," *Sensors 2021, Vol. 21, Page 7802*, vol. 21, no. 23, p. 7802, Nov. 2021, doi: 10.3390/S21237802.
- [20] F. Agrafioti, D. Hatzinakos, and A. K. Anderson, "ECG pattern analysis for emotion detection," *IEEE Trans. Affect. Comput.*, vol. 3, no. 1, pp. 102–115, Jan. 2012, doi: 10.1109/T-AFFC.2011.28.
- [21] V. Perciavalle *et al.*, "The role of deep breathing on stress," *Neurol. Sci.*, vol. 38, no. 3, pp. 451–458, Mar. 2017, doi: 10.1007/S10072-016-2790-8.
- [22] "Die App für Meditation und Entspannung - Headspace." <https://www.headspace.com/de> (accessed Jul. 13, 2022).
- [23] "PLUX Biosignals | Electrodermal Activity (EDA) Sensor." <https://www.pluxbiosignals.com/products/electrodermal-activity-eda-sensor-1> (accessed Jul. 13, 2022).
- [24] "PLUX Biosignals | Electrocardiography (ECG) Sensor." <https://www.pluxbiosignals.com/products/electrocardiography-ecg-sensor-1> (accessed Jul. 13, 2022).
- [25] "IELTS Home of the IELTS English Language Test." <https://www.ielts.org/> (accessed Jul. 13, 2022).
- [26] A. Paramythis, S. Weibelzahl, and J. Masthoff, "Layered evaluation of interactive adaptive systems: Framework and formative methods," *User Model. User-adapt. Interact.*, vol. 20, no. 5, pp. 383–453, Dec. 2010, doi: 10.1007/S11257-010-9082-4.

Real Virtual Magic – Modifying a VR game with a BCI to enhance immersion

Marius Klug^{1,2}

1) Technische Universität Berlin, Berlin, Germany

2) Zander Labs, Cottbus, Germany

Keywords: neurofeedback, gaming

Abstract

In neurofeedback applications, neural activity is measured and presented to the user in real time to help regulating behavior or mental states (Sitaram et al., 2017). In electroencephalography (EEG), neurofeedback often makes use of the default-mode network (Raichle et al., 2001), which can be measured using the theta (4-8 Hz) and alpha (8-13 Hz) frequency range (Fomina et al., 2015). While the efficacy of neurofeedback training in clinical applications such as the treatment of attention deficit hyperactivity disorder (ADHD) is often investigated, it is still not clear (Sitaram et al., 2017). One reason for the lack of a lasting effect could be the lack of immersion during the training, which might be alleviated by embedding it in a gamified scenario. Close-loop applications using the theta-alpha EEG frequency range in a passive brain-computer interface (pBCI; Zander, 2011) in games have been developed in recent years (Ewing et al., 2016; Krol et al., 2017), paving the way to enabling use cases that are closer to consumers.

In this work, a closed-loop neurofeedback application was implemented in the popular game *Skyrim VR*, a fantasy role-play game in virtual reality (VR), to exemplify the applicability of neurofeedback and BCI technology for consumers outside of the clinical context. To this end, the Muse meditation headband was used, a low-cost consumer EEG device with 4 dry electrodes that fits under a VR headset (see figure 1, left). The data is collected and processed locally in real-time using *Brainflow* (<https://brainflow.org>). For analyzing the data, the two anterior channels' theta power as well as the two posterior channels' alpha power values are collected every second. The ratio of this frontal theta and posterior alpha power is then z-scored using a 5-minutes moving baseline and subsequently modified by the level of motion by the player, as measured by gyroscope activity that is also available from the Muse headband. This is to ensure that the low signal strength of the EEG in the mobile context is augmented by taking additional body measures into account (Jungnickel et al., 2018). The values are then stored in a 10-seconds moving window hysteresis vector where more recent values are weighted higher. The weighted mean of this vector is finally taken as the "focus" that is used within the game and displayed in real-time using a meter bar (figure 2, right).

In the gameplay, the focus affects several magical abilities of the player: 1) It scales the regeneration of "magicka", the resource required to cast magical spells. 2) It scales the magical power itself, i.e. damage/healing done. 3) If the player attempts to cast a spell with low focus (<30%), damage is applied to the player. This modification has attracted significant media attention (e.g. <https://www.thegamer.com/skyrim-vr-real-virtual-magic-mod-interview>), was downloaded >40.000 times (although mostly by players who did not use it but wanted to show support), and is in active use by at least 15 confirmed players who responded to inquiry. Qualitative feedback showed that, as the players' magical abilities depend on their own personal abilities to focus, this modification enhanced their immersion and improved their user experience by giving them an experience of magic as though

it was real. To educate the public and discuss VR-BCI related topics and technological advancements, a public community has been established that connects neuroscientists, game developers, hardware creators, and interested players and currently has >800 members (<https://discord.gg/7MjQ3f>). The modification including the source code is available for download at <https://www.nexusmods.com/skyrimspedition/mods/58489>. This modification is still under development and will allow a use also in other game engines such as Unity or Unreal in the future.



Figure 1, Left: the Muse EEG headband can fit under a VR head-mounted display. Right: In the game, a meter is available that shows the measured “focus” (bottom pink bar), which affects magical abilities.

References

- Ewing, K. C., Fairclough, S. H., & Gilleade, K. (2016). Evaluation of an Adaptive Game that Uses EEG Measures Validated during the Design Process as Inputs to a Biocybernetic Loop. *Frontiers in Human Neuroscience*, 10(May), 1–13.
- Fomina, T., Hohmann, M., Schölkopf, B., & Grosse-Wentrup, M. (2015). Identification of the Default Mode Network with electroencephalography. *Proceedings of the Annual International Conference of the IEEE Engineering in Medicine and Biology Society, EMBS, 2015-Noem*, 7566–7569.
- Jungnickel, E., Gehrke, L., Klug, M., & Gramann, K. (2018). MoBI-Mobile Brain/Body Imaging. In H. Ayaz & F. Dehais (Eds.), *Neuroergonomics: The Brain at Work and in Everyday Life* (1st ed., pp. 59–63). Elsevier.
- Krol, L. R., Freytag, S.-C., & Zander, T. O. (2017). Meyendtris: a hands-free, multimodal tetris clone using eye tracking and passive BCI for intuitive neuroadaptive gaming. *Proceedings of the 19th ACM International Conference on Multimodal Interaction*, 433–437.
- Raichle, M. E., MacLeod, A. M., Snyder, A. Z., Powers, W. J., Gusnard, D. A., & Shulman, G. L. (2001). A default mode of brain function. *Proceedings of the National Academy of Sciences of the United States of America*, 98(2), 676–682.
- Sitaram, R., Ros, T., Stoeckel, L., Haller, S., Scharnowski, F., Lewis-Peacock, J., Weiskopf, N., Blefari, M. L., Rana, M., Oblak, E., Birbaumer, N., & Sulzer, J. (2017). Closed-loop brain training: The science of neurofeedback. *Nature Reviews. Neuroscience*, 18(2), 86–100.
- Zander, T. O., & Kothe, C. (2011). Towards passive brain-computer interfaces: Applying brain-computer interface technology to human-machine systems in general. *Journal of Neural Engineering*, 8(2). <https://doi.org/10.1088/1741-2560/8/2/025005>

An investigation of a passive BCI's performance in different user postures and presentation modalities

Diana E. Gherman¹, Thorsten O. Zander¹

1) The Brandenburg University of Technology Cottbus–Senftenberg, Germany

Keywords: passive brain-computer interfaces; workload; virtual reality; posture; EEG

Abstract

In recent years, passive brain-computer interfaces (pBCIs) became one of the most promising tools in researchers' quest for bridging the human mind and machine. It has been repeatedly shown that pBCIs can decode mental states without the need of one's awareness or volition (Fairclough & Zander, 2021). Among other such states, classifying different levels of cognitive workload proved to be successful in controlled laboratory contexts as well as some simulated realistic scenarios (Zander et al., 2017). However, by an overwhelming majority, the literature on pBCI involves tasks presented on a computer screen and performed in a sitting position by participants.

Meanwhile, real-life applications of pBCI might require a user to stand or switch between postures while performing the task. For example, a doctor could perform a surgery while standing, but also make use of a pBCI that monitors their level of workload in real-time (Zander et al., 2017). Postural discrepancies might impact brain dynamics by increasing the high-frequency oscillatory activity (Thibault et al., 2014) or by inducing muscle activity that alters the electroencephalography (EEG) signal (Zhong & Luo, 2021). Hence, it might be premature to generalize laboratory studies' results to application-based contexts, before investigating the impact of postural differences on pBCIs' performance.

Moreover, in view of growing Virtual Reality (VR) popularity charts, the way we interact with technology changes and more pBCI mediums should be explored (Putze et al., 2020). As we progress towards a more user-friendly approach to pBCI, we need to make sure our techniques are feasible for multiple settings. In this study, we investigate if a pBCI's ability to classify workload differs based on posture (sitting, standing) or presentation modality (computer screen, VR).

This study investigated if for a given previously tested paradigm (the "sparkles" paradigm) (Zhang, Krol & Zander, 2018), there is a significant difference between the BCI system's ability to detect workload in a real environment versus a virtual environment. If not, we would have a first indication that the brain signals produced even while wearing a VR headset are readable and useful for a pBCI. Moreover, we wanted to see if the user's posture while recording the brain activity during a workload-inducing task has a significant effect on the pBCI's ability to decode the cognitive state. The sparkles paradigm (approximately 8 minutes duration) involves a block of 40 trials in random order (20 with high load, 20 with no load). Each trial lasted 10 seconds, for a total of 200 seconds of EEG data per task workload class.

During the high workload trials participants were presented with a mathematical task, while in the rest trials subjects were instructed to rest. For each of the 22 subjects included in the study, this task was presented 4 times in a random fashion:

1. while sitting, wearing the EEG cap.
2. while sitting, wearing the EEG cap and VR headset
3. in standing position, wearing the EEG cap
4. in standing, wearing the EEG cap and VR headset.

Our findings suggest that there are no significant differences in the classifier's performance between conditions. As we wanted to see if there is more muscle activity present in the standing position conditions, we also analysed the signal variance.

References

- Fairclough, S. H., & Zander, T. O. (Eds.). (2021). *Current Research in Neuroadaptive Technology*.
- Putze, F., Vourvopoulos, A., Lécuyer, A., Krusienski, D., Bermúdez i Badia, S., Mullen, T., & Herff, C. (2020). Brain-computer interfaces and augmented/virtual reality. *Frontiers in human neuroscience*, 14, 144.
- Thibault, R. T., Lifshitz, M., Jones, J. M., & Raz, A. (2014). Posture alters human resting-state. *cortex*, 58, 199-205.
- Zander, T. O., Shetty, K., Lorenz, R., Leff, D. R., Krol, L. R., Darzi, A. W., ... & Yang, G. Z. (2017). Automated task load detection with electroencephalography: towards passive brain-computer interfacing in robotic surgery. *Journal of Medical Robotics Research*, 2(01), 1750003.
- Zander, T. O., Andreessen, L. M., Berg, A., Bleuel, M., Pawlitzki, J., Zawallich, L., ... & Gramann, K. (2017). Evaluation of a dry EEG system for application of passive brain-computer interfaces in autonomous driving. *Frontiers in human neuroscience*, 11, 78.
- Zhong, Z., & Luo, M. (2021, October). Study on Different Postures Based on EEG Signals. In *2021 2nd International Seminar on Artificial Intelligence, Networking and Information Technology (AINIT)* (pp. 169-174). IEEE.

Longitudinal Changes in Sensorimotor Functional Connectivity during Learning to Control a Brain-Computer Interface

Nikolai Kapralov^{1,2}, Mina Jamshidi Idaji^{1,2,3}, Alina Studenova¹, Carmen Vidaurre⁴,
Tomas Ros^{5,6}, Arno Villringer^{1,7}, and Vadim V. Nikulin^{1,8,9}

- 1) Neurology Department, Max Planck Institute for Human Cognitive and Brain Sciences, Leipzig, Germany
- 2) International Max Planck Research School NeuroCom, Leipzig, Germany
- 3) Machine Learning Group, Technical University of Berlin, Berlin, Germany
- 4) Department of Statistics, Computer Science and Mathematics, Universidad Pública de Navarra, Pamplona, Spain
- 5) Department of Neuroscience, University of Geneva, Geneva, Switzerland
- 6) Centre for Biomedical Imaging (CIBM) Lausanne-Geneva, Geneva, Switzerland
- 7) Department of Cognitive Neurology, University Hospital Leipzig, Leipzig, Germany
- 8) Institute for Cognitive Neuroscience, National Research University Higher School of Economics, Moscow, Russian Federation
- 9) Neurophysics Group, Department of Neurology, Charité-Universitätsmedizin Berlin, Berlin, Germany

Keywords: Brain-computer Interface, Motor Imagery, EEG, Coherency, Longitudinal Analysis

Abstract

Brain-computer interfaces (BCIs) provide an alternative pathway for communication between user and computer that does not require manual control of an input device such as a keyboard. Instead, intentions of the user are decoded in real-time based on features of recorded brain activity and are used to provide commands to external devices. Particularly, so-called sensorimotor BCIs decode imaginary movements of hands and/or feet from the spatiotemporal dynamics and power spectral density of oscillatory activity in a subject-specific frequency range.

Rehabilitation after stroke is a promising application of sensorimotor BCIs since imagination of a movement requires activation of similar brain areas as compared to the actual execution of the same movement (Decety, 1996), thus providing a possibility to induce plasticity in the cortex. However, in most cases, several training sessions are required for users to obtain control of the device, and performance varies considerably across subjects and between sessions. On average, around 20% of individuals (Alkoby et al., 2018) are unable to achieve reasonable levels of control, but the underlying mechanisms of unsuccessful learning are not clear yet.

Several studies have investigated neurophysiological predictors of performance in BCI tasks that can be extracted from recorded brain activity. In (Blankertz et al., 2010) signal-to-noise ratio of the sensorimotor alpha band activity during resting state recordings correlated with the accuracy of BCI control. Apart from that, more complex features such as multiscale temporal dynamics (Samek et al., 2016) and functional connectivity between sensorimotor areas (Vidaurre et al., 2020) also correlated with accuracy after controlling for the signal-to-noise ratio.

The latter connectivity-based predictor can be particularly important, as connectivity is a measure that quantifies interaction between brain areas, which might play a vital role in the multi-faceted process of BCI learning. In the current work, we aim to extend the findings about the relationship between connectivity and BCI accuracy and to study the longitudinal changes in connectivity during learning to control a BCI using a publicly available dataset. In (Stieger et al., 2021), participants ($n = 62$) performed 7 or 11 sessions of a 2-D cursor control task based on the imaginary movements of their left and right hand while 60-channel EEG was recorded.

Following (Vidaurre et al., 2020), we use the absolute value of the imaginary part of coherency as a measure of connectivity between sensorimotor cortical areas. To obtain higher spatial specificity, we perform the calculation of connectivity in the source space. We first apply inverse modeling to obtain an estimate of activity for 4502 sources located in the cortex, and then combine time series of source activity to extract one time series per region of interest (ROI) for pre- and post-central gyri of both hemispheres.

There are multiple methods for both inverse modeling and extraction of ROI time series that do not have a clear favorite among them. Since the problem of source reconstruction is ill posed, there are several solutions with different underlying assumptions, for example, eLORETA (Pasqual-Marqui, 2007) and linear constrained minimum variance (LCMV) beamformers (Van Veen et al., 1997). There are also several methods for extracting ROI time series, and in the current work, we considered singular value decomposition (SVD) with one or three components per ROI and averaging time courses of activity of sources in the ROI with sign flip depending on the orientation of the dipole. Thus, we used all aforementioned combinations of inverse modeling (eLORETA and LCMV) as well as ROI extraction techniques to provide a comprehensive framework for the estimation of connectivity changes in the context of BCI learning.

Since the selection of the pipeline might affect the result, we applied multiverse analysis (Steege et al., 2016) to address the problem of stability of connectivity estimation with respect to the choice of methods for inverse modeling and ROI time series extraction. Our preliminary results in general confirm a positive correlation between the imaginary part of coherency and BCI accuracy, yet our analysis also reveals variability in the results obtained with different pipelines.

References

- Alkoby, O., Abu-Rmileh, A., Shriki, O., & Todder, D. (2018). Can We Predict Who Will Respond to Neurofeedback? A Review of the Inefficacy Problem and Existing Predictors for Successful EEG Neurofeedback Learning. *Neuroscience*, 378, 155–164. <https://doi.org/10.1016/j.neuroscience.2016.12.050>
- Blankertz, B., Sannelli, C., Halder, S., Hammer, E. M., Kübler, A., Müller, K.-R., Curio, G., & Dickhaus, T. (2010). Neurophysiological predictor of SMR-based BCI performance. *NeuroImage*, 51(4), 1303–1309. <https://doi.org/10.1016/j.neuroimage.2010.03.022>
- Decety, J. (1996). Do imagined and executed actions share the same neural substrate? *Cognitive Brain Research*, 3(2), 87–93. [https://doi.org/10.1016/0926-6410\(95\)00033-X](https://doi.org/10.1016/0926-6410(95)00033-X)
- Pascual-Marqui, R. D. (2007). Discrete, 3D distributed, linear imaging methods of electric neuronal activity. Part 1: exact, zero error localization. *arXiv*. <http://arxiv.org/abs/0710.3341>
- Samek, W., Blythe, D. A. J., Curio, G., Müller, K.-R., Blankertz, B., & Nikulin, V. V. (2016). Multiscale temporal neural dynamics predict performance in a complex sensorimotor task. *NeuroImage*, 141, 291–303. <https://doi.org/10.1016/j.neuroimage.2016.06.056>

- Steegeen, S., Tuerlinckx, F., Gelman, A., & Vanpaemel, W. (2016). Increasing Transparency Through a Multiverse Analysis. *Perspectives on Psychological Science*, 11(5), 702–712. <https://doi.org/10.1177/1745691616658637>
- Stieger, J. R., Engel, S. A., & He, B. (2021). Continuous sensorimotor rhythm based brain computer interface learning in a large population. *Scientific Data*, 8(1), 98. <https://doi.org/10.1038/s41597-021-00883-1>
- Van Veen, B. D., Van Drongelen, W., Yuchtman, M., & Suzuki, A. (1997). Localization of brain electrical activity via linearly constrained minimum variance spatial filtering. *IEEE Transactions on Biomedical Engineering*, 44(9), 867–880. <https://doi.org/10.1109/10.623056>
- Vidaurre, C., Haufe, S., Jorajuría, T., Müller, K.-R., & Nikulin, V. V. (2020). Sensorimotor Functional Connectivity: A Neurophysiological Factor Related to BCI Performance. *Frontiers in Neuroscience*, 14, 575081. <https://doi.org/10.3389/fnins.2020.575081>

Acoustic stimulation during deep sleep using a mobile EEG system at home

Lina Kramer^{1,2}, Carlos F. da Silva Souto¹, Janick Bartels^{1,3}, Stefan Debener^{1,3,4}, Simon Doclo^{1,2,4}, Axel Winneke¹

- 1) Branch for Hearing, Speech and Audio Technology HSA, Fraunhofer Institute for Digital Media Technology IDMT, Oldenburg, Germany
- 2) Signal Processing Group, Department of Medical Physics and Acoustics, University of Oldenburg, Oldenburg, Germany
- 3) Neuropsychology Lab, Department of Psychology, University of Oldenburg, Oldenburg, Germany
- 4) Cluster of Excellence Hearing4All, University of Oldenburg, Oldenburg, Germany

Keywords: Closed-loop system, passive BCI, mobile EEG, classification of slow oscillation, acoustic stimulation

Introduction

Sleep has a crucial impact on health and memory consolidation (Rasch and Born 2013). Memory consolidation mainly takes place during the slow oscillations (SO) typical of the N3 deep sleep stage. SO are characterised by frequencies around 0.8 Hz and high amplitudes. The underlying neuronal activity appears to synchronise in an up-and-down-phase, reflecting membrane depolarisation and hyperpolarisation, respectively (Massimini et al. 2004). Brief acoustic stimulations during the up-phase of SO showed increased SO amplitudes and improved memory consolidation (Ngo et al. 2013; Ong et al. 2016). Ngo and colleagues (2013) demonstrated that if the stimulus is set out of phase, the SO activity is disrupted, and memory consolidation is not improved. Sleep EEG data are typically derived in a laborious process at a sleep laboratory. High-quality sleep EEG data can be recorded in a home environment using unobtrusive, easy-to-apply EEG electrode grids worn around the ear (Da Silva Souto et al. 2021). Moreover, a recent development relevant for sleep EEG is the trEEGrid sensor, which consists of nine single-use self-adhesive gel electrodes placed around the ear, one eye, the forehead, and the chin. Linear combinations of trEEGrid channels can be used to approximate the EEG that would be recorded at PSG-relevant scalp positions (Da Silva Souto et al. 2022). Here we developed a real-time acoustic SO approach to be used in a home setting with the trEEGrid layout.

Method

A closed-loop method detects the up-phase of SO, representing a phase-dependent acoustic stimulation. The control circuit is based on three processes: detecting the SO during sleep in real-time in the EEG, triggering and setting an acoustic pulse during the up-phase to amplify the SO amplitude. The acoustic stimuli are pink noise bursts of 50 ms and a level of 55 dB SPL. This algorithm identifies a local minimum in the EEG and presents an acoustic stimulus afterwards. Since the amplitudes in N3 sleep are higher than in the other sleep stages, this should also ensure a N3 classification. This approach is based on a paper by Ngo et al. (2013). The channel combination Fpz-M1 identifies the stimulation points. An initial threshold was determined from an already collected sleep dataset from 12 participants (Da Silva Souto et al. 2022) and set at -45 microvolts. The incoming EEG signal is buffered for five seconds and then bandpass-filtered between 0.25 Hz and 4 Hz (phase true Butterworth filter of 4th order). An acoustic stimulus is presented if a sample of the last

half period duration exceeds the negative threshold and represents a local minimum. The delay between negative peak and acoustic stimulation is adaptive to ensure synchronous stimulation with the SO up-phase. Every time the minimum is found, the following maximum is sought. The time interval between minimum and maximum is stored. The time delay from minimum to stimulation is adapted to one-half of the median of the last ten min-max distances. Every two seconds, the threshold under which the minimum must lie is adjusted to the root mean square of the last five seconds, provided it is below the initial threshold.

In an offline evaluation, the signal was divided into sections around the stimuli to evaluate the accuracy of the desired phase matches. The negative peak before and the positive peak after the stimulus was found. The time between these peaks is the rising slope of the SO. The rising slope was divided into four sections equal in length, and it was determined in which section the stimuli have been set; sections two to four were considered most ideal in terms of stimulus presentation to ensure that stimulation is not too early (i.e., close to the minimum) and therefore compromising SO activity. To evaluate the developed algorithm a pilot experiment was conducted. One participant slept two nights with the at-home system (this data is further referred to as pilot measurement). The algorithm operated online and detected the appropriate time points to trigger an acoustic stimulus as described above. To investigate the effect of acoustic stimulation on SO amplitude in only half of the instances an acoustic stimulus was actually presented. In the other half, only a marker was sent by the system, but no acoustic stimulus was played.

Results

Previously collected data from 12 participants were used to test the algorithm (Da Silva Souto et al. 2022). Of the 12 data sets, the median of setting the stimulus trigger in the targeted phase (i.e., sections 2-4) was 83% (SD = 4.8%). The pilot measurements suggest that the algorithm also works in an online setting. The stimulation was restricted to the first 4 hours of the night when N3 sleep tends to be more prominent compared to the second half of the night. The acoustic stimulus was presented in the targeted phase in 76.6% (SD = 6.9%) of the detected SO. Two measurements (i.e. two nights) with the same participant were divided into intervals with and without stimulation. In the interval without stimulation the time point for stimulation is marked but no actual stimulus is presented. Figure 1 represents the mean (\pm SEM) of all SO time-locked to the detected negative peak.

The positive peak amplitudes following the stimulation markers were significantly larger for the intervals with acoustic stimulation (red) against those without stimulation (blue).

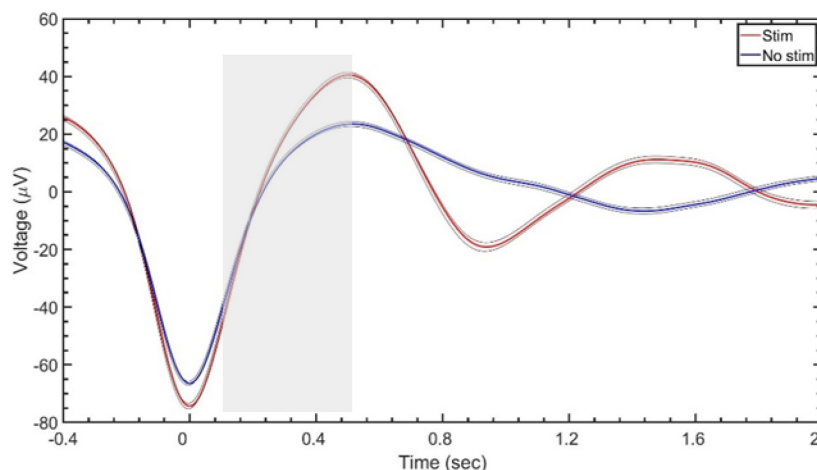

Figure 2: SO, time locked to negative peaks (0 ms); mean (\pm SEM) of the interval of two measurements (i.e. two nights) with intervals of acoustic stimulation (red) and intervals without acoustic stimulation (blue). Gray box indicates the time interval of acoustic stimulation

Outlook

So far, the focus was placed on developing and fine-tuning the algorithm. Up until now only limited pilot measurements were conducted. Even though the results are promising it is too early to draw definitive conclusions, particularly on the functional level with respect to cognitive effects. The setup will continue to be evaluated in healthy participants to determine whether the described approach modulates the amplitude of SO and contributes to improving memory consolidation. Each participant will be measured for two nights, one with a stim- and one with a sham condition. The stim condition places the stimuli during the rising slope of the up-phase, while the sham condition places the stimuli in a random phase of the EEG signal. A memory task will be performed in the evening and then tested the morning after.

The here-described approach for an acoustic closed-loop system provides promising results as a basis for an easy-to-use at-home system to modulate SO during sleep. This could be of particular interest in the context of neurodegenerative diseases. Papalambros and colleagues (2017) suggested that an SO enhancement associated with overnight memory improvement in people with amnesic mild cognitive impairment (aMCI) by acoustic stimulation offers a potential intervention approach.

References

- Da Silva Souto, Carlos F.; Pätzold, Wiebke; Paul, Marina; Debener, Stefan; Wolf, Karen Insa (2022): Pre-gelled Electrode Grid for Self-Applied EEG Sleep Monitoring at Home. In: *Frontiers in neuroscience* 16, S. 883966. DOI: 10.3389/fnins.2022.883966.
- Da Silva Souto, Carlos F.; Pätzold, Wiebke; Wolf, Karen Insa; Paul, Marina; Matthiesen, Ida; Bleichner, Martin G.; Debener, Stefan (2021): Flex-Printed Ear-EEG Sensors for Adequate Sleep Staging at Home. In: *Front. Digit. Health* 3, S. 688122. DOI: 10.3389/fdgth.2021.688122.
- Massimini, Marcello; Huber, Reto; Ferrarelli, Fabio; Hill, Sean; Tononi, Giulio (2004): The sleep slow oscillation as a traveling wave. In: *J. Neurosci.* 24 (31), S. 6862–6870. DOI: 10.1523/JNEUROSCI.1318-04.2004.
- Ngo, Hong-Viet V.; Martinetz, Thomas; Born, Jan; Mölle, Matthias (2013): Auditory closed-loop stimulation of the sleep slow oscillation enhances memory. In: *Neuron* 78 (3), S. 545–553. DOI: 10.1016/j.neuron.2013.03.006.
- Ong, Ju Lynn; Lo, June C.; Chee, Nicholas I. Y. N.; Santostasi, Giovanni; Paller, Ken A.; Zee, Phyllis C.; Chee, Michael W. L. (2016): Effects of phase-locked acoustic stimulation during a nap on EEG spectra and declarative memory consolidation. In: *Sleep Medicine* 20, S. 88–97. DOI: 10.1016/j.sleep.2015.10.016.
- Papalambros, Nelly A.; Santostasi, Giovanni; Malkani, Roneil G.; Braun, Rosemary; Weintraub, Sandra; Paller, Ken A.; Zee, Phyllis C. (2017): Acoustic Enhancement of Sleep Slow Oscillations and Concomitant Memory Improvement in Older Adults. In: *Front. Hum. Neurosci.* 11, S. 109. DOI: 10.3389/fnhum.2017.00109.
- Rasch, Björn; Born, Jan (2013): About sleep's role in memory. In: *Physiological reviews* 93 (2), S. 681–766. DOI: 10.1152/physrev.00032.2012.

Large-Scale Assessment of a Biofeedback Breathing Guide

Jérémy Frey¹, David Labrosse², Lucie Pariente², Loic Lagorce², Édouard Lhomme², Pauline Nicolas², Jean-Arthur Micoulaud-Franchi³

- 1) Uilo, La Rochelle, France
- 2) Tricky, Bordeaux, France
- 3) CHU Bordeaux, Bordeaux, France

Keywords: Biofeedback, Breathing guide, Evaluation methods

Introduction

There is a trend in human-computer interaction toward the development of systems that can improve well-being, such as devices meant to pace users' breathing or applications that encourage users to regulate their physiology through the use of biofeedback (Calvo & Peters, 2014). At the same time, settings involving groups of users are more and more studied, with the assumption that collaboration motivates participants and encourages positive behavior (Fowler & Christakis, 2009).

To assess the effectiveness of these interventions, questionnaires such as the STAI (Spielberger et al., 1983) or physiological markers can be used — e.g. increase in heart-rate variability (HRV) correlates with stress relief (Cowley et al., 2016). When dealing with biofeedback applications, the latter might be deemed less disruptive because users already wear sensors. Even though the controlled environment of a lab is necessary to ensure that participants are properly equipped, it is however far from ideal in order to gather ecological measurements. In order to achieve a setup that enables sufficient control over the experiment while creating a scenario that more closely mimics real-life situations, we propose to take advantage of escape rooms. Indeed, in an escape room (or escape game), participants are confronted to a series of tasks and challenges in a fixed environment, all during which they are monitored by a “game master” who closely follows their progression, triggering events depending on the advance of the team. This represents an ideal situation for experimenters, as they can leverage on the apparatus in place to integrate the sought-after experiment, knitting the supplementary hardware and instructions to the existing scenario.

We were interested in evaluating a tangible breathing guide that doubles as a collaborative biofeedback exercise. Our first hypothesis is that an explicit breathing guide is more effective as a relaxation exercise, compared to simple instructions. Our second hypothesis is that a biofeedback at a group level, where users strive to complete the task together, will improve user engagement. Through the escape room, we were able to enroll hundreds of participants in groups of four, whose heart rate was recorded during the entire duration of the session, the signal synchronized with the events triggered by the game master. The number of participants, an order of magnitude greater than traditional experiments in the field, helped to alleviate inter-subject variability and extract physiological markers which dynamic significantly changed over time depending on the condition.

Methods

Participants were recruited while they were playing a “serious escape room” conceived by the company Tricky, a learning tool based on the concept of escape rooms. It was proposed to practitioners working in nursing homes to raise awareness about muscle-skeletal disorders, for

example when they have to carry patients. The escape room involved groups of four participants. They signed a consent form about the study that would occur during the play, and were equipped with a smartwatch measuring heart rate (Polar OH1). In the middle of this scenario, which lasts around 30 minutes, players must take care of a patient not willing to get out of bed — a situation they are often confronted with in real-life. The patient (a mannequin delivering pre-recorded messages) suggests to do a breathing exercise to reduce the stress they are feeling around them. The task is meant to help participants calm down and solve the issue as a team. In one condition (“no-device”) players were given instructions to do deep breaths, with inspirations and expirations of 5 seconds each. In a second condition (between-subjects) players used a dedicated display (Ullo Flower; Hamon et al, 2019). The device was shaped as a flower and was meant to guide players’ breathing, its light growing outward during inspiration and shrinking inward during expiration (same 5s/5s cycle). Additionally, the device’s color would change depending on the overall HRV, measured in real time as the mean RMSSD of all participants. The light would turn red on low variability and green on high variability, with thresholds defined during pilot studies. If all players were to follow the breathing guide they would steer the color toward green, as higher HRV correlates with deep and slow breathing. The relaxation session lasted 147 seconds on average. It was extended by game masters if participants were deeply involved in the exercise, or terminated early if it was not followed.

560 participants in total were involved in the study, 127 of whom data was incomplete due to connectivity issues and removed from subsequent analysis. Consequently, there were 222 participants kept in the “device” condition and 211 in the “no-device” condition.

Results and Conclusions

Significance was tested using permutation statistics (Voeten 2022). During the relaxation session, once sessions’ duration were normalized, we observed in the “device” condition a significant diminution of heart-rate, as much as 3.8%, and up to 27.8% of increase in HRV, compared to “no-device” (see Figure). This indicates that the device was more effective as a breathing exercise than simple instructions. On our sample there was also a slight and yet significant difference after exposure (240s after and onwards), with a reduced heart-rate in the device condition (-0.58 BPM). As a proxy for engagement, we used the duration of the relaxation sessions, that lasted on average 130s for the “no-device” condition and 161s for the “no-device”. Interestingly, the game masters reported that people tended to take the breathing exercise more lightly (e.g. making fun of the situation) without the device and would be more focused with. This could be explained by the playful nature of the biofeedback, that incited players to concentrate and take part in the exercise.

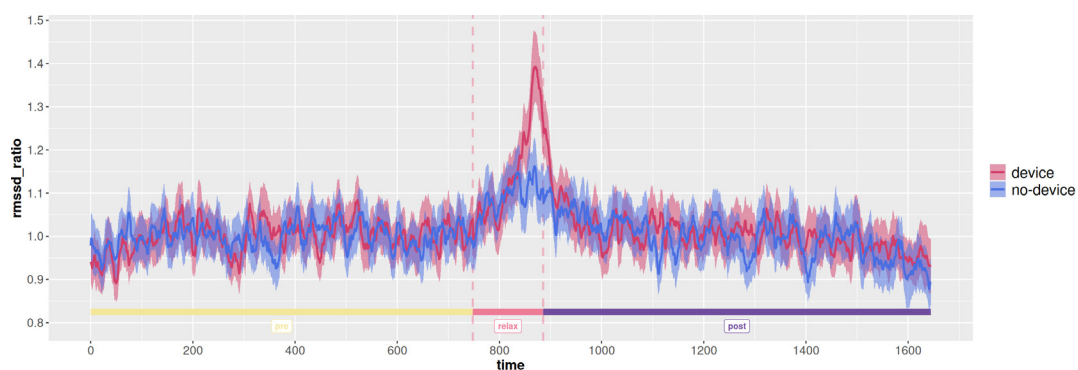

Evolution of HRV over time across all participants, normalized over the “pre” period.

Discussion

In this work, we used an escape room as a way to investigate the effect of a biofeedback breathing guide, with a sample size superior to traditional studies, and in settings that mirror real-life scenarios. Preliminary analyses support our hypotheses concerning the effect of a tangible device on stress and on user engagement. Further analyses will more closely focus on intra-groups dynamics, using synchrony measurements to better understand the effect of such devices when several persons are involved. We will also correlate physiological measurements with questionnaires filled before and after the experiment, inquiring about participants' psychological traits and user experience. Future studies will consider a third condition where the breathing guide does not provide a biofeedback, in order to pin-point the importance of a closed-loop system at a group level. We believe that this approach could help to answer long-lasting questions in the field of biofeedback application concerning the usefulness of an explicit biofeedback.

References

- Calvo, R. A., & Peters, D. (2014). *Positive Computing: Technology for Wellbeing and Human Potential*. The MIT Press.
- Cowley, B., Filetti, M., Lukander, K., Tornaiainen, J., Henelius, A., Ahonen, L., ... Jacucci, G. (2016). The Psychophysiology Primer: A Guide to Methods and a Broad Review with a Focus on Human–Computer Interaction. *Foundations and Trends in Human–Computer Interaction*, 9(3–4), 151–308. <https://doi.org/10.1561/1100000065>
- Hamon, M., Cousin, L., Ramadour, R., & Frey, J. (2019). Inner Flower: Design and Evaluation of a Tangible Biofeedback for Relaxation. *Physiological Computing Systems. Lecture Notes in Computer Science*, vol 10057. Springer, Cham. https://doi.org/10.1007/978-3-030-27950-9_8
- Fowler, J. H., & Christakis, N. A. (2009). Cooperative Behavior Cascades in Human Social Networks. <https://doi.org/10.1073/pnas.0913149107>
- Spielberger, C. D., Gorsuch, R. L., Lushene, R., Vagg, P. R., & Jacobs, G. A. (1983). *Manual for the State-Trait Anxiety Inventory*. Press, Consulting Psychologists.
- Voeten, C. C. (2022). *permutest: Permutation Tests for Time Series*. Data. R package version 2.6. <https://CRAN.R-project.org/package=permutest>

Session Ethics & Perspectives

Monday, October 10th

14:40 – 18:00

Symbiotic technology and the self

A challenge for meaningful human control theories

Giulio Mecacci^{1,2}, Pim Haselager¹, Lotte van Elteren³

1) Donders Institute, Radboud University

2) Delft University of Technology

3) Radboud University

Keywords: Meaningful Human Control, Passive BCI

Automated intelligent systems have been under scrutiny in the past two decades for its possibility to give raise to responsibility gaps. These are situations where for different reasons it is hard or even impossible to clearly and fairly attribute responsibility to one or more human agents for the behavior of an automated system (Matthias, 2004; Santoni de Sio & Mecacci, 2021). Crucially, this depends on a number of issues such as unpredictability and opacity of a system's behavior, and on the fact that operational control and human agency are complicated by the difficult interaction with intelligent artificial systems (Flemisch et al., 2017). In recent years there has been a substantial agreement among scholars that a clear set of normative requirements and criteria should be produced to identify whether and to what extent there is "meaningful human control" over intelligent systems, especially when deployed in high stakes scenarios (Ekelhof, 2019). The contexts of automated warfare, self-driving and surgical robotics have been the strongest drivers of this debate (Ficuciello et al., 2019; Horowitz & Scharre, 2015; Mecacci & Santoni de Sio, 2020). Theories of meaningful human control (MHC henceforth), as opposed to other accounts of control, do not focus on the amount of physical intervention that a human agent can exercise, and how appropriate the system's reaction is. Rather, they often rely on normative requirements that aim to minimize responsibility gaps. This is accomplished by demanding certain technical and institutional standards and capacities from both intelligent systems and their controllers (Ekelhof, 2019).

MHC theories are a valuable attempt at addressing responsibility gaps, but they still fail to properly account for cases where advanced neurotechnology is deployed to assist human controllers of automated systems. In particular, symbiotic passive brain computer interfaces (pBCI henceforth) have the capacity to elicit "hidden" intentions, and, moreover, induce their subsequent conscious endorsement from their user (Haselager et al., 2021). This capacity, we maintain, generates agency- and authenticity-problems that go beyond those that characterize standard human machine interaction, those that MHC theories are designed to address (Mecacci & Haselager, 2021).

Without requiring its user to actively engage in a task, pBCI collects information about them and gradually develops a model. The information can in turn be used to aid the user in different ways, from decision making to physical action performance. It is highly plausible that such support would find application in the context of controlling intelligent systems in complex, time-critical tasks. The peculiar characteristic of this technology is its capacity to tap into subconscious mental states of its user. Those states, that in absence of the technology may never be identified, are surfaced by the technology itself (Krol et al., 2020). This introduces the possibility that, based on those subliminal states, decisions and actions are triggered and communicated to the automated system (e.g. an UAV).

A first order of problems here concerns agency, in the sense that a human controller might tend to endorse those actions as their own even in the absence of conscious deliberation. This is a relatively

known problem that affects many kinds of interactions between humans and intelligent systems (e.g. automation overreliance), and depends on the specific conditions under which the sense of agency forms in humans. It is further aggravated here by the fact that action surfaced by the pBCI belongs to some extent to the human controller, rather than being simply provided by the system. This is challenging for any MHC theory that aims to establish a solid base for responsibility attribution, as potential candidates of moral reprisal will risk to either over- or understate their role in determining a system's undesired behavior.

A second order of problems with pBCI concerns authenticity, in the sense that pBCI assisted controllers of automated systems can become harder to identify as coherent, unified moral subjects. Where the agency issue is about establishing whether and to what extent the human agent—and not the automated system—is to be deemed responsible for initiating a certain behaviour of the system, the authenticity problem concerns the extent to which a controller's self is affected by the symbiotic nature of their relation with a pBCI. Controllers can be competent, well trained, perfectly aware of their moral role, and fully endorse an automated system's role, thereby satisfying every criterion of the most demanding MHC theories, while still deserving reduced moral responsibility in virtue of the fact that it is hard to identify their unadulterated, authentic self.

MHC theories, in their current state, lack the conceptual tools to make sense of fuzziness or disruptions in controllers' agency and authenticity. This is due to the fact that they tend to depict controllers as stable and consistently rational moral *selves*. They largely account for the problems in *controlling*, but less so for the problems in *controllers*. Neurotechnologies in general, and in particular those relevant in the context of control, such as pBCI, highlight how human controllers can become complex, co-constructed entities. Agency and authenticity effects should be explicitly accounted for in MHC theories, and specific requirements should be formulated to preserve the integrity of a controller's self. Specifically, clarifications of the processes involved in pBCI elicited intentions, and their potential subsequent conscious endorsement should be focused upon.

References

- Ekelhof, M. (2019). Moving Beyond Semantics on Autonomous Weapons: Meaningful Human Control in Operation. *Global Policy*, 10(3), 343–348. <https://doi.org/10.1111/1758-5899.12665>
- Ficuciello, F., Tamburrini, G., Arezzo, A., Villani, L., & Siciliano, B. (2019). Autonomy in surgical robots and its meaningful human control. *Paladyn, Journal of Behavioral Robotics*, 10(1), 30–43. <https://doi.org/10.1515/pjbr-2019-0002>
- Flemisch, F., Altendorf, E., Canpolat, Y., Weßel, G., Baltzer, M., Lopez, D., Herzberger, N. D., Voß, M. I., Schwalm, M., Schutte, P., Voß, G. M. I., & Schwalm, M. (2017). Uncanny and Unsafe Valley of Assistance and Automation: First Sketch and Application to Vehicle Automation. In *Advances in Ergonomic Design of Systems, Products and Processes* (Issue January, pp. 319–334). Springer Berlin Heidelberg. https://doi.org/10.1007/978-3-662-53305-5_23
- Haselager, P., Mecacci, G., & Wolkenstein, A. (2021). Can BCIs Enlighten the Concept of Agency? A Plea for an Experimental Philosophy of Neurotechnology. In O. Friedrich, A. Wolkenstein, C. Bublitz, R. J. Jox, & E. Racine (Eds.), *(Clinical) Neuroethics meets Artificial Intelligence: Philosophical, Ethical, Legal and Social Implications*. (pp. 55–68). Springer. https://doi.org/10.1007/978-3-030-64590-8_5
- Horowitz, M. C., & Scharre, P. (2015). *Meaningful Human Control in Weapons Systems: A Primer*.

Krol, L. R., Haselager, P., & Zander, T. O. (2020). Cognitive and affective probing: a tutorial and review of active learning for neuroadaptive technology. *Journal of Neural Engineering*, 17(1), 012001. <https://doi.org/10.1088/1741-2552/AB5BB5>

Matthias, A. (2004). The responsibility gap: Ascribing responsibility for the actions of learning automata. *Ethics and Information Technology*, 6(3), 175–183. <https://doi.org/10.1007/s10676-004-3422-1>

Mecacci, G., & Haselager, W. F. G. (Pim). (2021). Responsibility, Authenticity and the Self in the Case of Symbiotic Technology. *AJOB Neuroscience*, 12(2–3), 196–198. <https://doi.org/10.1080/21507740.2021.1904048>

Mecacci, G., & Santoni de Sio, F. (2020). Meaningful human control as reason-responsiveness: the case of dual-mode vehicles. *Ethics and Information Technology*, 22(2), 103–115. <https://doi.org/10.1007/s10676-019-09519-w>

Santoni de Sio, F., & Mecacci, G. (2021). Four Responsibility Gaps with Artificial Intelligence: Why they Matter and How to Address them. *Philosophy & Technology*. <https://doi.org/10.1007/s13347-021-00450-x>

Technologically Enhancing Our Moral Identity

Inken Titz¹

1) Ruhr-Universität Bochum

Keywords: AI Ethics, Behavior Change Technologies, Moral Enhancement, Moral Identity

Abstract

Information technologies can make our lives easier and more efficient. Can they also make us more moral? In this talk, I explore a new avenue for arguing that they can. Namely, I argue that moral technology design should focus on targeting our *moral identity* in order to make us sustainably more moral.

A common take on the impact of new information and communication technologies (ICTs) emphasizes their risk of leading to a moral deskilling in human agents (Vallor 2015). It is clear that ICTs' impact on human moral capacities greatly depends on their design. Accordingly, recent work on moral technologies—information technologies designed for the very purpose of improving our moral capacity—explores how ICTs should be designed in order to support the task of making us more moral (Savulescu & Maslen 2015; Klincewicz 2016; Giubilini & Savulescu 2018; Lara & Deckers 2020). One challenge those proposals face is the threat of moral disengagement or deskilling (Bandura 2002), along with a loss of autonomy. The recent answer to this threat consists in an almost exclusive focus on enhancement of morally relevant cognition or reasoning abilities (e.g., Klincewicz 2016, Giubilini & Savulescu 2018, Lara & Deckers 2020, Lara 2021).

In this talk, I argue for an alternative focus in technological moral enhancement. This argument draws on insights from moral psychology and recent technology design. Moral technologies have the aim of morally upskilling human agents and making them more morally competent. Drawing on debates about moral responsibility, I understand moral competence as the ability to recognize and respond to moral considerations (Talbert 2019). This ability is bound to our self-conception as moral agents (see e.g. Jones 2003, esp. 188 ff.). In fact, moral psychologists argue that moral identity is the prime predictor of moral actions and commitments (Damon & Hart 1992). Importantly, there is evidence that priming moral identity has an effect on moral emotions as well as moral behavior (Aquino et al. 2007; Aquino et al. 2009).

These psychological findings indicate that one route towards moral upskilling leads through enhancing an individual's moral identity. The focus on moral identity has several advantages. For one, it promises to reconcile debates about whether moral enhancement should target either behavior or reasoning, since the concept of moral identity has the potential to unify both (Hardy & Carlo 2011; Walker 2004). Second, changes to moral identity promise to lead to a deeper and more sustainable moral change in individuals. Focus on moral identity finally accounts for autonomy since a heightened moral sensitivity does not amount to mere compliance with any substantially defined moral values, but rather to ascribing a greater importance to moral considerations as such. Thus, focus on improving moral identity promises a fruitful avenue for the design of moral technologies.

References

- Aquino, Karl; Freeman, Dan; Reed, Americus; Felps, Will; Lim, Vivien K. G. (2009): Testing a social-cognitive model of moral behavior: the interactive influence of situations and moral identity centrality. In: *Journal of personality and social psychology* 97 (1), S. 123–141. DOI: 10.1037/a0015406.
- Aquino, Karl; Reed, Americus; Thau, Stefan; Freeman, Dan (2007): A grotesque and dark beauty: How moral identity and mechanisms of moral disengagement influence cognitive and emotional reactions to war. In: *Journal of Experimental Social Psychology* 43 (3), S. 385–392. DOI: 10.1016/j.jesp.2006.05.013.
- Bandura, Albert (2002): Selective Moral Disengagement in the Exercise of Moral Agency. In: *Journal of Moral Education* 31 (2), S. 101–119. DOI: 10.1080/0305724022014322.
- Damon, W.; Hart, D. (1992): Self-understanding and its role in social and moral development. In: M. H. Bornstein und M. E. Lamb (Hg.): *Developmental psychology: An advanced textbook*: Lawrence Erlbaum Associates, S. 421–464.
- Giubilini, Alberto; Savulescu, Julian (2018): The Artificial Moral Advisor. The "Ideal Observer" Meets Artificial Intelligence. In: *Philos. Technol.* 31 (2), S. 169–188. DOI: 10.1007/s13347-017-0285-z.
- Hardy, Sam A.; Carlo, Gustavo (2011): Moral Identity: What Is It, How Does It Develop, and Is It Linked to Moral Action? In: *Child Development Perspectives* 5 (3), S. 212–218. DOI: 10.1111/j.1750-8606.2011.00189.x.
- Jones, Karen (2003): Emotion, Weakness of Will, and the Normative Conception of Agency. In: *Royal Institute of Philosophy Supplement* 52, S. 181–200. DOI: 10.1017/S1358246100007967.
- Klincewicz, Michał (2016): Artificial Intelligence as a Means to Moral Enhancement. In: *Studies in Logic, Grammar and Rhetoric* 48 (1), S. 171–187. DOI: 10.1515/slgr-2016-0061.
- Lara, Francisco; Deckers, Jan (2020): Artificial Intelligence as a Socratic Assistant for Moral Enhancement. In: *Neuroethics* 13 (3), S. 275–287. DOI: 10.1007/s12152-019-09401-y.
- Lara, Francisco (2021): Why a Virtual Assistant for Moral Enhancement When We Could have a Socrates? In: *Science and Engineering Ethics* (2021) 27:42. DOI: 10.1007/s11948-021-00318-5.
- Savulescu, Julian; Maslen, Hannah (2015): Moral Enhancement and Artificial Intelligence: Moral AI? In: Jan Romportl, Eva Zackova und Jozef Kelemen (Hg.): *Beyond artificial intelligence. The disappearing human-machine divide*, Bd. 9. Cham: Springer (Topics in Intelligent Engineering and Informatics, 9), S. 79–95.
- Talbert, Matthew (2019): Moral Responsibility. In: Edward N. Zalta (Hg.): *The Stanford Encyclopedia of Philosophy*.
- Vallor, Shannon (2015): Moral Deskillling and Upskilling in a New Machine Age: Reflections on the Ambiguous Future of Character. In: *Philos. Technol.* 28 (1), S. 107–124. DOI: 10.1007/s13347-014-0156-9.
- Walker, L. J. (2004): Gus in the Gap: Bridging the Judgment-Action Gap in Moral Functioning. In: D. K. Lapsley und D. Narvaez (Hg.): *Moral development, self, and identity*: Lawrence Erlbaum Associates Publishers, S. 1–20.

Is speaking one's mind the same as moving one's arm? Extended cognition, bodily movement, and the differences between BCI-mediated speech and BCI-mediated action

Tom Buller¹

1) Department of Philosophy, Illinois State University

Keywords: Brain-Computer Interface, Extended Cognition

Abstract

A brain-machine interface (BCI) is a device that detects and decodes neural activity in order to effect bodily movement or the activity of an external device. Accordingly, BCIs have been described as devices that can “translate thought into action.” A speech brain-computer interface (SBCI) is designed to restore speech through the decoding and analysis of neural activity associated with “covert speech,” and the production of the speaker’s intended words through a speech synthesiser.

A BCI designed to restore motor control (MBCI) can be described as a device that decodes the person’s movement intentions, for example, the intention to reach out an arm. However, it might be objected that, strictly speaking, the device decodes motor information, for example, force, limb position and movement goals, rather than intentions. In other words, the device decodes sub-personal rather than personal-level states. The contention that BCIs translate thought into action appears much stronger, however, in the case of SBCIs, since a stronger claim can be made that the device is decoding neural activity that corresponds to cognitive processing: first, in order for a person to successfully communicate, speech has to accurately represent what the person is thinking at that time; second, the neural activity underlying covert speech - speech that is imagined but not vocalised - overlaps with the neural activity underlying overt speech.

Progress in BCI technology raises important questions regarding agency, responsibility, personhood, and embodiment. In regard to MBCIs and deep-brain stimulation (DBS) there has been discussion as to whether BCI-mediated behaviour enhances autonomy or undermines it on the grounds that the resultant behaviour may be regarded as “inauthentic.” Moreover, the development of neuroprosthetic limbs challenges our notions of physical action and embodiment. Although in a broad sense the function of a SBCI is to restore the loss of movement, as in the case of aphasia or locked-in syndrome, SBCIs can more properly be regarded as replacing “ordinary” activity rather than restoring it since, if successful, they do not increase movement. Furthermore, since SBCIs detect and decode neural activity that is common to both overt and covert speech, and that they enable the person to express what they consciously imagine, concerns about authenticity and autonomy appear less relevant.

SBCIs raise a different but an equally challenging set of issues that pertain to the nature of cognition and cognitive function. In particular, and in distinction to MBCIs, SBCIs can be seen to provide an instance of extended cognition. Although there are a number of different ways of understanding extended cognition (EC), in broad terms EC can be understood as the thesis that certain types of cognitive processes can be off-loaded into the world - external (environmental) elements can form part of a coupled, cognitive system in conjunction with “brain-bound” neural activity. For example, Clark and Chalmers have argued that dispositional beliefs need not be in the head if the following conditions are met: the information stored externally is reliable, automatically endorsed, and easily accessible (Clark and Chalmers 1998). Differently, Rowlands has endorsed a version of EC according to which an external element can be part of a cognitive process if it is designed to make information available for personal-level cognitive processing (Rowlands 2010).

References

Clark, A., and D. Chalmers. 1998. *The Extended Mind*. *Analysis* 58: 7-19.

Rowlands, M. 2010. *The New Science of the Mind: From Extended Mind to Embodied Phenomenology*. MIT Press.

Modeling subject perception and behaviour during neurofeedback training

Côme Annicchiarico¹, Fabien Lotte², Jérémie Mattout^{1,3}

1) Lyon Neuroscience Research Center, CRNL, INSERM U1028, CNRS UMR5292, Computation, Cognition and Neurophysiology Team, Lyon, France

2) Inria Bordeaux Sud-Ouest / LaBRI (Univ; Bordeaux – CNRS – Bordeaux INP)

3) Université Claude Bernard Lyon 1, Lyon, France

Keywords: Neurofeedback, Modeling, Active Inference

Abstract

Neurofeedback training (NFT) describes a closed-loop paradigm in which a subject is provided with a real time evaluation of his/her brain activity. As a learning process, it is designed to help the subject learn to apprehend his/her own cognitive states and better modulate them through mental actions. Its use for therapeutic purposes has gained a lot of traction in the public sphere in the last decade, but conflicting evidence concerning its efficacy has led to a two-pronged effort from the scientific community. First, a call for experimental protocols and reports standardization [1], aiming to reduce the variability of the results and provide a reliable set of data to describe empirical findings. Second, an effort towards a formal description of the neurofeedback loop and the main hypotheses that guide the design of our experiments, in order to explain or even predict the effects of such training [2,3].

This work intends to contribute to the second effort by proposing a mathematical formalization of the mechanisms at play in this complex dyadic dynamical system.

A typical Neurofeedback experiment aims at having a significant (positive) impact on behavioral symptoms (e.g. focusing and learning abilities in children with attention disorder). Therefore, strong hypotheses are made about the relationship between a related mental state (e.g. the ongoing covert attentional effort) and a neurophysiological marker (e.g. the ratio between theta and beta band power as measured with EEG [4]). In addition to such hypotheses made by the experimenter, it is also important to account for the subject's beliefs (e.g., his trust in the feedback), which partly depend upon the provided instructions, and will impact her/his expectations and the dynamics of training.

Our formulation makes those hypotheses explicit, in a quantitative manner, so that one can simulate the ensuing closed-loop interaction (Fig. 1.a) whose aim is the self-regulation of the targeted neuromarker. As such, it enables us to evaluate the consequences of various approximate or even erroneous hypotheses (e.g. targeting an inappropriate physiological marker [4], providing a suboptimal feedback,...).

Our model relies on the Bayesian framework. It enables to instantiate an agent who entertains and updates a probabilistic (generative) model of the Neurofeedback environment. This rests on the assumption that the agent can only infer its own mental state through sensory feedback and the knowledge of its own mental actions aiming at modifying that state. Hence, using Bayesian computation, we cast the Neurofeedback training as the active process, for a subject, of inferring her/his mental states as well as the environment dynamics despite multiple significant sources of uncertainty (Fig 1.b). To simulate this loop and the effect of various sources of uncertainty, we take

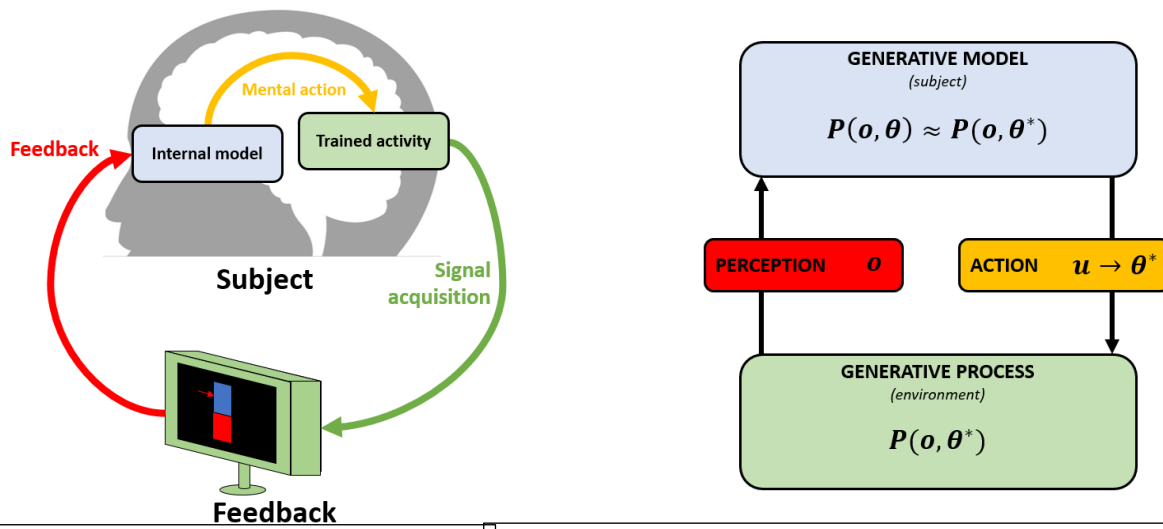

a. Neurofeedback paradigms measure subject physiological activity (green) and process it to design a feedback (red). The subject tries to make sense of the feedback and learn (blue) how to act upon it (yellow) to achieve an objective.

b. We cast the neurofeedback subject experience as a high uncertainty inference problem where he/she tries to figure out the hidden states of the world (hidden mental states θ^*) that caused the feedback observed (o) and the optimal actions to get better results (u). The subject gets better at it by learning the dynamics of the environment (Perception + action).

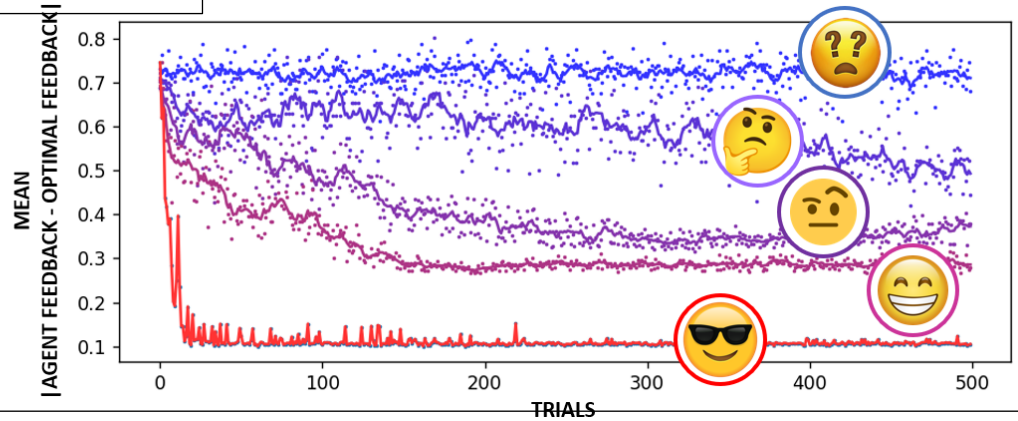
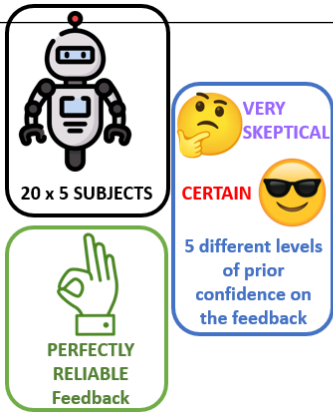

c. We simulate the feedback performance of various artificial agents across trials performing neurofeedback training, starting with different prior confidence levels regarding feedback reliability. We show that even if the feedback is truly reliable, agents with excessive initial skepticism (blue) perform much poorer than those with high/absolute confidence in the feedback. (red)

Figure 1. Our approach formalizes the various functional components of the neurofeedback loop (a.), relies on Bayesian formalism to cast it as an inference problem (b.) and uses Active Inference to simulate the performance of artificial agents with varying initial parameters (c.).

advantage of the Active Inference framework [5,6], a Bayesian approach to belief updating that provides a biologically plausible model of perception, action and learning. The framework proposes an account of how independent systems balance out explorative and exploitative behaviour to achieve their goals, which is crucial with NFT paradigms.

We introduce a generic NFT task and we simulate the evolution of Active-Inference embedded artificial agents performing this training with various initial parameters (initial beliefs, motivation, habits, feedback quality, etc.). Agents are tasked with learning the reliability of the feedback but also the effect of their own actions on the mental states. In a first illustrative example, we show that training efficacy drops quickly with feedback quality, but we also find that a perfect feedback signal is not quite enough to guarantee training success, even in a very simplified representation. By changing initial agent confidence about the feedback as well as prior knowledge about the effect of its actions, we can emulate very different learning trajectories. Interestingly, we found that although the feedback may be perfect, excessive skepticism about it yields poor performance when facing too much uncertainty

in the action model (Fig 1.c). Ongoing work consists in exploring the effects of various endogenous (e.g. motivation) and exogenous (e.g. feedback design) factors onto mental training.

References

- [1] Ros et al., Consensus on the reporting and experimental design of clinical and cognitive-behavioural neurofeedback studies (CRED-nf checklist). *Brain*, 143(6):1674–1685, June 2020.
- [2] Oblak et al., Self-regulation strategy, feedback timing and hemodynamic properties modulate learning in a simulated fMRI neurofeedback environment. *PLoS computational biology*, 13:e1005681, July 2017.
- [3] Davelaar, Mechanisms of Neurofeedback: A Computation-theoretic Approach. *Neuroscience*, 378:175–188, May 2018.
- [4] Arns, M., Clark, C.R., Trullinger, M. et al. Neurofeedback and Attention-Deficit/Hyperactivity-Disorder (ADHD) in Children: Rating the Evidence and Proposed Guidelines. *Appl Psychophysiol Biofeedback* 45, 39–48 (2020). <https://doi.org/10.1007/s10484-020-09455-2>
- [5] Friston et al., Active Inference: A Process Theory. *Neural Computation*, 29(1):1–49, January 2017.
- [6] Friston et al., Active inference and learning. *Neuroscience & Biobehavioral Reviews*, 68:862 – 879, September 2016.

A taxonomy of neurotechnologies enabling the notion of a hybrid mind

Colucci Annalisa¹, Vermehren Mareike¹, Buthut Maria¹, Finkbeiner Flurina¹, Soekadar Surjo¹

1) Clinical Neurotechnology Laboratory, Charité Universitätsmedizin Berlin, Berlin, Germany

Keywords: Taxonomy, Neurotechnology, Hybrid mind

Abstract

The direct coupling of the human mind with an artificial cognitive system - a concept we refer to as hybrid mind - is enabled by advanced neurotechnologies that allow for bidirectional interactions between the brain and a computer. Here, we introduce a structured taxonomy of neurotechnologies that are relevant to establish such hybrid mind. The taxonomy builds on three main dimensionalities:

1. Level of invasiveness, determining the permanence of interaction between brain and technology
2. specificity and adaptivity of neuromodulation, describing the extent to which the influence of neuromodulation on neural activity is constrained to a particular brain region or function and
3. Level of interaction, describing which functional domains are involved in direct coupling of the human mind with an artificial cognitive system. Moreover, we provide a theoretical framework to quantify the level of integration between biological and artificial processes that give rise to the notion of a hybrid mind.

BCIs for education: future steps for wider use

Federica Armani¹, Ian Daly¹, Alexei Vernitski², Helge Gillmeister³, Reinhold Scherer¹

1 Brain-Computer Interfaces and Neural Engineering Laboratory, School of Computer Science and Electronic Engineering, University of Essex, Colchester CO4 3SQ, U.K

2 Department of Mathematical Sciences, University of Essex, Colchester CO4 3SQ, U.K

3 Centre for Brain Science, Department of Psychology, University of Essex, Colchester CO4 3SQ, U.K

Keywords: Neuroadaptive BCIs, Affective computing, Adaptive neurotechnologies in education

Abstract

We discuss the application of neuroadaptive Brain Computer Interfaces (BCIs) in the context of education and personalized learning, presenting open issues, and future directions that will help us make such systems more easily available to the public.

A BCI is a powerful technology which links a human brain and a technical system by detecting patterns in brain activity and translating them into input commands for a dedicated machine. The primary use for such technology was to provide a communication system for people unable to use functional neuro-muscular channels (e.g., locked-in or paralyzed patients) (Wolpaw, 2002). In recent years, however, BCIs have extended their use to healthy people as well and the classical definition changed to reflect this shift, identifying BCIs as technological systems able to replace, restore, enhance, supplement, or improve the communication outputs of end users (Wolpaw, 2012).

In the context of adaptive learning systems, developing a closed loop neuroadaptive BCI is desirable as it allows the flexible adaptation of the tutoring system based on spontaneously generated brain signals that reflect the current mental state of the user (Fairclough, 2021). Such technology could detect specific brain states like anxiety, inattention, cognitive workload, mental fatigue or aversive emotions, even before they reach the user's consciousness and trigger behavioural responses that are non-conductive to learning. Such BCI would represent an optimal learning condition, defined as a 'zone of proximal development', in which the learning content is neither too difficult nor too easy, promoting optimal cognitive load for the learner (Vygotsky, 1978) and a state of flow in which both attention and performance are maximized (Csikszentmihalyi, 1991). The recent pandemic highlighted the importance of developing effective learning systems that students can use at home, which can supplement the lack of a normal school setting and at the same time provide emotional support to the learner. However, the current state of the art of neuroadaptive BCIs for learning does not yet live up to these expectations.

Here we highlight some important issues on improving the wider availability of such systems:

Neurophysiological markers: We need more studies focusing on understanding the interconnections and relationships between different coexisting mental states. Fairclough (2009) proposed an approach to the selection of neurophysiological measures based on three specific aspects, which help clearly define the measure of interest:

- Diagnostic, ability of the variable to specifically index the target mental state while remaining unaffected by related states,
- Sensitivity, ability of the variable to respond rapidly to changes in the mental state
- Reliability, consistency of the neurophysiological inference across different individuals and environments

An approach like this will clarify the specific and shared features of neurophysiological measures, allowing the development of BCIs able to detect multiple neurophysiological states at the same time, like mental workload, fatigue, attention or boredom. As emotion and learning are closely tied together, detecting other coexisting mental states could lead to a better understanding of the user's state, allowing for a precise adaptation of the learning contents. A system able to detect multiple mental states could be based on self-paced classifiers, able to recognize multiple mental states (Scherer et al., 2008). Concepts from affective computing should be implemented in the BCI framework as well to develop an affective adaptive tutoring system, which combines information about both the emotional and cognitive state of the user. This would allow the system to respond appropriately by adapting the learning content difficulty and at the same time considering the emotional state of the learner, like a real teacher would do in a classroom. BCI researchers should therefore pair up with educational researchers and tutors to develop tasks that promote efficient learning and information retention, instilling curiosity in the learner with well-designed tasks.

Classification: The need to re-calibrate the classifier every single session slows down the practical use of such systems both in laboratory and real-life settings. To reduce recalibration, the following machine learning techniques could be used:

- Automatic stop stepwise linear discriminant analysis (asSWLDA), which has been shown to classify workload levels in operational environments for up to a month without recalibration (Aricò et al., 2015).
- Adaptive classification approaches to minimize the effects of non-stationarities of the signal. For personal use, calibration data may not be available from the end user. However, transfer learning, sLDA, Riemannian minimum distance to the mean (RMDM) or random forest classifiers can help (Lotte, 2018).
- New online classification algorithms should be validated, to ensure they are sufficiently computationally efficient to be used in real-time situations by reducing calibration times and increasing robustness to real-life noise.

To guarantee an equal access to such technology we have to make it practical and easy to use for many different kinds of learners, with different technological backgrounds and of different ages. To do so we should reduce, or even better, completely eliminate, technical steps that are not ultimately central for the learning experience.

Biosensors: The current state of EEG sensors technology is hampering the wider use of BCI systems. The best signal quality is obtained with wet electrodes which, however, have the disadvantage of impedance drift as the gel dries, long set-up time, and the need to wash the gel away after using the system. To counteract this, many commercial dry-electrode products have been developed (like Muse and Neurosky), at the expense of signal quality. Some companies proposed high-level but expensive systems with dry electrodes (like BrainProducts or g.Tec), but these systems are less comfortable and very sensitive to the surrounding noise, which makes them difficult to use in real-life contexts. Therefore:

- Affordable, comfortable, high-quality EEG devices should be developed, as this will promote the diffusion of affordable BCI systems. Researchers and industries should also strengthen their cooperation to develop and test such systems in real life scenarios.

This is another important step that we can't ignore as what the learner should focus primarily on is the enhanced learning opportunity that neuroadaptive BCIs can offer. Since the end goal is to improve and facilitate learning, we should avoid all the possible elements of discomfort that may accompany the experience.

The points discussed above represent the main issues that slow down the wide use of neuroadaptive BCI in real-life settings for educational purposes. By considering and working towards the possible solutions proposed, collective efforts from companies and researchers in both BCI and educational

fields would substantially advance BCIs as affective adaptive tutoring systems that can be used by learners with confidence in the near future.

References

Aricò, P., Borghini, G., Di Flumeri, G., Colosimo, A., Graziani, I., Imbert, J. P., Granger, G., Benhacene, R., Terenzi, M., Pozzi, S., & Babiloni, F. (2015). Reliability over time of EEG-based mental workload evaluation during Air Traffic Management (ATM) tasks. *Annual International Conference of the IEEE Engineering in Medicine and Biology Society. IEEE Engineering in Medicine and Biology Society. Annual International Conference, 2015*, 7242–7245. <https://doi.org/10.1109/EMBC.2015.7320063>

Csikszentmihalyi, M., 1991. *Flow—The Psychology of Optimal Experience*. Harper Perennial.

Fairclough, S. H. (2009). Fundamentals of physiological computing. *Interacting with computers*, 21(1-2), 133-145.

Fairclough, S. H., & Zander, T. O. (Eds.). (2021). *Current Research in Neuroadaptive Technology*.

Lotte, F., Bougrain, L., Cichocki, A., Clerc, M., Congedo, M., Rakotomamonjy, A., & Yger, F. (2018). A review of classification algorithms for EEG-based brain–computer interfaces: a 10 year update. *Journal of neural engineering*, 15(3), 031005.

Scherer, R., Lee, F., Schlogl, A., Leeb, R., Bischof, H., & Pfurtscheller, G. (2008). Toward self-paced brain–computer communication: navigation through virtual worlds. *IEEE Transactions on Biomedical Engineering*, 55(2), 675-682

Vygotsky, L. (1978). *Mind in Society: The Development of Higher Psychological Processes*. Cambridge, MA: Harvard University Press.

Wolpaw, J., Birbaumer, N., McFarland, D., Pfurtscheller, G., and Vaughan, T. (2002). Brain-computer interfaces for communication and control. *Clin. Neurophysiol.* 113, 767–791. doi: 10.1016/S1388-2457(02)00057-3

J. Wolpaw and E.W. Wolpaw, *Brain-Computer Interfaces: Principles and Practice*. London, U.K.: Oxford Univ. Press, 2012.

EEG Brain Mapping with Interpretable Deep Learning

Maryna Kapitonova^{1,2}, Tonio Ball^{1,2}

1) Neuromedical AI Lab, Department of Neurosurgery, Medical Center—University of Freiburg, Faculty of Medicine, University of Freiburg, Freiburg, Germany

2) IMBIT//BrainLinks-BrainTools, Albert-Ludwigs-University, 79110 Freiburg, Germany

Keywords: saliency mapping, EEG, deep learning

Abstract

Deep learning techniques are increasingly used in brain science. Their interpretability, however, remains a topic of intense ongoing research. Interpretability for EEG is especially challenging, among other reasons, due to the absence of knowledge of the ground truth in many EEG decoding tasks. Here we used simulated data as a testbed for interpretability methods and transferred the gained insights to real movement-related EEG data. We introduce several innovations to improve the interpretability of EEG-based brain mapping, including cross-class attributions (CroCA) and attribution-map ensembling.

We constructed three simulated EEG prototypes with different informative features: WHAT - the frequency of an EEG oscillation (10-20 Hz vs 30-40 Hz); WHEN - the timing of the feature (early or late); WHERE - the location of the feature (right or left). The SNR was scaled for 5 difficulty levels. As real data, we used a publicly available EEG dataset (HGD) for a binary classification task (14 subjects, left vs right hand movement). We examined 7 widely used network architectures for EEG decoding: Deep4, ShallowNet, Deep4Relu, TCN, TIDNet, EEGResNet and EEGNetv4. All networks were trained for 1000 epochs. Preprocessing and training procedure was the same as described in Schirrmeyer 2017 (trialwise decoding).

Here, we introduce CroCA for visualization of EEG decoding, in contrast to the conventional in-class gradients, introduced by Simonyan et al. for computer vision. We tested the hypothesis that cross-class gradients may reduce the noise in attribution maps, compared to traditional in-class maps. Additionally, we explored the usefulness of ensembling attribution maps across models as well as occlusion sensitivity mapping in temporal and frequency domains.

Our findings show that different networks had different preferred prototypes. Deep4, Deep4Relu and TIDNet had a preference for the WHEN prototypes, while both EEGResNet and TCN failed to decode this case. For all networks most of the gradients were assigned to the appropriate time windows and channels. However, we observed a range of undesired effects: 1. Attributions to non-informative channels (all networks except TIDNet) and time windows (all networks except TCN), which we refer to as spatial and temporal ghosting. 2. Attributions were not the same for equivalently informative time windows. 3. "Confusion": Attribution where/when informative signal was present only in the other trials of the same or other classes, not in the trial looked at.

Generally, the frequency of all types of errors was reduced in the CroCAs, with the most notable exception being temporal ghosting present across all networks and methods.

Next, we investigated whether the CroCA picture was also clearer than the in-class results for real EEG data. Time-resolved attribution mapping and occlusion sensitivity analysis showed meaningful spatio-temporal patterns consistent with the physiological expectations. Variability across networks suggested that ensembling over the networks could be helpful. Thus we examined the quality of the mean attributions over all networks. The in-class maps showed substantially more background noise without any meaningful physiological topographic pattern (Fig. 1.).

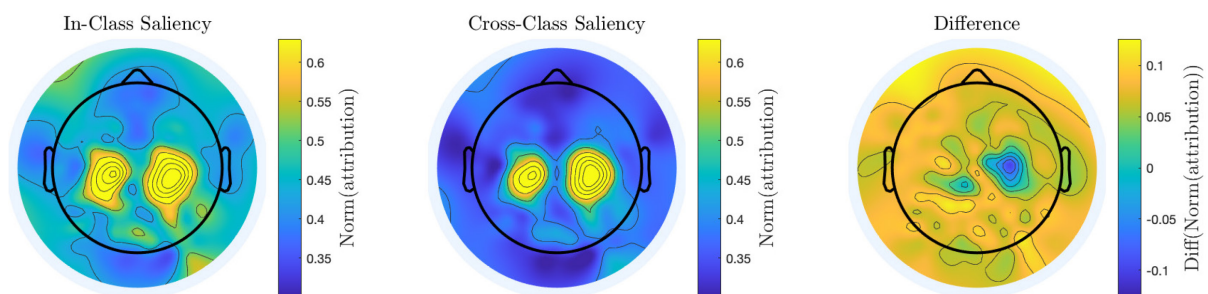

Fig.1. Mean across networks attribution maps for movement-related response in the HGD dataset, for in-class attribution (left), and cross-class attribution (middle). Cross-class attributions are more focalized on the bilateral sensorimotor hand regions. In-Class results show diffusely increased attributions including peripheral electrodes (difference on the right).

Finally, we analyzed the correlation of decoding accuracy vs. gradient magnitudes across the 14 subjects in HGD. For in-class gradients, there was a highly significant negative correlation ($p < 0.0001$), indicating increasing gradient saturation. This effect was greatly reduced and not significant ($p > 0.4$) for cross-class gradients.

Popular EEG-optimized deep networks have very different performance profiles for different features in simulated data. CroCA as a novel variant of saliency mapping gave a clearer picture both for synthetic and real EEG data. Attribution map "ensembling" has a potential to make EEG saliency maps clearer and more robust. Synthetic EEG data is a helpful tool for benchmarking interpretability.

References

1. Schirrmeister, Robin Tibor, Jost Tobias Springenberg, Lukas Dominique Josef Fiederer, Martin Glasstetter, Katharina Eggenberger, Michael Tangermann, Frank Hutter, Wolfram Burgard, and Tonio Ball. 'Deep Learning with Convolutional Neural Networks for EEG Decoding and Visualization'. *Human Brain Mapping* 38, no. 11 (2017): 5391–5420. <https://doi.org/10.1002/hbm.23730>.
2. Simonyan, Karen, Andrea Vedaldi, and Andrew Zisserman. 'Deep Inside Convolutional Networks: Visualising Image Classification Models and Saliency Maps'. *ArXiv:1312.6034 [Cs]*, 19 April 2014. <http://arxiv.org/abs/1312.6034>.

Towards Privacy-preserving Deep Transfer Learning for Heterogenous EEG Data Sets

Xiaoxi Wei¹, Aldo Faisal^{1,2}

1) Brain & Behaviour Lab, Imperial College London, United Kingdom

2) Institute of Artificial & Human Intelligence, University of Bayreuth, Germany

Keywords: Machine Learning, Transfer Learning, Domain Adaptation, Brain-Computer-Interfaces (BCI), Electroencephalography, Ethic, Privacy Preserving, Federated Machine Learning

Abstract

Transfer learning and meta-learning offer some of the most promising avenues to unlock the scalability of healthcare and consumer technologies driven by biosignal data [1,2,3,4,5]. However, these methods cannot handle learning from different heterogeneously collected EEG data sets with different channel locations and mental tasks, thus limiting the scale of training data. We organised an international competition (BEETL) [6] in NeurIPS 2021 on heterogenous EEG data sets with different motor imagery tasks, channel locations and protocols of data collection, which first brought public attention to utilising multiple heterogenous EEG data sets to enhance EEG decoding and reduce long calibration sessions for new subjects. Key findings were published recently [6] and will be presented in the conference.

With proof of concept that heterogenous EEG data sets from individuals or different data centres could be utilised for large-scale machine learning algorithms, biosignal data privacy becomes the next concern for data sharing and utilisation. Brainwaves are sensitive data which contain enriched private information that could be potentially decoded by algorithms, e.g., images, words, and identities. However, there is still limited focus on privacy-preserving techniques for EEG decoding to protect the data privacy of individuals or data centres. There were some studies on privacy-preserving in the machine learning literature [7,8,9], but they are either not suitable for brainwave decoding or introducing extra computational consumptions, which disadvantage the training for large-scale data.

We are developing a deep transfer learning technique, namely the Multi-dataset Federated Separate-Common-Separate Network (MF-SCSN), which integrates privacy-preserving properties into the deep transfer learning architecture design without introducing extra computational steps of data encryption. The MF-SCSN uses distributed parameters as both auto-encryption and feature extraction processes to reach out to the local data sets so that no external entities have access to the raw data. It has distributed learnable parameters that both personalised EEG data and parameters are preserved locally without being uploaded to the central server, while the common neural network in the server still learns from the general characteristics of source data sets. The proposed method is evaluated on the NeurIPS 2021 BEETL competition BCI task. Preliminary results show that the proposed method, with the advantage of integrating both transfer learning and privacy-preserving properties, outperformed the benchmark CNN in terms of decoding accuracies. Our

proposed method shows the potential to utilise larger heterogenous data sets for transfer learning while possessing better properties of privacy-preserving across data sets and data centres.

References

- [1] Pan, Sinno Jialin, and Qiang Yang. "A survey on transfer learning." *IEEE Transactions on knowledge and data engineering* 22.10 (2009): 1345-1359.
- [2] Jayaram, Vinay, et al. "Transfer learning in brain-computer interfaces." *IEEE Computational Intelligence Magazine* 11.1 (2016): 20-31.
- [3] Wei, Xiaoxi, Pablo Ortega, and A. Aldo Faisal. "Inter-subject deep transfer learning for motor imagery eeg decoding." *2021 10th International IEEE/EMBS Conference on Neural Engineering (NER)*. IEEE, 2021.
- [4] Wan, Zitong, et al. "A review on transfer learning in EEG signal analysis." *Neurocomputing* 421 (2021): 1-14.
- [5] Li, Denghao, et al. "Model-agnostic meta-learning for EEG motor imagery decoding in brain-computer-interfacing." *2021 10th International IEEE/EMBS Conference on Neural Engineering (NER)*. IEEE, 2021.
- [6] Wei, Xiaoxi, et al. "2021 BEETL Competition: Advancing Transfer Learning for Subject Independence & Heterogenous EEG Data Sets." *Proceedings of the NeurIPS 2021 Competitions and Demonstrations Track*, PMLR (2022): 205--219.
- [7] Boulemtafes, Amine, Abdelouahid Derhab, and Yacine Challal. "A review of privacy-preserving techniques for deep learning." *Neurocomputing* 384 (2020): 21-45.
- [8] Hao, Meng, et al. "Efficient and privacy-enhanced federated learning for industrial artificial intelligence." *IEEE Transactions on Industrial Informatics* 16.10 (2019): 6532-6542.
- [9] Lyu, Lingjuan, et al. "Privacy-preserving collaborative deep learning with application to human activity recognition." *Proceedings of the 2017 ACM on Conference on Information and Knowledge Management*. 2017.
- [10] Schirrmeister, Robin Tibor, et al. "Deep learning with convolutional neural networks for EEG decoding and visualization." *Human brain mapping* 38.11 (2017): 5391-5420.

Weight perception in exoskeleton-supported teleoperation

Mareike Förster¹, Su-Kyoung Kim¹, Michael Maurus¹, Shivesh Kumar¹, Bigna Lenggenhager²,
Elsa Andrea Kirchner^{1,3}

1) Robotics Innovation Center, German Research Center for Artificial Intelligence,
Bremen, Germany

2) Department of Psychology, University of Konstanz, Konstanz, Germany

3) Medical Technology Systems, Faculty of Engineering, University of Duisburg-Essen,
Duisburg, Germany

Keywords: force feedback, teleoperation, perception threshold, WUDM

Abstract

Despite advances and research in the area of teleoperation (e.g. (1-3)) over the last decades and the development of active exoskeletons that provide force feedback to the human for a transparent and intuitive interaction (4), it is still challenging to measure the subjective transparency of a teleoperation system. But this information is of high interest to be able to define the sensibility of the system and to optimize the interfaces used (5). To address the question of transparency, we measure the ability of a teleoperator to distinguish weights in two different conditions: weights added to the exoskeleton (“teleoperation OFF”) or to a robot under teleoperation (“teleoperation ON”, see Fig. 1a and 1b). In the latter case, weight information was transferred using force feedback between two different robot platforms, i.e., RH5 Manus humanoid [6] and Recupera-Reha exoskeleton [7]. The implemented teleoperation framework utilizes the force control available in the exoskeleton and kinematic control on the humanoid. The movement intention of the human inside the exoskeleton is transferred to the humanoid robot using workspace scaling. On the other hand, forces and torques felt by the end-effector of the humanoid are scaled and transferred as additional end-effector forces in the exoskeleton’s inverse dynamic model using HyRoDyn [8] to enable force feedback. Experiments were performed during a single-arm teleoperation setup without transferring movements from the human to the robot but only force feedback from the robot to the human via the exoskeleton. Both conditions, i.e., “teleoperation ON” condition (Fig. 1b) and “teleoperation OFF” condition (Fig. 1a) were compared when adding weights either to a basket attached to the robot’s end effector or to the end of the exoskeleton’s hand interface structure. An adaptive procedure was used to determine the perception threshold to optimize sampling level.

14 participants, between 21 and 30 years old and right-handed, took part in this study. Prior to the experiments, the minimally perceptible weight during teleoperation was defined at 200g. During weight changes the position of the arm of the exoskeleton and of the humanoid were predefined. The exoskeleton was under force control and the controlled robot (used in the teleoperation condition) was under position control to only transmit forces caused by the weight added to a basket that was fixed to the end effector of the robot. To avoid visual and auditory cues the participants were blindfolded and wearing noise cancelling headphones. Each experiment starts with an empty box. After 30 seconds the start of the experiment is declared. 7 subjects started in teleoperation mode and 7 subjects with the non-teleoperation condition. Weights were changed every 10s. Weights were removed or added, depending on the participants’ answers according to the weighted up-down staircase method (WUDM) by Karnbach (9). If the participant perceived no gravitational

forces, weight was added until it was perceivable. If they perceived weight, it was reduced. In this procedure for each trial the size of the increasing steps is weighted according to the last three answers of the participant. The weight is decreased one step after each correct response and increased three steps after each incorrect one leading to a convergence level of 75%. A total of 20 trials were carried out per condition.

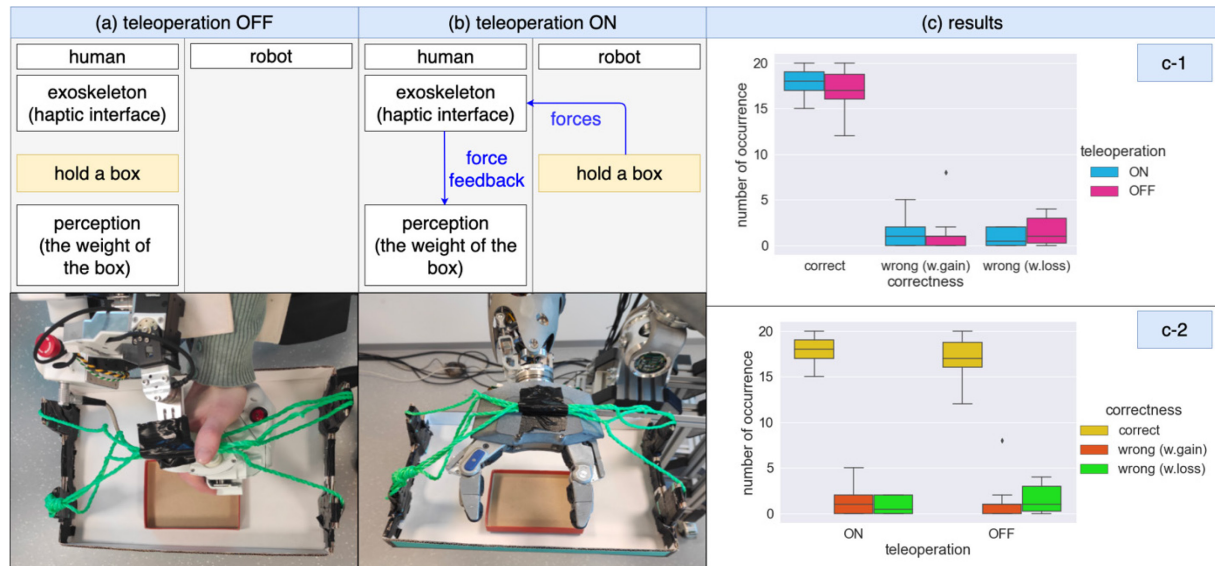

Figure 3 Experimental setup (a,b) and results (c)

For evaluation, we compared two teleoperation conditions (teleoperation ON and teleoperation OFF, see Fig. 1-c1). Further, we also compared two types of errors, which are distinguished according to whether errors occurred when the weight is decreased or increased (errors in w.gain and w. loss, see Fig. 1-c2). For statistical analysis, we performed Friedman test with two within subjects-factors (teleoperation and error type). Dunn's tests were performed as post-hoc analysis and Bonferroni correction was performed for multiple comparisons. We found no significant differences between both teleoperation conditions for both correct and erroneous responses [teleoperation ON vs. teleoperation OFF: $p = n.s.$, see Fig. 1c-1]. Further, we found high accuracy of weight estimation for both teleoperation modes [teleoperation ON in correct responses vs. teleoperation OFF in correct responses: $p = n.s.$, see Fig. 1c-2] and no significant differences between both error types [$p = n.s.$, see Fig. 1c-2].

In summary, we were able to show that our force feedback approach during teleoperation was able to transfer weight sensation comparably well as adding weights directly to the exoskeleton the user is wearing. In the future, we will conduct further experiments to measure the transfer of forces from a teleoperated system to a human via an exoskeleton while the human is teleoperating the robot, i.e., while both systems are under force control and the human is moving the robot via the exoskeleton. This will be a next step in evaluating the transparency of a teleoperation system.

References

- (1) Ji, Y. and Gong, Y., "Adaptive Control for Dual-Master/Single-Slave Nonlinear Teleoperation Systems with Time-Varying Communication Delays," in *IEEE Transactions on Instrumentation and Measurement*, vol. 70, pp. 1-15, 2021, Art no. 5503015, doi: 10.1109/TIM.2021.3075527.
- (2) Hokayem, P. F and Spong, M. W (2006). "Bilateral teleoperation: An historical survey". In: *Automatica* 42.12, pp. 2035–2057.
- (3) Melchiorri, C. (2013). "Robot Teleoperation". In: *Encyclopedia of Systems and Control*, p. 14.

- (4) Mallwitz, M. et al. (2015). The CAPIO Active Upper Body Exoskeleton and its Application for Teleoperation. In Proceedings of the 13th Symposium on Advanced Space Technologies in Robotics and Automation, (ASTRA-2015), ESA.
- (5) Feyzabadi, S. et al. (2013). Human Force Discrimination during Active Arm Motion for Force Feedback Design. In: IEEE transactions on haptics 6.3, pp. 309–319.
- (6) M. Boukheddimi, S. Kumar, H. Peters, D. Mronga, R. Budhiraja and F. Kirchner, "Introducing RH5 Manus: A Powerful Humanoid Upper Body Design for Dynamic Movements," *2022 International Conference on Robotics and Automation (ICRA)*, 2022, pp. 01-07, doi: 10.1109/ICRA46639.2022.9811843.
- (7) Kumar S, Wöhrle H, Trampler M, Simnofske M, Peters H, Mallwitz M, Kirchner EA, Kirchner F. Modular Design and Decentralized Control of the RECUPERA Exoskeleton for Stroke Rehabilitation. *Applied Sciences*. 2019; 9(4):626. <https://doi.org/10.3390/app9040626>
- (8) Kumar, S., Szadkowski, K. A. V., Mueller, A., and Kirchner, F. (February 6, 2020). "An Analytical and Modular Software Workbench for Solving Kinematics and Dynamics of Series-Parallel Hybrid Robots." *ASME. J. Mechanisms Robotics*. April 2020; 12(2): 021114. <https://doi.org/10.1115/1.4045941>
- (9) Kaernbach, C. (1991). "Simple adaptive testing with the weighted up-down method". In: *Perception & psychophysics* 49.3, pp. 227–229.

Session AI & Machine Learning

Tuesday, October 11th

09:40 – 11:00

12:20 – 14:00

Interactive Machine Learning for Neuroadaptive Technology

Stephen Fairclough¹, Alexander Karran²

1) Liverpool John Moores University, UK

2) HEC Montréal, Canada

Keywords: Interactive Machine Learning, EEG, Psychophysiology, Interest

Abstract

Neuroadaptive technology is heavily reliant on supervised machine learning for the real-time classification of psychological states. This approach generates a classification model that is based on a training data of labelled data. One significant challenge for supervised machine learning in the context of neurotechnology concerns the ability of the classification model to generalize to examples beyond the training dataset. This issue is particularly relevant when neuroadaptive technology must transition from the laboratory to real-world conditions, or from one population of users to another.

Interactive Machine Learning (IML) (Amershi et al. 2014; Dudley & Kristensson, 2018) represents a potential solution to this problem. IML describes a way of improving machine learning by allowing the human user to play an active role during the training of an algorithm. This idea is not new but its relevance has increased in light of complimentary initiatives to make artificial intelligence explainable in human terms (Barredo Arrieta et al. 2020).

This paper describes an exploration of IML in the context of real-time classification of participant responses to movie trailers. A group of 14 participants watched movie trailers and were asked to subjectively indicate their level of interest as high or low. Physiological data (EEG, ECG and SCL) were collected as participants viewed the movie trailers and used to predict a binary classification of interest via a Support Vector Machine (SVM) algorithm. The movie trailers were presented to participants in sequence of four batches, each containing 7-9 trailers. After the first batch, participants' subjective ratings were used to train the initial version of the SVM. During the second batch, participants received feedback from the SVM (i.e., high vs. low interest) and were invited to agree or disagree. The labels received from the participants were recorded and used to retrain the algorithm prior to presentation of the third batch. This procedure was repeated for the fourth and final batch. Both mathematical accuracy (F1) and subjective accuracy (the level of agreement between system feedback and participants' self-assessment) were recorded after each retraining of the SVM. Statistical analyses revealed no significant increase in F1 with each subsequent cycle of retraining, however there was a significant increase of subjective accuracy. Correlational analyses indicated a higher level of agreement between machine classification and subjective self-assessment during the final two cycles of retraining.

The study raises a question of how we should assess the accuracy of machine learning algorithms for implicit assessment of user states using neuroadaptive technology. It also demonstrates how the application of IML led to higher levels of agreement between system accuracy and subjective self-assessment. The implications of these findings for the future design of neuroadaptive technology are discussed.

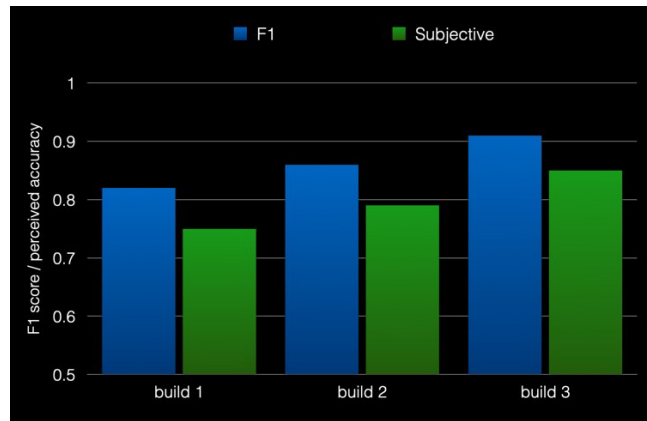

Figure 1. Mathematical accuracy (F1) and subjective accuracy of SVM algorithm to assess binary level of interest across all three re-builds of the system.

References

- Amershi, Saleema, Maya Cakmak, William Bradley Knox, and Todd Kulesza. 2014. "Power to the People: The Role of Humans in Interactive Machine Learning." *AI Magazine* 35(4):105–20. doi: 10.1609/aimag.v35i4.2513
- Barredo Arrieta, Alejandro, Natalia Díaz-Rodríguez, Javier Del Ser, Adrien Bennetot, Siham Tabik, Alberto Barbado, Salvador Garcia, Sergio Gil-Lopez, Daniel Molina, Richard Benjamins, Raja Chatila, and Francisco Herrera. 2020. "Explainable Artificial Intelligence (XAI): Concepts, Taxonomies, Opportunities and Challenges toward Responsible AI." *Information Fusion* 58:82–115. doi: <https://doi.org/10.1016/j.inffus.2019.12.012>.
- Dudley, John J., and Per Ola Kristensson. 2018. "A Review of User Interface Design for Interactive Machine Learning." *ACM Trans. Interact. Intell. Syst.* 8(2). doi: 10.1145/3185517.

BCI-based Deep Reinforcement Learning for Robot Training

Mathias Vukelić¹, Michael Bui¹, Katharina Lingelbach¹

1) Fraunhofer Institute for Industrial Engineering IAO, Stuttgart, Germany

Keywords: BCI, EEG, Deep Reinforcement Learning, Robotics

Abstract

Introduction: Deep reinforcement learning (DRL) can be used as a strategy to teach robots (or agents) how to independently solve complex tasks [1]. In real-world scenarios the agent, however, faces the challenge of sparse extrinsic rewards, also called *sparse reward environments*. Learning autonomously goal-directed behaviour is still very time-consuming or sometimes even impossible. Hence, it is appealing to use interactive DRL [2] or more generally *learning from human feedback (HF)* [3], [4]. Our work is mainly inspired by the proposed method of [5] and [6] using error-related brain potentials (ErrP) [7], [8]. As detailed in [5], [6], the *DRL + HF algorithm* consists of three stages: 1) calibration of a Brain-Computer Interface (BCI) for the automatic recognition of perceived errors (ErrP), 2) estimation of a human feedback (HF) policy (approximation of a fully-connected neural network in real-time) based on BCI feedback and 3) learning a final DRL strategy from sparse rewards in which the HF policy guides the RL policy.

Method: We extended the work of [5] and systematically evaluated the practical feasibility of different EEG-systems (gel vs. dry) for the ErrP-based BCI calibration in a physical realistic 3-D robot simulation environment. For this purpose, we developed a simulation environment in which a gripping, navigation, and collision avoidance task needs to be learned by the Frank Emika Panda 7-DOF robot, following [6], combining PyBullet [12], OpenAI Gym [13] and LSL [14]. In a **first study** ($N = 16$ participants), we aimed to compare the BCI classification performance of a high standard mobile gel-based EEG-system (64-channel actiCAP slim system and LiveAmp 64 wearable 24-bit amplifier from BrainProducts GmbH) with that of a high standard mobile dry-based EEG-system (CGX Quick-20r from Cognionics Inc). In all the experiments, participants were instructed to monitor the navigation steps of the robot behaviour while trying to reach a target and avoiding self-collision or collision with an obstacle. The shortest path (A* search algorithm calculated in each given state) from a defined start to the end position (goal) has been defined as the optimal path or the intended behaviour of the robot. Participants mentally evaluated whether the robot performed the intended behaviour (visually indicated in each state). 500 single robot movements from each of the participants were recorded while the robot performed erroneous actions with a fixed probability (20%) [8]. While [5] compared the BCI-based DRL + HF algorithm to a sparse reward function (RL sparse) and a richer reward function (RL rich), we were primarily interested in the difference between an *implicitly* trained version of a HF policy function compared to an *explicitly* trained one. We, thus, implemented two versions of the DRL + HF algorithm in a **second proof-of-concept study** ($N = 5$ participants): 1) allowing implicit BCI-based given feedback and 2) allowing explicitly given feedback. Based on the findings from the first study, we used the dry-EEG system and EEGNet [9] for calibration of the BCI model, while data collection for the calibration (stage 1) was the same as explained above. In stage 2, participants were instructed to observe the agent performing random actions while trying to reach the goal. For the implicit version, the calibrated BCI classifier was used to train in real-time the HF policy (prediction that an action will receive a positive feedback). As a comparison, the HF policy was also trained with explicitly given input using the same procedure, but

with the difference that the data for the evaluation were not predicted from the EEG but were queried directly via a keyboard input. In both versions, a total of 1000 feedback labels per participant were collected. To account for possible problem of noisy BCI classification [5], we also simulated noisy given explicit feedback, hence, participants trained two HF policy versions (good vs. poor). Finally, all HF policies were used for learning in stage 3: the robot agent was trained for the same task with a Deep Deterministic Policy Gradient (DDPG) from sparse rewards using the HF Policy as the initial policy to improve exploration. As learning progresses, the HF policy was reduced and increasingly the learned RL policy was used as the behavioural strategy. For evaluation, the success rate weighted by the normalised path length (SPL) [10] was used.

Results: Study 1: We compared the gel-EEG with 64 and 16 channels and dry-EEG with 20 channels in four machine learning algorithms. The algorithms comprised classical feature extraction in combination with linear classifiers 1) LDA and 2) SVC, 3) classification based on Riemannian geometry (Riemann Classifier) [11] and 4) a convolutional neural network (CNN) based EEGNet classifier [9] for the classification of observed optimal (positive) and suboptimal (error) robot behaviour. Model performance was evaluated and compared using Monte Carlo simulation (using averaged cross-validated ROC-AUC). Our results showed that the EEGNet performed best with no statistically significant difference between the gel- and dry-based EEG. The number of channels also showed no significant difference. On average, the EEGNet architecture achieved a ROC-AUC score of 0.911 (64ch gel-EEG), 0.910 (16ch gel-EEG) and 0.836 (dry-EEG). **Study 2:** As seen in the figure below, all three BCI-based versions show that the DRL learning process has been significantly accelerated and a better asymptotic learning performance is achieved (compared to sparse rewards). The implicit BCI version shows a comparable asymptotic behavior to that achieved by explicitly trained feedback (e.g., using 70% acc in B), showing that with better BCI accuracy the variance of the learning process is reduced. **Conclusion and Future Work:** With the first study, we show that the EEGNet classifier and dry-based EEG-system provide a robust and fast method for automatically assessing sub- and optimal robot behaviour. Results from study 2 show that the implicit BCI-based version with the dry EEG-system can significantly accelerate the DRL learning process in a realistic simulation environment with a comparable performance even to that achieved by an explicitly trained version. As a next step, we plan to verify our results in a larger cohort of subjects and transfer this approach to more complex scenarios. For example, in a dual-task scenario to answer additional research questions: Can we implicitly detect and classify error-related brain potentials in a dual-task task? How are the neuronal processes (and probably classification) dependent on different mental load levels?

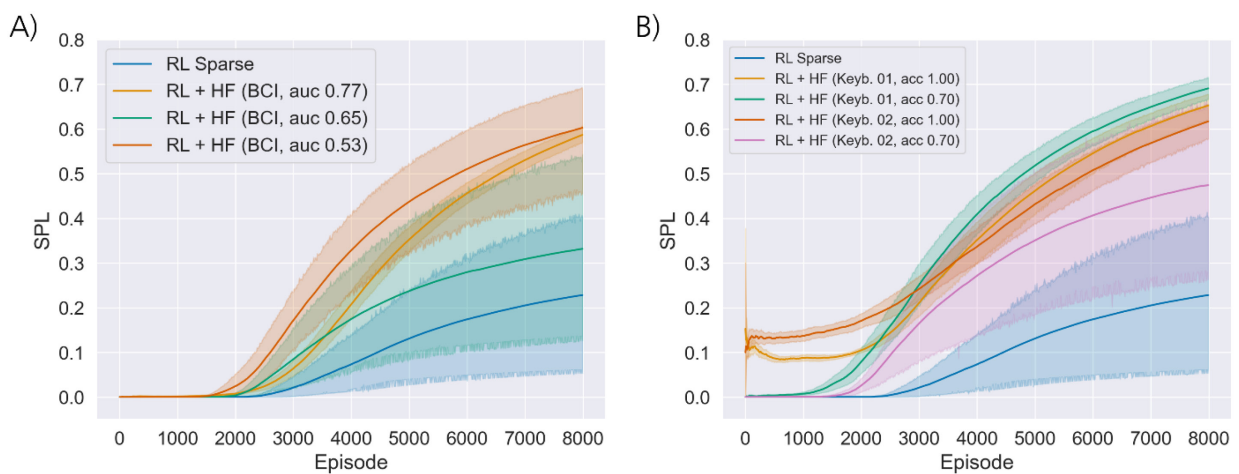

Three successfully trained models with BCI (A) and four versions with explicit feedback from two subjects each with a good (100%) and poor (70%) version (B). Blue shows the trained model using only sparse rewards. In all the experiments, 10 models of 8000 episodes were trained, where solid lines show the mean value estimated with bootstrapping and the shaded area the confidence interval.

References

- [1] V. Mnih *et al.*, “Human-level control through deep reinforcement learning,” *Nature*, vol. 518, no. 7540, pp. 529–533, Feb. 2015, doi: 10.1038/nature14236.
- [2] S. K. Kim, E. A. Kirchner, A. Stefes, and F. Kirchner, “Intrinsic interactive reinforcement learning – Using error-related potentials for real world human-robot interaction,” *Sci Rep*, vol. 7, no. 1, p. 17562, Dec. 2017, doi: 10.1038/s41598-017-17682-7.
- [3] P. Christiano, J. Leike, T. B. Brown, M. Martic, S. Legg, and D. Amodei, “Deep reinforcement learning from human preferences,” 2017, doi: 10.48550/ARXIV.1706.03741.
- [4] G. Warnell, N. Waytowich, V. Lawhern, and P. Stone, “Deep TAMER: Interactive Agent Shaping in High-Dimensional State Spaces,” *arXiv:1709.10163 [cs]*, Jan. 2018, Accessed: Apr. 08, 2022. [Online]. Available: <http://arxiv.org/abs/1709.10163>
- [5] I. Akinola *et al.*, “Accelerated Robot Learning via Human Brain Signals,” *arXiv:1910.00682 [cs]*, Aug. 2020, Accessed: Apr. 08, 2022. [Online]. Available: <http://arxiv.org/abs/1910.00682>
- [6] Z. Wang, J. Shi, I. Akinola, and P. Allen, “Maximizing BCI Human Feedback using Active Learning,” 2020, doi: 10.48550/ARXIV.2008.04873.
- [7] M. Spüler and C. Niethammer, “Error-related potentials during continuous feedback: using EEG to detect errors of different type and severity,” *Front. Hum. Neurosci.*, vol. 9, Mar. 2015, doi: 10.3389/fnhum.2015.00155.
- [8] I. Iturrate, R. Chavarriaga, L. Montesano, J. Minguez, and J. del R. Millán, “Teaching brain-machine interfaces as an alternative paradigm to neuroprosthetics control,” *Sci Rep*, vol. 5, no. 1, p. 13893, Nov. 2015, doi: 10.1038/srep13893.
- [9] V. J. Lawhern, A. J. Solon, N. R. Waytowich, S. M. Gordon, C. P. Hung, and B. J. Lance, “EEGNet: a compact convolutional neural network for EEG-based brain–computer interfaces,” *J. Neural Eng.*, vol. 15, no. 5, p. 056013, Oct. 2018, doi: 10.1088/1741-2552/aace8c.
- [10] P. Anderson *et al.*, “On Evaluation of Embodied Navigation Agents,” 2018, doi: 10.48550/ARXIV.1807.06757.
- [11] A. Appriou, A. Cichocki, and F. Lotte, “Modern Machine-Learning Algorithms: For Classifying Cognitive and Affective States From Electroencephalography Signals,” *IEEE Syst. Man Cybern. Mag.*, vol. 6, no. 3, pp. 29–38, Jul. 2020, doi: 10.1109/MSMC.2020.2968638.
- [12] <https://github.com/bulletphysics/bullet3>
- [13] <https://github.com/openai/gym>
- [14] <https://github.com/chkothe/pylsl>

Improving fNIRS-based BCIs with Convex Optimization for Generalized Classification and Semi-Supervised Learning

Ethan Harvey¹, Liang Wang¹, Mai Vu², and Robert J.K. Jacob¹

1) Department of Computer Science, Tufts University, Medford, MA, USA

2) Department of Electrical & Computer Engineering, Tufts University, Medford, MA, USA

Keywords: Brain-computer interface, convex optimization, functional near-infrared spectroscopy, mental workload, n-back task, regularized least squares, shallow neural networks

Abstract

In this paper, we show how recent approaches in convex optimization can be used to improve the classification of functional near-infrared spectroscopy (fNIRS) signal data for brain-computer interfaces (BCIs). Using the Tufts University fNIRS to Mental Workload (fNIRS2MW) open-access dataset, we found that a convex relaxation of single hidden layer neural networks underperforms regularized least squares (LS) optimization when the neural network model is individualized, but significantly outperforms LS when the model is generalized across all participants' data. We analyze a semi-supervised version of the shallow neural networks for relabeling bad data and show that this relabeling further improves the classification accuracy. Furthermore, we visualize the learned models and find that they capture distinct and meaningful features, specifically the changing oxygenation levels in the left and right hemisphere of the prefrontal cortex.

Introduction

In our work creating real-time fNIRS-based BCIs, a core challenge is to use the changes in received patterns of near-infrared light (650-900 nm) shone directly onto the brain through the skull to classify the intensity of mental workload of the user. Convex optimization is especially relevant for BCI problems, since linear processing methods, such as frequency filters, spatial filters, signal transformations, and classifiers, are widely used in BCI research (Heger *et al.*, 2014). Previous work by Heger *et al.* has shown that regularized LS optimization can achieve competitive results for solving feature extraction, feature selection, and classification for individualized models in fNIRS-based BCIs.

Since the work by Heger *et al.*, a convex relaxation approach for training shallow neural networks with theoretical guarantees has been introduced to solve non-convex training. Work by Tolga Ergen and Mert Pilanci shows that the introduced relaxation preserves the location of the global minimum for a single neuron which can be extended to multineuron single hidden layer networks, proving that a globally optimal solution can be efficiently found via a gradient method (Ergen *et al.*, 2017).

Methods

We used the Tufts University fNIRS2MW open-access dataset. The dataset includes fNIRS brain activity recordings from 68 participants during a series of controlled n-back experimental tasks

designed to induce working memory workloads of varying relative intensity. It also includes fNIRS brain activity recordings from 19 participants which are unqualified based off the performance of those participants (Huang et al., 2021).

We show that the problem of predicting fNIRS signal data can be formulated as the following optimization problem using shallow neural networks with a single neuron

$$\underset{x}{\text{minimize}} \frac{1}{2} \|g(Ax) - y\|_2^2 \quad (1)$$

where $g(\cdot)$ is a nonlinear activation function, $A \in \mathbb{R}^{n \times d}$ is the data matrix, $x \in \mathbb{R}^d$ is the parameter matrix, and $y \in \mathbb{R}^n$ is the observation matrix.

Work by Tolga Ergen and Mert Pilanci shows that for the ReLU function, i.e., $g(x) = \max\{0, x\}$, in order to make the problem convex, we can relax $f(x)$ as follows

$$f_r(x) = \|g(Ax)\|_2^2 - 2y^T Ax + \|y\|_2^2 \quad (2)$$

while preserving the location of the global minimum (Ergen et al., 2019). For multineuron single hidden layer networks, given enough samples, the true parameters can be achieved since we can obtain more equations than the number of parameters (Zhong et al., 2019).

Results

We evaluate one four-class task (**0-1-2-3**) with a window length of 30 seconds using 10-fold cross validation to compare the classification results of a convex relaxation of shallow neural networks to the classification results of regularized LS (Heger et al., 2014). We found that training individualized shallow neural networks resulted in overfitting and performed worse than regularized LS. However, training generalized shallow neural networks (generalized over all participants' data) for feature selection and classification performed better than regularized LS, increasing testing accuracy from 31.90% to 35.40% (chance = 25%).

Next, we implement and analyze a semi-supervised version of the multineuron single hidden layer networks for relabeling bad data, where the classified output of the neural network is used for relabeling the data before re-training the network, and compare the classification results of shallow neural networks with and without the relabeled data. We found that using semi-supervised learning to relabel bad data increased testing accuracy from 35.40% to 36.08%.

Furthermore, we visualize the learned models and analyze their characteristics. Figure 1 shows the learned parameters for a generalized semi-supervised shallow neural network with 10 neurons for feature selection. As seen in the figure, each of the 10 neurons learned a pattern that helps distinguish between changing oxygenation levels in the left and right hemisphere of the prefrontal cortex for the four-class task.

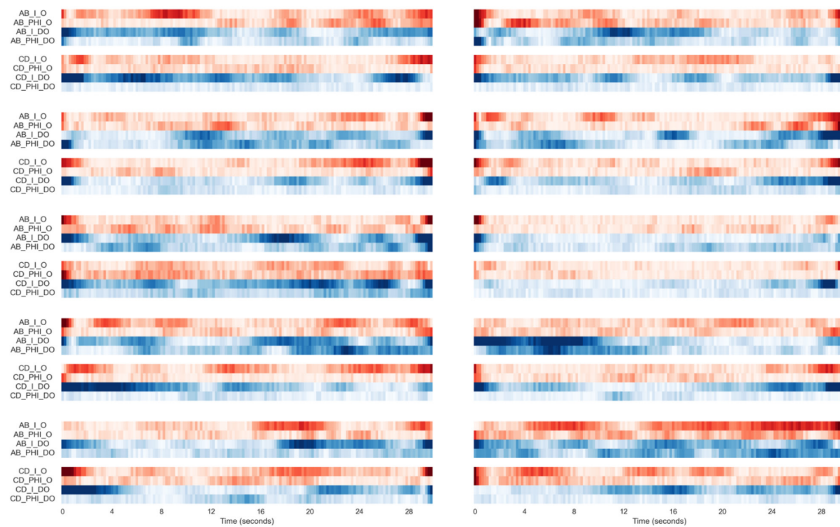

Figure 1. Visualization of the weights of each neuron learned by the generalized semi-supervised multineuron model.

References

- D. Heger, C. Herff, and T. Schultz (2014). Combining Feature Extraction and Classification for fNIRS BCIs by Regularized Least Squares Optimization. *In proceedings of the 36th Annual International Conference of the IEEE Engineering in Medicine and Biology Society.*
- T. Ergen and M. Pilanci (2019). Convex Optimization for Shallow Neural Networks. *In proceedings of the 57th Annual Allerton Conference on Communication, Control, and Computing.*
- Z. Huang, L. Wang, G. Blaney, C. Slaughter, D. McKeon, Z. Zhou, R. Jacob, and M. C. Hughes (2021). The Tufts fNIRS Mental Workload Dataset & Benchmark for Brain-Computer Interfaces that Generalize. *In proceedings of the Neural Information Processing Systems Track on Datasets and Benchmarks.*
- K. Zhong, Z. Song, P. Jain, P. L. Bartlett, and I. S. Dhillon (2017). Recovery Guarantees for One-hidden-layer Neural Networks. *In proceedings of the 34th International Conference on Machine Learning.*

Versatile neuroadaptive feedback platform using reinforcement learning

Martin Dinov¹, Lena Asai^{1,2}, Dzera Kaytati¹, Robert Leech³

1) MaaMind Ltd.

2) University College London

3) King's College London

Keywords: neuroadaptive delivery, multimodal alerts, attentional lapses

Abstract

We ran a multimodal study (n=48, 2 hours of tasks per participant) showing that neuroadaptively-targeted alerts are effective at improving reaction time (RT) on long (approx. 40 minutes and 1 hour in 2 different types of tasks), attentionally demanding tasks. In total, we collected almost 90 hours of high-quality multi-modal physiological and behavioral data. The study used reinforcement learning (RL) for training a neuroadaptive system in real-time per-participant. This led to the RL system learning meaningful internal representations within a few hundred trials, such that it learned to deliver stimulation feedback with different modalities (sound alerts, light flickers, tactile vibrations) through a variety of platforms for delivering feedback including smartphone, experiment laptop and a gamepad. We call this type of system a neuroadaptive feedback platform (NFP). We have thereby shown that this NFP technical setup and system is in principle adaptable to different usecases and settings.

Local and global alpha band power from electroencephalography (EEG) were used as the main input to the reinforcement learning (RL) system, along with a reward signal based on the recent reaction times on the experimental tasks. Alongside the EEG, we recorded heart rate variability (HRV), along with subjective mood and cognitive state through experience sampling questionnaires, as well as speech for tonality-based speech emotion recognition.

We extended the well-established [1] attention network test for interactions (ANT-I), by bringing in tactile and visual alerts along with the acoustic alert and the orienting signals. We call this extended version of the task the Attention Network Test for Interactions, Multimodal (ANTI-M). In addition, a more real-world simulation-like task, which we call the Luggage Monitoring Task (LMT), was used, based on work in [2], which was extended to allow neuroadaptive (and randomised) alerts, comparable to the ANTI-M. Finally, the RL-based alerting system extends prior similar research [3, 4].

The key novelty of this research project was:

- 1) A versatile neuroadaptive feedback delivery platform connecting real-time measurement, real-time learning system and a real-time delivery system in different forms. Having a final delivery system in the form of a smartphone, which can receive and act on neuroadaptive output triggers is a very general-purpose approach to providing neuroadaptive feedback to participants. This opens up multiple real-world usecases where the ubiquitous smartphone can intelligently guide human performance and behavior in targeted directions.
- 2) We showed that providing tactile feedback through a game controller (a PlayStation 4 controller) in one of the experimental conditions for half (n=24) of the participants, led to the highest effect on improving on-task performance. Tactile alerts delivered via the game controller led to an overall decrease in reaction time without significantly increasing error trials (which the acoustic alerts tended to do more frequently). This paves the way for incorporating neuroadaptive feedback in various settings where gamepad-like controllers are

being used, including in gaming, flying, drone control, but also to be applied in adjacent settings like cars with steering wheels able to deliver tactile feedback.

References

[1] Ishigami Y, Eskes GA, Tyndall AV, Longman RS, Drogos LL, Poulin MJ. (2016). The Attention Network Test-Interaction (ANT-I): reliability and validity in healthy older adults. *Exp Brain Res.* 2016 Mar;234(3):815-27. doi: 10.1007/s00221-015-4493-4. Epub 2015 Dec 8. PMID: 26645310.

[2] Langhals BT, Burgoon JK, Nunamaker JF. Using Eye-Based Psychophysiological Cues to Enhance Screener Vigilance. *Journal of Cognitive Engineering and Decision Making.* 2013;7(1):83-95. doi:10.1177/1555343412446308

[3] Dinov, M. (2018). The design and implementation of novel computational and machine learning approaches for modelling brain dynamics: Towards more interpretable and real-time brain analysis. Retrieved November 10, 2020, from <https://spiral.imperial.ac.uk/handle/10044/1/59105>

[4] Dinov, M., & Leech, R. (2017). Tracking and optimizing human performance using deep reinforcement learning in closed-loop behavioral- and neuro- feedback: A proof of concept. doi:10.1101/225995

Classifier Visualisation Reveals Saliency, Valence, and Serial Dependency in a Modified Implicit Cursor Control Paradigm

Laurens R. Krol^{1,2}, Juliane Pawlitzki^{1,2}, Klaus Gramann¹, Thorsten O. Zander^{1,2}

- 1) Biological Psychology and Neuroergonomics, Technische Universität Berlin, Germany
- 2) Neuroadaptive Human-Computer Interaction, Brandenburg University of Technology Cottbus-Senftenberg, Germany

Keywords: Implicit control, extended feature analysis, mental state detection

Introduction

Brain-computer interfaces (BCIs) use classifiers to detect specific patterns in brain activity, allowing them to interpret ongoing activity, both post hoc and in real time [1]. Some classifier types can be interpreted neurophysiologically, meaning an inspection of their weight vectors can reveal aspects of the underlying brain processes [2]. This makes these classifiers, originally designed for BCI experiments, particularly useful for post hoc analyses in traditional neuroscientific studies, effectively providing a data-driven method to study effects between conditions—provided that these effects can indeed be revealed using the chosen inspection method. Commonly, interpreting classifier weights is done by looking at their *pattern*, i.e. the forward model revealing the projection pattern of the brain process isolated by the classifier [2]. It remains a challenge, however, to interpret these scalp-level patterns in terms of cortical *sources*, i.e. the actual regions of the brain where the relevant brain activity originated. To that end, we have previously developed a classifier visualisation technique that combines these forward models with a blind source separation decomposition [3]. In its current iteration, this method returns a visual representation of the relevance of sources to the classifier. Here, this method was applied to a modified implicit cursor control paradigm. It allowed the separation of two different cognitive processes, and revealed a serial dependency in the experimental design hidden to any other analysis.

Implicit cursor control

Implicit cursor control here refers to an experimental paradigm, first shown in 2014 [4,5]. In it, the participants observe a cursor move on a computer screen, and, unbeknownst to them, a passive BCI interprets their implicit brain activity in response to individual cursor movements in order to guide the cursor towards a target. The target was originally given, but can be self-chosen as well [6]. Cursor movements were interpreted by the participant as either “good” or “bad” with respect to reaching this target. The classifier could detect this interpretation with roughly 70% accuracy, and use it to guide the cursor in the “good” direction, i.e., towards the target. A potential confound in the original design of this experiment was that the target was visually salient on the screen, and “good” movements were thus always “towards” a salient point, whereas “bad” movements were “away” from the salient point. It is thus possible that cognitive processes related to visual saliency (towards/away) overlapped with the main processes of interest related to valence (good/bad).

Methods

This current experiment uses a modified experimental paradigm in which the two processes of salience and valence are separated. This is done by placing the visually salient target in the middle of a semi-circular grid and having two conditions in which participants are told to either interpret 1) “towards” the target as “good” and “away” as “bad”, or 2) vice versa. We could thus isolate valence from salience by looking at cursor movements that went in the same direction but had different interpretations, and isolate salience from valence by looking at cursor movements in different directions that had the same interpretation. We used the same windowed-means paradigm as in [5] to implement the classifier, and applied the classifier visualisation method of [3] to interpret it.

Results and conclusion

Results are shown in Figure 1. A classifier calibrated to isolate valence (top) shows different source contributions than a classifier isolating salience (middle). The salience classifier sees more contributions from occipitoparietal sources whereas the valence classifier is focused more on medial-prefrontal sources. This is in line with expectations. Importantly, however, significant differences were also found in the contributed sources between participants who performed one, or the other condition first. The lower row in Figure 1 shows the sources, similar for both valence and salience classifiers, for participants who first interpreted “towards” as “bad”. This surprising finding of serial dependency in the study design was revealed only by the classifier visualisation method; other measures, e.g. reaction times and event-related potentials, did not produce significant differences.

To conclude, a visual inspection of different classifiers reveals that both valence and visual salience can play a role in implicit cursor control. The fact that it is possible to create a valence-focused classifier has potentially wide-ranging implications for human-computer interaction, but has an important ethical component as well, as the subjective interpretation of what is “good” and “bad” can potentially reveal highly sensitive information. Finally, in this experiment, the classifier visualisation method uniquely identified a serial dependency in the data not seen by other analyses.

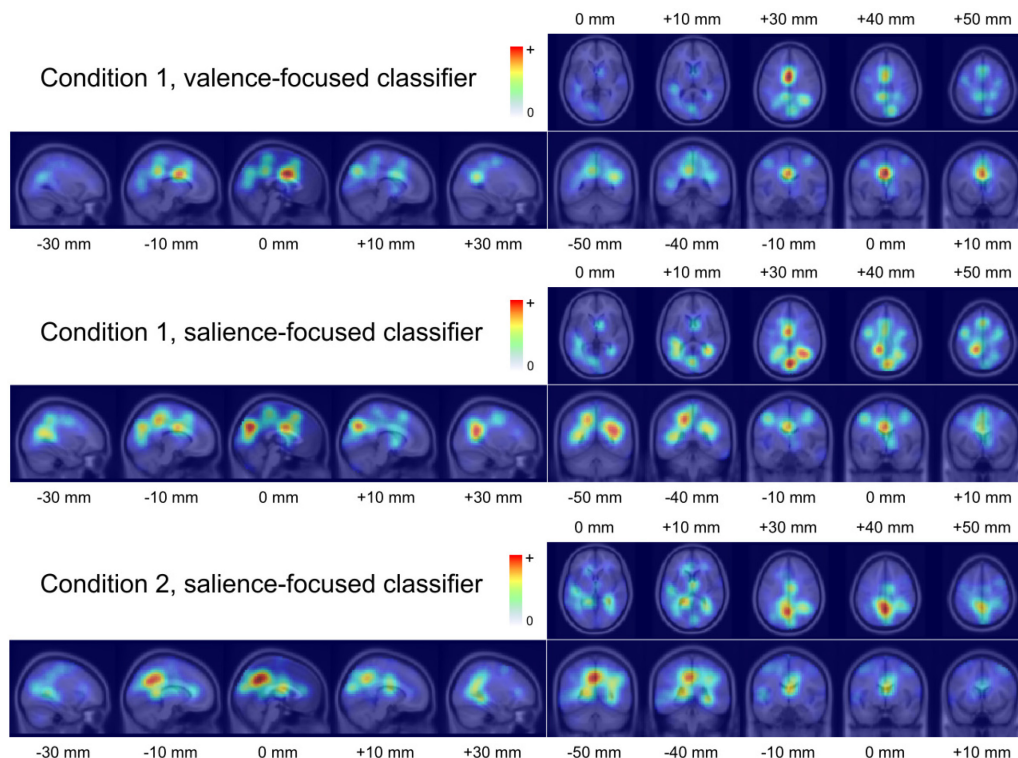

Figure 1. Classifier visualisation results.

References

1. Lotte, F., Bougrain, L., Cichocki, A., Clerc, M., Congedo, M., Rakotomamonjy, A., & Yger, F. (2018). A review of classification algorithms for EEG-based brain-computer interfaces: a 10 year update. *Journal of Neural Engineering*, *15*(3), 031005. doi: 10.1088/1741-2552/aab2f2
2. Haufe, S., Meinecke, F., Görgen, K., Dähne, S., Haynes, J.-D., Blankertz, B., & Bießmann, F. (2014). On the interpretation of weight vectors of linear models in multivariate neuroimaging. *NeuroImage*, *87*, 96–110. doi: 10.1016/j.neuroimage.2013.10.067
3. Krol, L. R., Mousavi, M., de Sa, V. R., & Zander, T. O. (2018). Towards classifier visualisation in 3D source space. In *2018 IEEE International Conference on Systems, Man, and Cybernetics (SMC)* (pp. 71–76). doi: 10.1109/SMC.2018.00022
4. Zander, T. O., Brönstrup, J., Lorenz, R., & Krol, L. R. (2014). Towards BCI-based implicit control in human-computer interaction. In S. H. Fairclough & K. Gilleade (Eds.), *Advances in physiological computing* (pp. 67–90). Berlin, Germany: Springer. doi: 10.1007/978-1-4471-6392-3_4
5. Zander, T. O., Krol, L. R., Birbaumer, N. P., & Gramann, K. (2016). Neuroadaptive technology enables implicit cursor control based on medial prefrontal cortex activity. *Proceedings of the National Academy of Sciences*, *113*(52), 14898–14903. doi: 10.1073/pnas.1605155114
6. Stivers, J. M., Krol, L. R., de Sa, V. R., & Zander, T. O. (2016). Spelling with cursor movements modified by implicit user response. In *Proceedings of the 6th International Brain-Computer Interface Meeting* (p. 59). Graz, Austria: Verlag der TU Graz. doi: 10.3217/978-3-85125-467-9-59

Interpretable Deep Neural Networks for EEG-based Auditory Attention Detection with Layer-Wise Relevance Propagation

Gabriel Ivucic¹, Felix Putze¹, Siqi Cai², Haizhou Li², Tanja Schultz¹

- 1) Cognitive Systems Lab, University of Bremen, Bremen, Germany
- 2) Department of Electrical Engineering, National University of Singapore, Singapore, Singapore

Keywords: EEG, Explainable AI, Deep Neural Network, Layer-Wise Relevance Propagation

Abstract

Deep Neural Networks (DNNs) recently found their way into cognitive neuroscience serving as powerful computational models. However, the complexity of deep learning models results in an uninterpretable black box, preventing neurophysiological insight into processes behind the decision of the model.

In this work, we present an explanation approach for a DNN in spatial auditory attention detection (AAD) with electroencephalography (EEG), based on Layer-Wise Relevance Propagation (LRP)¹. LRP decomposes the prediction of the DNN into relevance heatmaps that represent the importance of the spectro-spatial image features regarding the decision of the network, illustrated in Figure 1. To validate the LRP explanation for the DNN, (1) the relation between relevance heatmaps and the output of the network is examined via relevance-guided input perturbation. Further, (2) structural features and potential prediction strategies in the LRP heatmaps are investigated by spectral clustering of relevance heatmaps.

The results indicate that explanation heatmaps generated by LRP highlight areas in the cortical activation images that predominantly impact the decision of the network. The clustering approach found distinct patterns in relevance maps, individually for each subject, revealing the importance of neuro-physiologically plausible frontal, lateral, and rear brain areas for auditory attention. This work demonstrates that LRP can fill the interpretability gap in the development of DNNs for EEG-based AAD. The relevance heatmaps of single input samples combined with the knowledge of global prediction strategies open up the ability to investigate sample groups of interest at will, which renders LRP as a tool to reveal potential neural- or decisional processes underlying the deep learning model.

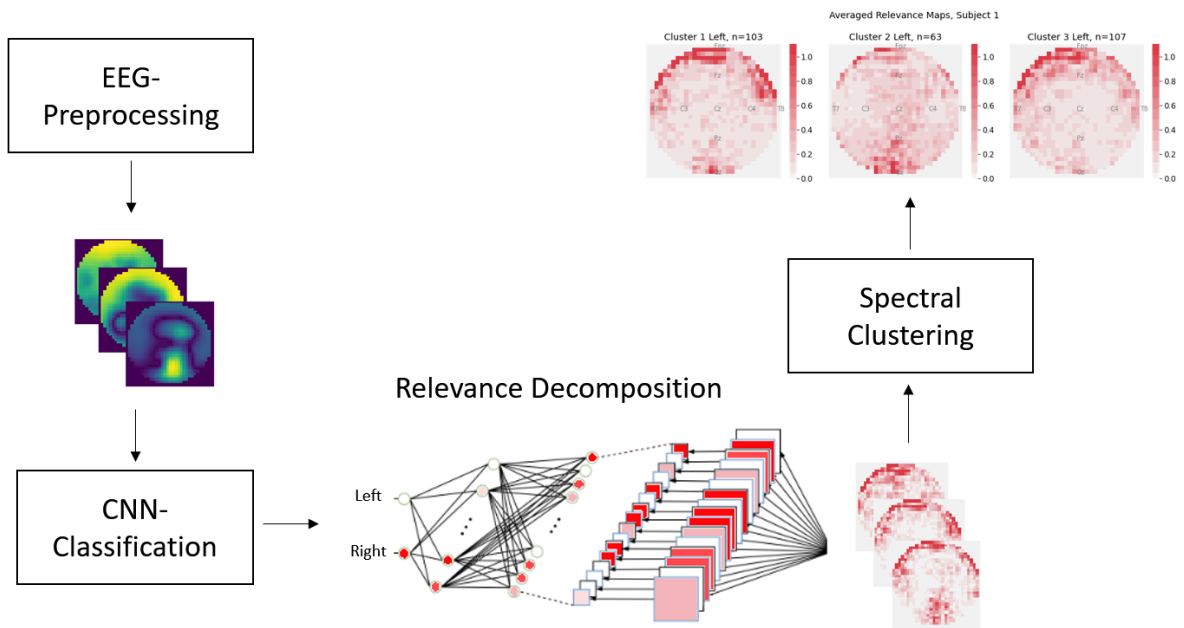

Figure 1: Pipeline for classification and interpretation of auditory attention with EEG: 1) Preprocessing of EEG-data to obtain 1-second decision windows as spectro-spatial image features (top of image: frontal brain area). 2) Convolutional Neural Network for the prediction of spatially left or right auditory attention. 3) Schematic visualization of the layer-wise decomposition procedure as defined by LRP. The resulting heatmaps for each decision window indicate relevant pixels for the classification result in red. 4) Spectral clustering of relevance heatmaps reveals three structural decision patterns for participant 1 and class left.

References

- 1 Montavon, G., Binder, A., Lapuschkin, S., Samek, W., and Müller, K.-R. (2019). Layer-wise relevance propagation: an overview. Explainable AI: interpreting, explaining and visualizing deep learning, 193–209

Simple Probabilistic Data-driven Model for Adaptive BCI Feedback

Jelena Mladenović^{1,2}, Fabien Lotte¹, Jérémie Mattout³, Jérémy Frey⁴

¹ Computation Faculty, Union university, Belgrade, Serbia; ² Potioc, Inria Bordeaux Sud-Ouest, France; ³CoPhy, CRNL, INSERM, University of Lyon, France; ⁴Ullo, La Rochelle, France

Keywords: Adaptive BCI, Probabilistic model

Abstract

Due to abundant signal and user variability among others, BCIs remain difficult to control. To increase performance, adaptive methods are a necessary means to deal with such a vast spectrum of variable data. Typically, adaptive methods deal with the signal or classification corrections (adaptive spatial filters [1], co-adaptive calibration [2], adaptive classifiers [3]). As such, they do not necessarily account for the implicit alterations they perform on the feedback (in real-time), and in turn, on the user, creating yet another potential source of unpredictable variability. Namely, certain user's personality traits and states have shown to correlate with BCI performance, while feedback can impact user states [4]. For instance, altered (biased) feedback was distorting the participants' perception over their performance, influencing their feeling of control, and online performance [5]. Thus, one can assume that through feedback we might implicitly guide the user towards a desired state beneficial for BCI performance. An adaptive, Active (Bayesian) Inference model was proposed as a way to develop entirely adaptive BCI as it can include different dynamics of signal and user variabilities by relying on user and task models [6]. In a simple case (one level of adaptation), by inferring dynamic user reactions to feedback, it can adapt the feedback in order to maximise performance. However, Active Inference demands explicit conceptions of user and task models specific to each case, and its current implementation seems to necessitate high computational power, making it sub-optimal for real-time BCI.

If we wish to maximise performance by influencing the user through dynamic feedback while accounting for user's reactions, we could achieve that with a simple probabilistic, adaptive model, as follows. Given a finite number of possible feedback or actions $a = 1, 2, \dots, n$, $a(r)$ per run $r = 1, \dots, m$, each action creates a corresponding user's reaction or observation $o_a(r) \in R$ as online performance. Next to the observations and actions, the model primarily contains: (i) the priors about the user k_a which are static but different for each action; (ii) the confidence about priors α which is a constant value (same for each action), and (iii) an exploration/exploitation parameter $w(r)$ that is a function of time but is the same for each action. The priors, if available, prescribe the best first action for a specific user type (e.g., a certain feedback for a certain personality trait). Otherwise they prescribe equal probabilities to each first action $k_a = p(\frac{1}{n})$. After every new run r , the model keeps the observation (online performance) from the previous run and each time calculates the new weighted average per action $\mu_a(r)$, with given parameters: $\mu_a(r) = w(r)\mu_a(o_a(r-1)) + \alpha k_a$. The model transforms the new mean vector of actions: $\mu(\mathbf{r}) = \mu_a(r) = [\mu_1(r), \mu_2(r), \dots, \mu_n(r)]$ into probabilities using a softmax function $\sigma(\mu(\mathbf{r}))$; resulting as a vector of probabilities to select one of n future actions: $[P(a(r+1))] = P(\sigma(\mu(\mathbf{r})))$. Thus, this model is not deterministic, which leaves a slight chance for the least probable action to be chosen, thus enabling exploration.

We tested our adaptive model offline on real data from 30 participants from [5]. In that study, participants were separated into 3 groups, each receiving one out of three possible feedback (actions) as: positive bias, negative bias, and no bias. Authors also collected personality traits, states and calibration performance of participants, and divided the participants into high and low scores depending on whether their scores were above or below the median value. As no participant received all 3 actions, to be able to test our adaptive model, we simulated virtual participants as follows. One virtual participant contained data from 3 actual participants (one from each group) such that all 3 of them shared at least 2 personality traits or calibration performance. For instance, if 3 participants had high scores on anxiety and low scores on calibration performance, then they would create one virtual participant. This way we expect to minimise the individual differences and homogenise the reactions to feedback, simulating a real participant. We managed to create 48 virtual participants. As the experiment in [5] was performed over two sessions, then the *average online performance* (observations per run per action) from the first session served to train our model's priors as *training data*. On the other hand, we randomly picked *average online performance* from the runs of the second session, to serve as *testing data*. The priors prescribe the best action (here, a bias type) for a specific user (given personality trait or calibration performance scores). Thus, priors are calculated as the normalized mean of *training data* per action of all real participants who share one trait. That is, if one virtual participant pairs low anxiety and high extroversion, we would first calculate the average of *training data* for each trait separately and then average them together to fit our virtual user. As result, our prior is different for each action, which enables one specific first action (bias) to be chosen for a user type.

As depicted in Figure 1, for 48 virtual users and 20 repetitions, we compare the following models: (i) Adaptive model without priors – called *ModelAdaptive*, (ii) Adaptive model with wrong priors, i.e., prescribing the worst first actions for each virtual user – *ModelAdaptive+AntiPriors*, (iii) Adaptive model with correct priors – *ModelAdaptive+Priors*, (iv) Static model performing always positive bias – *ModelFixed_positive*, (v) Static model performing always negative bias – *ModelFixed_negative*, (vi) Static model performing always realistic feedback – *ModelFixed_nobias*, (vii) Static model with priors for all participants – *ModelPriors*, (viii) Static model with wrong priors for all – *ModelAntiPriors*, (ix) Model performing completely random action without priors – *ModelRandom*.

1-way ANOVA (independent variable: model, dependent variable: performance) with FDR correction showed significant increase of performance ($p < 0.05$) of the *ModelAdaptive+Priors* when compared to all other models.

We are aware that this method has 2 flaws. First, the virtual users are not real, and second, the observations i.e., reactions to feedback are not consecutive but randomly picked from the testing dataset. However, those are common drawbacks of most offline methods. This adaptive model promises great potential as it is intuitive, simple to implement, fairly flexible and resilient to wrong priors. In the future, we plan to test this model online.

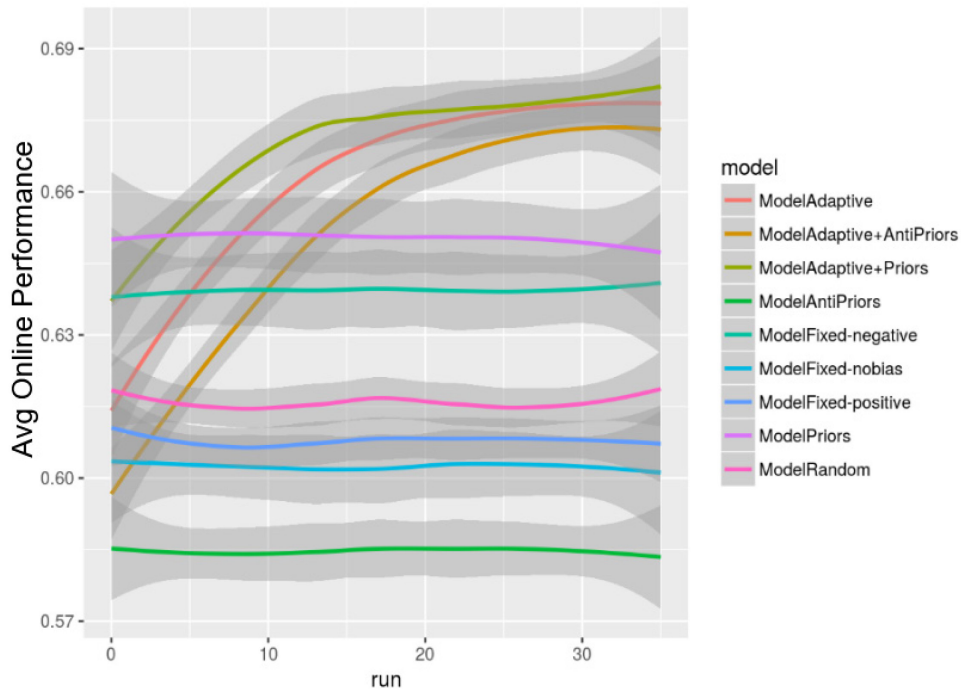

Fig.1. Evolution of models over 40 runs for 48 virtual participants and 20 repetitions, for online performance. We can observe that the adaptive model with priors reaches the highest performance, and that naturally the static model with wrong priors performs the worst.

References

- Sannelli, Claudia, et al. "Ensembles of adaptive spatial filters increase BCI performance: an online evaluation." *Journal of neural engineering* 13.4 (2016): 046003.
- Vidaurre, Carmen, et al. "Co-adaptive calibration to improve BCI efficiency." *Journal of neural engineering* 8.2 (2011): 025009.
- Vidaurre, Carmen, et al. "A fully on-line adaptive BCI." *IEEE Transactions on Biomedical Engineering* 53.6 (2006): 1214-1219.
- Mladenović, Jelena, et al.. "A generic framework for adaptive EEG-based BCI training and operation." *Brain-Computer Interfaces Handbook*. CRC Press, 2018. 595-612.
- Mladenović, Jelena, et al. "Towards identifying optimal biased feedback for various user states and traits in motor imagery BCI." *IEEE Transactions on Biomedical Engineering* 69.3 (2021): 1101-1110.
- Mladenovic, Jelena, et al. "Active inference as a unifying, generic and adaptive framework for a P300-based BCI." *Journal of Neural Engineering* 17.1 (2020): 016054.

Creating adaptive state-representation in neurophysiological systems using Gaussian state-space model

Nat Wannawas¹, A. Aldo Faisal^{1,2,3}

1) Department of Bioengineering, Imperial College London, UK

2) Department of Computing, Imperial College London, UK

3) the University of Bayreuth, Germany

Keywords: Reinforcement Learning, State Representation, real-time signal processing, partial observation, Neurostimulation

Abstract

Neuromodulation is a technique that applies interventions such as electrical stimulation to alter neural activities. The control of neuromodulation relies on observable neurological feedbacks such as EEG to determine appropriate interventions. However, the dynamics of neurological systems are not yet well-understood, and their corresponding observable feedbacks are difficult to interpret. This poses challenges in hand-crafting the closed-loop intervention policies. Reinforcement Learning (RL) is a promising approach that can learn the policies without interpretable observations. Recently, RL has been applied to adaptively control biological neural network stimulation [1], deep brain stimulation [2,3], and neuromuscular stimulation [4]. However, RL typically works on fully observable systems while the actual states of the neurological system may just be partially observed through the feedback signals. This partial observation can cause perceptual aliasing problems [5] in which the same observations are produced from the different internal states of the systems. These aliasing problems can lead to wrong intervention decisions as well as the failure of RL to learn the policies. Solving these aliasing problems is a stepstone to harnessing the full potential of RL in Neuromodulation applications.

Here, we approach the aliasing problem through state-space modelling in which observations are the partial and noisy parts of internal states. We want to infer the internal states or create their representation and use them in place of the observations to prevent the aliasing problem. We presume that the internal states can be inferred through the history of observations and create a method based on Gaussian State Space Model (GSSM) which combines recurrent neural network (RNN) with state-space modelling [6,7,8].

To concretely state the problem, we aim to learn the state representation x whose transition function, parameterized by θ , $p_\theta(x_{t+1}|x_t)$ is Markovian. The trajectory x is generated by an RNN, parameterized by φ , based on the history of observations $y_{1:t}$, expressed as $q_\varphi(x_t|y_{1:t})$. In the training, both θ and φ are updated such that the transition function produces the internal state trajectories that match those generated from the observation data. After the training, the RNN q_φ can be used to generate the state representation x in an online fashion; this can be view as an adaptive online filtering.

As a demonstration and experimentation, we apply this method to a simulation system of neuromuscular stimulation. This system has a human arm with the stimulation applied to the biceps muscle to lift the arm against gravity. The internal state comprises $[\theta_t, \dot{\theta}_t, f, stim.]^T$, where f is muscle

fatigue that causes the decline of muscle force production given a certain level of stimulation. This setup has an aliasing problem because f is not observed. Without knowing f , the next state $[\theta_{t+1}, \dot{\theta}_{t+1}]^T$ is difficult to precisely predict as illustrated by the red error bars in Fig.1b which is the result of fitting Gaussian Process (GP) to observation data. The prediction uncertainty greatly reduces, and the prediction accuracy greatly increases (Fig.1b, blue error bars) in the case of the state-space approach. This result shows that our method can distinguish the aliasing observations, leading to a more precise prediction of the results of the stimulation or the intervention. This proof-of-concept experiment suggests that our method could be used to infer the internal states of, for example, the brain activity, which is partially observed through EEG or ECoG recording, leading to better decoding or brain-computer interfacing.

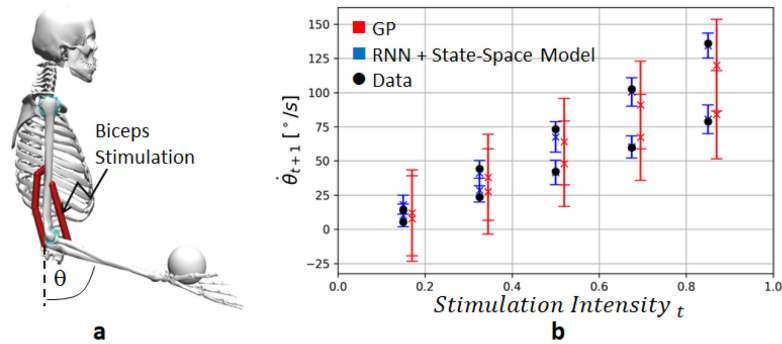

Fig.1 (a) A neuromuscular stimulation system of human arm. (b) The system's next states given the stimulation intensities. The dots in the upper and lower rows show the true responses when the fatigue levels are low and high, respectively. The error bars show the standard deviations of the predictions.

References

- [1] J. M. Wulfing, S. S. Kumar, J. Boedecker, M. Riedmiller, U. Egert (2019). Adaptive long-term control of biological neural networks with Deep Reinforcement Learning. *Neurocomputing* 342.
- [2] M. Lu, X. Wei, Y. Che, J. Wang, K. A. Loparo (2020). Application of Reinforcement Learning to Deep Brain Stimulation in a Computational Model of Parkinson's Disease. *IEEE Tras. On Neural System and Rehabilitation Engineering, Vol. 28, No. 1, 2020*.
- [3] J. Watts, A. Khojandi, R. Vasudevan, R. Ramdhani (2021). Optimizing Individualized Treatment Planning for Parkinson's Disease Using Deep Reinforcement Learning. *Proc. 42nd Intl. Conf. Engineering & Biology Society (EMBC)*.
- [4] N. Wannawas, M. Subramanian, A. A. Faisal (2021). Neuromechanics-based Reinforcement Learning of Neurostimulation Control of FES cycling. *Proc. 10th Intl. Conf. Neural Engineering*.
- [5] L. Chrisman (2017). Reinforcement Learning with Perceptual Aliasing: The Perceptual Distinctions Approach. *Conf. on Artificial Intelligence (AAAI 1992)*.
- [6] N. Wannawas, A. Shafti, A.A. Faisal (2022). Neuromuscular Reinforcement Learning to Actuate Human Limbs through FES. *Proc. IFESS 2022, 2022*.
- [7] R.G. Krishnan, U. Shalit, D. Sontag (2017). Structured Inference Networks for Nonlinear State Space Models. *Proc. 31st Conf. on Artificial Intelligence (AAAI 2017)*.
- [8] E. Eleftheriadis, T. Nicholson, M. P. Deisenroth, J. Hensman (2017). Identification of Gaussian Process State Space Models. *Proc. 31st Conf. Neural Information Processing Systems (NIPS 2017)*.

Signal Alignment for Cross-dataset Transfer Learning in P300 Brain-Computer Interfaces

Minseok Song¹, Daeun Gwon¹, Kyungho Won², Sung Chan Jun², Minkyu Ahn¹

1) Department of Computer Science and Electrical Engineering, Handong Global University

2) School of Electrical Engineering and Computer Science, Gwangju Institute of Science and Technology

Keywords: Signal alignment, Brain-Computer Interface, Transfer learning

Introduction

Over the past decade, more and more brain-computer interface (BCI) data such as electroencephalogram (EEG) have been opened to the BCI field. This trend probably facilitates the research to overcome various problems existing in BCIs and move BCI technology forward. However, there is still a big hurdle in reusing the shared data. Basically, data have different characteristics due to different paradigms, subjects, equipment, and experimental environments. This limits applying one data to another experiment or BCI application. For example, one model constructed by a dataset may not fit to classify trials in a different experimental setting, consequently causing poor performance in the system. To solve this problem, researchers have designed and attempted various algorithms including deep learning [1]–[3]. But those methods require intensive or complex computing. As known, the key point of P300 BCI is discriminating the intended object from the unintended. The main feature of this discrimination is based on the fact that the amplitude of the event-related potentials (ERP) of the target stimulus is higher than the amplitude of non-target ERP. Unfortunately, the pattern of ERPs may vary across datasets. For example, the amplitude scale and the phase of ERP could be different and consequently causing the shift of the distribution of features that do not fit the classification hyperplane constructed from another dataset. In this study, we propose a simple signal alignment approach for overcoming the signal differences among datasets of P300 BCIs possibly with different experimental settings.

Method

Given source data S and target data T consisting of ERPs of intended stimulus, the data T_i of i th subject in target data can be aligned into the standard ERP $\langle S_j \rangle$ in source data by a linear transformation as $\hat{S}_i = \alpha_i \{T_i, \beta_i\}$ using two parameters; scale (α_i) and delay (β_i). The symbol S_j is the ERP of j th subject in target data, $\{T, \beta\}$ denotes delaying the T signal by the points β , and $\langle \cdot \rangle$ denotes the average across subjects. The optimal α_i can be found from the ratio between the standard deviations of two ERPs as $\alpha_i = \sigma(\langle S_j \rangle) / \sigma(T_i)$ and β_i can be easily calculated by checking the shift showing the highest normalized cross-correlation coefficient between two ERPs. For example, the $xcorr()$ function in MATLAB can be used like $\beta_i = xcorr(\langle S_j \rangle, T_i, 'normalized')$.

The actual application of this method is illustrated in the left side of Fig.1. For evaluation, we employed P300 BCI datasets. Basically, the two P300 datasets were recorded from different subjects, devices, and application environments (e.g., User Interface).

The first EEG data [4] (Biosemi data) was obtained from the P300 BCI speller experiment with 55 healthy participants using Biosemi Active2 (Biosemi Inc., 32 channels and 512Hz sampling rates).

Subjects watched each letter of “BRAIN” and “POWER” sequentially, and the experiment was implemented by the default P300 BCI speller in BCI2000 software. This dataset was used as source data.

The second data [5] (DSI data) was recorded during playing the P300 BCI application controlling a flying drone from 20 healthy participants. DSI-VR300 (Wearable sensing Inc., 7 dry electrodes: Fz, Pz, Oz, P3, P4, PO7, and PO8, and 300Hz sampling rates) was used for signal acquisition. In the task of the experiment, subjects watched one of seven buttons marked with arrows indicating ‘forward’, ‘up’, ‘down’, ‘right’, ‘turn right’, ‘left’, and ‘turn left’ to control the drone. The overall experiment was implemented in OpenViBE software. This dataset was evaluated as target data.

Both datasets were preprocessed in the following order. First, all data were re-referenced (Common Average Reference) and band-pass filtered (0.5Hz to 30Hz). Second, epochs were extracted from 200ms to 600ms after the onset of each stimuli blinking, and the baseline was corrected using the average of the data from -200ms to 200ms. Finally, the data were down-sampled to 128Hz sampling rates to reduce the dimension of the data. Three classifier models were generated. First (without alignment) and second (with alignment) models were constructed using source data (Biosemi data). But the third model was constructed from the subject’s own data as a conventional approach for comparison. EEGNet [6] was employed for the classifier model in this study. These models were tested to classify target data (DSI data).

Result

The accuracy result is shown in the right side of Fig. 1. The mean accuracies of the three models are 80.3% (without alignment), 85.1% (with alignment), and 85.6% (conventional). In the right panel of Fig. 1b, the f-score is shown. The three models show 77.7% (without alignment), 79.2% (with alignment) and 79.7% (conventional). A statistical test revealed no significant differences between ‘with alignment’ and ‘conventional approach’.

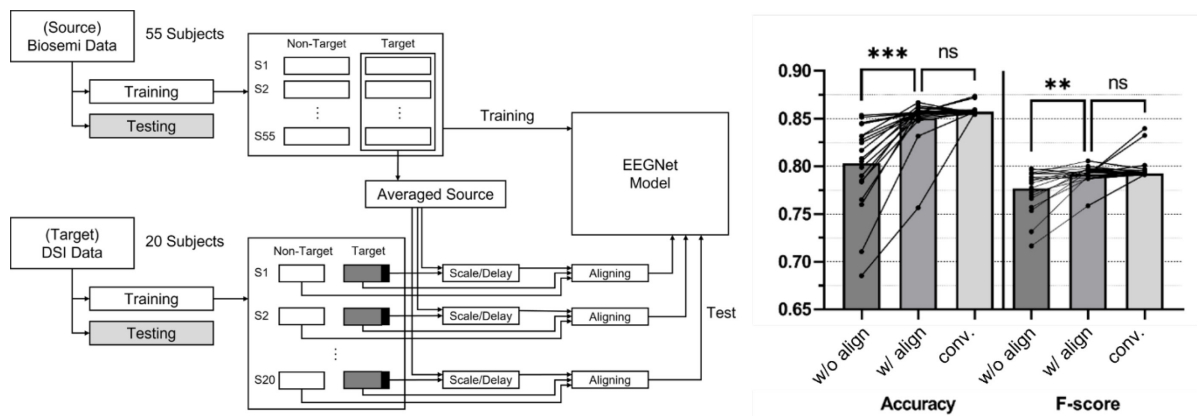

Figure 1. (Left) Workflows of proposed ERP alignment method. ERP of each subject in target data (DSI) is aligned into the template ERP of source data (Biosemi) using scale and delay parameters. (Right) Performance of EEGNet. Three models’ (without align, with align, and conventional model) results are illustrated.

Conclusion

In this study, we proposed a simple signal alignment method for P300 BCIs. The results demonstrated that the proposed method shows comparable performance to the conventional approach that a model is generated from the subject’s own data. We believe that the proposed method can be used for reducing the calibration time in P300 BCIs and also establishing effective transfer learning across different datasets.

Acknowledgement

This work was also supported by the Institute of Information & Communications Technology Planning & Evaluation (IITP) grant (No. 2017-0-00451) and National Research Foundation of Korea (NRF) grant (NRF-2021R111A3060828) funded by the Korea government.

References

- [1] E. Santamaria-Vazquez, V. Martinez-Cagigal, F. Vaquerizo-Villar, and R. Hornero, "EEG-Inception: A Novel Deep Convolutional Neural Network for Assistive ERP-Based Brain-Computer Interfaces," *IEEE Trans. Neural Syst. Rehabil. Eng.*, vol. 28, no. 12, pp. 2773–2782, 2020, doi: 10.1109/TNSRE.2020.3048106.
- [2] S. Chambon, M. N. Galtier, P. J. Arnal, G. Wainrib, and A. Gramfort, "A Deep Learning Architecture for Temporal Sleep Stage Classification Using Multivariate and Multimodal Time Series," *IEEE Trans. Neural Syst. Rehabil. Eng.*, vol. 26, no. 4, pp. 758–769, 2018, doi: 10.1109/TNSRE.2018.2813138.
- [3] S. Bakas *et al.*, "Team Cogitat at NeurIPS 2021: Benchmarks for EEG Transfer Learning Competition," pp. 1–4, 2022, [Online]. Available: <http://arxiv.org/abs/2202.03267>
- [4] K. Won, M. Kwon, M. Ahn, and S. C. Jun, "EEG Dataset for RSVP and P300 Speller Brain-Computer Interfaces," pp. 1–11, 2022, doi: 10.1038/s41597-022-01509-w.
- [5] S. Kim, S. Lee, H. Kang, S. Kim, and M. Ahn, "P300 brain–computer interface-based drone control in virtual and augmented reality," *Sensors*, vol. 21, no. 17, 2021, doi: 10.3390/s21175765.
- [6] V. J. Lawhern, A. J. Solon, N. R. Waytowich, S. M. Gordon, C. P. Hung, and B. J. Lance, "EEGNet: a compact convolutional neural network for EEG-based brain–computer interfaces," *J. Neural Eng.*, vol. 15, no. 5, p. 056013, Oct. 2018, doi: 10.1088/1741-2552/aace8c.

Poster Session

Tuesday, October 11th

11:00 – 12:20

Using Granger Analyses to Measure Functional Connectivity in Response to Demand and Experimental Pain

Stephen Fairclough¹, Kellyann Stamp¹, Chelsea Dobbins²

1) Liverpool John Moores University, UK

2) University of Queensland, Australia

Keywords: Pain, Attention, fNIRS, Functional Connectivity, Granger Causality

Abstract

Previous work on neuroadaptive gaming systems has utilised measures of functional connectivity in order to classify players' response to game demand. This work seeks to extend this analysis by applying Granger analyses to the dorsal and ventral attention networks (DAN & VAN) (Corbetta et al., 2008). It has been argued that cognitive demand distracts attention from painful stimuli via topdown reinforcement of task goals (DAN), whereas pain exerts an interruptive effect on performance via bottom-up pathways (VAN) (Torta et al, 2017). The current study explores this explanatory framework by combining functional near-infrared spectroscopy (fNIRS) with Granger causal connectivity analyses (GCCA) (Seth, 2010) while manipulating pain and task demand. 21 participants played a racing game at low and high difficulty levels with or without experimental pain (cold pressor test). Six channels of fNIRS were collected from bilateral frontal eye fields and intraparietal sulci (DAN) with right-lateralised channels at the inferior frontal gyrus and temporoparietal junction (VAN). Our first analysis revealed increased G-causality from bottom-up pathways (VAN) during the cold pressor test in isolation. However, an equivalent experience of experimental pain during gameplay increased G-causality in top-down (DAN) pathways with the left intraparietal sulcus serving a hub of connectivity. High game difficulty increased G-causality via top-down pathways and implicated the right inferior frontal gyrus as an interhemispheric hub. Our results are discussed with reference to existing models of both attention networks and potential for neuroadaptive technology.

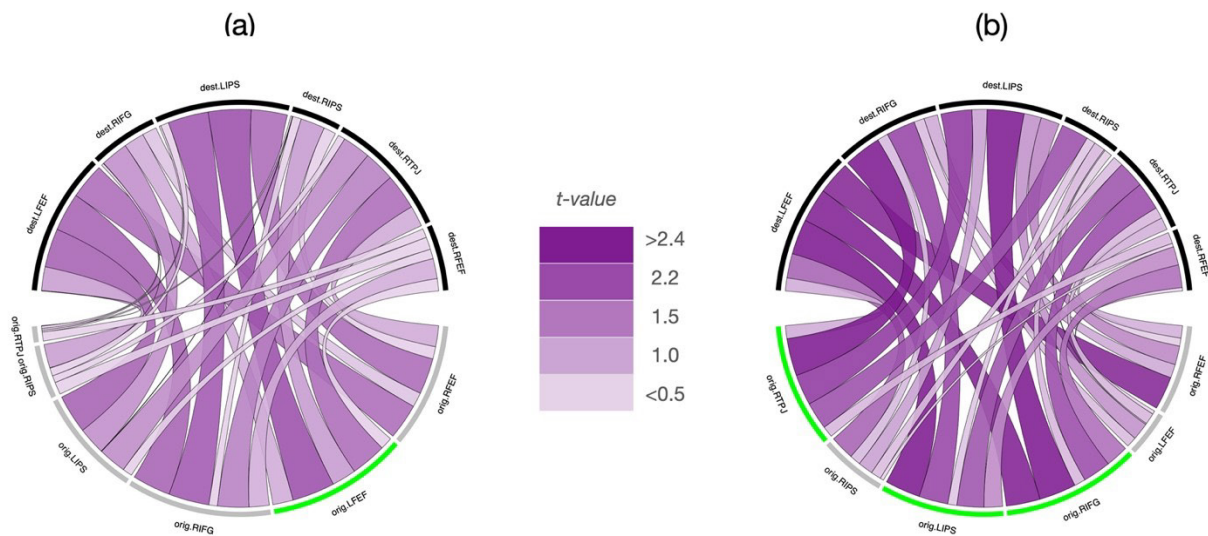

Figure 4. Chord diagram illustrating main effect of Game Difficulty as a main effect (a) and as an interaction (b) when participants also experienced the CPT. Positive values = higher G-causality due to high difficulty compared to low difficulty game. The origin of the pathway is represented by the lower half of the circle with destination provided in top half. Origin nodes illustrated in green indicate significant effect in the ANOVA model (see Table 4).

References

- Corbetta, M., Patel, G., & Shulman, G. L. (2008). The Reorienting System of the Human Brain: From Environment to Theory of Mind. *Neuron*, *58*(3), 306–324. <https://doi.org/10.1016/j.neuron.2008.04.017>
- Seth, A. K. (2010). A MATLAB toolbox for Granger causal connectivity analysis. *Journal of Neuroscience Methods*, *186*(2), 262–273. <https://doi.org/10.1016/j.jneumeth.2009.11.020>
- Torta, D. M., Legrain, V., Mouraux, A., & Valentini, E. (2017). Attention to pain! A neurocognitive perspective on attentional modulation of pain in neuroimaging studies. *Cortex*, *89*, 120–134. <https://doi.org/10.1016/j.cortex.2017.01.010>

Neurophysiological constraints on human-robot interfacing for augmentation

Renato Mio^{1,2}, A. Aldo Faisal^{1,2}

1. Institute of Artificial & Human Intelligence, Universität Bayreuth, Germany
2. Brain and Behaviour Laboratory, Imperial College London, United Kingdom

Keywords: Supernumerary robotics, Human augmentation, Motor learning

Abstract

Research on neurotechnology has been recently expanded to the realm of robotic augmentation. In particular, augmentation by wearing supernumerary (i.e. additional to the natural number of) robotic limbs has been the focus of neuroscientific research regarding human capability for controlling these devices. Specifically, supernumerary robotics fingers working in collaboration with natural fingers are a relevant testbed to study neurocognitive phenomena. Within this context, the choice of an interface modality to control augmentative devices has effects in their embodiment and in the motor learning process behind controlling them successfully [1-3].

One of the most common interfacing approaches to control supernumerary robotic limbs is substitution control, in which the extra limb is controlled by the kinematic output originally intended for other body parts. For instance, in our previous study, participants were trained to use an additional robotic finger attached to the side of the right hand and controlled by foot movements [4]. Moreover, they learned to use it in a piano playing task in under 30 minutes, which showcases human capability to quickly integrate augmentation devices in real-world tasks [4]. Crucially, it was also demonstrated that participants with better foot coordination skills also performed better in piano playing with the foot-controlled SRF [4]. This supports the idea that motor coordination metrics, in particular the ones related to the control interface, are predictive of success in robotic augmentation [4]. This can have implications for other types of interfaces with higher cognitive demands such as the ones based on neurophysiological signals decoding, in which subjects could benefit from tailored training in the modulation of these signals.

Substitution interfaces are an effective approach for short-latency real-time control. However, because essentially the degrees of freedom of one body part are transferred to the SRL, this strategy could be deemed as not being “true augmentation”, which instead implies simultaneous volitional control of natural and artificial limbs without hindering the control of the formers [5]. However, in able-bodied people, neural motor commands on the efferent pathways are already tasked with controlling all muscles. Hence, there is a shortage of signals available to voluntarily control augmentative devices without compromising the control of the biological body [6].

There have been some meaningful steps towards understanding the mechanisms for successful augmentation beyond natural motor constraints. Recent advances in non-invasive recording of individual motoneurons activity have facilitated the study of the human potential for controlling a subset of these signals independently from the motor unit pool that determines muscle force [7,8]. If attained, flexible control of spinal motor neurons will lead to the increase in the number of independently controlled neurophysiological signals available (neural output) required for true human augmentation.

References

- [1] Kieliba, P., Clode, D., Maimon-Mor, R. O., & Makin, T. R. (2021). Robotic hand augmentation drives changes in neural body representation. *Science Robotics*, 6(54), 1–14.
- [2] Zhu, Y., Ito, T., Aoyama, T., & Hasegawa, Y. (2019). Development of sense of self-location based on somatosensory feedback from finger tips for extra robotic thumb control. *ROBOMECH Journal*, 6(1), 0–9.
- [3] Amoruso, E., Dowdall, L., Kollamkulam, M. T., Ukaegbu, O., Kieliba, P., Ng, T., Dempsey-Jones, H., Clode, D., & Makin, T. R. (2022). Intrinsic somatosensory feedback supports motor control and learning to operate artificial body parts. *Journal of Neural Engineering*, 19(1), 016006.
- [4] Shafti, A., Haar, S., Mio, R., Guilleminot, P., & Faisal, A. A. (2021). Playing the piano with a robotic third thumb: assessing constraints of human augmentation. *Scientific Reports*, 11(1), 1–14.
- [5] Eden, J., Bräcklein, M., Ibáñez, J., Barsakcioglu, D. Y., di Pino, G., Farina, D., Burdet, E., & Mehring, C. (2022). Principles of human movement augmentation and the challenges in making it a reality. *Nature Communications*, 13(1), 1345.
- [6] Dominijanni, G., Shokur, S., Salviotti, G., Buehler, S., Palmerini, E., Rossi, S., Vignemont, F. de, Avella, A., & Makin, T. R. (2021). The neural resource allocation problem when enhancing human bodies with extra robotic limbs. *Nature Machine Intelligence*, 3(October), 850–860.
- [7] Farina, D., & Negro, F. (2015). Common synaptic input to motor neurons, motor unit synchronization, and force control. *Exercise and Sport Sciences Reviews*, 43(1), 23–33.
- [8] Formento, E., Botros, P., & Carmena, J. M. (2021). Skilled independent control of individual motor units via a non-invasive neuromuscular machine interface. *Journal of Neural Engineering*, 18(6).

Modelling the effects of sleep deprivation – from physiological to biochemical analyses

Serdar Özsezen¹, Lars Verschuren¹, Charelle Bottenheft¹, Ivo Stuldreher¹, Robert Kleemann¹, Jan van Erp¹, Anne-Marie Brouwer¹

1) TNO, the Netherlands Organisation for applied scientific research

Keywords: sleep deprivation, cognitive performance, autonomous nervous system, biochemical markers

Introduction

Sleep deprivation is unavoidable in certain professions but negatively affects well-being, health and performance. We are interested in the relation between sleep deprivation and cognitive performance. While sleep deprivation decreases cognitive performance in general, it does so at very different degrees between individuals. As of yet, we cannot predict decreased performance due to sleep deprivation, and we do not understand what causes this decrease. If we better understand the reasons, we may predict (momentary) resilience of individuals to sleep deprivation and develop (personalized) counter measures against the negative effects. Our working hypothesis is that sleep deprivation-induced inflammatory processes underlie cognitive decline due to sleep deprivation. These processes are reflected by biochemical analytes such as cytokines, lipids and cortisol in blood and saliva. Skin conductance and heart rate may be of interest as well since they reflect the level of arousal which may also have explanatory value. The advantage of the physiological measures is that they are non-invasive and continuous.

In the current study, we compare 1 night sleep deprived and control individuals on a number of physiological, biochemical and performance markers. To evaluate the biochemical and physiological effect of sleep deprivation, we use machine learning models to select features that best describe the difference between sleep deprived and control participants.

Methods

This study was approved by the METC Brabant (approval no. NL74961.028.20). In total, 102 participants were recruited through the institute's participant pool and through direct recruitment advertisements. Ages ranged from 19 to 55 years old ($M = 28.5$, $SD = 10.3$). They were randomly assigned to spend the night awake at the research institute ($n=58$) or at home sleeping ($n=44$). All participants underwent the same measurement procedures including cognitive tests (SYNWIN multi-tasking, Psychomotor Vigilance task, Go-no go inhibition task, Sternberg working memory task, TAP-M flexibility of task switching), exposure to social stressors (Sing-a-Song Stress Test and Trier Social Stress Test) and had standardized breakfasts the morning before and after the night. Heart rate and skin conductance were recorded throughout using a Tickr chest-strap (Wahoo Fitness, Atlanta, GA, USA) and EdaMove 4 (Movisens GmbH, Karlsruhe, Germany), respectively. Sampling of saliva and blood occurred both before and after the social stressors.

Heart rate and phasic skin conductance values were determined for several intervals before, during, and after the social stressors. The concentration of cortisol and cytokines were determined in saliva and blood. Via metabolomics analyses, using the Lipidzyzer lipidomics platform, a large panel of lipid species were analyzed in blood (only samples before the social stressors).

For the modelling, we used logistic regression with an elastic net penalty. We trained the model with data of 90% of the participants using 10-fold cross validation and tested the model with the remaining participants that were completely kept separately from the training procedure. This procedure was followed once with the physiological data and once with the biochemical data from blood and saliva. In total, 40 input features were used for the physiological model and 753 input features were used for the biochemical model (729 of which concern lipid species from blood, 2 cortisol metabolites from saliva, and 22 cytokines from blood and saliva). All features concern values from the second morning, baselined for each individual participant by the values on the first morning.

Results

For all cognitive tests, we found (strongly) significant effects of sleep deprivation, showing a decrease in performance for the sleep deprived group of participants compared to the controls.

The biochemical model distinguished sleep deprived versus control participants with an accuracy of 100% for the training data; for the test data the accuracy was 90%. In total, 114 out of the 753 features contributed significantly to the model. One of these was a cortisol feature, 7 cytokine features and the remainder were lipids from various classes. By contrast, the physiological model could not distinguish sleep deprived versus control participants (accuracy of 70% for the training data, but for the test data the accuracy was 44%).

Discussion

Our study resulted in a rich database that can help elucidate associations between cognitive performance, sleep deprivation and a range of biochemical, physiological and psychological factors. Our first analyses as described here suggest that sleep deprivation does not so much affect physiological parameters (indicative of physiological arousal), but rather biochemical markers, many of which are associated to inflammatory processes. In fact, biomarkers from blood and saliva allow for a very accurate estimate of whether or not an individual is sleep deprived. Further interpretation and analyses linking effects on biochemical markers to decreases in performance are required.

Comparative Analysis of Public Dataset of Motor Imagery to Infer Compatibility

Daeun Gwon¹, Kyungho Won², Minseok Song¹,
Chang Soo Nam³, Sung Chan Jun² and Minkyu Ahn⁴

1) Department of Computer Science and Electrical Engineering of Handong Global University, Pohang, South Korea

2) School of Electrical Engineering and Computer Science of Gwangju Institute of Science and Technology, Gwangju, South Korea

3) School of Industrial and Systems Engineering of North Carolina State University North Carolina, USA

4) School of Computer Science and Electrical Engineering of Handong Global University, Pohang, South Korea

Keywords: Brain-Computer Interface, Motor Imagery, Transfer Learning, Public dataset

Introduction

The brain-computer interface (BCI) is a next-generation interface that can provide an alternative control of external devices to people with movement restrictions, such as quadriplegics [1], [2]. Basically, BCIs detect neurophysiological biomarkers associated with specific functions or states in the brain and there are various control paradigms that effectively modulate such discriminative conditions. Motor imagery (MI) is one of them and has widely used in various BCI studies because of its intuitiveness as UI, and relatively high performance among imagery based control paradigms [3]. As other BCI paradigm, however, motor imagery BCI also needs long-term recording for system calibration and possibly expensive equipment for high-quality brain signals for reliable operation with high accuracy. Because of these issues, there is a large demand for public dataset in the field and related projects (the, *MOABB* [4], *Deep BCI* [5] and BCI competition [6]) have been launched and some BCI data are available through the repositories of the projects. Expectedly, the volume of open BCI dataset will grow and larger data will be usable for various studies in the future. However, there is an important issue before using the open datasets. Basically, the experimental and environmental settings must be different across datasets although they are all motor imagery data. This mismatch may cause the differences of signals between datasets, consequently limiting the use of open datasets. Thus, quantitative and qualitative evaluation of open datasets should be made. Nonetheless, none of studies have conducted such investigation. In this study, we conducted the thorough investigation of public motor imagery datasets to check the data quality and compatibility across datasets.

Methods

We collected 8 EEG datasets of healthy subjects related to MI from resources such as journals (*Gigascience* [7] and *Scientific data* [8]), platforms (*IEEE DataPort* [9] and *MOABB*), and research projects (*Deep BCI*). The selection criteria are as follows. The dataset should be a cue-based paradigm that includes the left hand (LH) and right hand (RH) imagination paradigms. Some data include imagined independently or in combination with the left foot (LF), right foot (RF), feet (F), and each finger (EF). The EEG electrode should measure the whole head from the frontal to the occipital areas regardless of the number of electrodes. For quality measure, we calculated offline classification accuracy under the same pipeline of signal processing. In this computing, we only used left and right motor imagery data for simplicity. Data were band-pass filtered (8 – 35 Hz) and temporally segmented (500 to 3000ms post cue). Common spatial pattern (CSP) [10] and Linear discriminant analysis (LDA) that are relatively standard methods in MI based BCIs, were used. Basically, data of each subject were divided in to 10 sets and 7 sets were used for training a classifier model and the 3 sets were tested. This process was repeated 10 times, and at each repetition sets were shuffled for fair evaluation.

Finally, the average accuracy over 10 estimates were assigned as the performance to each subject. Next, we compared the feature vector generated by eight CSP filters (first and last four filters respectively) for checking the similarity of datasets.

Results and Discussion

A specification of the public dataset is provided in Table 1. The datasets were recorded by different devices (*Neuroscan*, *BrainProducts*, *Neurofax*, and *Biosemi*). The number of EEG electrode is 51.25 and the number of subjects is 23.12 on average. The number of trials per class is from a minimum of 30 to a maximum of 483. The instruction given to subjects varies across data. There were instructions to simply vaguely instruct hands to imagine the action (simple motion instruction, SMI), to direct specific actions such as imagining open-closed hands (explicit motion instruction, EMI), or to imagine muscle movements (kinetic motion instruction, KMI). In addition, the specific class to imagine was indicated by different stimulus types such as arrow, letter, and hand symbol. The offline classification accuracy was 61.34% on average (44.84% to 74.1%). However, Kim (2018) show the low accuracy for all subjects because only BCI illiterate subjects were recruited for the aim of the study.

Table 1. Data specification of public dataset

Data Name (Release Year)	Resource	Num. of Subject	Device (Num. of Electrode)	Num. of Trial		Imagery Classes	Instruction Type	Cue Display	Accuracy (%)
				L	R				
Xiaoli(2020)[11]	IEEE DataPort	6	Neuroscan SynAmps2(122)	40 ~120	40~120	LH, RH	SMI	Arrow	47.84
Lee(2019)[12]	Deep BCI, MOABB, Gigascience	54	BrainProduct BrainAmp(62)	200	200	LH, RH	SMI	Arrow	74.10
Kim(2018)[13]	Deep BCI	12	BrainProduct BrainAmp(30)	30	30	LH, RH, RF	SMI	Arrow	43.89
Murat(2018)[14]	Scientific data	13	Neurofax EEG-1200(19)	138~ 477	144~ 483	LH, RH, LF, RF, EF	EMI	Object	69.36
Cho(2017)[15]	Deep BCI, MOABB, Gigascience	52	Biosemi(64)	100~ 120	100~ 120	LH, RH	EMI	Text	69.03
Shin(2016)[16]	MOABB	29	BrainProduct BrainAmp(30)	60	60	LH, RH	KMI	Arrow	59.92
Weibo(2014)[17]	MOABB	10	Neuroscan SynAmps2(64)	70~80	70~80	LH, RH, F, LHRF, RHLF	KMI	Text	65.46
Ahn(2013)[18]	Deep BCI	10	Biosemi(19)	60	60	LH, RH	SMI	Arrow	59.13

Figure 1a shows t-SNE map of the CSP feature visualization using Mahalanobis distance. Each circle represents a single subject, and each color represents each dataset in left figure. Subjects within the same dataset form clusters on the t-SNE map. Lee (2019) and Murat (2018) show to form similar clusters, even though they are measured on different days, even months apart, by the same subjects. It would be inferred that the diversity of the dataset is more affected by the environment than the subject's state.

Figure 1b is a visualization of eight features for eight datasets. Each subject and the average over subjects are marked with gray and black lines. Similar patterns are identified because the first filter maximizes the left MI while the last filter maximizes the right MI, but notable difference presents in scale. The Euclidian distances for eight-dimensional features between Murat (2018) and Kim (2018) were closest at $3.3841e+06$, and Cho (2017) were the most distant on average from all data ($1.4488e+11$). Therefore, it is expected to be less compatible with other data. Kim (2018) shows relatively flat pattern of features compared to other datasets. It is expected that CSP filters were not well constructed and consequently producing low accuracy.

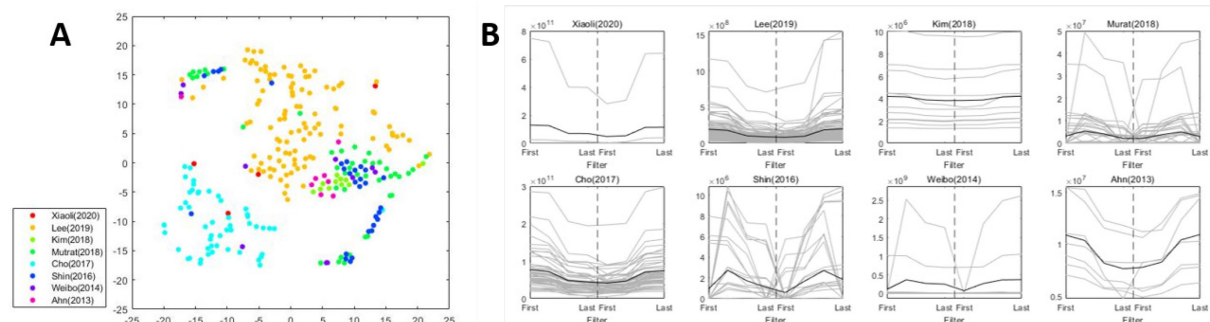

Figure 1. CSP feature visualization of dataset. A) t-SNE map of 8-dimensional features of each subject are compressed into a two-dimensional space. B) 8-dimensional features for datasets.

Conclusion

In conclusion, we collected the open MI BCI datasets, and investigated their quality and compatibility. As results, we observed that recording settings (device, trials, classes, instruction, cue) are different and the classification accuracy also varies across datasets. Additionally, we found that feature distributions may be distant between datasets although the feature patterns look similar. These findings can be used for designing the better approach of using multiple datasets to advance MI BCIs.

Acknowledgment

This research was supported by the Republic of Korea's MSIT (Ministry of Science and ICT), under the High-Potential Individuals Global Training Program (No. 2021-0-01537) supervised by the IITP (Institute of Information and Communications Technology Planning & Evaluation and National Research Foundation of Korea (NRF) grant (NRF-2021R111A3060828).

References

- [1] S. M. Grigorescu, T. Lüth, C. Fragkopoulos, M. Cyriacks, and A. Gräser, "A BCI-controlled robotic assistant for quadriplegic people in domestic and professional life," *Robotica*, vol. 30, no. 3, pp. 419–431, May 2012, doi: 10.1017/S0263574711000737.
- [2] D. Devasia, T. V. Roshini, N. S. Jacob, S. M. Jose, and S. Joseph, "Assistance for Quadriplegic with BCI Enabled Wheelchair and IoT," in *2020 3rd International Conference on Intelligent Sustainable Systems (ICISS)*, Dec. 2020, pp. 1220–1226. doi: 10.1109/ICISS49785.2020.9315992.
- [3] P. Wierzgała, D. Zapata, G. M. Wojcik, and J. Masiak, "Most Popular Signal Processing Methods in Motor-Imagery BCI: A Review and Meta-Analysis," *Frontiers in Neuroinformatics*, vol. 12, 2018, Accessed: Apr. 29, 2022. [Online]. Available: <https://www.frontiersin.org/article/10.3389/fninf.2018.00078>
- [4] V. Jayaram and A. Barachant, "MOABB: trustworthy algorithm benchmarking for BCIs," *J. Neural Eng.*, vol. 15, no. 6, p. 066011, Dec. 2018, doi: 10.1088/1741-2552/aadea0.
- [5] "Deep BCI – Deep BCI homepage." <http://deepbci.korea.ac.kr/> (accessed Apr. 30, 2022).
- [6] N. A. Alzahab *et al.*, "Hybrid Deep Learning (hDL)-Based Brain-Computer Interface (BCI) Systems: A Systematic Review," *Brain Sciences*, vol. 11, no. 1, Art. no. 1, Jan. 2021, doi: 10.3390/brainsci11010075.
- [7] "GigaScience | Oxford Academic," *OUP Academic*. <https://academic.oup.com/gigascience> (accessed Apr. 30, 2022).
- [8] "Scientific Data," *Nature*. <https://www.nature.com/sdata/> (accessed Apr. 30, 2022).
- [9] "IEEE DataPort," *IEEE DataPort*. <https://iee-dataport.org/> (accessed Apr. 30, 2022).
- [10] B. Blankertz, R. Tomioka, S. Lemm, M. Kawanabe, and K. Muller, "Optimizing Spatial filters for Robust EEG Single-Trial Analysis," *IEEE Signal Processing Magazine*, vol. 25, no. 1, pp. 41–56, 2008, doi: 10.1109/MSP.2008.4408441.
- [11] X. Wu, "Ear-EEG Recording for Brain Computer Interface of Motor Task." IEEE, Feb. 18, 2020. Accessed: Jul. 13, 2022. [Online]. Available: <https://iee-dataport.org/open-access/ear-eeg-recording-brain-computer-interface-motor-task>

- [12] M.-H. Lee *et al.*, “EEG dataset and OpenBMI toolbox for three BCI paradigms: an investigation into BCI illiteracy,” *GigaScience*, vol. 8, no. giz002, May 2019, doi: 10.1093/gigascience/giz002.
- [13] K.-T. Kim, H.-I. Suk, and S.-W. Lee, “Commanding a Brain-Controlled Wheelchair Using Steady-State Somatosensory Evoked Potentials,” *IEEE Transactions on Neural Systems and Rehabilitation Engineering*, vol. 26, no. 3, pp. 654–665, Mar. 2018, doi: 10.1109/TNSRE.2016.2597854.
- [14] M. Kaya, M. K. Binli, E. Ozbay, H. Yanar, and Y. Mishchenko, “A large electroencephalographic motor imagery dataset for electroencephalographic brain computer interfaces,” *Sci Data*, vol. 5, no. 1, Art. no. 1, Oct. 2018, doi: 10.1038/sdata.2018.211.
- [15] H. Cho, M. Ahn, S. Ahn, M. Kwon, and S. C. Jun, “EEG datasets for motor imagery brain–computer interface,” *Gigascience*, vol. 6, no. 7, Jul. 2017, doi: 10.1093/gigascience/gix034.
- [16] J. Shin *et al.*, “Open Access Dataset for EEG+NIRS Single-Trial Classification,” *IEEE Transactions on Neural Systems and Rehabilitation Engineering*, vol. 25, no. 10, pp. 1735–1745, Oct. 2017, doi: 10.1109/TNSRE.2016.2628057.
- [17] W. Yi *et al.*, “Evaluation of EEG Oscillatory Patterns and Cognitive Process during Simple and Compound Limb Motor Imagery,” *PLOS ONE*, vol. 9, no. 12, p. e114853, 9 2014, doi: 10.1371/journal.pone.0114853.
- [18] M. Ahn *et al.*, “Gamma band activity associated with BCI performance: simultaneous MEG/EEG study,” *Frontiers in Human Neuroscience*, vol. 7, 2013, Accessed: Jul. 13, 2022. [Online]. Available: <https://www.frontiersin.org/articles/10.3389/fnhum.2013.00848>

Loving Videos: A New Paradigm to Elicit Strong Positive Emotions

Meredith Sprengel^{1,2}, Sébastien Velut¹, Ivo Stuldreher^{1,3}, Femke van Engen¹, and Anne-Marie Brouwer¹

1) Human Factors, TNO, Soesterberg, The Netherlands

2) Subtle Energy Funders Collective, San Francisco, California

3) Human Media Interaction, University of Twente, Enschede, The Netherlands

Keywords: Infrared, affect-eliciting videos, positive emotions, arousal, heart rate, electrodermal activity

Introduction

Eliciting emotions in a laboratory environment is difficult, especially when it concerns strong positive emotions. Over the last few decades, affect-eliciting videos to evoke both positive and negative emotions have been used in the study of emotions. However, consistently and reliably eliciting strong positive emotions through the use of film clips is challenging. A meta-analysis examining the effectiveness of films to induce positive and negative emotional states found a larger effect size for levels of reported arousal and affective valence in videos designed to evoke negative emotions (such as fear and disgust) than videos designed to induce positive emotions (Fernandez-Aguila, 2019). We developed a paradigm to systematically produce video stimuli to participants designed to induce strong positive emotion in a controlled manner.

Previous research has found that presenting faces and names of loved ones not only elicits stronger subjective reports of positive feelings when compared to control faces and names, but is also associated with stronger physiological responses including the biphasic decelerative-accelerative heart rate response, increases in skin conductance and zygomaticus muscle activity, and decreases in the corrugator muscle activity (Guerra, 2010; Guerra, 2011; Lucas, 2019). In our paradigm, we exploit this personal aspect, and examine physiological and subjective responses to our video stimuli as well as towards video stimuli used to elicit emotion before.

Methods

Participants

A total of 23 participants (14 female, age range between 22 and 78) took part in the study. The study was approved by the TNO Institutional Review Board (IRB) under number 2022-012.

Creating Loving Videos

Participants recruited for the study provided us with the name and information of a loved one to contact for a Zoom interview. We specifically noted that we were looking to speak with someone with whom the participant has a close and loving relationship. An experimental lead contacted the loved one, explained the purpose of the experiment (making a video to elicit strong positive emotions), and scheduled a time to make the video. The loved one was instructed not to inform the participant about the exact purpose of this meeting.

During the recorded zoom meeting, the participant's loved one was asked the following questions:

- What do you admire most in (participant's name)?
- What is your fondest memory with (participant's name)?
- If you were to plan the perfect day with (participant's name) to make (him/her) happy, please describe to me would you do together?
- What is the impact (participant's name) has had on your life?
- What is something you want to say to (participant's name)?

The number of questions asked varied depending on the content and length of the loved one's answers. If needed, the experimental lead edited the video down to four minutes. Loved ones were asked for consent to show their video to their loved ones, and for consent to show their video to other (unknown) participants. All but one loved one consented to showing their video to an unknown participant.

Design and procedure

Participants were presented with two four-minute videos developed as described above: one of their loved one (strong positive emotion), and another pseudo-randomly chosen video of another participant's loved one (more neutral emotion). Twenty two videos were shown one time to an unknown participant, and one video two times. The comparison of responses to these two videos control for effects that the personalized video may have that are not related to the emotional content.

To compare effects of our videos to videos traditionally used in emotion research, we selected two two-minute videos that scored highest in rated valence and arousal as reported by Maffei (2019) ('Sea' and 'Waterfalls') and two two-minute videos that scored the most neutral (Maffei, 2019) ('Pietraperzia' and 'Quartesolo', both showing village scenery). The positive emotion videos were combined in one four-minute movie, and the neutral videos were also combined in one four-minute movie. All videos contained appropriate background music for their content.

The four types of movies (own loving video, other's loving video, traditional positive, and traditional neutral) were shown in counterbalanced order across participants.

Following each video, participants were presented with the Self-Assessment Manikin (SAM) and asked to rate their emotion when watching the video using three dimensions of the scale (pleasure, arousal, and dominance). Subsequently, they rated on a 9-point Likert scale the degree to which each of the following emotions were elicited by the clip: fear, sadness, rage, disgust, joy, surprise, and neutral (Maffei, 2019). Participants' heart rate (HR), electrodermal activity (EDA), skin temperature of the face (infrared camera), and electrical brain activity (EEG) were measured throughout the experiment.

Results

First analyses of the HR, EDA and infrared data indicate that differences between responses to the own and other's loving videos are stronger than between the positive and neutral traditional videos. In fact, no clear difference was seen between the two types of traditional videos and the other's loving video, while heart rate was around 5bpm higher for the own loving movie compared to all other movies during the first 40 seconds, phasic EDA quickly rose and stayed around 3.5 μ Siemens higher, and nose temperature increased by .7 °C.

Discussion

Our first results indicate that the videos created through our paradigm elicit strong emotions, much more effectively than the standardized video clips. Although through this experiment we demonstrate

that controlled positive stimuli in the lab can elicit strong responses, the data discussed here cannot be conclusive as to whether the strong effects of the own loved one's movie are caused by arousal, apart from the positive valence. To explore that, we will compare data from the present experiment to data of the same participants using the same sensors, but in response to a highly arousing, low valence stressor, the sing-a-song stress test (Brouwer & Hogervorst, 2014). These and other additional results will be presented at the conference.

References

- Alves, H., Koch, A., & Unkelbach, C. (2017). Why good is more alike than bad: Processing implications. *Trends in Cognitive Sciences*, 21(2), 69-79.
- Bradley, M. M., & Lang, P. J. (1994). Measuring emotion: the self-assessment manikin and the semantic differential. *Journal Of Behavior Therapy and Experimental Psychiatry*, 25(1), 49-59.
- Gray, E. K., & Watson, D. (2007). Assessing positive and negative affect via self-report. *Handbook of emotion elicitation and assessment*, 171-183.
- Guerra, P., Vico, C., Campagnoli, R., Sánchez, A., Anllo-Vento, L., & Vila, J. (2012). Affective processing of loved familiar faces: integrating central and peripheral electrophysiological measures. *International Journal of Psychophysiology: Official Journal Of The International Organization of Psychophysiology*, 85(1), 79–87.
- Fernández-Aguilar, L., Navarro-Bravo, B., Ricarte, J., Ros, L., & Latorre, J. M. (2019). How effective are films in inducing positive and negative emotional states? A meta-analysis. *PloS One*, 14(11), e0225040.
- Lucas, I., Sánchez-Adam, A., Vila, J., & Guerra, P. (2019). Positive emotional reactions to loved names. *Psychophysiology*, 56(7), e13363.
- Maffei, A., & Angrilli, A. (2019). E-MOVIE - Experimental MOVies for Induction of Emotions in neuroscience: An innovative film database with normative data and sex differences. *PloS One*, 14(10), e0223124.
- Rottenberg, J., Ray, R.D., Gross JJ. (2007). Emotion elicitation using films. In J. Coan (Eds.), *Handbook of emotion elicitation and assessment*. 2007. (pp. 2–28). Oxford university press.
- Vaish, A., Grossmann, T., & Woodward, A. (2008). Not all emotions are created equal: the negativity bias in social-emotional development. *Psychological Bulletin*, 134(3), 383.
<https://doi.org/10.1037/0033-2909.134.3.383>

Cross-lingual Voice Activity Detection for Human-Robot Interaction

Nils Höfling¹, Su-Kyoung Kim², Elsa Andrea Kirchner^{1,2}

- 1) Medical Technology Systems, Faculty of Engineering, University of Duisburg-Essen, Duisburg, Germany
- 2) Robotics Innovation Center, German Research Center for Artificial Intelligence, Bremen, Germany

Keywords: voice activity detection, speech recognition, embedded, robot

Abstract

The recognition of language is a two-step process: speech must be recognized as such (1,2) and then the semantics must be understood. For human-robot interaction voice activity detection (VAD) is of great importance (3). Once it is known that a human is talking, speech recognition can be triggered and additional modules in the robot can produce responses to the human, or other robotic behaviors. For online interaction with precise timing especially when using multimodal data (4), it might also be necessary to integrate VAD into a microcontroller or similar embedded system in the robot. Advanced methods exist to enable online and embedded VAD (3). However, some of these methods are trained on biased data, i.e., data in one language, usually English, which can cause problems when used in applications where the interacting human speaks a different language. This is well investigated for speech recognition (5) but poorly for VAD. Language-related issues need to be considered in some applications, such as supporting patients in non-English speaking environments, and may be as important as approaches that handle strong background noise (6, 7).

In this work, we analyze the performance of two different methods to distinguish background noise from spoken words running online on a Raspberry Pi comparing the well-known VAD script of the webRTC standard (8, 9) for real-time communication with a frequency-based approach developed by our group. Both the webRTC and the frequency-based approaches are suitable for online-usage and are independent of an internet connection. We compare latency and accuracy in VAD as a function of language (English and German) and environmental condition for both methods implemented with Python. To import the webRTC VAD-module an open-source python interface (10) was used. The VAD-module is based on a machine-learning model. The basic webRTC VAD often detects short noises as speech. To increase the accuracy of the method a control for the length of the detected signal is added, which greatly decreases the noise identified as speech. As a downside, this may lead to the labeling of some words where only one or two syllables are detected as noise. The frequency-based approach is using signal processing functions of the python library SciPy. Main feature for the feature-based approach is an artificial frequency which is digitally layered on top of the audio signal. The amplitude of the artificial frequency is higher than the amplitude of the audio signal and chosen so that the according peak in the normalized frequency-range only drops if the audio signal has a high enough amplitude but also covers a broad enough part of the spectrum. To increase the accuracy two additional features, which are both based on presence of signals in certain frequency-ranges, are added. Both approaches were implemented on a Raspberry Pi 4B. The onset of voice activity is indicated by a pulse on a GPIO pin of the Raspberry Pi 4B. In future research, this pulse can be sent on a trigger channel, in order to label electroencephalogram data of the interacting human,

for example. In this work the pulse is used to evaluate both methods. It is recorded on one audio-channel while the other channel simultaneously records the speech. The data can then be looked through in an audio program, for example Audacity. For every new spoken statement there should be an according signal on the onset-channel.

The approaches (webRTC VAD, short VAD, and the frequency-based) were tested with four subjects, two females and two males (from 21 to 28 years old). All participants are native German speakers, but also have good English pronunciation. They spoke 24 German and 20 English words each in 3 different environmental conditions: complete silence, background noise, and with echo. For data analysis, we calculated the number of errors (i.e., not recognized, doubly recognized, and recognized as noise) and the number of correct recognitions. We calculated the accuracy of word recognition in percent, because we have a different number of words depending on the language. We considered only two factors for each evaluation, e.g., we compared two methods for each language across three environmental conditions (4 subjects x 3 environmental conditions = 12 samples for each method, see Fig. 1-A). For statistical analysis, we formed Friedman test and Dunn's tests as post-hoc analysis. Bonferroni correction was performed for multiple comparisons.

We found no significant differences in word recognition between the two methods for English words [$p = n.s.$, Fig. 1-A1]. However, the frequency-based method outperformed the VAD method on German words [$p < 0.042$, Fig. 1-A2]. This indicates that the VAD method is less suitable for the recognition of German words. This evidence was supported by further analysis comparing both languages for each method (Fig. 1-B2a, B2b). This further analysis showed that English words were recognized better than German words when the VAD method was used [$p < 0.014$, see Fig. 1-B2a]. However, such language-specific differences were not observed in the proposed method [$p = n.s.$, see Fig. 1-B2b]. These results indicate that the proposed method (Frequency) works very robustly for both languages. Further, we found no significant differences among the three environment conditions when the frequency-based method was used [$p = n.s.$, see Fig. 1-B1b]. This indicates that the proposed method works robustly for all three environmental conditions. However, words in silent environments were much more likely to be detected as noise when the VAD method was used [no echo-VAD (Fig. 1-B1a) in errors (RN) vs. no echo-Frequency (Fig. 1-B1b) in errors (RN): $p < 0.046$].

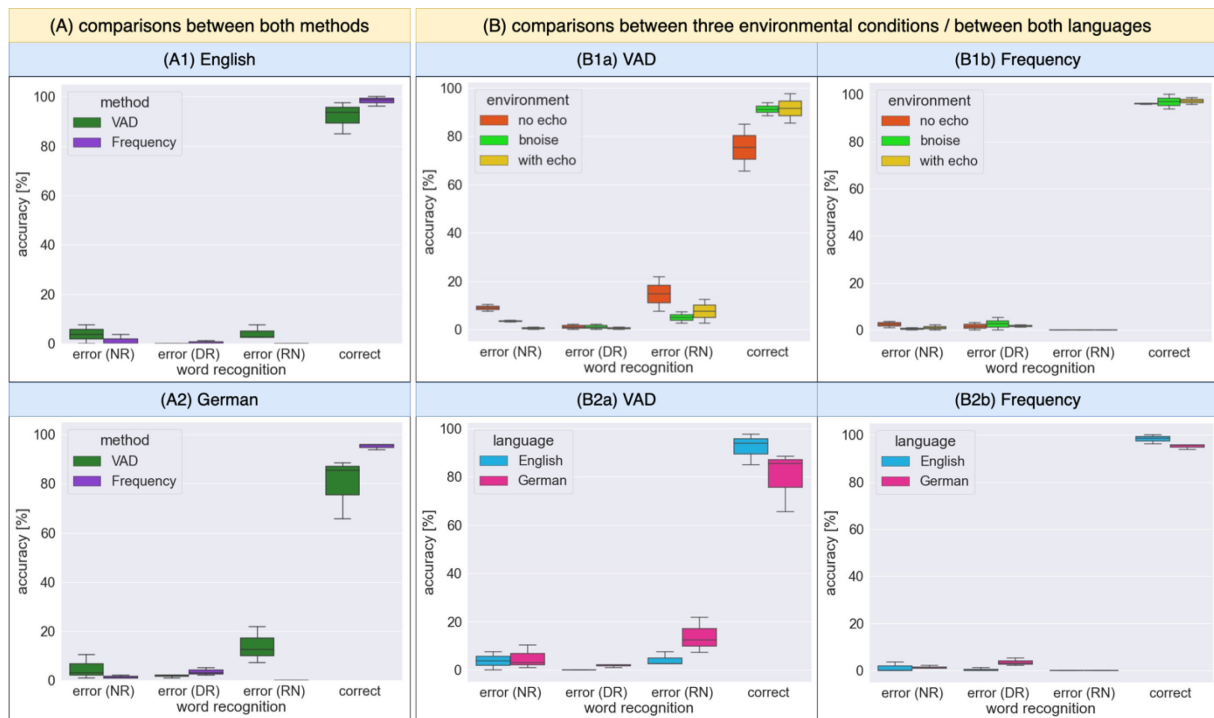

Figure 4 Accuracy in word recognition for both methods (NR: not recognized, DR: doubly recognized, RN: recognized as noise, no echo: completely silent without echo and background noise, bnoise: with background noise, with echo: with echo, but without background noise)

Main outcome of this study is that not only speech recognition approaches are language-dependent, but that VAD can also be so. Further, the environment might have a strong influence on VAD which must be considered when transferring approaches from the lab to a real environment. In our current work the developed frequency-based approach is applied to label EEG data for further machine learning based processing in the context of robot-based stroke rehabilitation.

References

- (1) Graf, S., Herbig, T., Buck, M. et al. Features for voice activity detection: a comparative analysis. EURASIP J. Adv. Signal Process. 2015, 91 (2015).
- (2) Mukherjee, H., Obaidullah, S.M., Santosh, K.C. et al. Line spectral frequency-based features and extreme learning machine for voice activity detection from audio signal. Int J Speech Technol 21, 753–760 (2018). <https://doi.org/10.1007/s10772-018-9525-6>
- (3) Phadke, S., Limaye, R., Verma S. and Subramanian, K., "On design and implementation of an embedded automatic speech recognition system," 17th International Conference on VLSI Design. Proceedings., 2004, pp. 127-132, doi: 10.1109/ICVD.2004.1260914.
- (4) Kirchner, E.A., Fairclough, S.H., & Kirchner, F. (2019). Embedded multimodal interfaces in robotics: applications, future trends, and societal implications. The Handbook of Multimodal-Multisensor Interfaces: Language Processing, Software, Commercialization, and Emerging Directions - Volume 3.
- (5) Mridha, M.F., Ohi, A.Q., Hamid, M.A. et al. A study on the challenges and opportunities of speech recognition for Bengali language. Artif Intell Rev 55, 3431–3455 (2022). <https://doi.org/10.1007/s10462-021-10083-3>
- (6) Singh, C., Venter, M., Muthu, R.K. et al. DSP-based voice activity detection and background noise reduction. Int J Speech Technol 21, 851–859 (2018). <https://doi.org/10.1007/s10772-018-9556-z>

- (7) Khan, W., Jiang P., and Chan, P., "Word recognition in continuous speech with background noise based on posterior probability measure," 2012 IEEE International Conference on Electro/Information Technology, 2012, pp. 1-7, doi: 10.1109/EIT.2012.6220711.
- (8) Available at: <https://webrtc.org/>
- (9) <https://www.w3.org/2021/01/pressrelease-webrtc-rec.html.en>
- (10) <https://github.com/wiseman/py-webrtcvad>

Passive BCI for gait assistance

Maziar Ahmad Sharbafi

Lauflabor Locomotion Lab, TU Darmstadt

Keywords: Passive BCI, gait assistance, Human-robot-Interaction, legged locomotion

Introduction

In contrast to Human-Human Interaction, Human-Machine-Interaction (HMI) suffers from a shared understanding of the interactive partners and the environment¹. This becomes more challenging if physical interaction is added, as in assistive technology, where this communication bottleneck provides a *coordination mismatch*. Specifically, for locomotion assistance, valid biomechanical and neurophysiological models of humans and adequate training sessions are required for understanding the behaviors. With a “*common language*,” the assistive system could quickly adapt its behavior to better match the user’s intention and action¹. However, the bottleneck is the complexity of the human musculoskeletal system (**body**), neural control (**brain**), and the inconsistency between humans’ and robots’ locomotion capabilities. Although machine learning poses an elegant solution by concentrating on the action-reaction of the robot-human-system, e.g., Human-in-the-loop-optimization (HILO)^{2,3}; collecting extensive data sets for individual subjects makes the black-box learning methods impractical for personalized assistance. Another bottleneck is that the human movement cost function is unknown and might change in different situations^{4,5}. Thus, learning-based methods lack the adaptability to new conditions and the ability to predict human behavior for more compatible reactions (termed *cognitive mobility*).⁶ In the current exoskeleton technology, the lack of mutual understanding hinders the coadaptation of the two systems. This vital issue comprises several challenges: the discrepancy between human and exo motor control, the absence of mechanical adaptability, and missing cognitive mobility and personalization. This study introduces a framework to address these issues, termed Brain-in-the-loop-optimization (BILO). The core idea for personalization and cognitive mobility is measuring the brain signals to approximate human evaluation of gait assistance using passive BCI and neuroadaptive technology, which have significant advantages for the BILO approach.

Adaptive exo design goals

Personalization means tailoring service to the user’s need. In assistive technology, personalization requires comprehending the human cost function (user need), which is unknown. In most studies, the metabolic cost is utilized for personalization^{3,7,8} in the HILO framework, which needs tedious measurement. Further, a slight change in the user-environment conditions or movement goal might require revising the controller. Recently, the reinforcement learning approach accelerated the exo personalization^{6,9}. Instead of metabolic cost, new metrics like transferred work ratio between the exoskeleton and wearer⁶ or following the leader command (non-impaired limb) are introduced for fast learning. These new metrics are not well established and generalizable. Moreover, the human locomotion cost function may change in different gaits and conditions^{5,10,11}, which is not considered in these methods. Therefore, no universal metric for personalizing assistance is introduced.

Here **cognitive mobility** means controlled locomotion, supervised minimally but significantly by human cognition. Minimally, because humans do not need full concentration for locomotion. In that sense, cognitive control plays the trainer role, giving few but crucial commands at critical moments. Involvement of cognition in locomotion control could generate efficient and individualized gait with natural gait transition and proper reaction to perturbations. Hypothetically, to predict human cognitive

control, we need to know a brain model or have the same brain in the exo. Yet, none of these options are available and cognitive control of assistive devices is limited to asking the users to relay their intention to change the gait (e.g., initiate walking), e.g., using brain-computer interface (BCI)^{12–15}. The state-of-the-art BCI, mainly focusing on motion imagery for control of assistive devices¹⁶, needs long training and full attention for Exo control, which hinders explosive growth in daily life applications.

Approach

Brain-in-the-loop optimization (BILO). Inspired by utility theory¹⁷, the human utility (or cost) function determines preference over a set of physical and mental parameters. We aim to identify locomotion cost function from brain activities, offering a unifying model of perception and action for optimizing gait assistance. This way, we will employ human brainpower for personalization and cognitive mobility with minimum user attention. Instead of using BCI for sending control commands, the pBCI¹⁸ will predict the human locomotion cost function to be later applied for exo adaptation. This method passively decodes mental states (i.e., cognitive workload, mental fatigue and vigilance, attention, error detection, emotions)¹⁹.

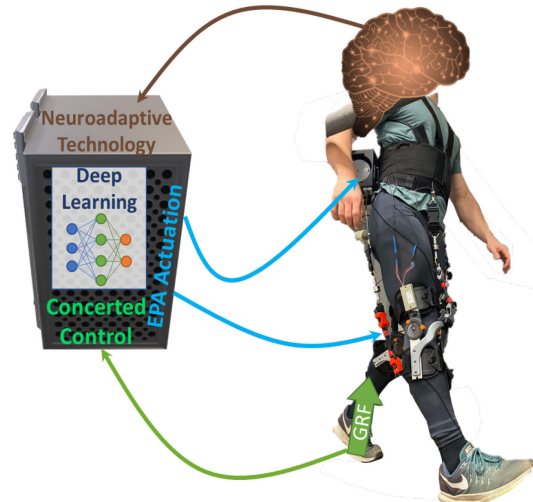

Figure 1. B+B concept to create a new language for human-exo coadaptation

With the improved quality of the EEG measurement devices, the applications of pBCI are growing fast to be utilized in daily life tasks²⁰ ranging from autonomous driving²¹ to gaming²² and task load detection in robotic surgery²³. Further, detecting neurophysiological activity was used to exert real-time adaptation in machines. This implicit control is implemented through neuroadaptive technology without requiring the user to exert any conscious effort²⁴. Our solution to define a new metric for human evaluation of the assistance level is to use pBCI to detect mental status. By conducting targeted experiments and presenting a meaningful fusion of different measures (effort, cognitive changes, emotional status, fatigue, acceptance, stability) we aim to identify the human locomotion cost function. Despite abundant efforts required for developing this metric, after its standardization, we only need reliable EEG signals to predict the cost function. In principle, the brain having full-body information and enormous computational power, could deliver the best assistance assessment. In this framework, we do not need precise control of all actuators of the assistive device, which might need high bandwidth and cause sensitivity to brain signal measurement. By including adjustable mechanical parameters (e.g., EPA design^{25,26}) and high-level control parameters (e.g., concerted control²⁷ as an underlying framework of continuous motor control), different levels of exo control will be adapted to individuals. This high-level feedback will be used to tune general exo properties (e.g., stiffness) for different individuals and situations when required. In this respect, the body and brain (B+B) methodology (Fig. 1) is a package with components complementing each other.

Outlook

Although active exoskeletons with BCI-based gait intention detection opened new possibilities in the assistance and rehabilitation fields, their vast potential to deploy these systems in clinical and daily life applications is unexploited²⁸. Instead of sending voluntary and directed commands to control, the pBCI fuses BCI technology with cognitive monitoring, users' intention information, emotional states, and situational interpretations. The proposed implicit control aims to get assistance from the human brain's reaction to adapt the exo to the users' desires without requesting them to contribute to control.

In that sense, the human brain assists the exo in learning how to optimize movement assistance. Thanks to machine learning methods, this *mutual assistance paradigm* within the BILO framework could provide a breakthrough in gait assistance and any human-robot interaction application.

References

1. Fischer, G. (2001). User modeling in human–computer interaction. *User modeling and user-adapted interaction*, 11(1), 65-86.
2. Walsh, C. Human-in-the-loop development of soft wearable robots. *Nat Rev Mater* 3, 78–80 (2018).
3. Zhang, J., Fiers, P., Witte, K. A., Jackson, R. W., Poggensee, K. L., Atkeson, C. G., & Collins, S. H. (2017). Human-in-the-loop optimization of exoskeleton assistance during walking. *Science*, 356(6344), 1280-1284.
4. Antos, S. A., Kording, K. P., & Gordon, K. E. (2022). Energy expenditure does not solely explain step length–width choices during walking. *Journal of Experimental Biology*, 225(6), jeb243104.
5. Yandell, M. B., & Zelik, K. E. (2016). Preferred barefoot step frequency is influenced by factors beyond minimizing metabolic rate. *Scientific reports*, 6(1), 1-9.
6. Tu, X., Li, M., Liu, M., Si, J., & Huang, H. H. (2021, May). A data-driven reinforcement learning solution framework for optimal and adaptive personalization of a hip exoskeleton. In *2021 IEEE International Conference on Robotics and Automation (ICRA)* (pp. 10610-10616). IEEE.
7. Gopinath, D., Jain, S., & Argall, B. D. (2016). Human-in-the-loop optimization of shared autonomy in assistive robotics. *IEEE Robotics and Automation Letters*, 2(1), 247-254.
8. Ding, Y., Kim, M., Kuindersma, S., & Walsh, C. J. (2018). Human-in-the-loop optimization of hip assistance with a soft exosuit during walking. *Science robotics*, 3(15), eaar5438.
9. Peng, Z., Luo, R., Huang, R., Hu, J., Shi, K., Cheng, H., & Ghosh, B. K. (2020, May). Data-driven reinforcement learning for walking assistance control of a lower limb exoskeleton with hemiplegic patients. In *2020 IEEE International Conference on Robotics and Automation (ICRA)* (pp. 9065-9071). IEEE.
10. Hunter, L. C., Hendrix, E. C., & Dean, J. C. (2010). The cost of walking downhill: is the preferred gait energetically optimal?. *Journal of biomechanics*, 43(10), 1910-1915.
11. Cajigas, I., Koenig, A., Severini, G., Smith, M., & Bonato, P. (2017). Robot-induced perturbations of human walking reveal a selective generation of motor adaptation. *Science Robotics*, 2(6), eaam7749.
12. Pons, J. L. (2010). Rehabilitation exoskeletal robotics. *IEEE Engineering in Medicine and Biology Magazine*, 29(3), 57-63.
13. Wang, C., Wu, X., Wang, Z., & Ma, Y. (2018). Implementation of a brain-computer interface on a lower-limb exoskeleton. *IEEE access*, 6, 38524-38534..
14. Ferrero, L., Ortiz, M., Quiles, V., Iáñez, E., Flores, J. A., & Azorín, J. M. (2021). Brain symmetry analysis during the use of a BCI based on motor imagery for the control of a lower-limb exoskeleton. *Symmetry*, 13(9), 1746.

15. Jeong, J. H., Kwak, N. S., Lee, M. H., & Lee, S. W. (2017, September). Decoding of walking Intention under Lower limb exoskeleton Environment using MRCP Feature. In *GBCIC*.
16. Olsen, S., Alder, G., Williams, M., Chambers, S., Jochumsen, M., Signal, N., ... & Taylor, D. (2021). Electroencephalographic Recording of the Movement-Related Cortical Potential in Ecologically Valid Movements: A Scoping Review. *Frontiers in neuroscience*, *15*.
17. Fishburn, P. C. (1970). *Utility theory for decision making*. Research analysis corp McLean VA.
18. Zander, T. O., & Kothe, C. (2011). Towards passive brain–computer interfaces: applying brain–computer interface technology to human–machine systems in general. *Journal of neural engineering*, *8*(2), 025005.
19. Clerc, M., Bougrain, L., & Lotte, F. (Eds.). (2016). *Brain-computer interfaces 1: Methods and perspectives*. John Wiley & Sons.
20. Aricò, P., Borghini, G., Di Flumeri, G., Sciaraffa, N., & Babiloni, F. (2018). Passive BCI beyond the lab: current trends and future directions. *Physiological measurement*, *39*(8), 08TR02.
21. Zander, T. O., Andreessen, L. M., Berg, A., Bleuel, M., Pawlitzki, J., Zawallich, L., ... & Gramann, K. (2017). Evaluation of a dry EEG system for application of passive brain-computer interfaces in autonomous driving. *Frontiers in human neuroscience*, *11*, 78.
22. Vecchiato, G., Borghini, G., Aricò, P., Graziani, I., Maglione, A. G., Cherubino, P., & Babiloni, F. (2016). Investigation of the effect of EEG-BCI on the simultaneous execution of flight simulation and attentional tasks. *Medical & biological engineering & computing*, *54*(10), 1503-1513.
23. Zander, T. O., Shetty, K., Lorenz, R., Leff, D. R., Krol, L. R., Darzi, A. W., ... & Yang, G. Z. (2017). Automated task load detection with electroencephalography: towards passive brain–computer interfacing in robotic surgery. *Journal of Medical Robotics Research*, *2*(01), 1750003.
24. Zander, T. O., Krol, L. R., Birbaumer, N. P., & Gramann, K. (2016). Neuroadaptive technology enables implicit cursor control based on medial prefrontal cortex activity. *Proceedings of the National Academy of Sciences*, *113*(52), 14898-14903.
25. Sharbafi, M., Shin, H., Zhao, G., Hosoda, K., & Seyfarth, A. (2017, October). Electric-pneumatic actuator: A new muscle for locomotion. In *Actuators* (Vol. 6, No. 4, p. 30). MDPI.
26. Galljamov, R., Ahmadi, A., Mohseni, O., Seyfarth, A., Beckerle, P., & Sharbafi, M. A. (2021). Adjustable compliance and force feedback as key elements for stable and efficient hopping. *IEEE Robotics and Automation Letters*, *6*(4), 6797-6804.
27. Sarmadi, A., Schumacher, C., Seyfarth, A., & Sharbafi, M. A. (2019). Concerted control of stance and balance locomotor subfunctions—leg force as a conductor. *IEEE Transactions on Medical Robotics and Bionics*, *1*(1), 49-57.
28. He, Y., Eguren, D., Azorín, J. M., Grossman, R. G., Luu, T. P., & Contreras-Vidal, J. L. (2018). Brain–machine interfaces for controlling lower-limb powered robotic systems. *Journal of neural engineering*, *15*(2), 021004.

Studying mechanisms of brain-computer interface induced plasticity after stroke: A preliminary outlook

Khosrov Alexander Grigoryan¹, Daa Masri¹, Matthias Wagner¹, Vadim Nikulin^{1,2}, Arno Villringer^{1,3}, Bernhard Sehm^{1,4}

- 1) Department of Neurology, Max Planck Institute for Human Cognitive and Brain Sciences, Leipzig, Germany
- 2) Neurophysics Group, Department of Neurology, Charité-Universitätsmedizin Berlin, Berlin, Germany
- 3) Day Clinic for Cognitive Neurology, University Hospital Leipzig, Leipzig, Germany
- 4) Department of Neurology, University Hospital Halle, Halle, Germany

Keywords: BCI, neurorehabilitation, stroke rehabilitation

Abstract

Stroke is one of the major causes of motor function impairment with a projected increase in prevalence attributable to the ageing population. Generally, stroke survivors experience some degree of spontaneous motor function recovery during the acute stage, however, with time, they reach a plateau in functional improvement after which the recovery is slow or stagnant.

There is evidence suggesting that the potential of brain-computer interface (BCI) based rehabilitation therapies may overcome said functional plateau [1-3]. However, the underlying neural mechanisms responsible for the improvement are not yet fully understood. To this end, we have recruited chronic stroke patients (preliminary sample: $n = 15$; 5 females) with moderate to severe hemiparesis, who underwent a week-long BCI training, preceded by a baseline and pre-training structural (multi-parametric maps, DTI) and functional MRI scans (resting state, visual metronome task), and followed by a post and follow-up scans. The BCI training consisted of 1.5-hour training session each day for a total duration of 6 days. Each session consisted of 5 trials, lasting approximately 10 minutes.

During a trial, the participants followed audio commands saying “left”, “right”, or “relax” by imagining performing dorsiflexion of the indicated wrist or by relaxing. When the system detected the motor imagination of the correct side, the feedback was generated in the feedback phase.

The mean accuracy score of all participants, calculated in percentage by dividing the number of correctly classified trials to the total number of trials, was 83.8% (SD: 9.6). When comparing the accuracy on day 1 (mean accuracy: 80.99%, SD: 10.71) against the accuracy achieved on day 6, out of 15 patients, 12 had an improved accuracy score (mean accuracy: 85.53%, SD:9.35). Out of the remaining 3 patients, two consistently maintained accuracy higher than 80% throughout the sessions, while the remaining 2 were slightly deviating around the chance level (i.e., 61%).

This is a preliminary analysis of the dataset with the aim to include 24 patients with pre/post-structural and functional MRI scans. The extensive pre-post multi-modal imaging should help shed light into the neural mechanisms of BCI-induced plasticity.

Additionally, it is worth investigating whether subgrouping patients based on lesion severity and location might serve as a selection criterion for benefiting from an MI-based BCI therapy.

References

1. Cervera, M. A., Soekadar, S. R., Ushiba, J., Millán, J. del R., Liu, M., Birbaumer, N., & Garipelli, G. (2017). Brain-Computer Interfaces for Post-Stroke Motor Rehabilitation: A Meta-Analysis. *BioRxiv*, 224618.
2. Bai, Z., Fong, K. N. K., Zhang, J. J., Chan, J., & Ting, K. H. (2020). Immediate and long-term effects of BCI-based rehabilitation of the upper extremity after stroke: a systematic review and meta-analysis. *Journal of NeuroEngineering and Rehabilitation*, 17(1), 57.
3. Yang, W., Zhang, X., Li, Z., Zhang, Q., Xue, C., & Huai, Y. (2022). The Effect of Brain–Computer Interface Training on Rehabilitation of Upper Limb Dysfunction After Stroke: A Meta-Analysis of Randomized Controlled Trials. *Frontiers in Neuroscience*, 15, 766879.

Neurophysiological constraints on human-robot interfacing for augmentation

Renato Mio^{1,2}, A. Aldo Faisal^{1,2}

1. Institute of Artificial & Human Intelligence, Universität Bayreuth, Germany
2. Brain and Behaviour Laboratory, Imperial College London, United Kingdom

Keywords: Supernumerary robotics, Human augmentation, Motor learning

Abstract

Research on neurotechnology has been recently expanded to the realm of robotic augmentation. In particular, augmentation by wearing supernumerary (i.e. additional to the natural number of) robotic limbs has been the focus of neuroscientific research regarding human capability for controlling these devices. Specifically, supernumerary robotics fingers working in collaboration with natural fingers are a relevant testbed to study neurocognitive phenomena. Within this context, the choice of an interface modality to control augmentative devices has effects in their embodiment and in the motor learning process behind controlling them successfully [1-3].

One of the most common interfacing approaches to control supernumerary robotic limbs is substitution control, in which the extra limb is controlled by the kinematic output originally intended for other body parts. For instance, in our previous study, participants were trained to use an additional robotic finger attached to the side of the right hand and controlled by foot movements [4]. Moreover, they learned to use it in a piano playing task in under 30 minutes, which showcases human capability to quickly integrate augmentation devices in real-world tasks [4]. Crucially, it was also demonstrated that participants with better foot coordination skills also performed better in piano playing with the foot-controlled SRF [4]. This supports the idea that motor coordination metrics, in particular the ones related to the control interface, are predictive of success in robotic augmentation [4]. This can have implications for other types of interfaces with higher cognitive demands such as the ones based on neurophysiological signals decoding, in which subjects could benefit from tailored training in the modulation of these signals.

Substitution interfaces are an effective approach for short-latency real-time control. However, because essentially the degrees of freedom of one body part are transferred to the SRL, this strategy could be deemed as not being “true augmentation”, which instead implies simultaneous volitional control of natural and artificial limbs without hindering the control of the formers [5]. However, in able-bodied people, neural motor commands on the efferent pathways are already tasked with controlling all muscles. Hence, there is a shortage of signals available to voluntarily control augmentative devices without compromising the control of the biological body [6].

There have been some meaningful steps towards understanding the mechanisms for successful augmentation beyond natural motor constraints. Recent advances in non-invasive recording of individual motoneurons activity have facilitated the study of the human potential for controlling a subset of these signals independently from the motor unit pool that determines muscle force [7,8]. If attained, flexible control of spinal motor neurons will lead to the increase in the number of independently controlled neurophysiological signals available (neural output) required for true human augmentation.

References

- [1] Kieliba, P., Clode, D., Maimon-Mor, R. O., & Makin, T. R. (2021). Robotic hand augmentation drives changes in neural body representation. *Science Robotics*, 6(54), 1–14.
- [2] Zhu, Y., Ito, T., Aoyama, T., & Hasegawa, Y. (2019). Development of sense of self-location based on somatosensory feedback from finger tips for extra robotic thumb control. *ROBOMECH Journal*, 6(1), 0–9.
- [3] Amoruso, E., Dowdall, L., Kollamkulam, M. T., Ukaegbu, O., Kieliba, P., Ng, T., Dempsey-Jones, H., Clode, D., & Makin, T. R. (2022). Intrinsic somatosensory feedback supports motor control and learning to operate artificial body parts. *Journal of Neural Engineering*, 19(1), 016006.
- [4] Shafti, A., Haar, S., Mio, R., Guilleminot, P., & Faisal, A. A. (2021). Playing the piano with a robotic third thumb: assessing constraints of human augmentation. *Scientific Reports*, 11(1), 1–14.
- [5] Eden, J., Bräcklein, M., Ibáñez, J., Barsakcioglu, D. Y., di Pino, G., Farina, D., Burdet, E., & Mehring, C. (2022). Principles of human movement augmentation and the challenges in making it a reality. *Nature Communications*, 13(1), 1345.
- [6] Dominijanni, G., Shokur, S., Salviatti, G., Buehler, S., Palmerini, E., Rossi, S., Vignemont, F. de, Avella, A., & Makin, T. R. (2021). The neural resource allocation problem when enhancing human bodies with extra robotic limbs. *Nature Machine Intelligence*, 3(October), 850–860.
- [7] Farina, D., & Negro, F. (2015). Common synaptic input to motor neurons, motor unit synchronization, and force control. *Exercise and Sport Sciences Reviews*, 43(1), 23–33.
- [8] Formento, E., Botros, P., & Carmena, J. M. (2021). Skilled independent control of individual motor units via a non-invasive neuromuscular machine interface. *Journal of Neural Engineering*, 18(6).

Task-Independent Workload Classification using Non-Binary Output and Task Scaling

Laurens R. Krol^{1,4}, Maya-Christin Müller², Antoniya A. Boyanova³, Andrea Kübler², Thorsten O. Zander^{1,4}

- 1) Neuroadaptive Human-Computer Interaction, BTU Cottbus-Senftenberg, Germany
- 2) Department of Psychology, Julius-Maximilians-Universität of Würzburg, Germany
- 3) School of Psychology, University of Aberdeen, Scotland, UK
- 4) Zander Labs GmbH, Germany

Keywords: Workload, Classification, Task-Independence

Introduction

Workload remains one of the most sought-after EEG-based measures in the context of neuroergonomics and neuroadaptive technology, given the high potential utility of its real-time detection in productive environments [1]. For real-world applications, a workload classifier that does not require (re-)calibration across different contexts, tasks, or users is of particular interest (e.g., [2]). In previous work, we have developed a workload calibration paradigm that calibrates in under ten minutes, with a corresponding classifier that appears to function well across tasks [3,4], particularly when looking at continuous rather than binary classifier output values [5]. Here, we expand on this work with a new selection of tasks and additional “scaling tasks” to further improve performance.

As shown in [5] and [6], a continuous interpretation of classifier output can help when translating values between tasks or contexts. For example, imagine a classifier that is calibrated on “high” versus “low” workload, where “high” load is induced using a particularly difficult arithmetic task. Because of this difficulty, both “high” and “low” conditions in different, subsequent task may both be relatively easy in comparison, resulting in a “low” workload detection by the classifier regardless of the actual condition. When looking at continuous classifier outputs rather than binary categorizations, however, this same classifier may still produce statistically significant differences between the two conditions. In other words, when the threshold between “high” and “low” is 0.5, interpreting both .1 and .4 simply as “low” ignores the meaningful difference that exists between them.

The effective workload induced by a standard calibration task can differ per participant depending on their skill or experience with respect to that task. The range of mental exertion thus captured by a classifier will differ, and may not correspond to or even include the range of exertion that that same individual would experience during a different task. To account for this, we propose using additional tasks to quantify participants’ skills. For this experiment, we hypothesized that different tasks induce workload to different extents, that a continuous interpretation of classifier output reflects these differences better than a binary interpretation, and that the aforementioned quantifications can additionally scale the classifier output to cover a range appropriate for different tasks and skills.

Participants, Tasks, and Methods

20 participants aged 20-39 were first given four scaling tasks to measure their general ability in four areas: mental arithmetic using a version of the computer-based MATH test [7], spatial cognition

using a pen-and-paper mental rotation test [8], linguistic ability using the German, pen-and-paper *Mehrfachwahl-Wortschatz Test B* [9], and short-term memory span using a computer-based version of the corresponding part of the Wechsler Adult Intelligence Scale IV [10]. Following this, 64-channel EEG (Brain Products actiCHamp) was recorded while participants performed the calibration task previously described in [3] and [5]. Then, in random order, they performed five more tasks: 1. An addition task (AD) requiring them to add two three-digit numbers in either high or low difficulty conditions (Q-values [11] >4 or <2); 2. A word recovery task (WR) where participants were shown words with letters in random order and were required to “unscramble” them, these words being longer, less common words (high workload) or shorter, more common words (low workload); 3. A mental rotation task (MR) using stimuli from [12], with difficulty varied by rotating the stimuli to different degrees across two planes (high) or one plane (low); 4. A backward digit span task (BDS) where participants were given a sequence of 5 (high) or 3 (low) digits one after the other and asked to reproduce it in reverse order; 5. An n-back task (NB) [13] with n=2 (high) and n=1 (low).

We trained individual classifiers for each participant on the data from the calibration task, and applied it to their data from the remaining five tasks. For this, data from each of the variable-length trials was segmented into 1-second epochs resulting in at least 150 epochs per class per task. A filter-bank common spatial patterns (FB-CSP, [14]) approach was used using frequency bands 4-7 and 8-13 Hz. The top three filter pairs were used to train a classifier using regularized linear discriminant analysis (LDA). In a first analysis, the trained classifier was applied in a binary fashion to the data of the five tasks. In a second analysis, the raw classifier output was used instead and inserted as dependent variable into a 2x5 (condition x task) repeated-measures analysis of variance (rmANOVA) across all participants. Bonferroni-adjusted pairwise comparisons were calculated to test for effects.

Results and Conclusion

For the first, binary analysis, average accuracies across participants for the five tasks were not significant, ranging between 46 and 50%. This was expected, as explained above. The rmANOVA results, however, showed a significant main effect of condition ($F(1, 19) = 25.59, p < .001, \eta_p^2 = .57$), indicating that “high” conditions did result in significantly higher classifier output across all five tasks.

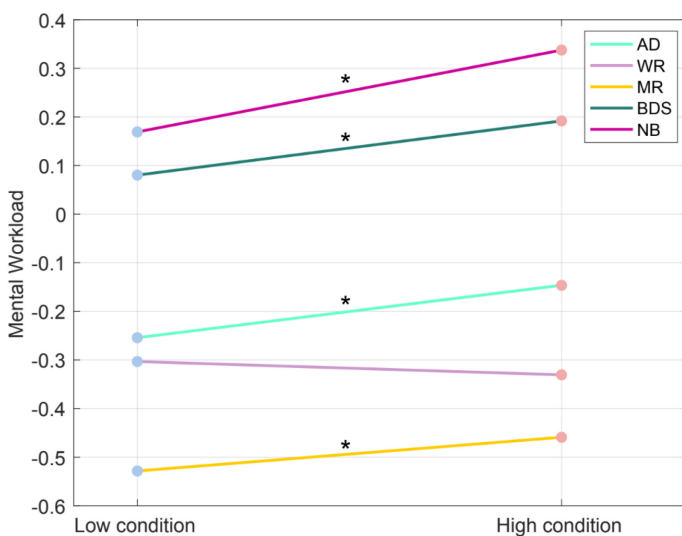

Fig. 1: Simple effects of factor condition from the rmANOVA. Asterisks indicate significance at, at least, $\alpha = 0.05$.

Fig. 1 illustrates the different values for the five tasks separately. Some tasks, e.g. the n-back, appear to consistently induce a higher load than e.g. the mental rotation task, which would confound binary classification, but still show significant differences between conditions. Pairwise comparison tests indicated that this effect was significant for all tasks but WR.

At the time of writing, the scaling tasks have not yet been included in the analysis, but the different levels of overall average workload across tasks, as seen in the figure, indicate that a scaling is useful. The next step is thus to evaluate how the participants’ scores on the scaling tasks correlate with their workload levels across tasks.

All in all, the results provide additional indications that a continuous approach, rather than a binary (“low” versus “high”) approach to workload classification is a viable method to obtain meaningful workload measures from EEG.

(This work was supported by the U.S. Air Force, FA8655-20-1-7007.)

References

1. Young, M. S., Brookhuis, K. A., Wickens, C. D., & Hancock, P. A. (2015). State of science: mental workload in ergonomics. *Ergonomics*, *58*(1), 1–17. doi: 10.1080/00140139.2014.956151
2. Mühl, C., Jeunet, C., & Lotte, F. (2014). EEG-based workload estimation across affective contexts. *Frontiers in Neuroscience*, *8*, 114. doi: 10.3389/fnins.2014.00114
3. Krol, L. R., Freytag, S.-C., Fleck, M., Gramann, K., & Zander, T. O. (2016). A task-independent workload classifier for neuroadaptive technology: Preliminary data. In *2016 IEEE International Conference on Systems, Man, and Cybernetics (SMC)* (pp. 003171–003174). doi: 10.1109/SMC.2016.7844722
4. Andreessen, L. M., Gerjets, P., Meurers, D., & Zander, T. O. (2021). Toward neuroadaptive support technologies for improving digital reading: a passive BCI-based assessment of mental workload imposed by text difficulty and presentation speed during reading. *User Modeling and User-Adapted Interaction*, *13*, 75–104. doi: 10.1007/s11257-020-09273-5
5. Zhang, X., Krol, L. R., & Zander, T. O. (2018). Towards task-independent workload classification: Shifting from binary to continuous classification. In *2018 IEEE International Conference on Systems, Man, and Cybernetics (SMC)* (pp. 556–561). doi: 10.1109/SMC.2018.00104
6. Krol, L. R., Klaproth, O. W., Vernaleken, C., Russwinkel, N., & Zander, T. O. (2022). Towards neuroadaptive modeling: assessing the cognitive states of pilots through passive brain-computer interfacing. In S. H. Fairclough & T. O. Zander (Eds.), *Current research in neuroadaptive technology* (pp. 59–73). London, UK: Academic Press. doi: 10.1016/B978-0-12-821413-8.00009-9
7. Turner, J. R., Hewitt, J. K., Morgan, R. K., Sims, J., Carroll, D., & Kelly, K. A. (1986). Graded mental arithmetic as an active psychological challenge. *International Journal of Psychophysiology*, *3*(4), 307–309. doi: 10.1016/0167-8760(86)90039-5
8. Peters, M., Laeng, B., Latham, K., Jackson, M., Zaiyouna, R., & Richardson, C. (1995). A redrawn Vandenberg and Kuse mental rotations test - different versions and factors that affect performance. *Brain and Cognition*, *28*(1), 39–58. doi: 10.1006/brcg.1995.1032
9. Lehrl, S. (2005). *Mehrfachwahl-Wortschatz-Intelligenztest: MWT-B* (5. Auflage). Spitta GmbH.
10. Wechsler, D. (2008). *Wechsler Adult Intelligence Scale - Fourth Edition (WAIS-IV)*. APA PsycTests. doi: 10.1037/t15169-000
11. Thomas, H. B. G. (1963). Communication theory and the constellation hypothesis of calculation. *Quarterly Journal of Experimental Psychology*, *15*(3), 173–191. doi: 10.1080/17470216308416323
12. Peters, M., & Battista, C. (2008). Applications of mental rotation figures of the Shepard and Metzler type and description of a mental rotation stimulus library. *Brain and Cognition*, *66*(3), 260–264. doi: 10.1016/j.bandc.2007.09.003
13. Kirchner, W. L. (1958). Age differences in short-term retention of rapidly changing information. *Journal of Experimental Psychology*, *55*(4), 352–358. doi: 10.1037/h0043688
14. Ang, K. K., Chin, Z. Y., Zhang, H., & Guan, C. (2008). Filter bank common spatial pattern (FBCSP) in brain-computer interface. In *IEEE International Joint Conference on Neural Networks (IJCNN), 2008* (pp. 2390–2397). doi: 10.1109/IJCNN.2008.4634130

Neural and Social-Psychological Correlates of Immersion in a Virtual Reality Safety Training

Isabel Alkhasli^{1,2} & Christin Hoffmann³

- 1) Section Clinical Cognitive Sciences, Department of Neurology, Faculty of Medicine, RWTH Aachen University
- 2) Chair of General Business Administration, Organisation and Corporate Governance, BTU Cottbus-Senftenberg
- 3) Chair of Decarbonization and Transformation of Industry, BTU Cottbus-Senftenberg

Keywords: Virtual Reality, Immersion, fNIR, Neurofeedback

Introduction

Virtual Reality (VR) applications continue to increase in importance in entertainment and, more recently, the working environment. Occupational VR training, for example, is a considerably growing field of technological innovation. It has been proven useful in creating immersive and realistic work experiences to enhance training effectiveness through improving training attention (Cho et al. 2002), participation (Shuang et al. 2015; Chen et al. 2021) and transfer into real-life situations. (Sacks et al. 2013; Shamsudin et al. 2018; Hwang et al. 2022) However, educational advantages and precise neural and social-psychological correlates of immersion and realism of virtual reality environments are not fully understood. New mobile, wireless fNIRS/EEG- and Biofeedback devices that can connect to and influence virtual environments offer exciting new perspectives to establish and probe neuroadaptive VR environments for use in research and occupational training and education (see, for example, Causse et al. 2019).

Methods

In the first phase of this project, a real-life occupational VR electrical safety training application is investigated in the form of a field experiment. VR user expectations, experience, technology affinity, workers' safety climate, real-life work incidences, and accidents were recorded. Data were collected through structured on-site training observations, pre and post-training questionnaires, and an already established, company-wide, app-based self-reporting system for safety-relevant occurrences and workplace accidents. A third follow-up questionnaire will be sent to previous participants six months after the first VR training to investigate long-term changes in technology affinity, readiness to use VR devices and workers' safety climate [as measured by the workers' subscale of the NOSACQ-50 (Kines et al. 2011)]. Additionally, the number of accidents and safety-relevant incidences of the participating companies will be compared between business units of the same company in which only the mandatory teacher-centred safety training took place and in which additional voluntary VR safety training was implemented. Furthermore, pre and post-implementation years (2021 and 2022) will be compared in terms of accidents and incidences.

Results

Sixty-six participants (mean age of 38.58 years, 95.5% male) with a mean professional experience in electrical work of 18.17 years (SD = 15.2 years) were observed and questioned during their annual electrical safety training. The Germany-based company comprises 607 employees and 15 business units, of which nine business units participated in the VR training. The technology affinity of subjects was relatively low, as they had an MD = 2.67 points on a 7-point Likert scale where a rating of 1 was a strong disagreement, and 7 was a strong agreement to statements associated with technology affinity. General physiological and psychological aspects of the VR experience (vision, audio, balance, handling, immersion, interaction, realism, comprehension and fun) were rated positively (MD = 5.7 points on a 7-point scale with higher values indicating a stronger agreement and a greater extent of the characteristic, IQR = 1.03). 15.1 % of participants reported feeling slightly dizzy or nauseous during or after the VR training, and 10.6% reportedly felt uncomfortable during the VR experience. Preliminary results further indicate that the investigated VR environment can significantly improve an already existing interest for VR (pre MD = 5, post MD = 6, Wilcoxon: $p < .001$), the readiness to use a VR application at work (pre MD = 4.67, post MD = 5.33, Wilcoxon: $p < .001$) and engagement and satisfaction with the occupational training (pre MD = 5.25 to post MD = 6, Wilcoxon: $p = .032$). The reluctance and unease with handling the equipment were significantly decreased after the training (pre MD = 3.5, post MD = 2, Wilcoxon: $p < .001$). The participating company had a highly established workers' safety climate (MD = 5.6, IQR = .63). Nevertheless, there were eight serious accidents involving electricity, of which one was deadly, and 478 reports of incidents of near-accidences in 2021.

Outlook

A follow-up project currently in an early planning phase will consist of laboratory experiments probing neural, physiological and cognitive VR correlates using an fNIRS/EEG- and biofeedback device. Questions concerning the role of immersion in VR experiences and skill transfer are sought to be answered. More precisely, we aim to probe different levels of immersion, realism and embodiment and their impact on executive functions such as attention, memory and decision-making. Consequently, the establishment of a neuroadaptive application for use in research and possibly occupational training is intended. The integration of spectroscopic and electrophysiological signals to aid optimal training effectiveness in terms of attention, participation and skill transfer is the eventual goal.

References

- Causse, Mickaël; Chua, Zarrin K.; Rémy, Florence (2019): Influences of age, mental workload, and flight experience on cognitive performance and prefrontal activity in private pilots: a fNIRS study. In: *Scientific reports* 9 (1), S. 1–12.
- Chen, Bo; Liang, Rui-Qi; Chen, Ru-Yan; Xu, Fang-yuan (2021): The effect of virtual reality training on the daily participation of patients: A meta-analysis. In: *Complementary Therapies in Medicine* 58, S. 102676.
- Cho, B. H.; Lee, J. M.; Ku, J. H.; Jang, D. P.; Kim, J. S.; Kim, I. Y. et al. (Hg.) (2002): Attention enhancement system using virtual reality and EEG biofeedback. *Proceedings IEEE Virtual Reality 2002: IEEE*.

Hwang, Gwo-Jen; Chang, Chun-Chun; Chien, Shu-Yun (2022): A motivational model-based virtual reality approach to prompting learners' sense of presence, learning achievements, and higher-order thinking in professional safety training. In: *British Journal of Educational Technology*.

Kines, Pete; Lappalainen, Jorma; Mikkelsen, Kim Lyngby; Olsen, Espen; Pousette, Anders; Tharaldsen, Jorunn et al. (2011): Nordic Safety Climate Questionnaire (NOSACQ-50): A new tool for diagnosing occupational safety climate. In: *international Journal of industrial Ergonomics* 41 (6), S. 634–646.

Sacks, Rafael; Perlman, Amotz; Barak, Ronen (2013): Construction safety training using immersive virtual reality. In: *Construction Management and Economics* 31 (9), S. 1005–1017.

Shamsudin, Nurshamshida Md; Mahmood, Nik Hasnaa Nik; Rahim, Abdul Rahman Abdul; Mohamad, Syazli Fathi; Masrom, Maslim (2018): Virtual reality for construction occupational safety and health training: a review. In: *Advanced Science Letters* 24 (4), S. 2444–2446.

Shuang, Dong; Qin, Yin; Heng, Li (2015): Positive safety participation and assessment by integrating sharing technology with virtual reality. In: *Procedia engineering* 123, S. 125–134.

Detecting threat identification from event-related brain potentials

Naomi du Bois¹, Leah Hudson¹, Damien Coyle^{1,2}

1) ISRC, Ulster University, Magee Campus, Londonderry, NI, UK

2) NeuroCONCISe Ltd., C-Tric Altnagalvin Hospital Campus, Glenshane Road, Londonderry, NI, UK

Keywords: Threat detection, EEG

Abstract

Introduction: Here we present a comprehensive study which aims to evaluate the potential for a neuroadaptive technology that can provide an advantage to the human user in various situations where threat may be present. The aim of the first phase, presented here, was to identify neural correlates of threat detection (measured via electroencephalography (EEG)) in a controlled experimental paradigm and determine how accurately these could be detected on a single trial basis against non-threat and distractor images.

Methods: Twenty-eight participants completed two EEG sessions (31 channels) – each involving a rapid serial visual presentation (RSVP) task (the background was removed from images in session one). A session consisted of two sets of three blocks; 3 runs, with 5x100 groups of images per run. One set required a button-press response to target stimuli. Both distractor images and threat targets each had a 10% prevalence during each run. Statistical analyses involved a 3-way repeated measures (ANOVA), for factors; button-press (2; button press and no button press) x category (3; first-person, faces, and objects/scenes) x Presentation rate (3; 100-175 ms, 200-275 ms, 300-375 ms) – and pairwise post-hoc analyses with paired t-tests, correcting for multiple comparisons using Bonferroni adjustments. The EEG data were preprocessed and epoched. Machine learning methods were applied for feature extraction, calibration and testing. A different classifier was setup and employed for each category and duration. For training and testing the data was split, 50% training and 50% testing, randomly selected with one cross validation performed on the training set for hyperparameter optimisation. The accuracies, achieved in detecting targets from non-target stimuli (ratio 1:8), were measured via area under the receiver operator characteristics curve (AUC) for each of the 28 participants.

Results and Discussion: Analysis of the first session's RSVP data (images without a background), found a significant main effect for all three factors; button-press due to greater accuracy under the button-press condition ($F_{(1,27)} = 28.27, p < 0.001, \eta p2 = 0.51$), category due to greater accuracy for first-person threat ($F_{(2,54)} = 28.32, p < 0.001, \eta p2 = 0.51$), and presentation rate ($F_{(1.54,41.58)} = 127.72, p < 0.001, \eta p2 = 0.83$), due to significant differences in AUC overall across each rate of presentation, with accuracy improving as presentation times increased. An interaction effect was found for button-press and presentation rate ($F_{(1.64,44.26)} = 7.82, p = 0.002, \eta p2 = 0.23$), as button-press accuracies, compared to those for no button-press, increased in significance with longer presentations. Overall, threat target classification was enhanced compared to distractor classification accuracies, with the highest accuracies occurring for the first-person category (Figure 1 a) – which was also the category that demonstrated the clearest ERP separability from ERP's elicited in response to non-threat images, having a grand average negative potential around 400ms (Figure 1 d). The results indicate the feasibility of classifying threat images with higher accuracy than distractor images, when classified against non-threat images (see Figure 1 b1-2 and c1-2). Topographical analysis showing the most active brain regions/electrodes for a response to threat versus non-threat stimuli, presented in Figure 1e, for each category and presentation duration indicate differences in the spatial and temporal neural

response to each category with first-person threat stimuli showing the earliest maximal response across broader occipital areas.

Conclusion: Threat images produce unique ERPs that contain information that enable detection of threats, even in the presence of distractors. The statistical analysis shows that accuracy is improved for threat classifications when a button response is made – which is consistent with previous research [1], [2]. ERP temporal and spatial patterns are modulated by stimulus, type and duration differently for threat, non-threat and distractor stimuli.

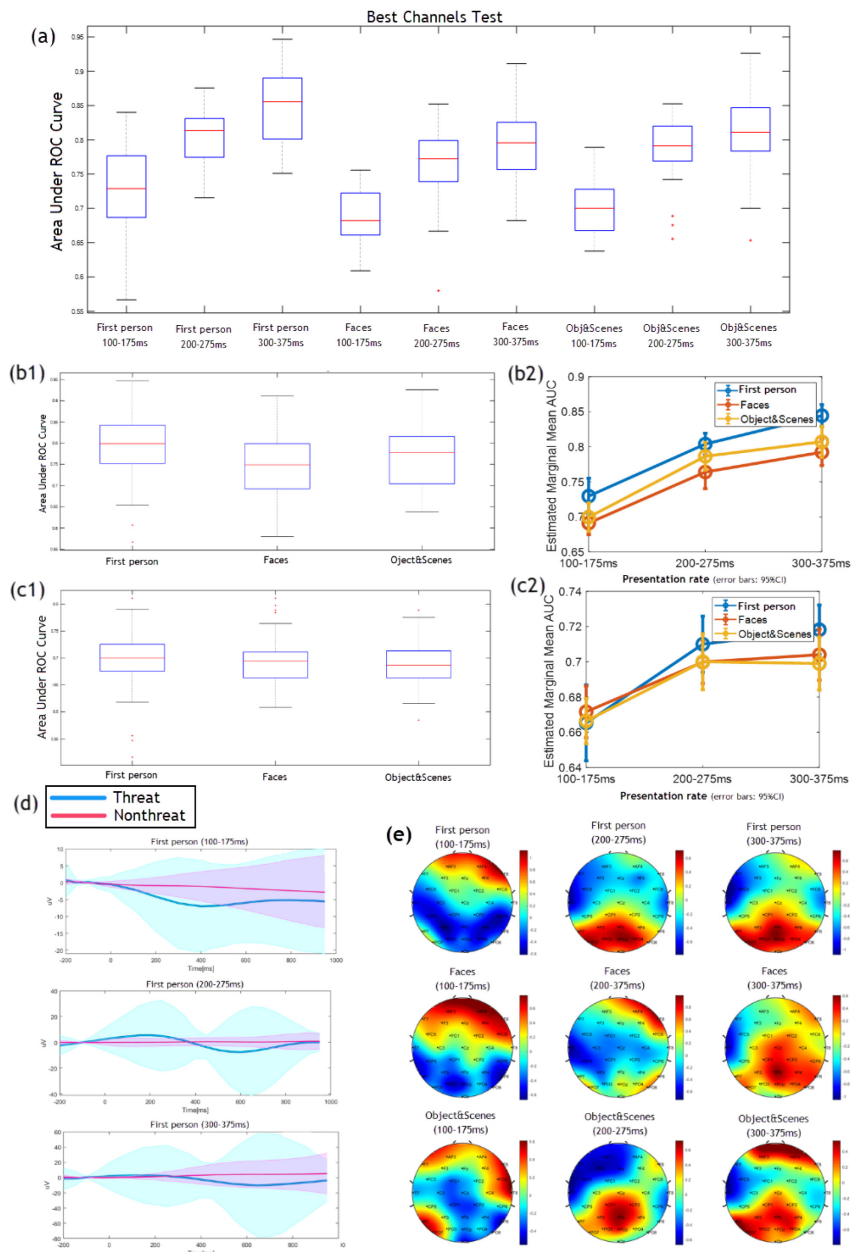

Figure 5. Button-press data: (a) Threat versus nonthreat; Boxplots showing the area under the ROC curve (AUC) obtained on the testing set for each of the different categories presented across all presentation speeds when classifying threat vs nonthreat stimuli. On each box, the central mark is the median, the edges of the box are the 25th and 75th percentiles, the whiskers extend to the most extreme datapoints the algorithm considers not to be outliers, and the outliers are plotted individually. **Threat versus nonthreat (b1 and b2)/ Distractor versus nonthreat (c1 and c2);** (b1 and c1) presents the AUC grouped per category and (b2 and c2) shows the estimated marginal means of AUC for classification accuracies – category had 3 levels; (1) first-person, (2) faces and (3) objects/scenes. Presentation rates were (1) 100-175ms, (2) 200-275ms, and (3) 300-375ms. **Event-related potential (ERP) (d):** plots for the first person threat versus nonthreat ERP grand averages (single channel), across each presentation rate. **Brain areas/EEG channels (e)** where the majority of information occurs to enhance separability between threat and non-threat stimuli elicited ERPs, for each category, at each presentation rate.

References

- [1] Y. Huang, D. Erdogmus, S. Mathan, and M. Pavel, "A fusion approach for image triage using single trial ERP detection," *Proc. 3rd Int. IEEE EMBS Conf. Neural Eng.*, pp. 473–476, 2007, doi: 10.1109/CNE.2007.369712.
- [2] S. Lees, P. Mccullagh, P. Payne, L. Maguire, F. Lotte, and D. Coyle, "Speed of Rapid Serial Visual Presentation of Pictures, Numbers and Words Affects Event-Related Potential-Based Detection Accuracy," *IEEE Trans. Neural Syst. Rehabil. Eng.*, vol. 28, no. 1, 2020, doi: 10.1109/TNSRE.2019.2953975.