



Wrocław
University
of Science
and Technology



Brandenburgische
Technische Universität
Cottbus - Senftenberg

21st EEEIC

International Conference on Environment and Electrical Engineering – Student Edition



Wrocław - Ostrava - Cottbus

June 2022

Harald Schwarz, Przemysław Janik, Radomir Gono, Dirk Lehmann

module at BTU: 12642

ISBN 978-3-940471-71-0

Presented by

Wrocław University of Technology
Department of Electrical Engineering
pl. Grundwaldzki 13
PL 50 – 377 Wrocław

Brandenburg University of Technology Cottbus - Senftenberg
Department of Power Distribution and High Voltage Technology
Siemens-Halske-Ring 13
D – 03046 Cottbus

VŠB - Technical University of Ostrava
Department of Electrical Power Engineering
17. listopadu
CZ - 15 Ostrava - Poruba

Publisher

Brandenburg University of Technology Cottbus - Senftenberg
Information, Communication and Media Center
University Library

Impressum

Brandenburgische Technische Universität
Cottbus-Senftenberg
IKMZ - Universitätsbibliothek
2022

ISBN 978-3-940471-71-0

[10.26127/BTUOpen-5998](https://nbn-resolving.org/urn:nbn:de:hbz:5:1-65862-p0011-9)

Legal rights

Creative Commons Attribution 4.0 International

Table of contents

IMPACT OF ELECTRICAL VEHICLE ON GERMAN ENERGY SECTOR	1
CARBON CAPTURE, STORAGE/ SEQUESTRATION AND UTILIZATION	9
GRAVITY ENERGY STORAGE	19
REVIEW OF PUBLIC POLICY: RENEWABLE ENERGY AS A PANACEA TO LINEAR ECONOMY LIMITATIONS	27
REVIEW OF RENEWABLE ENERGY EV CHARGING STATION	38

Key words: Electric vehicles; power system; dispatch model; renewable energy

Akshay Kumar SIRPA¹

IMPACT OF ELECTRICAL VEHICLE ON GERMAN ENERGY SECTOR

We look at future possibilities for integrating electric cars (EVs) into the German power grid based on various charging assumptions. We employ a numerical dispatch model with a unit commitment formulation to reduce dispatch costs over the course of a year. While the overall energy demand of electric vehicles is minimal in all circumstances, the influence on the system's load duration curve varies significantly. Charging happens mostly during the day and evening in a completely user-driven mode, when power demand is already high. Because of worries about generating adequacy, user-driven charging may have to be curtailed in the future. Cost-driven charging, on the other hand, is done at night and when there is a lot of PV available. We show that even a modest relaxation of totally user-driven charging results in more smoother load profiles and cheaper charging costs, using a unique model formulation that allows for intermediate charging modes. Different charging patterns correspond to different power plant dispatch patterns. By 2030, cost-driven EV charging will significantly boost the use of hard coal and lignite plants, whereas additional power will be generated primarily from natural gas and hard coal in the user-driven mode. EV CO₂ emissions are significantly higher than those of the whole power system and are highest when charging is cost driven. Electric vehicles become largely CO₂-neutral only in subsequent model runs in which we link the introduction of EVs to the deployment of extra renewable power capacity.

1. INTRODUCTION

Main challenges within the energy system of tomorrow are more volatile, less controllable and at the same time more decentralized electricity generation. Furthermore, the increasing research and development activities on electric vehicles (EV) make a significant share of electric vehicles within the passenger car fleet in 2030 more and more likely. This will lead to a further increase of power demand during peak hours. With the electrification of mobility accelerating, energy producers and distributors need to understand the potential impact of EVs on electricity demand. While the uptake in

¹ Brandenburg University of Technology – Cottbus – Senftenberg
Electrical Power Engineering

EV sales is unlikely to cause a significant increase in total power demand, it will likely reshape the electricity load curve. As Germany considers marching towards renewable energy sources, electric vehicles can be a potential challenge to meet energy demand. As Europe's largest national economy, Germany can play a significant role in reducing emissions. In accordance with the Paris Agreement, which aims to limit global warming to 1.5 degrees Celsius and achieve climate neutrality by mid-century, Germany has committed to reducing CO₂ emissions by 55 percent by 2030.[1] While the country has made a solid start, current reductions will clearly not be enough. By 2030, emissions from the transport sector in Germany must be reduced by 42 to 44 percent. [3] A fundamental change within the road transport sector is required if Germany wants to achieve its objective of a long-term transition to a low-carbon European economy. Electric vehicles charged with electricity from renewable sources can reduce future emissions of greenhouse gases and air pollutants from road transport.

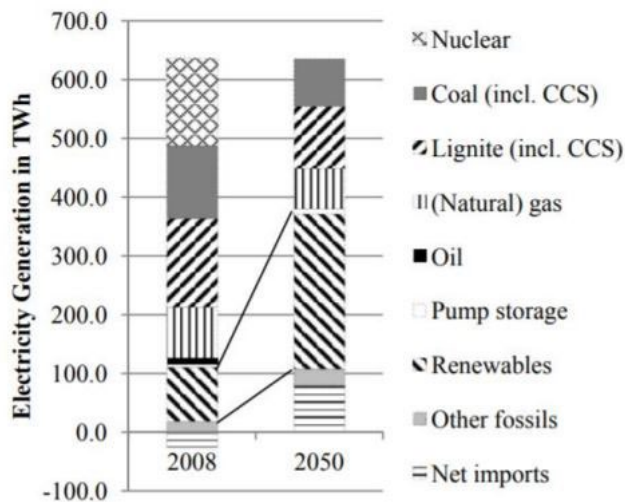

Figure 1 : Electricity generation in Germany in 2008 and 2050 by fuels in TWh. Source: EWI et al.

From the German perspective these challenges might be tremendous due to the ambitious aim of CO₂ emission reduction of up to 80 % in 2050 compared to 1990 levels and the nuclear phase-out until 2022 (German Atomic Energy Law – AtG). The development of the electricity generation and its composition in Germany until 2050 illustrates these challenges (Figure 1). While the share on conventional power generation (coal, nuclear, natural gas, and oil) was above 80 % in 2008, it is supposed to be below 50 % in 2050. This increase in power generation of renewable energy sources can lead to uncontrolled and unpredictable supply. Alongside the increase of electric vehicles, increases the energy demand during peak hours.

The new demand will need to be met by additional electricity production, thereby influencing the operation of generation plants. Crucially, the additional demand can influence the electricity generation of fossil fuel power plants and thus lead to an increase of greenhouse gas emissions of the energy sector. The decarbonizing of the transport sector is one of the primary motivations for introducing electric vehicles to the market. Therefore the critical question is what type of generation is used to cover this additional electricity demand. Electric vehicles only have a better environmental performance than conventional vehicles if the additional demand is met by a low carbon intensive energy mix. This is relevant not only for the use phase of the electric vehicles, but also for their production and their end-of-life phase. Electric vehicles can have significant higher emissions than conventional cars within a pure coal based electricity system.

Besides the influence of electric vehicles on the operation of generation plants, electric vehicles also have an impact on the grid infrastructure. So far, no relevant impact on the transmission grid level are foreseen, but the power requirements of electric vehicles can put local distribution grids under critical stress. It is expected that electric vehicle charging will first occur on a concentrated basis in urban suburban environments, among a homogenous owner group. Therefore the charging of electric vehicles will likely be highly geographically concentrated and will occur most likely after work with a high simultaneousness during evening, when demand is already high (Figure 2).

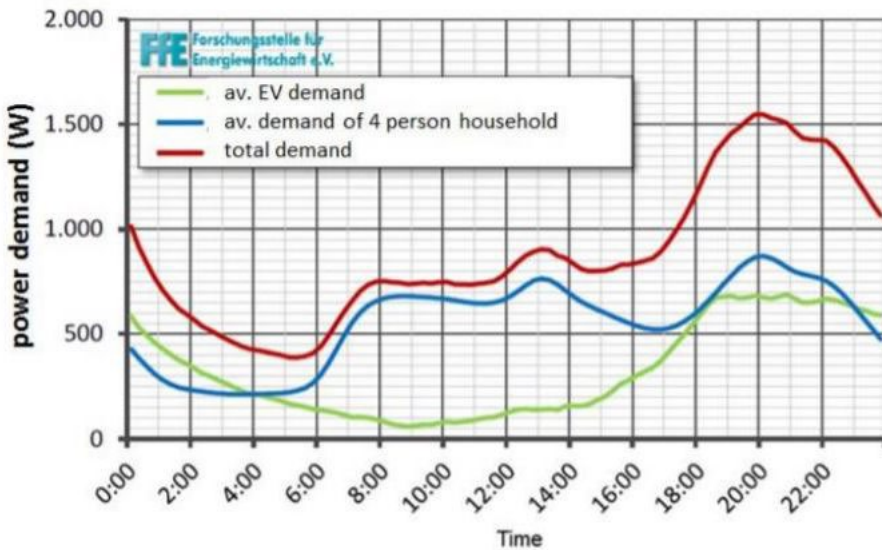

Figure 2 Load curves (user-driven charging) of electric vehicle charging, private

As local grids are not designed for this type and intensity of load, electric vehicles can bring local grids to their technical limits. The impact of EV charging on local grids is influenced by the power levels EV charging takes place. Charging with common household sockets with a charging power of 2.3 kW requires relatively long charging

times of 8-9 hours for a full battery re-charge. This slow charging puts less stress on local grids as the load is more evenly distributed over a longer period. Increasing the charging power to 22 kW or higher voltages reduces charging times significantly (down to 30 minutes) but also significantly increases the risk of negative impacts to the grid infrastructure.

2. SITUATION OF THE POWER GRIDS

2.1 DEMAND OF ELECTRIC VEHICLES

The electromobility boom continues. There is no doubt that electric mobility is booming. Tesla got the ball rolling, and established automakers followed suit. Every well-known manufacturer now has at least one electrically operated model in their catalogue. Of course, the picture is different on the streets of this world: the demand for electric cars is increasing rapidly. But compared to newly registered petrol and diesel vehicles, sales figures worldwide are still low. In 2018, over 80 million new cars were sold worldwide. Of these, around 2 million had an electric drive.

The Federal Motor Transport Authority reported more than 194,000 new electric vehicles and over 200,000 plug-in hybrids for 2020. One reason why the boom in e-cars could put strain on the power grids is due to a simple technical problem: charging an e-car places a high load on the grid infrastructure compared to other "electronic devices". If a single vehicle is charging, the power grid can easily handle this power," says Junge. If, on the other hand, many vehicles load at the same time in the same network section, this can be very heavily loaded and may reach its limits. If the power requirement rises above the load limit of the network section, the section is switched off as a precautionary measure to avoid damage – the entire street becomes dark. [5]

. In order to implement the federal government's goal from the climate protection plan of allowing seven to ten million electric vehicles by 2030, many more charging points must be implemented. Most will simply become wall boxes for your own garage or carport, which you can purchase when you buy the vehicle. But not everyone has their own parking space and they don't always want to only charge at public charging stations. [6] The conservative baseline scenario of the study of 8 million electric vehicles by 2030 reflects the goal of the current Climate Action Program 2030. The most aggressive scenario – which is no longer unrealistic in view of the probable recommendation of the National Platform for the Future of Mobility – with an accelerated introduction of 16 million electric vehicles by 2030 reflects the studies commissioned by the EU and an early implementation of the proposed EU Ban on vehicles with internal combustion engines (ICE), which would anticipate the switch to electric motors for both consumers and manufacturers. The additional power requirement is less than expected. In a base-case scenario, the demand for charging EVs in Germany could reach

around 23 TWh per year by 2030, in an accelerated deployment scenario. This would correspond to an increase of 4 or 8% compared to the current electricity demand. Overall, electricity consumption in Germany was 568 TWh in 2019, with a slight downward trend.

Electromobility suitable for everyday use requires a sufficient number of normal charging points (e.g. for overnight charging at home, on the side of the road or in an underground car park) and rapid charging stations (e.g. on motorways or in shop parking lots). Currently (March 2020) there are around 24,000 publicly accessible charging points, which is twice as many charging options as filling stations. Of these, 15 percent (approximately 3,600) are fast chargers.

2.2 PROBLEMS ASSOCIATED WITH INCREASE OF ELECTRIC VEHICLES

The main infrastructure components to invest in are residential transformers in areas with high EV penetration and, to a lesser extent, power circuits and switchgear. With the increasing spread of EVs and the evolution of charging tariffs from the current slow AC tariffs (less than 4 kW) to improved tariffs (four to 15 kW) and finally to fast AC tariffs (15 to 22 kW), the Number of potentially overloaded transformers in homes is increasing exponentially. Estimates show that the number of transformer upgrades will skyrocket once around 3 million EVs are in service, which could be as early as 2025. Successful grid integration is a central building block for the future ramp-up of electromobility and sector coupling, i.e. the integration of energy supply and end consumption. However, considerable risks, especially for grid balance, must be mitigated. For example, the rapid spread of fast charging stations is expected to increase the impact of emerging loads from uncontrolled charging of electric vehicles (EVs).

Providing an adequate power supply for the future fleet of electric vehicles will depend on the cooperation and cooperation of various stakeholders, including energy suppliers, policy makers and regulators, car manufacturers and EV charging companies. [7]

From a climate policy perspective, this is bad news: road transport is responsible for almost a fifth of global CO₂ emissions that can be traced back to the burning of fossil fuels. If all vehicles were powered by electricity from renewable energies, around 6 gigatonnes of CO₂ could be avoided. That is more than the annual greenhouse gas emissions of the entire European Union. In order to achieve the goals of the Paris climate agreement, it would therefore be a blessing if only electric vehicles crossed our streets as soon as possible. [8]

2.3 SOLUTION FOR GRID EXPANSIONS

In order to be able to meet the energy demand without restrictions, the use of smart charging stations in combination with the intelligent power grid plays an important role

in addition to the expansion of renewable energy sources. In this way, loading times can be automatically placed in a period in which the peak load is as low as possible. Instead of charging all e-cars at the private charging station at home after work between 7 p.m. and 8 p.m. charging, the intelligent wall boxes then charge the e-vehicle when they are controlled accordingly by the smart grid. For example, between 10 p.m. and 4 a.m. when there is no increased electricity demand from cooking, streaming and similar household activities. According to experts, the peak load increase resulting from the charging requirements of e-cars can be reduced by up to 80 percent. This also prevents power shortages.

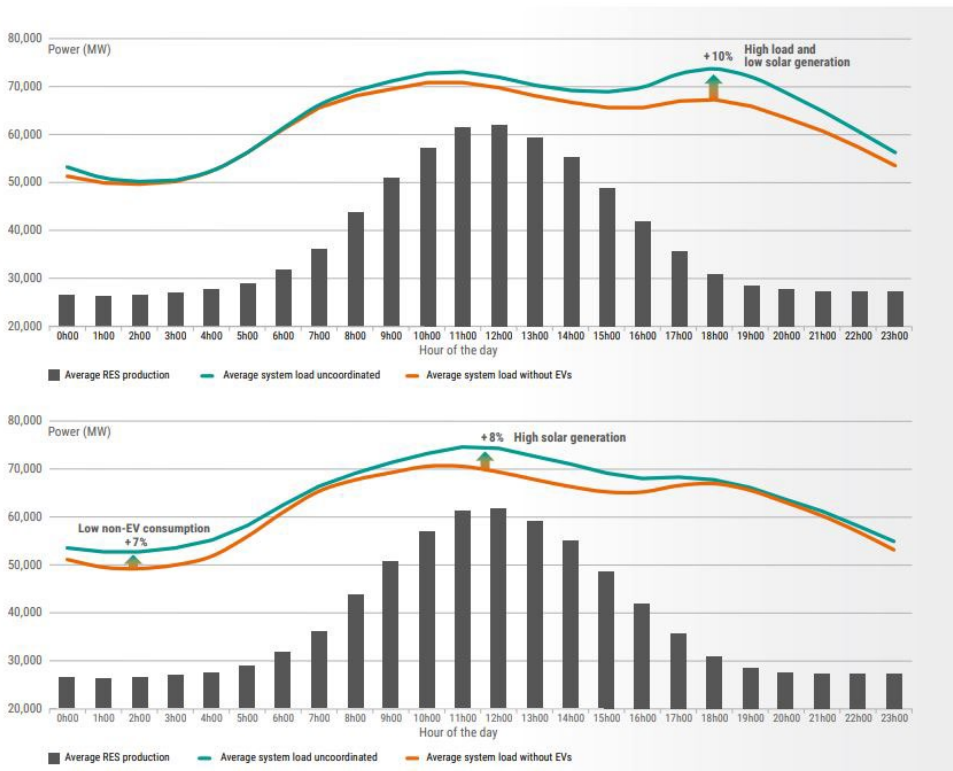

Figure 3– Average total electricity load in Germany with uncoordinated (left) and smart charging (right). (Source: Elia Group)

The basis for such an optimized power supply is the smart grid. The intelligent power grid controls the increasingly complex energy system, which is no longer only fed from central power plants, wind turbines or solar parks, but also decentrally from private energy producers. They are an important part of the energy transition and produce their own electricity using photovoltaic systems, for example. Surpluses are stored or fed into the grid. So there is always enough energy available, even if the electricity production from renewable sources such as sun and wind fluctuates due to the weather. Based on real-time market data on supply and demand as well as calculations on expected demand

and future generation, the smart grid distributes the energy proactively and efficiently to all players in the power grid. [9]

Charging infrastructure planning should consider transport, urban planning, private households buildings and energy system needs. The charging behaviour of EV users and configuration/characteristics of the charging infrastructure will have an impact both on transmission and distribution grids, as well as on the power system as a whole. Hence, a synergic and coordinated approach should be adopted. Moreover, by coupling the user's parking need with the charging need, the charging process can become a new, cost-effective resource of flexibility. [10]

Grid planning should be performed through a careful scenario definition. Improved modelling should be adopted to perform robust simulations of grids' impact and cross-sector optimisations scenarios by means of new models and algorithms as well as what-if and sensitivities analysis. Quantitative parametric and probabilistic models should assess the impact of progressive massive EV penetration on the electricity system, including modifications of hourly/weekly/seasonal load profiles, conditions for energy adequacy (primary energy supply) and power adequacy (grid congestions/reinforcements).

3. CONCLUSION

In the coming future, there are positive and negative impact due to Electrical Vehicles. Taking the positive impact into the account, the production of new electric vehicles and conversion of the Internal Combustion Engine vehicles should be given priority. The negative impact should also be considered and resolved well before than forecasted. There may be some disadvantages due to the electrical vehicles in terms of environmental concerns, which may be addressed by environmental friendly solutions. The improvement of infrastructure of energy sector is the highest priority to promote electrical vehicles.

REFERENCES

- [1]. https://unfccc.int/files/essential_background/convention/application/pdf/english_paris_agreement.pdf
- [2]. <https://www.mckinsey.com/industries/automotive-and-assembly/ourinsights/the-potential-impact-of-electric-vehicles-on-global-energy-systems>
- [3]. Klimaschutz in Zahlen: Fakten, Trends und Impulse deutscher Klimapolitik, Germany's Federal Ministry for the Environment, Nature Conservation and Nuclear Safety, 2018, bmu.de.
- [4]. P. Jochem, T. Kaschub, W. Fichtner "How to integrate electric vehicles in the future energy system?" working paper series in production and energy, Karlsruhe institute of technology. Volume 3 June 2013
- [5]. <https://www.enbw.com/blog/elektromobilitaet/laden/ist-das-stromnetz-den-e-autos-gewachsen>
- [6]. <https://www.bmu.de/themen/luft-laerm-mobilitaet/verkehr/elektromobilitaet/strombedarf-und-netze>
- [7]. <https://www.energie.de/et/news-detailansicht/nsctrl/detail/News/auswirkungen-der-elektromobilitaet-auf-das-deutsche-stromnetz>
- [8]. <https://new.siemens.com/de/de/unternehmen/stories/infrastruktur/2020/wie-viele-elektromobile-vertraegt-das-stromnetz.html>
- [9]. <https://www.enercity.de/magazin/unsere-welt/genug-strom-fuer-elektroautos>
- [10]. ENTSO-E Position Paper on Electric Vehicle Integration into Power Grids

Key words: Sequestration, Absorption, Adsorption, Miscible & Immiscible Injection, Mineralization

Vinay Reddy KAMBAM

Chandrashekar KURA

Sai Ram VISSAVAJHALA¹

CARBON CAPTURE, STORAGE/ SEQUESTRATION AND UTILIZATION

Emission of CO₂ into the atmosphere is a Universal problem which is leading in escalation of Earth's temperature resulting in environmental catastrophes. Capturing CO₂ from the exiting gases of Industries and Power Plants or directly from atmosphere by using different types of decarbonization methods can solve the issue. Separated CO₂ can be stored in the geological formations or can be permanently mineralized inside the rock formation or empty reservoirs. CO₂ can be utilized as a solvent for enhanced oil/gas recovery and can permanently be stored underground. By considering economic feasibility capturing carbon at the exhaust of the factories and using CO₂ for recovering fossil fuels is the preferable alternative.

1. OVERVIEW

1.1. CARBON CAPTURE

Elimination of carbon must take place either at

- a) Pre-Combustion – where the decarbonization of fuel happens prior to combustion or
- b) Post-Combustion – separation of CO₂ from the products of combustion or
- c) Oxyfuel Combustion – where fuel is mixed with pure O₂ (oxygen) and re-cycled flue gas to attain high concentration of CO₂ in the exiting stream.

¹ Brandenburg University of Technology – Cottbus – Senftenberg
Electrical Power Engineering

Several processes for carbon capture include sorption and desorption of CO₂ by chemically reacting with amine, ammonia, carbonate based, Metal oxide sorbents & novel sorbent materials, by physical dissolution with solvents such as rectisol, selexol, purisol and by using membranes such as zeolites, silica and activated carbon.

1.2. CARBON STORAGE/ SEQUESTRATION

- a) Geological storage – Two main storage options are non-potable water (saline aquifers) and oil/gas reservoirs. Due to highly developed and widely deployed monitoring technologies, site characterization and injection leads in application of this process for commercial development.
- b) Ocean storage – CO₂ can be stored as a lake of supercritical fluid by injecting at a depth of 3000m at which it becomes negatively buoyant in seawater where seabed topography provides lateral containments.
- c) Storage in terrestrial ecosystem
 - Land use (e.g., preserving, or reestablishing forests and wetlands)
 - Land-management practices, particularly relating to soil disturbance
 - Plant types and cropping systems: debris retention, water-use efficiency, and lignin production
 - Microbial community make-up: balance of fungal versus bacterial populations
 - Soil fertility and irrigation, including wetting – drying cycles.
- d) Storage by mineral carbonation – Mineral carbonation is a potential storage method that accelerates the geological weathering process. It involves the formation of stable carbonates by the reaction of CO₂ with naturally occurring oxides or silicates of magnesium, iron, and calcium. Igneous silicate rocks are globally abundant and contain important silicate minerals such as olivine, wollastonite and serpentine which are potential feedstocks for mineral carbonation.

1.3. CARBON UTILIZATION

Use of CO₂ is dominated by the production of urea as a nitrogen fertilizer which currently consumes ~ 65 Mt of industrially produced CO₂ per year. Other uses include the production of methanol, polyurethanes, and the food industry, and total industrial use is estimated at ~ 120Mt CO₂ per year.

Potential applications that could have a material impact are the production of precipitated calcium carbonate (PCC) for use in the paper and cement industries, and the direct use of cooled flue gases as a CO₂ source for microalgal photosynthesis, generating biomass for biofuel production. The latter application would be carbon neutral if the biofuel is subsequently burned without capture or would reduce net emissions if CO₂ is also captured in the biofuel combustion process.

2. SORPTION-BASED CO₂ CAPTURE

2.1. ABSORPTION SYSTEMS

A phenomenon involving atoms or molecules crossing the surface and entering the volume of the material. Example: Sponge absorbs water.

2.1.1. PHYSICAL ABSORPTION

Using physical solvents to absorb CO₂ without chemical reaction. This involves the physical absorption of CO₂ into a solvent based on Henry's law. The driving force for the CO₂ absorption in solvent is due to the solubility. Generally, the solubility will increase with increase of pressure and decrease of temperature. Hence, the best condition for CO₂ absorption process is at high pressure and low temperature. No external heat is required for the absorption process and the only significant energy consumption is due to the solvent.

Recycle pumps the solvent regeneration process can be easily carried out by pressure reduction, inert gas stripping, or thermal regeneration. Other than that, physical absorption can selectively absorb H₂S. Minor gas impurities such as COS and mercaptans can also be absorbed without solvent degradation. Typical solvents are Selexol (dimethyl ethers of polyethylene glycol) and Rectisol (methanol).

2.1.2. CHEMICAL ABSORPTION

Involves the reaction of CO₂ with a chemical solvent to form a weakly bonded intermediate compound which may be regenerated with the application of heat producing the original solvent and a CO₂ stream. The selectivity of this form of separation is relatively high. In addition, a relatively pure CO₂ stream could be produced. These factors make chemical absorption well suited for CO₂ capture for industrial flue gases.

2.2. ADSORPTION SYSTEMS

A process where the accumulation of a particular compound takes place on the surface of the material rather than entering the material. Example: Mist on Windows or Paint on walls.

2.2.1. PHYSISORPTION

Intermolecular attraction between the adjacent atoms or molecules of the adsorbent and the adsorbate, not resulting in formation of a chemical bond. By using regeneration techniques such as pressure, temperature, or hybrid swing adsorptions the sorbent regeneration takes places. Materials such as Zeolites, Silica-based sorbents are used.

2.2.2. CHEMISORPTION

Adsorbate sticks onto the adsorbent by forming a chemical bond. Regeneration of the sorbate happens usually by temperature swing adsorption, for better and faster regeneration sorbate hybrid swing adsorption is used. Adsorbents such as Metals Oxides, Metal organic frameworks are used.

3. CARBON SEQUESTRATION/STORAGE

3.1 MEMBRANE SEPARATION SYSTEM

3.1.1. SIZE SIEVING

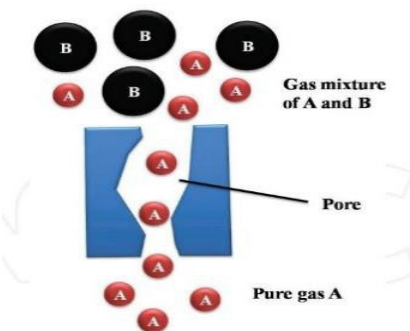

Fig. 1. Size sieving

The membrane pore size is just between the smaller gas molecule and larger gas molecule as depicted in Figure. The smaller gas molecule A passes the pore channel

freely, while the counterpart gas B is not able to enter the pore. As a result, pure component A is obtained in the permeate stream from the gas mixture A–B. This mechanism applies to separating gas mixtures with very different molecular sizes such as H₂ and CO₂, H₂ and hydrocarbons, etc.

3.1.2. SURFACE DIFFUSION

When the membrane material has higher affinity to one component than the other, this affinitive component is preferentially adsorbed on the membrane surface and then the adsorbed gas molecules move along the pore surface to the permeate side until desorbing to the permeate gas. Since the membrane is occupied by the highly adsorbable component, the less adsorbable component has lower probability to access the pore, which results in a much lower permeability. In such a way, the more adsorbable gas is separated from the gas mixture (Figure). This type of mechanism is generally used to separate adsorbing gas with non-adsorbing gas such as CO₂ with He, CO₂ with H₂. Surface diffusion generally acts in micro- and meso-porous membranes.

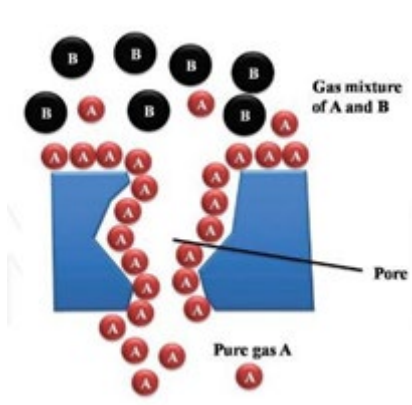

Fig. 2. Surface diffusion

3.1.3. SOLUTION DIFFUSION

The process of gas separation using dense membranes occurs in a three-step process, which is similar to surface diffusion. The dense membrane has no pore to accommodate gas molecules, however, it can solve specific gas component. As shown in Figure, due to the difference in solubility or absorbability in the membrane material, gas A solves or absorbs in the membrane after they contact at the feed interface, while gas B remains as gas phase at the interface. The second step is the solved A component diffusing across the membrane driven by the concentration gradient from feed interface to the permeate interface. Finally, component A desorbs from the permeate interface under a low pressure. This is a common mass transfer mechanism in polymeric membrane.

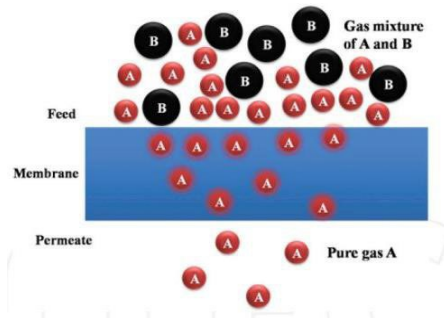

Fig. 3. Solution diffusion

3.1.4. FACILITATED TRANSPORT

The solution-diffusion process is often constrained by low permeate flux rates due to a combination of low solubility and/or low diffusivity. In contrast, facilitated transport that delivers the target component by a carrier can increase the permeate flow rate. As demonstrated in Figure 8, the gas A and carrier C form a temporary product A–C that is from a reversible chemical reaction. The product diffuses across the membrane under the concentration gradient of this product A–C instead of the concentration gradient of A. At the permeate interface, the reverse reaction takes place and A is liberated from this reverse reaction. A is released to the permeate stream and C diffuses back to the feed interface again to attach and deliver a new A. Facilitated transport mechanism normally exists in liquid membrane.

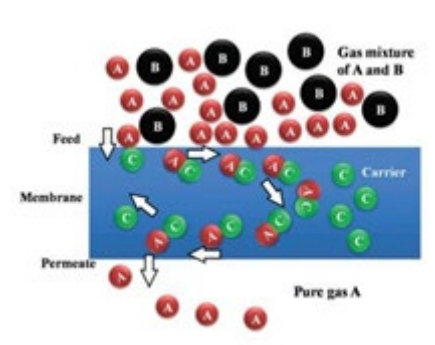

Fig. 4. Facilitated Transport

3.2. ENHANCED OIL/GAS RECOVERY

3.2.1. TYPES OF OIL/GAS RECOVERY

Primary Recovery/Production Phase – Extraction of Oil and Gas relies on the pressure difference between the surface and the underground reservoir.

Secondary Recovery/ Production Phase – After primary recovery, the pressure difference decreases. To maintain the reservoir pressure an external fluid such as water or gas is injected into the reservoir.

Tertiary Recovery/ Production Phase – With primary and secondary recovery phase 10% - 40% of oil in the well has been extracted. By using gas injection, chemical flooding and some thermal methods rest of the well is extracted.

In comparison the tertiary extraction is more expensive and could be uneconomical.

3.2.2. MAJOR OIL EXTRACTION EFFECTS

3.2.2.1. MISCIBLE OIL RECOVERY

- If the reservoir pressure is more than minimum miscible pressure necessary at the given temperature and oil composition, CO₂ dissolves in the oil.
- Dissolution of CO₂ in the oil leads to reduction of viscosity of the oil and reduction interfacial tension between the oil and rock surfaces takes place which allows oil to flow easily through porous medium.

Benefits/Challenges:

- Lack of capillary action i.e., retaining of oil in a particular place doesn't happen.
- Both vertical and horizontal injection can be applied through this process.

Applicable for

- Reservoirs with more than 250 API oil gravity and located at more than 915 m depths.
- Light and medium light oils (>300 API) in shallow reservoirs at low temperatures.

3.2.2.2. IMMISCIBLE OIL RECOVERY

- Partial or no dissolution of CO₂ into the oil leads to maintaining/increasing the pressure inside the reservoir. This helps in extraction of oil in both ways i.e., by partial miscibility and immiscibility.
- This no or partial dissolution mechanism leads to oil swelling, which helps in reduction of density and improves mobility.

Benefits/Challenges:

- Better choice for cases in which the reservoir pressure is lower compared to MMP value.
- Could be an option with oil composition which are not appropriate for Miscible CO₂-EOR.

Applicable for

- Immiscible oil recovery can be applied to moderately heavy oil reservoirs and shallower light oil reservoirs.
- 915 m depths or with oil gravities between 17.50 and 250 API.

3.3 MINERALIZATION

Vast quantities of carbon are naturally stored in rocks. Imitating and accelerating these natural processes, where carbon dioxide is dissolved in water and interacting with reactive rock formations, such as basalts, to form stable minerals providing a permanent and safe carbon sink. This technology provides a complete carbon capture and injection solution, where CO₂ dissolved in water i.e., sparkling water is injected into the subsurface where it reacts with favorable rock formations to form solid carbonate minerals via natural processes in about 2 years. Requirements for this technology are favorable rocks, water, and a source of carbon dioxide.



Fig. 5. Chemical reaction for mineralization

Carbonated water is acidic. The more carbon packed into water, the more acidic the fluid becomes. Carbonated water reacts with rocks underground and releases available cations such as calcium, magnesium, and iron into the water stream. Over time, these elements combine with the dissolved CO₂ and form carbonates filling up the empty space (pores) within the rocks. The carbonates are stable for thousands of years and can thus be considered permanently stored.

The injected carbonated water is denser than the surrounding water in the geological formation and therefore has the tendency to sink after it has been injected. This differs from conventional methods of carbon capture and storage, which depend on cap rock to prevent possible leakage of gaseous CO₂ injected into deep formations. Young basaltic rocks are highly fractured and porous such that water seeps easily through the interconnected cracks and empty spaces underground.

Benefits

- High reactivity and chemical composition of basalt rocks leads in formation of stable carbonate minerals.
- Permanent and efficient storing of CO₂ takes place within the basaltic rock formation.

4. UTILIZATION OF CO₂

4.1 SABATIER PROCESS

Production of Methane and Water using Carbon dioxide and Hydrogen at elevated temperatures and pressures. Usually at 300-400 °C and 3 MPa.



Applied for

Propellant for Mars

This process is especially used for projects on Mars such as Human mission to Mars, Mars Direct, SpaceX Starship due to presence of 95% CO₂. Importing hydrogen from earth and reacting it with carbon dioxide available in the Mars atmosphere yielding methane stored as fuel and water as side product is electrolyzed forms oxygen liquified stored as oxidizer and hydrogen which is later used in reactor.

4.2 CHEMICAL SYNTHESIS

- Conversion of CO₂ into Acetic acid, Urea, and Polycarbonates.
- Aliphatic compounds may degrade and release CO₂ back into the atmosphere in 6 months which explains that it is not a permanent solution for Storage or Utilization.

CO₂ can be converted to polycarbonates or other organic products such as acetic acid, urea & PVC.

It is not a permanent solution for storage or utilization of CO₂, as aliphatic (straight chain) compounds may degrade & release CO₂ back to atmosphere as easily as 6 months.

REFERENCES

- [1] Stephen A. Rackley, Carbon Capture and Storage, Gulf Professional Publishing, 2009, ch 02, pp 19-24., ch 04, pp 67.
- [2] Adsorption, Absorption and Desorption - What's the Difference?, <https://www.chromatographytoday.com/news/hplc-uhplc/31/breaking-news/adsorption-absorption-and-desorption-whats-the-difference/31397>, Aug 24 2014
- [3] Membrane Separation Technology in Carbon Capture, from the edited volume of Recent Advances in Carbon Capture and Storage Edited by Yongseung Yun, March 8th, 2017, DOI: 10.5772/65723.
- [4] A Review of CO₂-Enhanced Oil Recovery with a Simulated Sensitivity Analysis, Monash University, Commonwealth Scientific and Industrial Research Organisation (CSIRO), Ian Wark Laboratory, Editor: Thomas E. Amidon, 23 June 2016. [5] How it works, <https://www.carbfix.com/scientific-papers>, <https://www.carbfix.com/how-it-works>.
- [6] Sabatier/Water Electrolysis Process, [https://marspedia.org/Sabatier/Water Electrolysis Process](https://marspedia.org/Sabatier/Water_Electrolysis_Process).
- [7] Carbon Capture and Utilization, https://en.wikipedia.org/wiki/Carbon_capture_and_utilization#Chemical_synthesis.

Key words: Energy Storage, Renewable energy, Gravity Storage, Hydraulic, Pumped Storage Plant

Sai Krishna VALLABHANENI

Surendra Babu YARRAVARAPU¹

GRAVITY ENERGY STORAGE

Gravity Storage is a concept with which unprecedentedly large quantities of power can be stored for a long time of 6-14 hours and can be made available again. The fundamental principle is based on the hydraulic lifting of a large rock mass. Using electrical pumps, as already used today in pumped storage power plants, water is pumped beneath a movable rock piston, thereby lifting the rock mass. During times of insufficient generation of renewable power, the water, which is under high pressure from the rock mass, is routed to a turbine, as in conventional hydroelectric plants, and generates electricity using a generator.

1. INTRODUCTION

Renewables are projected to increase from their current 12% of the global energy supply to 90% in 2050. Yet the widespread use of renewables is challenged by the intermittency of solar and wind, and we're not yet at a place where we can store enough energy to avoid these problems. As renewable energy supply increases around the world, so too is the demand for grid-scale energy storage. It has been projected that the combined global stationary and transportation annual energy storage market will increase from today's baseline of around 600 GWh by a factor of four by 2030 to more than 2,500 GWh.

Today, global energy storage capacity is dominated by gravity-based pumped hydro (90%), followed by lithium, lead, and zinc batteries (5%), with the remaining capacity allotted to thermal and flow batteries, compressed air, flywheels, and other gravity-based mechanical systems. Within the framework of large-scale, grid-level energy stor-

¹ Brandenburg University of Technology – Cottbus – Senftenberg
Electrical Power Engineering

age, gravity-based solutions currently dominate the commercial space. Pumped hydro, for example, is a reliable technology with a rapid response time and proven longevity.

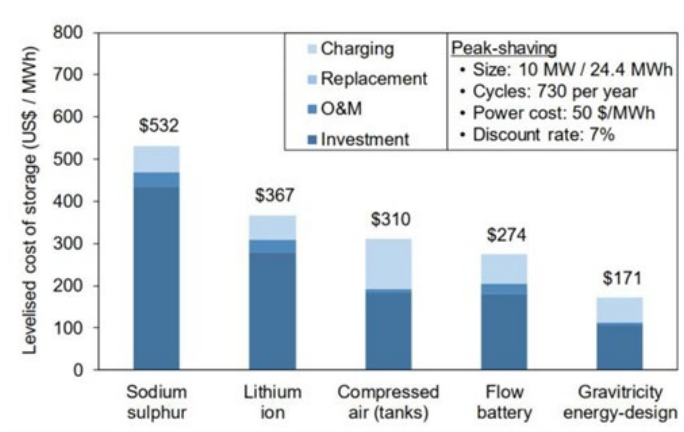

It suffers nevertheless from the availability, scalability, and cost of suitable mountainous and water-rich land, low round-trip energy efficiency (70%), carbon-intense construction, and the challenge of co-locating solar and wind.



Fig.1. Load Duration Curve

The fundamental idea of the hydraulic potential energy store, Gravity Storage, is based on the hydraulic lifting of a very large rock mass using water pumps. The rock mass acquires potential energy and can release this energy when the water that is under pressure is discharged back through a turbine. [1]

The decisive variable with such energy storage lies in the storage capacity. It increases with the fourth power of the radius, r^4 .

The construction costs however only increase with the square of the radius, r^2 . This means that the construction costs increase substantially more slowly than the storage capacity. Thus, very low costs per kilowatt-hour of storage capacity are possible. Strictly speaking, the price per kilowatt-hour of storage capacity decreases by $1/r^2$. This is the outstanding competitive advantage of this storage concept.

If a piston is selected for the Gravity Storage having a radius r and a length $l=2r$, then the piston can be lifted to the height $h=r$. The height $h=r$ results from the consideration that the seal must lie somewhat above the center of gravity, thus at a distance r above the bottom of the cylinder so that the cylinder is hydrostatically stable while floating.

The storage capacity E is given by the density of the rock and the density ρ_w of water, and the gravitational acceleration g :

$$E = (2\rho r - 3/2\rho_w) \pi g r^4 \quad (1)$$

The last term is decisive – the radius to the fourth power. This has two important consequences. First, the storage capacity can increase 16-fold by doubling the radius, and second, the construction costs only increase by approximately the square of the radius. Therefore, due to geometrical rules, the relative cost per energy unit decreases proportionally to $1/r^2$.

In Tab. 1 the values for the storage capacity are given for a rock density of 2600 kg/m^3 .

A diameter of 250 meters would already result in a storage capacity of 8 GWh, which is comparable to the largest pumped storage power station in Goldenthal, Germany (8.4 GWh).

1.1. STORAGE CAPACITY WITH DIFFERENT SIZES

Table 1. Storage capacity with different sizes

Usable Capacity [GWh]	1,0	3,0	8,0
Number of people supplied for 24 h*	250.000	750.000	2 million
Diameter [m]	150	200	250
Volume of water [1000m ³]	1,340	2,380	5,990
Pressure [bar]	41	67	71

The efficiency of Gravity Storage, at approximately 80%, is comparable with that of pump storage.

The storage requires mainly two central seals:

- Sealing the piston and the exterior walls
- Sealing ring around the Piston to withstand hydraulic pressure

The piston and its surroundings are sealed with concrete and steel so that no water can leak out of the displaced volume. A rolling membrane sealing is fixed between piston and cylinder.

Methods known from mining and tunnelling are used for the construction.

1.2. ADVANTAGES OF GRAVITY STORAGE

Table 2. Advantages of gravity storage

Profitability	Applicability	Sustainability	Performance
Gravity Storage is economically superior to all other energy storage solutions: Low investment costs between 120 and 380 USD/kWh storage capacity (varying according to size)	Gravity Storage requires no elevation difference (suitable for flat terrains, unlike pumped hydro storage)	Minimal raw material requirements (“just rock and water”)	The system buffers fluctuating energy on a GWh-scale and maximizes use of excess energy by enabling it to be used during periods of low generation
Low operational costs of less than 1% of capex per year	It can be easily integrated into any high voltage transmission grid	Requires much less water than pumped hydro storage	High round-trip energy efficiency of 80% or more
	More than 40% of the continental surface is basically suitable for Gravity Storage	Small land footprint per kWh	Provides a variety of system services: dispatching, black start capability, rotating masses
		No harmful chemicals required	Fast and steep load ramping comparable with that of any modern pumped hydro system

2. CONSTRUCTION

Construction steps:

- Drilling/excavation of access shafts and tunnels
- Excavation/separation of walls and base
- Sealing and strengthening of excavated surfaces using concrete Installation of rolling membrane seal around the piston Installation of machinery and electrical plant
- Construction of the reservoir

- Connection to the power grid

2.1. CONSTRUCTION OF ANNULUS

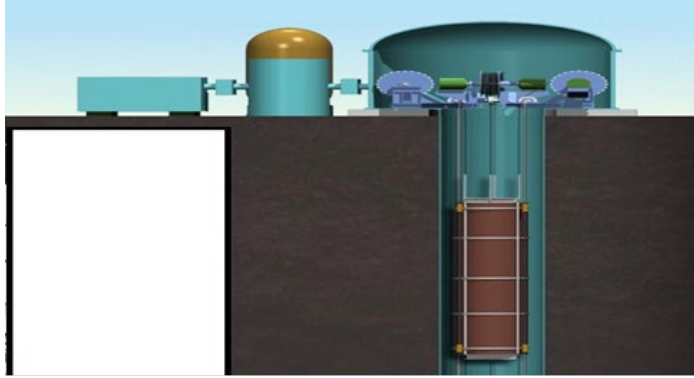

Fig.2. The Gravitricity storage system suspends individual weights of 500 to 5,000 tonnes with one weight per shaft.

The Gravity Storage will be built using methods and techniques already known from the mining and tunneling industry. The objective here, however, is not the removal of the raw materials (as in mining) or the removal of the stone (as in tunneling), but rather the preservation of the rocks.

In any event, tunnels or shafts must be installed in which vehicles and people can be transported to the bottom of the piston so that they can set up the technical equipment.

The piston is exposed using circular milling so that there is approximately a 2–3 meter distance between the outer surface of the piston and the shaft, in which the piston will later move. Therefore, there is enough space so that this region is accessible and can be supplied with seals (geomembranes, metal cladding).

For mechanical reasons, the easiest way to expose the trench between the piston and the shaft is from above. After the upper loose rock has been removed by digging, a stone mill operates continuously in a downward spiral. In parallel to this, the top surface is stabilized, if necessary, and coated with metal or geomembranes. Depending on the depth of the construction, the bottom surface of the piston is reached after a few months. The last few meters can be broken through from below so that structural safety is maintained for the personnel and machines.

2.2. SEPARATION OF BOTTOM

The separation of the piston base from the underlying rock is a particular challenge. It is based on the well-established “. and pillar” method of mining/extraction, with a series of parallel tunnels excavated as a first step (the remaining rock between the tunnels supporting the weight of the piston). Reinforced concrete pillars, split at mid-height

to allow the piston to be raised in service, are then constructed at regular intervals along each tunnel, enabling the remaining rock to be excavated thereafter.

As an alternative to the excavation of the whole rock mass beneath the piston, where appropriate for the given geological conditions, the remaining rock between the tunnels may be split at mid-height as illustrated in the centrefold.

3. ENGINEERING CHALLENGES

3.1. GEOLOGY

Gravity Storage plants should be located in areas with solid bedrock. The most favorable sites have stable, little-faulted rock such as granite or compact layers of otherwise solid rock material. The geological conditions must first be assessed in detail by a team of geologists. Heindl Energy provides all services required to evaluate potential sites.

In order to estimate how widespread suitable geological conditions for Gravity Storage might be, Heindl Energy has conducted a study analyzing different types of magmatic, metamorphic, and sedimentary rock. A total of 117 globally distributed sites were analyzed, and classification was performed based on the internationally recognized Rock Mass Rating (RMR) system. The suitability of the geological conditions for the construction of a Gravity Storage plant was found to be “very good” (RMR I) at 3% of the evaluated sites, and “good” (RMR II) at 43%. The remaining sites would require extensive, expensive rock stabilization measures, or would be suitable only for a relatively small Gravity Storage plant.

Geological suitability of evaluated sites for construction of a Gravity Storage plant (corresponding number of sites in brackets).

In addition, a large volume of water (depending on the size of the Gravity Storage – e.g., around 6 million cubic meters for a piston with a diameter of 250 m) must be available. This water is constantly re-used, and thus must only be provided once.

3.2. SEALING THE SURFACES

The Gravity Storage is cut out of surrounding rocks. Because rocks nearly always have crevasses and fine cracks through which water can flow, it is necessary to completely seal the piston and the surrounding piston-cylinder against the surrounding area. For this purpose, all freely exposed surfaces are sealed with a geomembrane and concrete.

3.3. SEALING THE PRESSURIZED WATER

The solution to the key challenge of sealing the gap between the piston and the cylinder, retaining the highly pressurized water below, is a “rolling membrane” that is securely connected to both piston and cylinder. The rolling membrane is assembled in situ from individual membrane elements that connect radially from the piston to the cylinder. The membrane elements, similar to conveyor belts as used in the mining industry, consist of vulcanized rubber reinforced with steel cables or aramid fibres. Features and design requirements:

- Typical pressure at rolling membrane: 50 to 60 bar
- High resistance to abrasion
- adaptable to the piston’s fluctuating position
- Self-centering
- Full access possible for maintenance

The operating life of the system is practically unlimited since its main component – the rock mass – is extremely durable. The operating equipment, such as pumps, turbines, and generators, can be designed for a service life of 60 years or more, and can then be replaced as required. The technical operation is very similar to how pumped storage plants are run.

3.4. OPERATING LIFE

The operating life of the system is practically unlimited since its main component – the rock mass – is extremely durable. The operating equipment, such as pumps, turbines, and generators, can be designed for a service life of 60 years or more, and can then be replaced as required. The technical operation is very similar to how pumped storage plants are run.

4. CONCLUSION

I believe this is one of the most promising sustainable solutions to global gridscale renewable energy storage. It almost certainly will prove to be an indispensable piece of the circular economy puzzle, having a positive ripple effect on creating new clean technology industries and jobs, avoiding environmental liability, ameliorating climate change, and mitigating global warming.

REFERENCES

- [1] <https://www.edn.com/using-gravity-for-energy-storage-viable-idea-or-impractical/>.
- [2] <https://heindl-energy.com/about-us/>
- [3] <https://www.advancedsciencenews.com/gravity-energy-storage-elevated-to-new-heights/>
- [4] <https://www.bbc.com/future/article/20220511-can-gravity-batteries-solve-our-energy-storage-problems>

Basil UGBOMOIKO¹

Mustafa AL KAWWAS²

Ahmed EL-HAKEEM³

REVIEW OF PUBLIC POLICY: RENEWABLE ENERGY AS A PANACEA TO LINEAR ECONOMY LIMITATIONS

Ever since the 18th century which marked the beginning of the industrial revolution, humanity has been on a roller-coaster of rapid innovation and qualitative development. While the early successes were largely helpful in advancing the pace of advancements in a vast range of sectors, they did come at a cost. The planet we inhabit is on the brink of collapse and after several signs of a deteriorating environment such as but not limited to floodings, earthquakes, and much more, reforms and consciousness of how living standards or human existence impacts the very environment we inhabit is finally gaining momentum.

A linear economy where natural resources are turned into finished products ultimately become waste because of the way they have been designed and manufactured has largely been a significant contributor to the degradation of the environment and is therefore unsustainable. A popular alternative that has been proposed is the transition towards a circular economy that will emphasize recyclable products from a design perspective.

This paper aims to review the progress of the war on climate change by examining (i) the role of governments as enablers through public policy in achieving desired or existing global objectives or standards, (ii) the possibilities that exist for private sector participation and justifying their intervention, (iii) if the existing rules and standards governing the climate change initiative are realistic, vague or even ambitious enough, (iv) factors that could accelerate the transition towards the circular economy.

1. INTRODUCTION

The concept of climate change has not aged well, after countless attempts at adoption on a supra-national level, traction is finally being felt. The traditional economic model has followed a simple but environmentally unhelpful model dubbed the linear economy

¹ BTU - Cyber Security

² BTU - Mechanical Engineering

³ BTU - Environmental and Resource Management

and this has contributed to the decline of the health of the planet. The linear economy can be described as the conventional method of production of goods and services without a plan for the post-consumption phase i.e. what to do when the good or service reaches its end of life. With this system in place, waste is generated and constitutes a problem to the environment as non-biodegradable waste tends to interfere with and damage components of ecological life such as food chains, marine environments, and much more if improperly managed.

A popular solution to this problem is the circular economy and this is simply the production of goods and services with a mindset for re-usability after its end-of-life. The beauty of this model is the ability to be implemented in multiple or several sectors making it scenario-agnostic. As the centrepiece of this paper, we will be focusing on renewable energy as a field for the implementation of the circular economy. Governments (*depending on the region*) have usually played a passive role in society instead of preferring to shape the structures and levers on which society operates and this ability mostly vested in the instrument of state power can be found in public policy. Public policy serves as the tool which the government uses to communicate its body language on a range of issues, and we will be discussing how we can utilize it in the fight against climate change.

2. RELEVANCE OR SIGNIFICANCE OF LINEAR ECONOMY & TRANSITION TO CIRCULAR ECONOMY

One of the most important and attractive qualities of the linear economic model is both cost and simplicity. Using a take, make, and waste approach is undoubtedly cost-efficient and is less time-intensive than some of the competition. Apart from being a decades-old practice, it is also responsible for some of the more beneficial inventions in human history. However, it is not possible without its merits

2.1. IMPORTANCE OF SUBSIDIZING POLICY FOR THE ENERGY TRANSITION

Public policies are one of the most important triggers for the energy transition. Subsidizing decisions from the government could be effective, especially with available potentials like climate and vast land areas for different initiative projects [1]. Implementation of Renewable Energy has nearly the same upfront costs with an increase of security of 60% compared to fossil fuel and nuclear energy [2]. Studies show that developing countries have fossil fuels as the major source of energy and therefore most countries are required to adjust environmental policies. With the over average solar potential in these countries, which ranges between 1800-2200 KWh/m² per year, policies that subsidize initiative actions towards renewable energy solutions (RES), infrastructure, socio-culture and management would have a large impact on green transition and emission

reduction. To highlight the effect of policymakers, two case studies of Iran and Pakistan are considered.

The Iranian government encourages individual and private implementation of solar water heaters and PV converting systems by granting subsidies, although the achievement regarding solar energy is still scattered. The country has installed a capacity of 150 KW PV generation and 250 KW solar thermal power in Shiraz [3]. The survey of 45 Iranian windy sites in 2010 showed an average efficiency of 33% [4], whereas some unique sites deliver an efficiency of 66%. This indicates that many sites for renewable energy projects could be chosen in a more efficient approach to utilize resources to the highest possible efficiency. Presently, the installed wind farms obtain a capacity of 75 MW, which is considered to ascend to 90 MW. Additionally, a further 90 MW is expected to be brought into reality. Iran has a unique status regarding the availability of wind power since major areas of the windy sites are of class 7 (800-2000 W/m²) according to the wind classification made by the US department of energy. Despite the potential and planned investment, the country is still far behind the deserved quantity according to the available potential and efficiency.

The requirement for subsidizing policies becomes larger, especially in the situation of possible energy shortages like in Pakistan. Cases have occurred, mainly since 2011, when the peak demand was unable to be met with the energy production. This resulted in power shortages in urban and rural areas for several hours per day in the country. To fill this gap between demand and production, constructive policies should be placed. A large part of the produced energy by independent power producers (Ca. 7,000 MW) in Pakistan is fossil dependent, which is mainly imported. Considering the continuously increasing population of 180 million, the energy demand is becoming proportionally higher and therefore the energy crisis is affecting the economic growth significantly [5]. The department of Pakistan water and power development authority (WAPDA) has installed Ca. 21,000 MW of hydropower capacity. A simulation study has shown that solar energy is more effective than wind energy and preferable for smart grid implementation. However, both energies should be added in case of load shedding [6].

2.2. IMPORTANCE OF POLICY STABILITY FOR INVESTMENT

Besides the main role of the intersection of supporting policies and available energy potential towards green energy transition, policy consistency is equally relevant. With unstable governmental action toward energy policies, the investments could be demotivated or affected by these sudden changes. Uncertainty in policies reflects difficulties in long-term investments and raising capital and therefore, policies should be predictable and not necessarily subsidizing. Two case studies in Canada and Norway are highlighted to elaborate further on this matter [7].

Ontario, Canada, is the first province to introduce and include a feed-in tariff (FIT) to encourage renewable energy. Subsequently, 16,000 FIT applications were initiated and consisted of 80% small ground-mount solar systems. Therefore, the government

treated ground-mount and rooftop systems similarly. This misjudgment resulted in the planned reduction of FIT for ground-mount application. Eventually, the solar industry and farmers, which form the source of project proposals, were affected by the reduction of the FIT since they already ordered inventory and hired staff. The government noticed an overwhelming number of planned projects related to ground-mount solar systems, which led to canceling a huge number of project proposals. This type of inconvenience could be a major concern for existing and potential investors since it places economics and logistics at high risk.

A similar case regarding misplaced changes in public policies occurred in Norway. By the year 2009, a tax exemption on Biodiesel was applied, which encouraged a group of investors to start a biodiesel plant. During the year, there was a governmental proposal for 2010 of dismissing this exemption, which can negatively affect such plants. As a result, a decision from the parliament stated that Biodiesel would receive 50% tax exemption by 2010 and 100% by 2011 which eventually led to the resignation of many planned large investments in initiative biodiesel plants. As an example, the company Uniol then required additional investment to compensate for this unexpected change in policies. If the company had known about this liquidation control, it could have been able to raise the required capital. While these changes could harm the side of the investors and energy producers, advantages on the consumers' side could rise.

In the Ontario case, the raised FIT is reflected in relatively higher taxes for electricity costs. The sudden policy change regarding FIT was mostly welcomed by the people since it resulted in lower electricity prices. The sample concerned about health and noise pollution was in favor of reducing wind energy production. Regarding the case of Norway, the policy change in 2019 had further results. Along with the withdrawal of tax exemption, the government decided to standardize the biodiesel consistency to 2.5% in diesel. This decision was in favor of oil companies that conduct fuel blending, which subsequently activated a market that became more stable. This experience still was faced with skepticism; therefore, policymakers should be more trusted with their promises.

3. COMPARATIVE ADVANTAGES OF RENEWABLE ENERGY

This comparison seeks to provide an insight into the state of existing solar technology and seeks an alternative that can be substituted for the same. It is done by matching some of the performance parameters and the economic factors elaborate between several solar cell technologies. Next step, an attempt is made to integrate this technology within the current power grid infrastructure of a developing nation. In order to select this nation, a wide set of strategies are prescribed including a topographical analysis of the geography and various other geopolitical aspects. Irrevocably, a broad overview of the possible outcomes is settled. Within this, it is expected to achieve a benchmark that can be developed by any organization, to successfully alternate existing non-renewables or

superseded renewables with a much more efficient and economically designed energy structure based on the existing landscape.

Everything nowadays is running on energy, this energy is supplied in bulk from conventional, non-renewable sources such as coal, natural gas, and nuclear energy. Nevertheless, when we look toward a cleaner and greener future for energy production, one technology prominently comes to mind.

3.1. RENEWABLE SOLAR ENERGY POTENTIAL

Solar energy is fast overtaking other forms of renewables as the single most economical and widely distributed energy source and nations and economies all around the world are fast adapting to meet their energy demands from solar/ solar-hybrid sources [8].

Another main viewpoint with regard to solar research is accompanying the current ambition toward reducing global carbon emissions, which has been a major worldwide environmental, social, and economic concern in recent years. As an example, 696,544 metric tons of CO₂ emissions have been avoided or deducted through the installation of 113,533 household solar systems in California, USA. Consequently, the adoption of solar technologies would significantly alleviate and improve issues associated with energy security, climate change, unemployment, etc. It is also anticipated that its use will play an important role within the transportation sector in the future as it does not require any fuel transportation. [9]

Only three renewable energy sources (biomass, geothermal, and solar) can be utilized to yield sufficient heat energy for power generation. Of these three, solar energy exhibits the highest global potential since geothermal sources are limited to a few locations and the supply of biomass is not ubiquitous in nature [9].

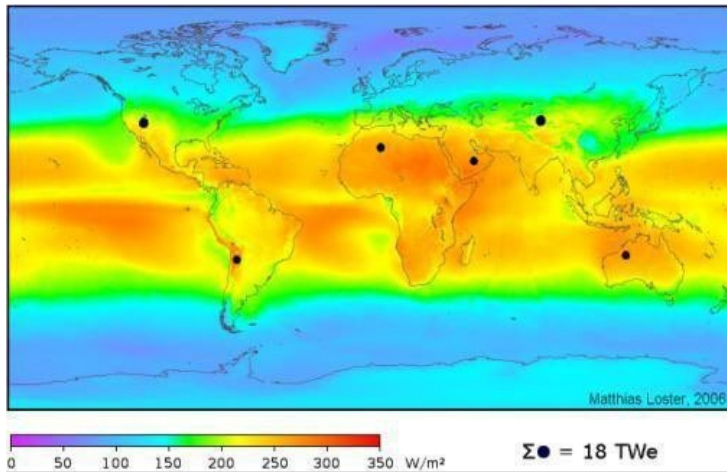

Fig. 1. Annual average solar irradiance distribution over the surface of the Earth

The annual efficient solar irradiance varies from 60 to 250 W m⁻² globally. (Fig1) shows the yearly average intensity of solar radiation over the surface of the earth. The “black dot” showed areas could provide more than the entire world's total primary energy demand, supposing that a conversion efficiency as low as 8% is accomplished. [9]

3.2. PERFORMANCE COMPARISON

Solar cell technology has been developed for years; however, the cost of electricity produced by the technology is still high. Perovskite solar cell (PSC) is one of the promising technologies to compete with the existing commercialized silicon cells.

The graph (Fig.2) shows the difference in the Power Conversion Efficiency (PCE) between PSCs, Si cells, and Si-PSC tandem cells.

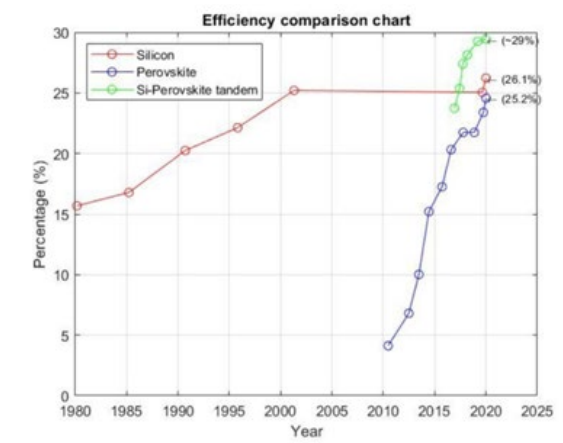

Fig.2. Performance efficiency comparison of PSCs, Si cells and Si-PSC tandem cells

The advantage of PSCs compared to Silicon PV and other solar cells is to determine if a developing world economy could use PSC technology to meet its energy demands.

Visible light falls within the wavelength spectrum of 380-750 nm, which is not ideal for a Si-based cell, whose absorptivity drops after 400 nm but the perovskites that have tunable bandgap have the potential to absorb a larger width of the visible light spectrum but still face some challenges impeding its path towards large scale manufacturing and global use. They are considered the most suitable upcoming technology for a new generation of PV modules. [10]

3.3. ECONOMIC COMPARISON

The manufacturing cost is one of the most important costs when it comes to commercialization. The cost consists mainly of processing and material costs.

Currently, the PSCs technology has not been introduced to the industrial scale, consequently, leading to the challenge of real manufacturing cost estimation. However, there are various publications that propose numerous cases of manufacturing estimation. [11]

The LCOE represents the unit cost of electricity over the lifetime of a certain generating technology, which is the measurement of competitiveness in the electricity market. There are various studies attempting to estimate the LCOE of Perovskite technologies with different methods. LCOE cost is dependent on module cost, efficiency, and lifetime. It is noticeable that the increase in lifetime and module efficiency reduces LCOE. The challenge of LCOE reduction in the lifetime of the PSCs. Since the material being used in PSCs are organic and inorganic substances, they are prone to be degraded and

can be affected by light illumination, temperature, humidity, and interfacial reaction between functional layers. Eventually, these parameters lead to critical impacts on the stability of PSCs. [12]

This will require more attention to subsidizing policies and stability policies for investment like Ontario Canada's case.

One of the biggest challenges that affected the solar industry lately was the COVID-19 epidemic which has caused a severe impact on global financial markets. Since that solar energy is a significant basis for future energy progress. Covid-19 lockdown procedures have resulted in weekly electricity needs decreasing by 10-35% across affected regions, increasing the total share of variable renewables to meet this need.

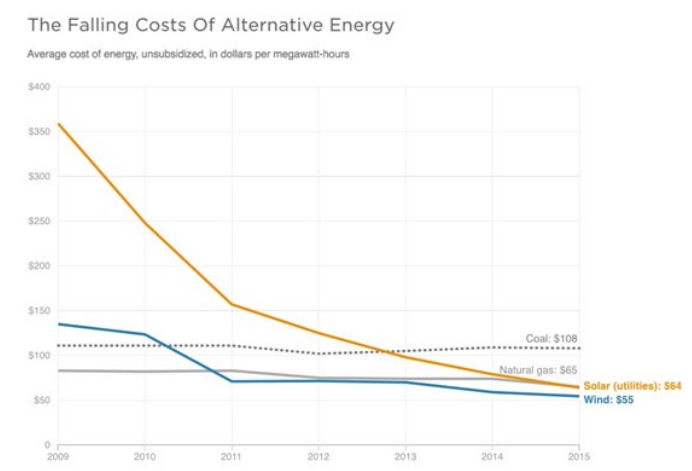

Fig3. The falling costs of Alternative Energy

While energy is an important basis for economic development, the COVID-19 epidemic has undoubtedly shocked the supply and demand of energy products, such as the renewable energy industries [13]. The subtle characteristics of the renewable energy industry have experienced more individual variations in supply and demand due to the shock of the epidemic. Renewable energy has a high price and therefore often depends on government support to accomplish the goal of market cultivation [16]. On the other hand, the epidemic is affecting people's income, and most traditional energy markets target basic customer consumption. Once the consumer's income changes and renewable energy policies disappear, they will seek out traditional energy consumption again. Thus, the epidemic has undoubtedly affected the supply and demand of the renewable energy market.

Second, as the severity of the epidemic increases, which attracts media attention and coverage. Such media reports may cause investors to panic [14], thus affecting investor sentiment.

Among types of renewable energy, solar energy is the one most affected by the COVID-19 pandemic. On the other hand, the pandemic will improve the efficiency of solar panels due to the reduction of atmospheric pollution. [15]

3.4. GEOGRAPHICAL COMPARISON

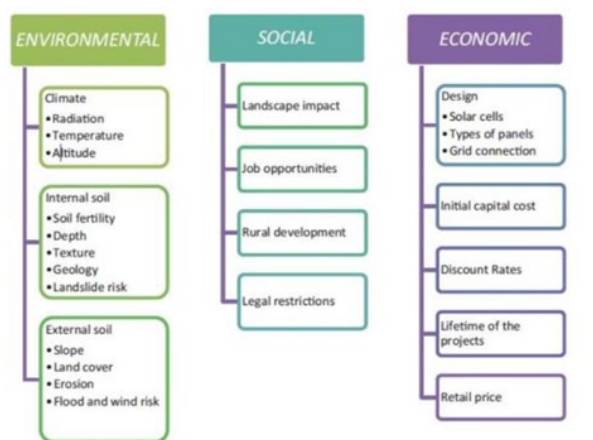

Fig.4. Representation of several major aspects during the selection of a region

With the increasing development of the solar cell and its output energy, a proper selection of the region of deployment plays a very crucial role in the solar energy management:

The most important criteria that can affect the decision of selecting a region or a country are divided into three groups of measurements.

Environmental aspects represent the solar radiation in this area, air temperature, and height. Moreover, the soil feasibility or the ability of the land to carry the deployment of a huge number of cells in one place. Social which means the impact on the social life of the region such as whether the deployment would offer new job opportunities in the place the plant would affect the landscape of the region and if the country has already legal restrictions on such technologies. And last, in the former sections, it was already mentioned the economic aspects of the selection of different technologies and how they would affect the total power output of the plant. [12]

For the most influencing criteria, it is the solar radiation factor that plays a very important role in power generation, as it is directly proportional to total power output.

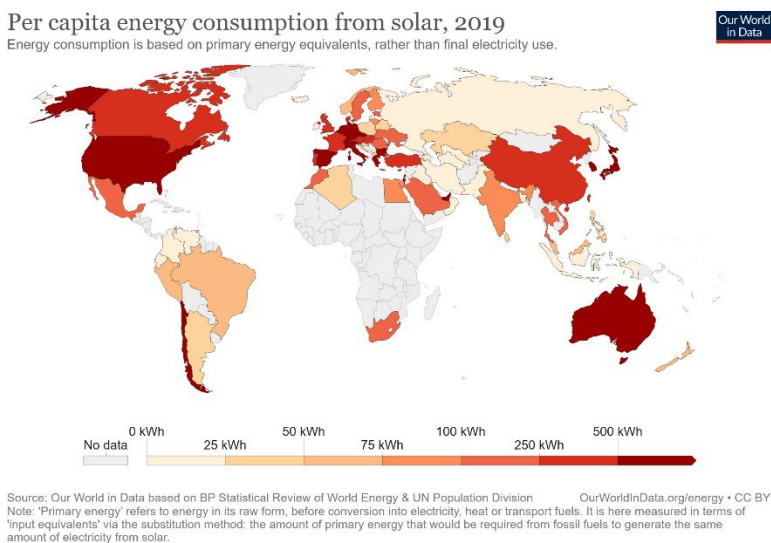

Fig.5 Per Capita energy consumption from solar, 2019

4. CONCLUSION

It is evident from the foregoing that humanity has made significant progress throughout the years and the consciousness of sustainable living is only just gaining momentum and can only be sustained by conceptualizing, designing, implementing sound public policies, and expanding the commercial manufacturing processes for usage in economies of scale. However, the task of sustainable living is not and needs much room to improve in terms of lifetime and efficiency to maintain its competitiveness.

REFERENCES

- [1] Qazi, A. a. (2019). Towards sustainable energy: a systematic review of renewable energy sources, technologies, and public opinions. *IEEE Access*, 63837--63851.
- [2] Pfenninger, S. a. (2015). Renewables, nuclear, or fossil fuels? Scenarios for Great Britain's power system considering costs, emissions, and energy security. *Applied Energy*, 83--93.
- [3] Ghorashi, A. H. (2011). Renewable and non-renewable energy status in Iran: Art of know-how and technology-gaps. *Renewable and Sustainable Energy Reviews*, 729--736.
- [4] Ministry of Petroleum. (2009). *Hydrocarbon balance 2007*. Tehran, Iran.
- [5] Energy Book of Pakistan. (2011-2012). Retrieved from <http://www.sbp.org.pk/reports/annual/>
- [6] Khalil, H. B. (2014). Smart grids: An approach to integrate renewable energies and efficiently manage the energy system of Pakistan. In *Fifth International Conference on Computing*,

Communications and Networking Technologie

- [7] White, W. a. (2013). The role of governments in renewable energy: The importance of policy consistency. *Biomass and bioenergy*, 97--105.
- [8] S. Jenner, F. Groba, J. Indvik, *Energy Policy* (2013), 52, 385. ^[1]_{SEP}
- [9] Kabir, E., Kumar, P., Kumar, S., Adelodun, A. A., & Kim, K.-H. (2018). Solar energy: Potential and future prospects. *Renewable and Sustainable Energy Reviews*, 82, 894–900. <https://doi.org/10.1016/j.rser.2017.09.094>
- [10] Qian, J., Ernst, M., Wu, N., & Blakers, A. Impact of perovskite solar cell degradation on the lifetime energy yield and economic viability of perovskite/sil
- [11] L. A. Zafoschnig, S. Nold and J. C. Goldschmidt, "The Race for Lowest Costs of Electricity Production: Techno-Economic Analysis of Silicon, Perovskite and Tandem Solar Cells," (2020) *IEEE Journal of Photovoltaics*, vol. 10, no. 6, pp. 1632-1641.
- [12] M. Cai, Y. Wu, H. Chen, X. Yang, Y. Qiang, and L. Han, "Cost-performance analysis of perovskite solar modules," (2017) *Adv. Sci.*, vol. 4, no. 1, Art. No. 1600269.
- [13] Wang, B., Z. Yang, J. Xuan, and K. Jiao. 2020. Crises and opportunities in terms of energy and AI technologies during the COVID-19 pandemic. *Energy and AI* 2. doi: 10.1148/ryai.2020190168.
- [14] Koçak, E., and A. Şarkgüneşi. 2017. The renewable energy and economic growth nexus in Black Sea and Balkan countries. *Energy Policy* 100:51–57. doi:10.1016/j.enpol.2016.10.007.
- [15] Mairal, G. 2011. The history and the narrative of risk in the media. *Health, Risk & Society* 13 (1):65–79. doi:10.1080/13698575.2010.540313.
- [16] Hosseini, S. E. 2020. An outlook on the global development of renewable and sustainable energy at the time of Covid-19. *Energy Research & Social Science* 68:101633. doi:10.1016/j.erss.2020.101633.

Key words Renewable energy, EV charging stations, Grid integration, Charging system configuration

Yusuf YURTSEVER

Ata UGUZ ¹

REVIEW OF RENEWABLE ENERGY EV CHARGING STATION

It is a known fact that the interest and investments on EV have increased significantly and new projects are still under development. As technological developments continue and investments in sustainability concepts have been taken into account, manufacturers have started to work on renewable energy energy related projects and have started to implement them on EV charging stations. Due to this development, new types of charging system concepts are introduced. As current PV prices have become considerably affordable, many projects for these charging stations are mainly based on PV arrays and a local battery to store this energy. However, there are still many hybrid concepts that have to be taken into account, such as wind energy implementation and a combined hybrid system. Even though the efficiency of PV arrays is dependent on solar irradiation and, for wind turbines, the weather conditions, grid integration is still considered as a secondary energy source in the event of an abundance of alternative sources. In this paper, different EV charging structures from renewable sources and grid integration are discussed. Brief models with block diagrams are presented. Charger types for these types of configuration comparison are given, and different modes of operation, including the limited output power from the grid, are presented.

1. INTRODUCTION

The integration of RES into the charging station can be defined as the revolutionization of a new dawn of the future. As a matter of fact, the modern technologies for electric vehicles (EV) are still developing and have a differentiable advantage compared to normal Internal Combustion Engine Vehicles (ICEV) such as fossil fuel consumption, emission effects, noise pollution, engine efficiency, and long-term sustainability opportunities. While these developments are still under way, with lead improvements, lead manufacturers are starting to handle the expectations of their customers. Depending on a variety of factors, including the significant development of electric vehicles (EVs), the integration of renewable energy sources has had a significant impact on its rise to prominence. The nation's low-carbon industry has been ingrained in society's consciousness. Electric cars have great potential in this scenario. Whether it is a rechargeable

¹ Wrocław University of Science and Technology, Faculty of Electrical Engineering

hybrid automobile or a fully electric vehicle, charging station support is essential [1]. Furthermore, the development of charging stations for EVs will continuously increase. Standards which were issued by the authorities, such as SAE J1772, concluded as in the following Table 1. [3]

Table 1. CHARGER TYPE [3,4,5,6,7]

Types	Level	Charger Type	Power Level	Charging Time
AC	Level 1	On-board	1.4kW	14-17h
	Level 2	On-board	4kW	4-6h
	Level 3	To be decided	>20kW	0.4-1h
DC	Level 1	Off-board	36kW	0.4-15
	Level 2	Off-board	90kW	10-20min
	Level 3	Off-board	240kW	<10min

Above, Table 1. presents the SAE J1772 standards [2], which are listed as in different power levels from Levels 1-3. This includes information related to AC and DC, which charger type to use, and the time of the charging. Meanwhile, Level 1 can be defined as the generally used method of charging, although a semi-fast one is for Level 2. In terms of consumption of minimal grid power, method 1 is ideal for during the night recharging electrical battery packs and, in terms of AC Level 3, that can be defined as a three-phase fast charging method. [3] The more comprehensive set of results along with installation cost data can be viewed in [4,5,6,7]. Fast charging and off-board charging stations are the DC types.

The rest of the paper is organised as the first part presenting the EV charging method and modes, and the second part is the output power analysis of different system modes and conclusion.

2. EV CHARGING METHODS

Different charging methods can be given as an example, Fig. 1. a) Universal charging system, Fig. 1. b) Off-grid Photovoltaic charging system, Fig. 1. c) On-grid Photovoltaic charging system, and Fig. 1. d) On-grid Wind Turbine Generator charging systems [8,9,10]. For the universal charging system (Fig.1.a), the battery is directly charged from the main grid. As for an alternative system (Fig.1.b), an off-grid PV array battery charging system dependent on an alternative battery storage due to intermittent solar irradiation [3]. The on-grid PV array (Fig.1.c) charging system is a constantly changing concept depending on the peak sunshine hours. When the levels are low, the system instantly switches to the grid to maintain continuity. Another charging method (Fig.1.d) uses wind turbines and on-grid system switching and works similar to PV on-grid system configuration. While using these methods, it is required to fulfil the DC-AC converter topologies which will be integrated with the battery [10,11].

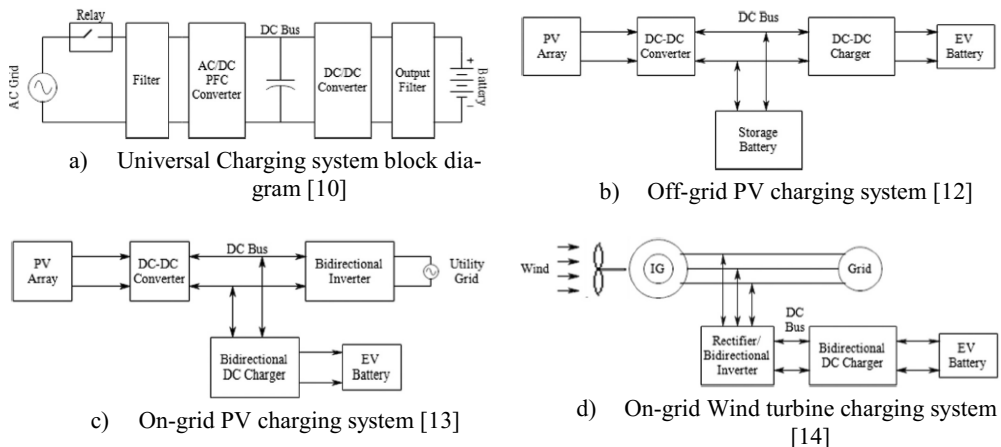

Fig. 1. Different system structures of battery charging concepts.

3. EV CHARGING MODES

The battery charging stations with these types of configurations mentioned can be implemented with different modes depending on the situation of the available energy which can be obtained from renewable energy sources [15]. Off-grid PV only mode is when the irradiation from the sun is available to produce electricity at peak performance. A DC to AC converter with maximum power point tracking (MPPT) is being used. The reason for the AC grid and the conversion is that it is used for setting AC voltage and frequency.

The auxiliary input, in this example, the outlet power, will dictate the charging station voltage and frequency. The EV station can function in one of the following modes, depending on the varied power flow possibilities and the availability of power sources. The solar inverter serves as a current source and functions as a slave.

Grid-only mode switches when there is no available energy from PV arrays or wind turbines and the local battery is empty. In this operation, an EV is being charged from the grid depending on the maximum allowed power regulated from that area. In general, this operation mode is more recommended for charging overnight.

A combination of PV array and grid can be implemented in the event that solar irradiance is not available enough to support charging. In this case, the local battery will be unusable and discharged while the system is supplemented by the grid to obtain maximum power, thereby offering a shorter time to charge the vehicle.

However, produced electricity from renewable sources can be sold to the grid in situations when the local battery is at maximum capacity and no vehicle is connected to the system. If the renewable sources become unavailable at any time but the local battery is at maximum capacity, the local battery is directly used. In case a shorter charging time is required, local battery charging can also be supplemented with the utility grid as well.

The same conditions apply to wind energy sources where, in the case of energy production from the turbines, there is sufficient and available energy to charge the batteries.

Local battery charging operations are desirable by using renewable energy sources to reduce energy costs. When there are no available renewable energy sources, batteries are charged by using the grid. To avoid unnecessary load, this operation is mostly done overnight.

In order to obtain an even shorter duration for charging the vehicle if the entire system is being used. This operation is the most efficient one because it allows the use of the maximum power being produced.

4. ANALYSIS

Table 2 represents the power output for different modes as mentioned above. The maximum grid power is 3.6kW in this configuration for 230 Volt power outlets and a 16 Ampere current limit due to the DC-AC inverter parameters used [3]. For better comprehensiveness, renewable sources (RS), grid and battery activity have been given attention.

In this system, different modes are represented by conditions which are possible due to the availability of the energy source as well as the recharging requirement of the battery for these sources. The most efficient performance of the system that makes it a supercharger is the condition when the entire system is active and producing 9.5 kW of output power. As a consequence of renewable sources' unavailability when solar irradiation and wind are inadequate for producing energy, the grid configuration only supports the system with 3.6 kW of power. The renewable system configuration without

grid-supplied power produces about 3.2 kW of energy in a slow charging mode, making it a cost-effective option. If the local battery is at its max capacity, the same power output charges the vehicle [15].

Table 2. Output power analysis for different system modes.

Mode	Grid	Renewable	Local Battery	Output
1 Only PV	-	Active	-	3.2 kW
2 Grid	Active 230 V 16 A	-	-	3.6 kW
3 Grid and RS	Active 230 V 16 A -	Active 1.5 kW	Discharged or Unavailable	~ 5.1 kW
4 RS - Energy trading	-	Active to grid 1.5 kW	Max	-
5 Local battery	-	-	Active	3.2 kW
6 Local battery - RS	-	Active 1.5 kW	Active	~ 5.1 kW
7 local battery - grid	Active 230 V 16 A	Insufficient	Active	6.2 kW
8 Entire system	Active 230 V 16 A	Active	Active	9.5 kW
9 Local battery re- charge	Active 230 V 16 A	Conditionally Ac- tive	Being charged 6.2 kW	-

5. CONCLUSION

The current study provides a renewable energy EV charging station that contains a readily available battery converter that may be utilized to minimize the charging time of the EV. The battery converter may be thought of as a "charging station" when combined with the grid and renewable systems. This charging station may be used with electric vehicles that have high-capacity on-board chargers, cutting down on charging time. In addition, in locations where the grid power is restricted to 230 volts at 16 amps,

this charging grid can assist high-power off-board chargers. The first problem that needs to be overcome is the possible location of this system to be implemented in order to produce and benefit from the renewable sources as efficiently as possible. Furthermore, with consideration of an integrating of wind turbines will have a great impact on improvement on a system efficiency.

In conclusion, based on the whole system structure, in terms of future planning analysis, instead of switching between renewable sources and charging a local battery for abundant conditions, a direct battery swap can be implemented to achieve an even shorter waiting duration.

REFERENCES

- [1] Wang, L. (2018). Design of Electric Vehicle Charging Station based on wind and Solar Complementary Power Supply. AIP Conference Proceedings. <https://doi.org/10.1063/1.5039004>
- [2] A. Zahedmanesh, D. Sutanto and K. M. Muttaqi, "Analyzing the impacts of charging plug-in electric vehicles in low voltage distribution networks: A case study of utilization of droop charging control system based on the SAE J1772 Standard," 2017 Australasian Universities Power Engineering Conference (AUPEC), 2017, pp. 1-6, doi: 10.1109/AUPEC.2017.8282409.
- [3] Sujitha, N., & Krithiga, S. (2017). Res based EV Battery Charging System: A Review. *Renewable and Sustainable Energy Reviews*, 75, 978–988. <https://doi.org/10.1016/j.rser.2016.11.078>
- [4] SAE International [Internet]. SAE charging configurations and ratings terminology [cited 07.02.14]. Available from <http://www.sae.org/smartsgrid/chargingspeeds.pdf> .
- [5] Inside EVs [Internet]. Welcome to 2009, SAE officially approves a new fast charging combo: coupler standard (SAE J1772) for plug-in EVs. [cited 07.02.14]. Available from: <http://insideevs.com/welcome-to-2009-sae-releases-new-fast-charging-combo-coupler-standard-sae-j1772-for-plug-in-evs/> .
- [6] Channegowda J, Pathipati VK, Williamson SS. Comprehensive review and comparison of DC fast charging converter topologies: Improving electric vehicle plug-to-wheels efficiency. In: IEEE Proceedings of the 24th International Symposium on Industrial Electronics (ISIE), Buzios; 2015. p. 263–8.
- [7] Inside Energy. Gov (Internet). Study shows average cost electric vehicle charger. [cited 01.02.16]. Available from: <http://energy.gov/eere/vehicles/fact-910-february-1-2016-study-shows-average-cost-electric-vehicle-charger>).
- [8] Tulpule PJ, Marrano V, Yurkovich S, Rizzoni G. Economic and environmental impacts of a PV powered workplace parking garage charging station. *Appl Energy* 2013;108:323–32.
- [9] Preetham G, Shireen W. Photovoltaic charging station for plug-in Hybrid Electric Vehicles in a smart grid environment. *Proc IEEE PES Innov smart grid Technol (IGST)* 2012:1–8.
- [10] Williamson SS, Rathore AK, Musavi F. Industrial electronics for electric transportation: current state-of-the-art and future challenges. *IEEE Trans Ind Electron* 2015;62(5):3021–32.
- [11] Mossoba J, Kromer M, Faill P, Katz S, Borowy B, Nichols S, et al. Analysis of solar irradiance intermittency mitigation using constant DC voltage PV and EV battery storage. *Proc IEEE Transp Electr Conf Expo (ITED)* 2012:1–6.
- [12] Abu-jasser A. A stand-alone photovoltaic system, case study: a residence in Gaza. *J Appl Sci Environ Sanit* 2010;5:81–91.
- [13] Mesentean S, Feucht W, Kula HG, Frank H. Smart charging of electric scooters for home to work and home to education transports from grid connected photovoltaic-systems. *Proc IEEE Int Energy Conf Exhib (Energy Con)* 2010:73–8.
- [14] Maggetto G, Van Mierla I. Electric and electric hybrid vehicle technology: a survey, electric, hybrid and fuel cell vehicles [Ref.no. 2000/050]; IEE Seminar; 2000. p. 1–111

- [15] P. Dorin, P. Toma, E. Radu and C. Marcian, "Renewable energy EV charging station," 2021 International Aegean Conference on Electrical Machines and Power Electronics (ACEMP) & 2021 International Conference on Optimization of Electrical and Electronic Equipment (OPTIM), 2021, pp. 28-33, doi: 10.1109/OPTIM-ACEMP50812.2021.9590053.