

The complex masonry of the Schönburg Castle Keep chimney system (1201 CE) in the context of contemporary examples

Jonas Lengenfeld

Department of construction history, Brandenburgische Technische Universität Cottbus-Senftenberg
Cottbus, Germany

Abstract

High Medieval chimneys, although often the focal point of contemporary representative buildings, are rarely a topic of construction history. More often they appear in art or



Fig. 1. Fireplace in the first storey viewed from the entering corridor. (R. Wieczorek)

architectural history where they are discussed regarding their style and ornamentation. It is however worthwhile to examine these important representative objects with the tools of the construction historian. In them, we can find important information regarding the contemporary craftsmanship and skills. Based on extensive first-hand examinations and building archaeology this paper aims to discuss the planning and building process of the highly complex cut-stone chimney system in the keep of Schönburg Castle (1201 CE) using new methods of reverse engineering.

The Tower of Schönburg Castle

On the southern bank of the Saale river, five kilometres east of the episcopal city Naumburg Schönburg castle sits enthroned on a red sandstone cliff. Its tower or *Bergfried* which houses the chimney system was erected at the beginning of the thirteenth century and is situated in the inner baily of the larger castle complex dating back at least to the twelfth century. (Fig. 2)^[1]



Fig. 2. View from the western bank of the saale river upon the inner Baily and Tower of the Schönburg. (R. Wieczorek)

The keep, built over a circular plan of 9.63 metres in diameter, reaches a height of 29.82 metres measured from the recent day walking level up to the battlements. The conical brick spire was erected in a younger phase of construction. The walls, up to 2.95 metres thick, which the chimney flue crosses diagonally, are constructed with a triple shelled masonry. (Fig. 3) A core of layered quarried red sandstone masonry laid in lime mortar is clad by an inner and outer ashlar facing laid in proper pseudoisodomic courses. The ashlars are cut precisely following the curvature of the wall surfaces with their faces hewed by the pick hammer in such a skilled manner that the well preserved parts of the surface appear completely smooth.

While the quality of the faces and the stringently conducted pseudoisodomic masonry, running around the tower in 82 carefully levelled layers, are unmatched in contemporary regional towers of comparable size, these are far from the only exceptional features. The bed

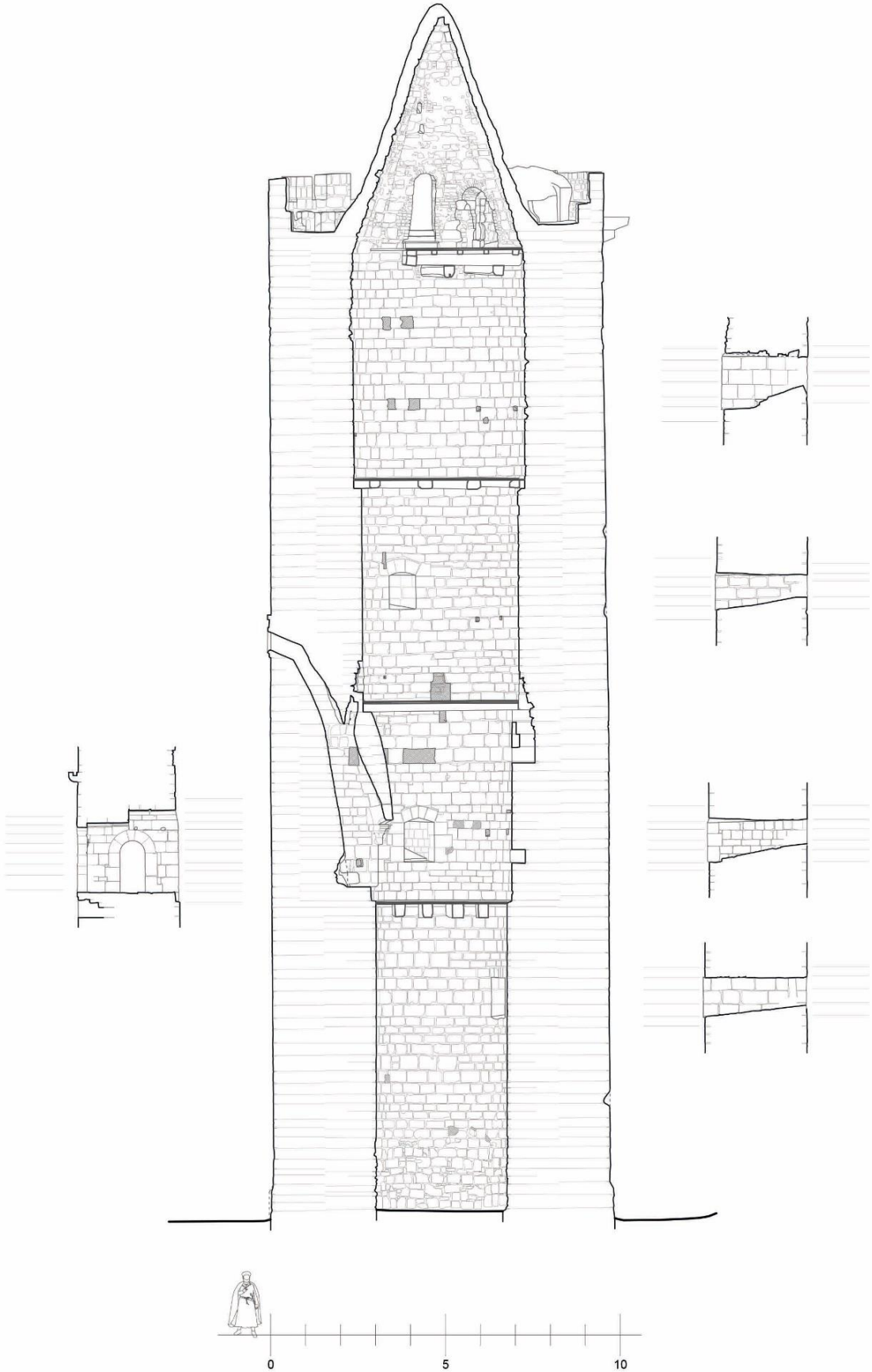

Fig. 3. Section of the Tower or Bergfried. The thin lines indicate the height of the courses. Left and right the corridor and windows are shown. Notice the flue leading diagonally trough the wall (author)

joints of the inner and outer shell share the same height, which is almost complete in the lower sections and still maintained in many places of the higher sections. (Fig. 3)

This is not structurally necessary, as the facing walls are separated by the quarry stone core – even though the few samples we have from the core masonry suggest that the quarry stone core was erected simultaneously, corresponding to the ashlar facing walls. It is most likely that the correspondence between the height of the layers of the outer and inner shell provides evidence for the planning process. Presumably, a specific height was chosen for every layer.

Based on this decision the necessary number of ashlars for both facing walls with their specific curvature were then produced, stored and laid accurately on the building site.

This requires the communication of relevant information as well as sophisticated planning and logistics. Qualities and processes that are better known from major building projects conducted by important cathedral lodges or *Bauhütten* during this time. Some of the best researched examples of which can be found in the big churches built in the Il-de-France during this era. [2]

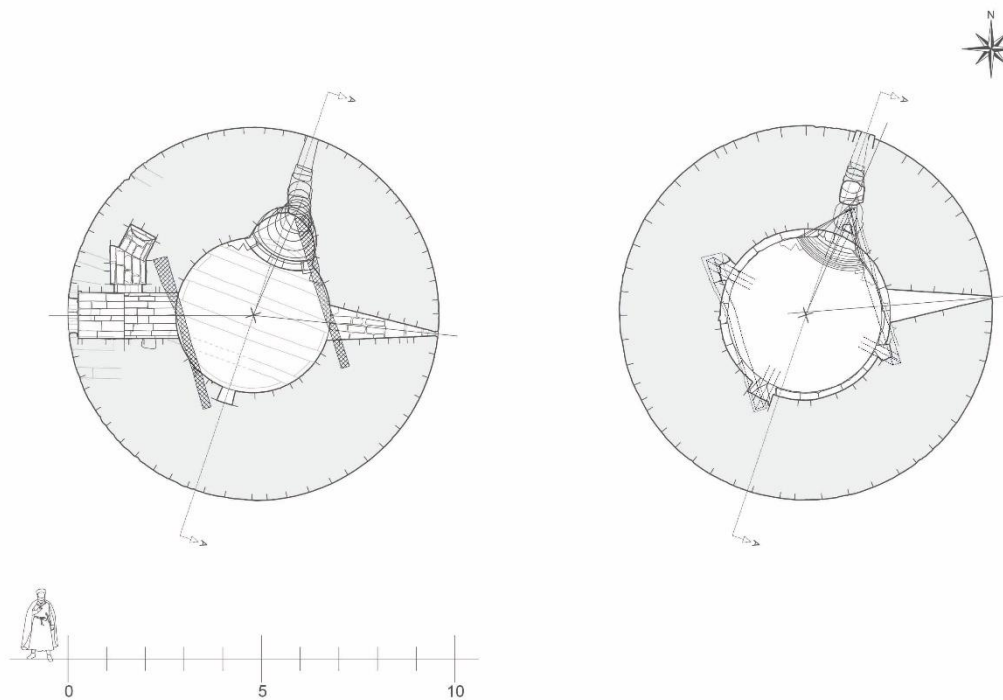

Fig. 4. Floorplan of the first storey (left) upwards view with features of the ceiling visible. Floorplan of the second storey (right) downwards view on chimney hood channels within the wall. (author)

The Kemenate

Internally the tower is split into four storeys plus the later one added underneath the spire. A slit window can be found on each floor orientated in a different direction. All ceilings are constructed as wooden joist ceilings resting on a wall recess between each storey. The only exception of this is the ceiling above the typical high ground floor. Its four massive oak Beams (0,30 x 0,40 metres in cross section) which, are embedded into the facing walls, were likewise planned to carry a heavy screed floor resting on them and the recess in the wall atop. This situation allowed the opportunity to use dendrochronology from this ceiling as the *terminus post quem* regarding the erection of the tower. The preserved forest edge dates to the summer of 1201. This makes an installation from the autumn of 1201 onwards most likely.^[3] The storey above these beams is the main floor of the tower and acted as the entrance floor as well. Formerly access to the tower was granted through a portal in the west wall of the first storey. As its threshold lies 8.80 metres above the ground level it has to be assumed that it was accessible over a wooden bridge from one of the ruined adjacent buildings, most likely the palace. (Fig. 12) The said portal (1.85 metres high) is covered by a round arch following precisely the curvature of the outer shell of the tower on the outside. The adjacent corridor



Fig. 5. North wall of the palace (Palas) at Münzenberg castle (1170). The remains of the chimney flue and Mantelpiece reaching trough two storeys dominate the wall. (author)



Fig. 6. The chimneys of Wildenberg castle (1190-1200) and Besigheim castle (1220-1230) (from left to right). (author)

leading through the 2.78-metre-thick wall is covered by a straight arch in the form of a flat gable and subsequently by a higher barrel vault. Both are carefully hewn and laid in a planned style. (Fig. 3) In the north wall a round arch portal leads into a small Garderobe. It is covered by a straight arch in the area of the possible door and a barrel vault above the toilet shaft.^[4] (Fig. 4) The whole construction is remarkably complex and lavish compared to other contemporary castles. Even the corridor in the imperial castle tower at Wimpfen is constructed in a simpler style.^[5] The barrel vault above the inner part of the corridor ends in a 2.3-metre-high round arch portal leading to the room. Its face is once again following the cylindrical shape of the room facing creating a complicated spatially curved arch. When entering the circular room measuring 4.00 metres in diameter and 5.39 metres in height the view is drawn to the fireplace in the northeaster section of the wall constructed from fair-faced masonry. (Fig. 1) Above a semi-circular fire room resting upon lavish early gothic capitals, a shallow segmental arch with spatial curvature spans 1.6 metres wide across the fireplace. Cut from limestone and consisting of two corbels and a keystone. it supports the mantelpiece. This complex structure in the form of a beehive reaches all the way up to the ceiling. Its elegant connection to the walls with a narrow joint bearing witness to excellent craftsmanship. Inside the chimney, the mantelpiece describes the same figure at an increased recline this time merging with the cone shaped back wall of the chimney. This results in a

drop-shaped cross section of the smoke hood that raises questions. (Fig. 3) The 7-metre-long flue carries on crossing diagonally through the wall before finally exiting from the wall at a height of 16,2 m above the ground through a 60 cm high opening with the shape of a gable crowned by the remains of an early gothic finial.

This complex chimney system, the planned flooring and the elaborate fireplace inside the first floor allow us to designate this room as a *Kemenate*: the German term deriving from the Latin *caminus* = fireplace that was used in the high medieval era to describe a heated room.^[6] This room could be heated either by a tiled stove, air heating or an open fireplace. In representative buildings however, the latter played an important role. Especially in the public hall of the palace, a big and elaborately designed open fireplace had pride of place.^[7] Remains of huge mantelpieces often reaching through several storeys, like in the ruins of the *Palas* at Münzenberg castle (ca. 1150-1174),^[8] or the lavish ornamented columns, corbels and decorative plates of the fireplace at the imperial *Palas* in Gelnhausen Palatinate (ca. 1170),^[9] give us a hint how important fireplaces and chimneys were for the medieval individual. The fireplace in the hall of Wildenburg castle (1190) possibly even found its way into the courtly poetry of Wolfram von Eschenbachs Parzival (1200-1210).^[10] The corbels of this example weighing approximately five metric tons demonstrate which structural tasks were taken on for this status symbol. (Fig. 6) This approach often made the chimney systems the most complex stone components of secular buildings like at Schönburg.

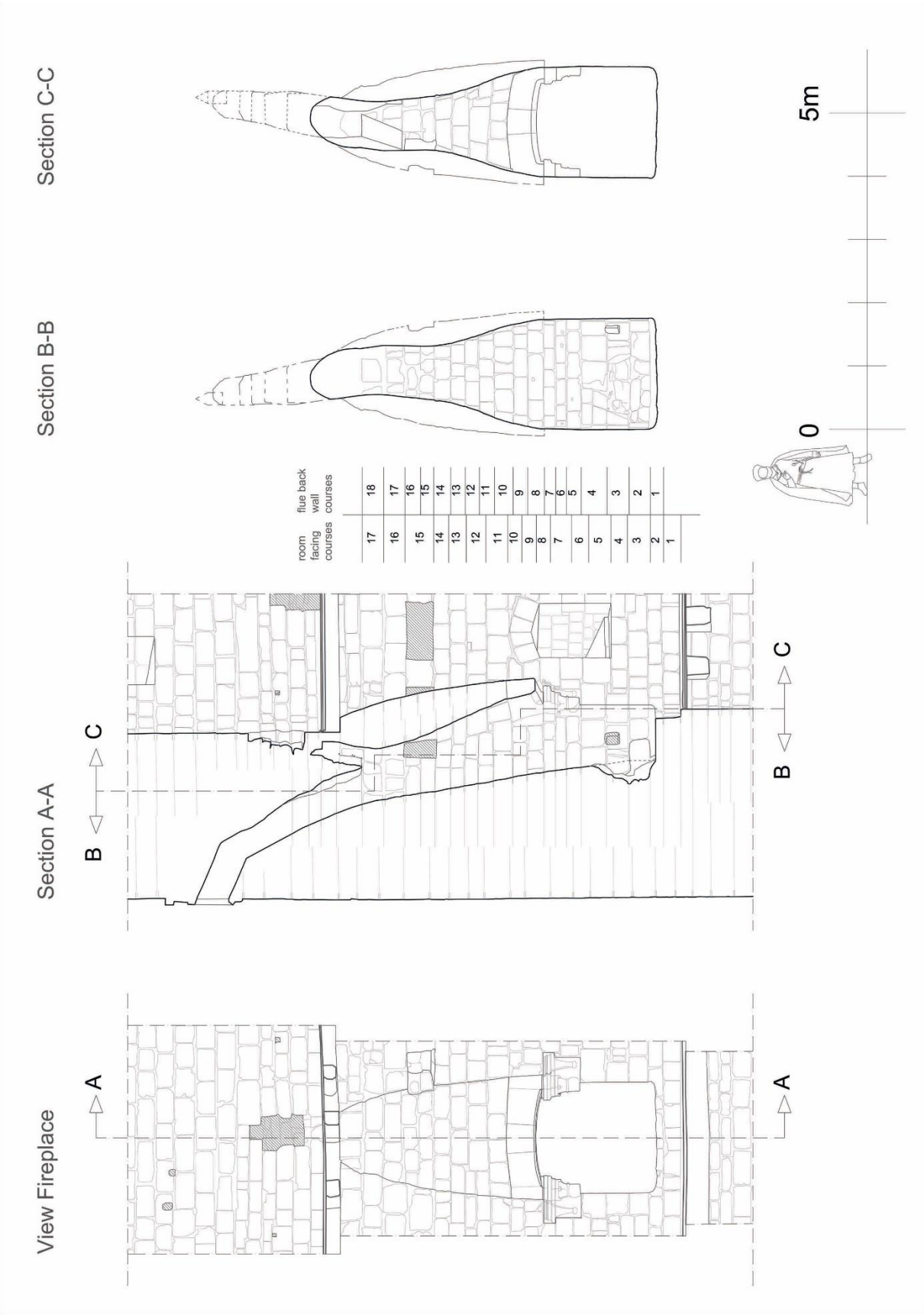

Fig. 7. View and cut sections of the chimney system in the Tower of Schönburg castle. Note the levels of the different bed joints shown on the table. (author)

The Chimney

The chimney itself presents the main source for this paper. (Fig. 7) Its fire room is defined by the layers one to seven of the chimney back wall. The bottom of the fire room is situated 0.36 metres above the recent day floor level. Like the chimney and the tower facings the fire room is constructed from red sandstone ashlar hewed finely with a pick hammer as fair-faced masonry. They are laid in tidy pseudoisodomic courses that match internally but do not correspond with the bed joints of the inner tower facing. The fact that these two systems are consistent within themselves, but incompatible with each other, suggests that the fireplace, like other more complex parts (window of the first floor, portals) was produced by specialists in advance of the building process. It was then fitted in when the tower reached the appropriate height for installation. This explains the use of smaller atypical ashlar around the fire room that were used to fit both parts together. (Fig. 1/10) This practice is well known in the construction of cathedrals but rarely documented in castles.^[11]

The plan of the fire room is unclear today since a large portion of its back wall was destroyed by the heat of a fire as the shell-like stone surfaces indicate. However, it was possible to reconstruct its former shape by building on archaeological findings on its floor. Based on these results the layers one and two described a semicircle with a radius of 0.88 metres. The centre of this circle is positioned in the middle of a line between the corner stones of the fire room. From the bed joint above layer two onwards the back wall of the fireplace as well as the flute up to layer 18 is inclined constantly at approximately 80° leading through the wall. Layers four and three maintain the diameter of the semicircle while following the inclination of the back wall. The centre of the circles thus shifts in a parallel manner. Above layer four the height of the courses is reduced significantly. A possible reason for this is that these layers do not feature the representative corner stones like layer two three and four. These stones forming the frame of the fireplace communicate between the circle of the fireplace and that of the room. Likewise, in an attempt to obtain a straight edge, they show a relatively big height of 0.32 to 0.41 metres. (Fig. 1/7)

Atop these corner stone's 1.58 metres above the floor rest two lavish early gothic limestone capitals with a complicated cornice. Regarding the profile of the cornice and the quality of the work they are comparable to those in the eastern parts of Naumburg Cathedral, although their layout and construction is more complex. While appearing monolithic at first sight, they consist of three blocks. The first block maintains the ground shape of the corner stones and features a chalice capital above the corner and a console facing the room with the edge. Atop this block the cornice blocks follow, coming to the same the height as layer seven. The first

cornice block picks up the form of the fire room wall and forms the cornice above the chalice capital. While the second forms the cornice above the console which features a different profile. Presumably in an attempt to prevent a visible joint on the face of the stones: the butt joint is angled facing into the second cornice stone. (Fig. 10)

Above the cornices at a height of 2.17 meters rests a shallow segmental arch consisting of two corbels and a keystone. Like the capitals, cornices and the arches of the portals it was not crafted from red sandstone but limestone. The reason for this is limestone's finer structure is better suited for the fine masonry needed for these special parts. This theory is further supported by the fact that the faces of these stones are much more processed than those of the red sandstone ashlars. They were hewn to times by the *Fläche* or *Steinbeil* = stone axe (fourteenth century designation) an axe like iron tool with a straight edge of 4-6 centimetres. This special method of hewing the stone twice became fashionable in the late Romanesque – early gothic period.^[12]

The corbels and the eastern corbel in particular are the most complex stones in the tower. With a weight of up to 700 kg their bounding box is the heaviest as well. They react to no less than six constraints: namely the radius of the room shell, the inner shell of the chimney, the room facing of the curved mantel piece, the chimney facing of the mantle and finally the



Fig. 8. View up the chimney flue from the fire room. Note the highly complex geometry and the second channel. (R. Wieczorek)

geometry's of the spatial bend arch. Even small mistakes would lead to problems with the other constraints making these stones a true masterpiece.

Furthermore, during examinations regarding the chimney arches intrados it became evident that it cannot be described by a single curve. Apparently, the intrados of all three components are described by individual circles. The axis on which the centre of these circles are placed form a fan-like structure. This allows the intrados of each stone to be marked on its face more easily. The slight wave line resulting from this method is too small to be seen by the uneducated eye. It was possible to detect this geometry with a modern Scan to CAD Software (Geomagic) that was used to geometrically analyse the chimney system. Due to its specialized form-analysing tools allow for a more exact geometrical analysis than those carried out by hand or CAD Programs. For further reading regarding this topic please read the publication in this endnote.^[13] It is worth mentioning that neither on these most complex parts nor on the well planned ashlar any masons mark could be found on a visible face.

Behind the corbels starting with layer eight the chimney shaft or flue begins. It measures 5.5 meters to the exit out of the wall, but since the flue above layer 18 is unclimbable and of a much easier construction than the lower part we going to focus on these 2.8 metres. The back wall, meaning the parts which are not defined by the mantel piece, resembles a semi-circular plan. (Fig. 8) But contrary to the fire room the radii of the courses are reduced with every

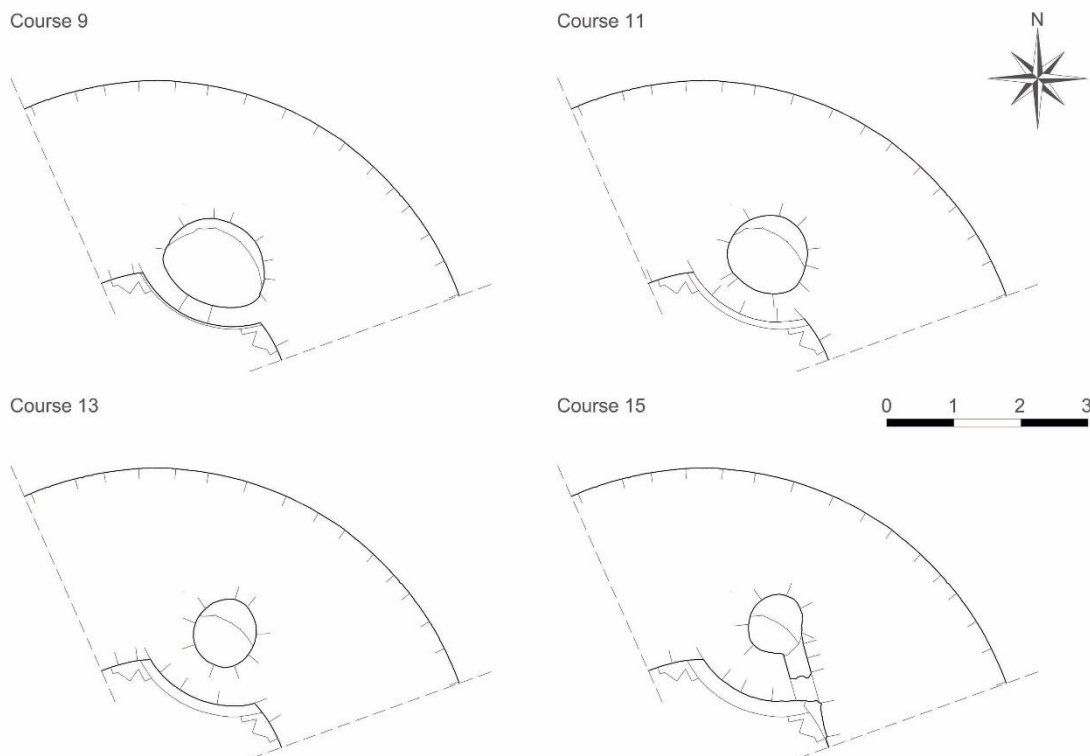

Fig. 9. Horizontal Section through the mantel and flue. Shown are the Bed joints above four courses of the chimney Back wall (left to right top to bottom). (author)

course leading it to shrink in diameter while following the defined line of the back wall. This leads to the organic form of the flute in the cross section when viewed frontal. (Fig. 7) The bed joint above layer 14 is the first one that equals a bed joint in the mantel piece and inner tower face alike. Potentially this marks the spot up to which the fireplace and back wall were preproduced off the building site.

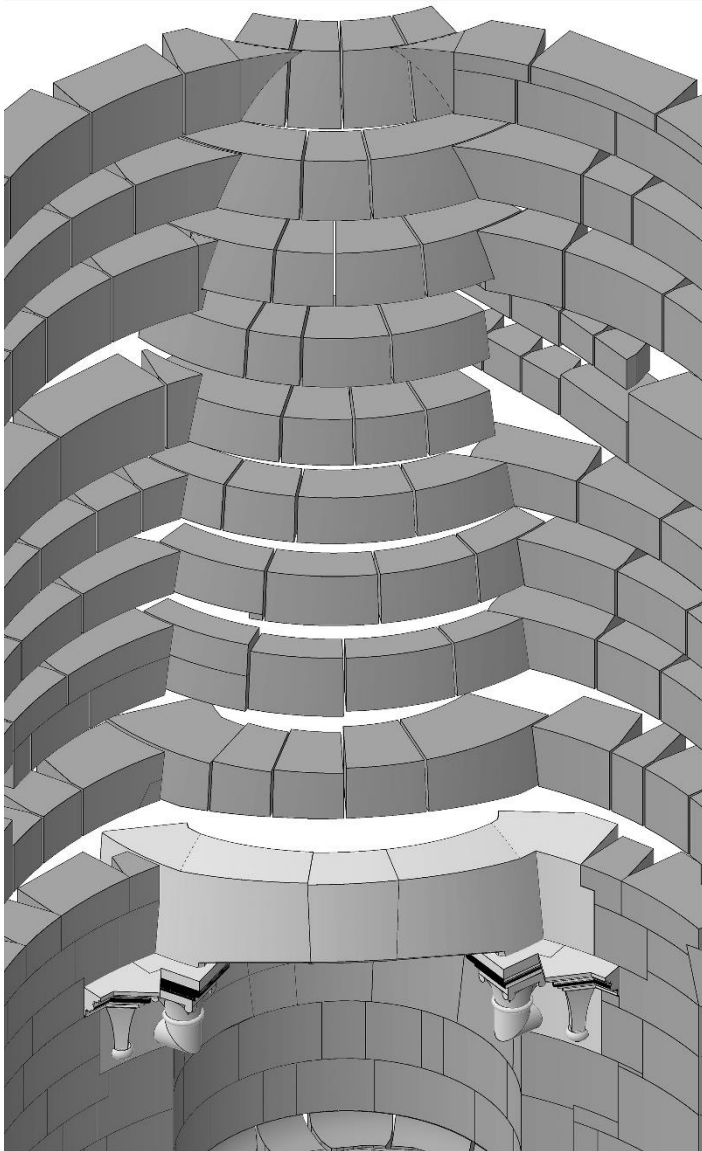

Fig. 10. Exploded assembly drawing showing the integration of the mantel stones in to the facing of the room at Schönburg castle tower. (author)

The front of the flute facing the room above the chimney arch is closed by the mantel piece. The feature cut from red sandstone resembling a beehive intersecting the cylinder of the tower face dominates the room. Normally the inside of the mantel would follow in a parallel course but instead it displays an increased recline towards the flute. The first layer is still describing a base circle similar to that of the hoods face in the room (0.99 metres) leading to an elliptical ground plan meeting the smaller circle of the back wall. (Fig. 9) But the second and third layer show a stronger decline and merge with the circle of the back wall. From the bed joint above layer three the mantel and the back wall form a closed circle with a radius of 0.52 metres.

We do not know what lay behind the builder's intention to decouple the course of the chimney shaft and the outer form of the mantle. Perhaps it was the wish to build a more representative mantle. This intention, however, brought challenges. The ashlar of the mantle have to react on the different internal and external geometries and get deeper with every course. In the first course, this task was fulfilled with stones that simultaneously formed the room and flue face of the fireplace while their underside had to even out the round

extrados of the chimney arch. (Fig. 7) On top of that, the ashlar of the mantle were not premade but fitted on sight according to the courses of the inner tower facing. This is particularly evident on the first two layers of the mantle in the flue and the first layer inside the room. Here the craftsman had to even out a height difference of seven centimetres within a span of 1.8 metres which occurred during the building process of the room facing. They solved this problem by arranging the height of the stones in the manner of a five stepped stairway. Although this looks strange in the plan, it is not visually apparent when examining the structure.

Only the first course of the mantle is constructed by ashlar reaching from the room to the flue. Above the first layer the mantle was executed in a double shell masonry as the butt joints and insights show.

The described method of erecting the mantle in a relatively late stage seems common according to my research up to this point. It is unusual though that, with two exceptions on the eastern joint, all ashlar of the outer mantle shell bind into the facing of the room. (Fig.10) Most contemporary examples like Münzenberg castle and Besigheim castle feature mantles that were built in front of the wall connected only by a few anchor stones. (Fig. 5/6)

The outer face of the mantle itself can be described by a circle with a radius of 16.94 metres describing the vertical curve and a second circle with a radius of 1.50 metres describing the horizontal curve of the first bed joint underneath layer one. (Fig. 11) Thus every ashlar is curved horizontally and vertically. In contrast to the fire room however the horizontal radius is not fixed thus leading its geometrical centre to wander following the vertical face. Instead, every bed joint features a different radius that all share the same centre. This centre can be defined by a vertical line starting where the bed joint between layer nine and ten meets the back wall of the chimney. (Fig. 11) The back wall of the chimney thus once again acted as a focal point for its design.

Layer six of the mantle's front marks the beginning of a different geometry. Its outer face is described by a circle with a radius of 5.99 metres describing the vertical curve while the horizontal one described by circle with a radius of 1.44 metres. The radius of the horizontal circle was kept for the following bed joints. The builders changed from a system of concentric circles to a system of steady circles which moved to form the desired inclination. The reason for this could be a kind of rationalisation. Despite its great accuracy and refinedness, the concentric method was also time consuming especially for the planner. Due to the different radii every bed joint needed a new template that had to be defined and produced. By simply shifting the same radius multiple times, the builders saved material and time. Further while

still using the same tools the faces of the ashlar above layer six of the mantles were crafted less properly. The bigger mortar joints between the room face and the mantle though are not signs of poor work. As stated earlier, the ashlar of the mantle bind into the wall while those of the wall are running against them. To meet this geometry, the ashlar of the room facing have to feature thinner and pointier sides with every course. At the Top of the mantel it became impossible to solve this problem using ashlar. The missing part is therefore filled with a mortar joint growing from course to course. (Fig. 1/10)

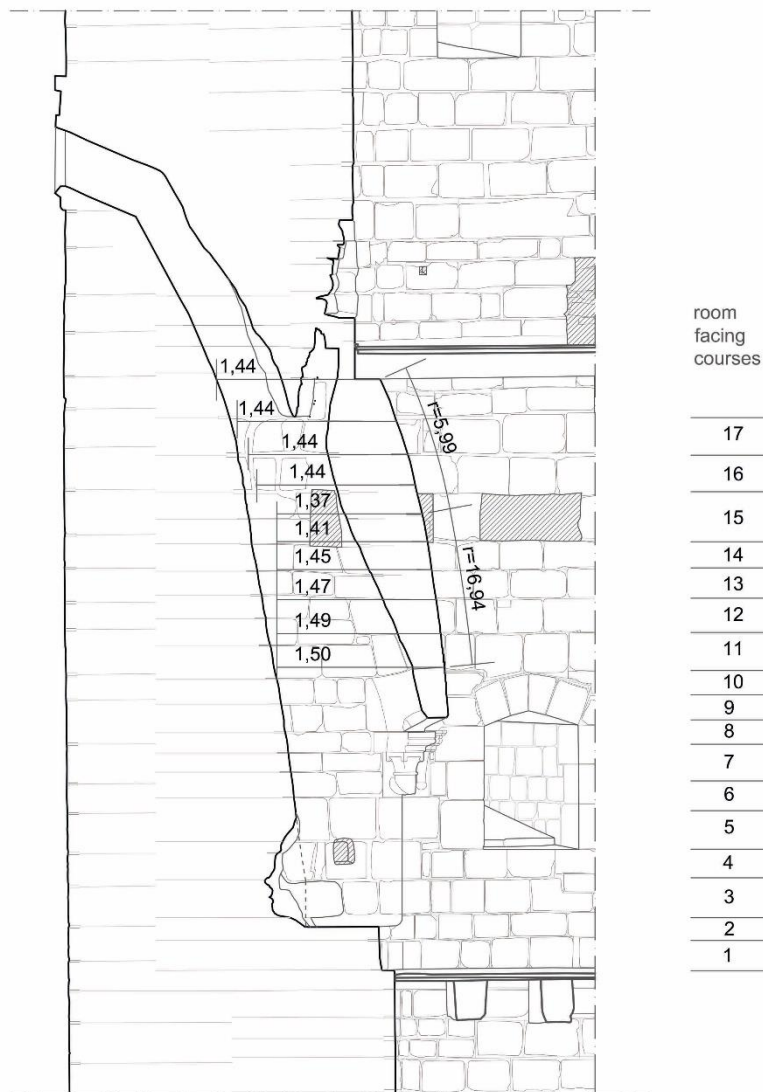

Fig. 11. Section trough the chimney System (A-A) showing the horizontal and vertical radii of the outer face of the mantle. (author)

This rationalisation, however, is accompanied by similar features which appear above the bed joint of Layer 14. The stone changes from a red sandstone to a more yellowish type this occurs in the chimney as well as on the inner and outer face of the tower. Above this bed joint only four red ashlar can be found on the mantle that may have been already produced as the change was decided. Further the mortar joints of above this mark are simple flush joints while every joint in the lower part of the tower, including those in the uninhabitable ground floor

are adorned with a groove (*Pietra Rasa*). (Fig. 1) Together this can be seen as a certain break within the design of the tower. Although not a complete break since it was still finished to the battlements and the chimney was completed as well.

The obvious height difference in the layers above this mark though is likewise not directly linked to this rationalisation. Mantle and flue are intersected by channels above Layer 14. Based on the finding of 0.2-metre-wide beam imprints on their floor they were constructed for a temporary wooden structure which was probably used during the building process. The structure consisted of two horizontal beams placed parallel to each other their middle running tangential along the inner face of the wall. From their heads reaching deep into the wall four beams rose upwards in the direction of the tower centre their channels ending in the next storey. (Fig. 1/4) It likely would have resembled a trestle frame of four times four metres in span with a significantly greater height. Possibly a crane which was set upon the rising wall at this point. This would explain the bigger and heavier ashlar of the faces from this layer on. The workmen surely planned to close this temporary channel in the last stages of the construction. But this didn't happen, the horizontal channel puncturing the mantle and the vertical one arising from the flute weren't closed until the 19th or early 20th century as the findings of sawn stone and a thick layer of organic material between this deposits and the medieval floor indicates. It seems the finishing touches were not executed and the chimney was never used during the middle ages.

When erecting the potential crane, it was nevertheless still intended to build and use it. The last 2.7 metres of the chimney flue were constructed in the significantly less complex form of a rectangular channel leading through the wall at an angle of 26 degrees. It finally exits the wall with an angle of 67 degrees' through a 60 cm high opening with the shape of a gable crowned by the remains of an early gothic finial. Together with the capitals, this is the only architectural ornament of the tower, both of which are found on the chimney.

Design and building process

Based on these findings it is bearable to formulate a theory what the design and building process of the chimney system might have looked like. Although Schönburg castle is not archaeologically surveyed the findings on the preserved enceinte and documents of the nineteenth century suggest that space within the baily was very limited. (Fig.12) Even if the eastern part was vacant a maximum of 600 square metres (30 x 20) was available of which 73 would be needed for the tower not including potential scaffoldings. This space is not large

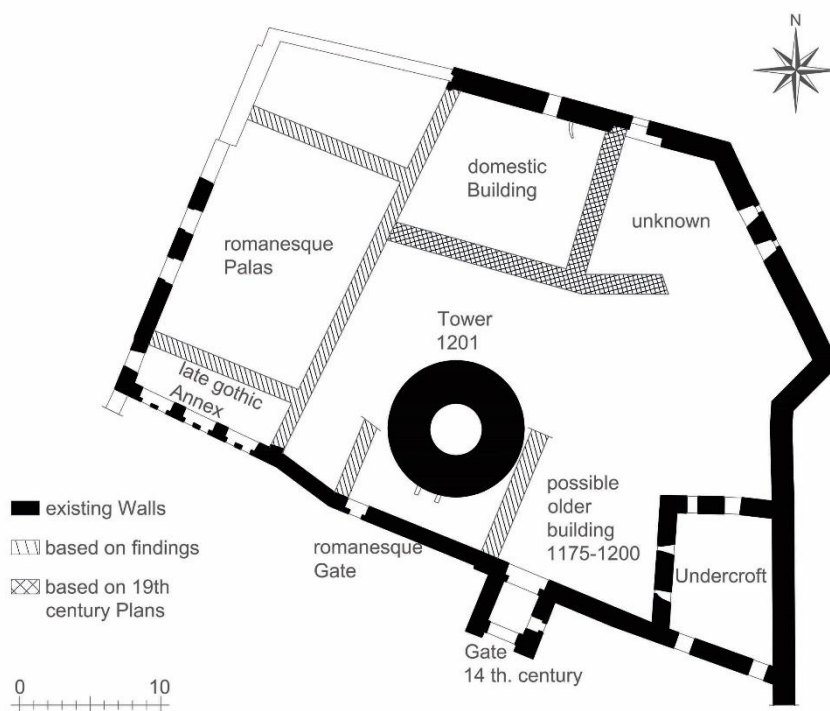

Fig. 12. Floorplan of Schönburg castles inner baily. (author)

enough to accommodate the necessary infrastructures (workshops, storage space, etc.) of a cathedral lodge. Planning and prefabrication of the components probably took place at one or more other locations. After receiving the building order, the timber was cut, the building site was selected, and the preparations began. The chimney was designed together with the tower with the aim of creating a representative effect. Its back wall (up to layer 14) the fire room and the arch were prefabricated early in the construction process, the latter by particularly talented workers. It was still unknown what height the layers of the first floor would have. The following spring, work began on the tower shaft. In midsummer or autumn, the prefabricated components were fitted into the fabricated masonry. The weight of the corbels

made a crane a necessity. For the laying of the keystone a false work was erected under the fireplace. Based on the now known course heights, the stones of the mantle were designed and adapted to the existing masonry on site. Mantle and inner wall were executed together up to layer 14. During the winter break, the quarry was changed, and the processes rationalised. The crane, now moved to the top of the wall, helped accelerate construction in 1203. The tower was completed but the chimney was never used for unknown reasons.

Client and Masons

The written sources do not tell us who planned to warm himself at this fireplace, nor whom was instructed to design and build it. But judging from the finds it is possible to formulate a thesis. Representative chimneys in towers are not uncommon at this time. But in towers of comparable size, they normally lack decoration and often consist of a simple niche with a flue above like in the neighbouring castle of Saaleck. (Fig. 13) Even in bigger residential towers of financially potent clients like the *Bergfried* III of Neuenburg castle (1180) reach neither size nor quality of the example in Schönburg.^[14] (Fig. 13) In its refined artistic construction and size, it satisfies the demands of elite culture. A similar elaborate but less complex chimney in a relatively small tower can be found in the palace of the margraves of Baden in Besigheim (1220-30).^[15] (Fig. 6) It can be assumed that the clients were at least similarly wealthy elites. The families of the *Edelfreie* and episcopal Naumburg Ministerials associated with the castle in the later twelfth and early thirteenth centuries do not seem to have lived up to this claim.^[16] It can therefore be assumed that the bishops of Naumburg, who are documented to have had a knight in the castle in 1217 and to have owned it in the fourteenth century at the latest, were the clients.^[17]

Based on the results of dendrochronology, it can then be assumed that Berthold II, a partisan of the Hohenstaufen dynasty, commissioned the construction.^[18] A possible reason which occurred earlier in the same year 1201 could be the change of his mighty territorial neighbour the Landgrave of Thuringia to the rival faction of the Welfs during a power struggle within the Holy Roman Empire.^[19] When this opponent was beaten by the emperor and finally openly subjected in 1204 the need for a defensive tower with a representative room was possibly no longer present.^[20]



Fig. 13. The chimneys in Bergfried III of Neuenburg castle (1180) and the tower of Saaleck castle (1200) (left to right). (author)

The question remains who planned and built the tower for the bishop. The high level of planning required in the areas of construction technology and construction operations, as well as the confident handling of complex design techniques such as the concentric chimney mantel and the spatially curved arches, required an experienced lodge. In addition, the quality of the workmanship and the desire to work on complex systems such as the chimney arch or the vaultings of the access corridor speak in favour of highly specialised experts who tend to work on a supra-regional basis. This is supported by the unusually early use of Gothic forms in this region. Against this background, it seems reasonable to assume that the workers of the then newly built Naumburg Cathedral were the creators of this small masterpiece.

Furthermore, this would explain where the craftsmen went after not finishing the last stages of the tower and where to locate the workshops. Initial investigations at Naumburg Cathedral seem to confirm the assumption based on similar construction methods and tool marks as well as the lack of Masons marks.

Conclusion

As demonstrated chimneys were a central object of feudal representation in the high Middle Ages. Due to their importance, a great deal of planning and material resources were invested in them. This means that new and complex building techniques can be found on these objects. Their study is therefore not only useful for increasing knowledge in this field but also promises to provide insights into historical construction methods and processes as a whole especially regarding the construction of thick stone walls.

Acknowledgements

This paper is an excerpt of my doctoral research project “The development of chimneys in High Medieval Central European residential buildings in construction and function” which is under way at the Brandenburg University of Technology supervised by Prof. Dr.-Ing. D. Wendland. If I was able to arouse your interest, I am thankful for any hint regarding potentially well preserved or complex chimneys of the said era and place. I would like to thank the staff of the *Denkmalamt* Naumburg and the honorary janitors of Schönburg castle securing the access to the tower. The survey at Schönburg was carried out with the assistance by J. Gebler and L. Wehrle. Professional Photos were taken by R. Wiczorek. Furthermore, I thank R. Schmitt for supporting me with many useful information's regarding the Saale area and in particular for the results of the dendrochronology carried out by T. Eißing. Last but not least I have to thank S. Krüger the archivist of Besigheim. A special thanks goes to A. Burns for proofreading this article and Prof. Dr. phil. U. Fauerbach who made this doctoral project possible.

Contact

Jonas Lengenfeld

E-Mail: Jonas.lengenfeld@b-tu.de

Phone: +49 355 69 3031

References

- [1] R. Schmitt, 'Zur Geschichte und Baugeschichte der Schönburg, Burgenlandkreis', *Burgen und Schlösser in Sachsen-Anhalt - Mitteilungen der Landesgruppe Sachsen-Anhalt der Deutschen Burgenvereinigung e.V.*, vol.12, 2003, pp.15-79.
- [2] The works of D. Kimpel are still authoritative in this field, L. Calstelfranchi, (ED), *Die Baukunst im Mittelalter*, Solothurn 1995. D. Kimpel, *Struktur und Wandel der mittelalterlichen Baubetriebe*.
- [3] Results handed out by R. Schmitt, dating carried out by Dr.-Ing. T. Eißing (Otto Friedrich University Bamberg) (2013)
- [4] J. Lengenfeld, D. Wendland, 'Die Planung der komplexen Werksteinkonstruktion im Bergfried der Schönburg – das Werk eines Naumberger Meisters', *proceedings Fünfte Jahrestagung der Gesellschaft für Bautechnikgeschichte*, Zürich 2021. Petersberg: Michael Imhof (forthcoming).
- [5] F. Arens, *Die Königspfalz Wimpfen*. Berlin: Deutscher Verlag für Kunstwissenschaften, 1967. Table 75.
- [6] W. Koch, *Baustilkunde*. Gütersloh: Bertelsmann Verlag, 2006. p.459.
- [7] J. Lengenfeld, D. Wendland, (Note 4)
- [8] B. Jost, *Burgruine Münzenberg*. Regensburg: Schnell und Steiner, 2000. p.48.
- [9] T. Biller, *Kaiserpfalz Gelnhausen*. Regensburg: Schnell und Steiner, 2015. p.48.
- [10] W. von Eschenbach, *Parzival*. Ditzingen: Philipp Reclam jun. GmbH & Co.KG, 1981. p.392.
- [11] D. Kimpel, (Note 2)
- [12] P. Völkle, *Werksteinplanung und Steinbearbeitung im Mittelalter*. Ulm: Ebner Verlag GmbH, 2016. p.78.
- [13] J. Lengenfeld, D. Wendland, (Note 4)
- [14] R. Schmitt, 'Schloß Neuenburg bei Freyburg/Unstrut. Amerkungen zur Baugeschichte der Vorburg', *Burgen und Schlösser in Sachsen-Anhalt - Mitteilungen der Landesgruppe Sachsen-Anhalt der Deutschen Burgenvereinigung e.V.*, vol.12, 2003, pp.150-177
- [15] H. Maurer, 'Die Türme des Markgrafen Hermann V. im Rahmen stauferzeitlicher Wehrbau-Architektur', *Oberrheinische Studien*, vol.24, 2005, p.126.
- [16] H. Helbig, *Der wettinische Ständestaat - Untersuchungen zur Geschichte des Ständewesens und der landständischen Verfassung in Mitteldeutschland bis 1485*. Köln, Wien: 1980. pp.159-163.
- [17] R. Schmitt, (Note 1), p.17.
- [18] Max-Planck-Institut für Geschichte, (Ed.) *Germania Sacra - Historisch Statistische Beschreibung der Kirch des Alten Reiches. Die Bistümer der Kirchenprovinz Magdeburg*. Berlin, New York: 1998. pp.785-790.
- [19] A. Fröhlich, 'Herrschaftsstrukturen und Herrschaftslegitimation in der Literatur - Der Thüringer Landgrafenhof unter Hermann I', (Ph.D. thesis, Johann Wolfgang Goethe-Universität zu Frankfurt am Main, 2007), (unbuplished), <http://core.ac.uk/download/pdf/14500418.pdf>, pp.30-36.
- [20] A. Fröhlich, (Note 18), p.34.