



Brandenburgische
Technische Universität
Cottbus - Senftenberg

17th EEEIC

International Conference on Environment and Electrical Engineering – Student Edition

Ostrava-Wrocław
Cottbus

11th – 16th of June 2018

Harald Schwarz, Przemysław Janik,
Radomir Gono, Dirk Lehmann

module at BTU: 11396

Presented by

Wrocław University of Technology
Department of Electrical Engineering
pl. Grundwaldzki 13
PL 50 – 377 Wrocław

Technical University of Cottbus
Department of Power Distribution and High Voltage Technology
Walther-Pauer-Straße 5
D – 03046 Cottbus

VŠB - Technical University of Ostrava
Department of Electrical Power Engineering
17. Listopadu
CZ - 15 Ostrava - Poruba

Publisher

Brandenburg University of Technology Cottbus - Senftenberg
Information, Communication and Media Center
University Library

Impressum

Brandenburgische Technische Universität
Cottbus-Senftenberg
IKMZ - Universitätsbibliothek
2018

[10.26127/BTUOpen-5713](https://doi.org/10.26127/BTUOpen-5713)

Legal rights

[Creative Commons Attribution 4.0 International](https://creativecommons.org/licenses/by/4.0/)

Table of contents

Microgrid - The Idea of a distributed Energy Supply	1
The potential of offshore wind farms	8
Oil sand extraction in Canada - Methods and Impacts	13
Impact of additive manufacturing on the environment – opportunities and challenges	18
Why solar energy is not the leading power source yet	21
Efficiency evaluation of wind farms	26
Environmental impact of nuclear power	30
Electric vehicles and the electric grid	34
The Importance of HVDC Transmission in Facilitating Green Energy Production	40
Smart meters - Data Mining	45
Vehicle to Grid: Benefits and Barriers	50
The Opportunities and Challenges of the Energy Change in Lusatia	53
Generating Electricity - Using Ocean Tidal Energy	56
The Integration of Renewable Energies into the German Electricity Grid	62
Introduction of the energy sector coupling in the future	66
Transition of the Energy Region Lusatia	70
Renewable Energy in Poland	73
A Study on the Concept of Decentralized Energy System	77
Coal: Energy Transition in Germany	80
Battery storage-breakthrough for storing regenerative energy	82

Microgrid

The Idea of a distributed Energy Supply

Philipp Schall

Chair of Energy Distribution and High Value Engineering
Brandenburg University of Technology
Cottbus-Senftenberg, Germany
schalphi@b-tu.de

Matthias Carl

Chair of Energy Distribution and High Value Engineering
Brandenburg University of Technology
Cottbus-Senftenberg, Germany
Matthias.Carl@b-tu.de

Abstract—This paper aims to present a short overview of the idea of distributed power supply. In order to establish a practical relevance, this draft comprises microgrids and the decentralized way to supply energy in general. Some differences against a centralized power supply and virtual power plants must also be made before gaining a thorough understanding of a small-scale microgrid. Taking on- as well as off-grid solutions into consideration, a change in the customers and the usages will be observed and evident. Owing the fact that technology still progresses, the Brooklyn microgrid based on blockchain technology will be presented in the end.

Keywords: *Microgrid, distributed energy supply, renewables, battery storage*

I. INTRODUCTION

The idea of a microgrid is based on the vision of a small-scale solution to generate electrical power and heat. In particular, the main concept of a microgrid is the distributed generation of various sources and the storage of electrical and thermal energy. Owing to communal heating power stations, the combined generation of power and heat has already been integrated to many households. But in terms of storage technology and battery containers, microgrids deliver a new way to store energy.

Speaking of microgrids, it seems indispensable to understand the network between the different components, as well as the intelligence behind it. Thereby, the second chapter introduces the most relevant components.

The third section of this paper deals with a practical example of a microgrid. There, a microgrid based on blockchain technology will be analyzed.

In the fourth section of this paper the distinction between an on-grid application and an off-grid application will be examined. In doing so, main criteria will be included to make the core differences apparent.

In the fifth section of this paper, in turn, the advantages and disadvantages of microgrids will be discussed properly. In comparison with other ways of energy production, microgrid's preferences will be evident.

In the final chapter, the most important data will be summarized in order to draw a conclusion. Besides, a forecast will be provided including some relevant technologies to enhance further microgrid solutions.

II. SET-UP

A. GENERATION

There are different ways to generate electricity and/ or heat. In the following, to make things easier, only the most important heat engines and the use of renewables will be submitted. Speaking of heat engines, one can guess that a capacity of 1 Megawatt is possible. Renewable energies are able to generate energy up to 200 Kilowatt.

a) Heat Engines

The Diesel engine is one device that can be used to generate the necessary engine. On the one hand, the key advantages are the quick startup and the fact that the engine is dispatchable. On the other hand, the machine causes a lot of greenhouse gas emissions. Besides, there are also nitrogen oxide and particulate emissions as well as noise generation.

Gas engines, like microturbines, can be also utilized to produce energy. They are also dispatchable. Plus, microturbines have very low emissions. But indeed, gas engine provoke also greenhouse gas emissions.

The most relevant fact, which makes both engines so suitable for microgrids, is that they are capable for combined heat and power. This enables the generation of electrical and thermal energy at the same time. This shows the higher efficiency and reflects environmentally responsible behavior.

b) Renewables

Renewables energy systems can also be utilized to generate the necessary energy. Solar photovoltaic cells as well as small wind turbines are the most common sources of energy in this case.

Photovoltaic system and wind turbines distinguish from other energy resources due to the fact that the fuel costs are exactly zero. The wind blows and the sun shines for nothing. Above all, there are zero emissions. Owing to the reason that

renewable energies are not dispatchable, a storage is indispensable.

B. BATTERY CONTAINER

As mentioned above, due to the increasing use of renewables, it is necessary to store energy. In this context, different energy types require different storage technologies. The most notable will be presented in the following. The capacity of a battery container is about 1 Megawatt.

a) Mechanical Storage

Kinetic energy storages, such as flywheels, are typical mechanical storage systems. This kind of storages response very fast and have got a high efficiency. But they have also high standing losses and a limited discharge time.

b) Chemical Storage

The most common way to store energies is the classical chemical way. Due to its long history of research and development, batteries, like lead acid or lithium ion, are the typical storage. But in the last years some questions about the waste disposal and the limited numbers of charge- and discharge-cycles have risen.

Flow batteries, or also called regenerative fuel cells, should challenge those kinds of issues. Despite the relatively early stage of deployment, they can decouple power which makes them an appropriate storage for energy.

c) Electrochemical Storage

Hydrogen form hydrolysis is an example for an electrochemical storage. Even though they are environmentally clean, it is quite challenging to store hydrogen. Above all, hydrogen has a relatively low end-to-end efficiency (Hirsch et al. 2018).

C. INTELLIGENCE

The coordination of the different components in a complex network requires a strong intelligence. In order to guarantee a safe operation mode, the microgrid possesses local controllers (cf. Fig.1). Those locale controllers take care that the particular component delivers the right data for example. Nonetheless, the entire microgrid is controlled and coordinated by a so-called microgrid central controller. An effective management and the correct coordination of distributed energy resources results into an improved system performance and a sustainable development.

But the microgrid controller does not only provide the interaction between the elements, it also tracks and collects data about the energy production and the energy costs. In this case, the microgrid controller exchanges information with the relevant components through a communication network. With the use of real-time data and timer series analyses, the

microgrid control system identifies and optimizes the appropriate mode of operation (Zia, Elbouchikhi, Benbouzid 2018).

D. LOAD

First of all, the power sources are normally installed near to the loads. By means of short distances, the consumers can be supplied with the satisfactory voltage. Due to the short ways, the generated power can be sent directly to the proper distribution network. Furthermore, the line losses are negligible.

The loads are multifaceted and diverging. A detailed explanation will be offered in latter capitals. Generally speaking, microgrids' capacity generation is ranging from Kilowatts to Megawatts.

E. INTEGRATION WITH THE GRID

Even though the microgrid is able to be off-grid applied, it can also be grid-connected. In grid-connected mode, the microgrid remains connected to the grid and imports or exports power from the main grid.

In case of any disturbances or other problems, the microgrid switches over to the stand-alone mode. Nevertheless, it still enables the microgrid to feed power to the priority loads (Dulău, Bică et al. 2018). The following figure is supposed to present the most essential constituents of a microgrid in a nutshell (Fig.1):

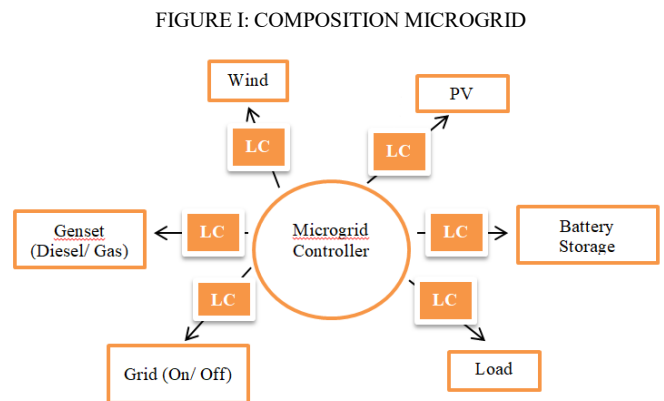

III. PRACTICAL EXAMPLE

A. CLASSY MICROGRID

In order to submit a better overview of this network, the interaction between those elements should be provided in the following. By the selection of appropriate components, it is possible to create a sustainable and energy efficient power grid. In this case, a diesel generator set produces energy. With the assistance of renewable energies, like photovoltaic panels or microturbines, the engine can be supported. If the sun shines strongly and the wind blows heavily as well, it is possible to shut down the heat engine completely.

Due to the use of photovoltaic panels, the electricity grid turns into an AC-/DC-microgrid. Furthermore, an electric switch decides whether the microgrid is an off-grid or an on-grid solution.

In terms of storage systems, batteries are able to safe energy if it is not consumed yet (Hirsch et al. 2018). Due to the fact that electric vehicles are mainly stand still, they can be treated like battery systems. The so-called vehicle-to-grid, more specifically grid-to vehicle, technologies enable a stable network and a better power supply to the customers.

Taking into consideration that electric vehicle's battery capacity is about 20 Kilowatt, it is notable that those cars also able to consume but also to give up energy. In addition, this would also avoid a power failure or as a last resort a total blackout (Rodrigues 2018). Electric vehicle charging stations stabilize the voltage and allow a better energy management. As a consequence, a better reliability is also given (Singh et al. 2018).

A so called microgrid can be observed in the second figure (Fig. 2). It is created with the help of the software Matlab Simscape™ Power Systems™:

FIGURE II: MODE OF OPERATION MICROGRID

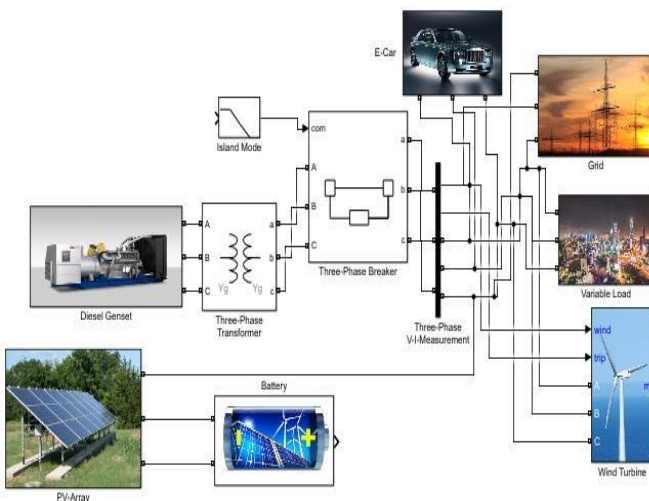

B. MICROGRID ON A BLOCKCHAIN PLATFORM

A very prominent example of a microgrid stands in Brooklyn. The reason is that this powergrid is based on a blockchain technology. Hence, this grid is able to generate electricity from distributed energy resources in the most modern way. The integration of blockchain technology with the Internet of Things enables a community energy marketplace that creates a decentralized Peer-to-Peer energy network that is coordinated with the power grid. It is the first ever energy-blockchain-platform that allows devices at the grid edge to securely and directly transact for energy sales among microgrid participants (Reyna 2018).

Besides, it is almost impossible to manipulate important data sets or at last the relevant components due to the blockchain platform. Additionally, blockchains mitigate the risk of double-spending by secure cryptography. As an information system, blockchain technology enables fully decentralized market platform. Conflicts of interests and providing information symmetry to all market participants can be guaranteed in this case.

Apart from this, the demand and supply is balanced by a superordinate grid as many microgrids before. In this context, it is very interesting that a clearing price will be determined in every time slot. Prices will vary according to demand and supply as well as socio-economic characteristics (Mengelkamp 2018).

IV. ADVANTAGE AND DISADVANTAGE

A. THE DISTINCTION BETWEEN A MICROGRID AND A LARGE-SCALE SMART GRID

Before going into details, it is obvious that a microgrid is also a smart grid. That's because both network structures are able to rule and regulate the power supply and are also able to react to unpredictable problems. But due to the small-scale character of a microgrid, a comparison between those grids becomes suitable and above all essential as well (Lund et al. 2017).

Speaking of small sizes, the main difference between a microgrid and a large-scale smart grid becomes obvious. Due to its set-up, a microgrid is a much more reliable energy resource to grid-edge communities in comparison to large-scale smart grids. That is why a microgrid can supply electrical and thermal energy to remote rural sites.

Furthermore, benefits in other cases from its design. A microgrid is not only very reliable but also flexible and adaptable to other grids for example. In case of any disturbances, a microgrid can moreover count on its high number of local controllers. With the assistance of those multiple controlling agents, a microgrid is very resilient and robust (Prinsloo et al 2018).

But nevertheless, a microgrid has also some disadvantages against a large-scale smart grid. For instance, if there is a huge

amount of microgrids in a small radius, a large-scale smart grid becomes crucial. A combination of those microgrids in order to build one huge smart grid would facilitate the communication and the data exchange. A smart grid would be the superordinate control technology in this case (Lund et al. 2018).

B. DIFFERENCES BETWEEN MICROGRIDS AND VIRTUAL POWER PLANS

Microgrids and virtual power plants are also very similar. This is related to the fact that both systems deal with the energy production and the energy supply. As a consequence, both systems try to optimize the energy consumption.

But taking into consideration that a centralized grid has not existed in the 19th century, it becomes obvious that both schemes distinguish in terms of their existence. Thomas Edison’s constructed power plant can already be stated as a microgrid. In contrast to a virtual power plant, a microgrid, has a long history.

However, virtual power plants differ not only from microgrids due to their shorter life time. They differentiate mainly from microgrids because of their dependence on given softwares. From this point of view, one can say that this makes virtual power plants in comparison to microgrids much more modern. Anyhow, the key distinction between both set-ups is that virtual power plants are not limited in terms of their geography. In addition, virtual power plants possess a bigger static set of resources (Asmus 2010).

But in contrary to microgrids, in many cases virtual power plants do not require a battery container to store energy. As one can guess, a microgrid relies much more on hardware while virtual power plants, as aforementioned, depend on software. Plus, virtual power plants are always grid-connected while a microgrid can switch into island-mode (Nosratabadi 2017).

Microgrids are somehow a prerequisite for virtual power plants. Because virtual power plants are highly synergistic with the more sophisticated billing systems, are often called as an evolution of smart microgrids.

Besides, virtual power plants can stretch supplies from existing generators without large infrastructure updates. As a result, virtual power plants can deliver great values to the customers for instance (Asmus 2010).

C. MICROGRIDS IN CONTRAST TO CENTRALIZED POWER SUPPLY

Speaking of microgrids, one can suppose that it is concerning the decentralized energy supply. On the one hand, large-scale power plants are notable for centralized power supply. They are utilized to generate electricity. As an advantage, the used resources are always dispatchable (Funcke 2016).

On the other hand, microgrids use low-carbon technologies. In contrast to the centralized power supply, microgrids work with renewable energies. Consequently, the pollution will be reduced. It follows that less greenhouse gas emissions are in the environment. Furthermore, the global warming will decrease as well (Dulău, Bică et al. 2018).

Decentralized technologies are often connected to the distribution grid while centralized technologies are always connected to the transmission grid. Besides, centralized technologies are located near to the resources. Decentralized technologies are located near to the load. Furthermore, centralized technologies are balanced through large-scale power generation and the transmission grid. This enables a well-balanced thermal and electrical energy supply. Decentralized technologies are balanced through distributed energy resources and demand-side management (Funcke 2016).

But renewable energy systems affect the grid negatively. The non-programmable renewable energy supply downgrades the grid safety. Due to the missing grid stability, network imbalance occurs which cannot guarantee a safe energy supply (Barelli et al. 2018).

However, feed-in tariffs have also affected the share of renewables in the electricity system which, in turn, influences the demand for distributed energy supply. Owing to the decentralized energy supply, new actors with less financial resources are now able to invest in generation. Thereby, feed-in tariffs guarantee a calculable remuneration for the produced electricity. Among these visionaries are private citizens, politician, non-governmental organizations as well as interest groups and many more (Funcke 2016).

The following table should summarize the most important data to understand the key advantages and disadvantages of a microgrid (Table 1):

TABLE I. ADVANTAGES AND DISADVANTAGES

ADVANTAGES	DISADVANTAGES
Energy supply to remote areas	Necessity of a superordinate smart grid in case of many microgrids
Good adaptability and high flexibility	Microgrid just a prerequisite for virtual power plants
Prominent Resilience and robustness characteristics	Virtual power plants with a better billing system
On-/ Off-grid mode of operation	Fossil resources are always dispatchable
Low-carbon technology	No balanced energy supply
Less greenhouse gas	Less grid stability

A. ON-GRID APPLICATION

a) Usage

Grid-connected microgrids are necessary for a greater penetration of renewables. In this case, the carbon emissions can be reduced substantially. A continuous interaction between power generation, storage and load requirements guarantee a better performance and reliability.

Moreover, an on-grid microgrid is an active player in the distribution network. In this manner, ancillary services to the main grid like peak shaving and power quality control can be used (Bifaretti 2017).

b) Costs

The microgrid market is expected to reach 38.99 billion people by 2022, with a compound annual growth rate of 12.45% in 2016–2022 (Khodayar 2017). Besides, fuel costs can be reduced with the assistance of renewables. In particular, if the sun shines strongly and the wind blows heavily, the diesel or gas generator set can be switched off (Bifaretti 2018).

As already mentioned before, decentralized technologies are balanced through demand-side management (Funcke 2016). But with the assistance of Peer-to-Peer energy trading, demand-side-management systems can also help to minimize the energy costs. Generally speaking, a Peer-to-Peer energy trading represents a direct energy trading between peers.

For instance, energy from small-scale distributed energy resources in dwellings is traded among local energy consumers. Somehow, it is an energy sharing model with price-based demand response. In addition, energy will also be balanced due to the record of settlement time periods. Due to forecasting, the total energy costs can be reduced. This optimizes the consumer's behavior and the expenditures of energy (Zhang 2018).

c) Customers

Grid-connected microgrids are very helpful to provide electricity for households and small communities. Moreover, there are three groups which are potential customers for on-grid solution. These are: industrials, commercials and residential areas (Fattahi 2018).

Those customer groups are not only aware of the climate change. They are also looking to optimize their energy costs in order to spend their money in other sectors. Some are also willing to save their money for the purpose of finding other investment possibilities (Ellabban 2016).

a) Usage

A microgrid is one of the most indispensable elements of smart power systems to improve the reliability and resilience of the grid. Off-grid microgrids mainly provide access to electricity for people who live in areas for which an extension of the grid cannot be performed with reasonable time and cost.

Therefore, the impact of off-grid microgrids is not only measured by the reduction in the electricity cost in rural and remote areas, but also by the extent of improvement in residents' quality of life. It is estimated that 1.18 billion people (17% of the world's population) have no access to electricity. This includes 512 million people in Asia, 244 million in India, 41 million in Indonesia, and 11 million in the Philippines.

For the developing world, providing and maintaining access to the electricity is the main driver for developing off-grid microgrids, as this technology provides the most economical solution for electrification of remote areas. In fact, microgrids could become an alternative to grid extensions.

b) Costs

The declining capital costs of renewable resources and energy storage promotes the application of such technologies. Furthermore, the variable costs for renewables are indeed zero.

However, remote microgrid solutions are expected to claim a considerable portion of the total microgrid market. The annual revenue for off-grid energy supply is expected to exceed \$25 billion by 2024.

The markets for residential and commercial applications, including healthcare, rural electrification, and telecommunications, are expected to grow at a considerable compound annual growth rate in 2016–2022. The growing market for off-grid microgrids for remote and rural electrification is supported by organizations such as the United Nations and World Bank.

c) Customers

These small power systems are built for a variety of applications. Small cell phone towers as well as large commercial, industrial, and military facilities are potential customers. In developed countries, microgrids are also used to improve the energy security, power quality, reliability, and resilience.

In critical infrastructure systems like hospitals, industrial facilities, universities, and military bases are typically customers for off-grid solutions.

The following table should show the main differences between an on- and an off-grid solution (Table 2):

TABLE II. MAIN DIFFERENCES

ON-GRID	OFF-GRID
Greater penetration of renewables	Electrification of isolated villages
Peak shaving and power quality control	Safe energy supply in critical infrastructures
Energy trading by means of Peer-to-Peer service	Alternative to grid extensions

VI. CONCLUSION AND FORECAST

Smart grids like microgrids are definitely a good solution to supply energy to the consumers. Owing to its smart character, an appropriate consumer behavior will be secured. Because of several application possibilities, microgrid and particularly distributed energy resources will affect the current energy supply. Off-grid solutions are, in fact, a proper way to supply electrical and thermal energy to remote areas. Moreover, microgrids fit perfectly to countries with a bad network infrastructure (Khodayar 2018).

In terms of battery storages, there is not already reached the final solution. This very important constituent of a microgrid has a quite high potential for improvement which is necessary due to the increasing use of renewables. The ongoing research and development will guarantee a better battery capacity. Especially, chemicals storages will play a huge role in the future (Hirsch et al. 2018).

In addition, the politic will support microgrids. The fuel costs will sink and renewable energies will reach higher efficiencies. The diesel or gas generator sets will become more and more a backup solution. The impact on the environment will be reduced. Due to higher carbon taxation, companies will be pushed to invest more money in development department (Mills et al. 2018). Microgrids based on a blockchain platform will be, from this point of view, only the beginning of following changes in the energy market. Due to its complexity, the energy market offers many optimization possibilities (Mengelkamp 2018).

Besides, the softwares Matlab Simscape™ Power Systems™ and HOMER Energy are both good tools to simulate microgrids. From this perspective, all components can be tested in order to optimize a proper operation mode.

REFERENCES

Asmus, Peter (2010): Microgrids, Virtual Power Plants and Our Distributed Energy Future. In: *The Electricity Journal* 23 (10), S. 72–82. DOI: 10.1016/j.tej.2010.11.001.

Barelli, L.; Bidini, G.; Bonucci, F.; Ottaviano, A. (2018): Residential micro-grid load management through artificial neural networks. In:

Journal of Energy Storage 17, S. 287–298. DOI: 10.1016/j.est.2018.03.011.

Bifaretti, S.; Cordiner, S.; Mulone, V.; Rocco, V.; Rossi, J. L.; Spagnolo, F. (2017): Grid-connected Microgrids to Support Renewable Energy Sources Penetration. In: *Energy Procedia* 105, S. 2910–2915. DOI: 10.1016/j.egypro.2017.03.658.

Dulău, Lucian Ioan; Bică, Dorin (2018): Optimization of generation cost in a microgrid. In: *Procedia Manufacturing* 22, S. 703–708. DOI: 10.1016/j.promfg.2018.03.101.

Ellabban, Omar; Abu-Rub, Haitham (2016): Smart grid customers' acceptance and engagement. An overview. In: *Renewable and Sustainable Energy Reviews* 65, S. 1285–1298. DOI: 10.1016/j.rser.2016.06.021.

Fattahi, Abbas; Nahavandi, Ali; Jokarzadeh, Mohammadreza (2018): A comprehensive reserve allocation method in a micro-grid considering renewable generation intermittency and demand side participation. In: *Energy* 155, S. 678–689. DOI: 10.1016/j.energy.2018.05.029.

Funcke, Simon; Bauknecht, Dierk (2016): Typology of centralised and decentralised visions for electricity infrastructure. In: *Utilities Policy* 40, S. 67–74. DOI: 10.1016/j.jup.2016.03.005.

Hirsch, Adam; Parag, Yael; Guerrero, Josep (2018): Microgrids. A review of technologies, key drivers, and outstanding issues. In: *Renewable and Sustainable Energy Reviews* 90, S. 402–411. DOI: 10.1016/j.rser.2018.03.040.

Khodayar, Mohammad E. (2017): Rural electrification and expansion planning of off-grid microgrids. In: *The Electricity Journal* 30 (4), S. 68–74. DOI: 10.1016/j.tej.2017.04.004.

Lund, Henrik; Østergaard, Poul Alberg; Connolly, David; Mathiesen, Brian Vad (2017): Smart energy and smart energy systems. In: *Energy* 137, S. 556–565. DOI: 10.1016/j.energy.2017.05.123.

Mengelkamp, Esther; Gärtner, Johannes; Rock, Kerstin; Kessler, Scott; Orsini, Lawrence; Weinhardt, Christof (2018): Designing microgrid energy markets. A case study: The Brooklyn Microgrid. In: *Applied Energy* 210, S. 870–880. DOI: 10.1016/j.apenergy.2017.06.054.

Milis, Kevin; Peremans, Herbert; van Passel, Steven (2018): The impact of policy on microgrid economics. A review. In: *Renewable and Sustainable Energy Reviews* 81, S. 3111–3119. DOI: 10.1016/j.rser.2017.08.091.

Nosratabadi, Seyyed Mostafa; Hooshmand, Rahmat-Allah; Gholipour, Eskandar (2017): A comprehensive review on microgrid and virtual power plant concepts employed for distributed energy resources scheduling in power systems. In: *Renewable and Sustainable Energy Reviews* 67, S. 341–363. DOI: 10.1016/j.rser.2016.09.025.

Prinsloo, Gerro; Dobson, Robert; Mammoli, Andrea (2018): Synthesis of an intelligent rural village microgrid control strategy based on smartgrid multi-agent modelling and transactive energy management principles. In: *Energy* 147, S. 263–278. DOI: 10.1016/j.energy.2018.01.056.

Reyna, Ana; Martín, Cristian; Chen, Jaime; Soler, Enrique; Díaz, Manuel (2018): On blockchain and its integration with IoT. Challenges and opportunities. In: *Future Generation Computer Systems* 88, S. 173–190. DOI: 10.1016/j.future.2018.05.046.

Singh, Shakti; Jagota, Shubhangi; Singh, Mukesh (2018): Energy management and voltage stabilization in an islanded microgrid through an electric vehicle charging station. In: *Sustainable Cities and Society* 41, S. 679–694. DOI: 10.1016/j.scs.2018.05.055.

Zhang, Chenghua; Wu, Jianzhong; Zhou, Yue; Cheng, Meng; Long, Chao (2018): Peer-to-Peer energy trading in a Microgrid. In: *Applied Energy* 220, S. 1–12. DOI: 10.1016/j.apenergy.2018.03.010.

The potential of offshore wind farms

Introduction of offshore wind farms as a future energy solution

Beatrice Blaschke, Nicole Gehring and Jan Ullrich
Brandenburgische Technische Universität Cottbus – Senftenberg
Cottbus, Germany

Abstract— The energy production in Germany has been changing in the last 2 decades. Because of the climate change caused by CO₂ emissions the whole world has to change its energy production, to produce less or no CO₂ during this process. Germany is one of the leading countries in this change. This paper will focus on the production of wind energy through offshore wind farms. These wind farms are a source of clean (CO₂ neutral) and highly reliable energy. The goal is to introduce the reader to this next generation solution.

For example: How are wind farms constructed? How do they operate? What is the economic potential and how is the outlook of this technology?

Keywords: construction; economic; maintenance; optimization of the construction; 1. Mai 2018

I. INTRODUCTION TO OFFSHORE WIND FARMS

Nowadays everyone has most likely seen a wind turbine. Wind farms are basically a couple or hundreds of wind turbines combined with a central gathering point from which the electricity is then transferred into the power grid. The most important parameter for a wind farm is a good location. This location basically depends on the average wind velocity which has to be at least 5-6 m/s to be economically viable. So why build wind farms offshore instead of onshore which is easier? The reason is again the average wind velocity. In Fig. 1 and 2

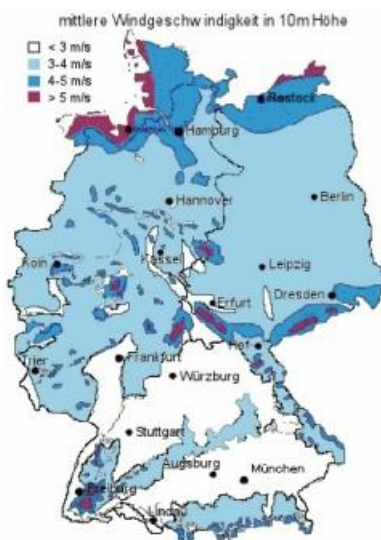

Figure 1. Average wind velocity in 10 m height [1].

you see the average wind velocity in Germany in heights up to 10 and 80 meter. Which shows that there are not many places in Germany where you can easily build very efficient and economic wind turbines. In most places they have to be at least 80 m high (see Fig. 2 in which yellow stands for 5 m/s wind velocity, the darker the color the

higher the wind velocity), which increases the costs. Offshore wind farm can be the solution to this problem. In the North Sea the average wind velocity is between 7-8 m/s, which makes those wind farms much more efficient. In Fig. 3 there is an overview of planned and already built wind farms with their electric capacity in the North Sea. So what are the differences between an onshore and an offshore wind farm. The basics are more or less identical, but the initial investment costs for offshore solutions are higher. The reason for this is the more complicated construction (like transport, fundamentals, weather conditions, shore connection, submarine cable) [3].

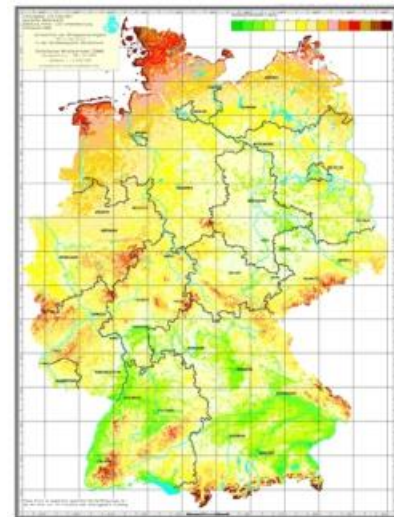

Figure 2. Average wind velocity in 80 m height [2].

The first step to build a wind turbine in the sea is the construction of the fundamentals. These are very important and have to be adjusted to the different weather conditions, the weight of the plant, the water depth, the dynamical load distribution and the conditions of the seabed. Also the weight of the fundamental itself and of the different component can influence the chosen type. Right now there are seven different types of fundamentals used (Jackets, Tripods, Monopiles, heavy weight, Tripiles, Bucket and swimming foundations). The construction procedure for these fundamentals can vary depending on the fundamental but are mostly done by ramming. For this there is a restriction in Germany, because the sound produced by this ramming can be damaging to the wildlife, so



Figure 3. Overview of Offshore projects in Germany [3].

technical solutions have to be implemented to reduce the noise production [4 & 5].

The building phase can be divided into different steps. But it is always the main goal to reduce the construction steps done on sea, because that is the most weather dependent part and restricts the construction on sea to specific times during the year. Which is why most of construction is pre-assembled at the nearest ports. On sea the only thing left to do is to connect the shaft segments the, windmill head (consisting of e.g. the turbine, generator) and the blades together. For the future there are plans to reduce this step to the complete shaft and the head to make it even faster. In the early 2000s most of the single units had a capacity between 2-3 MW and a blade diameter of 80-100m. Since the late 2000s this change to units with 4-6 MW capacity and 105-125m blade diameter. Right now the newest models were improved again to 6-8 MW with blade diameters of 150-170m and of course for future plans the units will be bigger again with estimated capacities of 10 MW+ and up to 200m of blade diameters [4 & 5].

II. PROJECTS IN GERMANY

As shown in Fig. 3 there are multiple offshore projects in Germany. The projects marked in dark green are already in use, the projects in light green are partly used, the projects in orange are in construction, the projects in dark orange are in a far developed planning phase (with investment phase already closed) and the projects in grey are planned for further constructed past the year 2020. By the way the dark blue part of the map indicated the German sea territory, so a big part of the possible territory is already in use. As of the end of 2017 1169 offshore wind turbines of 21 different wind farms are connected to the German Power Grid with a combined capacity of 5500 MW. Those wind farms range from small clusters under 100 MW to large wind farms with capacities up

to 900 MW. The average sea water depth for the units is 29 m with an average distance from the shore being of 69 km. In 2017 alone 201 units have been built with an increase of 1250 MW in capacity, which was the second highest increase since the start in 2008. For 2018 there are still 129 fundamentals free for new units. Right now the future plans reach until the year 2030. For 2020 the goal is to reach a total capacity of 7700 MW which will most likely be achieved and be 18% than the initial goal of 5500 MW. With the next step to reach 10,8 GW in 2025 and 15GW in 2030 [3].

Just to bring this into perspective, the total rated capacity needed in Germany is about 201 GW. With 44 GW produced by Solar Panels, 52 GW produced by Onshore wind farms, 76 GW produced by fossil energy (coal & gas), 10 GW through atomic power plants, 8 GW with biomass and 5.5 GW with water energy [6]. Unfortunately, those are just the possible capacity numbers. Which suggest that about 50,5% of the needed capacity can be produced by wind and solar energy. But those energy sources can have a large spread. This leads to over and underperformance throughout the year. In source of the Fraunhofer Institute [7] there is a chart which can be adjusted for each year from 2015 until now. It is possible to look at the energy production by month, week or even day. The mentioned spread is pretty big and ranges from under 30% up to 50% of the total energy production [7].

III. OPERATION AND SUPPLY OF THE ELECTRICAL CONNECTIONS OF OFFSHORE WIND FARMS (POWER GRID CONNECTION, WEATHER CONDITIONS, MAINTENANCE AND REPAIR)

The constructed wind farms have to be connected to the power grid on the mainland. For this, every single unit is connected in a main knot (the electrical substation) from which an undersea cable is connected to the power grid. In the North

Sea, the electricity is routed mainly via large DC links, in the Baltic Sea via AC lines. As a rule, the external cables for grid connection to the mainland are laid before the construction of the offshore wind turbine. However, the internal cable laying takes place only after the foundation and the construction of the transformer platform. Each offshore wind farm has its own transformer platform on which all plants are bundled. Here, the power is transformed to a higher voltage level for transmission on land. The power lines in the wind farm (inner parking cabling) are three-phase connections. For small and coastal projects, the power is routed via a submarine cable directly to the nearest network node on land. In wind farms with higher power and greater distance to the coast, however, three-phase technology would cause very high transmission losses. For this reason, the so-called cluster compound is used here, especially in the North Sea. This can be thought of as a multiple socket. The electricity is fed from the substations of several offshore wind farms to another offshore platform - the so-called converter platform. There, the alternating current from the connected wind farms is converted into direct current and routed via a submarine cable on land to the next network node, where it is in turn converted via an onshore converter into alternating current. Experts speak in this case of the high-voltage direct current transmission technology (HVDC). This allows a significantly higher performance per cable to be dissipated. The transmission losses are significantly lower than with three-phase current [4].

Trouble-free operation is the basic prerequisite for the cost-effectiveness of offshore wind turbines. Therefore, regular maintenance and fast response in case of failure is an important goal to minimize the resulting downtime. Three different maintenance options are listed here. On the one hand there is the automatic maintenance, where a permanent electronic condition monitoring system is used. The system provides electronic real-time monitoring of the components as well as the state of the system, also transmits data to various physical parameters such as vibration, pressure conditions, temperature, etc. In some cases, the system can correct errors automatically. For example, at high load wind speeds, the system will take the system out of the wind automatically. On the other hand, there is the remote maintenance, in which the system operators can make adjustments to the electronics via the control center on the mainland. The last option is on-site maintenance in the event of a fault. In strong wind, fog or high waves maintenance personnel and spare parts cannot be safely transported to the facilities. According to the experience of the Alpha Ventus operation, the weather conditions are only good enough in about 20% of the days of the year, so that the maintenance ships can safely approach the plant. If transport by ship is not possible, personnel and material will be flown in with helicopters. The experience in the operation of Alpha Ventus shows, that a helicopter transport in addition to the ship transport is possible in about 60% of the days over the year. In order to get to the wind turbines, the workers have to rappel down from the helicopters to the wind turbines, which makes the work even more difficult. In the remaining 20% of

the year maintenance is not possible due to strong winds, fog or other weather conditions. If a failure of the system falls within such a time window, the system failure can cause considerable economic damage. In addition to the maintenance already described, there is, of course, routine maintenance, which is a regular visual maintenance that is particularly important for the non-electronic parts of the plant, such as foundations or rotor blades, where attention is focused on the examination of cracks and corrosion of the materials or the so-called kolk development on the foundation structures. The kolk is an underwater vortex which is created when high velocity water passes an obstacle. This phenomenon can gradually dig out fundaments by removing the ground material around the fundament [8]. Every year, at least 25 percent of the facilities must be maintained, so that after 4 years at the latest, all facilities of an offshore wind farm have been visually inspected [4]

IV. OVERVIEW OF THE UPSIDES AND DOWNSIDES OF ONSHORE AND OFFSHORE WIND FARMS

Over the course of creating this paper the up- and downsides of offshore wind farms became apparent. Those can be found in Table 1.

Table.1 Up- and downsides of offshore wind farms

	Offshore	Onshore
upside	<ul style="list-style-type: none"> - higher wind velocity - high and more constant energy production (approximately double the production per unit) - less problems with local residents because offshore wind farms are not in their backyard 	<ul style="list-style-type: none"> - lower investment costs - long experiences - high and proven technology - easy connection to the power grid
downside	<ul style="list-style-type: none"> - higher investment cost - challenging construction on sea - short experience (about 10 years) - longer maintenance cycles - complicated and costly maintenance - complicated connection to the main power grid 	<ul style="list-style-type: none"> - less energy production per unit - higher spread because of weather conditions - legal problems with local residents (noise and visual view)

V. ECONOMIC EFFECTS, ENERGY PRICES AND THE ENVIRONMENT (INTRODUCTION OF EXAMPLES SUCH AS 1 MAY 2018)

Like most large investment decisions, offshore wind farms are financed by credit giving banks. These banks are a combination of private institutes and state owned banks like the KfW (Kreditbank für Wiederaufbau) and the European

Investment Bank. Despite banks and big energy companies, small companies and even private persons can invest in offshore wind farms through different bonds given out by the banks. Because of the high investment costs and this industry being young (first offshore wind farms build in 2008 in Germany) the government guarantees a fixed energy price of 15,4 ct/kWh over 12 years or 19,4 ct/kWh for 8 years. This type of government price guarantees is nothing new in Germany and is part of the reason why the energy costs in Germany are the second highest in Europe [9]. But prices are expected to go down for offshore wind farms with, the basic price for this energy of 3,9 ct/kWh after the guarantees. The end price will then be decided on the energy market itself. Furthermore, for all newly build offshore wind farms after 2020, the guarantees will go down as well, because it is expected that the investment costs will go down over the next years. This is due to an optimization of the construction process and more efficient wind turbines (see chapter I.).

A negative example of the rushed energy change from fossil to renewable energy happened on the 1 May, 2018. Due to excessive wind energy loads and too little demand on 1 May, the price for the base load delivery for electricity at was with -24.27 EUR / MWh on a 52-week low. As on Sunday and on Monday, the peak load price was below the base load.

The base load price on Monday had dropped to its lowest level since Christmas 2012. In the day-ahead auction on April 30, 2018, the price was 10 hours were below zero euros, resulting in a base load of -6.74 EUR / MWh. By noon on Sunday, the wind and photovoltaic system (PV systems = solar power system) had a peak production of 44 GW per hour, resulting in a price of -74.92 EUR / MWh between 14 and 15 o'clock.

On May 1, the electricity price was in total from 0 o'clock to 17 o'clock in the minus. The lower PV utilization in the evening and the weaker wind feed led to positive prices again. The correlation between the negative electricity prices on the two holidays as well as the high feed-in of renewable energies and low electricity demand is shown in the Fig. 4.

Moreover, this shows the sharp movement of prices in the transitional hours. It also further increases the need for solutions to store energy when the demand is low.

Also the production of wind energy is a steadily increasing industrial sector. In 2015 about 143000 jobs were directly or indirectly created because of this new industry. With the offshore branch responsible for about 20000 jobs. The whole industry generated sales of about 13 billion Euro in 2015 [11]. Most of the jobs created depend on specialist staff, so these jobs will be safe and secure in the near future, despite the growing automation in a lot of industry branches. With this sector growing even further after 2020 (inland and foreign markets) companies like Siemens, Nordex, GE are expected to increase their focus on offshore energy solutions even more. Furthermore, with this sector being highly dependable on a diverse mix of different industry sectors (e.g. logistic, construction, energy supplier etc.) the jobs created have a high range for people with or without university degrees.

Before a permit is issued for an offshore wind farm, the application is extensively examined for environmental compatibility at the Bundesamt für Schifffahrt und Hydrografie (government institution). Impacts on the marine environment are examined before and during construction and operation. In addition, the planners of the offshore wind farms must provide their own independent environmental assessments. Furthermore, the populations of migratory and resting birds, marine mammals, fish and the occurrences of other species is documented. The aim of this extensive documentation is to detect any negative effects early on and, if necessary, to counteract them in good time. Preliminary research indicates that the impact on migratory and marine mammals is lower than anticipated and can be further minimized through targeted conservation measures. However, these results should be further explored, as there are too few meaningful long-term data available [12].



Figure 4. Conventional power generation (gray), renewable (green), electricity demand (pink), and day-ahead electricity prices (blue) [10].

VI. OUTLOOK AND CONCLUSION

As already mentioned the outlook for wind energy and offshore wind farms in particular is expected to grow. Until 2030 the plans in Germany are to produce 30 GW of offshore energy. As of 2017 in the whole world only 18.8 GW of offshore wind energy are produced with the UK and Germany alone being responsible for 12 GW [13]. Looking at Germany in particular with its rather small coast line, the potential for offshore energy in countries like the USA, China, Australia, Japan and others seems rather limitless. But in the end the question will still be, how serious the change in energy production is pursued by the economic powers in the world. And can offshore energy compete with electricity generation costs of 3-8 ct/kWh (depending on the country) for fossil and atomic energy [14]. This question will have to be answered in the future. In Germany the change from fossil to renewable energy, even though it is costly, seems to advance even further with offshore wind energy.

- [12] <https://www.umweltbundesamt.de/sites/default/files/medien/pdfs/offshore-windenergie.pdf> (June 23, 2018)
- [13] <https://www.offshore-windindustrie.de/> (June 23, 2018)
- [14] http://www.forschungsradar.de/fileadmin/content/bilder/Vergleichsgrafiken/Stromgestehungskosten_0kt2014/AEE_Dossier_Studienvergleich_Stromgestehungskosten_sep14.pdf (June 23, 2018)

REFERENCES

- [1] <http://www.renewable-energy-concepts.com/german/windenergie/windkarte-deutschland.html> (June 23, 2018)
- [2] https://www.dwd.de/DE/leistungen/windkarten/deutschland_und_bundeslaender.html (June 23, 2018)
- [3] https://www.offshore-stiftung.de/sites/offshorelink.de/files/documents/Factsheet_Status_Offshore-Windenergieausbau_2017_0.pdf (June 23, 2018)
- [4] <https://www.erneuerbare-energien.de/EE/Navigation/DE/Technologien/Windenergie-auf-See/windenergie-auf-see.html> (June 23, 2018)
- [5] <https://www.offshore-stiftung.de/offshore-windenergie> (June 23, 2018)
- [6] https://www.energy-charts.de/power_inst_de.htm?year=all&period=annual&type=power_inst (June 23, 2018)
- [7] https://www.energy-charts.de/energy_pie_de.htm?year=2018&week=8 (June 23, 2018)
- [8] https://www.lufi.uni-hannover.de/uploads/tx_tkpublikationen/2_01_Wahrmund_et_al.pdf (June 23, 2018)
- [9] <https://1-stromvergleich.com/strom-report/strompreise-europa/> (June 23, 2018)
- [10] <https://blog.energybrainpool.com/wochenende-zum-1-mai-bringt-rekordtief-bei-strompreisen/> (June 23, 2018)
- [11] <https://www.windenergie.de/presse/pressemitteilungen/2017/zukunftsbranche-windindustrie-ist-bundesweit-ein-starker> (June 23, 2018)

Oil sand extraction in Canada

Methods and Impacts

René Tafelski, B.Sc.

Faculty 2 - Chair of Soil protection and recultivation
Brandenburg University of Technology Cottbus - Senftenberg
Cottbus, Germany
Rene.Tafelski@b-tu.de

Abstract — Vast reserves of oil are stored in the form of oil sands (bitumen) under boreal forests in the Province of Alberta, Canada. The estimated amount of this unconventional oil deposit is enough to secure the Canadian demand for oil and offers opportunities for export for several years. Due to the high viscosity and intermixture with sand, extraction of the fossil resource is rather complex. Surface mining is accompanied by complete deforestation, extensive landscape disturbance and immense water consumption. In situ methods require more energy, emit higher amounts of greenhouse gases and have lower oil recovery rates. Other environmental impacts arise from the habitat destruction, seeping of organic and metallic compounds from overburden piles and tailing ponds, and the interaction of the fauna and the tailings. On the other hand bitumen production creates several thousand jobs and increases Alberta's economic performance. The rapid population growth, caused by the migration of skilled workers, might induce negative social effects in the booming communities.

Keywords - oil sand; bitumen; mining; in situ; Alberta; Canada

I. INTRODUCTION

With a rising oil price, the production of oil from Canadian oil sands saw a steady growth in recent decades. Oil sands represent one form of the so called unconventional hydrocarbons. Their extraction, is difficult and therefore expensive compared to that of conventional oil reserves [1].

In 2013 it was estimated that Canada possesses $27,4 \cdot 10^9$ m³ (172,5 billion barrels) of recoverable crude oil, about $26,6 \cdot 10^9$ m³ (167,2 billion barrels, 97 %) of which is stored in oil sands in an area of approximately 142.000 km² [2]. With regards to global varified oil reserves Canada places third, following Venezuela and Saudi Arabia [1]. The total volume of Canadian oil sand resources is assumed to be $286 \cdot 10^9$ m³ (1,8 trillion barrels) [2]. The extraction is focused on the regions of Athabasca, Cold Lake and Peace River in the Province of Alberta, as illustrated in Fig. 1 [3].

Difficulties of recovering oil from oil sand are mainly caused by its physicochemical properties.

II. FORMATION AND PROPERTIES OF OIL SAND

Oil sand may occur where oil is stored in or migrates to a sand dominated calcareous soil in depths over 2 km. Under these conditions the cementation process of the sediment to



Figure 1. Oil sand deposits (yellow) in the Province of Alberta, Canada; from: Wikimedia [14]

sandstone is incomplete; therefore a significant part remains loose sand [4]. Volatile compounds of the oil are prone to disperse. Furthermore, it is highly likely such soils were not affected by temperatures above 70 – 80 °C. This means that they were not sterilized and thus promote the oil's biodegradation. In oil sands this degradation leads to a relative accumulation of non-volatile compounds, like asphaltenes and resins, as well as nitrogen, sulphur and nickel, resulting in a viscosity increase [4, 5]. Due to its high viscosity oil from oil sand appears tar-like and is therefore also known as tar sand or bitumen [5]. Tab. I provides a property-comparison of two conventional crude oil grades and bitumen. With its density of over 1 g cm⁻³ and a pour point at 32 °C, bitumen neither floats on water nor is it liquid at room temperature, like other oils. It also yields relatively small amounts of gasoline [5].

TABLE I. CHARACTERISTICS AND PHYSICO-CHEMICAL PROPERTIES OF CRUDE OIL, HEAVY CRUDE OIL AND BITUMEN FROM MEYER-REHHAUSEN (2007) [5], ALTERED

	Oil grades		
	Crude oil	Heavy crude oil	Bitumen
Reservoir depth [m]	1566	975	148
Asphaltenes [mass %]	8,8	38,4	69,6
Gasoline yield [vol. %]	9,2	2,0	1,4
Pour point [°C]	-9	-7	32
Density [g cm ⁻³]	0,836	0,958	1,041
Viscosity [m Pa s, at 100 °C]	9	593	292.991
Sulphur [mass %]	0,4	2,9	3,3

III. EXTRACTION METHODS

Due to its physicochemical properties, conventional extraction methods are unsuited for oil sand. Currently, there are two major recovery methods in oil sand production, open-pit mining and in situ extraction [6].

A. Open-pit mining

The oil sand is excavated using conventional mining equipment. power shovels remove the oil sand from the pit and load it into heavy hauler trucks. The trucks transport the ore to a transportation system, which moves it to an extraction plant. Previously used conveyor belts are nowadays replaced by hydrotransportation systems. From the truck the material is inserted into a cyclofeeder, crushed, mixed with water and caustic soda and pumped through pipelines to the extraction plant. During transportation in along the pipelines a first separation step of the oil sand is executed [5, 6].

At the extraction plant the material is induced into a conditioning drum. Under slow rotation it is heated with hot water and steam to break down remaining lumps of ore and support the agglomeration of the oil compounds. After sufficient size reduction the oil sand exits the drum through outlet holes and consist of 60 – 85 % solids with a pH of 7,5 – 8,5 [6]. From here it is pumped to a separation cell. The sand settles to the ground and is removed as waste material. The majority of the bitumen floats on the surface as a foam and is extracted. The fluid in between the floating bitumen and the settled sand is a mixture of water, fine mineral particles and some residual bitumen. Some of this intermediate fluid is redirected into the conditioning drum, the rest is piped to scavenger cells, where the separation process of the separation cell is repeated [5, 6].

The extracted bitumen contains approximately 10 % (weight) mineral material and 40 % (weight) water and has to be cleansed before further refining. The water and mineral particles are removed by centrifuging in two stages. First the solid material is removed by centrifugation with subsequent filtration. In the second stage, the water is removed. The process can be enhanced by addition of diluents like naphtha. Solid materials are dumped into piles or utilized to build tailing ponds to store process water [6].

Mining is profitable for reservoirs up to 75 m below ground. Approximately 10 - 20 % of Canadas bitumen reserves can be extracted by mining [2, 6]. In comparison with in situ methods surface mining has a higher recovery factor and is less energy-intensive but disturbs the landscape to a much greater extend [6].

B. In situ extraction

Commercially relevant in situ applications are based on thermal processes to separate the bitumen from the sand [6]. Which particular method is applied depends mostly on geological factors. In situ methods are used, when the oil sand layer is buried under more than 200 m of soil. Reservoirs between 75 and 200 m are lying too deep to be mined and too shallow for in situ extraction [7].

Steam-based processes are implemented in the extraction of conventional heavy oil since the 1960s. A well is drilled into the reservoir, like in conventional oil production [6]. High-pressure steam is injected into the reservoir to heat the bitumen in order to lower its viscosity until it can be extracted. It takes several days up to a few weeks to heat the bitumen sufficiently [7]. In recent years cyclic steam injection (CSI) or cyclic steam stimulation (CSS) was the most common steam based recovery method [6, 7]. The first phase of this process is steam injection, followed by the soaking phase, where the heated bitumen flows to the well. The third step consists of pumping the mixture of bitumen and steam condensate to a separation facility. After the separation the bitumen is sent to an upgrader or a refinery and the water is treated to be reused in steam injection. Steam injection, soaking phase and bitumen recovery are repeated several times through the same well [7]. The CSS-method yields recovery factors up to 30 %. Usually its recovery factor is less than 20 % [6].

Today most facilities in Canada implement the SAGD-method, rather than CSS. SAGD stands for steam-assisted gravity drainage. In SAGD two wells are drilled instead of one. At the bitumen layer the wells direction changes from vertical to horizontal, with one well located approximately 5 m above (injection well) the other (production well). High-pressure steam is injected into the injection well, to heat the surrounding bitumen and lower its viscosity. The liquid bitumen drains into the lower production well from which it is extracted. The following steps of separation, bitumen refinery and water treatment are identical to the CSS method. In contrast to CSS, SAGD is a continuous process; it furthermore yields recovery factors of approximately 60 % [7].

An illustration of both steam-based methods is provided in Fig. 2.

Even though all commercially operated oil sand production facilities in Canada utilize steam-based methods, some combustion based in situ methods have been developed. These processes revolve around the ignition of the bitumen in the ground and the aeration of the resulting combustion. The generated heat reduces bitumen viscosity and produces hot water and steam, and stimulates the expansion of other gases present in the reservoir, which in return drives the fluid bitumen out of the reservoir. Combustion methods are

advantageous where reservoirs are located so deep that temperature loss through heat dissipation renders steam-based methods ineffective. Combustion management must be exercised to prevent oil loss by backflow of the oil through the hot zones. Two basic concepts are forward and reverse combustion. In forward combustion the hot front moves from the injection well, from which it is aerated, to the production well, to which it drives the heated bitumen. All hydrocarbons behind the hot front are either mobilized or combusted. In reverse combustion the reservoir is ignited at the production well and aerated from the injection well on the other side of the reservoir. The bitumen flows along the hot zone to the production well. Some of it produces residual coke, which seals the sand and prevents oil leakage and sand erosion, but does not combust due to a lack of oxygen. In both methods

absolute bitumen production of $175 \cdot 10^6 \text{ m}^3$ for 2017 [8, 9]. Studies estimate positive economic effects generated by production growth in the oil sand industry over the period of 2010 - 2035. Depending on the scenario the GDP impact is estimated to range from \$2.283 to \$4.925 billion, in 25 years. The number of direct, indirect and induced employments is expected to increase from 390.000 to 1.600.000 [1, 10]. Following the development in the oil sand industry neighboring communities in Alberta register population growth. This growth is linked to a change in local social structure and communities' health. Services of the public sector like healthcare and education are under pressure to meet the increased demand. A rapid population growth demands affordable housing, which not all communities are able to deliver in short time. This shift in the supply and demand

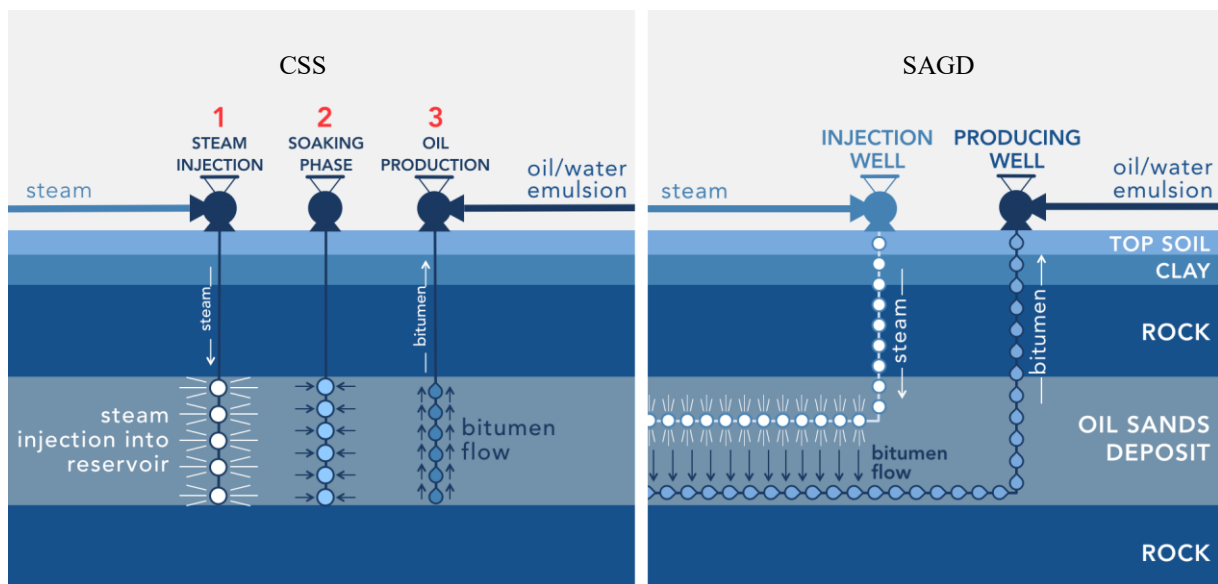

Figure 2. In situ methods: cyclic steam stimulation (CSS, left) and steam-assisted gravity drainage (SAGD, right); from Oil Sands Magazine [7], altered

water or steam may be added to the air to improve heat transfer into the reservoir. Toe-to-heel air injection (THAI) reduces the distance heated bitumen has to travel before reaching the production well. By extending the production well horizontally into the reservoirs, bottom instability issues of the combustion methods are reduced. The THAI process demonstrates a valid option for profitable combustion based in situ bitumen production [6].

IV. ECONOMIC AND SOCIAL IMPACTS

While approximately $197 \cdot 10^6 \text{ m}^3$ of bitumen were produced in 2011 and 2012, the Government of Alberta collected \$4,5 billion from oil sand production, which was equal to 11,4 % of its government revenue. The oil sand industry employed 22.340 workers directly, which is equivalent to 0,13 % of Canadian jobs [8, 9, 10]. According to Oil Sands Magazine, in late 2017 and early 2018 oil sand was produced in nine open-mining sites and 23 in situ production facilities. The combined daily gross production in 2017 was $0,25 \cdot 10^6 \text{ m}^3$ for mining and $0,23 \cdot 10^6 \text{ m}^3$ for in situ production, which results in an

structure may increase local prices for certain services, up to an extent where members of the pre-growth population cannot afford these services. This is referred to as the "boom town" effect [1]. Industrial camps are built near production facilities to accommodate workers when the local housing supply cannot meet the demands. These camps raise concerns in regards to forest fire safety, recreational pressure on the environment, traffic safety and the destruction of sacred sites of the First Nation and Métis people. First Nation communities launched law suits regarding violations of their treaty rights, to fish and hunt freely in locations now or planned to be occupied by production sites. Further they launched lawsuits to stop oil sand extraction for environmental protection [1, 11].

As of 2013 less than 67 km² (10 %) of the total disturbed landscape has been subjected to reclamation efforts. Completion of reclamation has been certified just for a portion of this area. Reports suggest that reclamation operations are not only relatively slow, but also not always sufficiently

financially secured. Financial liabilities would have to be carried by thy Province of Alberta [1].

V. ENVIRONMENTAL IMPACTS

Analogous to other mining and resource production operations oil sand production faces challenges of emission and waste management (sediment, acid drainage, metal deposition), as well as the disruption of natural habitats and biodiversity. Oil sand production affects land, air and water resources. Abiding by Alberta’s Environmental law as well as the land management and reclamation program, every enterprise has to develop a strategy for remediation and reclamation of disturbed areas productivity, before the beginning of the operation [1]. The applied extraction method, mining or in situ, determines the magnitude of disturbance environmental resources are exposed to [12].

Large portions of oil sand deposits are covered by boreal forests. In the period of 2000 - 2014 about 1.476 km² of forest were removed for oil sand production. This accounts for 15 % of forest cover over Alberta’s bitumen deposits. During this period an additional 6% has been lost to wildfire, unrelated to bitumen production. While the majority of deforestation is caused by mining operations in situ enterprises contribute significantly in terms of fragmentation of areas into smaller patches. In addition to intensive land disturbance mining operations water consumption is tenfold to the amount of in situ processes. Mining has an advantage over in situ production in terms of energy consumption and oil recovery factor [12]. Tab. II provides a comparison of average deforestation rate, water consumption and greenhouse gas (GHG) emission of both operation methods.

TABLE II. AVERAGE WATER CONSUMPTION, NET FOREST LOSS AND GREENHOUSE GAS EMISSION OF SURFACE MINING AND IN SITU OPERATIONS

	Extraction method	
	Mining	In situ
water consumption [m ³ (water) m ⁻³ (bitumen)]	28.520	2.770
Net forest loss [%]	100	6
GHG emission [kg (CO ₂ -eq) m ⁻³ (bitumen)]	711	868

from Rosa et al. (2017) [12], altered

A result of the land transformation during the mining process results in the total habitat loss of all local wildlife. Tailing ponds filled with process water represent another form of ecological risk. Timoney and Lee reported the leakage of such water, contaminated with chemicals of ecological concern like arsenic, ammonia, barium, chromium, bismuth, iron, lithium, manganese, naphthenic acids, selenium, strontium, tin, vanadium, zinc, methylnaphthalene and C2 naphthalene [13]. Seepage from tailing ponds and overburden piles can contaminate the ground water and local water bodies. An increase in mercury concentration of the Lower Athabasca River was observed in the period of 1976 - 2005. The mercury originated from overburden piles. Mercury accumulation in over 90 % of whitefish exceeded health guideline values in 2005. During spring migration tailing ponds are potentially harmful to waterfowl. As the area of tailing ponds exceeds that

of natural water bodies and they are less likely to freeze completely if at all, they are attractive to migrating birds. Birds landing on the ponds are prone to contaminate with oil residue and serve as a vector or get too heavy to fly [13].

VI. CONCLUSION

With its bitumen deposits Canada possesses the third largest recoverable oil resources presently known. These reserves may be an option for securing the global oil supply for years to come. Owing to its transformation process, the bitumen is mixed with loose sand and has high contents of asphaltenes and sulphur. Extraction of the highly viscose material is therefore relatively labor-intensive and is executed by surface mining or thermal in situ methods. Regardless of the extensive land devastation and water pollution surface, surface mining operations are still practiced disproportionately often, in comparison to the majority of bitumen reserves which are not suited for open-pit mining. This indicates environmental consequences are of secondary concern in relation to the lower production costs of surface mining. Reclamation of former production areas has to be accelerated.

REFERENCES

- [1] Poveda, C.A. & Lipsett, M.G., “The Canadian oil sands: environmental, economic, social, health, and other impacts” WIT Transactions on Ecology and the Environment vol. 173, pp. 575 – 587, 2013
- [2] Government of Canada, Minister of Natural Resources, “Oil Sands: A strategic resource for Canada, North America and the global market”, May 2015
- [3] Atkinson, Nigel, “Landscapes of the Alberta Oil Sands”, In: Slaymaker O. (eds) “Landscapes and Landforms of Western Canada” World Geomorphological Landscapes. Springer, Cham , pp. 395 – 410, 2017
- [4] Bjørlykke, Knut, “Unconventional Hydrocarbons: Oil Shales, Heavy Oil, Tar Sands, Shale Oil, Shale Gas and Gas Hydrates”, In: Bjørlykke K. (eds) Petroleum Geoscience. Springer, Berlin, Heidelberg, pp 581 – 590, 2015, DOI 10.1007/978-3-642-34132-8_23
- [5] Meyer-Renhausen, Martin „Ölsandgewinnung und Verarbeitung, Technologie – Ökonomie – Umweltaspekte“, Ökologie und Wirtschaftsforschung vol.73, Metropolis-Verlag, Marburg, 2007, ISBN: 978-3-89518-633-2
- [6] Speight, James G., “Petroleum and Oil Sands Exploration and Production”, In: Malhotra R. (eds) Fossil Energy. Springer, New York, pp. 25 – 60, 2013
- [7] Oil Sands Magazine, “In situ bitumen extraction”, 2018 <http://www.oilsandsmagazine.com/technical/in-situ> (last access 03.07.2018)
- [8] Oil Sands Magazine, ”Thermal in-situ facilities”, 2018 <http://www.oilsandsmagazine.com/projects/thermal-in-situ> (last access 03.07.2018)
- [9] Oil Sands Magazine, “Mining for bitumen”, 2018 <http://www.oilsandsmagazine.com/technical/mining> (last access 03.07.2018)
- [10] Dobson, Sarah, Lemphers, Nathan & Guilbeault, Steven, “Booms, Busts and Bitumen: The economic implications of Canadian oilsands development”, The Pembina Institute and Équiterre, 2013
- [11] Greenpeace Canada, “Deep trouble - The reality of in situ tar sands operations”, 2011
- [12] Rosa, Lorenzo, Davis, Kyle F., Rulli, Maria & D’Odorico, Paolo, “Environmental consequences of oil production from oil sands”, Earth’s Future vol. 5, pp. 158 – 170, 2017, DOI:10.1002/2016EF000484.

[13] Timoney, Kevin P. & Lee, Peter, "Does the Alberta Tar Sands Industry Pollute? The Scientific Evidence", *The Open Conservation Biology Journal* vol. 3, pp. 65 – 81, 2009

[14] Wikimedia - Athabasca Oil Sands map
https://commons.wikimedia.org/wiki/File:Athabasca_Oil_Sands_map.png

Impact of additive manufacturing on the environment – opportunities and challenges

Dennis Brüsche (Author)

Energy distribution and high voltage engineering
BTU-Cottbus-Senftenberg
Cottbus, Germany

Johannes Ewald (Author)

Energy distribution and high voltage engineering
BTU-Cottbus-Senftenberg
Cottbus, Germany

Abstract—This paper gives a broad view on additive manufacturing and 3-D printing from a technological and societal perspective. It gives ideas of future scenarios and highlights opportunities and challenges for business and their partner relations. (Abstract)

Keywords-additive manufacturing; 3D-printing; processes; energy consumption; resource efficiency; emerging markets; disruptive challenges

I. INTRODUCTION (HEADING 1)

In the last years and decades, additive manufacturing is getting an increasing amount of interest from various industrial fields. It is defined by ASTM International as a technology that “uses computer-aided design to build objects layer by layer. This contrasts with traditional manufacturing, which cuts, drills, and grinds away unwanted excess from a solid piece of material, often metal [1].” It is possible to use a growing number of material, e.g. different metals such as steel, titanium or aluminum alloys [2] as well as synthetic materials, e.g. plastics [1].

Depending on the material there are some existing procedures. The most common ones using metal can be divided into the categories direct energy deposition and powder bed fusion [3]. Powder bed fusion is based on the idea to apply loose metal powder on a building plate inside of a cabin. The cabin is air dense and normally filled with a non-reactive inert gas, e.g. argon. The metal powder gets melted by a beam with high power at the desired position to build the first layer. Afterwards the building plate is driven down and a recoater adds the next layer of metal powder to the platform and it is getting leveled by the recoater. That way the component is build layer by layer. Depending on the beam used the category contains three processes that are named after the beam. The electron beam melting utilizes an electron beam while a high energy laser is applied at the selective laser beam melting [4] and the selective laser beam sintering [3].

The next category using metal powder is the direct energy deposition. This category contains various processes such as the conventional metal inert gas welding and newer techniques, e.g. the laser metal deposition as shown in Fig. 1. The base idea of these processes is adding material as a powder with a nozzle or as a wire while simultaneously focusing a high energy

source at the same position of the workpiece. A possible energy source is a laser or an electric arc. That way a welding pool is created containing the original workpiece as well as the added metal [4]. The materials create a metallic connection while cooling and hardening. The melt pool is normally protected by an inert gas such as helium or argon which is supplied at the same time to avoid oxidation [2].

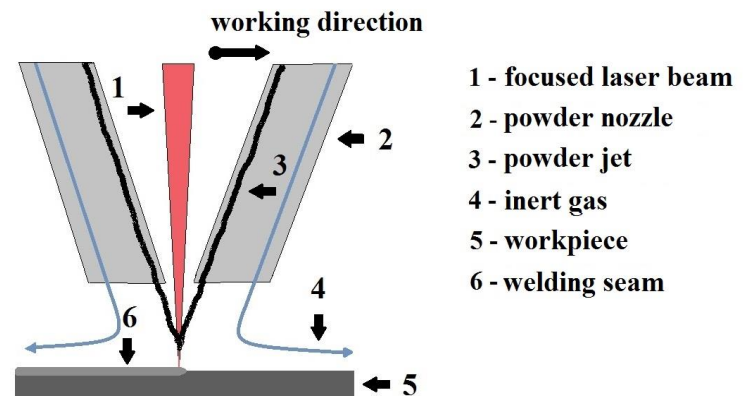

Figure 1. Scheme of laser metal deposition (adapted from [4])

The procedures used for plastics are similar. Binder jetting uses a chamber with a platform that is covered with powder. To harden the powder a binder is deposit on the powder layer at the desired position. Thereafter the platform is lowered to add the next layer. The same chamber principle is used for photopolymerization and the according process stereolithography. The difference is the usage of a liquid polymer that is hardening when exposed to UV light. Therefore, a moveable UV curing system is applied using either a laser or a mirror device reflecting the UV light. After each layer the platform is getting lowered and the liquid is spreading on its own creating a new fluid layer [5].

Another principle is the material extrusion which is more like direct energy deposition. The most common technique using this principle is the fused deposition modelling. It creates objects building them layer by layer. Therefore, the thermoplastic material is getting heated until it is partly-molten. Then the material is deposit by a nozzle looking like a round stripe and is hardening while cooling down. Another similar process is the material jetting. Here the machine is creating a thin layer of the whole object in each step instead of a string at

one position. This way the product is build up layer by layer [5].

In general, additive manufacturing is used in four different fields. The origin is the rapid prototyping where the technology is used for to quickly build prototypes for testing before entering mass production [3]. The second area is rapid tooling. The objective here is to build special tools or tool parts for the production that can be adapted to the individual requirements whenever they are needed. The third sector is the rapid manufacturing where the technique is used for the economical production of goods and components. It is especially useful for small series with a personalized and complex geometry. The last area of application is the rapid repairing. It is including the maintenance and repairing of components with signs of wear as well as die production of parts for which no source of supply exists [6].

Currently the technology is mostly used for rapid prototyping. Only 14% of the companies using additive technologies make use of rapid manufacturing. On the other side 40% produce tools via rapid tooling and 67% create models via rapid prototyping [6].

This paper will take a glance on the impact of these technologies on the environment from an ecological as well as an economical perspective.

II. IMPACT ON RESOURCE EFFICIENCY

Rapid prototyping is the most accepted area of the technology and may have the highest current impact [6]. It is mainly used in the medicine and the automotive industry, e.g. to build parts like cylinder heads or rear axles [3]. One positive aspect is that products can be tested under real conditions. Consequently, the company can evaluate if they want to use the design and if the product satisfies the requirements. Additionally, they need less time and money for the development of the product before entering the market [6]. Without rapid prototyping, more tools and machines would be build and modified during the development process that may not be needed later. Further on, more prototypes can be tested in the same time improving the quality of the product and reducing the need to customize the production if an error occurs. That way resources to produce these helping products and for modifications at the production can be saved as well as for defect products.

Rapid repairing is another field with potential to save resources. It is mainly used for complex parts like blade tips of turbines that are expensive to reproduce because of their aerodynamic and lightweight construction [3]. With advancing technology and lowering costs it can be used for much more everyday parts. If that happens the need to rebuy a whole new part and throw away the old one would be reduced and the old part can be fixed instead, e.g. by adding new layers of material to a worn-out product.

As already mentioned the aerospace is an industry with huge potential for additive manufacturing. The reason is the need to reduce the weight of the planes as much as possible to lower the fuel consumption. Additive manufacturing has the ability to create new geometries consisting of material only at

these positions where the most load is existing. An example for a load adjusted bike build by additive manufacturing can be seen in Fig. 2.



Figure 2. Airbus Light Rider [7]

Additionally, these geometries would require less material to be build. That would be impossible or at least hard to archive using conventional methods [8]. Despite being the currently second largest consumer of transport fuel, the aerospace industry is expected to grow even further. The global fuel consumption for aviation is estimated to grow by 200% until 2050 because of globalization and the economic expansion. But every plane first has to be produced before fuel can be burned. At the moment the buy-to-fly ratio of airplanes ranges from 12:1 to 25:1 for aluminum and titanium alloys. The ratio describes the rate of raw material bought and used to finish a part of an airplane, both calculated in mass. These high buy-to-fly ratios create a significant amount of rejects. That scrap may be recyclable, but they lead to high costs and energy consumption leading to a higher consumption of energy resources and a higher carbon emission [8].

As already mentioned the aerospace industry can benefit from the special geometry for lightweight building possible with additive manufacturing throughout its whole lifecycle. It is expected that a weight reduction of 100kg can save fuel worth an energy of 13.4 - 20.0 TJ over an estimated lifetime of 30 years or 0.45 - 0.67 TJ per year [8]. Calculated with the lowest estimated fuel reduction for 1 year that means a reduction of around 13.000 liters of kerosene for every 100kg.

III. EMERGING MARKETS AND DISRUPTIVE CHALLENGES

Next to its process, design and lifecycle advantages, additive manufacturing invites to rethink future visons of b2b and b2c relationships. As soon as the technology arrives in our everyday life, there will be obstacles and chances for established and emerging business cases.

One of the most common examples for chances and obstacles is the spare part supply chain. The shift from a centralized mass production with localized storage to a decentralized production on demand implies the need to compare storage cost to fulfillment time [9]. Both, as well as high investments in either spare parts or their production, are

key variables for established businesses and their decisions [10].

Other new business cases emerge in the field of organic printing. Progress has been made in cultivating tissue cells and printing them to organ parts or directly on destroyed skin. Other studies aim to print food or – on a much more complex level – vaccines. Even though these attempts appear to provide high value for our society, they also carry big risks. Drugs or fake medical treatments and foods could flood the black market and harm the individual [11].

When it comes to fake products, established industries could face disruptive challenges. In a scenario where printing facilities become a decentralized provided service, fake good production does not rely on large manufacturing facilities in developing countries anymore. Copying intellectual property could affect most original equipment manufacturers and asks for solutions to maintain their industrial status [11].

Other visions imagine a world where the globalized mass production is complemented by customization that takes place locally. The required structures are formed today by organizations like the ASTM Committee, that see the need to set internationally recognized standards for product, process and material certification [12].

The b2c relation might be biggest field for emerging markets and disruptive obstacles. In this area, future scenarios can be categorized by looking at the importance of file-sharing platforms and the acceptance of new business models as seen in Fig. 3. [13]. Independently from its extend, there will be the ability to buy your product files online and print them locally, if not at home [14].

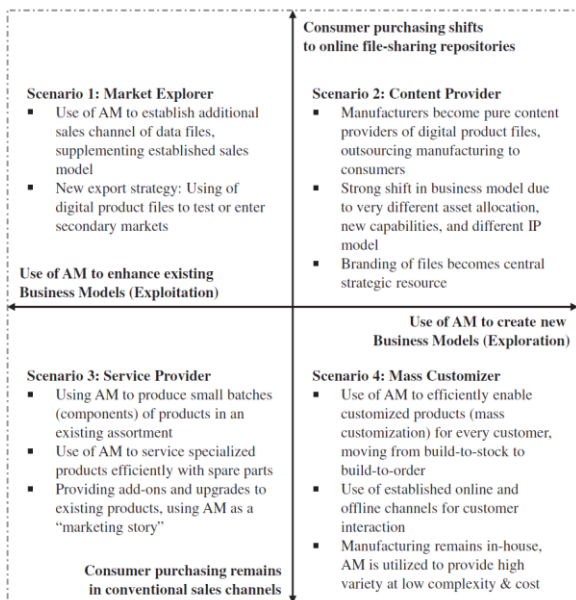

Figure 3. Future scenarios by 2030 [13]

IV. CONCLUSION

This paper presented a range of technologies and use case scenarios for additive manufacturing and 3-D printing. The technology offers a variety of benefits that empowers us to rethink designs, supply chains and customization. The advantages must be recognized throughout the whole lifecycle. Additive Manufacturing has great effects on the lifetime energy consumption in aerospace, it has the potential to displace great areas in the spare part supply chain and invites creates space for more individual customer relations. It also carries risks for those, who are not aware of the new and disruptive business cases that will emerge.

V. REFERENCES

- [1] Unknown, ASTM International, "Additive Manufacturing Overview", <https://www.astm.org/industry/additive-manufacturing-overview.html>, accessed on: 04.07.2018
- [2] D. Herzog, V. Seyda, E. Wycisk, C. Emmelmann, "Additive manufacturing of metals", *Acta Materialia*, vol. 117, p. 373, July 2016
- [3] A. Pinkerton, "Lasers in additive manufacturing", *Optics & Laser Technology*, vol. 78, p. 25-28, September 2015
- [4] M. Merklein, D. Junker, A. Schaub, F. Neubauer, "Hybrid additive manufacturing technologies – An analysis regarding potentials and applications", *Physics Procedia*, vol. 83, p. 550-551, 2016
- [5] A. Ambrosi, M. Pumera, "3D-printing technologies for electrochemical applications", *Chem Soc Rev*, vol. 45, p. 2741-2744, 2016
- [6] C. Feldmann, A. Gorj, "3D-Druck und Lean Production – Schlanke Produktionssysteme mit additiver Fertigung", Springer Gabler, p. 25-27, 2017
- [7] J. Oesterreich, "Neuheit: Airbus E-Bike aus dem 3D Drucker", <https://ebike-news.de/neuheit-airbus-e-bike-aus-dem-3d-rucker/118338/>, 23.05.2016, accessed on: 04.07.2018
- [8] R. Huang, M. Riddle, D. Graziano, J. Warren, D. Das, S. Nimbalkar, et. al "Energy and emissions saving potential of additive manufacturing: the case of lightweight aircraft components", *Journal of Cleander Production*, vol. 135, p. 1559-1568, April 2015
- [9] S. Huang, P. Liu, A. Mokeddar, L. Hou, "Additive manufacturing and its societal impact: a literature review", Springer London, p. 1198, May 2012
- [10] S. Khajavi, J. Partanen, J. Holsröm, "Additive manufacturing in the spare parts supply chain" *Computers in Industry*, vol. 65, p. 50, May 2013
- [11] J. Kietzmann, L. Pitt, P. Berthon, "Disruptions, decisions, and destinations: Enter the age of 3-D printing and additive manufacturing", *Business Horizons*, vol. 58, p. 213-215, 2015
- [12] D. Bourell, J. Baeman, M. Leu, D. Rosen, "A Brief History of Additive Manufacturing and the 2009 – Roadmap for Additive Manufacturing: Looking Back and Looking Ahead", *US – TURKEY Workshop On Rapid Technologies*, p. 7, September 2009
- [13] R. Jiang, R. Kleer, F. Piller, "Predicting the future of additive manufacturing: A Delphi study on economic and societal implications of 3D printing for 2030", *Technological Forecasting & Social Change*, vol. 117, p. 94, May 2016
- [14] B. Berman, "3-D printing: The new industrial revolution", *Business Horizons*, vol. 55, p. 16, 2016

Why solar energy is not the leading power source yet

Granit Ramadani

Business Administration and Engineering student
BTU Cottbus-Senftenberg
Cottbus, Germany

David Kalwellis

Business and Economics student
BTU Cottbus-Senftenberg
Cottbus, Germany

Bilal Karakus

Business and Economics student
BTU Cottbus-Senftenberg
Cottbus, Germany

Maurice Flindt

Business and Economics student
BTU Cottbus-Senftenberg
Cottbus, Germany

Abstract— Energy production is changing. To survive the inevitable exhaustion of fossil fuels, more and more countries (and companies) are trying to revolutionize energy production. Renewable energies seem to be the way to go but there are many challenges yet to overcome. One of the most promising technologies is solar energy but other than conventional power plants, energy from solar plants can only be generated during daytime, when the sun is shining. At this time, conventional power plants have to slow down or shut off production, so there is no overproduction which is very expensive and puts a lot of strain on these power plants and their operators. Scientists are working on reliable energy storage solutions, such as pumped hydro storages and batteries and even more advanced technologies like using electronic vehicle's batteries as a system of small batteries in larger amounts, to make a smoother transition between solar and conventional power production possible.

Solar energy; renewable energy; duck curve; energy sources;

I. INTRODUCTION

When you go into the kitchen and turn on the light switch, you expect the light to go on, right? Even if you connect your cell phone or laptop to the charging cable the night before you go to sleep, you want to find your electrical device fully charged the next morning.

For us humans, it has become a habit that no matter what day, which weather or at what time the stream works continuously, but that is not self-evident.

Renewable energy is the future of energy production, that's clear.

They are not only more environmentally friendly but also infinite in contrast to conventional energy production.

A large part of these renewable energies is generated by solar radiation, which can be used technically in the form of electricity, heat or chemical energy.

The problem that arises with this topic is the competition between solar energy and conventional energy, as solar energy is only available at daytime [1].

Most solar energy is gained over the middle of the day, where the sun shines the longest and most intense.

Exactly from this problem results the so-called "duck curve" [2] (Figure 1).

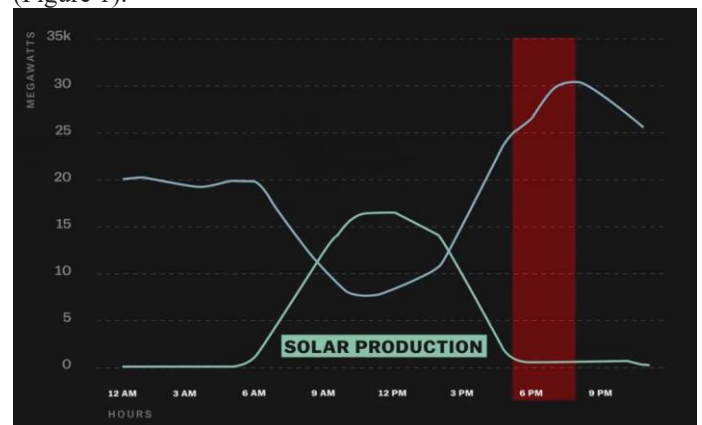

Figure 1 - 'duck curve', relation between solar production and conventional power production

Solar energy will be fed into the power system therefore less conventionally produced electricity is needed. At times when solar energy is at its peak, conventional power plants have to slow down or even stop producing energy, so it does not get wasted [3].

In order to prevent disturbances and overloads, individual areas of a photovoltaic system are switched off too depending on use. As you can see in Figure 1, this mainly happens in the period between 9 am and 3 pm, especially pronounced at noon [3]. Not only will part of the energy be lost, but some energy will be literally wasted, if power plant and electricity grid operators cannot communicate and anticipate demand.

Since, as usual, no sun shines at night, the biggest challenge for solar energy is to store the electricity and make it available when it is most needed.

Storing solar energy could be a solution to this problem, as it could help to smooth out the transitions between solar and conventional power or even replace conventional power plants all together.

The more energy can be stored, the less is wasted! As long as

there is no real solution to the storage of solar energy, in the near future fossil and nuclear energy production will always account for the largest share of total energy production.

Another problem why solar energy cannot be the main energy source is its dependence on seasons. Solar energy depends on sunlight and the position of the sun which determines the angle at which the sunlight will hit a particular location on earth. In the winter sun time sinks to a minimum and in some regions like Scandinavia there are days with no sunlight at all. Leading to less – or even no – solar energy production. At the same time energy consumption rises as no natural light is available as well as no heat radiated from the sun.

II. THE PROBLEM OF STORING ENERGY

A. Solutions

Energy that has been transformed into electricity cannot be stored in a direct long term solution. Capacitors can function as short term storage devices (few seconds), if there is a need for a high electricity output in short period of time, but for long term storage other solutions have to be created [4].

Storing electric energy for a long period of time requires conversion to mechanical or chemical energy. The conversion can then be reverted when the energy is needed [4].

But what is energy? Energy is the foundation of all life. It describes the ability of bodies or systems to perform work [5].

1) Conversion into mechanical energy

The conversion of electricity into mechanical energy can be divided into two groups; potential energy and kinetic energy. Energy in the form of potential energy is used in pumped hydro storages. Pumped hydro storages are the most common found storage units for electricity. The over produced electricity is used to pump water into reservoirs that are located above turbines. To convert the potential energy back to electricity, the water will be released into pipes, using gravity, the water will then flow down these pipes that lead to turbines, where the kinetic energy is converted back to electricity. Only about 15% of electricity will be lost during this process [4].

Another method of storing energy in the form of kinetic energy are compressed air reservoirs.

In compressed air reservoirs the electricity is used to power a compressor. The compressed air will heat up to about 600°C. The heat is then stored and the air sent underground to salt cavities. If the energy needs to be converted back to electricity, the air will be released from the salt cavity back into the heat storage where the air will be heated up again. From there the air will go into a generator, resulting in the conversion of kinetic to electric energy. This method is much less efficient than pumped hydro storages at only 43% efficiency. Nevertheless, compressed air reservoirs show promise for the future, as

experts expect an efficiency improvement with future technology [4].

2) Conversion into chemical energy

The most common way to store electricity as chemical energy are batteries. Lead-acid batteries are the most used way to store solar energy. With a price of just 250€/kWh, lead-acid-batteries are very cheap. However, they are not very lasting. Lead-acid batteries can only be recharged around 3000 times, which will be good for around 5 years. They are also dangerous, as these batteries hold a risk of gas explosions [6].

An alternative lead-acid batteries are valve-regulated lead-acid batteries (VRLA battery) or “gel cell”. These are more durable and can be used for up to 10 years. They are also much less prone to explode, as a gel inside the battery will reduce the release of hydrogen and oxygen when being charged. However, VRLA batteries are ore expensive at around 500€/kWh [6].

Another alternative is the lithium-ion battery. They have the highest durability with an expected lifecycle of around 20 years. Therefore, they are likely to be the future of solar energy storage. Lithium-ion batteries can be recharged around 7000 times; they are more efficient than lead based batteries but are also more expensive at around 550€/kWh.

Lithium-ion based batteries can be found in modern electric cars and could be used as mass energy storage. The more electric cars are in use the more cars are potentially available to store energy. In need, the energy in the car batteries can be fed back into the system to support the electricity manufacturers at night or during peak consumption [6].

a) Disadvantage – Disposal

The worst disadvantage of batteries is their environmental compatibility. Lead and lithium are poisonous and cannot be easily disposed. This throws a shadow at the so called “green energy” [6].

3) Conventional methods of storing energy

Electrochemical storing (batteries):

- Sodium-Sulphur
- Lead
- Nickel-cadmium
- Nickel-metal-hybrids
- Lithium
- Redox-flow

Storing potential and kinetic energy:

- Pumped hydro storages
- Compressed air cavity
- Flywheels

Electrostatic and electromagnetic storing:

- Flywheels
- double layer capacitor

4) Innovative approach by Eon

A future oriented solution to storing solar energy in individual households is suggested by Eon. Owners of home based solar solutions can send energy into the “Solarcloud”. The Solarcloud is virtual “account” where the energy will be saved. That way the energy demand can be satisfied for the own home and the unused energy can be used in someone else’s home – all with solar energy. The main requirement to apply for the Solarcloud is a 3,7 kW home solar plant [7].

The idea behind this system is so customers can save on investment and service costs. There is also the possibility to save up “energy credit”. In summer, when more solar energy can be produced due to stronger and longer sun exposure, the overproduced energy in one’s home will be send back to the Eon power grid and credits will be rewarded. In winter, when the owners solar plant cannot produce enough energy to support their home, the credit can be used to buy energy back from Eon. With this method customers could potentially support themselves only by their own solar power production [7].

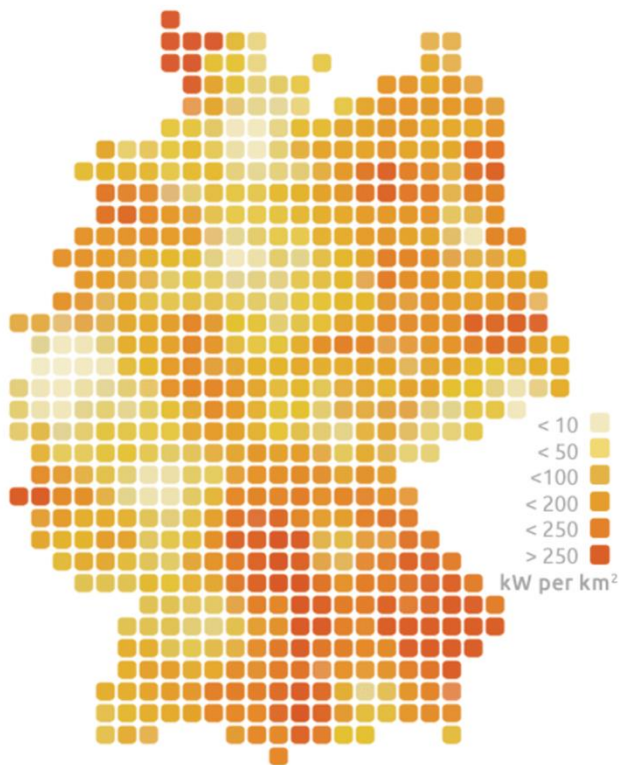

Figure 2 - Solar power in Germany, Installed photovoltaic capacity per square kilometer

Germany’s current solar capacity is 38,2 gigawatts. From small rooftop systems to large solar parks, Germany’s solar energy production covered only about 5.2% of Germany’s general electricity generation in 2014. Between 2004 and 2013 Germany has invested 88 billion € into photovoltaic installations. [8]

III. WHY CONVENTIONAL POWER PLANTS ARE NOT HERE TO STAY

Since energy storage is not yet available at the needed rates, another way of overcoming the solar energy’s duck curve difference has to be established. When solar energy cannot provide the needed electricity in the dark, traditional sources of electricity have to be used. The more solar energy will be provided throughout the day, the less active the power plants have to be at daytime. However, at night, when solar energy is not available, traditional power plants have to be fired up again [10].

There are three main groups of energy carriers, that are used to generate electricity [9]. Those three are nuclear, regenerative and fossil energy carriers. Most of the power which is currently used in Europe is generated from fossil fuels. Fossil fuels are coal, petroleum (fossil oil) and natural gas. Those were formed by plants and organisms that died millions of years ago and got trapped under sand, clay and other minerals, being exposed to a combination of high pressure and heat [10]. Considering that it takes millions of years and high amounts of pressure and heat for fossil fuels to form, they can only be found in limited supplies and are not easily reproducible [10]. This leads to the first major problem – the main source of energy that is currently use is not sustainable forever.

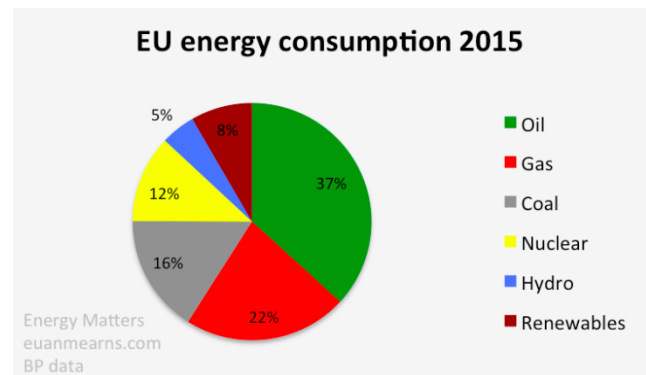

Figure 3 - EU energy consumption 2015

The above chart shows the energy usage within the EU in 2015. With a 37% share petroleum is the most use source for energy. Natural gas and coal make up 22% and 16%, respectively. Added together, fossil fuels make up three quarters of the entire energy supply in the EU and are therefore EU’s main source of energy.

Petroleum makes up more than a third of the EU’s energy source but is also highly limited and not reproducible. Not only is petroleum limited to the amount available, it is limited to specific regions on earth as well. Therefore, some countries are able to achieve political advantages with petroleum, as its demand is very high but its availability very limited. Many countries rely heavily on the supply of fossil fuels that they can receive through trade, leaving them in a vulnerable position. Coal can be separated into two categories: black coal and brown coal. The latter is commonly found throughout Europe, especially in Germany, Poland and the Czech Republic.

Scientists anticipate that the coal supply of the earth will only last for another 200-250 years [9].

Another issue of fossil fuels is extraction and transportation, as well as the environmental destruction that comes with it [9].

Petroleum can be found deep within earth's crust which makes it rather expensive to find and extract. Geological fault and impenetrable rock are some difficulties that extractors have to face in such depths. After extraction the petroleum has to be cleaned and processed before it can be used. The transportation and extraction of petroleum has led to some major accidents resulting in huge environmental damage.

Oil refineries blast considerable amounts of sulfur dioxide, which is a by-product of oil refining, into the atmosphere.

Natural gas has to be pressurized and cooled for transportation, leading to higher risk of explosion.

Brown coal on the other hand is rather easy to extract, as it is found just below the earth's surface. Nonetheless, coal cannot be burned 'cleanly' as it contains large amounts of sulfur, too. As coal is very heavy and hard to transport in large amounts, it is mainly used regionally.

Black coal contains a much larger amount of carbon but lies much deeper within the earth's crust, making it more difficult and expensive to extract.

The limitedness and environmental destruction of fossil fuels leads to a search for alternatives. Renewable energies are researched and used more and more these days in forms such as solar energy [9].

Nuclear energy, after fossil fuels, is the second most used form of energy production. The idea behind nuclear energy is that every atom contains energy in form of kinetic energy and binding energy. This energy is harvested in nuclear power plants with nuclear fission. Heavy atomic nuclei like in the uranium isotope 235 are shot with neutrons leading to nuclear fission and lighter atomic nuclei [11]. During fission the binding energy of the atoms is released and can be harvested. Nuclear fuel can be found in sufficient amounts on earth and because there are usually only used in nuclear power plants the supply won't be depleted any time soon. However, operating a nuclear power plant is not as cheap as expected in early development. Radioactivity is the main disadvantage and concern regarding the otherwise rather clean nuclear power. In case of leakage, the immediate surrounding of the nuclear power plants will be contaminated and becomes inhabitable and dangerous to any forms of life. Furthermore, large quantities of water are used to cool the fuel rods [11]. As there are multiple cooling circles, some of the cooling water will never be contaminated and therefore be sent back in to regional rivers and lakes [11]. Even though the water is considered clean, it can damage the ecological balance due to its unnatural heat.

Due to the limited amount of fossil fuels available scientists are more and more focused to find a solution in the field of renewable energy sources [9]. One of the best solutions might be solar energy. Solar energy is the term for energy that is radiated by the sun in form of electromagnetic energy that can be harvested or used in the form of electric energy, heat or

chemical energy [10]. The sun is one of the most reliable energy sources, because it constantly radiates energy and there are no obstacles that could block the sun for long amounts of time and it won't stop radiating energy any time soon.

The usage of solar energy can heavily reduce, if not stop the use of fossil fuels. Harvesting solar energy is emission free, resulting in less pollution. Another advantage is, that harvesting solar energy does not yield any waste like nuclear power plants do. It is only the storing of solar energy that might result in unwanted waste. Solar energy itself is free to use and available to anyone. Only the plants require funding to build and service.

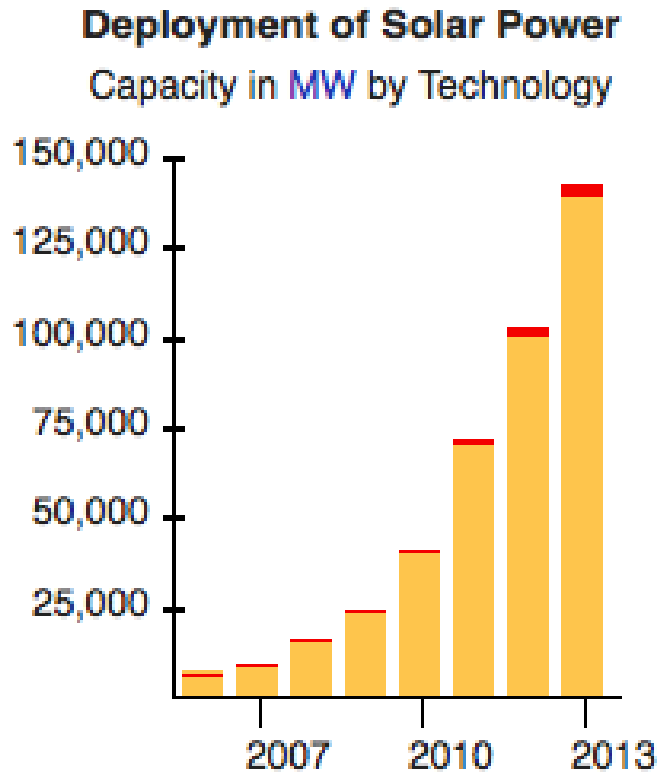

Figure 4 - Worldwide deployment of solar power by technology since 2006

Since 2006 the capacity of solar power has been constantly rising world wide. In 7 years the capacity has increased more than tenfold – and the trend is still going. Exponential growth in the field leads to the assumption that solar energy will have an evermore important role in energy supply.

IV. CONCLUSION

Unfortunately, renewable energies are not the knight in shining armor when it comes to reliable and clean energy production. Wind turbines are limited to wind. Water turbines are limited to water currents. Solar energy is limited to sunshine. Solar production only works during the day. Making the biggest hurdle for solar energy to overcome storing of overproduced

energy at daytime and providing energy at night. There are many different approaches to make solar energy as reliable as conventional power plants such as nuclear or fossil fuel based power plants. However, none of them are quiet satisfying enough to switch off the environmentally damaging power plants.

Converting electricity gathered by solar plants into mechanical energy for storage will result in loss of energy due to efficiency issues. Converting said electricity into chemical energy is not as environmentally friendly as the so called 'green energy' is supposed to be and not yet possible at large enough scales. A suggested workaround is underway, as more and more high capacity lithium-ion batteries are embedded into our day to day life and could be used to store energy and support electricity providers during high demand. Electric cars are equipped with high performance large capacity lithium ion batteries – however, the owners of the vehicle are the ones to decide whether or not their vehicle will support the power grid, meaning there is no reliable way to know how many batteries can be used to store energy or feed energy back into the system at any time.

Another method is using household based batteries like SolarCity is suggesting with their Powerwall [12]. This would require every household to store its own energy with only minor exchange between battery and power grid. Individuals and households could be incentivized to sell their own solar generated energy back into the system, like in Eon's approach. Overall the future for solar energy is bright as more advancements in the field of storing energy are made and scientists believe that there is much room for improvement.

REFERENCES

- [1] P. Denholm, M. O'Connell, G. Brinkman, and J. Jorgenson, "Overgeneration from Solar Energy in California: A Field Guide to the Duck Chart," National Renewable Energy Laboratory, November 2015 pp. 1-4, Available: <https://www.nrel.gov/docs/fy16osti/65023.pdf> last visit 04/07/2018 10:00 a.m.
- [2] D. Roberts, "Solar power's greatest challenge was discovered 10 years ago. It looks like a duck," Vox Media, 31/03/2018, Available: <https://www.vox.com/energy-and-environment/2018/3/20/17128478/solar-duck-curve-nrel-researcher> last visit 04/07/2018 1:00 p.m.
- [3] D. Roberts, "Why the 'duck curve' created by solar power is a problem for utilities," Vox Media, 10/02/2018, Available: <https://www.vox.com/2016/2/10/10960848/solar-energy-duck-curve> last visit 04/07/2018 3:00 p.m.
- [4] H.-F. Wagner, "Stromspeicherung," Deutsche Physikalische Gesellschaft e.V. 18/08/2017, Available: <https://www.weltderphysik.de/gebiet/technik/energie/strom/speicherung/> last visit 04/07/2018 3:00 p.m.
- [5] H. Lindner, "Physik für Ingenieure," Hansa Fachbuchverlag, 19. Auflage, 1991, pp. 93-99
- [6] "Solarstrom speichern – welche Möglichkeiten gibt es," Beko Käufer Portal GmbH, Available: <https://www.solaranlage.de/technik/solarstrom-speichern> last visit 03/07/2018 3:15 p.m.

- [7] S. Enkhardt, "Eon will Speicherung von Solarstrom ohne eigene Batterie ermöglichen," pv magazine group GmbH & Co.KG, 30/01/2018, Available: <https://www.pv-magazine.de/2018/01/30/eon-will-speicherung-von-solarstrom-ohne-batterie-ermoeglichen> last visit 03/07/2018 11:00 p.m.
- [8] Bundesnetzagentur, "German solar power map – Installed photovoltaic capacity per square kilometer," Available: <https://1-stromvergleich.com/strom-report/renewable-energy-germany/> last visit 03/07/2018 11:00 p.m.
- [9] M. Kleemann, M. Meliß, "Regenerative Energiequellen," Springer Verlag, 2013
- [10] V. Wesselak, Th. Schabbach, Th. Link and J. Fisher, "Regenerative Energietechnik," Springer Verlag, 2. Auflage, 2013, pp. 109-182
- [11] F. Hübner, J.J. Jung, F. Schultmann „Auswirkungen nuklearer Unfälle auf den Menschen und die Umwelt," Econstor, 2017, Available: <http://hdl.handle.net/10419/176747> last visit 04/07/2018 11:00 a.m.
- [12] „Powerwall," Available: <https://www.tesla.com/powerwall> last visit 04/07/2018 12:00 a.m.

FIGURES

- [1] D. Roberts: "The 'duck curve' is solar energy's greatest challenge," Available: <https://youtu.be/YYLzss58CLs> last visit 03/07/2018 6:00 p.m.
- [2] Bundesnetzagentur, "German solar power map – Installed photovoltaic capacity per square kilometer," Available: <https://1-stromvergleich.com/strom-report/renewable-energy-germany/> last visit 03/07/2018 11:00 p.m.
- [3] E. Mearns, "Primary energy in the European Union and USA compared," Energy Matters, 17/10/2016, Available: <http://euanmearns.com/primary-energy-in-the-european-union-and-usa-compared/> last visit 03/07/2018 11:00 p.m.
- [4] "Solar Power," Available: https://en.wikipedia.org/wiki/Solar_power#Early_days last visit 03/07/2018 11:00 p.m.

Efficiency evaluation of wind farms: Identifying the impact of wind speed as a flexible factor

Mostafa Korzaledin, Samira Talebi, Sara Riazi

Department of Power Engineering,
Brandenburg University of Technology,
Cottbus, Germany
mostafa.korzaledin@b-tu.de

Abstract— This study develops a framework for providing insight into the performance of Iran's wind farms in 2015. In the first step, data envelopment analysis is used to measure the efficiency of wind farms in producing electric energy using available resources and wind speed factor. In this study, different from other studies in the field of wind farms' efficiency evaluation, wind speed is considered as a flexible and strategic factor, which in the framework of evaluation means as unclear categorization of it in the input and output of the system. The results of the evaluation of 18 wind farms in Iran show that although this factor may be considered as a key factor in the assessment of wind farms, the proposed models reject the effect of this factor on efficiency.

Keywords—component; wind energy; efficiency; DEA; flexible factor

I. INTRODUCTION

Renewable energy production has been rising rapidly over the past two decades, and growth is likely to continue. Wind power generation has been considerably appreciated by investors. The profitability of wind power generation is determined by production costs, energy costs, and turbine efficiency. Although productivity plays a major role in the profitability of wind power production, productivity is heavily dependent on wind conditions, such as wind speed and change in production location.

One of the factors affecting wind energy productivity score is the efficiency that shows the gap between real production and the maximum amount of energy produced in the existing conditions and facilities. In the field of wind energy, the maximum output power is shown as a function of wind speed with a power curve. Power curves are usually calculated by turbine manufacturers for a particular turbine under ideal conditions. In fact, wind production does not occur in the ideal conditions, and therefore actual energy production deviates regularly from the power curve.

Few studies have been conducted to evaluate the efficiency of wind power generation. There are two kinds of efficiency estimation containing parametric and non-parametric approaches. [1-3] are some studies based on parametric methods and some other papers apply nonparametric mathematical programming methods to estimate the wind energy production frontier. Data envelopment analysis (DEA) is a nonparametric approach for evaluating the relative

efficiencies of a set of decision making units (DMUs) that use multiple inputs to produce multiple outputs. Due to the capabilities of DEA, this methodology has been applied in a wide range of applications, including hospitals, banks, maintenance crews and etc. In classical DEA models, the efficiency of a DMU is calculated by the conditional maximizing ratio of the weighted sum of its outputs to the weighted sum of its inputs. Evaluation based on the efficiency score is directly affected by the input and output variables. [4-7] applied data DEA to assess the efficiency of wind turbines, turbine downtime as the major reason for power curtailment and to analyze the entire process of wind energy production and include further production factors, such as land and investment cost.

This study presented a framework based on DEA to provide insights regarding the efficiency and ranking of the wind farms and different from other studies in the field of wind farms' efficiency evaluation, wind speed is considered as a flexible and strategic factor, which in the framework of evaluation means as unclear categorization of it in the input and output of the system.

This study is organized as follows: next section contains preliminaries on DEA method and a suggested approach. Section 3 presents the assessment of the efficiency of 18 Iranian wind power farms. Section 4 rounds up the paper with the main conclusions.

II. PRELIMINARIES ON DEA

A. CCR model

Suppose there are n decision making units (DMUs). Each DMU $_j$ ($j = 1, \dots, n$) produces s different outputs y_{rj} ($r = 1, 2, \dots, s$), using m different inputs x_{ij} ($i = 1, 2, \dots, m$). The CCR ratio model [8] in evaluating the efficiency score of DMU $_o$, $o \in \{1, 2, \dots, n\}$ is given by the following mathematical programming:

$$\begin{aligned}
 & \max \quad \sum_{r=1}^s u_r y_{ro} \\
 & \text{s. t.} \\
 & \sum_{i=1}^m v_i x_{io} = 1 \\
 & \sum_{r=1}^s u_r y_{rj} - \sum_{i=1}^m v_i x_{ij} \leq 0 \quad \forall j \\
 & u_r \geq 0 \quad \forall r \\
 & v_i \geq 0 \quad \forall i
 \end{aligned} \tag{1}$$

where u_r ($r = 1, \dots, s$) and v_i ($i = 1, \dots, m$) are weights on outputs and inputs, respectively, and $0 < \theta_o \leq 1$ is the efficiency of DMU_o which is a number between zero and one. If $\theta_o = 1$, then DMU_o is called efficient otherwise, it is an inefficient unit.

B. Classifying flexible measures

As the previous section, suppose we have n DMUs and each DMU_j : $j = 1, \dots, n$ consumes m inputs x_{ij} : $i = 1, \dots, m$ to produce s outputs y_{rj} : $r = 1, \dots, s$. Moreover, suppose also that there exist L flexible measures z_{lj} : $k = 1, \dots, L$, whose input/output statuses are not known. [9] proposed the following mixed integer programming for determining the status of L flexible measures, z_{lo} ($l = 1, \dots, L$):

$$\begin{aligned}
 & \max \quad \sum_{r=1}^s u_r y_{ro} + \sum_{l=1}^L \delta_l z_{lo} \\
 & \text{s. t.} \quad \sum_{i=1}^m v_i x_{io} + \sum_{l=1}^L w_l z_{lo} - \sum_{l=1}^L \delta_l z_{lo} = 1, \\
 & \quad \sum_{r=1}^s u_r y_{rj} + 2 \sum_{l=1}^L \delta_l z_{lj} - \sum_{i=1}^m v_i x_{ij} - \sum_{l=1}^L w_l z_{lj} \leq 0, \quad \forall j \\
 & \quad 0 \leq \delta_l \leq M d_l, \quad \forall l \\
 & \quad \delta_l \leq w_l \leq \delta_l + M(1 - d_l), \quad \forall l \\
 & \quad u_r \geq 0, \quad \forall r \\
 & \quad v_i \geq 0, \quad \forall i \\
 & \quad w_l, \delta_l \geq 0, d_l \in \{0,1\}, \quad \forall l
 \end{aligned} \quad (2)$$

where the binary variables d_l indicates that factor l is an output when $d_l = 1$, and $d_l = 0$ designates it as an input. Also, M is a large positive number. Model (2) lets each DMU identify the status of its flexible measures. Then, flexible measures' classification changes with respect to each DMU. So, to solve this problem, [9] presented an aggregate model. By this model, a unique category is defined to determine the nature of the flexible factors which expresses the advantage of this model in terms of management of a central system. But the failure of this model is a lack of logical justification and this method is influenced by large units. This aggregate model is as follows:

$$\begin{aligned}
 & \max \quad \sum_{r=1}^s u_r \tilde{y}_r + \sum_{l=1}^L \delta_l \tilde{z}_l \\
 & \text{s. t.} \quad \sum_{i=1}^m v_i \tilde{x}_i + \sum_{l=1}^L w_l \tilde{z}_l - \sum_{l=1}^L \delta_l \tilde{z}_l = 1, \\
 & \quad \sum_{r=1}^s u_r y_{rj} + 2 \sum_{l=1}^L \delta_l z_{lj} - \sum_{i=1}^m v_i x_{ij} - \sum_{l=1}^L w_l z_{lj} \leq 0, \quad \forall j \\
 & \quad 0 \leq \delta_l \leq M d_l, \quad \forall l \\
 & \quad \delta_l \leq w_l \leq \delta_l + M(1 - d_l), \quad \forall l \\
 & \quad u_r \geq 0, \quad \forall r \\
 & \quad v_i \geq 0, \quad \forall i \\
 & \quad w_l, \delta_l \geq 0, d_l \in \{0,1\} \quad \forall l
 \end{aligned} \quad (3)$$

where $\tilde{x}_i = \sum_{j=1}^n x_{ij}$, $\tilde{y}_r = \sum_{j=1}^n y_{rj}$ and $\tilde{z}_l = \sum_{j=1}^n z_{lj}$ are the aggregated values.

C. New common set of weights (CSW) approach

As can be seen in model (2), optimal weights in evaluating a decision maker may not be optimal for other units. In order to find the same optimal weights for all units, the following model based on [10] approach is presented:

$$\begin{aligned}
 & \min \quad \sum_{j=1}^n \varphi_j \\
 & \text{s. t.} \quad \sum_{r=1}^s u_r y_{rj} + 2 \sum_{l=1}^L \delta_l z_{lj} - \sum_{i=1}^m v_i x_{ij} - \sum_{l=1}^L w_l z_{lj} + \varphi_j = 0, \quad \forall j \\
 & \quad 0 \leq \delta_l \leq M d_l, \quad \forall l \\
 & \quad \delta_l \leq w_l \leq \delta_l + M(1 - d_l), \quad \forall l \\
 & \quad u_r \geq \varepsilon, \quad \forall r \\
 & \quad v_i \geq \varepsilon, \quad \forall i \\
 & \quad w_l \geq \varepsilon, \delta_l \geq 0, d_l \in \{0,1\} \quad \forall l
 \end{aligned} \quad (4)$$

where ε is a very small positive number. The above approach is well-known to CSW. If (u^*, v^*, w^*, d^*) be the optimal solution of model (4), then efficiency of DMU_j can be obtained by the following expression:

$$\theta_j^* = \frac{\sum_{r=1}^s u_r^* y_{rj} + \sum_{l=1}^L d_l^* w_l^* z_{lj}}{\sum_{i=1}^m v_i^* x_{ij} + \sum_{l=1}^L (1-d_l^*) w_l^* z_{lj}} \quad (5)$$

The advantage of model (4) than the aggregate model (3) is the introduction of a logical method without the intervention of the virtual unit. Also, the new method CSW for flexible factors is not influenced by the dimensions of the decision-making units, and this model adopts the same decision about the nature of the flexible factors.

III. EFFICIENCY EVALUATION OF IRANIAN WIND FARMS

In this section, we consider an example in the field of power generation in wind power plants and examine the mentioned DEA-flexible model to evaluate efficiencies of wind farms. A wind power plant or wind farm is a collection of several wind turbines located in one place. A large wind power plant could include several hundred wind turbines. Important items for identifying a prone area for installing wind turbines include:

- Establishment of windmills in places where the amount of energy produced is adequate for consumption.
- Avoiding places that could endanger wind turbines, like turbulence, frost, sand and salt particles in the air, low levels and slopes of the earth, which will reduce energy production.
- Economical production of energy compared to other energies.

In the construction of a wind power plant, finding an appropriate site is a very important factor in maximizing the exploitation of wind power. In this section, we evaluate a set of 18 wind farms in Iran using data envelopment analysis. In recent years, wind power has grown in Iran. The Iranian government plans to increase significantly the production of wind power each year. Since the establishment of Iran's wind power, energy production has increased, which has grown dramatically over the past 10 years. In 2004, Iran produced only 25 megawatts of wind power. A year later, their production increased to 32 megawatts, and in 2006, production of megawatts rose again to 45 megawatts. By increasing sustainable and stable production of electricity, Iran has continued to invest in wind farms; in 2009, their wind power has increased to 130 megawatts. This was the result of the production of larger wind farms in the coastal and windy

regions of Iran. With such rapid growth in the wind energy sector, Iran currently has the world's 30th largest wind power producer and is a member of the World Wind Power Council. Despite the significant and effective use of wind energy, wind energy as a renewable source and source of electricity, totaling 150 megawatts per year, is still a small part of Iran's annual energy of about 33,000 megawatts [11,12].

So far, studies have been carried out on the effectiveness of wind farms. In this study, like most studies, wind farm inputs are installed and the number of wind turbines installed and output is considered to be the amount of power produced. Wind speed is another factor, which in some cases is considered as an input of wind power plants. This factor has been taken into account in other studies on the location of wind farms as their output. In other words, wind speed is a factor in generating electricity in wind farms, and efficient fields that produce wind power at lower wind speeds and powerful power turbines, and on the other hand, the faster the wind speed (less than 25 m/s) indicates the spatial distribution efficiency of the wind farm. Therefore, in this study, we consider the wind speed as a flexible factor and the aggregate decision of farms identifies the nature of this factor in efficiency evaluation. Table 1 provides information on 18 wind farms of Iran in 2015. In this table x_1 , x_2 , y and z indicate inputs, outputs, and flexible factors, respectively, where,

- x_1 : Installed Capacity (MW)
- x_2 : Number of installed turbines
- y : Generated energy (GWh)
- z : Average wind speed (m / s)
- DMU $_j$: j th wind farm; $j = 1, \dots, 18$

The purpose of this assessment is to determine the priority of the installed turbines in the fields, which are made by several companies, and on the other hand, to determine the suitable locations for expanding wind farms and install more turbines.

TABLE I. DATA FROM 18 WIND FARMS.

j	x_1	x_2	y	z
1	15	14	28.7	7.9
2	11	12	19.3	16.6
3	19	15	27.2	11.3
4	20	16	19.9	11.2
5	19	19	34	12.7
6	12	9	16.8	9.5
7	10	13	12.9	6.7
8	24	20	55.5	17.1
9	18	17	27.5	12.2
10	27	22	38.1	14.6
11	9	12	9.7	7.4
12	12	14	23.1	8
13	21	19	32.5	13
14	20	15	37.8	19.6
15	20	18	42.2	17.8
16	29	21	58.2	16.3
17	8	10	10.6	6.8
18	12	15	15.3	11.5

TABLE II. RESULTS.

j	d	E_1	E_2	E_3	E_4
1	0	1	1	0.99	0.87
2	1	1	1	1	0.72
3	1	0.87	0.88	0.87	0.73
4	1	0.65	0.68	0.65	0.55
5	1	0.86	0.88	0.86	0.73
6	0	1	1	1	0.8
7	0	1	1	1	0.8
8	0	0.98	0.98	0.96	0.8
9	1	0.82	0.82	0.82	0.69
10	0	0.73	0.73	0.67	0.58
11	0	0.8	0.8	0.78	0.66
12	1	0.89	0.91	0.89	0.78
13	1	0.73	0.76	0.73	0.63
14	1	1	0.97	1	0.74
15	1	0.93	0.93	0.93	0.74
16	1	0.92	1	0.92	0.78
17	1	0.9	0.91	0.9	0.76
18	0	0.77	0.77	0.75	0.61

In Table 2, columns d and E_1 are related to the assessment of wind farms using model (2), that E_1 is the efficiency of the units (wind farms). Column d shows that 7 units among 18, classified wind speeds as inputs and 11 units as output. The implementation of the aggregate model (3) indicates the output nature of the wind speed for all farms. Column E_2 is related to the efficiency of the fields considering the wind speed factor as output ($d = 0$) and column E_3 shows the efficiency of the fields with the assumption that the wind speed factor is input ($d = 1$), both of E_2 and E_3 are based on model (1) and finally column E_4 is the result of the efficiency evaluation of the farms by the proposed common weight method. The results of the model (4) represent $d^* = 0$, which means that the wind speed is considered as the input factor. E_4 is obtained using the optimal solutions of model (4) and expression (5). Model (2) evaluates the units in the most optimistic way, while the common weight model (4) follows the same conditions for all units, and thus different results are found in identifying the nature of the wind speed. Figure 1 shows the change in the rating of wind farms based on the results of E_1 to E_4 . The higher the efficiency, the better rank of DMU.

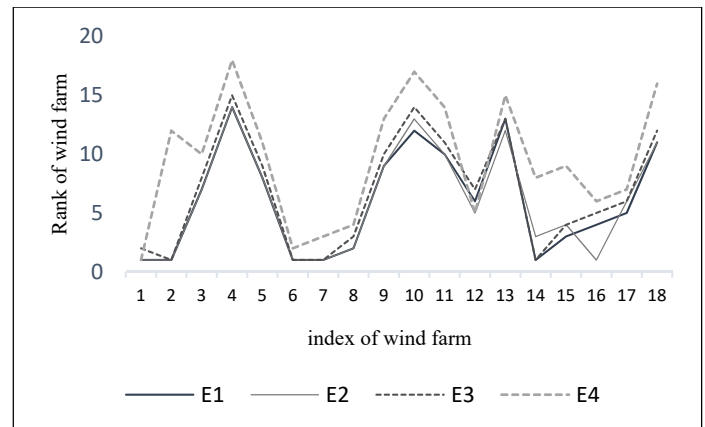

Figure 1. Changes in the rank of wind farms compared to different models.

As shown in Fig.1, the trend of changes in the rank of each farm is approximately the same according to different models. Then it can be concluded that in this example there is not much difference between the results when considering wind speed as input or output. For farms such as farms 2, 6 and 7, the efficiency is the same, therefore, the efficiency of these units is not affected by the shortage or surplus of this factor. Among five efficient farms with the E_1 rating, two farms classifies the wind speed as output and remaining three farms as input. This can indicate that most of the efficient farms identify the wind speed as input, although this assessment has been very optimistic.

IV. CONCLUSION

DEA has been accepted as an important approach for performance assessment and benchmarking in several sectors. Here, we studied a DEA framework to provide insights regarding the efficiency and ranking of the wind farms and different from other studies in the field of wind farms' efficiency evaluation, wind speed is considered as a flexible factor and by mathematical modeling, its nature as input or output of the system can be identified. Results of our method on an example of 18 wind farms in Iran revealed that there wasn't a meaningful difference between input or output nature of wind speed, then in this situation it can be showed that the weight of this factor in efficiency evaluation is negligible, i.e. the wind speed is not a core factor in wind farms efficiency evaluation.

REFERENCES

- [1] M. C. Homola, J. Byström, P. J. Nicklasson, and P. A. Sundsbo, "An improved method for wind power estimation," Working Paper, Narvik University College, Norway, pp. 1-13, 2009.
- [2] A. Ilinca, "Analysis and Mitigation of Icing Effects on Wind Turbines," 2011, Available at <http://www.intechopen.com/books/windturbines/analysis-and-mitigation-of-icing-effects-on-wind-turbines>.
- [3] G. Hughes, "The Performance of Wind Farms in the United Kingdom and Denmark," Renewable Energy Foundation, London, 2012.
- [4] D. Maradin, and L. Cerović, "Possibilities of Applying the DEA Method in the Assessment of Efficiency of Companies in the Electric Power Industry: Review of Wind Energy Companies," International Journal of Energy Economics and Policy, vol. 4(3), pp. 320-326, 2014.
- [5] C. Goodeve, "Efficiency and Productivity Assessment of Wind Farms," CIM Series in Mathematical Sciences, vol. 161(4089), pp. 377-378, 1948.
- [6] S. Pieralli, M. Ritter, and M. Odening, "Efficiency of wind power production and its determinants," Energy, vol. 90, pp. 429-438, 2014.
- [7] A. Kusiak, A. Verma, and X. Wei, "Wind turbine capacity data from SCADA," Wind Systems Magazine, vol. 2012, pp. 36-39, 2012.
- [8] A. Charnes A, W. W. Cooper, and E. Rhodes, "Measuring the efficiency of decision making units," European Journal of Operational Research, vol. 2(6), pp. 429-444, 1978.
- [9] W. D. Cook, and J. Zhu, "Classifying inputs and outputs in data envelopment analysis," European Journal of Operational Research, vol. 180(2), pp. 692-699., 2007.
- [10] F. H. F. Liu, and H. Peng, "Ranking of units on the DEA frontier with common weights," Computers and Operations Research, vol. 35(5), pp. 1624-1637, 2008.
- [11] Iran Announces New Renewable Energy Facilities - General news
- [12] <http://www.presstv.com/Detail/2015/07/23/421482/iran-electricity-turbine-power>

Environmental impact of nuclear power

Robert Guzinski, Safak Polat and Görkem Kablan

Abstract— Nuclear power plants are still one of the most important energy generation methods in the world, despite their impact on the environment and society. This paper shows the technology of power generation with nuclear power plants and shows the risks and their effects on the environment, people and their health. In this context, a brief look is taken at the current political discourse on this topic.

Index Terms— nuclear power, radioactive waste, environmental impact of nuclear power, nuclear risks, political measures

I. INTRODUCTION

CLEAN, powerful and cost-effective - these are the most important arguments of nuclear power supporters. One kilogram of uranium can generate around 350.000 kilowatt-hours of electricity. For comparison: one kilogram of oil is enough for about twelve kilowatt-hours.

A nuclear power plant initially produces heat to convert it into electricity. Unlike gas and coal-fired power plants, no greenhouse gases and air pollutants are produced and emitted, as the nuclear power plants do not use fossil fuels. Although nuclear power plants do not emit any harmful emissions, there are risks of leakage of radioactive material. The effects of radioactive material on the environment, food and society and how politicians and the European Union counteract them are discussed in detail in this article. [1]

II. WHAT IS NUCLEAR ENERGY?

Nuclear energy is obtained by splitting the nucleus of certain atoms. The plant that will use for the fission is called nuclear power plant. The principle of nuclear fission works within a reactor and is generated by firing a neutron at an unstable atomic nucleus. The speed of the neutron splits the core into two parts. The best way to do this is with the element uranium, a radioactive heavy metal. It is located in fuel rods that are combined into fuel assemblies. The fission leads to a chain reaction in which a lot of energy is generated. If chain reaction is controlled by humans, it is usually harmless. If too much energy is generated in a very short time, this process can get out of control, which in the worst case can result in an explosion of the nuclear power plant. [2]

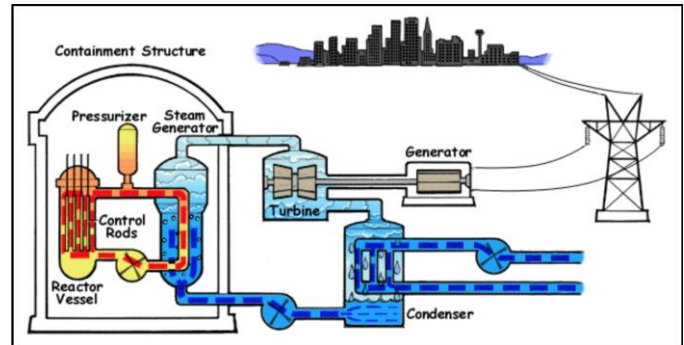

Figure 1: Schema of a nuclear power plant

III. HOW IS A NUCLEAR POWER PLANT CONSTRUCTED?

The world's first nuclear reactor is a 7,5 m high graphite block and has little in common with a modern nuclear power plant. Its name was Chicago Pile 1, his inventor was an Italian noble prize winner and physicist Enrico Fermi. On 2 December 1942 he and his team succeed for the first time in a self-sustaining chain reaction. This basic principle of a nuclear power plant still applies today. The fuel rods of the reactor contain uranium. Uranium atoms have the property of absorbing neutrons with a neutral charge. The atom disintegrates and energy is released. The special feature: when an atom decays, two to three new neutrons are released. These neutrons can split other nuclei. A chain reaction is created that generates further energy. A medium-sized nuclear power plant has an average output of 1200 megawatts. This corresponds to about 200 wind turbines. However, nuclear fission has an important condition. The fast neutrons only attach to uranium atoms if they have previously been decelerated by water. The fuel rods are therefore in deep water basins. The energy of nuclear fission is mainly released in the form of heat, so that the fuel rods do not melt, the reactor must be constantly cooled. This function is usually performed by the same water that slows down the neutrons. It is pumped under high pressure through the reactor. In any case, the heated water is cooled in the steam generator. The resulting steam is fed into the turbine, which in turn drives the generator for electricity production. In the next step, the steam is cooled again and released into the environment as cooling water. The energy of nuclear fission is first converted into water vapour and then into electricity in the turbine. All nuclear power plants in the world are based on this basic principle (cf. Figure 1). [3]

A nuclear power plant consists of a nuclear part, which has a nuclear reactor with light water reactors. The light water reactors slow down the neutrons released. On the other hand, a nuclear power plant also consists of a conventional part.

The conventional part is similar to other thermal power plants, in which the steam is fed into a turbine, which in turn drives a generator. This serves to convert heat into electricity. The energy initially occurs as heat energy, i.e. as heat. Therefore, a large amount of water is needed to cool a reactor. At the same time, the hot steam generated by nuclear fission drives a turbine. This then drives generators that generate electricity from the heat energy. [4]

IV. EFFICIENCY AND RISKS

Since a nuclear power plant operates at relatively low temperatures (300 °C), with gas and steam power plants requiring around 1200 °C, efficiency is 33%. Gas and steam power plants, on the other hand, can reach up to 58%. [5]

An accident in a nuclear power plant can have serious consequences. This has already happened in Fukushima (Japan) and Chernobyl (Ukraine): Large areas are contaminated, which means that nobody can live there because the radioactive radiation is too dangerous. The workers who had to clean up then usually died soon. In addition, the production of electricity generates radioactive waste. They can't be stored safely anywhere. It takes millions of years until they are no longer dangerous. Until now they have simply been stored in an interim storage facility. As with all large power plants, there is a general risk of accidents in nuclear power plants. In addition, special risks also arise from the use of nuclear energy. Accidents can range from insignificant internal incidents to a disaster with international repercussions, as was the case with the Chernobyl disaster. Normally, small amounts of radioactive substances are excreted from the nuclear power plant and get into the air through the exhaust air stack. These substances contain radioactive noble gases ^{85}Kr and the unstable hydrogen isotope tritium. Safety incidents or accidents can lead to the release of large quantities of radioactive material into the environment and onto foodstuffs. [6]

Another risk is the meltdown caused by a failure of the cooling system. This causes the fuel rods of an atomic reactor to overheat to such an extent that they liquefy and convert into a radioactive melt. This can lead to an explosion, as happened during the nuclear disaster in Fukushima, which led to a meltdown in three reactors. [7]

V. EFFECTS ON THE ENVIRONMENT

Radioactive elements harm humans not only through the inhalation of dangerous substances, but also through the supply of contaminated food and indirect radiation from soil and plants. The ways in which radioactive contamination can reach humans are shown schematically in Figure 2. It becomes clear that animals and the environment are also affected by the ionising radiation. After a high release of radioactive elements ^{131}I , ^{137}Cs and ^{90}Sr are the most dangerous for plants, animals and humans. [8]

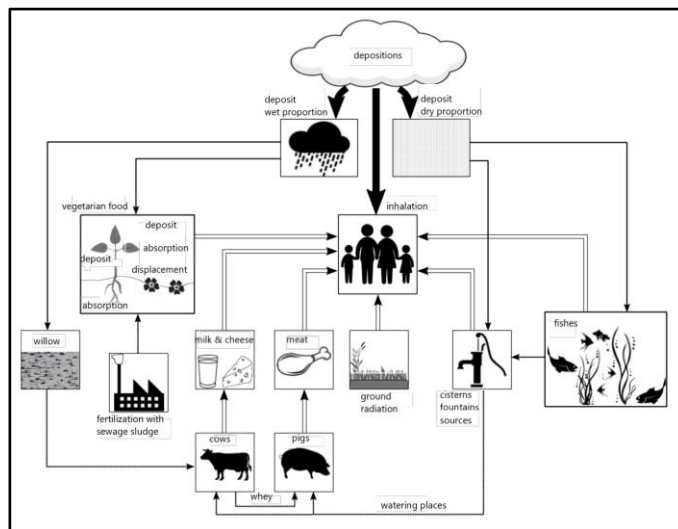

Figure 2: Radioactive elements in the natural cycle

Radioactive nuclides spread after release depending on meteorological conditions. Precipitation causes the fission products to enter the atmosphere close to the ground and settle on the soil or on plants. Ratschinski (1979) estimates the period for the decline of radioactive iodine from the troposphere at one month. ^{137}Cs and ^{90}Sr even reach the stratosphere. As a result, they remain in water-soluble form in the atmosphere and can be distributed over the entire globe many years later by precipitation. Food and other agricultural products are contaminated in this way. Furthermore, the environment can be endangered by flooding or irrigation with polluted water. The radioactive isotope ^{14}C enters plants via the air. [9]

The local pollution depends on the one hand on the amount of radioactive elements released and transported, and on the other hand on the amount of precipitation. Gaseous elements can be transported over long distances in the atmosphere as radioactive particles. [10]

The absorption of radioactive nuclides increases due to the large surface area of the plants. They reach the plant tissue either by diffusion or via the roots. [11]

In addition, the soil composition (humus content, mineral content, pH value, soil climate) influences the ability of radioactive elements to penetrate the soil and be absorbed by the roots. If many organisms are present in the soil, they absorb these radiant nuclides. The radioactive elements are confused with uncontaminated nutrients. This reduces the amount that can be absorbed by the roots of the plants, while moisture promotes the absorption of radiant nuclides. [12]

Radiation affects plants, animals and the human body either externally or through ingestion. In some cases, plants contaminated by radiation grow from a contaminated soil. Thus there is a danger for humans when eating plants as well as animals that have been given contaminated food. It is not enough simply to look at the burden on the mainland. Radioactive elements can also rain in seas, lakes and rivers. As a result, both the water and the animals living in it are contaminated. As radionuclides accumulate in plankton, fish in weakly flowing lakes are exposed to a higher load. Here plankton is increasingly available

as food. [13]

The absorption of dangerous substances into the human body is again possible via the food chain. There is also the possibility that radioactive nuclides may enter groundwater and contaminate drinking water. [14]

Most nuclear waste is generated in nuclear power plants. Radioactive waste is internationally divided into the categories low, medium and high-level radioactive waste. The radioactive radiation emanating from them must be safely stored for long periods of time in order to keep them as far away from people and the environment as possible until most of them have disintegrated. This can take from a few months to many thousands of years. [15]

VI. EFFECTS ON HUMAN HEALTH

Radioactive radiation that can be released in the event of an accident in a nuclear power plant or in the event of an atomic bomb explosion is of course highly dangerous. If the element strontium, which contains a highly active, radioactive isotope, enters the body in an unnaturally high concentration on the way to food intake, it deposits in the bones due to its chemical relationship with calcium and could cause bone cancer and leukaemia. Scientific findings about an increased risk of leukaemia in children living in the vicinity of nuclear power plants are repeatedly discussed, but are controversial for statistical reasons.

Unstable isotopes of iodine also occur during nuclear fission and can be released, for example, in a reactor meltdown. When inhaled, they accumulate in the thyroid gland and increase the risk of thyroid cancer. However, radioactive radiation also emanates from the inert gas radon, which is naturally produced during the decay of uranium. When workers in uranium mines are exposed to a high dose of radon, there is a risk of developing lung cancer and upper respiratory cancer. It is also suspected that people living in uranium mining areas are also exposed to this risk, as radon can also enter the residential area through the cellars of houses. [16]

VII. POLITICAL MEASURES

Many countries worldwide are trying in different ways to bring about an energy transition. Countries by the sea rely primarily on wind power, while solar energy is preferred in the sunny south. Electric mobility also plays an important role in the energy transition. In Germany, renewable energy should account for around 80% of total electricity by 2050. At the same time, emissions of greenhouse gases such as CO₂ are to be enormously reduced.

Nuclear energy is considered as a clean alternative to fossil energy. But unresolved problems such as the final storage of radioactive waste and the risk of major nuclear accidents as in Fukushima (Japan) are causing more and more countries to abandon this form of energy generation. [17]

Germany plans to phase out nuclear power. The last nuclear power plant is to be decommissioned by 2022 and a repository site with the best possible safety should be found by 2031. [18]

Italy's attempt to return to nuclear power failed in 2011, shortly after the Fukushima nuclear disaster. There are also

countries that maintain nuclear energy. In France, no exit is planned nevertheless the number of nuclear power plants is to be reduced by 20 by 2025, and the share of nuclear power is to be reduced from 75 % to 50%. [19]

In contrast to the above mentioned goals the development of the global electricity mix differs.

It emerges that in the foreseeable future coal-based power generation will be indispensable worldwide. It should also be added that between 2011 and 2030, the percentage of renewable energies will increase by almost one-third but that of nuclear power will decrease by only 2% (cf. Figure 3). [20]

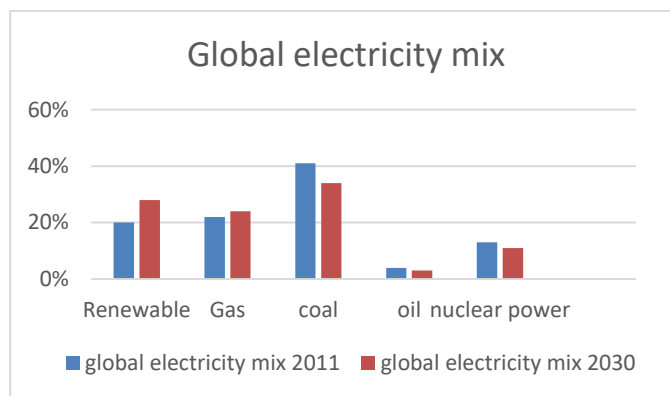

Figure 3: Global electricity mix

VIII. CONCLUSION

The results of the present study show that although nuclear power plants are one of the most important energy generation methods in the world, they also pose dangerous risks for the environment and society. Of course, efforts are being made to avoid or reduce these risks.

Therefore, continuous efforts should be made to support the phase-out of nuclear power worldwide.

In the short term, existing nuclear power plants should be modernised in order to minimise or avoid possible pollution. However, the risks remain, and in the longer term research should definitely focus on renewable energies. The complete abolition of nuclear power plants can only take place if renewable energies are able to meet the demand for nuclear power plants. This would require the creation of a global standard of energy infrastructure, which we are, however, still relatively far from due to the different standards in the respective countries, both technically and politically.

REFERENCES

- [1] https://www.planet-wissen.de/technik/atomkraft/grundlagen_der_atomkraft/index.html [30.06.2018 13:44 clock]
- [2] Paul Laufs (2018): Reaktionssicherheit für Leistungskernkraftwerke 1 – Die Entwicklung im politischen und technischen Umfeld der Bundesrepublik Deutschland, pp. 18-19, Springer Vieweg Verlag, Berlin
- [3] https://www.planet-wissen.de/technik/atomkraft/grundlagen_der_atomkraft/index.html [30.06.2018 13:44 clock]
- [4] <https://www.verivox.de/strom/themen/atomkraftwerk/> [26.07.2018 17:54 clock]
- [5] Monatsbericht über die Elektrizitätsversorgung Statistischen Bundesamts, Wiesbaden, Stand 4. Quartal 2008
- [6] Bundesamt für Strahlenschutz: Emissionsüberwachung bei Kernkraftwerken, Stand 1. Quartal 2012
- [7] <https://www.greenpeace.de/themen/atomkraft/alle-10-20-jahre-eine-kernschmelze> [17.06.2018 19:29 clock]
- [8] Ratschinski, W. (1979): Isotope und Strahlenquellen in der Landwirtschaft. p. 376, Berlin: VEB Deutscher Landwirtschaftsverlag, 1979
- [9] Ratschinski, W. (1979): Isotope und Strahlenquellen in der Landwirtschaft. pp. 371, Berlin: VEB Deutscher Landwirtschaftsverlag, 1979
- [10] Penkaitis, Norbert (1988): Tschernobyl und Folgen für die sowjetische Landwirtschaft. In: Zentrum für kontinentale Agrar- und Wirtschaftsforschung der Justus-Liebig-Universität Gießen in Verbindung mit der Kommission für Erforschung der Agrar- und Wirtschaftsverhältnisse des europäischen Ostens e.V. (Hrsg.): Giessener Abhandlungen zur Agrar- und Wirtschaftsforschung des europäischen Ostens Bd. 161. p. 32, Berlin: Duncker & Humblot, 1988. – ISBN 3-428-064-98-4
- [11] Ratschinski, W. (1979): Isotope und Strahlenquellen in der Landwirtschaft. pp. 381, Berlin: VEB Deutscher Landwirtschaftsverlag, 1979
- [12] Penkaitis, Norbert (1988): Tschernobyl und Folgen für die sowjetische Landwirtschaft. In: Zentrum für kontinentale Agrar- und Wirtschaftsforschung der Justus-Liebig-Universität Gießen in Verbindung mit der Kommission für Erforschung der Agrar- und Wirtschaftsverhältnisse des europäischen Ostens e.V. (Hrsg.): Giessener Abhandlungen zur Agrar- und Wirtschaftsforschung des europäischen Ostens Bd. 161. pp. 32, Berlin: Duncker & Humblot, 1988. – ISBN 3-428-064-98-4
- [13] Kröger, Wolfgang; Chakraborty, Sabyasachi (1989): Tschernobyl und weltweite Konsequenzen. pp. 103, Köln: Verl. TÜV Rheinland, 1989. – ISBN 3-88585-423-6
- [14] Penkaitis, Norbert (1988): Tschernobyl und Folgen für die sowjetische Landwirtschaft. In: Zentrum für kontinentale Agrar- und Wirtschaftsforschung der Justus-Liebig-Universität Gießen in Verbindung mit der Kommission für Erforschung der Agrar- und Wirtschaftsverhältnisse des europäischen Ostens e.V. (Hrsg.): Giessener Abhandlungen zur Agrar- und Wirtschaftsforschung des europäischen Ostens Bd. 161. p. 32, Berlin: Duncker & Humblot, 1988. – ISBN 3-428-064-98-4
- [15] <http://www.umwelt.niedersachsen.de/atomaufsicht/endlager/FAQ/FAQ-118000.html> [11.06.2018 16:20 clock]
- [16] Hellbrück, J., Kals, E. (2012): Umweltpsychologie, pp. 33-45, Springer Fachmedien, Wiesbaden
- [17] <http://www.faz.net/aktuell/wirtschaft/thema/energiewende> [27.06.2018 14:30 clock]
- [18] <https://www.tagesspiegel.de/themen/atomkraft/> [27.06.2018 14:47 clock]
- [19] <http://www.20min.ch/schweiz/news/story/Diese-Laender-haben-den-Atomausstieg-hinter-sich-22382878> [27.06.2018 14:58 clock]
- [20] Beckmann, M. (2017): Kraftwerkstechnik 2017 – Strategien, Anlagetechnik und Betrieb, pp. 37-41, SAXONIA, Freiberg

FIGURES

- [1] <http://www.nrc.gov/reading-rm/basic-ref/students/animated-pwr.html> [12.06.2018 clock]
- [2] Kröger, Wolfgang; Chakraborty, Sabyasachi (1989): Tschernobyl und weltweite Konsequenzen. p. 104, Köln: Verl. TÜV Rheinland, 1989. – ISBN 3-88585-423-6
- [3] Own representation based on: Beckmann, M. (2017): Kraftwerkstechnik 2017 – Strategien, Anlagetechnik und Betrieb. p. 40, SAXONIA, Freiberg

Electric vehicles and the electric grid

Aleksandra Łuba

Brandenburgische Technische Universität Cottbus-
Senftenberg
Cottbus, Germany
aleksandra.luba@b-tu.de

Oktawia Maria Bohn

Brandenburgische Technische Universität Cottbus-
Senftenberg
Cottbus, Germany
oktawia.bohn@b-tu.de

Hossam Ghazal

Brandenburgische Technische Universität Cottbus-Senftenberg
Cottbus, Germany
hossam.ghazal@b-tu.de

Abstract—In this paper, the basic functions of electric vehicles are described with a focus on the impact for the electrical grid. They have two functions in power system. Vehicle-to-grid technology is connected with charging and discharging electricity to and from the grid as well as it gives an opportunity for energy storage in electric vehicles batteries. This is particularly important due to the forecasted development of renewable energy sources. In the last step, the possibilities of reusing batteries in stationary energy storages will be shown.

Keywords—balancing power, electric vehicles, electricity grid, energy storage

I. INTRODUCTION

Electromobility becomes more and more popular nowadays. The aim is to increase the number of electric cars instead of diesel vehicles. More and more attention is paid to environmental efficiency. Restrictions related to emissions could cause that the future production and usage of combustion vehicles will become unjustified not only in ecological but also in economic terms.

Countries implement different support mechanisms. The aim is development in the electric car sector. In Poland, the Electromobility Development Plan was introduced. It assumes that by 2025, one million electric cars will be used on roads. Other countries are also trying to go in this direction. An example is China, where by 2020 5 million zero-emission cars on the roads are expected. Ten years later, in Germany in 2030, only electric cars are to be produced. The United Kingdom has, in turn, announced that after 2040, the sale of vehicles with internal combustion engines will be banned. A similar goal was set by the French government [1]. The answer to these plans is to enlarge the offers of car companies that want to meet the modern market requirements.

In addition, the power installed in renewable energy sources increases year by year. The generation of energy from renewable energy sources is connected with high instability associated with the current weather conditions. Characteristic are large changes in power over times that are difficult to predict. Therefore, it is possible to disturb the power balance in

the whole electric power system. In this situation, energy storage is a very significant solution. It allows maintaining the stability of the energy system by charging and discharging electricity to and from the grid. Based on the above information, it can be assumed that continuous development in the fields related to electric cars will be systematically progressing.

II. FUNCTIONS AND IMPACT OF BATTERIES ON THE GRID

Energy Storage Systems (ESS - Energy Storage System) consist of many devices and parts. The most significant, like inverter, control infrastructure and energy storage unit, will be presented. Such reservoirs may be water reservoirs, rotating masses, as well as batteries that are used in electric cars [2].

Energy Storage Systems can perform various functions in the power system depending on the demand [2]:

- Flattening peaks of power demand.
- Improvement of system stability in the case of renewable energy (In the period when the energy demand in the system is small, energy storage is loaded by renewable energy. In the case of high demand, they can work as generating sources, i.e. give back energy that has been previously collected.)
- Improvement of energy quality, work of the grid operators, and power supply reliability.
- Support for distributed generation.

Energy can be stored in different forms such as latent and sensible heat, kinetic energy, chemical energy and in an electrical field. Well-known portable solution for energy storage is the electrical vehicle.

In addition to the function of batteries associated with renewable energy, the electric car as the electricity consumer is also very significant. As the number of electric cars on the road will be increasing, the electricity needed to charge them will account for nearly 4.5 % of the electricity consumption from the grid. Therefore, both the grid and the distribution control rooms should be optimally prepared and modernized in order

to derive the maximum benefits in the shortest possible time already during the technology implementation phase. An additional factor to consider is the time when electric cars could be charged. If smart chargers would be available then charging would start when the energy prices are lowest and power plants and transmission lines have excess capacity. That solution would be more effective and would minimize costs. Such a situation takes place in the power system at noon, when people are at work, and also at night when the vast majority of people are asleep [3]. The graph (Fig. 1) presents the distribution of system loads within 24 hours with selected time intervals, in which cars could be charged.

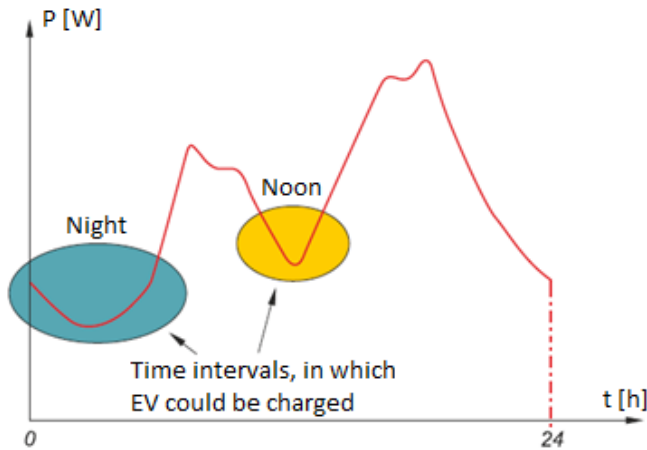

Figure 1. Electric grid demand curve [4]

Charging cars at this time would allow the consumption of unused energy, which would reduce the cost of electricity production and increase the profitability of the process.

The average daily number of kilometers traveled by one car is about 37 km. This ultimately gives 45 minutes of car use during the day with a city speed limit of 50 km/h. Looking at the current offer of electric cars, after calculations, the electric car consumes an average of 13 kWh/100 km. Based on the above data, it can be concluded that 4.81 kWh is consumed during one day's driving. For the rest of the time, the vehicle is parked near the house or in the city. At that time, it would be possible to use it for energy storage in order to improve stability and security of the grid.

The development of electromobility will be discussed by the example of Poland. The Electromobility Development Plan assumes that one million electric cars will be driven in Poland by 2025. Assuming earlier assumptions, 4.81 GWh would be used daily for electric cars. So much energy should be provided to charge these vehicles. The Polish installed renewable energy sources accounts for 8478 MW in size (as of June 2017) according to the Energy Regulatory Office's data. Assuming one car has a battery capacity of about 24 kWh, a million cars would give a total capacity of 24 GWh. It may be assumed that not all users agree to share their car. It can be approximated that about 1/4 of the owners will agree. By subtracting the energy necessary for users, which is necessary for everyday travel, the finally available energy will be at around 4.8 GWh.

These considerations are purely theoretical, and the real possibilities of energy storage are difficult to predict. They are related to, among others, various ways of using cars by people. In addition, other options, such as increasing trend of the car sharing, have not been taken into account.

III. USING ELECTRIC-DRIVE VEHICLES FOR GRID SUPPORT

An electric car in the power system could perform two functions. The first one is the energy consumption. On the other hand, vehicles can be treated as energy storage and energy suppliers. Individual units are not very important, but with the increasing number of electric cars, new possibilities will open up. This concept is called vehicle to grid (V2G). It would be possible to supply individual devices that are necessary at a given moment by this concept. The diagram (Fig. 2) presents the concept of V2G. Its basis is the connection of electric cars with the power grid and the conversion of energy between the two systems.

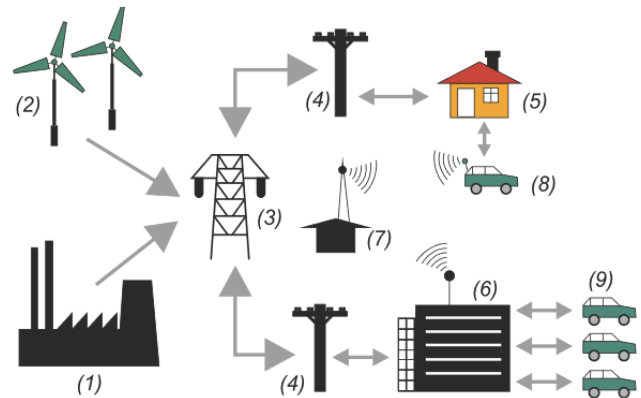

Figure 2. V2G concept [5] (1) power plants, (2) distributed renewable energy sources, (3) transmission lines, (4) low voltage distribution networks, (5) individual vehicle charging stations, (6) group vehicle charging stations - parking, workplaces, shopping centers, offices, (7) System Operator's headquarters, (8) electric vehicles with individual connectivity to the system, (9) vehicles connected as groups of energy storage

The V2G converter for providing the double-way energy flow can be part of this system. This is due to the fact that with the converter it is possible to convert the energy of batteries into AC power. Such processed energy can be transferred to the power grid. This converter is shown in the figure (Fig. 3).

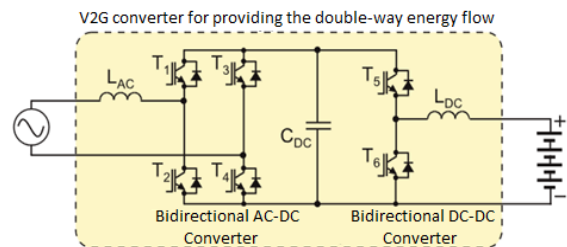

Figure 3. Structure of the V2G converter for providing the double-way energy flow [3]

To implement V2G, it is necessary to extend and modernize the infrastructure. With the continuous communication between the system operator's panel and electric cars, it will be possible to properly manage and coordinate distributed energy storage. This could be

implemented using the GPRS, GPS and GSM systems used today [6].

The main limitation and challenge is the large dependence of this concept on the agreement of car owners. It would be necessary to anticipate the use of batteries as storage in the same way as the load of the grid is currently planned. The user's declaration of readiness to give up energy could be associated with an increase in its profits. For proper operation of this system, it is necessary to determine reliable and transparent methods of energy settlement based on the V2G converter for providing the double-way energy flow.

The user deciding to participate in the V2G concept may also have objections about the specific amount of energy that he wants to give to the system. This is due to the fact that by discharging the battery until the end it would not be able to drive further. The technology must give the possibility to set an acceptable value to which the battery can be discharged in a given time. This could be done through a panel in the car [7]. An example view with available options that can be entered is shown in the figure (Fig. 4).

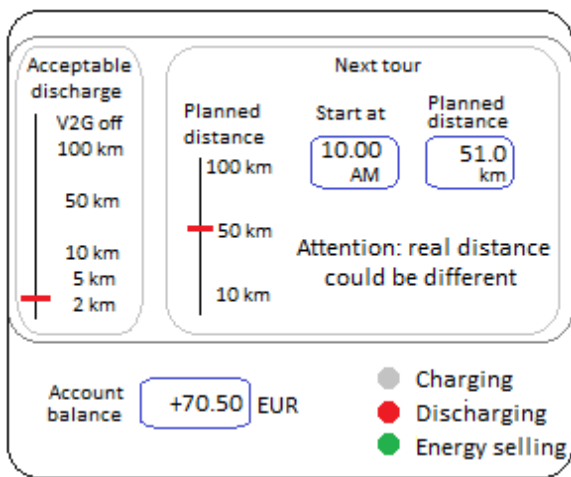

Figure 4. An example of a control panel solution in an electric car [7]

The user could enter data such as allowable discharge or planned distance to pass the planned route without any problems later.

IV. STATIONARY ENERGY STORAGE

One of the problems associated with the use of batteries in electric cars is the limited time of their use – about 8-10 years. Solutions are sought for their further use without the need to dispose of the battery. One of the ideas is to use them in stationary energy storage devices. According to Bloomberg, there are currently around 0.1 GWh on the market in used car batteries, but this value is expected to increase significantly. According to analyzes, by 2025 this amount is going to increase up to 95 GWh, of which about 1/3 could be adapter to energy storage devices. As a result, the cost of purchasing batteries would be much lower. However, there is a risk that in a few years, when the prices of new batteries will drop to 200 USD/kWh, the use of older batteries will no longer be profitable [8]. A Renault company currently selling a

significant number of electric cars (about 120,000 Renault Zoe cars have been sold so far), proposed the construction of a stationary energy storage. An additional idea is to create energy storages that could be used as support for charging stations for electric cars. It is connected with the fact that increasing the chargers' power would allow for faster charging of batteries. It is an indispensable element for the development of electromobility. At the same time it would be dangerous for power grids because of their overload. Energy storage would help to avoid such situations. Experimental stations were built in Belgium and Germany. On highways, it is important to quickly load vehicles, and thanks to the latest solution it has been made possible without the need to modernize the power grid, which would be very expensive [9].

Stationary energy storage devices do not have to concern only large system energy storage. In addition to the previous mentioned solution, Renault together with PowerVault decided to use the batteries in household energy storages [10]. This would reduce their prices by around 30% compared to new batteries. The appearance of such a solution and placing it in the home space is shown in the figure (Fig. 5).



Figure 5. Household energy storage of Renault and PowerVault [10]

Currently, research is underway and this solution is gradually being introduced in the UK to 30 houses with solar panels and to 10 households without such installations. Energy generated from photovoltaic panels would be stored there. At the peak of demand, energy would be returned to the network, and residents with energy storage devices would get paid for the readiness to provide it.

Nissan came out with a similar initiative. Together with Eaton, they predict that home energy storages will be more and more popular, and their sales will increase to around 100,000 in the next 5 years. The proposed solution of the two companies is called xStorage Home. Nissan Leaf is the most popular electric car. The latest version has accumulators with a capacity of 30 kWh and they could be used as energy storage devices [11].

This solution does not only apply to cars, but also to buses with electric drive. They are bought into cities to guarantee zero-emission public transport. A company – Impact Clean Power Technology – presented its vision at the Transexpo trade fair in Kielce (Poland) in 2016. It draws attention to the

difference in the use of batteries in buses, where it must be resistant to adverse weather conditions and tremors, and the operation of batteries in the energy store, when controlling its charging and discharging is the easier due to easier prediction of loads. Batteries have an algorithm that is called Residual Battery Value. Thanks to it, it is possible to determine the time when the battery should be transferred to stationary energy storage because using it in a vehicle is not sufficiently effective [12].

One of the pioneers in the market is Tesla, which offers energy storage solutions for both households and industrial as well as system purposes. When it comes to home energy storages, the company offers a product called Powerwall, which has already been presented the second generation. The first product had a capacity of about 7 kWh or 10 kWh depending on the chosen model. The new energy storage is called Powerwall 2 and has a nominal capacity of 14 kWh at a peak power of 7 kW. This product is intended for households with a photovoltaic installation [13]. When it comes to large energy storage, Tesla has launched the second largest energy storage device in the world. It was commissioned by SCE operator in California, USA after a breakdown resulting in a gas leakage. Ultimately, three energy storages were ordered, and the first of them was put into service at the beginning of 2017. It has a power of 20 MW and a capacity of 80 MWh. It was built of 396 pieces of energy storage devices intended for the industry, which are sold under the name Powerpack. The first version of single energy storage had a capacity of 100 kWh, while the improved product has a capacity two times larger.

At the beginning of December 2017, Tesla broke its record by setting the world's largest stationary energy storage in South Australia. It was built in less than 100 days. It has a power of 100 MW and a capacity of 129 MWh. The necessity of its construction was related to the failure of the power grid, which took place after violent storms. At that time, 1.7 million people were without power. It was not a one-off situation when residents did not have access to electricity. Therefore, the authorities decided to increase the security of energy supply by building energy storage systems [14].

Probably the title of the largest energy storage will soon be given to another installation. It is to be built in South Korea in the city of Ulsan. Office of Hyundai Electric & Energy Systems is located there. They want to build an energy storage device with lithium-ion batteries, the power of which is to reach 150 MW [15].

V. LITHIUM-ION BATTERIES

Currently, the most commonly used type of batteries in electric cars is lithium-ion battery. Research is underway to continuously improve existing batteries, as well as to develop new and more optimal energy storage solutions. There has been a decline in battery prices over recent years, but there may be a problem caused by limited lithium resources. Although it is a widespread metal, its sources are very scattered. Its largest resources are found in Chile, Bolivia, and Argentina, where salty lakes are dried up. The alternative may also be the recovery of lithium from used batteries when they cannot be

used in stationary energy storage due to insufficient capacity [16].

By using lithium-ion batteries as an alternative to currently popular internal combustion engines, it is possible to reduce exhaust emissions, which in turn leads to cleaner air. In addition, greater care for the human health and the environment is possible.

Lithium-ion batteries have an advantage over other types of batteries due to technological solutions that will be described below.

Taking into account the chemical composition of electrodes, we can distinguish four types of batteries [17], for which specific technical parameters have different values:

- NMC - cathode consists of lithium-nickel-cobalt oxides, the anode is made of graphite (this type is chosen for most electric vehicles, e.g. Nissan Leaf, BMW i3)
- LMO – the cathode consists of lithium-magnesium oxides, the anode is made of graphite,
- LFP – cathode consists of lithium-iron-phosphorus oxides, the anode is made of graphite,
- LTO – The cathode consists of lithium-cobalt oxide, the anode is made from graphite with lithium titanium oxide.

This division is necessary to distinguish the technological advantage of different types of lithium-ion batteries.

The first criterion is the working temperature. Thanks to the fact that the batteries are designed to work in the temperature range from -40°C to 60°C, they can be used in various locations, also outside. Temperatures vary depending on the type of batteries (Table I). The battery life is determined for about 20 years without taking into account the charging cycles. If the batteries do not work at extreme temperatures, then the battery life does not change. It should be taken into account that continuous operation at 60°C means that the battery can be used for a short time - about 10 years [17].

TABLE I. TEMPERATURE RANGES DEPENDING ON BATTERY TYPE [17]

Type of battery	Temperature range	Comments
NMC	from -20°C to 60°C	from -40°C to 20°C work is possible if the battery has built-in heating elements
LFP	from -40°C to 50°C	-
LTO	from -10°C to 40°C	from -40°C to -10°C work is possible if the battery has built-in heating elements

Comparing lithium-ion batteries with lead-acid in terms of battery life at higher temperatures, it can be noticed that the battery life of the first one is higher, as shown in the figure below (Fig. 6). Therefore, they could be used in stationary energy stores. Electric car batteries would be used there when they would not fulfill their role in vehicles.

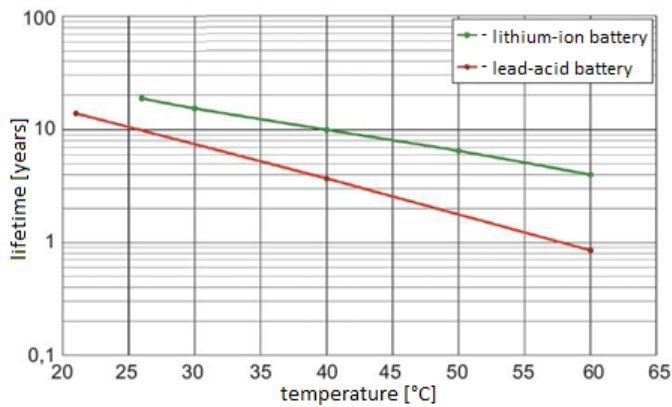

Figure 6. Influence of temperature on the lifetime of acid-lead and lithium batteries [17]

It follows that lithium-ion batteries are a better choice. The next criterion is the size and mass of the batteries. Alkaline and acidic batteries are 4 to 6 times heavier and bigger than lithium batteries. This makes them unsuitable for use in vehicles and the only justified choice is lithium-ion batteries. In comparison to lead-acid ones, they have much higher specific energy and energy density, as shown in Table II. The specific energy has a kW/kg unit. It determines what is the mass of storage 1 Wh of energy.

Therefore, the higher the specific energy, the smaller and the lighter the battery [17].

TABLE II. SPECIFIC ENERGY AND ENERGY DENSITY ACCORDING TO TYPE OF THE BATTERY [17]

	Type of battery			
	LA	NMC	LFP	LTO
Specific energy [Wh/kg]	20	200	130	90
Energy density [Wh/dm ³]	80	300	200	180

Obtain large power flows and currents in both directions are the third technological criterion that points to lithium-ion batteries. While describing the charging and discharging currents in batteries, the fraction of the nominal capacity C is used instead of absolute units, i.e. amperes and milliamps. For example, for a capacity of $C = 14\text{Ah}$, the current of $0.1C$ is expressed as $C / 10$, i.e., the current is equal to 1.4 A. For alkaline and acid batteries, the charging current is $0.1 C$ to $0.3 C$. $0.1 C$ is so-called a ten-hour current, i.e. for a full charge is 10-12 hours are needed. For lithium batteries, the current can be up to 100 times higher, so the charging time is much shorter and fluctuates between 10-15 minutes. As a result, lithium-ion batteries are irreplaceable in situations where actions to stabilize the power grid are necessary. In addition, lithium storage tanks can operate with high currents, so when it is necessary to maintain the appropriate voltage or frequency of the distribution network, they are able to receive or transfer from small capacity capacities that amount to several megawatts. Additionally using the LTO gives the possibility to

charge the electric vehicle in about 15 minutes. Using the LFP or NMC battery type, the charge could be expected after nearly an hour where alkaline and acid batteries should wait for a few days [18]. Different types of lithium-ion cells have different charging and discharging parameters, as shown in Table III.

TABLE III. CHARGING AND DISCHARGING CURRENT FOR VARIABLE TYPES OF BATTERIES [17]

	Type of battery		
	NMC	LFP	LTO
Charging current	1-2 C	2-4 C	5-10 C
Discharging current	3 C	3 C	10 C

If the charging current is 1 C, then the battery can be charged in an hour. With a capacity of 2-4 times, the charging will be half as much, i.e. it will last for 30 minutes. With LTO, the time is the shortest and is about 15 minutes.

Another issue is the battery lifetime due to the number of cycles. With alkaline and acidic cells, the number of cycles is 10-20 times smaller than with lithium-ion batteries, where it ranges between 10,000 and 20,000 cycles. Comparison of different technologies for $T=25^\circ\text{C}$ is shown in the graph (Fig. 7). In the case of batteries in which a very large number of charging and discharging cycles are required, the combination of them with a supercapacitor in a hybrid container is used. Then the lifetime is up to 2 million cycles. This solution is used in warehouses with an NMC or LFP storage tank operating at solar power plants and wind farms. It is connected with higher purchase costs and high mass [17].

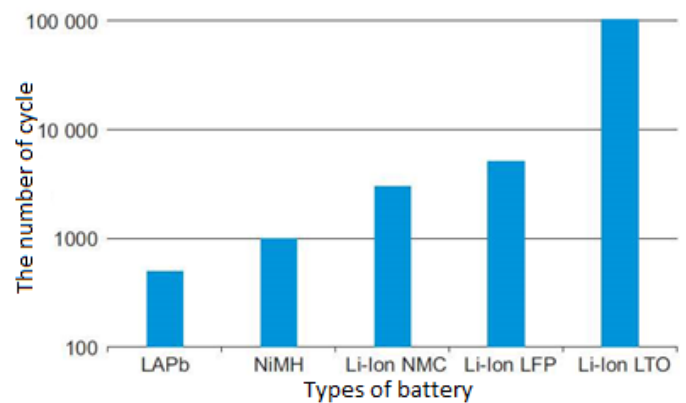

Figure 7. The number of cycles for variable technologies of batteries [17]

The further parameter is reducing the emission of corrosive, explosive and toxic gases. This is related to the working principle of battery because the electrolyte is not used in the process (no electrolysis), but only to ensure the conductivity between the electrodes. In the case of acid and alkaline batteries, toxic, corrosive and explosive compounds become airborne. It is corrosive sulfuric acid and lead in the case of lead-acid batteries, which is toxic. In addition, the evolution of hydrogen and oxygen is unavoidable as a result of electrolysis. Therefore, there is a risk of explosion, so you should use Ex zones (explosion hazards) and oxygen additionally increases the risk of corrosion. For lithium-ion storage, anti-static floors

do not need to be used. These batteries can be used inside rooms intended for general use and there is no need to install ventilation because they are in closed and sealed enclosures [17].

The use of a lithium-ion battery ensures greater reliability and mechanical strength. They are controlled by the Building Management System (BMS). The structure in the form of a matrix system of cells through a series-parallel connection means that in case of damage to one cell the rest can work without changes, without causing the entire system to be stopped. The failure is immediately reported by the system and can be repaired quickly. The broken bucket is temporarily isolated in its own section. In addition, the tight casing and the low weight of the cell make them mechanically resistant to various types of impacts and shocks [17].

Lithium-ion battery cells typically have very low self-discharge losses. In the comparison to the acid ones, it is about 10-15 times less. Monthly self-discharge of the lithium storage is less than 1%. It is possible to obtain information about the status of an online link, which means that the operational services are not forced to make frequent measurement and service visits. Therefore, the capacity tests are not needed and this saves the time and costs associated with it [17].

VI. CONCLUSIONS

The concept of electric vehicles will be still developing. In order to improve the power system flexibility and reliability, the Vehicle-to-Grid technology could be support for the electric grid. A low number of electric vehicles do not affect the grid. If the number of EV would increase, then they could become energy storage. Electric vehicles can also provide power to the electric grid when they are parked.

The most commonly used in electric cars are currently lithium-ion batteries. It is important to realize that lithium resources may run out if the production of batteries will start on a mass scale. Research is underway and scientists are looking for other solutions. Modern technologies are still too expensive and are unprofitable.

The challenge of the currently developing electromobility is to build infrastructure for charging electric vehicles. A long-distance trip without charging is impossible. The balance between electric and traditional vehicles is needed. With the further development of infrastructure and batteries, complete electrification of cars will be possible.

Smooth cooperation with the power system could cause mutual benefits. On the one hand, it could improve the security of power supply; on the other hand, it could be a solution to the

problem of energy storage from renewable sources, which are characterized by fluctuations in power generation.

REFERENCES

- [1] <http://nationalinstruments.lookbookhq.com/trend-watch-2018-en/vehicle-electrification-en>
- [2] H. Ibrahim, A. Ilinca, J. Perron, "Energy storage systems—Characteristics and comparisons" in *Renewable and Sustainable Energy Reviews*, vol. 12, pp. 1221-1250, June 2008.
- [3] J. Guziński, M. Adamowicz, J. Kamiński, *Pojazdy elektryczne – Rozwój technologii układów ładowania. Układy ładowania i współpraca z siecią elektroenergetyczną*, Wyd. Politechnika Gdańska.
- [4] H. Gładys, R. Matla.: *Praca elektrowni w systemie elektroenergetycznym*, Wrocław – Warszawa, WNT 1999.
- [5] W. Kempton, S. Letendre, *Electric vehicles as a new power source for electric utilities*. *Transportation Research Part D* 2 (3), 1997, pp. 157-175.
- [6] M. Skibowski, *Ładowanie pojazdów elektrycznych*, INPE vol. 186, 2013, pp. 21-28.
- [7] J. Guziński, M. Adamowicz, J. Kamiński, *Infrastruktura ładowania pojazdów elektrycznych*, *Automatyka, Elektryka, Zakłócenia*, vol. 1, 2014.
- [8] <https://www.climatecouncil.org.au/uploads/b5719aa238223c1b2acb126f734fc1fe.pdf>
- [9] <https://media.group.renault.com/global/en-gb/groupe-renault/media/photos/21194121/2017-batteries-seconde-vie>
- [10] <https://media.group.renault.com/global/en-gb/media/pressreleases/92203/renault-et-powervault-donnent-une-seconde-vie-aux-batteries-des-vehicules-electriques1>
- [11] https://www.tesla.com/de_DE/powerpack?redirect=no
- [12] https://www.tesla.com/de_DE/blog/Tesla-powerpack-enable-large-scale-sustainable-energy-south-australia
- [13] <https://newsroom.nissan-europe.com/uk/en-gb/media/pressreleases/145249/nissan-and-eaton-make-home-energy-storage-reliable-and-affordable-to-everyone-with-xstorage>
- [14] R. Czubiński, „Drugie życie” baterii z elektrobusów, <http://www.transport-publiczny.pl/wiadomosci/drugie-zycie-baterii-z-elektrobusow-53344.html>
- [15] <https://www.energy-storage.news/news/hyundai-group-awards-itself-65mw-130mwh-south-korea-solar-plus-storage-cont>
- [16] C. Grosjean, P.H. Miranda, M. Perrin, P. Poggi, *Assessment of world lithium resources and consequences of their geographic distribution on the expected development of the electric vehicle industry*, *Renewable and Sustainable Energy Reviews*, 16, 2012, pp. 1735-1744
- [17] J. Świątek, P. Biczal, *Baterie litowo - jonowe: zastosowanie produktu w energetyce zawodowej i przemysłowej*, w *górnictwie miedzi i węgla kamiennego*, w motoryzacji, *elektro.info*, 2016, 3, pp. 64-67
- [18] A.I. Stan, M. Swierczynski, D.I. Stroe, R. Teodorescu, S.J. Andreasen, *Lithium ion battery chemistries from renewable energy storage to automotive and back-up power applications—An overview*. In *Proceedings of the 2014 IEEE International Conference on Optimization of Electrical and Electronic Equipment (OPTIM)*, Brasov, Romania, 22–24 May 2014, pp. 713–720

The Importance of HVDC Transmission in Facilitating Green Energy Production

Marwan Ahmed
Elektrische Energietechnik
Abteilung,
Brandenburgische Technische
Universität, Cottbus
Email: ahmedmar@b-tu.de

Muhammad Hassan Akhtar
Elektrische Energietechnik
Abteilung,
Brandenburgische Technische
Universität, Cottbus
Email: akhtamuh@b-tu.de

Muhammad Ahmad
Elektrische Energietechnik
Abteilung,
Brandenburgische Technische
Universität, Cottbus
Email: ahmadmuh@b-tu.de

Abstract— In today's world where electricity generation from fossil fuels is diminishing by the day and that from renewable energy sources is ever increasing, HVDC transmission plays a vital role in facilitating the integration of renewable energy into the power grids. This paper discusses briefly why HVDC technology is the better counterpart to HVAC transmission technology, the different HVDC transmission configurations with their pros and cons and the social, economic and political impact HVDC technology has in today's world.

I. INTRODUCTION

Since the recent demand of increasing the share of renewable energy sources in the power grids, various challenges have risen that need to be tackled. One major issue is the large distance between the location of renewable energy sources and load centers. Furthermore, as the number of rotation masses from conventional power plants is decreasing by the year; grid stability and strength are adversely affected. These issues can be overcome by the use of High Voltage Direct Current (HVDC) transmission systems that will enable a smoother and easier control of power systems operations.

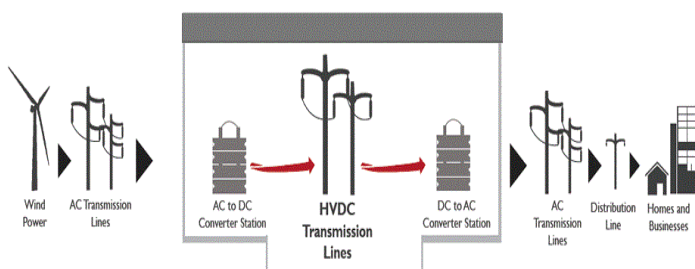

Figure [1]. Delivering Renewable Energy with HVDC [1]

II. HVDC BENEFITS

Fossil fuels can be moved anywhere according to the needs. It is costly but not impossible to build a new fossil fuel power plant close to the region where the demand of the power is more. On the other hand, renewable energy sources such as solar, wind and hydro are often located far away from the load

centers. The only viable solution to transport energy generated from these remote sources is through HVDC due to its low cost and losses for long-distance transmission.

HVDC is cost-effective for long-distance transmission as compared to AC lines. A HVDC transmission line costs less than an AC line for the same transmission capacity. However, the cost of converter stations on either end is generally high because of the fact they have to perform conversion from AC to DC and DC to AC. But over a certain distance of approx. 600km-800km, HVDC transmission becomes economical than AC as shown in the Figure [2]. For sub-sea cables, this break-even distance is much smaller (typically around 50 km) than for an overhead line. Moreover, the cost of power electronics required for HVDC grids is reducing gradually, hence the additional expense of converter stations is now becoming less of a concern in the bigger financial decisions. [2]

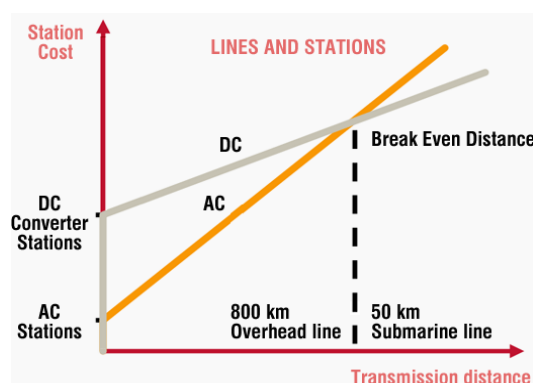

Figure [2]. Cost Comparison of HVDC and AC Line with Critical Distance of 600-800 Km [2]

HVDC has the benefit of changing the direction of power flow which makes it possible to connect wind, solar and other renewable energy sources beyond national borders such as in Europe. The power quality and stability can be well-managed in a HVDC network by injection of required power in case of peak or drop in demand. In the near future, even more new

HVDC networks will be integrated with the existing AC networks to make the system more flexible. [3]

The line losses in an HVDC transmission are lower than HVAC line of the same capacity as shown in the Figure [3], which shows that more power will reach the end consumer. A DC transmission line of the same capacity is generally cheaper to build, as it requires only two conductors in comparison to AC transmission (requires three conductors) along with narrower right-of-way requirement for transmission towers and other equipment. [4]

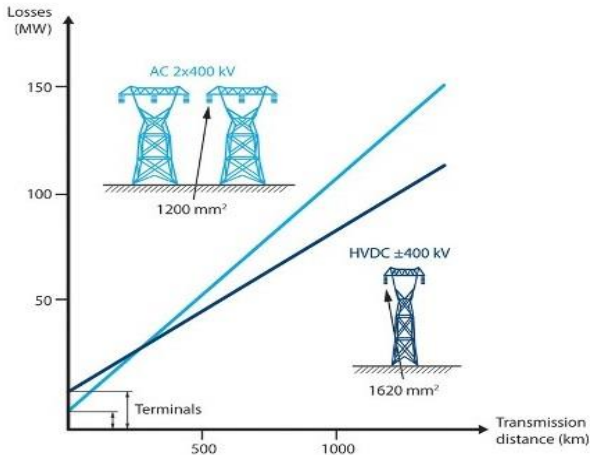

Figure [3]. Comparison of Losses in 1200 MW Overhead Line using HVDC and AC [2]

HVDC Transmission has been widely used for the past half century to fulfill the objectives of three applications namely:

- Long distance transmissions greater than 700 Km where they are more cost effective in comparison to their counter High Voltage Alternating Current (HVAC) Transmission Systems.
- Submarine cables transmission.
- Connecting two asynchronous AC systems i.e. AC systems with different frequencies from each other.

HVDC system has the capability to transfer power between two asynchronous systems by making use of converter stations at either end. AC transmission, on the other hand can only exchange power between systems that are in synchronization with each other. For the synchronization of two AC systems to be successful, the following four criteria has to be met where both AC systems must have: (1) same phase sequence, (2) same phase angle, (3) equal voltage magnitude, (4) same frequency. HVDC systems also provides the opportunity to disconnect two connected systems, in case of a fault at one end, which could prevent a possibly bigger outage event. [4]

HVDC system also has the advantage of interconnecting two different power systems. This interconnected system will help in efficient operation of existing generating plants tied to the network, so the building of new power plants can be postponed. The clear ecological benefit is not having to build a new power station instead using the available resources more

efficiently. For example, a large hydro power resource can be linked with thermal generation through HVDC. This will help in reducing thermal generation at peak demand and also facilitates more reliable operation of the power system as hydro helps thermal generation to work more efficiently at constant output.

Submarine DC cables are the most feasible option when connecting offshore wind farms to the main grid on land. The AC power generated from the generator of an offshore wind turbine is converted to DC current via a rectifier installed in the wind turbine housing. This DC output of the rectifier is then transmitted via submarine cables to an inverter converter station onshore where it is converted to AC and synchronized to the existing AC grid. A perfect example would be the offshore farms located in the North Sea in northern Germany.

III. HVDC CONFIGURATIONS

Power electronics technologies upon which HVDC transmission depends on is an ever evolving field with new innovations being constantly developed every day. However, the two most important, significant, common and robust HVDC transmission technologies available today are Line Commutated Converters (LCC) also known as Thyristor based converters and Voltage Source Converters (VSC) also known as Modular Multi Level Converters. LCC encourages energy trading and HVDC transmission, while VSC enables the connection of various variable energy resources and DC grids. In short, LCC is ideal for major bulk power projects and VSC is better suited for more compact projects [3]. This paper will focus on LCC technology.

A. LCC Technology: Principle of Operation and Ratings

Line commutated converters as their name implies depend on the instantaneous value of the line to line AC voltage to which the converter is connected to affect the commutation from one switching device (Thyristor or Diode) to its neighboring switch. In principle HVDC converters can be designed using diodes, however this makes the converter an uncontrolled unidirectional converter. This is impractical because for a HVDC transmission system that interconnects two AC systems to work, a converter operating in rectifier mode at one end of the HVDC line and another converter operating in inverter mode at the opposite end is imperative. For this reason, solely all converters are comprised of thyristor valves making them controlled converters with the possibility of operating as bidirectional converters in case anti-parallel thyristor are used as switching devices.

In LCC, the dc current output of the rectifier mode converter cannot change direction since it flows through a very large inductance and is therefore considered constant. As a result, on the AC side of the converter, the converter behaves like a current source injecting the fundamental grid frequency current and its accompanied harmonics. For this particular reason, LCC is also called a current source converter.

Each converter at a converter station is of the 12 pulse design. A 12 pulse converter is nothing more but two 6 pulse

converters connected in a such a manner that the lower commutation group of the first 6 pulse converter is connected to the upper commutation group of the second 6 pulse converter as shown in Figure [4].

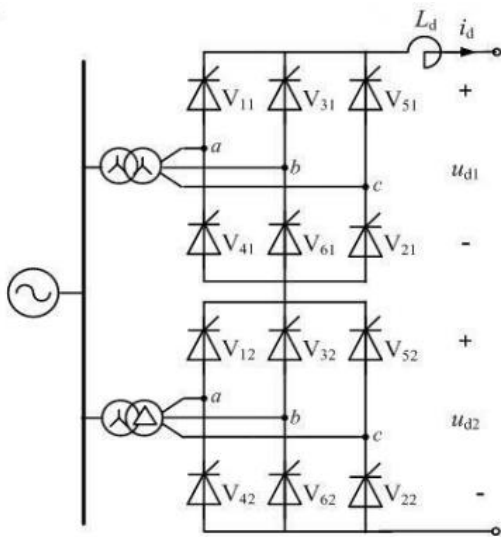

Figure [4]. 12 Pulse HVDC Converter using Thyristor Valves [5]

Twelve pulse converters have the advantages of an improved power factor and the harmonic components of the input line current is improved. This is possible by using a star-star connected transformer that is connected to the first 6 pulse converter and a star-delta connected transformer to the second 6 pulse converter. This creates a 30 electrical degrees shift between the output of both transformers which is simultaneously the input of each 6 pulse converter. The resulting output waveform of a 12 pulse converter can be seen in Figure [5].

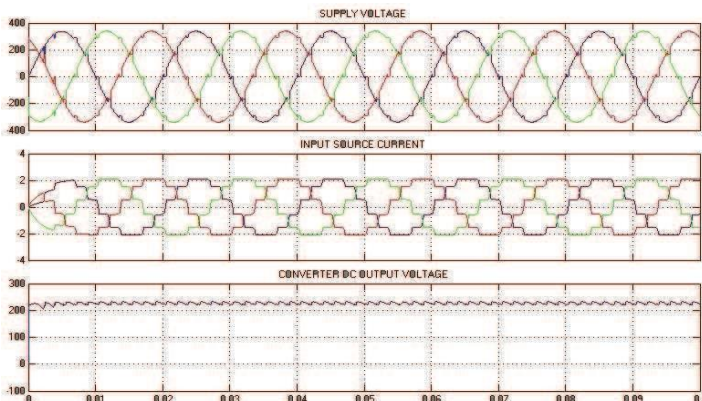

Figure [5]. Output Waveform of a 12 Pulse Converter with the same Gate Signal Firing Angle for all Thyristor Valves [6]

Since thyristors available by today’s standards have a rated voltage and current of approximately 8 KV and 6500 amperes respectively and the converter has to operate under voltages in the range of 500 KV and above. Therefore, each switch is comprised of several thyristors connected in series forming a single switch unit or as widely known a thyristor valve.

B. DC Circuit Configuration

Several DC circuit schemes exist however, only few are deemed practical. The most popular scheme is the bipolar configuration with ground return path shown in Figure [6].

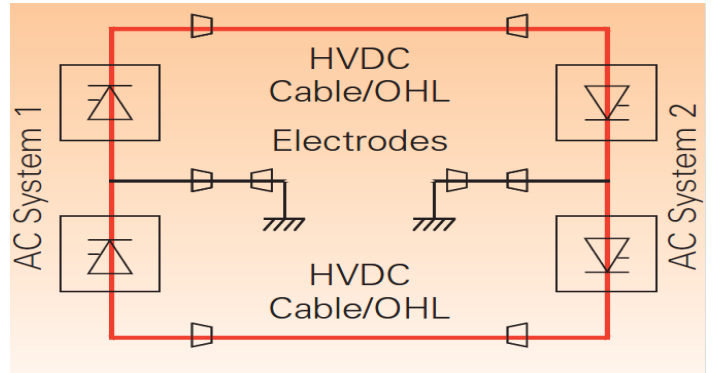

Figure [6]. Bipolar Configuration with Ground Return Path [7]

What makes this scheme is its versatility. For example, in case one or even two converter stations become out of operation, it is still possible to transmit power through the grid. This is achieved by performing several power system switching operations to convert the original bipolar with ground return scheme in to either a monopole with a metallic return path, Figure [7] or a monopole configuration ground return scheme, Figure [8].

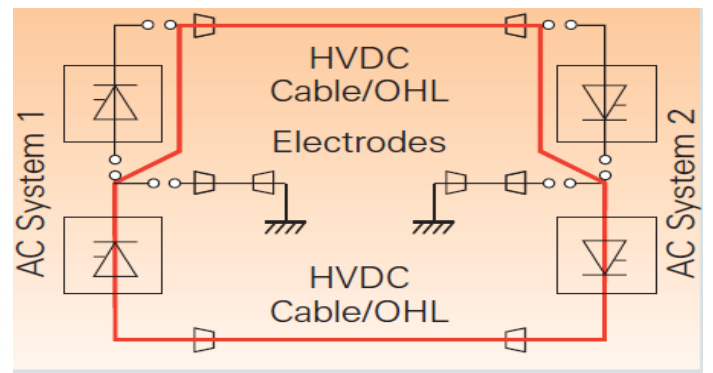

Figure [7]. Monopole Configuration with Metallic Return Path [7]

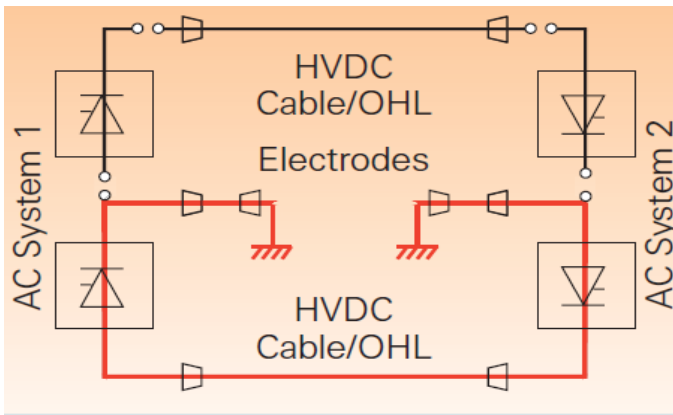

Figure [8]. Monopole Ground Return Scheme [7]

IV. HVDC'S ROLE IN SOCIAL, ECONOMICAL & POLITICAL ASPECTS

The notion for HVDC transmission started to gain attention after the Fukushima nuclear disaster in Japan. This accident led Angela Merkel, Chancellor of Germany to shutdown 8 of her country's 17 nuclear reactors and phase out the rest by 2022. South Germany which is a massive industrial load center, had its power needs met from the aforementioned nuclear power plants. In order to keep this massive industry in operation, the resulting power gap has to be filled by renewable energy sources that are located in the north of Germany. Around 10 gigawatts of power will need to be transmitted from north to south of Germany once the last nuclear plant is closed and the grid is not still up to the challenge. [9]

To fulfill this gap, Germany is considering HVDC transmission because HVDC seems cheaper option than settling only with AC grids. HVDC also offers an effective solution due to power electronics placed at either end. The direction and magnitude of the power transmitted on a line can be precisely controlled that is impossible for an AC line within the grids wide-open circuit. Due to these power electronics the cost of single HVDC line is well above than an AC line. But when the Germany's TSO's (Transmission System Operator) totaled up all the costs, they found that DC system would be less expensive way to enable the country's shift towards the renewables because less lines will be built or upgraded. [9]

One of the project that is planned to be in operation by 2025 is SuedOstLink. The SuedOstLink is a joint project of 50 Hertz and Tenne T. This HVDC link between Saxony-Anhalt and Bavaria will be able to transmit up to 2000 megawatts of electricity and will have approximated length of about 580 kilometers. This project was laid down as project No. 5 in the Federal Requirements Plan Act in May 2013. It has been codified by Germany's Federal Government and the Federal Parliament as a necessary element of its energy policy. [10]

There was also a debate on overhead lines and underground cables in Germany because the people in Germany were not in

the favor of overhead lines. So, Merkel's cabinet approved the plans for about 1000 km of high voltage underground cabling after protests against building lines above ground gathered momentum across the country, especially in the southern state of Bavaria. The underground cabling will cost between 3 billion euros and 8 billion euros more than the overland option and the extra expense is likely to be added to consumers' electricity bills.

However, the government argues that savings will be made with the underground cables in the medium-term because protests will be avoided and construction will be sped up. [11]

V. CONCLUSION

The share of HVDC technologies in power grids will increase exponentially in the next few decades. This increase in share is directly credited to the increase in power generation from renewable energy sources. This is an expected and easily predictable outcome since power generation from fossil fuels and nuclear energy is growing smaller by the year.

Last but not least, HVDC has proven on several scenarios it's the better option to its counterpart HVAC. Although HVDC has a higher initial cost, the pros gained over its running life time by far outweigh any gains from HVAC.

Finally, technical aspects are just one side of the coin when it comes to HVDC. Social, economic and political aspects play a vital role in shaping the future of power grids. HVDC has been the solution to several socio-economic/political demeanors in the past.

REFERENCES

- [1] Michael Hartnack, (2018), HVDC; The Future of Long-Distance and Renewable Transmission , URL: <https://www.navigantresearch.com/blog/hvdc-the-future-of-long-distance-and-renewables-transmission>
- [2] Electrical Engineering Portal (EEP), Analysing the costs of High Voltage Direct Current (HVDC) transmission, URL: <https://electrical-engineering-portal.com/analysing-the-costs-of-high-voltage-direct-current-hvdc-transmission>
- [3] Jennifer Van Burkleo, (2013), HVDC, the Key to Revolutionizing the Renewable Energy Grid, URL: <https://www.renewableenergyworld.com/articles/2013/09/hvdc-the-key-to-revolutionizing-the-renewable-energy-grid.html>
- [4] Chuck Ross, (2016), Power to the People: HVDC Brings Renewable Energy into the Mainstream, URL: <https://www.ecmag.com/section/systems/power-people-hvdc-brings-renewable-energy-mainstream>
- [5] Patrick Plas, (2017), Expediting a Renewable Energy Future With High-Voltage DC Transmission, URL:

<https://www.greentechmedia.com/articles/read/expediting-a-renewable-energy-future-with-high-voltage-dc-transmission#gs.XIQNall>

- [6] Shodh Ganga, URL:
http://shodhganga.inflibnet.ac.in/bitstream/10603/146770/10/10_chap2.pdf
- [7] Siemens AG Energy Sector, (2011), URL:
https://www.energy.siemens.com/ru/pool/hq/power-transmission/HVDC/HVDC_Proven_Technology.pdf
- [8] Siemens AG Energy Sector, (2014), URL:
<https://www.siemens.com/press/pool/de/feature/2013/energy/2013-08-x-win/factsheet-hvdc-e.pdf>
- [9] Peter Fairley, (2013), Germany Takes the Lead in HVDC, URL:
<https://spectrum.ieee.org/energy/renewables/germany-takes-the-lead-in-hvdc>
- [10] 50 Hertz, SuedOstLink Project, URL:
<http://www.50hertz.com/en/Grid-Extension/Onshore-projects/SuedOstLink>
- [11] Reuters Staff, (2015), German Cabinet agrees to costly underground power lines, URL:
<https://www.reuters.com/article/germany-energy-power/german-cabinet-agrees-to-costly-underground-power-lines-idUSL8N12722320151007>

BIOGRAPHICAL INFORMATION



Marwan Ahmed graduated with a BSc. Degree in Electromechanical Engineering from Alexandria University, Egypt back in 2012. In October 2017, he started pursuing a MSc. Degree in Electrical Power Engineering at Brandenburgische Technische Universität Cottbus, Germany. Prior to arriving in Germany he worked as a Senior Site Engineer with ORASCOM Construction Companies in a joint venture project with SIEMENS in the erection of a 4800 MW combined power plant. Marwan has been involved in several other projects with Mitsubishi, Toshiba and Deutsche Bahn.



Muhammad Hassan Akhtar received his BSc. Degree in Electrical Engineering from University of Engineering and Technology (UET), Taxila, Pakistan in 2014. Currently, he is pursuing his MSc. Degree in Electrical Power Engineering from Brandenburgische Technische Universität Cottbus, Germany since October 2017. Previously, he served as Electrical Engineer with SNGPL, Pakistan where he was involved in the technical

support of PLC & SCADA systems. His current research interests are in the field of power electronics and renewable energies.



Muhammad Ahmed received the BSc. Degree in Electrical Engineering from The Islamia University of Bahawalpur in 2015 and currently pursuing his MSc. Degree in Electrical Power Engineering from Brandenburgische Technische Universität Cottbus, Germany from 2017 and ongoing. During the course of his Bachelor thesis, he worked on “Design & Upgradation of a Substation using MATLAB Simulink”. He has now focused his research in the area of power electronics & its applications with the aim to build innovative technologies for the future world.

Smart meters

Data Mining

Esbol Naimen

Faculty 3 Industrial Engineering
BTU Cottbus - Senftenberg
Cottbus, Germany
esbol@naimen.de

Yan Cheng

Faculty 3 Industrial Engineering
BTU Cottbus - Senftenberg
Cottbus, Germany
chengyan0120@gmail.com

Abstract— Smart meters provide time-resolved data concerning utility consumption, by monitoring the usage of electricity, water and gas on the premises of the consumers. The data is transmitted to central servers where they are analysed and evaluated for multiple purposes, such as billing and deriving usage profiles, e.g. for further marketing. Furthermore, these profiles can be used for additional processing to gain insight about the infrastructure, the appliances, and the users. The data involved form the core of a rapidly emerging market, which causes debates about the legitimacy of the usage of data and the implications to privacy and human dignity.

Keywords- smart meters, data mining, utility providers, data protection, privacy

I. INTRODUCTION

Smart meters are devices for metering utility consumption data in industry and in private households. The meters are capable of monitoring, storing, analysing, and transmitting consumption-related data, as well as receiving information from the utility provider and other authorized users, e.g. instructions to shut off the supply at the user's volition, or initiated by the utility provider in case of non-payment, or technical defects on the premises.

Recent technical developments have enabled evaluating time-dependent consumption levels at such detail that user profiles and consumer-device identifying utility consumption profiles can be derived and further evaluated for market analysis and social grouping and stratification. This form of “data mining” has the potential of gaining rapidly in size and significance in an increasing information-driven market.

The objective of the present study is to identify the state-of-the-art technology of what is currently available for the purpose of data mining with smart meters, to point out some potential marketing strategies for the processed data, and to briefly address the concerns of data protection and privacy, as well as ownership of the raw and processed data extracted from the user-generated consumption data profiles.

II. TECHNICAL FEATURES OF SMART METERS

Smart meters which measure and monitor utility usage and have the capability to communicate with remote entities, e.g. the respective utility provider, using standard transmission protocols like GSM, or the Internet Protocol over fixed lines, were introduced in the 1990s. The first patent application

mentioning the term “smart meter” was published in 1998 in the USA [1]. The technical development of these smart meters grew over the course of the following decade and peaked in the period 2010-2013 [2]. The technical development focussed on the aspects of measuring and displaying the consumption data locally, as well as transmitting the raw or analysed and aggregated data to the utility provider and also for receiving information at the consumer site with a relevance to billing and technical operability. The components making up the networked devices from the bulk producer of the utility to the individual appliances at private residences is shown in Fig. 1.

A. Measuring and Monitoring

The consumption of electricity is most commonly measured in units of kilowatt-hours by means of an electromechanical type induction meter [3]. Such meters comprise coils and a revolving non-magnetic electrically conductive disc exposed to eddy currents driving the disc. The angular speed of the disc is proportional to the electrical power consumed by the load being monitored. A magnet attached to the disc can cause, e.g. a reed switch to produce a pulse each time the disc rotates a full turn and the magnet passes by the reed switch [4]. Each full turn of the disc corresponds to a certain amount of energy. The pulses of the reed switch may be counted and used for digital processing of the consumed electrical energy.

Meters for measuring flow of fluids, such as gas and water, function typically in a purely mechanical manner as rotary displacement meters and can be equipped with means for electronic output of consumption related data such as electric puls-

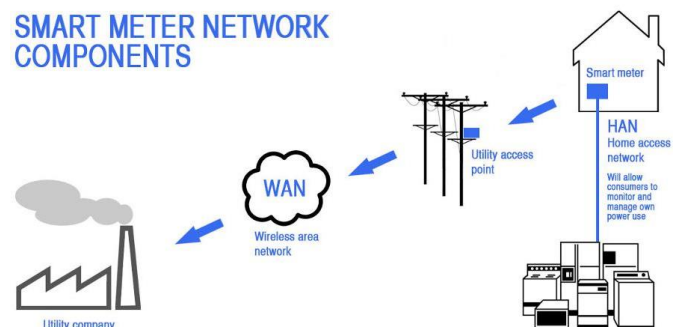

Figure 1: Smart meter network components [42]

es, in similar ways as the electricity meters [5], [6].

Smart meters do not only measure physical parameters of the utility being observed, i.e. electricity, gas, or water, but also track the usage over time, which is called monitoring [7]. The temporal resolution thereby may be as fine as seconds and may extend to long periods such as years, for displaying and evaluating real-time consumption and the evolution of usage patterns and cycles over vastly different time spans [8].

The monitoring may be implemented as locally installed individual appliance monitors or remotely read devices such as non-intrusive appliance load monitoring from a central server [9].

B. Storing

Mechanical meters with dials do not need electronic storage means, as they maintain their count value and present it to a (human) reader for noting and billing purposes.

Yet, smart meters rely on electronic storage and processing of the data retrieved from clocks and the actual metering device. Therefore, in smart meters electronic storage devices are used which are tamper-proof and fail-safe, also in the event of power failure or other technical faults, since the data is essential for the billing accuracy of the utility provider. These smart meter memory devices are long-life, non-volatile, and encrypted, with remote updating capability and attached to communications modules for presenting the data locally, e.g. on a display and for remote reading [10].

Wherever the amount of data becomes too large for local storage, or if big amounts of data are to be analysed, e.g. originating from numerous different smart meters or individual appliance monitors over extended periods of time, an aggregation and storage of the data in centralized servers has been established [11]. Such a system requires automated transmission of metering data to the central server, which in itself implies the implementation of the hardware and software features enabling the necessary functionality [9].

C. Analysing

The data collected for analysis are normally disaggregated, analysed and interpreted centrally [9], using different tools such as peak consumption identification [12], leakage detection in the water supply [13], load analysis by deconvolving usage patterns of individual appliances [14], and identifying consumer devices based on simplified data analysis such as the occurrence of certain power levels in a load cycle to generate a load signature which identifies the device [15].

These methods are capable of providing both summarized and detailed information about the times of usage of types of devices or individual appliances, the amount of energy consumed over short and long periods, the types of appliances used in households and industry, as well as daily, weekly, and seasonal usage patterns [9].

The purpose of the analysis is not limited to provide data relevant to the utility providers but also to the consumers and for other parties which may have legitimate interests in analysed and aggregated data, e.g. for planning infrastructure.

Economic interests of third parties may also be considered legitimate as the principle source of wealth [16].

D. Transmitting

For reading out smart meters, different technical solutions and legal restrictions apply.

There is the near-field operation, which includes displaying consumption-related data for local inspection and monitoring by the users of the appliances. Such monitoring by the users is intended to provide the consumers with relevant information on their usage patterns and behaviours, as well as to enable informed choices on different offers from utility providers. In a deregulated market with multiple competing utility provider companies, informed customers form an essential part of a functioning market. Smart meters may include near-field (NFC) radio-frequency (RF) transmission of consumption-related data, which can be read out by means of mobile reader devices [17]. Such devices may be used by the consumers at their premises as well as by staff of the utility provider. Meter reading from outside the premises requires different RF protocols having a somewhat larger range than NFC. Long-range transfer technologies and protocols are available for centralized communication with cloud servers and analysis systems, such as GSM using wireless transfer, TCP/IP over telephone and power grid lines, making use of wired and wireless networks. A multitude of transfer protocols are documented by the International Electrotechnical Commission [18].

Not all technically possible communication is desirable or within the applicable legal framework. In Germany, the Metering Point Operation Act limits the transmittal of data by default to once a year, and exclusively for billing purposes, or additionally on an opt-in basis for customers who want to provide additional information, also at a higher rate of data transmission [19].

E. Receiving

Smart meters are characterized by the bi-directionality of the communication pathway. In addition to sending consumption-related data, smart meters are also capable of receiving information, e.g. concerning the operational functions, such as software updates and tokens, but also emergency shut-off in case of faults or economically driven shut-off instructions in case of non-payment of bills or a change in the contracting partners. These wanted features of remote control can be abused by unauthorized agents and are therefore a source of an on-going debate on the security of remotely controllable smart meters [20].

III. ECONOMIC SIGNIFICANCE OF ANALYSED DATA

The technological evolution of and around smart meters is driven by strong economic interests for a multitude of reasons [21], such as of utility providers wanting to use the data retrieved from their customers for planning and billing, by manufacturers of household appliances to gain insight in the spatial distribution of their products, for adapting their devices according to user requirements, for making use of the temporally resolved data on the usage of various appliances, etc. Additionally, the data enables analysts to derive aspects of household

sizes and compositions, as well as life-style related aspects, which may be used for economic considerations [12].

A. Usage profiles

Usage profiles may be related to appliances or consumers, i.e. the users of the utility provided [14].

1) Devices

The analysis may produce aggregated data on groups and types of devices, based on location or time of use, and may make use of identifiers for such groups and single appliances [15].

2) Consumers

Usage profiles may be attributed to individuals or groups of users in industry, housing blocks, and single private households [9]. An important aspect relates to the economic significance of the ownership of the raw and processed data. As government agencies remain silent or vague on the issue and tend to focus the debate towards data security [19], the economic aspects of ownership are debated [22], whereby the utility providers assert the ownership of the data retrieved and processed [23].

B. Evaluation for Supply

Utility providers are highly concerned with the correct sizing of their installations and the maintenance thereof. Driving factors are both their own entrepreneurial drive for profits and the need to meet the regulatory requirements concerning safety and security as well as a guaranteed continuity of supply of the utility to the customers. In a competitive market, pricing is best based on the input of relevant, time-resolved data.

1) Installations

Peaks of instant demand infer overly large capacity of supplier installations (electricity) [24] and long-term dips in water consumption may indicate problems arising both with insufficiently flushed fresh-water pipes and sewers.¹

2) Maintenance

In addition to continuous servicing the utility provider's own installations, the grid operators also need to provide, monitor, and service their lines and pipes, in order to identify faults such as leaks and electrical shorts or creepage currents. Localization of these faults may be aided by evaluation of usage patterns of consumption data provided by smart meters to the utility and grid providers.

3) Pricing

Intelligent pricing requires the input of time-resolved information on demand, such that the price and the consumer's actions can be adapted accordingly [8]. This can be implemented not only for maximizing the profit but also to spread the usage over periods of lower demand, by making it financially more attractive than the peak times [25].

Additionally, pricing could also reflect under-usage of a utility, which makes the maintenance of the installations rela-

¹ Electrical energy must be generated and transported to the consumers at the time of the demand [25]. Peak demand periods constitute a costly challenge to the providers [38]. Under-consumption of drinking water may cause pathogenic legionella bacteria to grow in unused fresh-water pipes [39], and may cause clogging in sewers [40], and is therefore to be avoided.

tively costly or may even cause additional harm, as with unused fresh-water pipes and drainage systems.

C. Evaluation for Marketing

Intelligent networked devices ("internet of things") may be configured to respond flexibly to utility prices varying over time, such that the utility is used when prices are low, or at least not at times of peak prices [26]. Energy efficient appliances can be market by incentivizing their purchase and use over their detection in power consumption patterns analysed by the utility providers [27].

A multitude of agents have been identified who may have economically based interests in making use of data originating from smart meters [28]. Table I. lists the interested parties and how they could use the data obtained.

TABLE I. PARTIES INTERESTED IN SMART METER DATA²

Who wants smart meter data?	How could the data be used?
Utilities	To monitor electricity usage and load; to determine bills
Electricity usage advisory companies	To promote energy conservation and awareness
Insurance companies	To determine health care or life insurance premiums based on behaviours that might indicate illness
Marketers	To profile customers for targeted advertisements
Civil litigators	To identify property boundaries and activities on premises
Landlords	To verify lease compliance
Private investigators	To monitor specific events
The press	To get information about famous people
Employers	Knowledge of life-styles enables employers to select future and control current employees
Creditors	To determine behaviour that might indicate credit-worthiness

IV. EVALUATION FOR SURVEILLANCE AND CONTROL

The state as the institution for crime prevention, suppression and prosecution may be considered legitimately interested in evaluating data derived from smart meters, e.g. to identify suspicious or illegal activity.³

Smart meter data can form a part of a more comprehensive surveillance of consumers [29], be it for political steering via targeted user-specific appeals and manipulation in social media [30], or for early detection of usage patterns statistically correlated to criminal behaviour, although the latter may be not directly linked to the former [31].

V. DATA PROTECTION AND OWNERSHIP

Smart meter and smart grid technologies give rise to multifaceted considerations including economic aspects, such as ownership of data and potentials for a corresponding licensing market, and the highly important notion of human dignity in

² source:[29], amended by E. Naimen

³ In the 2001 legal case *Kyllo v. United States* [34], the government used monthly utility bills to "show that the suspect's power usage was 'excessive' and thus 'consistent with' a marijuana-growing operation."

context with data protection. In this chapter, two aspects which the authors consider highly relevant, are illustrated briefly.

A. Data Protection as a Human Right to Privacy

The German Federal Constitutional Court ruled as early as 1983 that the self-determination concerning personal data is fundamental to human dignity and therefore an unalienable human right [32]. Since then, both technology and mile-stone legislation and jurisdiction have further developed striving to balance legitimate economic and legal interests of the stake holders concerned with smart meter data mining. The underlying principles in the debate can be summarized as safeguarding individual freedom from excessive observation on the one hand [33], and on the other hand enabling technology-based law enforcement [34] and legitimate business interests as a growing branch of the economy. Additionally, increasing attention is given to the democratic autonomy of the consumers to agree to or disallow the use of their personal data, for purposes he or she is free to determine, e.g. in contracts and licensing agreements [35]. Contrastingly, attention is drawn to defects in the free-market oriented approaches, where local monopolies are effective or the users are subject to manipulative actions biasing their decisions and thereby infringing on their actual autonomy [36].

B. Ownership

Conventionally, the utility providers install and own the smart meters inside the premises of their customers, i.e. the consumers. The data being acquired by, stored in and transmitted, is then considered to be owned by the utility provider [23]. Following the notion of self-determination of personal data, as ruled by the German Supreme Court [32], it appears to be more consistent to consider the raw data, which was caused and thereby created by the users, to remain within their personal property. It may be considered an unalienable personal right, similar to an author's copy right of text or an artist's of his work. Revocable licensing agreements and contracts may be implemented in a legal framework, safeguarding the consumer's interests versus the overwhelming power of the utility providers. Regulations similar to the telecommunications and banking regulatory measures are thinkable. The ownership of processed data, along with a practical definition of what that constitutes, may be attributed to the agency which produced that data. This could take the form of a dependent ownership, similar to the concept of dependent patents⁴: The owner or processed data can use or sell that data only within the terms of the license he has acquired from the owner of the raw data.

VI. CONCLUSION

The market of smart meters and smart grids along with technically related fields is a rapidly growing technology driven market of goods, services, and data. It is a prime example of the rising economic significance of raw and processed data. In order to safeguard human dignity and to maintain the consumer's role and rights as the central agent who determines the conditions he lives in, in the sense of the user being the subject rather than the object of extraneous interests and activities, social and legal standards and regulatory measures need

⁴ If a later patent can only be used together with (a license of) an earlier patent, then the later patent is a dependent patent [41].

to be adapted rapidly, adequately, and continuously. Such adaptations have shown to be normally slow in democratic structures, yet should keep up with the rapidly increasing technical potential and creative economic use in this emerging market. Shifting the law-making process during its preparatory work away from economically driving interest groups and populist demagogues, towards persons skilled in technology, social sciences, and legal practise appears to be warranted. Engaging more highly skilled experts of various fields of technology, economics, social sciences, and legal practise, in the drafting of legal texts appears to yield more adequate solutions more rapidly than the present practise does.

VII. ACKNOWLEDGEMENT

The authors thank V. Kurze for proofreading and given his feedback.

- [1] Google. Google Patents. [Online]. <https://patents.google.com/?q=smart+meter:&q=measuring:&q=monitoring:&q=water:&q=gas:&q=electricity&language=ENGLISH&type=PATENT&num=100>
- [2] Wilfred, A. GILLBERRY, US Patent 1996071966, 1998
- [3] electrical4u. [Online]. <https://www.electrical4u.com/watt-hour-meter/>
- [4] Standex-Meder Electronics. Smart Utility Meters Use Reed Sensors To Measure Water Flow, Gas and Electricity. [Online]. <https://standelectronic.com/applications-markets/utility-meter/>
- [5] Kalwinder Kaur. (2013, July) Basic Principles of a Gas Meter. [Online]. <https://www.azosensors.com/article.aspx?ArticleID=250>
- [6] Teledyne Instruments. (2013, July) Basic Principles of a Water Meter. [Online]. <https://www.azosensors.com/article.aspx?ArticleID=251>
- [7] Félix GÓMEZ MÁRMOL, European Patent EP2540027, 02-01-2013.
- [8] Eon Energy. With smart meters, your energy's easier to understand because you can see what you're using. [Online]. <https://www.eonenergy.com/~media/energy/Chameleon%20SED%20guide.pdf>
- [9] L Stankovic, V Stankovic, J Liao, and C Wilson, "Measuring the energy intensity of domestic activities from smart meter data," *Applied Energy*, vol. 183, pp. 1565–1580, 2016.
- [10] Margery Conner. (2011, Aug.) What's inside a smart meter? [Online]. <https://www.edn.com/design/power-management/4368353/What-s-inside-a-smart-meter-iFixit-tears-it-down>
- [11] Wengting Li, Yan Zheng, Shaobo Liu, Zhaozhi Long, and Zhicheng Li, "Research of Smart Meter Massive Data Storage Based on Cloud Computing Platform," *Applied Mechanics and Materials*, vol. 341-342, pp. 1434-1438, July 2013.
- [12] Jing Dai, Feng Chen, Milind R. Naphade, and Sambit Sahu, "Utility consumption disaggregation using low sample rate smart meters," application US 2013/0103215 A1, Apr. 25, 2013.
- [13] Michael Edward Klicpera, "Water Use/Water Energy Use Monitor and/or Leak Detection System," patent application US20160163177A1, June 09, 2016.
- [14] Simon Richard Daniel and Christopher Verity Wright, "Systems, devices and methods for electricity provision, usage monitoring, analysis, and enabling improvements in efficiency," application US20100076615A1, Mar. 25, 2010.
- [15] Patrick A. Rada and John H. Magnasco, "Automatic detection of appliances," patent application EP2529190A1, Dec. 05, 2012.
- [16] Adam Smith, *The Wealth of Nations*. London, GB: W. Strahan and T. Cadell, 1776.
- [17] NXP Semiconductors. (2011, Oct.) NFC Enables Secure Wireless Access to Smart Meters. [Online]. <http://www.marketwired.com/press-release/nfc-enables-secure-wireless-access-to-smart-meters-nasdaq>

- nxi-1568479.htm
- [18] International Electrotechnical Commission. Publications relating to IEC 62056. [Online]. <https://webstore.iec.ch/searchform&q=62056>
- [19] Bundesministerium für Wirtschaft und Energie. FAQs about the Metering Point Operation Act and smart meters. [Online]. <https://www.bmwi.de/Redaktion/EN/FAQ/Smart-Meters/faq-smart-meters.html>
- [20] Mihai Costache, Valentin Tudor, Magnus Almgren, Marina Papatriantafillou, and Christopher Saunders, "Remote Control of Smart Meters: Friend or Foe?," in *2011 Seventh European Conference on Computer Network Defense (EC2ND)*, Gothenburg, Sweden, 2011, pp. 49-56.
- [21] Noelia Uribe-Pérez, Luis Hernández, David de la Vega, and Itziar Angulo, "State of the Art and Trends Review of Smart Metering in Electricity Grids," *Applied Sciences*, vol. 6, no. 68, 2016.
- [22] Michelle Froese, "So, who owns your energy-use data?," *Windpower Engineering & Development*, pp. 39-41, Oct. 2015.
- [23] Avista Corporation, "Who owns energy consumption data?," US Department of Energy,.
- [24] U.S. Energy Information Administration. (2017, Aug.) How Electricity Is Delivered To Consumers. [Online]. https://www.eia.gov/energyexplained/index.php?page=electricity_delivery
- [25] Raj C. Aswin, E. Aravind, B Ramya Sundaram, and K. Vasudevanb Shiram, "Smart Meter Based on Real Time Pricing," *Procedia Technology SMART GRID TECHNOLOGIES*, vol. 21, pp. 120-124, 2015.
- [26] Ivan O'Neill. (2010) Prices to Devices: Price Responsive Devices and the Smart Grid. [Online]. <https://www.oasis-open.org/committees/download.php/40685/Price>
- [27] Souvik Datta and Sumeet Gulati. (2010, Oct.) UTILITY REBATES FOR ENERGY STAR APPLIANCES: ARE THEY EFFECTIVE? [Online]. http://www.cepe.ethz.ch/content/dam/ethz/special-interest/mtec/cepe/energy-and-public-econ-dam/documents/people/sdatta/datta_energystar_october2010.pdf
- [28] Ariel Bleicher. (2010, Oct.) Privacy on the Smart Grid. [Online]. <https://spectrum.ieee.org/energy/the-smarter-grid/privacy-on-the-smart-grid>
- [29] Juliane Schiemenz. (2014, Aug.) Spiegel Online. [Online]. <http://www.spiegel.de/netzwelt/netzpolitik/anti-smart-meter-bewegung-widerstand-gegen-intelligente-stromzaehler-a-984085.html>
- [30] Samuel C. Woolley and Philip N. Howard, "Computational Propaganda Worldwide: Executive Summary,," *Project on Computational Propaganda*, July 2017.
- [31] Jana Diesner and Kathleen M. Carley. (2010) Relationale Verfahren in der Erforschung, Ermittlung und Prävention von Kriminalität. [Online]. http://jdiesnerlab.ischool.illinois.edu/publications/Diesner_Carley_crime_authorversion.pdf
- [32] Bundesverfassungsgericht. (1983, Dec.) Volkszählungsurteil. [Online]. <https://openjur.de/u/268440.html>
- [33] Thomas D. Colbridge, "Kyllo v. United States: Technology Versus Individual Privacy," *FBI Law Enforcement Bulletin*, vol. 70, no. 10, pp. 25-32, Oct. 2010.
- [34] Süddeutsche Zeitung. (2013, Aug.) Videoüberwachung in Bayern Gefühlte Sicherheit. [Online]. <http://www.sueddeutsche.de/bayern/videoeueberwachung-in-bayern-gefuehlte-sicherheit-1.1735967>
- [35] Department for Business, Energy & Industrial Strategy. (2018, Apr.) Smart Metering Implementation Programme. [Online]. https://assets.publishing.service.gov.uk/government/uploads/system/uploads/attachment_data/file/700382/SMETS1_maximising_interoperability_enrolment_mandate_consultation.pdf
- [36] Yu.I. Ossik, Z.N. Borbasova, O.V. Prokopenko, and V.Z. Valeeva. (2017) MARKETING OF INNOVATIONS & INNOVATIONAL MARKETING. [Online]. https://essuir.sumdu.edu.ua/bitstream/123456789/52055/1/Marketing_innovations_Osik_Prokopenko.pdf
- [37] Wilfred, A. GILLBERRY, US Patent 1996071966, 1998.
- [38] Krzysztof Gajowniczek, Rafik Nafkha, and Tomasz Żąbkowski, "Electricity peak demand classification with artificial neural networks," in *2017 Federated Conference on Computer Science and Information Systems (FedCSIS)*, Prague, Czech Republic, 2017, pp. 307-315.
- [39] MAR Services. (2016, Apr.) Preventing legionella - simple ways to keep this serious illness at bay. [Online]. <http://www.marservices.co.uk/preventing-legionella-simple-ways-keep-serious-illness-bay/>
- [40] Meiners. (2016, Oct.) VERSTOPFUNGEN DURCH WASSERSPAREN – URSACHE UND LÖSUNGEN. [Online]. <https://meiners-glueckstadt.de/verstopfungen-durch-wassersparen/>
- [41] Deutsches Patent- und Markenamt. Abhängiges Patent. [Online]. <https://www.dpma.de/service/glossar/a-d/index.html>
- [42] EMF & RF Solutions. Exploring The Truth About Smart Meter Dangers & Health Risks. [Online]. <http://www.emfrf.com/exploring-the-truth-about-smart-meter-dangers-health-risks/>

Vehicle to Grid: Benefits and Barriers

Omer Madani, Robin F. Seitz and Gamze Delioglu

Abstract - The current electric vehicles (EV) can not only contribute to an emission-free environmentally-friendly car drive but could also serve as a small storage and thus feed electricity into the domestic network. Vehicle-to-Grid (V2G) and Vehicle-to-Home (V2H) represent possible technologies that would create storage capacities and be intelligently and bidirectionally connected to the power grid. The expansion of the existing technology could help to invest more in EVs, to support the spread of EVs, and in this case to promote the use of renewable energies.

electricity, electricity market, electric vehicles (EV), renewable energy, smart grid, storage, vehicle-to-grid (V2G)

I. INTRODUCTION

Fossil fuels are currently crucial for global transport. That includes a number of sobering, negative environmental and social impacts [1]. On the other side, there's a rising demand for electric cars, that will inevitably affect the electricity grid. Additionally, renewable energies are constantly being expanded. This development of renewable energies has led to immense hydropower and solar power generation. However, nature is unpredictable this led to increased concern about disruption of energy production [2]. A possible solution for this problem is Vehicle-2-Grid (V2G).

II. FUNCTIONALITY OF V2G

V2G means that electric vehicles have the opportunity to be integrated in the grid, manage power flow and could displace the need for an electric utility infrastructure [1].

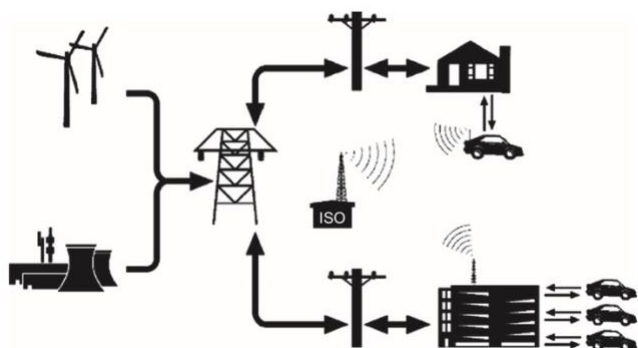

Figure 1. Concept of V2G

As we can see in Figure 1 electric cars can be used as power sources or for energy storage [1]. If V2G would be

accepted by the owners of electric cars, this technic could heavily decrease emissions in the transportation sector [3].

Also, Back-up power, support for load balancing and reduced peak-loads can be provided by V2G [4]. Furthermore, uncertainty in the forecast of daily and hourly electrical load can be reduced [5]. At least VG2 allows a better use of the existing generation capacity [6].

As we can see in Figure 2, according to a simulation from 2000 to 2100, in Europe, V2G offers the largest storage potential compared to other options such as standalone batteries, compressed air storages or pumped storage power plants [7].

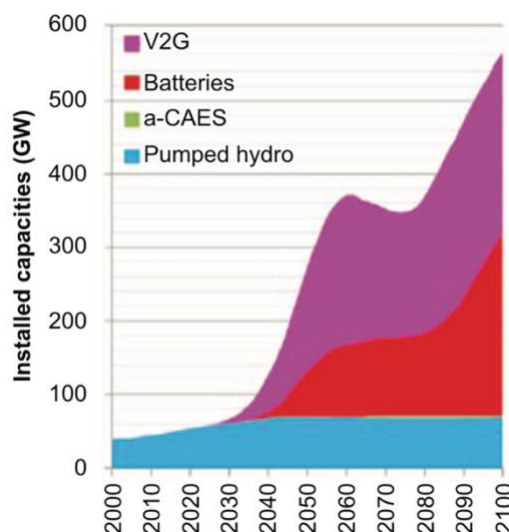

Figure 2. Simulated capacities of different energy storage technologies from 2000-2100

III. TECHNICAL REQUIREMENTS

The main problem on EV was always the electricity capacity. Different kind of batteries like lead acid, nickel cadmium, nickel metal hydride, and even lithium ion batteries

have already achieved progressively higher energy density measured in watt hours per kilogram. But some disadvantages like cost, energy, power (i.e., the amount of energy that can be released quickly), life expectancy, and safety have maintained [8].

Despite these constraints, there has already been a trend towards increased electrification of cars starting with increasingly powerful hybrids and nowadays even completely EV. And the market for them is immensely rising as you can see in the Forecast (Fig. 3) for the years 2016-2025 the share of electric vehicles is growing.

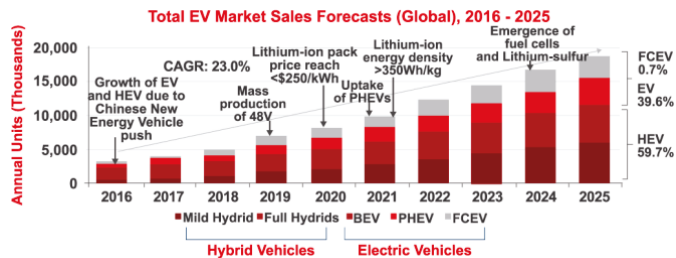

Figure 3. Total EV Market Sales Forecast (Global), 2016 -2025

Of all those metals named that are available for battery chemistry, the battery industry has long considered chemistries based on lithium to be the most efficient. Lithium is available in big amounts. 15 million tons of lithium are available in brine resources and approximately 2 million tons are available in ore deposits. These could be used to produce 1 billion fully electric or 10 billion hybrid electric vehicles. Lithium is not toxic and it is the lightest metal on the periodic table. The biggest advantage is that it has a high specific energy content and that the organic electrodes are protected from corrosion by a film, called the SEI layer, which protects the electrode and still allows lithium ions to pass through. Inside a lithium-ion battery there are the two electrodes, the cathode (+) and the anode (-) which accommodate the lithium ions. While the batteries discharge the lithium-ions move from the negative anode to the positive cathode and pass the electrolyte and the separator. While the battery charges the reversed process can be seen (Fig. 4). The batteries that will be used in the next generation electric vehicles are known as “Advanced Lithium Ion Batteries” [8].

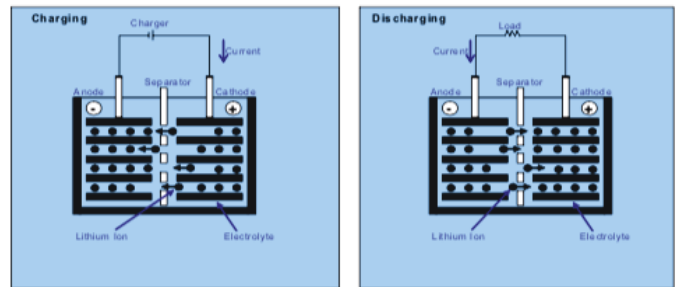

Figure 4. Functionality of lithium-ion battery

IV. INTEGRATION AND STORAGE OF RENEWABLE ENERGY

Several studies have shown that integrating V2G into a microgrid lowers operating costs, reduces the dependency on the outside grid and increases the benefits of renewable energy [9]. For example, a study found that in a great American regional transmission organization, an integrated V2G, can be boosted by renewable energies up to 51 GW, an increase of nearly 30% compared to a scenario without V2G [10].

In a study, the effects of V2G-usage on the lifetime performance of Li-ion cells were tested. For the study a nominal realistic driving schedule based on aggregating driving survey data and the Urban Dynamometer Driving Schedule were derived and a vehicle physics model was used to create a daily battery duty cycle. To perform the use of V2G use in the afternoon to displace grid electricity, different degrees of continuous discharge were imposed on the cells. The capacity loss of the batteries was measured as functions of the capacity that is integrated and of the energy that is processed by the cells. The tested cells showed that 95% of the original capacity of them lasted after a simulation of thousand days of driving. The percentage of capacity loss per Wh for V2G support is $-2.70 \times 10^{-3} \%$, which is quite low. It shows that the capacity loss of the cells for a thousand V2G supported driving days doesn't even reach 10%. Nonetheless there are V2G-Types which are more infrequent in nature and therefore could lead to a faster fade of the battery capacity [11].

V. POSSIBLE BENEFITS OF A V2G TRANSITION TO CONSUMERS AND THE ELECTRIC POWER SYSTEM

A. Consumers benefits

The consumers may profit from the launch of V2G since the prices for electricity are much cheaper than the ones for gasoline if they are compared for the same travelled distance. Also, could the additional earnings be made by the owners of electric cars by selling back the power to the grid. Owing to that the V2G could contribute the needed assistance for the transmission operators. The estimated earnings for the V2G ancillary services could be up to \$4,000 per vehicle.

B. Benefits to the electric power system

Another instance that could benefit from a V2G transition is the electric power system. One way is the supply of electricity to the electric cars. Another way is to draw electricity from them. Because most of the generated electricity is not used the excess electricity could be used to supply for example almost 84% of electrically powered cars, light trucks, and sport utility vehicles in the United States at off-peak times. Therefore, the supplying companies would gain extra earnings during these time periods. The V2G cars can serve as distributed generators-supplements to utility power plants that provide valuable generation capacity at peak times that is during the parts of the day when electricity is most expensive [12].

VI. CONCLUSIONS

All in all, the benefits and barriers of V2G became clear. A launch could improve the full load hour number and the economy of power stations by smoothing of the load curves, by filling of the nightly demand. V2G has the ability to provide positive as well as negative control power by storing energy and regenerating during the peak load times. Moreover, it would lead to a positive contribution to the system integration of fluctuating renewable energies such as solar and wind power and the provision of control energy is highly profitable for EV.

Nevertheless, the battery technology is despite progress the biggest obstacle for V2G as there are high production costs for the lithium-ion batteries for the EV and the loading infrastructure is still developing very slow. To realize V2G in the near future, standardized network connections and a coordinated battery management system are required.

REFERENCES

- [1] B. K. Sovacool, L. Noel, J. Axsen, and W. Kempton, "The neglected social dimensions to a vehicle-to-grid (V2G) transition: a critical and systematic review," in *Environ. Res. Lett.* 13, 2018.
- [2] R. Loisel, G. Pasaoglu, C. Thiel, "Large-scale deployment of electric vehicles in Germany by 2030: An analysis of grid-to-vehicle and vehicle-to-grid concepts," in *Energy Policy*, vol. 65, pp. 432-443, 2014.
- [3] W. Kempton and J. Tomic, "Vehicle-to-grid power fundamentals: Calculating capacity and net revenue," in *Journal of Power Sources*, vol. 144, pp. 268-279, 2005.
- [4] W. Kempton and S. E. Letendre, "The V2G Concept: A New Model For Power?," in *Public Utilities Fortnightly*, pp. 16-26, 2002.
- [5] M. Peng, L. Liu and C. Jiang, "A review on the economic dispatch and risk management of the large-scale plug-in electric vehicles (PHEVs)-penetrated power systems," in *Renewable and Sustainable Energy Reviews*, vol. 16, pp. 1508-1515, 2012.
- [6] D. Madzharov, E. Delarue and W D'Haeseleer, "Integrating electric vehicles as flexible load in unit commitment modeling," in *Energy*, vol. 65, pp. 285-294, 2014.
- [7] J. Després, S. Mima, A. Kitous, P. Criqui, N. Hadjsaid and I. Noirot, "Storage as a flexibility option in power systems with high shares of variable renewable energy sources: a POLES-based analysis," in *Energy Economics*, vol. 64, pp. 638-650, 2017.
- [8] Deutsche Bank Securities Inc., "Electric Cars: Plugged In 2 - A megatheme gains momentum," pp. 39-42, 2009.
- [9] A. Kavousi-Fard and A. Khodaei, "Efficient integration of plug-in electric vehicles via reconfigurable microgrids," in *Energy*, vol. 111, pp. 653-663, 2016.
- [10] L. Noel, J. F. Brodie, W. Kempton, C. L. Archer and C. Budischak, "Cost minimization of generation, storage, and new loads, comparing costs with and without externalities," in *Applied Energy*, vol. 189, pp. 110-121, 2017.
- [11] S. B. Peterson, J. Apt, J. F. Whitacre, "Lithium-ion battery cell degradation resulting from realistic vehicle and vehicle-to-grid utilization," in *Journal of Power Sources*, vol. 195, pp. 2385-2392, 2010.
- [12] B. K. Sovacool and R. F. Hirsch, "Beyond batteries: An examination of the benefits and barriers to plug-in hybrid electric vehicles (PHEVs) and a vehicle-to-grid (V2G) transition," in *Energy Policy*, vol. 37, 2009, pp. 1095-1103.

FIGURES

- [1] W. Kempton and J. Tomic, "Vehicle-to-grid power fundamentals: Calculating capacity and net revenue," in *Journal of Power Sources*, vol. 144, pp. 268-279, 2005.
- [2] J. Després, S. Mima, A. Kitous, P. Criqui, N. Hadjsaid and I. Noirot, "Storage as a flexibility option in power systems with high shares of variable renewable energy sources: a POLES-based analysis," in *Energy Economics*, vol. 64, pp. 638-650, 2017.
- [3] Hitachi Group (2018), "THE DIGITAL ENERGY ROADMAP," [Online] Available: <http://social-innovation.hitachi.eu/about/white-papers/digital-energy/the-digital-energy-roadmap.html> 20/06/2018 10:00 a.m.
- [4] Deutsche Bank Securities Inc., "Electric Cars: Plugged In 2 - A megatheme gains momentum," pp. 39-42, 2009.

The Opportunities and Challenges of the Energy Change in Lusatia

Maria Junusi

BTU Cottbus - Senftenberg
Faculty 3 – Mechanical Engineering, Electrical and Energy
Systems
Cottbus, Germany
Email: maria.junusi@b-tu.de

Mohamed Gulyas

BTU Cottbus - Senftenberg
Faculty 3 – Mechanical Engineering, Electrical and Energy
Systems
Cottbus, Germany
Email: enricomohamed.gulyas@b-tu.de

Abstract—The following paper gives an overview of the consequences of the political decisions regarding the lignite phasing-out for the region of Lusatia and the resulting challenges and opportunities. First, climate change is addressed and a brief analysis of the potential of renewable energies in the region is undertaken. The demographic change and its consequences for the region, as well as the shortage of skilled workers and the attempt to transform the region into an innovation area will also be examined. Furthermore, the opportunities to create and develop a tourism area are considered.

Keywords-Lusatia, energy change, lignite, renewables, tourism, climate change

I. INTRODUCTION

Lignite-fired power generation in Germany is not compatible with the climate policy goals of the UN, the EU and the federal government in the long term. The German government has already decided to transfer lignite-fired power plants with an initial capacity of 2.7 gigawatts to a capacity reserve, the provision of which will be reimbursed to the operators. The goal is to save 11 million tons of carbon dioxide in the short term. The current climate protection plan 2050 announces further steps of a phasing out [1]. This applies not only to the Rhenish and Middle German territories but also to Lusatia. A structural break occurred here as early as the 1990s, during which the number of employees in the mining and energy generation sectors fell from over 80,000 to around 8,000 [2]. The following paper is intended to shed light on the challenges of such a structural change and how they can be turned into opportunities for the Lusatia region.

II. POLITICAL DECISIONS CAUSED BY CLIMATE CHANGE

The politically induced risk for the continuation of lignite-fired power generation in Germany is due to climate change and the finding that this is mainly caused by carbon dioxide emissions. Two assumptions ensure continuous pressure on lignite power generation in Germany. Firstly, this is the premise that developed and industrialized countries, especially Germany, should play a pioneering role in climate protection. Secondly, the premise that the lignite-fired power generation sector is a preferred target for CO₂ reduction efforts within the climate-politically relevant economic sectors in Germany [3].

Even if the market situation for lignite is currently still good, it will deteriorate significantly in the future due to political frameworks at German and European level [4]. For example, efforts are being made to reform the European Emissions Trading Scheme (ETS) in order to achieve higher CO₂ prices through a shortage of emission certificates. For example, a market stability reserve was recently adopted and will enter into force in 2019 [5].

The strengthening of the ETS will affect lignite as the most emission-intensive energy source harder than hard coal or natural gas. The ETS reform will therefore not only increase the cost of lignite power generation but will also worsen its relative competitive position compared to other fossil fuels. If certificate prices rise far enough, lignite could still lag behind gas in the merit order and thus become uneconomical [5].

Furthermore, under the EU Directive on Industrial Emissions and the German Federal Immission Control Ordinance, stricter emission limits are expected to come into force from the year 2021. For power plants that do not comply with these limits, expensive retrofitting with pollutant reduction technology is usually necessary. Vattenfall has calculated, for example, that retrofitting all boilers in the Jänschwalde power plant with more effective nitrogen oxide catalysts would incur capital costs of €20.3 million and additional annual operating costs of €7.2 million [6]. Especially in the case of older lignite blocks with marginal profitability, energy suppliers will have to ask themselves whether such retrofitting is still worthwhile or whether closure would be preferable from an economic point of view [5]. At the end of 2014, Vattenfall announced that it intended to sell its lignite activities in Germany. In the bidding process, the Czech companies EPH and PFF prevailed over their competitors. In October 2016 the company was renamed LEAG. LEAG is the joint brand of Lausitz Energie Bergbau AG and Lausitz Energie Kraftwerke AG. Lausitz Energie Bergbau AG is responsible for lignite production in the four Lusatian opencast mines and for refining the raw material in the Schwarze Pumpe Industrial Park [7].

III. RENEWABLE ENERGIES

When talking about energy change, the side of the potential of renewable energies in the region should not be neglected.

Therefore, a short potential analysis of wind and water power, photovoltaics, solar thermal energy and geothermal energy is to be carried out. The following data used is based on a report from 2011. The region has relatively large areas suitable for wind power grooving. The high average wind speeds at high altitudes offer good conditions for an economical operation of the turbines. In 2011 with an installed capacity of approx. 1,010 MW and a resulting average final energy of approx. 2,000 GWh per year, wind energy already supplied a considerable part of the region's required electricity. This stock of wind turbines provides 1,958 GWh, which corresponds to an efficiency of about 23.6 %. After deduction of existing plants, the potential is 6,336 GWh per year, which represents significant potential for expansion. In the field of photovoltaics, there is extensive potential in the region, on the one hand on open spaces, but above all on roofs. This results in a total potential of 9,865 GWh, of which about 5 % is currently used. The potential for solar thermal energy amounts to 18,537 GWh, of which only 0.1 % is currently used. The hydropower plant potential is largely made up of the use of existing transverse structures on flowing waters. This potential has already been largely tapped (75 %) by existing plants, so that hardly any plant growth and a significantly higher energy yield are to be expected in the future. Geothermal energy has a current utilization rate of 14 % in the region and thus also further utilization potential.

IV. CHALLENGES DUE TO DEMOGRAPHIC CHANGE

Demographic change and the departure of an increasing number of young population groups are having a drastic impact on Lusatia and its economic development potential. While in 1995 there were still more than 1,430,000 people living in Lusatia, by 2015 there were still just under 1,170,000, which corresponds to a population decline of 18%. The proportion of the working population between the ages of 18 and 65 was reduced by 220,000 people, which corresponds to a drop of 24% [9]. According to current forecasts, Lusatia will still lose over 200,000 inhabitants by 2030 - a minus of 17%. Demographic change will have an even stronger impact on the development of the labour force potential. At just under 30%, the decline will be even more pronounced than the overall population trend. Between 2015 and 2030, the average age of the population in Lusatia will rise from around 48 to over 53 years. In the coming years, the number of people leaving the labour market will always exceed the number of people entering the labour market [3,10,11]. Targeted support is necessary to strengthen the economic structure in Lusatia. For the region as a whole, better training opportunities, sustainable economic development and the improvement of location factors are essential to counter migration and strengthen tourism [4]. As a reaction to the climate decisions of the Federal Government, the Innovationregion Lausitz GmbH (iRL) was founded. This is a foundation of the regional economy and the BTU Cottbus-Senftenberg. The iRL team develops ideas and strategies on how Lusatia can react to structural change. It helps affected companies to develop new business fields and develops growth projects for Lusatia [12].

V. TOURISM

After the end of lignite mining, the question arises as to how the region can continue to be used economically. The landscape of Lusatia is characterized by many artificial lakes. These offer a high potential what can be used for tourism [13]. For example, the Bergheider Lake, which is part of the Lusatian Lakeland, is the largest artificial water landscape in Europe with another 19 flooded open-cast mines and is increasingly developing into a tourist magnet. The number of overnight stays will increase from 460,000 last year to one million in 2020, expects Kathrin Winkler, Managing Director of the Lusatian Lakeland Tourist Board [14].

Another impressive hotspot is the decommissioned F60 conveyor bridge. A colossus of steel, weighing 11,000 tons and longer than the Eiffel Tower - the F60 in Lichterfeld is an impressive appearance. The former winding bridge has become a visitor mine and an event location for concerts or fireworks shows. Meanwhile, the Bergheider Lake with the old F60 conveyor bridge has become a spectacular setting for music festivals such as the Feel and the Artlake. Together with the lake, the visitor mine is to become part of a new recreation area: Bungalows, campsites and a floating house will be built here. The lake is supposed to attract water sports like windsurfing and kitesurfing. The remediation will make the former open-cast mining areas usable again. The aim is not to restore the original state, but to redesign the landscape in such a way that new life and development potentials arise from it. Tourism, for example. However, for coal mines to become bathing lakes, they not only have to be flooded, they also have to be paved beforehand and then limed. Otherwise the pH value of the lakes would be very acidic and harmful to the skin. Many of the lakes in the Lusatian Lakeland are at a similar stage to Lake Bergheide: somewhere between the coal mine and tourism. It will be a while before the largest artificial lake country in Europe is finished. According to the current flood forecast, the earliest possible date is 2021. However, the marketing concept for most lakes is already in place and tourism is definitely a huge opportunity for Lusatia in general [13].

CONCLUSION

The paper presented has drawn attention both to the challenges currently to be overcome and to the opportunities arising for the Lusatia region from energy change. The phasing out of lignite is unavoidable and the policy in the region is well advised if it uses potentials at different levels as early as possible and thus mitigates the consequences resulting from this phasing out. The reason for the energy change in the region lies in political decisions regarding climate change and CO2 reduction [1]. To ensure that the region can still be used economically in the future, the following approaches are available: Lusatia offers increased potential for the use of various renewable energies. In addition, the area is to grow into an innovation space through the establishment of companies. The landscape of Lusatia, for example, with its numerous lakes resulting from flooded opencast mines, is attractive. It is expected that the number of tourists will increase immensely. To sum up, it can be said that Lusatia has every chance of a good economic situation, even without lignite. It is still facing

some challenges, such as demographic change, but citizens are willing to face them.

REFERENCES

- [1] B. f. Umwelt, Naturschutz und B. u. Reaktorsicherung, Klimaschutzplan 2050: Klimaschutzpolitische Grundsätze und Ziele der Bundesregierung, Berlin: Druck- und Verlagshaus Zarbock GmbH & Co. KG, 2016.
- [2] S. d. Kohlenwirtschaft, „<https://kohlenstatistik.de/>“, 1 1 2018. [Online]. Available: <https://kohlenstatistik.de/19-0-Braunkohle.html>. [Zugriff am 2 7 2018].
- [3] G. Markwardt und S. Zundel, „Strukturwandel in der Lausitz - Eine wissenschaftliche Zwischenbilanz“, ifo Dresden, pp. 17-22, 2017.
- [4] J. Schwartzkopff und S. Schulz, „Zukunftsperspektiven für die Lausitz: Was kommt nach der Kohle?“, E3G, pp. 1-14, 2015.
- [5] R. d. E. U. Europäischer Rat, Treibhausgasemissionen: Einrichtung einer Marktstabilitätsreserve gebilligt, Brüssel: Press office - General Secretariat of the Council, 2015.
- [6] Vattenfall, Transposition of the IED into German law - NOx ELV 100 mg/m³ for existing combustion plants., Stockholm, 2013
- [7] LEAG, „LEAG: Das Unternehmen“, 2016. [Online]. Available: <https://www.leag.de/de/unternehmen/>. [Zugriff am 2 7 2018].
- [8] R. P. Lausitz-Spreewald, „Regionales Energiekonzept Lausitz-Spreewald“, Cottbus, 2011.
- [9] D. R. Deutschland, „Regionalstatistik“, 2018. [Online]. Available: <https://www.regionalstatistik.de/genesis/online>. [Zugriff am 30 6 2018].
- [10] A. f. S. Berlin-Brandenburg, „Bevölkerungsprognose für das Land Brandenburg 2014 bis 2040“, Potsdam, 2015.
- [11] S. L. d. F. Sachsen, „6. Regionalisierte Bevölkerungsvorausberechnung für den Freistaat Sachsen 2015 bis 2030“, Kamenz, 2016.
- [12] Innovationsregionlausitz, „Innovationsregionlausitz“, [Online]. Available: <https://www.innovationsregionlausitz.de/>. [Zugriff am 31 6 2018].
- [13] A. Böhm und S. Wenzel, „Es gibt ein Leben nach der Kohle“, rbb24, 17 3 17.
- [14] Lausitzer Rundschau, „Ab Sommer im Bergheider See baden?“, 24 01 2014.

Generating Electricity Using Ocean Tidal Energy

Mohammad Moniruzzaman

Abstract— Ocean tidal is gaining in significance as an important green energy source. The ocean has been long recognized as a potential source of energy. However, it was not used for its higher capital, operation and maintenance cost and its operation mechanism, but got some non-polluting green energy from it. Ocean tidal energy is a solution for increasing the reliability of remittent renewable sources. When the tide was going through to the turbine, turbine rotor was rotating for its speed; from this turbine we were collecting the tidal energy. The total energy was extract from many tidal turbines and makes an Ocean tidal power plant. This paper highlights the overall cost like capital cost, operation and maintenance cost, cost of extracting energy of tidal power plant and also the future advancements which can possibly expand the financial allure of such frameworks and it will reduce the power crisis and simulations using Homer software are included.

Index Terms—Basic physics of tides, Types of Ocean tidal plant, Power from Ocean Energy, calculation power in Homer Software Present Trend, Forecast.

I. INTRODUCTION

In our day to day life any kind of supporting articles are running by electrical energy. So scientists are trying best to update this energy sector and searching to find out better quality also. The instability of oil and gas prices and the increasing of people's awareness in environmental problems, renewable energy is the key solution of these problems. Tidal energy, with its advantages of being predictable and its high energy density, is one of the most promising renewable energy forms. Ocean tidal power is gaining in significance as an important renewable source of clean energy. The oceans have been long recognized as a potential source of energy. The ocean's motion carries energy in the form of tides, currents, and waves. Tidal energy is energy produced by the tides of the ocean. Tidal energy utilizes the gravitational energy of the attraction of the Sun, Earth and Moon. Tidal power is non-polluting, reliable and predictable. Tidal energy is a renewable source of electricity which does not result in the emission of gases responsible for global warming or acid rain associated with fossil fuel generated electricity. The introduction of renewable energy sources in the electrical grid, as like as tidal turbines, has opened the door of a clean and sustainable energy forms. Tidal is the one important element of renewable energy. When ocean tidal is flowing, it's kinetic and potential energy is worked. The floating tide was horizontally attacked in turbine and the turbine was rotating and it's created a

mechanical energy & converts this energy into electrical energy to get electricity. This process isn't creating any effect on environment. However it's total cost is so much high and getting output is lower than another energy source. But it has a great future in energy source.

The basic concept of the generating energy using ocean tidal energy is shown below in Figure 1.

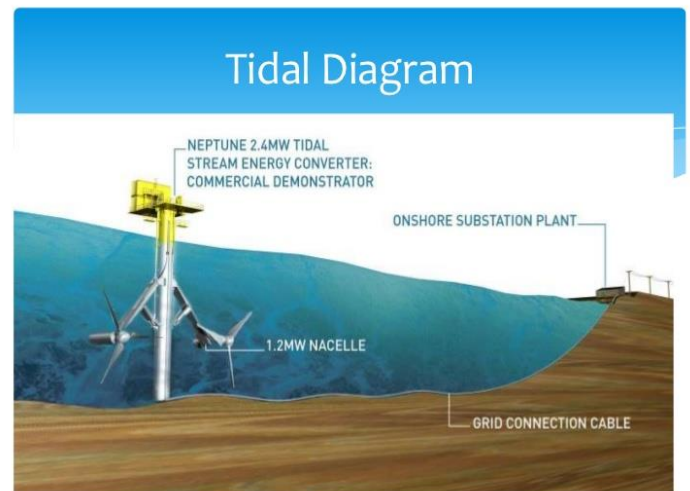

Fig 1: Basic diagram of power generating from Tidal Energy

II. PHYSICS OF TIDES

Tidal energy is the energy scattered by tidal movements, which derives directly from the gravitational and centrifugal forces between the earth, moon and sun. For the gravitational force of the sun and moon on the earth and the centrifugal force produced by the rotation of the earth and moon about each other a tide is the regular rise and fall of the surface of the ocean. Due to the moon is closer to the earth from sun the gravitational force of the moon is 2.2 times larger than the gravitational force of the sun. The tidal phenomenon occurs twice every 24 hours, 50 minutes and 28 seconds. A bulge of water is created by the gravitational pull of the moon, which is greater on the side of the earth nearest the moon. In parallel the rotation of the earth-moon system, producing a centrifugal force, causes another water bulge on the side of the earth furthest away from the moon illustrated in Figure 2. When a landmass lines up with this earth-moon system, the water around the landmass is at high tide[12]. In contrast, when the

landmass is at 90° to the earth-moon system, and the water around it is at low tide. Therefore, each landmass is exposed to two high tides and two low tides during each period of rotation of the earth systems.

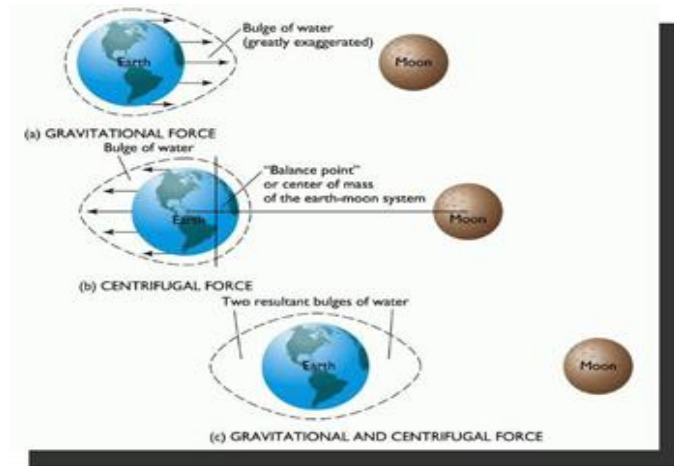

Fig 2: The effect of the moon on tidal range[9]

Tidal currents are experienced in coastal areas and in places where the seabed forces the water to flow through narrow channels. These currents flow in two directions; the current moving in the direction of the coast is known as the flood current and the current receding from the coast is known as the ebb current. The current speed in both directions varies from zero to a maximum. The zero current speed refers to the slack period, which occurs between the flood and ebb currents. The maximum current speed occurs halfway between the slack periods.

III. TYPES OF OCEAN TIDAL PLANT

Tidal energy consists of potential and kinetic components. Tidal power facilities can be divided into two main types: tidal barrages and tidal current turbines

A. Tidal barrages

A Tidal barrages make use of the potential energy of the tides. A tidal barrage is typically a dam, built across a bay or estuary that experiences a tidal range in excess of 5 m. Hydroelectric generation has a same principle as like as electricity generation from tidal barrages, except that tidal currents flow in both directions. A typical tidal barrage consists of turbines, sluice gates, embankments and ship locks. The turbines that are used in tidal barrages are either uni-directional or bi-directional, and include bulb turbines, straflo or rim turbines and tubular turbines. There are two types of tidal barrages system. One type is single basin system and another one is double basin system.[4]

Single basin-system:

During flood tide basin is filled and sluice gates are closed , trapping water. Gates are kept closed until the tide has ebbed sufficiently and thus turbines start spinning and generating electricity. The basin is filled through the turbine which generate at flood tide. Sluice gates and turbines are closed until near the end of the flood tide when water is allowed to flow through the turbines into the basin creating electricity. At the point where the hydrostatic head is insufficient for power

generation the sluice gates are open and kept open until high when they are closed. When the tide outside the barrage has dropped sufficiently water is allowed to flow out of the basin through the turbines again creating electricity.

Double-basin system:

There are two basins, but it operates similar to an ebb generation, single-basin system. The only difference is a proportion of the electricity is used to pump water into the second basin allowing storage.



Fig 3: The La Rance Tidal Power Station in France[1]

B. Tidal current turbines

Tidal current turbines extract the kinetic energy from moving water to generate electricity. Tidal current technology is similar to wind energy technology. However there are several differences in the operating conditions. Under similar conditions water is 832 times denser than air and the water flow speed generally is much smaller than wind. Since tidal current turbines operate in water, they face greater forces and moments than wind turbines. Tidal current turbines must be able to generate during both flood and ebb tides and be able to stand against the structural loads when not generating electricity.

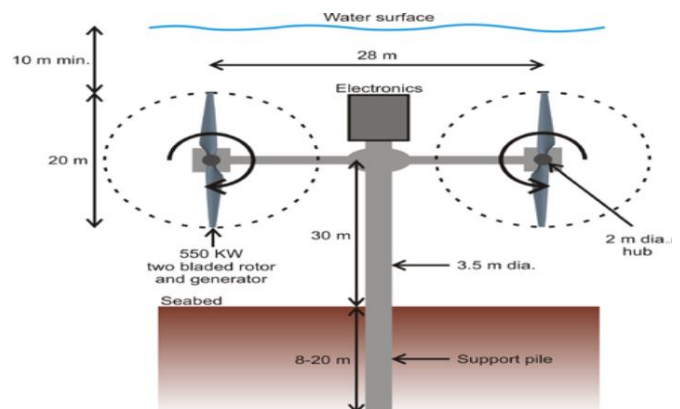

Fig 4: Schematic of the monopole-supported tidal current turbine[9]

The most common two type of current turbine is following

- Horizontal axis tidal current turbines: The turbine blades rotate about a horizontal axis which is parallel to the direction of flowing water.

- Vertical axis tidal current turbines: The turbine blades rotate about a vertical axis which is perpendicular to the direction of the flowing of water.

The tidal current turbine consists of a number of blades mounted on a hub (together known as the rotor), a gearbox, and a generator. The hydrodynamic effect of the flowing water past the blades causes the rotor to rotate, so the generator is turning to which the rotor is connected via a gearbox. The gearbox is used to convert the rotational speed of the rotor shaft to the desired output speed of the generator shaft. The electricity generated is transmitted to land through cables. These three parts are mounted to a support structure that is required to stand against the harsh environmental loadings. There are three main support structure options when considering installing a tidal current turbine. The first of these is known as a gravity structure which consists of a large mass of concrete and steel attached to the base of the structure to achieve stability. The second option is known as a piled structure which is pinned to the seafloor using one or more steel or concrete beams. The third option is known as a floating structure. The floating structure is usually moored to the seafloor using chains or wire. The turbine in this case is fixed to a downward pointing vertical beam, which is fixed to the floating structure.

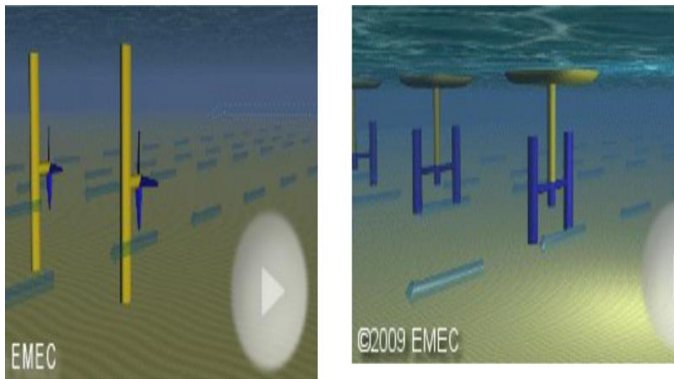

Fig 5: Horizontal and Vertical axis tidal current turbines [5]

IV. POWER FROM OCEAN ENERGY

A Theoretical power from ocean tidal energy:

The power $P_{a,cur}$ [W/m²] available per unit cross sectional area of the water mass in motion is given by Equation(1) , where $C_{P,cur}$ is the power coefficient, ρ_{sw} [kg/m³] is the density of sea water and V_{cur} [m/s] is the average current velocity.

$$P_{a,cur} = 1/2 C_{P,cur} \rho_{sw} V_{cur}^3 \dots\dots\dots(1)$$

The available energy in ocean currents is presented in a more thoroughly manner by reference which is also discusses the estimation of energetic potential. This equation is very similar to the equation for wind potential. These two energy resources are quite similar. For a real power plant consisting of a set of machines with a total area A [m²] perpendicular to the flow direction and an overall performance of the plant equal to

η_{cur} , the power P_{cur} [W], which may be available in equation(2).

$$P_{cur} = P_{a,cur} \cdot A \cdot \eta_{cur} \dots\dots\dots(2)$$

Substituting equation (1) in (2) can be written as following

$$P_{cur} = 1/2 C_{P,cur} \rho_{sw} V_{cur}^3 \cdot A \cdot \eta_{cur}$$

Practical power from tidal energy:

According to Albert Betz (a German physicist) no wind turbine can convert more than 16/27 (59.3%) of the kinetic energy of the wind into mechanical energy by turning a rotor. It's called Betz Limit or Betz' Law. The theoretical maximum power efficiency of any design of wind turbine is called the maximum power co-efficient (C_p) and it is,

$$C_p = 16/27 = 0.593$$

Regarding the efficiency, most devices currently in development involve performances between 30% to 40%, so $\eta_{cur} = 0.3$ to 0.4

Regarding the area A , conversion equipment with a design similar to horizontal axis turbines offers a circular area perpendicular to the flow.

$$\text{So } A = \pi R^2$$

Where,

$$\pi = 3.1416$$

R = radius of rotor.

V. METHODOLOGY

First of all getting data of

Current velocity from Bangladesh sea shore area

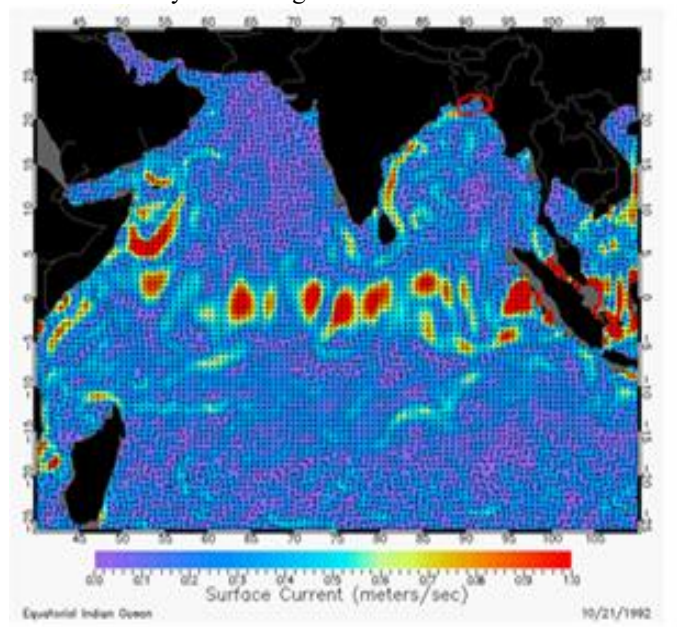

Fig 6: ocean motion, current speed analysis[10]

In fig 6 the red color area is declared that here has great tidal current velocity, the yellow color area is declared that here has moderate current velocity and other part has lower tidal current velocity.

For this area(fig 6) the tidal current velocity is following

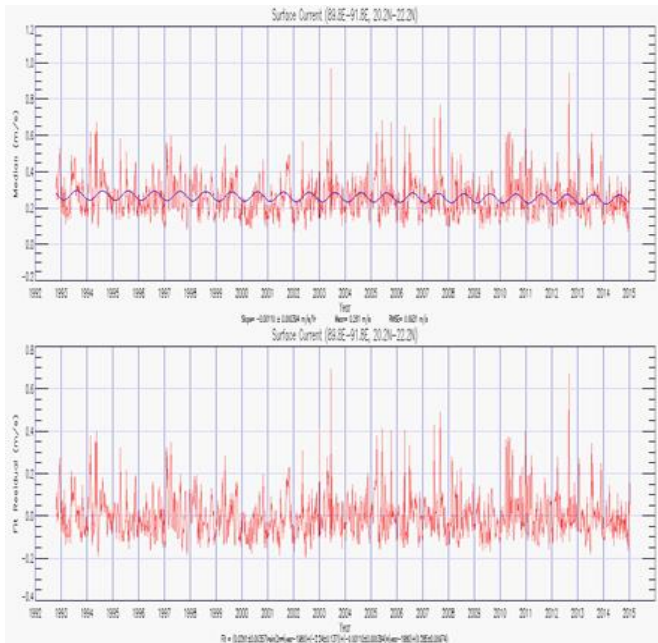

Fig8: the current velocity of Bangladesh sea side area [10]

The total power is calculated as following

$$P_{cur} = 1/2 CP_{cur} \rho_{sw} V_{cur}^3 A \eta_{cur}$$

$$Cp_{cur} = 0.59$$

$$\rho_{sw} = 1020 \text{ kgm}^{-3}$$

$$V_{cur} = \text{given}$$

$$A_{cur} = \pi R^2$$

$$R = 9 \text{ m}$$

$$A_{cur} = 254.5 \text{ m}^2$$

$$\eta_{cur} = 40\% = 0.40$$

Month	Speed (m/s)	Power (Kw)
January	0,3	0,827
February	0,15	0,103
March	0,27	0,603
April	0,28	0,672
May	0,15	0,103
June	0,5	3,83
July	0,35	1,313
August	0,15	0,103
September	0,12	0,053
October	0,16	0,125
November	0,21	0,284
December	0,52	4,307

Calculating load in HOMER:

Assume one home consume 8kwatt, an apartment consume 300kwatt, a small industrial consume 700kwatt, a school consume 20kwatt, a restaurant consume 100kwatt, a laundry consume 20kwatt, a commercial market consume 200kwatt. For 40 homes, 1 apartment, 1 industry, 1 school, 1 laundry, 1 restaurant and 1 commercial market, the total load is calculating in HOMER is following

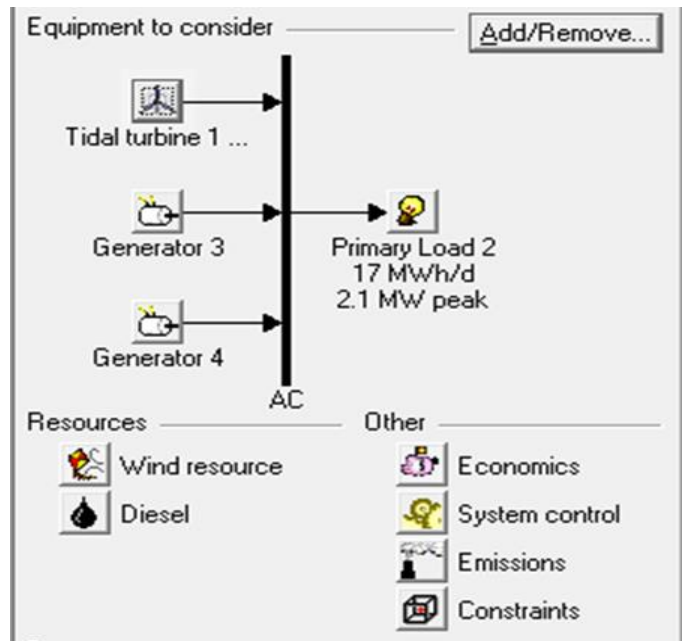

Fig 9: the monthly average load[3]

power output curve in homer

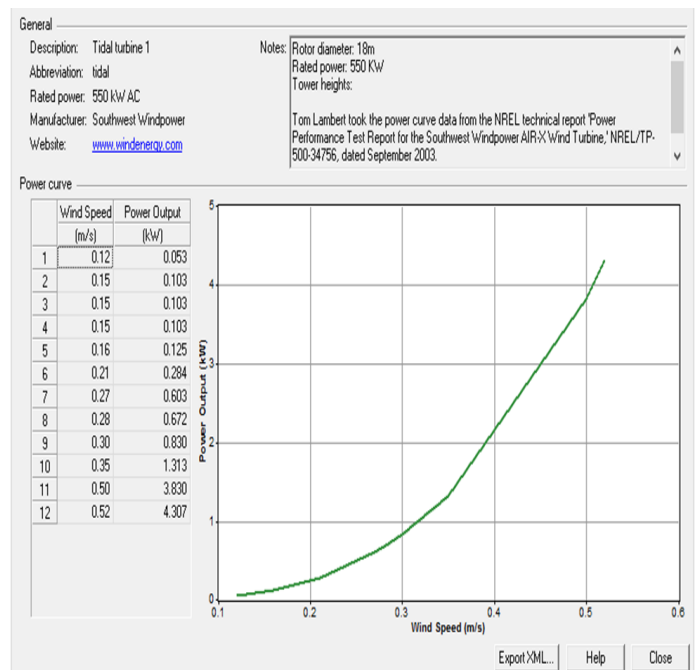

Fig 10 :the power output curve in Homer[3]

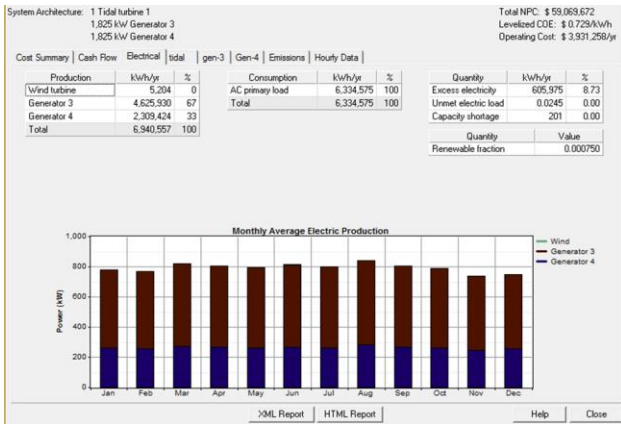

Fig 11 : Power output in 1 tidal turbine

In this above figure we can see here we use a turbine as following that tidal turbine 1 which size is 550kwatt.

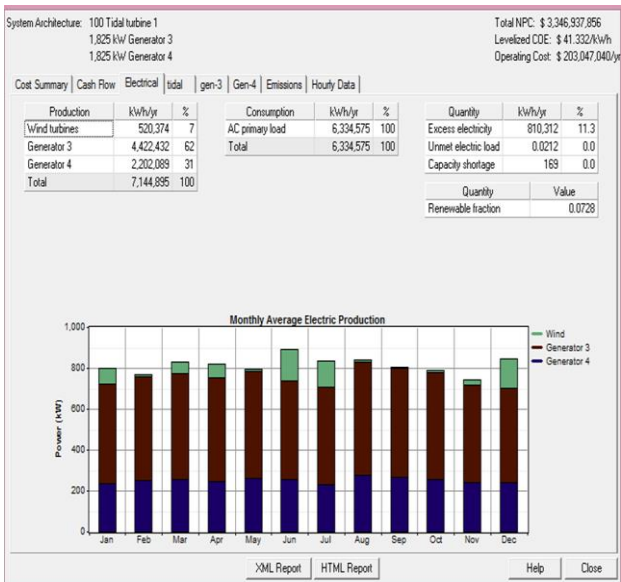

Fig 13: Power output in 100 tidal turbine [3]

V. IMPLEMENTATION

A. Present Trend

Many countries are concentrating to increase their installed capacity of tidal systems and rising their budgets for the promotion of renewable energy production. Every country is attempting to developing some systems reduce the production of electrical power from conventional power plants but it is not something which could be possible overnight so everything needs to be balanced. To maintain such balance is energy production renewables energy systems are adding up into a national grid to produce green energy. Below a chart shows the countries who have produced largest annual installed capacity from the tidal system in last decade. Horizontal-axis turbines (HAT) represent the most common type of tidal energy designs; accounting for 76% of R&D efforts in the development of tidal devices worldwide[11]

Station	Capacity (MW)	Country
Annapolis Royal Generating Station	20	Canada
Jiangxia Tidal Power Station	3.2	China
Kislaya Guba Tidal Power Station	1.7	Russia
Rance Tidal Power Station	240	France
Sihwa Lake Tidal Power Station	254	South Korea
Strangford Lough SeaGen (Decommissioned in 2016)	1.2	United Kingdom

Fig 12 ; installed capacity of different countries[11]

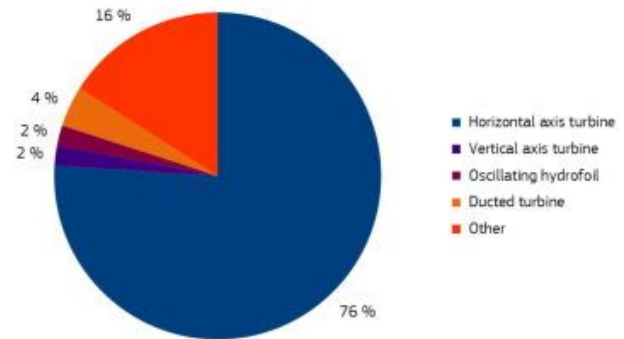

Fig 14: different types of tidal turbines [11]

B. Forecast

The future trends of energy production from renewables like tidal and clearly come to see that the future of green energy production is very bright and it will get to have more popularity than it was before. Figure 12 elaborates the future energy production trends from tidal energy renewables. More than 50% of global RD&D investments in wave and tidal energy projects are in the EU. Europe invested EUR 125 million in 2011 for R&D in ocean energy. Half of this investment came from industry and about a fifth from EU funds. 70% of EU R&D funding was dedicated to technology R&D. The total R&D investment in ocean energy is about 10% of that for offshore wind. In addition, 5 demonstration projects have been awarded EUR 142 million from the NER 300 programme. In 2011, wave energy attracted 58% of corporate investments, reflecting the role that this technology could play along the European coast; tidal energy attracted the remaining 42% [11]

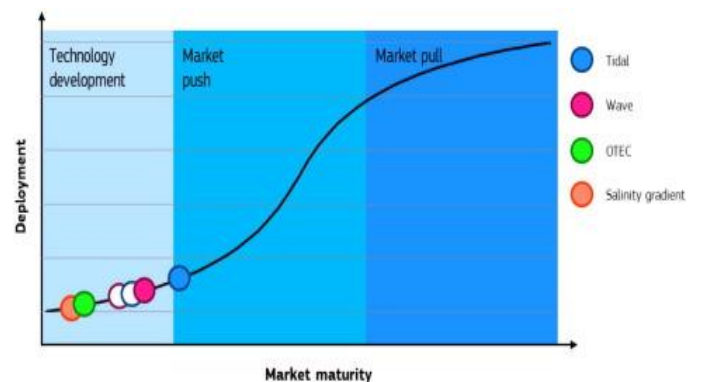

Fig 15 : Market maturity of tidal Energy [11]

VI. CONCLUSION

This research is concluded with a motivation to enhance the production of energy from renewables and move towards next generation of technology and install this system for the efficient, uninterrupted and smooth supply of electrical power to the domestic, industrial and commercial users. This paper has described in details different types of tidal systems which are proposed for the installation in the market and their impact in the future market. One particle project work has also been covered in this paper to give some reasonable understanding of the generating electricity from tidal form of renewables and synchronization of electrical parameters of different sources which are the part of the whole grid systems. Then future trends are shown which shows the coming time is of such type of systems are a lot of room is available for research to improve the quality much better than it is at present.

VII. ACKNOWLEDGEMENT

Author would like to thank Dipl.-Ing. Dirk Lehmann for giving us a chance to write this paper.

VIII. REFERENCES

- [1] (2016) Electro energy website [online] available:
<http://www.tidalelectric.com/history-of-tidal-power>
- [2] EMEC, The European marine Energy Centre Ltd. (2016) Tidal Devices.
www.emec.org.uk/marine-energy
- [3] Homer Energy (2009) Software HOMER, Version 2.68 Beta, the Micro power Optimization Model.
www.homerenergy.com
- [4] Lilienthal, P.D., Lambert, T.W. and Gilman, P. (2011) Getting Started Guide for Homer Legacy (version 2.68) Homer energy, Boulder, CO, National Renewable Energy Laboratory (NREL) of the USDOE, Golden, CO, 28 p.
- [5] Twidell, J. and Weir, T. (2006) Renewable Energy Resources. 2nd Edition, Taylor and Francis, London.
- [6] Ponticelli, F.A. and Beluco, A. (2014) Inclusion of Biodiesel and PV Modules in a Wind Diesel Hybrid System Supplying Electrical Loads on a Small Farm. International Journal of Renewable Energy Technology, 5, 239-250.
- [7] Renewable energy Alaska project(2016).
<http://oceanmotion.org/html/resources/oscar.htm>
- [8] ocean motion, current speed analysis[online](2016)
<http://oceanmotion.org/html/resources/oscar.htm>
- [9] The Effect of the Moon on Tidal Range, Available from:
<http://www.lhup.edu/~dsimanek/scenario/img008.gif>.
- [10] Renewable energy Alaska project(2016).
<http://oceanmotion.org/html/resources/oscar.htm>
- [11] <https://www.sciencedirect.com/science/article/pii/S2214166915000181#f0015>
- [12] International Energy Agency, World Energy Outlook 2007, 2007.

The Integration of Renewable Energies into the German Electricity Grid

Module 11396 - EEEIC

Authors:

Athira Indriaida (3746610)
Master – Wirtschaftsingenieurwesen
athira.indriaida@b-tu.de

Sijar Hamid (3312585)
Bachelor – Umweltingenieurwesen
ahmadsijar.hamid@b-tu.de

Introduction

With the expansion of renewable energies, there are naturally greater fluctuations in the power grid because the wind does not always blow and unfortunately, the sun often hidden by clouds. Electricity consumers also cause constant fluctuations in the power grid with unstable load profiles. Especially in areas where the expansion of renewable energies (RE) is rapidly progressing, e.g. near the coast, grid capacities for transporting the electricity produced are lagging behind. Until the necessary grid expansion has been completed, grid operators may avert critical situations via feed-in management. Feed-in management is to be understood as the ultimate measure that the grid operator may barely take if other ways of avoiding the bottleneck have failed.¹

The Renewable Energy Source Act

At the 21st UN Climate Conference, the states set themselves a goal of keeping global warming under 2 degrees Celsius below pre-industrial levels and avoiding and counteracting irreversible processes. On December 12, 2015, Germany ratified the Paris Agreement as the successor of the 1997 Kyoto Protocol and received the approval of the German Bundestag in the form of a federal law in accordance with the first sentence of Article 59(2) of the Basic Law [Paris Convention Draft Law].

Germany is strengthening itself at European level, especially for the energy industry and to some extent for the industry, and is committed to this as an effective emissions trading system. As an interim target for 2030, Germany's greenhouse gases must be reduced by at least 55 percent. Among other things, the entire power supply must take place almost completely without fossil energy sources by 2050.²

The expansion of renewable energies constitute the most important part of the power transition to become climate-neutral and independent of fossil fuels, power, and heating. The Electricity Feed-in Act of 1991 contained the first regulations for the remuneration of green electricity fed into the power grid. The remuneration was based on the average revenues to the final consumers, so there was no investment security and was replaced by the Renewable Energy Sources Act or EEG (German: *Erneuerbare-Energien-Gesetz*) on April 1, 2000 which was linked to technology-dependent rates. By EEG 2017, there were a total of five amendments for better promotion and expansion of the plants, with the aim of integrating renewable energy plants into the market with investment security.^{3,4,5}

²

http://www.bmub.bund.de/fileadmin/Daten_BMU/Download_PDF/Klimaschutz/klimaschutzplan_2050_kurz_f_bf.pdf

³https://www.bundestag.de/blob/194982/4cb1e1b813a7b5997b16adcfcb9b4af/die_f_rderung_der_stromerzeugung_aus_erneuerbaren_energien_in_deutschland-data.pdf

⁴<https://www.umweltbundesamt.de/themen/klima-energie/erneuerbare-energien/erneuerbare-energien-gesetz#textpart-2>

⁵https://www.erneuerbare-energien.de/EE/Redaktion/DE/Dossier/eeg.html?cms_docId=71110

¹ <https://www.next-kraftwerke.de>

According to paragraph 1 in the law for the expansion of renewable energies, aims to increase the share of extendable power generation plants in gross electricity consumption to 40-45% by 2025, to 55-60% by 2035 and to at least 80% by 2050. Its primary objectives are to protect the climate and the environment, facilitate sustainable development in energy supply, and conserve fossil energy resources in the long term. In order to achieve these goals, renewable power generation plants will be promoted. Development should be continuous, cost-efficient and grid-compatible.⁶ According to the Act grid operators must primarily purchase the generated raw electric power from renewable energy plants and provided for it into the grid.⁷

Renewable plant operators receive a remuneration for the generated green electricity as stipulated in the EEG. The electricity is marketed by the transmission system operator (TSO) on the electricity exchange. The EEG remuneration payments to plant operators often significantly exceed the amount of income from electricity exchange revenues. The difference is passed on to final consumers by the EEG levy. The EEG levy for 2018 is 6.79 ct/kWh and is a fixed component of the electricity price.

Furthermore, the electricity produced can be marketed directly by plant operators and receive an additional management premium for the direct marketing in addition to the market premium. The market premium includes the difference between stock exchange revenues and the feed-in remuneration. The market bonus model creates incentive through the additional management bonus to include as many plant operators as possible in the model.⁸

⁶ https://www.gesetze-im-internet.de/eeg_2014/_1.html

⁷ <https://www.umweltbundesamt.de/themen/klima-energie/erneuerbare-energien/erneuerbare-energien-gesetz#textpart-2>

⁸ <https://www.bundesnetzagentur.de/SharedDocs/FAQs/DE/Sachgebiete/Energie/Verbraucher/Energielexikon/EEGUmlage.html>

Network Security Management

Grid security management or feed-in administration is understood as the balancing or reduction of the feed-in power from the grid operator in the event of grid overload.⁹ However, renewable energies have a feed-in priority. In the event of power reduction, the system operator is entitled to compensation from the grid operator. The respective network operator passes the costs on system charges when all measures to expand the network capacity have been exhausted.¹⁰ Plants that were in operation before January 1, 2012 will be compensated with 100 percent of the lost income.

According to the hardship regulation in EEG 2017, operators of new plants are entitled to compensation amounting to at least 95 percent of the lost income. In 2016, a total output of 3743 GWh was reduced. This corresponds to approximately 373 million euros. Land-based wind turbines are the most frequently compensated, accounting for 86 percent of compensation claims. Feed-in management is a temporary interim solution. In the future, a reduction in the output of green electricity plants in the sense of EEG should be avoided as far as possible.¹¹ Nevertheless, power reduction or downtime work on renewable energy systems has increased sharply in recent years.

As Table 1 shows, compensation payments for wind turbines are the highest compared to other renewable energy installations. Very large sums of compensation payments are made for unproduced green electricity.

⁹ https://www.bee-ev.de/fileadmin/Publikationen/Studien/Plattform/BEE-Plattform-Systemtransformation_Ausgleichsmoeglichkeiten.pdf

¹⁰ https://www.bundesnetzagentur.de/SharedDocs/Downloads/DE/Sachgebiete/Energie/Unternehmen_Institutionen/ErneuerbareEnergien/Einspeisemanagement/Leitfaden_3_0/LeitfadenEEGEinspeisemanagement_Version3_0.pdf?__blob=publicationFile&v=2

¹¹ <https://www.wind-energie.de/themen/netze/einspeisemanagement>

From 2015 to 2016 alone compensation payments for wind energy increased by 68.3 percent due to grid security management.¹²

EEG plant	2014	2015	2016
Wind power	65.041.605	277.438.379	466.924.435
Solar energy	13.924.018	23.235.248	43.235.112
Biomass	3.537.993	13.935.764	132.758.847
Hydropower	4.979	117.301	90.967
Landfill gas	496	3.024	3.151
Plant operators after Power Law Index	182.414	107.200	12.997
Total	82.691.505	314.836.916	643.025.509

Table 1: Compensation payments in € according to §15 EEG¹³

Network expansion by Federal Network Agency

In recent years, the demands on our power grids have risen sharply. The main reasons for this are the goals that Germany has set itself: the switch to renewable energies, the maintenance of a high level of supply security and the realization of the European internal market. In the transmission grid, in particular, it is foreseeable that selective additions to individual lines will no longer suffice. In 2011, the legislator, therefore, created a new procedure with several steps to accelerate the necessary network expansion. First, a so-called scenario framework and network development plans based on it are used to determine the need for new lines. This is regularly laid down by law in the federal requirements plan.

¹²

https://www.bundesnetzagentur.de/SharedDocs/Downloads/DE/Sachgebiete/Energie/Unternehmen_Institutionen/ErneuerbareEnergien/ZahlenDatenInformationen/EEGinZahlen_2016_BF.pdf?__blob=publicationFile&v=3

¹³

https://www.bundesnetzagentur.de/SharedDocs/Downloads/DE/Sachgebiete/Energie/Unternehmen_Institutionen/ErneuerbareEnergien/ZahlenDatenInformationen/EEGinZahlen_2016_BF.pdf?__blob=publicationFile&v=3

The Federal Network Agency has a decisive role in this process. It examines the scenario framework, the network development plans and thus the necessity of each project. Once the needs assessment has been completed, another task is added: It acts as the procedural authority for all projects in the federal requirements plan that extend across several federal states or abroad. This means that it is responsible for the federal specialist planning and the planning approval. From these two process steps, a corridor for the new power line is first defined and then its exact course.¹⁴

Conclusion

The data from the power plant lists in Germany are included in a scenario framework presented by the transmission system operators to the Federal Grid Agency. It comprises at least three different scenarios for the following 10 to 15 years. Together they represent the range of probable developments in the German energy landscape. One of the scenarios also includes a second part that forecasts developments over the next 15 to 20 years. The public is intensively involved in the discussion at this early stage of the overall process. The Federal Network Agency takes the results of the discussion into account before finally approving the scenario framework.¹⁵

¹⁴

<https://www.bundesnetzagentur.de/DE/Sachgebiete/ElektrizitaetundGas/Verbraucher/Netzausbau/netzausbau-node.html>

¹⁵

<https://www.netzausbau.de/5schritte/szenariorahmen/de.html>

Introduction of the energy sector coupling in the future

M.Sc.Zhongjie Dou

Brandenburg University of Technology Cottbus-Senftenberg

Chair of Power Distribution and

High-Voltage Engineering

Abstract—Energy sector coupling means couple the energy used for heating and transport to the electricity sector, through this we can improve the efficiency of energy consumption, and reduce the emission of CO₂. Specially for Germany, because in the light of the resolutions agreed at the United Nations Climate Change Conference held in Paris in December 2015, GHG emissions in Germany must be reduced by 95 percent by 2050. To achieve this, efficiency measures must first be taken to significantly reduce the existing energy consumption in all three sectors. So using electricity, which supplied by renewable energy systems, for heating and transport must be considered. Otherwise this sector coupling is also proposed as flexibility option to stabilize power systems comprising large proportion of fluctuating electricity generation.

Keywords- energy sectors coupling; reduction of CO₂ emission; energy transition ; renewable energy; electrification.

I. INTRODUCTION

The German energy transition has stalled. Although wind power and photovoltaics have been massively expanded in recent years and already cover around 20 percent of electricity consumption, energy supply in Germany is still based on about 80 percent fossil energy sources. A linear update of this development shows that Germany clearly misses its climate targets if no substantial change occurs. Therefore, to make the energy transition a success, we need to rethink and increase the pace. This is only possible if we look at the energy system as a whole, interlink the sectors of electricity, heat, and transport more closely. For now, the individual gears run different powerful side by side, but do not interlock. Therefore, in this situation, Germany must enter a new phase of the energy transition. After wind power, photovoltaic and biomass have been continuously developed in recent years, the basic technologies for a comprehensive coupling of the sectors are now available. Only in this way can we participate in the internationally growing markets of future energy supply. And only then can we meet our international commitments and have a chance to reach the Paris climate goals. [1]

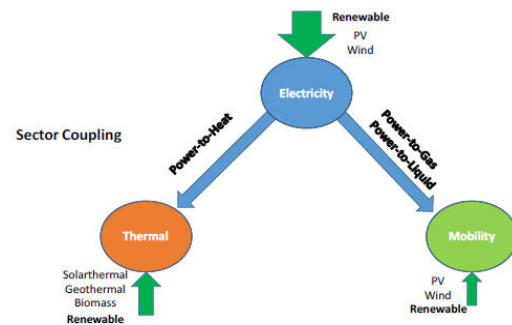

Figure 1: A scheme of three sectors coupling (electricity, heat and mobility) [2]

The figure above shows the coupling of the three sectors electricity, thermal (heating and cooling) and mobility, which can be realized by different technologies like power-to-gas or power-to-heat. Each sector can have its own direct renewable input. However, most of the expected input will be in the electricity sector. [2]

II. COUPLE THE ELECTRICITY TO HEATING

A. Use of electricity in the heating sector

To decarbonize the remaining energy demand, when it comes to a low-temperature supply, electric heat pumps are deemed to be the key technology for the integration of renewable electricity into the heating sector.[3] They can be used both locally in the buildings themselves and centrally to supply heating networks. In almost all existing scenarios, heat pumps will become one of the most important sources of heat for individual buildings by 2050. The technology is already relatively mature and technological progress is expected to lead to further efficiency gains. [4] With the advancing transformation of the energy system, projections and studies predict a necessary proportion of heat pumps in all heating installations of over 80 per cent. [5]

B. Why is heat pump

There are different means to convert electricity into heat. We distinguish between centralized and decentralized power-to-heat options. Under the centralized approach, electricity is converted into heat at a location that may be distant to the point of actual heat demand, and (district) heating networks are used

to distribute the heat to where it is needed. In contrast, decentralized power-to-heat options make use of electricity right at, or very close to, the location of heat demand.

The follow figure we compare the three options, heat pumps, electric boilers and power to gas in gas heating systems. With the criteria of electricity consumption. [6]

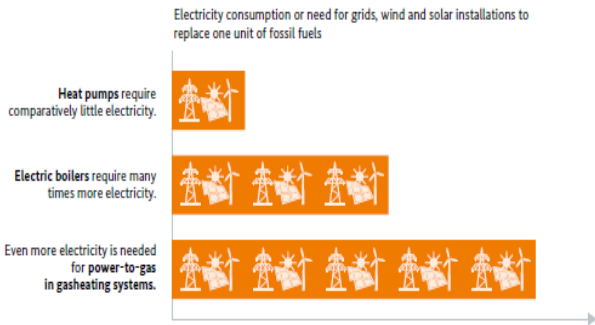

Figure 2: Comparison of the three options in PtH [6]

III. COUPLE THE ELECTRICITY TO MOBILITY

In contrast to the heating sector, electrification of some parts of the transport sector has already happened. Today, rail and public transport in cities (subway, trams, and urban trains) are close to a 100% being running by electric power. In line with the growing demand for public transport, this sector certainly will continue to grow. A further modal shift from individual transport to public transport, road to rail would be an additional lever for decarbonization. However, this possibility was not taken into the consideration that the share of public transport/rail has rather decreased in the past, despite stated political goals to increase it. [5]

A. Background

Transport sector makes up nearly one third of Germany’s energy system. Just like the below figure shows:

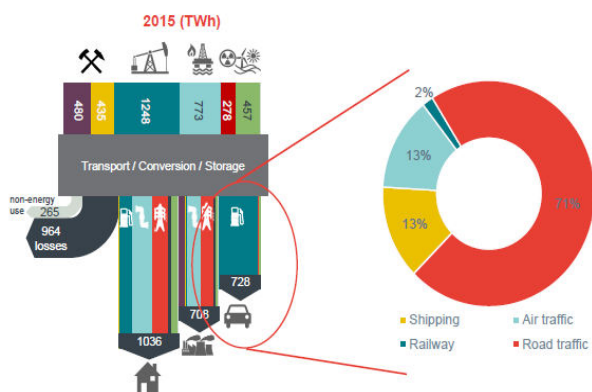

Figure 3: Energy consumption of transport sector in Germany 2015 [7]

B. Direct use of electricity

Rail transport offers a highly energy-efficient way of electrifying passenger and goods transport. Therefore, there is a large CO2 mitigation potential in shifting motorized transport onto the railways. Even if the amount of goods transported by rail were to grow by 160 percent by 2050, it is expected that there would only be a very modest increase to 61 PJ (2015: 54 PJ) or 17 TWh in the final energy demand for the rail sector as a whole. [8] After motorized private transport, goods transport makes up the highest proportion of the total emissions from transportation. As the carbon footprint of the electricity supply improves, a reduction in greenhouse gas emissions from goods transport amounting to approx. 8.6 Mt CO2 can be achieved by increasing the proportion of freight transported by rail to 25 percent by 2030 (from 17.7 percent in 2010).[9]

C Indirect use of electricity

The use of electrically generated fuels is primarily required in those transport segments where the use of battery-electric drives is technically limited. This relates in particular to shipping and aviation as well as to the share of road haulage that can neither be moved over to rail transport nor be electrified (based on current technical standards). Methane from renewables and obtained in PtG installations is liquefied in the PtL process and can thus also be used in the transport segments mentioned here. The energy efficiency of electrically generated fuels is, however, lower than that of electricity in direct use in the rail sector and in battery-electric drives. Their use will make a significant contribution to the final energy demand of the transport sector in 2050. [5]

D Comparison of the three options in transport sector

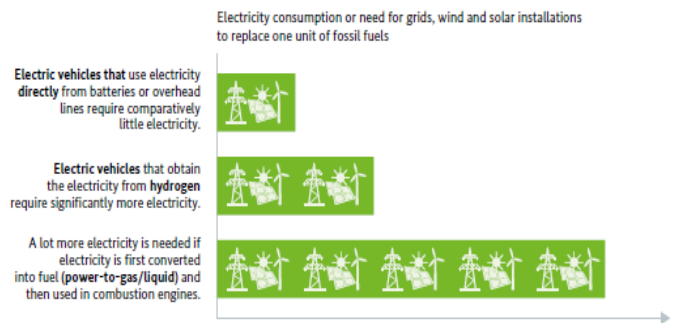

Figure 4: Comparison of transport options (battery, fuel cell using hydrogen, combustion engines) [6]

Figure 4 is like Figure 3, using the same criteria, and according figure 3 and figure 4, electric vehicles have more potential in both energy efficiency and decarbonization.

IV. SECTOR COUPLING: A NEW SOURCE OF FLEXIBILITY

The main input of renewable energy in our future energy system will come from wind and PV, which supply renewable electricity to our grids. Reaching higher shares of fluctuating renewables in the grids may cause a variety of problems. In order to avoid this and at the same time to even further increase the share of renewables in the system, renewable electricity can be distributed to other sectors, mainly the heating (and cooling) and the mobility sector. [2]

By coupling the sectors, the demand pattern of the “consuming” sectors, “thermal” and “mobility”, can help to better utilize the renewable input in the electricity sector. By implementing energy storage technologies between the sectors, where the energy has to be transformed (e.g. into heat and cold) or stored anyway (for mobility applications), the match of fluctuating supply and demand can be managed. The figure below shows the flexible sector coupling approach

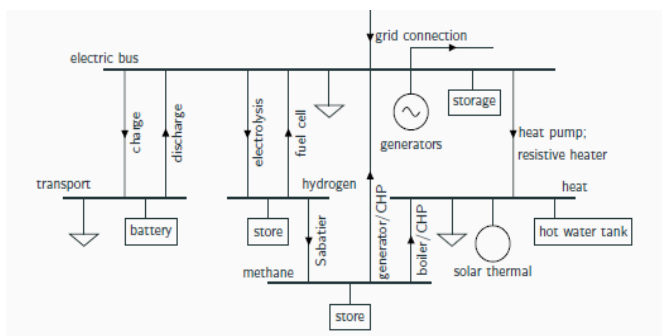

Figure 5: Couple the electricity sector to electrified transport and low-T heating demand [10]

CONCLUSIONS

- Energy efficiency is our biggest energy source.
- Think renewable energies and energy efficiency always together.
- Integration of all subsystems is our future task!
- The electrification of other energy sectors with the efficiency technologies heat pumps and e-mobility is the key to decarbonization of the entire energy supply system.
- This is no single solution for highly renewable systems, but a family of solutions with different costs and compromises.
- Understanding the need for flexibility at different temporal and spatial scales is key to mastering the complex interactions in the energy system

REFERENCES

[1] Sektorkopplung – Optionen für die nächste Phase der Energiewende. available https://www.leopoldina.org/uploads/tx_leopublication/2017_11_14_ES_Y_Sektorkopplung.pdf

[2] Flexible Sector Coupling by Energy Storage Implementation. Available https://iea-eces.org/wp-content/uploads/public/Background-document_Flexible-Sector-Coupling.compressed.pdf

[3] “Sektorübergreifende Energiewende – Robuste Strategien, kritische Weichenstellungen 2030”, lecture by Norman Gerhardt, Fraunhofer IWES, Berliner Energietage,

[4] “Wärmepumpen im zukünftigen Strom- und Wärmesektor”, Marek Miara, Fraunhofer

[5] “Energiesystem Deutschland 2050”, Hans-Martin Henning, Andreas Palzer, Fraunhofer

[6] Electricity 2030. available https://www.bmwi.de/Redaktion/EN/Publikationen/discussion-paper-electricity-2030.pdf?__blob=publicationFile&v=5

[7] Energy transition and sector coupling. available <https://www.frontier-economics.com/documents/2018/03/david-bothe-international-engine-conference-presentation.pdf>

[8] Cf. “Klimaschutzbeitrag des Verkehrs bis 2050”, ifeu/INFRAS/LBST [UBA], 05/2016.

[9] Data on emissions from goods transport include direct and upstream emissions. Assumptions based on: “Finanzierung einer nachhaltigen Güterverkehrsinfrastruktur”, INFRAS/Fraunhofer ISI [UBA], 06/2016.

[10] Sector-Coupling in a Simplified Model of a Highly Renewable European Energy System. Available <https://nworbmot.org/energy/brown-wiw.pdf>

List of abbreviations

GHG	Green Haus Gas
PtH	Power to Heat
PJ	Petajoule
TWh	Terawattstunde
Mt	Megatonne
PtL	Power to Liquid
PtG	Power to Gas
PV	Photovoltaik

Transition of the Energy Region Lusatia

What are the alternatives to lignite?

B. Sc. Tobias Heumann

B. Sc. Patrick Lahr

Brandenburg University of Technology Cottbus-
Senftenberg
Chair of Power Distribution and
High-Voltage Engineering
Germany

B. Sc. Hong Duc Nguyen

Brandenburg University of Technology Cottbus-
Senftenberg
Chair of Power Distribution and
High-Voltage Engineering
Germany

Abstract— With the conclusion of the Renewable Energy Act (EEG), the issue of conventional coal-fired power generation has been resolved politically. An entire region, Lusatia, is dependent on its lignite as energy source. The aim of this report is to present possibilities of the economic benefits offered by the open-cast mining area of Lusatia after lignite mining.

Keywords- potential, renaturation of the mining landscape, wind energy, solar energy.

I. INTRODUCTION

The move away from lignite leads to a new structural change in Lusatia. There will probably be no permanent mass unemployment this time, as the demographic development of the region indicates a sharp decline in the working age population in the future. However, the comparatively weak regional innovation system must be stimulated overall in order to generate a sufficient number of new projects and business ideas for the region. If a critical mass (new industrial cores) is to be achieved, additional support within the framework of a conversion program geared to innovation also seems sensible [1].

II. HISTORICAL CHANGE

150 years of mining have had a decisive influence on the Lusatia region. Particularly in GDR times, Lusatia was an important mining region due to its large lignite deposits which was of central importance for the country's goal of energy self-sufficiency and independence from coal and gas imports. In contrast to many hard coal deposits, Lusatian Lignite at depths of only 40 to 100 meters. Because of the sandy soils above, you can Mining is therefore relatively easy in large-scale opencast mining [2].

In 1990, the peak of lignite open-cast mining in the Lusatian mining district, around 200 million tons of lignite were mined in 17 open-cast mines each year. Lignite mining in the Lusatian

region was the largest employer at the time with approx. 73.00 employees. 25 years later and with the decision on the nationwide energy transition, which provides for the expansion of renewable energies, the production of lignite sank to approx. 60 million tons of lignite per year in 4 open-cast mines. Furthermore, approx. 15.000 jobs in Lusatia are directly and indirectly dependent on lignite power generation [3].

The chart below shows the employment figures of the four major lignite companies.

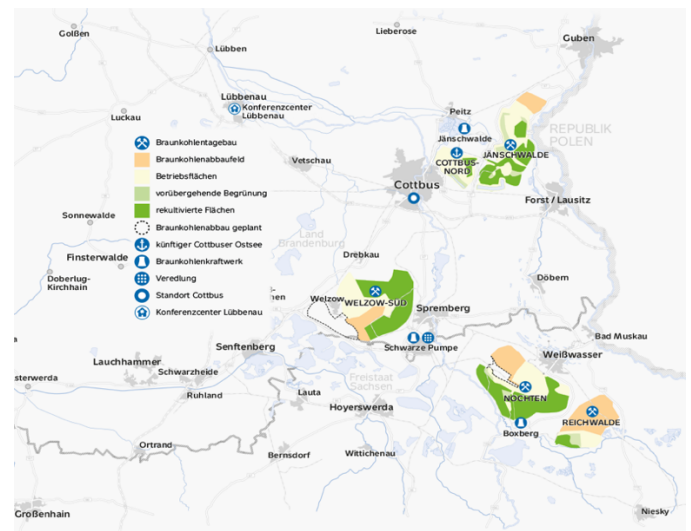

Figure 1: Lusatian lignite mining district, LEAG

III. POTENTIAL OF THE FUTURE MINING LANDSCAPE

Mining coal in open-cast mines leaves large holes in the landscape. Another problem is that water is needed for pumping, which is pumped on the ground. The closure of the open-cast mines creates new potential for renaturation and in the course of the energy transition to promote renewable energies.

A. Renaturation and design of the mining landscape

Since then, extensive measures have been taken to rehabilitate and revive the former industrial area. This includes the removal or securing of former landfills, the dismantling of former open-cast mining facilities and the flooding of residual holes. Europe's largest artificial lake landscape is currently being developed in the former lignite open-cast mining area of Lusatia. The former mines are transformed into lakes and linked together as a chain of lakes attractive to tourists. The aim is to compensate for the loss of importance as a former industrial area and to realign local economic structures through restructuring, modernization and diversification and to build them up in a competitive and forward-looking manner. On the other hand, environmental protection and nature conservation in the landscape, which is strongly influenced by mining, are to be promoted and new ecological impulses set [2]



Figure 2: The Spree floodplains are one of the major renaturation projects in Lusatia, LEAG

B. Solar Park

As early as the 1990s, the potential of today's LAG region in the wind energy sector was recognized. Against the background of structural change, these potentials were recognized as an opportunity and successfully exploited. Many former mining areas now contribute to regional added value. A number of important wind farms have been established in the region. In addition, there is the production site of the wind turbine manufacturer Vestas in Lauchhammer [2].

In addition, the Enercon E-126 at the Lausitzring is the world's most powerful wind power plant in the Lusatia region. At the time of construction, the Enercon E-126 type with a rotor diameter of 127 meters and a hub height of 135 meters was the most powerful turbine in the world. The nominal output is 7.580 kW. The aim of the plant is to cover the energy supply of the motor sport facility by regenerative energy sources, as well as surrounding households in the vicinity of the race track.



Figure 3: The Enercon E-126 next to Lausitzring, Energiequelle.de

C. Solar Park

In 2011, a solar park was opened on a former 103 hectare open-cast mining area near Senftenberg. At that time, the 150 MW solar park was the largest of its kind in the world. The plant supplies electricity to the grid for approx. 50.000 households [4].

The solar park in Senftenberg works as follows. The solar radiation heats the solar modules and the liquid in the collectors, which drives the turbine of the solar power plant. The generator is driven from the mechanical energy of the turbine and electrical energy is generated in the form of electricity.

Further solar parks could follow due to the space and the good energy infrastructure in Lusatia. At the same time, however, they are dependent on high feed-in tariffs in order to be able to use them economically.



Figure 4: Senftenberg Solar Park, Phoenix Solar Group

IV. CONCLUSION

The state of Brandenburg has been investing for some time in renewable energies and renaturation of the old open-cast mines in order to build up a functioning industry after lignite. The renaturation of the old open-cast mines and the development of the Cottbus Baltic Sea will promote tourism and the ecosystem. In the future, it will not be possible to supply energy from renewable energies alone. Since the energy requirement cannot be covered for technical and economic reasons. For this reason, lignite in Lusatia would be inconceivable without lignite when it comes to the security of supply in this region.

REFERENCES

- [1] G. Markwardt, S. Zundel, "Strukturwandel in der Lausitz – Eine wissenschaftliche Zwischenbilanz", ifo Dresden, 2017, p. 17, available: https://www.cesifo-group.de/DocDL/ifoDD_17-03_17-22_Markwardt.pdf
- [2] Arenum e.V., "Die Energieregion im Lausitzer Seenland – Bestand und Potentiale der Erneuerbaren Energien vor de Hintergrund des Strukturwandels in der Region", 2013, pp. 7-13, available: http://arenum.de/uploads/LEADER/energieerleben_Broschüre-3_Energieregion%20im%20Lausitzer%20Seenland%20-%20Bestand%20und%20Potentiale_web-k.pdf
- [3] U. Steffen, "Unterstützung des Strukturwandels in der Lausitz durch das Land Brandenburg", Land Brandenburg, 14.05.2018, p. 2, available: <https://www.ihk24.de/vstdbv3/download?secid=%7B3DES%7D434BBCE4A42DBB1D>
- [4] Dpa/ab, "Weltgrößter Solarpark in Senftenberg", Lausitzer Rundschau, 2011, p. 1, available: https://www.saferay.com/pdf/Senftenberg%20Weltgroesster_Solarpark_in-1406365036-Artikel.pdf

FIGURES

- Figure 1: LEAG, Das Lausitzer Revier, available: <https://www.leag.de/de/geschaeftsfelder/>
- Figure 2: LEAG, Die Spreeauen, available: <https://www.leag.de/de/blog/artikel/neue-landschaften-rekultivierung/>
- Figure 3: Energiequelle.de, Projekt Grüner Lausitzring, available: <https://www.energiequelle.de/projekte/>
- Figure. 4: Phoenix Solar Group, Solarpark Senftenberg, available: <http://www.phoenixsolar-group.com/de/referenzen/solarpark-senftenberg.html>

Renewable Energy in Poland

Is the German Investment in Wind Turbines Desirable?

Julia Rudolf

BTU Cottbus-Senftenberg
03046 Cottbus, Germany
rudoljul@b-tu.de

Melanie Schlag

BTU Cottbus-Senftenberg
03046 Cottbus, Germany
schlamel@b-tu.de

Abstract—This paper is about renewable energy in Poland. Germany is one of the main investors in wind turbines in the Polish Republic. The natural conditions for wind parks are advantageous. But Poland has many regulations for wind turbine operators, which can make it difficult for some companies to invest. Although not for all companies as shown in the examples RWE and Prokon.

Renewable energy; Poland; German investment; wind turbines; wind farms

I. INTRODUCTION

A lot of discussions are about renewable energy. Not only scientists' debate the problem of fossil energy yields rather even the political level feels confronted with this theme. [1] On the one hand some countries especially Scandinavian countries like Norway and Sweden are generating a lot of energy through renewable energies. On the other hand are countries like Poland, which relies little on renewable energy. The existing energy production plants in Poland are mainly based on the combustion of hard coal and brown coal. According to EU energy policy guidelines, the amount of coal should only be 6% of the energy production in the European Community by 2020. But currently, more than 90% of domestic electricity and heat generation in Poland is based on coal. [2]

The EU adopted a Directive 2009/28/EC on the promotion of the use of energy from renewable sources. Poland is therefore obliged to achieve a share of renewable energies in energy consumption of 15% by 2020. In 2005, the energy consumption of renewable energies in Poland already amounted to 7.2%. An increase of 4.62% was achieved compared to 2003. This shows that there is an increased use of renewable energies, which amount to 40% of the whole primary energy in 2009. [2]

It, therefore, appears sensible to concentrate on energy production from renewable energy sources. This is an area in which Poland has a lot of catching up to do. Therefore German companies can make greater use of their know-how and experience in this field. Whether the investment in wind turbines in Poland, in particular, is profitable is discussed below. [2]

II. GENERAL INFORMATION

A. Wind Farm conditions

For Poland, the average wind power is 2.8 m/s to 3.5 m/s, while 35-40% meeting the minimum requirements for the industrial use of wind energy. Therefore wind power is considered a potential and effective energy source in Poland. In summer, the wind speed reaches 50-70% of the annual average. However, in winter reaches the wind speed 150-170%. Especially on the Baltic Sea in Poland can be gained an increased amount of wind energy. The annual average wind speed reaches a speed of 8.5 m/s at a height of 40 m and distance 10 m to the coast. This situation is advantageous because the maximum seasonal wind resources with the highest energy output during the period coincide with the highest energy demand for heating. [2]

In 2020, 27% of the estimated potential of wind energy is expected to be used for energy production, which is 921.6 TJ. [2] Before the investment it is important to determine the exact wind conditions, as that can be the main cause for failure. PWE (Polish Wind Energy) states that such measurements should last at least 12 months. This is because of the monthly wind speed deviations are estimated at up to 20% of the annual average. [3]

B. Framework conditions

First, the framework conditions for the development of wind farms will be explained. A major barrier is an unclear legal situation and a lack of transmission infrastructures. [2] There is also the Polish Renewable Energy Act. This was re-regulated in 2016 and the elimination of the electricity purchase obligation by the energy suppliers as well as an auction model was anchored. [4] The Auction system has replaced the previous "green certificates". With the new funding program, the Ministry of Economy wants to endorse proven and tested technologies that are characterized by stability and lowest electricity production costs. [5] The existing funding conditions for present renewable energies will be maintained.

The new framework conditions did not apply directly to all operators. With a transitional period of two years, they were able to choose between following the new regulations or maintaining the old funding conditions. The mandatory

auction system is indispensable for new investments and will be introduced for all renewable energies.[5]

The auction system is classified by performance. A distinction is made between plants with an output of up to and over 1 MW. The subject of the auctions will be electricity production and the basic selection criteria for projects - the price per 1 MWh of electricity produced. In the auction system is the profit that the winner can relate green electricity over 15 years. Applicants may only participate if they do not exceed a certain reference price for the funding offered in the call for applications. The reference prices are determined according to the technology-dependent installed capacity for a given form of renewable energy. [5]

Subsequently, the power supply delivered at a fixed price. The price results from the bidder's who has undercut the competitors in the auction. It does not matter with which technology the green power is generated. Also, the location is not considered. The advantage is that the generation of wind power is cheaper than PV and biomass. However, the risk has shifted. In the certificate market, the operators of the wind farms had to carry a price and volume risk. Now the risk lies in project development. "To be successful, project developers must have a relatively large portfolio and be able to compare exactly how competitive their own wind farms are with others. This shift in risk is more likely to benefit larger companies. [6]

The Polish parliament has also passed a much stricter distance regulation for onshore wind turbines. The law provides for binding distances between wind turbines and residential buildings, nature reserves worthy of protection and national parks. The distance has to be ten times the total height of the wind turbine (hub height plus rotor length). This can make the development and marketing of further wind farms in Poland considerably more difficult. [4] The law specifies the conditions and procedures for the location, construction and operation of wind turbines. However, the law does not apply to investments implemented or used in the territorial waters of the Republic of Poland. [7]

These requirements can hardly be met at any location in Poland today. Wind farms that were already in operation when the law came into force and do not meet the new requirements may not be expanded or their capacity increased. The site permits already granted for wind farms that have not yet been implemented will become invalid. A new use permit or a new building permit for the wind farm must be obtained in accordance with the new legal requirements. [8] Moving the wind farm investment to the building permit stage is a difficult, time-consuming and costly process in which the developer has to go through a series of administrative and civil proceedings. [7]

In view of the different locations and circumstances, it is quite difficult to estimate precisely the costs incurred by the investor at the stage of the development of a wind farm project; however, it is assumed that these are high costs which may range between EUR 70 000 and 100 000 per planned megawatt of wind from the farm. If an investor gets involved

in several large projects, the damage can even amount to several dozens of millions of euros.[7] Furthermore, the real estate tax charged on wind turbines will increase up to fourfold from 2017. The Polish real estate tax of 2% is now imposed on the entire complex and not only, as before, based on the value of the foundation and tower. This means that the value of technical installations, rotor blades, drive technology, generators, nacelles, etc. can now also be used to calculate the real estate tax. [8] The higher tax rates are causing financial difficulties for onshore wind farms in Poland. Interested in taking over such parks at the lowest possible price is foreign funds, investors from the industry and state-owned companies.[9]

III. GERMANY AS AN INVESTOR

In the European Union Germany is currently the country with the greatest involvement in Europe. Therefore the German republic increases the share of renewable energies in energy production and consumption in the countries of the European Union. [10]

Figure 1 shows that at the end of 2013 the total value of German direct investments amounted 114 billion zloty.

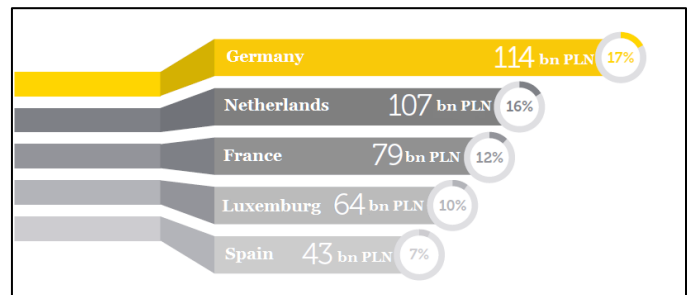

Figure 1. Cumulative values at the end of 2013 (based on [10]).

German companies have largely invested in the manufacturing industry as it is shown in figure 2. Only six of the 114 billion zloty are invested in the energy, gas and steam production and supply.

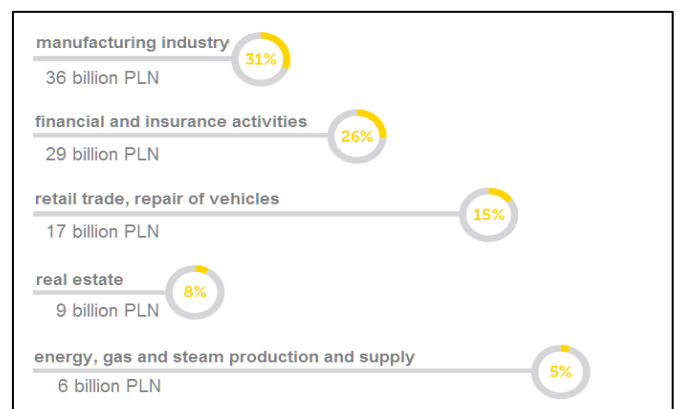

Figure 2. Structure of German direct investment at the end 2013 (based on [10]).

Identify applicable sponsor/s here. If no sponsors, delete this text box. (sponsors)

But German investors are aware of the importance of renewable energy sources. In Poland, two large German companies - RWE and E.ON - are investing in wind farms. Due to the positive weather conditions, most of the wind farms of German investors are located in the north of the country.[10]

At the end of 2014, RWE owned six mainland wind farms in Poland with a total capacity of 197 MW. A second important investor in this industry is E.ON. This investor owns five wind farms in Poland. German companies are also active in the production and supply of wind turbines. In Poland, Siemens and Enercon are important German suppliers of turbines for the construction of wind farms. [10]

A. RWE

RWE has set up projects in Poland under the "Green Certificates" funding program mentioned above. The last ones were Opalenica and Nowy Staw II. For RWE Poland is an important part of wind power energy, as it has very good wind conditions. In addition, there was also a high level of local acceptance on the part of RWE regarding renewable energies. RWE has not only invests in Polandbut also in the UK. There they tested similar systems like the auction system before 2016, instead of the "green certificates". As of 2016 they also want to participate in auctions with their own development projects. The development pipeline comprises more than 300 MW of good wind locations. [11]

Filip Thon, CEO of RWE Poland, explains: "Renewables are an important pillar in the Polish energy market of the future, so investing in wind projects, network infrastructure and other innovative technologies is a huge opportunity for RWE, and our Polish wind portfolio enables us to do more supply more than 250,000 Polish households with green electricity products from their own RWE wind farms." [11]

Figure 3shows RWE's Polish wind farms. Nowy Staw I is located near the city of Gdansk, Krzecin and Tychowo are in Western Pomerania and the wind farms Suwalki, Piecki and Taciewo are located side by side in Podlaskie in the northeast of Poland. [11]



Figure 3. The eight wind farms of RWE in Poland.

The eight onshore wind farms in Poland will supply 250,000 households.[11]

B. Prokon

Prokon has various locations such as Germany, Poland and Finland. It should be noted that they do not build any new wind turbines in Poland, but only restrict themselves to the conservation of already developed parks. Due to the 2016 amendment, Prokon wind projects are associated with considerable uncertainty. The "10H regulation", which means that a distance of at least 10 times the hub height to the neighbourhood must be complied with, complicates the planning permission of wind farms. However, in order to meet the increase in the share of renewable energy agreed in Europe, the best option is wind energy. [12]

For the time being the projects originally planned for 2016 have been discontinued. First of all, the new framework conditions with regard to the projects have to be examined. Total sales of around 10 million euros are expected in the 2017 financial year. [12]

By consistently concentrating on the key business areas of wind energy production and project development, it will be possible to apply the high level of expertise gained in the German market to the further development of these business areas in Poland. Prokon's energy trading activities will continue to be limited exclusively to the German market. [12]

Figure 4 shows Prokons wind farms in Poland.Brudzewice is located in West Pomerania, Gniewino and Subkowy are located in Pomerania, Ciechanow in Mazovia, Klodawa in Greater Poland and Dzialoszyn, Krosniewice, Radomsko, Rusiec, Sieradz, Wielun, Zleszyn-Ernestynow, Zloczew are located in Lodz.



Figure 4. The thirteen wind farms of Prokon in Poland.

C. Barriers for new investors

In the past, many investors have lost sight of one of the main difficulties that can stay in the way of setting up a wind farm in Poland. This is the fact that there is no sustainable grid connection.The reason for this is the Polish energy networks,

which are largely outdated. There is a lack of systematic technical modernization and reconstruction. Furthermore, there is not enough capacity for the connection of new energy sources. Poland has a large state-owned network operator, PSE-Operator SA, of which the Polish state is the only shareholder, and currently 20 energy suppliers, including the large international groups Vattenfall and RWE, which also own energy networks in Poland. Despite legal instruments to promote renewable energy sources, energy suppliers often refuse to connect new energy sources due to a lack of capacity for other foreign investors. Despite legal instruments to promote renewable energy sources, energy suppliers often refuse to connect new energy sources for further foreign investors due to a lack of capacity. The investor must therefore always contact the local energy supplier and apply for the technical conditions to be connected to the network. The energy company determines the conditions and capacities for the connection of the planned wind farm. This decision also has the effect of reserving the corresponding capacities for the respective applicant for a period of two years. During this period, the requestor is authorized to the conclusion of a contract for network connection with the relevant operator of the energy network. [13]

D. Support from the EU

One of the purpose of the Investment Plan for Europe is to encourage investment. Furthermore to create jobs, increase growth and competitiveness, meet long-term economic needs and strengthen EU production potential and infrastructure.[14] The EIB supported Sweden in the construction of wind farms to help them achieve the objective for renewable energy set by the EU Directives. The European Investment Bank (EIB) is investing together with the Mirova Eurofideme 3 fund and the wind power developer Eolus in the construction of the mainland long-term wind farm in Värmland (Sweden). Construction began in January 2016. The wind farm will have a total capacity of 23.1 megawatts (MW). The project will build six 3.3 MW wind turbines and two more. It is the first investment of the European Investment Plan for renewable energy. It includes an investment of up to 16 million euro. [14]

IV. CONCLUSION

Poland is largely dependent on coal and therefore often does not have up-to-date structures, such as outdated network connections. This is, in particular, a major challenge for new German investor. For example, the numerous recently introduced regulations by which the Prokon Group relies only on existing projects. Only after the removal of these barriers a

dynamic development in this area can be expected. Even though the natural conditions are favorable. By contrast, established groups such as RWE have strengthened their position in the market and have fewer difficulties in implementing the new regulations. The new market model also aims to reduce the cost of expanding renewables as much as possible and to ensure that no more capacity than absolutely necessary is built. Whereby Poland also wants to reduce the number of investors and to tries to reach higher quality investors.

The EU supports the project of investing in renewable energies. As in Sweden, German Investors could be investing in a new project in cooperation with the European Investment Bank in Poland. This can help new companies to make their investment profitable.

- [1] S. Geitmann, "Erneuerbare Energien und alternative Kraftstoffe: mit neuer Energie in die Zukunft," Hydrogeit Verlag, 2005, pp. 3-10.
- [2] A. Giesek and A. Grzelak, "Windenergie in Polen," 2013, pp. 26-49.
- [3] Gielnik, A. and Rosicki, R. "Energetyka wiatrowa w Polsce – mozliwosci rozwoju I zagrozenia", p.4.
- [4] PNE Wind AG, "Windkraft – Geschäftsbericht 2016," 2017, pp. 30-56.
- [5] A.Luszkak-Zajac, "Polen: Neues Förderprogramm für erneuerbare Energien," http://de.schindhelm.com/content/rechtsanwalt/deutschland/news_jusful/news/polen_neues_f%C3%B6rderprogramm_f%C3%BCr_erneuerbare_energien/index_ger.html.
- [6] WID Redaktion "Marktbericht Polen- 700-1000 MW Windkraft stehen kährlich zur Auktion," <https://www.windindustrie-in-deutschland.de/fachartikel/marktbericht-polen-700-1000-mw-windkraft-stehen-jaehrlich-zur-auktion/>.
- [7] P. Mrowiec, "Kräfte nutzen," November 2016, pp. 2-6.
- [8] GSK Stockmann, "Gegenwind für Windparks in Polen," 2017, <https://www.gsk.de/de/news-presse/newsarchiv/d/gsk-update-gegenwind-fuer-windparks-in-polen-schadensersatzansprueche-auslaendischer-investoren-gege/>.
- [9] GTAI, "Onshore-Windfarmen in Polen stehen zum Verkauf". 2018, <https://www.gtai.de/GTAI/Navigation/DE/Trade/Maerkte/suche,t=onshorewindfarmen-in-polen-stehen-zum-verkauf,did=1874206.html>.
- [10] KPMG, "Nachbarschaft mit Zukunft. Die Deutsch-Polnischen Wirtschaftsbeziehungen", 2015, p 32.
- [11] RWE Innogy, "RWE baut Windkraftportfolio in Polen aus", 2015, <http://www.rwe.com/web/cms/de/37110/rwe/presse-news/pressemitteilungen/?pmid=4014111>.
- [12] Prokon, "Konzern-Halbjahresabschluss per 30.06.2017," 2017.
- [13] J. Krawczyk; bnt Neupert, Zamorska & Partnerzy s.c., "Grid Connection of Wind Farms in Poland-Problems of Practical Implementation", pp. 26-27.
- [14] European Commission "Investment Plan for Europe: the EFSI supports construction of ne onshore wind farm in Sweden", https://ec.europa.eu/commission/commissioners/2014-2019/katainen/announcements/investment-plan-europe-efsi-supports-construction-new-onshore-wind-farm-sweden_en.

A Study on the Concept of Decentralized Energy System

Bejoy Philip Kuriyan

Master of Science (Power Engineering)
Brandenburg Technical University
Cottbus, Germany
kuriybej@b-tu.de

Subramanian Santhanam

Master of Science (Power Engineering)
Brandenburg Technical University
Cottbus, Germany
santhsub@b-tu.de

Ashwin Velusamy

Master of Science (Power Engineering)
Brandenburg Technical University
Cottbus, Germany
velusash@b-tu.de

Abstract—This paper discusses about the Decentralized Energy Systems, its Concept, all possible sources of Decentralized Energy Systems, Factors influencing its implementation. A detailed discussion on the Real Time Scenario, Examples and a cost analysis is also proposed. Finally, the challenges and advantages is discussed.

Keywords- Decentralized Energy, Renewable Energy, Energy

I. INTRODUCTION

All the nations in the world are conatus in contemplation of successful energy transition. With countries intending to reduce the footprint of conventional fossil fuel-based power plants, conducive to meet the greenhouse gas emission targets by producing more renewable energy cannot be solely accountable for outright energy transformation. There is a need for novelty in the way the energy is being generated and distributed. Also, contemporary advancements in the energy sector with contribution from Electric vehicles, Internet of Things, smart grids, consumer side power generation (roof-based solar panels), storage facilities along with the difficulties in distribution and frequency moderation are posing challenges to the prevailing centralized energy sources and also arising a necessitate for a shift in paradigm of energy distribution. Therefore, a model / system has to be put into action in order to address the above-mentioned issues.

II. DECENTRALIZED ENERGY SYSTEMS

A. Concept of Decentralized Energy System

The Distributed energy resources (DER) or Decentralized energy / distributed generation is a concept in which a close proximity of small energy generating and storage devices to the consumers is achieved, making it easier for the energy generation, transmission, and distribution [1].

B. Sources of Decentralization

The sources of Distributed generation are mainly Photo Voltaic, Combined Heat and Power, Onshore wind, other renewables like biomass, biogas and hydro power plants. Grid connected storage devices typically batteries and electric

vehicles are also considered in this regard. These sources are interconnected to a micro-grid and can be integrated with a central grid system by considering various technical and economic factors.

A. Factors influencing Decentralization

The following factors [2] influence the selection of Decentralized Energy Resources.

- Growth in energy demand and the need for energy distribution
- Increasing cost for distribution and transmission of energy
- Increase in transmission and distribution losses
- Phasing out of Fossil fuel based power plants and Nuclear Power plants.
- Increase in installed capacities of renewables like PV and wind and fall in prices of PV
- Better performance of decentralized energy systems

III. REAL TIME SCENARIOS

The population in the cities is increasing steadily and more people are dependent on Energy. With the renewable sources being highly unreliable, and with the heavy investment costs coming to the fore, it is possible to assume that the Decentralized Energy Systems could be problematic and difficult to implement in real time.

In order to be sustainable and achieve a green community, implementation of a Decentralized Energy System becomes mandatory. In the coming paragraphs, we will be seeing a real time example of DES.

C. Examples of Decentralized Energy System

A good example of Decentralized Energy Systems is the **Island of Eigg [3]** which is located to the West of Scotland. The island with a population of about 105 residents are disconnected from the world in means of electricity, but they get round the clock power through a combination of Hydroelectric generators, Wind Turbines, Photovoltaic array and a bank of batteries. The total installed capacity in the island is about 184

kW, which gives roughly about 1.75 kW per person. The power generated is stored in a well-maintained battery bank and taken for consumption. The system is being supported by two 80 kW diesel generators which act as a control strategy in case of low renewable energy generation.

D. Cost Analysis in the Island (Example)

- The whole costs were initially funded by the Government grants and money received as gifts to the community. However, the maintenance costs are being borne by the community members.
- They have one 100 kW hydro generator, two 5 - 6 kW hydro generators, four 6 kW wind turbines and a 50 kW solar panel installation at their disposal. They have a prepaid electricity card system, which ensures prompt payment of the electricity. [4]

An estimation of the costs for a DES, which could be incurred by a community of 100 people, is given below:

- Capital costs (including electrical equipment) – 2500 \$/kW
- Installation costs – 600\$/kW (variable depending on the region)
- Operation and Maintenance Costs – 200 to 250\$/kW
- Labor costs – 100 to 120\$/kW
- Taxes and interests on capital costs – 150 to 175 \$/kW
- Other Costs – 15 to 30 \$/kW
- Total Costs – 3550\$/ kW (approximately)

Dividing the total costs by the population gives a cost of about 35.5\$/kW per head. Assuming a lifetime of 20 years for the power sources, the cost per head/ year will be 1.775\$/kW which could be affordable for the people living in the community.

(Data Source: www.irena.org/costs)

Unfortunately, there was no information found on the money they charge for a unit of electricity in the Island.

E. LCoE Analysis

The Levelized cost of electricity (LCOE), also known as Levelized Energy Cost(LEC), is the net present value of the unit-cost of electricity over the lifetime of a generating asset. It is often taken as a proxy for the average price that the generating asset must receive in a market to break even over its lifetime. (Definition by: www.wikipedia.org). In the following graph, the LCoE costs of the various DES sources are shown.

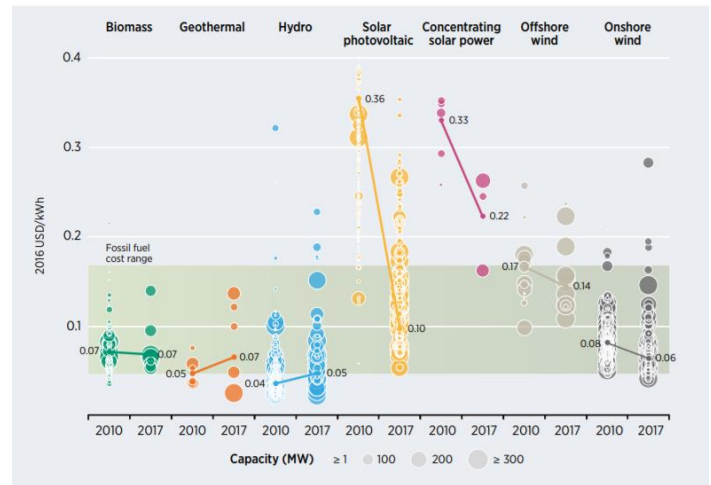

Source: IRENA Renewable Cost Database.

It is very clear that the LCoE costs of the majority of DES sources are decreasing and it will be expected to reduce further because of the rapid technological advancements in all segments of renewable energy systems.

IV. ADVANTAGES AND DISADVANTAGES IN DES

Decentralized Energy Systems will become a commonly spoken word soon because of the world’s paradigm shift from fossil fuel based energy generation to renewable energy generation. As like every other system, it comes with own sets of Advantages, Disadvantages and Challenges which will be discussed in this section.

F. Advantages of DES

Some of the advantages of DES [5] are as follows:

- In case of power failure in the centralized network, the entire grid fails and the restoration needs more time and effort when compared to decentralized energy resources.
- Resistive heat losses in long transmission cables of the centralized network are high when compared to the decentralized network.
- Energy efficiency and billing procedures are simpler in DER
- High level of energy security can be achieved in DER, whereas there may be chances of fraud energy thefts in the centralized network.
- Energy feed in from consumers (In case of rooftop solar panels and other renewable energy systems) can be properly organized and reimbursed in DER.
- Autonomous and local energy trading mechanism can be made possible with the help of DER, which reduces the energy prices on the locality.

G. Challenges and Disadvantages

The Challenges in the Implementation of a Decentralized Energy System could be a potential disadvantage and such factors will be discussed in the following points.

- Decentralized Energy Resources (DER) are typically renewables, the need for matching the demand and supply with

intermittent supply from solar and wind poses a major challenge in its implementation which could be a disadvantage while doing the planning.

- The Integration of DER with the central grid is considered as another major restriction as it could alter/fluctuate the frequency of central grid due to its intermittent supply [6].

- Social and political acceptance also plays an important role in bringing up Distributed energy resources. The formulation of policies, incentives, taxes and political commitment are the factors which influence its execution.

- Due to Innovation and Technological development, the cost of decentralized energy systems will become cheaper and this scenario makes consumers shift towards DER. But the competition and acceptance from the current market players add up to its adversities and difficulties.

- The location plays a very big role in the implementation of DES as only some places might have the possible terrain for implementing a Hydro Power plant as there must be a natural altitude difference.

- Finally, the concept of energy stability, energy security, the inclusion of smart grids, smart meters, the availability of storage facilities (in the form of batteries and pump storage) and demand-side management are also accountable for deciding upon DER.

V. CONCLUSION

The world is on a transition in all fields from Manufacturing of Products, Transportation, and ways of doing Business to Agriculture. Decentralized Energy Systems may be considered

as an Energy transition for a sustainable future. Though there are many challenges concerning Decentralized Energy Systems, the Advantages outweigh them. DES will also be a great contributing factor for the Climate change and Global Warming.

ACKNOWLEDGMENT

We would like to thank the Faculty 3 of Brandenburg Technical University, Cottbus for giving this opportunity to present this paper and a special thanks to Dipl.-Ing. Dirk Lehmann for guiding and supporting us with the needed inputs.

REFERENCES

- [1] Christoph Weber and Philip Vogel. Decentralized energy supply and electricity market structures. 01 2015.
- [2] Philipp Ringler, Hans Schermeyer, Manuel Ruppert, Marian Hayn, Valentin Bertsch, Dogan Keles, and Wolf Fichtner. Decentralized Energy Systems, Market Integration, Optimization: Project Report. 01 2016.
- [3] <https://www.ecowatch.com/scotland-eigg-island-off-grid-2368755983.html>
- [4] <https://www.independent.co.uk/news/world/europe/germany-green-technology-record-power-generation-35-per-cent-renewables-solar-wind-turbines-a7820156.html>
- [5] C.I. Buritica-Arboleda and C Alvarez. Decentralized energy: Key to improve the electric supply security. pages 1–6, 10 2011.
- [6] Frances Brazier, Elth Ogston, and Martijn Warnier. The future of energy markets and the challenge of decentralized self-management. 01 2012.

Coal: Energy Transition in Germany

How big is the impact on industry and society?

Keanu Kokott
BTU Cottbus-Senftenberg
Cottbus, Germany

EMail: sunfxll@gmail.com

Introduction

Coal is a profitable energy source since the 19th century. Various techniques got explored to get the maximum profit out of it. Unfortunately at the expense of the environment. Germany is one of the top 15 countries to dismantle coal. In 2015 Germany mine an amount of coal equivalent to 78,3 million tons of oil. Now Germany wants to switch to renewable energy sources, like many other countries all around the world. But despite the environmental pollution, the coal industry is a very important branch for Germany. Areas like Nordrhein-Westfalen and Brandenburg are heavily dependent on the open-cast mines. They offer a lot of potential workplaces, so the whole area gets modernized and wealthy. Many companies invested in coal mining in the last couple years, so there are far more subjects which depend on the coal exit, especially the people and their future. Experts seem to have solutions for the possible upcoming collapse of the industrial branch, but the theory often differs from the reality.

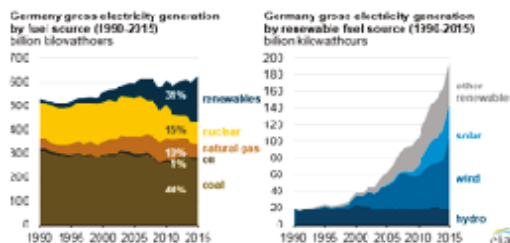

A. Germany and the coal exit

Environmental protection is now a mission for the whole world. Like the most countries Germany has to adapt renewable energies into their system. The EU managed to establish environmental goals for each country, and to reach these goals, Germany has to quit the coal mining immediately. Of course this won't happen that easily, but to not completely miss the goal, Germany has to initiate the exit as soon as possible. To begin with that process, Germany has to start with the reduction of the emission out of the power sector. In that case Germany could switch off 76 KW of coal performance. There is a new pollutant limit to coal power plants which may cause closures or at least new filtration technologies.

B. Politics

The coalition agreement of 2013 declared coal energy as a transition technology to switch to renewable energy. The coal lobby describe coal as a indispensable energy source for Germany.

The German minister of economy and energy Sigmar Gabriel said in 2015, that Germany wants to reach the environmental goals of 2020 but without the exit of coal energy. Otherwise its a very important step for the energy transition to stay away from coal energy, but with every year passing it will be much harder to do so.

The Green Party „Die Grüne 90“ established a plan for the coal exit which went viral across the country. Just about all other parties agreed, but still to this date, nothing really changed. The only real move that happened, was when the senate of Berlin declared the coal exit for 2030 in Oktober 2017. It is like already mentioned, everybody talks about it, but nobody really does something about it, maybe for a reason.

C. Nordrhein Westfalen

In Nordrhein Westfalen coal is considered as the gold of the region. It has a long tradition in the region, where 2/3 of the German energy needs gets covered. Because of the coal exit, 50.000 jobs are threatened. There is a clear acceleration, because more and more coal mines get closed, though the mining can be continued until 2045. Old mines are now museums or restaurants, but that doesn't eve cover a portion of the 50.000 workplaces.

But there is hope, many companies invested in the coal industry. Because of the energy transition they have to adjust their strategy. Nordrhein Westfalen is a very popular area for technology and innovations, so there are a lot of new opportunities for start ups in which the companies could be interested in.

D. Brandenburg

In Brandenburg the job places aren't the biggest problem. In comparison to the western mining areas, the ones in the east of Germany have a worse infrastructure, innovationpower and a low patent intensity. Different to other coal areas, 3,3% of the people in Brandenburg have a job to do with coal. These are also high valency jobs, most of them in the industrial sector and services.

Offside of the big energy companies there are no jobs alternatives at big companies.

More and more people leave the region, which makes the region even more unattractive.

Predictions say that until 2035 the amount of people who are capable go work will go down by 1/3, what makes the cover of professionals even harder.

Overall Brandenburg has no real perspectives of a structural change, the political and economical consequences with a immediate exit are too high. Especially the increased electricity prices will affect everybody.

Until 2035 the coal mines have the status quo, what means nothing will really change something but also no new mines will opened up.

Brandenburg needs new economical perspectives after the coal exit, otherwise the region will die down somehow, with more people leaving the region.

In the end Germany is facing a big problem. Of course they have to quit coal energy sooner or later, but in the right way. Especially the regions which exist only because of the coal energy are too dependent on coal. The government has to create new perspectives for the people, a future for their jobs so that the cities and villages which got built around the coal mines, don't get left empty like the mines.

1. Ortwin Renn, Energy Policy, Coal nuclear and renewable energy policies in Germany: From the 1950s to the „Energiewende“, December 2016, pp. 224-232
2. Ladislav Hanel, Applied Soil Ecology, January 2001, pp. 23-24
3. <https://www.cleanenergywire.org/factsheets/coal-germany> Kerstine Appunn 5.12.2017 (7.7.18)
4. <http://www.worldwatch.org/node/5834>, Ben Block (6.7.18).

Battery storage-breakthrough for storing regenerative energy

Autonomous power supply for wind energy

Bernd Willidal
BTU Cottbus-Senftenberg
Cottbus, Germany

Dietrich Lichi-Haasz
BTU Cottbus-Senftenberg
Cottbus, Germany

Abstract — The proportion of renewable energy is increasing and as a result, more flexible options will soon be necessary to compensate for the fluctuations. Especially regarding electricity generation, for example due to wind turbines and photovoltaics power plants. The supply of stable power supply is raising in importance.

This paper deals with the technical design and function of battery storage. Furthermore, it points out the technical and economic risks.

Keywords: battery management system; battery storage; battery technologie; cells; renewable energy;

I. INTRODUCTION

The importance of saving energy will constantly grow because of the expanding wind energy industry. Today wind energy is already the biggest part of renewable energy at German power production. With a cumulative work of 5.334 MW in 2017 the stock off onshore-wind energy plants increases to 50.777 MW.¹ Thus, the part of wind power at the German power production was 16,3%.² By setting goals for the climate targets of the government this contribution will grow in the future.³ In the next few years the tendency of bigger and powerful wind energy plants will further increase. While nowadays, a rated output of 2,8 MW is common, the average output will raise in the next years to about 4 MW in weak-wind regions.⁴ Technically it is already possible to build modern wind energy plants in areas like woodlands. So far, the generated renewable energy in Germany is saved in pump storage plants, air storage power stations and salt caverns.⁵ But these technologies are not completely proven or their efficiency is too low. Technologies like power-to-gas also couldn't establish at the market because of big investment costs and low efficiency. Therefore there's a need of flexible

and autarkic solutions that produce, save and distribute energy decentralised everywhere in Germany. The most appropriate solution today is a battery storage. This technique is used in pilot projects, for example in Feldheim or Schwerin, where the possibility of saving energy is tested.

II. FUNCTIONALITY

A battery is an electrochemical energy storage, that consists of several galvanic cells that are connected in series and protected in a single housing. Secondary batteries, also called accumulators, distance oneself from primary batteries because they are rechargeable and suitable for saving energy.⁶ During charging, the electrical energy gets transformed and saved into chemical energy by the redox reaction. When an electrical device is connected, this process gets reversed and electrical energy gets emitted. The energy transformation does take place in the galvanic cell. She has two electrodes that exist in an ionic conductive electrolyte. The electrons flow between the negatively charged anode and positively charged cathode. To prevent a short circuit, a non-conducting separator strictly separates the electrodes. Only the ionic current can pass the separator. Lithium cells also contain an electrically conductive top that also is called solid electrolyt interphase (SEI). That form of "coating" protects the anode material against contact with the electrolyte. The electrode materials that are used to for the electrochemical reaction are defined as "active material".

¹ Bundesverband WindEnergie, 2018

² Bundesministerium für Wirtschaft und Energie, 2018

³ Bundesministerium für Umwelt, Naturschutz, Bau und Reaktorsicherheit, 2018

⁴ Agentur für erneuerbare Energien, 2018

⁵ Bundesregierung, 2018

⁶ Carpus, 2018

The design of the batteries stretches from cylindrical shapes to prismatic shapes.⁷

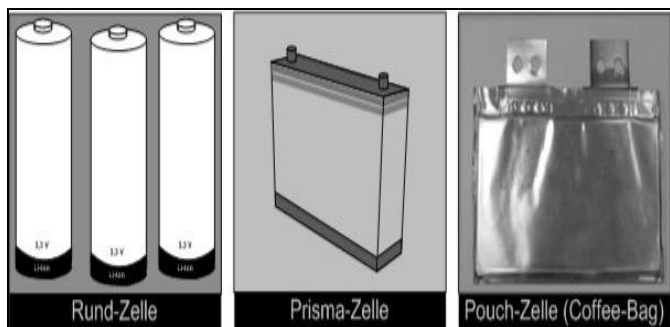

Illustration 1: different battery designs⁸

The interconnection of several cells into one battery pack requires a housing with ventilation, cooling system and also a battery management system (BMS). In the field of megawatt applications, the housing is typically used in shipping containers.



Illustration 2: presentation of a battery container⁹

The battery management system is necessary as an interface between the excess power and the current power and also for the electronic components in the battery. An electronic control unit observes the battery system and manages relevant functions depending on the operating status. The BMS manages for example voltages and temperatures during loading and unloading for the total battery and also for single cells. Furthermore, the BMS also manages the temperature management of the battery system. The BMS regulates the level of the temperature through cooling and heating and improves the power and lifetime of the battery. If errors occur in the battery system, they will get registered and will be shown on a display.¹⁰

⁷ ESB Business School, 2012

⁸ Umweltbundesamt, 2012

⁹ ADS-TEC, 2018

¹⁰ Umweltbundesamt, 2012

III. RISKS

Investments like for example in battery memory, entail not only the chance to achieve income in the long-term, but various risks. These risks can be separated into technical and economic risks.

A. Technical risks

With modern manufacturing standards, from the fact that battery technologies are being used with proper handling and use, one can assume the utilization as relatively safe. However, if, based on technical defects or improper use, it comes to an uncontrolled and quickened emission of the chemically stored energy, this generally occurs as thermal energy. As a result, this leads to fire.¹¹

Additionally, another technical risk would be the cycle stability. If cycle stability does not correspond to the given or supposed number in cycles, the efficiency of the memory will be increasingly reduced. An exchange of cells results in additional costs as well as short-term losses. Nevertheless, the assumed 3500 full cycles over more than ten years can be assumed as secure. That doesn't depend on the type of battery technology, whereas the only exceptions would be the battery of lead.

The battery management system shows an additional technical risk. The use of power electronics nowadays has matured as much as possible, but nevertheless, mistakes can still appear. Thus, the partial or entire failure of the battery management system can affect the function of the memory up to the shutdown.¹² This also leads to additional expenses and short-term losses of income. Nevertheless, this risk can be classified as relatively small. Besides, the additional expenses should be cushioned by a maintenance contract.

The destruction of the battery memory by environmental factors is nearly impossible. Because they're used in the most different branches for years, the electronics as well as the cells of the memory are imbedded in a container and therefore protected.¹³ Merely the external effects caused by humans show a risk, even though a very low one.

Another risk exists regarding the balancing energy market. The possibility exists, that the battery memory doesn't fulfil the prequalification for the market entry not properly.¹⁴ Because a battery memory is most suitable for the desired operating method in the balancing energy market, this risk can be evaluated as very low.

B. Economic risks

The economic risks outbalance the technical sources of error as much as possible because the operation of a battery memory takes place in a steadily changing market environment. Beside political influence, market developments stamped by insecurity and acceptance, play an essential role.

¹¹ ESB Business School, 2012

¹² ESB Business School, 2012

¹³ Tübke J., 2009

¹⁴ bves, 2017

On the one hand there are price on the electricity exchange. On account of the growing interest of EE stream (approx. 120 billion kWh) exchange prices in the market have strongly fallen in Germany. Currently they reach the level from 2007. Compared with 2012, the price of base-load electricity has sunk from January to December 2013 by 11.4 percent of 4.27 cents per kWh on 3.78 cents per kWh. In France the electricity price was clearly expensive.¹⁵

Base-load electricity was more favorable in Germany from January to December 2013, about nearly 13 percent more favourable than in the neighbouring country. During the first six months of 2014, the prices have further fallen in Germany. At the end of June 2014, base-load electricity in Day-Ahead-Trade cost 3.15 cents per kWh. The following chart illustrates the price trend.

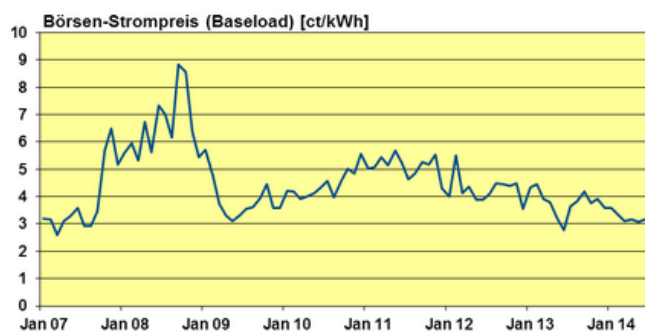

Illustration 3: day-ahead-trade¹⁶

Beside the sunk prize level, the melting price differences between peaking periods and off-peak periods is to be observed. This leads to the fact that even well-tried technologies, like pumped storage plants, can ensure no economic mode of operation. Also, the economic operation of a battery memory is not possible like described in scenario C. The development of the stock exchanges shows an essential economic risk. To guarantee a certain capacity level defined to begin with, the introduction of a capacity market is discussed quite long. As a result, price peaks should thereby be avoided and little volatility in prices should be created. The development and introduction of such cannot be estimated yet.¹⁷

The development of the balancing energy market shows another risk. After present market prices, the memory can be pursued economically. Because of steadily increasing expansion of the renewable energy, a steadily growing demand for control energy seems given. Nevertheless, the forecasts about wind and sun improve on and on. This reduces the demand in control energy. Additionally, the offer of control energy is further lowered by the shutdown of conventional power plants.

¹⁵ Iwr-Institut, 2018

¹⁶ Iwr-Institut, 2018

¹⁷ Fraunhofer Institut, 2017

The offer is raised by the participation of other adjustable producers like, for example by total cogeneration units. Furthermore, there still exist economic risks that must be taken into consideration, but first must be estimated. In the meantime, the supplier of the memory can go into insolvency or can no longer ensure an appropriate delivery because of their own value-added chain. Caused by the search of a new partner, the realisation of the project would be delayed further. The amendment of the political basic conditions is a hardly calculable risk. By amendment of legislations, for example the status of a memory or the market access in the balancing energy market, the conditions can change to the positive. However, also negative changes can occur.

IV. CONCLUSION

The focus of this work was to show the opportunities of battery storage. Therefore, the functionality and also the potential risks, which can be separated into technical and economic risks, were explained. After a short introduction in this branch of renewable energies, the meaning of storage in the field of energy revolution was discussed. After that the functionality and the associated risks were defined. This exposition can go beyond battery storages and depends on the specific battery technology. Beside the facts, other future implications can be suggested. At this point it can clearly be said that with the governmental settings for climatic goals, other laws and regulations will be introduced. This will increase the hype and technological innovations about regenerative energies. The meaning of costs will become less important. This can be assumed because the investment costs for photovoltaic plants and prices for modules are also decline.

It should be noted that the technologies in this branch had not reached sufficient maturity and therefore didn't reach the governmental climatic goals, to completely switch from fossil and nuclear fuels. There remains to hope that the technological progress produces other energy-self-sufficient features and innovations.

LITERATURE

- [1] Bundesverband WindEnergie (BWE), „Installierte Windenergieleistung Deutschland“, 2018, <https://www.windenergie.de/infocenter/statistiken/deutschland/installierte-windenergieleistung-deutschland>, 03.07.2018.
- [2] Bundesministerium für Wirtschaft und Energie (BMWi), „Erneuerbare Energien“, 2018, <https://www.bmwi.de/Redaktion/DE/Dossier/erneuerbare-energien.html>, 02.07.2018.
- [3] Bundesministerium für Umwelt, Naturschutz, Bau und Reaktorsicherheit, „Klimaschutz in Zahlen: Klimaschutzziele Deutschland und EU“, 2018, unter: https://www.bmu.de/fileadmin/Daten_BMU/Download_PDF/Klimaschutz/klimaschutz_in_zahlen_klimaziele_bf.pdf, 29.06.2018.
- [4] Agentur für erneuerbare Energien, „Landesinfo Wind Brandenburg“, 2018, https://www.foederal-erneuerbar.de/landesinfo/bundesland/BB/kategorie/wind/auswahl/486-durchschnittliche_le/#goto_486, 30.06.2018.

- [5] Bundesregierung, „Energiewende“, 2018, https://www.bundesregierung.de/Webs/Breg/DE/Themen/Energiewende/Fragen-Antworten/2_Netzausbau/6_strom-speichern/_node.html, 03.07.2018.
- [6] Carpus, “Die Welt der Batterien“, 2018, <https://www.carpus.org/content/media/548.pdf>, 01.07.2018.
- [7] ESB Business School, “Die Batterie als Schlüsseltechnologie für die Elektromobilität der Zukunft“, 2012, https://www.esb-business-school.de/fileadmin/user_upload/Fakultaet_ESB/Forschung/Publikationen/Diskussionsbeitraege_zu_Marketing_Management/2012-3-Reutlinger-Diskussionsbeitraege-Mark-Mngmt-E-Mobility-Batterie.pdf, 02.06.2018.
- [8] Umweltbundesamt, „Batterien und Akkus“, 2012, <https://www.umweltbundesamt.de/sites/default/files/medien/publikation/long/4414.pdf>, 01.06.2018.
- [9] ADS-TEC, https://www.ads-tec.de/uploads/media/Battery_Storage_ads_ICCS_container1_15x10_300_dpi.jpg, 01.06.2018.
- [10] Umweltbundesamt, „Batterien und Akkus“, 2012, <https://www.umweltbundesamt.de/sites/default/files/medien/publikation/long/4414.pdf>, 01.06.2018.
- [11] ESB Business School, “Die Batterie als Schlüsseltechnologie für die Elektromobilität der Zukunft“, 2012, https://www.esb-business-school.de/fileadmin/user_upload/Fakultaet_ESB/Forschung/Publikationen/Diskussionsbeitraege_zu_Marketing_Management/2012-3-Reutlinger-Diskussionsbeitraege-Mark-Mngmt-E-Mobility-Batterie.pdf, 02.06.2018.
- [12] ESB Business School, “Die Batterie als Schlüsseltechnologie für die Elektromobilität der Zukunft“, 2012, https://www.esb-business-school.de/fileadmin/user_upload/Fakultaet_ESB/Forschung/Publikationen/Diskussionsbeitraege_zu_Marketing_Management/2012-3-Reutlinger-Diskussionsbeitraege-Mark-Mngmt-E-Mobility-Batterie.pdf, 02.06.2018.
- [13] Tübke J., (2009): „Sicherheitskonzepte für Lithium-Ion-Batterien, erschienen in Energy 2.0-Kompendium“, 2009, München.
- [14] bves, “Faktenpapier Energiespeicher“, 2017, https://www.bves.de/wp-content/uploads/2017/05/Faktenpapier_2017.pdf, 01.06.2018.
- [15] IWR, 2018, <https://www.iwr-institut.de/de/presse/presseinfos-energiepreise-fuer-verbraucher-steigen-boersen-strompreise-sinken-auf-rekordtiefs>, 28.06.2018.
- [16] IWR, 2018, <https://www.iwr-institut.de/de/presse/presseinfos-energiepreise-fuer-verbraucher-steigen-boersen-strompreise-sinken-auf-rekordtiefs>, 28.06.2018.
- [17] Fraunhofer Institut, „Perspektiven zur aktuellen Kapazitätsmarktdiskussion in Deutschland“, 2017, <http://www.isi.fraunhofer.de/isi-wAssets/docs/x/de/publikationen/Perspektiven-zur-aktuellen-Kapazitaetsmarktdiskussion-in-Deutschland.pdf>, 28.06.2018.