



Brandenburgische  
Technische Universität  
Cottbus - Senftenberg

# 16<sup>th</sup> EEEIC

## International Conference on Environment and Electrical Engineering – Student Edition

Wrocław

Ostrava-Cottbus

19<sup>th</sup> – 23<sup>rd</sup> of June 2017

Harald Schwarz, Przemysław Janik,  
Radomir Gono, Dirk Lehmann

module at BTU: 11396

**Presented by**

Wrocław University of Technology  
Department of Electrical Engineering  
pl. Grundwaldzki 13  
PL 50 – 377 Wrocław

Technical University of Cottbus  
Department of Power Distribution and High Voltage Technology  
Walther-Pauer-Straße 5  
D – 03046 Cottbus

VŠB - Technical University of Ostrava  
Department of Electrical Power Engineering  
17. Listopadu  
CZ - 15 Ostrava - Poruba

**Publisher**

Brandenburg University of Technology Cottbus - Senftenberg  
Information, Communication and Media Center  
University Library

**Impressum**

Brandenburgische Technische Universität  
Cottbus-Senftenberg  
IKMZ - Universitätsbibliothek  
2017

[DOI 10.26127/BTUOpen-5712](https://doi.org/10.26127/BTUOpen-5712)

**Legal rights**

[Creative Commons Attribution 4.0 International](https://creativecommons.org/licenses/by/4.0/)

# Table of contents

Engineering Development in AC Coupled Hybrid Electrical Supply Systems and their Implementation	1
Environmental impacts of coal energy	8
Coal to Biomass Conversion for Efficient Thermal Power	12
Renewable Energy: A political, economic and technical comparison between Germany, Poland and Czech Republic	15
Effects of time change on economy and human health	21
Cables in Power Transmission Grid	26
Needs, potentials and applications for business model innovations with block chain-technology in the electric power industry	29
Vehicle-to-Grid: Opportunities and Challenges for the Energy Sector	33
Why have small wind power plants not been installed on private rooftops so far	38
SHALE GAS EXTRACTION: how to reduce consumption of oil	40
Dreiphasige Strommessung mit Brückengleichrichtung zur Leistungsmessung	45



# Engineering Development in AC Coupled Hybrid Electrical Supply Systems and their Implementation

Muhammad Noraiz Asif, Muhammad Ali Sheikh, Omar Ashraf Chaudhary

**Abstract**—The Hybrid Systems are the growing need of modern society in which the uninterrupted electric supply is the basic need around the globe now a day in the world. The popularity of these systems is triggering the engineers and scientist to make more development and research in the field of renewables and smooth electrical supply to the consumers. The basic idea behind hybrid systems in electric supply is the reduction of greenhouse gases emission from the environment which is being produced by conventional power plants and the production of cheap and clean energy supply. But overnight we cannot shift totally to green energy so new solutions should be implemented as the new trend is being set by synchronizing the energy produced by renewables with the AC systems and this combination is required where the grid connection is weak and these days we can expect such type of behavior where the reserves of oil are being got reduced and power plants cannot give their production at full capacity. So, there we need such type of AC coupled hybrid systems. This paper covers the comprehensive aspects and different types of hybrid systems and their implementation to which extent are applicable in the market presently.

**Index Terms**—AC Coupling System, Grid Tied Solar System With-out Battery, Grid Tied Solar Inverter with Battery, Off-Grid Solar Hybrid System, Stand Alone Solar-Wind Hybrid System, Experimental Design, Load Condition, Present Trend, Forecast.

## I. INTRODUCTION

IN THE 21<sup>ST</sup> century, the hybrid systems showed surprisingly high market demand due to the cutting-edge research and innovation in this area of technology in the whole world after acknowledging its spontaneous results and efficiency. In the Hybrid system, more than two electrical sources are combined and synchronized with each other by meeting the requirement of all necessary electrical parameter of each source for providing the smooth and continuous power to the desired load. Previously by constructing the solar and wind energy grids in rural, coastal, offshore, onshore and deserts areas where the electricity was still a dream for many inhabitants of backward areas. Those grids called stand-alone grids or even stand-alone hybrid grids where solar and wind energies are combined to produce the energy. But today innovation and demands in big cities require much more energies than it was before. To find out the solution intellectuals and engineers found the way to meet up the expanding load demand by developing hybrid systems of grid tie solar or wind systems rather than building new black coal and oil-fired power plants which are the

responsible for CO<sub>2</sub> emissions. The development in this area has emerged and became a pioneer in all fields of electrical engineering for the supply of energy from commercial to domestic users. These systems will reduce the pollution up to 30% of the total production. Researchers found that there will be a significant drop in the supply of oil by 2030 which is a worrying situation for the oil-fired power plants and these power plants are producing somehow 43% of total energy around the globe which means incoming time such power plants will not be able to produce energy to their full capacity [1]. To overcome this type of situation by synchronizing the power to the national grid produced from renewables which make a hybrid system is the only solution. The basic concept of the hybrid system is shown below in Figure 1.

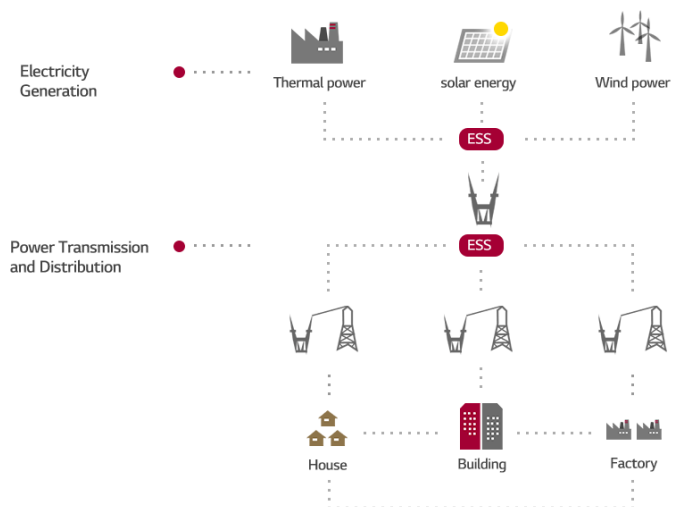

Figure 1: Thermal Power-Solar-Wind Hybrid System [2]

## II. AC COUPLING SYSTEM

The Figure 1 is obvious that solar and wind energies can be coupled with AC conventional power plant which depends on application and energy demand. This is advantageous when energy demand is higher which cannot be fulfilled only by the grid so that solar-wind energies are integrated with the grid line. So, this system can be expanded by multiplying different sources such as Biofuels power plants, Fossil Fuels, Diesel Generators, Batteries which totally depends on energy demand.

These systems are suitable for big cities and industrial areas where energy demand is high.

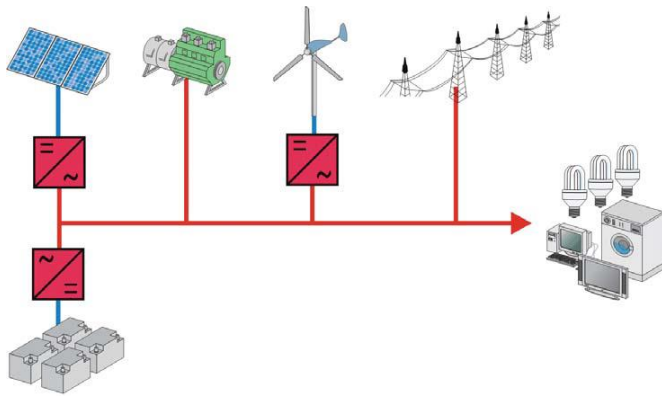

Figure 2: AC Coupled Hybrid System [3]

In the hybrid systems, solar systems are connected in two ways either with batteries or without batteries backup but the above Figure 2 illustrates the system with battery backup. In such systems when solar produces its power in DC cannot add-up in the AC system so for that purpose the inverters are built-up for the DC-AC operation and synchronizes with the AC system. Wind energy already produces AC power due to conventional generator mechanism. In the range of (2-100) kW the hybrid system does not require any complex controlling unit but <100 kW the special controlling unit is required for monitoring the parameter of each source. In large hybrid systems when the load demand increases it is much cost effective to use batteries as a backup instead of diesel generator because generator requires a maintenance and diesel cost while batteries have one-time cost with a longer lifetime. Furthermore, the merits and demerits of such system are [3].

Table 1  
Merits of AC coupled Hybrid Systems

a	100% Compatible with the national grid.
b	Very reliable system due to its redundancy.
c	Easily combinable in parallel with an isolated diesel generator, small hydro units etc.
d	Capacity range can be from KW to MW
e	Simple installing equipment is required
f	Easily expandable by multi sources

Table 2  
Demerits of AC coupled Hybrid Systems

a	Higher cost due to new technology
b	Improvement needed in battery technology
c	Weather dependent sometimes
d	Complex controlling system

### III. TYPES OF HYBRID SYSTEMS

#### A. Grid Tied Solar System With-out Battery

A Utility Interactive system is commonly known as Grid Tied Solar System or sometimes On-Grid Solar System works together with your energy provider in a building with sharing

of energy. Direct Current (DC) energy is produced by the working of solar panel when it receives sunlight and heat from the sun where this DC is converted into AC by the operation of Grid Tie Inverter (GTI). GTI controls the voltage and current level produced by the solar panels. These inverters produce alternating sine wave and match the sine wave with the Grid parameter and fed to main distribution panel of the home where home appliances use hybrid energy from the power system. GTI is the control system which synchronizes the electrical parameters of Solar and Grid to run a common load which is sometimes also called synchronous inverters. The inverters set the frequency normally 60Hz or 50Hz and phase angle for the energy produced from solar to meet up with the grid level frequency and phase angle. The voltage level in GTI is also set higher than the grid voltage level for excess flow of energy towards the grid in reverse operation because in this system extra power which is being produced in the daylight and exceeds the energy production than the load consumption then extra energy will be fed back to Grid to save further electricity bill. In this way, the user becomes the energy producer and can sell to the grid which reduces the bill near to zero in this case by using proper location and angle and mounting system. This feeding to the grid system is very rare and special power meters are installed for net metering which can calculate the real-time power produced by solar and grid in both directions from the grid to house and vice versa. The figure below clearly illustrates the working of this hybrid system [5].

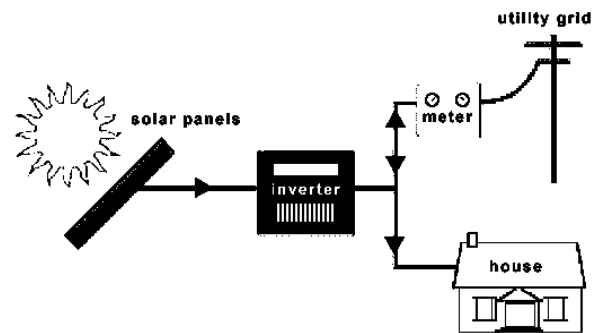

Figure 3: Grid-tied Solar Inverter Without Battery [4]

Table 3  
Merits of Grid Tied Solar Inverter without Battery

a	Net metering saves money
b	Higher Efficiency rates
c	Equipment and installation cost is economical
d	Selling of energy to grid in case of excess energy
e	Utility grid works as virtual battery
f	Electricity need meets up the requirement

Table 4  
Demerits of Grid Tied Solar Inverter without Battery

a	Solar system is weather dependent
b	Maintenance and cleanliness required for panels
c	No battery back-up for the night time

### B. Grid Tied Solar Inverter with Battery

This power system is same like as Grid Tied system without battery and called off-grid system because in the absence of grid power the energy can be consumed by the stored energy in the batteries because in this an extra feature of battery comes which is charged by solar system in the form of DC. The Batteries acts as backup power supplier in the case of emergency or in the evening time when there is no longer the sun is available and then normally a hybrid inverter take supply from grid and take energy from battery not from solar panel which is the main difference between two systems with and without batteries and combine the power from both sources by matching parameters of both sources by the working of GTI and supply it to main and common panel of electricity, from where all the load of home consumes energy. An extra feature to come in this system if battery bank is fully charged and load consumption is less than solar total generation then it fed back to Grid and save more energy which is done by the power metering system. This System is mostly used in these systems where load shedding occurs mostly and the system is unreliable mostly due to poor infrastructure.

In this type of systems when the power production is high during the daytime that extra energy is stored in the batteries for the back-up and when the batteries are fully charged again than the extra excessive energy is fed back to the grid. The working principle of GTI and power meters are same as described in above hybrid system. The main difference between in these two systems are the batteries.

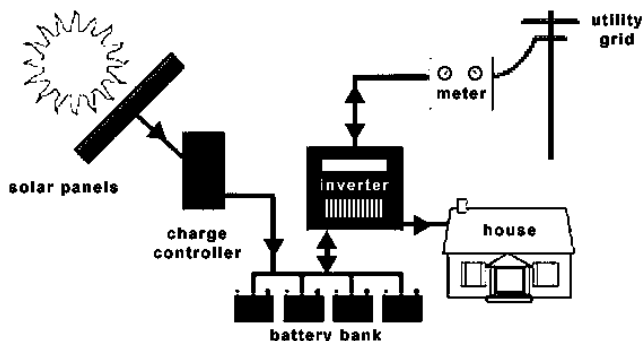

Figure 4: Grid-tied Solar Hybrid System with Battery [4]

The Charge controller, in this case, is necessary because charge controller regulates and limit the flow of current in batteries while adding or drawing power from it and prevents the batteries from overcharging and protects against overvoltage. This is very pivotal equipment for the protection because in the daytime when the sun is at its peak it could produce excessive current flow in the battery which can cause damage and shorten the lifespan of the battery. The typical household battery should not exceed 12.7V and 7A current. [6].

Table 5  
Merits of Grid Tied Solar Inverter with Batteries

- |   |   |
|---|---|
| a | Backup system of batteries makes reliable |
| b | Independent of grid supply                |
| c | Excess energy storage in the batteries    |

Table 6  
Merits of Grid Tied Solar Inverter with Batteries

- |   |                            |
|---|----------------------------|
| a | Expensive due to batteries |
| b | Complex controlling system |
| c | High equipment cost        |

### C. Off-Grid Solar Hybrid System

This off-grid system is also known as Stand-Alone Hybrid System in which it has two or more power/energy sources where utility grid has no access. Mostly solar, wind and small diesel generators are combined in this type of hybrid system. All the systems are converted into AC system and parameter of each source is being synchronized such as phase angle, voltage, and frequency before the power is delivered to the load. Such systems are mostly constructed in deserts and rural areas where these systems are used and seashore areas where grid supply is not possible.

The main part of the stand-alone hybrid system is Diesel generator which comes in the system for the purpose that big batteries cost too much for the working of several days in the case of cloudy weather, especially in the winter season. Such small generators run on gasoline, diesel, propane, and petrol. Installing such generators are much efficient and economical than building up the large battery system. Generators produce AC power so their energy is passed as it is from the inverter to the AC loads but for the energy storage in batteries their power is converted to DC by the power inverters [6].

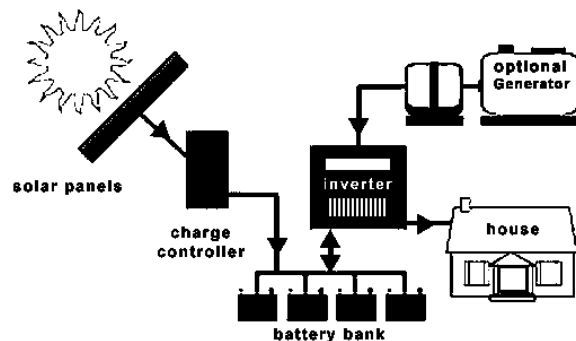

Figure 5: Stand-Alone AC Hybrid System [5]

Table 7  
Merits of Stand-Alone Hybrid System

- |   |   |
|---|---|
| a | Grid independent system                         |
| b | Saving of transmission lines cost from the grid |
| c | Battery back-up in case of cloudy weather       |
| d | More reliability due to backup generator        |

Table 8  
Demerits of Stand-Alone Hybrid System

- |   |  |
|---|--|
| a | Higher Generator Cost                                      |
| b | Large Batteries system                                     |
| c | Batteries are expensive and complicated connection network |

### D. Grid Integrated Wind-Solar Hybrid System with Battery Back-up

This system is one of the main and reliable hybrid systems. In such type of systems Solar, Wind and Grid powers are

synchronized with each other with the external battery backup system. This is more reliable in the sense that if the sun is not shining then wind can overcome that loss and vice versa. The other working of power metering and inverter is same like other hybrid systems. Figure 6 elaborates the working of hybrid system obvious.

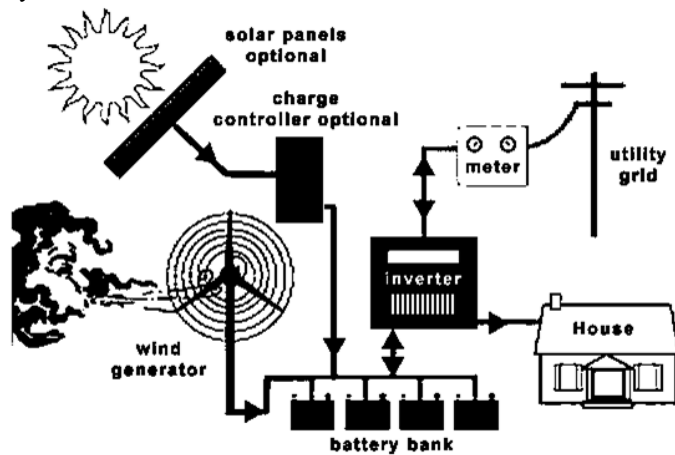

Figure 6: Grid integrated Wind-Solar Hybrid System [4]

Table 11

Merits of Grid Integrated Solar-Wind Hybrid System

a	Highly Reliable System
b	Higher Efficiency Rates
c	Load Consumption requirement easily meets up
d	Continuity of electric supply

Table 12

Demerits of Grid Integrated Solar-Wind Hybrid System

a	Costly system
b	Controlling mechanism gets complex
c	High Maintenance required

*E. Stand Alone Solar-Wind Hybrid System.*

A Utility Interactive system is commonly known as Stand-alone hybrid system which is installed in remote areas where it is very difficult to transport the transmission lines from the grid to that areas. Those areas are often located in hilly sides and very far from the commercial lives. They are totally independent of grid utility so they work and operate in standalone operation. This hybrid system can deliver power up to 24 hours a day. The functionality is shown in Figure 7.

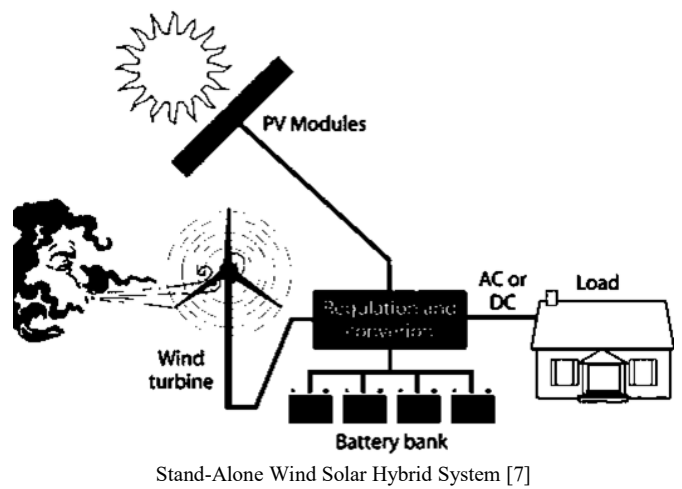

Table 13

Merits of Stand-Alone Wind Solar Hybrid System

a	Reliable system for remote areas
b	Continuity of supply
c	Backup batteries for supply
d	Easy Installation
e	Totally green energy production
f	Independent working

Table 14

Demerits of Stand-Alone Wind Solar Hybrid System

a	Batteries Maintenance
b	Weather dependent system

IV. EXPERIMENTAL WORK AND RESULTS

*A. Experimental Design*

The real hybrid system project on which we worked during bachelor studies in NFC Institute of Engineering & Technology, Multan, Pakistan we had successfully designed a Grid Tied Solar Hybrid System with the battery in 2016. The aim of developing and designing of the project was to apply theoretical knowledge to a practical work. The motivation to design such a project was to get involve and learn from a deep knowledge of growing technology of the world in hybrid systems. In this system, the prototype of hybrid power inverter was built to synchronize the parameter of two electrical sources one from solar and other from the grid by the modern methodology and ran a common load connected on the same bus bar. This project cost us approximately 500 US dollars. The main features of the project are given below.

- Synchronizing of solar energy with the grid.
- Synchronization of frequency, voltage and phase angle of both sources.
- Designing of an efficient inverter.
- Power sharing between two sources.
- Continuity of electrical supply even if one source is out of service.
- Reduction of the net electricity bill.



- Development of innovative technology.

The block diagram of the hybrid system is shown in Figure 8.

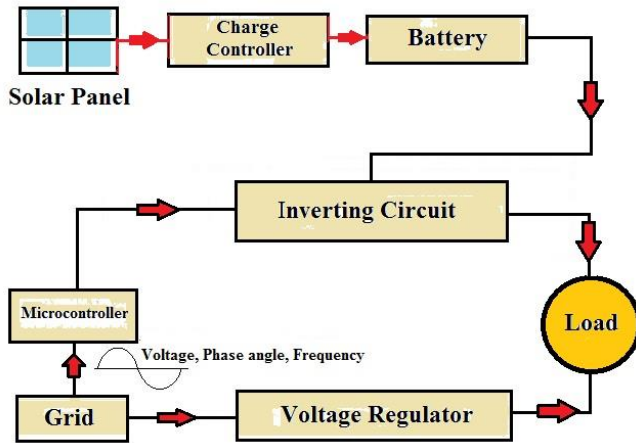

Figure 8: Block Diagram of Hybrid Inverter System

The Technical Characteristics of Hybrid Inverter are given in Table 15.

Table 15  
Features of Hybrid Power Inverter

a	Designing the 220V-5V power supply circuit
b	Zero crossing circuit designing
c	Efficient 12V-220V DC-DC Converter
d	Low-frequency inverter 220V DC-220V AC at 50Hz
e	High-frequency inverter 12V DC-220V AC at 50KHz
f	Microcontroller based synchronization unit.
g	H-Bridge circuit designing using IRF740 MOSFET
e	Rectifier circuit designing using IN4001 diode bridge

The final hardware project of proposed grid tied solar hybrid system is shown in Figure 9.

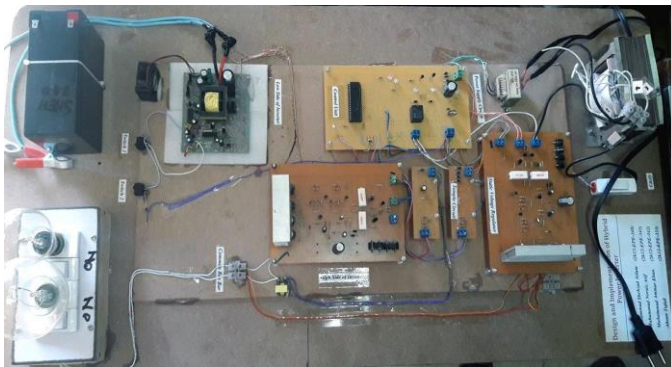

Figure 9: Hybrid Grid Tie Solar Power Inverter

### B. Load Conditions

As the project has also an independent standalone operating mode only on solar power without any interference of grid which makes it more unique. It has two conditions to run a load

a common load. The conditions are written below.

#### 1) Condition 1

- When the load is less than 200 watts the load will run purely on DC source means solar energy.

#### 2) Condition 2

- When the load exceeds the range of 200 watts then the relay on the power supply circuit operates and links the grid source with the solar source and the common load will run after the synchronization of both sources.
- In this condition, we are successfully achieving the level of synchronization of all parameters including voltage, frequency, and phase angle.

### C. Results

The question is that how we will come to know that synchronization is performing in this project as there is no clear visual evidence, but by testing, we had proved that all parameters were syncing. So, we tested by clamp meter and checked the current flowing from each source which should be equal to the total output current.

$$\text{Input Current of Solar Source} + \text{Input Current of WAPDA source} = \text{Total output Load Current}$$

Asper the project testing

$$0.5A + 0.7A = 1.2A$$

Voltage:

$$220V$$

Solar Input Power

$$0.5A * 220V = 110W$$

Grid Input Power

$$0.7 * 220V = 154W$$

Total Power

$$264W$$

The results clearly illustrate the evidence of synchronization.

## V. IMPLEMENTATION

### A. Present Trend

Many countries are paying attention to increase their installed capacity of solar and wind systems and increasing their budgets for the promotion of renewable energy production. Every country is trying to reduce the production of electrical power from conventional power plants but nothing could be possible overnight so everything needs to be balanced. To maintain such balance is energy production renewables energy systems are adding up into a national grid to produce green energy. Below a chart shows the countries who have produced largest annual installed capacity from the solar system in last decade.

TOP 10 COUNTRIES IN 2015 FOR ANNUAL INSTALLED CAPACITY











1		China	15,2 GW
2		Japan	11 GW
3		USA	7,3 GW
4		UK	3,5 GW
5		India	2 GW
6		Germany	1,5 GW
7		Korea	1 GW
8		Australia	0,9 GW
9		France	0,9 GW
10		Canada	0,6 GW

Figure 10: Largest annual installed capacity in 2015 [8]

Below in Figure 11 shows largest cumulative installed capacity of different countries.

TOP 10 COUNTRIES IN 2015 FOR CUMULATIVE INSTALLED CAPACITY

1		China	43,5 GW
2		Germany	39,7 GW
3		Japan	34,4 GW
4		USA	25,6 GW
5		Italy	18,9 GW
6		UK	8,8 GW
7		France	6,6 GW
8		Spain	5,4 GW
9		Australia	5,1 GW
10		India	5 GW

Figure 11: Largest cumulative installed capacity in 2015 [8]

These number shows that China, Germany, and Japan are taking the lead from rest of world in this field. These solar systems are being installed in multiple ways either in homes, offices and in commercial scale on an individual basis. But in larger scale, these systems are being installed as a stand-alone or hybrid system which is described in detail above. The most common type of hybrid system is grid tie solar hybrid systems.

B. Forecast

If we see the future trends of energy production from renewables and hybrid systems, we clearly come to see that the future of green energy production is very bright and hybrid system will get to have more popularity than it was before. Figure 12 elaborates the future energy production trends from renewables.

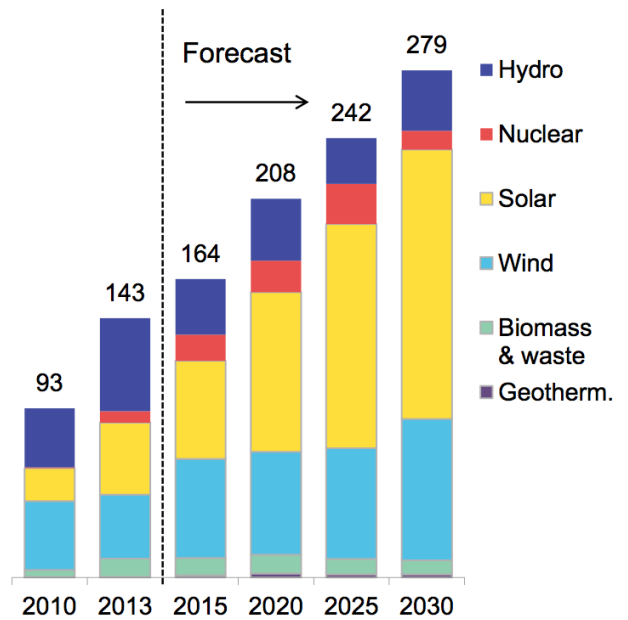

Figure 12: Forecast of different energies production [9]

The chart shows that solar and wind energies are still progressing and hybrid systems will implement much more in future as compared to today.

VI. CONCLUSION

This research is concluded with a motivation to enhance the production of energy from renewables and move towards next generation of technology and install the hybrid systems for the efficient, uninterrupted and smooth supply of electrical power to the domestic, industrial and commercial users. This paper has described in details different types of hybrid systems and inverters which are proposed for the installation in the market. The role of GTI and power meters in hybrid systems which are responsible for increasing the efficiency and improves the power quality delivered to the end consumers. We have discussed working and different scenarios and their impact in the future market. One particle project work has also been covered in this paper to give some reasonable understanding of the synchronization of electrical parameters of different sources which are the pivotal part of hybrid systems. Then future trends are shown which shows the coming time is of such type of systems are a lot of room is available for research to improve the quality much better than it is at present.

VII. ACKNOWLEDGEMENT

Authors would like to thank Prof. Dr.-Ing. Przemysław Janik and Dipl.-Ing. Dirk Lehmann for giving us a chance to write this paper.

VIII. REFERENCES

- [1] The World Bank, "Electricity from coal production (% of total)" [Online] Available: <http://data.worldbank.org/indicator/EG.ELC.COAL.ZS>
- [2] Product/ ESS/LG Chem, "Concept of Energy Storage System (ESS)".

<http://www.lgchem.com/global/ess/ess/product-detail-PDEC0001>

- [3] TechnologyCompendium 2 - Solar Stand-Alone Power and Backup Power Supply, "AC Coupling"  
[http://files.sma.de/dl/10040/INSELVENSOR\\_AEN101410.pdf](http://files.sma.de/dl/10040/INSELVENSOR_AEN101410.pdf)
- [4] WholeSaleSolar, "Grid Tied Power Systems".  
<https://www.wholesalesolar.com/solar-information/start-here/gridtie-information>
- [5] Energy Informative, "Grid-Tied, Off-Grid and Hybrid Solar Systems"  
<http://energyinformative.org/grid-tied-off-grid-and-hybrid-solar-systems/>
- [6] Wikipedia, "Charge Controller"  
[https://en.wikipedia.org/wiki/Charge\\_controller](https://en.wikipedia.org/wiki/Charge_controller)
- [7] Mr. Solar Wind, "The world first integrated solar and wind hybrid technology"  
<http://windandsolarhybrid.com>
- [8] Clean Technica, "1 Solar Energy Chart Puts the USA in its Place".  
<https://cleantechnica.com/2016/06/15/3-solar-energy-charts-put-us-place/>
- [9] Energy Matters, "The Difficulties of Powering the Modern World with Renewables".  
<Http://euanmearns.com/the-difficulties-of-powering-the-modern-world-with-renewables/>



**Muhammad Noraiz Asif** (Matriculation # 3643748) received the B.Sc. Degree in Electrical Power Engineering from NFC Institute of Engineering & Technology, Multan, Pakistan in October 2016. Further, he is currently pursuing his M.Sc. in Power Engineering with a specialization in the field of power electronics from Brandenburg Technical

University, Cottbus, Germany from November 2016 and ongoing.

He did an internship in Lalpir Thermal Power Limited, Muzaffargarh, Pakistan in electric drives sector and worked with the team in switch gears. He worked on a project in his bachelor thesis on the design and implementation of Hybrid Power Inverter. For the admirer of his innovative research work, his group won the first position in Innovative Competition for Engineers (ICE) 2016 in his university.

Mr. Muhammad Noraiz Asif is also a registered member of Pakistan Engineering Council (PEC). He has an interest in electric drives, Inverters, Electrical Circuits. For pursuing his career in this field, he has offered an internship of six months in an eminent company of Germany Robert Bosch GmbH in the research and development of Automotive Electronics and soon he will join his post.



**Muhammad Ali Sheikh** (Matriculation # 36165508) was born in Karachi in 1990, the biggest city of Pakistan. He received the B.S. Degree from FAST-National University of Computer and Emerging Sciences (FAST-NUCES) Karachi in Electrical Engineering and pursuing M.S. degrees in power engineering from the Brandenburg Technical University,

Cottbus, Germany from 2016 and ongoing.

From 2013 to 2015, he worked in the largest textile mill in Karachi where he worked on PLC's and enhanced his practical experience. He also did an internship at Dawlance during his bachelor studies in 2011.

Mr. Muhammad Ali Sheikh has now focused in the field of renewables and power electronics and pursuing his research to build new innovative technologies for the future modern world.



**Omar Ashraf Chaudhary** (Matriculation #3522312) received the B.S. degree in Electrical Engineering from University of Engineering & Technology, Lahore in 2013 and currently pursuing M.S. degree in Power Engineering from Brandenburg Technical University, Cottbus, Germany from 2015 and ongoing.

In 2015, he was a Research Assistant in his university. His research interest includes the automation of EMC anechoic chamber using LabVIEW. In October 2015, he joined the largest company of Germany Robert Bosch GmbH as an internee engineer where he was responsible for the automation of double pulse measurement test bench. Now he is pursuing his master thesis in the same company in the field of power electronics.

# Environmental impacts of coal energy

Zana Aga, Mehmet Volkan Kablan

**Abstract**— Coal power plants are still one of the major energy generation methods of the world despite the impacts to the environment and society. This paper will show the technique of power generation with coal and will explain the procedure of pollutants creating and the impacts of them to society and environment. Afterwards there will be explained how technically the emissions can be reduced. There will be also demonstrated how legal methods are used to reduce the emissions and how green energy is supported from the law and policy.

**Index Terms**— coal energy, environmental impacts of fuel energy, emission reduction methods, green energy laws, Kiyoto protocol

## I. INTRODUCTION

COAL energy is in Germany with an amount of 40% the biggest energy source for electricity (2016). Coal energy plants have an efficiency of only about 30 till 45% but are still a cheap energy source because of the high availability of the resource and can be run continuously and independently of the weather and other impacts. [1]

However, coal energy generation is also a main source of greenhouse gas like carbon dioxide and nitrogen monoxide. In addition, sulfur dioxide, fine dust and quicksilver are forming during combustion. Therefore, this paper will first show how a coal power plant is working. Then it explains the reasons and mechanisms of the formation of the emissions carbon dioxide and nitrogen monoxide and their impacts to the environment. Afterwards the paper shows how Germany and the United Nations are working legally to bringing the energy transition to green energy forwards.

## II. COAL ENERGY GENERATION

Coal energy plants are working through heat energy generation. Therefore, a conveyer belt transports the coal to the foreign substances separator, where they separate parts like Xylitol. Afterwards the coal reaches the grinder, where it will be grinded to dust and is being dried with exhaust gases from the plant. Then it will be blown into the combustion box and is mixed with air during the combustion. The produced heat is heating then the water tube boiler under high temperatures. The result is hot steam under high pressure, which is running a steam turbine. The turbine transfers the torque to a generator and electricity is produced. The steam is cooled again in the capacitor and will be recirculated. The produced exhaust gas is cleaned with a combination of a dedusting plant, electric filter

and flue gas desulfurization plant, before it will leave the plant during the chimney.[2] This procedure is shown in figure 1.

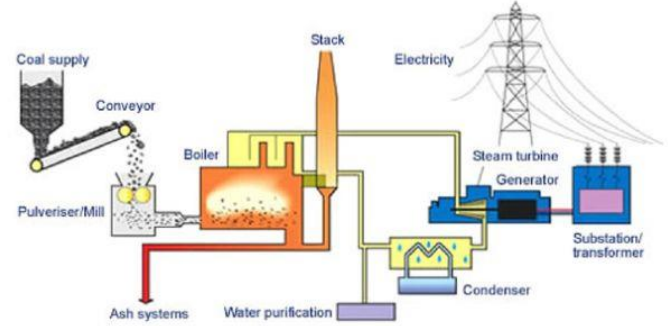

Figure 1 Schema of a coal power plant

## III. EMISSIONS

The main emissions that are formatting during the combustion process are CO<sub>2</sub>, NO<sub>x</sub>, sulfur dioxide, fine dust and quicksilver. The formation process of CO<sub>2</sub> and NO<sub>x</sub> during combustion and the impacts to the environment are shown in this chapter. [3]

### A. CO<sub>2</sub>

CO<sub>2</sub> is one of the major greenhouse gases and is one of the main reasons for climate warming. CO<sub>2</sub> is formatting during combustion through the carbon that is contained in coal and oxygen from the air.



The greenhouse effect occurs, because the greenhouse gases like CO<sub>2</sub> are remaining in the atmosphere. The solar radiation is passing the atmosphere and are absorbed from the earth. During this process, the solar radiation converts to infrared radiation. The infrared radiation is absorbed from the greenhouse gases in the atmosphere. They are reflecting it to all directions. Therefore, also back to the earth. The reason, why the solar radiation can pass the greenhouse gases and not the infrared radiation, is that the wavelengths are different. The greenhouse effect is also shown in figure 2.



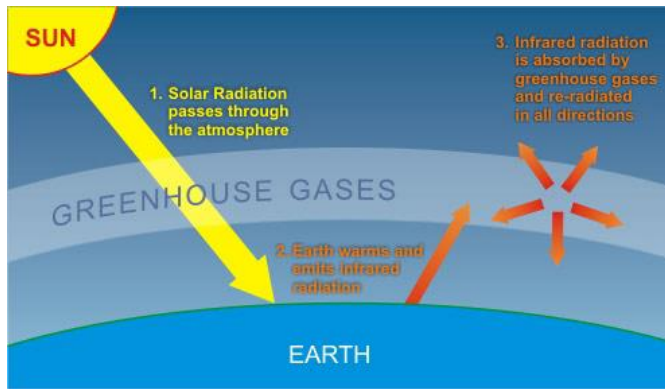

Figure 2 greenhouse effect

Approximately 60% percent of the greenhouse gases are CO<sub>2</sub>. [5] Therefore, it is important to know, where they mostly come from. From research of the international energy agency IEA 41,2 % of CO<sub>2</sub> is coming from the energy and heat producing sector. (shown in figure 3).

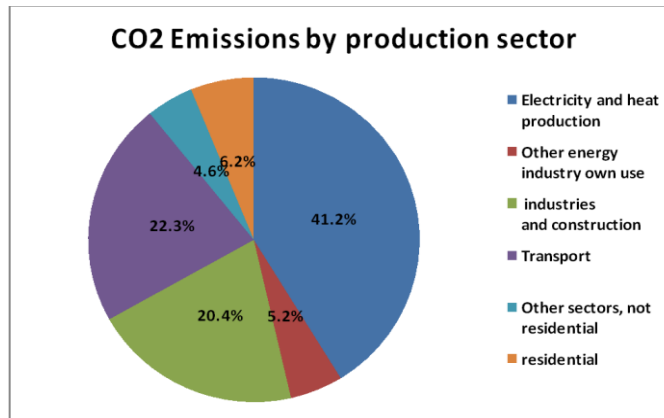
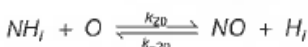
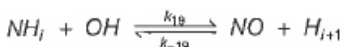
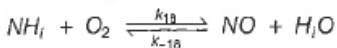
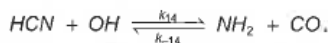
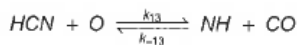

Figure 3 CO<sub>2</sub> Emissions by production sector

### B. NO<sub>x</sub>

Nitric oxide is formatted during combustion process because coal contains 0,8 – 2% nitrogen. During the combustion, the CN bounds are reacting to HCN. The HCN then reacts with oxygen and hydroxyl- radicals to Nitric oxide. [6]



Nitric oxide has different impacts to the environment. One of them is the reduction of the ozone. The Nitric Oxide reacts with O<sub>3</sub> to NO<sub>2</sub>. Reduction of Ozone is dangerous for the environment, because then dangerous radiation can radiate unfiltered and stronger to creatures and environment. [4] Nitric oxide is also a reason, why acid rain is occurring. Acid rain is

rain, which has a pH value under 5,5. Acid rain is toxic to the ground and one of the main reasons for forest decline. Nitric oxide is reacting in the atmosphere with water and oxygen to nitrous acid and nitric acid, which is causing the acid rain.

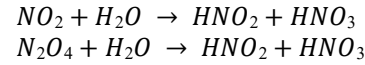

## IV. TECHNICAL REDUCTION METHODS

Modern power plants have technical methods to reduce their emissions. For example, Coal energy is usually producing around 750-1200g CO<sub>2</sub> per kWh. The modern power plant in Irsching, Bavaria reduced their CO<sub>2</sub> emissions to 350g per kWh. For Comparison: Solar Energy plants have a CO<sub>2</sub> footprint of 50-100g CO<sub>2</sub> and wind power plants only 10-40g CO<sub>2</sub> per kWh. Reducing methods of CO<sub>2</sub> and NO<sub>x</sub> are shown in this chapter.

### A. CO<sub>2</sub> Absorption technology

The CO<sub>2</sub> absorption technology is a post combustion CO<sub>2</sub> storage method, which can be easily installed at existing plants. The absorption takes place, while the CO<sub>2</sub> rich exhaust gas is passing the absorber. The process is using the amine monoethanolamine. During the process, a chemical bond is forming between the alkaline solvent and the CO<sub>2</sub>. Afterwards the CO<sub>2</sub> rich solvent is pumped to the stripper, where the CO<sub>2</sub> can be separated from the absorption material. The solvent is used again after a regeneration time and separation. The captured CO<sub>2</sub> can be then stored and used for different processes.

### B. Selective catalytic reduction of No<sub>x</sub>

The selective catalytic reduction method is a common way to reduce the No<sub>x</sub> emissions after the combustion and before the exhaust gas is leaving the plant system. During this process, the exhaust gas is mixed with a mixture of ammonia and water. In the catalyst, the ammonia is reacting as a reducing agent and de-oxygenates the nitrogen monoxide. The result of the reaction is water and molecular nitrogen, which is harmless. [6].

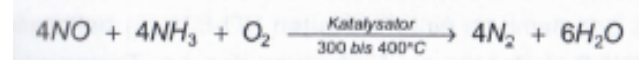

It should be noted, that ammonia have to be used in the accurate dosage. Otherwise, more nitrogen monoxide can be produced, which is the opposite of the method's purpose. [6]

## V. MEASURES TO PHASING-OUT OF FOSSIL FUELS

As a first step, the policy must actively deal with the issue, not only national but also international. One of the international treaties is the Kyoto Protocol, which adopted on 11 December 1997 an entered into force on 16 February 2005. A further agreement is the Paris Agreement, in which the 195 Member States of the United Nations agreed on the new targets of climate protection. The European Union also has mandatory

climate protection goals for its Member States. Germany decided a national climate action plan 2050 on 14 November 2016, which shows a clear goal for the future. The policy measures provide investors with the necessary security to invest in renewable energies. These investments favor technical progress. [7][8][9][10]

### KYOTO PROTOCOL

The Kyoto Protocol is the first binding international climate treaty to set goals for the emission of greenhouse gases. The states have committed themselves to reduce their greenhouse gas emissions between 2008 and 2012 by an average of 5.2 percent compared to the 1990 level. An important point in the Kyoto Protocol is dealing with emission rights. This regulates which total amount of greenhouse gases emitted within a certain period. A major problem is that the US has not ratified the protocol until today, but important emerging countries such as China and India have agreed to the protocol. Table one shows that the European countries Germany and Poland have exceeded the goal of 5.2 percent by a multiple. China, on the other hand, has emitted more emissions than the US, which have not ratified the protocol. [11][12]

	1990	2008	2013	Percentage of 1990 - 2013
United States	5444.6	5954.1	5599.9	2.9 % ↑
China	2387.0	7362.3	9218.8	286.2 % ↑
Germany	1030.5	806.5	795.1	22.8 % ↓
Poland	387.3	316.4	307.4	20.6 % ↓

Table 1: Emission of carbon dioxide in millions of tones

### GERMANY CLIMATE ACTION PLAN

On 14 November 2016, the German Federal Government adopted the Climate Action Plan 2050. The aim is to realize the objectives of the Paris Agreement for Germany. By 2050, the target is to reduce greenhouse gas emissions by 80-95% compared to 1990 levels. With the intermediate targets of 40% for 2020, 55% for 2030 and 70% for 2040, the climate action plan 2050 aims at a reduction of 85% in 2050. The major goal of the Federal Government is to reach 90-95% by 2050. [13][14]

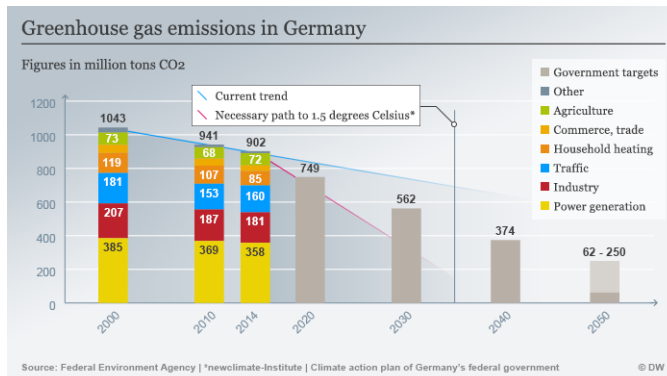

Figure 4: Greenhouse gas emissions in Germany

### VI. CONCLUSION

Coal power plants are one of the main reasons for greenhouse gases and the greenhouse effect. They are producing more emissions and therefore effecting the environment more than other energy sources. They cause acid rain, smog, ozone removal and health problems for humans. However, they are still important for the granting of continuous energy because of their ability to produce constant energy in high amounts. With modern technique, it is possible to reduce the amount of emissions, but they are still too high. Therefore, the research for alternative energy sources should be promoted and the technical standards for emission reduction of existing coal power plants should be legally high and building of new coal power plants should be legally difficult. Therefore intergovernmental organizations like the UN and countries like Germany are inventing new laws and guidelines like the German renewable energy laws or the Kyoto Protocol.

## REFERENCES

## Table

- [1] Professor Dr.-Ing. Hermann-Josef Wagner et al, CO2 Emissionen der Stromerzeugung, VDI, BWK Bd. 59 (2007) Nr. 10
- [2] S. Moazzem, M.G. Rasul and M.M.K. Khan (2012). A Review on Technologies for Reducing CO2 Emission from Coal Fired Power Plants, Thermal Power Plants, Dr. Mohammad Rasul (Ed.), InTech, DOI: 10.5772/31876. Available from:  
<https://www.intechopen.com/books/thermal-power-plants/a-review-on-technologies-for-reducing-co2-emission-from-coal-fired-power-plants>
- [3] Julia Huscher, the unpaid health bill, the Health and Environment Alliance, published March 2013
- [4] Bayrisches Landesamt für Umwelt: Umwelt Wissen- Schadstoffe, Bodennahes Ozon und Sommersmog, 2015, online zu finden auf:  
[https://www.lfu.bayern.de/buerger/doc/uw\\_47\\_bodennahes\\_ozon.pdf](https://www.lfu.bayern.de/buerger/doc/uw_47_bodennahes_ozon.pdf)
- [5] Dr. Dominik Schäuble et al, CO2-Emissionsgrenzwerte für Kraftwerke – Ausgestaltungsansätze und Bewertung einer möglichen Einführung auf nationaler Ebene, Institute for Advanced Sustainability Studies (IASS) Potsdam, April 2014
- [6] Dipl.-Ing. Christian Weichert, Anwendung von Primärmaßnahmen zur Optimierung der No<sub>x</sub> -Emissionen bei Feuernungsanlagen mit zeitlich veränderlichen Eintrittsgrößen insbesondere der Brennstoffzusammensetzung- Dissertation TU Clausthal, 30.09.2000
- [7] [https://treaties.un.org/pages/ViewDetails.aspx?src=TREATY&mtdsg\\_no=XXVII-7-a&chapter=27&lang=en](https://treaties.un.org/pages/ViewDetails.aspx?src=TREATY&mtdsg_no=XXVII-7-a&chapter=27&lang=en) [29.06.17 23:15 clock ]
- [8] [https://treaties.un.org/pages/ViewDetails.aspx?src=TREATY&mtdsg\\_no=XXVII-7-d&chapter=27&clang=\\_en](https://treaties.un.org/pages/ViewDetails.aspx?src=TREATY&mtdsg_no=XXVII-7-d&chapter=27&clang=_en) [29.06.17 23:19 clock]
- [9] <http://www.bmub.bund.de/themen/klima-energie/klimaschutz/nationale-klimapolitik/klimaschutzplan-2050/> [29.06.17 23:26 clock]
- [10] [http://www.bmub.bund.de/fileadmin/Daten\\_BMU/Download\\_PDF/Klimaschutz/klimaschutzplan\\_2050\\_bf.pdf](http://www.bmub.bund.de/fileadmin/Daten_BMU/Download_PDF/Klimaschutz/klimaschutzplan_2050_bf.pdf) [29.06.17 23:28 clock]
- [11] J. Reshöft and C. Bönning, Erneuerbare-Energien-Gesetz, Nomos, Baden-Baden, 2014
- [12] <http://www.bmub.bund.de/themen/klima-energie/emissionshandel/kurzinfo/> [29.06.17 23:50 clock]
- [13] <http://www.bmub.bund.de/themen/klima-energie/klimaschutz/nationale-klimapolitik/klimaschutzplan-2050/> [29.06.17 23:52 clock]
- [14] Heinrich-Böll-Stiftung e.V., Politische Optionen für Klimaschutz und Kohleausstieg, November 2016

- [1] Own representation based on  
<http://www.bp.com/content/dam/bp/en/corporate/pdf/energy-economics/statistical-review-2017/bp-statistical-review-of-world-energy-2017-full-report.pdf>

## Figures

- [1] <https://www.worldcoal.org/coal/uses-coal/coal-electricity> [26.06.17 12:15 clock]
- [2] <https://www.skepticalscience.com/empirical-evidence-for-co2-enhanced-greenhouse-effect-intermediate.html> [27.06.17. 13:00 clock]
- [3] <https://climatechangeinmylife.com/tag/building/> [28.06.17 12:00 clock]
- [4] Federal Environment Agency, Climate action plan of Germany's federal government

# Coal to Biomass Conversion for Efficient Thermal Power

Baskar Ramesh, Katarzyna Piepiora, Karolina Gajda

**Abstract-** Due to the Paris climatic agreement in December 2015, most of the industrial countries agreed to limit the climatic temperature rise well below 2°C as a long term action plan on climate. European Union and Germany has agreed on the energy policy to increase the electricity generation through the renewable and reduce the fossil fuel firing thereby reducing the carbon-dioxide emission and reduce the global temperature rise. In this action plan. Since wind and solar are not much reliable as it depends on the climate and biomass being renewable energy source as carbon neutral, for most of the IPP's it becomes an interesting option to convert the existing fossil fuel fired power plant into biomass firing power plant. On one side it is not required to dismantle the existing unit nor install the costliest back end equipment. Additionally, once the power plant is converted it becomes in their renewable energy portfolio and it is qualified for the subsidies. This paper gives the fair bid of assessment criterion for the renewable biomass conversion and the back end equipment used for reducing the emission.

**Index Terms-** Biomass, Boiler, Coal, Slagging, Fouling, Emission.

## I. INTRODUCTION

MOST of the utility boilers installed and operating are designed with limited available technology. Planning, designing and installing the biomass fired power plant to suit the energy requirement is the costliest way when the economically optimized way of converting the coal to biomass is available. By converting the existing coal fired power plant into biomass, it becomes the part of renewable energy portfolio and gives the second life by utilizing the unit and not to dismantle it. There are many ways for assessing the conversion. Below are some recommendation to understand before the conversion:

1. Biomass fuel understanding,
2. Steam generator or boiler understanding,
3. Emission understanding,
4. Layout understanding.

## II. CONVENTIONAL COAL FIRED BOILER

Before proceeding into conversion of coal fired boiler into biomass, it is required to understand the basic concepts followed in the history of art in designing the conventional fired boiler with respect to the fuel system as the cooling medium

(steam) remains the same irrespective of the type of fuel fired. Coal properties affecting the design of boiler needed to be set. Coal basic properties include the proximate analysis: the physical analysis of a coal reported in terms of moisture, volatile matter, ash and fixed carbon.

Moisture + volatile matter + ash + fixed carbon = 100%

Ultimate Analysis: the chemical analysis of a coal reported in terms of its carbon, hydrogen, nitrogen, sulfur, oxygen, moisture and ash contents.

$C + H + S + N + O + Cl + ash + moisture = 100\%$

Slagging: slagging processes occur at high temperatures on surfaces in direct receipt of radiation from the combustion.

The more important occurrences can be listed as follows.

- a) Deposition of ash on burner components can obstruct the combustion process during igniter light up and during the normal load.
- b) Deposition of ash on the furnace, reduces the heat transfer and leads to increased combustion chamber exit gas temperatures.
- c) Dislodgement of large deposits of ash on the pendant superheater in the furnace can damage the hopper slopes in the lower furnace.

Fouling: fouling is a low temperature and relatively slow deposition process which occurs in the convective section of the boiler. It is due to the volatilization of the alkali metals and subsequent deposit of the heat exchangers by condensation. Once it is deposited, as a result it reduces the path the flue gas flow through the tubes and creates the pressure drop which would increase the auxiliary power consumption.

Combustion chamber exit temperature: gas temperature must be restricted at furnace exit, this is achieved by restricting the FEGT to not more than the Initial Deformation Temperature (IDT - reducing conditions) of the ash, where a range of coals is specified.

Flue gas velocity limitation in the convective section: erosion in the convective tubes sides are caused majorly due to flue gas velocity. As erosion is generally proportional to the velocity power approx.3.1. so limiting the gas velocity based on the ash properties is important for the life time of the tube.

## III. BIOMASS CONVERSION - ASSESSMENT

Biomass fuel is considered as non- conventional as it falls into renewables category. Solid biomass is not a single fuel as it has a variety which has been derived from the wood mostly (wood pellets), agricultural residues (bagasse), energy crops



(straws). So every variety of the biomass has very different fuel properties (proximate and ultimate analysis, deformation temperature and ash properties). So before the Conversion Process Fuel study needs to be done in order to understand what extend the existing boiler shall be modified.

Below is the major variation in biomass fuel properties in comparison with coal/fossil fuel which would impact the combustion and convective section.

Fuel Moisture: it would majorly affect the boiler efficiency and to dry this fuel before feed in the boiler, combustion temperature needs to be checked.

Fuel Energy content: compared to coal, fuel energy is lower in biomass. It would affect the fuel flow (as lower the energy higher the mass of fuel feed in), air flow and the flue gas flow. So the existing fans and fuel feeding equipment's capacity needed to be check in.

Sulfur and chlorine content: this is the major problem today original equipment manufacturer who tries for conversion process as this would majorly corrode the heating surfaces. Chlorine content in coal is negligible or non-traceable whereas in the biomass (straws and bagasse) it has very high in the ash such as 4,82% and 9,10%.

Ash properties (fusion temperature, silica): compared to the coal the slagging and fouling characteristics are more in biomass as the consequence for slagging is to keep the lower furnace rating and for fouling is the rearrange the tube spacing.

As deeper into the conversion process as a whole, below are the recommended step by step approach. This approach shall determine whether the existing coal fired boiler shall be utilized for the given biomass fuel.

### **Step 1: Screening**

In this screening process it is easily able to identify the whether or not boiler is qualified for this 100% conversion. Mostly pulverized coal fired boiler as it has bigger furnace and convective surface. Oil and gas fired boiler may not be the perfect fit as the boiler must have been designed for high temperatures and high flue gas velocity. Being biomass having the high moisture content it is required to have the air preheater installed as most the coal fired boiler would be having the air preheater installed. If in case not here check for the spacing for the new air preheater to be installed.

If the above screening tested positive, then we shall proceed further otherwise it is not required to proceed further.

### **Step 2: Case Study**

The next step is the initial or proposal check on the boiler thermal performance and the major modification required for the conversion process.

Based on the selected Biomass fuel, carry out the fuel check and perform the combustion calculation and boiler thermal performance.

### Fuel Check:

It is an ultimate and proximate analysis check. Ash analysis check to slagging and fouling index. Maximum velocity checks based on the ash analysis.

It is important to check deformation temperature in comparison with the originally designed coal.

### Thermal Performance:

Calculate the fuel burned, air flow and flue gas flow.

Check the existing furnace and boiler performance and the flue gas velocity.

Calculate the back end temperature leaving the economizer and air preheater.

Calculate the Boiler efficiency.

Make the rough estimation on the equipment modification due to fuel change. Combustion equipment's like fans, air preheater and mills.

Boiler heat exchange tubes modification like pitching.

Emission control equipment's.

If this case study sums up to the expected modification, then proceed to the next step.

### **Step 3: Detail Engineering Evaluation**

At this step biomass conversion seems to be fine to be installed and needed to be a detailed engineering evaluation.

### Performance Evaluation:

Establish superheat and reheat performance.

Establish the furnace performance.

Estimate the additional surface area needed (superheat, reheat, economizer and furnace tubes)

Determine the metal temperature and pressure drop calculation as it is important to make sure the pressure drop is within the limit for the boiler feed pump and plant heat rate.

Establish the equipment modification needed to be installed.

Estimate the emission values and try to eliminate the SCR and FGD if not required as the biomass has lesser nitrogen and traceable sulfur.

If needed make a site visit and draw an arrangement drawing.

For all the sales / proposal shall make the budget estimation.

### **Step 4: Final design and bill of material**

Once the final design is ready, layout drawing shall be prepared. Cost estimate shall be prepared for the total modification which includes for auxiliary equipment's (static and rotating), boiler and furnace, and structural steel. After this step is positive with the decision maker, then the construction and commissioning and taking up the proposed load.

## **IV. CONCLUSIONS**

This paper address the concern over the climatic change policy and the Different regions motivation towards the renewable energy policy. These energy policy acts as driver for the conversion of coal fired boiler into biomass fired boiler which becomes the part of the renewable energy portfolio for the subsidies and not to decommission the existing boiler. This paper describes the some of the base criteria as the steps form before conversion. However, these criteria are more generalized

and it varies clearly based on the history of art used for the existing coal fired boiler and the fuel needed to replace. Since biomass being the carbon neutral with less sulfur and nitrogen content in the fuel, this fuel support more for the climatic change policies.

#### REFERENCES

- [1] W.R. Livingston (Doosan Babcock), "The status of large scale biomass firing," – IEA
- [2] European commission climatic action  
[https://ec.europa.eu/clima/policies/strategies/2020\\_en](https://ec.europa.eu/clima/policies/strategies/2020_en)
- [3] Curtis Schaaf, Kevin Toupin & Richard Abrams, "Biomass Conversion Strategies for Existing Power Plants"
- [4] Biomass Energy Foundation



**Baskar Ramesh** has worked as a boiler process engineer in India for an original equipment manufacturer like Doosan Babcock and engineering and Services, Ansaldo Caldaie Boilers India Private limited. Additionally, He is the contributing member of the ASME PTC 4 Committee. Currently, He is pursuing Masters in Power Engineering from Brandenburg University of Technology Cottbus – Senftenberg, in the state of Brandenburg.



**Katarzyna Piepiora** is a student of Power Engineering at West Pomeranian University of Technology in Szczecin and currently she is studying one semester Power Engineering at Brandenburg University of Technology Cottbus – Senftenberg. She is highly interested in renewable energy technologies and is planning to pursue a career in the energy sector.



**Karolina Gajda** is an architect student. She completed her Bachelor at the Technical University of Warsaw and at Fachhochschule München. Currently, she is studying with the aim of master's degree at BTU Cottbus. She gained her experience in offices like HG Merz, Ludloff+ Ludloff Architects or Glass-Kramer-Löbbert Architekten.

# Renewable Energy: A political, economic and technical comparison between Germany, Poland and Czech Republic

Philippa Luna Pflingsten, Christian Elfgen, Robert Menzhausen and Werner Benedikt Andreas Münzel

**Abstract—** This paper deals with the different handling of renewable energies by the EU Member States of Germany, Poland and the Czech Republic. The historical and political background, which in part still have a great influence on the current energy mix of the respective country, is discussed. Furthermore, the economic situation is considered. Finally, the paper discusses the technical possibilities that are of great importance for the future development of the power supply.

**Index Terms—**Renewable Energies, Energy Transition, Poland, Germany, Czech Republic, Climate Goals, EU, Energy Economy, Technical Part

## I. INTRODUCTION AND POLITICAL GOALS

For a long time, an EU-wide energy policy has been given a low priority and has only been pursued at country level. This has fundamentally changed after the Treaty of Lisbon came in place on December 1st, 2009. In Article 4 of the TFEU/AEUV, the shared competence of the Member States in the field of energy has been regulated in primary law. In the case of shared competence, EU Member States can only act as legislators unless the EU exercises their competence. The enlargement of the EU's energy policy has been included in the Act as a new competence and thus differs from the previous Treaty of Nice, where the fight against climate change has not been enumerated as such. Article 194 explicitly describes the "promotion of energy efficiency and energy saving as well as the development of new and renewable sources of energy" (TFEU/AEUV) as an objective of the Union.

Germany, Poland and Czech Republic are pursuing the same goals with their energy policies at the country level such as following the EU requirements or ensuring a long-term stable supply of energy to households and industry. However, different ways are chosen by both countries to achieve these objectives. The German withdrawal of nuclear power was

already decided in 2001. The nuclear disaster of Fukushima in spring 2011 caused a rise of political voices demanding the withdrawal of nuclear power in Germany to be accelerated. It was decided by the Federal Government that all nuclear power stations should be shut down by the year 2022. Based on this, §1 of the Renewable Energy Sources Act (EEG) regulates the proportion of renewable energy in gross electricity consumption to rise to at least 80 percent until 2050. This article follows the EU's objective of promoting the development of renewable energy sources. In 2010, the share of renewable energy in the electricity network was 17 percent. This year (2017) the share is already 33 percent.

After World War II Poland was confronted with varied problems in political and economic issues. Due to this fact the government did not attach importance to energy politics. Hence Poland was forced to use local raw materials for power generation. This was the starting point for Poland to concentrate on mining and winning coal for power supply and this technology expanded. Likewise, the current unstable political situation and the distrust between Poland and Russia pushes the independence of Poland's energy supply by deciding for coal.

Meanwhile in Germany the anti-nuclear movement started in the 1970ies. People joined groups to demonstrate against civil use of nuclear power for power generation. Hence the nuclear power phase-out is not only a result by the political situation in Germany but also related to a change in social values and standards.

The Czech Republic is considering the withdrawal from the energy supply by coal mining. However, the expansion of nuclear energy is being discussed at the same time. The development of the nuclear power infrastructure will be accelerated by the construction of a fifth reactor block of a nuclear power plant in the south-east of the Czech Republic. This is justified by the government as the sole source of energy, with the unstable energy production of renewable energies due

Monday, July 3, 2017

Philippa Luna Pflingsten, is a Student of Brandenburgische Technische University of Cottbus – Senftenberg, 1000 Berlin Germany (e-mail: Philippa.Pflingsten@b-tu.de)

Christian Elfgen, is a Student of Brandenburgische Technische University of Cottbus – Senftenberg, 03044 Cottbus Germany (e-mail: Christian.Elfgen@b-tu.de)

Robert Menzhausen, is a Student of Brandenburgische Technische University of Cottbus – Senftenberg,, 03044 Cottbus Germany (e-mail: Robert.Menzhausen@b-tu.de)

Werner Benedikt Andreas Münzel is a Student of Brandenburgische Technische University of Cottbus – Senftenberg, 03044 Cottbus Germany (e-mail: Benedikt.Muenzel@b-tu.de)

to external influences. The government commissioner for nuclear energy, Jan Stuller, even criticizes publicly Germany's withdrawal and switch to renewable energies

## II. THE INITIAL SITUATION FOR RENEWABLE ENERGY IN GERMANY

Germany's energy transition plans to move the country to nearly 100 percent renewable energy by 2050. The total cost of Germany's clean energy expansion is at €106 billion.

Germany's annual investment in fossil fuels are about €90 billion. Investments in energy transition go into electric grid upgrades, whereas fossil fuel investments leave the country. The Energy transition creates jobs, increases the gross domestic product and starts business. The German energy transition can lead to positive, balanced, and employment impacts.

In 2004, Germany's renewable energy sector employed 160,500 people and that number doubled to 367,000 by 2010.

Energy transition also promises to positively impact Germany's GDP. By 2030, German renewable energy exports are expected to reach €47–69 billion.

Big branches, small enterprises and private customers divide these economic advantages. In 2012 the renewable energy has done the wholesale prices about more than 10 percent more favorably to lower the operating expenses.

The costs for renewable energy like wind and solar in Germany have sunk, because the manufacturers collect experiences, improvements can carry out and enjoy dimensions advantages. The wind parks produce stream for a comparable price like with gas power stations and coal-fired power stations. In addition, the risen energy costs have sunk for the Photovoltaic during the past five years by 78 percent.

The energy transition has already affected positively the gross domestic product and the employment situation of the country, and these circumstances promise to continue, because the prices of renewable energy go down and the costs tend for the import of fossil fuels upwards. [1]

## III. ENERGY ECONOMY

### A. Introduction

The Energy economy characterize all activities and institutions among the way from raw material to electrical energy. The focus of the energy economy is to guarantee a substantial, save and constant energy supply for private and industrial customers. In times of global heating and the rising demand of electricity the energy economy faces great challenges.

To guarantee the energy supply for the future and fulfill the EU climate goals as well Germany, Poland and Czech Republic must make some big decisions. According to the historic influences the initial situation in each country is special. The potential for using and installing new renewable Energies is different between those three countries.

In the beginning of the 1990ies the energy sector in Poland was liberated and it there were formed three under sectors; 'power generation', 'power transportation' and 'energy distribution'. The system of the Energy sector still reminds at communistic system from the 80ies. The main source of energy generation back in this time was coal. This has not chance until today. Coal remains the main source for energy in Poland (see Fig. I). This huge influence from coal is based on the history form Poland, which was mentioned before in the introduction.

In the last ten years the energy mix in Poland dispers but coal remains the main source for energy production.

To guarantee a safe power supply Poland wants to decrease the dependence from Russia in fact of oil and Gas imports. More than 90 percent of the oil imports and over 70 percent of the gas imports to Poland are derived from Russia. This dependency to Russia is conditioed to the geographical location, historical situation and infratructural. [2]

Fig. 1: The energy generation in Poland for 2003, 2008, 2013.[2]

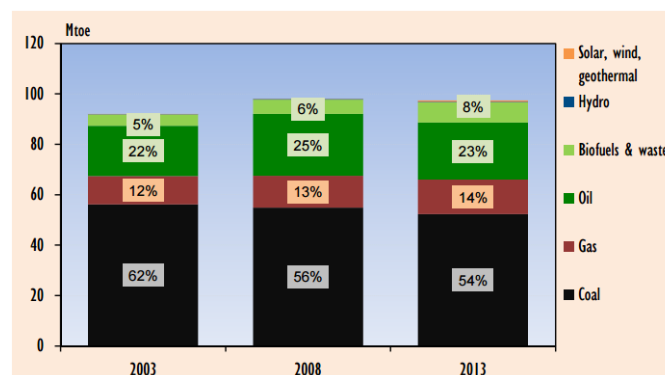

### B. The price for electricity

The economic in Poland is very energy intensive. The price for energy in Poland is low compared to the average cost in the EU.

In the past ten years the price for electricity raise over 50 percent in the whole EU. There are still regional variations in Europe. In table 1 you can see that the price for electricity is almost twice as high in Germany compared to Poland. In Czech Republic, the costumers pay the least for their energy.

The Price for electricity is affected by several factors. Network charges, cost for climate protection and government taxes are the main ingredients of the price for electricity.

In Germany 52 percent of the price are taxes and 21 percent

where caused by the EEG allocable. With this allocable the expansion on renewable energy in Germany is supported. In Poland and in Czech Republic there is not such an allocable for supporting the expansion of renewable energy.

This huge gap between the prices of electricity will shrink in the next years and Poland will lose some industries which needs a lot energy. It has already begun and the first companies are leaving Poland.

Country	Electricity price Cent/ kWh
Germany	29,51
Poland,	14,44
Czech Republic	12,73

Table 1 : Price for electricity in 2016 for Germany, Poland and Czech Republic.[3]

Poland should reduce in the next year their energy production from coal to achieve the EU climate goals 20-20-20. The target of the EU 20-20-20 plan is to reduce the CO<sub>2</sub> emission all over Europe at least for 20 percent and expanse the power supply from renewable Energy techniques up to 20 percent until 2020. For Poland that means they have to decrease the CO<sub>2</sub> emissions for 15 percent and at the same time expanse the renewable energies for 20 percent [2].

### C. Energy Mix in Germany

In Germany, the energy mix is more separated than in Poland. The main source for primary energy is delivered as well as in Poland by conventional raw materials like coal. But the part of energy generated by renewable technology is much bigger than in Poland and Czech Republic. In Germany, almost 30 percent of the energy was generated by renewable technologies in 2016. Germany is on a good way to substitute the coal and as well the nuclear energy generation by renewable energy. But it is still a hard challenge to reach the own political and the EU climate

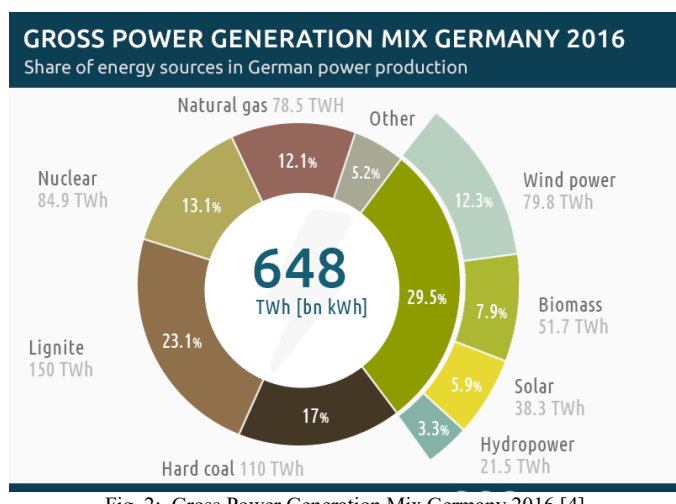

Fig. 2: Gross Power Generation Mix Germany 2016 [4]

goals as well.

### D. Prospects

To be able to guarantee a sustainable and constant energy supply for the future it is important to deliver a base load for the electricity grid. This base load is a basic need to deliver electricity to the consumers. If this base load variate the whole electricity grid will collapse and have to be reset. This reset is a worst-case scenario for the electrical supply. At least it would cause a black out over the whole grid. To keep the grid safe and there for as well the energy supply there have to be a constantly generation of electricity. Renewable energy always has some variation on the generation caused by natural influences. Because of these variations renewable energies cannot deliver the base load for the grids. Today in Germany as well as in Poland the base load for the grids were produced by big power plants that are based on coal. This is one of the main challenges for the energy transition.

In Poland a main impact for the energy supply is the age of the power plants. In average, they are about 30 years old. That means many of them work inefficient and often have to be repaired. The efficiency is a main focus for the electricity economic not only in the generation of electricity also the transportation and the use of the energy. The need of energy will not expanse in the next few years because efficiency get more important. But Poland may will get some problems with the energy supply when the older and bigger power plants were forced to shut down. Therefore it is important that Poland make big investments. Also they have to create a system to support the expansion of renewable energy in private level as well as on national level. Germany and the Czech Republic have done the first steps to substitute the emissions intensive electricity generation from coal with renewable energy. The development in Germany was very fast in the beginning. In the last years it slows down because on the one hand the easily accessible potentials of renewable energies were already used and on the other hand the political support is getting less.

## IV. TECHNICAL

The generation of energy from renewable resources has grown very fast in the past years. Different resources and new opportunities for power generation were developed. New techniques were invented or optimized for more efficiency, eco-friendly and cost-efficient. Renewable resources are characterized by being inexhaustible or by being renewed very quick. Comparing to fossil resources they are always available and they will never get empty.

## A. Potentials

The effectiveness of a power plant is the most important question. Ineffective plants are a waste of money and resources and they always effect the environment. Germany, Poland and the Czech Republic do not have the optimal conditions to use all techniques for effective power production. Important properties are the access to the cost for marine power like tide and wave energy. But the option for offshore wind plants are important conditions. For onshore wind power generation is a need for high and steady wind with wind velocities from at least 5m/s. These conditions are mostly present at the coast or in hills and mountains. Thermal power is applicable almost everywhere as surface powering. These techniques are suitable for a domestic use as heath pumps. But deep thermal energy is more effective for power generation. For these technique access to deep hot water is necessary. For solar power there is a need for steady and high solar radiation. South Europe has perfect conditions for these techniques. But also in the north it is possible to use the sun for power generation.

### 1) Germany

Germany has a leading part in the use of renewable energy. With a lot of universities and institutes Germany is doing a lot of research and develops a lot of techniques. The potential for renewable energies is very high in Germany. The great coastline brings opportunities for marine energy like wave or tide power. Also the use of wind energy benefits from the cost. This leads to a big potential for the use of wind energy as offshore and onshore plants. But it is not necessary to build wind energy plants offshore. With different und new techniques it is possible to generate wind power in almost whole Germany. Solar power has also a big potential for being an energy resource in Germany. With about 1000 kWh per year and square meter of solar radiation it is less than in the south of Europe but still enough for efficient energy production. The use of biomass as an energy source will also be a big part to achieve the goals for the year 2020. Germany does not use the whole landscape for farming and cropping food. There is still place for planting energy plants like raps or corn. But only a small Part of the biomass will use for power production. The most will be used for heath und fuel production. The same with geothermal energy. The most parts of Germany are useable for geothermal power but not for power generation. Geothermal power is more effective for heating, like heath pumps for domestic use [5].

### 2) Poland

The greatest potential in renewable energies is in the fields of biomass, wind energy und hydropower. Where biomass is mainly used for biogas and biofuel production from power crops and waste from agriculture, industry and forestry. Wind energy production is particularly good at the Baltic coast. But also in areas of unforested hills and slopes in the south part are suitable for wind energy. [6]

### 3) Czech Republic

The solar radiation in the Czech Republic is about 1200 kWh per square meter and year. This is a good potential to use the sun for photovoltaic or for solar heat. The Czech Republic has a long tradition with using wind power for windmills. But not the whole country is suitable for wind energy because there is not enough wind. The best parts are the borders with Germany and Poland with the Ore Mountains. There is enough wind for an efficient wind power generation. Geothermal energy could be produced in the whole country as surface geothermie like heath pumps. But there is only a little knowledge about the opportunities for deep geothermal generation and for techniques at all. The use of biomass is very promising. The Czech Republic has a lot of forestry and fertile ground for raising crops. The biomass could be used for fuel, gas, burning and for power generation. The use of hydroelectric power is not so big in the Czech Republic. But there are some potentials like the river Moldau with a flow rate of 164 m<sup>3</sup>/s and the Elbe with about 315 m<sup>3</sup>/s. [8]

## B. Progress

With the Renewable Energy Directive in 2009 the member states of the EU have to increase their amount of renewable energies. The countries have to use their potentials for an effective use. For this goals they have to develop and invest in different techniques to have a suitable mix of renewable energies.

### 1) Czech Republic

The Czech Republic developed a great renewable energy mix for electricity production. Over the past years they started to use their potential in bio-sources very good. Almost the half of the renewable resources are biomass and biogas. With the 2010's Czech Republic started to use solar power. This field increased very fast over the past years and is now a big part for electricity production. The use of hydro energy was over the years a big and steady part for the generation of electricity.

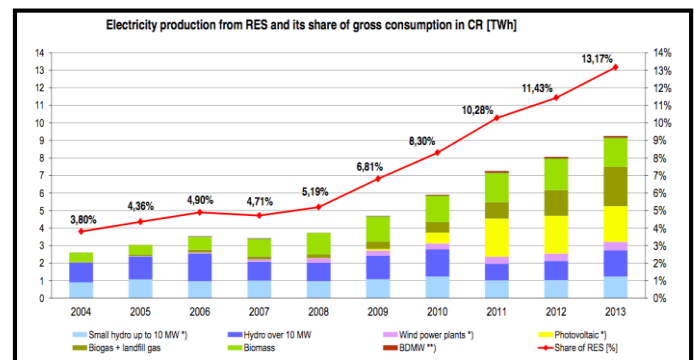

Fig 2: Development of Renewable Energies in the Czech Republic [9]



## 2) Poland

Poland's Action Plan presented biomass, biogas and wind energy as the most suitable resources for power generation. While hydro energy thermal and solar energy is presented as less suitable. This is shown in the following diagram. Where the generation of about 33.000 GWh of renewable energies is divided in 10 percent of hydro energy, 47 percent from wind and 43 percent from biomass. While there is no plan for photovoltaic and thermal energy. But the government is planning to support solar energy generation. [7]

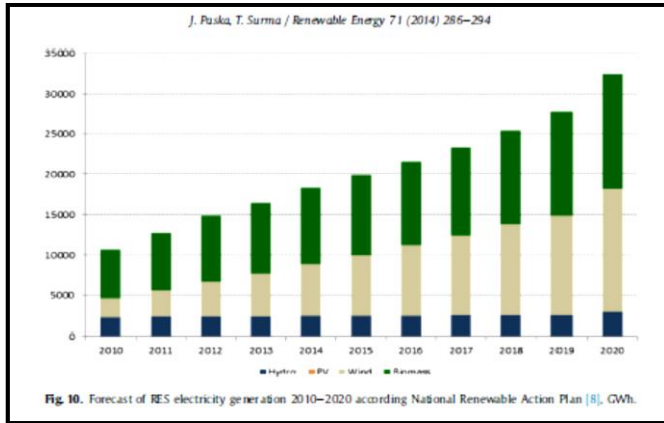

Fig. 3: Development of Renewable Energies in Poland [7]

## 3) Germany

Germany increased its generation of power from renewable resources very steady and fast in the past years. In the beginning of the 90ies Germany only used hydro power and some wind power. With the new century, Germany starts to use biomass for power production and from the year 2005 also photovoltaic. The diagram shows that the amount of hydro power was almost steady over the years. The greatest growth where in the fields of Wind power, solar power and biomass for generation of electricity. And today they are also the main sources of renewable energy. [10]

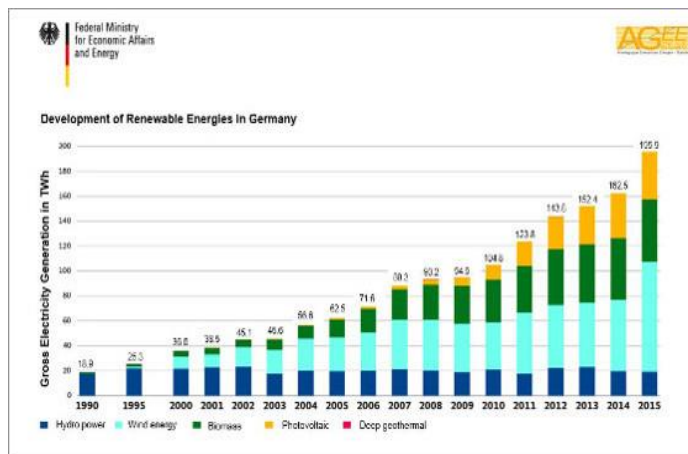

Fig. 4: Development of Renewable Energies in Germany [10]

## V. CONCLUSION

The global warming has a huge impact for the energy supply. In the future, the unilateral focus on emissions intensive power generation has to change to slow down the global warming. In terms of the climate politic of the European Union the member states has to expand the power generation from clean sources. The renewable Energies getting more important to the energy supply. But with the rising impact of renewable energies the supply is faced with big challenges. The development of the renewable energies are growing in different speed in Germany, Poland and Czech Republic. To archive the climate goals the investment and effort have to go on. In Germany the expanse in renewable Energy is fare advanced in compare to Poland and Czech Republic but there is still a long way to go for 100 percent of safe and clear energy in all of this the countries.

## REFERENCES

- [1] Energiewende Team. (2014, Oct.). While critics debate Energiewende, Germany is gaining a global advantage. [Online]. Available: <https://energytransition.org/2014/10/energiewende-is-gaining-germany-a-global-advantage/>
- [2] Adam Grzeszak. (2015, May) Polenanalyse Nr. 109, Energie – Herausforderungen für Polen [Online]. Available: <http://www.laenderanalysen.de/polen/pdf/PolenAnalysen109.pdf>
- [3] Strom report (2017, July) Strompreise Europa [Online]. Available: <https://1-stromvergleich.com/strom-report/strompreise-europa/>
- [4] Strom report (2016, May). Strommix Deutschland [Online]. Available: <https://1-stromvergleich.com/download/germany-power-generation-mix-2016/>
- [5] 4LIBERTY.EU AND ALES ROD (2015, June) Electro-Energy Sector in Czech Republic: Present Situation, Opportunities and Threats. [Online] Available: <http://4liberty.eu/electro-energy-sector-in-czech-republic-present-situation-opportunities-and-threats/>
- [6] NATIONAL RENEWABLE ENERGY ACTION PLAN of Poland: Minister of Economy, Warsaw 2010
- [7] Electricity Generation from renewable energy sources in Poland: J. Paska, T. Surma: Warsaw University of Technology: 11/2014
- [8] <http://www.dfic.de/en/geschaeftsfelder/energiewirtschaft.html>
- [9] Report on progress in the promotion and use of energy from renewable sources in the Czech Republic under Art 22 of the European Parliament and Council Directive 2009/28/EC, on support for the use of energy from renewable sources (2011 and 2012)
- [10] Nationaler Aktionsplan für erneuerbare Energie gemäß der Richtlinie 2009/28/EG zur Förderung der Nutzung von Energie aus erneuerbaren Quellen

**Philippa L. Pfingsten** was born in Hannover, Germany, in 1993. She began her studies in business administration at Brandenburgische Technische Universität Cottbus-Senftenberg but changed after three semesters to Freie Universität Berlin. She received her B.Sc. in business administration in 2016. Afterwards she decided to deepen her knowledge in business for her later job by continuing her studies in business administration M.Sc. with specialization in planning and innovation as well as organization and human resource management.

She decided to participate in International Conference on Environment and Electrical Engineering because she wanted to think out of the box and to learn about other topics than business to see the big picture.

**Christian Elfgen** was born in Paris, France in 1990.

He is a 26-years old, who is studying business engineering at Brandenburgische Technische Universität Cottbus-Senftenberg with specialization in construction engineering. He worked before his study at several different construction companies in Berlin. He chose to participate in International Conference on Environment and Electrical Engineering because he wants to get know more about the energy sector to supplement his studies.

**Robert Menzhausen** was born in Götting, Germany, 1991. He began his studies in process engineering at Brandenburgische Technische Universität Cottbus – Senftenberg. He received his

B.Sc. in process engineering in 2016. Afterwards he decided to deepen his knowledge by continuing his studies at the BTU Cottbus - Senftenberg in process engineering M.Sc

**W. Benedikt A. Münzel** was born in Cologne, Germany, in 1992. He began his studies in business administration at Brandenburgische Technische Universität Cottbus-Senftenberg with specialization on energy economic. In 2015 he worked for Siemens AG – Mobility - Technology and Innovation - Software and Prototypes for Automation (Siemens AG MO TI SPA) in the controlling unit to deepen his knowledge in business administration.

He decided to participate in International Conference on Environment and Electrical Engineering because it offers the chance to learn more about power generation and to compare the development status of renewable energies over Europe.



# Effects of time change on economy and human health

Katja Gräbedüinkel and Levin-Can Leuschner

**Abstract**— The draft at hand gives a rough overview over the current practice of daylight saving time (also called summer time) which was introduced in Germany in 1980. After a short overview of the development of German daylight saving time, it focuses on energy economical and health aspects of the custom. Current scientific positions on these topics are given to provide an adequate cross section of the consequences and benefits and to give an impression of the costs and benefits of daylight saving time. In the end, the collected perceptions are bundled within a conclusion and there will be a forecast trying to pinpoint the political future of the custom. This draft is part of the International Conference on Environment and Electrical Engineering - Student Edition module by Prof. Dr.-Ing. Harald Schwarz for the Brandenburg Technical University Cottbus – Senftenberg.

**Index Terms**— Adaptation, Circadian Rhythms, Daylight Saving Time, Energy consumption, European Standard Time, Summer Time.

## I. INTRODUCTION

TODAY the widely used daylight saving time, the one hour forward turning of the clock in the summer months, seems especially for younger people in Germany like an unalterable fact or at least an age old practice. That this is not the case and, even more, that summer time is a relatively new invention given the historical context, often baffles those who grew up with it.

With that in mind, it is easier to think about changing this custom. There is widespread aversion against the daylight saving time (usually cumulated two times a year) and so, again and again, it is in the center of discussions.

### A. Motivation

Together with the semiannual forward turning of the clock comes a great expenditure for man and machine and current surveys point out that 74 % of the German citizens think of it as redundant [6]. Justification comes today mainly with economic arguments. But what are these arguments and what are the effects of nearly 40 years of summer time for mankind and their energy usage? Have the expectations, which came

Paper submitted 07-03-2017. This work was financially supported in part by BaföG-department of Cottbus and the authors' parents.

Levin-Can Leuschner is with the Department of Media Technology, Technical University of Cottbus-Senftenberg, 03046 Cottbus, Germany (e-mail: leusclev@b-tu.de).

Katja Gräbedüinkel is with the Ecology Department, Technical University of Cottbus-Senftenberg, 03046 Cottbus, Germany (e-mail: graebkat@b-tu.de).

together with the time change validated itself and is daylight saving time really more economic?

These are a few of the questions which we try to answer on the following pages.

### B. History of summer time

The summer time or daylight saving time was introduced in Germany in 1980 as a reaction to the first and second oil price crisis. The goal was to make better use of the daylight to save (oil-)energy. An extra reason for adopting the summer time in Germany may have been to synchronize time with the neighboring countries which initiated summer time in the 1970s. But even before that a lot of experiments were going on with the summer time in Germany, again mostly for economic reasons. The first German summer time was introduced during World War I in 1916 with the Imperial Law Gazette No. 67 but was abandoned with the rise of the Weimar Republic [2][3][4].

Throughout the Second World War the daylight saving time was introduced again [5]. Industry in these days was a lot more dependent on daylight than it is now and an hour more sunlight meant an hour more time to work. This was especially important for the armament industry which flourished at this time.

After the Second World War the situation got more complicated. The territories occupied by western countries had to use daylight saving time while the Soviet occupation zone and all of Berlin was adjusted to the Moscow time which was two hours ahead of middle European standard time. To complicate things even more, there was a high summer time from 1947 to 1949 where the clock was turned forward for another hour [12]. The goal was again to make better use of the daylight, since infrastructure in Germany wasn't fully restored yet.

In 1950 both summer time and high summer time, were reinstated and weren't used until 1980. A last change was made in 1996 when all daylight saving times in Europe were harmonized. Since then, clocks are turned forward in March and backward at the end of October.

## II. IMPACTS OF SUMMER TIME

When talking about daylight saving time, two aspects are almost always in the center of discussion. First are the energy economic aspects of the time change since this is what the German government used as a justification in 1980 to introduce the daylight saving time. On the other hand, there

are health wise aspects which at least annually lead to big complaints within the population.

In this chapter a closer look is applied to both aspects and to studies which dealt with these topics.

### A. Energy economy

The main reason for introducing summer time in Germany in 1980 was to reduce energy consumption in private households. If people go to bed an hour early, when it is already dark, and wake up when the sun already shines (which happens in summer fairly often), they have one hour less to illuminate as illustrated in Fig. 1. But there is one uncalculated element in this equation. The longer lasting lightness in the evening can inflict a rise in outdoor activities which in turn needs more energy. An effect which in 2010 led the Bundesverband der Energie- und Wasserwirtschaft (BDEW), who organizes 1,800 German Companies who are, according to their own statements, representing 90% of electricity sales, 60% of the short- and long-distance heat sales and 90% of the natural gas sales, to the statement, that this overcompensates for the light saving effects [11]. Measuring electricity consumption proves to be fairly easy since data on this is gathered a few times per hour. This is not possible for data on fuel usage and thus, expensive field experiments are necessary to gather them. Another problem studies on this topic have to deal with is to isolate the effects of daylight saving time from other natural effects, which increases the number of needed

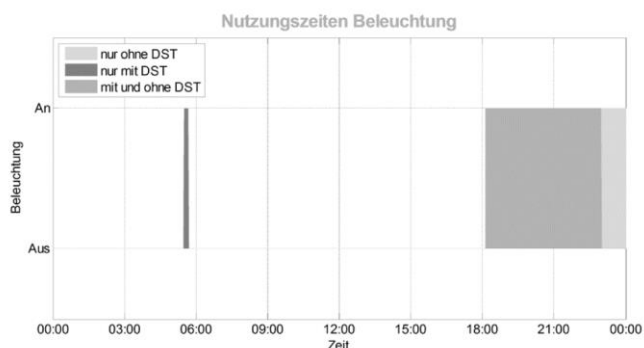

Fig. 1. Usage of illumination with (dark grey) and without (light grey) daylight saving time and the intersection (medium grey).

variables [7].

To do this, it is common practice in scientific studies to observe a control group which are unaffected by the tested condition. In case of the daylight saving time, it proves to be difficult to establish a control group living in standard time when everyone else uses daylight saving time or vice versa. Having a control group in another country which do not have daylight saving time also would alter the results since habits of energy consumption and heating differ from country to country (and sometimes even within regions of the country).

Luckily Kellogg and Wolff had the opportunity to do a study with a control group in Australia. During the Olympic Games in 2000, the daylight saving time period was prolonged for two months in New South Wales and Victoria but not in South Australia. The two adjacent states with different time zones

proved to be an ideal situation for solving the control group problem. The empirical analysis refers mainly to the years 1999 to 2001 (respectively 2005 to get a good average). While heating energy just could be measured indirectly through electric heaters, energy consumption and trade price were accurately recorded. Since the Olympic Games would have altered the data, the staging federal state New South Wales was not included in the study [10].

Even so, the study revealed no significant saving in energy consumption and because of the drastically different climate the heating data is not transferable to Germany [8].

Another study realized in 2010 in France by Energies Demain focuses with a simulation on illumination, air conditioning and heating in private households and in the service industry. The French climate is similar to the German climate, so that results obtained can be transferred to Germany. The data of this study was used to make assumptions of energy saving until the year 2030 and validated with real data from 2008. The data suggests that energy consumption, air conditioning and heating in private households will negate every other saving or additional consumption effects. Also, there will be a slight saving in the service sector. In the end savings from 0.095% in relation to the final energy consumption from 2008 were calculated.

Since this is not an empirical metering but an extrapolation to a relatively far-off future (then about 20 years), the results have to be taken with a grain of salt and will have to prove themselves. Another problem is the much more widely spread usage of electric heating which is more uncommon in Germany and may compromise the transferability [8].

A different approach was used by Tichler et al. in 2013 who started a study which covers not only energy-related aspects but also non-energetic-aspects in Upper Austria for the period 2010 until 2011. About 1,000 Austrian private households were empirically analyzed and the weeks before and after the time switching in autumn 2010 and spring 2011 were compared. They did not only count electricity consumption for the illumination, fuel use for the altered free time behavior and heating/air conditioning for the altered need of heat-/cooling demands, in but also the costs for non-energy-related effects like the consequences on the biorhythm which includes sleep disorders, performance ability in working life and traffic accidents. Also they counted the value of the altered free-time behavior in. As a measurement tool, they monetized all these factors to be able to compare them [13].

While they could show that there is no relevant energy saving regarding the energy-related aspects of the study, they could show that there are some money saving aspects because electricity is more expensive than fuel or oil for heating purposes. The study revealed that the energy related aspects saved 3.7 mil. Euro p. a. which is about 0.009% of the Upper Austrian gross domestic product (GDP). For the non-energy related aspects they evaluated a monetary saving about 4.4 mil. Euro p. a. (about 0.011% of the GDP) adding together to 8.1 mil. Euro or 0.02% of the GDP [8]. They also showed that non-energy-related aspects of the daylight saving time have the bigger impact on the monetary aspects. In the end they

recommended to introduce the all-year daylight saving time to make use of the extended possibilities of free-time activities which come with the prolonged sunlit hours. They calculated an entire saving potential of 85 mil. Euro p.a. for Upper Austria in comparison to the semiannual turning of the clock [13].

All in all, most studies reveal very little to no correlation of daylight saving time with electricity saving, mostly about less than 0.2 % of the electricity consumption of the country. For the final energy consumption, it is about 0.03 % [7]. In a simulation from the Institut für Ökologische Wirtschaftsforschung (IÖW) the electricity saving was about 0.21 % [9].

It is a little bit more divers when it comes to heating. This is often done individually by every household, presenting studies with a difficult methodical problem. Here the results range from 0.12 % savings to 9 % additional consumption. An observation of 50 Households in 1980 revealed no actual effect at all [7]. The monetary benefits of prolonged lit hours of free times mostly get compromised by the follow-up costs sleep disorders in the first few weeks causes [13].

An additional interesting effect comes in if we take a look on Photovoltaic-Units (PV-Units). As the IÖW points out: Through the daylight saving time there happens an electricity load transfer towards the main producing times of PV-Units which supports the efficiency of these and with this rises their profitability. This effect could benefit from a year-round daylight saving time. The IÖW simulation has shown that energy savings would rise another 50 % up to 1.2 % [9].

A survey of 736 corporative actors from the German energy supply sector resulted in a single quantitative answer from an electricity supplier who mostly delivers to tradespersons, which stated that in the last three weeks of summer time, energy consumption rises about 2.1 % than in the first few weeks with standard time. The company suggested to prepone the return to standard time about three weeks. [9]

### *B. Effects on human health*

The change of the clock twice per year does, of course, not alter the rhythm of dawn and sunset. What is altered is the “social clock”, which rules our work and private life. This leads to a discrepancy between the biological time that is mostly driven by daylight, and the social time which determines our wake up time. Many processes in the human body are taking place in circadian rhythms. Examples for this are the sleep-wake-rhythm, certain hormonal processes or the diurnal cycle of the body temperature. Those rhythms are mostly synchronized by daylight. Even in an environment devoid of daylight, circadian rhythms continue to determine many bodily functions, though with a period length slightly differing from 24 hours [7].

The 1h time change in spring and autumn (daylight saving time) alters the “social clock” people are supposed to follow at workplaces and in private life. The natural circadian rhythm is disturbed by this change [14]. The following paragraphs give an overview over the current state of knowledge considering

the effects this has on human health.

Monk & Folkard (1976) studied the adaptation time of 65 British test persons during the switch from summer to mean time (autumn). For six days before and eleven days after the change, people were asked to monitor their wake-up time and, at 09:00 o'clock, their oral temperature and feeling of alertness. Within one week, average wake up times were at the levels before the time change. Before, people woke up to 30 mins earlier than the “social clock” needed them to. Oral temperature was correlated to air temperature and in female persons to the menstrual cycle, but was shown to slowly increase over the six days following time change. Perceived alertness within the days following time change increased slightly but was more related to the length of time awake.

The authors compare their study to others of the jet lag effect. They conclude that the problem with adapting to the much shorter time change is that only the “social clock” changes whereas the physical one remains. In jet lag, both social habits (eating times etc.) and physical cues (sunrise etc.) change and that makes it easier to adapt [15].

Monk & Aplin (1980) compared the effects of autumn and spring time change. Between 1976 and 1978, during four time changes, bed and wake up times, mood and efficiency were documented each day one week before and after the time change. The results indicate that spring time change has adverse and greater effects on wake up time than autumn time change. While in autumn, people on average woke 15 mins earlier than normal, in spring they woke up to 45 mins later than normal. In both changes, people adjusted their bedtimes to the “social clock” immediately. Only in autumn did people’s mood improve in the course of the week following time change. No such effect was found in the groups asked in spring. The efficiency of solving calculations improved over the week following time change, though the authors see this as a correlation with alertness rather than actual adaptation to the “social clock” [16].

Lahti et al. (2007) used accelerometers to monitor the rest-activity cycles on ten people for ten days surrounding the transition to summer time in spring. The test persons’ sleep duration preferences as well as their usual activity patterns were assessed. The authors found that in average, after the switch to daylight saving time, sleep time was reduced by 60.14 mins and sleep efficiency (actual sleep time: time spent in bed) was reduced by 10 % [17].

Kantermann et al. (2007) conducted a survey among 55.000 participants to find out connections between the timing of sleep on free days and dawn time. They found that wake up time on free days corresponds with dawn time during standard time, but not during daylight saving time (Fig. 2). During winter, people slept for averagely 20 mins more than during summer.

The authors also investigated sleep timing and activity levels for eight weeks surrounding time change. They included the test person’s chronotype as an additional variable to find out if different chronotypes react differently to the change to daylight saving time.

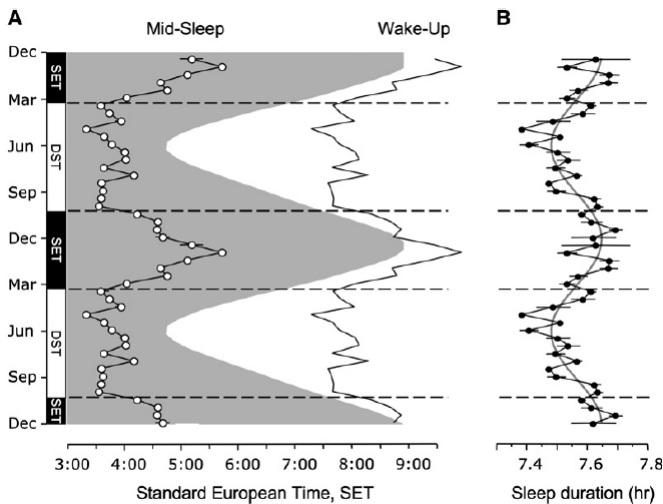

Figure 2. Seasonal sleeping time during Standard European Time (SET) and Daylight Saving Time (DST). (A) Average half-monthly mid-sleep times on free days [dotted line] and wake-up times [line]. Dawn time is shown as grey-white border. (B) Change in sleep duration due to season, averaged over free and work days (dark circles) show about 20 mins difference in sleep duration between summer and winter (altered after Kantermann et al. 2007, p. 1997).

Sleep timing and activity adjust to the time change in autumn easily, but not so to that in spring. Most affected are late chronotypes. The study indicates that our circadian biorhythms are disturbed by the introduction of summer time, so much that the natural adaptation to the seasonal changes in dawn time is disrupted [14].

An Australian study by Berk et al. (2008) reviewed the data of 30 years to determine a possible impact of the daylight saving time on suicide rates in the weeks surrounding the time change. There was a significant increase in male suicide rates in the weeks after the time change to daylight saving time, but none in the weeks after the change back to standard time. The authors conclude that small changes in our circadian rhythms can have destabilizing effects on vulnerable persons [18].

An older study (Shapiro et al. 1990) analyzing the effect of time change on three different psychiatric conditions found no link between daylight saving time and suicide rate. The authors give an overview of several studies that deal with the theory that many psychiatric disorders can be triggered or worsened by a disturbance of circadian rhythms [19].

Lahti et al. (2008) reviewed hospital data from 1987-2003 in Finland to determine possible effects of daylight saving time on mental illness and accident prevalence. They found no significant effect of the transition out of or into daylight saving time [20].

Varughese & Allen (2001) found a significant increase in traffic accidents for the Mondays following the time change to daylight saving time and the Sundays following the time change to standard time in the USA. For the other days surrounding the time change, no such link was found. The authors assume that sleep deprivation is responsible for the Monday rise and alcohol consumption on Saturday evening is responsible for the rise on Sundays [21].

### III. SUMMARY AND CONCLUSIONS

The effects of the daylight saving time on energy consumption are very hard to measure and, according to studies mentioned above, can be positive or negative. Variables like climate, regional habits in energy consumption and economic conditions of the user have a strong influence on the consumption of energy that must be taken into account when trying to assess the pure effects of daylight saving time. This is especially important when trying to apply data from one country to another. After the literature review we did for this article, we conclude that economically, the daylight saving time has only a minimal effect that is superimposed by greatly variable factors such as regional climate and user habits.

Concerning health, it seems that for the bigger part of the population, adaptation to the daylight saving time in spring is harder than that to the standard time in autumn. The “social clock” overrules the circadian biorhythm so much that our natural adaptation to dawn time is disrupted. In autumn, on the other hand, it seems that after a week of adaptation, people have no long-time trouble in coping with the time change. Contradictory studies exist concerning a supposed rise in suicide rates after the time change to summer time. The same can be said for the prevalence of traffic accidents. While there are first attempts namely by Tichler et al. to measure the economic repercussions of effects on health, this topic needs, to the authors’ knowledge, additional investigation.

### IV. OUTLOOK

The goal of establishing the daylight saving time in 1980 in Germany was to achieve a significant drop in energy consumption. Since it is very hard to provide evidence that this was actually achieved, the success of the daylight saving time remains questionable. Considering that, and the mentioned problems many people have while adjusting twice every year, it seems likely that the concept will be abandoned within a few years.

Within the EU that might take a while longer since there is no evidence that the time change is as such harmful. As of right now, the daylight saving time is established in the whole EU without a time limit. Initiatives from the EU parliament, the EU council, the EU commission or from citizen’s initiatives could start the process of changing this situation [7].

New ways to save energy or to use the given energy more efficiently, e.g. by avoiding peak energy consumption by great parts of the population, could also be established. Hopefully their effects will be more pronounced than that of the daylight saving time.

### REFERENCES

- [1] H.-J. Leersch. (2016 May) Sommerzeit macht vielen Probleme. *Das Parlament Nr. 18-19*. [online] Available: [http://www.das-parlament.de/2016/18\\_19/wirtschaft\\_und\\_finanzen/-/421228](http://www.das-parlament.de/2016/18_19/wirtschaft_und_finanzen/-/421228)
- [2] Delbrüd. (1916 Apr.) Bekanntmachung über die Vorverlegung der Stunden während der Zeit vom 1. Mai bis 30. September 1916. *Reichs-Gesetzblatt Nr. 67*. pp. 243.

- [3] Helfferich. (1917 Feb.) Bekanntmachung über die Vorverlegung der Stunden während der Zeit vom 16. April bis 17. September 1917. *Reichs-Gesetzblatt Nr. 5715*. pp. 151.
- [4] Wallraf. (1918 Mar.) Bekanntmachung über die Vorverlegung der Stunden während der Zeit vom 15. April bis 16. September 1918. *Reichs-Gesetzblatt Nr. 33*. pp. 109.
- [5] Göring, Frid, Lammers (1940 Oct.). Verordnung über die Verlängerung der Sommerzeit. *Reichsgesetzblatt Teil I*. pp. 1322.
- [6] H. Schmundt (2016 Mar.). Die Sommerzeit – ein übler Scherz *DER SPIEGEL* 13/2016. [online] Available: <http://www.spiegel.de/wissenschaft/natur/zeitumstellung-die-geschichte-der-umstellung-auf-sommerzeit-a-1084021.html>
- [7] C. Caviezel, C. Revermann, S. Rabaa. (2016, Feb.). Bilanz der Sommerzeit. Büro für Technikfolgenabschätzung beim deutschen Bundestag, Berlin, Germany. [Online]. Available: <https://www.tab-beim-bundestag.de/de/pdf/publikationen/berichte/TAB-Arbeitsbericht-ab165.pdf>
- [8] P. Lips, P. Lengsfeld, R. Röspel, R. Lenkert, H. Ebner (2016, Mar.) Bericht des Ausschusses für Bildung, Forschung und Technikfolgenabschätzung (18. Ausschuss) gemäß § 56a der Geschäftsordnung. Technikfolgenabschätzung. Bilanz der Sommerzeit. Ausschuss für Bildung, Forschung und Technikfolgenabschätzung, Germany, pp.39-43 [online] Available: <http://dip21.bundestag.de/dip21/btd/18/080/1808000.pdf>
- [9] M. Bost, S. Gähns (2016, Jul.) Auswirkungen der Sommerzeit auf den Energieverbrauch, Institut für ökologische Wirtschaftsforschung, pp.6/64-66, Germany, [online] Available: [https://www.ioew.de/fileadmin/user\\_upload/BILDER\\_und\\_Downloadaddateien/Publikationen/Schriftenreihen/IOEW\\_SR\\_211\\_Auswirkungen\\_der\\_Sommerzeit\\_auf\\_den\\_Energieverbrauch.pdf](https://www.ioew.de/fileadmin/user_upload/BILDER_und_Downloadaddateien/Publikationen/Schriftenreihen/IOEW_SR_211_Auswirkungen_der_Sommerzeit_auf_den_Energieverbrauch.pdf)
- [10] R. Kellogg, H. Wolff. (2006 Nov.) Daylight time and energy: Evidence from an Australian experiment. University of California, USA. [online] Available: [https://arefiles.ucdavis.edu/uploads/filer\\_public/2014/03/27/wolffjobmarkt.pdf](https://arefiles.ucdavis.edu/uploads/filer_public/2014/03/27/wolffjobmarkt.pdf)
- [11] R. Ballhaus. (2010 Mar.) Sommerzeit ist keine Energiesparzeit. *Pressemitteilung*. [Online] Available: [https://www.bdew.de/internet.nsf/id/DE\\_20100326\\_PM\\_Sommerzeit\\_ist\\_keine\\_Energiesparzeit](https://www.bdew.de/internet.nsf/id/DE_20100326_PM_Sommerzeit_ist_keine_Energiesparzeit)
- [12] S. Weyers (2003). Sommerzeiten und Hochsommerzeiten in Deutschland bis 1979. *Physikalisch-Technische Bundesanstalt – Arbeitsgruppe Zeitnormale*. [online] Available: <https://www.ptb.de/cms/ptb/fachabteilungen/abt4/fb-44/ag-441/darstellung-der-gesetzlichen-zeit/sommerzeiten-und-hochsommerzeiten-in-deutschland-bis-1979.html>
- [13] R. Tichler, H. Steimmüller, C. Friedl, M. Luger, M. Baresch. “Energetische und wohlfahrtsökonomische Auswirkungen der Zeitumstellungen im Frühjahr und im Herbst in Oberösterreich” for the press conference by R. Anshober, pp.4-14, Linz, Austria, 2013.
- [14] T. Kantermann, M. Juda, M. Merrow, T. Roenneberg. (2007, Nov.). Human Circadian Clock’s Seasonal Adjustment Is Disrupted by Daylight Saving Time. *Current Biology*. [online]. 17 (22), pp. 1996-2000. Available: <https://www.ncbi.nlm.nih.gov/pubmed/17964164>
- [15] T. H. Monk, S. Folkard. (1976, May). Adjusting to the changes to and from Daylight Saving Time. *Nature* [Online]. 261, pp. 688-689. Available: <https://www.nature.com/nature/journal/v261/n5562/pdf/261688a0.pdf>
- [16] T. H. Monk, L. C. Aplin. (1980, Mar.). Spring and Autumn daylight saving time changes: Studies of adjustment in sleep timings, mood, and efficiency. *Ergonomics*. [Online]. 23(2), pp. 167-178. Available: <http://www.tandfonline.com/doi/pdf/10.1080/00140138008924730?needAccess=true>
- [17] T. A. Lahti, S. Leppämäki, J. Lönnqvist, T. Partonen. (2006, Oct.). Transition to daylight saving time reduces sleep duration plus sleep efficiency of the deprived sleep. *Neuroscience Letters*. [Online]. 406(3), pp. 174-177. Available: <http://www.sciencedirect.com/science/article/pii/S0304394006007038?via%3Dihub>
- [18] M. Berk, S. Dodd, K. Hallam, L. Berk, J. Gleeson, M. Henry. (2008, Jul.). Small shifts in diurnal rhythms are associated with an increase in suicide: The effect of daylight saving. *Sleep and Biological Rhythms*. [Online]. 2008(6), pp. 22-25. Available: <http://onlinelibrary.wiley.com/doi/10.1111/j.1479-8425.2007.00331.x/epdf>
- [19] C. M. Shapiro, F. Blake, E. Fossey, B. Adams. (1990, Jan.). Daylight saving time in psychiatric illness. *Journal of Affective Disorders* [Online]. 19, pp. 177-181. Available: [http://www.jad-journal.com/article/0165-0327\(90\)90089-Q/pdf?showall=true](http://www.jad-journal.com/article/0165-0327(90)90089-Q/pdf?showall=true)
- [20] T. A. Lahti, J. Haukka, J. Lönnqvist, T. Partonen. (2008, Feb.). Daylight saving time transitions and hospital treatments due to accidents or manic episodes. *BMC Public Health*. [Online]. 2008(8), pp. 74-78. Available: <https://bmcpublichealth.biomedcentral.com/articles/10.1186/1471-2458-8-74>
- [21] J. Varughese, R. P. Allen. (2001, Jan.). Fatal accidents following changes in daylight savings time: the American experience. *Sleep Medicine*. [Online]. 2(1), pp.31-36. Available: <http://www.sciencedirect.com/science/article/pii/S1389945700000320?via%3Dihub>



**Katja Gräbedünkel** was born in Berlin-Buch in January 1989. After her A levels in 2008 she studied psychology at the Christian Albrechts University zu Kiel. She received the B.Sc. degree in land use and water management from Brandenburg Technical University Cottbus – Senftenberg in 2015 and is currently studying for her M.Sc. at Cottbus.

Since 2012 she works at the chair of Ecology as a tutor.



**Levin-Can Leuschner** was born in Oberhausen, Ruhr area, in 1992. He is a state-proved physically-technically assistant. He received the B.Eng. degree in media technology from the University of applied sciences Düsseldorf, Düsseldorf, in 2016.

In 2014 he worked at two different broadcasting companies, namely the ‘Westdeutscher Rundfunk’ (WDR) and ‘PHOENIX, der Ereigniskanal von ARD und ZDF’ where he worked in the technical departments. Since 2016, he studies for his M.S. information and media technology at the Brandenburg Technical University Cottbus – Senftenberg, Cottbus and works there for the media technology department. He is the author of more than 5 articles. His research interests include human-machine interfaces and human centered design processes and applications, video broadcasting technology, efficient structuring of template interfaces, and real-time 3D graphic applications. He is a web administrator of a middle-scale open air improvisation theatre group and student representative for his degree course.

# Cables in Power Transmission Grid

Xuejiao Liu<sup>1</sup>, Sascha Gregor Kurt Jenchen<sup>1</sup>

**Abstract** — To avoid the visual impact and reduce the land use, replacing overhead line in power transmission system by underground cable would be a better solution. However technical limitations, potential environmental impacts as well as economic problems make undergrounding high voltage electricity transmission system more challenging than installing overhead lines. Therefore, some pilot projects should be realized to gain more experience and develop the technology for installing and maintaining the underground cable system.

**Index Terms** — overhead line, underground cable, technical challenges, environmental impacts, economic problems

## I. INTRODUCTION

Due to the increasing population and land prices, underground cables are more preferred in high voltage power transmission system because of its less land occupation comparing to the equivalent overhead lines.

On 18 December 2015, the German Federal Council adopted the “Act to Change Provisions of Law on Energy Cable Construction”. The act points out that for major electricity highways (= new ultra-high voltage direct current transmission lines), priority will be given to underground cables as a principle in federal planning. In general, overhead DC powerlines are to be prohibited in places where people live. They will only be used in exceptional cases, for example in nature conservation or in the place where existing powerlines will not impact greatly on the environment. Furthermore, the new rules are now also expanding the possibilities for underground AC powerlines to a moderate degree. [1] Although this may encourage cable construction, there are still some issues making undergrounding of high voltage electricity transmission more technically challenging and more expensive than installing overhead lines.

## II. TECHNICAL CHALLENGES

The cable is symmetrically designed to avoid field surges, which can lead to discharges and later to breakdowns. In order to obtain a radially symmetric field distribution, the conductor is covered by a thin, smooth and conductive layer in order to avoid unevenness. Outside it is also covered

with insulating and waterproof materials and a shielding (Fig.1).

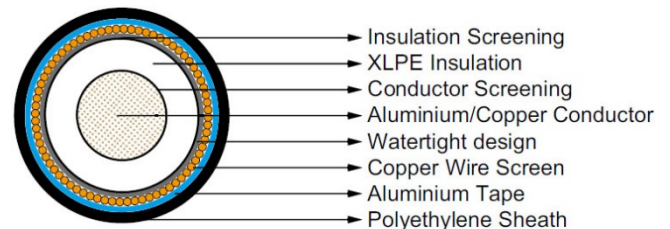

Fig.1 Structure of an XLPE insulated cable

As described above, the complex structure makes it very difficult to connect two cables together perfectly. Often cables are connected through expensive connecting sockets protected in houses. These sockets are also used when repairing a defected cable. The cable will be cut in to two parts at the defect location, then a piece of cable will be installed in between, which will be connected with the previous cable by two sockets.

During the operation, long-term overload is more critical for cables than for overhead lines. Previously medium voltage cables were insulated with polyvinyl chloride (PVC). This material can cause high dielectric losses that leads to thermal instability. Nowadays, crosslinked polyethylene (XLPE) is more often used because of its excellent electrical strength and thermal stability. However, when the cable is overloading, the protection device are set not to work to switch off the overload current. If the temperature increases to 90° C, XLPE insulated cable is not able to withstand a longer period due to the increase in aging.

When planning overhead line power transmission systems, (n-1) criterion is applied, which means that one circuit or busbar can be disconnected due to a fault without customer interruptions and without any other network component overload. This requires very short repair time so that the disconnected component can be taken back into operation again and during the repair no other new fault will occur, which is possible to reach in the overhead line transmission system. On the contrary, it is very hard to realize the short-time repair in the underground cable system. In this case, some other ways should be used to insure the power supply

<sup>1</sup> Faculty of Mechanical, Electrical and Industrial Engineering of the Brandenburg University of Technology Cottbus – Senftenberg, Cottbus, Germany

reliability, for instance, to install a spare cable or a double circuit cable or to apply (n-2) criterion. [2]

### III. ENVIRONMENTAL IMPACTS

There are significant environmental factors that must be considered regarding the underground cable installation.

During installation of the underground cable, the civil works will lead to considerable consequences for the environment. For example, when excavating cable trenches the construction site and the access to the construction site have to be cleared by heavy machinery needed for cable transportation and trenching. Plants obstructing the work should be removed, and animals inhabiting in this area will also be affected. Afterwards, the construction may cause soil compaction, which in turn will have negative impacts on biodiversity recover. [3]

The traditional and cheapest way of high voltage cable installation in rural areas is by direct burial. Trenches, approximately 1.5m in wide and 1.2m in depth, are required for each single cable Circuit. In this case, there are some limitations regarding land use to avoid the damage to the underground cable. General agricultural activities are possible right above the cable trench, but planting deep-rooting plants, trees and vineyards should be avoided. Because these deep roots can cause drying out of the ground around the cable causing a fall in the thermal conductivity and tree roots may also penetrate the back fill and cable construction causing electrical failure. If it is impossible to avoid the deep root plants within 2.5m distance from the cable trench, protective tubes for the cables are recommended.

In the early years, when oil insulated cables were applied, oil leakage could lead to sever water pollution. So is written in the law §19 (g) of the Wasserhaushaltsgesetz (WHG) (Water Resources Act), "Underground cables must be designed, installed, maintained and operated in such a way that they will not have any negative impact on the waters." This law is particularly applicable in the case of low-pressure oil cables, where the tightness of the cable must be checked continuously.

In the area where underground cable is buried, the soil might be contaminated from heavy metal if the soil pH value is less than 3. When the plastic insulated cable is installed, some environmentally harmful substances will be created in the fire case. [4]

People living in the vicinity of the construction site often have concerns that electromagnetic fields (EMF) could have impact on their health. Both overhead lines and underground cables produce EMF. But in the area which is right above the cables, the EMF intensity is considerably higher than which is generated by the overhead lines (Fig.2). If possible, underground cables should be shielded to further reduce EMF at the surface.

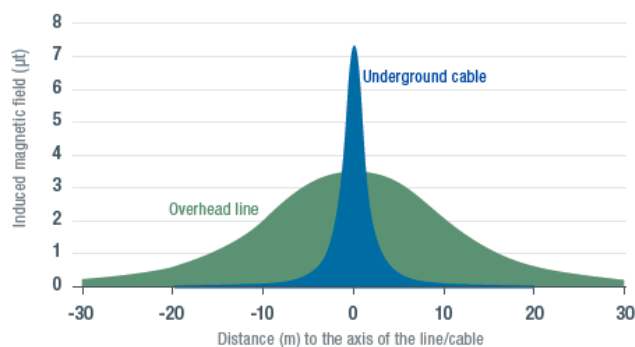

Fig. 2 EMF intensity around overhead line and underground cable

### IV. ECONOMIC PROBLEMS

The costs of underground cable systems can vary widely even for the same voltage, power and length, which makes it difficult to generalize. But it is still true that the investment cost of underground cables is much higher than the overhead lines. 50Hertz Transmission GmbH has indicated that the investment costs for an overhead line is approximately € 1 million and for an equivalent underground cable it will be approx. € 4-16 million per kilometer. The cable cost varies from € 4 million to € 16 million mainly depends on the location where the cable is installed. Furthermore, the underground cable normally has 40% to 80% shorter life time than overhead line, which makes underground cable even more expensive. On one hand underground cables have lower energy losses during transmission, on the other hand it has much higher error handling costs. Also due to lacking of experience, repairing an underground cable can last from weeks to months, comparing to overhead line that normally takes some hours to few days, which will lead to considerable economic losses. Thus, in most case overhead line is more preferred than underground cable in the power transmission system in order to keep the low network operation cost. [5]

### V. CONCLUSION

In Germany, underground cables are currently the norm at distribution grid level, and increasingly applied also in the medium and high voltage range. Since the technical limitations and impacts on the nature, the underground cables for high voltage AC power transmissions are initially tested as the pilot projects, in order to gather experience and advance technological development. Hence, it could be possible in the future to place the powerlines partially underground when it is necessary.

## REFERENCES

- [1] "Electricity Grids of the Future," Federal Ministry for Economic Affairs and Energy, [Online]. Available: [http://www.bmwi.de/Redaktion/EN/Textsammlungen/Energy/electricity-grids-of-the-future.html?cms\\_artId=255466](http://www.bmwi.de/Redaktion/EN/Textsammlungen/Energy/electricity-grids-of-the-future.html?cms_artId=255466).
- [2] P. N. J. F. N. U. K. Friedrich Kiessling, Overhead Power Lines: Planning, Design, Construction, Chicago: Springer, 11 Jul 2014.
- [3] "Environmental aspects of underground cabling," Renewables Grid Initiative, Berlin, 2013.
- [4] H. R. Mathias Fischer, Kabelhandbuch, Frankfurt am Main: VWEW Energieverlag GmbH, 2007.
- [5] "Freileitung oder Erdkabel Hintergrundinformation," 50Hertz Transmission GmbH, Berlin, 2012.



# Needs, potentials and applications for business model innovations with blockchain-technology in the electric power industry

Maximilian Meisel<sup>1</sup>

**Abstract**—this paper outlines potentials and applications of blockchain-technology in the electricity sector. A blockchain is a distributed ledger which can run an easily accessible, secured, transparent, public and tamper-proof peer-to-peer transaction system. Blockchain could change the current electricity system and enable a direct exchange of electricity between consumer and provider. The technology offers also potentials for E-mobility applications by offering an interoperating transaction platform. Next to the tremendous potential of the blockchain applications the technology has to face with different restrictions, like requirements for the transmission and distribution as well as regulatory and physical restrictions.

**Index Terms**—blockchain, business model, decentralized power generation, e-mobility, microgrids

## I. INTRODUCTION

TODAY, the primary use of blockchain-technologies takes place in the finance sector. Blockchain-based Cryptocurrencies developed from 2009 to 2017 from only one to currently 792 [1]. International finance institutes like the Fidor Bank or CBW integrated blockchain-based transaction systems in their business models and blockchain-Start-ups collected millions of dollars venture capital from investors [2], [3], [4]. Reasons for this success are easy to find. The management of digitalization, decentralized processes and fast and secure transactions [5]. That are points the electricity sector has also to face with. An increasing share of renewable energies, decentralized electricity generation and the electrification of the mobility need innovative business models. Blockchain-business models can become a game changer.

## II. BLOCKCHAIN BASICS

In 2009 Satoshi Nakamoto established the first cryptocurrency, based on a blockchain, the Bitcoin. It seemed to be a revolution in transaction technologies. The blockchain was enabling riskless transactions of bitcoins, without an intermediary like a financial institute, just peer-to-peer between two users.

This is possible because the transaction does not have to be validated from the intermediary in case of financial risks. The validation is taken place through a decentralized network of users [6].

The blockchain is a distributed ledger of transactions, which is easily accessible, secured, transparent, public and tamper-proof [7]. Batches of transaction are collate in blocks. The different blocks are electronically connected so they build a blockchain [6], [7]. This means, for manipulating one transaction, it is necessary to manipulate the whole blockchain. In addition, the blockchain ledger is not centralized on a single server, it is a distributed ledger, where lot of users participating in the transaction process [6], [8]. To secure the transaction it is also necessary, to encrypt the transaction information. The encrypting is a process that needs a lot of calculating capacity. This process is called “Mining”. “Miners” are users of that network, which offer their personal calculating capacity to confirm the correctness by finding the right encryption key of the encrypted transactions and enable secured transactions for other users [6], [7]. Therefore they got a marginal remuneration [6], [7], [8].

In the middle of the year 2015, the Russian programmer Vitalik Buterin developed the transaction platform Ethereum, which is also based on a blockchain. The main advantage to Bitcoin, is the possibility not only to transmit a cryptocurrency, but also non-monetary values [9]. He established so called “smart contracts”, which are digital equivalents of business contracts, where users can determine rules for transmitting properties, assets and transaction formats [7],[9]. That allows the establishing of multi-dimensional conditions of transactions without any intermediary. Coordinated and compatible smart contracts can build a so called “decentralized autonomous organization” (DAO). A DAO is a organization which is able to make decisions, only according to the determined rules of the corresponding smart contracts [7], [9].

## III. NEED OF BUSINESS MODEL INNOVATION

Business models are implemented operating instruments of the strategic management, which have to increase the customer

Submitted on 3 July of 2017

<sup>1</sup> M: Meisel was with University of Rostock, 18057 Rostock, Germany. He is now with the Brandenburg University of Technology Cottbus-Senftenberg, 03045 Cottbus, Germany (e-mail: Maximilian.meisel@b-tu.de).

value [10]. They are characterized by the value-added chain especially the underlying technologies, the distribution of roles, cash and service flows and the market environment [11]

The need of new business models in the electricity sector caused by tremendous requirements of the “Energiewende”. The centralized electricity generation got replaced by decentralized renewable energies. The share of renewable energies in total electricity generation in Germany was 29% in 2016 [12].

So on the one hand, the electricity generation becomes more and more a volatile parameter in the providing system and on the other hand, the also volatile consumption of electricity in Germany will, according to estimates, increase up to the year 2030 to an amount of 654.4 TWh. [13]

This will produce a situation of volatile supply and volatile demand, what furthermore will cause problems for energy providers, transmission and distribution system operators (TSO and DSO), which are forced to ensure the electricity supply and the permanent balance between electricity supply and demand. For this reason the whole supply chain of electricity, have to face with new business models. A trendsetting concept to handle the requirements published by the Bundesnetzagentur (BNetzA) in 2011. The paper “‘smart grid’ and ‘smart market’” should be an advisory, how innovative grid systems could manage the problems. Referring to the paper, a smart grid has been defined as grid that is able to record all actions in real time by using information-, communication-, automatization-, measurement and control technologies [14], [15]. This should enable the involvement of volatile renewable energies in the electricity system by intelligent peak shifting and demand side management to achieve higher relatively grid capacity [14]. Furthermore in 2015 the Federal Ministry of Economic Affairs and Energy of Germany passed the Act on the Digitization of the Energy Transition (Gesetz zur Digitalisierung der Energiewende). This law described general parameters for the digitalization of the electricity system, like the application of Smart Meter, that are intelligent metering systems consisting of to devices. An intelligent meter and a smart meter gateway to digitalize and transmit the measurement data [16]. An important role in a smart grid could be the “Prosumer”. That means a consumer, which is also a provider of electricity. The provided electricity could feed back into the distribution grid and offered to other consumers. For Prosumers, it would be more efficient to interact in geographically restricted areas, for example neighborhoods or communities to become independent from larger grids. There they could sell her generated electricity directly to other people [15], [17]. The integration of Prosumers, forces new business models in electricity markets. Especially solutions for intelligent trading platforms are required to offer a market archetype where Prosumer can easily sell or buy electricity.

In addition to electricity transmission topics, the development of E-mobility necessitate also new business models. A uniform and comprehensive network of public charging infrastructure for electric vehicles is a key for the development of E-mobility. The E-mobility market is a developing market, where roles have to be distributed other many market participants. For example, Charging Point Operators (CPO) have to offer a uniform

and comprehensive way of getting access to charging infrastructure for their customers. Because of the huge amount of CPO, customer are forced to make contracts with many CPO's, if they want to charge in different regions [17], [12]. A solution of this problem is to join into E-Roaming Platform like hubeject GmbH [18]. These intermediaries connect different CPO's to a network of charging infrastructure. Customers will get an access to the whole charging infrastructure of the E-Roaming platform by making a contract with the platform operator [18]. CPO's are forced to accept that intermediary-concept to stay into the market by offering flexible products. That causes problems for CPO's, caused by prices E-roaming platforms demand for their services and which are influencing the profitability of the CPO's business models.

#### IV. POTENTIALS AND APPLICATIONS OF BLOCKCHAIN-TECHNOLOGY

The main potential of blockchain technology is the possibility to build a transparent and tamper-proof peer-to-peer transaction network, where every transaction is secured and comprehensible. This could be also a potential to integrate decentralized electricity generation and demand in a smart grid. The blockchain could manage an electricity network between electricity consumer, provider and prosumers. In this peer-to-peer network every transaction of electricity is transparent and allocable for billing and has no need for an intermediary. Using the blockchain by connecting with a cryptocurrency, the electricity flow can translate in monetary values into seconds. Thereby, every electrical generator and consumer has to be equipped with a Smart Meter. With the Smart Meter technology, even the smallest electricity flow will be recognized and could transmit to the blockchain ledger, where it will be recorded, secured, transmitted in a monetary transaction and cleared. This could restructure the today's multi-tiered energy system, in which power producers, transmission system operators, distribution system operators and suppliers transact on various levels, by directly connecting producers and consumers [17]. Especially for distribution system operators these decentralized transmission structure could open spaces for new business models, by running an own blockchains for their customers.

This technology is applicate in the Brooklyn Microgrid of the joint venture of energy technology company LO3 and ConsenSys. In 2016, they build a blockchain-based community microgrid in Brooklyn, New York. The Prosumer generate electricity by electric solar plants on the rooftops of their houses and are able to sell it directly to their neighbors by using the Ethereum-Blockchain. The achievements of the project is to display, how an autonomously future distributed electricity grid can look like [19]. Today the transactions were initiate manually, but in future the developer will involve smartphone apps there the prosumer can determine parameters, for example the price for what they would buy or sell electricity. In connection to the smart contracts the transactions will run automatically. The project could also answer the question if there is an incentive for people to participate directly on the electricity market or change their consumer behavior [19], [20].

A blockchain-based billing system would be a solution that can achieve an easy way of payment. Smart contracts between the

EMP and the customer can enable an automatic loading process. The electric vehicle will authorize to the charging station autonomously. The user can charge his electric vehicle to the conditions laid down in the smart contract. An intermediary, like E-roaming provider are no longer necessary. This development got primary advanced by the cooperation between the Inogy SE and Slock.it from Germany, called Blockcharge [21]. They develop a blockchain-based peer-to-peer charging system. The system consists next to the blockchain of 2 main elements. The first, Smart Plugs, which have an installed computer chip inside. This enables the Plug to control who is authorized to use it. And Second, a smartphone app, which is authorizing the user and visualize the charging process [21]. It can also negotiate the best price for the charging. The blockchain will record and secure all charging data and provide a transparent, uniform and secure payment process. In order to inductive charging systems, it might be feasible, that blockchain-technology can become the key development. It allows an automatic authorization, charging and billing process, while users, for example are waiting for traffic lights [21].

Furthermore, it is conceivable, that blockchain-technology can overtake tasks to secure the grid stability and lower operating costs. For example, the charging of storage systems in times of energy excess and discharging in times of lacks, could work automatically, only instructed by the rules of the programmed smart contracts [22]. This shows also a potential for the balancing power market. The company Sonnen GmbH, the TSO TenneT and the software company IBM cooperate to offer energy services by connecting home storage systems. They achieve to avoid redispatching costs, by time-shifting electricity via a virtual power plant, realized as a network of connected storage systems from regions with high wind generation periods to regions where additional gas power plants have secure the electricity supply in peak hours [22].

A survey of the German Energy Agency (Deutsche Energie Agentur GmbH (dena) and the European School of Management and Technology (ESMT Berlin) display the expectations and experiences about the blockchain-technology of about 70 executives in the energy sector. The research identifies 2 general clusters of benefits. The first is related to blockchain-potentials of platforms. The most participants of the survey expect a development of peer-to-peer trading opportunities for prosumer or trading platforms for business-to-business actors including demand response and virtual power plants, which are already dependent on aggregators to trade on the wholesale market as well as advantages for general decentralized power generation [23]. The second cluster describes potentials for process optimization. The main potentials have been seen in billing, mobility, grid management, automation, metering and data transfer, communication, marketing and sales, caused by sinking wholesale market prices and consequently increasing cost pressure for all utilities in energy sector [23].

## V. RESTRICTIONS OF BLOCKCHAIN-TECHNOLOGY IN ELECTRIC POWER INDUSTRY

Even there are many potentials of blockchain-technology for the electric power industry, only a few economically used business models in electricity markets are popular. On the one hand this technology is on an early level of development and on the

other hand the application of blockchain in the general energy sector has to face with many restrictions [17].

The key restriction in contrast to applications in finance, is that next to monetary transactions, which are not more than simply transactions of data from one user to the other, electricity is a physical transaction. DSO's and TSO's have to adjust on the changing requirements of the decentralized structure and expanding bi-directional electricity flows [21], [22]. Primary the integration of blockchain-technology in the electricity transmission, demands the recording of every marginal electricity consumption and generation. A comprehensive Smart Meter Rollout would be required. But according to the Act on the Digitization of the Energy Transition, the installation of smart meter is today not obligatory for all devices. For example, only households up to a consumption of 6000 kWh or new build renewable energies electricity generators up to 0,25 kW capacity have to install smart meters. The complete Rollout will finish at the earliest in 2032 [14], [15].

Another restrictions will face regulatory requirements to realization of blockchain-technologies. In assumption of a direct exchange between consumer and provider the roles in the electricity system have to change or redefine [17]. For example, today every consumer have to be assign in a balance zone. Responsible balance zone manager has to report necessary data to the TSO, who has to clear estimated and real supply data. In a peer-to-peer blockchain-world, where consumer and provider are in a direct exchange without an intermediary, every consumer have to become an own balance circle with all responsibilities. That can cause risks and costs [17]. Furthermore it is not clear, who has to report data to the TSO for the necessary a day-ahead estimation of total electricity demand [17].

## VI. CONCLUSIONS

Even there are many restrictions that blockchain-technology has to face with to become an economically profitable alternative to current technologies, the involvement of nearly all big players in electricity sector on research and development projects, show how serious the interests are. That should display, that the benefits referring to blockchain-technology are too strong, to ignore this technology.

The potential to build a new architecture for independent electricity solutions, improve balancing operations, reducing process costs, making information streams faster and more immediate, and adding customer value through more detailed and transparent information about energy origin and evolution [23]. Concerning to the dena survey, 21 % of the respondents expect, that the blockchain-technology becomes the game-changer in electricity power industry. Further 60 % foresee a dissemination of the technology while only 5% don't see any potential [23].

## VII. REFERENCES

- [1] Coinmarketcap.com retrieved on 30th of June.2017
- [2] The Institute of International Finance, Inc (2015); Banking on the Blockchain Reengineering the Financial Architecture; <https://www.iif.com/publication/special->

- briefing/banking-blockchain-re-engineering-financial-architecture
- [3] Williams-Grut, O.(2015) in Uk Business Insider URL: <http://uk.businessinsider.com/santander-innoventures-invests-4-million-in-ripple-labs-2015-10?IR=T>
- [4] <https://angel.co/ripple-labs> retrieved on 30 June 2017
- [5] Bank of International Settlement (Bank für Internationalen Zahlungsausgleich) (2015): Digital currencies. November 2015. Basel: Bank for International Settlements. Online verfügbar unter <http://www.bis.org/cpmi/publ/d137.htm>. p. 9-10
- [6] Nakamoto, Satoshi (2009):Bitcoin: A Peer-to-Peer Electronic Cash System; p. 1-9
- [7] Sixt, Elfriede (2017): „Was sind Kryptotransaktionssysteme?“ P.5-8 und „Funktionsweise des Bitcoin Netzwerks“ p.29-44 in „Bitcoins und andere dezentrale Transaktionssysteme. Blockchains als Basis einer Kryptoökonomie“. Wiesbaden, s.l.: Springer Fachmedien Wiesbaden. Online verfügbar unter <http://dx.doi.org/10.1007/978-3-658-02844-2>;
- [8] Lee, David Kuo Chuen (Hg.) (2015): Chapter 3 Bitcoin Mining Technology in Handbook of digital currency. Bitcoin, innovation, financial instruments, and big data. Amsterdam: Academic Press. p. 53
- [9] Wood Dr., G. (2014): Ethereum -A secure decentralised generalised Transaction Ledger. Retrieved on 30th of June 2017 von <http://gavwood.com/paper.pdf>
- [10] Schneider, K. (2001): Geschäftsmodelle in der Internetökonomie. In: Ahlert, D.; Becker, J.; Kenning, P.; Schütte, R. (Hrsg.): Internet & Co. im Handel – Strategien, Geschäftsmodelle, Erfahrungen. Springer-Verlag, Berlin, Heidelberg 2001, p. 125
- [11] Scheer, C. et al. (2003): Geschäftsmodelle und internetbasierte Geschäftsmodelle –Begriffsbestimmung und Teilnehmermodell; Working Papers of the Research Group Information Systems & Management; Johannes Gutenberg-University Mainz; p. 21
- [12] Federal Ministry of Economic Affairs and Energy (Bundesministerium für Wirtschaft und Energie) (BMWi): Entwicklung der erneuerbaren Energien in Deutschland im Jahr 2016 [Online]. Berlin.: Feb. 2017, URL:[http://www.erneuerbare-energien.de/EE/Redaktion/DE/Downloads/entwicklung\\_der\\_erneuerbaren\\_energien\\_in\\_deutschland\\_im\\_jahr\\_2016.pdf;jsessionid=AD5A6AEA89E98B7EE32EF2F3B5693D4A?\\_\\_blob=publicationFile&v=17](http://www.erneuerbare-energien.de/EE/Redaktion/DE/Downloads/entwicklung_der_erneuerbaren_energien_in_deutschland_im_jahr_2016.pdf;jsessionid=AD5A6AEA89E98B7EE32EF2F3B5693D4A?__blob=publicationFile&v=17)
- [13] <https://de.statista.com/statistik/daten/studie/20157/umfrage/desertec-prognose-zum-stromverbrauch-deutschlands-bis-2050/>
- [14] Bundesnetzagentur (BNetzA) (2011): Smart Grid“ und „Smart Market“ Eckpunktepapier der Bundesnetzagentur zu den Aspekten des sich verändernden Energieversorgungssystems
- [15] Aichele, C. and Doleski, O.(2014): Idee des intelligenten Energiemarktkonzepts, in Aichele, C. and Doleski, O.(2014) Smart Market-Vom Smart Grid zum intelligenten Energiemarkt, Springer Fachmedien Wiesbaden 2014; p. 3-53
- [16] Act on the Digitisation of the Energy Transition (Gesetz zur Digitalisierung der Energiewende): Bundesgesetzblatt Jahrgang 2016 Teil I Nr. 43, published in Bonn 1 September 2016
- [17] PricewaterhouseCoopers International (2016): Blockchain – Chance für Energieverbraucher? Kurzstudie für die Verbraucherzentrale NRW, Düsseldorf, <http://www.verbraucherzentrale.nrw/media242404A.pdf> (30.06.2017)
- [18] Daiber, T and Hahn, C. (2013): hsubject GmbH URL: [https://www.hsubject.com/wp-content/uploads/2016/09/160905\\_SHARE\\_Produktdatenblatt\\_en\\_web.pdf](https://www.hsubject.com/wp-content/uploads/2016/09/160905_SHARE_Produktdatenblatt_en_web.pdf)
- [19] Brooklyn Microgrid (2016): Homepage von Brooklyn Microgrid, <http://brooklynmicrogrid.com> retrieved on 30th of June 2017
- [20] Rutkin, A. (2016): Blockchain-based microgrid gives power to consumers in New York. New Scientist, retrieved on 30<sup>th</sup> of June 2017 URL: <https://www.newscientist.com/article/2079334-blockchain-based-microgrid-gives-power-to-consumers-in-new-york/>
- [21] Stöcker, C. (2016): BlockCharge-EV Charging via the Ethereum Blockchain [Online]. YouTube Available: <https://www.youtube.com/watch?v=0A0LqJ9oYNg> [Accessed on 30th June 2017
- [22] Weimann, S. (2017): Die Blockchain ist die nächste Evolutionsstufe der dezentralen Energieversorgung; Sonnen GmbH; URL: <https://www.sonnenbatterie.de/de/die-blockchain-ist-die-naechste-evolutionsstufe-der-dezentralen-energieversorgung>
- [23] German Energy Agency (Deutsche Energie Agentur GmbH (dena), European School of Management and Technology (ESMT Berlin) (2016): Blockchain in der Energiewende. Eine Umfrage unter Führungskräften der deutschen Energiewirtschaft

# Vehicle-to-Grid: Opportunities and Challenges for the Energy Sector

Kevin Kudert, Mateusz Munacoha and Sebastian Maiwald

**Abstract**— The current electric vehicles (EV) can not only contribute to an emission-free environmentally-friendly car drive, but could also serve as a small storage and thus feed electricity into the domestic network. Vehicle-to-Grid (V2G) and Vehicle-to-Home (V2H) represent possible technologies that would create storage capacities and be intelligently and bidirectionally connected to the power grid. The expansion of the existing technology could help to invest more in EVs, to support the spread of EVs, and in this case to promote the use of renewable energies.

**Index Terms**— electricity, electricity market, electric vehicles (EV), renewable energy, recovery, smart grid, storage, vehicle-to-grid (V2G), vehicle-to-home (V2H).

## I. INTRODUCTION

THIS paper examines the possibilities, opportunities and challenges related to the power recovery to the mains recovery by EV. The technical and economic components of V2G are presented below. In general the advantages and disadvantages of this technology are shown. In this work, the interface between industry and technology will be presented. It is also shown what are the most economical applications of V2G. In the end, the results are summarized and developed proposals are summed up to a conclusion.

## II. ELECTROMOBILITY AND VEHICLE-TO-GRID

The idea of the EV is by no means new, already around 1881 the first electric car was presented at the International Electricity Exhibition [1]. "Electromobility" is not a clearly defined term. A broad concept of electromobility could in principle also include electrified public passenger transport. In the following, the term is defined more narrowly and used exclusively for motorized individual traffic [2]. Due to their energy source, electric cars can be divided into three categories. The first category consists of battery powered electric cars. In this vehicle type, a battery supplies all the energy required for the drive. This paper focuses on this type of EV. Most lithium-ion batteries nowadays have very high power-densities and many charging cycles are possible. The capacities of such batteries are from 1 up to 60 kWh for the most models [3]. The second category is the hybrid vehicles. These are driven by electric motors as well as by internal combustion engines. In the context of the electricity network,

we would only be interested in hybrid vehicles, which can also be plugged into a socket to charge the batteries. The batteries of hybrid vehicles reach capacities of about 1 to 8 kWh and are therefore less powerful than from battery powered EVs. Therefore, these EVs are not considered in this paper [1]. The third category includes cars with a fuel cell. These store energy in the form of hydrogen, which reacts together with oxygen in a fuel cell to form water. This process generates electrical energy. This energy is often delivered directly to the electric motors, but there are also models that include a battery to store current there between. This group of EVs is also not dealt within this paper [1].

### A. Utilization

Though being the most used means of transport, a car used only 4% of the time in average [4]. In the case of electric vehicles, it would therefore be possible to use the car as a power store during the remaining time. In order to be able to use electric cars as electricity storage, hardly any changes are necessary compared to today's models. Electric cars have inherently an inverter which can produce from direct current alternating current at different frequencies. Thus it is possible to feed electricity from the batteries of the electric cars into the grid without major additional costs [1].

Table 1 show opportunities and challenges, which would result from a widespread use of EV:

Opportunities
- Emission reduction (air pollution)
- Reduction of noise emissions
- High energy efficiency of 30% (gasoline 18%, diesel 23%)
- Avoiding supply problems caused by the independence of fossil fuels which must be imported
- Lower mobility costs (about half the price compared to the petrol vehicle)
Challenges
- Reduction of jobs due to fewer components (economic disadvantage)
- Increased driving performance of consumers due to low mobility costs
- Increased acquisition costs compared to combustion vehicles

Table 1: Opportunities and Challenges of EV

### B. Vehicle-to-Grid

The vehicle-to-grid concept (V2G, "vehicle-to-network") was first described by Kempton and Tomic [5][6]. Its basic idea is the integration of the batteries of parked electric vehicles into the electricity network through a physical cable connection,

which could lead to considerable synergies between the electricity system and the vehicle park [7]. The following Table show the different vehicle-to-grid strategies.

system service	strategy	required power supply	bottleneck components
filling of demand troughs	time-controlled charging in low-load periods (at night)	monodirectional	battery capacity
provision of peak load	use of the battery as a current storage: charging in low load periods, feeding back into the grid at peak load times	bidirectional	connected load, battery capacity
negative control power	provision of uncharged battery capacities and recharge in case of need	monodirectional	connected load
positive and negative control power	provision of partially charged battery capacities; Charging or feeding back into the mains as needed	bidirectional	connected load
provision of reserve and backup capacities capable of black start-up	provision of charged battery capacities or filled fuel tanks; Feed back into the grid as needed	bidirectional	connected load, battery capacity
storage of excess current from renewable energy sources	provision of uncharged battery capacity and use as electricity storage in case of surplus production	bidirectional	battery capacity

Table 2: Vehicle-to-Grid strategies

In addition, at any time, over 90 percent of all vehicles are parked, even during the rush hour [5][6]. The batteries of electric vehicles would thus be unused for most of the day, although they could provide valuable system services when connected to the power grid. Pure battery electric vehicles are best suited for all types of electric vehicles for V2G, since they have the highest battery capacities and the highest connection capacities [5]. Vehicles are optimized to carry out frequent and large load changes, while many power plants are slow in their output behaviour. That is an important point why EVs should participate in the energy supply [8]. A quarter of the 41 million cars in Germany [9], with a connection capacity of 15 kW, would suffice to double the installed German power plant line to a value of approximately 300 GW.

The following figure shows the energy flow of V2G. EVs are bidirectional connected to the grid through various connection possibilities. Via the distribution network, the energy is converted by transformers and fed into the high-voltage grid. TSOs regulate the power plant feed in. Under cooperation of TSOs the aggregator regulate the feed-in of the EV energy.

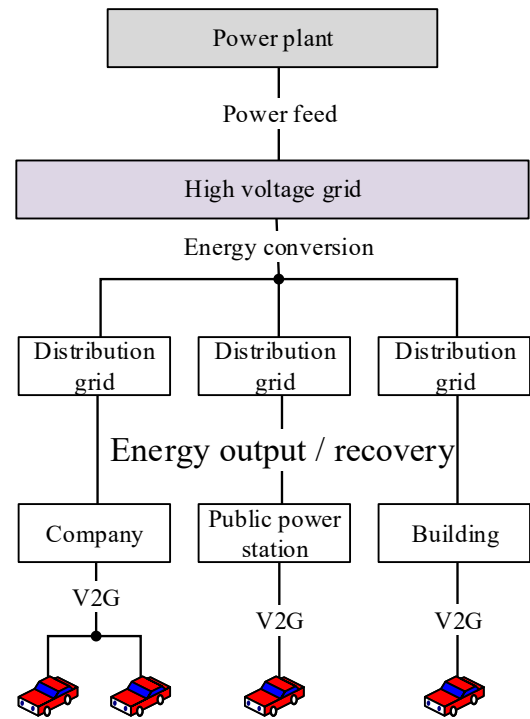

Fig. 1: Vehicle-to-Grid energy flow

### III. A CHANCE FOR THE ELECTRICITY MARKET

Since the nuclear disaster in Fukushima in the year of 2011, the energy revolution has been driven forward. At the same time, it was decided to completely abandon the supply of nuclear power and to implement the already decided reduction of fossil energy generation by means of renewable energies. [10] At the moment 33% of the energy that is generated in Germany is created by regenerative energy sources. [11]

Even if the expansion of renewable energies is an important component of the German energy policy, there is a conflict of interests. In this context, the so-called magical triangle of energy supply is mentioned. The energy supply in Germany should be as cost-effective as possible, environmentally compatible and provide a high level of supply security. In Germany one is willing to accept higher prices for a more environmentally friendly energy supply, but it is not an option to realize this at the expense of security of supply. [12] As a result, the fluctuation of energy becomes a serious problem. Above all, energy production by wind and sun can be predicted to some extent in the short term, but not controlled. This has a significant impact on the electricity market. At present, the energy suppliers handle times with peak load without sufficient production and production peaks without necessary need by purchasing and selling on the electricity market. The primary function of the electricity market is to ensure this. Thanks to its help it tries to synchronize the electricity consumption with the power generation. Electricity can therefore be transported internationally at will, if the existing network structures permit it. [13]



In summer when both the sun is shining and the wind blowing, Germany produces a huge amount of electricity. However, the generated current can not be consumed. In order to avoid overloading the electricity network, it is necessary to consume the electricity or to carry out forced shutdowns which causes high, economic costs. On May 8th. 2016 at 2 pm the electricity price at the Leipzig exchange fell to minus 130 euros per megawatt hour. [14]

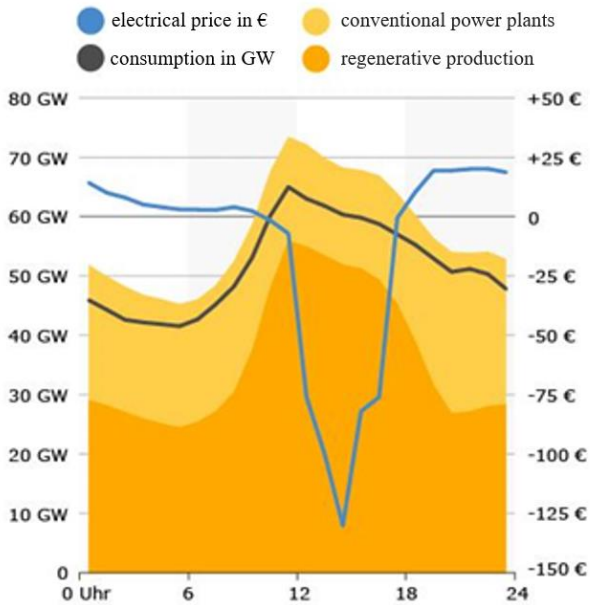

Fig. 2: 8th may - Low price on German electricity market

The problem in Germany is not that there is not enough energy produced, but that it can not be consumed at the required time. The solution to this problem would be to store energy short or even long term. However, up to the present day, insufficient storage capacities are available to optimize the electricity trade in Germany.

#### IV. TECHNICAL AND ECONOMICAL BACKGROUND

In the following section, we will now discuss the technical and economic aspects of V2G.

##### A. Technical components

The technical component of the V2G consisting of an EV, bidirectional charger, sources of renewable energies (especially photovoltaic or wind turbines), a domestic electricity network (including a DC and AC connection) and a certain communication and control software [15]. Here, the aggregator has the task of bundling the EVs into an energy-economic resource and controlling the loading and unloading. Overall, there are many significant types of vehicles that are powered by electric motors. However, in this case, we only want to focus on purely electric vehicles (BEV-Battery Electric Vehicles), since they have the highest battery capacities and connection capacities and are therefore best suited for V2G. Here, the battery of the EV carries the supporting role as this is necessary for the active exchange of electricity to the home network. In terms of charging times, the usual household connection power is approx. 3 kW. Here,

the average charging time for a 20 kW battery would be around 7 hours [2]. In recent years the most common battery types for hybrids and pure electric cars have been nickel metal hydride batteries [16]. Nowadays, lithium-ion batteries are preferred for plug-in hybrids and pure electric cars because of their high energy density and other favorable technical features [17]. However, compared to petroleum-based fuels, the energy density and range are very low. Other important key figures for batteries are also the weight, reliability, shock insensitivity and fluctuating temperatures. The battery capacity for pure electric vehicles can be between 15-20 kWh and a maximum up to 60 kWh. At present, most automotive manufacturers are putting their batteries firmly into the car so that they can be recharged in a parked condition at a charging station [2].

##### B. Charging options

In the following section the various loading options are shown.

###### 1) Current uncontrolled charging of electric vehicles (EV)

By plugging in the vehicle starts the charging process. There is no regulatory intervention and it is the price of electricity for the end user, which is currently on the market. In this case, when the battery is fully charged, the EV is unused for many hours. This condition would not only be inefficient, but also impairs performance, thus reduces battery life.

###### 2) Controlled charging

The controlled charging makes it possible that the vehicle preferred charges in the periods in which the price of electricity is particularly economical. Especially, it is also possible to select a period during a large amount of electricity is produced from renewable energy sources. Compared to the current variant, the battery is protected during controlled charging, since it remains as long as possible in optimized charging conditions.

###### 3) Bidirectional loading

During the charging time, in which the EV is not in use anyway, the EV could also feed back electricity into the grid and generate daily revenue [18]. So, additional costs for infrastructure, control, battery wear and other maintenance costs could be covered [2]. But it will last a long time until the producer can offer the batteries for a fair price. Now the costs of a lithium-ion battery are between 800 to 1000 euros per kWh and thus may be too expensive for the majority. Nevertheless, the daily electricity demand could also be ensured that there are no concern with power fluctuations or power interruptions. The daily electricity demand could also be ensured with power fluctuations or power interruptions. The battery is predominantly spared because it would be usually in an optimized charge condition. Bidirectional charging is a new, innovative way to load your EV intelligently and controlled and unload it as required [18].

##### C. Economic opportunities

According to a study from 2004, the daily way to work of more than 90% of the workforce is less than 50 km [9]. An EV

with an average consumption of 20 kWh / 100km and a 10 kWh battery could cover the majority of the daily way to work by car. In this case, it means that over 90% of the electric vehicles are in a parking mode, although they could provide valuable system services [2]. Regarding the feed-back of electricity, researchers estimate that potential net sales could be saved between 90 and 4000 US dollars per year [19]. On the basis of an analysis on the German market, Andersson et al. analyzed that approximately 30-80 euros per vehicle and month could be saved [20]. With regard to various electricity market segments, the provision of base load or peak load by EVs would be very low profitably. In contrast, the provision of high-quality and rapidly available storage capacities or regulatory services could be far more profitable [2]. Finally, the Table 3 summarizes further important opportunities and challenges.

Opportunities
<ul style="list-style-type: none"> <li>- Improvement of the full load hour number and economy of power stations (by smoothing of the load curves, by filling of nightly demand troughs) -&gt; Especially relevant in Germany because of the fact, that night-time heating systems, which have hitherto exercised this function, are abolished.</li> <li>- Ability to provide positive as well as negative control power (by storing energy and regenerating during peak load times)</li> <li>- Black start capability (energy can also be provided in the case of a full power failure)</li> <li>- Leads to a positive contribution to the system integration of fluctuating renewable energies such as solar and wind power</li> <li>- Provision of control energy is highly profitable for EV</li> </ul>
Challenges
<ul style="list-style-type: none"> <li>- battery technology is despite progress the biggest obstacle</li> <li>- High production costs of lithium-ion batteries for EV (800 - 1000 €/kWh)</li> <li>- Limited loading infrastructure</li> <li>- Relatively long charging times -&gt; Higher power connections are required</li> <li>- Reinforcement of local distribution networks is therefore necessary</li> <li>- Dependencies of lithium-producing countries (finite raw material)</li> <li>- Rejection of potential consumers due to cost intensity, novelty and insufficient testing</li> <li>- Rejection by restricted range and inflexibility of the loading process</li> <li>- Rejection based on data protection aspects (movement profiles)</li> <li>- Resistance of market players from the fields of conventional automotive and mineral oil industry</li> <li>- Intensified training activities are needed</li> </ul>

Tab. 2: Opportunities and Challenges of V2G

## V. CONCLUSIONS

The facts about the V2G mentioned in this article indicate that there is now considerable progress in the field of electric vehicles, which is being pushed forward more than ever by politics, automotive manufacturers and energy suppliers. V2G could prove to be a technology that does not require high investment thus accelerates the breakthrough of EVs. Besides the best-known advantages of EVs, such as the reduction of local emissions, the use of renewable energies and the consequent reduction in the dependency on crude oil, there are

many challenges. In economic aspects particularly, such high costs of acquisition and cost of batteries and the range of EVs could impede the progress of V2G. Nevertheless, this project could lead to significant CO<sub>2</sub> savings in the future. To avoid problematic peak loads and endangering grid stability in the future, intelligent and bidirectional charging controls would be indispensable. V2G is ideally suited for providing control services and valuable system services for the electricity system, but is less suitable for storage-intensive purposes. To realize V2G in the near future, standardized network connections and a coordinated battery management system are required. One of the biggest barriers could be also the distribution of V2G.

## REFERENCES

- [1] F. Dreier (2010): Elektroautos und ihre Rolle im Stromnetz. Departement für Informatik. ETH Zürich, Available: <https://pdfs.semanticscholar.org/6b39/d30c05020d3122d4728b83ecd29fce4e2da7.pdf> aufgerufen am 28.06.2017.
- [2] W. Schill (2010): Elektromobilität in Deutschland –Chancen, Barrieren und Auswirkungen auf das Elektrizitätssystem, in: Vierteljahrshefte zur Wirtschaftsforschung 79 (2010), 2, 139–159. Available: <http://ejournals.duncker-humboldt.de/doi/pdf/10.3790/vjh.79.2.139> 07/03/2017 10:00 a.m.
- [3] C. Guill (2009): A conceptual framework for the vehicle-to-grid (V2G) implementation. Energy Policy, 37:4379–4390, June 2009.
- [4] W. Kempton (2005): Vehicle-to-grid power fundamentals: Calculating capacity and net revenue. Journal of Power Sources, 144:268–279, April 2005.
- [5] W. Kempton, J. Tomic (2005a): Vehicle-to-grid power fundamentals: Calculating capacity and net revenue. Journal of Power Sources, 144 (1), 268–279.
- [6] W. Kempton; J. Tomic (2005b): Vehicle-to-grid power implementation: From stabilizing the grid to supporting large-scale renewable energy. Journal of Power Sources, 144 (1), 280–294.
- [7] B. Sovacool; R. Hirsh (2009): Beyond batteries: An examination of the benefits and barriers to plug-in hybrid electric vehicles (PHEVs) and a vehicle-to-grid (V2G) transition. Energy Policy, 37 (3), 1095–1103.
- [8] J. Jasna; W. Kempton (2007): Using fleets of electric-drive vehicles for grid support. Journal of Power Sources, 168 (2), 459–468.
- [9] BMVBS (2009): Verkehr in Zahlen 2009/2010. Vol. 38. Hamburg Bundesministerium für Verkehr, Bau und Stadtentwicklung.
- [10] K. Maubach, „Fukushima und Ausstieg (2011)“, in Energiewende: Wege zu einer bezahlbaren Energieversorgung, 2nd ed., Düsseldorf, Germany: Springer-Verlag, 2014, pp. 9- 27.
- [11] Bundesministerium für Wirtschaft und Energie (2017, März). Erneuerbare Energien. [Online]. Available: <https://www.bmwi.de/Redaktion/DE/Dossier/erneuerbare-energien.html> 07/03/2017 10:00 a.m.
- [12] F. J. Matzen (2017), „Ziele der deutschen Wirtschafts- und Energiepolitik,“ in Industrielle Energiestrategie: Praxishandbuch für Entscheider des produzierten Gewerbes, Wiesbaden, Germany: Springer Verlag, 2017, pp. 5-7.
- [13] S. Bode; L. Dietrich (2010). Der Import von Strom: Ein Beitrag zur Versorgungssicherheit?. Energiewirtschaftliche Tagesfragen, Vol. 3, pp. 30-32.
- [14] D. Loesche; S. Schultz; P. Stotz (2016, May). Bitte, nehmt meinen Strom! Ich zahl auch dafür!. Spiegel Online. [Online]. Available: <http://www.spiegel.de/wirtschaft/unternehmen/negative-strompreise-zunehmend-haeufiger-a-1092088.html>
- [15] L. Chunhua; K. Chau., (2013): Opportunities and Challenges of Vehicle-to-Home, Vehicle-to-Vehicle, and Vehicle-to-Grid Technologies, in: Proceedings of the IEEE November 2013, 2409-2427.
- [16] R. Lache; P. Nolan; D. Galves; Toulemonde, Gaetan; Gehrke, Jochen; Sanger, Kurt; Ha, Vincent; Srinivas, Rao; Crane, Joel (2008): Electric Cars: Plugged In. Deutsche Bank FITT Research.



- [17] W. Tillmetz (2009): Neue Technologien sollen Kraftstoff sparenden Autos zum Durchbruch verhelfen. *ew – das Magazin für die Energiewirtschaft*, 108 (17–18), 30–32.
- [18] O.V. (2017): Intelligentes Laden spart Geld, schont die Batterie und erwirtschaftet in Zukunft sogar Einnahmen, Available: <http://www.mobilityhouse.com/de/vehicle-to-grid-und-vehicle-to-home/>, 07/03/2017 10:00 a.m.
- [19] M. Yilmaz; P. Krein (2013): Review of the Impact of Vehicle-to-Grid Technologies on Distribution Systems and Utility Interfaces. In: *Power Electronics, IEEE Transactions on* 28 (12), 5673–5689.
- [20] S. Andersson; A. Elofsson; M. Galus; L. Göransson; S. Karlsson; F. Johnsson; G. Andersson (2010): Plug-in hybrid electric vehicles as regulating power providers: Case studies of Sweden and Germany. *Energy Policy*, 38 (6), 2751–2762.

#### FIGURES

- [1] D. Ciechanowicz; M. Leucker; M. Sachenbacher (2012): Ökonomische Bewertung von Vehicle-to-Grid in Deutschland, *Multikonferenz Wirtschaftsinformatik 2012*, 1-12, Available: <http://www6.in.tum.de/Main/Publications/ref7.pdf> 07/03/2017 10:00 a.m.
- [2] D. Loesche; S. Schultz; P. Stotz (2016, May). Bitte, nehmt meinen Strom! Ich zahl auch dafür!. *Spiegel Online*. [Online]. Available: <http://www.spiegel.de/wirtschaft/unternehmen/bild-1092088-994120.html> 07/03/2017 10:00 a.m.

#### TABLES

- [1] W. Schill (2010): Elektromobilität in Deutschland –Chancen, Barrieren und Auswirkungen auf das Elektrizitätssystem, in: *Vierteljahrshefte zur Wirtschaftsforschung* 79 (2010), 2, 139–159, in: <http://ejournals.duncker-humboldt.de/doi/pdf/10.3790/vjh.79.2.139> 07/03/2017 10:00 a.m.
- [2] W. Schill (2010): Elektromobilität in Deutschland –Chancen, Barrieren und Auswirkungen auf das Elektrizitätssystem, in: *Vierteljahrshefte zur Wirtschaftsforschung* 79 (2010), 2, 139–159, in: <http://ejournals.duncker-humboldt.de/doi/pdf/10.3790/vjh.79.2.139> 07/03/2017 10:00 a.m.
- [3] W. Schill (2010): Elektromobilität in Deutschland –Chancen, Barrieren und Auswirkungen auf das Elektrizitätssystem, in: *Vierteljahrshefte zur Wirtschaftsforschung* 79 (2010), 2, 139–159, in: <http://ejournals.duncker-humboldt.de/doi/pdf/10.3790/vjh.79.2.139> 07/03/2017 10:00 a.m.

# Why have small wind power plants not been installed on private rooftops so far?

Frederic Frantzheld, Lennard Döcke

**Abstract**—Wind turbines are increasingly a reliable source of energy in times of energy demand. In contrast to photovoltaic plants, they are not yet integrated into the urban landscape. Sound emissions and poor wind conditions have a detrimental effect on the operation of such a system. Quality, running time and utilization determine the profitability of a private small wind turbine. Financially, they can't compete with photovoltaic plants in the city of Cottbus.

## INTRODUCTION

IN times of energy demand in Germany, private households are supported by the state in the purchase of plants for the production of renewable energies. There is the possibility to use the produced electricity for the own purpose or to feed it into the power net for a reward. In the course of this development, the cityscape is increasingly characterized by photovoltaic installations on rooftops. In contrast, wind power plants have not yet established themselves in inhabited areas. In this article, the foundations of private small wind power plants are presented and their potential is assessed by means of a profitability analysis.

## ENERGY DEMAND OF THE CITY COTTBUS

The energy demand of the region Cottbus in Brandenburg is amounted up to 150 MW. The installed plants for electricity generation generated around 160 MW in 2011 and thus largely covered the electricity demand. [1]

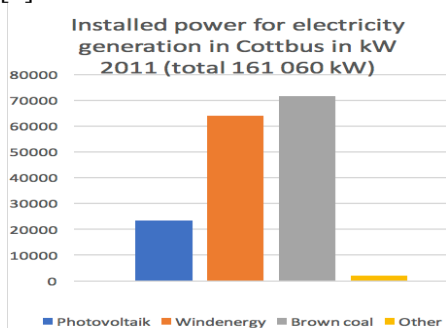

A good amount of the total energy, produced by the

Figur1: Installed power for electricity generation in Cottbus [1]

Cottbus region is generated from wind power. Therefore, the question arises whether the use of wind energy for private households is also a worthwhile investment. An average single-family house consumes about 9000 kWh per year. This value serves as a basis for further consideration.

## SMALL WIND POWER PLANTS FOR PRIVATE USE

In the case of small wind turbines, a distinction is made between horizontal and vertical construction. Horizontal designs largely correspond to the operating principle of large wind turbines. They have a mostly three-blade rotor with a horizontally arranged generator shaft mounted on a high mast. Due to the design, you can achieve high rotor speeds and a power coefficient of 50%. However, the noise emissions generated during operation and the optical impairment of the environment are disadvantageous.

Vertical constructions have a vertically arranged rotor, of different designs. They are also mounted on a mast. Due to the design, vertically arranged wind turbines rotate considerably more slowly and more smoothly than horizontally, which is also associated with a lower sound emission. Purely optically, they are perceived as more pleasing, because the relationship to large wind power plants is not clearly recognizable. The power coefficient is around 40%.

This reveals the decisive difference between the two designs. Wind turbines with a horizontal axis are usually more efficient than vertical systems. Vertical systems have significant advantages in terms of running stability and low noise emissions. Considering the overall efficiency, this is about 30% for small wind turbines with a horizontal rotor axis. Vertical fans reach values up to 20%.

The decisive factor for profitability is not the overall efficiency, but more the electricity production costs of a kilowatt hour of electricity. Regarding efficiency and marketability, horizontal small wind turbines are currently clearly ahead. The same design is also used for big multi mega watt wind turbines.

A building permit is required for the construction of a small wind turbine depending on the total height. In Brandenburg this is only necessary for turbines higher than an altitude of 10m. [2]

#### EFFICIENCY ANALYSIS OF SMALL WIND POWER PLANTS

In order to answer the question of why wind turbines on private house roofs have not yet been implemented, an exemplary efficiency assessment for operation in the Cottbus area is to be carried out. For this, the approximate acquisition costs of the plant, the mean wind speed, the current electricity price as well as the own electricity demand must be known. The acquisition costs are assumed for a 5kW plant for a budget of € 15,000. According to Windfinder.com, the annual average wind speed in Cottbus is 3.1 meters per second. The current electricity price is € 0.28 / kWh with an assumed increase of 2% per year. This enables the production of a horizontal wind turbine with a nominal output of 5 kW per year of about 2158 kWh / year. With an annual energy consumption of 9000kWh and the acquisition cost for the entire plant, the wind turbine will pay for itself after 7 years. The electricity generation costs an amount of 46.23 cents per kWh. [2]

The high investment costs of around 2000 to 8000€ per kilowatt can be explained by the fact that small wind turbines are not into mass production such as photovoltaic systems. In addition, wind turbines, in contrast to photovoltaic systems, have moving parts and a strong mechanical load. The system should run reliably and with minimal maintenance over a period of twenty years. This is only possible if a corresponding effort is involved in the development of the plant, as well as the use of high-quality components.

Compared to a small wind turbine, a photovoltaic plant in Germany with a capacity of 2 kW and 20 m<sup>2</sup> generates an average of 2000 kWh per year and costs around 8000 €. [3] [4]

#### CONCLUSION

Small wind power plants for private use are still quite expensive to buy. Their productivity depends on their geographical location, because the efficiency of the plant is only given at high average wind speeds. The height of the wind turbine influences the efficiency. Due to neighbouring objects, wind shadows and turbulence often develop near the ground. This has a negative effect on the productivity of the plant. Wind turbines with an installed height of more than 10m needs to be approved by a building permission, as they have a different effect on their environment compared to solar plants.

Especially in horizontal designs, the rotor emits sound, shadows and vibrations. After all quality also plays a role because in strong winds there is a high mechanical load on the components. Therefore, in urban areas mostly vertically rotating wind power plants are permitted. These are about 10-15% lower in efficiency than systems with horizontal construction.

The economic comparison of a 5 kW wind turbine in the Cottbus area with a total height of 10 m and a photovoltaic installation showed that an irradiated area of 20 m<sup>2</sup> comes to about the same annual electricity volume of about 2000kWh. The acquisition costs for a wind turbine are about 3 times higher than for the photovoltaic system.

In conclusion, a small wind turbine is not a worthwhile investment at this time. Much more, it would be a good addition to a photovoltaic system to generate enough renewable energy even in the darker seasons. Sun and wind are usually in direct interaction with each other, so that a combination brings big advantages.

#### REFERENCES

- [1] S. Cottbus, „Cottbus.de,“ 26 10 2012. [Online]. Available: [https://www.cottbus.de/.files/storage/aa/aa/mw/Energiekonzept\\_Cottbus\\_IST-Bilanz-\\_Szenarien\\_2-AG-Runde\\_26-10-2012.pdf](https://www.cottbus.de/.files/storage/aa/aa/mw/Energiekonzept_Cottbus_IST-Bilanz-_Szenarien_2-AG-Runde_26-10-2012.pdf).
- [2] E. Hau, Windkraftanlagen: Grundlagen Technik Einsatz Wirtschaftlichkeit, 5. Auflage Hrsg., Berlin Heidelberg: Springer Vieweg, 2014, pp. 68-71.
- [3] Kleinwindkraftanlagen.com, „Kleinwindkraftanlagen Rechner,“ Kleinwindkraftanlagen, 28 06 2017. [Online]. Available: <https://www.kleinwindkraftanlagen.com/kleinwindanlagen-rechner/>. [Zugriff am 28 06 2017].
- [4] solaranlagen-portal, „solaranlagen-portal,“ solaranlagen-portal, 28 06 2017. [Online]. Available: <https://www.solaranlagen-portal.com/photovoltaik/kosten>. [Zugriff am 28 06 2017].
- [5] energieheld.de, „energieheld.de,“ energieheld.de, 28 06 2017. [Online]. Available: <https://www.energieheld.de/photovoltaik/kosten-pv-anlage>. [Zugriff am 28 06 2017].

# SHALE GAS EXTRACTION: how to reduce consumption of oil?

1. History of shale gas commercialisation and exploitation.
2. What is the shale gas and how do we get it?
3. Shale gas reserves in the world.
4. Impediments and risks of shale gas extraction.
5. Economic and social profits.
6. Conclusion



## **1. History of shale gas commercialisation and exploitation:**

Shale gas extraction was one of many great inventions that came from the USA. In 1821 in Fredonia (New York) shale gas was first extracted as a resource from shallow, low pressure fractures. Horizontal drilling an American invention, which revolutionised natural gas extraction from shales began 90 years later in 1930.

Extremely profitable extraction of shale gas in the United States of America has convinced politicians and economists worldwide to ask whether there are reserves of this unconventional fossil fuel in their countries, among them Poland. The first news of estimated amounts of shale gas resources in Poland was met with an enthusiastic response in the Polish society and has started debate about potential benefits for the Polish economy. However, legal and infrastructural difficulties associated with the shale gas exploration and extraction caused earlier optimism to decline. This paper concentrates on the Polish

case and examines the chances of commercial extraction of shale gas and its possible impact on energy security of this country.

## **2. What is the shale gas and how do we get it?**

Shale gas is a natural gas occurring in underground resources of sedimentary rocks. It belongs to one of three types of gas from unconventional deposits. Because shales ordinarily are characterized by low permeability, gas from shales is produced using more complex and advanced technologies compared to conventional natural gas.

Exploration techniques in use today are horizontal drilling and hydraulic fracturing. The process of shale gas extraction starts with performing a vertical borehole (vertical drilling) in the sedimentary rock to get direct access to the deposits of this raw material which is located at the depth range of 3000–3500m. After that,

exploitation pipes are installed and cement grouting is pumped to seal the space between the exploitation pipe and the rock. During the next step of shale gas extraction, which is called hydraulic fracturing, the mixture of water, chemical additives and sand is pumped under high pressure into shale rock layers. This process causes cracking of rocks which leads to a more efficient exploitation.

The United States of America is a global leader in the development and production of shale gas. Estimated technically recoverable shale gas resources in that country amount to 18.8 trillion m<sup>3</sup>. The exploitation of this fuel has become increasingly substantial source of natural gas in the USA over the past decade. Shale gas increased from 1% of natural gas production in the United States in 2000 to over 20% by the year 2010. The Energy Information Administration predicts that the shale gas production will amount to 46% of total natural gas production by 2035.

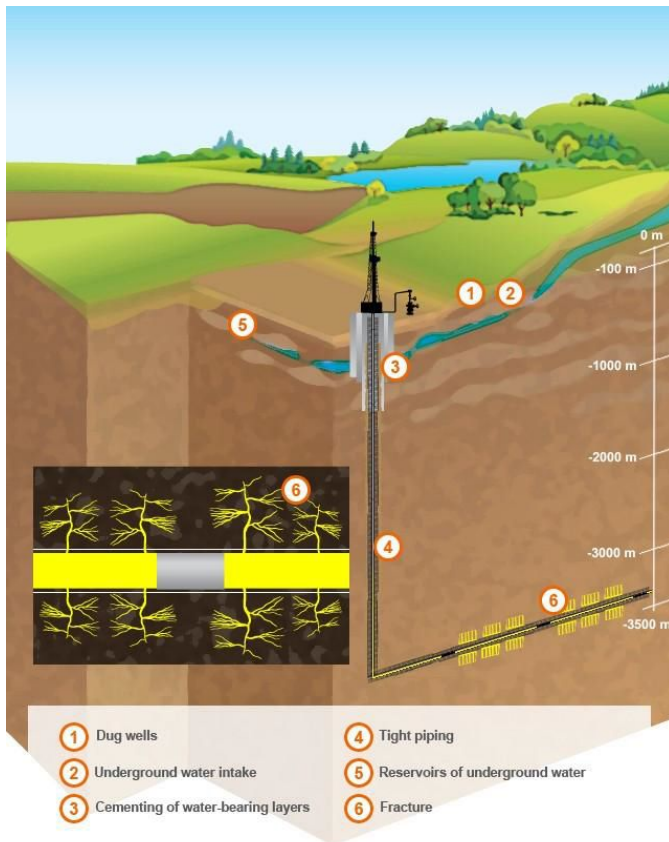

Fig. 1: Exploration strategies

### 3. Shale gas reserves in the world:

According to the report from the American Energy Information Administration from 2013, China owns the biggest shale gas resources in the world of 31.6 trillion m<sup>3</sup>. Significant unconventional gas reserves may also be found in Argentina (22.7 trillion m<sup>3</sup>), Algeria (20.0 trillion m<sup>3</sup>), Canada (16.2 trillion m<sup>3</sup>), Mexico (15.4 trillion m<sup>3</sup>) and Australia (12.4 trillion m<sup>3</sup>). Considerable resources (18.1 trillion m<sup>3</sup>) of this fossil fuel are available for extraction in Europe. Poland possesses largest in Europe deposits of recoverable gas reserves (4.2 trillion m<sup>3</sup>). Moreover, Poland is regarded as a pioneer in the field of exploration projects of shale gas (Reuters: October 12th 2016 quote “Polish firms concede defeat in search for shale gas riches”)

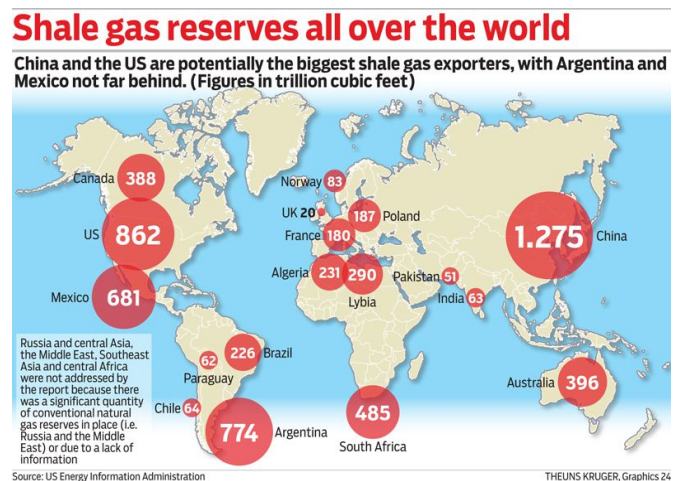

Fig. 2: Shale gas reserves in the world (in cubic feet)

#### Shale gas in Poland:

Published estimates of shale gas resources in Poland have been very different so far. Many optimistic reports shows, that Poland has around 5.3 trillion cubic meters of shale gas. Some American research proved only 38.1 billion cubic meters of shale gas. It shows how divergent scientific researchers can be.



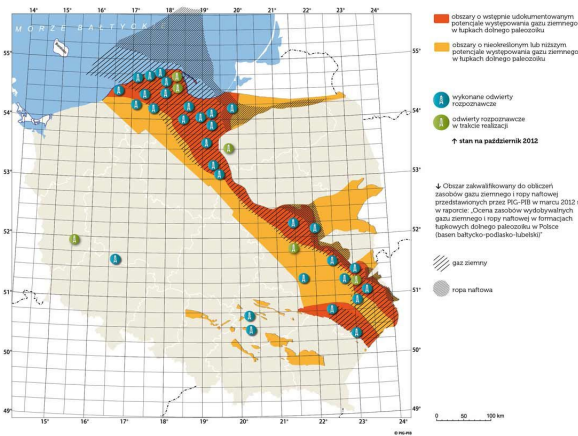

Fig. 3: Shale gas reserves in Poland.

**Orange field:** areas, where the scientist proved the presence of shale gas

**Yellow field:** areas, with low shale gas presence

**Blue „A” letter:** research-drills which were done

**Green „A” letter:** research-drills which are in progress

#### 4. Impediments and risks of shale gas extraction:

**FIVE** human and environmental impacts of shale gas extraction:

a) Risk of underground water and ground water pollution and influence for human and animal health:

During the shale gas extraction, many toxic chemicals are used. According to French research, about 75% of those chemicals are toxic, conversely American studies show about 632 chemicals used during shale gas production could have adverse effect on human health.

40-50% of the chemicals used could be dangerous for our kidneys, nerve or cardiovascular system. Prompted by these reports, scientists are doing researches and experiments on how to reduce the chemical components in the process of shale gas extraction (fracking). This amount could be reduced to 4% (from about 700 to about only 25

chemicals). Thanks to the experiments done by American and Canadian scientists, we can describe many disease-like symptoms caused by the shale gas fracking, such as: aches, vomiting, skin diseases, nose bleeding, asthmas, migraine and many more. After reducing those dangerous toxins, abovementioned symptoms should subside.

b) Water pollution as an after-effect of drilling ring cracks:

About 6% of concrete drilling rings will crack after 6 Months of exploitation and about 60% of concrete drilling rings will crack after 30 years of being used. In last 30 years, about 7'500 drilling holes were made and many of them haven't been. Poland should introduce strict norms on how to bore and protect the vertical wells. The companies, who extract the shale gas should ensure the safety of all underground operations and should guarantee financial compensation and environmental rehabilitation in case of any catastrophe or mining damages.

c) Threat of Hydrogen sulphide (H<sub>2</sub>S) and Sulphur dioxide (SO<sub>2</sub>) emission

Scientists calculate, that in Canada the process of shale gas extraction burns yearly around 200 million cubic meters of gas. In USA, it is like 30 million cubic meters daily. Those gases are highly poisonous and can cause acid rain. These rains are dangerous for agriculture, human or animal health. The emission of methane into the atmosphere has more significant effect on climate than emission of CO<sub>2</sub>.

d) Water consumption will increase significantly.

We should be aware that around 20'000 cubic meters of water is used during fracturing process. It leads to drought and limits water access. Water price may rise significantly. There are many solutions to resolve those issues. One of those is



to observe the water level. Other one is to commence drilling and fracking when nearby drilling or extraction has been completed. It will allow natural rain water reservoirs in the area to replenish

e) Psychological and social threat.

People fear new and unknown. The process of shale gas extraction is relatively new and is not widely publicised, therefore people might be afraid of losing their customers (tourists) or losing the healthy-food certificate. Next aspect is fear of noisy drilling which can increase level of stress. Scientist proved, that in area of shale-gas extraction, crime has increased. However, I think the shale gas extraction will assure new workplaces and people will be too busy to think about criminal life.

## 5. Economic and social benefits:

Optimists and supporters of shale gas extraction believe that the shale success achieved in the USA, could be repeated in Poland. Main benefit will be increase in financial income for the national economy, because:

- Poland will have income from taxes, gas sales, license and supplier fees,
- Use of transmission and distribution networks will increase, improving levels of public investments,
- exploitation of shale gas will lower the price of gas and energy, improving the purchasing power of citizens which will contribute to the development of other sectors of the economy.
- exploitation of shale gas reduces the need to import this fossil fuel, and it improves the balance of payments of the country,
- a country that obtains experience in exploitation, can export this knowledge and specialists,
- lower gas prices will improve the competitiveness of the home energy industry,
- the country receives more options for the distribution of gas, improving the efficiency of the industry,
- development of the shale industry will attract

foreign investors,

- a decrease in gas prices as well as a growing supply of gas will accelerate the modernization of the energy sector and will lead to the technological leap countrywide. Other advantage could be a development of local communities, because:

- shale gas enables the development of local enterprises around mining areas,
- Labour market will increase, providing employment for local communities - experts estimate that each year 33,000 to 115,000 new workplaces could be created,
- with the development of production comes the necessity to develop the infrastructure that will remain in the region after the completion of extraction. In addition to the above- mentioned positive effects, equally important benefit for the national economy could be significant independence in gas supply from the very limited number of suppliers

## 6. Conclusion:

This paper shows that shale gas extraction will not only increase the energy security of the country or region, but could also significantly affect the development of the Polish economy. Shale gas is a chance for Poland, but also a challenge due to complex geology which requires the use of modern technology, expertise and experience. Understandable is the optimism and enthusiasm that accompanied the start of exploration of unconventional gas reserves. However, attention should be paid to challenges and barriers that may stand in the way of exploration success. One of the major challenges is to create innovative technology to extract shale gas in Poland without any problems. Shale gas extraction in Poland could enable energy from additional sources and would also be a strong argument in negotiations for better conditions for the import from the current dominant supplier. If the predicted size of unconventional gas deposits are confirmed and Polish business entities participate in exploitation or exploration, shale gas could play an important role in this country. Unconventional gas extraction could contribute to cover the energy deficit, achieve energy independence and lead to diversification of energy sources in Poland.

*SOURCES:*

[1] <http://www.lupkipolskie.pl/>

[2]

[https://en.wikipedia.org/wiki/Shale\\_gas](https://en.wikipedia.org/wiki/Shale_gas)

[3] <http://gazlupkowy.info.pl/7-zagrozen-zwiazanych-z-wydobyciem-gazu-lupkowego/>

[4] <https://www.polskielupki.pl/gaz-lupkowy-w-polsce/zasoby>

[5]

<http://www.money.pl/gospodarka/wiadomosci/artykul/gaz-lupkowy-w-polsce-jest-ale-trzeba,218,0,1866202.html>

[6]

<http://www.ogj.com/articles/print/volume-109/issue-45/general-interest/unconventional-oil-gas-focus-poland-p1.html>

[7] L. Gawlik, „Gaz ziemny z łupków w Polsce - raport,” IGSMiE PAN, May 2013.

[8] U.S. Energy Information Administration, “Technically Recoverable Shale Oil and Shale Gas Resources: An Assessment of 137 Shale Formations in 41 Countries Outside the United States,” June 2013.

[9] US Energy Information Administration, *THE UNS KRUGER*, Graphics 24

[10]

<http://www.ekologia.pl/wiedza/slowniki/slownik-hydrogeologiczny/gaz-lupkowy>

# Dreiphasige Strommessung mit Brückengleichrichtung zur Leistungsmessung

A. von Auw und S. G. K. Jenchen

## I. EINLEITUNG

In diesem Paper soll kurz ein Überblick über unsere Projektarbeit am analogen Netzmodell als Abbild des Elektroenergieversorgungsnetzes. Wir beschäftigten uns mit dem Entwurf von Messeinrichtungen, um die wichtigen dreiphasigen, elektrischen Größen (Spannung, Strom, Frequenz und Leistung) aus einkanaligen Messungen abzuleiten. Dabei wird in diesem Paper speziell auf die Strommessung und die Leistungsbestimmung eingegangen.

## II. ENTWURF DER STROMMESSUNG

Die Hauptaufgabe bestand darin, eine Strommessung zu entwickeln, um die abgegebene elektrische Leistung berechnen zu können. Dabei war es von großer Bedeutung nur die verfügbaren Messgeräte zu nutzen, damit keine größeren zusätzlichen Kosten anfallen.

Zunächst wurde der Messaufbau für die Ermittlung der elektrischen Spannung analysiert. Die Spannungsmessung erfolgt mittels einer Sechspulsbrückenschaltung. Mit dieser Methode wird es ermöglicht, mit nur einem Messgerät die dreiphasigen Spannungen zu messen.

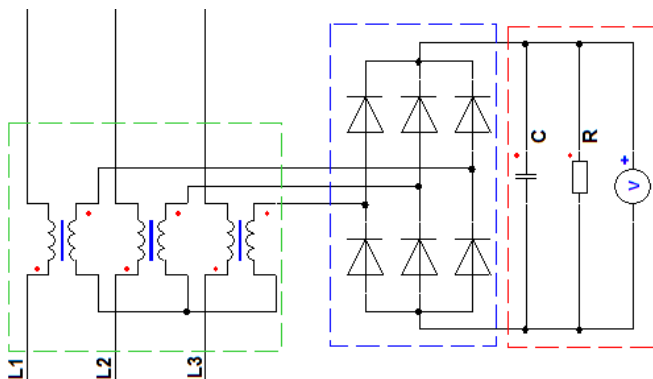

**Bild 1: Schaltung der dreiphasigen Strommessung mit Gleichrichtung und geglätteter Spannungsmessung**

Ähnlich dieser Methode wird auch die entworfene Strommessung realisiert. Hierbei wird von den drei Leitern des Drehstromnetzes über Stromwandler eine Spannung im Messstromkreis induziert. Durch

die Windungszahl der Stromwandler kann eine Spannung im jeweiligen Teilungsverhältnis zum Primärstromkreis abgenommen werden. Mittels Gleichrichtung mit einer Sechspulsbrückenschaltung und dem Einbau eines Strommessgerätes, kann ein positiver Summenstrom gemessen werden.

Da jedoch ein Strommessgerät über einen Messwiderstand eine Spannung in einen äquivalenten Strom umrechnet, ist es effizienter direkt über einen Messwiderstand eine Spannungsmessung vorzunehmen. Zudem bietet dies gleich ein Schutz gegenüber dem Kurzschlussfall.

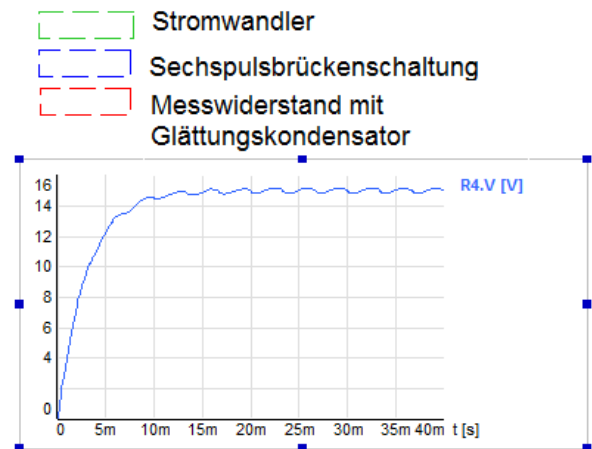

**Bild 2: Zeitkonstante und Verlauf der gleichgerichteten, dreiphasigen Strommessung**

Durch die Gleichrichtung der drei Phasen besitzt die der zeitliche Verlauf der Messspannung noch eine Restwelligkeit.

Für eine nahezu konstante Gleichspannung eignet sich die Verwendung eines Kondensators. Hierbei muss die Zeitkonstante beachtet werden, damit die Echtzeitregelung und die Messung bei Laständerungen noch gewahrt wird.

Die messbare Spannung, dann über eine Formel in den entsprechenden Strom eines Leiters umgerechnet werden.

Im jetzigen Zustand, ist die Strommessung nur über ein externes Messgerät funktionsfähig. Damit eine auswertbare Messung in der Regelung erfol-

gen kann, bedarf es noch der Implantierung des Messsignals in den Regelkreis. Zur Optimierung der Messung ist eine Anpassung des Stromwandlers (Teilungsverhältnis), des Messwiderstands und des Kondensators vorzunehmen.

### III. BESTIMMUNG DER ELEKTRISCHEN LEISTUNG

Bei der elektrischen Leistung ist es interessant eine Unterscheidung von Wirk- und Blindleistungsanteil vornehmen zu können.

Aufgrund der nur kurzen zur Verfügung stehenden Zeit war für uns nur eine Konzeptentwicklung möglich. Die Richtigkeit der These gilt es noch zu überprüfen.

Durch die Spannungs- und Strommessung ist es möglich die Scheinleistung zu berechnen. Momentan existiert keine Messung des Phasenwinkels am Generatoranschluss, wodurch die Bestimmung über die trigonometrische Beziehung die jeweiligen Leistungen nicht möglich ist.

nur noch notwendig den Wirkungsgrad zu bestimmen.

Dadurch, dass der Wirkungsgrad nicht konstant ist, ist es erforderlich eine Kennlinie über den Wirkungsgradverlauf über die mechanische Leistung im Regelkreis zu hinterlegen.

Somit bestände die Möglichkeit die Wirk- und die Blindleistung auf einfache Art und Weise zu ermitteln. Über entsprechendes Diagramm lässt sich Ergebnis grafisch darstellen. Damit wäre eine bildliche Veranschaulichung des Netzintegrationsmodells für Besucher gegeben.

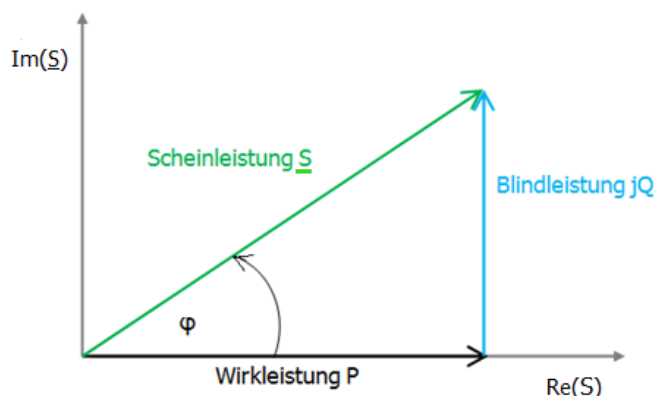

**Bild 3: Zusammenhang von Wirk-, Blind- und Scheinleistung im Zeigerdiagramm**

Jedoch besteht die Möglichkeit über die mechanische Leistung ermittelt aus Drehmoment und Drehzahl auf die elektrische Wirkleistung zu schlussfolgern.

Bei einem Drehstromsynchrongenerator gilt, dass die zugeführte mechanische Leistung der elektrischen Wirkleistung vermindert um den Wirkungsgrad entspricht. Durch diese Beziehung wäre es möglich auf den Leistungsfaktor zu schließen.

Die Drehzahl und das Drehmoment können direkt schon am Modell gemessen werden. Dadurch ist es