



Brandenburgische
Technische Universität
Cottbus - Senftenberg

15th EEEIC

International Conference on Environment and Electrical Engineering – Student Edition

Wrocław-Ostrava-Cottbus
20th – 24th of June 2016

Harald Schwarz, Przemysław Janik,
Radomir Gono, Dirk Lehmann

module at BTU: 11396

ISBN 978-3-940471-37-6

organiser / veranstalter

Wroclaw University of Technology
Department of Electrical Engineering
pl. Grundwaldzki 13
PL 50 – 377 Wroclaw

Technical University of Cottbus
Department of Power Distribution and High Voltage Technology
Walther-Pauer-Straße 5
D – 03046 Cottbus

VŠB - Technical University of Ostrava
Department of Electrical Power Engineering
17. Listopadu
CZ - 15 Ostrava - Poruba

copyright

Dieses Werk einschließlich aller seiner Teile ist urheberrechtlich geschützt.
Alle Rechte, insbesondere die der Vervielfältigung, Verbreitung und Übersetzung liegen beim Verlage. Kein Teil des Werkes darf ohne Genehmigung des Verlages, auch nicht für Unterrichtszwecke, fotografiert oder auch durch andere Verfahren reproduziert und verbreitet werden. Ebenfalls ist eine Einspeicherung und Verarbeitung in EDV-Anlagen ohne Genehmigung des Verlages strafbar.

publisher / verlag

Brandenburgische Technische Universität Cottbus-Senftenberg
IKMZ-Universitätsbibliothek
© 2017
ISBN 978-3-940471-37-6

Table of contents

Design, control, and operation of μ -CCHP enhancing energy efficiency	1
Wind Power in Germany	12
Dye-sensitized solar cells	16
The Organic Rankine Cycle	20
Fuel Cells - An Alternative Propulsion System	23
E-Cars - Status Quo, Challenges and Trends	26
Innovative and sustainable building materials	33
How realistic was the version of DESERTEC	37
From low energy houses to plus energy houses	43
Masdar City	46
Modern Electric, Hybrid Electric, and Fuel Cell Vehicles with Their Market and Future Trends	50

Design, control, and operation of μ -CCHP enhancing energy efficiency

Muhammad Taheruzzaman, Marius Levin Rediger

Department of Energy Distribution and High Voltage Engineering
Brandenburg Technical University-Cottbus, Germany

Abstract— Combined cooling heat and power mean the combined generation of heat, cooling, and power in one engine such as the microturbine, gas turbine internal combustion engine or fuel cell is utilized via several heat exchangers in the cooling water system and the flue gas system. The produced thermal energy is used for space heating, or these heat transfer through an absorption chiller for convert to cooling water or chill air for space cooling. μ -CCHP describes systems with power outputs up to 50 kW. The advantages of micro-CCHP in the domestic level are high utilization rate of the fuel and the low distribution losses. Also, the waste heat is utilized and is not released unused to the environment via a cooling facility. The fuel as natural gas not only enhances the energy efficiency but also dramatically reduce carbon dioxide emissions as well as NO_x and SO_x emissions in comparison to the separate generation of electricity and heat in oil-fired boilers and coal power plants. In this paper, μ -CCHP in domestic level and heat lead operation under consideration. The tri-generation concept deploys at the domestic; feasibility analysis of the optimal design of a DC micro grid configuration along with the wind energy, and solar energy integrated μ -CCHP system for electrification and enhancing energy efficiency. A model base predictive control strategy proposed for heat lead operation also discuss in this paper.

Keywords: μ -CCHP, Energy efficiency, Absorption chiller, model predictive control, heat lead operation, renewable energy.

I. INTRODUCTION

The whole world is struggling against climate change and global warming terrifyingly, while electricity is producing predominately use of fossil fuel which causes excessive CO₂ emission to the atmosphere, about 8,365 million metric tons of carbon been released which is represented all-time high and 1.7 % increases the number from 2006 [1]. The developing countries including BRIC (Brazil, Russia, India, and China) used traditional fuel such as natural gas, liquid gas, coal, and furnace oil that

contributes 42 % of shares to global total emission and release higher level of harmful emissions which contains NO_x and SO₂, besides release participle like ash those does not burn rather pollute the environment frighteningly [2]. Many research highlights electricity and heat generation produces over 25 % of global GHS emission contribution, and industrial emission 21 % due to burning coal, natural gas, oil [3].

Combined cooling, heat, and power is the pinnacle technology, the produced heat used for space heating, the heat transform cooling by using absorption chiller, and the generated electricity can have used within the facility and transfer to the main grid. The conventional refrigeration system contributes the huge amount of ozone-depleting chemicals, a regular refrigerator releases a large number of CFC (chlorofluorocarbons) and HFC (Hydrofluorocarbons). The tri-generation concept or μ -CCHP-generated electricity and cooling can be reducing this large contribution of ozone depleting chemicals. In this concept, the recovered heat only utilized for cooling by using absorption chiller. Yet the cogeneration is not economically viable but technically feasible in the low-income countries. The climate in the tropical countries high energy demand for air-conditioning and cooling. The agricultural based countries, micro-CCHP generated electricity can be used in the irrigation and heat can be used in both dryings and converted heat into cooling used in the cold storage.

Both increasing energy consumption and conventional fossil fuel resulting in an increase rapidly in global warming and environmental pollution. Harnessing renewable energy is an alternative but feasible technology that brought dramatic changes in the modern power system. The hybrid electric system along with PV, wind, micro-CCHP, and energy storage affords the

opportunity to supply the community based load. The intermittent renewable energy produces energy can be direct during production and off-peak hour stored in the battery. The diesel-fueled micro-CCHP is mainly used for additional electricity to meet the base load and converted thermal into cooling air or water for space cooling and cold storage. The decreasing PV prices, no fuel costs in the solar/wind energy integrated hybrid microgrid captivate substantial attentions in rural electrification.

The modern energy system access to electricity is more convenient, the developing countries which are integrating with local renewable energy sources are the paramount to resolve the energy shortage. About less than 60 % of the overall population in the developing countries have the access to electricity, whereas urban electrification rate 80 % and about 15 - 25 % of rural areas are electrified [4]. It is commonly agreed that to meet the present demand is the burden for natural gas, integration of local renewable sources such as biomass, the solar source would be the alternate source of energy. According to [5], adequate numbers of research had addressed the energy-related problem and renewable energy sources are more effective and efficient; cogeneration, tri-generation, and waste heat recovery have been salaried since a long time in the industry. Moreover, the modern energy system and global energy situation attract towards the distributed generation and micro level, the options of micro scale are distributed generation in households. The tri-generation and distributed cogeneration lead to 80% more efficiency than the conventional centralized system [6]. Residential environment tri-generation concept is appealing in the existing civil market, but the realistic practice in the larger scale such as commercial building and industry. The μ -CCHP mainly modeled followed by household environment and energy storage considered as community-based. Furthermore, the isolated and remote areas, RES distributed sources are being significantly recognized as cost-effective sources [7]. The remote areas, higher transmission line losses, and higher cost of transmission lines are encouraging to use of distributed renewable energy.

II. TRI-GENERATION TECHNOLOGY FOR POWER AND AIR-CONDITIONING

Decentralized power generation with local renewable energy fuel micro-CHP is an important source of electricity for improving energy efficiency, energy security and emission of CO₂. Electric power generation from CCHP (combined cooling, heating, and power) and convert the heat energy into cooling simultaneously technically feasible system for the tropical countries. By using absorption chiller, the heat converts into cooling water or cooling air for cold storage or air-condition. Natural gas fueled co-generation unit has to consider and specified in the terms of thermal rather electrical. There are many commercial CHP deliver heat to electricity ratio of 2:1, even down to 1:1; with organic ranking cycle can be possible as 5:1 [8]. The CHP technology always offers heat generation along with electricity for the developed cold countries but CCHP may also suitable during summer, on the other hand in the developing tropical countries CCHP with power ratio 1:1 can be used for electricity and heat converted into cooling for district cooling (DC). The proposed tri-generation have the ability to provide electricity, heating, and cooling [9], and Organic Ranking Cycle (ORC) based tri-generation have been widely used in electric power generation from low-temperature heat sources [10]. Natural gas micro-CHP, where electric power generation less than 3 kW, which has a great potential to meets the community-based energy both electricity, and cooling demand. Yet, electrical efficiency comes to be considered less important issue where the proposed micro-CHP due to simple design, low costs, favorable operation, durability, and high performance in community cooling system or cold storage facility [10]. Using μ -CCHP in the domestic level in UK enhancing 86 % to 93 %, and cost can be reduced 10 - 20%.

This proposed system considered with two cycles including hot water cycle heated by the biomass boiler and ORC cycle. The heat releasing from biomass combustion inside the boiler through heat exchanger, the hot water use follows ORC working principle to heat into vapour in the evaporator. The

generated organic vapour drives the expander¹ wheel in the evaporator of the system. The expander should be adaptable within the ORC system that utilizes small gas turbine as thermal source of energy to generate 2 to 10 kW of electricity [11]. In the present technology development, CCHP with 50 % heat recovery and about 80 % electrical efficiency configuration proposed in the paper. The system configuration considered with ORC or ICE. The proposed CHP might have above 80 % of electrical efficiency [12]. The conversion of final energy that generated by the micro-CHP, the energy efficiency factor (EEF) defined by the equation below.

$$EEF = \left[\frac{E_u}{E_p} \right] \times 100 \%$$

Where,

EU = Useful Energy
EP = Primary Energy

A. Standalone CCHP for electricity and air-conditioning

The air-conditioning system design by chilled water through an absorption chiller, which produced by the recovery heat and system operates as refrigerator [13]. In general, through vapour compression refrigeration, absorption refrigeration, and thermoelectric refrigeration technologies are mainly used for district cooling and commercial cooling [14]. Though thermoelectric refrigeration technology is not suitable for small-scale domestic space cooling, because of limited refrigeration capacity.

B. CCHP integrated DC-MG

At the present time, increasing the cooling system efficiency, the community based cooling system is more popular than the conventional district cooling. The conventional refrigerators contribute the huge amount of ozone-depleting chemicals; regular refrigerator releases a large number of CFC and HFC. A tri-generation CHP-generated electricity and cooling can be reducing this large contribution of ozone depleting chemicals. Yet the system is technically feasible but some cases economically

not viable for the low-income countries. The community based low temperature cold storage for storing agricultural crops and food is getting popular in the developing countries. In the fig. 1 presents a scheme of CCHP model for developing countries where heat converts into the cooling air for community based cold storage and produce electricity supplied to the cold storage and households simultaneously. As the electric load is peak during evening but CHP working during day time due to cooling flow for cold storage. A community based battery storage system adopted to meet the evening demand.

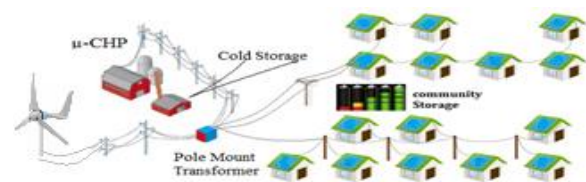

Figure 1: A scheme of Micro-CCHP for Developing countries (adopted microgrid concept)

In such cases the micro-CCHP operates in natural gas conversion technology has three choices for prime mover such as; gas turbine and fuel cells [15]. Fuel cells have the ability to reduce 33% of gas supply to produces electricity and space cooling². Up till now fuel cell is not economically feasible in the developing market due to gas capacity and price of the system. The electricity produces by congregating unit micro-CCHP which located on the site next to electric load, the distribution system considered either AC or DC bus that delivers electricity to the loads through to grid or directly to loads without grid. The voltage level for the anticipated system can be 48-220 DC V. The power generators show in top-left produce electric power and heat, rejected heat recovered by the heat exchanger and supply to residential house or commercial building for supply. The reject heat in various quantities and temperature that can be in the residential or commercial building for operation. CCHP system affording efficiency 86 % to 93 %. The various technologies can be used to design and configured residential and light commercial building energy system. The system configuration

¹ The expander wheel is a module in a turbine that rotate by the steam or vapor, the prime mover rotate coupling with the module and generate electricity through the electric generator.

²<http://www.ecuity.com/wp-content/uploads/2014/08/FUEL-CELLS-THE-SMART-POWER-REVOLUTION.pdf>

along with power generation, heat recovery, and air-conditioning. The power generators show in top-left produce electric power and heat, rejected heat recovered by the heat exchanger and supply to residential house or commercial building for supply. The reject heat in various quantities and temperature that can be in the residential or commercial building for operation. The table 1 represents the temperature range of rejected thermal energy from various and heat recovery, among all technology solid oxide fuel cell (SOFC) offers highest exhaust temperature from recovery and utilization.

Table 1: Prime mover rejected heat temperature ranges

Power Generation unit	Temperature (°C)
Solid Oxide Fuel Cell Exhaust	700-800
Reciprocal Engine Exhaust	600-650
Molten Carbonate Fuel Cell Exhaust	600
Gas Turbine Exhaust	510-540
Micro-turbine Exhaust	230-315
HRSO Exhaust	175
Reciprocal Engine Jacket Water	80-95
Phosphoric Acid Fuel Cell	80
Solar Thermal Collector	65-180

III. PRIORITY BASED OPERATION OF CHP

A. Heat (Thermal) Lead Operation Scheme

In the European Nordic countries, heat lead mode operation, the thermal energy supplied to the residential houses according to the demand. Moreover, the production of thermal energy is oriented on the thermal load curves shown in fig 2. The large thermal demand means; more thermal energy needs to heat the water to warm it up through the boiler. The electric power generation from the CHP is not compulsorily meet the electric demand. A compensation of electric power can be prescribed along with distribution network or a group of households can be integrated within a network, within this mode of operation, the overall efficiency of the micro-CHP assured because of the complete heat energy consumption by the individual household. In this operation, an electric energy

storage system such as the battery can be recommended. In general, In the CHP, three main prime movers frequently used technologies such as internal combustion engines (ICE), Stirling engines (SE), and Fuel cells (FC) [16]. ICE engines are popular in commercial based CHP whereas Stirling engines based CHP still in pilot phase, though SE based CHP-boiler available with owner-monitored system on the market in 2010, and owner have the information how much electricity is being produced by the CHP, but the major disadvantage is during switch on of space heating the system can produce electricity. Therefore, Stirling engines based CHP is the best for heat lead operation. Likewise, the fuel cell has the higher power-to-heat ratios, as not feasible in the heat lead operation compared to other two CHP technologies. It accounts almost 64% of total micro-CHP sales in 2012 worldwide³.

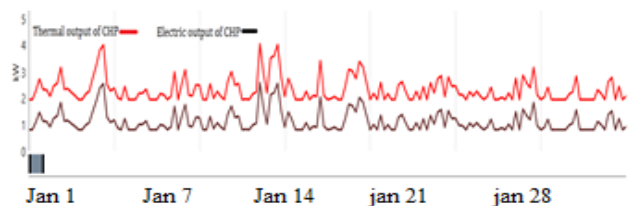

Fig. 2: Thermal and electrical Energy generation from CHP

B. Electric Lead Operation Scheme

The CHP unit operates along with the production of thermal not meet the demand of heat load but complying within the electrical power of demand of the residential house. In this mode, the electrical power consumption from the utility grid is prohibited [17] except to meet the base load of the household can consume electricity from the grid. As, overhangs thermal energy first stored in thermal storage during low demand of thermal energy. Though it is unrealistic, the peak demand of electricity and heat during the evening. Therefore, the efficiency of CHP unit decreases, as head lead operation mode recommended. In Europe and other cold countries, morning hours 5:00 to 7:00 am heat demand increases whereas the electric demand is not required, as thermal energy led operation mode is better. The fuel cells are more prevalent due to its higher electrical efficiency up to 55%, and

³<http://www.prnewswire.com/news-releases/technology-shift-in-micro-chp-fuel-cell-outsells-engines-for-the-first-time-214928111.htm>

according to [18] - [19], fuel cells offered some obtainable efficiencies in range from 30 - 40%.

IV. CONTROL STRATEGY OF MICRO-CCHP FOR HOUSEHOLD DEMAND RESPONSE

To response the demand of household, model-based predictive control (MPC) and control strategy proposed in the in cogeneration system [20]. The MPC controller connected to the energy storage tank and meter, and meter within the household has performed the price of energy as retail from the utility company. The operation of MPC controller within the micro-CHP, to determine how the system run and how heat should be supplied to the energy tank and response when heat needed. The main function of MPC to minimize the costs of operation by considering the operational constraints. The concept of Model-based Predictive control for CHP is shown in fig. 3.

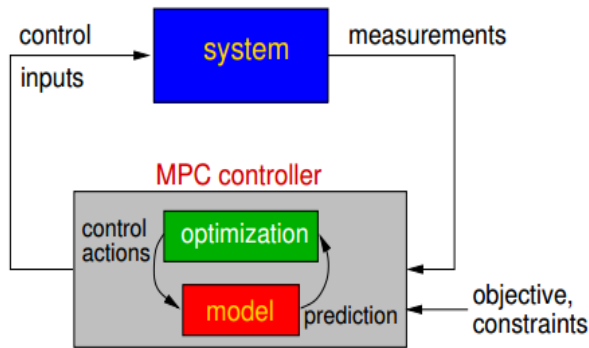

Fig. 3: Model predictive control strategy

In practice, to response the demand of domestic load micro-CHP controller strategy followed by the distinct and predictable patterns of energy demand in household and utility company prices. The MPC control strategy follows some restraints as bellow;

- (i) Decision freedom is taken into account as a consequence of self-generation of electricity and ability to export and import of electricity;
- (ii) Optimizing the capacity of heat tank for storage;
- (iii) Integrate the predictions of household electricity and thermal demand and future forecast of electricity.
- (iv) Combine models of constraints, energy conversion, and storage units.

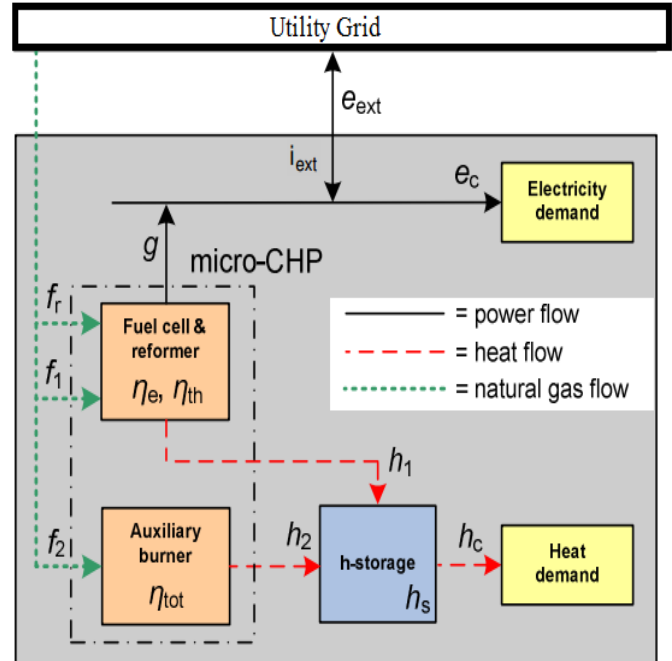

Fig. 4: Domestic μ -CCHP System Control Scheme [20]

A typical domestic house with micro-CHP is painstaking in fig. 4; where black line represents the electricity flow between household and utility grid, the red dotted line represents the heat flow between both prime mover and storage tank, and boiler and storage tank, green dotted represents the fuel flowing to the prime mover and boiler.

According to the presentation in fig. 4, f_1 amount of natural gas converts through fuel cell into electricity (g) and heat (h_1). The surplus heat (h_s) transform into of hot water into the thermal storage. The boiler act as the auxiliary burner, and if household needed additional heat then f_2 amount of natural gas converts into heat (h_2) and stored in the thermal storage (h_s). The prime mover generated electricity directly self-consumed (e_c) by the household loads and surplus electricity produced by the fuel cell that can be stored in the battery, which can be connected. The surplus electricity can also be imported (i_{ext}) from the utility grid and surplus electricity can also be sold back to the utility grid, which is followed by the SOC (in %) of battery. When the state of charge (SOC) is over 90% the system can sell back the surplus electricity to the grid. As primary fuel of micro-CHP and auxiliary burner consumes total $f=f_1+f_2$ of natural gas.

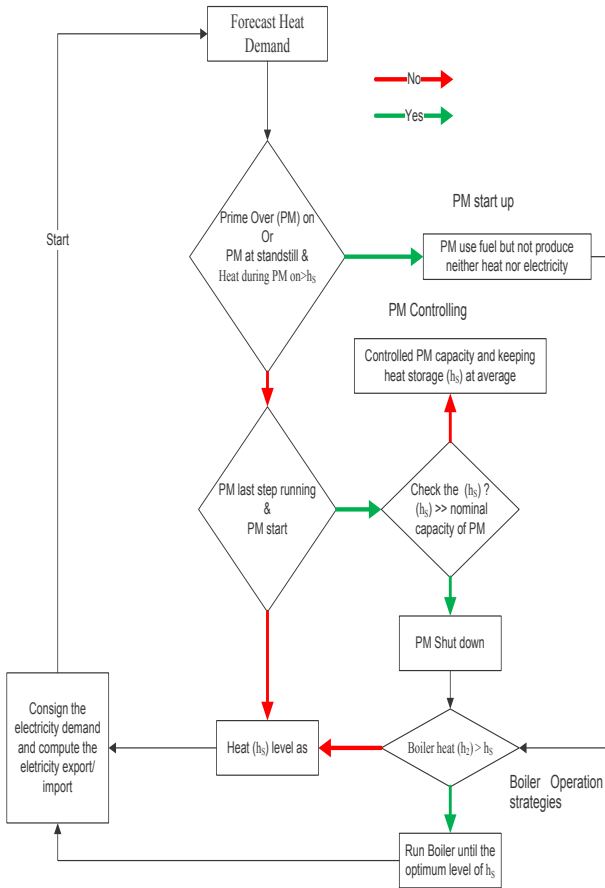

Fig. 5 Algorithm for Heat Lead Control

The thermal power lead control and operation has depicted in fig. 4, and algorithm is present in fig.5; when the Prime Mover is start up at the certain phase and thermal level of heat storage (h_s) decrease to the nominal level, the PM immediately starts to run. But if the thermal level is manageable as required then the Prime mover has been running in the past step with minimum energy generation. This phase the operation should follow the present step without excess heat production due to overheating the heat storage. Meanwhile, if the storage becomes overheated the PM shut down immediately. Again run the PM in the next phase until the water in heat storage heat up to the optimum level. In table 2 represents the temperature level of heat storage tank. In some typical European households, the minimum temperature level of 60°C .

Table 2: Temperature range of Water in Heat Storage for control strategy

Prime Mover	
Shut down mode of PM	$\geq 80^\circ\text{C}$
Turn on mode of PM	$= 60^\circ\text{C}$
Auxiliary Burner	
Shut down mode of Boiler	$\leq 55^\circ\text{C}$
Turn on mode of Boiler	$= 50^\circ\text{C}$

V. DOMESTIC HOUSEHOLD BASED μ -CHP

The electric load considers a typical European household where peak load 3.64 kW, and households load profile random variation as 5 % day-to-day. The daily energy demand about 26.83 kWh per day and average load 1.12 with a load factor 0.31 considered. The daily load represents in figure 4-9, and the average monthly based electric and thermal load represents in fig. 6 and fig.7.

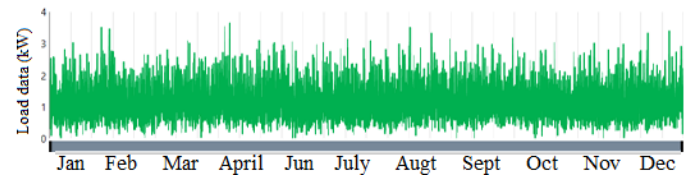

Fig. 6: Average monthly household electric Load

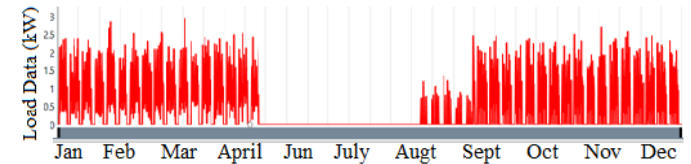

Fig. 7: Average monthly household thermal load

VI. RESULT AND DISCUSSION

A. Simulation

Homer Pro dedicated to evaluating and analysis the technical and economic feasibility of hybrid MG system. By using Homer Pro microgrid Analysis Tool, the physical configuration of renewable integrated energy system design, the capital cost of investment, life-cycle cost, operating and maintenance costs and different types of technical appraisal taken under consideration for the best suitable planning of small-scale power system modeling [21]- [22].

B. Optimization

The optimal microgrid system design by the optimizing system configuration. The simulation by Homer Pro simulation tools finds out the system configuration of cost effective and technically viable system, the optimization is calculated and displays the optimal microgrid configuration. The HOMER pro describes the optimal system configuration, which is that configuration with the minimum total net present cost by the constraints [23].

C. Comparison of various cases

The optimal design of microgrid configuration obtained by the optimization and simulation by Homer tool.

Case	Description of different scheme
1	Heat lead operation in European household μ-CCHP system for cooling and electrification
2	Grid connected AC system configuration
3	Standalone DC household configuration
4	Renewable energy integrated system

D. Heat lead operation in European household

The optimal configuration considered with the capacity of 3.2 kW of Micro-CHP which produces 10,338 kWh electricity and 20,892 kWh thermal energy produces by micro-CHP. In Europe, a typical household consumes 9,792 kWh electricity and 10,913 kWh of thermal per year. The load demand of electricity considered constant both summer and winter. On the other hand, the thermal energy demand in summer (May to August) is zero has shown in the fig. 7.

The optimal configuration system which produces electricity that meet 100% of electric and thermal energy produced by the gas fueled prime mover. The fig. 8 and fig. 9, the blue spike represents electricity produced by the micro-CHP and magenta spikes represents the thermal output of the system.

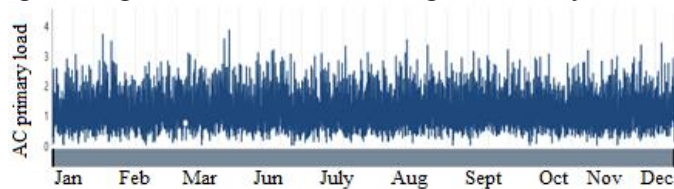

Fig. 8: Micro CHP produced Electric Power

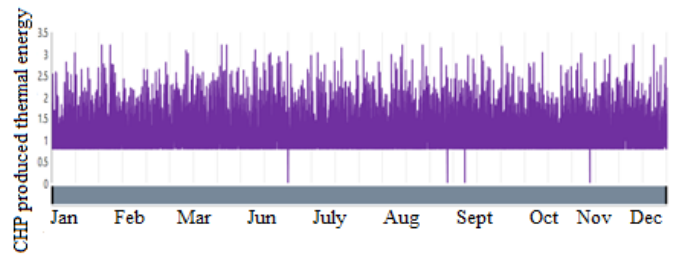

Fig. 9: Output of micro turbine (CHP): thermal

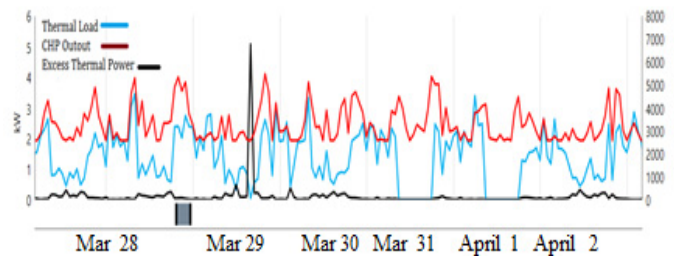

Fig. 10: Thermal Load, Generation, and Excess thermal

the red line represents the CHP generated thermal energy, light blue represents thermal load and black spike line represents the excess thermal generation, a week thermal results have shown where on 29 March evening thermal load almost zero but the heat produced by the CHP about 2.1 kW, as the excess thermal energy produced over 4 kW. On the specific time the electric load at that time about 3 kW, to meet the demand of electricity CHP generated a below fraction of 3 kW electricity shown in fig. 11 and over the fraction of 2 kW thermal energy.

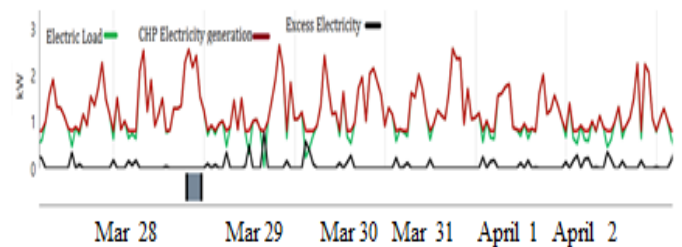

Fig. 11: Electric load, μ -CHP produced electricity and excess electricity

The μ -CHP consumes 11.86 m³/day, and in total 4,313.80 m³ of natural gas consumes to produce heat and electric energy through the year.

E. Grid connected μ-CCHP system for cooling and electrification

In the tropical countries and summer time in the cold country μ-CCHP generated electricity and cooling uses for electric appliances and space cooling or air-condition. The arrangement has designed with a gas fueled CCHP with 3.1 kW capacity, a community based cold storage and household loads for electric appliances. The household average electric load 23.7 kWh per day with 10% day to day variation. The community based cold storage system design with the cooling capacity of 3.4 kW which consumes 52.50 kWh heat energy per day, the system is working for 15-20 hours a day depending on seasons. The heat energy is converts into the cooling by absorption chiller technology. In this paper, a double effect direct fired chiller system proposed with the COP (coefficient of performance) range between 0.8-1.22, the ratio of cooling capacity and LHV (lower heat value) heat input of the system defines COP of the absorption chiller describes in the equation 1.

$$COP = \frac{\text{Cooling Capacity}}{\text{Heat input}} \quad (1)$$

An optimum μ-CCHP that produce 10,077 kWh electric power and 21,760 kWh of thermal energy per year. The fig. 12 represents the electric demand (both household appliances and air-conditioning) and generation and fig.13 represents the thermal energy produced by CCHP (harsh blue) spike and yellow spike represents boiler generation, the heat generation by the boiler over the year is 0 kWh per year as low demand of heat throughout the year. Together household appliances electric load and air-conditioning electric demand 9,107 kWh per year, but the total generation by the CCHP is 10,077 kWh. Therefore 970 kWh surplus electricity produced by the system present and this surplus electricity can sell back to the grid or neighboring household.

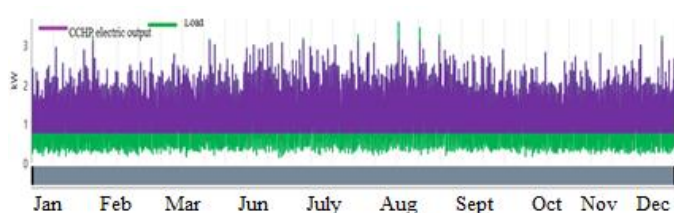

Fig. 12: μ-CCHP Average load and electricity generation

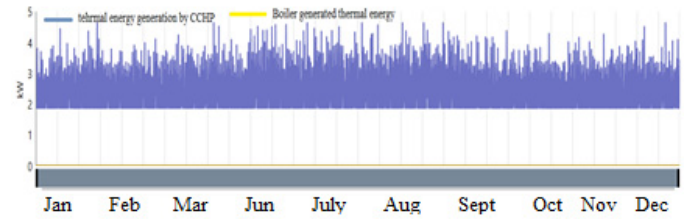

Fig. 13: Thermal Energy Produced by CCHP and Boiler

F. Standalone DC household configuration system

An optimum μ -CCHP system design with 2 kW capacity of prime mover that generates electricity which run DC household (dc appliances), and recovery heat converts into cooling water by absorption chiller for space cooling. The proposed scheme produces 4,683 kWh electric power and 8,131 kWh of thermal energy per year. The fig. 14 represents the electric demand and fig. 15 represents the unmet electric load by the red spikes in the month of July due to higher electricity consumption. To solve this delinquent, a battery arranges in the system with capacity of 1 kWh battery The figure 16 represents the SOC of battery that meet the electric shortage during the summer.

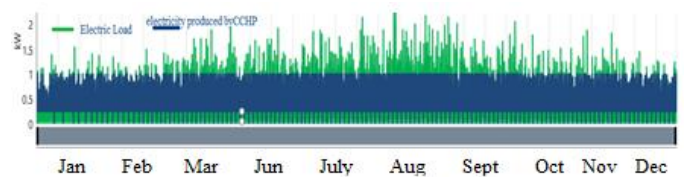

Fig. 14 μ-CCHP Average load and electricity generation

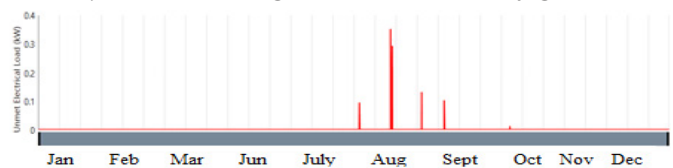

Fig. 15: Unmet electric load

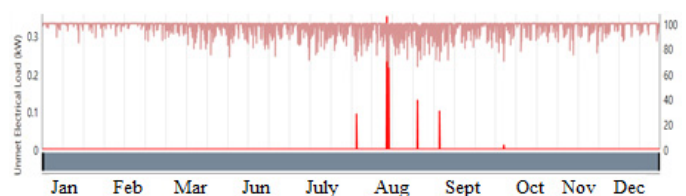

Fig. 16: Unmet Electric load vs SOC of Battery

In fig. 17, red spike represents the heat production by the μ -CCHP and blue spike represents the thermal load, the thermal load converts into cooling air or cooling water for cold storage. The imbalance between the thermal demand and production, an auxiliary burner introduced to produces thermal demand to mean the thermal load.

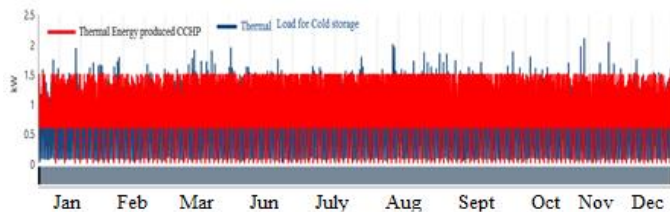

Fig. 17: Thermal Load and thermal generation by CCHP

Both CCHP and boiler (auxiliary burner) consumes $0.21 \text{ m}^3/\text{hr}$ and $4.93 \text{ m}^3/\text{day}$, and total $1,800.23 \text{ m}^3$ natural gas per year by the system.

G. Renewable energy integrated system

Renewable energy integrated μ -CCHP is proposed for the isolated community; the community based microgrid consisting of 50 houses considered. It has assumed that microgrid consisting of 10 solar home system (each SHS costing of 80 kW_p), 2 kW wind turbine, centralized battery storage and μ -CCHP with the capacity of 8 kW . The electric load comprises household appliances, and the μ -CCHP produces thermal energy converted into cooling used in the community based cold storage.

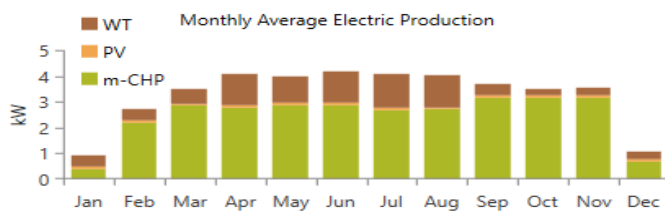

Fig. 18 Average Production by WT, PV, and μ -CCHP

The optimal system produces 5 % electricity by the PV, 16 % by the wind turbine and rest 79 % by the μ -CCHP, which present in the fig. 18.

The renewable energy integrated microgrid system, where μ -CCHP consumes over $5000 \text{ m}^3/\text{year}$ natural

gas, and the table 3 represents the comparison of case wise different components of system.

Table 3: case wise comparison of components

Components	Case-1	Case -2	Case-3	Case-4
μ -CCHP capacity (kW)	3.2	3.1	2kW	8 kW
Electric and thermal power Production (kWh) by CHP				
μ -CCHP/ μ -CCHP	10,381	10,077	4683	24,345
Surplus electricity	200	970	-	1567
Operation (hr)	4324	3134	3687	3786
Fuel (m^3/Year)	4313.8	3943	1800.23	5,154
Battery	-	-	2kWh	14kWh

VII. CONCLUDING REMARKS

In this paper presents μ -CCHP is well suitable for the for space heating, electric power, and space cooling. In the tropical countries, CCHP would be the best solution for the cooling, heating and electricity. The cooling or refrigeration technology adopted with absorption cooler or cooling tower. The model based simulation of different micro-scale CHP for domestic heating and electric loads. At Present scenario, the power system has dominated by centralized configured energy system, along with electricity distributed to users through a macro grid. Due to increase electricity demand while the rise of global emissions of greenhouse gasses, the current centralized energy generation system which is questioned for its future practicability that needs to be restructured to meet the world's growing electricity needs. In the developing countries, the conventional refrigeration system can be replaced by the CCHP and possible to reduced large amount of ozone depleting chemicals such as CFC and HFC.

The heat lead CHP system capacity is higher than then electric lead CHP, in the European domestic households the system can be designed with natural gas-fueled $2.5 - 3.2 \text{ kW}$ capacity to meet 3.64 kW , peak households electric load and 2.5 kW peak thermal load. On the other hand, in the developing and tropical countries electric power lead CHP also need the same capacity of CHP to produce

electricity and space cooling (the CHP generated heat converts into cool water or cool air by the absorption technology). The DC system also introduced in the system for the developing and low-income countries for electricity and refrigeration. A μ -CCHP with the capacity 1 to 2 kW can be produced 8,500 to 10,000 kWh electric power and 5000 kWh to 7000 kWh thermal power. The specific fuel consumption of the micro-CHP is about 0.4 m³/kWh and electrical efficiency over the fraction of 34%, and heat recovery 65% considered for the system. Renewable energy (including solar, wind energy) integrated system would an optimal design for the community based μ -grid, μ -CCHP would be higher energy efficient system for electric and thermal power.

REFERENCES

- [1] T. Boden, G. Marland and R. Andres, "Global, Regional, and National Fossil-Fuel CO₂ Emissions. Carbon Dioxide Information Analysis Center, Oak Ridge National Laboratory,," U.S. Department of Energy, , Oak Ridge, Tenn., U.S.A, 2010.
- [2] Z.A., Iftekhhar; A., M., Tausif; Shidujaman; et. al., "Consideration of Environmental Effect of Power Generation: Bangladesh Perspective," *Energy and Power Engineering*, vol. 5, pp. 1521-1525, 2013.
- [3] EPA, "Global Emission by Gas," Global Greenhouse Gas Emissions Data, 2011. [Online]. Available: <https://www3.epa.gov/climatechange/ghgemissions/global.html>. [Accessed 10 May 2016].
- [4] IEA, "World Energy Outlook 2015," 2015. [Online]. Available: <http://www.worldenergyoutlook.org/resources/energydevelopment/energyaccessdatabase/>.
- [5] H. Legmann, "Recovery of industrial heat in the cement industry by means of the ORC process," *IEEE-IAS/PCA 44th Cement Industry Technical Conference*, p. 29–35, May 2002.
- [6] I. Fabio, B. Alberto and B. Claudio, "trigeneration for residential applications, a feasible alternative to traditional micro cogeneration and trigeneration plants," in *Industry Applications Society Annual Meeting, 2008. IAS '08. IEEE*, Edmonton, Alta, 2008.
- [7] H. Omar and B. Kankar, "Optimal planning and design of a renewable energy based supply system for microgrids," *Renewable energy*, vol. 45, pp. 7-15 , 2012 .
- [8] H. Geoff, "Biomass Energy Centre," Forestry Commission, [Online]. Available: http://www.biomassenergycentre.org.uk/pls/portal/docs/PAGE/RESOURCES/REF_LIB_RES/PUBLICATIONS/4.%20CHP%20V5.1%209-2009%20DRAFT.PDF. [Accessed 31 December 2015].
- [9] Q. Guoquan; S. Yingjuan; L. Jinxing; et. al., "Experimental investigation of a biomass-fired ORC-based micro-CHP for domestic applications," Elsevier, Nottingham, 2012.
- [10] T.C. Hung; T.Y. Shai; S.K. Wang; at. el., "A review of organic Rankine cycles (ORCs) for the recovery of low-grade waste heat," *Elsevier B.V.*, vol. 7, no. 22, pp. 661-667, *Energy*, 22 (1997), pp. 661–667.
- [11] C. Roberto and H. Gustavo, "Preliminary Design and Simulation of a Turbo Expander for small rated power ORC," *energies* ISSN 1996-1073, Roma, Italy , 2014.
- [12] C. Castellana and H. Liu, "Thermodynamic analysis of a biomass-fired micro-CHP with Organic Rankine Cycle," Eighth international conference on sustainable energy technologies , Aachen, Germany, 2009^.
- [13] Institute for Sustainable Futures, "Tri-generation. How does," University of Technology, Sydney., June 2011. [Online]. Available: <http://www..> [Accessed 12 May 2016].
- [14] H. Feng, L. Jun and Z. Jie, "Feasibility of Heat Recovery for District Heating Based on Cloud Computing Industrial Park," in *4th International Conference on Renewable Energy Research and Applications.*, Palermo ,Italy, 2015.
- [15] H. Lie and Y. Neubauer, "High Temperature in Chemical Engineering," *Process Engineerng GmbH*, Vienna , 2010.
- [16] M. Pehnt; M. Cames; C. Fischer; et.al., "Micro Cogeneration: Towards Decentralized Energy Systems," Springer-Verlag, Berlin, Germany, 2006.
- [17] P. Magnus and K. Michael, INTEGRATION OF COMBINED HEAT AND POWER MICRO UNITS INTO THE LOW VOLATGE NETWORK BY USING GRID ORIENTED OPERATION MODE, Frankfurt, Germany : CIRED Seminar 2008: SmartGrids for Distribution , 2008.
- [18] I. Staffell; R. Green; K. Kendall, "Cost targets for domestic fuel cell CHP," *Journal of Power Sorce*, vol. 181, no. 2, pp. 339-49, 2008.
- [19] H. I. Onovwionaa and V. I. Ugursalb, "BResidential cogeneration systems: Review of Current technology," *Renewable and Sustainable Review* , vol. 10, no. 5, p. 389–431, 2006.
- [20] H. Michiel, R. N. Rudy and D. S. Bart, "Demand Response with Micro-CHP System," *Proceedings of the IEEE 0018-9219*, vol. 99, no. 1, pp. 200-213, 2010.
- [21] S. Mizani and A. Yazdani, "Optimal design and operation of a grid-connected," in *roceedings of IEEE Electrical Power and Energy Conference* , 2009.
- [22] Laicane, I; Blumbera, D; Blumbera, A; et al, "Reducing Household Electricity Consumption Through Demand Side Management: the Role home appliance Scheduling

and Peak load reduction," Energy procedia: 2015.
[Online]. Available:
<http://dx.doi.org/10/2016/j.egypro.2015.06.032>.
[Accessed 13 Feb 2015].

- [23] T. Lambert; P. Gilman; P. Lilienthal, "Micropower system modeling with Homer," National Renewable Energy Laboratory, USA.

Wind Power in Germany

Competitive even without government benefits?

Ben Slimane, Ines Amina
Faculty 3 – Mechanical, Electrical and
Industrial Engineering Chair of Power
Distribution and
High-Voltage Engineering
Cottbus, Germany

Bock, Moritz Konstantin
Faculty 3 – Mechanical, Electrical and
Industrial Engineering Chair of Power
Distribution and
High-Voltage Engineering
Cottbus, Germany

Abstract—Wind power in Germany has currently the strongest marked penetration of all the renewable energy technologies [7]. This is due to its, in comparison to other renewable power, far lower leveled cost of electricity and its competitiveness even to conventionally produced electricity. However it is still enjoying advantages through German law unlike its conventional counterparts [8]. In April 2016 the United Kingdom cancelled all subsidies for new onshore wind turbines [11]. What if a similar development took place in Germany? This leads up to the question of whether or not wind power would still be able to compete in the German energy market without its government benefits today or in the near future.

I. INTRODUCTION

In 2015 the total electricity produced in Germany amounted to 652 billion kilowatt hours. About 30 per cent of that was produced by renewable energy technologies. The most important renewable energy technology in Germany is wind power, producing 14, biogas 7, and photovoltaics 6 per cent of the total power generation in 2015 [5]. On May the 25th in 2015 renewable energy technologies supplied the entire power required for a few minutes [10]. Wind power was the largest contributor to this historic event. Furthermore about 137,800 people worked in the wind power sector in 2013 in Germany [9]. However Wind power wasn't always as successful in Germany as it is today.

II. HISTORIC DEVELOPMENT OF WIND POWER IN GERMANY

A. Development before 1991

Before the German government introduced laws to encourage the production of energy from renewable technologies in 1991, all these technologies combined accounted for less than 5 per cent of the total power generated in the previous year. While water energy produced by far the largest part of that, wind energy accounted for less than 1 per cent of the total power generation. This is because wind energy plants just couldn't compete with conventional energy sources like coal or nuclear energy at that time and therefore only very few of them were build [2].

B. Development after 1991

The “Act on granting priority to renewable energy sources”, the first law aimed to encourage the production of renewable energy to be introduced in Germany, guaranteed the energy from renewable sources to be bought by power companies for at least a fixed minimum price. Even though this price was below the price-level of power generated by conventional technologies, this law improved the situation for the companies producing renewable energies. This is because the larger power companies often made it difficult for the smaller companies producing renewable energy to access the electric power transmission or even denied access altogether [2].

Nonetheless wind power started its dramatic growth in Germany almost 10 years later, when the old law from 1991 was replaced. The “Renewable Energy Sources Act” was introduced in 2000. Although it has been chanced multiple times the basic principle has remained the same and it is still in use today. Among other things, it drastically improved the fixed prices that power companies had to pay to for renewable energy and is directly responsible for the influx [figure 1] in renewable energy, including wind power, available in Germany. The growth of renewable energies including wind power hasn't stopped since and can be seen in Fig. 1 [3].

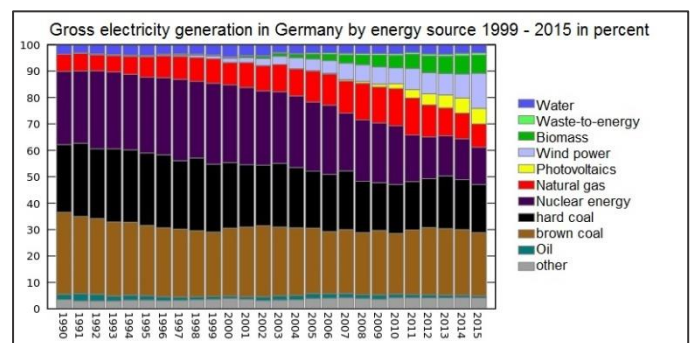

Figure 1: Gross electricity generation in Germany by energy source 1999 – 2015 percent, Wikipedia

III. “RENEWABLE ENERGY SOURCES ACT” AND ITS IMPACT ON WIND POWER IN GERMANY

The “Renewable Energy Sources Act”, EEG for short, was introduced to reduce carbon dioxide emissions and Germany’s dependence from foreign fossil fuel imports. By this law, renewable energy plant operators receive a guaranteed payment for their electricity generation. The payment is technology specific and has to be paid by the power companies and not by the state. Therefore it does not count as subsidies. It remains mostly fixed for 20 years, beginning with the commissioning of the plant. It varies with the generation costs and the capacity of the power plant. Unlike the payments guaranteed in the law from 1991, these payments are higher than the price level of electricity. Furthermore the EEG obligates power companies to connect newly build power plants for renewable energies to their electricity supply system [8].

These two changes to the law from 1991 reduce the costs for new power plants using renewable energies because the power companies have to pay for the connection to the electricity network and the guaranteed prices for 20 years make it easy to calculate the risks of an investment. Unsurprisingly investments in renewable energies increased ever since the law was passed and are at an all-time high in Germany today. This also applies for wind power [8].

IV. COMPETITIVENESS OF WIND POWER TODAY

To be able to answer the question of how competitive wind power compared to other renewable and conventional energies is, its economic situation has to be analyzed. For this purpose the cost of the generated electricity from multiple different technologies can be used as a scale. Therefore the different levelized costs of electricity, for short LCOE (1), are put into perspective in Fig. 2.

$$LCOE = \frac{\text{sum of costs over lifetime}}{\text{sum of electrical energy produced over lifetime}}$$

(1)

The LCOE represents the average price per kWh produced

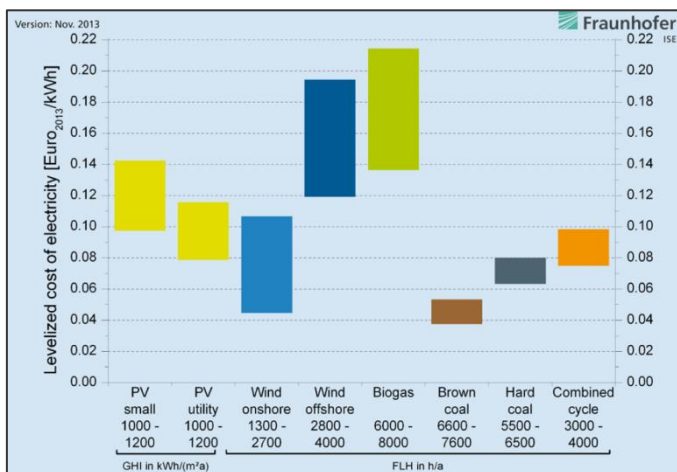

Figure 2: The LOCE of renewable energy technologies and conventional power plants in Germany 2013, Fraunhofer ISE [7]

over the lifetime of the plant in order for it to be profitable. It varies for the different technologies and the different locations and specific types of plants within a certain technology. For wind power, the location of the plant is the main factor, because it affects the accessible wind energy and the construction costs. Even though offshore wind power plants have more wind energy to work with than onshore power plants (Fig. 4), the construction costs are disproportionately higher. The Investments necessary for 1 kW for current wind power plant installations range from 1000 Euro to 1800 Euro onshore and from 3400 Euro to 4500 Euro offshore. This is why the LCOE of onshore wind power ranges from 0.044 to 0.107 Euro/kWh, while the LCOE for offshore wind power ranges significantly higher from 0.119 to 0.194 Euro/kWh [7].

Just how much of an impact the choice of the location of a wind power plant has on its economic efficiency is depicted in Fig. 3. The quality of the location can be measured in hours of full load per year, referring to the hours in which the plant operates at full capacity. The average wind speed needed to result in 1300 hours of full load per year is 5.3m/s, while 2000 full load hours require 6.3 m/s and 2700 full load hours 7.7 m/s [7].

When comparing the LCOEs of wind power to those of other technologies, especially the conventional energies, since these are the ones wind power would have to compete with in case its benefits from the EEG would be canceled, it becomes apparent that only onshore wind energy in favorable locations would be able to compete. These power plants reach at least 2000 full load hours per year and achieve an LCOE between 0.044 and 0.075 Euro/kWh which is lower than the LCOE of a combined-cycle power plant and just above the LCOE of brown coal. This does not mean the already existing plants in less favorable positions would stop being profitable, because they would continue to receive the fixed payments until 20 years after their commissioning. In case they exceed this calculated live time, their LCOE would drop significantly, since from that point on only their ongoing maintenance costs would be considered making a continued operation of these attractive. Rather the construction of new plants located in areas offering less than 2000 hours of full load per year just wouldn’t be economically viable anymore[7].

The same is true to some extent for offshore wind power.

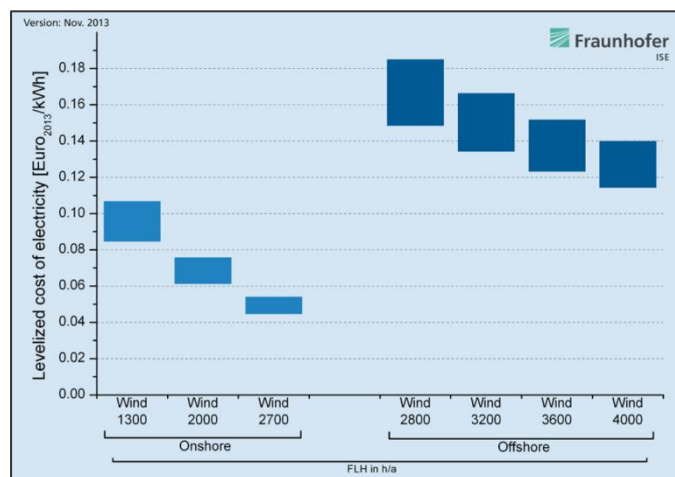
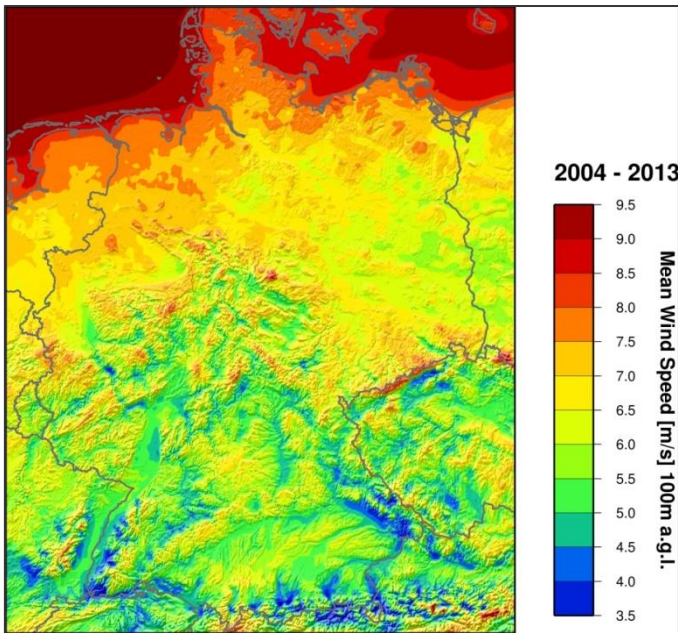

Figure 3: LCOE of wind power by location and full load hours in 2013, Fraunhofer ISE [7]



Existing plants would still profit from the EEG until 20 years after their commissioning. Since the average LOCE for offshore wind power is far higher than the average one for conventional energies further investments would not be profitable.

However, not being benefited by EEG would have other consequences as well. Without the power companies being required by law to connect new wind power plants to their electricity network, costs for new plants would rise. This combined with the fact that without the guaranteed prices for 20 years the investment in new wind power plants would be more risky would result in less wind turbines being built at only the most favorable locations. Still with these limitations, wind power would be able to prevail in the German energy market even if it was no longer favored by the EEG [7].

V. COMPETITIVENESS OF WIND POWER IN THE FORESEEABLE FUTURE

The competitiveness of wind power will change in the future [7]. How it will change, what the main factors are going to be and if it will still be economically valid would the EEG

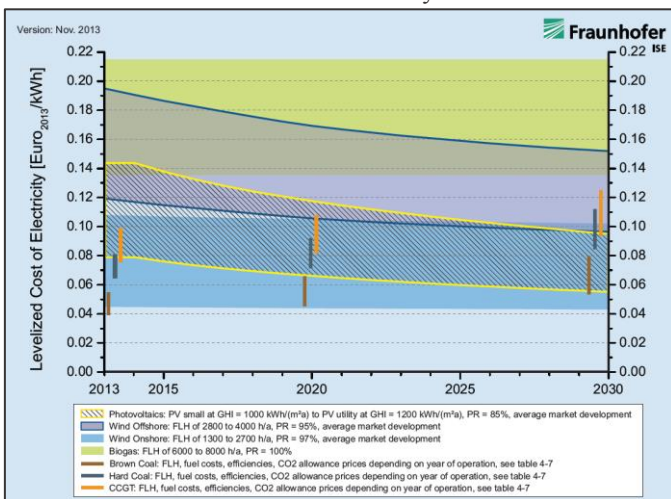

Figure 5: Forecast for the development of LCOE of renewable energy technologies as well as conventional power plants in Germany by 2030, Fraunhofer ISE, [7]

stop to include wind power in 2030 will be discussed in this paragraph. First the possible future development of wind power and the other power technologies will be analyzed.

A. Development of Wind Power

The future development of wind power in Germany can be modeled using data from the past. In recent years onshore wind power had a progress ratio of 97 per cent. This ratio represents the costs of production after the commutative production of the same product has doubled. This number implies that the necessary investment for the installation of 1 kW wind power will slowly decline over time and with it the LCOE of wind power. All the same, the LOCE of onshore wind power will only drop from between 0.044 Euro/kWh and 0.108 Euro/kWh in 2013 to between 0.043 Euro/kWh and 0.101 Euro/kWh in 2030 (Fig 4) [7].

It is currently impossible to determine the progress ratio of offshore wind power because of its low market volume. However, it is estimated to be about 95 per cent. Even though this is similar to the onshore progress ratio, the costs of installing 1 kW wind power offshore are going to decrease much faster than the ones for onshore wind power. This is because offshore wind power is predicted to have a much higher growth ratio. Its LCOE will fall from between 0.195 Euro/kWh and 0.12 Euro/kWh to 0.151 Euro/kWh and 0.096 Euro/kWh [7].

B. Development of other renewable Energies

While the LCOE of biogas is expected by experts to remain the same over the next 15 years, photovoltaics have a progress ratio of 85 per cent as well as a high growth ratio. Therefore it is believed that the LCOE of photovoltaics is going to drop from between 0.079 Euro/kWh and 0.0143 Euro/kWh in 2013 to between 0.055 Euro/kWh and 0.095 Euro/kWh in 2030. This would be cheaper than offshore wind power and almost as cheap as onshore wind power in 2030 [7].

C. Development of conventional Energies

The LCOE of brown coal, hard coal and combined-cycle power plants depend in large parts on the hours of full load of the individual plant. As renewable energies produce more power over time, the conventional power plants will produce less. This leads to less hours of full load for these power plants. Thus their LOCEs will rise significantly [7].

D. Conclusion

Even though of all renewable energies onshore wind power is predicted to have the least drop in LCOE it will be the most economical energy source by 2030. This is due to the fact that its LOCE will still be lower than that of any other renewable energy source and that the LCOE of the conventional energies will have risen to a level, at which onshore wind power is even more competitive than in 2013.

Offshore wind power will still be more expensive than onshore wind power. Yet offshore energy at a favorable location will be cheaper to produce than onshore wind power at an unfavorable location. Furthermore some offshore wind

power plants will be able to compete with hard coal and combined-cycle power plants. On the other hand it will no longer be more economic than photovoltaic power plants according to this prediction [7].

This is why onshore wind power would compete even better with other energy sources without the benefits of the EEG in 2030 than it would today. In good locations, it is believed to be the energy source with the lowest LCOE by that time and even at less advantageous locations it could compete with hard coal and would be less expensive than power generated by combined-cycle power plants. Consequentially there would be no reasons not to invest in additional onshore wind power plants from an economical perspective.

Offshore wind power would too compete much better with other technologies without the benefits of the EEG in 2030 than in 2013. While the already existing plants would still profit from the EEG until 20 years after their commissioning, new plants would have to compete on the energy market immediately. It would produce electricity cheaper than biogas, but more expensive than photovoltaics onshore wind power and brown coal. The competitiveness of the individual plant with hard coal and combined-cycle power plants would be dependent on its location. Therefore investments in new offshore wind power plants would still be economically valid, as long as the location has a high enough average wind speed per year [7].

- [1] Roland Berger, "Windkraft onshore – neue Spielregeln für den Markt", Roland Berger GmbH, 2016, pp. 3
- [2] Dipl.-Ing Martin Hoppe, "Entwicklung der Windenergie-technik in Deutschland und der Einfluss staatlicher Förderpolitik - Technikentwicklung in den 90er Jahren zwischen Markt und Forschungsförderung", Dissertation, University Kassel, 2003, pp
- [3] Birgit Götz, Alfred Voß, Markus Blesl, Ulrich Fahl, "Die Auswirkungen des EEG auf das Energiesystem Deutschlands – Eine Betrachtung mit dem Energiesystemmodell", 2011, pp.1 - 12
- [4] Umwelt Bundesamt, "Treibhausgas Emissionen in Deutschland", 25.04.2016, Available: ["http://www.umweltbundesamt.de/daten/klimawandel/treibhausgas-emissionen-in-deutschland"](http://www.umweltbundesamt.de/daten/klimawandel/treibhausgas-emissionen-in-deutschland)
- [5] Strom Report, "Windenergie in Deutschland", 2015, Available: <http://strom-report.de/windenergie/>
- [6] Bundestag, "Gesetz für den Ausbau erneuerbarer Energien", 2014, available: <http://www.bmwi.de/BMWi/Redaktion/PDF/G/gesetz-fuer-den-ausbau-erneuerbarer-energien.property=pdf,bereich=bmwi2012,sprache=de,rwb=true.pdf>
- [7] Christoph Kost, Johannes N. Mayer, Jessica Thomsen, Niklas Hartmann, Charlotte Senkpiel, Simon Philipps, Sebastian Nold, Simon Lude, Thomas Schlegl, "Stromgestehungskosten Erneuerbarer Energien", Studie Fraunhofer Institut, 2013, pp. 2 - 25
- [8] Martin Kaltschmitt, Wolfgang Streicher, Andreas Wiese, "Erneuerbare Energien – Systemtechnik, Wirtschaftlichkeit, Umweltaspekte, Springer Vieweg, vol. 5, 2013, pp. 523-542
- [9] Bundesverband Windenergie, "Beschäftigte in der Windindustrie", 31.12.2014, available: <https://www.wind-energie.de/infocenter/statistiken/deutschland/beschaeftigte-der-windindustrie>
- [10] Daniel Wetzels, "Gabriels Kalkül hinter der Windkraft – Deckelung", Die Welt, 2016, available: <http://www.welt.de/wirtschaft/energie/article155553764/Gabriels-Kalkuel-hinter-der-Windkraft-Deckelung.html>
- [11] BBC, Onshore wind farms cancelled as subsidies cut, 2015, available: <http://www.bbc.com/news/uk-politics-33227489>

List of figures

- Figure 1: Gross electricity generation in Germany by energy source 1999 – 2015 percent, available: https://upload.wikimedia.org/wikipedia/commons/c/c9/Energiemix_Deutschland.svg
- Figure 2: The LOCE of renewable energy technologies and conventional power plants in Germany 2013, Fraunhofer ISE [7]
- Figure 3: LCOE of wind power by location and full load hours in 2013, Fraunhofer ISE, [7]
- Figure 4: Mean Wind Speed m/s from 2004 – 2013 in Germany, Fraunhofer IWES, available: http://windmonitor.iwes.fraunhofer.de/opencms/export/sites/windmonitor/img/43_Mittlere_Windgeschwindigkeit_100_m_Deutschland.jpg
- Figure 5: Forecast for the development of LCOE of renewable energy technologies as well as conventional power plants in Germany by 2030, Fraunhofer ISE, [7]

List of abbreviations

LCOE: Levelized cost of electricity
 EEG: Erneuerbare Energien Gesetz
 kWh: kilowatt hours
 FLH: full load hours
 h: hours
 a: year
 GHI: solar irradiation in kW

Dye-sensitized solar cells

A promising alternative to conventional photovoltaic systems

B. Sc. Katharina Fuchs

B. Sc. Sinan Kaya

Brandenburg University of Technology Cottbus-
Senftenberg

Chair of Power Distribution and
High-Voltage Engineering
Germany

B.Sc. Kazim Koc

Brandenburg University of Technology Cottbus-
Senftenberg

Chair of Power Distribution and
High-Voltage Engineering
Germany

Abstract— As the research for solar cells has focused on a high energy conversion efficiency and also on a cost-effective production, several new types of solar cell technologies have been investigated. In this article we describe the dye-sensitized solar cell (DSC), a solar cell based on dye sensitized nanocrystalline oxide films. The DSC with its numerous possible applications and design options represents a promising alternative to conventional photovoltaic devices with an enormous potential to open up a new market segment for solar systems.

Keywords- dye-sensitive solar cell, nanocrystalline oxide films; energy conversion efficiency; photovoltaic systems; new market segment.

I. INTRODUCTION

In view of the worldwide high energy demand which is ongoing to increase, the limited resources of fossil fuels with their overall rising prices, and the constantly increasing environmental and climate concerns, it is of high importance to provide alternative energy sources in a sustainable and climate-friendly form [1]. Solar energy has an enormous potential in this context because “solar cells are not only clean and resourceful, but they also can be used wherever they are needed” [2]. During the past decades, solar energy has gained a growing importance and research efforts in that field have been intensified leading to advanced types of solar cells [3].

In this article we describe a new type of solar cell technology, namely solar cells “[...] based on dye sensitized nanocrystalline oxide films which successfully mimic the light reaction occurring in green leaves and algae during natural photosynthesis.” [4]. Already invented in 1991 by Michael Grätzel, Professor of Physical Chemistry at the École Polytechnique Fédérale de Lausanne (EPFL), the so called Grätzel cells or dye-sensitized solar cells, abbreviated DSCs, differ both in production costs and functional principle from conventional p–n junction photovoltaic devices [4], [5].

II. THE DYE-SENSITIZED NANOCRYSTALLINE SOLAR CELL: AN OVERVIEW

Dye-sensitized solar cells are photoelectrochemical devices that convert sunlight into energy. Following the example of plant photosynthesis, light absorption and charge carrier transport are separated here which differs them from conventional solar cells [6].

A. Basic structure

The DSC can be divided into three main parts: a photo electrode, also called working electrode, a counter electrode and an electrolyte solution. The cell basically consists of a thin layer made of two transparent conducting oxides (TCO for short) electrodes (typically consisting of glass). The working electrode is backed with a thin layer of nanoporous titanium dioxide (TiO₂), which is additionally sensitized with dye molecules, causing the molecules to bond to the surface of TiO₂. The counter electrode, made of a TCO glass, is coated with a catalytic material like platinum or graphite, whose task is to promote and accelerate the charge transport. An electrolyte solution acts as a bridge between the two electrodes and ensures the charge transport from the one side to the other [5].

B. Operation principle

Dye-sensitized solar cells (DSC) have the ability to convert light into electricity. Unlike other solar cells, this type of cell uses a dye to generate electricity. Fig.1 shows the operation principle of a DSC.

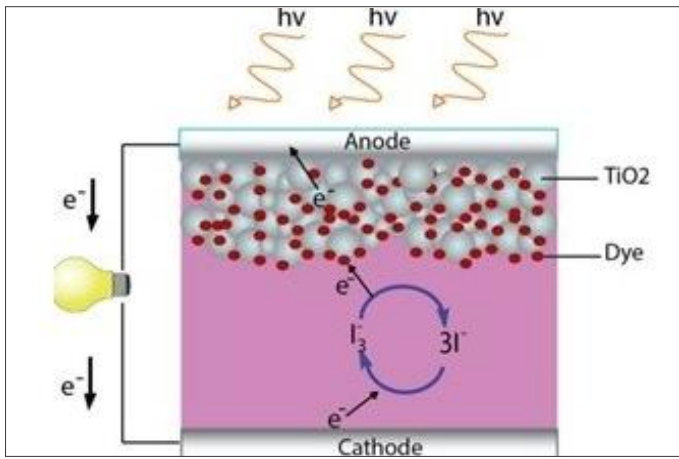

Figure 1: Operation principle of the DSC [7]

When sunlight ($h\nu$) hits the cell, the dye (S) on the nanocrystalline TiO_2 is triggered by light (1). This process leads to the release of electrons (e^-) causing a fast electron transfer from the dye excited state (S^*) into the conducting band of the TiO_2 (2). Subsequently, the oxidized dye (S^+) is returned back into its reduced state by transferring the positive charge to the iodide/ triiodide (I^-/I_3^-) redox couple, which is contained in the electrolyte (3). Free electrons travel towards the counter electrode (4), thereby generating an electrical current [6], [8].



With the use of the sensitized dyes having a broad absorption spectrum in conjunction with nanocrystalline oxide film, a large fraction of sunlight can be harvested allowing a nearly quantitative conversion of the incident photons into electric current [6],[9].

C. Characteristics

In contrast to conventional photovoltaic devices, DSCs can be made flexible, transparent and color-adjustable. Fig. 2 shows an example of a flexible, colored DSC:



Figure 2. Flexible dye-sensitized solar cell [10]

They can be integrated into different surfaces or elements including the roofs and windows of buildings, vehicles and telecommunication devices, e.g. smartphones [11]. Fig. 3 presents DSC implemented into glass units, generating electric power:

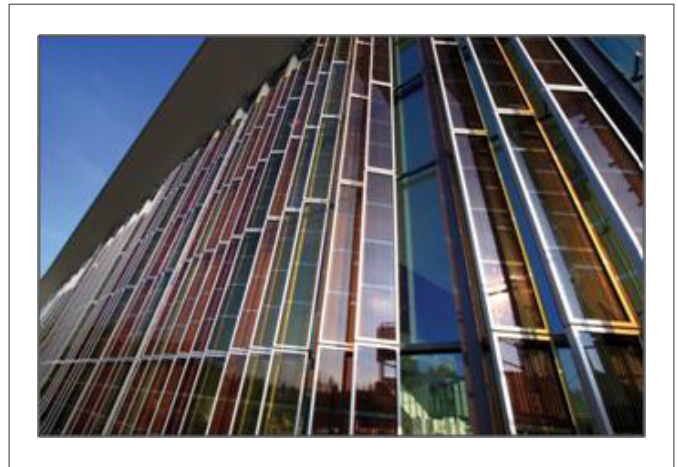

Figure 3: Dye-sensitized solar cells implemented into glass units [12]

Flexible DSCs are suitable for flexible electronics e.g. roll-up displays or smartphones and watches.

The variety of shape and design provides a unique selling point [10].

D. Recent developments

Commercial silicon photovoltaic modules achieve an efficiency of $\sim 20\%$. Research activities in this area focus on new trends to increase their performance for higher efficiency at lower costs. The efficiency of DSCs has also continued to increase [13], but the practical implementation of molecular systems that can reach similar conversion efficiency in comparison to conventional solar systems and at the same time meet the stability criteria for practical use, appear to be difficult [8].

In a current study, published in March 2016, Tang et al. presented a DSC that is excited by both sunlight and dropping raindrops using a layer of graphene. Due to a chemically based interaction, electricity can be generated as raindrops hit the graphene layer. It reaches a conversion efficiency of 6,53% [14]. In another study, Chung et al. demonstrated a new type of all-solid-state, inorganic solar cell “[...] that reaches a conversion efficiency of $\sim 10.2\%$ (...), and is the first example of an all solid-state dye-sensitized solar cell system that may eventually exceed the performance of a liquid electrolyte Grätzel cell.” [15]. Both studies provide interesting approaches on the way to improve the concept of the DSCs. Not discussed here are alternate approaches to building and improving DSCs including materials, dyes, production and chemical based systems. The development programs of prestigious chemical companies are an impetus to the refinement of DSC by providing new combinations of

materials, chemical formulation and cell structures. Main fields of potential improvements imply dyes, electrolytes, redox couples, photoanodes and tandem cell configurations. Professor Michael Grätzel, the G24 Power advisory board member and his team at EPFL, announced the fabrication of solid-state DSCs with 22.1% efficiency, reached by hybrid perovskite. This efficiency is in the range of the best silicon based solar cells on the market. This design replaces the liquid electrolyte and dye with a lead halide [13], [16], [17].

The production takes place in a classic wet-chemical process and therefore it is simple and inexpensive compared to silicon solar cells. The major problem is the insufficient long-term stability of dyes, liquid electrolyte and their sealing. For this reason, the priority of current research is to stabilize the efficiency of these cells [13]. Thus, further research and development is of high importance for the future success of cost-effective high efficient solar cells.

III. CRITICAL EVALUATION

In order to become an alternative to current photovoltaic systems it is necessary to meet several criteria that focus on both ecological and economical factors. The main advantages and disadvantages of the DSCs are listed below.

A. Main advantages

- The advantage of using sensitizing dyes having a broad absorption spectrum in conjunction with the nanocrystalline oxide film lies in the fact that a large fraction of sunlight can be harvested, including the spectral range from the UV to the near IR (near-infrared), allowing a nearly quantitative conversion of the incident photons into electric current [6],[9].
- Use of inexpensive, ecological friendly, widely available material (e.g. titanium dioxide) [5].
- Low cost production due to simplified manufacturing techniques (e.g. screen printing). DSCs offer the lowest costs of all printed solar cells
- Transparency and color design possibilities make them very versatile regarding aesthetic design [18].
- DSCs are flexible, thin and lightweight. Thus, easy to integrate into a variety of materials and suitable for everyday use in portable applications.
- DSCs capture light from all directions. The angular dependence is very low so the cells generate electric power even in diffused sunlight conditions that makes it suitable for a wide range of applications - indoors and outdoors [11].

B. Main disadvantages

- With regard to commercial photovoltaic modules, the reported efficiency of nanocrystalline DCSs is lower than the reported efficiency of silicon solar cells [13].
- The use of organic liquid electrolytes leads to serious problems regarding the durability: high volatility of the iodide/tri-iodide redox couple requires a good sealing of the cell; thermal stress as critical factor that negatively affects the long-term stability [19].
- Not considered for large scale manufacturing yet
- The larger the surface area of the semiconductor material, the higher the risk of energetic loss in the electrodes. This presents challenges for manufacturing [20].

IV. FUTURE OUTLOOK

The debate surrounding renewable energy has received increasing attention. The concept of the dye-sensitized solar cell has gained rising popularity because of the possibility to combine economic efficiency and climate protection. In addition to lower manufacturing costs, the specific characteristics of the DSC make it very versatile. For example, transparency and color design options allow modern architecture to combine visually attractive design with renewable energy. Accordingly, there is great potential i.e. for future construction of glass attachments, facades, furniture or windows. With a view to flexible elements e.g. smartphones or displays, the integration of flexible solar cells could become an integral component and hence extends the application possibilities.

V. CONCLUSION

Here, we have presented a broad overview of the basic structure and function of the DSC and the main benefits and disadvantages of its concept. Recent developments in this area open up new innovative possibilities to increase efficiency and potential usage of the DSC.

Durability concerns have slowed the adoption of DSCs. In this context, further investment and research into this new technology is important if the aim is to investigate a durable, sustainable, high efficient dye-sensitized solar cell. Nevertheless, with the production of flexible solar cells, the DSCs can establish a new market segment because they are less sensitive to the angle of the solar radiation and therefore they can be easily integrated in vertical walls and places with low light conditions. The variety of the design options provides a unique selling point.

The DSC has become a promising alternative to conventional photovoltaic systems. The cells are suitable for a wide range

of applications and easy to adapt to different requirements. Although they have not yet resulted in a breakthrough, the DSCs have an enormous potential to open up an attractive new market segment for solar systems with considerable growth potential.

REFERENCES

- [1] J. Twidell und T. Weir, *Renewable Energy Resources*, 3 Hrsg., London and New York: Routledge, 2015.
- [2] L. Hong, W. Wen-Li, L. Yi-zhu, L. Xin and L. Jian-bao, „New trends for solar cell development and recent progress of dye sensitized solar cells,“ *Frontiers of Materials Science in China*, vol. 4, p. 345, September 2009.
- [3] L. Hong, W. Wen-Li, L. Yi-zhu, L. Xin and L. Jian-bao, „New trends for solar cell development and recent progress of dye sensitized solar cells,“ *Frontiers of Materials Science in China*, vol. 4, pp. 345-352, September 2009.
- [4] EPFL, „EPFL,“ 2016. [Online]. Available: <http://lpi.epfl.ch/graetzel>. [Accessed 26 May 2016].
- [5] M. Grätzel, „Dye-sensitized solar cells,“ *Journal of Photochemistry and Photobiology C: Photochemistry Reviews*, pp. 145-153, July 2003.
- [6] L. Han, N. Koide, Y. Chiba, A. Islam, R. Komiya, N. Fuke, A. Fukui and R. Yamanaka, „Improvement of efficiency of dye-sensitized solar cells by reduction of internal resistance,“ *Appl. Phys. Lett.*, vol. 86, pp. 1-3, May 2005.
- [7] Hynae, „Hynae, Nanotec-KMUTT,“ 22 June 2013. [Online]. Available: <http://www.kmutt.ac.th/hynae/dye-sensitized-solar-cells/>. [Accessed 28 June 2016].
- [8] M. Grätzel and J.-E. Moser, „Solar energy conversion,“ *Electron Transfer in Chemistry*, vol. 5, pp. 589-644, 2001.
- [9] K. Hara and H. Arakawa, „Dye-sensitized Solar Cells,“ in *s Handbook of Photovoltaic Science and Engineering*, England, John Wiley & Sons Ltd., 2003, pp. 663-696.
- [10] R. Triggs, „Android Authority,“ 2014. [Online]. Available: <http://www.androidauthority.com/flexible-wearable-technology-390386/>. [Accessed 9 June 2016].
- [11] G24 Power Ltd., „GCell,“ 2016. [Online]. Available: <http://gcell.com/dye-sensitized-solar-cells/advantages-of-dscc>. [Accessed 31 May 2016].
- [12] M. P. Bailey, „Chemical Engineering. Essentials for the CPI professional,“ 1 October 2015. [Online] Available: <http://cdn.chemengonline.com/wp-content/uploads/2015/10/Solaronix-Facade-Lausanne.jpg>. [Accessed 1 July 2016]
- [13] V. Wesselak and S. Voswinckel, *Photovoltaik - Wie Sonne zu Strom wird*, Nordhausen: Springer, 2016, pp. 60 - 62.
- [14] Q. Tang, X. Wang, P. Yang and B. He, „A solar cell that is triggered by sun and rain,“ *Angew. Chem. Int. Ed.*, vol. 55, pp. 5243 –5246, March 2016.
- [15] I. Chung, B. Lee, J. He, R. P. H. Chang and M. G. Kanatzidis, „All-solid-state dye-sensitized solar cells with high efficiency,“ *Nature*, vol. 485, p. 489, May 2012.
- [16] B. V. Lotsch, „Ein Klassiker im neuen Gewand: Perowskit-Solarzellen,“ *Angew. Chem.*, vol. 126, pp. 647-649, January 2014.
- [17] S. Kazim, M. K. Nazeeruddin, M. Grätzel and S. Ahmad, „Perowskit als Lichtabsorptionsmaterial: ein Durchbruch in der Photovoltaik,“ *Angewandte Chemie*, p. 2854–2867, 12 February 2014.
- [18] P. Drachman, „SolarServer,“ 2016. [Online]. Available: <http://www.solarserver.de/solar-magazin/solar-report/farbstoff-solarzellen-und-organische-photovoltaik.html>. [Accessed 31 May 2016].
- [19] A. Hinsch, J. M. Kroon, R. Kern, I. Uhlendorf, J. Holzbock, A. Meyer and J. Ferber, „Long-term stability of dye-sensitized solar cells,“ *Prog. Photovolt: Res. Appl.*, vol. 9, pp. 425-438, October 2001.
- [20] B. O'regan and M. Grätzel, „A low-cost, high-efficiency solar cell based on dye-sensitized colloidal TiO₂ films,“ *Nature*, vol. 353, pp. 737-740, October 1991.

The Organic Rankine Cycle

A system for waste heat recovery

Jacob Böhnke

Fatih Karabulut

Tanja Lehmann

Brandenburgische Technische Universität
Cottbus-Senftenberg

Brandenburgische Technische Universität
Cottbus-Senftenberg

Brandenburgische Technische Universität
Cottbus-Senftenberg

boehnjac@b-tu.de

karabfat@b-tu.de

lehmatan@b-tu.de

Abstract—Many processes produce heat that cannot be used directly. Instead of dissipating this, so called, waste heat to the ambient it can be transformed into usable energy. There are several possibilities of converting waste heat into electricity. One out of those ways is the Organic Rankine Cycle (ORC), which will be explained in the following paper.

Keywords—organic, Rankine, heat recovery, transformation, energy, ORC

I. INTRODUCTION

Lots of applications and processes are producing heat that cannot be used directly in the process, therefore it is emitted to the ambient. This kind of lost energy is called waste heat and decreases the efficiency of the process. Several approaches have been made to use this kind of heat. For example it can be recuperated and fed into the original system, or be used for district heating. Another approach for using waste-heat is to transform it into mechanical work and afterwards into electricity by means of thermodynamic cycles. The Organic Rankine Cycle (ORC) is such a promising method of solving the hassle. The ORC-technology uses the basic principle of the Steam-Rankine-process, but instead of using water as working fluid another organic fluid is used. Boundary conditions for the used working fluids are given by temperature range of the waste heat source. The working fluid is ought to evaporate at comparatively low temperatures, being non-toxic, not flammable and not being climate damaging. Its thermodynamically properties can be chosen and designed optimally to the existing waste heat source [1][2].

By using organic working fluids there are several technical questions to be solved:

- Expanders have to be custom-made, because the working fluid differs from water
- Most of the working fluids are aggressive, so that the surfaces of expanders and heat exchangers have to be protected from corrosion
- Sealing of the cycle is more complex than for water

II. TECHNICAL FUNCTIONALITY

The cycle is as follows: the feed pump compresses the working fluid adiabatically, in which the temperature remains virtually equal. In the evaporator isobaric heat is supplied to the working fluid. Subsequently, the working medium is relaxed adiabatically in the expander and in the condenser, the residual heat is dissipated isobaric or recuperated and fed to the working medium after leaving the feed pump. With the recuperation of the process, the efficiency increases at suitable temperature level.

The structure of the process consists of feed-pump, evaporator, expander and condenser:

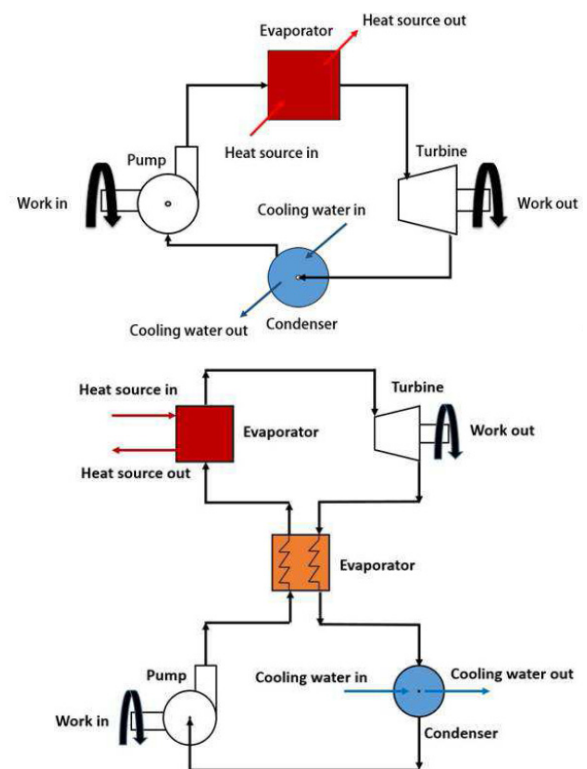

Figure 1. Structure of ORC (non-recuperated/recuperated)

III. DIFFERENCES BETWEEN CLASSIC STEAM POWER PROCESS AND ORC

The major differences are the operating conditions under which the process runs. The steam powered process runs on pressures of approximately 250 bar and temperatures of about 500 °C. The ORC on the other hand works with pressures of 20 bar and temperatures of 200 °C, which are rarely exceeded. Thus, it is possible to use it for low-temperature heat sources, from temperature levels starting at about 80 °C, transforming the heat into useable energy. This energy can be supplied as either mechanical work or in the form of electricity. By yielding it into the development process an increase in efficiency will be caused, or it can be supplied to other external processes. By conversion of waste heat into electricity it is easier to distribute the energy because the power grid is very broad in many locations and so it does not need an own distribution system, like district heating [3].

Possible heat sources for the application of ORC systems are industrial waste heat, waste heat from the engine exhaust stream, biogas and wood burning, such as solar thermal and geothermal sources. The four latter heat sources are converted into environmentally friendly and sustainable electricity without releasing emissions.

However, by now achievable efficiencies of ORC-applications are relatively small and depend on many parameters. For example, the isentropic efficiencies of feed pump and expander, the efficiency of the heat exchangers, the composition of the working fluid and the temperature level of the heat source play key roles which affect the efficiency of the entire system [4].

Because the energy for evaporation is already available, the ORC process enables a further increase of energy efficiency in the industrial sector and contributes to saving of fossil fuel resources and it reduces the CO₂ emissions [5].

Despite the differences, basically many of the developed process optimization method of classic steam process can transfer to the ORC process.

IV. USAGE OF THE ORC

In the following part there will be a short overview about the ways where ORC-systems can be used. The cost effectiveness of each system is depending on the circumstances like the size of the deducible potential and other factors [6].

A. Geothermal Power Plant

Geothermal energy is stored in the accessible part of the earth's crust. It includes the heat stored in the earth and is one of the renewable energies. They can be used both directly, as for heating and cooling in the heating market (heat pump heating), as well as for generating electricity or in a cogeneration [7][8]. Even with very deep holes, you do not reach temperatures higher than 100 °C for the transported water. But an ORC-system is able to gain electric power, albeit with a relatively low efficiency of often less than 20%. Since the waste heat from the plant obtained at an even much lower temperature level, their usage is difficult. Therefore, it makes

more sense to use the heat generated directly rather than for a relatively inefficient generation. However, when a geothermal energy source is available at a location with a low heat demand, power generation with the ORC-principle can be useful [6].

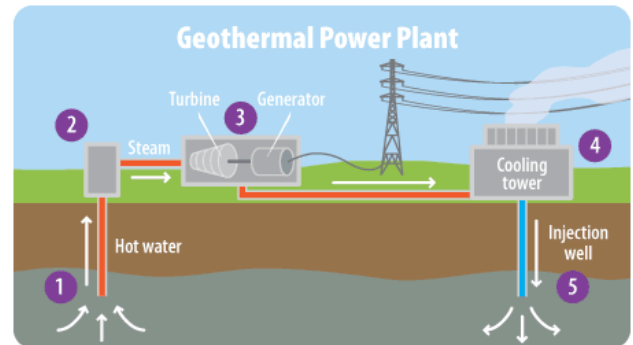

Figure 2. Usage of ORC with Geothermal Power Plant

B. Solar Power Plant

Solar power is a renewable and sustainable energy source and can be used around the world to generate electricity for a number of different purposes. It can be converted into electricity in one of two ways [9][10]. Larger solar power plants are often based on parabolic trough collectors. They reach temperatures of several hundred degrees. This is enough for operating a conventional steam turbine. For smaller decentralized plants, for example with a power of the order of one megawatt, the usage of an ORC-system makes sense. Especially when the heat should be cached, for example to make a generation of power at night possible, the ORC technology allows a much higher efficiency, cause in this case the temperature is lower than usual. This case is called SORC systems which stands for solar Organic Rankine Cycle. The number of realized SORC systems is pretty low [6].

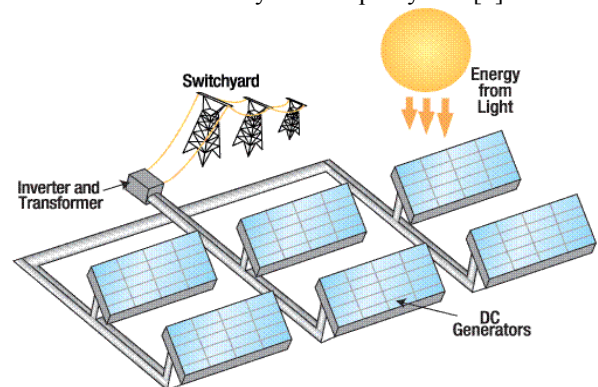

Figure 3. Usage of ORC with Solar Power Plant

C. Cogeneration

Cogeneration (Combined Heat and Power) is the simultaneous production of electricity and heat, both of which are used [11]. The usage of ORC- processes in the use of biomass in decentralized plants could enable a relatively good efficiency despite moderate temperatures. The combustion temperature of biomass is often significantly lower than in fossil fuels. A thermal oil boiler with silicone oil can be used for example. The oil is getting heated up to 300 °C and



supplied to the ORC process. The moderate temperature allows relatively good boiler efficiency [6][12].

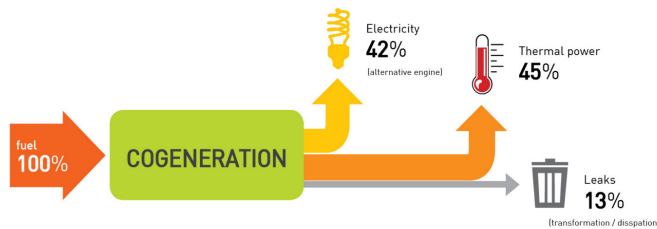

Figure 4. Usage of ORC with Cogeneration

D. Industrial waste heat

This method is a particularly interesting source for electricity generation using an ORC system. Industrial processes often result significant amounts of waste heat at temperatures above 100 °C [13]. Unless this heat is not directly usable again, they can be used with an ORC plant to generate electricity. For example, in cement kilns gases exhaust with a temperature of 280 °C, and this heat can be transformed into electricity with an efficiency of around 20%. Waste heat from a clinker cooler can also be utilized in this way. The producible electric power can be significantly over than one megawatt (with a firing capacity of 100 MW) so that a considerable yield arises [6][14].

V. CONCLUSION

The ORC is an excellent method of recovering waste heat at low temperature levels. Furthermore the process enables an increase of energy efficiency in the industrial sector and reduces the CO₂ emissions. Sustainable sources, like solar and geothermal power, can also be tapped. This young technology is worth to investigate more in the future.

REFERENCES

- [1] Silke Köhler und Ali Saadat, GeoForschungsZentrum Potsdam „Möglichkeiten und Perspektiven der geothermischen Stromerzeugung“ STR00/23, Geothermie Report 00-1
- [2] Heinz Peter BERG, Natthaphon BUN-ATHUEK, Thanapol POOJITGANONT, Boonchai WATJATRAKUL, “1D Simulation of Organic Rankine Cycle (ORC) by means of MATLAB
- [3] Christian Vetter, “Thermodynamische Auslegung und transiente Simulation eines überkritischen Organic Rankine Cycles für einen leistungsoptimierten Betrieb”, KIT Scientific Publishing, Karlsruhe, August 14, 2014
- [4] K. Gawlik, V. Hassani “Advanced binary cycles: optimum working fluids“ September 20-23, 1998 Geothermal Resources Council 1998 Annual Meeting, San Diego, California
- [5] GETEC heat & power AG, “ORC-PROZESS”: <http://www.getec-heat-power.de/de/orc-prozess.html>
- [6] Dr. Rüdiger Paschotta, „Organic Rankine Cycle“: https://www.energielexikon.info/organic_rankine_cycle.html, December 19, 2014
- [7] Union of Concerned Scientists, „How Geothermal Energy Works“: http://www.ucsusa.org/clean_energy/our-energy-choices/renewable-energy/how-geothermal-energy-works.html, December 22, 2014
- [8] Renewable Energy World, „Geothermal Power and Electricity Production“: <http://www.renewableenergyworld.com/geothermal-energy/tech/geoelectricity.html>
- [9] World Nuclear Association, „Renewable Energy and Electricity“: <http://www.world-nuclear.org/information-library/energy-and-the-environment/renewable-energy-and-electricity.aspx>, June 20, 2016
- [10] Rebecca Lake, „Definition of Solar Power and How it Works“: <http://www.livestrong.com/article/145221-definition-of-solar-power-and-how-it-works/>, June 10, 2010
- [11] COGEN Europe, „What is cogeneration?“, http://www.cogeneurope.eu/what-is-cogeneration_19.html, 2015
- [12] BIOS BIOENERGIESYSTEME GmbH, „Description of the ORC technology for biomass Combined Heat and Power plants as well as further possibilities for process integration“: <http://www.bios-bioenergy.at/en/electricity-from-biomass/orc-process.html>
- [13] C.C.S. Reddy and S.V. Naidu, Andhra University; G.P. Rangaiah, National University of Singapore, „Organic Rankine Cycle“: <http://www.chemengonline.com/waste-heat-recovery-methods-and-technologies/?printmode=1>, January 1, 2013
- [14] Konstantinos Vatopoulos, David Andrews, Johan Carlsson, Ioulia Papaioannou, „Study on the state of play of energy efficiency of heat and electricity production technologies“: <https://setis.ec.europa.eu/sites/default/files/reports/Study-on-the-state-of-play-of-energy-efficiency-of-heat-and-electricity-production-technologies.pdf>, 2012

FIGURES

Figure 1: Heinz Peter BERG, Natthaphon BUN-ATHUEK, Thanapol POOJITGANONT, Boonchai WATJATRAKUL, “1D Simulation of Organic Rankine Cycle (ORC) by means of MATLAB

Figure 2: “Geothermal Power Plant“: <https://www3.epa.gov/climatechange/kids/solutions/technologies/geothermal.html>

Figure 3: „Photovoltaic Solar Power Plant,“: <https://ngsuyasa.wordpress.com/2014/02/25/introduction-on-solar-energy-and-solar-power-plants/>

Figure 4: “Cogeneration” <http://enpowereolutions.com/our-solutions/power-generation-and-renewables/>



Fuel Cells - An Alternative Propulsion System

B. Sc. Clemens Mardek
 Brandenburg University of Technology Cottbus - Senftenberg
 Chair of Power Distribution and
 High-Voltage Engineering

Abstract—The fuel cell technology is a promising propulsion technology of the future. In this article the transformation process of a hydrogen-oxygen fuel cell is explained, as well as present an overview of the current market of fuel celled cars. A number of leading car manufactures has been investing millions of dollars for further research of the said technology, proving to be an alternative to existing conventional electric propulsion systems.

Keywords-component; fuel cell; green mobility; alternative propulsion system; Toyota Mirai; Hyundai IX35; Honda Clarity; Mercedes GLC F-Cell

I. THE FUEL CELL

At present, the automobile is the most important form of locomotion. More than 1.18 billion cars are used by roughly 7,3 billion people worldwide. One should consider that the car distribution among the population is not homogenous. The effects of rapid industrialization have resulted to more megametropolis with a population of more than 10 million people. The price for this mobility with the consequences brought about is cataclysmic both to man and the environment. Along with the increase in traffic density, the surging amount of gas exhaust from the combustion engines as well as the noise factor is blatant. These developments along with the limited fossil fuels have opened the discussion concerning alternative propulsion systems. This technology has a reduced noise level of local emission [1]. A trendsetting solution is the hydrogen-combustion engine (fuel cell). In general the word fuel cell is a term used to mean hydrogen-oxygen-fuel-cell. It transforms chemical energy reaction of a fuel into a usable electric energy without going through the process of heat energy and physical force which is conventionally used in heat engine maximizing the efficiency of the energy conversion level [2]. This transformation process of a simplified set up of the hydrogen-oxygen fuel cell is displayed in figure 1.

In a simple illustration fuel cell made up of anode and cathode coated with platinum or palladium catalyst, with an electrolyte membrane in between electrodes. The anode is continuously fuelled with H₂, analogous with the oxidizing agent (O₂) of a cathode. Hydrogen is catalytically oxidized to protons in an anode (1). With the potential difference of anode and cathode, the separated electrons by means of oxidation flow through an external electric circuit with electrical load to the side of the cathode and is electrically carried out. The oxidized protons

(hydrogen ions) pass through the membrane to the side of the cathode. The added oxidation agent is now reduced with the electrons to anions, reacting with hydrogen ions to water (H₂O) (2). This is the reversed process of an electroanalysis [2] [3].

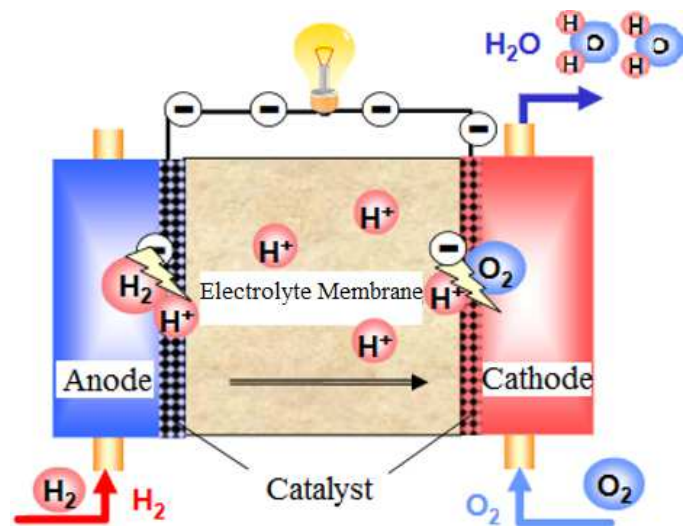
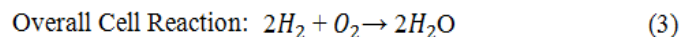
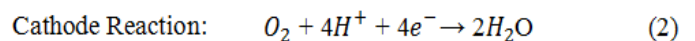
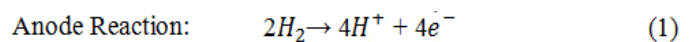

Figure 1: Way of functioning of a fuel cell [4]

Reaction process:



A single fuel cell potentially emits about 0.7 Volts. With the given voltage is obviously not adequate fuel a car, a great number of cells are then serially connected to form a fuel cell stack [4]. A huge advantage of a fuel cell car over a conventional electric car is the time involved in refueling, full tanking in roughly 3 minutes for a Toyota Mirai fuel cell car [5].

II. FUEL CELL CARS

As mentioned at the beginning of this paper, major car manufacturers are looking for alternative propulsion systems that could replace conventional combustion engines. Table I shows the actual market of fuel celled cars. In additional table II shows some other big manufacturers, which are planning to launch fuel cell cars in the future years.

Table I. Market of fuel cell cars at by of 2016

Manufacturer	Model	Range (km)	Power (kW)	Price (k€)	Launched	Sales (GER)
Toyota ^[5] [10]	Mirai	500	114	78	2014 Japan, 2015 Germany	---
Hyundai ^[11] [12] [13]	IX35 F-Cell	600	100	65	2013 Japan, mid 2015 Germany	120
Honda ^[4] [15]	Clarity	700+	130	60	March 2016 Japan	---

Table II. Fuel cell cars for launching

Manufacturer	Model	Range (km)	Power (kW)	Price (K€)	Planned Launching
Honda ^[4] [15]	Clarity	700	140	60+	September 2016 Europe
Audi ^[18]	h-tron A7	500+	170	---	---
Daimler ^[7]	GLC F-Cell	500	---	---	2017
Riversimple ^[16]	Rasa	480	8.5	Lease	2018

Based on Table I, it is clear that the Asian market is the real pioneering producer of fuel cell vehicles. Currently there are three manufacturers worldwide (two of

which are in Japan) that offer small-series production for hydrogen-fuelled cars. In Asia, particularly in Tokyo with a population of 37.5 Million (as of 2014), the alternative propulsion systems play a major role in the reduction of environmental and noise pollutions [6].

Based at Table II, it is clear that German car manufacturers are definitely behind their Asian counterparts. However, Daimler is planning to start manufacturing small-series in early 2017. According to BMW authorities, a major obstacle in manufacturing hydrogen-fuelled cars is the network of filling stations [7]. At present, only 30 hydrogen filling stations are available in the entire network of German petrol stations [8]. Moreover, as previously shown in the Tables, the prices are extremely high for a conventional hydrogen-fuelled car. A private customer will need to spend at least 60,000€ for a hydrogen-fuelled car from a Honda company and roughly 80,000€ for a Mirai model from Toyota. A small-series manufacturer called Riversimple from Wales offers another alternative profit model. Their long-time leasing program enables them solely to acquire vehicles without the burden of having to pay so much at once. This alternative could lead to a better and increased acceptance for hydrogen-fuelled cars [9].

III. Conclusion

With this research, we have learned how important the fuel cell technique is to the current technology. It is definitely superior over conventional electric cars in terms of refueling which is evidently faster. Just a small number of car manufacturers have truly recognized these potential, investing more on further research to the advancement of this technology. In Asia, leading auto manufacturers like Hyundai, Toyota and Honda are becoming more innovative and are producing fuel celled cars in full scale for their private clientele. With the ongoing trend, other well-known car manufacturers like Daimler are following the footsteps. The various list of results from this research paper would substantiate, that the hydrogen fuelled car concept of an electro-mobility niche market is actually, the current niche market. A downside for the numerous car manufacturers though is the overwhelmingly high-cost production as well as the inconvenience of the hydrogen filling station network.

REFERENCES

- [1] Stan Cornel, Alternative Antriebe für Automobile - Hybridsysteme, Brennstoffzellen, alternative Energieträger, 4th ed., Berlin Heidelberg: Springer Verlag, 2015, pp.1-3.
- [2] https://en.wikipedia.org/wiki/Fuel_cell
- [3] <http://www.brennstoffzelle-nrw.de/brennstoffzellen/grundlagen/>

- [4] Peter Pioch et al., Basisseminar Brennstoffzellen- und Wasserstofftechnologie, Weiterbildungszentrum Brennstoffzelle Ulm e.V., 2008.
- [5] <https://www.toyota.de/automobile/der-toyota-mirai.json>
- [6] <https://de.wikipedia.org/wiki/Tokio>
- [7] Interview between the author and an employee of BMW at the manufacturing base Leipzig at 6-22-2016.
- [8] <https://cleanenergypartnership.de/h2Tankstellen/mobile.html>
- [9] <http://www.treehugger.com/cars/riversimple-rasa-hydrogen-fuel-cell-car.html>
- [10] https://en.wikipedia.org/wiki/Toyota_Mirai
- [11] <http://www.hyundai.de/Modelle/Alle-Modelle/ix35-Fuel-Cell.html?hyucampaign=KMP-01405-58ZT&gclid=CIXX29CFp80CFRITGwodSq8Jew>
- [12] https://en.wikipedia.org/wiki/Hyundai_ix35_FCEV
- [13] <http://www.tagesspiegel.de/mobil/alternative-antriebe/hyundai-ix35-fuel-cell-wasserstoff-auto-wird-billiger/11567064.html>
- [14] <http://automobiles.honda.com/clarity>
- [15] <http://www.spiegel.de/auto/fahrkultur/honda-clarity-mit-brennstoffzelle-im-test-a-1060460.html>
- [16] <http://www.riversimple.com/the-technology-behind-the-hydrogen-car/>
- [17] <http://media.daimler.com/marsMediaSite/de/instance/ko/Unter-der-Lupe-Mercedes-Benz-GLC-F-CELL-Die-Brennstoffzelle-.xhtml?oid=11111320>
- [18] http://www.audi.de/de/brand/de/vorsprung_durch_technik/content/2014/11/audi-a7-sportback-h-tron-quattro.html

E-Cars - Status Quo, Challenges and Trends

*a comparison between the border triangle Germany, Poland and Czech Republic
as being part of the EU*

Sophia Dajana Stubbe
BTU Cottbus-Senftenberg
Cottbus, Germany
sophia.stubbe@googlemail.com

Simon Burges
BTU Cottbus-Senftenberg
Cottbus, Germany
simon.burges@gmx.de

Abstract—The ecologically damaging effect of greenhouse gases emitted in the process of energy extraction out of natural gas, crude oil, lignite and black coal is talked of. To stop climate change global policy has heralded the start of the energy turnaround not only in the electricity and heat sector but also in the field of mobility. Since the early 1990s climate protection has become an important aim in concrete terms. This paper presents the latest market innovations in the automotive industry concerning the available types of different electric drive technologies, the role of public charging stations as well as the status quo of their distribution, the various charging methods and the development of electric vehicles sold as a result of technology improvement. Thereby the investigation refers to the border triangle Germany, Poland and Czech Republic as compared to current European standards. Furthermore it gives summary of the relevant challenges especially with regard to battery ranges, battery raw materials, loading infrastructure and pricing as well as associated prospective solution proposals. The paper concludes with future prospects with regard to the long term goals in energy policies concerning electric vehicles.

Keywords—*E-mobility; border triangle; electric cars; batteries, charging stations and methods; challenges; business models*

I. INTRODUCTION

E-Mobility is a collective term for vehicles in private transport primarily using electricity as driving energy. Here this paper focuses on electric cars whereas it does not matter whether the electric motor is complemented by an auxiliary engine based on combustion processes or not [1]. But creating an eco-friendly car is more than enhancing the propulsion technology with regard to CO₂ emission reduction. It also involves building a new infrastructure providing charging stations extensively and integrating e-mobility in the power system [2]. As e-mobility is above that not only driven by climate change but also by resource scarcity, air pollution and noise disturbance [1] for EVs a new era has begun [3]. A new market has opened up in the transport sector both for established automobile manufactures expanding their range of conventional vehicles with electric vehicles (EVs) and start-up companies specializing in EVs (e.g. Tesla) as well as those in the supplier industry like battery producers or in the service provider industry like charging or system services [1]. But, despite all the efforts made by policy and industry, achieving the long term aims for the introduction of e-mobility seems to

be unlikely [4] because from an economic point of view, EVs are not lucrative: On the manufacturer side investing in EVs is not as cost-effective as distributing conventional vehicles and on the consumer side it is criticised that EVs are much more - not to say too - expensive [1]. Above that a combination of a lack of efficient batteries and insufficient charging stations are giving rise to serious doubts concerning EVs suitability for everyday use so that the majority of the consumers are still choosing vehicles driven by combustion engines [5].

II. STATUS QUO

A. The latest state of technology

Nowadays electric mobility seems to be a cutting-edge technology but actually it is more than 180 years old. In 1834 Thomas Deavenport invented the first battery-driven vehicle. Until 1900 EVs were even the fastest cars. Thereafter cars driven by fossil fuels have become more common due to higher speeds [6] whilst ensuring a longer driving reach and entailing lower costs in production [7].

Now the energy turnaround demands a change of thinking also in the transportation sector. Actually 14 percent of the worldwide greenhouse gas emissions derived from vehicles which are therefore the third largest emitter [8]. Fig. 1 gives an overview of the percentage distribution of the different emitter.

**Greenhouse gas emissions worldwide by sector
2014 in percent**

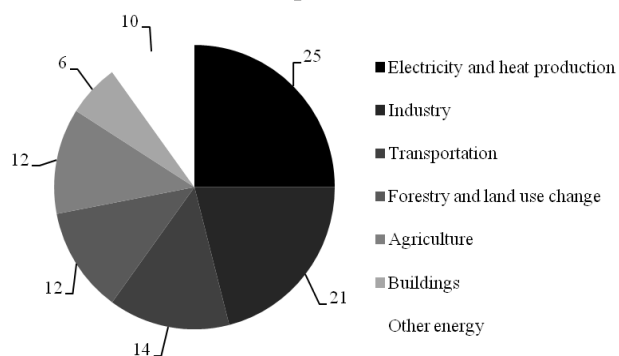

Figure 1. Distribution of emissions of greenhouse gases by industry sector worldwide as of 2014 [8]

In this regard new ideas and instruments have to be set up. But due to the fact, that e-mobility can be supported by many different policy options there occur variations in the state of technology by comparing different nations [4].

Essentially there exist the following main different types of drive technologies [9], [10]:

- *Combustion engines*: Diesel- and petrol engines that continue to be optimized in the future because they still show efficiency potential.
- *Hybrid (HEV)*: Hybrid electric vehicles are using both a combustion engine and an electric engine as support. The battery is charged via the combustion engine whilst driving.
- *Plug-in-Hybrid (PHEV)*: The storage battery of PHEVs can be charged additionally through the electricity grid and shows a much higher storage capacity than the battery of HEVs.
- *Range extended electric vehicle (REEV)*: The range of these EVs is increased by a combustion engine (range extender) providing, if needed, assisting power to the electric engine that significantly enhances its performance.
- *Battery-driven vehicle (BEV)*: The electrical power of a battery constitutes the only means of maintaining the motor. The battery is charged through the electricity grid.
- *Fuel cell vehicle (FCEV)*: The fuel cell of FCEVs converts the chemical energy generated by the reaction between oxygen and hydrogen into water directly into electrical power on board the car.

Vehicles powered by an internal combustion engine only, can reach in some cases a range of more than 1,500 km. For instance, the “OPEL Insigna 2.0 CDTI ecoflex” (since 2009) reaches a range of up to 1,627 km with one car tank, the “VOLVO S80 DRIVE” (since 2010) and the “VW Passat 1.6 TDI DPF BlueMotion Technology” (since 2009) reach up to 1,555 km.

HEVs only reach short electric distances due to the fact, that the electric engine is not used as primary propulsion but merely act as support for the combustion engine. HEVs therefore reach electric distances of 20 km to 50 km. One of the latest examples for an HEV is the “VOLVO V90 (since 2016) with a maximum electric range of 30 km to 40 km.

PHEVs and REEVs are similar. Both models can reach an electric range of up to 55 km until the battery has to be reloaded. A most recent PHEV model is the “Mitsubishi Plug-In Hybrid Outlander” (since 2013) with an electric range of 52 km and a total hybrid range of more than 800 km.

BEVs reach a range of 100 km to 200 km on average. For instance, the “E-Golf” (since 2014) reaches a range of 130 km to 160 km with one battery charge. Frontrunner is Tesla whose BEVs reach distances of 350 km to 500 km.

FCEVs can reach ranges of some hundred kilometers. For example the “Toyota FCHV” (since 2001) is recognized to a range of up to 800 km.

Although there are considerable advancements in FCEVs and hydrogen stations demonstrated the market doesn't grow nowhere near as the market for EVs. The main reason for this primarily lies in the significantly worse infrastructure of hydrogen stations [11].

The following tables give a summary of the main six different types of drive technologies as well as an overview of the most popular EVs and their range on average.

TABLE I. DRIVE TECHNOLOGIES AND ELECTRIC (EL.) AND TOTAL RANGES

Types of drive technology					
Combustion engine	HEV	PHEV	REEV	BEV	FCEV
	20 - 50km (el.)	20 - 55km (el.)	20 - 55km (el.)	100 - 200km (el.)	
450 - 1,700 km (total)	a	up to 800km (total)	400- 500km (total)		up to 800km (total)

a. no indication

EV range of selected electric vehicles as of July 2015 (in km)

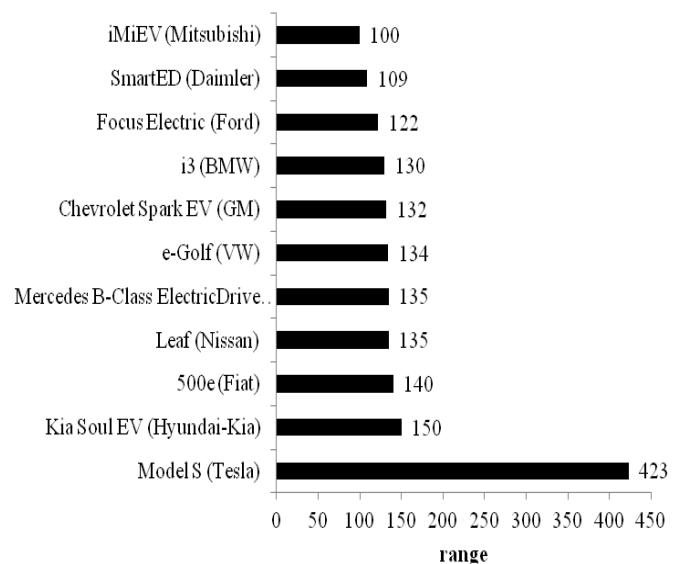

Figure 2. Range of selected EVs in km [12]

Indeed, these technologies are all available in the three countries under review [10]. Furthermore there are some suppliers of charging stations as well as a few different connector systems that must comply with local, state and national codes and regulations [13]. Fundamentally there are three different possibilities of charging an EV [14], [15]:

- **Cable:** Drivers of EVs can charge the battery either with electricity from the socket - which can last to ten hours - or alternatively to shorten the charging time via wallbox (e.g. obtainable from BMW that can reduce loading time at a minimum of 2.5 hours) at home. Besides consumers can use public charging stations. Currently researches are working on the development of quick public charging stations to shorten loading especially for travelers who do not want the journey time to drag on. Volkswagen has already developed such a quick charging station with which the battery can be charged within 20 minutes up to 80 percent of its full capacity. The station was inaugurated in Wolfsburg in 2013 with more to follow.
- **Wireless:** There exist prototypes of EVs that can be charged via inductive loading systems even while driving. Researchers from the Fraunhofer Institutes for Manufacturing Engineering and Applied Materials Research (IFAM) and for Traffic and Infrastructure Systems (IVI) constructed a 25 meters long test road in which coils had been integrated. The battery of the demonstrator EV “Frecco” could be charged while driving along at modest speed.
- **Battery change:** After “Better Place”, an US service provider in the field of e-mobility, finally founded on a “Battery Swap System” in 2013 Tesla has already successfully installed 312 quick charging stations in the USA being used. The chargeable battery swap takes three minutes and shall be reduced to one minute in the future.

In order to create a reliable infrastructure for loading EVs and to reach standardization concerning connector systems the European Parliament and the European Council brought the “Directive 2014/94/EU into being. Today there exist more than 4,300 charging stations in Germany, about 80 loading possibilities in Poland (although the area of Poland is almost as large as the one of Germany) and roughly 100 in Czech Republic (which area is smaller by more than one quarter) [12].

B. Data and facts

In order to reduce greenhouse gas emissions the European Commission limits CO₂ emissions to 95g/km for new cars [17] and governments set goals e.g. regarding market shares or sales volumes. In Germany in 2015 there are 55,250 EVs in total in use [18], 12,363 EVs of those were new registrations in this year [16]. In total, 44,400,000 passenger vehicles used are notified [19]. Since 2009 the number of e-cars sold per year has been rapidly increasing [20] (Fig. 2).

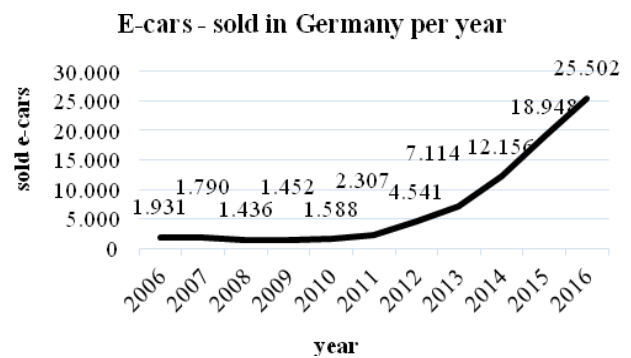

Figure 3. Number of e-cars sold in Germany yearly from 2006 until 2016 [20]

Worldwide there are 740,000 EVs reported in 2015 [12]. Furthermore the stock of EVs registered has increased by nearly 45 percent per year from 2014 until 2016 [21]. The development is illustrated in the following diagram.

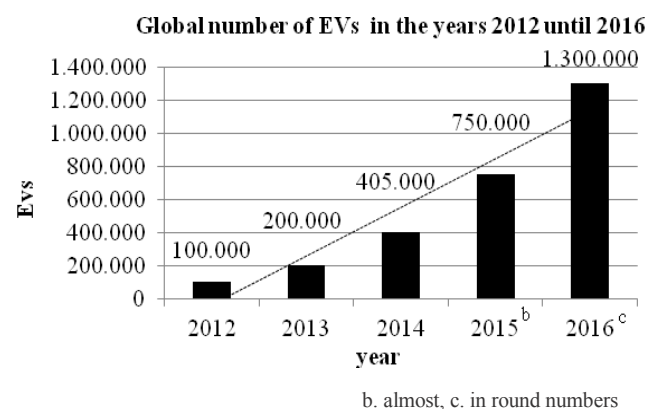

Figure 4. Development of the stock of e-cars registered worldwide [22]

Up to this time the German Federal Government has spent EUR 1.5 billion and the automotive industry further EUR 17 billion in the development of EVs in the region. By 2014 17 different series of e-cars were put on the market by automotive manufactures [23]. Until 2020 the German Federal Government want to be the lead market and provider for e-mobility - but 2015 Germany has fallen to fourth place according to the EV Index [12]. Furthermore there are to be one million electric cars on German roads [24] - but it's been on the horizon for quite some time that this goal will remain unachieved [25] because of various challenges still being up to date.

Regarding Poland and Czech Republic there is a lack of similar (non-chargeable) data of development. Instead, the following figure visualizes the EVs registered in different EU-member-states in 2015. According to that there were 298 EVs registered in Czech Republic and 259 EVs in Poland in 2015 [12].

EV-registrations in 2015

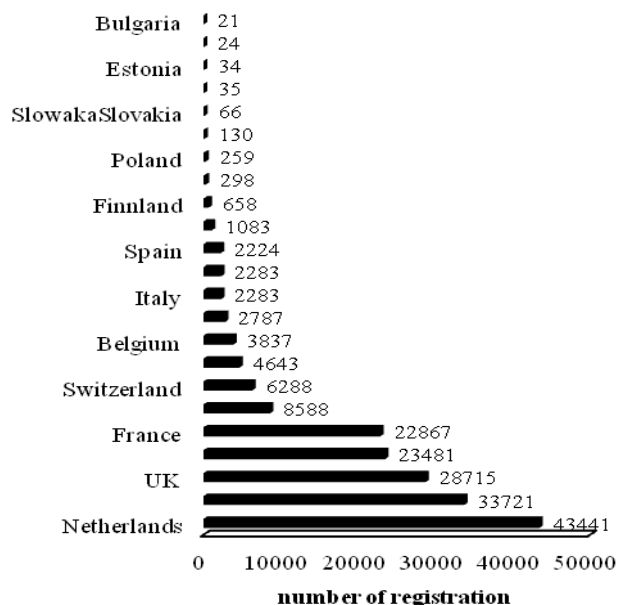

Figure 5. EV-registrations [12]

It becomes obvious that e-mobility is much more advanced in Germany than in Poland and Czech Republic. Comparing Poland and Czech Republic by taking the population into account there were more EVs sold per capita in Czech Republic than in Poland. One reason seems to be the more accessible loading infrastructure in Czech Republic. Another point could be seen in superior market support mechanisms or the more open attitude towards e-mobility as well as the stronger automotive industry in Czech Republic [26].

By comparing Germany, Poland and the Czech Republic regarding infrastructure Germany appears having a higher density of loading stations. Nevertheless a research study by McKinsey points out, that there is still potential for improvement [28]. Fig. 5 shows the level of the “Industry-Electric Vehicle-Index” and ranks the six leading countries. (Scala from zero – bad situation to 5 - perfect situation).

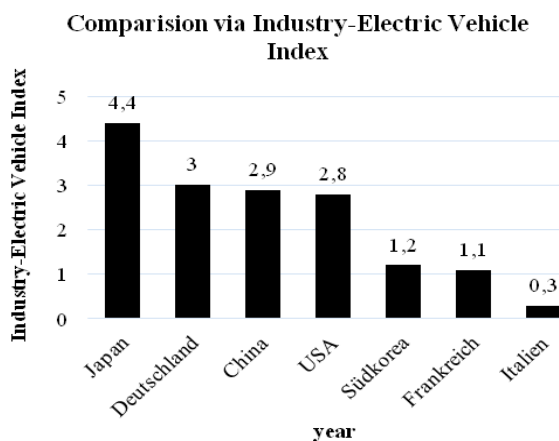

Figure 6. Industry-Electric Vehicle-Index [28]

III. CHALLENGES AND SOLUTION PROPOSALS

In a survey conducted by the World Wide Fund (WWF) in cooperation with Lichtblick SE today only about one third of the German population, in principle, can imagine going to have an e-car. 63 percent currently have no plans to buy an EV [5]. The reasons for the customer restraint in purchasing EVs may be found in technological, economical and infrastructural problems as well as in unattractive pricing conditions.

A. Technological, economical and infrastructural challenges

- One of the most fundamental problems of EVs being criticised by the consumer is the relatively short range of the *batteries*. In a survey with more than 1,000 respondents conducted by the Institute of Economics and Law of Dresden Technical University, the required battery range would be approximately 284 km which is on average twice the range consumers indicated (excluding Tesla who reaches almost 80 percent of the required range). Besides the consumers’ data deviate from the manufacturers’ data concerning battery range by a mean of 40 percent [29]. Another argument is the charging time: It can last up to ten hours depending on the model to load the EV. In the meantime, however, the charging process could be almost reduced to a minimum of 30 minutes to reach full capacity. The following figure gives an overview of selected examples.

Charging time depending on the model

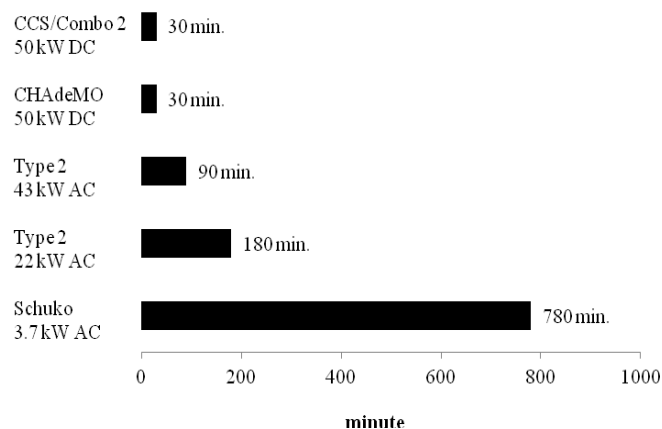

Figure 7. Comparison of different types of charging models regarding time [30]

- A further criticism made is that the raw materials the batteries were produced, *lithium* and *cobalt*, are also finite resources. Considering the fact that the future development of demand of lithium and cobalt is uncertain, the question arises if e-mobility has a promising future. Depending on different scenarios 74 to 248 percent of the lithium resources and 50 percent of the cobalt resources could be exhausted by 2050 [31]. Solutions do not yet exist. Besides EVs

environmental friendliness depends on the country-specific power mix if using public charging stations or the energy out of the socket at home. Because EVs are only as environmentally-friendly as the electricity is used to charge the batteries. In Germany the CO₂ emissions amount to 535 g/kWh (2015) [32], in Poland to 930 g/kWh (2015) [33] and in Czech Republic to 585 g/kWh (2009) [34]. For example, an e-car with an average consumption of 13.8 kWh per 100 km would lead to a Well-to-Wheel-CO₂-emission of 77 g per this line at the given German power mix today [19].

- Relating to the battery technology in need of improvement the still poor infrastructure regarding *charging stations* is another problem that deters customers from buying an EV. On an international comparison Germany is rated especially poorly in terms of having access to all kind of charging stations. Only 35 percent of the German population has full access, internationally it is 48 percent [29]. On the other hand, but, a study of the Fraunhofer Institute for Systems and Innovation Research from the year 2011 came to the result that 90 percent of the real largest user group of EVs won't need nor actually use public charging stations because they are the group of full time commuters living outside the city centre having their own garage. So they could charge their EV *at home* conveniently. Simultaneously consumers are advised that in this way they could further support the energy turnaround by charging their EV e.g. with clean power produced by PV modules assembled on the roof of the residential building [2].
- Even against the background of the research and development of *automatic driving* EVs are difficult. As an automated vehicle requires a relatively high amount of electricity EVs would have to be charged even more frequently [35].
- Another decisive challenge for the market penetration of EVs is the *pricing*. Indeed, EVs are not competitive compared to conventional fueled or relatively environmentally-friendly vehicles. An example is provided by the ADAC, which has compared the "VW-up! 1.0 EcoFuel BMT high up!", a subcompact powered by natural gas, to a "VW e-up!", a fully electrically driven subcompact. Although the "e-up!" actually entails lower variable costs e.g. regarding fuel it causes higher monthly costs calculated for an annual mileage of 15,000 kilometers with a period of four years. In this connection the "e-up!" causes monthly costs of about EUR 540 [19] and the "VW-up!" of about EUR 355 [17]. The main reasons are the much higher initial purchase costs of the "e-up!" that amount to almost 170 percent of the "VW-up!" [17], [19]. Apart from this when nevertheless buying an EV the consumer is even not satisfied with the quality concerning the battery technology [29]. Above that there is also great uncertainty about possible further costs that may occur after the purchase because there is a lack of long-term experience at the moment [1].

To tackle these problems, Germany recently introduced the so called "Elektromobilität (Umweltbonus)". According to the Federal Office of Economics and Export Control purchasers of a fully electrical driven car will receive an "Umweltbonus" if the listed price is below EUR 60,000 and the e-car is bought after May 18th 2016. Buyers of a PHEV will also get a subsidy of EUR 3,000 per car spent by the Federal Republic of Germany under the same conditions. The subsidy amount is limited to EUR 600 million disregarding time [30] and is planned to support the purchase of 400,000 EVs [14]. In Poland and in Czech Republic no similar subsidy exists.

B. In search of promising business models

To create an European and global market for e-mobility innovative and efficient business models are necessary because the typical car purchase, a contract of sale between vehicle manufacturer and customer, won't lead to the intended desired number of EVs on the roads and, what is more, not to the desired CO₂ emission reduction [2].

Currently the development of new integration strategies is particularly promising in regard to involve e-mobility in *car sharing*. Since 2011 EVs have been integrated successfully by different car sharing operators in the UK, U.S., in France and in Australia. Since 2013 Austria, Denmark, Finland, Germany, Italy, Japan, Norway, the Netherlands, Portugal and Switzerland have also swum with the tide [36]. In Germany a total of 5,000 e-cars already exist in 2011 and there are double-digit annual growth-rates forecasted for the years to come [2].

Another prominent example for a newly developed business model that raises the issue of the lack of efficient batteries and insufficient charging stations is the already mentioned *battery changing system* - being able to exchange an empty battery for a charged one within a very short time - developed by the company "Better Place" and now marketed by Tesla. Within this new approach, the e-car transfers to the ownership of the consumer but the battery actually not. This shall remain the property of the automotive manufacturer [2].

Another European program is called "ELECTROMOBILITY+". It has been established by the European Commission in 2010 and is a co-operation between governmental bodies, research institutes as e.g. the Fraunhofer Institute for Industrial Engineering, various universities as well as the private industry of the eleven countries. This program is an economic development scheme in so far as the EU supports the eleven countries (inter alia Germany and Poland) monetarily to develop a "green economy". The total funding amounts to EUR 10 million [37]. "ELECTROMOBILITY+" aims the expansion of e-mobility in Europe until 2025 [38]. This framework is integrated in the European Green Cars Initiative (EGCI) which tries reducing greenhouse gas emissions by 25 percent until 2020 e.g. by making companies working in this field in the EU competitive. The total costs (including private and state founding) are EUR 30,000 million. Germany and Poland take part, Czech Republic does not (Fig. 7) [39].



Figure 8. National partners of “ELECTROMOBILITY+” [20]

In the case of Poland the handling of the market is more private. “Alphabet”, a leading Polish company in the field of e-mobility, therefore provides a great support system for the consumer while offering especially *cheap leasing models* [40].

In Czech Republic subcontractors dominate in the automotive industry so that the subsidiaries being provided by the pan-European program “Europa 2020” are indispensable to support the economic growth path in this nation [41]. “Europa 2020” is provided by the European Commission and aims to reach growth of small and innovative companies participating in the energy turnaround and trying to achieve commodity and economic independence for their country [42].

But this and other concepts are still in an early phase of their development so that it remains to be seen what success they will bring [2].

IV. FUTURE PROSPECTS

EVs are discussed in politics, economy as well as in social networks. There are no doubts regarding their potential to help provide *commodity independence*. Besides e-mobility shall provide balancing energy by giving the opportunity to save energy in the batteries of the EVs whenever the energy produced is higher than the energy consumption or draw energy from the batteries if production is lower. But yet, due to a lack of battery capacity as well as a globally organized charging system integrating e-mobility into the *Electricity Balancing Market* is still a long way [2].

Further collaboration seems to be necessary to create a successful framework providing supranational standards (e.g. for expanding charging station density and assuring guarantees) to reduce the reluctance of buying EVs and in this manner contribute to the aims of CO₂ emission reductions. *Purchase advantages* must remain a key point which indicates a look at Norway leading in the number of EVs on the road.

In conclusion, despite the various challenges there seems to be a lucrative market for EVs in the future. According to a survey conducted by McKinsey the turnover will rise in the

following 15 years significantly up to EUR 300 billion in the world [43].

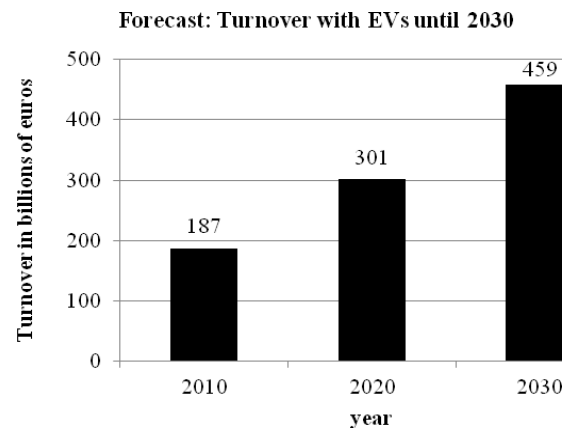

Figure 9. Development of the turnover with EVs until 2030 worldwide [43]

ACKNOWLEDGMENT

S. D. S. and S. B. thank the Chair of Power Distribution and High-Voltage Technology at Brandenburg University of Technology Cottbus-Senftenberg (BTU) and in particular those responsible Prof. Dr. -Ing Harald Schwarz and Dipl.-Ing. Dirk Lehmann of the Module 15th EEEIC SED International Conference on Environment and Electrical Engineering Student Edition for the content of teaching and the possibility to publish this paper and present it at the 15th EEEIC Conference at the BTU in front of a student audience. Another word of thanks addresses to Dr. Przemyslaw Janik of the Wroclaw University of Technology for the great support.

REFERENCES

- [1] W. L. Filho, R. Kotter, E-mobility in Europe. Switzerland: Springer, 2015.
- [2] Fraunhofer ISI, Gesellschaftspolitische Fragestellungen der Elektromobilität. October 2011 (www.isi.fraunhofer.de/isi-wAssets/docs/e/de/publikationen/elektromobilitaet_broschuere.pdf)
- [3] G. Schauer, R. Garcia-Valle, “Electrical Vehicles Activities Around The World,” in Electric Vehicle Integration Into Modern Power Networks, R. Garcia-Valle, J.A. Pecos Lopes, Eds. New York: Springer, 2013, pp. 273-319.
- [4] M. van der Steen, R.M. Van Schelven, R. Kotter, M.J.W. van Twist, P. van Deventer, “EV Policy Compared: An International Comparison of Governments’ Policy Strategy Towards E-Mobility,” in E-mobility in Europe, W. L. Filho, R. Kotter, Eds. Switzerland: Springer, 2015, pp. 27-53.
- [5] Lichtblick SE, Umfrage: E-Autos fördern, aber richtig. 2016.
- [6] Electric Auto Association, EV History. 2016 (<http://www.electrcauto.org/?page=evhistory>)
- [7] K. Theißing, Vorteile und Nachteile des Elektroautos. 2013 (<http://www.energie-fakten.de/html/elektroauto-vor-nachteile.html>)
- [8] World Bank, Distribution of emissions of greenhouse gases by industry sector worldwide as of 2014. 2016

- (<http://www.worldbank.org/en/news/infographic/2016/03/16/forests-slow-climate-change-and-increase-resilience>)
- [9] Nationale Plattform Elektromobilität, Fortschrittsbericht der Nationalen Plattform Elektromobilität. Berlin, May 2012.
- [10] TheiBing, K., Vorteile und Nachteile des Elektroautos. 2013 (<http://www.energie-fakten.de/html/elektroauto-vor-nachteile.html>)
- [11] California Environmental Protection Agency, 2015 Annual Evaluation of Fuel Cell Electric Vehicle Deployment and Hydrogen Fuel Station Network Development. July 2015.
- [12] Statista Dossier, Electric vehicles worldwide. April 2016.
- [13] U.S. Department of Energy, Charging Plug-In Electric Vehicles at Home. (http://www.afdc.energy.gov/fuels/electricity_charging_home.html)
- [14] eBusiness-Lotse Aachen, Leitfaden Elektromobilität. Aachen: April 2014.
- [15] Informationsdienst Wissenschaft, Elektrofahrzeuge kabellos laden und entladen. 2015 (<http://idw-online.de/de/news636663>)
- [16] Brandenburg, D., Aral Studie – Trends zum Autokauf 2015. Aral Aktiengesellschaft – Bereich Presse, Bochum, 2015
- [17] Europäisches Parlament, Begrenzung der CO2-Emissionen von PKW. February 2014 (<http://www.europarl.europa.eu/news/de/newsroom/20140221IPR36626/Begrenzung-der-CO2-Emissionen-von-Pkw>)
- [18] ZSW, Estimated electric vehicles in use in selected countries as of 2015. February 2016
- [19] Kraftfahrt-Bundesamt, Bestand in den Jahren 1960 bis 2016 nach Fahrzeugklassen. (http://www.kba.de/DE/Statistik/Fahrzeuge/Bestand/FahrzeugklassenAufbauarten/b_fzkl_zeitreihe.html?nn=652402)
- [20] European Commission, ELECTROMOBILITY – Guiding Europe’s journey towards greener transportation. 2016 (http://ec.europa.eu/research/infocentre/article_en.cfm?artid=25953)
- [21] Alphabet, Alphaelectric – Choosing the right car. 2016 (<https://www.alphabet.com/en-pl/alphaelectric>)
- [22] German Federal Ministry of Economic and Energy Affairs, Electric mobility. 2016 (<http://www.bmwi.de/EN/Topics/Economy/Industrial-policy/electric-mobility.html>)
- [23] W. MacDougall, “Electromobility in Germany: Vision 2020 and Beyond,” Germany Trade & Invest. February 2015.
- [24] Bundesregierung, Elektromobilität. Berlin, May 2013 (<https://www.bundesregierung.de/Content/DE/Infodienst/2013/05/2013-05-31-elektromobilitaet/2013-05-31-elektromobilitaet.html>)
- [25] Bain, Eine Million E-Autos in Deutschland bis 2020 nicht zu schaffen. December 2015 (<http://www.bain.de/press/press-archive/bain-analyse-zur-elektromobilitaet.aspx>)
- [26] Electromobility+ Call Secretariat and Pilot Group, Overview of Electromobility+ partners. 2016 (http://electromobility-plus.eu/?page_id=769)
- [27] Zentrum für Sonnenenergie- und Wasserstoff-Forschung Baden-Württemberg. Presseinformation 05/16 // Zahl der Elektroautos weltweit auf 1,3 Millionen gestiegen, 2016. Press information Stuttgart, February 2016.
- [28] Mc Kinsey & Company, Electric Vehicle Index (EVI). January 2016 (<https://www.mckinsey.de/elektromobilitaet>)
- [29] Technische Universität Dresden, Elektromobilität funktioniert?!. January 2016.
- [30] Gildemeister energy solutions, Ladezeitenvergleich. (<http://energy.gildemeister.com/blob/361428/ef50a5d6305bbfa3afd6221dc88e3eb1/bild-e-mobility-ladezeitenvergleich-data.png>)
- [31] A. Pehlken, S. Albach, T. Vogt, “Is there a resource constraint related to lithium ion batteries in cars?,” in Int J Life Cycle Assess, M. Cheng, Eds. Berlin-Heidelberg: Springer-Verlag, June 2015.
- [32] Bundesumweltamt. Strom- und Wärmeversorgung in Zahlen. June 2016 (<https://www.umweltbundesamt.de/themen/klima-energie/energieversorgung/strom-waermeversorgung-in-zahlen>)
- [33] H.-J. Wagner, CO2-Emissionen der Stromerzeugung – Ein ganzheitlicher Vergleich verschiedener Technologien. 2007 (https://www.vdi.de/fileadmin/vdi_de/redakteur_dateien/geu_dateien/FB4-Internetseiten/CO2-Emissionen%20der%20Stromerzeugung_01.pdf)
- [34] World Bank, POLAND’S GREENHOUSE GAS EMISSIONS. (<http://siteresources.worldbank.org/ECAEXT/Resources/258598-1256842123621/6525333-1298409457335/chapterA.pdf>)
- [35] K. Dietmayer, M. Buchholz, J. Wiest, “Autonomous driving and e-mobility, technical challenges and benefits,” 15. Internationales Stuttgarter Symposium, M. Bargende, H.-C. Reuss, J. Wiedemann, Eds. Wiesbaden: Springer, 2015, pp. 453-455.
- [36] S. A. Shaheen, N. D. Chan, “Evolution of E-Mobility in Carsharing Business Models,” Electric Vehicle Business Models, D. Beeton, G. Meyer, Eds. Switzerland: Springer, 2015, pp. 169-178.
- [37] Fraunhofer IAO, Making e-mobility user friendly. 2016 (<https://www.iao.fraunhofer.de/lang-en/about-us/press-and-media/1082-making-e-mobility-user-friendly.html>)
- [38] Statista, Führende Nationen bei der Elektromobilität nach dem Industrie-Electric Vehicle Index. 2016 (<http://de.statista.com/statistik/daten/studie/408719/umfrage/fuehrende-laender-bei-der-elektromobilitaet-industrie/>)
- [39] Electromobility+ Call Secretariat and Pilot Group, Electromobility+ - Boosting the role out of electromobility in Europe. 2016 (http://electromobility-plus.eu/?page_id=539)
- [40] Alphabet, Our approach. 2016 (<https://www.alphabet.com/en-ww/about-us>)
- [41] European Commission, Horizon 2020 – Smart Green and Integrated Transport. (<https://ec.europa.eu/programmes/horizon2020/en/h2020-section/smart-green-and-integrated-transport>)
- [42] Bosch Software Innovations Europe, The road to eMobility – eMobility Starter Package. (https://www.bosch-si.com/media/en/bosch_software_innovations/documents/brochure/mobility_1/emobility_starter_package_brochure.pdf)
- [43] Handelsblatt, Prognose zum weltweiten Umsatz mit Elektrofahrzeugen von 2010 bis 2030. February 2011, p. 27.

Innovative and sustainable building materials

binder, straw, loam

Annemarie Bunar
bunarann@b-tu.de

Jessica Heyde
heydejes@b-tu.de

Manja Schur
schurman@b-tu.de

Abstract—This paper describes the application of different innovative and sustainable building materials and explains their advantages and disadvantages under an ecological background.

Key words: Geopolymer concrete, Celitement, straw insulation, primary energy demand, loam, adobe brick

I. INTRODUCTION

The need to apply new materials being sustainable and at the same time as good as the conventional ones is obvious these days. Common concrete, steel or expanded polystyrene are highly used in almost every building, but already their production wastes much energy and influences our environment in a negative way like the removal too. For this reason we searched for alternatives with different applications and analyzed their potential to be suitable in sustainable building.

II. ALTERNATIVE BINDER IN CONCRETE

Nowadays, concrete is the most used building material worldwide and can be found in nearly every type of structure. Its high durability, strength and flexibility allow an almost unlimited variety of uses. However, concrete is not always the best option. Considering environmental issues, it still is in great need of improvement. The manufacturing process of concrete and especially its ingredients consume a lot of energy. Lowering the energy usage would provide a significant improvement for the concrete industry and the environment.

A. The downside of Portland cement

Concrete is made of cement, water, aggregate and additives (Fig. 1). The ingredient responsible for the superior features of concrete is cement. Mixed with water, it forms a rock-like material through the process of hydration. It is also cement which consumes a large amount of energy during its production process. Sintering the main ingredients limestone (calcium), clay, sand and iron ore at a temperature of 1450°C is considered to be a highly energy-intensive procedure [3]. However, this procedure is necessary to convert the raw materials into cement clinker. Furthermore, the use of fossil fuel and the burning of limestone releases carbon dioxide (CO₂) which increases the potential of global warming. Manufacturing one metric tonne of Portland cement releases nearly one metric tonne of CO₂. A large part (between 50% and 60%) of the CO₂ emissions is caused by sintering

limestone. The remaining amount of carbon dioxide emissions is a result of burning fossil fuel [2]. As a result, the global consumption of ca. 2 billion metric tonnes of cement means nearly 10% of the CO₂-emissions worldwide [3]. Lowering the amount of limestone in cements would therefore considerably improve environmental sustainability.

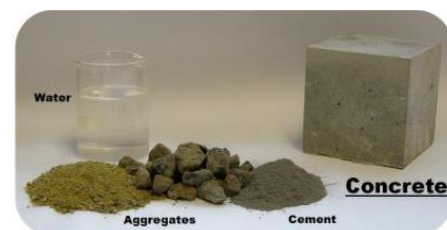

Figure 1. Conventional Portland cement concrete [10]

B. Composite cements

In order to reduce carbon dioxide emissions, the cement industry has already started to use composite cements. Composite cements have a lower amount of Portland cement meaning a lower amount of limestone and released carbon dioxide. Besides Portland cement, the mixture contains alternative materials such as fly ash or granulated blast furnace slag. They are considered as sustainable, since they are waste products from steel production. However, concretes with composite cements have some deficiencies regarding their material properties. Contrary to Portland cement concretes, composite cement concretes are often found not to be as resistant to the exposure to freeze-thaw or other extensive exposures. Therefore, composite cements could, without any doubts, still be improved. Furthermore, the amount of Portland cement still remains very high at nearly 80% (or higher). Thus, cement replacement materials are in great need and environmentally sustainable alternatives.

C. Innovative binder

There are already a few known alternatives to Portland cement which were developed during the last 3 decades and will soon be market-ready. One of them is, e.g., geopolymer. Geopolymer concrete (Fig. 2) has a higher durability than Portland cement concrete, and its production is more sustainable, since the CO₂ emissions are significantly lower [10]. The downside of this innovative binder is the purchase of raw materials. The main ingredients for geopolymer, silica and alumina, turned out to be very expensive [1]. Nonetheless, the alternative binder has a large potential for application, since its

high compressive strength and durability have shown to be very effective.



Figure 2. Geopolymer concrete [10]

However, a more promising alternative is a binder named Celitement developed in Germany at the “Karlsruher Institut für Technologie“(KIT) [4] (Fig. 3). Celitement is a hydraulic binder similar to Portland cement, meaning it reacts chemically with added water. Contrary to conventional cements, Celitement contains a small amount of water from the start. Therefore, the process of hydration is not solely depending on the addition of water but the amount of water. Using limestone and sand as main ingredients, Celitement may not seem to be much different to Portland cement. The difference lies in the fact that the amount of lime in Celitement is significantly lower. Furthermore, sintering temperatures are just around 300°C, whereas Portland cement needs a temperature of 1450°C. As a result, Celitement is more energy-efficient and has a lower carbon footprint than Portland cement. As a matter of fact, the CO₂ emissions would be reduced by 50% [4]. Thus, the environmental issues of Celitement are considerably better than the ones of Portland cement. In addition to that, the process technology of Celitement concrete is known and proven, since it is the same as Portland cement concrete. Furthermore, the alternative binder is compatible to Portland cement implying miscibility with other cements, a known workability and a similar hardening process. The homogeneous composition of Celitement enables a precise control of properties. The high resistance is caused by interconnected silicate phases.

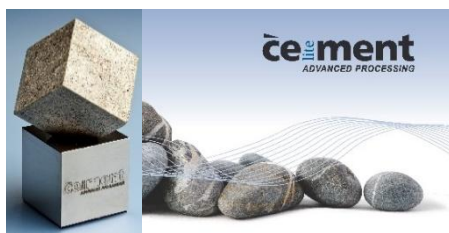

Figure 3. Celitement [4]

Overall, innovative binders like Celitement or even geopolymer would provide an excellent alternative to conventional cements. They are shown to be superior in terms of material consumption, CO₂ emissions and global warming potential.

III. STRAW AS A RESURGING BUILDING MATERIAL

Straw was already used as a building material more than hundred years ago, and even today, we can often see thatched roofs in the north of Germany. However, due to the rapid development of conventional materials it took a back seat. As

a result of the increasing interest in energy-saving and ecological construction in the last years, the sustainable resource straw comes back to the house builders’ fore. In several buildings all over the world, it could successfully prove to be an ideal and, at the same time, cost-efficient material.

A. Production

Building straw bales are made of crop straw (wheat or rye) compacted into a prismatic bale with a density of 85 to 115 kg/m³. With regard to moisture proofing, a water content of 18 mass-% should not be exceeded. Synthetic or sisal yarns are used to tie the bales. So far, there is only one licensed producer in Germany (Firma Baustroh) [5].

B. Sustainability

The ecological advantages of straw are obvious. It absorbs climate-damaging carbon dioxide while growing (88kg/m² for a straw-insulated timber structure [5]) and contributes to the reduction of global warming. Furthermore, this annually renewable plant is regionally available and an agricultural by-product, 20 per cent of which is not required. For this reason, a wooden framework insulated with straw has a 6 times lower primary energy demand (59kWh/m²) than an equivalent sand-lime brick wall with an external thermal insulation composite system (401 kWh/m²) [5]. Even the removal of the straw is easier than with conventional building materials. After its period of use, straw can be disposed of by composting or thermal utilisation.

C. Applications

Apart from roof covering, there are two main uses of straw. In Germany, straw insulation is the most common one. Therefore, a load-bearing timber framework is infilled with bales of straw (Fig. 4). Another method is to attach the insulation externally to the supporting structure. Then the wall is either plastered directly or encased with boards. In addition, it is possible to subsequently insulate a building by establishing a wooden, straw-filled structure connected with the existing walls. Straw can be used to insulate roofs as well as for placing the bales sublayer between the rafters. The handling of the bales is simple and easy to learn and therefore can also be done by beginners [6]. In addition, the building time is very short.



Figure 4. Timber framework with straw infill [5]

According to the official admission, the thermal conductivity value λ of straw is 0.052 W/(mK) (in comparison: mineral wool 0.039 W/(mK)) [5]. With the general insulating width of around 35cm (upright standing bale) and both-sided plastering, the wall reaches a U-value of

0.12 W/(m²K) which is better than the requirements for low-energy houses (0.20 W/(m²K) [6]). Moreover, straw has a high heat storage capacity leading to a comfortable thermal behaviour especially during the summer period. However, the needed width is definitely a disadvantage of straw insulation, because it causes very massive walls and needs a large area.

Apart from insulation, straw bales can be load-bearing members too. They are staggered like bricks in a masonry wall with the stems being horizontally oriented (Fig. 5). The lower bales are skewered on steel or wooden sticks connected to the foundation. Right on top of the wall, a solid ring beam made of wood or concrete distributes the roof loads uniformly to the bales [6]. Straw is quite a soft material and this property results in big settlements under load. Therefore, plastering should not be applied before the end of the setting time (around 6 to 8 weeks). It is possible to generate the whole settling in less time by pre-compressing the walls with threaded bars and tension belts [6]. In Germany, in individual cases, the construction of a building with load-bearing straw walls requires special authorization.

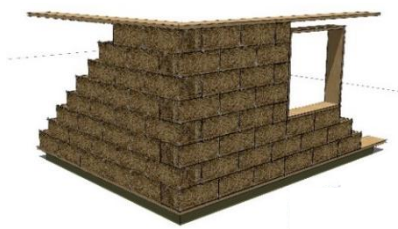

Figure 5. Load-bearing straw structure [5]

D. Structural-physical issues

Moisture can cause mould and initiates the composting of straw. Therefore, straw should only be inserted, where timber can also be used without any problems. Moreover, the bales have to be protected from rain during both storage and assembly. Wet material must not be built in. Concerning the wall structure, the particular courses have to be water-vapour permeable and an anti-capillary layer above the foundation and a moisture barrier prevent raising damp [6]. In case of a high driving rain load, a wooden facing and a tall roof overhang can help reduce the risk of mould appearance inside the straw insulation [6].

While loose, dry straw catches fire very fast, compressed straw hardly burns, since there is little oxygen in the bale. For this reason, bales of straw can be classified into class B (regular combustible). In experiments, a wall of straw insulation with a both-sided plastering could resist fire for more than 90 minutes (fire rating F90) [6].

In terms of rodents and insects, bales of straw are not any more susceptible than other materials. The tight compression prevents the formation of cavities where animals could nest [6]. Moreover, the straw does not longer contain amylaceous grains which could attract rodents. However, it is always important to build a cladding without any openings.

E. Conclusion

In fact, nowadays straw is one of the most adequate materials for sustainable and environmentally conscious building. It possesses a high functional potential and is not inferior to conventional and industrially produced insulations. Due to the regional availability and the possibility of self-made construction, straw is even a cheaper alternative and also accessible for people with a low budget. In addition, with a well-performing insulation, the operating costs of a building will be decreased as well. Moreover, building permission for a straw insulated house can be obtained without any great effort. Certainly, the use of load-bearing straw structures will also be explored in Germany within the next years to establish a better practicability.

IV. LOAM AS A NATURAL SUBSTANCE

Loam is one of the oldest binders, and, next to timber, it is also one of the oldest building materials. In history, many houses were made of loam. Nevertheless, loam as a building material was not used very much in Germany for quite a long time. That is because the application of loam in the building industry was very complex, due to the time-consuming processing and the drying time. Fortunately, this changed some time ago with the invention of new techniques of building with earth. Nowadays they form the plastic mass in factories and after drying it is much easier to work with. These are called prefabricated loam building materials, e.g., loam building boards and loam bricks.

A. Properties

Loam is an ideal material for the modern building of a house and also for healthy living. It can absorb excessive moisture from the air very quickly and it can also emit it again. Furthermore, unlike other building materials, loam can balance changes of temperature. Therefore it creates a room climate of high quality [8]. In addition to that, walls made of loam also absorb air pollution and bind dust. Another advantage is that loam has a good sound insulation. Because of its low moisture content, it can protect timber structures, and consequently a chemical wood preservative is not necessary [8].

There is some loam especially used for building. It can be natural loam which might be optimized with aggregates or recycled loam [9]. Natural loam consists of sand, clay and silt. The clay functions as the binder of the material. Since clay is available almost everywhere, it does not have to be transported over long distances, and the processing does not require high energy expenditures. Loam can replace building materials that use a lot of energy in their production [8]. Otherwise, there is a clear and not very complex cycle of loam used for building as well (Fig. 6). It also means that companies appreciate to recycle loam to make new elements. However, it is only possible if the material is not polluted [9].

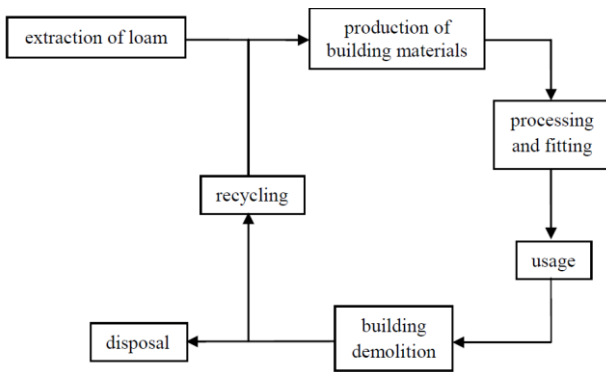

Figure 6. The cycle of loam [9]

One disadvantage of using loam is that it is a natural product and therefore has varying properties depending on its use. For this reason, special calculations with regard to different applications are needed.

B. Building materials

Several building materials made of loam have been found. In this paragraph, four of them are only mentioned but, of course, there are a lot more inventions.

Because of the development of loam building boards, it is now possible to use loam in dry construction. Besides, it is also used for covering timber structures, such as ceilings and roofs [7]. The purchaser can get different designs of building boards depending on the producer. They do not apply a heat treatment and therefore all the positive properties of loam remain. Building boards have a good sound insulation as well.

An adobe brick is a formed brick made of loam that dries in the air, meaning that adobe bricks only need a small amount of energy during their production, because a kiln with high temperatures is not needed (Fig. 7). Adobe bricks can be used for load-bearing parts of a structure, such as exterior and interior walls. Furthermore, it is also possible to fill the spaces in a half-timbered structure. After the brick has dried, the building workers can lay them with mortar. The mortar can also be loam. The amounts of the different ingredients depend on the later use of the adobe brick. If necessary, light aggregates can be added. That is how the bricks get both a high compressive strength and a good ability to store heat. However, if they are used for outer walls it is advisable to put up a layer of heat insulation as well [7]. Adobe bricks also have good sound insulation qualities.



Figure 7. Kindergarten Sorsum, vault made of loam bricks [9]

Building with rammed earth is a very common technique. They either use earth-moist loam to make walls on the building site and it has to dry there or it is also possible to use prefabricated walls made of rammed earth. They have already finished drying when they are transported to the building site. With on-site application, a formwork is required to make rammed earth walls. Therefore, there are no joints and the walls can be load-bearing elements [8]. It is also possible to mix loam with straw.

A wall made of loam and a wall heating is a good combination [7]. Another possibility is to put up a normal wall made of masonry or concrete, and a wall heating can be installed on the surface. Finally, they cover it with loam plaster. The heating evenly warms the wall or the plaster. Therefore, the wall also works as a thermal store and is a good heat conductor. They say this heat feels better than the warmth of traditional radiators that warm the air and circulate it in the room. For this reason, when using wall heating, the flow temperature can be a bit lower [9]. To achieve effectiveness, furniture should not block the walls and the heating should be installed on the internal wall. In connection with walls made of loam, there are two ways of heating [9]:

- Wall heating with heating coils filled with water
- Wall heating as a warm air system

V. CONCLUSION

During our studies, besides the materials mentioned in the article, we discovered many others with a lot of potential such as bamboo, reed and nanotechnology. The possibilities are various and combine several advantages that emphasise the increased efforts and the need to do more research into this subject. We are sure the employment of sustainable materials will increase within the next years and the benefits will be appreciable for everyone.

REFERENCES

- [1] M. N. Fardis, *Innovative Materials and Techniques in Concrete Construction*, New York, Springer, 2012
- [2] National Ready Mixed Concrete Association, *Concrete CO2 Fact Sheet*, February 2012
- [3] J. Hüniger, *Innovative Bindemittel*, BTU-Cottbus, 2014
- [4] <http://www.celitement.de/de/celitement-bindemittel.html> (04.06.2016)
- [5] D. Scharmer, *Strohgedämmte Gebäude*, Fachagentur Nachhaltende Rohstoffe e.V., 2013
- [6] H. and A. Gruber, *Bauen mit Stroh*, 2nd ed., Stauffen (Freiburg), ökobuch, 2003
- [7] A.-L. Huber, T. Kleespies, P. Schmidt, *Neues Bauen mit Lehm – Konstruktionen und gebaute Objekte*, 1st ed., Stauffen (Freiburg), ökobuch, 1997
- [8] K. Schillberg, H. Knieriemen, *Bauen und sanieren mit Lehm – Kork, Hanf und Schilf in modernen Lehmbautechniken*, Aarau (Switzerland), AT Verlag, 2001
- [9] H. Schroeder, *Lehmbau – Mit Lehm ökologisch planen und bauen*, 2nd ed., Springer Vieweg, 2013
- [10] <http://blogs.qub.ac.uk/geopolymer/geopolymer-background/> 17.06.2016)

How realistic was the version of DESERTEC

Schwarz, Christian; Master Student MSc Power Engineering, BTU Cottbus-Senftenberg

Abstract—Based on the principle idea of desertec, which can be found in the literature, an investigation will be made how many solar thermal power stations of the size of Noor 1 power plant (start of operation in Feb. 2016) in Morocco will be needed in the Sahara region to supply the energy demand of the north African states. Based on the existing transmission technology on the ultra high voltage level, it will analyzed how many transmission lines will be needed between the north African grid and the European Interconnected system to supply 10 ... 25% of the needed energy in Europe from the Sahara region.

Index Terms—Desertec, Solar thermal power plant, Andasol, Noor 1, Demand of electrical energy in Northern Africa and Europe.

I. INTRODUCTION

THE principle idea of desertec was to produce electrical energy from the solar thermal power plants in the Sahara region to supply the electricity demand of the Northern African states and parts of Europe. Starting from 2003 this project founds a lot of supporters throughout the world. In 2015 the desertec foundation was terminated. In the following contribution some investigations will be made on how realistic this project was from the technical point of view.

II. THE VISION OF DESERTEC

In the year 1913 the first solar thermal power plant was build up in Egypt by the American engineer Frank Shuman, who had the vision of the global supply of energy from the desert region in the world. Then 90 years later, his idea was taken up by the German branch of the Club of Rome and others. In the year 2004 the first feasibility study was conducted by the DLR, the German Center for Aerospace. The result of the feasibility study was that in principle enough renewable energy sources are available in Northern Africa to supply the countries of North Africa and parts of Europe. The following figure 1 shows the outline of the desertec project according to the first feasibility study of the DLR. There is pointed out that the renewable generation sides as well as conventional power stations should be located mainly along the African coast line and will be interconnect by different sea cable to Europe and a land connection via Syria and Turkey.



Fig. 1: Outline of Desertec project according to DLR study [1]

The potential of the solar thermal power depends on the solar radiation which is strongly linked to the global positioning of the installation. The energy density of the solar radiation in Northern Europe is about $1000\text{kWh}/(\text{a}\cdot\text{m}^2)$, which is much lower than in Southern Europe with $1800\text{kWh}/(\text{a}\cdot\text{m}^2)$. The highest value of the solar radiation can be found in Africa with $2500\text{kWh}/(\text{a}\cdot\text{m}^2)$. The overall radiation in Europe and Africa can be taken from Fig. 2 and Fig 3.

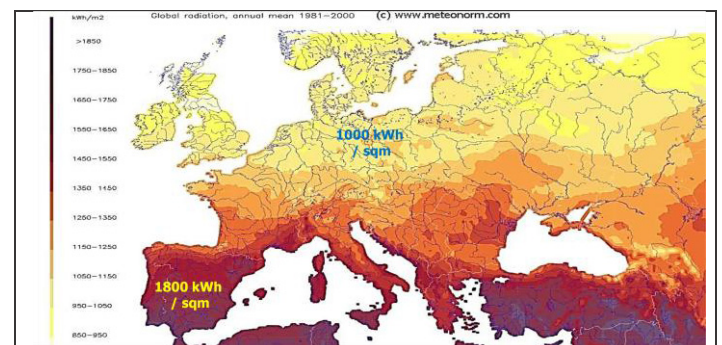

Fig. 2: Solar Radiation in Europe [2]

To produce electricity, solar radiation can be used in two different ways. The first technology is the photovoltaic. With the help of semi conductive elements, the solar radiation can be transformed direct transform into electricity. The problem of this technology is that the electric generation is very strongly linked to the solar radiation.

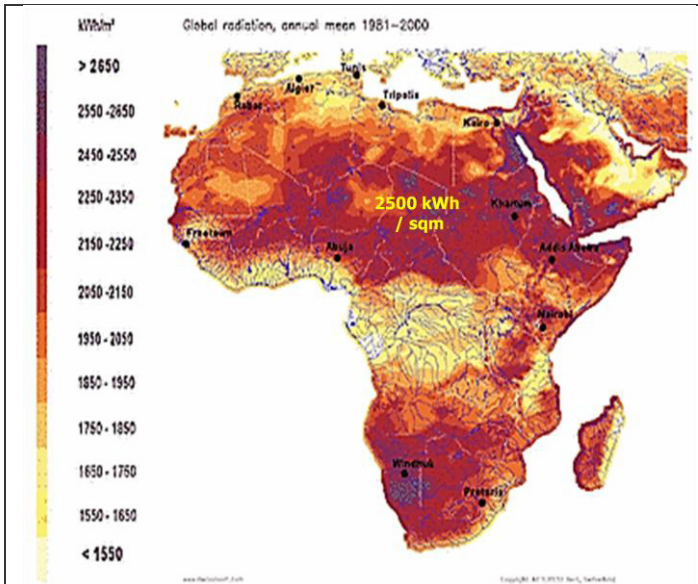

Fig. 3: Solar Radiation in Africa [3]

If any clouds will occur, electricity production will stop immediately. The same will also happen during the very fast sunset in the desert regions. Huge external storages will be needed to follow the demand.

The second possible technology is the solar thermal generation. In this process, the water will be heated by the solar radiation in the tubes with the help of mirage. The principle illustration of this is shown in the following Fig. 4.

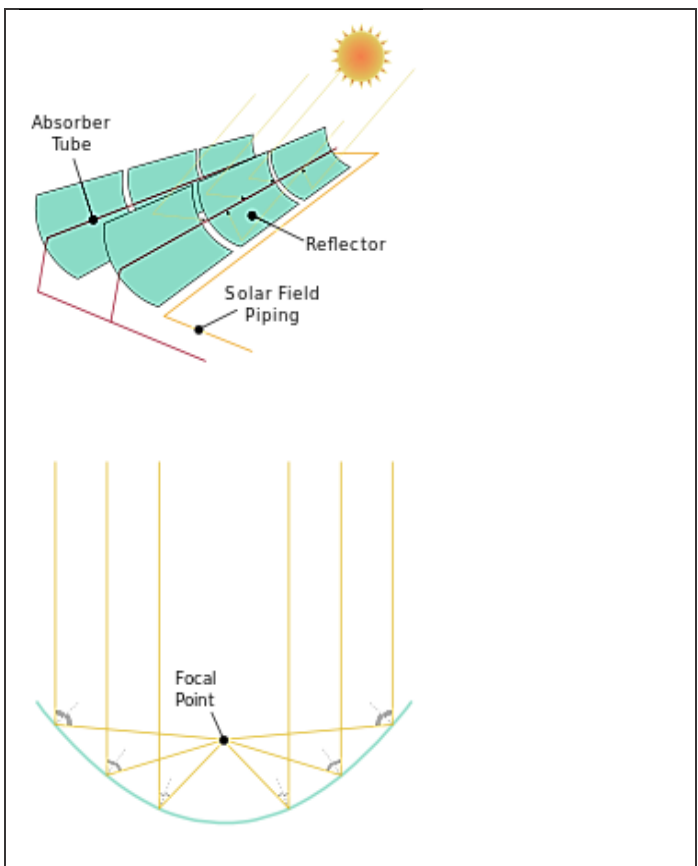

Fig. 4: Principle Illustration of the solar thermal process [1]

The heated water in the tubes will be transformed into steam. This steam operates a turbine, which generates electricity. The main technical advantage of this technology is, that the thermal energy can be storage easily into liquidized salt and so such a system can follow better the electricity demand of the consumers. The following figure 5 shows the complex system of the solar thermal power plant.

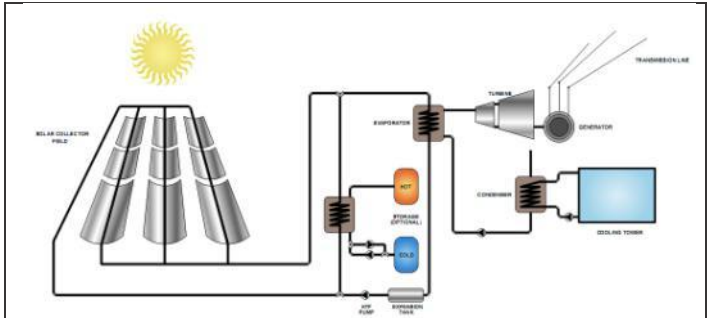

Fig. 5: Principle Illustration of the different components of a solar thermal power plant [4]

In the following figure 6 the power station in Andasol in Spain is shown as an example of a solar thermal power plant. The technology of this power plant is very similar to the ones planned to be used in the Sahara desert. Therefore Andasol power station can act as a kind of training side for DeserTec. Especially the large salt storage in Andasol is an interesting test object, to evaluate the behavior of the whole system. This storage is the large flat silo to be seen in fig. 6. This storage for thermal energy is designed to produce electricity for several hours, even if there is no sun.



Fig.6: Andasol Solar Thermal Power Station in Spain

In the past decade the DeserTec project found a lot of supporters throughout the world. Focusing on African countries the interest in this project depends strongly on how far the country is located away from the DeserTec region.

A. The Position of Morocco to DESERTEC

Mr. Said Mouline, who is the director of the Moroccan Agency for the development of renewable energy, has a very positive position to DeserTec. He welcomes the European plan, to use the solar radiation in the desert in Morocco. Mouline hopes that the desertec project will bring investments and work to his country and reduces the dependence from oil. Furthermore he hopes that the mirages could be produced in the new industrial region of Morocco due to the low laboring costs there and so can contribute to reduce poverty in the country. Due to these hopes, the Moroccan people will have less reason to leave Morocco. A first step in this direction was done by a Spanish company, which built up a new and big power plant at the border to Algeria, which used a combination of natural gas and solar thermal.

B. The Position of South Africa to DESERTEC

Mr. Saliem Fakir, who is the head of the living planet unit at the world wildlife fund in South Africa pointed out, that the benefits of the DeserTec project will be focused only on Europe and Northern Africa. The energy costs of solar thermal power generation are much higher than from biomass.

Due to the economic situation in South Africa biomass will be the most used energy resource for a very long time. A lot of interesting projects on renewable energies are on the way in South Africa. Nevertheless it will take a very long time to change the situation significant. In a first approach, nano- or pico-solution, for example off-grid photovoltaic installations with "some watts" will be a first step in the right direction.

C. The Position of Ethiopia to DESERTEC

Mr. Hilawe Lakew, who is a managing director of an energy and environmental consulting company in Ethiopia pointed out, that countries like China and India have increased their global technology activities for production and usage of renewable energies. Unfortunately Africa did not move in this direction. He also made clear, that the renewable energies are everywhere high on the agenda in economically, politically and ecologically discussions, but in the countries of Africa the renewable energies are not on the agenda. So there is a high risk that Africa again will come in a position, only to deliver resources without having any positive impact.

III. THE ENERGY DEMAND OF AFRICA AND EUROPE

The Energy demand of the countries in northern Africa is very low and between 14 TWh and 41 TWh in the year 2011, with the exception of Egypt, which has an energy demand of 138TWh in the same year. The detailed information is compiled in the following table 1.

Country	Energy Demand in 2011
Egypt	138 TWh
Libya	24 TWh
Tunisia	14 TWh
Algeria	41 TWh
Morocco	27TWh
Germany	581TWh

In the table the energy demand of Germany with 581TWh in the year 2011 is also given. The demand for Europe in total is much higher and it is shown in the following table 2. The table shows the energy produced, the energy demand and the peak load in Europe for the years 2010, 2011 and 2012.

Year	Generation	Demand	Peak load
2010	3.400 TWh	3.360 TWh	521 GW
2011	3.377 TWh	3.339 TWh	473 GW
2012	3.383 TWh	3.336 TWh	481 GW

With the DeserTec project it was planned to produce in the Sahara region also 10% up to 25% of the energy demand of Europe. These values are shown in the following table 3.

Year	10%	15%	20%	25%
2010	336 TWh	504 TWh	672 TWh	840 TWh
2011	334 TWh	501 TWh	668 TWh	835 TWh
2012	334 TWh	501 TWh	667 TWh	834 TWh

Based on table 3 a transport capacity of 300 TWh up to 800 TWh will be needed between North Africa and the European Interconnected Grid. To define this transport capacity assumptions have to be made on the power profile of this energy delivery. Because there are no data available in the literature to this profile, it will be assumed that the feeding profile from the DeserTec region to Europe will follow in principle the European load profile, reduced down to the factor 10...25%. The results can be taken from Tab. 4.

Year	10%	15%	20%	25%
2010	52,1 GW	78,15 GW	104,2 GW	130,25 GW
2011	47,3 GW	70,95 GW	94,6 GW	118,25 GW
2012	48,1 GW	72,15 GW	96,2 GW	120,25 GW

Therefore it is necessary to have a transport capacity of 50GW up to 130 GW between North Africa and the European Interconnected Grid.

IV. THE TECHNOLOGY NEEDED / AVAILABLE TO REALIZE THE DESERTEC PROJECT

Morocco plants to expand its production of energy from renewable sources up to 2.000 MW in 2020. The first solar thermal power plant (Noor 1) started its operation in February 2016. The power station Noor 1, shown in Fig. 7 has a capacity of 160MW and will generate electricity for 350.000 people. The expected production is approximately 300GWh per year.



Fig. 7: Solar thermal power plant Noor 1 in Morocco

In the following up figure 8 the whole huge dimension of Noor 1 can be seen in Morocco. The solar thermal power plants Noor2 up to Noor 4 are either under construction or in planning phase and will have another capacity of approximately of 400 MW. The power plant will have a storage capacity of about supply full load for 3..5 hours.



Fig. 8: Total view on solar thermal power station Noor 1 in Morocco.

To produce the energy mentioned in tab.3 up to 4.000 solar thermal power stations in the size of Noor 1 has to be commissioned in the Sahara region.

Actual the European interconnected HVAC system is only linked to northern Africa by a low power connection through the street of Gibraltar and a connection via the Near East States. This both connections can be seen in the European Transmission Grid Map, shown in the following figure 9.

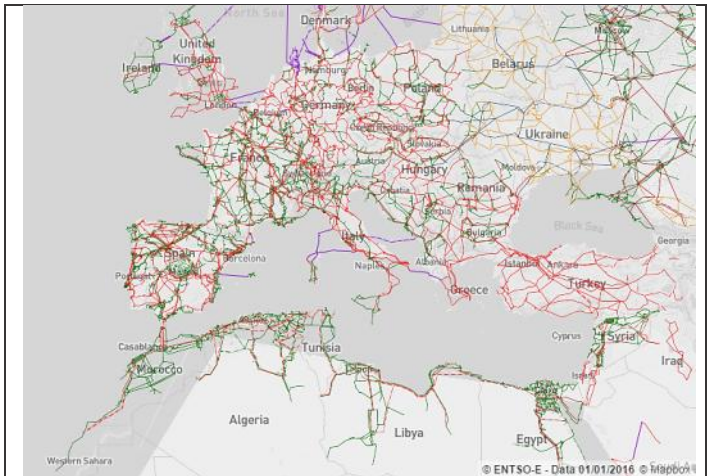

Fig. 9: The European Interconnected Grid and the Power Grid of Northern Africa

Some first idea, which can be taken from the literature for the interconnection of the DeserTec project with the European power system, is shown in figure 10.

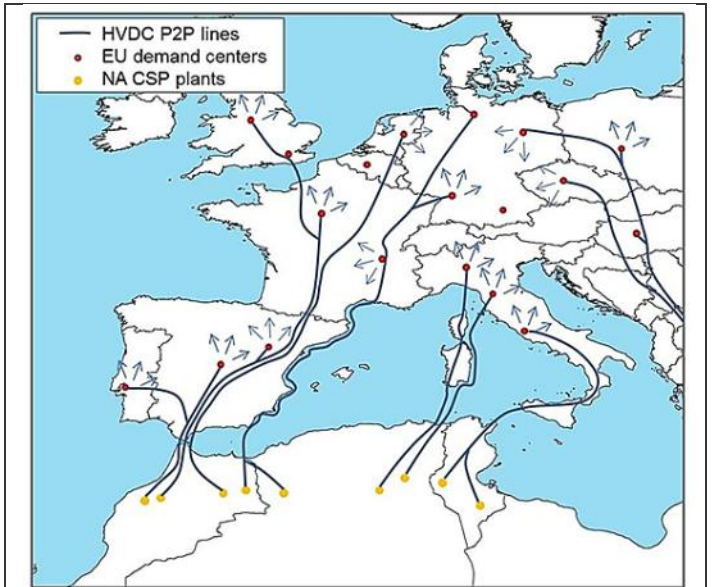

Fig. 10: First Idea of Interconnection between DeserTec and the European Power System [5]

In the basic concept studies for DeserTec an HVDC grid was published to collect the renewable generation from the Sahara region. Unfortunately there is no technology on the market to run a HDVC grid. Only HVDC-links from A to B, possibly with one station C in between can be operated. To run a grid, HVDC circuit breakers and other components will be needed, which do not exist yet. The energy should be transported with the help of the HVDC technology. Therefore it will be investigated, how many HVAC lines, HVDC lines or cables will be needed to realize the a.m. transport capacity between Northern Africa and Europe. Actual available are HVAC overhead lines up to 800 kV at several places in the world. China meanwhile developed AC-lines up to 1.000kV and 4.000 MW per system, which can be seen in Fig. 11.



Fig.11: Power pole of a HVAC system with 1.000 kV [12]



Fig. 13: Deck of the ship with the undersea cable [14]

To pass the Mediterranean Sea cables will be needed. Due to their high demand on reactive power, AC cables cannot be used to bridge the distance between Africa and Europe.

A possible technical solution to pass the Mediterranean Sea is to use under sea HVDC cable as a 2-terminal system, where the circuit breakers are installed before / behind the inverters on the AC side. The maximum voltage of undersea cables actually is 600kV with a power of 2.500 MW per system. Special ships (see Fig. 12) are needed to lower such cables in the sea.

The lowering of the HVDC cable into the sea must be done very carefully, as it can be seen in figure 14.



Fig.12: Special Ship for the laying of undersea cables [13]



Fig. 14: Laying of HVDC lowered into the sea [15]

The next image 13 shows the deck of such a special ship with the undersea cable in the middle.

The interconnection between the HVDC undersea cable on 600 kV bases and the on-shore overhead transmission lines can be done either by converter stations, if HVAC lines were used or direct connection to HVDC lines. The technology of HVDC overhead lines is available up to 600 kV on several places in the world. In China the first 800kV DC overhead line system is under testing. The capacity of this system is up to 2.500 MW per system.

The next picture shows a power pole of a HVDC system.



Fig. 15: Power pole of a HVDC system with 800 kV [11]

Based on the actual technical solutions an interconnection between North Africa and Europe will be possible on HVDC overhead lines and cable with about 600 kV and 2.500 MW transport capacity per system. Due to the investigation shown in Tab. 4, up to 50 of these systems will be needed, passing through the Mediterranean sea. The operation of these cable system are actually only possible as A to B connections. For a full grid operation, several new components have to be developed.

V. SUMMARY

The electricity, generated in the Sahara region will increase North African states only from 240TWh in 2011 to approximately 400 TWh in 2020. Additionally 300TWh up to 800 TWh has to be generated for Europe in the Sahara region. In total between 540TWh and 1.200 TWh of electricity should come from the DesertTec project. Therefore, between 1.800 up to 4.000 times the installation of the solar thermal power plant of Noor 1 will be needed in Northern Africa. Due to the size of Noor 1 and also the generation costs, this seems to be unrealistic. Nevertheless if the international community wants to move into this direction, the needed transport capacity to Europe seems to be realistic to build up. Such a capacity of 50GW till 130 GW will lead to 20 up to 52 HVDC lines of sea cable connection on 600 kV. Due to my opinion, this is a real challenge and very expensive, but possible.

REFERENCES

- [1] <https://www.impulse.de/unternehmen/desertec-bleibt-strom-aus-der-wueste-eine-fata-morgana/2007231.html>
- [2] <http://www.paradigma.de/globalstrahlung>
- [3] <http://www.renewable-energy-concepts.com/german/sonnenenergie/sonnenkarten/sonnenkarte-afrikas.html>
- [4] <http://www.welt.de/wirtschaft/article8166662/Solkraft-aus-Afrika-bleibt-Zukunftsmusik.html>
- [5] <http://www.dlr.de>
- [6] <https://www.boell.de>
- [7] <http://www.welt.de>
- [8] <http://www.spiegel.de>
- [9] <http://green.wiwo.de>
- [10] <http://www.fr-online.de>

- [11] <http://www.inmr.com/worlds-highest-hvdc-line-delivers-power-totibet/>
- [12] <http://www.inmr.com/composite-insulators-application-uhv-ac-dc-transmission-lines/>
- [13] <http://subseaworldnews.com/wp-content/uploads/2015/02/Nexans-Subsea-Cables-for-NordLink-Project.jpg>
- [14] <http://img.cdn2.vietnamnet.vn/Images/english/2014/02/07/16/20140207160928-2.jpg>
- [15] <http://subseaworldnews.com/wp-content/uploads/2012/03/Subsea-Cable-to-Link-Brazil-and-Angola.jpg>



Christian Schwarz was born in Mannheim, Germany, in 1992. In 2012, he finished the Max Steenbeck high school with the university-entrance diploma. Starting from fall semester 2012/2013 he began his bachelor studies in electrical engineering at the Brandenburg University of Technology Cottbus-Senftenberg. He is currently enrolled as a student in the master's program Power Engineering at the same University. During his studies he made some practical experiences within Vattenfall Europe Mining and Generation and German E-Cars Research & Development. From 2012 to 2014 he was employed as a student assistant at the department of energy distribution and high voltage engineering. He has written several internal reports during his time at high school and within the bachelor program.

From low energy houses to plus energy houses

Is it necessary to save even more energy?

Sophie Auch

In collaboration with the Chair of Energy Distribution and High Voltage Engineering
Student of Civil Engineering at BTU Cottbus-Senftenberg
Cottbus, Germany

Anika Maier

In collaboration with the Chair of Energy Distribution and High Voltage Engineering
Student of Civil Engineering at BTU Cottbus-Senftenberg
Cottbus, Germany

Abstract—The objective goal from the EU guideline of the total energy-efficiency is the zero energy houses. The research took a long time but now it is actually possible. This paper represents the advantages, disadvantages, prospects and limits of energy-saving construction.

Keywords- low energy house; passive house; zero energy house; zero heat energy house; autarkic house; plus energy house; Energy Saving Ordinance

I. INTRODUCTION

The Energy Saving Ordinance defines limits for heat losses because of transmission and how much primary energy per square meter of heated floor space annually is allowed to be produced. Till 2050 CO₂ emissions shall be halved and renewable energy sources shall be researched. Most houses should be energy efficient till then. Old houses don't have to fulfil the ordinances rules. If possible they can be renovated or additionally be insulated to get better energy efficiency. Environmental protection is maybe the most important reason why people want to build houses with low-energy standards. Another reason may be the high comfort which is a result of high standards that will not soon be replaced by new ones, so that investing in low-energy houses or something similar leads to long-term value conservation. For more than 30 years people were researching on earth positive liveable buildings.

At the beginning of the 90s low energy houses have been the future, but now they are legal minimum standard for 15 years. The result of intensive research are low energy houses with KfW 70, 55 and 40 standards, passive houses and zero energy houses.

II. LOW ENERGY HOUSES

A low energy house originally meant a house whose power consumption for heating and warm water fell 25% below that of the old Thermal Insulation Ordinance from 1995. It now means a house that uses less energy than an average contemporary house does. The contemporary house serves as a reference to compare whether a house can be called a low-energy house and has at least a KfW-100 standard, which means that the house does not use more than 100 kWh/m² energy annually. If a house is producing less than 70% of the primary energy of the reference house it can be called low-energy house. The German credit institution KfW (=KreditanstaltFürWiederaufbau) supports clients for whom low-energy buildings are being built or the refurbishment of old houses with loans. Typical renovation steps are the installation of a photovoltaic system, the insulation of the buildings envelope, the modernization of the heating system or the exchange of windows and front doors. The less energy the house produces the more money the clients get. Low energy houses look exactly like any other building, but are characterized by a small CO₂ emission and an efficient heating system consisting of a combination of gas condensing boilers

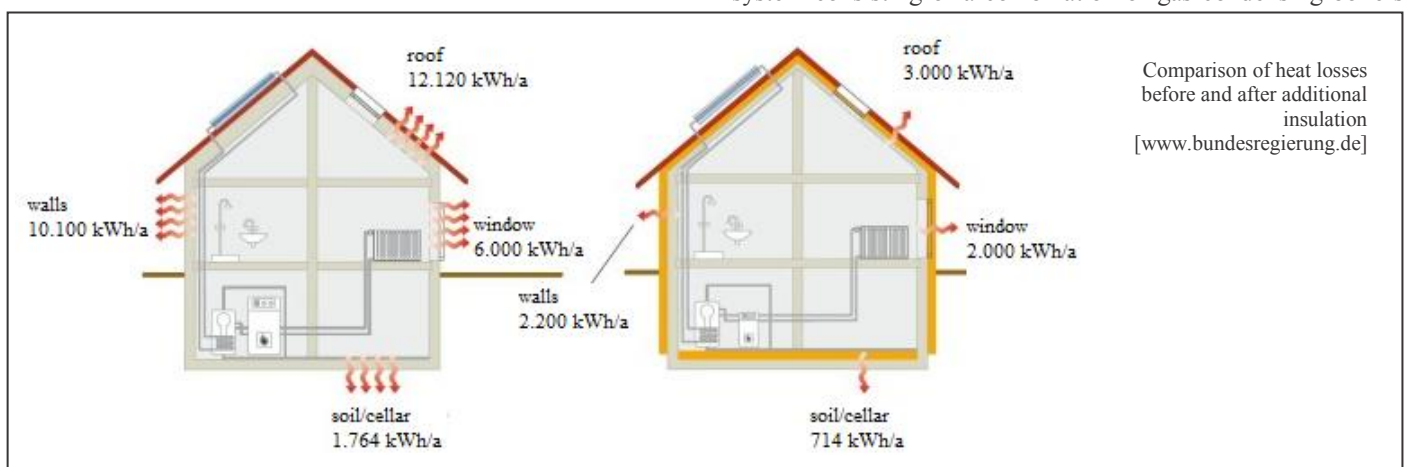

Figure 1: Comparison of heat losses

and solar thermal. Alternatively there can be used pellet heaters or heat pumps. The heat energy consumption is round about 2/3 smaller than in not rehabilitated buildings. Walls, baseplate and roof are insulated. The house is constructed airtight. A central ventilation system ensures that the warmth stays in the building by extracting heat from the exhausted air and adding it to the fresh air. The annual primary energy demand must not exceed 100 kWh/m². The Energy Saving Ordinance sets energetic standard values for every single component of the building.

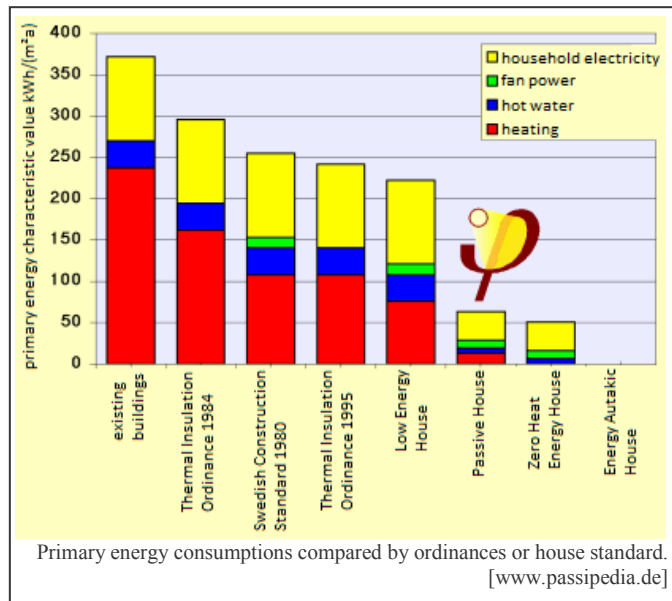

Figure 2: Primary energy consumptions

III. PASSIVE HOUSES

In a passive house the demand of energy for warm water and heating are solely produced by passive heat inputs through photovoltaic, solar thermal and heat pumps. Characteristically is a high insulation standard. The buildings envelope is constructed airtight and windproof. Thermal bridges should be avoided. There are large area glass fronts in the South to pass in warmth, wherefore in summer sun blinds are necessary. The windows persist of three-pane glazing to keep the warmth within the house. The maximum annual demand of primary energy besides heating and warm water consists of the energy for pumps, ventilators as well as the electric lightning and all kind of household aids. The limit therefore is 120 kWh/(m²a). It is important to include every source of energy because they all give off heat. Heaters are missing because of adjustable ventilation systems that spread the warmth to every room by using heat recovery systems. The thermal heat production can also be assumed by the hot water generation. It is even possible to use conventional building services as long as the annual heat demand falls below 15 kWh/(m²a). A passive house is easy and economically projectable and buildable, dependable, technically uncomplicated, user-friendly and comfortable but it is required to educate architects, engineers and workmen to make passive houses a standard. Innovative building materials like glazing with a lower heat transmission coefficient, insulated door and window cases or prefabricated elements to reduce thermal bridges can help introducing the standard.

IV. ZERO ENERGY HOUSES

Zero energy houses can be differentiated between zero heat energy houses, normal zero energy houses and completely zero energy houses, which are autarkic. The differences among these types, we want to explain in this part. Zero heat energy houses, are buildings whose annual heat demand is zero by definition. These buildings cancel each other out. They still need an electrical connection, justified by equipment like a fridge, washer, dishwasher, light and internet. Discontinuation of inner heat sources is not welcome in winter. The energy consumption has to be so small, that it is possible to have a sustainable feed. Our conclusion for that type of house is that it is from an ecological point of view not necessary to build these houses. Thereby arise more expense and effort, than the people profit.

Normal zero energy houses are buildings which produce as much energy for hot water and heating as they dissipate. There is a balance between energy production and usage. Zero energy houses have a heat demand. They have an electrical connection for the same reason as zero heat energy houses do.

Zero energy houses which are completely autarkic don't need any final energy from outside of its piece of land. Excluded are only natural energy flows like solar radiation, wind and as the case may be underground water. This type of house uses thermal rest energy out of solar panels to heat the water and to produce power. Wasted energy from summer is retained as hydrogen in fuel cells and is burned in winter.

Energy autarkic means that they don't refer to external energy. They feed themselves drawn on all applications in house like hot water supply and ventilation. People who live in an autarkic house have no electrical connection and no fuel supplies for any machines.

V. PLUS ENERGY HOUSES

A plus energy house is a building that produces more energy than its residents exhaust. It is independent from gas mains, power grid and fossil energy sources. Warmth and energy demand are covered by solar plants and photovoltaic modules. The architecture is guided by the path of the sun and the water demand is particularly covered by rainwater. Zero-emission concepts will most likely be assertive within the next 5-10 years. In 2010 the EU determined that every new built house from 2021 has to be a "lowest-energy building" which means that they have to produce even less energy than a low-energy building. Plus-energy houses could become standard. Since August 2011 clients can claim promotion for a plus energy house. They can get up to 70.000€ for project planning, documentation and evaluation. Thermal protection and the use of regenerative or innovative energy sources can be supported with 300€/m². When planning a new house it is easy to put energy saving measures and thermal insulation as well as well-insulated windows and doors into action. But renovating an old house to get plus energy standard brings many hurdles with it. Existing walls, ceilings and floors cannot simply be replaced. Apertures and doorways might have unfavorable dimensions or placing. After the supplementary application of insulation materials the roof overhang could fall out to short. To make a

modernization at all the engineer or architect also has to have the know-how to plan a plus energy house and a suitable plot of land is necessary. Solar thermal systems may not lie in shade of trees of neighbor buildings.



Plus energy house. Besides of solar plants and ventilation system you can't make out any optical differences to normal houses.

Figure 3: Plus energy house

VI. WHY DON'T WE BUILD SOLELY ENERGY SAVING HOUSES?

To build only energy saving houses political vision is still missing. Furthermore planners and operators do not have the needed know-how to plan and build these houses. Besides the house builders do not feel responsible. They count on competence and responsibility of the planning and executing parts.

Aim of the EU guideline about "total energy performance of buildings" is still the zero energy house. Zero energy houses are technically feasible but practically they will most likely be irrelevant. They are uneconomical because oversizing the energy production and a seasonal storage of the energy are required. Every additional system needs initially high energetic investments what is economically doubtful.

Zero heat energy houses are only feasible in connection with high efforts but don't relieve the environment much more than passive houses. Progress especially in terms of heat loss because of windows could probably reduce these efforts someday.

Energy autarkic houses as well won't show significant benefits for the environment in the foreseeable future mainly

because excess energy is not fed into the energy grid. They should not be built as long as buildings can be connected to the energy grid with arguable effort. The electrical network balances variations in energy demand. It can absorb excess supply and spread the excessive energy. Renewable energy sources can be used in economical quantities and seasonal storage is more economical in huge storage units than in single houses.

Passive houses could become generally established standard in Germany. Passive house standards do have extremely low total consumption values. They can easily be energized by renewable power sources and because feeding-in excessive energy is remunerated they are economically reasonable. If only renewable energy sources shall be used, high power efficiency is needed.

For a wide-ranging introduction especially further education of planners and operators is required. When building or renovating a house it should be planned for the future. Values should fall below legal requirements to build sustainable and to have long-term value conservation.

- [1] Haas, K.-H.: Der Weg zum Nullenergiehaus. Heidelberg: C. F. Müller Verlag, 2009.
- [2] Humm, O.: NiedrigEnergie- und PassivHäuser. Freiburg: ökobuch Verlag, 1998.
- [3] Gabriel, I.: Vom Altbau zum Effizienzhaus. Staufen: ökobuch Verlag, 2014.
- [4] KfW Effizienzhaus 40, unter: <http://www.energiesparen-im-haushalt.de/energie/bauen-und-modernisieren/hausbau-regenerative-energie/energieverbrauch/kfw-40-haus.html> (access at 9th of June).
- [5] Null-Energiehaus & Plus-Energiehaus, unter: <http://www.energiesparen-im-haushalt.de/energie/bauen-und-modernisieren/hausbau-regenerative-energie/energieverbrauch/null-plus-energie-haus.html> (access at 9th of June).
- [6] EnEV-Haus - Effizienzhaus - Passivhaus - Null-Energie-Haus - Plus-Energie-Haus, unter: <http://www.energie-effizient-sparen.de/fachbeitraege/standardhaus-enev-haus-effizienzhaus-passivhaus-null-energie-haus-plus-energie-haus/> (access at 9th of June).
- [7] So sparsam sind Niedrigenergie- Passivhaus und Co., unter: http://www.zuhause.de/wie-sparsam-sind-niedrigenergie-passivhaus-und-co/id_56574876/index (access at 12th of June).
- [8] Nullenergiehaus und Nullheizenergiehaus, unter: http://www.passipedia.de/grundlagen/energiewirtschaft_und_oekologie/nullenergiehaus_und_nullheizenergiehaus (access at 12th of June).
- [9] Was ist ein Nullenergiehaus?, unter: <http://www.passivhaus.org/nullenergiehaus.php> (access at 9th of June).

Masdar City

From Vision to Reality

Nils Engelhardt

Department of Architecture
Brandenburgische Technische Universität
Cottbus, Germany

Abstract—30 Kilometers from the capital of the United Arab Emirates lies Masdar City, a model city of the future. It should exist without creating any CO2 emissions and also draw all its power from renewable energy sources. The planning for this great feat began in 2006. By 2008, construction had already begun in Abu Dhabi. The goal was that the city would be ready to host 40,000 inhabitants and 50,000 commuters for 2016. [1]

The new target for completing the high-tech, eco-friendly city is 2030 [2].

The following outlines and illustrates the design objectives for the eco-friendly city, as well as what actually has been achieved by 2016, the original completion date.

Masdar City; high-tech, eco-friendly city; renewable energy; Abu Dhabi

I. INTRODUCTION

It all begins in Abu Dhabi. The emirate is part of the United Arab Emirates (UAE). The UAE use more drinking water per head as developed western countries and has the highest carbon dioxide emissions worldwide [3]. Abu Dhabi owns a tenth of the world's oil reserves. It is estimated that there is enough crude oil for up to 100 more years [1]. As with every UAE state, the rulers are aware of the finite nature of their raw materials. They are on the hunt for economic alternatives. [4]

Many countries in this region are searching for alternative forms of energy in order to prepare for the post-oil era. Saudi Arabia, Kuwait, Qatar, Bahrain, Oman and the UAE are planning to develop solar energy. The hope of the desert Gulf region is solar energy. [5]

The emirate strives for a leading role in the developing renewable energy and climate protection technologies, similar to that of the Californian Silicon Valley in the semiconductor industry forty years ago [4].

With this end in mind, planning for Masdar City began in 2006, the first carbon dioxide-free, waste-free and car-free city in the world [6]. The Arabic word "Masdar" means source or origin [4]. The rulers of Abu Dhabi have great promises for their vision of the eco-friendly city. This should form a foundation for the post-oil life. By 2050 around half the world's population are expected to live in cities, which urban planners are already taking into account today [7].

The city of superlatives will include a main building, which will be the world's tallest high-rise, it will also produce energy, rather than use it. The city should be cooled by the world's most efficient air-conditioning system and its energy will be supplied by the world's largest solar panels. [6]

40,000 people will live in the city of the future, with work for an additional 50,000 commuters [7]. Masdar is expected to grow to a city of 90,000 inhabitants, still exclusively run on solar and wind energy [3]. The UAE are ready to invest their money, earned through crude oil exports, in renewable energy development.

The second section of the paper lists the planners' goals for Masdar City. Following which is an explanation of how an eco-friendly town, built from scratch, in the middle of the Abu Dhabi desert can work. Now good ten years have passed since the planning and start of construction. In 2008 the first completion date was quoted for 2016. The third section evaluates to what extent the plans are in accordance with the reality today. The final section forms the summary, whether the effort of such a large-scale project like the Masdar City is sustainable.

II. PLANNING

A. Architecture

For half the year, the Abu Dhabi desert has temperatures over 30°C [1]. In order to place an eco-friendly, forward-looking city in the middle of the desert, an intelligent plan and vision was needed, for how the city should work.

Among the planners of the model city are renowned engineers and city planners. One of them is British architect Sir Norman Foster [1]. He also conceived the master plan of the 6,4 square kilometer area between the Abu Dhabi airport, Raha Beach and Yas Island. Foster drew up plans for Masdar with intelligent city planning and innovative technology. [6]

Foster studied the climate conditions of the Gulf Region and incorporated them in the construction and organizational plans for the eco-friendly city. He took the old town of Aleppo in Syria and the Moroccan city Fes as role models, which have their own networks of streets and shaded bazaars. This is how a walled town built around two parks was constructed, consisting

of a maze of streets running from North West to East. Both parks are designed as such, that the air circulation from both directions is absorbed both during the day and at night. The Masdar buildings are closely packed together. This creates narrow streets with shade from both sides. Between the streets are many both green and open spaces. For this region it is ideal, with temperatures of up to 45°C, settlements have their own micro climate. [3]

As a result of the compact structure, the city will be well suited for cyclists and pedestrians. To save energy from cooling the houses, the buildings will be plastered with white chalk. The type of facade whitens from the sun's heat during the day and cools down during the night. [3]

Another type of facade is a mounted provider of shade, such as the facade of the Institute. This is made of separate aluminium elements. These protect from the sun's rays, yet reflect enough daylight to light the laboratories, lecture theatres and library. On the ground level of the building, the footpaths are raised by seven meters. The buildings and streets are built on concrete columns, which allows cool air to circulate. A network of automatically driven electric cars is planned for the lower level of the city. [8]

Foster draws from traditional wind towers from Arabic cities for additional cooling elements in the squares and streets. They once served to direct the cool wind across squares and courtyards. Wind towers also used to be integrated in residential houses. The modern version is 43 meters tall and lies in the middle of a square. The top of the wind tower sprays water vapour, which induces the cool air to fall through a shaft to the square below. Washing used to be hung in the wind towers to dry, which had the same effect. [2]

B. Transport

According to the director of Masdar City, Khaled Awad, all the infrastructure and architecture of the Gulf states which was built in the last few decades have high environmental costs. As the city of the future, Masdar City should work differently. For this reason, all cars with combustion engines are forbidden in the city area. [5]

Those who arrive by car must leave their cars at a car park on the edge of the city [7]. Afterwards they board the local transport and are taken to their workplace, for example [6]. The entire local transport of the city should function with underground, unmanned electric cars, which are called Pods [5]. The goal is that nobody should have to walk more than 5 minutes [3]. Busses and conventional cars will become redundant [6].

C. Science

The intelligent, eco-friendly city has the goal to be the Silicon Valley of sustainable technologies. The city should grow to be a center for renewable energy, which should attract the best researchers and students [1]. This forms the heart of the city, the Masdar Institute of Science and Technology. It shall become an internationally recognized science center for renewable energy [8].

The campus construction work began in 2008, this consists of six buildings arranged around a central courtyard. The Crown Prince of Abu Dhabi, Sheikh Mohammed bin Zayed Al Nahyan, appointed the economist and engineer Sultan Ahmad Al Jaber as the city director. This is to entice renowned institutes and companies in the research and development of renewable energy to Masdar. Sultan Al Jaber has founded many collaborative partnerships. The Massachusetts Institute of Technology supported with the creation of the international course of study of Sustainability. The Fraunhofer Institute for Building Physics and Solar Energy Systems helped to construct a test center. Siemens is also a strategic partner in Masdar, by establishing an office for 2,000 Siemens employees. [1]

D. Energy

The entire infrastructure of Masdar City is based on sustainable energy supply [7]. This is in the region, which wastes more water and requires more electricity than anywhere else in the world. Environmentalists have calculated that if everybody were to use as much water as the Arabs, six planets would be needed to fulfil the water demand [5].

The seven desert sheikdoms electricity usage was 16,000 Megawatts in 2010, which is expected to rise to 40,000 by 2020 [5]. Water for the city of Masdar shall be sourced from the sea, solar and wind energy will be used to desalinate it [3].

The city's solar power plant will be the largest in the world. After the first stage of construction, the plant will provide 100 Megawatts of electricity. All waste will be recycled and the rest will be burned to generate additional energy. [4]

Any green electricity Masdar produces which is not required, will be fed into the Abu Dhabi electricity grid [3]. The water and electricity consumption per capita is going to be transparent: each day the consumption data will be published and in the case of excessive consumption, action will be taken. Martyn Potter works for Masdar City and is responsible for monitoring the inhabitants' consumption. Life in the controlled climate will also be monitored this way. [8]

In comparison to similarly large cities in the region, Masdar City will consume 60 percent less energy. According to Sir Norman Foster's rough estimate, the city of Masdar emits around 23,000 tonnes of carbon dioxide per year. A similar city of this size emits just over a ton of carbon dioxide each year. [3]

The CO₂ levels in the city were considered even in the construction work and all carbon dioxide emissions, whether it was flying in an advisor or making concrete. The city of Masdar is already the most extensively documented large construction site. [6]

For the current plans a budget of 22 Billion US Dollars has been specified. This year was the original completion date for the first eco-friendly city. [1]

III. REALITY

A. Economic Crisis

It has now been ten years of construction works. Thus far less than five percent of the six square kilometer area is complete. The completion date has been postponed to 2030. [11]

The project first came under pressure in 2009. The global economic crisis forced Masdar City planners to make considerable savings. Many international companies who were planning to take part in Masdar backed out. [9]

The city planners reduced the 22 Billion US Dollar budget to 19 Billion [8]. The director of Masdar, Sultan Ahmed Al Jaber, guaranteed the project and construction would continue during the crisis [6].

B. Residence

The Masdar Institute of Science and Technology building was completed in 2011. In 2012, the faculty comprised of 60 employees and 240 students [1].

Currently there are around 13 buildings and 300 students live on the institute campus. For Masdar inhabitants living near the institute facilities, there is a grocery store, bank, post office, canteen and a few coffee shops. They are located around the central square, where 45 meters tall wind tower provides cool air. [10]

The regional Siemens headquarters, designed by Sheppard Robson architects, was opened in 2011 [11]. There are less than 2,000 people currently working in Masdar although the Siemens building alone will host 2,000 people [10].

The first design errors are already clear among the few buildings, which already exist. For example, shadows appear over the photovoltaic system on the roofs of the model settlement. This leads to a loss of electricity. [1]

C. Electricity

The emirate Abu Dhabi continues to be one of the world's biggest polluters, 28 tones of carbon dioxide are produced per capita every year [1]. According to estimates, despite the 10 Megawatt photovoltaic system nearby, the city of Masdar will not produce enough renewable energy to sustain itself. The rest will come from the Abu Dhabi grid. [8]

There is a similar situation with the waste: according to current predictions, the city will have to buy rubbish from across the region in order to fully utilize the planned facilities [6]. The director of Masdar, Sultan Ahmad Al Jaber is of the opinion that the project must continually learn and adapt in order to make progress and fulfil the vision for Masdar, only then will the market development and technology fit [8].

As a result of this flexibility, the first sacrifices to the plans have already been made. The mobility concept, which consisted of underground driverless pods, will not be realized. These electric transporters were planned to transport people across the city, with pod stations planned for every 200 meters. These would bring passengers to their destinations without

intermediate stops and would be controlled centrally. Currently two stations exist; they lie 800 meters away from each other. [8]

The public transport system was revised due to the development of electric cars. Developing an independent system makes no sense, if there are electric cars being produced across the globe. [10]

Now bicycles and electric cars will complete the mobility concept. The plan to source electricity from geothermal heat will also not be realized. The bores required to reach the hot water would be too deep and expensive. Heat exchangers and solar powered cooling systems will be used instead, which contribute to the cooling of interiors. This should reduce the electricity consumption of air-conditioning. [8]

IV. CONCLUSION

Masdar City neither constitutes an ideal city of the future nor a practical example for existing cities. It is a testing ground from states where 28 tones of carbon dioxide are used per capita each year [1]. It is encouraging that an industrial nation is considering what the future holds, especially when the oil reserves have ran out, which gives rise to the hope that other countries will follow suit.

The research on renewable energy sources is a cause for the existence of Masdar. There is still a great deal of time until Masdar City is completed in 2030. The developments in research are only going to continue having an impact on the city's plans.

Deviations from the original plans should not always be regarded as failures, rather the whole project should be considered as a process of research and development of ideas. Masdar City is a testing ground and perhaps it will remain as such. There is nothing better for a new city. The development of technology and community are not static; there is no city in the world, which is fully developed.

REFERENCES

- [1] Rueter, Gero, "Auf Wüstensand gebaut: Ökostadt Masdar", in: <http://www.dw.com/de/auf-wuestensand-gebaut-ökostadt-masdar/a-16406174> [29.11.2012], last checked: 1.July 2016.
- [2] Ulrich, Angela, "Ökologisches Vorbild oder Illusion", in: http://www.deutschlandfunk.de/masdar-city-oekologisches-vorbild-oder-illusion.1773.de.html?dram:article_id=313802 [10.03.2015], last checked: 1.July 2016.
- [3] Kocher, Victor, "Abu Dhabi baut die Ökostadt der Superlative", in: <http://www.nzz.ch/abu-dhabi-baut-die-oekostadt-der-superlative-1.1293310> [21.11.2008], last checked: 1.July 2016.
- [4] Without specifying: "Masdar City: Die Null-Emissions-Stadt in der Wüste", in: *Geo Magazin*, 11/08, S. 190.
- [5] Gehlen, Martin, "Energiewende in Arabien", in: <http://www.zeit.de/wirtschaft/2010-01/arabische-emirate-atomenergie> [13.01.2010], last checked: 1.July 2016.
- [6] Uken, Marlies, "Öko-Traum Masdar im Praxistest", in: <http://www.zeit.de/online/2009/14/masdar-city> [08.04.2009], last checked: 1.July 2016.
- [7] Pichler, Roland, "Die Ökostadt wächst aus dem Wüstensand", in: <http://www.stuttgarter-zeitung.de/inhalt.saudi-arabien-die-oekostadt-waechst-aus-dem-wuestensand.2d67cfb4-aa96-48cf-b8a0-bc1a52036652.html> [10.03.2015], last checked: 1.July 2016.

- [8] Löffken, Jan Oliver, "Grüne Oase in der Wüste", in: <http://www.tagesspiegel.de/wissen/masdar-city-gruene-oase-in-der-wueste/4148360.html> [09.05.2011], last checked: 1.July 2016.
- [9] Uken, Marlies, "Inschallah, der Ölpreis steigt", in: <http://www.zeit.de/wirtschaft/2015-03/gabriel-saudi-arabien-masdar-city-abu-dhabi> [10.03.2015], last checked: 1.July 2016.
- [10] Goldenberg, Suzanne, "Masdar's zero-carbon dream could become world's first green ghost town", in: <https://www.theguardian.com/environment/2016/feb/16/masdars-zero-carbon-dream-could-become-worlds-first-green-ghost-town> [16.02.2016], last checked: 1.July 2016.
- [11] Hollenstein, Roman, "Kultur und Ökoarchitektur", in: <http://www.nzz.ch/kultur-und-oekoarchitektur-1.18263126> [15.03.2014], last checked: 1.July 2016.

Modern Electric, Hybrid Electric, and Fuel Cell Vehicles with Their Market and Future Trends

Muhammad Farooq

Chair of Energy Distribution and High Voltage Engineering
Brandenburg University of Technology
Cottbus-Senftenberg, Germany
muhammad.farooq@b-tu.de

Aafaq Azhar

Chair of Energy Distribution and High Voltage Engineering
Brandenburg University of Technology
Cottbus-Senftenberg, Germany
aafaq.azhar@b-tu.de

Abstract—The transport needs of our ever growing and evolving society are becoming increasingly stringent and more demanding. As the world is going towards renewable energy systems because of the strict regulations on carbon emissions, global warming, fuel economy and constraints on energy resources so in order to combat this, electric vehicles have been extremely attracted by automakers, customers, and governments. Electric vehicles have comparatively more advantages than conventional vehicles of an internal combustion engine such as higher energy efficiency, lower local emission, and decreased dependency upon natural fuel. Currently, research and development efforts in the automotive industry have been focused on low cost and energy efficient electric drive vehicles. This paper covers the comprehensive overview of modern electric, hybrid electric, and fuel cell vehicles, the concept of vehicle-to grid (V2G) integration, experimental designs and its results, market share and future trends of modern electric vehicles.

Keywords- Battery Electric Vehicle; Hybrid Electric Vehicle; Fuel Cell Vehicle; Vehicle-to-Grid, Experimental Design, Market Trends, Future Trends

I. INTRODUCTION

In this modern era, the transportation sector is sharply progressing. As conventional vehicles use IC engine that creates pollution so more scientific research is being focused on electric vehicles in order to develop more energy efficient vehicles which are faster and cleaner. In other words, electric vehicles play a significant role in addressing the energy and environmental impacts of a transport population. Hence, electric vehicles are more energy efficient and less polluting as compared to conventional internal combustion engine (ICE) vehicles. An electrically powered vehicle has essentially three major electrical components. These include energy source which is usually a rechargeable battery bank, motor controller and an electric motor. The energy source is typically a bank of batteries, which may be recharged from the electrical power grid or regenerative braking. The motor controller is typically a power electronics device which when supplied with the driver's input commands, controls the torque and speed of the electric motor. The electric motor converts the electrical energy supplied by the motor controller to mechanical energy used to propel the vehicle, usually through a vehicle transmission system [1]. Moreover, a very important aspect of electric vehicles is to connect with electrical power grid in order to charge the batteries or provide power to the grid as shown in Figure 1.

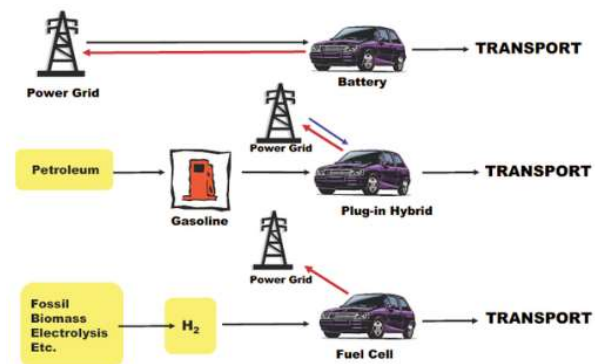

Figure 1: Vehicle to grid power [2]

Owing to more negative environmental impacts of conventional vehicles as increased CO₂ emissions and concerns for fuel conservation, more people have focused their attention towards green energy electric vehicles so the market share of these cars will be higher in the upcoming years. Also, the researchers have found new pathways to develop modern techniques such as self-driven electric vehicles and their geo-positioning tracking systems as future trends.

II. TYPES OF ELECTRIC VEHICLES

A. Battery Electric Vehicle (BEV)

A battery electric vehicle is a type of electric vehicle that uses batteries to power an electric motor to propel the vehicle. Battery vehicles store electrochemical energy in the batteries, with lead-acid is currently the cheapest option but with nickel metal-hydride (NiMH), lithium-ion, and lithium-metal polymer batteries are becoming more competitive due to longer cycle life, smaller size and lower weight. Operationally, they have an option to plug-in in order to charge the batteries. The batteries of the vehicles are recharged from the grid and from regenerative braking. However, a basic BEV is shown in Figure 2.

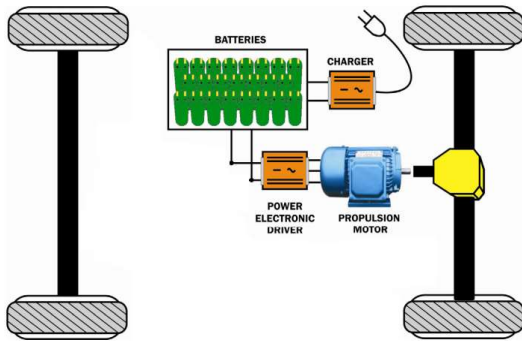

Figure 2: Battery Electric Vehicle

BEVs must have grid connections for charging. So the incremental costs and operational adjustments to add vehicle-to-grid (V2G) is minimal. Moreover, BEVs produce no emission, so these are perfect for city use. Furthermore, pros and cons of BEVs are in Table 1 and Table 2 respectively [3][4][5].

Table 1: Pros of Battery Electric Vehicle

a.	Zero tailpipe emissions
b.	Quiet operation
c.	Overnight battery recharging
d.	Recycled energy from regenerative braking
e.	Use of cleaner electric energy produced through advanced technologies or renewable
f.	Energy security by displacing imported petroleum with domestic generated electricity

Table 2: Cons of Battery Electric Vehicle

a.	Higher cost
b.	Mileage range
c.	Battery technology still to be improved
d.	Possible need for public recharging

B. Hybrid Electric Vehicles (HEV)

Hybrid electric vehicles are powered by both internal combustion engine and electric motor independently or jointly in order to double the fuel efficiency compared with a conventional vehicle. A hybrid is designed to capture the energy that is normally lost through braking and coasting to recharge the batteries, which in turn powers the electric motor, without the need for plugging in. Although, a plug-in hybrid electric vehicle (PHEV) is an HEV that can be plugged-in or recharged from Grid. PHEVs are distinguished by much larger battery packs when compared to other HEVs. The size of the battery defines the vehicle's All Electric Range (AER), which is generally in the range of 30 to 50 miles. PHEVs can be of any hybrid configuration. In order to convert a standard HEV into a PHEV by adding additional battery capacity and modifying the vehicle controller and energy management system, it has three configurations: Series Hybrid Electric Vehicles, Parallel Hybrid Electric Vehicles, and Series-Parallel Hybrid Electric Vehicles. Moreover, Figure 3 and Figure 6 show different configurations of hybrid electric vehicles and plug-in hybrid electric vehicles.

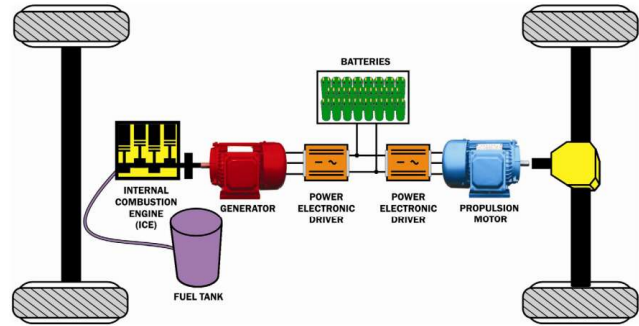

Figure 3: Series Hybrid Electric Vehicle

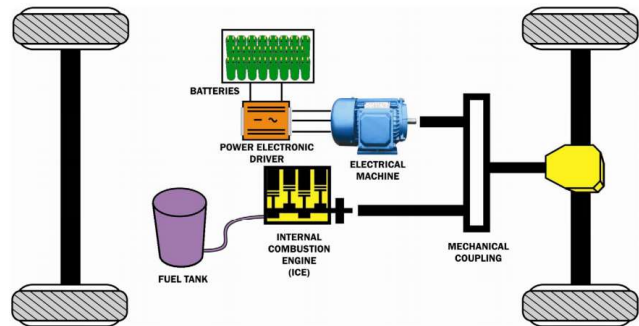

Figure 4: Parallel Hybrid Electric Vehicle

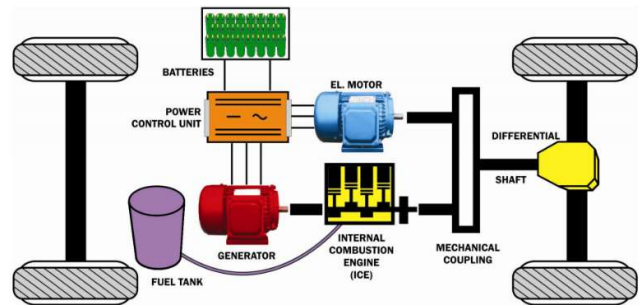

Figure 5: Series-Parallel Hybrid Electric Vehicle

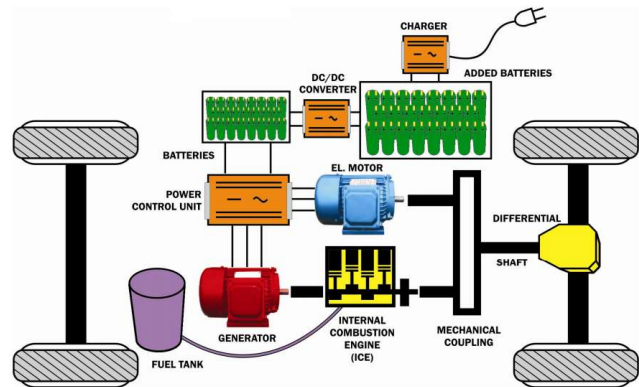

Figure 6: Plug-in Hybrid Conversion

A series hybrid electric vehicle uses the electric motor to provide added power to the internal combustion engine. A parallel hybrid electric vehicle can use the electric motor or the internal combustion engine to propel the vehicle. A series-parallel hybrid electric vehicle enables the engine and electric motor to provide power independently or in conjunction with one another. These types of vehicles are better for greater fuel economy than conventional gasoline-engine vehicles. In relation to V2G, the plug-in hybrid has a grid connection for its transportation function and a large enough battery to provide

V2G from the battery alone. Furthermore, pros and cons of HEVs and PHEV are in Table 3 and Table 4 [3][4][5].

Table 3: Pros of Hybrid Electric Vehicle

a.	Optimized fuel efficiency and performance with lower fuelling costs
b.	Reduced fuel consumption and tailpipe emissions
	Long driving range
c.	Potential of even lower fuelling costs compared to battery sustaining hybrids
d.	Recovered energy from regenerative braking
e.	Use of existing gas station infrastructure
f.	The PHEV has grid connection potential; cleaner electric energy thanks advanced technologies or renewable
g.	The PHEV ensures energy security by displacing imported petroleum with domestically generated electricity
h.	The PHEV has a potential of even lower fuelling costs compared to battery sustaining hybrids

Table 4: Cons of Hybrid Electric Vehicle

a.	Cost and complexity of two powertrains
b.	Component availability such as batteries, powertrains, power electronics
c.	Higher initial cost contributes to the European growth
d.	Cost of batteries and battery replacement
e.	Added weight

C. Fuel Cell Vehicles (FCV)

A fuel cell vehicle is type of hybrid electric vehicle that typically store energy in molecular hydrogen (H₂), which feeds into a fuel cell combining hydrogen fuel and oxygen to produce electricity which is further used to power an electric motor for the movement of vehicle. It produces heat and water as byproducts. The only exhaust produced is water. A number of fuel cell-powered electric vehicles are on the roads worldwide, including cars, delivery trucks, buses, and military vehicles, etc. Researchers are working to bring down fuel cell and related component costs and to improve durability to enable full commercialization. However, fuel cell vehicle can use battery or supercapacitor for storing energy that are shown in Figure 7 and Figure 8.

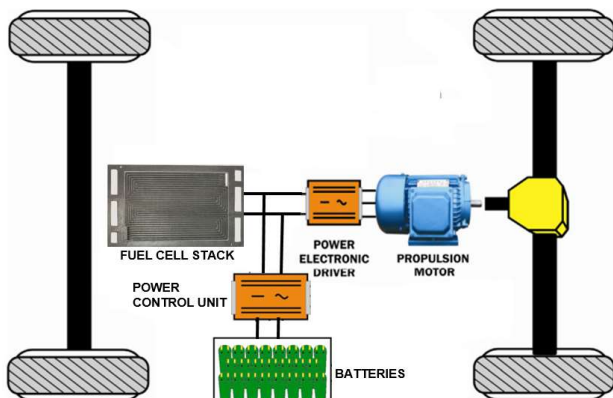

Figure 7: Fuel Cell Vehicle with Battery

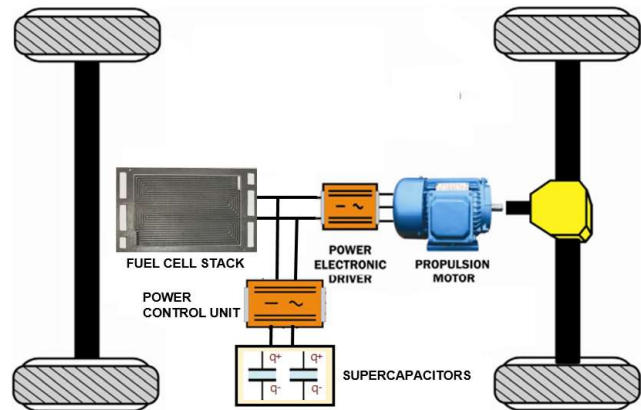

Figure 8: Fuel Cell Vehicle with Supercapacitor

Fuel cell Vehicles used for V2G would produce electricity from the fuel cell that is converted to 60 Hz AC by the on-board power electronics and supplied to the grid. The cost of grid connection is outside the transportation function, so in this analysis, the cost and driver inconvenience of plugging in a fuel cell vehicle are attributed to V2G costs. Furthermore, pros and cons of FCV are in Table 5 and Table 6 [3][4][5].

Table 5: Pros of Fuel Cell Vehicle

a.	Zero tailpipe emissions
b.	Higher energy efficient than the internal combustion engine
c.	Recovered energy from regenerative braking
d.	No dependence on petroleum
e.	Long driving range
f.	Technologically advanced

Table 6: Cons of Fuel Cell Vehicle

a.	Not really zero emissions
b.	Limited infrastructure
c.	Hydrogen is very expensive
d.	Unproven as the fuel cell stack decreases in efficiency

III. GRID-INTEGRATION OF ELECTRIC VEHICLES

The basic concept of vehicle-to-grid (V2G) is that electric vehicles provide power to the grid when they are parked. These electric vehicles can be a battery electric vehicle, plug-in hybrid electric vehicle, or fuel cell vehicle. BEVs can discharge when power is needed in the grid and charge during low demand times. PHEVs also act with the grid in the same way as BEVs. FCVs generate power from liquid or gaseous fuel. Each vehicle must have three required elements:

1. A connection to the grid for electrical energy flow
2. Control or logical connection necessary for communication with the grid operator
3. Control and metering on-board the vehicle.

These elements vary somewhat with the business model. Figure 9 shows the connections between the power grid and electric vehicles.

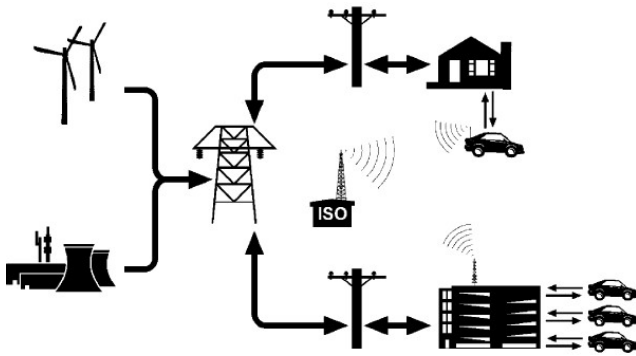

Figure 9: Illustration of vehicle-to-grid concept

As electricity flows in one-way from generators through the grid to consumers so electricity from BEVs, PHEVs or FCVs flows back to the grid meaning the flow is in two ways as shown lines with two arrows in Figure 9. The control signal from the grid operator named as Independent System Operator (ISO) could be a broadcast radio signal, through a cell phone network, direct internet connection, or power line carrier. For instance, the grid operator sends requests for power to a large number of vehicles. The signal may go directly to each individual vehicle as shown in the upper right of Figure 9. On the other hand, the signal goes to the office of a fleet operator that in turn controls electric vehicles in a parking lot as shown in the lower right of Figure 9. or alternatively by a third-party aggregator of dispersed individual electric vehicles. Moreover, the grid operator also dispatches power from traditional central-station generators using a voice telephone call or a T1 line [6].

IV. EXPERIMENTAL WORK AND RESULTS

A. Experimental Design

While studying in University of Engineering and Technology, Lahore, Pakistan, we had successfully designed Solar Car in July 2012 in order to cope the increasing demand of electric vehicles [7]. Initial aim was to make a prototype vehicle that could pull some weight using solar energy but the struggle towards the achievement of this aim continued and finally we were able to build single person solar car with the total cost of only 950 US Dollars (approx.). Major features of this project are:

- Electric power train of a solar car
- Designing the lightweight structure of a solar car by using aluminium and carbon fiber
- Automatic Door movement
- Electronic Power Steering
- Battery Charge Level Indicator
- Digital tachometer
- Digital temperature sensor
- Automatic Front and Rear Light Systems (daylight sensor)
- Speed up to 40 km/h

The basic of electric power train of solar car is shown in Figure 10.

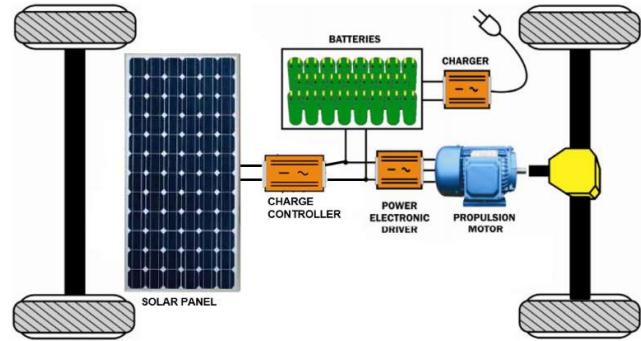

Figure 10: Electric Power Train of Solar Car

Moreover, characteristics of electric power train of a solar car are in Table 7.

Table 7: Features of Solar Electric Power Train

a.	A 200 watt (24 Volts and 8 Amp) Polycrystalline solar panel
b.	Two 12 V lead acid batteries use in series with 45 A current in ac
c.	Remote control system for a panel movement
d.	Efficient battery charging circuit from electrical power grid
e.	Efficient charge controller to charge the batteries from the solar panel
f.	0.5 HP permanent magnet DC motor assembling
g.	The 120 A PWM based DC drive used for vehicle

The final form of proposed vehicle in the limited budget is shown in Figure 11.



Figure 11: Pictorial view of designed solar car

B. Results

- The batteries were charged by the solar panel in minimum 3.5 hours but time may vary depending on ambient parameters. Once the batteries are fully charged the vehicle can easily cover a distance from 35 to 40 km with a speed of 40 km/h. This means that if the vehicle is running at maximum speed the batteries last for one hour. On the other hand, if the speed is slow battery time is increased. The external charging from the electrical power grid is also available through a rectifier circuitry, charging the batteries in 1.25 hours
- From the environmental aspects, the vehicle is best suitable in the Pakistani environment or any other

developing country. High intensity sun and longer days, especially in summer enhance the efficiency of the solar panel and its output ampere rating is increased.

- Compared with the IC engine, emissions from the solar vehicle are much lesser. The only addition to the atmosphere is the heat from the DC motor which is 98.5% less against IC engine. Further, there are no addition of toxic gasses or pollutants as in gasoline engines that are the main cause of contaminating the Pakistani environment. In comparison the solar car is considered to be a zero emission vehicle since none of the toxic material and pollutants are added by it into the environment. Thus, they can prove to be the most viable and sustainable energy vehicles in developing countries.
- Approximately zero running cost as compared with gasoline car and very little or no maintenance and are far more efficient than the IC engines [7].

V. MARKET AND FUTURE TRENDS

A. Market Trends

In the recent years, the market trends for using the green energy cars have increased. So, globally we have seen that markets of electric and hybrid electric cars have increased in sales in the last years as shown in Figure 12.

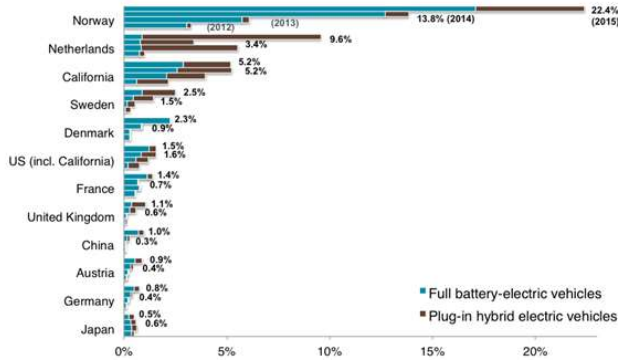

Figure 12: New sales of electric passenger car

In the second half of 2015, there was a boom in the sales of electric and plug-in electric vehicles when approximately one-millionth modern plug-in electric vehicles were sold. Seeing the statistics, we can observe that Norway is by far by leading in total EV sales, with a remarkable market share of 22%. On April 2015, Norway changed the policies of electric vehicles and almost 50,000 plug-in vehicles registered during that era. In 2014, there was a dip in EV sales of Netherland due to the changes in the tax system but still having the second highest share in PHEV sales [8]. The future market trend is being followed by the cost of the electric and hybrid vehicles and the cost of the batteries are the third highest in the construction of the cars. So, the cost of the batteries must come down. As batteries cost will continue to fall the demand for EV and PHEV will rise as we can see below in Figure 13 [9].

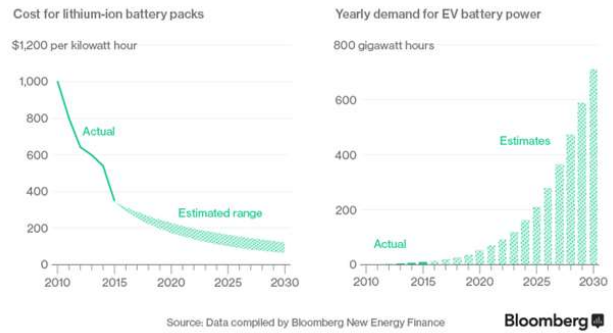

Figure 13: Battery vs demand of EVs

The market trends for fuel cell vehicles are becoming more in the scene, because the oil prices and the taxes associated with the car prices, plus the benefit of emission free environment, are urging the customers to shift their demands from conventional fuel vehicles to the fuel cell electric vehicles. The world market shares and the global sales of the fuel cell vehicles in the coming 10-15 years are booming as seen in the graph. From 2015 till 2020 the trend in the sales of fuel cell cars in Western Europe and Asia Pacific has seen a drastic and substantial increase due to some environmental concerns and some cost concerns that illustrates in Figure 14.

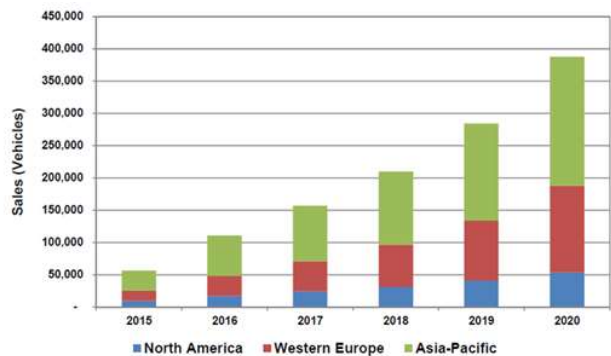

Figure 14: Fuel cell light-duty vehicle sales, world market: 2015-2020 (Source: Pike Research)

B. Future Trends

The future trends of green cars, especially electric vehicles are starting from various projects that are giving us an idea of self-driving cars and the Geo-positioning systems associated with them. One such project is being initiated by Google named as “Google Self-Driven Car Project” which has basic features as mentioned. The sensors on these cars and the respective software allow them to sense objects and obstacles as pedestrians, cyclists, vehicles and more, and are designed to safely drive around them that depicts in Figure 15 [10].

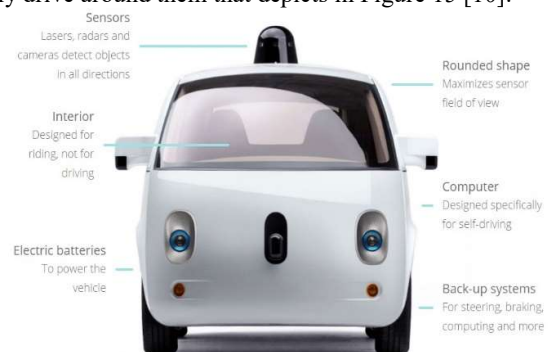

Figure 15: Concept of future electric vehicle

The main features are as follows:

- Using combination of sensors, GPS and Google maps integration, the car senses the location and position
- The sensors with the help of software, determine the type of objects and classify them according to its size and shape
- The sensors also detect the precise motion of the objects as cyclist or pedestrian and then give a signal for next move
- The respective software then selects the appropriate speed and the direction of the car according to safety standards

VI. CONCLUSION

This research is concluded with an agreement that we desire an emission free environment for our world so an increase in the demand of green energy vehicles will not be surprising for us. So, this paper has mainly focused its attention in the areas of architecture, modeling, working principles and importantly an increasing need for electric, hybrid electric and fuel cell vehicles with their development in modern systems for grid integration. We have also foreseen the future prospects of environmental protection as well as fuel conservation when talking about the replacement of conventional vehicles with the green vehicles. Discussing the major categories, system architecture and the environmental impact of these green energy vehicles, we have come to a point that in the recent years there has been a boom in the demand of electric vehicles and in the upcoming years, it can be well predicted that BEVs, PHEVs will gradually gain importance in the market due to the superior fuel economy and vehicle performance with less carbon footprints.

VII. ACKNOWLEDGEMENT

Authors would like to thank Prof. Dr.-Ing. Przemysław Janik and Dipl.-Ing. Dirk Lehmann for giving chance to write this paper.

VIII. REFERENCES

- [1] C. C. Chan, "The State of the Art of Electric, Hybrid, and Fuel Cell Vehicles," *Proc. IEEE*, vol. 95, no. 4, pp. 704–718, <http://ieeexplore.ieee.org/ielx5/5/4168011/04168013.pdf?tp=&arnumber=4168013&isnumber=4168011>, 2007.
- [2] B. Gav, *Peak Energy: Vehicle To Grid Power*. [Online] Available: <http://peakenergy.blogspot.de/2006/09/vehicle-to-grid-power.html>. Accessed on: Jul. 07 2016.
- [3] A. Emadi, "Energy Systems, Economics, and Sustainability," in *Research in Experimental Economics, Experiments on energy, the environment, and sustainability*, R. M. Isaac and D. A. Norton, Eds, Bingley: Emerald, 2011, pp. 213–222.
- [4] "Battery, Hybrid and Fuel Cell Electric Vehicles are the keys to a sustainable mobility," http://www.averre.org/www/Images/files/about_ev/Brochure.pdf.
- [5] I. Berry, "Electric Powertrains," http://web.mit.edu/evt/summary_powertrains.pdf.
- [6] W. Kempton and J. Tomić, "Vehicle-to-grid power fundamentals: Calculating capacity and net revenue," *Journal of Power Sources*, vol. 144, no. 1, pp. 268–279, <http://www1.udel.edu/V2G/KempTom-V2G-Fundamentals05.PDF>, 2005.
- [7] M. Farooq and A. Salman, *IEEE Global Humanitarian Technology Conference (GHTC), 2014: 10 - 13 Oct. 2014, San Jose/Silicon Valley, California USA ; [conference proceedings]*. Piscataway, NJ: IEEE, 2014.
- [8] International Council on Clean Transportation, *2015 Global electric vehicle trends: Which markets are up (the most) | International Council on Clean Transportation*. [Online] Available: <http://www.theicct.org/blogs/staff/2015-global-electric-vehicle-trends>. Accessed on: Jul. 07 2016.
- [9] *Here's How Electric Cars Will Cause the Next Oil Crisis*. [Online] Available: <http://www.bloomberg.com/features/2016-ev-oil-crisis/>. Accessed on: Jul. 07 2016.
- [10] *Google Self-Driving Car Project*. [Online] Available: www.google.com/selfdrivingcar