



Brandenburgische
Technische Universität
Cottbus - Senftenberg

13th EEEIC

International Conference on Environment and Electrical Engineering – Student Edition

Wrocław-Ostrava-Cottbus
19th - 23rd of May 2014

Harald Schwarz, Przemysław Janik,
Radomir Gono, Dirk Lehmann

module at BTU: 11396

ISBN 978-3-940471-34-5

organiser / veranstalter

Wroclaw University of Technology
Department of Electrical Engineering
pl. Grundwaldzki 13
PL 50 – 377 Wroclaw

Technical University of Cottbus
Department of Power Distribution and High Voltage Technology
Walther-Pauer-Straße 5
D – 03046 Cottbus

VŠB - Technical University of Ostrava
Department of Electrical Power Engineering
17. Listopadu
CZ - 15 Ostrava - Poruba

The German National Library – CIP

One of this publication is by the German National Library.

ISBN 978-3-940471-34-5

copyright

Dieses Werk einschließlich aller seiner Teile ist urheberrechtlich geschützt.
Alle Rechte, insbesondere die der Vervielfältigung, Verbreitung und Übersetzung liegen beim Verlage. Kein Teil des Werkes darf ohne Genehmigung des Verlages, auch nicht für Unterrichtszwecke, fotografiert oder auch durch andere Verfahren reproduziert und verbreitet werden. Ebenfalls ist eine Einspeicherung und Verarbeitung in EDV-Anlagen ohne Genehmigung des Verlages strafbar.

publisher / verlag

© 2015, Technical University of Cottbus, Informations-, Kommunikations- und Medienzentrum (IKMZ)

printing / druck

Technical University of Cottbus, Reprografie

Table of contents

<u>Nuclear phase-out</u>	1
<u>Energy as a Product</u>	5
<u>Measures to control power trough renewable energy sources in Germany’s electricity networks</u>	8
<u>Zero-energy buildings</u>	11
<u>Biorefinery</u>	14
<u>Solar chimney as future energy source</u>	18
<u>Demand-Side-Management</u>	24
<u>Fuel Cells – Energy For The Mobility Of The Future?</u>	29
<u>Perspectives of shale gas extraction and its importance for energy security in Poland</u>	33
<u>LNG for Europe</u>	37
<u>Solar energy in Poland</u>	44
<u>Geothermal energy in Germany</u>	50
<u>Nuclear Fusion</u>	54
<u>Natural Gas in Iran</u>	58
<u>Renewable Energy Technologies Of The Future</u>	63
<u>Green Conscience, Dull Neighborhood?</u>	70
<u>Project e-SolCar and integration of electric cars in power supply system</u>	75
<u>Carbon Capture and Storage</u>	80
<u>Application of Phase Shifting Transformers enabling high integration of Renewable Energies</u>	82

Nuclear phase-out

“Bad Bank” for electricity suppliers?

Marco Wolff (3019472)
Brandenburg Technical University Cottbus
Cottbus, Germany
wolffmar@tu-cottbus.de

Max Schubert (2912476)
Brandenburg Technical University Cottbus
Cottbus, Germany
schubmax@tu-cottbus.de

Marco Krüger (2915370)
Brandenburg Technical University Cottbus
Cottbus, Germany
Kruegma5@tu-cottbus.de

Abstract— This paper deals with the discussed nuclear phase-out with focus on Germany. We debate the reasons for the resulting ambition to shut down some atomic reactors by mentioning advantages and disadvantages of atomic energy. Additionally we consider the financing possibilities of the occurring energy lag attributable to the phase-out.

nuclear phase-out; atomic energy; bad bank; renewable energies; energy lag

I. THE NUCLEAR PHASE-OUT FOR GERMANY

A. History

The term "nuclear phase-out" includes the political decision of the Federal Government of Germany to finish the production of nuclear power. The term has its origin in the anti-nuclear movement and is required since the mid-1970s.

The phasing out of nuclear power began with the decision of the red-green federal government and the four large nuclear power operators in 2000. Two years later, the agreement was legally protected by amending the Atomic Energy Act. This includes the prohibition to build new commercial nuclear power plants as well as the limitation of its useful life to 32 years since the commissioning of the existing power plants. Based on this, in November 2003 the power plants Stade and Obrigheim were finally shut down (Vereinbarung zwischen der Bundesregierung und den Energieversorgungsunternehmen vom 14. Juni 2000, 2014: online).

In 2010, however, the Atomic Energy Act was modified by a lifetime extension for the power plants again. Those facilities which were built in 1980 received an additional 8 years and

the power plants which were built after that date received an extension for a further 14 years.

B. The change in the policy

Due to the Fukushima nuclear disaster in 2011, there was a change in energy policy in Germany. The nuclear moratorium caused a safety review of all 17 German nuclear power plants and a shutdown of the seven oldest power plants for three months. In addition, it was decided to leave off the non-running systems. This political decision was confirmed by a representative survey of the population in the fall of 2011, in which 82% of the Germans considered a nuclear phase-out to be right (Taz.de 2014: online).

On June 8, the government decided the closure of eight nuclear power plants and a gradual phase-out of nuclear power until 2022. Due to the weather dependence of alternative energy, in certain seasons there is the possibility that there will be shortage of energy supply. Therefore, three nuclear power plants must remain in operation until 2022 as a safety buffer. Moreover they serve as a security if the energy revolution will not proceed as planned. The decided lifetime extension of the power plants in 2010 was thus overridden. Already in 2012 the proportion of power from nuclear energy has fallen to 16.1%, which was still at 22.4% in 2010 (DIE Welt 2014: online).

This value is comparable with the share of electricity from renewable energy sources. Thus the lignite and hard coal is currently the most important source of energy for power generation. The following graph shows the production areas for power generation in 2013 (Hetzke, Günter Deutschlandfunk 2014: online).

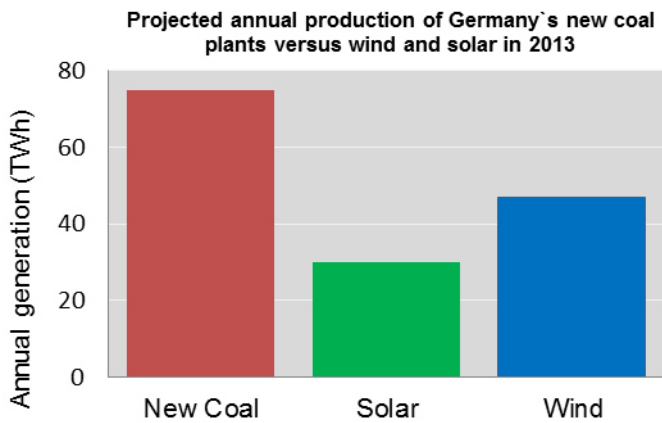

Figure 1: (Source: Own illustration, based on Wilson 2014: online)

C. Background

In 2013 Germany is still one of the largest nuclear power producers in the world.

Due to significant events in the last few years, particularly Fukushima, the confidence in this technology has decreased. In the past, people, technology or the environment caused unpredictable deviations from normal operation, which had disastrous consequences. The accidents at the nuclear power plants Harrisburg, Chernobyl and Fukushima demonstrated that not only technical problems but also human mistakes and environmental disasters are able to cause catastrophes. Thus the controllability of this technology remains questionable (Ministerium für Energiewende, Landwirtschaft, Umwelt und ländliche Räume (MELUR) 2014: online).

From an economic perspective, nuclear power plants are no longer viable. Responsible for this development are the declining electricity prices and new tax burdens. According to the International Economic Platform for Renewable Energies (IWR) Germany and the energy companies will save 82 billion in costs due to the nuclear phase-out (Internationales Wirtschaftsforum Regenerative Energien (IWR) 2014: online). In March 2014 the German Institute for Economic Research (DIW) announced, that nuclear power is a discontinued model due to a lack of profitability and that the exit is economically viable in the long run (DIW Wochenbericht 2014: online).

II. ADVANTAGES AND DISADVANTAGES OF A NUCLEAR PHASE-OUT

A. Advantages

Three catastrophic nuclear accidents in the past indicated that nuclear power implicates a certain danger. Threats like health risks and environmental damage from uranium mining, processing and transport, the risk of nuclear weapons proliferation or sabotage and the unsolved problem of radioactive nuclear waste are arguments, which bring up the question, whether this kind of energy sourcing is worthwhile. Proponents of the nuclear phase-out do not believe, that new technology will reduce the risk of conducting reactors due to the complexity of these machines.

They argue that when all the energy-intensive stages of the nuclear fuel chain are considered, from uranium mining to nuclear decommissioning, nuclear power is not a low-carbon electricity source.

As a contribution to the debate of the occurring energy lag, they say that the lag is compensable, because renewable energies are more fertile than expected.

B. Disadvantages

However opponents of the nuclear phase-out argue that the risks of storing waste are small and can be reduced due to the latest technology. Furthermore nuclear power is a sustainable energy source which reduces carbon emissions and causes no air pollution in contrast to fossil fuel. Especially in Germany you can observe, that there is far more brown coal mining since the shutting down of some nuclear power plants. Additionally the phase-out would increase the energy dependence for many countries.

III. BAD BANK

A. The Plan

The nuclear phase-out is a process that will take a long time. Until the final shutdown of the power-plants (inclusive storage of nuclear waste) it will take more than 20 years. That means to tear off all of the 18 remaining power plants, it requires billions of euros.

To financially achieve the nuclear phase-out the big three German energy-enterprises are planning to transfer their whole nuclear business to the state. That would mean that the entire risks of the exit are ultimately up to the taxpayer.

Specifically the plan provides that the nuclear power plants go into a public foundation whose owner is the German federation. In this context it is intended that the foundation operates the power plants until 2022 and additionally is responsible of the billion-euro demolition and storage of radioactive waste (Spiegel Online 2014: online).

REFERENCES

To support the procedure the electricity suppliers offered to participate with 35 billion euros. Money from reserves they had to set aside for the demolition and storage to this day. Since that amount of money are only reserves and not retained earnings that could mean that at least a part of the reserves would be gone, if one of the companies goes bankrupt.

So, to accept the proposal the government would at least protect oneself for the case of insolvency of an energy-company at a later stage. In return it is additionally speculated that the companies' management will drop parts of the 15 billion-euro claims for damages against the German federation. Though, these demands are regarded as unjustified by many politicians anyway (Aischmann 2014: online).

B. *The role of electricity suppliers in our system*

This development reflects parallels between electricity suppliers and banks. Like financial institutions the energy-companies are considered systemically relevant, in other words: "too big to fail".

This means the state is forced to save them. Against this background stock brokers are calling the planned foundation a "bad bank" for energy-enterprises. If one agrees with this perspective it seems necessary to reflect on the possibility of transferring the nuclear business to the German government. Even if outside of the energy companies this plan has mainly led to criticism (Mussler 2014: online).

C. *Valuation*

On first glance the intended project appears to be a smart solution for both. The German government would be protected of both, an insolvency of one of the suppliers and their billion-euro claims. The energy-enterprises on the other hand could get rid of their worries about the incalculable disposal costs. Experts and politicians, however, see things a little differently. They refer to the fact, that the companies bear responsibility for their business as well as for the dismantling and the associated risks (Diekmann 2014: online).

In the end that debate reflects the last chapter of nuclear power. Now that the phase-out is decided there remains the important question of who will pay the bill. The companies are trying to transfer the risk of incalculable costs to the government. The government, however, rejects the assumption of that kind of risk.

The argumentation that electricity suppliers are solely responsible for their nuclear business is understandable. However, there is the possibility that companies go bankrupt which would mean that the 35 billion euro reserves already formed cannot be used. This could possibly lead to an even more expensive phase-out for the taxpayers. Against the background of these problems it has to be carefully considered what might be the best solution.

o.V 2014. Plan der Energie-Konzerne: Bund soll Abriss von Atom-Meilern finanzieren. *Spiegel Online* 2014. Online im Internet: URL: <http://www.spiegel.de/wirtschaft/unternehmen/atomkraftwerke-energiekonzerne-fordern-bad-bank-vom-bund-a-968719.html> [Stand 2014-06-02].

Aischmann, Frank 2014. Raus aus dem Risiko. *Tagesschau* 2014. Online im Internet: URL: <http://www.tagesschau.de/inland/atom200.html> [Stand 2014-06-02].

Mussler, Hanno 2014. Die Bad Bank mit Atomkraft. *FAZ* 2014. Online im Internet: URL: <http://www.faz.net/aktuell/finanzen/aktien/die-boersenwoche-die-bad-bank-mit-atomkraft-12955090.html> [Stand 2014-06-02].

Diekmann, Florian 2014. Bad Bank für AKW: Alle gegen die Atomkonzerne. *Spiegel Online* 2014. Online im Internet: URL: <http://www.spiegel.de/wirtschaft/unternehmen/akw-entsorgungspolitik-lehnt-plaene-von-e-on-rwe-und-co-ab-a-969025.html> [Stand 2014-06-02].

Hetzke, Günter 2014. Der Atomausstieg: Deutschland zieht Konsequenzen. Deutschlandfunk. Online im Internet: URL: http://www.deutschlandfunk.de/der-atomausstieg-deutschland-zieht-konsequenzen.697.de.html?dram:article_id=79008 [Stand 2014-06-05].

Ministerium für Energiewende, Landwirtschaft, Umwelt und ländliche Räume (MELUR) 2013. Wendepunkt Fukushima – Warum der Atomausstieg richtig ist. Online im Internet: URL: http://www.schleswig-holstein.de/MELUR/DE/Service/Broschueren/Reaktorsicherheit/Wendepunkt_Fukushima__blob=publicationFile.pdf [Stand 2014-06-05].

DIE WELT 2014. Erneuerbare Energie mehr genutzt als Atomstrom. Online im Internet: URL: <http://www.welt.de/wirtschaft/energie/article117645523/Erneuerbare-Energie-mehr-genutzt-als-Atomstrom.html> [Stand 2014-06-05].

Internationales Wirtschaftsforum Regenerative Energien (IWR) 2014. Kernkraftwerke werden älter – Ersatz kostet weltweit über eine Billion Euro bis 2030. Deutschlandfunk. Original-Pressemitteilung vom 19.10.2012. Online im Internet: URL: <http://www.iwrpressedienst.de/Textausgabe.php?id=4310> [Stand 2014-06-05].

DIW Wochenbericht 2014. Atomkraft ohne Zukunftsaussichten. Ausgabe 13/2014. Online im Internet: URL: http://www.diw.de/documents/publikationen/73/diw_01.c.441191.de/14-13.pdf [Stand 2014-06-05].

Taz.de 2014. Die Wende wackelt nicht. Verbraucherumfrage zu Strompolitik. Online im Internet: URL: <http://taz.de/Verbraucherumfrage-zu-Strompolitik/!121697/> [Stand 2014-06-05].

Vereinbarung zwischen der Bundesregierung und den Energieversorgungsunternehmen vom 14. Juni 2000. 2014. Online im Internet: URL: <http://www.bmub.bund.de/fileadmin/bmu-import/files/pdfs/allgemein/application/pdf/atomkonsens.pdf> [Stand 2014-06-05].

Dr. Mae-Wan Ho 2010. Nuclear Energy is not a New Clear Resource. *The World Reporter* 2010. Online im Internet: URL: <http://www.theworldreporter.com/2010/09/nuclear-energy-is-not-green.html> [Stand 2014-06-05].

Figures

Wilson, Robert 2014. Why Germany's Nuclear Phase Out is Leading to More Coal Burning. Online im Internet: URL: <http://theenergycollective.com/robertwilson190/328841/why-germanys-nuclear-phase-out-leading-more-coal-burning.html> [Stand 2014-06-05].

Energy as a Product -

How big is the power of the four big players of energy industry yet

Oliver Friedrichs (3255630)
Brandenburg Technical University
Cottbus, Germany
oliverfriedrichs@me.com

Jan Richter (3262901)
Brandenburg Technical University
Cottbus, Germany
Jan_ri@hotmail.de

Abstract—For a long time the energy industry was dominated by a few big concerns. But government-sponsored competition and the nuclear phaseout put down the power of E.ON, RWE, Vattenfall and EnBW. Solar energy plants of individual consumer and wind farms for medium-sized companies increased in the recent past its shares. How big is the power of the four big players of energy industry yet?

to the Federal Network Agency , 52 percent of end users. Because customers changed and the energy companies sold shares, they provided only 42% in 2011.

I. INTRODUCTION (HEADING 1)

The turning point for Germany energy corporations was the nuclear disaster in Fukushima. In March 2011, the government imposed a moratorium for several nuclear power plants. Several reactors go permanently from the net and the German Bundestag decided the final phase out nuclear power by the end of 2020. After the political reforms RWE lost 25% of their profit in 2011. E.ON even recorded a loss of 1.9 billion euros to the previous year. Not only the quiescence of nuclear power plants but also the new nuclear fuel tax as well as losses in the gas business and the recession in southern Europe contributed to the profit declines in the big four. In subsequent years, the significant losses which could follow the structural changes in the energy sector by billionaire austerity programs provide deletions and are collected by enormous share disposals partially.

II. MAIN COMPONENT

On the retail market but the big companies have already fallen by new competitors since 1998 under strong pressure. With campaigns against the " nuclear companies " won four providers of green power one million households as customers and a market share of 2.5 percent. Local powerplants expanded their distribution on neighboring communities, some have electricity or gas now even nationwide on . Since 1998, as well as numerous private providers have established . In 2011 there were , according to the consulting firm AT Kearney 50 independent electricity and 55 gas companies.

The sales figures of E.ON , RWE, Vattenfall and EnBW have decreased accordingly since liberalization . Company-owned distribution companies and municipal utilities with majority participation of the big four supplied 2008 according

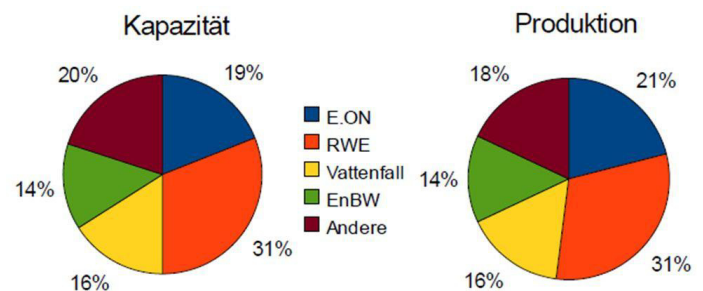

The importance of the power companies will continue to fall , not only because of the ongoing competition. Every third company checks due to rising electricity and heat prices to enter into their own power , a survey conducted by the German Chamber of Industry and Commerce day resulted in the fall of 2012. For home owners power is from our own solar system now cheaper than the reference for a cheap provider , business establishments with their more favorable wholesale prices , the cost parity in a few years also achieve .

Own consumption and a new generation of providers have the potential to be the next revolution in the energy market . Companies in the wind energy sector are already experimenting with the supply of green electricity without having to take development funds . "I am convinced that our market share in Germany is mandatory and sustained decline. It is not possible that we hold in a more decentralized energy world the same market share ," said John Teyssen , CEO of E.ON , 2012 in an interview.

In the ongoing development of renewable energy , E.ON , RWE, Vattenfall and EnBW have held back a long time. The

energy giants are specialized in part to capital-intensive large-scale power plants. On the other hand, they displace Renewable especially expensive electricity from natural gas plants from the market. Flexible peak load power plants with coal and gas as a fuel are also used less frequently because noon mass- flow solar power into the grid . Solar energy reduces then to the power exchange the price which was particularly high earlier due to the high demand at lunchtime. Therefore, the operator of fossil power plants have made it increasingly difficult to refinance investment from building their reactors .

E.ON in 2011 reached only a 13 percent share of green electricity in its power mix , lagging behind the national average of 20 percent. RWE even came only to a green electricity share of 2.6 percent. Most green electricity generating companies with up to 100 years old hydropower plants. In wind energy, photovoltaic and biomass they have hardly any own plants . The windmills of E.ON correspond only 0.7 percent of Germany's installed wind power capacity.

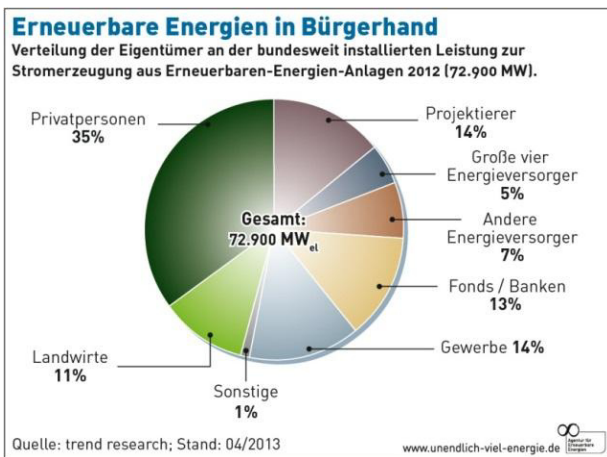

A U-turn Vattenfall has announced. After the Swedish government had lowered the return required for the state-owned company, the company announced in late 2012 to invest only in renewable energy. The same applies to the German subsidiary. In the Federal Republic, however, the company plans to finish building by 2020 half a dozen approved gas and coal power plants.

E.ON has promised to invest up to 2016 at least 1.2 billion euros per year in renewable energy. Thus, the Group would remain at the level of previous years, the vast majority will also flow abroad. RWE intends to increase the share of renewable energy in its capacity by 2020 to 20 percent internationally. EnBW has to spend the goal is to build about 3,000 megawatts of green power plants by 2020. This corresponds to the

performance of all modules, which were Germany's newly built in the first half of 2012.

III. CONCLUSION

If the four groups do not increase greatly their investments , they will play only a marginal role for the energy turnaround in Germany . Because of high debt , however, RWE and E.ON lack the capital for major investments , EnBW is struggling due to the elimination of two of its four nuclear power plants since 2011 with particularly high revenue losses .

E.ON tries , especially abroad, to grow and can choose for his investment , unlike the medium- drivers of the energy transition states with the most attractive conditions. Offshore wind farms build E.ON and RWE , especially in Great Britain, because the plants there not have to be built so far from the coast as in the German North and Baltic Seas. Due to the attractive remuneration hold the four energy companies but also concessions for offshore wind farms off the German coast . The contribution of the four power companies to the energy transition is expected to be greatest in this capital-intensive technology.

How much profit do the corporations future with a further increase in green electricity share in the net even with their fossil fuel power plants , depends primarily on political factors . Ambitious climate protection would increase emission and mainly make the lignite unprofitable . In the next few years, the Federal Government and the European Commission will have to decide also whether and to what extent electricity from fossil fuel power plants should be promoted. E.ON pointed in 2012 to the closing of unprofitable gas power plants. If even the last nuclear power plants shut down, generation capacity could be missing for the times in which too little green electricity is available. A rapid expansion of electricity grids would facilitate the situation of corporations : the lines are faster and more developed , the more easily they can sell their electricity to neighboring European countries.

REFERENCES

<http://www.100prozentukunft.de/sites/default/files/imagecache/Kapazit%C3%A4t%20Produktion.JPG>

<http://www.die-buergerenergie.wende.de/wp-content/uploads/2013/05/grafik-zur-eigentuemerverteilung-bei-erneuerbaren-energien-anlagen.jpg>

http://www.google.de/imgres?imgurl=http%3A%2F%2Fimg.welt.de%2Fimg%2Fwirtschaft_original%2Fcrop102052362%2F3022095336-ci3x2s-w260%2Fvideo-110812-eon-DW-Sonstiges-Grantee.jpg&imgrefurl=http%3A%2F%2Fwww.welt.de%2Fdiweltbewegen%2Farticle13573890%2FDer-deutsche-Strommarkt-steht-vor-dem-Umbruch.html&h=173&w=260&tbnid=AnLyYxutZmGM3M%3A&zoom=1&docid=VtiO1BGia6ijBM&ei=Rf2NU5ulLsbVPMHDgagG&tbn=isch&iact=rc&uact=3&dur=733&page=2&start=29&ndsp=26&ved=0CJUBEK0DMCA

<http://www.bpb.de/politik/wirtschaft/energiepolitik/152780>

<http://www.wiwo.de/unternehmen/energie/e-on-rwe-enbw-so-dramatisch-steht-es-um-die-zukunft-der-energiesen/9062794.html>

<http://corporate.vattenfall.de/uber-uns/investoren/>

http://corporate.vattenfall.de/Global/Deutschland/finanzberichte/annual_report_deutsch_2012.pdf

http://de.wikipedia.org/wiki/EnBW_Energie_Baden-W%C3%BCrtemberg

<http://www.spiegel.de/wirtschaft/unternehmen/verbraucher-produzieren-zunehmend-strom-in-eigenregie-a-972166.html>

<http://www.spiegel.de/wirtschaft/unternehmen/atomausstieg-energiesen-fordern-15-milliarden-euro-schadensersatz-a-838527.html>

Measures to control power trough renewable energy sources in Germany's electricity networks

Two german projects set new standards in energy transition

Kristian Platta

University of Technology, Cottbus - Senftenberg
Cottbus, Germany
Kristian.Platta@tu-cottbus.de

Today the gross electricity generation in Germany already comes from renewable sources to an extent of over a quarter. Great consuming part are the wind - and solar energy, whose share is expected to rise even further in the future years. However, two major problems occurred: the spreadability and storability of power. Thus, the number of decentralized feeders is always higher (with smaller amounts of energy) and there is an increased need for network expansion. The advent of the instability of the power system must therefore be greatly reduced in future. So far, the instrument of power control was realized only by conventional power plants. Now research projects also deal with the technical implementation of renewable energies.

I. LINE REGULATION AS ENERGY POLICY INSTRUMENT

Failures in power networks usually do not happen out of the blue. Often the instability of the network rocks up so far that suddenly large power supplies must be switched off. Electricity networks are therefore directed to absolute stability of the overall system at any time.

In this case, stability refers to the ability of a system to independently return to an equilibrium state when an error occurs. There must be equally as much energy produced as consumed at all times. For instance, if a feeder turns off, this balance between production and consumption is momentarily disturbed. Consequences are, among others, the increase / decrease of the grid frequency and grid voltage. The basis of this grid control is the stabilization of frequency to 50 Hz with a tolerance of ± 0.2 Hz.

In a conventional power grid control occurs through regulation of the generator. For example, a sudden increase in demand of power leads to an increase in grid frequency. So the speed of the generator is slowed down and consequently the grid frequency falls again. The problem is that particularly thermal power plants are often not significantly adaptable in a short time. By contrast, so-called bandload power plants are much better in the form of pumped storage power plants. Important characteristics of the network regulation are the primary control, secondary control and minutes reserve. They differ in terms of their scope of services and the time of activation. The primary control intervenes in a load change immediately and automatically and applies to all power plants in the interconnected network of transmission system operators. At

least 1 MW of power is achieved by provision of large centrifugal masses in the power plants. Preceding it is the instantaneous reserve, which, by definition, not belonging to the network control will jump up to an overload of 5%. Secondary control rises to coincide with the primary control, though only in the affected area. However, the minimum range performance is significantly higher amounting up to 5 MW. The minute reserve must be triggered manually within 15 minutes. It also only works in the affected service area and is capped up by law at 2.5 GW.

In practice, it is common for large transmission network operators to relate the power required by small, local power companies.

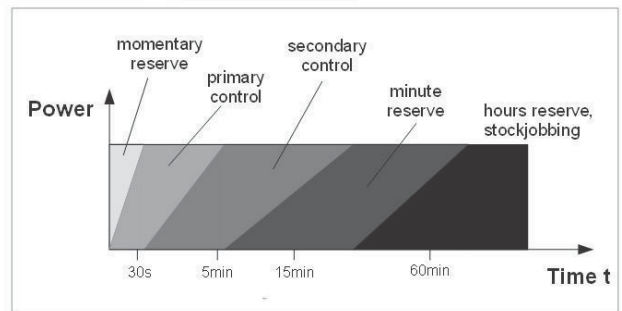

Figure 1. Levels of network control

II. GERMAN ENERGY VILLAGE SETS STANDARDS

Wildpoldsried, a village of 2,500 inhabitants in Bavaria / Germany, is currently the hottest iron in terms of energy policy. Here were five times as much energy generated as actually needed, solely together using renewable energies. In 2011, the project **IRENE** ("Integration of renewable energy and electric mobility") was started to the village and earned many national and international awards. Currently around 30,000 MWh / year are generated by renewably performance with a demand of nearly 6,500 MWh (as of 2013). This is done through a series of combined renewable generation - and memory technologies such as 25,000 square meters of PV plants, 11 wind turbines, one biogas plant and 50 e-cars. Thus, the energy village was the first municipality in Germany which could provide completely energy self-sufficient, both high -

and infrastructure standard. Heart of this pilot project is the so-called “So-Easy technology” developed by the cooperation partner Siemens.



Figure 2. Structure of the "So Easy Technology"

This self-organizing energy automation system regulates the interaction of distributed consumers and feeders in the local network. Main component is the **Personal Energy Agent (PEA)** which provides and monitors the energy management services. The **Network Transmission Agent (NTA)** is responsible for monitoring the network and attaches to more than 200 measuring points and nearly 80 network stations. On the basis of this the network usage fees were calculated. In conjunction with the NTA is the **Area Administrator (AA)**, which ensures the network stability and in case of failure may start emergency strategies. The **Balance Master (BM)** is the central point of the system to process the information from the PEA. It balances supply and demand in the network and controls the market mechanism in the energy supply. Last but not least the **Electricity Police (EP)** monitors all contracts and processes, thus ensuring a trouble-free operation. This interaction of the individual components results in almost a stand-alone operation and a self-sufficient supply independent from the electricity grid. The first test run of this smart grid under real conditions ended in 2013 and provided many key statements regarding the feasibility and cost-effectiveness of the use of this self-controlled, decentralized energy systems. Thus electric vehicles can be operated economically and provide real alternatives as a buffer system already today. Furthermore real-time control systems network expansion cost savings and yet the stability of the network with increased number of decentralized feeder can not compromise. An equally important issue is the consideration of the battery storages as a future possibility of network management. These are at present not as economically viable alternative for the solution of power - and memory problems.

III. PV NEXT GENERATION, MADE IN BRANDENBURG

In 2011 on an old aircraft border in Brandenburg was build one of the largest solar power plants of its time. A special point is the testing of novel battery storages the PV systems should also make baseload. Covering an area of 133 hectares more than 1 million solar panels were installed which deliver about

70 MW of power at peak times and can supply around 20,000 households with energy. Unlike conventional solar power plants storage technologies have been tested in this pilot project, the rule can provide energy to power system control. Thus, should a self-sufficient supply are guaranteed by the public network by compensating for the so-called shadow hours.

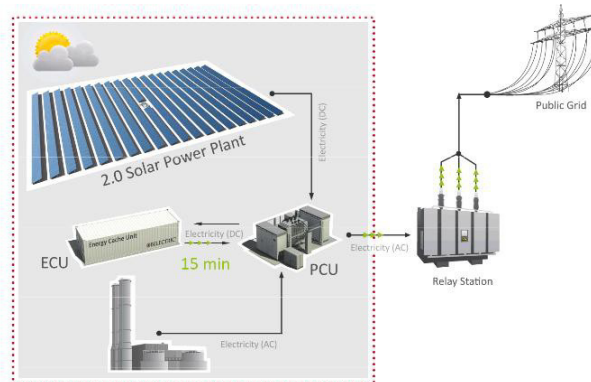

Figure 3. Construction of PV Next Generation

The core of this new technology are the **Power Conditioning Unit (PCU)** and the **Energy Buffer Unit (EBU)**. They both control the stabilization of the power supply and ensure the other hand for the storage of active power with intelligent battery storages. These two schemes provide higher availability in contrast to normal solar systems and prevent the use of shadow power plants. Although these ensure higher reliability, but are in just a few hours of operation per year and less resistance significantly inefficient. About a relay station, access to the public network takes place. This needs 365 days/year a certain base load of power that can be used simultaneously as a balancing power. If the sun does not shine, the battery jumps at each module and bridging the power flow required for a certain time. Sunshine and threatened overload the batteries can be charged against it. The developed battery storages currently have a rated capacity of 630 kW/h and can therefore provide either 800kW for 5 minutes or 300kW for an hour. As with all storage technologies there is also the problem of the permanent up - and discharge. However experiments have shown that after 4,000 cycles the charging capacity falls below 99% of the basic value. Currently the opening of this technology is discussed for the balancing energy market in the project. Here are the tender offer is not longer carried out based on performance but capacitive. Also available is an additional fee for such solar systems in space which could fall under some kind of “battery-EEG”.

IV. KEY POINTS OF REGENERATIVE POWER CONTROL

As already presented projects demonstrate the idea of regenerative power control is based on some key points without neglecting regional peculiarities. So far the pilot projects work effectively in a small room utmost. To achieve comprehensive benefits the extension to large metropolitan areas is essential. It is precisely there comes the need to expand the grid natural obstacles in rural areas and on the resistance of local residents. Rather it's a sensible symbiosis of network

expansion and network control to achieve. Furthermore the development of storage technologies is imperative as a core point. This includes large storages (eg pumped storage power plants) as well as smaller battery storages.

An already important infrastructure factor is the field of electric mobility. This has been established as economic management branch and offers many advantages in the implementation of renewable power control. The use of electric cars as a buffer memory can be done in terms of area in the whole of Germany largely independent of regional conditions. A fundamental point in the implementation is also the increased use of network monitoring – and measures in network automation. Local network stations for carrying out energy audits are basic instruments determined with the help of load flows and the need for balancing power for each region can be estimated. Using these data the amount of control energy and the feeder can be planned and included in the flows of individual municipalities. Using security technologies can then be taken in case of error measures to protect the individual network sections and their feeder and customers.

V. LINE REGULATION AS A MODEL FOR THE FUTURE

Line regulation is an important factor of the energy transition and will play a major role. The crucial point is to expand it on renewable energies. A special role is played by the development of storage technologies to buffer the energy. Needed for an optimal power flow is a complex monitoring system to detect problems early. The financing of the energy turnaround and the grid control is a central point for the investment opportunities through regional and national companies. So far specific cost estimates can not be foreseen and must be determined and assessed in the coming years on the basis of pilot projects.

Overall it should be noted that the grid control is a very young area of research and absolute in the regenerative area territory. The ongoing research projects need in the coming years especially extensive planning - and test phases for the optimization of technical processes and their commercial implementation. The projects shown all good beginnings but it requires a continuous development. Only then it's clear whether regenerative power control can be a real alternative in the energy turnaround.

-
- [1] Brabant, S./ Fallant, L. : "Alt Daber PV Next Generation – 2. Zwischenbericht zum Status der Entwicklung für einen Batteriespeicher zur Netzregelung" . BELECTRIC GmbH, 2012
 - [2] Braun M./ Garhamer M./ Köthe S.: "Beitrag der Photovoltaik zur Netzstabilisierung durch Einspeisemanagement". Fraunhofer IWES, 2012
 - [3] Canders, W.-R. : "Elektrische Energiespeicher für die Energieversorgung" . Wilhelmina Universität Braunschweig, Institut für Elektrische Maschinen, Antriebe und Bahnen, 2009
 - [4] Schulz, D. : "Netzintegration von Windenergieanlagen" . In: Etagreen, 2 (2011) , pp. 22-24
 - [5] Völker, J. : "Endbericht Integration der erneuerbaren Energien in den deutsch-europäischen Strommarkt" . Deutsche Energie-Agentur GmbH, 2012
 - [6] Kohler, S. : "Chancen und Risiken der Energiewende – Fakten für die Diskussion" . Deutsche Energie-Agentur GmbH, 2014
 - [7] Waffenschmidt, E. : "Elektrische Netze" . FH Köln, Institut für Elektrische Energietechnik, 2011
 - [8] <https://www.regelleistung.net>, unbekannter Autor, Ausschreibung Minutenreserveleistung , Sekundärregelleistung, Primärregelleistung , 15.05.2014
 - [9] <http://www.projekt-irene.de>, Für das Stromnetz der Zukunft, 06.05.2014
 - [10] <http://www.wildpoldsried.de>, Wildpoldsried – Das Energiedorf, 06.05.2014

Zero-energy buildings

An economic future?

Sascha Dahms

Chair of Power Distribution and High Voltage Engineering
Brandenburg University of Technology
Cottbus, Germany
sascha.dahms@tu-cottbus.de

Claudia Mrotzcek

Chair of Power Distribution and High Voltage Engineering
Brandenburg University of Technology
Cottbus, Germany
claudia.mrotzcek@tu-cottbus.de

Abstract—Zero-energy buildings are grid-connected buildings which provide a high standard of energy efficiency. This paper introduces the zero-energy building as one type of energy saving buildings. The construction and use of zero-energy buildings, as well as a comparison of advantages and disadvantages of zero-energy buildings are being explained.

Keywords: zero energy building, sustainability, renewable energy, energy prices, solar energy, operating expenses, sustainability, energy efficiency

I. INTRODUCTION

Due to the increase of energy prices in the last years it became very expensive to maintain the standard of living. In particular, the oil price has experienced a sharp increase as it is shown in figure 1.



Figure 1. Oil price development [1]

It means that the heating of buildings will be more expensive, too. Hence a new opportunity to save energy is needed. Old buildings have a huge loss of heat, which is caused by bad insulation. Thus there is a big potential to save energy. Therefore the research started to develop buildings, which do not need external energy sources, because they have the ability to save their warmth and produce additional needed energy by themselves.

Another reason for developing low energy houses is the goal of the Federal Government of Germany to decrease the energy consumption to reduce greenhouse gases.

This paper describes different types of low energy buildings and explains the functionality of zero energy buildings. Furthermore pros and cons of zero-energy buildings will be discussed.

II. CLASSIFICATION

In the last few years, the development of low energy buildings has been increasing rapidly. This is why the energy consumption of buildings decreases intensively. This brought out various types of buildings with different external requirements of energy.

Figure 2 is showing the development in research and building practice. There are also given the minimum requirements in accordance with the Energy Savings Ordinance (Energieeinsparverordnung, EnEV).

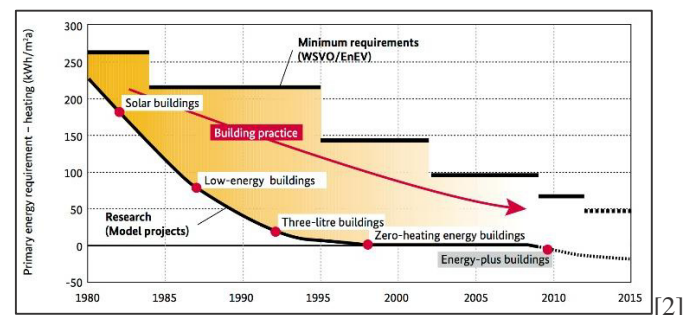

Figure 2. Developments in research and building practice [2]

It is shown that the building practice is different to the current research. This results mainly from the high investments for energy saving buildings, because of the materials that are used.

A. Solar buildings

Most buildings are dependent on external energy sources to heat the housing and conduct electrical devices. Houses, which will be supported by solar cells or solar collectors to reduce the external required energy, are called solar buildings. [3]

B. Low-energy buildings

A building, which has a very efficient insulating, loses fewer warmth and needs less energy to keep the indoor heat. Therefore these buildings are called low-energy buildings. [4]

C. Three-liter buildings

Three-liter buildings are low-energy buildings, which only need the energy of three liters oil per square meter to heat the housing. To reach this goal, a much better insulation is needed. [5]

D. Zero-heating buildings

Low-energy buildings, which generate their needed energy to heat the housing by themselves, are called zero-heating buildings. They receive their thermal heat from solar collectors and geothermics. The heated up water is used for radiators and daily use. In addition, electrical energy from solar cells is fed into the grid to compensate cold winter when extra energy is needed for heating. [6] *Note: Zero-heating buildings are not self-sufficient.*

E. Zero-energy buildings

A zero-energy building (ZEB) is an extension of the zero-heating building, which in addition produces its used electrical energy. To sum it up it is an energy efficient building which generates as much energy as it consumes [7]. The additional required energy for electrical devices is sourced from additional solar panels or a small wind turbine.

F. Energy-plus buildings

Energy-plus buildings are zero-energy buildings which have an energy surplus. This energy is fed into the grid to earn money and pay back the loan for the building. That can be realized by a much better insulation and more solar cells. [8]

G. Energy self-sufficient buildings

Low-energy buildings like mentioned above are not able to operate without grid connection due to the missing of storage. Therefore buildings can be equipped with possibilities to save heat and electricity. These buildings are independent and are called self-sufficient buildings. [9]

III. CONSTRUCTING A ZERO-ENERGY BUILDING

For the construction of a zero-energy building, the combination of four factors very is important [2]:

1) Optimized building envelope

The building envelope is one of the most important components for an energy-optimized building.

To decrease the heat transfer between the interior and exterior, due to differences in temperature, the building envelope requires a thermal insulation. This thermal insulation controls the heat, air and moisture flow. Therefore various layers of material, with very low thermal conductivity, are being added to the building envelope. Furthermore the ZEB is hermetically sealed because of the insulation. As a result the convective heat transfer decreases. Additionally airtight windows and doors are being used, to reduce the number of air leaks in the building.

The building exterior surface of zero-energy buildings, like building facade, windows, foundation, etc. should provide a low thermal transmittance or U-value. A low U-value stands for a high thermal insulation. This U-value has to be less than 0.6 W/ m²K for zero-energy buildings.

The ratio of surface to volume, significantly influences the heating energy demand of a building. A ZEB should have a small surface area to reduce the heat exchange and save energy. [10]

2) Efficient construction and technical building service system

Ventilation systems and heat recovery provide fresh tempered air inside the building. Energy efficient heat recovery supports radiators during heating period. In winter terrestrial heat can be used to warm up water and air used in the building. However, in summer it is used to cool down the inside air. This leads to a significant decrease of the energy demand for heating in ZEBs. Besides the integration of heat recovery in the ventilation system, heat recovery should be included in the drinkable water system, too.

Low-exergy systems are defined as a heating or cooling system. The process of heating or cooling is being supported by the system through air- or liquid-circulation to provide a temperature close to the room temperature. This way the heat is transferred into the room. [2]

3) Integration of renewable energy

The development of renewable energy plants is a key to improve energy efficiency of ZEBs. The on-site energy production is mostly a combination of different technologies. Common on-site renewable energy technologies for the generation of thermal heat are solar collectors, heat exchanger for fresh air and near surface geothermal power.

To generate electricity solar cells and wind turbines are being used. It is also possible to use heat for generating electricity with fuel cells. Hereby, most of the electrical and thermal energy can be provided. [11]

4) Optimized operation of integrated systems in conjunction with the defined use

In addition to the use of high efficient technologies and constructions, a ZEB requires an optimized operation of the integrated systems. To provide thermal comfort inside the building, hermetically sealed constructions and connections have to be applied. Furthermore thermal bridging on exterior surfaces such as windows should be avoided.

Ancillary to the integration of heat recovery, into the ventilation and water system, demand-controlled heating- and ventilation-systems are useful to avoid oversupply and losses.

Another point which can be optimized is the lighting. Large window areas with south exposure can be applied to reduce the heating energy and light demand by using daylight. Additionally to daylight, efficient lighting like energy saving lamps can reduce the energy demand. [7]

IV. PROS AND CONS

Energy-optimized buildings like ZEBs unite a various number of advantages. Zero-energy buildings enable many options for energy generation and savings. Due to their high energy efficiency ZEBs are more economical than normal buildings. This is an approach to protect the environment and climate. [12]

Nevertheless ZEBs obtain energy from fuel grid power to compensate weak solar days. Hence ZEBs receive electrical energy from energy sources which generate greenhouse gases during the transformation. But in terms of figures ZEBs are emission-free, because they produce their needed energy by themselves with renewable power plants. As a consequence there is a reduction of greenhouse gases. [11]

Another benefit of ZEBs is the fact of saving energy costs, which can be also called “second rent” [13]. But ZEBs should be considered critically when it comes to costs, because of the higher energy which has been used for building the house. This is also known as embodied energy and has not been included to the zero-energy calculation. That means the energy payback time of a ZEB, the time until energy can be actually saved, is significantly longer.

The high investment for construction and installation of ZEBs is a throwback for this sustainable solution, because it scares potential investors to invest. [11]

V. CONCLUSION

The usage of low-energy buildings reduces the energy demand from the grid. By better insulations, heat can be saved inside the housing. Different technologies of renewable energy provide warmth and electricity for the residents. Thereby costs can be reduced.

Another reason for zero-energy buildings is the reduction of fuel needed power because they generate their needed energy through renewables by themselves. In absolute terms, ZEBs are greenhouse gas free.

Because of extensive insulation and different technologies for generating and control energy, the investment is very high. Therefore the payback time is very long.

For environmental aspects it is not sure if ZEBs are sustainable in the long run. This is due to the materials used for

the insulation and solar cells. Therefore further research and calculations should be done.

REFERENCES

- [1] Data from: finanzen.net GmbH, *Ölpreis historische Kurse in Dollar | finanzen.net*. Available: <http://www.finanzen.net/rohstoffe/oelpreis@brent/historisch> (2014, Jun. 05).
- [2] Deutschland, Research for an environmentally sound, reliable and affordable energy supply: 6th Energy Research Programme of the Federal Government, 2011st ed. Berlin: Federal Ministry of Economics and Technology (BMWi) Public Relations, 2011.
- [3] A. G. Hestnes, R. Hastings, and B. Saxhof, *Solar energy houses: Strategies, technologies, examples*. London: James & James, 1997.
- [4] G. Dell, C. Egger, and C. Öhlinger, “Vom Niedrigenergiehaus zum Passivhaus — vom Schlagwort in die Praxis,” (German), *Elektrotech. Inftech*, vol. 120, no. 4, pp. 122-124, 2003.
- [5] *3-Liter-Haus*. Available: <http://www.das-energieportal.de/wohneigentuermer/3-liter-haus/> (2014, Jun. 06).
- [6] Science around us: From the 3-liter house to the zero-heating cost house - BASF - The Chemical Company - Corporate Website (2014, Jun. 06).
- [7] S. Berry, K. Davidson, and W. Saman, “Defining zero carbon and zero energy homes from a performance-based regulatory perspective,” *Energy Efficiency*, vol. 7, no. 2, pp. 303–322, 2014.
- [8] Robert Bosch GmbH, *Discover the Energy Plus Home | Theme special | insideBosch | Innovation | Bosch Group*. Available: http://www.bosch.com/en/com/innovation/insidebosch/energy_plus_home/discover_the_energy_plus_home.html (2014, Jun. 06).
- [9] C. Marino, A. Nucara, M. Pietrafesa, and A. Pudano, “An energy self-sufficient public building using integrated renewable sources and hydrogen storage,” *Energy*, vol. 57, pp. 95–105, 2013.
- [10] Di Giuseppe, E. “Nearly Zero Energy Buildings and Proliferation of Microorganisms”, *SpringerBriefs in Applied Sciences and Technology*, 2013.
- [11] Andresen, I., Bourrelle, J., & Gustavsen, A. “Energy payback: An attributional and environmentally focused approach to energy balance in net zero energy buildings”, *Energy and Buildings*. Vol. 65. pp. 84-92, 2013.
- [12] Lam, J., Li, D., & Yang, L. “Zero energy buildings and sustainable development implications”, *Energy*. Vol. 54. pp. 1-10, 2013.
- [13] Heinze, M., & Voss, K., “Ziel Null Energie.”, *DBZ*, no. 1, 2009.

Biorefinery

The sustainable innovation

Tom Kristian Hoffmann
BTU Cottbus-Senftenberg
Platz der Deutschen Einheit 1
03046 Cottbus, Germany
Tomkristian.Hoffmann@tu-
cottbus.de

Dai Cuong Phan
BTU Cottbus-Senftenberg
Platz der Deutschen Einheit 1
03046 Cottbus, Germany
Daicuong.Phan@tu-cottbus.de

Antonia Lamers
BTU Cottbus-Senftenberg
Platz der Deutschen Einheit 1
03046 Cottbus, Germany
Antonia.Lamers@tu-cottbus.de

Abstract—For two centuries renewable energy gains more and more in importance. Looking forward to the future the role of renewable energy is even getting more relevant. For example, the European Government sets their targets that they want to achieve till 2020. Some goals apply the climate change and sustainable development. The reason why renewable energy is getting significant is that the usage of fossil fuels is limited. Furthermore renewable energy resources are replacing the fossil fuels over the years. Biofuel is going to be used instead of fossil fuels. But to do that, Biofuel needs to be produced first, for example made out of biomass. Biomass as the new energy source?

Keywords-biorefinery biofuel; renewable energy resources; climate change; sustainable development; biomass, UPM

I. INTRODUCTION

In that concept “Targets 2020” the European Government has set many goals. Several goals concerning the climate change and sustainable development were defined in that concept. They plan to reduce the greenhouse gas emissions about 20 % in comparison with the emissions in 1990. In plus until 2020 the energy efficiency is planned to grow about 20 % and the percentage of renewable energy shall increase to 20 %. Several projects are already ongoing to raise the percentage of renewable energy. One of renewable energy producer is the biorefinery. The interest lies in the usage of waste and by-products, which are transformed afterwards in biomass. This biomass can be converted into biofuel, power and heat. The consideration will be lying explicit on the transformation of biomass into biofuel. [1][2]

II. UPM

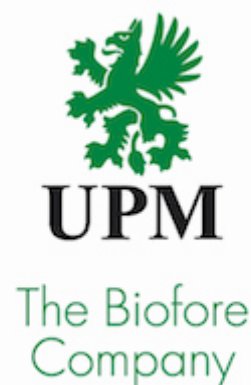

Figure 1 UPM Logo

UPM is a finish paper, pulp and timber manufacturer. This biofore company announced on February 2012 to build the first biorefinery for the production of biofuel made out of the by products in the paper industry in Finland. The term biofore describes the new forest industry. “Bio” stands for sustainable solutions and environmental performance. “Fore” stands for forest and the company's position at the forefront of the development. Their biofuel, named UPM BioVerno, should also reduce the greenhouse gas emissions. The reduction of the greenhouse gas emissions follows the concept of the term biofore. For UPM's hydrotreatment biorefinery in Lappeenranta the main raw material is untreated tall oil, which is a residue of chemical pulp production, mainly generated in the production of sulphate cellulose from softwood. A significant part of the raw material comes from UPM's own pulp mills in Finland. UPM's wood sourcing is based on the principles of sustainable forest management, chain of custody and forest certification. By further processing crude tall oil UPM is able to utilize the wood it uses for its pulp

production in a more efficient way without increasing wood harvesting. [3][4]

III. FACTS AND FIGURES

UPM invested 150 million EUR in total for the first biorefinery, which is still under construction. In the course of the year 2014 the build of the refinery should be finished. The annual amount, which the biorefinery should produce, is 100.000 tons of renewable diesels, equating to 120 million liters. With this build approximately 200 jobs are created. March 2013 UPM won the sustainable biofuel awards in Rotterdam for their innovation BioVerno. UPM also stands in corporation with the Technical research center of Finland VTT and the Auto-Group VW to test the biofuel. Results has shown that BioVerno reduces the greenhouse gas emissions by 80 % compared to fossil fuels and can also be mixed with other fuels, unlike the first generation of biodiesels. For another future project in Strasbourg, France the European commission has awarded UPM a grant of 170 million EUR for a solid wood-based biorefinery. This grant is from the European Commision's NER300 fund, which is for the support of innovative renewable energy technology.[5][6]

IV. PRODUCTION

Biofuel is produced from biomass conversion in several complicated proceedings. Depending on the desired biofuel there has to be used different precursors and conversions. Distinguished in first and second generation biofuel every end product has its own assets and drawbacks. The first generation fuels are based on the extraction of sugar, starch and vegetable oil[7]. Enzymes and microorganisms are the producer of the most commonly alcohol *ethanol* through the fermentation of sugar, starches or cellulose. In comparison, the substrates of the second generation fuels are lignocellulosic biomass or woody crops, agricultural residues or waste [8]. Even a third and new generation is defined, that contains sea weeds and algae. Both bioethanol and biodiesel are the most common forms of biofuel and distinguished in the first two generations.

A. BIOETHANOL

Two main reactions, hydrolysis and fermentation, are the keys to understand how biomass is converted to bioethanol.

a. HYDROLYSIS

Hydrolysis is the chemical reaction where the complex polysaccharide in the raw feedstock is converted to simple sugar, which would be processed later in the fermentation. [9]

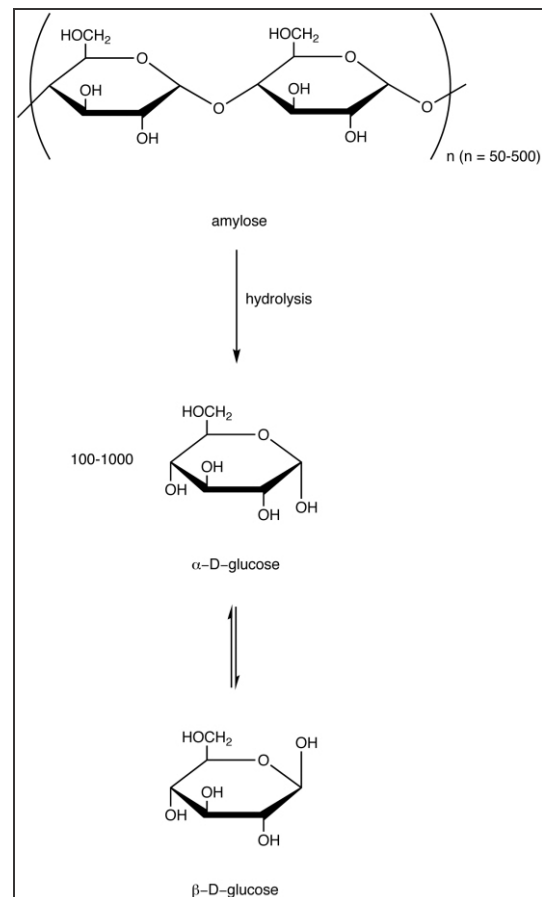
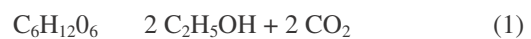

Figure 2 Hydrolysis of polysaccharides to glucose

b. FERMENTATION

The most common produced alcohol worldwide, ethanol, is produced by the action of microorganisms and enzymes through the main reaction fermentation of sugars or starches, or cellulose[10].

In the biology, fermentation is the anaerobic process of extracting energy from organic compounds. A conversion from sugar to ethanol (1).



In industrial terms, fermentation is the process of derivatization of organic materials to new products by means of enzymes. Even in the traditionally nutrition manufacturing it is possible to see this process (e.g. beer and bread).

The fermentation processes have just gained importance in those situations where high productions exist. It is quite costly because of the low concentration of the desired product, which needs efficient cleaning and concentration procedures. Even it is necessary to work under sterile conditions, so that other enzymes or microorganisms do not interfere with the desired product scheme.

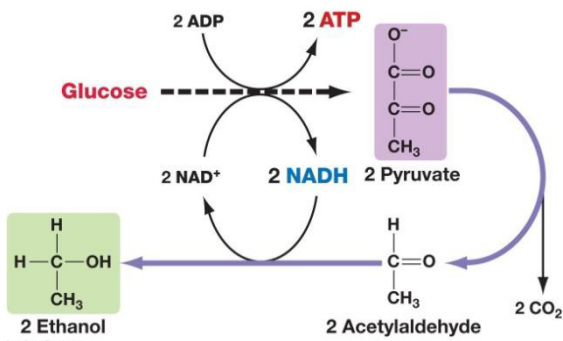

Figure 3 Fermentation process (Source:[11])

c. UPM

UPM's fuel would base on the renewable raw material from wood-based tall oil to produce the biodiesel. Cellulose the principal component of wood is used in the UPM biorefinery. It is a polysaccharide like glucose. [12]

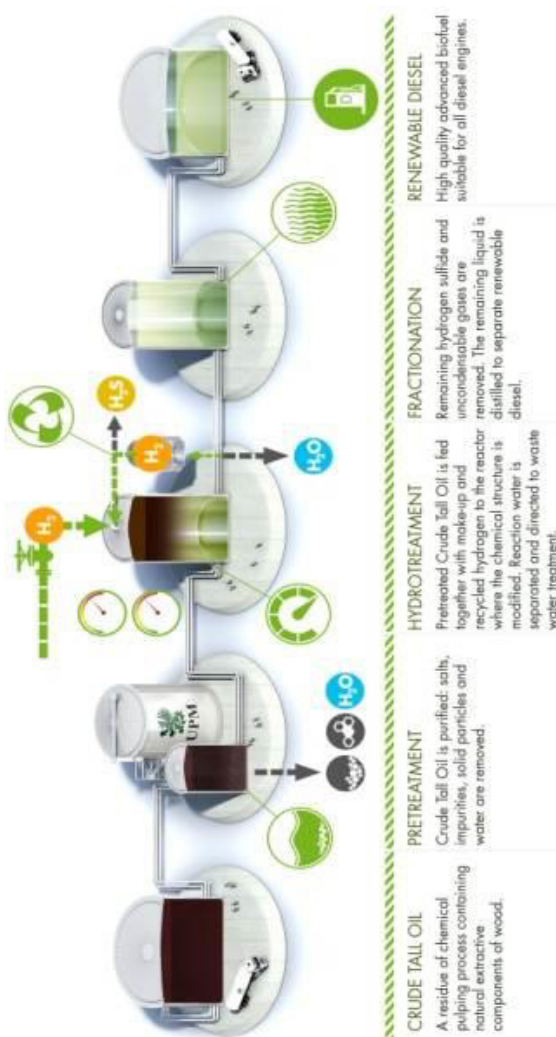

Figure 4 UPM's process to manufacture BioVerno

d. PRETREATMENT

The refinery will realize the manufacturing of the biodiesel from commercial and industrial waste, such as paper, cardboard, wood and plastic. A part of the waste would be used for generating ethanol and a part for generating energy. The solution makes it possible to manufacture cost-effective second generation biofuels for traffic in Europe without endangering the raw material supply of the forest industry. [13]

The pines grow in Short Rotation Forestry (SRF) in northern Scandinavia where UPM owns 1.1 million hectares of wood. [14]

SRF are sustainably managed forests.

The tall oil, also called "liquid rosin", is an oily, resinous mixture of rosin acid (33-47%), fatty acids (42-55%), sterols, unsaponifiable, colored and odorous material. Crude tall oil is gained as a result of the separation process of fibrous material from wood. It is a residue of the Kraft process in the paper pulp manufacturing from wood. The remaining "black liquor" is concentrated by evaporation after the separation, whereby the crude soap is salted out and collected. In the pretreatment water, salts, impurities and solid particles are removed so the tall oil becomes almost 100% pure.

The production of one ton of paper yields 30-40 kg of tall[15].

e. HYDROTREATMENT

In this chemical engineering process hydrogen is used to remove the impurities and sulfur in the pretreated crude tall oil. The reaction converts the complex polysaccharides in the raw feedstock to simple sugar. Enzymes and acids are used to catalyze the reaction. Even it is important to remove the remaining sulfur from the biofuel before it goes on to the refining[16].

f. FRACTIONATION

Fractionation is based on a process of separation. The process includes a certain mixture of gas, solids, liquids and isotopes. Furthermore the different kinds of elements are getting divided in a number of smaller amounts, the so called fractions. The content of the mixture varies according to a gradient.

The challenge is to find a perfect match between the fractions and the desired purity. Fractionation is a common technique, which can separate more than two elements in one proceeding.[19]

At least the finish produced renewable biodiesel is suitable for all diesel engines.

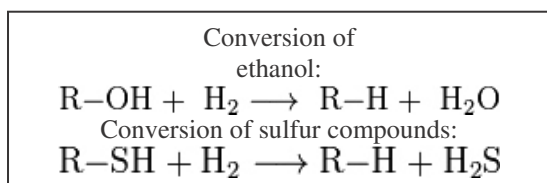

Figure 5 Chemical basic reaction in the hydrotreatment (Source:[17])

REFERENCES

B. ANOTHER PROCESS OF BIODIESEL

a. THE MAIN REACTION TRANSESTERIFICATION

In comparison to ethanol, biodiesel is commonly produced by the transesterification.

Only this reaction of alkyl esters of oils or fats with an alcohol leads to the product called biodiesel. The most commonly used ester is the methyl ester because it's basic material methanol is the least expensive alcohol in the production.[18] These reactions are often catalyzed by the addition of an acid or base catalyst. The reaction can also be accomplished with the help of enzymes (biocatalysts) particularly lipases. Even the chemical reaction esterification is adaptive in the production.

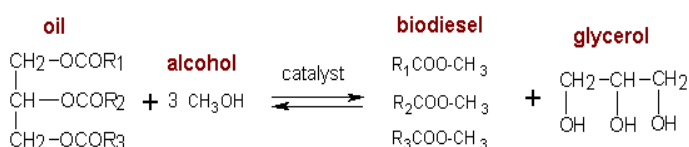

R_1, R_2, R_3 are hydrophobic rest of fatty acids

Figure 5 The transesterification reaction. The alcohol used for producing biodiesel is usually methanol ($R' = CH_3$) (Source[20]).

V. ADVANTAGES AND DISADVANTAGES OF BIODIESEL

Ideal for heavy engines, like heavy rails, trucks and marine engines, some companies are testing the biodiesel as fuel at present, like UPM does for cars. But it could not be used as jet fuel because it's freezing point is too high for those heights.[21]

In General biofuels cause less greenhouse gas emissions than fossil fuels. But they also stay in conflict with the food production due to their requirement of big areas of cultivable land. In comparison with Bioethanol Biodiesel is more expensive to produce and the production methods are more difficult. In return in the automobile industry the compression-ignition engines do not need a modification for diesel engines. [22]

- [1] <http://ec.europa.eu/europe2020/targets/eu-targets/>
 [2] <http://www.energieagentur.nrw.de/biomasse/themen/umwandlung-von-biomasse-7693.asp>
 [3] <http://www.upm.com/EN/MEDIA/All-news/Pages/UPM-to-build-the-world%E2%80%99s-first-biorefinery-producing-wood-based-biodiesel-001-Wed-01-Feb-2012-10-05.aspx>
 [4] <http://www.upm.com/EN/ABOUT-UPM/biofore-in-action/Pages/default.aspx>
 [5] <http://www.upmbiofuels.com/biofuel-production/biorefinery/Pages/Default.aspx>
 [6] <http://www.upm.com/EN/MEDIA/All-news/Pages/UPM-wins-Sustainable-Biofuels-Award-in-Rotterdam-001-Thu-14-Mar-2013-09-00.aspx>
 [7] V. K. Gupta, M. G. Tuohy, Biofuel Technologies Springer-Verlag: Berlin, 2013
 [8] <http://jatropa.pro/PDF%20bestanden/biofuel-1-and-2-generations.pdf>
 [9] R. A. Jansen, Second Generation Biofuels and Biomass, WILEY-CH: Weinheim, 2013
 [10] R. D. Schmid: Taschenatlas der Biotechnologie und Gentechnik, WILEY-VCH: Weinheim, 2006
 [11] <http://www.phillymag.com/fooboos/2013/04/08/weekend-fermentation-class-at-greengrow-community-kitchen/>
 [12] V. Böllert, R. Csuk, F. Hirsinger, F. Schierbaum, B. Zobelein, H. Zobelein, Dictionary of Renewable Resources, WILEY-VCH: Weinheim, 2001
 [13] <http://www.upm.com/EN/MEDIA/Press-kits/Business/Biofuels/Pages/default.aspx>
 [14] <http://www.upm.com/EN/RESPONSIBILITY/Forests/Pages/default.aspx>
 [15] V. Böllert, R. Csuk, F. Hirsinger, F. Schierbaum, B. Zobelein, H. Zobelein, Dictionary of Renewable Resources, WILEY-VCH: Weinheim, 2001
 [16] G. Knothe, J. Krahl, J. V. Gerpen, The Biodiesel Handbook, AOCS PRESS: Urbana (U.S.A), 2010
 [17] G. Knothe, J. Krahl, J. V. Gerpen, The Biodiesel Handbook, AOCS PRESS: Urbana (U.S.A), 2010
 [18] V. K. Gupta, M. G. Tuohy, Biofuel Technologies Springer-Verlag: Berlin, 2013
 [19] Brian Fry, Isotope Ecology, Springer Verlag, 2006
 [20] http://kfch.upce.cz/htmls/vedecká_cinnost_bionafta_EN.htm
 [21] R. A. Jansen, Second Generation Biofuels and Biomass, WILEY-CH: Weinheim, 2013
 [22] http://biodieselproject.de/vor_und_nachteile.html

Solar chimney as future energy source

Moein Pakdel Sefidi
Faculty of Power Engineering
Brandenburg University of Technology Cottbus-Senftenberg
Cottbus, Germany
Moein.p.s@gmail.com

Abstract—The various component Energy production based on renewable energies is one of the fundamental methods for energy generation in the 21st century. The solar chimney power plant is a simple solar thermal-wind power plant that is capable of converting solar energy into electricity. This paper explains solar chimney performance and its ability to produce electricity in future. Mathematical modeling of collector is done and equations are considered. Moreover some efficiency, environmental and economic challenges is discussed.

Keywords: *Solar chimney Power plant, Performance, Absorber, Collector*

I. Introduction

Without any shadow of a doubt, today's world energy demand is increasing remarkably. At this moment the world's population is growing with a high rate. In addition, due to the technology development, the need of energy for each person is rising continuously. Therefore, the amount of energy consumption of the world will be multiplied many times over. On the other hand, the main current resources of energy, including oil, gas and coal are not renewable and will be depleted in near future. Moreover, these fossil resources influence the environment intensively. One of the most substantial consequences is the global warming phenomenon. All the challenges mentioned above, have caused a tendency to supply energy with renewable and clean resources, of which solar energy can be counted. Because of being widespread and available in most countries, this source of energy has attracted the attention of many researchers around the world to find methods for utilizing sun radiation.

In 1903, Isidoro Cabanyes, a colonel in the Spanish army, proposed a solar chimney power plant in the magazine *La energía eléctrica*. [2] Another early description was published in 1931 by German author Hanns Günther. [3] Beginning in 1975, Robert E. Lucier applied for patents on a solar chimney electric power generator; between 1978 and 1981.

In 1982, a small-scale experimental model of solar chimney power plant was built under the direction of German engineer Jörg Schlaich in Manzanares, Ciudad Real, 150 km south of Madrid, Spain; the project was funded by the German government. About four years after his research, construction of a solar chimney pilot plant was started in Manzanares, Spain. The chimney had a height of 195 meters and a diameter of 10 meters with a collection area (greenhouse) of 46,000 m² (about 11 acres, or 244 m diameter) obtaining a maximum power output of about 50 kW. However, this was an experimental setup that was not intended for power generation. Instead, different materials were used for testing such as single or double glazing or plastic (which turned out not to be durable enough), and one section was used as an actual greenhouse, growing plants under the glass. During its operation, optimization data was collected on a second-by-second basis with 180 sensors measuring inside and outside temperature, humidity and wind speed.

This pilot power plant operated for approximately eight years but the chimney guy rods were not protected against corrosion and not expected to last longer than the intended test period of three years. So, not surprisingly, after eight years they had rusted through and broke in a storm, causing the tower to fall over. The plant was decommissioned in 1989. [4]



Figure 1- a solar chimney power plant, in Manzanares, Spain

Scale-up study of the experimental results of Manzanares to large solar chimney power plants was done by Schlaich et al. (1990). Yan et al. (1991) exploited practical correlations used for deriving equations of air flow characteristics, to make a modified analytical model of a solar chimney. Padki and Sherif (1992) explained the influence of dimensions and operating conditions on the solar chimney performance. For the first time, a numerical modeling of plant with a collector equipped by a water storage system was presented by Kreetz (1997) who indicated that a solar chimney can operate around the clock, even at night. Pasumarthi and Sherif (1998) performed an experimental and theoretical analysis on a pilot plant constructed in a college.

Solar energy is quite simply the energy produced directly by the sun and collected elsewhere, normally the Earth. The sun creates its energy through a thermonuclear process that converts about 650,000,000 tons of hydrogen to helium every second. The process creates heat and electromagnetic radiation. The heat remains in the sun and is instrumental in maintaining the thermonuclear reaction. The electromagnetic radiation (including visible light, infra-red light, and ultra-violet radiation) streams out into space in all directions. [1]

Only a very small fraction of the total radiation produced reaches the Earth. The radiation that does reach the Earth is the indirect source of nearly every type of energy used today. The exceptions are geothermal energy, and nuclear fission and fusion. Even fossil fuels owe their origins to the sun; they were once living plants and animals whose life was dependent upon the sun.

The total solar energy absorbed by Earth's atmosphere, oceans and land masses is approximately 3,850,000 exa joules (EJ) per year. In 2002, this was more energy in one hour than the world used in one year. Photosynthesis captures approximately 3,000 EJ per year in biomass. The technical potential available from biomass is from 100–300 EJ/year. The amount of solar energy reaching the surface of the planet is so vast that in one year it is about twice as much as will ever be obtained from all of the Earth's non-renewable resources of coal, oil, natural gas, and mined uranium combined. Solar is one of the most talked-about alternative energy sources in the world today.[4]

- Enough energy comes from the sun in one hour to power the global population for a year.
- Sunlight is a totally renewable resource, unlike oil, coal and natural gas.

Solar chimney is one of the most innovative plants designed and constructed for exploiting solar energy. This instrument makes a natural convection of air flow which is capable of driving wind turbines located in the air flow path. Generators coupled to wind turbines make electricity as the output energy.

II. Solar chimney structure

Solar chimney is a powerful instrument for exploiting the energy of Sun in order to generate electricity. This plant consists of three main parts: a surface for collecting solar radiation called 'absorber', a closed space for making greenhouse effect called 'collector' and a long tubular structure for leading air flow called 'chimney'. Fig.2 indicates the mechanism of a solar chimney performance.

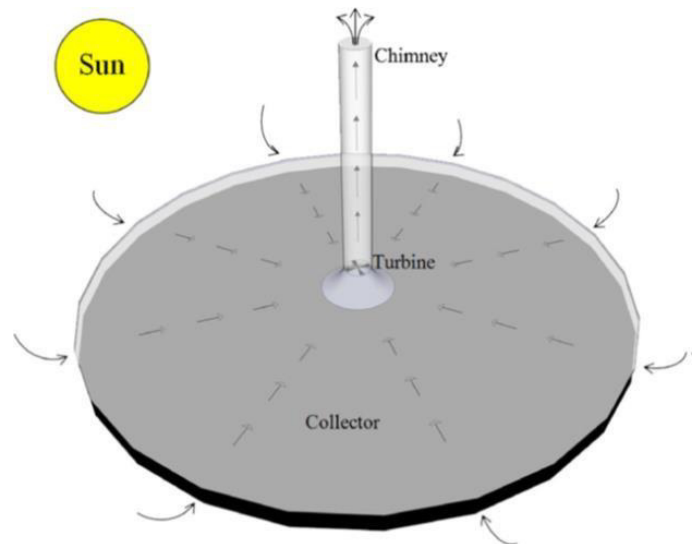

Figure 2. Schematic illustration of a solar chimney power plant.

III. System description

As seen in Fig.2, solar radiation is the running energy of the system, which illuminates to the plant. At the beginning, this radiation arrives at collector which is a transparent cover with high transmissivity and low conductivity. The sun radiation includes high energy electromagnetic spectrums having short wavelength, which easily pass the collector and reach the absorber. Absorber is a surface with high

absorbency which is selected as dark and rough as possible. Being dark and black, increases absorptivity and roughness reduces the reflectivity remarkably. When absorber obtains radiation, warms up gradually and its temperature increases. The air near the absorber and soil under the absorber start warming. Increasing absorber temperature causes emitting an IR spectrum. Infrared waves, because of having long wavelength, possess low energy and cannot pass the collector. Hence, the heat absorbed on the absorber traps in an enclosure which has been provided by the collector. This phenomenon is named the greenhouse effect. Air in the enclosure warms up moreover due to the greenhouse effect and heat accumulation causes heat penetrating into soil. Increasing the air temperature causes density decrease and density gradient occurs in the air flow body. Density gradient results in appearing buoyancy forces and the warmed air in the vicinity of the absorber starts climbing. The collector has trapped the air and there is no way for escaping except the chimney entrance. Chimney, which is located in the center of the collector, is like a long pipe and lets warmed air rises. When this warm air rises, the ambient air comes into the collector due to ventilation and fills the empty space made by the rising air. Thus, a flow of air enters the collector, warms and rises in the chimney. If some turbines would be located in the air flow passage, the energy of this flow can be converted to electricity by coupling generators to the turbines. [5]

On the other hand heat, which has penetrated into soil, is stored little by little in the levels of the ground. Just the upper levels of the ground, with a depth of lower than five meters, are influenced by the surface temperature changes. The ground temperature with a depth of more than five meters remains constant and unchanged in both summer and winter seasons. Fig. 3 shows the stated declaration.

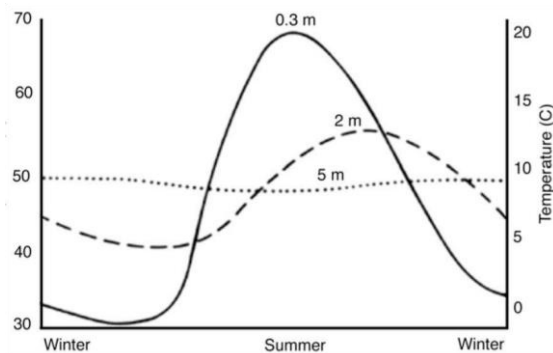

Figure 3- Temperature changes for different depths of the ground [5]

The amount of output energy is dependent on the air volume flow rate. Since dimensions are constant, the amount of the output energy is only on the air velocity. This means that more velocity magnitude results in more electricity output. Therefore, a region in which solar radiation provides more velocity magnitude in the air flow will be the best and the most efficient place in terms of power production.

IV. Mathematical modeling of collector

Considering the steady flow of air in the collector, the temperature distribution can be obtained as a function of collector radius. Air warms while it passes through collector inside. Convective heat transfer occurs from absorber to air and also from air to collector simultaneously. By considering a differential control volume in the collector, the energy balance can be expressed as:

$$\dot{m} c_p dT = [h_{ab}(T_{ab} - T) + h_c(T_c - T)]dA \quad (1)$$

(c: collector, ab: absorber)

Which dA equals to $2\pi r dr$. Furthermore, it is important to notice that heat transfers from the absorber to air and air to collector roof accordingly. Therefore the energy balance equation can be written as follows:

$$\dot{m} c_p dT = -[h_{ab}(T_{ab} - T) + h_c(T_c - T)]2\pi r dr \quad (2)$$

The temperature and heat transfer coefficient of both absorber and collector are not constant. As a primary approximation, these quantities (T_{ab} , T_c , h_{ab} and h_c) can be assumed constant. By this simplification, temperature distribution is expressed as:

$$T(r) \frac{1}{h_{ab} + h_c} \left\{ h_{ab} T_{ab} + h_c T_c + [h_{ab}(T_a - T_{ab}) + h_c(T_a - T_c)] e^{\frac{\pi(h_{ab} + h_c)(r^2 - R^2)}{m c_p}} \right\} \quad (9)$$

Mass flow rate can be calculated by quantities of density, velocity and area at the chimney throat (chimney entrance):

$$\dot{m} = \rho_{th} V_{th} A_{th} \quad (4)$$

In order to determine density, Boussinesq's approximation can be used:

$$\rho = \rho_a [1 - \beta_a (T - T_a)] \quad (5)$$

β is the thermal expansion coefficient which is defined by $\beta = 1/T$ for an ideal gas. Thus, $\beta_a = 1/T_a$ and Boussinesq's equation can be used as:

$$\rho_{th} = \rho_a [1 - \beta_a (T_{th} - T_a)] \quad (6)$$

A_{th} is simply defined by $(\pi D_{ch}^2)/4$ and V_{th} can be measured by an anemometer fixed in the chimney entrance. [5]

V. Why use solar chimney technology?

Also, because of the heat retaining material within the greenhouse, solar chimney can maintain constant upward draft and therefore energy generation for nearly 24 hours. This is different from wind farms, which can only generate electricity on an intermittent basis. The inside of the tower and greenhouse will be a forgiving enough environment to allow maintenance crews to enter it while it is operating. This is different from many types of plants, especially nuclear, that need to be shut down during maintenance. Finally, unlike photovoltaic cells, the greenhouse can heat air using both direct and diffuse sunlight, which is important for countries that often have cloud cover. [6] Besides it, there are several advantages of using solar chimney power plants.

- Power generation without fuel consumption. The plant does not require any non-renewable fuels in order to, so the plant would never have to deal with Fluctuation in electricity price and the costs can be kept constant for a long time.
- Do not require water. Solar chimney power plants require no cooling water, this is very important especially for arid regions.
- No environmental pollution. The solar chimney power plants generate electricity without polluting the air and do not produce harmful toxins in the air when fossil fuel power plants pollute their environment by consuming oil, gas or coal. Nuclear power plants produce radioactive nuclear waste that are dangerous and pollutes the environment and creates huge problems for the planet.
- Ability to supply small grids
- Low Depreciation and long life. The plant has a long operating life approximately 65-70 years

while fossil fuel power plants operate for 15-30 years.

- Low maintenance cost.
- The plant operates using simple technology. The technology of a solar chimney power plant will not become out-dated easily. Solar chimney power plants require no professional specialists except for possibly the turbo-generator, and can be applied automatically. While in other kind of power plants high level specialists have been required and these devices permanently need to have special care.
- The ground (soil) underneath the collector of a solar chimney power plant acts as a natural energy storage mechanism, which allows the plant to generate power at night.
- Construction materials that are used (mainly glass and concrete) for such a plant, are relatively inexpensive and readily available.
- Low maintenance cost.

“These are the primary advantages of a solar chimney power plant. Some secondary advantages of the construction of such a plant would include job creation during the construction period and boosted tourism to the area.

- The main disadvantages of solar chimney, which generally limit the use of these plants, are as follows:
- The efficiency of converting solar energy into electrical energy is very low.
- The accession to power with fossil fuel backup system is impossible.
- Large amount of construction materials and a wide flat field is required.
- A very high chimney is required to achieve high level of electrical power.

VI. Environmental challenges

Obviously, the tower releases no greenhouse gases such as CO₂ or methane. By generating 200 MW from a solar tower and not a fossil fuel, 830,000 tons of CO₂ per year could be kept out of the atmosphere. However, there are several environmental problems associated with solar towers.

The first is that they will be placed in the middle of the desert. The desert areas of the planet have a high albedo and currently reflect 35-45% of the sunlight they receive. Dark glass paneling, such as would compose the greenhouse of the solar tower, would reflect less of the sunlight and absorbing more heat. While the change in albedo is probably not large enough to significantly affect the albedo of the earth, it may have an effect on local climate.

Another heat problem is associated with the thermal plume that will come from the top of the tower. Air will be spewing out of the top of the tower at around 60 degrees Celsius, about 50 degrees warmer than the surrounding air at 1 KM high. Normally, air that is cooling will start to fall and release its moisture as it descends. Because of winds, this precipitation will land in areas closer to the poles than the deserts. However, with superheated, dry air streaming into the atmosphere above deserts, it will take longer for the air to cool and descend. Depending on the location of the solar towers, this could cause desertification in the areas near the deserts.

Solar towers, because they would dramatically heat large portions of air, might contribute to this problem. However, one wonders whether the lack of greenhouse gasses emitted from these towers might counterbalance the effects of the heat which they are producing, as opposed to a fossil-fuel burning power plant that produces both heat and greenhouse gas.

A more local problem is that of ecosystem degradation. The area around Buronga is mostly state land, pretty rural. Most solar towers would probably be placed in rural areas, and since they take up almost 32.5 KM squared it will have a pretty significant impact on local ecosystems. Road building and turbine noise will also cause problems. Also, these towers, at 1 km high, will be able to be seen from very far away. [6]

VII. Efficiency challenges

The solar updraft tower has a power conversion rate considerably lower than many other designs in the (high temperature) solar thermal group of collectors. The low conversion rate is balanced to some extent by the lower cost per square meter of solar collection.

Model calculations estimate that a 100 MW plant would require a 1,000 m tower and a greenhouse of 20 square kilometers. A 200 MW tower with the same tower would require a collector 7 kilometers in

diameter (total area of about 38 km²). One 200MW power station will provide enough electricity for around 200,000 typical households and will abate over 900,000 tons of greenhouse producing gases from entering the environment annually. The collector area is expected to extract about 0.5 percent, or 5 W/m² of 1 kW/m², of the solar energy that falls upon it. Concentrating thermal (CSP) or photovoltaic (CPV) solar power plants range between 20% to 31.25% efficiency (dish Stirling). Overall CSP/CPV efficiency is reduced because collectors do not cover the entire footprint. Without further tests, the accuracy of these calculations is uncertain. [4]

A solar updraft power station would require a large initial capital outlay, but would have relatively low operating cost. As with other solar technologies, some mechanism is required to mix its varying power output with other power sources. Heat can be stored in heat-absorbing material or saltwater ponds. Electricity can be cached in batteries or other technologies. [4]

VIII. Economic challenges

However, since the towers are rather interesting looking there could be a lot of revenue to be had from tourism. In fact, almost 35 jobs in the solar tower would be dedicated solely to tourist maintenance. Not only would people come to see the tower itself, thereby generating income for EnviroMission itself, the people would increase visitation to nearby towns and pour money into them. Wentworth Shire, where the Australian plant is to be located, is glad to have it near them for the tourism. However, there could be a negative impact as far as outdoors-type tourists are concerned. People who want to go hiking in the desert are going to avoid areas where they can see a 1 km tall tower looming above them. However, there probably will be many more people interested in seeing such an enormous structure than want to hike or camp in pristine desert areas. Also, solar towers will likely be placed close to cities and not out in the wild so that there is not much energy loss in transferring electricity to cities, where it is needed. Since solar towers do not generate greenhouse gases and are cheap to maintain, they seem like a very real alternative to fossil fuel energy. There is no information available as to the competitiveness of solar tower energy, since it is not yet being produced. One can imagine that for the first ten years the companies will suffer losses due to the large building expense. However, as they pay off that debt, and as green energy becomes more in demand (especially in Australia, with its governmental

mandate), the returns from a solar tower could be quite high, and the price could become very competitive. It is a good thing that the government of Australia is taking an interest in this technology, since it represents renewed commitment to the pressing problem of global climate change.

IX. Conclusion

Solar chimney converts solar energy to electricity using direct and diffuse solar radiation. It works on a simple principle. As thermodynamic efficiency increases with the tower's height, solar chimney must be large to generate electricity at a competitive cost. Constructing larger power plants require a lot of costs, in the other hand it can create many of new works for people. Solar chimney reduces the emissions which can be produced by fossil fuel power plants and this is great benefit for our environment. The construction of solar chimney needs simple materials which is already available in everywhere, as it mainly consists of concrete and glass. They produce energy from a sustainable source of energy.

At the end, for decision that whether this kind of plants should be practically constructed or not, one must compare all the benefits to our planet against negative effects.

References

- [1] E. W. Brown, 1998, An Introduction to Solar Energy
- [2] (Spanish) Lorenzo. Las chimeneas solares:De una propuesta española en 1903 a la Central de Manzanares De Los Archivos Históricos De La Energía Solar.
- [3] Günther, Hanns (1931). In hundert Jahren — Die künftige Energieversorgung der Welt. Stuttgart: Kosmos, Gesellschaft der Naturfreunde
- [4] J. Schlaich, solar updraft towers, Slovak journal of civil engineering
- [5] Kasaeian et al, ICRERA2013 „Numerical Simulation for Performance Evaluation of Solar Chimney Power Plants in Iran“
- [6] Nordell, Bo Thermal pollution causes global warming Global and Planetary Change Volume 38, Issues 3-4 , September 2003, Pages 305-312
- [7] <http://www.renewable-energy-info.com>

Demand-Side-Management

Contribution of a Demand Shift or a Decrease in Demand to the German Energy Transition

Benjamin Petters (2921303), Tobias Quint (2902291), Julius Wieczorke (2921297)

BTU Cottbus - Senftenberg

Cottbus, Germany

tobias.quint@tu-cottbus.de

Abstract— The energy transition creates new challenges for the German electricity system: More renewable and less conventional energies, insufficient storages and the nuclear phase-out are some reasons for that. With Demand Side Management, the consumers can support grid stability. Germany has a large unused potential for that. However, suitable regulations are missing yet.

Keywords – Demand Side Management; Demand Response, Load Management; Control Power; Redispatch; Detachable Load

I. INTRODUCTION (HEADING 1)

Due to energy transition, Germany faces a continuously increasing share of renewable energies in the electricity system. The amount of conventional capacity drops. This development involves new challenges. In order to balance generation and demand, storages are used and conventional power plants adjust their production to the feed-in of renewable energies. However, existing storages like pumped storage hydro power stations are not sufficient yet. Furthermore, investments into conventional power plants are less profitable because of a decline in exchange electricity prices. Because of the location of renewable energies (e.g. wind energy mainly in Northern Germany), existing power lines are not sufficient anymore. This is why, in an electricity system with an increasing share of non-dispatchable generation and a decreasing share of conventional generation, it is important to think of additional ways to stable the system. Demand Side Management can support the stability of the electricity system by involving the demand side.

This paper investigates a possible contribution of Demand Side Management (DSM) to the German energy transition. For that reason, the situation and development of the German electricity market is described in the next Chapter. Following this, some characteristics of DSM are explained (Chapter III). DSM can support or replace some existing regulations like control power or redispatching. The functionality of these regulations is shown shortly in chapter IV. Finally, possible sectors for DSM (chapter V) and an economic view (chapter VI) are considered.

II. NEW CHALLENGED OF THE GERMAN ELECTRICITY MARKET

With the “Energiewende”, Germany became one of the most ambitious countries trying to establish a sustainable

energy supply in the sectors of electricity, heat and mobility [1]. Basic aims are the reduction of risks, such as nuclear catastrophes, climate protection, the reduction of use of fossil fuels and the encouragement of local energy production. Therefore, different laws and regulations, such as the EEG, were implemented. The rising amount of renewable energy supply, the nuclear phase out in 2022 and a more decentralized energy feed-in create fundamentally changes of the electricity system [2]. The share of different technologies in the German electricity production as well as the development of fossil, nuclear and renewable sources in the last three years can be seen in figure 1.

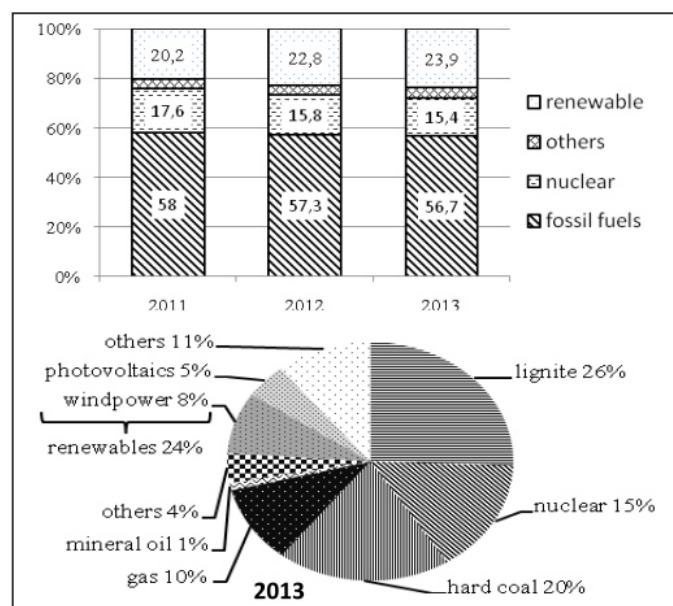

Figure 1. Share of different technologies to the relative gross electricity production in Germany (on the basis of [4])

Photovoltaic and wind power are characterized by fluctuating and non-dispatchable feed-in. The rising number of on- and offshore wind parks, as well as installation of photovoltaic increases power fluctuations. In an electricity system, demand and supply have to be equal every time. Otherwise frequency fluctuations emerge and the stability of the power grid is endangered. For that reason, conventional power plants and pumped storages hydro power stations (storage) adjust their production to the feed-in of renewable energies. This situation is shown in figure 2 by means of the

electricity demand and generation in Germany during an exemplary week in autumn. Conventional power plants (gray area) have to cover the so called residual load, which is the gap between load (red line) and renewable generations (colored areas). As illustrated with the white arrows, the residual load can differ strongly from day to day.

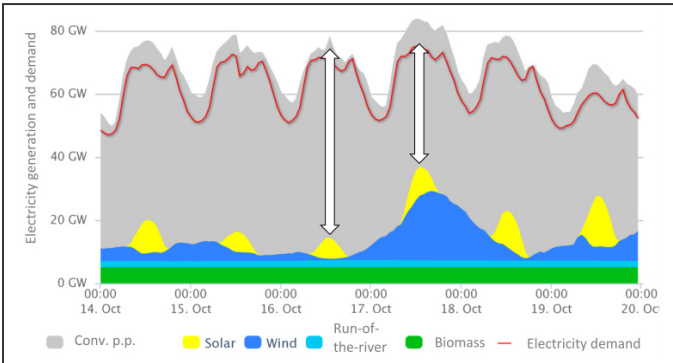

Figure 2. Electricity demand and generation in GER (14.-20.10.2013) [11]

Since renewable energies are subsidized by the German Renewable Energies Act (EEG), a rising share of these technologies leads to a drop of electricity prices at the electricity exchange. Hence, the profit of conventional power plants decreases (especially in case of gas turbines). That is why the share of conventional generation decreases [3].

An additional solution for balancing fluctuating renewable in-feed are storage systems. Pumped storage hydro power stations are able to consume electricity in times low demand and produce electricity in times of high demand. As mentioned earlier, the storage capacity in Germany is not sufficient. Due to long planning and building periods, resistance in the population and financial difficulties, this lack is going to continue [4].

Another challenge is the location of generation and demand. While the rising amount of wind energy is generated mainly in the windy north part of Germany, big industrial consumers are located in the southern part of Germany. This situation causes shortages in the existing power lines. New power lines (high voltage direct current transmission) are in construction, but not finished yet. The nuclear phase-out in 2022 will amplify this effect even more, since a lot of nuclear power plants are located in southern Germany. This is why Transmission System Operators (TSO) are more often forced to short-term power plant scheduling, which is also called redispatching (see Chapter IV) [1].

III. CHARACTERISTICS OF DEMAND SIDE MANAGEMENT

One of several approaches to balance the electricity demand, avoid power fluctuation and ensure a stable transmission network is DSM.

DSM describes flexible control of electric consumers for the optimization of own electricity delivery or superordinate use in energy grids.

Consumers in the sectors of industry, commerce and households can increase or decrease their demand of electricity

on enquiry of Transmission System Operators. Thus, DSM can help to balance between generation and demand. As well as conventional power plants increase their output in times of undersupply, large consumers can decrease their consumption. Both approaches lead to the same result [5].

DSM can have following advantages:

- Decrease differences between peak and valley load
- Flatten load curves
- Improve the utilization rate of power generation, supply and consumption equipment
- More consistently production of thermal power plants
- Avoided new constructions of thermal power plants or storages
- Savings in grid expansion [6] [13]

DSM can be divided into a direct and indirect mode. Direct load management allows transmission grid operators (TSO) to control terminal user load during peak power consumption periods [5]. Indirect load management allows consumers to control and regulate their load. In this way, firms can avoid higher prices for their maximum power consumption demand. Price signals can motivate consumers to accomplish peak load shifting autonomously [6].

To achieve a load curve adjustment different methods can be used:

- cooling energy and heat storage technologies, compressed air reservoir, other storages such as compressed gas, silo and pump storage should be used (see figure 3)
- Industrial consumers should adjusting the production and work procedures
- Developing consumers with flexible load
- Time-of-use price should be implemented

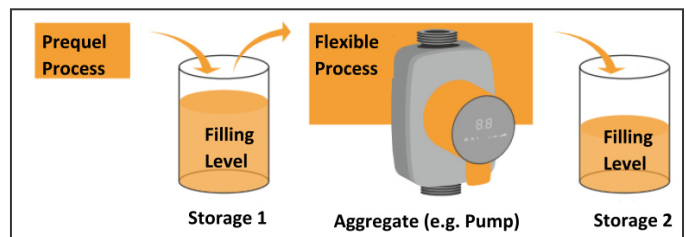

Figure 3. Exemplary flexible process with storages [5]

IV. USE OF DEMAND SIDE MANAGEMENT

As mentioned before, DSM can support the stability of the grid by reducing imbalances of electricity production and consumption. In Germany, there are different regulations for that reason. Mostly, these regulations refer to power plants (influence of production side). They can also be, at least partly, fulfilled by the electricity consumers (demand side). Hence,

DSM can participate in these regulations or replace a part of it. In these chapter, the different regulations are described shortly.

A. Control Power

Control power can be described as an instrument to maintain frequency in case of deviations in the balancing group (mismatch of production and demand). The German TSO's tender three kind of Control Power with the following characteristics:

- Primary control (PC) - activation within 30 sec. and at least 15 min. in action
- Secondary control (SC) - activation within 15 minutes and at least 15 min. in action
- Tertiary control (TC) - activation within 15 min. and up to 1 hour in action

Power supply companies bid for the control power. The cheapest bidder wins. They receive a price for the provided capacity and additionally a working price, if the control power is really needed [7] [8]. These services are basically applied by fossil fuel power plants and limited by its quantity. As a consequence of the rising share of renewable, fossil fuel power plants became less rentable, which leads to a reduction of possible balancing power sources [9].

DSM can complement Control Power. Instead of an Increase of electricity production there can be a decrease of electricity demand or vice versa.

B. Redispatch

Redispatch is a regulatory intervention in case of power line overloads. Energy suppliers prepare production schedules for their power plants in order to optimize their profits. These schedules have to be sent to the TSO until 14:30 of the previous day. The TSO analyses the schedules and tries to detect shortages in the grid. In this case, the TSO is authorized to alter the schedule. Power plants in front of the shortage have to produce less and power plants, which are located behind have to produce more. Affected by these regulation are power plants with a capacity of 50 MW or higher. Power plants that increase their production receive the fuel costs and power plants that decrease their production have to pay the saved fuel costs to the TSO. In this way, the profits of energy suppliers are not influenced by redispatching [7] [10].

DSM can help to reduce the need for redispatch by reducing the electricity demand behind the power line shortage.

C. Reduction of Company Peak Load

A third aspect that can be fulfilled by DSM is a reduction of the peak load in the production facility. Industrial Consumers with high electricity demand pay not only for used kWh but also for high load peaks. Therefore it is useful to smooth the demand in order to reduce electricity costs. This approach is already used by many companies. Even though a reduction of load peaks can support security of supply, this method is oriented towards a company level [5].

DSM can help to reduce a company peak load and save electricity costs.

V. POSSIBLE SECTORS FOR DEMAND SIDE MANAGEMENT

In general, DSM can be applied by the sectors industry, trade and commerce and households. Figure 4 provides an overview of these three sectors with different fields of application. In the sectors of households and trade and commerce, a rising potential is predicted until 2020. The potential that is already used is still small in these sectors. However, this is only one possible segmentation. In the following, so called cross-sectional technologies, heat pumps and electrical storage heating are considered separately.

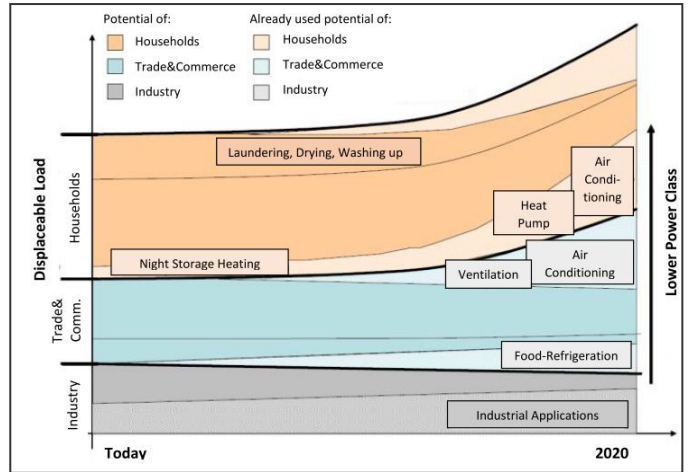

Figure 4. Potential of DSM in different sectors until 2020 [3]

A. Energy-intensive Industry

A big potential for the supply of DSM lies in the energy-intensive industry. A current study by order of the German initiative "Agora Energiewende" investigated the possible contribution of DSM to cover the peak load demand in the southern part of Germany [11]. As a result, they identified a potential of 2 GW within the observed area, whereof the half of this potential can be covered by energy-intensive industry. Since there is a distinction between technical, economical and actually usable potential of DSM, the authors of [11] conducted interviews as well as online surveys with companies and energy suppliers.

The **cement industry** is energy-intensive and can realize DSM. The use of cement mills can be postponed for 4 hours with a preannouncement of 30 minutes. Additional suitable processes can be found in the **paper industry** (e.g. wood grinder) and **chemical industry** (e.g. chlorine electrolysis). In both cases, it is possible to postpone or interrupt these processes for 2 hours. The **electric steel industry** is part of the energy intensive industry. Factories are able to lower their electricity consumption for 2 hours [11].

These industries are able to participate in the tender for the so called detachable load (in German: Abschaltbare Lasten). This law from 2012 enables electricity consumers to receive a remuneration when reducing their consumption after a request of the transmission system operator (see chapter VI). A

requirement to participate is a direct connection of the facility to the high voltage grid (at least 110 kV) [12].

The German research center “Forschungsstelle für Energiewirtschaft” estimated the technical DSM-potential of German industry in 2010. The result is shown in figure 5. The following effect can be observed: the shorter the shutdown time the higher the potential. Note, that this is only a technical potential, not an actual usable potential from an economical or practical point of view [13].

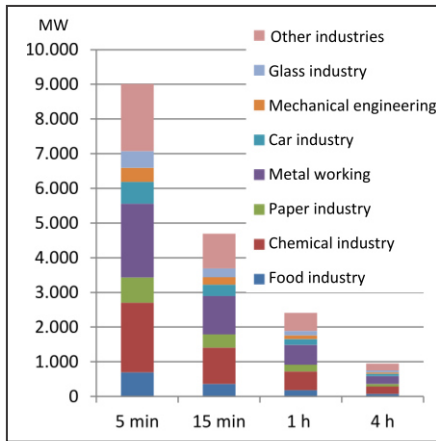

Figure 5. DSM-potential of German industry in 2010 [13]

B. Cross-sectional Technology

There are further fields of application for DSM in the industry. Cross-sectional technologies mean e.g. **pumps,**

compressors or **ventilators**. These devices are often used consistently and they are spread over the country, which allows a more efficient support of grid stability. These devices are only usable for DSM, if a temporary postponement of operation does not lead to any negative effects for the productivity of the company.

The potential of this group for DSM depends on several points like the operating time or the size of storages. This is why, the potential is rather high on weekdays and comparable low on the weekend. For South Germany, [11] detected a DSM-potential for that group of 240 MW at Sunday and 480 MW during the week. The survey showed that this group of DSM is mainly usable for a short time frame and therefore suitable for control power.

C. Heat Pumps and Electrical Storage Heating

In addition to industry, households can perform DSM, if they are heated by heat pumps or electric storage heating. Both systems consume electricity instead of natural gas. In this sector, some limitations have to be considered. Heating systems are working mainly in winter. During summer, only a small amount of the capacity is needed in households for hot water preparation. Hence, DSM-potential can be found mainly in the cold months [11].

VI. DEMAND SIDE MANAGEMENT FROM AN ECONOMICAL POINT OF VIEW

To guarantee a stable electricity supply in an electricity system with a high share of volatile feed-in, a couple of market linked arrangements have been installed. Control power and redispatch are two of these arrangements (see Chapter IV). A new alternative next to these two is DSM. This can also be described as “detachable load (DL)”. In 2012 the German

government implemented a new energy law which created a market for DSM. With this new market, TSO’s have a new tool to handle frequency balancing and congestions.

To understand how DL will be dealt on a market base and used on a daily basis, the DL market is compared with the control power market. As described earlier, there are three control power markets (PC, SC and TC). For the DL there are two markets, the first for immediate detachable load (IDL) and a second one for fast detachable load (FDL). DL offers another possibility on the control power market, so it faces similar regulations which are specified in the German energy law. Due to the “detachable load act”, IDL has to be available within one second, while the FDL has to be active within 15 minutes. The time of utilization can range from one to eight hours. While control power has to be available for the whole time of the proposition, DL has to be available only 16 hours per month.

Control power and DL are bid on their equivalent markets. DL is bid monthly while PC and SC are bid once per week and TC is bid on a daily basis. The minimum load which has to be supplied in case of DL is 50 MW. The TSO chooses the control power based on a merit order, according to the price the specific load was bid. While the suppliers of the control power can determine the price of their load on their own, the DL is dealt on a price range from 100 to 400 €/MWh. The German market for DL was starting to work in June 2013. Since then the maximum load of DL offered during this period was ranging between 251 MW of IDL and 550 MW of FDL. Because of the lack of supply, every offered load was accepted, that means that so far no real competition took place. This had an effect on the price, as which the load was offered. He ranged at 395 €/MWh, just 5 € less than the maximum allowed price defined in the law. In comparison to the price which were bid on the already existing and working control power market, the prices generated on DL market are no real competition. The average price for the TC was at 350 €/MWh, almost 65% of the TC bids were lower than the DL bids, and the price for SC was at 277 €/MWh in average. That means that every SC bid was lower than the bids on DL. Observing the first months of the DL market, you come to the conclusion, that applying DL is only cost-efficient if almost all of the Control Power is already in use [7].

Similar results appear if an actual control power supplier, such as a gas turbine, is compared with the potential of DL. If a company want to supply DL, you have to invest in some control and communication technology. This investment cost can easily reach the mark of a couple of thousand euros, consisting of additional personal costs and costs of material. Now a gas turbine used for control power and DSM are compared. The DL-act only allows a demand of DL for 208 hours per year. It allows guarantees a compensation of 30,000 €/MW per year and, as already mentioned, 100 to 400 €/MWh. This results in an accumulated compensation in the amount of 50,800 up to 113,200 €, given the maximum demand of 208 hours. As shown in the consideration of the DL market, it can be expected that DL has only limited demand hours. Based on 10 hours of demand a compensation in the amount of 31,000 to 34,000 € can be calculated. Figure 6 shows a comparison of a gas turbine (different investment costs) with the DL-

compensation (straight lines DL, dashed lines different gas turbines) [11].

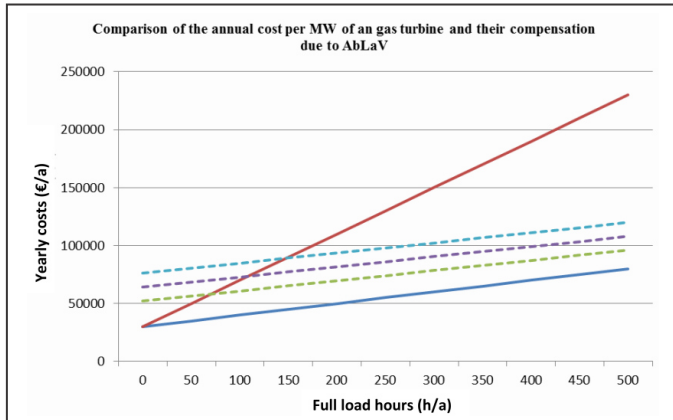

Figure 6. Comparison of the annual cost per MW of a gas turbine and the compensation due to AbLaV [11]

This figure shows that DSM has a good potential in the range of low demand hours. So DSM can be an excellent alternative for peak load covering, which will make it dispensable to hold units like gas turbines, just for high demand hours. Taking these results and the consideration of the control power and DL market into account, you can come to the conclusion, that there are chances for DL respectively DSM. But if you want to achieve a bigger role for DSM on the market, you have to use the potential of small and medium companies. At this point, a new service provider enters the market, the so called “aggregator”. His scope of duty is to identify, concentrate DL and bring it all on the market [14]. Doing that, DSM could have a significant contribution to the control power market and could be a cost-efficient alternative, especially in the range of TC.

VII. SUMMARY AND OUTLOOK

This Paper revealed DSM as an additional approach to support the stability of the German electricity sector. The rising share of renewable energies complicates the maintenance of grid stability. The share of conventional power plants, which play an important role in balancing the electricity system, decreases. A possible approach to that problem is a stronger integration of DSM into stabilization of the grid. DSM can partly replace control power as well as redispatch. Different studies show, that the potential of DSM in Germany is not utilized yet. The energy-intensive industry (e.g. cement or chemical industry), cross-sectional technologies (e.g. pumps, compressors) and households (heat pumps and electrical storage heating) can participate.

Even though DSM is already used in industry (the German detachable load act finances DSM), it is connected with an

additional effort. The necessary technical equipment like measurement and communication techniques are not yet installed in the households. Regulations and strategies to support DSM in the sector of households are missing. The already existing financial incentives by the detachable load act are not sufficient for a broad field of application. Furthermore, the uncertainty towards future revenues from DSM hinders the development. Additional planning effort or opportunity costs for companies can be further disadvantages [3]. That is why, it is not possible to forecast, if DSM will support the stability of the German electricity system efficiently in the future.

REFERENCES

- [1] C. Crastan, „Elektrische Energieversorgung 2 – Energie- und Elektrizitätswirtschaft, Kraftwerkstechnik und Stromversorgung“ vol. 3. Springer, 2012.
- [2] EEG – Erneuerbare Energie Gesetz der BRD.
- [3] Dena/BMWi, „Workshop: Flexibilisierung der Nachfrage zur Gewährleistung der Versorgungssicherheit in Deutschland (Ergebnispapier)“, December 2013.
- [4] Dena, „Die Entwicklung der Märkte für Flexibilität in der Stromversorgung“, December 2013.
- [5] Dena, „Lastmanagement in der Industrie: Erlöse erwirtschaften – zur Energiewende beitragen.“, http://www.dena.de/fileadmin/user_upload/Publikationen/Energiesysteme/Dokumente/Flyer_Lastmanagement_ES.pdf, August 2013.
- [6] Z. Hu, X. Han, Q. Wen, „Integrated Resource Strategic Planning and Power Demand-Side Management“, Springer, Heidelberg, 2013.
- [7] O. D. Flörcken, N. Täumel, “100 Tage abschaltbare Lasten – erste Erfahrungen“, in *Energiewirtschaftliche Tagesfragen*, vol. 11, 2013, pp. 38-40.
- [8] L. Hirth, I. Ziegenhagen, „Control Power and Variable Renewables – A Glimpse at German Data“, 2013.
- [9] H. Garz, R. Ötsch, A. Haas, P. Wirtz, S. Zank, „Deutsche Stromversorger – In der CO₂ – Falle ? – Ein neues Spiel hat begonnen“, executive summary, Düsseldorf, September 2009.
- [10] BNetzA, “Redispatch”, http://www.bundesnetzagentur.de/DE/Sachgebiete/ElektrizitaetundGas/Unternehmen_Institutionen/Versorgungssicherheit/Stromnetze/Engpassmanagement/Redispatch/redispatch-node.html, 02.06.2014.
- [11] M. Klobas et al., “Lastmanagement als Beitrag zur Deckung des Spitzenlastbedarfs in Süddeutschland,” Agora Energiewende, August 2013.
- [12] Bundesministeriums der Justiz und für Verbraucherschutz, “Verordnung über Vereinbarungen zu abschaltbaren Lasten (Verordnung zu abschaltbaren Lasten)“, December 2012.
- [13] Forschungsstelle für Energiewirtschaft e.V., „Demand Response in der Industrie“, December 2010.
- [14] Dena, „Marktrollen und Prozesse beim Einsatz von flexiblen Stromlasten im Energiesystem“, December 2013.

Fuel Cells – Energy For The Mobility Of The Future?

B. Sc. Kaya, Calgar Alper
B. Sc. Matti, Danny
Brandenburg University of Technology
Cottbus-Senftenberg – Germany
Faculty 3 – Mechanical, Electrical and
Industrial Engineering
Chair of Power Distribution and
High-Voltage Engineering
Professor Dr. Eng. H. Schwarz

B. Sc. Bloehm, Anastasia
B. Sc. Ivanov, Anton
Brandenburg University of Technology
Cottbus-Senftenberg – Germany
Faculty 3 – Mechanical, Electrical and
Industrial Engineering
Chair of Power Distribution and
High-Voltage Engineering
Professor Dr. Eng. H. Schwarz

Abstract — A fuel cell is a new and promising propulsion technology that has been a major topic of discussion since several years. Many car manufacturers are devoting hundreds of millions of dollars on research projects to develop consumer-affordable fuel cell systems and for many, it is considered to be the future of green mobility. But is it a pioneering innovation?

Keywords-component; fuel cell; propulsion; green mobility; pioneering innovation; alternative energy

I. What is a fuel cell?

The automobile has become one of the most important means of transportation since the past century. However, a significant feature has remained unchanged since the first car was manufactured up to the current Formula-1 racing cars: the internal combustion engine. The ICE produces mechanical energy by combusting a fossil fuel that sets the wheels of a gasoline vehicle in motion. Yet a combustion engine generates unreasonable amounts of pollutive gases that could be dangerous for both humans and environment – and the risk of pollution should not be underestimated. This raises the vigorous discussed question on whether it is possible to manufacture vehicles with alternative propulsion systems. A solution that seems to be worth considering is the propulsion by fuel cell technology. In general terms, a fuel cell is an electrochemical, pollution-free device that generates electricity through the conversion of chemical energy from a fuel such as hydrogen (H_2) with an oxidizing agent or oxygen (O_2) – it is the reverse process of water electrolysis [1]. A fuel (e.g. natural gas) is been transported to the reformer, where it is converted into hydrogen (H_2). At the anode, hydrogen decomposes in electrons (e^-) and protons (p^+). A fuel cell contains a polymer electrolyte membrane (approximately 0.1 mm thick) that is permeable for protons, but not for electrons. Due to the presence of the polymer electrolyte membrane, the electrons flow through the external circuit until they reach the cathode side of a fuel cell. At the cathode, oxygen (O_2) absorbs protons and electrons forming water (H_2O) [2]. Water vapour and heat are the main

emissions from a conventional fuel cell and those by-products could be harnessed and used for other things.

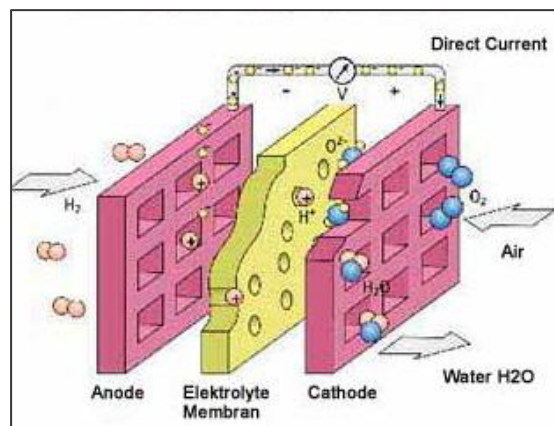

Figure 1: Schematic of fuel cell operation [20]

From a technical point of view, fuel cells don't operate according to Carnot's Law – they operate according to the Nernst Principle and hence higher energy conversion efficiency (η) can be reached. (Figure 1) shows a simplified schematic of a fuel cell operation. A single fuel cell generates approx. 0.6 V; this correlates to an electrical power of approx. 100 W. In order to increase the voltage of a fuel cell, several hundred cells are connected in series to form a fuel cell stack which is commonly referred to as a fuel cell unit. As the size of a fuel cell determines the performance of the vehicle, the sizes of the hydrogen tanks determine the range [1]. Fuel cells are different from batteries. Since batteries are closed energy storage systems, fuel cells can operate for infinite periods of time if inflows are constantly maintained [3].

II. Production of hydrogen

The production of hydrogen means in the general term the provision of molecular hydrogen (H_2). To be able to produce hydrogen (H_2), raw materials such as natural gas, biomass, hydrocarbons and hydrogenous compounds are needed. There are various methods for generating industrial hydrogen, however currently the

dominant technology for direct production is steam reforming from hydrocarbons. In the context of this paper, three different methods of hydrogen production will be highlighted [4].

1. Steam Reforming

This technique is considered to be the most common and the least expensive with an efficiency of approx.75%. Using this process, industrial hydrogen can be produced in two stages: At temperatures starting from 700°C up to 1100°C, methane and steam undergo a strongly endothermic (consumes heat) chemical reaction to yield hydrogen and carbon monoxide [4]:

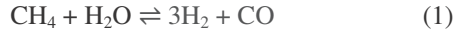

In the second stage, additional hydrogen can be recovered through a mildly exothermic (produces heat) water gas shift reaction, carried out at about 360°C [4]:

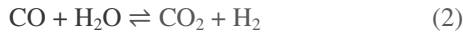

2. Partial Oxidation

The chemical reaction of the partial oxidation can be performed when a sub-stoichiometric mixture of fuel and air is partially combusted in a reformer (exothermic reaction), producing a hydrogen-rich synthesis gas. Possible reaction products are carbon monoxide and hydrogen. Idealized example reactions for heating oil and coal [4]:



Notice that the above mentioned processes of hydrogen production generate carbon monoxide (CO) as a by-product.

3. Electrolysis of Water

In this method (Figure 2), water (H₂O) is decomposed in oxygen (O₂) and hydrogen (H₂) in an electrolytic cell due to an electric current passed through the water. Two electrodes or metal plates which are placed in water are connected to electrical power. Anode is positively charged (+ve) and cathode is negatively charged (-ve). On the passage of electric current, water dissociates into hydroxyl ions and hydrogen ions. At the cathode, the positively charged hydrogen ions are discharged as hydrogen atoms that form hydrogen molecules. At the anode, the negatively charged hydroxyl ions are discharged that form water and oxygen gas. The amount of hydrogen generated is double the amount of oxygen [5].

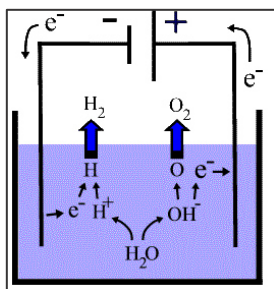
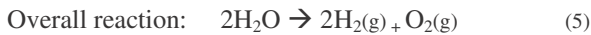

Figure 2: Scheme of water electrolysis [21]

To produce industrial hydrogen that can be used for powering fuel cell vehicles, demanding technical procedures are required in order to isolate it from other compounds. Therefore the provision of hydrogen continues to be expensive and time-consuming to generate. Moreover, unlike oil that can be sent via pipelines, the transportation of hydrogen seems to be challenging, making it unsuitable for numerous functions. Until the technology of hydrogen production advances, hydrogen energy will continue to be unaffordable for the vast majority of people [6].

III. Toyota's fuel cell vehicle (FCV)

The FCV (figure 3) and (figure 4) is a practical concept of a hydrogen-powered vehicle that Toyota plans to introduce in 2015 as a pioneer in the development of cars powered by alternative energy. It is equipped with an efficient down-sized fuel cell system realized through an arrangement beneath the car seats, which converts hydrogen into electric energy for an onboard electric motor [7]. The generated electricity drives the electric drivetrain of the limousine; this concept car shares the same components that are used in Toyota's hybrid vehicles such as the Prius. The FCV is a vehicle that doesn't need a gasoline engine or use any gas; in fact it's a complete alternative-energy vehicle that utilizes hydrogen as a fuel [8]. In addition, the vehicle has an approximate cruising range of 500 km (310 mile) with an electric drive motor enabling powerful acceleration. Toyota's fuel cell vehicle has a refuelling time of just three minutes, nearly the same time as for a gasoline car. Much of the smart thinking behind this concept car can be seen in the interior packaging. The vehicle is 4,870 mm (191.7 in) long, 1,535 mm (60.4 in) high and 1,810 mm (71.2 in) wide – a mid-size family sedan that can accommodate up to four occupants. The two 700 bar (70 MPa) high-pressure hydrogen tanks and the lightweight fuel cell stack placed beneath the specially designed body evoke the major characteristics of this vehicle. The hydrogen tanks were redesigned to increase the tank capacity and improve the cruising range. Moreover, the fuel cell unit is equipped with Toyota's high-efficiency boost converter. The FCV promises a top speed that is about 160 km/h (100 mph) and has double the power density of previous vehicles, generating 3 kW per litre. [7, 10]. The estimated purchasing price is between 36,600€ and 73,373€ [9]. A new feature of this concept vehicle is that when it is fully fuelled, it provides enough electrical power to meet the daily needs of an average Japanese home for about a week [11].



Figure 3: Toyota's next-generation hydrogen vehicle [7]



Figure 4: The FCV – Toyota’s alternative-energy vehicle [22]

Pictured below (figure 5) is the propulsion system of the FCV.



Figure 5: FCV’s propulsion system [7]

How does the hydrogen fuel cell of the FCV produce electricity? Hydrogen is supplied to the negatively charged side of the fuel cell, the (anode). When the hydrogen molecules are activated by the anode catalyst, they release electrons. The electrons move from the positively charged side of the fuel cell, the (cathode), creating an electrical current. The electrons that were released by the hydrogen molecules become hydrogen ions and travel through the membrane to the cathode side. Oxygen bonds with hydrogen ions and electrons on the cathode catalyst to form water. The electrical power that is generated by the fuel cells is directed to an onboard electric motor to deliver motion to the car. Recovered energy can be stored in a secondary battery that enhances power from a fuel cell by providing additional power to the electric motor [12].

The new developed fuel cells can utilize more than 60% of the power generated if hydrogen is directly converted to electrical power. In the absence of pure hydrogen, the efficiency drops to 30-40%. Meanwhile, vehicles powered by an internal combustion engine utilize about 25% of the generated power – primary loss is due to wasted energy = exhaust. The comparison proves that fuel cells are efficient, reliable and the cleanest of the current energy options [13]. Alongside Toyota, other companies are working to develop methods that might exploit the potential of hydrogen as an efficient source of energy for use in road vehicles. As of 2013, demonstration fleets of hydrogen powered vehicles are undergoing field testing including the Hyundai ix35, Honda FCX Clarity, the B-Class F-Cell from Mercedes-Benz and the Chevrolet Equinox Fuel Cell [14]. The GM hydrogen vehicle has a fuel cell unit consisting of 440 cells and an output of 93 kW. The high-pressure 70

MPa hydrogen tanks contain 4.2 kg of hydrogen, which can last for nearly 320 km. The mid-size crossover SUV has an acceleration from 0 to 100 km/h in 12 seconds and the maximum speed is about 160 km/h. GM’s new hydrogen SUV includes a variety of safety features such as a traction control system (TCS), ABS and GM’s OnStar telematics service, which offers drivers information on nearby hydrogen refuelling stations as well as advice on how to operate the vehicle. The vehicle’s performance was assessed as nearly the same as that of a 3.6 litre gasoline powered SUV [15].



Figure 6: Chevrolet Equinox Fuel Cell [15]

IV. Summery

For more than two decades, giant car manufacturers and renowned research institutes have been working to develop innovative propulsion systems based on the fuel cell technology. Toyota’s research ambitions into fuel cell technology began as early as 1992 and the culmination of its development toward green mobility can be seen in the FCV Concept. The benefits of a fuel cell are numerous: it is pollution-free with near-zero emissions, giving off only electricity, heat and water. Due to the absence of combustion processes in a fuel cell, the conversion of fuel to electricity can occur more efficiently compared to other propulsion systems available today. Since there are few moving parts in a fuel cell stack, the maintenance of fuel cells is technically simple to realize. The presence of the few moving components make a fuel cell operate quieter and is more reliable than a generator. In addition, hydrogen is a renewable source of energy, which means that hydrogen can be generated continuously on demand, unlike non-renewable energy sources which can’t be infinitely produced. However, similar to anything else in the world, hydrogen is not a perfect substance. Despite the achieved technological advances, the fuel cell technology faces serious limitations: The hydrogen infrastructure needs to be developed; in fact there no existing infrastructure for the production, distribution, storage and refuelling of hydrogen [16, 17]. Technologies are being developed to provide transportation, distribution and storage methods of hydrogen fuel. For instance, the state of California has a 200 million USD grant that gives Toyota the opportunity to put hydrogen refuelling stations in California – starting from South California and expanding up to the northern regions of California

[8]. Japan has also announced its interest to develop its hydrogen infrastructure and plans to install over 100 hydrogen refuelling stations all across Japan. As for Germany, the state of Baden-Württemberg aims to support the development of hydrogen refuelling stations for an efficient and sustainable use of mobility [18]. However, this very promising technology faces further challenges. One major obstacle is the production of economical, efficient and robust fuel cells has become complicated since some fuel cells use high-cost materials [13]. Furthermore, the starting time of a hydrogen-powered vehicle is longer, and the driving range is shorter than in a gasoline car and the production of industrial hydrogen is technically challenging and not clearly environmentally friendly – CO₂ is an undesirable by-product [19]. Even though hydrogen is a renewable energy source with minimal impacts on environment, further non-renewable sources such as natural gas, oil and coal are needed in order to split it up from other substances. Several less harmful technologies are being developed but they are still years from being perfected.

References

- [1] Brennstoffzellen - Energie der Zukunft? Ein Beitrag der Universität Chemnitz
- [2] <http://www.fuel-cell.basf.com>
http://www.fuel-cell.basf.com/cm/internet/Fuel_Cell/en/content/Microsite/Fuel_Cell/Principle
- [3] <http://www.alternative-energy-news.info/technology/fuel-cells/>
- [4] http://en.wikipedia.org/wiki/Hydrogen_production
- [5] <http://www.youtube.com/watch?v=IxANiKjUv0>
- [6] http://www.conserve-energy-future.com/Advantages_Disadvantages_HydrogenEnergy.php
- [7] http://www.toyota-global.com/innovation/environmental_technology/fuel_cell_vehicle/
- [8] <http://www.youtube.com/watch?v=2bluUNxVLhE>
<http://green.autoblog.com/2013/11/04/toyota-fcv-hydrogen-fuel-cell-vehicle-concept-ready-for-tokyo/>
- [10] http://www.toyota-europe.com/innovation/design/concept_cars/fcvt/index.tmex
- [11] www.sueddeutschezeitung.de. Artikel:
<http://www.sueddeutsche.de/auto/brennstoffzellenauto-von-toyota-mit-der-kraft-des-wasserstoffs-1.1897727>
- [12] http://blog.toyota.co.uk/how-does-toyotas-fuel-cell-vehicle-work#.U43tHfl_uoM
- [13] http://www.bluffton.edu/courses/TLC/MontelA/MonteI/Alternative_Energy_Website/Fuel_Cell.htm
- [14] http://en.wikipedia.org/wiki/Hydrogen_vehicle
http://en.wikipedia.org/wiki/Chevrolet_Equinox
- [16] http://www.conserve-energy-future.com/Advantages_Disadvantages_HydrogenEnergy.php
- [17] http://www.altenergy.org/renewables/fuel_cells.html
- [18] <http://de.wikipedia.org/wiki/Brennstoffzellenfahrzeug>
- [19] <http://en.fcc.gov.ir/FuelCell-Goodness.aspx>
- [20] <http://www.solarserver.com/>
- [21] <http://www.nmsea.org/>
- [22] www.toyota.de

Perspectives of shale gas extraction and its importance for energy security in Poland

Filip Jasiewicz
Cottbus, Germany
jasiefil@tu-cottbus.de

Piotr Pastusiak
Cottbus, Germany
pastupio@tu-cottbus.de

Szymon Żuk
Cottbus, Germany
zukszymo@tu-cottbus.de

Abstract—The extremely profitable extraction of shale gas in the United States of America has convinced politicians and economists worldwide to ask whether there are reserves of this unconventional fossil fuel in their homelands, among others in Poland. The first estimated amount of shale gas resources in Poland has met with an enthusiastic response in the society and has started a debate about potential benefits for the Polish economy. However, legal and infrastructural difficulties associated with the shale gas exploration caused earlier optimism to decline. This paper concentrates on the case of Poland in order to examine the chances for commercial extraction of shale gas and its possible influence on the energy security in this country.

Keywords—shale gas; unconventional gas; extraction; resources; Poland; energy security; diversification

I. INTRODUCTION

The first attempts of shale gas extraction took place at the end of 19th century. The industrial technology of exploitation was developed in the 1980s, and the large scale extraction started in the 1990s in the United States of America [1].

Shale gas is a natural gas occurring in underground resources of sedimentary rocks. It belongs to one of three types of gas from unconventional deposits. Because shales ordinarily are characterized by low permeability, gas from shales has to be produced using more complex and advanced technologies compared to conventional natural gas.

Exploration techniques in use today are horizontal drilling and hydraulic fracturing. The process of shale gas extraction starts with performing a horizontal borehole (horizontal drilling) in the sedimentary rock in order to get the direct access to deposits of this raw material which are located upon the depth range of 3000–3500m. After that, exploitation pipes are installed and cement grouting is pumped in order to seal the space between the exploitation pipe and the rock. During the next step of shale gas extraction, which is called hydraulic fracturing, the mixture of water with chemical additives and sand is pumped under high pressure into shale rock layers. This process causes cracking of rocks which leads to a more efficient exploitation (Fig. 1) [2].

The United States of America are actually a global leader in the development and production of shale gas [3]. Estimated technically recoverable shale gas resources in that country amount to 18.8 trillion m³ [4]. The exploitation of this fuel has become increasingly substantial source of natural gas in the

USA over the past decade. Shale gas increased from 1% of natural gas production in the United States in 2000 to over 20% by 2010. The Energy Information Administration predicts that the shale gas production will amount to 46% by 2035 [5].

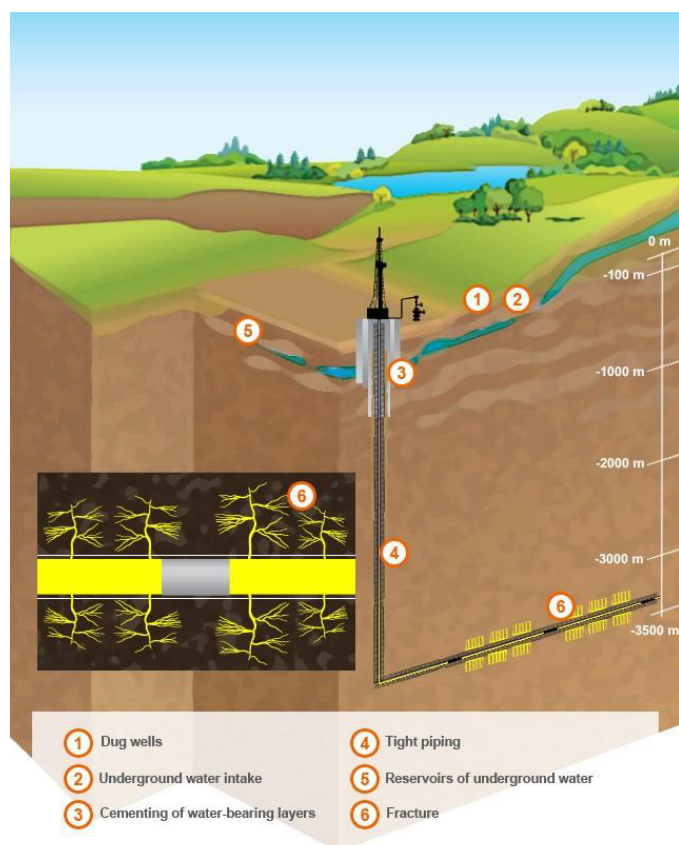

Figure 1. Exploration strategies [2]

According to the report of the American Energy Information Administration from the year 2013, China owns the biggest shale gas resources worldwide which reach 31.6 trillion m³. Significant unconventional gas reserves may also be found in Argentina (22.7 trillion m³), Algeria (20.0 trillion m³), Canada (16.2 trillion m³), Mexico (15.4 trillion m³) and Australia (12.4 trillion m³). Considerable resources (18.1 trillion m³) of this fossil fuel are also waiting for extraction in Europe. Poland possesses the largest deposits (4.2 trillion m³) on this continent. Moreover, it is regarded as a pioneer in the field of exploration projects of shale gas (Fig. 2) [4, 6].

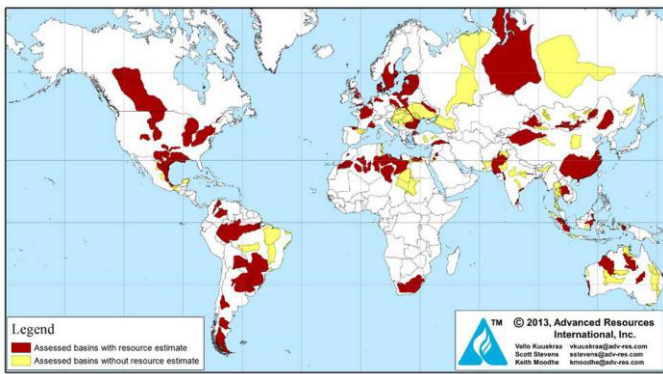

Figure 2. Shale gas resources in the world [4]

II. SHALE GAS IN POLAND

Availability of unconventional natural gas accumulated in shales has been one of the leading topics emerging in the Polish media. The prospect of the upcoming “shale revolution” in Poland started a discussion between supporters and opponents of shale gas extraction who bring forward a lot of arguments to confirm their theses. Optimists attempt to convince the public that shale gas could significantly improve the Polish energy security and influence diversification of energy sources. Some experts say that we have to deal with twenty-first century gold rush. [7]

A. Resources

The first drillings concerning the exploration of non-conventional gas in Poland began in the 1950s. Present geological studies have shown that shale gas can be found on the Sudeten Foreland, in the Lubelskie regions, in Mazovia, Podlachia, Pomerania and in the Polish economic zone of the Baltic Sea. These terrains form the so-called “shale belt” covering an area of 37,000 km² which is equal to about 12% of the territory of the whole country (Fig. 3).

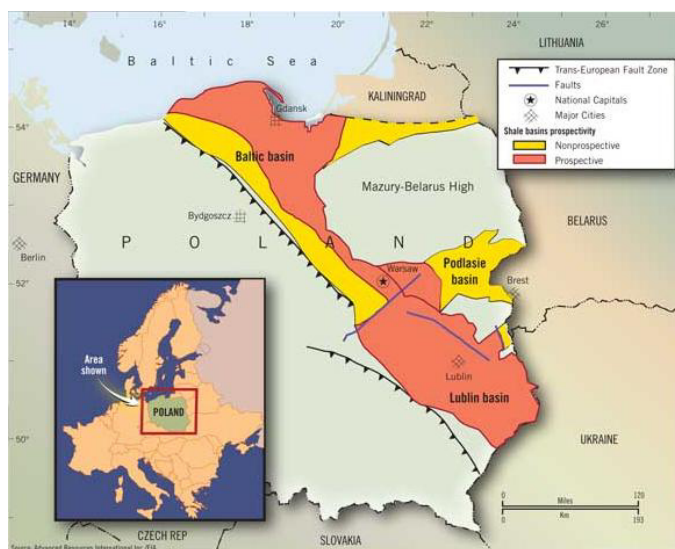

Figure 3. Prospective areas of shale gas in Poland [8]

Some estimates indicate that recoverable reserves of shale gas in Poland amount to 1 trillion m³, other increase this value to 3 billion m³, while the U.S. Energy Information Administration (EIA) in April 2011 calculated that Polish deposits reach 5.3 trillion m³. According to the Polish Geological Institute (PGI) the amount of shale gas resources in Poland is in the range of 0.34 trillion m³ to 0.76 trillion m³. Data provided by PGI are currently the most cautious, but the most reliable. In June 2013, the EIA published a new report which estimates that the size of unconventional gas deposits in Poland is 20% lower compared to projections for 2011. Differences between the highest and lowest estimates are very large, so it is difficult to say how many resources of shale gas are actually available in Poland. This issue is however the most important in terms of assessing the impact of shale gas on the energy security in this country. It should be emphasized that the estimated amount is not necessarily extractable in its entirety. Shale gas resources are subject to further verification. Accurate information about the quantity, quality and profitability of shale gas will be available around 2017, after series of 309 exploration boreholes. However, in the case of Poland, even if it would be possible to use only 1% of estimated reserves, it would be enough to cover the demand of the country for more than four years [2, 9, 10].

B. Potential benefits for the economy

Optimists and supporters of shale gas extraction believe that the shale success achieved in the United States of America, could be repeated in Poland.

The first benefit should be an increase in financial income for the national economy, because:

- the country will have profits from gas sales, license and supplies fees, as well as taxes,
- the use of transmission and distribution networks increases, improving the efficiency of public investments,
- exploitation of shale gas will lower the price of gas and energy, improving the purchasing power of citizens which will contribute to the development of other sectors of the economy.
- exploitation of shale gas reduces the need to import this fossil fuel, and it improves the balance of payments of the country,
- a country that obtains experience in exploitation, can export this knowledge and specialists,
- lower gas prices will improve the competitiveness of the home energy industry,
- the country receives more options for the distribution of gas, improving the efficiency of the industry,
- development of the shale industry will attract foreign investors,
- a decrease in gas prices as well as a growing supply of gas will accelerate the modernization of the energy

sector and will lead to the technological leap countrywide.

The second advantage could be a development of local communities, because:

- shale gas enables the development of local enterprises around mining areas,
- the labor market will increase, providing employment for local communities - experts estimate that each year from 33,000 to 115,000 new workplaces could arise,
- with the development of production comes the necessity to develop the infrastructure that will remain in the region after the completion of extraction.

In addition to the above-mentioned positive effects, equally important benefit for the national economy could be significant independence in gas supply from the very limited number of suppliers [10, 11].

C. Hurdles

Opponents of shale gas extraction argue that Poland will not repeat the success of the United States where the large territory and unpopulated space allow unhindered performing complex drilling works using large quantities of water and chemicals. Researchers also point out that the situation in Poland does not necessarily have to develop as in the United States, because all shales can differ from one another. Furthermore, the geology as well as lithology of rocks in Poland is different. They assure the public that the potential extraction is expensive and its positive impact on the economy is not quite sure, and moreover:

- it is not known what quantities of gas can be obtained, and whether it is worthwhile to invest public funds in this venture,
- shale gas extraction is a completely new sector of industry in Poland, therefore this country cannot rely on their own experiences and technologies in this field, but on the expertise and capital of foreign firms, in particular from North America,
- unconventional gas deposits extend between Pomerania and the Lubelskie regions where the transmission infrastructure is underdeveloped,
- the European Commission has so far not taken a clear position on shale gas and constantly explores the influence of extraction on the environment,
- government supervision over activities associated with the development of the shale sector can significantly burden the state budget,
- development of shale gas extraction can reduce the value of real estate in the region where mining operations would be conducted [10, 12, 13].

D. Influence on energy security

Energy security means ensuring coverage of the current and prospective demand for energy, taking into account economic

factors, technical capabilities and environmental protection requirements. The priority of the country's energy policy is to ensure stable and uninterrupted supply of energy in the required quantity, quality, time and at a fair price, or obtaining these materials on its own territory. Energy security is mainly connected with the need to diversify energy sources and directions of supply of natural gas. Diversification of directions of supply in Poland is very difficult to achieve, among others, due to the lack of transshipment port which would allow the import of gas from other suppliers by sea. This forces Poland to bring gas from a limited number of suppliers, mainly from Russia (54.2%) (Fig. 4) who provide this fossil fuel in the not always favorable price relations (Fig. 5).

EU imports of Russian gas

Russia is Europe's biggest gas supplier, providing about a quarter of continental demand. A third of gas is exported through Ukraine.

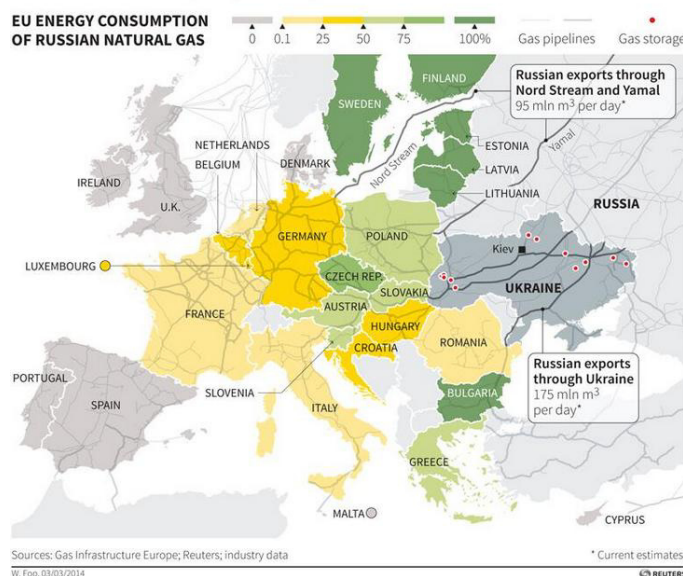

Figure 4. Dependence on Russian natural gas [14]

Prices of Russian natural gas (dollar/1000m3)

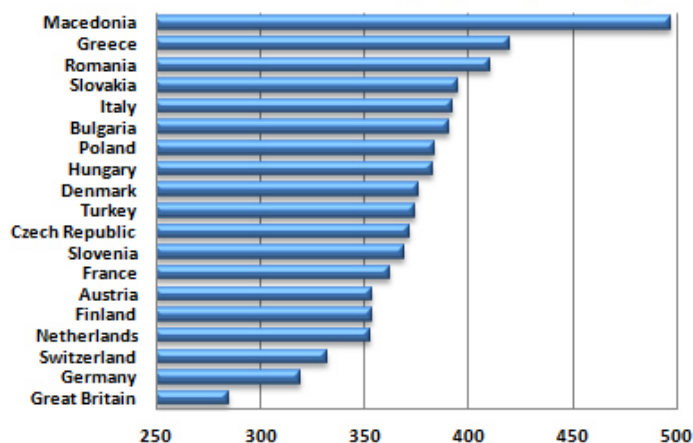

Figure 5. Prices of Russian natural gas in Europe in 2013 [15]

The commencement of production of domestic shale gas resources would create a new quality in the field of energy security and thereby contribute to diversification of energy

sources in Poland and abroad. If the expected size of shale gas deposits were confirmed, proven reserves of natural gas should be sufficient to cover the needs for the next 60 years. According to the International Energy Agency (IEA), using unconventional gas resources, this period could be extended up to 250 years. Some experts voice opinions that energy based on shale gas may be an alternative to nuclear energy which meets in Poland with a strong public resistance, as well as to renewable energy.

Therefore, in order to strengthen the energy security of Poland, there should be used all available resources - not only shale gas reserves. Unconventional gas extraction could help to improve the country's energy security only to a certain extent. The priority in obtaining the total energy security should be diversification of energy resources and raw material supply [2, 9, 10].

III. CONCLUSION

This paper shows that shale gas extraction will not only influence the energy security of the country or region, but could also significantly affect the development of the Polish economy.

Shale gas is a chance for Poland, but also a challenge due to complex geology which requires the use of modern technology, expertise and experience. Understandable is the optimism and enthusiasm that accompanied the start of exploration of unconventional gas reserves. However, attention should be paid to challenges and barriers that may stand in the way of exploration success. One of the major challenges is to create innovative technology to extract shale gas in Poland without any problems.

Shale gas extraction in Poland could enable energy from additional sources and would also be a strong argument in negotiations for better conditions for the import from the current dominant supplier. If the predicted size of unconventional gas deposits confirm and Polish business entities obtain the participation in exploitation, shale gas could

play an important role in this country. Unconventional gas extraction could contribute to cover the energy deficit, achieve energy independence and lead to diversification of energy sources in Poland.

REFERENCES

- [1] Z. Wang and A. Krupnick, "A Retrospective Review of Shale Gas Development in the United States," Resources for the Future, April 2013.
- [2] <http://www.lupkipolskie.pl/> Retrieved: 2014-06-03.
- [3] <http://prnews.pl/komentarze/duza-nadwyzka-gazu-ziemnego-w-usa-68213.html> Retrieved: 2014-06-04.
- [4] U.S. Energy Information Administration, "Technically Recoverable Shale Oil and Shale Gas Resources: An Assessment of 137 Shale Formations in 41 Countries Outside the United States," June 2013.
- [5] P. Stevens, "The 'Shale Gas Revolution': Developments and Changes," Energy, Environmental and Resources, August 2012.
- [6] C. Johnson and T. Boersma. "Energy (in)security in Poland the case of shale gas," Energy Policy, 2013.
- [7] <http://www.polskieradio.pl/7/129/Artykul/210386.Gaz-z-lupkow-goraczka-zlota-XXIwieku> Retrieved: 2014-06-04.
- [8] <http://www.ogj.com/articles/print/volume-109/issue-45/general-interest/unconventional-oil-gas-focus-poland-pl.html> Retrieved: 2014-06-05.
- [9] P. Wieczorek, "Perspektywy produkcji gazu łupkowego," Kontrola Państwowa nr 5, September-October 2013.
- [10] A. Otawa and W. Skomudek, „Ocena wpływu zasobów gazu łupkowego na gospodarkę, bezpieczeństwo energetyczne kraju oraz rozwój innowacyjnych technologii pozyskiwania energii,” Politechnika Opolska, 2014.
- [11] L. Gawlik, „Gaz ziemny z łupków w Polsce - raport,” IGSMiE PAN, May 2013.
- [12] P. Turowski, "Gaz łupkowy w Polsce – szanse, wyzwania i zagrożenia," Bezpieczeństwo Narodowe nr 21, I, 2012.
- [13] C. T. Szyjko, „Społeczno-gospodarcze bariery potencjalnej produkcji gazu łupkowego w Polsce,” Uniwersytet Jana Kochanowskiego w Kielcach, 2011.
- [14] <http://www.zerohedge.com/news/2014-03-09/does-russia-need-sell-gas-more-eu-needs-buy-it> Retrieved: 2014-06-06.
- [15] <http://wyborcza.biz/biznes/51,100897,15300829.html?i=1> Retrieved: 2014-06-07.

LNG for Europe

A way to diminish Russian influence and secure gas supply?

Armin Lünser

Brandenburg University of Technology
B.Sc. in Economical Engineering
Berlin, Germany
Armin.luenser@tu-cottbus.de

Martin Böhning

Brandenburg University of Technology
B.Sc. in Electrical Engineering
Cottbus, Germany
Martin.boehning@tu-cottbus.de

Abstract—LNG (Liquefied Natural Gas) is natural gas converted into its liquid form to ease transportation. With only a 1/600th part of its volume it is easier to transport, former unused reserves can be exploited and new trade routes become viable. Due to these promising properties it is often named as an alternative to Russian natural gas. This paper inquires into the structures of gas markets and whether a shift towards more LNG is a promising way to diminish the political connected with Russian gas.

Keywords: *russian gas; ukraine conflict; market design; LGN; political markets; security of supply*

I. INTRODUCTION

The Russian-Ukrainian gas conflict is a number of disputes between Russia and the Ukraine and their respective gas and supplier companies, which resulted in the current deep crisis. The dependence on Russian gas, rising prices and political dependence up to disputes about territorial issues struck the EU and its members with surprise and led to two issues that attracted a big audience within the European public within the last months. Is the EU dependent from Russia? How safe is the security of supply [1]? Thus we want to inspect and analyse the situation, dissect single problems, evaluate the economic, technical and political views involved in the problems and try to find out how these problems can be solved or anticipated. We start off with a brief historical review of the political parties and their actions that led to the current situation. In a second step we turn to the economic aspects and conclude with the technical side to estimate whether LNG can become a key factor.

II. A BRIEF HISTORICAL REVIEW OF THE RUSSIAN-UKRAINIAN GAS CONFLICT

In the last 10 years a number of conflicts emerged and evolved in Europe, involving countries bordering the EU or in its near proximity. The conflicts concerning the Ukraine have a special quality, because although members of the European Union are not actually part of the current conflict, they suffered and may suffer severe economic damages through it. The conflict started in 2005 after the Russian side stepped back from its old trade patterns which meant taking back discounts dating from the Soviet era. With “the Russian side” we mean both the mainly state-controlled company Gazprom as well as

the government, because they act as one entity and formulated several times economic as well as political offers and demands in this conflict. The Ukraine used up to 80 billion cubic meters natural gas each year in this time [2], which made it the fourth biggest import country in the world. These numbers date back before the conflict. Due to its highly inefficient usage – compared to its GDP Ukraine has the highest natural gas consumption – it is highly dependent on Russian gas deliveries. At the same time it is one of the most important transit countries for gas towards the EU. From 80% before the commissioning of Nord Stream (see Fig. 1), a gas pipeline from Russia through the Baltic Sea towards Germany, today still 50% of the gas addressed to members of the EU has to be channeled through the Ukraine. At the time gas prices within Russia were more expensive, than the gas delivered to Ukraine [3]. After the demands for new contract negotiations were rejected from the Ukrainian government, the Russian side stopped the 20% natural gas sent to Ukraine meant for the Ukraine, while still pumping the other 80% destined mostly for countries of the European Union into the Ukrainian grid. Several countries reported drops in their deliveries, ranging from 10 to 40% [4]. This first issue which had a direct impact on the EU was resolved within days, as Gazprom stabilized the network. The next part of the far more detailed conflict that had impacts on EU countries happened in 2008 after Russia demanded money for gas they delivered to cope with disturbances from the Caucasian gas fields. Both sides presented different calculations of the debt and they could not find a common ground especially against the background of threats of ever more raising prices from the Russian side. Two ultimatums expired and the Russian side stopped delivery on the 1st of January 2009 which resulted into a total stop of the deliveries to Turkey, Bulgaria, Greece and Macedonia for a week and thereby to closure of schools and factories. Austria’s imports decreased to 10%, but the country could cope better with the consequences due to her higher gas storage capacities [5].

III. POLITICAL ASPECTS

Although the Russian side stresses always the economic side of the problem, there are several connections to political aspects, too. The start of the conflict coincided with the end of the Orange Revolution in Ukraine, which led to a shift of the country towards Western Europe. The second big incident in 2008 matched the political negotiations between Ukraine and

NATO for closer ties between the two within a Membership Action Plan. The last incident, the cancelation of the Ukraine-European Union Association Agreement, was announced by Ukraine's Prime Minister Mykola Azarov to be the direct consequence of Russian sanctions, which included the gas price [6].

Arguments from the Russian side focused on the economic dimensions and stated that the former cheap gas prices would equal a subsidy for the Ukrainian Economy. If we compare the prices for Russian gas in several countries for 2006, we see that the Ukraine paid 230\$ for 1000 square meters natural gas while other states such as Armenia, Georgia, Moldavia and the Baltic States paid 110-125\$ and Belarus 128\$ per 1000 square meters natural gas. The price for natural gas delivered to Ukraine has risen to 480\$ in 2014. With this rather basic analysis we consider the gas price a politically influenced price.

With this we have political means and economic means that are intervened to achieve political and economic interests.

IV. THE ECONOMIC PERSPECTIVE

The gas market is a unique market and natural gas a unique commodity. Although natural gas is a perfect energy source with a high energy density and compared to other fuels excellent firing properties there is, however, one problem. Due to the high transportation costs roughly 150 to 170 billion cubic meters natural gas get burned every year even if they are extracted for free as a byproduct from the oil production [7]. To transport gas there are effectively only two options: Pipelines – the transport via a network of pipelines – and LNG – (Liquefied Natural Gas), that is natural gas converted into its liquid form with only a 1/600th part of its volume. Both require an enormous initial starting investment for compressor stations and pipelines on the one hand, LNG-ships and terminals on the other and in addition to that the high energy consumption of the compressor stations (10% of the natural gas every 4700km) or the liquidation process of LNG (10-25% of the natural gas once) must be taken into account [8]. The last possibility is the conversion to methane using Fischer-Tropsch process, which won't be discussed further in this paper.

These special requirements lead to a difficult investment decision. To set up the required infrastructure, a huge investment sum is needed and economic changes in demand or prices are risk factors that add up to political risks.

Long-term contracts between countries, then, seem to be an effective and appropriate modus operandi, which would reduce the political risk and split the risk between both parties according to the phrasing in the contract. This is another reason why we will assume gas as a directly politically influenced good and view both, the company and the country it belongs to as one. Examples of long-term contracts are the first 12 year contract between the Soviet Union and West-Germany in 1970 [9] and the recent 30-year-contract between China and Russia [10]. A recent development is shorter contracts in West and Central Europe to ensure competition. An example for that is the recent ban on long-term contracts by the German Kartellamt (Monopolies and Merger Commission) [11].

If we model the market applying game theory we have, depending on the perspective or regarding the ownership, two to three players. The first is the exporting country, in our example Russia, the importing country or countries, in our example Germany or the members of the EU and, if existing, the transit country, in our example the Ukraine. To make things easier we assume that all governments have direct access to or control over their respective firms or act in accordance with the interests of their firms and the other way around. All three countries have a monopoly in the short run regarding their role: demand, supply and transport. If all countries would act rationally and only based on economic interests we could predict their behavior. Given a utility matrix where for every party we have two alternative actions – Halt the trade and continue the trade – they would continue trading. If one country halts the trade, all three parties have a negative outcome. Only if all three participate and have a positive utility of the pipeline, like gas, revenues or the pipeline rent covering their respective payments, we achieve a Nash equilibrium.

Like many infrastructure projects, this seems to be a natural monopoly at first. But because there is no market to begin with, there is no equilibrium price [21]. The only conditions to make all three parties agree is that the rent of the pipeline is above the capital costs of the pipeline, the gas can be sold for the gas price charged in the importing country and the gas price covers the excavation costs of the exporting country. With no market mechanism the outcome of the negotiations or in short – the price – is up to the market power or, especially in our example, the political power of the participants.

This leads us to contract theory. Two parts of this theory are interesting for us. First the outcome of a negotiation is based on the bargaining power of both parties, which can be understood as the sum of market power and political power in our case and secondly, although rarely practiced, there has to be a mode to enforce the contract [12]. But this did not happen between the Ukraine and Russia. Every time Russia raised the prices it stated that the old contract has expired and Ukraine could not do anything against it. Without a balance in market and political power, short bargaining power, or some mechanism like an institutional framework, the contract depends only on externalities and secondary effects like the preference of the stronger party towards his own reputation.

In our specific case, Russia could use both, its market power as a big trade partner of Ukraine as well as her political power to push the price within 10 years from 2004 and 50\$ per 1000 square meters natural gas up to 480\$ in April 2014.

The member states of the EU have the market power to enforce contracts. One interesting question that cannot be covered in this paper, is whether a stronger separation between economic interests of firms and political representation in European countries especially Germany and the newfound ban on long term contract for German gas suppliers weaken the bargaining power on the German side, leading to higher prices for gas in the consequence.

V. TECHNICAL AND ECONOMIC FACTORS

If we look into the security of Russian gas supply for European member states there are several technical numbers we have to look into for each state.

The first big difference is the relative and absolute difference of the Russian gas imports and self-sufficiency. While 100% dependence on imports sounds much, it could have far less negative consequences if a country has own deposits, filled gas storages and a small absolute gas consumption in comparison to a country where these other factors are not met. In general we can say that countries further in the east and that are well implemented into the gas network as shown in fig. 1 are more dependent such as Finland, Estonia,

Latvia, and Lithuania, which import 100% of their imported gas from Russia, while having no own production. Poland (82.6% of the imports are Russian gas), Czech Republic (79.3%), Slovakia (92.7%), Hungary (81.4%), and Austria (61.8%) are less dependent [13], especially because some of them are partly gas producers as well (Poland 34.3%, Austria 21.1% and Hungary 21.6%) [14]. Germany with an import rate from 39% of its total consumption is in absolute numbers the biggest importer with 30 billion cubic meters of the total sum of 129.1 billion cubic meters exported by Russia into the EU.

Gas storage capacities in Europe are insufficient, as stated in a CEER (Council of European Energy Regulators) interim report from November 2013, with many countries with next to



Fig. 1: Major Russian gas pipelines to Europe, Open Source License

no storage capabilities. The incentive to build is only given due to the difference between market prices in summer and winter or to security of supply based on a steady political background. Especially a few of the Balkan countries can uphold the gas pressure only for hours. Germany has with a capacity of about 27% or 20 billion cubic meters of its yearly consumption the highest absolute storage volume [16], while Austria with 7 billion (bn) square meters has in reaction of the crisis in 2006 the highest relative storage volume of 86.1% [15].

With LNG as a possible solution we have to state, that with

Central European countries would mean investments for ships and terminals, taking at least 5 years to construct and implement into the gas market [15].

The idea to lower the percentage of Russian gas imports for Europe as a whole by lowering consumption and efficiency or to decrease imports by better usage of gas deposits within the EU are also not going to work. Several prognoses for gas consumption say that within the EU and Germany gas consumption is likely to go up and grow at a steady pace of 1-2%. In addition to that are the estimated reserves in the North

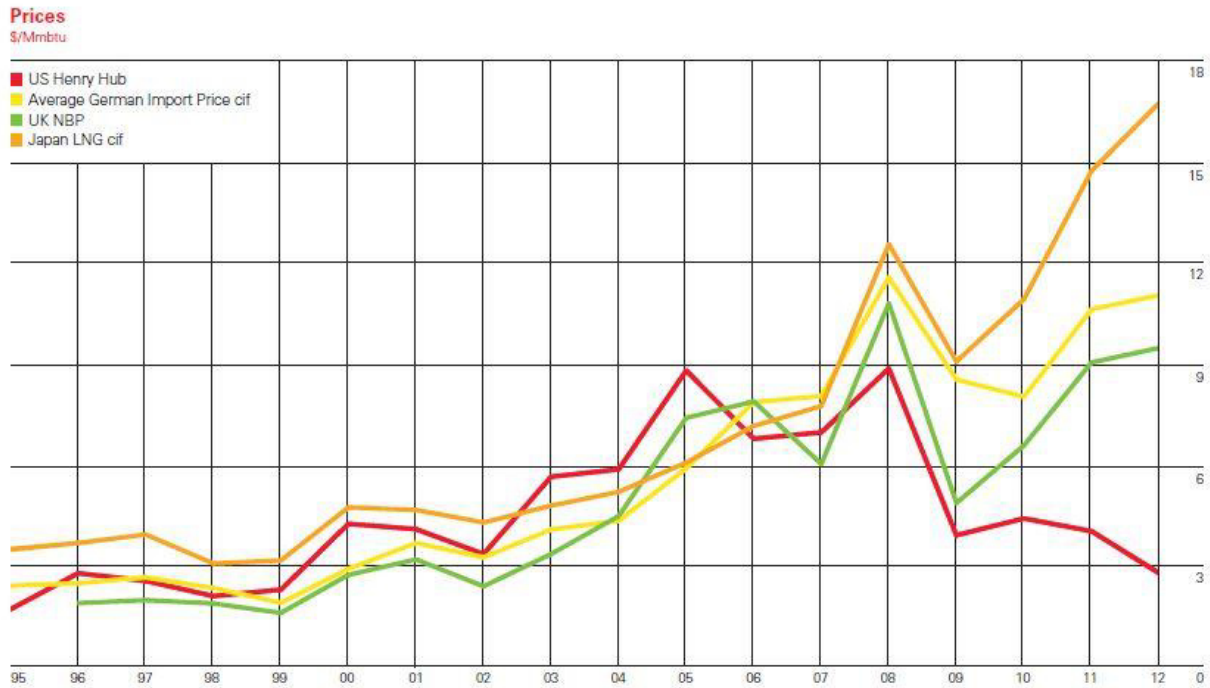

Fig. 2: Gas prices in the US, Germany, the UK and Japan [13]

the exception of Italy not a single country that imports Russian gas imports gas via LNG as well. The total Import into the EU with LNG was 69.3 bn square meters in 2012, compared to an import of 130 bn square meters from Russia [13]. This has effectively two reasons. First of all, if there is an existing working infrastructure that fits the needs investments into additional infrastructure are not promising unless the difference in prices covers the costs without any risk. Leaving out any other risks, like environmental risks, there is a strategic risk. The owner of the pipeline can always just lower the price below the other price, assuming that he paid his capital costs, because his investment amortized already. The second point is that pipelines are cheaper. Although the costs are hard to gasp even with given numbers, transport via pipeline from Russia is “a comfortable situation” according to a specialist from the German supplier RWE [24]. The costs for a pipeline from Russia were a huge investment, but now done the cheapest way to supply East and Central Europe with gas. LNG would need to get delivered from the Middle East and West Africa. LNG is, there are economists and technical specialist in accordance, the more expensive technology given the geographical disposition. Another point is the availability. LNG for East and

Sea not able to take over the supply of Russian gas.

VI. RESULTING POLITICAL-ECONOMIC ISSUES

Following our considerations so far we can formulate the problems more concrete, such as the following, and ask which political, economic and technical solutions might be viable:

- (1) Russia might be able to raise prices for natural gas for EU countries.
- (2) Russia might use its gas deliveries to exert political power.
- (3) Ukraine could exert its control over its pipelines and stop the transit.
- (4) The conflict in the Ukraine could escalate more, resulting in an environment, where the pipelines are no longer safe.

Before looking in possible solutions, we should notice some properties about these problems. (1) has an immanent effect but can be solved with a long-term solutions. (2) and (3)

are short-term problems, meaning that the effect comes without a warning and long-term solutions cannot be applied. (4) has an immanent effect and could be both less than a year or longer. In difference to the other problems are both conflict parties interested to keep the pipelines, which secure income and supply for the Ukrainian side and income for the Russian side.

The problems differ not only regarding the time, but also regarding quantity and price. Problems (2) up to (4) include a reduction or stop in the quantity delivered. Problem (1) and possibly (2) are likely to include a rise in prices.

The real problem in (1) is not the security of supply, but the price and the properties of the market as already mentioned. The supply is guaranteed, as long European Countries are willing to pay. The question is, whether this is a likely scenario. Our argumentation so far was that Russia wants to be slightly cheaper or around the same price as the next alternative, to make an investment in LNG for example uninteresting and to prevent to lose market share on markets where it has to compete with other sources, like we have seen in Italy, Germany and Austria. The same logic can be applied to countries, where they deliver 100% of the imported gas, because these countries are more likely to buy gas on the Central European markets if the price is cheaper. As we can see in Fig. 2 are the prices between the Germany and United Kingdom, a country that does not import Russian gas but can trade with Germany, always only slightly above or below their respective counterpart. An example for an East European country that bought gas from the Central European gas market is the Ukraine in April 2014 [19]. If we state that the Russian gas price is defined by our alternatives, one might say that we simply have to finish the South Stream pipeline that goes from Turkey to Greece and finally to Italy. This would connect the European gas market with Caspian, Egyptian and possibly Iraqi gas. But this might not change the price for Russian gas, just its market share, if the best strategic approach is charging marginal costs of the last unit in the gas market.

We conclude the first problem and come to the following results:

- Russia provides a market share of the European gas market and has due to its low cost an equally high economic incentive to do so.
- Although supply cannot be replaced short-term Russia has an interest not to charge monopoly prices to keep its market share in the long term.
- The usage of political power to achieve economic ends in the long term is restricted. If countries have different ways to buy gas, Russia is going to behave as any other competitor.

Problem (2) cannot be solved like shown with problem (1). The difference is the difference in time. While alternative transportation routes can only be explored and constructed within years, the political and economic pressure exerted by Russia in the gas conflict where always within days or month. If we model Russia as a rational actor we can state that the political power given by the means of the gas market outweighs the costs. This perspective might not be a good to model political power or gains, but we can estimate how much

it costs. Given a model situation of two countries where both countries own the pipeline on their respective land and a transmission party does not exist. The costs for a production stop are at least the lost profits from the gas, which was not sold in the time of the embargo. This is actually a special case, in which the importing country cannot use its market power or political power ($\text{Bargaining Power}_{\text{Importing Country}} \ll \text{Bargaining Power}_{\text{Exporting Country}}$) or is refraining from doing so. The costs from gas not sold are dependent of the time. Costs for the Exporting country through exerted market as a reaction from the Importing Country are a function from the time as well – they might stop or inhibit other trade flows and a longer time makes it more likely that they do it – and as already stated the Bargaining Power. The higher these costs are, the unlikelier is that the exporting country will exert its market power for political purposes.

The costs for the Importing Country depend as already stated from the importance of the imported gas. Can the gas be substituted on short notice with other fuels – for example in power generation – or is the industry structured in a way, in which the production processes in many other industries have to stop? How big is the market share of Russian gas regarding the import and the consumption? Are there gas storages and how long can they guaranty the gas level? If missing gas leads to closing schools and factories within days, like seen in 2009 for the Balkan Countries the respective costs for the importing country are high and the usage of market power is more likely to yield results, to a point where the gas has not even to be stopped to get the preferred results. In both formulas, the costs for the Importing as well as the Exporting Country the determining variable is time. And the only way to change the time component in favor of the Importing Country is gas storage. To compare it to LNG for example we have to find a storage capacity that covers political risk, as well as the risks stated in question (3) and (4). LNG would replace Russian gas and with would diminish the risk attached to it completely. Keeping in mind how much the Russian markets suffered through the latest sanctions a time of 1 year for the sake of a small calculation seems acceptable. If we simplify the numbers for Germany we have 10% self-supply, 40% Russian gas and 50% gas imported from other countries. With a consumption of 75 bn square meters natural gas it would equal a need of 30 bn square meters storage volume. The plus of storage is that it offsets the market power for political purposes only for the price of the storage, while still being able to use the existing infrastructure and prices. We compare this to a complete replacement with LNG or a replacement of the market share of consumption that cannot be covered with the existing storage.

We have to pay the price difference for the gas of the replaced market share between Russian pipeline gases to LNG, which includes huge investments and a transition time larger that the time needed to build the storage. This price difference can be expected to be large. Japan has a large rise in demand after the nuclear catastrophe in 2011 and paid about 50-80% more for its LNG [13] in the last 2 years compared to Germany and before the crisis (see Fig. 2).

For a short rough estimation we assume the following. The more LNG is needed, the more expensive it is. The consumption in Japan went up by 20bn square meters natural

gas which equaled 50-80%. A conservative estimate for the price increase will be 50%. We calculate in additional costs per bn square meters of Russian gas that has to be replaced or where the risk has to be secured, which make this calculation applicable for all countries. Although it is hard to estimate a price for the following years based on the volatile prices in the last years a price of 266\$ for pipeline gas and 400\$ for LNG seems supportable. This would equal costs of 133 million \$ per billion square meters additional costs for LNG. The costs for a storage facility are exemplary calculated with the pore storage in Rheden. In 2002 the costs per billion square meters were 91 million \$ [20], which equals 115 million in today's prices. In our simplified example calculation a single year of price differences is enough to pay the storage as a whole.

Not included in this calculation is the lower risk of storage due to its faster implementation [15] and the possibility to earn money with storage by buying and selling gas counter-cyclical for example between summer and winter.

VII. CONCLUSIONS

This excursus into the east European gas market showed the importance of services that are needed to cover risks but are not provided by the market itself and therefore have to be provided by the state and its national energy agencies. Both technologies LNG and storage will not develop by itself without an intervention [17][22] to diminish the risk, although LNGs market share is prognosed to rise. Whether this growing market share only replaces decreases production and supports the market or reduces the market share of gas freight with risk without being freight with risk is another open question.

The answer to the question if LNG is one of the key factors to tackle the named issue is no. We see no efficient way to implement LNG more than the normal growth rate and it is no appropriate response to the problems formulated.

The perspective chosen for this paper is not a national, but a European perspective. A successful strategy has to take the same approach. Investments into the grid in one country can have a key role in securing the supply in many. Countries approaches as well as political obligations regarding the building of storage are as different [18] as the geological conditions to do so. Germanys storage would not be enough to cover the 1 year gas storage guideline set in this paper, yet Denmark and Sweden plan to use German storage in case of an emergency. There is no common guideline regarding the risk management and needed capacities, and no European approach to estimate possible political risks and possible problems like congestion or the structure of the grid.

For these reasons the most important recommendation is a risk management that coordinates national energy agencies, that considers possible technical as well as political risks and implements guidelines comparable with the ones of the IEA. These guidelines demand for example that every country has enough oil and oil products for 90 days [25] to counteract disturbances on the oil market, as seen during the Liberian [23] crisis. Further research questions include a more detailed modeling that includes the overall structure of the network and a more detailed risk analysis to improve the rather crude assumptions.

- [1] DPA. (2014. may 25). EU bereitet sich auf Gas-Lieferstörungen vor. Frankfurter Allgemeine Zeitung [Online Article]. Available: <http://www.faz.net/aktuell/wirtschaft/wirtschaftspolitik/eu-bereitet-sich-auf-gas-lieferstoerungen-vor-12951659.html>
- [2] CIA. (2014). The World Fact Book. Available: <https://www.cia.gov/library/publications/the-world-factbook/geos/up.html>
- [3] Andrey Kolesnikov. (2005. december 9). Vladimir Putin Charged Ukraine. Kommersant [Online Article]. Available: <http://www.kommersant.com/page.asp?id=633921>
- [4] BBC News. (2006. january 2). Ukraine "stealing Europe's gas". BBC News [Online Article]. Available: <http://news.bbc.co.uk/2/hi/europe/4574630.stm>
- [5] RiaNovosti. (2009. january 21). Bulgarien will von Russland Entschädigung für Gaslieferausfall fordern. RiaNovosti [Online Article]. Available: <http://de.ria.ru/business/20090121/119742280.html>
- [6] Ambrose Evans-Pritchard. (2013. november 22). Historic defeat for EU as Ukraine returns to Kremlin control. The Telegraph [Online Article]. Available: http://www.telegraph.co.uk/finance/comment/ambroseevans_pritchard/10469065/Historic-defeat-for-EU-as-Ukraine-returns-to-Kremlin-control.html
- [7] Anselm Waldermann. (2007. september 6). Erdgas-Verschwendung. Spiegel Online [Online Article]. Available: <http://www.spiegel.de/wirtschaft/erdgas-verschwendung-profitdenken-schlaegt-umweltschutz-a-504278.html>
- [8] Landolt Börnstein (2008). New Series VIII, 3A, Natural Gas Exploitation Technologies, S. 40 ff.
- [9] Manfred Pohl, "Geschäft und Politik. Deutsch-russisch/sowjetische Wirtschaftsbeziehungen 1850-1988" 1st ed. Mainz, Germany. Hase & Koehler Verlag, 1988
- [10] DPA. (2014. may 21). Hoffnung in der Ukraine vor Präsidentenwahl wächst. News.de [Online Article]. Available: <http://www.news.de/politik/855532235/russland-und-china-schliessen-gasvertrag-ueber-30-jahre/1/>
- [11] DPA. (2007. january 17). Kartellamt verbietet Eon Ruhrgas langfristige Gasverträge. Der Tagesspiegel [Online Article]. Available: <http://www.tagesspiegel.de/wirtschaft/energiemarkt-kartellamt-verbietet-eon-ruhrgas-langfristige-gasvertraege/676074.html>
- [12] Schwartz, Alan and Scott, Robert E., "Contract Theory and the Limits of Contract Law" (2003). John M. Olin Center for Studies in Law, Economics, and Public Policy Working Papers
- [13] BP. (2013. june). BP Statistical Review of World Energy. Available: http://www.bp.com/content/dam/bp-country/de_de/PDFs/brochures/statistical_review_of_world_energy_2013.pdf
- [14] IEA. (2014). Gas Trade Flows in Europe. Available: <http://www.iea.org/gtf/index.asp>
- [15] Arvid Kaiser. (2014. April 17). Gas-Schock. Manager-Magazin [Online Article]. Available: <http://www.manager-magazin.de/politik/artikel/a-965144.html>
- [16] Statista. (2014). Speicherkapazitäten der Untertage-Speicher in Deutschland bis 2012. Available: <http://de.statista.com/statistik/daten/studie/164135/umfrage/kapazitaet-der-untertage-erdgasspeicher-in-deutschland-seit-1999/>
- [17] Dr. Olaf Däuper, Janka Schwaibold. (2014. january 27). Gasspeicher in Europa - Eine Momentaufnahme der Regulierer. Der Energieblog [Online Article]. Available: <http://www.derenergieblog.de/alle-themen/energie/gasspeicher-in-europa-eine-momentaufnahme-der-regulierer/>
- [18] Council of European Energy Regulators. (2013. november 20). Changing storage usage and effects on security of supply. CEER interim report. Available: http://www.ceer.eu/portal/page/portal/EER_HOME/EER_PUBLICATIONS/CEER_PAPERS/Gas/Tab3/C13-GWG-102-03_StorageUsageSoS_19112013_final2.pdf
- [19] Alfons Frese. (2014. april 15). RWE liefert Gas nach Kiew. Tagesspiegel [Online Article]. Available: <http://www.tagesspiegel.de/wirtschaft/krise-in-der-ukraine-rwe-liefert-gas-nach-kiew/9768394.html>

- [20] Margit Hebeda "Rolle und Funktion des Speicherzugangs. Wer hat sie und wer kann sich das leisten?", presented at the Berlin University of Technologies, Berlin, 2002. Available: http://www.google.de/url?sa=t&trct=j&q=&esrc=s&source=web&cd=1&ved=0CCsQFjAA&url=http%3A%2F%2Fwww.ensys.tu-berlin.de%2Ffileadmin%2Ffg8%2Fdocuments%2Fhebeda.ppt-4505f302dc5a344aaca6c4a8ee15c734.ppt&ei=7DOPU_iHGUVFyQOm hYGwDA&usg=AFQjCNElrJuceb14c4GObsmI2bf84MMetw&sig2=Zc2anEeKCOfxUQqq_qSXhA&bvm=bv.68235269,d.bGQ
- [21] Andrea Mas-Colell, Michael D. Whinston and Jerry R. Green. "Microeconomic Theory". 1st ed. New York. Oxford Press, 1995
- [22] Dirk Briese, Jens Gatena. (2012, september 14). Auf dem Weg in die LNG-Zukunft.trend:research [Online Article]. Available: <http://www.energy20.net/pi/index.php?StoryID=317&articleID=215888>
- [23] DAPD (2011, june 23). IEA zapft ihre Öl-Reserven an. Focus [Online Article]. Available: http://www.focus.de/politik/weitere-meldungen/oel-reserven-ia-zapft-ihre-oel-reserven-an_aid_639616.html
- [24] Stefan Judisch, Martin Czakainski, Werner Langen, Claudia Kemfert and Carsten Sürig (2007). LNG - Bedeutung für den europäischen Erdgasmarkt. Energiewirtschaftliche Tagesfragen Heft 11 [Interview]
- [25] H. Wagner and H. Hoffstätter. (2009). Zur Frage der Versorgungssicherheit mit fossilen Energieträgern. BHM Heft 8. Available: <http://link.springer.com/article/10.1007%2Fs00501-009-0489-3>

Solar energy in Poland

Dawid Muzyka
BTU Cottbus-Senftenberg
Cottbus, Germany
dawid.muzyka215@gmail.com

1. Introduction

The development of modern technology requires more and more electricity. Scientists are searching for new methods to satisfy the demand. Electricity production is mainly based on fossil fuels or nuclear energy and power sector is considered the main cause of environment pollution. However, more and more attention is paid to renewable energy sources.

2. Solar radiation

The Earth is the third-most distant planet from the Sun which seems to be an inexhaustible resource of renewable energy. When the light strikes an object the energy converts into heat. But when the light strikes suitable materials the energy changes into electrical current, which can be used to generate power. It is estimated that the Earth receives 174 petawatts (PW) of incoming solar insolation at the upper atmosphere [1]. Some sunlight is scattered and some is either absorbed or reflected by objects at ground level. About 30 per cent of the solar radiation is reflected back to space. The rest is absorbed by atmosphere, oceans and land.

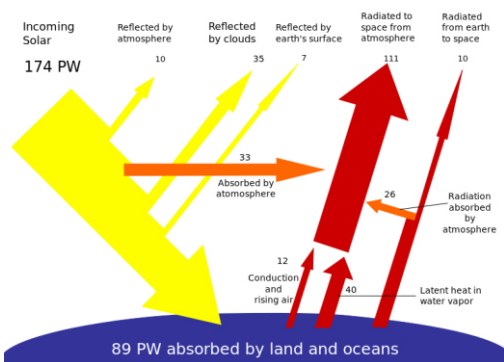

Diagram 1: Energy from Sun
Source: http://en.wikipedia.org/wiki/Solar_energy

[1] http://en.wikipedia.org/wiki/Solar_energy

The radiation at the Earth's surface differs due to a region, pollution, the season and the time of day, atmospheric effects such as absorption and scattering and local differences including water vapor or clouds in the atmosphere.

It is assessed that the solar radiation energy is adequate to produce an average 1.700 kWh (kilowatt) of electricity every year per square meter of ground [2].

Solar radiation can be turned into electrical current by the use of semiconductors that exhibit the photovoltaic effect. This method to generate electrical power is called photovoltaic (PV) [3].

3. How do Photovoltaics Work?

The photoelectric effect was first perceived by Edmund Bequerel in 1839. He realized that certain materials could produce small amounts of electricity when exposed to light. Later Albert Einstein described the photoelectric effect. However, Bell Laboratories built the first photovoltaic module in 1954.

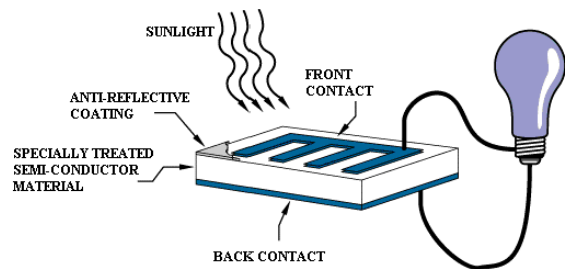

Diagram 2: A basic photovoltaic cell
Source: <http://science.nasa.gov/science-news/science-at-nasa/2002/solarcells/>

Diagram 2 illustrates the operation of a basic photovoltaic cell, the building block of solar panels, which can convert sunlight into direct current (DC). Solar cells are

[2] Mirjana Golusin, Stevan Popov, Sinisa Dodic, Sustainable Energy Management, Elsevier Science, 2013, p.244.

[3] <http://science.nasa.gov/science-news/science-at-nasa/2002/solarcells/>

made of semiconductor materials. A thin semiconductor plate is used to form an electric field. It is positive on one side and negative on the other. During the process light energy strikes the solar cell and electrons are released. If electrical conductors are linked to the positive and negative sides, forming an electrical circuit, the electrons are caught as electricity. A single cell of the photovoltaic panel generates a current of approximately 4 A at 0.5 V (voltage).

3.1. Present technology

A certain number of solar cells combined electrically and installed in a frame form a photovoltaic module. Multiple modules that are wired together form an array, the complete power-generating unit. The bigger the area of a module or array, the more electricity can produce. The amount of current depends on how much light strikes the module. 36 cell modules are the standard for large power production.

Silicon is widely used by photovoltaic designers. There are three types of them^[4]: monocrystalline silicon (efficiency 12-19 per cent), polycrystalline (10-18 per cent) and amorphous (5-10 per cent). Efficiency means the material's ability to process solar energy into electricity. Amorphous silicon has some economic advantages over other materials. It is the least efficient but the cheapest of all used.

Some research on multijunction cells is based on gallium arsenide as one of the component. Such cells are more effective than other materials. Their effectiveness reaches 35 per cent under concentrated sunlight. There are more materials studied for multijunction devices including copper indium diselenide.

Photovoltaic panels (usually up to 10 kW) are installed on roofs to generate electricity for a farm or a household. Larger installations must be installed directly on the ground. Three types of installations can be distinguished^[5]: on-grid, off-grid and mixed. PV system attached to the network is called on-grid. Electricity produced by PV panels is converted into the alternating current in an inverter according to the requirement of the power network. PV installations that are not attached to the network are called off-grid system and they can work regardless of the network. They are used as small power plants in remote areas for example a mountain hostel. Such systems, however, require energy to be stored in batteries. Finally, the third type of PV panels are mixed PV systems. They produce electricity mainly for their owners' use, for example on farms. But, in case power supply is insufficient, the battery is empty or in the event of failure, it is possible to receive electricity from another resource.

^[4] John R. Wilson and Griffin Burgh, *Energizing our Future - Rational choices for the 21st Century*, Hoboken, New Jersey 2008, p. 252.

^[5] http://issuu.com/boell/docs/poradnik_maloskalowe_oze_

The cost per kilowatt-hour of energy consists of the capital cost and running cost^[6]. The former includes the cost of PV modules and balance system (BoS), interconnection of modules to form an array, the array support structure, land foundation (if not on a roof), invertors, cabling, charge of regulators, switching, metering and the cost of connection to the grid or storage batteries. On the other hand, the running costs are low in comparison with those of other energy systems.

There are many producers worldwide but a few of them are the largest^[7]. Sharp Corporation is the main cell manufacture with 198 MW of production. Kyocera Corporation is the second but it focusses on residential off-grid solar systems, communication systems and water pumping applications. BP Solar manufactures 20 per cent of the world's solar electric panels.

Producing electric energy from solar power does not destroy the natural environment, which is its main advantage over the traditional energy production^[8]. No gaseous or liquid pollutants or no radioactive substances are emitted during the production or usage. In addition to this, PV modules have no moving parts and they are safe and noiseless. The photovoltaic modules should survive 25 years and after that they can be recycled and reused. However, with electrical equipment there are some risks of electric shock. But this electrical hazard is the same as in other electrical installations. PV arrays have some visual impact as they are visible from distance and may not be regarded as attractive in the landscape.

3.2. PV in Numbers

PV is, after hydro and wind power, the third most important renewable energy source in terms of globally installed capacity^[9]. In 2012 PV was the principal electricity source in terms of newly installed capacity in European Union. It covers 2.6 per cent of the electricity demand and 5.2 per cent of the peak electricity demand in Europe now.

The overall resource available from PV is enormous^[10]. If PV modules of 10 per cent average efficiency were installed on 0.1 per cent of the Earth's surface they would produce enough electricity to supply all of the world's current energy requirements.

^[6] Godfrey Boyle, *Renewable Energy - Power for a sustainable future*, Milton Keynes, 2004, p. 92.

^[7] John R. Wilson and Griffin Burgh, *Energizing our Future - Rational choices for the 21st Century*, Hoboken, New Jersey 2008, p. 260-261.

^[8] Godfrey Boyle, *Renewable Energy - Power for a sustainable future*, Milton Keynes, 2004, p.95.

^[9] http://www.epia.org/fileadmin/user_upload/Publications/GMO_2013_-_Final_PDF.pdf

^[10] Godfrey Boyle, *Renewable Energy - Power for a sustainable future*, Milton Keynes, 2004, p.98.

At the end of 2009, the world's installed PV capacity was 24 GW (gigawatts)^[11]. It was 40.7 GW a year later and in 2011 - 71.1 GW. In 2012, more than 100 GW of PV was installed overall. This represents about 70 per cent of the world's cumulative PV capacity. It is believed that 110 TWh (Terawatt) of electricity can be produced every year. This volume is enough for over 30 million European households to cover their annual needs.

Based on the capacity installed and connected to the grid at the end of 2012, PV can currently provide roughly 2.6 per cent of the electricity demand in Europe, up from 1.15 per cent at the end of 2010 and 2 per cent at the end of 2011. Globally, PV represented at the end of 2012 roughly 110 TWh of electricity or 0.6 per cent of electricity demand and 1.2 per cent of the peak power demand.

4. Passive and Active Solar Systems

Two solar systems are distinguished depending on the way they capture, convert and distribute solar energy: passive and active^[12]. Passive solar systems rely on direct heating or conversion to preserve or convey thermal energy from the Sun. These systems use the architectural design or absorptive structures of the building to absorb energy. The building itself can work as a storage device. A big window placed on the sunny side is an example. Similarly, flat plate collectors on a roof can heat liquid in tubes which supply a house with hot water. Gravity convection loops are used to transfer hot water into storage areas located above collectors. There are three types of thermal collectors. Formed thermal collectors consists of formed panels or tubes. Water circulates through them and it is heated by the Sun radiation. Flat plate collectors are composed of a thin black absorber sheet supported by a grid or array of fluid tubing. An insulating casing with a plastic or glass cover encloses the collector. Fluid is revolved through the tubing to move the heat from the absorber and transfer it to a heat exchanger or an insulated water tank. Vacuum tube collectors are the third kind of thermal collectors. Each tube contains its own collector, mainly of painted or coated copper with two glass tubes, which hold a partial vacuum. Fluid is circulated inside the collector through two tubes, which power a collector and circulate to the hot water storage tank. When the hot water is below the solar panel active hot water systems are used. Mechanical aids such as air blowers, circulation pumps or sun tracking systems are employed to increase the amount of energy gathered every day. They are usually powered by electricity and may require additional electronic controls. An active solar hot water system can contain pumps, flat-plate collectors, valves, remote storage tanks and heat exchangers to discharge thermal energy into the building at night. Apart from providing hot water, large active solar systems can work as a solar ventilation system that can be used to

^[11] http://www.epia.org/fileadmin/user_upload/Publications/GMO_2013_-_Final_PDF.pdf

^[12] John R. Wilson and Griffin Burgh, *Energizing our Future - Rational choices for the 21st Century*, Hoboken, New Jersey 2008, p. 248-253.

preheat air when it comes into a property. This heat from a collector can be used to cool a building too. Direct-gain systems use focussed mirrors to create intensive heat. It can generate steam or mechanical power to run a generator and create electrical power. Focused systems include dishes, towers or troughs to concentrate light energy. Towers provide light concentrations of 600-2000 times incident levels and reach temperatures of 1500 degree of Celsius which allows the use of high temperature steam turbines to generate electric power.

5. Solar energy in Poland

The history of solar energy production in Poland has been short. Solar energy is used to small extend in solar and photovoltaic installations to heat water for domestic purposes and produce electricity.

5.1. Solar radiation

Although the reserves of solar energy in Poland are relatively high, their utilisation is not easy because of high irregularity of solar radiation. The average annual insolation in Poland is 990 kWh/m² a year ± 10 per cent^[13].

It is relatively equal in different regions of the country^[14]. The best radiation is in Podlaski and Lublin region, due to frequent influx of dry air masses from Ukraine. It is estimated as 1048 kWh/m² a year.

The central part of Poland receives 1022-1048 kWh/m² a year. The atmosphere in coastal areas is the most transparent and this part of the country is also privileged in terms of solar energy. The lowest level of the solar energy can be observed in the most industrialized parts: around Warsaw, Silesia and near the borders of 3 countries: the Czech Republic, Germany and Poland. Apart from the pollution or weather conditions (cloud cover) periodic changes in insolation can be observed.

The littlest radiation was recorded in Suwalki - 833 kWh/m² a year, and the largest value of 1199 kWh/m² a year at Kasprowy Wierch^[15].

Distribution of solar radiation is uneven annually. There is approximately 80 per cent of the total annual solar radiation in the spring-summer period (April-September). In Poland, the annual average amount of sunshine is 1600 hours^[16].

^[13] http://www.tomi-solar.eu/informacje/energia_sloneczna_w_polsce.html

^[14] http://www.giwk.pl/files/186/168/204/4_rozdzial.pdf

^[15] http://www.tomi-solar.eu/informacje/energia_sloneczna_w_polsce.html

^[16] <http://www.enis-pv.com/en/insolation-in-poland.html>

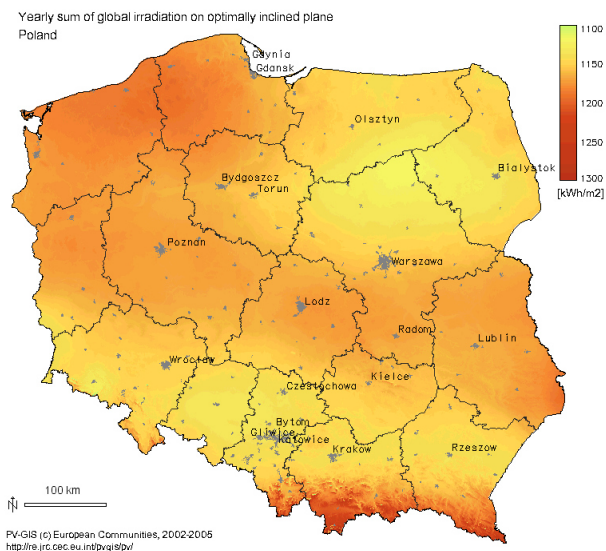

Diagram 3: Yearly radiation in Poland
 Source: <http://www.geni.org/globalenergy/library/renewable-energy-resources/world/europe/solar-europe/solar-polandbig.shtml>

5.2. Solar Power in Numbers

An increase in the installed capacity of renewable energy has been observed since 2005, when a certification system to subsidize renewable energy production was introduced. The total renewable energy sources of electricity installed in Poland in 2012 equalled 4.4 thousand MW^[17]. This was an increase of 1.3 thousand MW compared to the previous year. The amount of energy Poland receives from renewable sources was 11.5 per cent in 2012. The largest installed capacity was reported in wind power - approximately 2.5 thousand MW. Next, there are hydropower plants (966 MW), biomass power stations (876 MW), biogas plants (136 MW) and finally photovoltaic installations (about 1.3 MW).

5.3. Solar Collectors

In 2010 the total area of solar collectors used in Poland amounted 0.46 million m², while in Germany it reached the value of 9.7 million m²^[18].

In 2012 1.2 million m² of solar collectors were installed and used, which corresponds to 848 MW capacity. Poland was ranked second in sales of solar collector installations among European countries that year. According to European Solar Thermal Industry Federation (ESTIF) the market is going to grow to reach 20 million m² installed collectors in 2020 (which gives 0.5 m² per a person)^[19].

^[17] <http://www.forbes.pl/niedobory-mocy-w-polsce-mozna-uzupelnic-energia-sloneczna-,artykuly,147193,1,1.html>

^[18] http://www.carsev.eu/en/PV_In_Poland

^[19] <http://www.oze.pl/energia-sloneczna/energia-sloneczna,9.html#>

Currently there are 74 companies producing and distributing solar, more than half of them are distributors of foreign companies. Buying solar collectors seems to be fashionable in recent years. More and more newly built houses have solar installations. In 2010 a nationwide subsidy program for individuals and communities started. It provides a grant of 45 per cent of costs. Thanks to the program 141 thousand m² of solar installations were installed.

6. Photovoltaics in Poland

Polish people associate the use of solar energy with solar collectors. Grants for the purchase and financing loans supported the development of this part of energy. According to the Energy Regulatory Office, at the end of 2011 the total output of photovoltaic cells in Poland amounted to only around 2 MW with less than ten entities producing more than 20 kW^[20].

The biggest land installation in Poland, the photovoltaic farm in Wierzchosławice^[21], was built in 2012. It has the power of 1.0 MW, but it will reach 10MW in future. Another examples are: Upper Silesia Waterworks in Ruda Śląska (311 kW), a company CCC S.A (previously NG2 S.A.) in Polkowice (100 kW), Voivodeship Specialist Hospital in Łódź (82 kW), Frost Company in Bydgoszcz (0.5 kW), a church in Jaworzno (71.76 kW), Center for Photovoltaics at the Faculty of Environmental Engineering, Warsaw University of Technology, Law and Administration School in Rzeszów (20 kW) and Embassy of Japan in Warsaw (20 kW). The total photovoltaic power connected to the grid in Poland was about 1.290 MW in 2012.

Electricity generators and suppliers which provide electricity to customers are obliged to acquire a certain part of the energy from renewable sources^[22]. They are given so called certificates of origin or green certificates. If they do not fulfill a specified quota, they pay a replacement fee which goes to the National Fund for Environmental Protection. On 01.07.2012 the number of green certificates available on the market was 6.65 TWh. The demand in the photovoltaics market is now at a low level due to huge cost of investment and a small income in relation to the earlier cost. The participation of the solar radiation in energy production at 0.008% in relation to other sources of renewable energy is very small, but it shows its future capability.

More than a hundred businesses offer sale and installation of solar photovoltaic systems and sell their

^[20] http://www.carsev.eu/en/PV_In_Poland

^[21] http://en.wikipedia.org/wiki/Solar_power_in_Poland

^[22] <http://ris.slaskie.pl/files/zalaczniki/2013/07/10/1373465824/1377176785.pdf>

accessories^[23]. More than half of these companies provide the assistance, installation and service. There are ten home businesses specializing in the production of photovoltaic panels exported to many places in the world. Many panels on the Polish market are produced in China (28 per cent), Germany (24 per cent), Canada (17 per cent) and Japan (9 per cent).

When an investment is considered to be a small photovoltaic power plant mounted on a top of a building, it is not necessary to report the construction^[24]. Larger installations require the permission of the construction and other documents, such as: an extract from the land reference register, the decision on building conditions, a project map, technical documentation. The investors are obliged to comply with the study of conditions and directions of development, a local master plan. The local spatial development plan or the planning permit is necessary to apply to the regional grid operator for grid connection conditions. Other important documents include a building permit, a usufruct permit and a decision on the environmental conditions. If investors want to sell electricity to the network, they have to apply for a concession in Energy Regulatory Office.

Transfer grid operator named PSE Operator and the operators of major distribution grids – Enea, PGE, Tauron, Energa, and PKP Energetyka – have to balance the electricity and transfer this duty onto the current producers^[25]. Balancing is necessary for the installed capacity above 5MW. Solar power producers are required to inform and coordinate the powering of the solar energy into the grid. Central mechanism for balancing of energy allows to correct the planned energy amount that will supply the grid an hour before its production. Fees for balancing the energy including the risk of balancing by domestic grid operators amount to up to PLN 15 per MWh. It is necessary to sign a supply contract with the grid operator, a testing phase agreement and register green certificates. Finally the producer receives a license of a renewable energy source.

7. Future Outlook

The fast PV growth is expected in the world. It is estimated that till 2015 there will be 180 GW, and in Europe 100 GW PV installations^[26]. It is possible to reach 350 GW in the world production by 2020. A huge increase is expected after 2040 year (see: Diagram 4)^[27]. The diagram shows that solar energy will be one of the fundamental types of renewable energy in the future. In the last five years the price of PV decreased by 40 per cent. It is expected that till 2015 it will fall by further 40 per cent.

^[23] <http://www.oze.pl/energia-sloneczna/energia-sloneczna,9.html#>

^[24] http://issuu.com/boell/docs/poradnik_maloskalowe_oze_

^[25] http://www.greenreal.eu/uploads/files/psef_przewodnik.pdf s 13-14

^[26] http://www.giwk.pl/files/186/168/204/4_rozdzial.pdf

^[27] <http://www.sharp.eu/cps/rde/xchg/eu/hs.xsl/-/html/photovoltaic.htm>

To make solar power competitive in comparison with electricity from other sources the installed cost per peak watt needs to drop. The price of 'green' electricity should be lower, similar to average retail electricity prices. The key lies in mass production. Secondly, the overall annual conversion efficiency of the PV arrays needs to increase. Thirdly, the 'balance-of-system' (BoS) costs need to be reduced because today they are three-quarters of the module costs.

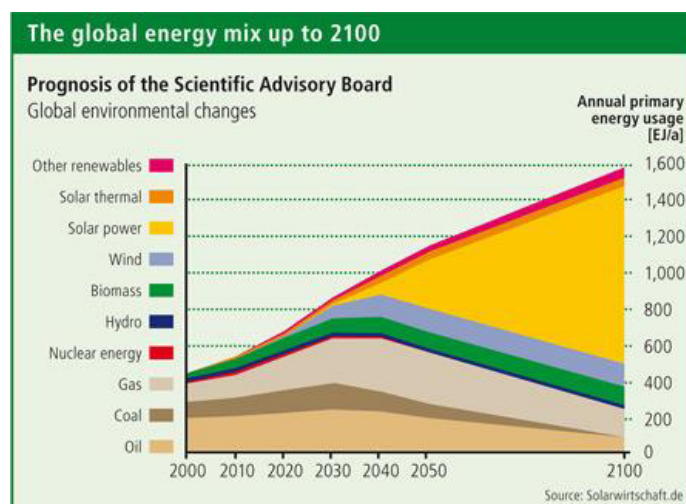

Diagram 4: The global prognosis till 2100
<http://www.sharp.eu/cps/rde/xchg/eu/hs.xsl/-/html/photovoltaic.htm>

An increase in the installed capacity of renewable energy is expected in Poland too. It should produce more than 30 TWh in 2020, in order to meet the European Union quota obligation^[28]. As in 2020 the share of energy from renewable sources is expected to be 15 per cent share of energy from renewable sources in gross final consumption of energy^[29].

It is believed that solar energy will be more and more accessible and cheaper in Poland. The reduction of the prices is expected due to an increase in the production and development of technology^[30]. In order to develop the solar energy market in Poland significant changes in the government policy are required, such as the introduction of feed-in-tariffs, simplifying the law and adapting it to the small distributed systems, the possibility to finance investments from the European Union and governmental programs, creating the target of 1.8 GWP installed capacity

^[28] http://www.greenreal.eu/uploads/files/psef_przewodnik.pdf

^[29] <http://www.forbes.pl/niedobory-mocy-w-polsce-mozna-uzupelnic-energia-sloneczna-,artykuly,147193,1,1.html>

^[30] <http://www.enis-pv.com/en/photovoltaics-in-poland.html>

in 2020 and 10 GWP in 2030, running the research program on future-oriented photovoltaic technologies.

Poland aims at reducing carbon dioxide production and increasing the amount of electricity produced from renewable energy is the only solution. Poland's government approved a long-awaited draft law in April 2014 which would introduce feed-in tariffs with different rates for different technologies and capacities. The tariffs for solar PV are going to be very attractive. The Polish Act on Renewable Sources of Energy is expected to be approved in 2014. In 2050 a reduction of carbon dioxide emissions should be at 80-95 per cent in European Union so it is necessary for Poland to start generating electricity by means of photovoltaic cells on a large scale.

8. Conclusions

Polish power supply is 90 per cent based on lignite and mineral coal combustion and causes too much pollution. Producing electric energy from the solar power does not destroy the natural environment and should be encouraged. Solar farms can be constructed even on protected areas,

References

Godfrey Boyle, Renewable Energy - Power for a sustainable future, Milton Keynes, 2004.

John R. Wilson and Griffin Burgh, Energizing our Future - Rational choices for the 21st Century, Hoboken, New Jersey 2008.

Mirjana Golusin, Stevan Popov, Sinisa Dodic, Sustainable Energy Management, Elsevier Science, 2013.

http://en.wikipedia.org/wiki/Solar_energy

<http://carsev.eu/en/Solarpower>

<http://science.nasa.gov/science-news/science-at-nasa/2002/solarcells/>

http://issuu.com/boell/docs/poradnik_malokalowe_oze_

http://www.epia.org/fileadmin/user_upload/Publications/GMO_2013_-_Final_PDF.pdf

<http://www.tomi->

[solar.eu/informacje/energia_sloneczna_w_polsce.html](http://www.tomi-solar.eu/informacje/energia_sloneczna_w_polsce.html)

http://www.giwk.pl/files/186/168/204/4_rozdial.pdf

landscape parks or habitats of birds. However, the use of the solar energy potential in our country is still not sufficient. The support system that exists in Poland now does not allow small power producers to achieve real benefits. Solar energy is regarded to be expensive but if the health and environmental costs of coal or natural gas were included in their prices, solar power would prove to be cheaper. The ongoing development of technology gives hope that in the near future more effective solutions will be available. The development of photovoltaics is also delayed due to legal and political obstacles. They need to be eliminated, otherwise Poland will stay behind other European countries. Thus, taking into account an enormous natural potential and a little scale of solar energy, there is no doubt that the prospects of the Polish solar market are enormous.

<http://www.enis-pv.com/en/insolation-in-poland.html>

<http://www.forbes.pl/niedobory-mocy-w-polsce-mozna-uzupelnic-energia-sloneczna-,artykuly,147193,1,1.html>

http://www.carsev.eu/en/PV_In_Poland

<http://www.oze.pl/energia-sloneczna/energia-sloneczna,9.html#>

http://en.wikipedia.org/wiki/Solar_power_in_Poland

<http://ris.slaskie.pl/files/zalaczniki/2013/07/10/1373465824/1377176785.pdf>

http://www.greenreal.eu/uploads/files/psef_przewodnik.pdf

<http://www.sharp.eu/cps/rde/xchg/eu/hs.xsl-/html/photovoltaic.htm>

<http://www.enis-pv.com/en/photovoltaics-in-poland.html>

Geothermal energy in Germany

Potentials of an independent and sustainable power supply

Maria Kohlmeyer
BTU Cottbus-Senftenberg
Platz der Deutschen Einheit 1
03046 Cottbus, Germany
maria.kohlmeyer@b-tu.de

Philipp Schulte Overberg
BTU Cottbus-Senftenberg
Platz der Deutschen Einheit 1
03046 Cottbus, Germany
philipp.schulteoverberg@b-tu.de

Abstract—Geothermal energy has the potential to produce independently of daytime, season and weather heat and electricity in an ecofriendly way. Because of enormous heat which is saved and created in the earth it is an inexhaustible source of energy. Due to worldwide efforts of reducing emissions and creating a sustainable and renewable energy supply the geothermal energy gets more and more attention. In Germany the use of geothermal is supported by the government to increase the power supply by renewable energies. However, geothermal energy is still a small business compared to wind or solar energy there is a steady increase especially in upper level geothermal heat supply of buildings.

Keywords—geothermal, risks, advantages, renewable energy, potential of Germany, heating, power supply, “Geothermie Unterhaching”

I. INTRODUCTION

Geothermal energy is based on the natural heat of the earth used for power generation and heating. The use of this kind of renewable energy began thousands of years ago by hot springs or other spots where geothermal water reached the surface [1].

The energy saved in the earth has theoretically enough potential to ensure the global energy supply for the next 100.000 years [2]. The use of this high potential for energy supply was low noticed in Germany until 2000. In 2000 the EEG (“Erneuerbare-Energien-Gesetz”) was published which raised the interest in this technology at many locations [1]. The EEG has the purpose to support the development of renewable energies in Germany to reach a minimum percentage of 30% in 2020 [3]. Moreover geothermal energy is the only renewable resource which can operate independent of the sun. In contrast to wind and solar energy geothermal energy is able to provide the base load of energy without great variations of the energy level [1].

II. GEOLOGICAL PRINCIPLES

Geothermal energy describes the use of geothermal heat generated by geological processes of the earth. In order to evaluate the potential of geothermal energy an accurate contemplation of the geological conditions is essential. There are two processes responsible for the genesis of geothermal heat. Residual heat of the formation of the planet outgoing from earth's core creates 30-50%. 50-70% of the heat are based on radioactive decay located in earth's mantle [4].

Geothermal resources are separated in upper and lower levels [5]. Furthermore lower level geothermal areas are separated in high-enthalpy, medium-enthalpy and low enthalpy fields. Those fields include hot water and steam or consist of hot rocks [6].

High-enthalpy fields are characterized by water and steam with a temperature above 180 °C in a low depth. They are connected with high volcanic or tectonic activity. These areas have the greatest potential for geothermal power generation [1,6].

Medium-Enthalpy fields contain resources with a temperature between 100-180 °C. Those areas are not necessarily connected to regions of volcanic activity. Potential for power generation is still existing [6].

Low-Enthalpy field's resources have a temperature under 100 °C. They can be used for heating systems but they are in most cases not utilizable for power generation [6].

The use of upper level resources is based on a maximum depth of 400 meters. In this area the temperature is about 25 °C in average which still allows a limited use for heating devices [7].

III. HEAT AND POWER GENERATION

There are three common ways to extract the heat of the ground for heating or power generation. Heat pumps are generally used for heating, exploiting the upper level geothermal potential [8]. The advantage of heat pumps using low temperatures is the possibility of a small and off-centered use even in private households to supply heat and hot water [9]. Two different systems are used in lower level geothermal. On the one hand geothermal systems up to a depth of 4500 m working with hot water resources and on the other hand so called “enhanced geothermal systems” up to a depth of 5000 m which are working independently of water occur. These systems using energy stored in hot rocks. Both systems have the ability of power generation [8].

IV. ADVANTAGES

Geothermal energy has a lot of advantages over other forms of obtaining thermal or electrical energy. The most important one is the high environmental sustainability. In contrast to fossil and nuclear energy sources geothermal energy has almost no environmental impacts in transport, preparation,

decomposition and storing of fuel [10]. Building Geothermal power plants is the most polluting point of them. During their application are no appreciable consequences for the environment existing [1].

Furthermore, geothermal energy has a low carbon dioxide content and an ecological high quality. The potential savings of carbon dioxide are about 100 %, if the production of power changes from the conventional way to deep geothermal energy. Its only condition is, that the geothermal water circuit has to be a closed system and that the power plants do not release gas. In Germany are only geothermal power plants built based on this principles. Geothermal energy produces power in an environmentally sensitive way [10].

In addition, geothermal energy is very reliable. It does not depend on seasons or the weather like solar or wind energy and it is usable all the time. This means a constant energy supply, which retains a fundamental provision. According to the latest technology geothermal energy can be used nearly everywhere [11]. Compared to wind and solar energy, geothermal energy produces among electricity also heat. This illustrates the many possibilities of using [12]. Another point is that it belongs to the renewable energy sources. The use of geothermal energy does not destroy the geothermal fields. Moreover after a deconstruction of a geothermal power plant are no irreversible damages like the problem of radioactive waste storage [1].

In relation to the output of energy geothermal power plants are very space-saving [12]. Most of the plant is located underground. Another positive effect is the low noise level, which is enabled by a good isolation and special technologies [1].

From an economic point of view, geothermal energy is characterised by price stability. In Germany, the EEG guarantees a high security of investment. The electricity suppliers have the duty to take the energy of renewable power and to remunerate the plant operators with a fixed price [13,3]. The compensation for geothermal energy is 25 ct/kWh and if it is generated utilising lower level petrothermal technology 30 ct/kWh [14].

V. RISKS

The risk potentials of geothermal systems distinguish a lot between near-surface and deep geothermal energy. A wide experience of near-surface geothermal projects minimizes the risks of its using. Attention must be paid to a certain distance between two adjacent plants. One risk is an inadvertent pressure balance because of bores through different groundwater reservoirs. The requirements of a safety plant are that it has to be properly planned, checked and maintained [1].

Deep geothermal systems bear a lot of more risks. The geological ones differ in earth tremor, land elevation and land settlement. Hydraulic fracturing could be one reason for earth tremors. Some geothermal energy systems only dehumidify the rock without injecting the steam back, which could cause land settlement. Different chemical reactions could produce calcium sulfate which has a 60 % scale up volume. The result could be a land elevation [1].

The prospecting risk is the most important point of exploitation of deep geothermal systems. A high feed rate of

geothermic water and a high reservoir temperature are necessary for a successful geothermal power plant [15].

Geothermal power plants are associated with high financing costs. The operational risk implies the unexpected problems because of e.g. corrosion. The outcome of this could be economic inefficiency [1].

Figure 1 recaps the different risks and their relevance.

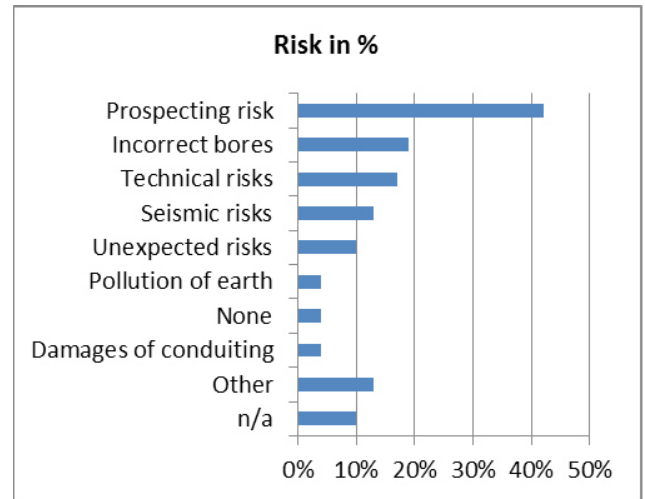

Figure 1. Risks of (deep) geothermal energy systems (Source: GtV [16])

VI. POTENTIALS

Germany is not a country characterized by volcanic or tectonic activity. In fact of that no high-enthalpy resources are available. Although medium-enthalpy and low-enthalpy resources are in place. The temperature in Germany increases by an average of 32 °C per 1 km. In some areas there is a higher geothermal gradient up to 100 °C per 1 km [17].

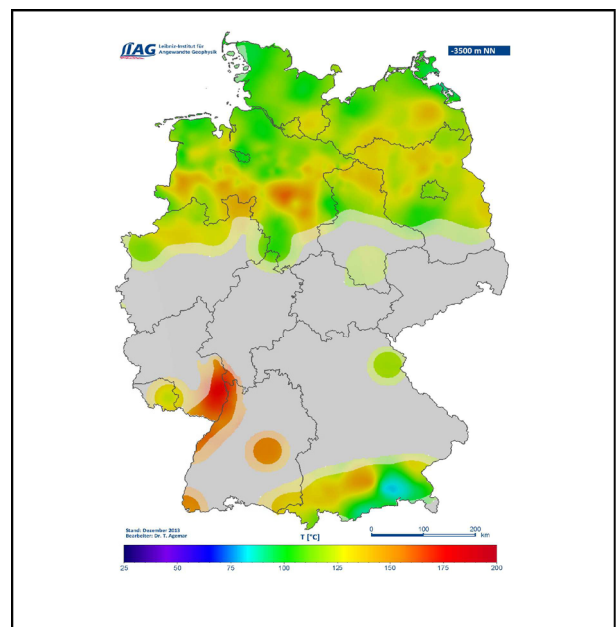

Figure 2. Temperature in Germany in a depth of 3500 m (Source: LIAG [18])

The most important areas for geothermal use for heat supply and power generation are “Norddeutsches Becken” in the north, “Oberrheingraben” in the southwest and “Molassebecken” in the south of Germany. In this areas the geothermal resources have temperatures above 60 °C which can be used for heating. Moreover there are some reservoirs with a temperature above 100 °C. These can be used for power generation [19].

In figure 2 the underground temperature in a depth of 3500 m in Germany is shown. The biggest area of geothermal potential is the “Norddeutsches Becken” in the north. The “Oberrheingraben” in the southwest is characterized by the highest temperatures.

VII. GEOTHERMAL IN GERMANY

For lower level geothermal energy an amount of 280 MW of electric capacity in 2020 is aimed by german government. This would lead to an annual electricity production of 1,8 million kWh. Furthermore an annual amount of 8,2 billion kWh of heat is assumed. An electric capacity of 850 MW shall be reached in 2030 [20].

At the moment there are 27 facilities using lower geothermal energy for heat production working in Germany. The total thermal capacity is 248,4 MW. At seven locations combined heat and power generation is existing with a combined electric capacity of 31,31 MW and 0,025 TWh provided electricity in 2013. About 48 projects are in process of planning or already under construction [21].

The upper level geothermal energy is used by about 318.000 heat pump devices in Germany in 2013. Those have a thermal capacity of 3.983 MW. 21.100 new heat pump devices with a thermal capacity of 230 MW were installed in 2013 [21].

The combined thermal capacity of upper and lower level geothermal devices was about 4.200 MW with 8 TWh of provided heat in 2013 [21].

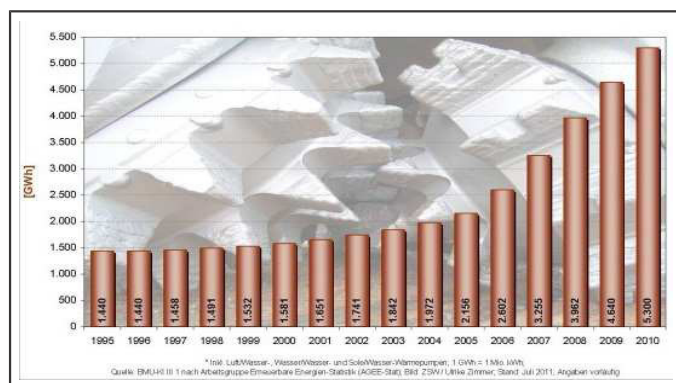

Figure 3. Development of installed upper level geothermal heat pumps in Germany (Source: BMU [8])

The development of installed heat pumps for upper level geothermal use is presented in figure 3. There was a small increase till the year 2005. A stronger growth is recorded since 2006 which reflect the increased expansion of geothermal energy.

VIII. PROJECT “GEOTHERMIE UNTERHACHING“

In 2004 the construction work for “Geothermie Unterhaching” started. A geothermal power plant for heat and power generation in Unterhaching in the south of Germany was planned [22].

For the extraction of hot water in the ground two boreholes were created. The first one reaches a depth of 3.350 m with a water temperature of 122 °C. The second one reaches a depth of 3.580 m with a water temperature of 133 °C. Both boreholes have a flow rate of 150 liters of water per second. The maximum capacity is 38 MW of heat and 3,36 MW of electricity [23].

In 2007 the heat supply started with a first output of 20 MW. Power generation started in 2009 [22]. In the first year of combined heat and power supply 4.069.775 kWh of energy and 51.934.000 kWh of heat were produced with a total saving of 16.708 tons of CO2 emissions [23].

Since 2009 the produced amount of energy and heat increased annually to 6.872.000 kWh of energy and 107.582.000 kWh of heat and generated sales of about 9 million euros in 2013. 29.159 tons of CO2 emissions were saved by use of geothermal energy in 2012 [23].

The project “Geothermie Unterhaching” developed to a successful usage of hydrothermal heat energy and is an excellent example for the realization of combined heat and power production [1].

IX. SUMMARY

The use of geothermal energy is part of the opportunities to create a sustainable and renewable heat and power supply by its features. With this technology of heat and power generation it can make a contribution to the goals of german government to reach a minimum amount of 30 % of renewable energies for the german power supply till 2020 [1,3]. It offers many promising advantages compared to only a few calculable risks. Geothermal energy is based on thermal heat which is inexhaustible and in contrast to other renewable energies like wind or solar energy independent of fluctuating climate conditions [11]. The possible risks can be reduced to a minimum if the geothermal facility is well planned and frequently controlled [1].

In Germany there is a good potential existing for the use of geothermal energy for heating and power generation which is used by 27 facilities producing thermal energy and 7 of them with a combined heat and power generation [19,21]. The influence on energy supply of geothermal in Germany will rise by about 48 projects in the process of planning or under construction [21]. The project “Geothermie Unterhaching” is an example for the use of energy stored in the earth producing heat and electricity in an environmentally friendly and profitably way with the ability of reliable supply and a steady growth [1,23]. Additionally the development of installed heat pumps and a number of 21.100 new installed devices in 2013 which can be utilized for small projects and even for heat and energy supply in private households display a growing use of the technology [8,21].

X. DISCUSSION

In our opinion the use of geothermal energy has a high potential to be part of a sustainable power supply in Germany. Especially by its advantage of independent and constant power generation in contrast to the discontinuous of solar and wind energy. On the one hand it is a possibility of regional and decentralized energy and heat production and on the other hand it is based on local resources to support the independence of import of energy sources.

Due to its ecofriendly and reliable characteristics and because of high costs for research and exploration of geothermal potential and possible economical uses a stronger promotion is required to increase the growth and success of geothermal business.

Compared to other renewable technologies for power supply the use of geothermal energy has a low level of awareness in public. The public communication of the possible use of geothermal energy by private households and individual buildings by heat pumps and provided heat and energy by geothermal power plants must be extended. With higher attention on geothermal energy the acceptance and trust of the population will raise. This can lead on to faster and stronger developments of geothermal energy.

REFERENCES

- [1] P. Schilliger and G. Theiler, "Geothermie, die Alternative. Wie Erdwärme zu Elektrizität wird", Gamma-Dr.-und-Verl.: Altdorf, 2011
- [2] Online: https://www.geothermie-unterhaching.de/cms/geothermie/web.nsf/id/pa_was_ist_geothermie.html (05. June 2014)
- [3] Online: <http://www.amprion.net/erneuerbare-energien-gesetz> (04. June 2014)
- [4] Online: <http://www.geothermie.de/wissenswelt/geothermie/einstieg-in-die-geothermie/ursprung-geothermischer-energie-und-geothermischer-gradient.html> (04. June 2014)
- [5] Online: <http://www.geothermie.de/wissenswelt/geothermie/einstieg-in-die-geothermie/einteilung-der-geothermiequellen.html> (04. June 2014)
- [6] G. Boyle, "Renewable energy. Power for a sustainable future", Oxford University Press in association with the Open University: Oxford; England, 1996
- [7] M. Kaltschmitt, "Energie aus Erdwärme. Geologie, Technik und Energiewirtschaft; mit 45 Tabellen", Spektrum: Heidelberg, 2009
- [8] Online: <http://www.bundesregierung.de/Content/DE/StatischeSeiten/Breg/Energiekonzept/1-EnergieErzeugen/23-11-11-erdwaerme.html?jsessionid=642656B91D3EAA6028DF845BA2680D32.s4t2> (05. June 2014)
- [9] F. Armstrong and K. M. Blundell, "Energy-- beyond oil", Oxford University Press: Oxford; New York, 2007
- [10] Online: <http://www.geothermie.de/wissenswelt/geothermie/einstieg-in-die-geothermie/oekologische-aspekte.html> (04. June 2014)
- [11] Online: <http://www.geothermie.de/wissenswelt/geothermie/einstieg-in-die-geothermie.html> (04. June 2014)
- [12] Online: <http://www.geoenergy.de/de/geothermie/vorteile.html> (04. June 2014)
- [13] Online: http://www.gesetze-im-internet.de/eeg_2009/BJNR207410008.html#BJNR207410008BJNG000700000 (04. June 2014)
- [14] Online: http://www.gesetze-im-internet.de/eeg_2009/_28.html (04. June 2014)
- [15] Online: <http://www.geothermie.de/wissenswelt/geothermie/einstieg-in-die-geothermie/risiken.html> (05. June 2014)
- [16] Online: <http://www.geothermie.de/wissenswelt/glossar-lexikon/t/risikentiefen-geothermischer-projekte.html> (05. June 2014)
- [17] Online: <http://www.liag-hannover.de/s/s4/forschungsfelder/temperaturfeld-im-untergrund-deutschlands/ergebnis.html> (04. June 2014)
- [18] Online: http://www.liag-hannover.de/fileadmin/user_upload/pix/Informationssysteme_Geomodelle/Untergrundtemperatur-3500uNN.png (04. June 2014)
- [19] Online: http://www.erneuerbare-energien.de/fileadmin/ee-import/files/pdfs/allgemein/application/pdf/broschuere_geothermie_tief_bf.pdf (04. June 2014)
- [20] Online: http://www.erneuerbare-energien.de/fileadmin/ee-import/files/pdfs/allgemein/application/pdf/bericht_geothermie_bf.pdf (05. June 2014)
- [21] Online: <http://www.geothermie.de/wissenswelt/geothermie/in-deutschland.html> (05. June 2014)
- [22] Online: https://www.geothermie-unterhaching.de/cms/geothermie/web.nsf/id/pa_historie.html (05. June 2014)
- [23] Online: https://www.geothermie-unterhaching.de/cms/geothermie/web.nsf/id/pa_daten_fakten.html (05. June 2014)

Nuclear Fusion

energy source of the future?

Fatemi, Arman
Faculty 3 – Mechanical, Electrical and
Industrial Engineering Chair of Power
Distribution and
High-Voltage Engineering
Cottbus, Germany

Acar, Oktay Ali
Faculty 3 – Mechanical, Electrical and
Industrial Engineering Chair of Power
Distribution and

Dawood, Rannin
Faculty 3 – Mechanical, Electrical and
Industrial Engineering Chair of Power
Distribution and
High-Voltage Engineering
Cottbus, Germany

High-Voltage Engineering
Cottbus, Germany

I. INTRODUCTION

Experts anticipate that our fossil fuels are going to be depleted within the next 50 years. What opportunity does humanity have left to receive energy? The solution has been found by observing the stars and understanding the way how they produce energy. The solution is supposed to be nuclear fusion. Nuclear fusion is a phenomenon that has been investigated for more than 80 years. Energy that is being produced in one second inside the sun would be enough to provide the worldwide demand of energy for one million years. That is why scientists and probably the whole world dream of being able to use that phenomenon and receive an almost unlimited source of energy. (1)

II. HISTORY

The first time a fusion reaction was observed in year 1919 when Ernest Rutherford created an oxygen isotope by bombarding nitrogen with alpha particles.(2) Ten years later in 1929 the first conjectures about the fusion of small atomic nuclei being the energy source of the sun and other stars were made. These theories were based on Robert Atkinson's and Fritz Houterman's researches which were proved by Hans Bethe in year 1938. Rutherford's next success was when he could accomplish the first deuterium-deuterium- and deuterium-tritium-fusion reaction in 1934. Especially these experiments became very important for further fusion experiments and future nuclear fusion projects. Only one year after Bethe proved the theories of Atkinson and Houterman, he and Carl Friedrich Weizsäcker were able to give a quantitative description about the entire fusion process inside the sun. Theories were proved, experiments were made but no one was actually sure whether nuclear fusion is possible to be used on our planet until the year 1950. The development of the hydrogen bomb (H-bomb) - two years later the USA fired the H-bomb (with the code-name Ivy Mike) the first time- made people believe and even witnessed that nuclear fusion could be really used on earth. But additionally, the H-bomb, an uncontrolled

nuclear fusion reaction, made nuclear fusion get more and more criticized and even almost socially rejected.



Figure 1: Atomic cloud of Ivy Mike

Until year 1958 most projects and labors have been kept a secret but after the second Geneva Conference everything changed and a peaceful utilization of nuclear energy was found. The most

interest in nuclear fusion were offered by the USA and the Soviet Union and even some European countries, especially the United Kingdom. (3&4)

A lot of time passed and some experiments were made mostly in vain until the breakthrough in 1991. The first power generation by controlled nuclear fusion was achieved and an actually at that time appreciable amount of energy has been released. Plus, 6 years later scientists were able to win an even higher fusion power than years before.(5) These days scientists from the United States even overcame the breakthrough of 1991. They succeeded a nuclear fusion where the energy balance was different than before. It was possible to gain a higher amount of energy than the amount that was put into the reaction. This progress made people believe in nuclear fusion for the future. (6)

III. GENERAL FACTS

First the question is what is going on inside the sun and other stars that inspired us. Under high pressure and a very high temper-

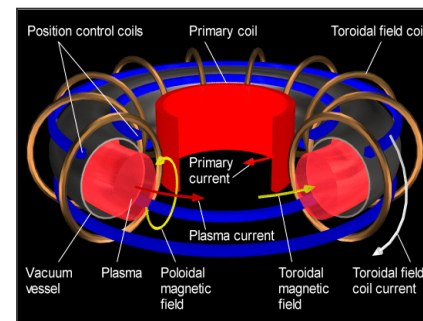

ature hydrogen nuclei get clustered and merge to a helium atom while they get pushed into each other. That process releases a huge amount of energy and is also the reason why the sun and other bright stars radiate energy. (7) There are different processes that could happen, for instance four protons merging to one helium nuclei. (8)

So in fact, the process of nuclear fusion is the merging of two light atomic nuclei (hydrogen) to a bigger and heavier one (helium). During this merging energy is being released as kinetic energy of the new nucleus and possible further reaction products, for example neutrons, or even as electromagnetic radiation (gamma- or beta- radiation).(9) Additionally, some interesting facts to that process: The common weight of the two light nuclei is heavier than the bigger nuclei. Furthermore, the “lacking“ mass of this reaction is directly transduced into energy in the form of heat (→ exothermic reaction). Besides at the “combustion“ of hydrogen to helium the bonding forces between the components of their atomic nuclei get released.(3) It has been always a goal of intensive foundational research to find out the details of interaction forces and to control their including energy in order to make use of it for power production in power plants. The reason for this is that fusion power plants would be an appropriate solution to provide big cities and industrial bases with energy.

These days scientists work on three approaches to realize the dream of using nuclear fusion on earth:

- Tokamak-System
- inertial confinement Fusion with the help of lasers or electric current

One of them is supposed to make that dream come true one day but having patience is probably most important because scientists don't expect being able to use nuclear fusion for the benefit of humanity before year 2050. (1)

IV. SET-UP OF A NUCLEAR FUSION REACTOR(TOKAMAK)

A tokamak reactor consists of a torus, which is the centerpiece of the power plant. In order to execute a nuclear fusion, the fuel (here deuterium-tritium mixture) must be converted into the plasma state. In- this state, the atoms lose their electrons and move as charged particles through the room. This effect is used to concentrate the several million degrees hot matter in an intangible container with the help of magnets that surround the torus. Without electrons, atomic nuclei are positively charged. Therefore, they only move on the magnetic field tracks and do not touch outer wall of the torus, which would cool down the Plasma. To put nuclear fusion in motion, the nuclei has to avoid the coulomb wall, which ensures that positively charged bodies repel each other. For that purpose the ions must come close to each other, before a merger can take place. In the sun, this is

done through a very high pressure of approximately 200 billion bar and a temperature of 15 million degrees. Such a high pressure can't be artificially generated on earth, because of that the fuel must be heated to high temperatures of over 100 million degrees instead to start a nuclear fusion. To achieve such high temperatures, different methods are being used:

Figure 2: Main Components of the magnetic confinement system

- Induction heating: Solenoids induced electric current on the plasma, which heats up to a temperature of 30°C. The electrical resistance decreases as higher the temperature gets, making a further temperature increase not possible with this method(1 &
- Microwave radiation: electromagnetic waves can stimulate the particles in the fuel and lead to additional energy.
- Neutral-beam injection: Neutral loaded particles are shot at high speed on the plasma and transfer their kinetic energy by shocks. The neutral particles ionize immediately in the plasma.

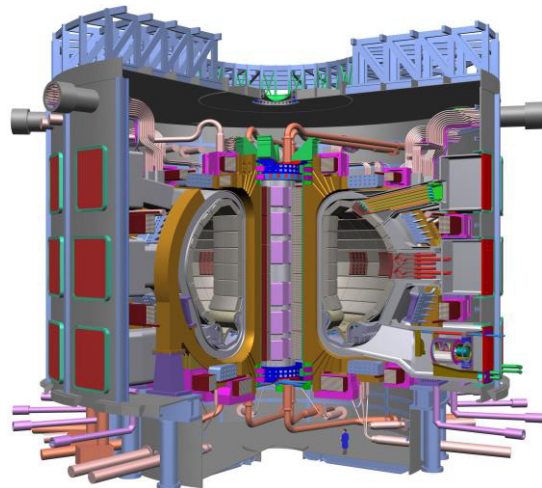

When the fuel reaches the required temperature, it starts to merge. The reaction process is simple: Tritium and deuterium merge to a helium-5 core, which quickly decays caused by instability. This gives rise to a helium-4 nucleus and a neutron, which move away from each other at a very high speed.



Figure 3: Profile of the Iter Reactor

The thermal energy that is released can be used for the production of electricity by conventional methods of heat exchange as applied in coal or nuclear power plants.

V. EXTRACTION OF FUEL:

The necessary fuel for an artificial fusion consists of deuterium and tritium, two isotopes of hydrogen. Deuterium is contained in seawater and can be obtained

through an enrichment process. Tritium occurs not naturally and must be generated artificially with the help of lithium. An atom of lithium-6 or 7 and a neutron is required for this so-called tritium breeding. Because neutrons are set free during the fusion reaction, they work on a procedure which allows the production of tritium in the blanket (outer shell of a nuclear fusion reactor). Lithium occurs mostly in the form of lithium-7 and lower percentage than lithium-6. Both isotopes can be used for the production of tritium. But there is an advantage and disadvantage of using lithium-7. The advantage is that a neutron is released in response to tritium, which can be used to react with a lithium-6 to tritium.(9)



Disadvantage is that the energy threshold for lithium-7 is higher and thus it's more difficult to achieve this than with lithium-6. For this reason, the latter is preferred.

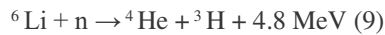

Nuclear fusion alone can unfortunately not deliver sufficient neutrons for tritium breeding. Therefore, a certain amount of beryllium is being added to the lithium, which is responsible for increasing the number of incoming neutrons in the blanket. (9)

VI. ADVANTAGES AND DISADVANTAGES OF THE CIVILIAN USE OF NUCLEAR FUSION

A. Advantages:

- **Safety:** Nuclear fusion is risk-free compared to fission. As soon as the conditions for the fusion are not available (like the necessary temperature or the pressure) the reaction stops by its own. So, an uncontrolled further reaction is being prevented.(1)
- **Environmentally friendly:** Nuclear fusion reactors are emission-free and produce no nominal values of radioactive waste. Although tritium is radioactive and ensures that the components of the power plant be subjected to radioactivity with the time, tritium has a half-life of only 12 years. Furthermore, the beta decay of tritium is so weak that it cannot even penetrate the human skin.(10)
- **High energy yield:** Theoretically with the merge of 1 kg deuterium-tritium you can produce as much Energy as there is set free during combustion of 8.596.000 kg crude oil (see oil unit)
- **Inexpensive and inexhaustible fuel:** the production of deuterium and tritium is relatively cheap, so that the fuel costs at the low consumption of around 100 kg per year in a reactor can be neglected. There are almost inexhaustible quantities of deuterium in seawater and tritium can be

produced by using lithium, which also has a very high presence on earth.

B. Disadvantages:

- **No successful generation of energy:** Unfortunately scientist succeeded only once to gain more energy than needed to apply the nuclear fusion until now. The amount of gained energy was too minimal to be even worth mentioning. (6)
- **Expensive research:** even just the construction of the ITER reactor, which is one of the leading nuclear fusion projects will cost 7.3 billion euros. Other projects are also in the single-digit billion range.(11 & 12)
- **No civil use in the near future:** the research for nuclear fusion started in the 1950s, and it is assuming that there will be no successful civilian use before 2050.(3 & 13)

VII. CONCLUSION

Nuclear fusion is a promising source of energy, which could someday solve the world's energy problems. Through its environmental friendliness and its theoretical high energy balances, fusion power plants could replace other large power plants. The sun is the best example to show how much potential nuclear fusion has. It is clear that we will reach a point, were all the fossil fuels will be depleted, so we have to find a way to replace the energy source such as coal, gas or oil. Renewable energy sources like solar panels or wind turbines could be an option, but there is a huge amount of disadvantages in comparison to nuclear fusion. The infrastructure and the capacity of saving energy has to be expanded to guarantee a stable energy supply.(16) To replace power plant with 2000 MW you would need 12,5 km² (1750 soccer-fields) of solar panels or 1000 wind turbines provided that the sun is shining or wind is blowing.(14 & 15) The nuclear fusion would be the best solution for energy problems that are facing us. That's the reason why so many countries, for instance Russia, India, USA, China, Korea, Japan and the EU are supporting and working to pave the way for civil use of nuclear fusion. Especially the ITER project is one of the important ones, because it's targeted to be a prototype of a nuclear fusion reactor. When the construction of the reactor is completed, several methods will be tested to fix the remaining problems. This will take a lot of time, but it will be worth waiting for it.

REFERENCES:

- [1] Arte documentation "Kernfusion – Mit Energie in die Zukunft" from 2010
- [2] http://en.wikipedia.org/wiki/Ernest_Rutherford (Rutherford and the gold foil experiment)

- [3] <http://www.schreiben10.com/referate/Physik/7/Physik-Spezialgebiet---Die-Kernfusion-reon.php>
- [4] http://private.freepage.de/cgi-bin/feets/freepage_ext/41030x030A/rewrite/fusion/history.htm
- [5] http://de.wikipedia.org/wiki/Kernfusionsreaktor#Erfolge_in_der_EU_und_den_USA
- [6] <http://www.zeit.de/wissen/2014-02/kernfusion-energie-erfolg-usa>
- [7] <http://wissenschaft.marcus-haas.de/technologie/kernfusion.html>
- [8] Christian Weißmantel, Kleine Enzyklopädie Atom- und Kernphysik, 1983 Leipzig, page 35
Jürgen Raeder, Kontrollierte Kernfusion, 1981 Stuttgart, page 9
- [9] <http://de.wikipedia.org/wiki/Kernfusionsreaktor>
- [10] <http://de.wikipedia.org/wiki/Tritium>
- [11] <http://www.iter.org/>
- [12] <http://de.wikipedia.org/wiki/ITER>
- [13] <http://www.heise.de/tp/artikel/34/34128/1.html>
- [14] http://www.vestas.com/en/products_and_services/turbines/v110-2_0_mw#!at-a-glance
- [15] <http://www.yinglisolar.com/de/products/multicrystalline/yge-72-cell-series/>
- [16] <http://www.stern.de/politik/deutschland/studie-des-umweltbundesamtes-erneuerbare-energien-koennen-strombedarf-der-zukunft-decken-1580849.html>

LIST OF FIGURES:

FIGURE 1: ATOMIC CLOUD OF IVY MIKE:

[HTTP://UPLOAD.WIKIMEDIA.ORG/WIKIPEDIA/COMMONS/3/3E/Ivy_Mike_%28ENIWETOK-ATOLL_-_31._Oktober_1952%29.JPG](http://upload.wikimedia.org/wikipedia/commons/3/3E/Ivy_Mike_%28ENIWETOK-ATOLL_-_31._Oktober_1952%29.JPG)

FIGURE 2: MAIN COMPONENTS OF THE MAGNETIC CONFINEMENT SYSTEM:

[HTTP://WWW.PLASMA.INPE.BR/LAP_PORTAL/LAP_SITE/FIGURES/TOKAMAK_SCHEMATIC.GIF](http://www.plasma.inpe.br/lap_portal/lap_site/figures/tokamak_schematic.gif)

FIGURE 3: PROFILE OF THE ITER REACTOR:

[HTTP://WWW.KENNISLINK.NL/UPLOAD/122632_276_1100172327901-ITER.JPG](http://www.kennislink.nl/upload/122632_276_1100172327901-ITER.JPG)

Natural Gas in Iran

(Current and future trends)

Milad Salimiseyedmahalleh¹, Adineh Fayazi²

BTU Cottbus -Senftenberg

Cottbus, Germany

¹salimmil@tu-cottbus.de

²Adineh.fayazi@tu-cottbus.de

Abstract—This article examines the present status and future plans of the natural gas sector in Iran including existing natural gas infrastructure, production, consumption and export/import potential. The main objective of this regional overview is to describe and analyze the systems of natural gas in Iran as a key role in today's world energy sector.

Keywords; *South Pars, residential use, CNG, bcm, pipeline, LNG*

I. INTRODUCTION

With 28.1 trillion cubic meters of proven natural gas reserves (15.5 percent of the world total), Iran has the second largest gas reserves after the Russian Federation. Iran's current gas production stands at 500 Mcm¹/d and it is projected to increase to 1480 Mcm/d by 2015. Although, similar to the oil sector, real gas production will be lower than expected [1].

II. NATURAL GAS PRODUCTION

Over the last two decades, natural gas production in Iran has been rapidly increased. According to the statistics, the production of natural gas has been raised from 25.5 Bcm² in the year 1991 to 153 Bcm in the year 2011. This means that Iran is one of the few countries capable of supplying much larger amounts of natural gas in the future.

Gross natural gas production totaled 6.33 Bcm in 2011, increasing nearly 2 percent compared with the year prior.

In 2011, Russia and the United States were by far the top natural gas producing countries, with more than four times that of Iran, the third largest producer of natural gas due in part to the development of the giant South Pars field. Meanwhile natural gas production has been expected to grow to 240 Bcm in 2030. Although Russia and the United States produced nearly the same amount of natural gas, Russia has far greater conventional natural gas reserves than the United States based on 2011 estimates [2].

III. NATURAL GAS FIELDS

A. Conventional Natural Gas Deposits

Natural gas can be associated from both conventional and unconventional deposits, and is also found in coal-bed methane. The total global deposits of conventional NG amount to about 198218 Bcm, while the global consumption in 2010 was about 3398 Bcm, and is projected to double by 2035. In Iran natural gas is commercially extracted from oil fields and

natural gas fields. Gas extracted from oil wells is called casing-head gas or associated gas [3].

Iran's estimated proven natural gas reserves stood at 33074 Bcm. Over 85 percent of Iranian natural gas reserves are located in non-associated fields and have not yet been developed. Major natural gas fields include South and North Pars, Kish, and Kangan-Nar.

The most significant natural gas project in Iran is the offshore South Pars field, which holds about 47 percent of its total natural gas reserves and accounts for about 35 percent of its total natural gas production. The field is being developed in 24 phases [4].

B. Main Gas Fields

As it mentioned above, Iran's main gas fields are conventional and the major part is located in south of Iran, in the region of Persian Gulf.

1) South Pars Gas Field

The South Pars field is a natural gas condensate field located in the Persian Gulf. It is also the world's largest gas field, shared between Iran and Qatar. In Iran it is called "The South Pars" and in Qatar it names "North Dome" gas field. According to the IEA³, the field holds an estimated 51 trillion cubic meters of in-site natural gas and some 7.9 Bcm of natural gas condensates. The South Pars field accounts for about 35 percent of Iran's total natural gas production, with sizeable production coming also from the Kangan and Tabnak fields. In addition, Gonbadli began producing in June 2011 and contributed about 708 thousand cubic meters during the remainder of the year [5].

Total gas field of South Pars (Iran) and North Field (Qatar) covers an area of 9700 square kilometers, of which 38% is in Iranian territorial waters and 62% is for Qatar. The Iran's part is the biggest gas field in Iran and the country invests much for developing production from this gas field. The depth of this field is 3000 meters below the seabed and it is in 65 meters below water [6].

1. Mcm = Million Cubic Meters

2. Bcm = Billion Cubic Meters

3. IEA = International Energy Agency



Figure 1. Iran's main offshore Gas fields

2) North Pars

North Pars Gas Field is the second biggest independent gas field in Iran and 13th in the world. This field which was discovered in 1967 is located south east of Bushehr province, in water depths of 2 to 30 meters in the Persian Gulf. The first exploration well was completed in the year 1967, by carrying seismic test. The total volume of the gas in this field is about 1.67 Bcm and the recoverable volume of sour gas is approximately 1.34 Bcm [7].

3) Kish Gas Field

Kish gas Field is the third biggest gas field in Iran. It is located close to Kish Island in the Persian Gulf. It is one of the NIOC⁴ recent discoveries according to the research carried out in the year 2006 and holds 1900 cubic kilometers of gas in place of which 1400 cubic kilometers is recoverable. The field also holds at least 160 Mcm of condensate gas of which at least 52.6 Mcm are recoverable [8].

4) Golshan Gas Field

The Golshan gas field is one of the NIOC recent discoveries which is situated at approximately 180 km south east of Bushehr and 65 km offshore the Persian Gulf. It is the fourth biggest gas fields in Iran. The volume of gas in place of the field is estimated around 1.2 to 1.6 tcm⁵ [7].

IV. NATURAL GAS CONSUMPTION

Iran is a country with more than 75 million population and places in the second rank in terms of gas reserves in the world. Natural gas is one of the main energy sources in Iran and the consumption is increasing annually. With a review in history we realize that Iranians were pioneers in gas utilization. Existence of fireplaces such as immortal fires near natural gas reservoirs proves this claim.

Using natural gas as a heating fuel is just one of the various usages of this precious fuel. For better understanding the fluctuations in natural gas consumption, the first step is to

know how natural gas is used in Iran and how much gas every purpose needs.

Natural gas is mainly used as the following purposes in Iran:

- Households (domestic uses)
- Transportation
- Industry
- Power plants

A. Domestic use of natural gas in Iran

Natural gas is a powerful domestic cooking and heating fuel. In much of the developed world it is supplied to homes via pipes where it is used for many purposes including natural gas-powered ovens, natural gas-heated clothes dryers, heating/cooling, and central heating.

Compressed natural gas is used in rural homes without connections to piped-in public utility services, or with portable grills. Due to CNG being less economical than LPG, LPG (propane) is the dominant source of rural gas [9].

B. Transportation uses

For transportation normally CNG⁶ is used in vehicles in Iran and it has been replaced by other fuels during a few years ago. CNG is made by compressing natural gas (which is mainly composed of methane, CH₄), to less than 1% of the volume it occupies at standard atmospheric pressure. It is stored and distributed in hard containers at a pressure of 200–248 bar usually in cylindrical or spherical shapes [10].

C. Industrial Uses

Natural gas has a multitude of industrial uses, including providing the base ingredients for such varied products as plastic, fertilizer, anti-freeze, and fabrics. Natural gas is consumed primarily in the pulp and paper, metals, chemicals, petroleum refining, stone, clay and glass, plastic, and food processing industries. These businesses account for over 84 percent of all industrial natural gas use [11].

D. Electricity Generation

Natural gas is a major source of electricity generation. It burns more cleanly than other hydrocarbon fuels, such as oil and coal, and produces less carbon dioxide per unit of energy released. For an equivalent amount of heat, burning natural gas produces about 30 percent less carbon dioxide than burning petroleum and about 45 percent less than burning coal. [12]

E. Natural gas consumption fluctuations by different sectors during time

Iran has the third largest consumption of natural gas in the world after United States and Russia. According to the data released by United States EIA⁷, Natural gas consumption in Iran has been increased dramatically and got almost doubled and has reached to almost 153.3 billion cubic meters.

For realizing the better use of natural gas and the issues due to this fuel in Iran, we should study how much natural gas is consumed in different sectors. Comparison of these amounts

4. NIOC = National Iranian Oil Company

5. tcm = Trillion Cubic Meters

6. CNG = Compressed Natural Gas

will give us a reasonable result and a clue to reduce natural gas consumption in the future.

Fig. 2 shows natural gas consumption by different sectors in 2003.

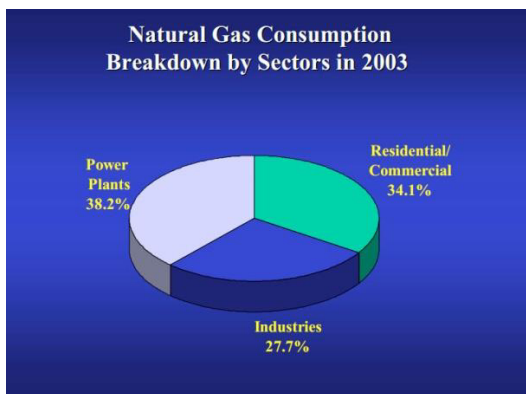

Figure 2. Natural Gas Consumption by Sectors in 2003

After 3 years (in 2006) the same study has done and it showed that the percentage of natural gas consumption has changed during this 3 years. Fig. 3 shows the percentage of gas consumption in different sectors and as we see, residential use has increased from 34% to 51% which is a very high rise in such a short time.

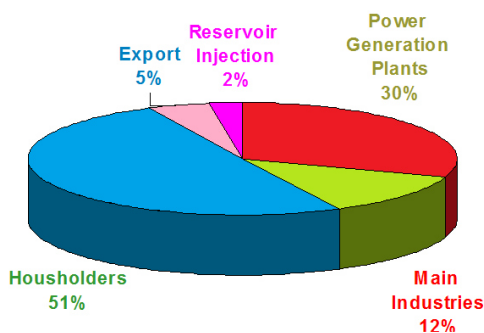
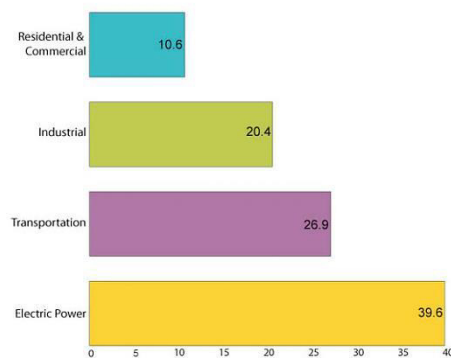

Figure 3. Natural Gas Consumption by Sectors in 2006

F. Comparison of Natural gas consumption by sectors in Iran and a developed country

According to Fig. 4 which shows gas consumption by different sectors in U.S. as a developed country, it is clear that the residential and commercial use percentage is quite different than Iran (about one fifth of the amount in Iran). This can be an alarm for Iranian government for legislation to reduce this sector's gas consumption.

Due to energy low price in Iran, consumers do not care about how much energy they consume and to solve this problem a firm law is really essential.



Source: U.S. Energy Information Administration, *Monthly Energy Review*, Table 2.1 (March 2012), preliminary 2011 data.

Figure 4. Natural Gas consumption in a developed country

V. NATURAL GAS TRANSMISSION AND DISTRIBUTION

Natural gas transfer from production origins and gas processing plants to various consumption points in various sectors of gas industry is of high sensitivity and importance. The total length of high-pressure gas transfer pipelines in Iran is around 32000 km. The pipelines transfer capacity is estimated at 500 Mcm/d and based on decisions adopted in the framework of the twenty-year outlook, the length of pipeline from 32000 km should reach 65000 km. Hence, Iranian Gas Transmission Company as one of the subsidiaries of NIGC⁸ benefits from all vast executive-logistic facilities and various machinery to implement general projects in the realm of engineering, basic and detailed designing gas especially in relation with designing gas transfer pipelines, supply and distribution networks, pressure reduction stations all over the country while observing international standards.

Besides, Iran's integrated and vast gas distribution network in home and business sector which consumes a lion share of the produced and processing natural gas, there are some other sectors including power plants, major industries and petrochemicals that consume a significant amount of the processing gas. The total consumption of the earlier – mentioned sectors, at present, has led the share of gas in the country's fossil fuel consumption basket to reach 62 percent and is expected to continue to grow. Currently the total length of Iran's urban gas distribution network is over 213000 km which is responsible for providing gas to 920 cities, 12500 villages and 40000 industrial plants. At present, 65 million persons in the form of 18.2 million households enjoy benefits of natural gas [13].

Fig. 5 shows Iran's natural gas pipeline grid. In this figure we can see that there are 11 series of large diameter pipelines constructed from gas producing areas in the south of Iran in order to transfer natural gas to the consumption centers in northern part of the country. These main pipelines are called Iran Gas Trunkline (IGAT) [7].

7. EIA = Energy Information Administration

8. NIGC = National Iranian Gas Company

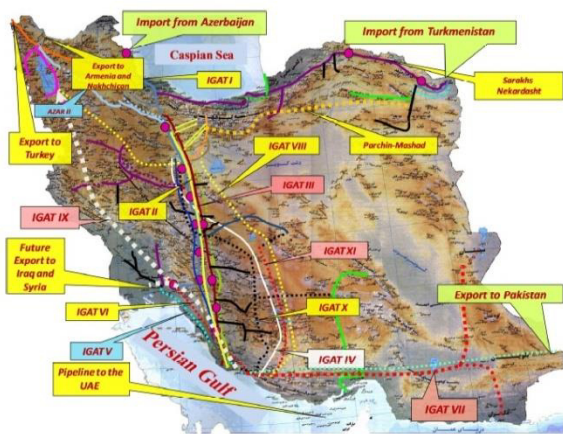

Figure 5. Iran's Natural Gas Pipelines Grid [14]

VI. NATURAL GAS EXPORTS & IMPORTS

Although Iran is the world's third largest producer of natural gas and holds the world's second largest reserves, its role in international trade in natural gas is far less significant. Iran, like the United States, is both an importer and exporter of natural gas. Iran exports relatively small-scale natural gas to Turkey, Armenia, and Azerbaijan, but it also receives pipeline imports almost exclusively from Turkmenistan. Since 2000, Iran's imports have exceeded its exports in all but one year (2010). In both 2010 and 2011, Iran accounted for less than 1 percent of global dry natural gas imports and exports [15]. As a consequence, almost 16% of the world's natural gas reserves remain absent from the regional and global markets [16].

EIA estimates that the average revenues from Iran's natural gas exports during the period July 2011-June 2012 were approximately \$10.5 million per day, or about 5 percent of the estimated \$231 million per day in revenues from crude oil and condensates exports over the same period. In 2010, natural gas exports accounted for less than 4 percent of Iran's total export earnings while crude oil and condensates accounted for over 78 percent [15].

A. Iran's Natural Gas Exports & Imports Pipelines

As it can be seen in Fig. 5, all Iran's natural gas exports are through 9 domestic pipelines (IGAT 1-9) from the major gas fields in the south of Iran. Turkey receives more than 90 percent of Iran's natural gas exports under a long-term contract. Armenia and Azerbaijan have swap arrangements with Iran that account for 6 percent and 3 percent of Iran's natural gas exports, respectively. Azerbaijan repays Iran for the natural gas sent to its Nakhchivan exclave by exporting similar volumes to northeastern Iran. Iran imports more natural gas than it exports. Iran's imports from Turkmenistan alone exceeded its exports during the July 2011-June 2012 period.

a) Exports

1. Turkey (Since 2001)
2. Azerbaijan (Since 2005)
3. Armenia (Since 2007)
4. Iraq & Syria (Since 2013)
5. Pakistan (In Progress)
6. Europe via Turkey (In Progress)
7. UAE (In Progress)
8. Kuwait, Oman & Bahrain (In Progress)

b) Imports

1. Turkmenistan (Since 1997)
2. Azerbaijan (Since 2005)

B. Iran's LNG Exports

In addition to regional pipeline trade, since the 1970s Iran has repeatedly tried to reach the global LNG⁹ market. But, because of the 1979 revolution and the subsequent war with Iraq, Iran forced to put its LNG plans aside throughout the 1980s. Iran has tried to build liquefaction plants after the war.

Iran LNG is a LNG plant under development at Tombak Port, approximately 50 kilometers north of Assaluyeh Port. According to NIGEC¹⁰, Iran LNG at South Pars has the highest priority of all Iranian projects. In June 2012, a South Pars official confirmed to the author that Iran stopped working on its other projects so as to concentrate all efforts on Iran LNG. Having already invested more than US\$1.3 billion, Iran LNG is planned to construct two liquefaction trains with a capacity of 5.4 mtpa. Partly in cooperation with Chinese and South Korean firms, Iran LNG made good progress on the construction of storage tanks and the utility section. At the same time, however, Iran and its Chinese contractors did not progress at all with regards to the central part of the project, the liquefaction facility. Iran LNG secured a liquefaction technology license from German Linde but due to European sanctions it is not possible for this project to go ahead. Regardless of this, NIGEC told reporters in April 2012 that Iran LNG will be ready by the end of 2014. However, experts doubt that Iran can access the latest LNG technology under the current sanctions until the announced date.

In 2010, two other LNG projects related to South Pars, Pars LNG and Persian LNG, were cancelled due to the international sanctions and political pressure on Iran's international partners (Total and Petronas in Pars LNG, Shell and Repsol in Persian LNG) [16].

Iran will start early production of LNG at the Iran LNG Plant within the next year in a bid to give a boost to its LNG output and exports. Managing director of Iran LNG Company said that the project is aimed to produce 10.8 million tons of LNG per year. Exporting the product will earn the country up to \$20 million per day. In October 2011, he told an Iranian News Agency that Iran plans to export 30 percent of its LNG output to Europe. China and India will be the two major markets for Iranian LNG in future.

9. LNG = Liquefied Natural Gas

10. NIGEC = National Iranian Gas Export Company

VII. SUMMARY

Iranian gas market is very complicated. All kind of challenges encompass the gas trade from Iran to the other countries. The demand side has its own obstacles. Iran is in developing phase and shifting toward maturing phase is essential to mobilize international gas trade originating from Iran. Iranian gas market is changing to adapt to the requirements of trade. Iran is potentially responsible for 20% of global gas trade in 2025 and seeking for restructuring energy sector including gas industry to comply with international treaties.

For the Islamic Republic of Iran the domestic development of natural gas has the same magnitude as its international trade. Therefore all kind of regulation will be introduced for stabilizing gas supply to consumers. Regional stability, financial supporting and international assurance is essential for a sustainable gas market. As demand in Iran growth rates persist, the potential for shortfalls in natural gas supply grows. Iran's natural gas exports likely will be limited due to rising domestic demand, even with future expansion and production from the massive South Pars project and other development projects.

However, the present adopted international sanction against Iranian regime creates some serious difficulties in reaching the mentioned target. That is why it is unlikely Iran in the near future will have any substantial surplus natural gas to export.

REFERENCES

- [1] Bijan Khajepour, "The Role of Economic & Energy Relations With Turkey and Russia In Iran's National Strategy", unpublished
- [2] U.S. Department of Energy, 2012
- [3] <http://www.sustainableplant.com/2012/01/safely-scraping-the-bottom-of-the-barrel-part-1/>
- [4] <http://www.energydelta.org/mainmenu/energy-knowledge/country-gas-profiles/iran#t67999/>
- [5] <http://www.eia.gov/countries/cab.cfm?fips=ir/>
- [6] http://en.wikipedia.org/wiki/South_Pars_North_Dome_Gas-Condensate_field/
- [7] <http://www.oilgas.ir/>
- [8] http://en.wikipedia.org/wiki/Kish_Gas_Field/
- [9] <http://theshaleacademy.com/noggin-log-in/>
- [10] <http://www.cnggas.com/>
- [11] <http://naturalgas.org/overview/uses-industrial/>
- [12] http://en.wikipedia.org/wiki/Natural_gas#Power_generation
- [13] US Agency International Development, "Overview of The Natural Gas Sector of The Southern Caucasus and Neighboring Countries", November 2012
- [14] www.mashreghnews.ir
- [15] Natural Gas Exports from Iran (October 2012), http://www.eia.gov/analysis/requests/ngexports_iran/
- [16] David Ramin Jalilvand, "Iran's gas exports: Can past failure become future success?", Oxford Institute for Energy Studies, June 2013

Renewable Energy Technologies Of The Future

Paul Pagel

Brandenburgische Technische Universität Cottbus-
Senftenberg
Cottbus, Deutschland
Paul.Pagel@b-tu.de

Abstract—This paper provides an overview about renewable energies of the next generation. The ocean is a giant and inexhaustible energy source that has not joint much attention until today. Furthermore strong winds above the hub heights of conventional power plants cannot be used. These are only a few examples for unused energy sources. The technologies explained in this paper could be the reason.

Keywords-ocean currents,power generation, tidal currents, renewable energies, underwater turbines, wave power, wind power

I. INTRODUCTION

The “international energy agency“, abbreviated IEA published in 2012 a scenario regarding the worldwide switch to renewable energies until 2050 (figure 1). It is assumed under this scenario that power generation by nuclear power will be almost completely stopped. Oil-, Gas- and cowl fired power plants will supply only 20% of the total worldwide energy generation in 2050. The most notable increases will be expected in the specific area of the energy supply by solar and geothermal energy. Wind power plants will also gain importance. There are no signs of a significant change concerning the generation of biomass and hydro-electric power plants[1].

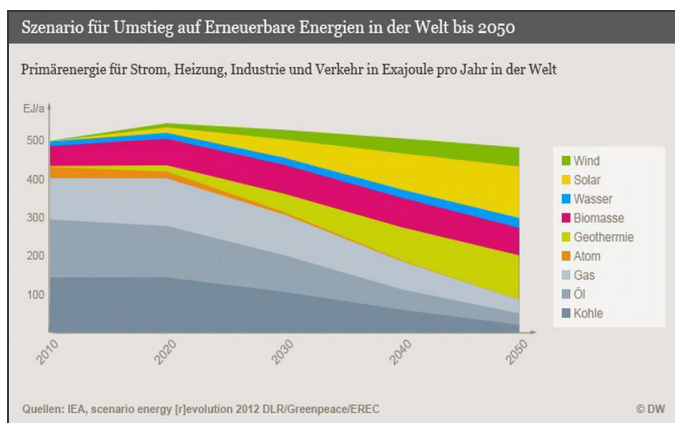

Figure 1: Scenario regarding the worldwide switch to renewable energies until 2050 [1]

There are many interesting and innovative concepts for generating electricity which not mentioned in scenario above. The present paper describes and explains some of the very

promising concepts. As energy sources can serve wind and wave energy as well as tidal and ocean currents.

According to estimates it is possible to generate about 800 terawatt-hours by tidal power plants per year. This roughly corresponds to 3-4 % of the worldwide annual power consumption. The biggest potential exists in the Coastal regions with strong tidal currents, for example regions like in the UK, Canada, France and East Asia [2].

II. MINESTOS “DEEP GREEN”

The following picture shoes the kite. “Deep Green” is composed of a wing (1). The wing is conceived to engender a high buoyancy force when stung by the current. “Deep Green” necessitates a stiff and lightweight structure with enough fatigue and material properties for a durability of 20 years. Furthermore the wing contains of watertight compartments for lift system, batteries and pressure sensors. [3]

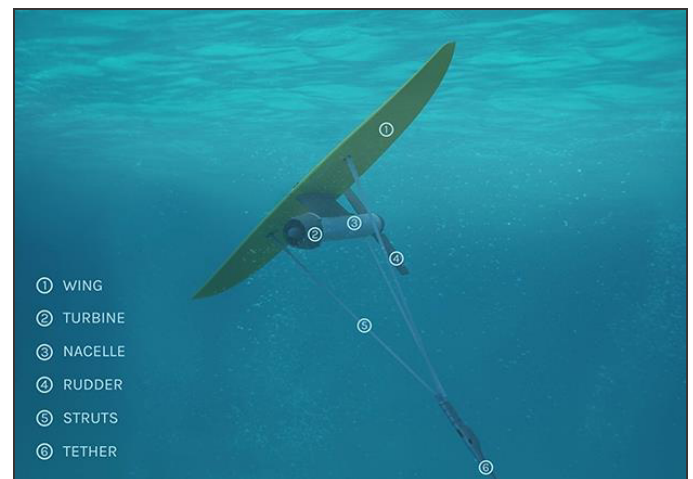

Figure 2: The parts of the “Deep Green” underwater kite [3]

This wing carries the turbine (2) which is directly coupled to the generator (3). These components are located in the nacelle. The kite is controlled by a rudder (4). The struts (5) are directly bound up with the tether (6). The tether’s main task is to handle with the high forces created by the wing. Hence the tether is a force bearer. Moreover there are lodged power and signal cables. To enhance performance the tether is engineered for the high hydrodynamic forces and also to reduce the water resistance. Those factors raise the electricity

production. “Deep Green” is bonded to the bottom panel by a joint. The bottom panel serves as an anchor for the system. The joint ensures that the tether can move in all directions according to the direction of the currents respectively the motions of the kite. It’s proposed to connect multiple power plants in an array. Such an array can consist of 100 abilities and supplies energy for 33,000 households [3].

The following picture illustrates how the unique principle of “Deep Green” works. The kite is pushed forward by the hydrodynamic lift which forces on the wing (1). The kite is directed by a rudder and does an 8-shaped trajectory. Thereby the kite’s reached speed is ten times higher than the water current speed (2). Because of the movement of the kite, water passes through the turbine. The turbine drives a gearless generator. The result is electricity (3). The wing is attached to the bottom by a tension cable. This cable contains an electrical wire for energy transmission to the station at the seabed (4). The energy will be transmitted by Sub-sea cables to the shore (5) [3].

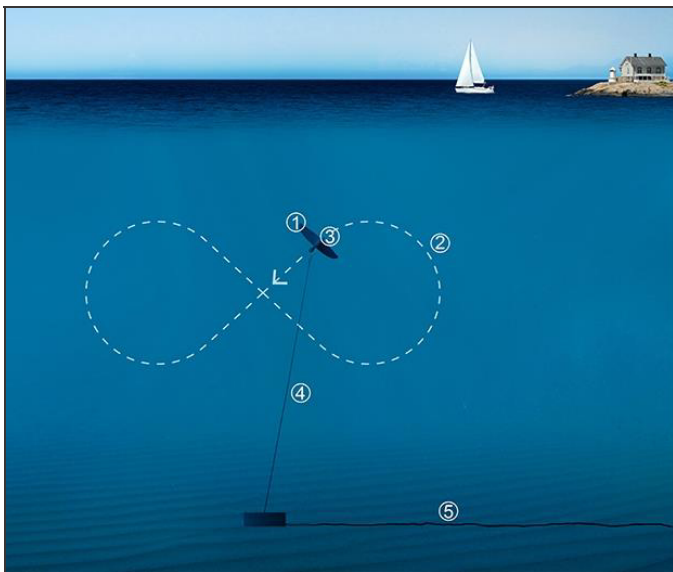

Figure 3: The functioning of “Deep Green” [3]

The advantages of “Deep Green” are listed below:

- it works cost efficient in tidal an ocean currents
- it’s the only known alternative which can supply electricity at flow speed between 1.2 and 2.5 m/s and soundings between 60 and 120 meters
- because of size and lightweight construction the power plant only weights seven tons, that is 10 to 25 times lighter per MW than other technologies, which are built for tidal flows over 2.4 m/s
- because of size and weight only small boats are needed for installation, maintenance and service.
- modularity enables lean factoring

- only attachment and detachment have to be done offshore, all other important things can be done onshore
- tidal currents can be forecasted by a precision of 100%, ocean currents are almost constant
- it creates fractional environmental and visual impact
- it operates all the time at least 15m below the mean sea level [3].

For the following years “Minesto” sets its sights high. The employees are focused on research and a product development plan. Already in the year 2016 they will install an 1.5 MW array. The next step will be a 10 megawatt array. Endurance tests with prototypes of "Deep Green" demonstrated the functionality and competitiveness of the technology. Actually five prototypes are existing. Those prototypes have been tested. The first time they produced electricity was in 2009. Only two years later they completed the first tests in authentic ocean environment. Nowadays a prototype in a ratio of 1:4 passes through an extensive endurance test in Strangford Lough, Northern Ireland [4]

Also the next described technology gains advantages by using the power of tidal currents. Since the middle of 2008 is a tidal current turbine in use in Ireland. This turbine is named “SeaGen”.

III. SEAGEN

The “SeaGen” tidal technology is the result of over 20 years of continuous leading research and development experience. The “SeaGen’s” main features are reliability and efficiency. These factors where combined with a solid and conservative design.

This two-rotor power plant has an installed capacity of 1.2 megawatt. The span of those rotors is 16 meters and sweep 200 square meters of flow. The rotor blades can rotate 180 degrees to secure the operation in both the ebb and flood tides. The tower of the device is firmly anchored in a maximal depth of 38 meters at the seabed. [6]

In October of the year 2012 the power plant sets two records. “SeaGen“ (figure 4) generates 22,53 megawatt-hours on one day and after 68 days it has already produced 1 gigawatt-hour. In the future the installed electrical power of “SeaGen” will increase significantly to 2 megawatts. There will be some changes concerning the rotor. It will receive a third rotor blade and the diameter will rise up to 20 meters.

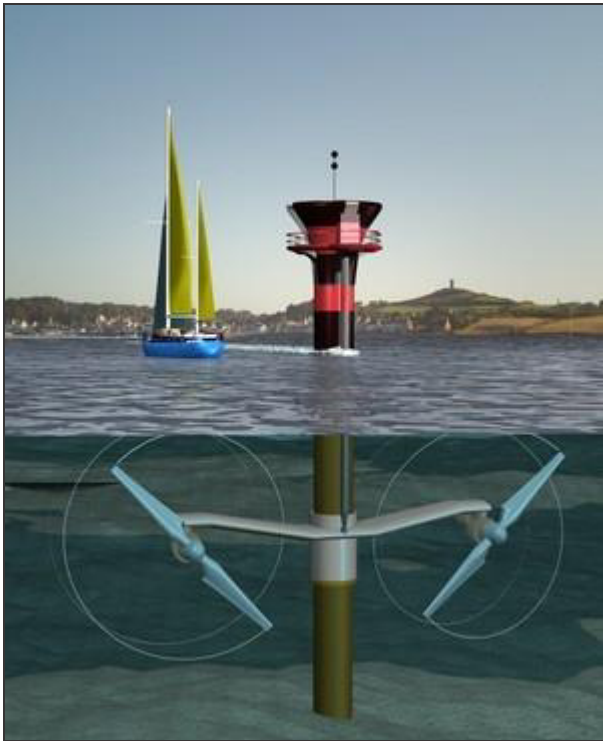

Figure 4: Scheme of the underwater turbine “SeaGen” [5]

Design features of the “SeaGen” technology:

- axial flow rotors that drive a generator in combination with a gearbox, like a wind turbine
- to optimize the gain of tidal energy and to minimize forces the rotors are pitch controlled
- in the first third of the water depth the tidal is most fast, so the blades where positioned there
- current speed must be higher than 2.4m/s
- “SeaGen” supplies grid compliant electricity, so no external power conditioning is needed
- turbine can be raised out of water easily

Advantages of the “SeaGen” technology:

- extensively tested
- guaranteed performance
- Maximized energy harvest
- Low maintenance and running costs
- high availability
- ecofriendly [7].

Due to the success of the prototype new projects are already planned. The following figure shows the scheme of such an intention. The ambitious plan, called “Kyle Rhea“, provides to install 8 megawatt in a narrow strait between the Scottish mainland the Isle of Skye (figure 5) [8].



Figure 5: Scheme of the 8 megawatt project called “Kyle Rhea” [9]

From the operation of “SeaGen” data of about 25,000 operating hours have been obtained. The data serves as the basis for the next generation of “SeaGen“

A subsidiary company of Siemens, called Marine Current Turbines Ltd. (MCT) and Bluewater Energy Services B.V. (Bluewater) are engineering a 2 megawatt floating tidal current turbine. Its name is “SeaGen F” (figure 6). They do spadework and install the first one of this type in Canada's Bay of Fundy, in cooperation with Minas Energy. The turbines are able to supply enough clean and reliable energy for more than 1,800 Nova Scotian households. The next step is a multi-megawatt array. “SeaGen F” complements the equipment for a standardized energy conversion system. [2]

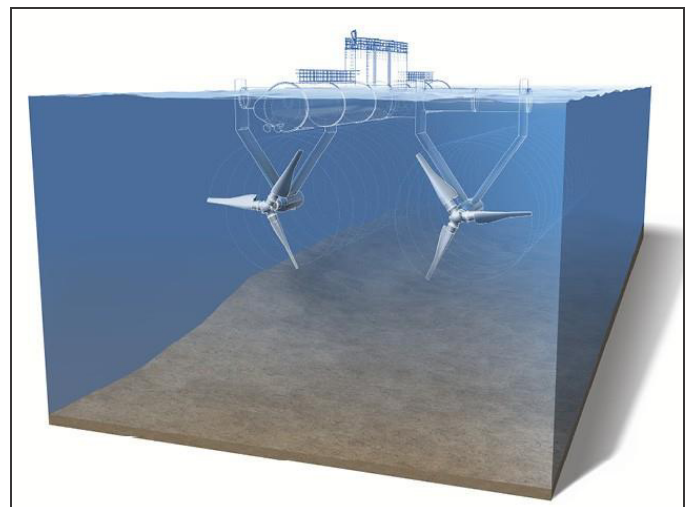

Figure 6: Scheme of the tidal current turbine “SeaGen F” [8]

IV. NEMOS

“NEMOS” is an innovative system for energy generation by the power of sea waves which is based on recent research findings. Waves occur by wind blowing over the sea surface on the high seas. There is a transformation from wind energy to wave energy. The peculiarity concerning waves is that they overcome long distances without losing energy before reaching the shore [10].

It achieves higher efficiency rates than other comparable systems. The device can be implemented cost effectively and is particularly suitable for the coupling with offshore wind power plants.

In general the system (figure 7) consists of an elongated buoyancy, which is anchored to the seabed by three metal ropes. This buoyancy is stimulated by the wave motion. Therefore mechanical energy can be transmitted to a generator which is water-protected attached to the tower of a wind power plant. The novelty of this development concerns the trajectory of the float. In connection with a new control strategy about 80% of the wave energy can be used to drive an electric generator. Conventional systems which use simple vertical movements can only reach less than 50%. If there is a change in the direction of the waves the float will change the bearing by itself because of a patented system. The trajectory is regulated by the erection of the waves. To protect against extreme wave loads the system can be saved by diving under the water. This is done by the metal ropes [11].

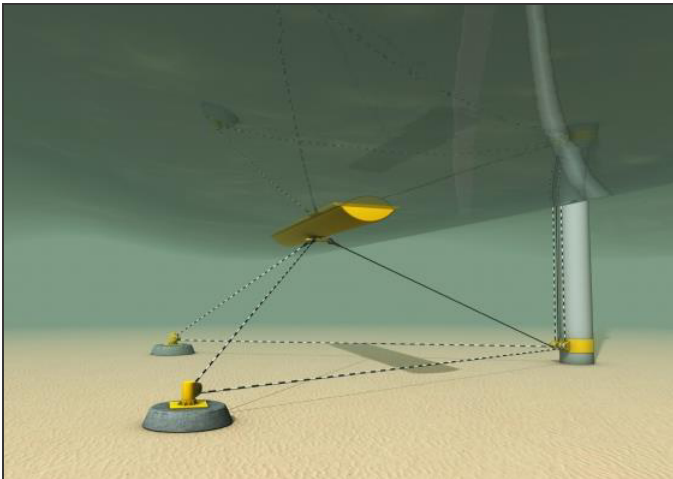

Figure 7: Scheme of “NEMOS” [11]

The fastening of the ropes on the float is designed to guarantee its free mobility around the central vertical axes. They use the so called swerving by the yaw moment for parallel adjusting to the crest of the waves. When a wave arrives and hits the float the result is a trajectional movement around the anchorage points at the wave faced side. Meanwhile a transmission of mechanical power to the generator takes place at the wave averted side. The generator is positioned for example at any offshore buildings or nearby on the shore. The function of the ropes switches by changes of the wave direction. So that the ropes at the side avert to the

waves take the control. The ropes at the waves faced side take the function for mechanical transmission to the generator. It is a simple, but ingenious system. Through the control of the rope kinematics, the trajectory of the float can be temporally and spatially adapted to the current wave conditions [11].

The system is characterized by:

- High levels of efficiency because of the optimized trajectory and the active control
- cost efficient construction by the use of the rope kinematics with low material input as well as the low complexity
- a great range of effects concerning the elongated, across the wave flow direction oriented shape of the float
- the adaptability of changing wave directions
- low maintenance costs because of the water protection of the sensitive components
- an effective survival strategy by saving the float under the surface [11].

In the coming years the construction of many offshore wind parks all over the world is planned. At those regions where the implementation is to be carried out, exist an enormous energy potential by sea waves.

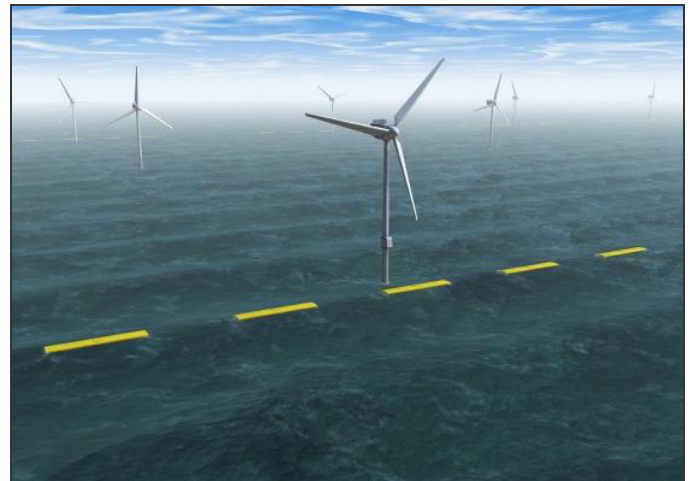

Figure 8: Scheme of an “NEMOS” array [13]

The effect of coupling both energy forms (figure 8) would not only increase the total energy amount but also straighten it. The background to this is the fact that the revenue of wind and wave power occur at different moments. That means if the wind starts to blow it takes some time until waves are formed and when the wind stops to blow the waves are still running for a long time. A study by the University of Stanford has succeeded this fact at the example of an American region. The study reveals that such a coupled energy park under the aspect of given power capacity increases the revenue by 20 % in comparison to a conventional wind park. In case of common use of the infrastructure like sub-sea cables and substations the

share of the coasts of energy transmission could be reduced [12].

V. WAVEROLLER

The next technology driven by the force of waves is named “WaveRoller” (figure 9). The unit is positioned in near-shore areas. That means round about 0.3 to 2.0 km from the waterside. The machine operates in depths of 8 to 20 meters [14].

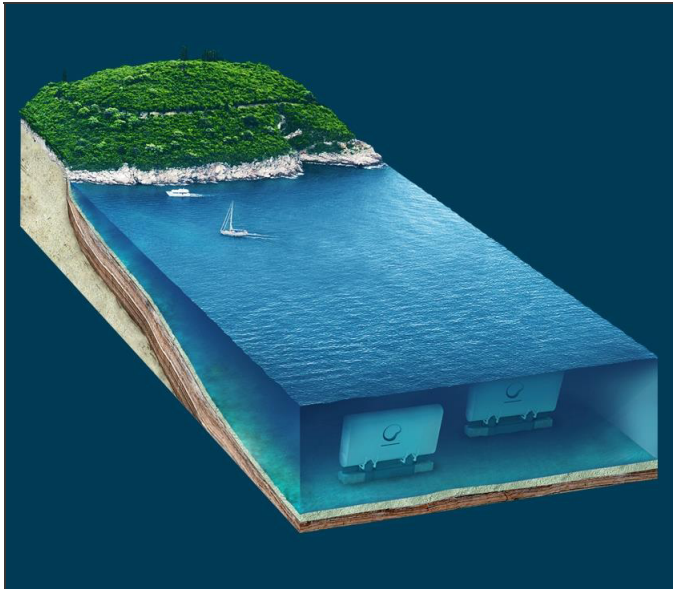

Figure 9: Scheme of a WaveRoller wave farm [14]

Relative to tidal circumstances a “WaveRoller” is mostly anchored to the bottom of the sea. The installed power of one unit is rated among 500 to 1000kw at a capacity factor of 25 to 50%. The idea for this power plant results from an observation of a diver. The diver noticed how a big part of a ship wreck moved forwards and backwards. The Panel of the power plant is driven by the motion of under-surface surge of water.

The unit was tested for some years in Portugal. The Prototype had a weight of 280 tons. Only the swinging blade weights about 20 tons. The canvas is linked to high-pressure-pumps, which haul hydraulic-oil into an engine that is coupled to a generator. This cycle is hermetically sealed to protect the environment. On the assumption of the installation of those power plants along the 2730 km of the coast of the Bretagne it is possible to reach 80 GW of installed power.

VI. THE OYSTER 800

The next picked up technology was fund in Edinburgh, Scotland by “Aquamarine power”. It is called “Oyster 800”. Aquamarine Power’s Oyster converts the energy of near-shore waves into clean sustainable electricity. All in all, the Oyster is a wave-powered pump. The power plant pushes high pressured water to drive a hydro-electric turbine onshore. The

device is a buoyant, versatile hatch which is anchored to the seabed at depths about 10 to 15 meters. It’s wide amounts 26 meters. The device is located approximately half a kilometer from the mainland. This region is called “the near-shore”. The picture mentioned below shows the way of the functional principle [10].

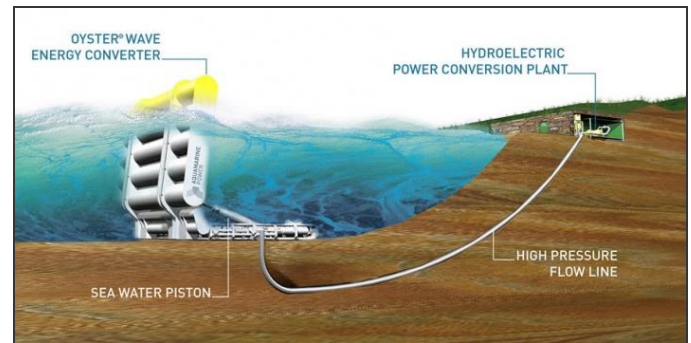

Figure 10: Scheme of functional principle [16]

The advantages at a glance:

- assembly takes place onshore
- a small number of underwater moving parts
- no internal monitoring system and gear unit
- no flamboyant offshore electronics
- versatile hatch ducks under largest waves
- near-shore position
- resistive offshore structure
- performs it’s work even in storm conditions
- “green” electricity
- no significant ecological impact on marine environment
- easy to approach
- high reliability of the hydro-electric plant [10].

Since 2012 “Aquamarine power” did operational tests of the second-generation “Oyster 800”. In the same month the first electrical power was already feed in the grid. The power plant is located at the European Marine Energy Centre in Orkney. Oyster’s maximum generating capacity amounts just about 800kW at any given time. The next step of the development team is to install our next-generation “Oyster 801” next to first-generation Oyster. The devices will be connected to provide the onshore hydroelectric power station. This will be the next milestone for demonstrate how much effective an array of many oysters will operate. It will be called a farm of oysters [15].

VII. ENERKITE

Next to the production of energy by the use of oceanic forces there are also concepts being developed on the basis of the power of wind. One innovative product is the so called “EnerKite” which has been developed in Brandenburg, Germany. Regarding to modern wind power-plants it can be noticed that an increase of power is combined with an increase of the hub height, because the wind speed depends on the height. “EnerKite“ inserts “hang-glider wings” to harness the resistant and strong winds above the hub heights of existing or conventional power plants (figure 11). These “hang-glider wings” offer phenomenal potential as shown in the figure [17].

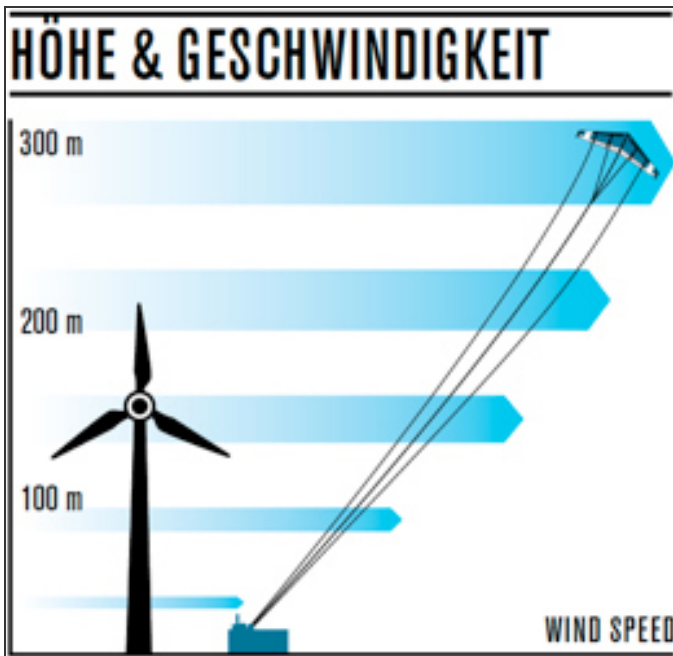

Figure 11: Wind speed and heights [17]

According to the manufacturer, the plant is at the end of the development able to generate 90% of the energy perennially. Based on a forecast, 4000 full load hours are expected. The plants are able to harness the winds up to heights of 100 to 500m. The enabling factors of the operating efficiency of these plants are the efficient material input, the good utilisation of the airspace as well as the reliable control and the low transport costs. This technology enables the development of low-wind locations. Furthermore the costs of the necessary grid expansion are reduced. This is based on the fact that these plants are not only used for decentralised energy supply they also can be used for mobile applications. Measured by the revenue, the material input in comparison to conventional wind power plants is reduced by up to 95%. The result is a reduction of the CO₂ footprint by 75%.

The functioning of the “EnerKite” is divided in two phases. In the first phase, which is defined as the working phase, the kite is flying across the wind and is rising in extreme heights. The kite draws an 8-shaped trajectory. By lifting in these heights the winch of the generator is mechanically driven and

produces energy. The kite is starting over a rotating launcher platform which is on top of the ground station.

The second phase which is defined as rewinding action serves to return the kite to the point of departure. Therefore the generator winch, which uses in this case exclusively the self-produced energy, is also responsible. According to that the winch has two main tasks.

The development of the prototype named EK30 was already completed in 2012 (figure 12). Today the second generation of the kite called EK60 is in the endurance test operation. This plant has a wing surface of about 10m² and an installed power of 30 kilowatts. The developers of the “EnerKite“ are working continuously on a new plant. Regarding the year 2015 the presentation of the EK200 is planned. The next generation of this kite will have a wing surface of 30m² and an installed power of about 100 kilowatts. The masterpiece called EK1M is based on a concept with a surface of 125m² and a remarkable installed power of 500 kilowatts and will be developed until 2017. If it is succeeded the “EnerKite“ has to be considered as a serious competitor for the conventional wind power plants. [17]



Figure 12: „EnerKite“ prototype EK30 [18]

VIII. CONCLUSION

Implementing the turnaround in energy policy is an ambitious goal. It is a fact that today’s technologies will substantially contribute to achieve this goal. But it will be impossible to reach this target by using only conventional devices. The described technologies can help to fill this gap. The latest research results confirm this statement. It is necessary to do further research in this field, so that the power plants become more efficient, reliable and cheaper. If this problem can be managed, the turnaround is only a question of time.

IX. REFERENCES

- [1] Deutsche Welle - Anstalt des öffentlichen Rechts. *Globaler Trend hin zu erneuerbaren Energien*. 2014. <http://www.dw.de/globaler-trend-hin-zu-erneuerbarer-energie/a-16519172> (Zugriff am 1. Juni 2014).
- [2] Marine Current Turbines. *Siemens, Bluewater and Minas to install floating tidal current turbines in Canada's Bay of Fundy*. 4. April 2014. <http://www.marineturbines.com/News/2014/04/04/siemens-bluewater-and-minas-install-floating-tidal-current-turbines-canadas-bay> (Zugriff am 1. Juni 2014).
- [3] Minesto. *Minesto - Ocean Energy Solutions Deep Green Technology*. 2013. <http://www.minesto.com/deepgreentechnology/index.html> (Zugriff am 1. Juni 2014).
- [4] Minesto. *Minesto - Ocean Energy Solutions Technology Development*. 2013. <http://www.minesto.com/technologydevelopment/index.html> (Zugriff am 1. Juni 2014).
- [5] Subsea World News. kein Datum. <http://subseaworldnews.com/2012/01/17/uk-seagen-tidal-turbine-gets-all-clear-from-environmental-studies/> (Zugriff am 1. Juni 2014).
- [6] Marine Current Turbines. *SeaGen S Marine Current Turbines*. kein Datum. <http://www.marineturbines.com/SeaGen-Products/SeaGen-S> (Zugriff am 1. Juni 2014).
- [7] Marine Current Turbines. *SeaGen Technology Marine Current Turbines*. kein Datum. <http://www.marineturbines.com/Seagen-Technology> (Zugriff am 1. Juni 2014).
- [8] Siemens AG. kein Datum. <http://www.intranet.siemens.de> (Zugriff am 4. Juni 2014).
- [9] Compute Scotland. 29. März 2011. <http://www.computescotland.com/anglesea-array-then-kyle-rhea-4156.php> (Zugriff am 3. Juni 2014).
- [10] Aquamarine Power. *Aquamarine Power - How Oyster wave power works*. 2011. <http://www.aquamarinepower.com/technology/how-oyster-wave-power-works/> (Zugriff am 3. Juni 2014).
- [11] Nemos GmbH. *Nemos - Technologie*. 2013. <http://www.nemos.org/technologie/> (Zugriff am 5. Juni 2014).
- [12] Nemos GmbH. *Nemos - Potenziale*. 2013. <http://www.nemos.org/potenziale/> (Zugriff am 4. Juni 2014).
- [13] Nemos GmbH. *Nemos - Projekt*. 2013. <http://www.nemos.org/projekt/> (Zugriff am 4. Juni 2014).
- [14] AW Energy Oy. *WaveRoller concept*. 2012. <http://aw-energy.com/about-waveroller/waveroller-concept> (Zugriff am 3. Juni 2014).
- [15] Aquamarine Power. *Aquamarine Power - Oyster 800 project - Orkney - wave power project*. kein Datum. <http://www.aquamarinepower.com/projects/oyster-800-project-orkney/> (Zugriff am 2. Juni 2014).
- [16] Inhabitat. *http--inhabitat.com-aquamarine-power-breaks-ground-on-oyster-wave-energy-farm-in-orkney*. 2014. <http://inhabitat.com/aquamarine-power-breaks-ground-on-oyster-wave-energy-farm-in-orkney/> (Zugriff am 5. Juni 2014).
- [17] EnerKite GmbH. *EnerKite - Windenergie neu definiert*. 2011. http://www.enerkite.de/Home_files/EK_Broschure_DE.pdf (Zugriff am 2. Juni 2014).
- [18] SPS-MAGAZIN Zeitschrift für Automatisierungstechnik. *SPS-MAGAZIN - Flugdrachen für die Windenergie*. 2013. http://www.sps-magazin.de/?inc=artikel/article_show&nr=70449 (Zugriff am 4. Juni 2014).

Green Conscience, Dull Neighborhood?

The influence of German energy policy on the Polish electricity network

I. Introduction:

In 1882 the first electric light illuminated the Kaiserstraße in Nürnberg/Germany [1]. With the triumph of alternating current, the security of supply as well as the scope of this revolution grew. Today, electricity has an important role in our society. Retrospectively, political and economic circumstances influenced the development of the production and supply of electricity. The liberalization of trade in electricity and the climatic changes have a growing influence in the field of modern electricity. However, these factors lead to a difference in goals and interests. It is therefore essential to find a common ground whereby such differences can be minimized. Power always seeks the path of least resistance and spares no boundaries. Political ideas usually end here.

II. The Power Supply

Comparison of Germany and Poland

As narrow as the political relations between the two countries seem, the idea of the energy transition developed quite differently. Poland currently produces ninety percent of its electricity from coal. The highest priority and future mission is self-sufficiency. Therefore, environmental

protection must give way to the primary objective of a safe and independent supply. However, both countries are members of the requirements of the EU climate package 20-20-20. The target is to reduce the emissions of greenhouse gases to the reference year 1990 levels by twenty percent.

The federal government wants to reach a value of forty percent. Poland relies on the increased expansion of gas-fired power plants. In addition, they are planning to build the first two nuclear power plants of the country by 2030. [2]

On the other hand, the German philosophy is strongly influenced by the development of a regenerative system, for example wind power or photovoltaic systems. These different views have not only economic or environmental impacts, but also have a strong effect on the load of the transmission systems. A smaller part of renewable energy makes the network generally less susceptible to fluctuations and provides better control. This is particularly a problem in Germany since the introduction of the EEG (Renewable Energy Law). There are two decisive factors. According to the second paragraph of the EEG, renewable energy sources have a priority for input in the German grid. In contrast, it means that the current is not utilized where it can be produced originally. Wind power is predominantly produced in the north of the country, whereas the greatest need is in the south. Five years after the introduction of the EEG in 2000, the German Energy Agency (DENA) concluded, that a total of 1.1 billion Euros needs to be invested for the network expansion to ensure the security of supply in the future. [3]

III. The European Interconnected Grid

Europe's most important network for connection and exchange of electricity is managed by the European Network of Transmission System Operators for Electricity (ENTSO-E). The ENTSO-E was founded in the year of 2009. The original name and also commonly referred name is UCTE. It includes almost all continental European countries. Because of technical reasons, the Scandinavian countries and Great Britain form an independent network provider. They are also connected to the ENTSO- E via high-voltage direct current transmission cables (HVDC). A conventional transmission by AC would not make sense because of economic aspects. This is due to a very high capacitive component of such cables and the associated enormous reactive power. With DC solutions the problem has been eliminated. The European countries east of the Polish border also form an independent network under the name of IPS / UPS. These associations have the assignment to control and directing their independent control loops. This offers opportunities as well as problems compared to a national regulation. At the best, the electricity can be provided to the last producer at minimal cost, the reason being the control power. In a great network loop there are good opportunities to balance the control power. It is needed because of a imbalance in supply and demand. All the members of the ENTSO-E are committed to hold back a certain percentage of their capacity. This is called primary control. The free capacities are divided to the percentage of the annual production of each control loop. The

primary control passed into the secondary control, where a power plant from the affected control area takes over the compensation. In the minute reserve the connection of a peak load power plant is done. The meaning behind this phased plan is the most flexible response to fluctuations with the fastest possible recovery of the most important capacities. The clocking to the next level should not exceed a 15 minute shifts. That supply is of course associated with high cost, especially the minute reserve strong price fluctuations. [4]

The countries management and behavior is quite different in the ENTSO-E. There are export, import and also increasingly acting transit countries.

While the importers and exporters generate their profits or losses in the direct trade example on the power exchange, the transit countries are obtaining usage charges. This was a EU decision. In the first way this is not a profit based business. Primarily it is merely the maintenance and the upkeep of the network. The problem is when it comes to cross- border power transfer at the expense of the security of supply.

IV. The German wind power and their way across Poland

After the introduction of the EEG there were two misunderstandings on the German side. Firstly, the quantity of transported current and also the required domestic network capacities that is needed for a safe transmission was underestimated. The current looked for the path of least resistance to the south and took the way through Poland and via the Czech Republic. The problem is that it seemed like not only by the high current transits the Polish network stability is jeopardized, but there was not even residual capacity for Polish electricity available. On 13/06/2013 German green power was booming. Sun and wind provided sixty percent of German electricity available. That hinted to another reason for the Polish dissatisfaction with the current situation. Due to the extreme variations in supply and still moving base load, the stock price fell dramatically. It even turned to a negative price, meaning a decrease, which made the purchase very attractive not only for Germany, but also for other countries. The result is a bad deal for coal-fired power plants and certainly to force a motivation for Poland on a solution. Main protagonists in this conflict are the North East German network operator 50 Hertz and the Polish PSE Operator.

To actively solve the problem, there are three possibilities, but these are only feasible at separate times. The aim for the future should be to develop a phased plan. This should solve the transit flow to all parties optimally with the inclusion of the EEG. The first way to reduce uncontrolled

flows is the so called Redispatch. Initially, the Dispatch sets the schedule of the power plant for the day. This regulates utilization, performance and temporal provisions on the daily production. The dispatch for the following day is to report by 2.30 p.m. to the respective control area. The better the schedule is analyzed, the lower are the later expenses during the network regulation. The problem, however, lies in assessing the amount of regenerative energy that can be directed into the system. A Redispatch is therefore always associated with high risks and costs. It is also necessary to always keep enough facilities of the power plant free. [5]

This harmful solution could now be solved by an agreement. On 11th of March, 2014, the German and Polish delegates of the European Union agreed on the second best but also only medium-term solution at the conference under the theme "Opportunities for co-operation in the electricity sector". The introduction of phase-shifting transformers (PST) on inter-connectors was decided. PSE and 50 Hertz shared the costs together. The decision was to conduct a test because of the hopeful expectation towards the expanding development of the electricity trading with the region of Central Eastern Europe (CEE). [6]

The basic idea during the (PST) is to influence two parallel lines, which will minimize the active power flow of one of them. The simplest variant of the PST consists of a delta-connected three-phase exciter transformer and a three-phase series winding. The circuit of the PST in the line takes place in series. In this case, an additional voltage will be induced, which displays ninety degrees to the phase earth-voltage. Due to the impedance of the network circuit, the currents, which have a

mainly inductive character, are induced. This results in a phase angle of 0 or 180 degrees. These are almost pure active power flows, which add themselves to the vectorization of the network. Depending on whether the auxiliary voltage is in phase or in anti-phase, this will increase or decrease the load flows. [7]

The unwanted network will be regulated for the first time on the border line Mikukowa-Hagenwerder from December 2015, and at the substation Vierraden from October 2017. That this is a perfectly viable interim solution could even be shown at other European borders with the same problem. [8]

Germany is Poland's most important European trading partner. That is not only from a technical perspective, but also from an economic and political point of view - a measure for stable trade in the future. A final measure can only be the network expansion. Particularly problematic is the shutdown of nuclear power plants by 2022 of which Bavaria and Baden Württemberg are still dependent to sixty percent. Therefore the plan includes an 800 kilometers long route with the name Süd Link, which will run through five states. This will be a major technical challenge for the network operators. A large number of citizens want ecological power in Germany, yet many of them do not want to live by the consequences, which are causing further complication and delays. In other words, many people fear the destruction of their landscape and therefore demand an alternative. The problem, therefore, is to convince the citizens of the technical advancements. The direct installation of cables underground was requested by many local residents. [9] Though this is more aesthetically pleasing,

it could lead to economic and physical problems could arise. One kilometer of underground cables will cost seven times the cost of overhead electrical lines. The fauna and flora would have to be destroyed completely during excavation but could be replanted in the long term. Another problem lies in the failure analysis and physics, i.e. cable defects in the earth are difficult to locate and would have to be dug up in case of failure. Another point to consider is the roughly four times higher reactive power in underground cables. In order to guarantee a reliable transmission, it is essential to install compensation systems at intervals of fifteen to twenty kilometers. These systems stand over ground in fenced buildings. As a result, the landscape stands to get disfigured. Whether this is actually the aesthetic variant, remains doubtful. The impact on groundwater, the thermal radiation on plants and soil are not yet sufficiently researched. [10] What remains to be seen is the chosen way for the route and the time that it goes into planning. Therefore, politicians took up a concealed position in order to not lose the favor of their voters. But without concrete solutions, the south of the country will have serious problems – they will probably have to rely on importing electricity from nuclear power plants abroad, after shutting down their own power plants from the network. Until then, the issue remains „electrifying “.

- [1] Siemens, Press Handout at: www.siemens.com/press/de/pressebilder/?press=/de/pressebilder/2011/corporate_communication/soaxx201117/soaxx201117-07.htm, 2011, access at 26.05.2014.
- [2] Bundeszentrale für politische Bildung, Analyse: Energie – Herausforderungen für Polen at: www.bpb.de/internationales/europa/polen/137784/analyse?p=all, 2012, access at 26.05.2014.
- [3] U. Steger, U. Büdenbender, E. Feess, and D. Nelles, Die Regulierung elektrischer Netze-Offene Fragen und Lösungsansätze, Springer Verlag Berlin , p.33, 2008.
- [4] P. Konstantin, Praxisbuch Energiewirtschaft, Springer Verlag Berlin, vol. 3, p.462-463, p.469-472, 2013.
- [5] D. Biermann, Wie Deutschland seiner Systemverantwortung auch zukünftig gerecht wird, 50Hertz Transmission GmbH Berlin, at: http://www.dena.de/fileadmin/user_upload/Veranstaltungen/2014/03_50hertz_dena-SDL, p.12, 2014, access at 30.05.2014.
- [6] S. Fischer, Energiepartnerschaft Deutschland-Polen: Eine neue Ära im Strommarkt, Energiewirtschaftliche Tagesfragen, at: www.et-energie-online.de/Aktuelles/Veranstaltungen/tabid/67/NewsId/959/Energiepartnerschaft-DeutschlandPolen-Eine-neue-Ara-im-Strommarkt.aspx, 2014, access at 30.05.2014.
- [7] ew dossier, Phasenschiebertransformatoren im APG, ew - Magazin für die Energiewirtschaft, Heft 11, p.36, 2007.
- [8] Die Bundesregierung, ENERGIEZUSAMMENARBEIT, at: <http://www.bundesregierung.de/Content/DE/Artikel/2014/03/2014-03-17-energiezusammenarbeit.html>, 2014, access at 01.06.2014.
- [9] M. Greive, and T. Vitzthum, Die-zehn-wichtigsten-Antworten-zur-Stromtrasse, Die Welt, at: <http://www.welt.de/politik/deutschland/article124593298/Die-zehn-wichtigsten-Antworten-zur-Stromtrasse.html>, 2014, access at 01.06.2014.
- [10] 50Hertz Transmission GmbH, Freileitung oder Erdkabel Hintergrundinformationen, at: <http://www.50hertz.com/de/file/Erdkabel-Freileitung.pdf>, 2014, access at 01.06.2014.

Project e-SolCar and integration of electric cars in power supply system

A model project at BTU Cottbus-Senftenberg

Marcel Kaßner
BTU Cottbus-Senftenberg
Cottbus, Germany
kassnmar@tu-cottbus.de

Gerald Kirschstein
BTU Cottbus-Senftenberg
Cottbus, Germany
kirsdcger@tu-cottbus.de

Abstract—This essay is about a project which is located at the Brandenburg University of Technology Cottbus-Senftenberg. It contains all the aspects about the part of electric mobility that will be analyzed at the e-SolCar project. Components will be explained, the idea of all and how it can work in the future. At the end a sneak peak of future developments in the project e-SolCar will be introduced.

Electric Mobility; eSolCar, energy storage; potentials; charging; discharging; bidirectional charging; aggregated schedules; save energy; model of future electro mobility; network integration;

I. INTRODUCTION

The power supply in Germany is changing since the nuclear disaster of Fukushima. Proven energy sources or the nearly infinite nuclear energy will be regulated in favor of renewable energies. The advantages of energy fuels are clear: they are available in high amounts for the next few years, but the big disadvantage is the increasing CO₂ emission. The same problems exist with the nuclear power: it is available in high amount but the result next to the energy is risky waste.

Because of this high risks and problems for the environment the society demand a more friendly solution for the power supply. The solution can be easy: the renewable energies. Solar-, wind- and waterpower are the main power supplier of the renewable energies. The development for the generation of electric power from these environmentally friendly resources took a long time. The technology has been field tested and proved in the last several years in practice. Every energy conversion process have his disadvantages, the renewables are no exception.

The biggest advantage of renewable energies is the fact that this energy source is carbon-neutral and renewable. In practice, cannot be a pure supply exclusively by solar, wind and hydro power, because the time of generating and usage do not match. There is a lack of storage technologies that will ensure the availability of electrical energy in sufficient amounts, if no "clean" energy can be provided.

A statistic of the Federal Environmental Agency of the gross electricity distributed to the primary energy in Germany

from 2010 provides the following Results:

- 22.7% of energy from lignite combustion
- 22.5% of energy from nuclear energy
- 18.2% of energy from coal combustion
- 16.9% of energy from renewable sources
- 14.1% of energy from natural gas
- 5.6% of energy from other (oil, refinery gas, waste)

If the generation of electricity from coal burning and nuclear power is to be reduced from the energy mix, a energy storage technology for renewable energies must be developed.

The electric mobility in Germany is currently in an early development stage. Only when conditions are met, such as lower cost, acceptable ranges and a developed infrastructure, the market in Germany will grow. The goal is clearly defined: zero-emission mobility.

The mobility is in the focus of political and social interest due to the high global fuel consumption and CO₂ emissions. Therefore, the federal government has set the goal to promote electric mobility as an emission-free transportation option. By the year 2020, therefore, in Germany according to the plan of the Federal Government one million electric vehicles should be registered.

II. PROJECT E-SOLCAR

A. The idea

In cooperation with Vattenfall Europe Generation AG, German E-Cars Research & Development GmbH (German e-Cars R & D) and Siemens AG, Brandenburg University of Technology Cottbus-Senftenberg wants to research the influence to the power grid of electric vehicles, integrated in a smart Grid. The project e-SolCar is the key project for electric mobility of the Berlin-Brandenburg region.

One approach to solving this problem is part of the project e-SolCar at the Brandenburg University of Technology

Cottbus-Senftenberg. This project examines whether electric vehicles and free battery storage capacities for the provision and the use of control power are available and useful.

By using an intelligent control of the electric vehicle power can be loaded into the car battery via the public electricity grid, and these are thus used as a storage medium. Furthermore, a discharge of the electric vehicle battery into the power grid should be possible to the so-called bi-directional charging (Vehicle to Grid). This is a first step towards emission-free mobility and a way to store excess energy.

The project e-SolCar is simulating a possible future idea. The project at the BTU campus has a retrofitted vehicle pool where 15 vehicles belong. The cars are exclusively made for extensively testing during this project. The configuration of the vehicles in e-SolCar can get a common solution in the future of electro mobility because electric vehicles will be purchasable at a lower cost, the infrastructure for electric cars will be expanded, a bi-directional energy management can form the basis of tomorrow. Electric vehicles will be a part of the Smart Grid.

For the realization of an intelligent charging management system requirements had to be created. Basically a charging station has to be present, which supplies the electric vehicle with energy. Communication-capable electric vehicles are not only loaded, but must be linked by a user-specific load timetable into the power grid energy storage. The charging station must specify the electric vehicle in both cases a current value will be the charge and discharge the battery of the vehicle. It must also be ensured that there is no time charging to dangerous situations.

B. Components in the charging station and network side

To researching the influence of electric vehicles in the power system a so-called micro-grid was built on the campus of the BTU Cottbus-Senftenberg. This is intended to represent a complete infrastructure. The following resources are installed for this project:

- Photovoltaic system with 116.6 kWp
- Lead-acid battery storage of 500 kWh
- 15 charging stations for electric vehicles

In the charging station components of the company Siemens were installed (see Figure 1). As the main component the charging controller CM-230 of Siemens was included. This device monitors the charging of the connected vehicle and works according to the current DIN standard DIN EN 61851.

The second main device is a programmable logic controller S7-1215C (PLC) also a product of the Siemens Company. This component is needed to build up a superior control because the charging controller CM-230 is a standalone charger only. The ability to communicate with this charging controller and using all the chargers as a group was programmed in the project e-SolCar.

The built-in multi-function meter PAC3200 by Siemens measures all relevant electrical data, including the actual current in all phases, the voltage, power, and the power value. The PAC3200 is connected via Ethernet to the network and sent via this line all the data to the superior controller.

To discharge the car there is an additional LIN-communication-component installed, which was developed by the company German E-Cars. This LIN-module communicates with the PLC and the superior logic. The ability to communicate between the component of German E-Cars and the S7-1200 was also programmed in the project e-SolCar. The RS232 interface is used, which exchanges data with an individual defined data protocol.

All devices are connected via Ethernet with a network switch and combined in the charging station. The network switch is connected via star connection to the superior system. A public access to this network is not possible.

With the current structure a three-phase charging of electric vehicles is possible. It is designed to provide a total energy of 20 kW per charging station to charge the vehicle. This corresponds to a maximum charging current of 28 A (three-phase). The charging station network can provide a maximum output of 70 kW (100 A per phase) for charging the electric vehicle. Due to the maximum power of 70 kW, the charging stations will be limited to 6 A, this corresponds to a total current of 90 A per phase.



Figure 1. Devices in charging station

As the superior system a software PLC (Siemens Microbox) is used, which manage all actions in the park. A developed system will get process data of the car and the park, calculate and limit the current for the vehicles and generate statistics. With the included user interface it is possible to monitor every charging station and get real time process data.

The car can be connected with a type-2 loading plug with the available charging socket or with an in Europe used plug type F (Schuko-plug). Both possibilities are integrated in the project's charging stations. A lock function, which is provided by the charging controller CM-230 during a charging process, will secure that the plug cannot be removed.

C. Components in the car

On the campus of the BTU Cottbus-Senftenberg project, 16 vehicles are available. It is one Mercedes Sprinter transporter and 15 Opel Corsa vehicles. These were rebuilt by the company German E-Cars R & D for electric vehicles. Among the new equipment in all vehicles include a new all-electric drive, a vehicle battery with a storage capacity of 22 kWh and a rectifier for charging and discharging of the vehicle battery.

As a counterpart to the LIN-communication module in the charging station an additional module for the vehicle was developed by German E-Cars. This module receives internal process data (CAN-BUS) of the car and processes it. Through a user input relevant data are collected and sent by the module to the charging station and the superior controller to charge the battery. For this purpose, the data are sent on the normalized standard charging cable type 2 to the charging station.

As well important charging operating data are sent to control the charging process of the electric car. An example is the maximum charging current of the electric vehicle. This is calculated by the superior controller and forwarded to the car. Through this information, the automobile can load with a defined current, which was calculated as a function of all other vehicles in the charging park and thereby ensures the safety of the plant.

The new type of communication between the two German E-Cars R&D devices is based on the DIN standard DIN EN 61851. A pulse width modulated signal is communicated between the charging station and electric vehicle. According to the standard, this contains only two pieces of information: the maximum charging current for the charging station side and the charging status of the vehicle. The German E-Cars R&D module of the vehicle is modulating further vehicle-specific data on the pulse width modulated signal. In this case, for example the values for the current battery capacity, the actual charging current or the remaining charge time will be sent to the charging station and also automatically to the superior logic.

D. Integration in the network

Responsible for the "integration into the network" is the upper superior logic. The overall energy management system (EMS – superior logic) is the central control of the charging

network that monitors all the processes, controls and logs. Its responsibilities include:

- Communication with fifteen charging stations,
- Set current for charging stations
- Generation of aggregated schedules
- Visualization of process states
- Archiving of process and resource data

The EMS was implemented using a Siemens Microbox. This consists firstly of a software PLC (WinAC called) and secondly of an embedded Windows 7. The visualization and archiving run on the Windows environment, while the control tasks are executed by the PLC.

The EMS communicates continuously at any charging station and receives the cyclic data, the event-controlled data as well as a possible ring buffer after a communication failure. The received data is then stored in a global database, where they are ready for further processing in other parts of the program.

One of the central tasks is to target current presetting for each charging station. In the first case, the total available power is evenly distributed to all vehicles. In the case of digital communication vehicle user can enter departure time and desire kilometers in the system. Additionally, process data from the vehicle's battery can be retrieved. Then, an algorithm was developed that computes a function of the overall situation of the loading parks, the input user information and the current battery status of the vehicles are used to calculate the target current for each charging station, taking into account the sum of timetable.

For an optimized network operation, it is possible to integrate aggregated schedules in the EMS to be able to reduce peak loads, for example at lunchtime. With the unidirectional charging, it is possible to reduce the total power of the charging station network at peak times. As part of the bi-directional loading, it is possible to reverse the power flow of the charging stations network to relieve the grid network.

The archiving of process data has been outsourced by the PLC in the Windows environment to ensure quick access for further research and evaluation purposes. The data will be handed over by the software PLC to an archiving program that runs on the Windows environment and then saved asynchronously.

E. Pilot project and the participants

In order to investigate the behavior of the power system through bidirectional loading operations, all 15 electric vehicles were raffled to employees of the Brandenburg University of Technology. Here, always five vehicles were distributed to employees with short, medium and wide daily commute to the university. The users of the vehicles can and should use this vehicle like their private vehicle.

Currently, not all vehicles are able to communicate with the superior system. They only work according to the standard DIN EN 61851. In the coming months all vehicles should be able to communicate digital with the charging stations to provide their battery information and user input data. The users of the vehicles will be able to enter two important data. On the one hand it is essentially to know the departure time of the vehicle and on the other hand how much energy is needed at departure. This data is sent to the EMS and is used to compile the aggregated schedule and to calculate the current for each charging station. Due to the data input, the user of electric cars can rely that their desired range is available at departure.

The driving performance, the power consumption and the influence of range per trip can be analyzed.

III. PROSPECT

The project is constantly evolving. The following new developments planned for the project e-SolCar will be explained.

A. *Setting up an aggregated schedule*

Through the gathered data about user behavior and the associated battery values the EMS is able to create the aggregated schedule which is constantly being improved. With an improved algorithm for the distribution of electricity, energy can be saved. A subsequent integration of other devices in the smart grid is done to meet the requirements.

B. *Better user input*

Currently, the drivers of electric cars must make their entries via an integrated in the car display. A better user experience can be accomplished by using a smartphone or tablet. In order to enable this, you have a new additional communication-module, which communicates with the mobile device and the car will be developed. Such a module is currently being developed and tested within the project e-SolCar.

With the help of an app for the major operating systems Android and iOS users can input their data. In addition to the inputs, the device will also transmit important data of the vehicle to the mobile device. The remaining charging time, the current amount of energy in the battery and other process data can be displayed. Thereby the charging process for the user becomes transparent. The module will be developed to exchange data using the Bluetooth interface. Both Bluetooth Classic and the new Bluetooth Low Energy (BLE, BT 4.0) are taken into account.

C. *Simulation of payment system*

An additional function will be a simulated payment system. This system will be developed later this year. In combination of the user's smartphone or tablet it should be possible to choose a fictional rate. The driver has to decide if the car's

battery should be available for use through the power supply network or not, the user is available to rents his battery.

With this simulation, other important behaviors of the driver can be analyzed and thus affect a part of the forecasts for the success or failure of the entire model e-SolCar.

D. *Extension of the Smart Grid components*

Currently, the smart grid at the University of Cottbus-Senftenberg consists of the components photovoltaic, battery and electric vehicles. A small thermal power station (CHP) plant will be added to the network. This adds another energy source to the Smart Grid. The entire grid can be operated autonomously and thus reflects a possible form of power grids in the future. Because of this structure and the autonomous operation can be researched on electrical values, for example, a short circuit behavior or the development of a protection system.

E. *System to the internet*

All user options should be accessible on the Internet. Also the input of the two important values of the departure time and the minimum range should be accessible there. The advantages of a network to the Internet exist, because users can make entries or change date from almost anywhere. However, a security system must be developed for a public solution. The same applies to settings of the entire system. The operator should be able to operate this comfortably via the internet, but this also needs to urgently protect against unauthorized access.

IV. CONCLUSION

The project e-Solcar is a unique pilot project in Germany. The special feature is the ability of the bidirectional loading. In the future, electric cars could serve as temporary storage for electrical energy. The project e-Solcar therefore checks whether this scenario could be for real in a large scale. Up to this point already many ways using the charging stations and electric vehicles were identified. With the further planned developments creating an autonomous network, which maps a real power grid in miniature. The analysis of the gathered data and also the users' experience will show whether this kind of electricity network and the use of vehicle batteries as a buffer have a future in Germany and the world.

REFERENCES

- [1] Dessau-Roßlau, Umweltbundesamt. <http://www.umweltbundesamt.de/energie/politik.htm>. Umweltbundesamt.de. [Online] [Zitat vom: 15. 05 2013.] <http://www.umweltbundesamt.de/energie/archiv/strommix-karte.pdf>.
- [2] e.V., Deutsches Institut für Normung e.V. und Verband der Elektrotechnik Elektronik Informationstechnik. DIN EN61851-1 (VDE 0122-1): Elektrische Ausrüstung von Elektro-Straßenfahrzeugen - Konduktive Ladesysteme für Elektrofahrzeuge - Teil 1: Allgemeine Anforderungen. 2011.
- [3] Blasius, Erik. Lastenheft Automatisierung von Ladesäulen für das bidirektionale Lademanagement von Elektrofahrzeugpools. Cottbus : s.n., 2012.

- [4] Kaßner, Marcel. Bachelorarbeit “Untersuchen einer uni- und bidirektionalen Kommunikation zwischen einer Simatic S7-1200 Steuerung und einem Elektroauto mit Hilfe des Lade-Controllers CM-230 und einem LIN-Gateway”. Cottbus, 2013.
- [5] Figure 1: Marcel Kaßner. Cottbus. 2013.

Carbon Capture and Storage

Gruchala Tomasz
BTU Cottbus-Senftenberg
Cottbus, Germany
gruchtom@tu-cottbus.de

Fraczkowski Krzysztof
BTU Cottbus-Senftenberg
Cottbus, Germany
fraczkrz@tu-cottbus.de

Abstract—What to do with excess of carbon dioxide emitted by large industrial installations? Geologists believe that the best solution is to inject it into the ground. In the deep structures, aquifers where it can be safely stored for hundreds or even thousands of years.

CCS, carbon dioxide, CO₂, capture, transport, storage

I. INTRODUCTION

CCS is defined as the capture, transport and storage of carbon dioxide, which otherwise would go to the atmosphere. CCS allows the use of fossil fuels while reducing CO₂ emissions into the atmosphere. CCS is used for the disposal of large quantities of this gas (million tons) derived from large industrial sources of emissions. The biggest quantities come from heat and power plants, iron and steel, cement and chemical plants.

Poland is the sixth emitter of greenhouse gases (including carbon dioxide) in the European Union. Annually Poland emits into the atmosphere about 330 million tons of CO₂, of which approximately 205 million tons of installation covered by the EU emissions trading scheme EU ETS (EU Emissions Trading Scheme). The energy sector with annual emissions of approximately 150 million tons of CO₂ is responsible for about 45% of the total national emissions and for about 70% of national emissions covered by the ETS. The EU's aim is to reduce CO₂ emissions by 20% by 2020 (compared to 1990). In connection with the production of electricity and heat using fossil fuels will lead to the increasingly higher costs of buying Permission to CO₂ emissions. Therefore, it is necessary to look for ways to reduce CO₂ emissions in the production of energy. One of these ways is the use of CCS [1].

II. IS THE CCS SAFE ?

Carbon dioxide is commonly found in nature, above and below ground. This represents about 0.04% in the mix of atmospheric gases that we breath, drink as a beverage or mineral water, which can contain up to several percent of CO₂. Natural carbon dioxide is a common phenomenon, especially in volcanic areas. In Poland carbon dioxide emits is naturally way in areas such as Krynica, Szczawnica and Muszyny. Those places are densely populated for centuries and it does not hurt anyone. They are even attractive for patients because of the healing mineral waters. Much more carbon dioxide emits in some areas in Italy and Germany, but also in those areas resides people since centuries. Carbon dioxide is neither toxic nor explosive. It does not burn - on the contrary is used to extinguish fires (extinguish with dry ice or solid carbon

dioxide). After getting into the atmosphere (e.g. chimneys all coal burning power plants) can be easily mixed with air, without hazard. Only at very large quantities in enclosed spaces (e.g. cave, basement) or trough area (e.g. quarry) could pose a risk for people staying there.

In addition, carbon dioxide, closed at a depth of over 800 m in well-studied terms of the natural geological seals is not possible to reach water utility quickly or even reach the surface.

Potential Risks associated with CCS project is negligible. The risk is definitely smaller in comparison with other forms of underground mining activity.

Today, carbon dioxide escapes into the atmosphere in considerable quantities, among others, the chimneys of power plants burning fossil fuels (especially coal, from whose depend on electricity supply). This is not a direct threat to the health of people living near, but contributes to the warming and climate change, and indirectly, among others, to more frequent and more extreme floods, droughts, hurricanes and other adverse weather events. High CO₂ emissions into the atmosphere increase the electricity prices [1].

III. CAPTURE, TRANSPORT, STORAGE

A. Capture

The three possibilities to capture the carbon dioxide:

- Oxy-fuel combustion capture: an oxy-fuel power plant burns coal in almost pure oxygen instead of normal air. The exhaust gases consist almost entirely of water and CO₂, which can be transported and stored.
- Pre-combustion capture: this technology separates the CO₂ already before combustion. The coal is converted by a gasification process in a mixture of CO₂ and hydrogen. From this mixture the CO₂ can be easily separated. This fuel is very clean. After the combustion comes only water.
- Post-combustion capture: in this case, the flue gas goes through a liquid cleaning substance, which receives the CO₂. The cleaning substance is returned into the process in order to make a continuous circulation.

B. Transport

Durable and secure storage of carbon dioxide in underground works only with suitable geological conditions. Ideally power plants are located in the vicinity of these places. This is not always possible. In this case, the captured CO₂ must be transported to the storage site. A pipeline infrastructure is needed, similar as at transport of natural gas or water. It can develop at sites with appropriate industry or many power plants. A CO₂ infrastructure in such metropolitan areas allows separating bundled carbon dioxide at lowest pollution and costs.

Such an infrastructure will be in the long run as a meaningful scenario. For the first CCS projects will be planed only single pipeline from the power plant to the storage. For smaller quantities of CO₂ it may be possible to transport the gas by tanker.

C. Storage

Generally allow two different types of geological formations, the underground storage of carbon dioxide. Firstly, these are the areas of oil and natural gas deposits. Secondly, these porous rock formations at 1,000 meters and more depth, which are filled with saltwater. A potential storage site must have sufficient capacity and the right physical properties to absorb large quantities of CO₂ and to be able to save permanently over a long period of time. Search sites deep underground are to be found both on land and on the high seas under the seabed [Fig.1]. To discover and to explore similar to the costly search for oil or natural gas. Thanks to this parallels the geological knowledge of the industry can be used to find safe storage sites for carbon dioxide and to develop a permanent CO₂ storage. In addition, the permanent storage of carbon dioxide can even be connected to the production of oil and natural gas. These CO₂ is pumped into nearly depleted oil or gas field, to increase enlarge the production rate. This method has been used successfully for many years [3].

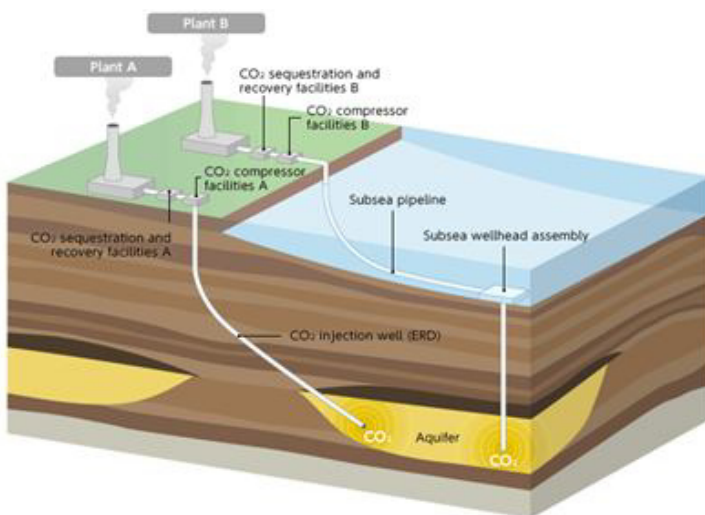

Figure 1. CCS [5]

IV. CCS IN POLAND AND GERMANY

A. Poland

The first polish CCS pilot was planted to be build in the Belchatow power plant. It should be integrated with the new power block of 858 MW. However, due to the lack of profitability of CCS and not granting by the European Commission in December 2012, the project was declined [2].

B. Germany

On May 29, 2006, the groundbreaking ceremony of the Schwarze Pumpe pilot plant took place and two years later on September 9, 2008, the pilot plant was inaugurated.

In 2005 Vattenfall decided on building the 30 MW Oxyfuel pilot plant, an investment of EUR 50 M. The pilot plant is the first visual sign of Vattenfall's project on CCS. The pilot plant is located near the existing lignite fired 1,600 MW power plant in Schwarze Pumpe, Germany. Operation at the pilot plant started in 2008. The plant is planned to be operate for at least 10 years [4].

CONCLUSION

The separation of CO₂ and subsequent storage can drastically reduced climate-damaging CO₂ emissions from power generation. CCS can be understood as a climate-friendly bridge which is contribute to the easy change from fossil fuels to renewable energy.

REFERENCES

- [1] http://www.pgegiel.pl/wp-content/uploads/2011/02/FAQ_CCS_A5_dodruk_2011_pol_ekran.pdf
- [2] http://pl.wikipedia.org/wiki/Sekwestracja_dwutlenku_w%C4%99gla
- [3] https://www.eon.com/content/dam/eon-com/de/downloads/0/090921_CCS_Broschuere_DE.pdf
- [4] <http://www.vattenfall.com/en/ccs/technology.htm>
- [5] https://www.japex.co.jp/english/technology/images/eng_ccs_img01.gif

Application of Phase Shifting Transformers in Central-East Europe enabling high integration of Renewable Energies

Saeed Salehinajafabadi, Gridlab GmbH

Abstract—With the high integration of renewable energies into power systems, incited by governments and forced by regulations, more and more change has to be done in the old fashion transmission systems to guarantee a secure power delivery. Unlike traditional networks with concentrated mass generation in optimized selected locations, new trend of generation tends to have more number of small generation sites mostly far from the load. Majority of transmission system operators (TSOs) in Europe have plans to install more lines and strengthen their grids by any means possible, allowing the power to pass through with less risks. One of commonly used measures to manage the power flow, enabling system operators to work in the safe margins, is Phase Shifting Transformer (PST) application. In this paper, after investigation the situation, the use and impact of PSTs will be studied. Calculation shows that PSTs can play a very important role for controlling power flow and enhancing the system operation with high penetration of renewable energies.

Keywords: Phase shifting transformers, system security, transfer capacity, renewable energies and congestion analysis

I. INTRODUCTION

HIGH price of fossil fuels, moving toward energy independencies from other countries especially other continents both from market and political point of views plus climate change policies to reduce greenhouse gas emissions and global warming impacts led to a huge trend to move toward renewable energies. In this movement, Europe is the most active player and Germany has the highest ratio of renewable energy integration due to the culture and government incentives.

A. 20-20-20

About 2005, discussions about change in the electricity production with conventional methods started in European Union (EU) mostly regarding climate change. First policy regulation was signed in 2007 by EU members with this goal to reduce its greenhouse gas production by 20% of year 1990 until 2020. This policy was welcomed by majority of members

This paper includes confidential information and data owned by 50Hertz and GridLab GmbH presented for the IEEE course.

and as numbers are showing, by 2011 the EU reached 17% reduction of CO₂ emissions (comparing to 1990). This fast achievement made the council to change the goal to 30% by 2020 which was more challenging than the 20-20-20 plan but not well seen back then.

B. Germany movement toward RES

Following the reactor accident of Fukushima-Japan, Germany made stricter regulations regarding renewable energies. Decision of turning off all nuclear power plants in Germany by 2020 and reaching 80% renewable energy production by 2050 by government was a big shock for power system operators. The unseen challenge by politicians was the fact that power system with high intermittent generation will be much more difficult and risky to operate.

This is a common problem by majority of studies regarding the renewable energies to overlook and neglect the stability of system and strength of grid by integrating high ratio of renewable energies. Studies mostly consider the availability of renewable source and business case of the project and since government is supporting the act, TSOs should keep up with this fast growth of integration.

II. THE CHALLENGE AND PLAN

High penetration of renewable energies will lead to a series of consequences challenging the system operators:

- Increased use of renewable energies leading to increased intermittency.
- Increased renewable on remote locations lead to more long distance transmission.
- Increased intermittency leading to increased variable load flows.
- Increased variable flows leading to decreased transfer capacity.
- Decreased transfer capacity leading to increased transmission congestion.
- Congestion results in price differences in different zones.

One of the main results of these consequences is the transfer capacity causing congestion in interconnections and interlines of transit grids. In Europe, some countries and TSOs are mostly consumer of cheap electricity of other TSOs or countries (e.g. 50Hertz Germany has a high production and

low load profile which will increase even more in the next few years by installing more off shore wind turbines and APG Austria has a high energy consumption and currently sharing the same market with Germany leading to high transit flow from north of Germany to Austria through several TSOs).

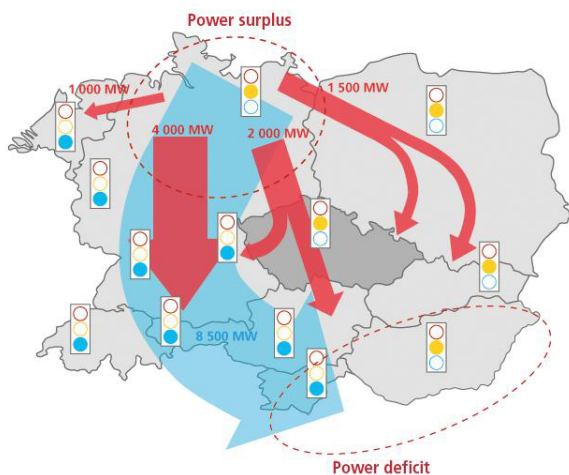

Figure 1. loop flows and transit flows caused by cheap energy production far away from the load [CEPS website]

To cope with this problem, system operators and grid developers tend to apply *generation re-dispatch, load curtailment/demand response, topological changes* and *installing FACTS devices*.

III. COMMON PST STUDY 50HERTZ-PSE-CEPS

As explained above, transit flow of unplanned green energy may lead to endanger the security of the system. Poland TSO (PSE) and Czech R. TSO (CEPS) have been the main path flows for the north-west transit flow caused by being Germany’s neighbor (high renewable penetration).

In March 2014, PSE and 50Hertz TSOs agreed to conduct a new study to solve the problem of unplanned cross border power flows between Poland and Germany based on Operation of Phase Shifting Transformers in the interconnections with this scope that system security will be strengthened and additional capacities between Germany and Poland will be available for cross-border electricity exchange, thus fostering the European energy market.

The search for a suitable joint solution for better controlling unplanned loop flows between PSE and 50Hertz were initiated in mid-2012, leading to a pilot agreement on a virtual Phase Shifting Transformer (vPST Pilot) on the German-Polish border based on redispatching measures. In the course of the vPST Pilot, it became obvious that these measures were insufficient: subsequently, both TSOs agreed upon the necessity of installing physical Phase Shifting Transformers (PSTs) at the German-Polish border. According to the PST Agreement, PSE commits to install the PSTs in the Mikułowa substation. This will enable the control of power flows on the

cross border line Mikułowa-Hagenwerder (planned December 2015). 50Hertz will install PSTs in Vierraden substation that controls the power flows on the cross border line Vierraden-Krajnik (planned October 2017).

The PST Agreement constitutes an important step towards the coordinated operation of interconnected system paving the way to limiting negative effects of unplanned cross border power flows in Central Eastern Europe and increase overall security of system operation. PSE and 50Hertz look forward to playing an active role in developing future approaches for coordinated power system operation and cross-border capacity allocation in other European regions.

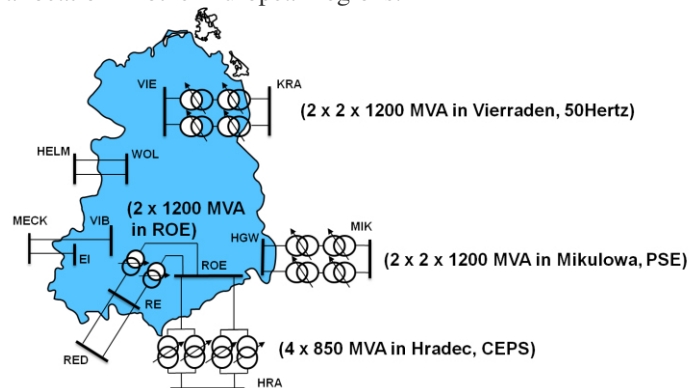

Figure 2. PST constellation of the project (blue area is 50Hertz control area)

It should be mentioned that none of PSTs have voltage regulation (ability to regulate magnitude of voltage) but PST tapping will result to voltage drop/rise in busbars. PSTs installed in each location have the same parameters and characteristics but different from other locations (except 50Hertz PSTs) Table 1.

Table 1. main parameters of PSTs

	Location	Rated power S_r	Rated voltage U_r	Number of taps	Phase angle regulation	Voltage regulation
50Hertz	Vierraden Röhrsdorf	1200 MVA	410 kV	65 ($\pm 32+0$)	$\pm 20^\circ$	No
PSE (Poland)	Mikulowa	1200 MVA	410 kV	65 ($\pm 32+0$)	$\pm 20^\circ$	No
CEPS (Czech)	Hradec	850 MVA	420 kV	65 ($\pm 32+0$)	$\pm 30^\circ$	No

IV. PREPARATION OF GRID MODEL, MARKET MODEL AND SCENARIOS FOR 2015

Since the first PSTs will be into operation by end of 2015, all the calculations should be done based on progress and network of year 2015. The used model for this study has been developed by 50Hertz TSO (Grid Dev. Dept.) based on 2013 actual grid. The update has been done with close cooperation with neighboring TSOs (TenneT, APG, PSE and CEPS) to be as close as possible to the real status of grid.

Used market model containing 8760 hours (one year) load and production for whole ENTSO-E region, is built up on

2007 actual data for 2015. This model contains all assumptions of nuclear power plants outages and installed PV and Wind generations by 2015 in Germany and other countries as well.

To have a better look to the situation, study was done by selecting limited scenarios out of 8760 hours to represent the worst case scenarios and have the chance to examine them more carefully. Selected scenarios are 8 hours with different characteristics in different months of year and different hours of days. As can be seen in the table 2, main focuses of selected hours are high/low wind, high/low PV, high/low load in Germany and high/low exchange in Germany. These hours are extracted from 8760 hours by screening the whole year by INTEGRAL 7 calculation tools.

Table 2. selected scenarios: 4 winter scenarios and 4 summer scenarios

Scenario	Wind infeed 50Hertz	PV infeed 50Hertz	Exchange saldo* 50Hertz	DE load	Exch. saldo* DE	Concrete hour in 2015
W1a	11895	0	7882	91700	4670	Thu, 18. Jan, 5-6 pm
W1b	6827	0	7073	83800	-8	Wed, 24. Jan, 4-5 pm
W2a	11961	445	12651	60200	12846	Sun, 14. Jan, 3-4 pm
W2b	770	1424	5514	46900	8366	Sun, 4. Mar, 8-9 am
S1a	6044	3296	8653	75600	81	Thu, 5. Jul, 9-10 am
S1b	2031	5130	6564	84100	6727	Wed, 19. Sep, 11-12 am
S2a	6414	2716	7309	55900	6860	Sun, 9. Sep, 8-9 am
S2b	627	6414	5912	60200	10880	Sun, 19. Aug, 10-11 am

* SALDO: IMPORT = -, EXPORT = +

V. CALCULATIONS

Handling of each scenario starts with loadflow of that specific hour to monitor the line loadings and bus voltages. First focus of any calculation is on 50Hertz control area (Figure 3).

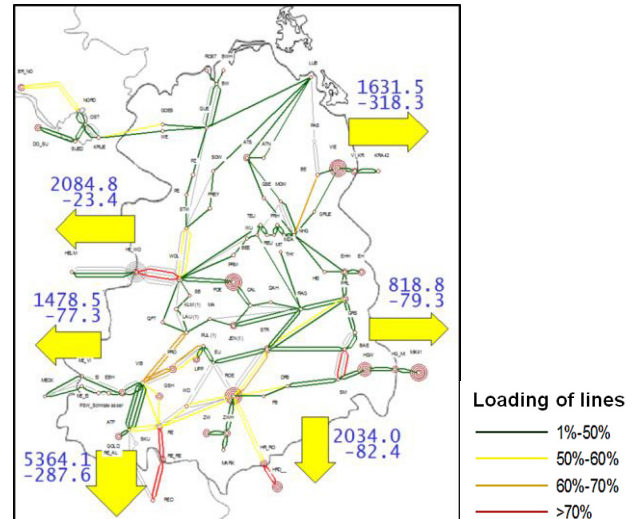

Figure 3. 50Hertz grid calculated condition for scenario W2a in 2015

Available measures to enhance system operational conditions are generation redispatch, PST tapping and reactors and capacitors in case of low or high voltages. It has been seen that redispatch is the most effective approach in extreme scenarios. Note that the interconnection between south of 50Hertz and Bayern part of TenneT is highly overloaded (not a faulty result considering high consumption of Bayern district and expensive power generation in this region).

A. Redispatch of conventional power plants

Redispatch is usually done when export from 50Hertz to TenneT is high (due to high renewable/wind generation in 50Hertz) and therefore to decrease the generation in 50Hertz and increase in TenneT. The list of available power plants with max and min limits is always considered for this procedure besides the overall minimum conventional generation limit of 50Hertz (about 4000 MW).

Another measure which can be taken into account in very sever conditions is to curtail the wind generations which is more costly and less likely in normal conditions.

In this scenario, conventional generation of 50Hertz power plants has been decreased from 10340 to 6340 This change in generation mostly solves majority of 50Hertz internal congestions (Figure 4) and even voltage profile. It can be shown that sometimes this measure will cause overloads inside TenneT grid but in majority of cases it also results in solving the 50Hertz-Bayern (RED-RE profile) congestion.

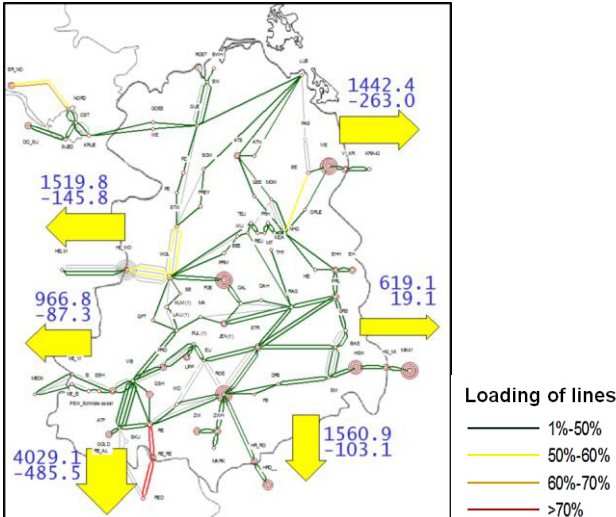

Figure 4. 50Hertz grid calculated condition for scenario W2a in 2015 after redispatch

B. PST tapping

After redispatch, PSTs are used to solve (or minimize) congestion problems in Poland and Czech R. This PST tapping is done in an iterative way by changing the tap position asymmetrically to get to the optimum position. The term “Asymmetric PST tapping” refers to change the tap position of PSTs independently and usually leads to different positions for each PST location. The process is done both by considering the effect of tapping in each PST on its own line and also on the other lines. In Figure 5 you can see that by tapping the VIE-MIK PST, loading of all lines will be affected.

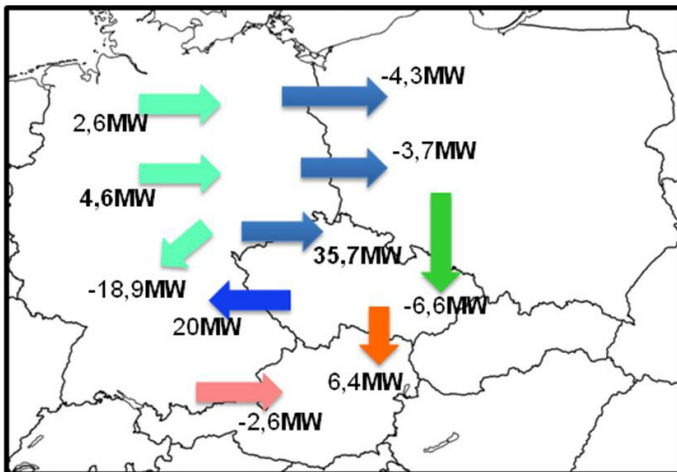

Figure 5. effect of changing the tap position in HRD (+ one tap toward pushing power)

Calculations have shown that this change is linear in majority of case for a broad range of taps. It should be mentioned that in the model, higher + taps indicated pushing the power forward and higher – taps will result to blocking (and in some cases reversing) the power flow through the PST.

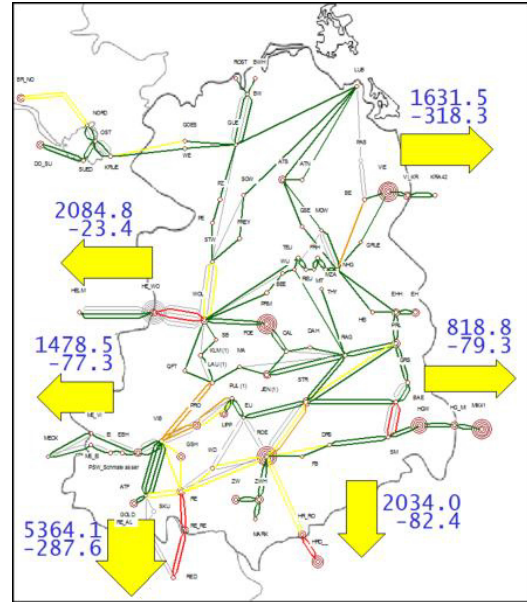
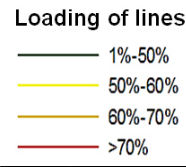

Fig 6. (a)



Legend for Fig 6.

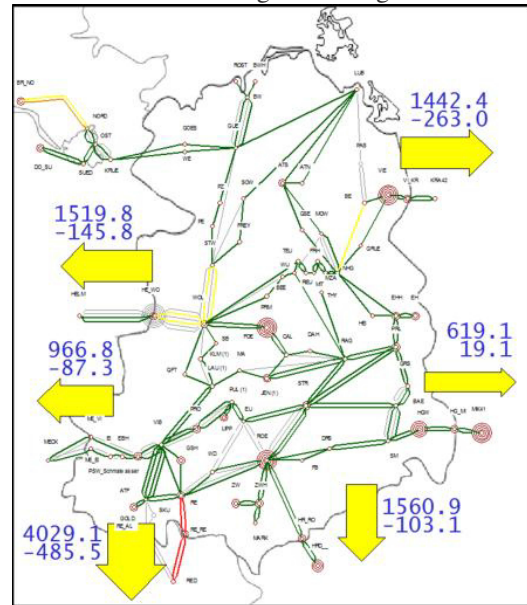

Fig. 6 (b)

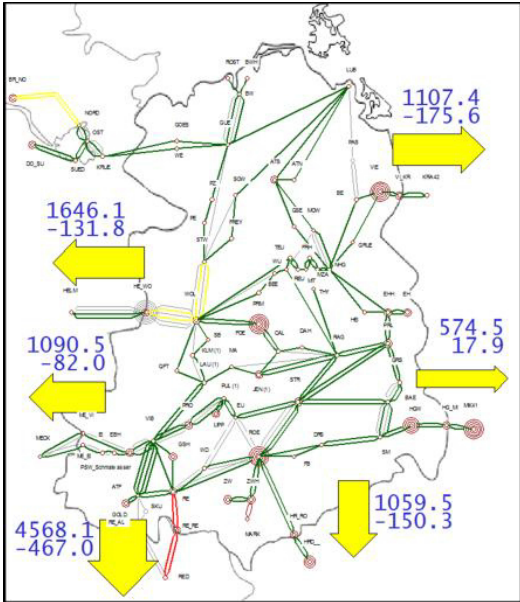
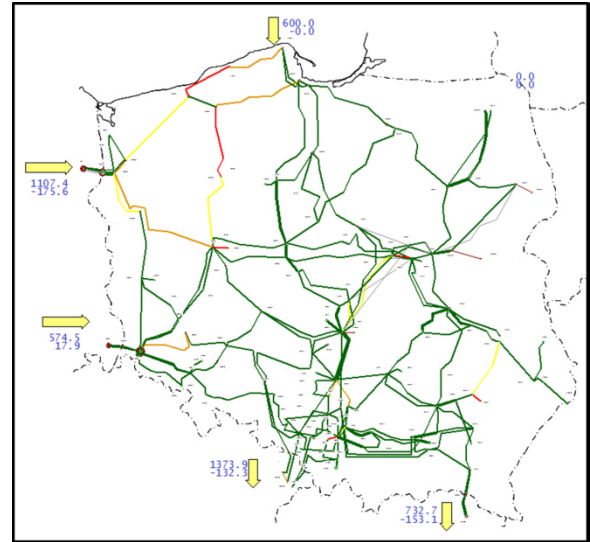

Fig. 6 (c)

Figure 6. loading of 50hertz control area and tie lines load flows a) before redispatch and PST tapping, b) after redispatch, c) after redispatch and PST tapping for scenario W2a



(b)

Figure 7. loading of PSE lines a) before PST tapping and redispatch, b) after PST tapping and redispatch for scenario W2a

It is to be seen that PST tapping is not beneficial to TenneT TSO since the blocking is being done to have more security in Poland and Czech which pushes more energy to TenneT, resulting to congestions inside their internal lines and more transit to Austria from southern corridor of Germany.

It can be shown that Bavaria and Austria are the biggest neighboring importers of 50Hertz (northern generation to be more accurate) energy causing the main north-south transit flow in the Central East Europe. ETSO-E data shows that Poland is an energy independent TSO in majority of hours of the year but a main corridor for the transit flow in CEE and Czech is mostly an exporter of energy and also the following path to Austria and Hungary.

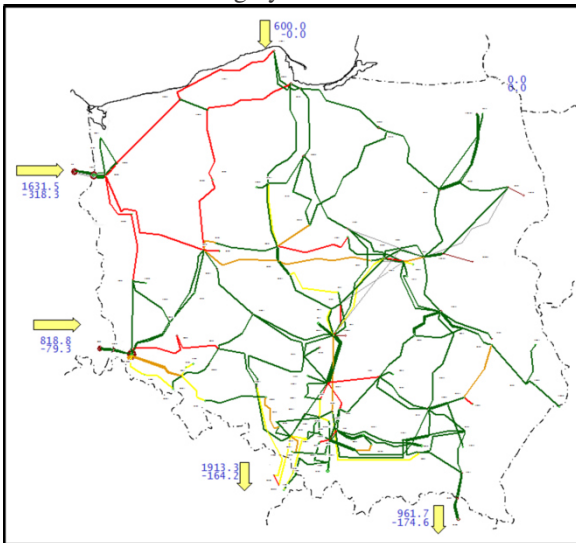

(a)

C. Effect of PST tapping of voltage

Since planned PSTs are big machines (from the power point of view) and the current passing through them is considerably high in upper tap positions, system will experience a high voltage drop in extreme tapping scenarios toward pushing. This effect can be more crucial in case of losing one circuit of tie lines or the parallel PSTs (n-1) leading to overloading the remaining PSTs and higher voltage drops.

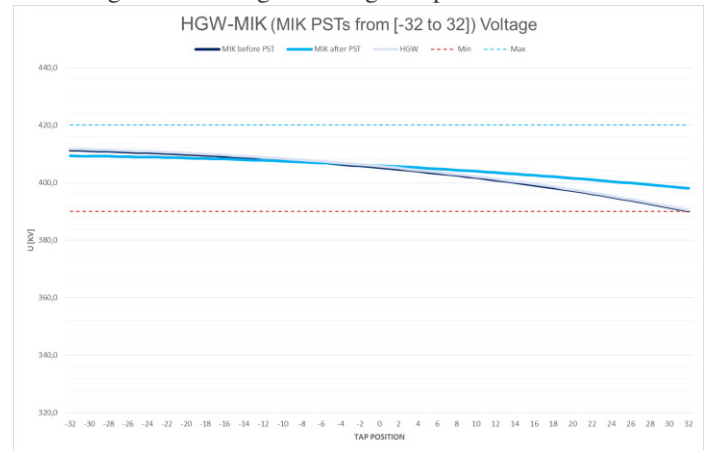

Figure 8. Effect of PST tapping in Mikulowa on neighboring busbars

This effect can be used as a solution during off peak times (during midnight and early morning) when low loading of system may lead to rise of voltage and PSTs can work as big reactors in grid via creating a loop flow in the network.

D. Resynchronization of interconnection

Since PSTs can change the phase angle of busbars directly in a broad range by tapping, they can be useful for resynchronization of interconnections that they are installed in.

There are some regulations for resynchronization of two systems like voltage difference and angle difference. Current regulation for high voltage transmission networks indicated that the difference between voltage magnitudes of two systems should be less than 40kV and phase angle difference lower than 20 degree. It can be easily concluded that in case of higher phase angles, PSTs can help in a very efficient way. In the following example, it has been assume that the line between ROE and HRD has been disconnected. As you can see in Figure 9, PSTs in HRA can change the phase angle to be able to connect the systems again.

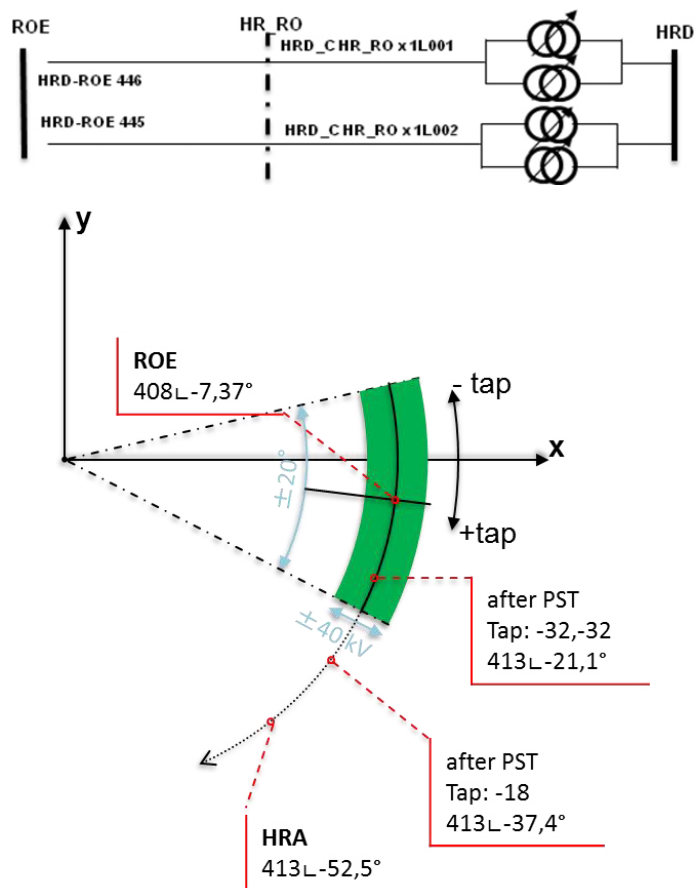

Figure 9. Resynchronization between ROE and HRA is possible by PST tapping in HRA

VI. CONCLUSION

With high renewable generation penetration to EU grid and expected to be more and more every year with a high rate, TSOs efforts to find the fastest and cheapest way to keep up with this trend and ensure a secure operation have resulted to move toward both grid extension and use of FACTS devices.

Phase shifting transformers are proven to be useful to enable the grid to have more strength for welcoming more renewable energy integration. They are common used devices to increase transfer capacity, higher security level, solve congestion problems, improve controllability of network and

sometimes to change the angle for resynchronization and in some cases to create a loop flow to decrease voltage of neighboring busbars.

Experiences in other parts of Europe have shown that coordinated PST utilization towards a global optimum can be more effective to increase the transmission capacity.

It easily can be seen that application of PSTs will affect different TSOs in the system with different impacts. In very extreme scenarios (high wind in north of Germany and high consumption in Austria, Italy and Bayern), blocking the loop flows by PSTs will lead to higher security level in PSE and CEPS but may lead to internal congestions in TenneT lines. This might be itself the very main reason to prove that PSTs are helpful devices but not the final solutions. Extending the grid and installing new lines (e.g. the North-South HVDC line in Germany) should be always considered as the real measure.

REFERENCES

- [1] **Council of the European Union** (2007): European Council, Brussels, 8/9 March 2007, Presidency Conclusions, Doc.7224/1/07 REV.1
- [2] **Fischer, Severin** (2009): Die Neugestaltung der EU-Klimapolitik: Systemreform mit Vorbildcharakter? Published in: Internationale Politik und Gesellschaft, 2/2009, pp. 108–126
- [3] **ENTSO-E** (2014): ENTSO-E position on European Union policy framework for climate and energy in the period from 2020 to 2030
- [4] European Wind Integration Study (EWIS), 2010. Available at: <http://www.wind-integration.eu/>
- [5] Czech Energy Agency, www.czrea.org
- [6] Czech Transmission System Operator, www.ceps.cz
- [7] **PSE publications** (2014): DEVELOPMENT PLAN for meeting the current and future demand for electricity for the years 2010 - 2025, Update for the period of 2014 - 2018, available on www.pse.pl
- [8] 50Hertz-PSE agreement (2014): Virtual PST study, available on www.pse.pl
- [9] ENTSO-E Draft Network Code for Operational Security (2012)
- [10] **REALISEGRID** (2010): Improving network controllability by coordinated control of HVDC and FACTS devices
- [11] www.50hertz.de