

4. INGENIEURTAG 2018

DER FAKULTÄT MASCHINENBAU, ELEKTRO- UND ENERGIESYSTEME und
DER FAKULTÄT ARCHITEKTUR, BAUINGENIEURWESEN UND STADTPLANUNG
NESEFF-NETZWERKTREFFEN 2018

TAGUNGSBAND

Herausgeber:
Prof. Dr.-Ing. habil. S. Simon
Dr.-Ing. A. Straub

Tagungsband zu den Veranstaltungen:

4. Ingenieurtag

der Fakultät Maschinenbau Elektro- und Energiesysteme und der Fakultät
Architektur, Bauingenieurwesen und Stadtplanung, neseff -Netzwerktreffen 2018

Herausgeber:

Prof. Dr.-Ing. habil. Sylvio Simon

Dr.-Ing. Andrea Straub

Brandenburgische Technische Universität Cottbus-Senftenberg
IKMZ, Universitätsbibliothek
Platz der Deutschen Einheit 2
03044 Cottbus

ISBN 978-3-940471-43-7



network for energy supply and energy efficiency

IURS e.V.
Institut für Umwelttechnik und
Recycling Senftenberg e.V.

www.b-tu.de

Vorwort

Im November 2018 wurden die 4. Ingenieurtage an der Brandenburgischen Technischen Universität Cottbus – Senftenberg begangen. Dabei fanden die Veranstaltungen an der Fakultät Maschinenbau, Elektro- und Energiesysteme am Campus Senftenberg sowie an der Fakultät Architektur, Bauingenieurwesen und Stadtplanung am Standort Campus Sachsendorf statt. Neben den Wissenschaftlern der BTU präsentierten auch eng mit der BTU verbundene Partneruniversitäten ihre wissenschaftlichen Ergebnisse.

An der Fakultät Architektur, Bauingenieurwesen und Stadtplanung standen einige Vorträge unter dem Motto des Klimawandels und dessen Auswirkungen auf den Baubereich sowie angrenzende Bereich unter Beachtung verschiedener Klimabedingungen. Dabei zeigte es sich, dass es signifikante Unterschiede aber auch einige Gemeinsamkeiten hinsichtlich des notwendigen Umgangs mit den sich verändernden Umgebungsbedingungen im Bauwesen gibt. Deutschland nimmt hier eine führende Rolle für energieeffizientes Bauen ein.

Die Veranstaltung führte zum breiten Konsens, dass eine Bündelung der Kompetenzen in der Wissenschaft und ein Ausbau der Zusammenarbeit global zu einer Verbesserung der Klimaschutzes in der eigenen Region führt.

In der Fakultät Maschinenbau, Elektro- und Energiesysteme wurden Vorträge zu den Themen Akustik und Simulation gehalten, die besonders Verbesserungen im Logistikbereich bringen. Diese Themen zeigen, dass im Maschinenbau durch energieeffiziente Verfahren aktive Maßnahmen für den Klimaschutz durchgeführt werden können.

Das internationale Netzwerk neseff, welches auf Anregung der BTU Cottbus-Senftenberg im Jahr 2015 in Baku (Aserbaidtschan) gegründet wurde, ist ein wichtiger Schritt für eine globale Zusammenarbeit von Wissenschaftlern unterschiedlicher Länder. Das internationale Netzwerk setzt auf Kooperationen in den Schwerpunkten Energieerzeugung und Energieeffizienz, in denen man sich mit bedeutenden und zentralen Fragen der modernen Volkswirtschaften beschäftigt. Durch dieses Netzwerk wird es auch möglich, Studierende aller Mitgliedsuniversitäten in die Zusammenarbeit zu integrieren und zu zeigen, was globale Zusammenarbeit bedeutet, wie sie gelebt wird und funktioniert.

Einige Vorträge sowie wissenschaftliche Arbeiten zu wichtigen Fragen/Problemen der Zeit werden hier in diesem Band präsentiert.

Sylvio Simon

wissenschaftlicher Leiter
des Netzwerkes neseff

✉: netzwerk_eseff@jurs-ev.de

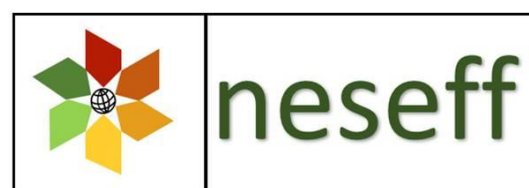

network for energy supply and energy efficiency

Inhaltsverzeichnis

THE INNOVATIVE DESIGN OF THREE-WHEELED HANDBIKE	1 - 7
EXAMINATION OF GAS BUBBLES FOR THE APPLICATION OF FOAM METALS	8 - 10
POSITIONING OF INDUSTRIAL ENTERPRISES BASED ON VOLUNTARY ENERGY STANDARDS	11 - 19
AN ADAPTIVE MANAGEMENT APPROACH IN THE CONTEXT OF CLIMATE CHANGE	20 - 31
PROBLEMS OF THE RENEWABLE ENERGY MARKET DEVELOPMENT IN UKRAINE	32 - 43
THE PROBLEMS OF THE SUSTAINABLE INDUSTRIAL USE OF LANDS UNDER CHANGING CLIMATE	44 - 55
THE INFLUENCE OF FORM OF SURFACE OF THE LAYERED OUTSIDE WALLS OF BUILDING ON THEIR CAPACITY TO ACCUMULATE (DISSIPATE) HEAT ENERGY AND ON THEIR THERMAL INSULATION CHARACTERISTICS	56 - 63
ПОРОШКОВЫЕ КОМПОЗИЦИОННЫЕ МАТЕРИАЛЫ НА ОСНОВЕ ЖЕЛЕЗА ПОСЛЕ ЦЕМЕНТАЦИИ И БОРИРОВАНИЯ POWDER COMPOSITION MATERIALS ON THE BASIS OF IRON AFTER CEMENTATION AND BORIATION	63 - 73
MULTI-CRITERIAL CHOICE OF ENERGY SAVING MEASURES FOR BUILDINGS IN DRAWING UP ENERGY CONSERVATION PROGRAMS	74 - 90
INFLUENCE OF RUSSIAN CLIMATE (ARCTIC, CENTRE, SOUTH) ON CONSTRUCTION AND RECONSTRUCTION OF ENERGY EFFICIENT BUILDINGS	91 - 98
SYSTEM FOR LNG PRODUCTION AND STORAGE AT POWER STATIONS	99 - 106
EXPERIENCE OF CAPILLARY MATS APPLICATION IN HEATING AND COOLING SYSTEMS IN GERMANY	107 - 114
EIN STOCHASTISCHES SIMULATIONSMODELL DER STREUFELDER DER ZU ERFÜLLENDE MAßE FÜR MEHRWERKZEUG-MEHRSUPPORT-EINRICHTUNGEN BEI DER DREHBEARBEITUNG	115 - 124
REGIONAL ANALYSIS OF THE HAZELNUT SECTOR IN AZERBAIJAN: REQUISITES FOR SUSTAINABLE DEVELOPMENT	125 - 145
DAS KOMBINIEREN ALLER WERKZEUGE ZU EINEM BLOCK IN AUTOMATISCHEN LINIEN MIT SYNCHRONEM MODUS	146 - 152

ПРИМЕНЕНИЕ МЕТОДОВ ПЛАНИРОВАНИЯ АКТИВНОГО ЭКСПЕРИМЕНТА ДЛЯ ОПРЕДЕЛЕНИЯ КОЭФФИЦИЕНТОВ УРАВНЕНИЯ РЕГРЕССИИ С ЦЕЛЬЮ ОПРЕДЕЛЕНИЯ ОПТИМАЛЬНОГО СОСТАВА ШИХТЫ В ПРОИЗВОДСТВЕ КЕРАМИЧЕСКИХ ИЗДЕЛИЙ	153 - 172
ЭНЕРГОАУДИТ ЗДАНИЙ КАК ИНСТРУМЕНТ ПОВЫШЕНИЯ ИХ ЭНЕРГОЭФФЕКТИВНОСТИ BUILDING ENERGY AUDITING IS A TOOL TO IMPROVE THEIR ENERGY EFFICIENCY	173 - 184
CLIMATE FACTOR IN THE RESIDENTIAL ARCHITECTURE OF BAKU	185 - 194
TECHNOLOGY FOR CORRECTED CALCULATIONS OF ESTIMATES OF STATISTICAL CHARACTERISTIC OF OUTPUT SIGNALS OF 16-CHANNEL CORRELATOR	195 - 204
UNTERSUCHUNGEN ZUR WIRKUNG VON HARMONISCHEN UND STOßARTIGEN KRAFTVERLÄUFEN AUF DIE LEBENSDAUER VON WÄLZLAGERN IN TRAGROLLEN AUF DEM VERSCHLEIßPRÜFSTAND DYTROP	205 - 224
ENTWICKLUNG DER TRAGROLLEN FÜR DEN LAUSITZER TAGEBAU	225 - 238

The innovative design of three-wheeled handbike

Mgr inż Wałęga Zdzisław, Tyliczszak Mateusz, Stamierowski Kamil,
Oskar Bednarski

Contact: University of Zielona Góra
Faculty of Mechanical Engineering
<http://www.wm.uz.zgora.pl/>.

E-mail : z.walega@ibem.uz.zgora.pl

Abstract. This projects presents the improved three-wheeled handbike designed for disabled people with paresis of lower limbs. It consist of two wheels at the back placed in a multi-link system and one drive wheel in front. The developed design is universal, cushioned, shake-absorbing, very light in weight and comfortable while riding.

1. Introduction

This projects presents the improved three-wheeled handbike designed for disabled people with paresis of lower limbs. It consist of two wheels at the back placed in a multi-link system and one drive wheel in front. The developed design is universal, cushioned, shake-absorbing, very light in weight and comfortable while riding. The new handbike might be used not only for everyday transport but also in extreme sports, riding on the road and off-road conditions as well as for rehabilitation purposes. It is easily carried and stored.

1. The most common solution used at present is a road bike with one wheel drive in front and two back wheels placed on the rigid rear axle.

This type of construction is not sufficiently convenient for recreation riding due to the lack of shock-absorbing feature which results in low comfort riding.

There is also a less commonly used solution of construction that a drive wheel is located at the back and two steering wheels with multi-link system are mounted in front. This type of construction might be found in mountain bikes.

2. In typical designs of hand bikes the cranks are driven by human hands and are set alternately, but in more modern models and in sports bikes , the cranks are aligned in parallel.
3. The existing types of suspension used in three-wheeled handbikes have not solved the problem of providing a shock-absorbing feature to the rear

suspension with double wishbone which makes a bike with two wheels at the back more stable and more comfortable in any riding conditions.

4. Moreover, the commonly used solutions are quite complex in construction due to the big amount of mounting and connecting elements necessary, as well as special racks needed.

The functionality of handbikes determines their possible applications and depends on many factors such as the geometry of a frame influencing a rider's position during motion as well as his/her comfort of riding, the stability and durability of a bike and finally the riding peremetres.

The previously fitted frames in three-wheeled bikes have enabled a rider to take only two body positions: either the sitting position or the lying one. This type of frames are usually constructed on a single longitudinal part of a square cross-section.

2. Detailed description of the design

The improved design of a handbike makes riding possible not only on the paved and tough surface but in the off-road conditions as well. It has been achieved by implementing the rear multi-link suspension and the properly selected gear.

Due to the use of an innovative solution in the frame construction, a rider is able to take an appropriate body position and additionally the level of comfort, the stability, the durability and riding parameters have been significantly improved.

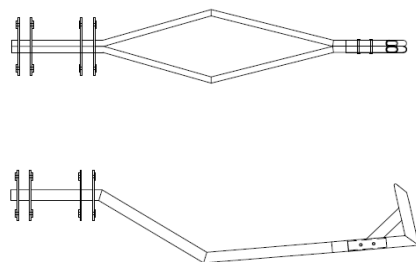

Fig. 6

Figure 1: Frame [1]

The frame can be easily disconnected with the front fork, that helps in transport and storage. The frame allows movement in any conditions of a surface, as the steering head point has been moved closer to the rider's thighs that improved the steering comfort so a rider does not hook his/her knees on the frame.

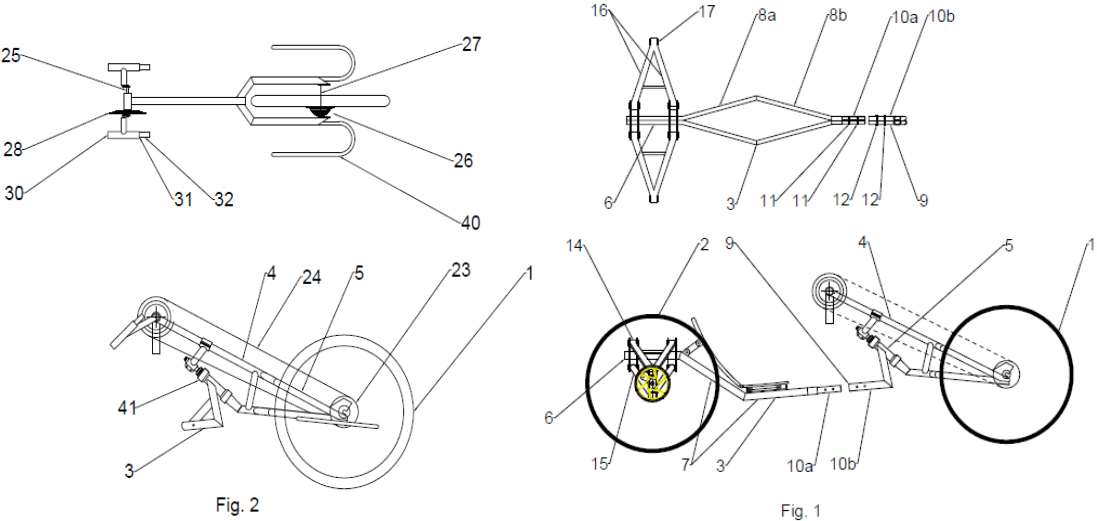

Figure 2: Overview [1]

The multi-link suspension used in the rear axle of a vehicle located just behind the rider's back has eliminated the unwanted effects on the stability of a bike that used to lower the track gauge. Additionally, the improved design of construction and the use of gas shock absorbers have ensured the sufficient cushioning and high riding comfort in any off-road conditions as well as an extreme riding on the road. The wishbone has been made of polyamide with nano carbon pipes that were developed through 3D printing method.

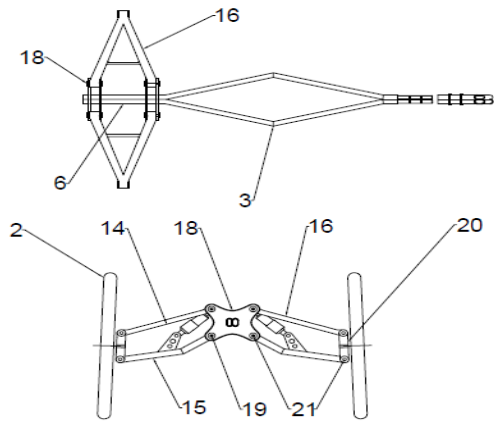

Fig. 3

fig. 2b

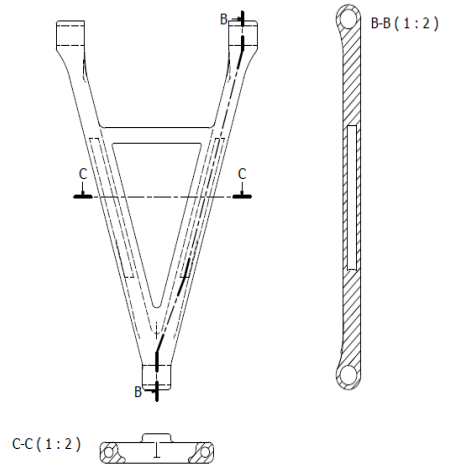

Figure 3: Details [1]

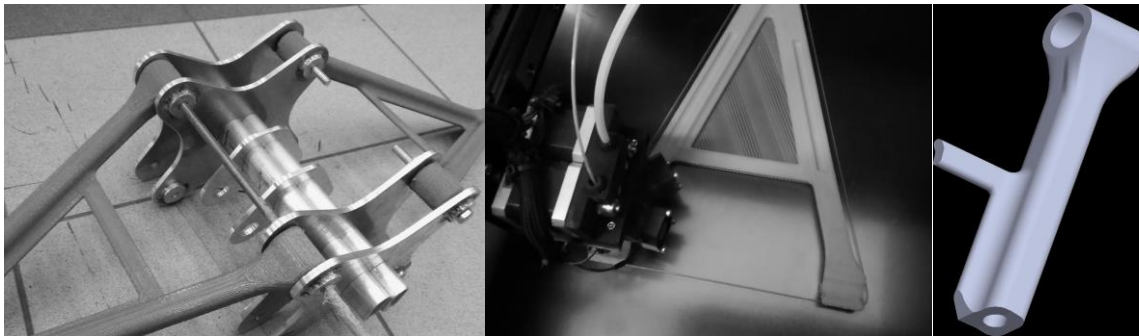

Figure 4: manufacturing details [1]

The rider's seat can be positioned at an optimal angle, not stressing the spine bone and providing the right comfort in different riding conditions. If there is a need of change or a rider wants to change a riding style, this design will allow to choose any wanted angle of the backrest.

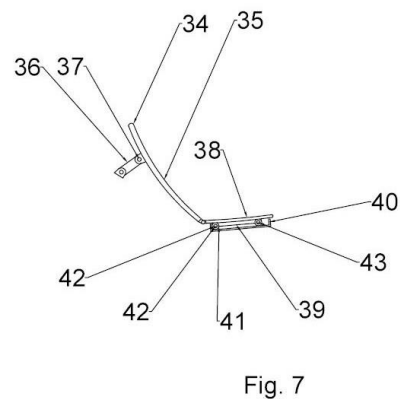
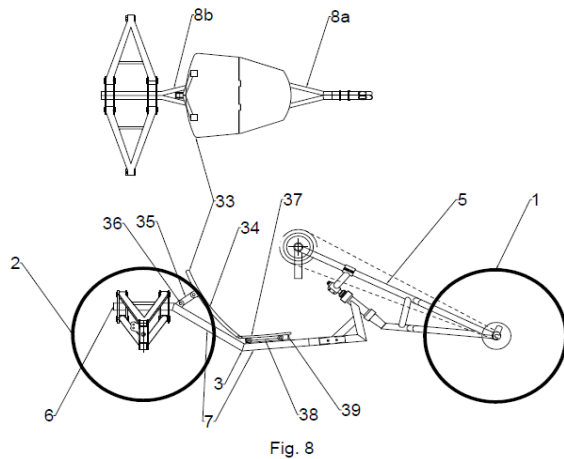

Figure 5: details of drive [1]

The applied solution of disconnecting the front fork from the rest of the main frame enables easy transport, and thus increases the possibility of using a bike in various conditions and places. Thanks to the materials used, the bike has a low weight. The three-wheeled hand-driven bicycle has a front wheel drive which simultaneously functions as a 26-inch steering wheel. It has two 26-inch rear wheels ratably mounted on its axis and a rigid fixed frame to which a steering wheel and a front fork combination assembly is attached to the steering wheel and frame with the steering wheel head. The wheels can be easily dismantled due to the application of a Lefty hub and screws with a clamping lever.

The bicycle frame is 1250 mm long and it has a rear longitudinal part connected to the central part forming a view similar to the view of rhomboid. It is shaped by two arms that form a rhomboid, where two adjacent sides of one rhomboid are bent at the angle of 143 degrees to each other, each side of the rhomboid is bent relative to the back of the frame at the angle of 163 degrees, and the contact points of the rhomboids arms are bent at the angle of 30 degrees to each other and a front longitudinal detachable part is connected to the middle part of the frame so they are bent to each arm of the central frame at the angle of 165 degrees and bent at the end connected to the head of the steering frame at the angle of 83 degrees. The front part of the frame is divided into two disjoint, longitudinal, bush-shaped parts that are fitted with holes and fastened by screws to the clamping lever. One disjoint longitudinal element of the front frame part has a smaller diameter than the second longitudinal element.

The front part of the frame at the bent end is fitted with a transverse reinforcing beam inclined at 130 degrees to the frame and 148 degrees to the connecting point of the disjoint longitudinal parts, and at 120 degrees and 128 degrees to the part connecting the frame to the steering wheel. The bent front part of the frame is welded to the head of the steering frame. The frame is disconnected at the least loaded and the most reinforced point, i.e. at the bent end of the frame equipped with a transverse reinforcing beam. The use of transverse reinforcing beams increases the rigidity of the frame and the safety of the connection in the disconnection point.

All parts of the frame have an oval cross-section. The oval height is 36.2 mm and the oval width is 20.2 mm. The frame is hollow, the wall thickness of the frame is 3.2 mm. The frame is made of aluminum alloy 2017 A - PN / PA 6.

The length of the bike has been chosen in the most convenient way for both styles of riding so that a rider should feel safe and have full control over a vehicle at any time. The width of a vehicle has been reduced in comparison to the width of typical structures. The improved frame structure, the steering wheel and the front fork assembly, have enabled to move the turning point closer to a rider's thighs which resulted in improving the turning comfort so that a rider does not hook his/her knees on the frame 3. The back part of a frame has been attached with a rear suspension unit which contains a pair of upper wishbones and a pair of lower wishbones having A letter shape and two arms, that have been placed between the back wheels.

The wishbone arms and the connection point of each wishbone are ended with longitudinal through holes in order to implement there rubber-metal bushes. The back part of a bicycle frame is fitted with two pairs of mounting plates and both pairs have four holes each. In the upper holes of mounting plates one arm of an upper rocker arm is mounted and the lower holes of each pair of mounting plates one arm of a lower rocker arm is attached. The arms of the wishbone are attached to the mounting plates by joints and hardened screws with self-locking thread preventing self-loosening of the nuts. The distance between one pair of mounting plates and the second one corresponds to the distance between the arms of the rocker arms and one pair of mounting plates is placed at the end of the rear part of the frame.

The lower part of the seat is equipped with two guides at the bottom, cooperating with two guides attached to the arms of the middle part of the frame. The lower part of the

seat is moved thanks to the use of four ball bearings, which move in properly designed guides. In bearings placed in openings made alternately at the contacting ends of the upper part of the seat and the bottom part of the seat, a movable transverse roller is mounted. This solution makes it possible to adjust the angle of the backrest by longitudinally adjusting the lower part of the seat and also ensures adjustment of the lower part of the seat mounted on the guides. Gradually changing the position of the lower part of the seat allows a manual, ratchet adjustment system.

The front fork improves steering comfort. The mounting location of the front wheel 1 driving the vehicle is located at the height of the driver's ankle, which improves steering quality and reduces the amount of force that he must use to make a turn. The front fork is also equipped with a vertical reinforcing beam. The fork at the height of the front wheel is equipped with support feet on both sides, with a mesh net.

The steering wheel and the front fork are connected to the frame through the steering wheel head ending with tapered roller bearings due to their resistance to forces acting transversely to their axis of rotation. The steering wheel is mounted inside the head of the steering wheel frame, which is finished on both sides with tapered bearings, pressed with pressure nuts. These nuts are used to tighten the bearings and the steering wheel mounting in the steering wheel head. One conical bearing is connected to an internal counter pin equipped with a counter nut to which the steering column disconnect element is mounted, ended with counter bolts with clamping levers mounted on the counter bolt and the front fork under the crank mechanism. The second conical bearing is connected to the fork at the height of the front wheel. The counter pin placed inside the steering wheel serves as a reinforcing steering wheel construction.

Thanks to the solution of the detachable frame and the detachable front fork, the bike can be transported after it has been previously stowed into two or a set of parts.

3. Reference:

[1] Zdzisław Wałęga, patent application Patent S. 425305, P.425304, P.425307, Warszawa, 24.04.2018

Examination of Gas bubbles for the application of Foam metals

Shehab Attia, Karel Frana

Contact : Technical University of Liberec

<https://www.tul.cz/en/>

E-mail: shehab.hassan.attia@tul.cz

Abstract: In this paper an experiment was made to find dependence of air bubble diameter & velocity on nozzle diameter, flow rate, viscosity and surface tension of water. Through obtaining change of diameter, values were obtained by laboratorial experiment by the use of an water tank, air pump set-up and monitored through a high frame per second rate camera (130FPS)

1. Experiment

From the illustrated figure, a water tank is filled with water while an air pump is

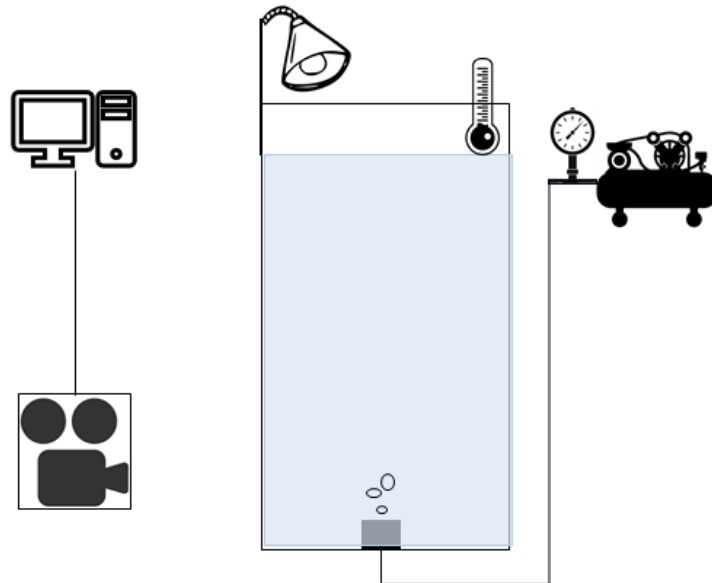

Figure 1: Experiment set-up

connected by tubes inside the water, while flow is observed using the flow meter and by connecting the speed camera to a computer, images of the frequency of 130 Frames per second are sufficient to see how the shape of air bubble will evolve, there is mainly 2 modes of airflow from the air pump, one of which is of a low flow rate (about 8 L/h) and in that phase, it is noticed that air bubble do not

merge during the ascend to the surface of the tank, on the other hand for the second mode, the flow average is more than 80 liter/hr and in this case it is observed air bubble merging into bigger bubbles, velocity is hard so for the goal of foaming the liquid, a low flow rate is more important to be studied clearly.

2. Results for nozzle of 3 mm and flow of 8 l/h

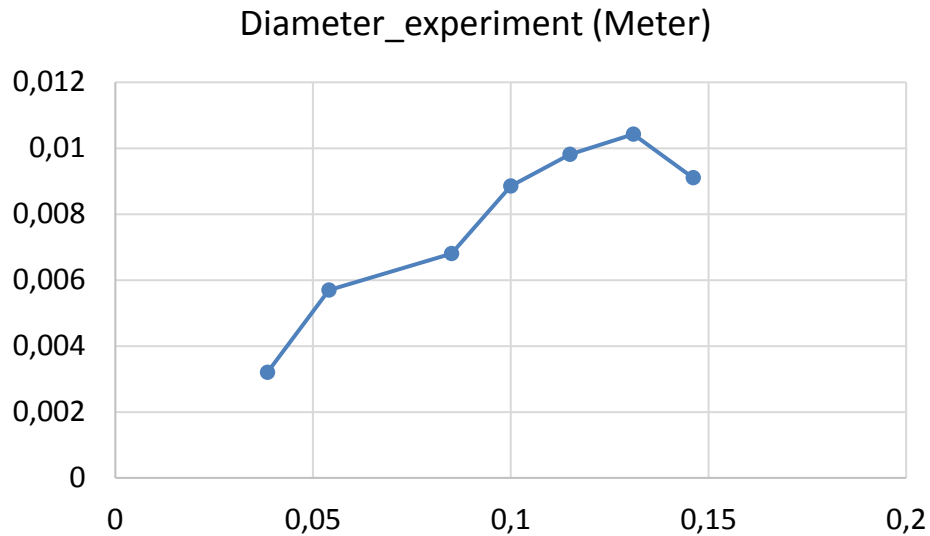

Figure 2: Diameter change with time

Main bubble shapes for tested flow rate:

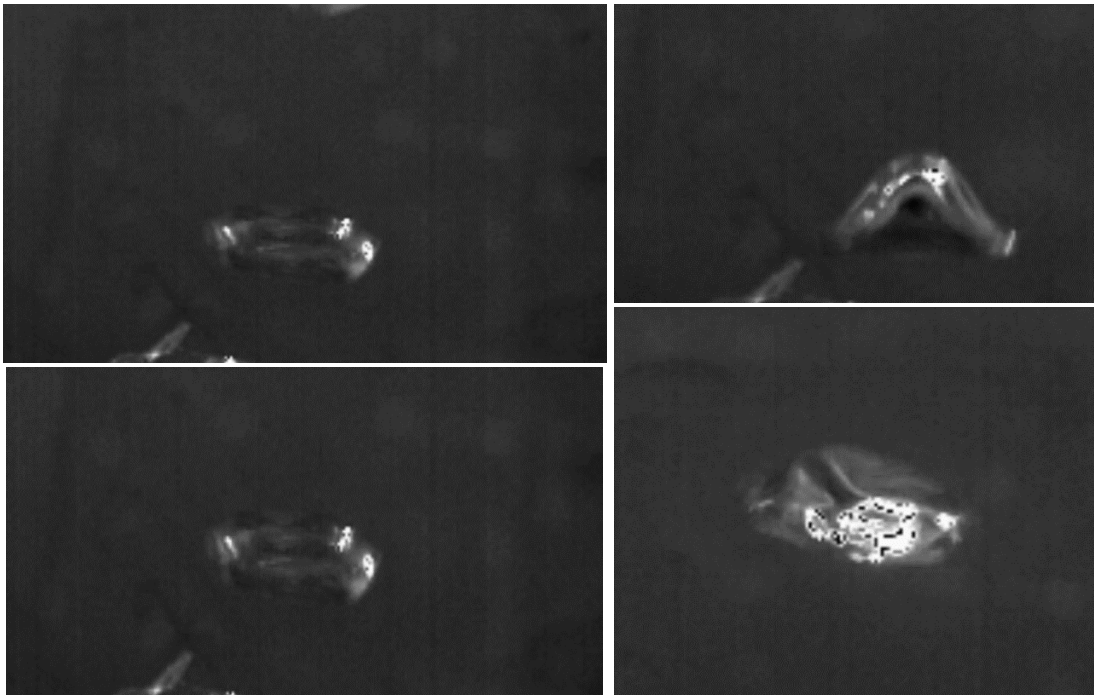

Figure 3: typical bubble shapes for 8 l/h

3. Conclusion

It is possible under the right factors to influence behavior of gas bubble to be

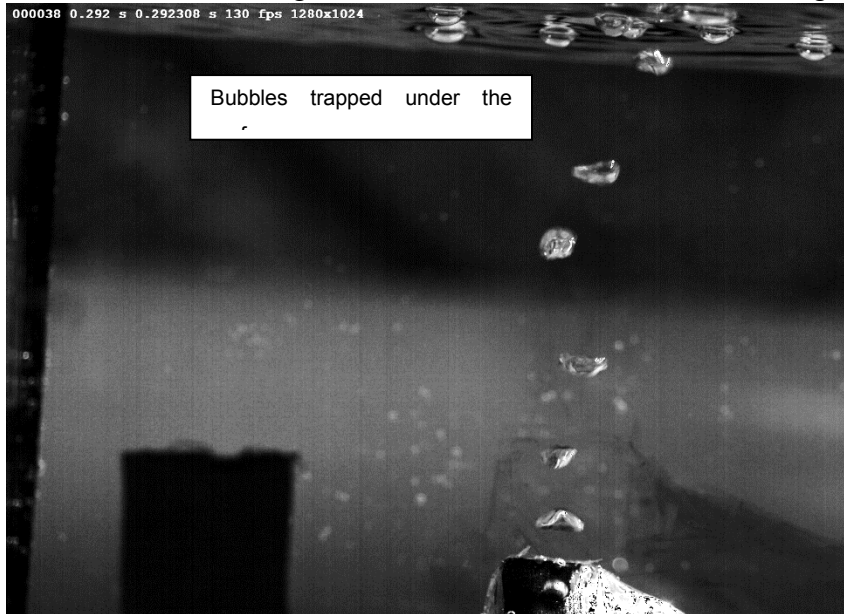

Figure 4: typical bubble shapes for 8 l/h

locked under the liquid surface tension, and this could be adapted in cases to create foam, for the flowrate of 8l/h and nozzle diameter 3 mm.

4. Acknowledgement

This work was supported by the Ministry of Education, Youth and Sports of the Czech Republic and the European Union - European Structural and Investment Funds in the frames of Operational Programme Research, Development and Education - project Hybrid Materials for Hierarchical Structures (HyHi, Reg. No. CZ.02.1.01/0.0/0.0/16_019/0000843).

Positioning of industrial enterprises based on voluntary energy standards

L. Palekhova¹ Cand. Sc. (Econ.), Assoc. Prof., orcid.org/0000-0003-0217-5755

Contact: Dnipro University of Technology
Dnipro Ukraine

E-mail: palehovall@gmail.com
vasil-shvetc@ukr.net

Purpose. The aim of the presented research is to discuss the key actions for to achieve sustainable development of Ukrainian industry by implementation of energy management systems, such as ISO 50001 system, in large industrial enterprises.

Methodology. The research was based on the exploration of the academic literature, international documents and reports, and on analysis of the statistical data referring to Ukrainian energy practice.

Findings. This article presents the analysis of the problem of transition of industrial enterprises to standards of energy management system in order to support global sustainable development principles, in particular, to lower greenhouse gas emissions and reduce energy costs in the production sector. Among other important aspect of this research is the study of the perspectives and difficulties of implementation universal standards of energy management in countries with transitional economies, such as Ukraine.

Originality. The conducted analysis revealed that energy management systems, such as ISO 50001, have a chain of core ingredients, which allow solving the problems of Ukrainian productive enterprises quickly and efficiently. Expected economic benefits could be, in particular, an increase of investment attractiveness; reduction of potential taxes and getting additional funds; acquirement of a marketing tool to attract a new business partners; acquirement of pos-

itive image of the company among consumers, the public and regulatory authorities.

Practical value. In Ukraine, many industrial enterprises have already switched to international management standards, such as ISO 14000 and ISO 90000; on their basis, ISO 50001 could be integrated for expansion of their utility and to enhance energy aspects in management.

Keywords: *energy management, ISO 50001 system, sustainable development, transition economy, Ukraine.*

1. Introduction

Since independence until recent years the energy sector remained the most vulnerable and the most disturbing issues facing the Ukrainian national economy. Today, the need to improve energy efficiency of industrial enterprises with an outlook of increasing competitiveness of the industrial sector through the implementation of voluntary international standards in this field can be clearly recognised [1].

The sustainable development of the production must be carried out in an adequate framework, where energy efficiency and safety are essential elements. At the same time, such framework must provide the necessary energy efficiency to all participants in the value chains [2]. Taking into account these considerations, the international scientific community offers universal voluntary energy efficiency standards, which were designed to ensure building systemic capacity for energy efficiency as tool to promote sustainable production, markets and market relations. The policy objective of voluntary energy standards most frequently emphasized for the industrial sector is enhanced energy efficiency to reduce emissions and to improve economic efficiency.

The experience of a number of countries with advanced economies, notably Germany, demonstrates that international energy standards, in addition to new energy efficiency technologies, offer the possibility of capturing economic returns that can be found in different links in the value chain. Such mechanisms not only enable the energy effective management of production activities, but

also ensure more effective use of resources and a well-sequenced approach to all-encompassing trade, investment and development issues [2].

However, while noting the progress made in developed countries, the special studies confirm that in countries with transitional economies, such as Ukraine, energy management remains limited to an outdated energy practice [3]. According to the World Energy Council, an energy intensity of the Ukrainian industrial sector in 2014 was 0.26, while in Germany it totaled only to 0.07. Global energy crisis has created a catastrophic stress in Ukrainian metallurgy, which is the basis of its export trade. The energy intensity of steel industry in Ukraine is 0.59, while in Germany this indicator is 0.31 [4].

Our reports at previous NESEFF conferences were shown that the existing Ukrainian policies, strategies, as well as the practice of coordination of economy- and energy-related issues, are inadequate to avert a further deepening of the crisis and the reducing energy consumption in the industrial sector. International energy standards are still an emerging type of management where little progress has still been made.

2. Analysis of the recent research

It is worthwhile to note that scientific debates on the energy standards in Ukrainian industrial sector are very weak. Among western studies in context of this research, of particular interest are the publications on reasons to adopt ISO 50001 (e.g. Frederic Marimon et al. 2015 [6]); monographs about energy efficient manufacturing (e.g. ed. by John W. Sutherland et al. 2018 [7]); about strategies for energy conservation in different countries (e.g. Sheldon S. Williamson 2013 [8]).

3. Unsolved aspects of the problem

Results of special studies on Ukrainian energy policy are described in a number of scientific monographs prepared, inter alia, by international organisations (e.g. OECD, 2018 [9]). However, there is very limited analysis in professional discussions on practical approaches to the implementation of energy management.

4. Objectives of the article

The aim of the presented research is to discuss the key actions for to achieve sustainable development of Ukrainian industry by implementation of energy management systems, such as ISO 50001 system, in large industrial enterprises.

In accordance with this aim the following specific objectives were formulated: 1) to assess the changes in energy strategy of the industrial sector of Ukraine, taking into account the global energy crisis; 2) to analyse the benefits of ISO 50001 for Ukrainian enterprises; 3) to identify the most significant barriers to faster and more widespread adoption of an energy management based on international energy standards.

5. Methods

The research was based on the exploration of the academic literature, international documents and reports, and on analysis of the statistical data referring to Ukrainian energy practice.

6. Presentation of the main research

Ukraine's obligation to EU mean adjusting and adapting the models of energy management so that they support nature conservation and reduction of fossil fuel consumption while minimising environmental impacts caused by emissions of greenhouse gasses into the atmosphere [2-3; 10].

The main energy danger facing Ukraine is that the persisting trends in energy intensity of production and consumption patterns continue to deplete non-renewable resources of country. This is illustrated, inter alia, by the following facts [4-5]:

- Self-sufficient in energy of own production is less than 60 per cent (Fig. 1-a);
- The share of natural gas consumed in electricity generation was about 25%, but the share of RES in the country's energy mix amounted to only 5.8 per cent (Fig. 1-b);
- Ukraine ranked first in the world ranking of energy consumption per dollar of gross domestic product (Fig. 2);

- The decoupling of economic growth of Ukraine still linked to consumption growth of primary energy;
- The largest consumer of natural gas remains industrial sector;
- In energy sustainability index, calculated by the World Energy Council in 2014 among 129 countries, Ukraine took the 94th place.

It is clear that as the price of natural gas increases, the need for new approaches to security of supply - through diversification of energy sources - arises. A number of analytical studies (e.g. Palekhov, 2016 [2]) show that energy management in the EU includes two main sets of actions: 1) demand management and efficient energy; 2) gradual increase in the percentage of low-carbon energy sources in energy supply. The Government may have an impact on companies through the regulatory policy, funding and market instruments.

(a)

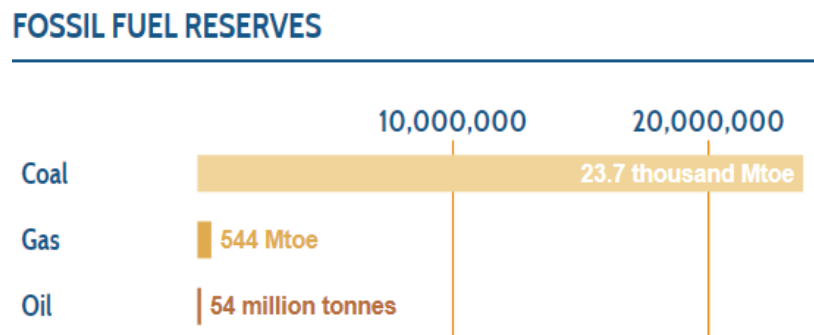

(b)

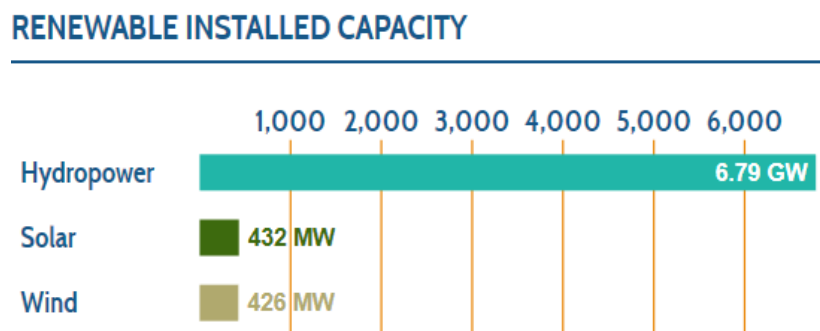

Figure 1: Energy resources of Ukraine [4]

Country	Energy intensity (koe/\$05p)
Germany	0.07
Italy	0.07
Slovakia	0.08
Poland	0.08
Romania	0.08
Czech Republic	0.09
Serbia	0.10
Kazakhstan	0.12
Russian Federation	0.16
Ukraine	0.19

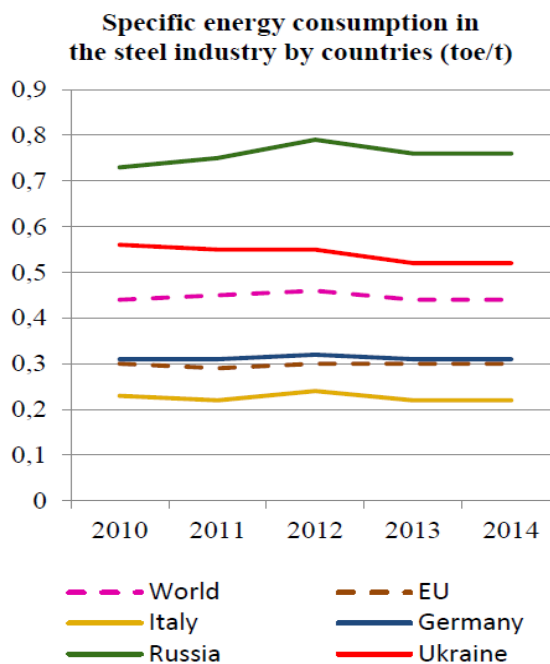

Figure 2: Energy resources of Ukraine [2]

In doing so, the international practices confirmed that voluntary standards of energy management systems are the best tool for market competition. Moreover, standards could also have widely different structures across regions and countries [11].

Nevertheless, the ISO 50001 standard is considered as universal, and its application can be integrated with other management systems for different types of enterprises [12].

Analysis of aircraft strengths of ISO showed that the economic benefits, which are more important for Ukrainian enterprises in the present situation, include: increase of competitiveness due to the presence of an internationally recognized certificate; increase of investment attractiveness, due to the reduction of environmental risks and risks associated with energy supply management; reduction of potential taxes and getting additional funds from the sale of quotas for greenhouse gas emissions; acquirement of a marketing tool to attract a new business partners; acquirement of positive image of the company among consumers, the public and regulatory authorities [13].

However, despite of all the benefits of energy standards Ukrainian enterprises still have barriers on their use. The most common ones are that Ukrainian business leaders do not see the connection between the implementation of ISO 50001 and competitiveness; a large enterprises that have implemented it, do not want to share information openly about their full benefits and difficulties; lack of qualified energy management specialists; Ukrainian tax legislation does not consider the issue of providing benefits to businesses that had a certification.

The Ukrainian Government, however, implements a number of international projects to overcome these barriers such as: Ukraine - District Heating Energy Efficiency Project : Environmental Assessment (Vol. 3) with funding from the International Bank for Reconstruction and Development in the amount of US\$ 382.00 million (Project ID P132741)¹, or UNIDO project Introduction of Energy Management System Standard in Ukrainian Industry with funding from Trust Fund GEF in the amount of US\$ 39.630 million (GEF Project ID 4784)².

Moreover within a case study can be examined a successful experience of JSC “Zaporizhstal” implementation of ISO 50001. JSC “Zaporizhstal” has not only improved technology in production, but also involved employees in a process of reducing the consumption of fuel and energy resources. Under this program,

¹ <http://projects.worldbank.org/P132741/district-heating-energy-efficiency?lang=en>

² <https://www.thegef.org/project/introduction-energy-management-system-standard-ukrainian-industry>

more than 80 no-cost projects were proposed by employees. All adopted measures resulted in decrease in natural gas consumption by 18% comparing to 2012 and by 13% comparing to 2013³.

7. Conclusions and recommendations for further research

The study showed that for future improvement in implementation of EnMS Ukraine requires the following: 1) Promote a policy measures adopted to mitigate climate change based on country experiences, especially on implementation of EnMS; 2) regional and international programmes for specialist training on industrial energy management should be developed; 3) support of the pilot projects are necessary that will show why the implementation of ISO 50001 is beneficial to enterprises; 4) the leaders of the Ukraine should give attention to reduce the tax burden to businesses that have been certified for compliance with energy standards; 5) in addition, more research and informing the companies are necessary to facilitate their effective integration into sectoral value chains that that uphold the highest energy standards.

8. References

1. Palekhova L., Palekhov D., 2017. Anwendung von Energieeffizienzkriterien für Marktstrategien von Großunternehmen in den Transformationsländern. *Energieeffizienz im Bauund Maschinenwesen* [Herausgeber: K.Fraña, S.Simon, J.Grunewald]. Technische Universität in Liberec, p. 44-53
2. Palekhov, D., 2016. Methods for achieving energy efficiency targets: analysis of experience in the EU. *Bulletin of the Pridneprovsk State Academy of Building and Architecture*, 3 (216), pp. 34-41
3. Shvets, V., Palekhova, L., 2015. Energy Strategy of Ukraine: Modern Challenges. *Proceedings of the International workshop "Energy supply and energy efficiency"*. TU Azerbaijan, Baku, 21.09.2015–27.09.2015. Brandenburg University of Technology Cottbus - Senftenberg, pp. 7-9

³<http://www.zaporizhstal.com>

4. World Energy Council, 2017. Energy Efficiency Indicators Database (Last update May 2016). Available at: <<https://www.worldenergy.org/data/efficiency-indicators/>> [Accessed 10 Nov 2018]
5. World Energy Council, 2017. World Energy Trilemma 2016: Benchmarking the Sustainability of National Energy Systems. WEC, London
6. Marimon, F., Casadesús, M., 2017. Reasons to Adopt ISO 50001 Energy. In: Sustainability 2017, 9, 1740; doi:10.3390/su9101740
7. Sutherland, J.W., Dornfeld, D.A., Linke B.S., 2018. Energy efficient manufacturing: theory and applications. Wiley-Scrivener, 1 edition, 468 p.
8. Williamson, S.S., 2013. Energy Management Strategies for Electric and Plug-in Hybrid Electric Vehicles. Springer New York
9. Green Finance and Investment Access to Private Finance for Green Investments. OECD Available at: < <https://doi.org/10.1787/9789264303928-en>> [Accessed 10 Nov 2018]
10. Shvetz, V., Palekhova, L., Simon, S., Palekhov, D., Mammadov, A., 2015. Convergence of energy efficiency policies in the EU and countries with economies in the transfer. *Socio - economic and environmental problems of the mining industry, construction and energy*. TSU, Tula, pp. 398-405
11. Palekhova, L., Simon, S., 2016. Competitive advantages through the implementation of international energy management standards. *Bulletin of the Pridneprovsk State Academy of Building and Architecture*, 3 (216), pp. 43-51
12. ISO 50001:2018 Energy management systems -- Requirements with guidance for use. Available at: < <https://www.iso.org/ru/standard/69426.html>> [Accessed 10 Nov 2018]
13. Palekhova, L., 2015. Implementation of the energy management systems standard in the industrial sector of Ukraine. *Proceedings of the International workshop "Energy supply and energy efficiency"*. TU Azerbaijan, Baku, 21.09.2015 - 27.09.2015. Brandenburg University of Technology Cottbus - Senftenberg, pp. 10-12.

An adaptive management approach in the context of climate change

V. Shvets¹: L. Palekhova¹

Contact: Dnipro University of Technology
Dnipro, Ukraine

Email: vasil-shvetc@ukr.net
palehovall@gmail.com

Purpose. The purpose of the presented research is to reveal the critical functions of adaptive management in the context of climate change adaptation in the countries with economies in transition.

Methodology. The research was based on the an exploration of the academic literature, and the analysis of the international documents and reports, statistical data and Ukraine practice relating to tasks of energy efficiency and climate mitigation.

Findings. This article presents a clarification of concept of adaptive management in order that must be implemented to support climate mitigation by the process of production operation of the enterprise. It reveals key areas of adaptive management approach where efforts are required to meet the climate targets. A second important aspect is the relationship between the Ukrainian climate initiatives and encourages the climate-oriented policies of productive enterprises that should promote only best available (lowest emission) technologies.

Originality. The conducted analysis revealed that productive enterprises in countries with economies in transitional have to take into account two groups of criteria for their integration into sustainable markets: 1) criteria related to the company's ability to mitigate the climate situation in its country or region; 2) criteria related to climate requirements and standards that are maintained or important for an adaptive management of specific enterprises.

Practical value. The significance of the new approach is that the company can change strategy for positioning its business on market, which would focus on sustainable development and climate protection. The adaptive management also should strengthen the cooperation of all parties concerned, in order to ensure that the climate goal is achieved

Keywords: *adaptive management, climate change adaptation, adaptive capacity, sustainable development, transition economy.*

1. Introduction

The Paris Climate Agreement for the post-2020 period sets out the goals and objectives on substantially reduce the risks and effects of climate change, in the context of sustainable development and efforts to eradicate poverty [1]. The way forward towards a sustainable future is to ensure that burden of mitigation of climate change was borne to all countries and economic entities. However, as is well known, climate problems affected the poorest countries more directly, although they do not responsibility for its root causes. And many reports of OECD, UNEP, IPCC and other international organizations emphasize the close relationship between their socio-economic underdevelopment and a growing problem of increased vulnerability related to climate risks [2-3].

A major challenge in developing, including post-Soviet, countries is the development of effective policy guidance and effective methods and technologies for the management of industrial enterprises so that they are able to participate effectively in climate protection.

The Government of Ukraine approved the Concept of State Climate Change Policy Implementation until 2030 [4]. The document formulates the new tasks arising from Ukraine's ratification of the Paris Agreement and subsequent implementation of its provisions with due account for the specific national circumstances, needs, and priorities. According to the Strategy, the prevention of climate change through reduction of anthropogenic emissions shall be achieved by:

- Reducing anthropogenic greenhouse gas emissions and meeting the ob-

ligations under international treaties on climate change, taking into account the indicators of country's socioeconomic development (the Ordinance of the Cabinet of Ministers of Ukraine "Some issues of definition of medium-term priority directions of innovation activity of the sectoral level for 2017-2021 years", № 980 on 16 September 2015);

- Reducing the energy intensity of Gross Domestic Product (the Sustainable Development Strategy Ukraine-2020 approved by Edict of the President of Ukraine № 5 on 12 January 2015);
- A number of activities to improve energy efficiency (the National Energy Efficiency Action Plan for the Period until the Year 2020 approved by Ordinance of the Cabinet of Ministers of Ukraine № 1228 on 25 November 2015);
- Increasing the share of energy produced from renewable energy sources in the overall structure of country's energy consumption (the National Renewable Energy Action Plan for the Period until the Year 2020 approved by Ordinance of the Cabinet of Ministers of Ukraine № 902 on 1 October 2014);
- Developing and implementing domestic greenhouse gas emission trading scheme (in accordance with the provisions of Directive 2003/87/EC);
- Introducing market and non-market mechanisms, and a system for monitoring, reporting that would enhance the effectiveness of and promote mitigation actions, etc.

2. Analysis of the recent research

It is worthwhile to note that scientific debates on the climate-oriented policies and management in the Ukrainian industrial sector have recently increased. In context of this research, of particular interest are the last publications on the economic growth issues in a changing climate impact (e.g. Castells-Quintana et al. 2015 [5]; Sequeira et al. 2018 [6]), socio-economic vulnerability to climate change impact (e.g. Esperón-Rodríguez et al. 2016 [7]), sustainable supply chains based on integrated energy efficiency (e.g. Palekhov et al. 2016 [8]), convergence of energy efficiency policies in the EU and countries with econo-

mies in transition (e.g. Shvetz et al. 2016 [9]), and others. Nonetheless, the adaptive management approaches in the context of climate change remain poorly understood.

3. Unsolved aspects of the problem

This publication is the ongoing researches by the authors under the framework of the NESEFF. The first articles of that series reviewed the main energy challenges in transition economies, convergence of energy efficiency policies in the EU and countries with economies in the transfer, and Ukrainian Energy Strategy [8-10]. These aspects were studied in the context of energy efficiency of production and distribution chains [11], and the issues of responsible production in the energy sector [12]. There were already several articles dealing with responsibility for implementation of the energy management standards as an instrument of competitiveness on industrial markets [13-16]. Separate presentations were also made on issues of the three EU energy packages, as well as their implementation in Ukraine [17]. One new contribution is the topics on adaptive management approach, which brings a energy dimension to the field of competitiveness and trading opportunities [18-19].

However, many issues required clarification and further consideration for countries in transition, particularly concerning the climate change adaptation in the management of enterprises (autonomous adaptation and active adaptation); vulnerability and adaptation assessment; climate-environmental stress and adaptive capacity; mitigation measures and adaptive management in different sectors of industrial activity. The publication of the training manual “Management for sustainable development: Handbook of key concepts” was the starting such work [20].

4. Objectives of the article

The purpose of the presented research is to reveal the critical functions of adaptive management in the context of climate change adaptation in the countries with economies in transition.

5. Methods

The research was based on the exploration of the academic literature, and the analysis of the international documents and reports, statistical data on Ukrainian challenges in delivering energy efficiency and climate mitigation.

6. Presentation of the main research

The Intergovernmental Panel on Climate Change (IPCC) defines adaptation to climate change as a adjustments to appropriate mechanisms of natural or social systems in response to actual or expected climatic effects in order to prevent harm or to obtain useful opportunities [21]. In this context, the UNDP Training Manual “Handbook on Vulnerability and Adaptation Assessment” (2010) defines a framework of vulnerability (V) and framework of adaptation (A) [22]. The entire adaptation program covers global, national and local levels, ensuring the participation of all parties involved at each stage (Fig. 1):

1. Framework V is designed to reduce the impact of activities on long-term climate change - a "first generation" of actions or actions "from top to bottom."
2. The A framework focuses on adapting to climate change, that is, "second generation" or "bottom-up" actions.

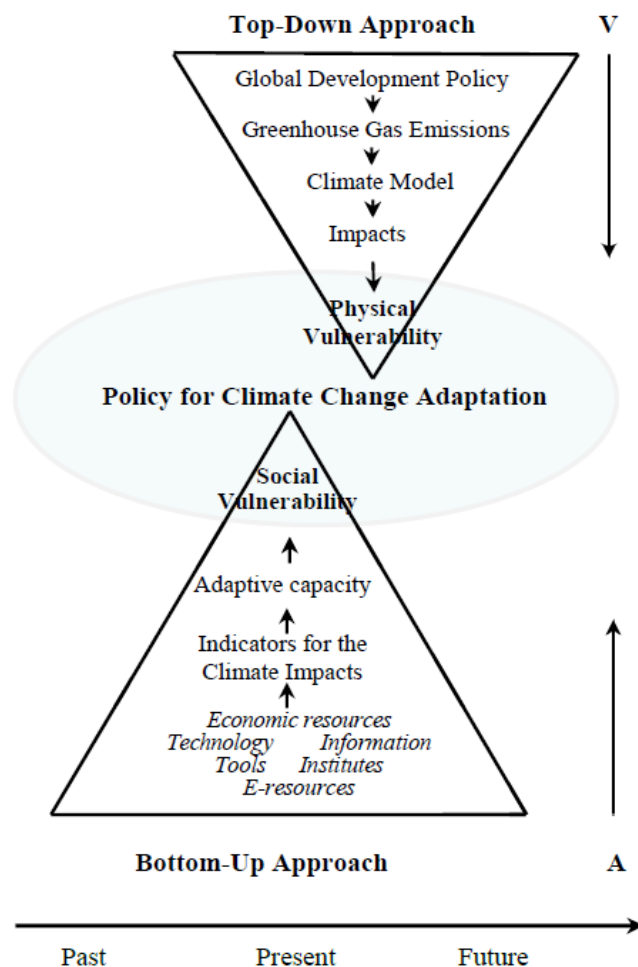

Figure1: UNDP Approaches to Developing Adaptation Actions to Climate Change [20]

As is known, the most significant effects of climate change are revealed not only in gradual global warming, but also in a strong climatic stresses (abnormal drought, hurricanes, floods, changing rainfall patterns, decreasing snow cover, rising sea levels, etc.), the interactions of which are not necessarily linear or additive, and produce varying outcomes in different contexts and regions. The effects of climate change are among the major challenges faced at the national level. The table 1 contains information on key sectors of the economy, which are the most vulnerable to the adverse effects of climate change in Ukraine, and that require adequate adaptive policy and programmatic responses.

Table 1: The most climatical vulnerable sectors of Ukrainian economy [20]

A strong climatic stresses	A vulnerable sector of the Ukrainian economy
Agriculture sector	
<ul style="list-style-type: none"> • Increases of temperature • Reduction in the number of days with sub-zero temperature and snow • Reduction in rainfall 	<ul style="list-style-type: none"> → Increasing the vulnerability of winter to reduce snow cover → Increase of moisture evaporation from the soil surface → Intensive expansion of humus, which leads to a decrease in soil fertility
Water resources	
<ul style="list-style-type: none"> • Increases of temperature • Reduction in rainfall, drought • Severe floods 	<ul style="list-style-type: none"> → Favorable conditions for the development of pathogenic bacteria in water supply → Reducing river flows in the summer, which may have an adverse impact on inland navigation → Physical damage to capital construction objects including buildings, roads, etc.
Ecosystem	
<ul style="list-style-type: none"> • Changes in temperature and precipitation • Increases of temperature • Sea-level rise • Drought 	<ul style="list-style-type: none"> → Changes in the nature of forest areas; increase the height of the line of trees → Water imbalance; secondary pollution from fires in radioactive contaminated areas → Increased estuarine salinity and degradation of river deltas; flooding of coastal lowlands
Energy	
<ul style="list-style-type: none"> • Increases of temperature • Windstorms, strong rainfall, etc. 	<ul style="list-style-type: none"> → Increasing number of emergency situations in energy supply → Changes in terms and flows of water resources for hydro-power
Human health	
<ul style="list-style-type: none"> • Increases of temperature • Heat waves • Extreme weather events 	<ul style="list-style-type: none"> → Impacts on the cardiovascular system → Increased risk of heat stroke, heart disease, respiratory disease, etc. → Reducing the risk to human health from extreme cold

Adaptive management allows to avoid the risks from climatic change by appropriate passive and active accumulation of knowledge about external factors, studying the mutual influences of the environment and the enterprise's activities.

The purpose of adaptive management is to find alternatives to management actions aimed at the effective operation of the company in the long run. The tasks

of adaptive management are realization of balanced development of the enterprise on the basis of continuous evolution, self-regulation and training.

The methodology of adaptive management is described in “Open Standards for the Practice of Conservation” [23], which were developed by the Conservation Measures Partnership (CMP) to integrate environmental aspects and sustainable development into strategic planning. Figure 3 shows the main stages of the adaptive management cycle.

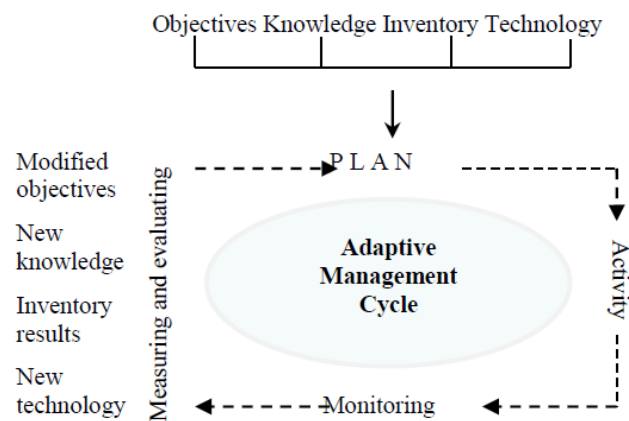

Figure 2: Contents of the adaptive management cycle [20]

New knowledge and experience can confirm existing practices and policies or identify the need for changes in the ‘architecture’ of solutions, goals and objectives of managerial influence, including resource selection, changes in management methods, technologies, processes, product program, etc.

For countries in transition, in particular for Ukraine, the adaptation to climate change is a present and immediate task. However, the study on Ukraine found that the climate-oriented policies and adaptive management are not perceived as a way to create new opportunities for manufacturing companies in domestic and regional markets. This greatly complicates things for the implementation of State policy on adaptation to climate change [8].

Moreover, progress toward sustainable development goals requires the creation of a global value chains with climate-oriented management, and a partnership which includes the companies from developing countries and economies in transition [10-11].

7. Conclusions and recommendations

In the context of new challenges of adaptation to climate change and mitigation of its effects, an important aspect is the relationship between national climate objectives and development policies of productive enterprises.

The concept of adaptive management must be implemented to support climate mitigation by the process of production operation of the enterprise.

The conducted analysis revealed that manufacturing companies in countries with economies in transitional have to take into account two groups of criteria for their integration into sustainable markets: 1) criteria related to the company's ability to mitigate the climate situation in its country or region; 2) criteria related to climate requirements and standards that are maintained or important for an adaptive management in the value chains in which the enterprise enters or wishes to enter.

8. References

1. Paris Agreement, adopted by the COP 21 in Paris, dated 12 Decembe2015. Available at: https://unfccc.int/sites/default/files/english_paris_agreement.pdf [Accessed 4 Nov 2018]
2. OECD, 2017. Poverty and Climate Change Reducing the Vulnerability of the Poor through Adaptation. Available at: <http://www.unpei.org/sites/default/files/publications/Poverty-and-Climate-Change.pdf> [Accessed 12 Nov 2018]
3. GFDRR, 2017. Bringing resilience to scale. The Global Facility for Disaster Reduction and Recovery. Available at: <https://www.gfdr.org/sites/default/files/publication/GFDRR-Annual-Report-2017.pdf> [Accessed 12 Nov 2018]
4. Concept of State Climate Change Policy Implementation until 2030. Approved by the Ordinance of the Cabinet of Ministers of Ukraine № 932-p, dated 7 December 2016
5. Castells-Quintana, D., Pilar Lopez-Urbe, M., McDermott, T., 2015. Climate change and the geographical and institutional drivers of economic development. *Centre for Climate Change Economics and Policy, Working Paper, №. 223*

6. Sequeira, T.N., Santos, M.S., Magalhães, M., 2018. Climate change and economic growth: a heterogeneous panel data approach. *Environmental Science and Pollution Research*, 25(23), pp. 22725–22735. DOI: <http://dx.doi.org/10.1007/s11356-018-2305-7>

7. Esperón-Rodríguez, M., Bonifacio-Bautista, M., Barradas, V.L., 2016. Socio-economic vulnerability to climate change in the central mountainous region of eastern Mexico. *Ambio*, 45(2), pp. 146–160. doi: [10.1007/s13280-015-0690-4]

8. Palekhov, D., Kizilova, M., 2016. Methods for Achieving Energy Efficiency Targets: Analysis of Experience in the EU. *Bulletin of the Pridneprovsk State Academy of Building and Architecture*, 3(216), pp. 34-41

9. Shvetz, V., Palekhova, L., Simon, S., Palekhov, D., Mammadov, A., 2016. Convergence of energy efficiency policies in the EU and countries with economies in the transfer. *Proceedings of the 11th International Conference “Socio-economic and environmental problems of the mining industry, construction and energy”*. Tula State University, pp. 398-405

10. Shvets, V., Palekhova, L., 2015. Energy Strategy of Ukraine: Modern Challenges. *Proceedings of the International workshop “Energy supply and energy efficiency”*, TU Azerbaijan, Baku, 21.09.2015–27.09.2015. Brandenburg University of Technology Cottbus - Senftenberg, pp. 7-9

11. Palekhova, L., Kuvaeva, T., 2016. Energy Efficiency of Production Supply and Distribution Chains: Mining Engineering Enterprises. *Proceedings of the 11th International Conference “Socio-economic and environmental problems of the mining industry, construction and energy”*. Tula State University, pp. 412-428.

12. Palekhova, L., 2015. Problem of responsible production in the energy sector. *Proceedings of the International workshop “Energy supply and energy efficiency”*, TU Azerbaijan, Baku, 21.09.2015 - 27.09.2015, Brandenburg University of Technology Cottbus - Senftenberg, pp. 13-15

13. Palekhova, L., Kizilova, M., 2016. Voluntary energy-efficiency standards as an instrument of competitiveness on industrial markets. *Proceedings of the 11th International Conference "Socio-economic and environmental problems of the mining industry, construction and energy"*. Tula State University, pp. 405-412

14. Palekhova, L., 2015. Implementation of the energy management systems standard in the industrial sector of Ukraine. *Proceedings of the International workshop "Energy supply and energy efficiency"*, TU Azerbaijan, Baku, 21.09.2015 - 27.09.2015. Brandenburg University of Technology Cottbus - Senftenberg, pp. 10-12

15. Palekhova, L., Simon, S., 2016. Competitive advantages through the implementation of international energy management standards. *Bulletin of the Pridneprovsk State Academy of Building and Architecture*, 3(216), pp. 42-51

16. Palekhova, L., 2016. Experience of using voluntary sustainable development standards in energy sphere. 3. *Ingenieurtag 2016 der Fakultät Maschinenbau, Elektro- und Energiesysteme - GUS und Osteuropatag - NESEFF-Netzwerktreffen: Tagungsband*. Brandenburgische Technische Universität Cottbus-Senftenberg, pp. 109-113

17. Palekhov, D., 2016. Energy efficiency targets in development planning. *Management for Sustainable Development in Transitional Economies: Monograph, 2nd Edition, Revised and Expanded (In Russian)*. Eds.: Schmidt, M. et al. *Universities in Support of Sustainable Development*, Vol. 2. Dnipro, pp. 268-285

18. Shvets, V., Palekhova, L., Palekhov, D., 2017. Adaptive Management for Circular Economics. *Budivnic, Component Management, Machining Machinery*, Vip 99. Dnipro, pp. 208-212

19. Palekhova, L., Palekhov, D., 2018. Anwendung von Energieeffizienzkriterien für Marktstrategien von Großunternehmen in den Transformationsländern. *Energieeffizienz im Bau und Maschinenwesen [Herausgeber: K.Fraña, S.Simon, J.Grunewald]*. Technische Universität in Liberec, p. 44-53

20. Palekhova, L., 2018. Management for sustainable development: Handbook of key concepts. Dnipro University of Technology, 318 p.

21. Climate Change, 2001. Impacts, Adaptation and Vulnerability. Contribution of Working Group II to the Third Assessment Report of the Intergovernmental Panel on Climate Change (IPCC). University of Cambridge, 1036 p.

22. Handbook on Vulnerability and Adaptation Assessment, 2010. UNFCCC : CGE. Available at: https://unfccc.int/sites/default/files/english_paris_agreement.pdf [Accessed 11 Nov 2018]

23. Open Standards for the Practice of Conservation: the Conservation Measures Partnership under a Creative Commons Attribution-ShareAlike. Version 3.0, April 2013. Available at: <http://cmp-openstandards.org/wp-content/uploads/2014/03/CMP-OS-V3-0-Final.pdf> [Accessed 10 Nov 2018]

Problems of the renewable energy market development in Ukraine

L. Palekhova¹; T. Reschetilova¹; D. Podzolkova¹

Contact: Dnipro University of Technology,
Dnipro, Ukraine

E-mail: reshetilovatb@gmail.com
daryapodzolkova11@gmail.com

Purpose. The purpose of the article is to determine the nature and extent of the problem on promotion of renewable energy in in the utilities and residential sector of Ukraine.

Methodology. The research was based on the an exploration of the academic literature, and the analysis of the international documents, statistical data and reports relating to tasks of energy efficiency and renewable energy market development in Ukraine.

Findings. This article presents an analysis of the energy policy of Ukraine, especially in the field of renewable energy. It reveals key approaches where efforts are required to meet the targets in the field of renewable energy, in particular solar power.

Originality. The conducted analysis revealed that concrete efforts of all interested parties are needed: 1) strengthening state control over the targeted use of land; 2) the creation of favorable conditions for entering the Ukrainian market of manufacturers of high-quality equipment of solar power plants, including Ukrainian ones; 3) solving the problem of knowledge and provision of accompanying services to owners of solar power plants for better planning of electricity generation; 4) improving the quality of meteorological services.

Practical value. Conclusions and recommendations can be the basis for further research and taking measures to develop the solar energy market, including to improve the loyalty of potential buyers of solar panels.

Keywords: *renewable energy market, climate change, sustainable development, Green Tariff, transition economy.*

1. Introduction

Since 2011, Ukraine has become a full member of the Energy Community, in 2014 it signed an Association Agreement between Ukraine and the EU, and in November 2016 signed Memorandum of Understanding on a Strategic Energy Partnership Between the European Union <...> and Ukraine. This treaty is primarily to provide the implementation of the EU's Third Energy Package for enhancing energy conservation and efficiency, and promoting the development of renewable energy sources [1].

It should be noted, however, that for the last twenty years, the questions of energy saving and energy efficiency had become more complex and challenging for the Ukrainian economy. The main consumers of primary energy resources in Ukraine are the industry (35-40 per cent) and the housing and utilities complex (approximately 30 per cent). It is these areas that are considered the most promising for the widespread use of renewable energy [2-3].

2. Analysis of the recent research

The steel industry is one of the major consumers of primary energy in Ukraine. The high energy intensity and non-competitive prices of Ukrainian industrial production are mainly attributable to the use of wasteful outdated technologies, the slow pace of technical re-equipment, and a weak interest in the western experience on promotion of renewable energy. This problem was considered in more detail in a series of studies [2-12]. Another growing concern is the change in housing and utility sector because it directly concerns the welfare and social guarantees of the Ukrainian people. Today, the Ukrainian government has enacted a policy of rapid expansion of renewable energy use in that area.

3. Unsolved aspects of the problem

The housing sector is a real “black hole” in the use of primary energy resources. Approximately 1.3 tonnes of fuel equivalent per year tons are consumed, which are almost two times more than in industrialized countries [9] The situation with energy consumption continues to deteriorate due to the natural aging of the country's housing stock. Nevertheless, studies have shown that the creation of favorable conditions for the organization of small and medium-sized businesses in this area reveals a huge potential in the pro-movement of "green" technologies. This problem was considered in more detail at previous NESEF conferences [9-12].

4. Objectives of the article

The purpose of the article is to determine the nature and extent of the problem on promotion of renewable energy in housing and utilities sector of Ukraine.

5. Methods

The research was based on the an exploration of the academic literature, and the analysis of the international documents, statistical data and reports relating to tasks of energy efficiency and renewable energy market development in Ukraine

6. Presentation of the main research

It should be noted that the most important part of EU energy policy is to increase the share of energy derived from renewable sources (RES). The European Union has set a goal to receive 20% of primary energy from renewable energy sources already in 2020. For example, since many years the policy of Germany was aimed at sustainability and focused on increasing electricity generation from renewable sources; since 1991, the country began promoting renewable electricity using high feed-in tariffs [3].

In contrast, in many countries with transition economies, e.g. in Ukraine, one of the main economic problems is high GDP energy intensity (see Table 1), which is attributable largely to the use of obsolete, wasteful technologies [5-6]. Studies show that Ukraine has a lack of experience and efficient stimulation, as well as

the country has a low level of commercial readiness to energy sustainable development [7-9].

Table 1: Dynamic of energy intensity and GDP growth [6]

	2000	2014	2000 - 2014, %/year	2000	2014
	Energy intensity of industry*			GDP (billion US\$)	
World	0.13	0.12	-1.0	-	-
European Union	0.11	0.08	-2.0	-	-
CIS**	0.36	0.20	-4.0	-	-
Ukraine	0.59	0.27	-5.4	31.3	131.8
Russia	0.35	0.23	-2.9	259.7	1 860.6
China	0.23	0.18	-1.9	1 205.3	10 354.9
Sweden	0.19	0.14	-2.4	259.8	571.1
Canada	0.18	0.14	-1.9	739.5	1 785.4
Australia	0.18	0.12	-2.6	415.0	1 454.7
South Korea	0.16	0.12	-2.0	561.6	1 410.4
India	0.13	0.11	-0.7	476.6	2 048.5
United States	0.13	0.09	-2.6	10 284.8	17 419.0
Japan	0.11	0.09	-1.2	4 731.2	4 601.5
France	0.11	0.08	-1.9	1 368.4	2 829.2
Germany	0.08	0.07	-1.1	1 949.9	3 868.3

*The energy intensity of industry is defined as the ratio between the final energy consumption of industry and the value added measured in constant purchasing power parities

**CIS – New Independent States, the former Soviet Union

A revision of the Ukrainian legislation on renewable energy implies, in particular, the implementation and enforcement of the RES Directive 2009/28/EC according to the provisions of the Decision D/2012/04/MC-EnC of the Ministerial Council of the Energy Community on the implementation of Directive 2009/28/EC and amending Article 20 of the Energy Community Treaty. Accord-

ingly, on 18 August 2017, the Cabinet of Ministers approved the new Energy Strategy of Ukraine until 2035. This document will ensure the completion of the reform of the energy sector of Ukraine in order to integrate it with the energy sector of the EU [2]. By 2035, in particular, it is planned to bring the share of RES in the total electricity generation to 25 percent (see Fig. 1; Table 2) [13].

In order to determine the total energy-saving potential of Ukraine, the SCM Group¹ has developed and calculated the Ukrainian Energy Index (UEI) for individual regions of the country [14].

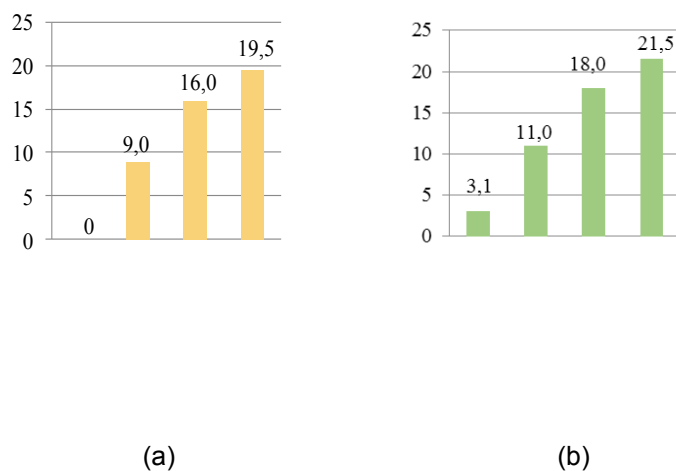

Figure 1 Indicators of the effectiveness of the New Energy Strategy of Ukraine until 2035: (a) - Energy efficiency growth; (b) - Renewable energy growth [2]

The UEI pilot проект demonstrates that applying EU approaches and technologies in the Ukrainian economic structure will save up to EUR 12 billion annually; and in addition, the experience of constructing UEI for regions shown that Dnepropetrovsk Oblast has the biggest energy saving potential (€2,629,900,000) as of 2015 [14].

The Law On Electricity Market of Ukraine, passed by the Ukrainian parliament on 13 April 2017 [15], introduced a new mechanism for supporting producers of electricity under the Green Tariff for electricity generated from renewable energy sources. It is assumed that the total amount of electricity produced from re-

¹SCM Group or System Capital Management is a major Ukrainian financial and industrial holding company.

renewable energy sources (RES) is purchased by a guaranteed buyer. The cost of a guaranteed buyer associated with such a purchase will be compensated by the transmission system operator (see Figure 3) [2]. Green Tariff Scheme will be open until 1st of January 2030.

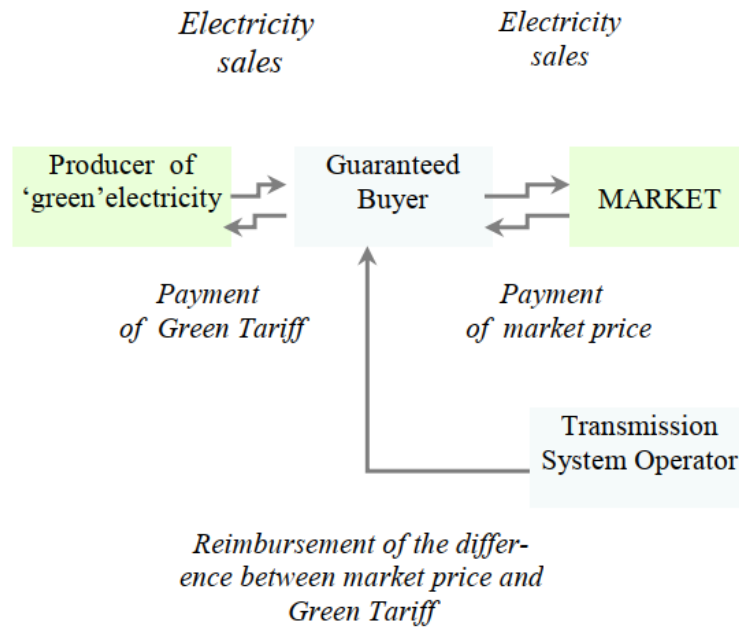

Figure 2: Functioning of Green Tariff on the electricity market [2]

Table 2: Key Indicators under the Energy Strategy of Ukraine “Safety, Energy Efficiency, Competitiveness” until 2035 [16]

Indicators	2015	2020	2025	2030	2035
Energy intensity of GDP, tonnes of oil equivalent / thousand dollars	0,24	0,20	0,18	0,15	0,13
Energy import dependency (gross energy imports in TPES ¹⁾ , %	>51,6	<50	<33	<33	<33
Share of RES in TPES, %	4	8	12	17	25
Share of RES in electricity generation, %	5	7	10	>13	>25
CO ₂ (carbon dioxide) emissions, % by 1990	-	<60	<60	<60	<50
Reducing emissions in CO ₂ equivalent on final fuel consumption, % by 2010	-	>5	>10	>15	>20

¹⁾TPES - the total primary energy supply, calculated as the sum of production (extraction), import, export, international bunkering of vessels and changes in the reserves of energy resources in the country

The National Commission for State Regulation in the Field of Energy and Utilities (NCSREU), due to the resolutions of December 29, 2017 № 1617 and № 1609, raised by 4% the rates of the ‘Green Tariff’ for electric energy, which have already entered into force on January 1, 2018 for business entities and for private households. (see Table 3).

Table 3: Green Tariffs for private households producing electricity by electric power industry (NCSREU Regulation No. 1609, dated December 29, 2017 [17])

Input period into operation	Tariff (excluding VAT-Value Added Tax), kopeks per kW · year
From the energy of solar radiation by objects of the electric power industry) which are mounted (installed) on roofs and / or facades of private households (houses, buildings and structures), put into operation in the period:	
01.01.2017 - 31.12.2019	587,05
01.01.2020 - 31.12.2024	527,65
01.01.2025 - 31.12.2029	469,99

From the wind energy , the objects of electric power ^{a)} , put into operation in the period:	
01.07.2015 - 31.12.2019	377,39
01.01.2020 - 31.12.2024	338,95
01.01.2025 - 31.12.2029	302,26

^{a)}The installed capacity does not exceed 30 kW

In Dnipro, at the expense of domestic and foreign investors, more than 10 solar stations of different capacities have already been built. In addition, in Pidhorodne (Dnipropetrovsk region) there is the first in the country, and unique for Eastern Europe, the SPS (Solar Power Station) with the tracker system (turning after the sun), which was built at the expense of domestic investments. The second such SPS was built in Nikopol (Dnipropetrovsk region) at the expense of a Canadian project.

It is important to emphasize that the territories allocated for these stations cannot be used in agriculture. In Nikopol, the SPS is located in the territory of the Nikopol Ferroalloy Plant and in Pidhorodne - in salt marshes. As a result, additional workplaces appear in the region of the station, filling the local budget, improving the territories and guaranteeing a stable supply of electricity to urban residents. In addition, there is a saving of gas and coal.

In addition, many housing and communal facilities are already equipped with solar panels. It should be emphasized that the Green Tariff is very favorable in the conditions of a rise in prices for primary fuel and electricity (see Table 4), so the demand for solar panels is gradually increasing. According to the statistics of the State Energy-Efficiency, over the past three years in Ukraine the number of solar power plants in private households reached 6,031 units, and in the first 9 months of 2018 more than 3,000 houses launched new solar power plants.

7. Conclusions and recommendations for further research

Studies have shown that the introduction of energy-saving technologies based on renewable energy might be an energy breakthrough for the whole country: the population will be able to reduce utilities, whereas the innovative business

gets stimulation and a sales market. Also, costs are being reduced for the renovation and maintenance of traditional power stations.

At the same time, barriers to mass transition to renewable energy sources in Ukraine were also identified. The main ones are as follows.

Firstly, the lack of strictly state control over the targeted use of land. Today, there are unscrupulous companies, which seeking access to cheap land resources (for example, Chinese companies are often accused of this).

Table4: Example of calculating the project's economic efficiency with the introduction of a network solar power station* [2]

Indicator of calculation ^{a)}	Result calculation
Efficiency of a photovoltaic station with a capacity of 10 kW (kilowatt) per year, Kw/year	10200
Own power consumption by household, kW/year, up to 250 kW per month	3000
Surplus of electricity transmitted to the network and sold at a "green" tariff, kW/year	7200
Indicator of the "green" tariff in March 2017, UAH / kWh · year	5,29
Total income for the year, UAH: 37512 (Green Tariff) + 5040 (Savings on own consumption)	42552
Cost of equipment for a network photoelectric station for a private household ^{b)} , UAH	284000
Payback without taxes on personal income, years	6,6

^{a)} Calculation of Photovoltaic Geographic Information System (PVGIS-CMSAF) for the European Community Resource Data. The calculated data are based on the level of solar insolation for southern conditions in Ukraine. In the western regions, the performance of solar panels is lower.

^{b)} The equipment includes: 40 photovoltaic modules of 250 W, inverters, mounting system, accessories and materials. The cost of the kit is taken at the average market rate at the time of calculation.

Secondly, the SPS equipment market is experiencing an excess of demand over supply. This factor leads to an inflow of low-quality Chinese-made products, which is reflected in a decrease in consumer confidence in the idea of renewable energy.

Thirdly, the problem of balancing electricity when using SPS remains in power systems. On the consumer and electrical networks adversely affects both the lack and excess of generated power. Therefore, the owners of power plants should predict the generation for each day and provide information to the appropriate authorities. From 2019 for new stations, from 2021 for operating stations, it is planned to gradually increase the fine by 10% annually. Since there is no such experience, the Ukrainians are not in a hurry to become the owners of the SES.

Fourthly, there are no reliable weather forecasts. The forecasting of SPS generation is influenced by a variety of weather factors, and lack of reliable meteorological forecast do not allow the operator to provide the required level of accuracy of the information on the production of energy from solar radiation.

The conducted analysis revealed that specific efforts of all interested parties are needed: 1) strengthening state control over the targeted use of land; 2) the creation of favorable conditions for entry into the Ukrainian market of manufacturers of high-quality equipment SPS; 3) solving the problem of knowledge and provision of accompanying services to SPS owners for better planning of electricity generation; 4) improving the quality of meteorological services.

8. References

1. Memorandum of understanding on a strategic energy partnership between the European Union together with the European Atomic Energy Community and Ukraine. Done at Brussels on 24 November 2016. Available at: <https://ec.europa.eu/energy/sites/ener/files/documents/mou_strategic_energy_partnership_en.pdf> [Accessed 10 Nov 2018]
2. Palekhova L. Management for sustainable development: Handbook of key concepts. Dnipro: Dnipro University of Technology, 2018
3. Palekhov, D. Energy efficiency targets in development planning. *Management for Sustainable Development in Transitional Economies: Monograph*,

2016. 2nd Edition, Revised and Expanded (In Russian). Eds.: Schmidt M. et al. Universities in Support of Sustainable Development, Vol. 2. Dnepropetrovsk, pp. 268-285
4. Palekhova, L., Simon, S., 2016. Competitive Advantages through the Implementation of International Energy Management Standards. *Bulletin of the Pridneprovsk State Academy of Building and Architecture*, 3(216), pp. 42-51
 5. Palekhova, L., Palekhov, D., 2017. Anwendung von Energieeffizienzkriterien für Marktstrategien von Großunternehmen in den Transformationsländern. Energieeffizienz im Bauund Maschinenwesen [Herausgeber: K.Fraňa, S.Simon, J.Grunewald]. Technische Universität in Liberec, p. 44-53
 6. Palekhov, D. Methods for achieving energy efficiency targets: analysis of experience in the EU. *Bulletin of the Pridneprovsk State Academy of Building and Architecture*, 3(216), p/ 34-41
 7. Palekhov, D., Palekhova, L. (2018) Methodical approaches to increasing the energy efficiency of global value chains. *Scientific Bulletin of NMU*, № 6, pp. 60-67.
 8. Palekhova, L., Kizilova, M. Voluntary energy-efficiency standards as an instrument of competitiveness on industrial markets. *Proceedings of the 11th International Conference "Socio-economic and environmental problems of the mining industry, construction and energy"*. Tula, pp. 405-412
 9. Shvets V., Palekhova L., 2015. Energy Strategy of Ukraine: Modern Challenges. *Proceedings of the International workshop "Energy supply and energy efficiency"*, TU Azerbaijan, Baku, 21.09.2015–27.09.2015. Brandenburg University of Technology Cottbus - Senftenberg, pp. 7-9
 10. Palekhova L., 2015. Implementation of the energy management systems standard in the industrial sector of Ukraine. *Proceedings of the International workshop "Energy supply and energy efficiency"*. TU Azerbaijan, Baku, 21.09.2015 - 27.09.2015. Brandenburg University of Technology Cottbus - Senftenberg, pp. 10-12.
 11. Palekhova L., 2016. Experience of using voluntary sustainable development standards in energy sphere. 3. *Ingenieurtag 2016 der Fakultät Maschinenbau, Elektro- und Energiesysteme - GUS und Osteuropatag - NESEFF-Netzwerktreffen: Tagungsband*. Brandenburgische Technische Universität Cottbus-Senftenberg, pp. 109-113

12. Palekhova L. Problem of responsible production in the energy sector. *Proceedings of the International workshop "Energy supply and energy efficiency" TU Azerbaijan, Baku, 21.09.2015 - 27.09.2015*, Brandenburg University of Technology Cottbus - Senftenberg, pp. 13-15
13. Concept of State Climate Change Policy Implementation until 2030. Approved by the Resolution of the Cabinet of Ministers of Ukraine № 932-p, dated December 7, 2016
14. Energy Efficiency Ranking, 2015. *SCM Group*. Available at: <https://www.scmholding.com/en/sustainability/scm_social_projects/energy-efficiency/energy_ranking/> [Accessed 9 Nov 2018]
15. Law of Ukraine On the Electricity Market of Ukraine. Approved on 13 April 2017
16. Energy Strategy of Ukraine "Safety, Energy Efficiency, Competitiveness" until 2035. Approved by the Resolution of the Cabinet of Ministers of Ukraine № 605-r, dated September 18, 2017
17. Regulation of the National Commission for State Regulation in the Field of Energy and Utilities (NCSREU) On Establishment of 'green' tariffs for electricity generated by private households, № 1609, dated December 29, 2017. Available at: <<http://www.nerc.gov.ua/?id=30172>> [Accessed 9 Nov 2018]

The problems of the sustainable industrial use of lands under changing climate

L. Palekhova¹: M. Trehub¹

Contact: Dnipro University of Technology
Dnipro, Ukraine

E-mail: palehovall@gmail.com

Purpose. The purpose of the presented research is to determine the current situation and to discuss the measures to be taken for sustainable land use in industrialized and urbanized areas of Ukraine.

Methodology. Research was based on the study of sustainable land management in Germany and analysis of current Ukrainian practice regarding land use management in urbanized areas, analysis of procedures for planning the land use through land administration systems in industrial cities. Also the research conducted was based on theoretical and statistical analysis. Special attention is paid to analysis of national system of tools (organizational and economic), which should ensure compliance with the Ukrainian Low Emission Development Strategy and environmental criteria.

Findings. The study showed that there is an urgent need to develop adequate land administration systems under changing climate supporting sustainable land tenure on the basis of land management, land valuation, land cadastres, and monitoring and supervision of land use in industrial cities of Ukraine. The German experience can be especially useful in relation to the conditions of Ukraine, especially regarding policies and measures to reduce and control industrial pollution, sustainable land use planning and cadastral land management.

Originality. Noting that the conservation and Sound land administration cannot be isolated from the sustainable development objectives, the urban development policy should be based on investigation of the economic, cultural and social costs of expansion of industrial land use and the benefits of sustainable use

of urban land. In this regard, urban development policies should pay particular attention to improving the management capacity of local authorities, including the upgrading of cadastral, revenue collection and information mechanisms.

Practical value. Developed recommendations and analytical result will be useful for the transition to the principles of sustainable cities in Ukraine.

Keywords: *sustainable use, industrial areas, climate change, cadastre reform, Ukraine.*

1. Introduction

For all the years of independence in Ukraine, the development industrial land use management has mainly been carried out through a 'top-down' approach, where the central authorities have drafted legislation and mechanisms for the integration of land-use and settlement planning in overall environmental and development administration. This include, for example: analysis of the productive development of energy and other natural resources of Ukrainian regions, the environmental assessments and cards of the regions, assessments of negative environmental and social impacts of proposed projects and programs, cadastral maps and the cadastral registers, etc. Under the current legislation, the size and composition of land plots that are granted for the industrial purposes are determined in accordance with the state norms and plan documentations that have been confirmed by the established procedure [1]. And each industrial enterprise must be issued a permit for the emission of pollutants into the atmosphere [2].

Nevertheless, Ukrainian industry was still one of the major sources of environmental pollution and greenhouse gas emissions. In addition, a large part of pollutants from the biggest industrial enterprises is released into the atmosphere in urban and densely populated areas. The industrial land use is not satisfactory in the context of a number of global environmental and climate agreements, and not only continues to have a negative impact on the health of the populations but also reduce the capacity of large urban centers to sustain their role as engines for sustainable development [3].

Ukrainian Low Emission Development Strategy (here after – LEDS) has become Ukraine's first experience in synergy approach application as vision on resolving the set of interrelated problems regarding environmental, energy, economic and social challenges against the backdrop of significant advances in climate change problem [4]. Priorities of LEDS are: energy efficiency, renewable energy, market and institutions, energy upgrade and innovation, waste management and resource recovery, CO₂ absorption. Realization of Strategy also implies the creation of the most favorable conditions for moving to paths of sustainable development by developing and adopting instruments for land management in industrial zones.

2. Objectives of the article

The purpose of the presented research is to determine the current situation and to discuss the measures to be taken for sustainable land use in industrialized and urbanized areas of Ukraine.

3. Methods

Research was based on the study of sustainable land management in Germany and analysis of current Ukrainian practice regarding land use management in urbanized areas, analysis of procedures for planning the land use through land administration systems in industrial cities. Also the research conducted was based on theoretical and statistical analysis. Special attention is paid to analysis of national system of tools (organizational and economic), which should ensure compliance with the Ukrainian Low Emission Development Strategy and environmental sustainability criteria.

4. Presentation of the main research

According to the Land Code of Ukraine, industrial lands are lands granted for the location and exploitation of basic, subsidiary and auxiliary buildings and structures of industrial, mining, transportation and other types of enterprises, their approaches, infrastructure, administrative and storing buildings, and other structures. Industrial lands may be in state, communal and private ownership [1].

The land fund of Ukraine is 60.3 million hectares, or about 6 per cent of the territory of Europe as of 1 January 2017. At the same time, there are significant disparities in the country's land use: more than 92 per cent of the territory is involved for economic use. Over 1.1 million hectares are already degraded and long-term contaminated lands that are subject to conservation, 143.4 thousand hectares of disturbed lands require reclamation, and 315.6 thousand hectares of unproductive lands that need improvement [5]. The targets of sustainable industrial lands use relate directly to objectives of the United Nations Framework Convention on Climate Change and the Kyoto Protocol targets to reduce greenhouse gases and advance the development and use of renewable sources of energy. These documents emphasize that a concerted effort, including global action and stronger political commitment of local and regional authorities, is required to achieve the climate objectives and implementation of sustainable development [6-7].

The Paris Agreement confirmed the importance of the existing efforts to mitigate climate change through land use activities [8]. First submissions of long-term low greenhouse gas emission development strategies by Parties also indicate that sustainable land use will be important for achieving a balance between anthropogenic emissions by sources and removals by sinks of greenhouse gases in the second half of this century [9].

Ukrainian Parliament ratified Paris Agreement on Climate Change on July 14, 2016. Later, Ukrainian LEDS outlined the expected nationally determined contribution to this Agreement. It was declared that in 2050 the GHG emissions might exceed 70 per cent of 1990 emissions level (see Fig. 1). The areas of actions under each objective of the LEDS offer considerable opportunities to addressing issues enhanced industrial land management by genuine complex approaches at all stages of developmental planning and implementation of projects at national and regional levels.

The strategy includes four development vectors, namely Economy + Energy + Environment + Engineering.

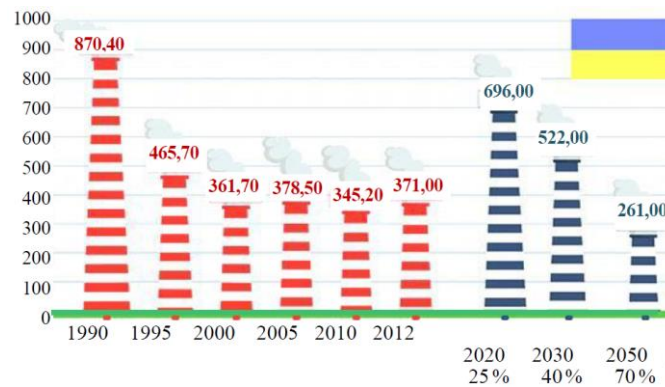

Figure 1: Paris Agreement: Ukraine's Goals by 2050 [4]

In Ukraine, the mining and metallurgy industry is a priority target for economic activities; country exports about 80 per cent of its metal products, of which about 30 per cent went to EU. In 2017, the production of metals provided 23.4 per cent of all revenues from the export of goods [10].

At the same time, the metallurgical sector is one of the largest consumers of electricity and heat energy in the Ukraine (21.3 per cent and 25.1 per cent respectively) [11].

Dnepropetrovsk region is an important industrial centre with 24 mining enterprises and 23 ferrous metallurgy enterprises. The region provides 39.5 per cent of total steel production in Ukraine (see Table 1).

Table 1: The volume of industrial production by types of activities in the Dnipropetrovsk region, 2017*

Types of economic activity	In thousands of US Dollars ^{a)}	In % of gross industrial output
Industry	15034796.37	100.0
Mining & Processing Industry	12961053.96	86.2
Mining Industry	4043070.45	26.9
Manufacturing Industry including:	8917983.52	59.3
Steel Production	5567593.70	37.0
Power industry	1891818.97	12.6

*According to the State Statistics Service of Ukraine, 2018 [12]

^{a)} The amounts are stated in United States dollars Ukrainian hryvnia / US dollar as of 26 November 2018.

Among other metallurgical companies in Dnipropetrovsk region, PJSC “ArcelorMittal Kryvy Rig” is one of the leaders among the largest enterprises of Mining and Steel Complex of Ukraine. The enterprise is one of few full metallurgical cycle enterprises in Ukraine, which produces pig iron, steel and rolled products. In 2017 the ArcelorMittal Kryvy Rig produced 5.6 million tons of pig iron, 6.35 million tons of equivalent steel and 5.1 million tons of rolled products. Designed capacity of mining and processing of PJSC ArcelorMittal Kryvy Rig is: 24.15 million tons of crude ore and 9.8 million tons of concentrate per year. The total area of mining and processing amounts to 5,221 ha [13].

However, ArcelorMittal Kryvy Rig is the largest polluter in the region. In 2017, its gross emissions of pollutants into the atmosphere amounted to 263.0 thousand tons. As a result, in 2017, the average concentration in Krivoy Rog was: dust –

2.7 MPC¹, nitrogen dioxide – 1.0 MPC, phenol – 0.3 MPC, ammonia – 0.3 MPC, formaldehyde – 3.0 MPC, sulfur dioxide – 0.3 MPC, carbon monoxide – 0.7 MPC; nitric oxide – 0.2 MPC. In addition, the enterprise discharged the contaminated reverse waters without treatment in the amount of 2613.7 thousand cubic metres [14].

The land use management must be considered not only as part of the problem of sustainable development, but also as part of its solution in industrial areas, where the environment and climate might be threatened by industrial waste and greenhouse gas emissions. The results of policies applied by the EU industrialized countries in relation to foster sustainable use of natural resources for production are particularly evident in examples showing changes of state of cities with particularly polluting industries such as mining and metallurgy. For example, Germany has amply demonstrated these good practices across its metallurgical centres at the Ruhr District and Brandenburg Region.

As compared with the ArcelorMittal Kryvy Rig, the ArcelorMittal Eisenhüttenstadt (Brandenburg Region) provides greater flexibility, stability and efforts to accept the highest sustainability standards. For ArcelorMittal Eisenhüttenstadt, social responsibility in all areas of corporate activity has already become a reality. In March 2015, the first country-wide sustainability report was published, and a Sustainable Development Committee has been established, which aims to develop a development plan towards achieving targets set on energy efficiency, environmental and social sustainability [15].

Analysis of issues related to the regulation of economic, energy and environmental efficiency of use of industrial land, and indeed all other natural resources in Ukraine, revealed that its dominating paradigm adheres to several fundamental theses, which is contrary to the very idea of sustainable development [16-17].

¹MPC – maximum permissible concentrations.

Firstly, the Ukrainian model of regional planning is based on domination of economic considerations over social and environmental.

We have already indicated our stand on this issue in previous articles, economic considerations does not always correspond to the objectives of sustainable development and did not always improve the social well-being is accepted as its aim [16]. For example, the analysis had shown that with respect to ArcelorMittal Kryvyi Rih, mainly tax instruments are used, which have little to do with its environmental and social indicators.

In 2017, the company paid rent for the land in the amount of 300 million hryvnia, which amounted to 50 per cent of all rent payments for the land to the budget of Krivoy Rog. In 2018, the City Council decided to increase the land rent for the ArcelorMittal by 60%, the main argument of this decision was to generate additional revenues of UAH 185 million for the budget [18].

Secondly, planning the economic activities at regional level is based on the extensive use of primary natural resources [16].

The analysis of the statistics on environment and economic activity in various districts of the Dnipropetrovsk oblast confirmed that there is a direct correlation between the quantities of natural resources in a district and the level of anthropogenic pressure in it.

Kryvyi Rih Iron-ore Basin is the largest in Ukraine with deposits of rich iron ore and the single source of iron in the former USSR. The extractive industry employs 62.5 percent of the work force in the city of Kryvyi Rih and 93 percent in the towns of Zhovti Vody and Inhulets [12].

However, poor compliance with environmental standards, low level of responsibility and transparency have a detrimental effect on the environment. For exam-

ple, in Krivoy Rog there are 8 tailing ponds which occupy an area of 90 sq km in height of 200-250 m. These factors have already reduced foundations for sustainable development, and environmental risks and damages are rising faster than improvements in mitigation. On the whole, the environmental situation in Krivoy Rog can be characterised as critical, and parts of its territory – as zones of environmental disaster [14].

Thus, Ukraine needs an effective mechanism for conserving natural resources and careful land use that would integrate current economic policy targets and sustainable development goals.

Thirdly, there is a greater reliance on market forces and a reduction in the scope of governance in the area of use mineral resources and industrial lands, resulting in increased anthropogenic pressure on large sections of society.

Currently, the natural resources and fossil fuels are still widely available for consumption, and society does not duly care about preserving natural resources for the needs of future generations. In Ukraine, the economic and administrative mechanisms are not particularly effective in compensating for the lost natural resources. In 2017, in the Dnipropetrovsk region, for example, these revenues accounted for 3,974 thousand hryvnia or 32 per cent of total fund, and 2,779 thousand hryvnia or 46 per cent of total fund respectively [14].

As can be seen, such contributions are not tied to any environmental, energy or any other conditions for sustainable use of industrial lands.

Administrative fines for non-compliance with the rules in force in Ukraine, do not have a deterrent effect. In 2017, in the Dnipropetrovsk region, for example, the State was sustained some environmental damage in the total amount of 25,824 thousand hryvnia, for which a claim of 2278 thousand hryvnia has been advanced; however, only 1,472 thousand hryvnia or 65 per cent were paid this year [14].

5. Conclusions and recommendations for further research

Noting that the conservation and Sound land administration cannot be isolated from the sustainable development objectives, the urban development policy should be based on investigation of the economic, cultural and social costs of expansion of industrial land use and the benefits of sustainable use of urban land. In this regard, urban development policies should pay particular attention to improving the management capacity of local authorities, including the upgrading of cadastral, revenue collection and information mechanisms.

6. References

1. Land Code of Ukraine. Article 66 “Lands of Industry”. Draft of 4 November 2018. Available at: <http://zakon.rada.gov.ua/laws/show/2768-14> [Accessed 11 Nov 2018]
2. Regulation of the Cabinet of Ministers of Ukraine “On approval of the Procedure for conducting and paying for work related to the issuance of permits for emissions of pollutants into the atmosphere by stationary sources <...>”, No. 302 of 13 March 2002. Available at: <http://zakon.rada.gov.ua/laws/show/302-2002-%D0%BF/print> [Accessed 11 Nov 2018]
3. Palekhova, L., Palekhov, D., 2018. Anwendung von Energieeffizienzkriterien für Marktstrategien von Großunternehmen in den Transformationsländern. *Energieeffizienz im Bauund Maschinenwesen [Herausgeber: K.Fraña, S.Simon, J.Grunewald]*. Technische Universität in Liberec, p. 44-53
4. Ukraine 2050 Low Emission Development Strategy. Kyiv, November 2017. Available at: https://unfccc.int/sites/default/files/resource/Ukraine_LEDS_en.pdf [Accessed 21 Nov 2018]
5. The Resolution of the Cabinet of Ministers of Ukraine “Strategy for improving the management mechanism in the use and protection of state-owned agricultural lands and their disposal”, No. 413 of 07.06.2017.

- Available at: <http://zakon.rada.gov.ua/laws/show/413-2017-%D0%BF>
[Accessed 20 Nov 2018]
6. United Nations Framework Convention on Climate Change. Article 4. Available at: <https://unfccc.int/resource/docs/convkp/conveng.pdf> [Accessed 20 Nov 2018]
 7. Kyoto Protocol to the United Nations Framework Convention on Climate Change. Article 10. Available at: <https://unfccc.int/resource/docs/convkp/kpeng.pdf> [Accessed 20 Nov 2018]
 8. Paris Agreement. Article 5. Available at: https://unfccc.int/sites/default/files/english_paris_agreement.pdf [Accessed 21 Nov 2018]
 9. Paris Agreement. Communication of long-term strategies. Available at: <https://unfccc.int/process/the-paris-agreement/long-term-strategies> [Accessed 21 Nov 2018]
 10. State Statistics Service of Ukraine, 2018. Foreign Economic Activity in 2017. Commodity structure of foreign trade. Available at: <https://unfccc.int/process/the-paris-agreement/long-term-strategies> [Accessed 21 Nov 2018]
 11. State Statistics Service of Ukraine, 2018. Supply and use of energy in 2017. Available at: <http://www.ukrstat.gov.ua/> [Accessed 21 Nov 2018]
 12. State Statistics Service of Dnipropetrovsk region, Ukraine, 2018 Available at: http://www.dneprstat.gov.ua/statinfo%202015/p/2017/p4_m1.pdf [Accessed 20 Nov 2018]
 13. PJSC ArcelorMittal Kryvy Rig. Available at: <https://ukraine.arcelormittal.com/index.php?id=8> [Accessed 20 Nov 2018]
 14. Regional report on the state of the environment in Dnipropetrovsk region in 2017. Dnipropetrovsk Regional State Administration. Department of Ecology and Natural Resources. Available at: https://adm.dp.gov.ua/storage/app/media/EKOLOGIA/regionalna_dopovid_za_2017_rik_ekologia.pdf [Accessed 21 Nov 2018]

15. ArcelorMittal Eisenhüttenstadt. Available at:
<https://eisenhuettenstadt.arcelormittal.com/Ueber-uns/ArcelorMittal-Eisenhuettenstadt> [Accessed 21 Nov 2018]
16. Palekhov, D., Palekhova, L., 2016. Conceptual framework for balancing economic growth and environmental sustainability at regional level. *Scientific Bulletin of the National Mining University*. No. 1, p. 144-148
17. Palekhov, D., 2014. Potential for Strategic Environmental Assessment (SEA) as a Regional Planning Instrument in Ukraine. Verlag Dr. Kovac, 374 p.
18. Deputies of the City Council of Krivoy Rog adopted a draft decision on the 'inadequate' rate of land tax. *1 Kr.ua. First Krivoy Rog* Available at:
<https://1kr.ua/news-34420.html> [Accessed 21 Nov 2018]

The influence of form of surface of the layered outside walls of building on their capacity to accumulate (dissipate) heat energy and on their thermal insulation characteristics

G. Afonina¹; V. Glazov²; E. Voelker³

Contact:

1. National Research University
"MPEI", Moscow, Russia,
2. National Research University
"MPEI", Moscow, Russia,
3. Voelker Eduard Konstantinovich Brandenburgische
Technische Universität (BTU), Cottbus, Germany

E-mail:

1. gal.afonina2010@yandex.ru
2. mamurik@bk.ru; GlazovVS@mpei.ru
3. eduard.voelker@b-tu.de

Abstract. The article presents assessment of the influence of form of surface of the layered outside walls of buildings on heat losses. The predominance of rectangular edges over other types of projections on the surface of buildings is revealed. The nature of the rectangular fins dependence of the heat transfer on their height and conductivity is stated.

The graphical material is presented to assess the feasibility of reducing the heat flow by selecting the height and thermal conductivity of rectangular fins.

Keywords: *rectangular fin, heat losses, heat transfer, thermal conductivity, mathematical model, optimization.*

1. Introduction.

In modern regulatory documents, the calculation of heat transfer resistance of building external walls is based on a one-dimensional process of heat transfer through a flat wall [1]. However, there are a huge number of buildings, the outer surface of which has an architectural ledges (edges, cornices, moldings, bas-relief, etc., Fig. 1). This type of projections (fins) of various shapes can lead to

increasing the heat transfer, which is used in heat exchangers [2-6]. Therefore, the assessment of the influence of the parameters and the shape of such projections (fins) on the heat losses through the elements of the external walls of the building is of scientific and practical interest.

2. Problem statement

Review of works by L. I. Roizen and I. N. Dulkin [2], D. Kern and A. Kraus [3], etc. showed:

- Optimization of fin parameters was performed for a single fin with a heat insulated end face;
- In determining the effectiveness of the fin the equality of heat transfer coefficients for the real and ideal fins was assumed;
- There is no assessment of the effect of the thermal conductivity of the fins on the maximum heat transfer for the fins of the same mass, but of different heights;
- Limitation on the thickness of the fin, which may be due to the strength of the design isn't considered;
- The solution is given for symmetric cooling conditions of the side surfaces of the fins.

Therefore, it is necessary to determine the parameters of the fin, providing maximum heat transfer under the given mass, restriction on the base size and the absence of thermal insulation on the top (free end).

The shape of the fin under studying is rectangular.

Mathematical model of optimization problem for rectangular fins is given below.

Objective function:

$$Q_{fin} \text{ ® max (min)} \tag{1}$$

Restrictions:

The differential equation of heat conduction:

$$d^2\theta(X)/dX^2 = Bi \cdot \theta(X), 0 < X < 1 \tag{2}$$

where $X = x/H$, $0 < x < H$, $\theta(X) = [t(x) - t_{out}]/(t_0 - t_{out})$, $F = \delta \cdot L$, $Bi = a \cdot \Pi \cdot H^2 / F$.

boundary condition:

$$\theta(X) = 0, X = 0; \quad (3)$$

$$-d\theta(X)/dX|_{X=1} = a \cdot H \cdot \theta(1)/l \quad (4)$$

2. Solution

The analytical solution of the equation system (2) – (4) for the calculation of the flow and of the temperature distribution along the height of a rectangular fin has the following form [5]

$$\theta(X) = \frac{\cosh[(1-X) \cdot \sqrt{Bi}] + \sqrt{Bi} \cdot \frac{F}{\Pi \cdot H} \cdot \sinh[(1-X) \cdot \sqrt{Bi}]}{\cosh(\sqrt{Bi}) + \sqrt{Bi} \cdot \frac{F}{\Pi \cdot H} \cdot \sinh(\sqrt{Bi})} \quad (6)$$

$$Q_{\text{реб}} = \sqrt{Bi} \cdot \frac{\lambda \cdot F}{H} \cdot (t_0 - t_2) \cdot \frac{[\sinh(\sqrt{Bi}) + \sqrt{Bi} \cdot \frac{F}{\Pi \cdot H} \cdot \cosh(\sqrt{Bi})]}{[\cosh(\sqrt{Bi}) + \sqrt{Bi} \cdot \frac{F}{\Pi \cdot H} \cdot \sinh(\sqrt{Bi})]} \quad (7)$$

3. Decision analysis

The procedure for solving this problem is performed for 4 types of fin materials (aluminum, steel, reinforced concrete and ceramic brick). A graphic illustration of the obtained solution is shown in Fig. 1.

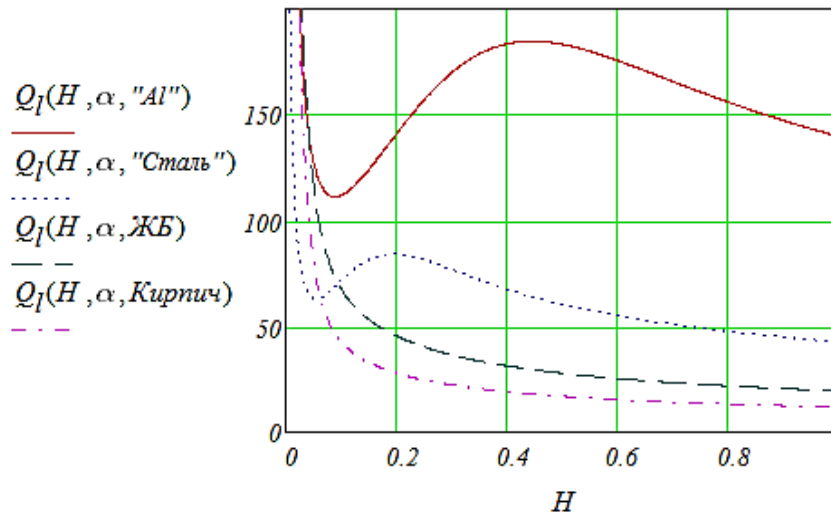

Figure 1: The fin Heat transfer depending on its height for different materials; the fin mass is constant

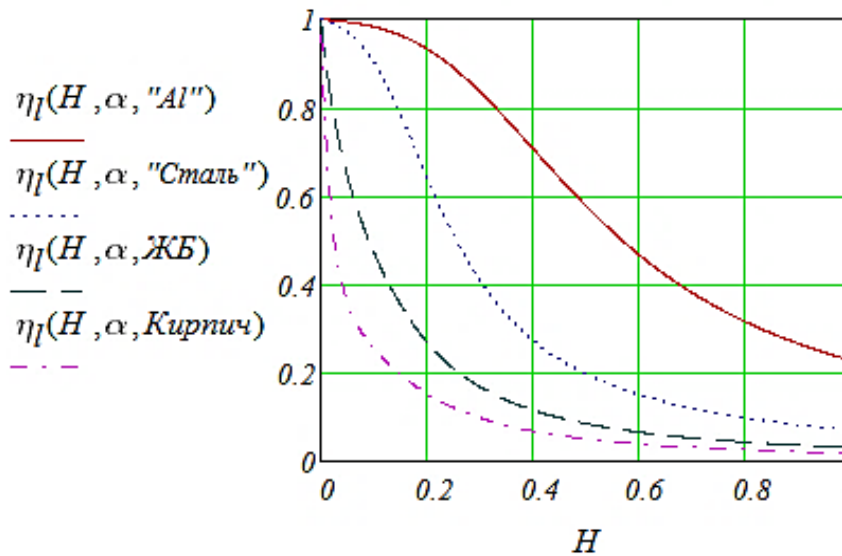

Figure 2: The single rectangular fin efficiency depending on its height for different materials; the fin mass is constant

Our studies have shown that the height of the rectangular shape projections (fins) of the same mass has different effects on heat transfer (Fig. 1). It is found that the fins of the material of a high coefficient of thermal conductivity have two extremums (local minimum and local maximum). If the rectangular fin has a heat-insulated end face, then at constant material capacity the increase in the thermal conductivity coefficient does not lead to a shift of the local minimum, but shifts the local maximum towards greater heights of the fin and the values of the heat flux.

If the fin end face is not heat-insulated and its mass does not change, the growth of the thermal conductivity of the fin shifts these extremums in the region of large heights and heat flow values. Reducing the value of the thermal conductivity coefficient of the fins leads to the disappearance of local extremums. Below, the estimation of influence of parameters of rectangular ribs (from ceramic bricks) on the magnitude of the heat transfer (heat flux) is given.

The following data are used:

- thermal properties of a rectangular ceramic brick fin:
 - Density $\rho=1400 \text{ kg / m}^3$;
 - Thermal conductivity coefficient $\lambda = 0.58 \text{ W/(m}\cdot\text{K)}$ [1]);
- the geometric parameters of fin:
 - Length $L = 1 \text{ m}$;
 - Thickness $\delta = 0.5 \text{ m}$;
 - Height $H = 0.06 \text{ m}$;

- Calculate date:

- Material capacity of an fin at mass $m = 42 \text{ kg}$

$$M_e = \delta \cdot H = m / (\rho \cdot L) = 42 / 1400 \cdot 1 = 0.03 \text{ m}^2;$$

- The temperature at the base of the fin:

$$t_0 = t_{in,w} - \alpha_{in} R_w (t_{in,air} - t_{in,w}) = -12^\circ\text{C} \quad (8)$$

where:

$t_{in,air} = 21^\circ\text{C}$ - indoor temperature according to [9],

$t_{in,wall} = 19.5^\circ\text{C}$ - indoor wall temperature according to [1],

$R_{wall} = 2.41 \text{ (m}^2\cdot\text{K)} / \text{W}$ – the required resistance to heat transfer of the enclosing structure for Moscow according to [1], [8],

$\alpha_{in} = 8,7 \text{ W / (m}^2\cdot\text{K)}$ - the heat transfer coefficient from the air to the inner wall of the room [1].

- The parameters of external heat transfer:

$\alpha_{out} = 23 \text{ W/(m}^2\cdot\text{K)}$) heat transfer coefficient on the surface of the fins [1];

$t_{out,air} = -25^\circ\text{C}$ – ambient temperature [7].

The graphic illustration of the obtained solution is shown in Fig. 4.

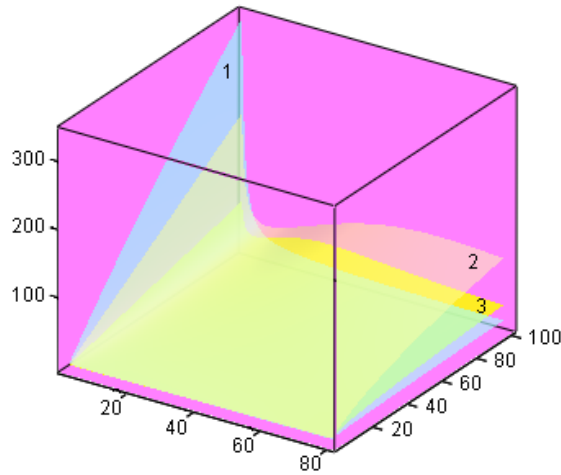

Figure 3: The fins heat transfer depending on their heights for different materials: ceramic bricks (1), aluminum (2) steel (3); the fin mass is constant

Economic assessment of the influence of the height of the rib on its heat transfer is shown in Fig. 4

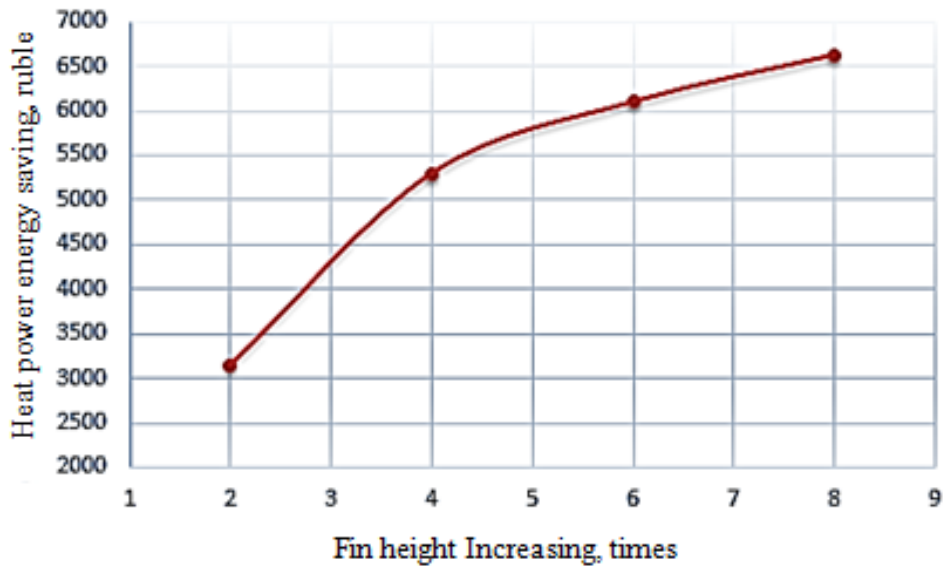

Figure 4: Heat energy ncreasing the fin height value due to decreasing the heat energy transferred to outside air (i.e. lost)

4. Conclusion

The study of the influence of the different materials and the height of the rectangular fin on its heat transfer at the same mass was carried out. It was found that the view (look) of the outer surface of walls can have different effects on the amount of heat losses of the building. The presence of fins can lead both to deterioration and to improvement of the thermal insulation properties of the elements of the outer walls of the building. Therefore, when designing a building, it is necessary to take into account not only the thermal insulation properties and the sequence of the layers in the outer walls, but also the view (look) of the outer surface of walls.

5. The list of designations

L — the width of fin, m;

δ — thickness of fin, m;

H_{fin} — height, m;

M_e — material capacity, m^2 ;

m_{fin} — weight, kg;

α — heat transfer coefficient, $W / (m^2 \cdot K)$;

t — temperature, $^{\circ}C$;

λ — coefficient of thermal conductivity, $W / (m \cdot K)$;

Q_{fin} — heat flow through the surface of the fins, W ;

θ - dimensionless temperature;

Bi is the number of Bio;

X — dimensionless coordinate;

x — coordinate along the x -axis;

Π — the perimeter of the fin, m;

F — area of fin, m^2 ;

Z_{hp} — number of days of the heating period, day;

S — the cost of thermal energy, RUB;

t_0 — fin base.

6. References

1. SP 50.133.2012 thermal protection of buildings. Updated version of SNiP 23-02-2003.
2. L. I. Roizen and I. N. Dulkan. Thermal design of finned surfaces. Under the editorship of V. G. Fastovsky. M., "Energy", 1977. - 256 p.
3. Kern, D. and Kraus, A. Advanced heat exchange surfaces. Per. with English. M., "Energy", 1977. 464 p.
A. D. Kraus, A. Aziz and J. Welty, 2001, Extended Surface Heat Transfer. Published simultaneously in Canada
4. Ramesh K. Shah and Dušan P. Sekulic, 2003, Fundamentals of Heat Exchanger Design. Published by John Wiley & Sons, Inc., Hoboken, New Jersey Published simultaneously in Canada.
5. Crate F., "The Basics of heat transfer." Per. from English, - M.: World, 1983. - 512c.
6. Bazhan p. N. et al. Handbook of heat exchangers / P. I. Bazhan, Kanavets, V. M. Seliverstov. - Moscow: Mechanical Engineering, 1989. - 368 p. ISBN 5217-004002.
7. SP 131.13330.2012 construction climatology. Updated version of SNiP 23-01-99*.
8. GOST 30494-2011. The buildings are residential and public. The parameters of the microclimate in the premises.
9. ПАО «МОЭК» — единая теплоснабжающая организация Москвы.
<http://www.oaomoek.ru>

ПОРОШКОВЫЕ КОМПОЗИЦИОННЫЕ МАТЕРИАЛЫ НА ОСНОВЕ ЖЕЛЕЗА ПОСЛЕ ЦЕМЕНТАЦИИ И БОРИРОВАНИЯ

Powder composition materials on the basis of iron after cementation and boration

С.Н. Намазов; В.Ф.Гахраманов; Ш.М. Машаев

Contact: National Research University
MPEI",Moscow, Russia

E-mail: Subhan_namazov@daad-alumni.de
gehremanovvurqun@gmail.com

АННОТАЦИЯ. В работе исследован процесс насыщения химико-термической обработкой поверхности железосодержащих композиционных материалов углеродом и бором и изучены механические свойства этих материалов.

Abstract: In this work, the process of saturation by chemical-thermal treatment of the surface of iron-containing composite materials with carbon and boron is investigated and the mechanical properties of these materials are studied.

Ключевые слова: железо, порошок, композиция, цементация, борирование, механические свойства, спекание, диффузия.

Keywords: iron, powder, composition, cementation, boration, mechanical properties, sintering, diffusion.

1. Введение

Эксплуатационные свойства порошковых композиционных материалов можно улучшить методом объемного или поверхностного легирования. Но повышение эксплуатационных свойств объемным легированием на производстве часто вызывает многочисленные затруднения, поэтому в большинстве случаев используется второй метод [1,2], метод поверхностного легирования химико-термической обработкой. Ранее проведенные исследования позволили установить в порошковых

композициях кинетику образования диффузионных слоев и аналитически описать их механизм [4]. Разработаны технологические режимы получения двухкомпонентных покрытий в порошковых композициях на основе железа. Определены структура и свойства двухкомпонентных покрытий на непроницаемых, полупроницаемых и проницаемых порошковых композициях.

Кроме того изучены структура и свойства покрытий полученных путем последовательно насыщения с несколькими элементами и определены необходимые технологические параметры насыщения. С этой целью на спеченных порошковых композициях изучена особенность последовательно насыщения порошковых композиций углеродом и бором, и разработаны соответствующие технологические режимы [3,4]

В конструкционных порошковых композиционных поверхностное легирование более экономично и целесообразно, чем объемное легирование, поэтому химико-термической обработка для этих групп материалов является более перспективным методом.

К второй группе относятся порошковые композиционные материалы специального назначения, например, фрикционные, антифрикционные, инструментальные, жаропрочные и т.д. Эти материалы как правило представляют собой высоколегированные сплавы, которые в отличие от обычных конструкционных материалов, достаточно удовлетворяют предъявляемых требования. Несмотря на это, эти материалы также могут подвергаться химико-термической обработке. Прежде всего это относится к инструментальном и жаропрочном порошковым композиционным сплавам. Например, известны примеры успешного применения борирования для повышения стойкости твердосплавных инструментов. Как правило, порошковые композиционные сплавы, на основе прочных трудно растворимых элементов дают положительные результаты после нанесения защитных покрытий, однако нецелесообразно применение нанесения в окислительной среде (например диффузией). Поэтому, необходимо проварить исследование химико-термической обработки порошковых композиционных материалов с целью повышения

эксплуатационных свойств рабочей поверхности деталей машин [5]. Поскольку спрос на материалы и сплавы повышаются методы днём в промышленности и в других производственных областях, но природные ресурсы остаются неизменными. Именно поэтому повышение качества используемых МА-териалов, а также рабочей поверхности деталей машин необходимо и является основной проблемой современной промышленности.

Известно [5], что большинство детали машин и технологического оборудования наряду с высокими механическими свойствами, должны обладать также высокой износостойкостью и сопротивляемостью к воздействию различных агрессивных сред. Получение таких изделий прессованием из высоколегированных стальных порошков связано с определенными техникоэкономическими трудностями. В связи с этим последовательное насыщение рабочей поверхности деталей машин и механизмов углеродом и бором, является актуальным научным направлением, так как при этом возможно получение карбоборированного слоя, обладающего высокими износо-и коррозионностойкостью.

2. Цель работы

В отличие традиционных методов получения порошковых композиций путем приготовления порошков, прессования, спекания и термической обработки методы упрочнения рабочих поверхностей спеченных композитов химико-термической обработкой, то есть последовательным комплексным насыщением углеродом и бором изучен недостаточно.

Целью данной работы является повышение комплекса свойств спеченных порошковых материалов образованием диффузионных покрытий на рабочей поверхности химико-термической обработкой. В работе проведятся результаты исследования диффузионного насыщения рабочих деталей из композиционных материалов путем обогащения углеродом и бором [1,2]

3. Изложение основного материала

В промышленности наши широкое распространение конструкционные и антифрикционные порошковые композиционные материалы. Они являются экономичными низколегированными сталями, вместе с тем технологичны при изготовлении, но часто имеют невысокие эксплуатационные характеристики. Их основой составляет порошковый композиционный материал на основе железа.

По мнению И. М. Федорченко [1] химико-термической обработка может значительно повысить надежность и долговечность деталей, изготовленных из конструкционных порошковых композиционных материалов.

4. Обсуждение результатов

В большинстве случаев процесс обогащения поверхности изделий неметаллами. Существует в твердой и газовой средах результате которого например после цементации на изделии получается высокоуглеродистая диффузионная поверхность [4].

Целью цементации является в углеродистых и легированных стальных изделиях, содержащих 0,1-0,25% углерода, сохранение вязкости, повышение на рабочей поверхности твердости и сопротивление усталости.

Во многих случаях, детали машин и технологического оборудования, наряду с высокими механическими свойствами, должны обладать высокой износостойкостью и стойкостью к воздействию различных агрессивных сред. Получение таких изделий из высоколегированного стального порошка путем прессования и спекания связаны с определенными технологическими трудностями.

В процессе борирования на поверхности изделий образуется высокая твердость (1800–2000 HV), в то же время повышаются сопротивление на износу и коррозии в различных сре-дах.

На рис-1-показано влияние состава насыщающей смеси и условий насыщения бором. Поверхности на углероджженного железа и сплава содержащее 3,6 и 9 % хрома, на глубину боридного слоя.

Процесс цементации композиций Ж и ЖХЗ проведены в специальном карбюризаторе, а композиции ЖХ6 и ЖХ9-в карбюризаторе следующего состава: % (по массе), 85% древесного угля, 15% бикарбонат натрия (T = 9750С, $\sigma = 4$ часа)



Рис. 1 – Рис.1. Влияние состава насыщаемых смеси и условий насыщения на глубины боридного слоя в первичной цементации: железо (1) и композиты (плотность 95%, T_{цем}=975°C, б=4 час, ЖХ3(2), ЖХ6(3) ЖХ 9(4): а-A1/B2O3 = 30%/70%, T=9500C,т=4 час; б-A-AI2O3, T=9500 C, т=4 часа; в-AI/B2O3=30%/70%, AI2O3=75%,т=4 час, г-AI/B2O3=39, AI2O3=75%,T=9500 C, т=4 час

В цементированных композитах относительно того же состава и первичного состава композиций, бо-ридные слои имеют более низкую глубину, а их целостность несколько высоки, из-за замедления диффузии уг-лерода в процессе борирования

Разница в глубине боридного слоя возрастает также по мере увеличения количества хрома. Кроме того, это объясняется увеличением концентрации углерода в цементированном слое и замедлением

поглощения его во время выдержки в процессе борирования. Хром также замедляет диффузию углерода в аустените.

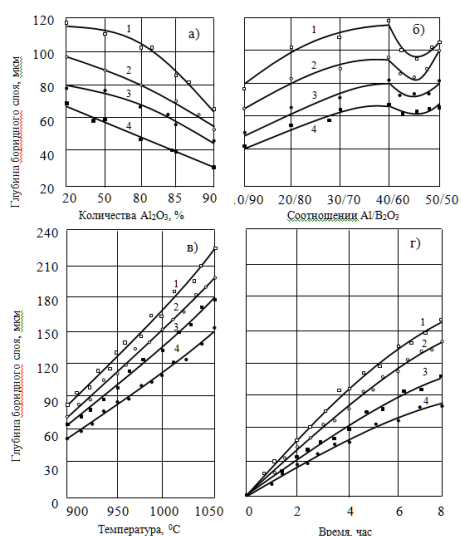
Кроме того хром усложняет продвижение боридного слоя в глубь композиций. Поэтому диффузионные процессы в цементированных железо-хромистых композициях требуют дополнительные затраты энергии и времени.

В первично цементированных слоях композиций количество высокоборидных (Fe P) фаз сразу на 10-20% меньше, чем в карбюризаторе. Науглероживание не оказывает существенного влияния на микротвердость боридных фаз [5].

Переходная зона композиций, железо-хром характеризуется высоким содержанием углерода и избыточные карбидные включения, имеют структуру перлита, который зависит от количества первичных цементированных слоев и определяется составом композиций. Переходная зона и основной металл металлографически не отличаются. Количество карбидных включений от боридного слоя к центру уменьшается умеренно. Увеличение содержания хрома от 0% до 9% в композициях приводит к уменьшению глубины оснований (подложку) примерно в 1,5 раза [6].



Рис.2. Влияние температуры первичной цементации ($\tau = 4$ часа) после борирования спеченного железа (а) и ЖХЗ (б) композита (плотность 95%) на их механические свойства ($T \approx 10000$ С, $\tau = 4$ часа)

1-твердость, 2-предел прочности при изгибе, 3-ударная вязкость

Основные закономерности влияния пористости на образование боридных покрытий типичны для железоуглеродистых материалов. Однако в композициях железо-углерод, изменение общей глубины боридных слоев не существенно, а по глубине всего слоя бориды относительно меньше железа. Это связано с дополнительным эффектом степени науглероживания переходной зоны на процессе боридования, который определяется плотностью исходного материала. Переходная зона и основание (подложка) имеют точные границы раздела в не прокаливаемых материалах 95% [4]. Уменьшением относительной плотности с 95% до 85% на границе переходной зоны структурные изменения менее важно и их металлографические не возможно отличить.

Образцы с плотностью 75% от боридного слоя к центра имеют структуру перлита.

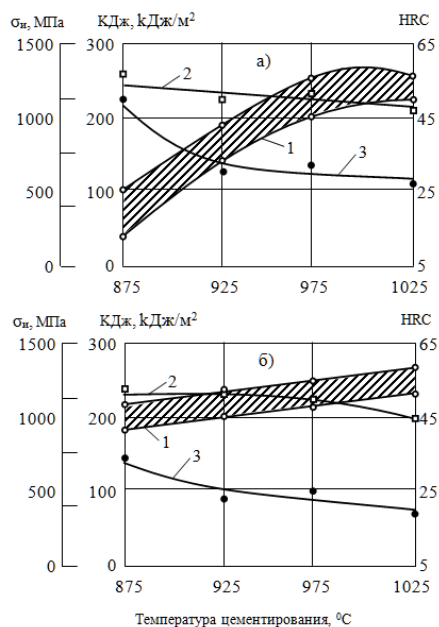
Влияние борирования на механические свойства первично цементированного железа относительно несколько ниже, чем после хромирования (рис.2).

Если ударная вязкость и предел прочности на изгиб после хромирования относительно выше, чему у отожженных образцов, а поверхностная твердость получается ниже, но после борирования обнаруживается противоречивые закономерности. Это, по сравнению с хромированием объясняется противоположным действием, бора и углерода, а также низкой температурой борирования [3].

При формировании боридного покрытия, углерод вытесняется в переходную зону. В переходной зоне повышение количества углерода и отсутствие бора благополучно влияет на прокаливаемость (рис.3). В этом случае упрочнение переходных зон достаточном по сравнению с цементации и хромированием и обнаруживается при более низкой температуре первой цементации.

При объемном легировании спеченного железа хромом облегчается получение под боридным слоем твердой переходной зоны. Например при

вводе в железо 3% хрома, твердая [H100 (400-600) МПа] переходная зона в спеченном железе может получаться примерно в 50°С ниже от температуры первичного цементации [4].

Это, в основном определяется одинаковым насыщением цементированного слоя железо-хромистых композитов повышенной концентрацией углерода и в последующем процессе борирования затрудненной диффузионной возгонкой и объясняется влиянием хрома на прокаливаемость композитов. Поэтому после двукратной обработки (цементация + борирование) в композиций [5], ЖХЗ толщина закаленной зоны в 2-2,5 раза больше, чем спеченного железа (рис. 3-в).

Насыщение углеродом и бором образцов с повышением содержания хрома в железе, от 3% до 9%-та не приводит к изменению поверхностной твердости и ударной вязкости, однако только повышается износостойкость.



Рис.3. Изменение микротвердости по глубине диффузионного слоя, последовательно насыщенный углеродом ($\tau = 4$ часа) и бором ($T \approx 10000$ С, $\tau = 4$ часа) железа (а) и ЖХЗ композита (а, б) (плотность 95%): $T_{цен} = 8750$ С (1) , 9250 С (2), 9750 С (3) и 10250 С (4)

5. Выводы

1. Исследование влияния температуры и долговечности покрытия на кинетику покрытий в первичных це-ментированных композициях показало, что образование карбидных покрытий происходит довольно интенсивно при температурах 1100°C и выше, а скорость роста диффузионного слоя резко уменьшается, когда продолжительность насыщения увеличивается более чем на 4-6 часов
2. В железо-хромистых сплавах боридные покрытия по сравнению с покрытиями на чистом железе имеют низкую износостойкость. Это вероятно объясняется относительной хрупкостью легированных хромом боридов.
3. Основные закономерности влияния пористости на образование боридных покрытий в железе также характерны для железоуглеродистых материалов. Однако в композициях железо-углерод при изменении пористости от общей глубины боридного слоя может изменяться а глубина сплошного слоя боридов относительно мало в железе.

6. Список литературы

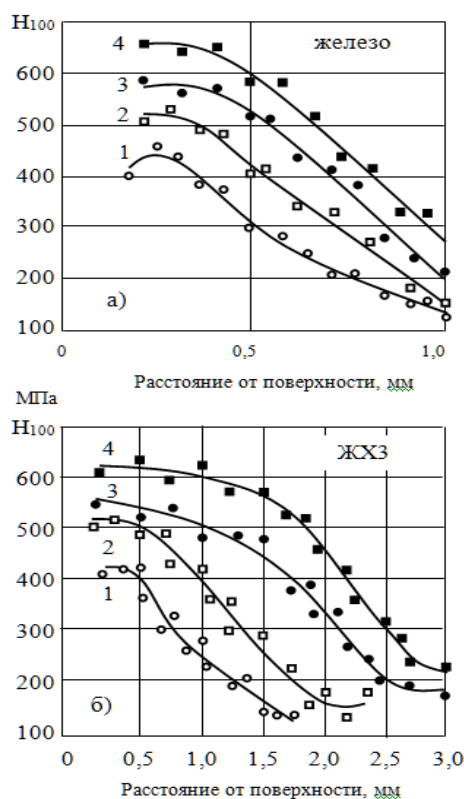
1. Андриевский Р.А., Федерченко И.М. Взаимная диффузия компонентов порошковых композиций. Изв. АН СССР, отделение техн. наук, 1991, №3, с. 728-732
2. Акциферов В.Н., Акименко В.В. Спеченные легированные стали.- М.: -Металлургия, 1993, 89 с.
3. Ворошнин Л.Г., Ляхович Л.С., Ловшенко Ф.Г., Протасевич Г.Ф. /Химико-термическая обработка металлокерамических материалов. Минск: Наука и техника, 1977. 272 с.
4. Ворошнин Л.Г., Алиев А.А. Борирование из паст: монография. Астрахан: АГТУ, 2006. 287 с
5. Ляхович Л.С. Ворошнин Л.Г., Борирование стали. М.: Metallurgy, 1997, 158 с.

6. Жунковский Г.Л, Колосветов Ю.П. Борирование твердых сплавов. Тезисы докладов VIII республиканской конференции. “Проблемы металлургия и прогрессивная технология термической обработки”. Минск, БИНИ-ИНТИ, 1982, 3 с.
7. Пантеленко Ф.И., Хусид Б.М., Ворошнин Л.Г. О росте борированного слоя на сферическом порошке железа. // Вести Академии наук БССР. Сер. Физикотехн. наук.1991. № 1. С. 22-24
8. Роман О.В., Беляев В.И., Куцер М.Я. Хромирование пористых материалов. В.кн. // “Порошковая металлургия и металлообработка”. НТО, Машинпром, 1985, с. 32-44
9. Самсонов Г.В., Жунковский Г.Л. Защитные покрытия в металлах. Вып. 7, Киев, “Наукова думка”, 1983, 230 с. Calmich P, Reviste de Metallurgie, 1990, 47, №3, p. 192-198
10. Calmich P, Reviste de Metallurgie, 1990, 47, №3, p. 192-198

Multi-criterial Choice of Energy Saving Measures for Buildings in Drawing up Energy Conservation Programs

G.P. Vlasenko; A.Z. Khalilullina; Y.I. Sliavin

Contact: National Research University MPEI,
Moscow, Russia

E-mail: vlasenkogp@yandex.ru

Abstract: currently, a lot of directions are being successfully developed in the field of resource and energy saving, but it is worth noting the special role of the housing and communal services sector, which is the largest consumer of fuel and energy resources and has a huge potential for energy saving.

The measures taken by the state policy in the town-planning sector in the period from 2007 to 2015 allowed to reduce the specific consumption of energy resources by 13 percent. Russian buildings and structures still have the largest reserves of savings: 102 million here or 22 percent of the total energy saving potential in the country. The urgency of the system approach to the selection of energy-saving measures is justified by the need to prioritize the introduction of buildings that require capital repairs in energy saving programs to save budget funds. The lack of a methodology for the systematic development of such programs within the framework of reconstruction does not allow obtaining informed decisions in a short time with minimal effort. The examples show the possibility of using the results obtained in the development of capital repair programs for buildings for various purposes. In the presented article the conclusions of applicability of this technique for buildings of various purposes are formulated. In addition, the possibility of using the results obtained within the framework of the capital repair program in buildings for various purposes is determined, as a result of which the energy consumption of these facilities can be reduced.

Keywords: energy saving, resource saving, energy efficiency, energy saving measures, energy efficiency measures, major repairs, energy saving potential, methodology, buildings, structures.

1. Introduction

All measures in the field of energy efficiency differ by numerous technical and technological characteristics, payback period, level of energy saving, peculiarities of operation, volumes of expenses, etc. Therefore, to form a list of measures, it is necessary to assess the feasibility of their implementation and conduct an energy audit of each building, what increases the cost and duration of work. The existing methodologies are based on a sequential phased comparison of measures, which is quite difficult to apply in practice and requires considerable time to estimate each of the expected energy-efficient measures. The article presents a simple and simultaneously multicriterion algorithm of selection of energy saving measures, which significantly simplifies the development of plans and programs for energy saving in the residential sector and social sphere. Development of multilevel classification of buildings at formation of list of energy-saving measures has allowed to systematize volume-planning decisions and to simplify choice of optimum decisions at carrying out of design and building-assembling works.

2. The need to use energy-saving measures in the buildings renovation

The state of the housing stock varies depending on the period of construction, material of the basic structures, applied typical models of houses in mass development of areas after 1961. Almost all brick and a huge part of large-panel and block houses, built before 1981, have wear more than 31% (Figure 1), i.e. need to be repaired [1,16].

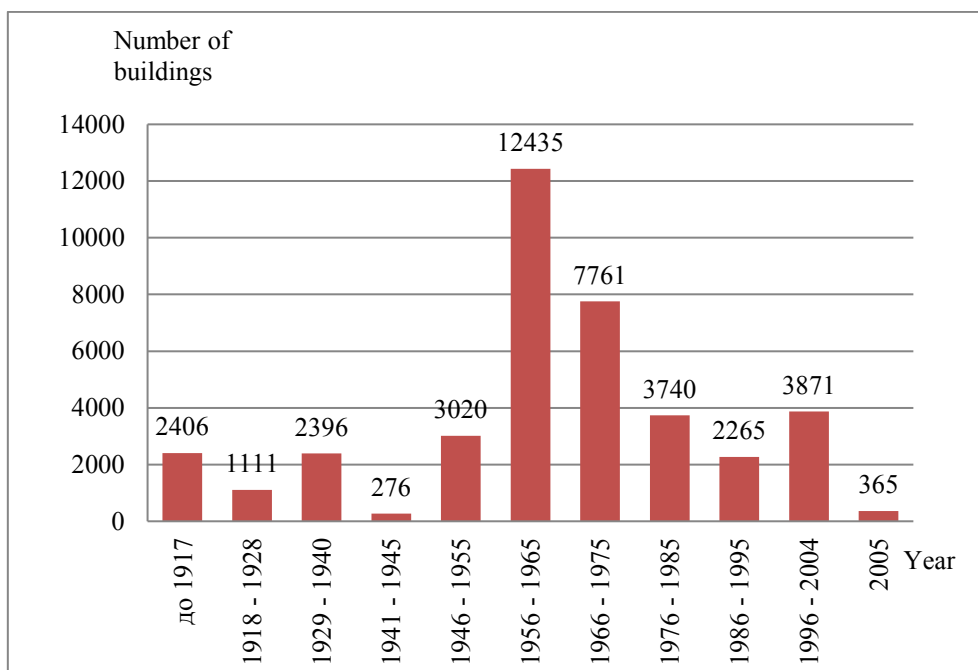

Figure 1: Distribution of residential buildings in Moscow by periods of construction

3. Influence of structural features of buildings on choice of energy saving measures criteria

In order to determine priorities during the renovation of the building, it is necessary to improve existing information systems, use the bases of modern technical solutions for energy saving and energy efficiency, update forms of statistical reconstruction observation [6]. The established method of multi-criteria selection of energy- and resource-saving measures allows to receive results in natural and value terms, including economic effect from introduction of the recommended program. The choice of the most effective energy saving measures is based on the system approach [10]. The algorithm of multi-criteria selection of energy and resource saving measures is developed on the basis of deep analysis of existing technical solutions and possesses a number of properties, shown in Figure 2.

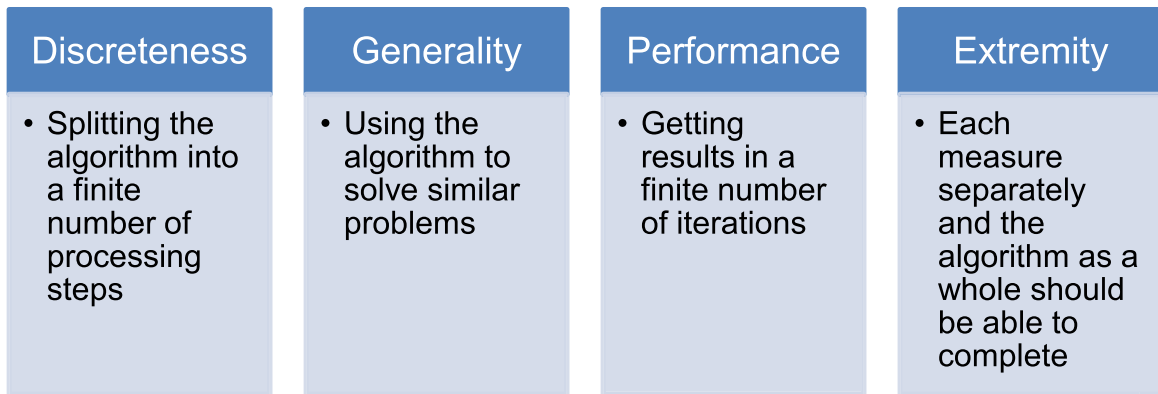

Figure 2: Algorithm Properties

Buildings and structures are classified using numerous parameters, each of which affects the energy efficiency of the facility. Often a particular organization or object has several buildings in the balance that correspond to different classes and specifics, which can significantly affect the list of recommended measures.

The main criterion in revealing the regularities between the choice of measures and the parameters of the building is its functional purpose, but with this approach can be selected specific features that affect the efficiency and cost of modernization in order to increase energy efficiency. In table. 1 is shown by the appropriate color influence of the characteristics of buildings on the selection criteria of energy saving measures.

4. Calculating energy efficiency criteria

Criteria of energy efficiency are subdivided into thermodynamic, technical and financial-economic. In developing the methodology, economic indicators have been adopted as criteria, subject to technical, technological, environmental and social constraints:

- Annual increase of net profit (criterion of effectiveness of the activity is the condition: positive value of annual growth of balance profit)

$$\Delta\Pi_{ch} = \Delta\Pi_b - \Delta H, \quad (1)$$

where $\Delta\Pi_b$ – annual growth of book profit, euro., ΔH – increase in the amount of established taxes and other payments, euro/year.

- annual saving of energy resources in monetary terms, euro.

$$E_t = Q_{\text{ЭК}} \cdot T_{\text{ЭР}}, \quad (2)$$

where $T_{\text{ЭР}}$ – tariff for the appropriate type of resources (thermal energy, hot water or electric energy) for the estimated period of time, euro.

- Payback period of investments (the choice of the most effective of several recommended measures is made on the maximal values of net profit at the acceptable payback time)

$$T_{pb} = \frac{Inv}{E_t}, \quad (3)$$

where Inv – Capital Investments (one-time expenses) for carrying out of the measure, euro, E_t – money saving in the period of time t , euro.

Properties and characteristics Energy saving measures	The capital structure of the building	Building floors	Material of walling	Technology of construction	Structural design of the building	Resource support of measures	Heated area	Climate zone	Measure selection criteria
	Replacement of window blocks	Green	Green	Orange	Orange	Green	Brown	Yellow	
Increase of heat protection of floor and basement walls	Red	Red	Green	Red	Red	Orange	Brown	Brown	<ul style="list-style-type: none"> • Internal air temperature in the building. • Thermal resistance of walling.
Increase of heat protection of external walls	Orange	Red	Brown	Brown	Orange	Brown	Yellow	Brown	<ul style="list-style-type: none"> • Internal air temperature in the building. • Thermal resistance of walling. • External air temperature.
Installation of the locking and control valves on heating radiators	Green	Green	Yellow	Yellow	Brown	Red	Brown	Brown	<ul style="list-style-type: none"> • Internal air temperature in the building. • Compliance with heat load normative value.
Installation of automatic control units of heat consumption	Yellow	Yellow	Yellow	Orange	Green	Brown	Green	Red	<ul style="list-style-type: none"> • External air temperature.

*Symbols used in table. 1:





	- No impact;
	- Impact is insignificant;
	- Noticeable impact;
	- Significant impact;
	- Must be taken into account when designing.

Figure 3: Influence of properties and characteristics of buildings and structures on selection criteria of energy saving measures*.

The following ratios are used to calculate the technical criteria for energy efficiency measures:

- Annual savings of energy resources because of the event in physical terms, tons of equivalent fuel.

$$Q_{ec} = Q_{h,bas}^y - Q_h^y, \quad (4)$$

where $Q_{h.bas}^y$ – current fuel and energy consumption, Q_h^y – projected consumption of fuel and energy resources (prior to the implementation of the measure).

- The ratio between calculated energy consumption and normative

$$K = \frac{Q_{norm}}{Q_{fact}} = \frac{q_{norm}}{q_{fact}}, \quad (5)$$

where q_{fact} – Actual specific consumption of thermal energy for building heating (or other types of resources), $\text{kW}\cdot\text{h}/\text{m}^2$, q_{norm} – Normalized specific consumption of heat energy for the heating of the building, $\text{kW}\cdot\text{h}/\text{m}^2$ (or other types of resources).

- Average reduction of the type of load or power of heating, ventilation, hot water supply or electricity, %

$$\Delta Q = \frac{Q_{h.bas}^y - Q_h^y}{Q_{h.bas}^y} \cdot 100\%, \quad (6)$$

5. Comparative analysis of activities by different criteria

Studies were used in the development of the methodology of multi-criteria selection of events in buildings of different purposes. [15]

The proposed method is characterized by ease of use and clarity – the separation of energy saving measures is carried out in the priority for the user order. For example, if the priority criterion is the payback period of the measure, then it will be evaluated at the first step of the algorithm. In the case when energy saving is the determining criterion, the sequence of steps changes.

Thus, the provisional list of activities is evaluated according to the selected criteria, and the number of such criteria may vary. Unlike other methods, the proposed approach can be applied to buildings of different purpose, with corresponding parameters and technical characteristics, so the methodology considered in the article is universal.

To illustrate the selection of energy-and resource-saving measures, an algorithm (Figure 3) has been formed, the beginning of which contains a plan of

initial selection of energy saving measures, followed by an analysis of the measure application, and the result is a list of recommended measures.

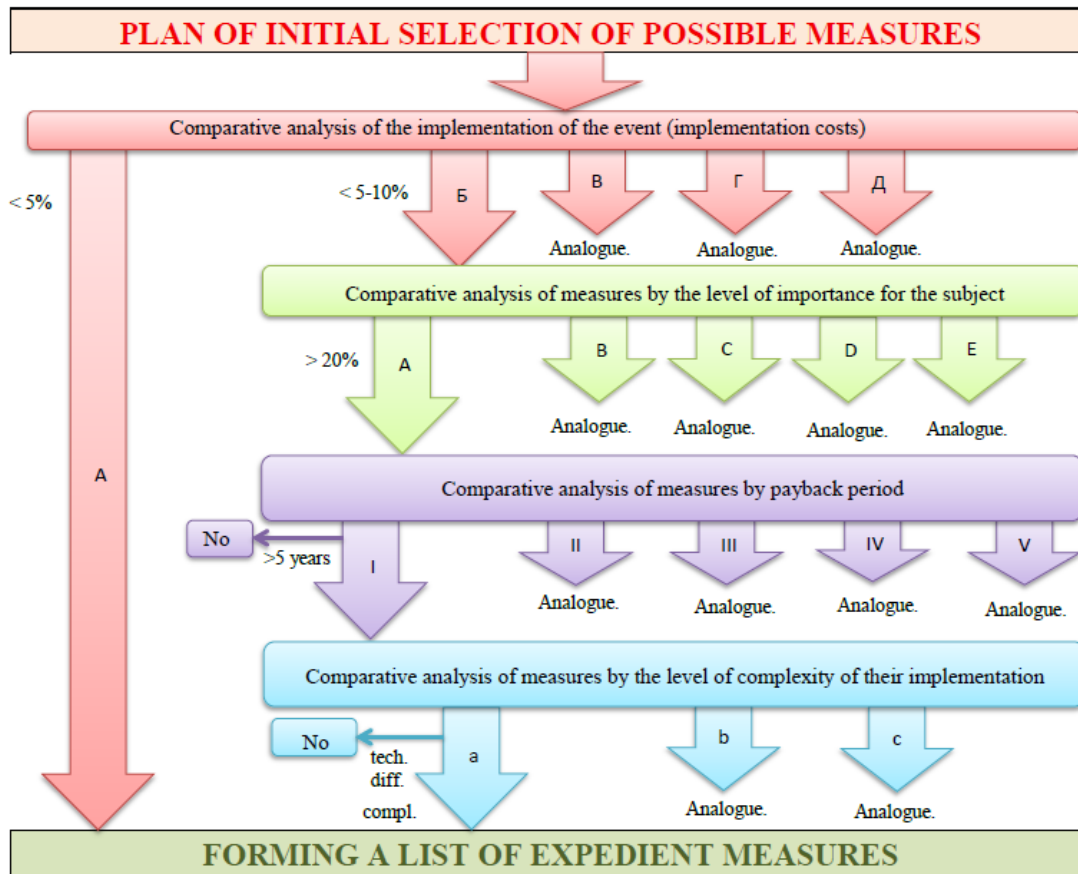

Figure 4: Algorithm for forming a list of recommended measures. The algorithm uses the block symbols shown in detail in Picture 5.

6. Formation of the list of recommended measures for buildings of different purpose

The comparative analysis allows to formulate for each considered building the list of preferable measures depending on the estimated expenses for realization of the project, magnitude of potential economy of natural resources, taking into account the complexity level of the measure and the degree of payback. The priority of the choice of measures also depends on the customer's goals and objectives. The proposed method of selection of measures for energy and resource saving is universal and differs from the known approaches in that such scheme is not a finite kind of algorithm and can be transformed for buildings of different purpose taking into account many parameters.

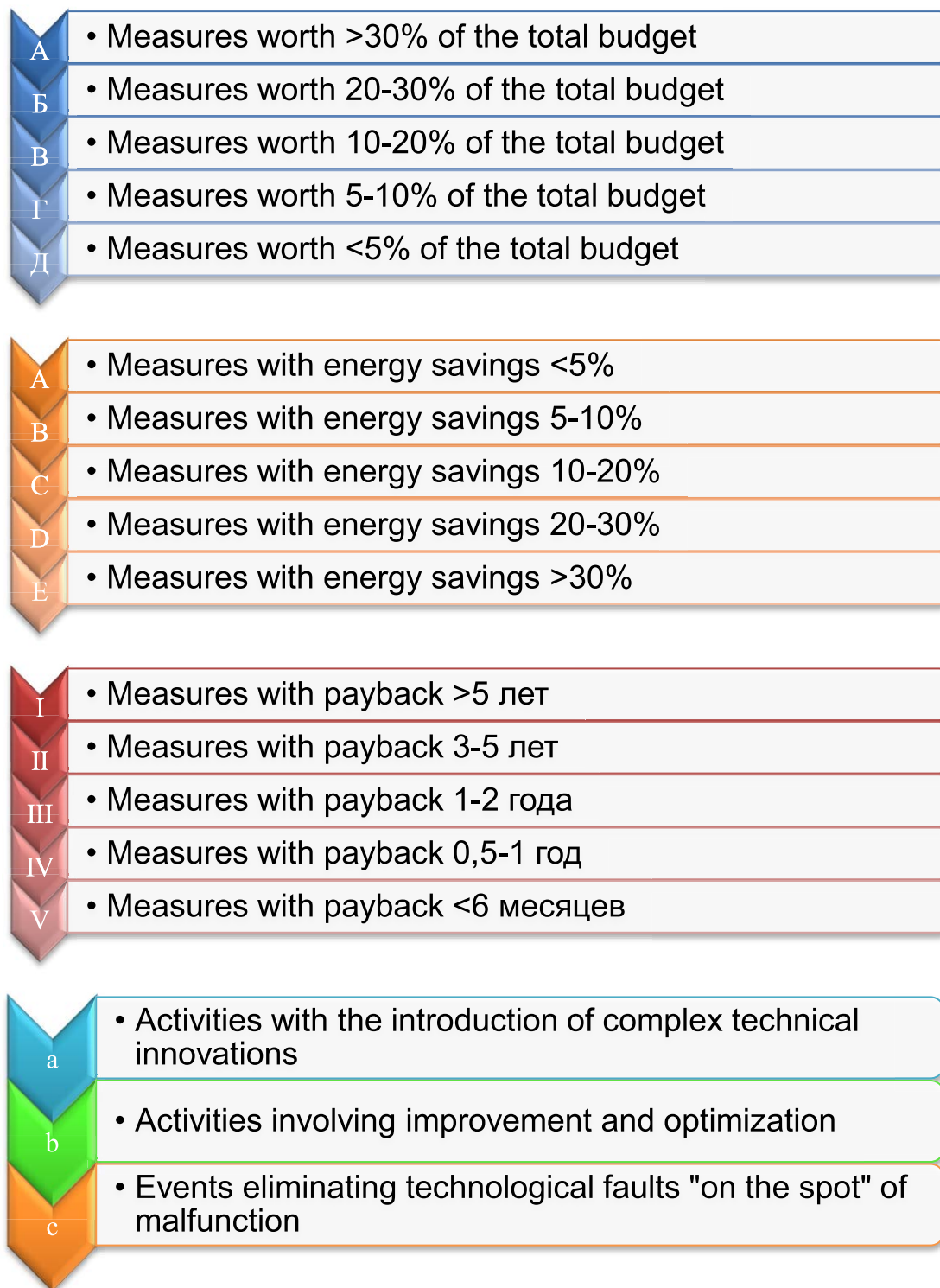

Figure 5: A comparative analysis of the implementation of measures by criteria: Block 1. By the cost of implementation; Block 2. By degree of importance for the subject (by complexity of implementation); Block 3. By payback period; Block 4. By the level of complexity of their implementation (on the complexity of the applied measures)

It is possible to harmonize the sequence of implementation of individual projects, as some of the recommended measures may be interrelated or vice versa, the implementation of some energy-saving solutions affects negatively the use of other measures (subject to technical parameters) [8].

In addition, it is necessary to take into account the fact that the implementation of each group of energy-saving measures is interrelated with the application of other measures aimed at energy and resource saving. For example, the operation of automated control units (ACU) showed that the use of ACU in conjunction with balancing valves on the risers of the central heating system, thermostatic valves on each heating device and carrying out of warming measures (including replacement of Windows) allows to save up to 25-37% of thermal energy and to provide comfortable conditions of residing in each premise.

The proposed method allows to choose the key measures both on the basis of identification of energy losses and taking into account the maximum effect of their implementation.

The developed algorithm can be used in the sphere of housing and utilities within the framework of the program of reconstruction in buildings of various purposes, as a result of which, the energy consumption of these objects should be reduced.

7. Examples of the method application for choosing energy saving measures

We will consider the application of the methodology for the selection of energy saving measures on the example of residential and administrative buildings requiring repair.

Typical measures to improve the energy efficiency of buildings (in the area of improving the thermal properties of walling), provided the installation of the ACU.:

- 1.1 Increase of thermal protection of walling.
- 1.2 Increase of thermal protection of windows and balcony doors.
- 1.3 Increase of thermal protection of roof or attic rooms.
- 1.4 Increase of thermal protection of floor and basement walls.
- 1.5 Increase of heat-technical homogeneity of external walling.
- 1.6 Sealing of interpanel compounds.
- 1.7 Sealing of external entrance doors.
- 1.8 Additional partitioning of input spaces.



Figure 6: Buildings in Example 1 and 2

Example 1. Object of study 4-storey residential building

The existing model structure was commissioned in 1896 and is located at the address: Moscow, str. Elektrozavodskaya, 37/4, corp. 4. Thermal energy characteristics of the building are presented in figure 7.

The basic criteria of energy efficiency are defined on the grounds of calculation, values of which are priority for formation of the list of recommended measures in the framework of reconstruction of dwelling building. These criteria include: the level of complexity of the implementation of the measure, the annual energy savings (tons of equivalent fuel), the annual energy savings in monetary terms (euro), the ratio of calculated consumption energy to the normative, average reduction of the load on engineering systems (%). For the sake of clarity the

obtained criteria of energy saving measures efficiency are summarized the in figures 8 - 10.

Analysis of data allows to form from the list of typical solutions the list of recommended measures on improvement of energy efficiency of a dwelling buildings taking into account priority of one of the factors specified in the table.

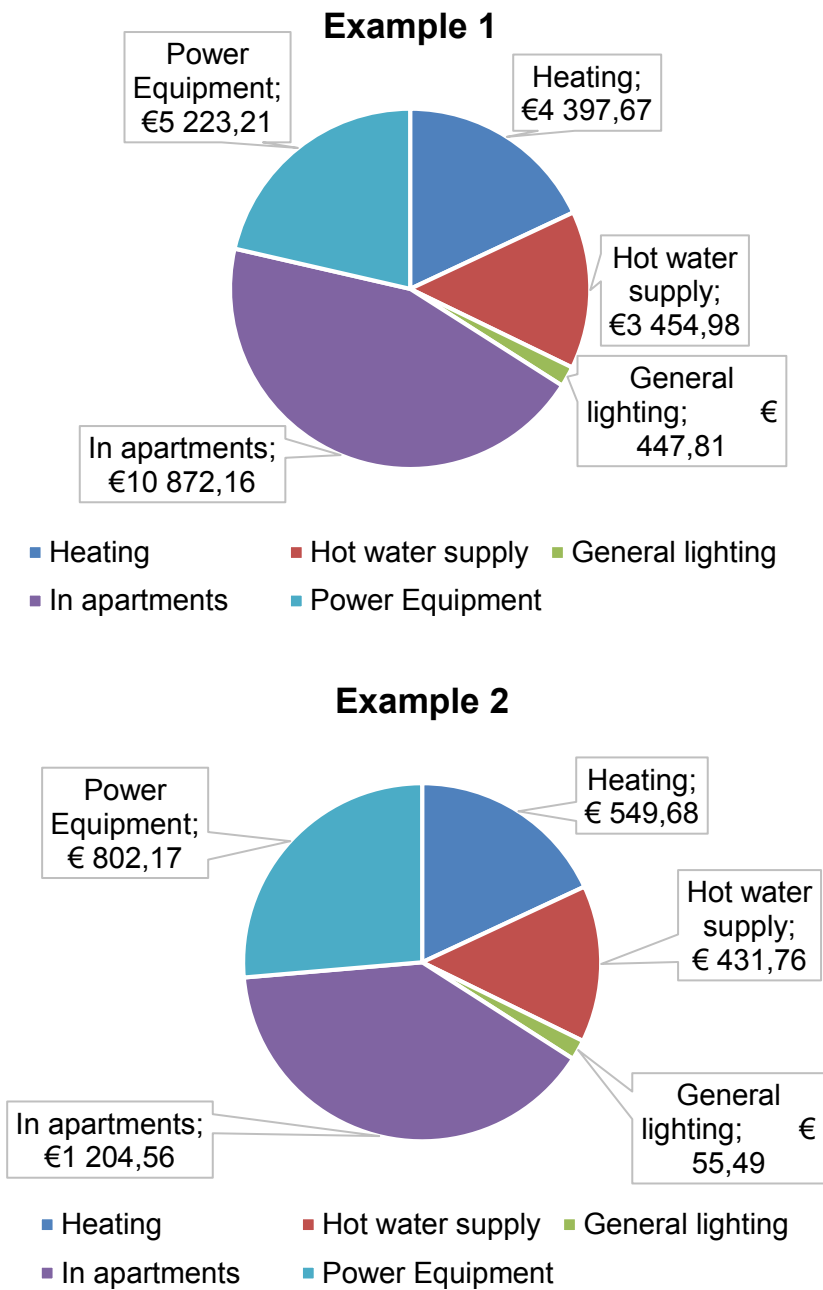

Figure 7: Annual energy consumption of the buildings, construct 1896 and 1932

In this example, you are prompted to use the following activities:

- 1) Increase of thermal protection of walling.
- 2) Increase of thermal protection of windows and balcony doors.
- 3) Increase of thermal protection of roof or attic rooms.

Example 2. Object of study 2-storey administrative building

The existing building with the basement under the part of the building was constructed on an individual project, commissioned in 1932 and located at the address: Moscow, str. Mareyeika, 11/4, p. 4. Thermal energy characteristics of the building are presented in table 2.

The criteria of energy saving measures efficiency are obtained as a result of calculations and are shown in Figures 5-7. Based on the analysis of criteria of recommended energy efficiency measures, a list of key activities is formed:

- 1) Increase of thermal protection of walling.
- 2) Increase of thermal protection of windows and balcony doors.
- 3) Increase of thermal protection of roof or attic rooms.
- 4) Increase of thermal protection of floor and basement walls.

Within the limits of the limited budget, technical peculiarities of objects, the shortest terms of carrying out energy audit, the proposed method of selection of measures for resource and energy saving is a simple and simultaneously accurate algorithm for detecting recommended measures to improve the energy efficiency of buildings for various purposes. The results of the work can be used in the sphere of housing and communal services, mostly in the framework of the program of buildings reconstruction, as a result of which the energy consumption of these facilities should be reduced, to ensure maximum possible increase in energy efficiency, and, therefore, optimal expenditure of allocated funds.

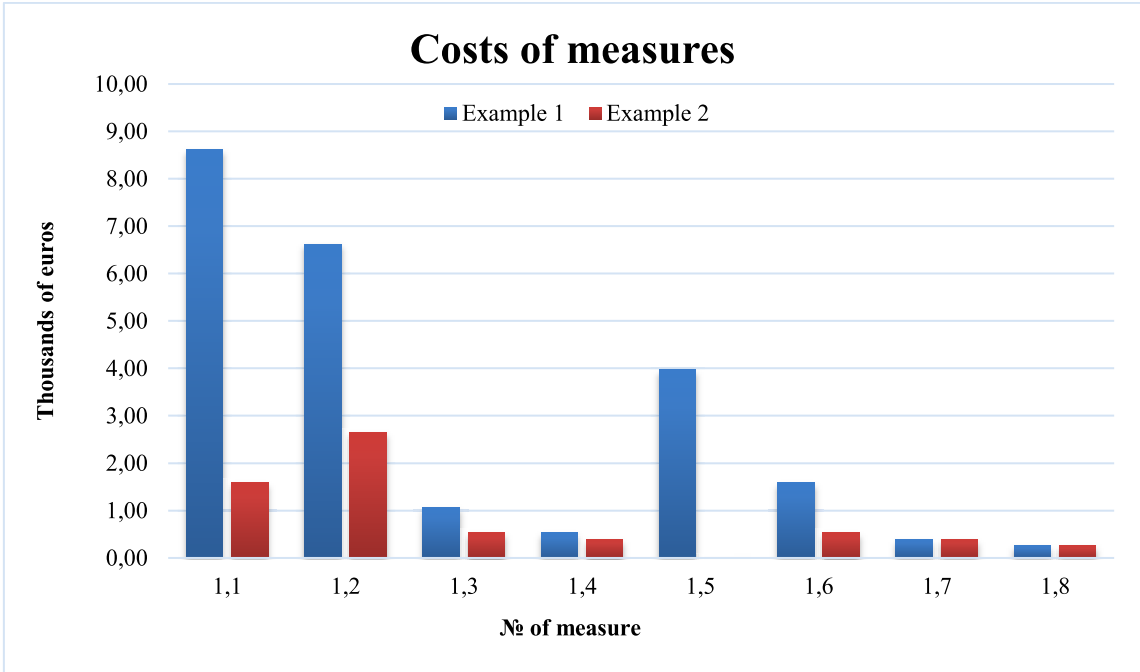

Figure 8: Costs of energy saving measures

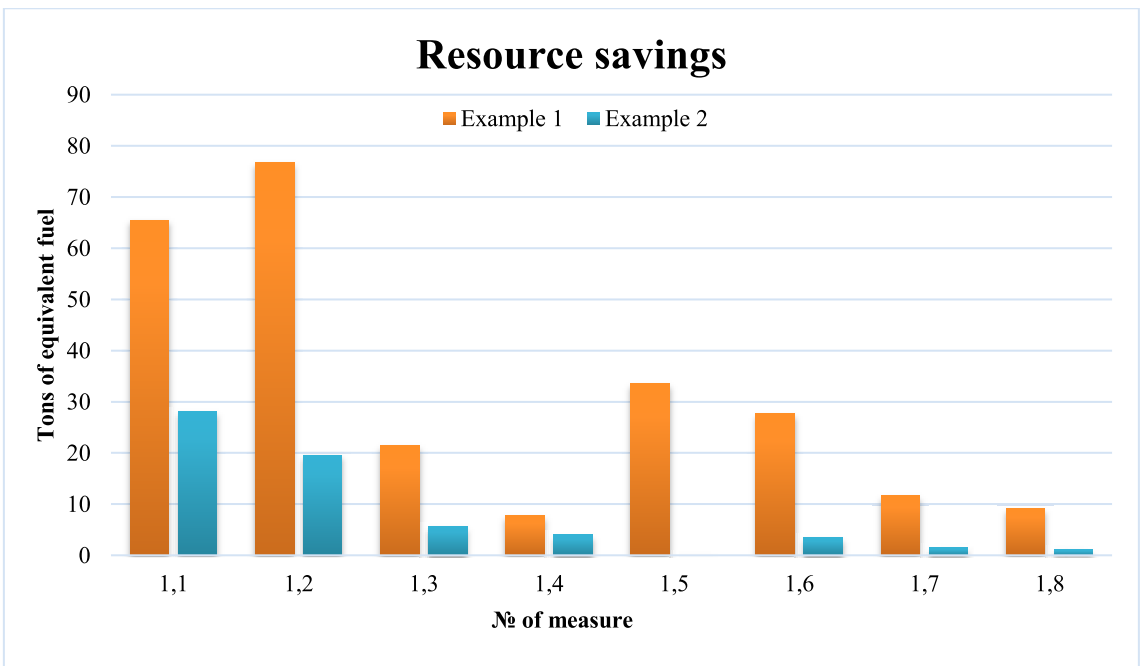

Figure 9: Savings of resources

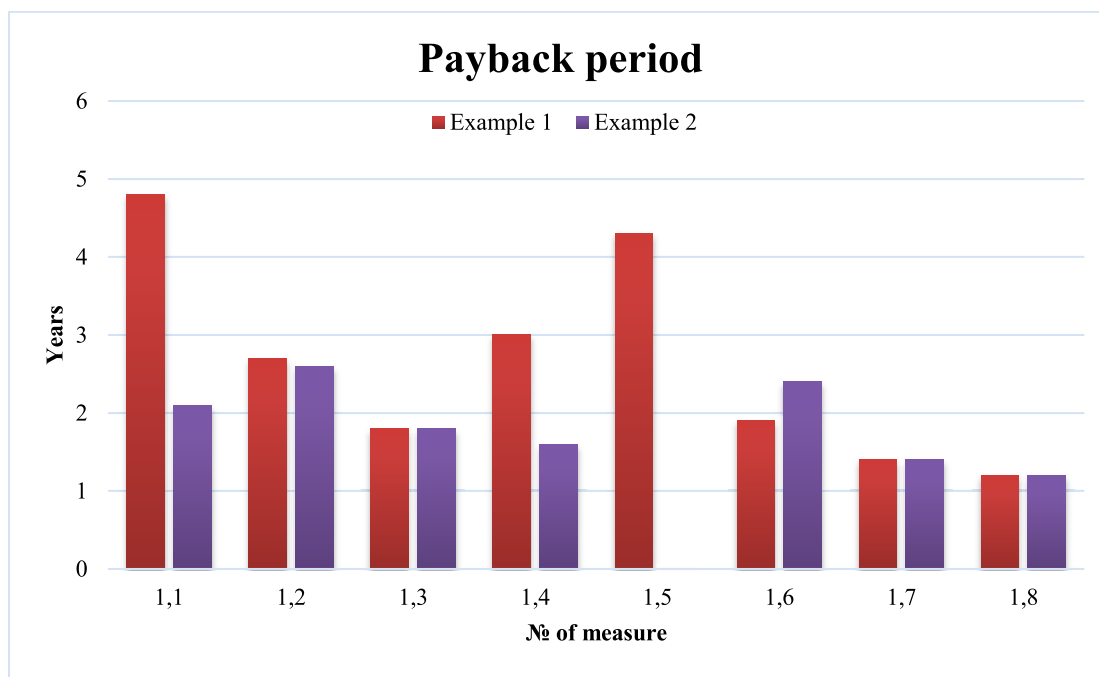

Figure 10: Payback period of measures

The analysis of actual (before reconstruction) and calculated (after reconstruction) thermal power characteristics of the objects, considered in the examples, shows that the recommended list of measures will allow to increase the energy efficiency class of buildings.

8. Conclusions

The problem of calculation and analytical substantiation and choice of energy saving measures for buildings is actual and requires deep analysis not only of applied technologies, but also methods of estimation of energy saving potential. The article proposes an algorithm that includes stages from the analysis of the current situation and the search for energy efficiency reserves before using the method in relation to a particular building (or urban scale).

The example of residential and administrative buildings shows that this approach allows to choose key measures based on the identification of losses of energy and resources, taking into account the maximum effect of their implementation. The results of work are supposed to be used in the sphere of housing and within the framework of the buildings reconstruction program. The

proposed algorithm can be used to select energy saving measures in conditions of changing climate.

9. References

1. Resolution of the Government of Moscow of April 22, 2014 № 205-PP "on amending the resolution of the Government of Moscow of September 27, 2011 № 454-PP".
2. Regulation of the Government of the Russian Federation of December 27, 2010 № 2446-P of the state program of the Russian Federation "Energy Saving and energy efficiency improvement for the period up to 2020".
3. Federal law of December 28, 2013 № 399-FZ "on amending the Federal law "On energy Saving and energy efficiency improvement and on amending certain legislative acts of the Russian Federation".
4. Order of the Ministry of Energy of the Russian Federation dated June 30, 2014 № 401 "On approval of the procedure for presenting information on energy saving and improving energy efficiency".
5. Resolution of the Government of the Russian Federation № 18 of January 17, 2017 «On approval of the rules of providing financial support from the funds of the State Corporation – Fund for assistance in reforming housing and communal services Carrying out overhaul of apartment buildings».
6. Bashmakov I.A. Energy use and energy efficiency in the Russian housing sector. M.: Center for efficient use of energy, 2014.
7. Bashmakov I.A., Myshak A.D. Energy consumption of regions of Russia. About the real dynamics and the quality of statistics. Energy saving. 2016. № 5. P. 24-28.
8. Stasievskaya V.V., Velenteenko A. M., Frolov V. A. Methods and means of energy and resource saving. Krasnoyarsk: PKI SFU, 2008.
9. Sviridova E.V. Trend on energy efficiency. Improving energy efficiency and energy saving for Russia is a strategic necessity. Modern building constructions. 2017. № 1 (28). P. 55-57.

10. Model measures for energy saving and improving energy efficiency of energy supply and energy systems in budget institutions. Methodical recommendations. Yekaterinburg: Gbu SO "InES", 2012.
11. Methodical recommendations on calculation of effects from realization of measures on energy saving and increase of energy efficiency under the general edition of Gassho E. Reference-analytical document. Analytical Center under the Government of the Russian Federation. 2016.
12. Methodical recommendations on estimation of energy saving measures efficiency. Tomsk, TSU ID, 2014.
13. Bashmakov I.A. Potential of energy saving in Russia, state information system in the field of energy saving and increase of energy efficiency. State information system in the field of energy saving and energy efficiency improvement [electron resource] gisee. RU/articles/SMI/1078/(Date of appeal: 27.04.2017).
14. Zilberova I. Y., Vongai A. O., Artsishevskiy M. D. Modeling of energy-saving organizational and technological processes of reconstruction of educational institutions buildings. Engineering Bulletin of Don, 2017, № 3 [electron resource] <http://ivdon.ru/>(date of appeal 20.07.2017).
15. Podskrabets A.D., Diagilev V.F. Choice of optimal measures for energy saving in the social sphere [electron resource] <https://fundamend-research.ru/>(date of appeal 10.06.2017).
16. MOSGORBTI [Official site]. <http://www.mosgorbti.ru/>(date of appeal 20.06.2017).
17. Ministry of Energy of the Russian Federation [official site]. <http://minenergo.gov.ru/>(date of circulation 25.06.2017).

Influence of russian climate (arctic, centre, south) on construction and reconstruction of energy efficient buildings

I. Sultanguzin¹; A. Govorin¹; I. Kalyakin¹; D. Kruglikov¹; Yu. Yavorovsky¹; E. Zhigulina¹; V. Khromchenkov¹

Contact: National Research University “Moscow Power Engineering Institute” Moscow, Russia

E-mail: SutanguzinIA@mpei.ru

Purpose. Definition of climate conditions influence on reconstruction and construction of energy efficient buildings from Extreme North to the southern regions of Russian Federation.

Methodology. Realization of the system approach to solution of problem, including the analysis of climatic conditions of the concrete region, calculation of heatlosses for constructed or reconstructed building, development of complex energy supply system of the building, the choice and realization of optimal variant of the energy efficient building.

Findings. The Russian Federation occupies very big territory with the most different climatic conditions. The climate very severe on Extreme North, where lives the small population. In the same place the main natural wealth of Russia settle down: oil, gas, coal, gold, diamonds, etc. It is necessary to provide harmonious development of these regions with minimum possible costs of energy and other resources. The analysis has shown that it could be achieved thanks to renewable energy sources (RES) and the greatest possible insolation of buildings and constructions. It is developed approach to construction of energy efficient buildings in the arctic conditions with use of heat pumps, wind power installations, wood pellet, biomass waste, solar collectors and photovoltaic (PV) solar batteries which will give energy in the conditions of polar summer. Calculation researches have shown that energy efficient buildings on the basis of use of modern materials and technical solutions could be built in the remote north-

ern regions. Important aspect is ensuring reliability of energy supply systems of buildings and constructions that it can be reached due to application of many alternative energy sources. It is necessary for this purpose carrying out scientific research on development of optimal solutions of heat and power supply of buildings in the conditions of Extreme North.

Similar approach has been realized for construction and reconstruction of energy efficient buildings in the conditions of the central regions of Russia and the southern regions. Calculation researches on selection of the equipment for power supply system of the reconstructed office building and constructed cottage house in the Moscow region have been conducted. Calculations have shown that the office building could be built with specific energy consumption of 15 kWh / (m²*year) that conforms to requirements of the passive house. For cottage house under construction energy consumption has appeared more large value (38 kWh / m²*year). However thanks to solar collectors and PV batteries it is possible come to level nearly zero energy consumption. Construction of 2-storey house shows that it is this level it will be possible to achieve within 1-2 years. The investigation of reconstruction of the canteen building in the International children's camp (ICC) "Artek" , located in the south region Crimea has been also conducted. Calculations have shown that this building thanks to good isolation of a roof and application of energy efficient windows could conform to requirements of the passive house. When using RES and modern energy saving technologies this building could become with zero energy consumption.

Originality. Our Department of Industrial thermal engineering systems within many decades applies system approach to a research of large power systems of the industrial enterprises (metallurgical, chemical, oil and gas, etc.) and the systems of heat supply of a housing-and-municipal complex and the cities in general. The acquired methods have been applied at a solution of the problem of creation of energy efficient buildings in various regions of Russia. Our experts possess as by calculation methods, so by methods of carrying out laboratory and industrial experiments with using of different measuring devices. Also we

well possess methods of mathematical modeling, optimization methods, dynamic and statistical modeling. All this allows find optimal solutions which can't be foreseen without use of powerful instruments of scientific research.

Practical value. The received results of investigation of climatic factors influence on construction and reconstruction of energy efficient buildings allow find and realize optimal solutions on the choice of construction materials and advanced technologies for any regions of Russia.

Keywords: *arctic, building, climate, construction, energy, heating, heat pump, reconstruction, region, ventilation.*

1. Introduction

The Russian Federation occupies very big territory with the most different climatic conditions.

The purpose of this work is definition of climate conditions influence on reconstruction and construction of energy efficient buildings from Extreme North to the southern regions of Russia.

Applying uniform approach, for each region various are reached different optimal solutions on materials and isolation of buildings and technical decisions. We will consider in more detail construction of energy efficient buildings for various regions of Russia, including the Arctic, central and southern regions.

2. Analysis of the recent research

The problem of climatic factors influence at choice of optimum designs and technologies for creation of energy efficient buildings is rather difficult and low-investigated. In the Arctic researches of influence of low temperatures on energy consumption of the building in relation to conditions in Greenland were conducted [1,2].

In relation to the Arctic conditions in Russia the research has been conducted [3].

Objective of the article is the definition of climate conditions influence on reconstruction and construction of energy efficient buildings from Extreme North to the southern regions of Russian Federation.

3. Methods

Analysis of climatic conditions of the concrete region, calculation of heatlosses for constructed or reconstructed building, development of complex energy supply system of the building, the choice and realization of optimal variant of the energy efficient building are used for realization of the system approach to decision of the problem.

4. Presentation of the main research

Extreme North

Territories of the Extreme North are characterized by severe climatic conditions and long heating period.

Construction is complicated by everfrost, and delivery of cargo, including fuel, is only possible during a short summer navigation period.

Successful experience in energy efficiency improvement and development of renewable energy sources (RES) in the Extreme North conditions will allow for achievement of the strategic goal of revival and active development of the Arctic territories.

Improvement of energy efficiency and development of RES can give annual savings of about RUR 100 billion of budget funds.

The total costs of power supply for all consumers of 15 regions of Extreme North is equal to 1,7 trillion RUR (2% of GDP).

Electricity rates reach 20–237 RUR/kW·h that is 5-55 times higher than averages across Russia.

Thermal energy rates reach 3–20 thsd. RUR/Gcal that is 3-17 times higher than averages across Russia [1].

Practically in all regions of Extreme North (except for extracting oil and gas) the share of expenses on power supply in Gross regional product (GRP) makes 20–37% and multiply exceeds thresholds of economic availability of energy (10%) that doesn't allow economy to develop dynamically.

Only 8% of the population of the country live in territories of Extreme North.

But 76% of the Russian oil, 93% of natural gas, 95% of coal, 95% of gold, 100% of diamonds, 100% of caviar of salmons are extracted in these regions.

Potential of economy of energy in regions of Extreme North exceeds 40%.

We will consider a question of the energy efficient buildings construction in the village Khatanga located in Krasnoyarsk Region behind a polar circle where 2645 peoples live.

Climate in Khatanga is very cold in winter. Absolute minimum temperature is -59 C. Weather in July is rather hot. Absolute maximum temperature is +36,7 C.

Khatanga requires a small warehouse for various equipment of 144 sq.m. It needs to be constructed with good thermal isolation. Thickness of eco cotton wool layer in wall is 60 cm. In framework of the building spatial elements – the double tee wooden farms and beams having width of 60 cm corresponding to thickness of isolation of a design are effectively used. In this case design thermal resistance is $R = 15,3 \text{ m}^2 \cdot \text{C/W}$. Such building meets requirements of the passive house [4,5]. Necessary resistance of heat transfer on new Construction Norms and Regulations is $5,28 \text{ m}^2 \cdot \text{C/W}$ for Yakutia.

Thermal scheme of warehouse in Khatanga present on figure 1. It consist of heat pump, ventilation system with heat recovery, hot water accumulators, pellet fireplace, wind turbine, solar collectors and PV batteries, heating radiators and ceiling capillary mats. The redundancy of the thermal scheme is necessary for increase of reliability in severe Arctic conditions.

Central part of Russia

The question of reconstruction of the office building of Scientific Research Institute “Center of Environmental Industrial Policy” (CEIP) and construction of a two-storeyed house has been considered [6,7].

Building CEIP consists of 5 floors with technical floor and cellar. Sizes of the squared building in respect are 16 m x 78,6 m.

Basic decisions on heat supply of "CEIP" building at reconstruction include:

- The system of ceiling heating on the basis of the capillary mats of GeoClimaDesign placed on top under gypsum cardboard;
- The system of heat pumps and solar collectors is provided for decrease in operational expenses;
- The temperature schedule of heating system is 32/28 °C from the heat pump. Giving temperature in the domestic hot water system of 60 °C with reheating from district heating network.

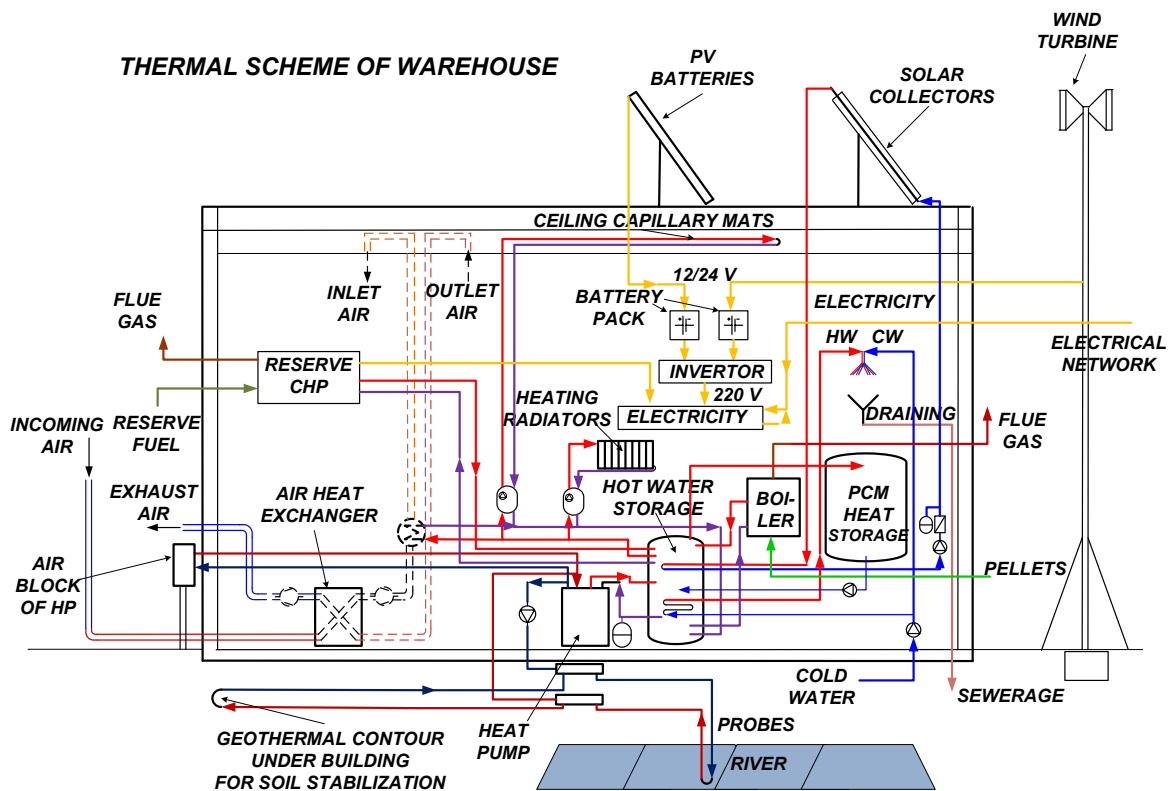

Figure 1. Thermal scheme of warehouse in Khatanga.

Calculation researches on selection of the equipment for power supply system of the reconstructed office building and constructed cottage house in the Moscow region have been conducted. Calculations have shown that the office build-

ing could be built with specific energy consumption of 15 kWh / (m²*year) that conforms to requirements of the passive house.

For cottage house under construction energy consumption has appeared more large value (38 kWh / m²*year) [6,7]. However thanks to solar collectors and PV batteries it is possible come to level nearly zero energy consumption. Construction of 2-storey house shows that it is this level it will be possible to achieve within 1-2 years.

Southern Regions

The investigation of reconstruction of the canteen building in the International children's camp (ICC) "Artek" , located in the south region Crimea has been also conducted [8]. Calculations have shown that this building thanks to good isolation of a roof and application of energy efficient windows could conform to requirements of the passive house. When using RES and modern energy saving technologies this building could become with zero energy consumption.

5. Conclusions and recommendations for further research

It is necessary to continue the investigation of climate influence on construction of energy efficient buildings. It is necessary to build few experimental houses in different climatic zones.

6. References

1. Anderson P.H.D., Rode C., Madsen H., 2013. Low energy house in Sisimiut – Measurement equipment. *Technical University of Denmark. Technical Report No. 17*, 59 p.
2. Anderson P.H.D., Rode C., Madsen H., 2013. Low energy house in Sisimiut –Data Overview. *Technical University of Denmark. Technical Report No. 18*, 22 p.
3. Bashmakov, I.A., 2017. Energy Supply Efficiency Improvement in Northern Regions of Russia. *Energoberezhniye*, 2, pp. 40–45.

4. Feist V., 2015. Basic provisions on design of passive houses. M.: OOO «KONTIPRINT», 144 s.
5. Schütz W., 2016. Energy saving regulations in Germany, history – status – future. 3. *INGENIUERTAG 2016. Der Fakultät Maschinenbau, Electro- und Energiesysteme Gus- und Osteuropatag. NESEFF-NETZWERKTREFFEN 2016.* Tagungsband. Brandenburgische Technische Universität. Cottbus-Senftenberg. 14-15 November 2016, pp. 167 - 173.
6. Sultanguzin I., Kalyakin I., Govorin A., Khristenko B., Yavorovsky Yu., 2016. Optimization of the energy efficient active house. 3. *INGENIUERTAG 2016. Der Fakultät Maschinenbau, Electro- und Energiesysteme Gus- und Osteuropatag. NESEFF-NETZWERKTREFFEN 2016.* Tagungsband. Brandenburgische Technische Universität. Cottbus-Senftenberg. 14-15 November 2016, pp. 8 -12.
7. Sultanguzin I., Schutz W., Kalyakin I., Govorin A., Yavorovsky Yu., Khromchenkov V., Zhigulina E., Malakhova A., Damen A., Lanzke B., 2017. Design, construction and survey of the front of the energy efficient house. *Stroitel'stvo i rekonstruktsiya*, 4, pp. 110-117.
8. Kalyakin I., Ashikhmina A., Sultanguzin I., Fedyukhin A., Yavorovsky Yu., 2016. Application of Passive House Modeling Software to Design Residential and Public Buildings. *Proceedings of the International Academic Forum AMO – SPITSE – NESEFF. – 20-25 June, Moscow–Smolensk. – Smolensk: Publishing “Universum”, p. 143*

System for LNG production and storage at power stations

A. Nikulina¹; E. Zhigulina²; O. Chehranova³

Contact: 1. Moscow Power Engineering Institute, Moscow, Russia
2. Moscow Power Engineering Institute, Moscow, Russia,
3. Moscow Power Engineering Institute, Moscow, Russia,

E-mail: 1. frufufu44@yandex.ru
2. zhigulinayv@mpei.ru
3. chehranova.olga@yandex.ru

Purpose. The paper presents the research results for the efficiency improvement of fuel economy operation at thermal power plants due to the transition to liquefied natural gas usage as the reserve fuel produced at the station itself instead of fuel oil.

Methodology. The use of the software package ASPEN PLUS, system modeling

Findings. An assessment of the reserve fuel requirements was made and technical solutions for the reserve fuel in the form of liquefied hydrocarbons of the required volume were considered.

Originality. The article considers the possibility of using, obtaining and storing liquefied natural gas instead of fuel oil as an emergency and reserve fuel at thermal power plants due to energy-saving technologies that allow in addition to electric energy to obtain cold, such a temperature level that is necessary to obtain liquefied natural gas fractions to accumulate the necessary amount of reserve fuel.

Practical value. Improvement efficiency of operation of fuel economy of thermal electric stations due to the transition to liquefied natural gas as reserve fuel produced at the station itself instead of fuel oil

Keywords: *thermal electric stations, liquefied natural gas (LNG), turbo-expander unit*

1. Introduction

Russia is one of the leading producers and suppliers of natural gas. Blue fuel is transported and sold to both foreign and domestic markets. Due to the fact that most manufacturers of various products use natural gas as an energy resource and raw material for their products, the demand for this fuel will increase. The energy sector is the main consumer of gas both in Europe and in Russia. First of all, these are enterprises that generate energy, industry, residential sector, etc. The issues of energy saving in the production, transportation, storage and processing of gas fuel every year arise more often and become more relevant. One of the most promising directions in the field of energy saving in the transportation of natural gas is the recovery of excess pressure energy at the nodes of its reduction and consumption.

2. Analysis of condition of fuel farms of thermal power plants in Russia

At the moment, combined production of electricity and heat in Russia is carried out mainly at large thermal power plants, which operate as part of industrial enterprises with partial heat release to urban thermal. Numerous discoveries of large gas fields in the second half of the 60s, provoked the widespread construction of boiler and thermal power plants running on natural gas. Significant reserves and low cost of gas, from the point of view of the economy, have become the main basis for the reconstruction of boilers and CHP because of their transfer to gaseous fuels. Fuel oil was used as a reserve or emergency fuel, but for a long time the rate of energy saving was not made, as the fuel and energy resources of the country seemed unlimited. In this regard, research in the field of calculations and design of fuel oil facilities has not been given sufficient attention. The main subject of attention in the operation of fuel oil farms are considerable energy costs for heating the content of fuel oil and its preparation for operation. Operating costs for the maintenance of fuel oil facilities are about 8-10 % of the boiler load. Based on this, it follows that it is necessary to analyse more thoroughly the possibilities of energy saving of fuel oil farms at large ther-

mal power plants and small-scale power boilers. Currently, the construction of energy facilities with autonomous gas supply is becoming more and more important, where gas fuel is used not only as the main fuel, but also as a backup fuel. In terms of consumer properties, gaseous reserve fuel has a number of advantages, the main of which are economic efficiency and environmental cleanliness. The use of gas as a reserve fuel provides full automation of power plants. As a reserve or emergency fuel, such energy resources as liquefied petroleum gas (LPG), otherwise propane-butane, and liquefied natural gas (LNG), consisting of 95% of liquefied methane (due to the low storage temperature, there is a limitation in its use as a reserve fuel) can be used.

3. Development and calculation circuitry of reserve fuel for thermal power plants

The gas is supplied to thermal power plants (TPP) with a pressure in the range of 0.6 - 1.2 MPa. As a fuel it is used at a much lower pressure in the range of 0.15-0.2 MPa. In our country, in most cases, throttling is used to reduce the pressure of natural gas. The use of expander-generator technologies will allow the consumer to use a sufficiently large energy-saving potential for the consumer of gas fuel. With the expansion of natural gas in the expander-generator unit without preheating the gas is cooled to -60 (-80) $^{\circ}\text{C}$, depending on its initial parameters. In some cases, at a certain content of high-boiling hydrocarbon fractions, such a temperature level of cold is sufficient to condense individual components of natural gas. The purpose of this study is to assess the principal possibility of using expander for liquefying part of the gas supplied to the thermal power plant for its further accumulation, storage and use as a reserve fuel. The usual scheme of using turbo-expander unit (TEU) involves preheating the gas to obtain the required temperature at the outlet of their expander. In this case, on the contrary, it is necessary to obtain the lowest possible outlet temperature to obtain condensate, so the gas is supplied to the expander with pre-cooling. Also, it is necessary to heat the gas after the expander before feeding into the boiler. We use a regenerative gas-gas heat exchanger at the entrance to the

expander. It will provide pre-cooling of the gas at the inlet and preheating at the outlet. After the heat exchanger, a separator for condensate separation is installed.

The scheme of the system with pre-cooling is shown in figure 1.

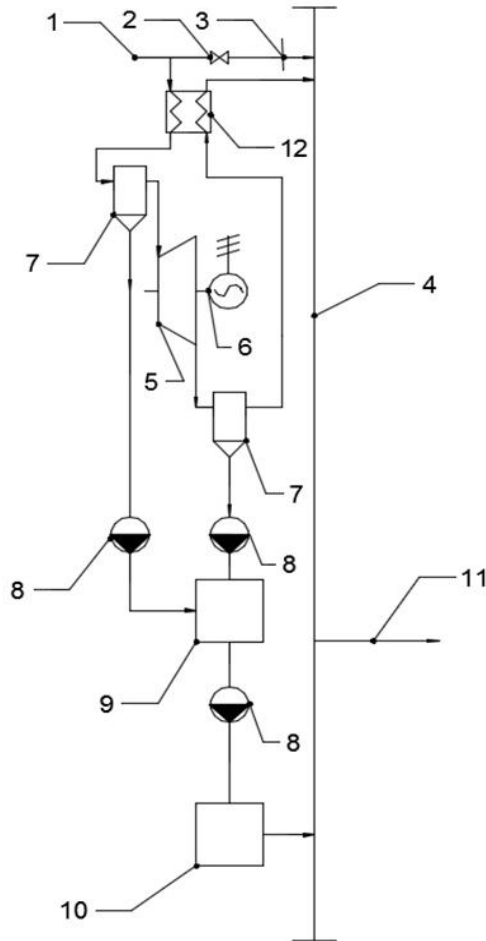

Figure 1: Scheme of the system with pre-cooling

- | | | | |
|---|-----------------------------|----|---------------------------------|
| 1 | high pressure gas pipeline, | 8 | pump, |
| 2 | throttle, | 9 | the storage of liquefied petro- |
| 3 | bypass, | | leum gas, |
| 4 | low pressure gas pipeline, | 10 | gasifier liquefied natural gas, |
| 5 | expander, | 11 | to the consumer of natural |
| 6 | electro-generator, | | gas, |
| 7 | separator, | 12 | heat exchanger |

The system works as follows. The natural gas coming from the high-pressure gas pipeline 1 at the TPP is cooled in the heat exchanger 12, then expanded in the expander 5 to the pressure required by the consumer. The electricity produced in this way from the generator 6 is supplied to the network. The gas expands in the expander, cools, the high-boiling fractions contained therein (propane, butane and above) are condensed and separated from the main natural gas flow in the separator 7. Natural gas after the separator through the low-pressure gas pipeline 4 is sent to the consumer 11, and the liquefied gas after separation is sent by the pump 8 to the liquefied gas storage 9, where it is accumulated. When the natural gas consumer moves to the reserve fuel consumption mode, the liquefied gas from the storage is pumped by the pump 8 to the liquefied gas detector 10, where it is heated and transferred to the gaseous state, and then fed to the consumer via a low-pressure gas pipeline. The circuit provides a bypass 3 in the form of a throttle 2, which is included in the circuit parallel to the circuit containing the expander. This method of obtaining an alternative reserve fuel makes it possible to completely abandon the traditionally used fuel oil at gas-consuming TPP as a reserve and emergency fuel.

Calculations have shown that the period of accumulation of the required amount of liquefied gas for its use as a reserve fuel with complete abandonment of fuel oil for the TPP-23 in Moscow is less than 3 months.

Figure 2 shows the dependence of the fraction of condensate output from the separator on the total fraction of alkanes above methane.

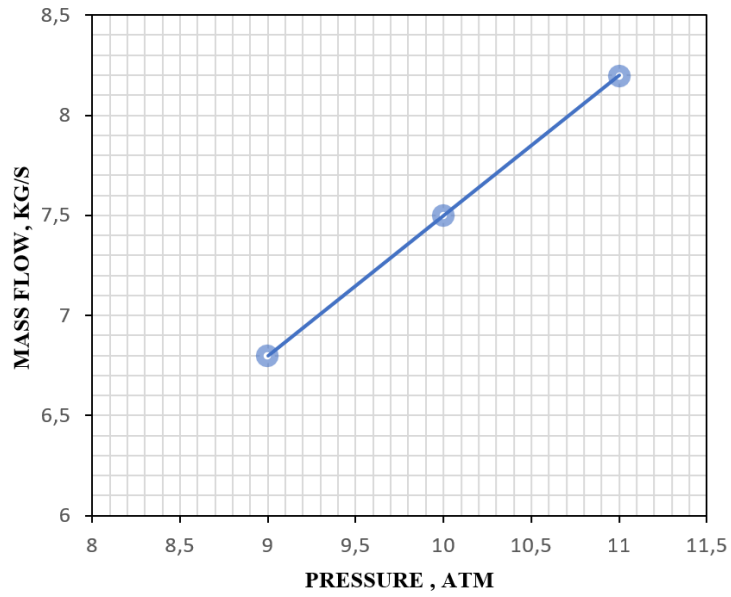

Figure 2: The dependence of the fraction of condensate of the total shares of the alkanes above methane

Figure 3 shows the dependence of the proportion of condensate yield on the pressure of natural gas before the expander.

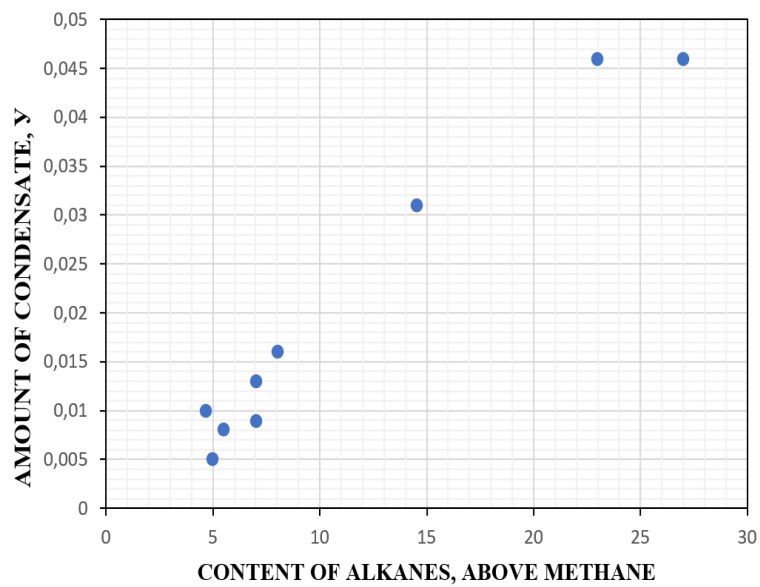

Figure 3: The dependence of the amount of accumulated condensate on the pressure at the entrance to the expander.

4. Analysis of design solutions for backup fuel storage at thermal power plants

Over the past few decades, the production and use of liquefied natural gas (LNG) has been increasing, this type of fuel makes it possible to solve the problems of gas supply to remote and inaccessible regions, where laying pipelines is technically difficult or economically impractical. In world practice, various types of LNG storage tanks are used. The diversity of reservoirs, which exists at the moment, can be classified by volume, geological environmental factors. With the help of new design solutions, in recent years it has become possible to build large surface tanks up to 400 thousand m³. The analysis of storage for LNG and producers was carried out, if the share of methane and ethane is high, then an isothermal storage should be chosen. If the mixture will consist of propane-butane, then suitable tanks for liquefied hydrocarbons. Production of tanks is actively developing in the domestic market, over the past 5 years it has become possible to design tanks up to 200000 m³.

5. Conclusions

A study was conducted on the possibility of using liquefied natural gas as a reserve fuel instead of fuel oil at the thermal power plant no. 23 in Moscow. The schemes of natural gas condensate production due to the cooling process in the turbo-expander for the reserve fuel required amount formation were considered. The scheme of LNG production realization was calculated on the example of the thermal power plant no. 23 in Moscow: with regeneration for pre-cooling of the gas supplied to the expander. During the work it was found that the implementation of all schemes will generate the necessary amount of reserve fuel. At the moment it became possible to organize a justified, from an economic point of view, the storage of LNG at power plants. If the share of this gas in the natural gas used is high, it is necessary to choose an isothermal storage, which

is not economically feasible. The volume of storage for liquefied hydrocarbons also depends on the composition of the source gas.

6. References

1. Kalenak, A. A., Tokmakov, E. A., 2016. The state and prospects of development of the gas complex of Russia: Problems and perspectives of economy and management: materials of the V mezhdunar. scientific. Conf. , St. Petersburg, December 2016. — SPb.: Own publishing house, p85
2. Ziyatdinov R. M. on the issue of fuel oil economy // Young scientist. - 2015 - №9.- p1509
3. Zhigulina E. V. increasing the efficiency of natural gas overpressure using on the basis of rational choice of heating system. Diss. on with the lawsuit. academic step. kand. tech. science M. MEI (TU), 2011
4. Patent for utility model № 152385 (RF). --3 p.: Il. System for preparation of natural gas for combustion in boilers / E. V. Zhigulina, V. G. Khromchenkov, V. M. Krivokon.
5. Rakhmanin I. Ensuring the safety of tanks for the storage of liquefied natural gas taking into account the negative operational factors. Diss. on competition of a scientific degree. academic step. kand. tech. of Sciences Gubkin Russian state University of oil and gas (NRU), 2014

Experience of capillary mats application in heating and cooling systems in Germany

M. Maksimova¹; E. Zhigulina¹; J. Zhgun¹; I. Sultanguzin¹; E. Voelker²

Contact: 1. Moscow Power Engineering Institute,
Moscow, Russia

2. Brandenburg Technical University,
03046, Cottbus, Germany

E-mail: 1. zhigulinayv@mpei.ru
2. Eduard.Voelker@b-tu.de

Purpose. The paper provides the information about the experience of capillary mats application in Germany for energy efficiency improving and providing the necessary microclimate of buildings.

Findings. In the system of water capillary mats, the radiation of heat is similar to solar radiation. Heat is evenly dissipated from the warm ceiling, the floor, in turn, reflects the heat received. As a result, we get a more uniform temperature variation. Moreover, due to the peculiarities of human skin, if the real air temperature in the room is +18 °C, the person feels heat + 20-22 °C. The water temperature in the system is only + 28-35 °C. Compared with other types of heating systems, radiant heating has a number of positive qualities, the most common of which are:

- Significant (up to 80%) energy cost savings;
- High degree of reliability and functionality of the system with minimal operating costs;
- Low production costs;
- Suitable for facilities with high purity requirements;
- Heating, cooling and air humidity reduction in a single system are possible;
- Higher level of comfort (uneven flow of warm / cold air from one point in the room) compared with other heating and air conditioning systems;

- "Silent" cooling, without sound;
- Self-regulating effect. The volume and, accordingly, the power of circulation of the air flow increases or decreases depending on temperature changes in the room;
 - An invisible installation of heating / cooling elements is possible, which is especially important in modern buildings with large glass spaces;
- Simple, quick installation system;
- Installation of convection cooling columns or cabinets is possible, which can serve simultaneously as design elements of the premises;
- Very fast possible regulation of power and temperature of the room (for example, 25% faster heating process compared to other technologies of the "heat" floor);
- Combination with central ventilation system is possible.

Originality. The use of water capillary mats in heating and cooling systems for buildings is only beginning to spread, but is already beginning to occupy a leading position in the market not only in Germany, but also in other countries, including Russia.

Practical value. The market of energy efficient equipment is growing rapidly. With the potential for research and development, the German company GeoClimaDesign AG sets a new high level for surface heating and cooling systems, including the "control" technology for the dew point. GeoClimaDesign capillary mats are successfully used in residential and non-residential premises. Due to the efficient heat transfer of laminar flow, capillary mats are finding more and more new applications, for example, as an "activator" of concrete panels used to maintain a predetermined temperature and humidity range of a number of consumers, for accumulating cold, as part of a server cooling system, lawn conditioning and football fields, in agriculture in greenhouses). Such systems are quite common in the Nordic countries and are used in various fields. More than 40 percents of the energy consumed in Germany comes from industry,

commerce, and the service sector. Therefore, future corporate strategies are unthinkable without efficient energy use.

Keywords: *heating and cooling systems, energy efficiency, capillary mats.*

1. Introduction

In the modern world, the technologies of heating and cooling air in residential premises, as well as in the production area at industrial facilities, are in a technological change. Heating with convectors as central heating was new in the 19th century. In the 21st century, radiant heat exchange is one of the most innovative systems for heating and cooling rooms. Its principle of operation is to heat or cool objects and surfaces with a stream of radiant energy carried by electromagnetic waves in the infrared range. Such radiant heating and cooling systems do not fundamentally use air as an intermediate coolant, but heat or cool directly all objects and surfaces in the room, including the surface of the human body. Heat transfer between the surface in which the capillary mats are mounted and the person is 80% due to radiant heat exchange, and only 20% due to convection, while the speed of the air flow is insignificant and the cooled air in the room moves naturally, which eliminates the formation of drafts. Capillary mats consist of thin polypropylene tubes, with a diameter of 0.29 to 1.1 mm, assembled in a single web. Such system primarily uses low potential sources of heat, that is, it requires lower temperatures in heating mode (about 30 ° C) than traditional radiators and than one-pipe floor systems, and higher (about 16 ° C) in cooling mode than traditional air conditioners. This makes them more effective. Capillary-tube mats are laid in plaster, concrete, as well as on any ceilings (figure 1). Warm or cold ceiling mats are connected to the hydraulic circuit through which heated or cooled water circulates



Figure 1: The application of capillary mats in rooms

2. Analysis of the recent research

A unique facility using the capillary mats system is the manufacturing facility and the headquarters of GeoClimaDesign AG in Germany, Brandenburg, which, thanks to the concept of building operation with “zero” energy consumption, created an example of its office building, which shows that it is advisable to combine the functions of protecting monuments and efficient energy use. In the past, this building was the largest Fuerstenwalde water mill in Germany, its area is 2500 m².

The main problem was the excessively high heat losses through the building envelope. As is known, the higher the temperature difference between the outer and inner sides of the walls, the greater the loss of energy. In this case, the radiators are least suitable because they have the highest temperature level. The goal was to create a heating system with the lowest coolant temperature. The capillary mats system was chosen for installation on the ceiling, as it has the lowest limiting value of the coolant temperature among all heating systems. And besides constructively has the preferred properties for the old design.



Figure 2: Fuerstenwalde mill after renovation in Brandenburg

Figure 2 shows a photograph of the building of the Fuerstenwalde mill, in which capillary mats were mounted in ceilings for heating and cooling. Laying behind the suspended plasterboard ceiling was made with the most flat support structure. For this purpose, capillary tube mats were made in accordance with the design. Ceiling heating laid in all parts of the building.

As another example of the use of capillary mats in an office building, a new building built upon the order of the company Stage Tec

Entwicklungsgesellschaft mbH, dealing with digital audio systems, located Berlin can be noted. The system of water capillary mats has been installed at this facility since 2013 and its area is 1,471 m². The indisputable advantage of the system of water capillary mats is the universality of the system (rooms for testing audio equipment can be cooled in the winter, while in the other side of the corridor rooms are heated) and also noiseless.

Another project is a medical center located in Karlsfeld (Figure 3), built by the Schütz Gruppe (the usable area is 4000 m²). Since 2013, the water capillary mats system has been used in the ceiling heating and cooling system in this building. As a result, the total operating costs for heating and cooling have decreased by more than 60%.



Figure 3: Medical Center in Karlsfeld

In Germany, to provide a favorable microclimate and high energy efficiency, capillary mats are widely used in the residential complex (both in apartment buildings and in cottages).

One example of an apartment building is the high-rise Iduna building in Osnabrück (Figure 4), Lower Saxony. This building is a high-rise building of panel type, the useful area of which is 7500 m². In this residential building, capillary mats were installed on the ceiling for cooling and heating. The joint use of a gas boiler and an air-to-water heat pump was chosen as the energy source. The use of this heating and cooling system made it possible to reduce the operating costs for heating by more than 70% compared to traditional systems. At this facility, capillary mats were installed in 2013-2014.



Figure 4: Apartment house in Osnabruck

It is advisable to use the system using water capillary mats in historical buildings, museums, galleries, various concert halls, philharmonic halls and theaters, since the capillary tubes are made of polypropylene - an environmentally friendly and flexible material; the tubes can “tune” to any building facade. GeoClimaDesign already has experience with such buildings. One of these objects is the Historical Department Store (Figure 5), located in a historical building. Due to the fact that the building is a historical monument, it is forbidden to make changes to the facade of the building, i.e. conduct additional modern insulation is impossible. Nevertheless, the building, thanks to the system of ceiling heat radiation, is distinguished by particularly low costs for heat carriers. The facility is located in the city of Galle, the city of Saxony-Anhalt. The usable floor space is 4000 m², the system using water capillary mats was installed in 2013. In this project, the system was designed for heating and cooling of the rooms.



Figure 5: Historical Department Store in Galle

In one of the projects in the Liebigstraße Osnabrueck building, the GeoClimaDesign system is located directly under the sports floor in a yoga studio. Such system has the lowest energy consumption and high comfort.

The system using water capillary mats is certainly effective in industrial buildings. Often the heat released during production or disposal is lost, never used, which is not rational. Nuthe-Spree HFT United Waste Management Association has not previously used the heat generated from waste management. Since 2013, this heat has been used to efficiently heat industrial buildings, capillary mats are located within the walls of the room (Figure 6). The useful area of the object is 183 m².



Figure 6: Waste Recycling Association at Nuthe-Spree HFT

The possibilities of using a radiant heating and cooling system are endless: they can also be used in swimming pools, animal cages, greenhouses, and for

heating special medical lounge chairs. Energy saving effect when using this system of heating and cooling is enormous.

Together with water capillary mats, it is also possible to use a system temperature control system depending on the dew point called GEO1. This is a new room temperature control product for capillary tube heating and cooling systems and all cooled ceilings. GEO1 replaces traditional control systems and has the following functions:

- humidity and temperature are constantly measured, dew point is constantly determined in all rooms;
- the temperature of the coolant in the system is constantly regulated depending on the dew point.

The control system GEO1 leads additionally to a potential saving of 6-12%. GEO1 can be controlled remotely and can be operated online by the user and service providers.

The authors thank the company GeoClimaDesign AG for the provided photographic materials used in the article.

3. Conclusions and recommendations for further research

The use of capillary mats in the heating and cooling systems of buildings is one of the most innovative measures for the energy saving of residential and public buildings. The authors of this article will contribute to the active implementation of this system on the Russian market and thereby increase the energy saving effect.

4. References

1. GeoClimaDesign AG, 2014. Referenzen. *Catalog GeoClimaDesign AG*, pp. 57-74.

Ein stochastisches Simulationsmodell der Streufelder der zu erfüllenden Masse für Mehrwerkzeug-Mehrsupport-Einrichtungen bei der Drehbearbeitung

Prof. Dr.-Ing. habil. N. Yusubov; Dr.-Ing. A. Maemmaedov, H. Abbasova

Kontakt: Aserbaidsschische Technische Universität,
Baku, Aserbaidsschan

Abstract Es wird ein stochastisches Simulationsmodell der zu erfüllenden Maße für Mehrwerkzeug-Mehrsupport-Einrichtungen für die Drehbearbeitung entwickelt. Die entstehenden Bearbeitungsfehler werden als Streufeld abgebildet und es wird möglich, den Einsatz von Mehrwerkzeug-Mehrsupport-Einrichtungen in einer beliebigen Komplexität zu modellieren.

1. Einleitung

Das analytische Modell der Streufelder der zu erfüllenden Maße [1], seine algorithmische Erweiterung und die Verallgemeinerung erfassen eine große Nomenklatur von Einrichtungen wie Einwerkzeug-, Mehrwerkzeug-Einsupport-, Mehrwerkzeug-Zweisupport-gedreht- und Mehrwerkzeug-Mehrsupport-Einrichtungen.

Die Entwicklung dieses Modells erfolgte unter einer Reihe erheblicher Einschränkungen, welche das Spektrum der Anwendbarkeit der analytischen Modelle einschränken.

Die Abhängigkeit der Größe des Streufeldes von der Struktur der Einrichtung und der Schnittregime bildet die Grundlage für die Linearisierung der Gleichungen für die Grenzenintervalle der Streuung der Maßabweichungen. Für die Schnittkraftkomponenten wird der Grad der Abhängigkeit verwendet. Die Linearisierung nach den Schwankungen der Bearbeitungszugaben Δt_i wird unter der Annahme erzeugt, dass für alle Schnittkraftkomponente ihre Abhängigkeit von der Schnitttiefe nahezu linear ist, also $x_{p_i}^j \approx 1$. Somit hängen die Vektoren der Belastung \overline{p}_i^j , \overline{p}_i^m , $\overline{p}_{\Delta t}^j$ und $\overline{p}_{\Delta t}^m$ im Modell [1] nur schwach von den Schnitttiefe ab und werden wie Parameter behandelt. Dadurch wird der

Einfluss der zu zerspanenden Bearbeitungszugaben und ihrer Schwankungen auf die Größe der Streufelder durch die angebotene lineare Abhängigkeit [1] beschrieben. Jedoch ist bekannt, dass bei einigen Werkzeugen der Abhängigkeitsgrad von dem angenommenen Wert 1 deutlich abweicht. So liegt bei der Bearbeitung eines Konstruktionsstahles mit HM-Meißel der Wert bei $x_{P_z} \approx 0.72$ $x_{P_y} \approx 0.73$; bei der Bearbeitung eines Konstruktionsstahls mit einer zusätzlichen Schneide bei $x_{P_y} \approx 0.6$ [2]. In diesem Fall erhält man bei der Bestimmung der Größe des Streufeldes eine transzendente Gleichung, die analytisch nicht gelöst werden kann.

Für die Streufelder bei Mehrwerkzeug-Einsupport-Einrichtungen wird die analytische Abhängigkeit des Streufeldes nur für gleichartige Einrichtungen (alle Werkzeuge vom gleichen Typ und einheitliche Abhängigkeit für die Schnittkräfte) gebildet. In der Mehrwerkzeugarbeit kommen jedoch oft Werkzeuge unterschiedlichen Typs; z.B. Längsdrehmeißel, Formdrehmeißel und Bohrer; kombiniert zum Einsatz. In diesem Fall ist es nicht möglich, eine lineare Abhängigkeit bezüglich der Schnitttiefe t_k^j und ihrer Schwankungen Δt_k^j zu erhalten und ein analytisches Modell [1] zu bilden.

Auf diese Weise ist das analytische Modell der Streufelder [1] für Mehrwerkzeug-Mehrsupport-Einrichtungen anwendbar, wenn auf jedem Support ein oder mehrere Werkzeuge gleichen Typs befestigt sind, wobei bei jedem Werkzeug die Abhängigkeit der Schnittkräfte von der Bearbeitungszugabe quasi linear ist. Diese Einrichtung bildet den bedeutenden Anteil der Nomenklatur der Mehrwerkzeugeinrichtungen auf modernen CNC-Werkzeugmaschinen der Drehgruppe. Jedoch gibt es einen wesentlichen Anteil von Einrichtungen, für welche die entwickelten analytischen Modelle der Streufelder nicht verwendbar sind. Es existiert ein umfangreiches Spektrum von ungleichartigen und kombinierten Einrichtungen [3], wobei der Anteil dieser Einrichtungen, besonders bei der Entwicklung einer Theorie für deren Projektierung, mit der Zeit wachsen wird.

2. Die wesentlichen Inhalte

Wegen der unbestimmten analytischen Schwierigkeiten (bei der Suche des Extremums der transzendenten Matrixfunktion) ist es erforderlich die Streufelder der zu erfüllenden Maße anders zu berechnen. Dafür betrachten wir den Sinn der untersuchten Prozesse. Das Streufeld der Maße wird als Intervall der Streuung der Maßabweichungen der zufälligen Streuung drei Ausgangsparameter Δt_k^j , ε und ν betrachtet.

Da die Maßabweichung eine Zufallsgröße ist, die von den zufälligen Werte der Parameter Δt_k^j , ε und ν bestimmt wird, ist es sinnvoll die vorgegebenen Prozesse unter Anwendung der Methoden der Wahrscheinlichkeitstheorie zu beschreiben. Durch Anwendung der mathematischen Statistik kann bei der Erstellung des analytischen Modells der Streufelder [1] nach den gegebenen Spannweiten der zufälligen Argumente Δt_k^j , ε und ν die zufällige Funktion Δg_i^j bestimmt werden.

Die Maßabweichung g_i^j ist eine zufällige Funktion (nach dem untersuchten Prozess). Die gesuchte Größe Δg_i^j ist in der Terminologie der Wahrscheinlichkeitstheorie eine Zahlengröße der Zufallsgröße Δg_i^j , und zwar das Maß der Streuung. Von den Positionen der mathematischen Analyse Δg_i^j handelt es sich um eine große Matrix-Dimensionsfunktion.

Entsprechend wird die folgende Vorgehensweise für die Lösung angewendet:

- die vorläufige Erzeugung der Menge der zufälligen Größen der Ausgangsvariablen Δt_k^j , ε und ν ;
- die Berechnung der für diese zufälligen Größen entsprechende Werte der gesuchten Funktion g_i^j ;
- die statistische Analyse der auf diese Weise erhaltenen Werte des Umfanges m der Werte der gesuchten Funktion $\{g_{iq}^j\}_q \rightarrow q \in (1 \div m)$.

Für die Erzeugung der Menge der zufälligen Werte der Ausgangsparameter Δt_k^j , ε und ν muss man die Gesetzmäßigkeiten ihrer Verteilung kennen. Bei hohen Stückzahlen und einer stabilen Produktion unterliegen diese Parameter dem

normalen Verteilungsgesetz [5]. Die technologischen Prozesse auf CNC-Werkzeugmaschinen sind oft auf Kleinserien gerichtet und erreichen dadurch nicht das Niveau der Normalverteilung. Die Gesetze der Verteilung können in den Fällen Anwendung finden, in denen man nach bekannten statistischen Methoden anhand von Untersuchung die Steifigkeit der Werkzeugmaschine und die Festigkeit und Härte des Werkstückes bestimmt [6]. Mehrwerkzeugbearbeitung, besonders Mehrsupportbearbeitung, gehört zur Klasse der Dimensionssysteme. Die Zahl der Argumente im Modell des Streufeldes entspricht der Zahl der Werkzeuge in der Einrichtung plus zwei (ε und ν). Dann strebt infolge des Grenzwertsatzes der Wahrscheinlichkeitstheorie, für die Erhöhung der Anzahl der Argumente das Verteilungsgesetz der Funktion asymptotisch zu normalen, unabhängig von den Verteilungsgesetzen der Argumente [6]. In der ersten Annäherung nimmt man somit an, dass die Zufallsgrößen Δt_k^j , ε und ν gleichmäßig verteilt sind:

- Aus die Verteilung der Festigkeit (Härte) der Ausgangsmaterialien (Werkstücke):

$$\varepsilon(x) = \begin{cases} 0 & x \leq C_n - \frac{\varepsilon}{2} \\ \frac{1}{\varepsilon} & x \leq C_n + \frac{\varepsilon}{2}; \\ 0 & x \geq C_n + \frac{\varepsilon}{2} \end{cases} \quad (1)$$

- Aus die Verteilung der Nachgiebigkeit der technologischen Untersysteme:

$$\nu(x) = \begin{cases} 0 & x \leq e_n - \frac{\nu}{2} \\ \frac{1}{\nu} & x \leq e_n + \frac{\nu}{2}; \\ 0 & x \geq e_n + \frac{\nu}{2} \end{cases} \quad (2)$$

- Aus die Verteilung der Bearbeitungszugaben für die Werkzeuge mit der Nummer k auf einem bestimmten Support j :

$$t_k^j(x) = \begin{cases} 0 & x \leq t_{k_n}^j - \frac{\Delta t_k^j}{2} \\ \frac{1}{t_k^j} & x \leq t_{k_n}^j + \frac{\Delta t_k^j}{2} \\ 0 & x \geq t_{k_n}^j + \frac{\Delta t_k^j}{2} \end{cases} . \quad (3)$$

Basis für die Simulation des Prozesses Mehrwerkzeugbearbeitung ist das Modell der Streufelder für die zu erfüllenden Maße. In [1] ist das Modell der Streufelder für die zu erfüllenden Maße für die Mehrsupport-Bearbeitung dargelegt. Dieses Modell ist in Form einer Matrixgleichung oder in der entfalteten Form vorgegeben. Beide diese Gleichungen sehen vor, dass für jeden Support, sowohl dem Haupt- als auch jedem Zusatzsupport, nach einem Werkzeug bestimmt ist. Auf Grundlage dieser Gleichungen wird das analytische Modell der Streufelder für Mehrsupporteinrichtungen mit einem Werkzeug auf jedem Support entwickelt.

Entsprechend den Ausführungen zu Mehrsupporteinrichtungen mit einer Werkzeuggruppe auf jedem Support wird das Modell [1] zusammengefasst. Das verallgemeinerte Modell der Streufelder für die zu erfüllenden Maße in Mehrwerkzeug-Mehrsupport-Einrichtungen lautet, nachdem das verallgemeinerte analytische Modell der Streufelder der Maße in gleichartigen Mehrwerkzeug-Mehrsupport-Einrichtungen erstellt wurde, wie folgt:

$$g_j = e^{0j} \sum_k \overline{P_k^j} + e^0 \sum_{m \neq j} \sum_{k_n} \overline{P_{k_n}^m} ; \quad (4)$$

Folgenden Bezeichnungen werden eingeführt:

- g_j - Der Vektor der Maßabweichungen auf dem Hauptsupport mit der Nummer j (die Verschiebung des Kontaktpunktes des j -ten Supports und des Ausgangsmateriales);

e^{0j} - Die vereinigte Matrix der Nachgiebigkeit des Untersystems 0 (die Spindel – Spannfutter - Ausgangsmaterial) und der Untersystems j (des Hauptsupportes);

\overline{P}_k^j - Der Vektor der Schnittkräfte des Werkzeuges mit der Nummer k auf dem Hauptsupport (die Nummer des Hauptsupportes j);

\overline{P}_k^m - Der Vektor der Schnittkräfte des Werkzeuges mit der Nummer k auf dem zusätzliche Support (die Nummer des Supportes m);

Die Summierung nach dem Index k wird nach allen Werkzeugen geführt, die sich auf dem betrachteten Support befinden. Die äußerliche Summierung im zweiten Summanden wird auf allen zusätzlichen Supporten durchgeführt.

Unter Berücksichtigung der Bezeichnungen, die aus dem verallgemeinerten analytischen Modell [1] übernommen sind, stellt sich das Matrixmodell (4) in der entfalteten Art wie folgt dar:

$$\begin{pmatrix} g_x^j \\ g_y^j \\ g_z^j \end{pmatrix} = \begin{pmatrix} e_{xx}^{0j} & e_{xy}^{0j} & e_{xz}^{0j} \\ e_{yx}^{0j} & e_{yy}^{0j} & e_{yz}^{0j} \\ e_{zx}^{0j} & e_{zy}^{0j} & e_{zz}^{0j} \end{pmatrix} \begin{pmatrix} \sum_k P_{xk}^j \\ \sum_k P_{yk}^j \\ \sum_k P_{zk}^j \end{pmatrix} + \begin{pmatrix} e_{xx}^0 & e_{xy}^0 & e_{xz}^0 \\ e_{yx}^0 & e_{yy}^0 & e_{yz}^0 \\ e_{zx}^0 & e_{zy}^0 & e_{zz}^0 \end{pmatrix} \begin{pmatrix} \sum_{m \neq j} \sum_{k_m} P_{xk}^m \\ \sum_{k_m} \sum_{m \neq j} (P_{zk}^m \sin \zeta^m + P_{yk}^m \cos \zeta^m) \\ \sum_{k_m} \sum_{m \neq j} (P_{zk}^m \cos \zeta^m - P_{yk}^m \sin \zeta^m) \end{pmatrix} .(5)$$

Die Simulation des Prozesses sollte zweckmäßig mit Computerunterstützung erfolgen. Deshalb ist es zweckmäßig, das verallgemeinerte Modell der Maßabweichungen (4 - 5) nach dem Vorbild des verallgemeinerten analytischen Modells der Streufelder zu strukturieren.

Für das strukturelle Modell der Maßabweichungen kann die Beschreibung der Einrichtung mit Hilfe der eingeführten Belastungsvektoren (Kräfte) eingeführt werden:

- Für die Werkzeuge des Hauptsupportes:

$$\overline{p}_k^j = \begin{pmatrix} C_{P_x^j} t_{jk}^{x_{P_x^j}} S_{jk}^{y_{P_x^j}} v_{jk}^{z_{P_x^j}} \\ C_{P_y^j} t_{jk}^{x_{P_y^j}} S_{jk}^{y_{P_y^j}} v_{jk}^{z_{P_y^j}} \\ C_{P_z^j} t_{jk}^{x_{P_z^j}} S_{jk}^{y_{P_z^j}} v_{jk}^{z_{P_z^j}} \end{pmatrix} k \in (1 \div n_j); \quad (6)$$

- Für die Werkzeuge der zusätzlichen Supports:

$$\overline{p}_k^m = \begin{pmatrix} C_{P_x^m} t_{mk}^{x_{P_x^m}} S_{mk}^{y_{P_x^m}} v_{mk}^{z_{P_x^m}} \\ C_{P_y^m} t_{mk}^{x_{P_y^m}} S_{mk}^{y_{P_y^m}} v_{mk}^{z_{P_y^m}} \cos \zeta_k^m + C_{P_z^m} t_{mk}^{x_{P_z^m}} S_{mk}^{y_{P_z^m}} v_{mk}^{z_{P_z^m}} \sin \zeta_k^m \\ -C_{P_y^m} t_{mk}^{x_{P_y^m}} S_{mk}^{y_{P_y^m}} v_{mk}^{z_{P_y^m}} \sin \zeta_k^m + C_{P_z^m} t_{mk}^{x_{P_z^m}} S_{mk}^{y_{P_z^m}} v_{mk}^{z_{P_z^m}} \cos \zeta_k^m \end{pmatrix} k \in (1 \div n_m) \quad (7)$$

Daraus ergibt sich das verallgemeinerte Matrixmodell der Maßabweichungen bei Mehrsupporteinrichtungen:

$$g_j = e^{0j} \sum_k \overline{p}_k^j + e^0 \sum_{m \neq j} \sum_{k_n} \overline{p}_{k_n}^m \quad (8)$$

Die Gesamtheit der Gleichungen (6, 7, 8) stellt das verallgemeinerte Matrixmodell der Maßabweichungen in Mehrwerkzeug-Mehrsupport-Einrichtungen allgemein dar. Dieses Modell bildet die Grundlage der Berechnung eines Simulationsmodells für den Prozess der Mehrwerkzeugbearbeitung. Mit dem Modell können die Werte der Funktionen g_i^j , der Maßabweichung (ausgeführt von Support j in Richtung i), berechnet werden (entsprechend gilt $i \in (x y z)$).

Die Berechnung nach Modell (8) ermöglicht es eine Menge der Werte der Funktion g_i^j (Stichprobengröße m) zu bilden, die man als Teilmenge m aus der Menge der rechnerischen Experimente ansehen kann. Für diese Teilmenge werden bekannte Methoden der statistischen Analyse angewendet. Als Ergebnis der Analyse werden die charakteristischen Zahlen der Hauptstichprobe bestimmt:

- Mittlere Stichprobe Mg_i^j (das statistische Äquivalent der mathematischen Erwartung), welche die Lage des Zentrums der Streuung der Maßabweichungen charakterisiert (infolge der Nichtlinearität des Systems kann es mit dem Rechen nominalwert nicht übereinstimmen);
- das Maß der Streuung, das über die Dispersion Dg_i^j beschrieben werden kann, oder deren Schwankung Rg_i^j .

Damit sind die Parameter der Generalgesamtheiten (Menge aller möglichen Bedeutungen der Zufallsgrößen) festgelegt und ihre Konfidenzintervalle erzeugt, was den Kenngrößen des untersuchten Prozesses entspricht.

Dann wird die Einschätzung der Parameter der Generalgesamtheiten nach diesen Charakteristiken und ihren vertraulichen Einschätzungen erzeugt, was den Kennziffern eigentlich des Prozesses entspricht:

- Mg_i^j - die Abweichung vom Rechen nominalwert des Zentrums des Streufeldes des erfüllten Maßes (vom Werkzeug auf dem Support j in der Richtung i);
- Rg_i^j - die Größe des Streufeldes des erfüllten Maßes (vom Werkzeug auf dem Support j in der Richtung i).

Im Ergebnis kann das entwickelte allgemeine Simulationsmodell der Streufelder der zu erfüllenden Maße für Mehrwerkzeug-Mehrsupport-Einrichtungen in Form eines Algorithmus (Abb. 1) dargestellt werden.

3. Der Schluss

Das entwickelte stochastische Simulationsmodell zeigt nicht nur die Gründe der Bearbeitungsfehler auf sondern ermöglicht auch den Prozess des Mehrwerkzeug-Mehrsupport-Einrichtungen in einer beliebigen Komplexität abzubilden, unter der Voraussetzung, dass es möglich ist die elastischen Verschiebungen beschreiben.

4 LITERATUR

1. Юсубов Н. Д. Единая модель полей рассеяния размеров, выполняемых в многосуппортных наладках//Механика, Машиностроение, АзТУ, Мин. Обзование Аз. Респ., Баку, 2007.-№1.
2. Справочник технолога - машиностроителя. - В 2-х т. / Под ред. А. Г. Косиловой, Р. К. Мещерякова.- М. : Машиностроение, 1985.- 656 с.
3. Юсубов Н.Д. Принципы классификации многоинструментных наладок//Механика, Машиностроение, АзТУ, Мин. Обзование Аз. Респ.Б Баку, 2006.-№4, с.23 - 26.
4. Словарь по кибернетике /Под ред. В.С.Михалевича.- К,1989.-751с.
5. Базров Б.М. Основы технологии машиностроения : Учебник для вузов. М.: Машиностроение, 2005.- 736с.: ил.
6. Р. Шторм Теория вероятностей. Математическая статистика. Статистический контроль качества. «Мир».М.- 1970. 368с.



Abbildung 1: Algorithmus zur Berechnung der Streufelder der Masse nach dem stochastischen Simulationsmodell

Regional Analysis of the Hazelnut Sector in Azerbaijan: Requisites for Sustainable Development

Mahammad Maharramov; Samira Amirli

Contact: Aserbajdschanische Technische Universität,
Baku, Aserbajdschan

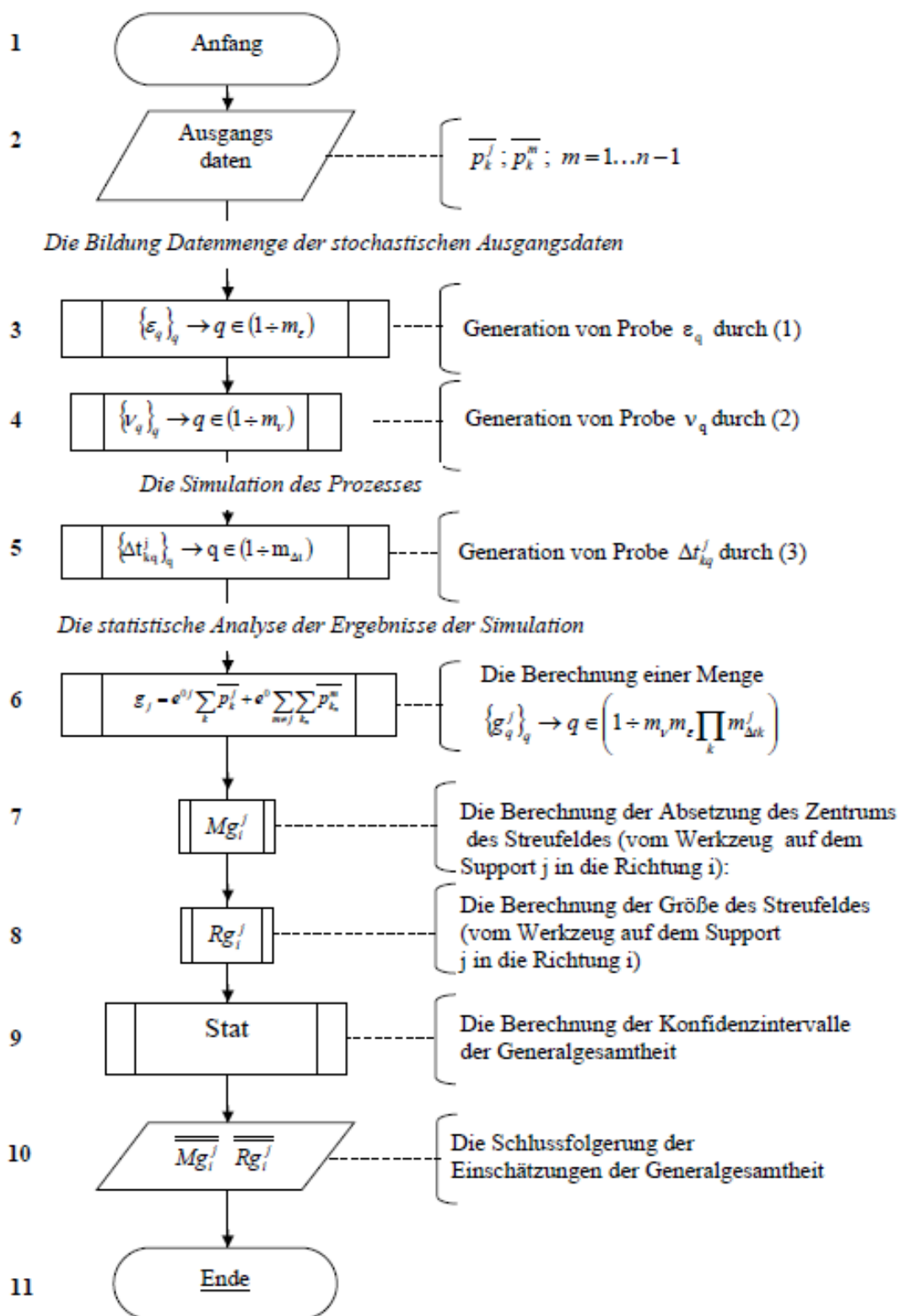
Abstract: In this paper we aimed at finding cross-regional determinants of the hazelnut production in Azerbaijan, observe implications associated with the results and utilizing policy recommendations for the development of the sector. For this reason, panel-data was used and previous literature was considered. Results suggest “re-allotment of lands” and improvement of educational level of the farmers issues to be raised and also indicate more supply-control measurement.

Keywords: hazelnut, fragmentation and subdivision, gravity model, proxy for trade costs, re-allotment of lands, supply-control measurement.

1. Introduction

Nuts are significant part of fruit production and hazelnut is the main part of that production in Azerbaijan. Considering the cultivated area which is incomparable with Turkey and Italy, Azerbaijan cannot compete with these countries, however, hazelnut production has potential to maintain bigger share in exports and non-oil GDP of Azerbaijan followed by decreased domestic price with increased productivity and specializing. In this paper, we will seek for determinants of production in this industry, do quantitative analysis based on our model and come up with solutions or recommendations to improve this industry.

Currently, hazelnut sector in Azerbaijan has a stable development trend. Due to the natural conditions of our country and quality of cultivated varieties of hazelnuts, our country stands in the fourth place in the world market in terms of hazelnut exports.

Production, imports and exports of hazelnuts in Azerbaijan during 2000-2016:

Basically, hazelnuts are widely used in Azerbaijani cuisine, and therefore, there is a great demand for them in domestic market. In this sense, hazelnut production has always been in the center of attention at least for internal needs. According to official

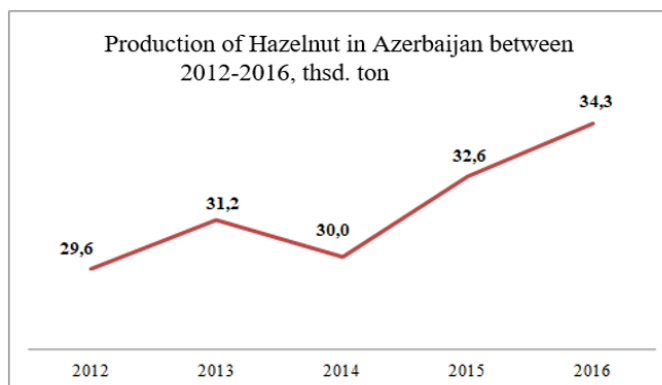

Source: State Statistics Committee of Azerbaijan Republic, the area of perennial crops, yield and harvest perennial plants, 2012-2016-s years

statistics, over the past 5 years hazelnut production demonstrates a volatile trend, however, it is able to meet the domestic demand in Azerbaijan, as well as maintain the export opportunities. On the other hand, some experts of the Ministry of Agriculture of Azerbaijan Republic do not agree with the official statistics, since several studies and interviews allow to insist on the fact that every year at least 40 thousand tons of hazelnuts are produced in Azerbaijan.

Besides the fact that the local production of hazelnuts is able to meet the demand in the domestic market, currently, the foreign production of hazelnuts is represented in the market of Azerbaijan as well. It should be noted that during 2000-2015 hazelnuts in

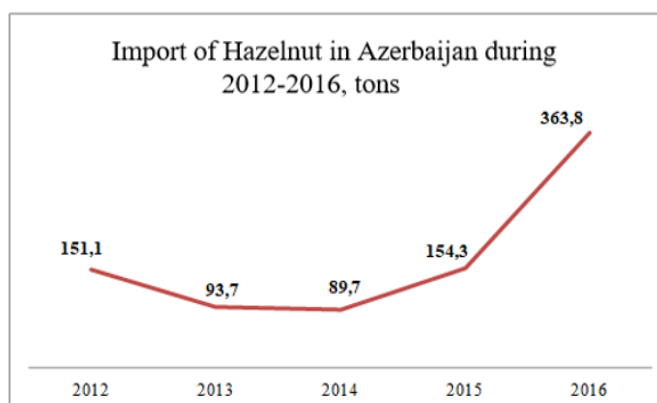

Source: State Statistics Committee of Azerbaijan, Bulletin External trade relations of Azerbaijan, 2012-2016

shell were not brought from other countries, however, since 2016 import of hazelnuts in shell has been realized. Particularly, various amounts of hazelnuts are imported at different times both for the use of delicacy and for the production of confectionary goods.

Now let's look at the data of hazelnut exports of Azerbaijan. Azerbaijan maintains the fourth place in the world hazelnut exports after Turkey, Italy and Georgia. During 2012-2016 years the volume of hazelnut exports is described as follows:

In the country the cumulative production of hazelnuts amounted to 35 thousand tons, however, it was noted that yield of hazelnuts did not change. Considering all these factors, however, Azerbaijan is now losing its ground in the global market,

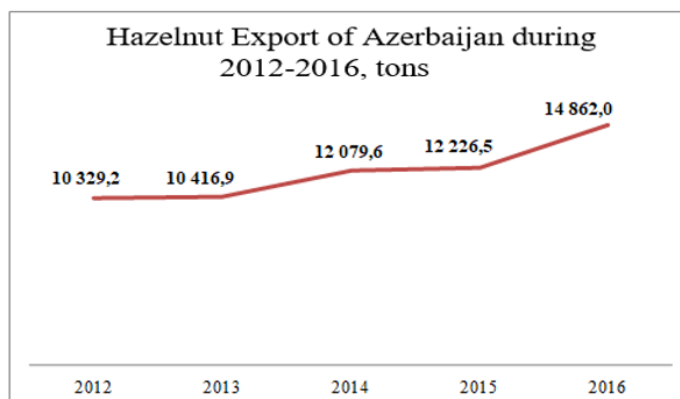

Source: State Statistics Committee of Azerbaijan, Bulletin External trade relations of Azerbaijan, 2012-2016

such as our country is under pressure as a consequence of tough competition in hazelnut sector. As a result, for the production of hazelnuts Azerbaijan stands in the fifth place in the world market, and for the exports it stands hardly in the fourth place. Hence, the government should stabilize the hazelnut production and invest in the latest irrigation systems and technology, it should allow for minimum investment in the form of stable annual inflow of foreign currency in the amount of 100-150 million dollars.

Production, import and export prices of hazelnut in Azerbaijan during 2000-

2016 years: Firstly, it should be noted that official statistics reflect only the prices of hazelnuts in shell sold in the domestic market and prices of imported refined hazelnuts. According to the official statistics, the sale prices of hazelnuts have changed as follows:

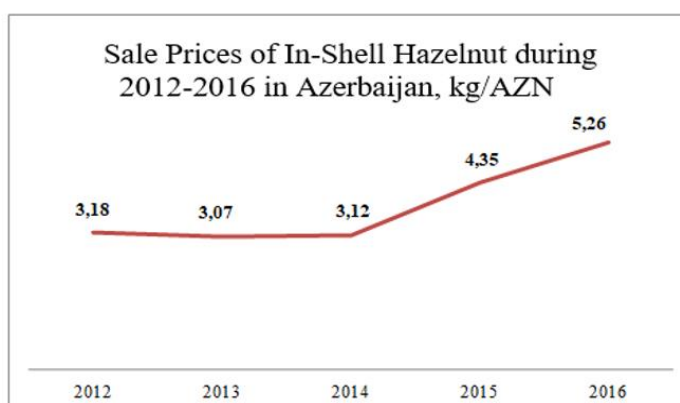

Source: State Statistics Committee of Azerbaijan, Bulletin of Statistics, 2012-2016.

2. Literature Review:

Hazelnut sector is considered one of the main significant sectors of Azerbaijan since it is profitable for further development of non-oil sector of Azerbaijan and also for maintaining the inflows of foreign currencies. Before conducting the research, we firstly relied upon the previous researches which mainly allude to either production levels or productivity differences across some countries during various years. Relying on previous researches, we expect to find sufficient evidence for the improvement of hazelnut sector in Azerbaijan on regional level rather than on overall country level.

In order to determine the productivity level among rice farmers in Nigeria, in his research Akinbile (2007) analyzed the important factors, which are the following: farm size, educational level of respondents, the quantity of labor used and their knowledge of use of recommended practices. This research demonstrates that farmers with larger farm size are more productive than the ones who cultivate small holdings, thus, farm size factor significantly affects the production and consequently, productivity levels. Then, the contribution of farm size is followed by education level, quantity of labor, and knowledge of improved practices factors, which indicate positive and significant impacts on productivity levels of rice farmers. Following this research and analyzing the determinants, we find the farm size and quantity of labor variables to be appropriate to include in our regression model.

At the same time, Swegal (2017) emphasizes that nuts have become main export commodity, and they play significant role among U.S. agricultural exports. Nut exports mainly consist of hazelnuts, almonds, pecans and walnuts. In 2016 although all these products experienced growth in their quantities, production gains associated with almonds were even higher than gains made by other nuts as demand increased among Asian economies and as well as domestic consumers. Therefore, in this research the author took into account the significance of the almond price variable. Since almond is considered to be the substitute for hazelnut, when we look at the overall usage of almond and hazelnut goods in the world across years, we observe perfect correlation between these two goods. For instance, when there is a shortage of hazelnut production in one country, we see higher production and higher consumption of almonds at that specific country.

What is more, Muyanga and Jayne (2011); and Josephson, Gilbert and Florax (2014) underlined the significant impact of population density on the agricultural intensification and productivity in their panel data analysis. These authors stress that increase in number of population causes the decline in farm size through land fragmentation, which means the decrease in the average size and individual plots in a farm holding. Farmers with limited land and technology inputs are not provided with sufficient amount of credits, which in turn reduces producing the surplus. In consequence, the threshold effects of population density constitute downward pressure on the agricultural productivity indicators.

3. Data Description

According to economic point of view, production is considered a process of combining different material inputs and immaterial inputs (know-how technology) in order to create output, which maintains special value and contributes to the individuals' utility. In this research paper, determination of the production level of hazelnut across regions, such as an analysis of economic factors which explain the production levels in Azerbaijan during 2000-2016 was taken as a main topic. The determinants of hazelnut production level are farm size that hazelnut orchards are located, population per region, a number of labor force which work in agriculture sector, non-oil GDP per region, and almond price. Data for the dependent variable, which is the production level of hazelnuts, and for independent variables, which are farm size of hazelnut orchards, population per region and labor force in agriculture sector, were collected from the State Statistical Committee of Republic of Azerbaijan for the years during 2000-2016 for 9 Economic Regions of Azerbaijan. Furthermore, the data for the world price of almond was taken from the United States Department of Agriculture: National Agricultural Statistics Service for years during 2000-2016. For the same years the data for non-oil GDP per capita per each Economic Region was obtained from the Central Bank of Azerbaijan Republic. Moreover, data for our purposes were collected for 9 Economic Regions of Azerbaijan, which are the following: Shaki-Zagatala, Absheron, Aran, Daghlig-Shirvan, Ganca-Gazakh, Lankaran, Nakhchivan, Guba-Khachmaz, Yukhari-Garabagh Economic Regions. However, Azerbaijan Republic contains 10 Economic Regions, in our research we just focus on the analysis of 9 of them by excluding Kalbajar-Lachin Economic Region. The main reason for the exclusion of this

Economic Region is that since all administrative regions within this region are under Armenian occupation, the measures for its social and economic development were not still planned under special program.

Relying on the analysis of previous researches, such as introduced by Kilic, Ceyhan and Alkan (2009) and also Akinbile (2007), we took farm size variable as a main explanatory variable for production level, since we expect harvest land size to demonstrate a significant and positive impact on the supply of hazelnuts. The researches by Muyanga and Jayne (2011); and Josephson, Gilbert and Florax (2014), scrutinize the impact of population density on smallholder agricultural production. Accordingly, increased population per region leads to rise in population density per region, which in turn causes inefficient land division and fragmentation. So, population per region is taken as an explanatory variable. Then based on the researches by Kilic, Ceyhan and Alkan (2009), Akinbile (2007), and Dayal (1984), number of labor force in agriculture sector was taken for analysis purposes. Basically, if labor is optimally allocated in hazelnut sector, we expect that it will affect positively our hazelnut production level. Subsequently, the data for non-oil GDP per capita was used in order to observe the effects of increasing population income on the hazelnut production level. Our purpose is to determine that when income of households increases, whether they are encouraged in further production activities of hazelnut or they rather prefer more leisure instead of working.

Below is the summary statistics of dependent and explanatory variables. In this table you see the number of observations, average values, standard deviations, maximum and minimum values of our variables. All variables except almond price are expressed

VARIABLES	(1) N	(2) mean	(3) s.d.	(4) max	(5) min
Almond Price	151	18.43	1.989	15.30	5.644
Hazelnut Production	151	5.716	2.383	10.16	0.531
Farm Size	151	4.947	2.581	10.07	1.253
Population Per Region	151	6.440	0.539	7.581	5.530
Agriculture Labor Force	151	7.082	1.001	9.293	3.664
Non-Oil GDP	151	20.55	1.029	22.71	18.38

All variables except Almond Price are given in terms of logarithms

in terms of logarithms. Almond price is expressed in terms of unit of dollars, hazelnut production is expressed in terms of tons, farm size is expressed in terms

of hectares, population per region is given in terms of thousands of people, labor force in agriculture sector is given in terms of number of agriculture workers per Economic Region, and non-oil GDP is given in terms of millions of AZN.

4. Methodology

As previously mentioned, in order to analyze the cross-regional production differences in hazelnut sector in Azerbaijan we considered the following equation:

$$\begin{aligned} \mathbf{Log(Production)}_{it} = & \beta_0 + \beta_1(\mathbf{Almond Price})_{it} + \beta_2\mathbf{Log(Farm Size)}_{it} + \\ & \beta_3\mathbf{Log(Population Per Region)}_{it} + \beta_4\mathbf{Log(Labor)}_{it} + \beta_5\mathbf{Log(Non -} \\ & \mathbf{Oil GDP Per Cap)}_{it} + \varepsilon_{it} \end{aligned}$$

For regression purposes we have used fixed effects model, since we think that there are some individual fixed effects which are unobservable such as specialization levels of the regions on hazelnut production (considering the history of production of each region), quality of the processing and so on. These effects are usually unobservable and they create omitted variable bias problem such that lacking these effects in one's regression model biases other coefficients in estimation because of their correlation with the independent variables. Relying on the Hausman's approach we conducted the Hausman Test in STATA and the results suggest that the difference in coefficients is systematic so that the fixed effect model is superior to random effect model given our panel data. Therefore, we will stick with the fixed effect model across regions. Another crucial point was to analyze if our data is serially correlated or not, since classical panel data assumes serially uncorrelated disturbance terms, it is a vital point to consider. The results from this test indicated that there is no first order serial correlation, which coincides with the panel data analysis assumptions. In addition to potential autocorrelation issue, heteroscedasticity is also of a major concern. Simple linear panel models share many characteristics with standard linear regressions, so heteroscedasticity issue is one of them. The null hypothesis tests if the cross-sectional (in our case regional) variances in the disturbances are constant for all regions and given the p-value of 0.0000 we reject the null hypothesis, so we are having heteroscedasticity problem.

Severe multicollinearity can also be considered as one of the most common and problematic things to deal with while doing a regression analysis. While checking for multicollinearity issue, one can see that hazelnut prices and almond prices are highly correlated with each other (around 75%) across regions, so we have a severe multicollinearity issue. However, as mentioned before, almond and hazelnut are considered to be complements of each other in the world of confectionery industries, so it should not be surprising why their prices are severely correlated. Therefore, to solve this issue and for the overall simplicity, we used almond prices to analyze whether hazelnut producers across Azerbaijani Economic regions are aware of the complement relationship between hazelnuts and almonds. Although finding almond prices' data for Azerbaijan was impossible, there was one way to collect this data. Since Azerbaijan is satisfying its almond demand mostly by imports from US, Turkey, Uzbekistan and Chile, it was easy to collect the world price for kg of almond by the report of "United States Department of Agriculture: National Agricultural Statistics Service" (2018). The reason why we consider world price of almond to be equal to Californian Almond Price Index is because California is providing 69.7% of world almond exports. For simplicity, we assume that all imported almonds to Azerbaijan are imported directly to Baku and are sold at the world prices. To adjust the prices to each Economic Region of Azerbaijan, we used the famous gravity model. One of the first researchers of the gravity model - Hans Linnemann (1966), in his book "An Econometric Study of International Trade Flows" uses distance between trading partners as a proxy for the total natural trade impediments which embodies transport costs, transport time and physic distance. Besides, Anderson and Wincoop (2003), Vido and Prentice (2003) and many other researchers mention the importance of the distance variable either by being the proxy for trade costs or by its significant impact on trade flows. Therefore, we utilized Linnemann's approach to adjust the prices for each Economic region and for this reason, kilometric distances between Baku and each Economic Region's main city were taken into account. Finally, logarithmic transformation of the distance variable was added to the US almond prices to account for cross regional price differences because of different transportation costs. According to many news agencies, almond prices are around 20 AZN per kg and while analyzing the average value of our almond price variable adjusted to trade costs and plus 15%

import tax, we see that it is 18.43 AZN/kg, significantly close to value reported by the news agencies.

5. Results

In order to analyze the fixed effects model, we approached this issue by two ways: 1) considering only individual-fixed effects; 2) considering only time-fixed effects. As discussed earlier, we believe that there exist individual or regional fixed effects, however, for the sake of general analysis we also looked at time fixed effects. As seen from the Table 1 (see Appendix), most of the variables turn out to be highly significant. First and third regressions are identical things, however, calculation methods are different, so that first column is calculated by the within group estimator by finding the averages of the variables and subtracting them from the original raw data. The third regression on the contrary, accounts for individual-fixed effects by generating dummy variables for each individual (in our case, regions) and by taking one of them as a benchmark. In addition, the second regression takes into account time-fixed effects by generating time dummies.

Looking at the first regression we see our primary model calculated with the within estimator. The coefficient of almond price turned out to be highly significant, as expected. It turns out to be that people in regions who are working in the hazelnut sector are well aware of the substitute relationship between hazelnut and almond. So, when they observe an increase (1 unit) in the almond prices, either by news agencies while watching TV or when observing the prices in regional bazaars, they boost their hazelnut production by more than 6% by applying more care to the orchard. Nevertheless, there arises a question: why producers do not shift their production towards almond, when the prices of almonds increase? The answer is straightforward, considering the specialization levels of the producers on hazelnut sector and also the time needed to grow almonds, it would not be as profitable as it seems at the first sight. Moreover, as it was expected, the harvest land size affects the supply of hazelnuts positively across regions and highly significantly, so that 1% increase in the average land size results in 0.84% increase in the average production. That is main reason, in our perspective, why Azerbaijani government aims at increasing the land size – to boost our production, and since almost 95% of overall production is exported to other

countries and that hazelnut industry provides the country with great volumes of foreign reserves, increasing the production of hazelnut remains to be the utmost long-term goal of the government in agriculture sector. It should not come as a surprise that President Mr. Ilham Aliev in a republican conference on the development of sericulture, tobacco and hazelnut production, which was held in Gakh district on 4th of August 2017, mentioned the importance of hazelnut production and the extreme need for the farm size expansion. Even though farm size expansion facilitates greater production growth, lower yield (kg/ha) in most of the Economic Regions remains as a challenging issue. Furthermore, as seen from the table, population per region variable was considered in both types of regression models: with only individual-fixed effects and with only time-fixed effects. Although other variables turn out to be highly significant and that their sign patterns are as expected by the theory in our time-fixed effects model, population per region variable's sign becomes positive, which is contrary to what we expected. According to fundamental economic theory, when population per region increases, population density also increases and as it is also emphasized in Josephson, Gilbert and Florax (2014) paper, more population density causes more pressure on land fragmentation or subdivision, which in turn decreases the farm size. What we mean with fragmentation and subdivision is that suppose there is a person who has an arable hazelnut land which will be inherited to his children, however, not all of his children will be hazelnut growers (either because being a female inheritor – who, in Azerbaijan, would not usually involve in hazelnut growing and who are instead typically involved in harvesting or basic processing; or because not having enough specialization for growing). So, after subdivision, less farm size per each specialized hazelnut grower leads to less cash inflow from product sales and it restricts farmers to purchase modern productivity enhancing inputs. Thus, more population growth should have affected production negatively, which is true for our individual-fixed effects model. Additionally, having insignificant time dummies also proves inefficient and biased estimates by time fixed effect model, so individual-fixed effects model becomes superior to any other model, as was expected. In above figure one can observe related densities for each Economic Region that has higher hazelnut production capabilities. Densities follow more or less the same trend for other 5 Economic Regions as well and since they are typically increasing, the resulting production is decreasing. What is more, labor force

variable turned out to be insignificant. Even though we do not have any appropriate answer for why the number of labor does not affect the hazelnut production, the only observation we had is that most of the hazelnut farms are controlled by the family growers, rather than big corporations or by the government itself. So, there are almost no hired workers in the hazelnut industry in Azerbaijan, instead, most workers are parts of the family who own the hazelnut orchard and who benefit from the overall income of the family due to hazelnut harvesting and sale, compared to most hazelnut growers in

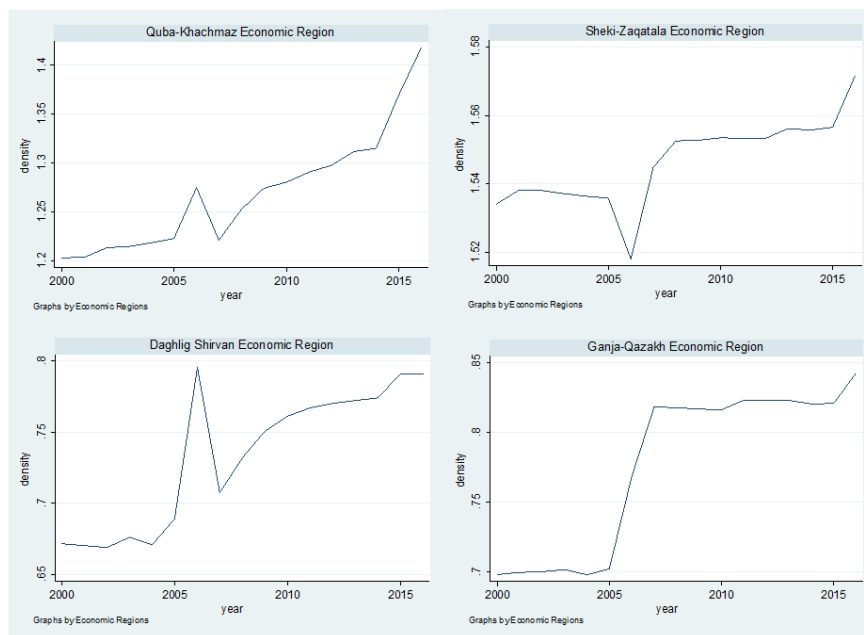

Turkey who hire some workers to help them with harvesting. Additionally, the data that we considered is the number of hired workers per region which may not represent the population that we were interested in. Although there are still

workers who work in basic processing firms in Azerbaijan, the number of such firms is limited and usually these types of firms do not affect the production level, since they do not grow hazelnuts on their own, rather they collect raw hazelnuts from individual farmers and use their capital to process and to sell. An example of such firm can be AHEC – Azerbaijan Hazelnut Exporters Consortium, which is based in Zagatala region and considered to be a unique firm in its sector for representing Azerbaijan’s hazelnut in many global festivals. The second problem related with the insignificance of the variable may be the technique used to fill in the missing values for labor variable in specific years to not to lose any observations in our analysis. Therefore, it is very likely that we ended up with inadequate data for labor variable which made its effect insignificant.

On top of that, non-oil GDP or non-oil income per capita variable turned out to be significantly affecting the production of hazelnuts across Economic Regions, so that 1

percent increase in income per capita results in 0.69 percent increase in hazelnut production. This result may suggest that for Azerbaijani hazelnut farmers' income effect dominates substitution effect. Likewise, following Borjas's (1996) book on Labor Economics – where he defined the utility of the respective household as dependent on working hours and leisure, in this paper we define the utility function of farmer as a choice between working hours of producer of hazelnut and leisure. Thus, the more income farmers received, the more incentivized they became to produce hazelnuts by applying more care either by new fertilizers or by up-to-date technology.

Finally, looking at the R-square of our main model, one can see that it is sufficiently

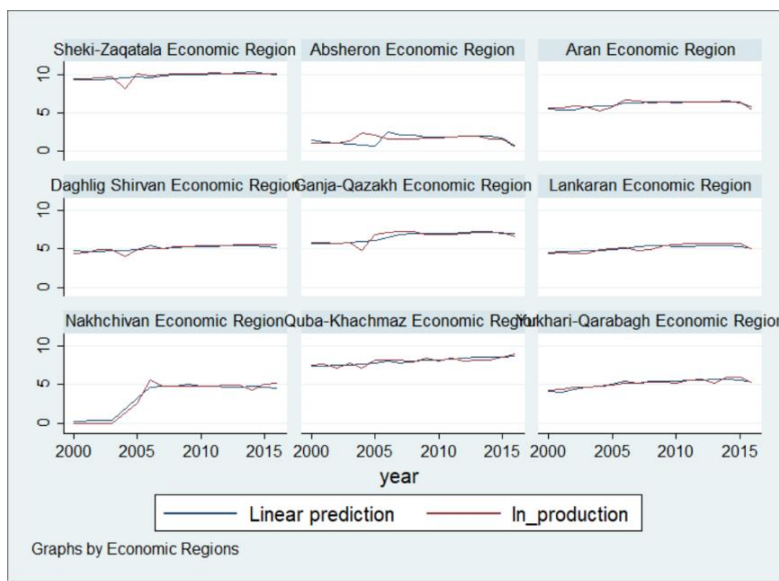

high, so that our independent variables explain 77.6% of deviation in our dependent variable. As seen visually from the graph, our data fits the model properly, so that our linear prediction coincides with the raw data proficiently.

6. Policy Recommendations

After deep analysis of our regression model, we find out that the education level of farmers could be added as a necessary independent variable in order to observe its effect on the hazelnut production level. However, since we do not have access to the data of skill levels of hazelnut farmers, it was not possible to add this in our regression model. We could separate the farmers into skilled and non-skilled parts, and regress them separately on the hazelnut production level. Based on the research “Assesing the efficiency of hazelnut production” by Kilic, Binici, Zulauf (2009), positive and statistically significant relationship was detected between education level of farmers and farm's technical efficiency. Basically, educational programs can lead to the

improvement in production efficiency, which in turn boost the earned profits of hazelnut farmers. Furthermore, since education partly demonstrates human capital stock, it usually shows positive impact on production level. Thus, Huffman (1977) revealed that the greater the human capital stock is, the better will be the capability of the hazelnut farmers to arrange factors of production for maximum efficiency. Moreover, considering the relationship between the farm size and the production level, education programs for farmers should not be aimed at specific farm sizes, such that this kind of programs should be implemented to all farmers regardless of their farm sizes. Consequently, the implementation of specific educational trainings for hazelnut farmers, as well as empowerment of consultation services, preparation and publication of educational materials, play directly significant role in the improvement of production level. In our case hazelnut farmers should be provided with such kind of trainings in order to expand their knowledge about the planting distance, special plantation techniques, humidity and accessibility of land, types and dosages of chemicals, fertilizers, and so on. As far as we know, there is already a place where farmers can acquire new knowledge and get a hand of help, which is called “Fermer Evi”, however, it is only in Guba region of Azerbaijan, so most of the farmers from various regions may not afford to come to Guba whenever they need help. Therefore, creation of such kind of institutions in each Economic Regions, near to place where large hazelnut farms are, is necessary for further development of the sector. Skilled human capital is needed everywhere in today’s complex world, and especially in hazelnut sector of Azerbaijan, for better production management.

Moreover, during our analysis we found out that land fragmentation issue is one of the severe problems in this sector, so that in Azerbaijan, land fragmentation management aspects should be taken into account properly while distributing farmlands based on equity principles. Otherwise, when such strict management principles are not implemented, the shares (or parcels) the farmers receive would be either too small or inappropriately shaped. Therefore, in some countries, like Azerbaijan, the utilization of imprecise distribution of cultivated lands makes it challenging to implement new production techniques and apply modern machinery equipments and relevant technologies, which in turn negatively affect hazelnut production level. Such inappropriate distribution of lands took place in Azerbaijan in 1996 in the “Law of

Republic of Azerbaijan on Land”, which led to free dispense of land to citizens living in the rural areas. Albeit distributing lands for free is considered to be a great step towards the improvement of the agricultural sector, it still creates challenges to the flourishing of the hazelnut sector. Instead of having two separate lands, each specializing in different crops, amalgamation of lands would lead to increased advantages. For instance, landowners can benefit from economies of scale in terms of decreasing their average costs by unification of their lands, or re-allotment of lands to specialized hazelnut growers can lead to higher efficiencies. Besides, one of the main problems that arises as a result of inappropriate allocation of lands in 1996 is that there are diversely specialized crop lands that are located side by side in Azerbaijan. To see the problems associated with side by side allocation of lands, consider the following example: there is a hazelnut land on one side and clover land on the other side. In addition, hazelnut orchards should be drained with special chemicals against various diseases. However, compared to other developed foreign countries, hazelnut orchards are drained with special medicines from certain height because of lack of proper capital in Azerbaijan. The role of medicines is that they can protect the hazelnut crops from special diseases, however, during windy weather conditions, these chemicals are spread with the wind to other crop lands, whether these lands are clover land or tomato land or whatever. Consequently, the crops of these lands are harmed by these medicines, which in turn decreases overall production and returns of the landowner. For this reason, the efficient re-allotment of lands should take place in Azerbaijan or some farmers, whose land is located near the hazelnut orchards, can be informed about the high returns associated with the sale of hazelnuts and encouraged to replace their lands with hazelnut orchards. Such kind of re-allotments were applied in many countries such as Finland, Germany, Turkey and so on and for this reason many experts’ algorithms and optimization methods were used. For instance, for Finland Tenkanen’s (1987) paper was used, for Netherlands Kik(1990) and for Turkey Ayranci (2007) papers were used. Main implemented approach is “GIS” or “Dutch Approach”, where government agency gathers together all the farmers who would like to re-allot their lands and firstly discusses main issues related with the current lands and then assigns experts to each farmer to re-allot their lands and to account for each farmer’s wishes, using linear programming tools such as ArcGIS, ArcView and others.

In the meanwhile, there are mainly two types of landowners in Azerbaijan: the one whose income comes only from hazelnut production and the other one who has a secondary source of income as well. In order to increase the returns coming from the sale of hazelnut, supply control measurements should be taken into account because small scale farmers have no other alternative except for hazelnut farming and they have to increase their production area in order to increase their family income. However, increasing the farm size is not always possible. Therefore, supply control measurement should be aimed at giving incentives to farmers who have a secondary source of income to decrease their hazelnut production and involve in non-farm activities in favor of increasing returns of farmers whose family income depends purely on hazelnut production. However, at some point, the farmer will have to increase its farm size to increase production and returns because price increase and associated returns resulting from the decreased supply of hazelnut may not be as high as expected. Supply contraction process can only affect domestic prices, however, the share of domestically sold production relative to overall production is only 5% and another problem is that contraction of rich farmer's production will lead to the underutilized farm. So, we came back to the same limitation, farm size should be increased. With the intention of solving this issue, we recommend the farmer with secondary source of income to rent his hazelnut farm to poorer farmer, so that both of the parties will be better-off. Poor farmer will be able to increase its overall production and to export surplus of production associated with increased farm size to get more returns. On the other hand, richer farmer, apart from his secondary income, will get rent returns and the farm will be utilized to its full potential. In addition, this policy would lead to higher efficiency in the overall hazelnut sector if poorer family's and richer family's hazelnut farms are located side by side, whose data should be collected by the government and this policy should be considered. Along with supply control measurement, demand control should be implemented to stimulate both domestic and international demand of hazelnut by preparing universal advertising program and applying common promotion plan in Azerbaijan. The question is how the profit should be shared in order to make this collaboration efficient?

We built a model for that and the variables are:

y - total production	β - coefficient	m -total revenue
ha_p - poor farmer's land (in ha)	β = [0,1]	
ha_r - rich farmer's land (in ha)	p – price	

$$\beta(y - (ha_p / ha_r) y)p = \lambda \quad (1)$$

we can denote,

$$p(y - (ha_p / ha_r) y) = m \quad (2)$$

we get,

$$\lambda = \beta * m \quad (3)$$

β indicates the share of total revenue that poor farmer gets. λ is function of β and total revenue. Depending on λ poor farmer will decide either to put high or low effort. (e_H and e_L)

Now we will have a look at utilities of poor and rich farmers,

$$u_r = m - \lambda \quad u_p = \lambda \quad d_L = \text{disutility of low effort}$$

$$d_H = \text{disutility of high effort}$$

Expected payoffs of poor farmer are,

$$E\pi_p(e_H) = p(e_H|\lambda_H) u_p(\lambda_H) + p(e_H|\lambda_L) u_p(\lambda_L) - d_H$$

$$E\pi_p(e_L) = p(e_L|\lambda_H) u_p(\lambda_H) + p(e_L|\lambda_L) u_p(\lambda_L) - d_L \quad (4)$$

If,

$$E\pi_p(e_H) > E\pi_p(e_L)$$

Then poor farmer will put high effort. Assume,

$$p(e_H|\lambda_H) = 0.8 \quad p(e_L|\lambda_H) = 0.2 \quad d_H = 500$$

$$p(e_H|\lambda_L) = 0.2 \quad p(e_L|\lambda_L) = 0.8 \quad d_L = 200$$

By substituting into (4) we get,

$$0.8 \lambda_H + 0.2 \lambda_L - 500 > 0.2 \lambda_H + 0.8 \lambda_L - 200$$

$$0.6 \lambda_H - 0.6 \lambda_L > 300$$

$$\lambda_H - \lambda_L > 500 \quad (5)$$

Substituting (3) into (5) we obtain,

$$\beta_H * m_H - \beta_L * m_L > 500 \quad (6)$$

If we assume that average production is 1000 kg/ha by using 20% margin we can assign $m_H = p * 1200$ and $m_L = p * 800$. We can derive that,

$$m_L = 0.67 m_H$$

From equation (6) we obtain,

$$\beta_H * m_H - \beta_L * 0.67 m_H > 500$$

$$\beta_H - 0.67 \beta_L > 500/m_H$$

$$\beta_H > 500/m_H - 0.67 \beta_L \quad (7)$$

For any β_H that satisfies in equality (6) the poor farmer will put high effort (e_H).

7. Conclusion

To recapitulate, hazelnut sector in Azerbaijan remains as a significant part of the non-oil GDP and provides the country with considerable amount of foreign exchange reserves. In this paper, we aimed at finding cross-regional production determinants considering production levels of 9 Economic Regions of Azerbaijan for hazelnut sector. Therefore, we took into account previous literature on this issue and utilized appropriate variables as determinants of production and regressed using fixed effects model for panel data. The results of the regression turned out to be highly significant except for variable representing the labor force and the reason for that is inadequate choice of the variable, so that it does not represent the variable we are interested in. As was expected, the farmers are aware of the substitute relationship between hazelnut and almond; and this effect finds its place in the coefficient before almond price variable, which was found by considering the market price for almond and by applying some assumptions adjusting this price for trade costs and import taxes. So, a unit increase in almond price forces the farmers to take more care of the hazelnut orchard to increase productivity. In contrast to other independent variables, population per region's effect resulted being negative, pointing at population density problems, which leads to fragmentation and subdivision issues. With the intention of improving production capacity of hazelnut industry in regional level in Azerbaijan, we emphasize the importance of education level of farmers and that special trainings should be organized by the government for further flourishing. Meanwhile, either amalgamation of hazelnut orchards under specialized landowners or efficient re-allotment of overall farms to experienced hazelnut growers and giving under-utilized hazelnut farms as a rent are all requisites for sustainable development of the sector.

8. APPENDIX

VARIABLES (1)	(1) Regional Within	VARIABLES (2)	(2) Time Dummies	VARIABLES (3)	(3) Regional Dummies
Almond Price	0.0608** (0.0252)	Almond Price	0.664*** (0.0874)	Almond Price	0.0608** (0.0252)
Log(Farm Size)	0.843*** (0.0533)	Log(Farm Size)	0.790*** (0.0254)	Log(Farm Size)	0.843*** (0.0533)
Log(Population Per Region)	-10.98*** (1.433)	Log(Population Per Region)	0.595*** (0.157)	Log(Population Per Region)	-10.98*** (1.433)
Log(Labor)	0.106 (0.0989)	Log(Labor)	0.270*** (0.0891)	Log(Labor)	0.106 (0.0989)
Log(Non-Oil GDP Per Cap)	0.695*** (0.103)	Log(Non-Oil GDP Per Cap)	-0.908*** (0.145)	Log(Non-Oil GDP Per Cap)	0.695*** (0.103)
		Dummy_2001	0.307 (0.251)	Region Dummy_2	-2.607*** (0.457)
		Dummy_2002	0.00955 (0.234)	Region Dummy_3	11.84*** (1.644)
		Dummy_2003	-0.405* (0.237)	Region Dummy_4	-7.090*** (0.917)
		Dummy_2004	-1.475*** (0.282)	Region Dummy_5	7.834*** (1.077)
		Dummy_2005	-1.599*** (0.344)	Region Dummy_6	4.261*** (0.684)
		Dummy_2006	-0.463** (0.233)	Region Dummy_7	-3.239*** (0.556)
		Dummy_2007	0.211 (0.210)	Region Dummy_8	-1.690*** (0.258)
		Dummy_2008	0.914*** (0.232)	Region Dummy_9	1.071*** (0.381)
		Dummy_2009	0.722*** (0.221)		
		Dummy_2010	0.689*** (0.225)		
		Dummy_2011	0.666*** (0.228)		
		Dummy_2012	-0.0821 (0.238)		
		Dummy_2013	-0.938*** (0.292)		
		Dummy_2014	-2.076*** (0.393)		
		Dummy_2015	-0.712** (0.279)		
		Dummy_2016	-		
Constant	56.71*** (7.456)		8.289*** (1.767)		55.50*** (7.223)
Observations	151		151		151
R-squared	0.776		0.860		0.845
Number of Economic Regions	9		9		9

Standard errors in parentheses. *Table 1*

*** p<0.01, ** p<0.05, * p<0.1

9. References

1. Anderson J. E. & Wincoop E. (2003). Gravity with Gravitas: A Solution to the Border Puzzle. *The American Economic Review*, Vol. 93, No. 1, pp. 170-192. Retrieved from: <http://www.econ.ku.dk/nguyen/teaching/Anderson%20van%20Wincoop%202003%20Gravitas.pdf>
2. Akinbile L.A. (2007). Determinants of productivity level among rice farmers in Ogun State, Nigeria. *African Crop Science Conference Proceedings*, Vol 8. Retrieved from: https://www.researchgate.net/publication/268405544_Determinants_of_productivity_level_among_rice_farmers_in_Ogun_State_Nigeria
3. Ayranci Y. (2007). Re-allocation Aspects in Land Consolidation: A New Model and its Application. *Journal of Agronomy*, Vol. 6, No. 2, pp. 270-277. Retrieved from: <http://docsdrive.com/pdfs/ansinet/ja/2007/270-277.pdf>
4. Borjas G. J. (2013). Chapter 2: Labor Supply. In *Labor Economics* (6th ed., pp. 35-39). The McGraw-Hill Companies, Inc., 1221 Avenue of the Americas, New York, NY 10020
5. Dayal E. (1984). Agricultural Productivity in India: A Spatial Analysis. *Annals of the Association of American Geographers*, Vol 74. Retrieved from: <https://www.jstor.org/stable/pdf/2562616.pdf?refreqid=search%3Aa1618a94681c56838b2ac523904601ae>
6. Hausman, J. A. (1978). Specification Tests in Econometrics. *Econometrica*, Vol. 46, pp. 1251-1271. Retrieved from: <https://www.jstor.org/stable/pdf/1913827.pdf>
7. Huffman E. W. (1977). Allocative Efficiency: The Role of Human Capital. *The Quarterly Journal of Economics*, Vol. 91, No. 1, pp. 59-79. Retrieved from: <https://www.jstor.org/stable/pdf/1883138.pdf?refreqid=excelsior%3A7bbce4f653259af21f38ab610cb87721>
8. Josephson A.L, Gilbert J.C, & Florax R. (2014). How does population density influence agricultural intensification and productivity? Evidence from Ethiopia. *Food Policy*, Vol 48. Retrieved from: https://ac.els-cdn.com/S030691921400044X/1-s2.0-S030691921400044X-main.pdf?_tid=aa47a8c3-b555-4802-96a8-88f69a432ff0&acdnat=1524307345_086cd1e013202fc63e8ec06261d5bb1d
9. Kilic O., Binici T., & Zulauf C. R. (2009). Assessing the Efficiency of Hazelnut Production. *African Journal of Agricultural Research*, Vol. 4 (8), pp. 695-700. Retrieved from: http://www.academicjournals.org/article/article1380901877_Kilic%20et%20al.pdf

10. Kilic O., Ceyhan V., & Alkan I. (2009). Determinants of economic efficiency: A case study of hazelnut (*Corylus avellane*) farms in Samsun Province, Turkey. *New Zealand Journal of Crop and Horticultural Science*. Retrieved from: <https://www.tandfonline.com/doi/pdf/10.1080/01140670909510272?needAccess=true>
11. Linnemann H. (1966). The Effect of the Distance Variable. In *An econometric study of international trade flows* (pp. 180-188). North Holland Publishing Company Amsterdam, Netherlands
12. Muyanga M., & Jayne T.S. (2011). Effects of Population Density on Smallholder Agricultural Production and Commercialization in Rural Kenya. Department of Agriculture, Food and Resource Economics. Retrieved from: http://ageconsearch.umn.edu/bitstream/124993/2/Muyanga%20and%20Jayne_Agricultural%20Commercialization%20in%20Kenya.pdf
13. Swegal H. (2017). The Rise and Fall of Almond Prices: Asia, Drought, and Consumer Preference. *Beyond the Numbers*, Vol 6. Retrieved from: https://digitalcommons.ilr.cornell.edu/cgi/viewcontent.cgi?article=2991&context=key_workplace
14. Tenkanen J. (1987). Computer-aided Allocation of Plots in Land Consolidation. Published by the Finnish Society of Surveying Sciences, No. 2, pp. 10-25
15. USDA, National Agricultural Statistics Service. (2018). 2017 California Almond Acreage Report. Sacramento, CA 95812
16. Vido E. & Prentice B. E. (2003). The Use of Proxy Variables in Economic Gravity Models: A Cautionary Note. *Journal of the Transportation Research Forum*, Vol. 57, No. 1, pp. 123-137. Retrieved from: https://www.umanitoba.ca/faculties/management/ti/media/docs/Proxy_Var_Economic_Gravity_2003.pdf

Das Kombinieren aller Werkzeuge zu einem Block in automatischen Linien mit synchronem Modus

Dr.Ing,habil,Professor Fariz Amirov

Kontakt: Aserbaidsschanische Technische Universität
Huseyn Javid Avenue, Baku, Aserbaidsschan

E-mail: fariz.67@mail.ru

Abstrakt:

In diesem Artikel werden alle Kombination der Werkzeuge in einem Block aufgrund der Optimierung des Abschneidemodus in den technologischen Übergänge angesehen werden, die in einer Position konzentriert und konsequent durchgeführt wird. In dem Fall, in dem die Zuverlässigkeit der technologischen Ausrüstung gering ist, ist es effektiver, technologische Verbindungen in eine Position zu verschmelzen.

Schlüsselwörter: technologische Ausrüstung, Werkzeuge Block, Betrieb, technologische Verbindungen, automatische Linie, Schneidbedingungen

1. Einführung

Aus der Produktivitätsperspektive, unter Berücksichtigung der Anzahl der technologischen Prozesse und Wiederholungen, ist es in jedem Fall möglich, sie per Zeitplan zu nummerieren, abgesehen von der Festlegung der Zusammensetzung der durchzuführenden Arbeiten. Ein optimaler Schneidmodus ist zu diesem Zeitpunkt nicht erforderlich, da nicht alle Optimierungsparameter die Verschiebungszeit der Schneidwerkzeuge für Leerlaufäufe berechnen sollen. So können in dieser Phase statistische Berechnungsmethoden verwendet werden, um die numerische Zeit für das technische Intervall zu berechnen. Es wird empfohlen, statistische Formeln zu verwenden, um die zyklische Zeitdauer zu bestimmen, die der technologischen Grundzeit und den technologischen Übergängen entspricht [1, 2, 5-8].

Aus der Sicht der Produktivitätssteigerung geht es darum, dass eine Vielzahl von Werkzeugen in Form von Werkzeugkopf- und -geräten in gleichbleibender Geschwindigkeit konzentriert wird. Die Lösung dieses Problems hängt von der Verfügbarkeit der Geräte ab [3, 4, 7, 8].

Das Problem besteht darin, die geformten Flächen (Zähne, Werkstücke etc.) in einstellbaren automatisierten Linien zu bearbeiten, gleichzeitig die Drehbearbeitungszentren, Fräsbohrergruppen, abgerundeten Rahmen auch verwendet werden. Es wird davon ausgegangen, dass die Kapazität der Toolbox auf der Basis eines Satzes von geeigneten Werkzeugen Ihnen erlaubt, Einzelheiten aller Sortimente zu entwerfen. Wenn diese Bedingung nicht erfüllt ist, wird es nicht möglich sein, die technologischen Fähigkeiten bestehender und überhöhter Maschinen in allen Grenzen zu nutzen.

2. Das Problem

Durch die Verwendung eines Werkzeugblocks schauen wir uns alle Werkzeuge in einen Block für die Definition einer möglichen Grenze zu kombinieren.

Der Artikel betrachtet die Idee der Bestimmung von m Anzahl von Werkzeugblock aus n Anzahl von Werkzeugen. Anfänglich betrachten wir die einfachsten Fälle, $m = 1$, d.h. die Kombination einer Anzahl von Werkzeugen in einem Werkzeugblock.

Aus der Sicht der strukturellen Dimension werden die automatisierten linearen Übergänge mit gleichzeitigen Betriebsarten mit n Anzahl einzelner Maschinen durch eine voneinander abhängige Maschine ersetzt (Bild 1).



Abbildung 1: Das strukturelle Schema des Ersetzens eines Einradantriebes mit Mehrfachautomatik

Basierend auf der Abb. 1 und dem Entwurfsmodell kann die Projektproduktivität der automatisierten Linie mit dem synchronen Betriebsmodus durch den folgenden Ausdruck berechnet werden:

$$Q_H = \frac{1}{1 + \sum_{i=1}^n B_i + \sum_{i=1}^n \frac{t_{Ein}}{T_{pv}}} \cdot \frac{1}{\max_{u=1 \div n} \{t_{hilf} + t_{haupt}\}} \quad (1)$$

Ein - Einstellung

Hilf - Hilfsmittel

V - Versagen

$$Q_b = \frac{1}{1 + B + B_b} \cdot \frac{1}{t_{db}} \quad (2)$$

$\sum_{i=1 \div n} \{t_{Hilf} + t_{haupt}\}$ der Zyklus des Freigabe-Taktes von AL (automatisierte Linien) synchronen Betriebsmodus;

B_b – besondere Verluste aus der Anpassung und dem Austausch der Instrumentenblöcke;

$\sum_{i=1}^n \frac{t_{ei}}{T_{pv}}$ - die gesamte Zeitverschwendung, resultierte aus dem Fall der Ablehnung von Instrumenten in AL's mit synchronen Betriebsmodus;

Unter Berücksichtigung der Tatsache, dass die Projektproduktivität des Synchron-AL- Projekts durch n Anzahl von automatischen und die Projektproduktivität eines Multiplikators bereitgestellt wird, dann ist es möglich, den automatischen Block als mögliche Grenze zu verwenden, indem man die Anzahl der durchzuführenden Maschinen berücksichtigt. Zu diesem Zweck wird die Kontextverteilung der Projektproduktivität akzeptiert. Die Verteilung der Projektproduktivität ist der Anteil der Produktivität pro Maschine. Um diesen Wert zu berechnen, kann die Anzahl der Werkzeugmaschinen durch die Anzahl der bearbeiteten Systemproduktivitäten geteilt werden.

In diesem Fall kann dieser Preis für AL mit synchronen Betriebsmodus nach dieser Formel berechnet werden:

$$Q_n^1 = \frac{Q_n}{n} \quad (3)$$

Für multifunktionale Maschine wird dieser Ausdruck wie folgt sein:

$$Q_b^1 = Q_b \quad (4)$$

Basierend auf den Aussagen (3) und (4) kann die Nutzungsgrenze aus folgender Formel berechnet werden:

$$Q_b^1 \geq Q_n^1 \quad (5)$$

oder

$$\frac{1}{1+B+B_b} \cdot \frac{1}{t_{db}} \geq \frac{1}{1+\sum_{i=1}^n B_i + \sum_{i=1}^n \frac{t_{Ein}}{T_v}} \cdot \frac{1}{\max_{u=1 \div n} \{t_{hilf} + t_{haupt}\}} \cdot \frac{1}{n}$$

Die folgenden Preise werden wie folgt akzeptiert:

$$\alpha = \frac{t_{db}}{\max_{u=1 \div n} \{t_{hilf} + t_{haupt}\}}$$

- der periodische Preis der Freigabe takt des Werkzeugblocks im AL-synchronen Betriebsmodus;

$$\psi = \left(\frac{B_b}{\sum_{i=1}^n \frac{t_{Ein}}{T_v}} \right)^{-1}$$

- das Verhältnis des Gesamtverlustes der operativen Instrumente zum Gesamtverlust dieser Instrumente in einem Block kombiniert

Wenn wir bedenken, dass der Verlust von einer oder Multiplizitäts-Werkzeugmaschinen fast identisch mit kleinen Wiederholungen ist, dann können wir (5) wie folgt schreiben:

$$\frac{1}{1+B+B_b} \geq \frac{\alpha}{1+nB+\psi B_b}$$

oder

$$n^2B + n(1 + \psi B_b) - \alpha(1 + B + B_b) \geq 0 \quad (6)$$

Formel (6) erlaubt es, die Nutzungsgrenze zu definieren. Deshalb schreiben wir es wie folgendes:

$$(n - r_1)(n - r_2) \geq 0 \quad (7)$$

Betrachten wir die in Fig. 2 dargestellte Eigenschaft unter der Formel (7)



Abbildung 2. Verbrauchsplan der Projektproduktivität, erhalten aus der Kombination von Werkzeugen in einem Block

Die Analyse des Ausdrucks (6) zeigt, dass, wenn der Wert von $\alpha = n$ angenommen wird, d.h. wenn

$\Sigma (thaupt + thilf) = n \cdot \max \{ (thaupt + thilf) \}$, dann ist es in diesem Fall bevorzugt, alle Instrumente unter der Bedingung von $n > B$ zu einem Block zu kombinieren.

3. Schlussfolgerung

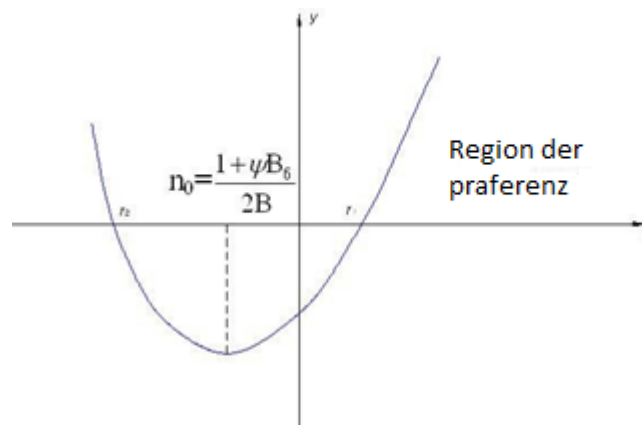
1. Der Vorgang der Vorbereitung der Einzelheiten unter Verwendung des Begriffs der bekannten Position und der Begrenzung der technologischen Übergänge gliedert sich in folgende Teilstufen:
 - Entwicklung der Verarbeitungswege für die Abfolge der technologischen Übergänge jeder Fläche;
 - Aufteilung aller technologischen Übergänge auf Positionen ohne Unterbrechung der Abfolge technologischer Übergänge;
 - Division durch Position unter Berücksichtigung der technologischen Fähigkeiten der Ausrüstung;
 - Operationen auf der Grundlage der erzielten Ergebnisse bilden.
2. Die durchgeführten Studien haben gezeigt, dass, wenn die Zuverlässigkeit der technologischen Ausrüstung niedrig ist, dann ist es effektiver, die technologischen Übergänge in einer Position zu verbinden.

4. Literatur

- [1] Амиров Ф.Г. Оптимизация режимов резания технологических переходов при их последовательной концентрации на одной позиции. «Azərbaycan milli aerokosmik agentliyinin xəbərləri», 2012, №3 (15), səh. 67-73
- [2] Амиров Ф.Г. Оптимизация режимов резания технологических переходов на одной позиции. «Технологическое обеспечение машиностроительных производств», Челябинск, изд. ЮУрГУ, с. 11-16
- [3] Базров Б.М. Модульная технология в машиностроении. М., Машиностроение, 2001, 368 с.
- [4] Владзиевский А П., Белоусов А.П. Основы автоматизации и механизации технологических процессов в машиностроении. М.: «Высшая школа», 1966, 382с.
- [5] Doz. Dr.-Ing. Fariz Amirov, Prof. Dr.-Ing. habil. Alakbar Huseynov Optimierung die Schnittbedingungen der Technologischen Übergänge. “Ingenieurtag 2014” On dear Brandenburgische Technische Universität Cottbus-Senftenberg 19.11.2014, pp. 6
- [6] Султан-заде Н.М. Метод оптимизации структурной компоновки автоматических линий. Сб.: «Системы управления станками и автоматическими линиями», М.: «ВЗМИ», 1982, 9-13 с.
- [7] Султан-заде Н.М., Тимковский В.Г. Метод оптимизации структуры однопоточных автоматических линий. Сб.: «Системы управления станками и автоматическими линиями», М.: «ВЗМИ», 1983, с.93-96.
- [8] Султан-заде Н.М., Амиров Ф.Г. Классификация деталей для изготовления их на переналаживаемых автоматических линиях с использованием обрабатывающих центров с числовым программным управлением // «Научные известия» Сумгаитского государственного университета, 2012, №2, с. 106-11

Применение методов планирования активного эксперимента для определения коэффициентов уравнения регрессии с целью определения оптимального состава шихты в производстве керамических изделий

Application of active experiment planning methods for determining the coefficients of the regression equation to determine the optimal composition of the charge in the production of ceramic products

Н.К.Абасова, ст.преп. каф. «Информационных технологий и систем»

Contact: Азербайджанский Архитектурно-Строительный Университет,
Баку, Азербайджан

E-mail: nigarabas@yahoo.com

Abstract. The article describes the method of statistical planning of the experiment to determine the optimal composition of the charge in the production of ceramic products based on the Box-Benken plan of $K = 3$ dimension. A plan for conducting an active experiment was proposed, the coefficients of mathematical models were calculated, and the adequacy of the models obtained and the significance of the coefficients of the regression equations were checked.

Ключевые слова: керамические изделия, активный эксперимент, математическая модель, адекватность, коэффициенты, уравнение регрессии

Keywords: ceramic products, active experiment, mathematical model, adequacy, coefficients, regression equation

1. Введение.

В последние годы требования, предъявляемые к строительным материалам, существенно повысились. Одним из направлений развития последних лет является развитие «зеленых» строительных материалов. Под «зеленым» строительным материалом понимается разработка материалов, соответствующих экологическим требованиям и обладающих полезными для человеческого здоровья свойствами. Эти свойства следующие:

- минимизация затрат на технический осмотр;
- минимизация энергетических затрат;
- минимизация вреда человеческому здоровью;
- минимизация затрат в связи с изменением планировки жилых площадей.

В связи с вышеизложенным, в последующие годы планируется повышение производства продукции подобного типа. Повышение потребностей обусловлено факторами понижения себестоимости, повышения цен на энергоносители, повышения цен на энергоносители, ужесточение законодательства в сфере окружающей среды и др. Среди «зеленых» строительных материалов потребность, в основном, наблюдается в «зеленых» покрытиях, «зеленом» цементе и «зеленом» кровельном материале.

Как известно, в Азербайджане, в последние годы бурно развивается строительная инфраструктура, и осуществляются широкомасштабные проекты. Необходимо отметить, что большая доля строительных работ (71,2%) относится к новостройкам и реконструкционным работам. В связи с этим, возросли в объемы производства строительных материалов. Также возросли и требования к качеству строительных материалов, в частности, керамических материалов, существенно возросли [7].

Технология ряда керамических материалов в последние годы претерпела существенные изменения. Выпуск керамических изделий постоянно обновляется как по ассортименту, так и по видам. Повышаются требования, предъявляемые к строительным материалам, таким как прочность, морозостойкость и т.д. Следствием этого является необходимость улучшения качества обработки сырьевых материалов, расширение сырьевой базы с вовлечением в производство новейших технологий. Использование новейших технологий, а также современных расчетных методик позволяет производить высококачественные керамические изделия и за счет этого увеличить срок службы зданий и сооружений, повысить его конкурентоспособность на рынке, а также обеспечить высокую рентабельность производства. Представляет особый интерес

использование расчетных методик, таких как метод Бокс-Бенкена для определения оптимального состава керамических изделий.

Как в фундаментальных, так и в прикладных исследованиях, проводимых как на теоретическом, так и на эмпирическом уровнях познания, для современной науки характерен системный подход к изучаемому явлению. Система определяется как ограниченное, взаимосвязанное противоречивым взаимодействием единства тел и предметов. В определении понятия «система» проявляется целевая ориентация этого понятия, рассчитанная на конкретное применение в рамках определенной системной теории для исследования и конструирования сложных объектов. Система определяется заданием системных объектов, их свойств и отношений между ними. Некоторые принципы такого определения можно пояснить на примере технологии производства керамических материалов как сложной технической системы [1].

Функцией такой системы является производство искусственного материала с таким комплексом свойств, в котором не только реализуются лучшие свойства компонентов, но и возникают новые свойства, обусловленные взаимодействием этих компонентов. Цель функционирования можно определить, как достижение материалом оптимального качества и поддержание его на уровне с максимальной стабильностью, при заданном объеме производства материала в течение времени τ при ряде ограничений на функционирование системы. Так для получения оптимальных качественных характеристик материалов необходимо проведение ограничения по введению в композицию тех или иных ингредиентов, тогда как наработанная априорная информация свидетельствует о влиянии этих ингредиентов на повышение тех или других качественных показателей. В этом случае не учитывается взаимодействие отдельных ингредиентов, которое зачастую может иметь отрицательное влияние на достижение конечного положительного результата.

Поведение системы оценивается по величине ее выходов Y_j (уровни показателей качества; например, прочности при изгибе, водопоглощения, плотности получаемого керамического материала из шихты заданного

состава), образующих поле поведения системы в пределах $Y_{j\min} \leq Y_j \leq Y_{j\max}$

Целенаправленное изменение поля поведения среды осуществляется за счет управления *уровнями входов* X_i или факторов, образующих факторное пространство в пределах $X_{i\min} \leq X_i \leq X_{i\max}$, границы которого также определяются возможностями существования данного фактора или нормативом. Уровнями входов X_i или факторами в данном конкретном случае, являются концентрации вполне конкретных ингредиентов смеси, которые могут быть выражены в массовых частях компонентов, вводимых в шихту для получения керамического изделия [2].

Каждый из выходов системы Y_j связан с уровнями входов X_i объективно существующей зависимостью, называемой *уравнением состояния* системы:

$$\varphi\{Y_j, X_1, X_2, \dots, X_i, \dots, X_k, \tau, \xi\} = 0, \quad (1)$$

для которого в технологических и других реальных системах неизвестны ни виды функции φ , ни граничные условия.

При изучении стохастических систем для определения их поведения могут быть использованы различные подходы. Одной из группы моделей является локально-интегральная полиномиальная модель, применяемая для решения практических задач, связанных с описанием и оптимизацией системы. Например, полином второго порядка (более высокий порядок применяется редко) от K факторов (независимых переменных) записывается в виде:

$$Y = b_0 + \sum b_i x_i + \sum b_{ii} x_{ii}^2 \pm \sum b_{ij} x_i x_j. \quad (2)$$

Коэффициенты уравнения регрессии (2) b_0 , b_i , b_{ii} , b_{ij} можно интерпретировать как коэффициенты ряда Тейлора, т.е. как значения частных производных в точке, вокруг которой производится разложение неизвестной нам функции, задающей решение неизвестных нам дифференциальных уравнений. Коэффициенты могут быть определены по экспериментальным данным по методу наименьших квадратов. Величины

$x_{i,j}$ являются независимыми переменными и называются *факторами* процесса [3].

В данной статье рассмотрен метод статистического планирования эксперимента на основе плана Бокса-Бенкена размерности $K = 3$. В качестве системы оптимизации рассмотрены керамические пористые материалы. Данные изделия широко применяются в виде строительных и огнеупорных материалов [5].

К реализации принимается D–оптимальный план Бокса-Бенкена размерности $K=3$, позволяющий провести математико-статистическую обработку данных при варьировании трех компонентов на трех уровнях. D–оптимальные планы обеспечивают минимальный объем эллипсоида рассеивания оценок параметров, минимизируют максимальную дисперсию в заданной области плана, обладают свойством рототабельности и имеют наименьший определитель ковариационной матрицы. Свойство рототабельности сводится к тому, что точки матрицы планирования подбираются с обеспечением одинаковой точности предсказания значений функций отклика и независимости от направления исследования.

План Бокса-Бенкена представляет собой определенные выборки из полного факторного эксперимента типа 3^k , где K - число факторов, а 3 – число уровней (-1, 0, +1), на которых варьируется каждая переменная. Факторы и уровни их варьирования представлены в таблице 1. План Бокса-Бенкена включает число экспериментов, незначительно превышающее число определяемых констант в уравнении регрессии и рекомендуется для использования полинома второго порядка при непоследовательном планировании. В таблице 2 представлен план Бокса-Бенкена размерности $K = 3$. Общее число опытов по плану Бокса-Бенкена для $K = 3$ составляет:

$$N_{общ} = N + N_0 = 12 + 5 = 17, \quad (3)$$

где N_0 - число опытов в центре плана.

Номер реализации опыта выбирался из таблицы случайных чисел с целью устранения временного дрейфа. После проведения эксперимента были

рассчитаны коэффициенты регрессии по расчетной матрице плана Бокса-Бенкена, приведенной в таблице 3.

Таблица 1: Факторы и уровни их варьирования

Факторы	Условное обозначение	Единица измерения	Уровни варьирования факторов		
			Нижний	Нулевой	Верхний
			Кодированное обозначение		
			-1	0	+1
Глина	X_1	Масс.ч.	60	75	90
Стеклобой	X_2	Масс. ч.	10	25	40
Доломит	X_3	Масс. ч.	1	2	3

Таблица 2: План Бокса-Бенкена размерности $K = 3$ (с одной центральной точкой)

№ №	Номер реализации	Кодированные переменные			Натуральные переменные		
		x_1	x_2	x_3	X_1	X_2	X_3
1	6	+	+	0	90	40	2
2	2	+	-	0	90	10	2
3	5	-	+	0	60	40	2
4	1	-	-	0	60	10	2
5	10	+	0	+	90	25	3
6	12	+	0	-	90	25	1
7	11	-	0	+	60	25	3
8	9	-	0	-	60	25	1
9	8	0	+	+	75	40	3
10	7	0	+	-	75	40	1
11	4	0	-	+	75	10	3
12	3	0	-	-	75	10	1
13	13	0	0	0	75	25	2
14	14	0	0	0	75	25	2
15	15	0	0	0	75	25	2
16	16	0	0	0	75	25	2
17	17	0	0	0	75	25	2

В уравнении регрессии (2) $b_0 = Y_{cp}$. Коэффициенты при квадратичных членах определяются по следующим формулам:

$$b_i = 0,125 \sum(iY), \quad (4)$$

$$b_{ii} = 0,25 \sum(iiY) + \rho_3, \quad (5)$$

$$\rho_3 = \rho_2 + \rho_1, \quad (6)$$

$$\rho_1 = -0,5 \sum(0Y), \quad (7)$$

$$\rho_2 = 0,1875 \sum(iiY), \quad (8)$$

где $\sum(0Y)$ - сумма значений выхода системы; $\sum(iiY)$ - сумма значений выхода системы ii - вектор-столбца с учетом знака; ρ_1, ρ_2, ρ_3 - расчетные коэффициенты. В качестве параметров оптимизации или функции отклика приняты:

Y_1 - открытая пористость, %;

Y_2 - кажущая плотность, г/см³;

Y_3 - полная усадка, %;

Y_4 - прочность при изгибе, МПа;

Y_5 - водопоглощение, %.

Коэффициенты при взаимодействиях факторов b_{ij} рассчитываются по формуле:

$$b_{ij} = 0,25 \sum(ijY), \quad (9)$$

где $\sum(ijY)$ - сумма значений выхода системы ij -го вектор-столбца с учетом кодированного знака.

Таблица 3: Расчетная таблица плана Бокса-Бенкена размерности $K = 3$

№ №	Значения выходов системы					Кодированные значения переменных								
	Y_1	Y_2	Y_3	Y_4	Y_5	x_1	x_2	x_3	x_1^2	x_2^2	x_3^2	x_{12}	x_{13}	x_{23}
1	2	3	4	5	6	7	8	9	10	11	12	13	14	15
1	13,5	2,092	1,8	17	6,5	+	+	0	+	+	0	+	0	0
2	19,4	2,067	1,2	5,3	9,4	+	-	0	+	+	0	-	0	0
3	9,8	2,091	2,3	22,5	4,7	-	+	0	+	+	0	-	0	0
1	2	3	4	5	6	7	8	9	10	11	12	13	14	15
4	19,9	2,055	0,8	8,2	9,7	-	-	0	+	+	0	+	0	0
5	19,4	2,041	0,9	9,8	9,5	+	0	+	+	0	+	0	+	0
6	17,4	2,069	0,8	10,2	8,4	+	0	-	+	0	+	0	-	0
7	19,3	2,0	0,9	15,5	9,6	-	0	+	+	0	+	0	-	0
8	15,9	2,074	1,1	16,5	7,7	-	0	-	+	0	+	0	+	0
9	15,4	2,044	1,2	19,0	7,5	0	+	+	0	+	+	0	0	+
10	14,2	2,063	1,8	19,2	6,9	0	+	-	0	+	+	0	0	-
11	21,1	2,032	0,7	6,7	10,4	0	-	+	0	+	+	0	0	-
12	18,9	2,068	0,7	7,3	9,2	0	-	-	0	+	+	0	0	+
13	17,4	2,061	0,7	11,8	8,4	0	0	0	0	0	0	0	0	0
14	18,3	2,052	0,9	12,2	8,9	0	0	0	0	0	0	0	0	0
15	18,1	2,065	0,8	12,7	8,8	0	0	0	0	0	0	0	0	0
16	17,6	2,054	0,8	13,2	8,6	0	0	0	0	0	0	0	0	0
17	16,1	2,093	1,1	12,7	7,7	0	0	0	0	0	0	0	0	0

Среднее квадратичное значение пяти параллельных опытов в центральной точке плана (нулевой уровень) определится по формуле:

$$Y_{cp0} = \frac{\sum_{i=1}^5 Y_i}{N}. \quad (10)$$

Среднеквадратичная дисперсия пяти параллельных опытов в центральной точке плана определится по формуле:

$$S_{cp\{Y_0\}}^2 = \frac{\sum_{i=1}^5 (Y_{cp0} - Y_i)^2}{N - 1}, \quad (11)$$

где N - число опытов.

Среднеквадратичное отклонение на нулевом уровне определяем по формуле:

$$S_{\{Y_0\}} = \sqrt{S_{cp\{Y_0\}}^2}. \quad (12)$$

2. Расчет уравнения регрессии для Y_1 (открытая пористость Π_o , %).

Расчет коэффициентов уравнения регрессии был произведен в вычислительной среде MatLAB. В соответствии с представленной в таблице 4 расчетной матрицей плана Бокса-Бенкена размерности $K = 3$, на основании формул (4)–(9), были получены нижеследующие значения коэффициентов [6]:

$$b_0 = 17.5;$$

$$\rho_1 = -110.85; \quad \rho_2 = 76.575; \quad \rho_3 = -34.275;$$

$$b_1 = 0.6; \quad b_2 = -3.3; \quad b_3 = 1.1;$$

$$b_{11} = -0.625; \quad b_{22} = -1.225; \quad b_{33} = 1.125;$$

$$b_{12} = 1.05; \quad b_{13} = -0.35; \quad b_{23} = -0.25.$$

Таблица 4: Расчетная матрица плана Бокса-Бенкена размерности $K = 3$

№	План			Расчетная матрица									
	x_1	x_2	x_3	y_1	x_1	x_2	x_3	x_1^2	x_2^2	x_3^2	x_1x_2	x_1x_3	x_2x_3
№	2	3	4	5	6	7	8	9	10	11	12	13	14
1	+	+	0	13,5	13,5	13,5	0	13,5	13,5	0	13,5	0	0
2	+	-	0	19,4	19,4	-19,4	0	19,4	19,4	0	-19,4	0	0
3	-	+	0	9,8	-9,8	9,8	0	9,8	9,8	0	-9,8	0	0
4	-	-	0	19,9	-19,9	-19,9	0	19,9	19,9	0	19,9	0	0
5	+	0	+	19,4	19,4	0	19,4	19,4	0	19,4	0	19,4	0
6	+	0	-	17,4	17,4	0	-17,4	17,4	0	17,4	0	-17,4	0
7	-	0	+	19,3	-19,3	0	19,3	19,3	0	19,3	0	-19,3	0
8	-	0	-	15,9	-15,9	0	-15,9	15,9	0	15,9	0	15,9	0
9	0	+	+	15,4	0	15,4	15,4	0	15,4	15,4	0	0	15,4
10	0	+	-	14,2	0	14,2	-14,2	0	14,2	14,2	0	0	-14,2
11	0	-	+	21,1	0	-21,1	21,1	0	21,1	21,1	0	0	-21,1
12	0	-	-	18,9	0	-18,9	-18,9	0	18,9	18,9	0	0	18,9
13	0	0	0	17,5	0	0	0	0	0	0	0	0	0

По полученному уравнению регрессии был проведен расчет значений функции отклика $Y_{\text{вых}}$, определены ошибки Δu и Δu^2 (результаты приведены в таблице 5). Здесь Δu - отклонение расчетного значения функции отклика от экспериментального значения: $\Delta u = Y_i - Y_{\text{вых}}$.

Таблица 5: Расчет выхода системы по уравнению регрессии для Y_1

Экспериментальные значения выхода, Y_1	Расчетные значения выхода, $Y_{вых}$	Отклонение от экспериментального, Δu	Квадратичное отклонение, Δu^2
1	2	3	4
19,4	18,5	-0,5	0,25
9,8	10,7	0,9	0,81
19,9	19,4	-0,9	0,81
19,4	19,35	0,05	0,25
17,4	17,85	-0,45	0,0025
19,3	18,85	0,45	0,2025
15,9	15,95	-0,05	0,2025
15,4	14,95	0,45	0,0025
14,2	13,25	0,95	0,9025
21,1	22,05	-0,95	0,9025
18,9	19,35	-0,45	0,2025
17,5	17,5	0	0
		$\sum \Delta u = 0$	$\sum \Delta u^2 = 4,74$

Далее была произведена оценка значимости коэффициентов уравнения регрессии (таблица 6).

Таблица 6: Оценка значимости коэффициентов уравнения регрессии

Коэффициенты	Ошибка для коэффициентов уравнения регрессии			
	b_0	b_i	b_{ii}	b_{ij}
T_i	1	0,3536	0,6614	0,5
$S\{b\}$	0,86313	0,3052	0,57088	0,43157
$b_{кр}$	1,50693	0,53285	0,99668	0,75347

Результаты регрессионного анализа модели представлены в таблице 7.

Таблица 7: Регрессионный анализ модели

Коэффициенты	$b_{нач}$	$b_{кр}$	$b_{кон}$
1	2	3	4
b_0	17,5	1,50693	17,5
b_1	0,6	0,53285	0,6
b_2	-3,3	0,53285	-3,3
b_3	1,1	0,53285	1,1
b_{11}	-0,625	0,99668	0

1	2	3	4
b_{22}	-1,225	0,99668	-1,225
b_{33}	1,125	0,99668	1,125
b_{12}	1,05	0,75347	1,05
b_{13}	-0,35	0,75347	0
b_{23}	-0,25	0,75347	0

Как видно из таблицы 7, для коэффициентов b_{11} , b_{13} и b_{23} $|b_{нач}| \leq |b_{кр}|$, поэтому уравнение регрессии в конечном итоге принимает вид:

$$Y_1 = 17.5 + 0.6x_1 - 3.3x_2 + 1.1x_3 - 1.225x_2^2 + 1.125x_3^2 + 1.05x_1x_2. \quad (13)$$

Расчетная средняя квадратичная дисперсия находится по формуле:

$$S_{\Delta U}^2 = \frac{\sum \Delta u^2}{N-1},$$

где $\sum \Delta u^2$ - сумма квадратичных отклонений (таблица 5); N - число опытов.

Расчетное среднеквадратичное отклонение определяем по формуле:

$$S_{\Delta U} = \pm \sqrt{S_{\Delta U}^2}.$$

В результате расчетов были получены следующие их расчетные значения:

$$S_{\Delta U}^2 = 0.395; \quad S_{\Delta U} = \pm 0.6285; \quad S_{\{Y_0\}} = \pm 0.863134.$$

Обычно адекватность уравнения регрессии оценивают по критерию Фишера F , однако, по плану Бокса-Бенкена допустимость применения полиномиальной модели можно делать на основании анализа $S_{\Delta U}^2$ без проверки адекватности. По критерию Фишера возможна такая ситуация, в которой модель неадекватна из-за малой ошибки эксперимента (прецизионный эксперимент) или наоборот, когда модель является адекватной, а ошибка эксперимента очень велика (грубый эксперимент). И в том, и в другом случае, такая модель не удовлетворяет целям исследования. Поэтому по плану Бокса-Бенкена адекватность полученной

модели проверяется на основании выполнения условия $S_{\{y_0\}} > S_{\Delta u}$. Таким образом, полученная модель является адекватной.

3. Расчет уравнения регрессии для Y_3 (полная усадка Y_{II} , %).

В соответствии с представленной в таблице 8 расчетной матрицей плана Бокса-Бенкена размерности $K = 3$, а также на основании формул (4) – (9), были получены нижеследующие значения коэффициентов:

$$b_0 = 0.86;$$

$$\rho_1 = -7.53; \quad \rho_2 = 5.325; \quad \rho_3 = -2.205;$$

$$b_1 = -0.05; \quad b_2 = 0.4625; \quad b_3 = -0.0875;$$

$$b_{11} = 0.245; \quad b_{22} = 0.42; \quad b_{33} = -0.18;$$

$$b_{12} = -0.225; \quad b_{13} = 0.075; \quad b_{23} = -0.15.$$

Таблица 8: Расчетная матрица плана Бокса-Бенкена размерности $K = 3$

№	План			Расчетная матрица									
	x_1	x_2	x_3	y_3	x_1	x_2	x_3	x_1^2	x_2^2	x_3^2	x_1x_2	x_1x_3	x_2x_3
№	2	3	4	5	6	7	8	9	10	11	12	13	14
1	+	+	0	1,8	1,8	1,8	0	1,8	1,8	0	1,8	0	0
2	+	-	0	1,2	1,2	-1,2	0	1,2	1,2	0	-1,2	0	0
3	-	+	0	2,3	-2,3	2,3	0	2,3	2,3	0	-2,3	0	0
4	-	-	0	0,8	-0,8	-0,8	0	0,8	0,8	0	0,8	0	0
5	+	0	+	0,9	0,9	0	0,9	0,9	0	0,9	0	0,9	0
6	+	0	-	0,8	0,8	0	-0,8	0,8	0	0,8	0	-0,8	0
7	-	0	+	0,9	-0,9	0	0,9	0,9	0	0,9	0	-0,9	0
8	-	0	-	1,1	-1,1	0	-1,1	1,1	0	1,1	0	1,1	0
9	0	+	+	1,2	0	1,2	1,2	0	1,2	1,2	0	0	1,2
10	0	+	-	1,8	0	1,8	-1,8	0	1,8	1,8	0	0	-1,8
11	0	-	+	0,7	0	-0,7	0,7	0	0,7	0,7	0	0	-0,7
12	0	-	-	0,7	0	-0,7	-0,7	0	0,7	0,7	0	0	0,7
13	0	0	0	0,86	0	0	0	0	0	0	0	0	0

Таким образом, предварительно уравнение регрессии принимает вид:

$$Y_3 = 0.86 - 0.05x_1 + 0.4625x_2 - 0.0875x_3 + 0.245x_1^2 + 0.42x_2^2 - 0.18x_3^2 - 0.225x_1x_2 + 0.075x_1x_3 - 0.15x_2x_3. \quad (14)$$

По полученному уравнению регрессии был проведен расчет значений функции отклика $Y_{\text{вых}}$, определены ошибки Δu и Δu^2 (результаты приведены

в таблице 9). Здесь Δu - отклонение расчетного значения функции отклика от экспериментального значения.

Таблица 9: Расчет выхода системы по уравнению регрессии для Y_3

Экспериментальные значения выхода, Y_3	Расчетные значения выхода, $Y_{вых}$	Отклонение от экспериментального, Δu	Квадратичное отклонение, Δu^2
1	2	3	4
1,8	1,7125	0,0875	0,007656
1,2	1,2375	-0,0375	0,001406
2,3	2,2625	0,0375	0,001406
0,8	0,8875	-0,0875	0,007656
0,9	0,8625	0,0375	0,001406
0,8	0,8875	-0,0875	0,007656
0,9	0,8125	0,0875	0,007656
1,1	1,1375	-0,0375	0,001406
1,2	1,325	-0,125	0,015625
1,8	1,8	0	0
0,7	0,7	0	0
0,7	0,575	0,125	0,015625
0,86	0,86	0	0
		$\sum \Delta u = 0$	$\sum \Delta u^2 = 0.0675$

Далее была произведена оценка значимости коэффициентов уравнения регрессии (таблица 10)

Таблица 10: Оценка значимости коэффициентов уравнения регрессии

Коэффициенты	Ошибка для коэффициентов уравнения регрессии			
	b_0	b_i	b_{ii}	b_{ij}
T_i	1	0,3536	0,6614	0,5
$S\{b\}$	0,151658	0,053626	0,100306	0,075829
$b_{кр}$	0,264776	0,093625	0,175123	0,132388

Регрессионный анализ модели представлен в таблице 11.

Таблица 11: Регрессионный анализ модели

Коэффициенты	$b_{нач}$	$b_{кр}$	$b_{кон}$
1	2	3	4
b_0	0,86	0,264776	0,86
b_1	-0,05	0,093625	0
b_2	0,4625	0,093625	0,4625
b_3	-0,0875	0,093625	0

1	2	3	4
b_{11}	0,245	0,175123	0,245
b_{22}	0,42	0,175123	0,42
b_{33}	-0,18	0,175123	-0,18
b_{12}	-0,225	0,132388	-0,225
b_{13}	0,075	0,132388	0
b_{23}	-0,15	0,132388	-0,15

Как видно из таблицы 11, для коэффициентов b_1 , b_3 и b_{13} выполняется условие $|b_{нач}| \leq |b_{кр}|$, поэтому уравнение регрессии (14) в конечном итоге принимает вид:

$$Y_3 = 0.86 + 0.4625x_2 + 0.245x_1^2 + 0.42x_2^2 - 0.18x_3^2 - 0.225x_1x_2 - 0.15x_2x_3. \quad (15)$$

В результате расчетов были получены следующие расчетные значения:

$$S_{\Delta U}^2 = 0.00562; \quad S_{\Delta U} = \pm 0.075; \quad S_{\{y_0\}} = \pm 0.151658.$$

Таким образом, как видно из расчетов, полученная модель является адекватной.

4. Расчет уравнения регрессии для Y_4 (прочность при изгибе $\sigma_{изг}$, МПа).

В соответствии с представленной в таблице 12 расчетной матрицей плана Бокса-Бенкена размерности $K = 3$, на основании формул (4) – (9), были получены нижеследующие значения коэффициентов:

$$\begin{aligned} b_0 &= 12.52; \\ \rho_1 &= -84.86; & \rho_2 &= 58.95; & \rho_3 &= -25.91; \\ b_1 &= -2.55; & b_2 &= 6.275; & b_3 &= -0.275; \\ b_{11} &= 0.34; & b_{22} &= 0.39; & b_{33} &= 0.14; \\ b_{12} &= -0.65; & b_{13} &= 0.15; & b_{23} &= 0.1. \end{aligned}$$

Таблица 12: Расчетная матрица плана Бокса-Бенкена размерности $K = 3$

№	План			Расчетная матрица									
	x_1	x_2	x_3	y_4	x_1	x_2	x_3	x_1^2	x_2^2	x_3^2	x_1x_2	x_1x_3	x_2x_3
1	+	+	0	17	17	17	0	17	17	0	17	0	0
2	+	-	0	5,3	5,3	-5,3	0	5,3	5,3	0	-5,3	0	0
3	-	+	0	22,5	-22,5	22,5	0	22,5	22,5	0	-22,5	0	0
4	-	-	0	8,2	-8,2	-8,2	0	8,2	8,2	0	8,2	0	0
5	+	0	+	9,8	9,8	0	9,8	9,8	0	9,8	0	9,8	0
6	+	0	-	10,2	10,2	0	-10,2	10,2	0	10,2	0	-10,2	0
7	-	0	+	15,5	-15,5	0	15,5	15,5	0	15,5	0	-15,5	0
8	-	0	-	16,5	-16,5	0	-16,5	16,5	0	16,5	0	16,5	0
9	0	+	+	19	0	19	19	0	19	19	0	0	19
10	0	+	-	19,2	0	19,2	-19,2	0	19,2	19,2	0	0	-19,2
11	0	-	+	6,7	0	-6,7	6,7	0	6,7	6,7	0	0	-6,7
12	0	-	-	7,3	0	-7,3	-7,3	0	7,3	7,3	0	0	7,3
13	0	0	0	12,52	0	0	0	0	0	0	0	0	0

Таким образом, предварительно уравнение регрессии принимает вид:

$$Y_4 = 12.52 - 2.55x_1 + 6.275x_2 - 0.275x_3 + 0.34x_1^2 + 0.39x_2^2 + 0.14x_3^2 - 0.65x_1x_2 + 0.15x_1x_3 + 0.1x_2x_3. \quad (16)$$

По полученному уравнению регрессии был проведен расчет значений функции отклика $Y_{вых}$, определены ошибки Δu и Δu^2 (результаты расчетов представлены в таблице 13).

Таблица 13: Расчет выхода системы по уравнению регрессии для Y_4

Экспериментальные значения выхода, Y_4	Расчетные значения выхода, $Y_{вых}$	Отклонение от экспериментального, Δu	Квадратичное отклонение, Δu^2
1	2	3	4
17	16,325	0,675	0,45563
5,3	5,075	0,225	0,05063
22,5	22,725	-0,225	0,05062
8,2	8,875	-0,675	0,45562
9,8	10,325	-0,525	0,27562
10,2	10,575	-0,375	0,14062
15,5	15,125	0,375	0,14063
16,5	15,975	0,525	0,27563
19	19,15	-0,15	0,0225
19,2	19,5	-0,3	0,09
6,7	6,4	0,3	0,09
7,3	7,15	0,15	0,0225
12,52	12,52	0	0
		$\sum \Delta u = 0$	$\sum \Delta u^2 = 2.07$

Затем была проведена оценка значимости коэффициентов уравнения регрессии, результаты которой представлены в таблице 14.

Таблица 14: Оценка значимости коэффициентов уравнения регрессии

Коэффициенты	Ошибка для коэффициентов уравнения регрессии			
	b_0	b_i	b_{ii}	b_{ij}
T_i	1	0,3536	0,6614	0,5
$S\{b\}$	0,26786	0,09472	0,17716	0,13393
$b_{кр}$	0,46766	0,16536	0,30931	0,23383

Регрессионный анализ модели представлен в таблице 15.

Таблица 15: Регрессионный анализ модели

Коэффициенты	$b_{нач}$	$b_{кр}$	$b_{кон}$
b_0	12,52	0,46766	12,52
b_1	-2,55	0,16536	-2,55
b_2	6,275	0,16536	6,275
b_3	-0,275	0,16536	-0,275
b_{11}	0,34	0,30931	0,34
b_{22}	0,39	0,30931	0,39
b_{33}	0,14	0,30931	0
b_{12}	-0,65	0,23383	-0,65
b_{13}	0,15	0,23383	0
b_{23}	0,1	0,23383	0

Как видно из таблицы 15, для коэффициентов b_{33} , b_{13} и b_{23} $|b_{нач}| \leq |b_{кр}|$, поэтому уравнение регрессии в конечном итоге принимает вид:

$$Y_4 = 12.52 - 2.55x_1 + 6.275x_2 - 0.275x_3 + 0.34x_1^2 + 0.39x_2^2 - 0.65x_1x_2. \quad (17)$$

В результате расчетов были получены следующие расчетные значения:

$$S_{\Delta U}^2 = 0.1725; \quad S_{\Delta U} = \pm 0.41533; \quad S_{\{y_0\}} = \pm 0.535724.$$

В результате проверки условия была подтверждена адекватность полученной модели.

5. Расчет уравнения регрессии для Y_5 (водопоглощение B , %). В соответствии с представленной в таблице 16 расчетной матрицей плана Бокса-Бенкена размерности $K = 3$, а также на основании формул (4)–(9), были получены нижеследующие значения коэффициентов:

$$b_0 = 8.48;$$

$$\rho_1 = -53.99; \quad \rho_2 = 37.3125; \quad \rho_3 = -16.6775;$$

$$b_1 = 0.2625; \quad b_2 = -1.6375; \quad b_3 = 0.6;$$

$$b_{11} = -0.3025; \quad b_{22} = -0.6025; \quad b_{33} = 0.6225;$$

$$b_{12} = 0.525; \quad b_{13} = -0.2; \quad b_{23} = -0.15.$$

Таблица 16: Расчетная матрица плана Бокса-Бенкена размерности $K = 3$

№	План			Расчетная матрица									
	x_1	x_2	x_3	y_5	x_1	x_2	x_3	x_1^2	x_2^2	x_3^2	x_1x_2	x_1x_3	x_2x_3
1	+	+	0	6,5	6,5	6,5	0	6,5	6,5	0	6,5	0	0
2	+	-	0	9,4	9,4	-9,4	0	9,4	9,4	0	-9,4	0	0
3	-	+	0	4,7	-4,7	4,7	0	4,7	4,7	0	-4,7	0	0
4	-	-	0	9,7	-9,7	-9,7	0	9,7	9,7	0	9,7	0	0
5	+	0	+	9,5	9,5	0	9,5	9,5	0	9,5	0	9,5	0
6	+	0	-	8,4	8,4	0	-8,4	8,4	0	8,4	0	-8,4	0
7	-	0	+	9,6	-9,6	0	9,6	9,6	0	9,6	0	-9,6	0
8	-	0	-	7,7	-7,7	0	-7,7	7,7	0	7,7	0	7,7	0
9	0	+	+	7,5	0	7,5	7,5	0	7,5	7,5	0	0	7,5
10	0	+	-	6,9	0	6,9	-6,9	0	6,9	6,9	0	0	-6,9
11	0	-	+	10,4	0	10,4	10,4	0	10,4	10,4	0	0	-10,4
12	0	-	-	9,2	0	-9,2	-9,2	0	9,2	9,2	0	0	9,2
13	0	0	0	8,48	0	0	0	0	0	0	0	0	0

Таким образом, предварительно уравнение регрессии принимает вид:

$$Y_5 = 8.48 + 0.2625x_1 - 1.6375x_2 + 0.6x_3 - 0.3025x_1^2 - 0.6025x_2^2 + 0.6225x_3^2 + 0.525x_1x_2 - 0.2x_1x_3 - 0.15x_2x_3. \quad (18)$$

По полученному уравнению регрессии был проведен расчет значений функции отклика $Y_{\text{вых}}$, определены ошибки Δu и Δu^2 , результаты которого приведены в таблице 17. Здесь Δu - отклонение расчетного значения функции отклика от экспериментального значения.

Таблица 17: Расчет выхода системы по уравнению регрессии для Y_5

Экспериментальные значения выхода, Y_5	Расчетные значения выхода, $Y_{вых}$	Отклонение от экспериментального, Δu	Квадратичное отклонение, Δu^2
1	2	3	4
6,5	6,725	-0,225	0,050625
9,4	8,95	0,45	0,2025
4,7	5,15	-0,45	0,2025
9,7	9,475	0,225	0,050625
9,5	9,4625	0,0375	0,001406
8,4	8,6625	-0,2625	0,068906
9,6	9,3375	0,2625	0,068906
7,7	7,7375	-0,0375	0,001406
7,5	7,3125	0,1875	0,035156
6,9	6,4125	0,4875	0,237656
10,4	10,8875	-0,4875	0,237656
9,2	9,3875	-0,1875	0,035156
8,48	8,48	0	0
1	2	3	4
		$\sum \Delta u = 0$	$\sum \Delta u^2 = 1.1925$

Далее было проведено определение значимости коэффициентов уравнения регрессии, результаты которой приведены в таблице 18.

Таблица 18: Оценка значимости коэффициентов уравнения регрессии

Коэффициенты	Ошибка для коэффициентов уравнения регрессии			
	b_0	b_i	b_{ii}	b_{ij}
T_i	1	0,3536	0,6614	0,5
$S\{b\}$	0,476445	0,168471	0,315121	0,238223
b_{kp}	0,831818	0,294131	0,550164	0,415909

Далее был произведен регрессионный анализ модели, представленный в таблице 19.

Таблица 19: Регрессионный анализ модели

Коэффициенты	$b_{нач}$	$b_{кр}$	$b_{кон}$
b_0	8,48	0,8318	8,48
b_1	0,2625	0,2941	0
b_2	-1,6375	0,2941	-1,6375
b_3	0,6	0,2941	0,6
b_{11}	-0,3025	0,5502	0
b_{22}	-0,6025	0,5502	-0,6025
b_{33}	0,6225	0,5502	0,6225
b_{12}	0,525	0,4159	0,525
b_{13}	-0,2	0,4159	0
b_{23}	-0,15	0,4159	0

Уравнение регрессии в конечном итоге принимает вид:

$$Y_5 = 8.48 - 1.6375x_2 + 0.6x_3 - 0.6025x_2^2 + 0.6225x_3^2 + 0.525x_1x_2. \quad (19)$$

И в заключение, в результате проверки условия $S_{\{Y_0\}} > S_{\Delta U}$, была подтверждена адекватность полученной модели.

6. Цель проведенных расчетов

На основании разработанных моделей можно оптимизировать состав шихты, для получения изделия с заданными свойствами. При этом анализ уравнений регрессии позволит выявить наиболее сбалансированное содержание ингредиентов в составе шихты. Для определения оптимального состава для производства качественного керамического изделия по значениям коэффициентов уравнений регрессии, полученным регрессионным анализом, решается задача оптимизации и может быть предложен оптимальный план состава ингредиентов, обеспечивающих максимальную прочность керамических изделий.

7. ЛИТЕРАТУРА

1. Вознесенский, В.А., 1981 г. Статистические методы планирования эксперимента в технико-экономических исследованиях. Финансы и статистика, 263 с.
2. Деденко, Л.Г., Керженцев, В.В., 1977 г. Математическая обработка и оформление результатов эксперимента. МГУ, 112 с.
3. Матушкин, Н.Н., 1977 г. Обработка результатов измерений и планирование эксперимента. Курс лекций. Пермь, 46 с.
4. Гришин, В.К., 1975 г. Статистические методы анализа и планирования экспериментов. МГУ, 128 с.
5. Спиридонов, А.А., 1981 г. Планирование эксперимента при исследовании технологических процессов. Машиностроение, 60 с.
6. <http://senaye.gov.az>

ЭНЕРГОАУДИТ ЗДАНИЙ КАК ИНСТРУМЕНТ ПОВЫШЕНИЯ ИХ ЭНЕРГОЭФФЕКТИВНОСТИ

Building energy auditing is a tool to improve their energy efficiency

Н.Я.Мамедов¹, к.т.н., доц; .М.Акперова², к.т.н., доц; Н.Э.Рзаева³, к.т.н.

Contact: 1. Азербайджанский университет архитектуры и строительства,
Баку, Азербайджан

2. АзУАС

3. АзУАС

E-mail: mammadov.nurmammad@azmiu.edu.az
sqiom@yahoo.com
nikanel1@gmail.com

Абстракт. По оценкам Государственного Комитета по Статистике Азербайджанской Республики потребление энергии строительным сектором составляет более чем 41,7% от конечного энергопотребления, подтверждая тем самым строительный сектор как крупнейший потребитель энергобаланса страны. Одним из путей решения проблемы фактической экономии энергии, природных ресурсов и уменьшения разрушающего воздействия на окружающую среду строительным сектором является проведение многодисциплинарного энергетического аудита зданий и сооружений. В данной статье даны основные показатели энергоэффективности, описывается рабочий процесс энергоаудита зданий, методология оценки инженерных систем. Представлены результаты многодисциплинарного энергетического аудита здания сельской школы и даны технические рекомендации локальных экспертов. Для обработки результатов было использовано специальное программное обеспечение расчета финансовых затрат и эффективности предлагаемых рентабельных мер энергосбережения. Оценены экологические выгоды и сокращение выбросов CO₂. Анализируются препятствия повсеместного применения энергоаудита зданий в республике.

Ключевые слова: детальный multidисциплинарный энергетический аудит; энергетический бюджет; энергопотребление; энергоэффективные меры; теплоизоляция.

Abstract. According to estimates by the State Statistics Committee of the Republic of Azerbaijan, the energy consumption of the construction sector account for more than 41,7% of the country's final energy consumption, it confirms the construction sector as the largest consumer of the final country's energy balance. One of the ways to solve the problem of the actual saving of energy, natural resources and reducing the destructive impact on the environment of the construction sector is to carry out a multidisciplinary energy audit of buildings and construction structures. This article represents the main indicators of energy efficiency, describes the workflow of building energy auditing, the methodology for assessing engineering systems. The results of a multidisciplinary energy audit of the rural school building are presented and technical recommendations from local experts are given. Special software was used to calculate the financial costs and profitability of the proposed cost-effective energy saving measures. Environmental benefits and reductions in CO₂ emissions are estimated. There are analyzed the obstacles to the widespread using of building energy auditing in the country.

Keywords: detailed multidisciplinary energy auditing of buildings; energy budget; energy consumption; energy efficient measures; thermal insulation

1. Введение

В Азербайджане основными потребителями энергии являются здания, промышленные предприятия и транспортные средства (рис.1). Сегодня Азербайджан полностью удовлетворяет свои внутренние потребности за счет собственных ресурсов, хотя эффективность использования первичных источников и преобразованных видов энергии внутри страны крайне низка.



Рис.1. Энергопотребление по секторам в Азербайджане, % [1]:

1-жилые дома; 2-коммерческие и общественные здания; 3-транспорт; 4-промышленные предприятия, 5- другие

По данным Государственного Комитета по Статистике Азербайджанской Республики, более 41,7% конечного энергопотребления приходится на долю зданий, в частности, удельный расход на отопление составляет около 277 кВтч/м². При рассмотрении жизненного цикла здания (производство строительных материалов, проектирование, эксплуатация, снос) огромное количество энергии теряется на этапе эксплуатации здания из-за недостаточной теплоизоляции наружных строительных конструкций, неэффективности работы систем отопления, вентиляции, кондиционирования воздуха, горячего водоснабжения, неправильной стратегии эксплуатации систем энергопотребления, отсутствия энергомониторинга и т.д. [2].

В категории общественных зданий школьные здания представляют особый интерес с точки зрения их энергоэффективности, т.к. имеют определенный режим работы, учащиеся 25% своего времени проводят в помещении, поэтому для продуктивности процесса обучения необходимо создание комфортного микроклимата и необходимо рассматривать здание как целостную энергетическую систему [3]. Для проведения энергоаудита требуется расширенный учет и контроль энергосбережения. Многодисциплинарный энергоаудит становится повсеместной тенденцией, потому что это может помочь сохранить энергию и природные ресурсы, а также уменьшить экологическое воздействие строительного сектора [4].

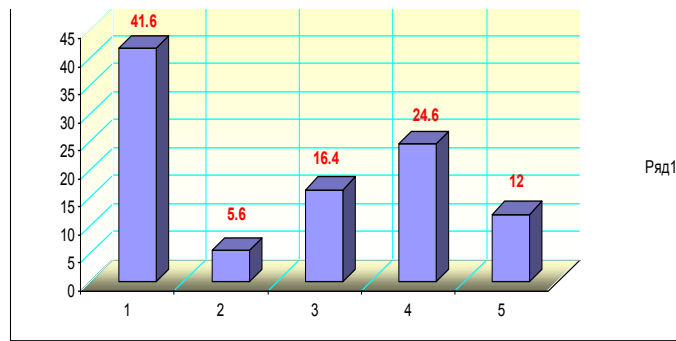
Основной целью многодисциплинарного энергетического аудита является получение информации о текущем состоянии здания: качестве внутреннего микроклимата, режиме эксплуатации инженерных систем. Эта информация имеет решающее значение для реализации энергоэффективных мер (ЭЭМ) в здании [5]. Проведение энергоаудита предусматривает применение рентабельных ЭЭМ, контроль жизненного цикла здания в отношении проектирования, производства строительных материалов, переработку и повторное использование после разрушения, эксплуатацию, техническое обслуживание и модернизацию зданий [6]. Общие инвестиции и показатели рентабельности являются одними из ключевых факторов при выборе наиболее ЭЭМ. Эта статья фокусируется на представлении результатов детального многодисциплинарного энергоаудита здания школы в поселке Тюркан близ города Баку и технические рекомендации по устранению потерь энергии.

2. Методология энергоаудита

Чтобы сократить потребление энергии в существующих и новых зданиях и улучшить внутреннюю среду, необходимо применять энергетический аудит и проводить ЭЭМ. Энергоаудит определяется как систематическая процедура для получения достоверных сведений о реальном состоянии энергопотребления здания, для выявления и оценки экономически рентабельных возможностей экономии энергии и для отчета о полученных результатах [7]. EN 16247-1 В зависимости от технических характеристик и состояния здания энергоаудит может быть упрощенным с точностью $\pm(10 - 15)\%$ или детальным с точностью $\pm (5 - 10)\%$. В целом энергетический аудит здания состоит из двух основных частей: первая часть - изучение энергетических потребностей оболочки здания и инженерных систем, таких как кондиционирование, отопление, вентиляция, освещение, горячее водоснабжение, электрические установки, лифты, пожарная сигнализация и спринклеры и т.д., другая часть включает рекомендации по эффективному использованию энергии, эксплуатации и обслуживанию (рис.1).



Рис. 2. Структурная схема многодисциплинарного энергоаудита

Для каждого здания следует рассматривать специальные возможности экономии энергии. Для детального аудита энергии должны быть оценены все функции, влияющие на потребление энергии здания: наружные ограждающие конструкции (окна, наружные стены, нижнее перекрытие и крыша), система механической вентиляции, кондиционирования, система горячего водоснабжения, система отопления, системы автоматического управления, различные электроустановки, освещение и т. д. Также необходимо учитывать режим эксплуатации. Благодаря интеграции и взаимодействию пассивных и активных энергосберегающих технологий с архитектурным дизайном можно достичь баланса между созданием условий теплового комфорта и энергосбережением здания.

Показатели энергоэффективности обеспечивают прямое количественное выражение энергетической эффективности здания, например: энергопотребление на 1 м² кондиционируемой площади, кВтч/м² (табл.1).

Табл.1. Основные показатели энергоэффективности

Показатели энергоэффективности	Значения
Коэффициент теплопередачи стены	$\leq 0,3 \text{ Вт}/(\text{м}^2 \cdot \text{К})$
Коэффициент теплопередачи верхнего перекрытия (крыша)	$\leq 0,2 \text{ W}/(\text{м}^2 \cdot \text{K})$
Коэффициент теплопередачи нижнего перекрытия (пол)	$\leq 0,2 \text{ W}/(\text{м}^2 \cdot \text{K})$
Макс.площадь окон для жилых зданий	$\leq 18 \%$
Макс.площадь окон для нежилых зданий	$\leq 25 \%$
Воздухопроницаемость (50 Па)	$\leq 3,0$ кратность воздухообмена в час
Кратность воздухообмена для жилых зданий	$> 3 \text{ м}^3/(\text{м}^2 \cdot \text{час})$
Коэффициент рекуперации тепла для нежилых зданий	$> 70\%$
Коэффициент компактности СНиП23-02-2003	0,32 — 6-9- этажных зданий

Результаты инспекции здания, оценка и анализ существующей ситуации отражены в отчете об аудите, здесь же представлены рекомендуемые ЭЭМ с соответствующими инвестициями, окупаемостью и рентабельностью. ЭЭМ ранжируются в соответствии с их рентабельностью. Результаты и выводы энергетического аудита также используются для подготовки энергосертификата здания в соответствии с национальными и международными кодексами. Энергетический аудит проводится специально обученными и опытными энергетическими аудиторами. Итоговый отчет аудита состоит из следующих основных частей: детальная информация о текущем состоянии и энергопотреблении здания, выявленных энергоэффективных возможностях, описание представленных ЭЭМ и их план реализации, описание предлагаемой стратегии эксплуатации и обслуживания, процедуры энергомониторинга.

3. Проведение энергоаудита.

3.1. Краткая информация о текущей ситуации

Здание для которого проводится энергоаудит является учебным корпусом в поселке Тюркан близ Баку, построено в 1976 году, подвергалось капитальному ремонту в 2009, общей площадью 4170 м² с неотапливаемым чердаком и подвалом. Стены сделаны из местного известняка, средний коэффициент теплопередачи составляет около 1,6 Вт/(м²°С), что способствует значительным теплотерям через ограждающие конструкции. Указанный коэффициент теплопередачи почти в 3 раза выше, чем существующие стандартные требования к теплоизоляции стен для стран Европейского союза с аналогичным климатом как для Азербайджана. Низкая тепловая защита стен приводит к возникновению конденсации на внутренних поверхностях наружных стен, что способствует ухудшению их теплозащитных свойств. Окна в здании в основном старые деревянные с двойным остеклением. Существующая система отопления однотрубная с верхней

разводкой. Отопительные приборы представляют собой чугунные и стальные радиаторы, конвекторы старого типа. Терморегуляция системы отопления отсутствует. Распределительные трубопроводы являются металлическими и не имеют теплоизоляции. Теплоснабжение в здании поступает из местной котельной, работающей на природном газе и дизельном топливе. График работы котельной часто не поддерживается должным образом. Из-за низкой тепловой защиты здания и несбалансированной системы отопления зимняя температура внутри помещений составляет около $+ 16^{\circ}\text{C}$, что значительно ниже минимально допустимых температурных стандартов. Из-за неадекватной комнатной температуры в зимний сезон дополнительные электрические нагревательные приборы используются для повышения температуры воздуха в помещении. В здании нет горячего водоснабжения, хотя оно должно предоставляться в соответствии со строительными нормами

3.2 Краткая информация о предлагаемых мероприятиях

Местные энергоаудиторы предложили следующий пакет ЭЭМ.

1. Кровельная теплоизоляция минеральной ватой Rockwool толщиной 8 см и коэффициентом теплопроводности около $\lambda < 0,04 \text{ Вт}/(\text{м} \text{ }^{\circ}\text{C})$, коэффициент теплопередачи кровли был 1,2 стал $0,36 \text{ Вт}/(\text{м}^2\text{ }^{\circ}\text{C})$.
2. Теплоизоляция фасада тем же материалом, коэффициент теплопередачи наружной стены был $1,6 \text{ Вт}/(\text{м}^2\text{ }^{\circ}\text{C})$ стал $0,49 \text{ Вт}/(\text{м}^2\text{ }^{\circ}\text{C})$.
3. Автоматическое управление теплоснабжением- установка регулфторов Viessmann Vitotronic Vitocrossal 4GCB на отопительные котлы, энергосбережения составляют 56685 кВтч/год.
4. Балансировка системы распределения тепла- установка термостатов Danfoss, энергосбережения составляют 50 391 кВтч/год.
5. Энергоэффективное освещение лампами LED 300 lx 25000 часов работы.
6. Установка солнечных панелей AZGUNTEX, энергосбережения составляют 70000 кВтч/год.

4. Обсуждение результатов

Поскольку зимой здание недостаточно нагрето, в нем нет системы горячего водоснабжения, необходимо рассчитать базовое потребление энергии и учитывать минимальные стандарты температуры воздуха внутри помещений. Энергопотребление до и после ЭЭМ суммируется в таблице 2. Бюджет энергии и рентабельность вычисляются специальным программным обеспечением. Общая экономия энергии от внедрения ЭЭМ рассчитывается на основе базового потребления энергии. Он составил 819 974 кВтч / год, что соответствует 56% экономии, в том числе:

- тепловая энергосбережение 779 777 кВтч / год;
- экономия электроэнергии 40 197 кВтч / год (установка солнечных панелей).

Результаты показаны таблице 3.

Табл. 2. Энергобюджет

Budget Item	До ЭЭМ	Базовая линия	После ЭЭМ
	Расчетная кВтч/м ² год	до ЭЭМ кВтч/м ² год	и реконстр. кВтч/м ² год
Отопление	125,2	226,9	72
Вентиляция (обогрев)	0,0	0,0	0,0
Горячее водоснабжение	0,0	15,4	6,2
Вентиляторы/ Насосы	0,0	0,0	0,0
Искус. освещение	8,7	20,7	6,2
Другое	7,5	7,5	7,5
Охлаждение	0,0	0,0	0,0
Итого	141,4	270,4	91,8

В табл. 3 все проведенные энергоэффективные меры перечислены и ранжированы в соответствии с их доходностью, например, наиболее

выгодной процедурой является кровельная теплоизоляция, потому что КЧПС = 2,10. Расчеты показывают, что рекомендация для установки термостатических клапанов в рамках модернизации системы отопления является экономически эффективной (КЧПС= 0,55), хотя затраты, требуемые для термостатических клапанов значительны. Таким образом, предлагаемые мероприятия не только улучшат внутренний микроклимат в здании, но и помогут снизить расходы на энергозатраты школы. Кроме того, внедрение энергоэффективных мероприятий сократит выбросы CO₂ на 209 тонн в год из-за сокращения потребления газа на местной котельной и сэкономит до 113 м³ природного газа.

Табл.3. Результаты энергоаудита и потенциал энергоэффективности

Энергоэффективные мероприятия	Инвестиции AZN	Чистая экономия [кВтч/год]	Чистая экономия [AZN/год]	ПО [год]	КЧПС *
1. Кровельная изоляция	16 680	92 999	4 035	4,1	2,10
2. Изоляция фасада	26 280	125 381	5 592	4,7	1,73
3. Автоматическое управление теплоснабжение	12 500	58 685	2 541	4,9	1,16
4. Установка термостатов	15 000	50 391	2 168	6,9	0,53
5. Энергоэффективное освещение	6 000	19 470	1 068	5,6	0,40
6. Установка солнечных панелей	35 500	69 393	3 598	9,9	0,30
Всего	34 800	70 000	4 150	8,4	0,27

Здесь коэффициент чистой приведенной стоимости составляет около 3,7% от реальной ставки дисконтирования, AZN - локальная валюта.

Выводы

Хотя проведение энергоаудита зданий непосредственно способствует оптимальным энергозатратам и рациональному потреблению природных

ресурсов этот процесс относительно новый и крайне медленно осуществляется в силу имеющихся в республике проблем: отсутствие местных сертифицированных специалистов в этой области; адекватных национальных технических стандартов; недостаточная осведомленность владельцев зданий; отсутствие государственных решений в этом направлении и систематического законодательства, низкие стандарты энергоэффективности наружных ограждающих конструкций. Несмотря на все это важно, чтобы местные эксперты продолжали разрабатывать и внедрять методологию многодисциплинарного энергоаудита на основе национальных норм и стандартов в сочетании с теоретическими исследованиями, сопровождаемыми соответствующим практическим опытом.

Список литературы

1. Energy balance of Azerbaijan., 2017. Report of State Statistical Committee of the Republic of Azerbaijan
2. Xiaofeng L., Xiancheng L., 2016. Research on the Low Energy Consumption Building Design. Journal *Chemical engineering transactions*, VOL. 51, pp:229-234, ISSN 2283-9216, DOI: 10.3303/CET1651039
3. Porhinčák, M., Eštoková, A. (2013). Comparative Analysis of Environmental Performance of Building Materials towards Sustainable Construction. Journal *Chemical engineering transactions*, VOL. 35, pp:1291-1296, ISSN 1974-9791, DOI: 10.3303/CET1335215
4. Mammadov N., Akbarova S. (2017). New methodology of multi- disciplinary energy auditing of buildings in Azerbaijan. Proceedings of the 5th International Symposium on Innovative Technologies in Engineering and Science, No. A10-ISITES2017ID46, 2017

5. Tchervilov L. (2014). Reaching high energy efficient building stock – European Approach and regulations and Norwegian experience and approach to realization. *Eko energetics*. N1, p.42-48, Baku
6. Tabunschikov Yu.A., (2014) Road Map of Green construction in Russia: Problems and Growth Perspectives. *Journal Sustainable building technologies*, No.3, www.abok.ru/for_spec/articles.5786
7. Shimon Y. Nof (2009). Springer Handbook of Automation p.718. Springer, Germany

Climate factor in the residential architecture of Baku

R.Samedov, Dr. Sc. (Ph.), Assoc. Prof.

Contact: Azerbaijan University of Architecture and Construction,
Baku, Azerbaijan,

E-mail: rovshan.samedov@yahoo.com

Abstract. Throughout the history of development of Baku, environmental factors have been taken into account in the architectural and planning solutions for residential buildings. In some examples, the use of certain building materials and structures, plastic and coloristic solutions was so well thought-out that they can be suitable for modern buildings.

Relevance. The continuing scientific and technological progress and development of building technologies today do not diminish the relevance of the connection between nature and climate and architecture. Modern architecture views a building not just as a physical form that protects the internal environment and people from adverse climatic effects, but also as a combination of architectural forms and techniques that allow better adapting it to climatic and natural environment and make this protection more efficient and less energy-intensive (8).

Purpose. The residential architecture of Baku has gone through certain stages in its development that are closely related to socio-economic factors and demands of social life. In terms of professional workmanship, it is residential buildings built since the late 19th century that stand out for their architectural planning techniques in the existing housing stock most sharply. There are three distinct stages of urban development, each of which is characterized by both commonality and individuality of the planning and architectural look: the end of the 19th and the beginning of the 20th century, the Soviet period and the modern stage. The positive aspect of the architectural practices of these periods was the use of traditional architectural techniques and elements shaped by climatic and natural environment and living conditions of Baku. The purpose of this paper is to analyze this positive experience.

Keywords: residential architecture, climate, Baku, summer residence, residential buildings.

1. Introduction

Baku is located in the southern part of the Absheron Peninsula, on the shore of the Caspian Sea. The climate of the city is borderline between temperate continental and subtropical continental semi-desert climates. Winter in the city is mild and warm. The average temperature of the coldest month, February, is +4.0°C. The summer season in Baku is sunny, hot and very dry. The climate of Baku is arid, with only 210 mm of precipitation a year, although the amount of evaporation can exceed 1000 mm. Strong, gusty north-northwestern winds called "khazri" by the local population are regular in and around the city. Also, southern winds ("gilavar") are frequent in the city, bringing dry air and sunny weather. The microclimate of the city is greatly affected by the relief and the position near the Caspian Sea (lake). It moisturizes the air, making it somewhat easier to tolerate the heat. However, in winter, humidity results in a sharp drop in the "feels-like" temperature, especially during periods of southern winds. (9). All these factors have had a tremendous impact on the residential architecture of the city over the years.

2. Analysis of the recent research

There are many architectural solutions shaped by the climate of Baku. One of them is the canonic ribbon development of residential areas. It is true that if we compare residential buildings of Baku to residential buildings of European cities of the early 20th century, then, with the exception of some trademark characteristics of the Baku housing, we will see a general trend in site development. And here we can see the insularity of planning patterns (4).

However, despite the prevailing compact residential design in Europe, groups of tenement houses there were often built among the existing continuous ribbon development; they were set up with gaps between them that improved the lighting and ventilation of apartments. Very often, houses had a small setback, the freed space being filled with a front garden. No such example can be found

in Baku of that period. Residential buildings in Baku always had courtyards enclosed on four sides, as the insularity of quarters arose not only from the need to save space, but also from the need to protect the interior from the scorching sunlight, strong winds, dust and noise.

The insularity of residential areas continued to exist in the Soviet period. This can be observed in the planning of workers' settlements that began to be built in the 1920s. As opposed to the worldwide practice of residential construction of that period, when functional architecture spread with its principles of loose layout, residential areas of Baku retained the principle of insular planning. This was based on the recognition of the implicit value of the virtues of this technique, as well as the Bakuvian mentality and traditions.

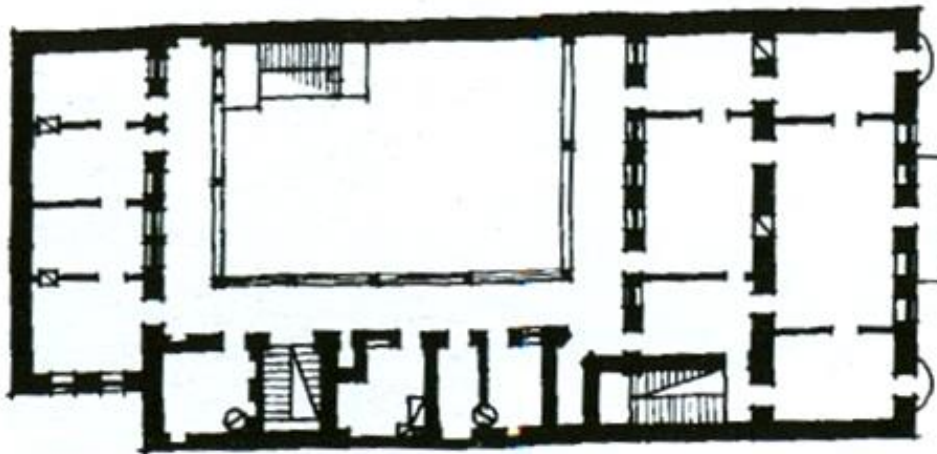

Figure 1: Residential building of the late 19th century at 3 U. Hajibeyov Str.

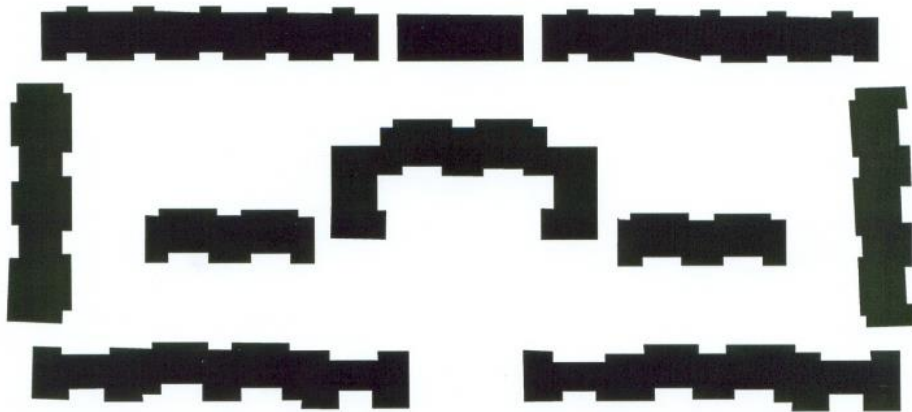

Figure 2: Residential areas of workers' settlements of the 1920s

In Baku, it is imperative that apartments have flow-through or angular ventilation. It is inadvisable to implement it through the kitchen and bathrooms. It was acceptable to arrange ventilation through the staircase, if it was an open or semi-open plan staircase. Sometimes, however, vernacular residential construction put more emphasis on the correct orientation of apartments than their ventilation. Winds have a considerable impact on the orientation of buildings on the Absheron Peninsula. Almost all houses here were built with one blind wall facing upwind, there were rarely windows and almost no entrances or driveways to the site on the upwind side. Strong winds brought sand and, in winter, cold. But there are many examples of Absheron summer cottages facing north and east. A northern orientation was convenient for catching the northern winds in hot summer periods, and an eastern orientation made it possible to pass time in the shade of the building and protect the premises from the scorching sun.

In residential buildings of the late 19th and early 20th century, dwelling units faced east. If the premises were on the south side, the main windows looked to the courtyard. Even in the mid-1930s, the density of the development in the central districts of Baku could not discourage architects from attempting to ensure that all rooms of dwelling units had flow-through ventilation and most living rooms faced south-east.

In the middle of the 20th century, Baku becomes one of the largest industrial centers of the former Soviet Union, both in oil industry and in other industries, which causes rapid growth of its population (9). Since the 1950s, the amount of the projected construction leads to the appearance of standard-design sections of residential buildings for Baku. In case of the orientation of dwelling units in those buildings to the unfavorable side, it was allowed to place no more than one room in two- or three-room apartments as an exception. In the corner sections, only one apartment was allowed angular ventilation.

In subsequent years, large-scale construction of standard-design housing units began. But even in such conditions, residential neighborhoods were designed in compliance with sanitary and hygienic requirements, which became of paramount importance. The internal layout of residential buildings took into account the requirements that were essential in the southern climate, such as flow-through or angular ventilation, the orientation of dwelling units to the favorable side, the required height and depth in terms of insolation. If it was impossible to ensure flow-through ventilation, architects suggested airing one apartment through the staircase using a folding transom over the entrance door. The hot climate of Baku forced the population to leave closed premises in certain months of the year to be in the open air. This led to the construction of flat roofs and summer dwellings at residential houses. Flat roofs, especially in the cramped conditions of the medieval city of Baku called "Icheri Sheher" served as an additional resting and sleeping place in summer. But the most striking traditional architectural technique and element shaped by the climatic and environmental and living conditions of Baku are summer dwellings.



Figure 3: Buildings in the medieval city “Icheri Sheher” (inner city)

At the turn of the 19th century, eclecticism naturally affected the architecture of summer dwellings, giving them rich details of various styles (5). Numerous balconies, loggias and various forms of bay windows with elements of modern, gothic, classical, baroque, national romantic styles created a rich sculptural design of the street space and of the city as a whole. And yet, with all their diversity, summer dwellings had a common compositional characteristic and served as an excellent means of achieving a compositional unity of buildings that had no shared stylistic characteristics.

Summer dwellings became even more significant in the period of constructivism. When architects abandoned the rich arsenal of decorative means of classical and national architecture to build low-cost working dwellings, the dominant shape of facades was created by balconies and loggias with blind fences and box-shaped bay windows casting deep shadows and giving buildings the trademark Baku style. The extensive use of summer dwellings in those years can also be considered an architectural attempt to more organically combine constructivist buildings and neighboring structures of other historical periods and styles in Baku. In the 1930s, i.e. during the exploration of the

classical heritage in the architectural design of summer dwellings, composite forms of the classical architecture begin to develop. Later, starting from the 1940s, these forms are enriched with the motives of the national architecture — lancet arches, graceful octagon columns with astonishingly fine carved or stalactite capitals with the national pattern, etc.

With all the architectural and planning commonality between residential buildings of Baku and similar buildings of Russian and European cities, their characteristic features are preserved here due to the climatic and natural environment and the local way of life. One of the most striking examples of this is “shushebend”, glazed galleries and balconies. In vernacular architecture, shushebend is used as a large front and common room in winter and as a spacious iwan in summer with windows fully open. The need for the shushebend design in Baku was dictated purely by the climatic conditions of the city. In the late 19th century, shushebends on the courtyard side along the perimeter and shushebend balconies on the main facade determined the compositional structure of the residential design in Baku (6).



Figure 4: Shushebend of a residential building at 4 A. Zeynalli

While residential construction techniques in Europe ensured that every room would have at least one window looking outside, this concern did not exist in Baku. Russian architects of that time could not fully comprehend why the use of shushebend was necessary in Baku. The following fact is very revealing in this context. The design of the governor's house in Baku drawn in 1898 by J. Goslawski was reworked by a Petersburg architect, who removed glazed galleries and balconies. Objecting to the alteration, Goslawski wrote that "the newly redrawn design has no covered exterior balconies or galleries on the courtyard side. Considering the heat prevailing in Baku, covered exterior balconies, as well as galleries, are necessary because they keep walls from heating up in summer and protect them from the northern winds raging in Baku in winter...". Goslawski's words show how keen his perception of the importance of essential factors in designing Baku buildings (hot summer, strong winds, etc.) was (6).

The functional justification of shushebend was also commented on by B. Brandt during his trip to Baku. "The peculiarity of the local architecture," he wrote, "as in all Asian cities, is the flat roofs of the houses; another similar feature is the covered glass galleries that encircle the houses from inside the courtyards and serve to protect the rooms from heat and dust..." (1).

The rich experience of the past shows that glazed premises were efficiently used by dwellers all year round as extra space, sometimes as a living area (2). It turns out that the arbitrary glazing of summer dwellings, which can often be found in Baku, reflects dwellers' requirements for summer dwellings, although it has many drawbacks. When a summer dwelling is glazed, rooms located behind it are blacked out and lose insolation. The exterior of buildings worsens. Not only does the chaotic manner of the glazing, the use of different articulation and color scheme of casements on the same facade destroy the architectural uniqueness of the facades of old buildings, it also tampers with the architectural integrity of the urban space.

Transformable window systems have now become a credible alternative in the issue of glazing summer dwellings in Baku housing. The transformation is

implemented through sliding or rolling sashes, making it possible to turn the glazed room into an open one and use it actively all year round.

It is known that the main problem in warm countries is overheating, which is prevented by building thick walls. In Baku, thanks to the facing limestone called “aglay”, the thickness of outer walls was determined mainly by static loads. Stone cladding, as an extra layer meeting the requirements of heat engineering, prevented an increase in wall thickness.

Aglay is a natural facing limestone. This natural stone is mined in the mountain quarries of the Absheron peninsula of Azerbaijan. Important characteristics of aglay as cladding material are its strength, durability, environmental friendliness, structural uniformity, ease of handling and installation, effective thermal insulation (10).

Aglay gained popularity in Baku in the late 19th century when it began to be used for the cladding of the facades of most buildings that remain excellent examples of Azerbaijani architecture today. This material made it possible to preserve in general the commonality, uniformity, unique visual shape and individuality of the architectural ensemble of Baku with its striking diversity of styles (7). Masterful handling of this material was a characteristic feature of the local construction school. Various architectural details and decorative components, such as door portals, window trims, socles and cornices, columns, pilasters, capitals and other elements, were made from it with near sculptural plasticity.

3. Conclusion

In conclusion, the following statement can be made: the architecture of Baku has been shaped by elements of various historical styles combined with modern functional planning solutions. However, despite its external diversity, the eclectic architecture of Baku as a whole possessed a certain unity of basic principles and artistic language.

4. Practical value

In the modern period, by using traditional elements shaped by the climate of Baku one can create comfortable conditions for every apartment and preserve the historical roots of the Baku architecture. Today, giving architects an endless choice of forms for interpretation, Baku maintains its gene pool. The authors will be able to work on the elements of vernacular architecture in a new interpretation. Various forms of summer dwellings, flat roofs, courtyards, "aglay" facing stone are excellent means to preserve the appealing appearance of the residential architecture of Baku.

5. References

1. Брандт Б. Из поездки в Баку // Вестник Европы, Санкт-Петербург, 1900, Т. 5, кн. 9, с. 281 – 300.
2. Магеррамов Н.З. Летние помещения 4 – 5-этажных жилых домов в климатических условиях Апшерона // Ученые записки АзПИ, 1963, серия X, № 1, стр. 3 – 5.
3. От Великой Отечественной до "холодной" войны // www.fedorin.newmail.ru
4. Самедов Р.Я. Особенности архитектуры жилых домов г. Баку. Летние помещения (конец XIX – первая половина XX века) // Диссертация на соискание ученой степени кандидата архитектуры, Баку, 2008, 127 с.
5. Фатуллаев Ш.С. Архитектура Баку на рубеже XIX – XX вв. // Известия АН АзССР. Серия общественных наук, 1961, № 6, с. 123 – 142.
6. Фатуллаев Ш.С. Градостроительство и архитектура Азербайджана XIX – начала XX века. Л.: Стройиздат, 1986, 455 с.
7. Эфендизаде Р.М. Архитектура Советского Азербайджана. М.: Стройиздат, 1986, 319 с.
8. https://studref.com/312869/ekologiya/arhitektura_klimat
9. <http://www.meteo-tv.ru/azerbaidzhan/baku-gorod/weather/climate/>
10. <http://ru.wikipedia.org/wiki/Аглай>

Technology for corrected calculations of estimates of statistical characteristic of output signals of 16-channel correlator

U. Sattarova¹, Dr. Sc. (Ph.), Assoc. Prof. orcid.org/0000-0002-0174-1412

Contact: Azerbaijan University of Architecture and Construction,
Baku, Azerbaijan,

E-mail: ulker.rzaeva@gmail.com

Abstract. The paper belongs to the field of information and measurement technology and deals with the methods of automated measurement and processing of signals received from systems equipped with correlator for measurement data processing.

Purpose. The object of the invention is to reduce the error in the parameters of the output signal of a multichannel correlator.

The proposed method allows ensuring the reliability of information estimators at the correlator output under any conditions, which contributes to the reduction of the error from 8 to 22% of output data and to adequate decision making in research.

Keywords: *correlator, statistical characteristics, noise, signal, variance, useful signal*

1. Introduction.

It is known that a correlator is a specialized device designed for statistical data processing by the method of automatic calculation of correlation and cross-correlation functions of stationary random processes.

Automatic calculation methods and operating principles of correlator itself vary depending on the area of application, which is quite extensive.

The operating principle of a multichannel (at least 16 channels) correlator and a navigation receiver is known (Fig. 1). Different channels of the correlator extract and process signals from geostationary satellites with different frequency ranges, the values of which are corrected on the basis of the calculated standard correlation function and then compared with the generated reference values.

The correlator carries out fast detection of navigation signals and speeds up the determination of navigation parameters in the receiver, using the information from geostationary satellites. The drawback of the described method is that such a signal processing system does not preclude the possibility of obtaining results with some errors due to the emergence of reflected, delayed-arrival signals that lead to distortion of the shape of the correlation peak of the signal and, consequently, to a shift in the estimate of the true delay. In addition, the signals coming in through the channels from different sources have, as a rule, different units of measurement, and a comparison of their indicators with the generated reference values shows discrepancies due to standardization or normalization [1,2].

We also know [2] the operating principle of the correlator designed for correlation processing of data received from several data sources in networks with very long baseline interferometry, with certain maximum values of the time shift and the relative spectral shift between the signals. Input data of signals from four sources arrive through a very long baseline interferometry network at the input of the hardware module, on one of its two FPGA (field-programmable gate array) — on the interface FPGA, which is used to control and communicate with the single-board computer, in whose memory frequency and delay divergences between data sources are compensated. After the compensation procedure, data arrive on the processing FPGA, where the cross-correlation processing of data flows with given averaging time is carried out. The results of the calculations are transferred to the interface FPGA, from which arrive, via Gigabit Ethernet interface, on the single-board computer intended for receiving calculation results and secondary data processing, as well as for the data transfer to end users.

2. Problem statement

The operating principle of the correlator ensures its high performance. However, the accuracy of its operation depends on the quality of the received signal, which is significantly influenced by such factors as intermittent breaks in signal continuity, atmospheric instability, multi-beam interference, ephemeris change

(coordinates of astronomical objects). In this mode of operation of the correlator, only the multi-beam interference error is taken into account, and the listed negative factors cause significantly large errors (when determining the navigation coordinates from 3–5 m to 30 m).

The aim of the proposed mode of operation is to reduce the error in the parameters of a multichannel correlator output signal.

The essence of the invention consists in the method for reducing the error in processing a signal from the output of a multichannel correlator that includes receiving signals with different length baselines from at least four sources on the interface FPGA, transfer of the received signals to the computer memory to compensate for frequency and delay divergences between data sources. After the compensation procedure, data enters the processing FPGA, where the standard cross-correlation processing of data flows with given averaging time and additional processing of data flows by the following algorithm are carried out:

$$r_{g^\circ g^\circ}^c(\mu) = \frac{R_{g^\circ g^\circ}(\mu)}{D_g - D_\varepsilon}, \mu \neq 0, \quad (1)$$

where $r_{g^\circ g^\circ}^c(\mu)$ -is the corrected value of the normalized autocorrelation function;
 $R_{g^\circ g^\circ}(\mu)$ -is the autocorrelation function of the real signal;
 D_g, D_ε - are the variances of the real signal $g(t)$ and the random noise $\varepsilon(t)$, respectively; μ - is the sample number.

The calculation results (1) are transferred to the interface FPGA, from which they are sent via interface of the program to the single-board computer for receiving the calculation results, comparative analysis and return of results with subsequent data transfer to end users.

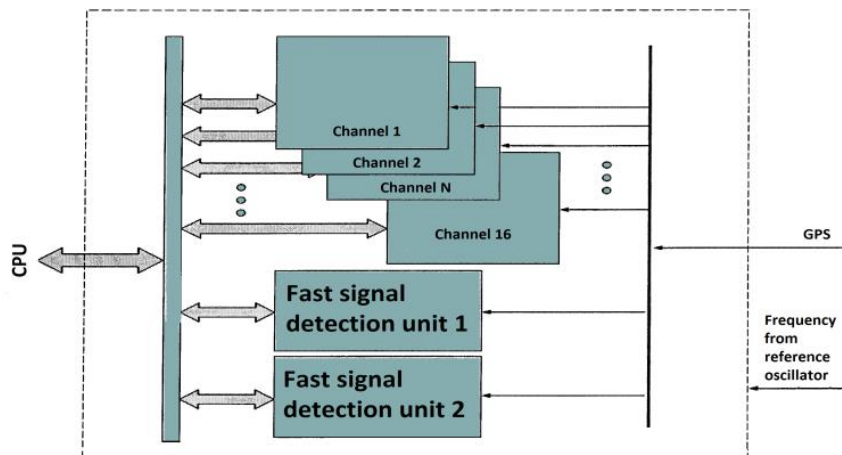

Figure 1: 16-channel correlator

3. Research methods

The method proposed in the paper differs from the known by additional processing of data flows by the above algorithm, calculation of the normalized cross-correlation function $r_{g^{\circ}g^{\circ}}(\mu)$, taking into account the random noise $\varepsilon(t)$ present in the noisy signals $g(t)$ and taking into account the estimates of the variance D_{ε} of the random noise. The proposed approach to solving the problem of reducing the error in signal processing in the correlator is substantiated by the fact that signals coming from different sources can have different units of measurement, and the indicators obtained by the traditional signal processing method cannot be adequately compared due to the lack of standardization. Therefore, there is a need for a transition from the correlation function to the normalized correlation function. The use of the proposed feature significantly reduces the error in the results of the correlator output signal, since it reduces the correlation function to a dimensionless value to allow comparative analysis [2]. The error is reduced not only by using the normalized correlation function, but also by taking into account the effect of the accompanying noise present in the real signal. It is known [3] that the real stationary signal $g(t)$ is the sum of the useful signal $X(t)$ and the random noise $\varepsilon(t)$ with zero mathematical expectation $m_{\varepsilon} = 0$. When $\mu \neq 0$, the useful signal $X(t)$ and the noise $\varepsilon(t)$ obey the normal distribution law and there is no correlation between them. When these conditions are fulfilled, the estimates of the autocorrelation functions of noisy signals are actually error-free at all time shifts μ except for zero time shift $\mu = 0$, where the estimate is the sum of the estimates of the autocorrelation function of the useful signal and the noise variance.

For this reason, in the classical case, in order to eliminate the effect of noise on the estimate of the autocorrelation function with zero time shift $\mu = 0$, the known method [4] for normalizing the estimates of correlation functions is commonly used. However, numerous experimental and in-situ methods have proved that normalization allows eliminating the effect of noise on the estimate of the autocorrelation function at zero time shift $\mu = 0$. In all other cases, i.e. for time shifts $\mu \neq 0$, normalization leads to the emergence of noise-induced errors in the

estimates of autocorrelation functions. Thus, the introduced new feature combined with the already known features allows creating a new technical effect that consists in improved accuracy (or reduced error) of the parameters of the signal at the correlator output. It also speeds up the performance of the correlator. The method is implemented as follows.

The interface FPGA receives signals with different length baselines and from at least four sources. The signals are transferred to the computer memory to undergo the procedure of compensation of frequency and delay divergences between data sources. After the procedure, data arrive on the two microcircuits of the processing FPGA. One of them carries out the standard cross-correlation processing of data flows with a given averaging time (see fig.1 fast signal detection unit 1) and the other performs processing by the proposed method (see fig. 1 fast signal detection unit 2) [4-7]. The results of the calculations are transferred to the interface FPGA, which sends them via interface to the single-board computer for receiving the results of calculations, comparison and return of results with subsequent data transfer to end users. The algorithm and order of suggested technology is as follows from fig.2.

1. Calculation of the correlation function block
2. Unit of calculating the mathematical expectation
3. Centering of output data unit.
4. Unit of autocorrelation function calculation for time shifts 0, 1, 2 ...
5. Block of correct (exact) normalization of the autocorrelation function of a noisy signal
6. Unit for calculating the variance of interference
7. Unit of the normalization of the autocorrelation function
8. Information output unit
9. Decision-making block

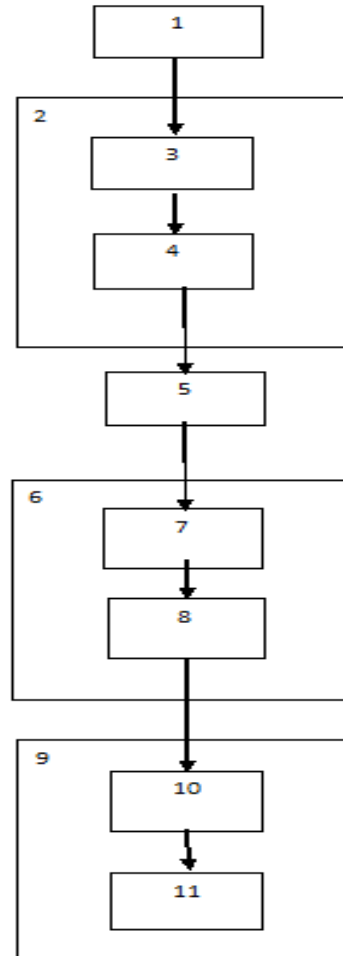

Figure 2: Information Source block

4. Results of the computational experiment.

The feasibility and validity of the proposed method is confirmed by the experimentally obtained examples illustrated by Table 1 and the charts in Fig. 1-2.

During the experiments, to obtain the estimates of the autocorrelation functions and to confirm the possibility of reducing the processing error for the correlator output signal, useful signals $X(t)$, noise $\varepsilon(t)$ and noisy signals $g(i\Delta t)=X(i\Delta t)+\varepsilon(i\Delta t)$ were generated with given characteristics. For each generated useful signal $X(t)$, the condition of constancy of the mathematical expectation at different time intervals T_1, T_2, \dots, T_n [4] is verified.

First, computational experiments were performed to find the values of the normalized correlation function from the classical formulas, i.e.:

1. normalization of the estimates of the useful signal was carried out according to the following formula:

$$r_{XX}(\mu) = \frac{R_{XX}(\mu)}{D_X},$$

where μ is the sample number, D_X is the variance of the useful signal, and $R_{XX}(\mu)$ is the autocorrelation function;

2. for the statistical characteristics of the real (noisy) signal $g(t)$ of the process under investigation, the normalized value of the autocorrelation function was calculated from the following formula:

$$r_{g^\circ g^\circ}(\mu) = \frac{R_{g^\circ g^\circ}(\mu)}{D_g}, \mu \neq 0, \text{ (fast signal detection unit 1)}$$

where $r_{g^\circ g^\circ}(\mu)$ - is the value of the normalized autocorrelation function, $R_{g^\circ g^\circ}(\mu)$ - is the autocorrelation function of the real signal, D_g - is the variance of the real signal $g(t)$, and μ is the sample number.

Further, according to the method proposed in the paper:

3. for the statistical characteristics of the real signal $g(t)$ of the process under investigation, the corrected normalized value of the autocorrelation function was found according to the formula (1) proposed in the method;

$$D_\varepsilon$$

4. (noise variance), in turn, was calculated from the known

$$\text{formula: } D_\varepsilon = \frac{1}{N} [g^{\circ 2}(i\Delta t) + g^\circ(i\Delta t) \cdot g^\circ(i+2)\Delta t - 2g^\circ(i\Delta t)g^\circ(i+1)\Delta t] \text{ [3] .}$$

5. Results of the computational experiment

The results of the experiments are illustrated by Table 1 containing for comparison the estimates of the signal parameters calculated by the standard method and by the algorithm proposed in the paper.

Table 1 Results of the computational experiment

	$r_{XX}(\mu)$	$r_{g^\circ g^\circ}(\mu)$	$r_{g^\circ g^\circ}^c(\mu)$	$\Delta r_{XX}(\mu)$	$\Delta r_{XX}^c(\mu)$
1	2	3	4	5	6
Experiment N1 $D(\varepsilon)=89.7642$ $D_\varepsilon=80.6617$	1	1	1	0	0
	0.9995	0.9014	0.9914	9.814	0.8115
	0.998	0.8936	0.9828	10.4641	1.5265
	0.9956	0.8982	0.9879	9.7756	0.7692
	0.9921	0.8898	0.9786	10.3116	1.3587
	0.9877	0.8861	0.9746	10.2834	1.3277
	0.9823	0.8878	0.9764	9.6176	0.5954
	0.9759	0.8778	0.9654	10.0523	1.0735
	0.9686	0.8727	0.9598	9.8999	0.9059
	0.9603	0.8711	0.9581	9.2873	0.2322
Experiment N2 $D(\varepsilon)=106.59$ $D_\varepsilon=101.35$	1	1	1	0	0
	0.9915	0.7713	0.9938	22.2141	0.2278
	0.9701	0.7664	0.9875	20.9924	1.8019
	0.9457	0.7496	0.9658	20.7376	2.1302
	0.9294	0.7479	0.9637	19.5237	3.6944
	0.9277	0.725	0.9342	21.8451	0.7033
	0.9394	0.7325	0.9438	22.0279	0.4677
	0.956	0.7573	0.9758	20.7912	2.0612
	0.9664	0.7573	0.9758	21.6355	0.9734
	0.9617	0.7543	0.9719	21.5688	1.0592

6. Comparative analysis of the obtained data.

A comparative analysis has shown that the calculated estimates of the noise variance D_ε of the noisy signal $g(t)$ practically coincide with the estimates of the variance $D(\varepsilon)$ of the noise $\varepsilon(t)$ given in the experiments (column 1), i.e. $D_\varepsilon \approx D(\varepsilon)$. The estimates of the normalized correlation function $r_{g^\circ g^\circ}(\mu)$ of the noisy signal $g(t)$ differ significantly from the estimates of the normalized correlation function $r_{XX}(\mu)$ of the useful signal $X(t)$ (columns 2, 3). The values of the relative error $\Delta r_{XX}(\mu)$ of the estimates of the normalized correlation function $r_{g^\circ g^\circ}(\mu)$ of noisy signals vary in different experiments from 8% to 22% (column 5).

The corrected estimates of the normalized correlation function $r_{g^\circ g^\circ}^c(\mu)$ practically coincide with the estimates of the normalized correlation function $r_{XX}(\mu)$ of the useful signal $X(t)$ (columns 3, 4). The values of the relative error $\Delta r_{XX}^c(\mu)$ of the corrected normalized correlation function are practically equal to zero or reduced to 2–4% even in the case when the classical conditions are not fulfilled (column 6). The method proposed in the paper makes it possible to ensure the reliability of information estimators at the correlator output under any conditions, which contributes to the reduction of the error (8–22%) of output data and to adequate decision making in research.

Conclusion. The method described in the paper helps reduce the error in the processing of output signals of a multichannel correlator that includes receiving on the interface FPGA signals with different length baselines from at least four sources.

7. References

1. Patent RU No 2 388 009, 19.05.2008
<http://russianpatents.com/patent/238/2388009.html>
2. Correlator of the radio astronomical data processing system by SPE
Digital Solutions 2003–2016
http://eng.dsol.ru/projects/electronic_design/modules/korrelator/

3. T.A.Aliev, U.E.Sattarova, N.E.Rzayeva, 2016 Robust correlation technology for online monitoring of changes in the state of the heart by means of laptops and smartphones, Elsevier, Biomedical Signal Processing and Control, p-44-51, 1746-8094.
5. Q. Ashton, Acton Issues in Optics, Light, Laser, Infrared, and Photonic Technology, Atlanta: Scholarly Media LLC, 2013. 216 p.
6. Ahmed El-Banbi Ahmed Alzahabi, Ahmed El-Maraghi 2018. PVT Property Correlations, Gulf Professional Publishing, 352 p.
7. <http://astronomy.swin.edu.au/cosmos/C/Correlator>
8. Ville Eerola, Jari Nurmi, Correlator design and implementation for GNSS receivers, by NORCHIP 2013 (Lithuania Vilnius 2013 Nov. 11 - 2013 Nov. 12) International Conference, IEEE, doi: 10.1109/NORCHIP.2013.6702037

Untersuchungen zur Wirkung von harmonischen und stoßartigen Kraftverläufen auf die Lebensdauer von Wälzlagern in Tragrollen auf dem Verschleißprüfstand DYTROP

Robert Schneider, Tim Fritsch, Thomas Rieder, Jan Magister,
Stephan Henschler, Sylvio Simon

Kontakt: Brandenburgische Technische Universität Cottbus – Senftenberg,
Universitätsplatz 1, 01968 Senftenberg
FG Werkzeugmaschinen, Tragrollenprüfstand,
<https://www.b-tu.de/tragrollenpruefstand/>

E-mail: Robert.Schneider#1@b-tu.de



Abbildung 1: Zerstörtes Wälzlager in einer Prüfrolle

1. Veranlassung und Einführung

Im Labor für Fördertechnik an der Brandenburgischen Technischen Universität Cottbus-Senftenberg besteht ein langjähriges Engagement in der Untersuchung von Geräuschemissionen an Tragrollen für Hochleistungsgurtt Förderanlagen. Durch ständige Optimierungen und technische Verbesserungen an den Tragrollen konnte die Lärmentwicklung beim Betrieb der Anlagen um ein Vielfaches reduziert werden. Im Gegensatz dazu sind jedoch die Produktionskosten für die Herstellung von lärmgeminderten Tragrollen im Vergleich zur herkömmlichen Bauart gestiegen. Eine Maßnahme zur Geräuschreduzierung besteht dabei in der Oberflächenbearbeitung des Tragrollenmantels mit vorgegebenen Toleranzen für die Exzentrizität der Drehachse und der Kreisformabweichung von der idealen Zylinderform. Ausfallstatistiken der LEAG¹ lassen jedoch den Schluss zu, dass es durch die Bearbeitung der Mantelfläche (i.d.R. Überdrehen) ebenfalls zu einer Steigerung der Lebensdauer der Tragrollen kommt.

Um das Schädigungsverhalten bei unterschiedlichen Kraftanregungen zu untersuchen, wurde ein Verschleißprüfstand entwickelt, konstruiert und gebaut. Mit dessen Hilfe ist es möglich, die dynamischen Kräfte, welche durch die Tragrollenmantelgeometrie über die Exzentrizität und die Kreisformabweichung impliziert werden, zu untersuchen. Ziel der derzeitigen Arbeit ist es, die für die Versuche notwendigen Randbedingungen und Parameter festzulegen. Auf den Ergebnissen aufbauend soll anschließend mit einer Reihe von empirischen Versuchen der Schädigungseinfluss auf die Wälzlager geprüft werden. Es ist beabsichtigt, die Toleranzen für die Geometrie, die Oberflächengüte und die Auswuchtgüte auf das erforderliche Maß anzupassen, um damit den Herstellungsaufwand und die Produktionskosten zu senken. Dadurch soll ein optimaler Kompromiss aus niedrigen Produktionskosten, geringen Werten für die Geräuschemission und langer Lebensdauer gefunden werden.

¹ LEAG: Lausitz Energie Bergbau AG

2. Verschleißprüfstand DYTROP

Der dynamische Tragrollen-Verschleißprüfstand, kurz DYTROP, wurde im Zuge eines Entwicklungsprojektes an der BTU Cottbus-Senftenberg entworfen und hergestellt. Er besitzt eine gummierte Antriebsrolle, welche über einen Flachriementrieb von einem Elektromotor mit einer Nennleistung von 5,5 kW angetrieben wird. Die Drehzahl ist variabel und ermöglicht Umfangsgeschwindigkeiten der Prüfrolle zwischen 2,4 und 12,2 m/s.

Als Prüfrolle kommt eine speziell angefertigte, überdrehte Stahlmantelrolle mit einem Manteldurchmesser von 114 mm und einer Mantellänge von 350 mm zum Einsatz. Diese wurde so konstruiert, dass die Schädigung der Lager in einem vertretbaren Zeitraum erzeugt wird.

Über eine Stahlkonstruktion aus Hohlprofilen wird die Prüfrolle gegen die Antriebsrolle gedrückt. Dadurch kann eine definierte Vorspannkraft gewährleistet werden, welche über einen Kraftsensor bestimmt wird.

Der Verschleißprüfstand ist mit vier Beschleunigungssensoren ausgestattet, welche sich links und rechts an den Achszapfen der Prüfrolle befinden. Mit diesen werden die auftretenden Beschleunigungen jeweils in horizontaler und vertikaler Richtung, orthogonal zur Drehachse, aufgenommen. Diese Daten ermöglichen es, den Schädigungszustand der Wälzlager zu bestimmen.



Abbildung 2: Verschleißprüfstand DYTROP

Erzeugen der dynamischen Kräfte

Die dynamischen Kräfte werden durch die Abrollgeometrie des Tragrollenmantels gegenüber der Drehachse erzeugt. Dabei wird zwischen Exzentrizität und Kreisformabweichung unterschieden.

Die Exzentrizität beschreibt den Versatz der theoretischen Drehachse des Mantels zur tatsächlichen Drehachse, welcher sich aus der Position der Tragrollenachse ergibt. Die Exzentrizität* (EXZ^*) entspricht der Doppelamplitude, welche die vollständige Wegänderung widerspiegelt (Siehe **Fehler! Verweisquelle konnte nicht gefunden werden.**). Während der Abrollbewegung wird eine oszillierende Radiusänderung der Kontaktstelle zum Drehpunkt hervorgerufen, was wiederum eine proportionale Kraftänderung impliziert. Die Folge ist ein harmonischer, sinusförmiger Kraftverlauf.

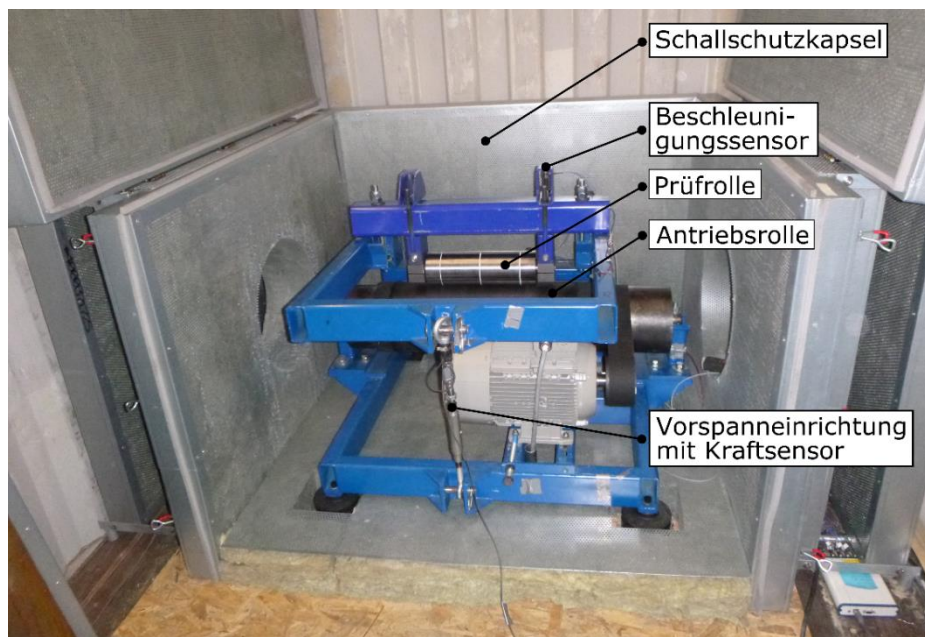
Die Kreisformabweichung bezeichnet die Geometrieabweichung des Tragrollenmantels zur Mantelfläche eines idealen Zylinders des gleichen Durchmessers. Um eine definierte Kreisformabweichung zu erzeugen, werden auf den Prüfrollen Metallbänder unterschiedlicher Stärke über die gesamte Mantellänge achsparallel aufgebracht. Beim Überrollen des Bandes kommt es zu einem schlagartigen Auseinanderdrücken der beiden Rollen und zu einem Kraftimpuls.

Festlegung der geometrischen Exzentrizität und Kreisformabweichung



Abbildung 3: Geometrische Exzentrizität und Kreisformabweichung

Um diese komplexeren Untersuchungen durchzuführen, ist es zunächst empfehlenswert die Funktionalität des Prüfstandes mit seinen Messeinrichtungen zu überprüfen und Erfahrungen im Umgang mit dem Prüfstand zu sammeln. Dazu sollen vergleichsweise einfache Vorversuche durchgeführt werden. Ziel ist es die Realisierbarkeit von Verschleißversuchen auf dem Prüfstand festzustellen und erste auswertbare Lagerschäden zu erzielen. Bei den Vorversuchen wird zuerst auf eine dynamische Krafteinleitung verzichtet und eine statische Belastung der Prüfrolle während der gesamten Versuchszeit beibehalten.

3. Wälzlagerschäden

Wälzlager sind Maschinenelemente, die aus einem Innenring und einem Außenring bestehen zwischen denen sich rollende Körper zur Verringerung des Reibwiderstands befinden. Ihre Hauptfunktion ist die Fixierung von Wellen und Achsen. Dazu können sie je nach Bauart radiale und/oder axiale Kräfte aufnehmen. Die Wälzkörper laufen dabei üblicherweise auf gehärteten Stahlflächen mit optimierter Schmierung.

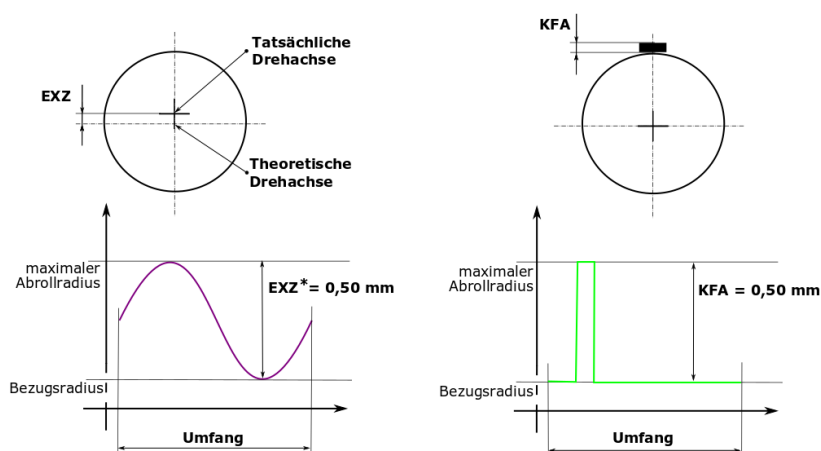

Abbildung 4: Aufbau eines Wälzlagers

Bei Tragrollen kommen hauptsächlich Rillenkugellager zum Einsatz. Diese verfügen über Kugeln als Wälzkörper, die sich in Rillenförmigen Laufbahnen bewegen. Rillenkugellager sind ausgelegt überwiegend radiale Kräfte aufzunehmen.

Schäden an Wälzlagern äußern sich normalerweise in einem sich allmählich verschlechternden Betriebsverhalten. Spontane Schäden, die zum Beispiel durch Montagefehler oder fehlenden Schmierstoff verursacht werden und zum sofortigen Stillstand führen, treten dagegen deutlich seltener auf. Abhängig von den Betriebsbedingungen können vom Beginn der Schädigung bis zum Ausfall des Lagers einige Minuten bis zu mehreren Monaten vergehen.

Typische Schadensursachen bei Wälzlagern sind Überbelastung, Verschmutzung, Montagefehler, zu lose oder zu feste Passung, Korrosion, schlechte Schmierung und der Kontakt mit aggressiven Medien.

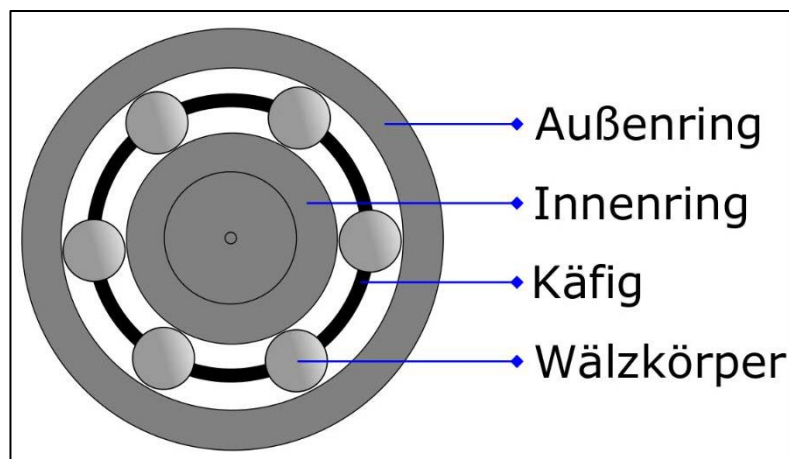
Die Schäden können sich durch unruhigen Lauf, ungewöhnliche beziehungsweise besonders laute Geräusche oder ungewöhnliches Temperaturverhalten äußern. Das Aussehen der demontierten Lagerteile gibt weitere Hinweise auf die Schadensursache. Einige Beispiele dafür sind Fremdkörpereindrücke, Ermüdungsschäden, Stillstandsmarkierungen, Schmelzkrater, Korrosionsschäden, Heißlaufschäden, Korrosionsschäden oder Brüche.

Bei der im DYTROP untersuchten Belastungsart kommt es hauptsächlich zu punktuellen Schäden beziehungsweise Ausbrüchen am Innenring des verwendeten Rillenkugellagers, da hier eine permanente Lastzone vorhanden ist. Der Außenring wird umlaufend belastet, weshalb dort eine gleichmäßigere Abnutzung vorliegt. Bei den so entstehenden Ausbrüchen auf der Laufbahn handelt es sich üblicherweise um Ermüdungsschäden. Diese Art von Schäden werden auch bei den hier durchgeführten Verschleißversuchen erwartet.

Örtlich begrenzte Schäden an einem Lager lassen sich gut mittels Schwingungsmessungen detektieren. Wenn die Wälzkörper lokale Vertiefungen überrollen kommt es zu mechanischen Wellen. Diese können durch Weg-, Geschwindigkeits- oder Beschleunigungsmessungen aufgezeichnet werden. Eine Signalanalyse durch Hüllkurvendetektion oder Untersuchungen mit der Fourier Transformation können Rückschlüsse auf die geschädigten Lagerkomponenten ziehen. Aus der Wälzlagerkinematik leiten sich Berechnungsvorschriften für Frequenzen ab, mit deren Hilfe die Bestimmung der Art von Schädigungen an Wälzlagern möglich ist.

Für die Berechnung der Lagerkennwerte sind die geometrischen Abmessungen, die Anzahl der Wälzkörper, die Betriebsart und die Drehzahl des umlaufenden Lagerrings erforderlich. Relevant für die Fehlerdiagnose sind die jeweiligen Überrollfrequenzen von Innen- und Außenring sowie die der Wälzkörper.

Die Überrollfrequenz am Außenring f_{AR} stellt die Frequenzkomponente dar, die beim Überrollen einer Fehlstelle auf der Außenringlaufbahn durch einen der z Wälzkörper entsteht [1].

$$f_{AR} = \frac{1}{2} * z * f_W * \left(1 - \frac{D_{WK}}{D_{pw}} * \cos\alpha_B \right) \quad \text{Gl. 1}$$

Die Überrollfrequenz am Innenring f_{IR} für das Überrollen einer Fehlstelle am Innenring ergibt sich nach [1]:

$$f_{IR} = \frac{1}{2} * z * f_W * \left(1 + \frac{D_{WK}}{D_{pw}} * \cos\alpha_B \right) \quad \text{Gl. 2}$$

Die Überrollfrequenz einer Wälzkörperstelle f_{WK} auf dem Außen- oder Innenring wird berechnet nach [1]:

$$f_{WK} = \frac{1}{2} * f_W * \frac{D_{pw}}{D_{WK}} * \left(1 - \left(\frac{D_{WK}}{D_{pw}} * \cos\alpha_B \right)^2 \right) \quad \text{Gl. 3}$$

Die Überrollfrequenz eines Wälzkörperbereichs auf beiden Wälzbahnen ist demnach:

$$f_{WK2} = 2 * f_{WK} \quad \text{Gl. 4}$$

In den Gleichungen sind:

f_W	Drehfrequenz der Welle
D_{WK}	Wälzkörperdurchmesser
D_{pw}	Teilkreisdurchmesser
α_B	Betriebsdruckwinkel (für rein radial belastete Rillenkugellager gilt: $\alpha_B = 0$)



Abbildung 5: Einige Kenngrößen eines Kugellagers

Im Realfall kommt es nicht zwangsläufig zu einem idealen Rollen. Der Schlupf des Wälzkörpersatzes kann je nach Einsatz und Belastungsverhältnissen relevante Werte annehmen. Deswegen kann es zu einigen Abweichungen zwischen der mathematisch bestimmten und der tatsächlichen kinematischen Frequenz kommen.

Wenn einmal Ausbrüche vorhanden sind geht die Schädigung des Lagers nun immer schneller vonstatten. Die ausgebrochenen Metallteile werden nun von den Wälzkörpern überrollt und sorgen für zusätzliche schadhafte Stellen auf den Laufbahnen, wo es zu weiteren Ausbrüchen kommt. Je mehr Schäden an der Laufbahn vorhanden sind, desto schneller können sie sich ausbreiten und weitere Schädigungen erfolgen. Bei weit fortgeschrittenen, großflächigen Ermüdungsschäden kommt es schließlich zum Dauerbruch der Lagerringe. **[2,3]**

Tabelle 1: Parameter Verschleißversuch

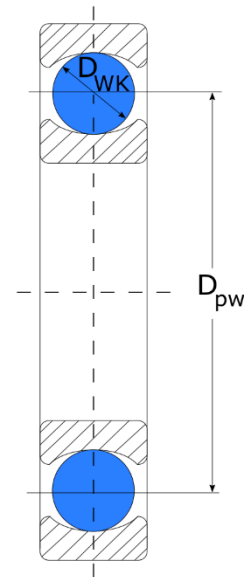
Drehzahl Prüfrolle	818 min ⁻¹
Anzahl Wälzkörper z	13
Wälzkörperdurchmesser D _W	6 mm
Betriebsdruckwinkel α _B	0°
Teilkreisdurchmesser D _T	45,03 mm

Für die Versuchslager vom Typ 61907 ergeben sich folgende Überrollfrequenzen:

Tabelle 2: Überrollfrequenzen der Versuchslager

Überrollfrequenzen [Hz]		
Außenring	f _{AR}	76,8
Innenring	f _{IR}	100,4
Wälzkörper auf Innen- oder Außenring	f _{WK}	50,2
Wälzkörper auf Innen- und Außenring	f _{WK2}	100,5

4. Ergebnisse

4.1. Lauf 18002

Der Verschleißlauf 18002 führte nach 132.000 s bzw. nach 36,7 h zu einer Erhöhung der Effektivwerte der Beschleunigung auf bis zu 12 m/s² in vertikaler Richtung (X). Die Beschleunigungen in horizontaler Richtung (Y) sind geringer, aber mit ca. 6 m/s² dennoch deutlich erhöht. Kurze Zeit nach dem Auftreten der gesteigerten Messwerte wurde der Versuch nach beendet und die Lager demontiert um sie auf Schädigungen zu überprüfen.

Die drei kurzen Dips zwischen 10.000 s und 40.000 s im Zeitverlauf der Beschleunigungswerte liegen an kurzzeitigen Unterbrechungen des Prüfvorgangs. Ursächlich hierfür sind fehlerhaft zu hohe Messwerte der Temperatursensoren, die mehrfach zu einer Notabschaltung geführt haben, bevor die Ursache behoben werden konnte. Das Problem ist seitdem nicht mehr aufgetreten.



Abbildung 6: Effektivwerte Beschleunigung Lauf 18002

Nach der Demontage ist ein punktueller Ausbruch auf der Laufbahn des rechten Innenrings erkennbar. Der Schaden befindet sich in der Mitte der Lastzone, hat an der Stelle der größten Ausbreitung eine Länge von ca. 2 mm und erstreckt sich über die gesamte Breite der Laufbahn. Vor der Demontage war ein deutlicher Austritt des Schmierfetts aus dem Inneren des defekten Lagers erkennbar.

Die anderen Lagerringe weisen lediglich geringe Verschleißspuren auf, die mit bloßem Auge nur schwer zu erkennen sind. Auch die Käfige, Wälzkörper und Dichtscheiben der Lager lassen keine Auffälligkeiten erkennen. Das Schadensbild entspricht insgesamt den eingangs erläuterten Erwartungen.

Durch die konstante Drehzahl der Prüfrolle von 818 min^{-1} kann die gesamte Anzahl der Umdrehungen des Lagers bis zur Schädigung einfach berechnet werden. Im Lauf 18002 ist der Schaden nach ca. 1,8 Millionen Umdrehungen der Tragrolle aufgetreten.

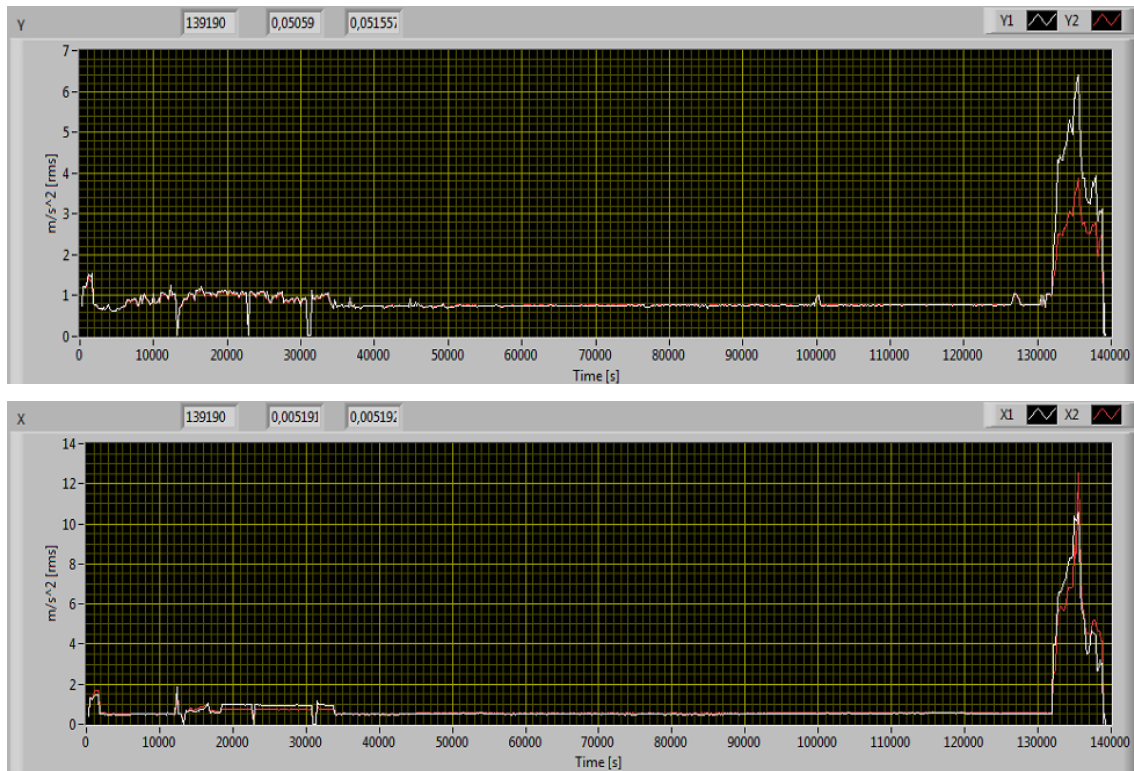

Abbildung 7: Testlauf 18002 rechter Innenring mit Schaden, demontierte Lagerringe

Analyse Lauf 18002

Die Auswertung der Beschleunigungsmessungen erfolgt mit der Analysesoftware DIAdem 2018 von National Instruments.

Da die Untersuchung aller Messdaten aufgrund der großen Datenmengen rechentechnisch zu aufwändig wäre, werden stichprobenartig kurze Messzeiträume untersucht. Zur Darstellung der Ergebnisse des Prüflaufs 18002 im Bericht wurde die Beschleunigungsmessung im Zeitraum von 135.100 s bis 135.105 s gewählt.

Die Erkenntnisse wurden zusätzlich mit der Untersuchung weiterer Messungen im selben Prüflauf verifiziert. Zunächst erfolgt die Darstellung der Ergebnisse der 5-sekündigen Beschleunigungsmessung.

Aus diesen rohen Messdaten lassen sich noch keine Rückschlüsse über Lagerschädigungen ziehen. Zu diesem Zweck sind weitere Analyseschritte erforderlich.



Abbildung 8: Beschleunigungen in horizontaler Richtung, Lauf 18002

Zur weiteren Untersuchung der Messergebnisse erfolgt eine Gleichrichtung des Beschleunigungssignals und anschließend eine Fast Fourier Transformation (FFT) des Signals. Dies transformiert die Daten in den Frequenzbereich und ermöglicht eine Untersuchung der Spektren des Prüfstands. Dadurch können die Messwerte gezielt auf das Vorhandensein der speziellen Schadfrequenzen von Wälzlagern untersucht werden.

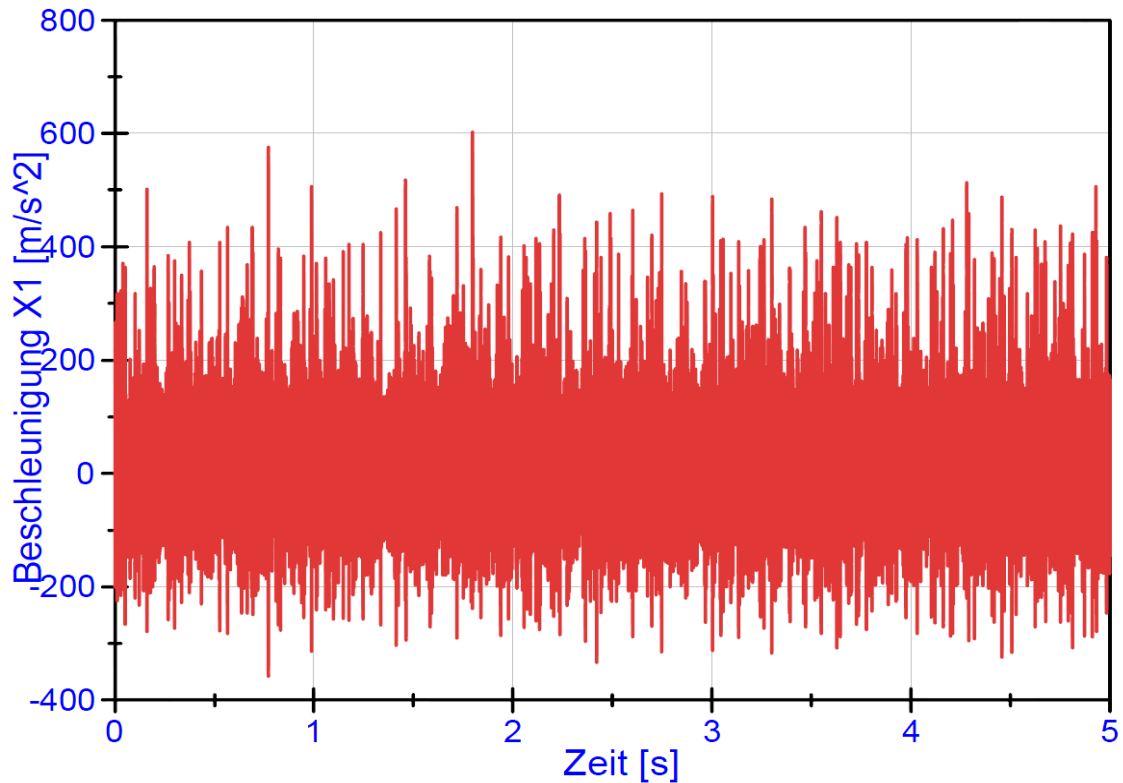

Abbildung 9: FFT Lauf 18002 nach Eintritt des Schadens

Die FFT Analyse zeigt eine hohe Amplitude bei 100 Hz. Die entspricht fast exakt der im Vorfeld berechneten Innenringpassierfrequenz und der Wälzkörperüberrollfrequenz an Innen- und Außenring der verwendeten Lager. Ebenfalls sind beim ersten und zweiten harmonischen Vielfachen (200 Hz und 300 Hz) weitere Peaks zu erkennen. Da bei der Demontage lediglich ein Schaden am Innenring und keine Beschädigungen der Wälzkörper zu erkennen sind, ist davon auszugehen, dass die Peaks im Spektrum vom Innenringschaden verursacht werden. Insgesamt entspricht das Beschleunigungsspektrum den Erwartungen beim Vorhandensein eines Innenringschadens.

4.2. Lauf 18003

Beim Verschleißlauf 18003 ist eine Erhöhung der Effektivwerte der Beschleunigungsmessungen nach 375.000 s bzw. 104 h aufgetreten. Auch im zweiten Versuch sind deutlich erhöhte Beschleunigungswerte von bis zu 10 m/s^{-2} in vertikaler Richtung und bis zu 4 m/s^{-1} in vertikaler Richtung gemessen worden.

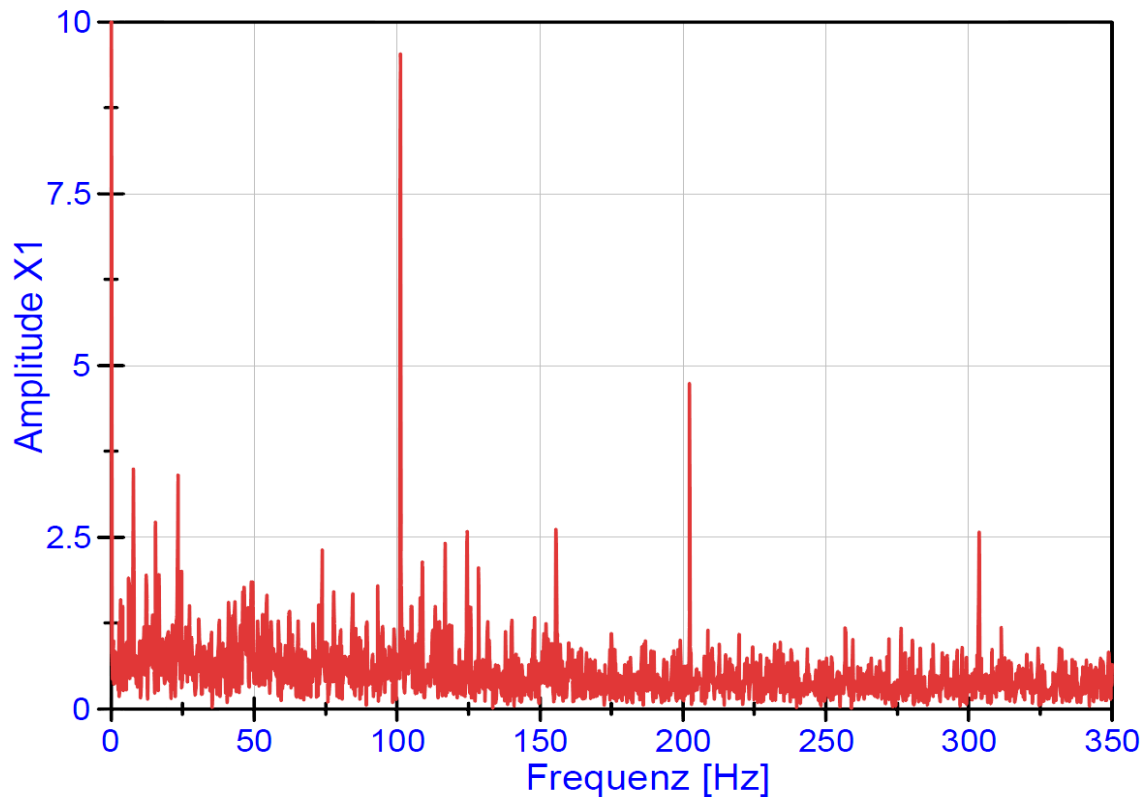
Bei 380.000 s verringern sich die Beschleunigungen aufgrund einer Drehzahl senkung von 818 min^{-1} auf 414 min^{-1} . Diese Maßnahme wurde durchgeführt, da aus organisatorischen Gründen der Prüfstand zu diesem Zeitpunkt ferngesteuert nicht vollständig abgeschaltet werden konnte. Nach der Senkung der Drehzahl kommt es nach ca. 3 h zu einem erneuten Anstieg der Effektivwerte. Ausgehend von den Ergebnissen des ersten Laufs könnte die weitere Ausbreitung des Schadens eine Ursache für die Erhöhung sein.



Abbildung 10: Effektivwerte Beschleunigung Lauf 18003

Die Demontage des Lagers zeigt einen punktuellen Ausbruch auf der Laufbahn des linken Innenrings. Der Schaden ist ungefähr 10° vom Mittelpunkt der

Lastzone entfernt und erstreckt sich mit einer Länge von ca. 1,5 mm über die gesamte Breite der Laufbahn.

Die anderen Lagerringe weisen lediglich geringe, kaum erkennbare Laufspuren auf. Auch die übrigen Bestandteile der Lager (Wälzkörper, Käfige, Dichtscheibe) waren bei der Demontage intakt. Insgesamt entspricht das Schadensbild den Erwartungen und stimmt weitgehend mit dem Prüflauf 18002 überein.

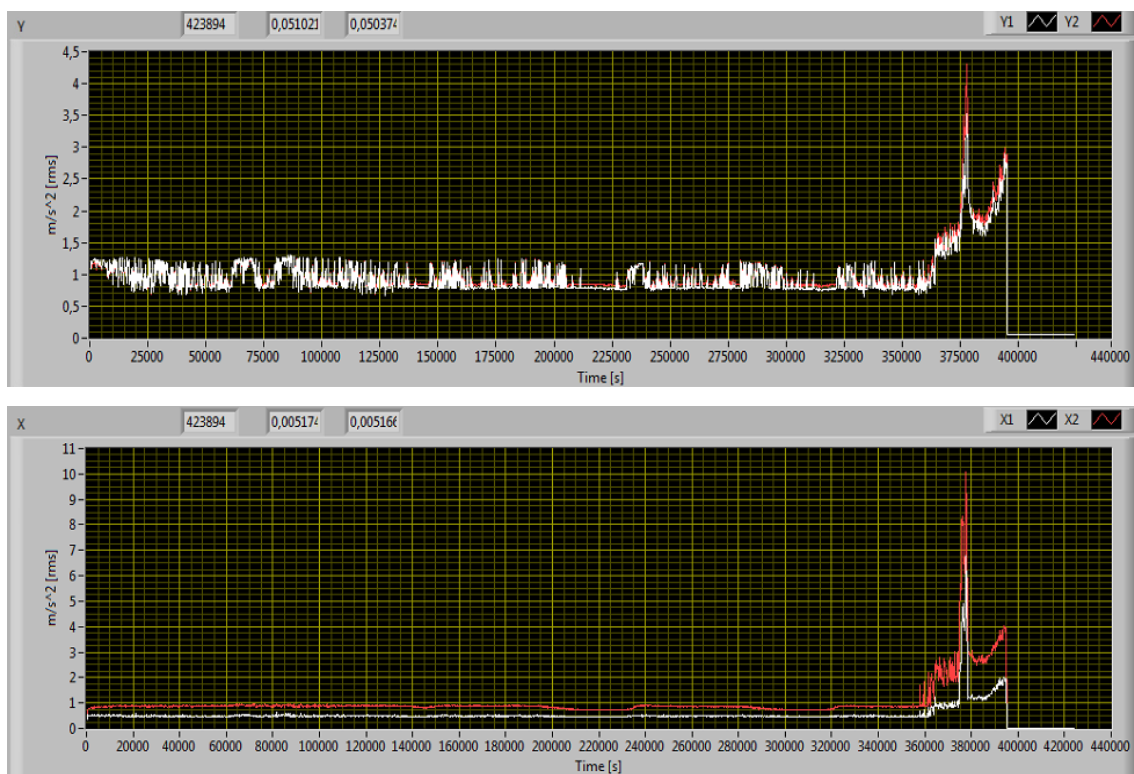
Bei einer konstanten Drehzahl von 818 min^{-1} lief die Tragrolle insgesamt ca. 5,1 Millionen Umdrehungen bis zum Eintreten des Schadens.



Abbildung 11: Testlauf 18003 linker Innenring mit Schaden, demontierte Lagerringe

Analyse Lauf 18002

Die Auswertung der Daten erfolgt durch Gleichrichtung und FFT analog zum Verschleißlauf 18002. Zusätzlich wird hier der Verlauf der Schäden dargestellt. Dazu werden die FFT Analysen von Beschleunigungsdaten zu verschiedenen Zeitpunkten verglichen. Um sicher zu gehen, dass die ermittelten Überrollfrequenzen tatsächlich vom defekten Wälzlager stammen wird zunächst

ein Messintervall von einem frühen Zeitpunkt untersucht. Es kann davon ausgegangen werden, dass das Lager zu diesem Zeitpunkt noch intakt war. Es sind keine Innenringüberrollfrequenzen und auch sonst keine deutlich hervorstechenden Amplituden erkennbar. Auch die Effektivwerte sind in diesem Messintervall niedrig. Ähnliche Ergebnisse wurden auch beim Verschleißversuch 18002 festgestellt. Demzufolge stammen die erhöhten Beschleunigungen und Peaks im Frequenzspektrum tatsächlich von einem defekten Wälzlager und werden nicht von anderen Bauteilen des Prüfstands oder intakten Rillenkugellagern verursacht.

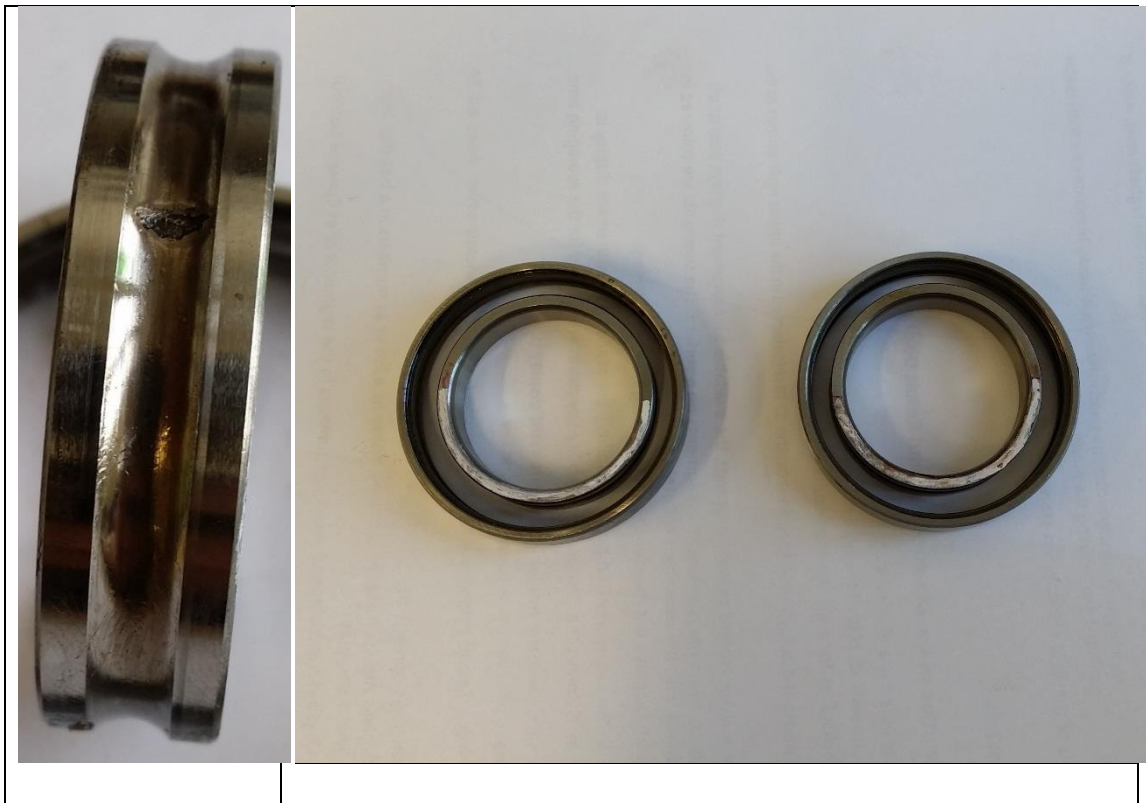

Abbildung 12: FFT Lauf 18003 kein Schaden (9.365 s)

Schon kurz nach der beginnenden Lagerschädigung sind bereits deutlich die Überrollfrequenz des Innenrings (100 Hz) und deren erste Harmonische (200 Hz) im Spektrum zu erkennen. Die Beschleunigungen sind sowohl beim Effektivwert als auch in der FFT Analyse noch vergleichsweise gering. Die zweite Harmonische der Überrollfrequenz ist noch nicht erkennbar.

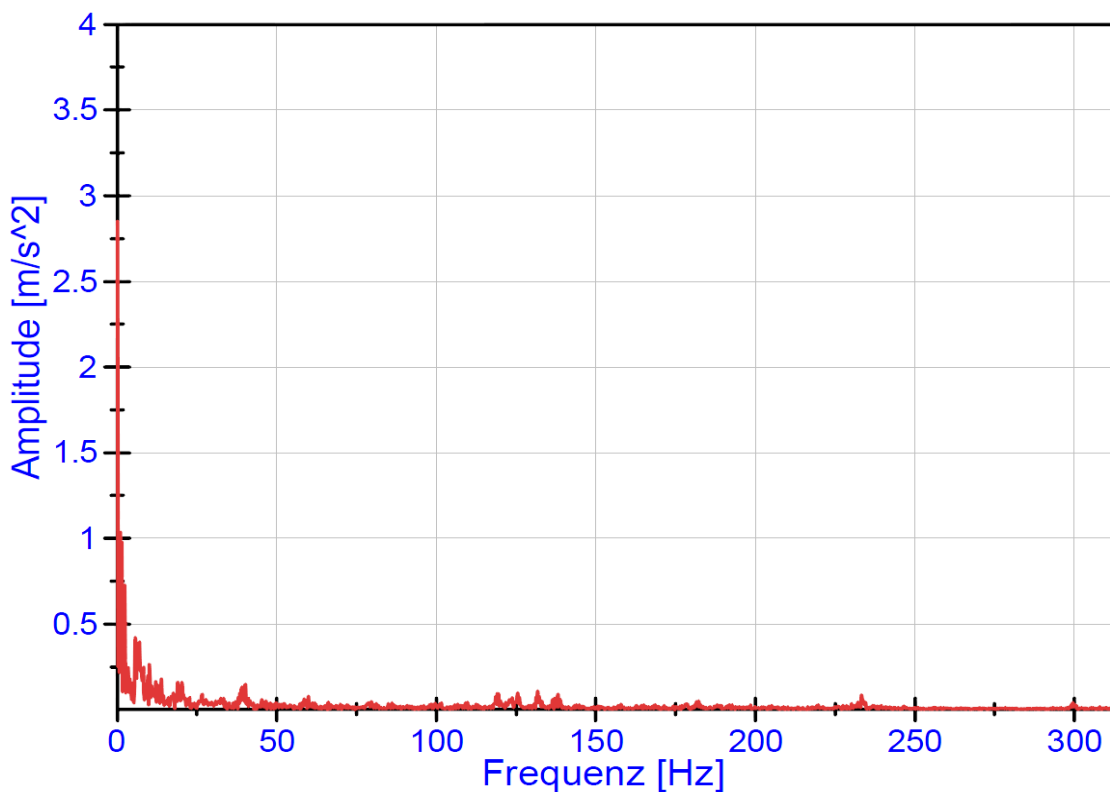

Abbildung 13: FFT Lauf 18003 beginnender Schaden (377.085 s)

15 Minuten später ist der Schaden bereits deutlich stärker ausgeprägt, was sich in höheren Beschleunigungswerten widerspiegelt. Es werden Werte von bis zu $3,4 \text{ m/s}^2$ erreicht und auch die zweite Harmonische bei 300 Hz ist sichtbar. Im Vergleich zu Versuch 18002 sind die Amplituden allerdings deutlich geringer. Dies kann an der variierenden Vorspannkraft liegen, die im aktuellen Ausbauzustand des DYTROP noch stark schwankt. Als Hauptursache für diese Schwankungen werden die Temperaturschwankungen im Verlauf des Tages angenommen. Bei höheren Temperaturen kommt es zur Aufheizung des Containers und zur Erhöhung der Vorspannkraft. Hinzu kommt, dass die Prüfung an sehr heißen Sommertagen stattfand. Der Defekt beim Versuch 18003 entstand allerdings in der Nacht kurz vor Sonnenaufgang. Zu diesem Zeitpunkt herrschen üblicherweise die geringsten Außentemperaturen und demzufolge ist die Vorspannkraft zu dieser Tageszeit am geringsten. Zusätzlich kann es auch bei der ersten Einstellung zu leichten Abweichungen kommen, da diese manuell mit einem Spannschloss aufgebracht wird. In zukünftigen Ausbaustufen des

Prüfstands soll die Vorspannkraft mithilfe eines Linearantriebs automatisch eingestellt, überwacht und aufgezeichnet werden.

Auch hier entsprechen die Auswertungsergebnisse qualitativ den Erwartungen und stimmen mit dem Schadensbild des ausgebauten Lagers überein.

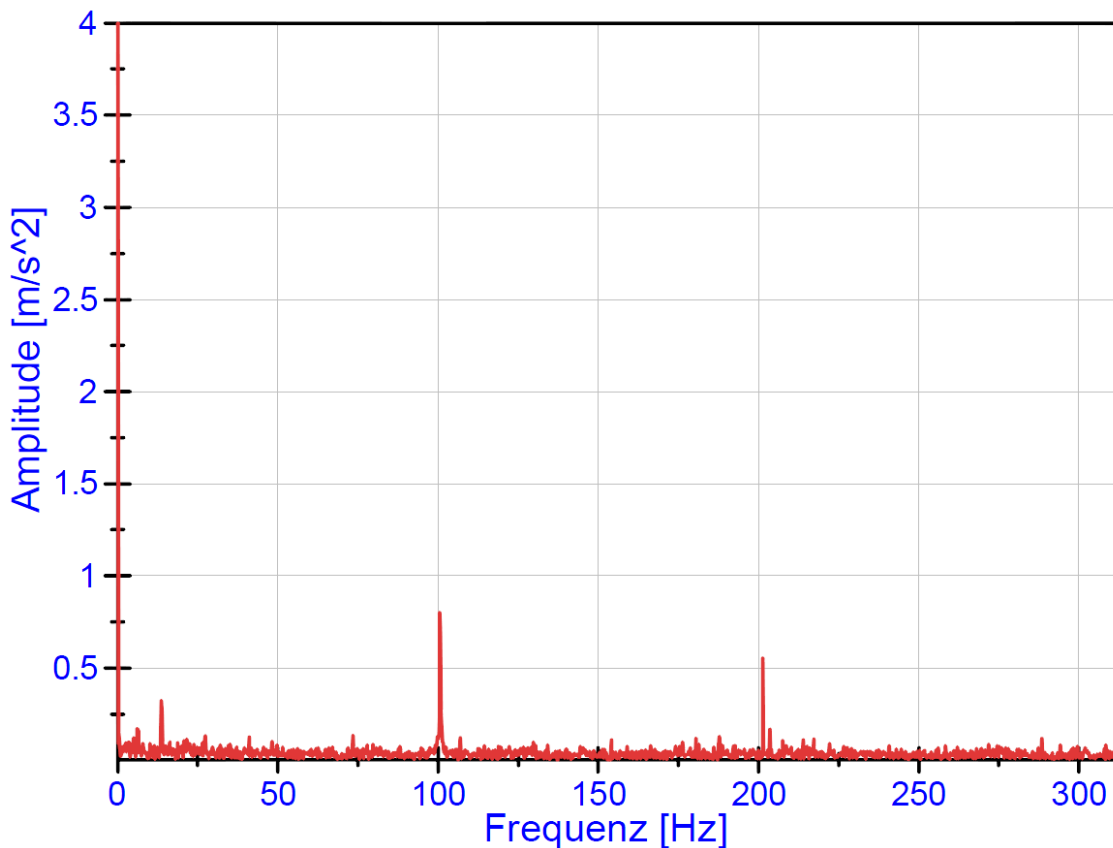

Abbildung 14: FFT Lauf 18003 ausgeprägter Schaden (378.010 s)

4.3. Beurteilung der Ergebnisse, Probleme, Lösungsansätze

Das Verhalten des Prüfstands und die auftretenden Schäden entsprechen den Erwartungen. Die punktuellen Schäden am Innenring und die festgestellten Überrollfrequenzen in den Beschleunigungsmesswerten stimmen mit den eingangs erläuterten Annahmen überein. Die Verschleißläufe 18002 und 18003 können als erfolgreich bezeichnet werden.

Abweichungen von den Erwartungen gab es bei den Laufzeiten bis zum Eintritt des Schadens. Der Versuch 18002 führte wesentlich früher als erwartet zur Schädigung des Lagers, während das Lager im Versuch 18003 75 % der erwarteten Lebensdauer erreichte. Diese Tatsache kann zum Teil durch die

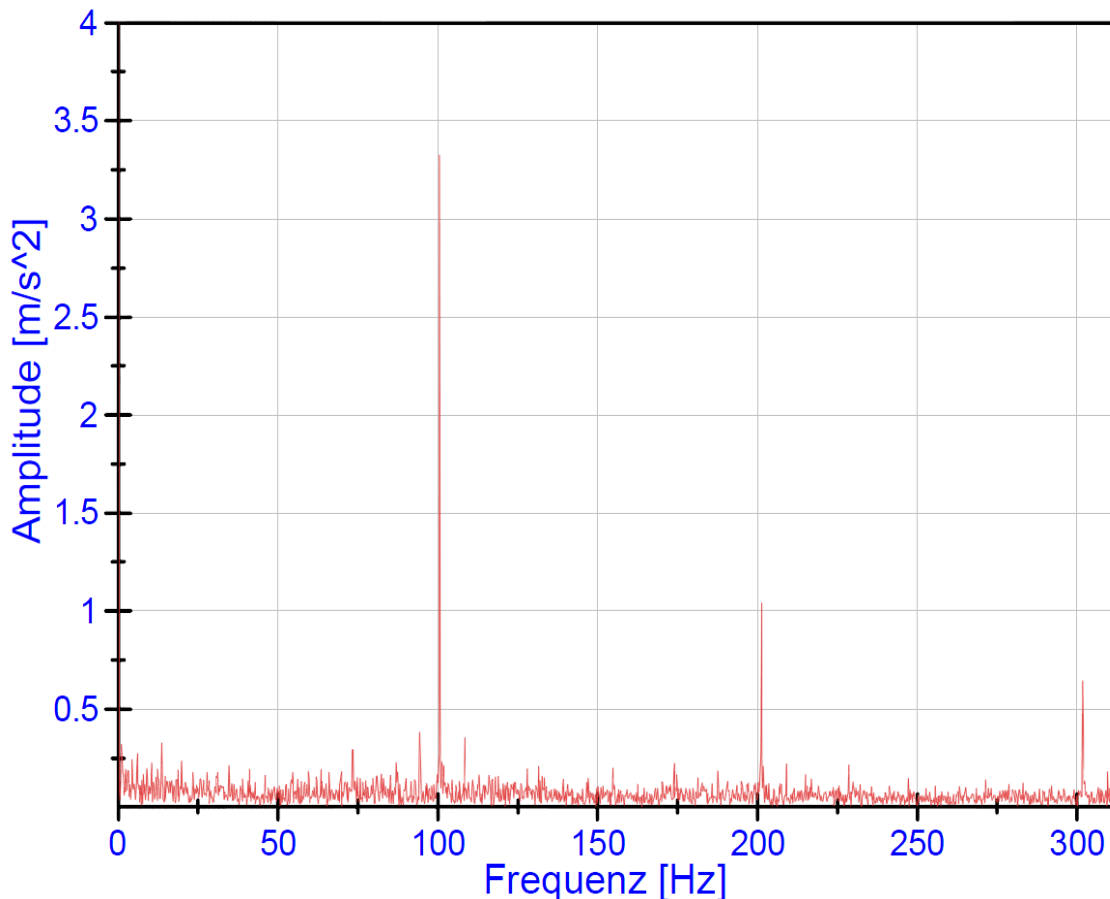
ständige Schwankung und Temperaturabhängigkeit der Vorspannkraft erklärt werden. Die Verwendung eines Spannschlusses zur ist zur Einstellung einer konstanten Vorspannkraft nur bedingt geeignet; der Prüfvorgang wird von den wetterabhängigen Temperaturschwankungen beeinflusst. Dieses Problem soll durch zukünftige Verbesserungsmaßnahmen des Prüfstandes wie beispielsweise den Einbau eines Linearantriebes zur automatischen Regelung der Kraft gelöst werden. Beim ersten Versuch 18002 gab es zudem einen Schiefstand der Schwinge, weshalb ein Lager deutlich stärker belastet wurde. Vor dem zweiten Lauf wurde dies behoben. Weiterhin ist die erwartete Lebensdauer ein statistischer Wert. In der Realität kann es selbstverständlich zu Abweichungen bzw. „Ausreißern“ in der Statistik kommen. Wie sich die tatsächliche Dauer bis zur Schädigung verhält, kann erst in weiteren Versuchen ermittelt werden.

Der Versuch 18004 zeigt, dass die derzeitige Konstruktion der Prüfrolle ungeeignet für diese Art der Belastung ist. Hauptproblem sind die Lagerhalter, die bereits nach zwei Prüfvorgängen starke Abnutzung aufweisen. Dies äußert sich darin, dass sich die Außenringe der Wälzlager ständig am Lagerhalter verkeilen. Auch ist bereits nach dem Prüflauf 18002 Passungsrost an Lagerhaltern und Achse erkennbar, welcher sich mit dem Lauf 18003 noch verschlimmert hat. Dadurch ist das Auspressen der Lager aus dem Mantel nur umständlich und mit hohen Kräften möglich. Durch diese hohen Kräfte kann es zu ungewollten Schädigungen der Lager wie zum Beispiel Wälzkörpereindrücken kommen. Für weitere Prüfläufe sind die Lagerhalter in diesem Zustand nicht geeignet. Auch die Prüfrolle sollte für zukünftige Versuche überarbeitet werden. Die Konstruktion und Herstellung einer neuen Prüfrolle mit wechselbaren Lagerhaltern ist zur Lösung dieses Problems vorgesehen.

5. Zusammenfassung

Die Vorversuche zeigen, dass die Erzeugung, Detektion und Untersuchung von Wälzlagerschäden mithilfe des DYTROP möglich ist. Die erzielten Ergebnisse entsprechen weitgehend den Erwartungen. Die im vorab angenommenen punktuellen Ausbrüche an den Innenringen sind ebenso aufgetreten wie die vorher berechnete Innenringüberrollfrequenz von 100 Hz. Insgesamt sind die Ergebnisse der Prüfläufe 18002 und 18003 zufriedenstellend.

Die Vorversuche haben aber auch Probleme aufgezeigt. Dazu gehören der schnelle Verschleiß der Lagerhalter und die schwankende Vorspannkraft. Allerdings existieren hierfür bereits vielversprechende Lösungsansätze wie die Konstruktion eines wechselbaren Lagerhalters und die Regelung der Vorspannkraft durch LabVIEW in Verbindung mit einem Linearantrieb. Die tatsächliche Lebensdauer bei konstanter Vorspannkraft kann dann mit einer ausreichenden Anzahl an Versuchen ermittelt und dann mit den theoretischen Werten verglichen werden.

Insgesamt können die Vorversuche als erfolgreich bezeichnet werden. Sie zeigen, dass der prinzipielle Aufbau des DYTROP geeignet für die angedachten Verschleißuntersuchungen an Rillenkugellagern ist. Im nächsten Schritt wird der Prüfaufbau so geändert, dass dynamische Kräfte aufgebracht und die Wirkung auf die Lagerlebensdauer simuliert werden kann.

Quellen

- [1] Rudolf Barwinek: „Analyse von Wälzlagerdiagnosen unter praxisnahen Einsatzbedingungen“, VDI-Verlag GmbH, 1997, Düsseldorf
- [2] FAG, Wälzlagerschäden – Schadenserkennung und Begutachtung gelaufener Wälzlager, Schaeffler, 2010
- [3] R. Wirth, Maschinendiagnose an Industriegetrieben. Teil II: Signalidentifikation in der Praxis., Antriebstechnik 37(1998), Nr. 11, S. 77-81

Entwicklung der Tragrollen für den Lausitzer Tagebau

Thomas Rieder, Robert Schneider, Stephan Henschler, Jan Magister,
Tim Fritsch, Sylvio Simon

Kontakt: Brandenburgische Technische Universität Cottbus – Senftenberg,
FG Werkzeugmaschinen, Tragrollenprüfstand,

<https://www.b-tu.de/tragrollenpruefstand/>

E-mail: thomas.rieder@b-tu.de

Abstract: Die besonderen geologischen Verhältnisse in den Lausitzer Braunkohletagebauen ermöglichen die Gewinnung der Braunkohle unter einem hohen Einsatz an Stetigförderern im offenen Abbau – dem sogenannten Tagebau. Stetigförderer gehören zu den effizientesten Fördermitteln, sie benötigen nur wenig Energie und fast kein Personal. Neben dem Fördergurt sind die Tragrollen ein Hauptmerkmal der Stetigförderer. Mit der Bewegung des Tagebaues entlang bewohnter Siedlungen ist es notwendig, die Geräuschemission vor allem der überirdisch angeordneten Förderer so gering wie möglich zu halten. Seit 2007 werden Tragrollen an der BTU Cottbus – Senftenberg auf ihre akustischen Eigenschaften geprüft. Durch die Zusammenarbeit mit den Herstellern konnte dadurch die Geräuschemission der Tragrollen in den letzten 10 Jahren um durchschnittlichen 10 dB reduziert werden.

1. Einleitung

Die Gewinnung von Braunkohle als Energieträger in der Lausitz ist seit dem 18. Jahrhundert nachgewiesen, vermutlich erfolgte die Nutzung bereits seit 1597 bei Weisswasser im Zuge der Alaun-Gewinnung[1]. Erfolgte der Abbau zuerst im klassischen Tiefbau in Form von Schächten, ermöglichte jedoch die industrielle Weiterentwicklung der Fördertechnik und die geologisch günstigen Bedingungen den Abbau der Braunkohle im offenen Grubenbetrieb, dem sogenannten Tagebau. Mit der Einführung der ersten Eimerketten- und Schaufelradbagger war es möglich, hocheffizient den Abraum, also die über der

Kohle lagernden Sedimente (vornehmlich maritime Sande und Schluffe)[1] abzutragen. Dabei erfolgte der Abtransport von Abraum und Kohle zuerst mit Zügen. Seit 1868, dem Jahr, wo erste dokumentierte Versuche mit Gurtbandförderern von Mr. Westmacott vorgenommen wurden [2], entwickelten sich diese Förderer stetig und fanden schnell Verbreitung in vielen Anwendungsbereichen. Daher wurden in der Braunkohleförderung sehr zeitig Gurtbandförderer eingesetzt, die sich zu Bandanlagen weiterentwickelten. Geschichtlich gesehen kann die Verwendung von Gurtbandförderern auf die Zeit bis etwa 1860 zurückverfolgt werden. Prof. M. Buhle von der Technische Hochschule Dresden schrieb 1906: „Gurtförderer sind seit über 50 Jahren im Gebrauch, und -zwar wurden sie zuerst angewendet zum Transport von leichten Sammelkörpern, wie Getreide, Hülsenfrüchte u. dergl. ... Als man später die Gurte zur Förderung von Sand, Kies, Zement, Erz, Kohle, Steinen usw., d. h. schweren Massengütern, verwendete, wurden die Schrägrollen jeder Tragrolle beigegeben, um gleichsam einen fortlaufenden Trog, eine bewegliche Rinne zu schaffen, in welcher das Gut allerdings nicht floß, vielmehr ruhte und zusammengehalten wurde. Erst allmählich kam man zu der heute gebräuchlichen, einfachen Gestaltung der Gurtträger, welche aus einer mittleren waagerechten Rolle und zwei seitlichen schrägen Rollen bestehen,“[3]

Ab1885 erfolgte eine Mechanisierung im Braunkohletagebau, um den Abraum zu beseitigen. 1924 wurde in bei Plessa in der Grube Agnes zum ersten Mal erfolgreich eine Abraumförderbrücke eingesetzt. Bis 1945 wurden weitere 25 Förderbrücken in Betrieb genommen. [1]



Abbildung 1: Schaufelradbagger aus der Grube Waidmannsheil, 1930 [4]



Abbildung 2: Eimerkettenbagger Werminghoff, 1941[5]

2. Die Lausitzer Tagebaue

Die Lausitzer Tagebaue werden von der LEAG, der Lausitz Energie Bergbau AG, Geschäftsfeld Bergbau [6], betrieben. Dazu gehören vier Lausitzer Tagebaue: Jänschwalde [7] und Welzow-Süd [8] in Brandenburg sowie Nochten und Reichwalde in Sachsen [9]. In den genehmigten Abbaufeldern liegen derzeit rund 825 Millionen Tonnen Braunkohle. Die Lausitzer Tagebaue versorgen die nahe gelegenen Braunkohlenkraftwerke: Jänschwalde, Schwarze Pumpe und Boxberg sowie den Veredlungsbetrieb Schwarze Pumpe mit Braunkohle. [10]. Die Lausitzer Tagebau fördern dabei Braunkohle aus dem 2. Miozänen Flözkomplex. Teilweise sind auch Schichten des 1. Miozänen Flözkomplex vorhanden. Dieser 2. Miozäne Flözkomplex entstand durch mehrfachen Wechsel zwischen Moorbildung und maritimer Überflutung. Zum Teil wird der Flözkörper in bis zu 3 Flözbänke aufgespalten.[11] Diese Zwischenmittel zwischen den Flözbänken [12] sorgen in der Braunkohlegewinnung für Prozessstörungen, da diese als Abraum gewonnen und abtransportiert werden müssen.

3. Stetigförderer

Stetigförderer sind Fördereinrichtungen mit endlosem umlaufendem Band (z. B. Gurt, Riemen, Seil) als Trag- und Zugorgan. Das Band wird von Tragrollen oder gleitend auf glatter Unterlage getragen. [13]

Gurtförderanlagen sind leistungsfähige Systeme zum Transport von Schüttgütern, die erfolgreich über mehrere Kilometer im Tagebau zur Gewinnung von Rohbraunkohle und zur Abraumbewegung eingesetzt werden. Deren Betrieb ist technisch bedingt mit Geräuschemissionen verbunden, die mit steigenden Umweltaforderungen an Bedeutung gewinnen. Diese Schallquellen werden bestimmend, wenn der Einfluss vergleichsweise lauter Aggregate an Großgeräten oder Antriebsstationen durch Lärmschutzmaßnahmen zurückgeht. Im Tagebauumfeld tragen die Förderstrecken zum allgemeinen Schalldruckpegel bei. In unmittelbarer Nähe von bewohnten Gebieten kann dies vor allem nachts zu Überschreitungen von Richtwerten führen. Lärminderung an der Quelle erfordert technische Schallschutzmaßnahmen, die durch

spezielle Anforderungen an Tragrollen im Obertrum der Gurtförderer umgesetzt werden können. [14]

4. Tragrollen

In Gurtförderanlagen werden Tragrollen [15] entweder einzeln in einer Station, oder als Girlande verbunden in einem Gerüstfeld eingesetzt. Abhängig von der Anzahl an Tragrollen in einer Girlande und dem Girlandenabstand, sowie der Länge des Gurtförderers können mehrere 10.000 Stück Ober- u. Untertrumtragrollen zum Einsatz kommen. Aus der nominell hohen Anzahl an Tragrollen folgt ein betriebswirtschaftlich und technisch relevanter zu berücksichtigender Einfluss. Zur Einhaltung von Normen und Richtlinien [16] müssen Tragrollen hinsichtlich der Lieferanforderung und Qualitätssicherung geprüft werden.



Abbildung 3: Tragrollenstation mit Girlanden

5. Tragrollenprüfstand

Die Lausitz Energie Bergbau AG (LEAG) hat in Zusammenarbeit mit der Brandenburgisch Technischen Universität Cottbus-Senftenberg und anderen Partnern einen Tragrollenprüfstand (Abb.4) entwickelt. Dieser kann einzelne Tragrollen eines Gurtförderers hinsichtlich ihrer mechanischen und akustischen Eigenschaften untersuchen. Mit Hilfe des Tragrollenprüfstandes können die

Eigenschaften einer Tragrolle in Abhängigkeit von deren Umfangsgeschwindigkeit bei möglichst realen Einsatzbedingungen aufgezeigt werden. Mit entsprechenden Rollen kann am Tragrollenprüfstand der Einfluss verschiedener Parameter, wie Rundlauf, Unwucht oder wirkende Kraft untersucht werden. Diese Informationen dienen der Präzisierung der Lieferanforderung für die Baugruppe, sodass die Tragrollen leise und langlebig, aber gleichzeitig die Herstellung bzw. die Beschaffung kostengünstig bleiben.



Abbildung 4: Tagrollenprüfstand

Zur Prüfung der akustischen Wirkung einer Tragrolle am Tragrollenprüfstand (Abb. 4) wird die über Gummidämpfer eingespannte Prüfrolle von einer Walze angetrieben. Hierbei kann eine Umfangsgeschwindigkeit der zu prüfenden Tragrolle von bis zu 15 m/s angefahren werden. An der Kontaktzone zwischen Antriebswalze und Tragrolle werden Belastungen von etwa 3,5 kN eingestellt. Die Ermittlung des Schalleistungspegels erfolgt im Hüllflächenverfahren, welcher dann in Abhängigkeit von der Umfangsgeschwindigkeit dargestellt wird [17].

6. Messungen und Messprotokoll

Die Messungen am Tragrollenprüfstand ermöglichen einen Vergleich typengleicher Tragrollen hinsichtlich ihrer Schallemission bei spezifischen Umfangsgeschwindigkeiten (Abb. 5) sowie eine akustische Bewertung der Tragrollen, die nach unterschiedlichen Fertigungsprinzipien hergestellt werden. Möglich ist auch ein Vergleich in den Lebensdauerphasen. [17]

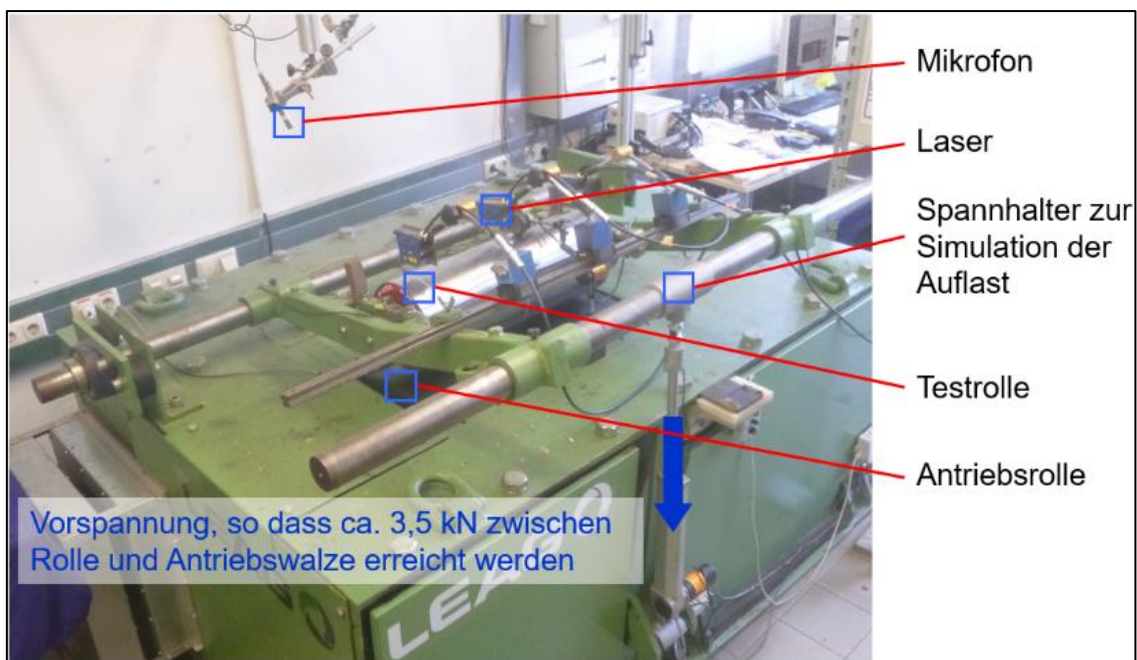

Abbildung 5: Schematische Darstellung von Schalleistungspegeln eines Tragrollentyps [17]



Abbildung 6: Anschlagversuch am Tragrollenmantel [11]

Eine weitere Methodik zur akustischen Bewertung von Tragrollen ist der sogenannte Anschlagversuch (Abb. 6). Hierbei wird der Tragrollenmantel durch einen definierten mechanischen Impuls angeregt, mit dem Ziel die Eigenfrequenzen (Abb. 6) und Abklingwerte (Abb. 7) des Tragrollenmantels zu bestimmen.[14]

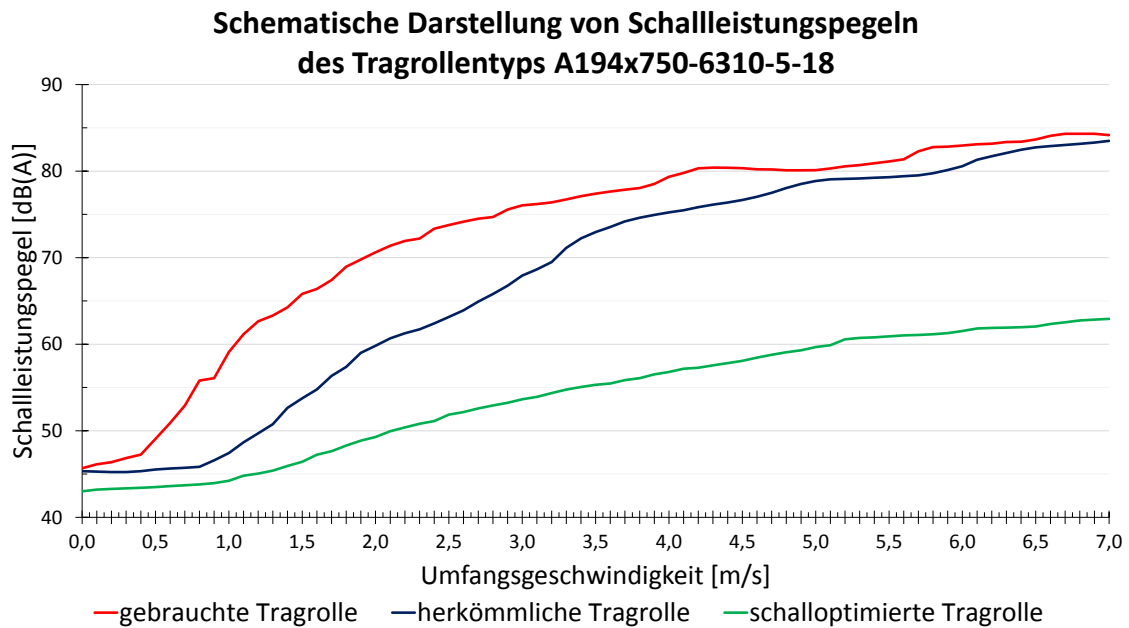

Abbildung 7: Vergleich verschiedener Abklingwerte [11]

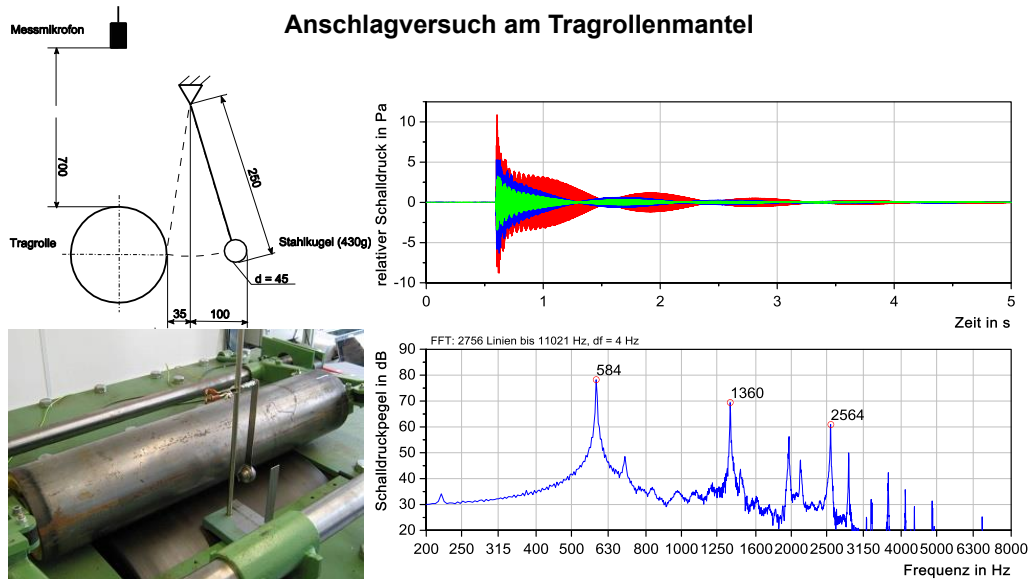
Die Abklingwerte stellen ein Maß für die Eigendämpfung einer Tragrolle dar. Eine hohe Dämpfung wirkt begünstigend auf Schalloptimierungsmaßnahmen. Die Eigenfrequenzen des Tragrollenmantels treten nachweislich als

Bestimmende in der Schallemission sowohl am Tragrollenprüfstand als auch im Feldversuch auf. [14]

Mit Hilfe eines stationären Lasermesssystems (Abb. 8) werden die Rundlaufeigenschaften eines Tragrollenmantels auf drei Messstellen ermittelt. Das angewandte Analyseverfahren ermöglicht die gemeinsame Darstellung von Rundlaufabweichung, Kreisformabweichung und Exzentrizität. [14]

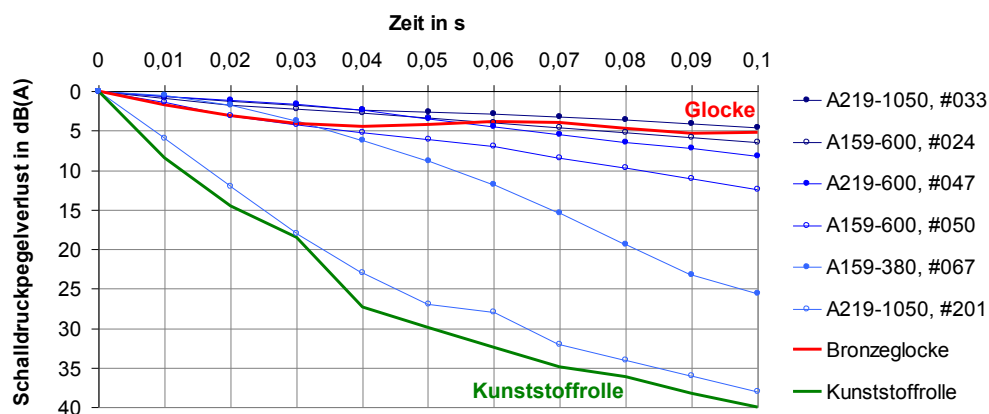

Abbildung 8: Lasermesssystem Tragrollenprüfstand[14]

Aus den verschiedenen Fertigungsprinzipien ergeben sich unter anderem unterschiedliche Rundlaufeigenschaften der Tragrollen, die sich in Verbindung mit der festgestellten Schallemission objektiv vergleichen und bewerten lassen (Abb. 8). [14]

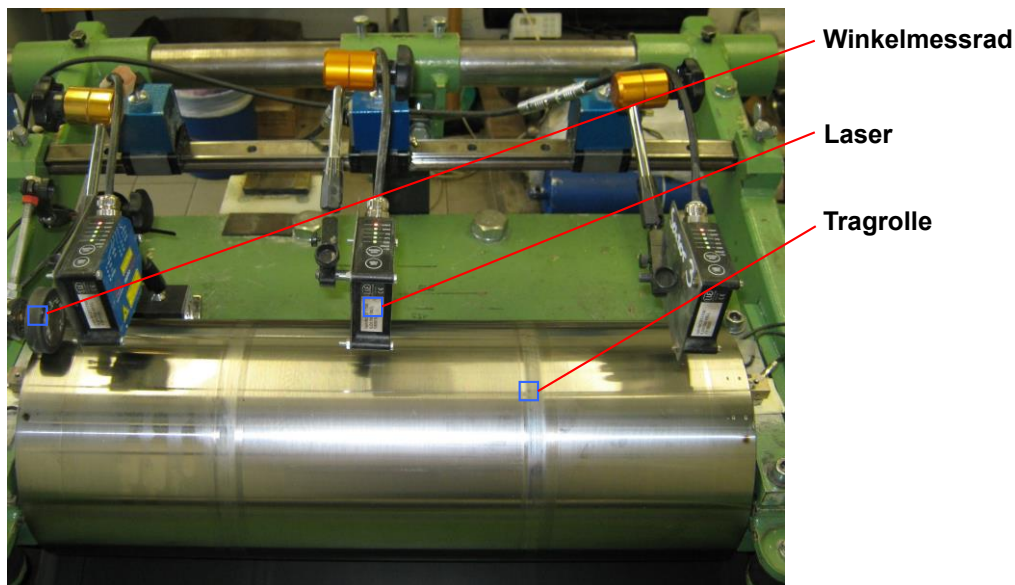

Abbildung 9: Vergleich Rundlaufeigenschaften und Schallemission von überdrehten und nicht überdrehten Stahlmänteln [11]

Im Messprotokoll werden für jede Tragrolle neben der Darstellung des Schalleistungspegels über der Umfangsgeschwindigkeit sowie Rundlaufabweichung, Kreisformabweichung, Exzentrizität, Eigenfrequenzen des Tragrollenmantels, Abklingwert der Tragrolle als auch Unwucht, Anlaufwiderstand und Masse angegeben. [18].

Die Rundlaufeigenschaften der Tragrollen beeinflussen den Energiebedarf der Förderlage, da der Fördergurt die Tragrollen „antreibt“. Eine Abweichung im Rundlauf führt zu einem periodischen Senken und Heben des Gurtes. Dabei muss Hubarbeit verrichtet werden, die dem Transportsystem Energie entzieht. Verbesserungen des Rundlauf führen damit auch zur Reduzierung des Energiebedarfes und damit zur Erhöhung der Energieeffizienz der Förderanlage.

Insgesamt werden aus den akustischen und mechanischen Messergebnissen Kennwerte abgeleitet um entsprechend eine Lieferanforderung zu formulieren und zu präzisieren. Mit Hilfe des Tragrollenprüfstandes wird der Stand der Technik, sowie die Qualitätssicherung beim Hersteller und Wareneingangsprüfung beim Anwender sichergestellt. [14]

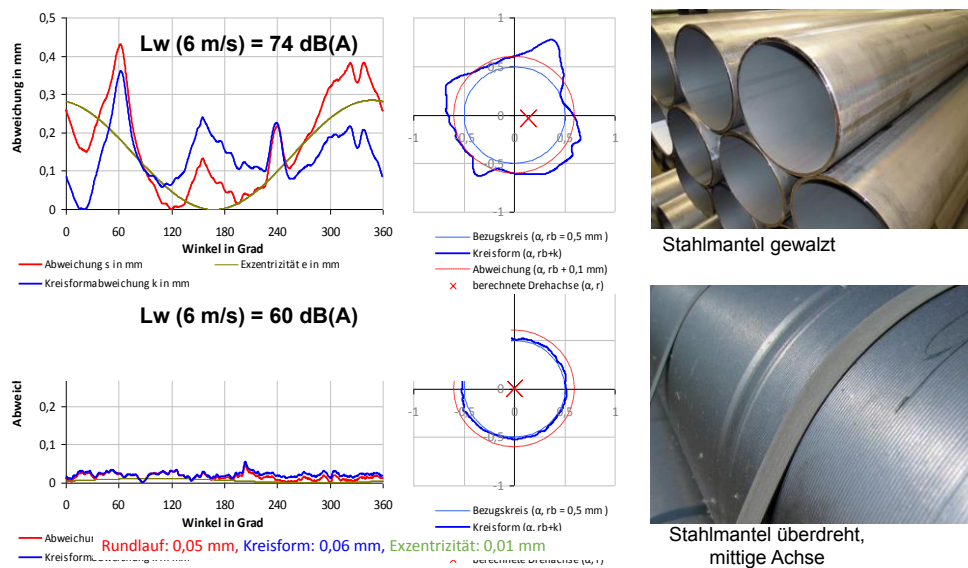
7. Entwicklung der letzten 10 Jahre

Es konnten mit Hilfe des Tragrollenprüfstandes Grundlegende Erkenntnisse gewonnen werden. Es wurde die Annahme bestätigt, dass die Schallemission an Gurtförderanlagen hauptsächlich von den Tragrollen aus geht, die Schallemission einer Tragrolle wird hauptsächlich durch den Tragrollenmantel abgestrahlt, die bestimmende Schallemission wird in den Eigenfrequenzen des Tragrollenmantels emittiert und eine hohe Dämpfung führt bei vergleichbarer Anregung zu geringerer Schallemission. [14]

Untersuchungen die den Zusammenhang zwischen Unwucht und Schallemission einer Tragrolle betrachteten, führten zu dem Ergebnis das die festgestellten Änderungen des Schalleistungspegels durch eine stufenweise Unwuchterhöhung innerhalb der Abweichungen vom Tragrollenprüfstand verlaufen. Dieses Ergebnis steht in Widerspruch zur VDI-Richtlinie „Gurtförderer für Schüttgut - Tragrollen und Tragrollenabstände“, welche von folgender Annahme ausgeht: *„Tragrollen mit hohen Unwuchten, die auch durch Fördergutanbackungen auf den Tragrollenmänteln entstehen, sowie größere Rundlaufabweichungen der Tragrollenmäntel führen in Verbindung mit dem Fördergurt zu erhöhten Laufgeräuschen.“* [17]



Abbildung 10: Differenzen des Schalleistungspegels über der Restunwuchtmass der Prüftragrolle im Lastlauf [14]

Es konnte auch nach dem Überschreiten der Gütestufe G80 keine signifikante Steigerung des Schalleistungspegels nachgewiesen werden (Abb.10). Das lässt die These zu, dass kein kausaler Zusammenhang zwischen Unwucht und Geräuschemission bei Tragrollen für Gurtförderanlagen besteht. Es sind weitere Untersuchungen erforderlich, um diese These im realen Förderbetrieb zu bestätigen. [17]

Die Analysen müssen z. B. folgende Fragen klären: War die Unwucht nicht ausreichend für eine Schallemissionserhöhung? War die Schallemission der Tragrolle vorab zu hoch? Zu welchen Ergebnissen gelangen die Prüfungen bei einer statistisch relevanten Anzahl an nicht gewuchteten Tragrollen? Wie verhalten sich diese Rollen als Girlande? Gibt es andere relevante Einflüsse für die Geräuschemission an Gurtförderanlagen und wie wirken diese? Die nächsten Schritte sind die Untersuchungen am Tragrollenprüfstand zur akustischen Wirkung von überdrehten und nicht gewuchteten Tragrollen verschiedener Hersteller aus dem Produktionsprozess heraus. Abschließend erfolgt die Betrachtung von Feldversuchen dieser Tragrollen in Gurtförderanlagen. Sollten Feldtests die eindeutigen Ergebnisse am Prüfstand bestätigen, sind bei Einhaltung von Geometrievorgaben durch eine Verminderung der Auswuchtgüte Kostenreduzierungen oder zumindest Vereinfachungen im Fertigungsprozess von Tragrollen zu erwarten [17].

8. Zusammenfassung und Ausblick

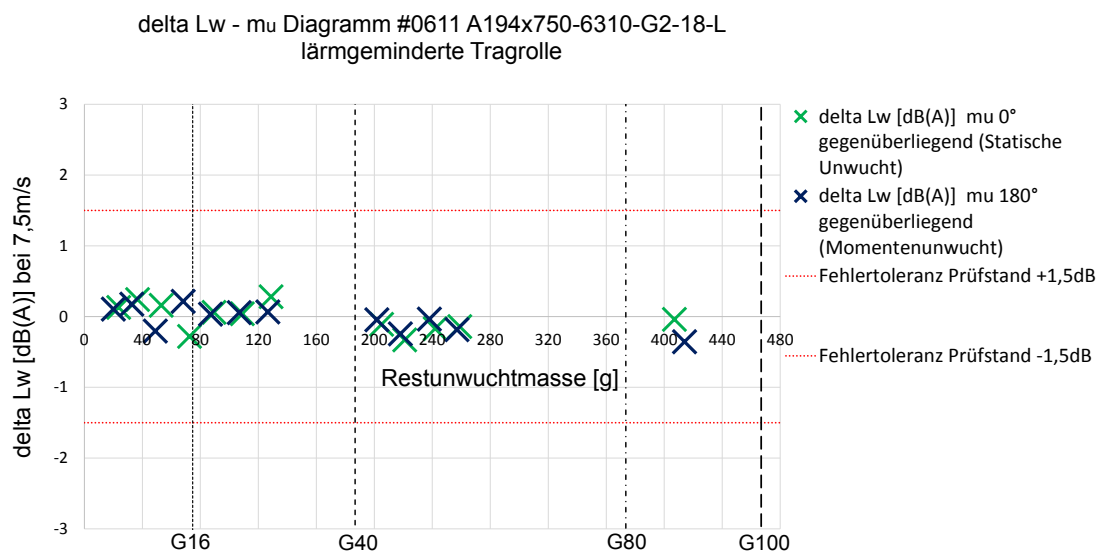
Mittels des Tragrollenprüfstandes ist es möglich, ein umfassendes akustisches Profil einer Tragrolle zu erstellen. Die diesbezüglichen Untersuchungen haben die Tragrollenhersteller in die Lage versetzt, in den letzten 10 Jahren ihre Tragrollen in einer solchen Fertigungsqualität herzustellen, dass ihre Schallemissionen um etwa 10 dB reduziert werden konnten. Dabei konnten weitere Effekte beim Betrieb der Tragrollen aufgedeckt und aufgeklärt werden. Positiver Nebeneffekt der Aufdeckung der Ursachen der Schallemission war, dass bei Einhaltung der geometrischen Vorgaben bei der Fertigung der Tragrollen auch der Energiebedarf zum Antrieb der Fördergurtes durch Entfall der ständigen Gurthubbewegung durch die Unrundheiten der Tragrollen

zurückging. Die Energiebilanz hat sich verbessert, der Förderprozess wurde energieeffizienter.

Zukünftige Untersuchungen werden sich dem Zusammenhang zwischen möglicher Tragrollenunwucht durch Fördergutanbackungen und deren akustischer Wirkung sowie den Untersuchungen zum Zusammenhang zwischen Tragrollenlebensdauer und Axialspiel bei Auslieferung der Tragrolle widmen.

9. Quellen:

1 Carsten Drebenstedt, Jochen Rascher; Zu den geologischen Bedingungen und den bergbautechnologischen Möglichkeiten der Wiedernutzbarmachung im Lausitzer Revier; online Veröffentlichung

2 Frederick G. Zimmer, The Mechanical Handling Storing of Material, Crosby Lockwood and Son, 3. Aufl., London, 1922; <https://www.dmg-lib.org/dmglib/streambook/index.jsp?bookid=16868009#page98>

3 M.Buhle, Technische Hilfsmittel zur Beförderung und Lagerung von Sammelkörpern (Massengütern), III. Teil, Springer-Verlag Berlin 1906

4 Archiv der Fa. Takraf Lauchhammer, mit freundlicher Genehmigung

5 Archiv der Fa. Takraf Lauchhammer, mit freundlicher Genehmigung

6 LEAG, Geschäftsfeld Bergbau, <https://www.leag.de/de/geschaeftsfelder/bergbau/>

7 LEAG, Kohle, Strom und Wärme, Tagebau Jänschwalde, https://www.leag.de/fileadmin/user_upload/pdf/LEAG_Standortflyer_TB_Jaenschwalde.pdf

8 LEAG, Kohle, Strom und Wärme, Tagebau Welzow-Süd, https://www.leag.de/fileadmin/user_upload/pdf/LEAG_Standortflyer_TB_Welzow_Su_d.pdf

9 LEAG, Kohle, Strom und Wärme, Tagebau Nochten und Reichwalde, https://www.leag.de/fileadmin/user_upload/pdf/LEAG_Standortflyer_TB_Nochten-Reichwalde.pdf

10 LEAG, Firmeninformationsschrift, 2018

11 J. H. Schroeder u.a.; Führer zur Geologie von Berlin und Brandenburg – Nr. 10 Cottbus und der Landkreis Spree Neiße; Selbstverlag Geowissenschaftler in Berlin und Brandenburg e.V., 2011; ISBN 978-3-928651-15-8

12 DIN 21919-3, 2001

13 DIN 15201-1, 1994

14 Dirk Täschner (2014): Untersuchungen der akustischen Wirkung von Tragrollen zur zielgerichteten Lärminderung an Gurtförderanlagen. In: Freiburger Forschungshefte, Bergbau, C 546, Technische Universität Bergakademie Freiberg, Freiberg,

15 DIN 15207-1, 2000

16 Heinrich Martin (2014), Transport- und Lagerlogistik - Planung, Struktur, Steuerung und Kosten von Systemen der Intralogistik

17 Thomas Rieder (2018), Untersuchung zur Wirkung von Unwucht auf die Schallemission einer Tragrolle, 23. Fachtagung Schüttgutfördertechnik 2018

18 Brandenburgisch Technischen Universität Cottbus-Senftenberg, Tragrollenprüfstand Messumfang, <https://www.b-tu.de/tragrollenpruefstand/messumfang>