

---

# **Optimization of converting food waste to hydrogen and Biogas in double-stage-fermentation**

Von der Fakultät für Umwelt und Naturwissenschaften  
der Brandenburgischen Technischen Universität Cottbus-Senftenberg  
zur Erlangung des akademischen Grades eines  
Doktor-Ingenieurs

genehmigte Dissertation

vorgelegt von

Master of Science

Yanjuan Lu  
aus Henan, VR. China

Gutachter: Prof. Dr. habil Marion Martienssen

Gutachter: Prof. Dr. habil Günter Busch

Tag der mündlichen Prüfung: 05.01.2017

## DECLARATION

The author of this dissertation hereby confirms with name and signature that this work was done independently and that appropriate credit has been given where reference has been made to the work of others.

This dissertation has never been published in any level or presented for a degree in this or any other university as partial work.

Doctoral Student:

Yanjuan Lu (M.Sc.)

\_\_\_\_\_

Chair of Waste Management, BTU Cottbus

Cottbus, \_\_\_\_\_

\_\_\_\_\_

## **Acknowledgements**

The Faculty Waste Management of BTU Cottbus has funded this work.

The author is deeply grateful to the people in the chair of the Waste Management who have contributed their time, knowledge and expertise in helping me to make this study. They have shaped the contents and presentation of this work on the basis of their experience and interest. In particular,

I would like to express my deepest appreciation to My Supervisor Prof. Dr. Ing. habil. G. Busch for giving me the chance to make this research. I want to say many thanks to him for his invaluable comments, constant help, timely counseling whenever I met the problems and indefatigable guiding me for this research. He provided both technical insight and a broad overview essential to this dissertation.

Furthermore, I should also give my thanks for Dr. Marko Burkhardt's assistance for Experiment planning, substrates organization, etc, Mrs. Nickel's kindly help in the lab analysis, and Mr. Ulrich Klopsch's technical supports during my experiment. And many thanks go to the entire members of the department for their support in realizing this dissertation.

I wish to express my gratitude to the whole staff of the chair of Waste Management for their full cooperation, encouragement and sincere friendship during the whole period of my study.

Moreover, I would like to extend my special thanks to my family and friends for their encouragement and moral supports.

## Abstract

### Aim of this study

The aim of this research is to develop batch scale and continuous reactor systems to evaluate technical and practical feasibility of sequential hydrogen and methane from food waste by two step dark fermentation process.

### Methodology

The effects of limiting factors, like pH, temperature, as well as inoculum sources and pretreatment methods on H<sub>2</sub> yields were studied in batch assays. In addition, the feasibility of sequencing producing H<sub>2</sub>+CH<sub>4</sub> via two stage dark fermentation process was evaluated in lab-scale tests based on batch assay results. Three kinds of Acid producing reactor, like CSTR, semi-percolator, and ASBR had been tested for bioH<sub>2</sub> production and well inoculated ASBR methane was used for further degradation of volatile organic acids produced in these acid producing reactor which acts as by-products of bioH<sub>2</sub>. Different limiting factors on fermentation process have been investigated in each reactor type for optimum energy recovery. Monodigestion of food waste for methane production was also studied and used as reference value for energy recovery from food waste.

### Main results and technical application from this study

Hydrogen production results from food waste were shown to be possible with aerated inoculum in *batch assays* in thermophilic range, with highest H<sub>2</sub> yields of 19.72L/(kg oTS) from food waste. The inoculated HPB (Hydrogen producing bacterial) sludge taken from *ASBR* acid producing reactor was proved the optimum H<sub>2</sub> yields with the value of 61.41 L/(kg oTS) in this batch test. Inoculum to substrates ratio at 3 was found the best situ for H<sub>2</sub> yields in batch test. Even H<sub>2</sub> productivity at hyperthermophilic range has been confirmed with faster and higher performance, thermophilic fermentation process was taken in continuously lab-scale investigation due to too high process requirements in hyperthermophilic process.

*Two-stage sequencing* producing H<sub>2</sub>+CH<sub>4</sub> was shown the potential in H<sub>2</sub> yields in the first acid producing phase. Methane yields from monodigestion in ASBR methane reactor with OLR of 3.88 kg oTS/(m<sup>3</sup>.d) and average CH<sub>4</sub> yields at 312.71L/kg oTS were achieved and act as reference value for total energy recovery.

In *CSTR+ASBR<sub>Me</sub>* system, the max. hydrogen yields of 69.15 L/(kg oTS) and CH<sub>4</sub> yields at 291.77. L/(kg oTS) were achieved; In *semi-Percolator+ASBR<sub>Me</sub>* system, the max. hydrogen yields of 77.34 L/kg oTS and average CH<sub>4</sub> yields at 293.87 L/(kg oTS) were achieved; In *ASBR+ASBR<sub>Me</sub>* system, the max. hydrogen yields of 196.85L/(kg oTS) and average CH<sub>4</sub> yields at 293.87 L/(kg oTS) were achieved. The max. H<sub>2</sub> concentration in hydrolysis gas was got in ASBR acid producing reactor at 54%.

The experimental results indicated that food wastes can be considered as suitable substrates for BioH<sub>2</sub> and CH<sub>4</sub> sequencing production. Moreover, the less production cost for H<sub>2</sub> due to higher OLR and shorting HRT.

## Table of Content

Abstract.....	3
1 Introduction.....	16
1.1 Background.....	16
1.2 Research objectives.....	22
2 Theoretical Fundamentals: Sequential hydrogen and methane production by dark fermentation Steps 26	
2.1 State of Research in the field of BioHydrogen production by dark fermentation .....	27
2.2 Pathway of Hydrogen via dark fermentation .....	30
2.3 Steps and Microorganisms of Hydrogen Production.....	32
2.3.1 Steps in Acidogenic Fermentation.....	32
2.4 Methanation Phase.....	36
2.5 Microbes in dark fermentation.....	37
2.5.1 Hydrogenase .....	37
2.5.2 Microbe in Acidogenic phase for hydrogen production .....	37
2.5.3 Methanogens.....	38
2.6 Inocula.....	38
2.6.1 Pure culture for hydrogen production .....	39
2.6.2 Co-mixed culture for hydrogen production .....	39
2.6.3 Co-mixed culture for methane production.....	39
2.7 Limiting factors effecting on Hydrogen and Methane Production .....	40
2.7.1 Temperature .....	40

---

2.7.2	pH.....	41
2.7.3	HRT.....	43
2.7.4	OLR.....	44
2.7.5	Hydrogen partial pressure .....	44
2.7.6	Nutrients.....	45
2.7.7	Ammonia.....	47
2.7.8	Specific surface of material .....	48
2.7.9	Oxidation Reduction Potential -- ORP .....	49
2.7.10	Salt concentration on Hydrogen and Methane production .....	49
3	Material and Methodology.....	51
3.1	Feedstock material .....	51
3.2	Batch System via Eudiometer.....	52
3.2.1	Inocula/seed sludge for biohydrogen production.....	52
3.2.2	Investigated Feedstock in Batch Test .....	53
3.2.3	Reactor configuration.....	55
3.2.4	Experimentation.....	57
3.3	Continuously lab-scale fermentation systems.....	61
3.3.1	Inocula/seed sludge.....	61
3.3.2	Investigated Feedstock in continuously fermentation system .....	62
3.3.3	Bioreactor configuration for hydrogen production .....	63
3.3.4	ASBR Bioreactor for methane production.....	70
3.3.5	Experimentation.....	71

3.4	Sampling and analysis method.....	81
3.4.1	Sampling campaign.....	81
3.4.2	Analysis method for collected samples.....	81
3.5	Mathematic Calculation Equations.....	83
3.5.1	Hydraulic retention time (HRT).....	83
3.5.2	Degradation Rate $\Delta$ .....	83
3.5.3	Organic Loading Rate.....	84
3.5.4	Substrate specific BioH <sub>2</sub> /Biogas yield $r_{\text{Gas, abg}}$ .....	84
3.5.5	Gompertz equation for H <sub>2</sub> production Regression Analysis.....	84
4	Evaluation and Results discussion.....	85
4.1	Batch test results from this study.....	85
4.1.1	The effect of inoculum to substrate ratio on BioH <sub>2</sub> production.....	85
4.1.2	The effect of inoculum pretreatment methods on BioH <sub>2</sub> production efficiency.....	91
4.1.3	The effect of temperature on BioH <sub>2</sub> production.....	92
4.2	Results and discussion for combination hydrogen and methane production in continuously lab-scale.....	94
4.2.1	CSTR Reactor for Hydrogen production + ASBR Methane production.....	94
4.2.2	Semi-Percolator Hydrogen + ASBR Methane production.....	99
4.2.3	ASBR Hydrogen production + ASBR Methane production.....	113
4.2.4	ASBR methane reactor.....	119
4.2.5	Summary.....	123
5	Case Studies of food waste anaerobic digestion plant in China by sequencing producing H <sub>2</sub> +CH <sub>4</sub> .	125



---

5.1	Brief project Information .....	125
5.2	Operation data in case study .....	127
6	Cost-benefit analysis of industry scale for sequencing production of H <sub>2</sub> +CH <sub>4</sub> via CSTR system....	130
6.1	Brief project Information .....	131
6.2	Mass balance .....	134
6.3	Economic assessment.....	135
6.4	Waste discharge control.....	140
7	Recommendation for the Future Experiments .....	141
8	Conclusion .....	143

## List of Table

Table 1-1: Theoretical H <sub>2</sub> , CH <sub>4</sub> and energy (MJ and kWh) yield from one mole glucose (M=180g/mol) assuming that glucose is degraded to acetate, H <sub>2</sub> and CO <sub>2</sub> in the acid producing phase.....	23
Table 2-1: Comparison of Hydrogen production rates and related bioreactor volume for FC .....	28
Table 2-2: Hydrogen yields of anaerobic fermentative hydrogen producing bacteria.....	30
Table 2-3: changes of standard Gibbs free energy of acidogens and glucose as substrate.....	35
Table 2-4: Changes of standard Gibbs free energy in Acetogenesis.....	35
Table 2-5: Principal Methanogenic reactions (Chynoweth 1995) .....	36
Table 2-6: Time of regeneration of different anaerobic microorganisms .....	40
Table 2-7: Ecological amplitude testing of Acidogens .....	43
Table 2-8: Micro-nutrients and Functions .....	47
Table 2-9: Effect of Ammonia Nitrogen on Anaerobic Digestion (WPCF 1987) .....	48
Table 3-1: Inocula characteristics .....	53
Table 3-2: Characterization of substrates used in Batch Test .....	54
Table 3-3: Characterization of Food waste in Batch Test.....	54
Table 3-4: Trace Element of Feedstock in Batch Test.....	55
Table 3-5: Inoculum Pretreatment Experiment Plan.....	59
Table 3-6: Experiments of temperature effects on BioH <sub>2</sub> production.....	61
Table 3-7: Characteristic of Investigated Feedstock in the Bioreactors.....	63
Table 3-8: Experiment Plan in percolator system.....	76
Table 3-9: Operation Regime for ASBR Hydrolysis System .....	78
Table 3-10: Experiment Plan for Continuously sequential production of H <sub>2</sub> +CH <sub>4</sub> via ASBR Reactor.....	80

---

Table 3-11: Analysis Plan for solid samples.....	81
Table 3-12: Analysis Plan for solid samples.....	82
Table 5-1: Substrate Component.....	125
Table 5-2: Physical composition (%TS) of food leftovers squeezed (TS 16.8%, VS 83%).....	125
Table 6-1: Substrate Component.....	131
Table 6-2: Physical composition (%TS) of food leftovers squeezed (TS 21%, VS 84%).....	131
Table 6-3: Total Estimate Table for CH <sub>4</sub> Recovery.....	138
Table 6-4: Total Estimate Table for CH <sub>4</sub> Recovery .....	139

## LIST OF FIGURES

Figure 1-1: Growing world energy demand.....	16
Figure 1-2: Atmosphere Carbon dioxide content.....	17
Figure 1-3: Production cycle for hogwash oil and swill pigs.....	20
Figure 1-4: Bebra Biogaslant, Bebra, Germany, 2010.....	21
Figure 1-5: Kangbashi Biogas Plant, Erdos, China, 2012.....	21
Figure 1-6: Kangbashi Biogas Plant, Erdos, China, 2012.....	22
Figure 1-7: Food wastes from household and restaurant in Qingdao, China.....	22
Figure 2-1: H <sub>2</sub> and CH <sub>4</sub> production from organic substrates [Dark fermentative hydrogen production shown with dashed line].....	27
Figure 2-2: Schematic Pathway for conversion of Organics to hydrogen via dark fermentation.....	31
Figure 2-3: Hydrolysis Reaction of different raw material.....	34
Figure 2-4: The influence of hydrogen partial pressure on the energy release during acetogenesis.....	45
Figure 2-5: Biogas yields from hay with and without grinded.....	48
Figure 3-1: Layout of Eudiometer Apparatus.....	55
Figure 3-2: Eudiometer Apparatus for Batch Test.....	56
Figure 3-3: CSTR Bioreactor.....	64
Figure 3-4: Semi-Percolator with Patent Nr: CN101585043B.....	66
Figure 3-5: Regime of Anaerobic sequencing batch reactor.....	68
Figure 3-6: Anaerobic Sequencing batch reactor system for CH <sub>4</sub> recovery.....	70
Figure 3-7: Experiment Flow chart of CSTR + ASBR.....	72
Figure 3-8: Experiment Flow chart of Percolator and ASBR <sub>Me</sub> .....	74

Figure 3-9: Experiment Flow chart of Continuously sequential production of H <sub>2</sub> +CH <sub>4</sub> .....	77
Figure 4-1: Accumulated H <sub>2</sub> yield at different R <sub>L/S</sub> .....	86
Figure 4-2: CH <sub>4</sub> and H <sub>2</sub> concentration via heat treatment.....	86
Figure 4-3: Accumulated H <sub>2</sub> yield at different R <sub>L/S</sub> .....	87
Figure 4-4: CH <sub>4</sub> and H <sub>2</sub> concentration via pH increasing .....	87
Figure 4-5: Hydrogen yield and concentration via Aeration treatment.....	88
Figure 4-6: Accumulative H <sub>2</sub> production at different R <sub>L/S</sub> .....	89
Figure 4-7: The Inhibition efficiency of CHCl <sub>3</sub> pretreatment.....	90
Figure 4-8: CH <sub>4</sub> Yields via CHCl <sub>3</sub> pretreatment.....	91
Figure 4-9: Time courses of Fermentation temperature dependency of Hydrogen production in Batch cultures ....	94
Figure 4-10: Total energy output in the CSTR system .....	96
Figure 4-11: Effects of R <sub>L/S</sub> on H <sub>2</sub> yields in the CSTR system .....	97
Figure 4-12: CH <sub>4</sub> concentration in biogas in the CSTR experiment.....	99
Figure 4-13: Total energy output via one-step and two-step percolator system .....	101
Figure 4-14: H <sub>2</sub> yields in two systems .....	102
Figure 4-15: CH <sub>4</sub> concentration in Hydrolysis Gas .....	102
Figure 4-16: oTS degradation rate in percolation hydrolysis process.....	103
Figure 4-17: Liquid to solid ration in Percolator system .....	105
Figure 4-18: Effect of R <sub>L/S</sub> on H <sub>2</sub> and CH <sub>4</sub> yields.....	106
Figure 4-19: H <sub>2</sub> content in hydrolysis gas of percolator .....	106
Figure 4-20: CH <sub>4</sub> % in hydrolysis gas in one-step Percolator.....	107
Figure 4-21: CH <sub>4</sub> % in hydrolysis gas in two-step Percolator .....	108

Figure 4-22: Accumulated extracted COD in semi-percolator system .....	109
Figure 4-23: Accumulated VFAs in semi-percolator system.....	110
Figure 4-24: VFAs distribution in 1-Step semi-percolator system .....	111
Figure 4-25: VFAs distribution in 2-Step semi-percolator system .....	112
Figure 4-26: CH <sub>4</sub> concentration in Biogas .....	113
Figure 4-27: Total energy output in ASBR System.....	114
Figure 4-28: BioH <sub>2</sub> yields at ASBR.....	116
Figure 4-29: Effect of pH on BioH <sub>2</sub> yields .....	117
Figure 4-30: Biogas quality in ASBR methane reactor.....	118
Figure 4-31: ASBR methane reactor performance.....	120
Figure 4-32: Ts, oTS Removal Efficiency in ASBR methane reactor .....	120
Figure 4-33: ME sludge SV <sub>30</sub> , SV <sub>180</sub> and settling velocity.....	121
Figure 4-34: Effect of Gas load rate on sludge settling performance at different Reactor Physical Dimension.....	122
Figure 5-1: Waste Discharging in semi-percolator .....	126
Figure 5-2: configuration of semi-percolator .....	127
Figure 5-3: Whole Flow Chart of Lanzhou Food Waste Biogas Plant .....	127
Figure 5-4: Hydrolysis gas production in case study .....	128
Figure 5-5: H <sub>2</sub> yield performance in case study.....	129
Figure 6-1: Process flow chart of Qinhuangdao Project .....	133
Figure 6-2: Mass Balance of Qinhuangdao Project .....	134

## LIST OF ABBREVIATIONS

AD	Anaerobic Digestion
ADP	Adenosine Diphosphate
ATP	Adenosine triphosphate
NADH	Nicotinamide adenine dinucleotide
BOD	Biological Oxygen Demand
COD	Chemical Oxygen Demand
CH <sub>4</sub>	Methane
CO <sub>2</sub>	Carbon Dioxide
DepV	Deponieverordnung
FC	Fuel Cell
FNR	Ferredoxin
H <sub>2</sub>	Hydrogen
HCB	Hydrogen Consuming Bacteria
HPB	Hydrogen Producing Bacteria
HRT	Hydraulic Retention Time
SRT	Solid Retention Time
kWh	Kilo Watt Hour
Ts	Total Solids
oTS	Organic Total Solids
OLR	Organic Loading Rate
ppmv	parts per million volume

SRB	Sulfate Reducing Bacteria
LCFA	Long chain fatty acids
TC	Total Carbon
TOC	Total Organic Carbon
TN	Total Nitrogen
UN	Europe Union
VFAs	Volatile Fatty Acids
NDRC	National Development and Reform Commission
MLSS	Mixed Liquid Suspended Solids
$R_{I/S}$	Ratio of Inoculum to Substrate
$R_{L/S}$	Ratio of Liquid to Substrate



# 1 Introduction

## 1.1 Background

Energy consumption has been tied to rising levels of prosperity and economic development in the last years. UN population Division forecasts that the world population will be increased from 7.4Billion to 8.3Billion between 2005 and 2030<sup>1</sup>. Correspondingly the energy demand all over the world increased continuously especially in the new economic entities like China and India with energy growth higher than 100%. Figure 1-1 as followed shows the growing energy demand in the world from 2004 to 2030. And now humanity finds itself confronting an enormous energy challenge and serious environmental problems.

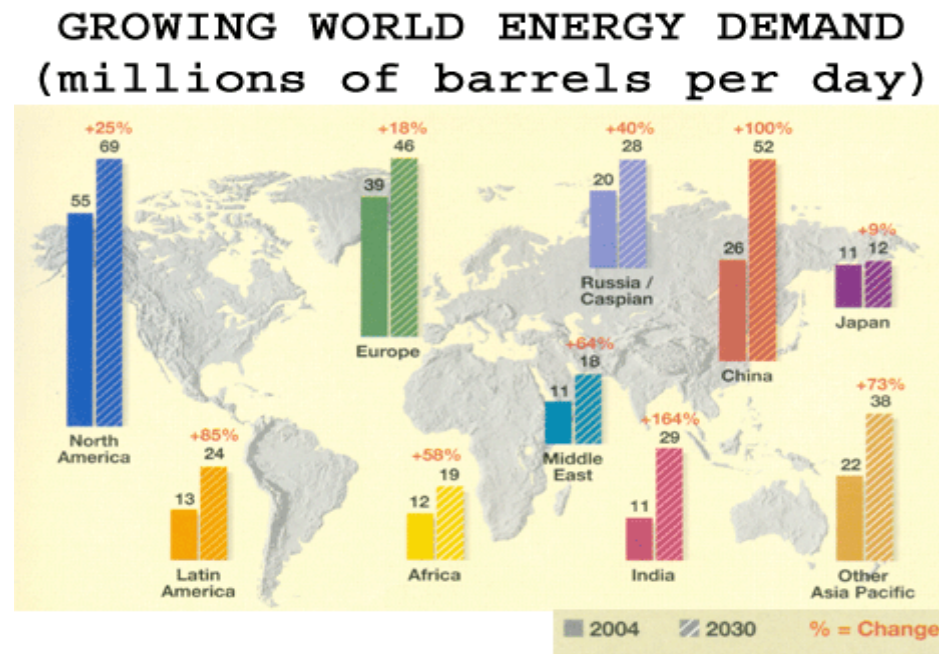

Figure 1-1: Growing world energy demand<sup>2</sup>

Over the past decades we have rapidly depleted these limited natural resources. The shortage of the fossil fuels is in the not too distant future and will affect the activities of all walks of lives and impede economic development.

The use of convenient energy like fossil fuel and gas has been caused an accelerated environmental pollution in the last years. As reported by German physical society, the CO<sub>2</sub> content before 1800 kept nearly constant at 280ppmv (parts per million volume) and from 1850 and 1950, increased by 15%, then with the dawn of the industrial age, the carbon dioxide concentration experienced an annual rise of 0.3 to

0.5%. In 2010 the atmosphere CO<sub>2</sub> content was as much as 359ppmv as shown in the following Figure 1-2. It is believed that the increasing atmosphere carbon dioxide content tends to global warming. Temperature changes vary over the globe. Since 1979, the temperature has increased between 0.13 and 0.22 °C per decade as reported<sup>3</sup>.

The Kyoto Protocol, initially adopted on 1977, aims to stabilization of greenhouse gas concentration in the atmosphere at a level that would prevent dangerous anthropogenic interference with the climate system. Otherwise an increased temperature will cause the world sea level increasing due to ice caps melting in the Arctic and Antarctic regions, and higher probability of extreme weather and many other natural disasters.

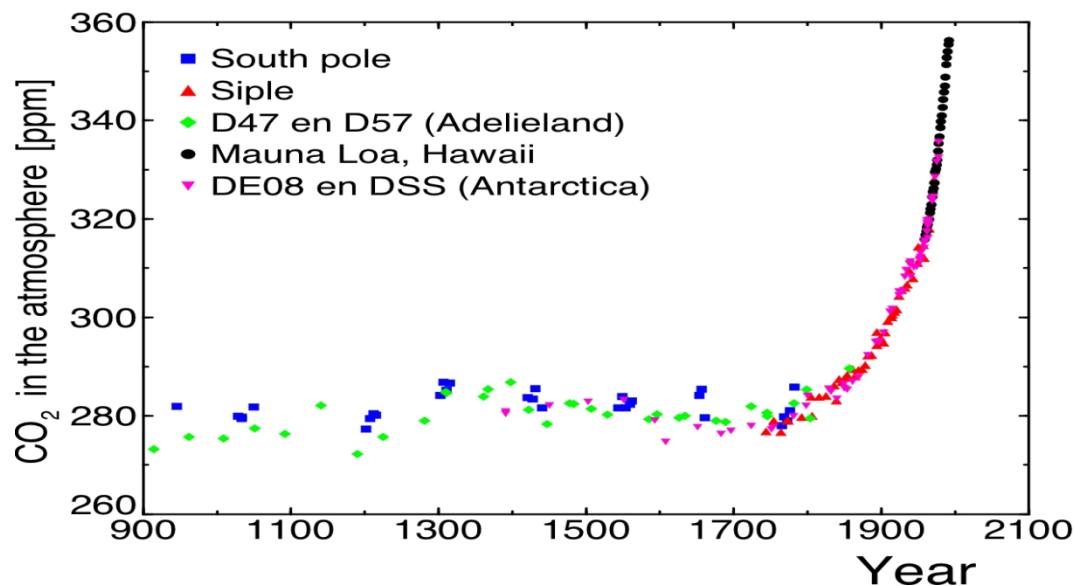

Figure 1-2: Atmosphere Carbon dioxide content<sup>4</sup>

Climate concerns and dwindling fossil fuel resources are driving an increasing demand for renewable energy solution. Large efforts are being conducted worldwide for the renewable energy exploration. Many counties have passed legislation to increase the use of renewable energy sources.

Bioenergy is one of important renewable energy which may be used. Different kinds of energy crops such as potato, wheat, leaf, rape, maize etc. were investigated as the substrates for energy production since 1990. While with the world food security deteriorating, the cost of substrates for the bioenergy production increased a lot. And also we cannot impute the energy crisis to food crisis. Therefore, more substrates that are suitable should be evaluated for renewable energy recovery.

Food waste, any food substance, raw or cooked, which is discarded, or intended to be discarded, seems ideal to achieve dual benefits of energy production and waste stabilization because of high organics content (volatile solids 15-30%) and moisture content (75-85%)<sup>5</sup>. It is a major burden to the environment due to resulting in various problems such as odor emanation, vermin attraction, toxic gas emission, and groundwater contamination. Due to the high moisture content, the heat value for food waste is only 2100-3100kJ/kg and cannot be properly treated by incineration/gasification process. Also, due to its high organic content food wastes are not allowed dumped into landfill site without pretreatment according to German DepV (Deponieverordnung).

Dark Fermentation process is ideal technology for this kind of material and it has the opportunity to be an integral part of the solution to two of the most pressing environmental concerns: waste management and renewable energy production. Methane production from biomass and organic wastes has been widely applied howbeit ignoring energy recover from hydrogen because it is rapidly taken up and converted into methane in monodigestion.

A significant amount of hydrogen gas is produced in the first stage of dark fermentation process as an intermediate product, which is used as electron donor by HCB (Hydrogen Consuming Bacteria) like methanogenic Archaea, acetogenic bacteria and SRB (Sulfate reducing Bacteria). Because the produced hydrogen is quickly utilized by HCB, only small amount of hydrogen is detected in the biogas. Research by Lay et al.<sup>6</sup> suggested that if the methanogenesis was blocked or inhibited, much more hydrogen, volatile acid and carbon dioxide can be collected during the first stage of fermentation process.

Today, more than 95% of H<sub>2</sub> is produced from fossil fuels via steam reforming or partial oxidation which are energy consuming and generate CO<sub>2</sub> which are climate-relevant reactive gases as by-product and should be prohibited as much as possible due to high energy consuming and environmental pollution in the future.

In 1971, the concept of two-stage fermentation was proposed to improve the process stability and efficiency by Ghosh and Pohland. Accumulation of organic acids and lowering pH are known to lead to suppression of methanogenic activity and process failure in single stage methanogenic digester. Using two-stage anaerobic process (consequent separation of acid producing phase, which includes hydrolysis, acidogenesis, acetogenesis, and methanogenesis) can provide considerable advantages ranging from optimization of particular stages up to the control of the whole process. Acidogenic phase can be

conducted in the first digester at a pH, temperature and HRT (hydraulic retention time) optimal for the hydrolysis, acidogenic and acetogenic bacteria. Methanogenesis can then be done in the second reactor at conditions optimal for this stage. The separation of acid producing phase and methanogenic phase make the recover hydrogen by collecting hydrolysis gas which mainly consists of H<sub>2</sub> and CO<sub>2</sub> possible.

Methane is useful renewable energy produced by dark fermentation process and has been promoted in the last years for sustainable development and decreasing green house effect caused by fossil fuel. While methane is a low heat value gas with relatively less energy content (ca. 56kJ/g CH<sub>4</sub>), the heating value of hydrogen is much higher (142.9kJ/g H<sub>2</sub>). Beside, methane and its combustion by-product carbon dioxide are greenhouse gases and responsible for global climate changes.

However, formation and consumption of hydrogen in dark fermentation are uncoupled to some extent, so hydrogen as the final product should be favorably recovered because of its unique advantages as following:

- Methanogenesis has a negative correlation with energy utilization, so H<sub>2</sub> consumption by methanogens should be inhibited and favorable H<sub>2</sub> production for higher energy recover efficiency should be promoted; total produced energy in two phase H<sub>2</sub>+CH<sub>4</sub> could in theory be raised by 7.14% (from 2.24 to 2.40MJ/mol glucose) and the share of H<sub>2</sub> will account for ca. 37.5%. While in two stages H<sub>2</sub>+CH<sub>4</sub> system has also been shown to improve CH<sub>4</sub> yield when concrete project compared to traditional one-stage methane process, as e.g. 21% more CH<sub>4</sub> was obtained in a two-stage system from household solid waste (Liu et al. 2006);
- Higher efficiency of total energy production and can significantly increase the energy conversion efficiency of anaerobic biological treatment;
- Higher commercial values e.g. faster reaction rate and lower investment cost;
- Higher energy transfer efficiency, e.g. electricity from H<sub>2</sub> 50%-80% while electricity from CH<sub>4</sub>: only 30%-40%;
- Zero emission;
- Fuel with highest energy density as 142.9kJ/g;
- Lower transportation cost, less energy loss than electricity;

- Resource for fuel cells which is expected to have large contribution in future energy provision with high efficiency, cleaning, no transmission part and no noise;<sup>7</sup>
- Raw material for synthesis of ammonia, alcohols, aldehydes, and for hydrogenation of various petroleum and edible oils.

With the development of economy and society, the amount of food waste production increased dramatically especially in some developing areas in Asia. Due to the food culture and habitat, the amount of produced food wastes is surprising. Only in Beijing China the food wastes production only from restaurants is over 3000ton/d and kept ca.10% increasing annually<sup>8</sup>. Food waste is rich in organic material, water and many other nutrients that microorganisms required. High organic part gives the chance for energy recover, while cause serious environmental problems without proper treatment like food safety problems caused by hogwash oil, swill pigs etc. which may lead cross infection between human and animals like mad cow disease, foot and mouth disease, hepatitis. The production cycle for hogwash oil and swill pigs are shown as following:

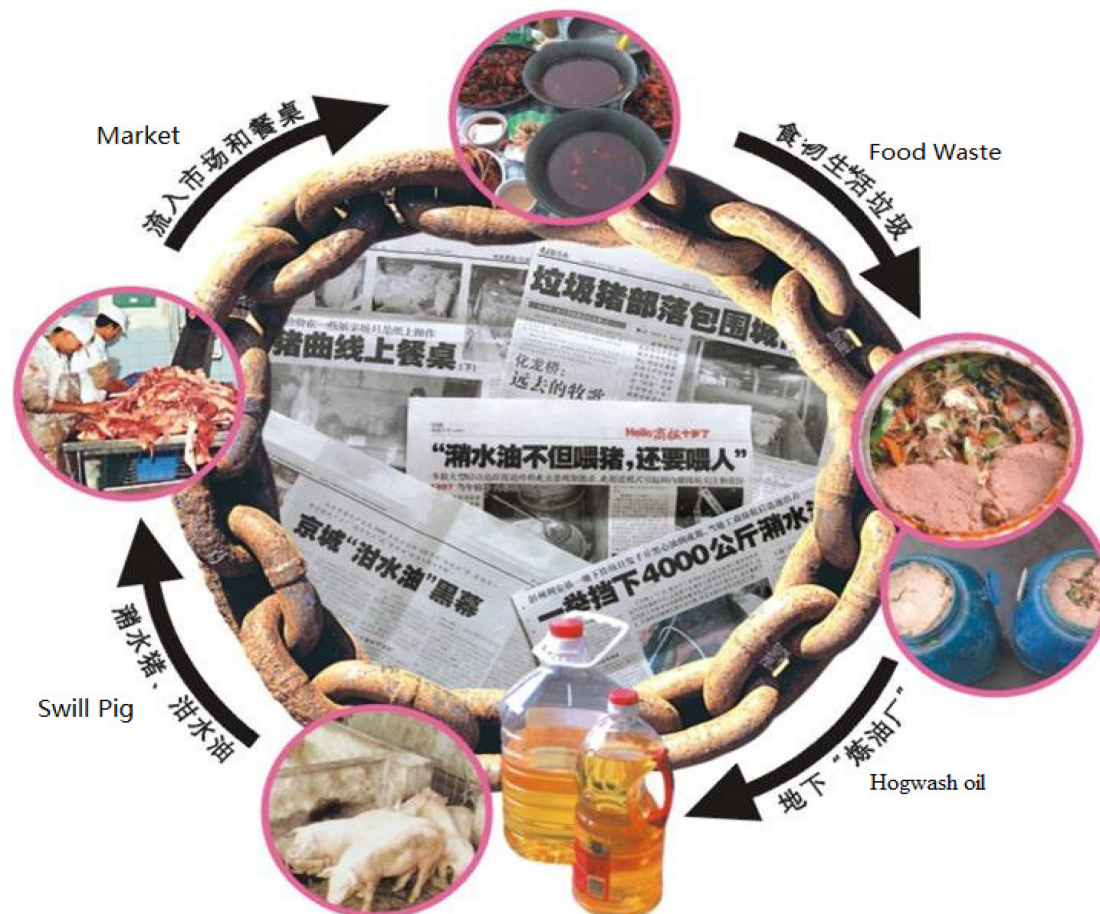

Figure 1-3: Production cycle for hogwash oil and swill pigs



The integration of energy recovery and waste treatment by dark fermentation from food waste has a great development since 2000 in EU and it got rapidly development in China since 2011. Several operating food waste biogas plant are presented here and all of them are only designed for biogas recovery.



Figure 1-4: Bebra Biogaslant, Bebra, Germany, 2010



Figure 1-5: Kangbashi Biogas Plant, Erdos, China, 2012





Figure 1-6: Kangbashi Biogas Plant, Erdos, China, 2012



Figure 1-7: Food wastes from household and restaurant in Qingdao, China

## 1.2 Research objectives

The methane production from food wastes by dark fermentation has been employed in the last years and implemented in the industry scale in many areas since 1990, while hydrogen production in the acid producing phase in the dark fermentation has been ignored in the past years and received more and more interests in these years due to higher energy recovery.

In traditional one stage dark fermentation process, the energy yield in the form of  $H_2$  is rather low resulted by HCB and lot of degradation by-products, e.g. VFAs and alcohols are present. The sequential

production of H<sub>2</sub> and CH<sub>4</sub> via two-stage fermentation was seemed as a feasible technology to improve the overall energy conversion efficiency (Hallenbeck 2009).

In theory, one mole of glucose can be degraded into 3 moles CH<sub>4</sub> and 3 moles CO<sub>2</sub> in traditional one phase AD, ignoring biomass synthesis (DiStefano & Palomar 2010). In two phase process one mole of glucose could be degraded in the first phase into 4moles of H<sub>2</sub>, 2moles of CO<sub>2</sub> and 2 moles of acetate. These two moles of acetate could be degraded in the second methanogenic phase to 2 moles of CH<sub>4</sub> and 2 moles of CO<sub>2</sub>. According to these reactions, the total produced energy in two phase H<sub>2</sub> + CH<sub>4</sub> system could in theory be increased by 7.14% (from 2.24 to 2.40MJ/mol glucose) and the share of H<sub>2</sub> will account for ca. 37.5%, which as shown in the following table:

Process	Unit	H <sub>2</sub>	CH <sub>4</sub>
H <sub>2</sub> production in the first stage	mol	4	0
	L	89.6	0
	MJ	0.90	0
	kWh	0.25	0
CH <sub>4</sub> production in the second stage	mol	0	2
	L	0	44.8
	MJ	0	1.49
	kWh	0	0.42
Total Energy (MJ/kWh)		2.40/0.67	
CH <sub>4</sub> production in the one-stage process	mol	0	3
	L	0	67.2
	MJ	0	2.24
	kWh	0	0.62
Total Energy (MJ/kWh)		2.24/0.62	
<b>Energy Increasing %</b>		<b>7.14%</b>	
Remarks: H <sub>2</sub> 10.05MJ/m <sup>3</sup> ; CH <sub>4</sub> : 33.37MJ/m <sup>3</sup>			

Table 1-1: Theoretical H<sub>2</sub>, CH<sub>4</sub> and energy (MJ and kWh) yield from one mole glucose (M=180g/mol) assuming that glucose is degraded to acetate, H<sub>2</sub> and CO<sub>2</sub> in the acid producing phase.

Most studies have been carried out with pure cultures of the isolated strains (Zeikus 1980; Heyndrickx et al. 1987; Taguchi et al. 1992; Rachman et al. 1998). High substrates and operation cost in sterilization conditions restrict its industrial implementation. However, hydrogen production by Co-mixed culture provides the possibility of economic recovering hydrogen via dark fermentation. The cultivation conditions for mixed culture HPB are much easier than pure culture and wide range of substrates and



HPB culture, strong ability to adapt the new situation or sustain the intense changes of system environment. Furthermore, alternation and metabiosis of microorganisms can lead to higher substrates utilization and hydrogen production ability, especially for complex organic compound.<sup>9</sup>

Since 2000, more studies have been done on hydrogen production through dark fermentation especially for complex organic wastes. However, so far it has not led to an increased appreciation of sequential hydrogen and methane production. Even high hydrogen yields 7.05LH<sub>2</sub>/L.d had been reported by Sun-Kee's research in 2004 and 21% more CH<sub>4</sub> was obtained in a two-stage system from household solid waste (Liu et al. 2006), the commercial plant for sequential hydrogen and methane production is still not available due to satisfactory of high and stable sequential hydrogen and methane production have not been obtained. It is no doubt that the sequential hydrogen and methane production from food wastes by two step dark fermentation can significantly enhance the economic viability of waste treatment theoretically.

Recent progress in Biohydrogen production has increased our understanding of biological H<sub>2</sub> production pathways via dark fermentation and has significantly improved the performance of H<sub>2</sub>-producing microorganisms. However, many critical issues still remain for the implementation of practical hydrogen production.

So, the presented study is aimed to develop batch scale and continuous reactor system to evaluate technical and practical feasibility of sequential hydrogen and methane from food waste by dark fermentation process. Therefore, the following specific tasks should be fulfilled:

1. To investigate the feasibility of hydrogen and methane production via two phase dark fermentation process;
2. Find the possible method for the enrichment of HPB in Acid producing phase in batch assays;
3. Find the optimum limiting factors for bioH<sub>2</sub> yields in batch assays;
4. Study the different strategies for enrich active HPB e.g. pretreatment seed materials, operation parameters control etc. in a mixed culture environment for continuously hydrogen and methane production;
5. To design and develop improved bioreactors to favor the HPB and methanogens growth and biomass

density in the reactor for higher hydrogen and methane production efficiency and lower the inhibition of products to achieve breakthrough in higher hydrogen and methane yield, and evaluate Hydrogen and methane production potential from different reactor configurations;

6. Case study analysis for continuous hydrogen and methane production in industry scale.

## **2 Theoretical Fundamentals: Sequential hydrogen and methane production by dark fermentation Steps**

Anaerobic treatment is one of the oldest forms of biological wastes treatment and was first describes the anaerobic process in 1776 by Court Alessandro Volta. In the 1920s and 1930s, many studies were performed on dark fermentation and led to wide-scale application of anaerobic digestion of domestic wastewater sludge throughout Europe and North America. While the second great growth of dark fermentation industry took place in the 1990`s due to climate concerns and impending depletion of fossil fuels becoming more apparent (Chynoweth 1995). Large efforts are being conducted worldwide to explore renewable energy technologies.

Anaerobic digestion has the opportunity to be an integral part of solution to two of the most pressing environmental concerns: waste stabilization and renewable energy production. Anaerobic digestion is a complex biochemical process mediated by consortia of microorganisms to convert organic compounds to biogas (methane and carbon dioxide) in the absence of oxygen. The organic matter is a food source for the microbes, and they convert it into oxidized materials, new cells, energy for their life processes, and some gaseous end products, such as methane and carbon dioxide.

Several species of microorganisms are involved in the overall reactions process, which include hydrolysis, acidification, acetogenic phase, acidogenic back reactions, and methanogenesis.<sup>10</sup> The complex organic compounds get degraded to monomers during Acidogenic phase by hydrolytic microorganisms with the help of external enzymes. Further, these monomers will be fermented by acidogenic bacteria to produce various kind of organic acids associated with H<sub>2</sub> production. Meanwhile, the reversible interconversion of acetate production from H<sub>2</sub> and CO<sub>2</sub> by acetogens and homacetogens can also be regarded for H<sub>2</sub> production. In the finally step, the methanogens convert these organic acids to CH<sub>4</sub> and CO<sub>2</sub> via methanogenesis. The hydrogenotrophic methanogens (H<sub>2</sub> consuming bacteria) can keep H<sub>2</sub> partial pressure lower enough to allow acidogenesis to become thermodynamically favorable for interspecies H<sub>2</sub> transfer. While, a sustained balanced fermentation requires the concerted activities of these organisms. When the methanogenic activity is suppressed, H<sub>2</sub> as sole metabolic by-product becomes possible.

Organic matter can be degraded into Alcohols, organic acids and H<sub>2</sub>/CO<sub>2</sub> via hydrolytic and fermentative microorganisms, in which approximately 76% of organics will be degraded into alcohols and organic acid,

the rest 24% will be converted into  $H_2+CO_2$ . During this process, the hydrogen production pathway has been shown with dashed line as shown in following Figure 2-1.

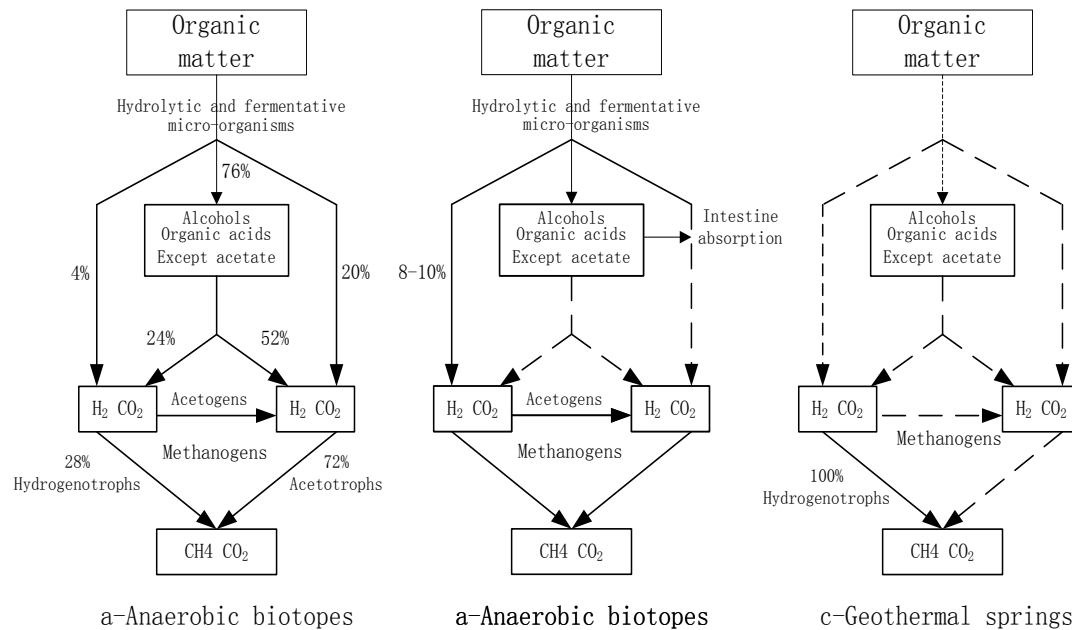

Figure 2-1:  $H_2$  and  $CH_4$  production from organic substrates [Dark fermentative hydrogen production shown with dashed line]

## 2.1 State of Research in the field of BioHydrogen production by dark fermentation

Hydrogen is considered as the energy carrier of the future and sustained program of research and development into many areas of hydrogen as energy carrier started in 1977.<sup>11</sup> Currently the most known industrial methods for hydrogen producing include steam reformation of natural gas, coal gasification and splitting waste with electricity typically generated from carbonaceous fuels. All these industrial process are energy intensive and more than 90% hydrogen refined from natural carbon hydrogen compounds. These processes are not only expensive but also not environmental friendly by releasing carbon dioxide and other greenhouse gas and pollutants are as byproduct. Thus, hydrogen producing by biological way offers promising pathway for hydrogen production. Biohydrogen production processes are found to be more environmental friendly and less energy intensive as compared to current technologies and received special attention.

Various methods have been investigated to generate hydrogen including photosynthesis, photo fermentation and dark fermentation. A comparison of hydrogen production rates of biohydrogen producing system and related Bioreactor volume is presented in the following Table 2-1:

BioH <sub>2</sub> System	H <sub>2</sub> Synthesis Rate mmol H <sub>2</sub> /L*h	Size of Bioreactor required to power a fuel cell L		
		1.0kW FC	2.5kW FC	5.0kW FC
Direct Photolysis	0.07 <sup>12</sup>	3.41*10 <sup>5</sup>	8.56*10 <sup>5</sup>	1.71*10 <sup>6</sup>
Indirect Photolysis	0.355 <sup>13</sup>	6.73*10 <sup>4</sup>	1.69*10 <sup>5</sup>	3.37*10 <sup>5</sup>
Photo Fermentation	0.16 <sup>14</sup>	1.49*10 <sup>5</sup>	3.74*10 <sup>5</sup>	7.58*10 <sup>5</sup>
Dark Fermentation	8.2--121 <sup>15</sup>	2910--198	7310--495	14600--989

Table 2-1: Comparison of Hydrogen production rates and related bioreactor volume for FC

The values above indicate that hydrogen synthesis rate by dark fermentation is much higher than photosynthesis, photo fermentation and photolysis. It appears promising pathway for hydrogen production. Meanwhile dark fermentation can realize continuously hydrogen production without light demand. Most studies on H<sub>2</sub> production via dark fermentation were mostly used soluble model substrates like sucrose, or glucose. However, when the organic wastes used as substrates operation cost can be sharply decreased by getting the waste treatment fees. But in general the yields of hydrogen are still low and for commercial biohydrogen from dark fermentation a lot researches are necessary.

Researchers have investigated hydrogen production with anaerobic bacteria since the 1980s (Nandi and Sengupta, 1998). There are a wide range of bacterial species which have been reported for dark hydrogen fermentation including strict anaerobes HCP and facultative anaerobes. The obligate anaerobes mainly include *Clostridium butyricum*, *Clostridium pasteurianum*, *C.kluyveri*, *C.tetanomorphum*, *Diplococcus glycinophilus*, *Peptostreptococcus elsdenii*, *Micrococcus lactilyticus*, *M.aerogenes*, *Veillonellagazogenes*, *Butyribacterium rettgeri*, *Methanobacterium ometianskii*, *Desulforibrio desulfuricans* and facultative anaerobes contain mainly *Escherichia*, *Aeromonas hydrophila*, *Bacillus macerans* and *Bacillus polymyxa* were identified for hydrogen production<sup>16-17</sup>.

Hydrogen yield of 1.7mol/mol (211NL/kg oTS) glucose in CSTR at pH 5.7 had been reported by Lin and Chang in 1999. In 2000 Narendra Kumar and Debabrata Das found that max. hydrogen of 62mmolH<sub>2</sub>/L h

(glucose) from *Enterobacter cloacae* II T-BT08 by using coconut shell fiber for bacteria fixing. Ueno et al. have found that anaerobic microflora in sludge compost which was made by forced aeration of aerobic activated sludge converted cellulose to hydrogen with high efficiency of 2.4mol/mol (298NL/kg oTS) Hexose in batch cultures at 60°C. And in 2004 specific hydrogen production of 221NL/kg oTS from glucose, 192 Nml/g oTS from sugar beet and 185 NL/kg oTS from fodder beet, respectively, were reported at a thermophilic temperature of 60°C in batch operation by using mixed cultural of natural anaerobes<sup>18</sup>.

Although the microbes which can produce hydrogen via dark fermentation are readily available in nature, study to date are mostly conducted using aseptic organic medium and pure culture of hydrogen producing bacteria. Most of the earlier experiments on H<sub>2</sub> production via dark fermentation were carried out in batch experiments, while some continuous H<sub>2</sub> production studies have been reported more recently in both pure and mixed cultures. The following table 2-2 shows the wide range of HPB and highest hydrogen yields what had been obtained.

A major limitation of dark fermentation is its low hydrogen yield. Chemically, there is enough energy in glucose to produce up to 12 mol of hydrogen. However, no single microbe is known to carry out this reaction pathway. To facilitate faster cell growth, microbes produce lesser amounts of hydrogen and various organic acids. While, these acids are normally accumulate since the conversion of these acids to H<sub>2</sub> are thermodynamically unfavorable (Classen et al. 1999). The byproducts during H<sub>2</sub> production phase must be addressed because these accumulated organic acids can cause following several problems: 1) acids as byproducts represents the energy loss; 2) Accumulated acids will lead lower pH in the culture medium which will cause less H<sub>2</sub> production due to suppression of HPB activity; 3) The accumulated acids may result in serious environmental pollution without proper further treatment.

The past researches on dark fermentation focus on optimization of methane production howbeit ignore the energy recover from acid producing phase. The energy loss including H<sub>2</sub> and CH<sub>4</sub> in the acid producing phase is up to 15% of the total methane production compared to calculated values.<sup>19</sup> Two stages H<sub>2</sub>+CH<sub>4</sub> system has been shown to improve CH<sub>4</sub> yield when compared to traditional monodigestion, as e.g. 21% more CH<sub>4</sub> was obtained in a two-stage system from household solid waste (Liu et al. 2006) and 22% more from lipid-extracted microalgae(Yang et al. 2011).

<b>Hydrogen yields of anaerobic fermentative hydrogen producing bacteria</b>				
<b>Microorganisms</b>	<b>Substrates</b>	<b>H<sub>2</sub> yields mol/mol</b>	<b>Condition culture</b>	<b>Source</b>
<b>Strict anaerobes</b>				
C. butyricum CGS5	Sucrose	2.78	Batch	20
Clostridium posteurianum	glucose	1.5	batch	21
Bacillus coagulans II T-BT S1	Glucose	2.28	Batch	22
Thermotoga elfii	Glucose	3.3	Batch	
<b>Facultative Anaerobes</b>				
E.coli strains	Formic acid	1	Batch	23
E.aerogenes E.82005	Molasses	5	CSTR	24
<b>Mixed culture</b>				
Sludge compost	Glucose	2.1	CSTR	25
Mixed culture	Glucose	0.93	Batch	26
Digested Sewage sludge	Patato starch	0.9	Batch	27

Table 2-2: Hydrogen yields of anaerobic fermentative hydrogen producing bacteria

However, systematic studies of the anaerobic fermentation of organic wastes for sequential hydrogen and methane production such as food residues, sludge, lignocellulosic waste, MSW, etc. certain inherent limitations—low substrate conversion efficiency, accumulation of carbon-rich acid intermediates, drop in system pH, etc.-still exist with the process, which needs considerable attention prior to process upscaling. At present, basic and applied research is on the way to gaining more insight into the process of understanding and establishing optimized conditions.

## **2.2 Pathway of Hydrogen via dark fermentation**

Dark hydrogen fermentation is a ubiquitous phenomenon under anoxic or anaerobic conditions (i.e., no oxygen present as an electron acceptor) and organic matters are degraded via dark fermentative bacterial to provide metabolic energy and building materials for growth. The excess electrons, generated during

dark fermentation process, will be disposed by dehydrogenation to main electrons neutrality and ensure the metabolic process to go smoothly. During this process hydrogen is produced from three routes: Pyruvate decarboxylation, formic acid decomposition and balance of NADH/NAD<sup>+</sup> ( Nicotinamide adenine dinucleotide).

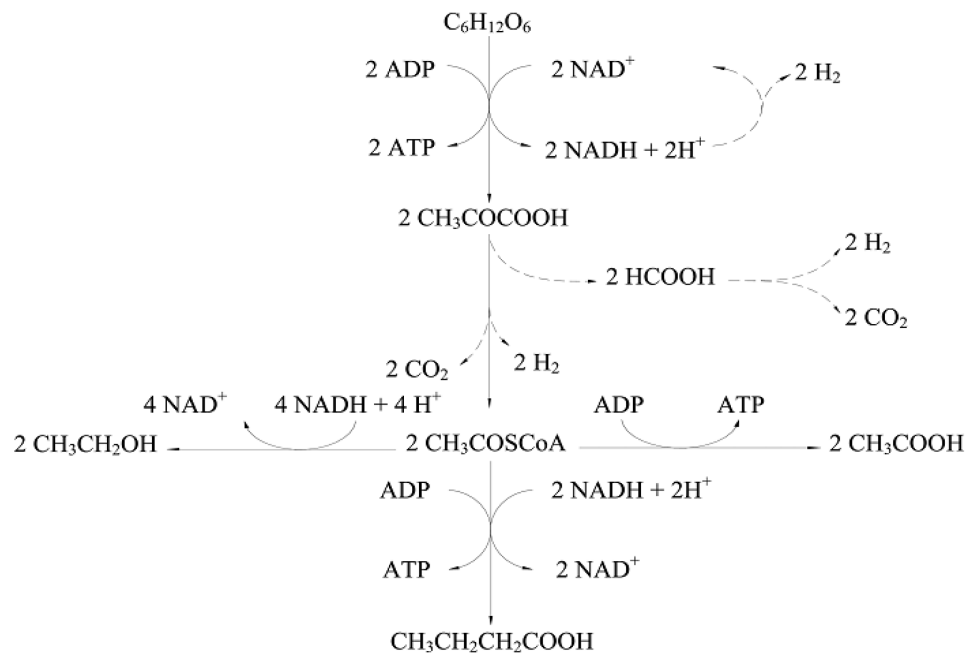
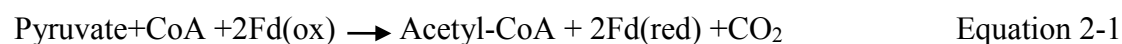

Figure 2-2: Schematic Pathway for conversion of Organics to hydrogen via dark fermentation<sup>28</sup>

Figure 2-2 illustrates the biochemical pathway for conversion of biomass in to hydrogen via dark fermentation. Glucose will be used as model substrate, which is first catabolized into pyruvate, produces ATP from ADP and reduced NADH (NAD is main carrier as H and electron) via glycolytic pathway. Pyruvate is then further oxidized to acetyl-CoA, CO<sub>2</sub> and H<sub>2</sub> by pyruvate-ferredoxin oxidoreductase and Hydrogenase as shown in following equations or to acetycoenzyme and formate, which may be readily converted to H<sub>2</sub> and CO<sub>2</sub> by bacteria such as *Escherichia coli*. Acetylcoenzyme (Acetyl-CoA) can be converted to acetyl phosphate and results in the generation of ATP and the excretion of acetate. Finally acetyl-CoA is converted into acetate, butyrate and ethanol, depending on microorganisms and environmental conditions. During the process Ferredoxin (Fd) is reduced of pyruvate oxidation to acetyl-CoA and the reduced Fd is oxidized by hydrogenase which generates Fd and releases electrons as molecular hydrogen (Hallenbeck and Benemann 2002).







NADH is used in the formation of Butyrate and ethanol and the residue NADH may be oxidized, producing  $\text{H}_2$  and  $\text{NAD}^+$  by NADH/ $\text{NAD}^+$  balance regulating system as shown in Equation 2-3. This reaction is addicted with the hydrogen partial pressure due to  $\Delta G^\ominus > 0$ .



$$\Delta G^\ominus = + 18.07 \text{ kJ/Reaction}$$

Because  $\text{CH}_3\text{COOH}$  pathway cannot reduce NADH to  $\text{NAD}^+$ , normally acetic fermentation will couple with other fermentation type.

Thus, the stoichiometric yields are 4mols  $\text{H}_2$  for each mole glucose in the production of acetic acid and 2mol  $\text{H}_2$  in the production of butyric acid. While in practice the actual  $\text{H}_2$  yields should be lower than these stoichiometric values for at least following reasons: 1. glucose degraded through other pathways without producing  $\text{H}_2$ ; 2. only part glucose degraded; 3. Inhibition during degradation process; 4. some glucose consumed for microorganism production.

## 2.3 Steps and Microorganisms of Hydrogen Production

### 2.3.1 Steps in Acidogenic Fermentation

In the earlier 1970s Pohland and Ghost first suggested the phase separation of anaerobic treatment which was thus proposed to improve the process stability and efficiency. The hydrolysis phase is the first steps in the anaerobic digestion of complex organic materials when they are degraded into methane and carbon dioxide. The basic steps involve conversion of the polymers present in organic matter into soluble monomers, which are quickly fermented into VFAs (lactic acids, acetic and butyric, propionic acids, etc), hydrogen ( $\text{H}_2$ ) and carbon dioxide ( $\text{CO}_2$ ) by the rapidly growing and pH-insensitive acidogenic bacteria. Many kinds of bacteria are involved in acidogenesis and, because they have different requirements on energy demand and redox ento-balance, several kinds of fermentation pathway are usually produced, namely, forming various acidogenic end-products. In general acid producing phase includes the following steps:

### 2.3.1.1 Hydrolyse-Phase ( Hydrolyse )

Hydrolysis is the cleavage of a chemical compound by reaction with water. This represents a hydrogen atom to the one "split track" is released, the remaining hydroxyl radical bound to the other split-off piece.<sup>29</sup>

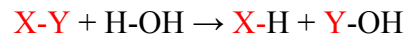

In this step hydrolysable products with micro-molecule are dissolved in water and can penetrate the cell membrane and then can be utilized directly by microorganisms. However, the macromolecular polymers such as cellulose, carbohydrates, proteins and fats cannot permeate the cell membrane because of its comparative high molecular weight. And thus it cannot be utilized directly by microorganisms. The first step, these macromolecular will be converted into soluble monomers which can be used directly under extracellular enzymes. The hydrolysis process is mediated by extracellular enzymes secreted by the microorganisms. Depolymerization can be mediated either by hydrolases or lyases, these being the most common modes of enzymatic depolymerization. E.g. cellulose can be hydrolyzed into glucose and cellobiose by cellulose enzyme; starch can be hydrolyzed into maltose and glucose by starch enzyme. When the neutral lipids fat and oil are hydrolyzed, the extracellular hydrolytic enzymes will be produced by fermentative bacteria to long chain fatty acids (LCFA) and glycerol. The main part of energy content of the oils is conserved in the LCFA, which are then further fermented by HPB via beta-oxidation (Weng and Jeris 1976). The figure 2-3 illustrates the hydrolysis reaction of raw materials of protein, carbohydrate and fat.

Hydrolysis of protein:

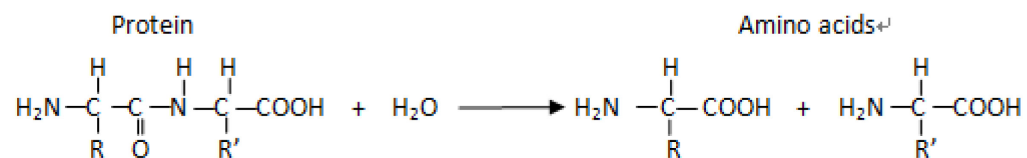

Hydrolysis of Carbohydrates:

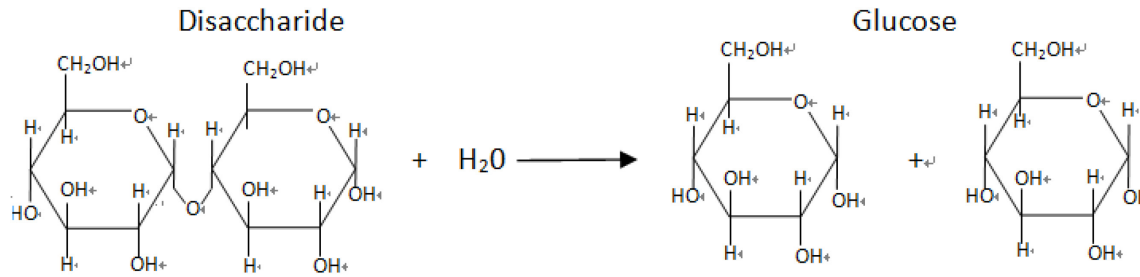

Hydrolysis of Fat:

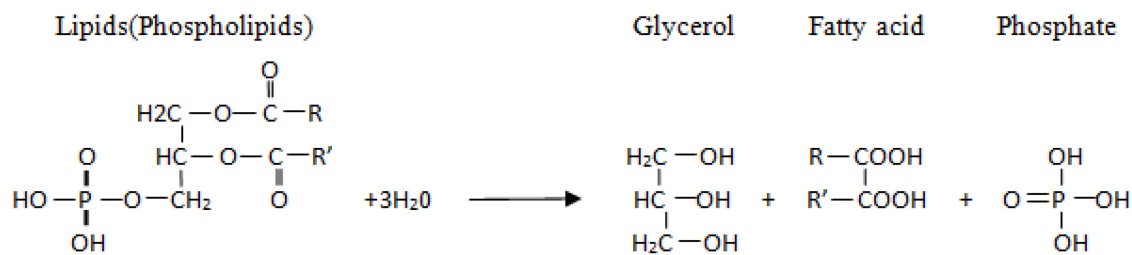

Figure 2-3: Hydrolysis Reaction of different raw material<sup>30</sup>

Hydrolysis is the first step during the whole anaerobic digestion and reported to be the rate-limiting step during anaerobic digestion of complex organic matter.

### 2.3.1.2 Acidogenic Phase

Hydrolysis is immediately followed by the acid-forming phase which was called acidogenesis. In this step further breakdown of these smaller molecules occurs. It can convert into fatty acids and alcohol, and new cell material. Acidogenic bacteria convert dissolvable monomer and dimer produced in hydrolysis into simple organic compounds, mostly short chain (volatile) acids (such as formic, lactic, butyric etc.), ketones (e.g. ethanol, methanol, glycerol, acetone) and alcohols. According Table 2-3, the changes of standard Gibbs free energy of acidogens and glucose taken as fermentation substrate, it can be deduced that all reactions can proceed spontaneously because all  $\Delta G^0 < 0$ .

The specific concentrations and spectrum of products formed in this step vary with the type of bacteria as well as with culture conditions, such as pH and temperature, ORP, OLR, etc. Due to the effects of these ecological factors, three fermentation types have been reported according literature: butyric acid type fermentation, propionic acid type fermentation, ethanol type fermentation. The typical end-products of butyric type fermentation are butyric acid, acetic acid and hydrogen/carbon dioxide; for the propionic type fermentation the typical products are propionic acid, acetic acid and carbon dioxide while very few

hydrogen produced; the ethanol type fermentation will produce ethanol, acetic acid, hydrogen/carbon dioxide and some butyric acid. Because acetic acid pathway cannot reduce NADH to NAD<sup>+</sup>, normally acetic fermentation will couple with other fermentation type.

pH = 7, T = 298.15K		$\Delta G^{\theta}$ (kJ/mol)
$C_6H_{12}O_6 + 4H_2O + 2NAD^+ \longrightarrow 2CH_3COO^- + 2HCO_3^- + 2NADH + 2H_2 + 6H^+$		-215.67
$C_6H_{12}O_6 + 2NADH \longrightarrow 2CH_3CH_2COO^- + 2H_2O + 2NAD^+$		-357.87
$C_6H_{12}O_6 + 2H_2O \longrightarrow 2CH_3CH_2CH_2COO^- + 2HCO_3^- + 2H_2 + 3H^+$		-261.46
$C_6H_{12}O_6 + 2H_2O + 2NADH \longrightarrow 2CH_3CH_2OH + 2HCO_3^- + 2NAD^+ + 2H_2$		-234.83
$C_6H_{12}O_6 \longrightarrow 2CH_3CHOHCOO^- + 2H^+$		-217.7

Table 2-3: changes of standard Gibbs free energy of acidogens and glucose as substrate.<sup>31</sup>

### 2.3.1.3 Acetogenic Phase

The next step is Acetogenesis in which the organic acids with more than two carbon (except acetic acid) and ethanol from the acidogenesis are used for the production of acetates, carbon dioxide and hydrogen. It is often considered with acidogenesis to be part of a single acid forming stage. Table 2-4 gives the changes of standard Gibbs free energy in acetogenesis, here we suppose water is pure liquid and the concentrations of all compounds in solution are 1.0mol/kg.

(pH=7, T=298.15K)		$\Delta G^{\theta}$ (kJ/mol)
$CH_3CH_2OH + H_2O$	$\longrightarrow$	$CH_3COO^- + H^+ + 2H_2$ +9.6
$CH_3CH_2COO^- + 3H_2O$	$\longrightarrow$	$CH_3COO^- + HCO_3^- + H^+ + 3H_2$ +76.1
$CH_3CH_2CH_2COO^- + 2H_2O$	$\longrightarrow$	$2CH_3COO^- + H^+ + 2H_2$ +48.1
$CH_3CHOHCOO^- + 2H_2O$	$\longrightarrow$	$CH_3COO^- + HCO_3^- + H^+ + 2H_2$ -4.2

Table 2-4: Changes of standard Gibbs free energy in Acetogenesis<sup>32</sup>

According the  $\Delta G^{\theta}$  showed in above, under standard condition the acetogenesis by ethanol, butyric acid and propionic acid cannot proceed spontaneously. While lower the hydrogen partial pressure ( $p_{H_2}$ ) will favor these conversions. The role of hydrogen as an intermediary is of critical importance to Anaerobic Digestion reactions. Under standard conditions, the presence of hydrogen in the solution inhibits oxidation. The reaction only proceeds if the hydrogen partial pressure is low enough ( $p_{H_2} < 9 \text{ Pa } 9 \cdot 10^{-5}$

bar)<sup>33</sup> to thermodynamically allow the conversion. The presence of hydrogen scavenging bacteria HCBs that consume hydrogen, thus lowering the partial pressure, is necessary to ensure thermodynamic feasibility and thus the conversion of all the acids. As a result, the concentration of hydrogen, measured by partial pressure, is an indicator of the health of a digester (Mata-Alvarez, 2003). And as reported the sequence of the conversion organic acids into acetic acid are: ethanol > lactic acid > butyric acid > propionic acid. Propionic acids cannot be utilized directly by methanogens and most difficult to convert into acetic acid, so they should be avoided in the products spectrum of acidogenesis. Otherwise these propionic acids will accumulate and cause the drop of pH in the digester. Because lactic acid has high potential to convert into propionic acid, they also should be avoided as possible as we can.

## 2.4 Methanation Phase

The methane forming bacteria, known as methanogens, are the same fastidious bacteria that occur naturally in deep sediments or in the rumen of herbivores. Methanogens can produce methane from a limited number of substrates in anaerobic digesters. Methane production occurs through two major routes: the splitting of acetate and use of carbon dioxide and hydrogen. Methanogenic substrates include acetate, methanol, dihydrogen/carbon dioxide, formate, methanol, carbon monoxide, methylamines, methyl mercaptans, and reduced metals as described in Table 2-5.

Hydrogen:	$4\text{H}_2 + \text{CO}_2$	$\longrightarrow$	$\text{CH}_4 + 2\text{H}_2\text{O}$
Acetate:	$\text{CH}_3\text{COOH}$	$\longrightarrow$	$\text{CH}_4 + \text{CO}_2$
Formate:	$4\text{HCOOH}$	$\longrightarrow$	$\text{CH}_4 + 3\text{CO}_2 + 2\text{H}_2\text{O}$
Methanol:	$4\text{CH}_3\text{OH}$	$\longrightarrow$	$3\text{CH}_4 + \text{CO}_2 + 2\text{H}_2\text{O}$
Ethonal:	$2 \text{CH}_3\text{CH}_3\text{OH} + \text{CO}_2$	$\longleftrightarrow$	$2\text{CH}_3\text{COOH} + \text{CH}_4$
Carbon monoxide:	$4\text{CO} + 2\text{H}_2\text{O}$	$\longrightarrow$	$\text{CH}_4 + 3\text{H}_2\text{CO}_3$
Trimethylamine:	$4(\text{CH}_3)_3\text{N} + 6\text{H}_2\text{O}$	$\longrightarrow$	$9\text{CH}_4 + 3\text{CO}_2 + 4\text{NH}_3$
Dimethylamine:	$2(\text{CH}_3)_2\text{NH} + 2\text{H}_2\text{O}$	$\longrightarrow$	$3\text{CH}_4 + \text{CO}_2 + 2\text{NH}_3$
Monomethylamine:	$4(\text{CH}_3)\text{NH}_2 + 2\text{H}_2\text{O}$	$\longrightarrow$	$3\text{CH}_4 + \text{CO}_2 + 4\text{NH}_3$
Methyl mercaptans:	$2(\text{CH}_3)_2\text{S} + 3\text{H}_2\text{O}$	$\longrightarrow$	$3\text{CH}_4 + \text{CO}_2 + \text{H}_2\text{S}$
Metals:	$4\text{Me}^0 + 8\text{H}^+ + \text{CO}_2$	$\longrightarrow$	$4\text{Me}^{++} + \text{CH}_4 + 2\text{H}_2\text{O}$

Table 2-5: Principal Methanogenic reactions (Chynoweth 1995)

Methanogens are very sensitive to change and prefer a neutral to slightly alkaline environment (Gas Technology 2003). If the pH is allowed to fall below 6, methanogenetic bacteria cannot survive.

Methanogenesis is the rate-controlling portion of the process because methanogens have a much slower growth rate than acidogens.

## 2.5 Microbes in dark fermentation

The process employs mixed microbial cultures readily available in the nature, such as compost, anaerobic digester sludge, soil etc. to convert organic wastes into VFAs, hydrogen, carbon dioxide. A sustained balanced fermentation requires the concerted activities of these organisms for the oxidation of substrates and removal of inhibitory acids, electrons, and hydrogen.

### 2.5.1 Hydrogenase

Hydrogenase is an enzyme that catalyzes the interconversion of H<sub>2</sub> into protons and electrons in bacteria, archaea, and eukaryotes, as shown in below:

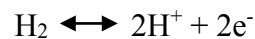

Hydrogen uptake is coupled to the reduction of electron acceptors such as oxygen, nitrate, carbon dioxide, and fumarate. On the other hand, proton (H<sup>+</sup>) is coupled to the oxidation of electrons donors like ferredoxin (FNR), and serves to dispose excess in cells (essential in pyruvate fermentation).<sup>34</sup>

Hydrogenases are classified as one of the following three types based on metal atoms of their active site, namely [NiFe]-hydrogenase, [FeFe]-hydrogenase, and [Fe]-hydrogenase.

Hydrogenase and nitrogenase are the two important enzymes involved in the BioH<sub>2</sub> production process by catalyzing the reversible reduction of H<sup>+</sup> to H<sub>2</sub>. Both enzymes contain the complex metal clusters at their active site with diverse subunits. Hydrogenases can catalyze the reduction of protons to H<sub>2</sub> by oxidizing a suitable strong reductant with redox potential near -420mV, while NADPH is too positive to serve as a direct reductant of hydrogenase.

### 2.5.2 Microbes in Acidogenic phase for hydrogen production

A wide variety of heterotrophic bacteria can produce hydrogen during dark fermentation process. Hydrogen producers associated with this process are popularly known as dark fermentation microorganisms. These microorganisms can be classified based on their sensitivity and temperature requirement. The microorganisms which are strictly sensitive to O<sub>2</sub> are called obligate anaerobes (e.g. clostridia, methylotrophs, methanogenic bacteria, and rumen bacteria); the microorganisms which can

sustain both anaerobic and aerobic environments are named as facultative anaerobes (e.g., *Escherichia coli*, *Enterobacter*, and *Citrobacter*). In the mixed-culture environment, these microbes may coexist and their abundance is governed by the relative competitiveness for the available substrates and environmental conditions. Further, based on the different temperature requirements, they can be classified as psychrophiles (10-25degree), mesophiles (30-45degree), thermophiles(50-60degree) and hyperthermophiles (70-80degree). An enriched culture of hydrogen producing bacteria such as *Clostridia* can be obtained by heat treatment, pH control, chemical control and HRT control of the treatment system.

### 2.5.3 Methanogens

Methanogens belong to the Archaea and is one of the oldest living organisms in the world. Biogas production from methanogens exists before 3.5billion years (Widmann 2000). The family of Methanogen includes three methanobacteriaceae genera which are *Methanobacterium*, *Methanosaracina* and *Methanococcs* of nine species (Bryant 1974). Then in 1979 due to RNA base sequence the methanogens are separated into three orders, four families, seven genera and 17species.

A number of techniques have been developed to study methanogenesis. Initially, anaerobic culturing techniques using roll tubes (Hungate 1967) and anaerobic chambers (Balch et al. 1979) facilitated isolation and culture of methanogens and associated anaerobes. Most probable number (MPN) techniques have been used extensively to estimate physiological groups (Zhang and Noike 1994; Ahring 1995). Methanogens have unique coenzymes for electron transfer, CoM and F<sub>420</sub> (Zinder 1993). The fluorescence property of F<sub>420</sub> has been used to locate methanogenic colonies and enumerate methanogens in mixed culture (Peck and Archer 1989; Peck and Chynoweth 1992). Certain of these traditional enumeration techniques have been used to estimate variations in populations of organisms in digesters during start-up and two stage operation (Anderson et al. 1994) and as a function of hydraulic retention time (Zhang and Noike 1994).

## 2.6 Inocula

Successful operation of anaerobic digesters depends on a sufficient population of specific microbial community. Although the fermentation bacteria are readily available in nature, it takes them a long time to multiply into an efficient treatment producing population. In order to reduce the time it takes for these bacteria to become established in the new digester, it is recommended that the active material/inocula to aid start-up phase used as the seed for the digester.

In a typical AD process hydrogen is not detected normally due to immediately consumed by hydrogen consuming microorganisms. The current research has showed that the sequencing production of  $H_2 + CH_4$  instead of sole  $CH_4$  is possible through inactivating hydrogen consuming bacteria and adjusting the process operation parameters. Various inoculums pretreatment methods have been found that they are effective for the inactivating of  $H_2$  consuming bacterial.

### **2.6.1 Pure culture for hydrogen production**

Till today, a lot of microorganisms have been proved for hydrogen production via dark fermentation. While the optimum living conditions, hydrogen production efficiency etc. have big differences during these HPB. Thus, how to find, select, cultivation and inoculation high hydrogen producing bacteria are the main aims for most researches in the past years. And lots of high hydrogen yield bacteria have been isolated.

Even pure culture hydrogen production has achieved great progress in the lab scale; there is slight chance to implement in industry scale because of rigor cultivation conditions and poor ability to adapt the new system environment.

### **2.6.2 Co-mixed culture for hydrogen production**

Compared to pure HPB, co-mixed culture is preferred for hydrogen production and received more and more interests in these years. The cultivation conditions for mixed culture HPB are much easier than pure culture and wide range of substrates, strong ability to adapt the new situation or sustain the intense changes of system environment. Furthermore, due to cooperation of mixed culturing bacteria the  $H_2$  producing ability especially for complex organic compound is normally higher than pure culturing bacteria.<sup>35</sup>

However, the produced hydrogen can be consumed through the interspecies hydrogen transfer. It should be eliminated by inhibiting or preventing the growth of HCB through pretreatment.

### **2.6.3 Co-mixed culture for methane production**

Animal manure and old digestate from other fermenters were chosen for the methanogenic treatment of organic acid rich and low solid content hydrolysate.



Methanogenic microorganisms have a long regeneration time in general (Table 2-6). So long time startup phase up to 3 months and certain amount of inoculating material are required.

<b>Anaerobic Microorganism</b>	<b>Time of Regeneration</b>
<b>Acidogenic Bacteria</b>	
<b>Bacterioids</b>	<24h
<b>Clostridia</b>	24-36h
<b>Acetogenic Bacteria</b>	80-90h
<b>Methanogenic Bacteria</b>	
<b>Methanosarina barkeri</b>	5-16d
<b>Methanococcus</b>	Ca.10d

Table 2-6: Time of regeneration of different anaerobic microorganisms

## 2.7 Limiting factors effecting on Hydrogen and Methane Production

The complete process of anaerobic digestion requires a complex interaction of several varieties of bacteria that must be in equilibrium in order for the digester to remain stable. Changes in environmental conditions can disturb the equilibrium and result in the buildup of intermediaries that may inhibit the overall process or shut it down altogether. Process engineering and optimization of operational factors govern the performance of any biological system and also have a considerable influence on fermentative H<sub>2</sub> production.

The most important factors affecting the rate of digestion and biogas production are temperature, pH, OLR, HRT, nutrient concentrations, reactor design and operation regime. All factors must be considered in the design and operation of an anaerobic process for the successful treatment of the organic wastes.

### 2.7.1 Temperature

Temperature has a major influence on the effectiveness of biological systems, affecting the metabolic rate, ionization equilibrium, solubility of substrates and fats, and bioavailability of iron (Speece 1996). Biological methanogenesis has been reported at temperatures ranging from 2°C (in marine sediments) to over 100°C (in geothermal areas) (Zinder 1993) and anaerobic microorganisms will function effectively normally over two temperature ranges, the mesophilic range (29 to 38°C) and the thermophilic range (49

to 58°C) (Eckenfelder 1989; Speece 1989). Bacteria in thermophilic digesters exhibit some differences compared to those in mesophilic digesters. For example, at thermophilic temperatures, acetate is oxidized by a two-step mechanism (syntrophic acetate oxidation to hydrogen and carbon dioxide followed by formation of methane) and at higher concentrations and in mesophilic digesters, the principal acetoclastic mechanism is direct conversion of the methyl group to methane. Anaerobic digestion is a function of temperature, where the rate of decomposition increases as temperature increase until the optimum growth temperature is reached. At temperatures above and below the optimum growth temperature, metabolic activity decreases, resulting in a decrease in reactor kinetics.

In general, the overall process kinetics doubles for every 10 degrees increase in operating temperature (O'Rourke 1968) up to some critical temperature (about 60°C) above which a rapid drop off in microbial activity occurs (Harmon et al. 1993). Also, ammonia is more toxic in thermophilic digesters due to a higher proportion of free ammonia.

Temperature is one of the most important non-biotic limiting factors. It has not only influence on the metabolism of organisms but also on the acidification efficiency (Breure, 1991). Temperature has big influence on the physio-metabolism especially when the temperature changes continually. Ren, Nanqi found that the hydrogen production rate by HPB is very sensitive with calfective and psytic changing. For example, when the temperature start increasing while the hydrogen producing rate decreased first and when the temperature keep constant the hydrogen producing rate will fall out to stabilization value after some time. <sup>36</sup>

### **2.7.2 pH**

The pH value within the reactor is a pivotal factor in the AD process and greatly affects the rate of hydrogen + methane production and the overall success of the anaerobic digestion process. A stable pH indicates system equilibrium and digester stability. Research has shown that AD process have different optimal pH values in different stages. The range of acceptable pH for the bacteria participating in digestion is varied from 3.5 to 8.5. PH value during the acidification phase can lower below 5 what is lethal for the methanogens and will cause decrease of methanogens populations. Most methanogens function in a pH range between 6.7 and 8.0, and with an optimum near pH 7.5 (Eckenfelder 1989; Speece 1989). At pH levels above 8.2 and below 6.5, unacclimated microorganisms begin to die as microbial

growth is inhibited and conditions become toxic to the existing population. Therefore, attention to pH is essential for the successful operation of anaerobic systems.

The measured pH value is the function of volatile fatty acid (VFA) concentration, bicarbonate concentration and alkalinity of the systems as well as the CO<sub>2</sub> in the gas phase. The pH was used as a key measure of stability for the reactors, due to the ease with which it could be monitored, and as discovered by Cunfang Liu<sup>37</sup> in 2007, the maximum energy recovery of organic waste can be obtained by using optimization control of pH.

pH can affect the physiological activity of microorganism. So it is one of the most important non-biological factors which influence the fermentative process, e.g. causing the charge changing in cell membrane therefore influence the nutrient absorption by acidogens; influencing activity of enzymes, etc. Each acidogen has its own living pH range, and normally also one optimum pH. Out of this pH range will cause loss of biological activity. Additionally the same acidogens while with different pH living conditions will cause different fermentation type because different pH cause changes of propagation rate and metabolism pathway. Table 2-7 gives the ecological amplitude of 8 predominant acidogens in different fermentation types.

Many researchers, Horiuchi et al.<sup>38</sup>, H.-Q. Yu, etc. have studied the dynamic behavior of the anaerobic hydrolysis reactor in response to pH changes performed by a continuous cultivation. By stepwise shifting the culture pH in the acid reactor from 4.0 to 8.0, the main products were changed from ethanol to butyric acids, acetic and propionic acids. They had found that the yield of each organic acid was depended on the pH of the medium. Ethanol will be the main end-product when the pH is regulated from 5 to 4. Butyric acid and acetic acid were predominantly produced at ca. pH=6; while, acetic acid and propionic acid were predominantly produced at pH 5 if ORP is higher than 0mv. Then with the decreasing ORP butyric acid and acetic acid become the predominant end-products. They had attributed the differences in yields to the different types of dominant microbial populations present in the medium, which were active only at certain range of pH. The control of culture pH was considered to be a useful way for controlling the product spectrum in the anaerobic acid reactor. This phenomenon was reproducible, reversible and was not affected by the dilution rate.

Fermentation Type	Acidogen	Character	pH 3.0	pH 5.0	pH 7.0	pH 9.0	Max. pH	Opt. pH	Min. pH
<b>Propionic F</b>	Propioni-bacterium	facultative	0	++	3+	+	9.0	5.0-7.0	5.0
	Veillonella	strict	0	++	3+	+	9.0	6.0-8.0	5.0
	Aeromonas	facultative	0	+	3+	+	9.0	6.0-7.0	5.0
<b>Ethanol F</b>	Zymomonas	facultative	+	++	3+	+	9.0	4.5-7.0	3.0
	Aerobacter	strict	+	++	3+	+	9.0	6.0-7.0	3.0
	Bacteroides	strict	+	++	3+	+	9.0	5.0-7.0	3.0
	Fuso-bacterium	strict	+	++	3+	0	9.0	5.0-8.0	3.0
<b>Butyric F</b>	Fuso-bacterium	strict	0	++	3+	+	9.0	5.0-7.0	5.0

Table 2-7: Ecological amplitude testing of Acidogens<sup>39</sup>

Construction of quadratic models<sup>40</sup> indicates that at HRT 15-20h and pH 5.0-5.6 offered a high hydrogen production.

### 2.7.3 HRT

As with all biological systems, the microorganisms require a certain amount of time to digest the organic matter and to achieve the desired level of treatment. The HRT is defined as the amount of time that the waste will be retained in the reactor to be digested and is defined by the volume of the reactor divided by the daily influent flow rate. It can be calculated using the following equation:

$$\text{Retention time (days)} = \text{Operating volume } V(\text{m}^3) / \text{Flow rate } Q(\text{m}^3/\text{day})$$

Retention time can affect the microbial communities in the digester. The different microbial communities existing in the digester operates on different retention time. The required HRT will depend primarily on the rate of digestion, which is dependent upon the waste characteristics, the operating temperature, the availability of microorganisms, the species in the bacterial population, the reactor design and the level of treatment required, and so on. Control of the HRT is one of important measure in our systems in order to

prevent slowing-growing methanogenic microorganisms while proliferate acidogens in the digester. The microbial populations which have bigger growth rate than the dilution rate (1/HRT) can stay in the reactor.

#### 2.7.4 OLR

The organics that may be treated efficiently and effectively in an anaerobic system will depend primarily on the biomass concentration in the reactor and characteristics of the wastes in addition to the system design parameters (i.e., reactor volume and HRT) (Evans 2001). Typically the chemical oxygen demand (COD) is used to measure the content of organic matter in wastewater while organic total solid (oTS) is more often used for food waste and thus the OLR for biological systems is stated in terms of COD/oTS per reactor volume per unit (e.g. kg COD/ m<sup>3</sup>.day or oTS/m<sup>3</sup>.day ) as necessary. Anaerobic systems with a higher OLR depend on large bacterial populations to achieve rapid treatment and can generate enough methane to be self-sufficient (producing enough energy to operate the system). Generally, anaerobic reactors can sustain much higher OLRs than aerobic systems since they are not limited by the lack of oxygen in the system or the oxygen transfer rate.

The loading rate was at the point in favor of the acidogenesis avoiding the CH<sub>4</sub> production and maximizing of H<sub>2</sub> production. The organic loading rate can be calculated by using the following equation:

$$\text{Loading rate } \left( \frac{\text{mg COD}}{\text{m}^3 \cdot \text{day}} \right) = \frac{\text{Organic mater } \left( \frac{\text{mg COD}}{\text{m}^3} \right) * \text{Flow rate } \left( \frac{\text{m}^3}{\text{day}} \right)}{\text{Operating volume } (\text{m}^3)}$$

#### 2.7.5 Hydrogen partial pressure

In dark fermentation glucose will be firstly catabolized into pyruvate, and produce ATP from ADP and reduced NADH via EMP. Pyruvate is then further oxidized into acetyl-CoA, H<sub>2</sub> and CO<sub>2</sub> by *C. butyricum* etc. fermentative microbes. Moreover, pyruvate can also be catabolized into acetyl-CoA and formate which may be readily degraded into H<sub>2</sub> and CO<sub>2</sub> by microbes such as *Escherichia coli*. In the end acetyl-CoA can be finally converted into acetate, propionate, butyrate and ethanol depending on different environmental conditions. And the rest NADH will be oxidized into NAD and release H<sub>2</sub>.

While, in generally a biological reaction is to take place, the reaction must be exergonic; i.e., the free energy must be negative. The hydrogen concentration should be thus well balanced. The hydrogen partial

pressure must be so low that acetogenic bacteria are not surrounded by too much hydrogen and consequently stop the acetogenesis for hydrogen production. The max. acceptable hydrogen partial pressure depends on the species of bacteria and also on the substrates. The following figure shows the influence of hydrogen partial pressure on the energy release during acetogenesis.

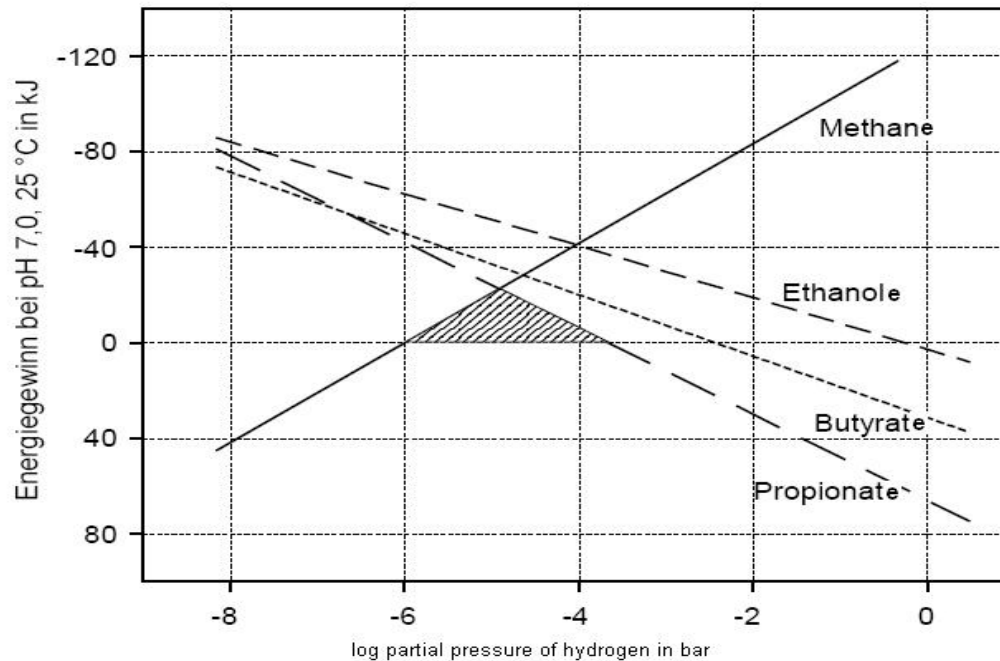

Figure 2-4: The influence of hydrogen partial pressure on the energy release during acetogenesis

Several factors have been shown to affect the H<sub>2</sub> yield and rate of production in dark fermentation, while p<sub>H<sub>2</sub></sub> (Hydrogen partial pressure) is a key factor for the continuously hydrogen production. Hydrogen production pathways are very readily affected by hydrogen partial pressure and inhibited by end products. When the p<sub>H<sub>2</sub></sub> increased, the produced H<sub>2</sub> yield decreased with metabolic pathway shifted to reduced state products.

Sparging the inert gas can remove the CO<sub>2</sub> and decrease the hydrogen partial pressure, thus decrease the competition for NADH and hydrogen production will be increased as reported.

### 2.7.6 Nutrients

Bacteria require a sufficient concentration of nutrients to achieve optimum growth. Nitrogen and phosphorus are the major nutrients required for anaerobic digestion. These elements are building blocks for cell synthesis and their requirements are directly related to the microbial growth in anaerobic digesters.

An average empirical formula for an anaerobic bacterium is  $C_5H_7O_2NP_{0.06}$  (Speece 1987a). Thus the nitrogen and phosphorus requirements for cell growth are 12% and 2%, respectively, of the volatile solids converted to cell biomass (about 10% of the total volatile solids converted); this would be equivalent to 1.2% and 0.02% of the biodegradable volatile solids, respectively, for nitrogen and phosphorus.

Previous studies have identified critical feedstock C/N ratios of 15 for seaweed (Chynoweth et al. 1987) and 25 for the organic fraction of MSW (Kayhanian and Hardy 1994) above which nitrogen was limiting. In fact, nutrient limitations are better related to concentrations; e.g., a value of 700 mg/L was recently reported for the optimum  $NH_3-N$  concentration in high solids anaerobic digestion of MSW (Kayhanian 1994). Nutrients may also be concentrated by certain design and operating practices. For example, designs that concentrate solids (Chynoweth et al. 1987) or reuse supernatant or leachate from process effluent (Chen et al. 1990; Chynoweth et al. 1992; O'Keefe et al. 1993) concentrate nutrients extracted from the feedstock. Ammonia is also an important contributor to the buffering capacity in digesters (WPCF 1987) and may also be toxic to the process (Table 2-9). In high solids digesters, ammonia toxicity was exhibited from feeds that had normal C/N ratios because ammonia was concentrated in the supernatant as digestion proceeds (Jewell et al. 1993; Kayhanian and Hardy 1994).

Other nutrients needed in intermediate concentrations, include sodium, potassium, calcium, magnesium, chlorine, and sulfur. Requirements for several micronutrients have been identified, including iron, copper, manganese, zinc, molybdenum, nickel, and vanadium (Speece 1987a). Available forms of these nutrients may be limiting because of their ease of precipitation and removal by reactions with phosphate and sulfide. Limitations of these micronutrients have been demonstrated in reactors where the analytical procedures failed to distinguish between available and sequestered forms (Jewell et al. 1993).

The addition of trace elements to the anaerobic digestion has positive effect on the anaerobic process to enable certain functions in the cell, while it will have negative effects when their concentrations exceed the range that the cell require. The following table 2-8 shows the main functions of main essential trace elements:

<b>Micro-nutrients</b>	<b>Functions</b>
Chromium Cr	Required by mammals for glucose, metabolism, no known microbial requirement
Cobalt Co	Vitamin B <sub>12</sub> ; transcarboxylase (propionic acid bacteria)
Copper Cu	Respiration; Cytochrome c oxidase; photosynthesis, plastocyanin, some superoxide dismutases
Manganese Mn	Activator of many enzymes; present in certain superoxide dismutases and in the water-splitting enzyme in oxygenic phototrophs (Photosystem 2)
Molybdenum Mo	Certain flavin-containing enzymes; nitrogenase, nitrate reductase, sulfite oxidase, DMSO-TMAO reductases, some formate dehydrogenases
Nickel Ni	Most hydrogenases; coenzyme F <sub>430</sub> of methanogens; carbon monoxide dehydrogenase; urease
Selenium Se	Formate dehydrogenase; some hydrogenases; the amino acid selenocysteine
Tungsten W	Some formate dehydrogenases; oxotransferases of hyperthermophiles
Vanadium V	Vanadium nitrogenase; bromoperoxidase
Zinc Zn	Carbonic anhydrase; alcohol dehydrogenase; RNA and DNA polymerases; and many DNA-binding proteins
Iron Fe	Cytochromes; catalases; peroxidases; iron-sulfur proteins; oxygenases; all nitrogenases

Table 2-8: Micro-nutrients and Functions<sup>41</sup>

### 2.7.7 Ammonia

Ammonia is produced as a by-product of anaerobic digestion, principally from the mineralisation of organic nitrogen during the deamination of proteins and amino acids. Nitrogen is an important nutrient for cell growth, so some ammonium uptake by cells can be expected. However, excess nitrogen can result in accumulation of ammonium in the bioreactor. The ammonium is in equilibrium with its unionized base, ammonia. Ammonium can be tolerated up to 1500mg/l however free ammonia up to 80mg/l can cause inhibition of the anaerobic digestion process. Table 2-9 gives the Effect of Ammonia Nitrogen on



Anaerobic Digestion; while with the adaptation of bacterial the tolerance in industrial can be increased up to 4500mg/l as investigated in BKE Berlin food waste biogas plant.

Ammonia concentration, $\text{NH}_4^+\text{-N}$ , mg/L	Effect
50-200	beneficial
200-1500	no adverse effects
1500-3000	inhibitory at pH over 7.4
Above 3000	toxic

Table 2-9: Effect of Ammonia Nitrogen on Anaerobic Digestion (WPCF 1987)

### 2.7.8 Specific surface of material

To support a biochemical reaction a material surface as big as possible is necessary. Most anaerobic digestion systems employ some type of pretreatment to enhance materials handling and microbial conversion. Figure 2-5 clearly demonstrates the advantage of comminution for biogas production. The degradation process is accelerated in the first few days as a result of the size reduction and biogas yield for the whole time of digestion is higher. While, the influence of comminution on easily degradable materials is not so much as difficult degradable materials especially like cellulose and lignin, etc and as shown in Figure 2-5

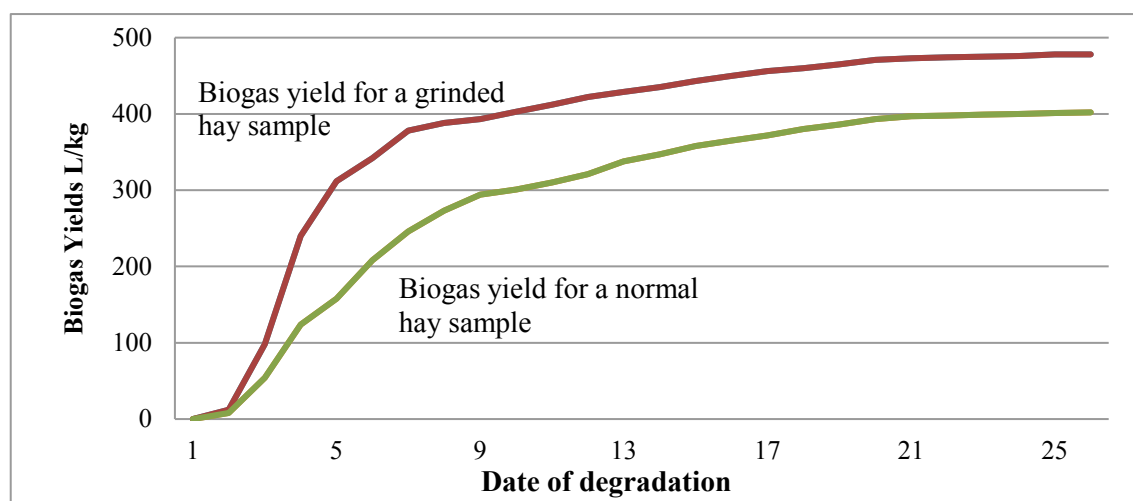

Figure 2-5: Biogas yields from hay with and without grinded<sup>42</sup>

Other pretreatment processes involving heat, silage, chemical, irradiation, and enzymatic operations have been studied for their ability to enhance extent and rate of conversion (Tsao 1987). In general, most methods substantially improve the rate and to a limited extent the efficiency of conversion but the benefits do not justify the added cost to the conversion system.

### **2.7.9 Oxidation Reduction Potential -- ORP**

Oxidation reduction potential (ORP) is a relative measure of the oxidizing or reducing capacity of the growth medium in aqueous environments and has been used on a limited basis as a performance parameter for anaerobic digestion (Dirasian et al. 1963; Gupta et al. 1994). ORP monitoring is normally accomplished by using a platinum measuring electrode. The process exposed to the platinum electrode produces a chemical reaction with the platinum and oxidizes or reduces the platinum band. This process generates a millivolt (mV) signal which is normally of the magnitude of  $\pm 2,000$  mV.

In the acidogenic reactor there are many redox-couple matter, such as acetic acid/aldehyde, aldehyde/ethanol,  $\text{CO}_2$ /formic acid, and  $\text{H}^+/\text{H}_2$ , etc. A lot of experiment showed that ORP was also one of important limiting factor in acidogenesis. The optimum ORP for ethanol and butyric acid fermentation is  $-400$  --  $-200$  mV while for the propionic acid fermentation the optimum is  $-250$  --  $+100$  mV. Although favorable Eh (ORP) amplitude maybe superimposed in different fermentation type, combination the pH and ORP can help determine the fermentation type frequently.

### **2.7.10 Salt concentration on Hydrogen and Methane production**

Organic wastes especially food wastes contain high content of inorganic salt like  $\text{Na}^+$ ,  $\text{K}^+$ ,  $\text{Cl}^-$ ,  $\text{SO}_4^{2-}$  etc. especially in Asia due to food culture. Sodium can build a Na-K-ATP enzyme pump to transfer nutrient substrates such as glucose to the intracellular region to improve the bio-reaction. So low salt concentration can promote the growth of microorganism; while high salt concentration especially the rapid increasing salt concentration can inhibit the biological process by dehydrate bacterial cells due to osmotic pressure. It will decrease the microbial metabolic activity, and even cause microbial death. Only halophilic bacteria and acclimated microorganisms can survive in solution with high salt concentration. Salt cannot be degraded by anaerobic fermentation. Due to high TS content of food wastes, process water are usually recycled for supply essential nutrients for microbes, buffering capacity to avoid pH dramatically variation and used to dilute the substrates instead of fresh water which can decrease fresh demand and wastewater discharge.

As a result, NaCl will be accumulated and its concentration will gradually increase for certain time until its maximum level and this can inactivate the Hydrogen-Producing Bacteria and Methane-Producing Bacteria. However, after the suitable adaptation of sludge, it seems that the critical value of salt inhibition can be increased.

### 3 Material and Methodology

Food waste, with higher fat, salt and water content was chosen as investigated substrates after waste adjustment in this study due to its high organic content and thus serious pollution problem resulted by these organics.

Two-step dark fermentation process gives the possibility for environmental pollution and energy recovery. Meanwhile, production of H<sub>2</sub> in acid forming phase can enhance energy recovery efficiency greatly as reported. The H<sub>2</sub> productivity is affected by many limiting factors. In order to optimize the BioH<sub>2</sub> production in acid producing phase, the following methodology will be employed in this study.

#### 3.1 Feedstock material

The feedstock used in this thesis is food waste collected from BTU student dormitory in batch assays includes rice, flour products like noodles, bread etc., potato, orange, apple, carrot, meat and others, while the feedstock used in continuously scale fermentation was the food waste collected by Schraden Biogas GmbH in Gröden which mainly consist food residues from restaurants. The composition of the food waste maybe varied depending on various factors like season, holidays and collection frequency etc.

Food waste consists of highly amount of monosaccharide, protein, fat/oil, cellulose and semi-cellulose which are with high potential of H<sub>2</sub> production. While, the main problem for the food waste substrate of H<sub>2</sub> production is its variable components and specific bio-chemical characteristics of these components. Different component has different optimal digestion key factors and H<sub>2</sub> production potential.

#### Food waste in China and its characteristics

The composition of food waste is variable depending on the time of the year, cultural habits, regions etc. Mostly Chinese food waste has the following features:

- High water content and varying from 70%-90%;
- High fat/oil content up to 6.5%;
- Easier degraded via dark fermentation;
- High salt content up to 1.5%;

- High impurities content which has caused many unexpected problems in concrete project.

The following experiments design is mostly based on the above mentioned features of Chinese food waste.

## **3.2 Batch System via Eudiometer**

### **3.2.1 Inocula/seed sludge for biohydrogen production**

Inocula are also known as seed sludge. It is the living microbial cells inoculated in the culture-medium or other ground-substance. Fermentation process requires the participation of microbial. Long regeneration time of anaerobes (described in Table 2-6) requires certain number and quality of microbial by prior trained with purpose for successful fermentation process. Inocula with high quality can speed up the startup phase of microbial activity.

Some pure strains of acidogenic bacteria, including *Enterbacter*, *Bacillus* and *Clostridium*, have been reported to generate hydrogen via dark fermentation process<sup>43</sup>. However, the components of food wastes are so complicated to keep sterile conditions for single strain organisms and pure culture anaerobes are easily contaminated in the practice and high operation cost by using aseptic techniques. So mixed culture of natural anaerobes have been chosen as the inocula for this study even the pure culture anaerobes like *Clostridium* have been got the higher hydrogen production in the lab research as reported. Furthermore, the optimum substrates for various HPB are not the same generally, and the synergies between HPB maybe lead higher hydrogen yield. And this has been confirmed by some past researches, thus the mixed liquid manure after incubation was used as seed sludge in this study.

#### **Seed sludge incubation:**

The seed sludge used in Batch Experiments was the liquid manure which was incubated at 37°C, 55°C and 70°C with periodically food wastes adding in and until gas production was detectable. The incubated sludge was then treated by various pretreatment methods to inhibit the activity of HCB. The main characteristics of used sludge were presented in the following table 3-1 and more related data is listed in Appendix 3-1:

Inoculum	Total Solid %	VS %	TOC g/kg Ts	TN g/kg Ts
Mixed inocula (Batch Test)	1.95-2.72%	83-89%	488.5	22.69

Table 3-1: Inocula characteristics

### 3.2.2 Investigated Feedstock in Batch Test

Various biogenic raw and waste materials can be used as the carbon source for fermentative hydrogen production like energy plants, industrial wastes, and organic food wastes. Food wastes generation increased in the past years with the economic development and accounted for 20-35% of municipal solid waste in China. Due to high organic part and moisture, they had caused serious problems when consolidated with other MSW during collection, transportation, and treatment. The main components of food wastes like rice, flour, potato, orange, apple, carrot, meat and mixed food waste were investigated to test their fermentative hydrogen production potential via batch test in this study.

Food wastes, collected from BTU student dormitory, were used as substrates after sample adjustment. The composition of the food waste was prepared by mixing meat, vegetables, fruits, rice and noodles, and food waste sludge which included oil, fat and small pieces of different food residue which are difficult to identify. This simulated food waste adequately represents a real food wastes collected from restaurants.<sup>44</sup>

Following Table 3-2 shows the mean parameters of the substrates:

<b>Substrates</b>	<b>Ts%</b>	<b>oTS%</b>
<b>Staple/main</b>		
Rice	33.48%	33.18%
flour	88.66%	88.22%
<b>Fruit and Vegetables</b>		
Orange	16.63%	16.01%
Salad	2.10%	1.70%
Carrots	9.58%	8.58%
Pork	37.60%	36.70%
<b>Mixed Food Waste</b>		
Mixed Food Waste	22.3%	20.86%

Table 3-2: Characterization of substrates used in Batch Test

The composition and characteristics of food wastes are listed in the following tables 3-3 and 3-4:

<b>Parameter</b>	<b>Components</b>				
	Rice Noodle %	Vegetable %	Fruit %	Meat %	Mixed %
<b>Content</b>	12	15	15	28	30

Table 3-3: Characterization of Food waste in Batch Test

Trace Element	Concentration mg/kg
Cd	0,01
Cr	0,12
Mo	0,08
Co	0,01
Ni	0,14
Pb	0,04
Se	0,18
Fe	11,77
Mn	2,37
S	580,04

Table 3-4: Trace Element of Feedstock in Batch Test

### 3.2.3 Reactor configuration

Figure 3-1: Layout of Eudiometer Apparatus <sup>45</sup>





Figure 3-2: Eudiometer Apparatus for Batch Test

According to the local norms (in Germany DIN 38414), Eudiometers<sup>46</sup> as figure 3-2 has been used for batch test of dark fermentation. Each measuring apparatus consists of a glass column filled with sealing liquid, it is connected via connecting tubes with a receiving bottle with volume of 1L and a glass bioreactor of a volume 1L by means of ground glass joints. The ancillary samples and inocula are added in the glass bioreactor and tempered by water bath at different designed grad. The gas produced from bioreactor forces the sealing liquid from the column into the receiving bottle. And the specific gas produced can be determined by taking the read of the scale on the column. Biogas production is given in liter per kg of volatile solids (NL/kg VS), i.e. the volume of biogas production is based on norm conditions after compensation: 273K and 1013mbar.<sup>47</sup> Then the gas production should be recalculated to stand norm according following Equation 3-1.

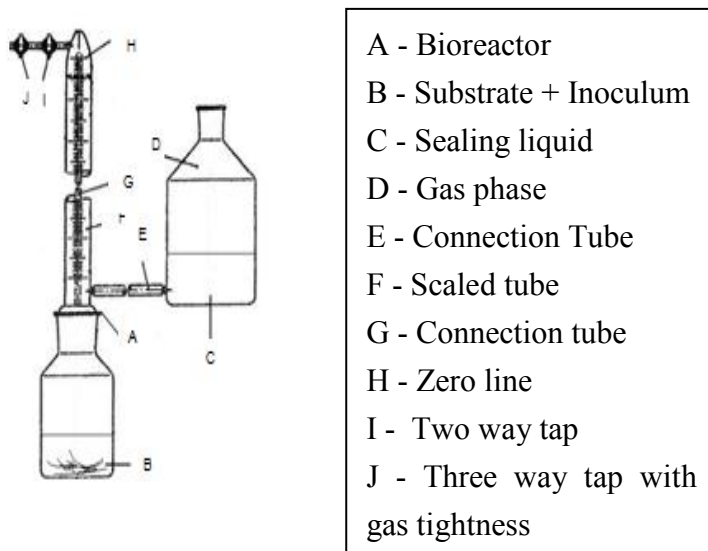
$$V_N = \frac{V * T_N * (p_L - p_W)}{T * p_N} \quad \text{Equation 3-1}$$

Where:

$V_N$ : Norm Volume under  $T_N$  and  $p_N$  (Nl or Nml)

$V$ : Gas volume

$T_N$ : Norm Temperature (273,15K)

$T$ : Environment temperature (K)

$p_L$ : Air pressure (mbar)

$p_w$ : Water vapour Pressure (mbar)

$p_N$ : Normpressure (1013.25 mabr)

### 3.2.4 Experimentation

Effect of inoculum pretreatment, inoculum to substrate ratio and temperature variation on BioH<sub>2</sub> production will be designed in batch test I to III.

#### Batch Test I: Effect of Inoculum to substrate ratio on BioH<sub>2</sub> production

##### Experiment Methodology

Inoculum is one key factor which may ensure the fermentation process stable and efficiently. Previous work on the effect of inoculum to substrate ratio in the BHP (Biochemical Hydrogen Potential) assay was limited. Biomass density in reactor has the effect on system performance. Low  $R_{I/S}$  may cause long lag phase (acclimation and Biomass propagation), nutrients deficiency and system instability. While, biomass activity may be decreased or repressed due to Biomass survival competition caused by nutrients deficiency at high  $R_{I/S}$ .

Meanwhile, the buffering capacity in inoculum can balance the produced organic acid and prevent the pH variation, thus influence the hydrogen yields in acidification phase.

##### Experiment Plan

	Aeration	Heating	pH Increasing	pH decreasing	Chloroform	Temperature
Inoculum to Substrate Ratio g/g	1:1	1:1	1:1	1:1	1:1	55degree
	1:2	1:2	1:2	1:2	1:2	
	1:3	1:3	1:3	1:3	1:3	
	1:4	1:4	1:4	1:4	1:4	
	1:5	1:5	1:5	1:5	1:5	
	1:6	1:6	1:6	1:6	1:6	

In this study, effects of different inoculum to substrate ratio with five different inoculum pretreatment methods were evaluated. For each inoculum pretreatment methods, the inoculum to substrate ratio was set from 1:1 to 1:6 for optimum bioH<sub>2</sub> yield. For higher H<sub>2</sub> yields, the digestion temperature was set at 55degree.

## **Batch Test II: Effect of inoculum pretreatment on BioH<sub>2</sub> production**

### **Experiment Methodology**

Sludge pretreatment can suppress methanogenic activity bacteria which may, in turn, enhance Biohydrogen production due to endospore which enable bacteria to lay dormant when they detect environmental conditions becoming unfavorable, and once favorable conditions return, those spores germinate and become vegetative cells<sup>48</sup>. Various pretreatment methods including heat, cooling, base, acid and loading shock have been conducted on the mixed inoculums to enrich HPB and their effects have been evaluated<sup>49</sup>. However, there are big disagreements on the optimal pretreatment method to enrich HPB from mixed inoculums. Mu<sup>50</sup> reported in 2007 that heat pretreatment was the most suitable method to enrich HPB from mixed inocula, while Hu and Chen<sup>51</sup> reported in 2007 that chloroform was the most suitable method. Such differences may be caused by inocula resources, substrates types, and cultivation condition and so on.

In this study 6 different pretreatment methods as showed in the following table, Acid, alkali, heat-shock, cooling-shock, aeration and chloroform, were conducted to evaluate their effects on hydrogen production via dark fermentation. The inocula used in this study are the mixture of liquid manure and digestate from dark fermenters in our lab which consist both hydrogen producing bacteria and hydrogen consuming bacteria.

## Experiment Plan

Number	Experiment	Pretreatment Conditions	Purpose
1	No Pretreatment	Nothing done	H <sub>2</sub> yields without pretreatment
2	Acid Pretreatment	Add HCl, keep pH 3.5 for 48h, then regulate to neutral pH	Inhibit HCB due to restricted low pH range
3	Alkali Pretreatment	Add NaOH, keep pH 10 for 48h, then regulate to neutral pH	Inhibit HCB due to restricted high pH range
4	Heat-shock	100°C for 30min <sup>52</sup>	Selectively enrich spore forming bacteria via high temperature
5	Cooling-shock	0°C for 48hours	Selectively enrich spore forming bacteria via low temperature
6	Aeration	Aerate sludge for 2weeks	Selectively enrich spore forming bacteria via oxygen
7	Chloroform	Add Chloroform during Batch Test with different concentration	Repression methanogenic activity by Chloroform
8	Inoculated sludge from ASBR Reactor	From continuously ASBR Reactor	Performance test of inoculated sludge

Table 3-5: Inoculum Pretreatment Experiment Plan

### Batch Test III: Effect of temperature on the BioH<sub>2</sub> production

#### Experiment Methodology

Simulated food waste was used as feedstock in this batch test as described in Table3-3. Seed sludge used in these experiments was mixture of liquid manure and digestate pretreated by aeration process based on results from batch test I and II.

The main impact of temperature on Biohydrogen production is caused by two factors biological factors and abiotic factors. Based on ABK Model (Enzyme-adsorption based kinetic model)<sup>53</sup> the hydrolysis and acidification rate are controlled by enzyme kinetics. With the increasing of enzyme concentration, activity and available absorption area for biodegradation, the hydrolysis and acidification rate for undissolved substrates also increased. Secondly, temperature has the direct influence on substrate solubilization by physicochemical mechanisms. Increasing temperature leads to an enhanced solubilization of undissolved substrates because of autolysis.<sup>54</sup>

At mesophilic conditions, with the temperature increasing the bioactivity of hydrolysis and acidification bacteria, an enhanced hydrolysis and acidogenesis rate are both achieved. While, with continuously temperature increasing, the hydrolysis rate continues to increase because of autolysis, however the acidogenesis rate is restricted. It is not possible to optimize both hydrolysis and acidogenesis at the same time.

Biohydrogen production via thermophilic anaerobic digestion, however, due to their merits in destruction of organic solids, improvement in solubilization of undissolved solid, and inactivation of pathogen organisms in food waste is regarded as better solution than mesophilic anaerobic digestion. (Buhr and Andrews, 1977; Rimkus et al. 1982).

Hyperthermophiles are a promising group for H<sub>2</sub> production because they have higher hydrogen conversion efficiency and hydrogen production rates in pure culture as reported. Moreover, these micororganisms grow at around 70-80degree and almost no microorganisms can survive at these temperature and hence sterilization.

To examine the effect of the fermentation temperature on the hydrogen production, three series of experiment have been conducted by Eudiometer Apparatus in this batch assay in 37degree, 55degree and 73degree, separately. Water content, which means the liquid to organic solid ratio, has serious influences on acidogenesis performance<sup>55</sup>. In each temperature region, six experiments have been done with the different water content as shown in the following table 3-6.

## Experiment Plan

Number	Experiment	Temperature	Water Content Liquid to Solid Ratio L/kg oTS	Seed Sludge Treated by Aeration
1	Mesophilic Digestion	37°C	55.81	2 Weeks
			164.73	
			274.55	
2	Thermophilic Digestion	55°C	55.81	2 Weeks
			164.73	
			274.55	
3	Hyperthermophilic Digestion	70°C	55.81	2 Weeks
			164.73	
			274.55	

Table 3-6: Experiments of temperature effects on BioH<sub>2</sub> production

### 3.3 Continuously lab-scale fermentation systems

#### 3.3.1 Inocula/seed sludge

##### Inocula/seed sludge for Biohydrogen production

The finding of the batch tests was used in developing a continuous lab scale fermentation system. The inocula which were used in the CSTR and ASBR system are the mixture of manure and digestate after batch experiments, and then aerated at least 14 days which was proved the optimum method based on the batch experimental results to inactivate hydrogenotrophic bacteria and to harvest anaerobic spore-forming bacteria for optimum H<sub>2</sub> production.

**Inocula/seed sludge for biomethane production**

The organic acids produced during biohydrogen production phase were then degraded for biomethane production for higher energy recovery and environment protection. Activated anaerobic sludge, taken from dark fermentation reactors in our lab with consisting of anaerobic digestion bacteria, suspended solids and colloidal material, was used as seeds in ASBR biomethane reactor.

**3.3.2 Investigated Feedstock in continuously fermentation system**

The substrates used in continuously experiments were collected by Schraden Biogas GmbH in Gröden which mainly consist food residues from restaurants. The food waste was stored in cooling cell in the lab at 4°C to prevent or slow down pre-acidification which will cause H<sub>2</sub> losing after collection.

The characteristics of these organic wastes are presented in the following table 3-7:

<b>Characteristics</b>	<b>Unit</b>	<b>Value</b>	
<b>Physical characteristics</b>			
Total Solid	%	22.17%±2	
Organic Total Solid	%	20.16%±3	
Bulk density	Kg/m <sup>3</sup>	0.97-1.02	
pH		4.5±1	
Salinity	‰	8±2	
<b>Composition</b>			
Vegetables and Fruits	%	20±5	
Bread, Noodle and Rice	%	12±4	
Meat	%	28±5	
Mixed	%	30±10	
<b>Chemical Characteristics</b>			Requirement Concentration <sup>56</sup>
Total organic Carbon TOC	g/kg oTS	514.39±35	
Total Nitrogen TN	g/kg oTS	24.37±1.5	
S	g/kg oTS	0.91±0.1	
P	g/kg oTS	2.95±0.2	
Cd	mg/kg	0.018±0.005	
Cr	mg/kg	0.15±0.06	0.005-50
Mo	mg/kg	0.09±0.04	0.05
Co	mg/kg	0.066±0.05	0.06
Ni	mg/kg	0.184±0.2	0.006
Pb	mg/kg	0.258±0.25	0.02-200
Se	mg/kg	0.21±0.12	0.008
Fe	mg/kg	17.74±4.6	1000-10000
Mn	mg/kg	5.02±1.7	0.005-50

Table 3-7: Characteristic of Investigated Feedstock in the Bioreactors

### 3.3.3 Bioreactor configuration for hydrogen production

Bioreactor configuration and function can affect fermentation performance directly. Improving the digestion performance, increasing the biomass density in reactor, and reducing the products inhibition in bioH<sub>2</sub> reactor are the main task for bioH<sub>2</sub> production via dark fermentation in the near future.

#### Bioreactor for continuously Hydrogen production

Most previous studies on continuously hydrogen fermentation were performed in CSTR by using simple substrates like glucose and sucrose. However reactor configuration is one of most important parameter that affects the fermentation performance. Biomass concentration is the driving forces of the fermentation



process. So, extend the retention of the biomass concentration in reactor and eliminate the products inhibition allowing greater volumetric hydrogen production.

In this study, the performance of CSTR, new designed patented semi-percolator and ASBR were investigated for bioH<sub>2</sub> production.

### **Continuous flow stirred Tank (CSTR)**

CSTR reactor is one of the most widely used bioreactor for wastewater and organics treatment especially for large scale plants due to the fact that they are simple and easy to operate and construction. In practice, mechanical or hydraulic agitation is required to achieve material uniform composition and facilitate the heat transfer. As shown in following figure 3-3.

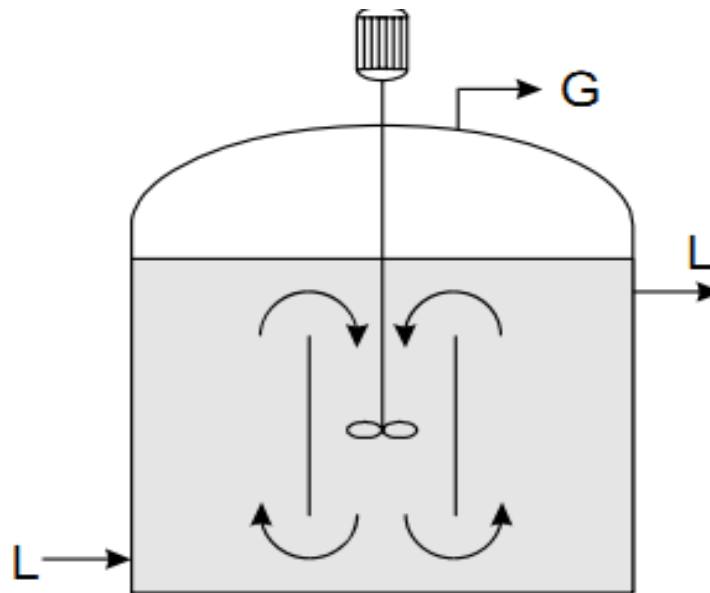

Figure 3-3: CSTR Bioreactor

The reactants and products are continuously or semi-continuously fed and withdrawn. New materials into the system are mixed and spread quickly, so that the substrate are easily contacted with microbial and substrate concentration remains relative low status due to dispersion.

CSTR is feasible to treat high solid content substrates. Uniform distribution of materials within the digester can avoid the hierarchical status and increase the chance of contact with the new feeding material and microorganisms. Due to the discharge of uniform material inside the reactor, the biomass concentration, the reaction driving forces, are relative low compared with other types of bioreactor. The

solid retention time of CSTR is equal to hydraulic retention time. So normally CSTR requires the largest volume to obtain desired conversion efficiency due to less biomass concentration.

Due to high solid content in the food wastes and high fast propagation rate of acidogens, the performance of CSTR for Hydrogen production was investigated in this study.

### **Semi-percolator reactor**

Normally the CSTR is time consuming with low volume efficient bioreactor due to less biomass concentration maintained in reactor. In 2004 Sun & Shin developed a semi-continuous mode BIOCELL-leaching bed reactor for anaerobic hydrogen and methane production. The BIOCELL consisted of four leaching-bed reactors and operated in a rotation mode. The dilution rate was controlled in each leaching-bed reactor to optimize biohydrogen production efficiency for different component. High hydrogen and methane gas production rate were reached at 0.31 and 0.21 m<sup>3</sup>/kg oTS<sub>added</sub> respectively. While, low permeability, screen blockage problems, complex operation and by-pass flow are the key problems for this system and prevent its implementation in the industrial scale.

An innovative reactor as shown in following Figure 3-4, semi-percolator, is thus designed to solve these problems in this study. It has got already the Chinese patent with Patent Nr: CN101585043B.

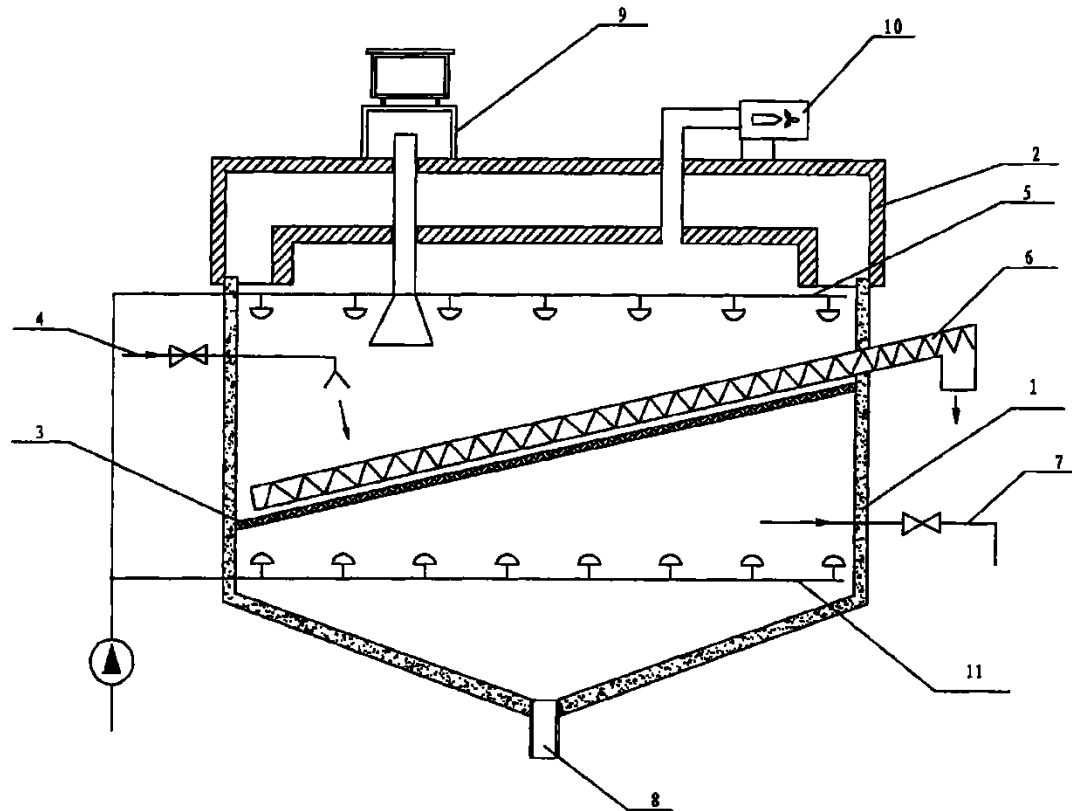

Figure 3-4: Semi-Percolator with Patent Nr: CN101585043B

As shown in Figure 3-4, the invention provides a food waste hydrolysis acidifying reactor with  $\text{bioH}_2$  production, which comprises a hydrolysis tank and a top cover (Nr.2) disposed thereon; a sieve (Nr. 3) is disposed slantways in the hydrolysis tank; a feed arrangement is disposed on the upper portion of the hydrolysis tank; a slag discharging device (Nr.6) and a liquid discharging devices (Nr. 7 and Nr. 8) are disposed on the lower portion of the hydrolysis tank respectively corresponding to the upper side and lower side of the sieve; the bottom of the hydrolysis tank is a funnel shaped structure with a silt orifice disposed on the bottom; the top cover is an outer-inner double layer structure with an oil-collecting device (Nr. 9) and a gas-exhausting apparatus (Nr. 10) disposed between the two layers; a spraying device (Nr. 5) is disposed on the bottom of the top cover; and a water-filling apparatus (Nr. 11) is disposed on the bottom of the hydrolysis tank. The invention can perform effective hydrolytic treatment to the un-sorted food wastes (after coarse disintegration) directly, and obtain  $\text{bioH}_2$  and acidifying liquid used for producing methane. It simplifies the pretreatment process of the food wastes greatly, saves energy consumption, and reduces equipment investment theoretically.

In this percolator system one inclined sieve has been set in the lower part of the reactor to support the weight of the substrates. Due to the slope of sieve substrates will be accumulated at the lower part of the screen and be transferred through spiral conveyor after digestion. Unlike the normal percolator, the liquid level will be set to keep the substrates suspended, floated or settled over the screen as required. The hydrolysate in the Buffer Tank should be used to reflush the sieve periodically for better mixing and avoid the sieve blockage problem. The produced acid rich hydrolysate will be discharged automatically to hydrolysate buffer tank based on the liquid level sensor for further degradation in methane reactor. In principle, this system can work continuously.

### **Anaerobic Sequencing Batch Reactor (ASBR)**

Tanisho and Lshiwata had studied the *Enterobacter aerogenes* for hydrogen production and got the hydrogen production rate of  $1.5 \text{ molH}_2/\text{mol}$  glucose at  $38^\circ\text{C}$ . Then they used Polyurethane foam to immobilize this strain and hydrogen production rate was increased to  $2.15 \text{ molH}_2/\text{mol}$  glucose. In 1997 Rachman published similar results by using *E. aerogenes* AY-2. The hydrogen production of  $1.17 \text{ molH}_2/\text{mol}$  glucose had been obtained by Rachman in batch test. Then, after immobilization of this strain in packed bed reactor the hydrogen specific production rate was increased to  $2.58 \text{ molH}_2/\text{mol}$  glucose.

The above results show that the packing material can increase biomass density inside reactor and specific hydrogen production rate per unit reactor volume and operation stability can thus be enhanced. But in this study due to blockage problem and mass transfer resistance caused by high  $T_s$  in the feedstock, fixed- or packed-bed reactor were abandoned even it can maintain high levels of biomass density. Instead of it, ASBR process has been introduced in this study which had been used for both hydrogen and methane production with high MLSS substrates.

Microbial degradation model<sup>57</sup> indicates that, they have general two degradation rates: high degradation rate for more easily biodegradable components in substrates and slower latter degradation of the more recalcitrant compounds<sup>58</sup>. In case of the food wastes the more recalcitrant components except liquid oil are normally in the solids fraction like protein in meat and lignin in fruit or vegetables. These more recalcitrant components require longer retention time than easier degradation components in reactor for higher removal efficiency. ASBR provides not only longer recalcitrant components digestion time in the

reactor but also increases biomass concentration in the reactor. Theoretically, it can increase the OLR of reactor and achieve higher organic degradation rate.

ASBR is a suspended growth reactor which operates in a cyclic batch mode with four distinct phases per cycle following as shown in figure 3-5. It was firstly described by Dague and coworker Sung in 1992 in Iowa state Uni. Reactor goes through sequence of steps, feed, reaction, settle and decant of the treated wastes. Most of recent researches for solid waste hydrogen production always used a CSTR as discussed above.<sup>59,60</sup> While the intermittent operation of ASBR system results in high initial substrate concentration, good effluent quality and high gas production rate compared with other reactor types.

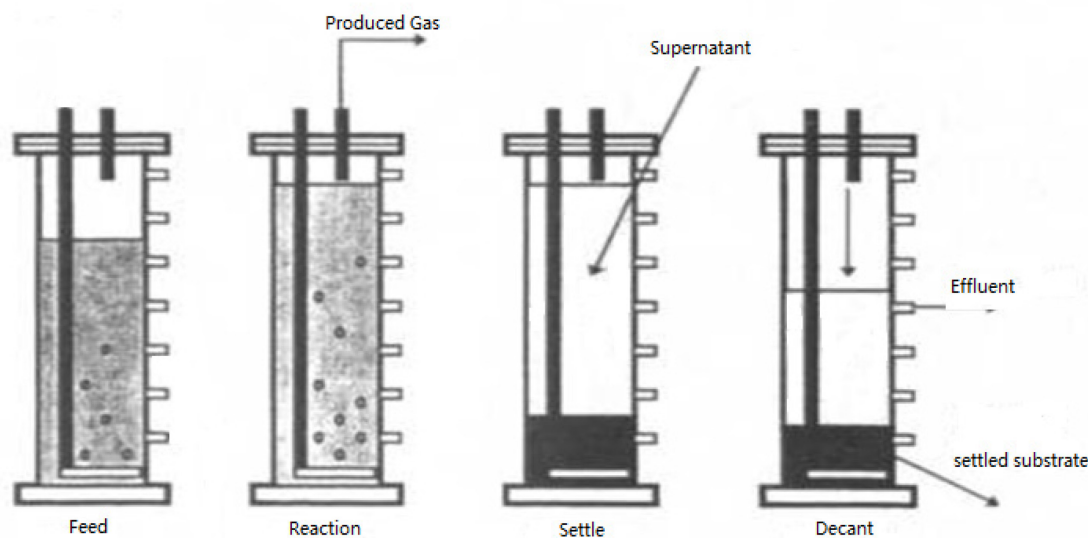

Figure 3-5: Regime of Anaerobic sequencing batch reactor

The batch mode of the operation selects for optimum kinetics during each phase.

**Feed:** the purpose is to add substrates to the reactor. During the feeding phase, the substrates concentration increases rapidly, and metabolic rate reaches its max. level.

**Reaction:** Reactions, which is initialed from feeding process. The liquid level remained at the maximum throughout react process. Mixing is very important during reaction step to make sure the contact between organics and bacteria, also substrate homogenization in concentration and temperature. But mixing in reactor should be as gentle as possible to avoid disrupting the formation of bacteria flocs. The complex organic substrates are converted into organic acids and energy rich gas. Produced gas increased internal mixing. The time required for this step is determined on the basis of substrate characteristic and strength, temperature, effluent quality, MLSS concentration and so on.

Settlement: External mixing is stopped and internal mixing effect is getting weaker and weaker due to gas production rate decreased with exhaust of degraded substrates. Only the biomass with good settling properties can remained in the reactor. The time required for this step may vary from several minutes to hours which are determined by settling velocity of biomass, MLSS and required quality of effluent.<sup>61</sup> During this phase the substrates concentration and gas production rate are at its min. level which creates optimum conditions for digestate separation before effluent discharging.

Decant: Remove of poorly settled biomass and discharge of treated substrate in this step. It is normally taken place before substrate feeding.

### **ASBR for H<sub>2</sub> production**

ASBR relies on internal solid liquid separation performance to keep higher biomass concentration in the reactor for higher organic removal efficiency. The MLSS (mixed liquid suspended solids) which consists of biomass, suspended organic substrate and inorganic substrates has significantly effect on sludge settling velocity as described in equation 3-2 mathematical formula by Akca and experimental results from Shihwu Sung and Richard R. Dague<sup>62</sup>. While, the effluent from Hydrolysis reactor-hydrolysate quality is not so strict as effluent from methane digester because it will be degraded in methane digester and acidogen have much higher reproduction rate than methanogens, so it gives the chance for ASBR for hydrogen production by using high solid content food waste as substrate. But the settled sludge which including settled flocs and granules, non-biodegradable organics, inorganic at the bottom of reactor should be discharged periodically to maintain a reasonably MLSS concentration for solid liquid separation performance.

Maximum theoretical Sedimentation velocity  $V_0$  was calculated based on the mathematical formula by Akca<sup>63</sup>:

$$V = V_0 \exp(-nX) = 28.1(\text{SVI})^{-0.2667} \exp\{-[0.177+0.0014(\text{SVI})]X\} \quad \text{Equation 3-2}$$

Where:

$$V_0 = 28.1(\text{SVI})^{-0.2667}$$

$$n=0.177+0.0014(\text{SVI}) \quad (r^2=0.867)$$

X: MLSS Concentration mg/L

SVI: Sludge volume index

This is simplification mathematical model which does not incorporate the influence of sludge concentration which may decrease sedimentation velocity because settling hindered by the high quantity of flocs to calculate of sedimentation velocity.

Food waste contains certain amount of fat and oil which are difficult to acidify because oil is not available for microorganisms. Packing materials, Bioflow 9 from Rauchert GmbH<sup>64</sup> with specific surface area  $870\text{m}^2/\text{m}^3$ , had been added into reactor to increase the contact area of oil and microorganism for higher degradation performance. So, unlike the ASBR for methane production, the valve for hydrolysate discharge was located 1/3 from the top of digester to avoid discharge of suspended packing material which surrounded by oil.

### 3.3.4 ASBR Bioreactor for methane production

The byproduct, organic acids produced during acidification phase with hydrogen simultaneously, are best suitable matrix for methanogens which can convert them to methane. For this study ASBR reactor, instead of fixed bed reactor, was proposed for organic acid further degradation and methane recovery because of high SS in hydrolysate which may cause packing material blockage.

While in this study decant step takes place at the same time with substrate feeding in ASBR reactor for hydrolysate treatment. Advantage: It is practical in lab scale investigation without automatic controlling system. Disadvantage: Few amount of fed fresh substrates discharged with clear supernatant which will decrease effluent quality and yields of  $\text{CH}_4$  production.

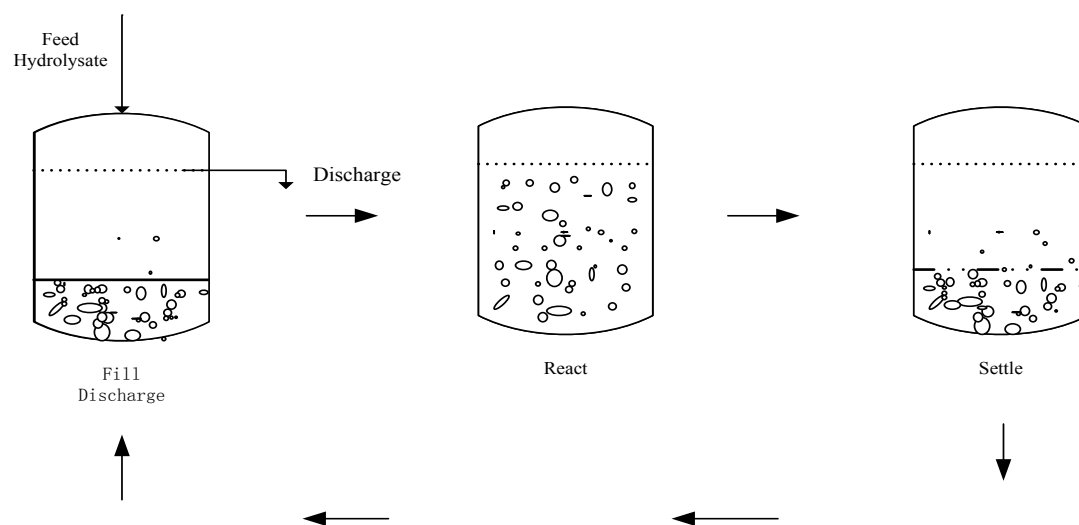

Figure 3-6: Anaerobic Sequencing batch reactor system for  $\text{CH}_4$  recovery

The fermentation liquid from methane reactor was recycled to hydrolysis reactor to buffer the pH changes, regulate the water content (ratio of liquid to solid) in substrates and supply essential nutrients required by microorganisms after aeration due to certain amount of active methanogens which are washed out from methane reactor and will consume the hydrogen yield in hydrolysis reactor without inhabitation its activity.

### **3.3.5 Experimentation**

#### **3.3.5.1 Continuously sequential production of H<sub>2</sub>+CH<sub>4</sub> via CSTR and ASBR<sub>Me</sub>**

##### **◆ Experiment Methodology**

BioH<sub>2</sub> production via hydrolysis was performed in polyethylene bioreactor ca. 30L with top-mounted central agitator of 45rpm. The simple experiment flow chart is given as following figure. The fresh substrate after pulping was fed into reactor two times per day through feeding valve manually. The hydrolysate was discharged before substrate feeding. Reactors are closed by air tight lids with several access points for gas quantity and quality/ pH/ temperature. 100L gas bag was connected with reactor for pressure balance when substrate feeding and discharging and gas collection. The temperature of the reactor is kept at 55°C through external warm water heating and reactor was insulated with styrene sheet. The hydrolysate was collected to Buffer Tank I and then digested by ASBR methane reactor. The process water from methane reactor, after inter-ventilation for suppressing the activity of methane bacteria even most methane bacteria activity were suppressed because of rough temperature variation, was repatriated to hydrolysis reactor for organic acid dilution, pH regulation, etc with different dilution rate.



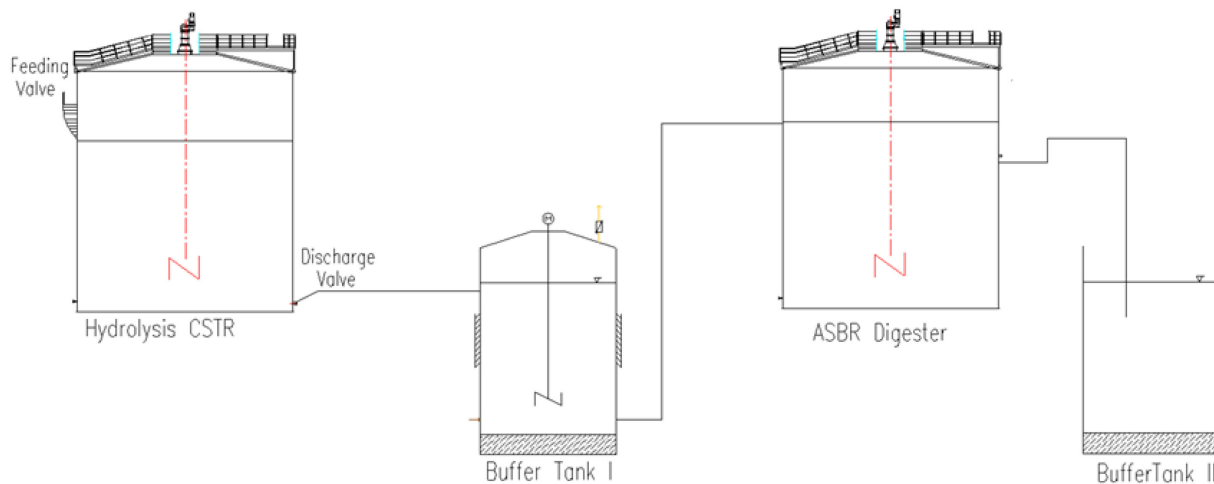

Figure 3-7: Experiment Flow chart of CSTR + ASBR

A 60L well inoculated ASBR provided with a 45rpm mixer was operated at 37 °C to treat high organic content hydrolysate for biogas production. The hydrolysate was fed at the cycle beginning and meanwhile the same volume of treated medium was discharged.<sup>65</sup> Hosepumps (Schlauchpump) are used to feed the hydrolysate into ASBR. The reactor were conducted under 37degree by mesophilic fermentation process in order to decrease the effect of methanogens on hydrogen production in the acidification phase and energy consumption. The produced biogas was analyzed by GC and Gasmonitor, while its quantity was determined by Gas Flow Meter (Fa. Riter Apparatebau GmbH).

#### ◆ Experimental Conditions

- ✚ CSTR acidification reactor was performed under thermophilic conditions at 55 °C for higher bioH<sub>2</sub> production, while ASBR methane reactor was Inoculated under mesophilic conditions at 37 °C to decrease the activities of methanogens brought in Acidification reactor for substrate dilution due to rough temperature variation;
- ✚ Seed sludge used in CSTR was from liquid manure and seeds of batch experiments after 2weeks aeration, while seed sludge from ASBR methane reactor was taken from matured methane reactor in our lab and domestication by using food waste;
- ✚ Hydrolysate from CSTR acidification reactor used as substrates for ASBR methane reactor;
- ✚ Effect of different dilution rates ( $R_{L/S}$ ) were investigated to optimize bioH<sub>2</sub> production;

- ✚ Cycle period of ASBR was set at 8h at beginning and then was reduced to 4h with the flocs and granulation process;
- ✚ Settled sludge in ASBR was discharged when  $SVI_{180min}$  higher than 50%, otherwise bad effect on the quality of output;

#### ◆ Experiment Plan

Aim	Investigate the effect of different dilution rate on BioH <sub>2</sub> production rate in CSTR and max. OLR					
Experiment	Dilution Rate R <sub>l/s</sub> L/kg oTS	OLR kg oTS/L.d	Feeding Cycle	oTS of Substrate	oTS of Op	Remarks
Exp 2-1-1	8.66	0-max	every 12h	22.59%	0.51%	OLR increased slowly unless H <sub>2</sub> productivity roughly dropped
Exp 2-1-2	12.71	0-max	every 12h	22.59%	0.51%	
Exp 2-1-3	17.57	0-max	every 12h	21.08%	0.56%	
Exp 2-1-4	35.21	0-max	every 12h	21.08%	0.56%	

#### 3.3.5.2 Continuously sequential production of H<sub>2</sub>+CH<sub>4</sub> via semi-percolator and ASBR<sub>Me</sub>

##### ◆ Experiment Methodology

Experiments were performed in polyethylene percolators ca. 30L at different dilution rate. The can was equipped with one removal waste bed with mesh 5mm to drain the hydrolysate and hold the substrates. The waste bed was made of polyethylene and fixed on ca. 15cm up to bottom for percolating leachate. Reactors are closed by air tight lids with several access points for gas quantity and quality/ pH/ temperature, percolates repatriation and irrigation water. 100L gas bag was connected with reactor for pressure balance and gas collection. The hydrolysate was re-circulated with the help of pneumatic pump and sprayed from the top of percolators continuously. Due to no mechanical mixer inside percolator the recirculation of the percolating culture from the bottom to top of percolator can result in homogeneous culture inside reactor and promote the hydrolysis and acidification by virtue of repeated seeding. The Patent ZL 2009 1 0117334.6 is based on this simplified reactor design. The temperature of the reactor is kept at 55°C through external warm water heating and reactor was insulated with styrene sheet. The hydrolysate from percolator was collected in Buffer Tank I and re-circulated to percolator reactor periodically. When liquid level in Buffer Tank I is reached at max level, it will be discharged automatically into Buffer Tank II which then will be digested by ASBR methane reactor based on

hydraulic balance. The process water from methane reactor stored in Buffer Tank III was repatriated to percolator to wash out produced organic acids and balance the pH in percolator for higher hydrolysis performance and higher  $H_2$  productivity. While, they should be inter-ventilated before repatriation to suppress the activity of methane bacteria which were washed and discharged with effluent, otherwise hydrogen was consumed.

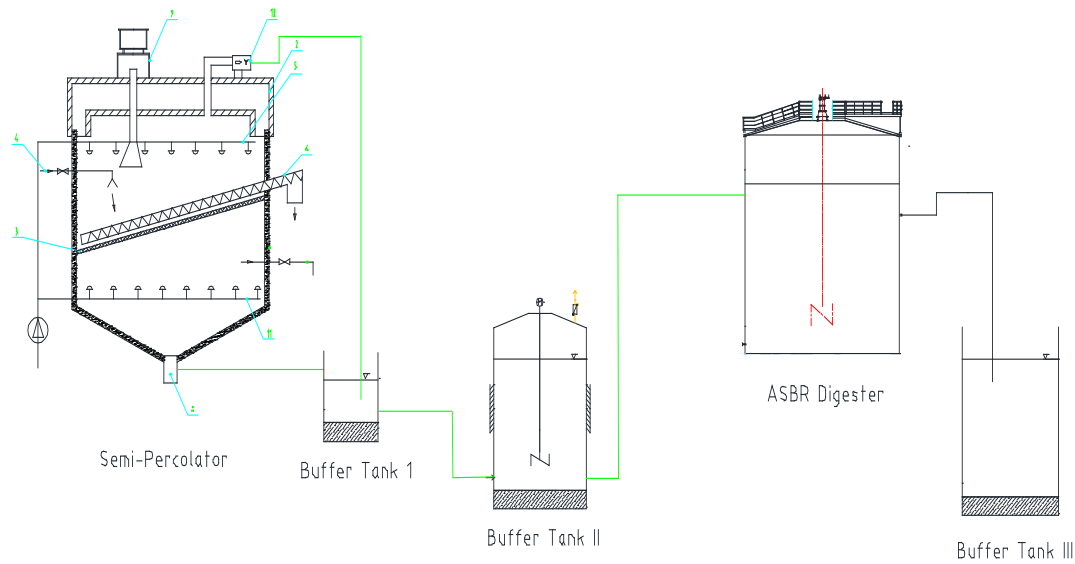

Figure 3-8: Experiment Flow chart of Percolator and ASBR<sub>Me</sub>

## ◆ Experimental Conditions

- ✚ Semi-Percolator reactor was inoculated under mesophilic conditions at 55 °C based on the Batch Experiment results for higher H<sub>2</sub> yield rate at thermophilic condition, while ASBR methane reactor (60L) was Inoculated under thermophilic conditions at 37 °C to decrease methane bacterial activity due to rough temperature variation;
- ✚ Process water from Buffer Tank III was aerated at least 14days before repatriated to percolators to inhibit activity of methane microorganisms;
- ✚ Hydrolysate in Buffer Tank I was re-circulated in percolator reactors periodically and then stored in Buffer Tank II which shall be digested by ASBR<sub>Me</sub> bioreactor soon;
- ✚ Operation Regime of Percolator:
  - Substrates were batch fed and discharged manually due to non-pumpable;
  - In one-step percolator system, hydrolysate in Buffer tank I was discharged into Buffer tank II based on liquid level control; while, in two-step percolator system, hydrolysate was taken out after 48hours and all discharged into Buffer tank II, and then feed process water in percolator; the pH in the second phase was set between 6-7;
  - SRT(solid retention time) was set at 4days in one-step hydrogen percolator and two-step hydrogen percolator (2d+2d);
  - Hydrolysate in Buffer tank I was re-circulated with the help of pneumatic pump and sprayed from the top of percolators periodically for homogeneous culture inside percolator and repeated seeding;
  - Process water from Buffer Tank III were pumped back to percolator by pneumatic pump for designed pH; Different pH regulation in Percolator were maintained with the help of ASBR<sub>Me</sub> effluent recirculation;

### Experiment Plan

Aim	Investigate the effect of pH on total energy output in one-step percolator system and two-step percolator system						
Experiment	pH in first step	pH in second step	SRT	Ts of Substrate	oTS of Substrate	Mass of Substrate	Remarks
<b>one-step percolator</b>							In two-step percolator system all hydrolysate will be discharged after 1 step and feed process water with pH 6.0-7.0
Exp 2-2-1	4.0-4.5	4.0-4.5	4	19.37%	17.30%	4kg	
Exp 2-2-2	4.5-5.0	4.5-5.0	4	19.37%	17.30%	4kg	
Exp 2-2-3	5.0-5.5	5.0-5.5	4	19.37%	17.30%	4kg	
Exp 2-2-4	5.5-6.0	5.5-6.0	4	19.37%	17.30%	4kg	
Exp 2-2-5	6.0-6.5	6.0-6.5	4	19.37%	17.30%	4kg	
<b>two-step percolator</b>							
Exp 2-2-6	4.0-4.5	6.0-7.0	2+2	19.37%	17.30%	4kg	
Exp 2-2-7	4.5-5.0	6.0-7.0	2+2	19.37%	17.30%	4kg	
Exp 2-2-8	5.0-5.5	6.0-7.0	2+2	19.37%	17.30%	4kg	
Exp 2-2-9	5.5-6.0	6.0-7.0	2+2	19.37%	17.30%	4kg	
Exp 2-2-10	6.0-6.5	6.0-7.0	2+2	19.37%	17.30%	4kg	

Table 3-8: Experiment Plan in percolator system

#### 3.3.5.3 Continuously sequential production of H<sub>2</sub>+CH<sub>4</sub> via ASBR and ASBR<sub>Me</sub>

##### ◆ Experiment Methodology

Hydrogen can be produced through fermenting food waste in a mixed culture under anaerobic conditions via semi-percolator system and CSTR reactor have been confirmed in above mentioned investigation. While, the bioH<sub>2</sub> yield and its content in hydrolysis gas were limited due to lower biomass concentration of HPB. As mentioned in Chapter 3.3.3, ASBR can not only provide longer retention time for recalcitrant components, but also increase the biomass concentration in the reactor via using the immobilized hydrogen culture; thereby the total energy recovery can be thus enhanced.

##### Seeding and Acclimatization of biomass of HPB

ASBR hydrolysis reactor was started up with seeding and acclimatization period. Active sludge biomass was obtained from liquid manure and residue of batch test after aeration pretreatment. The initial concentration of mixed liquor suspended solid MLSS in the ASBR acidification reactor was

approximately 2500 mg/l at the first period of acclimatization, the biomass concentration in ASBR was gradually increased with feeding of organics.

ASBR<sub>Me</sub> with 60L was started up by using well inoculated methane reactor with a 45rpm mixer. Thus, no extra commission phase had been done in this reactor. The produced hydrolysate from ASBR hydrolysis reactor was fed into it as preset program.

### Experimental Equipment

Experiments of bioH<sub>2</sub> production was performed in one 30L ASBR reactor at different R<sub>L/s</sub>. ASBR hydrolysis reactor was operated at 55°C and equipped with a 45rpm mixer for new fed organics quickly homogenization in the reactor. Reactors are closed by air tight lids with several access points for gas quantity and quality/ pH/ temperature and irrigation water. 100L gas bag was connected with reactor for pressure balance and gas collection. The food waste were firstly shredded and diluted by using process water from methane reactor after aeration pretreatment, then fed into reactor manually 1time/d due to hard pumpability. The process water will be pumped into irrigation water access point in tank lid for optimum bioH<sub>2</sub> yields investigation. The produced hydrolysate was discharged into Buffer tank I when substrate and process water pumped into reactor based on liquid level balance.

The same well inoculated ASBR provided with a 45rpm mixer has been used in this study. ASBR methane reactor was operated at 37 °C to treat high organic content hydrolysate for biogas production. The same feed cycle was used here.

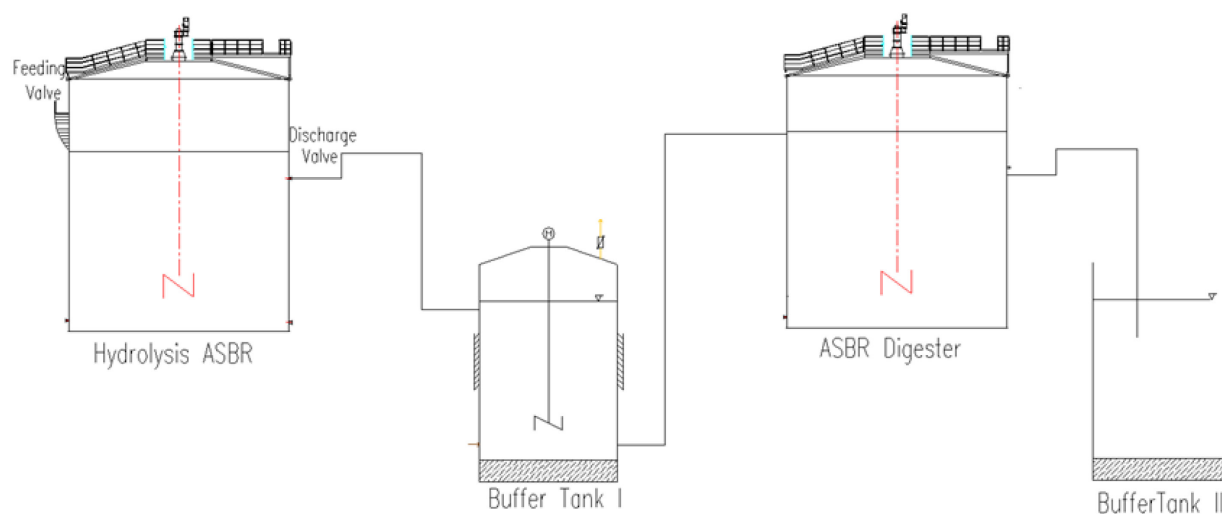

Figure 3-9: Experiment Flow chart of Continuously sequential production of H<sub>2</sub>+CH<sub>4</sub>

**Experiment Conditions:**

- ✚ ASBR was Inoculated under thermophilic conditions at 55 °C based on the Batch Exp results for higher H<sub>2</sub> yield rate;
- ✚ Seed sludge in ASBR hydrolysis reactor were from liquid manure and batch test residue after aeration pretreatment;
- ✚ Operation Regime in ASBR hydrolysis reactor as followed table 3-9:

Time	10	11	12	13	14	15	16	17	18	19	20	21	22	23	0	1	2	3	4	5	6	7	8	9
Task	D1																							
Task	F1																							
Task		F2																						
Task			R	R	R	R	R	R	R															
Task			M		M		M	S	S	S														
Task									F2															
Task									D2															
Task										R	R	R	R	R	R	R	R							
Task										M		M		M	S	S	S							
Task																		F2						
Task																		D2						
Task																			R	R	R	R	R	R
Task																			M		M		M	S
Task																						S	S	S

Table 3-9: Operation Regime for ASBR Hydrolysis System

Where:

- D1: Discharge Hydrolysate until Level 1      F1: Feed substrates manually
- F2: Feed process water by pump                R: Reaction
- M: Mixing    D2: Discharge Hydrolysate to Level 2
- S: Settlement

**Explanation:**

- Supernatant hydrolysate was discharged to Level 1 before substrates feeding;
- Un-pumpable Substrate was fed manually everyday due to high TS;
- Process water was then added by pump to regulate the pH in ASBR hydrolysis reactor and discharge level of supernatant hydrolysate is Level 2;
- Cycle period was set at 8h as shown in Table 3-9 with 5hours reaction period with mixing, 3hours settlement period. Time for feeding and discharge were be included in reaction time

- ✚ Supernatant Hydrolysate after settlement step was discharged automatically when process water was pumped in based on liquid level balance
- ✚ Settled sludge and non-degraded substrates were discharged manually based on the  $SV_{180\text{min}}$  values. After simple gravity separation, the liquids were used for methane production and solid residues were disposed
- ✚ ASBR methane was operated under mesophilic conditions at  $37^\circ\text{C}$  and Hydrolysate from ASBR acidification reactor used as substrates;
- ✚ Settled sludge in  $ASBR_{Me}$  was discharged when  $SV_{180\text{min}}$  higher than 50% for better effluent quality.

**Limitations:**

- ✚ Process water from methane reactor was carrying a certain amount of active methanogens even after aeration pretreatment which may decreased hydrogen yield in acidification phase, especially after certain time adaption;
- ✚ Produced biomass and non-degraded substrates had accumulated in ASBR hydrolysis reactor and high MLSS influenced seriously the separation performance;
- ✚ Oil and fat are easier degraded at near neutral conditions while the activities of methanogens carried with process water may not good suppressed during this pH range even after aeration pretreatment;
- ✚ The formed oil layer at the top of reactor hindered the produced hydrolysis gas release especially during settling time

**Experiment Plan:**



Aim	Investigate the effect of pH on total energy output in ASBR system							
Experiment	pH Range	pH initial	OLR in ASBR <sub>hyd</sub>	H <sub>2</sub> Yields in ASBR <sub>hyd</sub>	CH <sub>4</sub> Yields in ASBR <sub>met</sub>	Ts of Substrate	oTS of Substrate	Remarks
Exp 2-3-1	4.0-4.5	4.0	0-max.	0-max.	max.	19.37%	17.30%	During the setting pH range the OLR of reactor tried in increased to max. level. Hydrolysate from ASBR <sub>Hyd</sub> degraded in ASBR <sub>met</sub>
Exp 2-3-2	4.5-5.0	4.5	0-max.	0-max.	max.	19.37%	17.30%	
Exp 2-3-3	5.0-5.5	5.0	0-max.	0-max.	max.	19.37%	17.30%	
Exp 2-4-4	5.5-6.0	5.5	0-max.	0-max.	max.	19.37%	17.30%	
Exp 2-5-5	6.0-6.5	6.0	0-max.	0-max.	max.	19.37%	17.30%	

Table 3-10: Experiment Plan for Continuously sequential production of H<sub>2</sub>+CH<sub>4</sub> via ASBR Reactor

---

### 3.4 Sampling and analysis method

#### 3.4.1 Sampling campaign

The components of Food wasted used in this study, collected by Schraden Biogas GmbH from restaurants and some industries or from student dormitory, have certain difference due to season changes and high randomness. So the feedstock was firstly modified, then sampled and analyzed for each batch of wastes.

Furthermore, the key operation parameters like pH, salinity, temperature, acid component and concentration etc shall be analyzed periodically.

#### 3.4.2 Analysis method for collected samples

##### Solid samples analysis

In all experiments the same sampling protocol as following was used for the wastes that no matter for batch tests and middle-scale researches as following table.

Analyses	Process/Equipments
Total Solid Ts	DIN 38 414
Volatile Solid Vs	DIN 38 409
TOC	DIN EN 1484
TN	Kjeldahl digestion method
Trace Element	ICP

Table 3-11: Analysis Plan for solid samples

##### Liquid samples analysis

Liquid samples, effluents from hydrogen producing reactor and methane producing reactor were taken every day. The overview of liquid samples analysis plan is listed in the following table:

Analyses	Process/Equipments
pH	DIN 38 404-C5
ORP	DIN 38 404-C6
COD	DIN 38 404 H4 1-2
TOC	DIN EN 1484
NH <sub>3</sub> -N	DIN 15475
VFA (Total)	DIN 38 409-H 21
VFA Components	GC
Total Solid Ts	DIN 38 414
Volatile Solid Vs	DIN 38 409

Table 3-12: Analysis Plan for solid samples

Composition of VFA was determined by using GC SHIMADZU 2010 equipped with a flame ionization detector (FID) and a 30m \* 0.25mm (inner diameter) \* 0.25um (film thickness) BP21 column. The temperature of injector and FID were kept at 250°C. The column oven temperature was initially at 40°C for 2 min followed with a ramp of 10°C /min for 14min and final temperature of 250°C. N<sub>2</sub>/Air is used as makeup gas with a flow rate of 30ml/min. The sample injection volume was 0.2ul.

The composition of alcohol like methanol, ethanol etc. was determined by using same GC equipment while with different analysis method (process). The injection and FID temperature was kept the same with VFAs analysis method. While, the column oven temperature program was reset by initial temperature at 40°C for 4min, then it was increased with a ramp of 25°C /min for 5.6min to 180°C. The sample injection volume was also 0.2ul.

### **Gas sample analysis**

The components of Biogas and hydrolysis were determined by means of Gas Monitor and Gas Chromatograph (SHIMADZU GC-2010) respectively.

Gas Chromatography is a remarkable sensitive and selective method for the qualitative and quantitative determination of biogas, hydrogen and hydrogen sulfide with the help of TCD (thermal conductivity detector) and 3 meter Hayesep Q column. 100ul gas sample was taken and injected into GC injector by gas syringe. The temperature of injector and detector were kept at 78°C and 100°C, respectively. While we adopted temperature

---

increasing program for the column to shorten the analysis time and increasing gas separation efficiency in the column. The column temperature was set at 35°C and kept for 3.5min, then increased to 75°C with increasing rate 3.8. He used as carrier gas with a flow rate of 28ml/min.

Ansyco Biogas monitor was used to make the biogas component analysis produced in methane reactor. The measurement of CH<sub>4</sub> and CO<sub>2</sub> were done with the reliable infrared Method by measuring different wavelength and the concentration of O<sub>2</sub> was determined with a durable electrochemical cell<sup>66</sup>.

The produced hydrolysis gas and biogas from SGV and bioreactor have been calculated under Norm conditions (0°C, 1013mbar) by considering the effect of temperature, pressure and water vapor pressure in the detected gas. The calculation equation is as following:

$$V_N = [V * T_N * (P_L - P_W)] / (T * P_N) \quad \text{Equation 3-3}$$

Where, V<sub>N</sub> = Norm Volume

V = Volume of detected gas

T<sub>N</sub> = Norm Temperature (273,15K = 0°C)

T = Ambient Temperature (K)

P<sub>L</sub> = Pressure (mbar)

P<sub>W</sub> = Water Vapor Pressure (mbar)

P<sub>N</sub> = Norm Pressure (1013.25mbar)

### 3.5 Mathematic Calculation Equations

#### 3.5.1 Hydraulic retention time (HRT)

HRT is a measure of the average length of time that soluble organics remain in the fermenter. Based on the reactor volume and fed substrate quantity the HRT can be calculated according to the following equation:

$$\text{HRT [d]} = \left\{ \frac{\text{Reactor Volume [m}^3\text{]}}{\text{fed Substrate Volume } \left[ \frac{\text{m}^3}{\text{d}} \right]} \right\} \quad \text{Equation 3-4}$$

#### 3.5.2 Degradation Rate Δ

Degradation rate can be calculated based on Ts, oTS and COD.

---

$$\Delta T_s [\%] = \left\{ 1 - \frac{T_{sabg} [\text{kg/d}]}{T_s [\text{kg/d}]} \right\} * 100 \quad \text{Equation 3-5}$$

### 3.5.3 Organic Loading Rate

Organic loading rate is presented as the weight of organic matter per day applied over a unit area.

$$\text{OLR} [\text{kg/m}^3 * \text{d}] = \left( \frac{oTs \text{ fed} [\%] * \text{Substrates} [\text{kg/d}]}{\text{Reactor volume} [\text{m}^3]} \right) \quad \text{Equation 3-6}$$

### 3.5.4 Substrate specific BioH<sub>2</sub>/Biogas yield $r_{\text{Gas, abg}}$

$$r_{\text{Gas, abg}} [\text{Nm}^3/\text{kg}] = \left( \frac{\text{BioH}_2 / \text{Biogas} [\text{Nm}^3/\text{d}]}{oTs \text{ deg} [\text{kg/m}^3] * \text{Substrate} [\text{m}^3/\text{d}]} \right) \quad \text{Equation 3-7}$$

### 3.5.5 Gompertz equation for H<sub>2</sub> production Regression Analysis

The modified Gompertz equation (Eq.3-10) <sup>67</sup> has been used to estimate hydrogen production potential and rates.

$$H(t) = P \exp \left\{ -\exp \left[ \frac{R_m e}{P} (\gamma - t) + 1 \right] \right\} \quad \text{Equation 3-8}$$

Where:

H(t) is the cumulative hydrogen production ml

P is the hydrogen production potential ml

R<sub>m</sub> is the maximum hydrogen production rate ml/h

γ is the duration of the lag phase h

t is the time h

e is approximately 2.718

---

## **4 Evaluation and Results discussion**

### **4.1 Batch test results from this study**

#### **4.1.1 The effect of inoculum to substrate ratio on BioH<sub>2</sub> production**

There have been limited studies of the effect of inoculum to substrate ratio in the Biochemical Hydrogen Potential assay. The quantity and quality of inoculum are key factors for stable and efficient anaerobic digestion. Low  $R_{I/S}$  (in mass g/g ) may extend the lag phase (acclimation and biomass propagation), lead to a deficiency in nutrients or overall system instability. Although the system performance parameters of organic degradation rate, oTS removal, and methane or hydrogen production rate are not enhanced in a manner that is directly proportional to increased  $R_{I/S}$ , biomass activity may be decreased or repressed due to biomass survival competition caused by nutrients deficiency at high  $R_{I/S}$ .

pH is the most important non-biological factors that can influence the fermentation process by altering metabolism rate or fermentation type in acidification phase. By shifting the culture pH in the acid reactor stepwise from 4.0 to 6.5, the main fermentation types were changed from ethanol fermentation to butyric fermentation, acetic fermentation and propionic fermentation with different hydrogen yield potential. The buffering capacity in Inoculum can balance the produced organic acid and limit the pH variation, and thus influence the hydrogen yields in acidification phase.

#### **Effect of Heat Treatment**

Although heat treatment has been reported to be an effective methods for HCB repression and HPB enhancement, we obtained a very low hydrogen production rate at 1.56L/kg oTS was obtained in this study (as shown in Figure 4-1). Heat treatment at specific temperature of 100°C for 30min suppressed the most activity for HCB activity, and when  $R_{I/S}$  was set at 1-4, no methane was detected. While, when  $R_{I/S}$  was set at 5 and 6, methane was detected on the 8th day and 6th day, respectively. Thus, heat treatment is not recommended method for inoculum due to the suppression activity of HPB activity. The activity of HCB is not completely suppressed and may be recovered under moderate living conditions. The specifications are presented in Appendix 4-1 and Appendix 4-2.

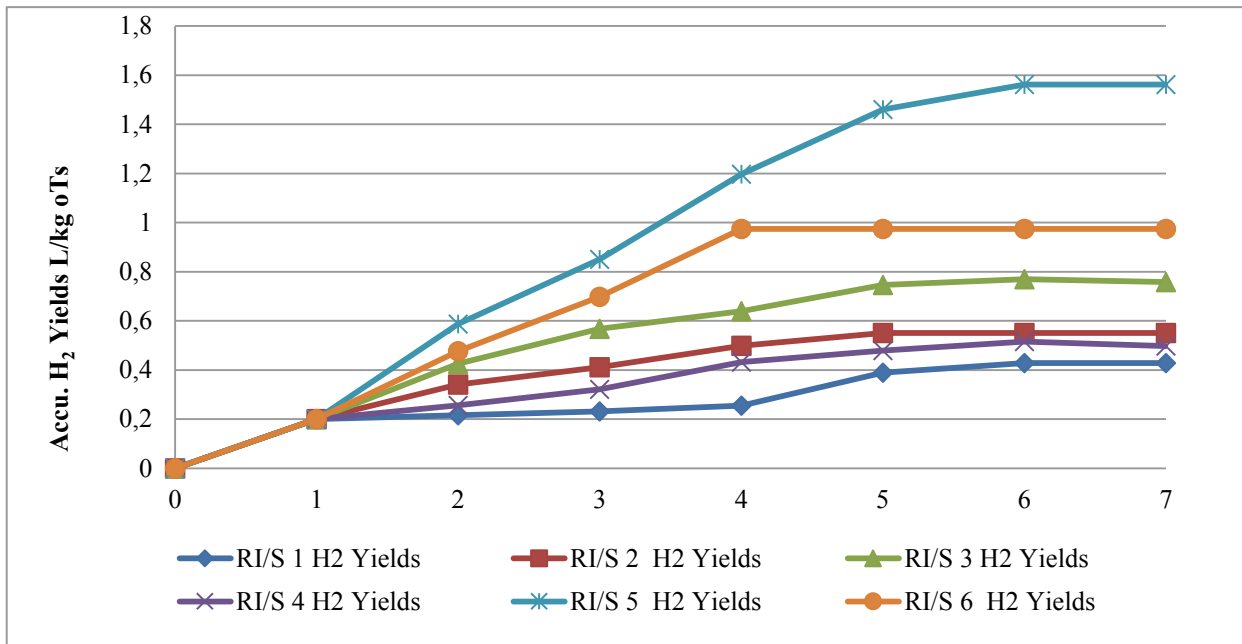

Figure 4-1: Accumulated H<sub>2</sub> yield at different R<sub>1/S</sub>

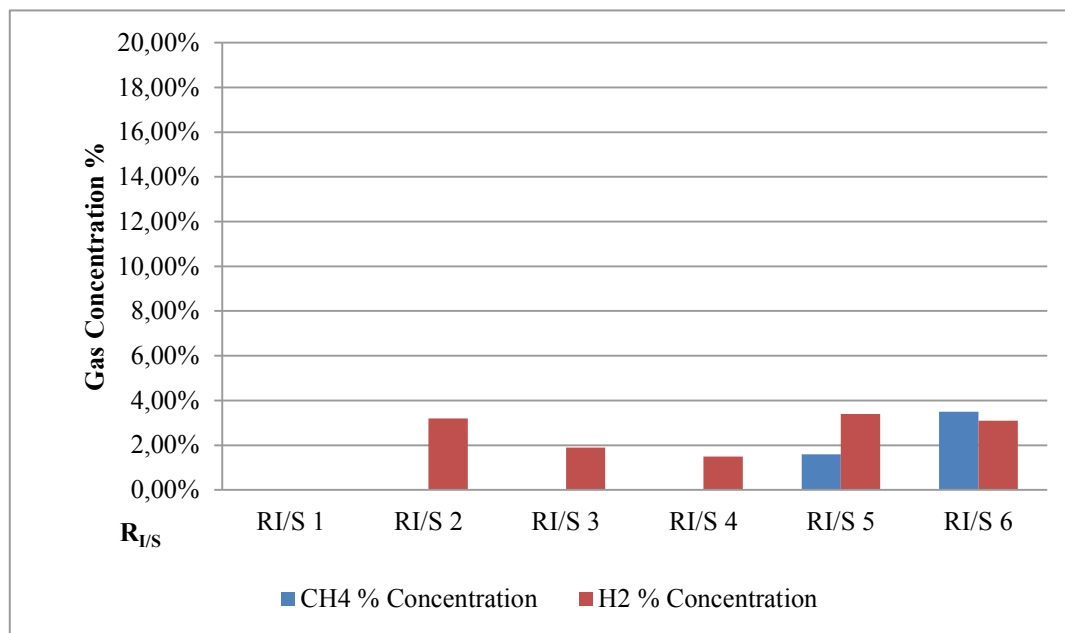

Figure 4-2: CH<sub>4</sub> and H<sub>2</sub> concentration via heat treatment

### Effect of pH increasing treatment

Experimental results (in Appendix 4-3) show that hydrogen productivity with the value of 60.62L/kg oTS by the pretreatment method of pH Increasing was much higher than other pretreatment methods except inoculated seeds. However, methanogenic activity was not be entirely eradicated from seeds at any R<sub>1/S</sub> except R<sub>1/S</sub> 1, which showed no gas production during the entire process. When R<sub>1/S</sub> >2, the CH<sub>4</sub> gas was detected and was

higher than 65% when  $R_{I/S} > 4$ . Even hydrogen production was enhanced by the pH increasing method, for continuously hydrogen production on the industrial scale, the activity of methanogens must be totally eradicated or suppressed to prevent acclimation and accumulation of the methanogens that will decrease hydrogen yields efficiency. For this reason, treatment by pH increasing is not a realistic option.

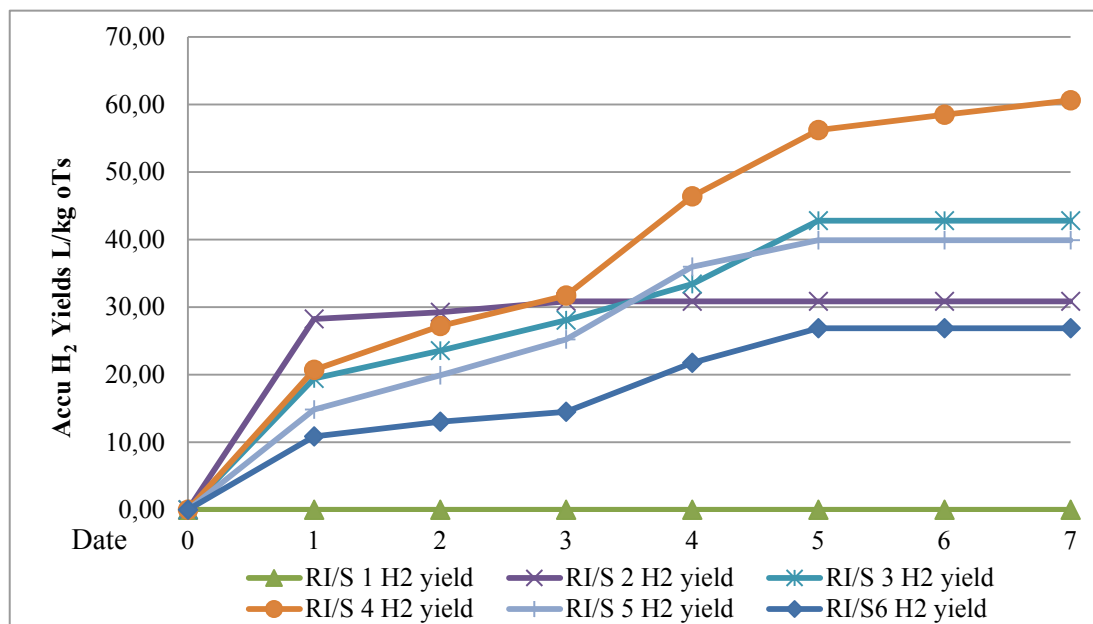

Figure 4-3: Accumulated H<sub>2</sub> yield at different R<sub>I/S</sub>

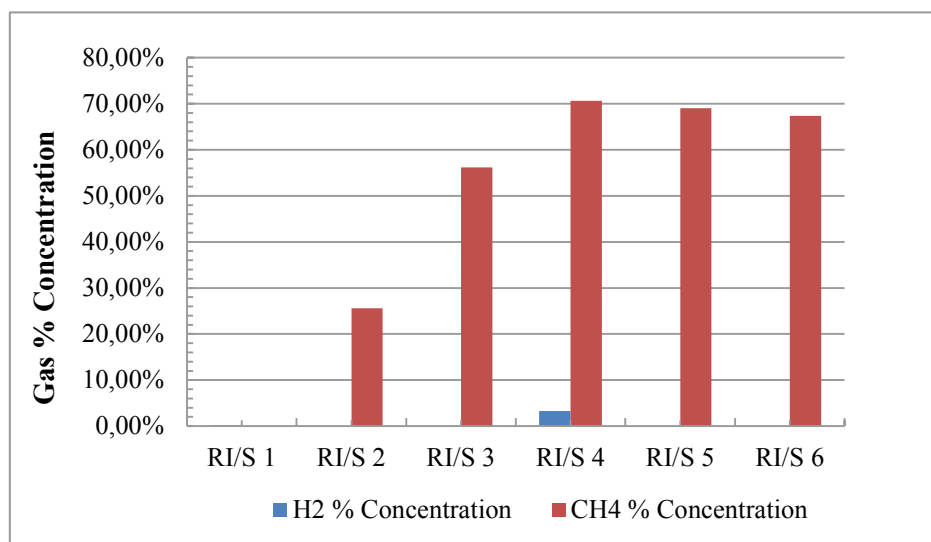

Figure 4-4: CH<sub>4</sub> and H<sub>2</sub> concentration via pH increasing

### Effect of pH decreasing treatment

The pretreatment method of decreasing pH was found to not be suitable for HPB enrichment. This is an effective for methanogens repression, but it also represses the activity of HPB. There was nearly no gas



produced (as shown in Appendix 4-4) at each  $R_{I/S}$  and no hydrogen was detected during the whole process. This is likely caused by high salt concentration from regulating of the pH of the seeds. High salt concentration inhibited the biological process by dehydration of bacterial cells due to osmotic pressure. This dehydration decreased the microbial metabolic activity, and even caused microbial death. Based on the previous results, the salt limit range for un-inoculated seeds in batch test is 1.4% to 2.1%<sup>68</sup>.

### Effect of aeration treatment

The inoculum from liquid manure and digestate was aerated for 14 days for better HCB inhibition efficiency. Six batch tests were done in this investigation with different  $R_{I/L}$  (ratio of Inoculum to Solid).

The seed treatment by aeration process was expected to be the most effective methods for methanogens repression and HPB enhancement based on above mentioned experimental results. The highest hydrogen production rate was obtained at 19.72L/kg oTS when  $R_{I/S}$  was 3 and  $H_2\%$  in hydrolysis gas was reached meanwhile at 18.2%. Throughout the whole experimental process, there was no methane detected. As shown in figure 4-5, there was no gas produced when  $R_{I/S}$  is set at 1. The activity of HPB and HCB were both suppressed and after 24h metabolism of HPB was resumed with  $H_2$  yields gradually. Although higher  $R_{I/S}$  can increase the biomass density and buffer the pH in bioreactor, ease the production inhibition, we observed that the bio $H_2$  yields dropped off when the  $R_{I/S}$  was higher than 3. This may be caused by different predominant strains in bioreactor due to the higher buffering capacity supported by added inoculum. Additional experimental data can be found in Appendix 4-5 and 4-6.

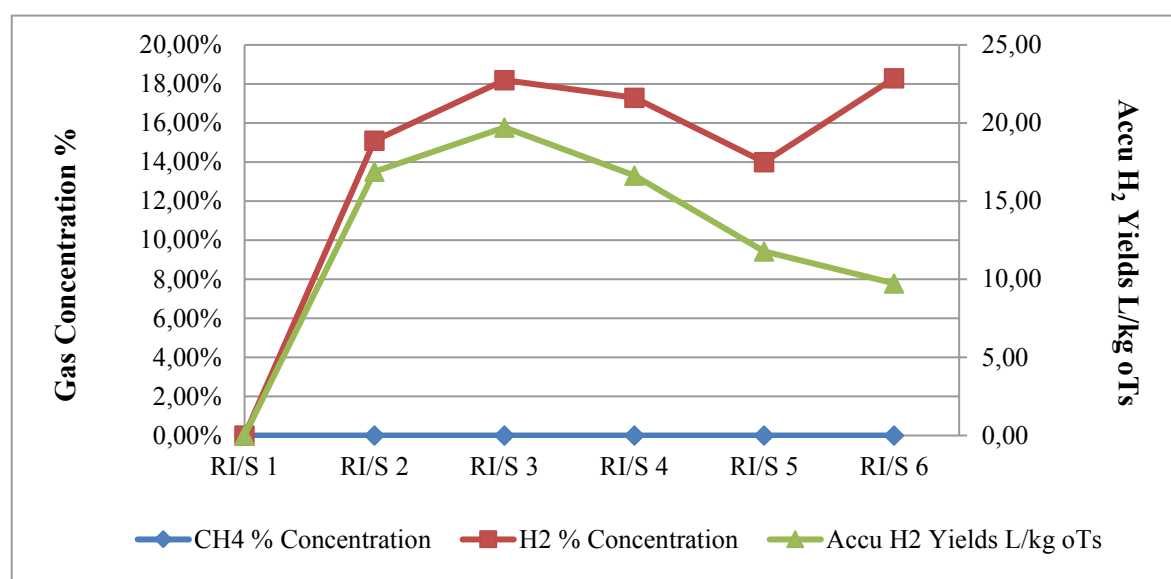

Figure 4-5: Hydrogen yield and concentration via Aeration treatment

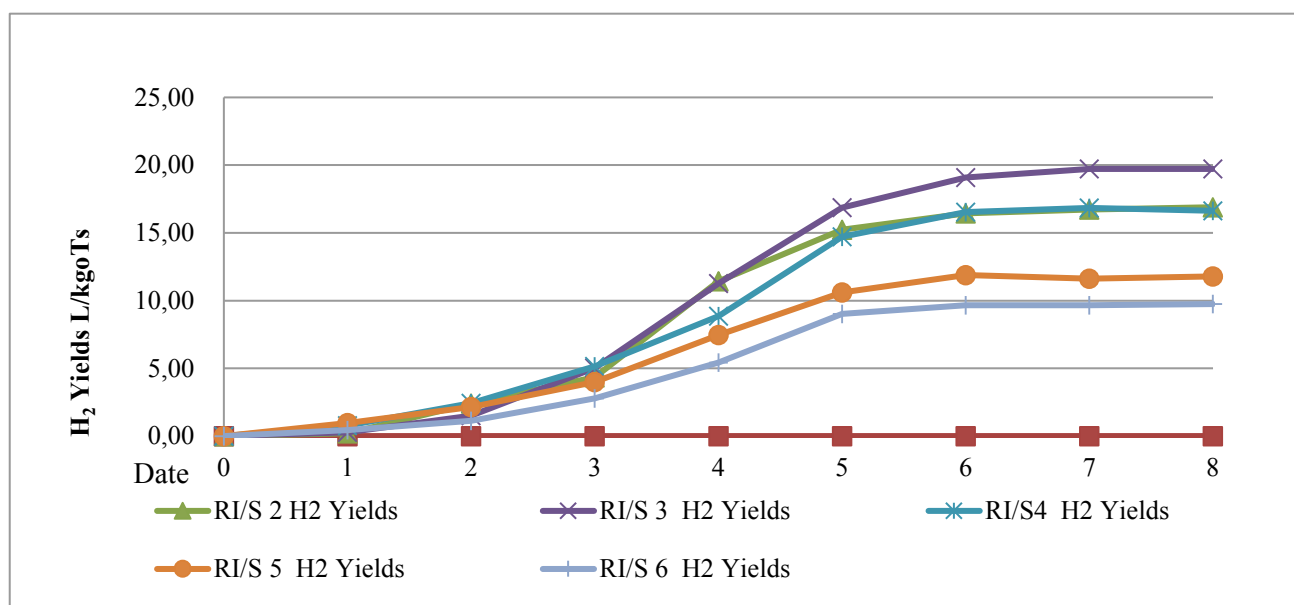

Figure 4-6: Accumulative H<sub>2</sub> production at different R<sub>I/S</sub>

### Effect of Chloroform Treatment

The inhibition by chloroform on methanation process can be explained by metabolism process. The last steps of the metabolic pathway of methanogens all require unusual co-enzymes and co-factors with novel structures, that are found only in methanogens<sup>69</sup>. The methyl group is first transferred to the co-factor tetrahydrosarcinapterin (THSPt), and then from CH<sub>3</sub>-THSPt to co-enzyme M (HS-CoM). The CH<sub>3</sub>-S-CoM is reductively demethylated to methane by methyl-CoM reductase<sup>70</sup>. Chloroform, with a labile carbon-hydrogen bond (bond energy,  $392.5 \pm 2.5$  kJ mol<sup>-1</sup>) is likely to serve as a competitive inhibitor of methyl groups<sup>71</sup>, which could participate in an enzyme reaction with THSPt or HS-CoM. Additionally, similar stereoscopic structures of chloromethyl and methyl could promote the combination of chloroform and co-enzyme. The chloroform concentration of 10-15 ul/L<sup>72</sup> was reported as the concentration limit for the methanation process.

The inhibition efficiencies of chloroform on Methanation process are shown in the following figure 4-7. Five batch experiments with different chloroform concentrations were performed to test their effects on the Biohydrogen and Methane production efficiencies. At a chloroform concentration of 5 μl/L, there was no inhibition on total methane production but an extended the methane production lag phase was observed, as shown in Appendix 4-7. However, when the chloroform concentration was higher than 10μl/L, the methane production was seriously inhibited and CH<sub>4</sub> inhibition rate is higher than 99%. When chloroform concentration is higher than 50μl/L, the activity of HPB and HCB were both suppressed and no gas was detected.

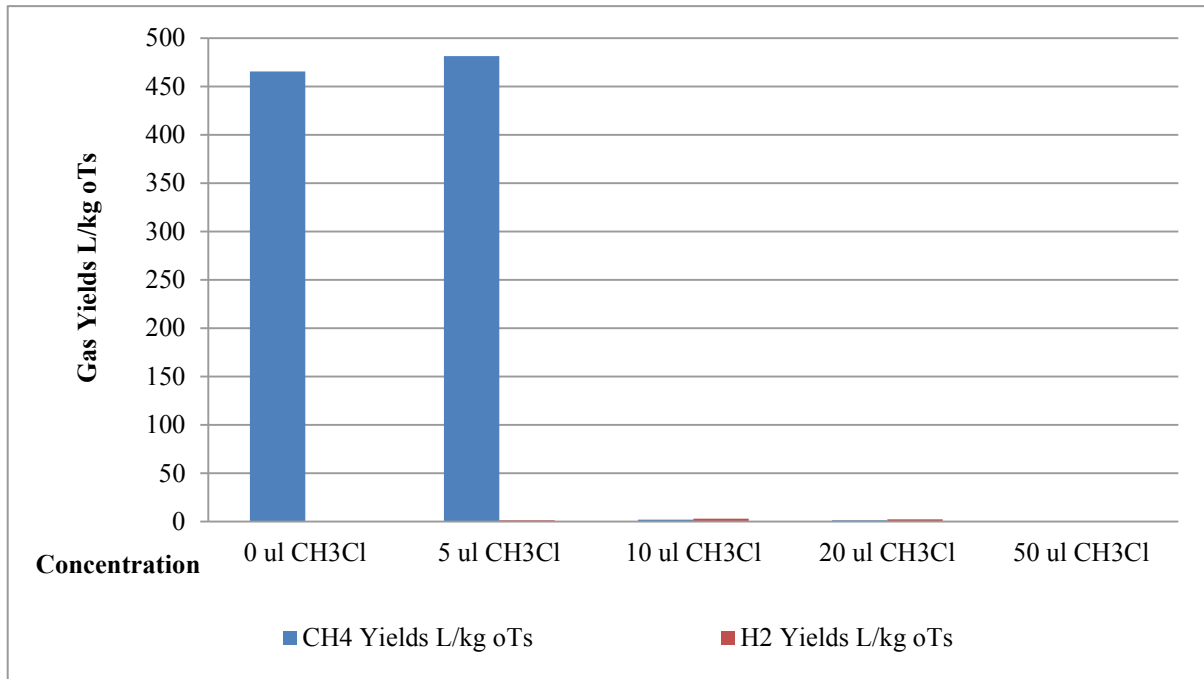

Figure 4-7: The Inhibition efficiency of CHCl<sub>3</sub> pretreatment

Thus, in the experiments testing the effect of Inoculum to substrate ratio on BioH<sub>2</sub> production, a chloroform concentration of 20ul/L was chosen to deactivate methanation process while HPB were still alive. As shown in Figure 4-8, at an  $R_{I/S}$  is 1, there was no gas production during the whole process. And when  $R_{I/S}$  is higher than 2, the produced CH<sub>4</sub> yields grew rapidly and reached to 365L/kg oTS when  $R_{I/S}$  is 4. Except at an  $R_{I/S}$  1, the activity of methanogens was not totally suppressed and had higher CH<sub>4</sub> yields after lag phase even small H<sub>2</sub> was also obtained. We concluded that pretreatment by chloroform is not a suitable method for BioH<sub>2</sub> sludge pretreatment at higher  $R_{I/S}$ , but this method may be used as a useful back-up to suppress methanogens in a continuously operated system for stable bio-hydrogen yields. More experimental data can be found in Appendix 4-8.

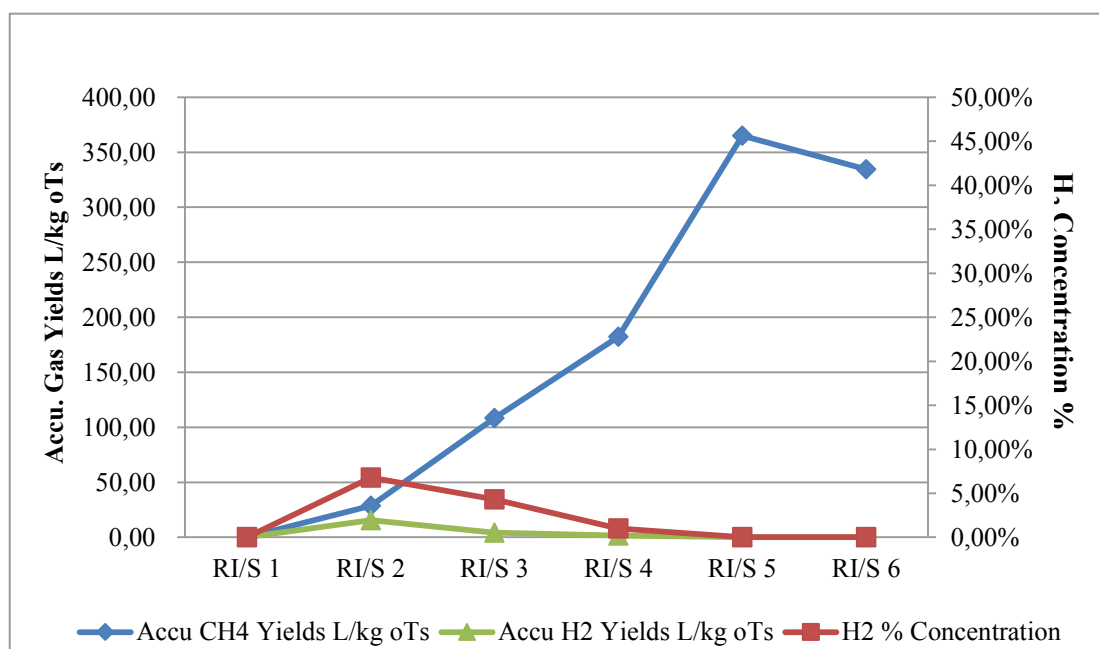

Figure 4-8: CH<sub>4</sub> Yields via CHCl<sub>3</sub> pretreatment

#### 4.1.2 The effect of inoculum pretreatment methods on BioH<sub>2</sub> production efficiency

The aim of this work was to test the inhibition efficiency of different pretreatment on mixed inoculums. Seven individual methods for hydrogen producing seeding including heat, cooling, pH increasing, pH decreasing, chloroform, aeration and well inoculation from continuously BioH<sub>2</sub> ASBR Reactor were investigated in this series of experiment. RI/S was set at 3 based on above investigation results that showed higher degradation rate and H<sub>2</sub> production yields.

For continuously hydrogen production on the pilot or industrial scale, the methanogenic activity must be entirely eradicated or suppressed, otherwise the HCB will multiply and thus consume in acid producing reactor thus reducing H<sub>2</sub> yields. Figure 4-9 shows accumulative H<sub>2</sub> Yields after various pretreatment methods. The highest hydrogen yield of 61.41L/kg oTS was much higher and faster than other pretreatment methods and was obtained by seed inoculation pretreatment from a BioH<sub>2</sub> ASBR Reactor. This results indicate that proper sludge inoculation process can significantly enhance the hydrogen production rate, shorten the lag phase of dark fermentation and suppress methanogens activity.

Pretreatment with Chloroform also allowed HPB enrichment. After 24h it reached hydrogen yield of 7.64L/kg oTS and then bioH<sub>2</sub> yield grew slowly until it reached maximum level of 11.91 L/kg oTS after 192h. The other pretreatment methods, like heating/cooling, acid/alkaline exhibited poor performance. With the pretreatment of acid/alkaline treatment, the activity of HPB and HCB was both suppressed and during the whole process,

nearly no H<sub>2</sub> and CH<sub>4</sub> were detected. This shall was likely to inhibition by high salt concentration in substrate due to pH regulation. With the pretreatment of cooling and heating treatment, the activity of HCB was only suppressed for certain time but still existed. After certain time activity of HCB was recovered and decreased the hydrogen production yields. Even Aeration pretreatment has longer lag phase for BioH<sub>2</sub> production, after 48h the activity of HPB slowly resumed and reached 16.88 L/kg oTS after 120h and reached max. hydrogen yield of 19.72L/kg oTS after 168h. Pretreatment methods via pH increasing, pH decreasing and cooling were find no H<sub>2</sub> produced due to too less produced for gas sampling. Thus, pretreatment of inoculum via aeration was found the optimum method for BioH<sub>2</sub> production. More experimental data are listed in Appendix 4-10.

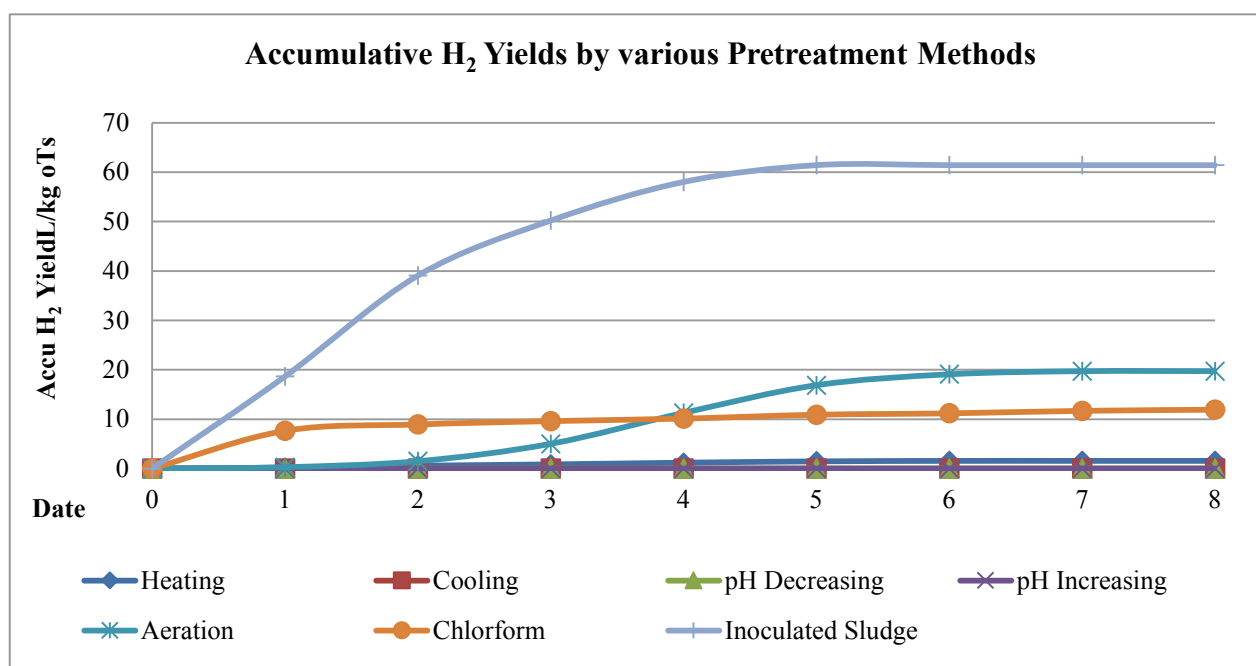

Figure 4-9: Accumulative H<sub>2</sub> Yields by various Pretreatment Methods

### 4.1.3 The effect of temperature on BioH<sub>2</sub> production

The effect of temperature on acidification rate is determined by two factors: 1. Biological factor: Based on the enzyme adsorption based kinetic model, the acidification rate of undissolved substrates will be increased with the enzyme concentration, activity and the biological absorption area; 2. Non-biological factor: The increasing temperature leads to changes of substrates in physical and chemical properties which resulted in particle autolysis.

A variety of bacterial includes mesophiles, thermophiles and hyperthermophiles have been reported to be capable of biohydrogen production. Three series experiments were conducted in this study parallel to evaluate

---

biohydrogen production efficiency from food wastes with different temperature ranges. Based on above experiments results, seed sludge after aeration pretreatment were used as inoculum in this investigation. While, the seed sludge in Experiment 73 °C -2 was cultured by batch experiments using 1L Eurodimeter at 73 °C under anaerobic conditions due to less bacterium species and low adaptive capacity as reported before aeration pretreatment. The optimum  $R_{I/S}$  ratio was set to 3 based on experimental results in Chapter 4.1.

The total amounts of produced hydrogen were strongly dependent on the incubation temperature as presented in following Figure 4-9 which presents the time course of hydrogen production during 8days fermentation period for food waste at temperature 37 °C, 55 °C and 73 °C, respectively. The two peaks of fermentation temperatures for hydrogen production were observed at 55 °C and 73 °C -2 in which inoculated seed sludge was used as inoculum with 13.71 and 13.27 H<sub>2</sub> L/kg oTS respectively. On day two, hydrogen production proceeded as an exponential phase and then reached the stationary phase. While hydrogen production were low at 37 °C and 73 °C -1 (4.71 and 2.59 H<sub>2</sub> L/kg oTS, respectively) even their productions were increased slowly during whole digestion period. The experiments were stopped on day 8 when the methane was detected. This result suggested that hydrogen production at 55 °C and 73 °C using well inoculated sludge have good hydrogen productivity while long time needed for inoculation process at 73 °C because hydrogen production in Exp 73 °C -1 is much lower than in Exp 73 °C -2. Low concentration of methane was detected in both mesophilic and thermophilic range from 5th day while not hyper-thermophilic range.

The detection of CH<sub>4</sub> maybe be caused by insufficient aeration. Despite using the same aeration pump and same aeration time (2weeks), the amount of aerated inoculums amount was much more than last lab test. Thus, the activity of HCB were not total suppressed and then recovered with fermentation proceeding. While, no CH<sub>4</sub> was detected in Exp 73 °C -1 and Exp 73 °C -2. This findings show that methanogens activity must be suppressed or longer generation time and lower reproduction rates occurs in hyperthermophilic process. The hydrogen production rate at 73 °C after seed sludge inoculation is a litter higher than that at 55 °C, and thermophilic hydrogen production should be more practical due to lower energy demand and devices requirements. From date 8, only very low content methane was detected and methanation process can be suppressed by adjusting operation parameters or adding chemicals. Overall, thermophilic hydrogen production is the more practical approach. More experimental data can be found in Appendix4-11.

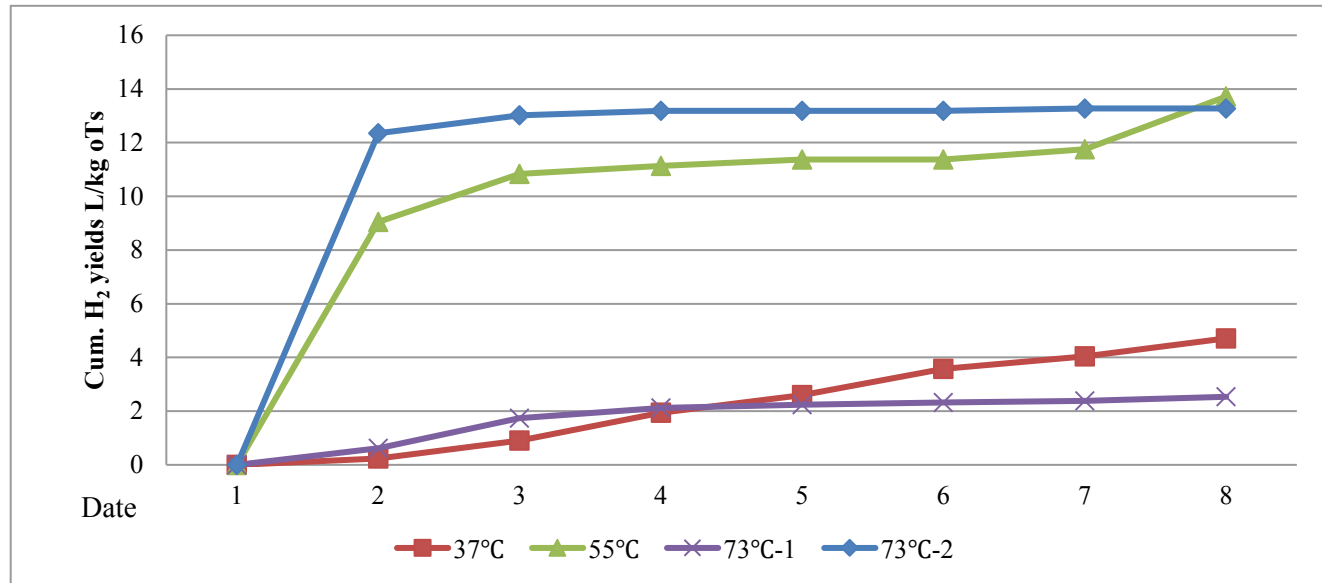

Figure 4-9: Time courses of Fermentation temperature dependency of Hydrogen production in Batch cultures

## 4.2 Results and discussion for combination hydrogen and methane production in continuously lab-scale

In the investigation of continuously bioH<sub>2</sub> production, three kinds of hydrolysis reactors were tested as explained in chapter 3.3. Due to high SS in hydrolysate, the fixed-bed bioreactor with good degradation performance was not implemented in this study due to blockage problem caused by solid particles included in hydrolysate. ASBR bioreactor, with high degradation performance and strong adaptability was thus proposed.

In this study, thermophilic hydrolysis appears promising for hydrogen production based on batch test results. There are significant differences between thermophilic and mesophilic methanogens with respect to structure and function, and the decay rate of mesophilic methanogens in the thermophilic range is extremely high.<sup>73</sup> Therefore, recycling the fermentation liquid from mesophilic methanation to thermophilic hydrolysis process leads to a considerable HCB inactivity or die-off due to rough temperature variation. Thus, the effect of HCB on hydrogen production should be eliminated or restrained.

### 4.2.1 CSTR Reactor for Hydrogen production + ASBR Methane production

---

## Total energy Output

The produced biohydrogen in Acid producing phase can be used as the energy source for a fuel cell, and the biomethane produced in methanation process via degradation of effluent from acid producing system can be used as energy source for CHP. The main aim for this study is to determine the optimum technology for energy recovery which consist both H<sub>2</sub> and CH<sub>4</sub>.

To calculate the energy output, energy conversion efficiency from heat value gas to kWh is not used to avoid misunderstanding due to different conversion factors for H<sub>2</sub> and CH<sub>4</sub>. In this study, conversion factors of 3 and 10kwh per 1Nm<sup>3</sup> for H<sub>2</sub> and CH<sub>4</sub> respectively were taken for energy output calculation.

Figure 4-10 illustrates that the optimum energy output was reached at 3199kWh per ton oTS of food waste in Exp 2-1-4 when dilution rate was kept at 31.98. The produced in H<sub>2</sub> in acidogenic phase contributes to energy output of 162.3kWh and the produced CH<sub>4</sub> in methanation phase contributes to energy output of 3037.4kWh.

The highest H<sub>2</sub> yields were reached 69.15kWh at a dilution rate of 19.39, but the total energy output was still lower than the monodigester energy recovery due to a very small contribution of H<sub>2</sub> to the total energy output. The total energy outputs in the CSTR system for the 4 sets of experiments were relatively similar. Due to the products inhibition caused by different kind of acids and effects of hydrogen partial pressure, the acidification performance was worse compared to the other two types of acidification bioreactor systems.

All the effluents from the CSTR acidification reactor were pumped into ASBR<sub>Me</sub> for CH<sub>4</sub> production, CH<sub>4</sub> was the main energy contributor with a maximal energy contribution rate of 96.68% and minimal energy contribution rate of 93.36% to the total energy output.

Hydrogen production alone clearly produces lower energy yields compared to traditional methane production. However, H<sub>2</sub> production before methane production should be also favored because of its cleanliness and as a pretreatment for methanation process to shorten HRT of food waste in methane digester and increase OLR. This may reduce digester volume and reactor investment.



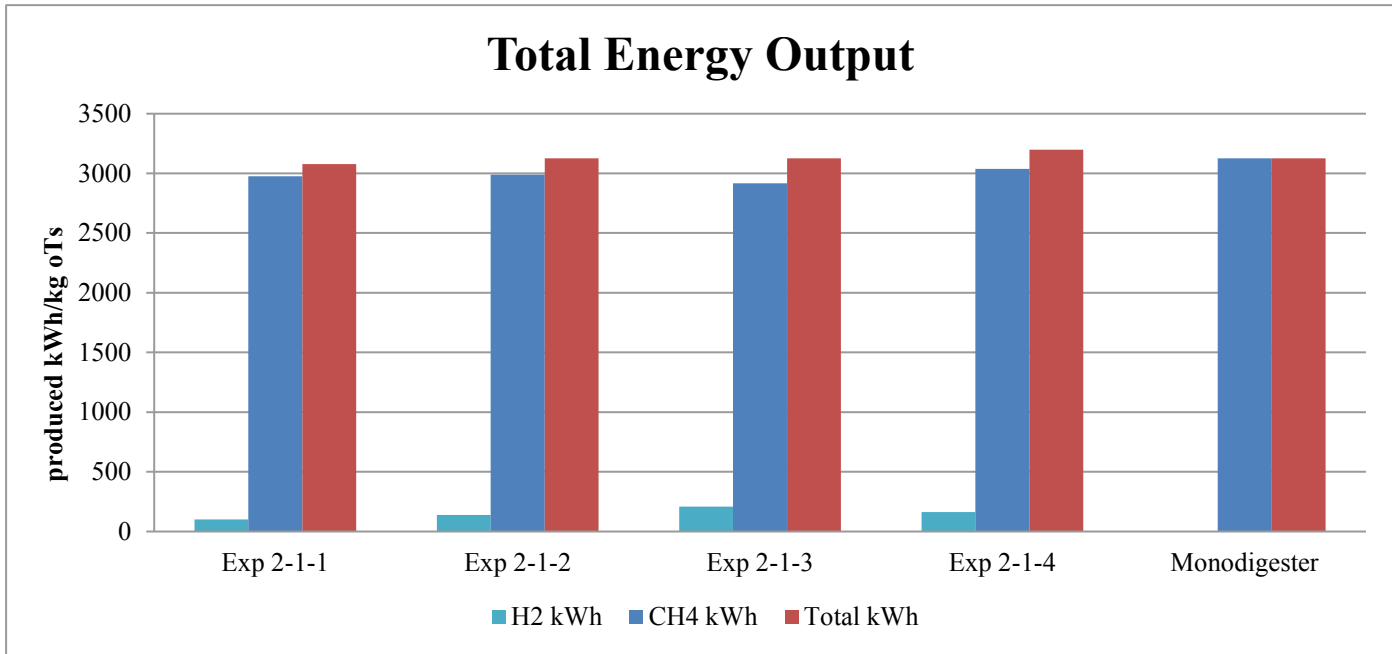

Figure 4-10: Total energy output in the CSTR system

## Effect of $R_{L/S}$ on Hydrogen yields

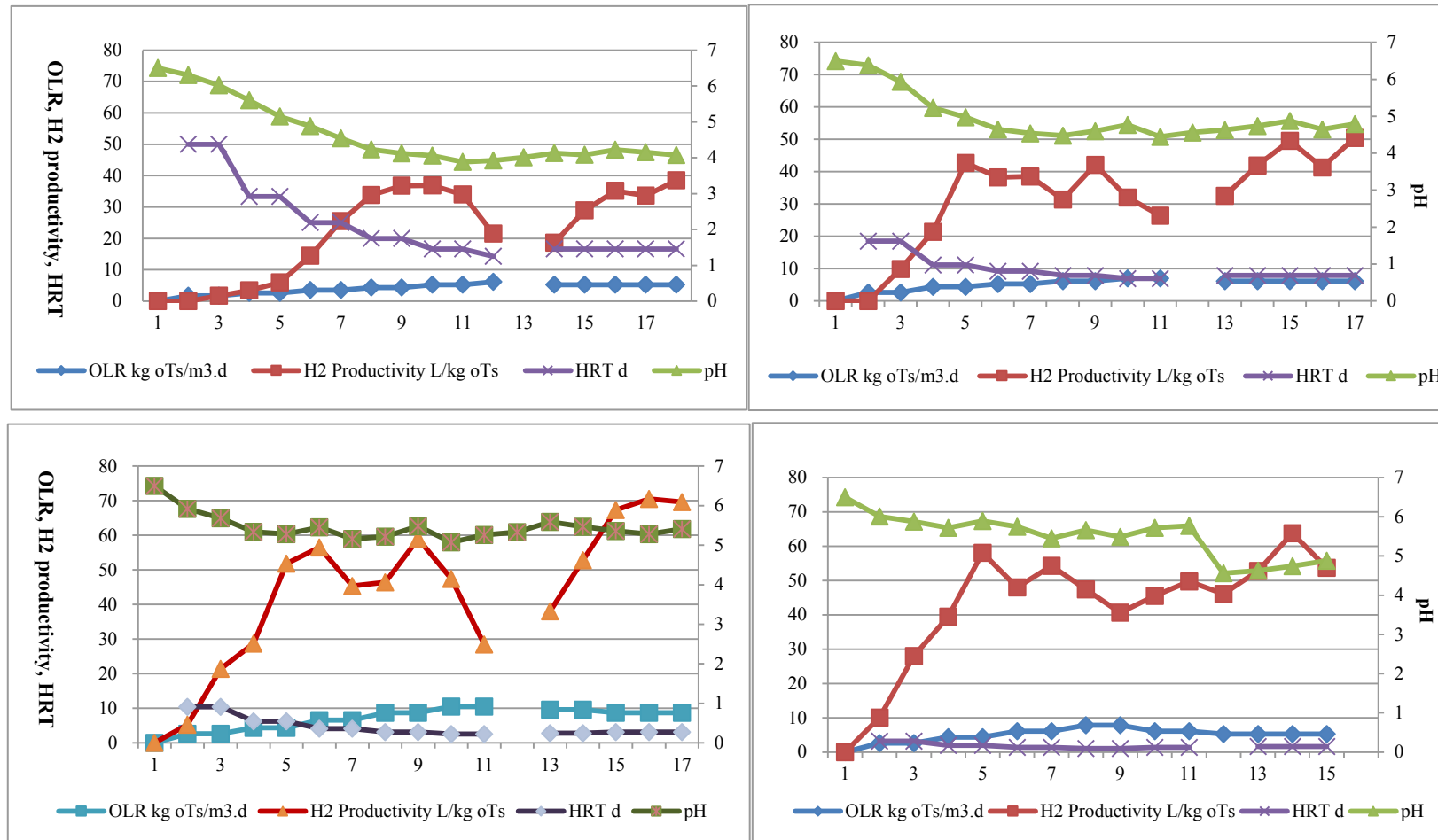

Figure 4-11: Effects of  $R_{L/S}$  on H<sub>2</sub> yields in the CSTR system

---

The liquid to solid ratio  $R_{L/s}$  means how many of liters of solvents will be used to dilute 1kg oTS of substrate. It has a big influence on the acidogenesis efficiency and the spectrum of VFAs. A higher liquid to solid ratio indicates that per kg oTS of substrates will be extracted by more solvents. Therefore, the concentration of produced VFAs during acidification phase should be decreased due to dilution by the solvents. Additionally, the use of effluents from methane reactor used as solvents can also deliver necessary nutrients for the microbial growth and buffering capacity.

Four different liquid to solid ratios were investigated in Exp 2-1 of 8.21, 13.27, 19.39 and 31.98, respectively. The effluent from the ASBR methane reactor was used as solvent after 2weeks of aeration. The pH in the CSTR seeding culture was regulated at 6.5 via chemical adding. As the acidification proceeding in reactor, the pH in each was decreased to varying extents. Higher  $R_{L/s}$  can offer higher buffering capacity for CSTR, and as the  $R_{L/s}$  increased, the pH in reactor culture after acidification process stabilization pH also mainly increased. In Exp 2-1-4 at  $R_{L/s}$  31.98 L/(kg oTS), when OLR was set at 5.24 kg oTS/(m<sup>3</sup>.d), the pH had sharply dropped from 5.77 to 4.56. Then, as OLR was increased to 7.86 kg oTS/(m<sup>3</sup>.d) in the following day, there was a clear decline of H<sub>2</sub> productivity. Thus, even higher reproduction rate for acidogens, too short HRT(<1.4d) and high OLR(>5.24 kg oTS/(m<sup>3</sup>.d)) had seriously inhibited the acidification proceeding. After that, with the OLR decreasing and extended HRT the acidification was thus enhanced with H<sub>2</sub> productivity picking up.

The use of higher  $R_{L/s}$  can buffer the pH produced in CSTR and decrease the inhibition caused by produced VFAs, and also shorten the HRT of substrates in CSTR reactor. At the lower pH, the hydrogen yields was decreased because the increased formation of acidic metabolites which destroys the ability of the cell to maintain internal pH. It results in lowering the intracellular level of ATP, therefore inhibiting organics uptake and decrease pH yields. As described in Chapter 2.6.3, acidogenic producing microorganisms have a short regeneration time and higher reproduction rate, so in Exp 2-1-2, 2-1-2,2-1-3 the shortened HRT with OLR increasing had no serious effects on acidification performance because of low feeding volume. While in Exp 2-1-4, with the OLR increased from 2.62 kg oTS/m<sup>3</sup>.d to 7.86 kg oTS/m<sup>3</sup>.d, the HRT of substrates was shortened from 3.21d to 1.07 d which seriously affected on acidification phase, particularly for solid substrates. More data is presented in Appendix 4-15.

### **ASBR methane production**

The hydrolysate discharged from the CSTR was pumped into the ASBR methane reactor for CH<sub>4</sub> recovery to enhance energy recovery and eliminate the secondary pollution due to high BOD/COD concentration in it. The

well inoculated ASBR methane reactor was selected due to its process stability, good performance for the efficient organics removal, and higher adaptability for hydrolysate degradation, where bigger particle sizes may be present in the influent.

The main objective of this ASBR methane system was to maximize CH<sub>4</sub> recovery from the effluent of the CSTR hydrolysis reactor. Thus, the OLR for this ASBR methane reactor was operated at a lower level in order to avoid effects of overloading or other problems on CH<sub>4</sub> productivity. As shown in the Figure 4-12, the produced hydrolysate from the CSTR reactor degraded very stable in ASBR and for each experiment the CH<sub>4</sub> concentration remained relatively constant. The concentration of CH<sub>4</sub> varied from 64.2% to 68.5% within the optimum range of methanogenesis. More data is presented in Appendix 4-16.

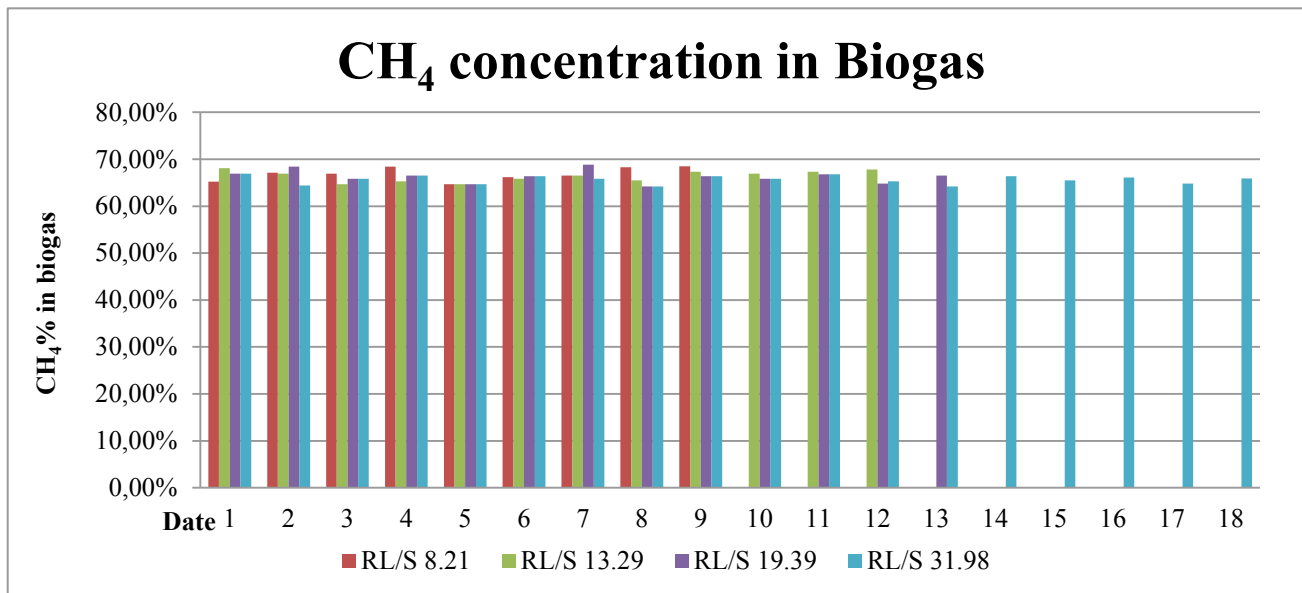

Figure 4-12: CH<sub>4</sub> concentration in biogas in the CSTR experiment

#### 4.2.2 Semi-Percolator Hydrogen + ASBR Methane production

Food waste is typically shredded and pulped to improve hydrolysis and liquefaction performance, processes that are expensive, consume a lot of energy, and accounts for a large portion of the total investment and operation costs. Furthermore, the raw food waste collected from restaurant, supermarket, and household contains a certain quantity of impurities, like stainless steel, metal products, plastics, and packing material, which can be easily destroyed by the size reduction machine, and disrupt the stable operation of an industrial project caused by pump/pipeline blockage, swimming layer in digester, sand sedimentation in pipeline and all tanks, and wear problems, etc. Semi-Percolator offers the good solution for such kind wastes and save the energy consumption meanwhile.

---

## **Total energy output in a one-step percolator or two-step percolator system**

As described in section 4.2.1, the produced biohydrogen and methane can be used as energy resources for fuel and CHP, specifically due to different conversion efficiency. So, the main aim for this study is to determine the best technology to maximize energy output of both H<sub>2</sub> and CH<sub>4</sub>.

In this study, one-step and two-step percolator systems were investigated with different pH regulation. SRT was set at 4 days for both systems. In the two-step percolator system all the hydrolysate was discharged by the third investigation day and re-fed percolator with process water after aeration treatment.

Overall, the two-step percolator system can promote the degradation of food waste and get higher energy recovery compared to one-step percolator system by maintaining the same reactor volume and solid retention time. Figure 4-13 illustrates the total energy output via one-step and two-step percolator system. The optimum energy output was reached at 3170.7kWh per ton oTS of food waste in Exp 2-2-8 in the two-step percolator system. The produced H<sub>2</sub> in Acid producing phase contributes to an energy output of 232kWh and produced CH<sub>4</sub> in methanation phase contributes to an energy output of 2938.7kWh. And the lowest energy output was observed in Exp 2-2-1 using the one-step percolator system.

The CH<sub>4</sub> was still the main energy contributor in this investigation with maximum energy contribution rate of 96.97% and a minimum energy contribution rate of 90.91%.

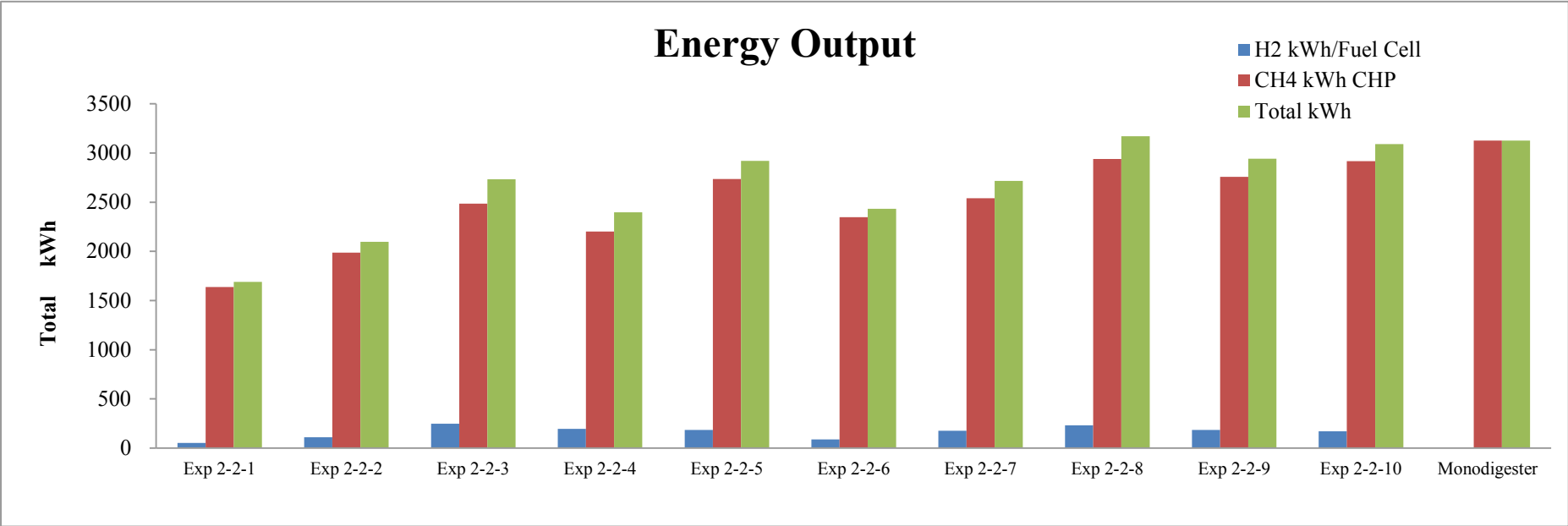

Figure 4-13: Total energy output via one-step and two-step percolator system

Total energy output was obtained in Exp 2-2-8 as using the two-step percolator system, and the highest H<sub>2</sub> yield (in kWh) was achieved in Exp 2-2-3 using the one-step percolator system. In the first two days, the cumulative H<sub>2</sub> yields were nearly the same, but in the second two days due to the replacement of hydrolysate by process water (effluent from methane reactor after aeration treatment), the H<sub>2</sub> yield in Exp 2-2-8 was obviously lower than in Exp 2-2-3. Thus, the pH range from 5-5.5 was the H<sub>2</sub> productivity.

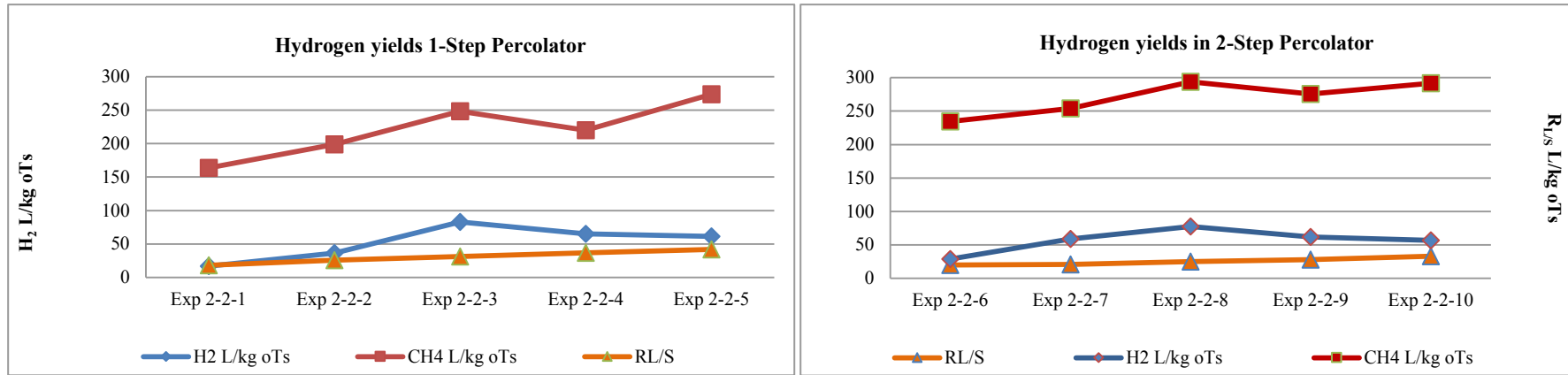

Figure 4-14: H<sub>2</sub> yields in two systems

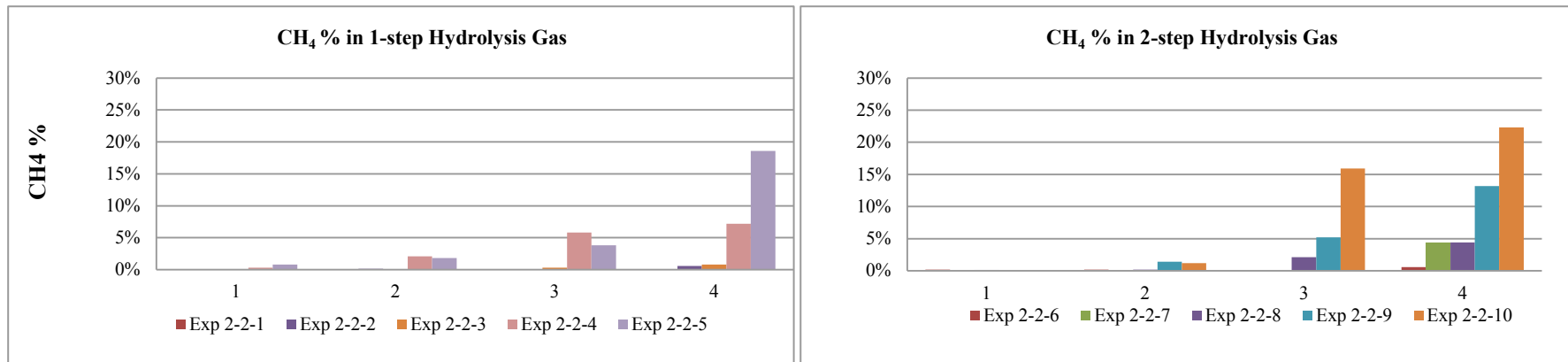

Figure 4-15: CH<sub>4</sub> concentration in Hydrolysis Gas

The H<sub>2</sub> yields in the one-step percolator system and two-percolator system are shown in Figure 4-14 and Figure 4-15. As pH increased from 4 to 5.5, the H<sub>2</sub> and CH<sub>4</sub> yields in methanation process kept constant increasing. Then, with pH further increased from 5.5 to 6.5, the H<sub>2</sub> yields dropped sharply accompanied with CH<sub>4</sub> yields decreasing during methanation process.

CH<sub>4</sub> was detected in both 1-step and 2-step percolation system particularly in the second phase of the 2-step system. The highest CH<sub>4</sub> concentration in Exp 2-2-10 was found at 22.3% on the 4th day, however the CH<sub>4</sub> production in acid producing phase is not included in the calculation of total energy recover which would have seriously bad effect on total energy recovery. Due to high amounts of process water requirement in this investigation, aeration pretreatment time was shortened to 7days to satisfy the process demand. However, the study results indicate that inefficient aeration may lead to incomplete repression of HCB which can be easier recovered especially in nearly neutral conditions. This should be a challenge for industrial project because it is difficult to control and monitor aeration performance.

### **oTS degradation rate in percolator system**

The well inoculated ASBR methane reactor has been used for hydrolysate further methanation process, moreover the operational OLR were lower than maximum rate for this methane reactor. During the whole study, the methanation reactor worked well with stable CH<sub>4</sub> content and effluent quality. Here, in this study only raw waste organic degradation in semi-percolator hydrolysis process was valued.

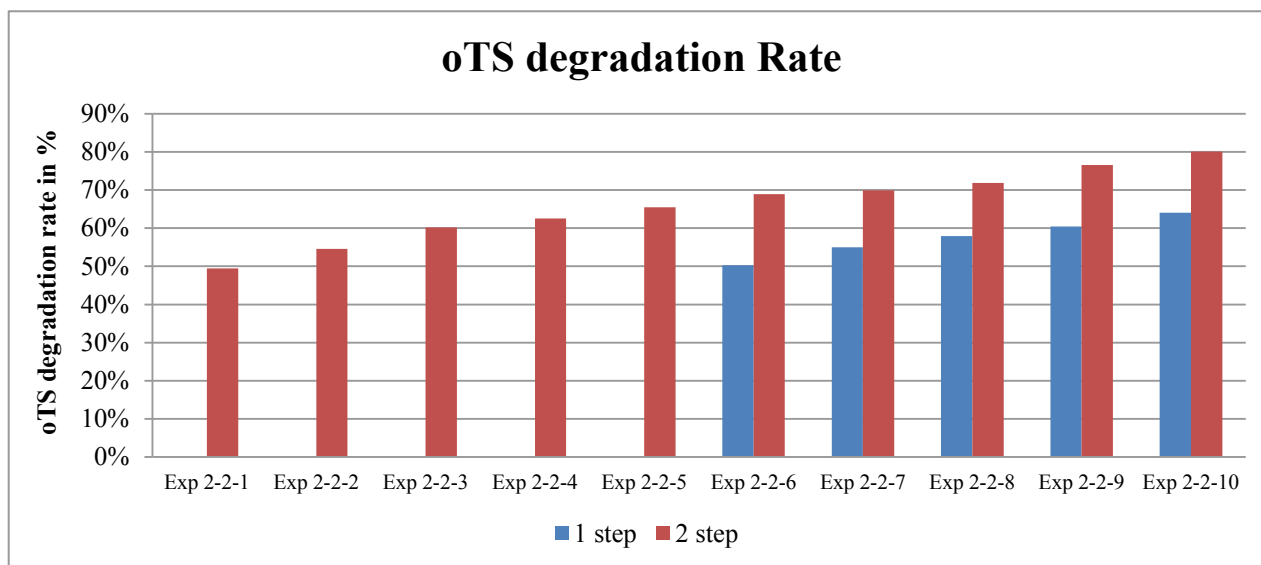

Figure 4-16: oTS degradation rate in percolation hydrolysis process



---

Figure 4-16 showed that the max. oTS degradation rate was reached in Exp 2-2-10 when pH was set between 6-6.5 in two-step percolator system, and the highest oTS degradation rate was also obtained in the same pH range in Exp 2-2-5 in one-step percolator system even 13.08% lower than in Exp 2-2-10. These two experiments were performed in nearly same environmental conditions except that the hydrolysate was taken out after 2 days in Exp 2-2-10 and refilled with process water by controlling pH in the range of 6-7. The results showed that the produced volatile fatty acid in Acidogenic phase showed seriously inhibited further hydrolysis proceeding that can cause lower oTS degradation rate and low total energy output recovery. This was also strongly confirmed in Exp 2-2-1 and Exp 2-2-6. The oTS degradation rate in Exp 2-2-1 and Exp 2-2-6 were 49.61% and 68.89%, respectively. While, in Exp 2-2-6 oTS degradation rate after first step hydrolysis was reached 50.3% which is nearly the same as the values in Exp 2-2-1. This indicates that the acidogenic process was totally inhibited and nearly no hydrolysis proceeded after two days (first step acidogenesis). Then, with hydrolysate discharging and pH increasing organic degradation was thus enhanced and reached at 68.89% in the second step hydrolysis. This indicates that two-step percolator system can promote the oTS degradation process due to nearly neutral living conditions in the second Acidogenic phase can enhance the physiological activity of microorganism. Additional experimental values are presented in the Appendix 4-18.

## **Effect of $R_{L/S}$ on hydrogen production efficiency**

### **1) Effect of $R_{L/S}$ on pH variation**

The measured pH within the reactor is determined by both the level of alkalinity and the rate of acid production. The pH can affect the physiological activity of microorganism. It is the most important non-biological factors which influence the fermentative process, e.g. causing the charge changing in cell membrane therefore influence the nutrient absorption by acidogens; influencing activity of enzymes, etc.

$R_{L/S}$  (Liquid to solid ratio) means how many Liters will be used to hydrolysis 1kg oTS of substrate. The ratio has a big influence on the acidogenesis efficiency and the spectrum of VFAs. Higher  $R_{L/S}$  means per kg oTS of substrate will be extracted by more solvents and produced VFAs concentration will decreased. Moreover, if special liquid with nutrients necessary for the microbial growth and buffering capacity e.g. recycled process water from methanogenesis reactor, higher liquid solid ration means more nutrients and higher buffering capacity that may promote degradation rate and stable pH in reactor. Of course, too high concentration of nutrients will also be fatal for the microbial synthesis.

The figure 4-17 showed that the at the nearly same pH range the  $R_{L/S}$  is obviously low in two-step than in one-step percolator system through hydrolysate discharge after 2days. The lower  $R_{L/S}$  can reduce the amount of re-circulated process water, which can not only reduce transportation cost in practice, but also increase the aeration efficiency for deactivating methanogens. Additional experimental date is presented in Appendix 4-19.

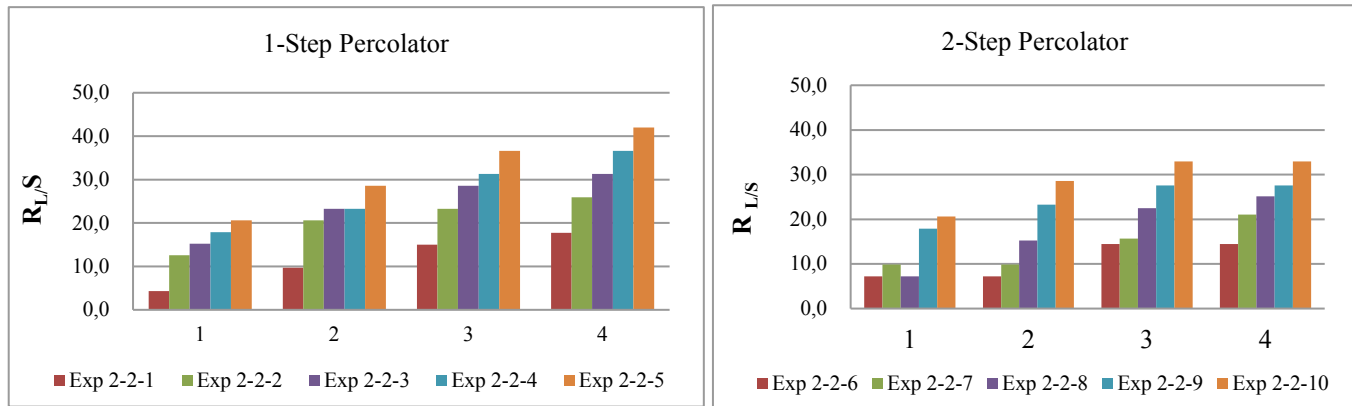

Figure 4-17: Liquid to solid ration in Percolator system

## 2) Effect of $R_{L/S}$ on hydrogen production efficiency

In all experiments the fermentation of food wastes started very quickly even without seeding material and maximum hydrogen content came forth in the first two days. The hydrogen content in acid situ was higher than in nearly neutral situ which should be caused by fermentation type and activity of HCB.

Due to high organic part in food waste, the hydrolysis and acidification processes would be suppressed by high acid concentration which resulted in low pH as 4 even lower in hydrolysis reactor. For this reason, food wastes have been diluted with effluent from methane reactor, meanwhile to wash out the produced acid and ease their inhibition on further hydrolysis proceeding. As reported by Sun-Kee Han<sup>74</sup> the degradation of each component in food waste like carbohydrate, cellulose, and protein in food waste is affected by environmental conditions. Each material has their own optimum pHs and retention time for degradation. So the pH in percolator system was regulated by  $R_{L/S}$  and discharging hydrolysate in two-step percolator system after 2days to ease the products inhibition.

In the two step hydrolysis percolator system, the pH range in first phase was regulated at 4-4.5, 4.5-5, 5-5.5, 5.5-6, 6-6.5 and 6-6.5 in the second phase by increasing  $R_{L/S}$  and slowly and hardly degradable substance such as cellulose and protein whose degradation rate can be enhanced in this step. Hydrolysate was completely

discharged after first phase hydrolysis and stored in cooling cell. Then it would be mixed with hydrolysate from second phase and fed to methane reactor by peristaltic pump for CH<sub>4</sub> recovery.

The Figure 4-18 indicate that the highest H<sub>2</sub> yield of 82.88L/kg oTS was obtained in Exp 2-2-3 when pH varied from 5-5.5 in one-step percolator system. Meanwhile, the H<sub>2</sub> yield in two-step percolator during the same pH variation (5-5.5) was also found the highest value of 77.34 L/kg oTS, even this value is lower than in one-step percolator system. But with R<sub>L/S</sub> varying in all investigation, there were no relation between gas yields and R<sub>L/S</sub> found.

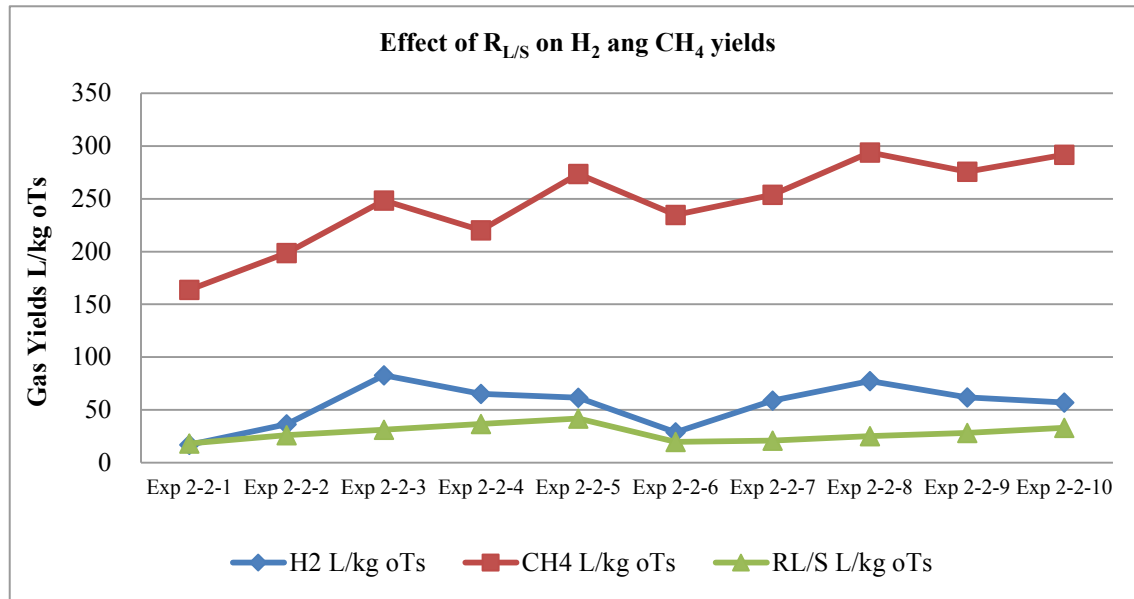

Figure 4-18: Effect of R<sub>L/S</sub> on H<sub>2</sub> and CH<sub>4</sub> yields

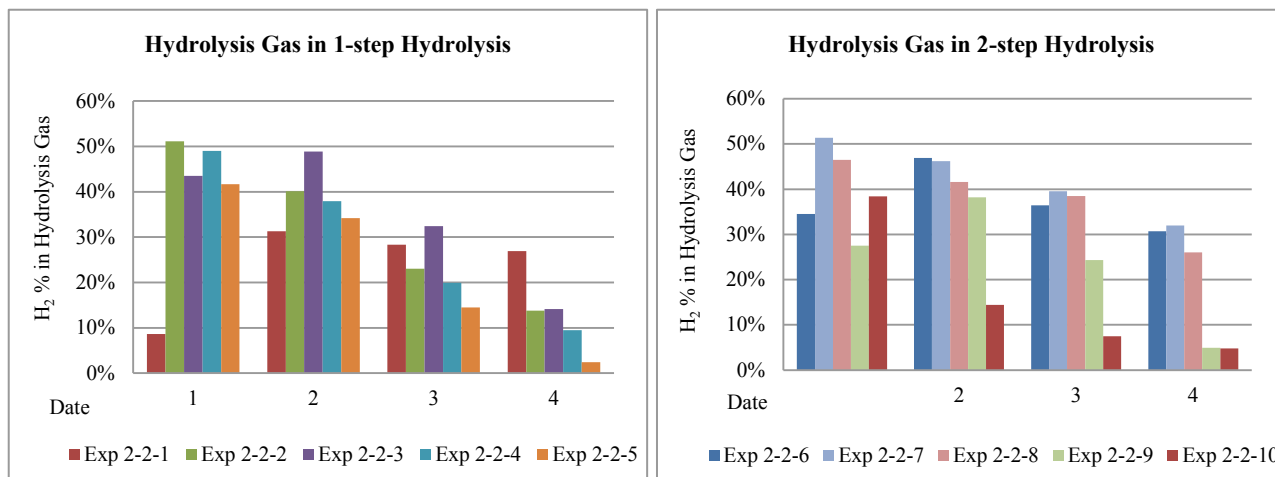

Figure 4-19: H<sub>2</sub> content in hydrolysis gas of percolator

The figure 4-19 showed us the hydrolysis gas quality (H<sub>2</sub> content) from Exp 2-2-1 to Exp 2-2-10. Though the max. H<sub>2</sub> yield were obtained when pH varied from 5-5.5 in both one-step percolator and two-step percolator

system, the highest H<sub>2</sub> content 51.10% and 51.35% was found when pH varied from 4.5-5 in the first investigation day in Exp 2-2-2 and Exp 2-2-7. The H<sub>2</sub> content in hydrolysis should be the results of both HPB and HCB in the reactor. Even short HRT and aeration pretreatment, the activity of HCB was not total repressed. So in nearly neutral living conditions the activity of some HCB may recover, allowing the consumption of some of the produced H<sub>2</sub> to decrease the total H<sub>2</sub> content in the hydrolysis gas. This can be confirmed by the following figure 4-20.

The results show that the activity of HCB was nearly repressed at pH value below 5.5. This was observed in Exp 2-2-1, Exp 2-2-2, Exp 2-2-3, where nearly no CH<sub>4</sub> was detected even when HRT was set at 4d. While, in Exp 2-2-6, Exp 2-2-7 and Exp 2-2-8, in the first 2days there was nearly no CH<sub>4</sub> was detected due to repression of CH<sub>4</sub> by low pH. But after 2days, when all the hydrolysate were discharged and process water were refilled into percolator, the pH in percolator were increased and controlled between 6-6.5 which thus recovered the activity of HCB and CH<sub>4</sub> was detected and increased obviously in second-step of hydrolysis. The energy loss in 2-step percolator system decreased the total energy recovery.

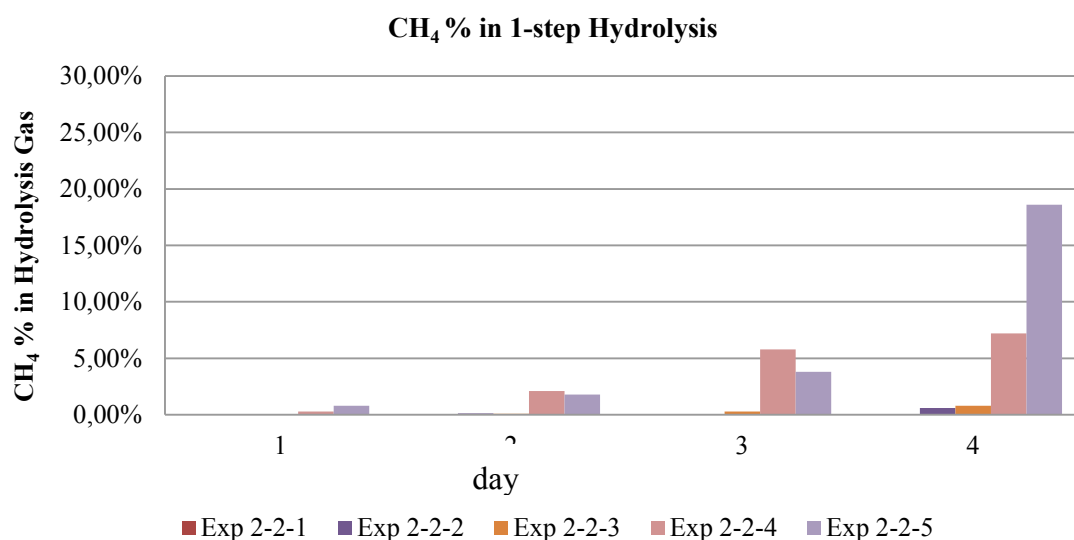

Figure 4-20: CH<sub>4</sub>% in hydrolysis gas in one-step Percolator

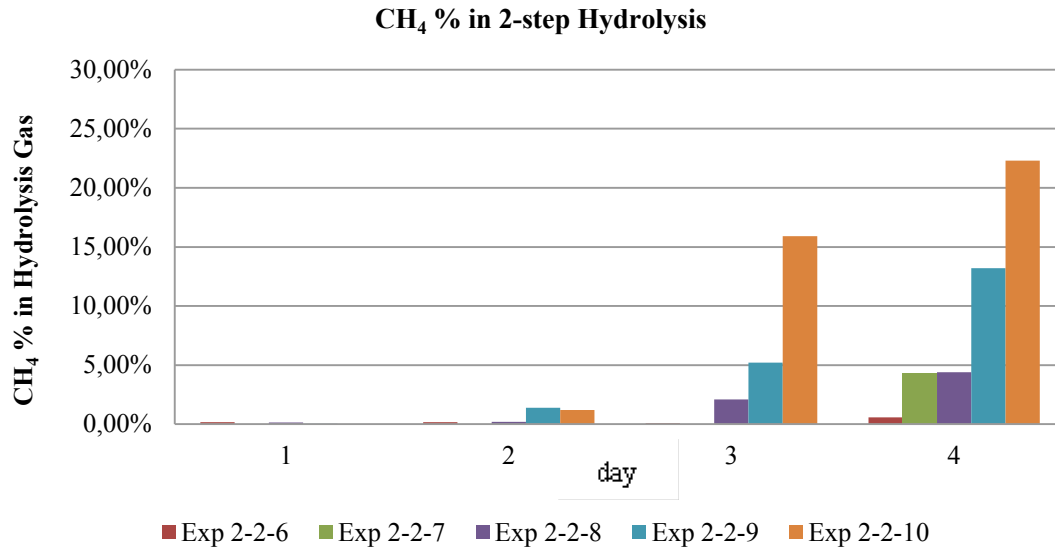

Figure 4-21: CH<sub>4</sub>% in hydrolysis gas in two-step Percolator

Thus, pH variation in 5-5.5 is the optimum conditions for H<sub>2</sub> production yield even H<sub>2</sub> content was not the highest H<sub>2</sub> content.

### Cumulative COD Extraction rate in Hydrolysis

COD is commonly used to indirectly measure the amount of organic compounds in water. Thus, the degree of acidogenic and changes of microorganism behavior can be evaluated by COD.

As discussed in Chapter 4.2.2, when hydrolysate in semi-percolator was discharged, the cumulative COD production stopped increasing but COD was able to be extracted with hydrolysis proceeding. Because the amount of these extracted COD was small, we suppose that when hydrolysate was total discharged there will be no more COD washed out. Here we ignored the COD eliminated by methanogenesis during Acidogenic phase even though CH<sub>4</sub> was detected because this energy is not usable because the level of CH<sub>4</sub> content in hydrolysis gas is too low.

As illustrated in the Figure 4-22 (more data in Appendix 4-22): the maximum ΣCOD production in one-step percolator system was reached 735g/(kg oTS) when target pH was set between 5-5.5 which was regarded as optimum pH range for bioH<sub>2</sub> production. Meanwhile, the maximum ΣCOD productions of 781.97g/(kg oTS) in two-step hydrolysis in Exp 2-2-8 when same target pH range was set between 5-5.5. In total, the amount of extracted COD in two-step hydrolysis system was higher than at the same target pH range in one-step

hydrolysis system. The results indicate that the neutral situ in percolator can enhance the degradation of hard degradable components in the second step, which can increase the total organics degradation efficiency.

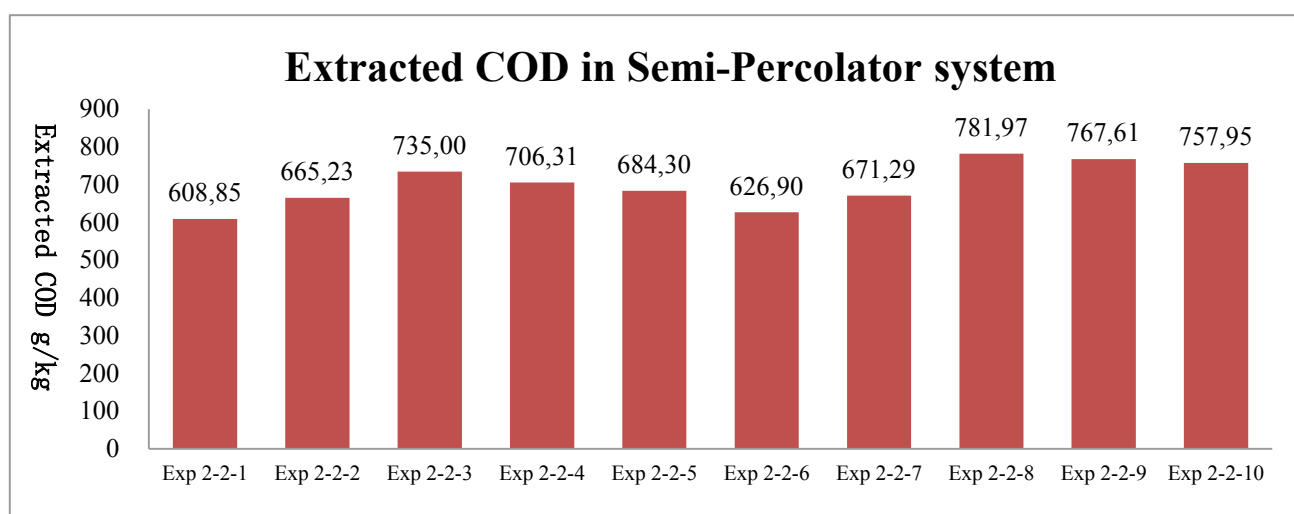

Figure 4-22: Accumulated extracted COD in semi-percolator system

### VFAs Extraction rate in acid producing phase

The particulates can be hydrolyzed into dissoluble organics, then make further acidification and produce VFAs, lactic acid, and ethanol for further methanogenesis. Figure 4-23 illustrates that the final cumulative VFAs production in one-step percolator and two-step percolator system for each target pH range. The results shows that two-step percolator system can promote the acidification process and more VFAs can be extracted. This is nearly consistent with the trend of H<sub>2</sub> yield, extracted COD and total energy output. But when the pH is percolator system was higher than 5.5, especially in two-step percolator system, the activity of methanogens are slowly recovered and the produced VFAs can be consumed by these HCB. The lowest  $\Sigma$ VFAs were still got at pH range 4-4.5 both in one-step and two-step percolator system. The extracted VFAs were obviously increased after the hydrolysate discharged in two-step semi percolator system. These results showed that high concentration of end-products will inhibit the organics degradation.

The maximal extracted VFAs was reached in Exp 2-2-2 at 246.80g/(kg oTS) in one-step percolator system. But the accumulative COD and methane production from produced hydrolysate in Exp 2-2-2 were lower than in Exp 2-2-3. Comparison with these experimental results suggested that this value was regarded as invalid. Mistakes should be taken place when we made lab analysis for VAFs concentration by GC. More values are presented in Appendix 4-23.

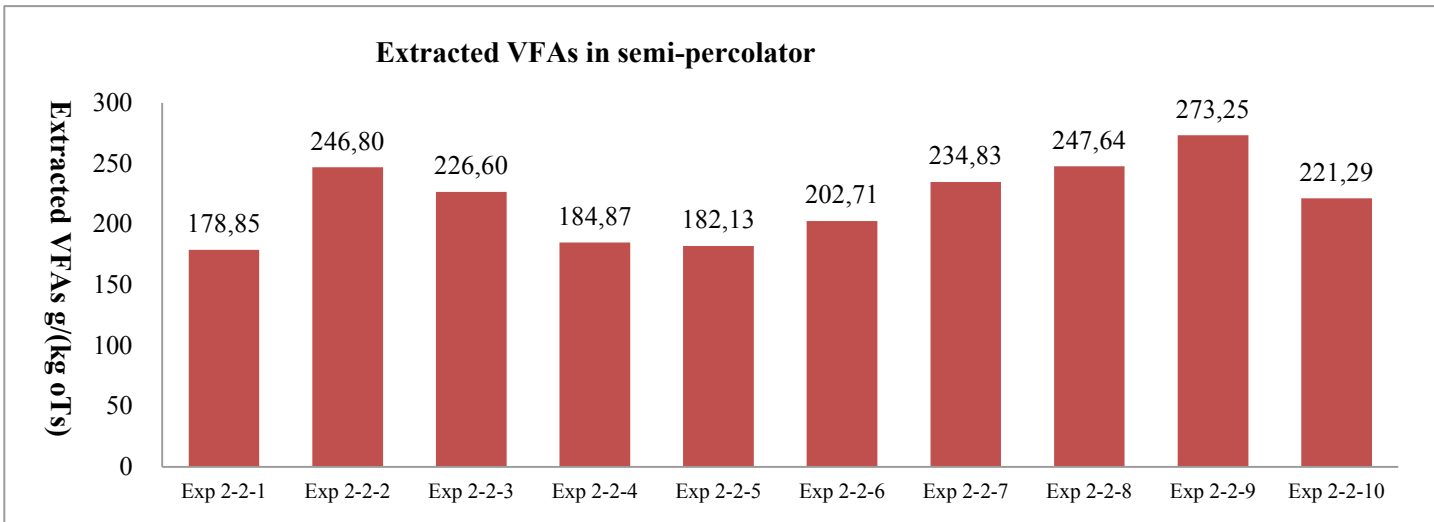

Figure 4-23: Accumulated VFAs in semi-percolator system

### The extracted VFAs profile

In the semi-percolator in our study, the acetate, propionate, butyrate and several alcohols were the main products and the distributions of the main VFAs in the hydrolysate were shown in the following figures:

The produced VFAs were analyzed by GC 2010. Following figure 4-24 shows the main VFAs profile with different target pH range. When pH varied between 4-5, the main VFAs were Ethanol, acetic acid, and butyric acid, in which the ethanol content accounted more than 55% and acetic acid content accounted more than 20%. Stable ethanol fermentation was occurred in Exp2-2-1 and Exp 2-2-2. Even ethanol and acetic acid are the good substrate which can be easier degraded in methanogenesis, but due to effect of low pH suppression of bacterial activity and inhibition of high end products concentration, the organics degradation rate and H<sub>2</sub> productivity in Exp 2-2-1 and Exp 2-2-2 were the lowest in this study. Meanwhile, the total energy outputs were also lower than other experiments. In Exp 2-2-1 the propionic acid content was obviously higher than in Exp 2-2-2. This should be caused by high hydrogen partial pressure which prevented the conversion of propionic acid to acetic acids.

When pH varied from 5-6.5, the ethanol content decreased sharply and the content of butyric acid increased. The main VFAs products are Butyric acid, acetic acid and ethanol which means stable butyric acid fermentation type were occurred. In Exp 2-2-4 high content of propionic acids was detected with butyric acid sharply decreased, the butyric acid fermentation type was not formed, and end products were mainly ethanol, acetic acid, propionic acid and butyric acid. With pH increasing from 6-6.5, the butyric producing organisms became dominant again.

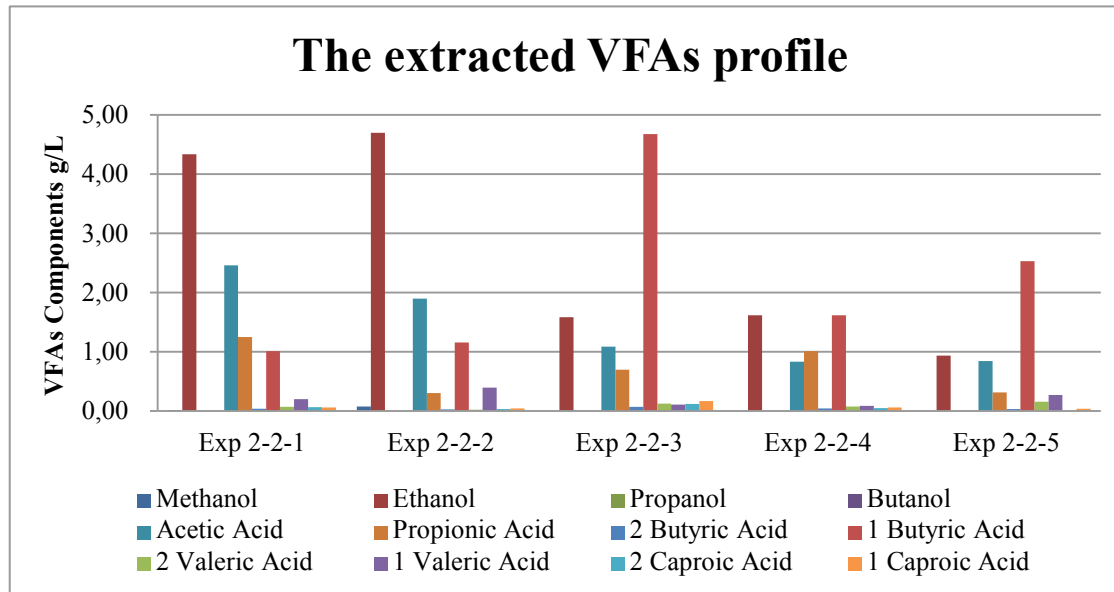

Figure 4-24: VFAs distribution in 1-Step semi-percolator system

The figure 4-25 showed the VFAs distribution in 2-step semi-percolator system. In the Exp 2-2-6 and Exp 2-2-7, with the pH increasing in the second step, the dominant fermentation types were changed from ethanol fermentation to butyric fermentation type. While in Exp 2-2-8, 2-2-9 and 2-2-10, with the pH changing in the second step the dominant fermentation type were remained and butyric acid was the main component in end products. More data can be found in Appendix 4-23.



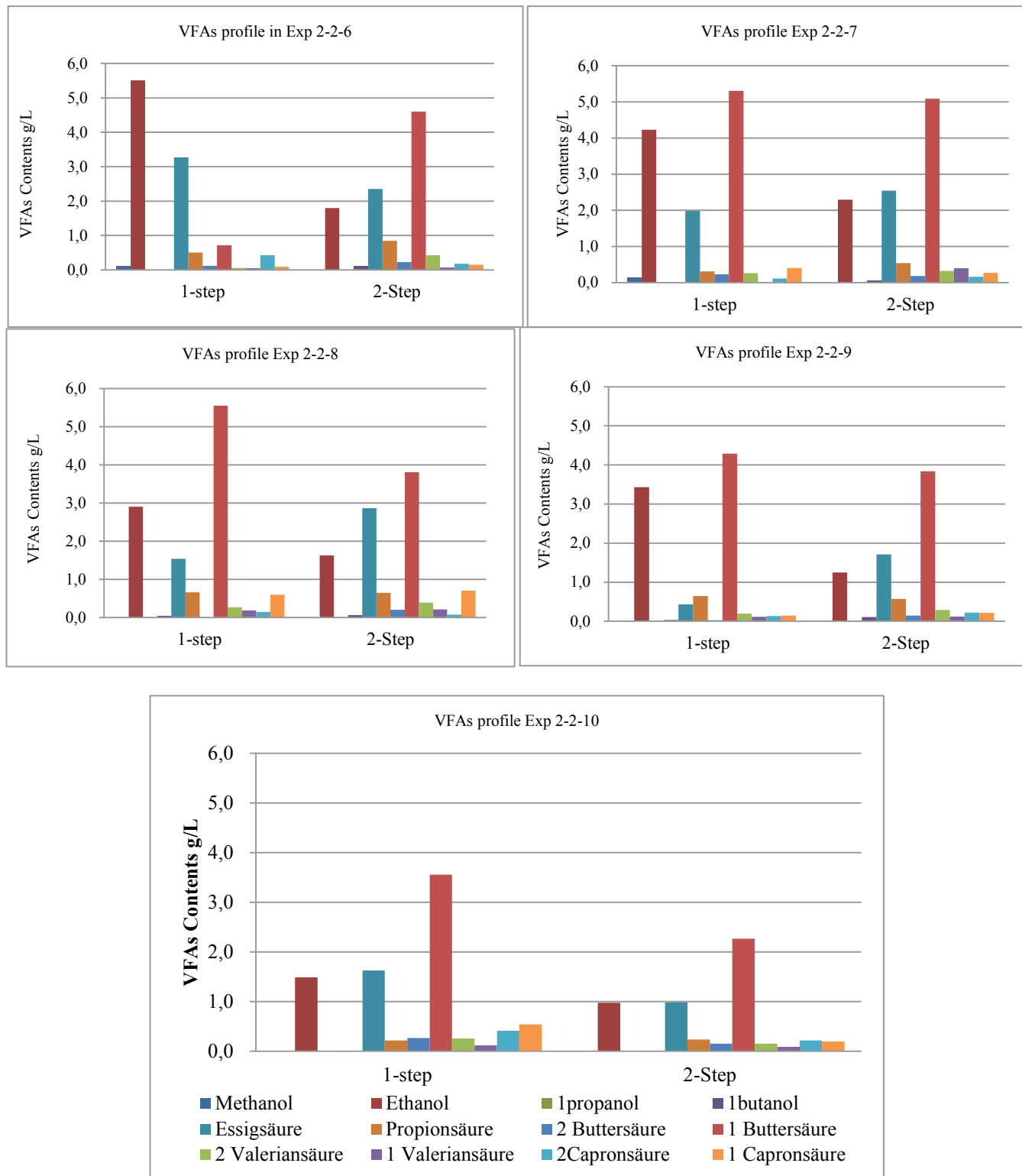

Figure 4-25: VFAs distribution in 2-Step semi-percolator system

## ASBR methane production

Semi-percolator system comprises two main parts: leaching-bed percolator reactors for H<sub>2</sub> recovery and post treatment by ASBR methane reactor for CH<sub>4</sub> recovery. Hydrogen fermentation was highly feasible because of high energy content and very clean energy resource. The hydrolysate rich in VFAs have been degraded in mesophilic methane reactor and the effluent has been re-circulated into percolator to dilute food waste and wash out the produced VFAs to eliminate the production inhibition on hydrolysis process, thus the hydrolysis process can be enhanced.

As shown in the following figure 4-26, the produced hydrolysate from semi-percolator degraded very stable in ASBR and for each experiment the CH<sub>4</sub> concentration remained relatively constant. The concentration of CH<sub>4</sub> varied from 64.8% to 69.8% which are in optimum range of methanogenesis. Because the hydrolysate volume pumped into ASBR methane reactor was set the same for easier control, the OLR of methane reactor varied with the different COD concentration in the hydrolysate. More data can be found in Appendix 4-24.

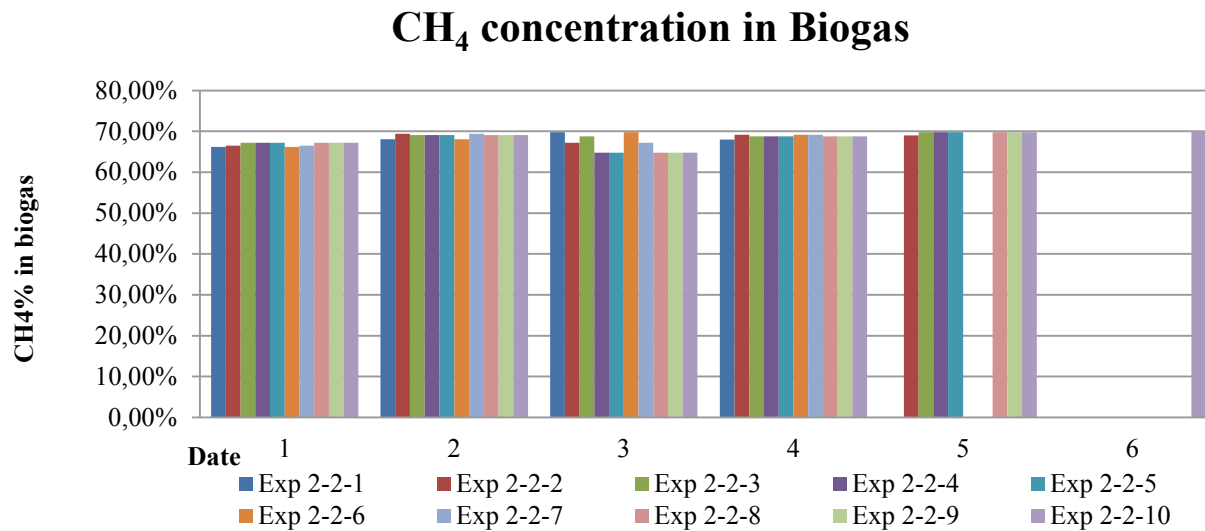

Figure 4-26: CH<sub>4</sub> concentration in Biogas

### 4.2.3 ASBR Hydrogen production + ASBR Methane production

#### Total energy output in ASBR system

As described in the previous chapter, the total energy output consist biohydrogen in Acidogenic phase which was used as the energy source of fuel cell, and the biomethane produced in methanation process via

degradation of effluent from hydrolysis system which was used as energy source of CHP. The main aim for this investigation is to find the optimum technology for total energy recovery.

The investigation results showed that the optimum energy output was reached at 3211 kWh per ton oTS of food waste in Exp 2-3-3 during a pH range of 5-5.5 which is nearly 10% higher than in semi-percolator system. In which the produced H<sub>2</sub> in Acidogenic phase contributes to energy output of 447.39 kWh and produced CH<sub>4</sub> in methanation phase contributes to energy output of 2764.1 kWh. And the lowest energy output 1934.4 kWh was achieved in Exp 2-3-5 when the target pH was set in 6-6.5 due to energy loss caused by CH<sub>4</sub> production in the ASBR acidification reactor. Although the methanogens activity were suppressed by adding additional CHCl<sub>3</sub>, the activity of HPB were also synchronous inhibited and caused low degradation of food waste. Same as semi-percolator system, CH<sub>4</sub> was still the main energy contributor in this investigation, but the max. energy contribution rate of bioH<sub>2</sub> was increased up to 19.73%.

In total, the ASBR hydrolysis system can promote the degradation of food waste and get higher BioH<sub>2</sub> yield compared with semi-percolator system and CSTR acidification system due to high active biomass concentration in digester except Exp 2-3-5. Nearly neutral living conditions in digester were found not good for BioH<sub>2</sub> production in ASBR system due to activity recovery of methanogens. More data will be presented in Appendix 4-25.

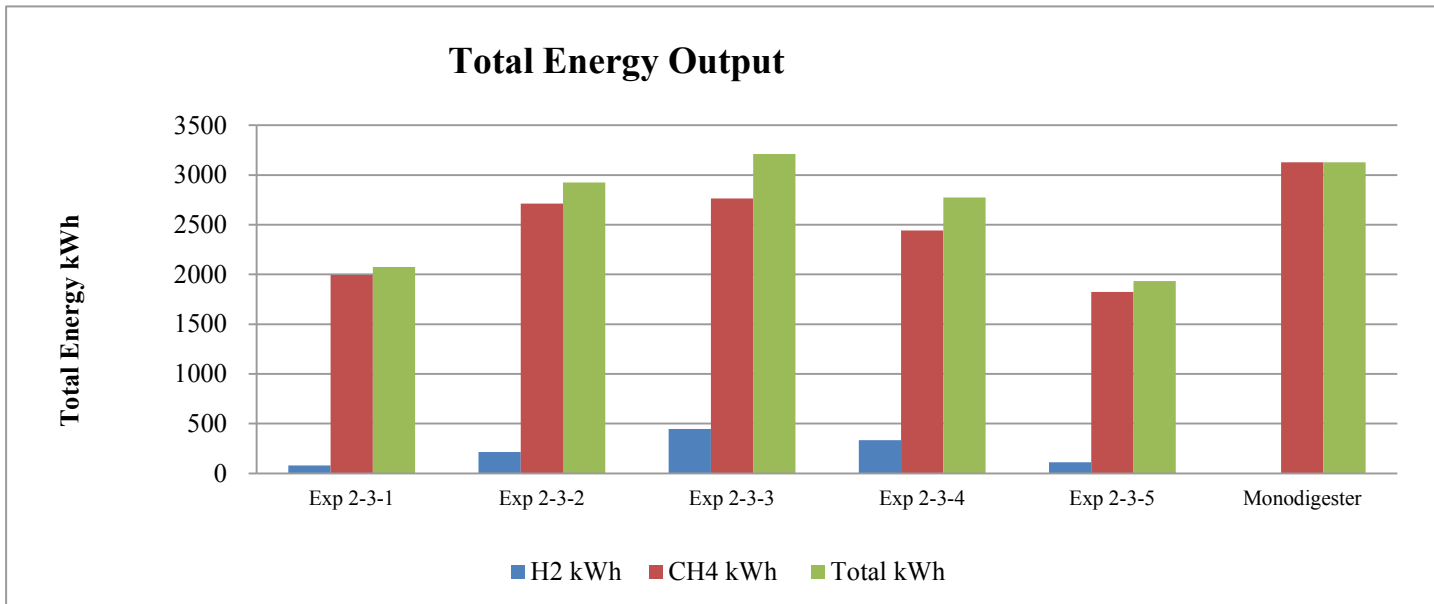

Figure 4-27: Total energy output in ASBR System

---

## **The influence of pH on H<sub>2</sub> production yields**

As explained in the above mentioned chapter, the effect of key factors on controlling intermediary metabolism of hydrogen fermentation leading to the production of hydrogen has been not studied in detail. However, environmental living condition changes can influence the hydrogen metabolism and hydrogen production rate as demonstrated in this study.

The pH is one of the most important non-biological factors which can influence the physiological activity of microorganism and then affect the fermentation process via its effects on enzyme activities, biological activities of microorganisms, etc. and then cause changes of prorogation rate and metabolism pathway. In this study pH was fuzzy controlled by setting the  $R_{L/S}$  dilution rate.

The investigation results, as showed in Figure 4-28 indicates that ASBR hydrolysis system can obviously promoted the bioH<sub>2</sub> yields via keeping high inoculated biomass density in reactor and was achieved at the 196.85NL/kg oTS in Exp 2-3-3. While, under nearly neutral pH the activity of methanogens partly recovered and thus consumed produced H<sub>2</sub> in Exp 2-3-5, the bioH<sub>2</sub> yield was even slightly less than in Exp 2-3-1 in the first 5 days.

In order to inhibit activity of methanogens, CHCl<sub>3</sub>, mixed with feeding substrate had been added continuously to ASBR hydrolysis reactor and CH<sub>4</sub> concentration decreased sharply from 16.3% to 3.1% and kept then at very low concentration. Even the hydrogen productivity increased and higher than Hydrogen productivity in Exp 2-3-1 after adding CHCl<sub>3</sub> on 5th day, but it still far lower than other experiments. CHCl<sub>3</sub> had not only inhibit the activity of HCB, it meanwhile deactivated HPB. More experiment results can be found in Appendix 4-26.

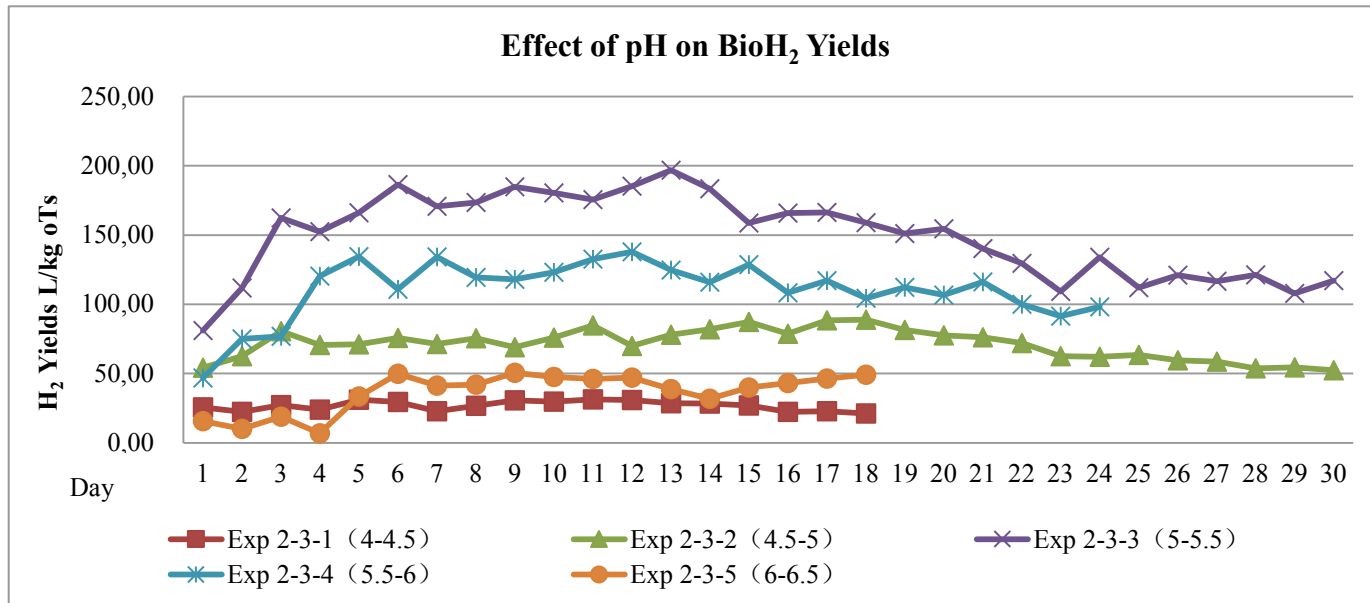

Figure 4-28: BioH<sub>2</sub> yields at ASBR

The pH can affect the physiological activity of microorganism and influence the fermentative process, e.g. causing the charge changing in cell membrane therefore influence the nutrient absorption by acidogens; influencing activity of enzymes, etc. Each acidogen has its own living pH range, and normally also one optimum pH. Out of this pH range will cause loss of biological activity. Furthermore, the same acidogens while with different pH living conditions will cause different fermentation type because it can cause changes of prorogation rate and metabolism pathway.

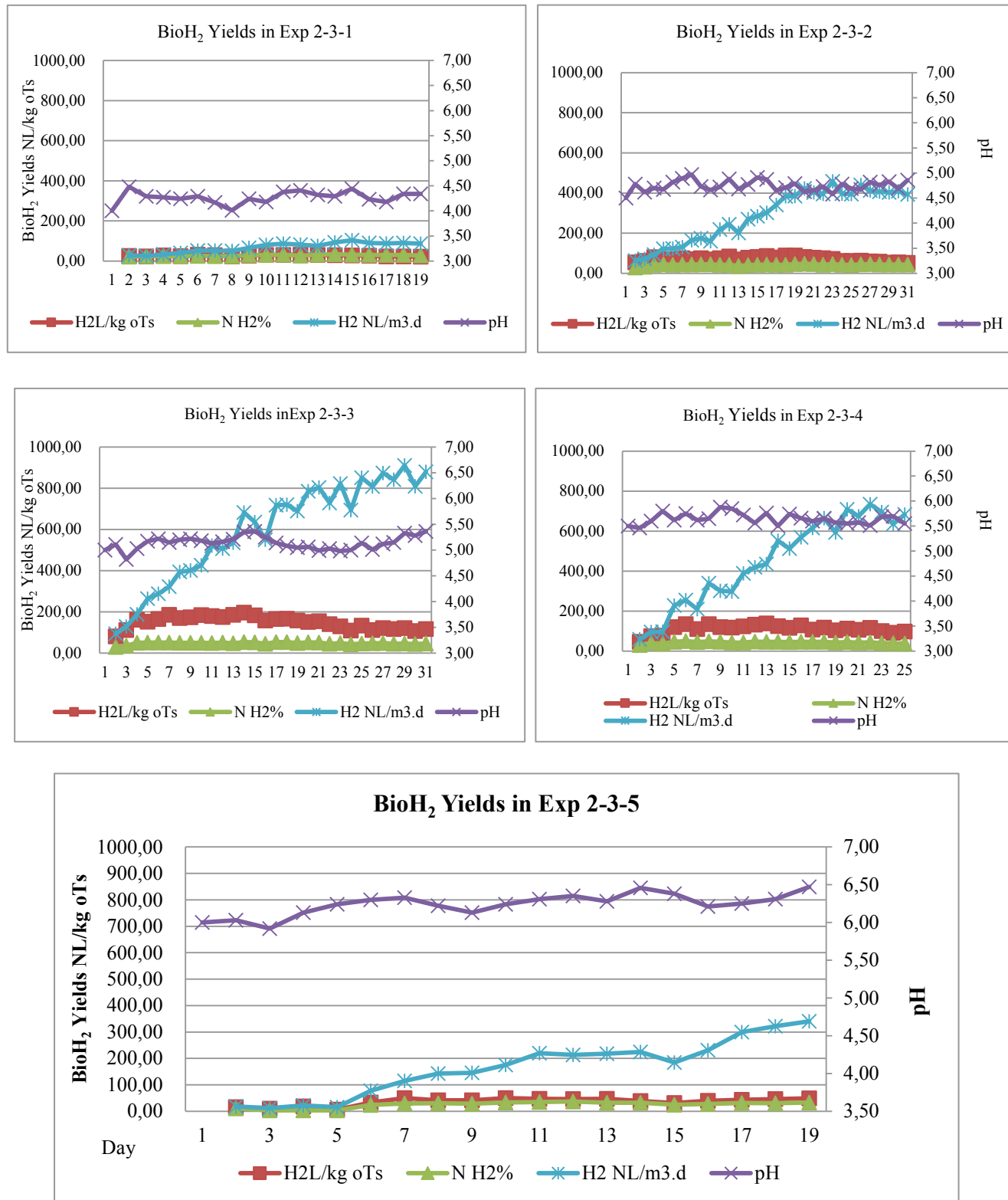

Figure 4-29: Effect of pH on BioH<sub>2</sub> yields

Figure 4-29 showed study results that the effect of pH on BioH<sub>2</sub> production. In Exp 2-3-3, in which pH range varied in 5-5.5, was found the optimum condition for BioH<sub>2</sub> yields at 196.85 L/kg oTS with H<sub>2</sub> concentration

of 53.4%. Due to good hydrolysis performance, the max. reactor efficiency (L H<sub>2</sub>/L reactor) at 910.79 H<sub>2</sub> L/m<sup>3</sup>.d was also reached in this experiment.

OLR has been found effects on reactor or hydrogen yield. In this study, the OLR were slowly and gradually increased from 1.2g/L oTS to their max. level when hydrogen yields continuously falling. At higher OLR, because of target pH control, the HRT were sharply shortened in high pH range due to large amounts of process water refilled. In Exp 2-3-3, HRT at 7day was found the optimum time for highest hydrogen yield. While HRT at 19 day was found the optimum time for highest hydrogen yield in Exp 2-3-5.

### ASBR methane production

The hydrolysis effluent was collected in Buffer Tank 1 and fed into ASBR methane reactor. In order to avoid overload the OLR of methane reactor was kept at low level even well inoculated reactor used. The presence of methane was observed in the biogas on the first day of operation under anaerobic conditions, indicating a rapid acclimation and adaption of inoculum to the substrates.

As shown in the Figure 4-30, the produced hydrolysate from hydrolysis reactor were degraded very stable in methane reactor and for each experiment the CH<sub>4</sub> concentration remained relatively constant. The concentration of CH<sub>4</sub> varied from 65.4% to 68.8% which are in optimum range of methanogenesis. More data can be found in Appendix 4-27.

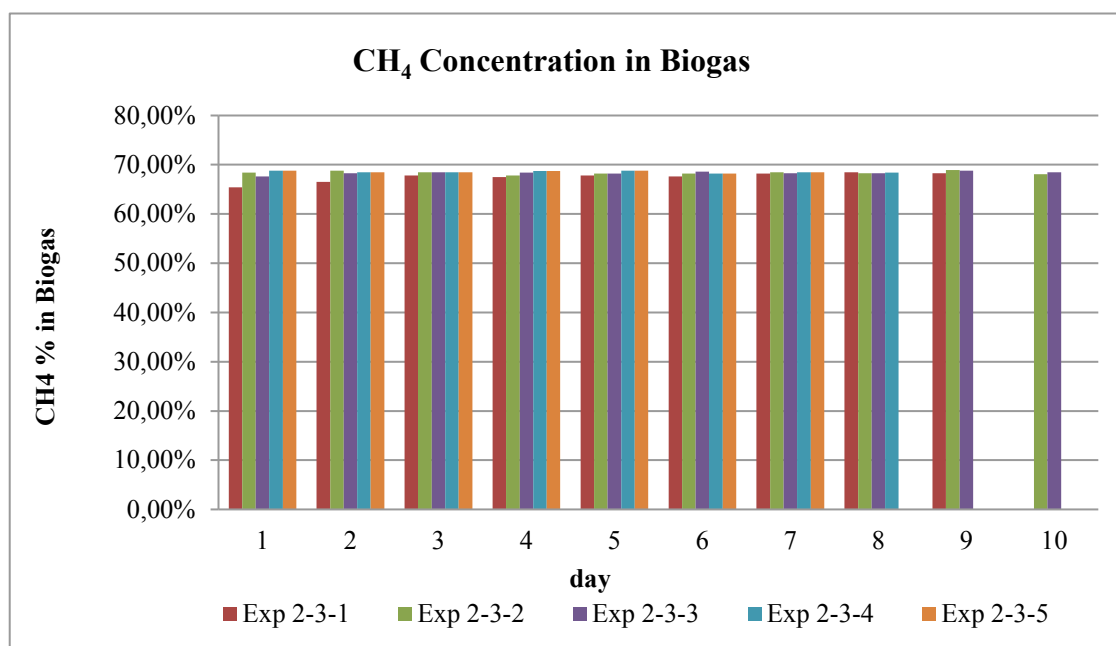

Figure 4-30: Biogas quality in ASBR methane reactor

---

#### 4.2.4 ASBR methane reactor

##### Total energy output of monodigester

One 55L with net volume of 48L ASBR under mesophilic condition methane digester was inoculated in advance for stable degradation of hydrolysis effluent. Liquid manure and digestate from well inoculated methane digester were used as seed materials in investigated reactor. The quality and quantity of inoculum is critical to the performance and stability of biomethanogenesis during anaerobic digestion. Trulear and characklis indicate that the colonization process in three consecutive phases, lag phase with OLR lower than 0.45g COD/L.d with a constant HRT to inoculate the reactor; biomass production phase with bacterial cells multiplying at their max. rate and accumulating with production of biopolymer matrix and OLR gradually increased to develop and acclimate the inoculums to the target level; stationary phase with relatively constant biomass concentration and OLR was relaxed to moderated values for granular sludge optimization.

As illustrated in 4.2.2 and 4.2.3, the total energy output of waste food in monodigester was reached at 3127.1kWh which are slightly lower than energy output in Exp 2-2-8 while with extreme longer HRT.

As shown in following Figure 4-31, in the first 21days was the lag phase of ASBR methane reactor which is conducive for biomass inoculation in the reactor. During the lag phase the CH<sub>4</sub> concentration in biogas was increased from 0.3% to 62% with the biomass growth and organics degradation of seed materials. Then food waste was fed into reactor with OLR gradually increased from 0-to 4.99 oTS g/L.d contribute bacterial cells multiplying at their max. rate and accumulating with production of biopolymer matrix. Thanks to the contribution of un-degraded organics in seed materials, the calculated biogas yields of food waste were extremely higher than normal from day 19 to day 24. And with the exhausting of organics in seed materials the food waste biogas yields kept relative stable with the OLR increasing. The OLR was increased slowly from 0.4g oTS/(L.d) on day 19 and achieved max. value of 6.15 g oTS/(L.d) on day 86. The OLR was decreased on day 78 due to pipeline blockage problem and feeding volume decreasing. On day 36 and day 37 no feeding for methane reactor because the feeding pump broken. Then the OLR kept increasing.

During the whole inoculation process the pH in methane reactor remains nearly constant and varied from 7.2-7.88. There were no significant changes on measured pH in day 56, 68 and 75 when methane reactor was overload even CH<sub>4</sub> concentration sharply decreased. Thus, pH can be used as indicator for digestion process but not as the key parameter for process control due to system buffer capacity.



ASBR methane reactor has got good performance for organics removal. After 75 days commission phase, oTS removal efficiency remained stable at ca. 85%. The following figure 4-32 shows the Ts/oTS removal efficiency of ASBR methane reactor during the commission phase. With the OLR increasing, the Ts/oTS in effluent of methane reactor also increased and kept constant on date 77. To keep better effluent quality and reactor effective volume, excess biomass and un-degraded substrate shall be discharged from the bottom of reactor. More data will be listed in Appendix 4-30.

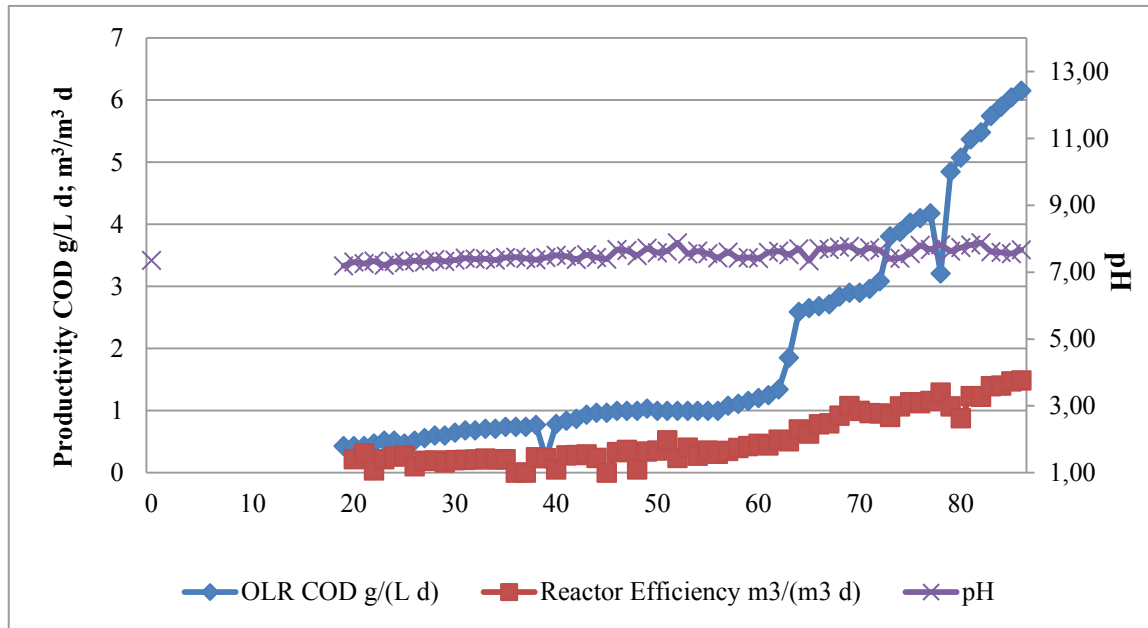

Figure 4-31: ASBR methane reactor performance

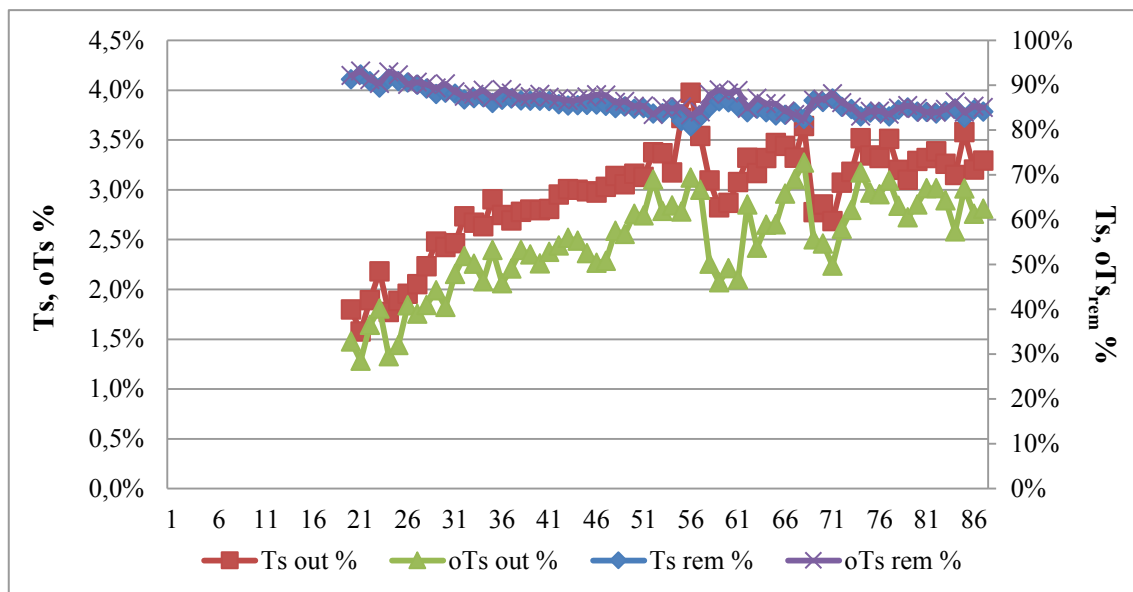

Figure 4-32: Ts, oTS Removal Efficiency in ASBR methane reactor

## Settling velocity/ sedimentation characteristics

Biomass presence with good settlement performance, mainly in granular form, is essential for operation stability of ASBR reactors, thus allowing high organic removal efficiency and high cellular retention time. Geometric characteristic has serious effect on the performance of ASBR. During the settling and decanting periods, selection pressure was increased by increasing the organic load or shortened HRT. Then decanting process tends to wash out the poorly settling flocs and dispersed organisms and retains the heavier, rapidly settling aggregates. The settling characteristics of sludge in ASBR was mainly determined by own nature of sludge and sludge concentration. So SV, SVI are used to comprehensive evaluate the sludge settling performance.

### 1) ME Sludge sedimentation Performance in ASBR

The following figure 4-32 illustrates the effect of MLSS on settling velocity.

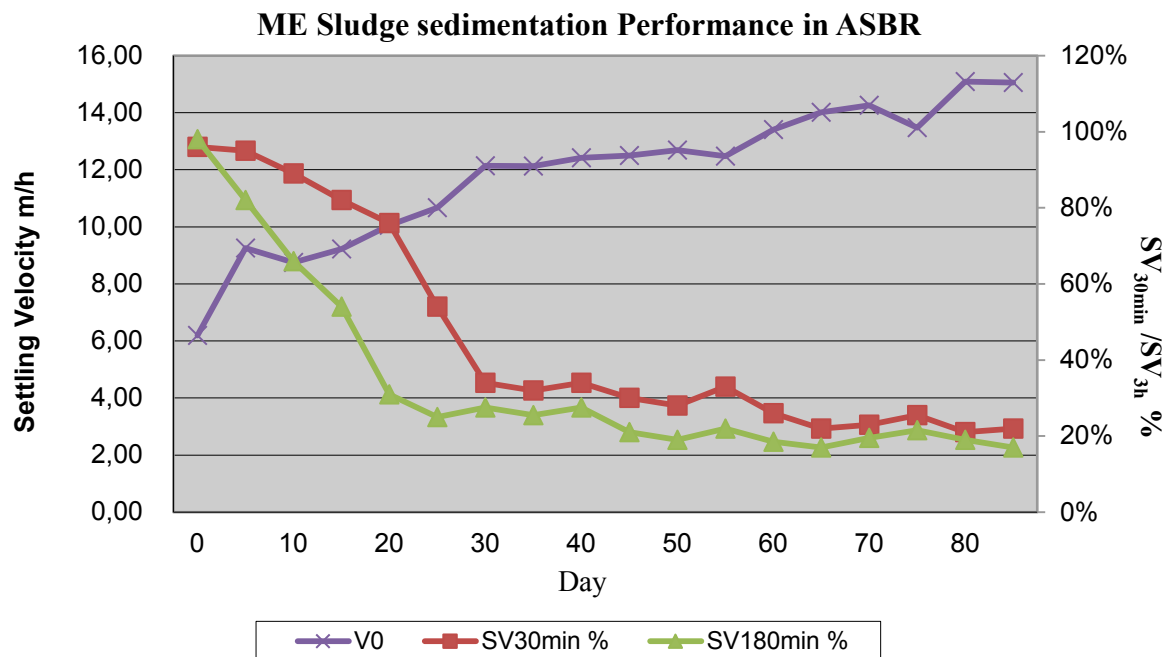

Figure 4-33: ME sludge SV<sub>30</sub>, SV<sub>180</sub> and settling velocity

Sludge samples from ASBR methane reactor were taken after reaction time for settling test. In the early stage, the first 42 days of the experiment, the flocculation was efficient and both SV<sub>30min</sub>% and SV<sub>180min</sub>% decreased rapidly from 96% in SV<sub>30min</sub>% and 98% in SV<sub>180min</sub>% to 34% and 28%, respectively. Then their velocities slowed down and fluctuated in the range of 20%-30%. The effluent valve was located at 1/5 of the ASBR top, so after 21 days 3hour settlement time was enough for sludge and solid separation.

With the increasing of biomass concentration in the ASBR, the increased MLSS concentration decreased the sedimentation velocity because settling was hindered by the high quantity of flocs, granulations and un-degraded particles.

**2) Gas load rate on sludge settling performance at different reactor physical dimension**

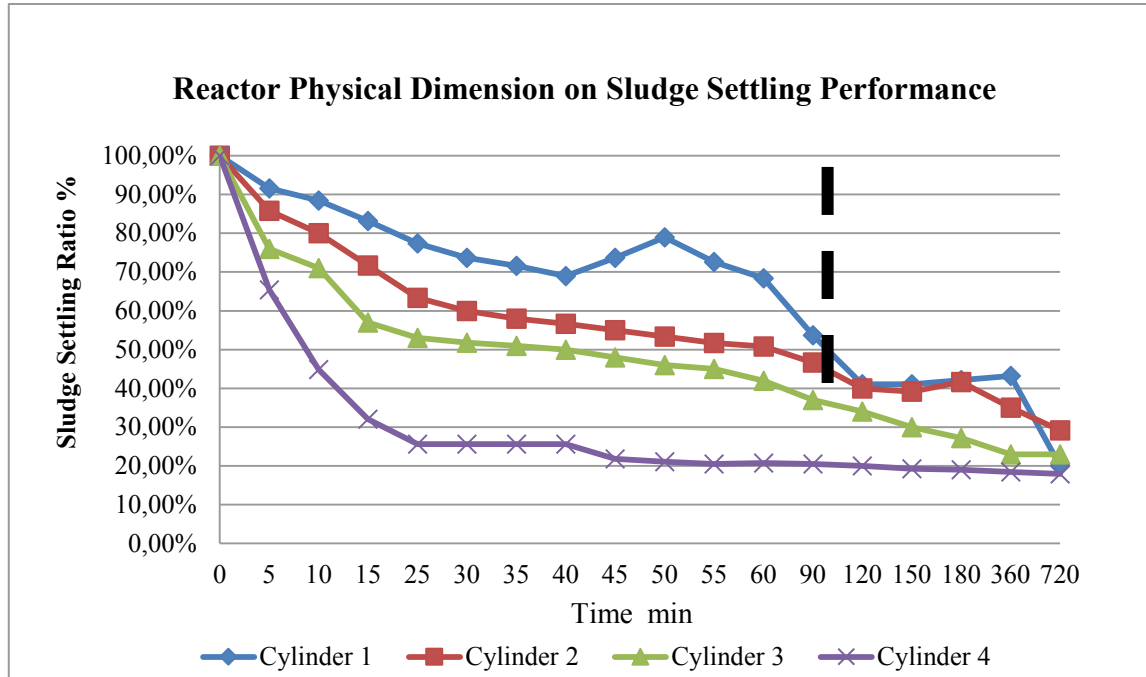

Figure 4-34: Effect of Gas load rate on sludge settling performance at different Reactor Physical Dimension

Gas load rate resulted by produced gas is one key factors affecting the sludge settling performance. After 129days operation, sludge sample from ASBR methane reactor with OLR 15.9kg COD/m<sup>3</sup>.d was taken after reaction step to investigate the effect of different D/H ratio resulting in different gas load rate on sludge sedimentation performance. Four manmade graduated cylinders with same volume and D/R ration from 0.1 to 0.82 were used for this test. The results showed that gas load rate (m<sup>3</sup>/(m<sup>2</sup>.h)) in ASBR still had obviously effects on sludge sedimentation performance especially for tall and slender reactor even after 3hour reaction period. The produced gas bubbles hindered the sludge sedimentation in tall and slender reactor, especially at first 30min with maximum gas production rate. Then with the substrates exhaust the gas load decreased and SV% decreased meanwhile. After 180min the min SV% was reached by Cylinder 4 at value 19% and max. SV% by Cylinder 1 and 2 at values 42.11% and 41.67%, respectively (more values shown is Appendix 4-31). SV % were reached min after 720min and kept constant. Thus, geometric characteristics of the reactor can affect the sludge sedimentation performance significantly and then has strong effect on removal of organic matter.

---

The study on the relationship between sludge settling ratio and reactor configuration (ratio of D/H) is far to enough. At the same investigated volume cylinder, we suppose that the produced gas was the same. Then, the gas load rate is inversely proportional to the  $r^2$  (diameter) of investigated cylinder. That means, with the cylinder diameter increasing, the gas load rate decreased proportional to  $r^2$ . Moreover, the heights of settled sludge is also inversely proportional to the  $r^2$  on the principle. But due to less experimental data no mathematical relationship has been reached in this study.

#### **4.2.5 Summary**

Successfully sequencing production  $H_2$  production in acidification step and  $CH_4$  in methanogenesis step is confirmed in this study. Aeration was found the best technology for HCB repression and used in continuously lab scale test of  $H_2$  production based on batch test. All three continuously studies were operated under thermophilic condition which have overcome thermal conversion obstacle and reach good degradation performance compared mesophilic condition process.

Separation  $H_2$  production in acidification step and  $CH_4$  in methanogenesis step have been found only 2.6% energy output higher when compared with monodigestion process. But two step fermentation process can sharply shorten HRT compared to monodigester, especially in semi-percolator system and ASBR<sub>Hy</sub> system, which shows very attractive in practice.

#### **Batch Test**

- Pretreatment of seeds material via aeration was proved the suitable method for HPB enrichment and methanogens inhibition in both batch test and continuously two-step dark fermentation of  $H_2+CH_4$  production;
- Dilution rate, represented as Inoculum to substrate ratio in batch test showed seriously effects as expected. Different  $R_{I/S}$  can influence the production inhibition, regulating pH, increase biomass concentration, and supply necessary nutrients in  $H_2$  producing bioreactor. The  $R_{I/S}$  3 in pretreatment via aeration was found the optimum values for  $H_2$  yields.
- Temperature has proved big effect on  $H_2$  yields as reported and hyperthermophilic process was found the optimum temperature range for  $H_2$  yields. While due to too high requirements in hyperthermophilic process, thermophilic degradation technology looks more practical and been applied in continuously fermentation system for  $H_2+CH_4$  production;

---

## **H<sub>2</sub> producing system**

- Three types of H<sub>2</sub> producing bioreactor, which are CSTR, semi-percolator and ASBR<sub>Hy</sub> have been investigated in this study and all demonstrate the possibility for continuously bioH<sub>2</sub> production;
- The pH range of 5-5.5 was showed the optimum situ for hydrogen production in all three acid producing reactors;
- ASBR<sub>hy</sub> was found the best technology for bioH<sub>2</sub>-yield at 196.85L kg/oTS with H<sub>2</sub> concentration of 53.4%;
- CSTR acidogenic system was found with lowest H<sub>2</sub> yields. The highest H<sub>2</sub> yields in semi-percolator reactor has reached at 69.15L kg/oTS which was slightly higher than highest value in CSTR 82.88 77.37L kg/oTS;

## **CH<sub>4</sub> producing system**

- ASBR<sub>Me</sub> was chosen as further degradation of by-products caused in H<sub>2</sub> producing phase and found good performance to treat such wastes in all three types of H<sub>2</sub> producing reactors;

## 5 Case Studies of food waste anaerobic digestion plant in China by sequencing producing $H_2+CH_4$

In this section the findings from one Chinese food waste biogas plants are presented in which the semi-percolator  $H_2$  production reactor was used. All the data were collected during the site visits and offered by plant operators.

### 5.1 Brief project Information

**Project Name:**

Lanzhou kitchen waste biogas project (Lanzhou, China)

**Substrate:**

Food residues collected directly from restaurants

**Treatment capacity:**

200ton/d (designed parameter)

**Substrate Components:**

TS(%)	TOC(%TS)	TN(%TS)	VS(%TS)	Fat(%)
17.1±1.2	50.1±5.5	3.8±1.3	80±5%	25±5.5

Table 5-1: Substrate Component

Food Waste	Paper	Fine	Plastic	Glass	Wood Waste	Metal	Textile	Residue
83.2%	4.00%	2.90%	4.80%	1.20%	0.20%	0.10%	0.40%	3.20%

Table 5-2: Physical composition (%TS) of food leftovers squeezed (TS 16.8%, VS 83%)

**Process Description:**

The food residues collected directly from restaurants in Lanzhou are handled in this plant via dark fermentation process which consists 4 semi-percolator hydrolysis acidifying reactors with specific reactor volume of 180m<sup>3</sup>/each as shown in the following Figure 5-1. This system has been awarded Chinese patent with Patent Nr:CN101585043, and as the system concept designer, Prof. G. Busch and i acts as patent inventor. Three

---

CSTR methanation reactors with specific reactor volume of 3300m<sup>3</sup> were designed to treat hydrolysate from semi-percolator system. The food wastes are dumped from collection vehicles into sieves which are slantways fixed in the reactor for easier discharging of hydrolysis residues. The solid part of the waste shall be retained above the sieve, while the liquid shall pass through the sieve and remained in the bottom of the reactor. The liquid digestate after decanter shall be refeed into semi-percolator through spraying system located in the top layer of reactor to regulate the optimum living conditions (pH at 5-5.5) of acidifying bacteria based on the control system. The liquid part of the waste will be pumped periodically to spray system to wash produced organic acids and supply the essential nutrients and bacterial to system. Re-flush device was installed to avoid sieve blockage problems. When hydrolysate reaches high level switch, it will be pumped to buffer tank automatically. The original HRT was fixed to 7days due to fewer amounts of collected wastes. The hydrolysis gas with rich in H<sub>2</sub> and CO<sub>2</sub> are emitted after biofilter without energy recovery due to difficulty of gas engine. The hydrolysate from buffer tank is pumped into methanation reactor for CH<sub>4</sub> recovery and the produced CH<sub>4</sub> will be burned in gas engine to produce electricity and waste heat from gas engine can be used to heat up the methanation reactor and supply hot water to plant. After dewater system (centrifuge) the solid digestate will be composted for fertilizer, and partly liquid digestate will be recycled into semi-percolator reactors based on pH regulation. The rest liquid digestate will be treated in wastewater treatment plant. The whole process flow chart is as followed in figure 5-2:



Figure 5-1: Waste Discharging in semi-percolator

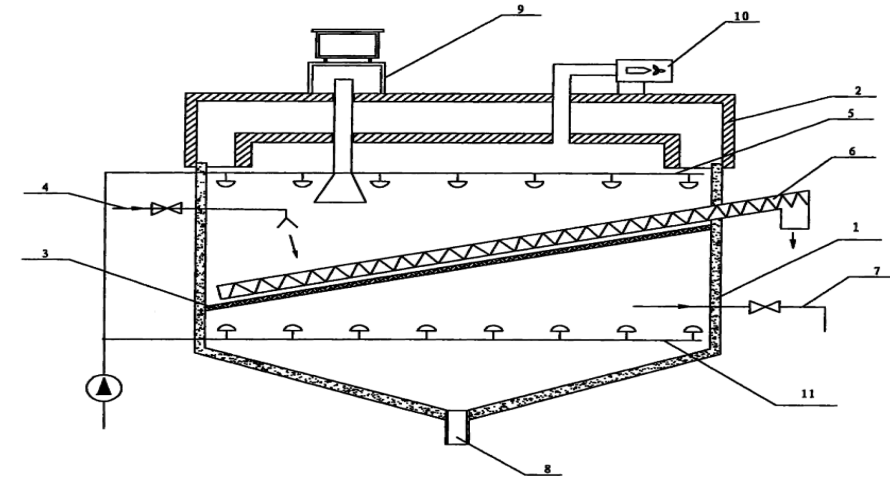

Figure 5-2: configuration of semi-percolator

Process Flow Chart:



Figure 5-3: Whole Flow Chart of Lanzhou Food Waste Biogas Plant

## 5.2 Operation data in case study

This system only lasted 3 months in total during the start-up phase, then pretreatment process had been reconstructed during serious problems of semi-percolators. Chinese food waste collected from restaurants are mostly cooked food residues, they are soft, higher viscosity, poor permeability, and the screen was very easily blocked by organics, pieces of shell, bones, stones, etc. even re-flushed with high pressure liquid. Because of less amount of liquid digestate during start up phase, pH of hydrolysate was controlled at ca.  $4.6 \pm 0.2$  via adding certain amount of lye. In the first month of the plant commission, the operation value are not presented



because of the equipments testing and meters calibration. From the second month, operation data in next 63 working days were recorded.

As shown in following figure 5-4, 1101tons of food wastes were treated in this system and 33987m<sup>3</sup> hydrolysis gas which contains 7168m<sup>3</sup> H<sub>2</sub> has been collected in 63 operation days. Because of non-continuously operation during practice, H<sub>2</sub> content in Hydrolysis gas were not stable and the highest value 28.8% was reached which is much lower than what we got in lab-scale result. The biogas yields were not valued here because effect of added inoculum on biogas productivity in this phase.

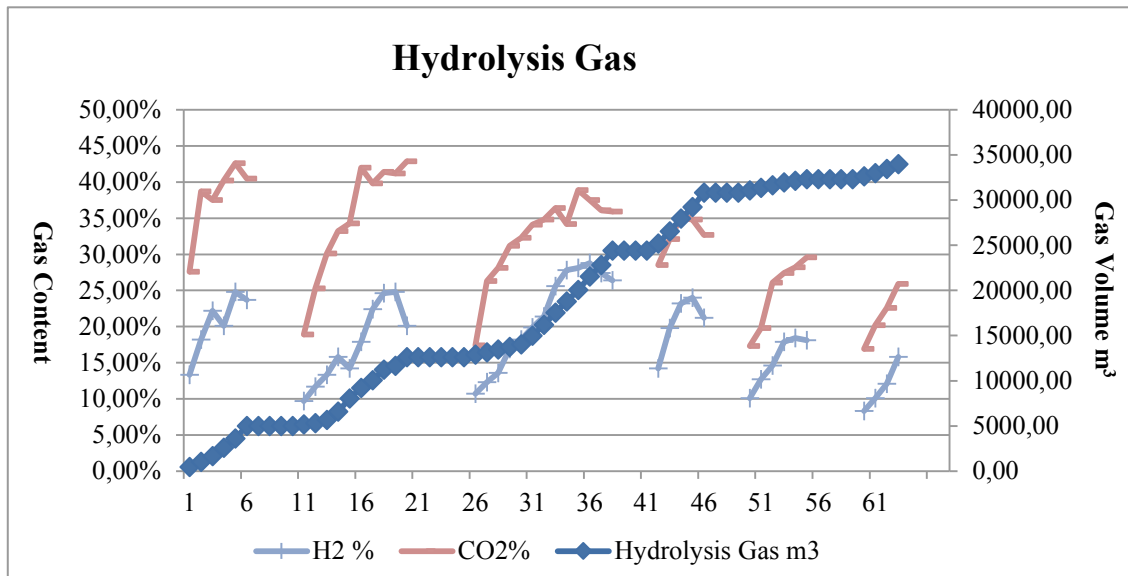

Figure 5-4: Hydrolysis gas production in case study

Figure 5-5 shows the hydrolysis gas quality and H<sub>2</sub> yields during whole operation period. Gas sparging system was not available in construction site, thus the H<sub>2</sub> contents in the first operation day were the lowest for every test because produced H<sub>2</sub> was diluted by air in semi-percolator reactor. Unlike the batch operation in lab study, in theory, the semi-percolator system can be operated continuously which can thus increase dominant bacteria species density, shorten lag phase and achieve the good performance of H<sub>2</sub> production. And this has been confirmed in this case study that with operation proceeding, both H<sub>2</sub> content and H<sub>2</sub> yields have a clearly upward trend.

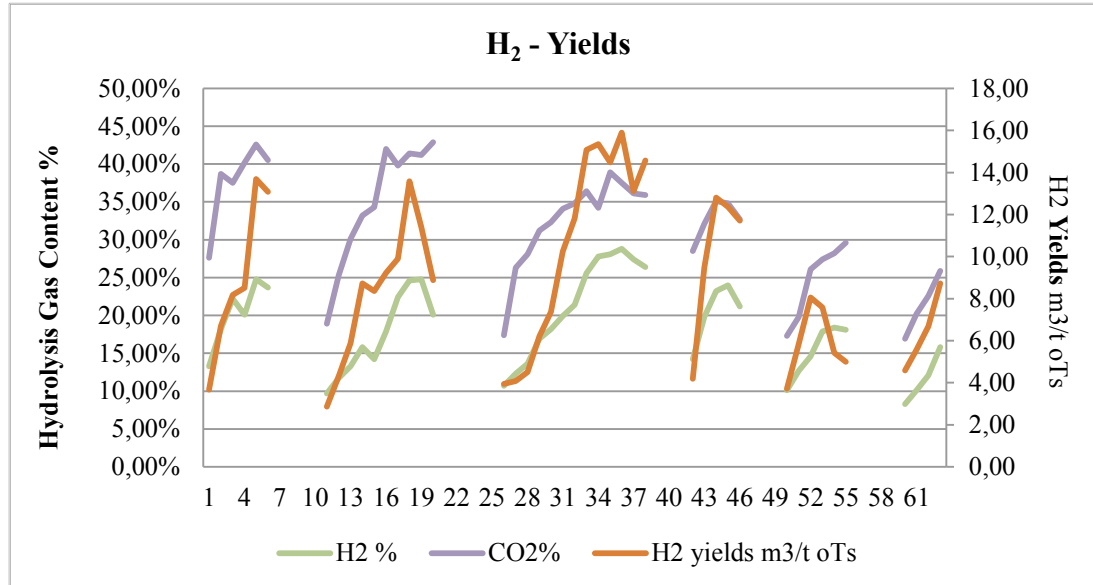

Figure 5-5: H<sub>2</sub> yield performance in case study

In Lanzhou project, unlike semi-percolator system in lab scale, the substrate feeding and discharging system has been optimized by realizing continuously feeding and discharging equipment. Thus, the well inoculated sludge with higher biomass concentration can be maintained in this reactor which can sharply increased the organic degradation rate, thereby bioH<sub>2</sub> yield in acid production phase can be enhanced in principle.

But, during commission phase, the semi-percolator reactor and its connection with feeding/discharging system are not completely gas tight. This is mechanical reason which caused so lower H<sub>2</sub> yields and H<sub>2</sub> content in hydrolysis gas in this study. The average H<sub>2</sub> productivity was only 8.96 m<sup>3</sup>/t oTS with max. yield at 15.9 m<sup>3</sup>/t oTS achieved. All the results from case study The Detail information can be found in Appendix 33.

---

## 6 Cost-benefit analysis of industry scale for sequencing production of $H_2+CH_4$ via CSTR system

The lingering haze has shrouded many Chinese cities in the last several years, especially in the east and north China. As reported, the low-quality growth and unreasonable economic pattern are the main reason for this heavy pollution which is driving an increasing demand for renewable energy solution.

In support of Chinese Central Government funds, National Development and Reform Commission (NDRC) has supported 5 batches pilot food waste treatment projects in total 100 projects for waste harmless treatment and renewable energy production from 2011. Bio $H_2$  +  $CH_4$  production from food waste via dark fermentation process seems one cost-competitive technology compared with traditional processes.

New patented semi-percolator system gained worse performance during start up phase and then reconstructed quickly to adapt the characteristics of Chinese kitchen waste. New process and related key equipments need carefully design and long term test before it shall be utilized in industrial scaled project. By the same token, even ASBR<sub>Hy</sub> reactor has been found very good performance on  $H_2$  production, more detailed investigations concerning on monitoring system, process parameter, discharging system, reactor configuration, etc shall be done before it comes into practice. While, in 100 chinese pilot kitchen waste projects, process of CSTR(hydrolysis)+CSTR(methanation) accounted for 80% of the total because of its relatively mature in process and system equipments. Due to comparative low  $H_2$  productivity in CSTR hydrolysis system, a carefully economic analysis needs to be done before project optimization.

It is difficult to purchase suitable mixed gas power generation due to Knocking combustion risk<sup>75</sup>. While,  $H_2$  and  $CO_2$  purification through cell membrane is one cost effective technology and widely used in Chinese market which can be used to separate and upgrading  $H_2$  and  $CO_2$  from hydrolysis gas to increase project benefit. Furthermore, market prices of  $H_2$  is higher than  $CH_4$ .

Thus, the second food waste biogas project -- Qinhuangdao has been chosen as our case study for cost benefit analysis for sequencing  $H_2$  and  $CH_4$  production.

---

## 6.1 Brief project Information

### Project Name:

Qinhuangdao kitchen waste biogas project (Qinhuangdao, China)

### Substrate:

Food residues collected directly from restaurants

### Treatment capacity:

150ton/d (designed parameter)

### Substrate Components:

TS(%)	C(%TS)	TN(%TS)	TP(%TS)	Cl-(g/kgTS)	Protein(%)	Fat(%)
20.1±2.7	50.1±5.5	3.8±1.3	0.92±0.65	19.27±7.2	5.96±2.0	15±4.5

Table 6-1: Substrate Component

Food Waste	Paper	Fine	Plastic	Composite	Glass	Inert	Metal	Residue	Textile	Wood Waste
88.74%	4.00%	3.90%	2.00%	0.56%	0.20%	0.20%	0.10%	0.10%	0.10%	0.10%

Table 6-2: Physical composition (%TS) of food leftovers squeezed (TS 21%, VS 84%)

### Process description:

This project uses anaerobic fermentation technology to treat food residues coming from Chinese restaurants. Because of high impurity content, the program uses "pre-treatment + anaerobic fermentation + biogas upgrading" in the main process. The collected food residues will be transported to treatment plant by specific vehicles and dumped into collection hopper. Then, the food residues are transported via lift shaftless spiral to Separation Hammermill, which can crush organic matter, separate and discharging extraneous materials like plastic, packing material, metal, etc in one procedure. Compressed air pump system will transfer the organic sludge from Hammermill to sand (heavy material) removal system for minimizing equipment wear, pipes blockage, and digester sedimentation problems, etc. After temperature regulation, the organic sludge will be pumped into hydrolysis tank via Netzsch pump. Hydrolysis gas will be collected in gas holder together with biogas from digester for the buffer of gas upgrading. After certain time, the hydrolysate will be pumped

---

continuously to digester and second digester for CH<sub>4</sub> production. H<sub>2</sub> and CH<sub>4</sub> can be recycled through gas membrane treatment system. After dewater system (centrifuge) the solid digestate will be dumped into landfill site, while the waste water will be treated in waste water treatment plant. During the emergency, the mixed gas will be burned by flare system.

Whole food residue treatment process includes the following process systems as you can see in Figure 6-1:

- 1) Receiving and pretreatment system
- 2) Anaerobic fermentation system
- 3) Biogas purification treatment system
- 4) Digestate processing system(dewater)
- 5) Flare system

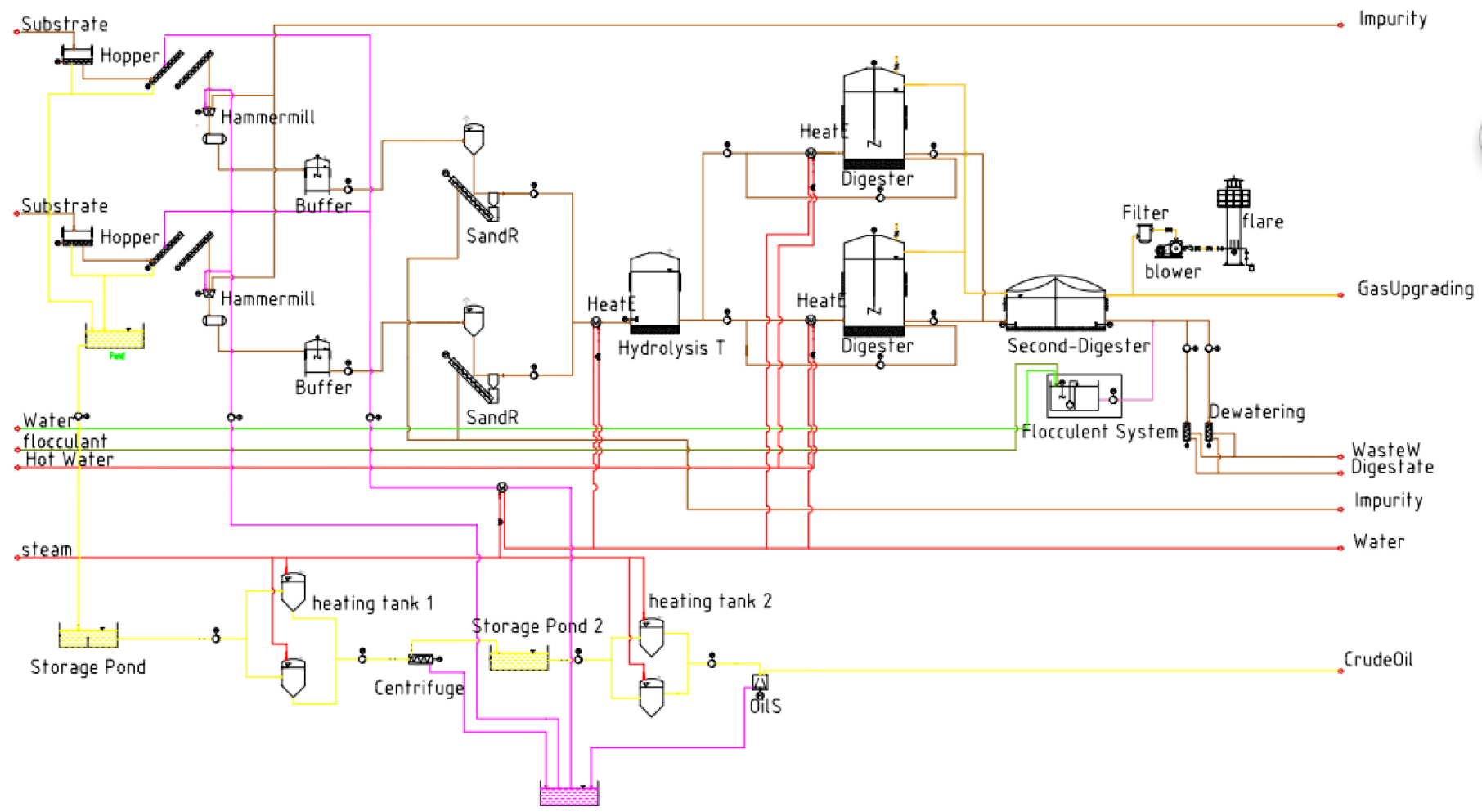

Figure 6-1: Process flow chart of Qinhuangdao Project

## 6.2 Mass balance

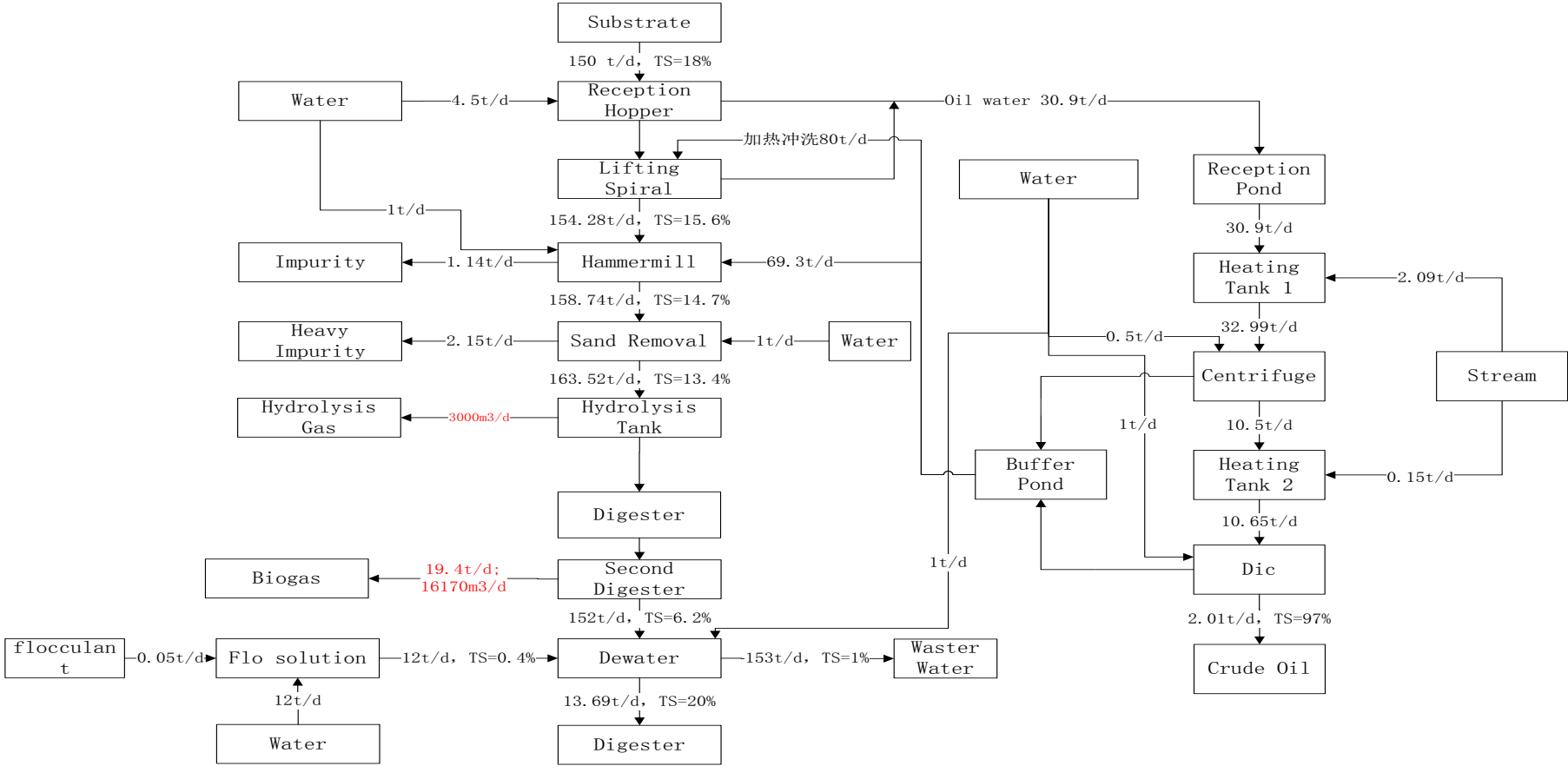

Figure 6-2: Mass Balance of Qinhuangdao Project

---

### 6.3 Economic assessment

Before the implementation of bioH<sub>2</sub> recycles in acid producing phase, a carefully economic assessment shall be done to ensure the economic benefit of project owner. Economic feasibility of bioH<sub>2</sub>+CH<sub>4</sub> production via dark fermentation is largely dependent on the new installed equipments and its related costs caused by construction, operation cost, and additional income from produced H<sub>2</sub> and CO<sub>2</sub> in CSTR hydrolysis reactor.

Prior to AD process, the substrate will pass through pre-treatment part for non-biodegradable contaminants separation such as plastic bags, glass, textile, and metal etc. A study was made using the Multi-Criteria Decision-Making (MCDA) method for economic assessment, based on the following criteria: (a) total investment (b) energy recovery, (c) Income, (d) operating costs, and e)ROI (return of investment).

Table 6-3 demonstrates the total estimate for only CH<sub>4</sub> recovery in methane reactor, and Table 6-4 demonstrates the total estimate for sequencing production H<sub>2</sub> and CH<sub>4</sub>, CO<sub>2</sub> from hydrolysis gas also calculated as project income because cell membrane gas separation process can easier separate H<sub>2</sub> and CO<sub>2</sub> due to big different transportation rate in this membrane separation system. The CO<sub>2</sub> produced in methane reactor will not separate due to difficult separation of CH<sub>4</sub> and CO<sub>2</sub>.



Total Estimate Table (CH <sub>4</sub> )						
Project Name: Qinhuangdao Food Waste Biogas Project						
Nr	Name	Parameter	Unit	Quantity	Unit Price	Remarks
					(Euro)	
1	Pretreatment System	150t/d	Set	1	850,000	Collection Vehicles not included
2	Anaerobic Digestion System	163.5t/d	Set	1	2,150,000	Digestate decanter not included
4	Oil Recovery System	31t/d	Set	1	300,000	Crude oil
5	Biogas Purification and upgrading System		Set	1	500,000	Including gas purification and upgrading
6	Digestate Treatment System	170t/d	Set	1	60,000	
7	Wastewater Treatment System	180t/d	Set	1	1,700,000	Including sewage water in Plant
8	Administrative Area		Set	1	1,200,000	
10	Green Plant		Set	1	10,000	
11	Education、Training Center		Set	1	50,000	
	Governmental Subsidy		time	1	2,046,000	
12	<b>Total</b>				<b>4,774,000</b>	
<b>Static Total investment</b>					<b>4,774,000</b>	
1	Treatment Fee	Food Waste	Year	1	547,500	10Euro/t
		Waste Oil Water	Year	1	0	0Euro/t

2	Product Revenue	CH <sub>4</sub>	Year	1	648,325	CNG: 0.5Euro/m <sup>3</sup> ;2000m <sup>3</sup> /d
		H <sub>2</sub>	Year	1	0	H <sub>2</sub> : 0.8Euro/m <sup>3</sup> ;
		CO <sub>2</sub>	Year	1		Not clear
		Crude Oil	Year	1	292,000	400Euro/t
		Plastic Recovery	Year	1	4,015	10Euro/t
3	Subsidy		Year	1	57,288	For demonstration Project with Education Training Center
	<b>Total</b>				<b>1,487,825</b>	
<b>Total Income</b>					<b>1,487,825</b>	
1	Operation Cost	Electricity	Year	1	115,632	5280kwh/d, 0.06Euro/kwh
		Water	Year	1	3,650	20t/d, 0.5Euro/t
		Steam	Year	1	20,148	2.3t/d, 24Euro/t
		Hot Water	Year	1	17,520	60t/d, 0.8Euro/t
		Labour Cost	Year	1	216,000	400Euro/P.M; 45 Labors
		Flocculant	Year	1	18,250	500Euro/t, 0.1t/d including wastewater plant
2	Repair and maintenance		Year	1	30,000	Including Office Management Expense
3	Straight line depreciation	25year	Year	1	190,960	
4	Financial Cost	Loan Interest 6.84%	Year	1	195,925	
<b>Total Cost</b>					<b>808,085</b>	

1	Tax Fees		Year	1	169,935	Average 25%
2	Net Profit after Tax		Year	1	509,805	
<b>Static ROI (Year)</b>					<b>9.36</b>	

Table 6-3: Total Estimate Table for CH<sub>4</sub> Recovery

<b>Total Estimate Table (CH<sub>4</sub>+H<sub>2</sub>)</b>						
<b>Project Name: Qinhuangdao Food Waste Biogas Project</b>						
Nr	Name	Parameter	Unit	Quantity	Unit Price	Remarks
					(Euro)	
1	Pretreatment System	150t/d	Set	1	850,000	Collection Vehicles not included
2	Anaerobic Digestion System	163.5t/d	Set	1	2,350,000	Digestate decanter not included
4	Oil Recovery System	31t/d	Set	1	300,000	Crude oil
5	Biogas/H <sub>2</sub> Purification, upgrading System		Set	1	750,000	Including purification and upgrading
6	Digestate Treatment System	170t/d	Set	1	60,000	
7	Wastewater Treatment System	180t/d	Set	1	1,700,000	Including sewage water in Plant
8	Administrative Area		Set	1	1,200,000	
10	Green Plant		Set	1	10,000	
11	Education、TraningCenter		Set	1	50,000	
	Governmental Subsidy		time	1	2,181,000	
12	<b>Total</b>				<b>5,089,000</b>	
<b>Static Total investment</b>					<b>5,089,000</b>	
1	Treatment Fee	Food Waste	Year	1	547,500	10Euro/t

		Waste Oil Water	Year	1	0	0Euro/t
2	Product Revenue	CH4	Year	1	629,728	CNG: 0.5Euro/m3;
		H2	Year	1	326,291	H2: 0.8Euro/m3;
		CO2	Year	1	199,032	CO2: 0.3Euro/m3;
		Crude Oil	Year	1	292,000	400Euro/t
		Plastic Recovery	Year	1	4,015	10Euro/t
3	Subsidy		Year	1	61,068	For demonstration Project with Education Training Center
	<b>Total</b>				<b>1,994,550</b>	
<b>Total Income</b>					<b>1,994,550</b>	
1	Operation Cost	Electricity	Year	1	115,632	5280kwh/d, 0.06Euro/kwh
		Water	Year	1	3,650	20t/d, 0.5Euro/t
		Steam	Year	1	20,148	2.3t/d, 24Euro/t
		Hot Water	Year	1	17,520	60t/d, 0.8Euro/t
		Labour Cost	Year	1	216,000	400Euro/P.M; 45 Labors
		Flocculant	Year	1	18,250	500Euro/t, 0.1t/d including wastewater plant
2	Repair and maintenance		Year	1	30,000	Including Office Management Expense
3	Straight line depreciation	25year	Year	1	203,560	
4	Financial Cost	Loan Interest 6.84%	Year	1	208,853	
<b>Total Cost</b>					<b>833,613</b>	
1	Tax Fees		Year	1	290,234	Average 25%
2	Net Profit after Tax		Year	1	870,703	
<b>Static ROI (Year)</b>					<b>5.84</b>	

Table 6-4: Total Estimate Table for CH4 Recovery

---

This study showed that sequencing production H<sub>2</sub> and CH<sub>4</sub> has better economic performance with ROI 5.84year than biogas production with ROI 9.36year. Even sequencing H<sub>2</sub> and CH<sub>4</sub> has higher investment cost and operation cost, while H<sub>2</sub> and CO<sub>2</sub> recovered by gas upgrading system has nearly same economic benefit compared with CH<sub>4</sub>. The annual net income will be increased from 509805 Euro to 870703, thus the project payback period will be shortened.

#### **6.4 Waste discharge control**

All discharging from Qinhuangdao food waste biogas plant should meet the environmental requirements as described in approved EIA (environmental impact assessment) report. According to mass balance calculation and ventilation calculation, 2.2tons of heavy impurities like stone, shell, metal, etc with Ts>60% will be separated via sand removal system, 14tons dewatered digestate will be produced after decanter with Ts 20%,153 tons wastewater will be produced with COD ca.10000mg/L, and 180m<sup>3</sup>/s odour will be produced. Heavy impurity and dewatered digestate shall be transported into landfill site as final treatment way; wastewater will be discharged into sewage wastewater pipeline after primary treatment with water quality meeting with Chinese Integrated wastewater discharge standard III(GB 8978-1996). The odour will be emitted via passing through biofilter system which can remove 99% of pollutants in odour. The emitted odour shall meet Emission standards I for odour pollutants (GB14554-93). All the treatment cost and discharge costs have been calculated in operation cost in Total Estimate calculation.

---

## 7 Recommendation for the Future Experiments

Successful sequencing production of H<sub>2</sub> and CH<sub>4</sub> has been proved in both laboratory tests and industrial operation. The cost and benefit assessment for Qinhuangdao project has showed that the production of H<sub>2</sub> accompany with CO<sub>2</sub> in hydrolysis phase can efficiently reduce the investment payback period and increase project profitability based on the experiment results what we achieved in lab tests.

While, improving H<sub>2</sub> production yield from organic wastes is still one of the major topics of further investigation. Even we got good performances (max.1.2molH<sub>2</sub>/mol organics) of H<sub>2</sub> yields in Percolator hydrolysis reactor and ASBR hydrolysis reactor, the H<sub>2</sub> yields potential upside still exists. Shapes, physiological and biochemical characteristics, optimum situ, etc. for dominant stains of HPB requires further investigations; Meanwhile, detailed study on investigated limiting factors and more factors, like H<sub>2</sub> partial pressure, NADH/NAD<sup>+</sup> regulation and many more shall be studied in the future prospect which have effect on H<sub>2</sub> yields for H<sub>2</sub> yields.

The implication of Percolator system in industrial scaled project was not as good as what we had expected. The studies on process parameters and reactor configuration thus far were rather qualitative and fragmented. The pretreatment methods for HPB inoculums have been approved that they are not suitable to be used as pretreatment method for process water which will be re-circulated into hydrolysis reactors as dilution solvents; Pretreatment performance monitoring system was missing; Hydrolysis reactors and key equipments need carefully detailed design and test in pilot project.

Based on the results and problems what we got in this study I give the following recommendation for the future prospect:

- Although dark fermentation for H<sub>2</sub> yields has many positive features like high production rate, better sustainability, low operation cost, etc., this technology is yet to be proved with commercial hydrogen production of product efficiency and reliability in practice.
- From the aspect of thermodynamics of biochemical reactions, the accumulation of propionic acid is one of most important factors which limit the H<sub>2</sub> yields. More researches should be done on physiology study of propionic acid generation.

- 
- H<sub>2</sub> yields potential upside still exists. Shapes, physiological and biochemical characteristics, optimum situ, etc. for dominant stains of HPB requires further investigations;
  - Detailed study on investigated limiting factors is far from enough. Limiting factors like reactor configuration, SRT and continuously operation process control in percolator system which can significantly increasing H<sub>2</sub> yields via keeping stable HPB biomass density in reactor, and many more should be investigated in next investigation.
  - More factors, like H<sub>2</sub> partial pressure, NADH/NAD<sup>+</sup> regulation effect on fermentation type, mixing intensity and rotation speed, operation regime in ASBR reactor, etc. shall be studied in the future prospect which have effect on H<sub>2</sub> yields for H<sub>2</sub> yields.
  - Hyperthermophilic process has been found the highest H<sub>2</sub> yields in batch test compared with mesophilic and thermophilic fermentation process. Due to experiment limitation, the study on hyperthermophilic process was not continued.
  - Though in batch test the aeration pretreatment can efficiently suppress the activity of methanogens in inoculum and effluent after digester, it works not so well in enlarged middle-scale test and industrial scaled project due to not efficient aeration and enough retention time. Effective pretreatment to deactivate HCB and on site control of deactivation performance in industrial scale shall be deeply investigated.
  - Due to missing of proper pretreatment method for suppress the methanogens activity in effluent which have been used as process water to dilute the acid concentration and regulate pH in acid producing phase, alkaline wastewater, rich in high concentration of buffer capacity like CaCO<sub>3</sub>, could be tested in the future for both wastewater treatment and energy recovery.

---

## 8 Conclusion

Waste materials from natural and anthropogenic activities are recently being considered as one of the important substrates for recover renewable bioenergy. Biological processes are normally preferred due to feasible, economical and eco-friendly technology. Main components of food wastes are water and renewable organic resource, and its utilization as energy resource serve for environmental clean-up and mitigation of global warm up. Biomethane production via dark fermentation process from livestock manure, activated sludge and energy crops have been implemented since 1990s, while the application of food wastes has been limited due to long HRT in monodigester, high pretreatment investment cost resulted by complex food waste components and lower decomposition efficiency.

The two-stage fermentation of hydrogen-methane based on anaerobic microbes is expected not only to solve these problems, but also to contribute to creation of very clean renewable energy  $H_2$  accompany with  $CO_2$ , reduced use of fossil fuels, suppression of carbon dioxide emission, lowered burden of waste disposal and enhance benefit from food waste biogas project.

The results from this study show clearly that the fermentative production of biohydrogen and biomethane has a high potential as a component of sustainable renewable energy supply and wastes stabilization. The followings results have been achieved based on this study:

- Pretreatment of seeds material via aeration was proved the suitable method for HPB enrichment and methanogens inhibition in both batch test and continuously two-step dark fermentation of  $H_2+CH_4$  production; The liquid to solid ratio  $R_{L/S}$  3 in pretreatment via aeration was found the optimum values for  $H_2$  yields with maximum  $H_2$  yields of 19.72L/(kg oTS) in thermophilic condition. Well inoculated  $H_2$  producing sludge can significantly increase  $H_2$  yields with highest yields of 61.41L/(kg oTS) in batch test.
- Three types of  $H_2$  bioreactor, which are CSTR, semi-percolator and  $ASBR_{Hy}$  have been investigated in this study and shows clearly that sequencing production of  $H_2$  and  $CH_4$  is feasibly and can increase the total energy output from 3127kWh in monodigester to 3211kWh in  $ASBR_{Hy}+ASBR_{me}$ ;
- A pH range of 5-5.5 was found the optimum situ for bio $H_2$  yield in all three continuously lab test, and stable butyric fermentation pathway occurred;  $R_{L/S}$  3 was found best  $H_2$  production; Hydrolysis



---

end products have demonstrated inhibition on complex organics to soluble VFAs, and thus semi-percolator system and ASBR<sub>Hy</sub> system showed better H<sub>2</sub> yield than CSTR system;

- CSTR hydrolysis system was found with lowest H<sub>2</sub> yields, while highest H<sub>2</sub> yields at 196.85 L kg/oTS with H<sub>2</sub> concentration of 53.4% has been reached in ASBR<sub>Hy</sub> due to high biomass concentration maintained in bioreactor; The highest H<sub>2</sub> yields in semi-percolator reactor has reached at 82.88L kg/oTS which was slightly higher than highest value in CSTR 69.15L kg/oTS;
- ASBR<sub>Me</sub> was chosen as further degradation of by-products caused in H<sub>2</sub> producing phase and found good performance to treat such wastes in all three types of H<sub>2</sub> producing reactors;
- The separation of H<sub>2</sub> production in acidification step and CH<sub>4</sub> in methanogenesis step can sharply shorten HRT compared to monodigester, especially in semi-percolator system and ASBR<sub>Hy</sub> system.
- Case study:

Semi-percolator bioreactor designed for H<sub>2</sub> yields and food waste acidification has been tested in Lanzhou food waste biogas plant in China. Even good performance has been got in lab test, this new innovative bioreactor encountered serious challenges in industrial scaled project;

Even CSTR has the lowest H<sub>2</sub> yields in three types of H<sub>2</sub> yields reactor, it still was regarded the most possible way for H<sub>2</sub> production in industrial scale due to related equipment availability, less alteration on current project, etc. Additional H<sub>2</sub>+CO<sub>2</sub> recycle from hydrolysis can increase project income and thus decreased ROI from 9.36year to 5.84year.

---

## Reference

---

- <sup>1</sup> United Nations, 2006, World Population Perspects the 2006 Revision, <http://eesa.un.org/unup/>.
- <sup>2</sup> [http://www.willisms.com/archives/2005/05/trivia\\_tidbit\\_o\\_59.html](http://www.willisms.com/archives/2005/05/trivia_tidbit_o_59.html)
- <sup>3</sup> Russell, Randy (May 16, 2007). "The Greenhouse Effect & Greenhouse Gases". University Corporation for Atmospheric Research Windows to the Universe. Retrieved Dec 27, 2009
- <sup>4</sup> <http://iter.rma.ac.be/en/Documents/Pictures/index.php>
- <sup>5</sup> Council Directive 75/442/EEC of 15 Julz 1975 on waste. EUR-Lex. 1975. Retrieved 2009-08-20.
- <sup>6</sup> Lay JJ, Lee YJ, Noike T (1999) Feasibility of biological hydrogen production from organic fraction of municipal solid waste. Water
- <sup>7</sup> Res 33(11):2579–2586
- <sup>8</sup> Study feasibility of food waste treatment by Fairyland. 2010
- <sup>9</sup> Lin Ming; Ren Nanqi; Wang Aijie; Wang Xiangjing, Cooperation of mixed culturing bacteria in the hydrogen production by fermentation, Chinese Journal of Environmental Science, 2003
- <sup>10</sup> Wellinger et al. 1991; Scherer 1995; Strauch 1997; Anon 2003
- <sup>11</sup> Public Report, Hydrogen from Biomass, 07 2006, Dr. P.A.M. Claassem, G.J.de Vrije
- <sup>12</sup> Francou N, Vignais PM, Hydrogen production by Rhodospseudomonas capsulata cells entrapped in carrageenan beads. Biotechnol 1995; 300-5
- <sup>13</sup> Taguchi F, Yamada K, Hasegawa K, Kontinuously hydrogen production by Clostridium sp. No. 2 from cellulose hydrolysate in an aqueous two-phase system. J Ferment Bioeng 1996.
- <sup>14</sup> Madigan MT, Martinko JM, Biology of microorganisms. Upper Saddle River, 1996 p. 649.
- <sup>15</sup> Moran M, Shapiro H. Fundamentals of engineering thermodynamics, 3<sup>rd</sup> ed. New York: Wiley, 1996
- <sup>16</sup> A. William Samuel, Y. Y. Lee and W.B. Anthony. Biotechnol. Bioeng. 1980, 22(4): 757-777
- <sup>17</sup> Uneo, Y., Haruta, S., Ishii, M., Igarashi, Y., 2001. Microbial community in Anaerobic Hydrogen-Producing Microflora Enriched from Sludge Compost, Applied Microbiology and Biotechnology, Vol. 57, pp.555-562
- <sup>18</sup> D.Rechtenbach, R.Stegmann, 2009, Fermentative Erzeugung von Biowasserstoff aus biogenen Roh- und Reststoff

- 
- 
- <sup>19</sup> D.Zurawski, R.Stegmann, 2004, Biohydrogen from biowaste using digested sewage sludge as inoculum
- <sup>20</sup> Chen, C.C., Lin, C.Y., Chang, 2001, Kinetics of hydrogen production with continuous anaerobic cultures utilizing sucrose as the limiting substrates, applied microbiology and biotechnology, Vol. 57, pp. 56-64
- <sup>21</sup> Brosseau and Zaiic
- <sup>22</sup> Schröder, C., Selig, M., Schönheit, P., 1994, Glucose fermentation to acetate, CO<sub>2</sub> and H<sub>2</sub> in the anaerobic hyperthermophilic Eubacterium Thermotoga maritime: Involvement of the embden-meyerhof pathway, archives of microbiology, Vol.161, pp.460-470
- <sup>23</sup> Yoshida, A., Nishimura, T., Kawaguchi, 2005, Enhancement hydrogen production from formic acid by formate hydrogen lyase-overexpressing Escherichia coli Strains, applied environmental microbiology, vol. 71, pp.6762-6758
- <sup>24</sup> Tanisho, S., Ishiwata, Y, 199, continuously hydrogen production from molasses by the bacterium Enterobacter aerogenes, international journal of hydrogen energy, vol. 19, pp.807-812
- <sup>25</sup> Fang, H.H.P., Liu, H., 2002, effect of pH on hydrogen production from glucose by a mixed culture, Bioresource technology, vol. 82, pp.87-93
- <sup>26</sup> Chin, H.L., Chen, Z.S., 2003, Fedbatch operation using clostridium acetobutylicum suspension culture as biocatalyst for enhancing hydrogen production, Biotechnology Progress, 19.
- <sup>27</sup> D.Zurawski, R.Stegmann, 2004, Biohydrogen from biowaste using digested sewage sludge as inoculum
- <sup>28</sup> Yan et al., 1988
- <sup>29</sup> <https://en.wikipedia.org/wiki/Hydrolysis>
- <sup>30</sup> Stahl, R. biukat. [Online] [Zitat vom: 10. 03 2010.]  
[http://biukat.de/wb/media/UTF2/Vortrag\\_UTF2\\_Stahl.pdf](http://biukat.de/wb/media/UTF2/Vortrag_UTF2_Stahl.pdf).
- <sup>31</sup> Ren NQ,Wang BZ. Technology of BioHydrogen production from waste organic water-principle and Method. 1995
- <sup>32</sup> Ren NQ,Wang BZ. Technology of BioHydrogen production from waste organic water-principle and Method. 1995

- 
- 
- <sup>33</sup> Dorothea Rechtenbach, Rainer Stegmann; Fermentative Erzeugung von Biowasserstoff aus biogenen Roh- und Reststoffen, Hamburger Bericht Band 34, 2009
- <sup>34</sup> Vignais, P.M., Billoud, B. and Meyer, J. (2001). "Classification and phylogeny of hydrogenases". *FEMS Microbiol. Rev.* **25** (4): 455–501..
- <sup>35</sup> Lin Ming; Ren Nanqi; Wang Aijie; Wang Xiangjing, Cooperation of mixed culturing bacteria in the hydrogen production by fermentation, Chinese Journal of Environmental Science, 2003
- <sup>36</sup> Ren, Nanqi, Wang, Aijie, 2005, Microbial physiological ecology of acidogens
- <sup>37</sup> LjupkaArsova, 2010, Anaerobic digestion of food waste: Current status, problems and an alternative product: 19-20
- <sup>38</sup> Horiuchi J 1, Shimizu T, Tada K. Selective production of organic acids in anaerobic acid reactor by pH control[J]. *Bioresour Technol*, 2002, 82: 209-213
- <sup>39</sup> Chen, Xiaolei, 1998
- <sup>40</sup> Jiunn-Jyi Lay, modeling and optimization of anaerobic digested sludge converting starch to hydrogen, 1999
- <sup>41</sup> Madigan, M., Martinko, J. and Parker, J. 2003. *Biology of microorganisms*. S.I.: Brock, 2003
- <sup>42</sup> Biogas from Waste <http://www.onehourpower.com/biogas-from-waste/parameter-specific-surface-of-material.html>
- <sup>43</sup> Davila-Vazquez G, Arriaga S, Alatríste-Mondragón F, et al. Fermentative biohydrogen production: Trends and perspectives. *Rev Environ Sci Biotechnol*, 2008, 7: 27—45
- <sup>44</sup> Neves L., Goncalo E., Oloveira R., Alves M. M., 2008. Influence of composition on the biomethanation potential of restaurant waste at mesophilic temperature, *Waste Manage.*, 28, 965-972.
- <sup>45</sup> [http://www.neubert-glas.de/laborglas/onlineshop/katalog\\_php](http://www.neubert-glas.de/laborglas/onlineshop/katalog_php)
- <sup>46</sup> [http://www.neubertglas.de/laborglas/onlineshop/katalog\\_php/1\\_995727484085\\_1030342691843\\_1081403291531\\_995727502912\\_1076850101703/1162481080791/Eudiometer-Faulverhalten.html](http://www.neubertglas.de/laborglas/onlineshop/katalog_php/1_995727484085_1030342691843_1081403291531_995727502912_1076850101703/1162481080791/Eudiometer-Faulverhalten.html)
- <sup>47</sup> DIN 38414, Determination of digestion behavior sludge and sediments, Beuth Verlag, Berlin 1985 (in Germany)
- <sup>48</sup> <http://en.wikipedia.org/wiki/Endospore>

- 
- 
- <sup>49</sup> S. Venkata Mohan, V. Lalit Babu, P.N. Sarma, Effect of various pretreatment methods on anaerobic mixed microflora to enhance Biohydrogen production utilizing dairy wastewater as substrate, 2006, Bioresource Technology
- <sup>50</sup> Mu, Y., Yu, H.Q., 2007. Evaluation of three methods for enriching H<sub>2</sub>-producing cultures from anaerobic sludge. *Enzyme Microb. Technol.* 4(4-5), 947-953
- <sup>51</sup> Hu, B., Chen, S.L., 2007. Pretreatment of methanogenic granules for immobilized hydrogen fermentation. *Int. J. Hydrogen Energy* 32 (15), 3266-3273
- <sup>52</sup> Shiwu Sung, 2004. Biohydrogen production from renewable organic wastes. DOE, 55
- <sup>53</sup> South C R, Hogsett D A L, Lynd D L R. Modelling simultaneous saccharification and fermentation of lignocelluloses to ethanol in batch and continuous reactor. *Enzyme Microbial Technology*, 1995, 17: 797-803
- <sup>54</sup> Penaud V ,Delgenes J P ,Torrijos M , et al. Definition of optimal conditions for the hydrolysis and acidogenesis of pharmaceutical microbial biomass. *Process Biochem* ,1997 32 :515~521.
- <sup>55</sup> Yanjuan, Lu. Investigation of the hydrolyzed extraction of maize-silage for a double-stage-fermentation. 2005, Master Thesis, Chair of Waste Management, p37
- <sup>56</sup> Bischofsberger, Wolfgang, et al. 1993. *Anaerobtechnik*. S.I.: Springer, 1993
- <sup>57</sup> G.C. Okpokwasili, C.O. Nweke. 2005. Microbial growth and substrate utilization kinetics. *African Journal of Biotechnology* Vol.5, pp. 305-317
- <sup>58</sup> P.M. Ndegwa, D.W. Hamilton, J.A. Lalman, H.J. Cumba. 2005. Optimization of Anaerobic sequencing batch reactors treating diluted swine slurries. *American Society of Agricultural Engineers* ISSN 0001-2351. Vol. 48(4) 1575-1583
- <sup>59</sup> A.T. Nielsen, H.Amandusson, R. Bjorklund... Hydrogen production from organic waste, *int. J. Hydrogen Energy* 2001
- <sup>60</sup> C.Y.Lin, R.C. Chang, Hydrogen production during the anaerobic acidogenic conversion of glucose, *J.Chem. Technol. Biotechnol.* 1999
- <sup>61</sup> R.R.dague, C.E. Habben and S.R.Pidapartu, 1992. Initial studies on the anaerobic sequencing batch reactor. *Wat.Sci. Tech* Vol. 26, No. 9-11, pp.2432.
- <sup>62</sup> Shihwu Sung, Richard R. Dague. 1993. Laboratory studies on the anaerobic sequencing batch reactor. *Water Environmental Research*, Volume 67, Number 3.

- 
- 
- <sup>63</sup> Akcal, Kinacl, Karpuzcu, M. 1993. A model for optimum design of activated sludge plants. *Wat. Res.*, 9, 1461.
- <sup>64</sup> <http://www.rvtpe.de/packing-and-honeycombs>
- <sup>65</sup> M. Zaiat, J.A.D.Rodrigues, 2000. Anaerobic sequencing batch reactors for wastewater treatment: a developing technology. *Appl Microbiol Biotechnol* (2001) 55: 29-35
- <sup>66</sup>[http://www.ansyco.de/CMS/frontend/media/pdf/Datenblatt\\_d\\_01I10\\_gl\\_BM2000\\_biogas.pdf](http://www.ansyco.de/CMS/frontend/media/pdf/Datenblatt_d_01I10_gl_BM2000_biogas.pdf)
- <sup>67</sup> Debabrata Das, Namita Khanna, Chitralkha Nag Dasgupta, 2008. Biohydrogen Production: Fundamentals and Technology Advances. 307-310
- <sup>68</sup> Zhang, Bin, 2010. Untersuchungen zur Auswirkung Zunehmender Salzkonzentration auf die Leistungsfähigkeit eines Schlammbed-Methansystems. *BTU Abfallwirtschaft*
- <sup>69</sup> DiMarco, A.A., Bobik, T.A. & Wolfe, R.S. (1990) Unusual coenzymes of methanogenesis. *Annual Review of Biochemistry*, 59, 355–394.
- <sup>70</sup> Ermler, U., Grabarse, W., Shima, S., Goubeaud, M. & Thauer, R.K. (1997) Crystal structure of methyl-coenzyme M reductase: the key enzyme of biological methane formation. *Science*, 278, 1457–1462.
- <sup>71</sup> Luo, Y.R. (2002) Handbook of bond dissociation energies in organic compounds. New York: CRC Press, 22–94.
- <sup>72</sup> Ferry, J.G. (1997) Methane: small molecule, big impact. *Science*, 278, 1457–1462.
- <sup>73</sup> Jules B. van Ier, Katja C. F. Grolle, Alfons J. M. Stams, Everly Conway de Macario, and Gatzke Lettinga, Start-up of a thermophilic upflow anaerobic sludge bed reactor with mesophilic granular sludge, *Applied Microbiology Biotechnology*, 1992
- <sup>74</sup> Sun-Kee Han, Hang-Sik Shin, Performance of an Innovative Two-Stage Process Converting Food Waste to Hydrogen and Methane. 2004. *Journal of the Air & Waste Management Association*
- <sup>75</sup> Xue Yun, Wang Bin. A Study of knock in engine fueled with Hydrogen. *China*: 1671-5292(2007)05-0053-04; <http://wenku.baidu.com/view/732f3ce74693daef5ef73d9f.html?re=view>