

Implementation of End-of-Life Vehicle's Recycling for Developing Countries: Case Study, Mexico

A Doctoral Dissertation, approved by the Faculty of Environmental Science and Process Engineering of the Brandenburg Technical University Cottbus and submitted in Fulfillment of the Requirements for the Award of the Degree of Doctor of Engineering

Submitted by

Master of Engineering

Reynaldo Cruz-Rivera

From Mexico City

Supervisor: Prof. Dr. rer. nat. Jürgen Ertel

Supervisor: PD Dr. habil rer. pol. Kai Rommel

Date of the Disputation: 03. 06. 2008

Implementierung des Altautorecyclings in Entwicklungsländern: Länder-Fallstudie Mexiko

Von der Fakultät für Umweltwissenschaften und Verfahrenstechnik der Brandenburgischen Technischen Universität Cottbus zur Erlangung des akademischen Grades eines Doktor-Ingenieurs genehmigte Dissertation

vorgelegt von

Master of Engineering

Reynaldo Cruz-Rivera

aus Mexiko Stadt

Gutachter: Prof. Dr. rer. nat. Jürgen Ertel

Gutachter: PD Dr. habil rer. pol. Kai Rommel

Tag der mündlichen Prüfung: 03. 06. 2008

Declaration and Disclaimer

Hereby, I declare that this dissertation is solely the result of my own effort. The research leading to the present dissertation was carried out under the supervision of Prof. Dr. rer. nat. Jürgen Ertel and PD Dr. habil rer. pol. Kai Rommel.

The opinions expressed in this dissertation are the author's and they do not necessarily reflect the position of the Brandenburg University of Technology in Cottbus, nor the Department of Industrial Sustainability. The author has used and cited only the materials and sources indicated in the reference list, and I have quoted all words, phrases or passages taken from these sources. The thesis is wholly the author's and has not been part of any presentation for any other qualification in its present form or similar version.

Zusammenfassung

Die vorliegende Arbeit entwickelt einen Vorschlag für ein geeignetes System, um End-of-Life Vehicles (ELV) in einem Entwicklungsland, Fallstudie Mexiko, zu recyceln. Der Vorschlag umfasst vorgeschlagene Maßnahmen und Ausstattung, ein Modell zur Finanzierung des Altfahrzeug-Managements in Mexiko sowie die Konfiguration der strategischen Netzwerke der Anlage für jede Phase des Altfahrzeug-Managements. Das Netz beschreibt Bezirke mit hoher Priorität, um Anlagen zu lokalisieren, die dazu gedacht sind, um die Altfahrzeug-Management-Aktivitäten auszuführen, d. h. Demontage, Schreddern, Gießen, energetische Verwertung und Entsorgung.

Die Arbeit wurde in fünf Teile geteilt: erstens die Studie über den Stand des Altfahrzeug-Managements in der Europäischen Union als eine Einheit, zweitens der Stand des Altfahrzeug-Managements in Deutschland aufgrund seiner einschlägigen Automobilindustrie und deren historischem Einfluss im Altfahrzeug-Management-Bereich, drittens die Gliederung des aktuellen Stands des ELV-Managements in den USA, die eine enorme Bedeutung für die mexikanische Fallstudie hat, viertens die Sammlung von Informationen über das aktuelle Altfahrzeug-Management in Mexiko sowie fünftens das vorgeschlagene Altfahrzeug-Management-System im mexikanischen Fall.

Stand des Altfahrzeug-Managements in der Europäischen Union

Die aktuelle produktorientierte Gesetzgebung zur Bewältigung des Altfahrzeug-Managements in der EU entsteht aus der frühen Besorgnis - bereits vor Jahrzehnten - in Schweden, Deutschland und anderen Ländern. Die Europäische Kommission identifizierte ELV als vorrangigen Abfallstrom in der Gemeinschaftsstrategie für die Abfallwirtschaft im Jahr 1989. 1997 wurde der "Vorschlag für eine Richtlinie des Rates über die End-of-Life Vehicles" (COM 97-358) erlassen, im Jahr 2000 nahm das Europäische Parlament diesen Vorschlag mit der Nummer 2000/53/EG an und verlangte die Erfüllung dieser Richtlinie bis zum Jahr 2002 von den Mitgliedsstaaten.

Die Richtlinie 2000/53/EG regelt das Altfahrzeug-Management derzeit in 27 Ländern in Europa und für die kommenden Jahre sind noch mehrere Beitrittsländer vorgesehen. Auf Grund des internationalen Charakters der Automobilindustrie hat diese Richtlinie auch Branchen außerhalb der EU beeinflusst. Demzufolge sind Länder mit wichtiger nationaler Automobil-Industrie auf dem Weg, diese Rechtsvorschrift zu erfüllen, um ihre Wettbewerbsfähigkeit in den europäischen Märkten zu behalten. Im Allgemeinen zielt die Richtlinie auf die Vermeidung von Abfällen aus ELV sowie den Impuls zu Wiederverwendung, Recycling und andere Formen der Verwertung.

Die Gesetzgebung in der EU verpflichtet die Mitgliedstaaten, Sammlungs-Netzwerke für Altfahrzeuge zu organisieren und umzusetzen, Bescheinigungen von den letzten Besitzern über die Vernichtung des Altfahrzeugs vorzulegen, Verbesserungen und Zertifizierungen von Management-Operationen durchzuführen sowie Kennzeichnungen von recycelbaren Materialien durchzuführen. Hierfür wurden die folgenden Bedingungen festgelegt:

- a) bis zum Jahr 2006 Steigerung der Recyclingquote bei Wiederverwendung und bei Verwertung von ELV von mindestens 85% und für Wiederverwendung und Recycling von 80%, und
- b) bis zum Jahr 2015 Quote für Wiederverwendung und Verwertung von mindestens 95% und für Wiederverwendung und Recycling von 85%.

Darüber hinaus ist alle drei Jahre eine Berichterstattung über die Umsetzung der Richtlinie an die Kommission erforderlich.

Die Altfahrzeug-Kette in der EU ist ein komplexes System, welches mehrere kommerzielle Beziehungen zwischen den verschiedenen Branchen beinhaltet. Als wichtigste Branchen wurden die Auto-Industrie und deren Zuliefer-Industrie, die Demontage-Industrie, die Schredder-Industrie sowie Verbraucher und Regierungen identifiziert. Am stärksten und am besten organisiert hiervon sind die Auto-Produktions- und die Schredder-Industrien. Ihre wirtschaftliche Bedeutung wird benutzt, um Einfluss auf die Entscheidungsprozesse im Hinblick auf das Altfahrzeug-Management auszuüben.

Im Jahr 2004 zählte die EU-15 mit der Fahrzeug-Flotte, den Personenkraftwagen (PKW) und den leichten Nutzfahrzeugen 215 Mio. Einheiten. Der Markt für diese Art von Fahrzeugen in der EU-23 betrug 14,3 Mio. Einheiten bis 2006. Die Generation von ELV in der EU-15 betrug rund 11,4 Mio. Einheiten im Jahr 2005. Die errechnete Gesamtzahl an Altfahrzeugen unter Berücksichtigung der neuen Mitgliedsländer ist noch unbekannt. Die Zahl der behandelten Altfahrzeuge in der EU-15 betrug 7,7 Mio. Einheiten. Die fehlende Anzahl an Altfahrzeugen ist auf illegale Behandlungen und Export von gebrauchten Fahrzeugen ins Ausland zurückzuführen.

Es gibt einige Hindernisse bei dem bereits umgesetzten ELV-Management in der EU zu überwinden. Die Hauptschwierigkeiten hängen zusammen mit der Zurückhaltung der automobilherstellenden Industrie bei der Umsetzung der in der Richtlinie enthaltenen Bestimmungen in Bezug auf Verbot der Verwendung bestimmter Stoffe bei Automobil-Anwendungen und in Bezug auf Recycling-Quoten. Ein weiteres Hindernis ist der Export von ELVs aus der EU, was einen Verlust an Input-Material für das System bedeutet.

Stand des Altfahrzeug-Managements in Deutschland

Die deutsche Altfahrzeug-Management-System legt besondere Bedeutung auf die aktuelle produkt-orientierte Gesetzgebung in der EU. Die deutsche Automobilindustrie begann in den 70er Jahren das ELV-Problem anzugehen. Nach mehreren Projekten und einem langen Prozess der Gesetzgebung in dieser Hinsicht wurde im Jahr 1998 die Verordnung "Altauto V" erlassen, welche ein direkter Vorläufer der Richtlinie 2000/53/EG ist.

Die Umsetzung der Richtlinie 2000/53/EG in nationales deutsches Recht ändert "Altauto V" in die "Altfahrzeug-Verordnung". Der Inhalt ist im Wesentlichen der gleiche wie in der Richtlinie 2000/53/EG. Eines der Hauptmerkmale, das die deutsche Version der Richtlinie 2000/53/EG charakterisiert, ist die konditionierte kostenlose Rücknahme der Altfahrzeuge.

Die Struktur der deutschen Altfahrzeug-Kette ist der allgemeinen europäischen Struktur sehr ähnlich und die Rolle der Beteiligten ist ebenfalls ähnlich. Das Altfahrzeug-Management in Deutschland gliedert sich in zwei dezentrale Netzwerke. Das erste Netzwerk basiert auf der Grundlage bilateraler Vereinbarungen zwischen Pkw-Herstellern und Demontagebetrieben. Hier hat jeder Auto-Hersteller ein dediziertes Netzwerk von Demontagebetrieben, das ELVs aus der eigenen Marke behandelt, zur Verfügung. Der Auto-Hersteller überwacht die Leistung dieser Anlagen und liefert Ausrüstung sowie Beratung. Das zweite Netzwerk besteht zwischen den Metall-Zerkleinerungs-Firmen und den Auto-Herstellern. Die metallzerkleinernden Unternehmen organisieren die Demontage und die Sammel-Netzwerke, um die ELVs von den automobilherstellenden Unternehmen abzuholen, mit denen sie eine Vereinbarung haben.

Im Jahr 2006 zählte die deutsche Fahrzeug-Flotte für Personenkraftwagen und leichte Nutzfahrzeuge 46,1 Mio. Einheiten. Im Jahr 2005 wurden im deutschen Markt 3,3 Mio. Einheiten verkauft und die Generierung von ELV in Deutschland liegt bei etwa 3,1 Mio. Einheiten pro Jahr.

Die deutsche ELV-Management-Infrastruktur besteht aus 15.000 Sammelstellen, 1.178 Demontage-Betrieben und 41 Zerkleinerungs-Anlagen. Das aktuelle ELV-Management-System behandelt rund 1,2 Mio. Altfahrzeuge pro Jahr. Damit ist Deutschland eines der Länder mit dem höchsten Unterschiede zwischen abgemeldeten und behandelten Altfahrzeugen in der EU. Der Hauptgrund für diese Differenz ist die hohe Anzahl der gebrauchten Fahrzeuge, die exportiert werden.

Aufgrund der hohen Bedeutung der deutschen Automobilindustrie in Europa ist ein großer Teil der Ablehnung der Umsetzung der Richtlinie aus dieser Branche gekommen, was einen großen Einfluss auf die Entscheidungsprozesse in der EU bedeutet.

Stand des Altfahrzeug-Managements in den USA

Das aktuelle ELV-Management in den USA hat keine spezifische Gesetzgebung in Bezug auf die Sammlung und das Recycling von ELV, dennoch gab es einige Vorschläge hierfür. Der erste Versuch, diesen Bereich zu regulieren, war im Jahr 1991 mit einem Vorschlag namens H.R.3369. Dieses Gesetz wurde von der Automobil-Industrie wie die Vorboten des obligatorischen Recyclings gesehen. Der Vorschlag wurde vom US-Repräsentantenhaus gemacht und wurde „Automobile Recycling Study Act of 1991“ genannt. Der Vorschlag wurde nicht verabschiedet und auch von den anschließenden Kongressen nicht wieder eingeführt.

In den letzten Jahren wurde eine Reihe von freiwilligen Initiativen von der Recycling-Industrie gegründet. Ein Beispiel für diese Vereinbarungen ist die „Certified Automotive Recycler (CAR)“, die im Jahr 1994 als Teil der „Automotive Recyclers Association (ARA)“ lanciert wurde. Dieses Programm errichtete - als Orientierungshilfe für die Mitglieder - eine Leitlinie für allgemeine Geschäftsbedingungen sowie Umwelt- und Sicherheitsfragen.

Im Jahr 2003 strukturierte das U. S. Department of Energy das „Cooperative Research and Development Agreement (CRADA)“ zur Erleichterung der Forschung zur nachhaltigen Verwertung von aktuellen und künftigen Abfallströmen von ELVs. Die wichtigsten Teilnehmer an dieser Vereinbarung waren das US-Department of Energy, das Argonne National Laboratory, die Vehicle Recycling Partnership Gruppe und das American Plastics Council.

Allerdings gibt es derzeit in den Vereinigten Staaten von Amerika keine Vorschrift, die den Automobilherstellern auferlegt, die Verantwortung für ihre Produkte zu übernehmen, die Altfahrzeug-Abfälle, die in Deponien entsorgt werden, zu begrenzen oder eine Recovery-Rate für ELVs verlangt. Es gibt einige Regelungen auf staatlicher Ebene im Zusammenhang mit der Entsorgung von festen und gefährlichen Abfällen, z. B. das Verbot der Entsorgung von freien Flüssigkeiten und Blei-Säure-Batterien auf Deponien. Diese Praktiken werden in einigen Bundesstaaten des Landes durchgeführt.

Die Struktur der Altfahrzeug-Kette in den USA ist ähnlich wie sein Pendant in der EU. Der wichtigste Unterschied liegt in den Demontage- und Post-Zerkleinerungs-Branchen. 80% der Demontageindustrie besteht aus Schrottplätzen, die nicht-standardisierte Abläufe durchführen, und die restlichen 20% sind von hochwertigen Teil-Demontagebetrieben vertreten. Eine Besonderheit des Systems ist die Klassifikation von ASR als nicht-gefährlicher Abfall, was zu fast keiner Motivation zur weiteren Behandlung führt.

Bis zum Jahr 2003 zählte die gesamte US-Fahrzeug-Flotte 226 Mio. Personenkraftwagen und leichte Nutzfahrzeuge. Im gleichen Jahr betrug die Zahl der abgemeldete Kraftwagen 11,3 Mio. Einheiten. Die Infrastruktur für die Durchführung der Altfahrzeug-Management in den USA umfasst 7.000 Demontage-Anlagen, 200 Zerkleinerungs-Anlagen und 10 Sink-Schwimm-Anlagen.

Es gibt keine verfügbaren Informationen über die Anzahl der behandelten Altfahrzeuge durch das Altfahrzeug-Management in den USA. Allerdings werden laut verschiedener Autoren mehr als 95% aller abgemeldeten Fahrzeuge von der Recycling-Infrastruktur der USA erfasst. Die derzeitige Recyclingquote für diese Fahrzeuge liegt bei 75% mit einer virtuellen Recycling-Rate von 100% für Stahl und Eisen sowie einer hohen Recycling-Quote für nicht-eisenhaltige Metalle.

Das derzeitige System des Altfahrzeug-Managements in den USA arbeitet mit relativer Effizienz. Allerdings gibt es noch Punkte, die verbesserungswürdig sind, z. B. die mangelhaften Demontage-Praktiken einer großen Anzahl von Demontage-Einrichtungen (Schrottplätze), die Verwendung von gefährlichen Stoffen bei der Auto-Herstellung, die Entsorgung von ASR als nicht-gefährlichem Abfall, Altreifen usw.

Stand des Altfahrzeug-Managements in Mexiko

Die Altfahrzeug-Problematik hat unterschiedliche Konnotationen in Entwicklungsländern wie Mexiko im Vergleich zu Industrieländern. Dieses Problem wirkt sich auf die mexikanische Wirtschaft, Umwelt und Gesellschaft aus.

Der Wirtschaftssektor wird vor allem durch die Einführung von alten Fahrzeugen aus den USA nach Mexiko betroffen. Die verfügbaren Informationen geben eine Einführungsrate in Höhe von 200.000 bis 300.000 Fahrzeugen pro Jahr an. Diese Fahrzeuge haben ein Durchschnittsalter von 10,7 Jahren und / oder sind repariert worden, nachdem sie in Unfälle verwickelt waren, zugleich enthalten die meisten dieser Fahrzeuge Schwermetalle wie Quecksilber-Schalter. Auf Grund ihrer nahen Stilllegung aus dem Verkehr und ihrer immer größer werdenden Anzahl sind diese Fahrzeuge von einer großen Besorgnis für die verschiedenen mexikanischen Branchen.

Schlecht durchgeführte Praktiken während der Demontage und den Zerkleinerungs-Prozessen sowie der Mangel an Kontrolle über die Stilllegungsaktivitäten und die Entsorgung gefährlicher Abfälle bedeuten große Umweltauswirkungen in Mexiko. Diese Auswirkungen sind vermutlich höher als die Auswirkungen, die von der gleichen Art von Fahrzeugen in industrialisierten Ländern verursacht werden. In industrialisierten Ländern macht die End-of-Life-Phase der Personenkraftwagen weniger als 10% von der gesamten Umweltbelastung dieser Fahrzeuge aus. Die größten Auswirkungen treten während der Betriebsphase auf.

Im Jahr 2002 verdiente ein durchschnittlicher mexikanischer Arbeiter 18% der Kaufkraft (Material Lebensqualität) im Vergleich zu seinem US-amerikanischen Pendant. Eine große Anzahl der mexikanischen Bevölkerung kann es sich auf Grund ihrer niedrigen Löhne nicht leisten, neue Fahrzeuge zu kaufen. Dadurch entsteht eine Präferenz für gebrauchte Fahrzeuge (nationale oder importierte) mit der sich daraus ergebenden Alterung der mexikanischen Fahrzeug-Flotte.

Die alten, aus den USA eingeführten Fahrzeuge verursachen auch gesellschaftspolitische Probleme. Der illegale Status dieser Art von Fahrzeugen hat in den letzten Jahren verschiedene politische Gruppen begünstigt, ihren Vorteil aus dieser Situation zu ziehen, um daraus politische Macht und Profite zu erzielen. Darüber hinaus hat die fehlende Registrierung dieser Fahrzeuge ihre Verwendung bei verschiedenen Verbrechen favorisiert.

In Mexiko existiert keine spezifische Gesetzgebung zur Regelung des Managements von ELV. Diese Art von Produkten in ihrer End-of-Life-Phase und die Abfälle, die durch ihre Behandlung entstehen, wurden bis zum Jahr 2004 durch die allgemeine Gesetzgebung geregelt. In letzter Zeit wurde ein semi-spezifisches Gesetz im Bezug auf feste Abfälle verordnet, das LGPGIR.

Das LGPGIR stuft ELV als speziellen Abfall ein und fordert von den Produzenten, den Importeuren, den Exporteuren und den Händlern die Aufstellung von Plänen zur Verwaltung ihrer Produkte, d. h. der Fahrzeuge, nach ihrer Nutzungsdauer. Die Verantwortung für die Überwachung und Kontrolle der Erfüllung des Gesetzes ist den Regierungen und den Ländern vorbehalten. Jedoch gibt es derzeit keine spezifischen Normen oder Pläne zur Verwaltung dieser Art von Fahrzeugen. Das gewinnbringende Material aus ELV wird unter marktüblichen Bedingungen gemanagt und das bestehende System wird durch die Profitabilität eines jeden involvierten Unternehmens angetrieben.

Die Struktur der Altfahrzeug-Kette in Mexiko ist ähnlich wie diejenige in den USA und der EU, mit Ausnahme einer zusätzlichen Phase. Diese Phase findet zwischen Demontage und Zerkleinerungs-Aktivitäten statt und zählt rund 5.000 Betreiber entlang Mexiko. Sie führen handwerklich-intensive Tätigkeiten durch, um die wertvollen Materialien aus den verschiedenen Abfallströmen, einschließlich ELV, rückzugewinnen.

Die genaue Zahl der Betreiber von Demontage-, Zerkleinerungs- und Schmelz-Aktivitäten im ELV-Management ist nicht bekannt. Selbst die Einstufung der durchgeführten Aktivitäten von jeder Anlage in Bezug auf das Altfahrzeug-Management ist nicht genau definiert, da z. B. in einer Anlage Aktivitäten wie Karosserie-Reparaturen und Demontage zur gleichen Zeit durchgeführt werden könnten. Dadurch beschreibt die vorliegende Arbeit die verfügbaren Informationen über die Zahl der mexikanischen Betreiber auf jeder Stufe des Altfahrzeug-Managements.

Bis zum Jahr 2005 zählte die gesamte mexikanische Fahrzeug-Flotte 21,4 Mio. zirkulierende Fahrzeuge. Im gleichen Jahr gab es im mexikanischen Markt im Einzelhandel 1,1 Mio. Einheiten. Es gibt jedoch weder verfügbare Informationen über die aktuelle ELV-Generation noch Informationen über die Zahl der behandelten Fahrzeuge in Mexiko.

Die beschriebenen Erkenntnisse stellen ein mangelhaftes Management der ELV in Mexiko dar. Das derzeitige Management ermöglicht eine maximale Recyclingquote von 75%, welches hauptsächlich dem beinhaltenen Eisenanteil in den Fahrzeugen entspricht, die in das Management-System einfließen.

Das vorgeschlagene System für ELV-Management in Mexiko

Der erste Teil dieses Vorschlags ist die Einschätzung der zukünftigen Zahl von generierten Altfahrzeugen in Mexiko. Diese Schätzungen erfolgen auf der Grundlage von zukünftigem PKW-Einzelhandel und zukünftigen PKW-Flotten in Mexiko. Daher ist die zukünftige Generation von Pkws in Mexiko für zwei Szenarien von 2007 bis 2010 durchgeführt. Anschließend wurde ein Ansatz hinsichtlich der breiten Anwendung im Bezug auf die Zuverlässigkeit der Branche umgesetzt, die Weibull-Verteilung. Dieser Ansatz bietet dynamische Massenströme, die das Stilllegungs-Verhalten der mexikanischen Fahrzeugflotte in zwei zusätzlichen Szenarien für den Zeitraum von 2007 bis 2025 aufzeigen. Diese Arbeit schätzt eine aktuelle ELV-Generation von rund 687.000 Einheiten im Jahr 2007 und bis 2020 im Bereich von 1,1 bis 1,3 Mio. Einheiten pro Jahr.

Der zweite Teil dieses Vorschlags ist die Struktur der Altfahrzeug-Kette in Mexiko. Eine vorgeschlagene Struktur wird beschrieben sowie die empfohlenen Maßnahmen, Ausrüstungen und Konfigurationen der Einrichtungen in jeder Phase des Managements. Die Konfiguration erfolgt in Stilllegungs-, Demontage- und Zerkleinerungs-Phasen. Geschätzte Mengen von Materialströmen werden aus der zukünftigen Anzahl von ELV, d. h. Eisen- und nicht-eisenhaltige Metalle sowie ASR, geschätzt. Die Konfiguration umfasst den Ansatz zur energetischen Verwertung von ASR in Zementwerken und die endgültige Beseitigung von Strömen, die nicht recyclebar sind.

Der dritte Teil des Vorschlags ist die Konfiguration der Anlagen des strategischen Netzwerks in jeder Phase des Altfahrzeug-Managements in Mexiko. Das System ist konfiguriert unter der Annahme von drei verschiedenen Szenarien, d. h. 100%, 90% und 75% der anfallenden Nachfrage nach Altfahrzeug-Management. Der Algorithmus wurde für dieses spezielle Problem als ein „*Fixed Charge Facility Location Problem*“ identifiziert. Der Algorithmus wurde durch „*Facility Location Software SITATION*©“ gelöst. Die Ergebnisse zeigen die optimale Anzahl von Anlagen in jeder Phase des Managements zur Deckung der Nachfrage nach Altfahrzeug-Management für die verschiedenen Szenarien.

Der vierte Teil dieses Vorschlags ist die Struktur eines Modells zur Finanzierung des Altfahrzeug-Managements in Mexiko. Die drei Hauptschemen zur Finanzierung des Altfahrzeug-Managements in der EU werden als kostenlose Rücknahme-, Recycling-Gebühr/Recycling-Subvention und Pfandregelung beschrieben. Die Auswirkungen, die durch ihre Umsetzung in Ländern wie Deutschland, den Niederlanden und Schweden verursacht wurden, sind skizziert, um die wichtigsten Vor- und Nachteile für die Betroffenen in den jeweiligen Ketten zu verstehen. Letztendlich wird ein System vorgeschlagen, das für den mexikanischen Markt geeignet ist. Die wichtigsten Merkmale dieses Schemas werden erläutert sowie ihre Vor- und Nachteile und die Anreize, die erdacht wurden, damit sie in die mexikanische ELV-Kette passen.

Executive Summary

The present work develops a proposal for a suitable system to manage End-of-Life Vehicles (ELV) in a developing country, case study Mexico. The proposal comprises suggested operations and equipment, a model to finance the ELV management in Mexico, and the configuration of strategic facility network for every stage of ELV management. The network describes preference counties to locate facilities, thought to perform the ELV management activities, i.e. dismantling, shredding, melting, energy recovery and final disposal.

The work was divided in five parts: First, the study of the state of ELV management in the European Union as a unit. Second, the state of ELV management in Germany owing to its relevant automotive industry and its historical influence in the ELV management field. Third, the outline of current ELV management in the USA that has an enormous importance for the Mexican case study. Fourth, the gathering of information about the current management of ELV carried out in Mexico. Fifth, the ELV management system proposed for the Mexican case.

State of ELV Management in the European Union

The current product-oriented legislation addressing the ELV management in the EU arises with the early concern, borne decades ago in Sweden, Germany, and other countries. The European Commission identified ELV as priority waste stream on the Community Strategy for Waste Management in 1989. In 1997, the “Proposal for a Council Directive on End-of-life Vehicles” (COM 97-358) was enacted, and in 2000 the European Parliament adopted this proposal with the number 2000/53/EC, requiring the fulfillment of this Directive by 2002 on the member states.

The Directive 2000/53/EC regulates the ELV management in 27 countries in Europe, and for the forthcoming years, more accession countries are foreseen. Since the international nature of automotive industry, the Directive has affected industries beyond the EU. Hence, countries with important national-based automotive industry are moving towards the accomplishment of this legislation, in order to keep their competitiveness in European markets. In general terms, the Directive aims the prevention of waste coming from ELV, the impulse of re-use, recycling and any other forms of recovery.

The legislation in the EU requires member’s states: to organize and implement collection networks for ELV, to provide Certificate of Destruction to last owners, for the improvement and certification of management operations, to carry out labeling of materials able to be recycled under following conditions:

- a) by 2006 to raise the recycling rate of reuse and recovery of ELV by at least 85%, and for reuse and recycling by 80%, and
- b) by 2015 the rate for reuse and recovery by at least 95% and for reuse and recycling by 85%.

Moreover, it requires reporting information about the Directive's implementation to the commission every three years.

The ELV chain in the EU is a complex system, which involves several commercial relationships between different sectors. The main identified sectors are the car-manufacture industry and suppliers, dismantling industry, shredder industry, consumers and governments. The strongest and the best organized are the car-manufacture and shredder industries. Their economic relevance is used to influence the decision making processes regarding the ELV management.

In 2004, the EU-15 counted with a vehicular fleet, passenger cars and light trucks, of 215 million units. The market of this kind of vehicles in the EU-23 was 14.3 million units by 2006. The generation of ELV in the EU-15 was around 11.4 million units in 2005. The total number of ELV generated, considering the accessing countries, is still unknown. The number of treated ELV in the EU-15 was 7.7 million units. The missing number is due to illegal treatments and export of used vehicles to foreign countries.

There are some obstacles to be overcome by ELV management already in implementation in the EU. The main difficulties are related to the reluctance of car-manufacture industry to implement Directive's provisions related to: ban of use of specific substances in automotive applications, and about recycling quotas. Another obstacle is the export of ELV from the EU, which represents a loss in input material for the system.

State of ELV management in Germany

The German ELV management system comprises especial relevance to the current product-oriented legislation in the EU. The German automotive industry started to address the ELV issue in the 70s. After several projects and a long process of legislation in this issue, in 1998 the Ordinance “Altauto V” was enacted, which is a direct precursor of Directive 2000/53/EC.

The implementation of Directive 2000/53/EC into national German law modifies the “Altauto V” into the “Altfahrzeug-Verordnung”. The content in essence is the same as in Directive 2000/53/EC. One of the main features characterizing the German version of Directive 2000/53/EC is the conditioned free take-back of ELV.

The structure of German ELV chain is very similar to the general European structure, and the roles played by stakeholders, are also similar. The ELV management in Germany is divided in two decentralized networks. The first network is based on bilateral agreements between car-manufacturers and dismantlers. Here, each car-manufacturer has a dedicated network of dismantlers handling ELV from their brand. The car-manufacturer supervises the performance of these facilities, and supplies them with equipment and advisory. The second network is led by shredder-metal companies and car-manufacturers. The shredder-metal companies organize dismantling and collecting networks to collect ELV from the car-manufacture companies, with which they have an agreement.

The German vehicular fleet for passenger cars and light trucks counted to 46.1 million units in 2006. The German market represented a retail of 3.3 million units in 2005, and the generation of ELV in Germany is around 3.1 million units per year.

The German infrastructure to manage ELV counts with 15,000 collection facilities, 1,178 dismantling facilities and 41 shredder plants. The current ELV management system treats around 1.2 million ELV per year. This is one of the countries with highest differences, between de-registered against treated vehicles, in the EU. The main reason for this difference is the high number of used vehicles being exported.

Owing to the high relevance of German automotive industry in Europe, a big part of the rejections about Directive’s implementation have come from this industry, which represents a big influence on the decision-making processes in the EU.

State of ELV Management in the USA

The current ELV management in the USA does not have specific regulations regarding the collection and recycling of ELV, however, there have been some proposals for the same. The first attempt to regulate this field was in 1991 with a proposal called H.R.3369. This legislation was seen, by the automobile industry, as the harbinger of mandatory recycling. The proposal was made by the U.S. House of Representatives and it was called the Automobile Recycling Study Act of 1991. The Proposal did not pass and it was not reintroduced in subsequent Congresses.

In recent years, a series of voluntary initiatives are been established, by the recycling industry. An example of these agreements is the Certified Automotive Recycler (CAR) launched in 1994, as part of the Automotive Recyclers Association (ARA). This program established a guideline for general business practices, as well as environmental and safety issues, aimed to provide guidance for member facilities.

In 2003, the U.S. Department of Energy structured the Cooperative Research and Development Agreement (CRADA) to facilitate the research for sustainable recycling of current and future waste streams from ELV. The main participants of this agreement were the U.S. Department of Energy, Argonne National Laboratory, the Vehicle Recycling Partnership group and the American Plastics Council.

Even though, currently in the United States of America, there is no regulation requiring car manufacturers to take responsibility for their products, to limit the ELV waste disposed in landfills, or requiring recovery rates from ELV. There exist some state-level regulations related to solid and hazardous waste disposal, e.g. the ban of free liquids and lead-acid batteries in landfills. These practices are carried out in some states of this country.

The structure of the ELV chain in the USA is similar to its counterpart in the EU. The main difference lies in dismantling and post-shredder sectors. The 80% of dismantling industry is composed of salvage/scrap yards performing no-standardized operations, and the remaining 20% is represented by high value parts dismantlers. One special feature of the system is the classification of ASR as no-hazardous waste which generates almost no incentives for further treatment.

By 2003, the total US vehicular fleet counted to 226 million of passenger cars and light trucks. The number of vehicular retirements was 11.3 millions of vehicles, for the same year. The infrastructure to carry out the ELV management in the USA comprises seven thousand dismantling facilities, 200 shredder plants, and 10 sink-float plants.

There is no available information on the number of ELV treated by the ELV management in the USA. However, according to different authors, more than 95% of all vehicles retired from circulation enter to recycling infrastructure of the USA. The current recycling rate for these vehicles is 75%, with a virtual recycling rate of 100% of steel and iron content and a high recycling rate for non-ferrous metals.

The current system of ELV management in the USA works with relative efficiency. However, there are still items to be improved, e.g. poor dismantling practices in a big number of dismantling facilities (scrap yards), use of hazardous materials in car-manufacture, disposal of ASR as non-hazardous waste, scrap tyres, etc.

State of ELV Management in Mexico

The ELV problem has different connotation in developing countries like Mexico than in industrialized countries. This issue affects the Mexican economy, environment and society.

The economic sector is mainly affected by the introduction of old vehicles from the USA into Mexico. The available information states an introduction rate of 200 to 300 thousand vehicles per year. These vehicles have an average age of 10.7 years and/or have been repaired, after being involved in accidents, along with most of these vehicles contain heavy metals as mercury switches. Because of their close retirement from circulation and their increasing numbers, these vehicles are of a big concern for different Mexican sectors.

Poor practices performed during dismantling and shredder processes, and the lack of control on de-pollution activities and hazardous waste management, represent high environmental impacts in Mexico. These impacts are presumably higher than the impacts caused by the same kind of vehicles in industrialized countries. In industrialized countries, the End-of-Life phase of passenger cars represents less than 10% of the whole environmental burden produced by these vehicles. The largest impact occurs during the operation phase.

In 2002, an average Mexican worker earned 18% of the purchasing power (material quality of life) enjoyed by their equivalent U.S. counterpart. Large number of the Mexican society cannot afford to buy new vehicles owing to their low wages. Thus, there is a preference for second hand vehicles (national or imported), with the consequent ageing of the Mexican vehicular fleet.

The old vehicles introduced from the USA also generate socio-political problems. The illegal status of this kind of vehicles in the last years has favored different political groups to take advantage of this situation, obtaining political power and profits. Moreover, the lack of registration number for these units has favored their use for committing crimes.

In Mexico, there exists no specific legislation to regulate the Management of ELV. This kind of product, at its End-of-Life stage and wastes generated by its treatment, has been ruled by general laws before the year 2004. More recently a semi-specific law has been addressed to solid wastes, the LGPGIR.

The LGPGIR classifies ELV as special waste, and it requires from producers, importers, exporters and distributors to establish plans to manage their products which are the vehicles after their useful life. The responsibility for supervising and controlling the accomplishment of the law is reserved to the governments and counties. However, at present, there are no specific norms or plans to manage this kind of vehicles. The profitable material from ELV is managed under market conditions, and the existing system is propelled by the profitability of every business involved.

The structure of ELV chain in Mexico is similar to its counterpart in the USA and the EU, except for an additional stage. This stage is placed between dismantling and shredder activities and counts to around 5000 operators along Mexico. They perform hand-intensive activities to recover valuable materials from several waste streams, including ELV.

The exact number of operators performing dismantling, shredder and melting activities for ELV management is not known. Even the classification of activities performed by every facility is not well defined in terms of ELV management, because one facility could perform for example activities like body repairs and dismantling at the same time. Thereby, the present work depicts the available information about the number of Mexican operators, at every stage of ELV management.

By 2005, the total Mexican vehicular fleet counted to 21.4 million circulating vehicles. For the same year, the Mexican market represented a retail of 1.1 million units. Neither available information about the current ELV generation, nor information about the number of vehicles treated by the management in Mexico exists.

The described evidence presents a deficient management of ELV in Mexico. The current management allows a maximum recycling rate of 75%, which mainly corresponds to the ferrous fraction content in vehicles which enters to the management system.

The Proposed System for ELV Management in Mexico

The first part of this proposal is the estimation of future numbers of ELV generated in Mexico. These estimations are carried out based on future vehicular retails and future vehicular fleets in Mexico. Therefore, the future vehicular population in Mexico is performed for two scenarios, from 2007 to 2010. Afterwards, an approach widely used in reliability engineering was implemented, the Weibull distribution. This approach provides dynamic mass flows which represent the retirement behavior of Mexican fleet in two additional scenarios for the period 2007 to 2025. This work estimates a current ELV generation of around 687,000 vehicles by 2007, and by 2020 in the range of 1.1 to 1.3 million units per year.

The second part of this proposal is the structure of the ELV chain in Mexico. A proposed structure is described, as well as the recommended operations, equipment and facilities' configuration at every stage of the management. The configuration is performed at depollution, dismantling and shredder stages. Estimated amounts of material streams are provided from future numbers of ELV, i.e. ferrous and non-ferrous metals and ASR. The configuration includes the energy recovery approach from ASR performed in cement plants, and the final disposal of streams unable to be recycled.

The third part of the proposal is the configuration of strategic facility network at every stage of ELV management in Mexico. The system is configured under assumption of three different scenarios, i.e. 100%, 90% and 75% of covered demand for ELV management. The algorithm is identified for this specific problem as a Fixed Charge Facility Location Problem. The algorithm is solved through Facility Location Software SITATION[®]. The results show the optimal number of facilities at every stage of the management, to cover the demand for ELV management considered in the different scenarios.

The fourth part of this proposal is the structure of a model to finance the ELV management in Mexico. The three main schemes to finance the ELV management in the EU are described as free take-back, recycling fee/subsidy and deposit-refund systems. The impact caused by their implementation in countries like Germany, the Netherlands and Sweden, are outlined, in order to understand the main advantages and disadvantages for stakeholders in their chains. Finally, a scheme attempted to be suitable for the Mexican case is proposed. The main features of this scheme are explained, as well as its advantages, disadvantages and incentives thought to be triggered into the Mexican ELV chain.

Acknowledgements

The present work was carried out under the Doctorate Program in Environmental Sciences at the Chair of Industrial Sustainability at the Brandenburg University of Technology, Cottbus.

I express my special gratitude,

to the German Academic Exchange Service (DAAD), for the economic support given during the development of my Doctorate studies, and for the opportunity to undergo this study experience in Germany, with its people and culture.

to my main supervisor, Prof. Dr. rer. nat. Jürgen Ertel, for his assistance in guiding me throughout this research and for providing me with the facilities that made this work possible.

to my second supervisor, PD Dr. habil rer. pol. Kai Rommel, for his constructive discussions and remarks, his innumerable advices and ideas, and especially for his support during my stay at the BTU-Cottbus.

to Prof. Mark S. Daskin from Northwestern University, for his kind provision of facility location software SITATION[®], which was a tool of core importance in the development of the present work.

to Dr. Ma. De Lourdes Álvarez Medina from UNAM, for her assistance in the research on Mexican state of ELV problem.

to the Brandenburg University of Technology, Cottbus for allowing me to be a part of its Doctorate Program.

to the people I met at the Chair of Industrial Sustainability, for their partnership and kindness during my Doctorate studies.

to my family in Mexico and in Poland, for their support and unconditional love.

to my friends at the BTU-Cottbus and from Cottbus, for their friendship and for being my family in Germany, during this great experience.

In addition, I would like to thank all the people who have contributed with information and ideas on the performance of this work, and the achievement of this Degree.

Cottbus, October 2007

Reynaldo Cruz-Rivera

Content

Executive Summary.....	i
Acknowledgements.....	ix
Content.....	xi
List of Graphs.....	xvii
List of Tables.....	xxi
List of Abbreviations and Symbols.....	xxvii
1. Introduction.....	1
2. Objectives.....	3
2.1 Main Objective.....	3
2.2 Specific Objectives.....	3
2.3 Scopes.....	4
2.4 Methodological Approach.....	4
3. State-of-the-Art on ELV Management in Industrialized Countries.....	5
3.1 The European Union.....	5
3.1.1 Legal and Institutional Aspects.....	6
3.1.2 Main Actors in ELV Management.....	11
3.1.2.1 Car-manufacturers and Suppliers.....	11
3.1.2.2 Dismantling Industry.....	12
3.1.2.3 Shredder Industry.....	13
3.1.2.4 Consumers.....	14
3.1.2.5 Governments.....	14
3.1.3 Current Situation of ELV Management in the EU.....	15
3.1.3.1 The EU Vehicular Production and Fleet Features.....	16
3.1.3.2 Collection, Dismantling and Shredder Infrastructure.....	21
3.1.3.3 Difficulties in ELV Management.....	23
3.2 Germany.....	27
3.2.1 Legal and Institutional Aspects.....	28
3.2.2 Main Actors in ELV Management.....	34
3.2.2.1 Car-manufacturers and Suppliers.....	35
3.2.2.2 Automobile Dealers and Garages.....	36

3.2.2.3 Dismantling Industry.....	36
3.2.2.4 Shredders and Scrap Dealers.....	37
3.2.2.5 Consumers.....	38
3.2.2.6 Ministry for the Environment.....	39
3.2.3 Current Situation of ELV Management in Germany.....	39
3.2.3.1 Vehicular Fleet and De-registrations in Germany.....	41
3.2.3.2 Collection and Dismantling.....	44
3.2.3.3 Shredding.....	46
3.2.3.4 Costs in ELV Management.....	46
3.2.3.5 Difficulties in ELV Management.....	50
3.3 The United States of America.....	53
3.3.1 Legal and Institutional Aspects.....	54
3.3.2 Main Actors in ELV Management.....	56
3.3.2.1 Car-manufacturers.....	57
3.3.2.2 Government.....	58
3.3.2.3 Dismantlers.....	59
3.3.2.4 Shredders and Post-shredder Processors.....	60
3.3.2.5 Consumers.....	62
3.3.3 Current Situation of ELV Management in the USA.....	63
3.3.3.1 Vehicular Feet and De-registrations in the USA.....	64
3.3.3.2 Collection, Dismantling and Shredder Infrastructure.....	68
3.3.3.3 Costs in ELV Management.....	69
3.3.3.4 Difficulties in ELV Management.....	73
3.4 Summary of the Chapter.....	75
4. State-of-the-art of ELV Management in Mexico.....	77
4.1 Automotive Industry in Mexico.....	77
4.2 The Problems Caused by ELV in Mexico.....	79
4.2.1 Economic Problems.....	79
4.2.2 Social and Political Problems.....	81
4.2.3 Environmental Problems.....	82
4.3 Legal and Institutional Aspects.....	84
4.4 Main Actors in the ELV Management.....	88
4.4.1 Car-manufacturers and Suppliers.....	88
4.4.2 Government.....	88
4.4.3 Scrap Yards and Dismantlers.....	89

4.4.4 Shredders and Post-shredder Processors.....	91
4.4.5 Consumers.....	93
4.5 Current Situation of the ELV Management in Mexico.....	95
4.5.1 Vehicular Production and Retail.....	96
4.5.2 Vehicular Fleet and De-Registrations.....	97
4.5.3 Infrastructure for ELV Management.....	100
5. Proposal for ELV Management System for Mexico.....	103
5.1 Objective.....	103
5.2 Main Assumptions.....	104
5.3 Numbers of ELV in Mexico.....	104
5.3.1 Estimation of Future Trends in ELV Generation.....	105
5.4 Take-back of Vehicles.....	111
5.5 De-pollution and Dismantling.....	112
5.5.1 Health & Safety Considerations.....	113
5.5.2 Equipment.....	113
5.5.3 Facilities.....	114
5.5.4 Process.....	116
5.6 Treatment.....	118
5.6.1 Car Body Pressing.....	118
5.6.2 Shredding.....	118
5.7 Re-use and Recycling.....	121
5.7.1 Re-use of Auto Parts.....	121
5.7.2 Ferrous Metal	121
5.7.3 Non-ferrous Metal Fraction.....	123
5.8 Energy Recovery and Final Disposal.....	125
5.9 Strategic Facility Networks in ELV Management.....	129
5.9.1 Scenario-1.....	135
5.9.1.1 Dismantling Stage.....	136
5.9.1.2 Shredder Stage.....	138
5.9.1.3 Melting Stage.....	141
5.9.1.4 Energy Recovery Stage.....	143
5.9.1.5 Final Disposal Stage.....	145
5.9.2 Scenario-2.....	149
5.9.2.1 Dismantling Stage.....	150
5.9.2.2 Shredder Stage.....	152

5.9.2.3 Melting Stage.....	154
5.9.2.4 Energy Recovery Stage.....	155
5.9.2.5 Final Disposal Stage.....	156
5.9.3 Scenario-3.....	161
5.9.3.1 Dismantling Stage.....	162
5.9.3.2 Shredder Stage.....	164
5.9.3.3 Melting Stage.....	165
5.9.3.4 Energy Recovery Stage.....	167
5.9.3.5 Final Disposal Stage.....	168
6. Economic Issues in ELV Management.....	171
6.1 Economic Instruments and the Environmental Protection.....	173
6.2 Economic Instruments for ELV Management.....	176
6.2.1 Free Take-back System.....	176
6.2.2 Recycling Fees/Subsidies System.....	179
6.2.3 Deposit-Refund System.....	181
6.3 Economic Instrument to Finance the ELV Management in Mexico.....	183
6.3.1 Structure of Economic Instrument.....	184
6.3.1.1 Creation of Fund.....	185
6.3.1.2 Fund Administration.....	186
6.3.1.3 Resource Distribution.....	187
6.3.2 Financing Model for Mexico.....	188
7. Conclusions and Recommendations.....	191
7.1 Product-oriented Legislation in Industrialized Countries.....	191
7.2 Stakeholders in ELV Management.....	192
7.3 Performance of ELV Management in Selected Industrialized Countries.....	194
7.4 ELV Problem in Mexico.....	196
7.5 System for ELV Management in Mexico.....	198
7.6 Facility Networks in ELV Management.....	200
7.7 Economics in ELV Management.....	203
8. Summary of Findings.....	205
9. References.....	207

Appendix A.....	A-1
Appendix B.....	B-1
Appendix C.....	C-1
Appendix D.....	D-1

List of Graphs

- Figure 3.1 Current EU Environmental Regulatory Framework
- Figure 3.2 Main Steps in ELV Recycling According to Directive 2000/53/EC
- Figure 3.3 Current Material Streams in the Recycling and Disposal of ELV
- Figure 3.4 Material Streams from 2006 and 2015 for Recycling and Disposal of ELV
- Figure 3.5 Stakeholders in the ELV Chain for Germany
- Figure 3.6 Main Stakeholders in the Management of ELV in the USA
- Figure 3.7 Current ELV Management System in the USA
- Figure 4.1 Current Management of ELV in Mexico
- Figure 5.1 General Description of ELV Management System for Mexico
- Figure 5.2 Retirement Behavior for New Sold Vehicles in Mexico from 1995 to 2010, Scenario A.
- Figure 5.3 Retirement Behavior for Used Vehicles Introduced from the USA to Mexico from 1995 to 2010, Scenario A.
- Figure 5.4 Total Retirement Behavior for Used Vehicles Introduced from the USA and New Vehicles sold in Mexico from 1995 to 2010, Scenario A.
- Figure 5.5 Total ELV Generation in Mexico for the Two Scenarios from 2005 to 2025
- Figure 5.6 Shredder with Horizontal Hammer Mill
- Figure 5.7 Shredder Plant Layout with Water Injection at the Shredder
- Figure 5.8 Geographic Locations of Landfill Sites in Mexico
- Figure 5.9 Implementation of FCFLP in the Configuration of ELV Facility Network Management
- Figure 5.10 Graphic Solution of UFCFLP for Dismantling Stage in 2007, with 100% Coverage
- Figure 5.11 Graphic Location of Dismantling Facilities as Solution for Scenario-1
- Figure 5.12 Graphic Solution of UFCFLP for Shredder Stage in 2007, with 100% Coverage
- Figure 5.13 Graphic Location of Shredder Facilities as Solution for Scenario-1
- Figure 5.14 Graphic Locations of Foundries Facilities as Solution for Scenario-1
- Figure 5.15 Graphic Locations of Cement Plants Using RDF for *Scenario-1*
- Figure 5.16 Selected Landfills to Cover the Disposal Demand by Dismantling Facilities for *Scenario-1*
- Figure 5.17 Selected Landfills to Cover the Disposal Demand by Shredder Facilities for *Scenario-1*

-
- Figure 5.18 Selected Landfills to Cover the Demand for Final Disposal by Melting Facilities for *Scenario-1*
- Figure 5.19 Selected Landfills to Cover Disposal Demand by RDF Facilities for *Scenario-1*
- Figure 5.20 Graphic Solution of UFCFLP for Dismantling Stage in 2007, with 90% Coverage
- Figure 5.21 Graphic Configuration for Dismantling Facilities as Solution for *Scenario-2*
- Figure 5.22 Graphic Solution of UFCFLP for Shredder Stage in 2007, with 90% Coverage
- Figure 5.23 Graphic Location of Shredder Facilities, as Solution for *Scenario-2*
- Figure 5.24 Graphic Location of Melting Facilities, as Solution for *Scenario-2*
- Figure 5.25 Graphic Location of Cement Plants Using RDF for *Scenario-2*
- Figure 5.26 Selected Landfills to Cover the Disposal Demand by Dismantling Facilities for *Scenario-2*
- Figure 5.27 Selected Landfills to Cover the Disposal Demand by Shredder Facilities for *Scenario-2*
- Figure 5.28 Selected Landfills to Cover the Disposal Demand by Melting Facilities for *Scenario-2*
- Figure 5.29 Selected Landfills to Cover Disposal Demand by RDF Facilities for *Scenario-2*
- Figure 5.30 Graphic Solution of UFCFLP for Dismantling Stage in 2007, with 75% Coverage
- Figure 5.31 Graphic Location of Dismantling Facilities, as Solution of *Scenario-3*
- Figure 5.32 Graphic Location of Shredder Facilities, as Solution of *Scenario-3*
- Figure 5.33 Graphic Location of Melting Facilities, as Solution of *Scenario-3*
- Figure 5.34 Graphic Location of Cement Plants Using RDF, as Solution of *Scenario-3*
- Figure 5.35 Selected Landfills to Cover the Disposal Demand by Dismantling Facilities for *Scenario-3*
- Figure 5.36 Selected Landfills to Cover the Disposal Demand by Shredder Facilities for *Scenario-3*
- Figure 5.37 Selected Landfills to Cover the Disposal Demand by Melting Facilities for *Scenario-3*
- Figure 5.38 Selected Landfills to Cover Disposal Demand by RDF Facilities for *Scenario-3*
- Figure 6.1 Financing Model for ELV Management in Germany
- Figure 6.2 Financing Model for ELV Management in the Netherlands
- Figure 6.3 Financing Model for ELV Management in Sweden
- Figure 6.4 Finance Model for ELV Management in Mexico

-
- Figure A.1 Mexican Population Structure
- Figure A.2 Distribution of Ages in Mexican Vehicular Fleet
- Figure A.3 Future Trends in Mexican Vehicular Fleet
- Figure A.4 Implementation of Weibull Probability Density Function to Vehicular Inputs from 1995 to 2010. New Sold Vehicles in Mexico, Scenario-A.
- Figure A.5 Implementation of Weibull Probability Density Function to Vehicular Inputs from 1995 to 2010. New Sold Vehicles in Mexico, Scenario-B.
- Figure A.6 Implementation of Weibull Probability Density Function to Vehicular Inputs from 1995 to 2010. Used Vehicles Introduced from the USA to Mexico, Scenarios A and B.
- Figure A.7 Total ELV Generation in Mexico for Scenarios A and B
- Figure B.1 Localities in Mexico for ELV Generation
- Figure C.1 De-Pollution Rig with A Capacity of 25 ELV/Day
- Figure C.2 De-Pollution Rig with A Capacity of 50 ELV/Day
- Figure C.3 Mobil Unit for De-Pollution of End-of-Life Vehicles
- Figure C.4 Mobil Unit for De-Pollution of End-of-Life Vehicles
- Figure C.5 High Volume Pack Equipment for Fuel, Oil, Coolant, Washer Bottle, Brake Fluid, Air Con. Removal and Oil Filter Treatment.
- Figure C.6 Fuel Tank Drill with Water Separator
- Figure C.7 Airbag Deployer, 24 Airbags Deployment Capacity
- Figure C.8 Airbag Deployer for ELV
- Figure C.9 Air Conditioning Unit
- Figure C.10 Car Baler to Compact ELV in Dismantling Centres.
- Figure C.11 Car Baler to Compact ELV in Dismantling Centres.
- Figure C.12 Skid Steer Loader
- Figure C.13 Wheel Loader
- Layout C-1 Island Dismantling Facility Configuration
- Layout C-2 Semi-Industrial Dismantling Facility Configuration
- Figure D.1 Graphic Location of Collection Facilities at Dismantling Stage, Scenario-1
- Figure D.2 Graphic Location of Shredder Facilities, Scenario-1
- Figure D.3 Graphic Location of Foundries, Scenario-1
- Figure D.4 Graphic Location of Cement Plants Using RDF, Scenario-1
- Figure D.5 Graphic Location of Landfills to Cover Demands at Dismantling Stage, Scenario-1
- Figure D.6 Graphic Location of Landfills to Cover Demands at Shredder Stage, Scenario-1

- Figure D.7 Graphic Location of Landfills to Cover Demands at Melting Stage, Scenario-1
- Figure D.8 Graphic Location of Landfills to Cover Demands at Energy Recovery Stage, Scenario-1
- Figure D.9 Graphic Location of Collection Points at Dismantling Stage, Scenario-1
- Figure D.10 Graphic Location of Shredder Facilities, Scenario-2
- Figure D.11 Graphic Location of Foundries, Scenario-2
- Figure D.12 Graphic Location of Cement Plants Using RDF, Scenario-2
- Figure D.13 Graphic Location of Landfills to Cover Demands at Dismantling Stage, Scenario-2
- Figure D.14 Graphic Location of Landfills to Cover Demands at Shredder Stage, Scenario-2
- Figure D.15 Graphic Location of Landfills to Cover Demands at Melting Stage, Scenario-2
- Figure D.16 Graphic Location of Landfills to Cover Demands at Energy Recovery Stage, Scenario-2
- Figure D.17 Graphic Location of Collection Facilities at Dismantling Stage, Scenario-3
- Figure D.18 Graphic Location of Shredder Facilities, Scenario-3
- Figure D.19 Graphic Location of Foundries, Scenario-3
- Figure D.20 Graphic Location of Cement Plants Using RDF, Scenario-3
- Figure D.21 Graphic Location of Landfills to Cover Demands at Dismantling Stage, Scenario-3
- Figure D.22 Graphic Location of Landfills to Cover Demands at Shredder Stage, Scenario-3
- Figure D.23 Graphic Location of Landfills to Cover Demands at Melting Stage, Scenario-3
- Figure D.24 Graphic Location of Landfills to Cover Demands at Energy Recovery Stage, Scenario-3

List of Tables

Table 3.1	Vehicle Production in the European Union (2003-2005)
Table 3.2	Passenger and Light Commercial Vehicles in Use in the European Union (1999-2004)
Table 3.3	New Registrations of Passenger Cars in the European Union (1999-2006)
Table 3.4	Projection of Scrapped Passenger Cars in the EU15
Table 3.5	Modeled Number of Passenger Cars Scrapped Per Capita of New Member of the EU
Table 3.6	Deregistration of Passenger Cars in the EU15
Table 3.7	Collection and Dismantling Infrastructure in the EU15
Table 3.8	Shredder Operators in the EU15
Table 3.9	Number of De-Registered Cars and Treated ELV in the EU-25 by 2005
Table 3.10	ASR Landfill Costs in Different Countries.
Table 3.11	Current Vehicle Fleet in Germany (1970-2006)
Table 3.12	New Registrations of Motor Vehicles in Germany (1970 – 2005)
Table 3.13	Scenarios of Number of Passenger Cars (2003-2030)
Table 3.14	Deregistration of Vehicles in Germany (1970-2003)
Table 3.15	Average Amount of Operating Fluids Drained from ELV in 2005
Table 3.16	Drainage and Dismantle Process in Germany.
Table 3.17	Trade of Steel Scrap in Germany
Table 3.18	Structure of Recycling Costs in the ELV Management
Table 3.19	Operating Costs of Two Dismantling Companies
Table 3.20	Revenues and Costs in the Dismantling Sector
Table 3.21	Operating Costs and Revenues in Shredder Facilities
Table 3.22	North America Vehicle Production
Table 3.23	U.S. Light Vehicles Sales by Company in 2006
Table 3.24	Vehicular Fleet in the USA (1970 - 2003)
Table 3.25	Retired Vehicles in the USA ('000)
Table 3.26	Recovered Material from ELV Treatment in the US from 2000 to 2003
Table 3.27	Components and Materials Typically Removed from ELV in the USA
Table 3.28	ELV Procurement Costs
Table 3.29	Scrap Yards' Overall Economics
Table 3.30	Wrecks' Value and Transportation Costs for Dismantlers
Table 3.31	Estimate of Overall Economics Shredder Sector
Table 3.32	Cost of Transportation from Shredder to Metal Processors

Table 3.33	Sale Revenues Estimated from Sold Recovered Material (Ferrous and Non-Ferrous)
Table 3.34	Costs of ASR Transportation to Landfills
Table 3.35	Main Data About ELV Management in the EU, Germany and the USA
Table 4.1	NAFTA's Share of Vehicle Production by Country
Table 4.2	Main Automotive Producers (Terminal Automotive Industry) in Mexico.
Table 4.3	Vehicles Illegally Introduced to Mexico from the USA during 1999-2004
Table 4.4	Mexican Steel Production and Production, Imports and Exports of Steel Scrap
Table 4.5	Motor Vehicles Production in Mexico 1995-2004
Table 4.6	Motor Vehicle Sales in Mexico
Table 4.7	Registered Vehicles in Mexico
Table 4.8	Mexican Vehicles Out of Circulation (ELV)
Table 4.9	Generation of ELV in Mexico from 1996 to 2005
Table 4.10	Infrastructure for ELV Management in Mexico
Table 4.11	Recycled Material Inventory in Mexico 2000.
Table 5.1	Variables for Scenarios A and B by 2010
Table 5.2	Number of ELV Generated in Mexico from 2005 to 2025
Table 5.3	Drainage and Dismantling Process for Mexico
Table 5.4	Average Time Required for ELV De-Pollution and Dismantling
Table 5.5	Sequence of Steps Towards De-Pollution and Dismantling of ELV
Table 5.6	Advantages and Disadvantages of Configuration Facilities
Table 5.7	Potential Amount of Scrap Material from ELV in Mexico
Table 5.8	Estimation of the Melting Capacity in Mexico
Table 5.9	Potential Amount of Non-Ferrous Metals from ELV in Mexico
Table 5.10	Imports and Exports of Different Non-Ferrous Scrap Metals in 2003.
Table 5.11	Cement Plants Using RDF in Mexico
Table 5.12	Typical ASR Composition (Different Authors)
Table 5.13	Potential Amount of ASR in Mexico
Table 5.14	SITATION Results for Dismantling Stage of ELV Management in Mexico, Scenario-1
Table 5.15	Current Existing Shredder Facilities in Mexico
Table 5.16	SITATION Results for Shredder Stage of ELV Management in Mexico, Scenario-1
Table 5.17	Current Existing Melting Facilities in Mexico

Table 5.18	SITATION Results for Melting Stage of ELV Management in Mexico, Scenario-1
Table 5.19	Current Cement Plants Using RDF in Mexico
Table 5.20	Potential ASR Production in Mexico by 2007-2025
Table 5.21	SITATION Results for Cement Plants Using RDF in Mexico, Scenario-1
Table 5.22	Landfills to Cover Total Demands at Different Stages for Scenario-1, 2007 to 2025
Table 5.23	SITATION Results for Dismantling Stage of ELV Management in Mexico, Scenario-2
Table 5.24	SITATION Results for Shredder Stage of ELV Management in Mexico, Scenario-2
Table 5.25	Melting Facilities in Mexico for <i>Scenario-2</i> from 2007 to 2025
Table 5.26	SITATION Results for Cement Plants Using RDF in Mexico, Scenario-2
Table 5.27	Landfills to Cover Total Demands at Different Stages for <i>Scenario-2</i> , 2007 to 2025
Table 5.28	SITATION Results for Dismantling Facilities of ELV Management in Mexico, Scenario-3
Table 5.29	SITATION Results for Existing Shredder Facilities of ELV Management in Mexico, Scenario-3
Table 5.30	SITATION Results for Melting Facilities of ELV Management in Mexico, Scenario-3
Table 5.31	SITATION Results for Cement Plants Using RDF in Mexico, Scenario-3
Table 5.32	Landfills to Cover Total Demands at Different Stages for <i>Scenario-3</i> , 2007 to 2025
Table A.1	Generation of ELV in Mexico from 1996 to 2004
Table A.2	Variables for Scenarios A and B by 2010
Table A.3	Variables for Scenarios A and B by 2010
Table A.4	Amount of ELV Generated in Mexico from 2005 to 2025
Table B.1	Localities and ELV Generation in Mexico (1/14)
Table B.2	Localities and ELV Generation in Mexico (2/14)
Table B.3	Localities and ELV Generation in Mexico (3/14)
Table B.4	Localities and ELV Generation in Mexico (4/14)
Table B.5	Localities and ELV Generation in Mexico (5/14)
Table B.6	Localities and ELV Generation in Mexico (6/14)
Table B.7	Localities and ELV Generation in Mexico (7/14)
Table B.8	Localities and ELV Generation in Mexico (8/14)

Table B.9	Localities and ELV Generation in Mexico (9/14)
Table B.10	Localities and ELV Generation in Mexico (10/14)
Table B.11	Localities and ELV Generation in Mexico (11/14)
Table B.12	Localities and ELV Generation in Mexico (12/14)
Table B.13	Localities and ELV Generation in Mexico (13/14)
Table B.14	Localities and ELV Generation in Mexico (14/14)
Table D.1.1	Location of Collection Points at Dismantling Stage by 2007
Table D.1.2	Location of Collection Points at Dismantling Stage by 2010
Table D.1.3	Location of Collection Points at Dismantling Stage by 2015
Table D.1.4	Location of Collection Points at Dismantling Stage by 2020, Scenario-A
Table D.1.5	Location of Collection Points at Dismantling Stage by 2020, Scenario-B
Table D.1.6	Location of Collection Points at Dismantling Stage by 2025, Scenario-A
Table D.1.7	Location for Facilities at Dismantling Stage by 2025, Scenario-B
Table D.1.8	Location of Facilities at Shredder Stage by 2007 To 2015
Table D.1.9	Location of Facilities at Shredder Stage by 2020, Scenarios A & B
Table D.1.10	Location of Facilities at Shredder Stage by 2025, Scenarios A & B
Table D.1.11	Location of Facilities at Melting Stage by 2007 to 2025
Table D.1.12	Location of Cement Plants at Energy Recovery Stage by 2007 to 2025
Table D.1.13	Location of Landfills for Final Disposal to Cover Demands at Dismantling Stage by 2007
Table D.1.14	Location of Landfills for Final Disposal to Cover Demands at Dismantling Stage by 2010
Table D.1.15	Location of Landfills for Final Disposal to Cover Demands at Dismantling Stage by 2015
Table D.1.16	Location of Landfills for Final Disposal to Cover Demands at Dismantling Stage by 2020, Scenario-A
Table D.1.17	Location of Landfills for Final Disposal to Cover Demands at Dismantling Stage by 2025, Scenario-A
Table D.1.18	Location of Landfills for Final Disposal to Cover Demands at Dismantling Stage by 2025, Scenario-B
Table D.1.19	Location of Landfills for Final Disposal to Cover Demands at Shredder Stage by 2010 to 2015
Table D.1.20	Location of Landfills for Final Disposal to Cover Demands at Shredder Stage by 2020, Scenarios A & B
Table D.1.21	Location of Landfills for Final Disposal to Cover Demands at Shredder Stage by 2025, Scenarios A & B

Table D.1.22	Location of Landfills for Final Disposal to Cover Demands at Melting Stage by 2007 to 2015
Table D.1.23	Location of Landfills for Final Disposal to Cover Demands at Melting Stage by 2020 & 2025
Table D.1.24	Location of Landfills for Final Disposal to Cover Demands at Energy Recovery Stage by 2007 to 2015
Table D.1.25	Location of Landfills for Final Disposal to Cover Demands at Energy Recovery Stage by 2020 & 2025
Table D.2.1	Location of Collection Points at Dismantling Stage by 2007 to 2025
Table D.2.2	Location of Facilities at Shredder Stage by 2007 to 2025
Table D.2.3	Location of Facilities at Melting Stage by 2007 to 2025
Table D.2.4	Location of Cement Plants at Energy Recovery Stage by 2007 to 2025
Table D.2.5	Location of Landfills for Final Disposal to Cover Demands at Dismantling Stage by 2007 to 2025
Table D.2.6	Location of Landfills for Final Disposal to Cover Demands at Shredder Stage by 2007 to 2025
Table D.2.7	Location of Landfills for Final Disposal to Cover Demands at Melting Stage by 2007 to 2025
Table D.2.8	Location of Landfills for Final Disposal to Cover Demands at Energy Recovery Stage by 2007 to 2025
Table D.3.1	Location of Collection Points at Dismantling Stage by 2007 to 2025
Table D.3.2	Location of Facilities at Shredder Stage by 2007 to 2025
Table D.3.3	Location of Facilities at Melting Stage by 2007 to 2025
Table D.3.4	Location of Cement Plants at Energy Recovery Stage by 2007 to 2025
Table D.3.5	Location of Landfills for Final Disposal to Cover Demands at Dismantling Stage by 2007 to 2025
Table D.3.6	Location of Landfills for Final Disposal to Cover Demands at Shredder Stage by 2007 to 2025
Table D.3.7	Location of Landfills for Final Disposal to Cover Demands at Melting Stage by 2007 to 2025
Table D.3.8	Location of Landfills for Final Disposal to Cover Demands at Energy Recovery Stage by 2007 to 2025

List of Abbreviations and Symbols

ABS	Anti-Lock Brake System
ACEA	European Automobile Manufacturers Association
ADA	Italian Association of Car Dismantlers
ADEME	French Environment and Energy Management Agency
AMDA	Mexican Association of Distributors of Motor Vehicles
AMIA	Mexican Association of Automotive Industry
ANFAC	Spanish Association of Automobile and Truck Manufacturers
ANPACT	National Association of Producers of Heavy Vehicles
ARA	Automotive Recyclers Association
ASR	Automotive Shredder Residue
BDSV	Federal Association of German Steel Recyclers
BMU	German Federal Ministry of Environment
BOF	Basic Oxygen Furnace
BUND	Federal Agency for Environment and Nature Protection in Germany
BVSE	Federal Association for Second Raw Material and Disposal
CANACAR	National Association of Freight Transportation
CANACERO	Mexican Iron and Steel Chamber
CAR	Certified Automotive Recycler
CARI	Canadian Association of Recycling Industries
CARS	Competitive Automotive Regulatory System
CIA	Central Intelligence Agency
CLEPA	European Association of Automotive Suppliers
CMPL	Mexican Center for the Cleaner Production
CoD	Certificate of Destruction
CRADA	Cooperative Research and Development Agreement
DOE	Department of Energy
DOF	Official Journal of the Federation
DRS	Daily Report Sheet
DWAD	Demand Weighted Average Distance
DWTD	Demand Weighted Total Distance
EAA	Economic Association Agreement
EAF	Electric Arc Furnace
EC	European Commission

EDV	Electronic Data Administration
EFTA	European Free Trade Association
EGARA	European Group of Automotive Recycling Association
ELV	End-of-Life Vehicle
EoL	End-of-Life
EPR	Extended Producer Responsibility
EU	European Union
FARE	Fiat Auto Recycling
FAT	German Association for Research on Automobile-Technique
FSV	Voluntary Self-Commitment
GDP	Gross Domestic Product
GVW	Gross Vehicle Weight
ICSG	International Copper Study Group
IDIS	Dismantling Information System
IKA	Institute of motor Vehicle Design Aachen
INA	Mexican Institute of Auto Parts
INARE	Mexican Institute of Recyclers
INE	Mexican Institute of Ecology
INEGI	Mexican Institute of Statistics, Geography and Information
IPP	Integrated Product Policy
ISRI	Institute of Scrap Recycling Industries
JAMA	Japan Automobile Manufactures Association
KAMA	Korea Automobile Manufacturers Association
KBA	Federal Bureau of Motor Vehicles and Drivers
KrW-/AbfG	Waste Avoidance, Recovery and Disposal Act
LCA	Life Cycle Assessment
LGEEPA	Federal General Law of Ecological Equilibrium and the Protection of the Environment
LGPGIR	General Law for the Prevention and Integral Management of Wastes
LT	Light Trucks
NAFTA	North American Free Trade Agreement
NGO	Non-Governmental Organization
NOM	Mexican Official Norm
NPDES	Federal National Pollutant Discharge Elimination System
NSF	National Science Foundation
OECD	Organization for Economic Cooperation and Development

PC	Passenger Car
PCB	Polychlorinated biphenyls
PKW	Person Vehicle
PRAVDA	Auto Recycling Project of German Automotive Industry
PROFEPA	Federal Environmental Protection Attorney's Office
PVR	Public Vehicular Registry
R & D	Research and Development
RDF	Refuse Derived Fuels
SCADA	State of California Auto Dismantler's Association
SEMARNAT	Secretariat of Environment and Natural Resources
SITATION	Facility Location Software
SMF	Mexican Association of Melters
STAT-USA	Statistical Database of the USA
SUV	Sport Utility Vehicle
TA Abfall	Technical Guideline on Hazardous Waste
UFCFLP	Uncapacitated Fixed Charge Facility Location Problem
UNECE	United Nations Economic Commission for Europe
USA	United States of America
USAI	United States Automotive Industry
USA-TEAM	United States Alliance for Technology and Engineering for Automotive Manufacturing
USCAR	United States Council for Automotive Research
USEPA	US Environmental Protection Agency
VDA	German Automotive Industry Association
VKE	German Association of Plastic Producers
VRP	Vehicle Recycling Partnership
WMA	Waste Management Act

1. Introduction

Automotive vehicles as one of the most complex products are also one of the most regulated in the market. The regulation addressing this kind of products covers different aspects of their whole life cycle, from cradle to grave. In recent years, the management of complex products, during their last life-cycle stage, has been addressed by product-oriented legislation in industrialized countries. This stage is the core issue of this work, the management of End-of-Life Vehicles (ELV).

The management of ELV has been present since the beginning of the automotive industry in the world. However, the requirements and the conditions for this management have changed with time. The tremendous rise in the number of vehicles in circulation, and the rapid evolution in the composition of vehicles has activated the concern of the government and different industrial sectors. These concerns are focused on the environmental and economical problems, caused by this product at its End-of-Life (EoL) stage. Hence, countries with more interest to prevent the rise of unexpected legislations have initiated projects with focus on finding solutions for identified problems. The level of interest of every country was set by the relevance of their national-based automotive industry and the constraints in resources availability, e.g. landfill capacity.

The European Union (EU) has steered the ELV management with the implementation of Directive 2000/53/EC. This directive is a part of strategy on waste management, whose main target is the reduction of negative effects from waste streams on the environment. This target is thought to be reached through prevention, recycling, energy recovery and safe final disposal. Owing to the nature of stakeholders involved in the ELV management, i.e. automotive industry, dismantling, scrap metal industry, recycling industry, etc., the directive implemented by the EU has become an international issue, as other countries with developed automotive industry are moving towards the same direction as the EU.

On the other hand, other countries, with an important national-based automotive industry such as the USA and Canada, are carrying out the ELV management with minimum government interference. Here, the system is propelled by the profitability of every involved business. The differences between regulated and non-regulated systems are significant, as well as the effects on the stakeholders in the ELV chain, and on the environment.

The product-oriented legislation concerning the ELV management has directly and/or indirectly affected the automotive and recycling industry of countries within the EU and beyond Europe. The countries out of the EU have accelerated the process to address specific regulations and/or voluntary agreements, related to ELV issue. This fact favours their competitiveness in the international market, and a consequent consolidation of car recycling industry for concerned countries.

Currently, most of the countries addressing the improvement of ELV recycling processes are industrialized countries, with a high national based automotive industry, and especially those competing in European automotive markets¹. Therefore, several sectors in the recycling industry of industrialized countries are expanding worldwide in order to integrate technologies, processes and markets to improve the value recovery of EoL products (Gesing, 2006). Moreover, the problems caused by ELV are not exclusive of industrialized countries and the implementation of strict product-oriented legislation will arise sooner or later as a prime issue in developing countries (Togawa, 2006).

The Mexican recycling industry should issue the improvement of its structure and its activities, in order to face the challenges and opportunities offered by the growing demand for sound management of EoL products. These improvements in this industry constitute ensured amounts of recycled material to be used by the national industry, and reduced amount of imports for recycled material, along with environmental benefits for this management.

The main aim of this work is the proposal for a suitable ELV management system in Mexico, as a developing country. The achievement of this target requires a detailed description of systems already implemented in selected industrialized countries, a description of problems caused by ELV in Mexico, and a roadmap of current ELV management carried out in Mexico. The proposal aims to trigger several incentives along the chain, in order to promote the consolidation of the recycling industry. For this reason, the earlier the Mexican ELV stakeholders respond; the better would be the opportunities to exploit the advantages offered by this management.

This work is based on exhaustive bibliographical research, personal communications with relevant stakeholders and researchers, analytical calculations, and own estimations. The information in this work is until February 2007.

¹ China and Korea are in preparation for implementing similar requirements for ELV management as Directive 2000/53/EC (Dutrieux, 2006)

2. Objectives

2.1 Main Objective

Development of a proposal for a Management System of End-of-Life Vehicles, suitable to be implemented in Mexico taking into consideration economic, environmental and social aspects prevailing in the case study.

2.2 Specific Objectives

- a) To outline the End-of-Life Vehicle's management in selected industrialized countries, with legislation addressed to ELV management, i.e. the European Union and Germany,
- b) To outline the End-of-Life Vehicle's management in industrialized countries, without legislation addressed to ELV management, i.e. the United States of America,
- c) To describe the current End-of-Life Vehicle's management in Mexico, the associated problems and the necessity for a sound management of End-of-Life Vehicles,
- d) To identify and characterize the stakeholders involved into the Mexican End-of-Life Vehicle's chain,
- e) To estimate the current and future numbers of End-of-Life Vehicles in Mexico,
- f) To design the facility network at every stage of End-of-Life Vehicle's management, i.e. dismantling, shredder, melting, energy recovery and final disposal,
- g) To outline a model to finance the End-of-Life Vehicle's management in Mexico.

2.3 Scopes

The developing country considered in this work is Mexico. Therefore, the proposal will take into a consideration Mexico as area of interest, for the qualitative and quantitative analysis related to the proposal of ELV management system.

2.4 Methodological Approach

The current work is undertaken through exhaustive bibliographical research and personal communications with End-of-Life Vehicle's stakeholders from selected countries. There are no experimental activities thought for this research.

The information content of this work depended on the availability of information. The constraints and assumptions for analytical approaches used for the performance of this research are explained in detail in the corresponding Appendices.

3. State-of-the-Art on ELV management in Industrialized Countries

The present chapter is dedicated to describe the state-of-art of ELV management in industrialized countries. The countries chosen for this purpose are the European Union (EU) as a group of countries with implemented product-oriented legislation, Germany as member of the EU and because its high relevance in the European automotive industry², and the United States of America (USA) as the strongest automotive market without product-oriented legislation addressing ELV.

The main objective of this section is to describe the way in which the management of ELV is carried out, the role played by stakeholders and its importance in the ELV chain, the current status on ELV management, the infrastructure, and the difficulties faced by every case. Moreover, during this section several features concerning to economic, technical, social and legal, aspects are broken down.

3.1 The European Union

The EU is a group of 27 European countries, which altogether represents a surface of 4,325,675 km² and a population of 493 million inhabitants³. Although, each member state has the last responsibility for the decision-making in the implementation of policies, each member state transfers partial sovereignty rights to the European Commission in order to have common policies in several areas, such as monetary⁴, agricultural, defense, foreign policy, etc. The EU is a unique entity that can be considered as a mixture of a federative state and a supranational institution (Klaus and Simone, 2004).

The GDP of the 25 member states amounted in 2005 to US\$13.4 trillion with annual real growth rate from 1.7 % (CIA, 2006)⁵. Only in 2003 the GDP had a growth rate of 0.5% in the Euro area, and 1% in EU25 (ACEA, 2005). Because of this growth the EU is the largest single market of the World.

Different policies are subject of European regulation. Environmental Policies of Member states are mainly shaped by European Environmental Law in order to achieve certain environmental standards. An example of that is the implementation of Directive 2000/53/EC addressing the sound management of ELV, with the main aim to reduce the amount of waste generated by this sector⁶, and consequently, the amount to be disposed of in European Landfills.

² According to VDA in 2007, German corporate brands produced 13.5 million vehicle motors in 2005. This represents 21% of total worldwide production. ACEA in 2006 reported that Germany is the strongest market with more than 3.5 million registrations of motor vehicles, followed by the United Kingdom and Italy. France is placed at the 4th rank

³ Update 2007

⁴ Only 13 members have already adopted the Euro as national currency, Austria, Belgium, Finland, France, Germany, Greece, Ireland, Italy, Luxemburg, the Netherlands, Portugal, Slovenia and Spain.

⁵ Not yet considered Bulgaria and Romania

⁶ According to information given by ACEA in 2006, it represents 1% of total waste generation in the EU.

The implementation of 2000/53/EC is especially important, due to different sectors affected, and because it affects one of the most important sectors in the EU, the automotive one. This sector is a huge contributor to the prosperity of the EU, and it has always attracted the interest of politicians, regulators and the media. The importance of this sector is owed to the industry's size, its complexity and its overall economic contribution (3% of EU GDP and 7.5 % of total EU manufacturing), and also because it generates 2 million direct jobs (supporting an additional 12 million indirect jobs). It is a significant investor and a key contributor to the European trade balance, as well as a major player in R&D expenditure, and an important source of fiscal revenue (ACEA, 2005).

The state of ELV management in the EU will be discussed from different points of view. Several aspects are broken down as follows.

3.1.1 Legal and Institutional Aspects

Owed to the complexity of Automotive Industry, automotive vehicles belong to the most regulated products in the market. More than 80 directives and 117 pieces of legislations from United Nations Economic Commission for Europe (UNECE), address this product. From 80 EU directives, 57 are type-approval, and thus public authorities check the accomplishment of motor vehicles regarding quality, safety, environmental and legal requirements (Reinhardt W., 2005¹).

The legal background in environmental policy addressing the car recycling has its origins in Sweden. In 1975 there was a Swedish legislation proposal addressing the recycling of passenger cars. This legislation consisted of two parts. In the first part a law was concerned with the requirements to approve an auto shredder plant. The second part consisted of an ordinance regulating the management of old cars and the condition under which the last owner would receive a payment for delivering their ELV to recycling (Brockmann et al., 2000).

Other activities, addressing the car recycling in the 70s were carried out in Germany. The automotive industry started to address this issue after viewing the rising content of plastics in vehicles, scarcity of resources and limited capacity of landfills (Orsato et al., 2002). The developed policies in Germany influenced other countries, such as the Netherlands. In the late 1980s the Netherlands started a voluntary agreement for ELV recycling that resulted in the Scrap Vehicle Implementation, presented by the Minister of the Environment in 1992.

In 1991, France accepted the responsibility for coordinating the European ELV project group established by the European Commission. The Agence de l'Environnement et de la Maîtrise de l'Energie (ADEME), the French Environment and Energy Management Agency aimed to represent France in the decision-making process in the EU, and to anticipate emerging European policies related to the Automotive Industry. Months before, in Germany the work

group called Projekt Altfahrzeugverwertung der deutschen Automobilindustrie (PRAVDA) was created, that aimed political and technical cooperation among its participants. A main aim for PRAVDA group was to advance industry-wide recycling activities related to ELV. In this work group were represented the main stakeholders in the chain of ELV management (Orsato et al., 2002 and Zoboli et al., 2000).

The French working group ADEME, rejected the model of German draft regulation. Instead, they thought that industry-wide cooperation, collective liability, and commercial relations between the various parties involved, were better principles to solve the ELV waste problem (Orsato et al., 2002). In 1993, the group agreed upon following targets,

- a) by 2002, a maximum of 15% waste disposal per passenger car, with a maximum of 200 kg per vehicle,
- b) from 2002 onwards, for new models marketed, a maximum waste disposal of 10%,
- c) in the long term, a maximum waste disposal of 5%.

ADEME stated that operators⁷ may freely choose technological alternatives to perform their activities. Moreover, the free market should coordinate the activities in the chain, thus also it would rule the transaction costs for every activity on ELV management.

In Italy, the Fiat Auto Recycling group (FARE) was inaugurated in 1992. The main criterion for this group was the self-sufficiency. This meant that, the price of an auto-part made by recycled material should be the same as that of the part made by virgin raw material plus the disposal cost of the auto-part made by recycled material. This working group has set up a network of "Green Centers" joined to the Associazione Nazionale Demolitori Autoveicoli (ADA, Italian Association of Car Dismantlers) to collect ELV. The last owner received economic and technical incentives to dispose its ELV in one of these centers. FARE and ADA together could only cover the 15% (1.5 million) of total ELV produced by 1997 (Orsato et al., 2002).

The initiatives implemented by Germany, France and Italy were different starting points addressing the concern about the waste stream generated by ELV in the EU. In the Community Strategy for Waste Management (1989), the European Commission identified ELV as the priority waste stream. After a long process of problem identification and solution, the "Proposal for a Council Directive on End-of-life Vehicles" (COM 97-358) was enacted in July 1997.

⁷ Dismantlers, shredders companies, metal processors, etc

At the beginning of the process, there was a general rejection of this proposal by several industrial sectors. The process of adoption went on during 1998 and 1999 until a common position reached by the Council. After that, the European Parliament adopted the proposal in September 2000 with the number 2000/53/EC, requiring the member States the fulfillment of this Directive by 2002.

The Directive 2000/53/EC is the current European legislation regulating the End-of-Life Vehicle's management in the EU⁸. The main aims of this Directive are *the prevention of waste from vehicles and, in addition, the encouragement of reuse, recycling and other forms of recovery of end-of life vehicles and their components so as to reduce the disposal of waste, as well as at the improvement in the environmental performance of all of the economic operators involved in the life cycle of vehicles and especially the operators directly involved in the treatment of end-of life vehicles (2000/53/EC).*

The figure 3.1 presents the Directive 2000/53/EC in context with other environmental directives in the EU.

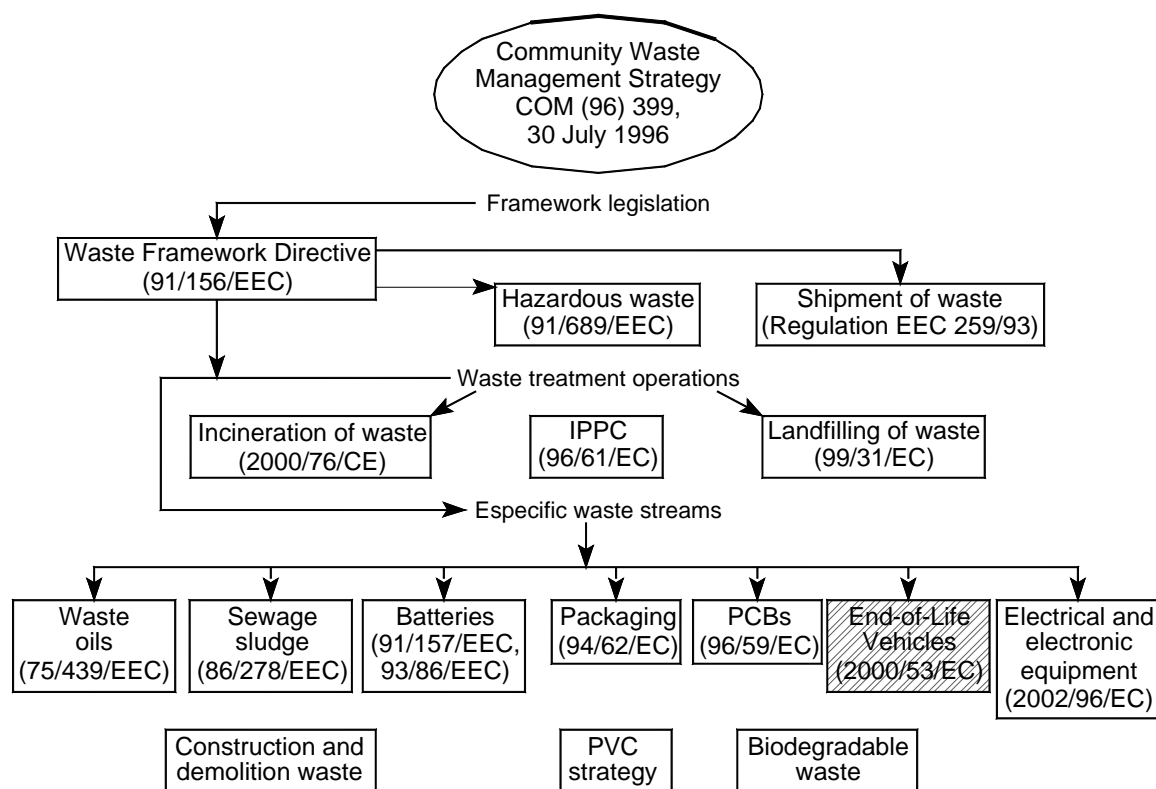

Figure 3.1 Current EU Environmental Regulatory Framework

Source: Reinhardt W., 2005¹

⁸ Including its Amendments, secondary and related legislation

The general content of this Directive is broken down as follows,

- a) *Area of application*: It is valid for vehicles, including their components and materials, under M1 and N1 classifications⁹, pursuant to Annex IIA to Directive 70/156/EEC. Three-wheeled motor vehicles also apply.
- b) *Waste prevention*: The Directive encourages a limit in the use of hazardous materials in the whole life cycle of a vehicle, and improvements in designs and production process to facilitate reuse, recovery and recycling. As from 1st July 2003, components of vehicles shall not contain lead, mercury, cadmium or hexavalent chromium¹⁰.
- c) *Collection*: The Directive requires member states to set up collection networks for ELV within their territories, and ensure the transference of these vehicles to authorized treatment facilities. Certificates of destruction shall be given to last owners when the unit is delivered. The delivery should be free of cost for last owners, and producers should meet all, or significant part of costs of this measure. The free take-back does not apply when vehicles do not contain essential components, or contain added waste. Moreover, the dates to apply this provision are, 1st July 2002 for vehicles put on the market after that date, and 1st January 2007, for vehicles put on the market before 1st July 2002.
- d) *Treatment*: The Directive obliges technical requirements for ELV treatment and for facilities at de-pollution stage of vehicles.
- e) *Reuse and recovery*: The directive encourages the reuse, recovery and recycling of components, when environmentally viable, and without compromise safety and other environmental requirements. Two main recycling targets are established: By 1st January 2006, the rate of reuse and recovery of ELV should be at least 85%, and for reuse and recycling 80%. By 1st January 2015, minimum rates of reuse and recovery of 95% and for reuse and recycling 85% are demanded. For vehicles produced before 1980, reuse and recovery rate shall be at least 75%, and for reuse and recycling 70%.
- f) *Coding standards/dismantling information*: The Directive encourages member states the standardization of material coding to facilitate their identification and improve recycling processes. Moreover, car-manufactures are required to provide dismantling information of new vehicles put on the market, for customers and dismantling processors.

⁹ According to Directive 70/156/EEC, vehicles M1 are Motor vehicles having at least four wheels, or having three wheels when the maximum weight exceeds 1 metric ton, and used for the carriage of passengers and comprising no more than eight seats in addition to the driver's seat. Vehicles N1 Motor vehicles having at least four wheels, or having three wheels when the maximum weight exceeds 1 metric ton, and used for the carriage of goods and having a maximum weight not exceeding 3 75 metric tons

¹⁰ Exemptions to this are listed in Annex II of this Directive

- g) *Reporting and information:* Member states are required to send three year report to the Commission, about the implementation of this Directive. This report shall contain relevant data about this issue and about all the ELV chain. Stakeholders are required to make information public about relevant data on ELV management, concerning every sector.
- h) *Implementation:* Member States are required to bring into force the Directive by 21st April 2002. Also, member States are required to inform the commission about the provisions to transpose this Directive into national law, along with agreements in the ELV chain.

In Article 7(4), the Directive 2000/53/EC states the amendment of Directive 70/156/EEC¹¹, in matters of type-approval of motor vehicles regarding their reusability, recyclability and recoverability. In this context on 25th November 2005, the Directive 2005/64/EC was published in the official Journal of the EU. This Directive lays down administrative and technical provisions for type-approval process, of vehicles covered by Directive 2000/53/EC. Art. 3 of Directive 2005/64/EC addresses minimum percentages of reuse, recycling and recovery, of vehicular components, parts and materials. Member States are required to implement this Directive as from 15th December 2006.

There is a group of secondary legislation related to ELV management in the EU, these are as follows:

- a) Commission Decision 2001/753/EC concerning a questionnaire for Member States reports on the implementation of Directive 2000/53/EC.
- b) Commission Decision 2002/151/EC on minimum requirements for Certificate of Destruction (CoD) issued in accordance with Art. 5(3) of Directive 2000/53/EC.
- c) Commission Decision 2003/138/EC establishing component and material coding standards,
- d) Council Decision 2005/673/EC amending Annex II of Directive 2000/53/EC on end-of-life vehicles.
- e) Commission Decision 2005/293/EC establishing detailed rules to monitor compliance with ELV targets.
- f) Directive 2005/64/EC on type-approval of motor vehicles with regard to their reusability, recyclability and recoverability; and amending Council Directive 70/156/EC.

¹¹ Council Directive 70/156/EEC of 6 February 1970 on the approximation of the laws of the Member States relating to the type-approval of motor vehicles and their trailers

3.1.2 Main Actors in the ELV Management

The ELV management involves several industries including a wide range of material treatments and waste streams¹². Thereby, the ELV chain is a complex system of economic relationships, which comprises of various perspectives and interests. This section will describe the general features of roles played by the different stakeholders in the EU, and the effects caused by a product oriented legislation regarding the ELV management. For the sake of this work, the chain is divided into groups for its better analysis. The division was done according to the cars life cycle stages, which can be grouped in car-manufacturers and suppliers, dismantlers, shredders, consumers and governments.

3.1.2.1 Car-manufacturers and Suppliers

The car manufacture industry introduces into the market, a “product” having specific features chosen as a result of a long conception/design process years before. That is why, this industry is one of the major actors in ELV management.

In the last two decades, the car industry has suffered disintegration at its different production stages. The production stage has been split in two main parts, the component and car-manufacture industry. The car-component industry has largely become a separated industry that supplies many companies, products from different brands. Nevertheless, the car-manufacture industry still drives the evolution of motor vehicles, as the car conception and design process is carried out by this industry, along with assembling the vehicles.

One of the most important roles played by this industry is related to decisions taken in the conception and design processes. These decisions will define the vehicle’s performance during their useful life, and evidently they will have consequences at ELV stage. However, it is important to point out, that recovery and recycling properties are just some of the functional features to be considered by designers and manufacturers of vehicles. Other features, regarding to the comfort, safety, energy consumption, emissions and cost, also have strong influence on conception and design processes.

As it is presented in point 3.1.1, the car industry has been actively involved on ELV management since decades, with voluntary agreements and several participations in the decision making process for product oriented legislations. Recently, with the implementation of Directive 2000/53/EC and its amendments, the automotive industry has claimed that these provisions represent an enormous burden for the industry, and consequently a loss on competitiveness (VDA, 2003). For this reason, the European automotive Industry, along with the Japanese and Korean manufacturers, have sent several position papers to the commission to amend different requirements stated on this Directive (Reinhardt W., 2005¹).

¹² See figure 3.5

3.1.2.2 Dismantling Industry

The main role played by this industry is the collection, de-pollution and dismantling of ELV. Once the vehicles are delivered by the last owner at their facilities, the dismantling industry has prime importance in the ELV management in the EU. Their activities determine the quality and quantity of material going to treatment facilities for recycling and recovery processes. Moreover, the re-use of several components and materials from ELV, is defined at this stage of ELV management.

The dismantling sector is a key stakeholder in the allocation of economical resources of the system. This industry consists of a big number of operators with small businesses, performing high intensive operations¹³. The small size of businesses and low qualifications of its workforce, do not allow in many cases to standardized operations. Hence, the small dismantling businesses are prone to disappear. The implementation of Directive 2000/53/EC has brought intensive standardization processes for activities, performed by this sector in the EU. Moreover, there is an important group of well organized dismantlers who are working in agreement with car-manufacture, shredder or metal scrap trade companies.

After Directive's implementation in the EU, this sector is characterized by three main types of businesses,

- a) *collection facilities*: This kind of businesses perform just the collection and inspection of vehicles to extend the certificate of destruction. The activities carried out at these facilities are those regarding to de-pollute the unit because of safety reasons. Later on, the units are transferred to the dismantling facilities,
- b) *dismantling facilities*: The activities integrated into this kind of facilities are, delivery of old vehicles by last owners, as well as de-pollution and dismantling activities. An additional activity performed, not by all dismantling facilities, is the pre-treatment of ELV that consists of compacting the ELV before they are sent to shredders facilities,
- c) *non-standardized facilities*: In these businesses, the activities of de-pollution and dismantling are not standardized, as those performed by certified facilities. These types of businesses are mainly found in the new EU-accession countries and sporadically in countries from the EU-15.

Owing to the importance of this sector in the ELV chain, important stakeholders, such as car-manufacturers and shredder companies, have already designed agreements with several dismantling companies to facilitate the accomplishment of provisions of Directive 2000/53/EC (Nakajima and Vanderburg, 2005).

¹³ The facilities are characterized to work with two to five, rarely more than ten employees with generally low qualifications (Jørgens H. & Busch P., 2000)

3.1.2.3 Shredder Industry

The treatment stage of ELV is performed by shredder industry. At this stage, the wreck¹⁴ is sent to shredder facilities to be cut in small pieces. The material resulting from that operation is separated in several fractions. The ferrous stream is obtained through magnetic operations, and the non-ferrous fraction is mainly separated through media separation processes. After this, the streams are introduced to different recycling processes. At the end of these processes, the fraction not feasible to be separated is called Automotive Shredder Residue (ASR).

In the EU, this industry is integrated by few large companies, which are exploiting plant of economies of scale. Some of these companies are in collaboration or are owned by recycling companies and the steel industry (Zoboli et al, 2000). According to the European Automobile Manufacturers' Association (ACEA), in their Country Charts of ELV management, there are around 147 shredder companies with 180 facilities in the EU-15.

The shredder industry finds several incentives on ELV management. The main are described as follows,

- a) *reduction of operation costs*: The proper de-pollution and dismantling activities of ELV reduce the amount of ASR, and they improve the quality of material resulting from shredder processes,
- b) *stable amount of input material*: With an obligatory delivery of old vehicles to certified facilities, the amount of material entering into shredder facilities is thought to be stable or increase,
- c) *improved quality of ASR*: Obligatory de-pollution and dismantling, improve the quality of ASR, thus there are better possibilities to use it in other processes, such as energy recovery without environmental disadvantages.

Because of the incentives mentioned above, shredder companies are promoting agreements with other stakeholders, such as car-manufacturers and dismantlers. (Nakajima and Vanderburg, 2005; Zoboli et al., 2000).

¹⁴ A wreck is an ELV after de-pollution and dismantling activities, it consists mainly of a metal frame with other remaining components from the original vehicle.

3.1.2.4 Consumers

The participation of this stakeholder, into the ELV management, is important and diverse. In recent years, the environmental features of products have gained more importance within the industry, and the automotive one is not an exception. Nowadays car features related with the environment; i.e. emission of pollutants, fuel consumption, waste prevention and recyclability, play an important role to define the preference of consumers (Reinhardt W., 2005¹). Moreover, Directive 2000/53/EC Art.9 (2) requires car-manufactures to inform prospective customers about recycling features of their vehicles. Thus, car recycling features enter to play a role in the product marketing.

Other roles played by consumers of vehicles, are related to the useful stage of vehicles as they decide how long a vehicle stays in circulation, and when it is retired. Also, the consumer or owner can decide in which way an old vehicle is managed at its end-of-life stage, i.e. either to abandon the vehicle in the environment, or to deliver it in a certified collection facility.

3.1.2.5 Governments

The role played by governments in the ELV management is of prime importance as they enact specific legislation addressed to this issue in every Member State of the EU. Governments act as initiators of incentives in the ELV chain. These incentives are generated through legislation in complex systems, such as management of ELV (Zoboli et al., 2000). Moreover, Governments of Member States have strong influence at community level to object Directives and appeal amendments, in case where Directives have negative impacts on the countries sectors.

Governments act also as intermediary between different stakeholders. This activity has a main aim to bring in accordance the different perspectives about common topics, which could affect them in several and different manners. An example of this important activity is the stakeholder consultation, concerning the amendment of Annex II from Directive 2000/53/EC, carried out by the European Commission during 2006.

Recently, the European Commission and the European Automobile Manufacturers Association launched an initiative called CARS 21 (Competitive Automotive Regulatory System for the 21st Century). The main aim of this initiative is to make recommendations about sustainable solutions to increase the European automotive industry's competitiveness worldwide. CARS 21 involves the European Commission, Member States, the Automotive Industry and other stakeholders, such as trade unions and non-governmental organizations (NGOs). This initiative covers key issues in the automotive industry; i.e. regulation, environment, road safety, trade, research and development, taxation and fiscal incentives, intellectual property, etc. (EC, 2005).

3.1.3 Current Situation of ELV Management in the European Union

The implementation of Directive 2000/53/EC by the EU Member States has been more complicated than expected. By June 2005, 11 of the old Member States and nine of the new ones had officially communicated to the European Commission, the transposition into national law the provisions of the Directive (Reinhardt W., 2005¹). The ELV management process, followed by the Member States, is described in figure 3.2.

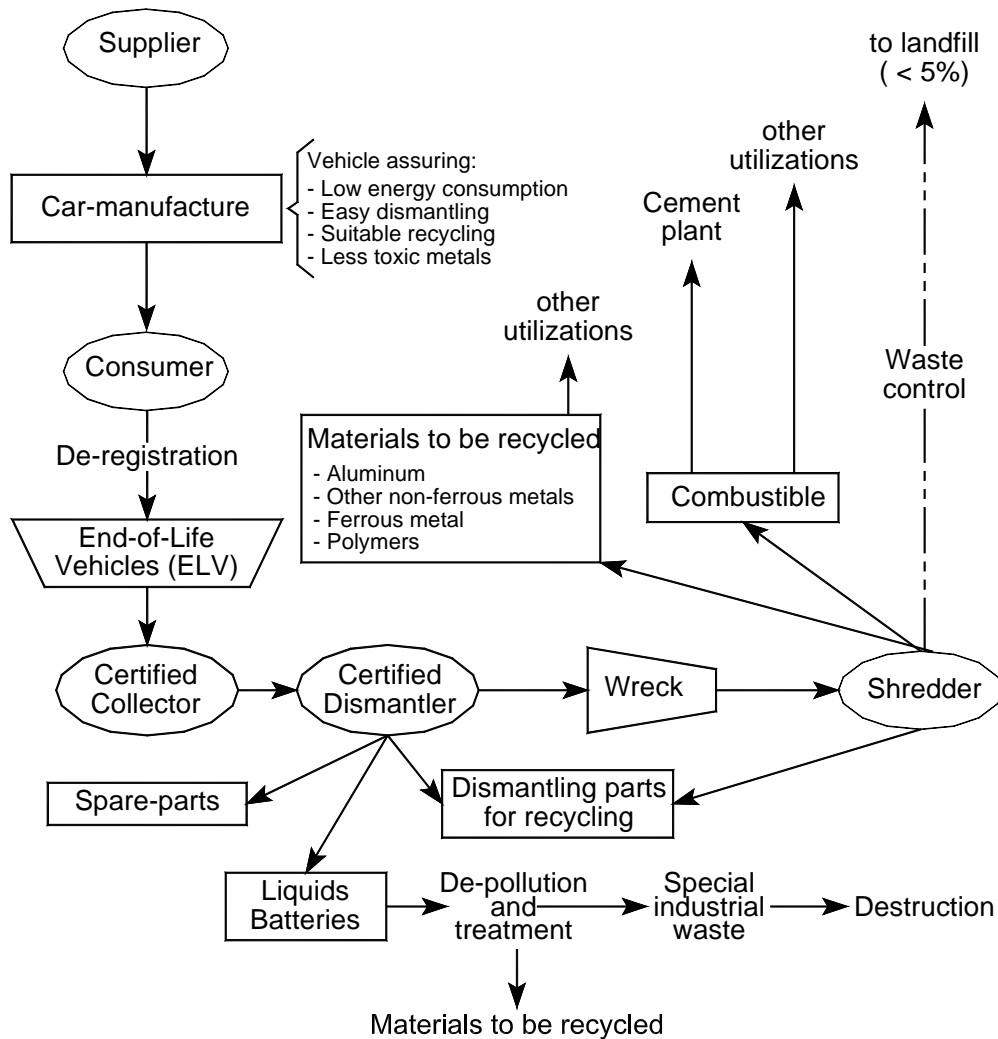

Figure 3.2 Main Steps in ELV Recycling According to Directive 2000/53/EC

Source : Modified from Kanari N., et al, 2003

3.1.3.1 The EU Vehicular Production and Fleet Features

In the EU, the automobile manufacture is concentrated in five countries, Germany, France, Spain, Italy and Great Britain (90.3% in 2005). The EU produced a total number of 14.2 millions of passenger cars by 2005. The growth rate had a drop of -3.2% with respect to 2004. In the table 3.1, the automotive manufacture by the EU is shown.

Table 3.1 Vehicle Production in the European Union (2003-2005)

Year	Motor Vehicles (x 10 ³)			
	Passenger Cars	Light commercial vehicles	Heavy trucks	Buses and Coaches
2003	14,695	1,635	436	32
2004	14,748	1,589	524	31
2005	14,272	1,641	549	31

Note: The figures include EU-15, Czech Republic, Hungary, Poland and Slovak Republic

Source: ACEA, 2006

The vehicular fleet of passenger cars in the EU as reported in 2004, by the Spanish Association of Automobile and Truck Manufacturers (ANFAC) was 192.2 million units with an increase of 1.4% with respect to the year before. The table 3.2 presents the vehicular fleet in the EU and its description.

Table 3.2 Passenger and Light Commercial Vehicles in Use in the European Union (1999-2004)

Country	Units ('000)					
	1999	2000	2001	2002	2003	2004
Austria	4,010	4,361	4,453	4,248	4,322	4,384
Belgium	4,926	5,029	5,106	5,161	5,229	5,301
Denmark	2,171	2,178	2,219	2,243	2,259	2,303
Finland	2,299	2,357	2,387	2,424	2,507	2,601
France	32,454	33,170	33,948	34,498	34,978	35,388
Germany*	44,411	46,013	46,689	46,981	47,353	47,724
Great Britain	29,441	29,908	30,564	31,326	31,927	32,417
Greece	3,375	3,657	3,919	4,164	4,393	4,675
Ireland	1,430	1,493	1,572	1,648	1,724	1,583
Italy	4,455	35,139	36,037	36,686	37,456	37,074
The Netherlands	6,748	7,039	7,295	7,507	7,691	8,043
Portugal	4,389	4,601	4,803	4,982	5,085	5,250
Spain	20,232	21,003	21,866	22,584	22,634	23,709
Sweden	4,169	4,296	4,337	4,376	4,422	4,478
The EU	164,509	200,244	205,195	208,829	211,979	214,929

Note: Commercial light vehicles are < 3.5 tons

Source: ACEA, 2006

*1999 (1st July)

In May 2004, ten countries acceded to the EU; Estonia, Latvia, Lithuania, Poland, Slovakia, Slovenia, the Czech Republic, Hungary, Cyprus and Malta, and in 2007, Bulgaria and Romania were added. This growth makes the EU the most significant single market with an economic zone of 493 million inhabitants (VDA, 2007).

The new members of the EU act as high potential market areas. Already in the years preceding the access, the EU has incorporated fast growing markets, especially from the automotive sector. Thus, the number of vehicles is expected to increase in the coming years, with a consequent growth of the fleet of vehicles in the EU. This growth is shown in table 3.3, which presents the new registration in the EU.

Table 3.3 New Registrations of Passenger Cars in the European Union (1999-2006)

Country	New registrations (x10 ³)							
	1999	2000	2001	2002	2003	2004	2005	2006
Austria	314	309	294	279	300	311	308	291
Belgium	490	515	489	468	459	485	480	505
Denmark	144	113	96	112	96	121	147	141
Finland	136	135	109	117	147	142	148	140
France	2,148	2,134	2,255	2,145	2,009	2,014	2,068	1,850
Germany	3,802	3,378	3,342	3,253	3,237	3,267	3,319	3,165
Greece	262	290	280	268	257	290	270	255
Ireland	174	231	165	156	145	154	172	178
Italy	2,338	2,423	2,413	2,280	2,246	2,265	2,237	2,180
Luxembourg	40	42	43	43	44	48	49	48
The Netherlands	611	598	530	511	489	484	464	469
Portugal	273	258	255	226	190	198	206	181
Spain	1,406	1,381	1,426	1,332	1,383	1,517	1,529	1,376
Sweden	295	291	247	255	261	264	274	259
United Kingdom	2,198	2,222	2,459	2,564	2,579	2,567	2,440	2,211
EU (15)	14,633	14,319	14,402	14,008	13,843	14,127	14,111	13,249
Iceland	15	14	7	7	10	12	18	17
Norway	101	97	92	89	90	116	110	98
Switzerland	317	317	317	295	270	269	265	247
EFTA (3)	434	427	416	391	370	397	393	361
EU(15) + EFTA(3)	15,066	14,747	14,818	14,399	14,213	14,524	14,504	13,611
Czech Republic					153	144	152	144
Estonia					16	16	20	24
Hungary					208	207	199	176
Latvia					9	11	17	23
Lithuania					8	9	10	13
Poland					358	318	236	216
Slovakia					60	57	57	53
Slovenia					60	62	59	56
New EU Members					871	825	749	704
Total EU23					14,714	14,953	14,860	13,954
Total EU23+EFTA					15,084	15,350	15,253	14,315

European Union = EU (15) + New EU Member States + EFTA (3)

Source: Statistics of ACEA in 2006

The growth of automotive fleet in the EU or in any other country represents an unavoidable growth in numbers of ELV. The impacts on the environment depend on how those ELV are managed. Due to the age of the vehicle fleet and the large number of second hand imports, to countries such as Lithuania, Poland and Latvia, in most of the new EU members, the number of ELV will grow at a larger rate than those in the rest of member states.

Detailed flow of used vehicles between European Member States and third countries is not fully known. What can be stated so far, is that many cars brought to the market in Member States will become ELV elsewhere, making this problem grow, and it will be added to the problems already existing in these countries (Sander et al., 2002).

The data of EU 15 given by the European Environmental Agency contains a projection of the number of scrapped passenger cars for the next 10 years. The estimation is presented in table 3.4; the number grows from 10 millions in 1990 to almost 17 millions in 2015.

Table 3.4 Projection of Scrapped Passenger Cars in the EU15

Country	Passenger cars ('000)					
	1990	1995	2000	2005	2010	2015
Austria	168	195	217	257	290	299
Belgium	407	461	515	552	587	620
Denmark	97	104	112	118	125	132
Finland	94	120	135	136	139	156
France	1.849	1.885	2117	2247	2348	2475
Germany	2.410	2.664	3113	3490	3631	3965
Greece	24	39	70	91	106	129
Ireland	75	69	94	111	113	126
Italy	1.590	1.820	2335	2476	2549	3072
Luxembourg	19	22	27	31	36	40
The Netherlands	576	635	687	706	775	786
Portugal	38	54	85	121	147	185
Spain	785	879	1223	1349	1528	1699
Sweden	296	347	355	361	395	395
United Kingdom	1.620	2.041	2156	2330	2633	2699
(EU15)	10.048	11.335	13.241	14.376	15.402	16.778

Source: EEA-ETC/WMF, 2001.

Corresponding to the recently acceded members to the EU, the European Environmental Agency presents a projection for number of scrapped cars between 2000 and 2015.

Table 3.5 Modeled Number of Passenger Cars Scrapped Per Capita of New Member of the EU

Country	Scrapped cars/1000 inh.		
	2005	2010	2015
Bulgaria	9	12	17
Cyprus	10	15	16
Czech Republic	13	16	22
Estonia	10	18	27
Hungary	12	13	13
Latvia	6	10	13
Lithuania	8	10	13
Malta	40	38	42
Poland	9	12	16
Romania	5	6	10
Slovakia	9	10	13
Slovenia	15	18	25
Turkey	1	2	3
Acceding Countries AC-13	148	182	236

Source: EEA-ETC/WMF, 2001.

Data about the current ELV management in new Member States is not yet available¹⁵. These new member states are in process of improvement in many fields, in order to accomplish the European requirements. This improvement is carried out in many areas including the environment one. For this achievement, the EU gives financial support through instruments like, the Poland and Hungary Assistance for Restructuring their Economies (PHARE) Program, the Instrument for Structural policies for Pre-Accession (ISPA) and The Special Accession Programme for Agriculture and Rural Development (SAPARD) (CEC, 2001).

In order to compare estimation and historical data; ANFAC published in the European Motor Vehicle Parc 2004, data about deregistration figures of passenger cars in eleven countries of EU-15. The table 3.6 presents this data.

¹⁵ The content of this work is information until February 2007.

Table 3.6 Deregistration of Passenger Cars in the EU15

Country	Passenger cars ('000)					
	1999	2000	2001	2002	2003	2004
Austria	173	227	225	n.a.	213	256
Belgium	460	433	433	427	411	439
Denmark	n.a.	n.a.	250	272	268	296
Finland	102	112	97	100	110	102
Germany	3,046	2,554	3,024	3,216	3,057	3,068
Greece	40	38	42	44	53	n.a.
Ireland	137	n.a.	99	114	n.a.	n.a.
Italy	1,231	1,823	1,787	1,868	1,806	1,774
The Netherlands	271	310	304	295	292	293
Spain	687	785	883	824	872	831
Sweden	776	853	814	796	814	841

n.a. = not available

Source: ANFAC, 2006

3.1.3.2 Collection, Dismantling and Shredder Infrastructure

According to ACEA's report in 2006, the infrastructure for the main activities in the ELV management is presented in tables 3.7 and 3.8.

Table 3.7 Collection and Dismantling Infrastructure in the EU15

Country	Certified return Stations	Dismantlers			Obligation of De-Pollution	Certificate of Destruction (COD)	
		Licensed Enterprises	Thereof 3rd Party Certified (C)	Thereof Car industry Approved		Issued	Required for De-Registration
Austria	4,800	200	-	200	Yes	Yes	Planned
Belgium	0	37	37	0	Yes	Yes (F)	Yes (O)
Denmark	190	190	0	0	Yes	Yes	No
Finland	(D)		30	0	Yes	Yes	No
France	1,000 (D)	1,000	420	310	Yes (F)	No	No, proposed
Germany	15,000	1,178	1,178	300	Yes	Yes	Yes
Greece	0	2	?	(A)	Yes	Yes	Yes (M)
Ireland	35	35	35	0	Yes	No planned	No planned
Italy	(D)	1,800 (3000)	0	314	Yes	Yes	Planned
Luxembourg	2	2	1	1	Yes	Yes	Yes
The Netherlands	(D)	700	265	265	Yes	Yes	Yes
Norway	(D)	144	0	0	Yes	No	No
Portugal	(D)	6 (E)	0	1 (P)	Yes	Yes	Yes
Spain	339	633	0	220 (B)	Yes	Yes	Yes
Sweden	(D)	371	40 - 50	80	Yes	Yes	Yes
United Kingdom	(D)	972 (June 05)	732	30	Yes	Yes	Yes

Notes: Greece: AMVH has signed 17 letters of intent and will sign at least 8 more by September 2005

(A) Licensed by State & AMVH approved,

(C) Certification performed by accredited body,

(D) Dismantling enterprises act as a return station,

(E) 3 additional to follow soon,

(F) If certified.

(O) No obligatory;

(M) Where AMVH is active

Source ACEA, 2006.

Table 3.8 Shredder Operators in the EU15

Country	Total number of Shredder operators (Companies)	Total number of Shredder locations	Thereof Shredder Operators certified by a Third Party	Operators take untreated ELV and process them not De-Polluted	
				No	Yes
Austria	6	6		X	
Belgium	10	12	0		X
Denmark	5	13	0	X	
Finland	2			X	
France	15	42			X (2)
Germany	41		41	X	
Greece	4	4			X (5)
Ireland	2	2	0		X
Italy	16	18	16	X (4)	
Luxembourg	0	0	0	-	
The Netherlands	5	11	5/11 (1)	X	
Norway	4	4		X	
Portugal	3	3 (P)	0	X	
Spain	18	23	0	X	
Sweden	3	7	3	X	
United Kingdom	13	37	13	X	

Notes:

(P) Third operator will be established,

(1) ARN dismantlers can only deliver dismantled cars to ARN contracted shredders, also in Belgium and Germany,

(2) 40% ELV arrived not fully treated, 1 shredder de-pollutes. Planned to equip all shredders with de-polluting facilities

(3) In practice up to now, no longer legal,

(4) De-Pollution is mandatory before any shredding operation.

(5) Those not signed with AMVH

Source ACEA, 2006.

As is stated by different authors, e.g. Reinhardt W. in 2005² and Hodac in 2004, the implementation of Directive 2000/53EC has been more difficult than expected. This fact is, as all members of EU-15 failed to meet the deadline of 21st April 2002. In the case of the new EU member States and their obligation to implement the directive by the date of their accession in 2004, these countries have also failed. Nevertheless, in the EU-15 the Directive is already fully implemented and working, and for new EU members some figures have started being published. The main data about ELV management in the EU is shown in table 3.9.

Table 3.9 Numbers of De-Registered Cars and Treated ELV in the EU-25 by 2005

Country	'000 (units)		Country	'000 (units)	
	De-Registered	ELV Treated		De-Registered	ELV Treated
Austria	247	124	Czech Rep.	0	0
Belgium	92	92	Estonia	0	0
Denmark	73	73	Hungary	0	15
Finland	105	89	Latvia	220	0
France	1.800	1.300	Lithuania	0	20
Germany	3.068	1.200	Poland	0	50
Greece	30	20	Slovakia	0	80
Ireland	130	130	Slovenia	0	0
Italy	1.830	915	Malta	0	0
Luxembourg	10	9	Cyprus	0	0
The Netherlands	473	272	Total New-members	235	165
Norway	90	81	Total EU25	11.621	7.869
Portugal	130	52			
Spain	850	1.000			
Sweden	258	237			
United Kingdom	2.200	2.110			
Total EU15	11.386	7.704			

- The differences between "De-Registrations" and ELV treated" is explained with treatment paths unknown to the Associations (shredding without pre-treatment, illegal treatment and abandoned vehicles as well as exports)
- Source: Update ACEA, 2006

3.1.3.3 Difficulties in ELV Management

The complexity of ELV chain and the variety of economies involved in the EU generate several difficulties in the implementation of product-oriented legislation. Therefore, this section will refer to some of the main difficulties faced by the management of ELV in the EU.

The Automobile Shredder Residue (ASR) is considered the weak point of ELV recycling system not only in the EU, but also in the worldwide automobile industry. According to the study carried out by Kanari et al. in 2003, it is estimated that around 2 million tons of ASR is generated annually in the EU (EU-15)¹⁶. This residue is considered as hazardous waste by the EU, therefore is no more able to be disposed off in the landfills¹⁷.

¹⁶ The amount of ASR generated annually is considered less than 1% of total waste generated by EU (Kanari et al. , 2003)

¹⁷ Since 1st January 2005, the disposal in landfills of ASR is no more possible without pre-treatment (Reinhardt and Richers, 2004)

In recent years, the ASR has become a major issue to be solved by the recycling industry worldwide. Different alternatives have been researched, i.e. physical separation, incineration, pyrolysis, and using composite materials. However, disposal in landfills seems to be the most appropriate option for ASR (Kanari et al., 2003). In the EU, the situation is different for each country due to landfill costs (Table 3.10); therefore the ASR is currently one of the most controversial issues in this field.

Table 3.10 ASR Landfill Costs in Different Countries

Country	Cost (USD\$ / t)	Country	Cost (USD\$ / t)
E.U. countries		Eastern European countries	
Austria	140	Poland	25–30
Belgium	55	Czech Republic	30
Denmark	70–110	Non-E.U. countries	
France	40–60	Australia	20
Germany	60–170	Japan	135–160
Italy	75–80	Norway	50
The Netherlands	70–90	United States	50–60
Spain	20–60	South Africa	25–40
Sweden	90–100	Switzerland	120
United Kingdom	30–35		

Source Kanari N. et al., 2003

Another obstacle to be overcome for the management of ELV in the EU is the reluctance of several stakeholders to fully implement the Directive 2000/53/EC under the current terms. The most controversial issue is related to the ban of hazardous substances in several automotive applications (Article 4(1 & 2)), which has triggered objections by automobile manufacturers since the Directive was published. Due to these objections, the Commission services launched a consultation for the revision of certain entries of Annex II of the ELV Directive. This consultation was addressed to the different stakeholder affected by this issue.

The submissions to this consultation were sent by stakeholders like Member States, Local and Regional Authorities, Trade Associations, NGOs, Economic operators, Academic Institutions and by Experts on this field. The main content of submissions, sent to the commission, is described as follows,

- 1) *Member States*: Germany as one of the largest car manufacturers of the EU had gathered opinions about the use of heavy metals in car manufacture. The results consulted with different organizations, such as ACEA (European Automobile Manufacturers Association), JAMA (Japan Automobile Manufacturers Association), CLEPA (European Association of Automotive Suppliers), KAMA (Korean Automobile Manufacturers Association), are given as follows:

- a. Concerning to the use of Lead in Aluminum for machining purposes, a prolongation of the exemptions for the 2% threshold is not necessary and they proposed an expiry date for the 1.5% threshold (1st July 2008). The revision concerning problems with corrosion might be done until 1st January 2006 (EU, 2004).
 - b. Concerning to the use of Lead as vulcanizing agent, Germany proposes that elastomers in fluid handling and powertrain applications containing up to 0.5% lead (percent of weight of the elastomer concerned), would not have an expiry date; due to the problems presented with the substitutes already analyzed (EU, 2004).
 - c. Concerning to the use of heavy metals in batteries, Germany concluded that alternatives to NiCd batteries exists and are described as superior to NiCd by the main suppliers of NiCd batteries, thus no extension of the exemption is needed (EU, 2004).
- 2) *NGOs*: These organizations claim that further derogations for the ban implemented by Annex II could be unfair to the pro-active companies or countries, which have invested in substitutes. The use of substitutes of heavy metals in aluminum for machinery purposes, wheel balance weights, as vulcanizing agents or in batteries are successfully used by many companies, thus those alternatives are technically feasible (EEB, 2004).
- 3) *Trade Associations*: The position of Associations, such as VDA (Verband der Deutsche Automobilindustrie), argues an unfair directive, as it is banning the use of heavy metals in the manufacture of automobiles, while the use of the same materials are allowed in other industries. VDA states that, it is not possible to use substitutes which have not been completely proved, to ensure their correct performance and granting the standards required by the current norm. Examples of that are the brake system, the chassis and the transmission system; whose elements contain lead, and their substitution is not technically feasible to reach on the stipulated dates. The problem related to that is not only technical but also from the logistical point of view, the phase-out requires more time (VDA, 2004²).

Another difficulty in the implementation of Directive 2000/53/EC, is related with the Article 7 (2). This Article requires recycling quotas by 2006 and 2015. Reinhardt W. states in 2005 that the automotive industry is able to achieve the target set by 2006 and under certain conditions to achieve those for 2015. However, the achievement of additional percentage points in recycling results disproportionately expensive. In the same work, the non-quota strategy preference by automotive industry in the progress of car-manufacture is stated.

The problem related to exports of ELV can be divided in two parts. The first, the export of de-polluted metal frames which are considered as green waste, are able to be transported across borders without restrictions. The second, the cross-border shipment of used vehicles and ELV.

The export of these units is carried out internally between EU-15 and the new EU members, and with third countries. The main problems lie not just in the export of vehicles, but also in the export of an environmental burden, and in the loss of material inputs for recycling industry of the EU (Reinhardt W., 2005¹). Nowadays, there is no specific data from the EU members about the export of used cars and ELV. Only the Netherlands, Sweden and Switzerland¹⁸ reported exports of 158,000, 17,069 and 83,319 used vehicles in 2001, respectively. In case of Switzerland, 29% was exported to new Acceded Countries, 36% to African Countries, 13% to the EU Member States and the rest around 50 different countries in the world (Sander et al., 2002).

The 2001 data showed that the exported cars by the Netherlands were older than nine years. This number of vehicles rose considerably from 115,000 in 2000 to 158,000 in 2001 (Sander et al., 2002). There are some overall figures regarding the export of used vehicles by the EU, for example; the ICSG (International Copper Study Group) reported a rate of 5.7% of exported used cars in the EU countries (ICSG, 2004).

¹⁸ Non member country of the EU

3.2 Germany

The German automotive industry plays a decisive role in the entire German economy. This industry is composed of manufacture of cars, trailers, special vehicles and engines, vehicle parts, and accessories. In 2006, the total world production of passenger vehicles by German manufacturers was 13.8 million, of which 5.8 million vehicles were produced in Germany. From that number, 10.1 million corresponded to PC production that included foreign and domestic production (VDA, 2007).

The total sales of this industry in Germany were € 279.3 billion by 2004 which was a 20% turnover share of the manufacturing sector (Hild, 2005). In 2001, the gross output obtained from this industry by the development, production, sale and use of automobiles, accounted for almost a fifth of Germany's gross national product (VDA, 2003).

In the labor field, the German Automotive Industry has a big importance, since it has generated more than 1.5 million employees worldwide. In Germany, the employees directly linked to this industry are 770,000 and 5.3 million indirectly (VDA, 2006).

Due to the big relevance of this industry, the efforts to maintain its competitiveness on the market have been enormous. In 2005, the German automotive industry has spent 16 billion euros on research and development (one third of the total R&D spending for economy as a whole). For the same year, this sector has applied for 3,600 patents, which represents more than 30% of all patent applications in Germany for 2005 (VDA, 2007).

In recent years, the whole automotive industry around the world has mapped out a comprehensive strategy towards the sustainable development that includes social progress, economic growth and environmental protection. The last aspect has been considered one of the most important with regard to sustainable development, as it has a growing concern from consumers. A study carried out by Kuckartz in 2002, about the environmental awareness of German population, showed that 92% of German population considers environmental protection to be an important or very important issue, thus it occupies the fourth place in the priority list of current political issues.

The strategy mapped out by the automotive industry consists of three basic issues, reduced emissions, reduced fuel consumption, and reduced use of resources and landfill space. It is possible to realize from this strategy that the environmental aspect plays a big role for current automotive industry as there is a clear trend in the market, towards taking care of the environment.

A primary goal of the German automotive industry has been the reduction of fuel consumption and, by consequence, reduced CO₂ emissions. The industry has reduced the fuel consumption from 10.75 L/100 km (end of 1970s) to 3.0 L/100 km (2003). In consequence, there has been a high reduction of emissions of about 25% (CO₂ and others) over the 1990 levels (VDA, 2003). Along with these improvements in engines performance, the industry has developed new kind of fuels producing less emission and having better efficiency.

The third basic issue of automotive industry's strategy is an intensive research and development work. This work should issue to the manufacture of cars more friendly with the environment, using recyclable materials and smaller amounts of hazardous materials. All these efforts are thought to be in harmony with the accomplishment of companies' objectives.

In the last vehicle's life cycle stage, the End-of-Life Vehicles (ELV) management, the design and vehicle's manufacture is of prime importance. The sound management of this kind of old product is influenced by the features given to the vehicles in design and manufacture stages. This issue is also of a central concern to the German automotive industry strategy, and nowadays the regulation of this kind of waste in Germany is a controversial topic because the concerned stakeholders come from different sectors whose interests and objectives are divergent.

3.2.1 Legal and Institutional Aspects

This section describes the legal frame for the management of ELV in Germany. A brief chronological description about the development of product-oriented legislation is carried out.

At the beginning of the 70s, the German automotive industry began the debate referring the reuse of some materials contained in vehicles. At that time, the long-term research institute of the German automotive industry, the Forschungsvereinigung Automobiltechnik (FAT), addressed the increasing use of plastics in vehicle's designs, the limits of landfill capacity, and the increasing scarcity of natural resources. These topics were considered relevant enough to justify a dedicated working group on automobile recycling, which during 1970 to 1980 published a number of studies on related topics. The work performed by FAT set the agenda, providing arguments for the policy debate around the environmentally sound management of ELV in the late 1980s (Orsato et al., 2002).

In 1986, the Waste Avoidance and Waste Management Act (WMA) was promulgated. The Act stipulated the avoidance of waste generation and the preference for waste-treatment and re-utilization, rather than incineration and disposal. It also included producer responsibility for the treatment of post-consumer waste by mandating product take-back and recycling schemes. This policy culminated in 1990 with the proposal of a draft regulation from the Bundesministerium für Umwelt, Naturschutz und Reaktorsicherheit (BMU, the German Federal Ministry of Environment), which made some proposals based on the following,

- a) responsibility for recycling in automotive industry would be borne by the car-manufacturers,
- b) amounts in weight and volume, of shredded waste and used pieces, had to be reduced or recycled,
- c) manufacture processes in the automotive industry, had to use materials which were harmless to the environment,
- d) car recycling costs would be distributed between all stakeholders (from manufacturers to shredding enterprises).

In 1991, the Projekt Altfahrzeugverwertung der deutschen Automobilindustrie (PRAVDA, the Project for Car Recycling of German Automotive Industry) was initiated. This project composed of the main automotive producers in Germany: BMW, Ford, Mercedes Benz, Opel, Porsche und Volkswagen/Audi. The project studied different techno-economical aspects of car recycling, addressing the reuse and recycling of materials never reused or recycled before like textiles, plastics, tyres, glass and shredding residues.

PRAVDA projects made clear the need to have close cooperation between raw materials enterprises with the manufacture ones. This cooperation had the objective to develop suitable materials to be reused or recycled, and to enhance the design of shredding equipment (EDV System) in order to improve sorting techniques (Schwald, 2001).

On 7th October 1996, the Kreislaufwirtschafts- und Abfallgesetz (KrW-/AbfG, the Waste Avoidance, Recovery and Disposal Act) came into force. This Act had a purpose to promote closed substance cycle waste management (Kreislaufwirtschaft) in order to conserve natural resources and to ensure environmentally compatible disposal of waste (§1). To reach these objectives, the Act settled the Basic Principles of Closed Substance Cycle Waste Management (Kreislaufwirtschaft), where (§4):

- a) the main principle is the avoidance of waste, through the changing to low-waste product design and consumer behavior oriented, for acquisition of low-waste and low-pollution products,
- b) at the end, the waste must be submitted to substance recycling, or used in order to obtain energy (energy recovery).

The third Part of this Act addressed the Product responsibility, where in general (§22),

- a) parties which develop, manufacture, process and treat, or sell products have "product responsibility". Therefore the product must be designed under the "low-waste" concept and be environmentally compatible,
- b) the "product responsibility" comprises of the development, production and marketing of products that can be reused and recycled in an environmentally compatible manner,
- c) there is a preference for second raw materials in the production of products,
- d) there must be a labeling of materials containing noxious substances,
- e) products must be labeled with information concerning possibilities for returning, re-use, recovery, deposit-payment arrangements.

The KrW/AbfG takes into consideration the ELV waste in the Article 15. Here, public-law parties responsible for waste management are required to carry out recovery of motor vehicles or trailers without valid official registration, when they are parked in public areas or outside of contiguously built up municipal areas, when there are no indications that they have been stolen, or that they are being used as intended, and when they have not been removed within one month, after a plainly visible relevant request has been attached to them (§15).

In 1996, the German Automotive Industry as well as stakeholders of this branch (16 stakeholders in total) made a voluntary agreement. It was known as the Freiwillige Selbstverpflichtung (FSV) and its main objective was to reduce the amount of disposed waste by this branch in the landfills. This measure aimed to fulfill the KrW/AbfG requirements regarding product responsibility. The main requirements of this FSV are as follows (Lucas and Schwartze, 2001),

- a) facility network for collection of ELV and their different parts, in order to be recycled,
- b) gradual reduction of disposal waste from ELV by 15% (until 2002) and 5% (until 2015) in weight average per ELV,
- c) general obligation of taking back ELV to their corresponding brand or through the take-back facilities,
- d) possibility of take-back free of charge, for complete ELV free of waste and which has age up to 12 years,
- e) improvement in the design, parts and materials used in car manufacture, to enhance the possibility of recycling.

Almost parallel to FSV, in 1998 “Verordnung über die Entsorgung von Altfahrzeugen und die Anpassung straßenverkehrsrechtlicher Vorschriften” (Altfahrzeug V) came into force. This was basically the complement of FSV which gave it the level of decree and thus made it official. The Altfahrzeug V had as main objective the reduction in the amount of disposed waste from ELV through the increased dismantling and recycling processes, as well as reduction of unavailable recycling parts up to 15% (2002) and 5%(2010). In order to reach these objectives, it established:

- a) Altfahrzeug V is valid for a Person vehicle (PKW), M1 and light emergency vehicles, N1 (see section 3.1.1),
- b) it is an obligation to take back ELV to the recognized facilities to recycle,
- c) minimal requirements for facilities, which are charged to store, treat and recycle ELV,
- d) for facility certification, the companies can apply for it at the corresponding public offices,
- e) after the delivery of ELV, the receiving station must cede a certificate of destruction to the last owners, which allowed certain control and connection with the vehicular offices.

The current Ordinance that regulates the ELV management in Germany is the Altfahrzeug-Verordnung. This is an improved version of Altfahrzeug V, which was published on 21st June 2002 in the Federal Law Gazette, and announced its implementation by German Law on June 28th 2002.

The core of this ordinance is the European Directive 2000/53/EC, where the first priority is the prevention of waste from vehicles. Other priorities are the reuse, recycling and other forms of recovery of end-of life vehicles and their components, so as to reduce the disposal of waste. Another important aspect of this ordinance is the improvement of environmental performance of economic operators involved in the life cycle of vehicles, and especially the operators directly involved in the treatment of End-of life vehicles (2000/53/EC, §1). The main content of Altfahrzeug-Verordnung is as following,

- a) *Area of application:* It is valid for vehicles M1 and N1 up to 3.5 tons weight and eight seats, pursuant to Annex IIA of Directive 70/156/EEC. The three-wheeled motor vehicles also apply (see section 3.1.1.),

- b) *Collection obligation*: It requires the car-manufacturers to collect all vehicles of their brand at free cost from the last owners. The take back of the vehicle must be done at a certified collection center. The manufacturers are required to organize or contract collection centers to develop a network and inform the owners about the location of these facilities, in order to be at a reasonable distance from the last owner (not to exceed 50 km). The manufacturers are also required to ensure that used parts are properly re-manufactured, recycled or disposed of. The free cost collection applies under certain conditions, such as the vehicle must still contain essential components, free of waste, still registered, etc,
- c) *Transfer obligations*: It requires anybody willing to dispose of a vehicle must transfer such vehicle to certified collection centers. The confirmation of this process is the delivery of a Certificate of Destruction, which can be ceded just by certified facilities. The transfer of wrecks to shredder facilities must be performed only by certified facilities.
- d) *Disposal obligations*: The ordinance set the recycling targets for empty weights of vehicles. By 2006, recovery and reuse at least 85%, and for recovery and recycling at least 80%. By 2015, recovery and reuse at least 95%, and for recovery and recycling 85%.
- e) *Notification duties*: It requires every treatment facility involved in ELV management, their certification and audit under current law and notification to corresponding authorities.
- a) *Waste prevention*: Since 1st July 2003, the use of heavy metals as Cadmium, Mercury, Lead and Hexavalent Chrome were banned in the car-manufacture, except for the cases cited in Annex II of Directive 2000/53/EC¹⁹.
- b) *Coding standards and dismantling information*: The car-manufacturers are required to label the materials used by their industry in order to identify those suitable to be recycled. Manufacturers are also required to cede information about their models put in the market within six months, to dismantling centers, in order to reach the ordinances provisions.
- c) *Duty of information*: Car-manufacturers are required to publish information about the environmental features of their units, and all operators in the ELV chain are required to publish information about the sound treatment of vehicles, reuse, recovery and recycling in their facilities.

¹⁹ The Annex II addresses the exemption from Article 4(2)(a) for heavy metals and their applications in steel and aluminium for machinery, several application in alloys to prevent corrosion and other applications in automotive industry (2000/53/EC)

The figure 3.3 shows the current material stream in the ELV management in Germany.

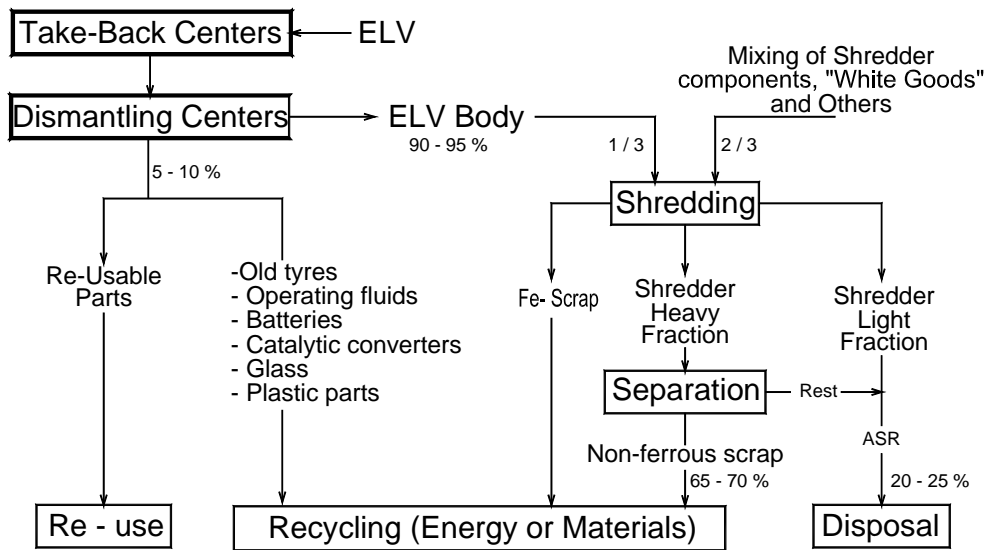

Figure 3.3 Current Material Streams in the Recycling and Disposal of ELV
 Modified from Reinhardt and Richers, 2004

The figure 3.4 describes the material stream by 2006 and 2015 in the ELV management in Germany. The parts in blue show the main changes in the material streams.

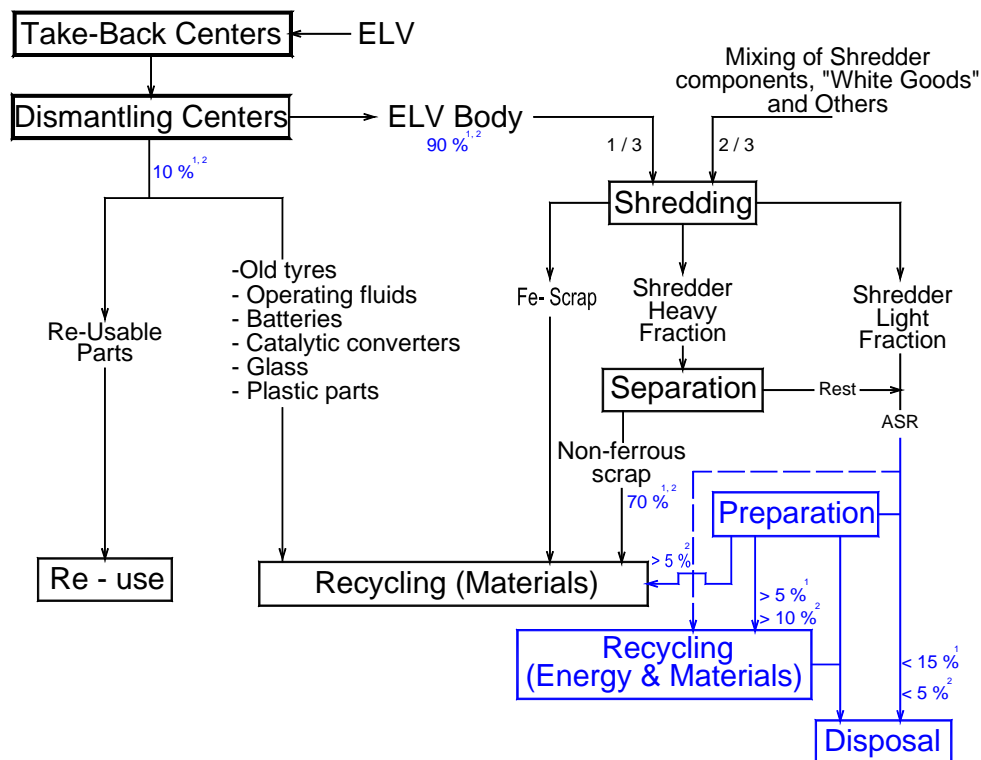

Figure 3.4 Material Streams from 2006 and 2015 for Recycling and Disposal of ELV

Modified from Reinhardt and Richers, 2004

Note: New features in the material stream in comparison with figure 3.3 are in color blue

1 Percentage by 2006

2 Percentages by 2015

Directive 2000/53/EC contains the essence of the concept used by Altauvo V and FSV, which was implemented in Germany some years ago. For this reason Germany has been one of the first countries to fully implement the Directive into national law²⁰.

3.2.2. Main Actors in the ELV Management

Economic aspects play a determining role in the ELV management, especially in a country like Germany, where automotive industry plays a primary role in the national economy. Thereby a modification, in any part of the automotive chain, affects directly or indirectly stakeholders involved in the chain. For this reason, it is important to identify the main stakeholders involved and the role they are playing, with the objective of a better understanding of ELV management in Germany.

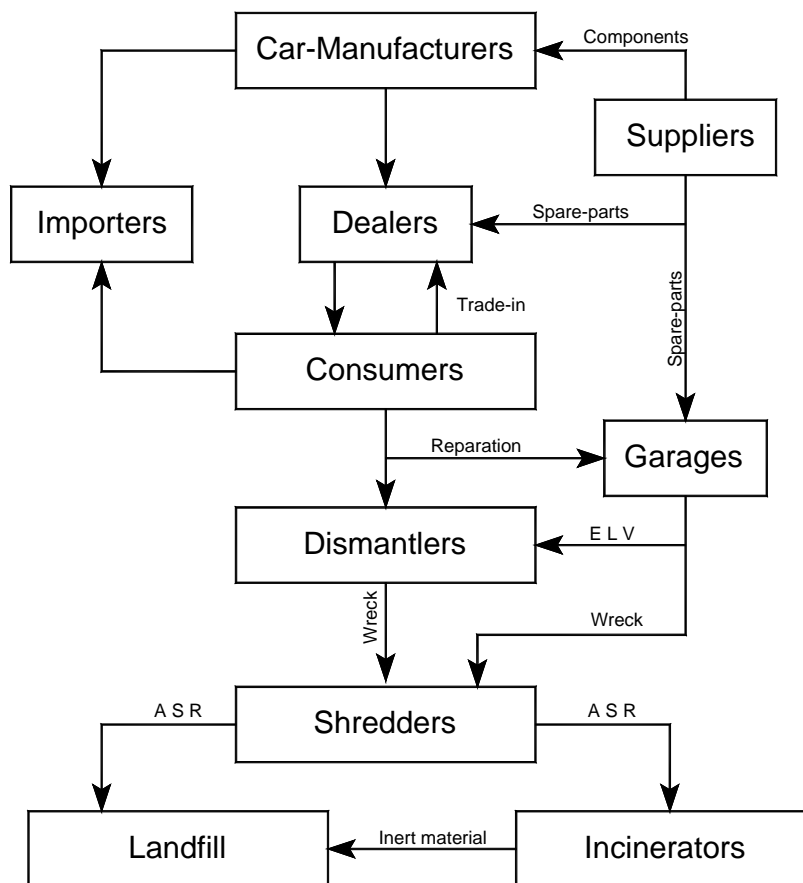

Figure 3.5 Stakeholders in the ELV Chain for Germany

²⁰ Germany together with Austria, Denmark, Spain, Luxembourg, the Netherlands and Sweden, were the first seven countries to implement the Directive 2000/53/EC by 2004, after coming into force on April 2002 (Hodac, 2004)

The stakeholder's configuration in the ELV management is far away to be homogeneous. The figure 3.5 describes the relationships within the ELV chain, as it is mentioned in the FSV made in 1996 by Germans stakeholders, where 16 stakeholders from different industrial branches participated, i.e. material producers, car producers, shredders, recyclers etc. (Schwald, 2001). The further part of the work addresses the description of role played by different stakeholders and the impact from ELV legislation.

3.2.2.1 Car-manufacturers and Suppliers

Since car-manufacturers introduce automotive vehicles to the market through importers and concessionaries, this group is considered the first actor in the ELV management chain. The decisions taken, at the developing stage of vehicles i.e. design, material selection and production, affect directly the later stages in ELV management. Therefore, the influence of these decisions is against or in favor of many other actors like recyclers, dismantlers or scrap processors in the ELV chain. It is even possible to say, that the most relevant decisions concerning the recycling and disposal of old cars are made early during the developing phase. During the later phases of the product life cycle these decisions are difficult to correct or can be altered only at considerable expense (Jörgens and Busch, 2000).

The product-oriented legislation enacted in Germany in the last decades has motivated the German automotive industry to be involved in the ELV management. The VDA stated in 2003 that the fulfillment of Directive 53/2000/EC under current terms represents an enormous economical burden, and consequently a loss of competitiveness at International markets, that is why this industry has been searching for amendments in the mentioned Directive since its publication in 2002. Currently, one of the biggest incentives for this industry in the development process is the improvement of environmental image of car companies. However, this task is difficult, since directly promoting a new car by rendering its recyclable features, is related to a negative prospect like the cars disposal. Best results for this issue have been reached with the reduction of fuel consumption and emissions.

Another incentive for car producers in Germany could be given by insurance companies who classify cars in specific types, taking into account the conditions and expected reparation costs. In this way, the car owner prefers a car with better design which allows less expensive and more efficient reparation, and thus its insurance is less expensive. On the other hand, the same incentive could be a disadvantage for other actors, as easy repairs causes conflicts with the economic interest of garages which are often owned by car producers. In a similar way, ELV management affects the suppliers because it encourages the reuse and recycling of spare parts and materials from ELV, thus there is a reduction in consumption.

This group of stakeholders has been taking measures on ELV management since decades, and their main incentive for this is the proactivity in the chain, which gives them certain advantages to prevent unexpected policies and to gain influence in the decision making processes (Jörgens and Busch, 2000).

3.2.2.2 Automobile Dealers and Garages

In comparison with the car-manufacturers, the structure of automobile dealers and garages is characterized by a large number of small and medium size businesses, which play many roles in the ELV management. The garages can sell new spare parts, used components and refurbished parts to car owners. Dealers can buy or take-back ELV, either for reconstruction or to recover spare parts. They can receive an old car as a “trade-in”, for a new or used car, and they can either resell the car or pass it on for treatment.

Since these actors represent a relatively dense network in Germany, they were considered as a reasonable option to include them in a nation-wide system for take-back and treatment of ELV. However, dealers are economically only interested in taking-back ELV, if it is connected with a customers desire to get a new or used car. Furthermore, many dealers are reluctant to hold ELV in their facilities as it creates a negative image. Garages have no real incentive, as any improvement on dismantling of cars represents a reduction in repair costs, which are the major sources of income for garages (Jörgens and Busch, 2000).

3.2.2.3 Dismantling Industry

After the delivery of ELV to a certified facility, the dismantling process is the first stage in ELV management. Through this process it is possible to reach substantial rise of recycling rates, and the environmental problem of Automobile Shredder Residues (ASR) depends mostly on the quality and quantity of dismantling parts from ELV. Therefore, this sector plays a substantial role in the ELV chain.

The dismantler’s structure is very heterogeneous. In a small business are working two to five, rarely more than ten employees with generally low qualifications. The average output for most of these dismantlers is less than 1,000 ELV/year, apart from this; most of them do not fulfill the environmental standards (Jörgens and Busch, 2000). The small size of these businesses in Germany makes difficult the ascertainment of accurate numbers. One of the reasons for this is the difficult distinction between dismantlers and other enterprises such as car dealers or garages. Even though, until now 1,178 licensed enterprises are registered in Germany (ACEA, 2006).

There are about three branch organizations claiming to represent dismantlers at national level in Germany. Owing to their weak structure, the small number of employees, the relatively bad public image and the weak lobbying, this sector have been weakly considered in the political process for ELV management in Germany (Jörgens and Busch, 2000).

Regarding the incentives for dismantlers in ELV management, there are some conflicts between environmental and economic goals. Dismantlers only recover those materials, which are suitable for reuse, recycling or sale. Therefore a growth in the amount of materials to dismantle represents an economical burden to them, as it needs more man-hours of work, space to store, and at the same time a weight reduction of wrecks. All this represents a less income when they sell them to shredder companies.

One way to solve some difficulties in this sector could be done by automobile producers in the car development processes, where it is possible to enhance the cars design and construction with improved dismantling characteristics in order to reduce the time and costs for dismantling activities. Furthermore, the dismantling experience of this sector might be used by car producers to integrate them in the design process of new cars.

3.2.2.4 Shredders and Scrap Dealers

The main activity of this sector is to shred the wrecks and recover the metal and no-metal fraction from ELV. Currently, there are 41 shredders operating in Germany (ACEA, 2006). In 2003, they produced about 300,000 tons of shredder steel coming from ELV treatment, which is an important raw material for the steel industry²¹. World-wide about 45% of the steel production is based on the use of scrap steel (Reinhardt and Richers, 2004).

Large steel companies own and operate several shredder facilities, and there are only few independent shredders operating in Germany (BDSV, 2004). This sector reduces ELV to small pieces and extracts different metals from this shredder stream, disposing the remaining i.e. ASR, mainly into normal landfills together with household waste. In 2003, about 450,000 tons of shredder residues were disposed in Germany, almost 2/3 of this entire mass came from processing ELV (Reinhardt and Richers, 2004).

It is important to point out, that ASR is considered into the Technical Guideline on Hazardous Waste (TA Abfall) of 1991, thus a special deposition and treatment is required. However, in practice state agencies have granted broad exceptions to this rule, due to the comparatively high costs of hazardous waste disposal, which would economically threaten the operations of shredder companies (Jörgens and Busch, 2000).

²¹ Other important input materials, for this sector, are the house appliances and industrial waste. The ELV share on the input materials is 10 % to 15% (BDSV, 2004)

Shredder companies have strongly participated in the ELV management in recent years. The main incentive for these actors is the provision of a guaranteed income of input material to their facilities. This fact has special importance considering the problem of ELV exports (Nakajima and Vanderburg, 2005).

3.2.2.5. Consumers

Commonly the Consumer of this kind of product, the car owner, is not recognized as one main actor in the ELV issue, even when their consumption preferences drive the design of vehicles. Normally, car owners have only an indirect influence on the product policy of automobile producers and on the ELV management. Such influence is exercised on legislation for environment protection, such as KWr/AbfG, the Integrated Product Policy (IPP), or Directive 200/53/EC, which protects human beings' integrity as a part of the environment.

In recent years, a growing public concern on environmental issues around the world has been noticeable. In Germany, those issues occupy the fourth place in the priority list of political topics (Kuckartz, 2002). In this way, politicians and other sectors as the productive one, have responded to the consumers claims. The response can be observed in the Research and Development (R+D) programs in the automotive industry, whose results comply with respective legislation and fulfill the consumer's preferences, in order to keep the competitiveness in the market.

Fuel consumption and pollutant emissions by cars are topics that traditionally have received attention by consumers. Nowadays, the implementation of product-oriented legislation, addressing the content of substances by vehicles and plans to manage the product at their EoL stage, has created a new awareness about environmental topics in customers. The result is the creation of consumers with higher awareness about the product they acquire, and with more criterions to decide what to buy. This is the main role played by consumers, and to fulfill the consumer's requirements is a big competition in the market.

Another important role played by car owners in the ELV management, consists of changes made by owners in the vehicle during its useful life, through repairs, maintenance and modifications in the original construction that could affect the value of ELV.

In the last stage of car's useful life, the owner decides how the ELV is disposed. The alternatives are to sell the car dealers for export, the illegal disposal (dumping) and the legal way, which is the take-back to dismantling or shredder companies.

3.2.2.6 Ministry for the Environment

The Ministry for the Environment plays one of the most important roles in the ELV management chain, the regulation. This stakeholder is in charge of evaluation, certification, implementation of fines, and conciliation of different relationships between the actors. The intervention of the Government to accomplish with a Directive is necessary, as the self-regulation by the Industry is difficult to maintain without any sanction (Orsato et al., 2002).

A strong incentive for the Ministry for the Environment, for participating in ELV management, is the importance that citizens give to environmental problems. European citizens pointed out that environmental protection belonged to the most important priorities for action, and they expect concerted action at the EU level (RIVM, 2004).

3.2.3 Current Situation of ELV Management in Germany

The present part of the work presents the main features in the operation of ELV management system currently implemented in Germany.

The ELV management system consists of two decentralized networks, as follows (Nakajima and Vanderburg, 2005),

- a) the first network is based on bilateral agreements between car-manufacturers and dismantlers. Here, each car-manufacturer has a dedicated network of dismantlers handling ELV from their brand. The car-manufacturer supervises the performance of these facilities, along with the supply of equipment and advisory. There are several advantages for both stakeholders. One of them is the convenient prices of spare parts coming from ELV.

- b) the second network is lead by shredder and metal companies, and car-manufacturers. The shredder and metal companies organize dismantling and collecting networks for those companies whom they have contract with. In this way, these companies guarantee certain amount of input material to their facilities. This issue is considered important taking into account the ELV export problem²².

²² See point 3.2.3.5

As the Directive 2000/53/EC encourages the preservation of competitiveness into the ELV chain for every Member State, directive's provisions are given on a generic level and the interpretation is left to individual Member States. These provisions are related to setting up a local take-back and recycling regime (Reinhardt W., 2005²). In this context, stakeholders in Germany have made several voluntary agreements attending the accomplishment of legislation. In this way, de-registration process, technical standards and procedures for collection, de-pollution, dismantling and shredding activities, are as mandated by the Directive. The activities concerning design for recycling and network relationships are carried out under voluntary agreements between stakeholders (Zoboli et al., 2000).

Due to the scarcity of information about the performance and results from every network, it is not possible to break down the data available for everyone. Therefore, the present work presents the figures concerning the German system as a unit.

3.2.3.1 Vehicular Fleet and De-registrations in Germany

In order to analyze the current ELV management in Germany, it is necessary to analyze the amount of input material to the system. And because passenger vehicles are products, the amount of this kind of product in current use has especial importance for ELV management. Vehicular registrations at the time describe the behavior of vehicle consumption, and serves to calculate the coming number of ELV in the future. The table 3.11 shows the current number of passenger vehicles in Germany until 2006, which is slightly higher than 46 million of Passenger Cars (PC).

Table 3.11 Current Vehicle Fleet in Germany (1970-2006)

Year	Passenger vehicles	Motor bus	Trucks	Tractors	Others	Trailers	Motorcycles
1970	13,941,079	47,253	1,028,116	1,446,955	91,220	632,822	228,604
1975	17,898,422	59,967	1,121,254	1,560,515	1,28,781	930,863	454,811
1980	23,191,616	70,458	1,277,167	1,640,132	1,98,598	1,328,993	738,180
1985	25,844,520	69,388	1,280,809	1,704,908	311,147	1,763,249	1,406,869
1990	30,684,811	70,370	1,388,505	1,756,488	434,430	2,245,616	1,413,674
1995	40,404,294	86,258	2,215,236	1,899,627	613,435	4,100,751	2,267,428
1996	40,987,547	84,954	2,273,493	1,899,874	625,405	4,263,455	2,470,451
1997	41,371,992	84,019	2,315,483	1,900,235	630,547	4,405,085	2,716,780
1998	41,673,787	83,285	2,370,599	1,902,627	630,347	4,521,370	2,925,843
1999	42,323,672	84,687	2,465,535	1,916,043	641,768	4,655,767	3,177,437
2000	42,839,906	85,574	2,526,896	1,919,920	654,529	4,853,066	3,337,848
2001	43,772,260	86,656	2,610,885	1,941,783	665,231	4,960,189	3,410,480
2002	44,383,323	86,461	2,649,097	1,951,077	678,612	5,105,276	3,557,360
2003	44,657,303	85,880	2,619,267	1,952,243	684,269	5,210,788	3,656,873
2004	45,022,926	86,480	2,586,329	1,952,298	689,165	5,317,433	3,744,971
2005	45,375,526	85,508	2,572,142	1,961,934	696,644	5,449,135	3,827,899
2006	46,090,303	83,904	2,573,077	1,975,979	284,092	5,570,026	3,902,512

Source: KBA, 2006

The table 3.11 describes the growth of the fleet of passenger cars in Germany along the years. The peak of this growth was registered until beginning of the 90's (reunification of Germany), after that, the growth slowed. By 2006, there was a strong increase of 1.6% in the new registrations fleet with reference to the year before. That means roughly 715,000 more vehicles.

Another important factor in the ELV management is the number of input units in the vehicular fleet. This means the new registrations of vehicles. The table 3.12 presents the new registrations of motor vehicles in Germany during the last decades.

Table 3.12 New Registrations of Motor Vehicles in Germany (1970 – 2005)

Year	PC	Motor bus	Trucks	Tractors	Others	Trailers	Motorcycles
1970	2,107,123	5,219	146,037	72,501	6,976	78,683	8,892
1975	2,106,048	5,339	90,605	69,202	8,843	89,973	75,821
1980	2,426,187	6,508	143,749	53,376	18,933	137,462	141,929
1985	2,379,261	4,046	106,830	41,534	16,946	118,887	122,343
1990	3,040,783	4,565	157,782	41,690	30,504	158,663	111,208
1995	3,314,061	5,352	212,200	42,383	28,324	218,719	217,791
1997	3,528,179	5,514	212,954	45,196	26,988	223,536	313,973
1998	3,735,987	5,802	237,184	52,511	28,889	234,180	289,982
1999	3,802,176	6,321	258,215	56,504	31,908	250,512	282,462
2000	3,378,343	6,243	246,797	53,859	33,882	254,836	253,138
2001	3,341,718	6,121	229,223	50,762	35,290	236,216	228,703
2002	3,252,898	5,737	207,788	49,400	33,291	214,904	208,252
2003	3,236,938	5,669	202,417	49,342	31,029	220,535	207,420
2004	3,266,826	5,398	215,023	56,403	32,298	240,304	198,683
2005	3,342,122	5,426	222,933	60,711	11,957	235,990	189,264

Source: KBA, 2006

The number of passenger cars in Germany seems to increase year after year. This fact is confirmed by Shell-Deutschland in its 24th Passenger Cars Study, where an estimation of future numbers of PC by 2030 is calculated. The estimation was based on two scenarios, “*Tradition and Impulse*”.

The scenario *Tradition* considers a gradual movement of consumers’ behavior towards the vehicle consumption in Germany, with a real growth of the German economy around 1.6 percent per year in average. On the other hand, the scenario *Impulse* considers that the consumers will take the liberation of trade and globalization as a chance towards the consumption of vehicles, and with a real growth of the German economy around 2.0 percent per year in average. Table 3.13 presents the results of these estimations (Shell, 2004).

Table 3.13 Scenarios of Number of Passenger Cars (2003-2030)

	2003	Scenario- "Tradition"			Scenario- "Impulse"		
		2010	2020	2030	2010	2020	2030
Passenger cars (x 10 ⁶)	44.7	47.5	49	49	47.5	51	53.5
Motorization (PC/ 1000 adults)	664	690	715	725	690	740	785
New registrations per year (x10 ⁶)	3.24	3.5	3.3	3.1	3.6	4.2	4.9
Average mileage per year and PC (km)	11,400	11,200	10,900	10,600	11,300	10,800	10,500
Total mileage (x10 ⁹ km)	509	533	534	518	536	552	563
Average consumption in fleet (l/100 km)	8.4	7.9	7.4	6.9	7.9	7.2	6.5
Total fuel consumption by PC traffic (x10 ⁶ tons)	32.8	32.5	30.5	27	32.8	31	28
CO ₂ -Emissions in PC traffic (x10 ⁶ tons)	1990	97.5	87	78	98	88	79
Reduction in %	110	-12	-21	-30	-11	-20	-29

Source: Shell, 2004

The growth in the vehicular fleet of passenger cars brings as a consequence more ELV after the average service age of cars. This age in Germany is around 11.9 years as stated in 2004 by the Kraftfahrt-Bundesamt (KBA), the Federal Bureau of Motor Vehicles and Drivers. The number of de-registered PC was around 3 million units²³, 3.7% more than that in the previous year. The table 3.14 presents the number of de-registrations in Germany in last decades.

Table 3.14 Deregistration of Vehicles in Germany (1970-2003)

Year	Motorcycles	PC	Motor bus	Trucks	Tractors	Others	Trailers
1970	54,197	931,376	2,555	91,926	36,633	4,455	34,026
1975	67,243	1,353,473	3,325	112,513	51,779	7,070	53,525
1980	87,515	1,938,600	4,701	106,179	50,193	9,227	59,837
1985	155,153	1,776,114	4,287	98,920	36,206	13,183	59,642
1990	151,460	2,632,716	4,880	115,427	48,864	22,282	75,161
1994	114,373	2,695,384	7,159	137,995	50,355	26,138	111,924
1995	120,342	2,949,704	7,325	143,398	53,887	29,266	127,255
1996	120,186	3,145,259	6,601	164,371	58,869	32,420	132,389
1997	126,681	3,392,358	6,327	185,507	60,068	35,264	138,178
1998	144,776	3,468,798	5,591	188,723	61,788	38,396	142,787
1999	178,625	3,290,203	5,419	198,064	62,419	41,423	161,118
2000	107,054	2,554,137	5,375	165,745	46,400	28,530	106,200
2001	144,176	3,023,777	6,815	211,691	59,052	35,096	135,286
2002	166,980	3,215,926	6,757	252,985	65,388	40,140	150,629
2003	176,837	3,056,895	5,278	241,970	65,551	38,379	152,259
2004	172,312	3,068,119	6,447	234,694	63,839	38,026	146,507
2005	174,307	3,183,069	7,107	231,890	64,035	16,051	149,564

Source: KBA 2006

²³ According to ACEA 2006, Germany had a total de-registration of passenger cars of 3 million units, of which 1.2 million were treated. The difference between those figures is caused by illegally treated units (not de-polluted before shredding), abandoned cars and export of de-registered vehicles.

3.2.3.2 Collection and Dismantling

Germany has a network of 15,000 certified take-back centers, which extend to the last owner a Certificate of Destruction (COD). The network for dismantling activities has 1,178 certified facilities, which are obliged to accomplish with the provisions stated by Altfahzeug-Verordnung (ACEA, 2006).

The activities carried out by take-back and dismantling facilities are the de-pollution and dismantling of several components from ELV. The de-pollution consists of draining operative fluids and other elements that endanger the quality of material sent to the shredders.

In a study carried out by Boes et al. in 2002 is described the current state of ELV de-pollution activities in Germany. This study shows the main features concerning two companies with different capacities (450 ELV/year and 11000 ELV/year). Some results of this study stated the time-span for this process, which varies from 9 to 144 minutes, with an arithmetic average of 57 minutes, and standard deviation of 35 minutes. Boes et al. concluded that the average time necessary to de-pollute a car in Germany depends on many factors such as the size of the company, proficiency of employees, equipment, etc.

The table 3.15 shows the average amount of operating fluids, which are recovered by de-pollution activities. Those values can be used to obtain the total amount of operating fluids in Germany, concerning the 1.2 million ELV treated by 2005.

Table 3.15 Average Amount of Operating Fluids Drained from ELV in 2005

Fluid	*liters/ELV	Total amount (liters x10 ³)
Oil (All together)	5.08	6,096
Brakes fluid	0.44	528
Refrigerant fluid	2.83	3,396
Fuel	5.29	6,348
Windscreen wiper water	0.54	648

*Source: Boes et al., 2002

Concerning the dismantling activities, the Annex of Altfahrzeug-Verordnung requires a minimum amount (10% of ELV empty weight). The substances, parts and materials being removed from ELV, are presented in table 3.16.

Table 3.16 Drainage and Dismantling Processes in Germany

Process	Group of product	Process	Group of product
Hazardous substances	Batteries	Dismantle process 1	Radiator
	Airbags		Starter
	Seat belt		Generator
Drainage process	Gasoline	Dismantle process 2	Transmission
	Diesel		Wires
	Oil from motor		Catalytic converter
	Hydraulic oil		Instrument panel
	Transmission oil		Shock absorber
	Differential oil		Seats
	Shock absorber oil		Laminated glass
	Brakes fluid		
	Cooler fluid		
	Windscreen wiper water		
	Oil filter		
	Air filter		
	Fuel filter		
	Wheels and tires		

Source: Schwald, 2001

The time required for dismantling activities vary considerably from company to company. The proficiency of the work force, the equipment, the capacity of facilities and the amount of dismantled parts, are some of the most important factors influencing the average time of dismantling activities. In 2000, Stücheli presented an average time for dismantling activities of 285 minutes from extended pilot plants in Germany. The activities were divided into four stages as follows:

1. Pre-treatment and de-pollution activities from vehicle reception to preparations for delivery to shredder, Time = 75 min
2. Dismantling of parts and materials, excluding reparation and refurbishing activities, Time = 60 min
3. Plastic removal, with around 50 kg of dismantled material, Time = 60 min
4. Glass recovery, glued and window screens, Time = 90 min

In 2006, Duranti presented the total time for mandatory de-pollution and dismantling operations in Europe. The total time for these operations is estimated from 137 to 327 min.

3.2.3.3 Shredding

The next step of the ELV management is carried out by 41 operators in Germany. There is no available data about the amount of input and recovered material, from ELV, from these 41 companies. The Bundesverband Sekundärrohstoffe und Entsorgung (BVSE), the Federal Association for Second Raw Material and Disposal displays information about the trade of steel scrap for steel industry in Germany. The table 3.17 shows the available data.

Table 3.17 Trade of Steel Scrap in Germany

Trade of steel scrap (x 10 ⁶)	2003	2004	2005
Steel plants	14.4	16.2	15.2
Foundries	3.2	3.4	3.6
For export	7.4	8.2	6.7
Import	6.6	6.0	5.0
Total produced in Country	24.9	27.7	25.5

Source: BVSE, 2006

According to the figures from the Bundesvereinigung Deutscher Stahlrecycling und Entsorgungsunternehmen (BDSV), the Federal Association of the German Steel Recyclers the fraction corresponding to ELV, entering to shredders facilities is around 10% to 15%. Thus, the amount of steel scrap from ELV in 2005 was around 2.5 to 3.8 million tons.

In regard to ASR produced by this industry, Reinhardt and Richers carried out a study in 2004 that addressed to the management of ASR in Germany. This study stated that by 2003, 450,000 tons of residues was produced by the shredder industry of which 300,000 tons came from ELV treatment. Reinhardt and Richers state an estimation of 1.25 million tons of residues that could be reached by 2015.

An important fraction of ASR is composed of plastics. This fraction, according to the German Association of Plastic Producers (VKE), is around 25% to 35% (Orth P., 2002; Zoboli et al, 2000).

3.2.3.4 Costs in ELV Management

Since the heterogeneity in the ELV chain, the costs calculation for ELV management in Germany is not an easy subject. Moreover, authors such as Reinhardt W. and Mazzantti in their works published in 2005, point out an absence of formal cost benefit analyses performed by policy makers, to ELV stakeholders, before Directive 2000/53/EC was introduced.

The costs of recycling operations depends on local conditions, specific capital invested, labor costs, costs of disposal, price of the scraped car and other supplies, values of the recycled material fractions, etc. However, some fragmented data are available and can be used to help in a better understanding of costs and revenues situation on this topic.

The structure of recycling costs in ELV management identifies the main expenses and revenues. These are described in table 3.18 (Goldhan, 2002).

Table 3.18 Structure of Recycling Costs in the ELV Management

Areas	Expenses	Revenues
<ul style="list-style-type: none"> ○ Dismantling ○ Logistic ○ Shredder ○ Treatment 	<ul style="list-style-type: none"> ○ Investment costs (equipment and installations) ○ Labour costs ○ Maintenance costs (energy and material consumption logistics, repairs, etc.) ○ Management and insurance costs ○ Waste disposal costs (landfill, incineration) ○ Capital charge ○ Feeds for recycling or recovery (including dismantling and logistics) 	<ul style="list-style-type: none"> ○ Sale of dismantled parts for reuse ○ Sale of recycled/recovered material fractions

The study performed by Boes et al. in 2002, addressing the statement of de-pollution activities, also describes the annual expenses from two companies with different capacities (450 ELV/year and 11,000 ELV/year). The data available is shown in table 3.19.

Table 3.19 Operating Costs of Two Dismantling Companies

Concept	Company 450 (€7year)	Company 11000 (€7year)
Energy	1,750	35,000
Insurance and taxes	2,125	42,500
Maintenance	2,927	48,312
Operating material	750	15,000
Others	625	12,500
Plants depreciation	5,854	96,625
Building depreciation	17,500	149,000
Wages	75,980	1,200,000
Total	115,690	1,752,250
Cost / ELV	257	159.3

Source: Boes et al., 2002

The described costs in table 3.19 include the costs of draining activities, pre-treatment and dismantling.

From the same work, it is possible to know the possible revenues corresponding to the sale of spare parts and/or materials, taken out from ELV, and the costs for disposing materials, fluids and wastes. These revenues and costs are given in table 3.20 (Boes et al., 2002).

Table 3.20 Revenues and Costs in the Dismantling Sector

Part / Material	Revenues			Unit
		to		
Laminated glass	-40	to	-10	€/ t
Glass	-5	to	10	€/ t
Headlamp, Back lamp, Flasher (Base PC/PMMA/ABS)	0	to	25	€/ t
Elastomer (without metal)	-75	to	0	€/ t
Electric motor	10	to	75	€/ t
Wires	50	to	300	€/ t
Wheels	-1,25	to	2,9	€/Unit
Polyolefin, like Shock absorbers	0	to	50	€/ t
FE Metal pre-dismantled	15	to	70	€/ t
Car body	10	to	30	€/ t
Catalytic converter	5	to	20	€/Unit
Aluminium pre-dismantled	800	to	1000	€/ t
Cooler fluid	-0,64	to	0	€/ Litter
Brakes fluid	-0,43	to	-0,22	€/ Litter
Windscreen wiper water	-0,10	to	0	€/ Litter
Motor - + operating oil	-0,10	to	-0,07	€/ Litter
Hydraulic oil	-0,08	to	-0,07	€/ Litter
Gasoline / Diesel	-0,21	to	0	€/ Litter
Filter oil	-120	to	-60	€/ t

Source: Boes et al., 2002

In reference to the costs of shredder sector in ELV management, there is no available information about the German system. ADEME published a study addressing this issue in 2003. It is not possible to say how similar the costs are in comparison with the German industry, but in order to have a reference line, the operating costs and revenues, coming from a sample of 5 shredders in France, are presented in table 3.21.

Table 3.21 Operating Costs and Revenues in Shredder Facilities

Operating costs (€/incoming tons)	Sample audited			
	Average	% costs	Minima	Maxima
Transport prior to arrival	4.9	5	1.8	8.4
Purchase of material	37.8	42	21.0	51.3
Wages & Salaries	6.3	7	3.9	8.6
Disposal of shredder residues (SR)	9.6	11	6.7	16.0
General costs	20.4	23	13.3	29.4
Depreciation and provisions	10.9	12	3.4	27.4
Total operating costs	89.9		50.1	141.1
Operating revenues (€/incoming tons)				
Sales of materials	Average	% revenues	Minima	Maxima
- sales of ferrous materials	72.2	78	66.3	78.7
- sales of non-ferrous materials	20.2	22	13.1	26.7
Total operating revenues	92.4		79.4	105.4
Operating result for shredding (€/incoming ton)	2.5		29.3	-35.7

Source: ADEME, 2003

3.2.3.5 Difficulties in ELV Management

The implementation of 2000/53/EC into German national Law has been full of criticisms from different stakeholders, in regard to different issues. The major opposition has been presented by the strongest and well organized sector, the car-manufacturers. The rejections are especially in terms of take-back of ELV free of charge from last owners, recycling quotas and exclusion of specific material from automotive applications.

Regarding the take-back obligation free of charge of ELV, the industry argues that it represents a significant additional burden in the competitiveness of the German Industry, given the following (VDA, 2004²),

- a) German brands will account for almost half vehicles taken back in the European Union,
- b) Germany accounts for approximately one quarter of the total European market,
- c) in German markets, the proportion of cars of German brands is particularly high,
- d) recycling cost in Germany are among the highest in the European Union.

Talking about the recycling quotas, the industry argues that,

- a) high material recycling rates make virtually impossible the use of materials, indispensable for light weight manufacture. This situation favors an inconsistency in the policy. As on one hand there are recycling ratios imposed by ELV Directive, which makes vehicles heavier, therefore, they require more fuel, while at the same time the Commission is demanding redoubled efforts to reduce CO₂ emissions.
- b) the high material recycling rates intensify the conflict between objectives on safety, comfort and environmental protection in automotive manufacturing.

On the other hand, for the Commission the recycling quotas stipulated in the Directive 2000/53/EC are not unfeasible, as such high targets have already been achieved in other countries, such as Japan, where car producers such as Mitsubishi claim to achieve recycling rates up to 98% since 2001 (Van de Vlies, 2004).

The automotive industry also rejects the exclusion of specific materials (lead, mercury, cadmium and hexavalent chromium) in vehicle materials and components. Their reasons are exposed as follows,

- a) Lead is necessary component of steel and aluminum alloys, which are mostly light metals and which therefore contribute to a reduction in fuel consumption and lower emissions,

- b) Hexavalent chromium serves to improve rust-proofing and helps to produce long-lasting products,
- c) certain materials are banned or restricted in case of automotive manufacturing, while the same materials continue to be permitted in other areas of daily life.

The German dismantling and shredder industries criticize the implementation of Directive 2000/53/EC into German law from a different point of view. The criticisms have been stated by the BDSV, which counts to hundreds of members in the whole country. The BDSV has specifically remarked the following (Jörgens and Busch, 2000),

- a) they have rejected the Directive's implementation under current terms, as the operation of recycling and dismantling network will be led by the automobile producers and subsequently, there will be a significant market concentration with the elimination of large number of independent dismantlers. In consequence the general cost-free take back obligation is also rejected,
- b) the association accepts the necessity for improvements in the environmental performance on their activities in the ELV management, specially for those working without certification,
- c) the BDSV claims for a provision, which avoids exports of ELV in foreign countries, as this represents an insufficient and unstable material income.

The discussion about several effects caused by the implementation of Directive 2000/53/EC into national laws is yet to be finished. Stakeholders have already reached agreements in some issues, such as the responsibility for network organization²⁴ and the extension of deadlines for the exclusion of substances in automotive applications (EC, 2004; EC, 2006). Nevertheless other topics are still in discussion.

The export of ELV to foreign countries is one of the main difficulties faced by the ELV management, not just in Germany but also in many countries of European Union. The figures of ELV export goes up to 25% of the total number of ELV, according to the figures given by Teschers et al. in 1999.

The phenomenon of ELV export is caused by economic factors. According to the study carried out by De Jong et al. in 2001, most of the vehicular retirements are due to the decrease of vehicle' value with age, and because the value depends on local conditions, a vehicle with null value in a certain country could have higher value in a different one. In this way, ELV are exported by car dealers abroad (most of the times to the east European countries), where the conditions allow a higher value for old vehicles from Germany.

²⁴ See point 3.2.3

Another difficulty for the ELV management in Germany is the abandonment of ELV or wild disposal. According to the figures from the Federal Agency of Environment and Nature Protection in Germany (BUND) there are from 50,000 to 100,000 abandoned cars in Germany (BUND, 2001).

The high significance of German automotive industry in many sectors of economy, has led this industry to the proactivity in the field of ELV management and others. The main objective of this proactivity is to prevent unexpected provisions from the government, in order to maintain their competitiveness in the global market. This proactivity has produced effects upstream and downstream in the ELV chain, e.g. consolidation of the recycling industry and improvement in the ELV management infrastructure.

The government's intervention with product-oriented legislation has served as a catalyst in the implementation process of a sound ELV management, bringing together different stakeholders' perspectives. Nevertheless, some discussions are still open, especially regarding recycling rates, the ban of heavy metals in car-manufacture applications, economic responsibilities on ELV management, etc.

The major difficulties to overcome in the near future by this system are mainly those related with export of ELV, recycling of plastics and ASR treatment.

3.3 The United States of America

The U.S. Automotive Industry (USAI) represents one of the most important pillars of the U.S. economy and its growth²⁵. This is due to the high level of output that represented 699 billions of dollars in 2005. In 2002, the output of this industry represented 3.3% of the U.S. Gross Domestic Product (GDP). The employment contribution currently associated to the USAI is estimated to be around 4.7 millions jobs in total (2.4 millions directly and 2.3 millions indirectly), which included private sector and its suppliers (McAlinden et al., 2003).

In terms of manufacture and sales of vehicles, the USAI is the largest automotive industry in the world, with 16.94 millions of sold vehicles and 11.52 millions of manufactured vehicles in 2005 (VDA, 2006). The last figures include data of passenger cars and light trucks, which recently have had a growing popularity being used as passenger vehicles and has impacted significantly the figures²⁶ (DOE, 2006).

Referring the field of Research & Development (R&D), the USAI is traditionally ranked the top among all U.S. industries by the National Science Foundation (NSF). The expenditure of this industry in R&D was \$ 18,306 millions in 2000, which was higher than other industry groups, such as Pharmaceutical & Medicines and Electronic components (McAlinden et al., 2003).

The impact of the USAI in other industries can be observed upstream and downstream. The use of large amounts of materials to manufacture its products, such as steel, iron, aluminum, electronics, plastics, etc, makes the purchase of many products and services from other American industries indispensable. Downstream of the chain, there is also impact of the USAI, the operation of motor vehicles foster diverse set of requirements, such as energy supply, repair services, highways construction, etc. The management of ELV is a part of this downstream, in which are employed around 46,000 people at 6,000 recycling businesses (McAlinden et al., 2003).

The present section will describe the main features of ELV management system currently working in USA and also several features about the automotive industry, vehicular fleet and market in this country.

²⁵ The growth in the U.S. economy in 2006 was 4.2 %, higher than 3.5 % reached in 2005, the unemployment rate stated in 2003 at 5.8 %, grew slightly to 6.0 % by December, but it fell to 4.7% in March 2006. Consumer confidence measures increased moderately in the first quarter of 2006 (NADA, 2006).

²⁶ Light trucks are trucks less than 10,000 lbs (4.5 tons) gross vehicle weight, vehicles from this class, minivans Sport Utility Vehicles (SUV), and pick-up trucks. This class has more than tripled from 1970 to 2003 (DOE, 2006).

3.3.1 Legal and Institutional Aspects

The ELV Management in the US has been subjected to less specific direct regulations, regarding the ELV management. The first attempt to regulate this field took place in 1991, with a proposal called H.R.3369. This proposal has been considered by the automobile industry as harbinger of mandatory recycling legislation (Staudinger and Keoleian, 2001). The US House of Representatives made the proposal and named it as the Automobile Recycling Study Act of 1991. The proposed legislation would have required the US Environmental Protection Agency (USEPA), to consult with the secretaries of Transportation and Commerce, in order to study the potential for increased automobile recycling rates, along with the following,

- a) identify major obstacles in the increased recycling of auto components and develop new ways to overcome those obstacles,
- b) define methods for incorporating recyclability into the planning, design and manufacturing of new autos,
- c) identify the toxic and non-recyclable material used in the autos and possible substitutes for those materials,
- d) study the feasibility of establishing design standards for autos that would result in a gradual phase out of hazardous and non-recyclable materials used in autos,
- e) examine methods for creating more recyclable plastics for use in autos.

The Proposal did not pass and it was not reintroduced in the subsequent Congresses.

In recent years, a serial of voluntary initiatives are being established by the recycling industry. An example of these agreements is the Certified Automotive Recycler (CAR), launched in 1994, as part of the Automotive Recyclers Association (ARA). This program established a guideline for general business practices, as well as environmental and safety issues, aimed to provide guidance for member facilities (ICSG, 2004).

Currently in the United States of America, there is no regulation requiring car manufacturers to take responsibility for ELV, limit the ELV waste disposed in landfills, or requiring certain amounts of recovery from ELV (Nakajima and Vanderburg, 2005). There are some state-level regulations related to solid and hazardous waste disposal, such as the ban of free liquids and lead-acid batteries in landfills. These practices are carried out in some states of this country. Other significant legislative/policy issues regarding ELV management in different states of the US include the following points (Arbitman and Gerel, 2003; Gesing, 2004),

- a) the US EPA requires de-pollution of the ELV before shredding by removal of all liquids (refrigerant, coolant, gasoline, and oil), removal of the lead acid battery, and deployment of air bags,
- b) stabilized ASR is approved as an alternate daily landfill cover, in some cases,
- c) ASR is considered hazardous waste only by some of the US states, such as California,
- d) the ban on the sale of new vehicles that have hood and/or trunk convenience lights containing mercury switches,
- e) other states impose pretreatment and/or special management requirements regarding ASR disposal in landfills, e.g. requirement of ASR stabilization prior to landfilling to pass metal-leachability test,
- f) state-level landfill restrictions on mercury-containing devices (such as auto convenience lighting switches),
- g) state-level interest in scrap tyres management leading to recycling and energy recovery.

Regarding the lighting and Anti-Lock Brake System (ABS) switches, containing mercury, there are programs in some States, such as Pennsylvania, Maine and Oregon. These programs encourage a “product responsibility” for recovering mercury switches by those businesses handling ELV, the program includes a payment of one dollar for each switch removed (Boselovic, 2004).

Government Agencies and the automotive industry have acknowledged concerns about the use of automotive mercury since 1990s. In 1995, there was a voluntary agreement by automakers to phase out mercury switches and to educate ELV dismantlers to remove the switches from the existing vehicles. By 2000 the use of Mercury in new vehicles continued and even increased in ABS application (Griffith et al., 2001). An estimation of 223.5 tons of Mercury contained by the American vehicular fleet is made and, thus a program to take care of the switches in vehicles is necessary to be implemented (Ecology Center, 2004).

One of the most significant regulations and leading improved dismantling operations in the US is the Federal National Pollutant Discharge Elimination System (NPDES) Storm Water Permit. This permit requires any business handling hazardous materials, a detailed storm water pollution prevention plan, through which is possible to have better practices in dismantling business, avoiding the discharge of hazardous substances to the sewage system or water bodies (Arbitman and Gerel, 2003).

In the US, non Governmental Organizations (NGOs) are working in programs that inform American consumers about the lack of “producer responsibility” in the case of auto manufacturers and other products. The main aim of these programs is lobbying with the industry to improve the composition of their products and protect consumer’s interests. Some examples of these programs are the “Clean Car Campaign”, or the “Californians Against Waste”, which has developed legislation proposals for better recycling practices and put pressure on State Governments to implement them. For these Organizations it is clear that market-based voluntary solutions would not be viable, unless stakeholders in the ELV chain are motivated through legislation (Arbitman and Gerel, 2003).

3.3.2. Main Actors in ELV Management

In this section, a description about the main stakeholders integrating the ELV chain, in the US is presented. In this context, the importance and interaction of every stakeholder as well as incentives for everyone in the ELV management in the US is described.

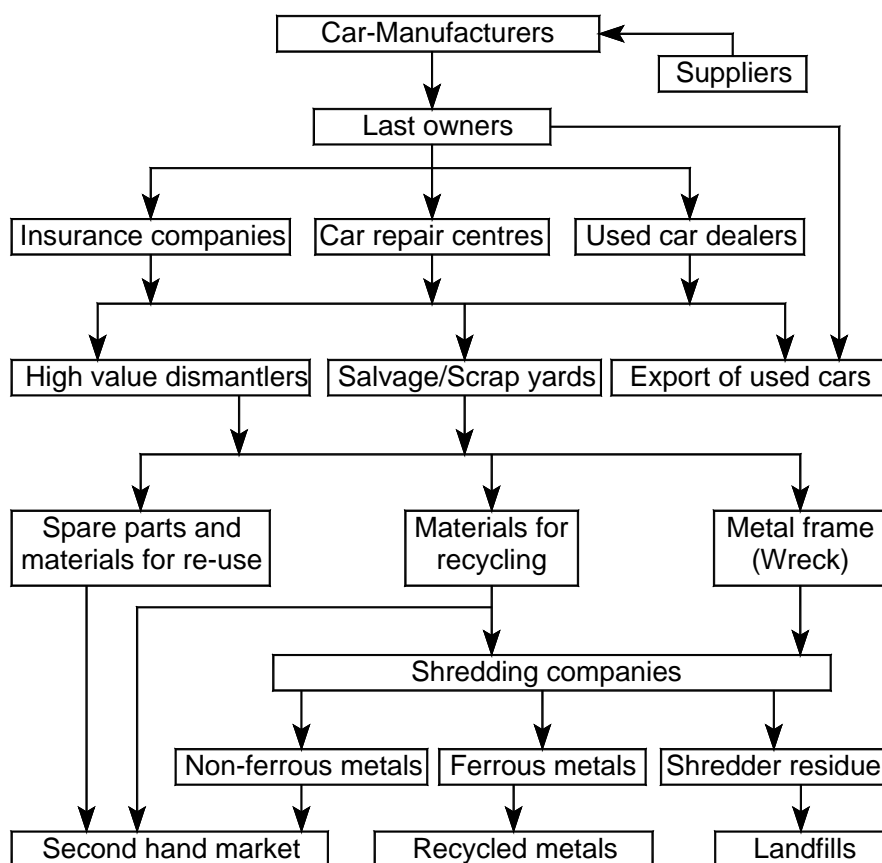

Figure 3.6 Main Stakeholders in the Management of ELV in the USA

3.3.2.1 Car-manufacturers

American car-manufacturers, as in the European Union, play a decisive role in the ELV management, as they have tremendous influence and impact on the recycling industry through the design and construction of their products. Only in the last two decades the content of materials in vehicles has changed and the total weight of a typical passenger car has decreased by almost 136 kg. The use of typical materials, such as, steel and iron, has been reduced, and the use of other materials like plastics has increased (Daniels et al., 2004). These changes were in response to the demands for improved fuel consumption, better performance and safety features.

The participation of USAI in the ELV management started in early 90s. In 1992, the Big Three founded the United States Council for Automotive Research (USCAR). The major targets for this council were the following:

- a) monitor current research projects in the automotive field and consider new opportunities,
- b) coordination of industry's interaction with the government researches,
- c) share results of joint projects with the members companies,
- d) seek and recommend funding from public and private sources for shared R&D.

The USCAR grouped several work teams in order to cover all areas concerning the automotive industry. These teams conducted projects related to enhancement of the design, construction and performance of vehicles, improvement of the materials, fuels, devices used in the manufacture, etc. The projects were being carried out in cooperation with the government and other industries. An example of these collaborations is the United States Alliance for Technology and Engineering for Automotive Manufacturing (USA-TEAM), which is constituted by the USCAR and the U.S. Department of Commerce's Technology Administration. The main objective of this project is the enhancement of technologies in the automotive manufacture that will contribute to the future competitiveness of the U.S. automotive industry (USCAR, 2006).

The Vehicle Recycling Partnership (VRP) is one of the teams, part of USCAR. The VRP team conducts researches addressing the Car Recycling in the USA. The main target of this team is to achieve an integrated and sustainable approach to recycle vehicles in the USA (USCAR, 2006). The VRP has been formed since early 90s and it has being collaborated with several governmental and private institutions.

3.3.2.2 Government

As mentioned in point 3.3.1, the ELV management system in the USA is mostly driven by the market²⁷, thus the operation of the system is solely propelled by the profitability of each business. Therefore, materials and auto parts, which are not profitable to be re-used and/or recycled by the system, are sent for final disposal in the landfills, thus the system works well in terms of profits, but in terms of environmental protection, the current system is unsuccessful (Ecology Center, 2004; Griffith et al., 2001).

The involvement in ELV management issue by the US Government has been carried out through the U.S. Department of Energy (DOE). In 2000, the DOE organized representatives from industry, academia and government, to establish "A Roadmap for Recycling End-of-Life Vehicles of the Future" for the USA. The main targets of this effort were to outline the priorities in this sector and to set suitable approaches to cover the needs. Other findings from this event are as following (DOE, 2001),

- a) the present recyclability of ELV in USA is limited, several technical and economic barriers need to be overcome,
- b) the development of technology to recycle current materials, will provide basis for the recycling of materials in the future,
- c) the initial focus of collaborative researches should be in the post-shredder sector,
- d) the challenges and key factors for the next 20 years are similar to the key factors and challenges that the industry faces today²⁸,
- e) wide collaboration between industries (national and international) is required to maintain and enhance sustainable ELV recycling,
- f) intervention from the government can serve as a catalyst bringing together the diverse perspectives across the ELV chain.

In 2003, the DOE structured the Cooperative Research and Development Agreement (CRADA)²⁹ to facilitate research for sustainable recycling of current and future waste streams from ELV. The main participants in this agreement are the U.S. Department of Energy, Argonne National Laboratory, the VRP and the American Plastics Council (APC). The main targets of this agreement are described as following (CRADA, 2006),

- a) research, development and validation of market-acceptable ELV options, compatible with the US infrastructure,

²⁷ There are some state regulations (such as in California and Maine) and some programs designed and implemented by trade organizations (Ecology Center, 2004)

²⁸ This considers that materials that are not recycled today, i.e. polymers, composite materials, and specialty metals and alloys, are similar in nature to the materials expected to be increasingly used in automotive applications for the near future (Daniels et al., 2004)

²⁹ According to Daniels et al., 2006, there were two previous versions of CRADA in 1994 and 1997. The participants were the VRP, Argonne National laboratory and APC

- b) development and demonstration of sustainable technologies and processes for ELV recycling,
- c) demonstrate feasibility for resource recovery from shredder residue to re-introduce it in automotive and other applications, as well as chemical conversion and energy recovery,
- d) development of viable strategies for the control, minimization, or elimination of hazardous substances,
- e) benchmark emerging recycling technologies and to provide data to stakeholders,
- f) stimulate markets for reprocessed materials to support economical collection, processing, and transportation,
- g) transfer technology to commercial practice.

Four main areas are being researched by CRADA to reach their objectives. These areas are: the regulatory framework, life cycle of alternative recycling technologies, post-shredder technologies and removal of Polychlorinated biphenyls (PCB) and other substances from ASR (Daniels et al., 2004).

3.3.2.3 Dismantlers

The role played by this sector in the management of ELV, starts once the last owner has taken the decision to get rid permanently of one's vehicle and the ELV is delivered to them. However, dismantlers obtain vehicles also from salvage auctions³⁰.

Dismantling activities play an important role in the current ELV management system in the USA. This sector makes business basically with the sale of spare parts from retired vehicles. These businesses allocate the spare parts through internet sites, which makes possible to localize spare parts and sell them to any part of the US, or even abroad. Once the re-usable and saleable parts are removed, the car's body is compacted and sent to a shredder plant. In some cases, when transport costs are high the ELV are disposed or abandoned (Staudinger and Keoleian, 2001).

³⁰ Approximately 90% (Arbitman and Gerel, 2003)

Dismantling activities in the USA are carried out by two kinds of businesses, the description of these are as follows,

- a) *High-value parts dismantler*: They remove and inventory useful high-value spare parts for sale. The inventories are maintained in nationwide computer databases allowing a quick and efficient finding and purchase. These businesses are a reliable source of parts for re-use, and tend to have good profits. After processing, the wreck is delivered directly to shredder companies or even to scrap yards.
- b) *Salvage/scrap yards*: Small businesses (fewer than ten employees), low-tech operations, that essentially store ELV while their parts are gradually removed or sold. In average, there are no inventories, and the sale of spare parts is for repair shops and individuals. Due to the low volume of trade and with lack of reliability, the operation is done with low profits. Therefore, they are located on the fringes of towns, where lower operation costs prevail.

Due to the high number of Salvage/scrap yards³¹ which is around 80% of total dismantling facilities in the USA, there exists currently several certification programs promoted by important associations in the sector, such as the Certified Automotive Recyclers (CAR), the State of California Auto Dismantler's Association (SCADA), etc. The main objectives of these programs are to standardize the dismantling activities to accomplish environmental and institutional requirements, obtain a certification, and certain benefits from the association.

In 2001, the American Recyclers Association (ARA) had fully certified the basic CAR program only to 200 facilities and 22 more were in the process. The main reason for this lack of certification is their tendency to become small businesses³². Thereby, it is found increasingly difficult to profitably operate and get a certification (Staudinger and Keoleian, 2001).

3.3.2.4 Shredders and Post-shredder Processors

Not only the US Steel Industry, but also the scrap recycling industry is of high importance in the American economy. The products of this industry are worth at \$20 billions USD a year which includes ferrous, non-ferrous, plastics, glass and tyres processed scrap (ISRI¹, 2005).

³¹ See Nakajima N., 2005 and Staudinger and Keoleian, 2001

³² There are an estimated number of 6,000 to 7,000 dismantlers in USA, of which 80% are scrap yards and 20% high-value parts dismantlers. Moreover, 86% of US dismantler's employee are 10 or fewer people (Staudinger and Keoleian, 2001)

This industry contributes to maintain the current success of the American Steel Industry. One third of the new steel production in the US is produced from ferrous scrap metal, approximately 60% of the metals and alloys produced in North America are made from non-ferrous scrap. The steel, aluminum, copper and brass industries depend on a steady supply of scrap metals in the production of new products (ISRI², 2005).

The importance of ELV management in this industry is evident. In 2006, 14 million tons of steel was recycled from automobiles (USGS, 2007). The recycled metals from this industry represent benefits to the American economy and the environmental protection, as for every ton of recycled steel, 1.8 ton of raw materials, 1.1 ton of iron ore, 0.6 ton of coal, 50 kg of limestone and 74% of energy are saved (AISI, 2004).

Another part of this scrap industry is related to the post-shredder processors, which are charged to separate the stream at the shredder facility in two basic types, the ferrous fraction (iron and steel), which represents from 65% to 75% by weight (Staudinger and Keoleian, 2001), and the non-ferrous fraction (copper, aluminum, stainless metal, etc). After separation processes, the ferrous fraction is sent for recycling to steel smelters, almost exclusively to Electric Arc Furnaces (EAF), which can work virtually with 100% of scrap steel, to produce new steel (AISI, 2004). The non-ferrous fraction is separated into two streams,

- a) *Individual non-ferrous metal streams (5%-10% by weight)*: aluminum, brass, bronze, copper, lead, magnesium, nickel, stainless steel and zinc,
- b) *Auto Shredder Residue (ASR)*: plastics, glass, rubber, foam, carpeting, textiles, etc. along with dirt and metallic fines.

In the USA, the ASR is not considered as hazardous waste³³. This fact in combination with low disposal costs, in comparison with recycling ones, produces final disposal of ASR into the landfills. The amount of ASR disposed in American landfills each year is estimated as five million tons, according to Daniels in 2006.

The largest association, representing the shredder and post-shredder sector, is the Institute of Scrap Recycling Industries (ISRI), which groups most of the shredder companies in the USA. The main target of this association is to represent and safeguard the interest of its members, and also to participate in the decision-making processes, regarding ELV management and other issues related to this industry. Currently in the USA, there is a conflict between car-manufacturers and scrap processors. The reason is that the scrap industry is strongly affected by materials, e.g. mercury and plastics contained in new models of vehicles, which represents losses of material or high expenses in the recycling processes. This was exposed by the executive director of the Canadian Association of Recycling Industries (CARI) (Shaw, 2002).

³³ California is the only the US State considering ASR as hazardous waste (Daniels, 2006; Staudinger and Keoleian, 2001)

3.3.2.5 Consumers

There are three main roles played by consumers of automotive vehicles in the USA. First, the purchase of new vehicles; where the consumer preferences are determinant for car-manufacturers, as they have to fulfill consumer requirements; e.g. technical, safety and environmental features. Thus, the consumers indirectly define some features in vehicles that influence the future of ELV management. Second, vehicle changes during its useful life stage, as the consumers decide through the maintenance and repairs, the mechanical integrity of their units. Third, the retirement of vehicles from circulation to convert them into ELV; which possesses prime importance, as the last owners in many cases are the ones who decide to whom the old car should be delivered³⁴.

In this section is noteworthy to mention some reasons why owners retire permanently an automotive vehicle from circulation. These reasons are as follows,

- a) loss of structural or mechanical integrity from being used, or accident,
- b) poor reliability of parts and components,
- c) degraded performance

In the most of the cases, the above exposed problems could be overcome with the investment of additional resources. Reparation of these vehicles can potentially extend their lifespan; that's why it is a decision influenced by economic aspects. The literature review carried out by De Jong et al. in 2001 covers the last 25 years of published studies about theoretical and empirical aspects of car scrappage models. It established that most of the vehicular retirements occur not because of accidents and/or technical failure, but because of a decrease in its value with age.

Due to the enormous number of potential customers, these actors are not well organized. Vehicle owners are grouped in trade organizations, NGOs across the USA (Californians Against Waste and Sustainable Conservation), and research institutes; as the Massachusetts Institute of Technology. These organizations carry out different projects aiming at environmental conservation and currently have some projects addressed to the ELV issue.

³⁴ There are two options, i.e. high value parts dismantlers and salvage/scrap yards. Arbitman and Gerel reported in 2003, that 90% of vehicles obtained by dismantlers were from salvage auctions.

3.3.3 Current Situation of ELV Management in the USA

The management of ELV in the USA has a similar structure as in Europe. However, its operation is driven by market conditions with almost no intervention of the government, thus the system is solely propelled by the profitability of each business in the chain. The infrastructure includes automotive dismantlers that recover components and materials for repair and reuse, automotive re-manufacturers who remanufacture a full range of components including starters, alternators, and engines; to replace defective parts, and ultimately, the shredders and scrap processors, which treat the “wrecks” in order to recover metals, e.g. iron, steel, aluminum, and copper. The flow of the ELV management system of the USA, is described in the figure 3.7 below,

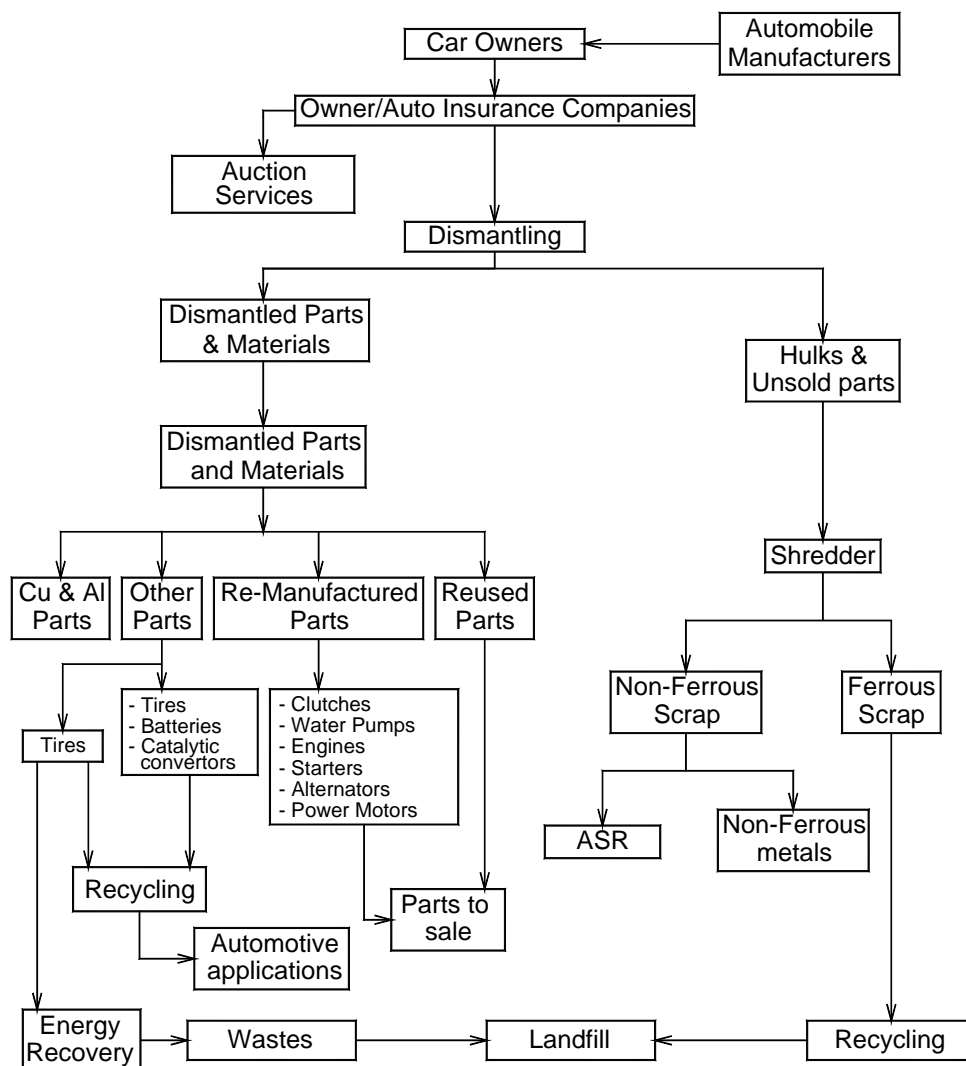

Figure 3.7 Current ELV Management System in the USA

Source: Staudinger and Keoleian, 2001

3.3.3.1 Vehicular Fleet and De-registrations in the USA

The North American Free Trade Agreement (NAFTA) shared around 25.2% of the global automotive production in 2006. From this figure, the USAI contributed 71% of the production (11.3 million motor vehicles). The break down of the North American automotive production is shown in table 3.22,

Table 3.22 North America Vehicle Production

Feature	January - December		% Share	
	2006	2005	Current	Year-Ago
U.S. Car	4,366,220	4,321,272	27.5	26.5
U.S. Light Truck	6,435,825	7,202,978	40.5	44.1
Total Light Vehicle	10,802,045	11,524,250	68.0	70.6
U.S. Med./Hvy. Truck	461,941	422,403	2.9	2.6
Total U.S. Vehicle	11,263,986	11,946,653	70.9	73.2
Canada Car	1,389,536	1,356,271	8.7	8.3
Canada Light Truck	1,107,831	1,266,609	7.0	7.8
Total Light Vehicle	2,497,367	2,622,880	15.7	16.1
Canada Med./Hvy. Truck	74,925	65,012	0.5	0.4
Total Canada Vehicle	2,572,292	2,687,892	16.2	16.5
Mexico Car	1,097,619	846,048	6.9	5.2
Mexico Light Truck	858,164	759,800	5.4	4.7
Total Light Vehicle	1,955,783	1,605,848	12.3	9.8
Mexico Med./Hvy. Truck	89,735	78,390	0.6	0.5
Total Mexico Vehicle	2,045,518	1,684,238	12.9	10.3
Total Car	6,853,375	6,523,591	43.2	40.0
Total Light Truck	8,401,820	9,229,387	52.9	56.6
Total Light Vehicle	15,255,195	15,752,978	96.1	96.5
Total Med./Hvy. Truck	626,601	565,805	3.9	3.5
Total Vehicle	15,881,796	16,318,783	100.0	100.0

Source: Ward's, 2006

In regard to vehicle sales, the well known Big Three; DaimlerChrysler, Ford and General Motors which are the biggest car manufacturers in the USA, counted to 55% of the total light vehicle's retail in the American market, as it is shown in the table 3.23.

Table 3.23 U.S. Light Vehicles Sales by Company in 2006

	January - December		% Chg.
	2006	2005	
Chrysler Group	2,142,505	2,304,833	-7.0
Ford	2,848,121	3,106,798	-8.3
GM	4,067,599	4,456,799	-8.7
Big 3 Total	9,058,225	9,868,430	-8.2
Honda	1,509,358	1,462,472	3.2
Hyundai	455,520	455,012	0.1
Isuzu	13,300	17,344	-23.3
Kia	294,301	275,851	6.7
Mazda	268,786	258,339	4.0
Mitsubishi	118,558	123,995	-4.4
Nissan	1,019,461	1,076,945	-5.3
Subaru	200,699	196,002	2.4
Suzuki	100,990	82,101	23.0
Toyota	2,542,525	2,260,296	12.5
Asia Total	6,523,498	6,208,357	5.1
BMW	313,603	307,020	2.1
Mercedes	247,887	224,753	10.3
Porsche	34,227	31,933	7.2
Volkswagen	325,256	307,261	5.9
Europe Total	920,973	870,967	5.7
Total Light Vehicles	16,502,696	16,947,754	-2.6

Note: Light vehicles are cars and light trucks (GVW Classes 1-3, under 14,001 lbs.). DSR is daily sales rate.
Source: Award's, 2006

Special features for an industrialized country as the USA make it to own one of the highest rates of motorization. By 2006, the USA counted 535 passenger cars per thousand people³⁵. The 58% of the total vehicular fleet are passenger cars and 42% (95.2 millions) are light trucks. The number of vehicles in use in the USA is shown in the table 3.24.

³⁵ Andorra, Monaco and Liechtenstein are the countries with the highest motorization rate worldwide, 926,707 and 705 PC/1000 inh. respectively (CIA, 2006)

Table 3.24 Vehicular Fleet in the USA (1970 - 2003)

Year	Units ('000)		
	Automobiles	Trucks	Total
1970	80,448	17,688	98,136
1975	95,241	24,813	120,054
1980	104,564	35,268	139,832
1985	114,662	42,387	157,049
1990	123,276	56,023	179,299
1995	123,242	70,199	193,441
1996	124,613	73,681	198,231
1997	124,673	76,398	201,071
1998	125,966	79,077	205,043
1999	126,869	82,640	209,509
2000	127,721	85,579	213300
2001	128,714	87,969	216,683
2002	129,907	91,120	221,027
2003	130,800	95,262	226,062

Note: Under trucks classification there are light trucks (SUVs, minivans and pickups), which are used for personal travel
 Source: DOE, 2006

The average age of vehicular fleet in the US is 8.9 years for passenger cars and 6.6 years for trucks. In average, the lifespans for the same kind of units are 16.9 and 15.5 years respectively (DOE, 2006).

According to the “*Global Automotive Financial Review 2003*” carried out by PricewaterhouseCoopers, the North American Automotive Industry expects to increase its assembly capacity by 12.5% from 2003 to 2011. Moreover, the US market for passenger cars and light trucks is forecasted to grow by 10.1% over 2004 to 2008, with an estimated 20.7 million sold units by 2008 (Euromonitor International, 2005).

An increase in the vehicular fleet affects directly the number of ELV generated year after year in the USA. The new retails represent a growth in the vehicular fleet, but also a replacement of obsolete vehicles; which are retired from circulation. The table 3.25 shows the number of retired vehicles in the USA from 1989 to 2002.

Table 3.25 Retired Vehicles in the US ('000)

Year	Passenger Cars			² Light trucks			Total
	New sales	In use	¹ Retired	New sales	In use	¹ Retired	
1989		122,758			53,202		
1990	9,301	123,276	8,783	4,845	56,023	2,024	10,807
1991	8,175	123,268	8,183	4,365	58,179	2,209	10,392
1992	8,213	120,347	11,134	4,905	61,172	1,912	13,046
1993	8,518	121,055	7,810	5,681	65,260	1,593	9,403
1994	8,990	121,997	8,048	6,420	66,717	4,963	13,011
1995	8,635	123,242	7,390	6,480	70,199	2,998	10,388
1996	8,527	124,613	7,156	6,930	73,681	3,448	10,604
1997	8,272	124,673	8,212	7,226	76,398	4,509	12,721
1998	8,139	125,966	6,846	7,826	79,077	5,147	11,993
³ 2000	8,971	127,721	7,216	8,307	85,579	1,805	9,021
³ 2001	8,308	128,714	7,315	8,020	87,969	5,630	12,945
³ 2002	8,336	129,907	7,143	8,673	91,120	5,522	12,666
³ 2003	7,698	130,800	6,805	8,617	95,262	4,475	11,280

Source: Modified from Staudinger and Keoleian, 2001

1 The number of retired vehicles is calculated with the following equation: $E_i = R_i + S_i - R_{i-1}$, where: E_i , is the number of vehicles retired from circulation in year i ; R_i , is the number of registered vehicles in year i ; S_i , is the number of sold vehicles in year i , and R_{i-1} , is the number of registered vehicles in year $i - 1$.

2 Truck figures include "light" (0-10,000 lb GVW), "medium" (10,001-26,000 lb GVW) and "heavy" (26,000 lbs and over GVW). The majority (93%) of trucks currently on the road are "light," with most of these (67%) being 6,000 lb and less GVW. Furthermore, the majority (75%) of light trucks are used for personal use.

3 The source data of sold vehicles and vehicles in use is from: DOE, 2006

It is important to point out that the data given in table 3.25 has to be taken with caution, as it was generated from the information made available by statistics of Automotive Industry and others, and also because official figures about the number of retired vehicles in the US is not available.

The work performed by Staudinger J. & Keoleian G., in 2001, presented the average composition of vehicle models of 90s. The information from table 3.25 can be used to calculate the potential material streams from ELV in the USA. These results are shown in the table below.

Table 3.26 Recovered Material from ELV Treatment in the US from 2000 to 2003

Year		2000	2001	2002	2003
Retired Vehicles		9,028	12,945	12,666	11,280
Fraction	kg/ELV ¹	Metric tons x 10 ⁶			
Ferrous Metals	989	8.9	12.8	12.5	11.2
Non-ferrous Metals	122	1.1	1.6	1.6	1.4
ASR ²	206	1.9	2.7	2.6	2.3
Fluids	83	0.7	1.1	1.1	0.9
Scrap Tires	36	0.3	0.5	0.5	0.4
Total	1,437				

1 Data obtained from Staudinger and Keoleian, 2001

2 It ignores presence of moisture, dirt and metallic fines found in "real-world" ASR

3.3.3.2 Collection, Dismantling and Shredder Infrastructure

There is no precise number of dismantling facilities in the USA. Staudinger and Keoleian, 2001 state a number ranging from 6,000 to 7,000 dismantlers, of which 80% are scrap yards and 20%, are high-value parts dismantlers. Daniels in 2006, stated 15 thousand dismantlers operating within the USA.

The removal of specific parts and materials from ELV in the USA is driven by economic conditions, thus only marketable spare parts and materials are dismantled³⁶. Some operating fluids, i.e. refrigerant gases and batteries, are removed from ELV due to environmental based legal requirements. Other materials and parts, such as old tyres, have to be removed because there is a general rejection of ELV containing fuel tanks and old tyres, by the shredder companies.

³⁶ In case of explosive materials, i.e. fuels and fuel tanks, the removal is obligatory for safety reasons.

The most common parts and materials removed from ELV by dismantlers in the USA are as listed in the table 3.27.

Table 3.27 Components and Materials Typically Removed from ELV in the USA

Nr.	Component and/or material
1.	Electro-mechanical parts, such as clutches, water pumps, starters, etc
2.	Structural body parts, such as panels and wheels for reuse or reparation
3.	Aluminum and copper parts, to be recycled
4.	Fuel for use
5.	Operating fluids for recycling
6.	Batteries (lead-acid) for recycling
7.	Tires, for recycling or reuse
8.	Catalytic converters, for recovering precious metals
9.	Refrigerant gases, for reuse or elimination
10.	Air bags, for disposal
11.	Fuel tanks, made of metal for recycling and made of plastic for disposal

Source: Modified from Staudinger and Keoleian, 2001

It is noteworthy to compare the last table with table 3.15. This shows a comparison between the parts and materials dismantled in the USA and the EU³⁷.

In 2002, Recycling Today stated 200 shredder companies, 10 sink-float plants (recovering Al & Mg, sink metals and wires) and one metal sorter owned by *Huron Valley Steel Corporation*, operating within the USA (Gesing, 2004). This data is confirmed in works from Daniels, 2006 and Nakajima and Vanderburg, 2005.

3.3.3.3 Costs in ELV Management

The complex system that represents the ELV chain in the USA, the relationships between stakeholders, and the size of businesses involved, make it difficult to establish an accurate economic analysis and determine unitary costs for every process implicated. Moreover, the limited available data about this issue does not allow a more detailed description of the economic situation in the management of ELV in the USA. This section presents information about costs and revenues related to the management of ELV in the USA. The majority of the data is obtained from Staudinger and Keoleian, 2001.

The information is divided in the following parts,

³⁷ Seat belts, windscreens wiper water, oil filters, wires, laminated glass and others are not removed from ELV in the USA. These parts are sent to the shredder plants to be a part of the ASR.

a) Acquisition of ELV by dismantlers

This acquisition is the costs that represent to the dismantlers, the purchase of old vehicles from owners. These costs include the payment to the owner or the handler, the disposition, and the cost of the towing in case of the non-functional vehicles. The costs for this concept are displayed in table 3.28.

Table 3.28 ELV Procurement Costs

Concept		Costs (\$) ¹
Towing		30
Last owner	With out towing	20 - 50
	In dismantling yard	50 - 80

¹ The amount of money always depends on the conditions and vehicle type.
Source: Staudinger and Keoleian, 2001

b) Dismantling costs and revenues

In regard of dismantling processes, this sector in the USA consists of 80% of scrap yards and the rest of high-value parts dismantlers. The main differences between these kinds of businesses lie basically on the amount of operating costs per ELV.

The high-value parts dismantlers carry out some operations that make significant expenditures, e.g. high labor-intensive activities to get the undamaged auto-parts, use of National Database to put spare parts offers on, shipment of sold auto-parts to the customers, etc. Conversely, scrap yards rely on low capital and operating costs³⁸. The common feature between these two kinds of dismantlers is their source of incomes; which are the retail of removed auto parts and materials.

Due to the lack of detailed information about high-value parts dismantlers, it only gives an estimate of overall economics of scrap yards; which represent 80% of dismantlers in the USA as described by Staudinger and Keoleian in 2001.

Table 3.29 Scrap Yards' Overall Economics

Concept	(\$/wreck)
Total fixed and variable costs ¹	146
Total credits ²	216
Gross profit margin	70

¹ The acquisition costs of an ELV is assumed as \$30, and the stripped wreck sales value to the shredders is also \$30.

² Income assumed from recovery of catalytic converters, batteries, tyres and fluids is \$70

Source: Staudinger and Keoleian, 2001

³⁸ There are operations called, "Do-it-yourselfers", where the customer dismantles the required part on his own, in order to minimize expenses.

As explanation of some costs and credits shown in table 3.29, the determination of wrecks value to shredders, and the costs for transportation from dismantlers to shredders facilities are shown in table 3.30.

Table 3.30 Wrecks' Value and Transportation Costs for Dismantlers

Concept	Amount	Unit
Weight of ELV (average) ¹	3,167	lb
Removed parts for sale (10%)	317	lb
Weight of wreck	2,850	lb
Price per wreck	0.03	\$/lb
Value	86	\$/wreck
Transportation		
Price	0.15	\$/ton-mile
Average distance to shredder	100	miles
Weight of wreck	1.3	tons
Cost	19.4	\$/wreck

¹ Weight from a "generic equivalent vehicle" used by: Staudinger and Keoleian, 2001

c) Shredder costs and revenues

In case of shredding businesses, the basic costs consists of wreck's purchase, processing, transportation of recovered metals to metal processors, and the transportation of ASR to disposal. The basic incomes of these businesses come from the sales of recovered materials (ferrous and non-ferrous).

Table 3.31 presents an estimate of overall economics of this sector, as a result of simple payback achieved in 17.5 years compiled by Staudinger J. & Keoleian G. in 2001.

Table 3.31 Estimate of Overall Economics Shredder Sector

Concept	(\$/wreck)
Total Fixed and variable costs	117
Total credits	125.6
Gross profit margin	8.6

Source: Staudinger and Keoleian, 2001

The cost of transportation of recovered materials (ferrous and non-ferrous) is described in detail in table 3.32

Table 3.32 Cost of Transportation from Shredder to Metal Processors

Concept	Amount	Unit
Weight of ELV (average)	3.167	lb
Metal content (75% / ELV)	1.08	ton
Price	0.12	\$/ton-mile
Average distance to metal processing facility	200	mile
Cost	26	\$/wreck

Source: Staudinger and Keoleian, 2001

Retail revenues from the recovered material are estimated as follows,

Table 3.33 Sale Revenues Estimated from Sold Recovered Material (Ferrous and Non-Ferrous)

Metal	Kg/ELV ²	\$/ton ¹	\$/ELV
Ferrous metals	989	85	84.1
Non-ferrous metals	lb/ELV ²	\$/lb ¹	\$/ELV
Aluminium	148	0.71	105.1
Stainless steel	32	0.27	8.6
Copper	32	1.02	32.6
Brass	15	0.52	7.8
Zinc castings	19	0.5	9.7
Total			248

¹ Updated with prices of 2004

² The content is the estimated average composition for models of 1985 and 1990 used by Staudinger and Keoleian, 2001

The costs related to the final disposal of ASR in landfills depend on the state in which the ASR is generated and disposed, as there is no unique disposal fee across the USA. Final disposal fees lie in the range of 25 to 75 \$/ton, according to the data published by Daniels, 2006; Bandivadekar et al., 2004; Kanari et al, 2003. For the sake of this work, an average of 50 \$/ton is considered, thus the cost for final disposal of ASR generated by each ELV (206 Kg), is considered as \$10.3 per ELV.

The last cost to take into account for this sector is the transportation of ASR from metal processor facilities to the landfills. Applying the same translated cost as in table 3.32, the cost for this concept is broken down as follows,

Table 3.34 Costs of ASR Transportation to Landfills

Concept	Amount	Unit
ASR ¹	206	kg
Price	0.12	\$/ton-mile
Average distance to metal processing facility ²	100	mile
Cost	2.5	\$/wreck

¹ The content is the estimated average composition for models of 1985 and 1990 used by Staudinger and Keoleian, 2001

² Considering the location of shredders, metal processors and landfills (typically at fringes of the cities)

The unitary cost calculation for ELV is difficult to establish for selected countries. The main reason for this is the absence of cost-benefit analysis at every stage in the chain. The costs presented in the sections 3.2 and 3.3 should be taken as reference lines of two different systems. The comparison of shown data is not possible as the local conditions, specific capital invested, labor costs, costs of disposal, price of the scrapped car and other supplies, values of the recycled material fractions, are different.

3.3.3.4 Difficulties in ELV Management

The main three barriers to overcome by the ELV management system in the USA are:

- a) *recycling of scrap tyres*: By 2005, a total number of 299 million scrap tyres were generated in the USA, 52% were used as fuel (energy recovery), 46% recycled, remanufactured or re-use, and 14.4% were disposed in landfills (RMA, 2006),
- b) *content of hazardous material in vehicles (such as mercury and lead)*: This is one of the most urgent issues to overcome by the system, because the amount of mercury contained in the current float of vehicles including new vehicles is higher than 246 tons (Ecology Center, 2004). Several programs to remove and replace mercury switches are currently being carried out by the US Environmental Protection Agency (EPA), along with other Non-Governmental Organizations (EPA, 2006),
- c) *disposal of ASR*: This is a challenge for the US ELV management system. Daniels, 2006 reports an annual amount of five million tons of ASR disposed in landfills within the USA.

According to the data given by Daniels in 2006, more than 95% of all vehicles retired from circulation enter into the recycling infrastructure of the USA. The current recycling rate for these vehicles is 75%, with a virtual recycling rate of 100% of the steel and iron content and a high recycling rate for non-ferrous metals (Daniels, 2006).

The current system of ELV management in the USA works with relative efficiency. However, there are still other items to improve, along with those mentioned above such as, poor practices by a big number of dismantling facilities (scrap yards), use of hazardous materials in auto-manufacture, disposal of ASR as non-hazardous waste, etc. The improvement in the management of ELV will definitely impact the competitiveness of the recycling industry in the USA, and as a consequence, the USAI.

One reason for this impact is because automotive manufacturing industry is one of the largest consumers of materials in the USA³⁹, thus an ensured source of recycled materials (steel, non-ferrous metals and plastics from ELV) will affect their market prices and also of other materials. Moreover, the amount of saved energy for using second raw materials plays a relevant role in the improvement of ELV management in the USA (Daniels, 2006).

³⁹ Automotive industry's consumption of steel accounts for 20% of all domestic steel use, one third of the total domestic use of aluminum. The primary energy consumed for the production of materials used by USAI is in the order of 1.5 quadrillion BTU, roughly 20% of the domestic industrial energy use (Daniels, 2006)

3.4 Summary of the Chapter

In order to summarize the information presented in this chapter, the table 3.35 shows the main data about the state-of-the-art of ELV management in the industrialized countries chosen for this chapter.

Table 3.35 Main Data about ELV Management in the EU, Germany and the USA

Concept	Unit	The EU	Germany	The USA
<i>Economy</i>				
Population	Inhabitant	493 x 10 ⁶	82.4 x 10 ⁶	301 x 10 ⁶
Surface	km ²	4.3 x 10 ⁶	349,223	9.8 x 10 ⁶
GDP	USD x 10 ¹²	13.4 ^a	2.63	13.3
GNI per capita	USD/inh.-year	29,900	31,900	44,000
<i>Automotive Industry</i>				
GDP contribution	%	3	20	3.3
Direct employment	job x 10 ⁶	2	0.77	2.4
Indirect employment	job x 10 ⁶	12	5.3	2.3
Global production share	%	29	21	19
Total production	Vehicle x 10 ⁶	16.5	13.8 ^c	11.2
PC production	Vehicle x 10 ⁶	14.2	10.1 ^c	10.8
Total retail	Vehicle x 10 ⁶	18	4	--
PC retail	Vehicle x 10 ⁶	14.3 ^a	3.3	16.5
PC fleet	Vehicle x 10 ⁶	214.9 ^b	46.1	226
Motorization	PC/1000 inh	--	573	535
<i>Main legislation driving ELV management</i>				
		2000/53/EC	Altfahrzeug-Verordnung	--
<i>ELV Industry</i>				
De-registration	Vehicle x 10 ⁶	11.4 ^b	3.1	11.3
Treated	Vehicle x 10 ⁶	7.7	1.2	10.6
Collection facilities	Facility	25,300 ^b	15,000	6,000 – 7,000 ^d
Dismantling facilities	Facility	5,150 ^b	1,178	6,000 – 7,000 ^d
Shredder plants	Plant	182 ^b	41	200
ASR	ton/year x 10 ⁶	2	0.3	5
ASR landfill cost	USD/ton	20 -170	60 - 170	50 - 60

a Corresponding the EU-25

b Corresponding the EU-15

c Domestic and foreign production

d A collection facility could carry out dismantling operations

Moreover, it is possible to state that the product-oriented legislation addressing the ELV management in industrialized countries has worked as a catalyst worldwide, especially in countries with intensive automotive industry as the EU. The influence of this legislation has gone beyond the EU borders, as other countries have already addressed the ELV management as a prime issue. This impact is mainly due to the competitiveness in the automotive markets that has influenced other industrialized countries without similar legislation like the USA and Australia.

The implementation of product-oriented legislation in the EU has been more complicated than expected. This legislation has been mainly criticized because of the absence of cost-benefit analysis before the introduction of ELV regulation. Nevertheless, the automotive industry in the EU has already achieved an average recycling rate of more than 80%, thus the industry is going well towards achieving the ELV targets for 2015.

Countries with no product-oriented legislation for ELV management like the USA have already started addressing the issue through voluntary agreements. The agreements include industrial and governmental participation in different projects issuing the ELV management. However, there are no fixed obligations for recycling rates. This situation is mainly due to three existing conditions in the USA: First, the US vehicular production is almost entirely consumed by the national market, thus there is no necessity to comply with the European legislation. Second, the final disposal capacity by landfills is much higher in the USA than that in Europe. Third, the prices for final disposal in landfills are lower in the USA than those in Europe.

The main difficulties in ELV management are very similar in all industrialized countries. These difficulties are related with the management of ASR, recycling of plastics, exports of ELV, and hazardous materials' content in vehicles.

4. State-of-the-art of ELV Management in Mexico

This chapter is attempted to describe the current situation of ELV management in Mexico. The description includes the situation of its automotive industry, the main features of Mexican vehicular fleet, vehicular market for passenger vehicles and light trucks, and the outline of environmental, social, and economic problems caused by ELV in Mexico. Moreover, the main stakeholders and their roles along the chain are identified. In the last part of this chapter, the current management of ELV in Mexico, and estimation of the current number of ELV generated in Mexico, is described.

In the absence of specialized information sources about the ELV management in Mexico, the gathered information in this work is a result of an exhaustive research and collection of data from many sources, i.e. public, private, phone and personal communications.

Mexico is a country situated in the northern part of the American Continent, it has a surface area of 1,964,375 Km² with 97.5 millions inhabitants by 2000 (INEGI, 2000). As Mexico shares its largest border (3,152 km) with the United States of America (USA), there is a strong historical link between these countries. Recently, with the implementation of the North American Free Trade Agreement (NAFTA) in 1994, Mexico accessed to one of the world's largest market along with trading partners Canada and the USA.

Currently, Mexico is the second major trading partner of the USA with a trade of 266,000 million USD in 2004 (Bancomext, 2006). The Mexican economy ranked 10th in the world and 13th in the list of main exporters and importers by the World Trade Organization in 2005.

4.1 Automotive Industry in Mexico

One of the pillars of the Mexico's economy is the manufacturing sector. This industry represented 81% of the total exports in 2005 (Bancomext, 2006). As a part of this sector, the Mexican automotive industry also plays an important role in the Mexican economy. In 2005, it contributed 14.3% of the total Gross Domestic product (GDP) from manufacturing sector and 2.6% of the total Mexican GDP, along with the generation of 480,000 direct employees (INEGI, 2006; Colín, 2006).

The Mexican automotive industry is integrated by two main branches. The first, the terminal automotive industry, which represents 57% of the GDP of the industry, and is composed of 13 plants (100% foreign companies) distributed in six Mexican states. The second, the auto-components industry with 898 plants (70% foreign and 30% national companies), which contributes to the rest 43% of the GDP produced by this industry (Melgar, 2005; SEDESU, 2004).

In 2005, a total of 64.9 million motor vehicles were manufactured worldwide, 3% more than the year before (63 million vehicles). From these figures, NAFTA countries (the USA, Canada and Mexico) contributed 16.4 million units, sharing the 25.2% of the global production. The Mexican production represented 10.3% of the NAFTA's production or 2.6% of the worldwide motor vehicles production.

Table 4.1 NAFTA's Share of Vehicle Production by Country

Year	Total	NAFTA		
		The USA	Canada	Mexico
		%	%	%
2001	15800000	72.3	16.0	11.7
2002	16703400	73.5	15.7	10,8
2003	16200000	74.5	15.7	9.7
2004	16200000	73.8	16.5	9.7
2005	16354800	73.2	16.5	10.3
2006	15881796	70.9	16.2	12.9

Source: VDA, 2007; Ward's, 2006

The decline of the Mexican motor vehicle production, for 2003 and 2004, was due to certain manufacturers who had transferred their operations elsewhere within NAFTA. However, as it was estimated by VDA in 2003, the Mexican capacity was boosted by the establishment of new plants, and the results are shown with a bigger share in NAFTA's vehicular production. It is noteworthy to mention that in recent years, important investments have been done in the Mexican automotive industry, e.g. FORD (1,200 million USD during 2004 and 2005), Economic Association Agreement (EAA) between Mexico and Japan⁴⁰.

The main companies integrating the terminal automotive industry, producing passenger cars, light vehicles and heavy trucks, placed in Mexico, are described in the table 4.2. These companies represent 57% of participation in this sector, the rest 43% corresponds to the auto parts industry with more than thousand supplier companies (SEDESU, 2004).

⁴⁰ This agreement was signed in September 2004 and came into force on 1st April 2005. The EAA will eliminate 91% of Japan's tariffs on Mexican goods and 44% of Mexico's tariffs on Japanese goods; other tariffs will be reduced gradually over the next 10 years. Among other sectors, the automotive one is one of the most regarded. Within this agreement is logical to expect a big amount of direct investment by Japan, especially in the automotive sector, because it is well known that, Japanese companies use Mexico as a platform to export their vehicles to USA. With all stated above, the Mexican Secretary of Economy and the Mexican Automotive Manufacturers Association agree with the governmental objective, to produce 4 million vehicles by 2010, is possible to achieve (Expansion, 2004).

Table 4.2 Main Automotive Producers (Terminal Automotive Industry) in Mexico

Passenger cars and Light trucks	Heavy Trucks
BMW	Daimler Chrysler Commercial Vehicles
Daimler-Chrysler	General Motors
Ford Motor Co.	International
General Motors	Kenworth
Honda	MAN
Mercedes Benz	MCI
Nissan	Scania
Renault	Volkswagen
Volkswagen	Volvo Bus
	*Others

* Others represented in 2005, 0.15% of the total production, as Mercedes Benz.

Source: ANPACT, 2006; INEGI-2004

The automotive producers are associated in four main organizations, the Mexican Association of Automotive Industry (AMIA), the Mexican Association of Distributors of Motor Vehicles (AMDA), the Mexican Institute of Auto Parts (INA) and the National Association of Producers of Heavy Vehicles (ANPACT).

4.2 The Problems Caused by ELV in Mexico

This section addresses the description of impacts caused by ELV in Mexico. As the economic situation and industrialization level is different in Mexico than that in other countries, e.g. the European Union, Germany and the USA, the problems caused by ELV seem to be different. Social, economic and political aspects, among others, affect the management of this kind of product at its last life stage, and cause impacts on different sectors, as well as on the environment.

4.2.1 Economic Problems

The main economic problem associated with the ELV issue in Mexico is caused by vehicles illegally introduced from the USA to Mexico. These vehicles are in most of the cases considered as ELV in the USA⁴¹. The factors common between these vehicles are an average age of 10.7 years, and/or that they have been repaired after being involved in accidents. Therefore, the performance of these vehicles is poor needing repairs more often and causes a lot of costs to the owners (CESOP, 2004; Melgar, 2005; AMDA, 2005; Contralínea, 2005).

⁴¹ The average age of passenger cars in the USA is 8.9 years, and for trucks is 6.6 years (DOE, 2006). Thereby, old vehicles introduced from the USA to Mexico, in a certain year, are closer to become ELV than new vehicles, introduced in the same year for circulation.

According to the information published by CESOP in 2004, AMDA in 2005 and the study carried out by *Melgar de México* in 2005, every year around 200,000 to 300,000 vehicles are illegally introduced into Mexico. Currently, the Mexican vehicular fleet has 2.3 million vehicles introduced from the USA, and 1.8 million vehicles are still waiting for legalization, which sum to around 4.1 million vehicles illegally introduced from the USA to Mexico (AMDA, 2005)⁴².

A study carried out by the STAT-USA Market Research Reports, published that during 2001 and 2002, over four million automobiles were illegally imported into Mexico (De Keratry, 2004).

Owing to the nature of this kind of illegal activities in the last years, there are no precise figures about the introduction of old vehicles to Mexico. There are some sources with estimations that differ from each other. In table 4.3 an estimation of the number of vehicles introduced from the USA to Mexico is presented by *Melgar de Mexico* in 2005¹.

Table 4.3 Vehicles Illegally Introduced to Mexico from the USA during 1999-2004*

Year	1999	2000	2001	2002	2003	2004	Total
Vehicles/Year	269,567	319,744	272,236	289,732	223,293	218,975	1,593,546
<i>1. Passenger cars</i>	<i>110,884</i>	<i>129,487</i>	<i>109,223</i>	<i>114,967</i>	<i>84,955</i>	<i>76,413</i>	<i>625,930</i>
1.1 Subcompacts	20,927	21,289	18,806	20,268	14,941	11,326	107,558
1.2 Compacts	62,914	73,959	59,956	63,023	46,497	44,115	350,464
1.3 Sports	17,191	21,552	17,427	18,267	13,312	11,841	99,591
1.4 Luxury	9,851	12,688	13,033	13,410	10,205	9,131	68,318
<i>2. Light Trucks</i>	<i>151,201</i>	<i>183,300</i>	<i>151,645</i>	<i>162,852</i>	<i>128,451</i>	<i>134,579</i>	<i>912,028</i>
2.1 SUVs	12,847	22,746	19,234	20,281	16,100	19,195	110,402
2.2 Light Truck class 1	48,732	61,937	58,521	63,295	50,598	52,464	335,547
2.3 Light Truck class 2	51,010	59,746	50,384	54,167	42,204	43,208	300,718
2.5 Light Truck class 3	38,612	38,872	23,506	25,109	19,549	19,713	165,360
2.6 Light Truck class 4	0	0	0	0	0	0	0
2.7 Light Truck class 5	0	0	0	0	0	0	0
<i>3. Trucks</i>	<i>3,868</i>	<i>3,633</i>	<i>8,330</i>	<i>8,508</i>	<i>6,614</i>	<i>4,967</i>	<i>35,920</i>
3.1 Truck class 6	428	284	273	306	308	337	1934
3.2 Truck class 7	2,706	2,537	7,387	7,450	5,583	3,815	29,478
3.3 Truck class 8	734	812	671	752	723	815	4507
<i>4. Freight Truck class 8 (5th wheel)</i>	<i>3,538</i>	<i>3,263</i>	<i>2,925</i>	<i>3,279</i>	<i>3,151</i>	<i>2,778</i>	<i>18,935</i>
<i>5. Passenger Bus</i>	<i>76</i>	<i>60</i>	<i>113</i>	<i>126</i>	<i>121</i>	<i>237</i>	<i>734</i>

* The Information in the table has an uncertainty of +/- 8.97%

Source: *Melgar*, 2005¹

⁴² In August 2005, a Decree was enacted to legalize illegal vehicles introduced to Mexico from the USA, as the rate of introduction of vehicles from USA was estimated as 100 thousand vehicles per month (AMDA, 2006)

The same study carried out by Melgar de México in 2005 foresees an increment of 5.43% by 2006 compared with the period 1972 to 2005.

All sectors in the Mexican automotive industry, i.e. spare parts, assembling, distributors and second hand vehicle's distributors, are affected by the illegal introduction of vehicles from the USA. Furthermore, the Mexican government is defrauded due to the evasion of import taxes, registration fees and ticket fines. In 2004, the Mexican Economy Secretariat reported 3,740 Mio USD less after perceiving taxes, and was one of the main reasons for the illegal introduction of vehicles from the USA (AMDA, 2005). The main causes for the economical impact can be resumed as follows,

- a) the non-existent taxes paid by the owners of this kind of units,
- b) the illegal units substitute the retail of national new and used vehicles,
- c) their manufacture did not produce employment in Mexico,
- d) the inability to reach NAFTA's targets by the Mexican automotive industry

Other economical burdens are produced by the environmental damage caused by the ELV in Mexico. This is due to the improper management of these vehicles, as well as the abandoned vehicles along the country, which produces air pollution, oil leaks, and delivery of hazardous wastes to the environment. There is no specific available information about this economical burden caused by ELV in Mexico.

4.2.2 Social and Political Problems

According to a study carried out by CESOP in 2004, the market of second hand vehicles in Mexico is very important, due to the number of vehicles daily traded and due to the lack of enough economical resources to purchase new vehicles by the Mexican consumer.

The low purchase power in regard to purchase of a new vehicle is mainly caused by the low level of the Mexican wages⁴³. In 2002, an average Mexican worker earned 18% of the purchasing power (material quality of life) enjoyed by their equivalent counterpart in the USA (TSJGA, 2004). This fact indicates that, there is an important number of persons needing vehicles for mobility or working, but the scarcity of economical resources makes the purchase of new vehicles impossible. Therefore, they purchase second hand vehicles (illegal or legal), which results in a consequent ageing of the Mexican vehicular fleet⁴⁴.

⁴³ The wages in the manufacturing sector, that represents 89% of total Mexican exports, represented 11.6% of the US wages in the same sector in 2001 (Dussel, 2004)

⁴⁴ AMDA reported in 2004 an average age of 14 years for passenger cars, and 17 years for freight vehicles.

Old vehicles illegally imported from the USA also generate a socio-political problem. The reason is that currently, there are more than 1.8 million vehicles of this kind in process to be legalized by the Mexican government (AMDA, 2005). The desire to legalize these vehicles has created several groups and organizations. This fact polarizes the society, between owners who buy legal vehicles in the national market (paying at least around \$6,000 USD for a new compact vehicle), and the owners which buy vehicles illegally introduced to Mexico, which can cost around \$1,300 to \$1,800 USD, according to studies carried out by AMDA in 2004.

The social polarization is shown by different rallies organized in many states, in which the owners require the legalization of their vehicles arguing that, those vehicles represent an important investment for them. However on the other hand, there are people requiring the same rights and obligations for all, i.e. payment of taxes, and trade organizations, who argue about the protection of national automotive industry.

Along with the socio-political problem caused by ELV in Mexico, mentioned before, the public security is added to this issue. According to the statistics of the Mexican Secretariat of Public Security, 60% of the crimes in which a car was used; the cars were illegal. This obeys the fact that, criminals take advantage of the lack of registration numbers of these vehicles, thus they cannot be prosecuted (CESOP, 2004).

4.2.3 Environmental Problems

The automotive vehicles produce several impacts on the environment during their whole life cycle. This takes place during processes of material production, assembling, operation, maintenance, and the End-of-Life stage. The assessment of these impacts has become a major issue for different stakeholders, such as the automotive industry and the government. For this reason the car-manufacturers have been carrying out projects to improve the environmental performance of their vehicles. At the beginning of 90's, councils and associations were founded worldwide aiming to the improvement of automobiles performance, and to increase their competitiveness. The EUCAR (European Council for Automotive R & D), USCAR (United States Council for Automotive Research) and JAMA (Japan Automobile Manufacturers Association) are some of the most important groups.

The assessment mostly accepted is the Life Cycle Assessment (LCA) approach, according to ISO 14040. The development of a LCA addressing the passenger vehicles in Mexico is beyond the scope of this work, and a similar study is not yet available. Therefore, the environmental impact of vehicles in Mexico will be only described and compared with the studies recently published.

Schmidt et al., 2004; Castro et al., 2003 and Batterman et al., 2001 have already carried out assessments for the environmental impacts caused by vehicles during their whole life cycle, i.e. production, use and end-of-life stages. Regarding to the production stage, the international nature of the automotive industry and the global standardization of industrial processes make the environmental impacts due to the automotive industry in Mexico very similar to those caused by the automotive industry in industrialized countries. Thereby, it is possible to assume similar impacts of Mexican vehicles in their production stage.

In regard to the use stage of passenger vehicles, owing to the particular features of the Mexican vehicular fleet, i.e. the average age of 14 years and older and others, the impact caused by this stage is expected to be higher than that in the case studies performed by Schmidt et al., 2004; Castro et al., 2003 and Batterman et al., 2001.

The mentioned researches stated that impacts caused by vehicles at their End-of-Life (EoL) stage, represented less than 10% of the whole environmental burden produced by these vehicles in industrialized countries⁴⁵. They stated also that the largest impact occurs during the operation phase (around 90%) of the passenger vehicles (Schmidt et al., 2004; Castro et al., 2003).

However, the Mexican case study presents different features than the researches performed in industrialized countries, i.e. the Netherlands, Germany or the USA⁴⁶, as these researches take into consideration an EoL management system for ELV⁴⁷. The differences between conditions prevailing in developing countries, as Mexico, and industrialized countries lie mainly in the following,

- a) there is no collection system for ELV in Mexico,
- b) non-standardized operations in dismantling and shredding activities,
- c) there is no specific plan to manage ELV,
- d) only profitable materials from ELV are recovered and recycled,
- e) the disposal of ASR is not always in landfills, but rather on dumping sites.

The conditions mentioned above produce several problems, which impact the environment in Mexico. The main problems are the following,

- a) *Dumped vehicles*: These vehicles release operating fluids and gases, which disturb water flows or aquifers by leaching, air by air-conditioning gases released to the atmosphere, and also loss of resources,

⁴⁵ Castro et al., 2003 reports that due to processes carried out in EoL stage, there is a compensation (30%) for burden caused in the production stage of vehicles.

⁴⁶ A management system for ELV covers the collection, de-pollution, dismantling, shredding, post-shredding processes.

⁴⁷ In the study carried out by Schmidt et al., 2004, a management system for ELV is taken into account. Moreover this system is thought to work with the provisions of Directive 2000/53/EC

- b) *Poor practices by ELV stakeholders:* There is no standardized dismantling and shredding operations. The operating fluids are delivered to the sewage systems or to the environment. There is also a loss of resources as many materials do not enter the recycling streams,
- c) *Landfill contamination:* Due to the poor dismantling practices, the disposed material is contaminated by fluids, heavy metals, PCBs, PVC, etc. The impact of landfills rise, and the recycling processes become more complicated and expensive,
- d) *Waste volume:* High volume of waste from ELV are sent to landfills or to dumping sites

Taking into account the last features for the Mexican case study and the impact categories of Eco-indicator 99 approach⁴⁸, as it was used by Castro et al., 2003, the environmental impact of vehicles, at the EoL stage in Mexico, apparently seems to be higher than in the mentioned studies⁴⁹. However a specific study must be performed to establish quantitative results about the environmental impact of EoL stage of passenger vehicles in Mexico.

4.3 Legal and Institutional Aspects

In Mexico, there is no specific legislation to regulate the management of ELV. This kind of product at its EoL stage and the wastes generated by its treatment has been ruled by the general laws before 2004, and more recently by a semi-specific law addressed to solid wastes.

The first law, which regulated the management of ELV, was the Ley General del Equilibrio Ecológico y la Protección al Ambiente (LGEEPA) the Federal General Law of Ecological Equilibrium and the Protection of the Environment. This law establishes framework and authority for the entire environmental regulation in Mexico. The LGEEPA is a very important document for the understanding of environmental regulatory system in Mexico, and its relationship with different norms and standards, e.g. the Normas Oficiales Mexicanas (NOM) the Mexican Official Norms.

In regard to solid waste management, the LGEEPA established in the Articles 7, 8 & 11, the responsibility of every federal entity and localities to set management systems for solid wastes, with an exception of hazardous wastes⁵⁰. ELV are also included in the wastes described in Arts.7, 8 & 11.

⁴⁸ See Gödkoop and Spriensma, 2001

⁴⁹ Schmidt et al., 2004; Castro et al., 2003 and Batterman et al., 2001 stated a total burden for EoL stage of vehicles less than 10%.

⁵⁰ The responsibility of hazardous wastes is reserved in the 5th Article to federal competence

The LGEEPA considers ELV generated in Mexico as products at their last life cycle stage. These vehicles are classified as special waste being composed of many materials and components, which in case of improper treatment become hazardous waste. Therefore, the ELV treatment had to be ruled under NOMs regarding to non-hazardous and hazardous waste emitted by LGEEPA.

Nowadays, there is no specific NOM addressing the management of ELV, but rather a group of NOMs ruling the management of many solid waste streams, in which wastes from ELV are included. The related NOMs are listed as follows,

- a) *NOM-052-ECOL-1993*: Establishes the characteristics of hazardous wastes, the list of them, and the limits of toxicity to the environment, to consider a waste as hazardous.
- b) *NOM-053-ECOL-1993*: Establishes the procedure for carrying out the extraction test for determining the chemical compounds that make a waste hazardous by its toxicity to the environment.
- c) *NOM-054-ECOL-1993*: Establishes the procedure for determining the incompatibility between two or more wastes considered hazardous by the Official Mexican Standard *NOM-052-ECOL-1993*
- d) *NOM-055 to 058-ECOL-1993*: Establishes the requirements (design, construction, operation and closure) to be met for the sites designated for the controlled confinement of hazardous wastes, except for radioactive wastes.
- e) *NOM-056-SEMARNAT-1993*: Establishes the requirements for the design and construction of the complementary works of a controlled confinement for hazardous wastes.
- f) *NOM-057-SEMARNAT-1993*: Establishes the requirements that must be observed in the design, construction, and operation of controlled confinement cells for hazardous wastes.
- g) *NOM-058-SEMARNAT-1993*: Establishes the requirements for the operation of a controlled confinement of hazardous wastes.
- h) *NOM-083-SEMARNAT-2003*: Establishes the conditions which the sites designated for the final disposition of municipal solid wastes must comply with.
- i) *NOM-087-ECOL-SSA1-2002*: Environmental Protection – Environmental Health – Biological –infectious hazardous wastes – Classification and handling specifications.
- j) *NOM-133-ECOL-2000*: Environmental protection - polychlorinated biphenyls (PCBs) – handling specifications.

In this way, the legal status of substances and components contained in ELV, i.e. used oils, operative fluids, air bags, batteries, etc. are legislated under this frame. Due to the lack of direct legislation addressed to ELV, the rest of the material contained in these vehicles which is able to be re-used or recycled is regulated under market conditions.

In recent years, the growing problem of solid waste in Mexico and especially with the resulting waste of industrial processes demanded a legislation process on wastes in a single law, which establishes a better management. For this reason, in October 8, 2003 a new Law, the Ley General para Prevención y Gestión Integral de los Residuos (LGPGIR), the General Law for the Prevention and Integral Management of Wastes was published in the Diario Oficial de la Federación (DOF), the Official Journal of the Federation (DOF, 2003). This Law came into force on January 6, 2004.

The new law addresses to grant an environment for sustainable development, through reduced generation, valorization and integral management of hazardous, municipal and especial wastes. Moreover, this law required a new registry for tracking hazardous materials and wastes. The new law foresees new regulations for different waste streams, and several changes in the existing regulations, standards and NOMs.

ELV are classified by the LGPGIR under Art. 5 & 19, as "*Especial Waste*". This kind of waste is defined under technological wastes from informatics, electronics or automotive industry among others, which at the final of their life cycle, due to their characteristics require specific management.

In the same Art.5, the law establishes that there is a shared responsibility regarding the wastes, which are generated by activities of social necessities. Therefore, the integral management of waste must be a result of a coordinated and differentiated participation of producers, distributors, consumers and authorities, under market feasibility and environmental efficiency. The conception of shared responsibility of this law is an important step towards the efficient management of wastes, and also to establish a base to create a better waste management infrastructure e.g. legal employees, investments, etc, giving advantages to the Mexican economy.

In Art.7, the LGPGIR establishes the competence of federal government to formulate NOMs setting the management systems for wastes. In the case of ELV, the Chapter II-Art.28-Paragraph III requires the producers, importers, exporters and distributors to establish plans to manage their products, vehicles after their useful life in this case. The responsibility of supervising and controlling the accomplishment of the law is reserved with the governments and localities, in the Art.96.

Since the relative recent enact of the LGPGIR, there is no information about the implementation of this law yet published, and more specifically about ELV waste stream.

At present, there are no specific norms or plans to manage this kind of vehicles. The profitable material from ELV is managed under markets conditions, and the existing system is propelled by the profitability of each business involved.

Another legislation closely related to ELV management, is the Law of Public Vehicular Registry, approved in 2004 by the Mexican Senate. The main aims of this law is the creation of a register to identify and control the inscriptions, retirements, registration numbers, infractions, robberies, recuperations and destruction of vehicles, and also to inform the general public. The included vehicles are those which are manufactured, assembled, imported or are being used in the national territory. This Law came into force on 2nd September 2004 (DOF, 2004). Before this Law, there was no official list with the features of Mexican vehicular fleet. Therefore, there is a lack of reliable data about the number of vehicles, their age, number of ELV and illegal vehicles imported from the USA, etc.

Regarding to the vehicles illegally introduced to Mexico from the USA, the Supreme Court of Mexico declared in June-2005 that, any person owning a vehicle introduced to Mexico and who does not have the required permission for it, would be declared criminal for contraband. This important measure was attempted to stop the illegal introduction of old vehicles from the USA, and encouraging the owners of illegal units to purchase new legal ones, using special financing programs offered by the industry. However, in August of 2005 a decree was enacted to legalize old vehicles introduced from the USA and Canada, and is still in force (DOF, 2005).

4.4. Main Actors in the ELV Management

The following section describes the main stakeholders involved in the management of ELV in Mexico. The description covers available information about the activities performed by every stakeholder along the ELV chain and the importance of their participation. As there is no established management system for ELV in Mexico, some stakeholders are not well defined as stakeholders, and therefore specific information is scarce.

4.4.1 Car-manufacturers and Suppliers

The role played by these stakeholders is very similar to the role played in the industrialized countries mentioned before i.e. Germany, the EU and the USA. The design and composition of vehicles directly affects their future EoL stage. Owing to its economic importance, the Mexican automotive industry is highly motivated to participate in the decision making process, in case of looming plans or projects related to ELV management take place in Mexico.

Currently, the concern about the ELV management in Mexico is not yet strongly taken into account by the car-manufacturers. Their concerns in this issue are towards the accomplishment with environmental requirements, e.g. reduction of vehicle emissions, ELV management, content of hazardous waste, etc, required by the international markets. It is not clear, if vehicles being sold in the Mexican market accomplish the same environmental features as that of their exported counterpart⁵¹.

There is no group of car-manufacturers aiming the ELV management as an important subject. This statement is also mentioned by the coordinator of Automotive Industry affairs in *PricewaterhouseCoopers-Mexico*, who declared that “*the Mexican fleet has a big amount of obsolete, unsafe and polluting vehicles. This is a reason because a recycling system is urgently required, due to the current system is so incipient*” (PwC, 2003).

4.4.2 Government

In recent decades, the Mexican government has been addressing environmental impact of vehicles in their use stage. The main target of this intervention was the reduction of air-pollutants from automotive vehicles, especially in the main cities i.e. Mexico City, Monterrey and Guadalajara, with the enactment and implementation of the NOM-041-ECOL-1996, which established the maximum permissible limits on vehicles emissions. The requirements stated by this NOM indirectly established a base to declare old vehicles obsolete, and thus forced their retirement from vehicular circulation.

⁵¹According to personal communications with environmental head officers of different European car-manufacture companies, the environmental features of vehicles being sold in Mexican market seem to be similar to their counterpart in Europe. Efforts for communication with personal from Mexican car-manufacture companies were unsuccessful.

Since old automotive vehicles were identified as high producers of air-pollutants, the government established several programs to renew the vehicular fleet in the main cities. The programs offer to owners of old vehicles for public transportation (taxis and micro-buses), financial support to replace their vehicles older than 10 years by a new one. The governments of different Mexican states with problems of air pollution, such as Guadalajara, Mexico State, and Monterrey have similar programs to replace the old fleets of public transportations vehicles.

Other programs performed by the government in agreement with the freight associations, e.g. the Cámara Nacional del Autotransporte de Carga (CANACAR), the National Association of Freight Transportation have as target the total renewal of Mexican freight transport in a period of 10 years, with an investment around 600 million USD. This program has started in 2005 and its main aim is to enhance the competitiveness of the Mexican freight fleet in the frame of NAFTA. As the average age of Mexican freight fleet is around 17 years, while for the American and Canadian fleets the average age is around of three and four years (CANACAR, 2005). The government support consists of fiscal incentives for owners of old trucks to replace their units with new ones.

Another participation of the Mexican government is the retirement of thousands of vehicles. This is performed through the sale of confiscated vehicles parked on fiscal yards; which are sold to the shredder companies to be scrapped. This activity is periodically carried out by fiscal authorities.

The participation of the Mexican government in the management of ELV in Mexico is decisive. The creation of oriented legislation addressing the ELV issue and the supervision of law's fulfillment by stakeholders, are the main ways to grant a proper management of ELV in the country.

4.4.3 Scrap Yards and Dismantlers

As in Mexico there is not yet a specific legislation addressing the management of ELV, the different activities for their management are carried out by many kind of businesses. These businesses aim the obtainment as much profitability as possible from ELV. In case of dismantling, there are three main kinds of businesses performing these activities,

- a) *small automotive repair/body shops*: According to the Economical Census carried out in 2000 by the National Institute of Statistics, Geography and Information (INEGI), there are around 149,000 businesses related to the maintenance and repair of cars and trucks, of which 28,100 businesses are body shops that in average have 2.3 employees. The main activity of these shops is to repair body vehicles, or replace the damaged parts for new or used ones. The parts can be obtained from their own stock of parts, buying the parts to scrap yards within Mexico or in the USA,

- b) *scrap yards*: Small businesses that essentially store ELV while its parts are gradually sold to the individual owners or to body repair shops. Due to these businesses are small, they work with low technology and volume, and are located on the fringes of towns and cities. According to INEGI in 2000, 5,000 businesses dedicated to these activities were counted with an average of 2 employees,
- c) *high value part dismantlers*: Small group of indeterminate number of businesses that are dedicated to the purchase of ELV of recent vehicle models from insurance companies or from individual owners. Their main target is to remove, repair or remanufacture high-value spare parts, and put them into a nationwide computer database to re-sell them within the country or abroad.

These businesses carry out dismantling of ELV as a necessary activity. Their main target is to obtain certain parts and components from ELV to repair other vehicles, to sell the spare-parts, or to remanufacture components and re-sell them in the second-hand market. The common materials, parts or components dismantled in Mexico are the following,

- a) electro-mechanical parts such as clutches, water pumps, starters, etc, as spare-parts to be sold or remanufactured,
- b) structural body parts such as panels, bumpers, windshields for reuse or reparation,
- c) aluminum and copper parts as recycling materials,
- d) fuel for use,
- e) batteries (lead-acid) to be sold,
- f) tyres for reuse,
- g) catalytic converters for recovering precious metals,
- h) fuel tanks as replacements or as recycling materials.

The components such as, air bags, laminated glass, refrigerant gases, textiles, rubber and operating fluids, are not intentionally removed in most of the cases, specially for small businesses.

According to the Procuraduria Federal de Protección al Ambiente (PROFEPa), the Federal Environmental Protection Attorney's Office, the 90% of automotive repair shops in Mexico did not fulfill the law related to the proper management of wasted oils by 2004, thereby it is difficult to expect a right management of other substances or materials contained in vehicles.

In Mexico, there is no strict control of operations performed by the dismantlers. Their activities are carried out in most of the cases under no certification, only the repair or body shops associated with concessionaries of car-manufacturers and some others, fulfill the requirements set by law.

According to a study carried out by De Keratry in 2004, for the STAT-USA Market research Reports, there are over 40,000 after market automotive parts retail stores in Mexico, however, less than 8% sell used parts. Salvage or wrecked car automotive lots are found in just about every city in Mexico, especially along the U.S.-Mexico border, where they are called "junk yards". These businesses are the principal sellers of used collision repair parts, and there are several large importers of used or refurbished replacement and collision automotive parts.

In Mexico, usually there is a step between dismantling and shredding processes. After the removal of most valuable parts from ELV is done, the dismantlers sell the wreck to classifier businesses which remove, separate, classify and store materials from several waste streams. The main target of these businesses is to sell materials to the recycling industry, i.e. scrap steel, iron, copper, aluminum, plastics, textiles, paper, cardboard, glass, etc.

According to INEGI, there are 6,900 businesses dedicated to handle industrial waste for recycling. Around 64% of these businesses is dedicated to scrap metal, including the ELV materials, 19% is dedicated to paper, 3% to glass, 4% is dedicated to plastics and the rest 9% is dedicated to other kind of materials able to be recycled (INEGI, 2000).

4.4.4 Shredders and Post-shredder Processors

The scrap-steel industry is directly related with the steel Industry in Mexico. This industry carries out the collection of End-of-life house appliances and vehicles and industrial metal residues. Its main target is the material recovery to re-introduce it to the melting processes and obtain new steel products.

The Mexican steel industry had an installed capacity of 19.4 million tones by 2004. In this year, Mexico produced 16.7 million tones of steel, amount that represented 13% of NAFTA's steel production and 1.6% of steel production worldwide. For the same year, Mexico produced 4.4 million tones of steel scrap, imported 2.1 million tones and exported 0.44 million tones of the same material, mainly to the USA (CANACERO, 2005¹ & ²). The table 4.4 shows the development of the Mexican steel industry, as well as the scrap metal production, import and export.

Table 4.4 Mexican Steel Production and Production, Imports and Exports of Steel Scrap

Year	Steel production (ton)	Steel scrap (tons)		
		Production	Imports	Exports
1999	15,300,000	3,449,441	2,626,944	158,776
2000	15,600,000	3,800,836	1,961,935	183,855
2001	13,300,000	4,015,453	1,547,493	183,379
2002	14,051,000	3,319,853	1,822,505	221,136
2003	15,128,000	4,036,732	1,764,204	472,767
2004	16,700,000	4,455,036	2,074,180	445,372

Sources: CANACERO 2005²

According to the data from the Instituto Nacional de Recicladores (INARE), the Mexican Institute of Recyclers, and other sources, there are four main specialized companies of metal shredding in Mexico. These facilities handle ELV, house appliances and industrial metal residues. In Mexico, some steel companies have their own shredder equipment to treat the second raw material they purchase. However, the lack of available information does not allow locating and characterizing other shredder companies and shredders at steel facilities. For this reason, this work considers only four facilities of this sector in Mexico⁵².

Referring to post-shredder activities, the Secretaría de Medio Ambiente y Recursos Naturales (SEMARNAT), the Secretariat of Environment and Natural Resources, have granted 28 permissions for enterprises to recycle metals. The 80% corresponds to the facilities for recycling ferrous-metal and the rest for non-ferrous metals (SEMARNAT, 2005).

The scrap industry in Mexico recovers only the most valuable materials for the Mexican scrap market, i.e. aluminum, wires, copper and metals from catalytic converters, etc. The rest is sent for final disposal on landfills or dumping sites. In this frame, shredder companies have some operational specifications to receive ELV for shredding. Tyres, seats, batteries and fuel must be retired from ELV before entering into the process. This responds to safety measures and the willingness to have cleaner products from shredding processes⁵³.

As part of shredder and post-shredder businesses, there exists a Mexican Association of Melters (SMF), which counts to 482 facilities to carry out melting processes of metals by 2000. However, there is no available detailed information about the amount and kind of processed materials by these facilities (INE, 2000).

⁵² There is no clear evidence about the shredder equipment at Melting facilities of the steel industry, and the efforts of communication with these companies were unsuccessful. Only four specialized facilities for shredding activities within Mexico could be found (see section 5.9).

⁵³ According to the information given by Álvarez in 2006, the shredder industry is reluctant to receive ELV for shredding processes, due to this input is usually polluted with other substances, i.e. oils, fuels, operative fluids, etc.

In regard to ASR, there are no available studies addressing the quantity and quality of ASR generated in Mexico. The ASR composition described in works performed by Reinhardt and Richers in 2004 and more specifically by Staudinger and Keoleian in 2001, stated that ASR are contaminated with PCB and hydrocarbons. Hence and according to Mexican legislation⁵⁴, ASR must be considered as hazardous waste. Moreover, from the information available about shredder and dismantling activities⁵⁵, the ASR generated in Mexico is evidently hazardous waste.

4.4.5 Consumers

The Mexican automotive consumers represented a market of 1.2 million sold vehicles in 2006, from which 96% were passenger cars and light trucks. The Mexican automotive production targets national consumers and international consumers, as well as the Mexican consumer is addressed by national and foreign automotive industries, e.g. the USA, the EU, Japan, Korea, etc⁵⁶.

There are three most important roles played by the Mexican automobile consumers related to the management of ELV. The *First*, they define the consumer preference, the main objective of car-manufacturers. The second, they define the final fate of the ELV. The third, many Mexican car consumers introduce old vehicles from the USA into Mexico.

The first role played by the consumers is observed in the physical, safety, economic and environmental features of vehicles. The car industry tries to reach the consumer's preferences through these features. Another factor influencing the design and construction of new vehicles, is the consumer's awareness in certain topics, e.g. safety, society, environment, etc. A clear example of this is the consumer's awareness about the important participation of vehicular emissions of CO₂ in the global warming effect. Governments worldwide are currently developing strategies and plans to reduce their emissions of this pollutant, and thus they address the automotive industry to modify features of their products to reach lower levels of emissions⁵⁷. In Mexico, the automotive industry is also working towards the fulfillment of new requirements, and with these features, the vehicles are being advertised as environmental friendly vehicles (PwC, 2003).

⁵⁴ NOM-052-ECOL-1993 and NOM-133-ECOL-2000

⁵⁵ ELV are not properly de-polluted before shredder processes

⁵⁶ In 2006, Mexico exported 74% of its total vehicular production. In 2005, from the total number of sold vehicles in Mexico, 65% (of passenger cars and light vehicles) and 7.4% (of heavy trucks) were imported (INEGI, 2005 and AMDA, 2006)

⁵⁷ The European union under the framework of the European Climate Change programme has addressed a strategy to reduce CO₂ emissions, from light-duty vehicles up to 120 grams of CO₂ per kilometre by 2012 (EC, 2007)

In relation to the second role played by the consumer of vehicles, there are four main options for the average vehicle's owner in Mexico,

- 1) sell the vehicle as a second hand vehicle in the national market,
- 2) sell the vehicle as spare parts source,
- 3) sell the vehicle as scrap,
- 4) abandon the vehicle on the road.

The main reason to retire permanently a vehicle from circulation is due to economic reasons⁵⁸. The scarcity of economic resources by a big part of the Mexican car owners, does not allow them to replace their old car for a new one. Therefore, they have to operate the same vehicle for more years⁵⁹, sell their old car and purchase a second hand car, or to get rid of the vehicle in any way mentioned above. This entire situation causes an ageing of Mexican vehicular fleet, which currently is around 14 years for passenger cars and 17 years for freight vehicles (AMDA, 2004).

Regarding to the third role played by Mexican car-consumer, the current import of vehicles from the USA represents thousands of units per year. As mentioned before, these vehicles are older than 10 years and/or have already been repaired from accidents. Due to these features, the illegal imported vehicles produce impacts on an economic, environmental, political and social level. The major impact caused by these vehicles is the rise in the number of vehicles close to be retired, as they have an inefficient performance and scarcity of spare parts, because the most of the models are illegally imported and are not currently produced in Mexico (AMDA, 2005 and CESOP, 2004).

⁵⁸ See point 5.3.1

⁵⁹ See De Keratry, 2004

4.5 Current Situation of the ELV Management in Mexico

In Mexico, there is no proper system for the ELV management as in the industrialized countries (seen in third chapter). However, the process of vehicular retirement takes place in Mexico, thus undoubtedly there is ELV management even though not under optimal conditions.

The current section presents the actual status in the ELV management in Mexico. The main features and figures of the existing infrastructure as well as the available information about the number of vehicles produced and sold in Mexico are presented. According to the data presented in the sections above, the current ELV management in Mexico can be illustrated as in the figure 4.1.

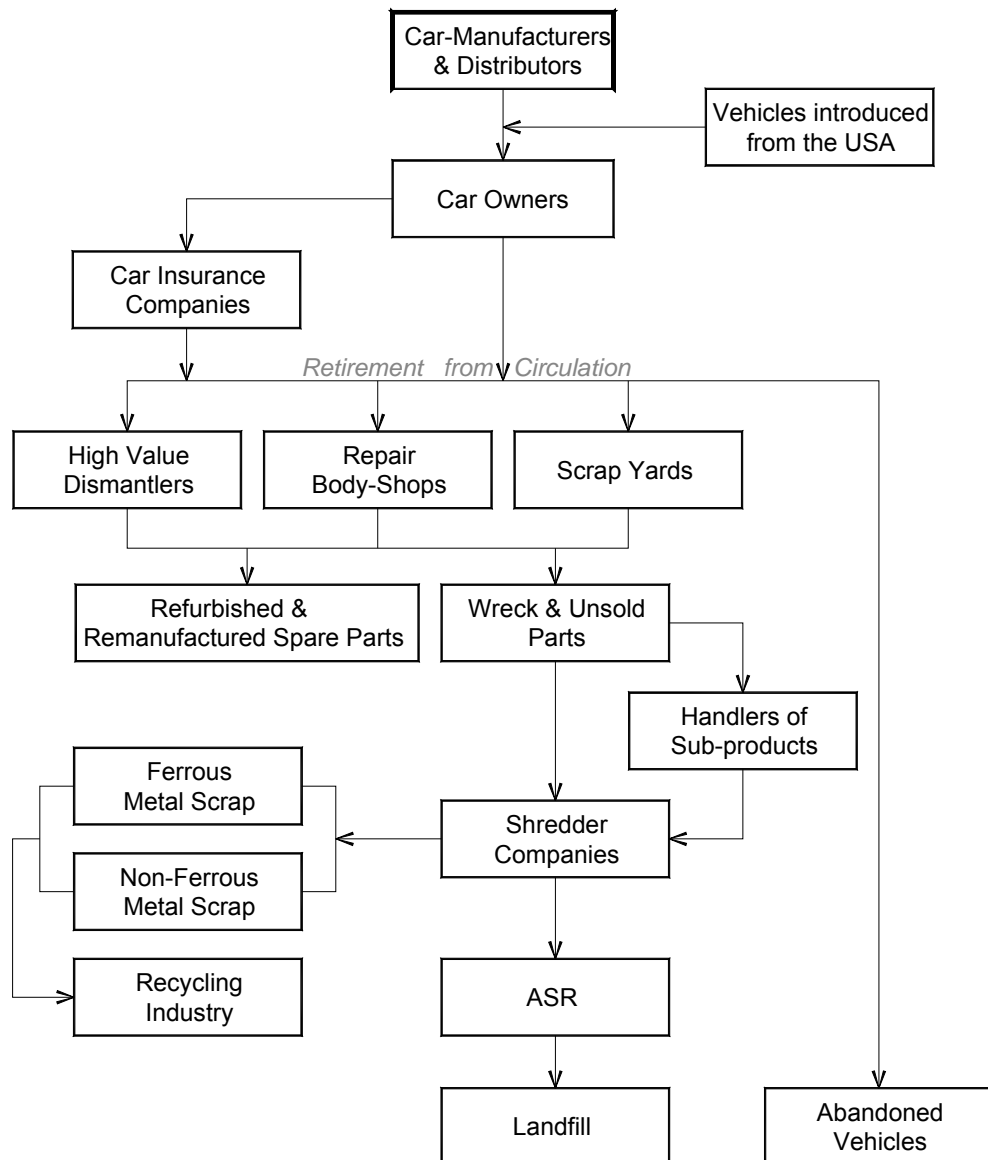

Figure 4.1 Current Management of ELV in Mexico

4.5.1 Vehicular Production and Retail

The Mexican terminal automotive industry is divided in two sectors. The production designated to the national consumption (26% in 2006) and the production for export (74% in 2006), is presented in table 4.5. According to INEGI, by 2005 the main destinies for exported passenger cars were 76% to the USA, 12% to Germany and 7% to Canada. For trucks, the main destinations were 92% to the USA, 7% to Canada and 0.4% to Germany.

Table 4.5 Motor Vehicles Production in Mexico 1995-2004

Destiny	National Market			For Export	Total (units)
Year	Passenger cars and light trucks (units)	Heavy vehicles (units)	Total (units)	Passenger cars, light trucks and heavy trucks (units)	
1995	152,500	5,163	157,663	778,678	936,341
1996	240,423	10,017	250,440	970,874	1,221,314
1997	353,572	23,532	377,104	984,430	1,361,534
1998	448,832	37,540	486,372	978,758	1,465,130
1999	416,449	57,086	473,535	1,077,217	1,550,752
2000	456,488	46,041	502,529	1,432,998	1,935,527
2001	435,371	38,201	473,572	1,382,436	1,856,008
2002	454,994	48,341	503,335	1,319,376	1,822,711
2003	370,362	48,446	418,808	1,170,203	1,589,011
2004	405,617	63,298	468,915	1,101,558	1,570,473
2005	413,610	84,418	498,028	1,108,432	1,606,460
2006	422,173	92,284	514,457	1,464,314	1,978,771

Source: AMIA, 2006; ANPACT, 2006

Regarding the market for motor vehicles in Mexico, the table 4.6 illustrates the retail of automotive vehicles in this country for the last years. One of the main features of this market is the importance of export of motor vehicles, and therefore, its economic importance to the Mexican economy. Another feature is the number of imported vehicles sold in Mexico, mainly for passenger cars and light trucks, which counted to around 63% of the total sales in 2005. A lower number corresponded to heavy trucks that represented 0.3% of total import of vehicles in the same year (INEGI, 2006).

Table 4.6 Motor Vehicle Sales in Mexico

Year	National Market (units)				Total	Exported (units)			Total
	Passenger cars and light trucks		Heavy vehicles			Passenger cars and light trucks	Heavy vehicles	Total	
	National	Imported	National	Imported					
1998	446,981	196,379	21,961	1,566	666,887	971,979	14,458	986,437	1,653,324
1999	417,190	250,098	24,103	2,389	693,780	1,073,529	33,527	1,107,056	1,800,836
2000	440,040	413,735	30,076	4,729	888,580	1,434,110	16,820	1,450,930	2,339,510
2001	439,927	478,908	27,307	3,018	949,160	1,403,715	11,094	1,414,809	2,363,969
2002	426,100	551,458	24,046	2,144	1,003,748	1,325,775	23,626	1,349,401	2,353,149
2003	378,191	599,679	23,875	1,524	1,003,269	1,170,121	25,026	1,195,147	2,198,416
2004	401,565	694,231	26,085	2,186	1,124,067	1,094,306	37,916	1,132,222	2,256,289
2005	395,562	732,835	39,264	3,138	1,170,799	1,186,346	43,171	1,229,517	2,400,316
2006	*	*	43,233	5,170	1,208,440	1,536,768	50,402	1,587,170	2,795,610

* The total counted number of Passenger cars and light trucks in 2006 is reported as 1,160,037 units. There is no available information about the share of imported and national sold vehicles.

Source: INEGI, 2006; AMIA, 2006; ANPACT, 2006

4.5.2 Vehicular Fleet and De-registrations

Owing to the lack of Public Vehicular Register in Mexico, the information about the Mexican vehicular fleet is spread in private and public offices, and sometimes these figures do not fit each other. Furthermore, the continuous imports of used vehicles from the USA make difficult an accurate and updated register. The table 4.7 presents the available data about the Mexican vehicular fleet.

Table 4.7 Registered Vehicles in Mexico

Year	Passenger cars			Passenger Trucks			Heavy vehicles	Σ
	Public	Not public*	Total-1	Public	Not public*	Total-2	Total-3	
1995	264,902	7,184,474	7,449,376	78,409	41,420	119,829	3,571,703	11,140,908
1996	304,568	7,508,217	7,812,785	80,860	15,139	95,999	3,619,481	11,528,265
1997	297,550	8,085,547	8,383,097	84,147	39,157	123,304	3,852,137	12,358,538
1998	339,751	8,714,205	9,053,956	100,296	73,914	174,210	4,038,149	13,266,315
1999	344,551	9,213,151	9,557,702	111,335	86,835	198,170	4,305,916	14,061,788
2000	359,515	9,785,583	10,145,098	110,660	88,443	199,103	4,901,118	15,245,319
2001	373,413	10,948,116	11,321,529	150,124	121,089	271,213	5,353,366	16,946,108
2002	374,995	11,845,426	12,220,421	163,143	133,873	297,016	5,819,449	18,336,886
2003	375,466	12,335,666	12,711,132	159,038	146,913	305,951	6,279,520	19,296,603
2004	374,438	12,983,209	13,357,647	115,664	147,181	262,845	6,667,930	20,288,422
2005	423,802	14,208,203	14,632,005	125,522	148,976	274,498	7,068,042	21,974,545

* Not public correspond mainly to vehicles owned by persons and not by the state

Source: INEGI, 2007.

In regard to the number of ELV generated in Mexico every year, there is no accurate register of these vehicles. The main reasons for this lack of information are the absence of a Public Vehicular Register before 2004 and a big number of vehicles introduced from the USA without register numbers. Thereby, the number of ELV generated in Mexico is unknown.

There are not available studies about the number of ELV in Mexico. However several sources have published some figures in this respect. AMIA established that around 100 thousand vehicles retire from the circulation each year in Mexico (AMIA, 2005), although, there is not analysis to support this figure. *Melgar de México*⁶⁰ in 2004 stated some figures about the ELV generation in Mexico, this figures are shown in table 4.8.

Table 4.8 Mexican Vehicles Out of Circulation (ELV)

Period	ELV	ELV/year	Causes
Before 1972	3,916,536		Diverse
1972-2002	382,934	12,764	Wasted
1972-2003	408,031	13,162	Accidents
1972-2004	400,846	12,526	Retirement
Total		38,453	

Source: Melgar, 2005².

According to a study carried out by Melgar in 2004, the number of vehicles taken out of circulation was around 38.5 thousand units annually. This figure does not include the illegal vehicular fleet, thus the total number is certainly bigger than shown figures in this study.

The usual approach to calculate the number of retired vehicles is using official data of vehicular registers⁶¹, and implementing the following equation,

$$E_i = R_{i-1} + S_i - R_i \quad (4.1)$$

with,

$$E_i \geq 0, R_{i-1} \geq 0, S_i \geq 0, R_i \geq 0$$

Where, E_i is the number of vehicles retired from circulation in year i . R_i is the number of registered vehicles in year i . S_i is the number of sold vehicles in year i , and R_{i-1} is the number of registered vehicles in year $i-1$. This is taking into account the figures obtained at the end of each year.

⁶⁰ Consulting enterprise with vast experience doing studies for the Mexican automotive industry

⁶¹ See DOE, 2006 and Staudinger and Keoleian, 2001

The direct implementation of equation (4.1) with information from tables 4.6 & 4.7, for passenger cars and light trucks, gives no logical results. The results indicates that the numbers of de-registered vehicles are negative (see table 4.9, fifth column), thus no vehicle is retired from circulation, rather vehicles are added to the vehicular fleet. This situation is apparently caused by the vehicles introduced from the USA to Mexico. Thereby, the equation (4.1) must be modified in order to obtain logical results.

The modification consists of adding the number of old vehicles introduced from the USA to the number of vehicular retails. The implementation's results of equation (4.1) are presented in the table 4.9 (sixth column).

Table 4.9 Generation of ELV in Mexico from 1996 to 2005

Year	Fleet	Retail	Illegal	ELV ^a	ELV ^b	ELV ^c
1995	7,490,796	226,316	123,463			
1996	7,827,924	325,154	123,463	-11,974	111,489	111,489
1997	8,422,254	482,146	123,463	-112,184	11,279	11,279
1998	9,127,870	643,360	123,463	-62,256	61,207	61,207
1999	9,644,537	667,288	262,085	150,621	412,706	412,706
2000	10,233,541	853,775	312,787	264,771	577,558	577,558
2001	11,442,618	918,835	260,868	-290,242	-29,374	460,630
2002	12,354,294	977,558	277,819	65,882	343,701	343,701
2003	12,858,045	977,870	213,406	474,119	687,525	687,525
2004	13,504,828	1,095,796	210,992	449,013	660,005	660,005

a Number of ELV implementing the equation (4.1)

b Number of ELV taking into account the illegal introduction of vehicles from the USA, thus ($S_i = \text{Sold vehicles in year } i + \text{Illegal vehicles in year } i$)

c Number of ELV ignoring the bias and with linear interpolation.

The number of ELV generated in Mexico in 2004 was around 660,000 vehicles. The implementation of modified equation (4.1) provides results with relative accuracy. However it makes evident the necessity of an up-dated vehicular register in Mexico. Moreover, the table 4.9 shows the relevance of old vehicles introduced from the USA, as they have big influence in the calculations of ELV generated in Mexico. The figures presented in table 4.9 could serve as reference for further studies in this field.

4.5.3 Infrastructure for ELV Management

In section 4.4 were described the role played by stakeholders and some features about the businesses carrying out the ELV management in Mexico. Due to the lack of specific legislation, plans for management and specialized infrastructure for ELV management, it is possible to state that there is no proper system for the sound management of this product at its EoL stage. Even though, there is a system that currently processes an unknown number of ELV in Mexico⁶². The present section aims to describe the existing infrastructure for the management of ELV in Mexico.

According to the gathered data about de-pollution, dismantling and shredding processes for ELV management in Mexico, it is possible to assume a rate of 75% of recyclability for those ELV entering into the management in Mexico⁶³.

In regard to existing infrastructure carrying out the current management of ELV in Mexico, table 4.10 presents the available information in this respect. Every sector is driven by market conditions, thus everyone looks for the major possible profitability in their businesses. The ELV chain in Mexico works, but there is no integration between stakeholders. The non-standardized practices characterize the majority of the businesses in this chain, with a consequent impact to the environment.

Table 4.10 Infrastructure for ELV Management in Mexico

Activity	Type of business	Units
Dismantling	Small body shops	148,682
	Scrap yards	4,956
	High value parts dismantlers	ND
Store and classification of sub-products*	Metal	4,448
	Paper	1,305
	Glass	238
	Plastics	289
	Others	626
Shredder*	Shredders	4
Post shredder process	Ferrous metal	24
	Non-ferrous metal	4
Hazardous waste treatment**	Batteries	75
	Oil	68
	Tires	23

Source: SEMARNAT, 2005 and INEGI, 2000

* These businesses trade ELV parts as well other sub-products from other waste streams

** These businesses treat hazardous waste coming from ELV among others

ND= No data available.

⁶² There is no available information either from public or from private institutions about the number of ELV already treated in Mexico, the material stream from these units sent to the Mexican recycling system, nor the costs for the processes.

⁶³ This percentage corresponds mainly to the ferrous fraction of the vehicles that is recovered by the Mexican steel industry

The Mexican Institute for Recyclers (INARE) groups as collection, handling and recycling companies. Its main aim is the improvement of commercial relationships between its members. INARE in 2000 published an inventory of recycled material in Mexico, which presents a general view on several recycled materials, in which are included the fraction corresponding to ELV. The table 4.11 presents the information from INARE in 2000.

Table 4.11 Recycled Material Inventory in Mexico 2000

Material	ton/month	ton/Year
Ferrous metal	506,200	6,074,400
Non-ferrous metal	39,200	470,400
Glass	24,570	294,840
Plastic	35,000	420,000
Textile	10,000	120,000
Others	163,816	1,965,780
Total	778,786	9,345,420

Source: Modify from INARE, 2004.

According to the official figures, the percentage of ferrous metal collected, reused and/or recycled in Mexico is 80%, 95% of batteries from ELV are recycled, and the wasted tyres in the northern-border are being used by the cement industry for energy recovery (SEMARNAT, 2004).

5. Proposal for ELV Management System in Mexico

The current chapter addresses a proposal for a suitable ELV management system to be implemented in Mexico. The diagram below describes an overall configuration of proposed ELV management for the Mexican case.

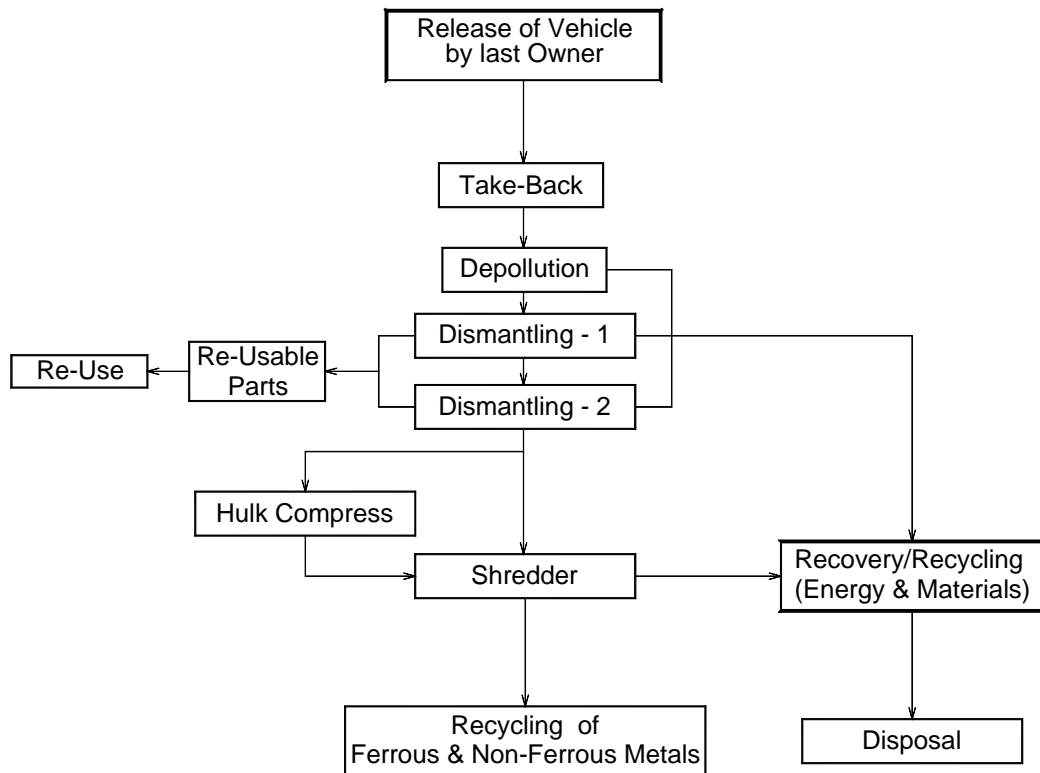

Figure 5.1 General Description of ELV Management System for Mexico

5.1 Objective

The main objective for this proposal is the prevention of waste from vehicles at their EoL stage, through structuring the ELV chain in Mexico. Moreover, the proposal addresses the reuse, recycling and any other recovery form from ELV. Moreover, it takes into account the Mexican social, political and economical features.

The expected result from the implementation of this kind of system is the minimization of negative impacts caused by the ELV to the environment, economy and society, and the recycling industry consolidation and its economic operators.

5.2 Main Assumptions

Due to the current state of ELV management and the incipient recycling industry in Mexico⁶⁴, the implementation of a product-oriented legislation, addressing the ELV management is an essential prerequisite for the success of this proposal. Another important requirement for this proposal is the full operation of a Public Vehicular Register in which all vehicles in Mexico⁶⁵ are taken into account.

The complexity of the ELV management does not allow the transfer of systems from other countries to the Mexican case, basically because its implementation would not be feasible. The present work assumes a gradual implementation of ELV management system in Mexico, with following specific targets,

- a) the minimization of ELV abandonment,
- b) establishment of collection, dismantling and shredder network,
- c) de-pollution of retired vehicles by certificated facilities,
- d) achievement of recycling/reuse rate of 75% by weight of ELV, which will mainly consist of ferrous fraction contained in ELV,
- e) proper disposal or energy recovery from ASR.

The present proposal has as major recycling target the recovery of the ferrous fraction contained in ELV, and the proper treatment of the rest of materials. Further recycling rates are beyond the scope of this work, and it is strongly recommended to perform further studies in this field.

5.3 Numbers of ELV in Mexico

In section 4.5 was exposed the usual way to calculate the number of generated ELV, based on information of vehicular registers. In the table 4.9 the number of ELV generated in Mexico from 1996 to 2004 was presented. However, the design of any management system requires the estimated amount of input material in the future, in order to design the needed infrastructure. Hence, it is important to know future trends of vehicle's retirement in Mexico.

⁶⁴ See chapter four.

⁶⁵ The Public Vehicular register must take into account the old vehicles introduced from the USA

5.3.1 Estimation of Future Trends in ELV Generation

For a better understanding of ELV generation, it is necessary to analyze the influencing factors in the retirement of automotive vehicles from circulation. This knowledge will be of core importance in the estimation of future numbers of ELV in Mexico⁶⁶.

The reliability engineering is a discipline dedicated to describe the reliance on systems and the study of reliability/failure time of the product. Thereby, calculations of product's scrappage are performed as a part of this discipline. Passenger car as products can be modeled by approaches used in reliability engineering. One of these approaches is the Weibull distribution, which is commonly used in reliability engineering to find the probability of failure and the mean life time of products⁶⁷.

The Weibull Probability density function is defined as follows,

$$f(t) = \frac{\beta}{\theta^\beta} t^{\beta-1} e^{-\left(\frac{t}{\theta}\right)^\beta} \quad (5.1)$$

and the Cumulative Distribution Function,

$$F(t) = 1 - e^{-\left(\frac{t}{\theta}\right)^\beta} \quad (5.2)$$

Where $F(t)$ is the probability that the retirement age occurs by age t given in years, β is the shape parameter, and θ is the spread parameter of Weibull distribution.

In this work, the Weibull distribution is implemented to estimate the future number of ELV generated in Mexico, the estimation is performed for two scenarios. The scenarios take into account different economical behaviours, which result in passenger vehicles purchases, tendencies in introduction of used vehicles from the USA, and Mexican population of potential car-owners. The table 5.1 presents the main variables taken for the estimations.

⁶⁶ For a detailed description of this section, see Appendix A.

⁶⁷ See Sliker, 2003 and Van Schaik, 2001

Table 5.1 Variables for Scenarios A and B by 2010

Variable	Scenario-A		Scenario-B	
Population _{15-64 years} (inh.)	74,540,192		74,540,192	
Vehicle per Person _{15-64 Years}	0.35		0.25	
PC & LT Fleet (Units)	26,089,067		18,635,048	
Reposition rate (%)	10		8	
Retail _{PC&LT} (Units)	3,727,010		2,129,720	
Weibull parameters	Nv	Ovi	Nv	Ovi
β	6.4	4.3	6.4	4.3
θ	21.5	11	21.5	11
Average Lifespan (years)	20	10	20	10

Nv= New vehicles

Ovi= Old vehicles introduced from the USA

Scenario-A is characterized by the achievement of objectives established by the Mexican Automotive Industry by 2010⁶⁸, and a maintained Mexican economy growth of 5% in the GDP per capita. Thereby, it is assumed a retail of passenger cars and light trucks reaching a reposition rate of 10% based on the entire vehicular fleet.

In regard to vehicles introduced from the USA, the migratory conditions will remain in the middle term, and even the number of persons immigrating to the USA is foreseen to increase (CONAPO, 2000). Thus, the number of vehicles introduced from the USA is assumed with a growth rate of 5.43 % as set by Melgar in 2005. This tendency is disrupted in 2005 by the National Decree⁶⁹, which gave amnesty for the vehicles in illegal condition, and in 2009 by implementation of NAFTA's Annex 300-A.2 (Paragraph 24.a)⁷⁰.

The conditions aforementioned were as consequence of an increased Mexican vehicular fleet, and a rate of 0.35 vehicles/person (15 - 64 years old), as it is shown in table 5.1.

Scenario-B assumes an unfinished achievement of objectives set by the Mexican Automotive Industry by 2010, a Mexican economy growth under optimal rates, described by Werner and Ursúa, 2004. Hence the retail of passenger cars and light trucks is considered with a reposition rate of 8 %.

The conditions for migration are maintained as in previous scenario, thus the number of vehicles introduced from the USA remains as in Scenario-A.

68 The Mexican Association of Automotive Industry (AMIA) and the State Secretary of Economy have the purpose to double the production of vehicles in Mexico by 2010. This means, a production of four million vehicles, three millions for export and one million for national market (Expansion, 2004; Mortimore and Barron, 2005).

69 See point 4.3

70 Mexico may adopt or maintain prohibitions or restrictions on imports of used vehicles from the territory of another Party, except as follows: (a) beginning January 1, 2009, Mexico may not adopt or maintain a prohibition or restriction on imports from the territories of Canada or the United States of originating used vehicles that are at least 10 years old.

The assumptions considered by Scenario-B allow to reach a rate of 0.25 vehicles per person (15- 64 years old), with a consequent increase in the vehicular fleet as shown in table 5.1.

In respect to Weibull parameters, the main difference in each scenario is the average vehicular lifespan. For the sake of this work and due to the lack of specific information about the survival rates of Mexican vehicular fleet, the parameters implemented in this work have been modified from Sliker, 2003 and Van Schaik, 2001.

The average lifespan of new vehicles sold in Mexico is assumed as 20 years. This value is longer than in studies carried out by Sliker, 2003 and Van Schaik, 2001, for vehicles in the USA and the Netherlands. The main reason for this longer lifespan is the difference in the Mexican consumers' behaviour to keep the vehicle working longer than in other countries, due to economical reasons (De Keratry, 2004).

The Weibull parameters for vehicles introduced into Mexico from the USA have been considered with an average vehicular lifespan of 10 years. This responds to the fact that most of them have already been 10 years on the road, along with that, there is a scarcity of spare-parts for those models, thus the probability of these units to become ELV is raised.

After setting vehicular retails and registrations by 2010, the Weibull probability distribution function is implemented to represent the vehicle retirement behaviours in time. Hence, a dynamic mass balance is developed describing the accumulation of ELV as a function of vehicular inflows (sold and introduced from the USA) and the total retirement probability year after year. The total number of ELV in a certain year is the sum of all model-year retirements.

The figure 5.2 describes the retirement behaviour for new sold vehicles in Mexico for the period of 1995 to 2010 for Scenario-A.

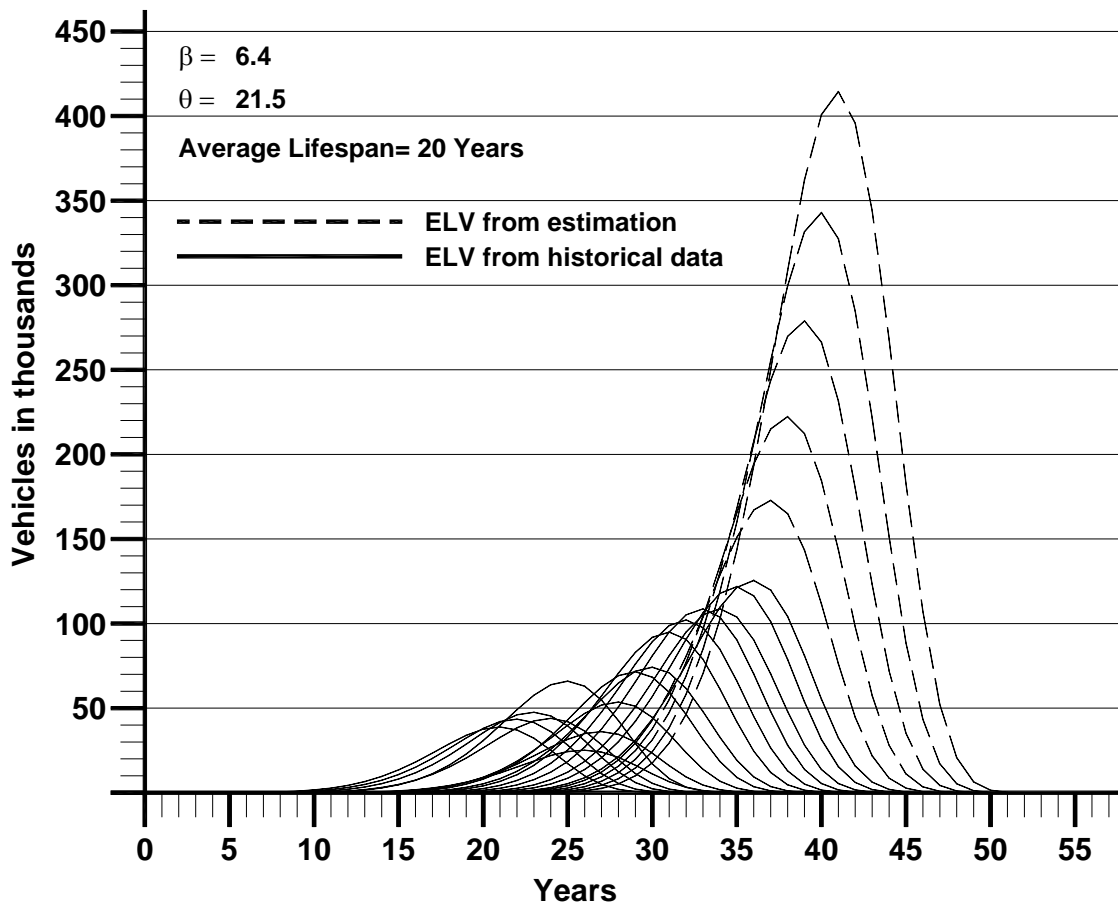

Figure 5.2 Retirement Behavior for New Sold Vehicles in Mexico from 1995 to 2010, Scenario A.

The figure 5.3 presents the retirement behaviour for used vehicles introduced from the USA to Mexico during the period of 1995 to 2010. Every curve is the retirement behaviour for vehicles introduced in a certain year.

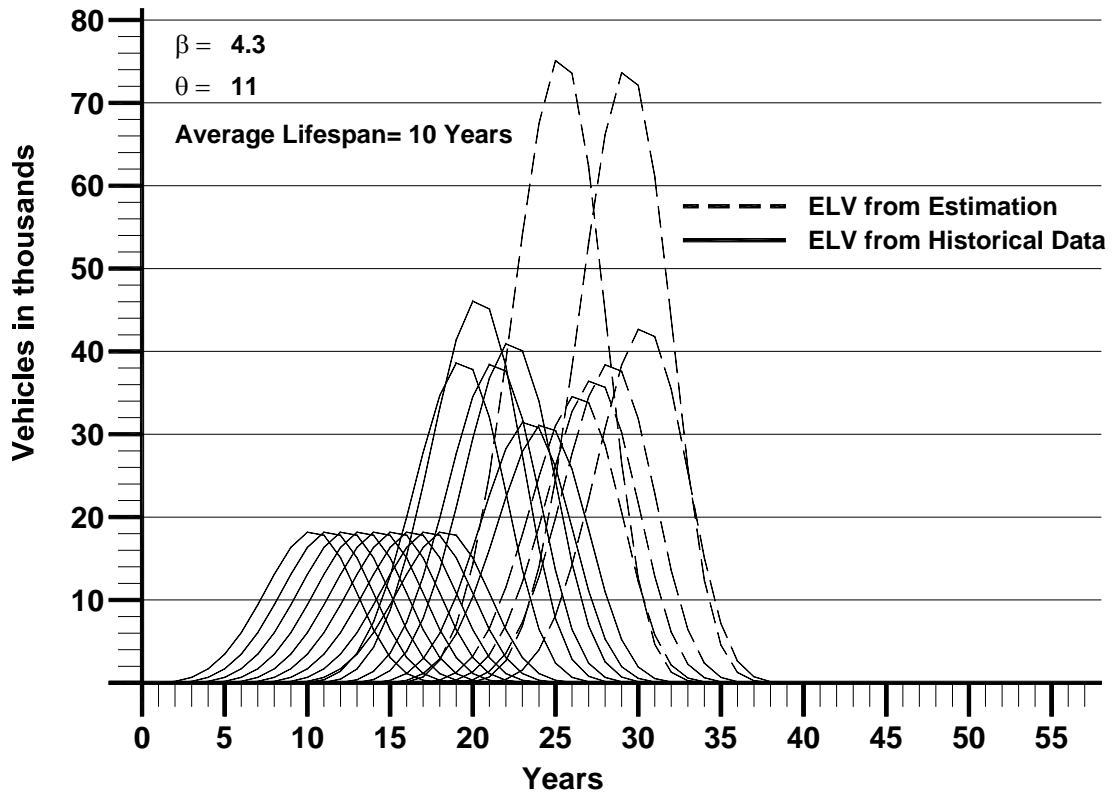

Figure 5.3 Retirement Behavior of Used Vehicles Introduced from the USA to Mexico from 1995- to 2010, Scenario A

The figures 5.2 and 5.3 show that in a same year there are retirements of different model-years, and at the same time these retirements are from new sold vehicles and also from used vehicles from the USA. Therefore, the sum of all curves' values in a certain year shows the total number of vehicular retirements for that year. The figure 5.4 shows the sum of all values presented in figures 5.2 and 5.3.

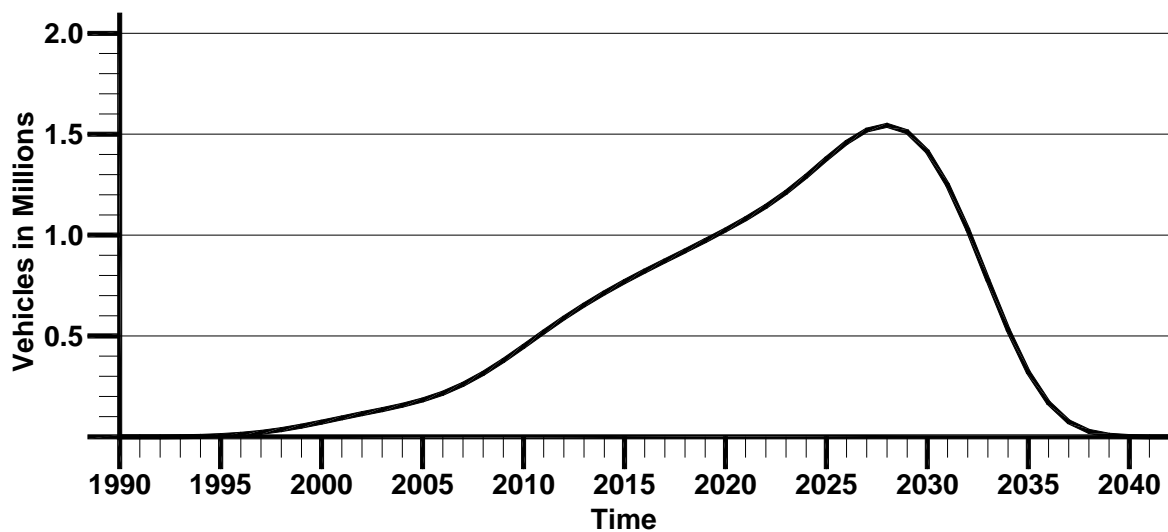

Figure 5.4 Total Retirement Behavior of Used Vehicles Introduced from the USA and New Vehicles Sold in Mexico from 1995 to 2010, Scenario A

The process described in figures 5.2 to 5.4 is performed in the same way for conditions described for Scenario-B. The figure 5.5 shows the total number of ELV generated in Mexico from 2005 to 2025, for *Scenario-A* and *Scenario-B*, and the table 5.2 presents the curves' values of figure 5.5.

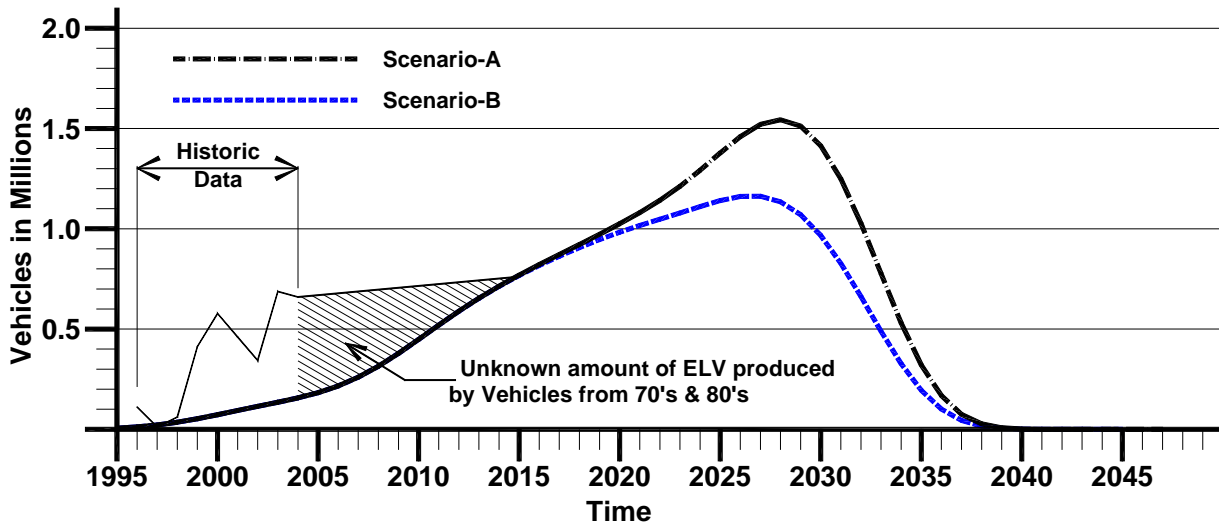

Figure 5.5 Total ELV Generation in Mexico for the Two Scenarios from 2005 to 2025

According to the ordinates and their corresponding years along the curves in Figure 5.5, the total number of ELV generated in Mexico from 2005 to 2025, for Scenarios A and B, are broken down as shown in table 5.2.

Table 5.2 Number of ELV Generated in Mexico from 2005 to 2025

Year	ELV	
	SC-A	SC-B
2005	669,200	669,200
2006	678,390	678,390
2007	687,580	687,580
2008	696,780	696,780
2009	705,970	705,970
2010	715,160	715,160
2011	724,350	724,350
2012	733,550	733,550
2013	742,740	742,740
2014	751,930	751,930
2015	769,320	766,960
2020	1,025,000	983,100
2025	1,378,100	1,140,680

5.4 Take-back of Vehicles

The process of delivery for vehicles out of circulation, by last owners to the collection points or to the dismantlers, is a core activity in the ELV management. The delivery conditions must be carefully planned because it decides the entry of ELV to the downstream activities (de-pollution, dismantling, shredder, recycling material, energy recovery, etc.). These conditions should trigger incentives for the last owners and dismantlers in order to maximize the number of vehicles delivered, the amount of ferrous material collected, and the achievement of environmental targets. Thus, this work proposes the establishment of a network of collection facilities to carry out the take-back of ELV in Mexico.

An important condition for vehicle's take-back is the cost of ELV at the delivery. This price is set by several factors, i.e. vehicle's age, mechanical integrity, model-year, market prices, etc.

As the main business of car dismantlers is the recovery of high-value spare parts for resale, and considering the current status of vehicular fleet in Mexico⁷¹; the price of Mexican ELV is presumably negative when delivered to dismantle centers. On the other hand, the charge to the last owner would be a negative incentive for this delivery, and the vehicle abandonment would become an easy alternative.

In case of the retired vehicles with a positive price, such as those from insurance companies⁷², the price could be set under negotiation between the dismantler and the last holder, as is currently being carried out.

The implementation of Certificates of Destruction given by dismantlers to the last owners is a necessary and important improvement in dismantling processes for ELV management in Mexico. This document will release the last owner from duties related to his/her old vehicle. At the same time, dismantlers will be able to inform vehicular authorities about the delivered vehicles, in order to de-register vehicles from Public Vehicular Register (PVR). For the cases, in which the last owners do not deliver the vehicle to certified dismantlers, and thus do not de-register from PVR, an economical sanction should be charged to last owners.

The payment of sanctions can be traced by the PVR, if a person is identified as debtor, the payment can be conditioned with the registration of another vehicle under same person's name, or the bill can be easily sent by post.

⁷¹ The average age of 45% vehicular fleet in Mexico is 14 years (AMDA, 2004)

⁷² Vehicles of recent models been involved in accidents

5.5 De-pollution and Dismantling

After last owner's delivery to the take-back centers, the following step is the vehicle's de-pollution. In essence, this part of ELV management involves the drainage of operative fluids and removal of parts and components containing hazardous materials whose improper management could lead to safety and environmental impacts. These activities are very important for the ELV management, and their importance should not be underestimated, because an improper performance could produce several impacts on downstream activities.

The de-pollution and dismantling of ELV are thought to be carried out at the same facilities where take-back operations are performed, in order to favor the efficiency of the management. The proposed parts to be removed from ELV are listed in table 5.3, but the total amount of parts removed will depend on market conditions prevailing for ELV.

Table 5.3 Drainage and Dismantling Process for Mexico

Drainage	Dismantling 1	Dismantling 2
Fuel	Batteries	Radiator
Engine oil	Airbags	Starter
Gear-box oil	Air conditioning system	Generator
Transmission oil	Wheels	Transmission
Axle oil	Wires	Instrumental panel
Power-steering oil	Filters (Oil, Fuel, Air)	Shock absorbers
Coolant	Catalytic converter	Seats and seat belts
Brake-fluid		Laminated glass
Washing-fluid		

For the Mexican case, the priority in drainage and dismantling processes is set by the potential damage represented by fluids or materials contained in the ELV. Therefore, fluids and parts under columns "*Drainage*" and "*Dismantle 1*" are considered by this work as mandatory to be removed from the ELV. At initial stage of the Mexican ELV management, the parts listed under the "*Dismantle 2*" could be considered optional and their removal would be a decision of dismantlers. For a later stage of the system, these parts and other additional ones might be considered obligatory.

These operations represent an essential step for the entire sound management of ELV in Mexico, because the quality of scrap metal and other materials depends directly on the performance at this stage. Additionally, the removal of hazardous substances from ELV, through drainage and dismantling operations, favors the proper management of these substances.

5.5.1 Health & Safety Considerations

As the ELV de-pollution involves manipulation of substances, part of the hazardous material group, i.e. either explosive or corrosive. The facilities, as well as employees must take into account the current Mexican workplace health and safety regulations⁷³.

The design, construction and operation of facilities carrying out ELV de-pollution and dismantling operations have to consider all the provisions stated by the legislation dealing with the control of solid waste and waste water discharges⁷⁴.

5.5.2 Equipment

The equipment to carry out ELV de-pollution and dismantling operations is thought to be specifically designed for carrying out the required operations. The use of such equipment ensures high efficiency in de-pollution and dismantling activities in a relatively short time-frame, and under safety conditions⁷⁵. Examples of this kind of equipment are presented in Appendix C.

This work assumes that that small facilities⁷⁶ carrying out ELV de-pollution and dismantling operations are a good option for an initial stage of ELV management in Mexico. It is also assumed that simpler and alternative methods to carry out de-pollution will be preferred than sophisticated and more expensive equipment⁷⁷. In this context, the de-pollution by leaking and features of these processes become especial importance. A study carried out by Boes et al. in 2002, presented the time required to remove several operative fluids from the ELV by leaking. According to the study, the necessary time to leak over 95% of oil from an ELV is 17 minutes.

The time required for ELV de-pollution and dismantling hardly depends on the workforce's training and equipment. These factors are identified as crucial by dismantlers, as is cited by Paul in 2006. The table 5.4 presents the results of different studies about de-pollution and dismantling operations for ELV, regarding the amount of drained fluids and time involved in these activities.

⁷³ The following Mexican legislation addresses the health and safety in workplaces, NOM-001-STPS-1999, NOM-002-STPS-2000, NOM-004-STPS-1999, NORMA OFICIAL MEXICANA NOM-005-STPS-1998 and -026-STPS-1998.

⁷⁴ See point 4.3

⁷⁵ The removal over 95% of fluids contained in the ELV (SEDA GmbH)

⁷⁶ Small facilities are considered those with capacity less than 25 ELV/day

⁷⁷ In the case of using simpler and alternative equipment, health and safety requirements should not be compromised. The performances of alternative methods for de-pollution and dismantling operations must take into account the risks and provisions stated by the relevant health and safety legislation in Mexico.

Table 5.4 Average Time Required for ELV De-Pollution and Dismantling

Author	Average time (min./ELV)	Activity
Boes et al., 2002	65	De-pollution
Scharff, 2005	100	De-pollution
Duranti, 2006	120	De-pollution & Dismantling
Paul, 2006	127	Dismantling

A variety of equipment for ELV de-pollution is presented in Appendix C, from different brands and capacities.

5.5.3 Facilities

In regard to the facilities' configuration for de-pollution and dismantling operations of ELV, there are two main configurations (Schwald, 2001),

- a) Line-dismantling facility: The de-pollution and dismantling activities are performed in a semi-industrialized process with a relative high capacity (more than 30 ELV/day),
- b) Island-dismantling facility: The de-pollution and dismantling activities are performed in batch processes. This configuration is suitable for small facilities, which have no more than five workers and capacity of less than 25 ELV/day.

For the Mexican case and in an initial stage of ELV management system, the Island-dismantling facility configuration is highly recommended.

For the case of thinly car populated areas mobile units of dismantling and de-pollution are considered suitable. This method is widely implemented in countries with low density of population, such as Sweden and Norway (Domini, 2005)

In essence, configuration of island and line facility needs to carry out required operations in several areas. These areas are described below,

- a) *Reception and de-registration*: This area performs the set of ELV price and de-registration of delivered vehicles,
- b) *Storage of ELV*: This area stores delivered vehicles (ELV) ready to be introduced to the de-pollution process. The area must be constructed with impermeable surface and appropriate spillage collection facilities. The facility should have equipment for waste water treatment, including storm water,

- c) *De-pollution*: In this area activities of de-pollution are performed. The area must be constructed with impermeable surface and appropriate spillage collection devices, equipment for waste water treatment, including storm water, appropriate storage of dismantled spare parts, as well as impermeable area for oil- contaminated spare parts, impermeable containers for batteries, and appropriate containers for operative fluids from ELV,
- d) *Dismantling*: In this area dismantling-1 and/or dismantling-2 operations are carried out. The area must be constructed with impermeable surface and appropriate spillage collection devices, appropriate storage of dismantled spare parts, as well as impermeable area for oil- contaminated spare parts,
- e) *Storage of parts*: In this area removed valuable parts and/or components from ELV are stored. The area must be constructed with impermeable surface and appropriate spillage collection devices, appropriate storage of dismantled spare parts, as well as impermeable area for oil- contaminated spare parts, especial area for storage of old tyres, with fire danger prevention,
- f) *Storage of wrecks*: In this area de-polluted and dismantled ELV are stored and wrecks are ready to be sent to the shredder facilities. The area must be constructed with impermeable surface and appropriate spillage collection facilities, the facility should have equipment for waste water treatment, including storm water,
- g) *Container of operative fluids*: In this area special containers drained operative fluids from ELV are stored. The area must be isolated from the rest. The area has to be constructed with impermeable surface, and appropriate spillage collection devices.

The facilities must accomplish with the current regulation established by the Mexican office of health and safety, enacted for facilities which store large amount of hazardous and/or highly flammable materials.

The main features of Line and Island configuration facilities for de-pollution and dismantling operations of ELV are presented in Appendix C. The first describes a small facility with a capacity up to 30 vehicles per day, and the second presents a facility with semi-industrialized dismantling process.

5.5.4 Process

A close cooperation between car manufacturers and dismantlers is necessary, due to the huge diversity of vehicular models and features existing in circulation. The provision of technical information by car-manufacturers about their vehicles is thought to boost the activities of de-pollution and dismantling with consequent economic benefits. The core importance of this information access is stated by the Institut für Kraftfahrwesen Aachen (IKA), the Institute of Motor Vehicle Design Aachen, in a study published in 2004.

One of the projects carried out in Europe to supply technical information to the dismantlers about vehicles, towards a suitable ELV management, is the International Dismantling Information System (IDIS). The system was designed to provide information identifying various components, materials and, the location of all hazardous substances in the vehicles. IDIS is currently available in 23 languages and provides information on a total of 51 brands and 477 different models. (IDIS, 2006)

For the Mexican case, it is necessary to have technical information about vehicles sold in Mexican market and those coming from national or foreign production, along with the technical information about the American models which were not sold in Mexico, but were introduced from the USA.

The sequence of activities proposed for de-polluting and dismantling activities are presented in table 5.5. The sequence is based on the process carried out by the European Group of Automotive Recycling Association (EGARA).

Table 5.5 Sequence of Steps towards De-Pollution and Dismantling of ELV

Take-Back process	
1	Receiving the vehicle and inspection of documents and vehicle
2	Location and verification of VIN-Number
3	Entering Vehicle and Owner data into System
4	Issuing Certificate of Destruction (COD)
Preparing ELV-Treatment	
5	Locating and evaluating dismantling information
6	Preparing work-sheet and planning de-pollution and removing of materials
7	Moving vehicle to storage area
8	Moving vehicle from storage to working area
De-pollution and removing waste fractions	
9	Emptying of fuel-tank and /or LPFG-tank incl. removing LPG-tank
10	Removing main battery and Ni-Cd-batteries
11	Removing or neutralizing pyrotechnical equipment
12	Draining of engine-oil
13	Draining of other oils (gear box, transmission, axles, power-steering, etc)
14	Draining of coolant

15	Draining of brake-fluid
16	Draining of washing fluid
17	Emptying AC System
18	Removing all components containing heavy metals or asbestos
19	Removing oil and fuel filters
20	Removing catalytic converters
21	Removing wheels and tyres
22	Removing large plastic components
23	Removing wires and glass
Other necessary work-items	
24	Removing general waste in vehicle
25	Moving depolluted vehicle to storage area
26	Preparing for processing of vehicle hulk
27	Process the vehicle hulk
28	Storage the processed hulk and preparation for transportation

Source: Modified from Scharff, 2005

The configuration facilities mentioned in point 5.5.3 offer different advantages and disadvantages in the performance of de-pollution and dismantling operations. These features are presented in table 5.6,

Table 5.6 Advantages and Disadvantages of Configuration Facilities

Type	Advantages	Disadvantages
Island-dismantling	Flexible	Unfavorable amount of dismantled material in many lifting platforms, bigger area required
	No timing restriction	Big variety of tools are required
	Suitable for exotic vehicles	High wage costs
	High level of dismantling if required	Limited capacity (approx. 15 ELV/day)
	Low investment costs because its low automatic process	
	Small area required for performance	
Line-dismantling	Favorable amount of dismantled material in each station	The timing restriction is not flexible
	Acquisition of high costly equipment worth, low wage costs	High investment required, because the high automatization of the process
	High automatization of process	Low acceptance from public
	High volume of dismantling (approx. 7000 to 25000 ELV/year)	Wide area required, scarcity of suitable places
	Reduction of unit costs	The location, high transport costs

Source: Modified from Schwald, 2001, p.46

5.6 Treatment

5.6.1 Car Body Pressing

The treatment of ELV is referred to physical processes to change the composition and physical features of these vehicles. A first logical treatment is the size reduction of wrecks, which is carried out at the end of dismantling process.

Since the wreck has to be stored before being shipped to shredder facilities, the space becomes of capital importance, therefore de-polluted and dismantled ELV have to be compacted to save space at facilities and to make the transportation process more efficient. The level of compaction depends largely on equipment used in it. A common practice is the reduction of volume using just the crashing method with a loader⁷⁸. This practice is widely used, especially in small facilities in which the acquisition of a car-baler is difficult to afford. For the Mexican case, this method is advisable in order to reduce investments in equipment.

At facilities with high volume of ELV de-pollution and dismantling, the acquisition of car-body pressing machine, also called car-baler, is reasonable. These machines offer the ability to compact wrecks and others metals in bales of 0.8 to 1.2 tons per cubic meter of density. The car baler is able to handle virtually any automobile, appliances, white goods, and scrap metal. The wreck is loaded into the baling box with a crane, automatically the first and second lids of the baling chamber close, then the main rams extend, retract and the side lids open and the bale is removed. The Appendix C shows the main features of fixed and mobile car balers.

5.6.2 Shredding

The current proposal does not take into account new shredder facilities. It is assumed that the mentioned facilities⁷⁹ are enough at the beginning of ELV management system implementation. Therefore, the following is just a short description of the process and the main recovered material streams.

Shredding is an essential process which reduces the size of input material into predictable size and shape pieces. This enables the material to be efficiently sorted and transported for further treatment. The processes of dismantling and shredding are complementary. The dismantled parts need to be shredded for cost-efficient handling, storage, transport and material recovery (Gesing, 2004)

⁷⁸ The wheel loader hits the top of the wreck until reach a reduced volume and a suitable shape to be piled and stored

⁷⁹ See table 4.15

There are basically three types of shredding operators: shredders, crushers and scrap mills. Wrecks, miscellaneous scrap and house appliances can be fed without any pre-processing directly into shredders, which basically operate as is shown in the figure 5.6.

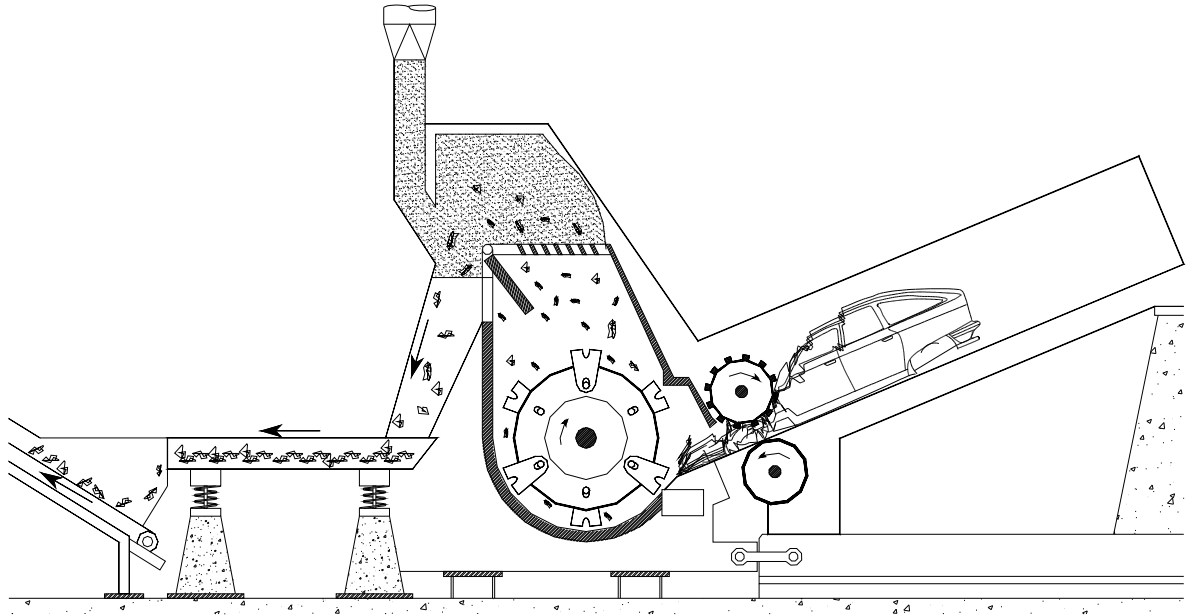

Figure 5.6 Shredder with Horizontal Hammer Mill

Vertical and horizontal hammer mills consist of a central rotor on which are pinned radial hammers that are swinging around the pins. The shredded material remains in the housing until it has reduced enough to pass through specifically sized grate openings. Shredded material is transported by conveyors to the sorting area, in which the material is first separated by magnetic devices in order to obtain the major ferrous-metal material as much as possible (Bilitewski et al., 1996). Besides magnetic devices to sort ferrous materials, the shredding plants are equipped with flotation⁸⁰ and pneumatic processes, to sort materials by density differences, leaving valuable materials to pass into further stages for segregation. A widely used method is eddy-current⁸¹ separators, which induces energy that reacts with different metals, according to their specific mass and resistivity creating a repelling force on the charged particle. If a metal is light, e.g. aluminum, it is easily levitated and ejected from the normal flow of the product stream making separation possible (BIR, 2006). The figure 5.7 shows a typical shredder plant configuration.

⁸⁰ Flotation is a process of recovering small particles of defined material by immersing mixture of materials in water or other fluids and skimming off the particles which float on the surface.

⁸¹ Electromagnetic non-destructive testing method, in which eddy-current flow is induced in objects. Changes in the flow caused by variations in the object are reflected into a nearby coil or coils where they are detected and measured by suitable instrumentation.

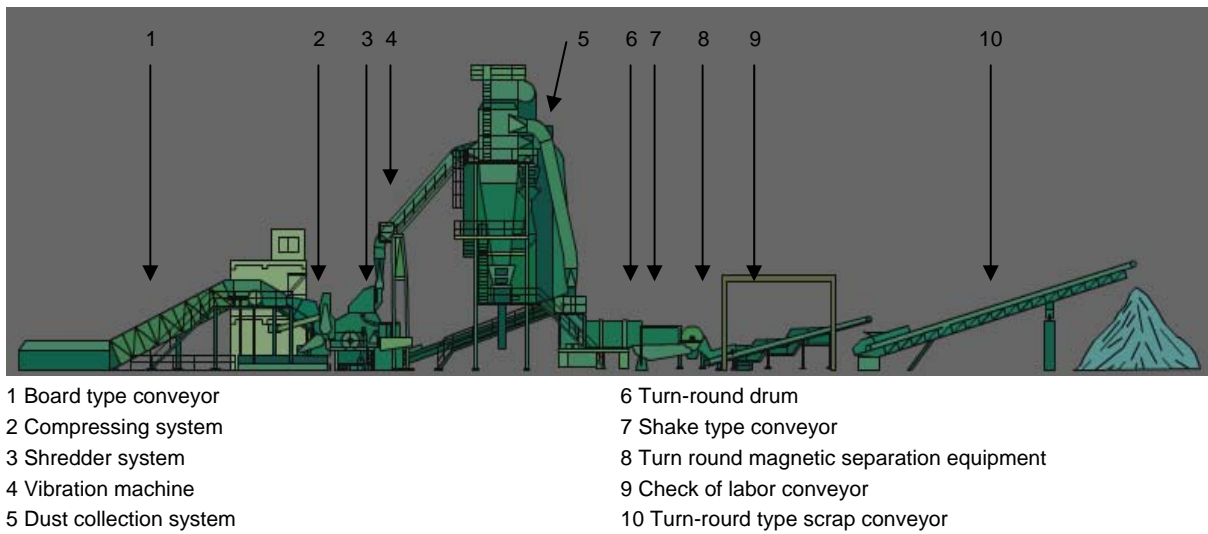

Figure 5.7 Shredder Plant Layout with Water Injection at the Shredder

Source: Cheng Ho Hsing Heavy Industries CO., LTD.

The three main streams obtained from shredding processes are as follows,

- a) *ferrous-metal fraction*: iron and steel (65% – 70%),
- b) *non-ferrous metal fraction*: aluminum, stainless steel, copper, brass, lead, magnesium, zinc, and nickel (5% - 10%),
- c) *Automotive Shredder Residue (ASR)*: rust, paint, plastics, glass, rubber, foam, carpeting, textiles, etc. (25% – 35%)⁸².

There is no available information about the current shredder capacity in Mexico. The only available information is referring to the production of steel scrap in Mexico, which is described in table 4.4.

⁸² According to studies carried out by Reinhardt and Richers, 2004; Kanari et al, 2003 and Staudinger and Keoleian, 2001, the ASR represents around 25 to 35% of the average ELV weight.

5.7 Re-use and Recycling

5.7.1 Re-use of Auto Parts

This work proposes the creation of a National Inventory for re-usable and re-manufactured spare-parts, obtained from dismantling operations through the network of dismantling facilities in Mexico. The publication of this inventory in an electronic data-base, would access an enormous number of potential buyers, looking for used and refurbished spare-parts. This represents an additional possibility for investors of dismantling facilities to make business.

High-value part dismantlers are disaggregated in Mexico, and from the 40 thousand after market automotive retail stores, less than 8% sell used and/or refurbished parts. The major amount of used and refurbished spare-parts are sold in salvage and wrecked car lots without any control (De Keratry, 2004).

The possibilities of Mexican market for used and refurbished spare-parts is largely due to the current condition of Mexican vehicular fleet and the increasing number of vehicles introduced from the USA. Moreover, the major amount of used parts come from salvage or wrecked car automotive lots, found in every city in Mexico and especially along the U.S.-Mexico border where they are called "junk yards". These businesses are the principal sellers of used collision repaired-parts, however, demand is growing and there are just 27 registered used part importers throughout Mexico (De Keratry, 2004).

The sale of used and remanufactured spare-parts through electronic data-bases is nowadays a common practice in the EU, the USA and other countries. Examples of that are the Callparts GmbH in Germany and LKQ Corporation Inc. in the USA. In Mexico, this practice is incipient, and therefore, it represents an opportunity for dismantlers or junk yards, willing to certify their activities.

5.7.2 Ferrous Metal

The recycling of scrap metal containing iron and steel is already carried out by the steel industry since many decades in Mexico. These scrap metals can be processed in two ways (SRI, 2004),

- a) *Basic Oxygen Furnace (BOF)*: process which is able to include 25 to 35 percent of scrap steel in its process to make new steel,
- b) *Electric Arc Furnace (EAF)*: process which uses virtually 100 percent of scrap metal to produce new steel.

In Mexico, the iron and steel industry counts to 19 facilities for melting in primary process of iron and steel. The installed capacity is 19.4 million tons per year. In 2004, the production was 16.7 million tons of steel (86% of its installed capacity, 70% by EAF and 30% by BOF) (SIEC, 2003 & CANACERO, 2005²). There is no available information about the process used in each facility of iron and steel industry in Mexico. According to the information from CANACERO, the use of steel scrap was around 6 million tons in 2004.

Moreover, CANACERO published a document in 2004 which inputs such as scrap metal which was identified as scarce material for Mexican industry. The scarcity is due to increased demand and the rise on prices⁸³. The table 5.7 indicates the amount of potential scrap metal, obtained from ELV in coming years⁸⁴, as well as other materials streams contained in vehicles.

Table 5.7 Potential Amount of Scrap Material from ELV in Mexico

Year	ELV ('000)	Iron & steel (tons)	Non-Fe (tons)	Plastics (tons)	Textiles (tons)	Tires (tons)	Glass (tons)	Operative fluids (tons)	Others (tons)
		57.5%	10.0%	7.5%	7.3%	3.9%	5.2%	2.6%	6.0%
2005	669	384,789	66,920	50,190	48,851	26,099	34,798	17,399	40,152
2006	678	390,074	67,839	50,879	49,522	26,457	35,276	17,638	40,703
2007	688	395,360	68,758	51,569	50,194	26,816	35,754	17,877	41,255
2008	697	400,646	69,678	52,258	50,865	27,174	36,232	18,116	41,807
2009	706	405,932	70,597	52,948	51,536	27,533	36,710	18,355	42,358
2010	715	411,218	71,516	53,637	52,207	27,891	37,188	18,594	42,910
2011	724	416,504	72,435	54,327	52,878	28,250	37,666	18,833	43,461
2012	734	421,789	73,355	55,016	53,549	28,608	38,144	19,072	44,013
2013	743	427,075	74,274	55,705	54,220	28,967	38,622	19,311	44,564
2014	752	432,361	75,193	56,395	54,891	29,325	39,100	19,550	45,116
2015	769	442,361	76,932	57,699	56,161	30,004	40,005	20,002	46,159

Note. Vehicular weight of one ton, and composition of vehicles from Reinhardt and Richers U., 2004

⁸³ The price of scrap metal has increased by 243% from 1999 to 2004 (CANACERO, 2005)

⁸⁴ See point 5.3.1

5.7.3 Non-ferrous Metal Fraction

As mentioned in the point 5.6.2, the non-ferrous metal stream is sorted at shredder facilities through different processes, or in some cases, further separation of specific material streams is performed at different facilities obtaining aluminum, copper, zinc, etc.

According to a study carried out by the Instituto Mexicano de Ecología (INE), the Mexican Institute of Ecology, in 2000 and a study performed by the Mexican Center for the Cleaner Production (CMPL) in 1998, the melting industry in Mexico counts to around 482 facilities, which are under the umbrella of Mexican Association of Melters (SMF). These businesses address primary and recycled (secondary) metals. The number and capacities of these facilities could be divided as follows:

- a) 2 micro-businesses, with a capacity of less than 200 tons/month,
- b) 194 small businesses, with a capacity from 200 to 500 tons/month,
- c) 193 mid-sized businesses, with a capacity from 500 to 1000 tons/month,
- d) 93 large businesses, with a capacity more than 1000 tons/month.

An important feature of the Mexican melting industry is the versatility of small businesses to process more than one metal; meanwhile large companies are more specialized and concentrate on one or two metals (INE, 2000).

Since there is no more specific information about the capacity of facilities of melting non-ferrous metals, the calculation of national capacity for recycling this stream is difficult. It is possible to make a rough estimation, taking into consideration the middle value of capacities multiplied by the number of each type of facility. The results are as follows:

Table 5.8 Estimation of the Melting Capacity in Mexico

Facilities	Capacity (tons/month)	Total (tons/month)
2	100	200
194	350	67,900
193	750	144,750
93	1000	93,000
	Sum	305,850

According to table 5.8, the yearly capacity of the Mexican melting industry would be around 3.7 million tons. The ELV composition, given by Reinhardt and Richers, 2004, states a content of non-ferrous metals as 10%. From that percentage of non-ferrous metals, 8% corresponds to aluminum and 2% to copper, zinc, magnesium and lead (Kanari et al, 2003). The potential production of this stream is broken down in table 5.9.

Table 5.9 Potential Amount of Non-Ferrous Metals from ELV in Mexico

Year	ELV ('000)	Aluminium (tons)	Zinc, Copper, Magnesium, Lead (tons)
		8 %	2 %
2005	669	53,536	13,384
2006	678	54,271	13,568
2007	688	55,007	13,752
2008	697	55,742	13,936
2009	706	56,477	14,119
2010	715	57,213	14,303
2011	724	57,948	14,487
2012	734	58,684	14,671
2013	743	59,419	14,855
2014	752	60,155	15,039
2015	769	61,546	15,386

On the other hand, Mexico imports every year scrap metals from different countries to fulfill its demands. The Mexican Yearbook of Foreign Trade in 2004 reported the following amount of import and export of non-ferrous scrap metals,

Table 5.10 Imports and Exports of Different Non-Ferrous scrap Metals in 2003

Scrap material (Tons)	Aluminium	Copper	Nickel	Lead	Tin	Zinc
Import	73,981	9,170	1	245	61	0
Export	103,319	76,043	794	168	213	7,001

Source: INEGI, 2004.

The amount of non-ferrous metals obtained from ELV could cover a big part of national demand for these kinds of materials. Moreover, Mexico has a good advantage in the price of work force which is not expensive as compared to other countries (TSJGA, 2004). Therefore, the investment in plants with hand separation processes to carry out the sorting of valuable materials from the shredded ELV is a good option for the forthcoming stages of ELV management system in Mexico.

5.8 Energy Recovery and Final Disposal

Since 90's, the Mexican cement industry has started to use industrial wastes as secondary fuels to be co-incinerated in their processes (SEMARNAT, 2005). These secondary fuels are also known as Refuse Derived Fuels (RDF).

The thermal treatment of ASR and the use of ASR as RDF in cement kilns is widely practiced and well studied (Gendebien et al., 2003; Mirabile et al., 2002; Galvagno et al., 2001). The study carried out by Gendebien et al. in 2003 for the European Commission, addressed the use of Municipal Waste and Industrial Waste (included ASR) as RDF. The conclusions of this work reported that, the use of ASR as RDF caused a definitive increase of heavy metals such as lead, cadmium, copper and zinc, along with other by-products in cement (Gendebien et al., 2003). These effects were even more evident when co-incineration took place in brown coal power stations than that in hard coal power stations or fossil fuels of average quality.

It is important to take into account that, ASR studied by Gendebien et al. in 2003, has been produced before the implementation of Directive 2000/53/EC, which aims to reduce the contaminant levels in vehicles. Therefore, the improved quality of ASR coming from ELV treated under this Directive should influence the products and by-products using ASR as RDF in cement kilns.

Other approaches for final disposal of ASR fraction are the final disposal on special landfills, and its incineration in special facilities for hazardous wastes.

The final disposal in special landfills is the least favourable option in terms of environmental impacts and efficient use of resources, because no net benefit can be obtained from this disposal. The lack of benefit from this option clearly devalues the landfill alternative, especially for high calorific value wastes, which is literally wasted when landfilled. The option should only be considered for waste streams where energy recovery might cause a high environmental impact (Gendebien et al., 2003).

Regarding the second approach, the lack of capacity for incineration of hazardous waste in Mexico⁸⁵ and the increasing amount of ASR⁸⁶ might result in high capital investments dedicated to incineration facilities. Therefore, the use of ASR as RDF in industrial processes offers more flexibility than incineration, as it leaves an opened door for future recycling programmes.

⁸⁵ According to SEMARNAT in 2002, there is a generation of hazardous waste of 8 million tons per year, the total capacity for the management of this amount is 4.5 million tons a year

⁸⁶ Assuming the number of ELV generated in Mexico set in table 5.2

Aforementioned, this work recommends the use of ASR as RDF in industrial processes, as in cement production. This recommendation is valid as long as special measures are being developed to control the high emissions of hazardous substances, caused due to its co-incineration⁸⁷.

Mexico has a well developed cement Industry. There are six companies with 30 plants within Mexico. 21 plants are already carrying out the co-incineration of industrial wastes. The table 5.11 presents the total cement industry and those plants using industrial wastes as RDF.

Table 5.11 Cement Plants Using RDF in Mexico

Company	Total Plants	Plants using RDF
CEMEX México	15	11
Holcim Apasco	6	6
Cruz Azul	3	2
Cementos Chihuahua	3	1
Cementos Moctezuma	2	1
Lafarge Cementos	1	0

Sources: CANACEM, 2006

The total capacity to use RDF in Mexico is not yet well established. SEMARNAT has already granted 23 permissions to use RDF with a capacity of 700 thousand tons per year. This number has to be verified because not all companies have declared their capacity to use RDF (SEMARNAT, 2005)

According to studies carried out by different authors, such as Reinhardt and Richers, 2004, Zevenhofen and Saeed, 2003 and Gendebien et al., 2003, the Calorific Value of ASR is in a range of 7 – 28 MJ/kg, and density of around 0.28 – 0.40 ton/m³, with a moisture content in a range of 1 to 20%. The composition of ASR given by different authors is presented in the table 5.12.

⁸⁷ The NOM-098-ECOL-2000 set the limits for emissions due to the incineration of wastes, and the NOM-040-ECOL-2002 set the limits for emissions by cement industry, also including non conventional fuels.

Table 5.12 Typical ASR Composition (Different Authors)

% Weight	[1]	[2]	[3]	[4]	[5]
Plastics	30-48	20	32	41	33
Plastics (Foam)					15
Plastics (incl. Coatings, Textiles)					
Elastomers (incl. Rubber)	10-32	20	25	21	18
Fibres (Textile, Wood, Paper)	4-26	25	8	10	10
Paints, Lacquer	3-10		4	5	
Metals	~20		2		3
Glass, Ceramics, Electric materials	3-16			19	
Dust, Oil, etc.	10-20				
Inert (Glass, Sand, Grit, etc.)		35	29		
Other (Residues)				4	21
Oils, Water	15-17				

[1] Keller, 2003; [2] Galvano et al., 2001; [3] Orth, 2002; [4] Mirabile, et al., 2002; [5] Ambrose et al., 2002

The potential amount of ASR produced in Mexico by ELV in coming years can be calculated from the total number of ELV set in the point 5.3.1. The percentage of ASR in ELV is given by different authors, such as Reinhardt and Richers, 2004; Zevenhofen and Saeed, 2003 and CDEH, 2002, where ASR fraction is typically around 25 – 35% of weight. Hence, the expected amount of ASR for coming years in Mexico is shown in table 5.13.

Table 5.13 Potential Amount of ASR in Mexico

Year	ELV ('000)	ASR					
		25 % to 35%					
		(tons)			*(m ³)		
2005	669	167,300	to	234,219	492,057	to	688,880
2006	678	169,598	to	237,437	498,816	to	698,343
2007	688	171,896	to	240,654	505,576	to	707,806
2008	697	174,194	to	243,872	512,335	to	717,269
2009	706	176,492	to	247,089	519,094	to	726,732
2010	715	178,790	to	250,306	525,854	to	736,195
2011	724	181,089	to	253,524	532,613	to	745,659
2012	734	183,387	to	256,741	539,372	to	755,121
2013	743	185,685	to	259,959	546,132	to	764,584
2014	752	187,983	to	263,176	552,891	to	774,048
2015	769	192,331	to	269,263	565,679	to	791,950

* The density of ASR is in a range of 0.28 - 0.40 ton/m³, thus an average value of 0.34 ton/m³ was used.

Regarding the final disposal of remaining material from ELV, there are 198 landfill sites along Mexico⁸⁸. The total capacity of final disposal in Mexico is not yet established. The geographical distribution of these sites is shown in the figure 5.8.

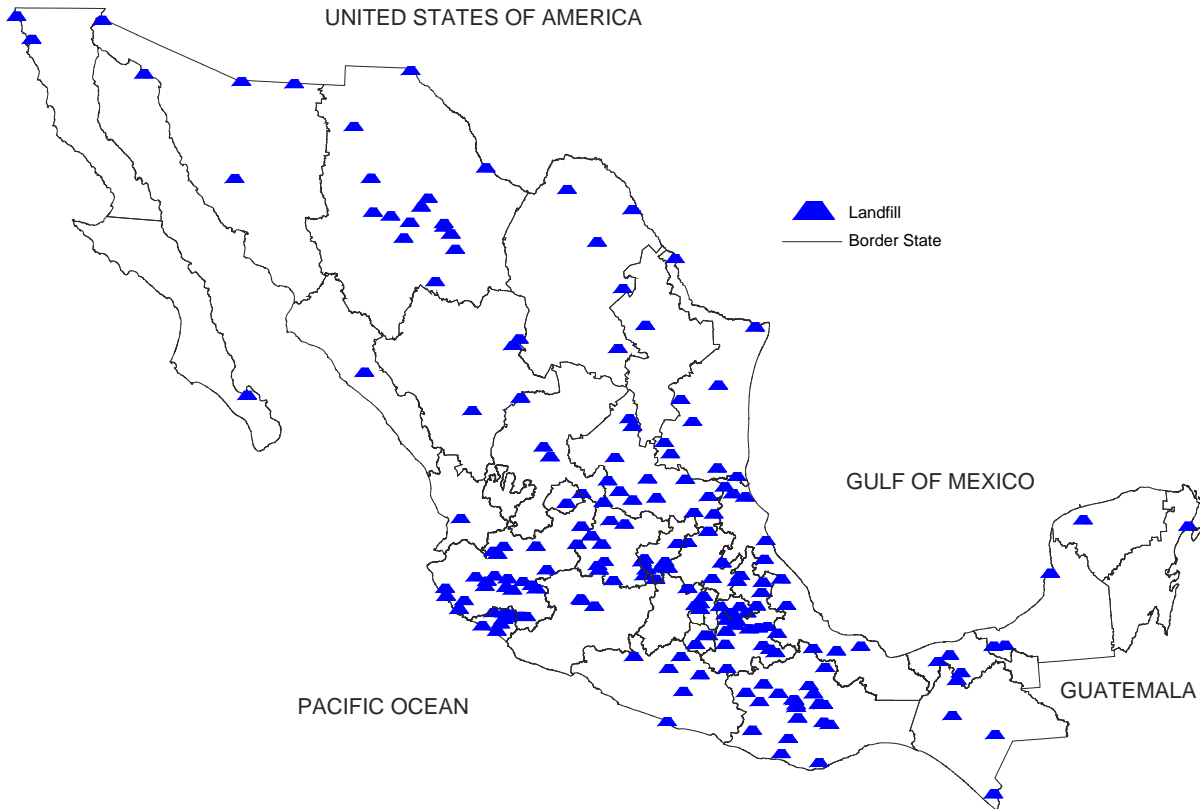

Figure 5.8 Geographic Locations of Landfill Sites in Mexico

⁸⁸ Due to the fact that there is no up-dated list of landfill sites in Mexico, the information was gathered through bibliographical search and telephonic communications with correspondent authorities in each state of Mexico.

5.9 Strategic Facility Networks in ELV Management

This section presents the general configuration of ELV management system for Mexico, which is proposed by this work. The configuration includes the number of facilities at every stage of ELV management⁸⁹, and their strategic geographical location within Mexico. Moreover, the configuration shows in detail, the transportation links between the stakeholders into the ELV chain.

The optimal solution for ELV management would be a complete management system located at the same place in which ELV are generated. Then every county would have dismantling, shredder and melting facilities, to cover that demand⁹⁰. However, mainly due to economic factors, the optimal solution is not feasible. Therefore, another configuration should be found in order to maximize the use of resources, and to grant success of the Mexican ELV management system. In this context, the Reverse Logistic Network and Facility Location theories might be very useful to find logistic structures that enable optimal ways of material flows, aiming at maximum recovery of value from the ELV (See Dekker et al., 2003).

The localities within Mexico can be considered as points given by coordinates in which ELV generation produces a demand of management. In terms of this work, every county has particular features, i.e. number of generated ELV, geographical location and some of these localities have already installed facilities, carrying out or able to perform activities related to ELV management. All these features can be translated in weights and distances to be introduced in an algorithm to obtain the best configuration under fixed conditions.

The identification of suitable algorithm to solve this problem in terms of Facility Location Theory has core importance. For this reason it is necessary to define three features of this case,

- a) number of possible points to allocate facilities to carry out the ELV management,
- b) objective of the system in terms of coverage and costs, and
- c) capacity of every facility.

The number of possible places to locate facilities are represented by every considered locality within Mexico, thus it is finite. Hence, the problem belongs to the wide range of Discrete Location Problems. A further definition is established by the objective of the system, which is minimization of the cost for satisfying the highest demand of ELV management, and by the capacity of facilities, which are considered unlimited. Thereby, the problem to solve is identified as Uncapacitated Facility Location Problem, which has been widely studied by Facility Location Theory (Mirchandani and Francis, 1990).

⁸⁹ The stages considered by this proposal are dismantling, shredding, melting, energy recovery and final disposal

⁹⁰ The demand is generated when an owner wants to retire permanently his/her vehicle from circulation

The Uncapacitated Facility Location Problem is referred by Daskin, 1995, as Fixed Charge Facility Location Problem. The formal way to present this problem is as following,

Inputs:

f_j = Fixed cost of locating at candidate site j

h_i = Demand at node i

d_{ij} = Distance from demand node i to candidate location j

α =cost per unit distance per unit demand

Decision variables

$$X_j = \begin{cases} 1 & \text{if we locate at candidate } j \\ 0 & \text{if not} \end{cases}$$

Y_{ij} = fraction of demand at node i that is served by facility at node j

Then, the formulation for the Uncapacitated Fixed Charge Facility Location Problem implemented in the ELV management is as follows,

$$\text{Minimize} \quad \sum_j f_j X_j + \alpha \sum_i \sum_j h_i d_{ij} Y_{ij} \quad (\text{b1})$$

$$\text{Subject to:} \quad \sum_j Y_{ij} = 1 \quad \forall i \quad (\text{b2})$$

$$Y_{ij} \leq X_j \quad \forall i, j \quad (\text{b3})$$

$$X_j = 0,1 \quad \forall j \quad (\text{b4})$$

$$Y_{ij} \geq 0 \quad \forall i, j \quad (\text{b5})$$

The objective function b1 minimizes total costs, which are the sum of fixed facility costs and total demand-weighted distance multiplied by the cost per unit distance per unit demand. The constraint b2 forces each demand node i to be served. The constraint b3 assigns the demand from node i to node j , just in case a facility is located at node j . The constraint b4 and b5 are the integrality and nonnegativity constraints, respectively. Since facilities are uncapacitated, all demand at node i will be assigned to the nearest open facility, thus the assignment variables Y_{ij} will naturally assume integer values (Daskin, 1995).

Other parameters used in the algorithm of this problem, are the Demand Weighted Total Distance (DWTD) and Demand Weighted Average Distance (DWAD), whose definitions are given as follows,

$$DWTD = \sum_i \sum_j h_i d_{ij} Y_{ij} \quad (b6)$$

$$DWAD = \frac{\sum_i \sum_j h_i d_{ij} Y_{ij}}{\sum_i h_i} \quad (b7)$$

The implementation of objective function (b1) will be done in five stages. Every stage corresponds to an ELV management stage, as it is described below,

- a) *Dismantling (last owners – collection points)*: Last owners can deliver their vehicle, or pay the towing to collection facilities, which are thought to perform take-back, de-pollution and dismantling operations. De-pollution and dismantling activities are carried out as described in point 5.5,
- b) *Shredder (collection points – shredder facilities)*: The rest of ELV, after de-pollution and dismantling operations is sent from dismantling facilities to shredder ones, to treat and homogenize the material in order to make it recyclable. The description of the activities carried out at this stage is in point 5.6,
- c) *Melting (shredder facilities – melting facilities)*: The metal fraction i.e. ferrous and non-ferrous fraction is freighted from shredder to the Iron & Steel Industry facilities within Mexico. The description of the activities carried out at this stage is explained in point 5.7.2,

- d) *Energy Recovery (shredder facilities – cement plants)*: Since most of the material to be disposed comes from the shredder stage, the material is thought to be freighted from shredder facilities to cement plants to use ASR as RDF, as considered in point 5.8,
- e) *Final disposal (collection, shredder, melting & cement facilities – landfills)*: The material not able to be recycled or recovered is thought to be sent into landfills for final disposal. The landfills able to accept this kind of residue considered by this work are presented in point 5.8.

For the solution of objective function (b1), taking into account all variables, constraints and parameters, the Facility Location software SITATION[®] is used. This software, developed by Prof. Mark S. Daskin in 2006 at the Northwestern University is specialized to solve a wide range of Location Problems.

The formulated model will be solved for three different Scenarios. Every scenario differs from the other in the percentage of ELV collection. Scenario-1 considers 100% coverage for ELV collection demand. In other words, the total number of ELV generated will be collected by the network. The second and third Scenarios consider 90% and 75% of coverage respectively. The sequence to solve the abovementioned model is shown in Figure 5.9.

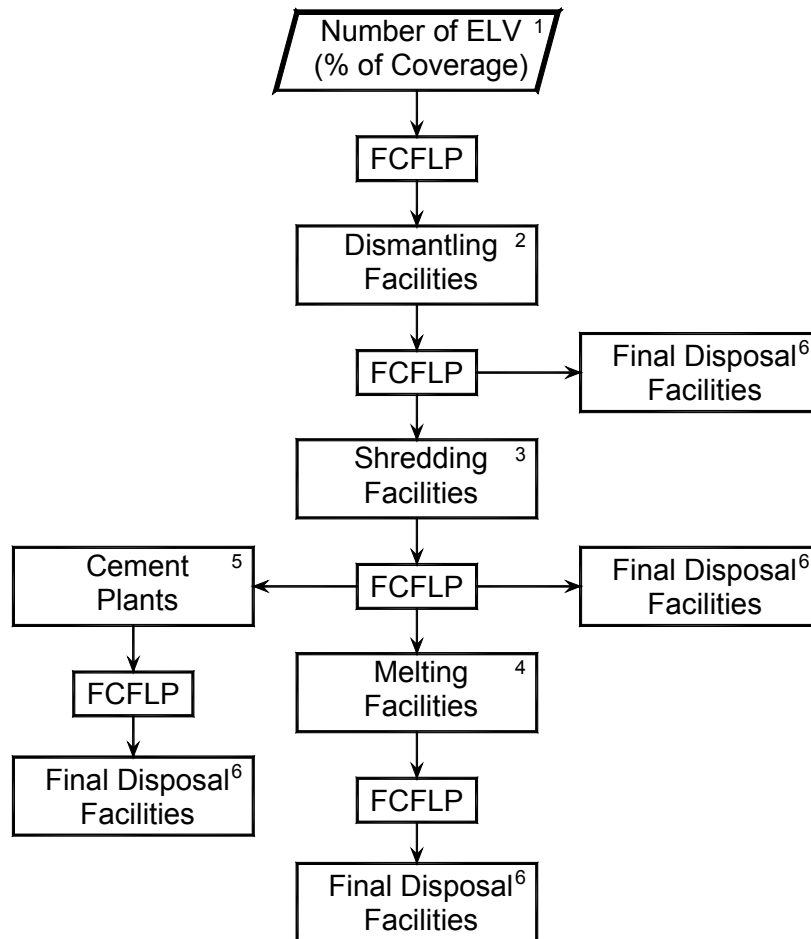

Figure 5.9 Implementation of FCFLP in the Configuration of ELV Facility Network Management

- 1 Number of ELV depends on the coverage percentage: 100%, 90% or 75%
- 2 Total numbers of facilities obtained from FCFLP solution
- 3 The solution should include existing facilities within Mexico
- 4 The solution includes only existing shredding facilities
- 5 The solution includes only existing plants using RDF
- 6 The solution includes only existing landfills

5.9.1 Scenario-1

The main feature of *Scenario-1* is 100% coverage in the collection of ELV generated in Mexico. This means that every ELV generated in Mexico enters into the ELV management system. Additional assumptions considered by this scenario are listed below,

- a) the main target for *Scenario-1* is the minimization of total costs for facility location and transportation. The material flows take place at dismantling, shredder, melting, energy recovery and final disposal stages,
- b) *Scenario-1* takes into a consideration the number of ELV generated in years 2007, 2010, 2015, 2020 and 2025. For years 2020 and 2025 the scenario is sub-divided in two scenarios A and B. These scenarios are described in the Appendix A,
- c) the available information takes into consideration 699 localities (from 2496 municipalities existing in Mexico). These localities include urban and rural municipalities as points where ELV would be generated in forthcoming years. The input data for this scenario is presented in detail in Appendix B,
- d) *Scenario-1* does not foresee new melting facilities to cover demand generated at shredder stage. The capacity of current facilities is considered enough for the considered period of time,
- e) Scenario-1 takes into account current existing shredding and melting facilities into computed solutions,
- f) the problem is set as Fixed Charge Facility Location Problem whose objective function is solved through the Facility Location software SITATION[®] (Daskin M. S., 2005). Since the US System is used by this software, the distances are given in miles. Results of SITATION's implementation are show in Appendix-D.

5.9.1.1 Dismantling Stage (Last Owners – Collection Points)

The behavior of fixed, transport and total costs of the facility network design at dismantling stage of ELV management in Mexico is presented in figure 5.10. The minimum point of total costs curve is the optimal solution for objective function (b1) for Scenario-1. Here, there is a 100% of demand covered at minimal cost.

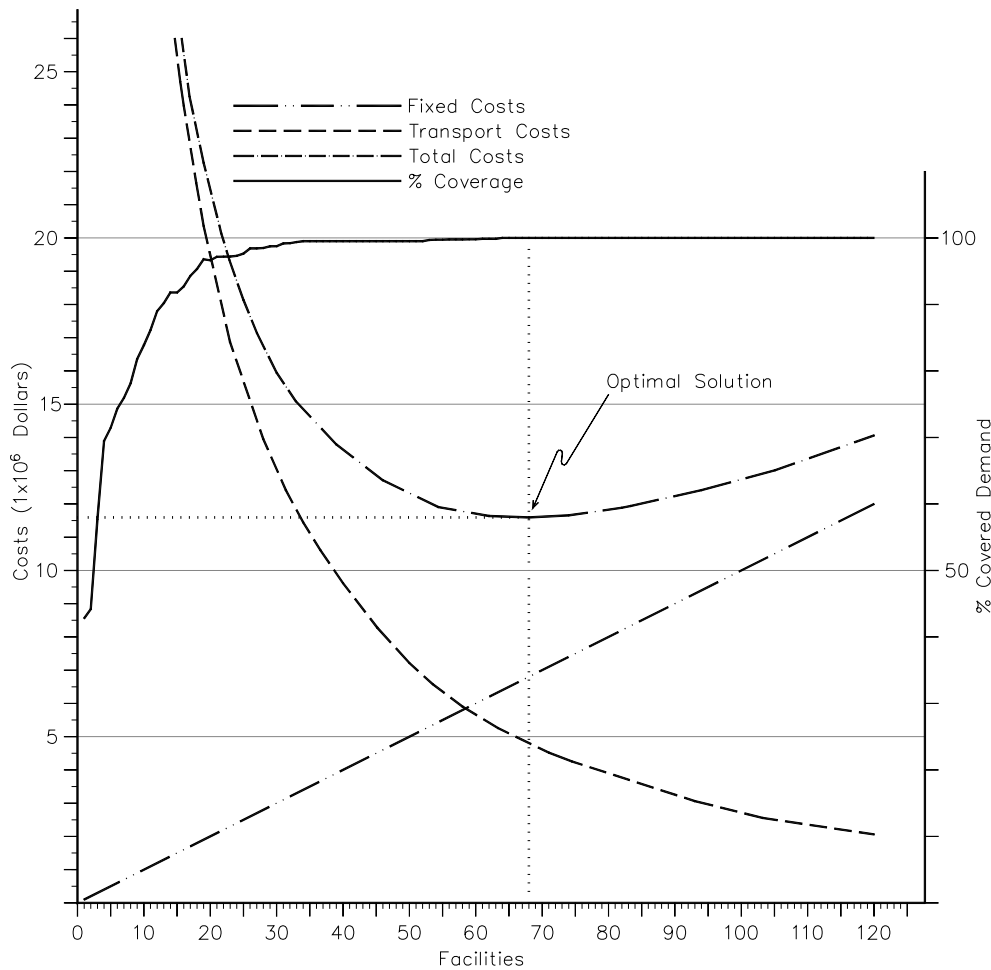

Figure 5.10 Graphic Solution of UFCFLP for Dismantling Stage in 2007, with 100% Coverage

The input data to construct the figure above takes into account facility fixed costs of \$100,000 USD/facility, transport fee of \$1.0 USD per mile per unit demand, and a coverage distance of 132 miles (212.4 km)⁹¹. It is important to point out that, changes in transportation fees and/or in facilities fixed costs would modify the optimal solution with a consequent difference in number of dismantling facilities⁹² to cover the demand.

⁹¹ For this specific problem, this is the minimal coverage distance required by the algorithm to compute the optimal solution for year 2007. A bigger coverage distance has no effect in the optimal solution, and a smaller coverage distance has as consequence less than 100% of total coverage

⁹² In terms of this work, collection points are referred also as dismantling facilities.

The figure 5.10 presented the solution for Scenario-1 by 2007. The same process has been performed for every year considered by this scenario, considering the corresponding numbers of ELV generated in every locality (see Appendix B). The results of this iterative implementation are presented in the table 5.14 and figure 5.11 presents the configuration at the dismantling stage in the ELV management system in Mexico. The figure shows the links between collection points and ELV generators. The corresponding points (graphic locations) and covered demands for these computations are presented in detail in Appendix D.

Table 5.14 SITUATION Results for Dismantling Stage of ELV Management in Mexico, Scenario-1

Feature \ Year	2007	2010	2015	Scenario A		Scenario B	
				2020	2025	2020	2025
Facilities	68	69	74	85	96	84	89
Coverage Distance (mi.)	132	132	132	132	132	132	132
% of Coverage	100	100	100	100	100	100	100
Average Weighted Distance (mi.)	7.94	7.78	7.05	5.78	4.84	5.89	5.41
Demand Weighted Total Distance ('000 Unit*mi.)	4,793	5,002	5,406	5,932	6,671	5,789	6,176
Total Traveled Distance (mi.)	23,949	23,693	23,235	21,650	20,211	21,702	21,104
Maximum Distance (mi.)	132	132	132	114	114	114	114

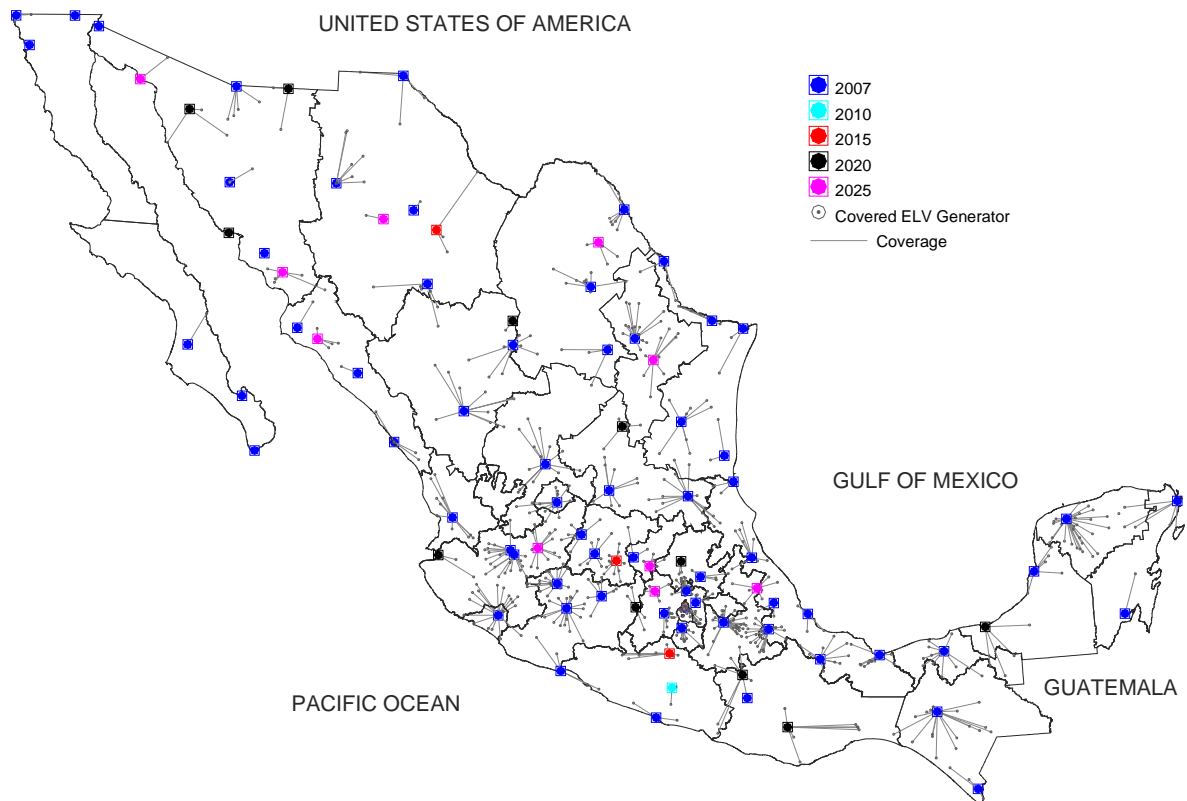

Figure 5.11 Graphic Location of Dismantling Facilities as Solution for Scenario-1

Note: The dismantling facilities, by 2020 and 2025 in the figure above correspond only to Scenario "A" presented in table 5.14.

5.9.1.2 Shredder Stage (Collection Points – Shredder Facilities)

The calculation of optimal number of shredder facilities to cover 100% of demand generated by dismantling facilities is calculated by the implementation of objective function (b1). These facilities are thought to treat resulting wrecks from ELV de-pollution and dismantling activities. At the shredder stage, the solution for *Scenario-1* has to consider current facilities existing in Mexico⁹³, as a part of the optimal solution. The main features of these facilities are shown in table 5.15.

Table 5.15 Current Existing Shredder Facilities in Mexico

Facility\ Feature	Input	Capacity (ton/month)	Location
CFF	ELV and house appliances	20,000	Ecatepec, Edo. Mexico
ECOREC	ELV and house appliances	5,500	Ciudad Juárez, Chihuahua
IRASA	ELV and house appliances	30,000	Apodaca, Nvo. León
PROME	ELV and house appliances	ND	Apodaca, Nvo. León

ND= No data available

The figure 5.12 presents the costs behaviour for fixed, transport and total costs at the shredder stage.

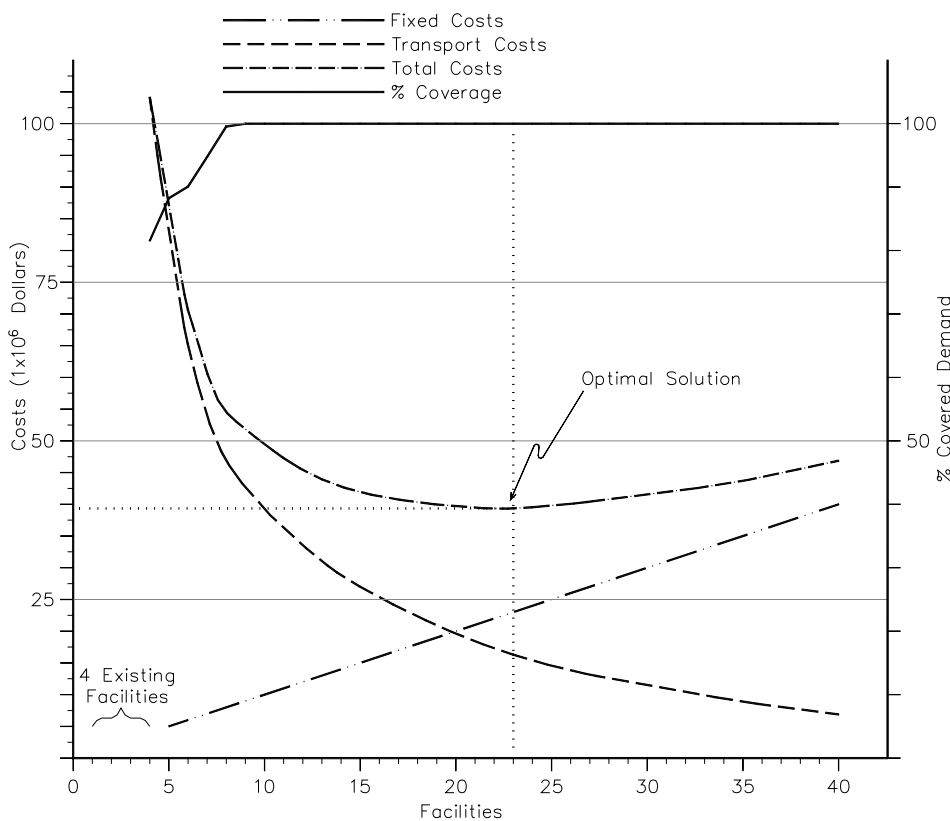

Figure 5.12 Graphic Solution of UFCFLP for Shredder Stage in 2007, with 100% Coverage

⁹³ The available information until the last update of this work allowed the localization of these facilities. However, there are some notes given in state newspapers about more facilities within Mexico. After many tries to contact the companies, only four existing facilities were available and thus only these are considered in the strategic network design.

The demands for this stage are represented by the number of ELV coming from every facility at the dismantling stage. The coverage distance taken into account for this calculation is 300 miles (482.7 km)⁹⁴. The fix costs for shredder facilities are considered as \$1,000,000.0 USD⁹⁵, and a transport fee of \$1.0 USD per mile per unit demand.

The figure 5.12 showed the behavior of fixed, transport and total costs curves, which presents the optimal number of shredder facilities to serve the demand, generated by dismantling facilities in Mexico by 2007. It is possible to observe the absence of fixed costs for shredder facilities which already exist. The existing facilities just generate transport costs in the material flows from dismantling facilities to shredder ones.

The optimal solution is the one which combines the minimal number of facilities and the minimal traveled distance. Therefore, minimal transport costs are appreciated in the minimum point of total costs curve. This point might change if there is a variation in transport fees and/or in fixed costs of facilities.

An iterative procedure similar to the previous point is implemented to set the optimal number of shredder facilities to cover the total demand and for the period of time covered by this work. The results of these calculations are shown in table 5.16, as well as the graphical configuration of the facilities within Mexico in figure 5.13. The corresponding points (graphic locations) and covered demands for these computations are presented in detail in Appendix D.

Table 5.16 SITUATION Results for Shredder Stage of ELV Management in Mexico, Scenario-1

Feature \ Year	2007	2010	2015	Scenario A		Scenario B	
				2020	2025	2020	2025
Facilities	23	23	25	29	34	27	30
Coverage Distance (mi.)	300	300	300	300	300	300	300
% of Coverage	100	100	100	100	100	100	100
Average Weighted Distance (mi.)	26.98	27.42	24.92	20.6	18.0	23.58	20.75
Demand Weighted Total Distance (´000 Unit*mi.)	16,299	17,633	19,117	21,121	24,820	23,181	23,702
Total Traveled Distance (mi.)	4,196	4,250	3,975	4,358	4,263	4,567	4,461
Maximum Distance (mi.)	226	226	226	180	178	226	180

⁹⁴ For this specific problem, the maximal coverage distance required by the algorithm to compute the optimal solution is 226 miles (363.6 km), however 300 miles (482.7 km) were considered for a round trip journey on a normal working day.

⁹⁵ The fix costs of a typical shredder facility in Europe is 933,172 €/year, according to Lander S., 2005.

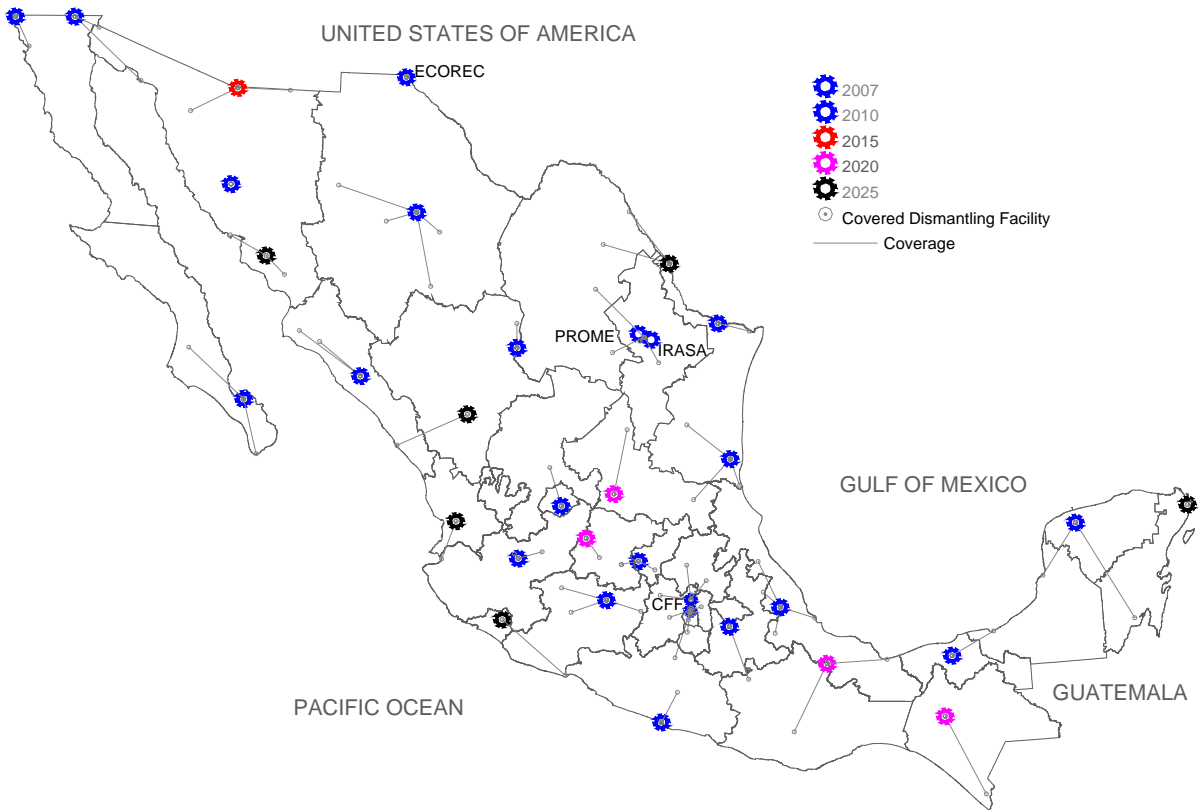

Figure 5.13 Graphic Locations of Shredder Facilities as Solution for Scenario-1

Note: The Shredder facilities, by 2020 and 2025 in the figure above correspond only to the scenario "A" presented in table 5.16

5.9.1.3 Melting Stage (Shredder Facilities – Melting Facilities)

The current existing facilities from the Iron & Steel Mexican Industry as indicated in the point 5.7.2 comprise of 19 facilities carrying out melting and primary processes of iron and steel in Mexico. These facilities are taken into account by *Scenario-1* as potential recyclers of ferrous fraction from shredded ELV. The name and location of existing melting facilities in Mexico are shown in table 5.17.

Table 5.17 Current Existing Melting Facilities in Mexico

Facility\ Feature	Location	Facility\ Feature	Location
Cia. Siderúrgica de California	Mexicali, B.C.N.	Siderúrgica Lázaro Cárdenas	Lázaro Cárdenas, Michoacán
Procesadora Mexicali	Tijuana B.C.N.	HYLSA S.A. de C.V.	Apodaca, Nvo. León
Altos Hornos de México	Monclova, Coahuila	DEACERO S.A. de C.V.	Monterrey, Nvo. León
DEACERO S.A. DE C.V.	Ramos A., Coahuila	DEACERO S.A. DE C.V.	Puebla, Puebla
HYLSA S.A. De C.V.	D.F.	HYLSA S.A. de C.V.	Cholula, Puebla
DEACERO S.A. DE C.V.	Villagrán, Guanajuato	Aceros San Luis	S.L.P., S.L.P.
Cia. Siderúrgica de Guadalajara	Guadalajara, Jalisco	Metalúrgica Veracruzana, SA de CV	Cosamaloapan, Veracruz
DEACERO S.A. de C.V.	El Salto, Jalisco	Talleres y Aceros de México	Orizaba, Veracruz
Siderúrgica Tultitlan	Tultepec, México	Tubos de Acero de México,	Valente Díaz, Veracruz
DEACERO S.A. DE C.V.	Tultitlán, México	Siderúrgica de Yucatán	Mérida, Yucatán
DEACERO S.A. DE C.V.	Tlalnepantla, México		

* Collection facility of shredded material

Due to the well established steel industry in Mexico and high investment that represents new melting plants of iron and steel primary processes, the current *Scenario-1* does not consider new plants. Thereby, the material resulting from shredder facilities is planned to be sent to the existing melting plants described in table 5.17.

The potential capacity for steel scrap in Mexico is not known. However, a good indicator is the amount of imports of this material described in table 4.4, which reported in 2004, imports around 2.1 million tons. A theoretical collection of 100% of steel scrap from ELV by 2007 would be around 347,000 tons (see table 5.7). Therefore, it is assumed that there is enough capacity to treat steel scrap with current facilities from Iron & Steel Mexican Industry.

Under the consideration that no new melting facilities are required, the number of existing melting facilities to send shredder material, and the main features of the computation from SITATION[®], are described in table 5.18. The corresponding points (graphic locations) and covered demands for these computations are presented in detail in Appendix D.

Table 5.18 SITUATION Results for Melting Stage of ELV Management in Mexico, Scenario-1

Feature \ Year	2007	2010	2015	Scenario A		Scenario B	
				2020	2025	2020	2025
Facilities	15	15	15	15	16	15	15
Coverage Distance (mi.)	300	300	300	300	300	300	300
% of Coverage	89.8	89.8	90.7	90.7	91.05	90.69	91.05
Average Weighted Distance (mi.)	66.422	66.506	65.533	64.078	67.408	63.128	64.154
Demand Weighted Total Distance ('000 Unit*mi.)	40119	42765	50264	65680	92955	62055	73264
Total Traveled Distance (mi.)	3053	3053	3432	3748	4865	3451	3991
Maximum Distance (Miles)	503	503	503	503	503	503	503

According to the results obtained from computation, the maximal coverage given under fixed conditions, i.e. lowest cost, coverage within 300 miles (482.7km)⁹⁶ and transport fee of \$1.0 USD per mile per unit demand, could not reach 100% of the total demand. Nevertheless, the percentage of coverage is considered enough for Scenario-1 (89% to 91%). The geographical locations of selected melting facilities and the configuration of this stage is presented in figure 5.14.

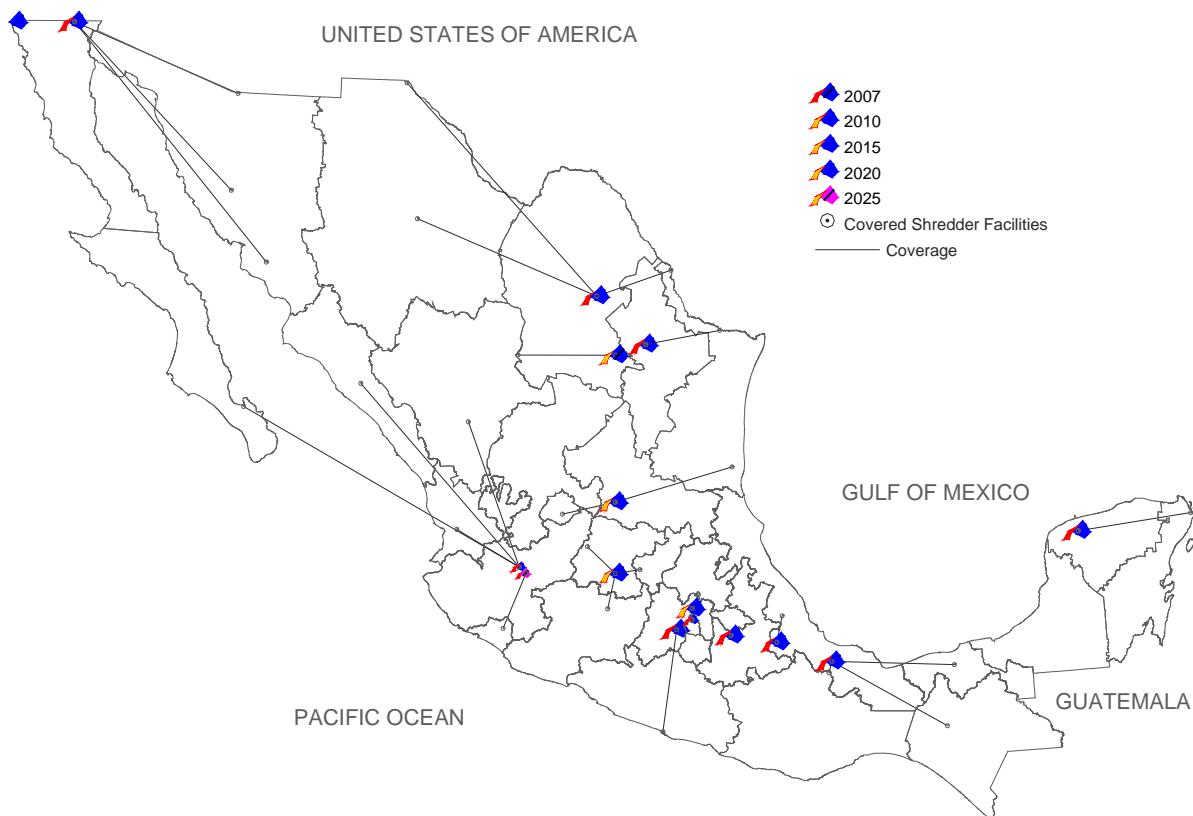

Figure 5.14 Graphic Locations of Foundries Facilities as Solution for Scenario-1

⁹⁶ For this specific problem, the maximal coverage distance required by the algorithm to compute the optimal solution is 503 miles (809.3 km), however 300 miles (482.7 km) were considered for a round trip journey on a normal working day.

5.9.1.4 Energy Recovery Stage (Shredder Facilities – Cement Plants)

In order to avoid high environmental burdens produced by ASR, and to impulse the sustainability in ELV management, the *Scenario-1* foresees energy recovery from ASR produced at shredder facilities. The point 5.8 gives a wide description of RDF use in Mexico, mainly by cement plants.

The current Mexican plants using RDF are listed in table 5.19, and the amount of ASR expected by the period of time considered by *Scenario-1* is shown in table 5.20.

Table 5.19 Current Cement Plants Using RDF in Mexico

Company	Plant
CEMEX-Mexico	Atotonilco
	Ensenada
	Guadalajara
	Hidalgo
	Huichapan
	Merida
	Monterrey
	Torreon
	Valles
	Yaqui
	Zapotilic
HOLCIM-Asasco	Acapulco
	Apaxco
	Macuspana
	Orizaba
	Ramos Arizpe
	Tecoman
Cruz Azul	Hidalgo
	Lagunas
Chihuahua-Cement	Samalayuca
Moctezuma-Cement	Tepetzingo

Source: CANACEM, 2006

Table 5.20 Potential ASR Production in Mexico by 2007-2025

Feature \ Year	2007	2010	2015	Scenario A		Scenario B	
				2020	2025	2020	2025
ELV ('000 Unit)	604	643	767	1025	1379	983	1142
ASR * (tons)	151,013	160,696	192,331	256,252	344,525	245,775	285,171

* The content of ASR in ELV is considered 25% of ELV total weight

Scenario-1 does not foresee new Recovery Energy facilities, which is thought to use the current existing infrastructure, as in the previous point. Therefore, the main aim is to minimize the demand weighted average distance and maximize the coverage of demand given by shredder facilities. The table 5.21 presents the number of existing cement plants needed to cover the demand for the period of time, taken into account by this work. The corresponding points (graphic locations) and covered demands for these computations are presented in detail in Appendix D.

Table 5.21 SITUATION Results for Cement Plants Using RDF in Mexico, Scenario-1

Feature \ Year	2007	2010	2015	Scenario A		Scenario B	
				2020	2025	2020	2025
Facilities	15	15	15	15	16	15	15
Coverage Distance (mi.)	300	300	300	300	300	300	300
% of Coverage	98.8	98.8	98.8	98.8	98.8	98.8	98.8
Average Weighted Distance (mi.)	51.42	51.40	53.59	55.35	57.74	54.94	55.60
Demand Weighted Total Distance ('000 Unit*mi.)	7,764	8,262	10,276	14,182	19,905	13,503	15,873
Total Traveled Distance (mi.)	1,626	1,626	1,903	2,283	2,834	2,119	2,414
Maximum Distance (mi.)	321	321	321	321	321	321	321

The achievement of 100% coverage with the current infrastructure and fixed conditions, i.e. lowest cost, coverage within 300 miles (482.7km)⁹⁷ and transport fee of \$1.0 USD per mile per unit demand, could not be reached. One facility at the shredder stage is out of this distance with 321 miles (516.5 km), thus transportation costs are higher for that uncovered facility. Selected plants are shown in figure 5.15, as well as their geographic distribution within Mexico, and their links with shredder facilities.

⁹⁷ For this specific problem, the maximal coverage distance required by the algorithm to compute the optimal solution is 321 miles (516.5km), however 300 miles (482.7 km) were considered for a round trip journey on a normal working day.

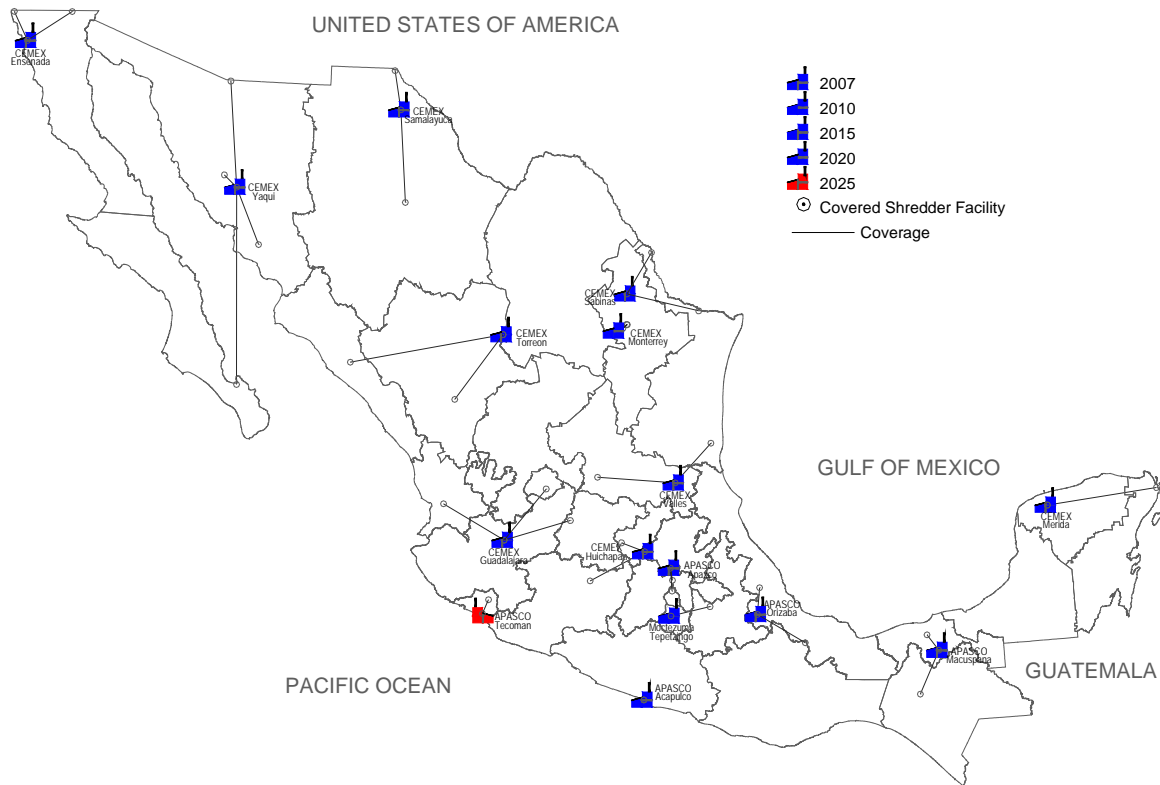

Figure 5.15 Graphic Locations of Cement Plants Using RDF for Scenario-1

5.9.1.5 Final Disposal Stage (Dismantling, Shredder, Melting & Cement Facilities – Landfills)

The present work proposes final disposal in landfills for the remaining ELV material coming out from every process in the ELV management system, and which is not considered by the Mexican law as hazardous waste.

The amount of waste generated by every facility in the system, and able to be landfilled, is considered a percentage of every ELV received at facilities. Thus, facilities with more ELV inflows will generate more waste to be landfilled. Thereby, the selection of existing landfills at the closest distance represents lower transportation costs. Hence, the objective function (b1) is implemented to reduce the transportation costs at minimum, and with total cover of demands.

The number of landfills available for final disposal is presented in point 5.8. Table 5.22 presents the number of landfills necessary to cover the demand generated by the system for the considered period of time, and at every stage of ELV management system.

Table 5.22 Landfills to Cover Total Demands at Different Stages for Scenario-1, 2007 to 2025

Stage	Feature \ Year	2007	2010	2015	Scenario A		Scenario B	
					2020	2025	2020	2025
Dismantling	Landfills	54	55	58	65	71	65	66
	Total Traveled Distance (mi.)	1,584	1,584	1,643	2,028	2,425	1,996	2,162
	Maximum Distance (mi.)	159	159	159	159	161	159	159
Shredder	Landfills	21	21	23	27	31	25	28
	Total Traveled Distance (mi.)	265	265	289	281	447	305	281
	Maximum Distance (mi.)	51	51	51	51	126	51	51
Melting	Landfills	12	12	13	13	13	13	13
	Total Traveled Distance (mi.)	287	287	227	227	227	227	227
	Maximum Distance (mi.)	95	95	42	42	42	42	42
Cement plants	Landfills	14	14	14	14	15	14	14
	Total Traveled Distance (mi.)	253	253	253	253	253	253	253
	Maximum Distance (mi.)	64	64	64	64	64	64	64

The current number of landfills within Mexico is enough to cover the demand for final disposal, generated by different facilities in the ELV management system. The available information does not allow establishing total capacity of disposal, thus this estimation takes into account just the distance between facilities and landfills. Figures 5.16 to 5.19 present selected landfills linked to facilities at every stage of ELV management in Mexico for Scenario-1 by 2007 to 2025. The corresponding points (graphic locations) and covered demands for these computations are presented in detail in Appendix D.

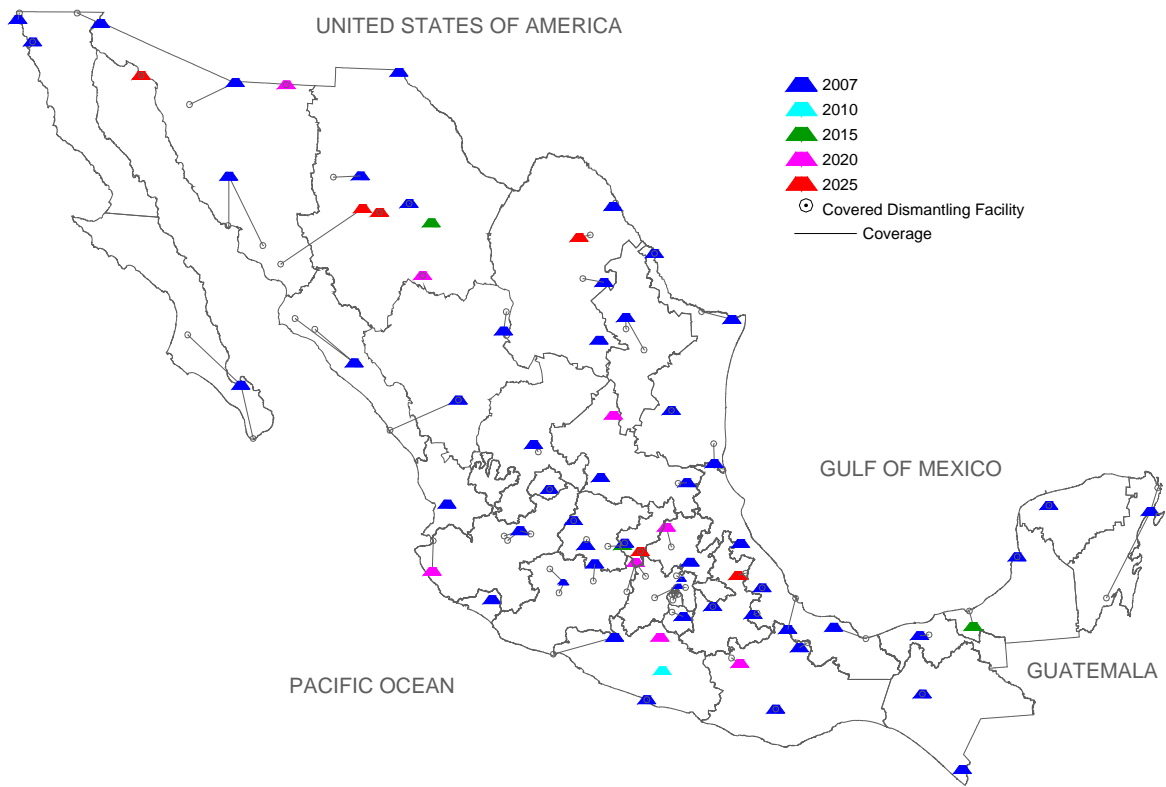

Figure 5.16 Selected Landfills to Cover the Disposal Demand by Dismantling Facilities for Scenario-1

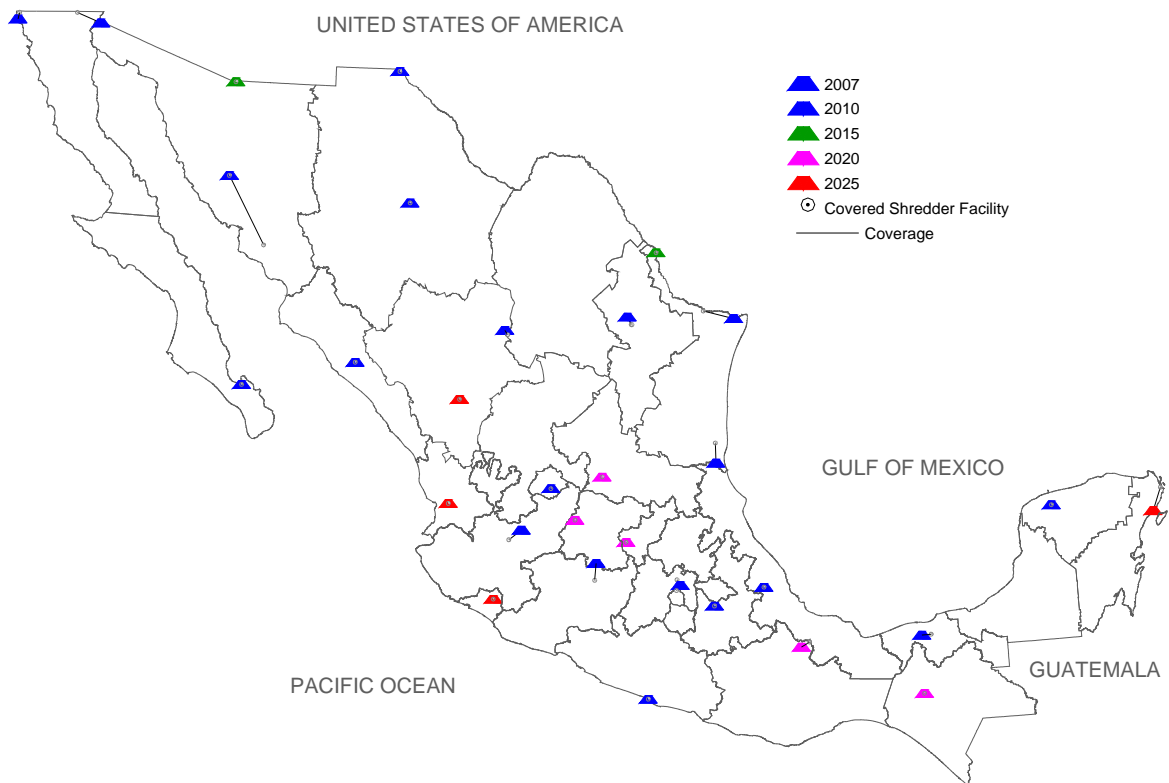

Figure 5.17 Selected Landfills to Cover the Disposal Demand by Shredder Facilities for Scenario-1

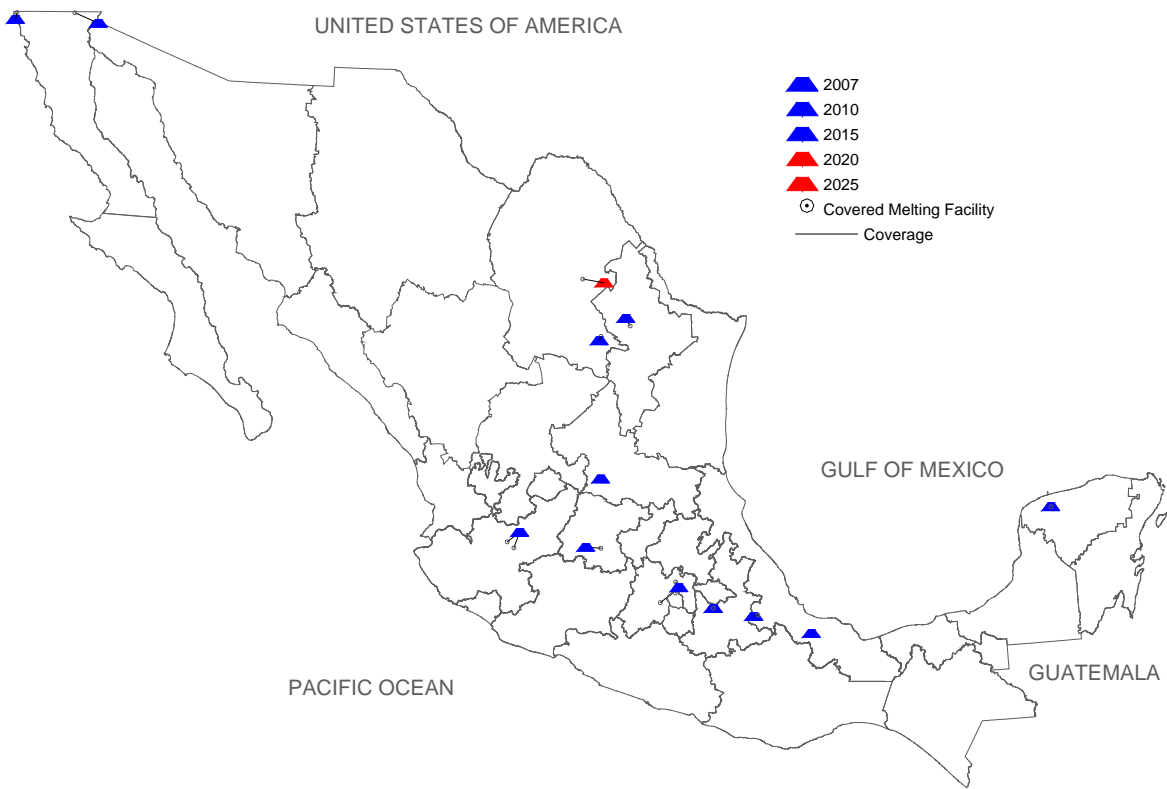

Figure 5.18 Selected Landfills to Cover the Disposal Demand by Melting Facilities for Scenario-1

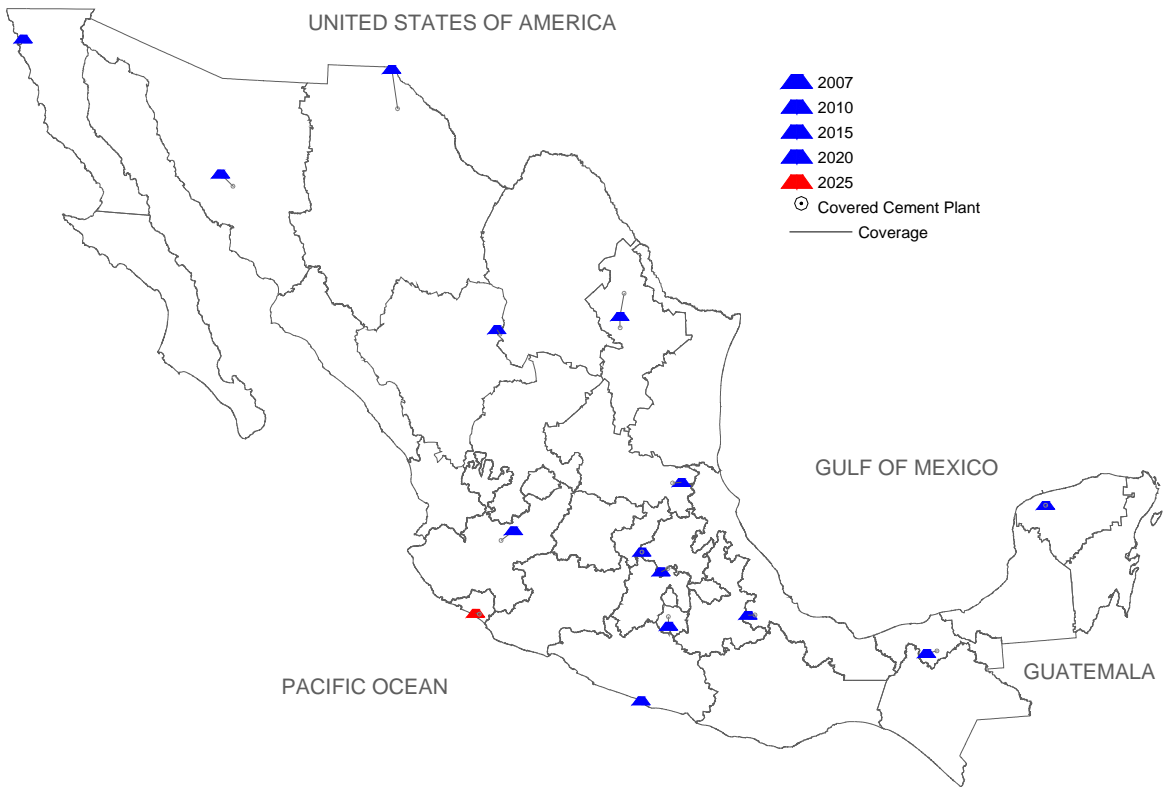

Figure 5.19 Selected Landfills to Cover the Disposal Demand by RDF Facilities for Scenario-1

5.9.2 Scenario-2

The main feature of *Scenario-2* is at least 90% coverage in collection of ELV generated in Mexico. This means that a reduced number of ELV generated in Mexico, in comparison with Scenario-1, would enter into the ELV management system. Additional assumptions considered by this scenario are listed below,

- a) the main target for *Scenario-2* is the minimization of total costs for facility location and transportation. The material flows take place at dismantling, shredder, melting, energy recovery and final disposal stages,
- b) *Scenario-2* takes into a consideration the number of ELV generated in years 2007, 2010, 2015, 2020 and 2025. For years 2020 and 2025 the scenario is sub-divided in two scenarios A and B. These scenarios are described in point 5.3.1,
- c) the available information takes into consideration 699 localities (from 2496 municipalities existing in Mexico). These localities include urban and rural municipalities, as points where ELV would be generated in the forthcoming years. The input data for this scenario is presented in detail in Appendix B,
- d) *Scenario-2* does not foresee new melting facilities to cover demand generated at the shredder stage. The capacity of current facilities is considered enough for the considered period of time,
- e) Scenario-2 takes into account the current existing shredding and melting facilities into computed solutions,
- f) the problem is set as Fixed Charge Facility Location Problem, whose objective function is solved through the Facility Location software SITATION[®] (Daskin M. S., 2005). Since the US System is used by this software, the distances are given in miles. Results of SITATION's implementation are show in Appendix-D.

5.9.2.1 Dismantling Stage (Last Owners – Collection Points)

The behavior of fixed, transport and total costs, generated as solution of objective function (b1), is presented in the figure 5.20. For *Scenario-2* a reach of 90% in the coverage of demand is considered⁹⁸, thus a reduced number of facilities for collection is required. In case of ELV generated by 2007, the required number of facilities to cover 90% of the demand is 13.

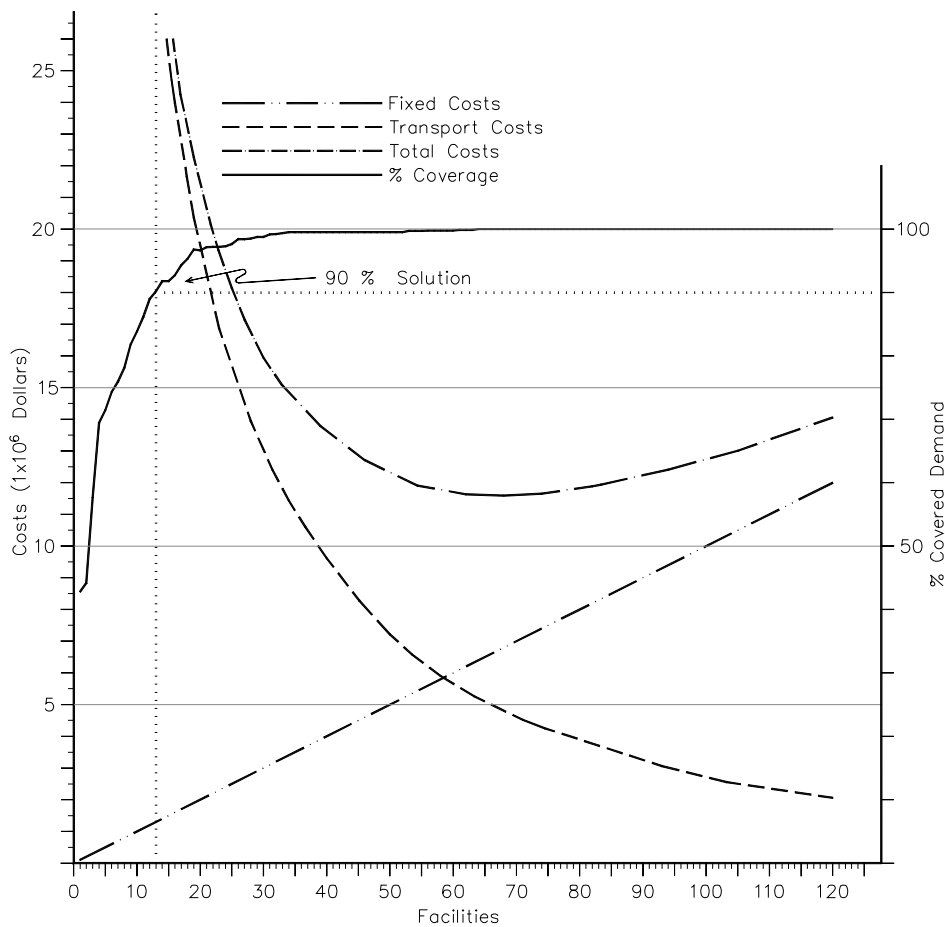

Figure 5.20 Graphic Solution of UFCFLP for Dismantling Stage in 2007, with 90% Coverage

The table 5.23 shows that 13 facilities are enough to cover 90% of the demand generated during the whole period of time taken by this work. It is evident that this solution is not the optimal one, as the cost of transportation grows up enormously with the solution of 13 facilities. The corresponding points (graphic locations) and covered demands for these computations are presented in detail in Appendix D.

⁹⁸ Total demand is the total number of ELV generated in Mexico, by 2007 and the period of time taken into account by this work.

Table 5.23 SITUATION Results for Dismantling Stage of ELV Management in Mexico, Scenario-2

Feature \ Year	2007	2010	2015	Scenario A		Scenario B	
				2020	2025	2020	2025
Facilities	13	13	13	13	13	13	13
Coverage Distance (mi.)	132	132	132	132	132	132	132
% of Coverage	90.19	90.19	90.19	90.19	90.19	90.19	90.19
Average Weighted Distance (mi.)	47.5	47.5	47.5	47.5	47.5	47.5	47.5
Demand Weighted Total Distance ('000 Unit*mi.)	28,667	30,519	36,402	48,647	65,448	46,655	54,200
Total Traveled Distance (mi.)	34,864	34,864	34,864	34,864	34,864	34,864	34,864
Maximum Distance (mi.)	268	268	268	268	268	268	268

It is assumed that coverage distance (132 miles = 212.4 km), transport fees and fix costs remain constant for the period of time considered. The percentage of coverage is reached with the same number of facilities and therefore, all the features in table 5.23 appear the same for all years, except in the DWTD (Demand Weighted Total Distance) that increases as demand rises.

The graphic configuration at this stage of ELV management with 13 facilities and their coverage is shown in figure 5.21.

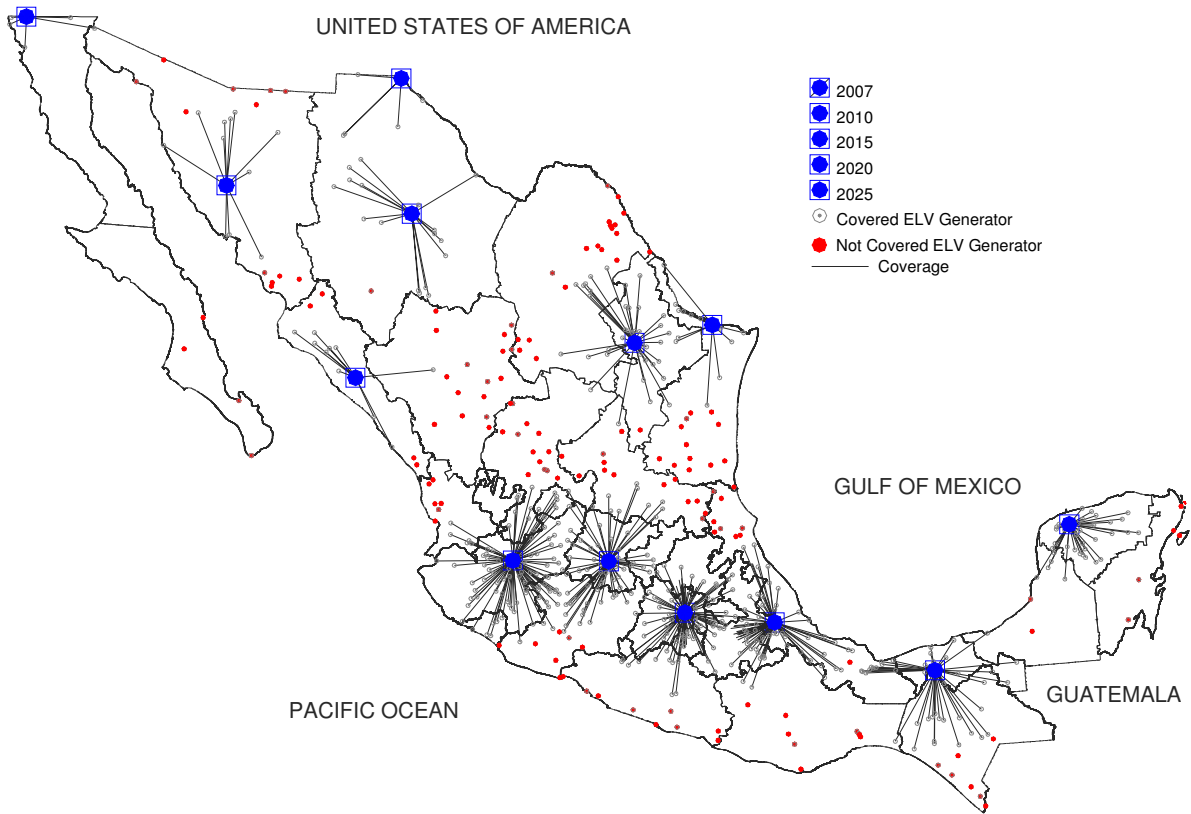

Figure 5.21 Graphic Configuration for Dismantling Facilities as Solution for Scenario-2

The uncovered points shown in the figure above (in red) represent counties, whose generation of ELV and distance to other counties were unfavorable to be included in the solution to cover at least 90% of the total number of ELV generated in Mexico.

5.9.2.2 Shredder Stage (Collection Points – Shredder Facilities)

The shredder stage considers 90% of collection at dismantling stage, thus the objective function (b1) is implemented obtaining the optimal number of shredder facilities needed to treat that amount of material. The result is 14 as is shown in figure 5.22, which corresponds to the solution of an Incapacitated Fixed Charge Facility Location Problem implemented at the shredder stage. It is important to point out the inclusion of existing shredder facilities in Mexico, which are described in table 5.15.

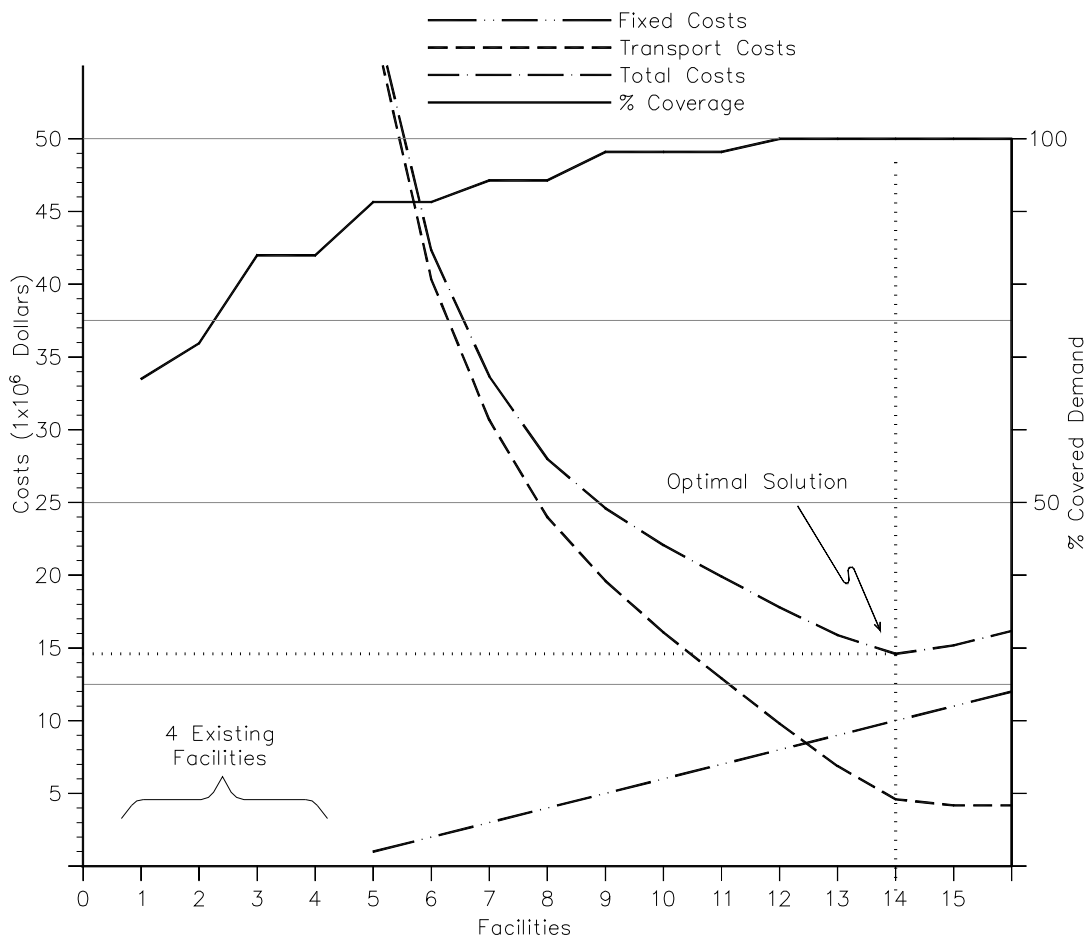

Figure 5.22 Graphic Solution of UFCFLP for Shredder Stage in 2007, with 90% Coverage

The figure above, as well as in *Scenario-1*, takes into account facilities fixed cost of \$1000,000 USD, transport fee of \$1.0 USD per mile per unit demand, and a coverage distance of 300 miles (482.7 km). The objective function (b1) was also implemented by different years and their corresponding demands, considering an initial collection of 90% of total ELV generation (with 13 dismantling facilities). The optimal number of shredder facilities to cover this demand for treatment is presented in table 5.24. The corresponding points (graphic locations) and covered demands for these computations are presented in detail in Appendix D.

Table 5.24 SITATION Results for Shredder Stage of ELV Management in Mexico, Scenario-2

Feature \ Year	2007	2010	2015	Scenario A		Scenario B	
				2020	2025	2020	2025
Facilities	14	14	14	14	14	14	14
Coverage Distance (mi.)	300	300	300	300	300	300	300
% of Coverage	100	100	100	100	100	100	100
Average Weighted Distance (mi.)	8.4	8.4	8.4	8.4	8.4	8.4	8.4
Demand Weighted Total Distance ('000 Unit*mi.)	4,593	4,890	5,833	7,795	10,487	7,475	8,684
Total Traveled Distance (mi.)	27	27	27	27	27	27	27
Maximum Distance (mi.)	18	18	18	18	18	18	18

The graphic configuration at shredder stage, as solution for *Scenario-2*, is presented in figure 5.23.



Figure 5.23 Graphic Locations of Shredder Facilities, as Solution for *Scenario-2*

5.9.2.3 Melting Stage (Shredder Facilities – Melting Facilities)

As the main assumption for *Scenario-2* is a collection of 90% of the total number of ELV generated in Mexico, at the melting stage are selected existing melting facilities from the Mexican Iron and steel Industry for recycling the material coming from the shredder stage. As well as in Scenario-1, the main objective function (b1) pursues minimal total costs for stage configurations. Although new melting facilities are not allowed, i.e. no fixed costs, distances and transport costs are the only two factors to consider. The results for implementing objective function (b1) at this stage for different years are presented in table 5.25. The corresponding points (graphic locations) and covered demands for these computations are presented in detail in Appendix D.

Table 5.25 Melting Facilities in Mexico for *Scenario-2* from 2007 to 2025

Feature \ Year	2007	2010	2015	Scenario A		Scenario B	
				2020	2025	2020	2025
Facilities	10	10	10	10	10	10	10
Coverage Distance (mi.)	300	300	300	300	300	300	300
% of Coverage	91.2	91.2	91.2	91.2	91.2	91.2	91.2
Average Weighted Distance (mi.)	46.2	46.2	46.2	46.2	46.2	46.2	46.2
Average Covered Distance (mi.)	14.4	14.4	14.4	14.4	14.4	14.4	14.4
Demand Weighted Total Distance ('000 Unit*mi.)	25,166	26,792	31,680	42,707	57,459	40,958	47,583
Total Traveled Distance (mi.)	352	352	352	352	352	352	352
Maximum Distance (mi.)	451	451	451	451	451	451	451

Coverage of 100% could not be reached with a coverage distance of 300 miles (482.7 km). The computation given by SINATION[®] shows that there are shredder facilities 451 miles (725.7 km) away to the closest facility. Thereby 91.2% of coverage was the maximum reached with 10 facilities during the entire considered period of time. The graphical presentation of results in table 5.25 is shown in figure 5.24.

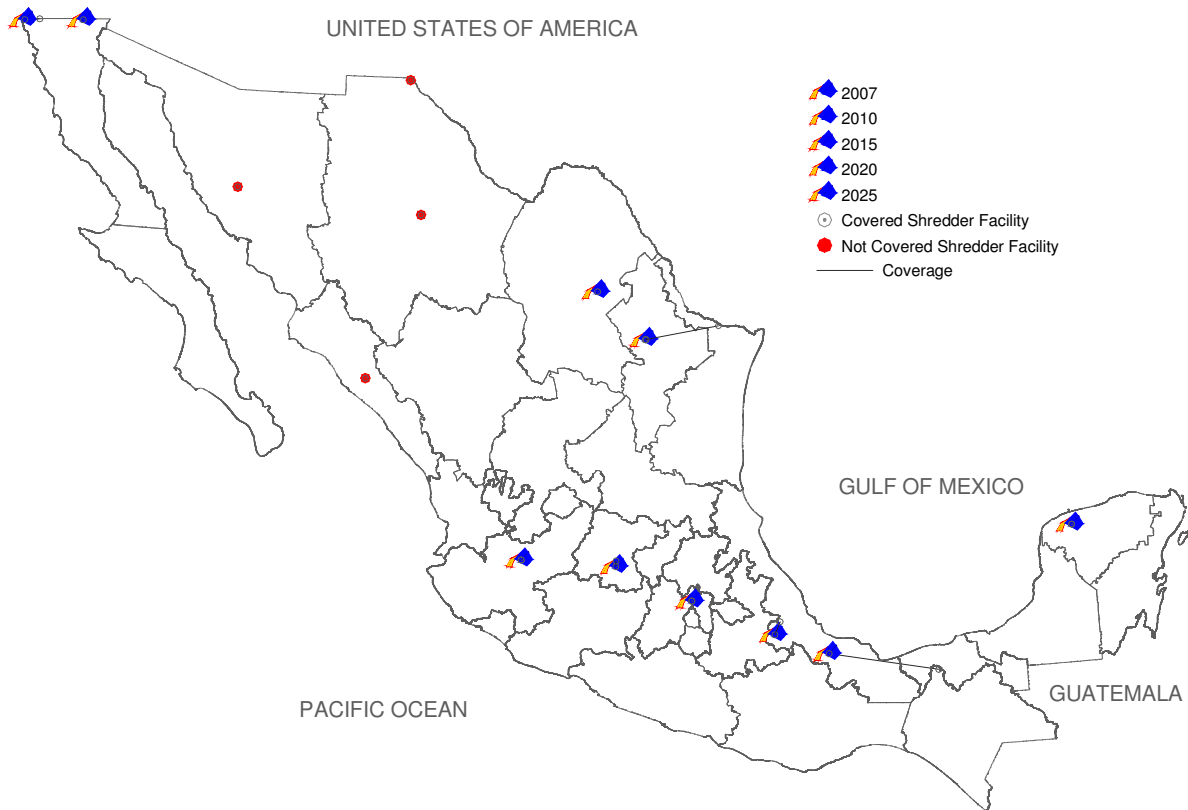

Figure 5.24 Graphic Location of Melting Facilities, as Solution for Scenario-2

5.9.2.4 Energy Recovery Stage (Shredder Facilities – Cement Plants)

The cement plants using RDF listed in table 5.19 are thought to cover the demand generated at shredder facilities of ELV management system. As well as in Scenario-1 the objective function (b1) is used to select the closest cement plants to shredder facilities, in order to reduce the transport cost at the minimum. The results for implementing objective function (b1) are given in table 5.26. The corresponding points (graphic locations) and covered demands for these computations are presented in detail in Appendix D.

Table 5.26 SITATION Results for Cement Plants Using RDF in Mexico, Scenario-2

Feature \ Year	2007	2010	2015	Scenario A		Scenario B	
				2020	2025	2020	2025
Facilities	12	12	12	12	12	12	12
Coverage Distance (mi.)	300	300	300	300	300	300	300
% of Coverage	100	100	100	100	100	100	100
Average Weighted Distance (mi.)	37.1	37.1	37.1	37.1	37.1	37.1	37.1
Demand Weighted Total Distance ('000 Unit*mi.)	5,050	5,376	6,379	8,570	11,530	8,219	9,548
Total Traveled Distance (mi.)	840	840	840	840	840	840	840
Maximum Distance (mi.)	252	252	252	252	252	252	252

The 12 selected facilities from the current infrastructure of cement plants using RDF are enough to cover the total demand generated at the shredder stage of ELV in Mexico, for the Scenario-2. The greatest distance between an RDF facility and a shredder is 252 miles (405.5 km), as is shown in the results presented in table 5.26.

The graphic configuration at energy recovery stage, as results given in table 5.26 is broken down in figure 5.25.



Figure 5.25 Graphic Locations of Cement Plants Using RDF for Scenario-2

5.9.2.5 Final Disposal Stage (Collection, Shredder, Melting & Cement Facilities – Landfills)

The amount of waste generated by every facility in the system, and able to be landfilled, is considered a percentage of every ELV received at facilities. Thus, facilities with more ELV inflows will generate more waste to be landfilled. Thereby, the selection of existing landfills at the closest distance represents a lower transportation costs. Therefore, the objective function (b1) is implemented to reduce the transportation costs at minimum, and with total cover of demands.

The number of landfills available for final disposal is presented in point 5.8. Table 5.27 presents the number of landfills necessary to cover the demand generated at every stage. The same table presents these results for the entire period of time considered by this work.

Table 5.27 Landfills to Cover Total demands at Different Stages for Scenario-2, 2007 to 2025

Stage	Feature \ Year	2007	2010	2015	Scenario A		Scenario B	
					2020	2025	2020	2025
Dismantling	Landfills	13	13	13	13	13	13	13
	Total Traveled Distance (mi.)	199	199	199	199	199	199	199
	Maximum Distance (mi.)	51	51	51	51	51	51	51
Shredder	Landfills	13	13	13	13	13	13	13
	Total Traveled Distance (mi.)	210	210	210	210	210	210	210
	Maximum Distance (mi.)	51	51	51	51	51	51	51
Melting	Landfills	8	8	8	8	8	8	8
	Total Traveled Distance (mi.)	285	285	285	285	285	285	285
	Maximum Distance (mi.)	97	97	97	97	97	97	97
Cement plants	Landfills	11	11	11	11	11	11	11
	Total Traveled Distance (mi.)	224	224	224	224	224	224	224
	Maximum Distance (mi.)	64	64	64	64	64	64	64

The reduced number of ELV entering the ELV management in Mexico considered for Scenario-2 affects the amount of waste generated by every facility of the system. The number of required landfills at every stage is evidently lower than that in the previous scenario. The graphic configuration at final disposal stage for Scenario-2 is presented in figures 5.26 to 5.29.

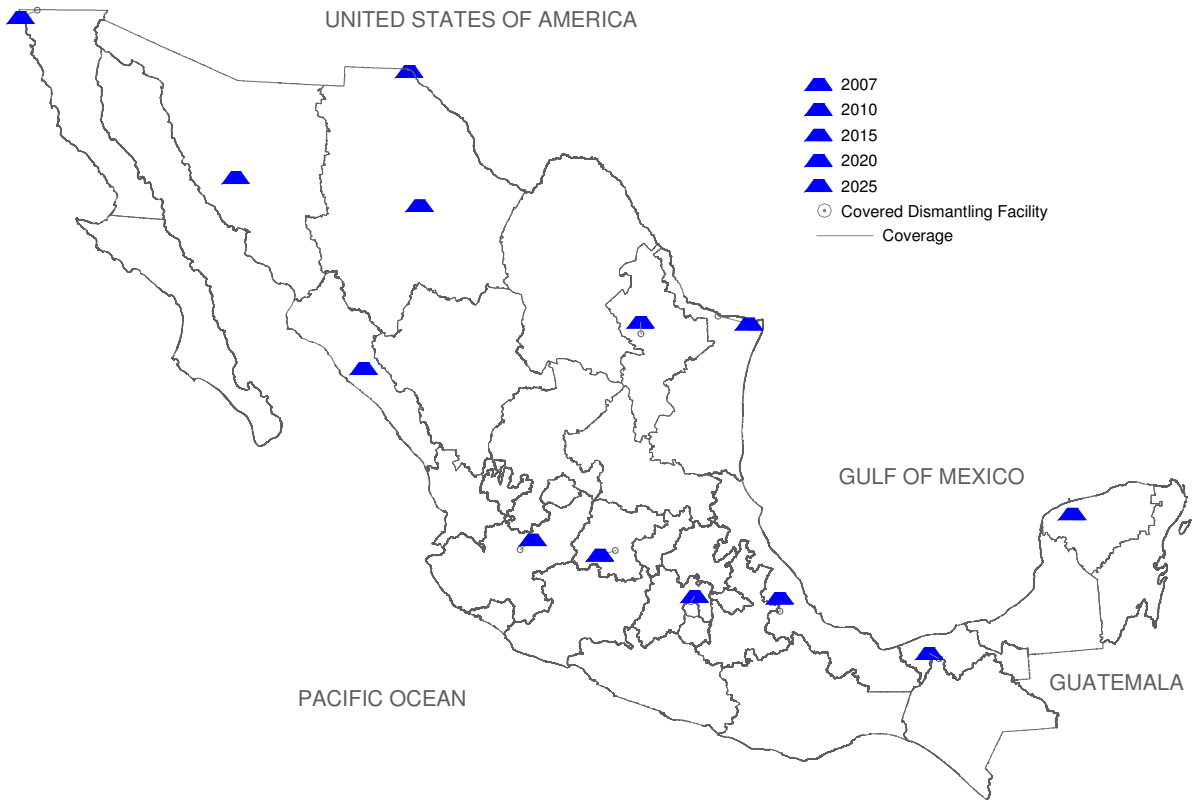

Figure 5.26 Selected Landfills to Cover the Disposal Demand by Dismantling Facilities for Scenario-2

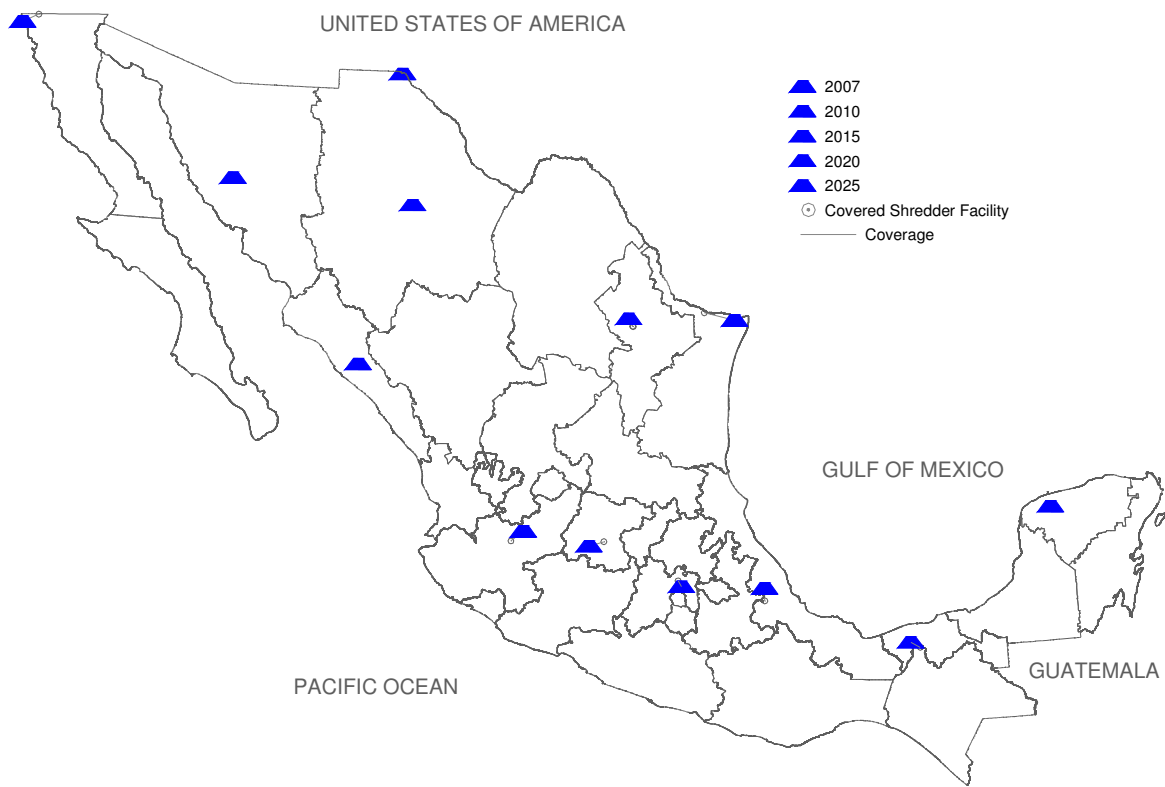

Figure 5.27 Selected Landfills to Cover the Disposal Demand by Shredder Facilities for Scenario-2

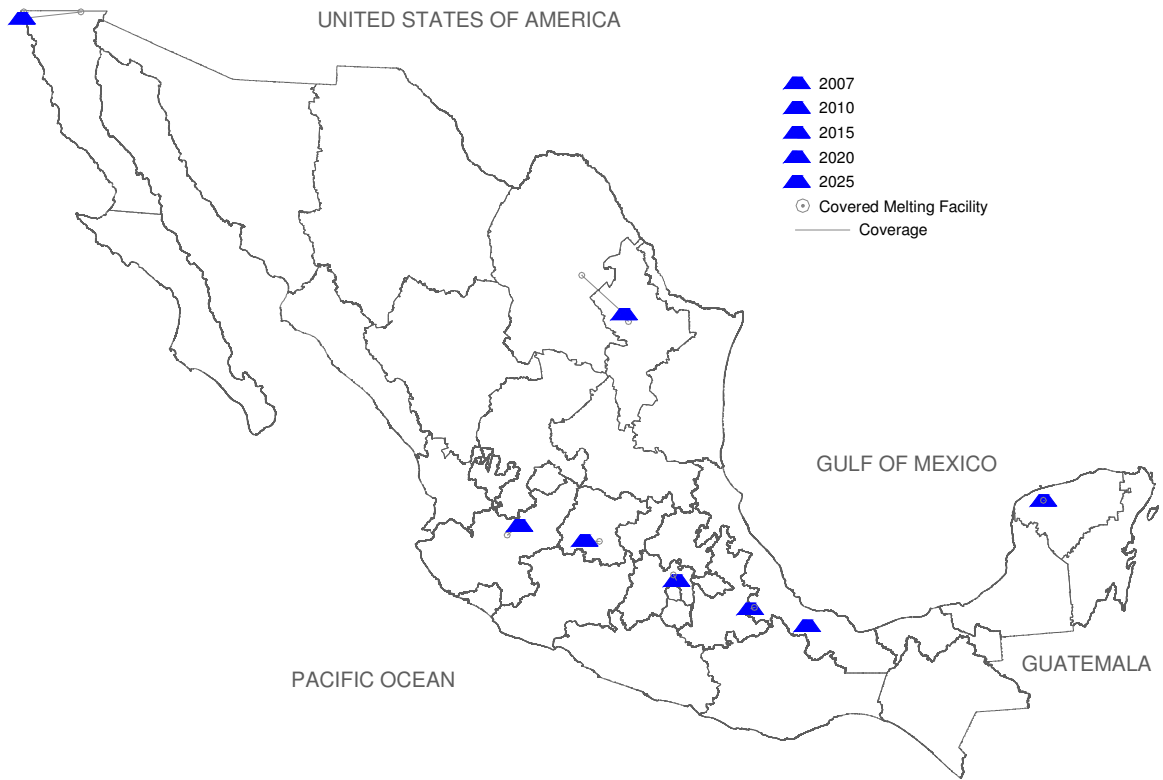

Figure 5.28 Selected Landfills to Cover the Disposal Demand by Melting Facilities for Scenario-2

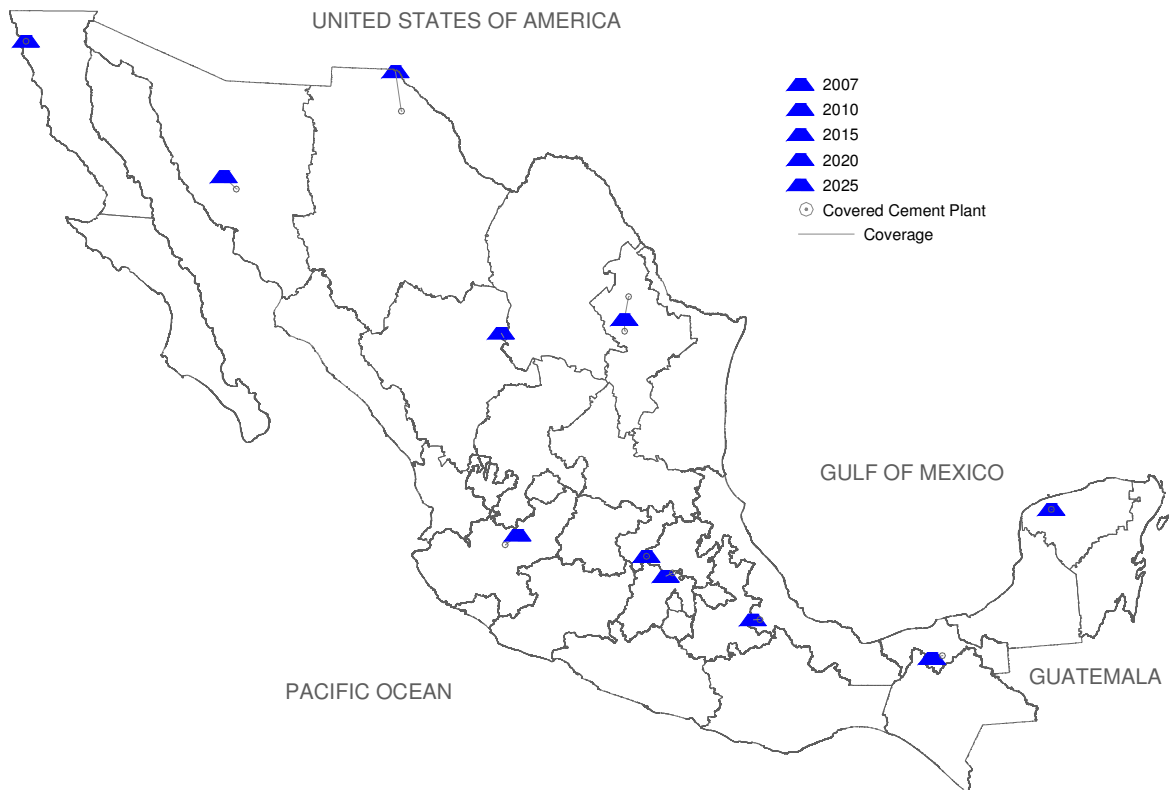

Figure 5.29 Selected Landfills to Cover the Disposal Demand by RDF Facilities for Scenario-2

5.9.3 Scenario-3

Scenario-3 is characterized for considering the minimal number of new facilities in all stages of management. This condition is found when an initial collection of 75% takes place. In other words, only 75% of total number of ELV generated in Mexico would enter into the ELV management. Additional assumptions considered by this scenario are listed below,

- a) the main target for *Scenario-3* is the minimization of total costs for facility location and transportation. The material flows take place at dismantling, shredder, melting, energy recovery and final disposal stages,
- b) *Scenario-3* takes into a consideration the number of ELV generated in years 2007, 2010, 2015, 2020 and 2025. For years 2020 and 2025 the scenario is sub-divided in two scenarios A and B. These scenarios are described in point 5.3.1,
- c) the available information takes into consideration 699 localities (from 2496 municipalities existing in Mexico). These localities include urban and rural municipalities, as points where ELV would be generated in the forthcoming years. The input data for this scenario is presented in detail in Appendix B,
- d) *Scenario-3* does not foresee new melting facilities to cover demand generated at the shredder stage. The capacity of current facilities is considered enough for the considered period of time,
- e) *Scenario-3* takes into account current existing shredding and melting facilities into computed solutions,
- f) the problem is set as Fixed Charge Facility Location Problem, whose objective function is solved through the Facility Location software SITATION[®] (Daskin M. S., 2005). As the US system is used by this software, the distances are given in miles. Results of SITATION's implementation are show in Appendix-D.

5.9.3.1 Dismantling Stage (Last Owners – Collection Points)

The behavior of fixed, transport and total costs, at the dismantling stage as solution of objective function (b1) are presented in figure 5.30. Hence, one can observe the number of facilities at the dismantling stage which cover 75% of the total demand produced by ELV generation in Mexico.

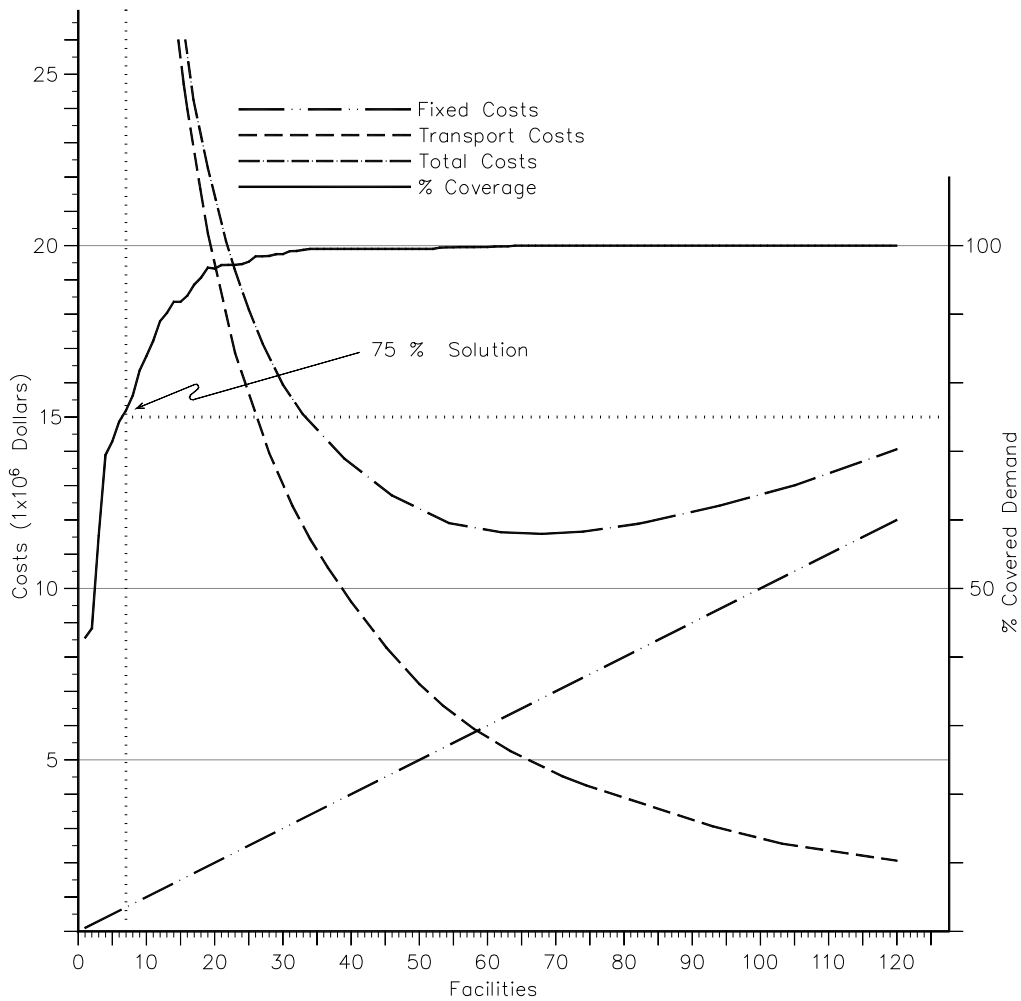

Figure 5.30 Graphic Solution of UFCFLP for Dismantling Stage in 2007, with 75% Coverage

Seven dismantling facilities can reach collection coverage of at least 75% of total number of ELV generated in Mexico by 2007. Since this solution is not the optimal one, the costs are enormous, especially those related with transport from generation points to dismantling facilities. The table 5.28 describes the results for implementing objective function (b1) for different years with the consequent growth in numbers of ELV, and the required facilities to maintain at least 75% of the covered demand at the dismantling stage. The corresponding points (graphic locations) and covered demands for these computations are presented in detail in Appendix D.

Table 5.28 SITATION Results for Dismantling Facilities of ELV Management in Mexico, Scenario-3

Feature \ Year	2007	2010	2015	Scenario A		Scenario B	
				2020	2025	2020	2025
Facilities	7	7	7	7	7	7	7
Coverage Distance (mi.)	132	132	132	132	132	132	132
% of Coverage	76	76	76	76	76	76	76
Average Weighted Distance (mi.)	74.6	74.6	74.6	74.6	74.6	74.6	74.6
Demand Weighted Total Distance ('000 Unit*mi.)	45,078	47,990	57,244	76,498	102,920	73,365	85,232
Total Traveled Distance (mi.)	28,713	28,713	28,713	28,713	28,713	28,713	28,713
Maximum Distance (mi.)	443	443	443	443	443	443	443

According to the results computed by SITATION[®], the achievement of at least 75% of coverage in different years, at dismantling stage can be carried out by seven facilities. As in Scenario-2, the coverage distance (132 miles = 212.4 km), transport fees and fix costs are considered constant during the entire period of time. Therefore, the required percentage of coverage is reached with the same number of facilities. For this reason, all the features in table 5.28 appear the same for all years, except in the DWTD, in which the increasing demand is involved.

The graphic configuration at this stage including covered and uncovered points is presented in figure 5.31.

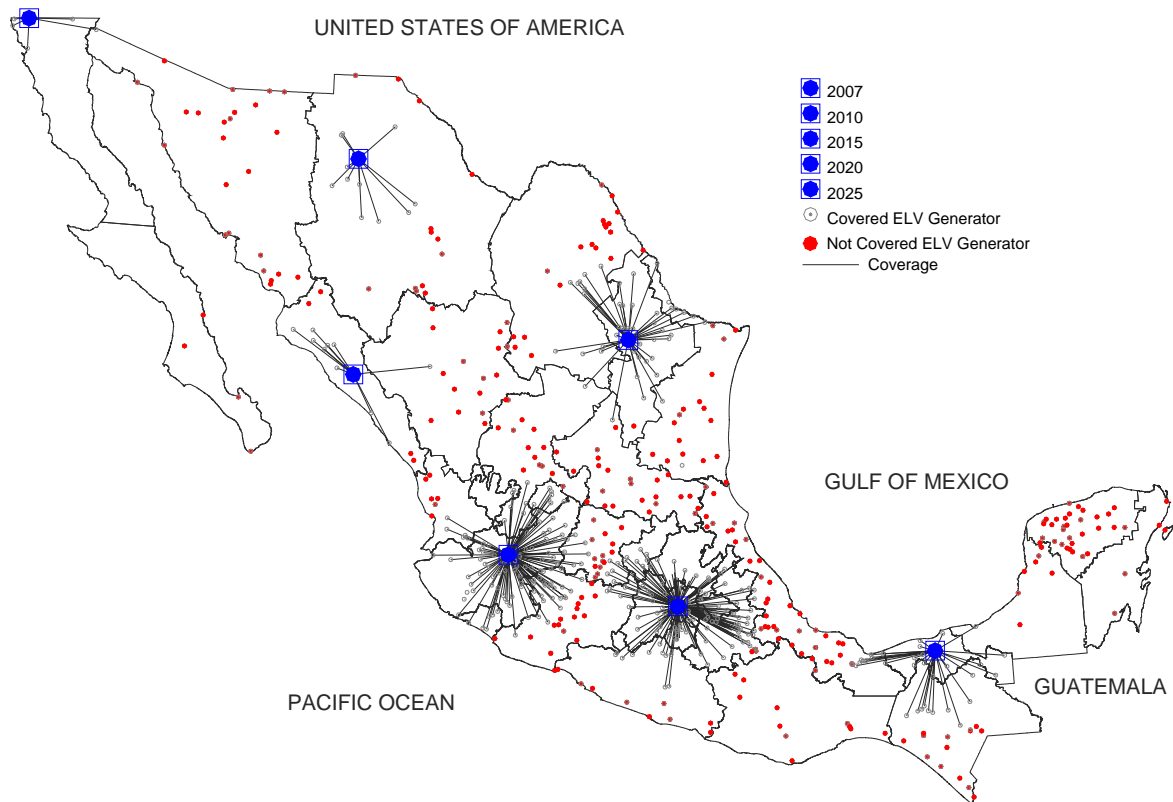

Figure 5.31 Graphic Location of Dismantling Facilities, as Solution of Scenario-3

5.9.3.2 Shredder Stage (Collection Points – Shredder Facilities)

According to the assumptions given for *Scenario-3*, any new facility is foreseen at this stage. Thus, the four existing shredder facilities, described in table 5.15, are claimed to cover as much as possible from 75% of the total number of ELV generated in Mexico. The results implementing objective function (b1), at this stage and for different years, are given in table 5.29.

Table 5.29 SITATION Results for Existing Shredder Facilities of ELV Management, Scenario-3

Feature \ Year	2007	2010	2015	Scenario A		Scenario B	
				2020	2025	2020	2025
Existing Facilities	4	4	4	4	4	4	4
Coverage Distance (mi.)	300	300	300	300	300	300	300
% of Coverage	85.7	85.7	85.7	85.7	85.7	85.7	85.7
Average Weighted Distance (mi.)	136.6	136.6	136.6	136.6	136.6	136.6	136.6
Demand Weighted Total Distance ('000 Unit*mi.)	62,646	66,694	79,553	106,313	143,031	101,957	118,449
Total Traveled Distance (mi.)	451	451	451	451	451	451	451
Maximum Distance (mi.)	603	603	603	603	603	603	603

Due to the same number of shredder facilities prevailing during the period of time considered for *Scenario-3*, the same points will be served with a single change in the amount of material from ELV each year. The four current facilities could reach coverage of 85.7%⁹⁹. Therefore, most of the features described in table 5.29 remain similar, just for DWTD there is a variation which is affected by increasing the amount of demand. The graphic configuration at this stage is presented in figure 5.32. The corresponding points (graphic locations) and covered demands for these computations are presented in detail in Appendix D.

⁹⁹ This percentage is referred to the initial number of ELV collected and considered by *Scenario-3*, which at the same time was only 75% of the total, thus a 64.3% of the total number of ELV material is treated by this stage in Mexico.

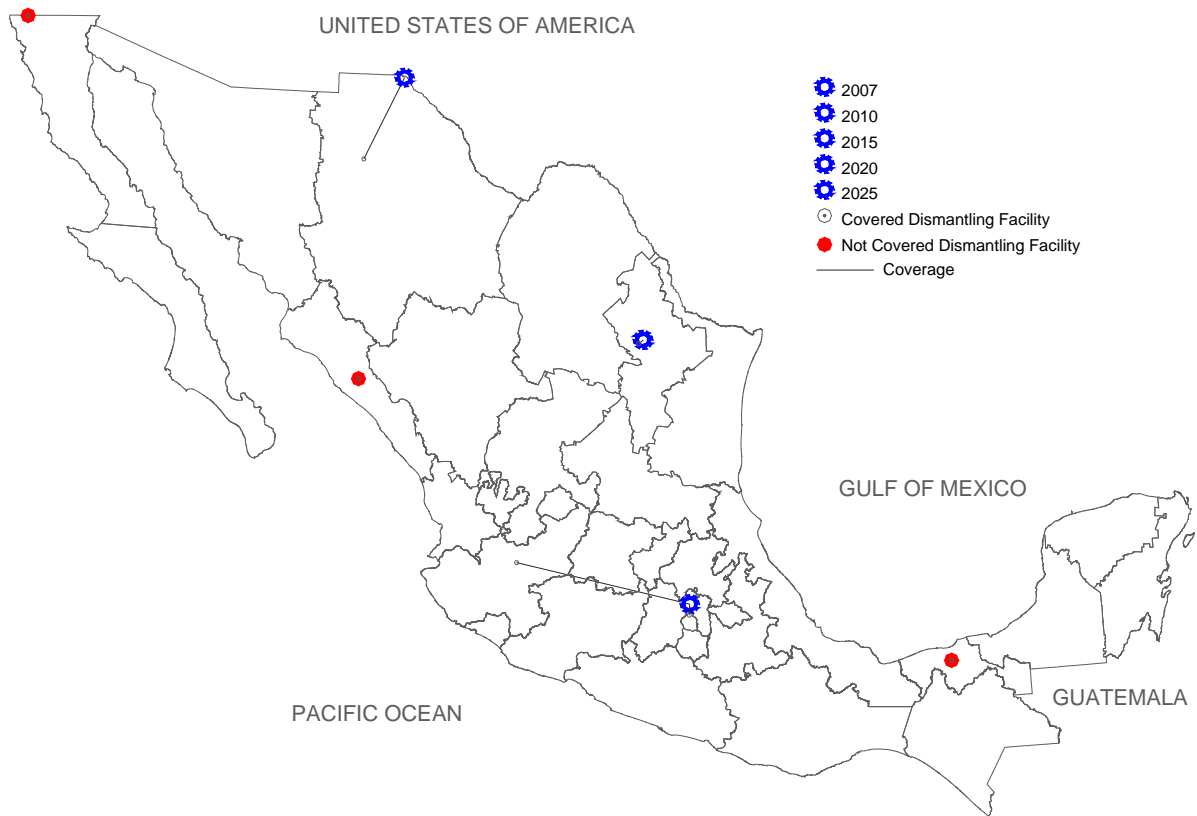

Figure 5.32 Graphic Locations of Shredder Facilities, as Solution of Scenario-3

5.9.3.3 Melting Stage (Shredder Facilities – Melting Facilities)

Treated material coming from the collected ELV, is planned to be sent to the Iron & Steel Industry facilities already existing within Mexico. As it was established in the assumptions for Scenario-3, there are considered no new facilities of this kind. Therefore, facilities described in table 5.17 are thought to cover the demand given at shredder stage of ELV management. The number of facilities used at this stage, and the main features of their coverage is described in table 5.30. The corresponding points (graphic locations) and covered demands for these computations are presented in detail in Appendix D.

Table 5.30 SITUATION Results for Melting Facilities of ELV Management in Mexico, Scenario-3

Feature \ Year	2007	2010	2015	Scenario A		Scenario B	
				2020	2025	2020	2025
Facilities	3	3	3	3	3	3	3
Coverage Distance (mi.)	300	300	300	300	300	300	300
% of Coverage	97.2	97.2	97.2	97.2	97.2	97.2	97.2
Average Weighted Distance (mi.)	12.8	12.8	12.8	12.8	12.8	12.8	12.8
Demand Weighted Total Distance ('000 Unit*mi.)	5,014	5,339	6,368	8,510	11,449	8,161	9,481
Total Traveled Distance (mi.)	1	1	1	1	1	1	1
Maximum Distance (mi.)	451	451	451	451	451	451	451

According to the results computed by SITATION® for the UFCFLP implemented, to set the number of melting facilities, to cover the demand at shredder stage, three facilities cover 97.2% of demand for Scenario-3. Therefore, at the shredder stage the total demand is not covered with a maximal coverage distance of 300 miles (482.7 km). For coverage of 100%, it is necessary that the maximal distance would be expanded to 451 miles (725.7 km). This change also brings increments in the transport corresponding costs.

The graphic configuration at this stage is presented in figure 5.33.

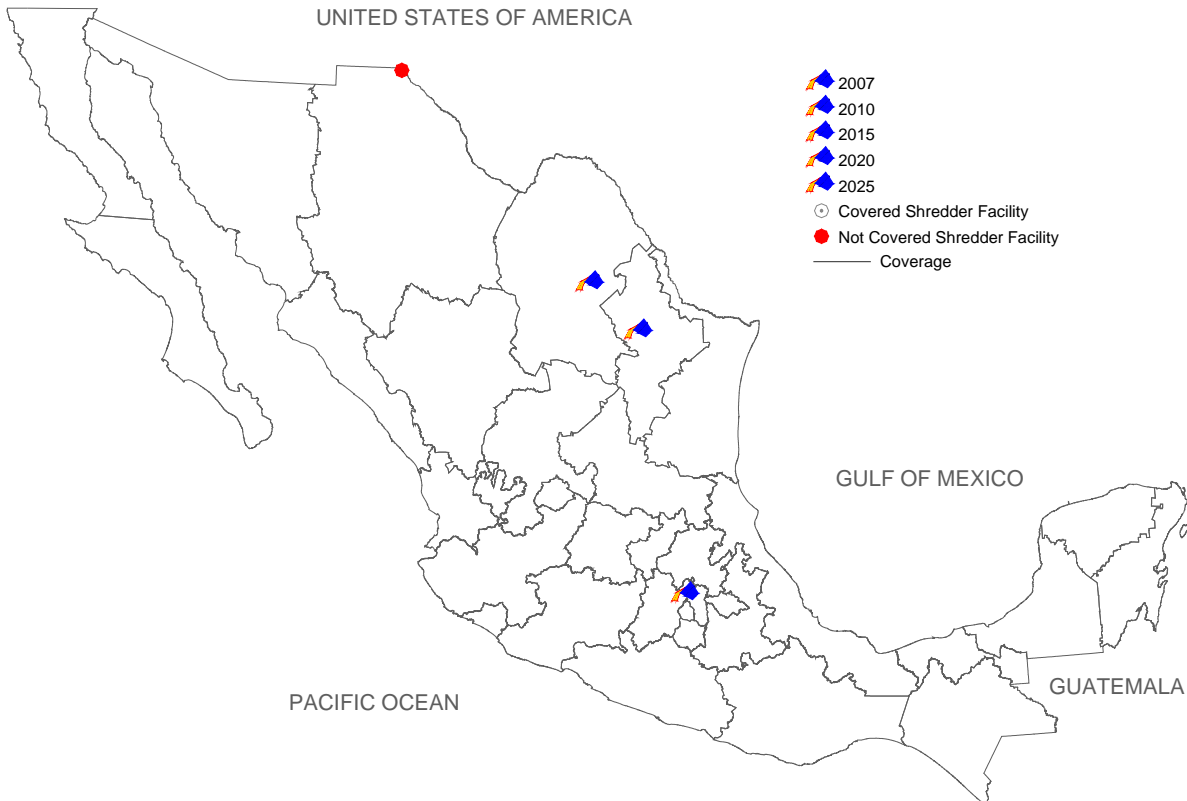

Figure 5.33 Graphic Location of Melting Facilities, as Solution of Scenario-3

As one can observe in Figure 5.33, there is no melting facility less than 451 miles (725.7 km) away from the shredder facility ECOREC (red point). Therefore, this facility is not considered by the solution shown in table 5.30.

5.9.3.4 Energy Recovery Stage (Shredder Facilities – Cement Plants)

From the previous scenarios, the material coming from the shredder stage is thought to be sent to cement plants, to be used as RDF. The current scenario does not foresee new facilities, thus the current infrastructure is used to cover the demand at shredder stage. The implementation's results for solving objective function (b1) are presented in table 5.31. The corresponding points (graphic locations) and covered demands for these computations are presented in detail in Appendix D.

Table 5.31 SITUATION Results for Cement Plants Using RDF in Mexico, Scenario-3

Feature \ Year	2007	2010	2015	Scenario A		Scenario B	
				2020	2025	2020	2025
Facilities	3	3	3	3	3	3	3
Coverage Distance (mi.)	300	300	300	300	300	300	300
% of Coverage	100	100	100	100	100	100	100
Average Weighted Distance (mi.)	19.6	19.6	19.6	19.6	19.6	19.6	19.6
Demand Weighted Total Distance ('000 Unit*mi.)	1,925	2,049	2,444	3,267	4,395	3,133	3,640
Total Traveled Distance (mi.)	102	102	102	102	102	102	102
Maximum Distance (mi.)	64	64	64	64	64	64	64

The coverage of the total demand at the shredder stage can be achieved by three cement plants. The maximal distance is 64 miles (103 km) from the shredder facilities. The graphic configuration at this stage for Scenario-3 is shown in figure 5.34.

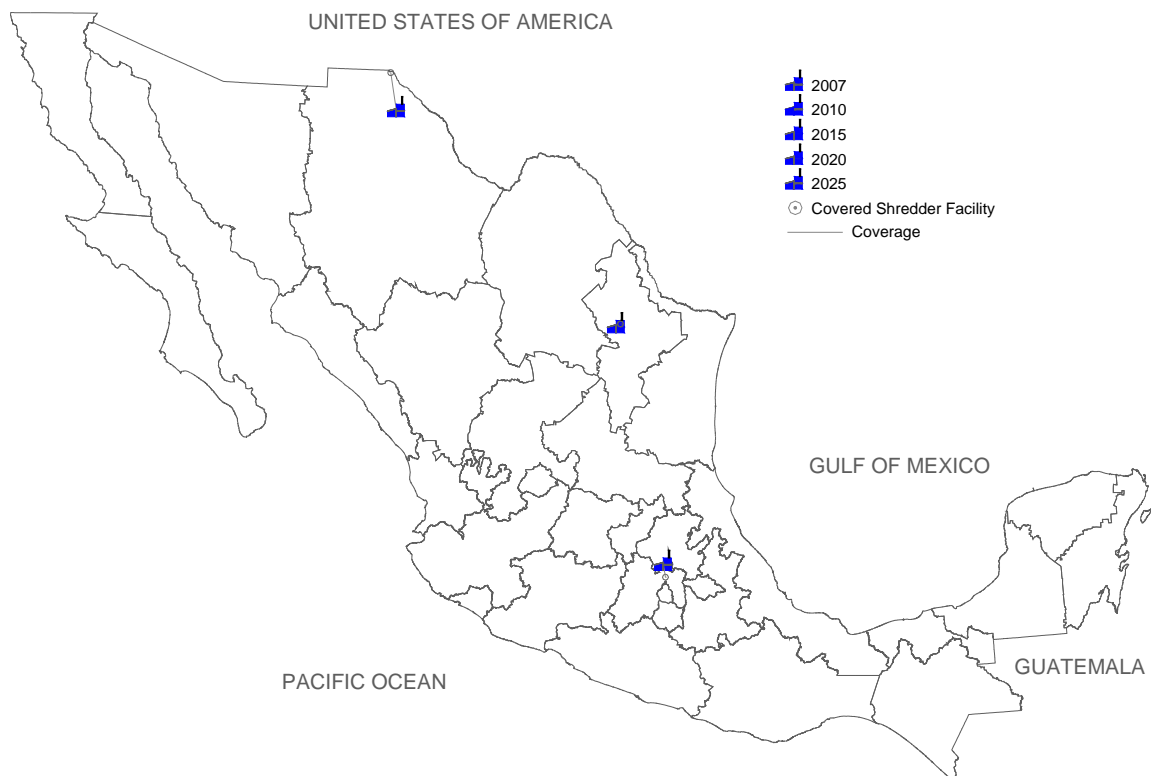

Figure 5.34 Graphic Locations of Cement plants Using RDF, as Solution of Scenario-3

5.9.3.5 Final Disposal Stage (Collection, Shredder, Melting & Cement Facilities – Landfills)

The present work proposes final disposal in landfills for the remaining ELV material coming out from every process in the ELV management system, and which is not considered by the Mexican law as hazardous waste.

The amount of waste generated by every facility in the system, and able to be landfilled, is considered a percentage of every ELV received at the facilities. Thus, facilities with more ELV inflows will generate more waste to be landfilled. Thereby, the selection of existing landfills at the closest distance represents lower transportation costs. Therefore, the objective function (b1) is implemented to reduce the transportation costs at minimum, and with total cover of demands.

The number of landfills available for final disposal is presented in point 5.8. Table 5.32 presents the number of landfills necessary to cover the demand, generated by the system for the considered period of time, and at every stage of ELV management system. The corresponding points (graphic locations) and covered demands for these computations are presented in detail in Appendix D.

Table 5.32 Landfills to Cover total Demands at Different Stages for Scenario-3, 2007 to 2025

Stage	Feature \ Year	2007	2010	2015	Scenario A		Scenario B	
					2020	2025	2020	2025
Dismantling	Landfills	7	7	7	7	7	7	7
	Total Traveled Distance (mi.)	140	140	140	140	140	140	140
	Maximum Distance (Mi.)	41	41	41	41	41	41	41
Shredder	Landfills	3	3	3	3	3	3	3
	Total Traveled Distance (mi.)	40	40	40	40	40	40	40
	Maximum Distance (Mi.)	15	15	15	15	15	15	15
Melting	Landfills	2	2	2	2	2	2	2
	Total Traveled Distance (mi.)	120	120	120	120	120	120	120
	Maximum Distance (Mi.)	95	95	95	95	95	95	95
Cement plants	Landfills	3	3	3	3	3	3	3
	Total Traveled Distance (mi.)	95	95	95	95	95	95	95
	Maximum Distance (Mi.)	64	64	64	64	64	64	64

The graphic links between landfills and facilities at different stages of ELV management are shown in figures from 5.35 to 5.38.

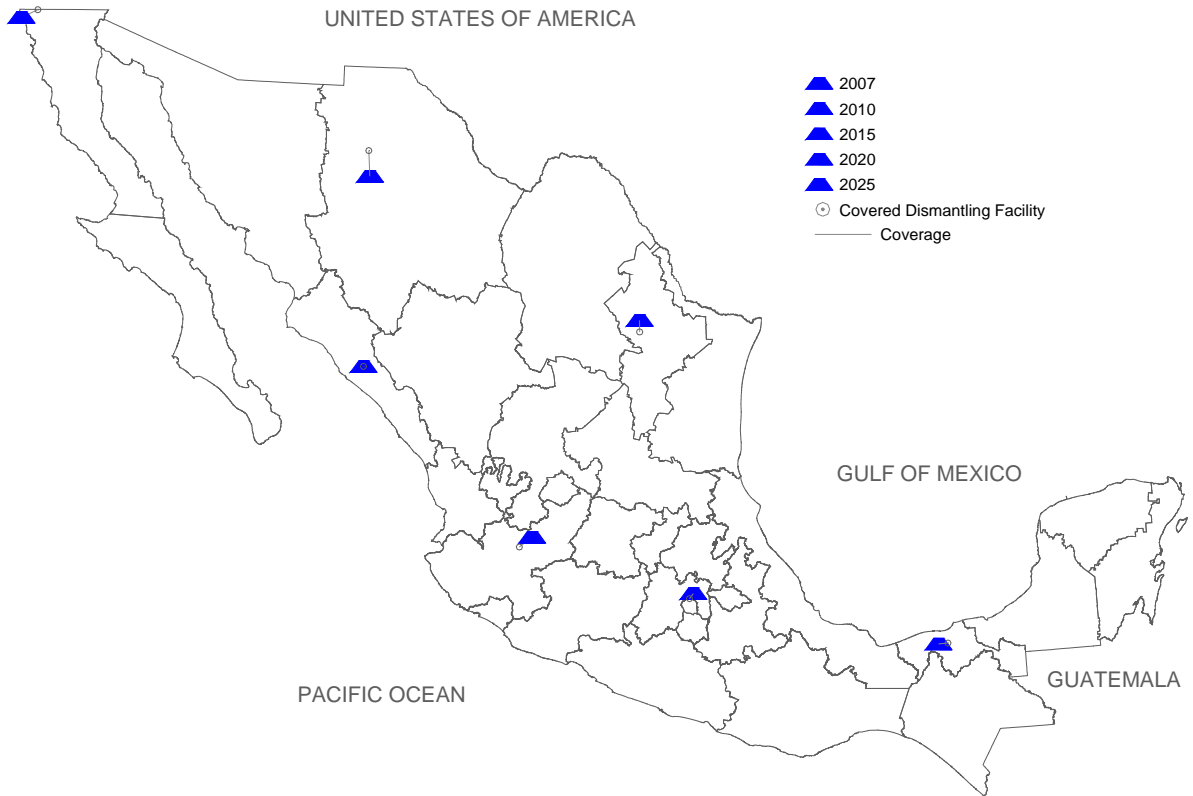

Figure 5.35 Selected Landfills to Cover the Disposal Demand by Dismantling Facilities for Scenario-3

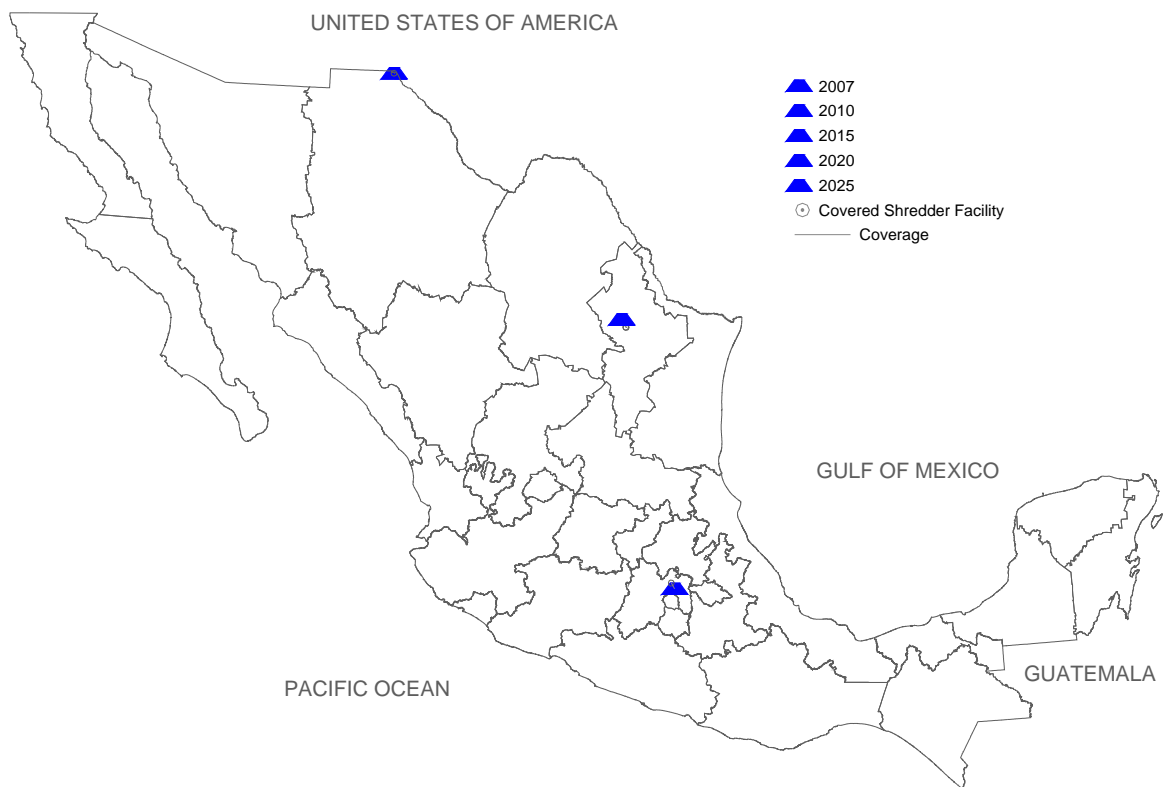

Figure 5.36 Selected Landfills to Cover the Disposal Demand by Shredder Facilities for Scenario-3

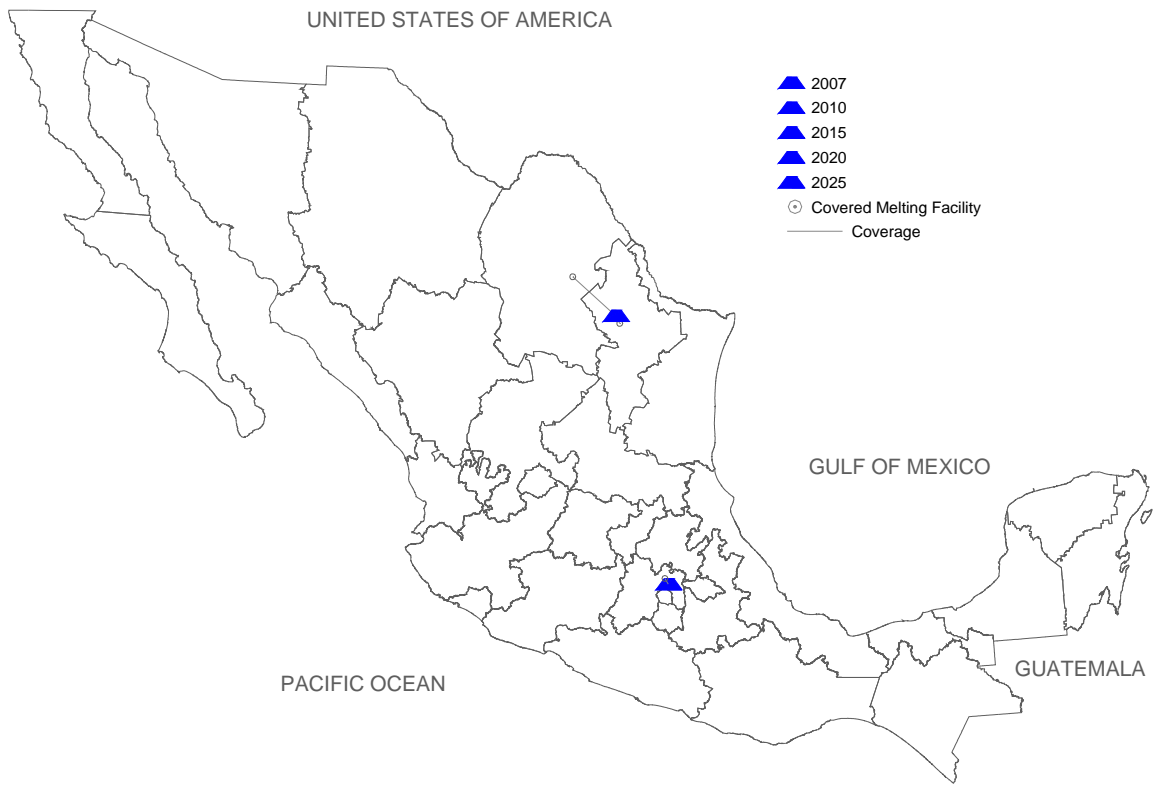

Figure 5.37 Selected Landfills to Cover the Disposal Demand by Melting Facilities for Scenario-3

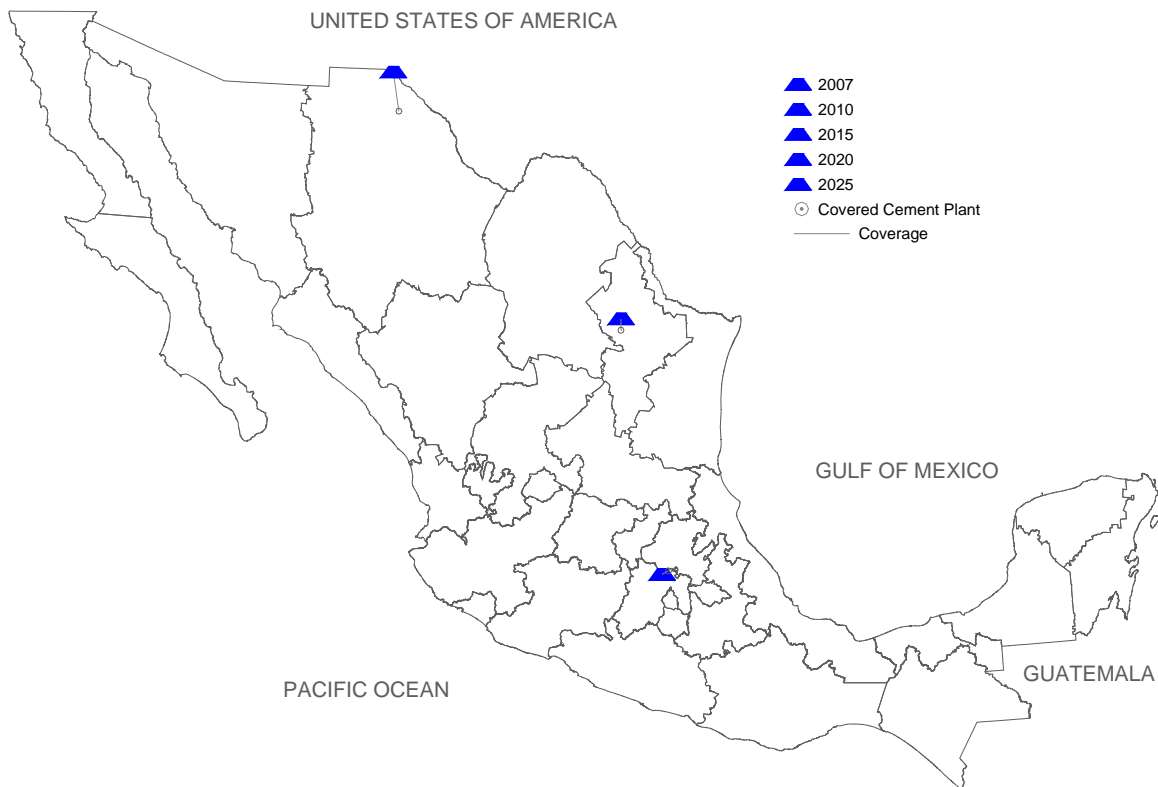

Figure 5.38 Selected Landfills to Cover the Disposal Demand by RDF Facilities for Scenario-3

6.0 Economic Issues in ELV Management

In this chapter, a discussion is performed regarding the way by which ELV management system in Mexico could be financed. Hence, a synthesis about different schemes already in use in the European Union is carried out, with the main aim to propose a first attempt of a suitable scheme for the Mexican case.

The concern about complex products, such as vehicles at their last life stage, comes from the fact that this kind of product produces several negative externalities¹⁰⁰. Nonetheless, externalities are produced by every good and service exchanged in the market, and by every process of production that modifies the satisfaction or the profit of concerned agents. The economists identify an externality when the market does not evaluate charge or pay the complete cost of goods and/or services exchanged in the market, thus an externality results from a market failure. In the case of vehicles, externalities are implicit on production, distribution, use and disposal chains (Varian, 2002; Wallart, 1997 and Turner et al. 1994).

Regarding externalities caused by the vehicles at their last stage of life, policy makers from different countries have already addressed this issue, and have identified three main sources of environmental externalities related to ELV (Mazzanti and Zoboli, 2005),

- a) abandonment of ELV in the environment,
- b) release of pollutants by ELV treatment operations,
- c) final disposal of ASR in Landfills.

The internalization of these environmental externalities has been mainly endeavored by the product-oriented legislation in the European countries since 1970s and more recently in Japan¹⁰¹. Policy makers may use various instruments to induce consumers and producers to modify their environmental behavior up to a level that maximizes social welfare. These instruments include the definition of property rights, the imposition of standards and the use of economic and financial instruments, among others.

Most used approaches are the command and control regulation, and the economic and financial instruments. For the first approach, the regulator sets a desired behavior; typically by imposing a limit on the amount of emissions that polluter can produce. These limits are called emissions standards, thus the regulator controls and enforces compliance with the chosen standard. The incentives are produced by penalties imposed on the polluters that do not comply with the limit of the pollutant emission. For the second approach, the instruments aim to act on the pollution through charges paid for the inputs or received for the outputs, to a production process.

¹⁰⁰ There are negative and positive externalities, like those caused by education, public health, research and development, etc. (Wallart, 1999)

¹⁰¹ See chapter three

In 2002, Markandya et al. presented a brief comparison between the command and control regulation with the economic instrument approach. The used criteria were as follows:

- *Cost-effectiveness*: Marginal abatement costs are lower implementing economic instruments in the achievement of environmental objectives. Command and control strategies have been criticized for not achieving various legislative mandates and deadlines, and for being economically inefficient and difficult to enforce.
- *Dynamic incentives*: The economic instruments generate incentives on polluters, as they have always the incentive to reduce its emissions so as to reduce its total tax payments or to sell permits it no longer requires. Command and control approach has reduced generation of incentives as the firm can pollute up to the standard, free of charge, after that there is no incentive for reducing their emissions.
- *Implementation issues*: For this issue, none of the approaches have a relevant advantage. In every case, the polluters must report their level of emissions, the regulator must verify the accuracy of these reports, thus there must be monitoring.
- *Flexibility*: Command and control approach cannot take advantage of various forms of flexibility for polluters who already have invested in some type of pollution control system. For economic instruments as tradable permits, the regulator intervenes to change the level of the charge, in order to maintain aggregate emissions at their desired level when economic conditions are changing.

According to the last comparison, the economic instruments have the advantage of being more efficient for society as they can achieve environmental objectives and targets with relatively low marginal abatement costs. Moreover and according to Sterner in 2003, the economic instruments are generally more efficient than other instruments when pollution is uniformly mixed and marginal abatement costs are heterogeneous. When this heterogeneity is large, the companies that hold comparative advantage should be responsible for the largest part of the reparation, and the economic instruments offer better alternatives to allocate the appropriate tasks.

However, a growing number of industrialized and developing countries are adopting combination of instruments in order to maximize the social welfare and minimize the marginal abatement costs. The present work focuses on the implementation of economic instruments for environmental protection, and more specifically in their implementation for the ELV management.

6.1 Economic Instruments and Environmental Protection

Economic instruments provide continuous inducements, financial or otherwise, to encourage responsible parties to modify their behavior, in order to correct market failures (EPA, 2004). Among other economic instruments for managing the environment, there exist:

- *Pricing mechanism including fees, charges and taxes:* These are mainly implemented on air and water pollution, and solid waste. Examples of this approach are taxes on pesticides, sulphur, water, consumption products, wastes, etc,
- *Deposit-refund system:* Implemented to encourage recycling or proper disposal of products as well as performance bonds, which also may be viewed as deposits with subsequent refunds. This approach is used worldwide to control the disposal of batteries, beverage containers, pesticide containers, tyres, etc,
- *Pollution trading system, including cap-and-trade and credit systems, market-based approach to control pollution:* A central authority sets a limit on the amount of pollutant that can be emitted, or which is set as socially acceptable. In this way, tradable permits for that cap are shared between industries producing that pollutant; the total amount must not exceed that limit. This approach is currently used by the EU with the Emission Trading Scheme (EEA, 2006),
- *Subsidy system including grants, low-interest loans, favorable tax treatment, lending practices of international banks, and preferential procurement policies for products believed to be environmental friendly:* This approach is widely used to support for example; private-sector pollution prevention and control activities, the cleanup of contaminated industrial sites, alternate fuels, new technologies in vehicles, and municipal waste water treatment,
- *Compensation when sources release pollution that harms human health or the environment:* It also acts as a mechanism to encourage sources to comply with environmental regulation,
- *Information disclosure that can affect the polluting behavior of firms and product purchase decision by consumers.* This kind of incentive is currently implemented by the Directive 2000/53/EC¹⁰², and other European Directives,
- *Voluntary measures and non-monetary rewards:* Through this approach the government encourages firms and individuals to improve their environmental performance. In Japan, voluntary pollution control agreements date back to the 50s. Currently thousands of these agreements are in force (EPA, 2004).

¹⁰² Article 9, Paragraph 2

The selection of certain economic instrument or a package of them depends on many pragmatic considerations and criteria. The criteria include static and dynamic allocative efficiency, cost-effectiveness, fairness, effects on income distribution, and other aspects related with the distribution of welfare, provision of dynamic and continuous incentives, implementability, flexibility and political feasibility (EEA, 2004; Sterner, 2003 and Markandya, 2002).

In the field of ELV management, the determination of financing responsibilities is an important issue to discuss, especially while addressing the choice of economic instruments. The principle of Extended Producer Responsibility (EPR), followed by policy makers in many countries and mainly in the European Union, aims at the Polluter Pays Principle. This principle has generated strong controversy, as the industrial groups argue that consumers are the “polluters” and not producers, in context of product externalities, because consumers introduce this product into the environment by ELV’s abandonment, or due to bad practices in the management of these vehicles.

A different and strong argument is given by Industrial Ecology¹⁰³, which argues that environmental externalities are caused by producers, with their design decisions of products, and with the decision to produce a certain product in the first place. Thereby, impacts caused by a product in its life cycle are determined by design decisions taken by producers (Sachs, 2006). The discussion about this issue is still not finished and many arguments arise in favor or against the above mentioned.

Another important issue regarding the selection of a suitable economic instrument to finance the ELV management is to know in which measure every stakeholder in the ELV chain could be affected by a certain instrument. The implementation of ELV legislation in the EU could be used as reference to know the effects on the chain. However, as Mazzanti and Zoboli pointed out in their studies carried out in 2000 and 2005, there was an absence of formal and transparent cost-benefit analyses performed by policy makers before the introduction of ELV regulation. Therefore, the cost-benefits balances and the economical impact for its implementation, for every stakeholder involved in the ELV management, are still unknown. The main difficulty to asses these economical impacts is due to the heterogeneous preferences and interests of stakeholders, as interests converges for one and at the same time diverges for others, depending on the chosen path to finance the system.

¹⁰³ Industrial ecology is the study of the flows of materials and energy in industrial and consumer activities, of the effects of these flows on the environment, and of the influences of economic, political, regulatory, and social factors on the flow, use, and transformation of resources.

Nevertheless, the EPR mechanism has been followed by the product-oriented legislation for ELV (2000/53/EC), in which is required that producers shall meet “all or a significant part” of costs for Directive’s implementation. The compliance with the directive’s provisions involves extensive sets of technological and organizational adaptations by different industrial actors, upstream and downstream of the automobile chain (Mazzanti and Zoboli, 2005; Zoboli et al., 2000). For this reason, economic instruments have been preferred over regulatory approach, as their advantages offset the main drawbacks of the regulatory approach (Sterner, 2003).

The discussion about the best path for implementation of product-oriented legislation to reach the minimization of environmental externalities produced by ELV, has not yet been concluded. The success of economic instruments introduced inside a complex industrial setting, such as automotive one depends on the part of the chain which is directly affected, on the market power and its relationships with other industries, and on the stakeholder’s technological and organizational capabilities. Consequently, different innovation paths, including those not preferred by policy makers, may emerge from innovation role and expected share of induced cost-benefit impacts of actors. Clear examples of this are the Voluntary Agreements between carmakers and other stakeholders (Nakajima and Vanderburg, 2005; Mazzanti and Zoboli, 2005; Schwald, 2001).

6.2 Economic Instruments for ELV Management

The current part will describe the main features of economic instruments, which are being considered and implemented in the European Countries to finance the ELV management.

The current ELV management already implemented in the European Union is far to be homogeneous. The Directive 2000/53/EC (Art.10) provides an allowance to take the necessary measures for its implementation into national laws, by means of agreements between competent authorities and economic sectors concerned. Therefore, the implementation has been carried out under different financing models and several agreements, responding to national recycling industry needs. According to extended studies carried out by Mazzanti and Zoboli in 2005 and 2000, as well as Brockmann et al. in 2000 and Lehman in 2001, the main economic instruments implemented for the ELV management in the European Union can be divided in three main paths:

- a) Free take-back system
- b) Recycling fees/subsidies system
- c) Deposit-refund system

The above mentioned economic instruments share several features, although, they have differences in the level of impact that affect each stakeholder in the chain. The description of these instruments is given in the forthcoming section.

6.2.1 Free Take-back System

This mechanism is the one chosen by policy makers in the European Union and considered under Directive 2000/53/EC. It implies that, the last owner of an old vehicle can deliver the car to a dismantling facility free of cost. Since, dismantling and recycling industries are considered the weak stakeholders in the ELV chain; they should not support the cost of incremental dismantling and recycling activities imposed by policy, because it is a consequence of car-making choices regarding material mix and design. Thereby, the car maker sector provides financial resources to this weak ring to perform additional dismantling activities and grant more and better materials to recyclers downstream, i.e. shredders, post-shredder recyclers, energy recovery companies, etc, in the chain.

The final targeted actors are car makers and recycling industries. The incentive is set in the negotiation between the last-owner and the dismantlers. This mechanism is thought to be an incentive instrument based on expected economic reactions on the chain, which should transmit incentives upstream and downstream actors (Zoboli et al., 2000).

The free take back mechanism creates the following incentives for the ELV chain,

- a) incentives to the final car owners to deliver ELV to the dismantlers without payment,
- b) as a consequence of financial support from the car makers, there is an incentive for the dismantlers and the recyclers to improve ELV recycling and create self sustained markets for spare parts and second raw materials,
- c) the financial burden for the car maker sector should bring an incentive to improve the design and manufacture of future vehicles.

On the other hand, the free take-back mechanism allows dismantlers to establish a negative price for ELV freely, thus the last owner will be fully reimbursed by the car manufacture sector. Here, there is an absence of car manufacture intervention in the negotiation, for setting the ELV's price, between the last owner and the dismantlers. Hence, there are possibilities of bad practices and abuses, generating excessive dismantling costs¹⁰⁴. A deep analysis of this issue is given by Zoboli et al., 2000.

The probable actions to be taken by the car-manufacture sector are as following,

- i) accept the free take back burden and improve the design and material mix of vehicles, with a reduction on free take back costs as consequence, thus well established markets of second raw materials, are expected,
- ii) accept the free take back burden and, not improve the design and material mix of vehicles. The free take back is likely to be passed to the consumers in new car prices, with consequent creation of new recycling steadily subsidized by consumers¹⁰⁵,
- iii) increase their economic participation in downstream activities as coordinator of collection networks for ELV from their brand. In this case, the control would be passed to the car maker sector and therefore, the burden for the free take-back.

The free take-back financing approach has been implemented by the German ELV system; where the system follows the provisions established by Directive 2000/53/EC, and transposed into a German national law viz. AltfahrzeugV.

¹⁰⁴ Incremental costs for the Dismantlers are totally covered by payments they receive from the car-manufacturers, thus the possibility that they can enjoy extra-profits by establishing high negative prices cannot be ruled out.

¹⁰⁵ This possibility is highly depending on the prevailing conditions in the market structure.

There exist two decentralized networks carrying out the ELV management in Germany. The first is a network based on bilateral agreements between the car-makers and the dismantlers. The second is a network, based on agreements between the shredder and metal companies with the car-makers (Nakajima and Vanderburg, 2005). These networks accomplish with Producer Pays Principle and allows the last owners to deliver their old vehicles to certified dismantle centers, free of cost¹⁰⁶.

The main features of financing model for Germany are presented in figure 6.1¹⁰⁷. The available information allowed only a resume about the financing model for both networks. There can be identified several elements, such as contributors to the fund, administration structure and allocation of revenue.

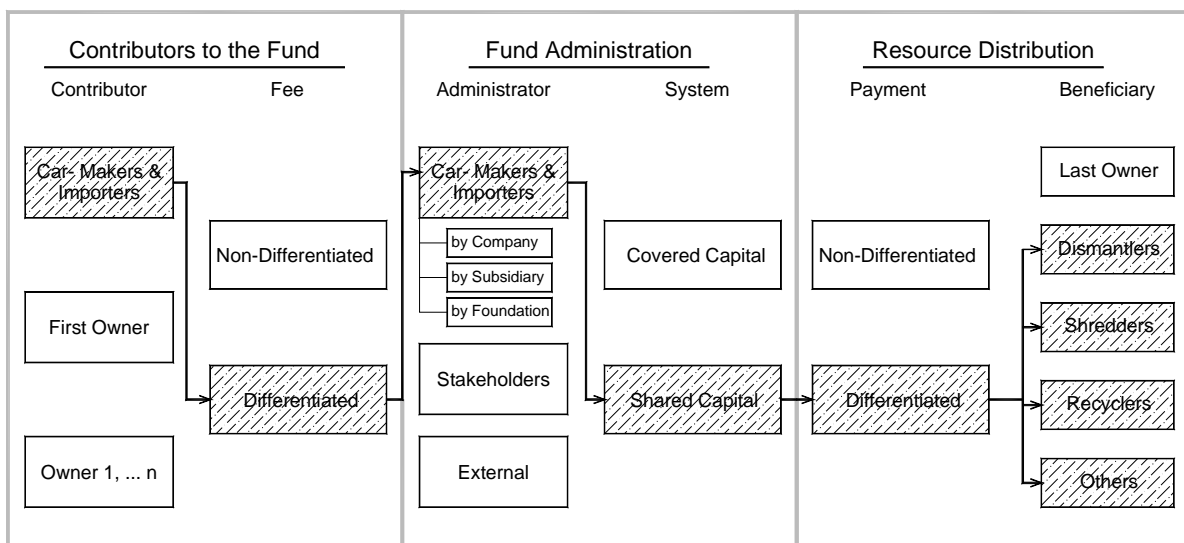

Figure 6.1 Financing Model for ELV Management in Germany

Source: Brockmann et al., 2000

¹⁰⁶ The delivery free of cost is currently performed under certain conditions (BMU, 2006; Nakajima and Vanderburg, 2005)

¹⁰⁷ The differentiation for fees and payments in figure 6.1 depends on vehicles' features. Vehicles with more environmental friendly features pay less than vehicles without these characteristics.

6.2.2 Recycling Fees/Subsidies System

The approach of fee/subsidy for ELV management has been implemented in the Netherlands since 90's. In this mechanism, the recycling fee/subsidy is established by fund administrators at a certain level, corresponding to estimated net incremental dismantling costs. The recycling fee is paid by everyone applying for a car registration for first time. Later, when the vehicle is retired from circulation the final owner can deliver the vehicle to a dismantling facility, without charge.

The system is managed by a private company acting on the provisions of Dutch legislation. The recycling subsidy is shared by recycling industries, i.e. dismantlers, shredders, material industries, etc. The subsidy should work as an incentive to create new recycling markets. The mechanism foresees that, the consumer does pay the financial transfer, while car makers are not born for ELV management.

The mechanism of recycling fee/subsidy generate the following incentives into the ELV chain,

- a) there is an incentive for the last owners to deliver their old vehicle to dismantling facilities, thus the abandonment and pollution, through bad practices on ELV handling, are reduced,
- b) the mechanism addresses car buyers and last owners, as well as dismantlers and recyclers through the payment by first owners and the recycling "premiums" paid to dismantlers, transporters and recyclers for extra-costs of increasing the recycling rate,
- c) the subsidy downstream of ELV chain incentives the creation of secondary material and spare-part markets.

On the other hand, this mechanism to finance the ELV management has been strongly criticized. The criticisms are focused on the over-administrated working of the system, the creation of subsidized markets, and their potential disincentive for innovation (Zoboli et al., 2000 and Bernstein, 1997). The central criticisms are as following,

- i) there is no consistency with the polluter-pays-principle, since the first owner subsidizes the cost of specific polluters,
- ii) there is an incentive to rule out the positive price of ELV, as in the free take-back mechanism,
- iii) there is no incentive for the last owner to keep the vehicle in good conditions to receive a positive price for the ELV,

- iv) there is no incentive for innovation processes, due to full reimbursement by increments in the dismantling and recycling costs,
- v) the fund administration should have strong control in order to avoid frauds, that is translated into expensive costs,
- vi) the reduction in costs of materials for recycling could produce an oversupply and affect other markets.

The recycling fee/subsidies approach has some shortcomings from the previous approach (free take-back), such as the fee or subsidy which is not freely set by dismantlers, but rather set from an estimated rise in the net dismantling costs (Zoboli et al., 2000). The Netherlands has been one of the first countries with empirical evidence, thus it suggests effectiveness, achieving recycling targets as established by the European Union.

In the case of the Netherlands, the economic instrument of Recycling fees/subsidies seems to be successful with the achievement of different environmental and economic targets (Mazzanti and Zoboli in 2005, Zoboli et al., in 2000). The description of this approach is presented in section 6.1.2

The figure 6.2 presents the financing model implemented in the Netherlands.

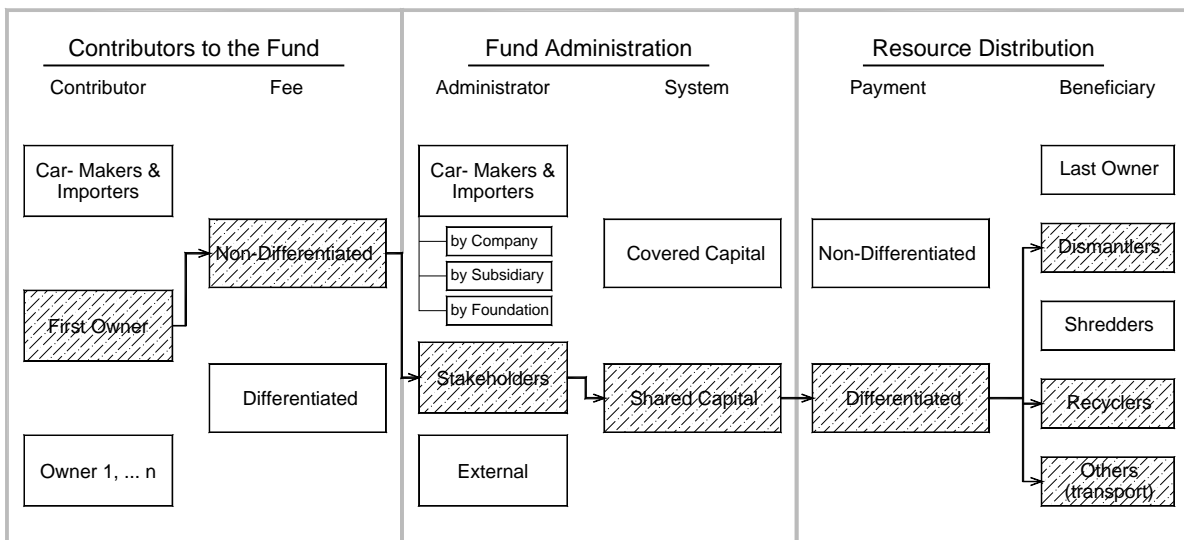

Figure 6.2 Financing Model for ELV Management in the Netherlands

Source: Brockmann, et al., 2000

6.2.3 Deposit-Refund System

The mechanism of product tax/recycling, or as it is often referred as deposit-refund system, has been widely implemented for controlling the disposal of products containing hazardous materials and other products, such as packages. This approach is appropriate for discrete, solid commodities that could cause environmental harm through their improper management (Turner et al., 1994).

The deposit/refund system has already been implemented for ELV management since middle of 70's in Sweden, and recently in Norway and Greece (EPA, 2004; Zoboli et al., 2000 and Brockmann et al., 2000).

The mechanism basically consists of a recycling fee paid by producers and importers of new or old vehicles, on behalf of potential buyers when the vehicles enter the market. This fee is transferred into new car prices. The surcharge is set by the government and paid to the fund administrators. The revenues of the fund are distributed in form of premiums to the last owners and the dismantlers, at the moment when the old vehicles are delivered to the certified centers. In this case, the price of ELV either negative or positive is established by negotiation between the last owner and the dismantler.

The incentives generated by implementing the deposit-refund approach can be listed as follows:

- a) there is an incentive for the last owners to deliver their old vehicles to the dismantlers, thus there is a reduction in ELV abandonment,
- b) there is an incentive for the improvement of organizational capabilities of the dismantlers,
- c) owing to the negotiation between the last owners and the dismantlers, there is an incentive to keep vehicles in good condition to get a positive price and enjoy the scrapping premium,
- d) improvement in ELV condition and dismantling activities could promote the creation of markets for high-value spare parts.

Conversely, owing to the empirical evidence generated by this mechanism during the time implemented in Sweden, it is possible to mention the following,

- i) since the recycling fee is transferred to the consumers, there is no incentive upstream to innovate the design and material mix,
- ii) low premiums to the dismantlers do not incentive appropriate dismantling operations,
- iii) empirical evidence points out high administration costs, since in most of the cases, the government administrates the fund.

Sweden has already this approach in order to finance its ELV management system. According to Mazzanti and Zoboli in 2005 and 2000, and Brockmann et al., 2000, the system does not reach successfully some environmental targets, such as to trigger the incentives upstream of the chain. Nevertheless, the system is being increasingly implemented by other countries.

The figure 6.3 presents the financing model implemented in Sweden, which corresponds to the deposit-refund system.

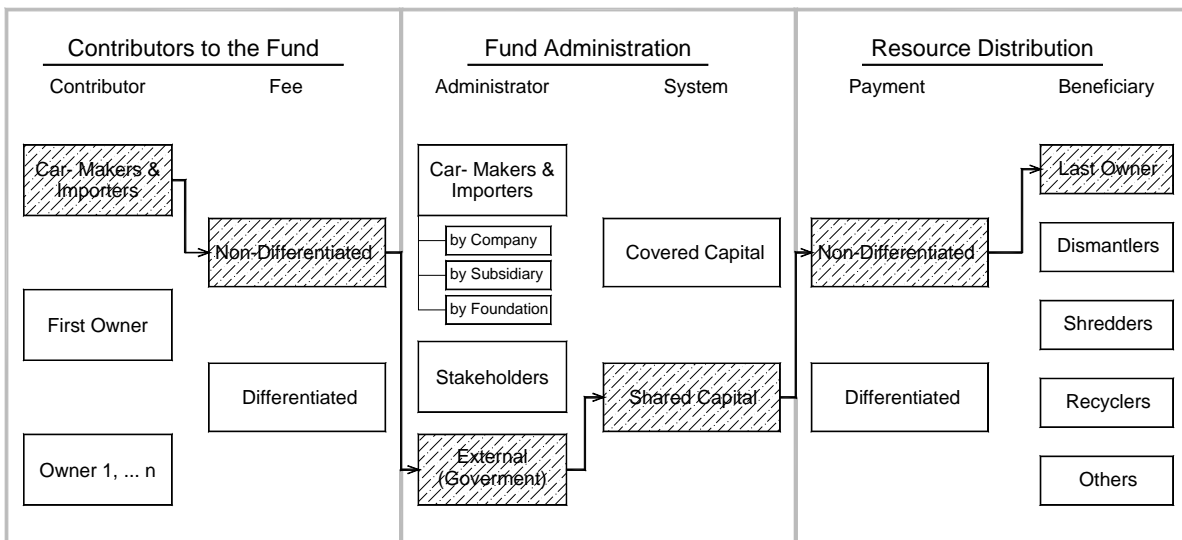

Figure 6.3 Financing Model for ELV Management in Sweden

Source: Brockmann et al., 2000

6.3 Economic Instrument to Finance the ELV Management in Mexico

The upcoming part is a proposal for a mechanism to finance the ELV management in Mexico, which describes the main features and different relationships between stakeholders in the Mexican ELV chain. Formal and detailed cost/benefit analysis about the impacts on every stakeholder is beyond the original scope of this work.

According to the studies carried out by different authors, e.g. Mazzanti and Zoboli in 2005, Zoboli et al. in 2000, Brockmann et al. in 2000 and Lehman in 2001, the empirical and theoretical evidence reveals that, there is no unique mechanism to successfully finance the ELV management. The influence of these mechanisms in the achievement of specific targets might depend on their costs and benefits implications for the addressed actors, and also on specific features prevailing in national ELV chain, as organizational and technological capabilities.

At this point, it is important to point out that specific legislation determines which externalities within a product chain will be internalized and which will remain social costs, as well as which economic actors will bear a share in financing responsibilities for that internalization (Sachs, 2006 and Brockmann et al., 2000). Therefore, it is very important that the creation of a product-oriented legislation in Mexico addresses the ELV management under provision of the General Law for the Prevention and Integral Management of Wastes (LGPGIR)¹⁰⁸.

The studies carried out by Sachs, 2006; Mazzanti and Zoboli, 2005; Arbitman and Gerel, 2003; OAAT, 2001; Zoboli et al., 2000; Lehman, 2001; and Brockmann et al., 2000, indicate that the implementation of a product-oriented legislation regarding the ELV management, should aim at the creation of incentives in whole product chain, downwards and upwards. It is highly recommended that this trigger effect, for innovation paths in technological and organizational level, should be also aimed by policymakers in Mexico, as it has been expected in the European Union¹⁰⁹. Thus, the intervention of government through legislation can serve as a catalyst to bring together diverse perspectives from the ELV chain stakeholders (OAAT, 2001).

¹⁰⁸ Law already in force and described in point 4.3

¹⁰⁹ Due to the nature of economy of scale of the Automotive Industry, the incentive given by Directive 2000/53/EC has influenced different countries around the world, such as Japan and United States, as it is described by Sachs, 2006 and Zoboli et al., 2000.

6.3.1 Structure of Economic Instrument

In section 6.1, we described some of the main implemented economic instruments for ELV management, along with the expected effects at different levels of the ELV chain. This section addresses the outline of a mechanism to finance the ELV management in Mexico.

According to several works and the evidence mentioned above, the pricing mechanisms have been successfully implemented for recycling schemes in reducing waste streams¹¹⁰.

Regarding the different approaches in the pricing mechanisms, many politicians have encountered considerable resistance to environmental taxes, and accepted mostly local or sectorial charges, as well as for environmentalists that favor earmarking¹¹¹ as one of the best approaches for publicly financed abatement.

Conversely, economists are skeptical of earmarking taxes for special purposes, arguing that all tax revenues should go to the treasury and that public good, including assigning revenues from the designated sources to finance designated expenditures. However, in the absence of optimal tax and transfer instruments, earmarking may be considered as the second best mechanism. Therefore, earmarking is thought to be implemented for financing the ELV management in Mexico.

Earmarking approach has major advantages when there is a close benefit link between the payment of the earmarked tax and the use of the revenues to finance additional expenditures. If properly implemented, the benefit-related earmarking reveals taxpayer preferences for public services, sending a clear demand signal to the public sector about how much of the public service should be supplied. Moreover, since the revenues received are spent on the service in question, supply is automatically adjusted to the demand and economic efficiency is achieved.

The earmarking under abovementioned conditions may also be considered equitable in the sense that no one either receives a service without paying for it or pays without receiving service. Provided the public service in question resembles a privately supplied service in the sense that both an individual's consumption of the service and the marginal cost of providing the service can be satisfactorily measured (Bird and Jun, 2005).

The implementation of this approach has been carried out since decades in many countries. Funds are commonly earmarked for such major economic undertakings as road construction, water supply, control of several, etc. In the field of ELV management, the approach is currently implemented by the Netherlands in Europe. Some of the features of this approach are mentioned in the section 6.2.2 and with more detail by Mazzanti and Zoboli in 2005, Zoboli et al., in 2000.

¹¹⁰ See EEA, 2004; EPA, 2004; Markandya et al., 2002; Brockmann et al., 2000

¹¹¹ Assigning revenues from designated sources to finance designated expenditures. See Bird and Jun, 2005.

Therefore, the basic principle for the mechanism thought to be implemented in Mexico is the creation of an economic fund¹¹² to finance the proposed ELV management system. The three fundamental parts of the mechanism will be displayed as follows,

- a) Creation of fund
- b) Fund administration
- c) Resource distribution

6.3.1.1 Creation of Fund

This section describes financing responsibilities and those stakeholders thought to bear the creation of the fund for financing the ELV management in Mexico, as well as especial features of the fund contributions. The probable fund contributors are following,

- i) *Car makers and importers*: These stakeholders would be required to pay a set amount of money for each vehicle introduced in circulation,
- ii) *First car owner*: The first owner would be required to pay a set amount of money for the future ELV management of his/her vehicle,
- iii) *All car holders*: The first and all subsequent possible car holders would pay periodically a fee, for the ELV management of that vehicle.

Since a financing mechanism for ELV management should trigger incentives downstream and upstream of the ELV chain, and according to the description of economic instruments (section 6.1) the creation of a fund bearing car-makers, importers and first owners, is thought to reach the aforementioned targets.

Regarding the payments to the fund, there exist two ways. The first consists of a non-differentiated fee that is an independent fee from model, company and environmental friendly features of vehicles. The second way consists of a differentiated fee that will depend on car model, company and environmental friendly features.

On behalf of this proposal, for financing the ELV management in Mexico, the creation of fund is proposed to be charged to the car-makers, the importers and the first car owners. This part of the proposal is under the assumption of a fully working Public Vehicular Register in Mexico, which includes used vehicles introduced from the USA to Mexico, which also must accomplish with the contributions to the fund for the ELV management. Moreover, the liability of these stakeholders goes in accordance with the established principles by the General Law for the Prevention and Integral Management of Wastes (LGPGIR)¹¹³.

¹¹² Sum of money saved or invested to reach a particular purpose.

¹¹³ The Art.5 establishes that there is a shared responsibility regarding the wastes, which are generated by activities to reach social necessities, therefore, the wastes integral management must be a result of a coordinated and differentiated participation of producers, distributors, consumers and authorities under market feasibility and environmental efficiency.

6.3.1.2 Fund Administration

A specific body that carries out the allocation of funds' resources is very important in the ELV management system. The administration body should aim the equality of marginal benefit as the marginal cost, thus it strives Pareto Efficiency¹¹⁴. This condition is very desirable in the ELV management system as it requires the resources to be allocated efficiently. The different options to configure the administration body are presented as follows:

- i) *Individual administration by car makers and/or importers*: Every company develops its own fund and administrates vehicles from their brands,
- ii) *Association of car makers and/or importers*: A group of car makers and/or importers constitute a subsidiary to administrate the fund resources for the ELV management of their own companies,
- iii) *Car makers and importers*: All these stakeholders constitute a foundation to administrate fund resources for the ELV management,
- iv) *Group of stakeholders*: The administration is represented not just by the car makers and the importers, but rather by the recyclers, the dismantlers and the government entities,
- v) *Without car makers and Importers*: In case where the participation of these stakeholders is avoided, a private administration is carried out possibly by an external entity.

According to the objectives aimed by this administration entity and the options aforementioned, an administration consisting of representatives of all stakeholders in the ELV chain is thought to allocate with efficiency the resources of the fund. Moreover, this arrangement is planned to reach better understanding, and the creation of incentives along the ELV chain in Mexico.

The revenues of the fund are proposed to be managed with shared capital system. This system is similar to those used to administrate resources for the retirement and health insurances, where basically the revenues from new vehicles will be used to finance the management of ELV¹¹⁵.

¹¹⁴ Pareto Efficiency is named in honour of Vilfredo Pareto (1848-1923). It establishes that, an economic outcome is Pareto efficient if there is no way to rearrange resources so that at least one person is done good without making anyone else' worse. This definition basically denotes "Not Wasting Resources" is good and that all "win-win" opportunities should be exploited.

¹¹⁵ See Brockmann et al., 2000, chapter 3

6.3.1.3 Resource Distribution

The way in which economical resources will be allocated, is a capital issue to be set in the financing of the ELV management in Mexico. The recipient of financial resources from the fund in an ELV chain could be one, some or all stakeholders, i.e. last owners, dismantlers, shredders, recyclers, etc.

The possible paths to allocate revenues from the fund could be one of the following two:

- a) *first allocation path*, a fix amount of money paid per mass unit or per vehicle,
- b) *second allocation path*, a payment that depends on especial features of vehicles, as environmental friendly designs and constructions (in the case of dismantlers).

In view of the incipient ELV management currently existing in Mexico and owing to the objectives established by this work¹¹⁶ the initial stage of ELV management in Mexico should address the maximization of ELV deliveries to the certified dismantling network and the recycling industry. Therefore, the main receptors of the financial support by the fund should be the last owners and the dismantlers, and for the sake of simplicity at the initial stage of the system, the amount of money given to the dismantlers must be independent of the vehicle features.

At the beginning of implementation of a specific oriented legislation regarding ELV in Mexico, the price of ELV is presumably negative¹¹⁷, due to the conditions of the Mexican vehicular fleet (see Section 4.5.3). For this reason, the fund should equalize at the most the additional activities for de-pollution and dismantling of these vehicles, and in this way avoid possible excesses in the prices of ELV.

¹¹⁶ See chapter four.

¹¹⁷ The economic value of an ELV to the final owners may be either positive or negative. When a car deregistration and delivery involves a payment to a dismantler, because there are few or no valuable parts to reuse, an incentive to illegally abandon the car in the environment arises (Mazzanti and Zoboli, 2005).

6.3.2 Financing Model for Mexico

The figure 6.4 presents in a schematic way, the main elements discussed in the paragraphs above about the approaches' structure for financing the ELV management in Mexico. The structure of this scheme is taken from Brockmann et al., 2000 and modified for the sake of this work.

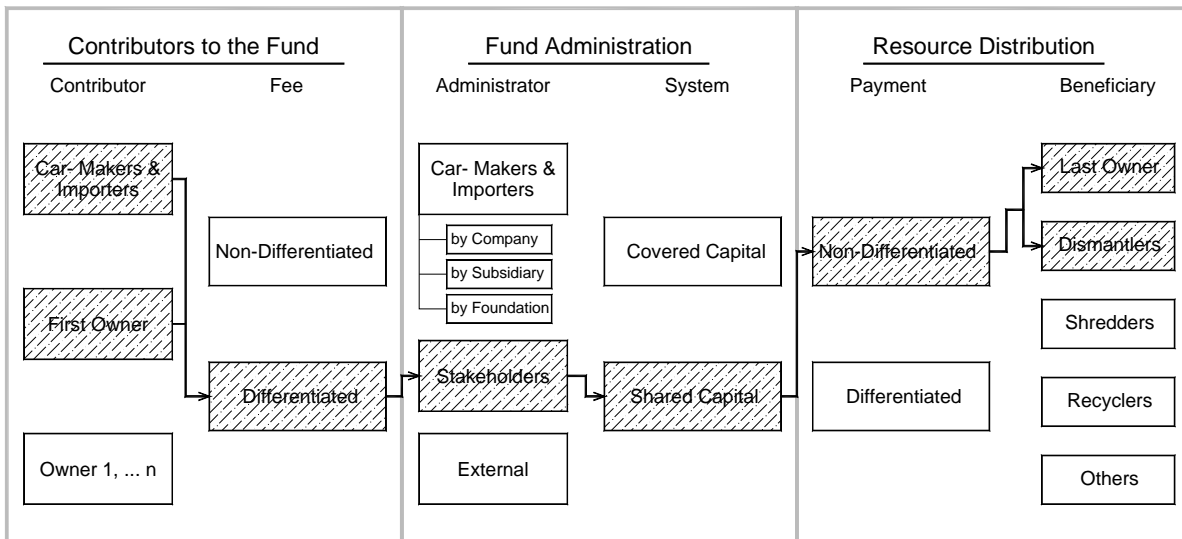

Figure 6.4 Finance Model for ELV Management in Mexico

Source: Derived from Brockmann et al., 2000

The proposed mechanism for the ELV management presented in figure 6.4, shares several features with mechanisms mentioned in point 6.2. As mentioned before, the main target addressed by this proposal is to maximize the delivery of ELV into certified dismantling centers for proper management, and to minimize the externalities caused by the ELV. Furthermore, there are other expected incentives thought to be triggered by this proposal, which are described as follows:

- the economical support to the dismantlers and the last owners is thought to maximize the delivery of ELV to the certified centers, thus reducing illegal practices,
- the fund creation by the car-makers and the first owners is thought to trigger incentives upstream for enhancing the design and construction of new vehicles sold in Mexico. In this way, there is a reduction of funds' contributions by car-manufacturers that affects their competitiveness in the market. Moreover, this arrangement allows a share in financial responsibilities within the ELV chain¹¹⁸,

¹¹⁸ The share of financial responsibilities in the ELV management must be fixed by fund administration. And at the same time, this share should follow the principles established in LGPGIR, in which responsibilities must be differentiated.

- c) due to the negotiation between the dismantler and the last owner for setting ELV prices, there is an incentive to keep vehicles in good conditions, as in the deposit/refund system. This condition increases the probability to have an ELV with positive prices being delivered at dismantling centers ,
- d) the differentiation in surcharges for new vehicles is thought to incentive upstream stakeholders to improve the environmental features of the vehicles, as higher surcharges mean loss of competitiveness,
- e) participation of all stakeholders in the administration of revenues from the fund attempts to incentive all the chain towards a better ELV management.

On the other hand, the proposed mechanism to finance the ELV management in Mexico could lead to unexpected incentives along the chain. These incentives are described below,

- a) the surcharge corresponding to the car-makers could be passed to the first owners owing to the higher prices of new vehicles. In this case, the system would be subsidized only by the consumers ,failing with the provisions of LGPGIR,
- b) fund administration should have strict control on the resources, in order to avoid frauds or corruption, which is translated into incremented costs,
- c) the rise on ferrous material for recycling from ELV collected by the system could affect other markets.

The emergence of different approaches apart from those proposed by the policy makers should be taken into account by the product-oriented legislation for ELV management in Mexico. These approaches rely on two additional stakeholders, the community and the market.

Markandya et al. states evidence from cases in Asia, Latin America and North America, that suggests powerful influence of neighboring communities on factories' environmental behavior. In places with formal regulators, communities use the political process to influence the tightness of enforcement. In places where formal regulators are absent or ineffective, an informal regulation takes place and is implemented through community groups or non-governmental organizations. The influence of the community varies from country to country and also varies with income, education and bargaining power.

Since economic stakeholders within the ELV chain operate in national and/or international markets, there are many factors that affect revenues and costs. One factor that recently has covered high relevance is the environment, because investors have to weigh the potential of financial losses from the regulatory penalties and the liability settlements. Therefore, international and national suppliers of financing, industrial equipment and engineering services are increasingly reluctant to do businesses with flagrant polluters. Moreover, in industrialized and developing countries, environmental protection in middle and upper classes is a significant factor in consumer decisions¹¹⁹.

The increasing influence of communities and markets on the environmental behavior of industries has led to voluntary agreements, in which several industrial sectors are participating. The main aim of these agreements has been to develop pro-active projects towards the solution of different issues related to the environment. At the same time, this pro-activity aims the prevention of unexpected legislation that affects the industry. The empirical evidence presented in different studies¹²⁰ for the European Union and the USA shows the important role played by these mechanisms in the creation of paths to achieve targets set by the legislation, in harmony with businesses' objectives.

¹¹⁹ Studies from the USA and Canada suggest that gains from "good environmental news" or losses from "bad news" can be of the order of 1 to 2 per cent of the stock market value (Markandya et al., 2002).

¹²⁰ See Nakajima and Vanderburg, 2005; Mazzanti and Zoboli, 2005 and OAAT, 2001 & Zoboli et al., 2000

7.0 Conclusions and Recommendations

The findings of this work are described in this section. Moreover, a series of recommendations are done, especially in the section corresponding to the case study. The description of the main findings follows the same structure as that of the main content of the work.

7.1 Product-oriented Legislation in Industrialized Countries

Automotive products are a part of the most regulated products in the market. The regulation addressed to the automotive industry affects every stage of their life cycle. In the last decades, the regulation dealing with the environmental issues has rather been concerned with the reduction of pollutant emissions by automotive vehicles, and more recently the attention has turned to externalities caused by the vehicles at their End-of-Life stage. This stage is more linked to earlier design and manufacture processes.

Currently, there is a growing number of industrialized and developing countries addressing the sound management of ELV worldwide. Some of the main reasons for that are the international nature and the economic importance of the automotive industry.

The major concern about the ELV management is the internalization of the environmental externalities caused by the ELV. These externalities have been addressed decades ago by the industrialized countries like Sweden, Germany, the Netherlands, France and the USA. At the initial stages, the concern was centralized on resource recovery and reduction of abandonment. Sweden is considered as the first country addressing this issue legislating the recycling of ELV in the 70s.

Direct precursors of current ELV legislation in the EU were the promulgation of the German Waste Avoidance and Waste Management Act in 1986, and the German Decree for ELV management (Altauto V) in 1998. These legislations established a basis for Producer Responsibility principle towards the management of ELV, along with the promotion of preference for waste-treatment and re-utilization, rather than incineration and disposal. The proactivity of the German automotive industry in this issue has been reasonable as the relevance of its industry worldwide.

The current Directive (2000/53/EC) in the EU has had a difficult process of implementation. The process has been so difficult that the EU-15 countries failed to accomplish with their first deadline which was in 2002, and also the new member states were unable to accomplish their deadline in 2004.

Other obstacles in the full implementation of this Directive were the reluctance of the several stakeholders to fully implement the Directive 2000/53/EC under current terms. The most controversial issue was related to the ban of hazardous substances in several automotive applications (Article 4(1 & 2)), and the issue related with recycling quotas by 2015, where the car-manufacturers argue that the achievement of additional percentage points in the recycling rates results disproportional expensive.

The Directive 2000/53/EC has had a strong repercussion on the worldwide automotive industry. This effect is evident in the strategies developed by the countries outside the European Union, such as Japanese and Korean industries. These countries are aiming at accomplishing with the EU regulations in order to become competitive with the European markets.

Any specific legislation addressing the ELV management in the USA is not foreseen in the coming years. This issue has been addressed through voluntary agreements. The agreements include industrial and governmental participants in different projects issuing the ELV management. However, there are no fixed obligations for the recycling rates. Some reasons for this situation are: First, the US vehicular production is almost entirely consumed by the national market, thus there is no necessity to accomplish with the European legislation. Second, the final disposal capacity of landfills is much higher in the USA than those in Europe. Third, the prices for the final disposal in landfills are lower in the USA than in Europe.

7.2 Stakeholders in ELV Management

There is an evident need for industry-wide cooperation, collective liability and commercial relationships within the automotive chain, towards the achievement of targets in harmony with commercial objectives.

Governments have participated as initiators of incentives within the complex system of ELV management. Several incentives have been generated through product-oriented legislation and stakeholder consultation. This role is also played by the governments in countries without product-oriented legislation, like the USA. The main roles played by the governments are to bring in accordance different perspectives about common topics, and work as a catalyst for plans concerning ELV management.

The importance of economic operators or stakeholders in the ELV management, for selected industrialized countries, is enormous. The complex system of economic relationships existing in ELV chain requires harmony between their stakeholders to accomplish regulative objectives and at the same time, without affecting their interests.

The producer responsibility implemented in the EU has led to the car-manufacture and suppliers to be the most addressed industries, by this product-oriented legislation. Thereby, these sectors are strongly motivated to participate in the decision-making processes concerning this issue. Moreover, these industries have been identified as main actors influencing the dismantling, re-use and recycling processes for the ELV management through the features given in the early stages of design and manufacture of the vehicles and their components.

The car-manufacture sector has certain advantages in comparison with other sectors in the ELV chain. The main one is their well organized structure that has strong influence at different levels of decision-making processes. The strong influence of this sector is evident in issues concerned in Annex II and recycling rates of Directive 2000/53/EC.

In the USA, the automotive industry plays an important role in this topic. This industry is strongly motivated for participating in the decision-making processes related to car-recycling issues and several projects towards the improvement of environmental performance of their products.

The second sector in the ELV chain is the dismantling industry. Its importance lies in the incorporation of ELV into the management processes, as the processes of collection, de-registration, de-pollution and dismantling have strong repercussions in the quality of recycling material and components to re-use, and over the final vehicular recycling rate.

In European countries, the structure of dismantling industry is far away to be solid and homogeneous. The facilities of this sector are characterized by their ability to work with less than ten employees, with generally low qualifications. The operations performed by this sector are already standardized in the member states of the first EU-15, and are in process to be standardized in the new EU member states.

The role played by the dismantling sector in the USA has different features than that in its European counterpart. The main activities performed by this sector are dismantling and retail of used spare-parts. The major business for this sector is found on the sale of re-manufactured and used spare-parts to individuals. Since, there is no national legislation requiring specific de-pollution and dismantling of ELV, their operations are not standardized. The existence of big number of salvage/scrap-yards, in comparison with the number of high-value part dismantlers, indicates high frequency of non-standardized operations and bad practices in the management of ELV.

The shredder sector occupies second place in the economic importance within the ELV chain, and third within the ELV chain management processes. Their close commercial relationship with the iron & steel Industry, and their successful and solid organization allow a big influence on the decision-making processes, regarding ELV management. In some European countries, this sector is driving the ELV management in agreement with car-manufacture companies. Their main aim is the guarantee of material input from ELV to their facilities.

The major activities of shredder sector in the ELV chain are the treatment and recovery of valuable materials from ELV, like ferrous metals and non-ferrous metals. Further processes of recovery for conventional materials and/or other materials as plastics, are performed at the shredder facilities or at the facilities owned by the post-shredder companies. This combination is getting more common in the European countries, because of the influence of product-oriented legislation.

The shredder sector in the USA recovers the majority part of conventional fractions (ferrous and non-ferrous metals) from ELV, and the rest is sent for final disposal in the landfills. While, there are several projects that address the recovery of non-conventional fractions as plastics and rubber, which are mainly endeavored by the CRADA group.

Consumers of automotive products play different roles concerning the ELV management. These are mainly: the purchase of new vehicles, the use of vehicles and the consequent modification of vehicle's features, the vehicular retirement, and the delivery of old vehicles to certified collection points, salvage/scrap-yards or to the abandonment. The main influence practiced by consumers is through the purchase of new vehicles, because their preferences are considered by vehicle's designers and manufacturers.

7.3 Performance of ELV Management in Selected Industrialized Countries

The management of ELV is being carried out in different ways by the industrialized countries, i.e. the USA, Canada, the EU-15 member states, Japan, etc. The management in most of these countries is based on product-oriented legislations, including countries outside the European Union which are moving towards the same requirements. In the case of the USA and Canada, the management of ELV is solely propelled by the profitability of every business involved i.e. under market conditions.

The implementation scheme of Directive 2000/53/EC for the EU member states is not unique. The possibility to configure the system in different ways is foreseen by the legislation. This obeys the provision to encourage the competitiveness and to avoid negative effects in the European ELV chain.

Countries from the EU-15 have a well organized ELV management system. Proactive projects carried out by the car-manufacture companies in the last decades have allowed them to anticipate in product-oriented legislations, addressing environmental issues of vehicles, and to set commercial relationships between stakeholders within the chain. This issue can be appreciated in the case of Germany that has carried out bilateral agreements for the implementation of Directive 2000/53/EC.

A common critique of the European ELV management system is the absence of cost-benefit analysis for stakeholders in the chain. The performance of complete impact analysis, related to economic, ecological and social aspects, of product-oriented legislations comprise a determinant importance, as the information given by these analyses is the base for setting feasible goals, as well as avoiding difficulties in the implementation's process. Another important factor identified in the European system is the export of used vehicles.

In the EU, the current performance of the ELV management system has an efficiency of 68%. The analysis of this efficiency highlights significant differences between de-registered and treated ELV in countries like Germany, Austria, the Netherlands, Spain and Poland. The differences are mainly attributed to the exports of used vehicles to other countries. Moreover, the reuse-recovery and reuse-recycling quotas reached by the EU-15 are 85% and 80% respectively.

The operations for ELV management in the USA are not generally standardized. The lack of standardization lies especially in the sectors performing de-pollution and dismantling processes. The evidential information about collection and dismantling, suggests less material recovery from ELV by the system in the USA in comparison with its counterpart in the EU. This assumption took into consideration the number of salvage/scrap-yards performing dismantling operations, and the low number of dismantlers carrying out standardized operations.

In general, the final disposal of ASR in the landfills seems to be the major constraint in the solution of ELV problem by the industrialized countries. International automotive industry is trying to exploit all the possibilities to use recycled materials in the new automotive applications, especially for plastics, and the reduction of plastic material regime in the automotive industry favors this effort. Another alternative, to the current limitation on mechanical recycling for plastics, has been the use of ASR as a fuel in cement plants for co-incineration, which is a process widely studied and implemented in different countries with positive results.

7.4 ELV Problem in Mexico

Currently, there is no product-oriented legislation addressing the ELV management in Mexico. There exists a general law (LGPGIR) concerning the integral management of solid wastes, excluding hazardous wastes. ELV are considered under this law as especial wastes, which require specific plans for their management.

The economic and social conditions existing in Mexico have a direct influence on the ELV management. Three main problems were identified in Mexico: First, the rising demand for second-hand vehicles in Mexico which is due to the impossibility of new vehicle purchases by a big number of Mexicans, and because the big number of vehicles introduced from the USA to Mexico. Second, the Mexican recycling industry remains disaggregated. Third, there is a lack of a National Vehicular Registry.

Regarding the rising introduction of second-hand vehicles from the USA, the concern is especially due to their mechanical and environmental features. Most of them are older than 10 years and contain hazardous substances as mercury and lead. Moreover, the problem is aggravated due to the lack of proper management of these vehicles at their End-of-Life stage in Mexico. Another negative aspect of old vehicles from the USA is the direct replacement which these vehicles represent to new purchases from national automotive market. Therefore, it represents a serious threat to the national automotive dealer industry.

The current management of ELV carried out in Mexico is driven by the market conditions. The current system aims at the major profitability as possible for operators in the ELV chain, thus only the most valuable materials and components are recovered from ELV. The ELV chain remains disaggregated. There exists a scarcity of commercial relationships between the stakeholders. The main reason for this is the lack of awareness for their participation in the management of waste streams. Owing to this disaggregation, most of the operations for ELV management are not standardized. This fact produces rejection of material inputs, as shredders with wrecks coming from non-standardized de-polluting and/or dismantling operations.

The structure of the ELV chain in Mexico is similar to that in the EU and the USA; however, there is an additional group of stakeholders that performs an important role in the system. This work presented the available information gathered. However a field research is required to identify in detail the total amount and features of stakeholders in the Mexican ELV chain.

There exists an undetermined number of businesses carrying out de-pollution and dismantling activities. Most of these businesses are automotive repair/body shops and scrapyards that perform non-standardized operations. Thereby, only valuable material and components for re-sale are dismantled, the rest is sent to landfills and shredders. These activities cause several strong impacts on the environment, especially those related with the improper management of operative fluids from ELV.

Classifiers of sub-products from waste streams are the transition stage from dismantling to shredder facilities. These stakeholders comprise of a big number of small facilities performing hand intensive activities to sort several materials from different waste streams. Materials like ferrous and non-ferrous metals, plastics, paper, wood, rubber, glass, etc. are sorted and stored to be sold to the Mexican recycling industry. Wrecks are acquired by these operators in order to manually obtain the valuable streams, after which, the metal frame is sold to the shredder facilities. This additional step, in the ELV chain, is typical of developing countries. This transition stage represents an opportunity for further sorting activities towards the reduction of ASR from ELV and other waste streams.

The number of facilities performing shredder activities is not clearly known, because apart from shredder companies, there is evidence about the existence of shredder equipment at Mexican Iron and Steel industry facilities. However, further studies should be carried out to set features and capacities of those facilities. The current shredder companies have no standardized operations addressing the ELV management. As in the dismantling stage, the operations aim at conventional fractions. There is no evidence for recovery of further fractions as plastics and textiles. A fraction widely exploited is that coming from tyres which have several applications as recycled material, or as RDF.

The Mexican Iron and Steel Industry has been carrying out the recycling of material streams from ELV since decades. Due to its strategic importance, this industry is performing standardized operations concerning the re-introduction of second raw materials to the market, and one of the main second raw input materials comes from ELV and household appliances.

Third main ELV problem in Mexico is a lack of information about the Mexican vehicular fleet. This fact has several repercussions for the ELV management. There is no certain data about the total vehicular fleet. There exists no complete registers regarding the vehicles introduced from the USA, and there is no data about vehicular retirements. Thereby, the management conditions of vehicles at their EoL stage remain unclear.

The presented evidence describes a deficient management of ELV in Mexico. The current management allows a maximum recycling rate of 75%, which mainly corresponds to the ferrous fraction content in vehicles that enter to the management. However, further studies with field evidence should be carried out to affirm this figure. In this context, the environmental impact caused by automotive vehicles at their End-of-Life stage in Mexico is presumably higher than that in their counterpart in the European industrialized countries and the USA. This statement is mainly due to non-standardized operations and bad practices during the management, although specific studies with quantitative evidence should be performed.

7.5 System for ELV Management in Mexico

The ELV management system required for Mexico shares several features with systems currently implemented in the industrialized countries. Although, the specific conditions in Mexico require modifications in the targets and scopes of the system, these modifications are thought to ensure a successful implementation process.

The legal basis is already established in LGPGIR with respect to the integral management of wastes. However, a specific product-oriented legislation directly addressing the management of ELV in Mexico is urgently required. Moreover, the existence of a full working Public Vehicular Register is imperative in Mexico. These two pre-requisites are essential for accomplishing the goals proposed by this work.

The performance of cost benefit analysis for the stakeholders in the ELV chain is highly recommended. The aim of these analyses is to identify the impacts produced by a specific product-oriented legislation and plans for management, as well as to identify and to evaluate businesses opportunities within the chain.

The bibliographical evidence indicates that a gradual implementation of an ELV management system is rather recommended, than sudden requirements for sophisticated management operations. Hence, the initial stage of a system for Mexico should start aiming at the minimization of abandoned ELV and the maximization of ferrous metal recovery. Moreover, a principle of shared responsibility, regarding the complex products at their EoL stage, is thought to bring easily stakeholder's perspectives in concordance.

The number of ELV generated in Mexico remains unknown. This data is essential for designing any management system. There exist several empirical figures given by commercial associations with no analytical basis, and only some figures are supported by registers and analytical procedures. An accurate figure about this issue is also difficult because of the lack of a Public Vehicular Register in Mexico. Thereby, analytical estimations to set current and future numbers of ELV are of a core importance.

The analysis of causes for definitive vehicular retirements brings a better understanding about the ELV process and the constraints affecting ELV management. In this context, a general decrease in the value of the vehicles is identified as a major cause for vehicular retirements. Hence, economic features of markets are important because while the used product has no value in one country, in another one, the value remains the same for the old product, thus a natural consequence of this phenomenon is the export of used products.

Due to the remaining value of old vehicles in developing countries, passenger cars and light trucks tend to have larger lifespan than those in their counterpart in industrialized countries. This fact delays the vehicular retirement in developing countries.

The Reliability Engineering provides several analytical approaches to estimate the vehicular retirement behavior. The Weibull distribution is identified as an analytical approach widely used by Reliability Engineering, which is frequently used in product's life data analysis. Its probability density function is commonly used to model the product's retirement from marketplace i.e. the time the product has operated successfully before it failed. The results obtained when using this approach point out a strong relationship of new vehicle purchases with vehicular lifespans and vehicle's use factors. Thereby other important factors affecting the ELV generation are the behavior of new vehicle markets, population able to purchase a vehicle, and the purchasing power, influenced by GDP per capita.

The dynamic mass flow, resulting from Weibull distribution's implementation to estimate future numbers of ELV in Mexico provides logical behaviors of vehicular retirements in the forthcoming years. Nonetheless, these results should be improved with parameters resulting from specific studies about vehicular lifespan in Mexico, for new vehicles and old vehicles introduced from the USA.

Regarding the scenarios taken into consideration in the calculation of future trend of ELV generation, the author considers the conditions described for *Scenario-B* as the most probable to take place in Mexico in the forthcoming years. Hence a generation of around one million ELV by 2020 is foreseen.

Historical data about new purchases and illegal vehicular introduction from the USA in 70's & 80's, do not allow the estimation of vehicular retirements for the 90s and current years. Therefore, an interpolation between available historical data and future estimations is required to estimate the current number of ELV generated in Mexico. Hence a generation of around one 687,580 ELV in 2007 is considered.

The design and implementation of a collection facility network in Mexico is required to enhance the efficiency of the current management. The activities thought for these facilities consist of collection, de-pollution and dismantling of ELV. The standardization of these operations is seen as imperative to accomplish the system's targets. The island dismantling facility configuration is found as suitable for small businesses performing these activities in Mexico. Moreover, the price of workforce in Mexico offers several advantages in comparison with that in industrialized countries.

At the initial stage of the ELV management system in Mexico, the main target is the minimization of vehicle abandonment and the maximization of ferrous metal recovery from ELV. These targets are identified as logical to reach the consolidation of ELV recycling industry in Mexico.

Due to the unavoidable generation of ASR in the ELV management, the energy recovery approach is identified as a suitable process for ASR generation in Mexico, where ASR is used as RDF in cement plants. This fact obeys the well established Mexican cement industry, whose operations are fully standardized and widely certified. On the other hand, recent studies state that, the impacts caused by the disposal of ASR in landfills are higher than that in energy recovery approaches.

The existence of numerous businesses performing classification, storage and retail of several sub-products constitute an opportunity for further ASR recovery from shredder facilities. Their workforce's costs and their wide distribution along Mexico offer advantages that do not exist in industrialized countries. This measure could minimize the amount of ASR disposed off in landfills and/or sent for co-incineration.

The final disposal of ASR in landfills is ultimately recommended for those fractions which are not recyclable and/or recovered.

Since this work represents one of the first attempts to describe the ELV problem in Mexico and to propose a configuration for its solution, a lot of information could not be gathered. The main reason of this is because it is not published or it does not exist. Thereby, further studies with more field, experimental and analytical evidence are required.

There exist still no economic analyses about every stakeholder in the Mexican ELV chain. This fact does not allow a better knowledge about costs and revenues for activities related to the current ELV management in Mexico. This is another field in which specific studies should be performed.

7.6 Facility Networks in ELV Management

The implementation of strategic facility network for ELV management provides several advantages in the system design. On one side, preferable places are identified. The preference is stated through their geographical position in relationship with the rest of the places and due to its importance in terms of ELV generation. On the other side, the number of required facilities for covering the demand and transport costs is reduced to minimal.

The identification of preferable places to locate specific new facilities for dismantling and shredder activities, and the selection of preferable existing facilities for melting, cement plants and landfills represent an important stage in the ELV management system design. This stage provides advantages in the use of resources.

The features of the problem set by this work described an Uncapacitated Facility Location Problem. This problem is referred by specific authors as Fixed Charge Facility Location Problem. The objective function to solve this problem had as main objective the minimization of transport and fixed costs at every stage in the ELV management, i.e. dismantling, shredder, Melting, Energy recovery and final disposal in landfills.

The algorithm's calculation through SITUATION[®] software provided a better understanding about the cost's behavior in the design of the ELV management chain. The preponderant importance of transport costs was evident in comparison with facilities' fixed costs. This fact was observed at every stage of the ELV management, considered by this work. In this context, the value variables like maximal coverage distance and freight price comprises of high importance in the relationship with the percentage of covered demand and transport costs.

The configuration of ELV management system in three different scenarios provided three different paths for facility networks, carrying out ELV management in Mexico. Every path comprises different economic and environmental implications from 2007 to 2025.

The Scenario-1 considered an optimal scenario that embodies the required number of facilities at every stage to cover the total demand for ELV management in Mexico. It comprised the minimal number of required facilities at the optimal places, at every stage of the ELV management, with the consequent minimal total cost.

The existing infrastructure at melting, energy recovery and final disposal is enough to cover the demand required by this scenario. The rest of the stages required new facilities to cover the demand. The probability to reach an infrastructure with 100% covered demand is very low because this is the optimal solution, and especially because the current Mexican infrastructure is incipient in the ELV management. Nevertheless, the data provided by this scenario is very useful in the identification of localities with high ELV generation.

The Scenario-2 considered a non-optimal scenario. It embodied the necessary infrastructure to accomplish 90% of the covered demand for the ELV management. In this scenario it was possible to observe a drastic rise in the transport costs, and a significant decrease in the required number of facilities, to reach the set coverage.

Due to the abatement in the collected material, the number of facilities for further management stages also decreases. In this scenario, the existing infrastructure at melting, energy recovery and final disposal is enough to cover the required demand. The cases with less coverage (less than 100%) were out of the considered coverage distance. A drastic improvement in the current ELV management in Mexico might reach a system with similar percentages of covered demand as this scenario. The probability to reach this level is higher than the probability to reach the level depicted for Scenario-1.

The Scenario-3 considered a non-optimal scenario. It embodied minimal infrastructure requirements with maximal covered demand. The shredder stage was identified as the limiting infrastructure in the current ELV management in Mexico. Its capacity in the covered demand is 75%, thus the percentage of coverage for this scenario was set also at 75%. In this way, there are required only seven new collection points carrying out de-registration, de-pollution and dismantling activities at strategic places for the next 20 years. No new facilities are required at shredder, melting, energy recovery and final disposal stages.

The probability to have a configuration like Scenario-3 was considered by the author as the highest from the scenarios depicted in this work. The reason is that, the ELV problem in Mexico does not have the priority which the other waste streams have, e.g. hazardous waste and municipal solid waste. Thereby, important investments towards the sound ELV management are considered to have low probability.

The places of preference identified by the Scenarios 1, 2 & 3, are good reference to appreciate where the ELV problem has current and future priority in Mexico. Moreover, these results can lead to business opportunities at every stage of ELV management.

The implementation of a certification process addressing scrap-yards, repair body shops and garages carrying out dismantling activities, would be an efficient measure to include these stakeholders into the configuration depicted by the aforementioned scenarios. It is important to use the current infrastructure for dismantling stage, in order to achieve a collection network close to the optimal. In this way, the fix costs could be reduced and the amount of material entering the management might be maximized. Moreover, the more collection facilities distributed in Mexico, the lower journey distances and thus, less transport costs.

Through the facility network design for the ELV management in Mexico, the centralization and the absence of certain ELV stakeholders in certain geographical regions are evident. Half of the shredder capacity identified for ELV is concentrated in Nuevo Leon state. The presence of melting facilities in the north-west and south-part of Mexico is much lower than in the central part of Mexico. These put up the transport costs and the number of required facilities in the ELV management system for Mexico. This information is valuable for plan's developing processes of investments in new shredder and melting facilities along Mexico.

7.7 Economics in ELV Management

The study about economic instruments already into implementation for financing the ELV management in industrialized countries of Europe can supply important information for finding a suitable instrument for the Mexican case. The experience accumulated by these countries might help to avoid undesirable results.

The product-oriented legislation already implemented by the European and other countries concerning the ELV management, addresses the internalization of three main environmental externalities, i.e. abandonment of ELV, release of pollutants by treatment operations, and final disposal of ASR in landfills. Economic instruments have been identified as generators of incentives to induce the improvement of environmental behaviors of several stakeholders.

There exist three main economic instruments already implemented in the European countries to finance the ELV management: The free take-back, recycling fees/subsidy and deposit-refund system. These instruments share several features with each other, although their main difference lies in the level of impact on each stakeholder in the ELV chain, and on the generated incentives, because it is closely linked to national features of ELV chain.

The success in implementing certain instrument is strongly influenced by the predominant industry in the system. In this context, the German free take-back system has been a suitable option with a system lead by the car-manufactures and the shredder industry. In the case of the Netherlands, the Recycling fee/subsidy system has been a good solution in a country with no nationally-based car industry. Sweden has a strong governmental influence on the implementation of the Deposit-Refund system. The Swedish car-manufacture industry has promoted several amendments to the original system in order to preserve their competitiveness and at the same time to accomplish with the requirements of the EU legislation.

The implementation of economic instruments addressed specific stakeholders in every case. However, policy makers expect indirect incentives from the rest of stakeholders in the chain.

In reference to a suitable economic instrument to finance the ELV management in Mexico, several pre-requisites are needed before the selection of an adequate option. The main pre-requisite is the performance of cost-benefit analyses addressing stakeholders in the Mexican ELV chain. After that, the conditions should be established to enact a specific product-oriented legislation concerning the ELV management in Mexico.

The current available information about the Mexican ELV chain suggests a strong influence of the automotive and steel industry over any issue concerning the ELV management. Therefore, a leadership in a system by these stakeholders is highly probable.

Regarding the proposal for financing the ELV management in Mexico, there is a definition of financing responsibilities in the LGPGIR. This law declares that the share of responsibilities must be distributed within the stakeholders in the chain according to their capabilities. With this frame, the economical contribution by the car-manufacturers, the importers and the first owners is thought to trigger several incentives downstream and upstream of the ELV chain in Mexico. The contribution should be charged for every new car put into circulation, considering its environmental features. This measure attempts to keep the competitiveness in the market along with the creation of awareness in the car consumers.

The participation of every stakeholder in the administration of the fund is strongly recommended. This measure is thought to consolidate the recycling industry and especially those stakeholders related to ELV management. New vehicles put into circulation would finance the management of vehicles proximal or already retired from circulation.

For an initial stage of ELV management in Mexico, the main target of the system should be the maximization of ELV deliveries into certified facilities for management. Thereby, the financing support should be given to the weakest link in the ELV chain, last-owners and dismantlers. The prices of ELV should be strongly supervised in order to avoid excesses procured by dismantlers. Thereby, the support should equalize maximum the costs for additional de-pollution and dismantling activities.

8.0 Summary of Findings

The solid waste management in Mexico has many gaps to solve and one of these gaps is the management of End-of-Life products. In this context, the ELV are managed without control and under market conditions. This situation not always ensures a proper management of these products; hence several impacts are caused in different Mexican sectors, like the environment, economy and society.

The present research has been one of the first researches addressing the ELV management issue, not only as an environmental problem, but rather, as a possible source of secondary raw materials. Therefore, the results of this work can be very useful to solve the impacts caused by ELV in Mexico, and at the same time, to trigger business opportunities.

The most important findings obtained by the development of this research are listed as follows:

- a) The impacts caused by ELV in Mexico in several sectors, as the economy, environment and society,
- b) Bibliographical revision of the legal status of ELV in Mexico,
- c) Identification of the main stakeholders in the Mexican ELV chain,
- d) Description of the role played by the main stakeholders in the Mexican ELV chain,
- e) Inventory of the recycling infrastructure related to ELV management in Mexico,
- f) Geographical location of the main businesses performing ELV management operations in Mexico,
- g) Identification of main aspects related to the ELV generation in Mexico,
- h) Calculation of current and future numbers of ELV in Mexico,
- i) Calculation of potential amounts of ferrous and non-ferrous materials from ELV,
- j) Identification of Mexican localities with high priority for an ELV management system,
- k) Configuration of strategic facility networks for the ELV management in Mexico,
- l) Identification of strategic locations for new dismantling and shredder facilities in Mexico,
- m) A suitable proposal for ELV management in Mexico,
- n) Identification of mexican regions with scarcity of recycling infrastructure,
- o) A proposal for a suitable scheme to finance the ELV management in Mexico.

9. References

- 2000/53/EC. Directive of the European Parliament and of the Council on End-of-Life Vehicles - Commission Statements, Official Journal of the European Communities.
- ACEA, 2006. Country Report Charts, Issue: September 2005. Association des Constructeurs Européens d' Automobiles. Country Report Charts, p.12, Brussels, Belgium, 2006.
- ACEA, 2005. European Union, Economic Report. Association des Constructeurs Européens d' Automobiles European Automobile Manufacturers Association. Economic Report, p.57, Brussels, Belgium, 2005
- ADEME, 2003. Economic Study on the Management of End-of-Life Vehicles, Summary. French Agency for Environmental and Energy Management (ADEME in French), p. 59, September 2003, France.
- AISI, 2004. The New Steel, Sustainable, World Leader in Recycling. American Iron and Steel Institute (AISI). Fact sheets, USA, 2004. <http://www.steel.org/facts/recycling.htm>
- AltfahrzeugV, 2002. Verordnung über die Überlassung Rücknahme und umweltverträgliche Entsorgung von Altfahrzeugen. Bundesministerium für Umwelt, Naturschutz und Reaktorsicherheit, Germany 2002.
- Álvarez M. de Lourdes, 2006. Personal Communication with Dr. M. de Lourdes Álvarez, head of *Automotive Recycling Network in Mexico* Project, UNAM, Mexico 2006.
- AMDA, 2005. AMDA News. Mexican Association of Distributors of Motor Vehicles (AMDA in Spanish), Mexico 2005. <http://www.amda.com>
- AMIA, 2006. The Retail of New Vehicles in Mexico in 2006. Mexican Association of Automotive Industry (AMIA in Spanish), Mexico, 2005. <http://www.amia.com.mx>
- ANFAC, 2006. European Motor Vehicle Parc 2004. Spanish Association of Car and Truck Manufacturers (ANFAC), p.54, January 2006.
- ANPACT, 2006. National Association of Producers of Heavy Vehicles (ANPACT in Spanish). Mexico 2006. <http://www.anpact.com.mx>
- Arbitman N. & Gerel M., 2003. Managing End-of-Life Vehicles to minimize Environmental Harm, White Paper on Sustainable Conservation's Auto Recycling Project. Sustainable Conservation, US, 2003. http://www.suscon.org/autorecycling/pdfs/autorecycling_whitepaper_elvs.pdf

-
- Bancomext, 2006. Opportunities for Mexican Products in Middle East of US. Bancomext-Chicago (in Spanish), Illinois 2006.
- Batterman S.A. et al., 2001. Evaluating the Environmental Performance of Passenger Vehicles. LCA Case Studies 6 (4), 251-253.
- BDSV, 2004. Bundesvereinigung Deutscher Stahlrecycling- und Entsorgungsunternehmen e.V., Germany 2004. <http://www.bdsv.de/organi/unterorg/fas.php>
- BDSV, 2002. Statistische Daten für die Stahlrecycling-Wirtschaft. Bundesvereinigung Deutscher Stahlrecycling und Entsorgungsunternehmen e.V. (BDSV). Annual meeting of BDSV in Berlin, 2002. http://www.bdsv.de/download/pdf/statistik_02.pdf
- Bernstein J.D., 1997. Water Pollution Control - A Guide to the Use of Water Quality Management Principles. United Nations Environment Program, Chapter 6, Economic Instruments
- Bilitewski B. et al., 1996. Waste Management. Springer-Verlag, Heidelberg, 1996.
- BIR, 2006. Shredding and Media Separation. Bureau of International Recycling (BIR), Brussels, 2006. <http://www.bir.org/aboutrecycling/EOLV/index.asp>
- Bird R.M. and Jun J., 2005. Earmarking in Theory and Korean Practice. Presented at the Asian Excise Tax Conference, Sponsored by the International Tax and Investment Center and the Centre for Commercial Law Studies, National University of Singapore, Singapore, March 2-4, 2005.
- BMU, 2006. Gesetzgebung in Deutschland: Altfahrzeug-Gesetz und –Verordnung. Bundesministerium für Umwelt, Naturschutz und Reaktorsicherheit (BMU), Deutschland 2006.
- Boes J. et al, 2002. Beschreibung des Standes der Technik bei der Vorbehandlung, insbesondere der Trockenlegung von Altautos gemäß Altauto V. tec4U Ingenieurgesellschaft mbH, UBA-FB, Germany, 2002.
- Boselovic L., 2004. State Targets Auto Switches as Mercury Pollution Source. Pittsburg Post-Gazette, September 1st 2004.
- Brockmann K.L. et al., 2000. Evaluierung von Finanzierungsmodellen zur Durchführung der kostenlosen Rückgabe von Altautos. Forschungsbericht 299 31 302 UBA-FB 000080, Umweltbundesamt, pp.273, Berlin 2000.

-
- BUND, 2001. Autos nur von zertifizierten Betrieben verschrotten lassen. BUND Presse, Deutschland, 2001.
<http://www.bund-naturschutz.de/oekotipps/muellentsorgung/altautos.html>
- BVSE, 2006. Schrottbilanz Deutschland, Zahlen der Deutsche Schrottwirtschaft. Bundesverband Sekundärrohstoffe und Entsorgung e.V. (BVSE), Germany.
<http://www.bvse.de>
- CANACAR, 2005. Renewal of National Freight Float. National Association of Freight Transportation (CANACAR), <http://www.canacar.com.mx>, Mexico 06/04/05.
- CANACEM, 2006. Mexican Cement Industry Experience in Co-incineration Practices, Thermal Treatment and Energy Recovery. Mexican Chamber of Cement (CANACEM), April 2006, Mexico.
- CANACERO, 2005¹. Perspectives of Steel Industry 2005. Mexican Iron and Steel Chamber (CANACERO in Spanish), <http://www.canacero.org.mx/>, Mexico 2005.
- CANACERO, 2005². Mexican Production, Import and Export of Scrap Metal. Personal Communication with the Mexican Iron and Steel Chamber (CANACERO in Spanish), Mexico 2005.
- CANACERO, 2004. Competitiveness in the Mexican Iron & Steel Industry. Presentation given by the Mexican Iron and Steel Chamber (CANACERO in Spanish) on the VII Conference & Expo, Iron & Steel Technological Improvements, Ixtapa 2004, Mexico.
- Castro Maria B.G. et al., 2003. Life Cycle Impact Assessment of the Average Passenger Vehicle in the Netherlands. *LCA Case Studies* 8 (5), 297-304.
- CDEH, 2002. Environmental Impact of End-of-Life-Vehicles: An Information Paper. Commonwealth of Environment and Heritage (CDEH), Australia.
- CESOP, 2004. The Vehicles of Illegal Foreign Origin in Mexico. Center of Social Studies and Public Opinion (CESOP in Spanish) and Edited by the Mexican Chamber of Deputies, Mexico 2004.
- CEC, 2001. The Challenge of Environmental Financing in the Candidate Countries. European Commission (CEC), COM (2001) 304 Final, Brussels 2001.
- CIA, 2006. The World Factbook, 2006. Central Intelligence Agency (CIA), USA 2006.

-
- Colín M., 2006. Aumentaron 50.2 por ciento las exportaciones de automóviles en el primer semestre; totalizaron 790 mil 427 unidades. *El Financiero*, 7 de Agosto de 2006, México.
- CONAPO, 2000. Migration Mexico – USA, Present and Future. National Council of Population (CONAPO), pp.162, January, 2000.
- Contralínea, 2005. Battle for Legalization for Vehicles of Illegal Foreign Origin. *Contralínea Magazine*, Guanajuato, Mexico, May 2005. <http://www.contralinea.com.mx>
- CRADA, 2006. U.S. End-of-Life Vehicle Recycling CRADA Team, http://www.es.anl.gov/Energy_systems/CRADA_Team_Link/Index.html
- Daniels J.E., 2006. Market Driven Technology Development for Sustainable End-of-Life Vehicle Recycling: A Perspective from the United States. Presented by Argonne National Laboratory at 6th International Automobile Recycling Congress Amsterdam, Netherlands, March 15-17, 2006
- Daniels J.E., Carpenter A.J., Duranceau C., Fisher M., Wheeler C. and Winslow G., 2004. Sustainable End-of-Life Vehicle Recycling: R&D Collaboration Between Industry and the U.S. DOE. *The Minerals, Metals & Materials Society's Journal* 56 (8).
- Daskin M.S., 1995. Network and Discrete Location, Models, Algorithms, and Applications. Wiley-Interscience Series in Discrete Mathematics and Optimization, 247-303.
- Daskin M.S., 2006. SITATION, Facility Location Software Version 5.7.0.12. Developed at Northwestern University, Evanston, IL, USA.
- De Jong, G.C., Vellay C. and Fox J., 2001. Vehicle Scrappage: Literature and a New Stated Preference Survey. European Transport Conference 2001, PTRC, Cambridge.
- De Keratry, E., 2004. Used and Refurbished Autoparts. STAT-USA Market Research Reports, July 2004, USA.
- Dekker R., Fleischmann M., Inderfurth K, and Van Wassenhove L.N., 2003. Reverse Logistics, Quantitative Models for Closed-Loop Supply Chains. Springer, Chapter 4th, pp.65-94, Rotterdam 2003.
- DOE, 2006. Transportation Energy Data Book: Edition 25. Oak Ridge National Laboratory for the Office Planning, Budget Formulation and Analysis Energy Efficiency and Renewable Energy U.S. Department of Energy, U.S., 2006.

-
- DOE, 2001. A Roadmap for Recycling End-of-Life Vehicles of the Future. Report of the Workshop Sponsored by U.S. Department of Energy (DOE), the Office of Advanced Automotive Technologies and Argonne National Laboratory, US, May 25, 2001.
- DOF, 2005. Decree to Establish the Conditions for the Definitive Import of Old Automotive Vehicles. Official Journal of the Federation (DOF in Spanish), No. 16, Vol. DCXXIII, pp.11-16, 22/08/2005, Mexico.
- DOF, 2004. Law of Public Vehicular Register. Official Journal of the Federation (DOF in Spanish), No.1, Vol. DCXII, pp.7-11, 01/09/2004, Mexico.
- DOF, 2003. General Law for the Prevention and Integral Management of Wastes (LPGGIR). Official Journal of the Federation (DOF in Spanish), No.6, Vol. DCI, pp.10-37, 08/10/2003, Mexico.
- Domini P., 2005. How to Fulfill the ELV Directive Cost Effectively in Thinly Populated Areas?. STENA Gotthard AB, Presentation given at the Congress for Car Recycling in Europe, Cologne, 2005
- Duranti F., 2006. A World View from the Bureau of International Recycling. Presentation given at the 6th International Automobile Recycling Congress, March 15-17, Netherlands.
- Dussel P. E., 2004. Conditions and Evolution of Employment and Wages in Mexico. The Jus Semper Global Alliance (TJSGA), Sustainable Economic Development, USA, 2004. <http://www.jussempere.org/>
- Dutrieux M., 2006. Japan Automobile Manufacturers Association's vision on ELV recycling in Europe. Presented by JAMA-E/Honda Motor Europe at 6th International Automobile Recycling Congress Amsterdam, Netherlands, March 15-17, 2006
- EC, 2007. European Climate Change Program. European Commission, 2007. <http://ec.europa.eu/environment/climat/eccp.htm>
- EC, 2006. Stakeholder Consultation on Adaptation to Scientific and Technical Progress under Directive 2000/53/EC of the European Parliament and of the Council on End-of-Life Vehicles for the Purpose of a possible Amendment of Annex II. European Commission, Environment, 2006 http://ec.europa.eu/environment/waste/elv_index.htm
- EC, 2005. CARS 21, a Competitive Automotive Regulatory System for the 21st Century. Final Report, European Commission, p.71, Brussels 2005.

- EC, 2004. Submissions to the Consultation Round on the Revision of Certain Entries of Annex II of the ELV Directive, Germany. European Commission, Environment, 2004. <http://europa.eu.int/comm/environment/waste/submissions.htm>
- Ecology Center, 2004. Environmental Impact of Cars, Mercury in Vehicles Update. Update Produce by Ecology Center, US, 2004. www.cleancarcampaign.org/reports.shtml
- EEA, 2006. Application of the Emissions Trading Directive by EU Member States. European Environment Agency, Technical Report No 2/2006, Copenhagen.
- EEA, 2004. European Packaging Waste Trends and the Role of Economic Instruments. European Environment Agency, European Voice Conference Packaging our Futures, Brussels 2004.
- EEA, 2002. Paying the way for EU Enlargement. Indicators of Transport and Environment Integration. Environmental Issue Report No. 32, TERM 2002. EEA (European Environment Agency), Copenhagen.
- EEA-ETC/WMF, 2001. Scraping of Passenger Cars in 16 Accession Countries to the European Union until 2015. Assessment/scenario Made by the European Topic Centre of Waste and Material Flows of the European Environment Agency (EEA-ETC/WMF), Risoe National Laboratory (Kilde, N. and Larsen, H.), Denmark, December 2001.
- EEB, 2004. EEB Written Comments on the Consultation Round on the Revision of Certain Entries of Annex II of the ELV Directive (Directive 2000/53/EC). European Environmental Bureau (EEB), Federation of Environmental Citizens' Organizations, Belgium 2004.
- EPA, 2006. Auto Mercury Switch Removal Program. U.S. Environmental Protection Agency (EPA), <http://www.epa.gov/Region5/air/mercury/autoswitch.htm>
- EPA, 2004. International Experiences with Economic Incentives for Protecting the Environment. U.S. Environmental Protection Agency (EPA), EPA-236-R-04-001, p. 66, November 2004.
- Expansion, 2004. The Big Bet, Ford Makes the Major Investment its History in Mexico. Expansion Magazine, Ed. 900, September 2004, Mexico. <http://www.expansion.com.mx/>
- Galvagno S., Fortuna F., Cornacchia G., Casu S., Coppola T., Sharma V.K., 2001. Pyrolysis Process for Treatment of Automobile Shredder Residue: Preliminary Experimental Results. Energy Conversion & Management., Vol.42, pp. 573-586.

- Gendebien, A. et al., 2003. Refuse Derived Fuel, Current Practice and Perspectives, Final Report B4-3040/2000/306517/MAR/E3. European Commission- Directorate General Environment, Report No: CO 5087-4, July 2003,
- Gesing A., 2004. Assuring the Continued Recycling of Light Metals in End-of-Life Vehicles: A Global Perspective. *The minerals, Metals & Materials Society's Journal* 56 (8), 18-27.
- GHK, 2006. A Study to Examine the Benefits of the End of Life Vehicles Directive and the Costs and Benefits of a Revision of the 2015 Targets for Recycling, Re-use and Recovery Under the ELV Directive. Gilmore Hankey Kirke (GHK) in Association with Bio Intelligence Service, No. J2232, United Kingdom, May 2006.
- Giermanski J.R., 1999. Information Collection and Report: United States-Mexico Used Vehicle Trade. Texas A&M International University (TAMIU) and the United States Environmental Protection Agency (EPA), USA 1999.
- Gödkoop and Spriensma, 2001. The Eco-Indicator 99, A Damage Oriented Method for Life Cycle Impact Assessment. PRé Consultants B.V., nr.1999/36A, Netherlands 2001.
- Goldhan G., 2002. Costs Considerations of Mechanical Recycling of Dismantled Plastic Parts from ELVs. Technical Paper, Fraunhofer Institute, Germany.
http://www.plastics-in-elv.org/abstracts/abs_matrec_18.htm),
- Griffith C., Gearhart J. & Posselt H., 2001. Toxics in Vehicles: Mercury, Implications for Recycling and Disposal. Ecology Center, Great Lakes United and University of Tennessee (Center for Clean Products and Chain Technologies), US, January 2001.
- Hild R., 2005. Automobilindustrie: stark reduzierte Wertschöpfungsquote und gebremste Produktivitätsentwicklung. ifo Schnelldienst 21/2005, pp. 39-46, Germany
- Hodac I., 2004. Car Recycling in Europe. Key Note Addressed by Ivan Hodac, ACEA given in the Congress Organized by Haus der Technik in Stuttgart, February 12th 2004, Germany
- ICSG, 2004. ICSG Information Circular, End-of-Life Vehicles (ELV). International Copper Study Group (ICSG), ICSG/IC/13, p.9, Lisbon 2004.
- IDIS, 2006. The International Dismantling Information System (IDIS). <http://www.idis2.com>
- IKA, 2004. Do Motor Vehicle Suppliers Give Independent Operators Effective Access to all Technical Information as Required under the EC Competition Ruler Applicable to the Motor Vehicle Sector?. Institut für Kraftfahrwesen Aachen (IKA), under European Commission Contract, Nr.33520, p.336, Aachen, October 2004.

-
- INARE, 2004. A View of Recycling Industry in Mexico. Letter from Mexican Institute of Recyclers (INARE in Spanish) to the National Convention of Finance, published in web page, Mexico 2004. <http://cnh.gob.mx/documentos/8/3/art/archivos/9wqhuq0j.html>
- INE, 2000. Status of Mercury in Mexico. Mexican Institute of Ecology (INE in Spanish), p.30, pp. 15-16, Mexico, June 2000.
- INEGI, 2007. Registered Automotive Vehicles in Circulation. National Institute of Statistics, Geography and Information (INEGI in Spanish), Mexico 2007.
- INEGI, 2006. Automotive Industry in Mexico. National Institute of Statistics, Geography and Information (INEGI in Spanish), Mexico 2006.
- INEGI, 2004. Statistical Yearbook of Mexican Foreign Trade, Imports and Exports in 2003. National Institute of Statistics, Geography and Information (INEGI in Spanish), Mexico 2004.
- INEGI, 2000. Economical Census 1999. National Institute of Statistics, Geography and Information (INEGI in Spanish), Mexico 2000.
- ISRI¹, 2005. What is the Scrap Recycling Industry. Presentation from the Institute of Scrap Recycling Industries Inc. (ISRI), USA 2005. <http://www.isri.org>
- ISRI², 2005. Letter from ISRI to New York Times. Robin K, Wiener, (President ISRI) to Daniel Okrent Public editor New York Times, January 25, 2005. <http://www.isri.org/isri-downloads/nyt13105.pdf>
- Jörgens H. & Busch P., 2000. Germany: Agreement on the Environmentally Sound Management of End-Of-Life-Vehicles. NEAPOL Closing Conference, FUB, Berlin, Germany, 2000.
- Kanari N. et al, 2003. End-of-Life Recycling in the European Union. The minerals, Metals & Materials Society's Journal 55 (8), 15-19.
- KBA, 2005. Jahrespressebericht 2004/2005. Kraftfahrt-Bundesamt (KBA), Germany 2005.
- Klaus J. & Simone K., 2004. European Union Case Study, Analysis of National Strategies for Sustainable Development. Environmental Policy Research Centre, Freie Universität Berlin, 2004.

-
- Kuckartz Udo, 2002. Environmental Awareness in Germany 2002. Results from a Representative Citizen Questioner, Philips-University, Marburg, p.107, Federal Ministry for the Environment, Nature Conservation and Nuclear Safety, Berlin, Germany.
- Lander S., 2005. Strategische Planung von Kreislaufwirtschaftssystemen. Doctorate thesis in German, Faculty III – Process Sciences of Technical University Berlin, p.243, Berlin 2005.
- LfU, 2005. Dismantling and Recycling of ELV. Proceedings, Office for Environment in Bavarian Region (LfU), from Business Division of Bavarian Ministry of Environment, Health and Consumer Protection (StMUGV), p.120, Augsburg, 2005.
- Lohse J. & Sander K., 2001. Stellungnahme zum ersten Monitoringbericht der ARGE Altauto. ÖKOPOL Institute for Ecology and Politics GmbH, Germany, 2000.
- LUA, 2004. Leichtfraktion und Filterstaub aus Abluftreinigung. State Office for Environment in Nordrhein – Westfalen, Waste data sheet Shredder Residue, <http://www.lua.nrw.de/abfall/bewertung/DBShredder.pdf>, Germany 2004.
- Lucas R. & Schwartze D., 2001. End-of-Life Vehicle Regulation in Germany and Europe – Problems and Perspectives. Wuppertal Institute for Climate, Environment and Energy, p.30, Germany, 2001.
- Markandya A., Harou P., Bellù L.G. and Cistulli V., 2002. Environmental Economics for Sustainable Growth. A Handbook for Practitioners. World Bank, UK 2002. 165-218.
- Mazzanti M. & Zoboli R., 2005. Economic Instruments and Induced Innovation: The Case of End-of-Life Vehicles European Policies. Fondazione Eni Enrico Mattei, p. 34, Italy, May 2005.
- McAlinden Sean P, Hill Kim & Swiecki Bernard, 2003. Economic Contribution of the Automotive industry to the U.S. Economy- An Update. Alliance of Automobile Manufacturers, Economics and Business Group, Center for Automotive Research, p.41, Michigan, Fall 2003.
- Melgar, 2005¹. Illegal Vehicles Introduced to Mexico from 1999 to 2004. Information given through Electronic Communication with Melgar de México, Consulting Enterprise Specialized in Automotive Sector, Mexico 2005.
- Melgar², 2005. End-of-Life Vehicles in Mexico from 1972-2004. Information given through Electronic Communication with Melgar de México, Consulting Enterprise Specialized in Automotive Sector, Mexico 2005.

-
- Mirabile D., Pistelli M.I., Marchesini M., Falciani R. and Chiapelli L., 2002. Thermal Valorization of Automobile Shredder Residue: Injection in Blast Furnace. *Waste Management* 22, 841-851.
- Mirchadani P.B. and Francis R.L., 1990. *Discrete Location Theory*. Wiley Interscience Series in Discrete Mathematics. New York, USA.
- Mortimore M. & Barron F., 2005. Inform about the Mexican Automotive Industry. Productive Development Division and CEPAL, Nr. 162, p.53, Santiago de Chile, 2005
- NADA, 2006. NADA Data, Economic Impact of America's New Car and New-Truck Dealers. National Automobile Dealers Association, *AutoExec Magazine*, U.S. May 2006.
- Nakajima N. & Vanderburg W.H., 2005. A Failing Grade for the German End-of-Life Vehicles Take-Back System. *Bulletin of Science, Technology & Society* 25 (2), 170-186.
- Orsato R.J., De Hond F. & Clegg S.R., 2002. The Political Ecology of Automobile Recycling in Europe. *Journal Organization Studies*, Volume 23 (4), 639-665.
- Orth P., 2002. Lösungsansätze für die Verwertung der Shredderleichtfraktion. Verband Kunststoffherstellende Industrie E.V. (VKE), Mainz, September 2002, Germany.
- Passel S. J., 2006. The Size and Characteristics of the Unauthorized Migrant Population in the U.S., Estimates Based on the March 2005 Current Population Survey. Pew Hispanic Center, USA, p.26.
- Passel S. J. and Suro, R., 2005. Rise, Peak, and Decline: Trends in U.S. Immigration 1992-2004. Pew Hispanic Center, USA, pp.64.
- Passel S. J., 2005. Unauthorized Migrants: Numbers and Characteristics. Pew Hispanic Center, USA, pp.44.
- Paul R. T., 2006. Recyclables of Selected Vehicles in North America. Presentation given at 6th International Automobile Recycling Congress, March 15-17, Netherlands.
- PwC, 2004. Global Automotive Financial Review 2003, an Overview of Industry Data, Trends and Financial Reporting Practices. PricewaterhouseCoopers, 2004.
- PwC, 2003. The Global Automotive Industry and Mexico in the Context. Interview to Enrique Ochoa-Báez, Coordinator of Automotive Industry affairs, PricewaterhouseCoopers-Mexico, 2003.
<http://www.pwc.com/extweb/indissue.nsf/docid/47CB5155BC9CE09485256D6D005B65DD>

-
- Recycler's World, 2004. RecycleNet Scrap Metal Index, Online Market Prices. March 14th, 2004. <http://www.recycle.net/price/metals.html>
- Reinhardt T., & Richers U., 2004. Entsorgung von Shredderrückständen – ein aktueller Überblick. Research Institute Karlsruhe in the Helmholtz – Community, FZKA 6940, p. 67, Germany, 2004.
- Reinhardt W., 2005¹. Drive Towards Compliance. Waste Management World Magazine, Markets Policy Finance, July-August-2005, Germany
- Reinhardt W., 2005². Steer Towards Clarity. Waste Management World Magazine, Markets Policy Finance, November-December-2005, Germany
- RIVM, 2004. Outstanding Environmental Issues. National institute for Public Health and the Environment, Netherlands in Cooperation with the European Environment Agency, Netherlands, 2004.
- RMA, 2006. Scrap Tire Markets in the United States, 2005 Edition. Rubber Manufacturers Association (RMA), p. 93, November 2006.
- Ruiz Rojas L.E., 2002. Air Pollution Due to Motor Vehicles in Mexico Valley: A Point of View from Public Politic. Master thesis, Latin-American Faculty of Social Sciences (FLACSO), Chapter 2, Mexico 2002.
- Sachs N., 2006. Planning the Funeral at the Birth: Extended Producer Responsibility in the European Union and the United States. Harvard Environmental Law Review, Vol. 30, No. 51, pp. 51-98, 2006.
- Sander K., Schilling S., Zangl S. & Lohse J., 2002. Rules on Compliance with Article 7.2 of Directive 2000/53/EC. ÖKOPOL, Institute for Ecology and Politics GmbH, Report compiled for the Directorate General Environment, Nuclear Safety and Civil Protection of the Commission of the European Communities, p.92, Germany, 2002.
- Scharff L., 2005. The Determination of the Value of an ELV, Some Considerations Concerning a Calculation Model. Presentation given at the Congress for Car Recycling in Europe, Cologne, 2005
- Schmidt W., et al., 2004. Life Cycle Assessment of Lightweight and End-of-Life Scenarios for Generic Compact Class Passenger Vehicles. LCA Case Studies, J LCA 9 (6), pp. 405-415.

- Schwald B.P. 2001. Auswahl verfahrenstechnischer Technologien unter Nutzung synergetischer Ansätze beim Altautomobilrecycling. Diploma Thesis, Environmental Engineering, Fraunhofer-Institut of Production and Automation Engineering, p. 152, Stuttgart, Germany
- SEDESU, 2004. Automotive Industry, Mexico-Queretaro. Secretary of Sustainable Development of Queretaro (SEDESU), p.31, Mexico 2004.
- SEMARNAT, 2005. Concessions, Permissions and Authorization offered by SEMARNAT. Secretariat of Environment and Natural Resources (SEMARNAT in Spanish), Mexico, 2005. <http://portal.semarnat.gob.mx>
- SEMARNAT, 2004. Important Actions in Environment and Natural Resources Sector, December 2000 to October 2004. Secretariat of Environment and Natural Resources (SEMARNAT in Spanish), Mexico, 2005. <http://portal.semarnat.gob.mx/avisos/14Dic04/indice.html>.
- SEMARNAT, 2002. Hazardous Waste Management in Mexico, Current Situation. Secretariat of Environment and Natural Resources (SEMARNAT in Spanish) in the Regional Forum of Waste Disposal, 26th - 27th November 2002, Mexico.
- Shaw L., 2002. Auto Shredder List-Tearing it Up. Recycling Today, Specialized Magazine, US, October 22nd, 2002.
- Shell, 2004. Shell Pkw-Szenarien bis 2030, Flexibilität bestimmt Motorisierung, Szenarien des Pkw-Bestands und der Neuzulassungen in Deutschland bis zum Jahr 2030. Shell Germany Oil, p.48, Hamburg 2004.
- SIEC, 2003. Production in Iron and Steel Industry. INEGI and the Information Service of Conjuncture Statistics (SIEC in Spanish), Mexico 2004.
- Sliker B.K., 2003. Steps towards Modeling the Distribution of Automobile Retirements. U.S. Department of Commerce, Bureau of Economic Analysis, paper prepared for the Federal Committee on Statistical Methodology Research Conference, pp.91-111, Arlington 2003, USA.
- SRI, 2004. The Inherent Recycled Content of Today's Steel. Steel Recycling Institute (SRI), April 2004, USA.
- Staudinger J. & Keoleian A.G. 2001. Management of End-of Life Vehicles (ELVs) in the US. Center for Sustainable Systems, University of Michigan, Report No. CSS01-01, p. 58, US 2001.

-
- Sterner T., 2003. Policy Instruments for Environmental and Natural Resource Management. Resources for the Future, USA 2003. 133-149.
- Stücheli A., 2000. Technologien und Wirtschaftlichkeit von Recycling und Entsorgung von Altautos. Bericht, Zürcher Hochschule Winterthur, p.101, Mai 2000.
- Teschers R., et al, 1999. Aluminiumrückführung aus dem Automobilbereich. Institute für Bergwerks- und Hüttenmaschinenkunde, RWTH Aachen, p.18, Germany, 1999.
- TJSGA, 2004. Mexico's Wage Gap Charts, Wage Gap Charts for Mexico Vis-à-vis Developed and "Emerging" Selected Economies and Others Selected Economies, with Available Wage and PPP Data (1975-2002). Jus Semper Global Alliance, Living Wages north and South, USA, 2004. <http://www.jussempere.org/>
- Togawa, K., 2006. Background of the automobile recycling law enactment in Japan. Presented by Professor Dr. ECS, K. Togawa, Kumamoto University, at 6th International Automobile Recycling Congress Amsterdam, Netherlands, March 15-17, 2006.
- Turner K., et al, 1994. Environmental Economics, an Elementary Introduction. Harvester Wheatsheaf, p.318, Great Britain, 1994
- USCAR, 2006. United States Council for Automotive Research (USCAR). <http://www.uscar.org>
- USGS, 2007. Iron and Steel Scrap Statistics and Information. U.S. Geological Survey (USGS), USA 2007.
- Van der Vlies R., 2004. The ELV Directive – Implementation and the Future Developments. DG Environment, European Commission, Haus der Technik, Stuttgart, Germany, 2004.
- Van Schaik A., 2001. Design for Recycling. Faculty of Civil Engineering and Geosciences, Department of Applied Earth Sciences, Section of Raw Materials Technology, TU-Delft, Netherlands 2001.
- Varian H.R., 2002. Intermediate Microeconomics, A Modern Approach. Sixth Edition, W.W. Norton & Company, USA 2002, 602-622
- VDA, 2007. Auto Annual Report 2007. German Automotive Industry Association (VDA), chapter 1, Frankfurt/Main, Germany.
- VDA, 2006. Auto Annual Report 2006. German Automotive Industry Association (VDA), chapter 1, Frankfurt/Main, Germany.

-
- VDA, 2004¹. Jahreszahlen der Verband der Automobilindustrie. German Automotive Industry Association (VDA), p.203, Germany 2004.
<http://www.vda.de/de/aktuell/statistik/jahreszahlen/allgemeines/index.html>
- VDA, 2004². Stellungnahme des VDA zur Internetberatung, Überarbeitung einiger Einträge des Anhangs II der EU-Altfahrzeugrichtlinie 2000/53/EC. German Automotive Industry Association (VDA), Environment Division, Germany 2004.
- VDA, 2003. Auto Annual Report 2003. German Automotive Industry Association (VDA), pp. 238, Frankfurt/Main, Germany.
- Wallart N., 1997. The Political Economy of Environmental Taxes. Edward Elgar Publishing Inc. p. 213, Great Britain, 1997
- Ward's, 2006. North America Production Summary - December 2006. Ward's auto, Specialized Magazine, <http://wardsauto.com/keydata/NAProductionSummary0612/>
- Werner A.M. and Ursúa J.F., 2004. The Evolution for Growth of GDP Per Capita in Mexico: An International Comparative Analysis. Preliminary Version of PhD thesis, University of Harvard, p.40, 2004.
- Woidasky J. & Stolzenberg A., 2003. Verwertungspotenzial für Kunststoffteile aus Altfahrzeugen in Deutschland, Gutachten. Fraunhofer Institute of Chemical Engineering, p.25, Pfinztal, Germany.
- WTO, 2004. International Trade Statistics. World Trade Organization (WTO), Annual publication, p.229, 2004. <http://www.wto.org>
- Zevenhoven R. & Saeed L., 2003. Automotive Shredder Residue (ASR) and Compact Disc (CD) Waste: Options for Recovery of Materials and Energy. Helsinki University of Technology, Energy Engineering and Environmental Protection, p.69, Espoo.
- Zoboli R., Barbilioni G., Leoncini R, Mazzantti M. and Montresor S., 2000. Regulation and Innovation in the Area of End-of-Life Vehicles. F. Leone DG JRC-IPTS, EUR 19598 EN, p.428, Milan, Italy, March 2000.

Appendix-A: Future End-of-Life Vehicle Generation in Mexico

A.1 The Scrappage of Vehicular Fleet

The analysis of causes, for definitive vehicular retirements, brings a better understanding about the ELV process and the constraints affecting the ELV management. In this context, a general decrease of value in vehicles is identified as major cause for vehicular retirements.

The literature review carried out by De Jong et.al. in 2001, which covers the last 25 years of published studies about theoretical and empirical aspects of car scrappage models, establishes that most of scrappage occurs not because accidents or technical failures, but rather because of a decrease of vehicle's value with age. Some of the results, of cited survey, stated the following conditions that drive owners to scrap or keep a vehicle:

- a) the older the household's existing vehicle, the more likely it is to be scrapped,
- b) the older the replacement vehicle, the more likely the household is to keep the existing vehicle,
- c) the greater the value of the new vehicle, the more likely the household is to keep the existing vehicle,
- d) the greater the running costs of the existing vehicle, the more likely the household is to scrap it,
- e) the greater the running cost of the new vehicle, the more likely the household is to keep its existing vehicle,
- f) the lower the tax on the existing vehicle and/or the higher the tax on the newer vehicle, the more likely that the household will keep their existing car,
- g) the higher the scrap value of the car and/or the higher the scrappage bounty, the higher the likelihood that the household will scrap their car,
- h) the higher the engine size, the more durable the car, and therefore it is more likely that the household will keep it,
- i) households with old people are more likely to keep a car,
- j) households with low incomes and/or high mileage are more likely to scrap vehicles, and
- k) high occupancy households are less likely to sell, whereas households with no children and those who use their car primarily for shopping are more likely to sell.

A.2 Factors Affecting the ELV Generation in Mexico

The decision for vehicles' scrappage is affected by several factors, which importance changes over the time and varies from owner to owner. The ELV generation in Mexico follows the same rules as those mentioned by De Jong et al. in 2001. However, the conditions under these rules take place, are different. In the following paragraphs are described the main factors affecting the ELV generation in Mexico.

A.2.1 Mexican Demographic Evolution

The Mexican population is a crucial factor regarding the Mexican vehicular fleet. As passenger cars and light trucks are products, the consumers introduce these products into the vehicular fleet. The present work addresses the population sector between 15 to 64 years old, as persons from this sector are potential consumers of cars (Shell, 2004).

Estimations given by CONAPO in 2002 showed the trend of Mexican population (15-64 years) for the period of 2000 to 2050. The number of persons in productive age (15-64 years) will increase in the next decades, especially since 2015, as can be observed in figure A.1. As a consequence, the number of potential car consumers will increase.

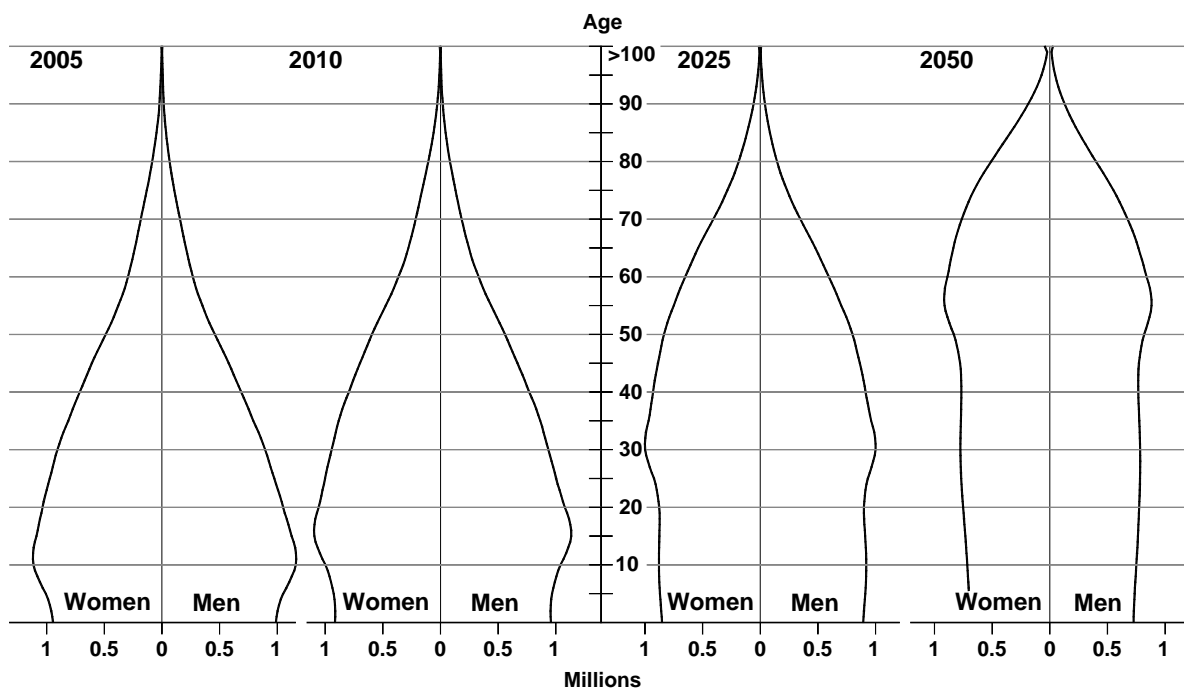

Figure A.1. Mexican Population Structure

Source: CONAPO, 2002

A.2.2 Mexican GDP per Capita

Passenger cars and light trucks, as many other products, are ruled by market conditions, and citizens are the main consumers. Therefore, the economical situation in Mexico is a crucial factor to take into account for the estimation of vehicular fleet, in the coming years.

The average wealthiness in a country is frequently described by the Gross Domestic Product per capita (GDP per capita). This indicator allows an international and easy comparison. For that reason, this indicator is used as main economic item to take into account for the estimation of coming vehicular fleet in Mexico. The work carried out by Werner and Ursúa in 2004, showed in detail the evolution of GDP per capita in Mexico during the last century and the last years. In that work is possible to observe the heterogeneous growth of Mexican economy, considering political circumstances and economical behaviours during the last century.

According to Werner and Ursúa, the development of the Mexican GDP per capita has not reached the wished levels to raise the Mexican wealthiness. One of the main causes for that is the inability to follow the growth rate of other countries, e.g. emergent Asian countries, which at the beginning had similar economies as Mexico. As consequence of this fall behind, Mexico has lost competitiveness in different markets.

In the mid term, Mexico has to take advantage of future opportunities. One of these is the mentioned demographical bonus for the next decades. By 2025 onwards, the structure of Mexican population shows a substantial growth in the economically active sector (15 – 64 years) and a reduction in the birth rate. These facts among others, under certain circumstances could lead the Mexican economy to grow in a rate of 5% in the GDP per capita, and reach the growth presented by other countries from the OECD (Organization for Economic Cooperation and Development) and emergent Asian countries (Werner and Ursúa, 2004).

A.2.3 Mexican Automotive Industry

The Mexican automotive industry has had a good development in the last decades. This industry has been transformed from a national oriented industry into an export platform. This industry has developed high competitiveness and it is mainly oriented to the American market, the largest automotive market worldwide (Mortimore and Barron, 2005).

The current challenge for this Industry in Mexico is stated by the Mexican Association of Automotive Industry (AMIA) and the State Secretary of Economy. The challenge consists in to double the production of vehicles in Mexico by 2010. That means a production of four million vehicles, three millions for export and one million for national market (Expansion, 2004; Mortimore and Barron, 2005).

According to opinions of many experts, the objective described above is feasible if Mexico accomplish the following three conditions. First, the maximization of its access to new markets through its trade agreements with different countries, i.e. the USA, Japan and the European Union. Second, the Mexican automotive suppliers become in an integrated industry. Third, the improvement of the automotive productive chain (Mortimore and Barron, 2005).

The advantages, of geographical location and lower workforces' costs, in combination with international trade agreements, are triggering important investments for the coming years. Some example of that are the investments done by Ford, Nissan and Volkswagen. Therefore, there are good possibilities that Mexico reach the objective proposed for 2010 (Expansion, 2004; Mortimore and Barron, 2005).

A.2.4 Retail of New Vehicles

Another factor direct related with the vehicular fleet and more specific with passenger cars, is the retail of new vehicles in Mexico. The historical data of Mexican market is shown in the table 4.6, where is possible to point out the importance of export of motor vehicles. That is way the automotive industry in Mexico plays an important role for the Mexican economy. Another special characteristic of the Mexican automotive market is the number of imported vehicles sold in Mexico. This retail is mainly comprised by passenger cars and light trucks, with around 60% of the sales in 2003 (INEGI, 2004).

Recent publications reported a retail of 1,160,037 passenger cars and 48,403 heavy vehicles in 2006 (AMIA, 2007 and ANPACT, 2007).

A.2.5 Registered Vehicles

The available information about the Mexican fleet of passenger cars is given by the Mexican Association Automotive Industry (AMIA) and the National Association of Producers of Heavy vehicles (ANPACT) in 2004. Here, it is important to point out that in Mexico there is still any available information from Vehicular Public Registry^{A-1}. Therefore, the data on this topic is administrated by some organizations related to the automotive branch. The table 4.7 presents the current Mexican vehicular fleet.

In 2004, the Mexican Association of Motor Vehicles Distributors (AMDA) reported that 45% of total number of vehicles is concentrated in five states: Federal District (17%), Jalisco (9%), Mexico (7%), Nuevo León (6%) and Baja California (6%). The average age of those vehicles is around 14 years.

^{A-1} In 2004 the senate in Mexico approved the Law of Public Vehicular Register, its main aim is the creation of a register to identify and control the inscriptions, retires, registration numbers, infractions, robberies, recuperations and destruction of vehicles which are manufactured, assembled, imported or are being used in national territory, as well to inform the general public. This Law entered into force the 2nd September 2004

In the same document, the distribution of models is described as follows: 41% of registered vehicles are from models before 1990, 18% of this fleet is located in the range of 1991 to 1995, 16% has models between 1996 and 2000, and 25% belongs to models between 2001 and 2005. The last data can be represented in the figure A.2.

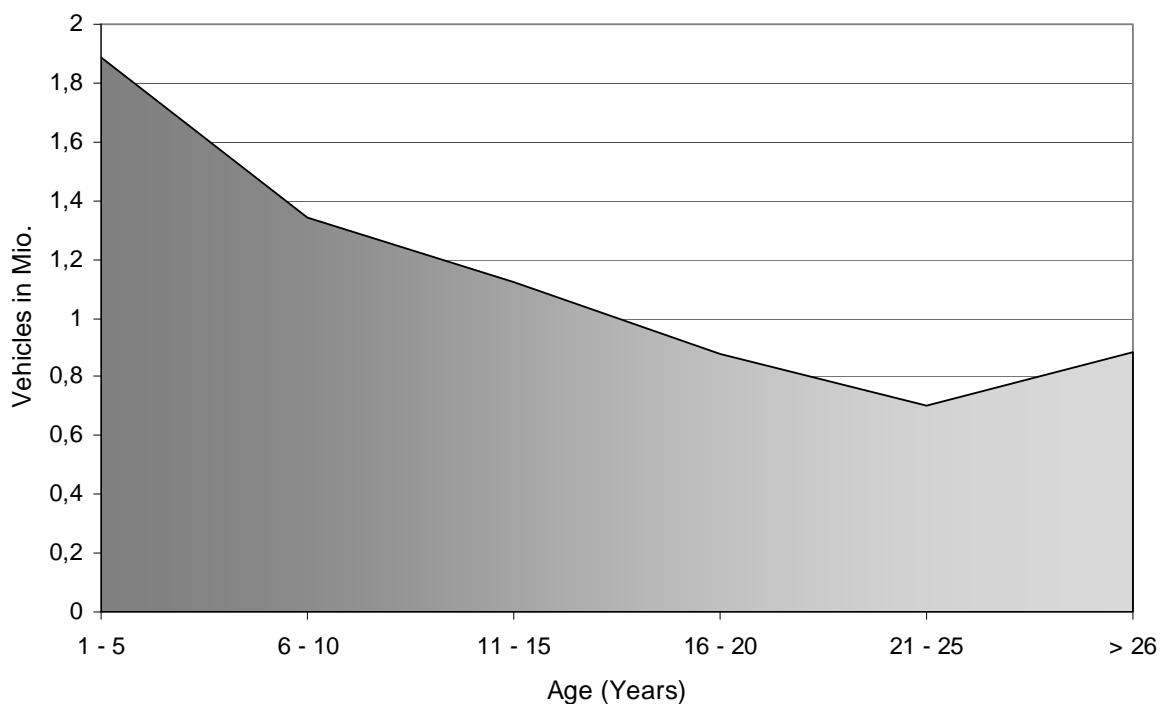

Figure A.2. Distribution of Ages in Mexican Vehicular Fleet

Source: AMDA, 2005

A.2.6 Vehicles Introduced from the USA

Seeing that scrappage decision is mainly driven by economic factors through the time, the behaviour of vehicles' scrappage is presumable different from one economical region to another one. This is because vehicles' value differences between regions. Hence, a natural consequence for these differences is the export of old vehicles.

The study carried out by Sander et al. in 2002 makes evident the export of significant number of used vehicles from the EU to east European and African countries. The most of these vehicles are already 10 years old, or even older. These car exports obey the fact that while in export countries these vehicles have a reduced value, in the import countries these units are still functional units with significant value. This difference is mainly due to the economic differences between export and import countries. Thus, the lifespan and retirement behaviour, on those countries (export and import ones), are evidently different.

On account of the paragraphs above, the lifespan of vehicular fleet in developing countries, as Mexico, can not be the same as the lifespan for the USA or the EU. Hence, the retirement behaviour is different. The lifespan of Mexican vehicles is larger, because the remaining value in old vehicles. This fact is evident in the average age of the vehicular fleet in Mexico, which is around 14 years old (AMDA, 2005), while in the Netherlands and Germany for instance, is 7 years (Sander et al., 2002).

The phenomenon of introduced vehicles from the USA to Mexico affects directly the population of passenger vehicles in Mexico. There is a big uncertainty on the information about these kind vehicles, due to a big part of those vehicles were illegally introduced to Mexico years ago. Thereby, there is no specific data about their features.

Reports published by AMDA in 2005 and CESOP in 2004 declare that the major part of these vehicles are considered ELV in the USA^{A-2}. The main reason for this is their average age of 10.7 years. Therefore, their mechanical performance is presumable poor.

According to information from CESOP in 2004, AMDA in 2005 and the study carried out by *Melgar de México* in 2005 (table 4.3), every year there were illegally introduced around 200,000 to 300,000 vehicles. By 2005, the Mexican fleet counted with 2.3 million of vehicles already in the fleet. These vehicles came in this way were already legalized. Moreover, there were 1.8 million vehicles still waiting for the legalization. Therefore by 2006, there were around 4.1 million vehicles introduced from the USA into Mexico (AMDA, 2005). The same study carried out by *Melgar de México* in 2005, foresees an increment of 5.43% by 2006, compared with the period from 1972 to 2005.

From August to February 2006, the Mexican authorities implemented a decree to legalize used vehicles introduced from the USA. This allowance attempted to regulate the illegal condition of these vehicles and avoid the problematic associated with these vehicles. In behalf of mentioned decree, 510 thousand vehicles were imported from August to February 2006, as is stated by the Mexican Administration of Customs (Martínez, 2006).

In 2004, CESOP reported that there are two main causes for this kind of introduction of vehicles from the USA. First, there is a lack of economical resources to purchase new or second hand vehicles from national market. Therefore, a vehicle introduced from the USA offers a better option. Second, the biggest part of vehicles is introduced with temporal permissions; however they stay definitely in Mexico. These vehicles are brought by migrants, which are working in the USA and come back to Mexico (Giermainski, 1999).

^{A-2} The average age of American passenger cars is 8.4 years according to DOE, 2006.

Due to the emigration of Mexicans to the USA plays a determinant role in the number of old vehicles introduced to Mexico. It is important to analyse the immigrant flows to the USA coming from Mexico. Studies carried out by Passel and Suro in 2005 and Passel in 2006, reported an average of 485,000 unauthorized arrivals to the USA for the period of 2000-2004. The same studies showed the close relationship between the annual flow of Mexican migrants and the US employment rates.

CONAPO in 2000 carried out estimations for different scenarios about the future migration rates from Mexico to the USA. In that work there were considered scenarios with the following hypothesis:

- a) Hypothesis A. Good development of the Mexican economy and constant remittances per capita.
- b) Hypothesis B. Slow development of the Mexican economy and constant remittances per capita.
- c) Hypothesis C. Good development of the Mexican economy and rising rates on remittances per capita.
- d) Hypothesis D. Slow development of the Mexican economy and rising rates on remittances per capita.

Considering the conditions described in the aforementioned study, the scenario considered by this work as the most probable to happen is the one corresponding to hypothesis D. Therefore, it is considered that the number of Mexican migrants to the USA tends to rise in coming years.

The remittances, sent by Mexican migrants to their families in Mexico are other important factors that indirectly affect the vehicular population in Mexico. According to the Mexican Central Bank there were sent 16,600 Mio USD to Mexico (2.2% Mexico's GDP) in 2004. CONAPO stated that 1.2% of that money is spent in purchasing different fixed assets, in which are included vehicles (CONAPO, 2000).

A.3 Historic Generation of ELV in Mexico

In theory, the number of End-of-Life vehicles generated each year could be obtained using a simple arithmetic equation, as implemented by Staudinger and Keoleian in 2001.

The equation is as follows:

$$E_i = R_{i-1} + S_i - R_i \quad (\text{A.1})$$

Where: E_i , is the number of vehicles retired from circulation in year i . R_{i-1} , is the number of registered vehicles in year $i-1$. S_i , is the number of sold vehicles in year i , and R_i , is the number of registered vehicles in year i . This is taking into account that figures are obtained at the end of each year. The last equation works, taking into consideration an efficient vehicular register that controls the registrations, retails and de-registration, among others.

In the absence of that kind of vehicular register and owing to the continued introduction of vehicles from the USA. The equation A.1 must be modified in order to obtain logical results. The implementation of equation A.1 to calculate the ELV generation in Mexico is presented in table A.1.

Table A.1 Generation of ELV in Mexico from 1996 to 2004

Year	Fleet	Retail	Introduced	*ELV	**ELV	***ELV
1995	7,490,796	226,316	123,463			
1996	7,827,924	325,154	123,463	-11,974	111,489	111,489
1997	8,422,254	482,146	123,463	-112,184	11,279	11,279
1998	9,127,870	643,360	123,463	-62,256	61,207	61,207
1999	9,644,537	667,288	262,085	150,621	412,706	412,706
2000	10,233,541	853,775	312,787	264,771	577,558	577,558
2001	11,442,618	918,835	260,868	-290,242	-29,374	460,630
2002	12,354,294	977,558	277,819	65,882	343,701	343,701
2003	12,858,045	977,870	213,406	474,119	687,525	687,525
2004	13,504,828	1,095,796	210,992	449,013	660,005	660,005

* Number of ELV implementing the equation (A.1)

** Number of ELV taking into account the illegal introduction of vehicles from the USA, thus (S_i =Sold vehicles in year i + Illegal vehicles in year i)

*** Number of ELV ignoring the bias and with a lineal interpolation.

The fifth column in table A.1 presents the number of ELV calculated with equation A.1. The results are not logical, as instead of retirements, seems to have even more registrations. The reason of that is because the number of introduced vehicles from the USA. Therefore, if these vehicles are considered as inputs to the vehicular fleet (together with retails), the sixth column shows the result. The seventh column presents the interpolated figures avoiding bias. This column contains the number of retired vehicles in Mexico using available information, however these figures should be taken carefully, as vehicular data is incomplete.

A.4 The Future Trend of ELV Generation in Mexico

There is a strong relationship between vehicular fleet and retail with ELV generation. For that reason, a first condition to estimate ELV generation is to estimate future number of vehicular registrations, afterwards the estimation of future number of ELV is possible.

A.4.1 Trends in Vehicular Fleet

The first part of this section comprises the estimation of future trends in the Mexican vehicular fleet. This calculation is divided in two scenarios. The main considerations and assumptions for every scenario are described below.

Scenario-A. This scenario is characterized by the full achievement of objectives established by the Mexican Automotive Industry by 2010 (see point A.2.3). Moreover, it is considered a maintained Mexican economy growth of 5% in the GDP per capita. Hence, it is assumed that the retail of passenger cars and light trucks could reach the reposition rate of 10%, of the entire vehicular fleet.

Due to the migratory conditions will remain for the middle term, and even the number of persons immigrating to the USA is foreseen to increase (CONAPO, 2000). The number of vehicles introduced from the USA is assumed with a growth rate of 5.43 %, as it is set by Melgar in 2005. This tendency is only disrupt in 2005 by the National Decree, which gave the amnesty to those vehicles in illegal condition, and in 2009 by enter into force the NAFTA's Annex 300-A.2^{A-3}.

The last assumptions in combination with retail of new vehicles and introduced vehicles from the USA will allow 0.35 vehicles per person (15 - 64 years old) by 2010.

^{A-3} Mexico may adopt or maintain prohibitions or restrictions on imports of used vehicles from the territory of another Party, except as follows: (a) beginning January 1, 2009, Mexico may not adopt or maintain a prohibition or restriction on imports from the territories of Canada or the United States of originating used vehicles that are at least 10 years old.

Scenario-B. This scenario foresees an uncompleted achievement of objectives set by the Mexican Automotive Industry, and a Mexican economy growth under optimal rate (as described by Werner and Ursúa, 2004). The growth rate in the number of introduced vehicles from the USA is assumed as in previous scenario.

The number of vehicles per person (15- 64 years old) would reach just a 0.25, by 2010. As a consequence, the retail of passenger cars and light trucks would have a rate of reposition of 8 %.

Population growth is taken into account by scenarios as CONAPO has foreseen in its study in 2002.

Table A.2 Variables for Scenarios A and B by 2010

Year	Population 15-64 years	Motorization 15-64 Years		PC & LT Fleet		Reposition rate		Retail PC<	
	(inh.x10 ⁶)	(vehicle/person)		(units x 10 ⁶)		(%)		(units x 10 ⁶)	
Scenario	A & B	A	B	A	B	A	B	A	B
2005	68.2	0.22	0.22	14.8	14.8	5.5%	5.5%	1.1	1.1
2006	69.5	0.24	0.22	16.9	15.5	6.4%	6.0%	1.6	1.3
2007	70.8	0.27	0.23	19.1	16.3	7.3%	6.5%	2.0	1.5
2008	72.1	0.30	0.24	21.4	17.1	8.2%	7.0%	2.5	1.7
2009	73.3	0.32	0.24	23.7	17.8	9.1%	7.5%	3.1	1.9
2010	74.5	0.35	0.25	26.1	18.6	10%	8%	3.7	2.1

The implementation of variables (table A.2) in Scenarios A & B gives as result, two different trends in the Mexican vehicular fleet for the coming years. These trends are shown in figure A.3.

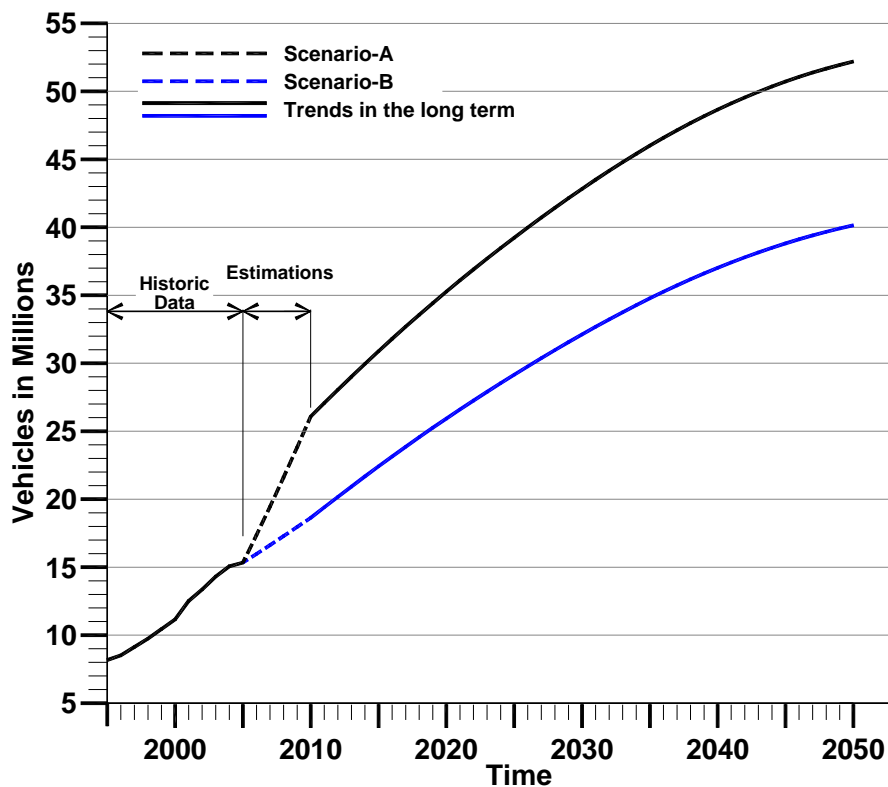

Figure A.3 Future Trends in Mexican Vehicular Fleet

Figure A-3 shows the curves describing the trends for future vehicular fleets in Mexico, considering the two scenarios. It is possible to see a peak in the Mexican vehicular fleet between 2005 and 2006 due to a rise in the number of vehicles, introduced from the USA. Another interesting point for both scenarios is the year 2009, when NAFTA's Annex 300-A.2 comes into force.

For the period of time between 2010 and 2050, scenarios have been drawn only considering a linear growth on the number of vehicles per person. This value is assumed as 0.65 for Scenario-A and 0.50 for Scenario-B by 2050. The considered population is the 15 to 64 years old sector from population projections given by CONAPO 2002.

A.4.2 Trends in ELV Generation

The reliability engineering is commonly used by researchers on scrappage models, such as Sliker, 2003 and Van Schaik, 200, as a tool to describe the reliability/failure-time of products. This engineering is supported by several analytical tools, as the Weibull distribution. This analytical tool is used to estimate important characteristics of products, as reliability or probability of failure at a specific time. The Weibull distribution describes the behaviour of products' retirement from the market, during the time.

The formal definition of this distribution is as following,

Weibull Probability Density Function

$$f(t) = \frac{\beta}{\theta^\beta} t^{\beta-1} e^{-\left(\frac{t}{\theta}\right)^\beta} \quad (\text{A-2})$$

where,

$$t = \frac{T - \gamma}{\eta}, f(t) \geq 0, T \geq 0 \text{ or } \gamma, \beta > 0, \eta > 0, -\infty < \gamma < \infty,$$

Cumulative Distribution Function

$$F(t) = 1 - e^{-\left(\frac{t}{\theta}\right)^\beta} \quad (\text{A-3})$$

Where, $F(t)$ is the probability that the retirement age occurs by age t given in years; β is the shape parameter, and θ is the spread parameter of Weibull distribution.

Weibull mean life

$$\bar{T} = \gamma + \eta \cdot \Gamma\left(\frac{1}{\beta} + 1\right); \gamma = 0 \quad (\text{A-4})$$

Where, \bar{T} is the average lifespan in years, and Γ is the gamma function.

Different studies have obtained the distribution of automobiles' lifespan for different model-year vehicles, and the variation of these parameters depending on the model-year and the time^{A-4}. In the work carried out by Sliker in 2003 there were presented the retirement histograms against their fits using the Weibull probability distribution function. The histograms used vehicle models from 1964 to 1989. Van Schaik in 2001 carried out a work that presented statistical data about de-registered cars in the Netherlands from 1997 to 1999, regarding to vehicles produced in 1971 onwards. The fit of those data was done implementing Weibull distribution with positive results.

The parameters used for this work have been modified from those used by Sliker, 2003 and Van Schaik, 2001. This is because the lack of specific information about survival rates of Mexican fleet, and in order to represent as much as possible the Mexican situation. The average lifespan of new vehicles (Equation A.4.) is considered 20 years. This lifespan is assumed longer than stated in studies carried out by Sliker, 2003 and Van Schaik, 2001. The reason is due to Mexican consumers tend to keep their vehicles in circulation a longer time, than in industrialized countries (De Keratry, 2004).

For used vehicles introduced into Mexico from the USA, the average lifespan is considered 10 years. This lifespan obeys the fact that most of them have already 10 years on the road. Moreover, the scarcity of spare-parts raises the probability of these units to become ELV. Table A.3 shows the variables used for the Weibull distributions' implementation.

Table A.3 Variables for Scenarios A and B by 2010

Variable	Scenario-A		Scenario-B	
	Nv	Ovi	Nv	Ovi
β	6.4	4.3	6.4	4.3
θ	21.5	11	21.5	11
Average Lifespan (years)	20	10	20	10

Nv= New vehicles

Ovi= Old vehicles introduced from the USA

The implementation of Weibull distribution provides a dynamic mass balance describing the accumulation of ELV as function of vehicular inputs (new vehicles retail + imported vehicles from the USA) and the retirement probability, year by year. The total number of ELV in certain year is the sum of all model-year retirement curves. Figure A.4 describes the dynamic mass balance in Scenario-A for new vehicles sold in Mexico for the period of 2005 to 2010.

^{A-4} See Sliker, 2003 and Van Schaik, 2001

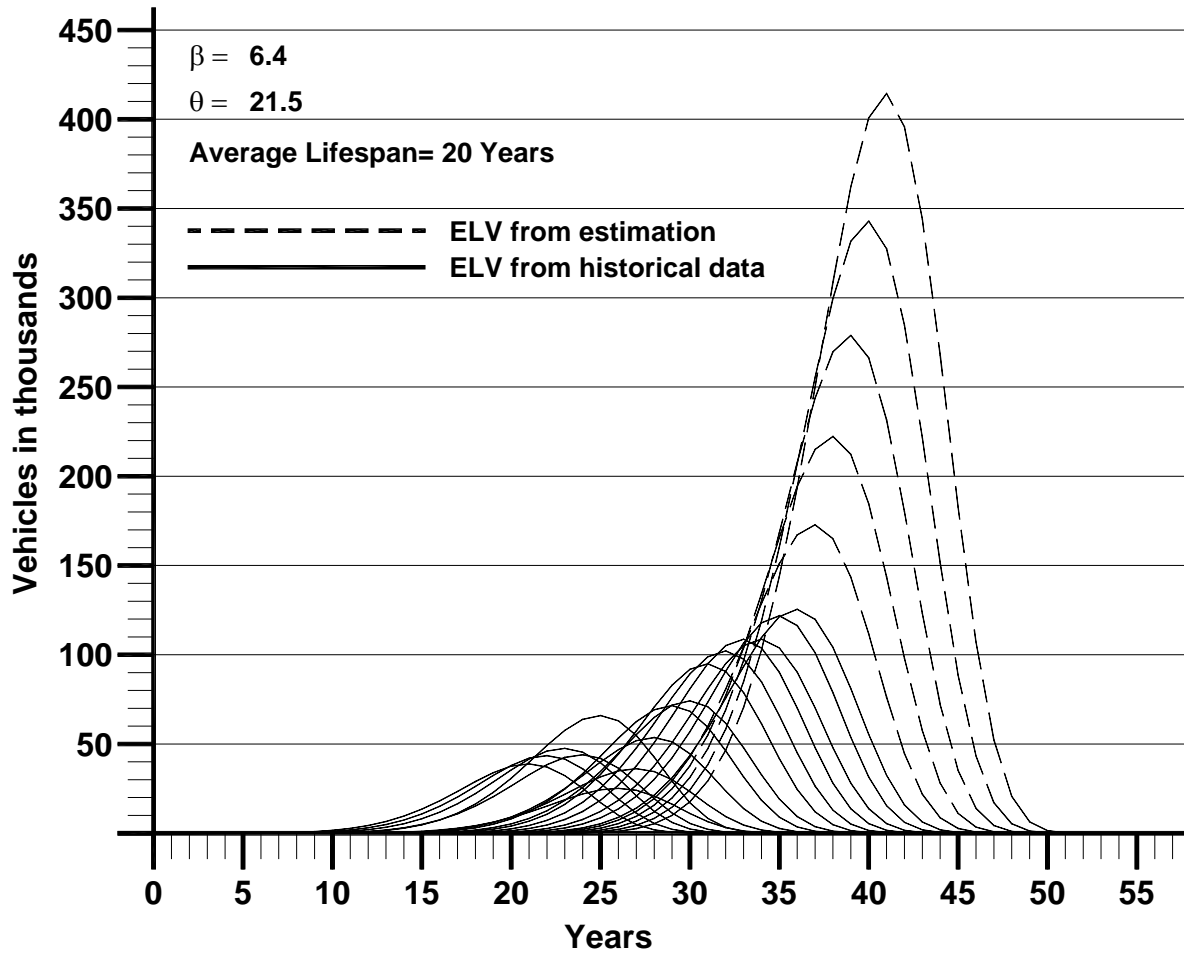

Figure A.4 Implementation of Weibull Probability Density Function to Vehicular Inputs from 1995 to 2010. New Sold Vehicles in Mexico, Scenario-A.

Figure A.5 describes the dynamic mass balance in Scenario-B for new vehicles sold in Mexico for the period of 2005 to 2010.

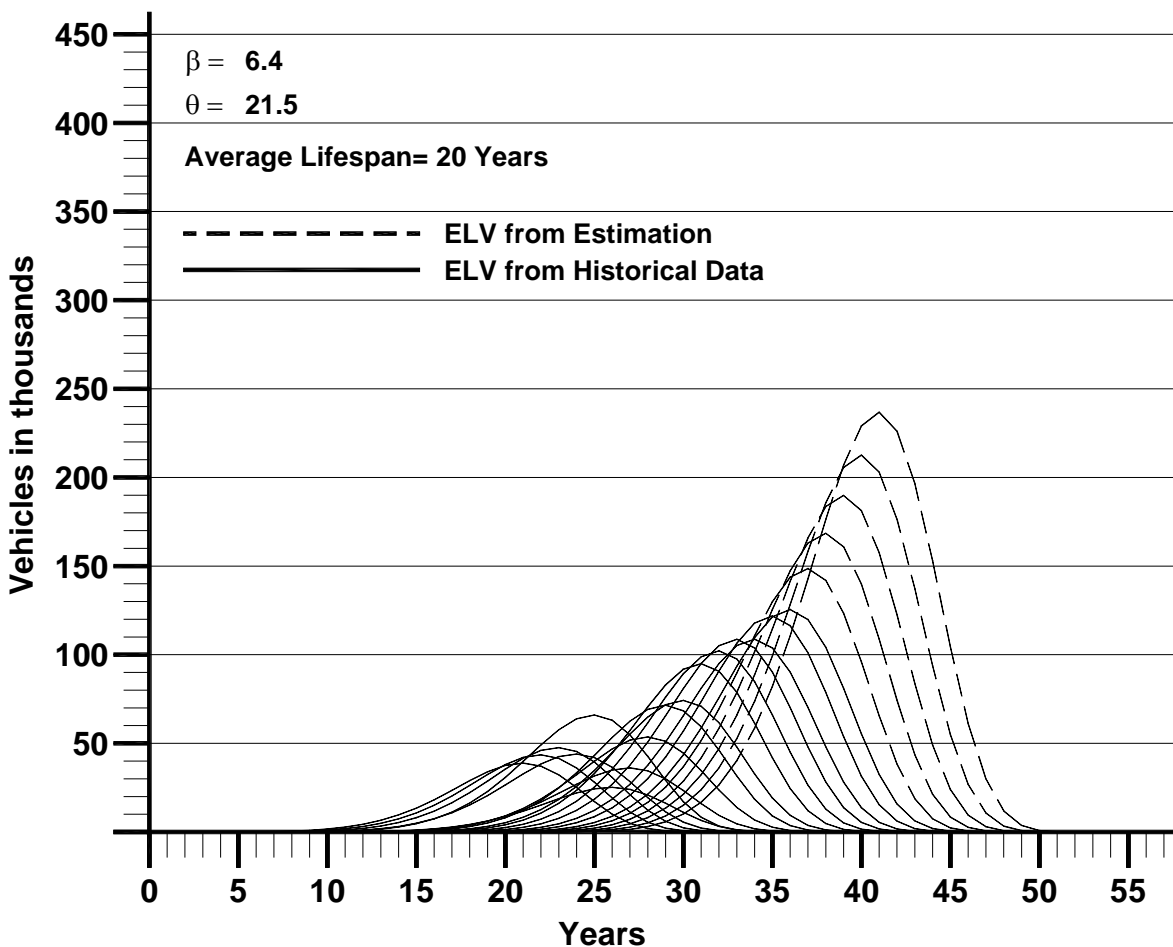

Figure A.5 Implementation of Weibull Probability Density Function to Vehicular Inputs from 1995 to 2010. New Sold Vehicles in Mexico, Scenario-B.

The figure A.6 displays the implementation of Weibull distribution to vehicular inputs from importation of used vehicles from the USA to Mexico. According to the conditions for vehicles introduced from the USA to Mexico, the retirement behavior is considered equal for scenarios A and B.

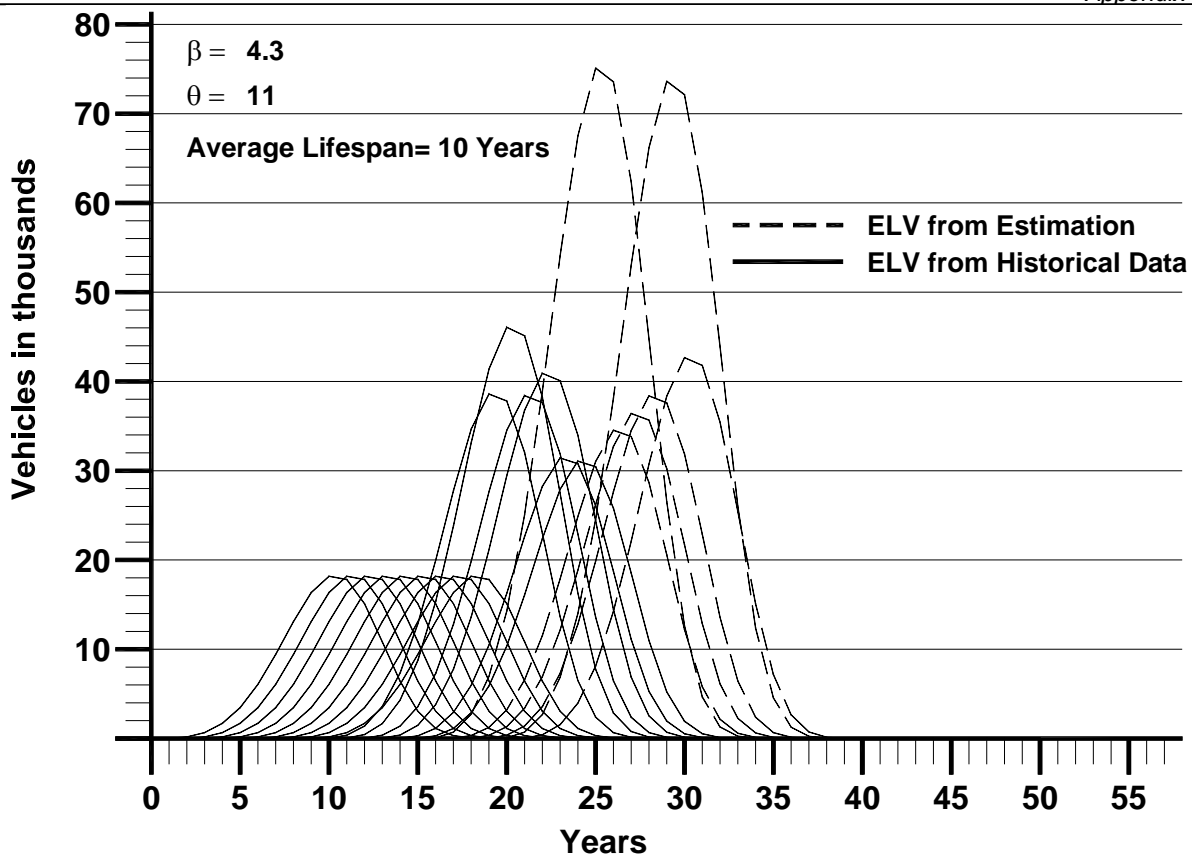

Figure A.6 Implementation of Weibull Probability Density Function to Vehicular Inputs from 1995 to 2010. Used Vehicles Introduced from the USA to Mexico, Scenarios A and B.

Each curve in figures A-4 to A-6 represents the retirement behavior of vehicular inputs for a certain year. The total number of ELV generated in a certain year is the sum of all corresponding values for every curve in that year. The figure A-7 displays the total ELV generation of vehicular inputs, from 1995 to 2010 considered for Scenarios A and B. Moreover, the historical data about ELV generation by 2004 is transposed with the future trends of ELV generation in Mexico

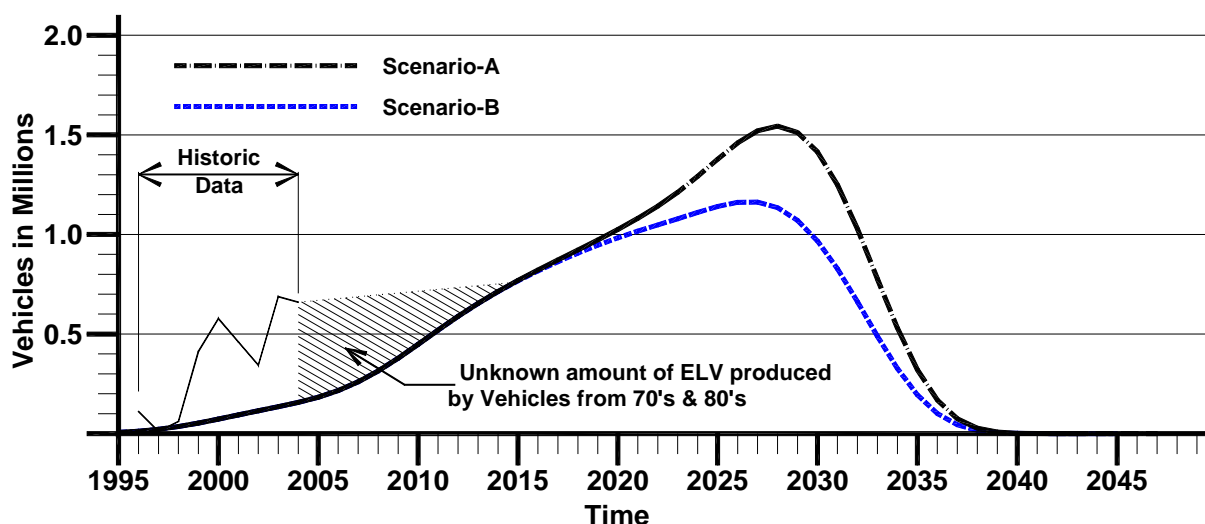

Figure A-7 Total ELV Generation in Mexico for Scenarios A and B

The plot in figure A-7 shows a shaded area, which corresponds to the number of ELV generated from new sold vehicles in Mexican market and used imported vehicles from the USA, during 70s to 90s. There is no available information about those inputs to the Mexican vehicular fleet. Therefore, the number of ELV generated in that period is assumed as linear growth. This assumed growth fills the gap on the number of ELV, and connects the historic data with estimated data. According to curves' values for different years (in figure A-7), the numbers of ELV generated in Mexico from 2005 to 2025, for Scenarios A and B, are broken down in table A-4.

Table A.4 Number of ELV Generated in Mexico from 2005 to 2025

Year	E L V	
	Scenario-A	Scenario-B
2005	669,200	669,200
2006	678,390	678,390
2007	687,580	687,580
2008	696,780	696,780
2009	705,970	705,970
2010	715,160	715,160
2011	724,350	724,350
2012	733,550	733,550
2013	742,740	742,740
2014	751,930	751,930
2015	769,320	766,960
2020	1,025,000	983,100
2025	1,378,100	1,140,680

Appendix-B: ELV Generation in Mexican Localities

Since a direct relationship, between vehicular fleet with ELV generation; the amount of ELV generated in every locality is assumed as a percentage of total amount of ELV in Mexico, this percentage is defined by their participation in the national vehicular fleet (passenger cars and light trucks). In other words, if a locality “X” counts with 1.5% of national vehicular fleet, then is assumed that locality “X” will generate 1.5% of total amount of ELV in a certain year.

In this way, the Municipal System of Data Base (SIMBAD) from the National Institute of Statistics, Geography and Information (INEGI) provided the amount of registered vehicles for 2,444 localities along Mexico^{B-1}. However, there was available cartographic information to localize only 699 urban localities^{B-2}, the vehicular fleet of the rest 1,745 localities were added to their corresponding urban locality. The figure B.1 shows the geographical position of these localities.



Figure B.1 Localities in Mexico for ELV Generation

The list of 699 localities, with their correspondent amount of ELV generated in forthcoming years, are described in tables B.1 to B.14

^{B-1} These amount comprises urban and rural localities

^{B-2} Urban localities are defined as towns with a population higher than 2,500 inhabitants, or those with less population, but being head of municipal government.

Table B.1 Localities and ELV Generation in Mexico (1/14)

Nr.	Locality name		Coordinates		%	End-of-Life Vehicles						
						2007	2010	2015	2020	2020	2025	2025
			SC-A	SC-B					SC-A	SC-B		
1	AGUASCALIENTES	010010001	1,535.1	681.2	0.981%	6745	7016	7547	10056	9644	13519	11190
2	CALVILLO	010030001	1,507.9	678.8	0.025%	175	182	196	261	251	351	291
3	JESUS MARIA	010050001	1,531.9	686.6	0.044%	303	315	339	451	433	606	502
4	PABELLÉN DE ARTEAGA	010060001	1,536.2	699.3	0.022%	152	158	170	227	217	305	252
5	RINCÉN DE ROMOS	010070001	1,533.3	705.0	0.034%	233	243	261	348	334	468	387
6	SN FRCO DE LOS R	010100001	1,536.5	694.0	0.014%	94	98	105	140	134	188	156
7	PALO ALTO	010110001	1,556.1	683.6	0.017%	120	124	134	178	171	240	199
8	ENSENADA	020010001	692.4	1,411.1	0.749%	5152	5358	5764	7680	7366	10325	8547
9	MEXICALI	020020001	765.0	1,458.1	2.412%	16585	17250	18557	24724	23713	33241	27514
10	TECATE	020030001	694.9	1,459.6	0.215%	1476	1535	1651	2200	2110	2958	2448
11	TIJUANA	020040001	670.9	1,458.4	2.724%	18728	19479	20955	27919	26777	37536	31070
12	ROSARITO	020040223	668.5	1,447.6	0.154%	1059	1102	1185	1579	1515	2123	1758
13	CIUDAD INSURGENTES	030010133	945.1	933.2	0.163%	1121	1166	1254	1671	1602	2246	1859
14	PAZ, LA	030030001	1,031.9	851.3	0.716%	4925	5123	5511	7342	7042	9871	8171
15	CABO SAN LUCAS	030080054	1,051.9	764.1	0.293%	2016	2097	2256	3005	2883	4041	3345
16	LORETO	030090001	975.2	982.9	0.009%	63	65	70	94	90	126	104
17	CALKINA	040010001	2,325.2	609.9	0.014%	97	101	108	144	138	194	161
18	CAMPECHE	040020001	2,297.6	571.2	0.215%	1477	1537	1653	2202	2112	2961	2451
19	CIUDAD DEL CARMEN	040030001	2,219.5	482.7	0.179%	1229	1278	1375	1832	1757	2463	2038
20	CHAMPOTÉN	040040001	2,287.7	536.5	0.027%	183	190	204	272	261	366	303
21	HECELCHAKAN	040050001	2,320.8	596.1	0.005%	37	38	41	55	53	74	61
22	HOPELCHÉN	040060001	2,342.2	568.4	0.005%	38	39	42	56	54	76	63
23	TENABO	040080001	2,315.7	586.4	0.001%	10	11	11	15	14	20	17
24	ESCATEPEGA	040090001	2,290.4	485.6	0.014%	96	100	108	143	137	193	159
25	ACUÑA	050020001	1,617.0	1,191.7	0.138%	951	989	1064	1417	1359	1905	1577
26	ALLENDE	050030001	1,623.7	1,124.2	0.023%	157	163	175	234	224	314	260
27	CASTANOS	050060001	1,588.6	1,016.9	0.015%	101	105	113	151	145	203	168
28	CUATRO CIEGAS	050070001	1,549.8	1,030.8	0.007%	46	48	51	68	66	92	76
29	ESCOBEDO	050080001	1,589.8	1,048.0	0.001%	7	7	8	11	10	14	12
30	FRANCISCO I. MADERO	050090001	1,475.0	947.9	0.025%	175	182	196	261	250	351	291
31	GENERAL CEPEDA	050110001	1,586.4	920.5	0.002%	15	15	16	22	21	29	24
32	HIDALGO	050130001	1,683.6	1,086.8	0.001%	8	8	9	12	11	16	13
33	JIMENEZ	050140001	1,633.8	1,174.3	0.005%	32	33	36	48	46	64	53
34	JUÁREZ	050150001	1,631.7	1,073.8	0.001%	4	4	5	6	6	9	7
35	LAMADRID	050160001	1,566.4	1,035.3	0.001%	8	8	9	12	12	16	13
36	MATAMOROS	050170001	1,477.4	931.1	0.043%	293	305	328	437	419	588	487
37	MONCLOVA	050180001	1,589.3	1,025.1	0.304%	2088	2172	2336	3113	2985	4185	3464
38	MORELOS	050190001	1,621.4	1,128.6	0.008%	54	56	61	81	78	109	90
39	MIZQUIZ	050200001	1,583.4	1,092.3	0.049%	339	353	380	506	485	680	563
40	NADADORES	050210001	1,578.7	1,033.6	0.004%	31	32	34	46	44	62	51
41	NAVA	050220001	1,628.8	1,129.7	0.023%	158	164	177	235	226	316	262
42	OCAMPO	050230001	1,529.4	1,053.5	0.001%	10	10	11	15	14	20	16
43	PARRAS DE LA FUENTE	050240001	1,542.6	924.8	0.025%	174	181	195	259	249	349	289
44	PIEDRAS NEGRAS	050250001	1,642.7	1,148.3	0.282%	1937	2014	2167	2887	2769	3882	3213
45	PROGRESO	050260001	1,615.8	1,061.4	0.001%	10	10	11	14	14	19	16
46	RAMOS ARIZPE	050270001	1,619.1	932.0	0.050%	346	360	387	515	494	693	574
47	SABINAS	050280001	1,607.5	1,090.5	0.060%	411	428	460	613	588	825	683
48	SALTILLO	050300001	1,616.1	924.7	0.731%	5025	5226	5622	7491	7184	10071	8336
49	SAN BUENAVENTURA	050310001	1,581.8	1,036.4	0.018%	123	128	138	184	176	247	204
50	NUEVA ROSITA	050320014	1,601.4	1,096.2	0.051%	349	363	390	520	499	699	578

Table B.2 Localities and ELV Generation in Mexico (2/14)

Nr.	Locality name		Coordinates		%	End-of-Life Vehicles						
						2007	2010	2015	2020	2020	2025	2025
			SC-A	SC-B					SC-A	SC-B		
51	SN PEDRO COLON	050330001	1,492.7	947.1	0.042%	285	297	319	426	408	572	474
52	TORREÓN	050350001	1,464.9	932.3	0.664%	4564	4747	5107	6804	6526	9148	7572
53	VIESCA	050360001	1,503.9	917.9	0.004%	27	28	30	40	38	53	44
54	VILLA UNIÉN	050370001	1,631.3	1,116.1	0.005%	33	35	37	50	48	67	55
55	ZARAGOZA	050380001	1,619.4	1,134.4	0.015%	105	110	118	157	151	211	175
56	CIUDAD DE ARMER=A	060010001	1,425.5	480.2	0.009%	65	68	73	97	93	130	108
57	COLIMA	060020001	1,441.4	501.1	0.203%	1393	1449	1559	2077	1992	2792	2311
58	COQUIMATL=N	060040001	1,435.8	498.6	0.007%	51	53	57	76	73	102	85
59	CUAUHTI=MOC	060050001	1,449.4	506.8	0.102%	703	731	787	1048	1005	1409	1167
60	MANZANILLO	060070001	1,402.5	488.4	0.098%	673	700	753	1004	963	1349	1117
61	TECOM=N	060090001	1,431.5	478.5	0.044%	304	316	340	453	434	609	504
62	ANGEL ALBINO CORZO	070080001	2,172.9	288.5	0.012%	81	85	91	121	116	163	135
63	BERRIOZ=L	070170001	2,132.4	349.9	0.017%	118	123	132	176	169	237	196
64	COMITAN DE DMGZ	070190001	2,210.5	317.2	0.075%	516	536	577	769	737	1034	856
65	CONCORDIA, LA	070200001	2,174.1	305.5	0.004%	28	29	31	42	40	56	47
66	CHIAPA DE CORZO	070270001	2,150.0	344.7	0.024%	165	172	185	246	236	331	274
67	HUIXTLA	070400001	2,193.6	239.2	0.015%	104	108	116	155	148	208	172
68	TRIUNFO, EL	070410081	2,228.8	315.1	0.002%	10	11	12	16	15	21	17
69	JIQUIPILAS	070460001	2,107.9	339.4	0.005%	32	33	36	47	45	64	53
70	MAPASTEPEC	070510001	2,163.2	257.9	0.005%	32	33	35	47	45	63	53
71	MARGARITAS, LAS	070520001	2,220.3	322.2	0.005%	37	39	41	55	53	74	61
72	OCOSINGO	070590001	2,209.9	362.3	0.028%	191	199	214	285	274	384	318
73	OCOZOCOAUTLA DE ESP	070610001	2,125.8	346.8	0.014%	94	98	105	140	134	188	156
74	PALENQUE	070650001	2,214.4	404.4	0.016%	109	114	123	163	157	219	182
75	PIJUJAPAN	070690001	2,141.2	273.5	0.005%	37	39	42	55	53	75	62
76	REFORMA	070740001	2,136.1	423.9	0.047%	323	336	362	482	462	648	536
77	ROSAS, LAS	070750001	2,194.3	324.1	0.004%	27	28	30	40	38	54	44
78	SN CRISTÉBAL DE LAS C	070780001	2,174.9	348.4	0.104%	716	745	801	1067	1024	1435	1188
79	SAN FERNANDO	070790001	2,136.4	355.1	0.005%	32	34	36	48	46	65	54
80	CIUDAD HIDALGO	070870001	2,216.6	208.8	0.005%	35	36	39	52	50	70	58
81	TAPACHULA	070890001	2,208.1	224.1	0.179%	1230	1279	1376	1833	1758	2464	2040
82	TONAL=L	070970001	2,103.2	299.1	0.035%	240	249	268	357	343	480	398
83	TUXTLA GUTI=MOC	071010001	2,142.9	347.4	0.468%	3219	3348	3602	4799	4602	6452	5340
84	VILLA CORZO	071070001	2,135.2	307.8	0.007%	48	50	54	72	69	96	80
85	VILLAFLORES	071080001	2,135.0	311.1	0.026%	177	184	198	264	253	355	294
86	MIGUEL AHUMADA	080010001	1,284.3	1,284.9	0.009%	59	62	66	89	85	119	99
87	JUAN ALDAMA	080020001	1,316.7	1,161.2	0.019%	133	139	149	199	191	267	221
88	PUERTO PALOMAS	080050068	1,220.7	1,367.7	0.054%	370	385	414	551	529	741	614
89	SAN BUENAVENTURA	080100001	1,225.3	1,233.6	0.015%	101	106	114	151	145	203	168
90	SANTA ROSALIA DE CAM	080110001	1,359.9	1,080.8	0.052%	355	370	398	530	508	712	590
91	CASAS GRANDES	080130001	1,197.7	1,271.5	0.007%	49	51	54	73	70	98	81
92	CUAUHTI=MOC	080170001	1,257.9	1,133.3	0.153%	1052	1094	1177	1569	1504	2109	1746
93	CHIHUAHUA	080190001	1,306.2	1,147.4	1.395%	9593	9977	10733	14300	13716	19226	15914
94	CIUDAD DELICIAS	080210001	1,342.5	1,115.9	0.178%	1226	1275	1371	1827	1752	2456	2033
95	GÉMEZ FAR=AS	080250001	1,207.7	1,200.9	0.008%	56	59	63	84	81	113	94
96	GUACHOCHI	080270001	1,241.8	1,024.9	0.009%	64	66	71	95	91	128	106
97	LIC ADOLFO LOPEZ MAT	080310003	1,230.2	1,139.2	0.024%	166	172	185	247	237	332	275
98	HIDALGO DEL PARRAL	080320001	1,328.3	1,029.9	0.127%	870	905	973	1297	1244	1744	1443
99	IGNACIO ZARAGOZA	080340001	1,207.1	1,220.6	0.005%	32	33	36	48	46	64	53
100	JUAREZ	080370001	1,289.7	1,361.8	2.008%	13808	14361	15449	20584	19742	27674	22906

Table B.3 Localities and ELV Generation in Mexico (3/14)

Nr.	Locality name		Coordinates		%	End-of-Life Vehicles						
						2007	2010	2015	2020	2020	2025	2025
			X	Y					SC-A	SC-B	SC-A	SC-B
101	MADERA	080400001	1,182.6	1,190.4	0.093%	640	666	716	954	915	1283	1062
102	MATAMOROS	080440001	1,332.9	1,018.1	0.002%	16	17	18	24	23	32	27
103	PEDRO MEOQUI	080450001	1,342.0	1,121.5	0.041%	283	294	316	421	404	567	469
104	NAMIQUIPA	080480001	1,227.0	1,192.5	0.019%	132	138	148	197	189	266	220
105	NVO CASAS GRANDES	080500001	1,199.9	1,274.1	0.072%	495	515	554	738	708	992	821
106	OJINAGA	080520001	1,408.1	1,208.7	0.056%	382	397	427	569	546	765	633
107	PORVENIR, EL	080530006	1,323.3	1,326.7	0.011%	73	76	81	108	104	146	121
108	SAN FRCO DEL ORO	080590001	1,317.0	1,025.7	0.004%	30	32	34	45	44	61	51
109	SANTA B ^L RBARA	080600001	1,318.6	1,021.4	0.038%	259	270	290	386	371	519	430
110	SAUCILLO	080620001	1,353.1	1,104.8	0.024%	165	171	184	245	235	330	273
111	Gustavo A Madero	09005	1,741.0	519.3	2.937%	20195	21005	22596	30106	28875	40476	33503
112	Azcapotzalco	09002	1,737.2	518.7	1.339%	9204	9573	10298	13721	13160	18447	15269
113	Miguel Hidalgo	09016	1,736.2	515.0	2.151%	14792	15385	16550	22050	21149	29646	24539
114	Cuauhtemoc	09015	1,739.5	515.0	2.452%	16857	17533	18861	25129	24102	33786	27965
115	Venustiano Carra	09017	1,742.6	515.0	1.336%	9184	9553	10276	13691	13132	18408	15236
116	Iztacalco	09006	1,742.3	512.6	1.198%	8237	8568	9217	12280	11778	16510	13666
117	Benito Juarez	09014	1,738.5	511.6	2.395%	16468	17129	18426	24550	23546	33007	27321
118	Alvaro Obregon	09010	1,734.2	510.1	1.898%	13053	13576	14604	19458	18662	26161	21654
119	Coyoacan	09003	1,739.3	507.9	2.355%	16191	16841	18116	24137	23150	32452	26861
120	Iztapalapa	09007	1,745.0	509.9	2.584%	17765	18478	19877	26483	25401	35606	29472
121	Tlahuac	09011	1,747.5	506.1	0.288%	1979	2058	2214	2950	2829	3966	3283
122	Xochimilco	09013	1,742.7	504.0	0.560%	3850	4004	4308	5739	5505	7716	6387
123	Magdalena Contre	09008	1,733.9	507.2	0.482%	3312	3444	3705	4937	4735	6637	5494
124	Cuajimalpa de Mo	09004	1,731.0	510.1	0.332%	2279	2371	2550	3398	3259	4568	3781
125	VILLA MILPA ALTA	090090001	1,747.8	498.7	0.094%	645	671	722	962	923	1293	1070
126	SAN MIGUEL AJUSCO	090120026	1,736.1	500.6	1.467%	10085	10489	11284	15034	14419	20213	16730
127	CIUDAD CANATL ^L N	100010001	1,379.8	863.8	0.013%	90	94	101	134	129	180	149
128	CUENCAM ^F DE CENICER	100040001	1,447.7	886.4	0.008%	57	59	63	84	81	114	94
129	VICTORIA DE DURANGO	100050001	1,386.4	826.9	0.562%	3864	4019	4324	5761	5525	7745	6411
130	CD GUADALUPE VICTO	100080001	1,420.7	857.4	0.016%	109	114	122	163	156	219	181
131	LE ^E N GUZM ^L N	100120021	1,450.7	929.5	0.106%	726	756	813	1083	1039	1456	1205
132	BERMEJILLO	100130014	1,453.2	955.9	0.009%	59	62	66	89	85	119	99
133	VILLA LAS NIEVES	100170025	1,344.5	993.1	0.028%	195	202	218	290	278	390	323
134	SANTA MAR ^A DEL ORO	100180001	1,345.2	962.4	0.006%	40	41	45	59	57	80	66
135	PED ^E N BLANCO	100210001	1,426.6	881.2	0.003%	19	20	21	28	27	38	31
136	VILLA UNI ^E N	100220001	1,425.0	825.3	0.009%	60	62	67	89	85	119	99
137	SALTO, EL	100230001	1,342.2	813.5	0.012%	83	87	93	124	119	167	138
138	RODEO	100240001	1,394.2	908.4	0.004%	30	31	34	45	43	60	50
139	SNTIAGO PAPASQUIARO	100320001	1,340.4	900.1	0.025%	172	179	192	256	246	344	285
140	TLAHUALILO DE ZARAGO	100360001	1,464.5	970.8	0.257%	1768	1839	1978	2636	2528	3544	2933
141	VICENTE GUERRERO	100380001	1,428.8	808.7	0.010%	66	69	74	99	95	133	110
142	NUEVO IDEAL	100390001	1,361.8	889.0	0.012%	85	89	96	127	122	171	142
143	ABASOLO	110010001	1,584.2	583.4	0.024%	162	168	181	241	231	324	268
144	ACAMBARO	110020001	1,636.7	554.8	0.053%	366	381	410	546	524	734	608
145	SN MIGUEL DE ALLENDE	110030001	1,634.7	615.2	0.063%	433	450	484	645	619	868	718
146	APASEO EL ALTO	110040001	1,642.7	584.0	0.018%	123	128	138	183	176	247	204
147	CELAYA	110070001	1,630.1	588.2	0.416%	2863	2978	3204	4269	4094	5739	4750
148	CD MANUEL DOBLADO	110080001	1,557.0	602.3	0.013%	93	97	104	138	133	186	154
149	COMONFORT	110090001	1,633.7	602.1	0.016%	110	115	123	164	158	221	183
150	CORTIZAR	110110001	1,620.9	585.6	0.036%	249	259	279	371	356	499	413

Table B.4 Localities and ELV Generation in Mexico (4/14)

Nr.	Locality name		Coordinates		%	End-of-Life Vehicles							
						2007	2010	2015	2020	2020	2025	2025	
			SC-A	SC-B					SC-A	SC-B			
151	DOLOES HIDALGO, CUNA	110140001	1,622.4	631.7	0.045%	310	322	346	461	443	620	514	
152	GUANAJUATO	110150001	1,601.4	622.2	0.136%	936	974	1048	1396	1339	1876	1553	
153	IRAPUATO	110170001	1,595.4	599.2	0.416%	2862	2977	3202	4266	4092	5736	4748	
154	JARAL DEL PROGRESO	110180001	1,614.4	578.0	0.009%	65	67	72	96	92	129	107	
155	LEÓN DE LOS ALDAMA	110200001	1,574.4	629.9	1.036%	7125	7411	7972	10622	10188	14281	11821	
156	MOROLEÓN	110210001	1,606.5	561.7	0.054%	371	386	415	553	530	743	615	
157	PANAJAMO	110230001	1,571.8	581.5	0.053%	363	377	406	541	519	727	602	
158	PURÍSIMA DE BUSTOS	110250001	1,561.7	622.8	0.024%	165	171	184	246	236	330	273	
159	SALAMANCA	110270001	1,605.6	591.5	0.208%	1430	1487	1600	2131	2044	2865	2372	
160	SALVATIERRA	110280001	1,626.4	567.1	0.038%	260	270	291	387	372	521	431	
161	SAN FELIPE	110300001	1,604.1	653.8	0.019%	132	137	147	196	188	264	218	
162	SAN LUIS DE LA PAZ	110330001	1,648.9	641.6	0.083%	569	591	636	848	813	1140	943	
163	SANTA CRUZ DE JUVE	110350001	1,618.7	596.5	0.019%	127	133	143	190	182	255	211	
164	SILAO	110370001	1,590.5	617.0	0.055%	376	391	421	561	538	754	624	
165	TARIMORO	110390001	1,634.2	572.1	0.010%	69	72	78	103	99	139	115	
166	VALLE DE SANTIAGO	110420001	1,606.4	579.2	0.036%	248	258	278	370	355	497	412	
167	VILLAGRÓN	110440001	1,618.5	587.5	0.019%	128	133	143	191	183	256	212	
168	YURIRIA	110460001	1,610.3	567.0	0.024%	165	172	185	247	237	332	274	
169	ACAPULCO DE JUÁREZ	120010001	1,693.7	337.9	0.793%	5455	5673	6103	8131	7799	10932	9049	
170	ARCELIA	120070001	1,666.5	437.4	0.037%	252	262	282	376	360	505	418	
171	ATOYAC DE ALVAREZ	120110001	1,657.4	361.1	0.022%	151	157	169	225	216	302	250	
172	COYUCA DE CATALÁN	120220001	1,639.2	437.6	0.008%	55	57	61	82	79	110	91	
173	CUAJINICUILAPA	120230001	1,792.2	312.7	0.007%	47	48	52	69	67	93	77	
174	CHILPANCIÑO D BR	120290001	1,719.0	385.3	0.265%	1820	1893	2037	2713	2602	3648	3020	
175	CIUDAD DE HUITZUCO	120340001	1,728.7	437.5	0.018%	124	129	138	184	177	248	205	
176	IGUALA DE LA INDEPEN	120350001	1,715.1	440.1	0.193%	1327	1380	1484	1978	1897	2659	2201	
177	ZIHUATANEJO	120380001	1,583.7	390.8	0.067%	464	482	519	691	663	929	769	
178	TIERRA COLORADA	120390001	1,717.2	359.0	0.029%	199	207	222	296	284	398	330	
179	OMETEPEC	120460001	1,792.4	327.6	0.067%	461	480	516	688	660	925	765	
180	PETATLÁN	120480001	1,602.1	383.3	0.018%	124	129	138	185	177	248	205	
181	CIUDAD ALTAMIRANO	120500001	1,641.3	440.0	0.047%	321	334	359	478	459	643	532	
182	SAN MARCOS	120530001	1,727.0	333.7	0.026%	175	182	196	261	251	352	291	
183	TAXCO DE ALARCÓN	120550001	1,710.6	454.4	0.097%	667	694	746	994	954	1337	1106	
184	TEOLOAPAN	120580001	1,693.2	441.2	0.025%	169	175	189	251	241	338	280	
185	TEPECOACUILCO DE TR	120590001	1,720.1	436.1	0.014%	98	102	110	146	140	197	163	
186	TIXTLA DE GUERRERO	120610001	1,725.3	386.8	0.020%	138	144	155	206	198	277	229	
187	TLAPEHUALA	120670001	1,649.9	431.9	0.006%	43	44	48	64	61	86	71	
188	PETACALCO	120680063	1,546.4	413.9	0.007%	51	53	57	76	73	103	85	
189	ACTOPLÁN	130030001	1,751.1	572.8	0.048%	329	343	368	491	471	660	546	
190	AJACUBA	130050001	1,740.5	560.4	0.008%	58	60	65	87	83	116	96	
191	APAN	130080001	1,784.1	535.2	0.035%	238	247	266	354	340	477	394	
192	ATITALAQUIA	130100001	1,733.8	557.9	0.034%	233	243	261	348	334	468	387	
193	ATOTONILCO DE TULA	130130001	1,733.9	554.6	0.028%	194	202	217	290	278	390	322	
194	TLAXCALILLA	130290029	1,695.1	579.2	0.051%	352	366	394	525	503	706	584	
195	IXMILQUILÁN	130300001	1,733.5	587.2	0.253%	1741	1810	1947	2595	2489	3489	2888	
196	MINERAL DEL MONTE	130390001	1,769.1	564.3	0.014%	96	100	107	143	137	192	159	
197	MIXQUIAHUALA DE JRZ	130410001	1,734.2	569.8	0.024%	164	171	184	245	235	330	273	
198	PACHUCA DE SOTO	130480001	1,764.5	562.6	0.824%	5668	5895	6342	8449	8104	11360	9403	
199	STGO TULANTEPEC	130560001	1,789.8	557.8	0.020%	140	145	156	208	200	280	232	
200	TECOZAUTLA	130590001	1,706.5	590.1	0.010%	70	73	78	104	100	140	116	

Table B.5 Localities and ELV Generation in Mexico (5/14)

Nr.	Locality name		Coordinates		%	End-of-Life Vehicles						
						2007	2010	2015	2020	2020	2025	2025
									SC-A	SC-B	SC-A	SC-B
201	CIUDAD SAHAGUN	130610002	1,776.0	539.4	0.082%	561	583	627	836	802	1124	930
202	TEPEJI DEL RIO DE OCA	130630001	1,726.2	547.0	0.065%	447	465	500	666	639	895	741
203	TETEPANGO	130650001	1,738.1	561.7	0.008%	55	57	61	82	78	110	91
204	TEZONTEPEC DE ALDAM	130670001	1,730.2	566.9	0.023%	155	162	174	232	222	311	258
205	TIZAYUCA	130690001	1,749.7	543.4	0.113%	778	809	870	1159	1112	1559	1290
206	TLAXCOAPAN	130740001	1,733.7	560.2	0.018%	126	131	141	188	180	253	209
207	TULA DE ALLENDE	130760001	1,725.7	557.4	0.138%	948	986	1061	1414	1356	1901	1573
208	TULANCINGO DE BRAVO	130770001	1,789.0	560.8	0.154%	1062	1104	1188	1583	1518	2128	1761
209	ACAYUCA	130820002	1,758.4	556.1	0.014%	97	101	109	145	139	195	161
210	ACATIC	140010001	1,495.1	606.0	0.008%	52	54	58	77	74	103	86
211	AHUALULCO DE MERCAD	140030001	1,426.5	601.3	0.012%	79	82	89	118	113	159	132
212	AMECA	140060001	1,421.6	590.7	0.050%	344	358	385	513	492	689	570
213	ANTONIO ESCOBEDO	140070001	1,424.7	607.9	0.003%	19	20	21	29	27	38	32
214	ARANDAS	140080001	1,531.5	600.6	0.059%	406	422	454	605	580	814	673
215	ATEMAJAC DE BRIZUELA	140100001	1,442.0	562.5	0.025%	174	181	194	259	248	348	288
216	ATOTONILCO EL ALTO	140130001	1,521.0	590.2	0.035%	244	253	273	363	348	488	404
217	AUTLÁN DE NAVARRO	140150001	1,400.2	537.6	0.038%	262	272	293	390	374	525	434
218	AYUTLA	140170001	1,402.0	562.3	0.006%	41	42	45	60	58	81	67
219	BARCA, LA	140180001	1,518.5	572.3	0.028%	193	201	216	288	277	388	321
220	CASIMIRO CASTILLO	140210001	1,395.5	526.5	0.019%	132	137	148	197	189	264	219
221	CIHUATLÁN	140220001	1,386.6	501.4	0.015%	101	105	113	151	145	203	168
222	CIUDAD GUZMÁN	140230001	1,458.5	532.3	0.082%	562	585	629	838	804	1127	933
223	COCULA	140240001	1,435.9	578.0	0.013%	87	90	97	129	124	173	144
224	COLOTLÁN	140250001	1,473.2	697.3	0.021%	147	153	165	220	211	296	245
225	CHAPALA	140300001	1,476.9	573.0	0.037%	253	263	283	377	361	507	419
226	DEGOLLADO	140330001	1,545.2	583.0	0.016%	111	116	124	166	159	223	184
227	ENCARNACIÓN DE DÍAZ	140350001	1,538.5	656.9	0.021%	143	149	160	213	204	286	237
228	ETZATLÁN	140360001	1,419.8	605.7	0.010%	68	70	76	101	97	136	112
229	GRULLO, EL	140370001	1,409.8	540.0	0.033%	227	236	254	338	324	455	376
230	GUADALAJARA	140390001	1,466.7	597.9	3.788%	26043	27088	29139	38824	37236	52197	43205
231	ATEQUIZA	140440002	1,480.2	579.5	0.014%	97	100	108	144	138	193	160
232	JALOSTOTILÁN	140460001	1,523.7	632.3	0.013%	91	94	102	135	130	182	151
233	JESÚS MARÍA	140480001	1,539.3	593.7	0.012%	85	89	95	127	122	171	141
234	JOCOTEPEC	140500001	1,461.4	572.3	0.020%	137	142	153	204	195	274	227
235	LAGOS DE MORENO	140530001	1,558.2	645.3	0.065%	447	464	500	666	638	895	741
236	MAGDALENA	140550001	1,426.3	615.4	0.008%	55	58	62	83	79	111	92
237	MASCOTA	140580001	1,373.7	590.1	0.018%	126	131	141	187	180	252	209
238	MAZAMITLA	140590001	1,487.6	546.6	0.008%	53	55	59	79	75	106	88
239	OCOTLÁN	140630001	1,504.0	576.6	0.108%	741	770	829	1104	1059	1484	1229
240	PONCITLÁN	140660001	1,493.9	578.5	0.014%	99	103	111	148	142	199	165
241	PUERTO VALLARTA	140670001	1,345.5	597.3	0.190%	1305	1357	1460	1945	1866	2615	2165
242	SALTO, EL	140700001	1,477.5	588.1	0.059%	409	425	457	609	585	819	678
243	SAN JUAN DE LOS LAGO	140730001	1,532.5	637.8	0.038%	261	272	292	390	374	524	434
244	SAN JULIÁN	140740001	1,542.2	621.6	0.008%	53	55	60	79	76	107	88
245	SAN MARTÍN HIDALGO	140770001	1,429.1	583.0	0.020%	139	145	155	207	199	278	231
246	SAN MIGUEL EL ALTO	140780001	1,527.8	622.9	0.023%	159	166	178	237	228	319	264
247	SANTA MARIA DE LOS AN	140810001	1,475.6	701.5	0.001%	7	7	8	10	10	14	12
248	SAYULA	140820001	1,450.0	544.8	0.017%	120	125	134	179	172	241	199
249	TALA	140830001	1,444.0	597.5	0.034%	234	243	262	349	334	469	388
250	TAMAZULA DE GORDIAN	140850001	1,472.6	530.7	0.038%	262	272	293	390	374	524	434

Table B.6 Localities and ELV Generation in Mexico (6/14)

Nr.	Locality name		Coordinates		%	End-of-Life Vehicles						
						2007	2010	2015	2020	2020	2025	2025
			SC-A	SC-B					SC-A	SC-B		
251	TAPALPA	140860001	1,439.9	549.1	0.004%	30	32	34	45	44	61	51
252	TECALITLÁN	140870001	1,468.7	516.4	0.008%	54	56	60	80	77	108	89
253	TECOLOTLÁN	140880001	1,421.4	567.0	0.008%	57	59	64	85	82	114	95
254	TEOCALTICHE	140910001	1,516.9	650.7	0.015%	103	107	115	153	147	206	171
255	TEPATITLAN DE MORELO	140930001	1,504.6	608.4	0.122%	842	875	942	1255	1203	1687	1396
256	TEQUILA	140940001	1,435.5	613.4	0.017%	116	121	130	173	166	233	193
257	TIZAPÁN EL ALTO	140960001	1,486.1	563.4	0.006%	42	44	47	62	60	84	69
258	TLAJOMULCO DE ZUNIG	140970001	1,460.3	585.3	0.054%	371	386	416	554	531	744	616
259	TUXPAN	141080001	1,464.3	522.2	0.018%	123	128	137	183	175	246	203
260	UNIÉN DE SAN ANTONIO	141090001	1,553.4	629.6	0.005%	34	36	38	51	49	69	57
261	UNIÉN DE TULA	141100001	1,406.7	550.4	0.009%	62	64	69	92	88	124	102
262	VILLA HIDALGO	141160001	1,516.2	667.0	0.013%	87	91	97	130	125	175	145
263	YAHUALICA DE GLZ	141180001	1,496.8	633.3	0.016%	112	117	125	167	160	225	186
264	ZACOALCO DE TORRES	141190001	1,452.1	568.4	0.013%	90	94	101	135	129	181	150
265	NUEVO MEXICO	141200142	1,460.9	605.0	1.854%	12747	13258	14263	19003	18226	25549	21147
266	ZAPOTILIC	141210001	1,461.7	527.1	0.020%	139	145	155	207	199	278	231
267	ZAPOTLANEJO	141240001	1,484.9	595.3	0.033%	229	238	256	341	327	459	380
268	AMECAMECA DE JRZ	150090001	1,764.6	494.5	0.023%	161	168	180	240	230	323	267
269	APAXCO DE OCAMPO	150100001	1,737.0	552.4	0.010%	66	69	74	99	95	133	110
270	ATLACOMULCO DE FABE	150140001	1,691.6	539.4	0.173%	1186	1234	1327	1769	1696	2378	1968
271	ATLAUTLA DE VICTORIA	150150001	1,763.9	487.9	0.007%	48	50	54	72	69	97	80
272	COYOTEPEC	150230001	1,735.0	538.7	0.013%	92	96	103	137	131	184	152
273	CHALCO DE DIAZ COVAR	150250001	1,755.8	504.0	0.124%	855	889	956	1274	1222	1713	1418
274	CHICONCUAC DE JRZ	150300001	1,755.6	524.2	0.018%	124	129	139	185	177	248	206
275	HUEHUETOCA	150350001	1,735.3	543.7	0.009%	62	65	70	93	89	125	103
276	HUEYPOXTLA	150360001	1,743.4	548.1	0.008%	58	61	65	87	83	117	97
277	IXTAPALUCA	150390001	1,756.6	507.4	0.154%	1057	1100	1183	1576	1512	2119	1754
278	IXTAPAN DE LA SAL	150400001	1,705.7	474.2	0.010%	68	71	77	102	98	137	113
279	IXTLAHUACA DE RAYÉN	150420001	1,698.9	523.8	0.033%	226	235	253	337	323	453	375
280	XALATLACO	150430001	1,722.2	497.5	0.007%	51	54	58	77	74	103	85
281	JALTENCO	150440001	1,742.4	537.1	0.018%	124	129	138	184	177	248	205
282	JILOTEPEC DE MOLINA E	150450001	1,713.7	550.4	0.036%	250	261	280	373	358	502	415
283	JOCOTILÁN	150480001	1,697.4	533.3	0.020%	139	145	156	207	199	279	231
284	JUCHITEPEC DE MARIAN	150500001	1,757.3	492.7	0.007%	49	51	55	74	71	99	82
285	LERMA DE VILLADA	150510001	1,716.0	504.7	0.056%	385	401	431	575	551	773	639
286	MELCHOR OCAMPO	150530001	1,739.3	533.7	0.022%	151	157	169	226	217	303	251
287	OCOYOACAC	150620001	1,719.2	503.8	0.023%	160	166	179	238	229	321	265
288	ORO DE HIDALGO	150640001	1,675.1	539.4	0.010%	69	72	77	103	98	138	114
289	OZUMBA DE ALZATE	150680001	1,762.9	488.6	0.007%	48	50	54	72	69	97	80
290	SN MARTIN DE LAS PIR	150750001	1,759.3	533.8	0.009%	61	64	68	91	87	123	101
291	SAN MATEO ATENCO	150760001	1,714.5	503.0	0.034%	237	247	265	353	339	475	393
292	TECEMAC DE FELIPE VIL	150810001	1,750.6	534.7	0.101%	694	722	777	1035	993	1391	1152
293	TEJUPILCO DE HIDALGO	150820001	1,674.6	478.1	0.029%	200	208	224	298	286	401	332
294	TEMASCALCINGO DE JO	150850001	1,683.0	547.4	0.013%	89	93	100	133	127	178	148
295	TENANCINGO	150880001	1,711.1	482.4	0.084%	578	601	646	861	826	1158	958
296	HEROICA TENANGO DE A	150900001	1,711.0	492.1	0.024%	164	171	184	245	235	329	272
297	TEOLOYUCAN	150910001	1,736.6	536.6	0.035%	239	249	268	357	342	480	397
298	TEOTIHUACAN DE ARIST	150920001	1,757.3	532.9	0.032%	221	229	247	329	315	442	366
299	TEPETLIXPA	150940001	1,761.3	487.7	0.004%	27	28	30	40	38	54	44
300	TEQUIQUIAC	150960001	1,738.9	547.8	0.009%	63	65	70	94	90	126	104

Table B.7 Localities and ELV Generation in Mexico (7/14)

Nr.	Locality name		Coordinates		%	End-of-Life Vehicles						
						2007	2010	2015	2020	2020	2025	2025
			SC-A	SC-B					SC-A	SC-B		
301	TEXCOCO DE MORA	150990001	1,756.7	521.1	2.384%	16394	17052	18343	24440	23440	32859	27198
302	SANTIAGO TIANGUISTENCO	151010001	1,718.9	497.5	0.026%	178	185	199	265	254	356	295
303	TOLUCA DE LERDO	151060001	1,706.5	504.3	1.050%	7220	7509	8078	10763	10323	14470	11977
304	TULTEPEC	151080001	1,740.2	532.6	0.055%	379	394	424	565	542	760	629
305	VALLE DE BRAVO	151100001	1,675.5	497.8	0.045%	307	319	344	458	439	615	509
306	VILLA DEL CARBÉN	151120001	1,718.6	534.7	0.009%	62	65	70	93	89	125	103
307	XONACATLAN	151150001	1,714.6	512.8	0.014%	100	104	112	149	143	200	165
308	ZUMPANGO DE OCAMPO	151200001	1,742.0	540.2	3.082%	21194	22044	23713	31595	30303	42478	35160
309	AGUILILLA	160020001	1,502.4	465.8	0.005%	37	38	41	54	52	73	61
310	APATZINGAN DE LA CON	160060001	1,530.2	489.8	0.085%	585	608	655	872	836	1173	971
311	ARIO DE ROSALES	160090001	1,573.0	497.9	0.017%	118	123	132	176	169	237	196
312	ARTEAGA	160100001	1,534.8	439.7	0.005%	35	36	39	52	50	70	58
313	BUENAVISTA TOMATLÁN	160120001	1,515.5	498.2	0.014%	99	103	110	147	141	198	164
314	COAHUAYANA DE HGO	160140001	1,444.9	463.4	0.007%	46	48	52	69	66	93	77
315	COALCOMAN DE VQZ	160150001	1,477.9	468.8	0.007%	48	50	54	72	69	96	80
316	COTIJA DE LA PAZ	160190001	1,508.2	539.2	0.013%	91	94	102	135	130	182	151
317	CHARAPAN	160210001	1,537.5	528.2	0.001%	8	9	9	13	12	17	14
318	CHAVINDA	160230001	1,524.0	552.8	0.004%	29	30	33	44	42	59	48
319	CHERÁN	160240001	1,556.8	530.6	0.006%	39	41	44	59	56	79	65
320	CHURUMUCO DE MOR	160290001	1,576.8	460.5	0.001%	4	4	4	5	5	7	6
321	LOMBARDÍA	160330001	1,550.7	494.5	0.006%	44	46	49	65	63	88	73
322	CIUDAD HIDALGO	160340001	1,647.6	531.7	0.077%	526	547	589	784	752	1054	873
323	ZICUÍRÁN	160350113	1,555.8	475.3	0.006%	43	44	48	64	61	86	71
324	HUANDACAREO	160360001	1,600.9	551.7	0.007%	48	50	54	71	68	96	79
325	JACONA DE PLANCARTE	160430001	1,533.6	548.7	0.034%	233	242	260	347	333	466	386
326	JIQUILPAN DE JUÁREZ	160450001	1,507.3	551.8	0.031%	215	224	241	321	308	432	357
327	MARAVATIO DE OCAMPO	160500001	1,654.6	545.6	0.042%	287	299	321	428	411	576	476
328	SAN JOSÉ DE GRACIA	160510001	1,487.6	551.8	0.009%	60	62	67	89	85	119	99
329	CIUDAD LAZARO CARD	160520001	1,541.2	412.3	0.153%	1053	1095	1178	1569	1505	2110	1746
330	MORELIA	160530001	1,606.5	531.7	1.329%	9140	9506	10226	13625	13068	18318	15163
331	NUEVA ITALIA DE RUÍZ	160550001	1,547.6	485.5	0.020%	140	146	157	209	201	282	233
332	NAHUATZEN	160560001	1,559.0	528.7	0.004%	24	25	27	36	35	49	40
333	PAJACUARÁN	160620001	1,517.1	560.5	0.006%	42	44	47	63	61	85	70
334	ANTÚNEZ	160640003	1,540.5	484.8	0.005%	36	37	40	53	51	72	59
335	PARACHO DE VERDUZC	160650001	1,550.8	528.0	0.013%	91	95	102	136	130	182	151
336	PÉTZCUARO	160660001	1,579.1	519.2	0.057%	390	406	436	581	557	781	647
337	LA PIEDAD DE CABADAS	160690001	1,551.9	576.1	0.120%	827	860	925	1233	1182	1657	1372
338	PURÍPERO DE ECHAZ	160700001	1,553.5	546.0	0.013%	93	96	104	138	132	186	154
339	PURUÍNDIRO	160710001	1,585.1	558.4	0.031%	216	224	241	322	309	433	358
340	QUERÉNDARO	160720001	1,625.7	539.6	0.005%	33	35	37	50	48	67	55
341	QUIROGA	160730001	1,584.6	529.3	0.012%	80	84	90	120	115	161	133
342	REYES DE SALGADO,	160750001	1,523.2	524.1	0.036%	248	258	277	369	354	497	411
343	SAHUAYO DE MORELOS	160760001	1,507.5	556.4	0.051%	353	367	395	526	505	708	586
344	SANTA CLARA DEL COBR	160790001	1,577.2	511.6	0.010%	70	73	78	104	100	140	116
345	TACÍMBARO DE COD	160820001	1,589.1	499.8	0.026%	179	186	200	267	256	358	297
346	SANTIAGO TANGAMAND	160840001	1,525.7	549.2	0.000%	2	3	3	4	4	5	4
347	TANGANCICUARO DE ARI	160850001	1,540.3	544.5	0.022%	151	157	169	225	216	302	250
348	TEPALCATEPEC	160890001	1,498.8	496.7	0.013%	89	92	99	132	127	178	147
349	TOCUMBO	160950001	1,519.8	531.9	0.011%	75	78	84	111	107	150	124
350	URUAPAN	161020001	1,550.5	512.3	0.305%	2096	2180	2346	3125	2997	4202	3478

Table B.8 Localities and ELV Generation in Mexico (8/14)

Nr.	Locality name		Coordinates		%	End-of-Life Vehicles						
						2007	2010	2015	2020	2020	2025	2025
			X	Y					SC-A	SC-B	SC-A	SC-B
351	VISTA HERMOSA DE NEG	161050001	1,523.1	571.0	0.010%	68	71	77	102	98	137	114
352	YURUPUÁ CUARO	161060001	1,535.4	575.3	0.018%	126	131	141	188	180	253	209
353	ZACAPU	161070001	1,567.3	539.6	0.063%	435	452	486	648	621	871	721
354	ZAMORA DE HIDALGO	161080001	1,535.5	551.3	0.225%	1549	1611	1733	2309	2215	3105	2570
355	ZINAPUÁ CUARO DE FIGU	161100001	1,629.9	543.0	0.029%	202	210	226	301	289	405	335
356	HEROICA ZITLACUARO	161120001	1,661.0	514.1	0.172%	1184	1231	1324	1764	1692	2372	1963
357	AXOCHIAPAN	170030001	1,766.6	451.6	0.036%	250	260	279	372	357	500	414
358	CUAUTLA	170060001	1,753.1	473.8	0.198%	1358	1413	1520	2025	1942	2723	2254
359	CUERNAVACA	170070001	1,734.6	480.9	0.591%	4064	4226	4547	6058	5810	8144	6741
360	EMILIANO ZAPATA	170080001	1,737.8	474.4	0.024%	166	173	186	248	238	333	276
361	JIUTEPEC	170110001	1,738.3	477.3	0.157%	1077	1120	1205	1605	1540	2158	1786
362	JOJUTLA DE JUÁREZ	170120001	1,738.3	459.1	0.033%	228	237	255	339	326	456	378
363	MIACATLÁN	170150001	1,726.4	469.1	0.017%	116	120	129	173	165	232	192
364	XOXOCOTLA	170170009	1,734.0	463.8	0.020%	140	146	157	209	201	282	233
365	TEOZTLÁN	170200001	1,743.1	484.7	0.051%	349	362	390	520	498	698	578
366	TLALTIZAPÁN	170240001	1,742.3	463.9	0.010%	72	75	81	107	103	144	119
367	TLAQUILTENANGO	170250001	1,739.5	460.3	0.005%	32	33	36	47	45	64	53
368	YAUTEPEC DE ZARAGOZ	170290001	1,745.7	477.7	0.015%	101	105	113	151	145	203	168
369	ZACATEPEC	170310001	1,737.7	461.9	0.003%	22	23	24	32	31	44	36
370	ACAPONETA	180010001	1,340.0	725.6	0.011%	73	76	82	109	105	147	121
371	AHUACATLÁN	180020001	1,394.0	625.8	0.005%	36	37	40	53	51	72	59
372	COMPOSTELA	180040001	1,367.5	639.0	0.046%	319	331	357	475	456	639	529
373	IXTLÁN DEL RÍO	180060001	1,401.2	624.5	0.022%	155	161	173	230	221	310	256
374	JALA	180070001	1,397.2	629.2	0.003%	19	20	21	28	27	38	32
375	RUISEÑOR	180110001	1,352.8	688.2	0.005%	35	37	40	53	51	71	59
376	SAN BLAS	180120001	1,343.3	660.3	0.010%	67	70	75	100	96	135	111
377	SANTIAGO IXCUINTLA	180150001	1,348.9	678.7	0.016%	109	113	122	162	155	218	180
378	TECUALA	180160001	1,333.7	719.2	0.008%	56	58	62	83	79	111	92
379	TEPIC	180170001	1,368.3	657.2	0.399%	2745	2855	3072	4092	3925	5502	4554
380	TUXPAN	180180001	1,342.9	687.7	0.009%	60	62	67	90	86	120	100
381	AGUALEGUAS	190020001	1,705.8	985.9	0.005%	31	32	35	46	44	62	51
382	ALLENDE	190040001	1,676.9	915.1	0.043%	295	307	331	440	422	592	490
383	ANÁHUAC	190050001	1,668.2	1,049.3	0.022%	155	161	173	230	221	310	256
384	CIUDAD APODACA	190060001	1,666.2	948.9	0.306%	2107	2191	2357	3140	3012	4222	3495
385	ASCENSIÓN, LA	190070008	1,684.6	849.5	0.004%	27	28	30	40	38	54	45
386	BUSTAMANTE	190080001	1,645.9	1,000.3	0.003%	20	20	22	29	28	39	33
387	CADEREYTA JIMÉNEZ	190090001	1,678.6	936.2	0.111%	761	791	851	1134	1088	1525	1262
388	CARMEN, EL	190100001	1,655.2	959.4	0.009%	59	62	67	89	85	119	99
389	CIUDAD CERRALVO	190110001	1,701.3	970.2	0.012%	84	87	94	125	120	168	139
390	CILLAGUANA DE FLORES	190120001	1,667.3	960.8	0.013%	92	95	102	137	131	184	152
391	CHINA	190130001	1,725.2	944.6	0.012%	82	86	92	123	118	165	137
392	DOCTOR ARROYO	190140001	1,668.6	804.6	0.011%	78	81	87	116	112	156	129
393	GALEANA	190170001	1,674.0	883.6	0.021%	141	147	158	211	202	283	234
394	GARCÍA	190180001	1,640.7	950.7	0.018%	127	132	142	189	181	254	210
395	GENERAL BRAVO	190200001	1,728.8	950.7	0.006%	40	42	45	60	58	81	67
396	GENERAL TERÁN	190220001	1,698.3	913.4	0.014%	98	102	110	147	141	197	163
397	HERRERAS, LOS	190270001	1,714.5	958.2	0.003%	19	20	21	28	27	38	31
398	CIUDAD BENITO JUÁREZ	190310001	1,672.1	939.8	0.047%	325	338	363	484	464	651	539
399	LAMPAZOS DE NARANJO	190320001	1,645.4	1,033.9	0.003%	20	21	23	31	29	41	34
400	LINARES	190330001	1,705.8	886.4	0.075%	518	539	580	773	741	1039	860

Table B.9 Localities and ELV Generation in Mexico (9/14)

Nr.	Locality name		Coordinates		%	End-of-Life Vehicles						
						2007	2010	2015	2020	2020	2025	2025
									SC-A	SC-B	SC-A	SC-B
401	MINA	190370001	1,644.8	963.8	0.002%	16	17	18	25	24	33	27
402	MONTEMORELOS	190380001	1,689.1	908.5	0.070%	479	498	536	714	684	959	794
403	MONTERREY	190390001	1,659.7	942.8	5.538%	38080	39607	42607	56767	54446	76322	63173
404	RAMONES, LOS	190420001	1,701.3	943.6	0.004%	27	28	30	40	38	54	45
405	SABINAS HIDALGO	190440001	1,666.1	998.6	0.048%	329	343	368	491	471	660	546
406	SALINAS VICTORIA	190450001	1,659.4	961.3	0.043%	295	307	330	440	422	591	489
407	HIDALGO	190470001	1,649.7	961.8	0.014%	94	98	105	140	134	188	156
408	SANTIAGO	190490001	1,668.8	924.7	0.077%	529	550	592	789	756	1060	878
409	VILLALDAMA	190510001	1,650.9	998.1	0.006%	38	40	43	57	54	76	63
410	ASUNCIÓN IXTALTEPEC	200050001	2,015.3	323.2	0.002%	13	14	15	20	19	26	22
411	CIUDAD IXTEPEC	200140001	2,012.6	326.9	0.002%	14	15	16	21	20	29	24
412	CUILAPAM DE GUERR	200230001	1,899.4	352.3	0.001%	9	9	10	13	13	18	15
413	CHAHUITES	200250001	2,073.3	311.3	0.016%	110	115	123	164	157	221	183
414	EJUTLA DE CRESPO	200280001	1,903.8	322.7	0.114%	787	819	881	1174	1126	1578	1306
415	ESPINAL, EL	200300001	2,016.3	321.9	0.024%	168	174	188	250	240	336	278
416	HUAJUAPAM DE LEÓN	200390001	1,831.7	406.0	0.092%	634	659	709	945	906	1270	1051
417	JUCHITÁN DE ZARAGOZ	200430001	2,018.0	318.5	0.014%	98	102	110	146	140	197	163
418	LOMA BONITA	200440001	1,955.9	431.0	0.646%	4443	4621	4971	6624	6353	8905	7371
419	MIAHUATLÁN DE PORFIR	200590001	1,913.6	306.7	0.006%	38	40	43	57	54	76	63
420	SAN PEDRO POCHUTLA	203240001	1,923.5	267.1	0.006%	43	45	48	64	61	86	71
421	HRCA CD DE TLAXIACO	203970001	1,839.3	369.1	0.032%	220	229	246	328	314	441	365
422	VILLA DE TAMAZULAPAM	205400001	1,845.6	397.0	0.053%	364	379	407	543	521	730	604
423	ACAJETE	210010001	1,817.8	494.7	0.008%	57	59	64	85	82	115	95
424	ACATLÁN DE OSORIO	210030001	1,813.1	432.5	0.020%	136	141	152	202	194	272	225
425	ACATZINGO DE HIDALGO	210040001	1,829.0	486.4	0.008%	54	56	60	81	77	108	90
426	AJALPAN	210100001	1,864.6	446.1	0.004%	30	31	34	45	43	60	50
427	ALTEPEXI	210130001	1,862.1	445.4	0.002%	12	12	13	18	17	24	20
428	AMOZOC DE MOTA	210150001	1,812.0	490.2	0.017%	114	119	128	170	163	229	190
429	ATLIXCO	210190001	1,786.6	480.2	0.058%	400	416	447	596	572	802	663
430	ATOYATEMPAN	210200001	1,820.9	475.2	0.002%	13	14	15	19	19	26	22
431	SAN ANDRÉS CALPAN	210260001	1,784.3	493.7	0.001%	8	8	9	12	12	16	14
432	CUAPIXTLA DE MADER	210380001	1,826.6	481.8	0.001%	9	9	10	13	13	18	15
433	CIUDAD SERDÁN	210450001	1,851.2	487.4	0.010%	69	72	78	103	99	139	115
434	CHIAUTLA DE TAPIA	210470001	1,776.7	438.2	0.034%	232	241	260	346	332	465	385
435	SN PABLO DE LAS TUNA	210650001	1,833.8	487.5	0.001%	8	8	9	12	11	16	13
436	GUADALUPE VICTORIA	210670001	1,857.1	508.6	0.002%	15	15	17	22	21	30	25
437	HUAUCHINANGO	210710001	1,808.8	567.7	0.041%	285	296	319	425	407	571	473
438	HUEJOTZINGO	210740001	1,788.0	497.5	0.023%	161	168	180	240	230	323	267
439	SANTA CLARA HUITZILTE	210790001	1,823.1	471.7	0.001%	10	10	11	14	14	19	16
440	IXCAQUITLA	210820001	1,826.9	450.6	0.002%	12	12	13	18	17	24	20
441	IZCAR DE MATAMOROS	210850001	1,785.0	459.3	0.033%	227	237	254	339	325	456	377
442	LIBRES	210940001	1,834.5	519.8	0.008%	54	56	61	81	77	108	90
443	SAN FRANCISCO MIXTLA	210970001	1,821.8	481.0	0.000%	3	3	4	5	5	7	5
444	MORELOS CADADA	210990001	1,853.1	470.4	0.004%	27	28	30	40	39	54	45
445	SAN MIGUEL XALTEPEC	211100023	1,840.3	479.5	0.003%	19	20	21	28	27	38	32
446	HCA PUEBLA DE ZGZA	211140001	1,801.3	489.8	1.886%	12971	13492	14513	19337	18546	25998	21519
447	QUECHOLAC	211150001	1,837.3	485.0	0.004%	28	29	31	42	40	56	46
448	SAN GABRIEL CHILAC	211240001	1,858.9	442.4	0.001%	10	10	11	15	14	20	16
449	SAN JOSÉ CHIAPA	211280001	1,829.5	504.1	0.001%	5	5	6	8	7	10	8
450	SAN MARTIN TEXMELUC	211320001	1,785.9	505.9	0.075%	519	539	580	773	742	1040	860

Table B.10 Localities and ELV Generation in Mexico (10/14)

Nr.	Locality name		Coordinates		%	End-of-Life Vehicles						
						2007	2010	2015	2020	2020	2025	2025
			X	Y					SC-A	SC-B	SC-A	SC-B
451	CHOLULA DE RIVADABIA	211400001	1,794.8	490.7	0.076%	526	547	588	784	752	1054	872
452	SAN SALVADOR EL SECO	211420001	1,837.8	497.0	0.003%	19	20	22	29	28	39	32
453	SANTIAGO MIAHUATL-N	211490001	1,852.4	457.4	0.002%	16	16	17	23	22	31	26
454	SNTOT: HUEYOTLIPA	211510001	1,823.8	480.1	0.002%	16	17	18	24	23	32	27
455	TECALI DE HERRERA	211530001	1,816.7	480.7	0.009%	60	62	67	89	85	119	99
456	TECAMACHALCO	211540001	1,832.5	479.7	0.022%	155	161	173	231	221	310	257
457	TEHUAC-N	211560001	1,855.6	451.5	0.132%	908	945	1016	1354	1299	1821	1507
458	TEPANCO DE LÉPEZ	211610001	1,844.5	457.6	0.002%	16	16	18	23	22	31	26
459	TEPATLAXCO DE HGO	211630001	1,816.6	492.8	0.001%	9	9	10	13	12	17	14
460	SN HIPÉLITO XOCHILTEN	211640012	1,823.0	483.5	0.023%	157	163	175	233	224	314	260
461	TEPEACA	211690001	1,821.3	485.1	0.003%	22	23	25	33	32	45	37
462	TEZIUTL-N	211740001	1,854.8	544.4	0.151%	1041	1083	1165	1552	1489	2087	1727
463	TLACOTEPEC DE BENITO	211770001	1,838.2	466.1	0.005%	34	35	38	50	48	67	56
464	TLACHICHUCA	211790001	1,852.7	496.4	0.004%	29	30	33	43	42	58	48
465	TOCHTEPEC	211890001	1,826.7	476.6	0.003%	22	22	24	32	31	43	36
466	TULCINGO DE VALLE	211910001	1,787.6	421.1	0.002%	15	16	17	22	22	30	25
467	XICOTEPEC DE JU-REZ	211970001	1,814.9	575.0	0.017%	114	119	128	170	163	229	189
468	XOCHITL-N	212030001	1,830.2	467.3	0.000%	3	3	3	4	4	5	4
469	YEHUALTEPEC	212050001	1,837.2	473.7	0.002%	16	17	18	24	23	32	27
470	ZACATL-N	212080001	1,815.6	551.5	0.023%	160	166	179	239	229	321	265
471	ZARAGOZA	212110001	1,842.3	541.0	0.006%	38	40	43	57	55	77	64
472	ZINACATEPEC	212140001	1,865.5	443.2	0.001%	8	8	9	12	12	16	13
473	COLÉN	220050001	1,679.6	606.5	0.013%	87	90	97	129	124	174	144
474	EL PUEBLITO	220060001	1,654.3	589.2	0.087%	596	620	667	888	852	1194	988
475	EZEQUIEL MONTES	220070001	1,689.3	598.7	0.045%	307	319	344	458	439	615	509
476	PEDRO ESCOBEDO	220120001	1,673.6	587.3	0.023%	159	166	178	237	228	319	264
477	QUERÉTARO	220140001	1,657.5	593.6	1.050%	7223	7513	8082	10768	10327	14477	11983
478	SAN JUAN DEL R=O	220160001	1,683.2	579.6	0.179%	1232	1282	1379	1837	1762	2470	2045
479	TEQUISQUIAPAN-N	220170001	1,689.9	589.2	0.032%	222	231	248	331	317	444	368
480	COZUMEL	230010001	2,524.0	637.6	0.070%	481	500	538	717	688	964	798
481	FELIPE CARRILLO PTO	230020001	2,459.5	567.4	0.014%	98	102	109	146	140	196	162
482	BACALAR	230040011	2,442.9	503.8	0.108%	743	772	831	1107	1062	1488	1232
483	CANCUN	230050001	2,526.6	683.6	0.304%	2094	2178	2343	3121	2993	4196	3473
484	PLAYA DEL CARMEN	230080001	2,514.7	645.3	0.039%	269	280	301	401	384	539	446
485	CARDENAS	240050001	1,704.3	690.8	0.011%	77	80	86	114	110	154	127
486	CEDRAL	240070001	1,634.2	814.2	0.008%	58	60	65	86	82	116	96
487	CERRITOS	240080001	1,663.1	719.4	0.011%	72	75	81	108	104	145	120
488	CIUDAD DEL MA=Z	240100001	1,706.4	717.9	0.023%	161	168	180	240	231	323	268
489	CIUDAD VALLES	240130001	1,744.6	691.1	0.194%	1334	1387	1492	1988	1907	2673	2212
490	CHARCAS	240150001	1,609.9	766.6	0.008%	54	56	60	80	77	108	90
491	EBANO	240160001	1,784.6	706.9	0.024%	168	175	188	251	240	337	279
492	MATEHUALA	240200001	1,639.3	802.3	0.095%	651	677	728	970	931	1305	1080
493	MOCTEZUMA	240220001	1,612.0	740.9	0.004%	29	30	32	43	41	57	47
494	RAYÉN	240230001	1,704.3	679.8	0.005%	32	33	35	47	45	63	52
495	R=OVERDE	240240001	1,682.1	685.5	0.047%	320	333	358	477	457	641	531
496	SALINAS DE HIDALGO	240250001	1,571.7	732.0	0.014%	95	99	106	141	136	190	157
497	SAN CIRO DE ACOSTA	240270001	1,693.5	666.5	0.003%	21	22	23	31	30	42	35
498	SAN LUIS POTOS=	240280001	1,618.5	700.2	1.261%	8674	9022	9705	12930	12402	17384	14389
499	SANTA MAR=A DEL R=O	240320001	1,635.0	676.0	0.011%	79	82	88	118	113	158	131
500	SN VTE TANCUAYALA	240340001	1,772.1	672.4	0.001%	9	9	10	13	13	18	15

Table B.11 Localities and ELV Generation in Mexico (11/14)

Nr.	Locality name		Coordinates		%	End-of-Life Vehicles							
						2007	2010	2015	2020	2020	2025	2025	
			SC-A	SC-B					SC-A	SC-B			
501	TAMU=N	240400001	1,759.1	692.0	0.012%	85	89	96	127	122	171	142	
502	TANQUI=N DE ESCOBED	240420001	1,767.4	664.3	0.003%	22	23	25	33	32	45	37	
503	VENADO	240450001	1,611.3	753.2	0.004%	30	32	34	45	44	61	51	
504	VILLA DE ARRIAGA	240460001	1,593.3	683.0	0.016%	107	111	119	159	152	214	177	
505	BARRIL, EL	240490005	1,544.1	762.9	0.002%	13	14	15	20	19	26	22	
506	VILLA DE REYES	240500001	1,622.1	676.3	0.008%	57	60	64	86	82	115	95	
507	VILLA JU=REZ	240520001	1,664.2	712.2	0.001%	8	8	9	12	12	16	14	
508	VILLA DE ARISTA	240560002	1,626.9	733.6	0.004%	26	27	29	39	37	52	43	
509	NARANJO, EL	240570001	1,724.1	726.4	0.003%	19	19	21	28	26	37	31	
510	MOCHIS, LOS	250010001	1,120.2	959.8	0.317%	2181	2269	2441	3252	3119	4372	3619	
511	ANGOSTURA	250020001	1,170.3	927.9	0.022%	153	159	171	228	219	307	254	
512	CULIAC=N	250060001	1,216.9	887.5	0.790%	5434	5652	6080	8101	7770	10891	9015	
513	CHOIX	250070001	1,164.3	1,020.4	0.004%	29	30	33	43	42	58	48	
514	CRUZ, LA	250080001	1,245.8	825.8	0.013%	87	90	97	130	124	174	144	
515	ESCUINAPA	250090001	1,314.2	749.5	0.015%	104	108	116	154	148	208	172	
516	FUERTE, EL	250100001	1,145.2	1,001.2	0.025%	174	181	195	259	249	349	289	
517	GUASAVE	250110001	1,152.5	942.2	0.151%	1039	1081	1163	1549	1486	2083	1724	
518	MAZATL=N	250120001	1,275.0	777.5	0.316%	2174	2261	2432	3241	3108	4357	3606	
519	MOCORITO	250130001	1,185.9	935.2	0.016%	112	116	125	167	160	224	185	
520	ROSARIO, EL	250140001	1,309.4	760.5	0.015%	105	110	118	157	151	211	175	
521	GUAM=CHIL	250150001	1,175.8	934.2	0.068%	469	488	525	699	670	940	778	
522	ESTACI= NARANJO	250170495	1,151.9	958.9	0.018%	127	132	142	190	182	255	211	
523	JUAN ALDAMA	250180065	1,190.6	897.9	0.052%	356	370	398	531	509	713	591	
524	AGUA PRIETA	260020001	1,106.1	1,341.1	0.127%	871	906	975	1299	1246	1747	1446	
525	ALAMOS	260030001	1,127.7	1,043.6	0.004%	27	28	30	40	38	54	44	
526	ALTAR	260040001	967.4	1,307.4	0.005%	32	33	35	47	45	63	53	
527	BENJAM=N HILL	260160001	1,007.7	1,267.1	0.004%	25	26	28	38	36	51	42	
528	HEROICA CABORCA	260170001	948.1	1,308.9	0.115%	791	823	886	1180	1132	1586	1313	
529	CIUDAD OBREG= N	260180001	1,067.7	1,078.9	0.425%	2923	3040	3270	4357	4179	5858	4849	
530	CANANEA	260190001	1,059.7	1,320.2	0.086%	590	614	660	880	844	1182	979	
531	EMPALME	260250001	1,016.6	1,114.4	0.033%	226	235	253	337	323	453	375	
532	ETCHOJOA	260260001	1,084.9	1,038.2	0.010%	71	74	80	106	102	143	118	
533	HCA GUAYMAS DE ZGZA	260290001	1,010.8	1,111.4	0.143%	984	1024	1101	1467	1407	1972	1633	
534	HERMOSILLO	260300001	1,012.3	1,192.2	1.018%	7000	7281	7832	10435	10009	14030	11613	
535	HUATABAMPO	260330001	1,083.6	1,032.4	0.057%	391	407	438	583	559	784	649	
536	IMURIS	260350001	1,025.8	1,308.2	0.008%	52	54	59	78	75	105	87	
537	MAGDALENA DE KINO	260360001	1,018.7	1,298.1	0.056%	387	403	433	577	553	776	642	
538	NACO	260390001	1,082.1	1,342.6	0.010%	71	74	80	107	102	143	119	
539	NACAZARI DE GARC=A	260410001	1,093.9	1,276.3	0.019%	131	136	146	195	187	262	217	
540	NAVOJOA	260420001	1,096.7	1,048.5	0.144%	994	1033	1112	1481	1421	1991	1648	
541	HEROICA NOGALES	260430001	1,022.9	1,345.0	0.427%	2939	3056	3288	4381	4202	5890	4875	
542	PUERTO LIBERTAD	260470065	912.8	1,255.5	0.004%	31	32	34	46	44	62	51	
543	PUERTO PEDASCO	260480001	869.3	1,356.6	0.084%	579	602	648	863	827	1160	960	
544	SN LUIS RIO COLORADO	260550001	803.2	1,441.1	0.371%	2548	2650	2851	3798	3643	5106	4227	
545	SANTA ANA	260580001	1,009.2	1,292.6	0.015%	102	106	114	152	146	205	170	
546	URES	260660001	1,048.3	1,213.4	0.007%	45	47	50	67	64	90	74	
547	SONOITA	260700001	912.8	1,391.0	0.015%	106	111	119	159	152	213	177	
548	VILLA JU=REZ	260710001	1,072.8	1,053.8	0.007%	47	49	52	70	67	94	78	
549	VILLA EL TRIUNFO	270010074	2,265.7	436.6	0.007%	47	49	53	71	68	95	79	
550	CARDENAS	270020001	2,120.6	432.3	0.112%	772	803	864	1151	1104	1548	1281	

Table B.12 Localities and ELV Generation in Mexico (12/14)

Nr.	Locality name		Coordinates		%	End-of-Life Vehicles							
						2007	2010	2015	2020	2020	2025	2025	
			SC-A	SC-B					SC-A	SC-B			
551	FRONTERA	270030001	2,166.1	471.6	0.011%	75	78	84	111	107	150	124	
552	VILLA UNIÉN	270040176	2,153.8	443.8	0.522%	3592	3736	4019	5354	5135	7199	5959	
553	COMALCALCO	270050001	2,129.4	450.6	0.062%	428	446	479	639	612	859	711	
554	CUNDUACÁN	270060001	2,133.8	437.5	0.020%	140	146	157	209	200	280	232	
555	EMILIANO ZAPATA	270070001	2,227.6	421.2	0.024%	163	170	183	244	234	328	271	
556	HUIMANGUILLO	270080001	2,120.1	420.7	0.029%	198	206	222	295	283	397	329	
557	MACUSPANA	270120001	2,173.0	418.9	0.052%	359	373	402	535	513	720	596	
558	PARAISO	270140001	2,129.7	460.1	0.042%	290	302	325	433	415	581	481	
559	TEAPA	270160001	2,150.4	402.7	0.015%	102	107	115	153	146	205	170	
560	TENOSIQUE DE PINO S	270170001	2,251.4	404.7	0.009%	65	68	73	97	93	130	108	
561	ABASOLO	280010001	1,781.7	833.1	0.008%	58	60	65	86	83	116	96	
562	ALDAMA	280020001	1,802.6	755.7	0.372%	2559	2661	2863	3814	3658	5128	4245	
563	CIUDAD CAMARGO	280070001	1,749.4	986.9	0.032%	223	232	250	333	319	447	370	
564	GONZÁLEZ	280120001	1,780.5	749.0	0.023%	156	162	174	232	223	312	259	
565	GOMEZ	280130001	1,742.2	822.6	0.004%	30	31	34	45	43	60	50	
566	NUEVA CIUDAD GRO	280140001	1,724.7	1,003.4	0.010%	66	69	74	99	95	133	110	
567	CD GUSTAVO DIAZ ORDZ	280150001	1,764.6	981.0	0.038%	258	269	289	385	369	518	429	
568	HIDALGO	280160001	1,714.7	844.5	0.020%	135	141	151	202	193	271	224	
569	SANTANDER JIMÉNEZ	280180001	1,774.6	843.8	0.008%	58	61	65	87	83	117	97	
570	LLERA DE CANALES	280190001	1,741.8	781.4	0.008%	56	59	63	84	81	113	94	
571	CIUDAD MANTE	280210001	1,746.4	741.4	0.109%	751	781	840	1119	1073	1505	1246	
572	HEROICA MATAMOROS	280220001	1,832.6	958.6	0.805%	5537	5759	6195	8255	7917	11098	9186	
573	MIER	280240001	1,729.6	994.2	0.017%	118	122	132	175	168	236	195	
574	CDAD MIGUEL ALEMÁN	280250001	1,737.1	992.5	0.076%	524	545	586	781	749	1050	869	
575	NUEVO LAREDO	280270001	1,706.2	1,066.0	0.673%	4628	4814	5178	6899	6617	9276	7678	
576	OCAMPO	280290001	1,722.8	748.7	0.003%	18	18	20	26	25	35	29	
577	NUEVO PADILLA	280300001	1,748.5	831.7	0.010%	66	69	74	99	95	133	110	
578	CIUDAD REYNOSA	280320001	1,783.0	971.0	1.127%	7748	8059	8669	11551	11078	15529	12854	
579	RIO BRAVO	280330001	1,795.8	965.9	0.206%	1414	1471	1582	2108	2022	2834	2346	
580	SAN FERNANDO	280350001	1,794.5	887.6	0.065%	448	466	501	668	641	898	744	
581	SOTO LA MARINA	280370001	1,792.8	813.5	0.018%	126	131	141	188	180	253	209	
582	TAMPICO	280380001	1,817.3	714.2	0.377%	2594	2698	2902	3867	3709	5199	4303	
583	TULA	280390001	1,699.0	759.1	0.010%	69	71	77	102	98	138	114	
584	VALLE HERMOSO	280400001	1,813.7	944.4	0.126%	864	899	967	1288	1235	1732	1433	
585	CIUDAD VICTORIA	280410001	1,733.8	809.9	0.441%	3033	3155	3394	4522	4337	6079	5032	
586	XICOTENCATL	280430001	1,747.5	759.5	0.014%	96	100	107	143	137	192	159	
587	APIZACO	290050001	1,804.9	515.5	0.091%	629	654	704	938	899	1261	1044	
588	CALPULALPAN	290060001	1,776.8	526.6	0.061%	419	436	469	625	599	840	695	
589	CHIAUTEMPAN	290100001	1,801.6	508.5	0.062%	428	445	479	638	612	858	711	
590	HUAMANTLA	290130001	1,819.4	508.9	0.042%	289	300	323	430	413	578	479	
591	VILLA VICENTE GRO	290250001	1,803.7	495.3	0.024%	168	175	188	250	240	337	279	
592	TLAXCALA DE XICOH	290330001	1,798.8	508.7	0.119%	821	854	918	1224	1174	1645	1362	
593	ZACATELCO	290440001	1,798.8	501.3	0.044%	305	317	341	454	436	611	505	
594	ACAYUCAN	300030001	2,019.7	423.0	0.030%	208	216	232	310	297	416	345	
595	ACULTZINGO	300060001	1,860.6	469.2	0.002%	17	18	19	25	24	34	28	
596	ALTOTONGA	300100001	1,862.5	541.2	0.011%	77	80	86	114	110	154	127	
597	HEROICA ALVARADO	300110001	1,961.6	476.8	0.013%	87	90	97	129	124	174	144	
598	NARANJOS	300130001	1,830.6	649.0	0.020%	138	144	155	206	198	277	230	
599	JOSÉ CARDEL	300160001	1,920.1	516.1	0.021%	142	148	159	212	203	284	235	
600	GRAL MIGUEL ALEMÁN	300210017	1,894.0	482.6	0.005%	32	34	36	48	46	65	54	

Table B.13 Localities and ELV Generation in Mexico (13/14)

Nr.	Locality name		Coordinates		%	End-of-Life Vehicles						
						2007	2010	2015	2020	2020	2025	2025
			X	Y					SC-A	SC-B	SC-A	SC-B
601	CATEMACO	300320001	2,005.2	454.8	0.009%	61	64	68	91	87	123	101
602	CERRO AZUL	300340001	1,827.3	637.7	0.027%	186	194	208	278	266	373	309
603	COATEPEC	300380001	1,881.7	520.6	0.605%	4163	4330	4658	6206	5952	8344	6906
604	COATZACOALCOS	300390001	2,050.8	437.6	0.311%	2138	2224	2393	3188	3057	4286	3547
605	CERDOBA	300440001	1,884.9	481.6	0.149%	1023	1064	1145	1525	1463	2050	1697
606	COSAMALOAPAN CA	300450001	1,960.5	449.0	0.022%	153	160	172	229	219	308	255
607	HCA COSOLEACAQU	300480001	2,038.1	427.4	0.037%	253	263	283	377	362	507	420
608	CUITLAHUAC	300530001	1,898.7	477.2	0.010%	68	71	76	102	98	137	113
609	CHINAMECA	300590001	2,035.0	429.1	0.004%	26	27	30	39	38	53	44
610	CHOAPAS, LAS	300610001	2,073.8	423.7	0.036%	247	257	277	369	353	495	410
611	FORTIN DE FLORES	300680001	1,880.4	482.5	0.038%	258	269	289	385	369	518	429
612	GUTZ ZAMORA	300690001	1,871.1	588.6	0.008%	53	55	59	78	75	105	87
613	HUATUSCO DE CHIC	300710001	1,881.9	499.7	0.021%	146	152	163	217	208	292	242
614	JUAN DIAZ COVARR	300730022	2,001.2	436.6	0.008%	57	59	63	84	81	113	94
615	ISLA	300770001	1,979.2	426.5	0.010%	70	72	78	104	100	140	116
616	XALAPA ENRIQUEZ	300820001	1,884.4	526.8	0.009%	62	65	70	93	89	125	103
617	JALTIPAN DE MLOS	300890001	2,032.7	424.9	0.013%	93	96	104	138	133	186	154
618	JUAN RGUIZ CLARA	300940001	1,987.4	424.4	0.005%	32	33	36	48	46	64	53
619	LERDO DE TEJADA	300970001	1,977.9	467.8	0.010%	71	74	80	106	102	143	118
620	MALTRATA	300990001	1,862.7	475.7	0.002%	12	12	13	17	17	23	19
621	MTZ DE LA TORRE	301020001	1,873.6	562.2	0.086%	591	614	661	880	844	1184	980
622	MINATITLAN	301080001	2,042.9	428.1	0.151%	1036	1078	1159	1545	1482	2077	1719
623	MISANTLA	301090001	1,887.6	553.6	0.013%	93	96	104	138	132	186	154
624	OLUTA	301160001	2,021.0	421.7	0.004%	30	32	34	45	43	61	50
625	ORIZABA	301180001	1,873.6	479.0	0.286%	1963	2042	2197	2927	2807	3935	3257
626	PANUCO	301230001	1,797.4	696.2	0.038%	263	273	294	391	375	526	436
627	PAPANTLA DE OLAR	301240001	1,855.6	587.7	0.033%	228	237	255	340	326	458	379
628	PEROTE	301280001	1,862.9	527.3	0.028%	189	197	212	282	270	379	314
629	PLATEN SANCHEZ	301290001	1,786.5	642.8	0.004%	30	31	34	45	43	60	50
630	PLAYA VICENTE	301300001	1,961.1	412.0	0.010%	66	68	74	98	94	132	109
631	POZA RICA DE HGO	301310001	1,846.6	593.0	0.263%	1807	1879	2021	2693	2583	3621	2997
632	SN ANDRES TUXTLA	301410001	1,998.5	456.4	0.026%	181	188	202	270	259	363	300
633	TANTOYUCA	301550001	1,795.9	648.3	0.016%	111	115	124	165	158	222	183
634	ALAMO	301600001	1,832.4	618.7	0.021%	144	150	161	215	206	289	239
635	TEMPOAL DE SCHZ	301610001	1,785.3	659.3	0.008%	54	56	60	81	77	108	90
636	TEPETZINTLA	301670001	1,820.3	635.9	0.001%	10	11	11	15	15	21	17
637	TEXISTEPEC	301720001	2,026.4	419.5	0.001%	9	9	10	13	13	18	15
638	TEZONAPA	301730001	1,901.5	463.0	0.007%	50	52	56	75	72	101	83
639	TIERRA BLANCA	301740001	1,923.4	452.9	0.037%	254	264	284	378	363	508	421
640	PLAN DE AYALA	301750052	1,845.0	593.1	0.030%	206	215	231	308	295	414	342
641	PIEDRAS NEGRAS	301810071	1,935.0	475.5	0.010%	68	71	76	102	98	137	113
642	TUXPAN DE RGUIZ C	301890001	1,849.3	622.5	0.167%	1146	1192	1283	1709	1639	2297	1902
643	VERACRUZ	301930001	1,936.2	503.4	0.742%	5102	5307	5709	7606	7295	10227	8465
644	AGUA DULCE	302040001	2,069.6	438.9	0.052%	357	371	399	532	510	716	592
645	NANCHITAL	302060001	2,052.6	433.1	0.053%	366	381	409	545	523	733	607
646	TRES VALLES	302070001	1,938.8	439.0	0.021%	141	147	158	210	202	283	234
647	ACANCEH	310020001	2,361.1	643.3	0.003%	22	23	25	33	32	44	37
648	AKIL	310030001	2,371.0	606.6	0.002%	11	12	13	17	16	23	19
649	CENOTILLO	310120001	2,414.5	658.7	0.000%	3	4	4	5	5	7	6
650	CHEMAX	310190001	2,459.3	641.7	0.003%	19	20	22	29	28	39	32

Table B.14 Localities and ELV Generation in Mexico (14/14)

Nr.	Locality name		Coordinates		%	End-of-Life Vehicles							
						2007	2010	2015	2020	2020	2025	2025	
			X	Y					SC-A	SC-B	SC-A	SC-B	
651	DZIDZANT	310270001	2,384.6	675.3	0.009%	65	68	73	97	93	131	108	
652	ESPITA	310320001	2,433.2	663.4	0.002%	12	13	14	18	17	24	20	
653	HALACHO	310330001	2,322.7	617.0	0.005%	33	35	37	50	48	67	55	
654	HUNUCM	310380001	2,332.7	655.0	0.006%	38	40	43	57	54	76	63	
655	IZAMAL	310400001	2,388.3	654.0	0.012%	79	82	89	118	113	159	131	
656	KINCHIL	310440001	2,328.6	647.6	0.001%	4	4	4	6	6	8	7	
657	MAXCANU	310480001	2,326.8	624.8	0.003%	20	21	23	30	29	41	34	
658	MOTUL RIDA	310500001	2,349.2	655.0	1.209%	8313	8646	9301	12393	11886	16662	13791	
659	MOTUL DE FELIPE CARR	310520001	2,370.2	663.5	0.010%	67	70	75	100	96	134	111	
660	MUNA	310530001	2,346.2	619.4	0.002%	15	16	17	23	22	31	25	
661	OXKUTZCAB	310560001	2,366.3	608.6	0.006%	44	45	49	65	62	88	72	
662	PETO	310580001	2,399.3	599.5	0.003%	24	25	27	35	34	48	40	
663	SEYIT	310670001	2,366.1	645.4	0.001%	7	7	8	11	10	14	12	
664	SOTUTA	310690001	2,390.9	631.1	0.003%	23	23	25	34	32	45	37	
665	TEABO	310750001	2,374.4	616.0	0.000%	2	3	3	4	4	5	4	
666	TECOH	310760001	2,360.1	638.4	0.001%	8	8	9	12	11	16	13	
667	TEKAX DE ALVARO OBRE	310790001	2,375.2	602.6	0.008%	56	58	63	84	80	112	93	
668	TEKIT	310800001	2,370.4	624.9	0.001%	6	7	7	10	9	13	11	
669	TELCHAC PUERTO	310830001	2,370.0	680.5	0.002%	12	12	13	17	17	23	19	
670	TEMAX	310840001	2,391.9	669.3	0.001%	5	5	5	7	7	9	8	
671	TETIZ	310870001	2,329.2	650.9	0.000%	2	2	3	3	3	5	4	
672	TICUL	310890001	2,358.0	614.6	0.034%	233	243	261	348	334	468	387	
673	PISTIT	310910006	2,417.1	640.6	0.000%	3	3	4	5	5	7	6	
674	TIXKOKOB	310930001	2,363.5	656.7	0.001%	4	4	4	5	5	7	6	
675	TIZIMIN	310960001	2,442.4	673.5	0.025%	173	180	194	259	248	348	288	
676	TZUCACAB	310980001	2,391.5	595.0	0.001%	10	10	11	14	14	19	16	
677	UMIN	311010001	2,341.7	646.3	0.016%	113	117	126	168	161	226	187	
678	VALLADOLID	311020001	2,442.2	642.2	0.026%	179	186	200	267	256	358	297	
679	VICTOR ROSALES	320050001	1,509.2	754.3	0.023%	157	164	176	235	225	316	261	
680	CADITAS DE FELIPE PES	320060001	1,507.8	799.3	0.003%	21	22	24	32	30	43	35	
681	CONCEPCIÓN DEL ORO	320070001	1,590.2	868.2	0.011%	76	79	85	114	109	153	126	
682	FRESNILLO	320100001	1,498.7	769.9	0.132%	908	944	1016	1353	1298	1819	1506	
683	GUADALUPE	320170001	1,521.1	740.3	0.136%	936	973	1047	1395	1338	1876	1552	
684	JALPA	320190001	1,491.2	664.5	0.016%	111	116	125	166	159	223	185	
685	JRZ DE GARCIA SALINA	320200001	1,490.8	733.9	0.051%	350	364	392	522	500	701	581	
686	JUAN ALDAMA	320220001	1,466.4	846.5	0.010%	69	72	78	103	99	139	115	
687	LORETO	320240001	1,554.7	707.8	0.034%	237	246	265	353	339	475	393	
688	MIGUEL AUZA	320290001	1,462.7	846.8	0.009%	64	67	72	95	91	128	106	
689	NOCHISTLÁN DE MEJÍA	320340001	1,499.4	646.0	0.051%	349	362	390	520	498	698	578	
690	OJOCALIENTE	320360001	1,537.5	728.4	0.019%	132	138	148	197	189	265	220	
691	RO GRANDE	320390001	1,488.8	814.7	0.025%	169	176	190	253	242	340	281	
692	SAN ALTO	320400001	1,474.8	797.9	0.005%	33	34	37	49	47	65	54	
693	SOMBRERETE	320420001	1,450.3	801.8	0.057%	390	406	437	582	558	783	648	
694	TABASCO	320440001	1,495.4	680.2	0.007%	51	53	57	76	73	102	84	
695	TEPEL DE G ORTEG	320470001	1,460.3	653.0	0.004%	29	30	32	43	41	58	48	
696	TLALTENANGO DE SANC	320480001	1,470.6	674.7	0.018%	127	132	142	189	181	254	210	
697	GLEZ ORTEGA	320510008	1,523.6	770.2	0.007%	50	52	56	75	72	100	83	
698	VILLANUEVA	320550001	1,497.2	713.9	0.014%	95	99	106	142	136	190	158	
699	ZACATECAS	320560001	1,516.7	742.1	0.291%	2002	2082	2240	2984	2862	4012	3321	
					Σ =	100%	687583	715161	769323	1025009	983100	1378098	1140628

Appendix C: Basic Equipment and Facilities for ELV Management

C.1 De-pollution Rigs

Capacity: Up to 25 ELV /day

Description: Metallic structure to lift the ELV in a convenience high to access the operative fluids containers, as well as the parts to be dismantled. The commercial units work with pneumatic power to lift the ELV or with support of Skid steer loaders.

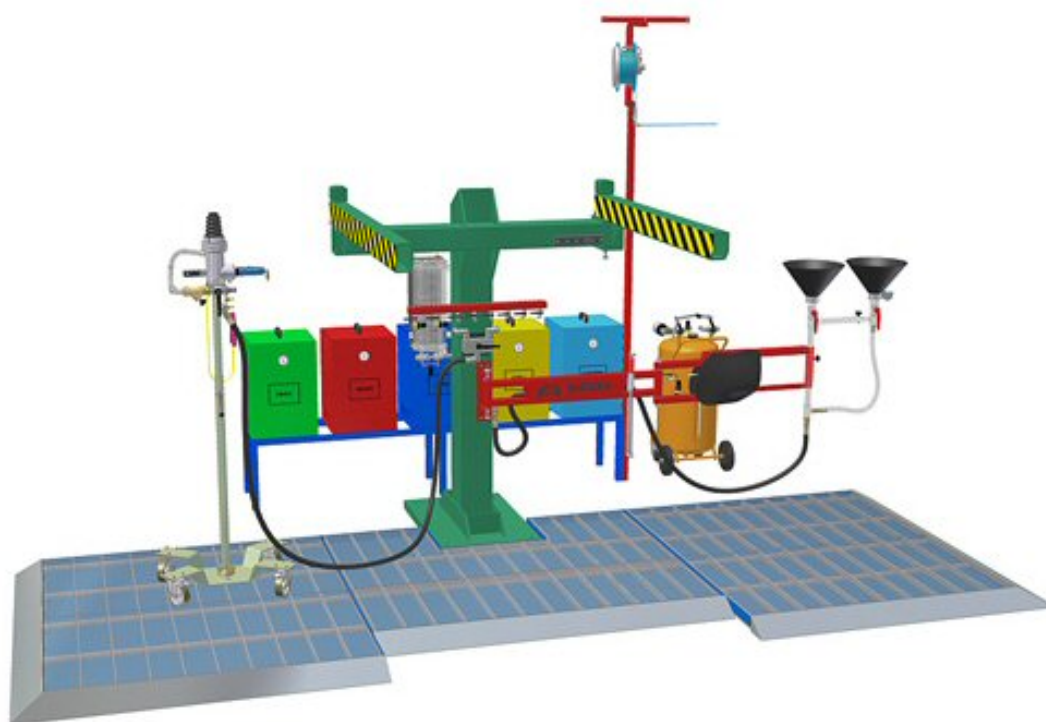

Figure C.1 De-pollution Rig with a Capacity of 25 ELV/day

Source: SEDA GmbH

Capacity: Up to 50 ELV /day

Description: Metallic structure to lift the ELV in a convenience high to access the operative fluids containers, as well as the parts to be dismantled. The commercial units work with pneumatic power to lift the ELV or with support of Skid steer loaders.



Figure C.2 De-pollution Rig with a Capacity of 50 ELV/day

Source: SEDA GmbH

Capacity: Up to 25 ELV /day

Description: Mobile drainage station including a hydraulic activated vehicle ramp, gear and tank drilling machines, individual vacuum pumps for de-pollution activities. The station is fixed in an easy roll on – roll of lorry.



Figure C.3 Mobil Unit for De-pollution of End-of-Life Vehicles

Source: STH GMBH

C.2 De-pollution Containers

Capacity: Low and High Volume Packs

Description: Metallic containers for safety removal and storage of operative fluids, such as, Fuel, Coolant, Washer, Brake fluid, Air Condition, Oils. The equipment works under pneumatic power given by a compressor, the operative deposits in ELV are pressurized to remove the fluid or the removal is carried out by direct suction. Also, the removal of operative fluids can be carried out by leaking.



Figure C.4 Mobil Unit for De-pollution of End-of-Life Vehicles

Source: AutoDrain



Figure C.5 High Volume Pack. Equipment for Fuel, Oil, Coolant, Washer Bottle, Brake Fluid, Air Con. Removal and Oil Filter Treatment.

Source: AutoDrain

C.3 Fuel Tank Drills

Special features: Pneumatic stand, with included water separator

Description: The drill works with pneumatic power to remove the fuel from the deposits in ELV



Figure C.6 Fuel Tank Drill with Water Separator

Source: AutoDrain

C.4 Air Bag Deployer

Special features: Electronic device

Description: The pyrotechnical components in ELV are deployed under strict safety and controlled conditions. The capacity is variable and different suppliers offer until 24 airbag capacity at once.



Figure C.7 Airbag Deployer, 24 Airbags Deployment Capacity

Source: SEDA GmbH



Figure C.8 Airbag Deployer for ELV

Source: AutoDrain

C.5 Air Conditioning Gas Unit

Special features: Pneumatic device with variable capacity.

Description: The unit recovers every type of gas contained in ELV. The operation is automatically and once the recovery bottle reaches its maximum safe level the unit switches off and indicates to the operator that gas remains in the vehicle and a fresh bottle is required.



Figure C.9 Air Conditioning Unit
Source AutoDrain

C.5 Car Body Pressing Machine (Car Baler)

Capacity: 3 to 10 tons per hour

Description: Car baler design for ELV and light metal scrap. The crane loads the scrap to the compression box, later wings then longitudinal pressing ram compress the scarp from all three sides. After compressions, bale is discharged by crane and new scrap is charged to the compression box.



Figure C.10 Car Baler to Compact ELV in Dismantling Centres

Source: Birim Makina



Figure C.11 Car Baler to Compact ELV in Dismantling Centres.

Source: Sierra Europe

C.6 Steer Loaders

Capacity: 1 to 5 tons

Description: Suitable wheel loaders for dismantling facilities.



Figure C.12 Skid Steer Loader



Figure C.13 Wheel Loader

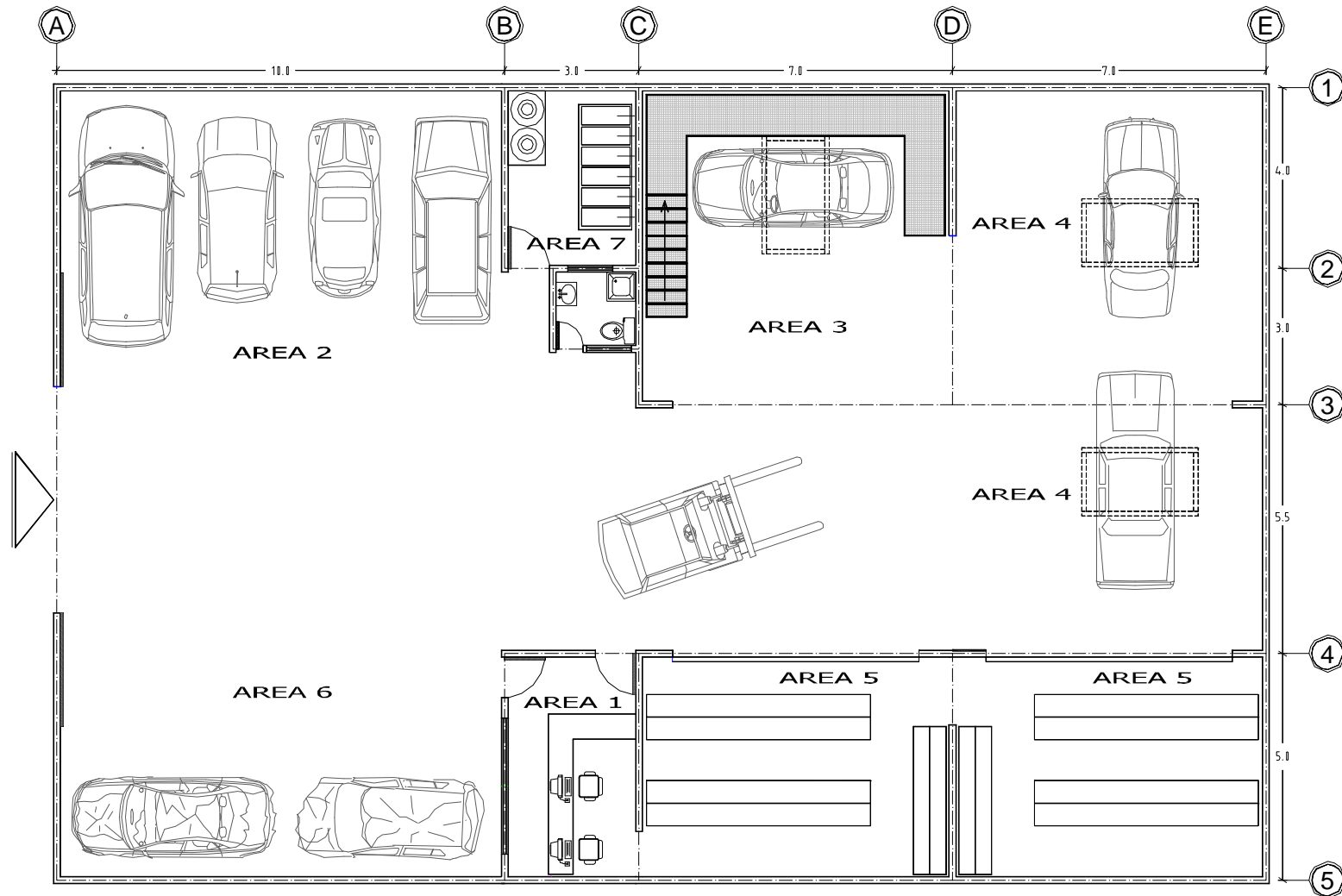

DESCRIPTION OF AREAS

- AREA 1 Reception and de-registration of vehicles
- AREA 2 Storage of de-registered vehicles (ELV)
- AREA 3 Depollution of ELV
- AREA 4 Dismantling 1 & 2
- AREA 5 Storage of re-usable parts
- AREA 6 Storage of wrecks
- AREA 7 Containers for drained operative fluids from ELV

 Brandenburgische Technische Universität Cottbus
 Faculty of Environmental Sciences and Process Engineering
 Chair of Industrial Sustainability

Implementation of End-of-Life Vehicle's
 Recycling for Developing Countries in America.
 Case Study, Mexico.

Description: Island
 Dismantling Facility Configuration
 Capacity: 30 ELV/day

Observations:
 -De-pollution and dismantling activities performed in batch processes with low capacity (up to 30 ELV/day)
 -Suitable for small facilities which no more than five workers

Supervisors:
 Prof. Dr. rer. nat. Jürgen Ertel
 Prof. Dr. rer. agr. Kai Rommel

PhD Fellow:
 Reynaldo Cruz-Rivera

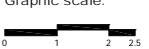
Graphic scale:

 0 1 2 2.5
 meters

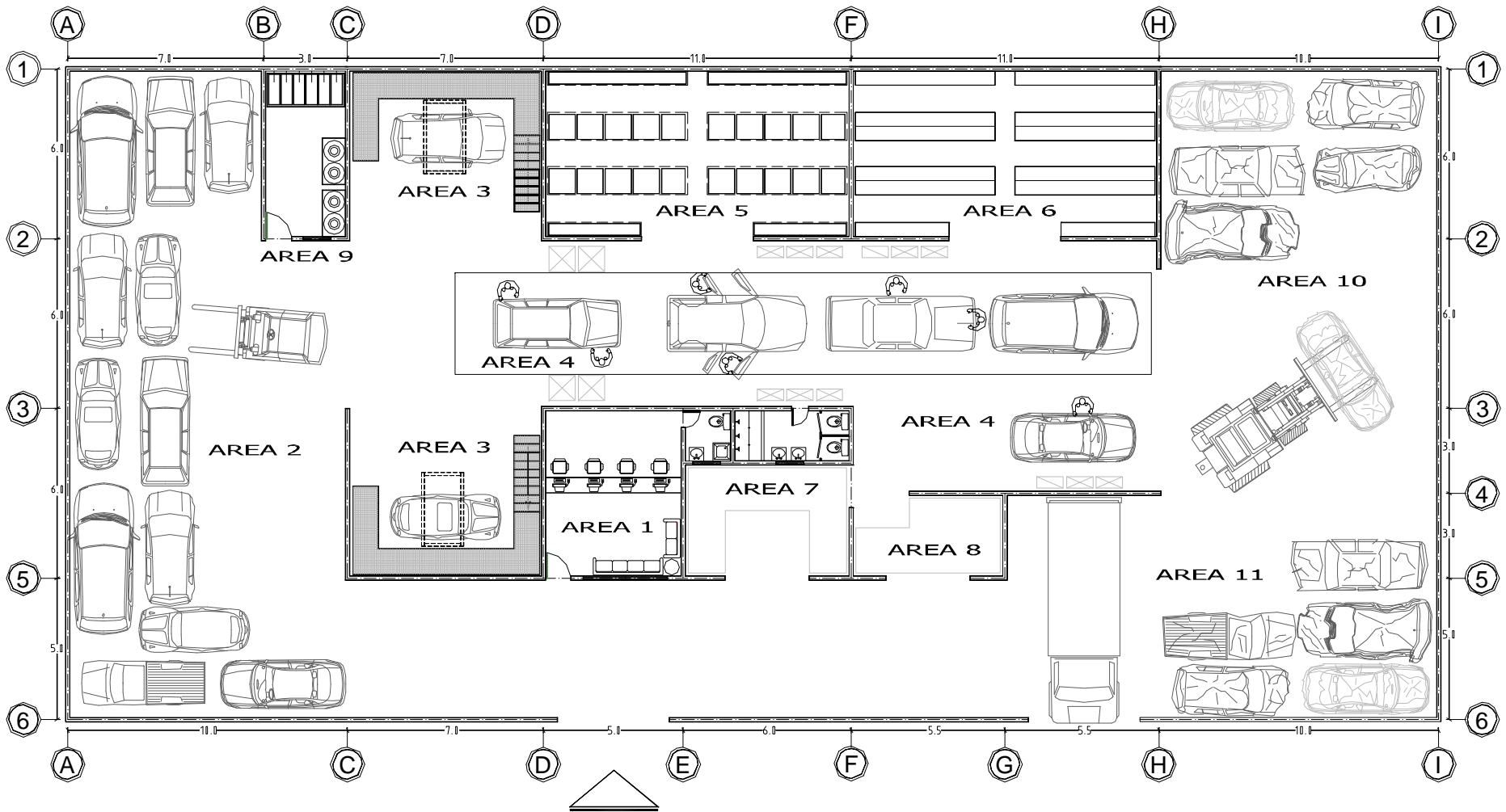
C-1



DESCRIPTION OF AREAS

- AREA 1 Reception and de-registration of vehicles
- AREA 2 Storage of de-registered vehicles (ELV)
- AREA 3 Depollution of ELV
- AREA 4 Dismantling 1 & 2
- AREA 5 Storage of dismantled parts
- AREA 6 Storage of re-usable parts
- AREA 7 Storage of old tyres
- AREA 8 Storage of waste material
- AREA 9 Containers for drained operative fluids from ELV
- AREA 10 Compress and storage of wrecks
- AREA 11 Departure of wrecks

Observations:

-De-pollution and dismantling activities performed in a semi-industrialized process with relative high capacity (more than 30 ELV/day)



Brandenburgische Technische Universität Cottbus
 Faculty of Environmental Sciences and Process Engineering
 Chair of Industrial Sustainability

Implementation of End-of-Life Vehicle's
 Recycling for Developing Countries in America.
 Case Study, Mexico.

Description:

Semi-industrial
 Dismantling Facility Configuration
 Capacity: Over 30 ELV/day

Supervisors:

Prof. Dr. rer. nat. Jürgen Ertel
 Prof. Dr. rer. agr. Kai Rommel

PhD Fellow:

Reynaldo Cruz-Rivera

Graphic scale:

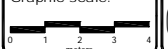

G-2

Appendix-D: Computation Results from SITATION[®]

D.1 Scenario-1

Dismantling Stage (Last Owners – Collection Points)

Table D.1.1 Location of Collection Points at Dismantling Stage by 2007

Nr	Coordinates (miles)		Covered Demand (Units)	Locality Name	Nr	Coordinates (miles)		Covered Demand (Units)	Locality Name	Nr	Coordinates (miles)		Covered Demand (Units)	Locality Name
	X	Y				X	Y				X	Y		
1	1535.145	681.210	9121	10010001	24	1595.383	599.219	7421	110170001	47	1618.459	700.226	9136	240280001
2	692.400	1411.122	5152	020010001	25	1574.435	629.914	8469	110200001	48	1120.186	959.799	4172	250010001
3	765.007	1458.095	16585	020020001	26	1693.688	337.884	7938	120010001	49	1216.871	887.536	5902	250060001
4	670.937	1458.354	21263	020040001	27	1764.454	562.572	10303	130480001	50	1274.953	777.548	2470	250120001
5	945.120	933.193	1184	030010133	28	1466.721	597.896	29094	140390001	51	1067.704	1078.873	5663	260180001
6	1031.943	851.254	4925	030030001	29	1460.905	605.045	13830	141200142	52	1012.280	1192.236	7101	260300001
7	1051.879	764.104	2016	030080054	30	1756.661	521.053	17457	150990001	53	1022.902	1344.996	6072	260430001
8	2297.605	571.158	1938	040020001	31	1706.484	504.338	13212	151060001	54	803.224	1441.091	3127	260550001
9	1589.291	1025.068	3198	050180001	32	1741.974	540.150	26428	151200001	55	2153.779	443.845	7892	270040176
10	1642.659	1148.309	3776	050250001	33	1541.173	412.276	1764	160520001	56	1802.634	755.748	2841	280020001
11	1616.143	924.689	5636	050300001	34	1606.454	531.676	11421	160530001	57	1832.567	958.579	6849	280220001
12	1464.945	932.335	8003	050350001	35	1550.482	512.314	4559	161020001	58	1706.194	1066.025	4857	280270001
13	1441.362	501.060	5398	060020001	36	1535.490	551.324	5747	161080001	59	1782.959	971.024	10407	280320001
14	2208.093	224.140	1401	070890001	37	1734.581	480.905	10360	170070001	60	1817.275	714.164	3025	280380001
15	2142.911	347.402	5878	071010001	38	1368.262	657.185	5105	180170001	61	1733.807	809.865	4415	280410001
16	1306.198	1147.413	12834	080190001	39	1659.720	942.786	44564	190390001	62	1881.719	520.573	5824	300380001
17	1328.256	1029.855	1829	080320001	40	1955.931	431.037	5468	200440001	63	2050.846	437.631	5117	300390001
18	1289.656	1361.795	14310	080370001	41	1839.307	369.117	2603	203970001	64	1873.561	479.013	4617	301180001
19	1182.630	1190.449	1671	080400001	42	1801.337	489.797	18665	211140001	65	1846.606	593.034	4623	301310001
20	1739.497	515.041	94937	09015	43	1657.487	593.599	14702	220140001	66	1936.183	503.363	5399	301930001
21	1739.304	507.929	48770	09003	44	2442.903	503.817	841	230040011	67	2349.250	655.016	9234	310500001
22	1744.991	509.933	22634	09007	45	2526.567	683.644	3225	230050001	68	1516.733	742.136	5115	320560001
23	1386.444	826.923	5052	100050001	46	1744.630	691.125	3044	240130001					
Total demand of													687,583	ELV

Table D.1.2 Location of Collection Points at Dismantling Stage by 2010

Nr	Coordinates (miles)		Covered Demand (Units)	Locality Name	Nr	Coordinates (miles)		Covered Demand (Units)	Locality Name	Nr	Coordinates (miles)		Covered Demand (Units)	Locality Name
	X	Y				X	Y				X	Y		
1	1535.145	681.210	9,486	10010001	24	1595.383	599.219	7,718	110170001	47	1744.630	691.125	3,164	240130001
2	692.400	1411.122	5,358	020010001	25	1574.435	629.914	8,809	110200001	48	1618.459	700.226	9,503	240280001
3	765.007	1458.095	17,250	020020001	26	1693.688	337.884	6,012	120010001	49	1120.186	959.799	4,340	250010001
4	670.937	1458.354	22,116	020040001	27	1718.958	385.343	2,607	120290001	50	1216.871	887.536	6,138	250060001
5	945.120	933.193	1,231	030010133	28	1764.454	562.572	10,714	130480001	51	1274.953	777.548	2,569	250120001
6	1031.943	851.254	5,123	030030001	29	1466.721	597.896	30,259	140390001	52	1067.704	1078.873	5,890	260180001
7	1051.879	764.104	2,097	030080054	30	1460.905	605.045	14,385	141200142	53	1012.280	1192.236	7,386	260300001
8	2297.605	571.158	2,016	040020001	31	1756.661	521.053	18,157	150990001	54	1022.902	1344.996	6,316	260430001
9	1589.291	1025.068	3,326	050180001	32	1706.484	504.338	13,380	151060001	55	803.224	1441.091	3,252	260550001
10	1642.659	1148.309	3,927	050250001	33	1741.974	540.150	27,492	151200001	56	2153.779	443.845	8,212	270040176
11	1616.143	924.689	5,861	050300001	34	1541.173	412.276	1,833	160520001	57	1802.634	755.748	2,954	280020001
12	1464.945	932.335	8,326	050350001	35	1606.454	531.676	11,879	160530001	58	1832.567	958.579	7,124	280220001
13	1441.362	501.060	5,614	060020001	36	1550.482	512.314	4,742	161020001	59	1706.194	1066.025	5,052	280270001
14	2208.093	224.140	1,456	070890001	37	1535.490	551.324	5,976	161080001	60	1782.959	971.024	10,826	280320001
15	2142.911	347.402	6,117	071010001	38	1734.581	480.905	10,773	170070001	61	1817.275	714.164	3,146	280380001
16	1306.198	1147.413	13,347	080190001	39	1368.262	657.185	5,308	180170001	62	1733.807	809.865	4,593	280410001
17	1328.256	1029.855	1,903	080320001	40	1659.720	942.786	46,351	190390001	63	1881.719	520.573	6,058	300380001
18	1289.656	1361.795	14,884	080370001	41	1955.931	431.037	5,686	200440001	64	2050.846	437.631	5,323	300390001
19	1182.630	1190.449	1,740	080400001	42	1839.307	369.117	2,708	203970001	65	1873.561	479.013	4,802	301180001
20	1739.497	515.041	98,746	09015	43	1801.337	489.797	19,410	211140001	66	1846.606	593.034	4,810	301310001
21	1739.304	507.929	50,725	09003	44	1657.487	593.599	15,293	220140001	67	1936.183	503.363	5,616	301930001
22	1744.991	509.933	23,543	09007	45	2442.903	503.817	874	230040011	68	2349.250	655.016	9,606	310500001
23	1386.444	826.923	5,258	100050001	46	2526.567	683.644	3,344	230050001	69	1516.733	742.136	5,321	320560001
Total demand of													715,161	ELV

Table D.1.3 Location of Collection Points at Dismantling Stage by 2015

Nr	Coordinates (miles)		Covered Demand (Units)	Locality Name	Nr	Coordinates (miles)		Covered Demand (Units)	Locality Name	Nr	Coordinates (miles)		Covered Demand (Units)	Locality Name
	X	Y				X	Y				X	Y		
1	1535.145	681.210	10,205	10010001	26	1386.444	826.923	5,656	100050001	51	2526.567	683.644	3,598	230050001
2	692.400	1411.122	5,764	020010001	27	1630.124	588.154	5,550	110070001	52	1744.630	691.125	3,404	240130001
3	765.007	1458.095	18,557	020020001	28	1595.383	599.219	7,482	110170001	53	1618.459	700.226	10,221	240280001
4	670.937	1458.354	23,791	020040001	29	1574.435	629.914	9,475	110200001	54	1120.186	959.799	4,670	250010001
5	945.120	933.193	1,324	030010133	30	1693.688	337.884	6,468	120010001	55	1216.871	887.536	6,603	250060001
6	1031.943	851.254	5,511	030030001	31	1718.958	385.343	2,414	120290001	56	1274.953	777.548	2,763	250120001
7	1051.879	764.104	2,256	030080054	32	1715.144	440.090	3,417	120350001	57	1067.704	1078.873	6,336	260180001
8	2297.605	571.158	2,059	040020001	33	1764.454	562.572	11,526	130480001	58	1012.280	1192.236	7,944	260300001
9	2219.508	482.714	1,792	040030001	34	1466.721	597.896	32,551	140390001	59	1022.902	1344.996	6,795	260430001

10	1589.291	1025.068	3,579	050180001	35	1460.905	605.045	15,475	141200142	60	803.224	1441.091	3,499	260550001
11	1642.659	1148.309	4,225	050250001	36	1756.661	521.053	19,532	150990001	61	2153.779	443.845	7,152	270040176
12	1616.143	924.689	6,305	050300001	37	1706.484	504.338	13,976	151060001	62	1802.634	755.748	3,178	280020001
13	1464.945	932.335	8,955	050350001	38	1741.974	540.150	29,571	151200001	63	1832.567	958.579	7,663	280220001
14	1441.362	501.060	6,039	060020001	39	1541.173	412.276	1,972	160520001	64	1706.194	1066.025	5,434	280270001
15	2208.093	224.140	1,566	070890001	40	1606.454	531.676	12,078	160530001	65	1782.959	971.024	11,645	280320001
16	2142.911	347.402	6,578	071010001	41	1550.482	512.314	5,099	161020001	66	1817.275	714.164	3,384	280380001
17	1306.198	1147.413	14,357	080190001	42	1535.490	551.324	6,431	161080001	67	1733.807	809.865	4,940	280410001
18	1342.466	1115.883	2,047	080210001	43	1734.581	480.905	8,922	170070001	68	1881.719	520.573	6,518	300380001
19	1289.656	1361.795	16,010	080370001	44	1368.262	657.185	5,712	180170001	69	2050.846	437.631	5,727	300390001
20	1182.630	1190.449	1,870	080400001	45	1659.720	942.786	49,862	190390001	70	1873.561	479.013	5,167	301180001
21	1740.982	519.308	32,894	09005	46	1955.931	431.037	6,118	200440001	71	1846.606	593.034	5,173	301310001
22	1739.497	515.041	73,330	09015	47	1839.307	369.117	2,912	203970001	72	1936.183	503.363	6,041	301930001
23	1734.195	510.127	20,917	09010	48	1801.337	489.797	20,882	211140001	73	2349.250	655.016	10,336	310500001
24	1739.304	507.929	33,708	09003	49	1657.487	593.599	12,424	220140001	74	1516.733	742.136	5,726	320560001
25	1744.991	509.933	25,325	09007	50	2442.903	503.817	940	230040011		2526.567	683.644	3,598	230050001
Total demand of													769,326	ELV

Table D.1.4 Location of Collection Points at Dismantling Stage by 2020, Scenario-A

Nr	Coordinates (miles)		Covered Demand (Units)	Locality Name	Nr	Coordinates (miles)		Covered Demand (Units)	Locality Name	Nr	Coordinates (miles)		Covered Demand (Units)	Locality Name
	X	Y				X	Y				X	Y		
1	1535.145	681.210	13,596	10010001	30	1630.124	588.154	7,392	110070001	59	1744.630	691.125	4,534	240130001
2	692.400	1411.122	7,680	020010001	31	1595.383	599.219	9,967	110170001	60	1639.342	802.306	1,252	240200001
3	765.007	1458.095	24,724	020020001	32	1574.435	629.914	12,625	110200001	61	1618.459	700.226	13,540	240280001
4	670.937	1458.354	31,698	020040001	33	1693.688	337.884	8,617	120010001	62	1120.186	959.799	6,220	250010001
5	945.120	933.193	1,765	030010133	34	1718.958	385.343	3,215	120290001	63	1216.871	887.536	8,799	250060001
6	1031.943	851.254	7,342	030030001	35	1715.144	440.090	4,553	120350001	64	1274.953	777.548	3,682	250120001
7	1051.879	764.104	3,005	030080054	36	1733.493	587.239	3,701	130300001	65	1106.075	1341.147	1,601	260020001
8	2297.605	571.158	2,744	040020001	37	1764.454	562.572	12,519	130480001	66	948.061	1308.868	2,333	260170001
9	2219.508	482.714	2,387	040030001	38	1466.721	597.896	43,370	140390001	67	1067.704	1078.873	6,637	260180001
10	1589.291	1025.068	4,770	050180001	39	1345.509	597.252	2,192	140670001	68	1010.843	1111.358	1,804	260290001
11	1642.659	1148.309	5,629	050250001	40	1460.905	605.045	20,619	141200142	69	1012.280	1192.236	10,502	260300001
12	1616.143	924.689	8,401	050300001	41	1756.661	521.053	26,024	150990001	70	1022.902	1344.996	6,068	260430001
13	1464.945	932.335	9,208	050350001	42	1706.484	504.338	15,864	151060001	71	803.224	1441.091	3,798	260550001
14	1441.362	501.060	7,986	060020001	43	1741.974	540.150	39,172	151200001	72	2153.779	443.845	9,525	270040176
15	2208.093	224.140	2,087	070890001	44	1541.173	412.276	2,627	160520001	73	1802.634	755.748	4,234	280020001
16	2142.911	347.402	8,763	071010001	45	1606.454	531.676	15,309	160530001	74	1832.567	958.579	10,211	280220001
17	1306.198	1147.413	16,068	080190001	46	1550.482	512.314	6,794	161020001	75	1706.194	1066.025	7,240	280270001
18	1342.466	1115.883	3,592	080210001	47	1535.490	551.324	8,567	161080001	76	1782.959	971.024	15,516	280320001
19	1328.256	1029.855	2,196	080320001	48	1661.012	514.083	3,968	161120001	77	1817.275	714.164	4,509	280380001
20	1289.656	1361.795	21,332	080370001	49	1734.581	480.905	11,886	170070001	78	1733.807	809.865	5,410	280410001
21	1182.630	1190.449	2,492	080400001	50	1368.262	657.185	5,475	180170001	79	1881.719	520.573	8,681	300380001

22	1740.982	519.308	43,827	09005	51	1659.720	942.786	66,435	190390001	80	2050.846	437.631	7,192	300390001
23	1739.497	515.041	97,700	09015	52	1903.815	322.712	1,745	200280001	81	1873.561	479.013	6,882	301180001
24	1734.195	510.127	27,793	09010	53	1831.686	406.041	2,815	200390001	82	1846.606	593.034	6,892	301310001
25	1739.304	507.929	29,876	09003	54	1955.931	431.037	8,151	200440001	83	1936.183	503.363	8,049	301930001
26	1744.991	509.933	33,743	09007	55	1801.337	489.797	27,579	211140001	84	2349.250	655.016	13,769	310500001
27	1736.090	500.603	15,111	090120026	56	1657.487	593.599	15,496	220140001	85	1516.733	742.136	7,628	320560001
28	1386.444	826.923	7,533	100050001	57	2442.903	503.817	1,253	230040011	86	1744.630	691.125	4,534	240130001
29	1464.531	970.835	2,725	100360001	58	2526.567	683.644	4,794	230050001		1639.342	802.306	1,252	240200001
Total demand of													1,025,009	ELV

Table D.1.5 Location of Collection Points at Dismantling Stage by 2020, Scenario-B

Nr	Coordinates (miles)		Covered Demand (Units)	Locality Name	Nr	Coordinates (miles)		Covered Demand (Units)	Locality Name	Nr	Coordinates (miles)		Covered Demand (Units)	Locality Name
	X	Y				X	Y				X	Y		
1	1535.145	681.210	13,040	10010001	29	1630.124	588.154	7,092	110070001	57	2526.567	683.644	4,597	230050001
2	692.400	1411.122	7,366	020010001	30	1595.383	599.219	9,561	110170001	58	1744.630	691.125	4,349	240130001
3	765.007	1458.095	23,713	020020001	31	1574.435	629.914	12,110	110200001	59	1639.342	802.306	1,202	240200001
4	670.937	1458.354	30,402	020040001	32	1693.688	337.884	8,266	120010001	60	1618.459	700.226	12,987	240280001
5	945.120	933.193	1,692	030010133	33	1718.958	385.343	3,084	120290001	61	1120.186	959.799	5,967	250010001
6	1031.943	851.254	7,042	030030001	34	1715.144	440.090	4,368	120350001	62	1216.871	887.536	8,439	250060001
7	1051.879	764.104	2,883	030080054	35	1733.493	587.239	3,549	130300001	63	1274.953	777.548	3,531	250120001
8	2297.605	571.158	2,632	040020001	36	1764.454	562.572	12,007	130480001	64	1106.075	1341.147	1,535	260020001
9	2219.508	482.714	2,289	040030001	37	1466.721	597.896	41,595	140390001	65	948.061	1308.868	2,236	260170001
10	1589.291	1025.068	4,574	050180001	38	1345.509	597.252	2,104	140670001	66	1067.704	1078.873	6,366	260180001
11	1642.659	1148.309	5,400	050250001	39	1460.905	605.045	19,774	141200142	67	1010.843	1111.358	1,730	260290001
12	1616.143	924.689	8,057	050300001	40	1756.661	521.053	24,958	150990001	68	1012.280	1192.236	10,073	260300001
13	1464.945	932.335	11,444	050350001	41	1706.484	504.338	15,216	151060001	69	1022.902	1344.996	5,820	260430001
14	1441.362	501.060	7,660	060020001	42	1741.974	540.150	37,569	151200001	70	803.224	1441.091	3,643	260550001
15	2208.093	224.140	2,001	070890001	43	1541.173	412.276	2,520	160520001	71	2153.779	443.845	9,134	270040176
16	2142.911	347.402	8,404	071010001	44	1606.454	531.676	14,683	160530001	72	1802.634	755.748	4,061	280020001
17	1306.198	1147.413	15,411	080190001	45	1550.482	512.314	6,516	161020001	73	1832.567	958.579	9,793	280220001
18	1342.466	1115.883	3,445	080210001	46	1535.490	551.324	8,218	161080001	74	1706.194	1066.025	6,944	280270001
19	1328.256	1029.855	2,108	080320001	47	1661.012	514.083	3,805	161120001	75	1782.959	971.024	14,881	280320001
20	1289.656	1361.795	20,460	080370001	48	1734.581	480.905	11,401	170070001	76	1817.275	714.164	4,324	280380001
21	1182.630	1190.449	2,391	080400001	49	1368.262	657.185	5,252	180170001	77	1733.807	809.865	5,188	280410001
22	1740.982	519.308	42,035	09005	50	1659.720	942.786	63,715	190390001	78	1881.719	520.573	8,326	300380001
23	1739.497	515.041	93,707	09015	51	1903.815	322.712	1,673	200280001	79	2050.846	437.631	6,898	300390001
24	1734.195	510.127	26,656	09010	52	1831.686	406.041	2,701	200390001	80	1873.561	479.013	6,603	301180001
25	1739.304	507.929	28,655	09003	53	1955.931	431.037	7,819	200440001	81	1846.606	593.034	6,610	301310001
26	1744.991	509.933	32,364	09007	54	1801.337	489.797	26,453	211140001	82	1936.183	503.363	7,720	301930001
27	1736.090	500.603	14,493	090120026	55	1657.487	593.599	14,862	220140001	83	2349.250	655.016	13,205	310500001
28	1386.444	826.923	7,225	100050001	56	2442.903	503.817	1,202	230040011	84	1516.733	742.136	7,315	320560001
Total demand of													983,100	ELV

Table D.1.6 Location of Collection Points at Dismantling Stage by 2025, Scenario-A

Nr	Coordinates (miles)		Covered Demand (Units)	Locality Name	Nr	Coordinates (miles)		Covered Demand (Units)	Locality Name	Nr	Coordinates (miles)		Covered Demand (Units)	Locality Name
	X	Y				X	Y				X	Y		
1	1535.145	681.210	17,398	10010001	33	1630.124	588.154	9,940	110070001	65	2442.903	503.817	1,684	230040011
2	692.400	1411.122	10,325	020010001	34	1595.383	599.219	13,399	110170001	66	2526.567	683.644	6,444	230050001
3	765.007	1458.095	33,241	020020001	35	1574.435	629.914	16,132	110200001	67	1744.630	691.125	6,097	240130001
4	670.937	1458.354	42,617	020040001	36	1693.688	337.884	11,586	120010001	68	1639.342	802.306	1,685	240200001
5	945.120	933.193	2,372	030010133	37	1718.958	385.343	4,323	120290001	69	1618.459	700.226	18,202	240280001
6	1031.943	851.254	9,871	030030001	38	1715.144	440.090	6,123	120350001	70	1120.186	959.799	4,721	250010001
7	1051.879	764.104	4,041	030080054	39	1733.493	587.239	4,130	130300001	71	1216.871	887.536	11,604	250060001
8	2297.605	571.158	3,691	040020001	40	1764.454	562.572	16,510	130480001	72	1152.451	942.189	3,809	250110001
9	2219.508	482.714	3,209	040030001	41	1466.721	597.896	56,093	140390001	73	1274.953	777.548	4,950	250120001
10	1589.291	1025.068	4,880	050180001	42	1345.509	597.252	2,948	140670001	74	1106.075	1341.147	2,152	260020001
11	1642.659	1148.309	6,868	050250001	43	1504.649	608.381	6,894	140930001	75	948.061	1308.868	1,762	260170001
12	1616.143	924.689	11,295	050300001	44	1460.905	605.045	27,720	141200142	76	1067.704	1078.873	5,858	260180001
13	1601.424	1096.212	2,232	050320014	45	1691.583	539.365	3,928	150140001	77	1010.843	1111.358	2,425	260290001
14	1464.945	932.335	12,380	050350001	46	1756.661	521.053	34,989	150990001	78	1012.280	1192.236	14,120	260300001
15	1441.362	501.060	10,736	060020001	47	1706.484	504.338	18,219	151060001	79	1096.666	1048.531	3,124	260420001
16	2208.093	224.140	2,805	070890001	48	1741.974	540.150	52,162	151200001	80	1022.902	1344.996	8,158	260430001
17	2142.911	347.402	11,785	071010001	49	1541.173	412.276	3,533	160520001	81	869.322	1356.639	1,373	260480001
18	1257.937	1133.251	2,441	080170001	50	1606.454	531.676	20,581	160530001	82	803.224	1441.091	5,106	260550001
19	1306.198	1147.413	19,493	080190001	51	1550.482	512.314	9,139	161020001	83	2153.779	443.845	12,806	270040176
20	1342.466	1115.883	4,830	080210001	52	1535.490	551.324	8,563	161080001	84	1802.634	755.748	5,693	280020001
21	1328.256	1029.855	2,954	080320001	53	1661.012	514.083	5,018	161120001	85	1832.567	958.579	13,728	280220001
22	1289.656	1361.795	28,680	080370001	54	1734.581	480.905	15,981	170070001	86	1706.194	1066.025	9,735	280270001
23	1182.630	1190.449	3,019	080400001	55	1368.262	657.185	7,363	180170001	87	1782.959	971.024	20,614	280320001
24	1740.982	519.308	58,923	09005	56	1689.125	908.530	3,462	190380001	88	1817.275	714.164	6,062	280380001
25	1739.497	515.041	98,350	09015	57	1659.720	942.786	86,154	190390001	89	1733.807	809.865	7,219	280410001
26	1738.465	511.615	33,007	09014	58	1903.815	322.712	2,346	200280001	90	1881.719	520.573	8,791	300380001
27	1734.195	510.127	37,366	09010	59	1831.686	406.041	3,785	200390001	91	2050.846	437.631	9,671	300390001
28	1739.304	507.929	40,168	09003	60	1955.931	431.037	10,959	200440001	92	1873.561	479.013	9,254	301180001
29	1744.991	509.933	45,367	09007	61	1801.337	489.797	36,972	211140001	93	1846.606	593.034	8,084	301310001
30	1736.090	500.603	20,316	090120026	62	1854.839	544.415	4,496	211740001	94	1936.183	503.363	10,822	301930001
31	1386.444	826.923	10,128	100050001	63	1657.487	593.599	16,985	220140001	95	2349.250	655.016	18,512	310500001
32	1464.531	970.835	3,663	100360001	64	1683.182	579.618	4,694	220160001	96	1516.733	742.136	10,253	320560001
Total demand of													1,378,098	ELV

Table D.1.7 Location for Facilities at Dismantling Stage by 2025, Scenario-B

Nr	Coordinates (miles)		Covered Demand (Units)	Locality Name	Nr	Coordinates (miles)		Covered Demand (Units)	Locality Name	Nr	Coordinates (miles)		Covered Demand (Units)	Locality Name
	X	Y				X	Y				X	Y		
1	1535.145	681.210	14,402	10010001	31	1464.531	970.835	3,032	100360001	61	2526.567	683.644	5,334	230050001
2	692.400	1411.122	8,547	020010001	32	1630.124	588.154	8,226	110070001	62	1744.630	691.125	5,048	240130001
3	765.007	1458.095	27,514	020020001	33	1595.383	599.219	11,093	110170001	63	1639.342	802.306	1,395	240200001
4	670.937	1458.354	35,276	020040001	34	1574.435	629.914	13,352	110200001	64	1618.459	700.226	15,067	240280001
5	945.120	933.193	1,963	030010133	35	1693.688	337.884	9,590	120010001	65	1120.186	959.799	3,956	250010001
6	1031.943	851.254	8,171	030030001	36	1718.958	385.343	3,579	120290001	66	1216.871	887.536	9,606	250060001
7	1051.879	764.104	3,345	030080054	37	1715.144	440.090	5,067	120350001	67	1152.451	942.189	3,152	250110001
8	2297.605	571.158	3,056	040020001	38	1733.493	587.239	4,119	130300001	68	1274.953	777.548	4,097	250120001
9	2219.508	482.714	2,655	040030001	39	1764.454	562.572	13,930	130480001	69	1106.075	1341.147	1,782	260020001
10	1589.291	1025.068	4,038	050180001	40	1466.721	597.896	46,431	140390001	70	948.061	1308.868	2,596	260170001
11	1642.659	1148.309	5,685	050250001	41	1345.509	597.252	2,441	140670001	71	1067.704	1078.873	7,386	260180001
12	1616.143	924.689	9,349	050300001	42	1504.649	608.381	5,707	140930001	72	1010.843	1111.358	2,008	260290001
13	1601.424	1096.212	1,847	050320014	43	1460.905	605.045	22,945	141200142	73	1012.280	1192.236	11,687	260300001
14	1464.945	932.335	10,248	050350001	44	1756.661	521.053	28,960	150990001	74	1022.902	1344.996	6,753	260430001
15	1441.362	501.060	8,888	060020001	45	1706.484	504.338	17,651	151060001	75	803.224	1441.091	4,227	260550001
16	2208.093	224.140	2,323	070890001	46	1741.974	540.150	43,587	151200001	76	2153.779	443.845	10,601	270040176
17	2142.911	347.402	9,756	071010001	47	1541.173	412.276	2,924	160520001	77	1802.634	755.748	4,713	280020001
18	1306.198	1147.413	17,881	080190001	48	1606.454	531.676	17,035	160530001	78	1832.567	958.579	11,363	280220001
19	1342.466	1115.883	3,998	080210001	49	1550.482	512.314	7,563	161020001	79	1706.194	1066.025	8,057	280270001
20	1328.256	1029.855	2,446	080320001	50	1535.490	551.324	7,087	161080001	80	1782.959	971.024	17,267	280320001
21	1289.656	1361.795	23,740	080370001	51	1661.012	514.083	4,415	161120001	81	1817.275	714.164	5,018	280380001
22	1182.630	1190.449	2,774	080400001	52	1734.581	480.905	13,228	170070001	82	1733.807	809.865	6,021	280410001
23	1740.982	519.308	48,772	09005	53	1368.262	657.185	6,093	180170001	83	1881.719	520.573	9,662	300380001
24	1739.497	515.041	81,406	09015	54	1659.720	942.786	73,929	190390001	84	2050.846	437.631	8,004	300390001
25	1738.465	511.615	27,321	09014	55	1903.815	322.712	1,942	200280001	85	1873.561	479.013	7,661	301180001
26	1734.195	510.127	30,929	09010	56	1831.686	406.041	3,132	200390001	86	1846.606	593.034	7,671	301310001
27	1739.304	507.929	33,248	09003	57	1955.931	431.037	9,071	200440001	87	1936.183	503.363	8,957	301930001
28	1744.991	509.933	37,550	09007	58	1801.337	489.797	30,693	211140001	88	2349.250	655.016	15,322	310500001
29	1736.090	500.603	16,815	090120026	59	1657.487	593.599	17,244	220140001	89	1516.733	742.136	8,488	320560001
30	1386.444	826.923	8,384	100050001	60	2442.903	503.817	1,394	230040011		2526.567	683.644	5,334	230050001
Total demand of													1,140,680	ELV

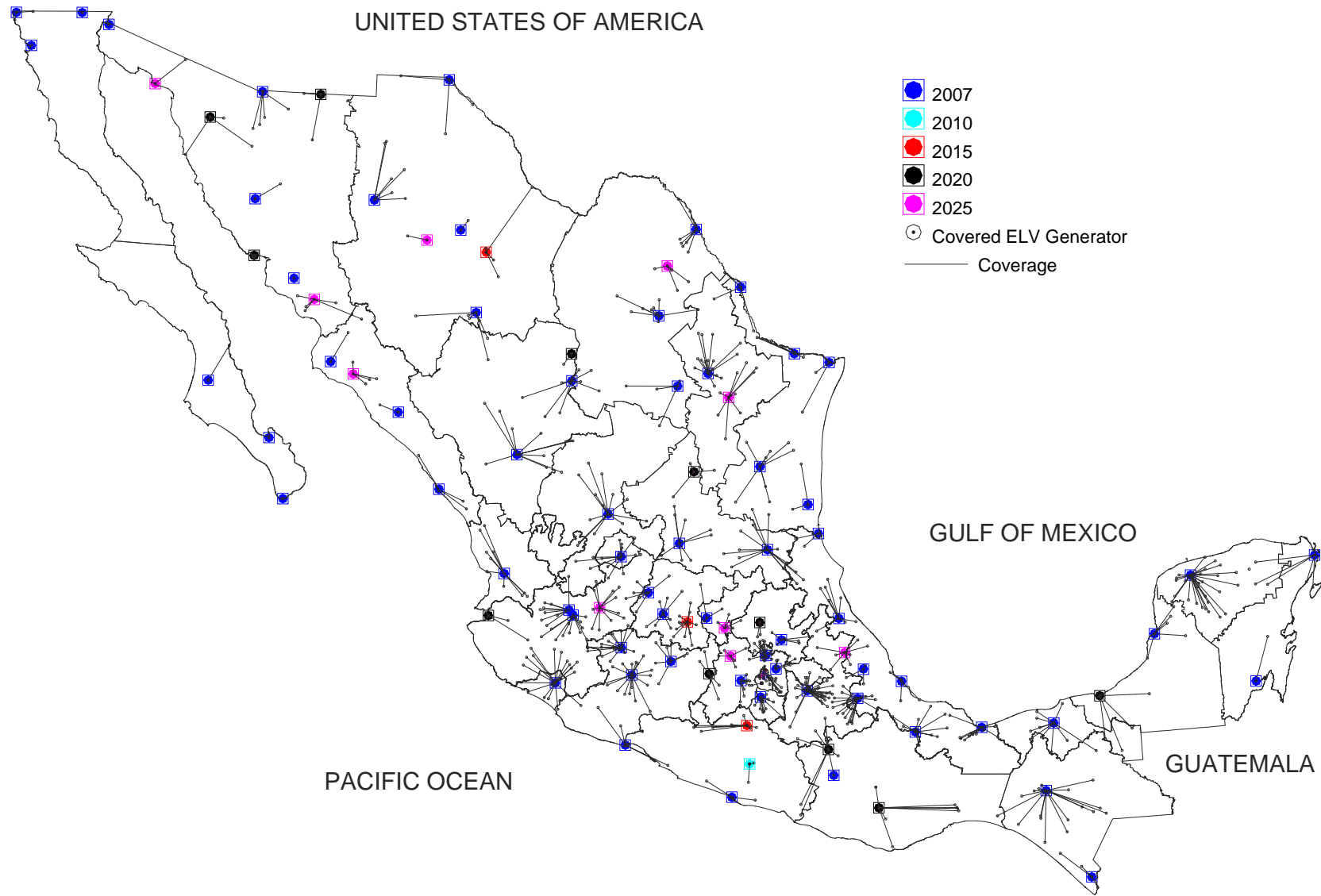

Figure D.1 Graphic Location of Collection Facilities at Dismantling Stage, Scenario-1
Implementation of End-of-Life Vehicle's Recycling for Developing Countries: Case Study, Mexico

Shredder Stage (Collection Points – Shredder Facilities)

Table D.1.8 Location of Facilities at Shredder Stage by 2007 to 2015

Nr	Coordinates (miles)		Covered Demand (Units)	Locality Name	Nr	Coordinates (miles)		Covered Demand (Units)	Locality Name	Nr	Coordinates (miles)		Covered Demand (Units)	Locality Name
	X	Y				X	Y				X	Y		
1	1535.145	681.210	31,841	10010001	1	1535.145	681.210	33,119	010010001	1	1535.145	681.210	35,627	10010001
2	765.007	1458.095	19,712	020020001	2	765.007	1458.095	20,502	020020001	2	765.007	1458.095	22,056	020020001
3	670.937	1458.354	26,415	020040001	3	670.937	1458.354	27,474	020040001	3	670.937	1458.354	29,555	020040001
4	1031.943	851.254	8,125	030030001	4	1031.943	851.254	8,451	030030001	4	1031.943	851.254	9,091	030030001
5	1464.945	932.335	13,055	050350001	5	1464.945	932.335	13,584	050350001	5	1464.945	932.335	14,611	050350001
6	1306.198	1147.413	16,334	080190001	6	1306.198	1147.413	16,990	080190001	6	1306.198	1147.413	18,274	080190001
7	1739.497	515.041	207,370	09015	7	1739.497	515.041	215,324	09015	7	1739.497	515.041	232,021	09015
8	1693.688	337.884	7,938	120010001	8	1693.688	337.884	8,619	120010001	8	1630.124	588.154	25,456	110070001
9	1466.721	597.896	53,427	140390001	9	1466.721	597.896	55,566	140390001	9	1693.688	337.884	8,882	120010001
10	1606.454	531.676	23,491	160530001	10	1606.454	531.676	24,430	160530001	10	1466.721	597.896	59,777	140390001
11	1801.337	489.797	21,268	211140001	11	1801.337	489.797	22,118	211140001	11	1606.454	531.676	25,580	160530001
12	1657.487	593.599	22,123	220140001	12	1657.487	593.599	23,011	220140001	12	1801.337	489.797	23,794	211140001
13	1216.871	887.536	12,544	250060001	13	1216.871	887.536	13,047	250060001	13	1216.871	887.536	14,036	250060001
14	1012.280	1192.236	18,836	260300001	14	1012.280	1192.236	19,592	260300001	14	1012.280	1192.236	14,280	260300001
15	2153.779	443.845	20,288	270040176	15	2153.779	443.845	21,108	270040176	15	1022.902	1344.996	6,795	260430001
16	1802.634	755.748	13,325	280020001	16	1802.634	755.748	13,857	280020001	16	2153.779	443.845	22,815	270040176
17	1782.959	971.024	22,113	280320001	17	1782.959	971.024	23,002	280320001	17	1802.634	755.748	14,906	280020001
18	1881.719	520.573	25,931	300380001	18	1881.719	520.573	26,972	300380001	18	1706.194	1066.025	9,659	280270001
19	2349.250	655.016	15,238	310500001	19	2349.250	655.016	15,840	310500001	19	1782.959	971.024	19,308	280320001
20	1289.656	1361.795	14,310	ECOREC	20	1289.656	1361.795	14,884	ECOREC	20	1881.719	520.573	29,017	300380001
21	1740.183	532.551	36,731	CFF	21	1740.183	532.551	38,206	CFF	21	2349.250	655.016	16,933	310500001
22	1666.835	948.487	48,340	IRASA	22	1666.835	948.487	50,278	IRASA	22	1289.656	1361.795	16,010	ECOREC
23	1665.903	948.922	8,834	PROME	23	1665.903	948.922	9,187	PROME	23	1740.183	532.551	41,097	CFF
										24	1666.835	948.487	49,862	IRASA
										25	1665.903	948.922	9,884	PROME
Total demand by 2007=			687,583	ELV	Total demand by 2010=			715,161	ELV	Total demand by 2015=			769,326	ELV

Table D.1.9 Location of Facilities at Shredder Stage by 2020, Scenarios A & B

Nr	Coordinates (miles)		Covered Demand (Units)	Locality Name	Nr	Coordinates (miles)		Covered Demand (Units)	Locality Name
	X	Y				X	Y		
1	1535.145	681.210	21,224	10010001	1	1535.145	681.210	32,465	10010001
2	765.007	1458.095	28,522	020020001	2	765.007	1458.095	27,356	020020001
3	670.937	1458.354	39,378	020040001	3	670.937	1458.354	37,768	020040001
4	1031.943	851.254	12,112	030030001	4	1031.943	851.254	11,617	030030001
5	1464.945	932.335	19,466	050350001	5	1464.945	932.335	18,669	050350001
6	2142.911	347.402	10,850	071010001	6	1306.198	1147.413	23,355	080190001
7	1306.198	1147.413	24,348	080190001	7	1739.497	515.041	293,853	09015
8	1739.497	515.041	306,375	09015	8	1630.124	588.154	31,515	110070001
9	1574.435	629.914	22,592	110200001	9	1693.688	337.884	11,350	120010001
10	1693.688	337.884	11,832	120010001	10	1466.721	597.896	76,385	140390001
11	1466.721	597.896	79,641	140390001	11	1606.454	531.676	35,742	160530001
12	1606.454	531.676	37,264	160530001	12	1955.931	431.037	16,390	200440001
13	1955.931	431.037	17,088	200440001	13	1801.337	489.797	29,154	211140001
14	1801.337	489.797	30,393	211140001	14	1618.459	700.226	14,189	240280001
15	1657.487	593.599	22,887	220140001	15	1216.871	887.536	17,937	250060001
16	1618.459	700.226	14,791	240280001	16	1012.280	1192.236	18,169	260300001
17	1216.871	887.536	18,701	250060001	17	1022.902	1344.996	9,591	260430001
18	1012.280	1192.236	18,943	260300001	18	2153.779	443.845	21,828	270040176
19	1022.902	1344.996	10,001	260430001	19	1802.634	755.748	17,922	280020001
20	2153.779	443.845	11,912	270040176	20	1706.194	1066.025	12,344	280270001
21	1802.634	755.748	18,687	280020001	21	1782.959	971.024	24,674	280320001
22	1706.194	1066.025	12,869	280270001	22	1881.719	520.573	29,259	300380001
23	1782.959	971.024	25,725	280320001	23	2349.250	655.016	21,636	310500001
24	1881.719	520.573	30,504	300380001	24	1289.656	1361.795	20,460	ECOREC
25	2349.250	655.016	22,560	310500001	25	1740.183	532.551	53,125	CFF
26	1289.656	1361.795	21,331	ECOREC	26	1666.835	948.487	63,715	IRASA
27	1740.183	532.551	55,391	CFF	27	1665.903	948.922	12,631	PROME
28	1666.835	948.487	66,435	IRASA	Total demand by 2020-B =			983,100	ELV
29	1665.903	948.922	13,171	PROME					
Total demand by 2020-A =			1,025,000	ELV					

Table D.1.10 Location of Facilities at Shredder Stage by 2025, Scenarios A & B

Nr	Coordinates (miles)		Covered Demand (Units)	Locality Name	Nr	Coordinates (miles)		Covered Demand (Units)	Locality Name
	X	Y				X	Y		
1	1535.145	681.210	27,651	10010001	1	1535.145	681.210	22,890	10010001
2	765.007	1458.095	39,720	020020001	2	765.007	1458.095	31,741	020020001
3	670.937	1458.354	52,942	020040001	3	670.937	1458.354	43,823	020040001
4	1031.943	851.254	16,284	030030001	4	1031.943	851.254	13,479	030030001
5	1464.945	932.335	16,043	050350001	5	1464.945	932.335	13,280	050350001
6	1441.362	501.060	14,269	060020001	6	2142.911	347.402	12,079	071010001
7	2142.911	347.402	14,590	071010001	7	1306.198	1147.413	27,099	080190001
8	1306.198	1147.413	32,737	080190001	8	1739.497	515.041	340,947	09015
9	1739.497	515.041	408,809	09015	9	1386.444	826.923	12,481	100050001
10	1386.444	826.923	15,078	100050001	10	1574.435	629.914	24,445	110200001
11	1574.435	629.914	29,531	110200001	11	1693.688	337.884	13,169	120010001
12	1693.688	337.884	15,909	120010001	12	1466.721	597.896	92,505	140390001
13	1466.721	597.896	90,707	140390001	13	1606.454	531.676	39,024	160530001
14	1606.454	531.676	43,301	160530001	14	1955.931	431.037	19,017	200440001
15	1368.262	657.185	10,311	180170001	15	1801.337	489.797	33,825	211140001
16	1955.931	431.037	22,976	200440001	16	1657.487	593.599	25,470	220140001
17	1801.337	489.797	40,757	211140001	17	1618.459	700.226	16,462	240280001
18	1657.487	593.599	31,619	220140001	18	1216.871	887.536	16,714	250060001
19	2526.567	683.644	6,444	230050001	19	1012.280	1192.236	21,081	260300001
20	1618.459	700.226	19,887	240280001	20	1022.902	1344.996	11,131	260430001
21	1216.871	887.536	20,134	250060001	21	2153.779	443.845	13,256	270040176
22	1067.704	1078.873	11,407	260180001	22	1802.634	755.748	20,800	280020001
23	1012.280	1192.236	14,120	260300001	23	1706.194	1066.025	15,589	280270001
24	1022.902	1344.996	12,072	260430001	24	1782.959	971.024	28,630	280320001
25	2153.779	443.845	16,015	270040176	25	1881.719	520.573	33,951	300380001
26	1802.634	755.748	25,071	280020001	26	2349.250	655.016	25,106	310500001
27	1706.194	1066.025	18,835	280270001	27	1289.656	1361.795	23,740	ECOREC
28	1782.959	971.024	34,342	280320001	28	1740.183	532.551	61,636	CFF
29	1881.719	520.573	41,447	300380001	29	1666.835	948.487	73,929	IRASA
30	2349.250	655.016	23,887	310500001	30	1665.903	948.922	13,387	PROME
31	1289.656	1361.795	28,680	ECOREC	Total demand by 2025-B =		1,140,680	ELV	
32	1740.183	532.551	76,730	CFF					
33	1666.835	948.487	89,616	IRASA					
34	1665.903	948.922	16,175	PROME					
Total demand by 2025-A =			1,378,100	ELV					

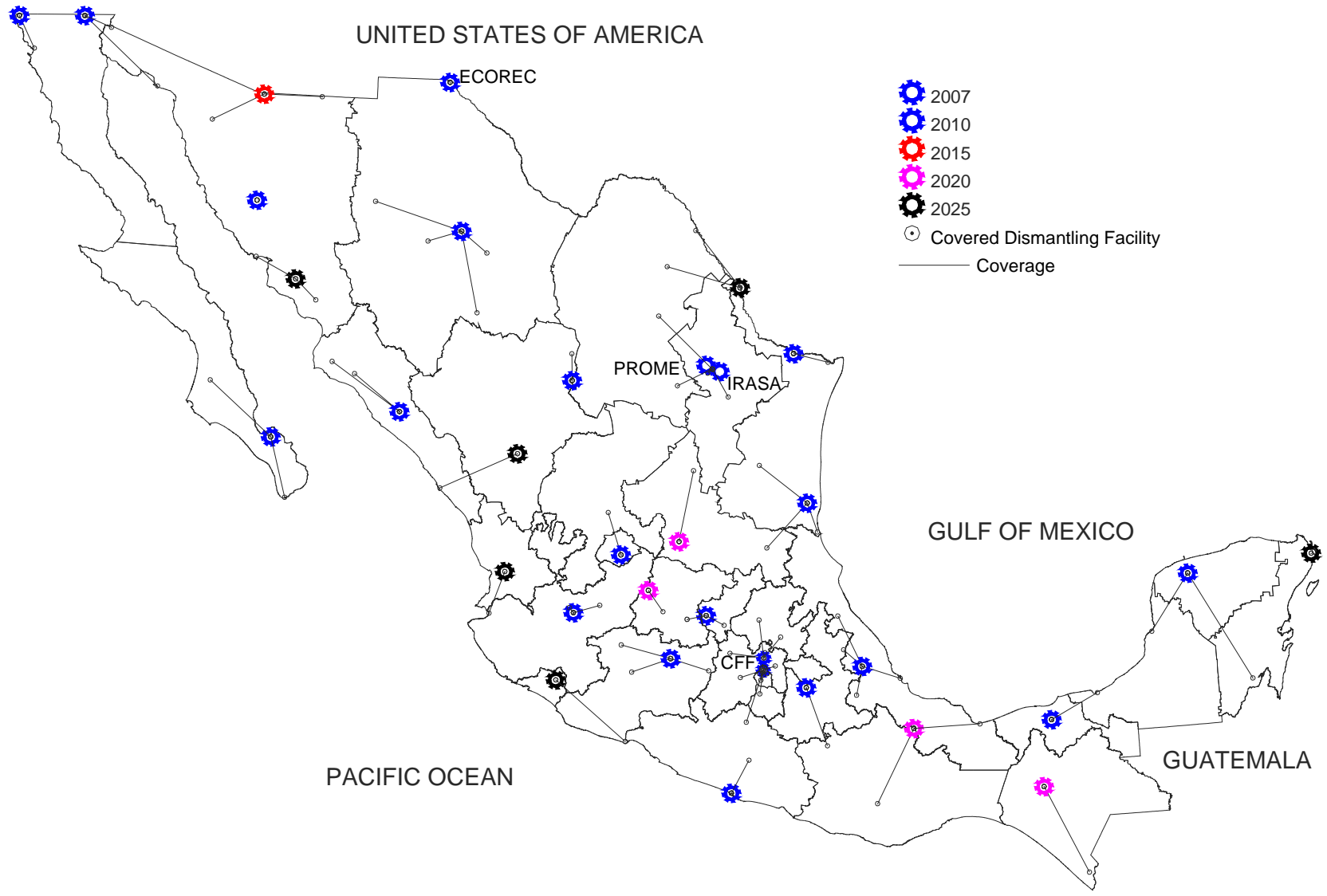

Figure D.2 Graphic Location of Shredder Facilities, Scenario-1
Implementation of End-of-Life Vehicle's Recycling for Developing Countries: Case Study, Mexico

Melting Stage (Shredder Facilities – Melting Facilities)

Table D.1.11 Location of Facilities at Melting Stage by 2007 to 2025

Nr	Coordinates (miles)		Covered Demand (Units)								Company Name
	X	Y	2007	2010	2015	2020		2025			
						A	B	A	B		
1	765.007	1458.095	19,712	20,502	28,851	38523	36947	38523	36947	Cia. siderurgica de califo	
2	670.937	1458.354	26,415	27,474	29,555	39378	37768	39378	37768	Procesadora Mexicali	
3	1589.291	1025.068	0	0	9,659	12869	12344	12869	12344	Altos Hornos de Mexico (AHMSA)	
4	1619.099	931.960	13,055	13,584	14,611	19466	18669	19466	18669	DEACERO S.A. DE C.V.	
5	1739.711	514.630	207,370	215,324	232,021	306375	293853	306375	293853	HYLSA S.A. De C.V.	
6	1618.541	587.530	45,614	47,441	51,036	82743	67257	82743	67257	DEACERO S.A. DE C.V.	
7	1466.721	597.896	53,427	55,566	59,777	79641	76385	79641	76385	Compania Siderurgica de Guadalajara	
8	1740.183	532.551	36,731	38,206	41,097	55391	53125	55391	53125	Siderurgica Tultitlan,	
9	1715.323	499.076	7,938	8,619	8,882	11832	11350	11832	11350	DEACERO S.A. DE C.V.	
10	1666.214	948.922	79,287	82,467	79,054	105331	101020	105331	101020	HYLSA S.A. de C.V.	
11	1801.337	489.797	21,268	22,118	23,794	30393	29154	30393	29154	DEACERO S.A. DE C.V.	
12	1618.459	700.226	45,166	46,976	50,533	54702	64576	54702	64576	Aceros San Luis	
13	1960.461	449.006	20,288	21,108	22,815	39850	38218	39850	38218	METALÚRGICA VERACRUZANA, S	
14	1873.561	479.013	25,931	26,972	29,017	30504	29259	30504	29259	Talleres y Aceros de Mexico	
15	2349.250	655.016	15,238	15,840	16,933	22560	21636	22560	21636	SIDERÚRGICA DE YUCATÁN, S.A	
16	1477.510	588.059				0	0	14269	0	DEACERO S.A. de C.V.	
Total demand =			617,440	642,197	697,635	929558	891561	1254734	1038573	ELV	

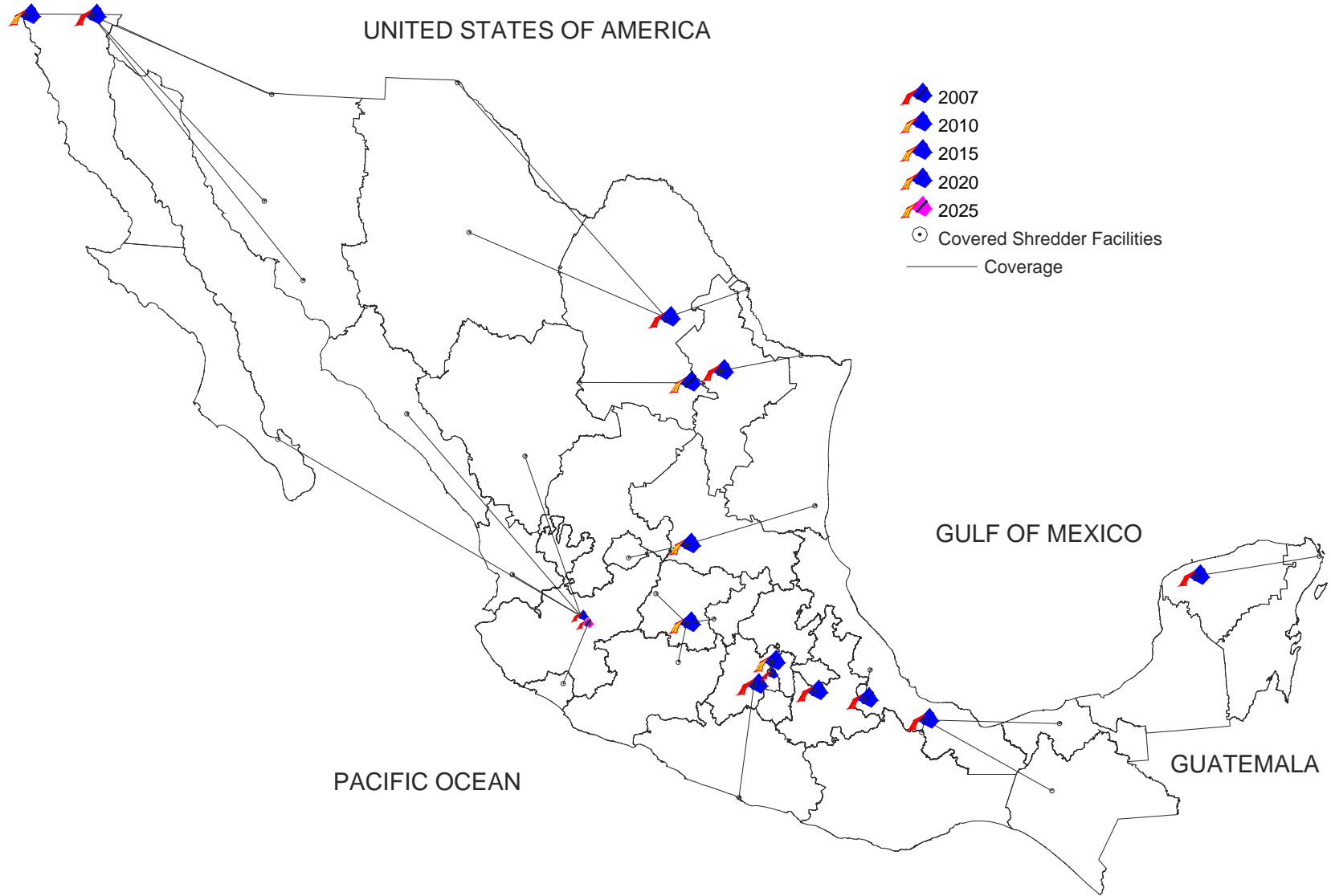

Figure D.3 Graphic Location of Foundries, Scenario-1

Energy Recovery Stage (Shredder Facilities – Cement Plants)

Table D.1.12 Location of Cement Plants at Energy Recovery Stage by 2007 to 2025

Nr	Coordinates (miles)		Covered Demand (Units)							Company Name	
	X	Y	2007	2010	2015	2020		2025			
						A	B	A	B		
1	692.400	1411.122	46,127	47,976	51,611	67,900	65,124	92,662	75,564	Ensenada	CEMEX
2	1466.721	597.896	85,268	88,685	95,404	123,457	108,850	158,200	139,840	Guadalajara	CEMEX
3	1666.085	998.648	22,113	23,002	28,967	38,594	37,018	53,177	44,219	Hidalgo	CEMEX
4	1695.050	579.236	45,614	47,441	51,036	60,151	67,257	74,920	64,494	Huichapan	CEMEX
5	2349.250	655.016	15,238	15,840	16,933	22,560	21,636	30,331	25,106	Merida	CEMEX
6	1659.720	942.786	57,174	59,465	59,746	79,606	76,346	105,791	87,316	Monterrey	CEMEX
7	1464.945	932.335	25,599	26,631	28,647	38,167	36,606	51,255	42,475	Torreon	CEMEX
8	1744.630	691.125	13,325	13,857	14,906	33,478	32,111	44,958	37,262	Valles	CEMEX
9	1032.280	1172.236	18,836	19,592	21,075	28,944	27,760	37,599	32,212	Yaqui	CEMEX
10	1693.688	337.884	7,938	8,619	8,882	11,832	11,350	15,909	13,169	Acapulco	APASCO
11	1736.974	552.400	244,101	253,530	273,118	361,766	346,978	485,539	402,583	Apaxco	APASCO
12	2173.002	418.878	20,288	21,108	22,815	22,762	21,828	30,605	25,335	Macuspana	APASCO
13	1878.239	477.099	25,931	26,972	29,017	47,592	45,649	64,423	52,968	Orizaba	APASCO
14	1298.954	1298.017	30,644	31,874	34,284	45,679	43,815	61,417	50,839	Samalayuca	CHIH
15	1737.809	474.424	21,268	22,118	23,794	30,393	29,154	40,757	33,825	Tepetzingo	MOCTZ
16	1431.463	478.511				0	0	14,269	0	Tecomán	APASCO
Total demand =			679,464	706,710	760,235	929558	891561	1361812	1127207	ELV	

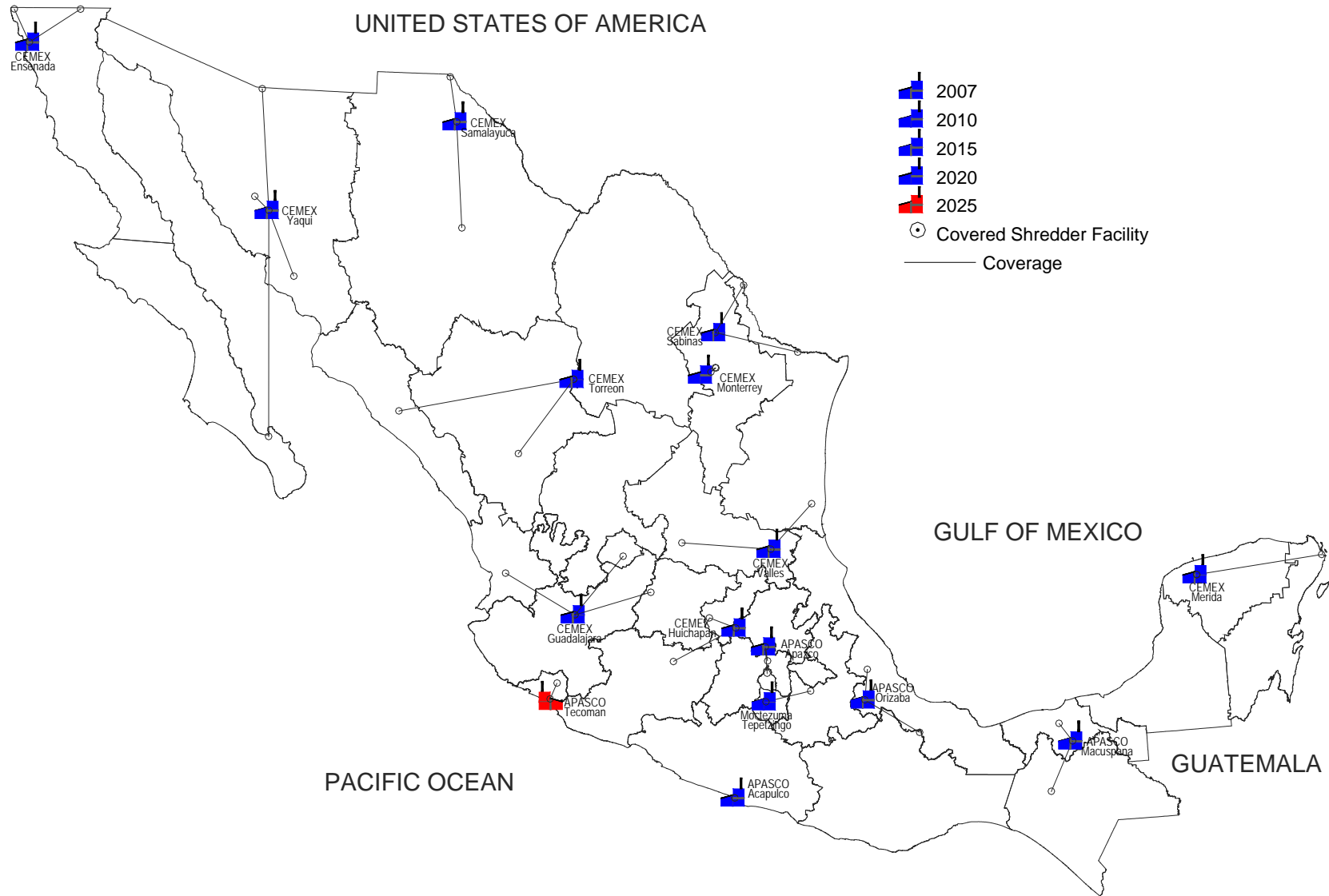

Figure D.4 Graphic Location of Cement Plants Using RDF, Scenario-1
 Implementation of End-of-Life Vehicle's Recycling for Developing Countries: Case Study, Mexico

Final Disposal Stage (Dismantling, Shredder, Melting & Cement Plants)

Table D.1.13 Location of Landfills for Final Disposal to Cover Demands at Dismantling Stage by 2007

Nr	Coordinates (miles)		Covered Demand (Units)	Locality Name	Nr	Coordinates (miles)		Covered Demand (Units)	Locality Name	Nr	Coordinates (miles)		Covered Demand (Units)	Locality Name
	X	Y				X	Y				X	Y		
1	1,535.14	681.21	9,121	10010001	19	1,594.42	589.25	7,421	110240001	37	1,618.46	700.23	9,136	240280001
2	692.4	1,411.12	5,152	20010001	20	1,608.69	559.5	11,421	110410001	38	1,759.06	691.99	3,044	240400001
3	668.52	1,447.56	21,263	20040223	21	1,693.69	337.88	7,938	120010001	39	1,216.87	887.54	10,074	250060001
4	1,031.94	851.25	8,125	30030001	22	1,764.45	562.57	10,303	130480001	40	1,012.28	1,192.24	12,764	260300001
5	2,297.61	571.16	1,938	40020001	23	1,487.01	613.65	42,924	141290001	41	1,022.90	1,345.00	6,072	260430001
6	1,623.86	1,018.92	3,198	50020001	24	1,745.55	523.24	17,457	150330000	42	803.22	1,441.09	19,712	260550001
7	1,638.68	1,143.13	3,776	50250001	25	1,750.64	534.68	26,428	150810001	43	2,138.62	442.46	7,892	270100001
8	1,616.14	924.69	5,636	50300001	26	1,745.75	513.97	166,341	150990001	44	1,803.68	723.11	5,866	280030001
9	1,441.36	501.06	5,398	60020001	27	1,738.08	520.61	13,212	151040000	45	1,832.57	958.58	17,256	280220001
10	2,208.09	224.14	1,401	70890001	28	1,556.79	530.57	12,070	160240001	46	1,706.19	1,066.03	4,857	280270001
11	2,142.91	347.4	5,878	71010001	29	1,753.06	473.77	10,360	170060001	47	1,733.81	809.87	4,415	280410001
12	1,306.20	1,147.41	12,834	80190001	30	1,368.26	657.18	5,105	180170001	48	1,881.72	520.57	5,824	300380001
13	1,328.26	1,029.86	1,829	80320001	31	1,659.45	961.34	44,564	190450001	49	1,867.05	476.84	4,617	301150001
14	1,289.66	1,361.80	14,310	80370001	32	1,942.68	422.87	5,468	201840001	50	1,846.61	593.03	4,623	301310001
15	1,226.97	1,192.54	1,671	80480001	33	1,839.31	369.12	2,603	203970001	51	1,998.48	456.41	5,117	301410001
16	1,386.44	826.92	7,522	100050001	34	1,801.34	489.8	18,665	211140001	52	1,923.44	452.86	5,399	301740001
17	1,460.18	939.63	8,003	100070001	35	1,657.49	593.6	14,702	220140001	53	2,349.25	655.02	9,234	310500001
18	1,574.43	629.91	8,469	110200001	36	2,514.74	645.3	4,066	230080001	54	1,509.19	754.31	5,115	320050001
Total demand =													687,583	ELV

Note: The covered demand refers the amount of ELV treated by facilities at dismantling stage; the material sent for final disposal can be considered a percentage of total ELV weight

Table B.1.14 Location of Landfills for Final Disposal to Cover Demands at Dismantling Stage by 2010

Nr	Coordinates (miles)		Covered Demand (Units)	Locality Name	Nr	Coordinates (miles)		Covered Demand (Units)	Locality Name	Nr	Coordinates (miles)		Covered Demand (Units)	Locality Name
	X	Y				X	Y				X	Y		
1	1,535.14	681.21	9,486	10010001	20	1,608.69	559.5	11,879	110410001	39	1,759.06	691.99	3,164	240400001
2	692.4	1,411.12	5,358	20010001	21	1,693.69	337.88	6,012	120010001	40	1,216.87	887.54	10,478	250060001
3	668.52	1,447.56	22,116	20040223	22	1,718.96	385.34	2,607	120290001	41	1,012.28	1,192.24	13,276	260300001
4	1,031.94	851.25	8,451	30030001	23	1,764.45	562.57	10,714	130480001	42	1,022.90	1,345.00	6,316	260430001
5	2,297.61	571.16	2,016	40020001	24	1,487.01	613.65	44,644	141290001	43	803.22	1,441.09	20,502	260550001
6	1,623.86	1,018.92	3,326	50020001	25	1,745.55	523.24	18,157	150330000	44	2,138.62	442.46	8,212	270100001
7	1,638.68	1,143.13	3,927	50250001	26	1,750.64	534.68	27,492	150810001	45	1,803.68	723.11	6,100	280030001
8	1,616.14	924.69	5,861	50300001	27	1,745.75	513.97	173,014	150990001	46	1,832.57	958.58	17,950	280220001
9	1,441.36	501.06	5,614	60020001	28	1,738.08	520.61	13,380	151040000	47	1,706.19	1,066.03	5,052	280270001

10	2,208.09	224.14	1,456	70890001	29	1,556.79	530.57	12,551	160240001	48	1,733.81	809.87	4,593	280410001
11	2,142.91	347.4	6,117	71010001	30	1,753.06	473.77	10,773	170060001	49	1,881.72	520.57	6,058	300380001
12	1,306.20	1,147.41	13,347	80190001	31	1,368.26	657.18	5,308	180170001	50	1,867.05	476.84	4,802	301150001
13	1,328.26	1,029.86	1,903	80320001	32	1,659.45	961.34	46,351	190450001	51	1,846.61	593.03	4,810	301310001
14	1,289.66	1,361.80	14,884	80370001	33	1,942.68	422.87	5,686	201840001	52	1,998.48	456.41	5,323	301410001
15	1,226.97	1,192.54	1,740	80480001	34	1,839.31	369.12	2,708	203970001	53	1,923.44	452.86	5,616	301740001
16	1,386.44	826.92	7,827	100050001	35	1,801.34	489.8	19,410	211140001	54	2,349.25	655.02	9,606	310500001
17	1,460.18	939.63	8,326	100070001	36	1,657.49	593.6	15,293	220140001	55	1,509.19	754.31	5,321	320050001
18	1,574.43	629.91	8,809	110200001	37	2,514.74	645.3	4,218	230080001					
19	1,594.42	589.25	7,718	110240001	38	1,618.46	700.23	9,503	240280001					
Total demand =												715,161	ELV	

Note: The covered demand refers the amount of ELV treated by facilities at dismantling stage; the material sent for final disposal can be considered a percentage of total ELV weight

Table D.1.15 Location of Landfills for Final Disposal to Cover Demands at Dismantling Stage by 2015

Nr	Coordinates (miles)		Covered Demand (Units)	Locality Name	Nr	Coordinates (miles)		Covered Demand (Units)	Locality Name	Nr	Coordinates (miles)		Covered Demand (Units)	Locality Name
	X	Y				X	Y				X	Y		
1	1,535.14	681.21	10,205	10010001	21	1,608.69	559.5	12,078	110410001	41	1,618.46	700.23	10,221	240280001
2	692.4	1,411.12	5,764	20010001	22	1,693.69	337.88	6,468	120010001	42	1,759.06	691.99	3,404	240400001
3	668.52	1,447.56	23,791	20040223	23	1,718.96	385.34	2,414	120290001	43	1,216.87	887.54	11,273	250060001
4	1,031.94	851.25	9,091	30030001	24	1,715.14	440.09	3,417	120350001	44	1,012.28	1,192.24	14,280	260300001
5	2,297.61	571.16	2,059	40020001	25	1,641.25	440.03	1,972	120500001	45	1,022.90	1,345.00	6,795	260430001
6	2,225.77	457.92	1,792	40030001	26	1,764.45	562.57	11,526	130480001	46	803.22	1,441.09	22,056	260550001
7	1,623.86	1,018.92	3,579	50020001	27	1,487.01	613.65	48,026	141290001	47	2,138.62	442.46	7,152	270100001
8	1,638.68	1,143.13	4,225	50250001	28	1,745.55	523.24	19,532	150330000	48	1,803.68	723.11	6,562	280030001
9	1,616.14	924.69	6,305	50300001	29	1,750.64	534.68	29,571	150810001	49	1,832.57	958.58	19,308	280220001
10	1,441.36	501.06	6,039	60020001	30	1,745.75	513.97	132,363	150990001	50	1,706.19	1,066.03	5,434	280270001
11	2,208.09	224.14	1,566	70890001	31	1,738.08	520.61	67,787	151040000	51	1,733.81	809.87	4,940	280410001
12	2,142.91	347.40	6,578	71010001	32	1,556.79	530.57	11,530	160240001	52	1,881.72	520.57	6,518	300380001
13	1,306.20	1,147.41	14,357	80190001	33	1,753.06	473.77	8,922	170060001	53	1,867.05	476.84	5,167	301150001
14	1,342.47	1,115.88	2,047	80210001	34	1,368.26	657.18	5,712	180170001	54	1,846.61	593.03	5,173	301310001
15	1,289.66	1,361.80	16,010	80370001	35	1,659.45	961.34	49,862	190450001	55	1,998.48	456.41	5,727	301410001
16	1,226.97	1,192.54	1,870	80480001	36	1,942.68	422.87	6,118	201840001	56	1,923.44	452.86	6,041	301740001
17	1,386.44	826.92	8,419	100050001	37	1,839.31	369.12	2,912	203970001	57	2,349.25	655.02	10,336	310500001
18	1,460.18	939.63	8,955	100070001	38	1,801.34	489.8	20,882	211140001	58	1,509.19	754.31	5,726	320050001
19	1,574.43	629.91	9,475	110200001	39	1,657.49	593.6	17,974	220140001					
20	1,594.42	589.25	7,482	110240001	40	2,514.74	645.30	4,538	230080001					
Total demand =												769,326	ELV	

Note: The covered demand refers the amount of ELV treated by facilities at dismantling stage; the material sent for final disposal can be considered a percentage of total ELV weight

Table D.1.16 Location of Landfills for Final Disposal to Cover Demands at Dismantling Stage by 2020, Scenario-A

Nr	Coordinates (miles)		Covered Demand (Units)	Locality Name	Nr	Coordinates (miles)		Covered Demand (Units)	Locality Name	Nr	Coordinates (miles)		Covered Demand (Units)	Locality Name
	X	Y				X	Y				X	Y		
1	1,535.14	681.21	13,596	10010001	23	1,693.69	337.88	8,617	120010001	45	2,514.74	645.30	6,047	230080001
2	692.4	1,411.12	7,680	20010001	24	1,718.96	385.34	3,215	120290001	46	1,639.34	802.31	1,252	240200001
3	668.52	1,447.56	31,698	20040223	25	1,715.14	440.09	4,553	120350001	47	1,618.46	700.23	13,539	240280001
4	1,031.94	851.25	12,112	30030001	26	1,641.25	440.03	2,627	120500001	48	1,759.06	691.99	4,534	240400001
5	2,297.61	571.16	2,744	40020001	27	1,764.45	562.57	16,220	130480001	49	1,216.87	887.54	15,019	250060001
6	2,225.77	457.92	2,387	40030001	28	1,343.92	547.53	2,192	141000001	50	1,106.08	1,341.15	1,601	260020001
7	1,623.86	1,018.92	4,770	50020001	29	1,487.01	613.65	63,988	141290001	51	1,012.28	1,192.24	18,943	260300001
8	1,638.68	1,143.13	5,629	50250001	30	1,745.55	523.24	26,023	50330000	52	1,022.90	1,345.00	8,400	260430001
9	1,616.14	924.69	8,401	50300001	31	1,750.64	534.68	39,171	150810001	53	803.22	1,441.09	28,522	260550001
10	1,441.36	501.06	7,986	60020001	32	1,745.75	513.97	176,430	150990001	54	2,138.62	442.46	9,525	270100001
11	2,208.09	224.14	2,087	70890001	33	1,738.08	520.61	87,483	151040000	55	1,803.68	723.11	8,743	280030001
12	2,142.91	347.40	8,763	71010001	34	1,556.79	530.57	15,361	160240001	56	1,832.57	958.58	25,725	280220001
13	1,306.20	1,147.41	16,068	80190001	35	1,753.06	473.77	11,886	170060001	57	1,706.19	1,066.03	7,240	280270001
14	1,342.47	1,115.88	3,592	80210001	36	1,368.26	657.18	5,475	180170001	58	1,733.81	809.87	5,410	280410001
15	1,328.26	1,029.86	2,196	80320001	37	1,659.45	961.34	66,435	190450001	59	1,881.72	520.57	8,681	300380001
16	1,289.66	1,361.80	21,331	80370001	38	1,903.82	322.71	1,745	200280001	60	1,867.05	476.84	6,882	301150001
17	1,226.97	1,192.54	2,492	80480001	39	1,942.68	422.87	8,151	201840001	61	1,846.61	593.03	6,892	301310001
18	1,386.44	826.92	11,215	100050001	40	1,845.61	397.00	2,814	205400001	62	1,998.48	456.41	7,192	301410001
19	1,460.18	939.63	11,933	100070001	41	1,801.34	489.80	27,579	211140001	63	1,923.44	452.86	8,049	301740001
20	1,574.43	629.91	12,625	110200001	42	1,675.40	561.72	3,968	220010001	64	2,349.25	655.02	13,769	310500001
21	1,594.42	589.25	9,967	110240001	43	1,654.34	589.22	7,392	220060001	65	1,509.19	754.31	7,628	320050001
22	1,608.69	559.5	15,308	110410001	44	1,657.49	593.60	15,495	220140001					
Total demand =													1,024,993	ELV

Note: The covered demand refers the amount of ELV treated by facilities at dismantling stage; the material sent for final disposal can be considered a percentage of total ELV weight

Table D.1.17 Location of Landfills for Final Disposal to Cover Demands at Dismantling Stage by 2020- Scenario-B

Nr	Coordinates (miles)		Covered Demand (Units)	Locality Name	Nr	Coordinates (miles)		Covered Demand (Units)	Locality Name	Nr	Coordinates (miles)		Covered Demand (Units)	Locality Name
	X	Y				X	Y				X	Y		
1	1,535.14	681.21	13,040	10010001	23	1,693.69	337.88	8,266	120010001	45	2,514.74	645.30	5,799	230080001
2	692.4	1,411.12	7,366	20010001	24	1,718.96	385.34	3,084	120290001	46	1,639.34	802.31	1,202	240200001
3	668.52	1,447.56	30,402	20040223	25	1,715.14	440.09	4,368	120350001	47	1,618.46	700.23	12,987	240280001
4	1,031.94	851.25	11,617	30030001	26	1,641.25	440.03	2,520	120500001	48	1,759.06	691.99	4,349	240400001
5	2,297.61	571.16	2,632	40020001	27	1,764.45	562.57	15,556	130480001	49	1,216.87	887.54	14,406	250060001
6	2,225.77	457.92	2,289	40030001	28	1,343.92	547.53	2,104	141000001	50	1,106.08	1,341.15	1,535	260020001
7	1,623.86	1,018.92	4,574	50020001	29	1,487.01	613.65	61,369	141290001	51	1,012.28	1,192.24	18,169	260300001
8	1,638.68	1,143.13	5,400	50250001	30	1,745.55	523.24	24,958	50330000	52	1,022.90	1,345.00	8,056	260430001
9	1,616.14	924.69	8,057	50300001	31	1,750.64	534.68	37,569	150810001	53	803.22	1,441.09	27,356	260550001

10	1,441.36	501.06	7,660	60020001	32	1,745.75	513.97	169,219	150990001	54	2,138.62	442.46	9,134	270100001
11	2,208.09	224.14	2,001	70890001	33	1,738.08	520.61	83,907	151040000	55	1,803.68	723.11	8,385	280030001
12	2,142.91	347.40	8,404	71010001	34	1,556.79	530.57	14,734	160240001	56	1,832.57	958.58	24,674	280220001
13	1,306.20	1,147.41	15,411	80190001	35	1,753.06	473.77	11,401	170060001	57	1,706.19	1,066.03	6,944	280270001
14	1,342.47	1,115.88	3,445	80210001	36	1,368.26	657.18	5,252	180170001	58	1,733.81	809.87	5,188	280410001
15	1,328.26	1,029.86	2,108	80320001	37	1,659.45	961.34	63,715	190450001	59	1,881.72	520.57	8,326	300380001
16	1,289.66	1,361.80	20,460	80370001	38	1,903.82	322.71	1,673	200280001	60	1,867.05	476.84	6,603	301150001
17	1,226.97	1,192.54	2,391	80480001	39	1,942.68	422.87	7,819	201840001	61	1,846.61	593.03	6,610	301310001
18	1,386.44	826.92	10,756	100050001	40	1,845.61	397.00	2,701	205400001	62	1,998.48	456.41	6,898	301410001
19	1,460.18	939.63	11,444	100070001	41	1,801.34	489.80	26,453	211140001	63	1,923.44	452.86	7,720	301740001
20	1,574.43	629.91	12,110	110200001	42	1,675.40	561.72	3,805	220010001	64	2,349.25	655.02	13,205	310500001
21	1,594.42	589.25	9,561	110240001	43	1,654.34	589.22	7,092	220060001	65	1,509.19	754.31	7,315	320050001
22	1,608.69	559.5	14,683	110410001	44	1,657.49	593.60	14,862	220140001					
Total demand =													983,100	ELV

Note: The covered demand refers the amount of ELV treated by facilities at dismantling stage; the material sent for final disposal can be considered a percentage of total ELV weight

Table D.1.18 Location of Landfills for Final Disposal to Cover Demands at Dismantling Stage by 2025, Scenario-A

Nr	Coordinates (miles)		Covered Demand (Units)	Locality Name	Nr	Coordinates (miles)		Covered Demand (Units)	Locality Name	Nr	Coordinates (miles)		Covered Demand (Units)	Locality Name
	X	Y				X	Y				X	Y		
1	1,535.14	681.21	17,398	10010001	25	1,693.69	337.88	11,586	120010001	49	1,683.18	579.62	4,694	220160001
2	692.4	1,411.12	10,325	20010001	26	1,718.96	385.34	4,323	120290001	50	2,514.74	645.30	8,128	230080001
3	668.52	1,447.56	42,617	20040223	27	1,715.14	440.09	6,123	120350001	51	1,639.34	802.31	1,685	240200001
4	1,031.94	851.25	16,284	30030001	28	1,641.25	440.03	3,533	120500001	52	1,618.46	700.23	18,202	240280001
5	2,297.61	571.16	3,691	40020001	29	1,764.45	562.57	16,510	130480001	53	1,759.06	691.99	6,097	240400001
6	2,225.77	457.92	3,209	40030001	30	1,725.75	619.56	4,130	130760001	54	1,216.87	887.54	20,134	250060001
7	1,623.86	1,018.92	4,880	50020001	31	1,343.92	547.53	2,948	141000001	55	1,106.08	1,341.15	2,152	260020001
8	1,583.36	1,092.27	2,232	50200001	32	1,487.01	613.65	90,707	141290001	56	1,012.28	1,192.24	25,527	260300001
9	1,638.68	1,143.13	6,868	50250001	33	1,745.55	523.24	34,989	150330000	57	1,022.90	1,345.00	9,920	260430001
10	1,616.14	924.69	11,295	50300001	34	1,750.64	534.68	52,162	150810001	58	869.32	1,356.64	1,373	260480001
11	1,441.36	501.06	10,736	60020001	35	1,745.75	513.97	237,208	150990001	59	803.22	1,441.09	38,347	260550001
12	2,208.09	224.14	2,805	70890001	36	1,738.08	520.61	114,508	151040000	60	2,138.62	442.46	12,806	270100001
13	2,142.91	347.40	11,785	71010001	37	1,556.79	530.57	17,702	160240001	61	1,803.68	723.11	11,755	280030001
14	1,257.94	1,133.25	2,441	80170001	38	1,753.06	473.77	15,981	170060001	62	1,832.57	958.58	34,342	280220001
15	1,306.20	1,147.41	19,493	80190001	39	1,368.26	657.18	7,363	180170001	63	1,706.19	1,066.03	9,735	280270001
16	1,342.47	1,115.88	4,830	80210001	40	1,659.45	961.34	89,616	190450001	64	1,733.81	809.87	7,219	280410001
17	1,328.26	1,029.86	2,954	80320001	41	1,903.82	322.71	2,346	200280001	65	1,881.72	520.57	8,791	300380001
18	1,289.66	1,361.80	28,680	80370001	42	1,942.68	422.87	10,959	201840001	66	1,867.05	476.84	9,254	301,150,001
19	1,226.97	1,192.54	3,019	80480001	43	1,845.61	397.00	3,785	205400001	67	1,846.61	593.03	8,084	301310001
20	1,386.44	826.92	15,078	100050001	44	1,801.34	489.80	36,972	211140001	68	1,998.48	456.41	9,671	301410001
21	1,460.18	939.63	16,043	100070001	45	1,842.34	540.95	4,496	212110001	69	1,923.44	452.86	10,822	301740001
22	1,574.43	629.91	16,132	110200001	46	1,675.40	561.72	8,946	220010001	70	2,349.25	655.02	18,512	310500001
23	1,594.42	589.25	13,399	110240001	47	1,654.34	589.22	9,940	220060001	71	1,509.19	754.31	10,253	320050001

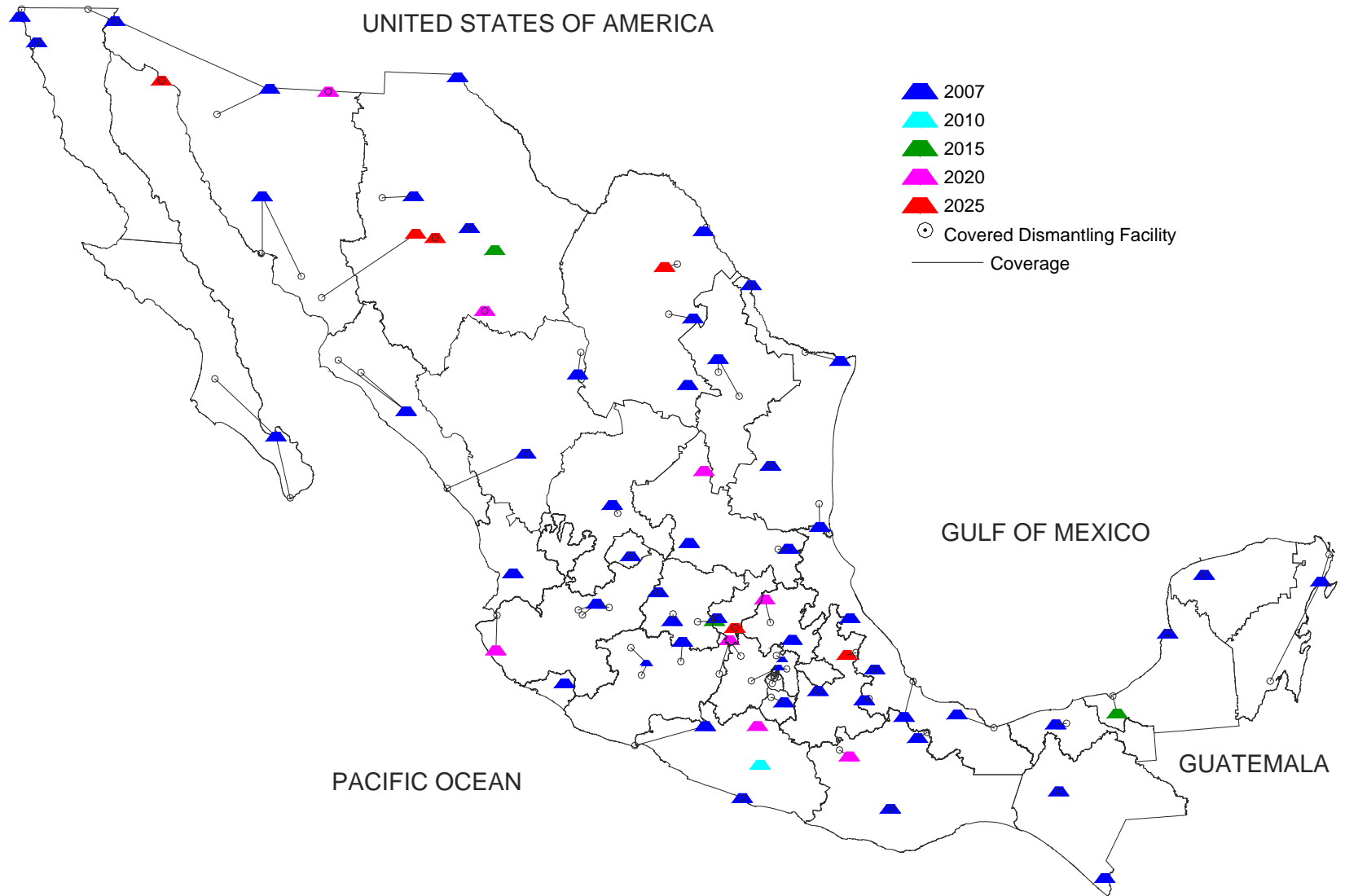

Figure D.5 Graphic Location of Landfills to Cover Demands at Dismantling Stage, Scenario-1

Table D.1.20 Location of Landfills for Final Disposal to Cover Demands at Shredder Stage by 2010 to 2015

Nr	Coordinates (miles)		Covered Demand (Units)	Covered Demand (Units)	Locality Name	Nr	Coordinates (miles)		Covered Demand (Units)	Locality Name
	X	Y	2007	2010			2015			
1	1,535.15	681.21	31,841	33,119	10010001	1	1,535.14	681.21	35,627	10010001
2	668.52	1,447.56	26,415	27,474	20040223	2	668.52	1,447.56	29,555	20040223
3	1,031.94	851.25	8,125	8,451	30030001	3	1,031.94	851.25	9,091	30030001
4	1,306.20	1,147.41	16,334	16,990	80190001	4	1,306.20	1,147.41	18,274	80190001
5	1,289.66	1,361.80	14,310	14,884	80370001	5	1,289.66	1,361.80	16,010	80370001
6	1,460.18	939.63	13,055	13,584	100070001	6	1,460.18	939.63	14,611	100070001
7	1,608.69	559.51	23,491	24,430	110410001	7	1,608.69	559.50	25,580	110410001
8	1,693.69	337.88	7,938	8,619	120010001	8	1,693.69	337.88	8,882	120010001
9	1,487.01	613.65	53,427	55,566	141290001	9	1,487.01	613.65	59,777	141290001
10	1,738.08	520.61	244,101	253,530	151040000	10	1,738.08	520.61	273,118	151040000
11	1,659.45	961.34	57,174	59,465	190450001	11	1,659.45	961.34	59,746	190450001
12	1,801.34	489.80	21,268	22,118	211140001	12	1,801.34	489.80	23,794	211140001
13	1,657.49	593.60	22,123	23,011	220140001	13	1,654.34	589.22	25,456	220060001
14	1,216.87	887.54	12,544	13,047	250060001	14	1,216.87	887.54	14,036	250060001
15	1,012.28	1,192.24	18,836	19,592	260300001	15	1,012.28	1,192.24	14,280	260300001
16	803.22	1,441.09	19,712	20,502	260550001	16	1,022.90	1,345.00	6,795	260430001
17	2,138.62	442.46	20,288	21,108	270100001	17	803.22	1,441.09	22,056	260550001
18	1,803.68	723.11	13,325	13,857	280030001	18	2,138.62	442.46	22,815	270100001
19	1,832.57	958.58	22,113	23,002	280220001	19	1,803.68	723.11	14,906	280030001
20	1,881.72	520.57	25,931	26,972	300380001	20	1,832.57	958.58	19,308	280220001
21	2,349.25	655.02	15,238	15,840	310500001	21	1,706.19	1,066.03	9,659	280270001
						22	1,881.72	520.57	29,017	300380001
						23	2,349.25	655.02	16,933	310500001
Total demand of			687,589	715,161	ELV	Total demand of			769,326	ELV

Note: The covered demand refers the amount of ELV treated by facilities at dismantling stage; the material sent for final disposal can be considered a percentage of total ELV weight

Table D.1.21 Location of Landfills for Final Disposal to Cover Demands at Shredder Stage by 2020, Scenarios A & B

Scenario - A					Scenario - B				
Nr	Coordinates (miles)		Covered Demand (Units)	Locality Name	Nr	Coordinates (miles)		Covered Demand (Units)	Locality Name
	X	Y				X	Y		
1	1,535.14	681.21	21224	10010001	1	1,535.14	681.21	32,465	10010001
2	668.52	1,447.56	39378	20040223	2	668.52	1,447.56	37,768	20040223
3	1,031.94	851.25	12112	30030001	3	1,031.94	851.25	11,617	30030001
4	2,142.91	347.4	10850	71010001	4	1,306.20	1,147.41	23,355	80190001
5	1,306.20	1,147.41	24348	80190001	5	1,289.66	1,361.80	20,460	80370001
6	1,289.66	1,361.80	21331	80370001	6	1,460.18	939.63	18,669	100070001
7	1,460.18	939.63	19466	100070001	7	1,608.69	559.50	35,742	110410001
8	1,574.43	629.91	22592	110200001	8	1,693.69	337.88	11,350	120010001
9	1,608.69	559.5	37264	110410001	9	1,487.01	613.65	76,385	141290001
10	1,693.69	337.88	11832	120010001	10	1,738.08	520.61	346,978	151040000
11	1,487.01	613.65	79641	141290001	11	1,659.45	961.34	76,346	190450001
12	1,738.08	520.61	361766	151040000	12	1,942.68	422.87	16,390	201840001
13	1,659.45	961.34	79606	190450001	13	1,801.34	489.80	29,154	211140001
14	1,942.68	422.87	17088	201840001	14	1,654.34	589.22	31,515	220060001
15	1,801.34	489.80	30393	211140001	15	1,618.46	700.23	14,189	240280001
16	1,657.49	593.6	22887	220140001	16	1,216.87	887.54	17,937	250060001
17	1,618.46	700.23	14791	240280001	17	1,012.28	1,192.24	18,169	260300001
18	1,216.87	887.54	18701	250060001	18	1,022.90	1,345.00	9,591	260430001
19	1,012.28	1,192.24	18943	260300001	19	803.22	1,441.09	27,356	260550001
20	1,022.90	1,345.00	10001	260430001	20	2,138.62	442.46	21,828	270100001
21	803.22	1,441.09	28522	260550001	21	1,803.68	723.11	17,922	280030001
22	2,138.62	442.46	11912	270100001	22	1,832.57	958.58	24,674	280220001
23	1,803.68	723.11	18687	280030001	23	1,706.19	1,066.03	12,344	280270001
24	1,832.57	958.58	25725	280220001	24	1,881.72	520.57	29,259	300380001
25	1,706.19	1,066.03	12869	280270001	25	2,349.25	655.02	21,636	310500001
26	1881.720	520.570	30504	300380001					
27	2349.250	655.020	22560	310500001					
Total demand of			1,024,993	ELV	Total demand of			983,100	ELV

Note: The covered demand refers the amount of ELV treated by facilities at dismantling stage; the material sent for final disposal can be considered a percentage of total ELV weight

Table D.1.22 Location of Landfills for Final Disposal to Cover Demands at Shredder Stage by 2025, Scenarios A & B

Scenario - A					Scenario - B				
Nr	Coordinates (miles)		Covered Demand (Units)	Locality Name	Nr	Coordinates (miles)		Covered Demand (Units)	Locality Name
	X	Y				X	Y		
1	1535.15	681.21	27,651	10010001	1	1535.15	681.21	22,890	10010001
2	668.52	1447.56	52,942	20040223	2	668.52	1447.56	43,823	20040223
3	1031.94	851.25	16,284	30030001	3	1031.94	851.25	13,479	30030001
4	1441.36	501.06	14,269	60020001	4	2142.91	347.40	12,079	71010001
5	2142.91	347.40	14,590	71010001	5	1306.20	1147.41	27,099	80190001
6	1306.20	1147.41	32,737	80190001	6	1289.66	1361.80	23,740	80370001
7	1289.66	1361.80	28,680	80370001	7	1386.44	826.92	12,481	100050001
8	1386.44	826.92	15,078	100050001	8	1460.18	939.63	13,280	100070001
9	1460.18	939.63	16,043	100070001	9	1574.44	629.91	24,445	110200001
10	1574.44	629.91	29,531	110200001	10	1608.69	559.51	39,024	110410001
11	1608.69	559.51	43,301	110410001	11	1693.69	337.88	13,169	120010001
12	1693.69	337.88	15,909	120010001	12	1487.01	613.65	92,505	141290001
13	1487.01	613.65	90,707	141290001	13	1738.08	520.61	402,583	151040000
14	1738.08	520.61	485,539	151040000	14	1659.45	961.34	87,316	190450001
15	1368.26	657.19	10,311	180170001	15	1942.68	422.87	19,017	201840001
16	1659.45	961.34	105,791	190450001	16	1801.34	489.80	33,825	211140001
17	1942.68	422.87	22,976	201840001	17	1657.49	593.60	25,470	220140001
18	1801.34	489.80	40,757	211140001	18	1618.46	700.23	16,462	240280001
19	1657.49	593.60	31,619	220140001	19	1216.87	887.54	16,714	250060001
20	2514.74	645.30	6,444	230080001	20	1012.28	1192.24	21,081	260300001
21	1618.46	700.23	19,887	240280001	21	1022.90	1345.00	11,131	260430001
22	1216.87	887.54	20,134	250060001	22	803.22	1441.09	31,741	260550001
23	1012.28	1192.24	25,527	260300001	23	2138.62	442.46	13,256	270100001
24	1022.90	1345.00	12,072	260430001	24	1803.68	723.11	20,800	280030001
25	803.22	1441.09	39,720	260550001	25	1832.57	958.58	28,630	280220001
26	2138.62	442.46	16,015	270100001	26	1706.19	1066.03	15,589	280270001
27	1803.68	723.11	25,071	280030001	27	1881.72	520.57	33,951	300380001
28	1832.57	958.58	34,342	280220001	28	2349.25	655.02	25,106	310500001
29	1706.19	1066.03	18,835	280270001					
30	1881.72	520.57	41,447	300380001					
31	2349.25	655.02	23,887	310500001					
Total demand of			1,378,096	ELV	Total demand of			1,140,680	ELV

Note: The covered demand refers the amount of ELV treated by facilities at dismantling stage; the material sent for final disposal can be considered a percentage of total ELV weight

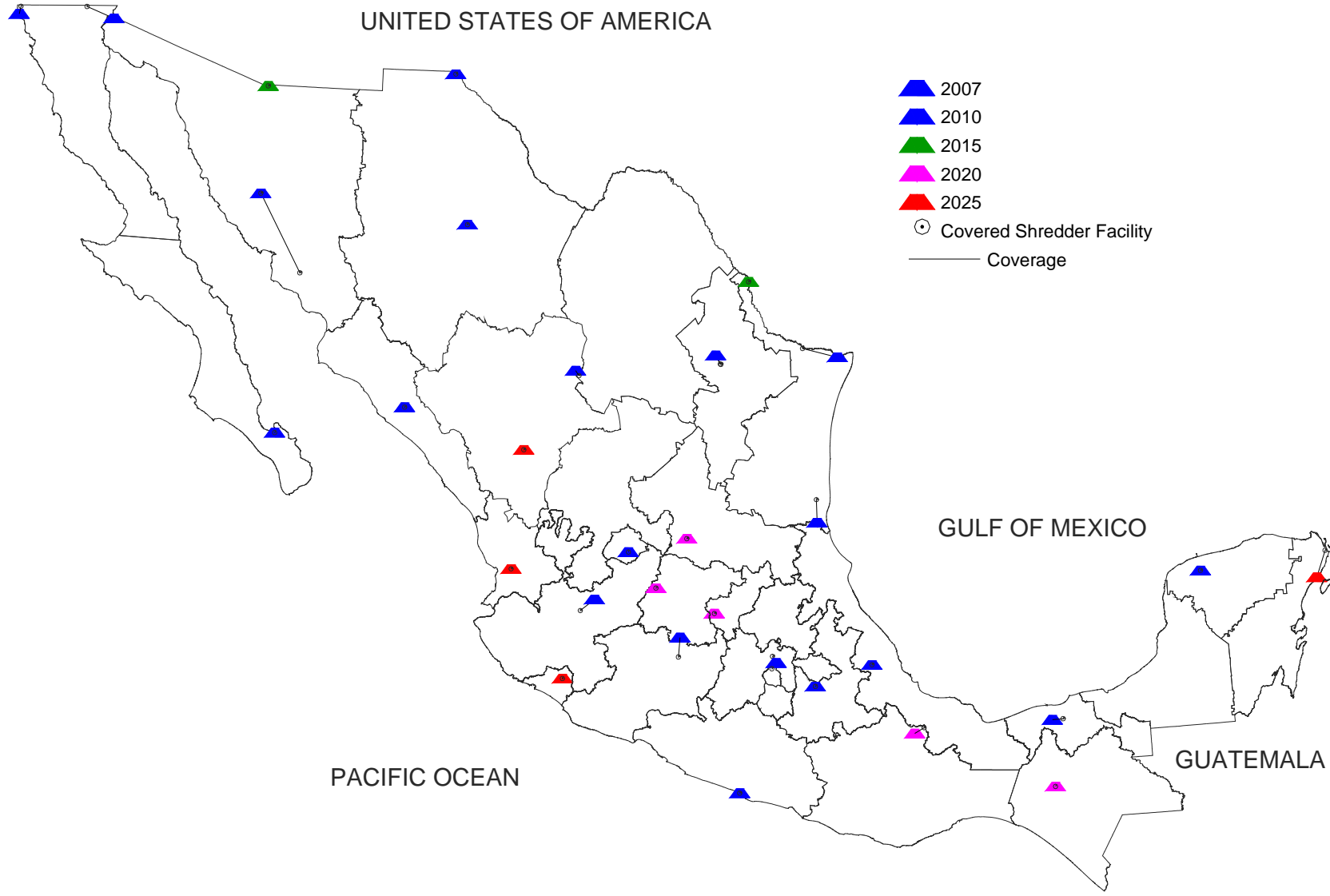

Figure D.6 Graphic Location of Landfills to Cover Demands at Shredder Stage, Scenario-1

Implementation of End-of-Life Vehicle's Recycling for Developing Countries: Case Study, Mexico

Table D.1.23 Location of Landfills for Final Disposal to Cover Demands at Melting Stage by 2007 to 2015

Nr	Coordinates (miles)		Covered Demand (Units)	Covered Demand (Units)	Locality Name	Nr	Coordinates (miles)		Covered Demand (Units)	Locality Name
	X	Y	2007	2010			X	Y	2015	
1	668.52	1447.56	26,415	27,474	20040223	1	668.52	1447.56	29,555	20040223
2	1616.14	924.69	13,055	13,584	50300001	2	1623.86	1018.92	9,659	50020001
3	1594.43	589.26	45,614	47,441	110240001	3	1616.14	924.69	14,611	50300001
4	1487.01	613.65	53,427	55,566	141290001	4	1594.42	589.25	51,036	110240001
5	1738.08	520.61	252,039	262,149	151040000	5	1487.01	613.65	59,777	141290001
6	1659.45	961.34	79,287	82,467	190450001	6	1738.08	520.61	282,000	151040000
7	1801.34	489.80	21,268	22,118	211140001	7	1659.45	961.34	79,054	190450001
8	1618.46	700.23	45,166	46,976	240280001	8	1801.34	489.80	23,794	211140001
9	803.22	1441.09	19,712	20,502	260550001	9	1618.46	700.23	50,533	240280001
10	1960.46	449.01	20,288	21,108	300450001	10	803.22	1441.09	28,851	260550001
11	1867.05	476.84	25,931	26,972	301150001	11	1960.46	449.01	22,815	300450001
12	2349.25	655.02	15,238	15,840	310500001	12	1867.05	476.84	29,017	301150001
13						13	2349.25	655.02	16,933	310500001
Total demand of			617,440	642,197	ELV	Total demand of			769,326	ELV

Note: The covered demand refers the amount of ELV treated by facilities at dismantling stage; the material sent for final disposal can be considered a percentage of total ELV weight

Table D.1.24 Location of Landfills for Final Disposal to Cover Demands at Melting Stage by 2020 & 2025

Nr	Coordinates (miles)		Covered Demand (Units)				Company Name
	X	Y	2020		2025		
			A	B	A	B	
1	668.52	1,447.56	39,378	37,768	52,942	43,823	20040223
2	1,623.86	1,018.92	12,869	12,344	18,835	15,589	50020001
3	1,616.14	924.69	19,466	18,669	16,043	13,280	50300001
4	1,594.42	589.25	82,743	67,257	104,451	88,939	110240001
5	1,487.01	613.65	79,641	76,385	130,365	104,986	141290001
6	1,738.08	520.61	373,598	358,328	501,448	415,752	151040000
7	1,659.45	961.34	105,331	101,020	140,133	115,946	190450001
8	1,801.34	489.8	30,393	29,154	40,757	33,825	211140001
9	1,618.46	700.23	54,702	64,576	72,609	60,152	240280001
10	803.22	1,441.09	38,523	36,947	51,792	42,872	260550001
11	1,960.46	449.01	39,850	38,218	53,581	44,352	300450001
12	1,867.05	476.84	30,504	29,259	41,447	33,951	301150001
13	2,349.25	655.02	22,560	21,636	30,331	25,106	310500001
Total demand =			929,558	891,561	1,254,734	1,038,573	ELV

Note: The covered demand refers the amount of ELV treated by facilities at dismantling stage; the material sent for final disposal can be considered a percentage of total ELV weight

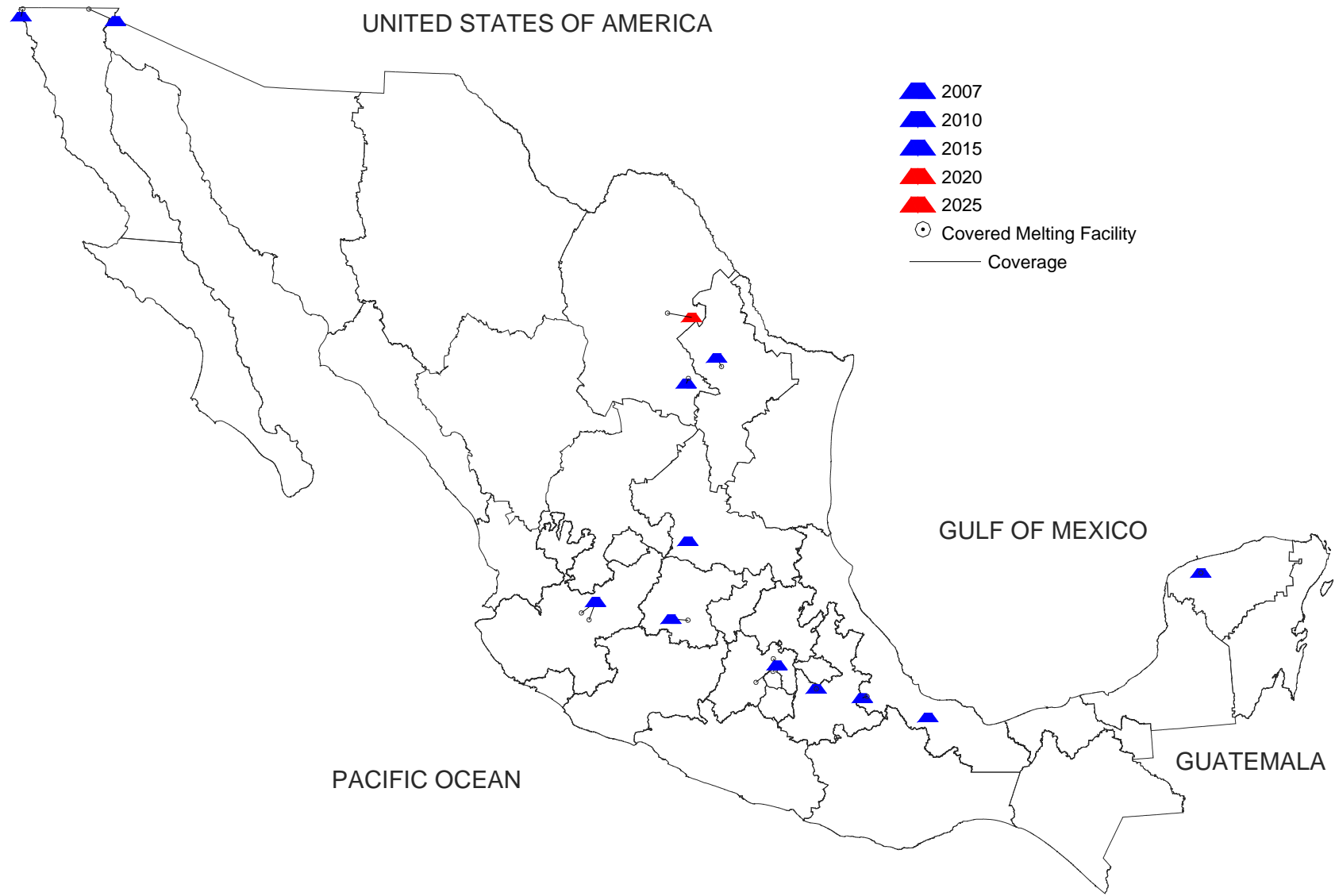

Figure D.7 Graphic Location of Landfills to Cover Demands at Melting Stage, Scenario-1

Table D.1.25 Location of Landfills for Final Disposal to Cover Demands at Energy Recovery Stage by 2007 to 2015

Nr	Coordinates (miles)		Covered Demand (Units)	Covered Demand (Units)	Covered Demand (Units)	Locality Name
	X	Y	2007	2010	2015	
1	692.40	1,411.12	46,127	47,976	51,611	20010001
2	1,289.66	1,361.80	30,644	31,874	34,284	80370001
3	1,460.18	939.63	25,599	26,631	28,647	100070001
4	1,693.69	337.88	7,938	8,619	8,882	120010001
5	1,695.05	579.24	45,614	47,441	51,036	130290029
6	1,726.16	547.02	244,101	253,530	273,118	130630001
7	1,487.01	613.65	85,268	88,685	95,404	141290001
8	1,738.29	459.06	21,268	22,118	23,794	170060001
9	1,659.45	961.34	79,287	82,467	88,713	190450001
10	1,759.06	691.99	13,325	13,857	14,906	240400001
11	1,012.28	1,192.24	18,836	19,592	21,075	260300001
12	2,156.41	414.66	20,288	21,108	22,815	270090001
13	1,867.05	476.84	25,931	26,972	29,017	301150001
14	2,349.25	655.02	15,238	15,840	16,933	310500001
Total demand of			679,464	706,710	760,235	ELV

Note: The covered demand refers the amount of ELV treated by facilities at dismantling stage; the material sent for final disposal can be considered a percentage of total ELV weight

Table D.1.26 Location of Landfills for Final Disposal to Cover Demands at Energy Recovery Stage by 2020 & 2025

Nr	Coordinates (miles)		Covered Demand (Units)				Locality Name
	X	Y	2020		2025		
			A	B	A	B	
1	692.40	1,411.12	67,900	65,124	92,662	75,564	20010001
2	1,289.66	1,361.80	45,679	43,815	61,417	50,839	80370001
3	1,460.18	939.63	38,167	36,606	51,255	42,475	100070001
4	1,693.69	337.88	11,832	11,350	15,909	13,169	120010001
5	1,695.05	579.24	60,151	67,257	74,920	64,494	130290029
6	1,726.16	547.02	361,766	346,978	485,539	402,583	130630001
7	1,487.01	613.65	123,457	108,850	158,200	139,840	141290001
8	1,738.29	459.06	30,393	29,154	40,757	33,825	170120001
9	1,659.45	961.34	118,200	113,364	158,968	131,535	190450001
10	1,759.06	691.99	33,478	32,111	44,958	37,262	240400001
11	1,012.28	1,192.24	28,944	27,760	37,599	32,212	260300001
12	2,156.41	414.66	22,762	21,828	30,605	25,335	270090001
13	1,867.05	476.84	47,592	45,649	64,423	52,968	301150001
14	2,349.25	655.02	22,560	21,636	30,331	25,106	310500001
15					14,269		60010001
Total demand =			1,012,881	971,482	1,361,812	1,127,207	ELV

Note: The covered demand refers the amount of ELV treated by facilities at dismantling stage; the material sent for final disposal can be considered a percentage of total ELV weight

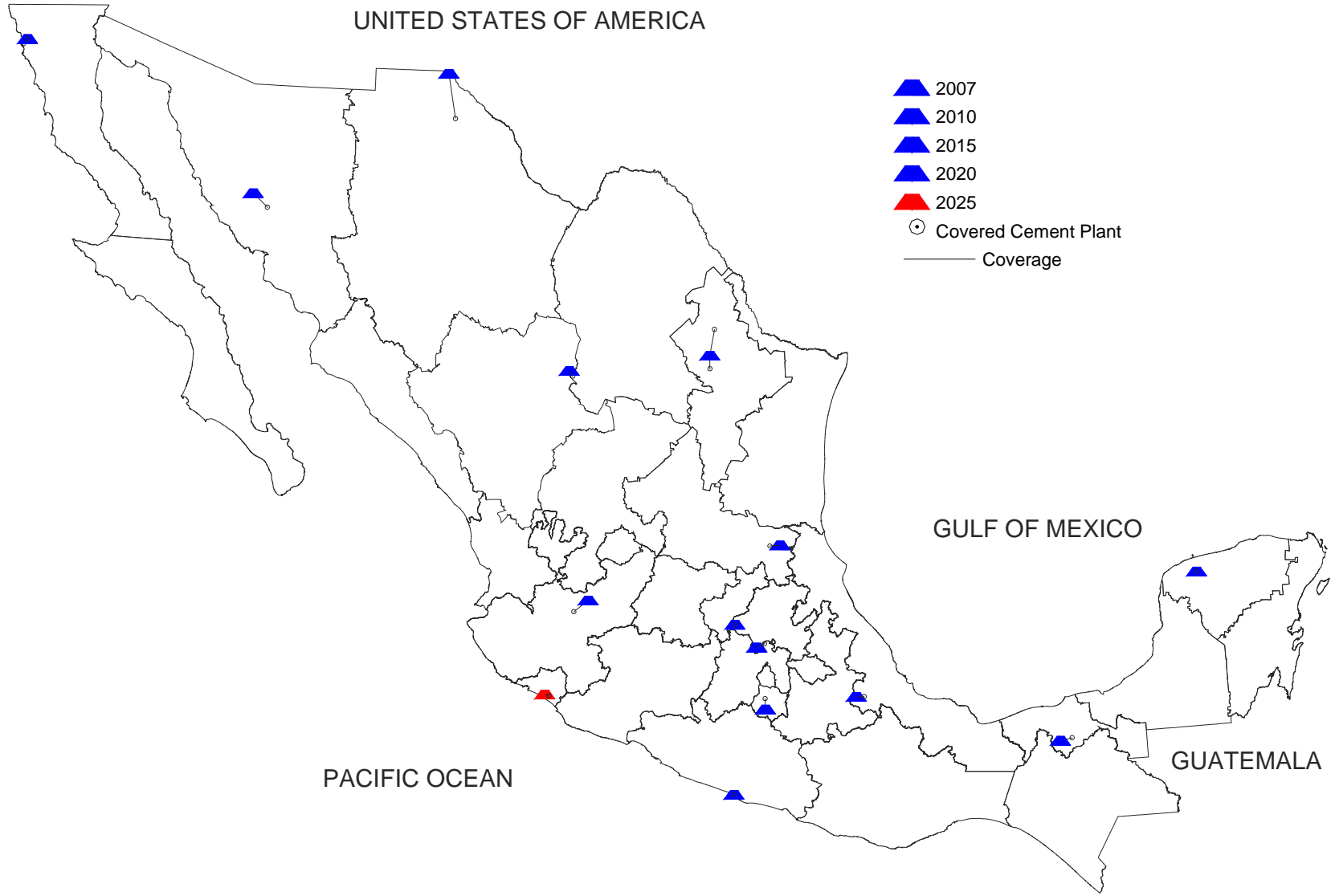

Figure D.8 Graphic Location of Landfills to Cover Demands at Energy Recovery Stage, Scenario- 1

D.2 Scenario-2

Dismantling Stage (Last Owners – Collection Points)

Table D.2.1 Location of Collection Points at Dismantling Stage by 2007 to 2025

Nr	Coordinates (miles)		Covered Demand (Units)	Covered Demand (Units)	Covered Demand (Units)	Covered Demand (Units)				Locality Name
	X	Y	2007	2010	2015	2020		2025		
						A	B	A	B	
1	694.92	1459.61	45,548	47,374	50,963	67,900	65,124	91,289	75,564	020030001
2	2136.14	423.85	18,405	19,148	20,599	27,441	26,317	36,896	30,542	070740001
3	1306.20	1147.41	15,491	16,115	17,332	23,093	22,151	31,049	25,702	080190001
4	1289.66	1361.79	14,854	15,450	16,618	22,143	21,238	29,770	24,642	080370001
5	1739.50	515.04	264,005	274,597	295,388	393,567	377,477	529,144	437,970	09015
6	1618.74	596.53	55,400	57,622	61,948	82,584	79,212	111,032	91,904	110350001
7	1466.72	597.90	68,212	70,944	76,320	101,682	97,527	136,709	113,162	140390001
8	1659.72	942.79	52,963	55,085	59,258	78,956	75,721	106,149	87,861	190390001
9	1216.87	887.54	12,304	12,797	13,766	18,344	17,593	24,660	20,412	250060001
10	1012.28	1192.24	11,938	12,417	13,355	17,796	17,068	23,927	19,806	260300001
11	1782.96	971.02	22,008	22,894	24,625	32,812	31,469	44,114	36,515	280320001
12	1881.87	499.70	27,740	28,848	31,040	41,349	39,661	55,597	46,019	300710001
13	2349.25	655.02	11,264	11,718	12,607	16,796	16,108	22,582	18,692	310500001
Total demand of			620,132	645,009	693819	924,463	886,666	1,242,918	1,028,791	ELV

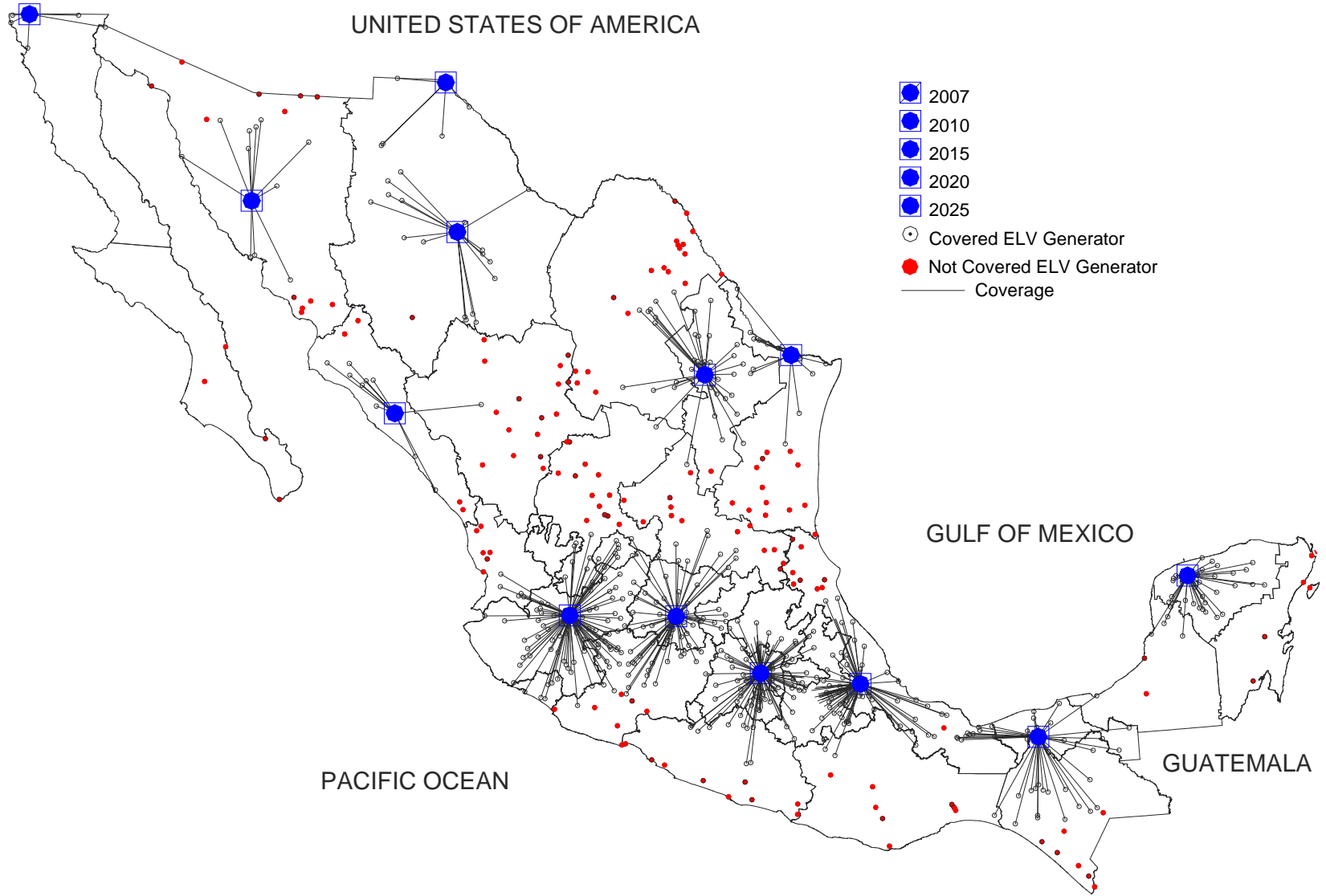

Figure D.9 Graphic Location of Collection Points at Dismantling Stage, Scenario- 2

Implementation of End-of-Life Vehicle's Recycling for Developing Countries: Case Study, Mexico

Shredder Stage (Collection Points – Shredder Facilities)

Table D.2.2 Location of Facilities at Shredder Stage by 2007 to 2025

Nr	Coordinates (miles)		Covered Demand (Units)	Covered Demand (Units)	Covered Demand (Units)	Covered Demand (Units)				Locality Name
	X	Y	2007	2010	2015	2020		2025		
						A	B	A	B	
1	694.92	1459.61	45,548	47,374	50,963	67,900	65,124	91,289	75,564	020030001
2	2136.14	423.85	18,405	19,148	20,599	27,441	26,317	36,896	30,542	070740001
3	1306.20	1147.41	15,491	16,115	17,332	23,093	22,151	31,049	25,702	080190001
4	1618.74	596.53	55,400	57,622	61,948	82,584	79,212	111,032	91,904	110350001
5	1466.72	597.90	68,212	70,944	76,320	101,682	97,527	136,709	113,162	140390001
6	1216.87	887.54	12,304	12,797	13,766	18,344	17,593	24,660	20,412	250060001
7	1012.28	1192.24	11,938	12,417	13,355	17,796	17,068	23,927	19,806	260300001
8	1782.96	971.02	22,008	22,894	24,625	32,812	31,469	44,114	36,515	280320001
9	1881.87	499.70	27,740	28,848	31,040	41,349	39,661	55,597	46,019	300710001
10	2349.25	655.02	11,264	11,718	12,607	16,796	16,108	22,582	19,692	310500001
11	1289.66	1361.79	14,854	15,450	16,618	22,143	21,238	29,770	24,642	ECOREC
12	1740.18	532.55	264,005	274,597	295,388	393,567	377,477	529,144	437,970	CFF
13	1666.84	948.49	52,963	55,085	59,258	78,956	75,721	106,149	87,861	IRASA
14	1665.90	948.92	0	0	0	0	0	0	0	PROME
Total demand of			620,132	645,009	693,819	924,463	886,666	1,242,918	1,029,791	ELV

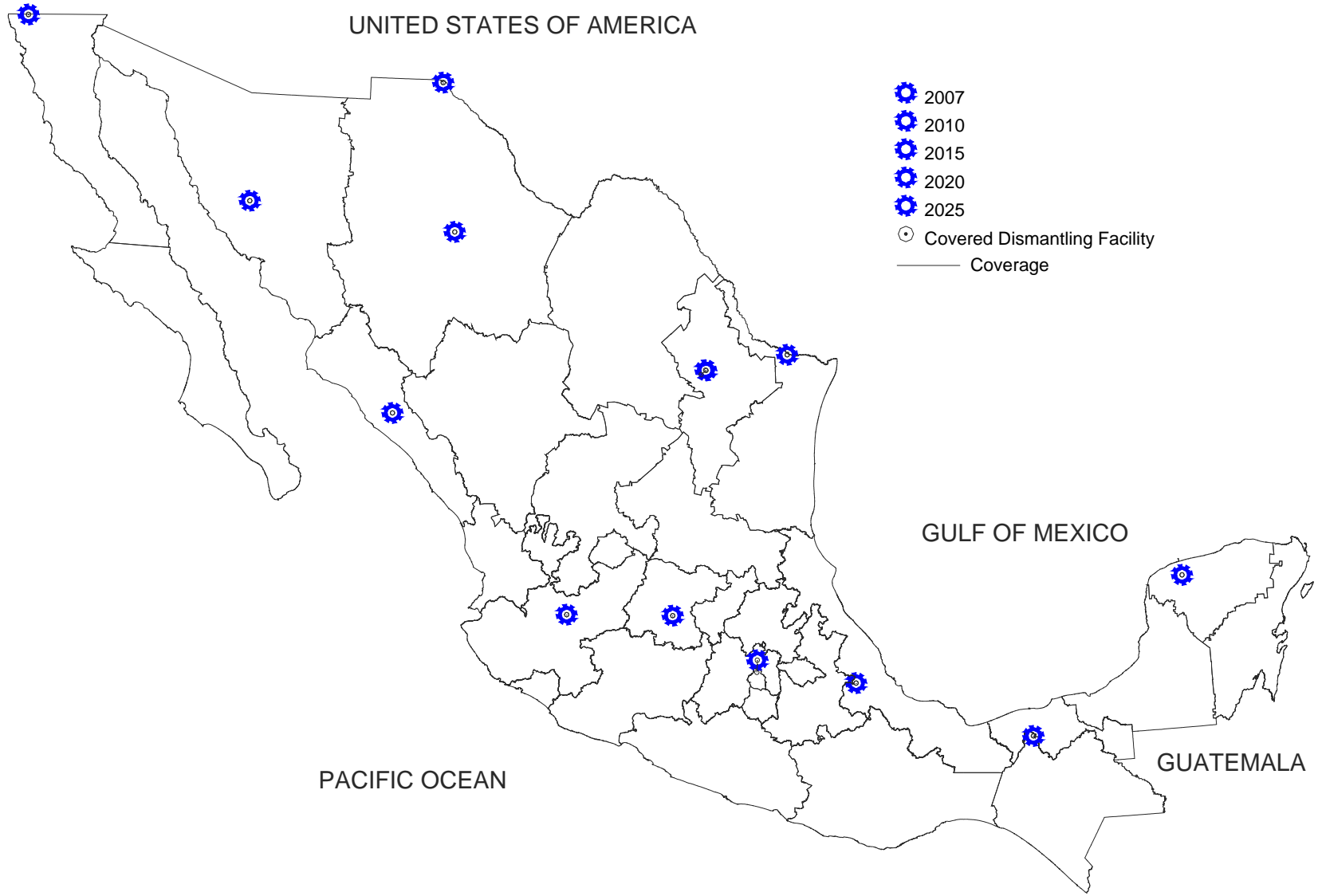

Figure D.10 Graphic Location of Shredder Facilities, Scenario-2
Implementation of End-of-Life Vehicle's Recycling for Developing Countries: Case Study, Mexico

Melting Stage (Shredder Facilities – Melting Facilities)

Table D.2.3 Location of Facilities at Melting Stage by 2007 to 2025

Nr	Coordinates (miles)		Covered Demand (Units) 2007	Covered Demand (Units) 2010	Covered Demand (Units) 2015	Covered Demand (Units)				Company Name
	X	Y				2020		2025		
						A	B	A	B	
1	765.01	1458.10	0	0	0	0	0	0	0	Cia. siderurgica de California
2	670.94	1458.35	45,548	47,374	50,963	67,900	65,124	91,289	75,564	Procesadora Mexicali
3	1589.29	1025.07	0	0	0	0	0	0	0	Altos Hornos de Mexico (AHMSA)
4	1618.54	587.53	55,400	57,622	61,948	82,584	79,212	111,032	91,904	DEACERO S.A. DE C.V.
5	1466.72	597.90	68,212	70,944	76,320	101,682	97,527	136,709	113,162	Cia. siderurgica de Guadalajara
6	1740.18	532.55	264,005	274,597	295,388	393,567	377,477	529,144	437,970	Siderurgica Tultitlan, DEA
7	1666.21	948.92	74,971	77,979	83,883	111,768	107,190	150,263	124,376	HYLSA S.A. de C.V.
8	1960.46	449.01	18,405	19,148	20,599	27,441	26,317	36,896	30,542	Metalurgica Veracruzana SA
9	1873.56	479.01	27,740	28,848	31,040	41,349	39,661	55,597	46,019	Talleres y Aceros de México
10	2349.25	655.02	11,264	11,718	12,607	16,796	16,108	22,582	19,692	Siderurica Yucatan SA
Total demand of			565,545	588,230	632,748	843,087	808,616	1,133,512	939,229	ELV

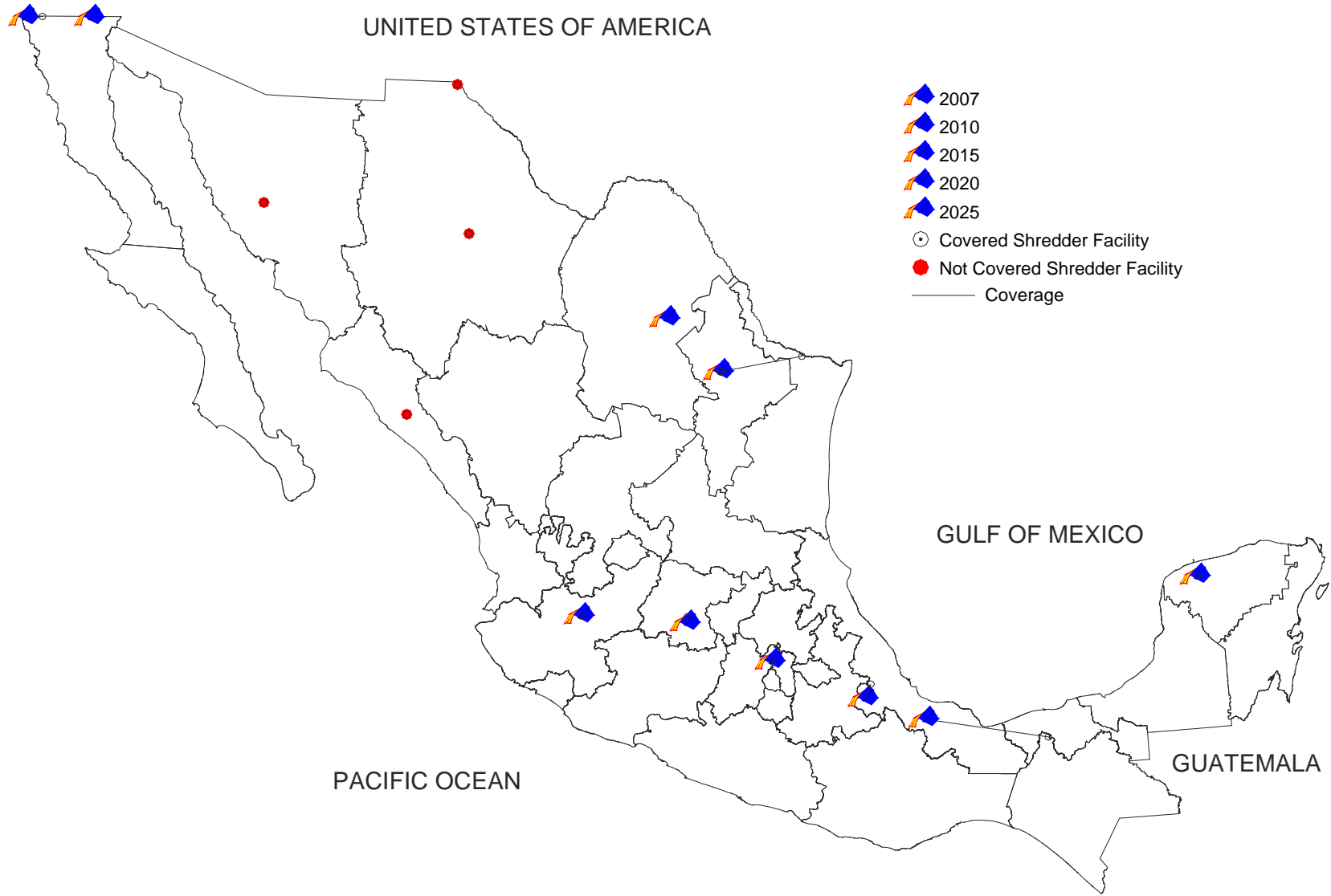

Figure D.11 Graphic Location of Foundries, Scenario-2

Energy Recovery Stage (Shredder Facilities – Cement Plants)

Table D.2.4 Location of Cement Plants at Energy Recovery Stage by 2007 to 2025

Nr	Coordinates (miles)		Covered Demand (Units) 2007	Covered Demand (Units) 2010	Covered Demand (Units) 2015	Covered Demand (Units)				Company Name	
	X	Y				2020		2025			
						A	B	A	B		
1	692.40	1411.12	45,548	47,374	50,963	67,900	65,124	91,289	75,564	Ensenada	CEMEX
2	1466.72	597.90	68,212	70,944	76,320	101,682	97,527	136,709	113,162	Guadalajara	CEMEX
3	1666.09	998.65	22,008	22,894	24,625	32,812	31,469	44,114	36,515	Hidalgo	CEMEX
4	1695.05	579.24	55,400	57,622	61,948	82,584	79,212	111,032	91,904	Huichapan	CEMEX
5	2349.25	655.02	11,264	11,718	12,607	16,796	16,108	22,582	19,692	Merida	CEMEX
6	1659.72	942.79	52,963	55,085	59,258	78,956	75,721	106,149	87,861	Monterrey	CEMEX
7	1464.95	932.33	12,304	12,797	13,766	18,344	17,593	24,660	20,412	Torreon	CEMEX
8	1032.28	1172.24	11,938	12,417	13,355	17,796	17,068	23,927	19,806	Yaqui	CEMEX
9	1736.97	552.40	264,005	274,597	295,388	393,567	377,477	529,144	437,970	Apaxco	APASCO
10	2173.00	418.88	18,405	19,148	20,599	27,441	26,317	36,896	30,542	Macuspana	APASCO
11	1878.24	477.10	27,740	28,848	31,040	41,349	39,661	55,597	46,019	Orizaba	APASCO
12	1298.95	1298.02	30,145	31,565	33,950	45,236	43,389	60,819	50,344	Samalayuca	CHIHUAHUA
Total demand of			619,932	645,009	693,819	924,463	886,666	1,242,918	1,029,791	ELV	

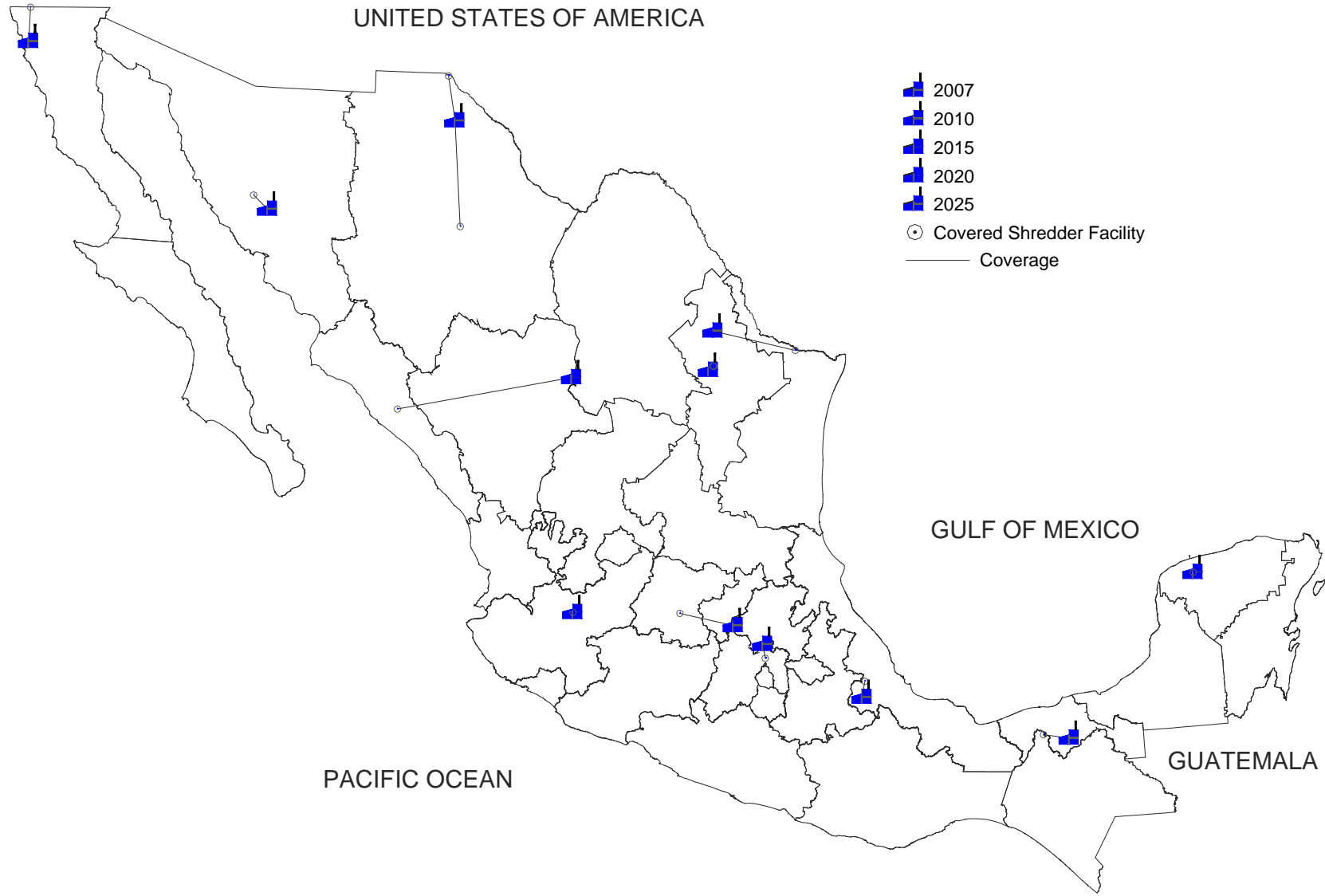

Figure D.12 Graphic Location of Cement Plants Using RDF, Scenario-2
Implementation of End-of-Life Vehicle's Recycling for Developing Countries: Case Study, Mexico

Final Disposal Stage (Dismantling, Shredder, Melting & Cement Plants - Landfills)

Table D.2.5 Location of Landfills for Final Disposal to Cover Demands at Dismantling Stage by 2007 to 2025

Nr	Coordinates (miles)		Covered Demand (Units)	Covered Demand (Units)	Covered Demand (Units)	Covered Demand (Units)				Locality Name
	X	Y				2020		2025		
			A	B	A	B				
1	668.52	1447.56	45,548	47,374	50,963	67,900	65,124	91,289	75,564	20040223
2	1306.20	1147.41	15,491	16,115	17,332	23,093	22,151	31,049	25,702	80190001
3	1289.66	1361.80	14,854	15,450	16,618	22,143	21,238	29,770	24,642	80370001
4	1594.42	589.25	55,400	57,622	61,948	82,584	79,212	111,032	91,904	110240001
5	1487.01	613.65	68,212	70,944	76,320	101,682	97,527	136,709	113,162	141290001
6	1745.75	513.97	264,005	274,597	295,388	393,567	377,477	529,144	437,970	150990001
7	1659.45	961.34	52,963	55,085	59,258	78,956	75,721	106,149	87,861	190450001
8	1216.87	887.54	12,304	12,797	13,766	18,344	17,593	24,660	20,412	250060001
9	1012.28	1192.24	11,938	12,417	13,355	17,796	17,068	23,927	19,806	260300001
10	2120.61	432.27	18,405	19,148	20,599	27,441	26,317	36,896	30,542	270020001
11	1832.57	958.58	22,008	22,894	24,625	32,812	31,469	44,114	36,515	280220001
12	1881.72	520.57	27,740	28,848	31,040	41,349	39,661	55,597	46,019	300380001
13	2349.25	655.02	11,264	11,718	12,607	16,796	16,108	22,582	18,692	310500001
Total demand of			620,132	645,009	693,819	924,463	886,666	1,242,918	1,028,791	ELV

Note: The covered demand refers the amount of ELV treated by facilities at dismantling stage; the material sent for final disposal can be considered a percentage of total ELV weight

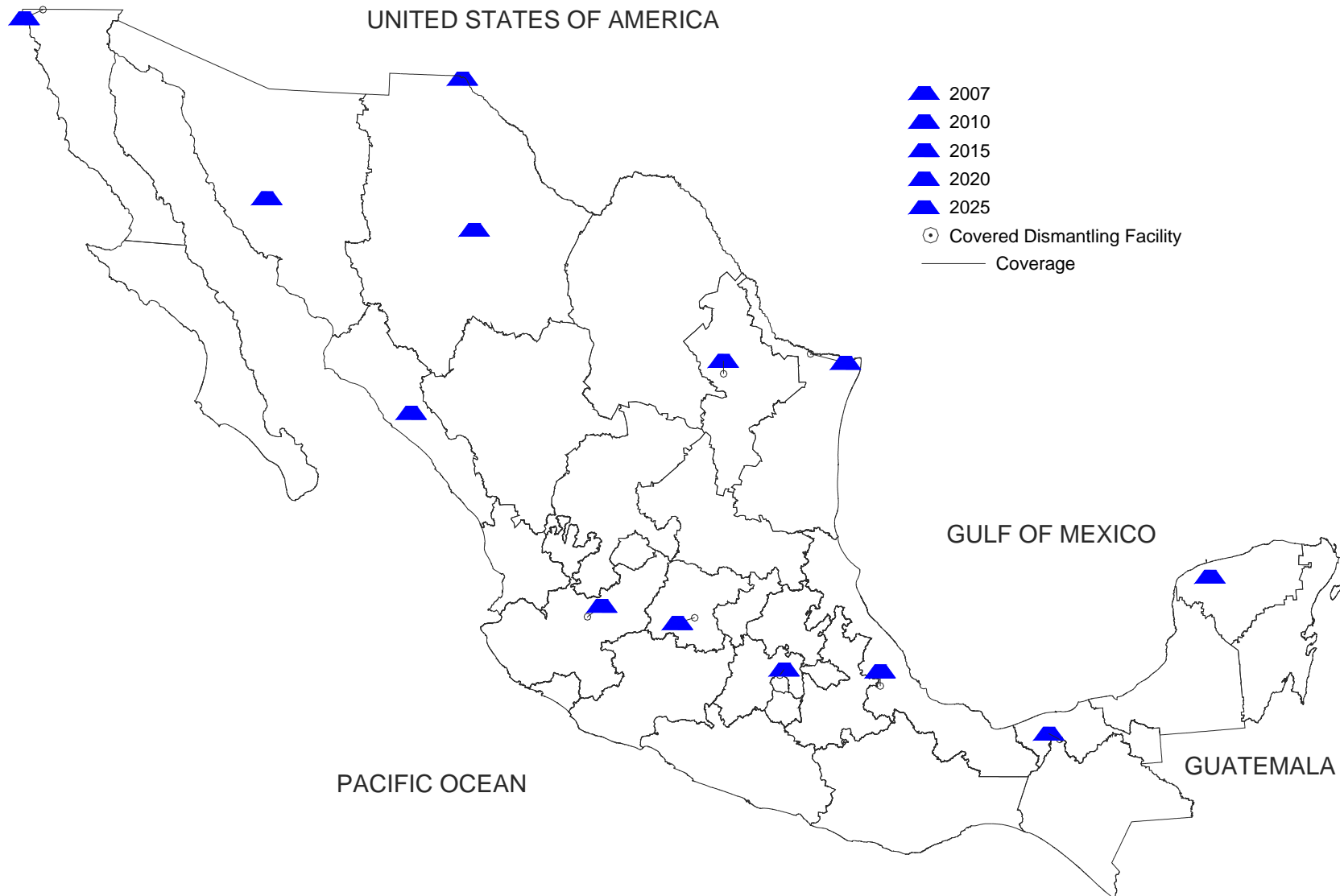

Figure D.13 Graphic Location of Landfills to Cover Demands at Dismantling Stage, Scenario-2

Table D.2.6 Location of Landfills for Final Disposal to Cover Demands at Shredder Stage by 2007 to 2025

Nr	Coordinates (miles)		Covered Demand (Units) 2007	Covered Demand (Units) 2010	Covered Demand (Units) 2015	Covered Demand (Units)				Locality Name
	X	Y				2020		2025		
			A	B	A	B				
1	668.52	1447.56	45,548	47,374	50,963	67,900	65,124	91,289	75,564	20040223
2	1306.20	1147.41	15,291	16,115	17,332	23,093	22,151	31,049	25,702	80190001
3	1289.66	1361.80	14,854	15,450	16,618	22,143	21,238	29,770	24,642	80370001
4	1594.42	589.25	55,400	57,622	61,948	82,584	79,212	111,032	91,904	110240001
5	1487.01	613.65	68,212	70,944	76,320	101,682	97,527	136,709	113,162	141290001
6	1745.55	523.24	264,005	274,597	295,388	393,567	377,477	529,144	437,970	150330000
7	1659.45	961.34	52,963	55,085	59,258	78,956	75,721	106,149	87,861	190450001
8	1216.87	887.54	12,304	12,797	13,766	18,344	17,593	24,660	20,412	250060001
9	1012.28	1192.24	11,938	12,417	13,355	17,796	17,068	23,927	19,806	260300001
10	2120.61	432.27	18,405	19,148	20,599	27,441	26,317	36,896	30,542	270020001
11	1832.57	958.58	22,008	22,894	24,625	32,812	31,469	44,114	36,515	280220001
12	1881.72	520.57	27,740	28,848	31,040	41,349	39,661	55,597	46,019	300380001
13	2349.25	655.02	11,264	11,718	12,607	16,796	16,108	22,582	19,692	310500001
Total demand of			619,932	645,009	693,819	924,463	886,666	1,242,918	1,029,791	ELV

Note: The covered demand refers the amount of ELV treated by facilities at dismantling stage; the material sent for final disposal can be considered a percentage of total ELV weight

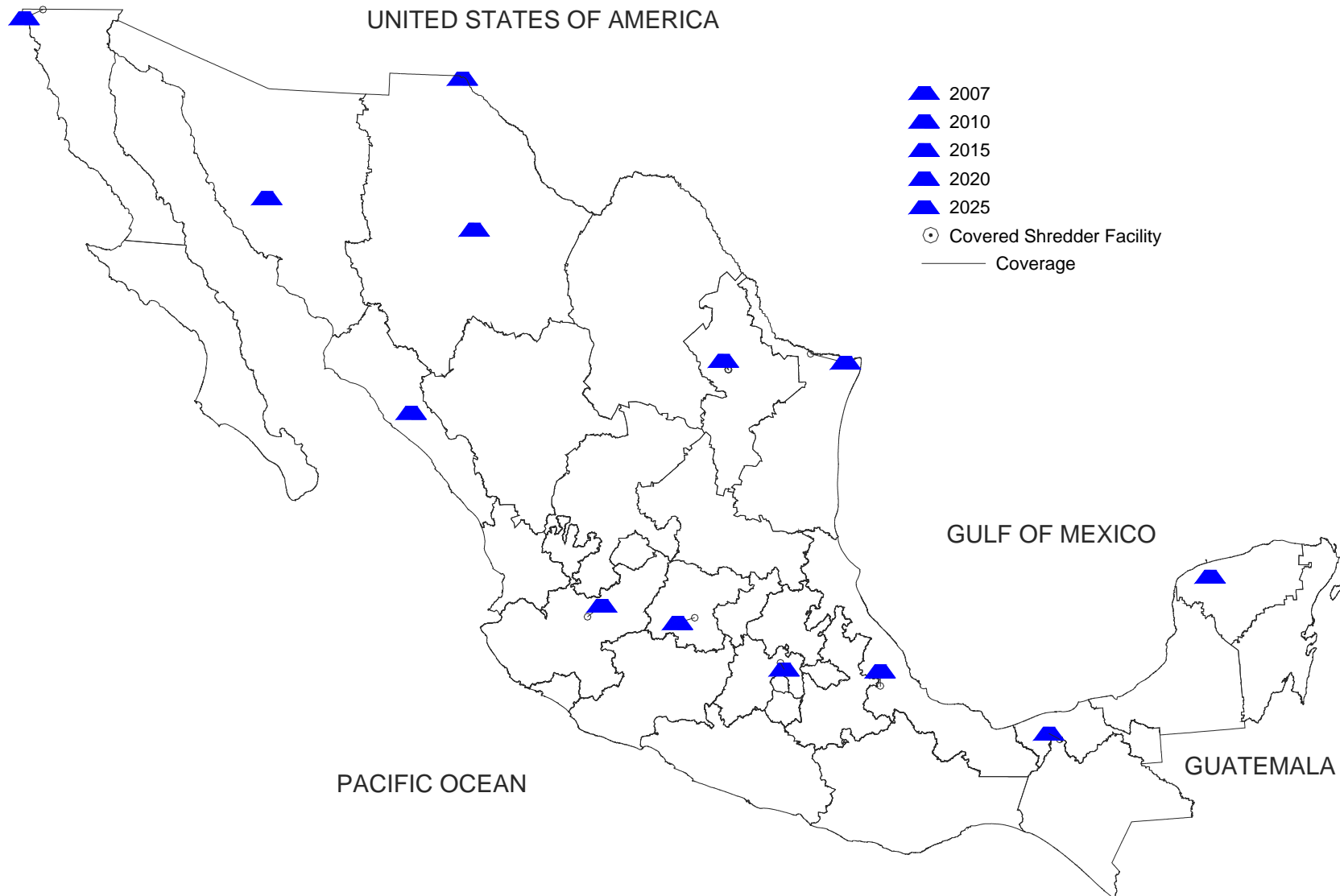

Figure D.14 Graphic Location of Landfills to Cover Demands at Shredder Stage, Scenario-2

Table D.2.7 Location of Landfills for Final Disposal to Cover Demands at Melting Stage by 2007 to 2025

Nr	Coordinates (miles)		Covered Demand (Units)	Covered Demand (Units)	Covered Demand (Units)	Covered Demand (Units)				Locality Name
	X	Y				2020		2025		
			A	B	A	B				
1	668.52	1447.56	45,548	47,374	50,963	67,900	65,124	91,289	75,564	20040223
2	1594.42	589.25	55,400	57,622	61,948	82,584	79,212	111,032	91,904	110240001
3	1487.01	613.65	68,212	70,944	76,320	101,682	97,527	136,709	113,162	141290001
4	1750.64	534.68	264,005	274,597	295,388	393,567	377,477	529,144	437,970	150330000
5	1659.45	961.34	74,971	77,979	83,883	111,768	107,190	150,263	124,376	190450001
6	1960.46	449.01	18,405	19,148	20,599	27,441	26,317	36,896	30,542	300450001
7	1867.05	476.84	27,740	28,848	31,040	41,349	39,661	55,597	46,019	301150001
8	2349.25	655.02	11,264	11,718	12,607	16,796	16,108	22,582	19,692	310500001
Total demand of			565,545	588,230	632,748	843,087	808,616	1,133,512	939,229	ELV

Note: The covered demand refers the amount of ELV treated by facilities at dismantling stage; the material sent for final disposal can be considered a percentage of total ELV weight

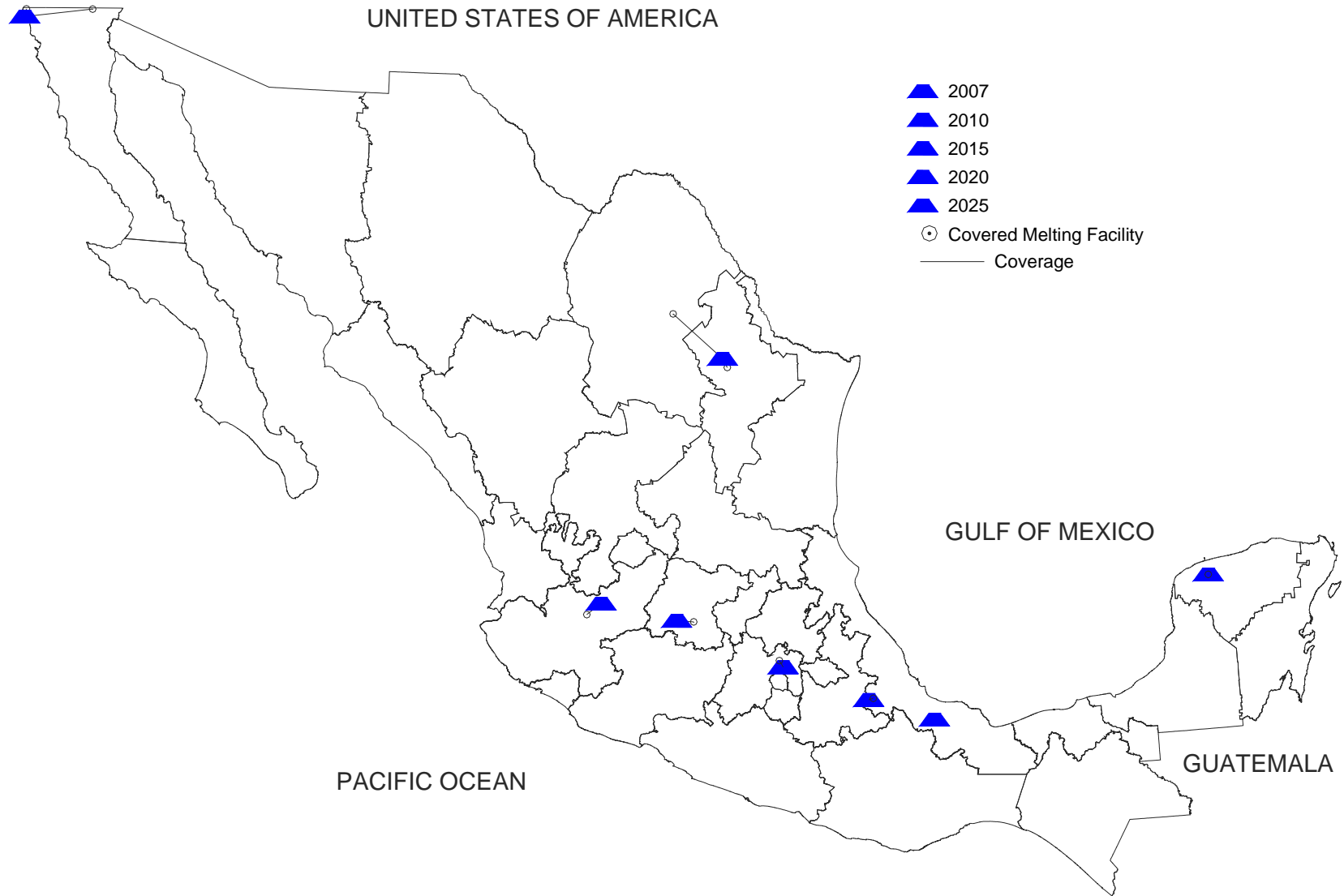

Figure D.15 Graphic Location of Landfills to Cover Demands at Melting Stage, Scenario-2

Table D.2.8 Location of Landfills for Final Disposal to Cover Demands at Energy Recovery Stage by 2007 to 2025

Nr	Coordinates (miles)		Covered Demand (Units)	Covered Demand (Units)	Covered Demand (Units)	Covered Demand (Units)				Locality Name
	X	Y				2020		2025		
			A	B	A	B				
1	692.40	1,411.12	45,548	47,374	50,963	67,900	65,124	91,289	75,564	20010001
2	1,289.66	1,361.80	30,145	31,565	33,950	45,236	43,389	60,819	50,344	80370001
3	1,460.18	939.63	12,304	12,797	13,766	18,344	17,593	24,660	20,412	100070001
4	1,695.05	579.24	55,400	57,622	61,948	82,584	79,212	111,032	91,904	130290029
5	1,726.16	547.02	264,005	274,597	295,388	393,567	377,477	529,144	437,970	130630001
6	1,487.01	613.65	68,212	70,944	76,320	101,682	97,527	136,709	113,162	141290001
7	1,659.45	961.34	74,971	77,979	83,883	111,768	107,190	150,263	124,376	190450001
8	1,012.28	1,192.24	11,938	12,417	13,355	17,796	17,068	23,927	19,806	260300001
9	2,156.41	414.66	18,405	19,148	20,599	27,441	26,317	36,896	30,542	270090001
10	1,867.05	476.84	27,740	28,848	31,040	41,349	39,661	55,597	46,019	301150001
11	2,349.25	655.02	11,264	11,718	12,607	16,796	16,108	22,582	19,692	310500001
Total demand of			619,932	645,009	693,819	924,463	886,666	1,242,918	1,029,791	ELV

Note: The covered demand refers the amount of ELV treated by facilities at dismantling stage; the material sent for final disposal can be considered a percentage of total ELV weight

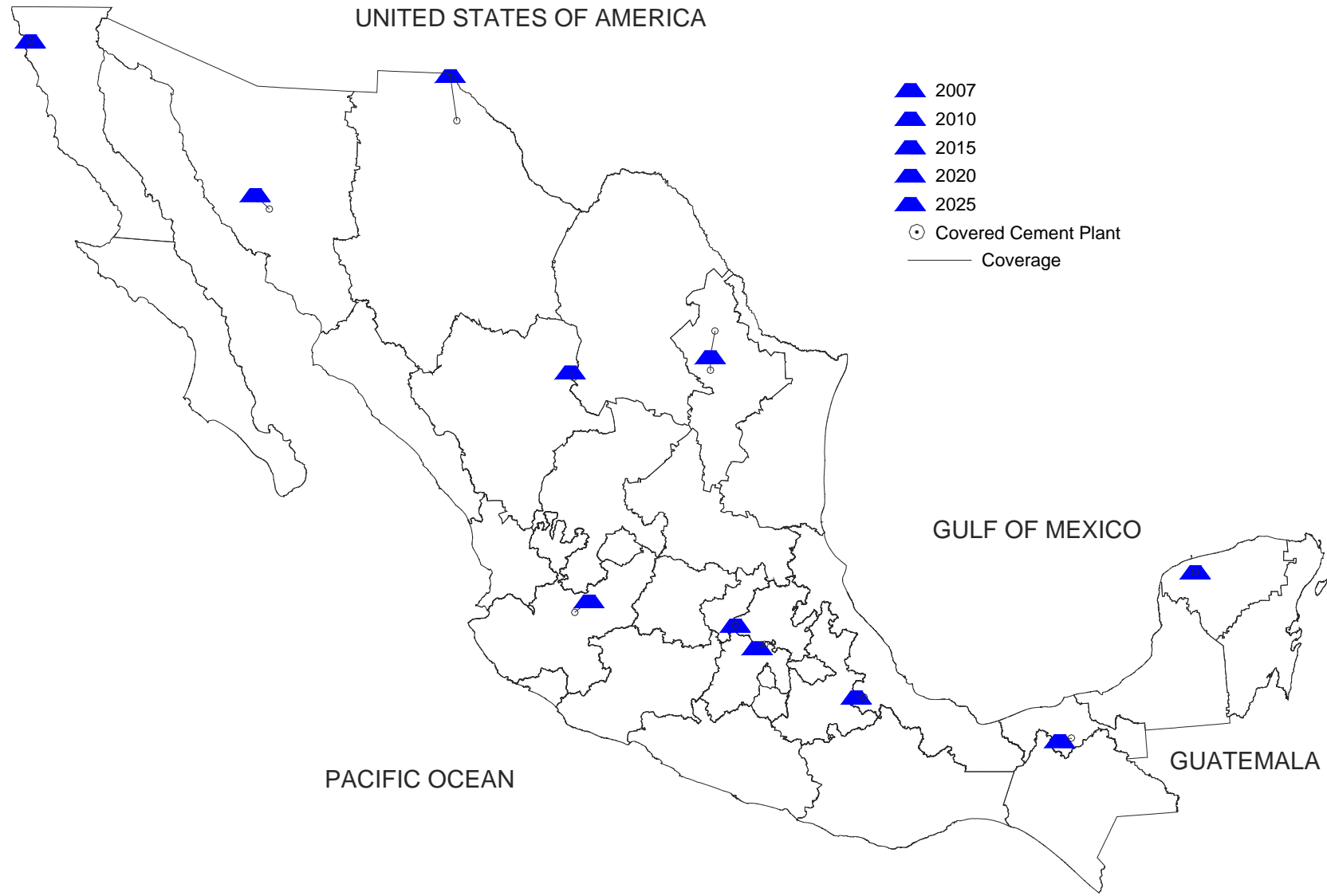

Figure D.16 Graphic Location of Landfills to Cover Demands at Energy Recovery Stage, Scenario-2
Implementation of End-of-Life Vehicle's Recycling for Developing Countries: Case Study, Mexico

D.3 Scenario-3

Dismantling Stage (Last Owners – Collection Points)

Table D.3.1 Location of Collection Points at Dismantling Stage by 2007 to 2025

Nr	Coordinates (miles)		Covered Demand (Units) 2007	Covered Demand (Units) 2010	Covered Demand (Units) 2015	Covered Demand (Units)				Locality Name
	X	Y				2020		2025		
						A	B	A	B	
1	694.92	1459.61	45,548	47,374	50,963	67,900	65,124	91,289	75,564	020030001
2	1225.31	1233.63	12,508	13,012	13,955	18,649	17,887	25,072	20,754	080100001
3	1739.50	515.04	284,351	295,757	318,157	423,892	406,568	569,919	471,723	09015
4	1466.72	597.90	83,891	87,249	93,861	125,055	119,943	168,133	139,172	140390001
5	1659.72	942.79	66,650	69,323	74,573	99,362	95,292	133,584	110,570	190390001
6	1216.87	887.54	12,304	12,797	13,766	18,344	17,593	24,660	20,412	250060001
7	2153.78	443.84	17,011	17,698	19,041	25,363	24,325	34,103	28,228	270040176
Total demand of			522,263	543,210	584,316	778,565	746,732	1,046,760	866,423	ELV

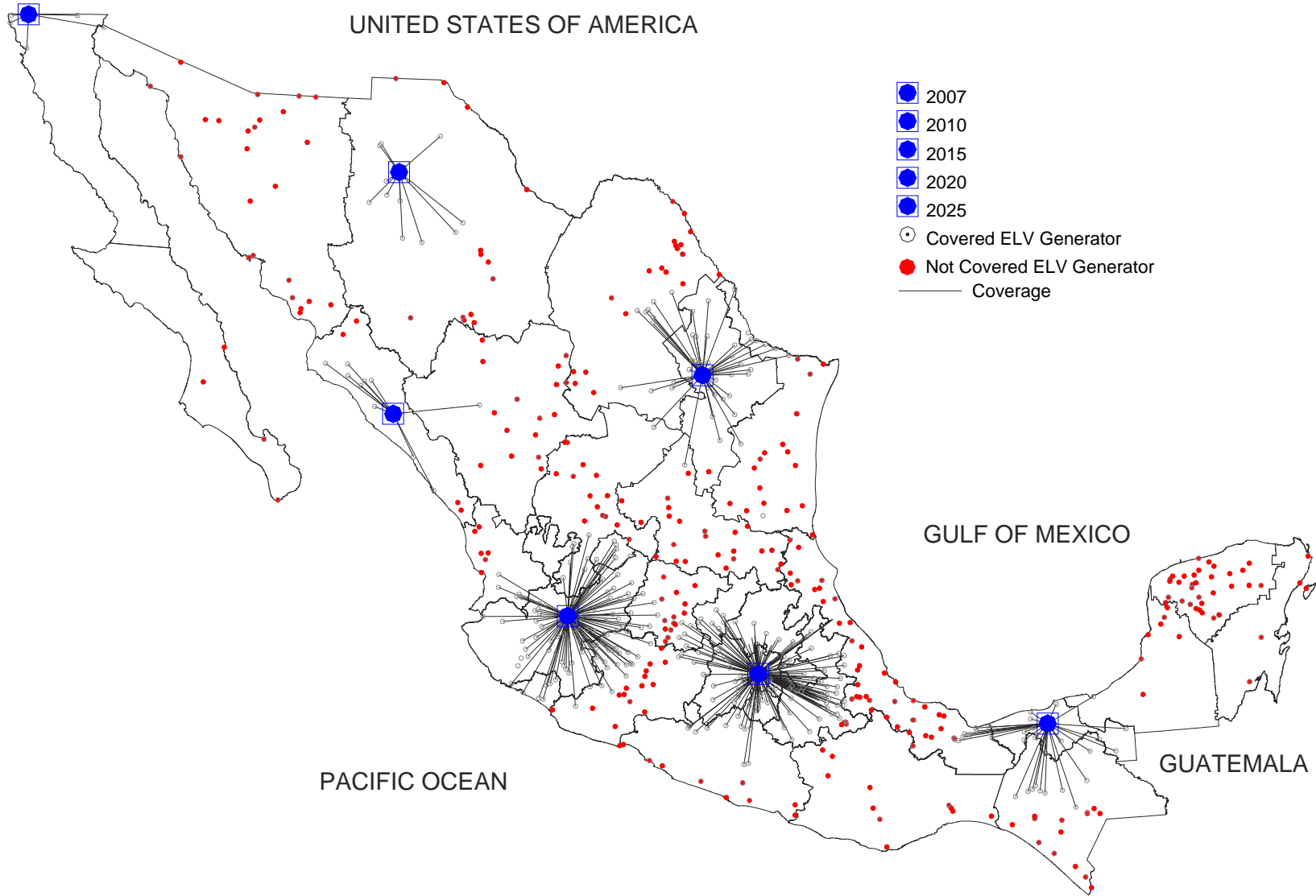

Figure D.17 Graphic Location of Collection Facilities at Dismantling Stage, Scenario-3

Implementation of End-of-Life Vehicle's Recycling for Developing Countries: Case Study, Mexico

Shredder Stage (Collection Points – Shredder Facilities)

Table D.3.2 Location of Facilities at Shredder Stage by 2007 to 2025

Nr	Coordinates (miles)		Covered Demand (Units) 2007	Covered Demand (Units) 2010	Covered Demand (Units) 2015	Covered Demand (Units)				Company Name
	X	Y				2020		2025		
						A	B	A	B	
1	1289.66	1361.79	30,345	13,012	13,012	18,649	17,887	25,072	20,754	ECOREC
2	1740.18	532.55	415,357	383,006	383,006	548,947	526,511	738,052	610,895	CFF
3	1666.84	948.49	74,971	69,323	69,323	99,362	95,292	133,584	110,570	IRASA
4	1665.90	948.92	0	0	0	0	0	0	0	PROME
Total demand of			520,673	465,341	465,341	666,958	639,690	896,708	742,219	ELV

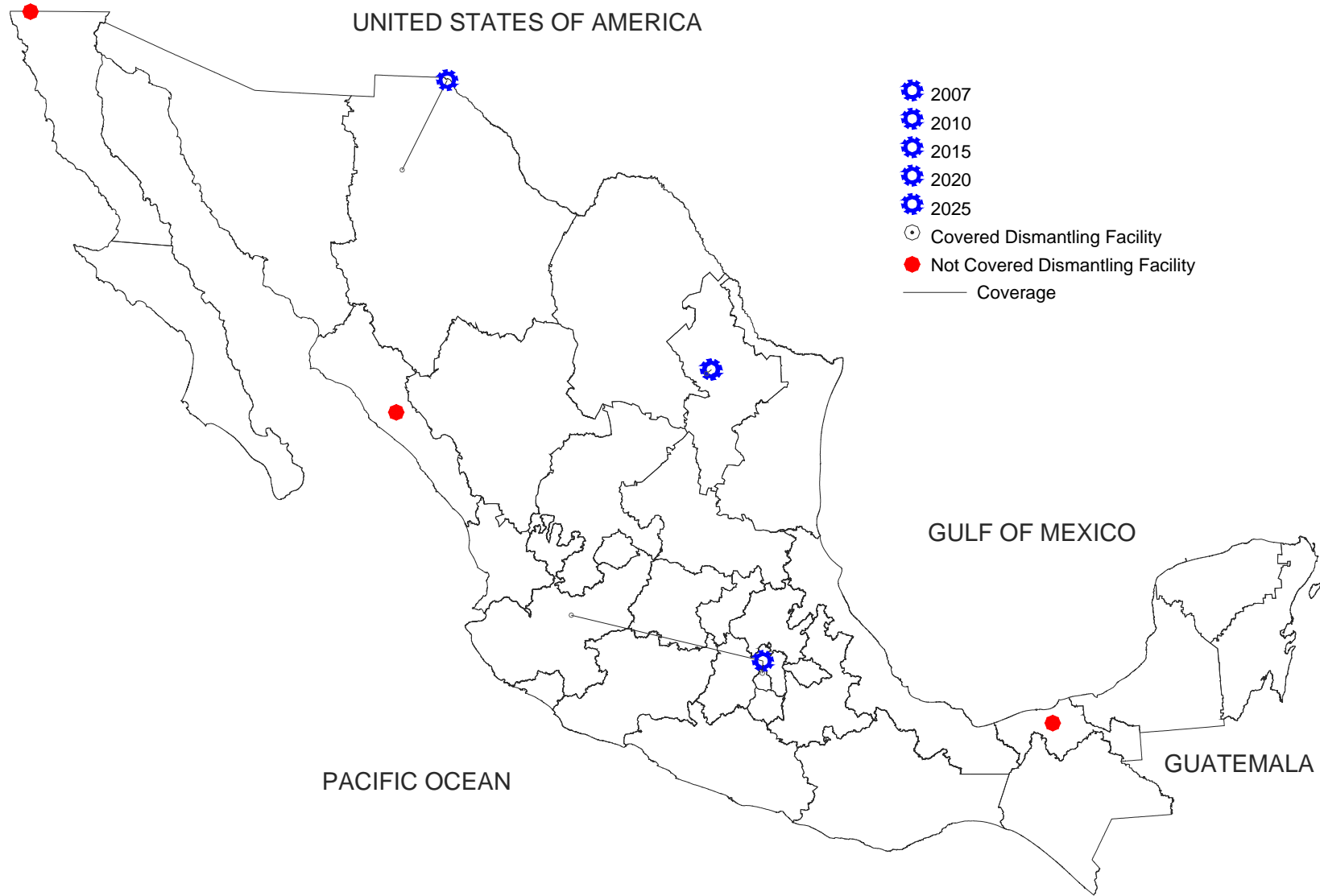

Figure D.18 Graphic Location of Shredder Facilities, Scenario-3

Melting Stage (Shredder Facilities – Melting Facilities)

TableD.3.3 Location of Facilities at Melting Stage by 2007 to 2025

Nr	Coordinates (miles)		Covered Demand (Units) 2007	Covered Demand (Units) 2010	Covered Demand (Units) 2015	Covered Demand (Units)				Company Name
	X	Y				2020		2025		
						A	B	A	B	
1	1589.29	1025.07	0	0	0	0	0	0	0	Altos Hornos de Mexico (AHMSA)
2	1740.18	532.55	415357	383006	412,018	548947	526,511	738,052	610,895	Siderurgica Tultitlan
3	1666.21	948.92	74971	69323	74,573	99362	95,292	133,584	110,570	HYLSA S.A. de C.V.
Total demand of			490,328	452,329	486,591	648,309	621,803	871,636	721,465	ELV

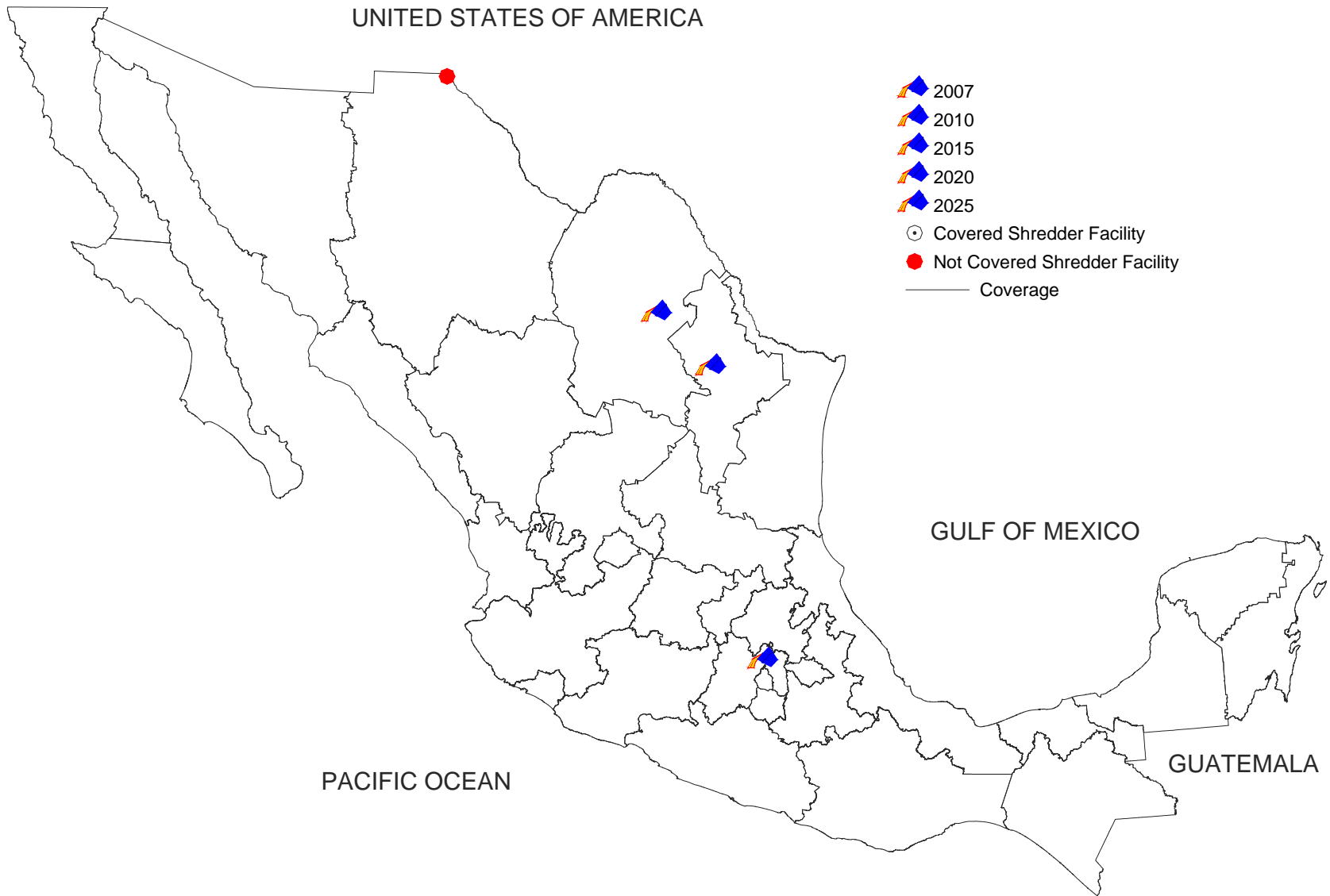

Figure D.19 Graphic Location of Foundries, Scenario-3

Energy Recovery Stage (Shredder Facilities- Cement Plants)

Table D.3.4 Location of Cement Plants at Energy Recovery Stage by 2007 to 2025

Nr	Coordinates (miles)		Covered Demand (Units)	Covered Demand (Units)	Covered Demand (Units)	Covered Demand (Units)				Company Name	
	X	Y	2007	2010	2015	2020		2025			
						A	B	A	B		
1	1659.72	942.79	74,971	69323	69323	99,362	95,292	133584	110570	Monterrey	CEMEX
2	1736.97	552.40	415,357	383006	383006	548,947	526,511	738052	610895	Apaxco	APASCO
3	1298.95	1298.02	30,345	1302	13012	18,649	17,887	25072	20754	Samalayuca	CHIHUAHUA
Total demand of			520,673	453,631	465,341	666,958	639,690	896,708	742,219	ELV	

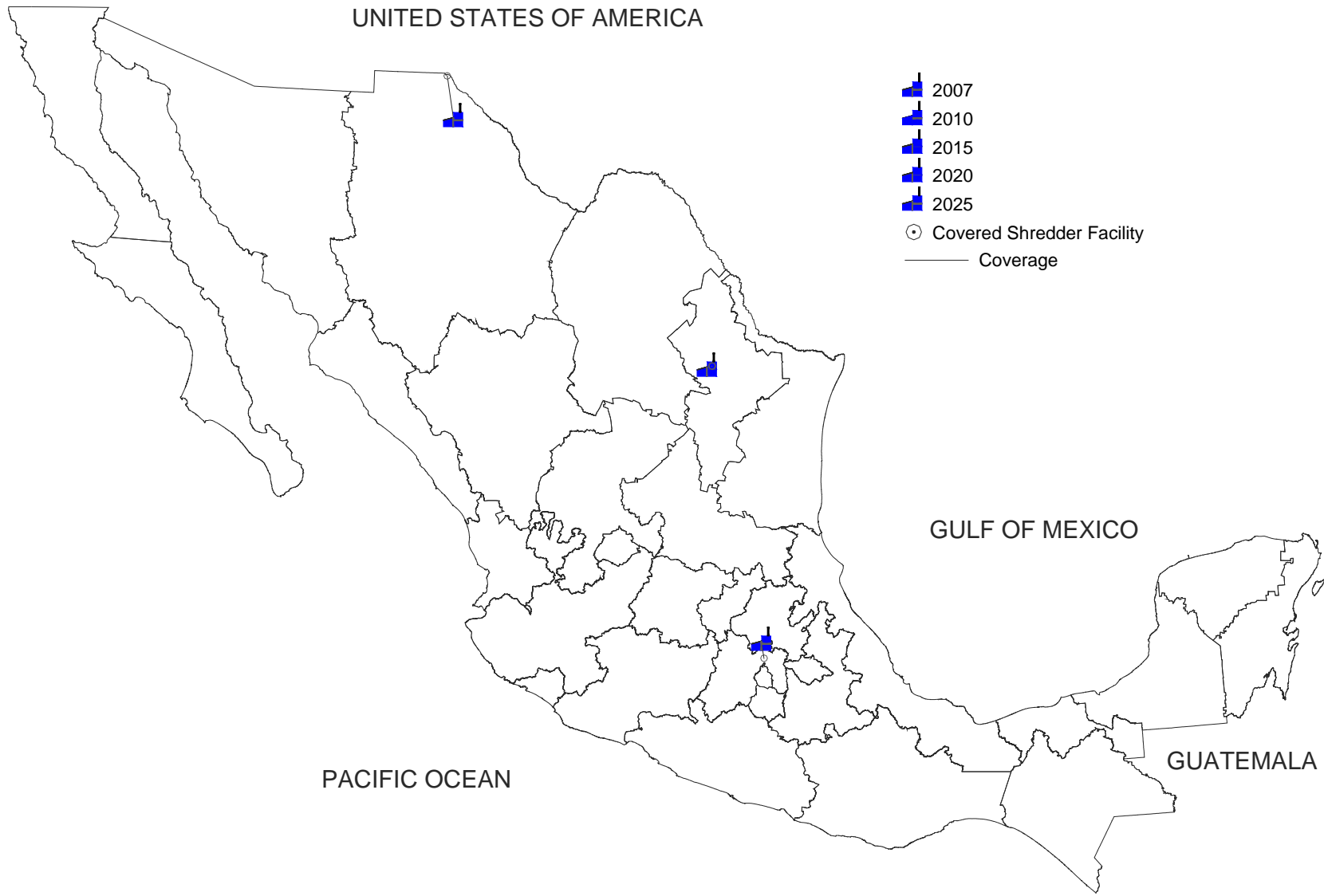

Figure D.20 Graphic Location of Cement Plants Using RDF, Scenario-3

Implementation of End-of-Life Vehicle's Recycling for Developing Countries: Case Study, Mexico

Final Disposal Stage (Dismantling, Shredder, Melting & Cement Plants - Landfills)

Table D.3.5 Location of Landfills for Final Disposal to Cover Demands at Dismantling Stage by 2007 to 2025

Nr	Coordinates (miles)		Covered Demand (Units) 2007	Covered Demand (Units) 2010	Covered Demand (Units) 2015	Covered Demand (Units)				Locality Name
	X	Y				2020		2025		
						A	B	A	B	
1	668.52	1447.56	45,548	47,374	50,963	67,900	65,124	91,289	75,564	20040223
2	1226.97	1192.54	12,508	13,012	13,955	18,649	17,887	25,072	20,754	80480001
3	1487.01	613.65	83,891	87,249	93,861	125,055	119,943	168,133	139,172	141290001
4	1745.75	513.97	284,351	295,757	318,157	423,892	406,568	569,919	471,723	151040000
5	1659.45	961.34	66,650	69,323	74,573	99,362	95,292	133,584	110,570	190450001
6	1216.87	887.54	12,304	12,797	13,766	18,344	17,593	24,660	20,412	250060001
7	2138.62	442.46	17,011	17,698	19,041	25,363	24,325	34,103	28,228	270100001
Total demand of			522,263	543,210	584,316	778,565	746,732	1,046,760	866,423	ELV

Note: The covered demand refers the amount of ELV treated by facilities at dismantling stage; the material sent for final disposal can be considered a percentage of total ELV weight

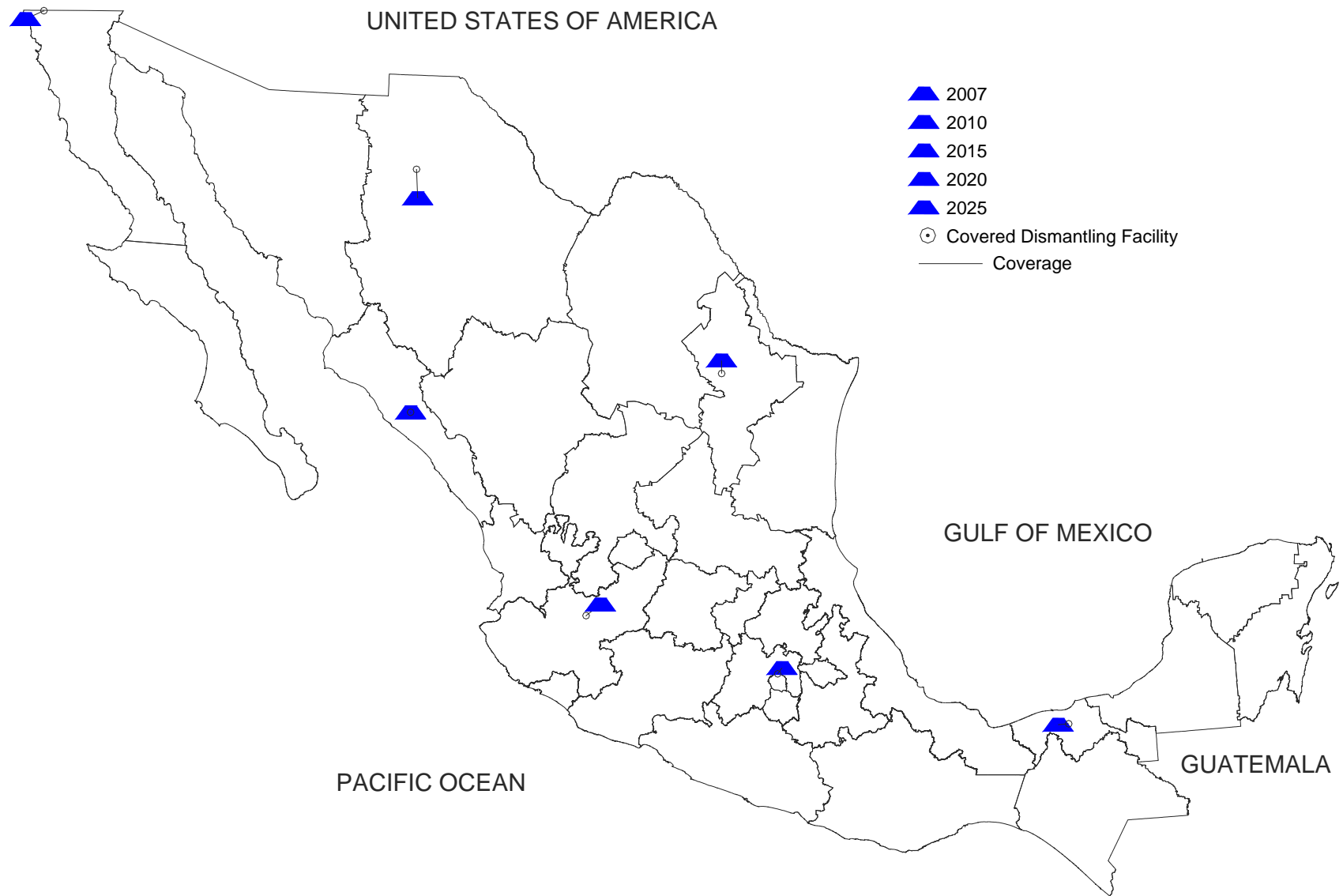

Figure D.21 Graphic Location of Landfills to Cover Demands at Dismantling Stage, Scenario-3

Table D.3.6 Location of Landfills for Final Disposal to Cover Demands at Shredder Stage by 2007 to 2025

Nr	Coordinates (miles)		Covered Demand (Units) 2007	Covered Demand (Units) 2010	Covered Demand (Units) 2015	Covered Demand (Units)				Locality Name
	X	Y				2020		2025		
						A	B	A	B	
1	1289.66	1361.80	30,345	13,012	13,012	18,649	17,887	25,072	20,754	80370001
2	1750.64	534.68	415,357	383,006	383,006	548,947	526,511	738,052	610,895	150330000
3	1659.45	961.34	74,971	69,323	69,323	99,362	95,292	133,584	110,570	190450001
Total demand of			520,673	465,341	465,341	666,958	639,690	896,708	742,219	ELV

Note: The covered demand refers the amount of ELV treated by facilities at dismantling stage; the material sent for final disposal can be considered a percentage of total ELV weight

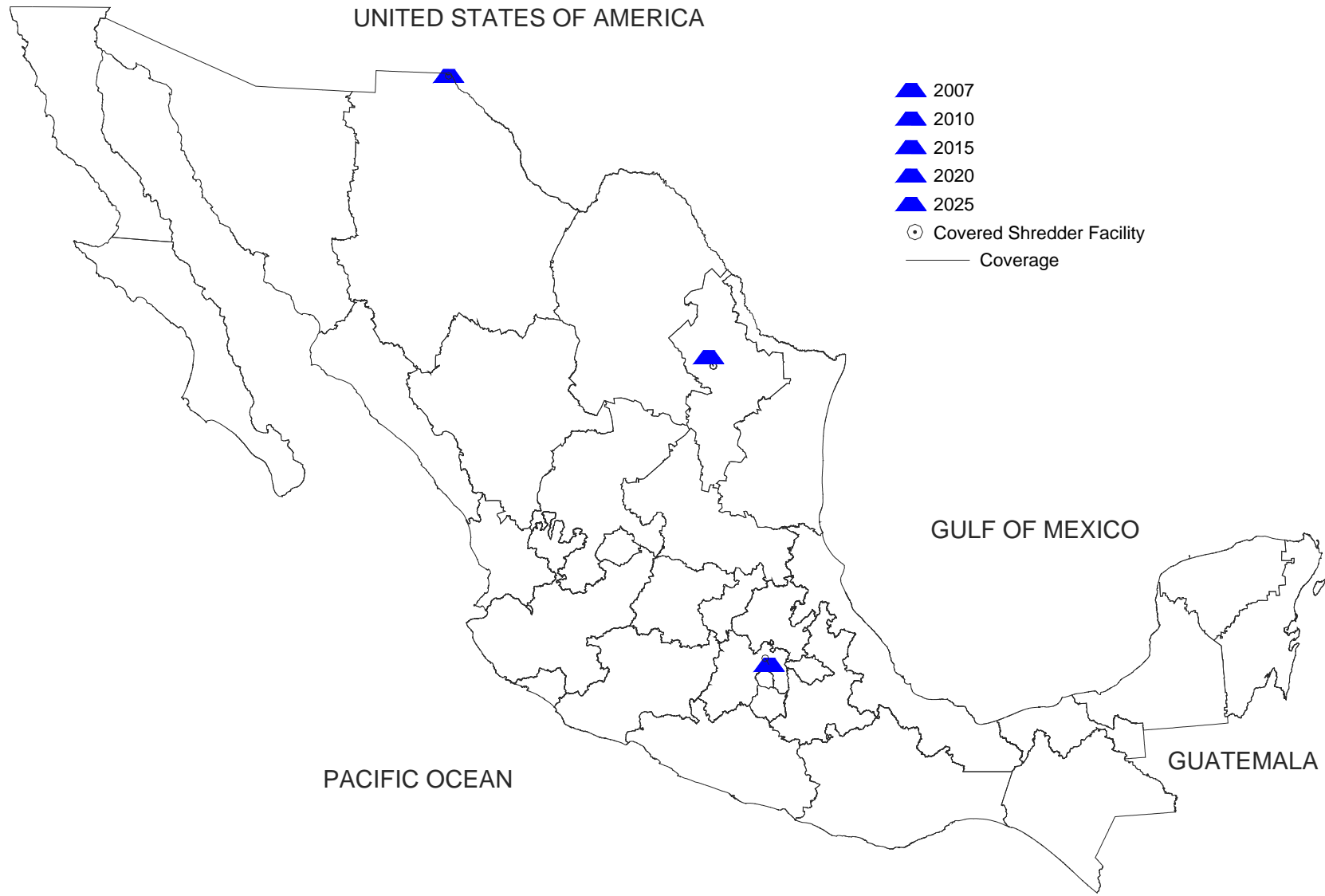

Figure D.22 Graphic Location of Landfills to Cover Demands at Shredder Stage, Scenario-3

Implementation of End-of-Life Vehicle's Recycling for Developing Countries: Case Study, Mexico

Table D.3.7 Location of Landfills for Final Disposal to Cover Demands at Melting Stage by 2007 to 2025

Nr	Coordinates (miles)		Covered Demand (Units)	Covered Demand (Units)	Covered Demand (Units)	Covered Demand (Units)				Locality Name
	X	Y				2007	2010	2015	2020	
			A	B	A				B	
1	1745.55	523.24	415,357	383,006	412,018	548,947	526,511	738,052	610,895	150330000
2	1659.45	961.34	74,971	69,323	74,573	99,362	95,292	133,584	110,570	190450001
Total demand of			490,328	452,329	486,591	648,309	621,803	871,636	721,465	ELV

Note: The covered demand refers the amount of ELV treated by facilities at dismantling stage; the material sent for final disposal can be considered a percentage of total ELV weight

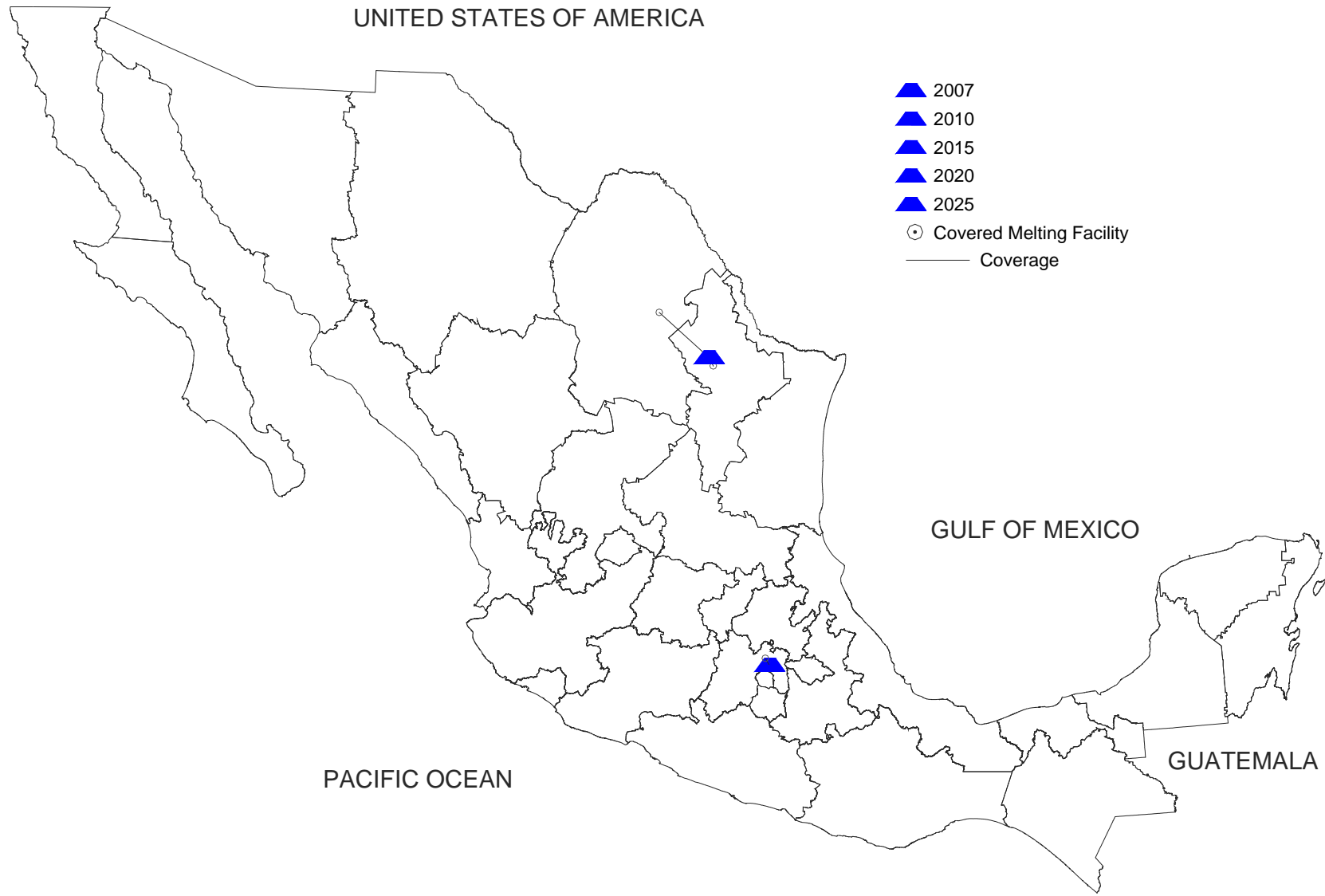

Figure D.23 Graphic Location of Landfills to Cover Demands at Melting Stage, Scenario-3

Implementation of End-of-Life Vehicle's Recycling for Developing Countries: Case Study, Mexico

Table D.3.8 Location of Landfills for Final Disposal to Cover Demands at Energy Recovery Stage by 2007 to 2025

Nr	Coordinates (miles)		Covered Demand (Units)	Covered Demand (Units)	Covered Demand (Units)	Covered Demand (Units)				Locality Name
	X	Y				2020		2025		
			A	B	A	B				
1	1289.66	1361.80	30,345	1,302	13,012	18,649	17,887	25,072	20,754	80370001
2	1726.16	547.02	415,357	383,006	383,006	548,947	526,511	738,052	610,895	130630001
3	1659.45	961.34	74,971	69,323	69,323	99,362	95,292	133,584	110,570	190450001
Total demand of			520,673	453,631	645,341	666,958	539,690	896,708	742,219	ELV

Note: The covered demand refers the amount of ELV treated by facilities at dismantling stage; the material sent for final disposal can be considered a percentage of total ELV weight

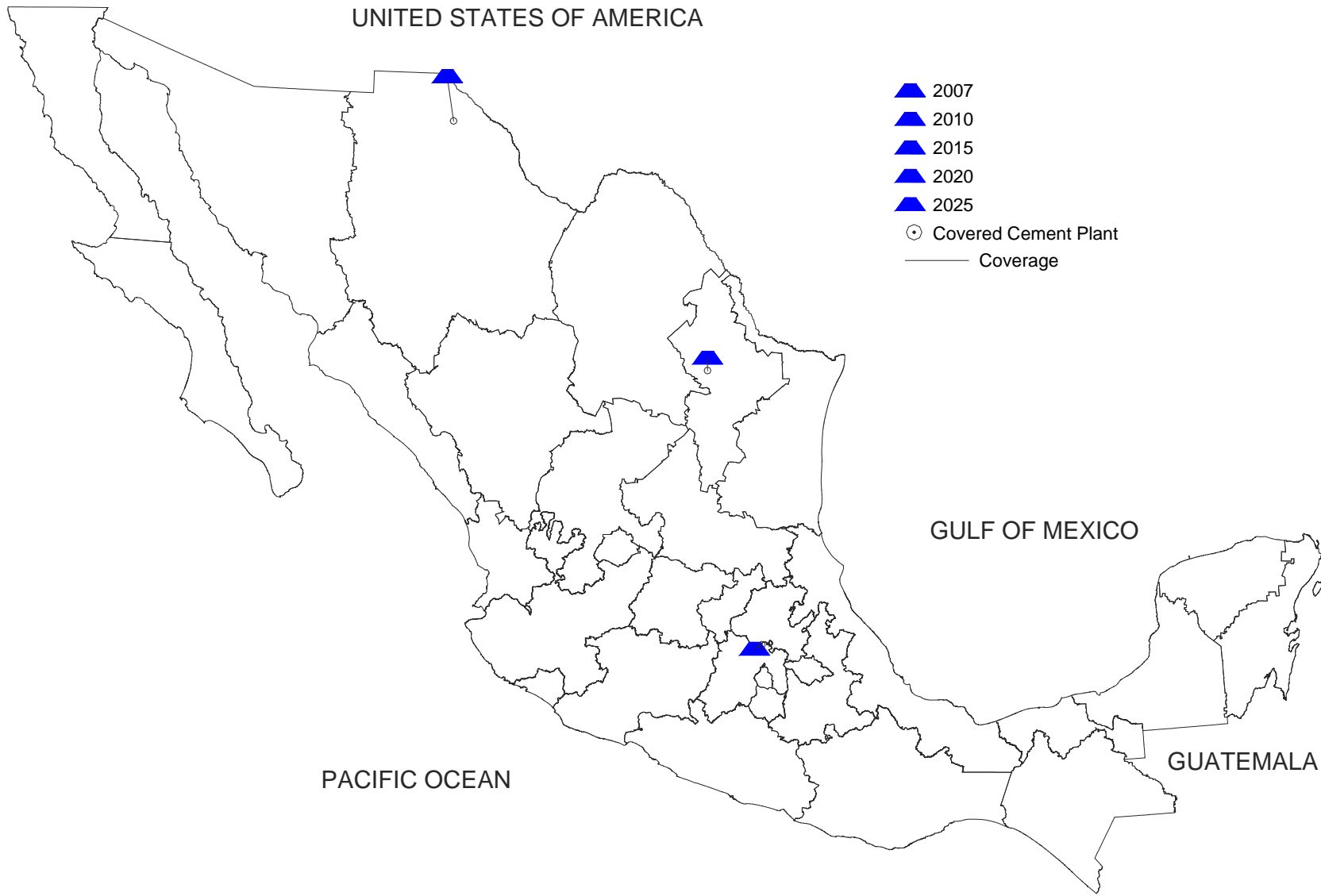

Figure D.24 Graphic Location of Landfills to Cover Demands at Energy Recovery Stage, Scenario-3

