

**BRANDENBURG UNIVERSITY OF
TECHNOLOGY COTTBUS**

Faculty of Environmental Sciences and Process Engineering

Chair of Chemical Engineering and Hazardous Waste

Bioremediation of Petrohydrocarbons Contaminated Groundwater

PhD Thesis

Submitted by: Violeta Bravo Sepúlveda

(Matriculation Nr. 2006809)

(Born in Mexico City, February 6th, 1973)

Supervisor

Prof. Dr. Ing. Wolfgang Spyra

Second Supervisor

Prof. Dr.-Ing. Günter Busch

Date of defense Cottbus, 11 April, 2006.

Purpose and Tasks

The purpose of this research is to carry out a laboratory research concerning suitability of biotechnology methods for the remediation of gasoline and diesel to contaminated groundwater:

The Laboratory work consists in the following tasks:

1. Literature search of the use of organic pollutants, their behaviour in the environment and description of available treatment technology.
2. Isolation and selection of autochthonous microorganisms from contaminated sites.
3. Realisation of biodegradation tests under different conditions.
4. Investigation in the liquid culture and fixed-bed systems respectively.
5. Influence of different parameters (e.g. cosubstrates and the aeration conditions) on the microbial degradability of organic substances.
6. Construction of the Trickling Fixed-bed columns

Cottbus, 05.01.2006
Prof.Dr.Ing. W. Spyra

Abstract

Four column reactors were designed and studied under laboratory conditions in order to stimulate conditions affecting the bioremediation of diesel and gasoline.

The objective of this thesis is to obtain drinking water adapting the processes of bioremediation of diesel and gasoline in a Fixed Bed Column Reactor to the specific conditions of groundwater contamination that are present in Mexico (Refinery of Salamanca).

The thesis is divided in two main sections in order to understand bioremediation processes and implement a Fixed Bed Reactor. The first section will focus on a Literature Study. The Literature Study consists in the investigation of the Drinking Water Regulations, the knowledge of the current situation in Mexico in availability of groundwater its uses and necessities, the description and principle of the problem, groundwater treatment and the knowledge of the Hazardous and Risk of the contaminants. This section also includes the theoretical bases where the biological and chemical processes are studied. Biochemical reactions destroy or chemically modify compounds through bacterial metabolism during the phases of the Microbial Growth such that these compounds are neither a threat to human health nor to the environment and are important to be understood when designing or operating the reactor.

The second section will focus on a Laboratory Study. This experimental part consists in the analysis of the chemical and physical parameters of the groundwater, a series of Bioassessment Tests to determine whether biodegradation was taking place. Biostimulation tests were done in order to obtain the best condition of biodegradation. After, the columns were designed and constructed. The diesel was analysed in a Gas Chromatograph (FID) during the biodegradation process.

The results show that the concentrations required by the German Law of drinking water were met with 0.1 mg/L for total petrohydrocarbons and 0.001 mg/L for Benzene.

Statutory Declaration

This Thesis was written under the supervision of Prof. Dr. Ing. Wolfgang Spyra and following the requirements and guidelines for the Environmental and Resource Management International PhD Study Program at Brandenburg Technical University, Cottbus Germany.

I herewith declare that all work contained within in this text to be original except where appropriately noted as an additional source. Quotations and all other indirect information have been clearly marked and noted.

This work has not been submitted to other examination bodies and is currently unpublished.

Violeta Bravo Sepúlveda
Cottbus, 05.01.2006

Acknowledgement

I want to thank Prof. Dr. Ing. Wolfgang Spyra for giving me the opportunity of being part of this Chair and for sharing with me knowledge, that will be very useful in my country.

I am grateful to Consejo Nacional de Ciencia y Tecnología CONACYT for the financial support of my studies during this research (PhD).

I especially appreciate the help of Dr. Francisco J. Rodríguez Valadez and Dra. Refugio Rodríguez Vázquez for their help, advice and cooperation to obtain the soil and groundwater samples from Mexico for the purposes of my research.

Abbreviation

ADME	adsorption, distribution, metabolism and excretion
ADP	adenosine diphosphate
ATP	adenosine triphosphate
BTEX	benzene, toluene ethylbenzene and xylene
ρ_b	bulk density
CFU ml⁻¹	colony forming units per milliliter (CFU ml ⁻¹)
CO₂	carbon dioxide
DNA	dexyribonucleic acid
DNAPLs	dense nonaqueous-phase liquids
Fe⁺³	iron (III)
(f_{oc})	fraction of organic carbon on soil
FID	flame ionization detector
ΔG⁰	gibbs energy
GTP	guanosine triphosphate
H₂	hydrogen
LNAPLs	light nonaqueous-phase liquids
Mn⁺⁴	manganese (IV)
MTBE	methyltertiary-butyl ether
MLSS	mixed liquor suspended solids
MSM	mineral salts medium
μ_m	maximum specific growth rate
NO₃⁻	nitrate
NAPL	nonaqueous-phase liquids
NAD	nicotine adenine dinucleotide
O₂	oxygen
PAH	polycyclic aromatic hydrocarbons
K_{ow}	octanol-water partitioning coefficient
K_s	constant referred to the “Monod constant
TCA	tricarboxylic acid
TPH	total petrohydrocarbons

TABLE OF CONTENTS

<u>PURPOSE AND TASKS</u>	<u>II</u>
<u>ABSTRACT</u>	<u>III</u>
<u>ABBREVIATION</u>	<u>VI</u>
<u>PART 1</u>	<u>1</u>
<u>1 INTRODUCTION</u>	<u>1</u>
<u>2 DRINKING WATER REGULATIONS</u>	<u>3</u>
2.1 Source protection	3
2.2 Organisation	3
2.3 Drinking Water Ordinance (Trinkwasserverordnung)	4
2.4 EC Water Framework Directive (Länderarbeitsgemeinschaft Wasser (LAWA))	4
2.5 Mexican Limits for drinking water:	4
<u>3 CURRENT SITUATION OF MEXICO</u>	<u>5</u>
3.1 Availability of Groundwater in Mexico	7
3.2 Use of the water	8
<u>4 DESCRIPTION OF THE PROBLEM</u>	<u>8</u>
4.1 Groundwater treatment	10
<u>5 GOAL OF THE THESIS</u>	<u>11</u>
<u>6 CONTAMINANTS OF SALAMANCA (GASOLINE AND DIESEL)</u>	<u>14</u>
6.1 Hydrocarbons	14
6.1.1 Defining petroleum	14
6.2 Hydrocarbons Structure	14
6.3 Hydrocarbon Products	17
6.4 Diesel Fuels	19
6.5 Refining process	19
6.5.1 Separation	19
6.5.2 Conversion	20
6.5.3 Treatment	21
<u>7 HAZARD AND RISK</u>	<u>22</u>
7.1 SOURCE	22
7.2 EXPOSURE	23
7.3 RESULTING TOXICITY	24

8	<u>TECHNOLOGY</u>	26
8.1	Principle of the problem	26
8.1.1	Density driven migration of hydrocarbons	27
8.1.2	Secondary Contaminants due to NAPLs	32
8.1.3	NAPL Migrations	33
8.1.4	Solubility of Aromatics in groundwater Systems	33
PART 2		36
1	<u>THEORETICAL BASES</u>	36
1.1	Aerobic and Anaerobic	36
2	<u>ENHANCEMENT OF BIOREMEDIATION</u>	36
2.1	Three Bioremediation Treatment Approach	36
2.1.1	Biostimulation	Fehler! Textmarke nicht definiert.
2.1.2	Bioaugmentation	38
2.1.3	Intrinsic treatment	Fehler! Textmarke nicht definiert.
3	<u>CLASSIFICATION OF MICROORGANISMS</u>	38
3.1	Classification	38
3.1.1	Prokaryotes Organisms	39
3.1.1.1	The Bacteria	40
4	<u>HYDROCARBON DEGRADING MICROBES IN GROUNDWATER</u>	44
4.1	Archaea	45
4.2	Bacteria in Groundwater systems	45
4.2.1	Gram negative Bacteria Found in Groundwater Systems	45
4.2.2	Aerobic Gram-Negative Rods	45
4.2.3	Facultative Anaerobic Gram-Negative Rods	46
4.2.4	Anaerobic Gram-Negative Rods	47
4.2.5	Gram-Positive Bacteria in Groundwater Systems	47
4.2.6	Abundance of Bacteria in the terrestrial subsurface	48
5	<u>BACTERIAL METABOLISM</u>	49
5.1	ATP Synthesis- Storing Energy	50
6	<u>MICROBIAL DESTRUCTION OF ENVIRONMENTAL POLLUTANTS</u>	52
6.1	Biom mineralization vs Biotransformation	52
6.2	Biodegradation Process for Organic Compounds	53
6.2.1.1	Aliphatics	53
6.2.1.2	Alkanes	53
6.2.1.3	Alkenes	54
6.2.1.4	Alicyclics	55

6.2.1.5	Aromatics	55
7	<u>MICROBIAL GROWTH</u>	56
7.1	Temperature	56
7.2	Water	57
7.3	Microbial Nutrition	57
7.4	Electron Acceptors	59
7.5	pH	59
7.6	Population Interactions	59
7.7	Neutralism	60
7.8	Commetabolism	60
7.9	Synergism and Symbiosis	61
7.10	Competition	61
7.11	Antagonimsm, Parasitism and Predation	61
7.12	Mixed Population	62
8	<u>PHASES OF MICROBIAL GROWTH</u>	63
8.1	Acclimation	63
8.2	Exponential Phase	64
8.3	Stationary Phase	65
8.4	Death Phase	66
8.5	Monod Kinetics	66
	<u>REMEDICATION TECHNOLOGIES</u>	69
8.6	Bioavailability	69
9	<u>IN SITU BIOREMEDIATION OF GROUNDWATER</u>	69
9.1	Biosparging	70
9.1.1	Applicability and Limitations	70
10	<u>EX-SITU BIOREMEDIATION TECHNOLOGIES FOR TREATMENT OF CONTAMINATED GROUNDWATER</u>	72
10.1	Bioreactors	72
10.2	Activated Sludge	72
10.3	Sequencing Batch Reactors (SBRs)	73
10.4	Rotating Biological Contactors (RBCs)	74
10.5	Trickling Filters	74
10.5.1	Characteristics of Trickled Fixed-film reactor:	75
10.5.2	Definition of the biofilms	76
10.5.3	Structure	76
10.5.4	Adhesion of the cells	76
10.6	Fixed Film Plug Flow	77
	<u>EXPERIMENTAL PART 3</u>	79
1	<u>PURPOSE AND TASKS OF THE PHD WORK</u>	79

2	<u>METHODOLOGY</u>	81
2.1	Bioassessment Screening Studies	81
2.2	Biotratability	81
3	<u>LABORATORY CHRONOGRAM</u>	82
	<u>METHODS AND MATERIALS</u>	84
4	<u>BIOASSESSMENT SCREENING STUDIES</u>	84
4.1	Analysis of the groundwater and soil	84
4.1.1	Chemical and physical parameters of the soil and groundwater	84
4.1.2	Soil	84
4.1.3	Groundwater	84
4.1.4	1 st Measurement of Total Hydrocarbons in Groundwater	85
4.1.4.1	Calibration	86
4.1.4.2	Measurement Method	86
4.1.5	2 nd Measurement of Total Hydrocarbons in Groundwater “Analytical Method”	86
4.1.6	Gas Chromatography (Principle)	87
4.1.6.1	Carrier gas	88
4.1.6.2	Sample injection	88
4.1.6.3	Columns	89
4.1.6.4	Column Temperature	90
4.1.6.5	Flame Ionisation Detector for GC	90
4.1.6.6	Response Mechanisms of the FID	90
4.1.7	Gas Chromatographic Method	91
4.1.8	The Internal Standard Method of Chromatogram Evaluation via Peak Area	92
4.1.8.1	Calibration of the GC EN ISO 9377-2	94
4.1.8.2	Extraction	94
4.1.8.3	Appropriate Extracted Volume	95
4.1.9	Measurement of Total Hydrocarbons in the soil	95
4.1.10	Sample use in the Laboratory	95
4.2	Biofeasibility test	96
4.2.1	Method	96
4.2.2	Extraction of cells from soil	96
4.2.3	Preparation of the dilutions and Inoculation	97
4.3	Biostimulation	99
4.3.1	Proper Balance of Nutrients	100
4.3.2	First, Second and Third Group of Experiments	100
4.3.3	Fourth experiment	101
4.4	First test of biodegradation	101
5	<u>BIOTRATABILITY (DESIGN OF THE FIXED-BED REACTOR (COLUMNS))</u>	101
5.1	Soil adsorption	101
5.1.1	Second test of biodegradation and adsorption	102
5.1.2	Conditions for the new Adsorption measurement	102
5.1.2.1	Solubility	102
5.1.2.2	Xylite preparation	103
5.1.2.3	Construction of the columns	104
5.1.3	Measurement of the Adsorption	104
5.2	Reactor design	105

5.3	Steps for the reactor design	105
5.3.1	Bench scale studies	105
5.3.2	Microbial Growth Kinetics	106
5.3.2.1	Growth of the microorganism for their inoculation to the columns	106
5.3.2.2	Biodegradation test and microbial growth kinetics	106
5.3.3	Construction of the Columns	107
5.3.4	Trickle-bed reactor and support medium	109
5.3.5	Columns	110
5.3.6	Equilibrium in the columns	110
5.3.7	Measurement of the microbial activity CO ₂	111
5.3.8	Optimization of the columns.	111
5.4	Last Part	111

RESULTS AND DISCUSSION **113**

6 BIOASSESSMENT SCREENING STUDIES **113**

6.1	Groundwater and soil chemical and physical parameters	113
6.2	1st Measurement of Total petrohydrocarbons (TPH) in groundwater	113
6.2.1	2 nd Measurement of total petrohydrocarbons in groundwater using a Gas Chromatogram-FID technique	114
6.2.1.1	“Heptane” Standard calibration curve	114
6.2.2	Diesel calibration curve	117
6.2.2.1	Preparation of the samples	120
6.2.3	Concentrations of Original Mexican Groundwater	122
6.3	Biofeasibility test	124
6.3.1	Calculation	124
6.3.2	Results of the First test of biodegradation	125
6.3.2.1	<i>Calculation of Mineral Salts Medium (MSM):</i>	125
6.4	Bioestimulation	127
6.4.1	Proper Balance of Nutrients	132
6.4.1.1	Salts calculation	132
6.4.2	First, Second and Third Group of Experiments Comparison of three experiments and different salts	136
6.4.3	Conclusion	139
6.4.4	Final Conclusions	141

7 BIOTRATABILITY **142**

7.1	Xylite adsorption	142
7.1.1	Soil adsorption	143
7.1.2	Results of the 2 nd adsorption experiment (200 mg/L mg/L)	146
7.1.3	Results of the 2 nd adsorption experiments (30 mg/L)	150
7.1.4	Growth Condition:	151
7.1.4.1	Microorganism growth for their inoculation in the columns	151
7.1.5	Biodegradation diesel test	153
7.2	Bench Scale Studies	158
7.2.1	Order of the reaction	158
7.2.2	Microbial growth kinetics	160
7.2.3	Construction of the columns	162
7.2.4	Columns performance and results	165
7.2.5	Equilibrium in the columns	167
7.2.6	Measurement of the microbial activity	170
7.2.7	Columns Optimization	172

7.2.7.1	One Column working continuous and recirculated constantly	172
7.2.7.2	Microbial growth Kinetics in one column	175
7.2.8	Four columns working in parallel as a Submerged Fixed Film reactor and recirculated constantly	177
7.2.9	The first column had a retention time of 2 days, on the third day the rest of the three columns worked in series and a new sample was introduced into the first column. The same process was repeated continuously.	185
7.2.10	The sample was introduced in the first column and the flow velocity was controller by the retention time of the sample inside the reactor.	188
7.2.11	Optimization	189
7.2.12	Recomendations	190
7.2.13	Result Benzene Biodegradation	191
7.3	Construction of Benzene biodegradation curve	191
8	<u>GENERAL DISCUSSION OF THE THESIS</u>	197
9	<u>CONCLUSION</u>	207
10	<u>BIBLIOGRAPHY</u>	209
	<u>LIST OF FIGURES AND TABLES</u>	215
11	<u>APPENDIX</u>	222

PART 1

1 INTRODUCTION

The total volume of water in the world remains constant. What changes is its quality and availability. In terms of total volume, 97.5% of the world's water is saline with 99.9% of this found in the oceans, the remainder making up the salt lakes. This means that only 2.5% of the volume of water in the world is actually non-saline. However, not all of this freshwater is readily available for use by humans. About 75% of this freshwater is locked up as ice-caps and glaciers, with a further 24% located underground as groundwater. Which means that less than 1% of the total freshwater is found in lakes, rivers and soil. Therefore, only 0.01 % of the world's water budget is present in lakes and rivers, with another 0.01% present as soil moisture but unavailable to humans supply. So, even when it appears to be a lot of water around, there is in reality very little which is readily available for human use. Water supplies come from two principal resources, surface and groundwater. Each of these resources is interrelated and are sources of drinking water (N.F. Gray, 1994).

Groundwater contamination is a complex phenomenon and is a widespread problem of worldwide importance. In as much as groundwater provides drinking water to so many people, the quality of the groundwater is of paramount importance. The Public or private water suppliers should be obligated to furnish water to their consumers that meets specific drinking water standards. If the water does not meet the standards when it is withdrawn from its source it must be treated (C.W. Fetter, 1999).

As aquifers restoration began to be recognized as an important aspect of environmental management in the 1980s, the diversity of scientific involvement increased even further. The change from a descriptive science (identifying existing subsurface characteristics, and providing the necessary engineering) to a prescriptive science (modifying subsurface conditions in a controlled manner) for the purpose of aquifer restoration provided a better understanding of all the operating parameters; physical, chemical, and biological process are all interactive in its dynamic setting.

At specific sites, where the contaminants are petroleum hydrocarbons and related products, the spectrum of necessary professional expertise has been greatly expanded. Subsurface recovery and production of multiphase petroleum hydrocarbons has been the primary goal of petroleum engineers. Sorption of organic materials on soil particles has been principally studied by agronomist. Biodegradation of organic chemicals fell into the realm of the

microbiologist. The quantitative analysis of chemicals and an understanding of their respective reactions and by products are within the purview of the chemist.

According to a study commissioned by the country's environmental officials, Germany has become the world's leading exporter of environmental technology for the first time in a decade.

Modern biotechnology in Germany has come a long way. The change in public, political and scientific attitude is the result of many efforts in recent years. Small and medium sized enterprises (SMEs) have helped speed up the process and are now playing a key role in the transformation of scientific progress into commercial products. The number of biotech companies has doubled twice since 1997. Vereinigung deutscher Biotechnologie Unternehmen VBU was founded in October 1996 by 55 German biotechnology companies. It is part of DECHEMA, Germany's largest non profit organization in biotechnology. By January 2004, the number of VBU member companies had risen to over 240.

Environmental Health in Germany

Keeping in mind the central role of environmental protection for health maintenance, the Federal Ministry for the Environment and the Federal Ministry of Health agreed on a joint Action Programme Environment and Health for Germany. It was presented at the Third Conference of the European ministers of health and the environment held in London in 1999. But not only Germany has developed such an action programme. Since the situation in other European countries is comparable to that in Germany, the subject has been tackled also on the international level. In 1989, the First European Conference of ministers of health and the environment was held in Frankfurt/Main, which had been initiated by the World Health Organization and actively supported by Germany, (Last publication 2002). At the Second European Conference on Environment and Health, organised by the World Health Organization and held in Helsinki in the summer of 1994. At this conference, the European ministers of health and the environment also decided to develop national environmental health action plans in their countries

Germany has implemented the decisions of Helsinki by means of the Action Programme Environment and Health. This linkage between environment and health was the reason to initiate an intensified collaboration between the responsible federal ministries and the associated superior federal authorities (*April 2004*).

One of the principal topics of this Environmental Program of Health is "*drinking water*"

2 Drinking Water Regulations

Drinking water is defined as all water, either in its original state or after treatment, that is intended for drinking, cooking, preparation of food and beverages or, in particular, for the further domestic purposes (Ordinance Definition Section 3)

2.1 Source protection

The major source for drinking water abstraction in Germany is groundwater (74 %), surface water (17 %) and other sources, e.g. bank filtrate (9 %). “Water Protection Areas” are a well-established instrument for the protection of catchments areas for drinking water resources in Germany and have existed for 50 years.

2.2 Organisation

The German Ministry of Health is responsible for regulations concerning drinking water quality, fixed the so-called “Drinking Water Ordinance” (Trinkwasserverordnung) in force since 1 January 2003.

It is based on the European Council Directive 98/83/EC on the quality of water intended for human consumption. Compliance with the legal provisions along the way ending with the consumer’s tap is controlled by the local health authorities. Through its Advisory Committee on Drinking Water, the Federal Environmental Agency (UBA) has played an important decisive role in the revision of the Drinking Water Ordinance. It is one of the preferential tasks of the WHO Collaborating Centre for Research on Drinking-Water Hygiene also hosted by the UBA to assist all activities which contribute to an adequate supply of safe drinking water, both on the national and international levels.

Water suppliers are obliged to fulfil the requirements laid down in this ordinance. They are supervised by local health authorities who check that the microbiological, chemical and physical standards are met. As soon as an outbreak of waterborne diseases may be expected local health authorities decide what measures have to be taken to ensure drinking water supply. In each and every case they have to be sure that possible exemptions to quality standards do not cause any health-related risks to the customers.

2.3 *Drinking Water Ordinance¹ (Trinkwasserverordnung)*

The purpose of this Ordinance shall be to protect human health from the adverse effects of any contamination of water intended for human consumption, through the guarantee of its whole quality and purity as the standards indicate.

2.4 *EC Water Framework Directive (Länderarbeitsgemeinschaft Wasser (LAWA))*

The directive defines 32 priority substances which have limits for emission. Quality standards of surface waters, sediments and biota must be obeyed. For pollutants, which present a significant risk to or via the aquatic environment, measures shall be aimed at the progressive reduction and for priority hazardous substances at the cessation or phasing-out of discharges, emissions or losses to surface waters after the year 2020.

Table 1 Limits for drinking water in Germany

Parameter	Limits
Benzene ¹	0.001 mg/L
BTEX ²	0.02 mg/L
Mineral oil ²	1 mg/L
Polycyclic Aromatics ¹	0.0001mg/L

¹Trinkwasserverordnung

²Brandenburgische Liste

2.5 *Mexican Limits for drinking water:*

In Mexico the effective norms of drinking water quality do not regulate organic compounds, this explains the nonexistent infrastructure and the irregular monitoring of these types of compounds in drinkable water. The Secretary of Health, through the National Advisory Committee of Normalization, develops at the present time the norm "Environmental Health", water for purposes of human use and consumption - permissible limits of quality and the treatments that should undergo the water for its purification ". This new norm, besides the traditional of bacteriological and inorganic parameters, will consider at least some organic compounds of those that have been proved that has or it is suspected, negative effects in the human health. *Source: National Institute of Ecology, last actualisation 21-11-02*

¹*Ordinance on the quality of water for human use (Drinking Water Ordinance – TrinkwV 2001) of 21.05.2001, Federal Law Gazette, 2001 I, p. 959*

3 Current Situation of Mexico

For the acquisition of petroleum derivatives, Mexico has several refinement plants. The oldest refineries existed before the oil expropriation and they are located in Minatitlán, Poza Rica, Ciudad Madero, Azcapotzalco, Reynosa and Salamanca. The most recent refineries are Tula, Cadereyta and Saline Cruz. The development of the oil industry has generated a net of pipelines and storage plants. On the other hand, it has an important oil fleet. PEMEX has a net of ducts that undertakes 61 thousand kilometres (Figure 1), from which 36 thousand 738 correspond to transport ducts for the service of liquid and gas hydrocarbons, 24 thousand 400 kilometres of ducts correspond to the discharge wells lines and other services, and near 8 thousand are outside of operation.

The transport ducts, are classified according to its services:

*13 thousand 700 kilometers of gas ducts

*9 thousand kilometres of poliducts for refined products

*1800 kilometres of ducts for gas LPG (Liquefied Petroleum Gas)

*2400 kilometres for other services, especially for petrochemical products.

The Mexican oil industry has a total production of crude oil of 3, 83 millions barrels daily (PEMEX 2004). In reference with the 13th first oil producers Mexico occupied the 5th place (Table 2)



Figure 1 Mexican Refineries Infrastructure
Source: PEMEX, 2005

Table 2 Total World Oil Producers

Top World Oil Producers, 2004* <i>(OPEC members in italics)</i>		
1	Country	Total Oil Producers, 2004 Millions barrels per day <i>(OPEC Members in Italics)</i>
1	<i>Gaudi Arabia</i>	10.37
2	Russia	9.27
3	United States	8.69
4	<i>Iran</i>	4.09
5	Mexico	3.83
6	China	3.62
7	Noria	3.18
8	Canada	3.14
9	Venezuela	2.86
10	<i>United Arab Emirate</i>	2.76
11	<i>Kuwait</i>	2.51
12	<i>Nigeria</i>	2.51
13	United Kingdom	2.08
13	<i>Iraq</i>	2.03
*Table includes all countries total oil production exceeding 2 million barrels per day in 2004		
**Total Oil Production includes crude oil, natural gas liquids, condensate, refinery gain, and other liquids.		

Source: Organization of Petroleum Exporting Countries OPEC, 2004

The products obtained from the crude oil process are fundamentally the elaboration of combustible, gasoline and diesel (Table 3).

Table 3 Crude yields in the production of oils

Oils	Thousands barrels daily 2005
Combustible	372
Gasoline	472
Diesel	327
Turbosine	252
Gas	8.3
Other	114

Source: Mexican petroleum Institute, data based in PEMEX

In 2003 the Refineries, Cadereyta and Madero increased their crude oil process, so that, the production increased 40 thousand barrels daily more than in 2002.

The national Refineries have a total production of 1,750 thousands of daily barrels oil (2005) (Figure 2)

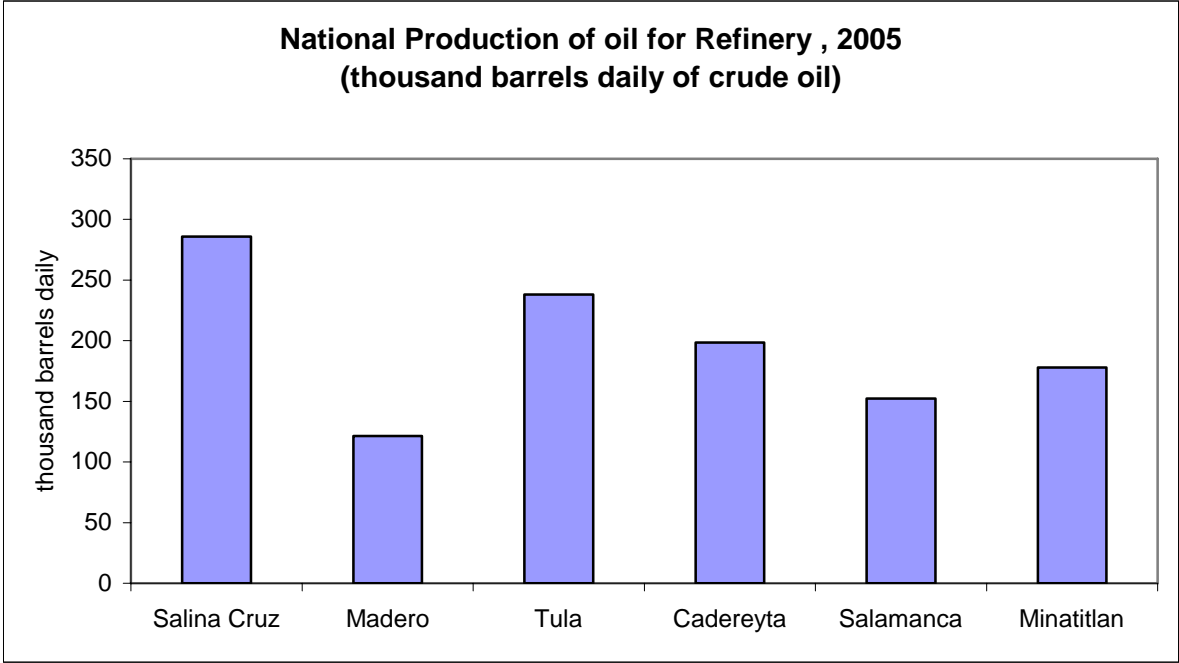

Figure 2 Include: gasoline, combustible, diesel, turbosine and petroleum coke
Source:PEMEX

3.1 Availability of Groundwater in Mexico

In Mexico there is an availability of water from 188 aquifers (January, 2003). In December 2003, were published, the annual average groundwater availability of 14 aquifers more, and the availability of the Central Valleys aquifer, in the state of Oaxaca, reaching a little more than 80% of the volume of total groundwater that is extracted from the aquifers of the country.

At the moment 102 aquifers are overexploited; withdrawn the extraction is bigger than the recharges. Since 1975 the number of overexploited aquifers has increased substantially: 32 in 1975, 36 in 1981, 80 in 1985, 97 in 2001, and 102 in 2003. Approximately 57% of all groundwater employed for all uses is withdrawn from overexploited aquifers. Due to this overexploitation, the groundwater reserve is being diminished at a rate of some 6 km³ per year.

3.2 Use of the water

Around 70% (56,070 hm³/year) of all water withdrawn is used for agricultural and livestock, 13% (9,633 hm³/year) is used for public water supply (Table 4). From the total volume of water used in the agricultural 68% (38259 hm³/year) is from surface water and 31% (38,259 hm³/year) is from groundwater. Otherwise from the total water used in the public water supply 65% is from groundwater and 34% is from the surface water.

Table 4 Volume of water granted in concession for off stream water use (Cumulative figures as of december, (2002) (km³per year)

Use	Origin		Total Volume	Percentage withdrawal Groundwater
	Surface water	Groundwater		
Agricultural and livestock ^a	38.3	17.8	56.1	77
Public water supply (including Industry connected to the network) ^b	3.3	6.3	9.6	13
Self-Supply Industry (includes Thermolectric-plants ^c)	5.3	1.6	6.9	10
National Total	46.9	25.7	72.6	100

Source: Gerencia del Registro Público de Derechos de Agua. SGAA. CNA.

Notes: In agricultural and livestock use, volumes of water that are in the process of being regularized are included.

^a Includes agricultural, livestock, aquaculture, and multiple uses, as well as others.

^b Includes urban public and domestic uses.

^c Includes uses by self-supplied industry, agroindustry, services, commerce, and thermolectric plants.

4 Description of the problem

Since Mexico ranks 5th in world crude oil proven production (Secretaría de Electricidad, 2004), great part of the industrial activities that are carried out are guided to the exploration, exploitation, processing, storage and transportation of hydrocarbons. The above-mentioned increases the possibility of spills in industrial areas and transportation routes. Fuels tanks, of either the aboveground or underground variety, are prone to corrosion, which often causes leaks. Human errors, such as not opening or closing the right valves at the right times, frequently results in spills. Finally, transporting petroleum products in ships, trucks, and pipelines regularly leads to accidents. The inevitable result of handling the huge volumes of these materials consumed by industrialized societies is the reason for so frequent contamination of shallow groundwater systems by petroleum hydrocarbons.

The problem of the contamination of groundwater in Mexico undertakes the whole country. In Mexico 12 million of entire population (100 millions) suffers the lack of drinking water and 24 million do not have a sewer system.

The groundwater plays an important part in the supply of certain areas, like in the case of Mexico City, where 1,366 wells capture water from the aquifers of the Valley of Mexico and the Lerma watershed, contributing to 85% of the total water consumed in the Capital of Mexico. Those of the Valley of Mexico contribute with 28 m³/seg and those of the Lerma with 10.5 m³/seg. Recently it was incorporated to the metropolitan supply the water of the Cutzamala watershed, therewith, the total supply to the metropolitan area is considered in 60 m³/seg, volume that does not reach to satisfy the metropolitan, agricultural and industrial necessities of the area. The population of the metropolitan area of Mexico City overcomes 18 million inhabitants. Even supposing a minimum consumption of 200 l/daily per person the current supply is insufficient to cover the domiciliary necessities. Therefore, a population estimated in more than two million people does not reach to satisfy their basic necessities of water. On the other hand, the extraction rhythm overcomes in that of recharge widely (40%). This overexploitation is manifested in diverse phenomena: the descent of the floor in more than nine meters in the Center of the City during this century, the disappearance of the lagoons in the Lerma watershed, and as a consequence the forcing of the use of wells; and finally, the extraction of water from deeper depths, where the water is characterized by an high content of minerals, which needs a previous treatment. All these factors lead to a considerable increase of the cost of supply of water to the metropolitan area of Mexico City.

At the same time the urban areas and the industry discharge 4,242.5 million m³ per year or 134 m³/seg, from which 61.6% comes from the urban areas and the rest from the industry. The difference among extraction and discharges is imputed to the population's metabolic consumption, to the industrial consumption and some leakage in the system. The Biological Oxygen Demand (BOD) in the residual waters of the urban and industrial sectors is around 2,033,745 tons/year; in this case the population contributes with 39% and the industry with 61%.

The watershed of the river, Lerma-Santiago, is that of more concern, not only due to the discharges extraction rates that it suffers, but also for its high level of contamination originated in the urban and industrial masses that are along all its journey from Almoloya of Alquisiras, going by the industrial area of the valley of Toluca, where it receives residual waters, then to the State of Mexico and all the municipalities and industries which are located

in his course until its ending in the Chapala lake in Jalisco. According to the Secretary of Agriculture and Hydraulic Resources (SARH), the waters of the lake presents almost a completely lack of dissolved oxygen, therewith has disappeared practically all the biological processes, the fauna and flora.

In Mexico the discharges come from the sugar industry 38.8%, total chemical industry 21%, petroleum industry 8.25% and paper and cellulose 6%, from the total of residual waters discharged by the industry, these main branches of the industrial activity contribute with 82%. In the specific case of this project the Salamanca facility was the largest refinery in the PEMEX system and the 11th largest crude oil refinery in the world until 2002. Its finished products include various fuels, oils, and crude oil derivatives. In July, of the same year the refinery opened two more units that produced 18 thousand barrels daily of high octane gasoline.

4.1 Groundwater treatment

Local groundwater in Salamanca is the only water supply for the urban and industrial area. Salamanca, being part of the hydrological region of the Lerma River. As explained previously the superficial water, Lerma River, is only used for watering due the level of contamination that present its waters. The competition for the use of the water (population agricultural, cattleman, industrial and of services) increases every day, reason why the extraction of the groundwater from the watershed storage is increasing year by year. Therefore, the well density is very high. There are more than 1600 active wells in 560 km². The intense abstraction had provoked subsidence and a flaw system. The main flaw is hydraulic connecting two of the three components of the watershed system. The shallow one, not exploited, is receiving pollutants from different sources.

This explains the great density of active wells in the area. The intense extraction has provoked subsidizing problems, which gave place to the appearance of a system flaw that affects the urban infrastructure. These facilitate the incorporation of superficial pollutants to the aquifer system.

In the urban area with industrial development and near the agricultural areas are feasible to find complex potential sources of aquifer contamination. These sources can undertake leaks in the systems of drinkable water and drainages pipes, containers leaching of industrial agricultural wastes and temporary storages of inputs or residuals (Mejía, Rodríguez, 2000).

5 Goal of the Thesis

The goal of this project is to adapt the different processes of bioremediation of diesel and gasoline contaminated groundwater to the specific conditions of contamination that are presents in Mexico, in order to solve the problem of drinking water. This Thesis is based on previous research that has been conducting by The Chair of Chemical Engineering and Hazardous Wastes for about ten years in the field of biological remediation of contaminated sites and on the construction of bioreactors in the form of trickle-bed reactors (Joachim Venus, Horst Beitz, and Wolfgang Spyra, 2000; Kay Winkelmann, Joachim Venus, Wolfgang Spyra, 2003; Joachim Venus, Wolfgang Spyra, 2003). In these reactors, the microorganisms are immobilized on a fixed bed made up of black straw (xylite), a substance that is mined together with lignite. In this fixed bed reactor, much higher concentrations of microorganisms are possible than in a fluidised bed reactor.

The goal of bioremediation is to exploits the ability of certain microorganisms heterotrophic bacteria and fungi to degrade hazardous organic materials to innocuous materials such as carbon dioxide, methane water, inorganic salts and biomass. Microorganisms may derive the carbon and energy required for growth through biodegradation of organic contaminants, or, transform more complex, synthetic chemicals through fortuitous cometabolism. After degrade organic pollutants the concentration should be either undetectable or, if detectable, to concentrations below the limits established as safe or acceptable by International law appropriated to Mexico.

Bioremediation technologies have been sufficiently developed so that they can be used in full-scale applications and is being used for the destruction of chemicals in soil, groundwater, wastewater, sludges, industrial-waste systems, and gases. Environmental biotechnology is not a new field. Biodegradation is useful for many types of organic wastes and is a cost effective natural process. Many techniques can be conducted on site, eliminating the need to transport hazardous materials. It will not always be suitable, however, as the range of contaminants on which it is effective is limited, the time scales involved are sometimes relatively long. Although the methodologies employed seems not to be technically complex. The control and optimization of bioremediation processes is a complex system of many factors and considerable experience and expertise may be required to design and implement a successful bioremediation program, due to the need to thoroughly assess a site for suitability and to optimize conditions to achieve a satisfactory result.

Because bioremediation seems to be a good alternative to conventional clean-up technologies research in this field, especially in the United States, rapidly increasing.

Bioremediation has been used at a number of sites worldwide, including Europe, with varying degrees of success. Techniques are improving as greater knowledge and experience are gained, and there is no doubt that bioremediation has great potential for dealing with certain types of site contamination.

It is important to know the pros and cons of the technique, and the issues to be considered when dealing with a proposal for bioremediation. Some tests make an exhaustive examination of the literature of bioremediation of organic and inorganic pollutants, and another test takes a look at pertinent field application case histories. The extent of biodegradation is highly dependent on the toxicity and initial concentrations of the contaminants, their biodegradability, the properties of contaminated soil, and the particular treatment system selected.

Advantages of bioremediation

- Bioremediation is a natural process and is therefore perceived by the public as an acceptable waste treatment process for contaminated material such as soil. Microbes able to degrade the contaminant increase in numbers when the contaminant is present; when the contaminant is degraded, the biodegradative population declines. The residues for the treatment are usually harmless products and include carbon dioxide, water, and cell biomass.
- Theoretically, bioremediation is useful for the complete destruction of a wide variety of contaminants. Many compounds that are legally considered to be hazardous can be transformed to harmless products. This eliminates the chance of future liability associated with treatment and disposal of contaminated material.
- Instead of transferring contaminants from one environmental medium to another, for example, from land to water or air, the complete destruction of target pollutants is possible.
- Bioremediation can often be carried out on site, often without causing a major disruption of normal activities. This also eliminates the need to transport quantities of waste off site and the potential threats to human health and the environment that can arise during transportation.
- In cases where the potential hazard from discharges and emissions are very serious, the likely technology to use would be by bioreactors

- Bioremediation can prove less expensive than other technologies that are used for clean-up of hazardous waste.

Disadvantages of bioremediation

- Bioremediation is limited to those compounds that are biodegradable. Not all compounds are susceptible to rapid and complete degradation.
- There are some concerns that the products of biodegradation may be more persistent or toxic than the parent compound.
- Biological processes are often highly specific. Important site factors required for success include the presence of metabolically capable microbial populations, suitable environmental growth conditions, and appropriate levels of nutrients and contaminants.
- It is difficult to extrapolate from bench and pilot-scale studies to full-scale field operations.
- Research is needed to develop and engineer bioremediation technologies that are appropriate for sites with complex mixtures of contaminants that are not evenly dispersed in the environment.
- Contaminants may be present as solids, liquids, and gases.
- Bioremediation often takes longer than other treatment options, such as excavation and removal of soil or incineration.
- Regulatory uncertainty remains regarding acceptable performance criteria for bioremediation. There is no accepted definition of “clean”, evaluating performance of bioremediation is difficult, and there are no acceptable endpoints for bioremediation treatments.

6 Contaminants of Salamanca (Gasoline and Diesel)

6.1 Hydrocarbons

6.1.1 Defining petroleum

The term petroleum is derived from the Latin derivative *petra* for rock and *oleum* for oil. Current usage defines petroleum as any hydrocarbon mixture of natural gas, condensate and crude oil. Crude oil is a heterogeneous liquid consisting of hydrocarbons comprising almost entirely the elements hydrogen and carbon in ratio of about 1.85 hydrogen atoms to 1 carbon atom. Minor constituents, such as sulphur, nitrogen and oxygen, typically make up less than 3% of the total volume (Appendix 1). Trace constituents that typically constitute less than 1% in the total volume include phosphorous and heavy metals such as vanadium and nickel. The composition of crude oil may vary with the location and age of an oil field, and may even be depth dependent within an individual well or reservoir. Crudes are commonly classified according to their respective distillation residue, which reflects the relative contents of three basic hydrocarbon structural types: paraffins (composed of aliphatic hydrocarbons), naphthenes and aromatics. About 85% of the crude oils can be classified as either asphalt bases, paraffin based, or mixed based (predominantly condensed aromatics). Sulphur, oxygen, and nitrogen contents are often relatively higher in asphalt based crude in comparison with paraffin-based crudes, which contain little to no asphaltic materials. Mixed based crude contains considerable amounts of both wax (longer chain aliphatics) and asphalt (contain larger concentrations of cycloaliphatics and high viscosity lubricating oils).

A petrochemical is a chemical compound or element recovered from petroleum or natural gas, or derived in whole or in part from petroleum or natural gas hydrocarbons, and intended for chemical markets.

6.2 Hydrocarbons Structure

Hydrocarbons in general are simply compounds of hydrogen and carbon that can be characterized based on their respective chemical composition and structure. Each carbon atom can essentially bond with four hydrogen atoms. Methane is the simplest hydrocarbon (Table 5) Each dash represents a chemical bond of which the carbon atom has four and each hydrogen atom one.

More complex forms of methane can be developed by adhering to the simple rule that a single bond exists between adjacent carbon atoms and that the rest of the bonds are saturated with hydrogen atoms. With the development of more complex forms, thus, there is also an increase in molecular size. Hydrocarbons that contain the same number of carbons and hydrogen atoms, but have a different structure and therefore different properties, are known as isomers. As the number of carbon atoms in the molecule increases, the number of isomers rapidly increases. The simplest hydrocarbon having isomers is butane (Table 5).

Hydrocarbon derivatives are formed when there is a substitution of a functional group at one or more of these positions (Ebbing, Darrell D, 1990).

Hydrocarbon compounds can be divided into four major structural forms: 1) alkanes C_nH_{2n+2} , 2) cycloalkanes, 3) alkenes C_nH_{2n} , and 4) arenes. Petroleum geologists and engineers commonly refer to these structural groups as 1) paraffins 2) naphthenes or cycloparaffines 3) aromatics as benzene (C_6H_6), toluene ($C_6H_5CH_3$) ethylbenzene (C_8H_{10}) and xylene ($C_6H_4(CH_3)_2$) (BTEX) and 4) olefins, respectively. Olefins are characterized by double bonds between two or more carbon atoms. The polyaromatic hydrocarbons (PAHs) are also components of concern in petroleum hydrocarbons. These compounds derive from a series of benzene rings (Table 5) (Appendix 2).

Paraffin type hydrocarbons are referred to as saturated or aliphatic hydrocarbons. These hydrocarbons dominate gasoline fractions of crude oil and are the principal hydrocarbons in the oldest, most deeply buried reservoir. Paraffins can form normal (straight) chains and branched chain structure. Normal chain form a homologous series in which each member differ from the next member by constant amount (Table 5) (Appendix 5) where each hydrocarbon differs from the succeeding member by one carbon and two hydrogen atoms.

Naphthenes or cycloparaffines are formed by joining the carbon atoms in ring type structures, the most common molecular structure in petroleum. These hydrocarbons are also referred to as saturated hydrocarbons since all the available carbon atoms are saturated with hydrogen (Table 5) (Appendix 6).

Aromatic hydrocarbons usually comprise less than 15% of a total crude oil although often exceed 50% in heavier fractions of petroleum. The aromatic fraction of petroleum is the most important environmental group of hydrocarbon chemicals and contains at least one benzene ring comprising six carbon atoms in which the fourth bond of each carbon atom is shared

throughout the ring. Benzene is known as the parent compound of the aromatic series and, along with toluene, ethylbenzene and three isomers of xylene (ortho, meta and para) are major constituents of the gasoline (BTEX) (Table 5) (Appendix 7).

Table 5 Petrohydrocarbons typical properties and structures

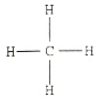
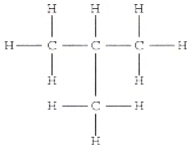
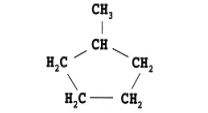
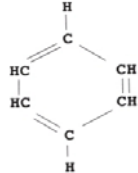
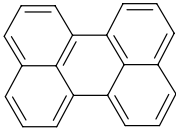
Group-Substance	Structure Example	Water Solubility	Log Koc	Biodegradability
Alkanes Normal paraffins Branched chain paraffins	 <p>Methane (CH₄)</p>  <p>Isobutane (C₄H₁₀)</p>	around 10 mg/L	2.0-3.5	From easily to less degradable (long chains)
Cycloparaffins (Naphthenes)	 <p>Methylcyclopentane (C₆H₁₂)</p>	less than 10 mg/L	2-3.9	From easily to less degradable (long chains)
BTEX	 <p>Benzene (C₆H₆)</p>	140-1800 mg/L	2.1-3.2	easily degradable
PHA	 <p>Perylene C₂₀H₁₂</p>	0.0002-30 mg/L	2.9-6.0	less degradable

Sources: Kay Winkelmann, Joachim Venus, Wolfgang Spyra, 2003. Lehrstuhl Atlanten
Stephen M. Testa, Duane L. Winegardner, 2000

6.3 Hydrocarbon Products

A refinery converts crude oil and other hydrocarbons feedstocks into useful products and raw materials for other industries. Refining involves the separation and blending, purifying and quality improvement of desired petroleum products. The primary products of a refinery are as follows:

- Fuels such as gasoline and diesel fuels, aviation and marine fuels, and fuel oils
- Chemical feedstocks such as naphtha, gas oils, and gases
- Lubricating oils, gases and wastes
- Bitumens and asphalts
- Petroleum coke and
- Sulphur

Transportation fuels are by far the primary products of refineries. The variables that determine gasoline quality include blend, octane level, distillation, vapor pressure ratings, and other considerations, such as sulphur content or gum forming tendencies. The petrochemical and other industries also utilize refinery products to manufacture plastics, polyester clothing, certain pharmaceuticals and other useful products. The primary fuels familiar to all are gasoline, diesel (or Number 2 fuel oil), and fuel. Gasoline comprises a mixture of volatile hydrocarbons suitable for use in internal combustion engines (Figures 3, 4).

Gasoline and diesel oil generally contain low amounts of alkenes. They are both composed of four main structural classes of hydrocarbons (R. Marshall, S. Penet, 2003):

- *n*-alkanes or *n*-paraffins
- isoalkanes or isoparaffins
- cycloalkanes or naphthenes
- aromatics compounds including the BTEX compounds

In gasoline composition, aromatics amount to about 20-40% of the total hydrocarbons content. Isoalkanes amount to about 60-80%. Alkanes, alkenes and cycloalkanes are present in minor quantities. There are about 230 individual hydrocarbons in gasoline composition. The constituting hydrocarbons can be separated and identified by gas chromatography (Durand 1998; Durand *et al.*, 1995).

The BTEX components of Gasoline (% weight) are:

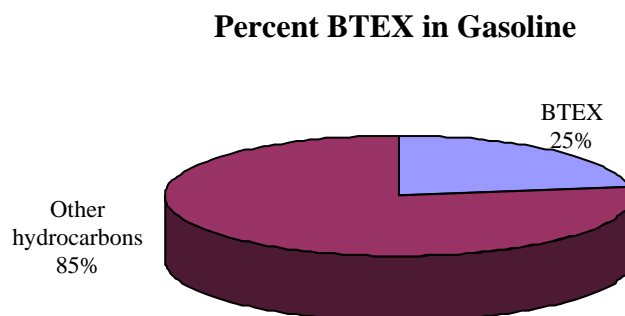
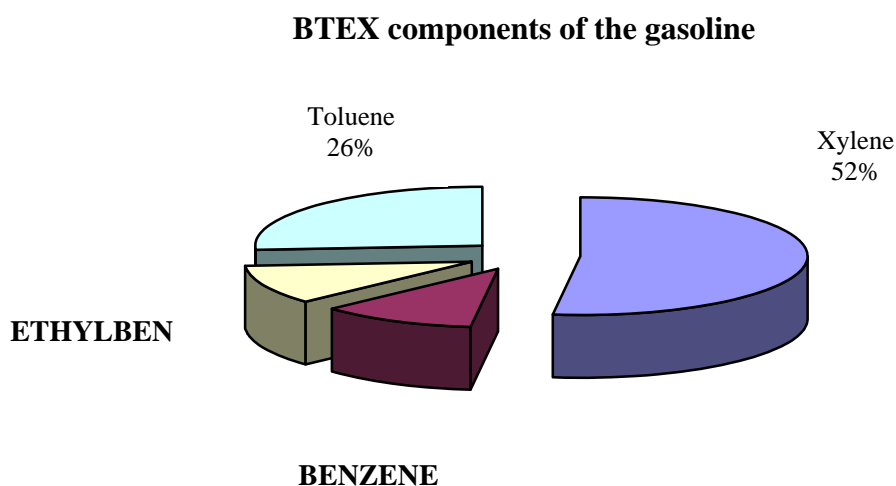

Figure 3 Percentage of BTEX in gasoline (% weight), others hydrocarbons as ethylene, propylene, butene, pentene, etc. Mexican National Institute of Ecology



BENZENE
Figure 4 BTEX components of the gasoline (% weight) Mexican National Institute of Ecology

In contrast, diesel oil contains 2000 to 4000 hydrocarbons, which cannot be totally separated by gas chromatography. In fact, only *n*-alkanes and a few branches hydrocarbons can be identified as separated compounds. However, the separation of the main structural hydrocarbons classes can be carried out by using a standard procedure of liquid chromatography (Olson *et al.*, 1999).

Diesel fuel is composed primary of unbranched paraffins. Fuel oils are chemical mixtures, with flash point grater than 38°C. These petroleum mixtures basically represent progressive fractions of distillation column, with the major petroleum hydrocarbons easily represented by increasing the boiling point in a gas chromatograph separating column.

6.4 Diesel Fuels

Diesel fuel is formulated for engines found in buses, trucks, ships, and locomotives, which are commonly heavier and more powerful than gasoline engines. Diesel fuel, is less volatile than gasoline and is made up of heavier petroleum fractions, ignites by compression in the cylinder rather than by a spark. In the same way that gasolines are labelled with an octane rating, the ignition performance rating of diesel fuel is called the cetane number. Diesel fuel is generally classified into the following three grades:

Diesel No. 1 is relatively volatile (C8-C19) when compared to other diesel fuels. It is used in high-speed diesel engines that vary in speeds and loads, and was originally formulated to meet the specifications for Detroit Diesel Series 71 engines in city buses.

Diesel No. 2 is composed of lower volatility, heavier (C9-C21) petroleum compounds than Diesel No. 1. It is used in high-speed diesel engines involving high loads and uniform speeds such as automobiles and trucks.

Diesel No. 4 is the most viscous and least volatile diesel blend and is a mixture of heavy diesel distillates and residual (C25 to C78) fuel oils (alkanes nonsoluble aromatics predominantly PAHs (Frankling W. Schwartz/ Hubao Zhang, 2002). It is for use in low-and medium-speed services involving sustained loads and constant speeds. It is mainly used by large stationary power generators, locomotives, and ships.

6.5 Refining process

Petroleum refining is the process of separating the many compounds present in crude petroleum. The principle which is used is that the longer the carbon chain, the higher the temperature at which the compounds will boil.

The refining uses three primary processes in converting crude oil into these varied fuel products: separation, conversion and treatment.

6.5.1 Separation

The principal method for separating crude oil into useful products is through distillation. Distillation is the heating process whereby hydrocarbons, which make up the crude oil, are converted to vapor form and are releasing from the oil by heating. The released hydrocarbon vapors are then cooled back to liquid form. As a crude sample (or any hydrocarbon blend) is heated in increasing increments, the hydrocarbon compounds having a boiling point at or

below the current temperature sequentially volatilise. The remaining hydrocarbons compounds in the sample will not volatilise until the temperature is raised to their respective boiling points. By drawing off the hydrocarbons vapors that have similar boiling points refineries produce a variety of products, such as diesel, kerosene, naphtha, gasoline, and butane. The boiling temperatures for various products range from high to low divided into the following products types: residue, heavy gas-oil, light gas-oil, diesel, kerosene, naphtha, gasoline, and butanes (Table 6).

Table 6 Major Petroleum Distillation Products

Fraction	Distillation Temperature °C	Carbon Range
Butanes	-	C ₁ to C ₄
Gasoline	40-205	C ₅ to C ₁₄
Naphtha	60-100	C ₆ to C ₇
Kerosene	175-280	C ₉ to C ₁₈
Diesel	170-338	C ₉ to C ₂₀
Light gas-oil	275	C ₁₄ to C ₁₈
Heavy gas-oil	275	C ₁₉ to C ₂₅
Residue	-	>C ₄₀

(Frankling W. Schwartz/ Hubao Zhang, 2002)

6.5.2 Conversion

Conversion transforms the chemical composition of various fractions produced by distillation. The results of conversion are common intermediate components that eventually become parts of other end products. Conversion processes include fluid catalytic cracking, thermal cracking, hydrocracking, coking, and alkylation and reforming. Cracking refers to the process of breaking down large hydrocarbon molecular into small ones. Cracking uses intense heat (358°C), low pressure, and finely powdered catalyst to convert most heavy hydrocarbons into small hydrocarbons within the gasoline range.

One of the oldest conversion processes is thermal cracking where heat and pressure continue to change heavy molecules in fuel oil and asphalt into lighter ones. The use of lower temperature, greater pressures, hydrogen to promote chemical reactions is referred as a hydrocracking. This form of conversion is utilized at all higher quality products. Coking uses heat and moderate pressure to convert the residual from other conversion process into lighter products. Coking produces a hard, coal like substance that is used as an industrial fuel.

The making of materials suitable for blending into gasoline from liquid petroleum gases produced via catalytic cracking is a process referred to as alkylation. This is accomplished by

using acidic catalysts to combine hydrocarbon molecules, rather than cracking or breaking apart molecules. Reforming utilizes heat, moderate pressure, and special catalysts to convert nonaromatic hydrocarbons such as naphtha a relative low-value fraction, into aromatic hydrocarbons such as high-octane gasoline components (including benzene). Aromatic hydrocarbons are building blocks for many plastics and other products generated to petrochemical industry. One barrel of crude petroleum contains only 30-40% gasoline. The conversion of some petroleum fractions to gasoline may be done by "cracking" changing molecular structures of low quality gasoline molecules; or "polymerisation" - forming longer molecules from smaller ones

6.5.3 Treatment

A process to a hydrotreating removes certain substances that may inhibit refinery processes or result in poor emission performance of fuels. Because of the presence of sulfur and nitrogen, the resulting refining product may still be considered undesirable because these naturally occurring substance create sulphur oxide and nitrogen oxide emissions when the refined product is burned. A process called hydrotreating utilizes hydrogen with a catalyst to react with sulphur compounds and form hydrogen sulphide. Hydrogen sulphur can easily separate from hydrocarbons and processed to form sulphur.

API Gravity

Probably the simplest tool in discriminating between, notably, LNAPL product types is the measurement of API gravity. API gravity is similar to specific gravity but differs by the following conversion:

$$^{\circ}API = \frac{141.5}{specificgravity}(-131.5)$$

By using this conversion, water has a specific gravity of 1 (unit less) and an API gravity of 10°. The higher the API gravity, the lighter the compound. Typical API gravities for various refined products are listed in the. Specific gravity corresponding to API gravity is provided in (Appendix 3) (Stephen M. Testa, Duane L. Winegardner, 2000).

7 Hazard and Risk

By Risk is meant the likelihood, or probability, that the toxic properties of a chemical will be produced in populations of individuals under their actual conditions of exposure. To evaluate the risk of toxicity occurring for a specific chemical at least three types of information is required:

- 1) The types of toxicity the chemical can produce (its targets and the forms of injury they incur)
- 2) The conditions of exposure (dose and duration) under which the chemical's toxicity can be produced
- 3) The conditions (dose, timing and duration) under which the population of people whose risk is being evaluated is or could be exposed to the chemical (Joseph V. Rodricks, 1992).

Hazard is the potential to produce harm. Hazard is qualitative; risk is quantitative. Risk assessment, the process defining just how dangerous a particular substance is to ourselves and our environment, involves four overlapping components: 1) Hazard identification or evaluation, 2) dose-response evaluation, 3) exposure, evaluation, and 4) risk characterization.

7.1 Source

In a Refinery, where fuel storage and delivery systems are in physical contact with air, soil, and groundwater, exist thousands of reasons for its contamination for example, faulty and poorly maintained underground storage tanks, large bulk facilities, surface spills and leaks provoked from diversity of origins as ruptures by the robbery of products (diesel and gasoline), the call ducts "milks" and the affectations to the conduction lines for natural phenomena as earthquakes, floods, volcanic activity and reactivation of geologic flaws.

The moment a fuel release occurs, it is subject to a variety of physical and chemical changes. Volatile components begin to vaporize, indigenous microbial action will begin to break down the fuel into less harmful components, and hydrocarbons will begin to be adsorbed into/by organic matter in the environment or inevitably seep into the groundwater aquifer causing a contaminant plume.

7.2 *Exposure*

Exposure is the key to intoxication and risk. Exposure ordinarily is defined simply as a contact of an organism's exterior with a chemical, but toxicologically, it is the means by which the organism acquires a dose. The dose is the total amount of chemical received through any body areas that contact the outside world: skin or integument, mouth, nose, gills, eyes.

Exposure can take a number of forms: respiration of air, drinking or imbibing water, contacting soil, and taking in nutrients. The form and extent of dissipation govern contact. Volatility and dissolution quickly reduce a substance's availability, while adsorption and bioconcentration often prolong it (Donald G. Crosby, 1998).

Chemicals in the environment may enter the mouth (consuming water contaminated with Benzene, the most toxic from the BTEX compounds) and be swallowed into the gastrointestinal tract. If they are in the vapor state or are attached to very fine dusts in the air (inhalation of organics can occur while pumping gasoline) they may be inhaled through the nose and mouth and thereby enter the airways leading to the lungs (in so called alveolar area) and into the blood. Some chemicals reach the skin (spilling gasoline onto one's skin or by bathing in BTEX contaminated water), sometimes dissolved in some medium, sometimes not. The skin acts as a barrier to the entry of chemicals, but some chemicals get through it. Dermal or percutaneous absorption, as it is technically called, generally involves diffusion of a chemical through the so called epidermis, which includes the outer layer or dead cells called the stratum corneum. This is a tough barrier for chemical through, and may don't make it. If they do, they also have to negotiate passage through the less protective second layer called dermis, once by this they are into the blood.

The effectiveness of the stratum corneus in blocking the passage of the chemicals varies from one part of the human body to another. It is particularly difficult for the chemicals to cross the palms of the hands and soles of the feet, but they get by the scrotum fairly easily. Abdominal skin is of intermediate effectiveness in preventing absorption. Age and sex also influence the rates of dermal adsorption.

The physical properties of a chemical, which are in turn functions of its chemical structure, have a powerful influence on the likelihood it will get through the skin. Generally, chemicals must be capable of dissolving fairly readily in both water and fat like materials. Substances that dissolve only for fatty materials do not get far. Large molecules can not move as easily

through the skin as can smaller ones. Substances that do not dissolve well in water or any other solvents just cannot penetrate in measurable amounts.

After the community and the industry personal will be exposed to organic chemicals, the severity of damage, and the likelihood that the damage can be reversed, depend upon the process of adsorption, distribution, metabolism and excretion, ADME for short. The combined effects of these processes determine the concentration a particular chemical (the chemical entering the body of one or more of its chemical reactions, products or metabolites) will achieve in various tissue and cells of the body and the duration of time its spend there. Chemicals forms, concentration, and duration in turn determine the nature and extent of injury produced. Injury produced after absorption is referred to as a *systematic toxicity*.

Once the chemicals enters to the body by these three routes happens the following; first, the chemicals come into intimate contact with the fluids, tissues, and cells that make up these three passages into the body. This contact may or may not result in some type of injury to tissue and cells; if some adverse response occurs in the tissues comprising these entryways, it is referred to as local toxicity.

In most cases, however, chemicals enter the bloodstream after the *distribution* starts they can move around the body with relative ease, going just about everywhere blood goes. It generally will not be distributed equally to all organs and systems; and the pattern of distribution will vary greatly among chemicals, according to their particular structural characteristics and physical properties.

There are fortunately a few natural biological barriers that prevent or impede distribution to certain organs. The most important are the blood brain barrier and the placental barrier the one retarding entry of the chemicals to the brain, the other protecting the developing fetus. These barriers are not perfect, and certain chemicals can migrate through them. Other biological barriers, non perfect, exist in the eye and testicles.

7.3 Resulting Toxicity

Certain chemicals can be store in the body, a major site of storage is bone, therefore, when sufficiently intense exposure to benzene occurred and enters the bloodstream , the marrow bond, which contain stem cells which are immature predecessors of the blood cells (erythrocytes, leucocytes and thrombocytes) can lead to *anemia* (decrease level of

erythrocytes), leukaemia (increase number of leukocytes), thrombocytopenia or Pancytopenia, a severe form of poisoning, refer to the reduction in circulatory levels of all three elements of the blood.

Exposure to diesel fuel may cause irritation and dermatitis; therefore, skin contact should be avoided, and diesel fuel should not be used for cleaning purposes.

Acute exposures to high levels of gasoline and its BTEX components have been associated with skin and sensory irritation, central nervous system depression, and effects on the respiratory system. This can happen with vapors of the gasoline and certain solvents. Sometimes such chemicals cause local toxicity everything from minor, reversible irritation of the airways to serious irreversible injury such as lung cancer.

Prolonged exposure to these compounds has similar effects, as well as the kidney, liver and blood systems. The reason is that the cells of the body, particularly those of the liver, and with important contributions from those of the skin, lungs, intestines and kidneys, have the capacity to bring about chemical changes in a large number of the natural and synthetic chemicals that are not essential to life. As we have said, these chemical changes yield metabolites of the absorbed chemical, and the process whereby metabolites are produced is called *metabolism*. Toluene, a volatile chemical present in petroleum products and readily absorbed through the lungs, is converted to benzoic acid. At high exposures toluene molecules can reach and impair the nervous system. But the liver has certain enzymes that can eliminate the three hydrogen atoms attached to the carbon atom, those of the methyl group, and introduce oxygen atoms in their places. The rest of the toluene molecule is unaffected. But this metabolic change is enough. Benzoic acid is much less toxic than toluene indeed, and it is more readily excreted from the body: This metabolic pathway detoxifies toluene. Of course, if an individual inhales huge amounts, such that the amount of toluene absorbed and distributed exceeds the capacity of the liver to convert it to benzoic acid, then toxicity to the nervous system can be caused by the excess toluene. Though toluene is chemically related to benzene, the latter is a far more toxic chemical, it can cause certain blood disorders and forms of leukemia in humans, in part because it cannot so readily be metabolized to chemical forms having reduced toxicity (Joseph V. Rodricks, 1992).

8 Technology

8.1 Principle of the problem

The unsaturated zone is the zone immediately below the land surface and above the water table down the capillary hem where the pores contain both water and air, but are not totally saturated with water. This zone differs from the saturated zone, where the pores are saturated with water. The unsaturated zone is sometimes called the vadose zone. The capillary hem varies in thickness depending on the soil makeup and particle size (lithography). The water table is the point of 100% water saturation, lies at the base of the capillary hem, and is the uppermost extent of the phreatic (saturated) zone. The water table can fluctuate seasonally due to the rainfall and the pumping of wells for irrigation and domestic water supply as well as pumping during an aquifer remediation. The permeability of soils (both above and below the water table) is the rate at which a fluid can flow through them. Soils of high permeability allow faster flow in centimetres/second than soil of low permeability (Figure 5).

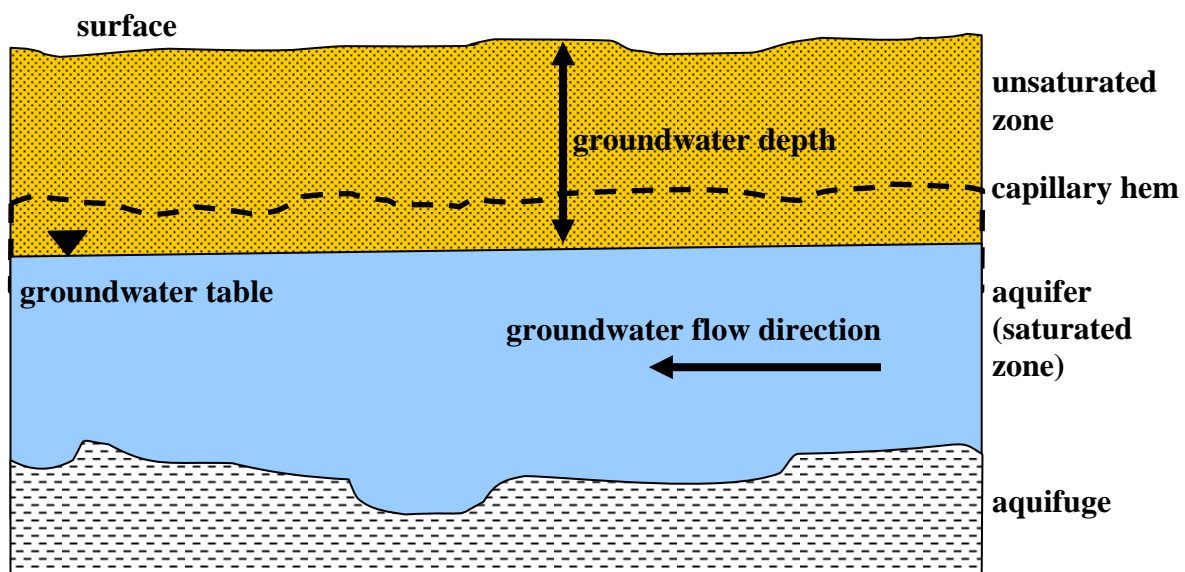

Figure 5 Saturated and unsaturated groundwater zone
Chair of Chemical Engineering and Hazardous Waste
Prof. Dr. Ing. W Spyra

An aquifer is defined as a natural zone (geological formation) below the surface that yields the water in sufficient large amounts. An aquifer that is sandwiched between two impermeable layers of formation that are impermeable is called *confined aquifer* if it is totally saturated from the top to the bottom. An unconfined aquifer possesses no overlaying confining layer, but may be sit upon an impermeable or slightly permeable bed (Jaques W. Delleur, 1999). The floor of an aquifer is referred to as an aquatar. An aquifuge is the ultimate low

hydraulic conductivity unit, which is a poor conductor of groundwater and is essentially impermeable (Figure 6). An aquitard is a low permeability unit that is capable of storing water and transmitting water between adjacent aquifers (Franklin W Schwartz, Hubao Zhang, 2002). If the aquitard is fractured (either naturally or by drilling activities), there can be communication or water flow between these aquifers. When a surface aquifer is contaminated, but the lower confined aquifer is not, extreme care must be exercised to avoid drilling through the aquatar. A small contamination in the vadose zone may trap percolating contaminants and water. This small pocket of contamination must be carefully removed to avoid contamination of the aquifer below.

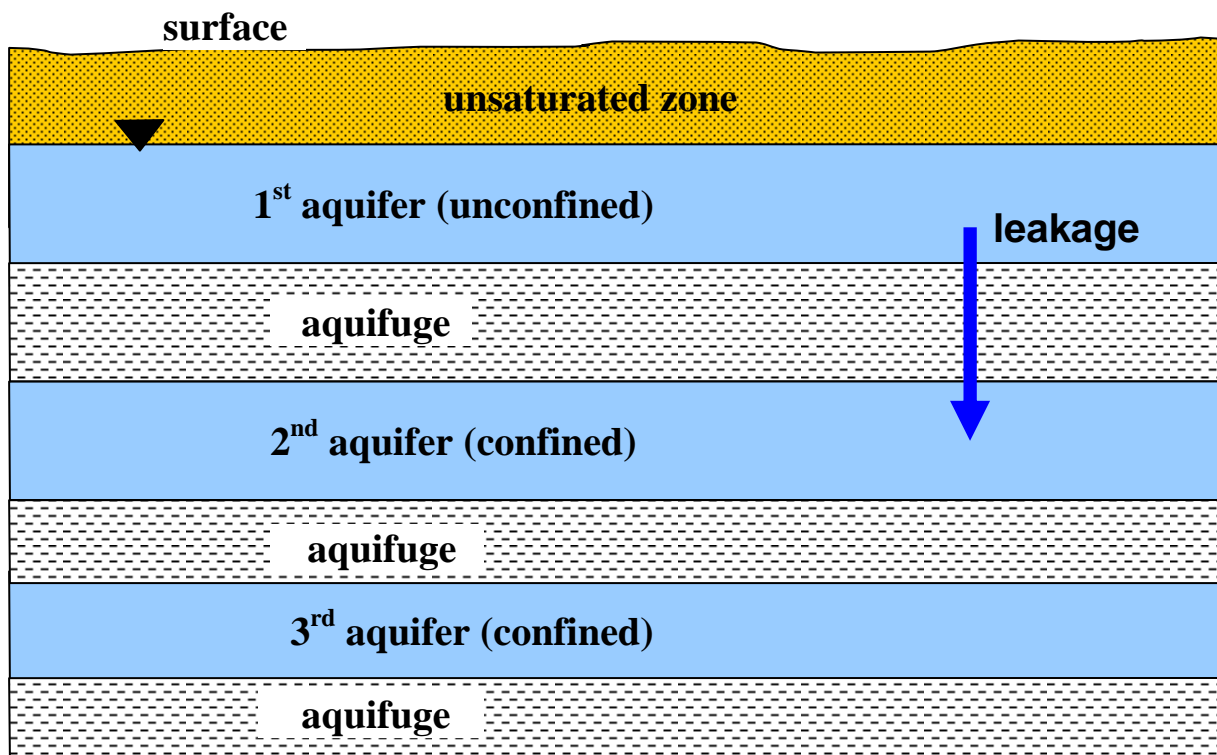

Figure 6 Groundwater Strata
 Chair of Chemical Engineering and Hazardous Waste
 Prof. Dr. Ing. W Spyra

8.1.1 Density driven migration of hydrocarbons

An uncontaminated shallow groundwater system may be viewed as being composed of two immiscible fluids (air and water) that are separated by an interface. Once a spill has occurred at land surface, a third immiscible fluid is added to the system and the movement of the hydrocarbon is determined by the sum of the forces acting on it. Gravity tends to pull it downward, whereas the air in the unsaturated zone and capillary forces tend to buoy it up. In general, if the pressure at the leading edge of the hydrocarbons is greater than air pressure, the

hydrocarbon phase will move downward, displacing air as it goes. If the pressure of the hydrocarbon drops below the displacement pressure of the air, as often happened with small spills, movement of the hydrocarbons will cease and the hydrocarbons will be immobilized in the saturated zone. If the pressure is sufficient, the hydrocarbon fluid will continue displacing air and moving downward until it encounters the water table.

Once it encounters the water table, the pressure relationship moving the hydrocarbon fluid changes. In order to continue moving downward, there must be sufficient pressure to displace the water. On the other hand, hydrocarbons that still above the water table can continue to displace air laterally. The net effect of this is that a lens of hydrocarbons develops on the surface of the water table and spreads laterally over time. Lateral spreading continues until the hydrocarbon is at or just below the displacement pressure of hydrocarbon into air and water at all points (Francis H. Chapelle, 2000).

At most contaminated sites, the bulk of the contaminant mass is in what remediation professionals call “source zones”. Some of these sources can be easily located and complete or partial removal or containment may be possible. However, other common types of sources often are extremely difficult to locate and remove or contain. One case is the NAPL (nonaqueous-phase liquids). There are two types of NAPLs those that are more dense than water (dense nonaqueous-phase liquids, or DNAPLs), and those that are less dense than water (light nonaqueous-phase liquids, or LNAPLs). When released to ground, these types of fluids move through the subsurface in a pattern that varies significantly from that of the water flow because NAPLs have very different physical properties than water. LNAPL can accumulate near the water table, DNAPLs can penetrate the water table and form pools along geologic layers, and both types of NAPLs can become entrapped in soil pores. These NAPL accumulations contaminate the groundwater that flows by them by slow dissolution. Common LNAPLs include fuels (gasoline, kerosene, diesel, and jet fuel) and common DNAPLs include industrial solvents (trichloroethene, tetrachloroethene, and carbon tetrachloride) and coal tar (Figure 7). Normally, the total mass of a contaminant within source zones is significantly larger compared to the mass dissolved in the plume. The rate at which contaminants dissolve from a typical NAPL pool is so slow that many decades to centuries may be needed to dissolve the NAPL completely by dissolution without any intervention (Suthan S. Suthersan, 2002).

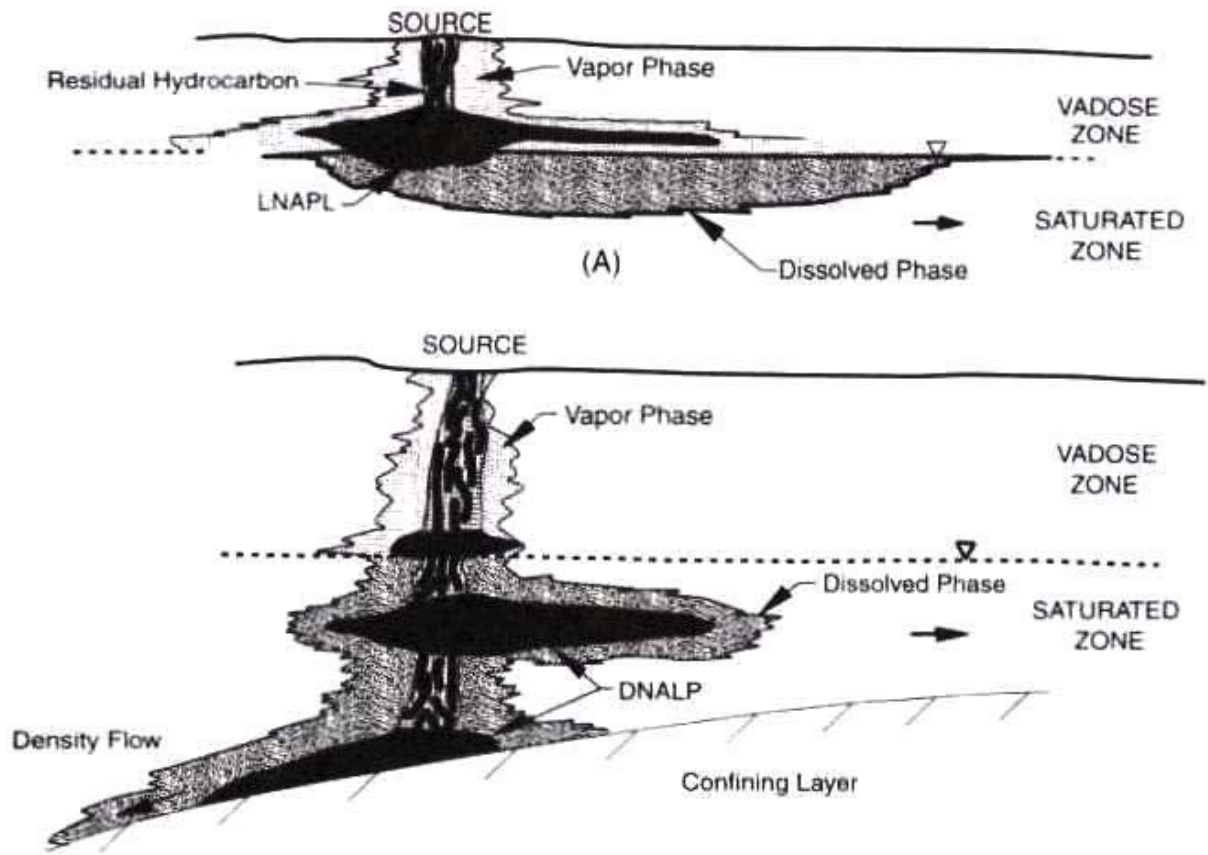

Figure 7 Schematic showing general distribution of LNAPL and DNAPL in the subsurface (Stephen M. Testa, Duane L. Winegardner, 2000)

Several important factors control the flow of NAPLs. In case of noncontinuous source (Figure 8), the volume of free product gradually decreases because some of the downward-moving NAPL is trapped in each pore at residual saturation. Thus, if the spill is relatively small, downward percolation in the unsaturated zone will stop once the total spill volume is at residual saturation. Another pulse of NAPLs is necessary to move the product downward. The main threat to groundwater from such small spills is the opportunity for continuing dissolution of the NAPL by infiltration or vapor phase migration in the vadose zone. The NAPL (Figure 8) also trends to spread horizontally as it moves downward. The spreading is due to capillary forces, which operate together with gravity forces to control migration. The presence of layers of varying hydraulic conductivity also influences NAPL spread (Farmer, 1993).

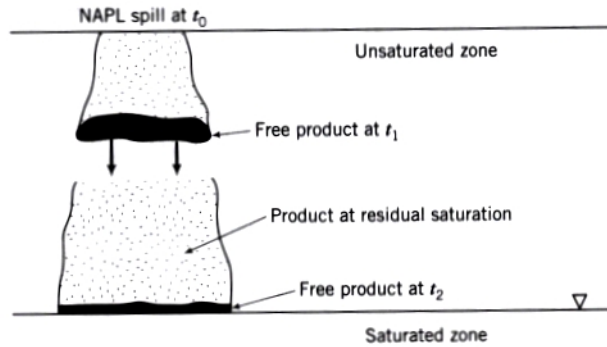

Figure 8 Downward percolation of a NAPL in the unsaturated zone (Franklin W Schwartz, Hubao Zhang, 2002)

Even in a relatively thin, low permeability unit (Figure 9) will inhibit downward percolation, and forces the free product to move laterally. If such a layer is continuous, the NAPL will spread only within the unsaturated zone. If the layer is discontinuous, the NAPL will eventually spill over and continue to move downward toward the water table.

The flow of NAPLs also depends on the way to spill occurs (Farmer, 1993). Releasing a relatively large volume of contaminants over a relatively short time causes rapid downward and lateral migration (Figure 9.1a). Spreading of maximized, and a relatively large volume of residual contamination remains in what Farmers, 1993, refers to as the descent cone (Figure 9.1a). With slow leakage over a long time, the contaminant moves along the most permeable pathway (Figure 9.1b). This pathway can be a single channel or a more complex array of small channels, arranged in a dendritic pattern. Both the extent of lateral spreading and the volume of product held at residual saturation are considerably less than with a large-volume spill. Overall, more of the mobile liquid will reach the water table from slow leakage.

The way LNAPL interact with the capillary fringe depends on the rate at which product is supplied (Faemer, 1993). A large volume of fluid, reaching the capillary fringe over a relatively short period of time, collapses the fringe and depresses the water table (Figure 9.1a). The extent of depression depends on the quantity of product and its density.

Alternatively, a slow rate of supply has little effect on the capillary fringe or the configuration of water table (Figure 9.1b). With this loading, the fluid occurs mainly within the capillary fringe. For spills that reach the capillary fringe, spreading continues until the total spill is at residual saturation.

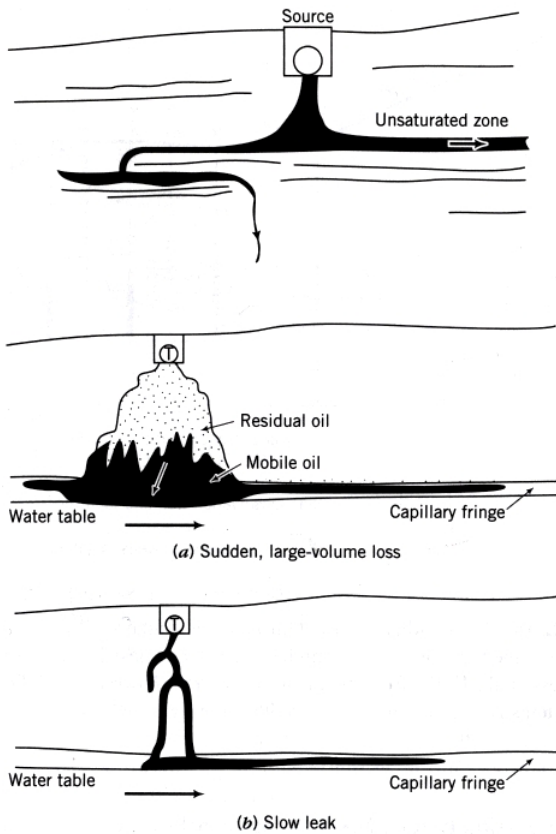

Figure 9 Presence of zones of low hydraulic conductivity within the unsaturated zone can cause NAPLs to mound and spread laterally (Franklin W Schwartz, Hubao Zhang, 2002).

Figure 9.1 Pattern of flow is determined by the nature of the spill. In a) a sudden, large volume loss results in maximum spreading, large residual saturation, and collapse of the capillary fringe. In b) a slow leak causes the product to follow a set of channels, a large volume of products to reach the water table, and minimal disturbance of the capillary fringe (Franklin W Schwartz, Hubao Zhang, 2002)

Another feature of a groundwater system that influences LNAPL distributions is water table fluctuation. The complexities in LNAPL saturation outline above and the lack of mobility may conspire to trap LNAPL below a rapidly rising water table. Over the long term, continuing water table fluctuations will smear the free product above and below the water table.

8.1.2 Secondary Contaminants due to NAPLs

NAPLs in the subsurface can serve as an important source of secondary contamination. Problems develop when organic contaminants present as the free or residually saturated products partition into the soil gas through volatilization or into the ground water through dissolution. (Figure 10) illustrates how even a small volume spill of a volatile organic liquid in the unsaturated zone can produce a plume of dissolved contaminants more significant than the original spill (Mendoza and Mc Alary, 1990). The spreading of volatiles laterally and downward away from the source can partition into available soil moisture. Through continued infiltration, this water ultimately contaminates the aquifer.

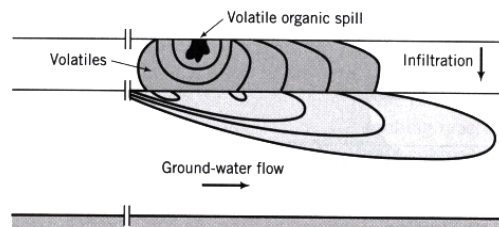

Figure 10 NAPLs in the vadose zone as a source of groundwater contamination (Franklin W Schwartz, Hubao Zhang, 2002)

What is surprising about the results that many authors obtained simulated the vapor of volatile organic solvents in the unsaturated zone is the speed and extent to which volatiles are able to spread through the soil-gas system. Simulation results showed vapor migration of up to several tens of meters in a few weeks. This tendency for volatile NAPLs to contaminate soil gases will be enhanced as the spill grows in size and spread along the capillary fringe.

NAPLs in the subsurface also have the opportunity to dissolve into the mobile water that moves through the zone of contamination. (Figure 7) illustrates the plume of dissolved contaminants that could develop in conjunction with a free LNAPL moving along the capillary fringe. (Figure 7) also shows the plume from DNAPLs at the residual saturation within the cone of descent and from the free product (Franklin W Schwartz, Hubao Zhang, 2002).

If a Nonaqueous Phase Liquid (NAPL) or free phase hydrocarbon is present, the first activity should be to remove this liquid phase because it is the most concentrated source of hydrocarbon material. Hydrocarbon materials in high concentrations can pose a threat to contamination. Previously, treatment media are sometimes toxic to microorganisms and are seldom biodegraded in free form.

8.1.3 NAPL Migrations

Subsurface migration of LNAPL and DNAPL are affected by several mechanisms depending upon the vapor pressure of the liquid, the density of the liquid, the solubility of the liquid (how much dissolves in water at equilibrium) and the polar nature of the NAPL.

NAPL will migrate from the liquid phase into vapor phase until the vapor pressure is reached for the liquid. NAPL will move from the liquid phase into the water phase until the solubility is reached. Also, NAPL will move from the gas phase if hydraulic conductivities can be so low under highly unsaturated conditions, the gas phase may move much more rapidly than either of the liquid phases, and NAPLs can be transported to wetter zones where the NAPL can then move from the gas phase to previously uncontaminated water phase. To understand and model these multiphase systems, the characteristic behavior and diffusion coefficients for each phase must be known for each sediment or type of porous media, leading to an incredible amount of information, much of which is at present lacking.

NAPLs migrate in response to organic liquid pressure gradients. NAPLs are generally less easily adsorbed than water because of their lower surface tensions and lower dipole moments, and will preferentially move in larger channels, pores, or fractures. This may cause irregular and discontinuous flow patterns relative to the flow of water flow saturation vary. However some organic NAPLs such as alkyl phosphates, which are used in many extraction processes are highly polar and will behave differently.

8.1.4 Solubility of Aromatics in groundwater Systems

Many hydrocarbon compounds present in gasoline, particularly the n-alkanes and branched alkanes have very limited solubility in water. Other compounds such as the benzene, toluene, ethylbenzene and xylene (universally referred as BTEX compounds), and fuel oxygenates such as methyltertiary-butyl ether (MTBE), are highly soluble. BTEX compounds typically comprise only 2% or 3% of the fuel as a whole. Fuel oxygenates in gasolines formulated after 1990 may comprise up to 15% of the fuel. However even fuels containing high percentage of fuel oxygenates, about 80 percent of the compounds present are composed of C₉ and larger hydrocarbons with fairly limited solubility. Thus, only a fairly small portion of the gasoline as a whole is available to dissolve in water. Nevertheless, this fairly small portion can cause substantial contamination of groundwater systems.

The difference in solubility of the BTEX portion of most fuels compared to the C9 and larger hydrocarbons. Benzene is the most soluble of the BTEX compound, has an aqueous solubility of 1,780 mg/L, MTBE, in contrast, has an aqueous solubility of 50,000 mg/L. In 1960s, before the widespread used of MTBE, the total soluble fraction of gasoline was about 3%. With MTBE reformulated gasoline, this soluble fraction is as high as 20%. The separation of soluble from insoluble hydrocarbons is and important characteristic of all fuel spills that affect groundwater systems. Most of the effect in terms of dissolved components comes form the BTEX and fuel oxygenates fraction (Figure 11). Conversely, the heavier aliphatic components do not dissolve readily affect both the migration and biodegradation of petroleum hydrocarbons in groundwater systems.

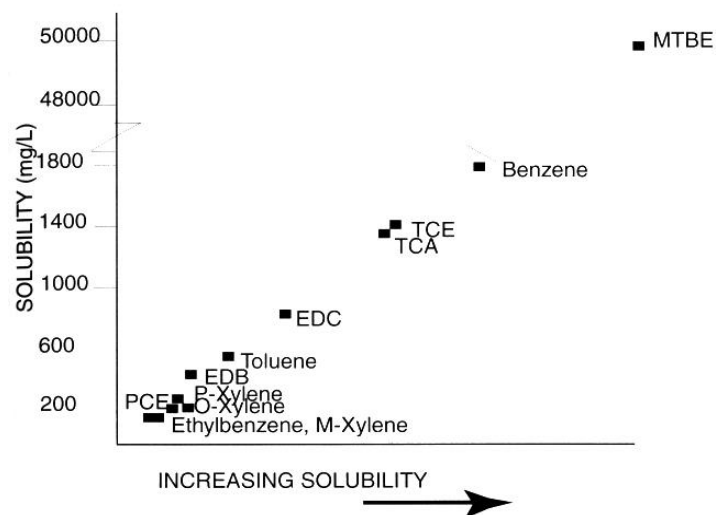

Figure 11 Relative Solubilities of BTEX, MTBE and others (Stephen M. Testa, Duane L. Winegardner, 2000)

Method for determining residual NAPL based on organic chemical concentrations in soils samples are:

- Water solubility, is the measurement of the maximum concentration of a chemical that will dissolve in pure water at a specific temperature, measured in mg/L.
 - Soluble
 - Quickly distribute
 - Dilute easily
 - Insoluble
 - Tend to adsorb on solids
 - Bio accumulate

Fuels spilled on water spread out almost immediately; polar and low-relative-molecular-mass components dissolve and leach out. Once they reach the groundwater they behave as follows:

- low mobility: fluorene, phenanthrene, pyrene, benzanthracene, benzo[*a*]pyrene, fluoranthene;
 - medium mobility: naphthalene, dimethylbenzenes, ethylbenzene, toluene;
 - high mobility: benzene, quinoline, cresols, phenol.
-
- Octanol-water partitioning coefficient is a ratio of the concentration of a dissolved substance in a two-phase system at equilibrium. After a chemical has been mixed in an octanol and water solution the system is allowed to reach equilibrium. The two phases will partition and a ratio of the chemicals concentration in the octanol phase and water phase is taken. This ratio gives a relation of a chemicals accumulation in water. More polar compounds will tend to have a low K_{ow} . This is also a measurement of the hydrophobicity of an organic. The more hydrophobic the more the contaminant will adsorb to soil and have a low solubility. This coefficient can be obtained from the Literature Sources (Appendix 8)
 - The fraction of organic (f_{oc}) carbon on soil is determined from a laboratory analysis of clean site soil. Values for f_{oc} typically range from 0.03 to 0.00017 mg/mg
 - Dry bulk density ρ_b is obtained or estimated from the laboratory soil tests. Typical values range from 1.8 to 2.1 g/cm³. Water-filled porosity, of soils is determined or estimated from laboratory test.
 - The Henry's Law constant is a property of a chemical that expresses its partition between the air and water phases. It helps to predict the behavior of an organic compound in the environment and in remediation procedures such as air stripping processes. These values also describe a chemicals movement from water to air and vice versa. High values mean that the chemical will move more toward the gas phase where as low values will stay in the aqueous phase (Martin N. Sara, 2003).

Part 2

1 THEORETICAL BASES

Indigenous microorganisms are those microorganisms that are found already living at a given site. To stimulate the growth of these indigenous microorganisms, the proper soil temperature, oxygen, and nutrient content may need to be provided.

If the biological activity needed to degrade a particular contaminant is not present in the soil at the site, microorganisms from other locations, whose effectiveness has been tested, can be added to the contaminated soil. These are called *exogenous* microorganisms. The soil conditions at the new site may need to be adjusted to ensure that the exogenous microorganisms will thrive (EPA 542-F-96-007).

1.1 *Aerobic and Anaerobic*

Bioremediation can take place under aerobic and anaerobic conditions. In aerobic conditions, microorganisms use available atmospheric oxygen (O₂) in order to function. With sufficient oxygen, microorganisms will convert many organic contaminants to carbon dioxide and water. Anaerobic conditions support biological activity in which no oxygen is present so the microorganisms break down chemical compounds to release the energy they need. Sometimes, during aerobic and anaerobic processes of breaking down the original contaminants, intermediate products that are less, equally, or more toxic than the original contaminants are created (EPA 542-F-96-007).

2 Enhancement of Bioremediation

2.1 *Three Bioremediation Treatment Approach*

Whenever bioremediation is contemplated as a cleanup technology, a serious consideration is choosing the particular mode of biotreatment that will offer the greatest advantage. There are three options for application of bioremediation.

2.1.1 Natural Attenuation

The third bioremediation option might be available when stimulation and augmentation have been found to be too expensive, too slow, or otherwise inappropriate.

The term intrinsic bioremediation has evolved to emphasize the essential role of indigenous microorganisms in achieving site remediation by natural attenuation (R. Barry King, Gilbert M. Long, John K. Sheldon, 2000).

The U.S. EPA's Office of Research and Development and Office of Solid Waste and Energy Response defines the term "natural attenuation" as: The biodegradation, dispersion, dilution, sorption, volatilisation and or chemical and biochemical stabilization of contaminants to effectively reduce contaminant toxicity, mobility, or volume to levels that are protective of human health and ecosystems. As part of this definition, abiotic oxidation and hydrolysis are also attenuation mechanisms that destroy the contaminants to innocuous end products and thus reduce contaminant mass (Barker, J.F, 1987, Wilson J, 1990).

2.1.2 Enhanced Natural Attenuation

If the result of site characterization and biofeasibility testing have shown that the presence of a viable native population or community of specific contaminant degrading microbes are already in the site, then biostimulation becomes an available option (R. Barry King, Gilbert M. Long, John K. Sheldon, 2000).

Biostimulation is a process in which the conditions for microbial growth are optimised by supplying adequate amounts of electron acceptor(s), nitrogen, phosphorous, and trace metals (W. Zhang, E. Bouwer, L. Wilson and N. Durant 1995).

It is the essence of this option that the native (indigenous) microbial community is found to be able to degrade the target site contaminants if managed properly. It is the object of the process design team to provide the environment and resources required by the native microbes to accomplish the destruction and or toxicity reduction of the contaminants to acceptable regulatory levels (R. Barry King, Gilbert M. Long, John K. Sheldon, 2000).

2.1.3 Bioaugmentation

Whenever testing indicates that stimulation of the native community will probably not accomplish an acceptable treatment when applied to a specific site. This happened in the sites assessment that insufficient numbers of specific degraders microbes are present at a specific site, then the addition of appropriate cultures, inoculation of the site with foreign microbes; might be entertained

A question arises as to weather the bioremediation design specialists can purchaser and employ species of microbes that are artificially introduced into the soil and /or water.

The choice for bioaugmentation should be considered with the aid of sufficient laboratory data site-specific degradation rate, products cost analysis, and monitoring requirements to justify the added expense. The reality is that some commercially cultured organisms have been acclimated to contaminants that may not even occur at a specific site. As a consequence, some of the projects failures that have resulted when organisms were added have been widely reported and remembered, while some of their success (regrettably) were little noted and soon forgotten.

It is to the credit of a farsighted technical business firms that the science of bioaugmentation has advanced during the last few years and now shows much improvement for some applications. The simple test of the matter is to watchful for the sometimes wild and undocumented vendor claims as opposed to good quality, verifiable data on product viability, nutrient requirements, contaminant compatibility, survivability in the site environment, and specific degradation rates for site contaminants.

The key parameter that must be demonstrated when contemplating bioaugmentation is the viability of the proposed specific degraded organisms in the site environment (R. Barry King, Gilbert M. Long, John K. Sheldon, 2000).

3 Classification of Microorganisms

3.1 Classification

Organisms are classified according to structure and function. The biological world is divided into three kingdoms: plants, animals and protists. Animals and plants are generally classified according to their visible structure. Protists do not have visible structural differences and they are therefore classified according to chemical differences and biochemical properties.

Microorganisms, the major form of organisms for biotechnology, can be split into several groups based upon biochemical activity and structure. The basic classification of protist is shown in the following figure (Figure 12):

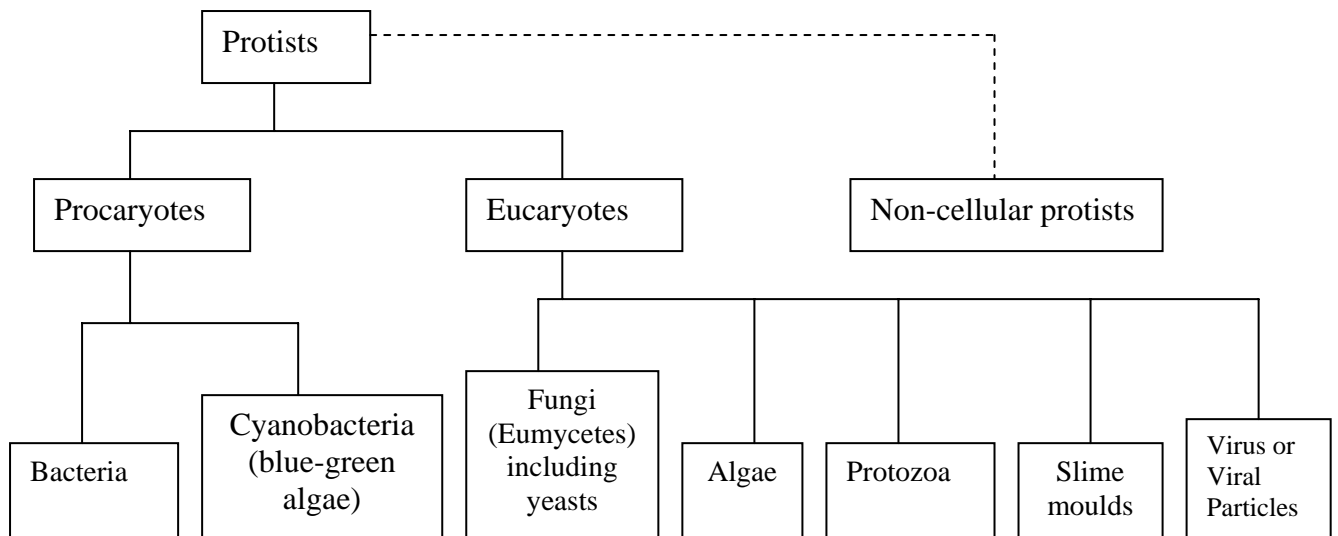

Figure 12 Classification within the kingdom of the Protists

If we referred as domains, to which all life on earth, not just microorganisms belong, we have to consider Archaea, the Bacteria, and the Eucarya. Of these domains, the Bacteria and the Archaea are single cell prokaryotic in nature, whereas the Eucarya are more complex single and multicelled organisms that are eukaryotic in nature (Raina M Maier, Ian L. Pepper and Charles P. Gerba, 2000). Viruses are also prevalent in the environment, however, these particles can only exist as parasites in living cells of other organisms and will not be discussed in this text.

3.1.1 Procaryotes Organisms

Prokaryotic organisms do not include nuclear material bounded by a membrane and therefore have no true nucleus. The membrane is the most important structural component. The membrane not only contains lipids, which partitions the interior of the cell from the environment, but also is packed with proteins and carrier molecules. It is these molecules that make it an energised selective barrier from importing and exporting materials. The membrane also provides an essential component in the mechanisms of energy generation, by electron transport processes in which differences of chemical potential (usually in the form of pH gradient) over the membrane are exploited to generate ATP (adenosine triphosphate), to cause the movements of flagella and to drive active transport processes.

Prokaryotic organisms are metabolically the most diverse of all living systems and are responsible for most degradative processes in the biosphere. They can be grown in the presence or absence of oxygen and form a wide range of organic products.

The two prokaryotic domains can be further classified on the basis of their cell wall properties into four types (Raina M Maier, Ian L. Pepper and Charles P. Gerba, 2000):

- 1) Gram negative (Figure 13)
- 2) Gram positive (Figure 13)
- 3) Cell wall lacking peptidoglycan-the Archaea

All four prokaryotic types are characterized by organisms geared toward rapid growth and cell division under favourable conditions. The ability to grow and reproduce cells quickly means that these organisms have the ability to adapt quickly to changing environments or environmental stimuli.

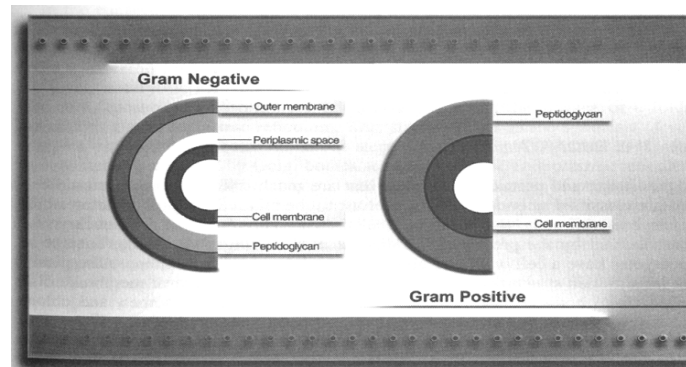

Figure 13 Configuration of a) gram-negative and b) gram positive cell wall (Francis H. Chapelle, 2001)

3.1.1.1 The Bacteria

The most important cell types of the prokaryotes are bacteria and as such are the simplest of microbial cells. Bacteria morphology is rather limited and only under light microscope (0.3-5µm) may be observed: cocci (spherical forms), bacilli (rod of cylindrical forms) and spirilla (spiral forms) (Figure 15). Bacteria without a well-defined shape are said to be pleomorphic.

They are among the most common and ubiquitous organisms found on earth (Paul and Clark, 1989). A few of their important effects are: biogeochemical processes, nutrient cycling in soils, bioremediation, human and plant diseases, plant-microbe interactions, municipal waste treatment, and production of important drugs agent including antibiotics.

All bacteria cells have a cell envelope and protoplasm that contains a cell membrane, ribosomes, and Nucleoid. Most also have a cell wall, although a few do not (Raina M Maier, Ian L. Pepper and Charles P. Gerba, 2000). A Schematic representation of a typical bacteria cell is shown in (Figure 14)

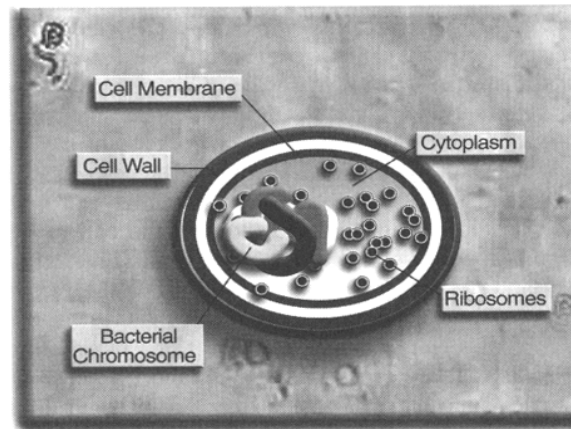

Figure 14 Cellular structure of bacteria
(Francis H. Chapelle, 2001)

Bacteria are classified on the basis of cell morphology (Figure 15), type of cell wall, cell growth, biochemical transformations carried out by the cell, nutrition, and sequences of Ribonucleic acids (rRNA) and Dextrynucleic acid (DNA). All of these characteristics are determined by the genetic information stored in the cell's chromosomal DNA.

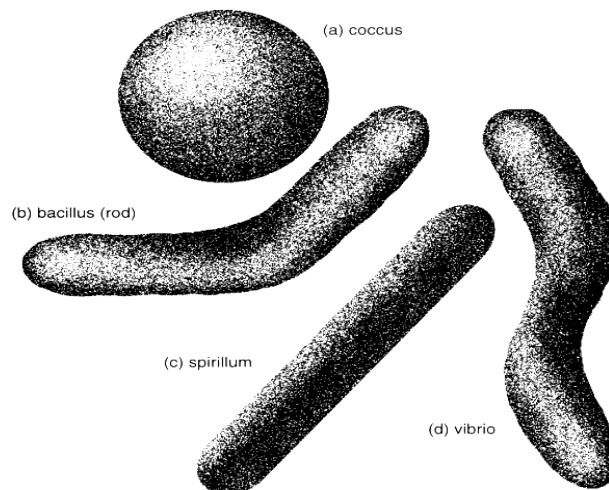

Figure 15 Common shapes of bacteria cells
(Francis H. Chapelle, 2001)

Nutrition, or the types of substances used for carbon and energy sources, as a logical basis upon which to classify bacteria is the following:

Heterotrophs are organisms that use organic carbon as energy and carbon sources. For **Chemoheterotrophs** energy is derived through the oxidation of organic compounds via respiration. **Photoheterotrophs** are organisms that derive energy from light and use organic compounds as a reducing power (Raina M Maier, Ian L. Pepper and Charles P. Gerba, 2000). **Lithotrophs** use inorganic carbon, such as carbon dioxide or bicarbonate, as carbon sources and external sources of energy. **Chemolithotrophs** are a type of lithotroph that obtain energy by oxidizing reduce inorganic chemicals, such as ferrous iron or sulfides, and can metabolise and grow in environments which contain little or no organic carbon. **Photolithotrophs** are lithotrophs that are able to obtain energy from light.

Metabolism, the ways in which bacteria utilize their nutrients, is also used in classification (respiration, fermentation and phototrophic growth). In order to obtain energy from a substrate, microorganisms remove electrons and transfer them to other chemicals that serve as electron acceptors. Aerobic respiration uses the oxidation of organic and inorganic electron source coupled to the reduction of oxygen and an ultimate electron acceptor to generate energy.

Substrate components in the waste matrix will be converted to CO_2 , H_2O (Equation 1) and various other organic ligands (chemical species) utilized in the formation of new biomass and in biochemical assimilation and excretion within the respiring organisms. Generally the reaction can be depicted as:



Anaerobic respiration uses the same principle, except that the terminal electron acceptor is not O_2 , but some other inorganic ion such as NO_3^- , Fe^{+3} , or Mn^{+4} .

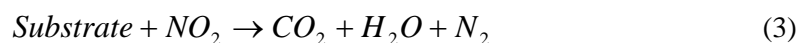

Fermentation refers to internally balance oxidation reduction reactions of organic compounds in cells that yield energy, it does not require an external electron acceptor. Phototrophic metabolisms is the photosynthesis. Bacteria that use oxygen as an electron acceptor are called **aerobes**. Some kinds of obligate aerobes, while requiring oxygen in order to grow cannot tolerate oxygen in high concentrations. These are termed *microaerophilic* bacteria (Francis H.

Chapelle, 2001). Bacteria that use oxygen when it is available but are also capable of fermentation are termed **facultative anaerobes**. Facultative anaerobes preferentially use O₂ when it is present but can use another electron acceptor when O₂ is not available. Generally they grow more efficiently in the presence of oxygen. So then, aerobic organisms depend on oxidation of suitable substrates where O₂ is the final electron acceptor, and facultative anaerobes can utilize the oxygen combined in nitrates (R. Barry King, Gilbert M. Long, John K. Sheldon, 2000). Microorganisms that grow only in the absence of oxygen are called obligate **anaerobes**. Some organisms, through anaerobic, can tolerate oxygen and grow equally well whether it is present or not. These are termed **aerotolerant** anaerobes.

In fact, many anaerobic bacteria do not tolerate the presence of oxygen. When molecular oxygen is dissolved in water, hydrogen peroxide is formed by the reaction (Equation 4):

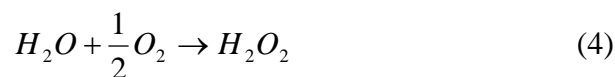

Hydrogen peroxide formed by this reaction is a strong oxidant and is highly toxic to all bacteria. Aerobic bacteria, which must live in oxygenated environments, produce an enzyme called catalase, which break down the peroxide to oxygen and water and keeps the peroxide from damaging the cell. Anaerobic bacteria generally lack catalase and therefore have no defence against the toxic effect of peroxide and are called **strict anaerobes**. Other anaerobes do have the protective enzymes but still cannot use O₂ as an electron acceptor. Strict or **obligate anaerobes** depend on oxidation of substrates where the final electron acceptor is something other than free oxygen or nitrate and can tolerate no oxygen at all. Some kinds of anaerobes, such as methanogens, tolerate oxygen very poorly and must be cultured under strict anaerobic conditions. Other kind of anaerobes, such as some sulphate reducers, can tolerate exposure to oxygen but generally cannot grow in its presence. In many groundwater systems oxygen is delivered with infiltrating rainwater. In these systems, aerobic microorganisms are the predominant species present. However, because of the heterogeneity of subsurface sediments, particularly the discontinuous distribution of organic carbon and lack of oxygen create the anaerobic microenvironments that by then become the focus of anaerobic metabolism. Thus, the presence of dissolved oxygen in groundwater systems does not generally exclude the presence of anaerobic metabolism (Francis H. Chapelle, 2001).

4 Hydrocarbon degrading microbes in groundwater

Groundwater and soils contain many kinds of microbes including fungi (molds and yeasts), protozoans, and bacteria etc. Of these common native (*indigenous*) microorganisms, the majority are bacteria but protozoa and fungi account too for the degradation of practical all the hydrocarbons and organic contamination entering the natural environment (R. Barry King, Gilbert M. Long, John K. Sheldon, 2000,).

There are two possible sources for microorganisms in extant aquifer sediments:

1. The organisms and their descendants may have remained with the sediments ever since initial colonization during surface deposition;
2. The organisms may have been transported to the buried strata via hydrologic flow

Recent discoveries have revealed that many terrestrial soil bacteria are quite efficient hydrocarbons degraders. These comprise common soil and aquatic bacteria that also inhabit subsurface vadose zone soils and aquifers. In fact, viable bacteria, including many aerobic, have been found at depths up to 1500 m below ground surface in deep soils and groundwater. It must be emphasized that although microbes are present in deep vadose zones, rates of metabolic activities are much lower than rates in surface soils (Raina M Maier, Ian L. Pepper and Charles P. Gerba, 2000).

As a general rule, the total number of bacteria in a shallow surface system is less than in a surface soil. The decrease in number is directly correlated with the low amounts of inorganic nutrients and organic matter in subsurface material and the physiological and nutritional requirements of subsurface organisms are not well understood. The physiology of subsurface microorganisms differs from that of surface microbes in that when subsurface cells are examined, they are rarely dividing and contain few ribosomes or inclusion bodies.

Intermediate and deep aquifers are characterized by low rates of recharge and groundwater flow that create a habitat for microorganisms different from the shallow aquifers. There is a wide diversity of microorganisms in deep saturated zones. The types of organisms detected included aerobic and facultatively anaerobic chemoheterotrophs, denitrifiers; and nitrogen-fixing bacteria. Low numbers of unicellular cyanobacteria, fungi, and protozoa were also detected in some samples. Despite the high total number of bacteria, culturable counts were much lower. (Raina M Maier, Ian L. Pepper and Charles P. Gerba, 2000).

4.1 Archaea

The archaea, which include the methane producing “bacteria”, are morphologically indistinguished from bacteria, but they are not bacteria, they are restricted to anaerobic environments, such as organic rich sediments and the intestines of higher animals, or hypersaline environments.

Archaea exhibit many differences from the prokaryotes. The archaea include three distinct kingdoms. Kingdom *Crenarchaeota* consists mainly of thermophilics (heat-loving) organisms. Kingdom *Euryarchaeota* includes the methanogens (microbes that produce methane from carbon dioxide and hydrogen), extremes halophiles (microbes that live in concentrate salt brines), and thermoacidophiles (microbes that lives under extreme conditions of heat and low pH). Of these types, methanogens most commonly affect the geochemistry of groundwater. They are restricted to environments where oxygen has been excluded and where hydrogen and carbon dioxide are available. Because subsurface environments are often anoxic, they are extensively colonized by methanogens (Francis H. Chapelle, 2001).

4.2 Bacteria in Groundwater systems

4.2.1 Gram negative Bacteria Found in Groundwater Systems

Gram-negative bacteria are found extensively in groundwater systems. This group of microorganisms, are important components of the terrestrial subsurface flora.

4.2.2 Aerobic Gram-Negative Rods

Aerobic gram-negative rods are widely distributed in soils and shallow groundwater systems. Most of these bacteria have an enzyme called cytochrome oxidase that enables the organism to transfer electrons onto molecular oxygen, this using oxygen as a terminal electron acceptor. Such microorganisms are termed oxidase positive. In deeper anaerobic aquifers the presence of gram-negative aerobic rods becomes less common.

Members of the genera *Pseudomonas*, *Azobacter*, *Rhizobium*, *Alcaligenes*, *Flovobacterium*, and *Bordetella* are representative of aerobic gram-negative rods.

Pseudomonas appears to be particularly common in groundwater systems. One reason pseudomonas are common in shallow water table aquifers is that they are extraordinarily

versatile in the kinds of organics substrates on which they can grow. Its adaptability of growing in innumerable organic carbon compounds make it an ideal candidate for inhabiting aerobic aquifers where organic carbons substrates are largely limited to dissolved organic carbon leaching out of the soil zone above. In addition, many species do not required specific vitamins, growth factors, or amino acids and readily live on a number of different carbon sources. *Pseudomonas* are always respirative and do not have the ability to ferment if conditions become anaerobic. Some species of *Pseudomonas*, however, do have the ability to use alternative pathways of respiration. For example, some strains are able to use nitrate as an alternative electron acceptor if oxygen concentrations become limiting for growth. The flexibility of these microorganisms, both in terms of the organic substrates utilized and the electron acceptors used, makes them well adapted for the variable conditions encountered in the terrestrial subsurface.

Azobacter and *Rhizobium* are notable that in some members of these genera are capable of nitrogen fixation, that is, these bacteria take inorganic nitrogen gas, N_2 , and transform it into organic nitrogen compounds.

Azobacter, unlike *Rhizobium* (symbiotic association with the roots) are free living and are known to inhabit subsurface environments below the soil zone.

Flavobacterium is widely distributed in soils and water. It is not possible to determine unequivocally if these bacteria occur naturally in the aquifer or if they colonized the well subsequent to drilling. However, because these bacteria are so common in soils, its likely that they are present in some aerobic groundwater systems. An interesting attribute of *Flavobacterium* is that they are nutritionally diverse and are able to utilize many kinds of organic compounds as substrates.

Brucella, *Bordetella*, and *Francisella* these genera are not jet been observed in ground water systems.

4.2.3 *Facultative Anaerobic Gram-Negative Rods*

Because these kinds of bacteria are relatively common in soils, it is probable that they are also widely distributed in shallow groundwater systems. The enteric bacteria, or *Enterobacteriaceae*, are the most important members of this group of bacteria.

4.2.4 Anaerobic Gram-Negative Rods

Many species of sulphate-reducing bacteria, notably *Desulfovibrio*, are gram-negative anaerobic rods. These microorganisms can use H₂ or simple organic compounds such as acetate as energy sources and sulphate as a terminal electron acceptor. *Desulfovibrio* is not autotrophic; that is, it cannot obtain all of its carbon from Carbon dioxide (CO₂) but, rather requires organic compounds.

Sulphate-reducing bacteria are widely distributed in groundwater system. They have been reported from petroleum reservoirs and anaerobic groundwater systems. It is probable that anaerobic microenvironments in predominantly aerobic aquifers support the growth of these organisms.

Because of their widespread occurrence, sulphate-reducing bacteria are one of the most important types of microorganisms in terms of their impact on groundwater geochemistry. An important limitation of sulphate reducing bacteria is that they are not capable of completely metabolising carbohydrates to CO₂ and water with the reduction of sulphate. Rather, they are dependent on associated fermentative bacteria to oxidize partially the carbohydrates to simple organic acids and hydrogen (H₂). The organic acids and H₂ are then coupled with sulphate reduction in order to provide energy for growth. Because they consume the products of fermentation, sulphate reducing bacteria prevent the build up of fermentation products, which in turn aid the metabolism of fermentative microorganisms. Sulphate-reducing bacteria and fermenters thus have symbiotic relationship with each other, each contributing to the energy metabolism of the other.

4.2.5 Gram-Positive Bacteria in Groundwater Systems

There are not as many kinds of gram-positive bacteria as there are gram-negative bacteria. Even though they also have been widely reported from many groundwater systems and may play important roles in modifying groundwater chemistry. They can be well adapted to environments subjected to wide variations in water availability and low nutrient conditions (Alexander 1977; Henis 1987; Brock & Madigan 1988). Actinomycetes have not been detected in significant abundance in any subsurface microbiological studies deeper than 3 m in the surface soil and until 13 m in the unsaturated zone reported to date. Low numbers of fungi were detected in many subsurface samples too (2 m in soil and 19 m in unsaturated and

saturated zones). The gram-positive bacteria include, however, many important human pathogens.

Spore-forming, thermophilic, sulphate-reducing bacteria have been isolated from oil field waters. The spores were extremely heat resistant and could survive at temperatures of up to 131°C for limited periods of time. This suggests that spore-forming bacteria may be common in deep subsurface environments, particularly those in which heat tolerance is an asset important to survival (Francis H. Chapelle, 2001).

Fungi and actinomycetes could be very active in aerobic heterotrophic metabolisms within the large subsurface microbial community. Thus, the contribution of these organisms to potential aerobic metabolic activity may be significant, even when they are initially present at low numbers.

4.2.6 Abundance of Bacteria in the terrestrial subsurface

The major chemical and physical influences which govern bacterial abundances in soil, available organic carbon, nitrogen, phosphorous, sulphur, moisture, pH, electron acceptors, grazing by predators, immigration of microorganisms from other habitats, etc, are modified in the subsurface along the hydrological flow path. The nature of the geological stratum, mineral type, particle size distribution, texture, hydraulic conductivity, etc. also may determine the abundance and distribution of bacteria in a given subsurface zone.

In descending from A to B soil horizons into C horizon (Figure 16), a decline in nutrients levels is accompanied by a proportional decline in bacterial abundance. This decline may be very drastic. The C soil horizon marks the beginning of the unsaturated subsurface zone, which supports far fewer bacteria than B soil horizon. However, the number of bacteria usually does not continue to diminish with depth. Instead, microbial abundance typically increases substantially at the water table and just above it in the capillary fringe zone. It is speculated that these interface zones between the unsaturated and saturated zones may be the site of relatively dynamic mixing of oxygen and recently recharged nutrients in shallow unconfined aquifers. Both horizontal saturated flow and vertical seasonal fluctuations of the water table may contribute to this effect. It was proved that the abundance and potential activities of microorganisms generally remain high relative to the unsaturated zone. It can be concluded that depth has not be found to govern the abundance and activity of bacteria in the saturated zone; rather, the hydrological, physical and geochemical properties of each stratum

appear to govern the population density and degree of metabolic activity of its own community (Timothy E. Ford, 1993).

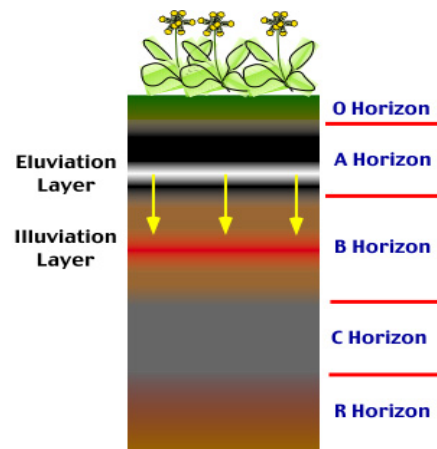

Figure 16 Representation of soil horizons

5 Bacterial Metabolism

The ability to utilize energy in an organized way, is the hallmark of life processes. The term metabolism denotes the complex series of energy utilizing chemical reactions carried out by the cell. There are two broad types of metabolic processes:

- Catabolism, extracts energy from organic compounds by breaking them down into components parts, thereby releasing energy.
- Anabolism does just the reverse, using energy to build organic compounds by fitting the component parts together in the proper sequence. Anabolism concerns the synthetic pathways of metabolisms which are involved in the generation of the building blocks and the subsequent sequence synthesis of macromolecules (JF Richardson, DG Peacock, 2003).

The metabolic functions of the cell include extracting energy from certain compounds, storing the energy temporarily within the cell, using the energy for construction of cells parts, synthesis of enzymes, nucleic acids, and polysaccharides. An enormous amount of energy is necessary in order to support such extensive functions. Some bacteria are capable of metabolising an amount of nutrients equivalent to their own weight in just a matter of seconds (Francis H. Chapelle, 2001).

5.1 ATP Synthesis- Storing Energy

Living cells use the free energy released in redox reactions of compounds for temporarily storing energy and for using this energy to couple exergonic (net release of free energy) and endergonic (absorb free energy) reactions. These energy storing compounds include adenosine triphosphate (ATP), guanosine triphosphate (GTP), acetyl-coenzyme A; and others. By far the most important of these is ATP. The formation of ATP stores energy, and the hydrolysis of ATP releases energy.

The basic reaction in forming ATP is shown schematically in (Figure 17). In this reaction, adenosine diphosphate (ADP) acquires an additional phosphate group to form ATP. This formation is driven by the energy generated when the fuel molecules are oxidised in heterotrophs, or when light energy is trapped in phototrophs. This type of reaction is called phosphorylation and requires energy input.

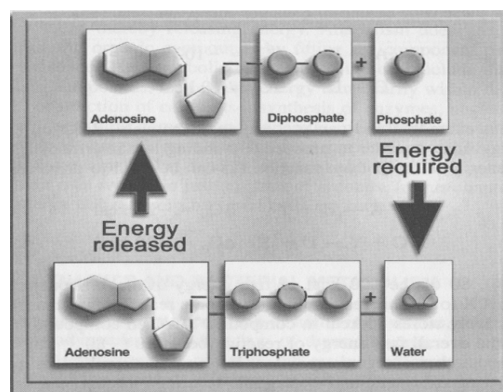
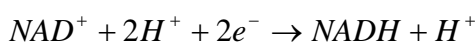

Figure 17 Formation of ATP from ADP with the storage of energy
(Francis H. Chapelle, 2001)

In the reverse of this reaction, ATP functions as an energy carrier by virtue of its two high energy phosphate anhydride bonds. When these bonds are hydrolysed, this process involves breaking the high energy bond and liberates energy.

In addition to using intermediate compounds for storing energy, living cells also use intermediate compounds for storing electrons that are generated in energy releasing oxidation reactions. Enzymes that remove electrons from energy-rich compounds (called dehydrogenases) often have electron-storing intermediate compounds as their coenzymes. One of these coenzymes is called nicotinamide adenine dinucleotide (NAD). NAD can exist in a reduced ($\text{NADH} + \text{H}^+$) or oxidized (NAD^+) form, with the electron transferring reaction written as:



In the breakdown of fuel molecules (catabolism), energetically favourable reactions produce the high energy phosphorylated compounds for which the Gibbs energy (ΔG^0) value for hydrolysis is greater than that of ATP. Such compounds can spontaneously transfer phosphate groups to ADP, producing ATP, with a net negative ΔG^0 . In biosynthesis, ATP is used to phosphorylate intermediates, thereby producing activated derivatives capable of further reaction (Figure 18).

All organisms use the same pair of pyridine nucleotides as carried molecules for hydrogen and electrons. Both of these molecules accept hydrogen and electrons in the redox reactions of catabolisms and become reduced. NADH and NADPH have different metabolic functions. NADPH generally transfers H^+ and $2e^-$ to oxidised precursors in the reduction reactions of biosynthesis. Therefore, NADPH cycles between catabolic and biosynthetic reactions and serves as a carried in the same way that ATP serve as the energy carried. NADH is used almost exclusively in redox processes associated with energy metabolism.

Fuel molecules are oxidised in catabolism; they lose electrons and these reducing equivalents are transferred to an environmental acceptor such as oxygen, with concomitant ATP production. However, some reducing equivalents are conserved and re-utilised in the synthesis of cellular components, with the consumption of ATP, as oxidised intermediates are reduced to synthetic precursors with subsequent polymerisation. The pyridine nucleotide thus have roles both synthetic and energy generation.

Another important set of reactions in living systems comprises those that involve redox processes (JF Richardson, DG Peacock, 2003).

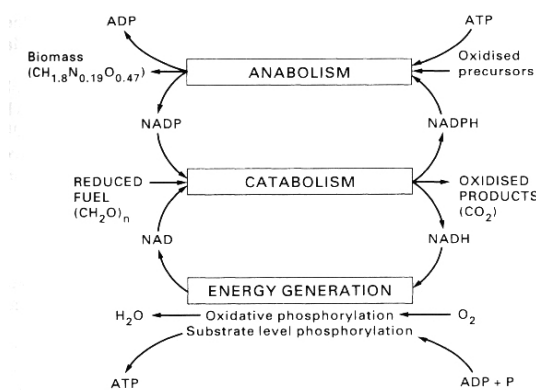

Figure 18 The inner-relationship between metabolism, energy and redox process (JF Richardson, DG Peacock, 2003)

6 Microbial destruction of environmental pollutants

Whenever an organic substrate is biodegradable, microbes obtain energy and the carbon metabolite biochemical building block necessary for growth and reproduction. In the calculation of mass balance for carbon, that portion of the original carbon of the target organic substrate utilized for nutrition ends up as more cellular biomass (about 65%). The portion, which supplies energy requirements for cellular metabolism, is converted to carbon dioxide (about 35%).

6.1 Biomineralization vs Biotransformation

In the majority of bioremediation applications, and certainly in all site remediations, the object of treatment should always be complete destruction of the contaminants, if possible. Another term for *complete destruction* is mineralization, or reducing the contaminant to its basic mineral constituents. In the case of hydrocarbons, the end point reaction products of biological mineralization will be carbon dioxide and water.

If the biodegradation of an organic contaminant goes only part way to mineral (obtaining only a partial degradation), then the contaminant is said to have been *transformed*. These could result in worse site conditions than existed before the remediation began (R. Barry King, Gilbert M. Long, John K. Sheldon, 2000).

In general, microbes will first attack and degrade compounds that offer the greatest amount of energy at the least expenditure of biochemical effort in the part of the microbe. They know it chemically (due to thermodynamics), because the laws of thermodynamics are built into every molecule in the universe. This leads to a situation in which a light hydrocarbon will biodegrade far sooner and faster than a heavy end component. So the light ends and O- or N-substituted compounds always go first, followed by *aliphatics* and multiring (PAH) compounds. The last to go are the long-chain paraffinic hydrocarbons (R. Barry King, Gilbert M. Long, John K. Sheldon, 2000).

Groundwater pollution often involves a mixture of contaminating substances. The degradation process deals with the pollutants in order in which they are utilizable.

The degradability of aliphatics decreases as follows:

Alkanes > isoalkanes > alkenes > cycloalkanes.

BTEX aromatics and alkylbenzenes are readily biodegradable. Their relative degradability is better than that of cycloalkanes and worse than that of isoalkanes. However, monocyclic

aromatic compounds possess a greater solubility making them biologically more available than aliphatics (Edel H-G and Meyer-Murlowsky T., 2000). The persistence of fuel released in the environment depends on the biodegradability of the constituting hydrocarbons, on the presence of microorganisms suitable for biodegradation and on various environmental factors (R. Marshall, 2003).

6.2 Biodegradation Process for Organic Compounds

6.2.1.1 Aliphatics

Some general rules for aliphatic biodegradation are:

1. Midsize straight-chain aliphatics (n-alkanes C₁₀ to C₈ in length) are utilized more readily than n-alkanes with either shorter or longer chains.
2. Saturated aliphatics and alkenes are degraded similarly
3. Hydrocarbon branching decreases biodegradability

6.2.1.2 Alkanes

Because of the structural similarity to fatty acids and plant paraffins, which are ubiquitous in the nature, many microorganisms in the environment can utilize, n-alkanes (straight chain alkanes) as a sole source of carbon and energy. In fact, it is easy to isolate alkane-degrading microbes from any environmental sample. As a result, alkanes are usually considered to be the most readily biodegradable type of hydrocarbon. Biodegradation of alkanes occurs with a high biological oxygen demand (BOD) using one of the two pathways shown in (Figure 19). The more common pathway is the direct incorporation of one atom of oxygen onto one of the end carbons of alkane by a monooxygenase enzyme. This result on the formation of a primary alcohol (pathway I). Alternatively, a dioxygenase enzyme can incorporate both oxygen atoms into the alkane to form hydroperoxide (pathway II). The end result of both pathways is the production of a primary fatty acid. Fatty acids are common metabolites found in all cells. They are used in the synthesis of membrane phospholipids and lipid storage materials. The common pathway used to catabolise fatty acids is known as *β-oxidation*, a pathway that cleaves off consecutive two-carbon fragments. Each two common fragments is removed by coenzyme A as acetyl-CoA, which then enters the tricarboxylic acid (TCA) cycle from

complete mineralization to CO_2 and H_2O . Propionyl-CoA is then converted to succinyl-CoA, a four carbon molecule that is intermediate of the TCA cycle.

Microbes prefer midsize straight chain aliphatics. Solubility continues to decrease with increasing chain length. In contrast short chains have higher aqueous solubility but they are can be toxic to cells.

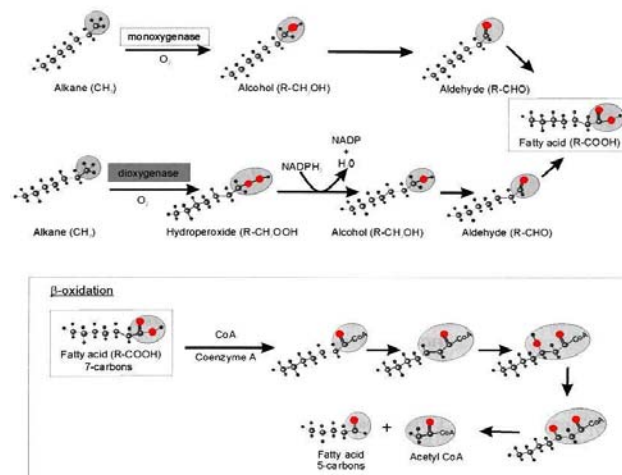

Figure 19 Biodegradation of Alkanes
(Raina M Maier, Ian L. Pepper and Charles P. Gerba, 2000).

6.2.1.3 Alkenes

The studies have shown that alkenes and alkanes have comparable biodegradation rates (Figure 20). The initial step in 1-alkene degradation can involve attack at the terminal (1) or a subterminal (2) methyl group as described for alkanes. Alternatively, the initial step can be attack at the double bond, which can yield a primary (3) or secondary alcohol (4) or an epoxide (5). Each of these initial degradation products is further oxidized to a primary fatty acid, which is degraded by β -oxidation as in alkanes.

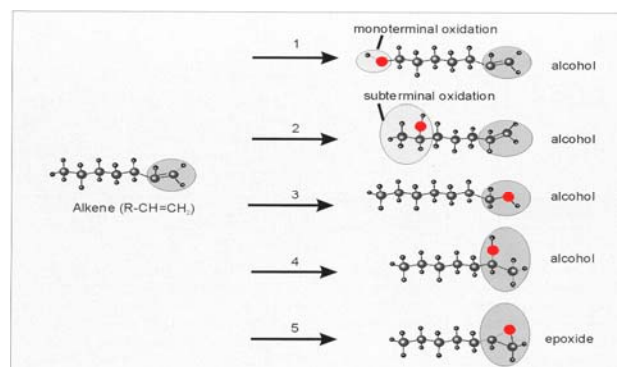

Figure 20 Biodegradation of Alkenes
(Raina M Maier, Ian L. Pepper and Charles P. Gerba, 2000)

6.2.1.4 Alicyclics

It is known that there is no correlation between the ability to oxidize cycloalkanes fully. Further it is difficult to isolate pure cultures that degrade alicyclic hydrocarbons using enrichment techniques. Although microorganisms with complete degradation pathways have been isolated (Trower et al., 1985), alicyclic hydrocarbons degradation is thought to occur primarily by comensalistic and cometabolic reactions as for the cyclohexane (Figure 21). In this series of reaction one organisms converts cyclohexane to cyclohexanol via cyclohexanone, but is unable to open the ring. A second organism that is unable to oxidize cyclohexane to cyclohexanone can open the ring and mineralise the remaining aliphatic compound (Perry, 1984).

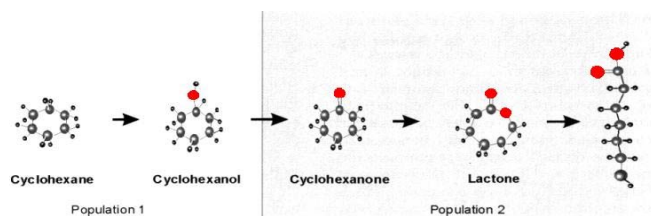

Figure 21 Degradation of cyclohexane
(Raina M Maier, Ian L. Pepper and Charles P. Gerba, 2000).

6.2.1.5 Aromatics

Under aerobic conditions, the most common initial transformation is a hydroxylation that involves the incorporation of molecular oxygen. The enzymes involved in these initial transformations are either monooxygenases or dioxygenases. In general prokaryotic microorganisms transform aromatics by an initial dioxygenase attack to cis-dihydrodiols. The cis-dihydrodiol is rearomatized to form a dihydroxylate intermediate, catechol. The catechol ring is cleaved by a second dioxygenase between the two hydroxyl groups (ortho pathway) or next to the hydroxyl groups (meta pathway) and further degraded to completion (Figure 22).

In general, aromatics composed of one or two or three condensed rings are transformed rapidly and often completely mineralised, whereas aromatics containing four or more condensed rings are transformed much more slowly often as a result of cometabolic attack. This is due to the limited bioavailability of this high molecular weight aromatics. Such PAHs have very limited aqueous solubility and sorb strongly to particle surface in soil and sediments. However, it has been demonstrated that chronic exposure to aromatic compounds will result in increased transformation rates because of adaptation of an indigenous population to growth on aromatic compounds.

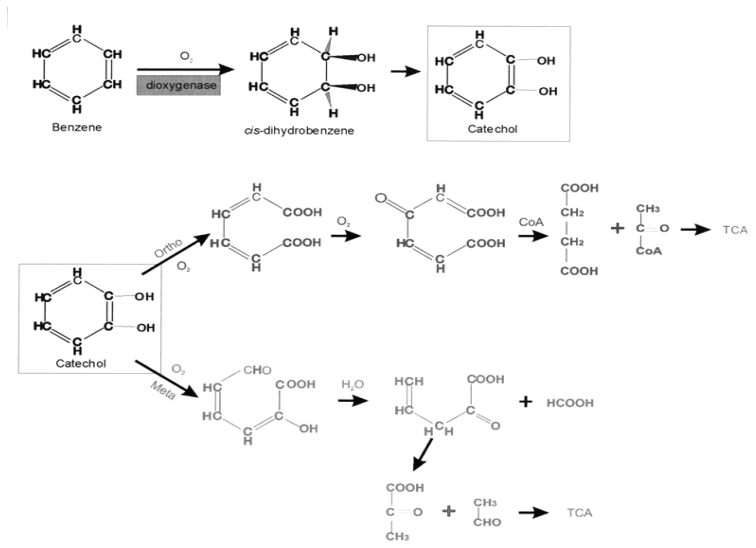

Figure 22 Incorporation of oxygen into the aromatic ring by the dioxygenase enzyme, followed by meta or ortho cleavage
(Raina M Maier, Ian L. Pepper and Charles P. Gerba, 2000)

7 Microbial Growth

The manipulation of many factors is involved in successful microbial growth. Key among these are the parameters given to the microorganisms and the nutritional factors that will induce the biodegradation of target contaminants, and which will produce the desired remedial end point.

An understanding of how such conditions affect microbial growth is essential to understanding their observed distribution abundance in nature and reproduce these conditions in the laboratory for purposes of bioremediation.

It is characteristic of microbial populations that not all species respond positively to the same set of conditions. In fact, the conditions that are necessary for the growth of one particular strain may be toxic to other strains.

7.1 Temperature

The temperature is an important factor in the growth of microorganisms. As temperature increases, the rates of chemical reactions tend to increase. So, to a point, an increase in temperature is favourable for biochemical processes. However, the enzymes and nucleic acids that organize and facilitate these processes are heat sensitive. If temperatures increase too

much, the structure of some proteins may become distorted to the point that they no longer catalyse life sustaining reactions.

It is universally observed that particular strains of microorganisms exhibit a characteristic envelope of temperature tolerance. First, there is a temperature minimum, below which the microorganisms cannot grow. As the temperature increases above the minimum, the growth rate increases until the temperature optimum is reached. This is the temperature at which the organisms can grow at its maximum rate. As the temperature increases above the optimum, there is typically a sharp decrease in the growth rate. The temperature maximum is the highest temperature at which a microorganism can grow effectively.

Microorganisms which grow at low temperatures between 0° and 20° centigrade, are termed psychrophiles and microorganisms with temperature ranges in the range of 20-40°C are called mesophiles. Microorganisms that grow above 45°C are said to be thermophilic (Francis H. Chapelle, 2001).

7.2 Water

All microorganisms required water in order to carry out life processes, but a few require liquid water in order to grow. Moisture is essential for growth and multiplication of microbes. Lacking mouths, microbes are limited to soluble materials that can be transported across their cell membranes into the interior cellular fluid where digestion takes place (although digestion can take place outside bacterial cells in certain instances; *extracellular digestion*). Optimal growth rates take place when there is sufficient moisture in liquid form to solubilise the substrate for transport (R. Barry King, Gilbert M. Long, John K. Sheldon, 2000).

Many microorganisms, however, are especially designed to resist drying. In groundwater systems drying would not be a limiting factor to microbial growth. However, there are several ways in which moisture availability may be a problem for bacteria in aquifer systems. The most obvious one is the unsaturated zone (Francis H. Chapelle, 2001).

7.3 Microbial Nutrition

Food for microbes must provide a source of carbon for building essential biochemicals and cellular components (growth), and which is also a source of energy. The carbon source (food) for the microbes is also termed *the nutritional substrate* and should be restricted to the contaminant; i.e., no other carbon source should be made available whenever possible.

Microorganisms are capable of using a wide variety carbon bearing compounds as carbon sources for cell growth. Simple sugars, polysaccharide, organic acids, and proteins are the most common carbon sources that are utilized in preparing growth media

Major nutritional factors that are essential compounds of importance for microbial nutrition in bioremediation are: Nitrogen and Phosphorous. The addition of these inorganic nutrients will stimulate mineralization rates of petroleum hydrocarbons under aerobic conditions (Timothy E. Ford, 1993).

For many environmental applications, it is of particular interest to determine if indigenous bacteria are capable of utilizing xenobiotics, or carbon compounds not commonly found in nature, as carbon source. For example, carbon sources, such as petroleum hydrocarbons, phenolic compounds, or chlorinated hydrocarbons, may be used in preparing growth media.

Nitrogen is need by microorganisms for protein and nucleic-acid synthesis. Nitrogen can be obtained either from organic or inorganic sources. The most common inorganic sources are ammonia and nitrate. As a general rule, nitrogen must be present in the form of ammonia, although certain bacteria can utilize nitrate or nitrogen gas. When nitrate is used as a nitrogen source, it must first be reduced to ammonia. The simple fact is that bacteria are quite able to utilize ammonia for direct incorporation into amino acids etc., while nitrate must first be reduced to ammonia for use, or nitrogen gas must be fixed by reduction to ammonia. These reactions converting nitrate and nitrogen to ammonia are a waste of energy for the microbe and will slow the process of bioremediation. Ammonia nitrogen is the preferential nutrient.

Phosphate is utilized by microorganisms for synthesizing nucleic acids. In addition the energy currency of the cell is largely controlled by adenosine triphosphate (ATP). Thus, phosphate is an important component of growth media and is generally provided as a potassium salt usually, orthophosphate (phosphoric acid) (K_2HPO_4 or KH_2PO_4).

Analysis for total phosphorous will often give high number while the available orthophosphates may have been depleted, therefore the Nitrogen as ammonia and Phosphorous as an orthophosphate may become the limiting factor in sustaining bioremediation (Francis H. Chapelle, 2001, Phelps & White, 1991).

7.4 *Electron Acceptors*

Once the oxygen is depleted and nitrate is present, anaerobic microbes will use nitrate as the electron acceptor. These first two reactions occur nearly instantaneously. Many hydrocarbons can degrade using the following electron acceptors:

- Nitrate
- Oxidized manganese
- Ferric iron
- Sulphate
- Carbon dioxide under methanogenic conditions

Once the available oxygen and nitrate are depleted, the environment becomes more anaerobic and the slower reactions begin, such as microbes using ferric iron as an electron acceptor. When the reduction oxidation (redox) conditions are further reduced, sulphate may act as the electron acceptor. Under substantially lower redox conditions, methanogenic conditions will exist and the microbes can degrade the petroleum contaminants using water as the electron acceptor (Evan K, and Michael E., 1998).

7.5 *pH*

Bacteria in nature are capable of living in a surprisingly wide range of pH. Some bacteria are perfectly in an acid pH range of 3 to 4. This is not surprising since many bacteria produce sulphuric acid or other acid as by-products of their metabolism. Other bacteria are quite capable of growth at alkaline pH of 10 or above. Many of these bacteria live in unusual environments such as alkaline lakes, where such pH occur naturally.

Regardless of pH that they are adapted for, bacteria usually maintain an intercellular pH of 7.5. Thus, in order for bacteria to live in environments where pH conditions are significantly different from 7.5, they must employ specialized proton-transporting mechanisms in order to remain viable, through these mechanisms bacteria utilize proton gradients across their cell membranes in order to harness energy (Francis H. Chappelle, 2001).

7.6 *Population Interactions*

Positive interactions between microbial populations are those that enhance the ability of populations to survive within a community. In some cases, development of positive

interactions allows the exploitation of resources that otherwise be closed to them. Negative interactions act as negative feedback mechanisms that limit population densities. These feedback mechanisms, adjust populations to resources of the habitat. Negative interactions also tend to preclude the invasion of an established community by allochthonous populations and tend to maintain community stability.

7.7 Neutralism

The neutralism is the first kind of possible interactions and actually is a lack of interactions. Neutralism occurs for some reason in populations that are physically separated from each other. Furthermore, is more likely to occur under conditions of low population density that increase the chances for lack of contact. There is not direct evidence for the presence of absence of neutralism in subsurface environments, this reflects the lack of techniques for documenting such interactions.

7.8 Commetabolism

Degradation by a *mixed population* in which two or more organisms acting together effect the stepwise destruction of a specific compound is NOT cometabolism. The authors have seen this term improperly used to describe degradation by a mixed population, a concept in which organism A causes the partial destruction of a compound, but cannot degradate it further. The end product metabolite of organism A is then attacked by organism B (and possibly C, D, and E in a series), which carries out the remainder of the degradation to yield a nontoxic end product through a process termed *commensalisms*. Therefore, degradation by two or more organisms or a mixed population does not constitute cometabolism.

The generally accepted definition of cometabolism is limited to *microbial action that modifies chemical structure without yielding energy utilize for growth* of the organism involved. In other words, the cometabolized compound is not utilized as food for organism. In fact, the concept is actually applied to the substrate rather than the organism. As they are not useful to the organisms involved, the microorganisms and metabolic pathways that are commonly employed in cometabolic degradation of environmental pollutants are not even necessarily *biochemically aware* of the target compounds that the site manager is trying to remediate. A site contaminant that is targeted for destruction that cannot be easily degraded through microbial action, it is often the case that recalcitrant compounds, are considered by many to be nonbiodegradable *directly*. However though experience, it might be know that the target

compound can be destroyed *indirectly* by cometabolic action of certain organisms by simply providing a *primary substrate*. In other words, by enticing the microorganisms to attack an *alternated food source* (the primary substrate that will add to the site), the metabolic machinery that accounts for the degradation of the primary substrate will fortuitously also destroy the target compound we wish to degrade (R. Barry King, Gilbert M. Long, John K. Sheldon, 2000).

7.9 Synergism and Symbiosis

Synergism and Symbiosis refer to relationship that benefits both populations. The difference is that two synergic populations, while benefiting from interaction, are capable of living without each other. Symbiotic populations, on the other hand, require the interaction to sustain life.

7.10 Competition

Different microbial populations in particular environments often strive to utilize the same resource. In this case, the relationship between the populations becomes competitive. The resource that is the object of competition can include nutrients, moisture, space, or any other commodity that is necessary for life functions and is in scarce supply.

7.11 Antagonism, Parasitism and Predation

When one population produces a substance that inhibits another population, the interaction is term antagonistic. The population that produces the inhibitory substance thus gains a competitive advantage over the other.

A parasitic relationship occurs when one population derives its nutritional requirements from host of another population. The parasitic population is clearly benefited by this relationship, generally to detriment the host population. Host parasite interactions required long-term contact between the populations, and members of the parasite population are generally much smaller than members of the host population.

When one population actively consumes another population, the interaction is termed predation. The predatory population derives nutrients from this interaction and is clearly beneficial.

7.12 *Mixed Population*

Natural and polluted environments are quite different from those present in the laboratory. In contrast to the pure culture and single substrate systems of classical microbial investigation, the field environment is extremely varied and complex. In virtually no circumstance is a single microbial species responsible for the degradation and destruction of pollutants in the field.

Most natural environments are simply loaded with microbes. Even a heavily polluted site contains multiple microbial species and many of these may have become acclimated to existing contaminants. It is common for these mixed populations to acclimate to existing contaminants and to act in concert in metabolising and degrading the organics available through the concept of *commensalisms*. Sometimes the species available cannot completely destroy the contaminant of interest. The target organic is degraded to a certain point and left there. Whenever a site characterization shows that there is an accumulation of these intermediate metabolites, it might indicate the lack of a class of microbes that would be beneficial to the site remediation. The question of whether to add the “missing link” microbes in the degradation pathway lies in whether or not the intermediates are harmful. If the end point of the remediation can tolerate the presence of the intermediate, then the remediation might be accomplished by biostimulation of the indigenous species present at the site. If the intermediates are not tolerable, then inoculation (bioaugmentation) may be considered or some other remedial approach may be warranted.

Here a word is in order concerning those who will insist that is necessary to specifically identify the bacteria (down to genus and specie) found in a site undergoing bioremediation. Outside of theses and dissertations, the wisdom of this exercise is doubtful. The reason is that so many of the naturally occurring bacteria are simply unknown. It is estimated that there are no less than 5 million bacteria in existence, and probably many more. In other words, there is only about 20% chance of being able to identify any specific bacteria organism, or, conversely, about 80% probability of discovering an organisms that is unknown (R. Barry King, Gilbert M. Long, John K. Sheldon, 2000). Since this problematic and in order to facilitate studies of biodegradation of individual hydrocarbons by microflorae in the environment, specific methods have been developed, in which hydrocarbons mixtures are used as substrates (Solano-Serena, F.R. Marchall D. and J.P. Vandecasteele, 1998).

8 Phases of Microbial Growth

Once the liquid medium supplies all nutrients required for growth and environmental parameters are optimal, the increase in number of bacterial mass can be measured as a function of time to obtain a growth curve (Figure 23) (Raina M Maier, Ian L. Pepper and Charles P. Gerba, 2000).

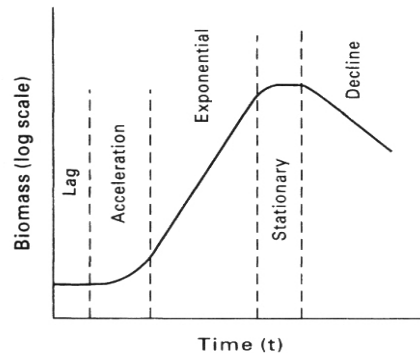

Figure 23 Phases of grow of a microbial culture
(JF Richardson, DG Peacock, 2003)

8.1 Acclimation

When an inoculum is placed into fresh medium, growth begins after a period of time. Microbes are sensitive to abrupt changes in their environment. Whenever the physical or chemical environment is suddenly changed there is a transition time during which the microbial population gets reacquainted with the new conditions. The growth and metabolism of the organisms may be temporarily interrupted. This *lag phase* or “acclimation” period is caused by the microbial population shifting its metabolism, gene induction or derepression, protein synthesis to meet new culture requirements. The lag phase may also be due to low initial densities of organisms that result in dilution of exoenzymes (enzymes released from the cell) and nutrients that leak from growing cells. Normally such materials are shared by cells in close proximity. But when cell density is low, these materials are diluted and not as easily taken up. As a result, initial generation times may be slowed until a sufficient cell density is reached. The length of the lag phase can be controlled to some extent because it is dependent on the type of medium as well as on the initial inoculum size (Raina M Maier, Ian L. Pepper and Charles P. Gerba, 2000).

Generally speaking, the longer a contaminant has been in contact with a microbial population, the better acclimated will be that population. In short, sites with a long history of contamination have been better likelihood of possessing strongly acclimated contaminant

degrading native microbial populations (R. Barry King, Gilbert M. Long, John K. Sheldon, 2000).

8.2 Exponential Phase

Once the population of specific degraders has acclimated and sufficient nutrients and all other growth factors have been provided, they reach an exponential phase. The exponential phase is characterized by a period of cell division when the rate of increase of cells in the culture is proportional to the number of cells present in any particular time.

There are several ways in which this concept can be expressed both theoretically and mathematically. Mathematically can be describe the cell growth during the exponential phase using the following equation:

$$\frac{dX}{dt} = \mu X$$

where X is the number or mass cell, t is time, and μ is the specific growth rate constant (1/time). The time it takes for a cell division to occur is called generation time or doubling time. This equation can be used to calculate the generation time as well as the specific growth rate using data generated from a growth curve (Raina M Maier, Ian L. Pepper and Charles P. Gerba, 2000). The slope of this curve (the growth rate) will be dependent of many factors. The ultimate concern for the remediation specialist is to maximize this growth rate by doing whatever is necessary (within the law) to accommodate the microbes. The initial control parameters will emerge from the biotreatability testing (R. Barry King, Gilbert M. Long, John K. Sheldon, 2000).

The generation time for a microorganism is calculated from the linear portion of a semilog plot of growth versus time. The mathematical expression for this portion of the growth curve is given by the Equation 5, which can be rearrange and solved as following:

$$\frac{dX}{dt} = \mu X \quad (5)$$

rearranging

$$\frac{dX}{X} = \mu dt \quad (6)$$

integrating

$$\int_{X_0}^X \frac{dX}{X} = \mu \int_0^t dt \quad (7)$$

$$\ln X = \mu t + \ln X_0 \quad \text{or} \quad X = X_0 e^{\mu t} \quad (8)$$

For the project to be successful microbial metabolism in this early stage of the remediation must result in the establishment of a steady rate of decline for the contaminants. The mere observance of an increase in microbial numbers does not mean the site is cleaning up. The microbial population might instead be using some other substrate and leaving the contaminant intact. Therefore, it becomes necessary to monitor both the microbial counts and the contaminant concentration (R. Barry King, Gilbert M. Long, John K. Sheldon, 2000).

8.3 *Stationary Phase*

Microbes that are degrading the contaminants will continue to increase in number until they find a balance in terms of available food, nutrients, habitat, in other words it can be defined as a state of not net growth, which can be expressed by the following Equation 9:

$$\frac{dX}{dt} = 0 \quad (9)$$

This point at which all these considerations reach equilibrium will determine where the microbe population count stabilizes. When this point is reached, the population numbers will simply remain stationary over time by an equal number of cell division and death rates. This is the condition during which the contaminant degradation rate is at its maximum. There are several reasons to reach this stationary phase. One common reason is that the carbon and energy source or an essential nutrient becomes completely used up. When a carbon source is used up it does not necessarily mean that all growth stops. This is because dying cells can lyse and provide a source of nutrients. Growth on dead cells is called **endogenous metabolism**. Endogenous metabolism occurs throughout the growth cycle, but can best be observed during stationary phase when growth is measured in terms of oxygen uptake or evolution of carbon dioxide. Thus, in many growth curves the stationary phase actually shows a small amount of growth. Again, this growth occurs after the substrate has been utilized and reflects the use of dead cells as a source of carbon energy. A second reason that stationary phase may be observed is when the concentration of their own waste products can become quite toxic to a point where they begin to inhibit cell growth. This generally occurs when they are allowed to be accumulated (cultures with high cell density). (Raina M Maier, Ian L. Pepper and Charles P. Gerba, 2000) Fortunately, it is the case that other microbes in the site soil or water matrix can degrade or detoxify these wastes. (R. Barry King, Gilbert M. Long, John K. Sheldon, 2000). Regardless of the reason why cells enter stationary phase, growth in the stationary phase is unbalanced because it is easier for the cells to synthesize some components than others. As

some components became more and more limiting, cells will still keep growing and dividing as long as possible.

8.4 Death Phase

As the target contaminants diminish to low levels, waste products begin to accumulate and the microbes begin to experience local overcrowding. The competition for available resources gets severe and some of the microbes just cannot keep up. The death rate exceeds the cell division rate and total microbial counts begin to decline. At this point, the target contaminants should have been degraded to below action level concentrations and the microbe population should return to numbers that were observed prior to treatment. When plate counts indicate a decline in the microbial population, further reductions in the contaminant will take place slowly, but do not necessarily stop. Any remaining pollutants may very well remediate to lower levels over time and continued monitoring will substantiate this (R. Barry King, Gilbert M. Long, John K. Sheldon, 2000). Even in the death phase there may be individual cells that are metabolising and dividing, but more viable cells are lost than are gained so there is net loss of viable cells. The death phase is often exponential, although the rate of cell death is usually slower than the rate of growth during the exponential phase. The death phase can be described by the following Equation 10:

$$\frac{dX}{dt} = -k_d X \quad (10)$$

where k_d is the specific death rate (Raina M Maier, Ian L. Pepper and Charles P. Gerba, 2000).

8.5 Monod Kinetics

Monod proposed the use of saturation-isotherm type of equation to relate the growth rate of microorganisms culture to prevailing feed concentration and for the description of the entire growth curve.

$$\mu = \frac{\mu_{\max} \cdot S}{K_s + S} \quad (11)$$

where, μ is the specific growth rate ($1/time$), μ_{max} is the maximum specific growth rate ($1/time$) for the culture, S is the substrate concentration ($mass/volume$), and K_s is a constant referred to as the “Monod constant” ($mass/volume$).

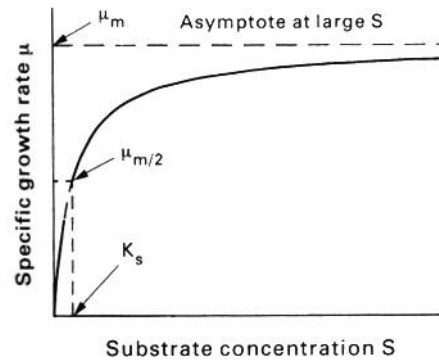

Figure 24 The general form of Monod Equation
(JF Richardson, DG Peacock, 2003)

The (Figure 24) shows the general form of the relation. The microbe may well require several substrates for its growth to proceed, but it is assumed that the substance to which S relates is the limiting substrate component. The value of K_s will be linked to the particular limiting substrate component in any given mixture, and for different substrate mixtures it will also be expected that μ_{max} will change. It is usual to quote μ_m and K_s for the substances, which is the primer supplier of carbon (and energy) for the organisms being grown.

At low substrate concentration, growth rate becomes a function of the substrate concentration. The equations (5, 7, 9 and 10) which are independent of substrate concentration. Thus, Equation 11 describes the relationship between the specific growth rate, and the substrate concentration when $K_s \cong S$. Monod assumed in writing Equation 11 that no nutrients other than the substrate are limiting and that no toxic by-products of metabolisms build up.

As shown in Equation 11, the Monod equation can be expressed in terms of cell number or cell mass (X) by equating it with Equation ($dx/dt=\mu X$).

$$\frac{dX}{dt} = \frac{\mu_{max} \cdot S \cdot X}{K_s + S} \quad (12)$$

The Monod equation has two limiting cases as shown in the (Figure 25). The first case is at high substrate concentration where $S \gg K_s$ (Figure 25). In this case as shown in Equation 13

the specific growth rate μ is essentially equal to μ_{\max} . This simplifies the equation and the resulting relationship is zero order or independent of substrate concentration.

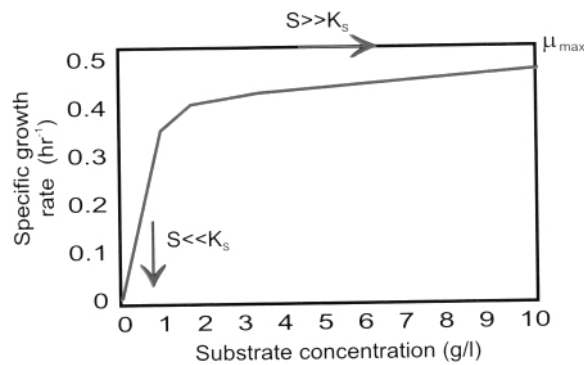

Figure 25 Dependence of the specific growth rate, μ on the substrate concentration (Raina M Maier, Ian L. Pepper and Charles P. Gerba, 2000)

$$\text{For } S \gg K_s: \frac{dX}{dt} = \mu_{\max} X \quad (13)$$

Under these conditions, growth will occur at the maximum growth rate. There are relatively few instances in which ideal growth as describe in (Figure 24) can occur. One such instance is under the initial condition found in pure culture in batch flask when substrate and nutrient levels are high. It must be emphasized that this type of growth is unlikely to be found under natural conditions in a soil or water environment where either substrate or other nutrients are commonly limiting.

The second limiting case occurs at low substrate concentration $S \ll K_s$ (Figure 25) as shown in the Equation 14. In this case there is a first order dependence substrate concentration

$$\text{For } S \ll K_s: \frac{dX}{dt} = \frac{\mu_{\max} \cdot S \cdot X}{K_s} \quad (14)$$

As shown in the Equation 14 when the substrate concentration is low, growth $\left(\frac{dX}{dt}\right)$ is dependent on the substrate concentration. Since the substrate concentration is in the numerator, as the substrate concentration decreases, the rate of growth will also decrease.

Remediation Technologies

8.6 Bioavailability

There are two steps in the biodegradation process. The first is the uptake of the substrate by the cell, and the second is the metabolisms of degradation of the substrate. Assuming the presence of an appropriate metabolic pathway, degradation of contaminant can proceed rapidly if the contaminant is available in a water-soluble form. However degradation of contaminants with limited water solubility or that are strongly sorbed to soil or sediments can be limited due to their low bioavailability (Miller, 1995)

Growth on an organic compound with limited water solubility poses a unique problem for microorganisms because the compound is not freely available in the aqueous phase. Most microorganisms required high water activity for active metabolisms (Athlas and Bartha, 1993), and thus the contact between the degrading organisms and organic compounds with low water solubility is limited..

There are three possibilities of microbial uptake of a liquid organic:

- 1) Utilization of the solubilized organic compounds
- 2) Direct contact of cells with the organic compound, (Zhang Y, and Miller, 1994) (hydrophobicity) which increase attachment of the cell to the organic compounds
- 3) Direct contact with fine or submicrometer size substrate droplets dispersed in the aqueous phase

The mode that predominates depends largely on water solubility of the organic compound. In general direct contact with the organic compounds plays an important role as water solubility decrease.

9 In Situ Bioremediation of Groundwater

In situ bioremediation of groundwater speeds the natural biodegradation process that take place in the water soaked underground region that lays below the water table. For sites, at which both the soil and groundwater are contaminated, this single technology is effective at treating both.

Generally, an in situ groundwater bioremediation system consists of an extraction well to remove groundwater from the ground, an above-ground water treatment systems where nutrients and an oxygen source may be added to the contaminated groundwater, and injection

wells to return the “conditioned” groundwater to the subsurface where the microorganisms degrade the contaminants.

9.1 Biosparging

The air sparging process involves the injection of air below the water table in an attempt to:

1) remove volatile contaminants and 2) to provide atmospheric oxygen to enhance natural biodegradation. Narrow well points are installed below the soil plume in the groundwater, and air is gently injected into the points to strip the compounds and move them into the soil air above. It was originally believed that the air formed discrete bubbles, which floated up through the groundwater, but current thinking is that the air opens channels in the soil/water matrix and strips the compounds directly out of the water. The result of this infusion of oxygen and volatile compounds into the vadose zone, where a vapour extraction system can be installed to remove the infused Volatile organic Carbons (VOC). This constitutes bioventing from below. Above the water table, the system behaves as a bioventing system and the vapour extraction system may not be necessary if the compounds are degraded in the subsurface. Some form of control is generally required to insure that these contaminants do not reach the ambient air.

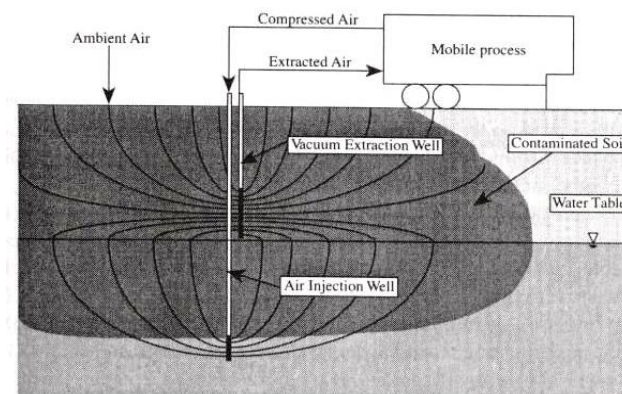

Figure 26 Groundwater Sparging with Optional in situ vapour Stripping for Management of Vapors (William C. Anderson, 1995)

9.1.1 Applicability and Limitations

In-situ air sparging becomes a very attractive remedial option when volatile and or easily biodegradable organic contaminants are present in the groundwater.

There are three mass transfer phenomenons which take place during this process: in-situ stripping of dissolved VOCs, volatilisation of adsorbed phased contamination below the water

table, and enhanced biodegradation of both dissolved and adsorbed phase contaminants due to the increases in dissolved oxygen levels.

Among the above mass transfer process, the contaminant applicability will be mainly influenced by its Henry's law constant and compounds such as benzene, toluene, xylene, ethylbenzene, trichloroethylene and tetrachloroethylene are considered to be very easily strippable. Direct volatilisation of a compound is governed by its vapor pressure and most volatile organic compounds are easily volatilised by their definition. Biodegradability of any compound under aerobic conditions is depended of its chemical structure and the environmental parameters. Some of the VOCs are consider to be easily biodegradable under aerobic conditions. The geology of the site must also be considered when applying air sparging. Physical implementation of in-situ sparging is greatly influenced by the ability of the injected air bubbles to travel in a vertical direction. The two main geology limitations are air (or hydraulic) conductivity and homogeneity. As with any technology that relies on a fluid moving through the aquifer, air sparging requires certain conductivity in order for the air to move in an appropriate manner. Problems can occur if the permeability is too high or too low. Explanation for the slow degradation of oil in the natural environment include: the usually low counts of hydrocarbon degrading microorganisms in the contaminated place, toxicity of some components, the limiting oil water interface, insufficiency of dissolved oxygen, suboptimal temperatures and lack of essential mineral nutrients. Artificial biostimulation to the polluted area (Tagger et al, 1993) and addition of fertilizers to accelerate the natural process of oil degradation (Anon, 1989) is possible. The problem of accessibility of the oil to the bacteria due to limited oil/ water interfacial area is often caused by the formation of water-in-oil emulsions. Biosurfactants produced by microbes are an important aspect in the uptake of hydrocarbons in this respect and artificial dispersants are aid to overcoming this problem with the purpose of increasing surface area, therefore accelerating biodegradation (Leahy and Colowell 1990). However, in the past the use of dispersants with a degree of toxicity has resulted in a large ecological impact than the oil spill itself (Atlas, 1981).

A new alternative is the developing of immobilized bacteria technology as a method for the treatment of chemical waste and this method is applicable to the treatment of oil pollution in water to overcome the problem of limited oil/water interfacial area. This method involves the immobilization of cells on a support material, and the method can utilize high selected, chemical degrading bacteria. In immobilized state, the cells are offered and optimal environment, giving the physical characteristics of the support material while still maintaining

the level of biochemical activity of the free catalyst. The biosupport can act as an intermediary between the oil and the microbes, which can result in higher rates of reaction (Rosevear et al. 1987).

10 Ex-situ Bioremediation Technologies for treatment of contaminated groundwater

Ex situ bioremediation is implemented to treat contaminated water that is removed from a contaminated site. This system contains a series of injection wells or galleries and a series of recovery wells. The recovery wells remove contaminated groundwater, which is treated above ground, in this case a Fixed-bed reactor is proposed, containing microorganisms that are acclimated to the contaminant with nutrients and oxygen supply, and then it is reinjected into the site (Raina M Maier, Ian L. Pepper and Charles P. Gerba, 2000).

10.1 Bioreactors

There are several types of bioreactors but in general a bioreactor is nothing more than a reaction vessel, cylindrical or rectangular, that can be stationary, skid mounted, or mobile. The internal engineering of the reactor is the most important factor accounting for the survival of the many successful bioremediation firms surviving in today's marketplace. Fixed-film, totally submerged, plug flow, fluidised bed, and sequencing batch reactors are all used commercial bioremediation. These include activated sludge systems, rotating biological contactors, trickling filters, aeration lagoons, and extended aeration. There are soil slurry reactors and reactors that are design to treat contaminants in the vapour phase (biofilters).

Bioreactors are classified into two separated categories. Essentially, this is determined by the manner in which they provide contact between the biomass and the contaminants entering the system. These categories are 1) suspended growth and 2) fixed film.

10.2 Activated Sludge

This process typically involves a two-phased approach to treatment of process wastewater, surface water, or groundwater. The technique employs the suspension of microbes in an aqueous waste-filled tank. Nutrients are added and the tank is aerated. All treatments take place in this tank and a clarification step for removal of excess biomass follows. This involves the settling of the biological sludge, some of which is recycled back to the front end of the

plant, and the remainder is wasted. Finally, treated effluent is discharge from the clarifier tank skimmers.

Activated sludge systems have found wide applicability in situations where there are high Biological Oxygen Demand (BOD), Total Organic Compounds (TOC) and Chemical Organic Compounds (COD) concentrations in the wastewater. It is common to see activated sludge as a pre-treatment step prior to a fixed film bioreactor. They are used to knock down gross concentrations of organic carbon. The chief disadvantages have been their relative high cost, their inability to deal with variations in influent concentrations, high costs due to labour requirements, difficulty in controlling volatile emissions, and the need to deal with large volumes of waste sludge, which may contain adsorbed contaminants.

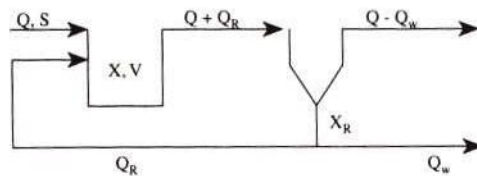

Figure 27 Activated Sludge
(William C. Anderson, 1995)

10.3 Sequencing Batch Reactors (SBRs)

SBR technology is one of the more highly useful and versatile reactor approaches. While having many similarities to activated sludge systems described above, it differs in that the entire operation is conducted in one tank. The typical mode of operation is first to acclimate a population of microbes contained in the treatment tank prior to their contact with the waste. After acclimation is complete, waste is introduced. On a time basis, the contents of tank are thoroughly mixed and aerated to maximized biodegradation.

The next step in the process involves a complete stoppage of all activity within the tank and the solids are allowed to settle. This is followed by a step where the liquid is drawn off and further polished (or is sent to discharge). Finally, a portion of the acclimate sludge is retained in the tank for the next round of treatment. SBR technology is ideal for batch-type waste streams and has great tolerance to fluctuation in influent contaminant concentrations. It has proven to be an extremely reliable approach, but it does have some disadvantages. Among the disadvantage are the temperature, sensitivity of the system, the need for rigorous solids control, and the need to provide treatment for vapor emissions. The hydraulic retention time in the tank can be rather substantial.

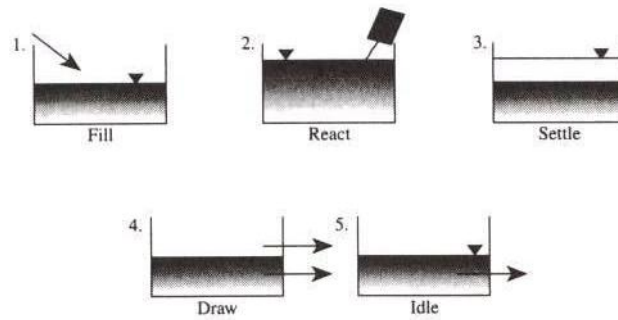

Figure 28 Sequencing Batch Reactor Treatment Stages
(William C. Anderson, 1995)

10.4 Rotating Biological Contactors (RBCs)

RBC technology has characteristics of both fixed-film and activated sludge system. In this approach, polyethylene disks are mounted in series on a turning shaft and the assembly is mounted in the tank half filled with wastewater. Biomass grows as a mat on the disks as they rotate through the waste. As much as 40% for the disk surface can be submerged in the waste at any given time. When the disk is not submerged, it is being exposed to oxygen to help drive the aerobic biological reactions. Excess biomass sloughs off the disks via the shear forces associated with the turning action in the tank.

This type of system tends to support lush biomass and is relatively shock resistant. Interestingly enough, RBCs are not considered able to provide the same level of treatment efficiency as that of an activated sludge system. The system also tends to have significant requirements for sludge disposal and off-gas treatment.

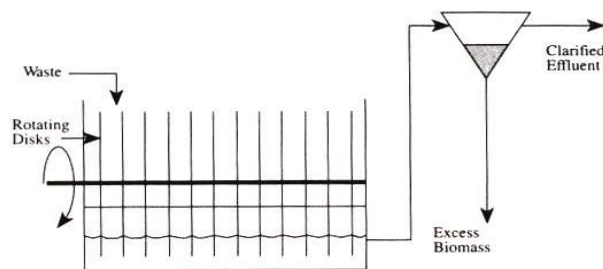

Figure 29 Rotating Biological Contactor
(William C. Anderson, 1995)

10.5 Trickling Filters

Trickling filters systems are closely related to fixed film reactors, except that they operate in continuous flow mode. They are typically filled with packing material of plastic, cobbles, or with silicate sand, providing a fixed surface to which microbes can attach. The waste slowly passes down over the biomass attached to the packing.

Trickling filters are characterized by short retention times and must run in a recirculation mode in order to produce significant reductions in contaminant concentrations. These units are also quite adaptable to fluctuating waste streams and have proven to be particularly effective when used in pretreatment mode. Release of volatiles from these units is not as significant an issue as with other types of reactors described already.

Disadvantages include difficulty in rebounding if the operation of the system is disrupted for any reason, and possible dead spots that can occur within the unit when proper contact of biomass, contaminants, oxygen, and nutrients fails.

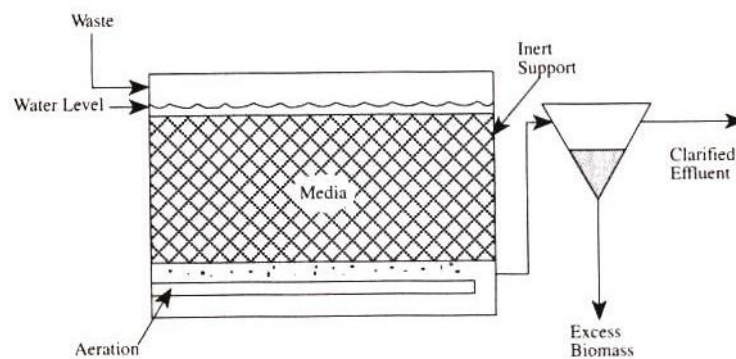

Figure 30 Trickling Filter
(William C. Anderson, 1995)

10.5.1 Characteristics of Trickled Fixed-film reactor:

Attached bacteria had an advantage over suspended bacteria as they can remain near the source of fresh substrate and nutrients contained in water flowing by them. The biofilm provides a large specific surface area. The microbes remain in a high-growth phase, but they form a fully developed food chain, in which larger organisms consume smaller ones.

Continuous operation with periodic renewal of the biofilm layer makes it possible to maintain a diverse microbial population. Those microbes do not cause sludge bulking problems, because they are agglomerated with other organisms on the packing media, and get removed during air shearing as large particles, rather than individual suspended cells.

Environmental variables can be almost completely controlled. Organisms can be completely killed subsequent to treatment. Another advantage is year round operation.

10.5.2 Definition of the biofilms

A biofilm is a layer of organic matter and microorganisms formed by the attachment and proliferation of bacteria on the surface of an object. Biofilms are characterized by the presence of bacterial extracellular polymers, which can create a visible slimy layer on a solid surface. The secretion of extracellular polysaccharides (glycocalyx) provides a matrix for the attachment of bacterial cells and forms the internal architecture of biofilm community. Actually, any surface in contact with a biological fluid, i.e. interfaces, is a potential target for cell adhesion. It is assessed that 99% of the organisms on earth are living in biofilms (Costeron et al., 1987).

This very successful form of organized microbial life presents numerous ecological advantages for microorganisms (Flemming, 1993):

- Scavenging and enrichment of nutrients from flowing water phase into the matrix.
- Protection from short-term pH fluctuations, salt and biocide concentration shocks
- Development of micro-consortia such as symbiosis, utilization of less readily biodegradable substrates by specialized organisms eg. Anaerobic zones under aerobic biofilms or nutrient.

10.5.3 Structure

Biofilm spatial structure has been commonly described as a mono layer of cells embedded in a matrix, rather homogeneous with specific density and thickness.

Biofilms may form highly complex structures containing cell layers and clusters as well as pores and void. It has been speculated that the porous structure may enable liquid movement in the biofilm, increase transfers from the liquid growth medium (De Beer and Stoodley, 1995). But biofilm properties are also influenced by the type of available substrates and their concentrations, the chemical and physical structure of the carrier the adsorption, the substratum and, in general, culture conditions (Lazarova and Manem, 1995). However in the same growing conditions, two organisms would not form the same arrangement (Siebel, 1987).

10.5.4 Adhesion of the cells

In an aqueous medium most organisms are able to fix to almost every submerged surface.

Biofilm development is a complicated issue and is usually initiated by the attachment of bacteria to a solid surface.

Biofilm formation is a dynamic phenomenon and the adhesion of cells on a surface can be reversible or irreversible. There is a constant equilibrium between the suspended cells, the reversible adsorbed cells and the irreversibly adsorbed cells (Characklis and Marshall, 1990)

Permanent attachment of bacteria requires two stages:

1. reversible attachment, which is transitory physicochemical attraction and
2. irreversible attachment, which is a biologically mediated stabilization reaction

Reversible attachment is a function of the initial attraction of a bacterium to a surface and is controlled by several competing forces, including hydrophobic, electrostatic, and Van der Waals forces. The Van der Waals forces attract an object to a solid surface; while the hydrophobic and electrostatic forces can be attractive or repulsive, depending on the surface properties of the bacterium and the solid surface.

The initial reversible attachment of organisms to surface can, with time, become permanent. Irreversible attachment is initiated by the excretion of extracellular polymers by the reversible attachment bacteria. The extracellular polymers create a matrix that surrounds the cell and forms a strong chemical bridge to the solid surface.

The transition from initial microbial attachment to the development of mature biofilm is due not only to the proliferation of the attached cells but also to the continued deposition of cells from the bulk fluid. In systems known as trickling filters and fixed-bed reactors, the biomass of the film is maximized by providing a porous network of solid support for bacterial attachment.

10.6 Fixed Film Plug Flow

The most widely accepted reactor available today is the fixed-film, plug flow unit. This particular reactor has the reputation of being the most effective of all the other types and tends to be so versatile in its treatments ability that it can be installed as treat groundwater, surface water, or process water. It frequently can be installed as a “package plant” to treat industrial wastewater. This reactor to be somewhat shock-proof; that is, the unit can withstand great fluctuations in organic loadings. Its resistant biomass maintains itself for long periods of time. One of the unique features of these reactors as currently marketed is their design flexibility. A fixed-film, plug flow reactor can be designed with single or multiple cells to enhance the

system shock resistance even more. Inside is a submerged packing material (structured or random), which encourages the formation of a microbiological film, which ultimately builds into a lush mat of biomass. With this type of design, sloughing of the biomass is minimized. This leads to an effluent that has only moderate total suspended solids (TSS). The effluent can be discharge if the minor concentrations of biomass floc are of no concern to regulators.

Another key aspect of this type of bioreactor is the fact that it can be sometimes successfully utilized to deal with relatively low levels of organics found in groundwater, and still be able to deal with levels of organics found in wastewater often greater than 1000 ppm. This assumes, of course, that a Total Organic Carbon TOC:N:P ratio of 100:5:1 can be maintained. Flow rates through this type of reactor can exceed 100 gpm with a package volume within the reactor of greater than 1500 ft³. Commercial fixed-film plug flow reactors can be as large as 30 ft in length, 9 ft wide and 10 ft height. This depends on design flow rates and organic loadings. If flow rate and organic loadings dictate, bioreactors can be stage in series. Also, if several different waste streams required treatment simultaneously, then one could operate these bioreactor in parallel. More and more complex waste streams may have BOD values greater than 5000 ppm and COD values greater than 15,000ppm. In order to overall size of bioreactor system and many as ten fixed film reactors can be aligned for this type of application (William C. Anderson, 1995).

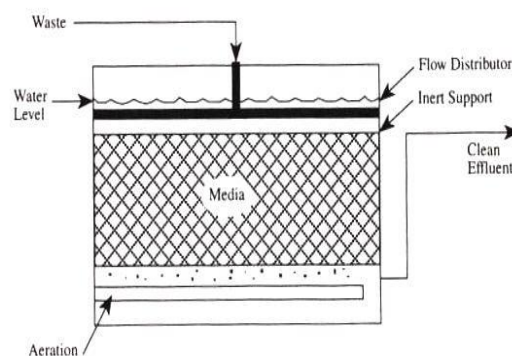

Figure 31 Submerged Fixed Film
(William C. Anderson, 1995)

EXPERIMENTAL PART 3

1 Purpose and Tasks of the PhD Work

The basic purpose of the current PhD work was to carry out a laboratory research concerning suitability biotechnology methods (Fixed Film Bed Reactor) for the remediation of groundwater contaminated with diesel in order to obtain drinking water.

To achieve this purpose it was necessary to solve the following tasks:

- Review of the literature appeared during last years about the microbial degradation of petrohydrocarbons by means of immobilized microorganisms. In this cases, the Fixed Bed Reactors have been successfully proved with autochthonous microorganisms isolated from contaminated areas (for example from a kerosene groundwater spill), and they have been used for the degradation of BTEX, kerosene and other organic substances (Kay Winkelmann, Joachim Venus, Wolfgang Spyra, 2003; Joachim Venus, Wolfgang Spyra, 2003).
- Autochthonous mixed culture, was taken from the contaminated groundwater and soil. There was no further characterization of the autochthonous mixed culture, but previous experiments proved that a high active biomass reservoir can achieve high degradation rates in the field of biological water purification (Joachim Venus, Horst Beitz and Wolfgang Spyra, 2000). Some colony forms were identified using 16S rRNA as *Novosphingobium pentaromativorans*, *Rhodococcus erythropolis* between others (cooperation between Chair of Chemical Engineering and Hazardous Wastes with Dr. Bär, Carl-Thiem-Klinikum by Dr. Mona Gouda).
- The influence of the main limiting environmental factors –assimilative forms of nitrogen, phosphorous and potassium must be determined.
- The degradation of diesel composition was analyzed by Gas Chromatography on a Sichromat 1-4 with a Flame ionisation detector (FID). The Method used in the Gas Chromatograph (FID) (ISO 9377-2) was just able to measure concentrations higher than 0.1 mg/L. For more exact concentrations (0,001 mg/L) referred to the concentration of Benzene after the bioremediation process, a new method was applied, based on Method DIN 38407-F9 (limit range 5µg/L Benzene)

- The degradation process was aerobic, the amount of oxygen has to be monitored to avoid the process of volatility of some hydrocarbons. Microbial Activity was measured as an indirect method to show that microorganisms must be able to use the pollutant as a carbon source in their metabolism
- The diesel degradation must be carried out in a four step fixed bed reactor in equilibrium. The four columns were optimized to meet the levels permitted by the drinking water regulation in Germany.

2 Methodology

It is useful to divide laboratory studies into two categories:

1. Bioassessment screening studies
2. Biotreatability studies

2.1 *Bioassessment Screening Studies*

Bioassessment is a set of screening tests designed to assess whether biological treatment can be utilized at a particular site. A screening study for bioremediation compares the results of a series of physicochemical and microbiological indicator tests to those factors known to be required for successful bioremediation of similar contaminants and site-specific parameters. These tests are relatively simple and under most situations, these results lead to a “go” or “no go” decision for bioremediation as a viable treatment option for a specific site. Screening studies are designed to determine:

- whether biodegradation of the target contaminants occurs when a suitable population of microbes contacts contaminants under an appropriate set of site conditions. These conditions include:
 - proper balance of nutrients
 - adequate moisture
 - the required electron acceptor in sufficient supply (oxygen in most cases)
 - and a conducive environment

These tests seek to identify problem factors that will inhibit or prevent the use of biological treatment. They are also geared to predict the efficiency of nutrient transport through the contaminant matrix or the engineer treatment system. The screening study is typically implemented after the physical and chemical parameters are reviewed (temperature, pH, electrical conductivity and redox, O₂ and organic concentration) providing a close idea of the contamination extent.

2.2 *Biotreatability*

The objective is to identify the optimal conditions for degradation of the target compounds. Generally, treatability studies do not determine the extent of degradation or define the ultimate bioremediation end point, they just give an idea of how long you can go. That kind of requirement and level of knowledge can only be approached in the construction and optimization test of the columns. (R. Barry King, Gilbert M. Long, John K. Sheldon, 2000,).

3 Laboratory Chronogram

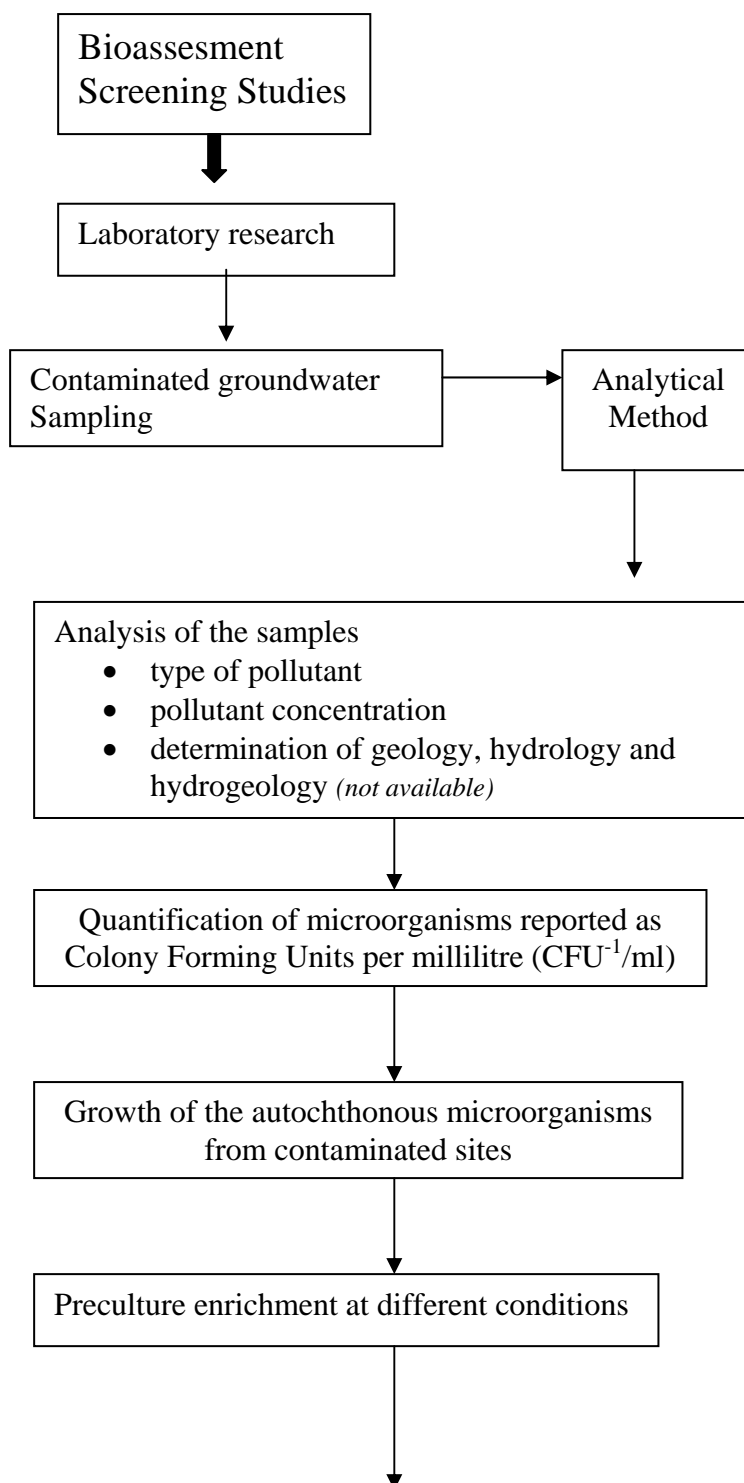

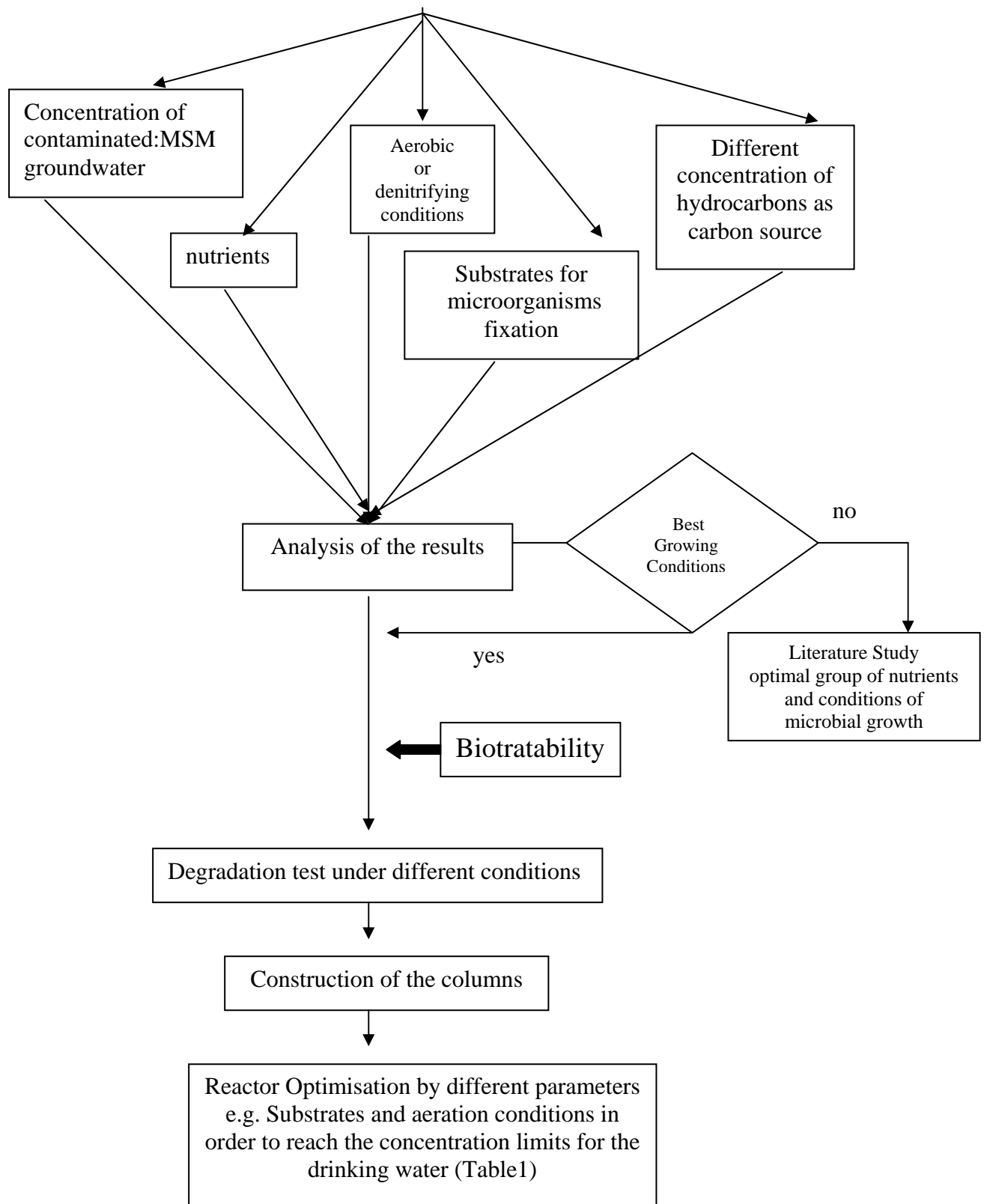

Methods and Materials

4 Bioassessment screening studies

4.1 Analysis of the groundwater and soil

4.1.1 Chemical and physical parameters of the soil and groundwater

The most common physical and chemical parameters evaluated in a screening study for bioremediation include (Table 7 and 8):

Table 7 Groundwater parameters

Water
pH
Temperature
Redox
Electrical Conductivity
Hardness (Ca, Mg)
Metals
Dissolved oxygen
Dissolved nutrient content (P, N)
Specific organic carbon contaminants (TPH, O&G, BTEX, etc.)
Total organic carbon
Biochemical oxygen demand
Chemical oxygen demand
Total suspended solids

Table 8 Soil parameters

Soil and Sludge
pH
Temperature
Redox
Metals (Cr; Pb)
Total Organic Carbon
Nutrient content (P,N)
Specific organic carbon contaminants (TPH, O&G, BTEX, etc.)

4.1.2 Soil

The pH, density and redox potential were measured with Dr. Lange ECM Multi equipment. For the Redox measurement 100 gr. of soil were diluted in 25 ml of distillate water for one hour, then 10 ml of potassium chloride (KCL) or 10 ml of calcium chloride (CaCl₂) was added and left untouched for 20 minutes, after which time the measuring was done. The electrical conductivity was measured with a pH Meter CG840.

4.1.3 Groundwater

The groundwater measurements (pH, density and redox potential) were taken directly from the sample with the same equipment, Section 4.1.2.

Small amounts of diesel and gasoline polluted soil are used for the biodegradation of the contaminated groundwater. This soil was chosen because it had been contaminated by PAHs.

for more than five years (Table 17), therefore it is very probable that the microorganisms are very good acclimated to hydrocarbons. In general, microbes will first attack and degrade compounds that offer the greatest amount of energy at the least expenditure of biochemical effort of the microbes, this is due to thermodynamics, which means that a light hydrocarbon will biodegrade far sooner and faster than a heavy end compound (R. Barry King, Gilbert M. Long, John K. Sheldon, 2000). If the indigenous microorganisms are adapted to PAHs then it will be easier for them to degrade the BTEX in diesel and gasoline (Bauer and Capone, 1988). Their efficiency is further enhanced by two main mechanisms. The first one is the cometabolism by which a strain is able to oxidize recalcitrant hydrocarbons provided an energy source available. The second is cooperation between strains. The two mechanisms explain why soil microflorae have great capability to eliminate pollution from contaminated environments (R. Marchal et al, 2003).

4.1.4 1st Measurement of Total Hydrocarbons in Groundwater

An Oil Counter Analyzer (OCMA-310) was used to perform the Total Hydrocarbons (THC) analysis in the contaminated groundwater. The Horriba oil Counter Analyzer makes use of the principle of the infrared absorption measurement that reflects the chemical structure of the molecules and a characteristic absorption pattern is shown by the chemical structure of the substances. Therefore, the absorption of various wavelengths in the infrared range is measured, and the position and strength of the absorption bands enable us to make a qualitative and quantitative analysis of the substances. There is an absorption band that follows the expansion and contraction movements of the radicals in (-CH₂-), (-CH₃-), etc. that are characteristic of hydrocarbons which are composed of C-H unions near the 3.4 to 3.5 μm (2,941 to 2,857 cm^{-1}) wavelengths. The wavelengths spectrum for this range can be measured at the same sensitivity with almost no dependency on the type of oil (plant oil, animal oil or mineral oil).

On the other hand the solvent S-316 has no absorption band within this wavelength range. Further, when is dissolved in water, the difference in specific gravity is large, so that oil is easily dissolved. Taking advantage of these features, we can measure the oil concentration in test sample water, after the oil which has been dispersed in water is extracted (dissolved) in S-316, the oil concentration in the sample is measured from the changes in the amount of infrared absorption in the 3.4 to 3.5 μm wavelength range of the extracted liquid (Instruction Manual code: I042206100).

4.1.4.1 Calibration

- 1) Add 20 ml of water + 10 ml of the pure solvent into the inlet
- 2) Make the extraction
- 3) After the extraction wait 30 seconds
- 4) ∅ open the extract cock to send a solvent to the cock
- 5) ∅ close
- 6) Measurement
- 7) If the same value is obtained in both measurement then
- 8) Press the bottom zero calibration

4.1.4.2 Measurement Method

1. Insert 20 ml of the test sample water into inlet
2. Insert 10 ml of pure solvent into the inlet
3. Insert one drop of chloridric acid
4. Then press EXTRACT to begin the extraction
5. Open the extract cock to send a solvent to the cock
6. Press MES to start the stability judgment

4.1.5 *2nd Measurement of Total Hydrocarbons in Groundwater “Analytical Method”*

This second Method is proposed in order to have a comparable method with Mexico. To choose this method it is considered many aspects some of them are the following; total petroleum hydrocarbon (TPH) measurements are conducted to determine the total amount of hydrocarbon present in the environment. There are a wide variety of TPH methods. In practice, TPH is defined by the method used to analyse it. Different methods often give different results because they are designed to extract and measure slightly different subsets of petroleum hydrocarbons.

No single method gives a precise and accurate measurement of TPH for all types of contamination. The most popular TPH methods are based on gas chromatographic (GC), infrared (IR), or gravimetric analytical techniques. GC-based methods are currently the preferred laboratory methods for TPH measurement because they detect a broad range of hydrocarbons, they provide both sensitivity and selectivity, and they can be used for TPH identification as well as quantification.

The GC-based methods usually cannot quantitatively detect compounds below C6 because these compounds are highly volatile and interference can occur from the solvent peak. As much as 25% of fresh gasoline can be below C6. This is not a problem for the analyst with weathered gasoline range and/or diesel range contamination because most of the very volatile hydrocarbons (<C6) may no longer be present in the sample (Analysis of Petroleum Hydrocarbon in Environmental Media, 1998).

The next step after choosing the method was to understand how the equipment works and to learn the methodology for the analysis:

4.1.6 Gas Chromatography (Principle)

Gas chromatography (GC) is the common name of separation methods, which are based on the differential adsorption of volatile solutes, when the mobile phase is gas and the stationary phase is solid or liquid (the distribution coefficient is called adsorption coefficient K_a). To use a chromatographic column properly, one must operate within the range of concentration where the distribution, partition or adsorption, isothermal is linear. Under these conditions, the chromatographic peak is a symmetrical Gaussian curve and equilibrium of the solute is reached in every theoretical plate, allowing the full utilization of the column's separation power.

Several factors determine the rate at which an injected compound travels through the column and reaches the detector. A compound's volatility at the column temperature influences the distribution of the compound between the gaseous mobile phase and the stationary phase. The most relevant physical property of a compound for GC is its volatility. The analyte needs to have appreciable vapor pressure at temperatures below 350-400°C.

Other things being equal, a compound's band will move through the column more quickly if its distribution favours the mobile phase. Boiling points are often used as a measure of the relative volatilities of compounds in a mixture. However, volatility alone does not determine the distribution between the stationary and mobile phase. Specific interactions between the injected compound and the stationary phase play an important role as well. A polar compound will tend to strongly distribute into a polar stationary phase. Conversely, a polar compound will not have a strong affinity for a non-polar stationary phase and, thus, will elute relatively quickly. In summary, components in a mixture can be identified by analysing the difference in their retention times, which is dependent upon their volatility and polarity.

Another important characteristic is a compound's ability to rapidly vaporize without decomposition or reacting. Instability at high temperatures usually renders a compound unsuitable for GC.

Common gas chromatography equipment consists of a carrier gas (mobile phase) delivery system, injecting apparatus, separation column, detector and data processing unit (Tibor Cserháti, Esther Forgács, 2001).

The separation of the mixture is recorded as a series of peaks. The area under each of these peaks is uniquely proportional to the concentration of that component in the original mixture, and following integration can be used for quantification. The time, under a given set of conditions, that each component of the sample is retained by the column (t_r) is used for identification

4.1.6.1 Carrier gas

The carrier gas must be chemically inert. Commonly used gases include nitrogen, helium, argon, and carbon dioxide. The choice of carrier gas is often dependent upon the type of detector which is used. The carrier gas system also contains a molecular sieve to remove water and other impurities.

4.1.6.2 Sample injection

The liquid sample is introduced by a split injection technique, it is introduced through a septum made of heat-stable silicon-rubber into the carrier gas flow, vaporized and mixed with the carrier gas. The carrier gas flow is divided into two parts with a variable ratio of flows, the smaller part of the carrier gas-sample mixture enters the column only, whereas the large flow bypasses the column inlet and leaves the system. In this line of the carrier gas flow there is a variable flow resistance (needle valve), by means of which the ratio of gas flows in the two branches (column and needle valve outlet) can be varied according to the ratio of the flow resistances of the outlet line and the column itself. The smaller the flow resistance of the needle valve relative to that of the column, the smaller the proportion of the sample which enters the column will become. The by-pass or split flow is much greater than the flow through the column when the flow resistance of the column is correspondingly much larger than that of the needle valve (Figure 32).

For optimum column efficiency, the sample should not be too large, and should be introduced onto the column as a "plug" of vapour - slow injection of large samples causes band broadening and loss of resolution. The most common injection method is where a microsyringe is used to inject sample through a rubber septum into a flash vaporiser port at the head of the column. The temperature of the sample port is usually about 50°C higher than the boiling point of the least volatile component of the sample.

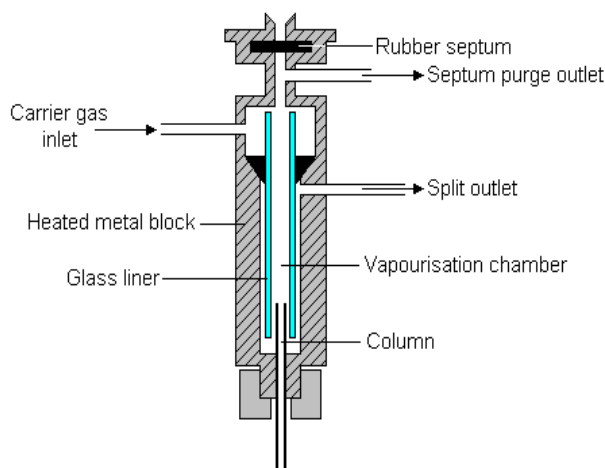

Figure 32 Split injector
Source: Ian A. Fowils, 1994.

4.1.6.3 Columns

Capillary columns for GC are made of tubing with an inner diameter of about 30-500 μm fabricated from glass, preferably fused-silica material but soda and borate glasses are also used. Columns length between 1 and 100 m or even longer can be applied without extreme pressure drops. The capillary material, is made from *fused silica* it is available at high purity and offers relatively inert surfaces without special pre-treatment although there are acidic Si-OH groups present on the surface, at low concentrations

The stationary phase in capillary columns only covers the inner surface and can also be anchored by chemically bonding to the surface if suitable anchor groups such as Si-OH on silica gel surfaces are available in high enough concentrations. With very low film thickness (ca. 0.1 μm) the total content of stationary phase is very small, and may amount to only a few milligrams. With such columns compounds of very low chromatographic volatility can be separated at low temperatures which are far below the boiling points of the solutes. (Gerhard Schomburg, 1990).

4.1.6.4 Column Temperature

The column temperature has a significant influence on the absolute and relative chromatographic volatilities. Temperature is the most important GC parameter apart from the polarity of separation phase, which has to be optimised for practical separations considering the particular properties of the sample and the aim of the analysis. The total analysis time and the resolution depend on the separation temperature.

The samples, which have to be separated in practice usually, contain several or many components with a wide range of volatilities and polarities. With isothermal operation only an average temperature of the column can be maintained which do not lead to elution of the volatile components with too short retentions or of less volatile constituents with too long retentions. Programming rates (0.5 and 10°C/min) are common.

The chromatographic volatility is not only determined by the vapor pressure but also by the polarity of the solute and the stationary phase. Polar solutes have much shorter retentions in non-polar phases.

4.1.6.5 Flame Ionisation Detector for GC

The flame ionisation detector (FID) is the most commonly used detector in gas chromatography (GC) and is probably the most important.

4.1.6.6 Response Mechanisms of the FID

The flame ionisation detector has a very wide dynamic range, has a high sensitivity and with the exception of some low-molecular-weight compounds (CH_2O , CO , COS , CO_2 , H_2CO_2 and also inorganic compounds H_2O , H_2S , SO_2 , NO_x , NH_3 etc) will detect all substances that contain carbon.

The principle of the FID lies in the fact that when an organic molecule is burned in a hydrogen flame, a number of ions are formed, which if the flame burns within an electrical field created by two electrodes of different polarity give rise to an ion current, which can be measured. The great success of the FID is due to the following characteristics:

1. When pure hydrogen is burned in a flame fed by pure air or oxygen in the absence of any organic compound, the ion current generated is extremely low. This implies a negligible baseline noise;

2. If an organic compound burns in a flame, a very large number of ions is produced compared to that produced by the hydrogen;
3. The signal produced by the detector response is strictly proportional to the mass flow of the organic compound over a very large range.
4. The sensibility of FID toward hydrocarbons, either aliphatic or aromatic, is very large, and an appreciable signal can be obtained by a small number of ppb of this type of molecule. A similar behaviour is observed with organic compounds containing etheroatoms (Fabrizio Bruner, 1993).

As soon as the electron-ion pair is produced, recombination starts to take place. The longer the ions take to reach the electrode and be collected, the more the recombination takes place. Thus, the greater the distance between the electrodes and the lower the voltage, the greater the recombination. As a result, initially the current increase with the applied voltage and then eventually flattens out, and at this point, it would appear that all the ion-electron pairs were being collected. In practice, the applied voltage would be adjusted to suit the electrode geometry and ensure that the detector operates under conditions where all electrons and ions are collected (Jack Cazes, 2001) (Figure 33).

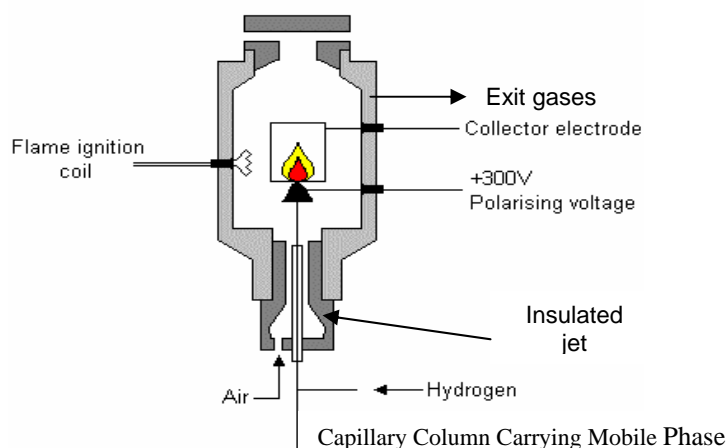

Figure 33 Schematic view of a Flame ionisation detector
Source: Ian A. Fowils, 1994.

4.1.7 Gas Chromatographic Method

The Gas Chromatographic (GC) analysis was performed on a Sichromat 1-4. Replicate dilutions were prepared and analysed for each sample. A flame ionisation detector (FID) at

300°C. An injection of 1.0 µL for each replicate sample. A split injector at 250°C with a split flow of 2 ml/min was used along with a non polar BPI (100% dimethylpolysiloxane) capillary column. The oven profile was 50°C to 280°C at a rate of 5°C/min (Kevin J. Johnson, Susan L. Pehrsson and Robert E Morris, 2004; A. Paschke, P.Poop, 2004) and held for 10 minutes at 280°C giving a run of 66- min. In the GC the mobile phase was an inert gas, Helium with 5 psi head pressure. The stationary phase is packed inside the column which was placed in an oven. The stationary phase used in this experiment was a fused silica with a film thickness of 1 micron (Figure 34).

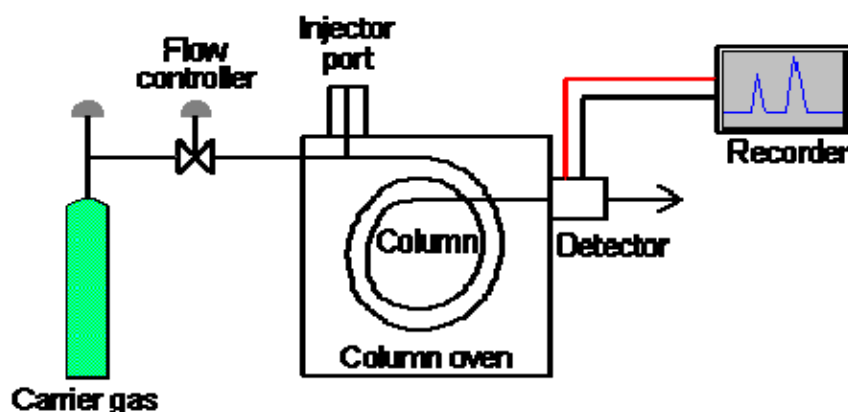

Figure 34 Gas Chromatograph 1-4 Sichromat

4.1.8 The Internal Standard Method of Chromatogram Evaluation via Peak Area

This method is important in quantitative chromatographic analysis because data of high precision and accuracy are obtained for individual components of even complex mixtures. This method eliminated the need for accurate injections since a reference standard is included in each sample analysis (A. Braithwaite and F.J. Smith, 1997). The evaluation of all peaks in a chromatogram is not necessary, but nevertheless the concentrations of a single or several components in the original sample are obtained.

This method is executed as follows. A standard compound (the internal standard) is added to the original sample at an accurately known concentration.

The standard compound is selected according to the following criteria:

- The retention time of the standard must be known
- The peak of the standard should be located in a section of the chromatogram where overlapping with the peaks of other components does not occur

- The retention of the standard should not be too different from those of the components to be quantified
- The volatility of the standard should not be too different from that of the significant sample components; this is important for the application of sample introduction techniques the performance of which is influenced by discrimination according to volatility; it may happen that compounds of the same boiling points are eluted with different retentions, because they have different polarities
- The concentration of the standard within the sample should be of the same order of magnitude as those of the analyte components; the signals of both the standard and the sample component should fit into the linear dynamic range of the detection system, which is especially important in trace analysis where extremely large differences in signal intensities occur; response factor calibrations with the standard should of course be performed under the same conditions and in the same range of concentration (in the mobile phase).

Unlike external standard methods, the internal standard method accounts for any variances in gas chromatographs performance. The analyte chosen for the internal standard has a predictable retention time and area, allowing it to be used to determine if abnormalities have occurred.

The Single Point Internal Standard method requires at least two analyses. The first analysis contains a known amount of internal standard and the compounds of interest as follow Equation 15:

$$\text{Internal Response Factor} = \frac{\text{area}_{IS} * \text{concentration}_{SC}}{\text{amount}_{IS} * \text{area}_{SC}} \quad (15)$$

IS=Internal Standard

SC=Specific Compound of Interest

Then a known amount of the internal standard can be added to the sample containing analytes of unknown concentrations and the amount of the unknown can be calculated using the following Equation 16:

$$\text{Amount of specific compound} = \frac{\text{amount}_{IS} * \text{area}_{SC} * IRF_{SC}}{\text{area}_{IS}} \quad (16)$$

IRF=Internal Response Factor

4.1.8.1 Calibration of the GC EN ISO 9377-2

For the calibration of the GC a monosubstance is used as a Standard Substance at different concentrations. This concentration should cover the most possible range of the detection system. In this case the Standard is Heptane.

The first step is to run one hexane blank, it is expected that the chromatogram recorder will shows a constant baseline in the x-axis =0.

The concentrations proposed for the calibration are: 1, 10, 20, 30, 40, 100, 200, 300, 400, 500, 600, 800 mg/L.

4.1.8.2 Extraction

According to the new ISO 9377-2 the contaminated groundwater is extracted with a light hydrocarbon liquid with a boiling point between 36-69 °C, (in this case hexane). Then the extract is concentrated to an appropriate volume. Components with retention times between those of n-decane (C₁₀H₂₄) and n-tetracontane (C₄₀H₈₂) are reported as “oil in water”.

The groundwater and the hexane (5%) are intensively mixed with a magnet for 30 minutes, therewith the two phases are well mixed. Magnesiumsulfat should be added in case an emulsion or foam comes up during the extraction (ISO 9377-2, (6.4)) (Figure 35).

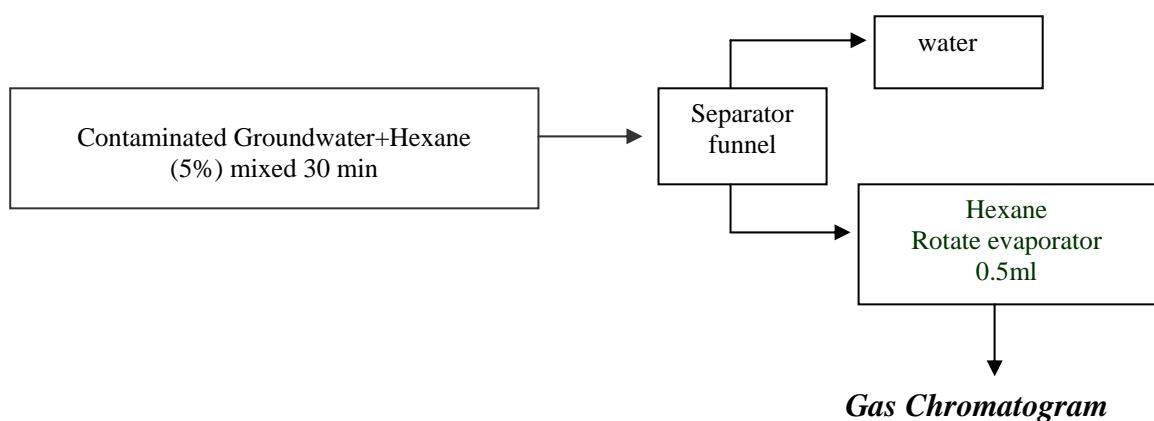

Figure 35 Extraction process

4.1.8.3 Appropriate Extracted Volume

Then the sample is introduced to a separator funnel where the water and the solvent with the organics are separated. No water is allowed in since it can damage the separating column (ISO 9377-2, (6.3)). The hexane is evaporated in a Rotate Evaporator and the volume can be reduced down to 0.5 ml. The extraction should be stored in a vial completely closed and in the refrigerator.

With this procedure it is possible to detect concentrations above 0.1 mg/L of Total Hydrocarbons.

4.1.9 *Measurement of Total Hydrocarbons in the soil*

The soil was dried in the sun for three days, after which time it was milled in a hammer mill. The characterization of the soil was qualitative and quantitative and carried out in the laboratories of the School of Postgraduate of Teaching and Agricultural Sciences Research Institution in Mexico, using standard methods.

4.1.10 *Sample use in the Laboratory*

The groundwater sample is not enough for the complete research; therefore it was necessary to prepare a similar sample in the laboratory. Table 9 shows the comparison between the Mexican and German gasoline and diesel. The German diesel in this experiment is commercially available and was obtained from a gasoline pump at a typical gas station. From this table we can conclude that Mexican and German diesel and gasoline are quite similar with the differences that the German diesel and gasoline have a wider range of carbons, higher amounts of aromatics and lower amounts of olefins. But it can still be said that conditions for bioremediation are similar. Therefore it was decided to prepare the sample from German diesel.

Table 9 Comparison between the Mexican and German diesel and gasoline

	Carbon	Sulfure ppm	Octane	Aromatics % V	Cetane	Olefins % V	Paraffine	Temp _{evaporation} °C
Diesel PEMEX	C ₁₅ -C ₁₈	350-500		22	55			250-310
Desulfure Diesel	C ₁₅ -C ₁₈	50		22	55			250-310
German Diesel	C ₉ -C ₁₉	10-50		40	50			50
Gasoline Magna	C ₅ -C ₉	87	87	23		9	7.36	40-190
Gasoline Premium	C ₅ -C ₉	93	92	23		7.48- 12.5	6.22	40-190
German Gasoline	C ₅ -C ₉	50-100	87	30-45		6-15		40-190

1 Petroquímica y Sociedad, Susana Chow Pangtay "Fondo Cultural Economica", 1998

2 Infineum Worldwide Winten Diesel Fuel 2002, January 2003

3 Fuel Quality and Vehicle Emission Standards, 1990

4 Major Scientific and Technical challenges about development of new process in Refining and Petrochemistry

4.2 Biofeasibility test

In addition to the specific testing described above, it was necessary to ascertain the presence of a native population or community of degrading microbes in the site and the microbial health of all media (sludge, soil and water) to be bioremediated. This requires an analysis to determine the relative number of microbes and the extent to which they can utilize the target compounds for growth and metabolism.

4.2.1 Method

The presence of microorganisms in groundwater and soil was determined by the enumeration of the total heterotrophic bacteria. The quantification of microorganisms was reported as Colony Forming Units per milliliter (CFU ml⁻¹). The soil was taken from well No. 10, property of PEMEX, located in Cd. Poza Rica, Veracruz. With the same conditions of contamination as it was founded by its use. The groundwater was taken from the Refinery of Salamanca in Mexico.

4.2.2 Extraction of cells from soil

For an accurate count of microorganisms on the plate it is necessary to have an efficient extraction of the microorganisms that are attached to the soil particles or are present in the pores of the soil aggregates. The extraction was done as follows:

1. Add 10 g soil + 100 ml of dispersing agent (Na-pyrophosphate) to the Erlenmeyer flask. This agent is added in order to encourage bacteria to desorb from sediment surfaces (Francis H. Chapelle, 2001).
2. Shake the solution for 30 min

4.2.3 Preparation of the dilutions and Inoculation

The extraction is followed by serial dilutions of the sample to enable discrete colonies to be seen on each plate.

3. Preparation of the Petri plates with Agar. Agar is a polysaccharide gelling agent that is derived from certain kinds of algae. The agar medium mix is heated to dissolve the agar and then autoclaved, that is, sterilized by heating at 121°C under 15 atmospheres of pressure for 15-30 minutes, and then poured into sterile petri dishes. When the medium is cooled it solidifies, providing a surface of nutrients on which aerobic bacteria can grow.
4. Dilution of the soil solution to 10^{-4} (just as the first estimate)

The dilutions of the soil solution were prepared making serial decimal dilutions successively to 10^{-4} (each one made by adding one part of inoculums to nine parts of sodium chloride (0.9%)) and inoculating 100 μ l in each of the Petri plates.

- first dilution = solution, 10^{-1}
- second dilution = 1ml first solution + 9 ml NaCl (0.9%), 10^{-2}
- third dilution = 1 ml second solution + 9 ml NaCl (0.9%), 10^{-3}
- forth dilution = 1 ml third solution + 9 ml NaCl (0.9%), 10^{-4}

Two different methods can be used for the application of the diluted sample to the growth medium. The spread plate method and the pour plate method. For aerobic and facultative anaerobic bacteria, by far the most common dilution procedure is the spread-plate method. This method is advantageous in that it allows colonies to develop on the surface of the agar, making it easier to distinguish different microorganisms on the basis of morphology and also facilitates further isolation of the colonies. The spread plate method generally gives bacterial counts that are higher than the pour plate method perhaps of improve aeration and desegregation of clumps of bacteria with this method.

5. Starting with the weakest dilution (10^{-4}), pipette 100 μl onto each of Petri plates. Spread over the entire surface using the sterile glass stirring rod (the 10^{-4} dilution first.). Follow the same steps for others dilutions.
6. After plating the microorganisms the samples are incubated in the Petri plates at room temperature.
7. Observation after 9 days. This allows the bacteria to multiply into macroscopic, isolated colonies known as CFUs. Because it is assumed that each CFUs originates from a single bacterial cell, colonies may arise from chains or clusters of bacteria, resulting in underestimation of the true bacterial number. The range of colonies acceptable for counting is 30-300 on a standard 150 mm diameter agar plate. Below 30 accuracy is reduced, above 300 accuracy increases only slightly and, in fact, numbers may reduced by overcrowding and competition between organisms growing on the plate.

Note: The procedure to plate groundwater bacteria is without the first and the second step.

The next step was to investigate the capacity of the native (indigenous) microbial community founded in the previous experiment to mineralize aromatic compounds. The experimental conditions were: 2000 mg/L of diesel as a source of carbon (Tables 14, 21) and the nutrient amendment level between (C:N:P) of 100:10:1 (Wilfred F.M. Röling, Michael G. Milner, D. Martin Jones, Kenneth Lee, Fabien Daniel, Richard J.P. Swannell and Ian M. Head, 2002).

Four types of solutions were prepared:

- I. Contaminated Groundwater:Mineral Salt Medium (1:50)
 - Soil
- II. Contaminated Groundwater:Mineral Salt Medium (1:50)
 - Soil
 - 2 g xylite
- III. Contaminated Groundwater:Mineral Salt Medium (1:50)
 - Waste Water Sludge 1-2ml
- IV. Contaminated Groundwater:Mineral Salt Medium (1:50)
 - Waste Water Sludge 1-2ml
 - 2 g xylite

The xylite is an intermediate product of the transformation from wood to coal, which has preserved wood structure. The xylite presence is objectionable in coal enrichment and xylite has to be separated. Thereby ash content, which is coal, will be decreased. In other words, the xylite is a waste product and it can rationally be utilized as inert support medium with large surface for attaching and growing of microorganisms in bioremediation of waters, contaminated with organic compounds like petroleum hydrocarbons, phenols, arsenic-containing organic compounds, etc (Venus J., 1998) (Appendix 10)

The biofilm well developed over the xylite as organic substance, is more stable than the biofilm, built in different inorganic bearers.

Advantages of the xylite:

- a) Average sorption capacity promoting bioremediation processes
- b) Low prime cost
- c) Very big available quantities

4.3 Biostimulation

Before choosing the proper nutrients and growth conditions a Literature Study was done. Table 28 shows the different Mineral Salts Medium (MSM) that has been used in many biodegradation hydrocarbon researches. Since it is very expensive to isolate bacterial strains able to grow on selected hydrocarbons, and it is well know that a microbial mixture is more efficient for degradation of diesel, the considerations showed in the results helped to select the proper nutrients to stimulate the growth of the microorganisms from the native (indigenous) microbial community (Venus, J; Beitz, H.; Spyra, 2000). From the total population of microorganisms the goal was to growth as much as possible aerobic and facultative bacteria. Therefore, a mixture of two enrichment methods were used. One is the **pre-enrichment or resuscitation medium**, which is a liquid medium that allows the microorganisms in the environment sample to start metabolizing actively an increase in its number. There are two purposes for the pre-enrichment method. First, damaged cells receive time and necessary nutrients to repair and grow. This step is important because direct inoculation of a sample into a selective enrichment medium may result in the death of some bacteria. The second purpose of pre-enrichment is to increase the number of cells. The second method is a **specialized isolation medium** that consists in the nutritional needs of specific groups of organisms.

Table 10 Experiments with different amounts of diesel, different level of N: P and different groups of salts

Amount of diesel	1000 mg/L	2000 mg/L	4000 mg/L
1st group N:P 10:1	NaNO ₃ +KH ₂ PO ₄ (NH ₄) ₂ SO ₄ + KH ₂ PO ₄ NaNO ₃ +(NH ₄) ₂ SO ₄ +KH ₂ PO ₄	NaNO ₃ +KH ₂ PO ₄ (NH ₄) ₂ SO ₄ + KH ₂ PO ₄ NaNO ₃ +(NH ₄) ₂ SO ₄ +KH ₂ PO ₄	NaNO ₃ +KH ₂ PO ₄ (NH ₄) ₂ SO ₄ + KH ₂ PO ₄ NaNO ₃ +(NH ₄) ₂ SO ₄ +KH ₂ PO ₄
2nd group N:P 20:2	NaNO ₃ +KH ₂ PO ₄ (NH ₄) ₂ SO ₄ + KH ₂ PO ₄ NaNO ₃ +(NH ₄) ₂ SO ₄ +KH ₂ PO ₄	NaNO ₃ +KH ₂ PO ₄ (NH ₄) ₂ SO ₄ + KH ₂ PO ₄ NaNO ₃ +(NH ₄) ₂ SO ₄ +KH ₂ PO ₄	NaNO ₃ +KH ₂ PO ₄ (NH ₄) ₂ SO ₄ + KH ₂ PO ₄ NaNO ₃ +(NH ₄) ₂ SO ₄ +KH ₂ PO ₄
3rd group N:P 5:0.5	NaNO ₃ +KH ₂ PO ₄ (NH ₄) ₂ SO ₄ + KH ₂ PO ₄ NaNO ₃ +(NH ₄) ₂ SO ₄ +KH ₂ PO ₄	NaNO ₃ +KH ₂ PO ₄ (NH ₄) ₂ SO ₄ + KH ₂ PO ₄ NaNO ₃ +(NH ₄) ₂ SO ₄ +KH ₂ PO ₄	NaNO ₃ +KH ₂ PO ₄ (NH ₄) ₂ SO ₄ + KH ₂ PO ₄ NaNO ₃ +(NH ₄) ₂ SO ₄ +KH ₂ PO ₄

4.3.1 Proper Balance of Nutrients

Since degradation of gasoline and diesel are limited by the supply of inorganic nutrients, (Wilfred F., Michael G., D Martin Jones, Kenneth Lee, Fabien Daniel, Richar J.P and Ian M., 2002), the following experiments will be carried out to find the optimal nutrient amendment levels between (C:N:P) at different concentrations of diesel 1000, 2000 and 4000 mg/L. The three levels of N:P tested were 10:1, 20:2 and 5:0.5. The levels of N:P were obtained from three different groups of salts, NaNO₃ + KH₂PO₄, (NH₄)₂SO₄ + KH₂PO₄ and a mixture of salts of NaNO₃ + (NH₄)₂SO₄ + KH₂PO₄ (Table 10).

The highest concentration, of 4000 mg/L, was chosen to prove if that high concentration was toxic for the microorganisms (Martin Alexander, 1999).

The experiments were done in 100 ml flasks that contained:

- Concentration of diesel (Tables 14, 21)
- Soil (0.5 g)
- Mineral Salt Medium (100ml) (Table 26)

4.3.2 First, Second and Third Group of Experiments

Three different amounts of diesel were studied for the first experiments group: 1000, 2000 and 4000 mg/L (2000 mg/L simulating the Mexican groundwater sample, Tables 14, 21). These experiments took place to analyze the behavior of the mixture of microorganisms at different amounts of diesel. It is very important to create a broad range of possibilities with optimum results. The level of N:P (10:1) was the recommended by the literature (Wilfred

F.M. Röling, Michael G. Milner, D. Martin Jones, Kenneth Lee, Fabien Daniel, Richard J.P. Swannell and Ian M. Head, 2002). The first group of experiments were carried out during seven days and for the three different groups of salts previous mentioned.

Since the experiments are too expensive the two following sessions were carried out for a shorter period of time.

For the second group of experiments the concentrations and the three different groups of salts were the same as the previous ones but this time with a level of N:P 20:2. The experiments were carried out for three days.

For the third group of experiments the concentrations of diesel and the salts were the same as the previous ones but with a level of N: P 5:0.5.

4.3.3 Fourth experiment

The next step consisted in carrying out an experiment at the critical conditions of nutrients with a concentration of 2000 mg/L of diesel for a larger period of time.

4.4 First test of biodegradation

Once biofeasibility was proved, biostimulation was the next step. To reach an optimal biostimulation it is important to know that several factors, such as pollutants concentration, active biomass concentration, temperature, and pH value, availability of inorganic nutrients and electron acceptors, and microbial adaptation influence the rate and extent of biodegradation of BTEX (Pedro J.J., Timothy M., 1991) and other hydrocarbons. To stimulate the growth of the microorganisms, the proper amount and conditions of the previous factors should be provided.

5 Biotratability (*Design of the Fixed-bed reactor (columns)*)

5.1 Soil adsorption

Due to the results obtained in the previous experiments, soil adsorption should be tested (Figure 51).

Four types of solutions were prepared:

Microbial Experiments

1) For 2000 mg/L of diesel

- Mineral Salts Medium (100 ml)
- Soil (0.5 g)
- Mineral Salts Medium (100 ml)
- Soil (0.5 g)
- Xylite (2 g)

Microbial + adsorption

Mineral Salts Medium (100 ml)

- Soil (0.5 g)
- NaN_3
- Mineral Salts Medium (100 ml)
- Soil (0.5 g)
- Xylite (2 g)
- NaN_3

adsorption

5.1.1 *Second test of biodegradation and adsorption*

The results obtained in the previous experiments showed high adsorption of diesel in the xylite. Unfortunately, this information was not enough for a screening study, in which it is necessary to compare the results of a series of physicochemical (absorption, desorption and adsorption) and microbiological (reaction) tests. The following experiment was designed for two reasons. The first was to measure the amount of diesel that can be adsorbed by the xylite until it reaches equilibrium. The second was to find out how long do the columns need to be in equilibrium. A column of adsorption was prepared in order to simulate adsorption inside the reactor.

5.1.2 *Conditions for the new Adsorption measurement*

5.1.2.1 Solubility

- Differences in the solubility of the diesel compounds
- Volatile compounds
- Temperature in the preparation and storage of the samples

The water solubility is the maximum amount of pure substance dissolved in a pure volume of pure water at a defined temperature in presence of sediment or a floating phase. This solubility measurement depends on some characteristics of the substance, which give certain affinity to the aqueous phase. Each of the different compounds that exist in diesel has different solubility in the water Table 11.

Table 11 Diesel solubility and its compounds in water

Compound	mg/l H₂O 25°C
Diesel	2-200
Benzene	1800
Toluene	520
Xylene	170
Ethylbenzene	140

Source: Schwarzenbach et al. 1993 und Hazardous Substances Database 2000

Such big differences in the solubility of diesel compounds in water complicate the preparation of a saturated solution. To prepare the saturated solution it is necessary to add the exact concentration of diesel referred in the literature as the limit concentration of solubility (Table 11). Then the flask must be closed immediately and vigorously shaken, to avoid oxygenation and evaporation of certain diesel compounds. To prove if this is the right saturated concentration, a drop of diesel can be added, and if it is not dissolved then the saturation is reached. The temperature of the water in the moment in which diesel is added is a very important factor. Water must be at 25°C, and once the solution is prepared it has to be stored in the refrigerator in order to keep the concentration for a longer period of time. Before diesel, 2 mg/L (Pedro J.J and Timothy M., 1991) of sodium azide should be previously added in order to avoid any microbial activity.

5.1.2.2 Xylite preparation

The xylite was washed three times with distillate water and dried in the oven at 70°C for 24 hours or until it gets completely dried.

- CFU/ml measurement (inhibition of the microbial activity with 2 mg/ml NaN₃)

5.1.2.3 Construction of the columns

- 2 columns 6X25cm (500 ml in volume)
 - 1st column as control=distillate water
 - 2nd column=diesel+water+NaN₃

The column (500 ml in volume), packed with approximately 100 g of xylite and operated in a closed system with a continuous recirculation of water contaminated with diesel concentrated as its limit solubility in water. The contaminated water flow rate will be 19.20 L/day (Figure 36).

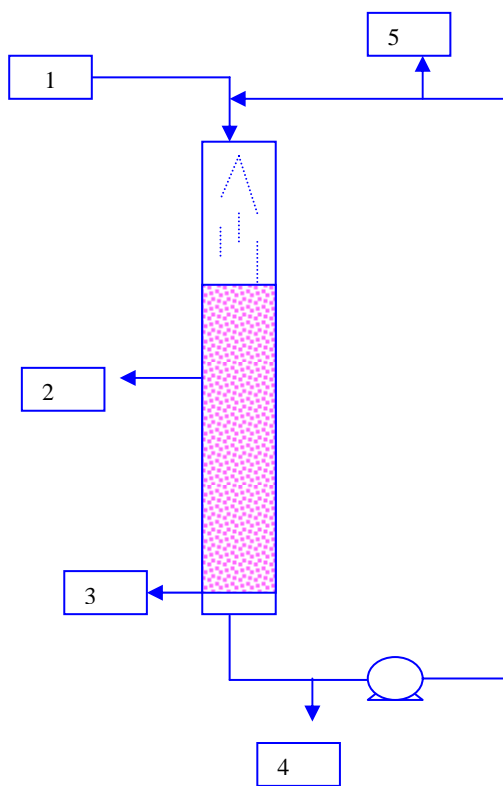

Symbol	Name
1	Diesel saturated solution+ NaN ₃
2	xylite
3	Glass fibber
4	sample
5	recirculation
	pump

Figure 36 Diagram of adsorption columns

5.1.3 Measurement of the Adsorption

The water contaminated with diesel will be circulated constantly and the samples will be taken from the top of the column until the equilibrium is reached. This sampling obeys to the uncertainty in the diesel solubility in water. The equilibrium will be reached when the concentration of diesel becomes constant or starts increasing, in other words, this is the moment when the xylite stops adsorption process. The analysis of these data will show the

time period xylite adsorption plus an estimation of the amount of adsorbed diesel. It is important to consider there is no certainty in which compounds of diesel are more easily adsorbed. This was not only consequence that the total amount of compounds existent in diesel were unknown, but also due to the limitation of the analytic analysis. The sample analysis was done in the Gas chromatograph, based on ISO 9377, which establishes a procedure to determine hydrocarbons in drinking, surface and waste water in concentration higher than 0.1 mg/L). The procedure for the analysis is the same as the explained in Section 4.1.7.

5.2 Reactor design

It is required to choose the reactor mode of operation that yields the greatest profit for the future construction of a larger scale reactor.

5.3 Steps for the reactor design

The design of the reactor consisted in two general parts. The first part carries out the bench scale studies that yield the best information about the intrinsic chemical kinetics and the associated rate expression. The second part is the construction of the columns, for a future larger scale reactor.

5.3.1 Bench scale studies

A knowledge of the dependence of the rate on composition, temperature, fluid velocity, the characteristic dimensions of any heterogeneous phase present, and any other process variables, may be significant.

To obtain the order of the reaction of the microorganisms to degrade the hydrocarbons, it is necessary to acquire the concentration of the substrate mg/L by Gas Chromatography during a period of time necessary until the concentrations required by the German regulations (Table 1) is obtained. Data is graphically represented for zero order in the concentration of diesel mg/L versus time. For the first order consider the logarithmic of the concentration versus time and for the second order the inverse of the concentration versus time.

The design of the fixed bed reactor requires information about the mechanisms and kinetics of degradation in biofilm systems.

5.3.2 *Microbial Growth Kinetics*

5.3.2.1 Growth of the microorganism for their inoculation to the columns

The soil (200 g) will be inoculated directly in a mineral salts medium (200 ml) and agar (2.5 g/L) in a separated flask (2 L) with enough oxygen and xylite (50 g), with a constant pH of 7 at 20°C. The cell concentration in the soil was $3.47 \cdot 10^7$ CFU/ml (Table 22), amount enough for bioremediation (W. Zhang, E. Bouwer, L. Wilson and N. Durant 1995). The mineral salts medium contains the following salts mixtures:

$\text{NaNO}_3 + (\text{NH}_4)_2\text{SO}_4 + \text{KH}_2\text{PO}_4$ with the different levels of N:P (100:5:0.5) mentioned before. This decision of this salts mixture resulted from the previous experiments in which the growth of the microorganisms was monitored in presence of different salts, different concentration of organic material and different concentrations of Nitrogen and Phosphorous, Section 4.3.1 200 ml of MSM, 2 ml of diesel are constantly supplied to the separates glass. Agar Plates are used to determine the population size of the microorganisms.

5.3.2.2 Biodegradation test and microbial growth kinetics

After the microorganisms reached a steady state they were inoculated to a separated flask with (1 L) of water contaminated with 2000 mg/L of diesel under exactly the same conditions, pH value, temperature and MSM (Table 32, Figure 61). This experiment was done to monitor the biodegradation of diesel as well as the microbial growth kinetics. No xylite was added to avoid adsorption.

This experiment provided data for the fixed bed reactor design about the mechanisms and kinetics of degradation. For the determination of the growth kinetics, the mode of cell cultivation was done in the flask working as a batch continuous. The continuous cultivation offers the ability to provide a constant environment to the cells but unfortunately the estimation of the maximum specific growth rate may be less accurate, and results may be affected by the wall growth and mutation over a long cultivation periods required by this technique. The same flask was used to measure the biodegradation kinetics. The Monod Kinetics Model will be used to relate the microbial growth with the decrease of the substrate (concentration of hydrocarbons obtained by Gas Chromatography, Section 4.1.7). And to prove, as Monod Model describes, that the growth rate of microorganisms is not just a function of the microbial concentration but also of a limiting substrate or nutrient (Equation

11). The graphical significance of the constants in the Monod equation, K_s particular substrate component in any given mixture and μ_m maximum specific growth rate, were necessary for the next step of the design. The pH was maintained in 7 with a solution of 1 mol/L of NaOH, sometimes it was decrease to 6 or 5.5 during the experiments due to the production of acids.

5.3.3 Construction of the Columns

1. The engineer faced the task of maintaining a careful balance between analytical reasoning expressed in quantitative terms and engineering judgement. In an attempt to maintain this balance some or all of the following questions presented in the (Table 43) must be answered.

2. Material Balance

The Material Balance establish “the total of flows of reactant into the volume element is equal to the total of flows of reactant out of the volume element” and takes into account the rate at which molecular species are concerted from one chemical form to another

The steps are:

- I. Draw a diagram defining the complete process
- II. Name with symbols each flow rate stream and its compositions
- III. Show all the known flows and compositions. Calculate the additional compositions starting from the known ones when it is possible.
- IV. Write the total Material Balance

For a better understanding of the Material Balance a segment of a tubular reactor should be considered. Since the fluid composition varies with longitudinal position, the material balance must be written for a reactant species over a different element of reactor (dV_R).

General Balance Material

$$\left(\begin{array}{c} \text{Rate of flow} \\ \text{of reactant} \\ \text{into volume} \\ \text{element} \end{array} \right) = \left(\begin{array}{c} \text{Rate of flow of} \\ \text{reactant out of} \\ \text{volume element} \end{array} \right) + \left(\begin{array}{c} \text{Rate of disappearance of} \\ \text{reactant by chemical reaction} \\ \text{within the volume element} \end{array} \right) + \left(\begin{array}{c} \text{Rate of} \\ \text{accumulation of} \\ \text{reactant within the} \\ \text{volume element} \end{array} \right)$$

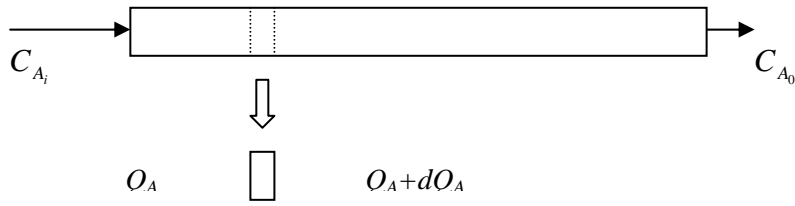

$$QC_{A_i} - QC_{A_0} + r_A V_R = V_R \frac{dC_A}{dt} \quad (17)$$

where

Q = Volumetric flow rate of the contaminated groundwater into the volume element L/day

C_{A_i} = Input Amount of diesel mg/L

C_{A_0} = Output Amount of diesel mg/L

$\frac{dC_A}{dt}$ = diesel rate accumulation mg/L day

V_R = Reactor Volume

r_A = Reaction rate (units depending on the reaction order)

Since plug flow reactors are operated at steady state except during start up and shut down procedures, the accumulation term is missing.

$$\frac{dC_A}{dt} = 0$$

The equation 17 becomes:

$$Q_A = (Q_A + dQ_A) + (-r_A)V_R \quad (18)$$

for a segment of a tubular reactor

$$dQ_A = r_A dV_R \quad (19)$$

if

$$Q_A = Q(1 - q_A) \quad (20)$$

Differentiating

$$dQ_A = -Q dq_A \quad (21)$$

Combining equation 19 and 21 gives:

$$\frac{dV_R}{Q} = \frac{dq_A}{(-r_A)} \quad (22)$$

Integrated over the entire reactor volume and considering that the density is constant the equation 22 can be written in terms of concentration:

$$\frac{V_R}{Q} = \frac{(C_{A_1} - C_{A_0})}{-r_A} \quad (23)$$

It should be emphasized that for ideal tubular reactors, it is the total volume per unit of feed that determines the conversion level achieved. The ratio of the length of the tube to its diameter is irrelevant, provided that plug flow is maintained and that one uses the same flow rates and pressure-temperature profiles expressed in terms of reactor volume elements.

For a heterogeneous catalytic reaction the reaction rate must be expressed per unit weight or per unit area of catalyst. If we used the equation 19 but in terms of weight of catalyst dW :

$$dQ_A = r_A dW \quad (24)$$

and equation 23:

$$\frac{W}{Q} = \frac{(C_{A_1} - C_{A_0})}{-r_A} \quad (25)$$

In this case the reaction rate will depend not only on the system temperature and pressure but also on the properties of the catalyst.

- V. Solve the equations in order to define the space time to obtain the required concentration in the outflow and prove the solutions with the experiments.

5.3.4 *Trickle-bed reactor and support medium*

The columns 6 by 25 cm (4 L in volume), packed with approximately 800 g of xylite and operated as a single pass of groundwater contaminated with diesel in amount of 2000 mg/L. The contaminated groundwater flow rate was of 6.24 L/day (A. Massol, R. Weller, L. Ríos, J.Z. Zhou, R.F. Hickey and J.M. Tiedje, 1997). The columns were operated aerobically as a tricked- bed system. Air was pumped from the bottom and nutrients were constantly supplied in the feed, 200 ml of MSM was constantly supplied during the duration of the reactor process. The nutrients were nitrogen and phosphorous and were calculated with a relation of 100:5:0.5, of C: N: P respectively (Table 31). The columns were colonized by indigenous soil microbial population (Refinery of Poza Rica in Mexico) with diesel as a sole carbon source.

The microorganisms were immobilized on a special material (xylite) to form a biofilm. The recommended temperature is 20 °C, at this temperature the metabolic activity was promoted and accelerates the degradation of the pollutants (Edel H-G and Meyer-Murlowsky T., 2000). The groundwater organically contaminated was prepared in the Laboratory Section 4.1.10. The solution from the separated glass Section 5.3.2.1 was filtrated and was used to inoculate the reactor. Agar Plates were used to determine the population size of the microorganisms. 200 ml of MSM and 2 ml of diesel were constantly supplied to the separates glass. The inoculum was recycled in the reactor during 73 days and the microorganisms growth monitoring samples were taken from the bottom of the columns. Since the only source of carbon was diesel the inoculums was recirculated constantly in parallel with the contaminated groundwater through the four columns. The pH value was maintained in 7 as explained previously (Section 5.3.2.2)

5.3.5 *Columns*

The columns (Figure 135) were operated constantly, the removal efficiency were monitored sampling everyday at the same time.

5.3.6 *Equilibrium in the columns*

1. The literature says that the solubility of diesel is around 2-7 mg/L (Stephen M. Testa, Ruane L. Winegolden 2000). A sample with a concentration of 7 mg/L was prepared. In case that the result showed a lower concentration, new samples with lower concentrations were prepared until the solubility of diesel was reached. The analysis of the concentration was checked in the GC-FID.
2. A solution with diesel (limit of solubility) was recirculated within the columns until equilibrium was reached. That means that the concentration of diesel should be the same in the output and input of each column (Figure 136). The concentration measurement was carried out using a GC-FID.

5.3.7 *Measurement of the microbial activity CO₂*

The mere observance of an increase in microbial number does not mean that the groundwater is cleaning up. The microbial population might instead be using some other substrate and leaving the contaminants intact. Therefore, it became necessary to monitor other parameters. In this case the extent of diesel degradation was examined by measuring carbon dioxide %CO₂ over time in the vapor phase from the top of the column. The measurements were carried out with a 1309 Multipoint Sampler (INNOVA Air Tech Instrument). The columns worked at a velocity of 19.20 L/ day and continuous recycled process. The measurements were from the Column 1, 3 and 4.

5.3.8 *Columns Optimization*

Four different arrangements were carried out in the columns:

- 1) One Column working continuous and recycled constantly
- 2) Four columns working in parallel and recycled constantly.
- 3) The first column had a retention time of 2 days, on the third day the rest of the three columns worked in series and a new sample was again introduced into the first column. The same process was repeated continuously.
- 4) The sample was introduced in the first column and the flow velocity was the controller by the retention time of the sample inside the reactor

5.4 *Last Part*

Of all the many components of petroleum hydrocarbons, the aromatic compounds such as BTEX are among the most mobile and most potentially toxic when released to the environment. Even though aromatic compounds comprise only a minor portion (2-8% by weight) of gasoline, these compounds are relatively soluble in water. Benzene has been shown to be carcinogenic and is now considered to be a hazardous substance. In assessing the

risk associated with fuel spills, regulatory agencies consider concentrations of benzene to be of primary importance.

The last part of the thesis consisted in a detail study of Benzene. The next experiments should be designed in order to measure the biodegradability of Benzene in the range of 2,000-0.001 mg/L.

A very detail analysis is necessary to prove that the groundwater reach the German limits of drinking water (Table 1) referred to the concentration of Benzene after a bioremediation process.

Summary of the Previous Results

The results obtained until now show that the reactor is able to biodegraded the diesel from a concentration of 2000 mg/L to 0.5mg/L. Even the percentage of degradation was very high, it was impossible to identify that the water can be used for drinking purposes (Table 1). The problem was that the Method used in the FID Gas Chromatograph was just able to measure concentrations higher than 0.1 mg/L. Therefore a new method should be applied in order to met the goals of the thesis. The new method is based on Method DIN 38407-F9 (limit range 5µg/L Benzene)

Experiments

1. A separated flask containing 1 L contaminated groundwater with Benzene (1270 mg/L benzene solubility) inoculums of microorganisms and nutrients without xylite should be prepared. The first sample was taken after 24 hours and the sample was sent to analyse. If an amount of benzene still in the sample, following samples were taken every 24 hours until the benzene was completely biodegraded. If after 24 hours no benzene was present the sampling was repeated from the beginning but this time the sampling was taken every two hours. The microbial growth was monitored during the whole process.

Results and Discussion

6 Bioassessment screening studies

6.1 Groundwater and soil chemical and physical parameters

Table 12 Groundwater chemical and physical characteristics

Test	Sample 1	Sample 2	Sample 3
pH	8,2	8	8.55
Density	0.92 g/cm ³	0.92 g/cm ³	0.92 g/cm ³
Electrical conductivity	5 µs/cm	3 µs/cm	2.81 µs/cm
Redox potential	97 mV	91 mV	89 mV
Hardness (Ca, Mg)	-	-	-
Metals	-	-	-
Dissolved oxygen	5.70	7.68	9.32
Dissolved nutrient content (P, N)	P=2.27 mg/L N=23.5 mg/L	P=2.27 mg/L N=23.5 mg/L	P=6.91mg/L; N=17.8mg/L
Total organic carbon	1950 mg/L	302 mg/L	137 mg/L
Biochemical oxygen demand			
Chemical oxygen demand	340 mg/L	258 mg/L	206 mg/L
Total suspended solids	28	20	20
Specific organic carbon Contaminants Gas Chromatography	2000 mg/L Total Hydrocarbons	63.24 mg/L Total Hydrocarbons	35.8 mg/L Total Hydrocarbons

Table 13 Soil chemical and physical characteristics

pH	7.7
Density	1.17 g/cm ³
Electrical Conductivity, T=22°C	0.80 µs/cm
Redox potential	10 mV
Metals (Fe, Cu, Mn)	no available
% Water	8.67%
% Organic material	16.31%
Nutrient Content (P,N)	P= 8 ppm, N=no available
Specific organic carbon contaminants	PHA

The pH of the groundwater was 8.55, which was within the necessary range (5-9) for a typical condition of groundwater bioremediation (R. Barry King, Gilbert M. Long, John K. Sheldon, 2000), the groundwater density was 0.92 g/cm³.

6.2 1st Measurement of Total petrohydrocarbons (TPH) in groundwater

Table 14 Quantification of TPH of Mexican contaminated groundwater using a Horriba oil Counter Analyzer, (Sample 1)

Contaminated groundwater (dilution)	CONCENTRATION (mg/L) (Sample 1)
1:10	2060
1:20	First measurement 2060 Second measurement 1840 <hr style="width: 10%; margin: 0 auto;"/> Average 1950

Table 15 Quantification of TPH of Mexican contaminated groundwater using a Horriba oil Counter Analyzer, (Sample 2)

DILUTION Contaminated groundwater (dilution)	CONCENTRATION (mg/L) Sample 2
1:10	302

Table 16 Quantification of TPH of Mexican contaminated groundwater using a Horriba oil Counter Analyzer, (Sample 3)

DILUTION Contaminated groundwater (dilution)	CONCENTRATION (mg/L) Sample 3
1:10	137

Table 17 PAHs concentrations in soil

PAHs	Concentration (mg/L)
Fluorene	1755
Phenanthrene	2384.6
Antracene	1547
Flurantene	4732
Pyrene	5296.6
Chryseno	2497.8

6.2.1 2nd Measurement of total petrohydrocarbons in groundwater using a Gas Chromatogram-FID technique

6.2.1.1 “Heptane” Standard calibration curve

The concentrations presented in the (Table 18) cover most of the possible range of detection.

Table 18 Range of detection of Heptane

Concentration	Area 1	Area 2	Area 3
1	154025	197880	167880
3	230128	250128	240128
4	305653	315653	308652
10	440461	440308	433016
20	699162	809201	719262
30	1011611	905938	1101087
40	1307176	1218299	1353722
100	2957787	2871036	2721267
300	4910512	6576131	5812421
400	6434230	6073713	6605435
500	6497570	6756379	7089353

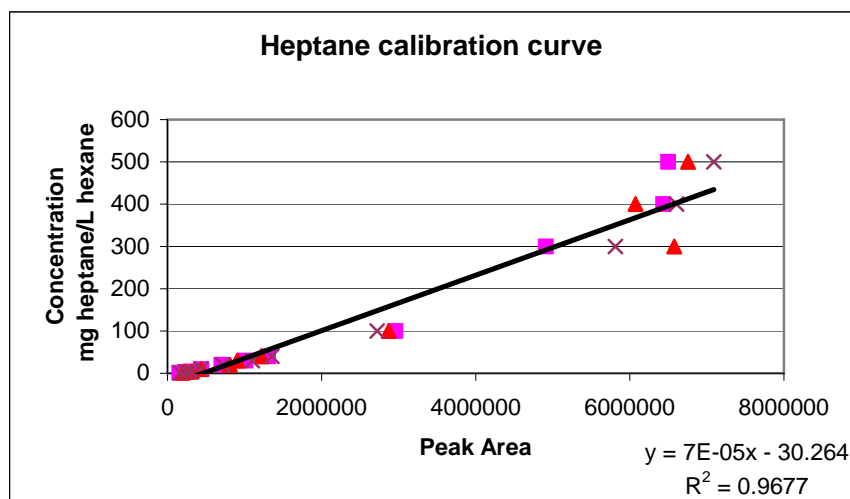
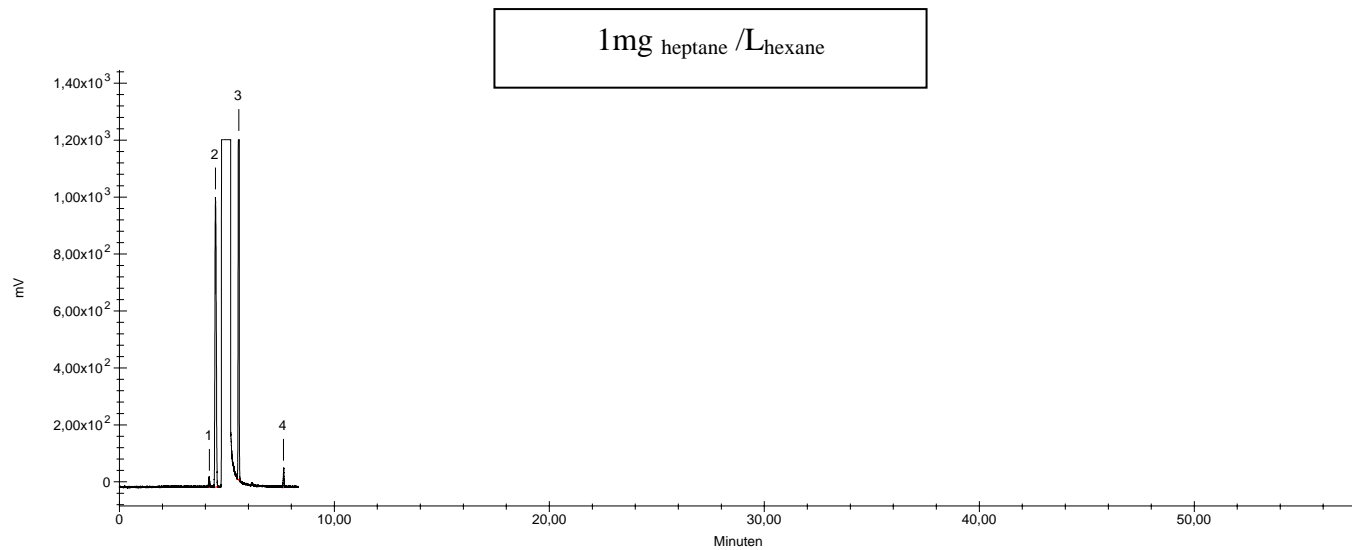
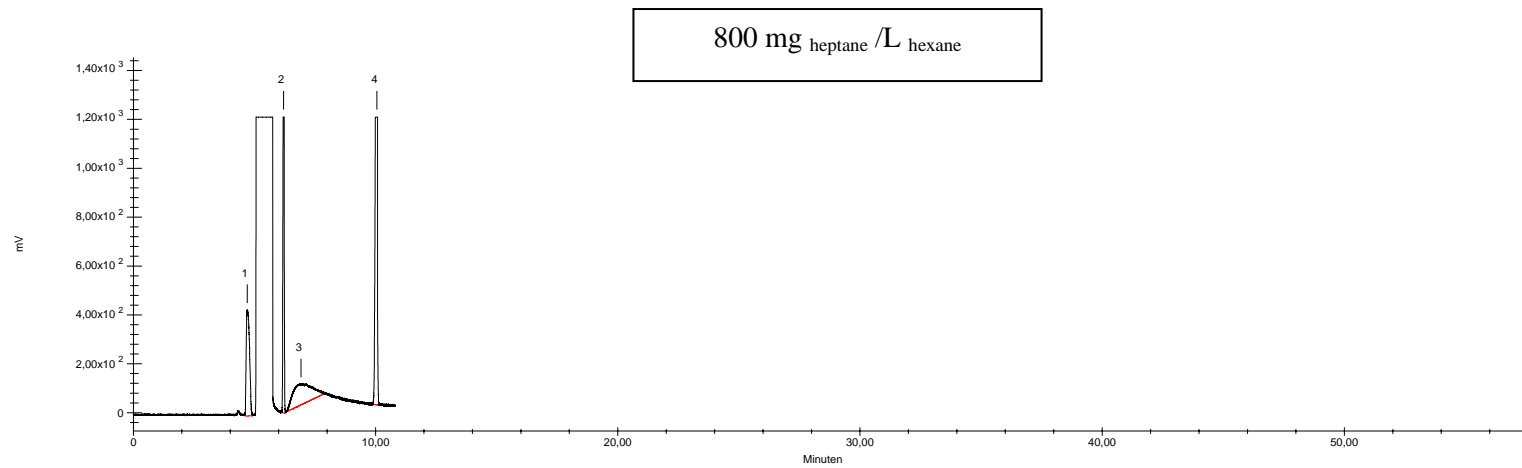

Figure 37 Heptane calibration curve

The Gas Chromatograph used for this analysis was able to detect lower (page 3 EN ISO 9377-2:2000) and higher concentrations of Heptane, see Figure 38 for higher concentrations and Figure 39 for lower concentrations. However, these concentrations can not be used as a standard because the signal that is needed should be within a middle range of detection. The regression of the curve gave an $R^2=0.96$, which is very acceptable value. Using this equation is possible to obtain all the concentrations that are within possible this range. The data in the Figure 37 show that a reasonable range of area for the standard should be between 30 to 100 mg/L. The concentration that was chosen was of 34 mg/L with a peak area of around 1,904,393 to 1,761,403.



Figures 38, 39 Gas Chromatogram a) maximum concentration of heptane
 b) minimum concentration of heptane

6.2.2 Diesel calibration curve

In order to determine the sensibility of the Gas Chromatograph (FID) it was necessary to prepare a diesel calibration curve (Table 19) (Figure 40).

Table 19 Diesel calibration curve data

Concentration mg/L	Peak area 1	Peak area 2
0,1	296373	296373
0,484	1211736	1129257
1	4297000	2027866
5	7400489	11605531
10	30365839	23151185

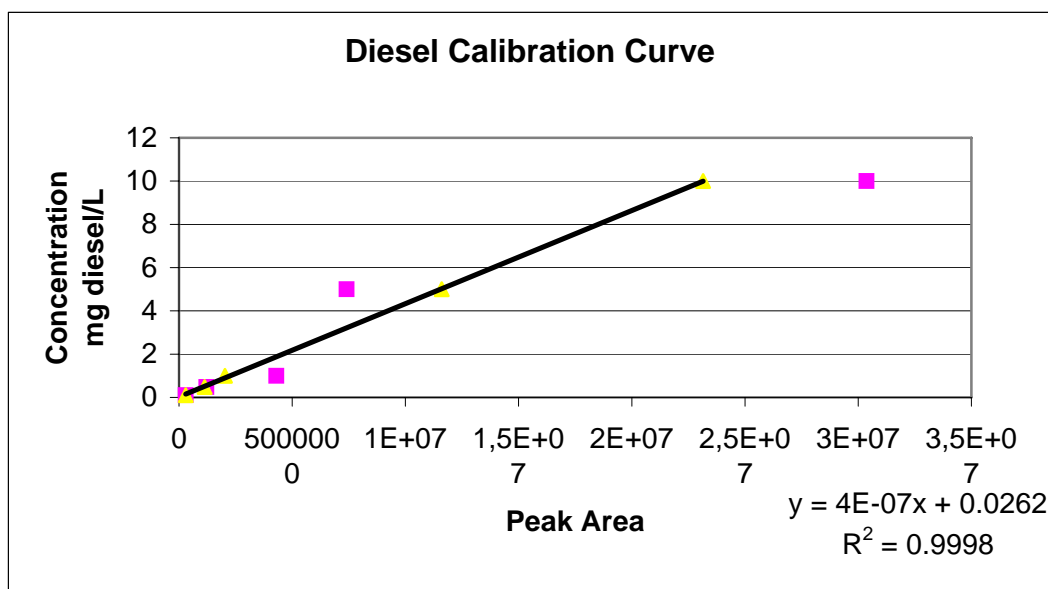

Figure 40 Diesel Calibration Curve

Table 20 Analysis of different amounts of diesel to prepare a diesel calibration curve using a Gas Chromatograph (FID)

Amounts of diesel for the calibration curve										
Single Point Internal Standard test of concentration										
Date	Method	conc. Hep. (mg/ml)	Chromatogram							Error
Conc. (mg/L)			Area Hep. In.st.	A. st. diesel	Conc. st. Diesel	I.F.R.	Area Hep.	Area diesel	A. diesel GW	Absolut
standard solution diesel	50°(10)3/280(20min)	34	1170321	33060823	20	0.021				
standard solution diesel	50°(10)3/280(20min)	34	1390336	32955301	20	0.025				0.004
0,1	50°(10)3/280(20min)	34	1390336	32955301	20	0.025	2649262	345482	0.11	0.01
0,484	50°(10)3/280(20min)	34	1390336	32955301	20	0.025	2141613	1211736	0.48	-0.01
0,484	50°(10)3/280(20min)	34	1390336	32955301	20	0.025	1441464	1129257	0.66	0.18
1	50°(10)3/280(20min)	34	1370968	32974669	20	0.024	3888636	3160195	0.68	-0.32
1	50°(10)3/280(20min)	34	1370968	32974669	20	0.024	2079028	2027866	0.81	-0.19
5	50°(10)3/280(20min)	34	1370968	32974669	20	0.024	2570721	13340250	4.32	-0.68
5	50°(10)3/280(20min)	34	1370968	32974669	20	0.024	1695724	11605531	5.69	0.69
10	50°(10)3/280(20min)	34	1370968	32974669	20	0.024	2027088	30365839	12.46	2.46
10	50°(10)3/280(20min)	34	1370968	32974669	20	0.024	1518614	23151185	12.68	2.68

conc.Hep. Heptane concentration

Conc. Concentration (mg/L)

Area Hep. Int.st Area Heptane Internal Standard

A.st.diesel Standard Amount of diesel

I.R.F internal respond factor

Area Hep Area of Heptane

A. diesel GW amount of diesel in contaminated groundwater

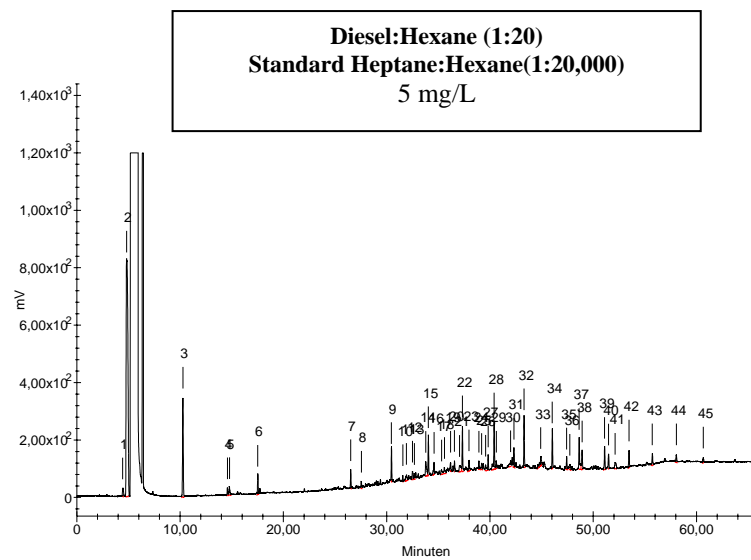
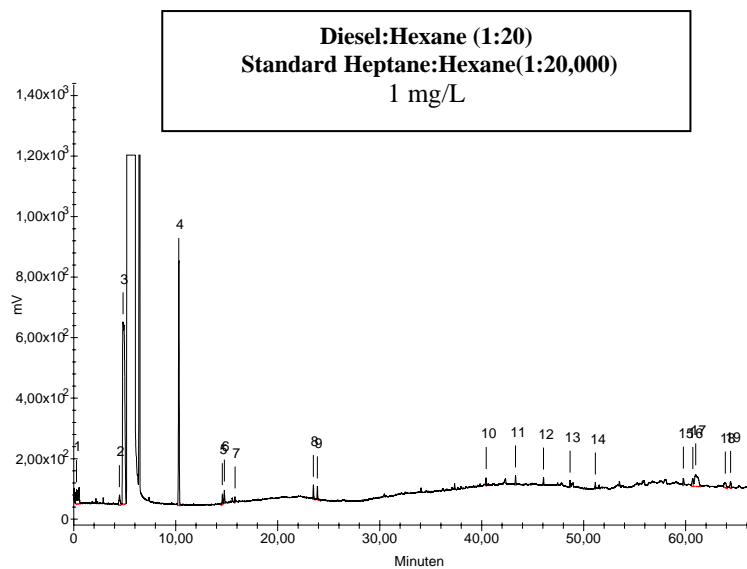
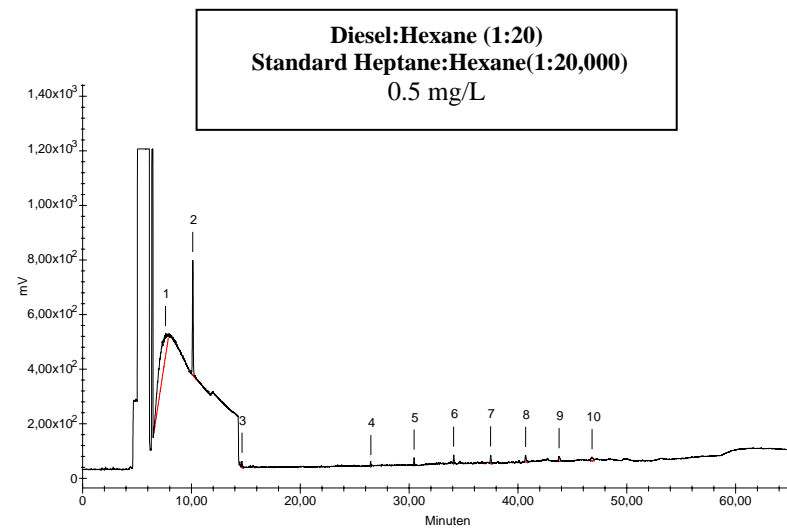
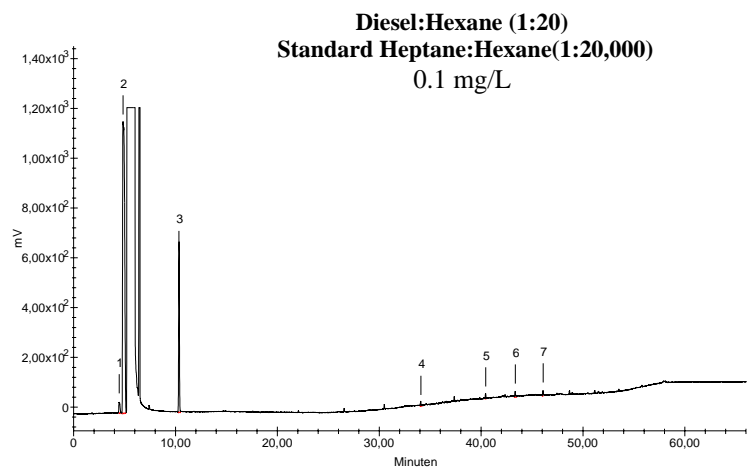

Figures 41, 42, 43, 44 Gas chromatogram; extraction (1:20); Standard Heptane:Hexane (1:20,000) dilution
a) Calibration 0.1 mg/L b) Calibration 0.5 mg/L c) Calibration 1 mg/L d) Calibration 5 mg/L

6.2.2.1 Preparation of the samples

Due to the conditions present in this case, the sample was an emulsion, that consists of at least one immiscible liquid, in this case diesel, which was dispersed in another liquid, water, in the form of droplets. Emulsified oil is oil that has been broken up into droplets that disperse in the water. The smaller the droplets, the more stable the emulsion. When the droplets contact each other, they tend to coalesce and rise to the surface. If oil is not emulsified, it floats on top of the water but if not then it is very difficult to separate the two phases. From the part of diesel that tends to float on top of the water, just a small fraction is water-soluble. Some compounds may be already adsorbed to solids. Low-molecular-weight alkanes such as pentane and hexane are slightly water-soluble. Alkenes are slightly more water-soluble than alkanes, and aromatics are even more water-soluble.

To obtain better results three different standard dilutions (diesel:Heptane) were used. The dilution (1:80) had a detection range between 2000 mg/L and 100 mg/L of diesel (Figure 45). The second dilution (1:44) had a detection range between 200 mg/L and 1 mg/L of diesel (Figure 46). To obtain more exact peaks at low concentrations it was necessary to prepare a dilution (1:20) with a detection range between 20 mg/L and 0.1 mg/L of diesel (Figure 47). To analyze the samples liquid-liquid it was necessary to prepare extractions within a range concentration compatible with the sensibility and detection limits of the instrumentation. The extraction volume was 1.8 ml for the dilution (1:80), 1 ml for the dilution (1:44) and 0.5 ml for the dilution (1:20). This covers all the possible concentrations that are able on this range during biodegradation. Another tool was the Gas Chromatogram standards found in the Literature. A comparison of the results obtained in the Gas Chromatogram (Figures 45, 46 and 47) with those standards can be very useful in order to have a better idea of which refined product could be present as contaminant (Appendix 9)

It was possible to calculate and get the standards for this specific case as previously explained. The diesel standards are as follows:

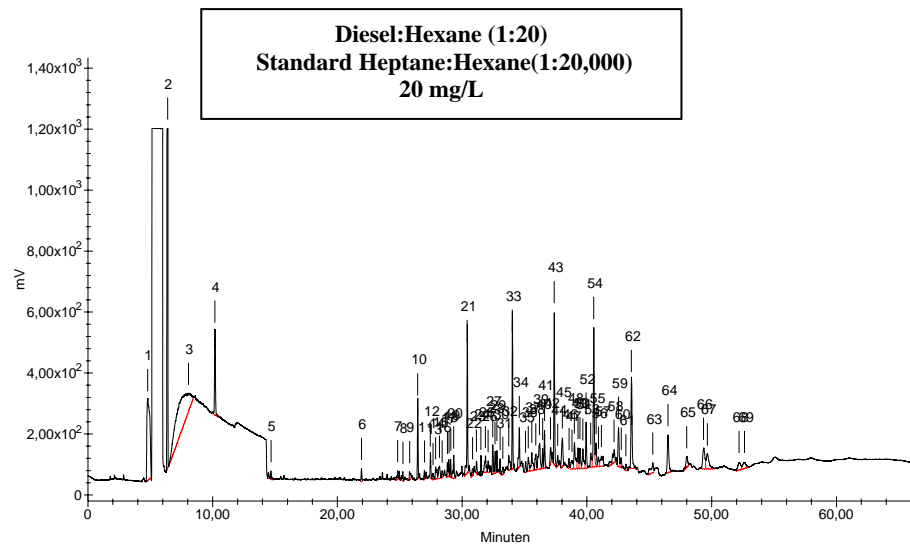
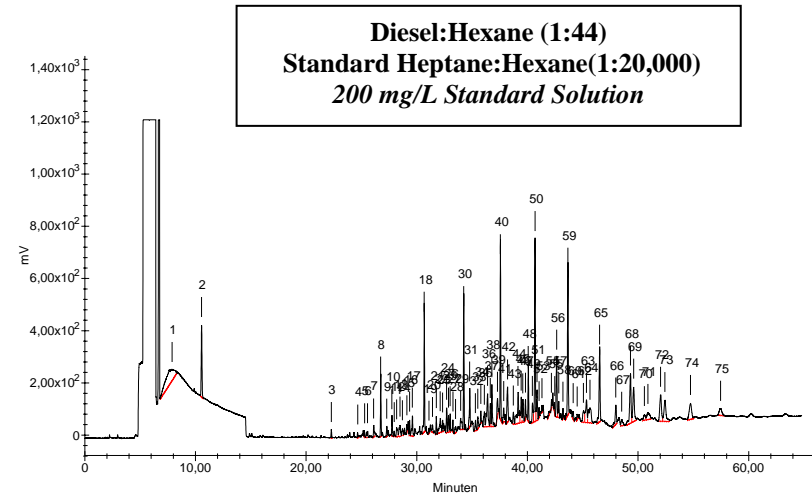
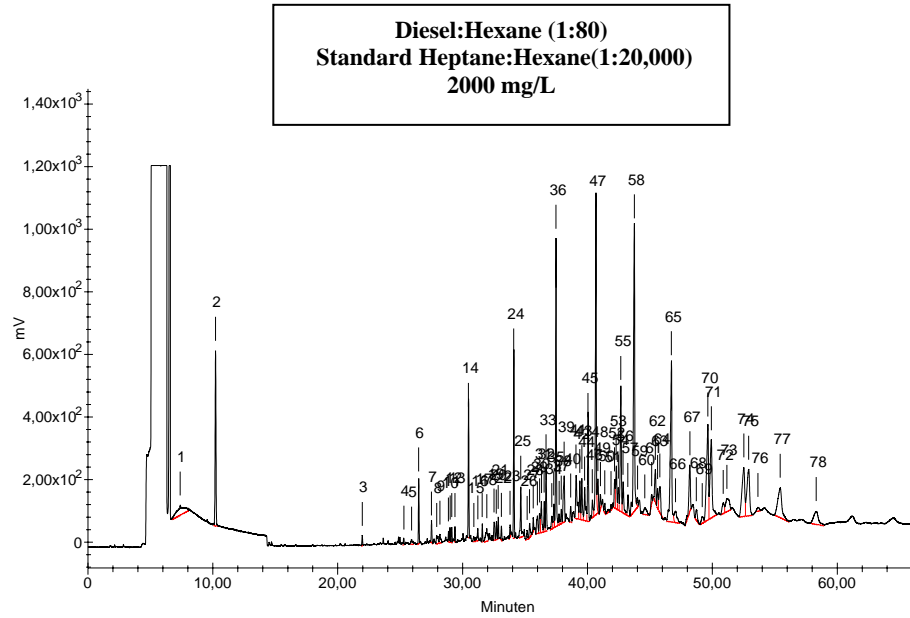

Figure 45 Gas chromatogram; extraction (1:80); Standard Heptane:Hexane(1:20,000) dilution a) Standard solution 2000 mg/L

Figure 46 Gas chromatogram; extraction (1:44); Standard Heptane:Hexane(1:20,000) dilution b) Standard solution 200 mg/L

Figure 47 Gas chromatogram; extraction (1:20); Standard Heptane:Hexane(1:20,000) dilution c) Standard solution 20 mg/L

6.2.3 Concentrations of Original Mexican Groundwater

Table 21 Analysis of different amounts of diesel in the Original Mexican Samples using a Gas Chromatograph (FID)

Amount of diesel in the Original Mexican Samples									
Single Point Internal Standard test of concentration									
Conc. (mg/L)	Method	conc. Hep. (mg/ml)	Chromatogram						
			Area Hep. In.st.	A. st. diesel	Conc. st. Diesel	I.F.R.	Area Hep.	Area diesel	A. diesel GW
standard solution diesel	50°(10)3/280(20min)	34	1893054	100516877	2000	1.108			
Sample 1	50°(10)3/280(20min)	34	1893054	100516877	2000	1.108	2071030	108621446	1975.53
Sample 1	50°(10)3/280(20min)	34	1893054	100516877	2000	1.108	1893054	98623823	1962.33
standard solution diesel	50°(10)3/280(20min)	34	1370968	44945726	200	0.179			
Sample 3	50°(10)3/280(20min)	34	1370968	44945726	200	0.179	3034305	17797145	35.78
Sample 3	50°(10)3/280(20min)	34	1370968	44945726	200	0.179	2688772	13326343	30.24
Sample 2	50°(10)3/280(20min)	34	1370968	44945726	200	0.179	2961955	32059402	66.03
Sample 2	50°(10)3/280(20min)	34	1370968	44945726	200	0.179	2572511	26668892	63.24

conc.Hep. Heptane concentration

Conc. Concentration (mg/L)

Area Hep. Int.st Area Heptane Internal Standard

A.st.diesel Standard Amount of diesel

I.R.F internal respond factor

Area Hep Area of Heptane

A. diesel GW amount of diesel in contaminated groundwater

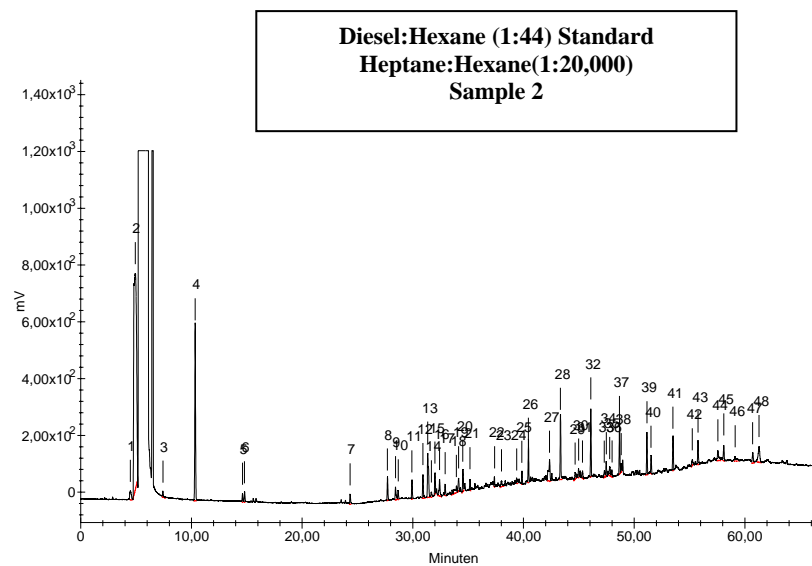
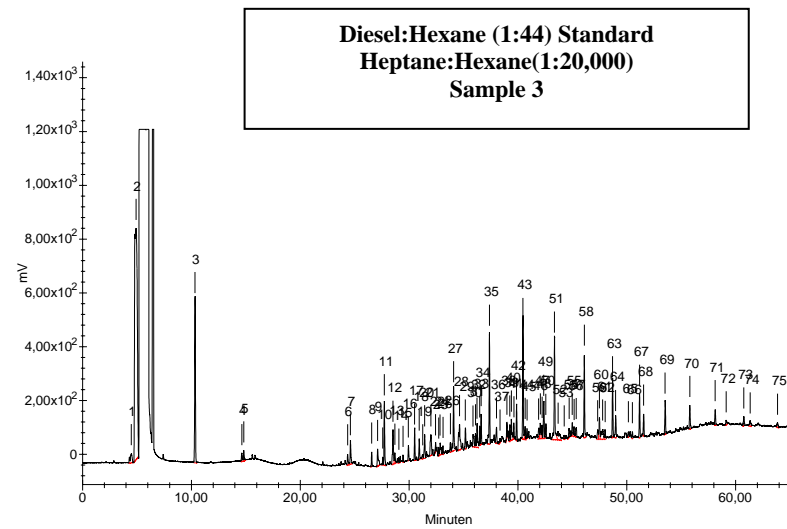
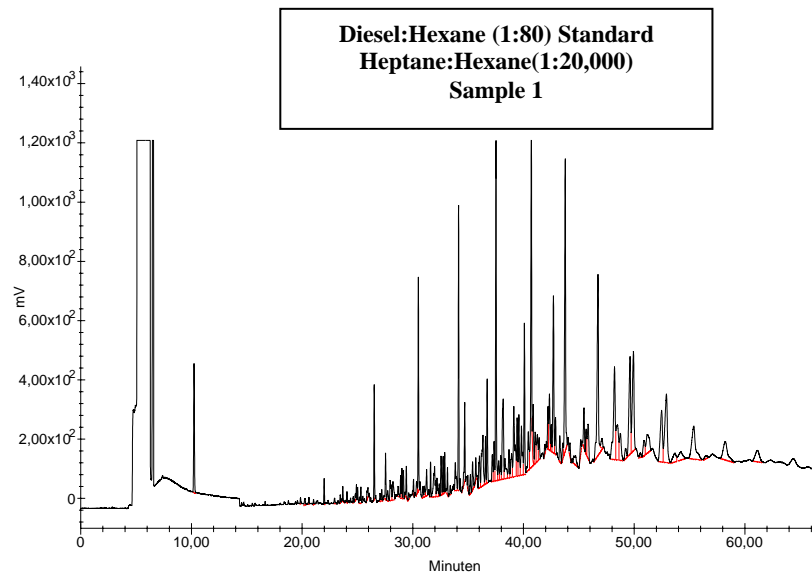

Figure 48 Gas chromatogram; extraction (1:44); Standard Heptane:Hexane(1:20,000) dilutiona) Sample 1 Original Mexican Sample 2000 mg/L

Figure 49 Gas chromatogram; extraction (1:44); Standard Heptane:Hexane(1:20,000) dilutionc) Sample 2 Original Mexican Sample 63.24 mg/L

Figure 50 Gas chromatogram; extraction (1:88); Standard Heptane:Hexane(1:20,000) dilution b) Sample 3 Original Mexican Sample 35.8 mg/L

6.3 Biofeasibility test

The results obtained with the first dilution of 10^{-3} were of 500 to 518 microorganisms. As explained previously a range between 30-300 microorganisms is the best. Therefore, another two soil solutions were prepared in order to obtain smaller amounts. These last dilutions were prepared at 10^{-5} for soil and 10^{-4} for groundwater.

The results are:

Table 22 Cell concentrations in soil

Sample	Dilution	Number of colonies (CFU/ml)	Number of colonies (CFU/ml)	Average (CFU/ml)
Soil 1	10^{-4}	$1.78 \cdot 10^7$	$1.80 \cdot 10^7$	$1.79 \cdot 10^7$
Soil 2	10^{-5}	$3.3 \cdot 10^7$	$3.5 \cdot 10^7$	$3.4 \cdot 10^7$

Table 23 Cell concentrations in groundwater

Dilution	Number of colonies (CFU/ml)	Number of colonies (CFU/ml)	Average (CFU/ml)
10^{-3}	$1.20 \cdot 10^6$	$1.52 \cdot 10^6$	$1.36 \cdot 10^6$
10^{-4}	$2.5 \cdot 10^6$	$5.4 \cdot 10^6$	$3.9 \cdot 10^6$

6.3.1 Calculation

For soil

Table 24 Soil plating calculations

	Step	Dilution
10 g soil	100 ml saline (solution A)	10^{-1} (weight /volume)
1ml solution A	9 ml saline (solution B)	10^{-2} (volume/volume)
1ml solution B	9 ml saline (solution C)	10^{-3} (volume/volume)
1ml solution C	9 ml saline (solution D)	10^{-4} (volume/volume)

100µl of solution D is plated in agar plates. These result in 178 bacteria colonies.

$$\text{Number of CFU} = \frac{1}{\text{dilution factor}} * \text{number of colonies}$$

$$\frac{1}{10^{-4}} * 178 \text{ CFU} / 100 \mu\text{l} = 1.78 * 10^6 \text{ CFU} / 100 \mu\text{l} = 1.78 \cdot 10^7 \text{ CFU} / \text{ml}$$

For groundwater

Table 25 Groundwater plating calculations

Step		Dilution
1 ml groundwater	(solution A)	10^0 (weight /volume)
1ml solution A	9 ml saline (solution B)	10^{-1} (volume/volume)
1ml solution B	9 ml saline (solution C)	10^{-2} (volume/volume)
1ml solution C	9 ml saline (solution D)	10^{-3} (volume/volume)

100µl of solution D is plated in agar plates and these result in 54 bacteria colonies.

The cell concentration in soil was of $3.4 \cdot 10^7$ CFU/ml (Table 22). The soil concentration was calculated in 1 ml of solution in order to be comparable with the concentration of $3.9 \cdot 10^6$ CFU/ml in the groundwater (Table 23). These amounts of microorganisms are enough for bioremediation (W. Zhang, E. Bouwer, L. Wilson and N. Durant 1995).

6.3.2 Results of the First test of biodegradation

6.3.2.1 Calculation of Mineral Salts Medium (MSM):

Table 26 Mineral Salts Medium (100:10:1)

Mineral Salts Medium	Concentration (g/L) Relative amounts	Concentration (g/L) C:N:P (100:10:1)
$\text{Na}_2\text{HPO}_4 \cdot 2\text{H}_2\text{O}$	2	0.91
$(\text{NH}_4)_2\text{SO}_4$	4	9.33
KH_2PO_4	0.8	0.35
MgSO_4	0.12	0.12

Contaminated groundwater concentration 2000 mg/L (Tables 14, 21):

$$12g \quad C \rightarrow 1mol$$

$$2g \quad C \rightarrow x$$

$$x = \frac{1}{6} mol \cong 0.15 \frac{mol}{L}$$

$$2000 \frac{mg}{L} Diesel \cong 0.15 \frac{mol}{L}$$

Table 27 TPH bioremediation results (mg/L) (daily measurements)

Diesel	1 st day		2 th day		3 th day		4 th day	
	mg/L	mg/L	mg/L	mg/L	mg/L	mg/L	mg/L	mg/L
I (1:50) MSM dilution ; Soil		706	200	124	83	78	81	80
II (1:50) MSM dilution; Soil 2 gr. Xylite/100ml	181	150	97	95	102	103	83	81
III (1:50) MSM dilution Waste Water Sludge 1-2ml	1960	2007	527	554	60	58	23	23
IV (1:50) MSM dilution Waste Water Sludge 1-2ml 2 g Xylite	858	726	56	52	20	16	0	0

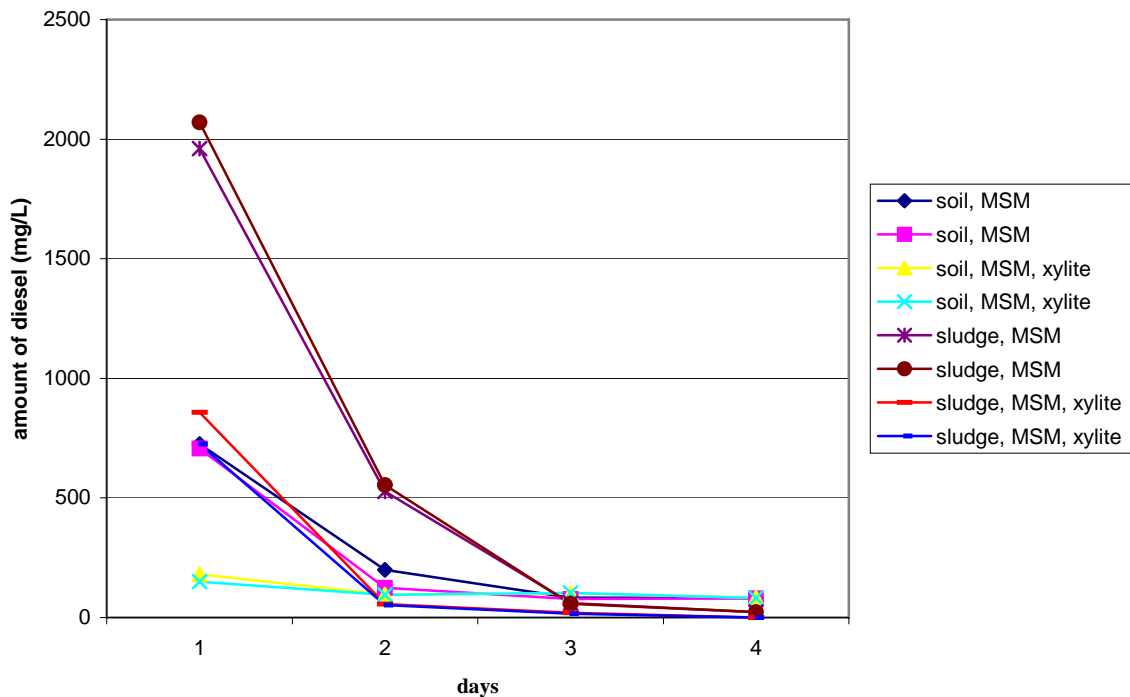

Figure 51 Diesel biodegradation vs. days; (1:50) dilution contaminated groundwater:MSM

Figure 51 and Table 27 show that the indigenous microbial community exhibited a high capacity to mineralize the diesel, this can be concluded due to the decrease of the amount of diesel (mg/L) through time. The compounds that remained in the water or the intermediate products that appeared as a consequence of the reaction of biodegradation can not be identified due to the limitation of the equipment.

The first concentration measurement in each case is different, even though the amount of diesel in all the samples was the same. The samples with soil MSM xylite and sludge MSM xylite show the smallest concentrations in the first measurement. It is expected that the xylite and the soil have an influence in this behavior by adsorption. More studies about adsorption will be carried out.

6.4 Bioestimulation

Literature study for the justification of the salts group

- Organisms isolated from a petroleum contaminated site had the capacity to degrade toluene under aerobic and denitrifying conditions when O_2 and NO_3^- are used as electron acceptors and NH_4^+ and HPO_4^- as nutrients (Annathina Hess, Boris Zarda, Ditmar Hahn, Andreas Häner, Dietmar Stax, Patrick Höner and Josef Zeyer, 1997).
- O-Xylene is usually reported to be the most recalcitrant of the BTEX compounds. Although pure cultures capable of growing on o-xylene have been isolated, partial degradation of o-xylene concomitant to toluene metabolism has been observed in several mixed cultures of denitrifying (Pedro J.J and Timothy M., 1991).
- Substrate interactions are important in understanding the behaviour of BTEX compounds in the environment and the similarity or differences in their biodegradation. The presence of a given BTEX compounds can theoretically simulate the degradation of another BTEX compound by inducing the required catabolic enzymes. Another beneficial substrate interaction would be a BTEX compound acting as a primary substrate and stimulating microbial growth, which could enhance cometabolism of another BTEX compound. On the other hand, a BTEX compound could inhibit the degradation of another by exerting toxicity, diauxy, catabolite depression, competitive inhibition for enzymes, or depletion electron acceptors. Experimentally was proved that using the Mineral Salt Medium (Table 28 Hutchins:99) the presence of p-xylene in a mixed culture slurries increased the lag period for the degradation of both benzene and toluene. The inhibitory effect on acclimation of benzene degraders was increased when both toluene and p-xylene were present. Since the initial total BTEX concentration was relatively high in this case (150 mg/L), toxicity was probably responsible for this phenomenon. Cometabolism of p-xylene by toluene degraders was probably an important interaction observed in the mixed culture. This phenomenon is suggested by the rapid disappearance of p-xylene while toluene was being degraded and by the subsidence of p-xylene degradation rate after toluene had been degraded. (Pedro J.J and Timothy M., 1991).

- Compare to aerobic process denitrifying conditions is generally less robust and compounds such as benzene, o-xylene, and 1, 2, 3-trimethylbenzene are often recalcitrant. Nevertheless, denitrifying bacteria can often degrade fuel aromatic hydrocarbons using nitrate as the alternate electron acceptor (Stephen R. Hutchins, 1999)
- Bacteria strain that were isolated with the salt medium (Table 28, Serena:00) which show that Mycobacterium sp. Strain IFP 2173 isolated from a gas-online-polluted groundwater sample, present the ability to degrade isooctane (one of the major octane boosters in the gasoline), and other various molecular structures such as n-alkanes, isoalkanes, aromatic compounds, or oxygenates which are commonly introduced into gasoline formulations. It could also attack a wide range of compounds with chain length ranging from 4 to 16 carbon atoms. The degradation of short alkanes is note worthy since these compounds are usually considered toxic to bacteria cells because of their solubility in culture media. Moreover, it is known that propane and butane are degraded by bacteria strains that specialize in short chain alkane metabolism, the ability to degrade branched alkanes, the ability to degrade some isoalkanes that have a quaternary carbon structure.
- Ammonia nitrogen is the preferential nutrient. Usually, orthophosphate (phosphoric acid) must be available as the source of phosphorous. Analysis for total phosphorous will often give high number while the available orthophosphates may have been depleted, therefore the Nitrogen as ammonia and Phosphorous as an orthophosphate may become the limiting factor in sustaining bioremediation (R. Barry King, Gilbert M. Long, John K. Sheldon, 2000).
- Diesel fuel consist of a large variety of hydrocarbons that can degraded under aerobic conditions and partially degraded under anaerobic conditions (O_2 and NO_3^- as electron acceptors and NH_4^+ and HPO_4^- as nutrients). During the last few years, many pure cultures of bacteria that are able to degrade toluene under aerobic and anaerobic that is denitrifying conditions have been obtained (Annathina Hess, Boris Zarda, Ditmar Hahn, andreas Häner, Dietmar Stax, Patrick Höner and Josef Zeyer, 1997)

- Toluene is the most commonly reported BTEX compound to degrade under denitrifying conditions, toluene removal and nitrate reduction are coupled. Ethylbenzene has been reported to degrade under denitrifying conditions, although its anaerobic degradation commonly occurs after toluene and xylene degradation. Several studies with mixed cultures under denitrifying conditions have shown partial degradation of o-xylene concomitant with toluene degradation (P.J.J. Alvarez and T.M. Vogel, 1995).
- Benzene is the most recalcitrant under strictly anoxic conditions. The recalcitrance of benzene, but not alkylbenzenes, under nitrate reducing conditions is probably due to the relationship between the chemical structure of these compounds and the functioning catabolic pathways. Unlike aerobic pathways that use molecular oxygen as a co-substrate in initial oxidative biotransformation, the initial catabolic step under anoxic denitrifying conditions might involve nucleophilic attack with water. While alkylbenzenes have electrophilic substituents which facilitate such nucleophilic attacks (P.J.J. Alvarez and T.M. Vogel, 1995).
- *Pseudomonas fluorescens* is able to present a carbon degradation of 24% for C₁₂, 52.2% for C₁₃, 87.7% for C₁₄, 85.7% for C₁₅, 100% for C₁₆, 93.6% for C₁₇, and 89% for C₁₈. The mineral salt medium that was used is in (Table 28) (N.G. Wilson and G. Bradley, 1996).

Table of nutrients

Table 28 Nutrients for the preparation of MSM

Article	Röling:02	Hess:97	Serena:00	Hutchins:99	Wilson 96
Year	2002	1997	2000	1999	1996
site	Oil on beaches	aquifer	aquifer	aquifer	aqueous system
microorganisms	<i>Erythrobacter longus</i> and <i>E. citreus</i>	<i>Azoarcus toluliticus</i>	<i>Mycobacterium</i> <i>astroafricanum</i>	<i>Indigenous aquifer</i> <i>microorganisms</i>	<i>Pseudomonas</i>
contamination	<i>n</i> C ₁₁ -to <i>n</i> C ₃₅ 31.2% - 3.8%, alkanes 12.7% - 0.6%, BTEX 1.9% - 0.2%	diesel-fuel	gasoline	BTEX	Diesel
carbon source		toluene (0.19 mM) xylene (0.16 mM)	2,2,4-trimethylpentane (isooctane)	BTEX	Diesel
nutirents			soln (liter ⁻¹)	soln (liter ⁻¹)	g/L
NaNO ₃ NH ₄ NO ₃	0.25, 0.5, 0.75, 1,2,4,6,10 (%N wt/wt in oil)			10 mg	1
KH ₂ PO ₄	0.2, 0.025, 0.05, 0.075, 0.1, 0.4, 0.6, 1.0 (%N wt/wt in oil)	0.75 g	1.4 g	700 mg	1
K ₂ HPO ₄		1.04 g		1,000 mg	3
Na ₂ HPO ₄			5.3 g (12 H ₂ O)		
Na ₂ SO ₄		1.4 mM		5 mg	
MgSO ₄		0.2 (7 H ₂ O)	0.2 g (7H ₂ O)		
KNO ₃		5 mM			
NH ₄ -N					
(NH ₄) ₂ SO ₄		0.5 g	1.0 g		2
NH ₄ Cl				100 mg	5
NaCl		0.1 g		10 mg	
CaCl ₂		0.025 g		10 mg	
MgCl ₂				10 mg	
CuCl ₂ 2H ₂ O				0.0392 mg	

Table 28 Nutrients for the preparation of MSM

ZnCl ₂				0.1363 mg	
FeCl ₂ 4H ₂ O				0.013 mg	
AlCl ₃				0.7016 mg	
MnCl ₂ 4H ₂ O				0.2807 mg	
MgSO ₄ 7H ₂ O					0.1
NaMoO ₄ 2H ₂ O				0.0254 mg	
Na ₂ SO ₄				0.1420 mg	
biotin	1 µg			0.02 mg	
folic acid				0.02 mg	
pyridoxine HCl				0.1 mg	
riboflavin				0.05 mg	
thiamine hydrochloride	500 µg			0.05 mg	
nicotinic acid	500 µg			0.05 mg	
pantothenic acid				0.05 mg	
Vitamin B ₁₂	2 µg			0.001 mg	
p-aminobenzoic acid				0.05 mg	
Vitamine solution				1ml	
glucose	1 g				
Ca _{DL} -pantothenate	500 µg				

Based on the literature review it can be assumed that it is very probable that aerobic, denitrifying bacteria and facultative anaerobic bacteria are present in soil. The final criteria used to choose the salts was based on the clauses written previously, and its low cost. Three groups of salts were chosen; therefore it is necessary to prove which one gives better results. Three different concentrations of diesel were tested to try to optimize microbial growth by supplying adequate amounts of electron acceptor(s), nitrogen and phosphorous.

6.4.1 Proper Balance of Nutrients

6.4.1.1 Salts calculation

Table 29 Calculations C:N:P 100:10:1

2000 mg/L		
For NaNO₃		
Constants		
Carbon Concentration (g/L)		2
Concentration NaNO ₃ literature data(g/L)		0.1
Total molecular weight (g/gmol)		85
Nitrogen molecular weight (g/gmol)		14
% of Nitrogen		0.1
Moles _{Nitrogen}		0.016666667
moles of C	X_{nitrogen}	Total amount of NaNO₃ (g)
0.16666667	0.164705882	8.601190476
For (NH₄)₂SO₄		
Constants		
Carbon concentration (g/L)		2
Concentration (NH ₄) ₂ SO ₄ literature data (g/L)		1
Total molecular weight (g/gmol)		132
Nitrogen molecular weight (g/gmol)		28
% of Nitrogen		0.1
Moles _{Nitrogen}		0.016666667
moles of C	X_{nitrogen}	Total amount of (NH₄)₂SO₄ (g)
0.16666667	0.212121212	10.37142857
For KH₂PO₄		
Constants		
Carbon Concentration (g/L)		2
Concentration KH ₂ PO ₄ literature data (g/L)		1.4
Total molecular weight (g/gmol)		136
Phosphorous molecular weight (g/gmol)		31
% of phosphorous		0.01
Moles _{Nitrogen}		0.001666667
moles of C	X_{phosphorus}	Total amount of KH₂PO₄ (g)
0.16666667	0.227941176	0.994408602

For the mixture of the three salts		
For el NaNO₃		
Constants		
Carbon Concentration (g/L)		2
Concentration NaNO ₃ literature data (g/L)		0,1
Total molecular weight (g/gmol)		85
Nitrogen molecular weight (g/gmol)		14
% of Nitrogen		0,1
Moles _{Nitrogen}		0,008333333
moles of C	X_{nitrogen}	Total amount of NaNO₃ (g)
0,16666667	0,164705882	4,300595238
For (NH₄)₂SO₄		
Constants		
Carbon concentration (g/L)		2
Concentration (NH ₄) ₂ SO ₄ literature data (g/L)		1
Total molecular weight g/gmol		132
Nitrogen molecular weight (g/gmol)		28
% of Nitrogen		0.1
Moles _{Nitrogen}		0.008333333
moles of C	X_{nitrogen}	Total amount of (NH₄)₂SO₄ (g)
0,16666667	0,212121212	5.185714286

Table 30 Calculations C:N:P 100:20:2

C:N:P 100:20:2		
2000 mg/L		
For el NaNO₃		
Constants		
Carbon concentration (g/L)		2
Concentration NaNO ₃ literature data (g/L)		0.1
Total molecular weight (g/gmol)		85
Nitrogen molecular weight (g/gmol)		14
% of Nitrogen		0.2
Moles _{Nitrogen}		0.033333333
moles of C	X_{nitrogen}	Total amount of NaNO₃ (g)
0.16666667	0.164705882	17.20238095
For (NH₄)₂SO₄		
Constants		
Carbon concentration (g/L)		2
Concentration (NH ₄) ₂ SO ₄ literature data (g/L)		1
Total molecular weight (g/gmol)		132
Nitrogen molecular weight (g/gmol)		28
% of Nitrogen		0.2
Moles _{Nitrogen}		0.033333333
moles of C	X_{nitrogen}	Total amount of (NH₄)₂SO₄ (g)
0,16666667	0,212121212	20.74285714

For KH₂PO₄		
Constants		
Carbon concentration (g/L)		2
Concentration KH ₂ PO ₄ literature data (g/L)		1.4
Total molecular weight (g/gmol)		136
Phosphorous molecular weight (g/gmol)		31
% of Phosphorus		0.02
Moles _{Phosphorus}		0.003333333
moles of C	X_{phosphorus}	Total amount of KH₂PO₄ (g)
0.16666667	0.227941176	1.988817204
<i>For the mixture of salts</i>		
For el NaNO₃		
Constants		
Carbon concentration (g/L)		2
Concentration NaNO ₃ literature data (g/L)		0.1
Total molecular weight (g/gmol)		85
Nitrogen molecular weight (g/gmol)		14
% of Nitrogen		0.2
Moles _{Nitrogen}		0.016666667
moles of C	X_{nitrogen}	Total amount of NaNO₃ (g)
0.16666667	0.164705882	8.601190476
For (NH₄)₂SO₄		
Constants		
Carbon concentration (g/L)		2
Concentration (NH ₄) ₂ SO ₄ literature data (g/L)		1
Total molecular weight (g/gmol)		132
Nitrogen molecular weight (g/gmol)		28
% of Nitrogen		0.2
Moles _{Nitrogen}		0.016666667
moles of C	X_{nitrogen}	Total amount of (NH₄)₂SO₄ (g)
0.16666667	0.212121212	10.37142857

Table 31 Calculations 100:5:0.5

C:N:P 100:5:0,5		
2000 mg/L		
For el NaNO₃		
Constants		
Carbon concentration (g/L)		2
Concentration NaNO ₃ literature data (g/L)		0.1
Total molecular weight (g/gmol)		85
Nitrogen molecular weight (g/gmol)		14
% of Nitrogen		0.05
Moles _{Nitrogen}		0.008333333
moles of C	X_{nitrogen}	Total amount of NaNO₃ (g)
0.16666667	0.164705882	4.300595238

Constants		
Carbon concentration (g/L)		2
Concentration (NH ₄) ₂ SO ₄ literature data (g/L)		1
Total molecular weight (g/gmol)		132
Nitrogen molecular weight (g/gmol)		28
% of Nitrogen		0.05
Moles N		0.008333333
moles of C	X_{nitrogen}	Total amount of (NH₄)₂SO₄ (g)
0,16666667	0,212121212	5.185714286
For KH₂PO₄		
Constants		
Carbon Concentration (g/L)		2
Concentration KH ₂ PO ₄ literature data(g/L)		1.4
Total molecular weight (g/gmol)		136
Phosphorous molecular weight (g/gmol)		31
% of Phosphorus		0.005
Moles Phosphorus		0.000833333
moles of C	X_{Phosphorus}	Total amount of KH₂PO₄ (g)
0.16666667	0.227941176	0.497204301
For the mixture of salts		
For el NaNO₃		
Constants		
Carbon concentration (g/L)		2
Concentration NaNO ₃ literature data (g/L)		0.1
Total molecular weight (g/gmol)		85
Nitrogen molecular weight (g/gmol)		14
% of Nitrogen		0.05
Moles Nitrogen		0.004166667
moles of C	X_{nitrogen}	Total amount of NaNO₃ (g)
0.16666667	0.164705882	2.150297619
For (NH₄)₂SO₄		
Constants		
Carbon concentration (g/L)		2
Concentration (NH ₄) ₂ SO ₄ literature data (g/L)		1
Total molecular weight (g/gmol)		132
Nitrogen molecular weight (g/gmol)		28
% of Nitrogen		0.05
Moles Nitrogen		0.004166667
moles of C	X_{nitrogen}	Total amount of (NH₄)₂SO₄ (g)
0.16666667	0.212121212	2.592857143

moles of C: moles of carbon amount
X nitrogen: fraction mol of nitrogen

The same calculations were done for the other two amounts of diesel 1000 and 4000 mg/L.

6.4.2 First, Second and Third Group of Experiments Comparison of three experiments and different salts

First session of experiments

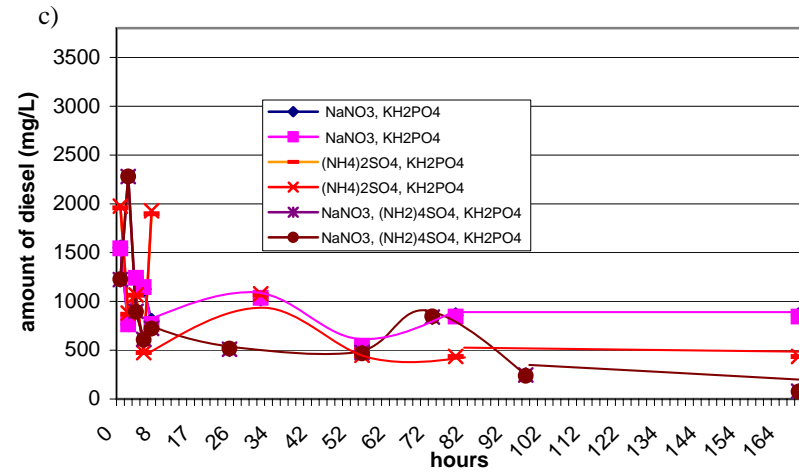
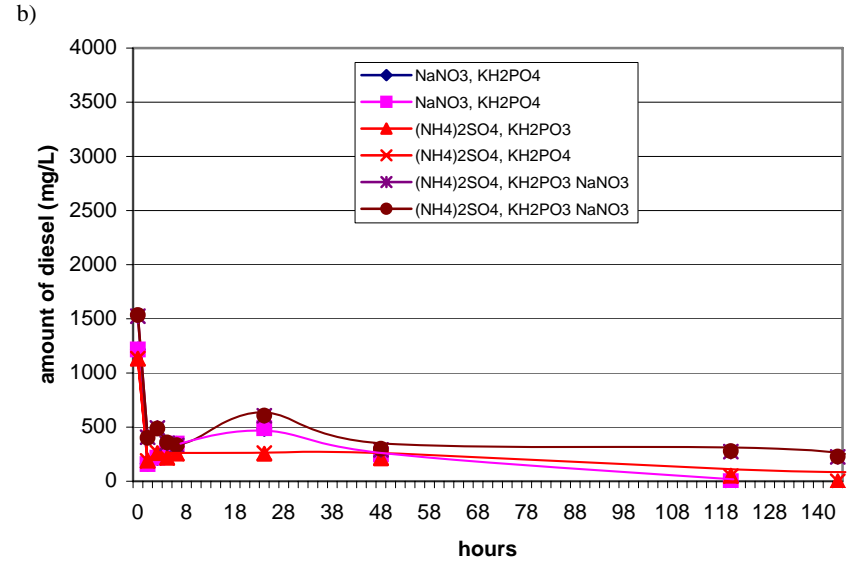
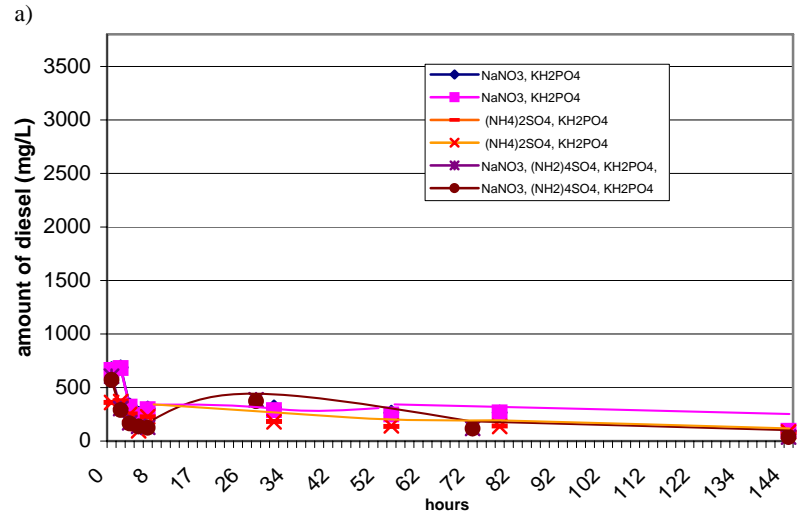

Figures 52, 53, 54 Comparison of the results of three experiments with different salts and N:P 10:1 a) 1000 mg/L b) 2000 mg/L c) 4000 mg/L

Second session of experiments

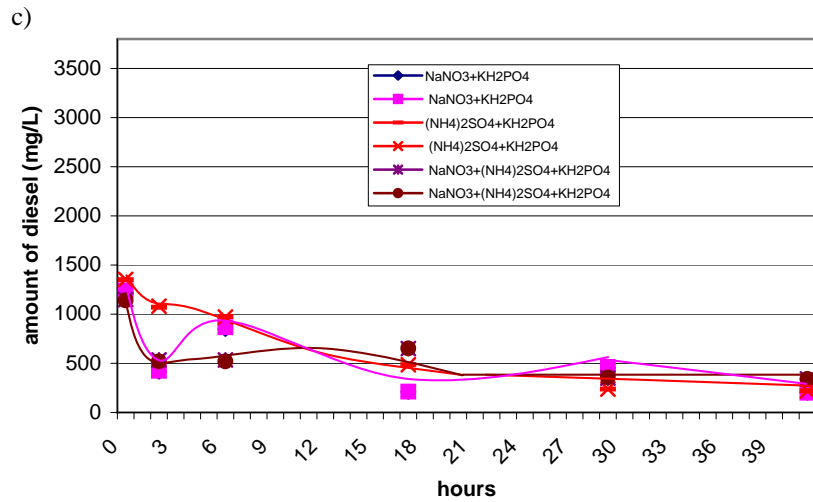
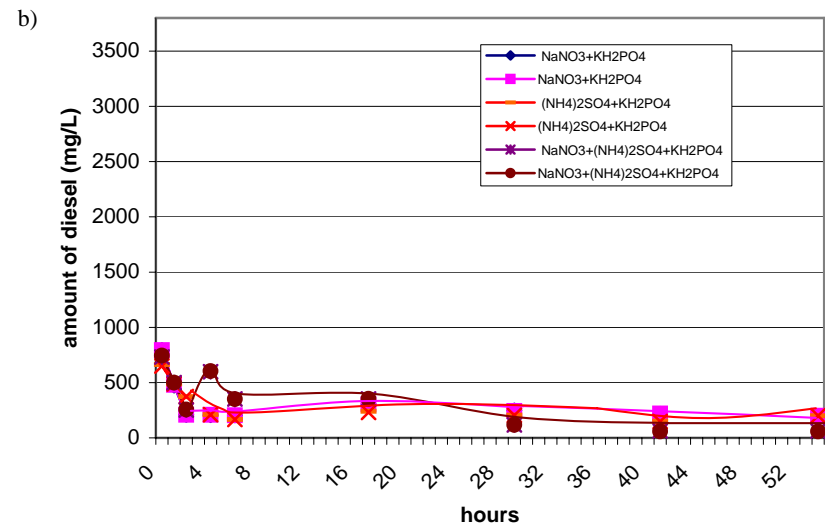
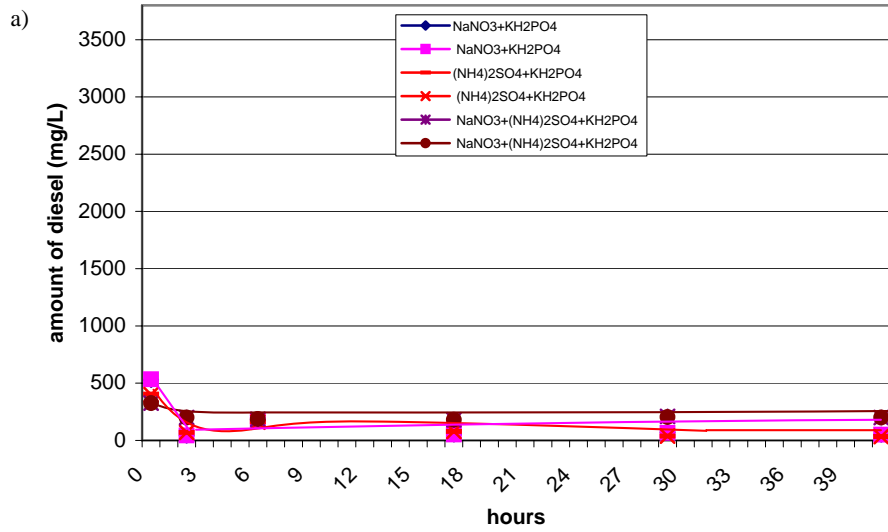

Figures 55, 56, 57 Comparison of the results of three experiments with different salts and N:P 20:2, a) 1000 mg/L and N:P 20:2; b) 2000 mg/L;c) 4000 mg/L

Third session of experiments

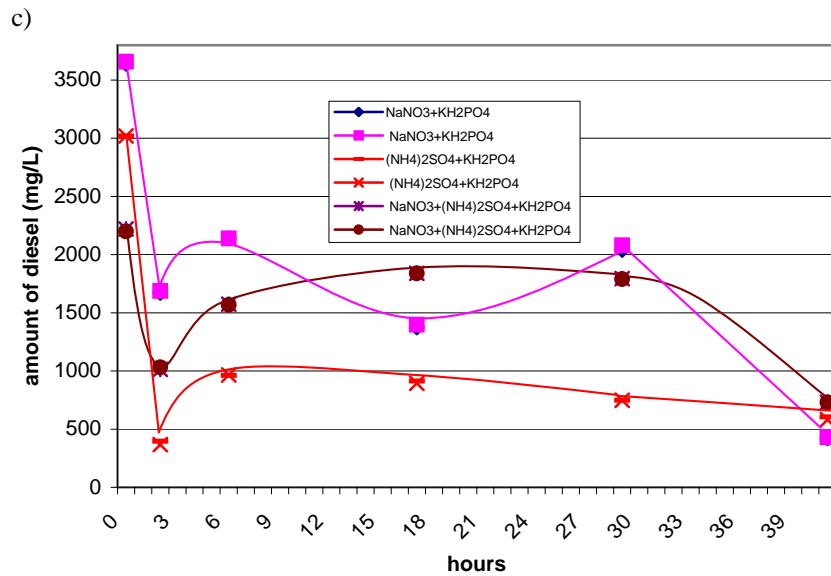
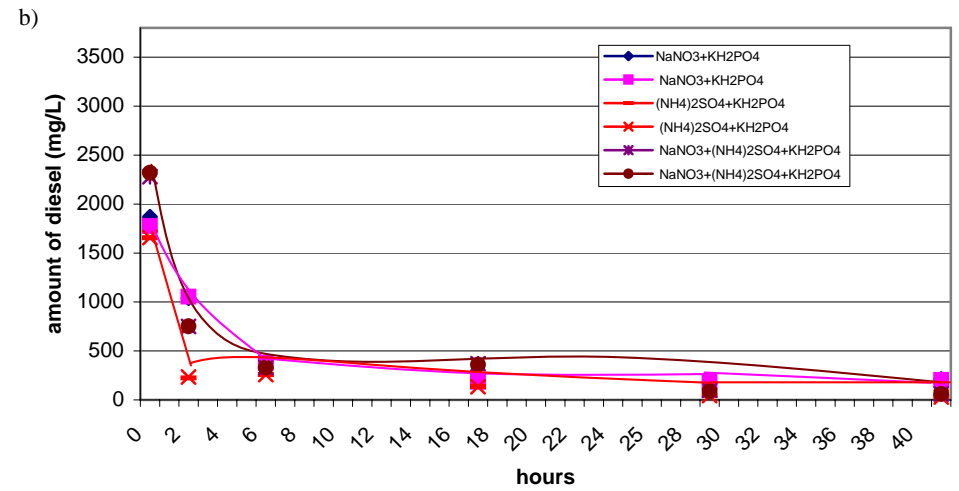
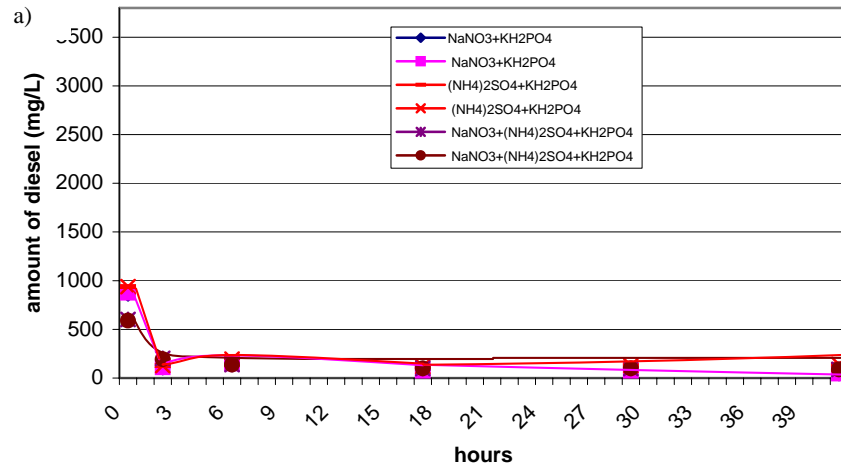

Figures 58, 59, 60 Comparison of the results of three experiments with different salts, and N:P 5:0.5 a) 1000 mg/L; b) 2000 mg/L; c) 4000 mg/L

First session of experiments

Figures 52, 53, and 54 show the results of the first session of experiments with a level of N:P of 10:1. The microorganisms experienced a lag period of 3, 2, and 4 days for 1000, 2000 and 4000 mg/L of diesel respectively before the bioremediation started. The best degradation was observed for a diesel amount of 1000 mg/L with the mixture of salts for a period of six days. For 2000 mg/L of diesel on the sixth day the best degradation was almost completed with $\text{NaNO}_3 + \text{KH}_2\text{PO}_4$ on the 6th day, and for 4000 mg/L of diesel the lowest concentration was reached with the mixture of salts on the 7th day.

Second session of experiments

Figures 55, 56 and 57 show the results of the second session of experiments with a level of N:P of 5:0.5. The microorganisms experienced a lag period of one day before the bioremediation started for 1000, 2000 and 4000 mg/L. The lowest concentration was reached on the third day for a concentration of 1000 mg/L with $(\text{NH}_4)_2 + \text{KH}_2\text{PO}_4$, and for 2000 and 4000 mg/L it was reached with the mixture of salts.

Third session of experiments

Figures 58, 59 and 60 show the results of the third session of experiments with a level of N:P of 20:2. The microorganisms experienced a lag period of 1, and 2 days for 1000, 2000 and 4000 mg/L of diesel. For a diesel amount of 1000 mg/L, 2000 mg/L and 4000 mg/L the lowest concentration was reached with the mixture of salts and with the salt of $(\text{NH}_4)_2\text{SO}_4 + \text{KH}_2\text{PO}_4$ on the first hours of the 3rd day.

6.4.3 Conclusion

- For all the N:P levels the graphs for amounts of 1000 and 2000 mg/L of diesel are very similar. Bioremediation took place and significant results were obtained.
- For the experiments carried out with an amount of 4000 mg/L the lag period was longer, this could be because the high concentration might be toxic to the microorganisms. This toxicity may suppress the fast-growing species that usually predominate in the mixture of microorganisms. This could be a selective advantage and the longer acclimatization is simply a reflection of the longer time needed to

increase the biomass of the slow growing organisms resulting in chemical loss (Martin Alexander, 1999).

- It could be concluded that new experiments should be carried out at critical level of N:P (5:0.5) and with 2000 mg/L of diesel but for a longer period. (The results from the second and third sessions of experiments are not really representative since the lag period is sometimes on the fourth day but it was considered that if we had the first group of experiments for 7 days we could do the rest for shorter time and compared them. With this method we can not know the exact results of biodegradation of the diesel until it was completely removed but they are usefull to observe how the microorganisms react with each group of salts. It is clear that when just the salt of nitrate is present in the MSM biodegradation takes place, that means that existing microorganisms are able to use nitrate and reduce it to ammonia for its incorporation to the cell, in other cases better curves were observed with salts of ammonia, this means that other microorganisms preferred to take ammonia.
- In general the mixture of salts and $(\text{NH}_4)_2\text{SO}_4 + \text{KH}_2\text{PO}_4$ were the ones which gave better result. More experiments were conducted for a longer period (18 days) to finally decide which group of salt can give the most favourable conditions for the biodegradation of hydrocarbons.

Table 32 Results of the last experiment 18 days

N:P 5:0.5																				
Time (days)		2		4		6		8		10		12		14		16		18		
2000 (mg/L)	$\text{NaNO}_3 + \text{KH}_2\text{PO}_4$	start remedia- tion	A		A		A		A		A		A		A		A		A	
	$(\text{NH}_4)_2\text{SO}_4 + \text{KH}_2\text{PO}_4$		A		A		A		A		A		A		A		A		A	$\cong 0$ mg/L
	$\text{NaNO}_3 + (\text{NH}_4)_2\text{SO}_4 + \text{KH}_2\text{PO}_4$		A		A		A		A		A		A		A		A		A	$\cong 0$ mg/L

A=Available data

NA=No available data



The best bioremediation

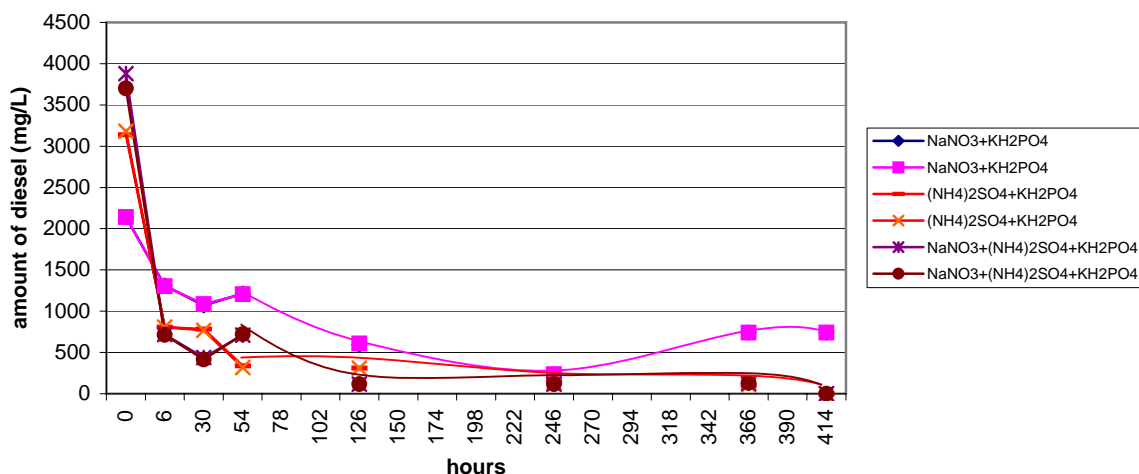

Figure 61 New comparisons of the results of three experiments with different MSM, all of them with 2000 mg/L of diesel and N:P 5:0.5

Figure 61 and Table 32 show the results of the comparison of the three experiments with different salts with 2000 mg/L of diesel and a level of N:P 5:0.5 over a longer period of time (18 days). All of them showed a lag period of 2 days before the bioremediation started. In the experiments where the salt NaNO₃ was used the lowest amount of diesel was detected on the 10th day, and then an increment of the amount of diesel was observed. Finally an amount of diesel became constant at 740 mg/L after 18 days. Whereas, in the experiments where the salts (NH₄)₂SO₄+KH₂PO₄ and the mixture of salts were used the diesel was almost completely removed within 18 days. This can be explained since, microbes have a range of tolerance in certain conditions, and, as long as this conditions remain stable, they can effectively grow and bioremediate. Even in some cases, microorganisms exhibit remarkable ability to grow under adverse conditions (4000 mg/L of diesel). Bacteria from groundwater environments are particularly known for their tolerance to grow under adverse conditions ((Francis H. Chapelle, 2001).

6.4.4 Final Conclusions

- Figure 72 shows that the result obtained with (NH₄)₂SO₄+KH₂PO₄ and the mixture of the salts are very similar. The mixtures of the salts will be used, because a combination of oxygen and nitrate may lead to complete mineralization of certain aromatic hydrocarbons (W. Zhang, E. Bouwer, L.Wilson and N. Durant, 1995) and additionally there will be the possibility that aerobic and facultative anaerobes microbes can grow.
- The level of N:P of 5:0.5 gives optimum results at a low cost.

7 Biotratibility

7.1 Xylite Adsorption

Due to the results obtained before in the Section 6.3.2 the Adsorption of xylite and soil should be tested:

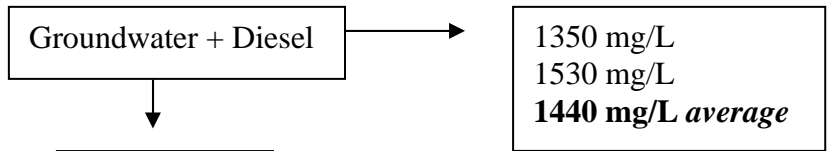

Table 33 Xylite adsorption experiment 1 and 2, average

Time (hour)	(mg/L)	(mg/L)	(mg/L)
0	2780	2780	2780
2	2060	2000	2030
6	628	623	625
8	745	756	750
22	586	586	587
46	520	517	518
114	463	461	462
162	448	443	445

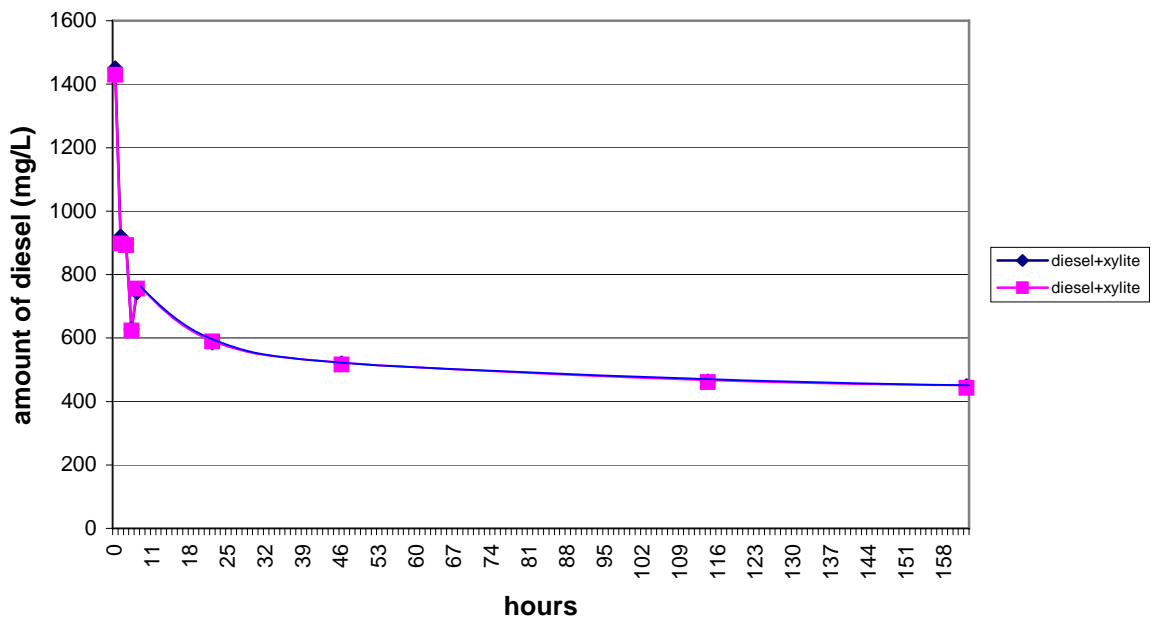

Figure 62 Xylite adsorption vs. hours; 2000 mg/L of diesel
Experiment 1 and Experiment 2

Table 32 and Figure 62 show a 70% adsorption of the xylite which is a very high percentage. Nevertheless, it was important to consider the possibility of microbial bioremediation due to the microorganisms present in the xylite and also that the capacity of adsorption promotes the bioremediation process. Therefore, the decrement of contaminants due to adsorption can not be just considered as a negative effect. To understand the mechanisms that affect subsurface

biotransformation was necessary to develop suitable remediation strategies. Critical to our understanding are the fundamental interactions among microorganisms, organic contaminants, soil and the interactions between the microorganisms and organic contaminants in the water phase (Altas, 1981; Leahy and Colwell, 1990; Bouwer and Zehnder, 1993). Therefore the next step was to prove the adsorption effect of the soil mentioned before, the soil is used as a source of indigenous microorganisms. Once the adsorption of xylite and soil are known, the real biodegradation can be estimated. Therefore the soil adsorption should be determined.

7.1.1 Soil adsorption

Table 34 Mineral Salt Medium+soil+NaN₃; Mineral Salt Medium+soil

TIME (hr)	Average Concentration (mg/L) Mineral Salt Medium+soil	Average Concentration (mg/L) Mineral Salt Medium+soil+NaN ₃
0	2660	2780
1	3930	
2	1474	2030
4	1334	
6	913	3340
18	904	2050
40	956	2120
112	1557	
130	1076	2430
202	532	2390

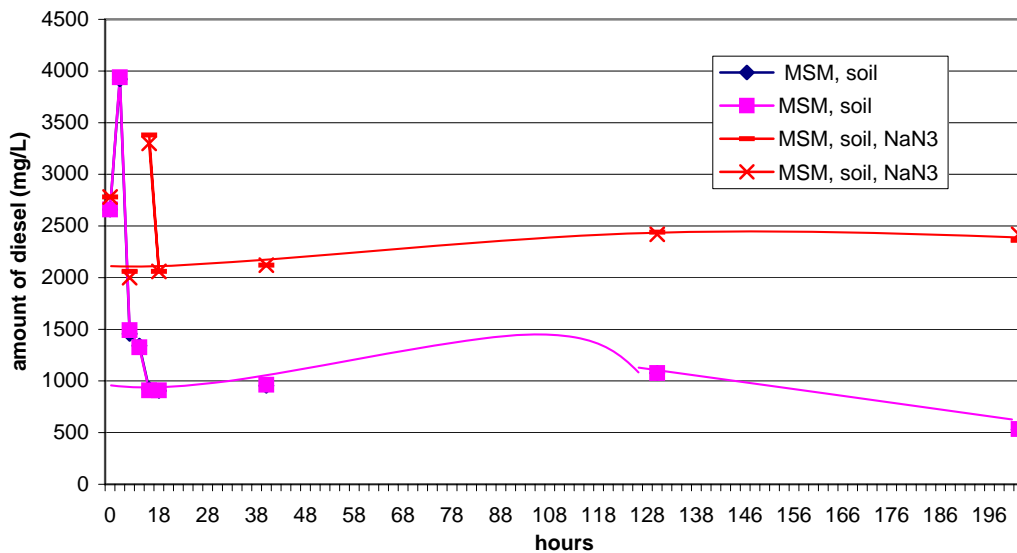

Figure 63 Soil adsorption vs. time; 2000 mg/L diesel
MSM, soil and NaN₃

Table 35 Mineral Salt Medium+soil+xylite; Mineral Salt Medium+soil+xylite+NaN₃

TIME (hr)	Average concentration (mg/L) <i>Mineral Salt Medium+soil+xylite</i>	Average concentration (mg/L) <i>Mineral Salt Medium+soil+xylite+NaN₃</i>
0	814	935
1	1157	349
2	889	234
4	823	454
6	1120	376
18	313	
30		378
48	650	
54		380
66	748	
78		235
138	426	235
163	408	310
212	170	320

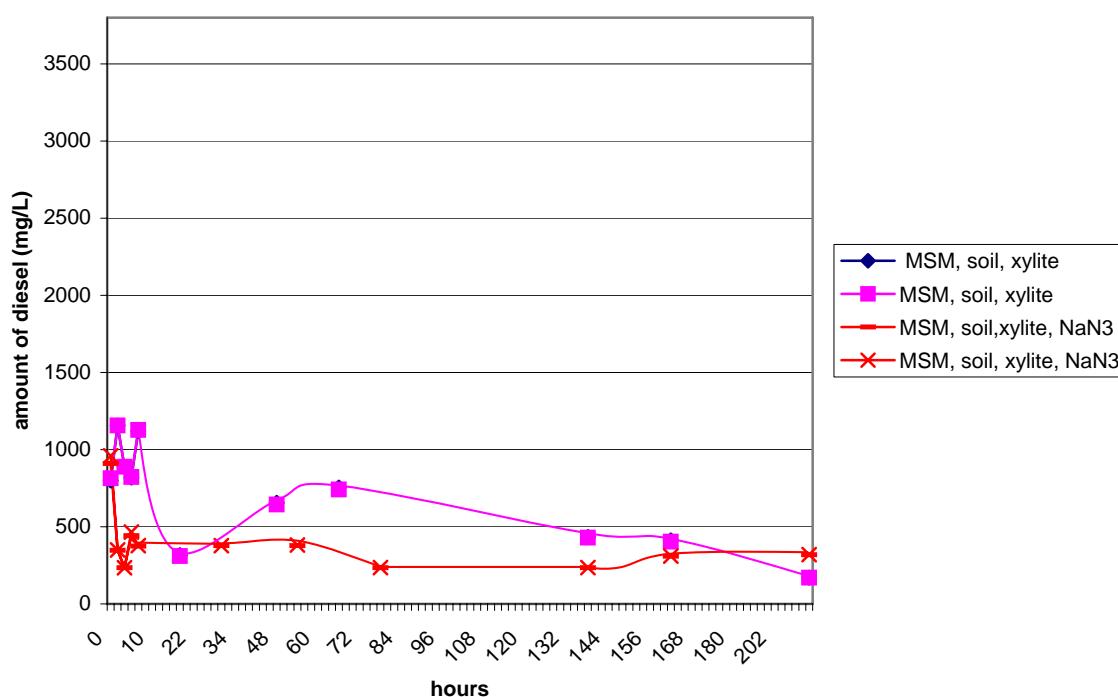

Figure 64 Xylite and soil adsorption vs. time; 2000 mg/L diesel
MSM, soil, xylite and NaN₃

Sodium Azide (NaN₃) was added to the sample to inhibit microbial activity and to assess if a remediation process was taking place or whether the decrease of contaminants was just due to their adsorption in soil or xylite. The amount of sodium azide that was used was 2 mg/L (Pedro J.J and Timothy M., 1991), after inoculation in agar plates, no microorganisms were present in the sample. During the first hours in both cases adsorption is responsible for removal of the organic compounds from the bulk water. Initially in the sample with MSM, soil biotransformation is insignificant as the amount of biomass present is very small.

Figure 63 and Table 34 show that the concentration of diesel in the sample with MSM, soil and NaN_3 decreased faster (first 48 hours) compare to the amount of diesel in the sample with MSM and soil. After this time, the diesel amount of the sample with MSM, soil and NaN_3 started to increase, this could be due an adsorption and desorption process of the soil (W. Zhang, E. Bouwer, L. Wilson and N. Durant 1995).

Figure 64 and Table 35 show that the sample with MSM, soil, xylite and NaN_3 have a lower amount of diesel within a period of 18 hours, then this amount started to increase and finally it became constant. Over this period the increase can be explained due to desorption process of the xylite and soil. Since there are no too many microorganisms attached to the soil, no process of bioremediation took place, this phenomenon is often called bioregeneration in water. The amount adsorbed gradually reached a steady state (W. Zhang, E. Bouwer, L. Wilson and N. Durant 1995).

In Figure 63, the amount of diesel in the sample with MSM and soil remained decreasing with time as well as similarly showed in Figure 64 with MSM and soil and xylite. This can be explained as biomass accumulates from utilization of organic contaminants and removal by biotransformation becomes significant. On the other hand, the amount of diesel in the sample with MSM, soil, xylite and NaN_3 remained constant, this means that the adsorption capacity was nearly saturated, thus the adsorption capacity became slow. In both cases where soil was present biodegradation took place.

The decreasing tendency shown on the graphs can be explained as previously mentioned, but the percentage of sorption was very high in both cases (Table 36). Therefore new experiments in more detail should be conducted.

Table 36 Adsorption and Bioremediation percentage

Samples	% of Sorption	% Bioremediation
MSM, soil	-	80
MSM, soil and NaN_3	14	-
MSM, soil, xylite	-	47.6
MSM, soil, xylite and NaN_3	65.83	-

7.1.2 Results of the 2nd adsorption experiment (200 mg/L mg/L)

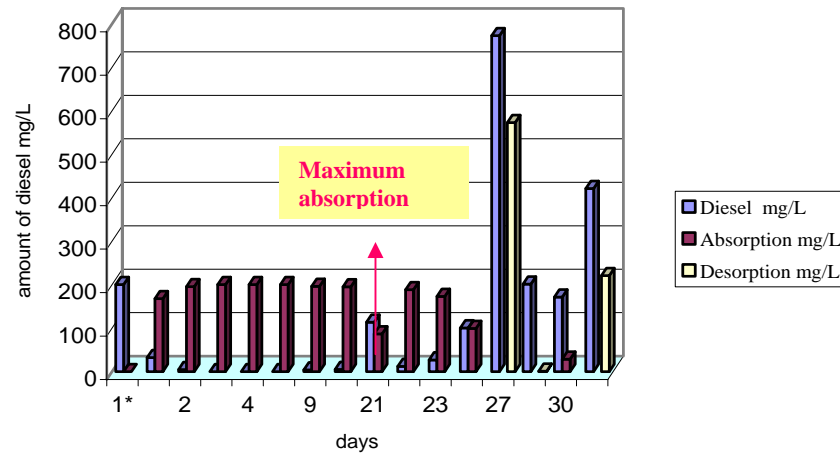
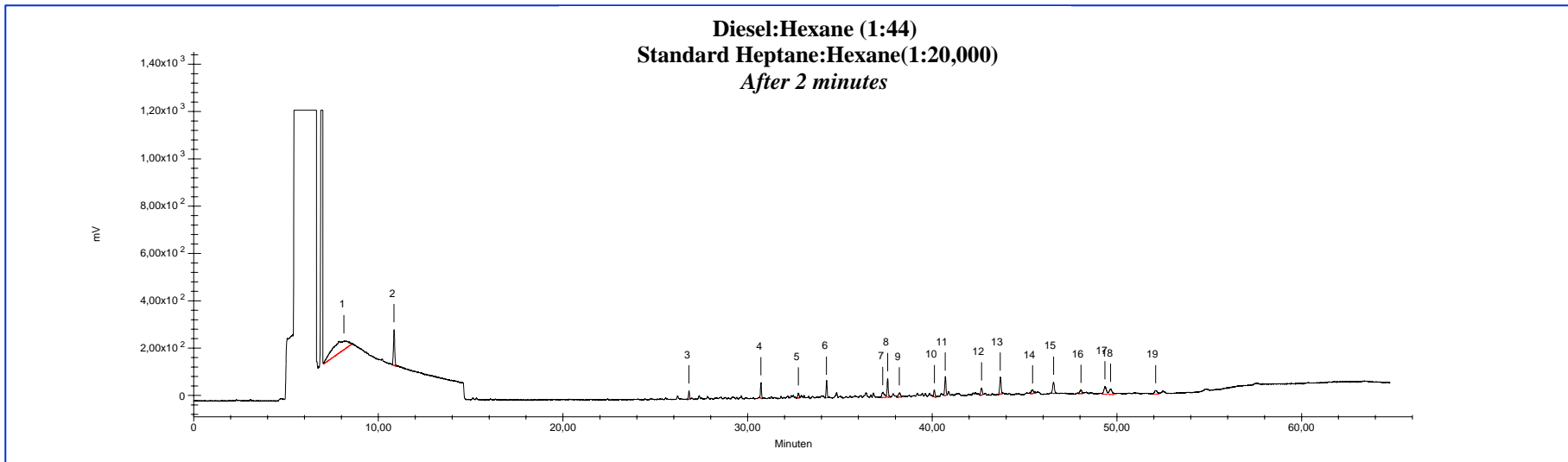
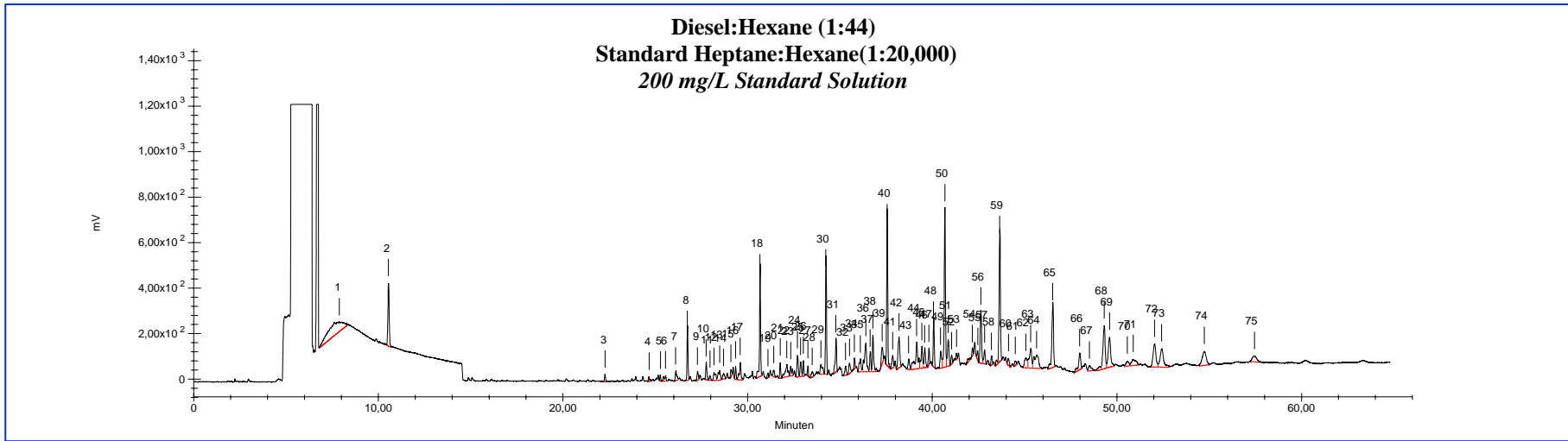

Figure 65 Adsorption and desorption of diesel vs. time in a column with xylite

Conclusion

1. The amount of diesel adsorbed decrease as time increases, after twenty days the total volume of solution was almost adsorbed
2. An extra 400 ml of solution was added to the columns, since the columns were already saturated, the desorption begins to be important until it reach a steady state, then the amount of diesel becomes almost constant (200 mg/L).
3. It is important to mention that after the xylite was saturated not only desorption and adsorption process was present but also the solubility of the diesel plays a very important role, diesel has the tendency to form two phases once it is not longer adsorbed.



Figures 66, 67 Gas chromatogram; extraction (1:44); Standard Heptane:Hexane (1:20,000) dilution
a) Standard Solution 200 mg/L; b) Measurement of adsorption after 2 minutes

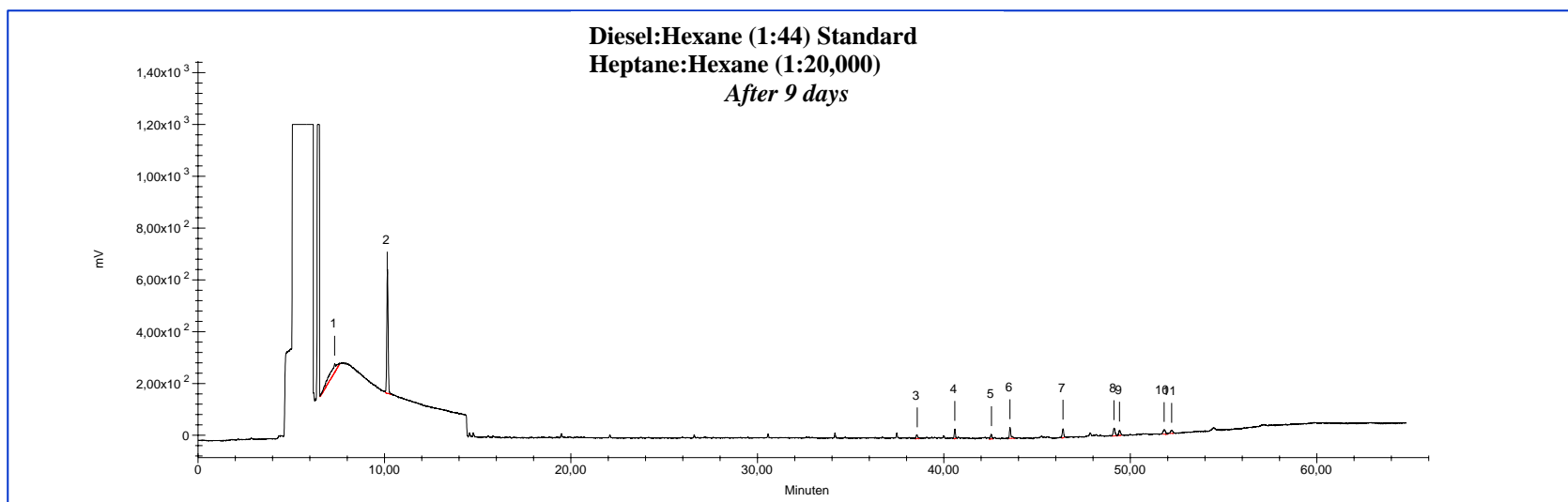
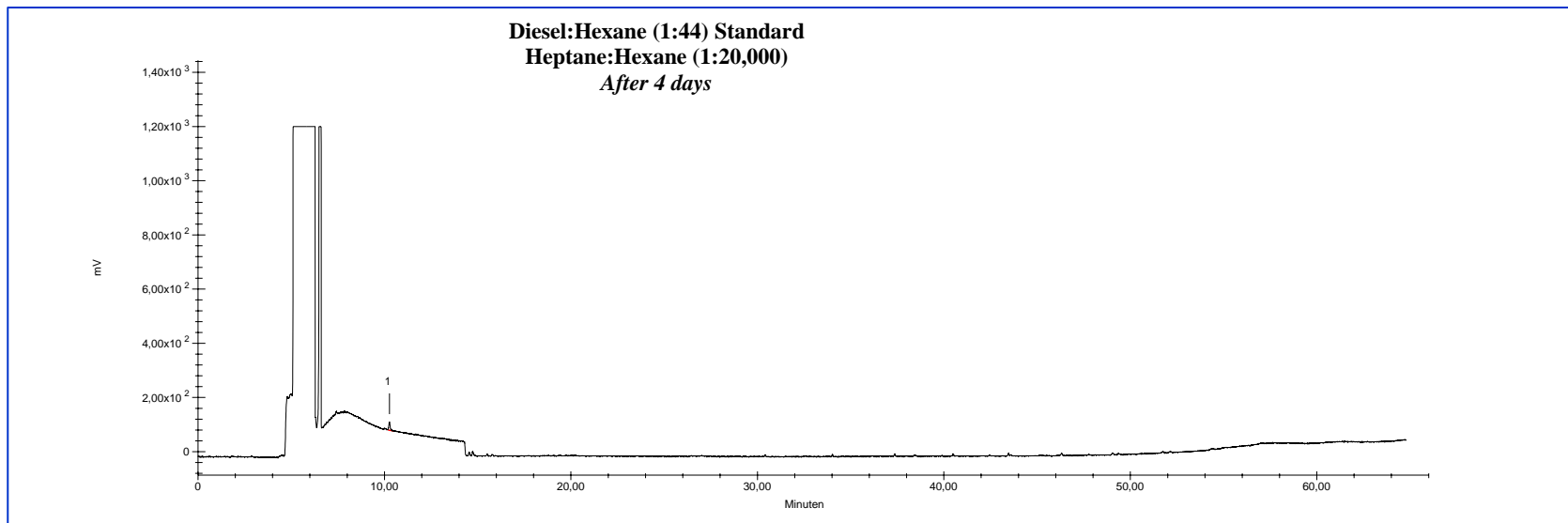

Figures 68, 69 Gas chromatogram; extraction (1:44); Standard Heptane:Hexane (1:20,000) dilution
c) Measurement of adsorption after 4 days; d) Measurement of adsorption after 9 days

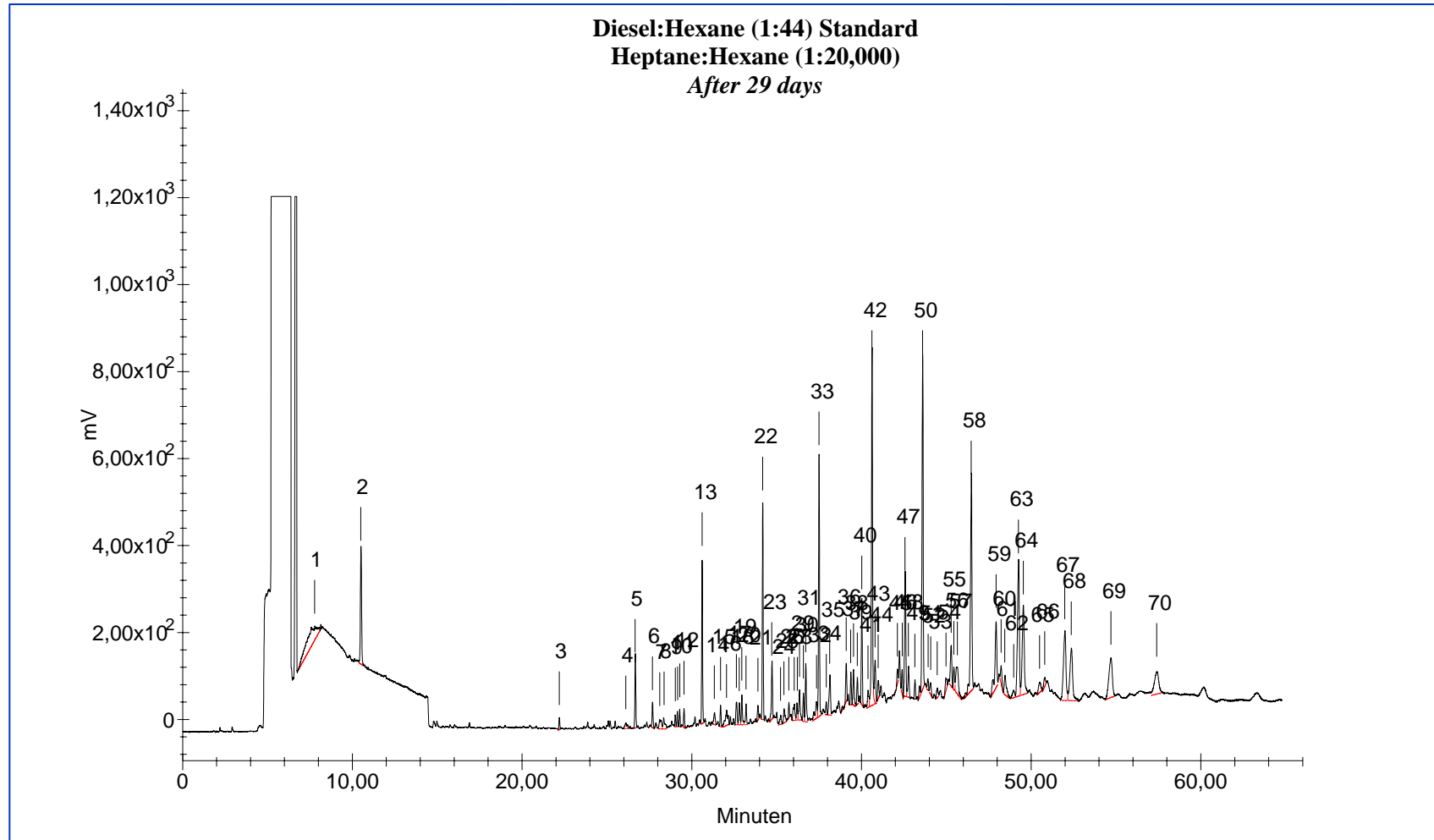

Figure 70 Gas chromatogram; extraction (1:44); Standard Heptane:Hexane (1:20,000) dilution
 e) Measurement of adsorption after 29 days

7.1.3 Results of the 2nd adsorption experiments (30 mg/L)

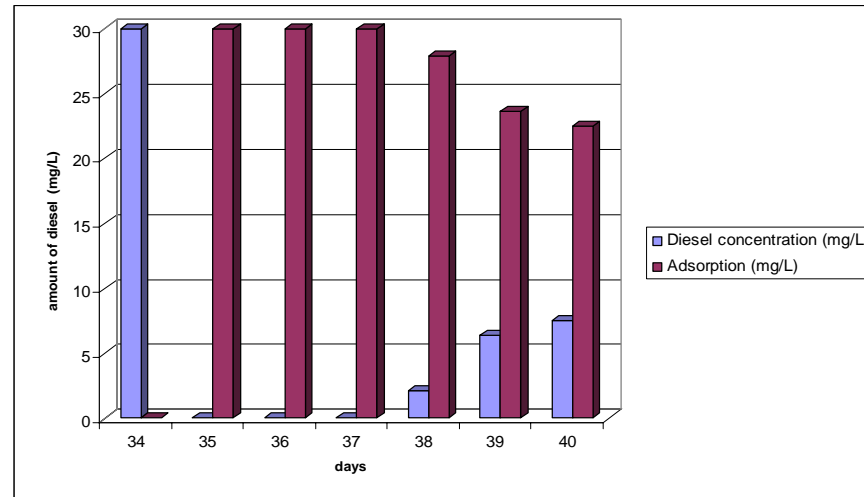

Figure 71 Adsorption and desorption of diesel vs. time in a column with xylite

1. The goal of this experiment was to determine if the process of adsorption continues after saturation is reached, and when a new solution is added with different amount of diesel.
2. The experiment was done with the same conditions as before, but with a different amount of diesel, 30 mg/L. The solution was prepared adding drop by drop of diesel to the water shaking vigorously and constantly. The columns work during 33 days and showed almost the same behaviour as the previous experiments (columns 200 mg/L).
3. On the 34th day the solution was changed for a new one. The first day no adsorption was observed. When the xylite was not saturated, the adsorption was 83% after two minutes (Figure 65 previous experiments)
4. On the second day adsorption was observed but this time it took only two days and then the total equilibrium was reached. After some time the process of adsorption started again and remained constant at 27-25%.
5. It can be concluded that saturation of the xylite can be reached after 34 days.

7.1.4 Growth Condition:

7.1.4.1 Microorganism growth for their inoculation in the columns

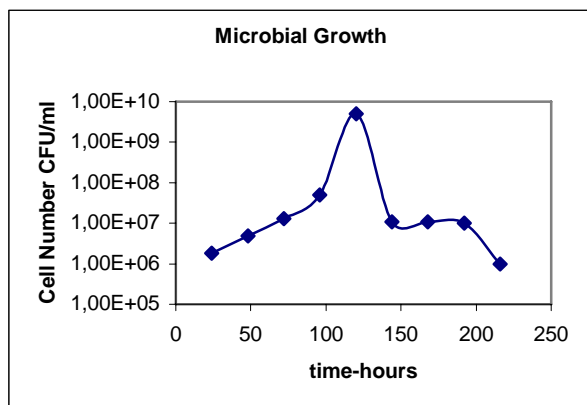

Table 37 CFU/ml vs. days (control)

days	CFU/ml
1	$1.8 \cdot 10^6$
2	$4.8 \cdot 10^6$
3	$1.3 \cdot 10^7$
4	$5 \cdot 10^7$
5	$5 \cdot 10^9$
6	$1.10 \cdot 10^7$
7	$1.08 \cdot 10^7$
8	$1 \cdot 10^7$
9	$1 \cdot 10^6$

Figure 72 Microorganisms growth in a separated glass. Amount of diesel 2000 mg/L, MSM+Agar logarithmic scale

In the Figure 72 (Table 37) it can be observed that the microorganisms suffer a *lag period* during which the microbial population is shifting metabolisms (internal enzymatic changes). After one day of inoculation there was a density of 10^6 cells/ml which is sufficient amount of microorganisms for the initial generation time. Even though the inoculum is taken from a stationary phase culture (Mexican soil) only it took the cells two days to adjust to the new conditions and shift physiologically from stationary phase to exponential phase (Raina M Maier, Ian L. Pepper and Charles P. Gerba, 2000).

During the next two days the population of specific degraders has acclimatized, and they began to show a logarithmic rate increase. During this *exponential growth* phase, the microbes undergo a doubling in number per unit time. The slope of this curve goes until a concentration of $5 \cdot 10^7$ CFU/ml and then it increase to $5 \cdot 10^9$ CFU/ml.

The concentration was almost constant ($1.10 \cdot 10^7$, $1.08 \cdot 10^7$ and $1 \cdot 10^7$ CFU/ml) during three days and the microorganisms reached a *stationary phase*, this means that the microbes that are degrading the contaminants finally found a balance in terms of available food, nutrients, habitat, and the concentration of their own waste products. At this point the cell division and the death rates are equal as they degrade the target contaminants. This is the condition during which the contaminant degradation rate is at its maximum.

On the fifth day, the number of microorganisms begins to decrease, at this moment the waste products begin to accumulate and the microbes begin to experience local overcrowding. The competition for available resources gets severe and some of the microbes can not keep up. The death rate exceeds the cell division rate and the total microbial counts begin to decline. At this point, the target contaminants should have been degraded to below action level concentrations. After the sixth day the microbe population has returned was 83% to 10^6 which is almost the number that was observed prior to treatment.

With this data the biodegradation test in a separated glass was done, the results are the follows, (Table 38, Figures 73-82):

7.1.5 Biodegradation diesel test

Table 38 Test Analysis of different amounts of diesel using Gas Chromatograph (FID)

Biodegradation Test									
Single Point Internal Standard test of concentration									
Conc. (mg/L)	Method	conc. Hep. (mg/ml)	Chromatogram						
			Area Hep. In.st.	A. st. diesel	Conc. st. Diesel	I.F.R.	Area Hep.	Area diesel	A. diesel GW
standard solution diesel	50°(10)3/280(20min)	34	1893054	100516877	2000	1.108			
standard solution diesel	50°(10)3/280(20min)	34	1370968	44945726	200	0.179			
1	50°(10)3/280(20min)	34	1893054	100516877	2000	1.108	2605158	66563930	962.41
1	50°(10)3/280(20min)	34	1893054	100516877	2000	1.108	2469001	62130785	947.85
3	50°(10)3/280(20min)	34	1893054	100516877	2000	1.108	6040767	54968642	342.75
3	50°(10)3/280(20min)	34	1893054	100516877	2000	1.108	2200688	13542099	231.78
4	50°(10)3/280(20min)	34	1893054	100516877	2000	1.108	2144319	13117074	230.41
4	50°(10)3/280(20min)	34	1893054	100516877	2000	1.108	2967812	7096505	90.07
5	50°(10)3/280(20min)	34	1370968	44945726	200	0.179	3314302	11357286	20.91
5	50°(10)3/280(20min)	34	1370968	44945726	200	0.179	3082128	6977656	13.81
6	50°(10)3/280(20min)	34	1370968	44945726	200	0.179	3693906	26176902	43.23
6	50°(10)3/280(20min)	34	1370968	44945726	200	0.179	3655188	29893145	49.89
7	50°(10)3/280(20min)	34	1370968	44945726	200	0.179	4617860	33233954	43.90
7	50°(10)3/280(20min)	34	1370968	44945726	200	0.179	3929129	25448349	39.51
8	50°(10)3/280(20min)	34	1370968	44945726	200	0.179	3616409	9433365	15.91
8	50°(10)3/280(20min)	34	1370968	44945726	200	0.179	3861555	10612870	16.77

Table 38 Test Analysis of different amounts of diesel using Gas Chromatograph (FID)

11	50°(10)3/280(20min)	34	1370968	44945726	200	0.179	4738021	6146938	7.91
11	50°(10)3/280(20min)	34	1370968	44945726	200	0.179	4159780	6738596	9.88
13	50°(10)3/280(20min)	34	1370968	44945726	200	0.179	3309834	1509302	2.78
13	50°(10)3/280(20min)	34	1370968	44945726	200	0.179	3612096	1618759	2.73
14	50°(10)3/280(20min)	34	1370968	44945726	200	0.179	3712096	1518759	2.50
14	50°(10)3/280(20min)	34	1370968	44945726	200	0.179	3912096	1705867	2.66
15	50°(10)3/280(20min)	34	1370968	44945726	200	0.179	3298250	1631123	3.02
15	50°(10)3/280(20min)	34	1370968	44945726	200	0.179	5902269	2564385	2.65
16	50°(10)3/280(20min)	34	1370968	44945726	200	0.179	3470061	288724	0.51
16	50°(10)3/280(20min)	34	1370968	44945726	200	0.179	3020172	265574	0.54

conc.Hep. Heptane concentration

Conc. Concentration (mg/L)

Area Hep. Int.st Area Heptane Internal Standard

A.st.diesel Standard Amount of diesel

I.R.F internal respond factor

Area Hep Area of Heptane

A. diesel GW amount of diesel in contaminated groundwater

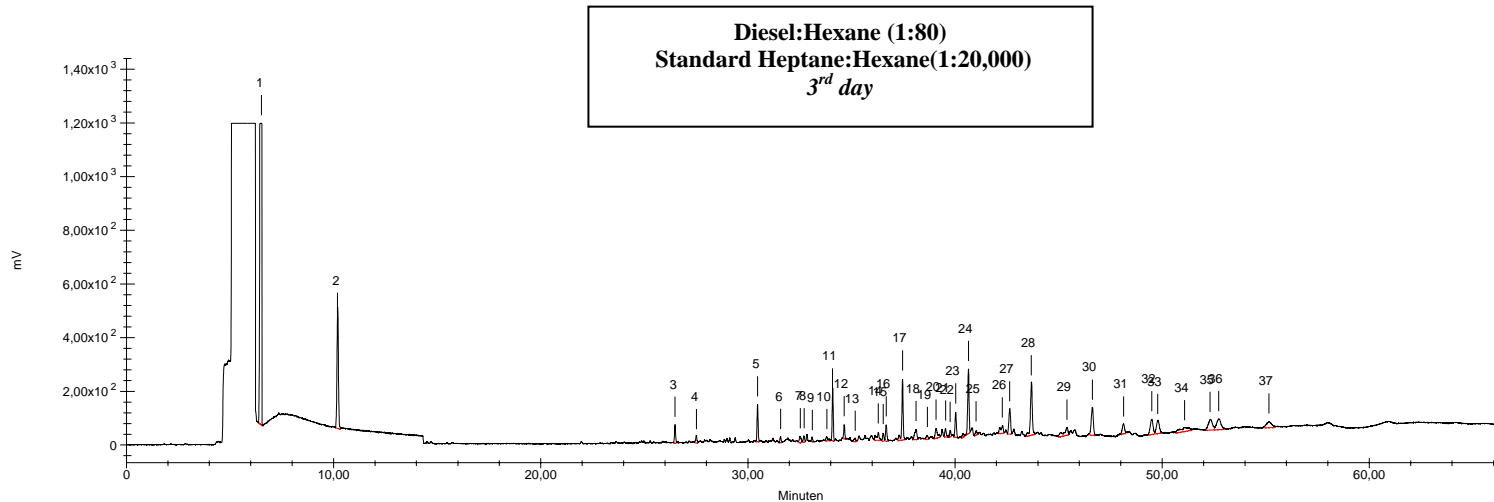
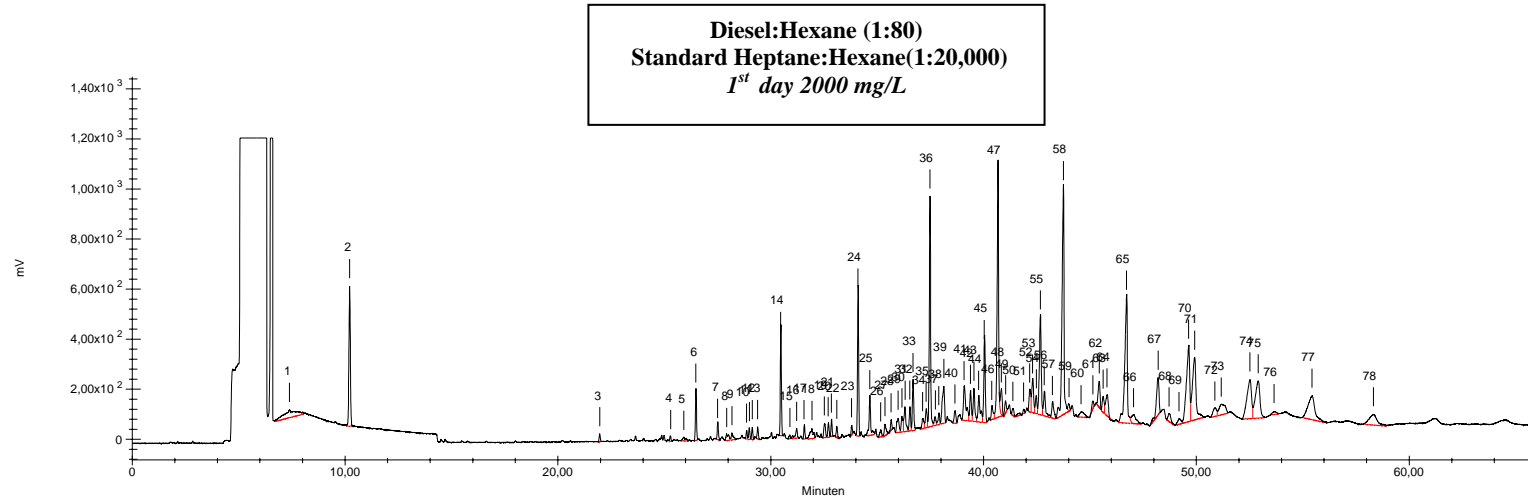

Figures 73, 74 Gas chromatogram; extraction (1:88); Standard Heptane:Hexane (1:20,000) dilution
a)Standard Solution 2000 mg/L b)Concentration Measurement after 3 days

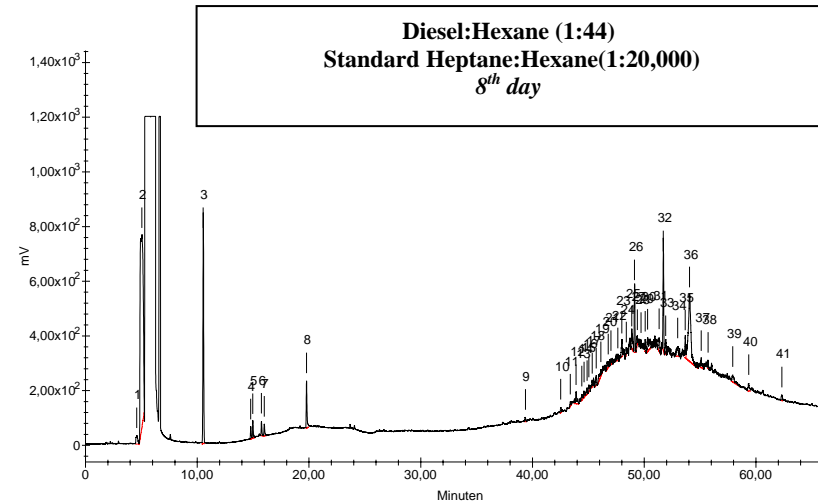
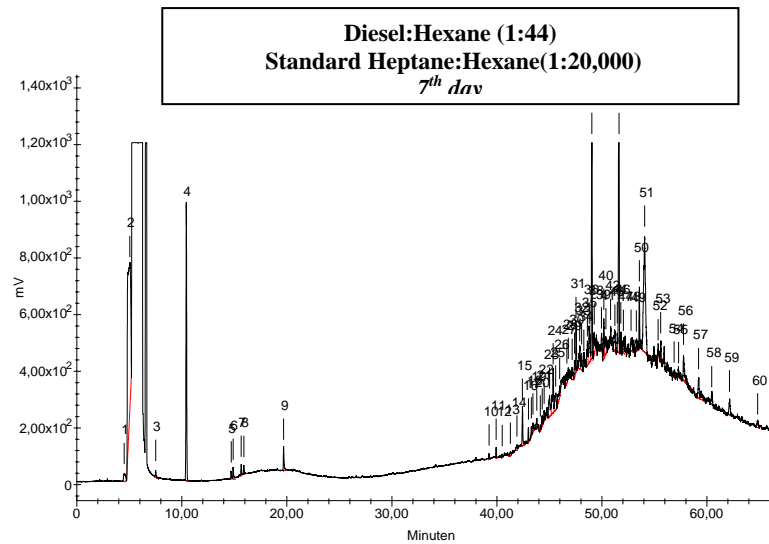
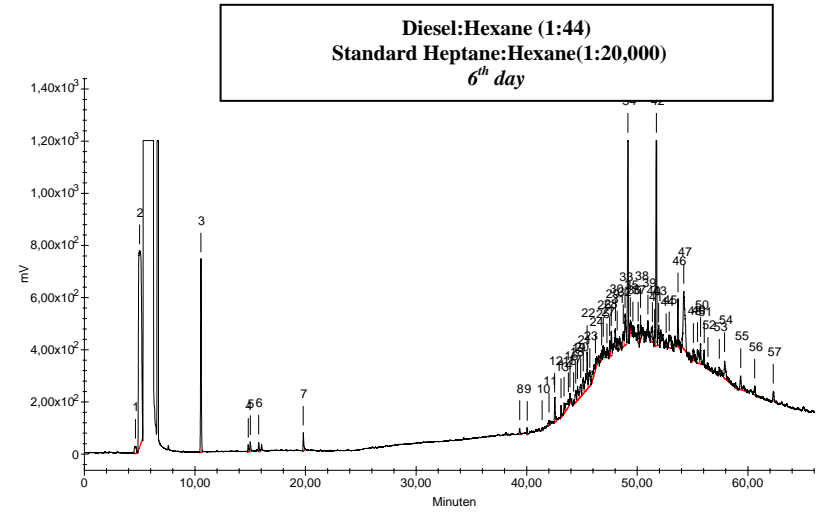
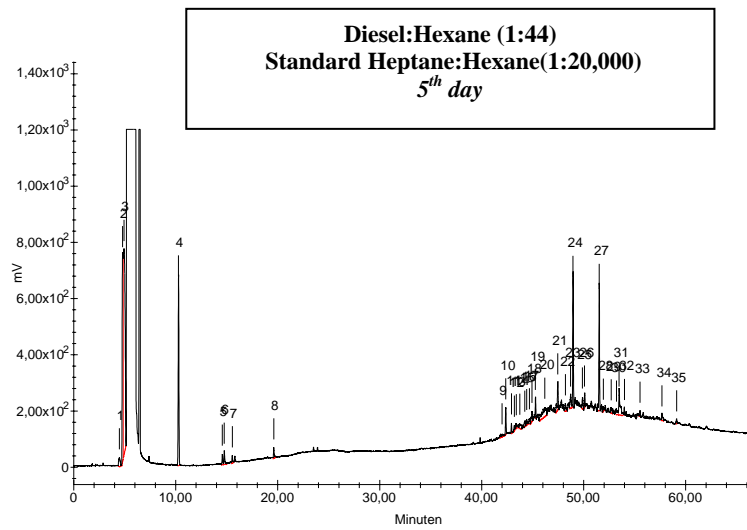

Figures 75, 76, 77, 78 Gas chromatogram; extraction (1:44) Standard Heptane:Hexane (1:20,000) dilution
Measurement a) after 5 days b) after 6 days c) after 7 days d) after 8 days

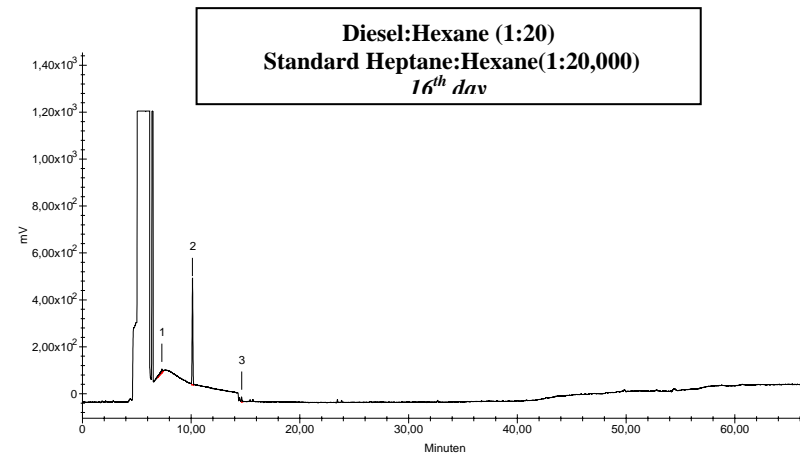
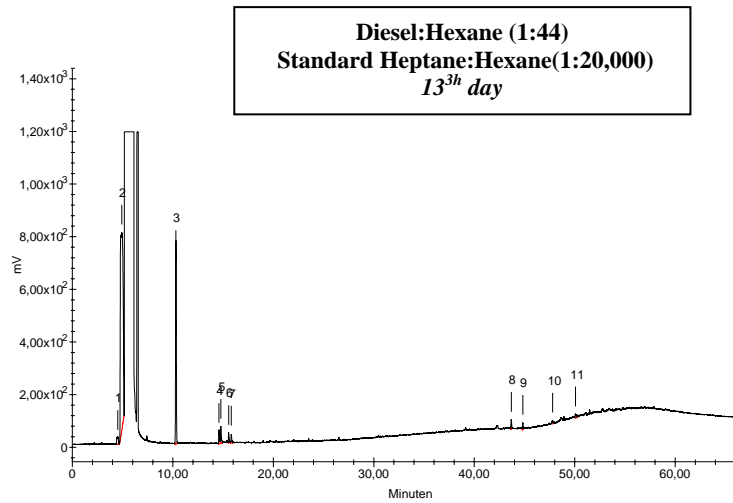
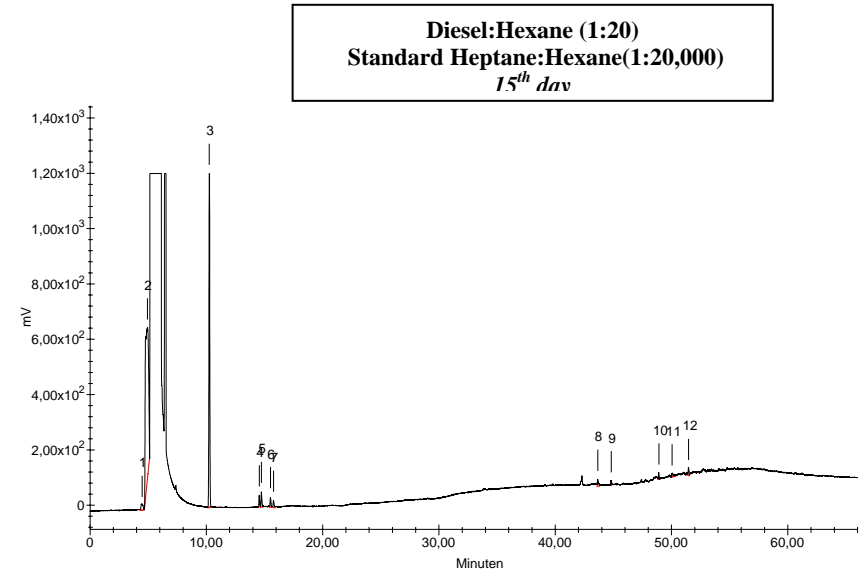
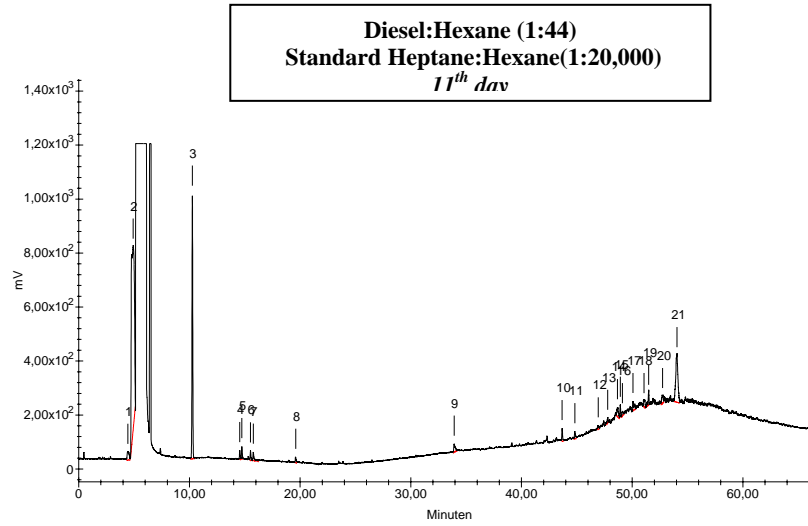

Figures 79, 80, 81, 82 Gas chromatogram; extraction (1:44); Standard Heptane:Hexane (1:20,000) dilution
Concentration Measurement a)after 8 days b)after 11 days c) after 13 days d) extraction (1:22) after 16 days

7.2 Bench Scale Studies

7.2.1 Order of the reaction

Time (days)	Substrate (mg/L)	Substrate (mg/L)
0	2000	2000
1	980.88	947.84
3	272.53	230.41
4	79.6	90.06
5	20.9	13.81
6	43.23	49.89
7	43.9	39.51
8	16.76	15.91
11	7.91	9.88
13	2.78	2.49
14	2.49	1.4
15	3.01	2.66
16	0.5	0.7

Table 39 Data zero order reaction

Substrate: Amount of diesel in contaminated groundwater

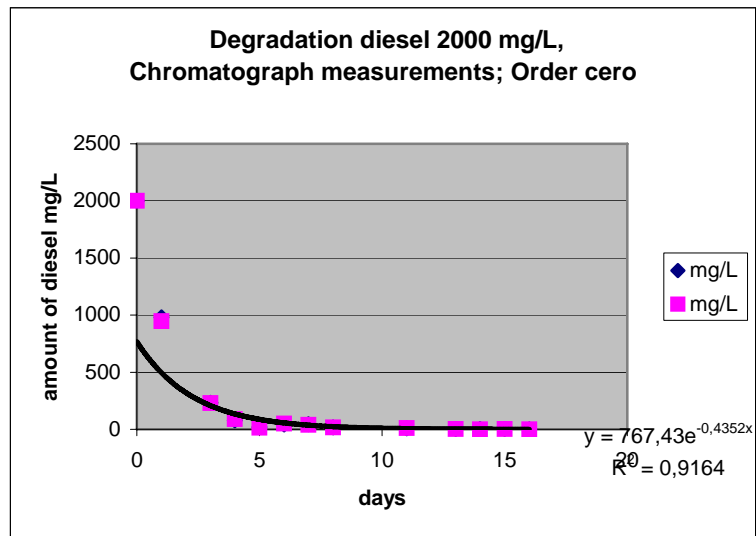

Figure 83 Diesel amount vs. time (Experiment 1 and Experiment 2)

Time (days)	Substrate (mg/L)	Substrate (mg/L)
0	3.30	3.30
1	2.99	2.98
3	2.37	2.36
4	1.90	1.95
5	1.32	1.14
6	1.64	1.70
7	1.64	1.60
8	1.22	1.20
11	0.90	0.99
13	0.44	0.40
14	0.40	0.15
15	0.48	0.42
16	-0.30	-0.15

Table 40 Data first order reaction

Substrate: Amount of diesel in contaminated groundwater

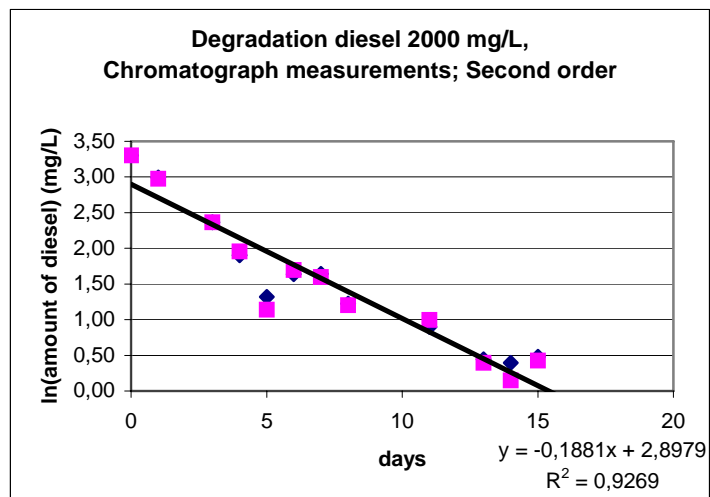

Figure 84 Diesel amount vs. time (Experiment 1 and Experiment 2)

Time (days)	Substrate (mg/L)	Substrate (mg/L)
0.00	0.50	0.50
1.00	1.02	1.06
3.00	4.31	4.34
4.00	12.56	11.10
5.00	47.85	72.41
6.00	23.13	20.04
7.00	22.78	25.31
8.00	59.67	62.85
11.00	126.42	101.21
13.00	359.71	401.61
14.00	401.61	714.29
15.00	332.23	375.94
16.00	2000.00	1428.57

Table 41 Data second order reaction
 Substrate: Amount of diesel in contaminated groundwater

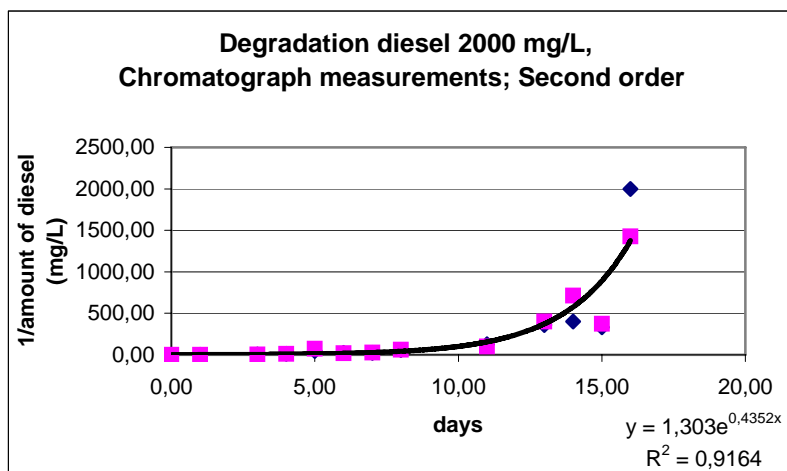

Figure 85 Diesel amount vs. time (Experiment 1 and Experiment 2)

The Kinetics of a chemical reaction can be described in terms of its order (Snoeyink and Jenkins, 1980). Some authors (Jean-Pierre Arcangeli and Erik Arvin, 1995) adequately described their hydrocarbon degradation data using a first-order kinetic model. In the present study, the experimental results were also described using a first-order kinetic model.

To determine the order, the data were plotted in a scatter diagram. The zero-order reaction, should show the amount of diesel mg/L versus time. The first-order reaction should show, the $\ln(\text{amount of diesel/L})$ versus time as a straight line. The second-order reaction ($1/\text{amount of diesel mg/L}$) should be linear. Data plots of first order reaction versus time (Figure 84, Table 40), presents the best description for the model since the coefficient of correlation is of 0.926, this means that the reaction rate is dependent of the concentration. Coulson and Richardson, in 2003 mentioned that if the experiments were developed at high concentrations the reaction should be considered of zero order and limited by the enzyme concentration. But in this study it is not only important to consider the chemical reaction engineering but also the biochemical reactions, which are characterized by their use of enzyme or whole cells to carry out specific conversions. Therefore, it is impossible to determine the order of reaction without the study of the kinetic microbial growth. It is important to mention that the authors mentioned previously worked with very low concentrations. It is contradictory that the best coefficient of correlation is for a first order reaction since we are working with very high concentration and this can be explained with a study of the Microbial growth Kinetics.

7.2.2 Microbial growth kinetics

The Monod Model is used to describe microbial kinetics growth used for diesel biodegradation:

Table 42 Microbial growth in a separated flask

Time (hours)	Substrate (mg/L)	microbial population (CFU/mL)	Specific growth rate (Calculation)
0	2000	$5.9 \cdot 10^6$	
24	980.88	$4.5 \cdot 10^7$	0.0847
72	395.28	$3.6 \cdot 10^7$	0.0754
96	272.53	$3.1 \cdot 10^7$	0.0691
120	79.6	$2.8 \cdot 10^7$	0.0649
144	20.9	$2.50 \cdot 10^7$	0.0602
168	43.23	$2.4 \cdot 10^7$	0.0585
192	43.9	$2.3 \cdot 10^7$	0.0567
264	16.76	$1.8 \cdot 10^7$	0.0475
312	7.91	$1.6 \cdot 10^7$	0.0264
336	2.78	$1.2 \cdot 10^7$	0.0296
360	2.49	$1.0 \cdot 10^7$	0.0220
384	3.01	$9.9 \cdot 10^6$	0.0216
408	0.5	$2.4 \cdot 10^7$	-0.0375

Substrate: Amount of diesel in contaminated groundwater

The growth rate is directly proportional to the existing population. The experiments were conducted once a concentration of at least $4 \cdot 10^6$ CFU/ml was reached on the flask concentration at which the exponential growth phase starts (Table 37 Figure 72). Table 42 shows the relationship between the growth of the microbial population and the amount of substrate. When time=0 hours the amount of substrate (amount of diesel in contaminated groundwater) is $S=2000$ mg/L. when the time of the process increased, the concentration of substrate will be reduced. At the same time, the biomass will start with a concentration of $4 \cdot 10^6$ and will be increased over the time as the substrate will be eliminated and will be converted to cellular material. After sixteen days the diesel is almost consumed, from 2000 mg/L to 0.5mg/L.

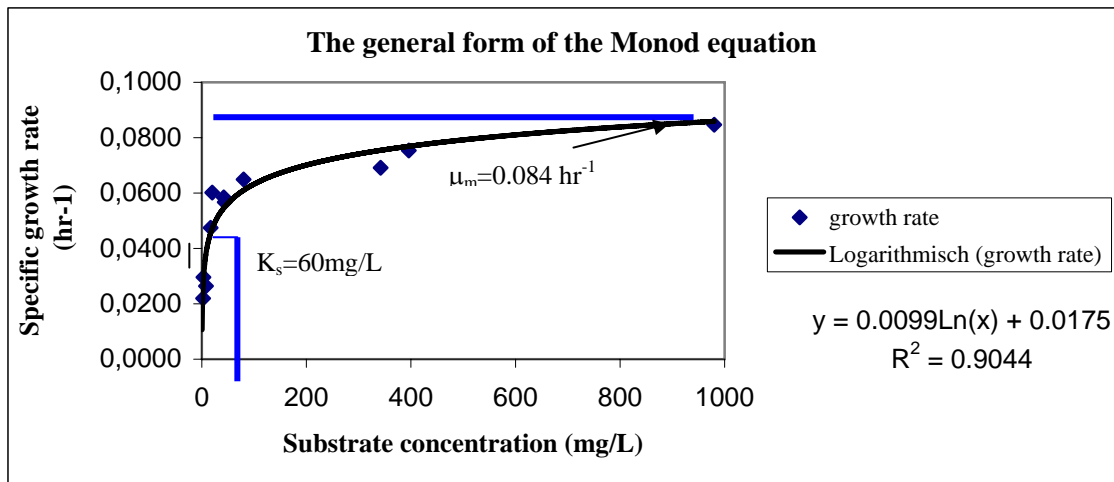

Figure 86 Growth rate versus amount of diesel

The Figure 86 graphically represents the equation of Monod. (Equation 11), it explains the dependence of the specific growth rate of microorganism culture on the substrate concentration. In this case the amount of diesel, is the limiting substrate mixture. The constant K_s for the reaction is the concentration of the substrate. (60 mg/L), required to give half the maximum rate. At the same time it is linked to the particular limiting substrate mixture. The specific growth rate initially increase with high substrate concentration and reach a limiting value of μ_{max} at the highest substrate level, 0.084 hr^{-1} . Note that μ approaches μ_{max} when $\text{Substrate} \gg K_s$ and becomes independent of the substrate concentration. When $\text{Substrate} \ll K_s$, the specific growth rate is very sensitive to the substrate concentration exhibiting a first-order dependence. The experiments where repeated several times. The biodegradation duration in the separated glass was always between 15 to 16 days. It can be concluded that with a specific growth rate of 0.084 hr^{-1} an almost complete biodegradation of diesel can be reached. In the following experiments at least this specific growth rate should be reach.

7.2.3 Construction of the columns

The following questionnaire will be very useful to consider several different factors for selecting the physical configuration, mode of operation and to make a check list of all the data that are necessary for the design.

Table 43 Data necessary for the design of the Trickle bed reactor (Charles G. Hill, Jr. 1977)

Question	Answer
1.-What is the composition of the feedstock and under what conditions is it available? Are any purification processes necessary?	2000 mg/L. T=25°C more information (Tables 13. 20) no
2.-What is the scale of the process? What capacity is required?	4 Column of 2 L depend on characterization site
3.-Is a catalyst necessary or desirable? If a catalyst is employed what are the ramifications with respect to the product distribution, operation conditions most desirable type of reactor, process economics?	Yes. Xylite Section 5.1-5.1.3
4.-What operating conditions (temperature. pressure. degree of agitation. etc.) are required for most economic operation?	Temperature=20-25°C; Pressure=1 atm; no agitation
5.-It is necessary or desirable to add inerts or other materials to the feedstock to enhance yields of desired products. to moderate thermal effects. or to prolong the useful life of any catalysts that may be employed?	no
6.-Should the process be continuous or intermittent? Would batch or semibatch operation be advantageous?	semibatch
7.-What type of reactor best meets the process requirements? Are there advantages associated with the use of combination of reactor types, or with multiple reactors in parallel or series?	Trickle Fixed bed reactor will be tested
8.-What size and shape reactor(s) should be used?	Tubular reactor; Size=4L
9.-How are the energy transfer requirements for the process best accomplished? Should one operate isothermally, adiabatically, or in accord with an alternative temperature protocol?	isothermally adiabatic
10.-Is single pass operation best. or is recycle needed to achieve the desired degree of conversion of the raw feedstock?	will be tested
11.-What facilities are required for catalyst supply, activation and regeneration?	The catalyst is available
12.-What are the reactor effluent composition and conditions? Are any chemical separation steps or physical operations required in order to bring the effluent to a point where it is satisfactory for the desire end use?	Drinking water regulation (Table 1) Low Solubility of diesel in water $\cong 1 \text{ mg/L}$ Yes. Adsorption .
13.- Are there any special materials requirements imposed by the process conditions? Is the process fluid corrosive? Are extremely high temperatures or pressure required?	no no no

Material Balance

The steps are:

- VI. Draw a diagram defining the complete process (Figure 135)
- VII. Name with symbols each flow rate stream and its compositions
- VIII. Show all the known flows and compositions. Calculate the additional compositions starting from the known ones when it is possible.
- IX. Write the total Material Balance

For one column:

From Equation 18 but in terms of weight catalyst:

$$QC_{A_1} - QC_{A_0} + r_A W = W \frac{dC}{dt} \quad \begin{matrix} Q = cte \\ W = cte \end{matrix} \quad (26)$$

Consider the real kinetics (Equation 11)

$$r_A = \frac{dC}{dt} = \frac{M\mu_{\max} C}{K_s + C} \quad (27)$$

where M is the Mixed liquor suspended solids (MLSS) The microbial suspension in the aeration tank containing living and dead micro-organisms and inert biodegradable matter. the operating concentration of which may vary in the range 100 to 500 mg/l. This is an important parameter in that their presence in levels greater than 100 ppm can have a dramatic plugging effect within the reactor (R. Barry King, Gilbert M, Long and John K. Sheldon, 1997). Filter a known volume of mixed liquor through a Buchner Funnel onto predried and preweighed filter paper. Dry at 103°C to a constant weight (usually one hour) and reweigh:

From Equation 27

$$\int_0^t dt = \int_{C_{A_0}}^{C_{A_1}} \frac{K_s + C}{M\mu_{\max} \cdot C} dC \quad (28)$$

$$\int_{C_{A_0}}^{C_{A_1}} \frac{K_s + dC}{C} + \int_{C_{A_0}}^{C_{A_1}} dC = \int_0^t M\mu_{\max} dt \quad (29)$$

$$M\mu_{\max} \cdot t = K_s \cdot \ln \frac{C_{A_0}}{C_{A_1}} + (C_{A_1} - C_{A_0}) \quad (30)$$

- X. Solve the equations in order to define the space time to obtain the required concentration in the outflow and prove the solutions with the experiments.

$$t = \frac{(K_s)mg/L \cdot \ln \frac{(C_{A_0})mg/L}{(C_A)mg/L} + \left((C_{A_0})mg/L - (C_A)mg/L \right)}{\left((M)mg/L \cdot (\mu)hours \right)}$$

t=hours

Table 44 Theoretical residence time

Reactor Design								
Q	C_{A_0}	C_A	M	μ	K	$\ln \frac{C_{A_0}}{C_A}$	ΔC	t (h)
1.92-5.76	2000	0.1	100	0.084	60	9.90	1999.5	308.82

The theoretical result shows that the expected theoretical residence time is of 308 hours or 12.9 days. This theoretical value is very similar to the results obtained experimentally for diesel biodegradation, which took 15 days. This means that the parameters of microbial growth, specific growth rate and the initial concentration are very relevant for the prediction of the residence time of the pollutants until its complete degradation. In practice this can be very useful to lower the cost of the experiments, since the count of cells is cheaper than the concentration analysis of pollutant. With this equation it is possible to calculate the concentration of diesel in a certain period of time.

7.2.4 Columns performance and results

With the results of the microorganism growth, the analysis of the microbial kinetics, the desorption test and the material mass balance of the reactor, it was possible to start the construction of the columns for its inoculation. The first step was to run the columns with distilled water during seven days to verify that there were no leakages or any other problems which may affect the performance of the columns. Afterwards contaminated groundwater was introduced into the columns and recirculated. On the ninth day the inoculum was added to the columns. The MSM was added every, four days, since the analysis of the previous results indicated that this was the optimal time for the microbial growth during the acclimation period. The number of microorganism was quantified (Table 45).

Table 45 Monitoring of the microorganisms growth within the column

Day	Add to Columns 1.2 3 and 4	Add to Separated Glass	Agar plates (CFU/ml)
1	H ₂ O _{des} + xylite		
7	Contaminated groundwater 2000 mg/L		
9	Inoculum	200 ml H ₂ O _{des}	
12	inoculum +MSM 200ml/column +Agar 200ml/column	200 ml H ₂ O _{des}	
15	Contaminated groundwater 500 ml	2 ml diesel	2.8·10 ⁵ CFU/ml
20	+ MSM 200 ml +Agar 200ml	+ MSM 200 ml + Agar 200ml	3.6·10 ⁴ CFU/ml
22	Filtrated H ₂ O from glass	200 ml H ₂ O _{des}	
23	inoculum +MSM 200ml/column +Agar 200ml/column	200 ml H ₂ O _{des} + MSM 200 ml +Agar 200ml	
26	inoculum	200 ml H ₂ O _{des}	
30	Contaminated groundwater 2000 mg/L	2 ml diesel	3·10 ⁵ CFU/ml
33	inoculum +MSM 200ml/column	+MSM 200ml	
36	inoculum	200 ml H ₂ O _{des}	2.7·10 ⁷ CFU/ml
39		2 ml diesel	
43	inoculum MSM 200 ml/column	+MSM 200ml	3·10 ⁸ CFU/ml
47	+MSM 200ml		1.4·10 ⁸ CFU/ml
50	Filtrated H ₂ O from the glass +MSM 200ml/column	2 ml diesel	
57	Filtrated H ₂ O from the glass +MSM 200ml/column	+MSM 200ml	1.41·10 ⁹ CFU/ml
66	Filtrated H ₂ O from the glass +MSM 200ml/column +Agar 200ml/column	+MSM 200ml +Agar 200ml	1.11·10 ⁸ CFU/ml
73	Filtrated H ₂ O from the glass +MSM 200ml/column +Agar 200ml/column	2 ml diesel	2·10 ⁸ CFU/ml

H₂O_{des}= distillate water

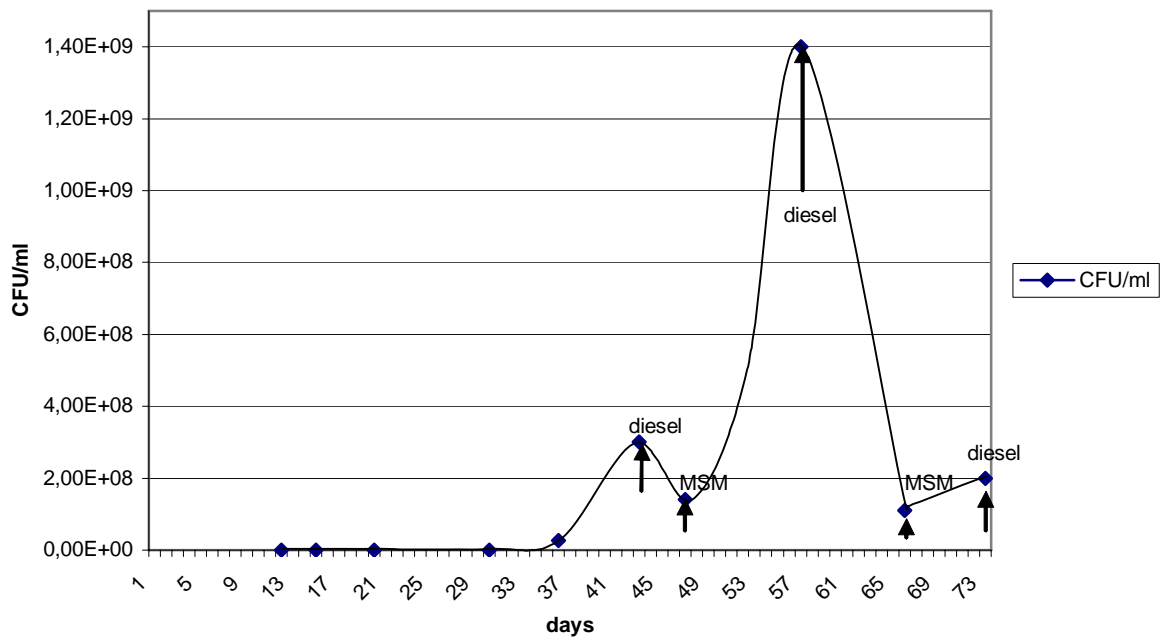

Figure 87 Microorganisms growth within the columns CFU/ml vs time

Significant changes in microbial population have been reported by other authors who have been experimenting with nutrient-supplemented hydrocarbons soils (Ting et al., 1999; Vasudevan and Rajaram, 2001). Ting et al (1999) shows that microbial population in the nutrient system decrease after the initial increase and then increase again, as in the biostimulation method of Dibyendu Sarkar, Michael Ferguson, Rupali Datta, Stuart Birnbaum, using a fertilizer rich in N and P. A similar pattern was observed in this experiment once the microorganisms were inoculated into the column, between the 37th and the 69th day. The microbial population changes could be due to the interactions between various microbial populations.

The Figure 87 and Table 45 show that even though the cell concentration in the soil was of $3.4 \cdot 10^7$ CFU/ml (Table 22) previous to the application of oil and nutrients, on the 9th day when the microorganisms were inoculated into the columns the bacterial population was diminished to $4 \cdot 10^4$ CFU/ml. On the 36th day the population showed a significant increment to greater than 10^8 CFU/ml. Before this day the diesel and nutrients were added every four days during this period of time the bacterial population did not present a considerable increment but after this day the nutrients and diesel were added every eight or seven days, on the 57th day the concentration increased to $1.41 \cdot 10^9$ CFU/ml. After this day the population became constant to a concentration of 10^8 CFU/ml (steady state). This means that the microorganisms are completely adapted.

After 72 days the adsorption process was finished. This means that at the moment when the contaminated water is added no adsorption will take place during the first hour, as it was proved in previous experiments and then the percentage of absorption will be constant with a range of 27-25%. The following results show the equilibrium of the columns

7.2.5 *Equilibrium in the columns*

1. A sample with a concentration of 7 mg/L of diesel was prepared. The analysis of the amount of diesel was determined with a GC (FID). The result shows a concentration of 1.35 mg/L (Figure 88). Due to the result obtained a new solution of 5mg/L was prepared and analyzed. The result obtained was 0.70 mg/L (Figure 89). Finally a new sample with a low concentration of 2 mg/L was prepared, the result shows a concentration of 0.79 mg/L (Figure 90). Therefore, it can be concluded that the solubility of the diesel in this case is between 1.35 and 0.79 mg/L.
2. With the results obtained in the solubility tests of diesel. a solution of 1 mg/L will be introduced within the columns until the equilibrium is reached. That means that the concentration of diesel should be the same in the output and input of each column (Figure 136).
3. The measurement of this concentration will be done by using a GC(FID). For the first column several samples were taken until the concentration decreased (10 minutes. 30 minutes. 1. 2 and 4 hours). The equilibrium was reached during the first half an hour (Figures 91, 92, 93, 94 and 95) after one hour the concentration started to decrease, which means that the biodegradation and adsorption started. It is supposed that biodegradation took place since the peaks areas in the last period of time between 50 and 60 minutes disappeared and new peak areas appeared during the period of 20 to 30 minutes. These peak areas can represent subproducts of the reactions of biodegradation. since the concentration remains almost constant.

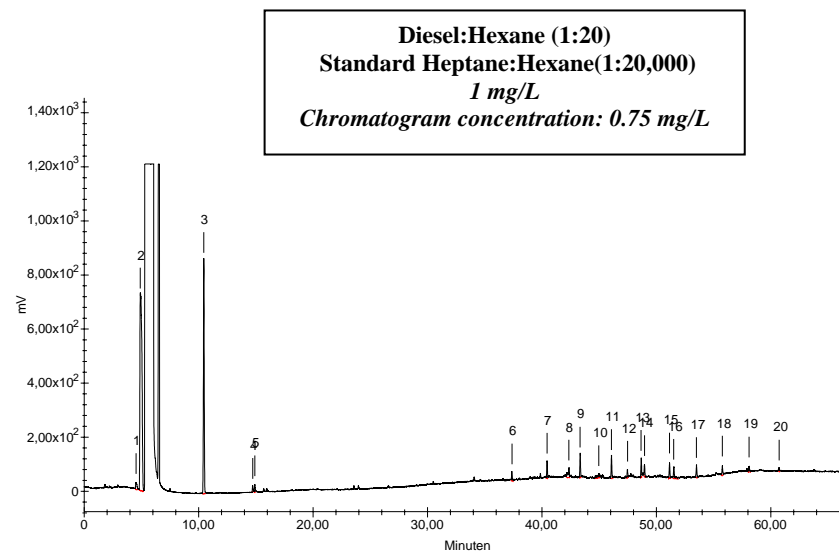
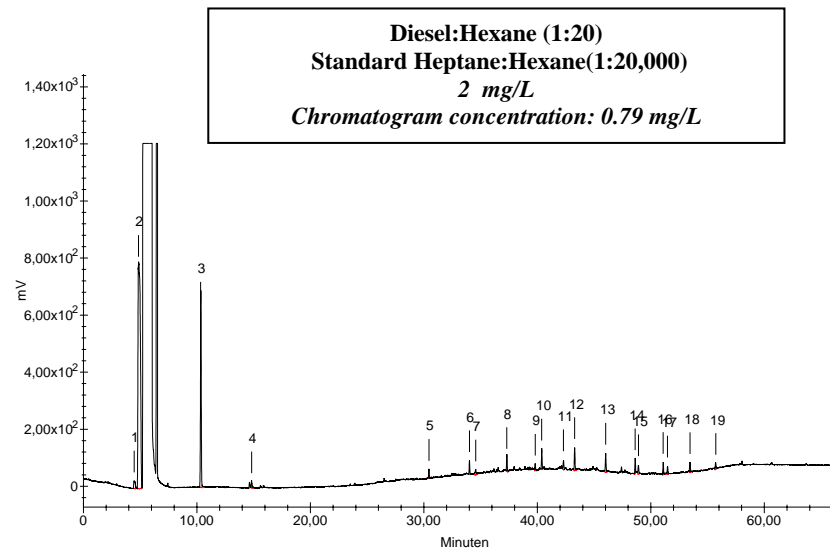
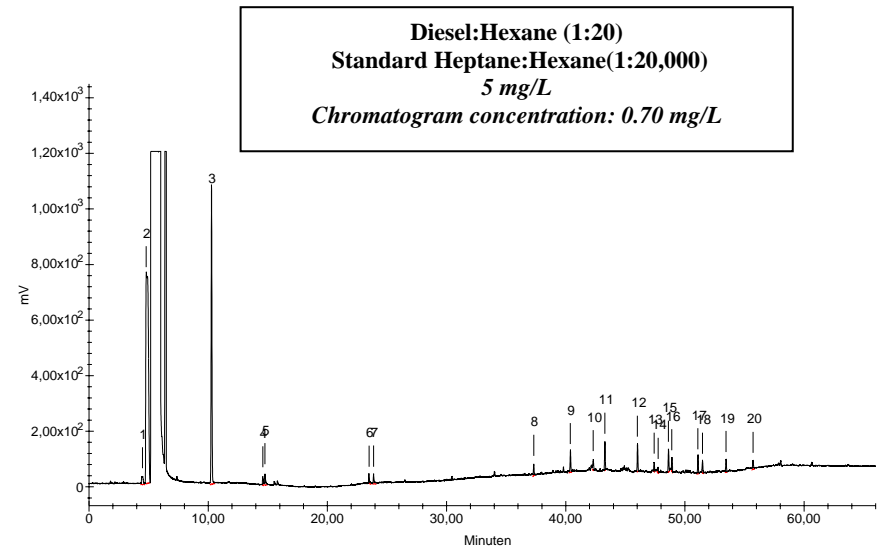
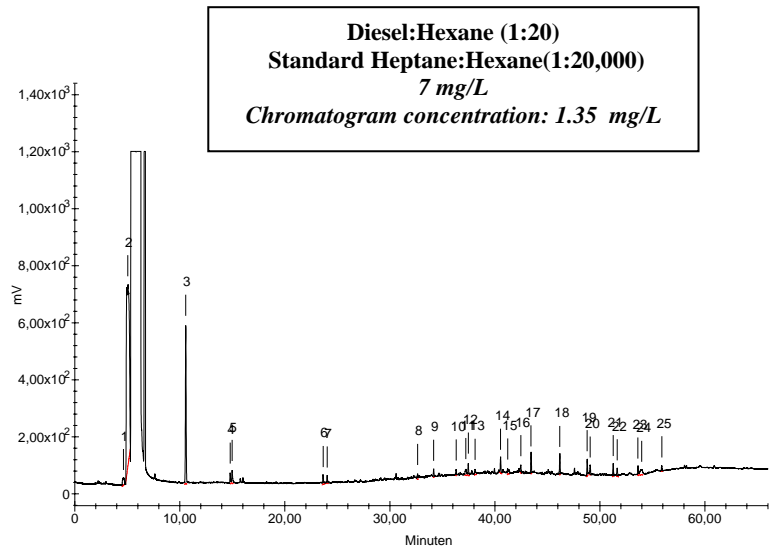

Figures 88, 89, 90, 91 Gas chromatogram; extraction (1:20); Standard Heptane:Hexane (1:20,000)dilution Solubility Test at different concentrations a) 1.35 mg/Lb) 0.70 mg/L c) 0.79 mg/L d) 0.79 mg/L after 10 minutes

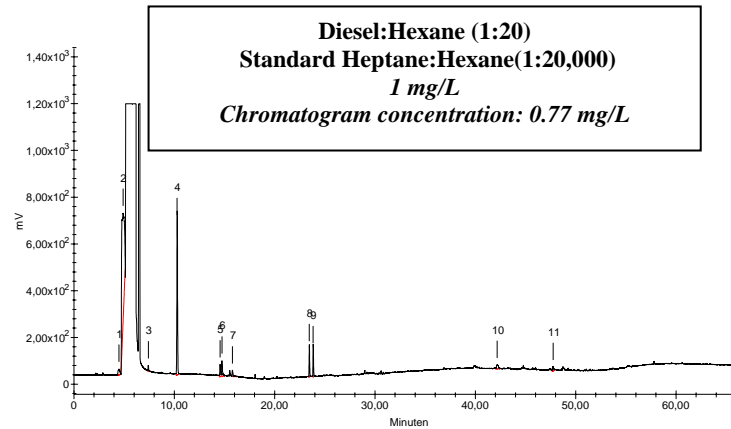
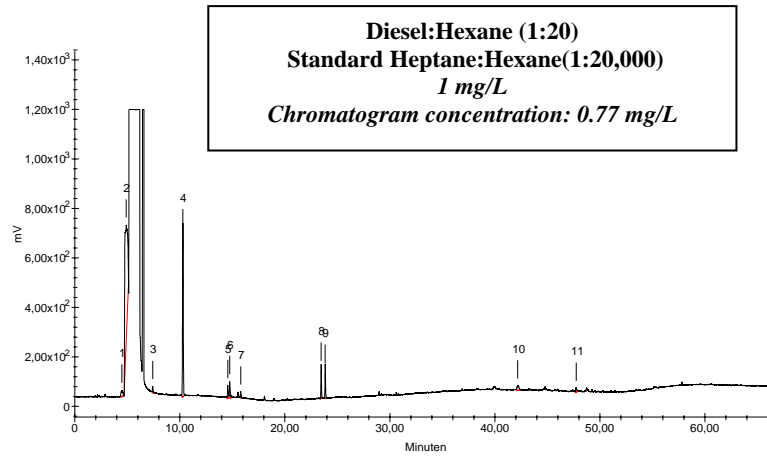
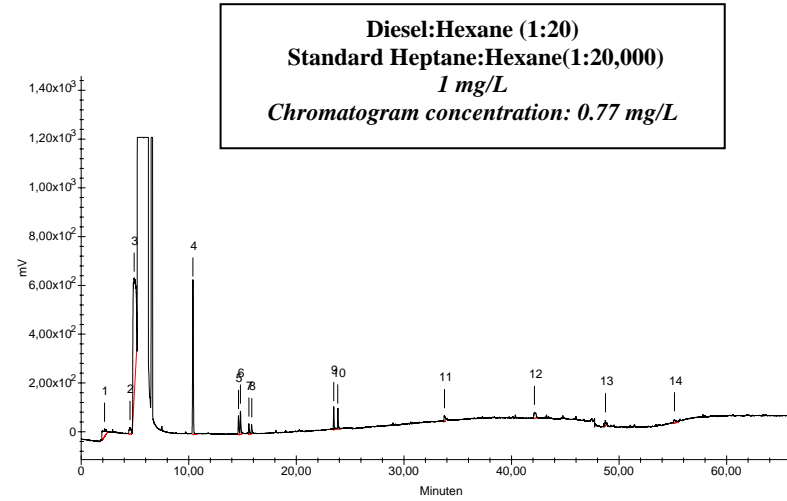
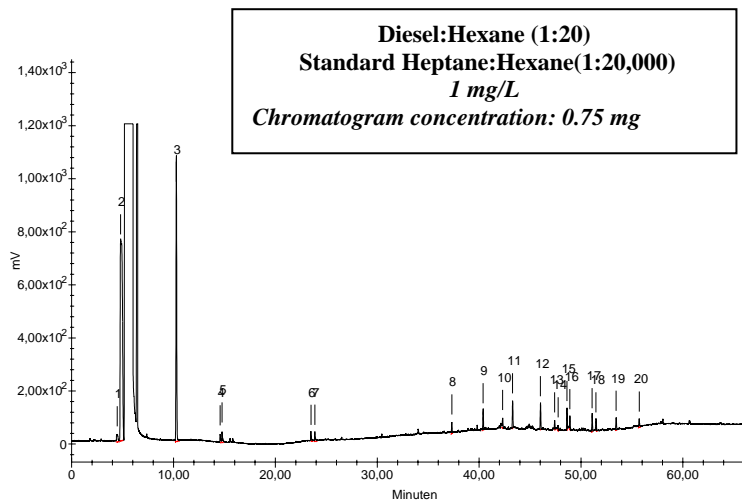

Figures 92, 93, 94, 95 Gas chromatogram; extraction (1:20); Standard Heptane:Hexane (1:20,000)dilution.

Solubility test at different concentration a) 0.75 mg/L after 30 minutes; b) 0.77 mg/L after 60 minutes; c) 0.77 mg/L after 120 minutes d) 0.77 mg/L after 240 minutes

7.2.6 Measurement of the microbial activity

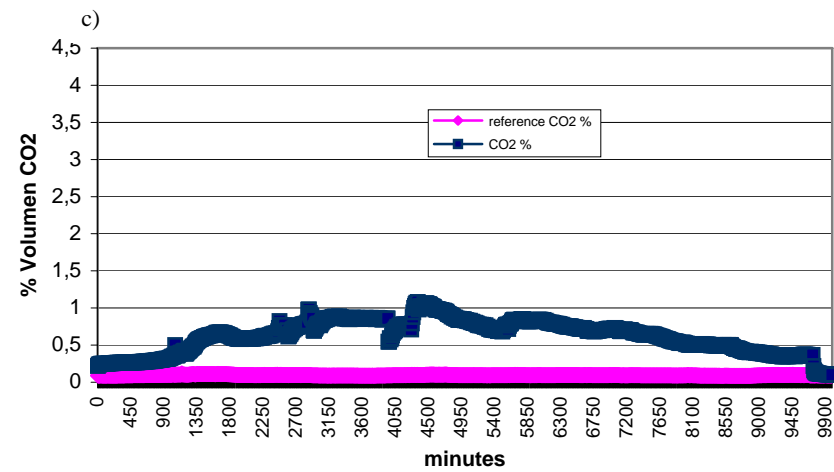
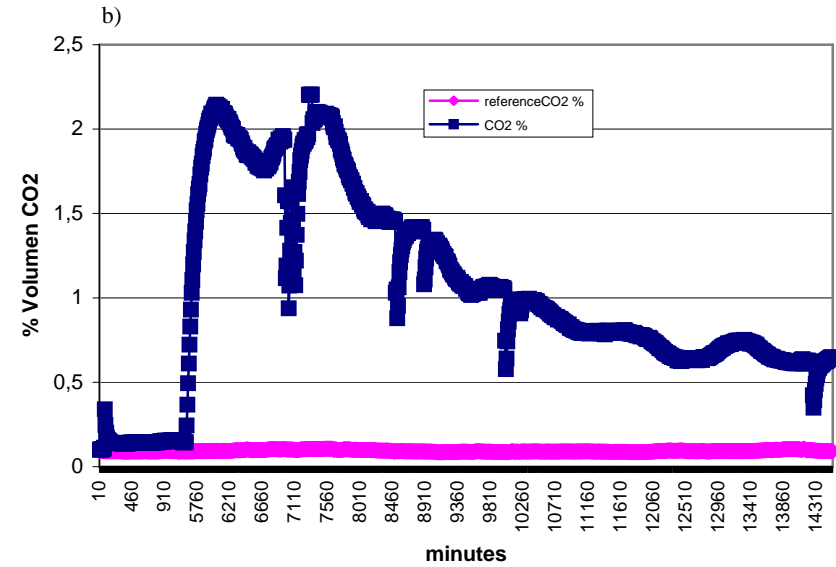
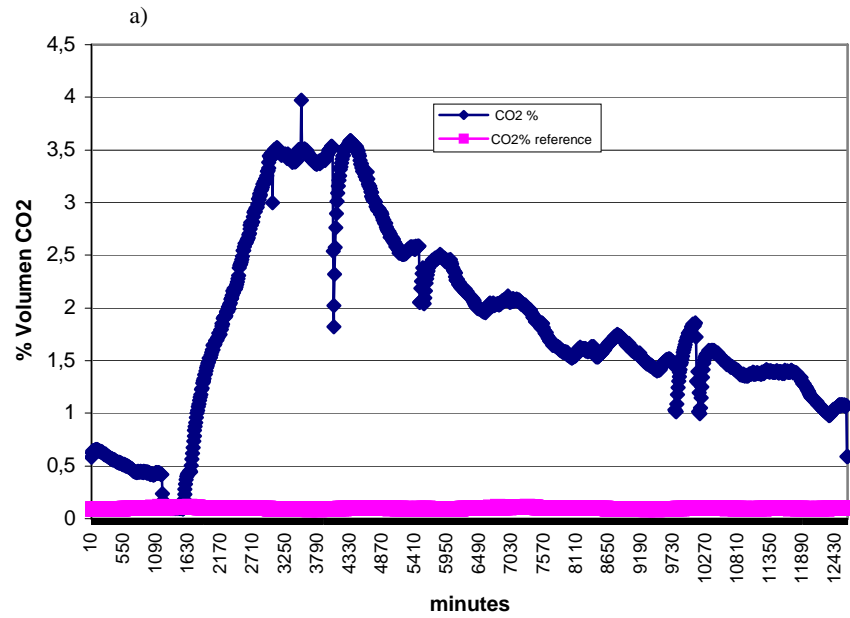

Figures 96, 97, 98 Measurements of microbial activity carbon dioxide (CO₂) vs. minutes; velocity 19 L/day a) Column 1 b) Column 3 c) Column 4

During the measurement of CO₂ the O₂ was constant with a value of approximately 20% and no CH₄ was produced. The microbial activity was measured in two different Columns

Table 46 CO₂ Measurement

Velocity (L/day) No. Column	Maximum % volume CO₂ referenced to dry gas condition	Period	Degradation
19.20 Column 1	$\cong 1\%$ volume CO ₂ <ul style="list-style-type: none"> • 1.2-1.5 day during 8.33 hrs. • 4.4-4.6 day during 2.5 hrs. • 5-8.7 day during 89 hours $\cong 2\%$ volume CO ₂ <ul style="list-style-type: none"> • 1.6-1.9 day during 7.8 hrs. • 3.3-4.4 day during 28 hrs. • 4.5-5 day during 11 hrs. $\cong 3\%$ volume CO ₂ <ul style="list-style-type: none"> • 1.9-3.3 day during 32.6 hrs. 	9 days	No available
19.20 Column 3	$\cong 1\%$ volume CO ₂ <ul style="list-style-type: none"> • 3rd day during 4.5 hr 	7 days	No available
19.20 Column 4	1.030-2.204 from the 1 st to the 7 th day	10 days	No available

Microbial activity was present in the four columns. The columns were operating with a continuous and recycled flow under a serial arrangement. The percentage of CO₂ produced was higher in the first column, this could be due to a high amount of diesel during the first steps of the biodegradation that takes part in this column. The columns now were ready for evaluation of the first biodegradation of the diesel. The results were as follows:

7.2.7 Optimization of the columns

7.2.7.1 One Column working continuous and recirculated constantly

Table 47 Determination of diesel concentration using a Gas chromatograph (FID), one column.

Diesel concentration in one column									
Single Point Internal Standard									
Date	Method	conc. Hep. (mg/ml)	Chromatogram						
Conc. (mg/L)			Area Hep. In.st.	A. st. diesel	Conc. st. Diesel	I.F.R.	Area Hep.	Area diesel	A. diesel GW
standard solution diesel	50°(10)3/280(20min)	34	1893054	100516877	2000	1.108			
standard solution diesel	50°(10)3/280(20min)	34	1370968	44945726	200	0.179			
1	50°(10)3/280(20min)	34	1893054	100516877	2000	1.108			2000.00
2	50°(10)3/280(20min)	34	1893054	100516877	2000	1.108	1685623	67154539	1500.61
3	50°(10)3/280(20min)	34	1893054	100516877	2000	1.108	2148306	36048252	632.04
4	50°(10)3/280(20min)	34	1893054	100516877	2000	1.108	2135009	2403215	42.40
5	50°(10)3/280(20min)	34	1370968	44945726	200	0.179	1537853	1201506	4.77
7	50°(10)3/280(20min)	34	1370968	44945726	200	0.179	1958285	556669	1.73
8	50°(10)3/280(20min)	34	1370968	44945726	200	0.179	2225277	95656	0.26

conc.Hep. Heptane concentration

Conc. Concentration (mg/L)

Area Hep. Int.st Area Heptane Internal Standard

A.st.diesel Standard Amount of diesel

I.R.F internal respond factor

Area Hep Area of Heptane

A. diesel GW amount of diesel in contaminated groundwater

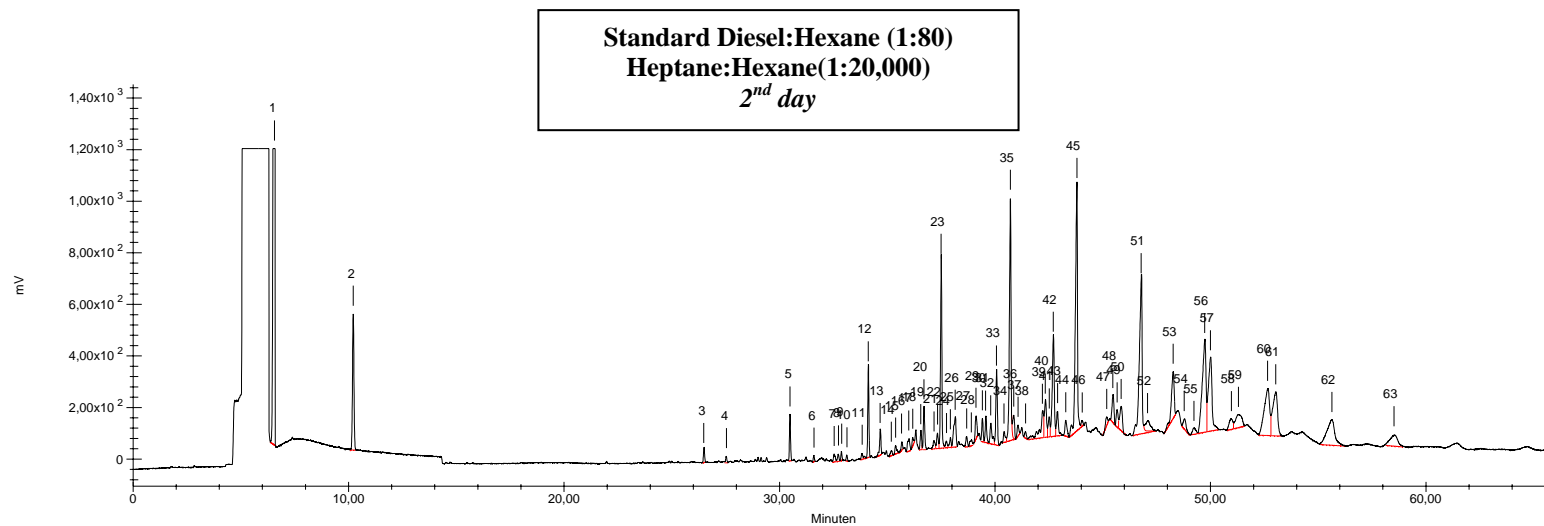
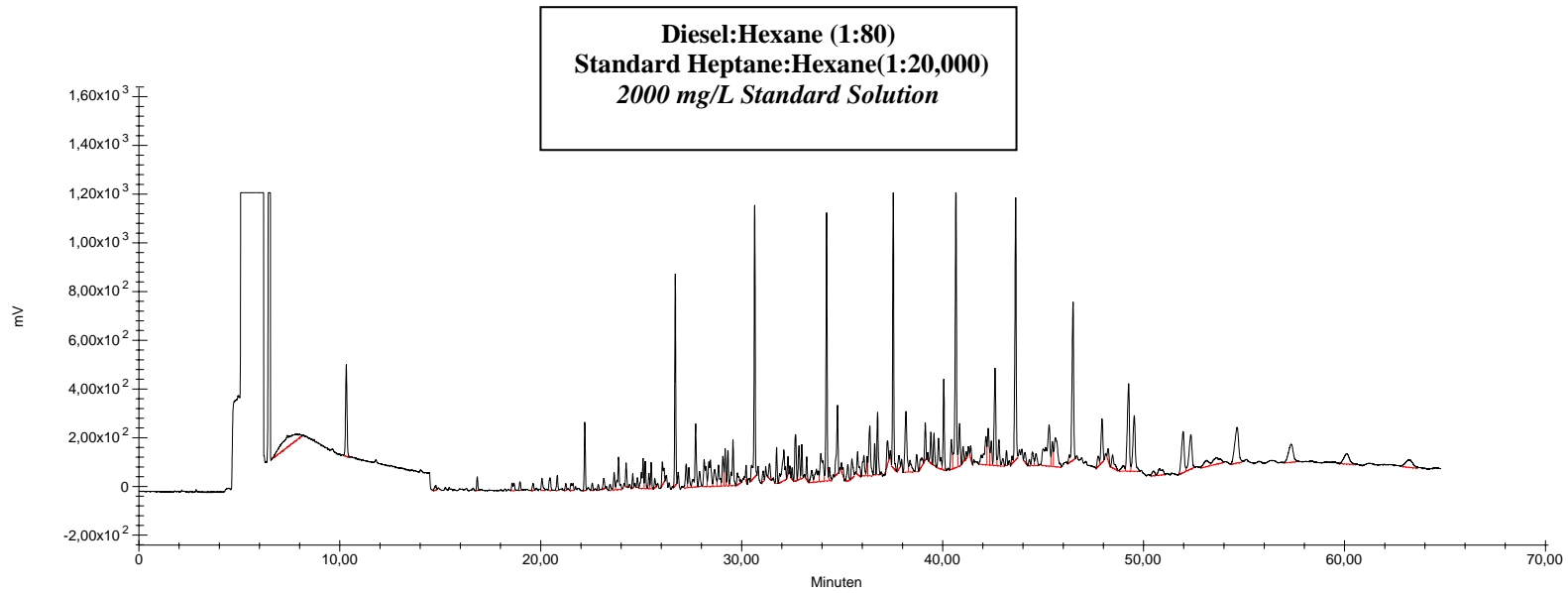

Figures 99, 100 Gas chromatogram; extraction (1:80); Standard Heptane:Hexane (1:20,000)dilution
a) Standard Solution 2000 mg/L b) Measurement after 2 days

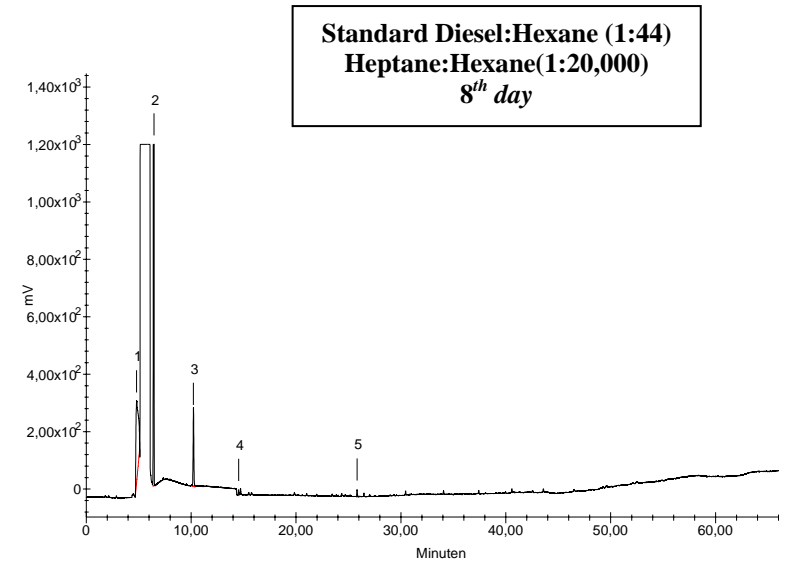
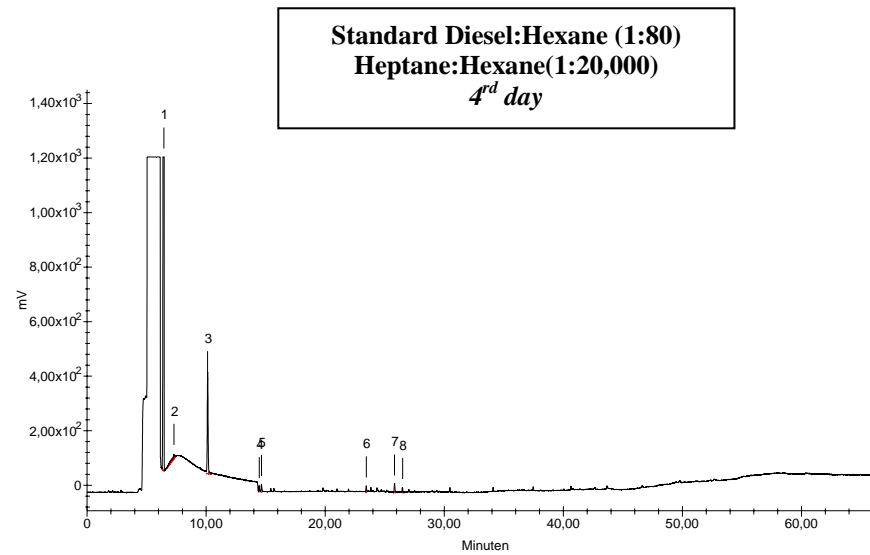
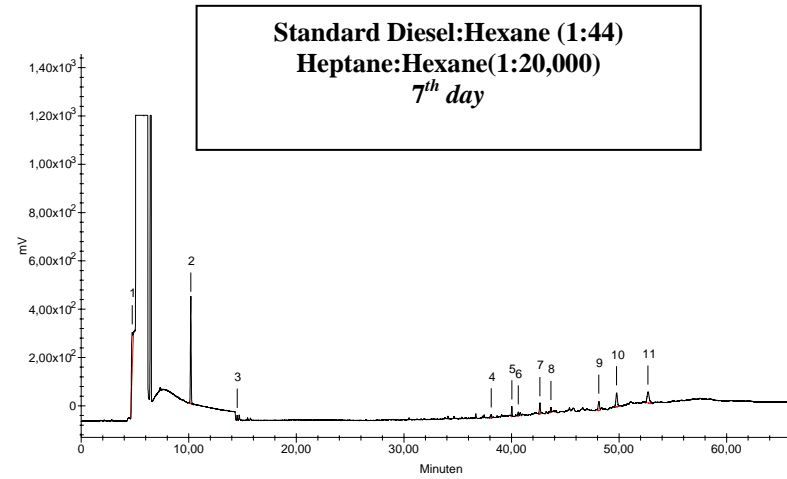
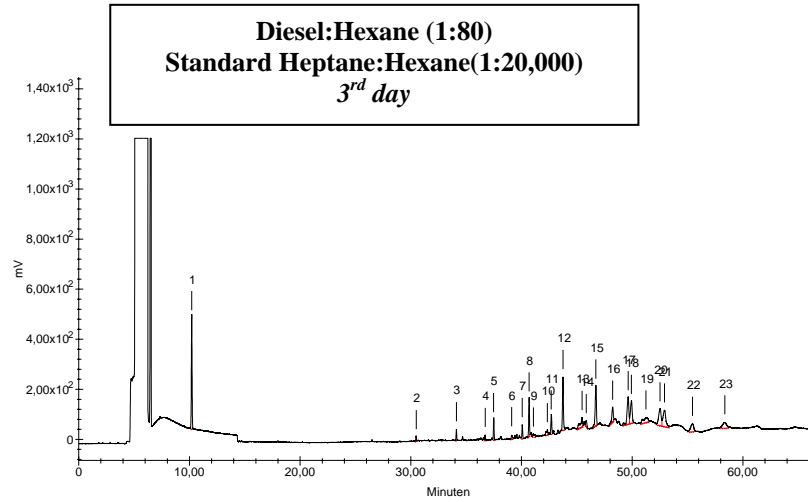

Figures 101, 102 Gas chromatogram; extraction (1:80); Standard Heptane:Hexane (1:20,000)dilution a)after 3 days b) after 4 days
Figure 103, 104 Gas chromatogram; extraction (1:44); Standard Heptane:Hexane (1:20,000)dilution a)after 7 days b) after 8 days

7.2.7.2 Microbial growth Kinetics in one column

The Monod Model was again used to describe the growth kinetics inside the column and the Equation 8 (specific growth rate) was used to model the biodegradation of diesel. The results are the following:

Table 48 Microbial growth of the microorganisms in one column

time (days)	Substrate (mg/L)	microbial population (CFU/mL)	μ (1/h)
0	2000	2.00E+05	
24	1500.61	1.40E+06	0.0811
48	632.03	6.00E+06	0.1417
72	42.39	4.20E+06	0.1269
96	4.7	4.20E+06	0.1269
168	1.7	4.00E+06	0.1248
192	0.26	2.40E+06	0.1035

Substrate: Amount of diesel in contaminated groundwater

The experiments were done after reaching the concentration of microorganisms reported previously ($\cong 2 \cdot 10^8$ CFU/ml Table 38). After, the contaminated groundwater was added to the column the concentration decrease until $2 \cdot 10^5$ CFU/ml. The stationary state was almost during all the process of biodegradation. The most important data in this experiment is the specific growth rate in the first step 0.0811 which is very similar to the one that we expected to have. But in this experiment the microorganisms still growing until they reach a maximum growth rate of 0.141 this can be due to the presence of the xylite. One of the most interesting process is that the immobilized cells in the xylite allow the reactor function in very high cell concentration. This results in a better utilization of the substrate. This means that the microorganisms will be able to degrade the diesel in less than 15 days until 0.5 mg/L. In the column the diesel was already consume after eight days. The adsorption of the diesel in the xylite must play an important role too.

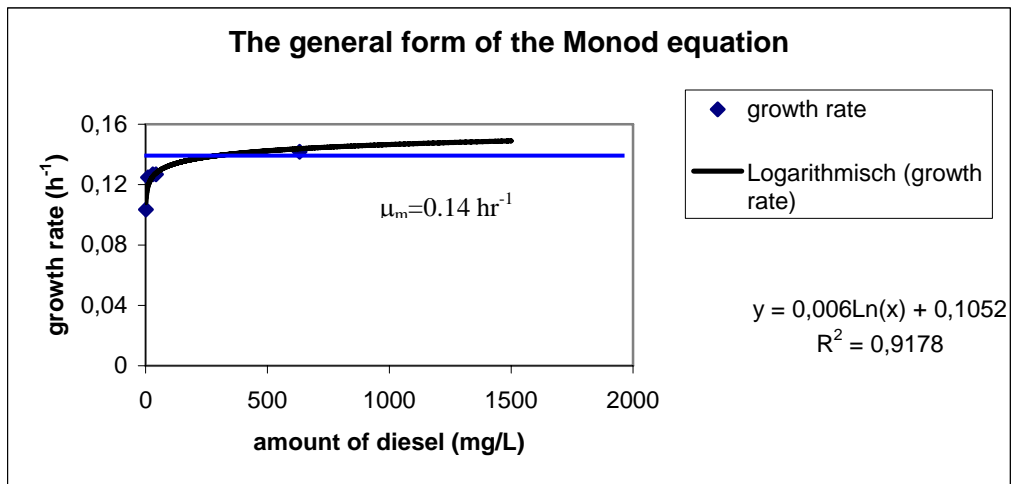

Figure 105 growth rate (h^{-1}) versus amount of diesel mg/L

The experiment where repeated several times the biodegradation duration in one column was always between 7 and 8 days.

7.2.8 Four columns working in parallel as a Submerged Fixed Film reactor and recirculated constantly

Table 49 Determination of diesel concentration in four columns using a Gas chromatograph (FID)

Diesel concentration in four columns									
Single Point Internal Standard test of concentration									
Conc. (mg/L)	Method	conc. Hep. (mg/ml)	Chromatogram						
			Area Hep. In.st.	A. st. diesel	Conc. st. Diesel	I.F.R.	Area Hep.	Area diesel	A. diesel GW
standard solution diesel	50°(10)3/280(20min)	34	1874254	114683772	2000	0.961			
standard solution diesel	50°(10)3/280(20min)	34	1370968	44945726	200	0.179			
standard solution diesel	50°(10)3/280(20min)	34	1390336	32955301	20	0.025			
First day Column 1	50°(10)3/280(20min)	34	1874254	114683772	2000	0.961	1605431	3084288	62.79
First day Coulmn 2	50°(10)3/280(20min)	34	1874254	114683772	2000	0.961	3562636	98435435	903.10
First day Column 3	50°(10)3/280(20min)	34	1874254	114683772	2000	0.961	2071030	108621446	1714.30
First day Column 4	50°(10)3/280(20min)	34	1874254	114683772	2000	0.961	2240689	26706735	389.58
Second day Column 1	50°(10)3/280(20min)	34	1874254	114683772	2000	0.961	3284347	11040882	109.88
Second day Coulmn 2	50°(10)3/280(20min)	34	1874254	114683772	2000	0.961	4043507	54394222	439.69
Second day Column 3	50°(10)3/280(20min)	34	1874254	114683772	2000	0.961	3380449	39126960	378.32
Second day Column 4	50°(10)3/280(20min)	34	1874254	114683772	2000	0.961	4034468	9615767	77.90
Third day Column 1	50°(10)3/280(20min)	34	1370968	44945726	200	0.179	2056477	1307650	3.88
Third day Coulmn 2	50°(10)3/280(20min)	34	1370968	44945726	200	0.179	1679139	1453670	5.28
Third day Column 3	50°(10)3/280(20min)	34	1370968	44945726	200	0.179	1987250	18968515	58.23
Third day Column 4	50°(10)3/280(20min)	34	1370968	44945726	200	0.179	2882187	27475944	58.16

Table 49 Determination of diesel concentration in four columns using a Gas chromatograph (FID)

Fourth day Column 1	50°(10)3/280(20min)	34	1370968	44945726	200	0.179	1830641	532484	1.77
Fourth day Coulmn 2	50°(10)3/280(20min)	34	1370968	44945726	200	0.179	1199768	399674	2.03
Fourth day Column 3	50°(10)3/280(20min)	34	1370968	44945726	200	0.179	2396655	1901630	4.84
Fourth day Column 4	50°(10)3/280(20min)	34	1370968	44945726	200	0.179	2763191	2271625	5.02
Seventh day Column 1	50°(10)3/280(20min)	34	1390336	32955301	20	0.025			-
Seventh day Coulmn 2	50°(10)3/280(20min)	34	1390336	32955301	20	0.025			-
Seventh day Column 3	50°(10)3/280(20min)	34	1390336	32955301	20	0.025	2641436	6135191	1.96
Seventh day Column 4	50°(10)3/280(20min)	34	1390336	32955301	20	0.025	2985322	10693106	3.02
Eigth day Column 1	50°(10)3/280(20min)	34	1390336	32955301	20	0.025			-
Eigth day Coulmn 2	50°(10)3/280(20min)	34	1390336	32955301	20	0.025			-
Eigth day Column 3	50°(10)3/280(20min)	34	1390336	32955301	20	0.025	3074186	450373	0.12
Eigth day Column 4	50°(10)3/280(20min)	34	1390336	32955301	20	0.025	2312928	1189538	0.43

conc.Hep. Heptane concentration

Conc. Concentration (mg/L)

Area Hep. Int.st Area Heptane Internal Standard

A.st.diesel Standard Amount of diesel

I.R.F internal respond factor

Area Hep Area of Heptane

A. diesel GW amount of diesel in contaminated groundwater

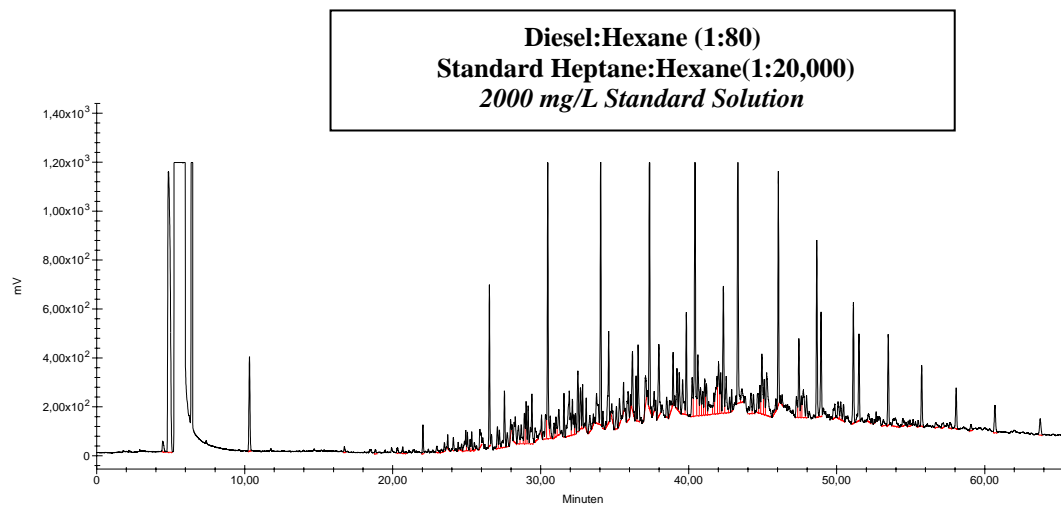
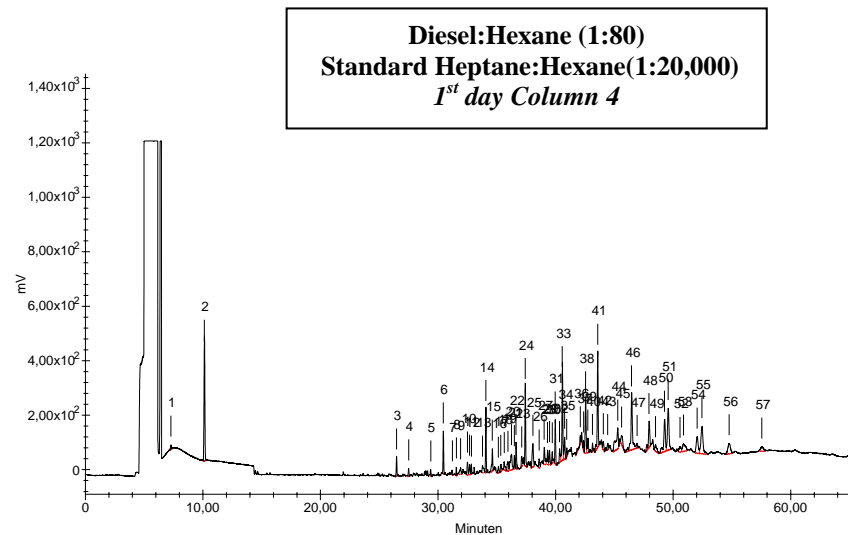
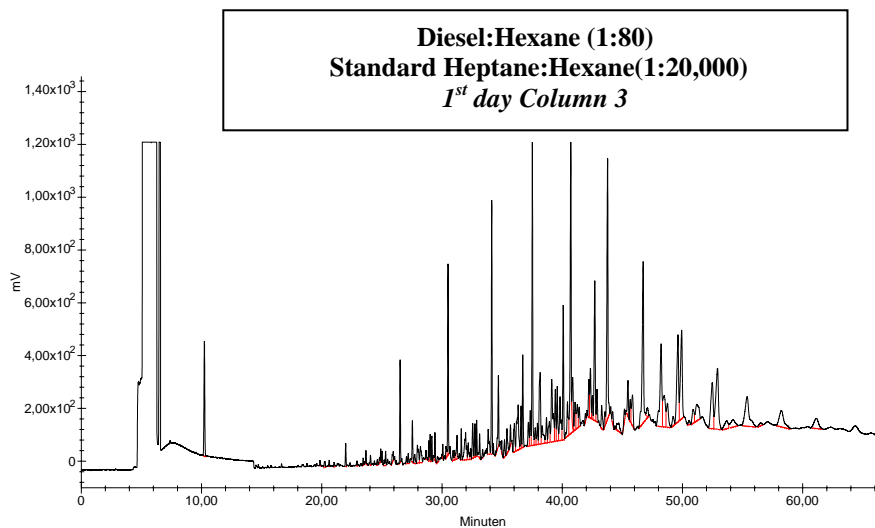
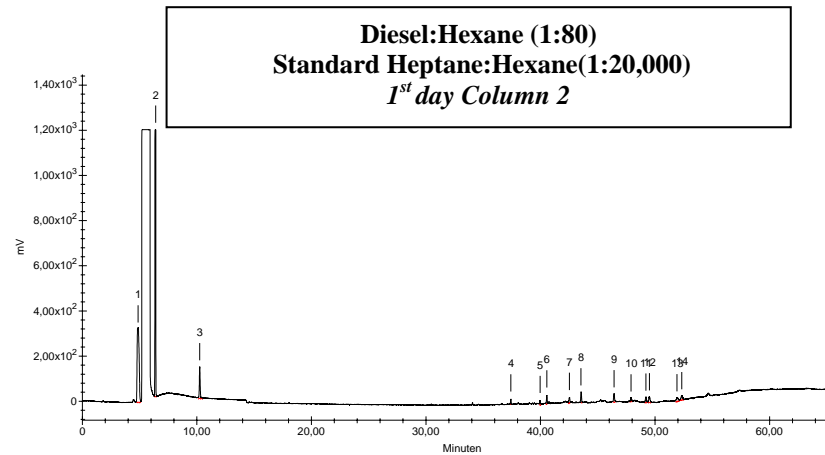
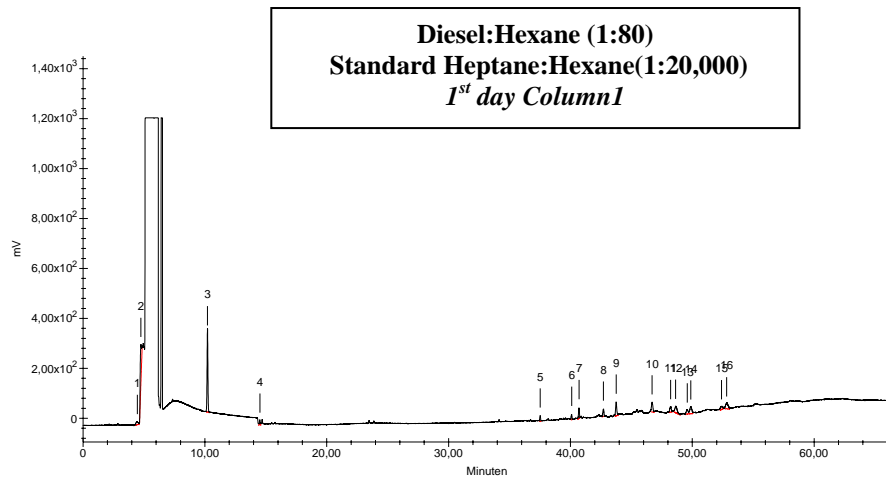
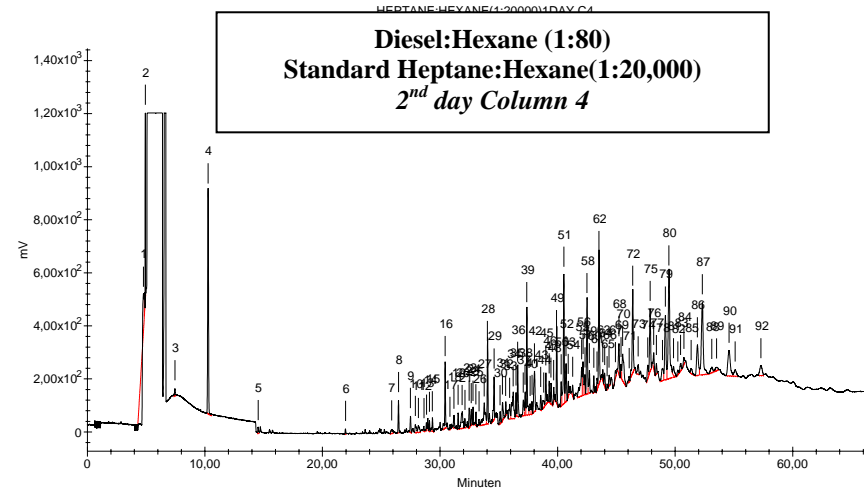
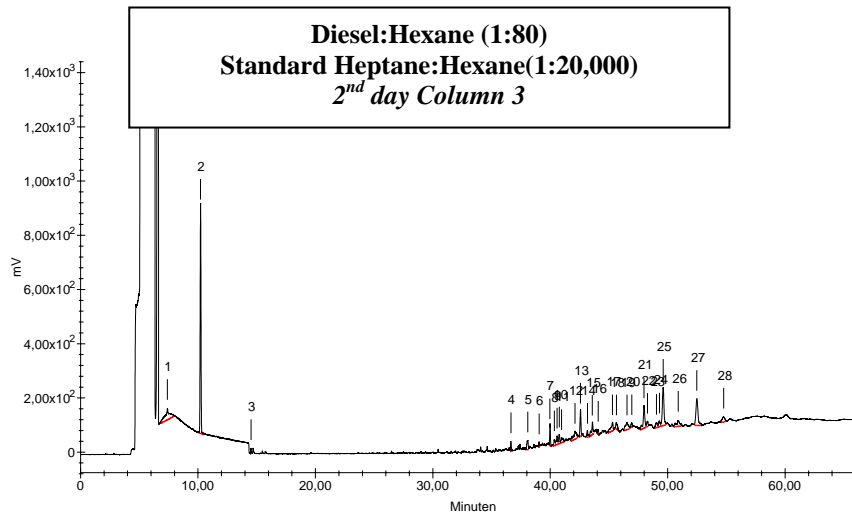
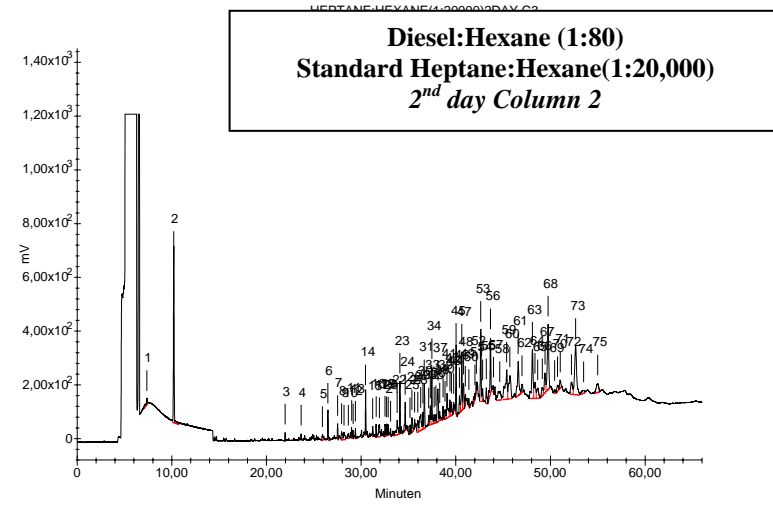
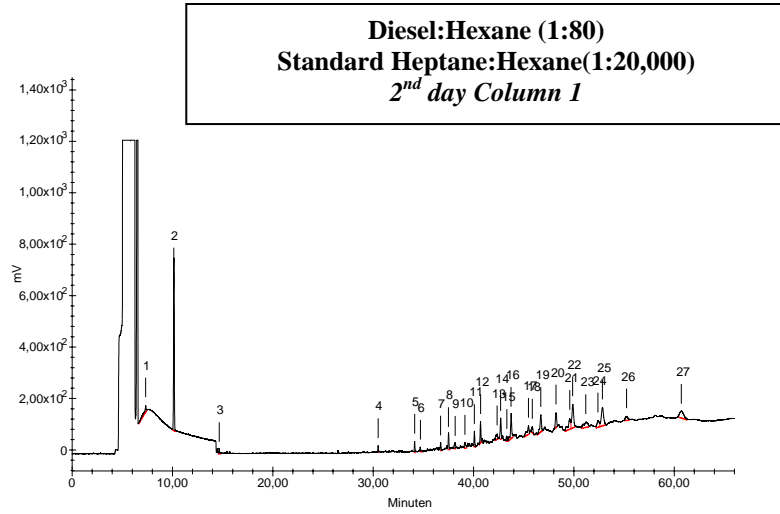

Figure 106 Gas chromatogram; extraction (1:80); Standard Heptane:Hexane (1:20,000) dilution Standard Solution 2000 mg/L



Figures 107, 108, 109, 110 Gas chromatogram; extraction (1:80); Standard; Heptane:Hexane (1:20,000) dilution
Measurement after 1 day a) Column 1 b) Column 2; c) Column 3 d) Column 4



Figures 111, 112, 113, 114 Gas chromatogram extraction (1:80); Standard; Heptane:Hexane (1:20,000)dilution
 Measurement after 2nd day a)Column 1 b) Column 2; c) Column 3 d) Column 4

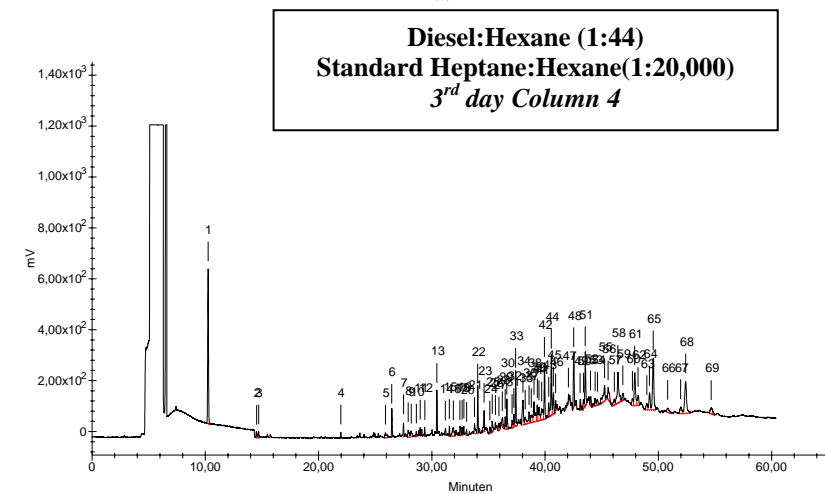
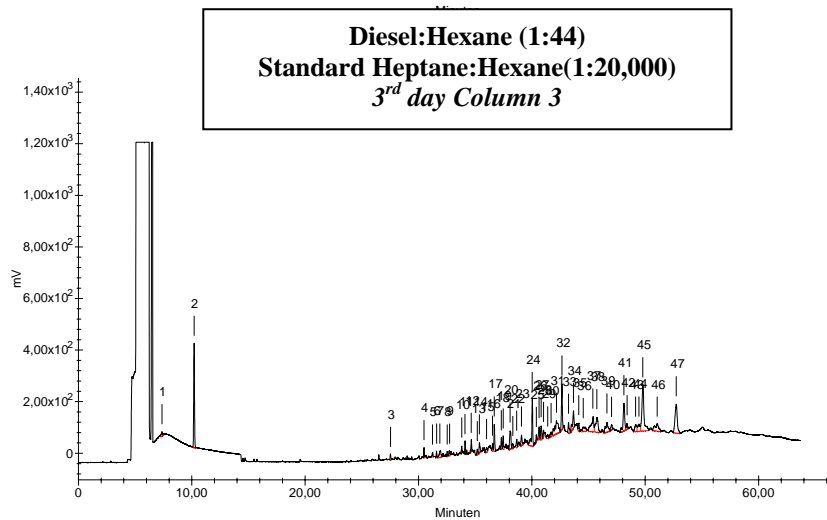
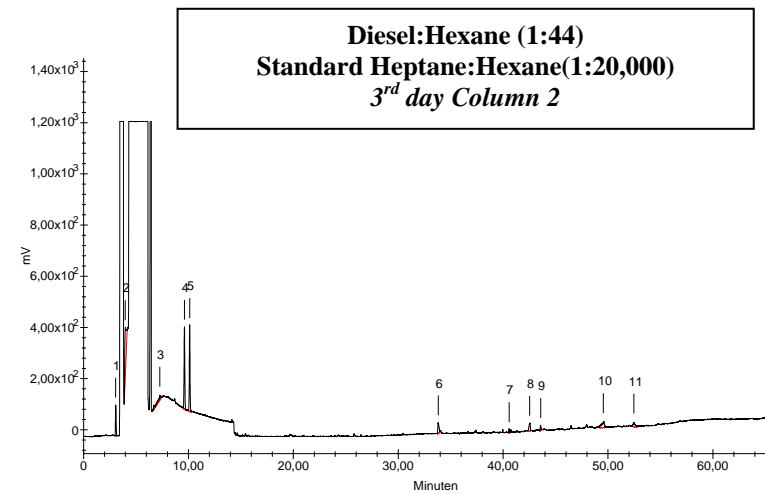
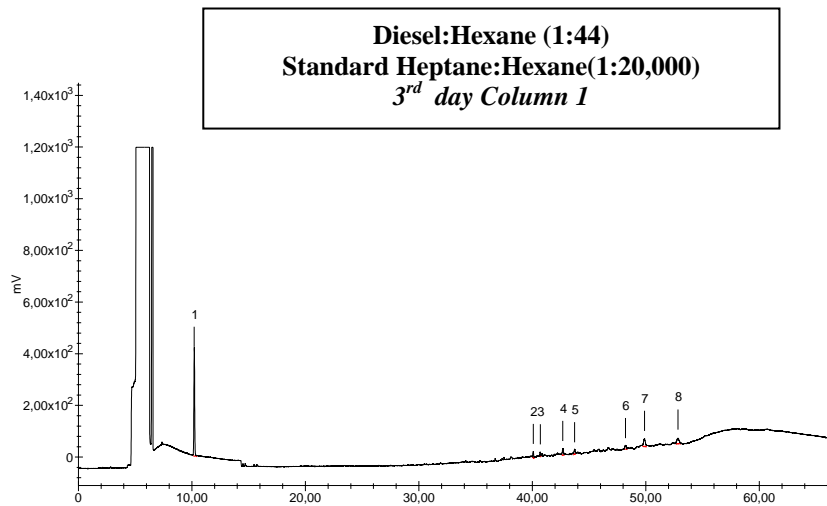

Figures 115, 116, 117, 118 Gas chromatogram extraction (1:44); Standard Heptane:Hexane (1:20,000)dilution
Measurement after 3days a) Column 1; b) Column 2 c) Column 3; d) Column 4

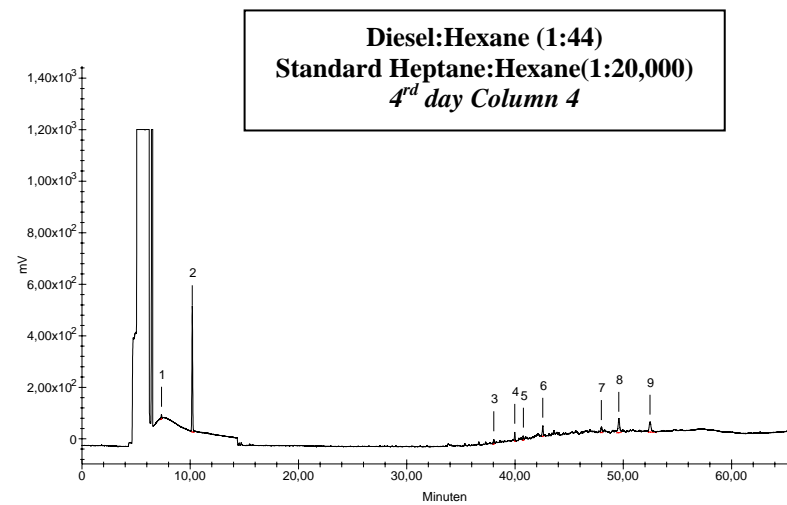
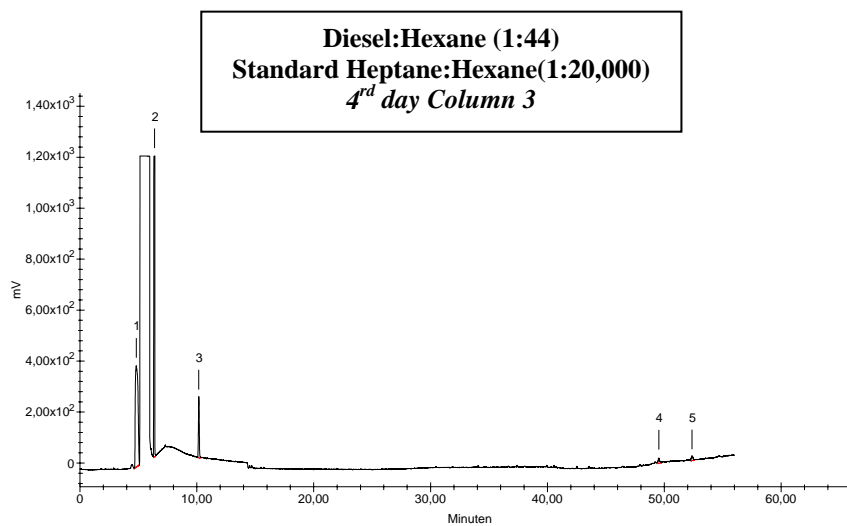
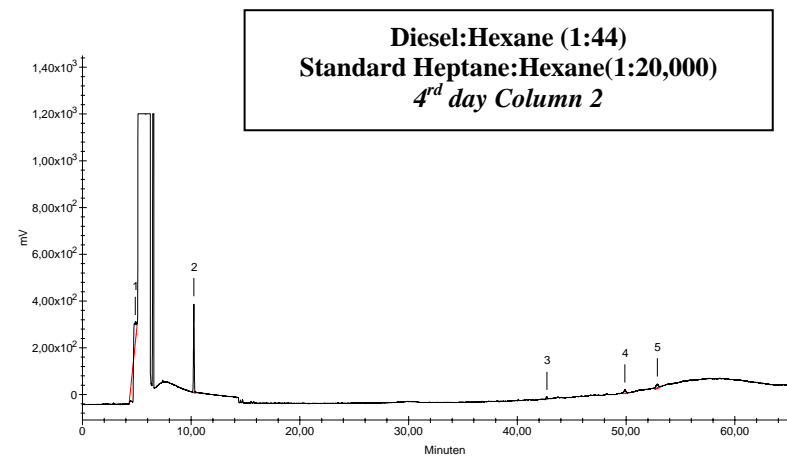
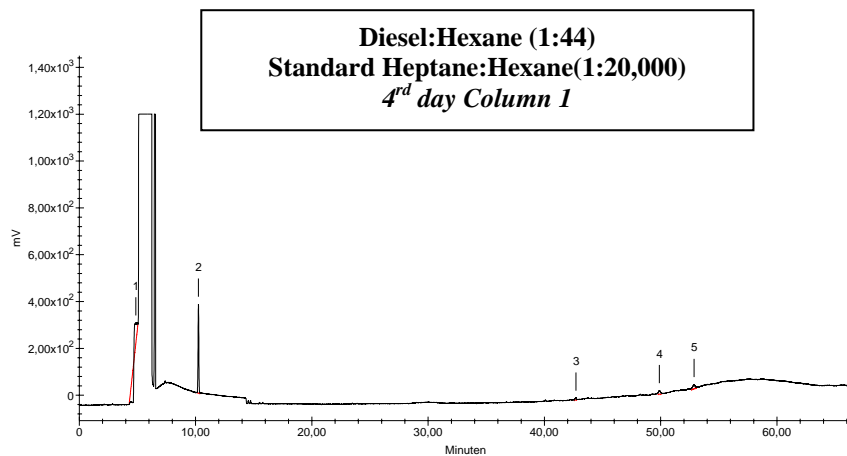

Figures 119, 120, 121, 122 Gas chromatogram; extraction (1:44); Standard Heptane:Hexane (1:20,000) dilution
Measurement after 4 days a) Column 1; b) Column 2 c) Column 3; d) Column 4

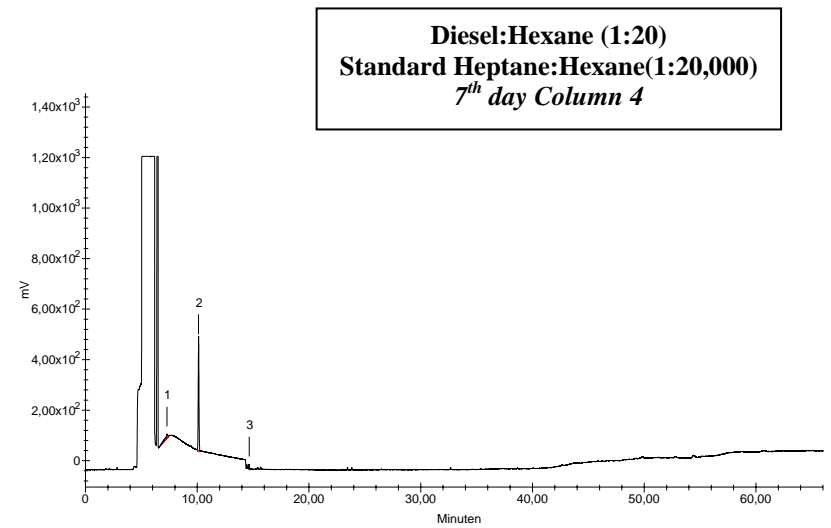
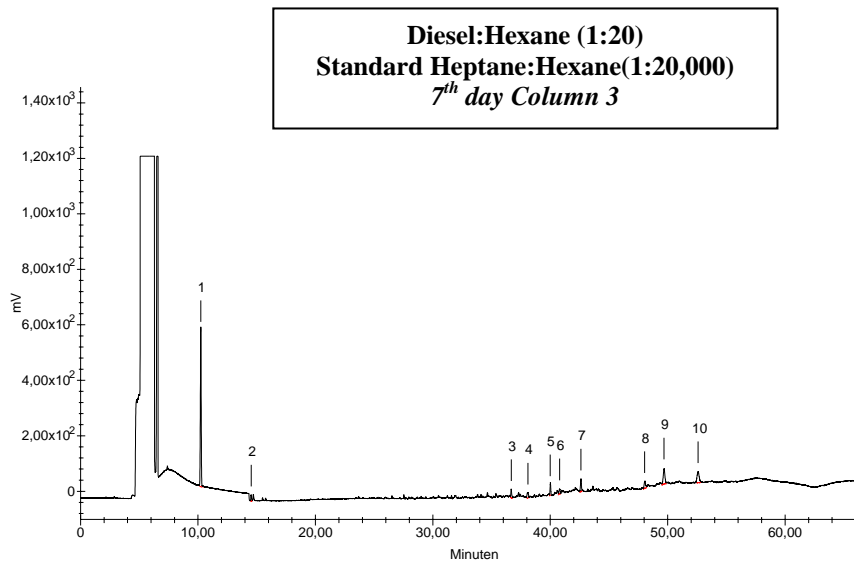
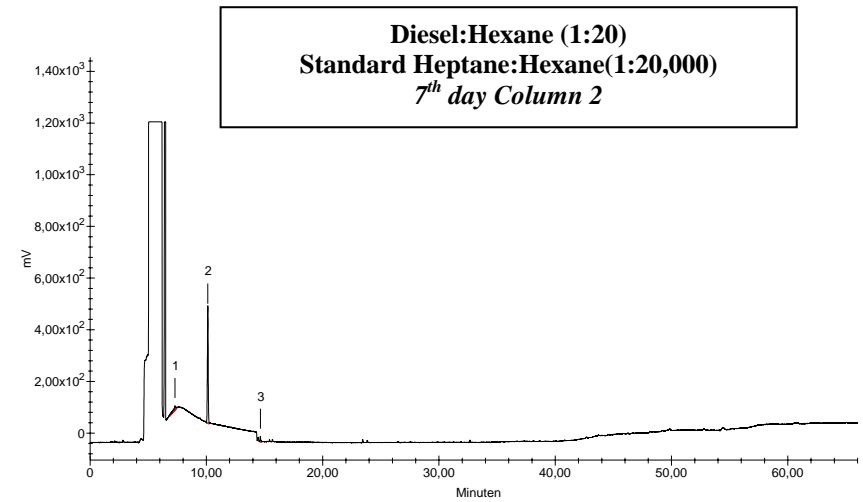
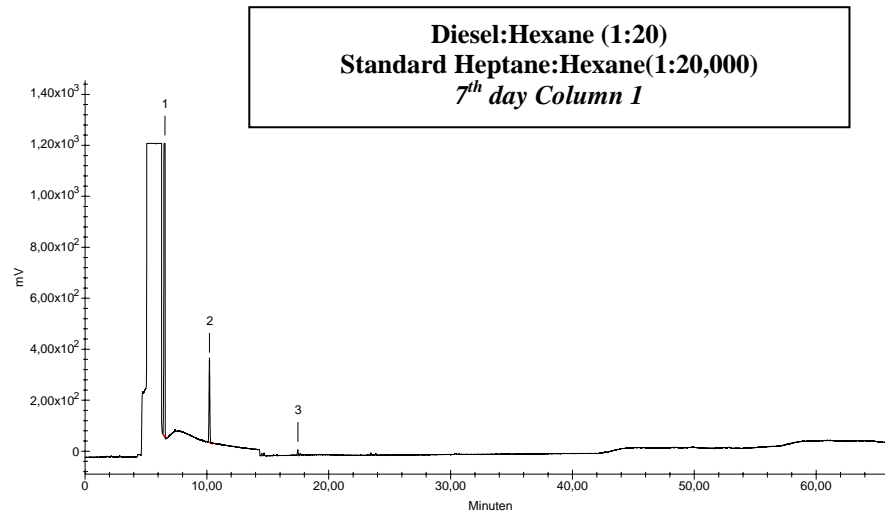

Figures 123, 124, 125, 126 Gas chromatogram; extraction (1:20); Standard Heptane:Hexane (1:20,000)dilution
Measurement after 7 days a) Column 1; b) Column 2 c) Column 3 d) Column 4

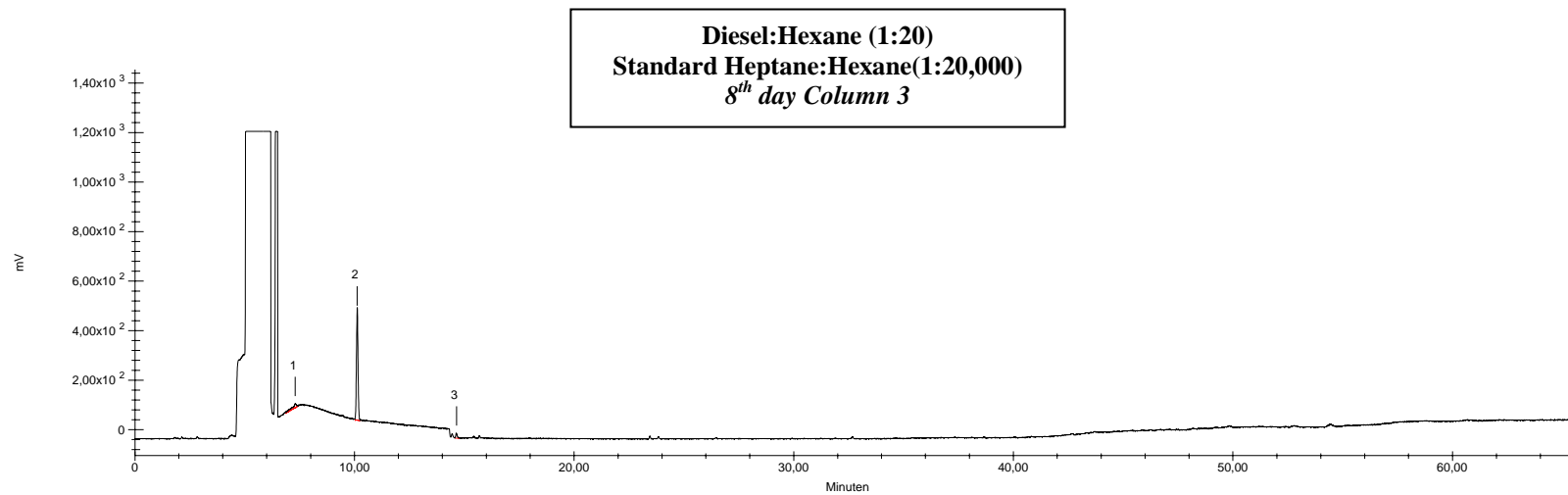
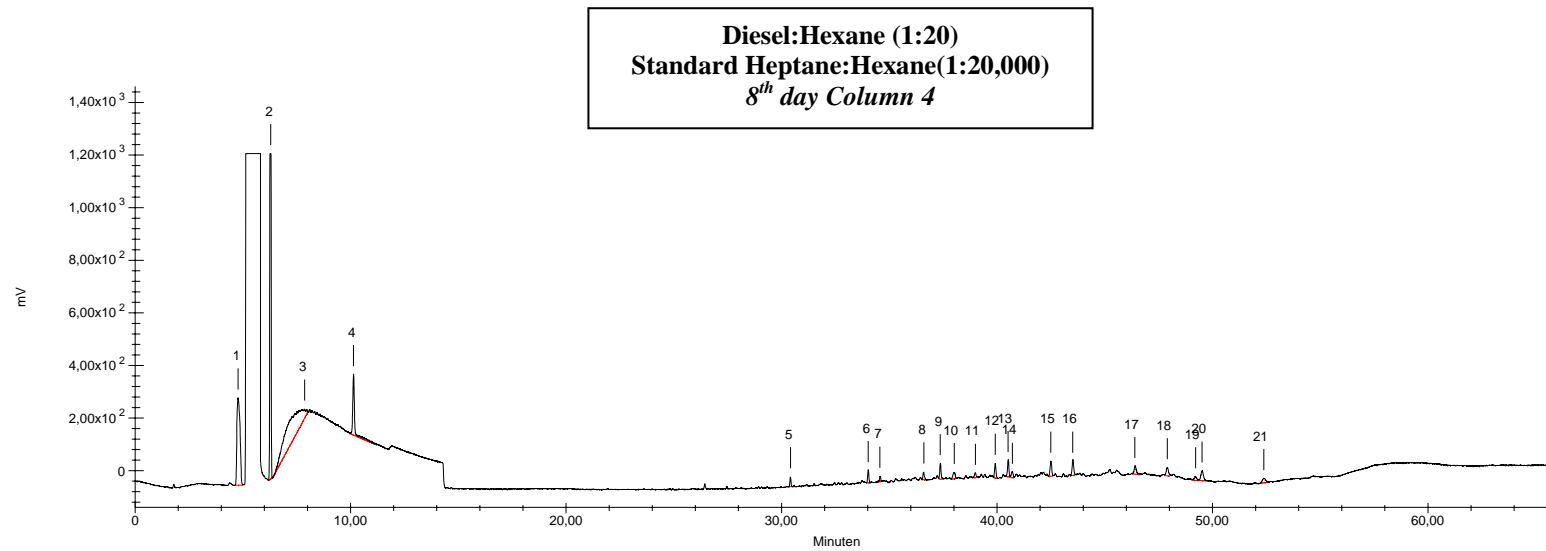

Figures 127, 128 Gas chromatogram; extraction (1:22); Standard Heptane:Hexane (1:20,000)dilution
Measurement after 8 days a) Column 3; b) Column 4

7.2.9 The first column had a retention time of 2 days, on the third day the rest of the three columns worked in series and a new sample was introduced into the first column. The same process was repeated continuously.

Table 50 Determination of diesel amount with a retention time of 1 day in Column 1 and after the second day three columns in series using a Gas chromatograph (FID)

Diesel concentration in one+3column in series									
Single Point Internal Standard test of concentration									
Conc. (mg/L)	Method	conc. Hep. (mg/ml)	Chromatogram						
			Area Hep. In.st.	A. st. diesel	Conc. st. Diesel	I.F.R.	Area Hep.	Area diesel	A. diesel GW
standard solution diesel	50°(10)3/280(20min)	34	1959638	109967590	2000	1.048			
standard solution diesel	50°(10)3/280(20min)	34	1370968	44945726	200	0.179			
standard solution diesel	50°(10)3/280(20min)	34	1390336	32955301	20	0.025			
1	50°(10)3/280(20min)	34	1959638	109967590	2000	1.048	4923127	116115130	840.60
2	50°(10)3/280(20min)	34	1390336	32955301	20	0.025	-	-	-

conc.Hep. Heptane concentration

Conc. Concentration (mg/L)

Area Hep. Int.st Area Heptane Internal Standard

A.st.diesel Standard Amount of diesel

I.R.F internal respond factor

Area Hep Area of Heptane

A. diesel GW amount of diesel in contaminated groundwater

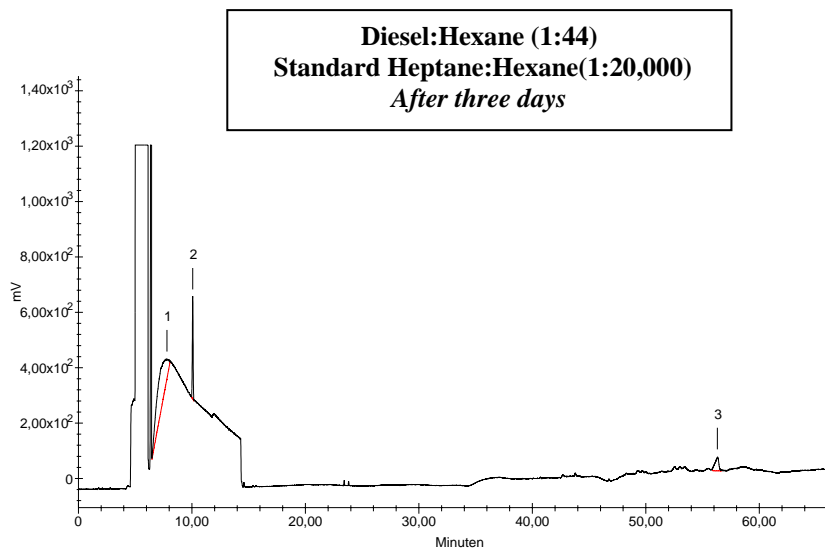
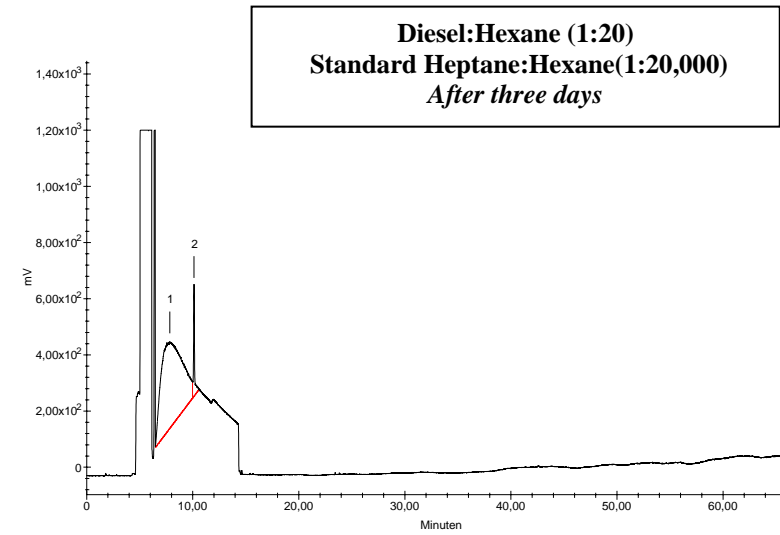
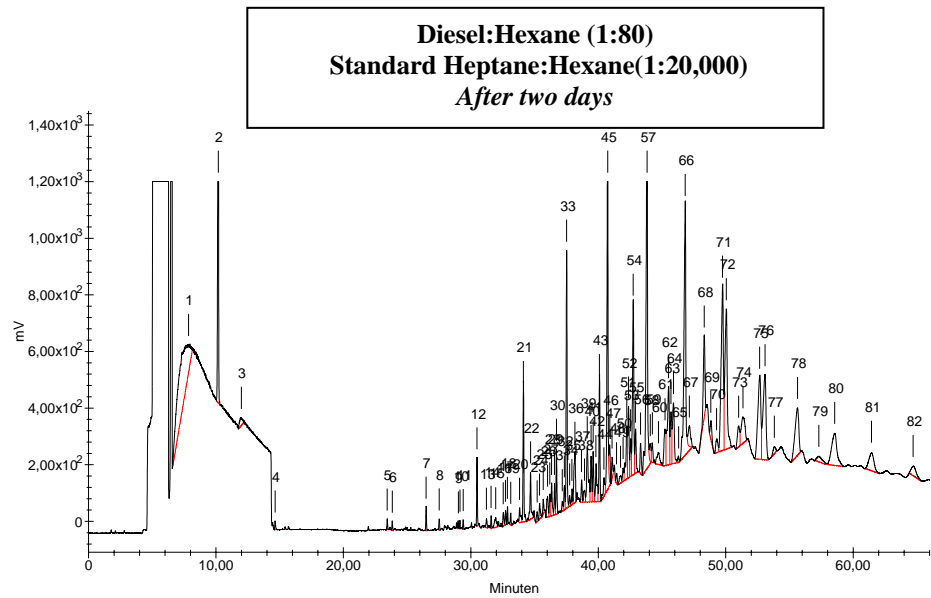

Figure 129 Gas chromatography; extraction (1:80); Standard Heptane:Hexane (1:20,000) dilution. Measurement after 2 days Column 1

Figure 130 Gas chromatography; extraction (1:44); Standard Heptane:Hexane (1:20,000) dilution. Measurement after 3 days outlet

Figure 131 Gas chromatography; extraction (1:20); Standard Heptane:Hexane (1:20,000) dilution. Measurement after 4 days outlet

Table 51 Second determination of diesel amount with a retention time of 2 days in Column 1 and on the third day three columns in series using a Gas chromatograph (FID)

Diesel concentration in one+3column in series									
Single Point Internal Standard test of concentration									
Conc. (mg/L)	Method	conc. Hep. (mg/ml)	Chromatogram						
			Area Hep. In.st.	A. st. diesel	Conc. st. Diesel	I.F.R.	Area Hep.	Area diesel	A. diesel GW
standard solution diesel	50°(10)3/280(20min)	34	1959638	109967590	2000	1.048			
standard solution diesel	50°(10)3/280(20min)	34	1370968	44945726	200	0.179			
standard solution diesel	50°(10)3/280(20min)	34	1390336	32955301	20	0.025			
1	50°(10)3/280(20min)	34	1959638	109967590	2000	1.048	2741698	243840549	3169.77
2	50°(10)3/280(20min)	34	1390336	32955301	20	0.025	-	-	-

conc.Hep. Heptane concentration

Conc. Concentration (mg/L)

Area Hep. Int.st Area Heptane Internal Standard

A.st.diesel Standard Amount of diesel

I.R.F internal respond factor

Area Hep Area of Heptane

A. diesel GW amount of diesel in contaminated groundwater

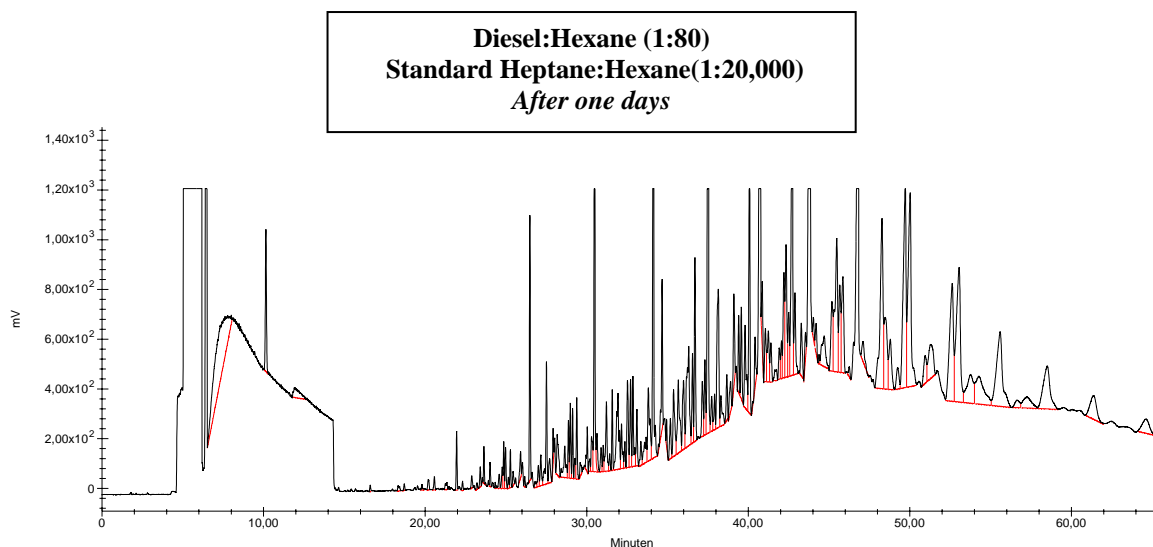

Figure 132 Gas chromatogram extraction (1:80); Standard Heptane:Hexane (1:20,000)dilution Measurement after 1 day Column 1

7.2.10 The sample was introduced in the first column and the flow velocity was controller by the retention time of the sample inside the reactor.

Table 52 Determination of diesel amount four columns in series using a Gas chromatograph (FID)

Diesel Concentration in four columns in series									
Single Point Internal Standard test of concentration									
Conc. (mg/L)	Method	conc. Hep. (mg/ml)	Chromatogram						
			Area Hep. In.st.	A. st. diesel	Conc. st. Diesel	I.F.R.	Area Hep.	Area diesel	A. diesel GW
standard solution diesel	50°(10)3/280(20min)	34	1893054	100516877	2000	1.108			
standard solution diesel	50°(10)3/280(20min)	34	1370968	44945726	200	0.179			
standard solution diesel	50°(10)3/280(20min)	34	1390336	32955301	20	0.025			
1	50°(10)3/280(20min)	34	1390336	32955301	20	0.025	1373842	12262408	7.53
2	50°(10)3/280(20min)	34	1390336	32955301	20	0.025	-	-	-

conc.Hep. Heptane concentration

Conc. Concentration (mg/L)

Area Hep. Int.st Area Heptane Internal Standard

A.st.diesel Standard Amount of diesel

I.R.F internal respond factor

Area Hep Area of Heptane

A. diesel GW amount of diesel in contaminated groundwater

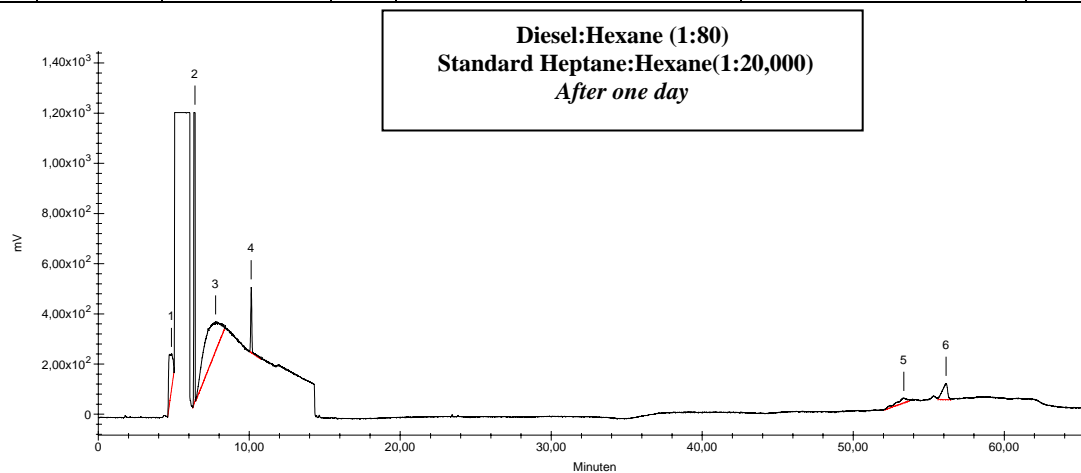

Figure 133 Gas chromatogram extraction (1:80); Standard Heptane:Hexane (1:20,000) Measurement after 1 day Column 1

7.2.11 Optimization

Previous experiments (Table 38, Figures 73-82) show that in a batch reactor the biodegradation of diesel needs around 16 days.

The results of the degradation test with the autochthonous mixed cultures in the columns can be summarized as follows: 1) *an emulsion of high amounts of diesel 2000 mg/L*; for both experiments –that with one column (Table 47, Figures 99-104) and that with four columns working in parallel as a Submerged Fixed Film Reactor with recirculation- the time of degradation was of 8 or 9 days. Additional experiments were also carried out for the optimization of the columns, for example, one with four columns working in series in which case the results showed that the degradation time was 2 or 3 days. The first experiment done in the columns working in series consisted of maintaining a retention time of 2 days in the first column, this was done because in previous experiments it had been observed that a large stage of biodegradation is reached during the first 2 days. The degradation of diesel reached a concentration of around 800 mg/L during one single day, as it had been observed in previous experiments, on the third day the contaminated groundwater was introduced in the other columns working in series. At the end of the third day no diesel was detected in the outlet.

When the experiment was repeated the measurement of the amount of diesel in the first column was higher than the amount that was introduced (Table 51, Figure 132) that means that the diesel of the previous experiment was retained by the xylite. This can be explained by the low solubility of diesel in water (Table 11). These big differences in the solubility of the diesel compounds in water complicate its behavior inside the columns. In this case the equilibrium inside the columns were impossible to be reached. During the first 2 days, when the contaminated groundwater was kept in Column 1, the reactor worked as a Submerged Fixed Film reactor. In this type of system (water-hydrocarbons) many studies were carried out by some authors, Claire Joannis –Cassan, Marie Delia and Jan Pierre Riba, 2005, prove that biofilm growth took place on the hydrocarbon surface too. This surface, estimated from the size of hydrocarbons droplets, decreased during the growth of the biofilm due to the consumption of the hydrocarbon. At the same time, the thickness of the biofilm increased due to the development of the microorganisms. Then the contaminated groundwater was transported to the other columns. After 4 hours Column 1 was almost empty. The amount of diesel that still insoluble remained capillary trapped in the xylite of Column 1 (Claire Joannis –Cassan, Marie Delia and Jan Pierre Riba, 2005) and just the soluble part of diesel went to the next columns.

- *Are there advantages associated with the use of combination of reactor types. or with multiple reactors in parallel or series?*

For an emulsion of high amounts of diesel (2000 mg/L) the columns should work in parallel as a submerged fixed film reactor and at lower concentration of diesel the columns can work in series as a trickled bed reactor with very low flow velocities and very low flow of oxygen.

- *Is single pass operation best or is recycle needed to achieve the desired degree of conversion of the raw feedstock?*

In both cases when the columns work in parallel as a submerged fixed film reactor and in series as a trickled bed reactor, recirculation is necessary with at very low flow velocity (3.84 L/day).

7.2.12 Recomendations

Even the parallel arrangement was better with a Submerged Film reactor more studies should be done in the biofilm growth kinetics. Some authors, Claire Joannis –Cassan, Marie Delia and Jan Pierre Riba, 2005, founded that the protein content of the biofilm was 51% in the liquid-liquid system and 12% in a solid-liquid system. From one side proteins are partially responsible for the cohesion of the biofilm, and from the other side a very thick biofilm can growth and a diffusion limitation of oxygen and hydrocarbons within the film had been already observe in other experiments. It can be possible too that the microorganisms consume by themselves the polymer of the biofilm but more studies should be done.

7.2.13 Result Benzene Biodegradation

7.3 Construction of Benzene biodegradation curve

Table 53 Optimisation of microbial growth

day	1 st experiment (1L sample) (CFU/ml)	2 nd experiment (1L sample) (CFU/ml)	3 rd experiment (1L sample) (CFU/ml)	O ₂ (mg/L) 3 rd experiment	Air Flow	4 rd experiment	O ₂ (mg/L) 4 rd experiment	Air Flow
0	$9.7 \cdot 10^5$	$5.4 \cdot 10^6$	8×10^6	16:00 hrs 9.26 18:00 hrs 7.19 19:00 hrs 6.56	- 10ml/min 10ml/min	$1.12 \cdot 10^7$	16:00hrs. 9	-
1	$5.3 \cdot 10^7$	$4.8 \cdot 10^7$	1.1×10^7	10:00 hrs 3.95 11:00 hrs 5.06 14:00 hrs 5.50 17:00 hrs 5.70	- 10ml/min 10ml/min 10ml/min	$3.5 \cdot 10^7$	10:00hrs 6.50	10ml/min
2	$9.8 \cdot 10^7$	$9.1 \cdot 10^7$	1.07×10^7	10:00 hrs 4.96 15:00 hrs 5.70	- 10ml/min	$3.1 \cdot 10^7$	10:00hrs 6.85	10ml/min
3	$1.5 \cdot 10^8$	$1.1 \cdot 10^8$	9.7×10^6	10:00 hrs 3.88 17:00 hrs 4.15 19:00 hrs 5.00	- 10ml/min 10ml/min	$2 \cdot 10^8$	-	-
4	$1.21 \cdot 10^8$	$1.20 \cdot 10^8$	7.6×10^7	10:00 hrs 2.37 12:00 hrs 2.80 15:00 hrs 0.82 17:00 hrs 2.57 19:00 hrs 2.74 20:00 hrs 3.29	- 10 ml/90 s 10 ml/90 s 10 ml/90 s 10 ml/90 s 10 ml/90 s	$5.3 \cdot 10^7$	16:00hrs 0.65 18:00hrs 0.25	10 ml/90 s 10 ml/90 s
5	$1.34 \cdot 10^8$	$5.7 \cdot 10^7$	1.6×10^8	10:00 hrs 6.25 13:00 hrs 6.34 16:00 hrs 5.80 17:30 hrs 5.60 19:00 hrs 5.70	10 ml/90 s 10 ml/90 s 10 ml/90 s - -	$7.8 \cdot 10^7$	10:00hrs 1.26	10 ml/90 s
6		$5.9 \cdot 10^7$	8×10^7	13:00 hrs 4.90	-	$6.4 \cdot 10^7$	14:00hrs 0.65	10 ml/90 s

7		$3.9 \cdot 10^7$	$4.5 \cdot 10^7$	14:00 hrs 5.00	10 ml/90 s	$6.4 \cdot 10^7$	8:00hrs 0.25 14:00hrs 0.65 17:00hrs 0.80 19:00hrs 2.97	10 ml/90 s 10 ml/90 s 10 ml/90 s 10 ml/90 s
8		$4.6 \cdot 10^7$	$5 \cdot 10^7$	10:00 hrs 6.70	10 ml/90 s	$1.10 \cdot 10^8$		
9		$3.7 \cdot 10^7$	$5.6 \cdot 10^8$	10:00 hrs 6.97	10 ml/90 s	$3.3 \cdot 10^8$		
10		$3.0 \cdot 10^7$	$4.1 \cdot 10^7$	11:30 hrs 6.97	10 ml/90 s	$1.6 \cdot 10^8$		
11			$4.8 \cdot 10^7$	10:00 hrs 6.70	10 ml/90s	$9.9 \cdot 10^7$		
12			$5 \cdot 10^7$	10.00 hrs 6.83	10 ml/90 s			

Note: The temperature was almost constant in a range of 23-25°

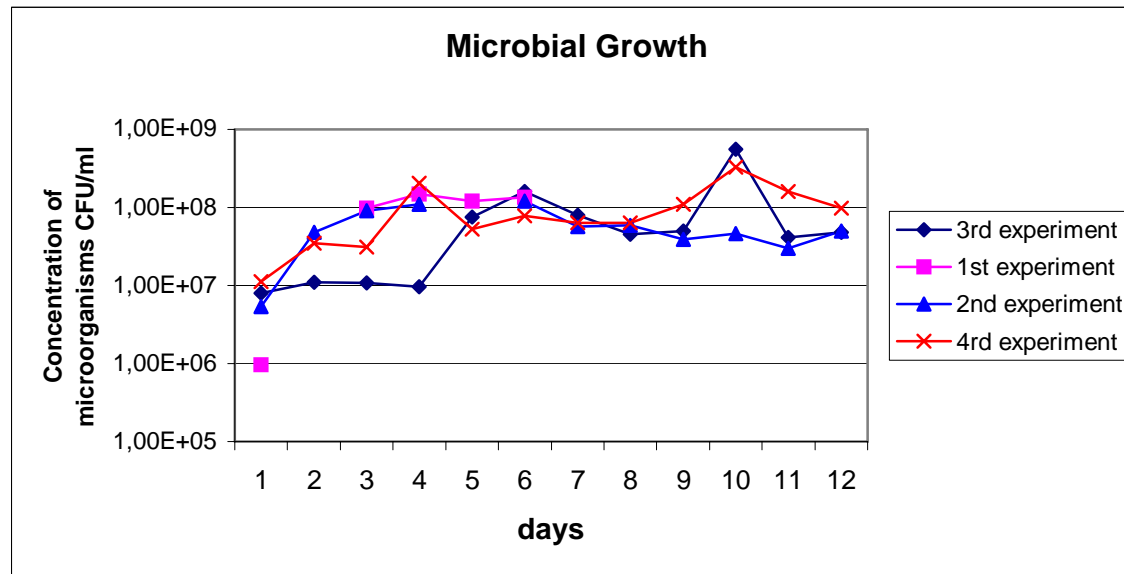

Figure 134 Microbial Growth 1st and 2nd experiment with constant O₂ and 3rd experiment with no constant oxygen; 4th experiment optimised

Table 54 Benzene concentration after 24 hours; oxygen flow

Parameter	Concentration (mg/L)	Method
Solubility of benzene	1270	DIN 38407-F9
Benzene+microorganisms	22.5	DIN 38407-F9
Benzene test of evaporation	195	DIN 38407-F9

Table 55 Benzene concentration after 11 days

Parameter	Concentration (mg/L)	Method
Benzene+microorganisms	0.0001 mg/L	DIN 38407-F9

Acclimation is solely a reflection of time for the population size to become larger enough to effect a detectable change any factor that enhances (or diminished) the growth rate would shorten (or lengthen) the acclimation (Martin Alexander. 1999), in this case it was proved that the principal factor is the concentration of oxygen. It was necessary to add oxygen just in certain periods of time due the evaporation of benzene in the first experiments (Table 54). In many environments the low concentration of N:P or possible other inorganic nutrients are the principal reason for longer acclimation phase, this in not the case. On the 7th day when a decrease in the biomass was register the amount of nitrate and phosphate was measure. enough amount of both salts still present. With the previous analysis it is evident that the acclimation may appear to be longer at high substrate concentrations: more time is required for the cell density to become larger enough to give a detectable loss at higher than at lower substrate concentrations. There are many reasons to explain the longer acclimation at higher than at lower concentration, since the microorganisms need longer time to give the necessary cell number. But this effect was avoided with the second addition of chemicals to the same microorganisms the population became sufficiently large as a result of the first addition. The population size rises following the first treatment. If the cell number or biomass remains large from season to season or between the chemical application the second increment disappears more readily than the first. This effect can be observed in the first experiment the biomass concentration at the beginning was of $9.7 \cdot 10^5$ on the second experiment where the contaminant was added to the same biomass the first concentration was bigger $5.4 \cdot 10^6$ and in the third even more $8 \cdot 10^6$. If the population declines to about its original size before the next addition a long acclimation will again be evident but this is not the case. Because the contaminant are added constantly to the same biomass an acceleration in the reaction will appear at the start of each growing season in a population size that is larger than that at the start of the previous growing season (even if the cells die after all the chemical is metabolised) this ever larger number of cells would result in an even shorter acclimation phase.

The analysis of these experiments is very useful in the optimisation of the acclimation time. the acceleration of the reaction to prove if no MSM should be added during the process of bioremediation and to know the optimal flow of oxygen (10ml/90 seconds) to maintain a concentration between 8-6 mg/L which is the optimal for growing. The oxygen was added just when it decreases in more than 4 mg/L. After 24 hours benzene was present (Table 54). Therefore with the optimal conditions that could be concluded from the analysis of the first and second experiment a new test was done after 11 days the sample was sent to analysis to know the concentration of benzene (Table 55). The concentration of benzene reaches the German regulations (Table 1). The fourth and last experiments where done at the same conditions as the third experiment, the results are as follows (Table 56).

Table 56 Benzene biodegradation

Parameter	Concentration (mg/L)	Method
Solubility of benzene (0 day)	1270	DIN 38407-F9
Benzene+microorganisms (2 nd day)	488	DIN 38407-F9
Benzene+microorganisms (4 rd day)	204	DIN 38407-F9
Benzene+microorganisms (7 th day)	7.22	DIN 38407-F9
Benzene+microorganisms (9 th day)	0.001	DIN 38407-F9

A new sample was prepared and was introduced into the Trickling fixed bed reactor. The columns were in equilibrium, that means that the concentration of benzene is the same in the outlet and inlet of each column. The initial concentration of benzene was the same of the previous experiments (1270 mg/L). The reactor was working at a velocity of 8 L/day and with flow oxygen of 10 ml/30 seconds. The sample was constantly recirculated. The results are as follows:

Table 57 Benzene biodegradation in the four columns

Parameter	Concentration (mg/L)	Method
Solubility of benzene (0 day)	1270	DIN 38407-F9
Benzene+microorganisms (2 nd day)	50.5	DIN 38407-F9
Benzene+microorganisms (4 rd day)	27.9	DIN 38407-F9
Benzene+microorganisms (7 th day)	7.22	DIN 38407-F9
Benzene+microorganisms (9 th day)	0.755	DIN 38407-F9
Benzene+microorganisms (12 th day)	0.001	DIN 38407-F9

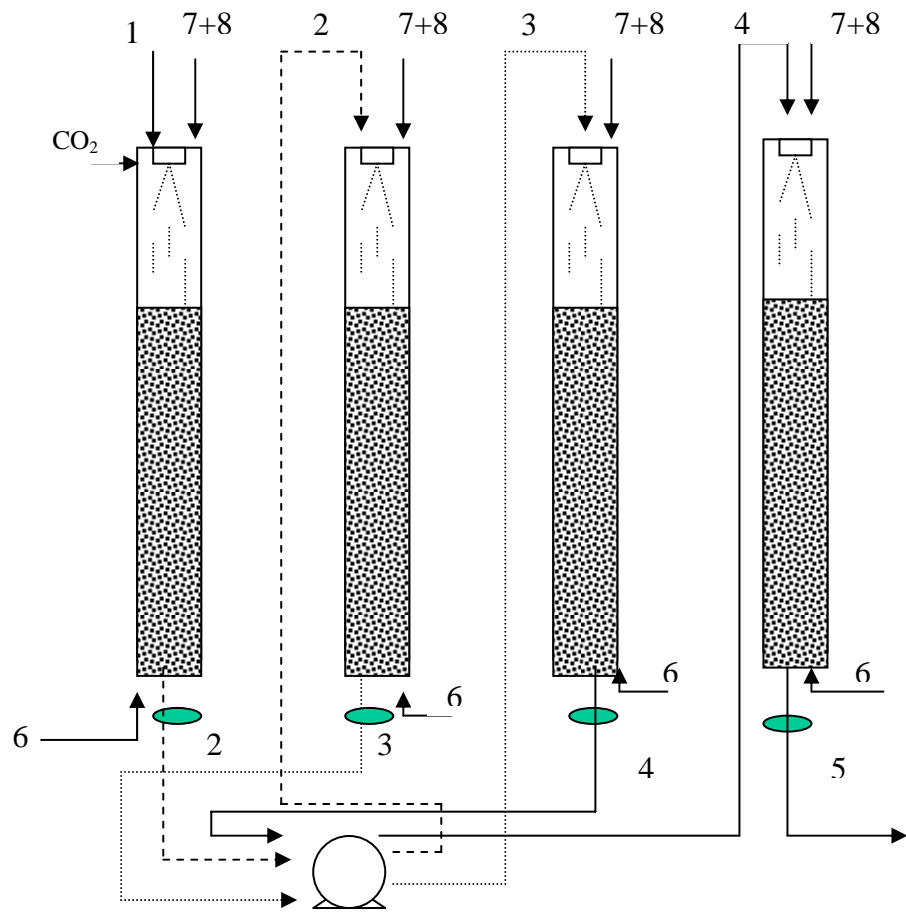



Symbol	Name
1	groundwater + diesel 2000 mg/L (inlet)
2	groundwater + oil form outlet of Column 1
3	groundwater + oil from outlet Column 2
4	groundwater + oil from outlet Column 3
5	groundwater ≈ 0.1 mg/L (outlet)
6	oxygen
7	mineral salt medium CNP (Table 30)
8	Inoculum
	sampling point
	xylite

Figure 104 Scheme of the construction of the column



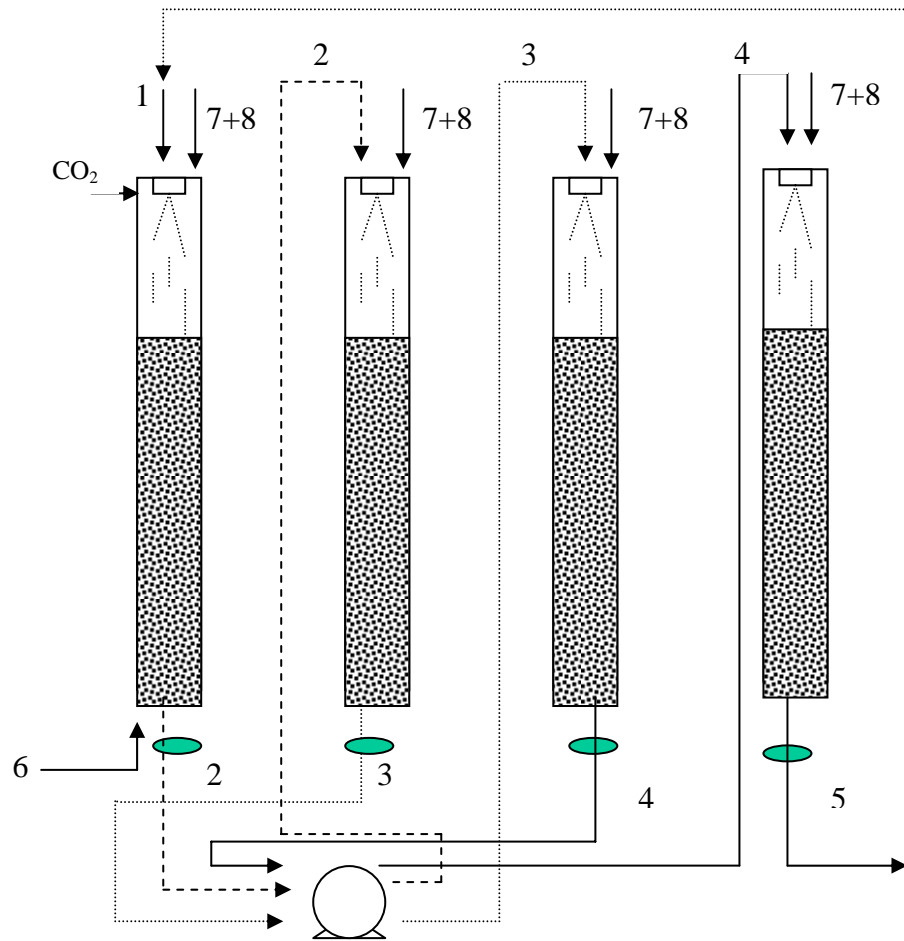

Symbol	Name
1	groundwater + diesel 1 mg/L (inlet)
2	groundwater + diesel 1 mg/L (Column 1)
3	groundwater + diesel 1 mg/L (Column 2)
4	groundwater + diesel 1 mg/L (Column 3)
5	groundwater = 1mg/L (outlet)
6	oxygen
7	mineral salt medium CNP (Table 27)
8	Inoculum
	sampling point
	xylite

Figure 105 Columns in equilibrium

8 General Discussion of the Thesis

The most important phase of a remediation project is developing the strategy. A good strategy will save more money than implementing the most advanced treatment technology on a project. The first step is setting the right objective (Evan K. Nyer, 1998).

An important determinant for successful application of bioremediation is the physical nature of the contaminated matrix. Site features strongly influence whether bioremediation is feasible and which bioremediation approaches will be effective.

The successful practice of bioremediation of wastes and contaminated materials requires the completion of sequence of steps, which are the following:

1. Site Characterization
2. Initial feasibility testing
3. Detail biotreatability testing, pilot testing, and design (including hydrogeology)
4. Procurement, installation, and start up
5. Process monitoring and operation
6. Final Sampling and closure
7. Reporting and management

The *Site Characterisation* should be started with the records concerning the site and its history. In this step it should be defined if the field is proposed to be remediated due to 1) an investigation as part of the real estate transaction, 2) a notice of violation for an operating permit as a facility or 3) a voluntary action because the owner knows the site is contaminated as a result of previous or current activities conducted there. The typical questions that should be asked are: a) Have any spill or leaks been reported? b) What chemicals were stored, used or handled at the site? c) What agencies have responded to incidents at the site? d) Are there or were there any underground storage tanks at the site? What are stored in them? A site history is required to answer the questions. The methods for measuring the concentration of contaminants is important to be defined in this step.

The most important part of the site Characterization is a sidewalk to review the locations of potential trouble spots. Almost all the authors with high experience recommended to write a report of all the commentary and observations. This is the

first opportunity to estimate how extensive the potential contamination is and what may be required to clean the site. It is also time to determine where to make borings for initial samples of soil and groundwater in order to begin outlining the extent of the contamination or to prove that no contaminants exist. After the site walk, the site map is marked and a detail sampling plan is developed, often for review and approval by the appropriate regulatory agency. Obviously, the sample locations are not usually known in advance with a high degree of accuracy or certainty. Therefore, the samples for feasibility testing often are taken during a second sampling round to delineate the extent of contamination found as a result of the first sampling event. The purpose of the sampling exercise is to determine, the maximum extent possible, the nature of (and the horizontal and vertical extent of) the contamination at the site. This sampling exercise often takes more than one sampling event to complete.

Finally the objective of the Site Characterization Site is to answer three principal questions: 1) what is the contamination (including materials that are high toxicity) and what are the concentrations of these materials? 2) What is the soil texture, and can materials be moved through it using air or water carriers? 3) Is the contamination above, below, or in the water table, and what is the degree of contamination of these horizons? These three questions required that the site chemistry, geology, and hydrogeology be initially characterized in order to determine whether bioremediation appears to be a viable option. If these conditions are favourable, then further work can be done as the project progresses to get a sharper picture of these site parameters and to develop an effective bioremediation design.

Few commentaries can be said about the Site Characterization of this project since this investigation is basically a laboratory study, even though it is very important to mention because no laboratory study can be started without having the basic data that this study provides. Evaluation of the magnitude of the problem and the ultimate remediation strategy depends initially upon the accurate detection of the contaminants and its volume evaluation. It is obvious that a whole bioremediation project needs the participation of many technical professionals but all of them should know what are the contributions of its participation to the project (Raina M Maier, Ian L, Pepper and Charles P. Gerba. 2000).

Many authors affirm that “No all biological treatment system designs and contemplated bioremediation activities require extensive up-front laboratory testing as part of the phased approach to successful bioremediation”. This sentence brought me to a big confusion and it was contradictory of what I usually read. At the end of this project I can concluded that this sentence means that the experience of the expert is very important in this cases, sometimes the expert can find that some projects can be approach with confidence and very little preparatory investigation. This decision can be also influenced by the person or institution that will pay the project. However, when the decision of a *Laboratory Study* is taken, these tests served a number of functions associated with the project, including:

1. The provision of valuable design information
2. A determination of existing condition at a site
3. A search for potential “knock out” factors which might preclude the use of bioremediation
4. A basis from which to determine the probability of success

I agree with some authors (R. Barry King, Gilbert M. Long, John K. Sheldon, 2000) that laboratory testing is sometimes erroneously looked upon as an unnecessary delay in a project “re-inventing of the wheel” or the display of a lack of confidence or competence on the part of the professionals who are recommending a biological treatment approach. These are unfortunate misconceptions based on ignorance and indifference to acceptable bioremediation practice. The design and conduct of a quality laboratory study (or even minimum effort) can save valuable time on a project and can significantly *reduce the ultimate cost*.

In this study I took the decision to make a deep Laboratory Study.

The measurement of the concentrations with the two different equipment that were used are not the same, this could be because the Oil Counter Analyzer (OCMA-310) is able to detect Total Hydrocarbons and the Gas Chromatograph FID can just detect components with retention times between n-decane ($C_{10}H_{24}$) and n-tetracontane ($C_{40}H_{82}$) and compounds with very high volatility and.

In the selection of the nutrients, which are requirement of the microbes to build cells, the macronutrients were just considered in this project. The first reason for this consideration is that macronutrients, which are nitrogen and phosphorous are elements

of major components of all cells and that the required supply of micronutrients as sulphur, potassium, sodium and other metals such as copper, magnesium, zinc and iron is very small.

The second reason is that in case of scalability of the fixed-bed reactor the most economical option should be considered. In this study good results were reached with a level of C:N:P (100:5:0.5) even with higher concentration of 4000 mg/L of diesel. Once the Screening studies were gathered it was determined that the results obtained in the *Bioassessment Screening Studies* did not show a knockout factor. This means that no of the following was present:

- Lack of suitable indigenous bacterial populations
- Precipitation of essential nutrients by soil components (especially calcium precipitation of orthophosphate)
- Unsuitable environment initially as indicated by pH or Eh problems (this can also be indicated by low bacterial counts)

Therefore, until this point there was no reason that would eliminate bioremediation, and a more detailed study was required to identify more factors and parameters involved in the bioremediation process.

Before starting the first study of the second part, *Biotreatability*, in the Laboratory Work, was very important to know the really objective of these steps. The objective is to identify the optimal conditions for (and to determine a general rate) degradation of the target compounds. Treatability studies generally do not determine the extent of degradation or define the ultimate bioremediation end point, often referred to as “how low” could you go? The extent of testing will depend on the equipment available and the target compounds of interest.

Regular sampling and analysis for the target contaminant concentrations was monitored as the remediation proceeds. In some cases the predicted degradation by-products in the first steps when the biodegradation is not known could take a lot of time and a big number of tests. Because they are quite expensive, these analytical procedures will tend to affect the cost of the design phase more dramatically than any other component. If frequent analysis are considered it is better to use a broad-based parameter such as *total organic carbon* (TOC) *total petroleum hydrocarbons* (TPH), all of which are relatively inexpensive. In this case a Gas Chromatograph (FID) was

used. The limit of detection is of above 0.1 mg/L of Total Hydrocarbons and the accuracy of the equipment is not very high. But for high concentrations and to get the experience of the biodegradation process is enough. The Method that was chosen was the *The Internal Standard Method of Chromatogram Evaluation via Peak Area*. The principal reason was because this method eliminated the need for accurate injections since a reference standard is included in each sample analysis in this case heptane (A. Braithwaite and F.J. Smith. 1997). The procedure of calibration and extraction was based in the European Standard following the International Norm (ISO 9377-2:2000). The objective of the thesis is to reach the limits of drinking water, therefore, when the remediation proceeds was known, less frequent use of analyses for all the target compounds was necessary to provide a detail degradation rates. Then the analytical analyses were minimized and the samples were send to a Laboratory.

The first study in the Tratability tests was related to the adsorption of the xylite and the soil that was present in the first test of bioremediation.

The soil presented an adsorption of 14% but it was eliminated having a preculture in a separated flask where the microorganisms are constantly growing at the best conditions. 50 ml of the preculture is filtrated and after inoculated to the column, with this the direct addition of soil was avoided.

The xylite needed 34 days of constant recirculation of contaminated groundwater for its saturation. After this day there is a period of time where no adsorption appears but after some days the process of absorption started again and still constant with a percentage of 27-25%.

The amount of diesel is not the only factor that saturated the xylite the cell immobilization on the solid surface play an important role too. It has been proved that when a high solid adsorbent is use in a reactor as a packed bed and the adsorbent has been saturated with the substrate (diesel) then as the film grows, this substrate will slowly desorbs and feed the base of the film. Furthermore, any organic products formed can adsorb onto the packed bed thus reducing their inhibitory effects on the biomass. The cells themselves are very large to enter the pores of the adsorbent depending on the size of pores of the packed material (Murray Moo-Young. 1988). This could be the case of the xylite since is a high adsorbent material but more studies should be done. Other parameters should be taken in account too as:

- PH has a considerable effect on microbial attachment. Several studies (Navarro. J.M. and Durand. 1980 and Marcipar A., Cochet. N., Brackenridge. L., Lebeault, J: M., 1978) found that a simple modification in pH induces and important variation of the carrier retention properties as a consequence of the particle microenvironment modification. it has been proved although that the rate of adsorption is rather specific for each microorganism.
- Ion strength plays an important role in microbial adsorption too. At equal pH values, an increase in ionic strength of the medium results in an increase in the percentage of cells adsorbed. At pH 4, in the absence of NaCl, the percentage of cells immobilized was 8.86%. With addition of NaCl to a final concentration of 2 M. the percentage of cells immobilized increase to 16.03%. An increase in microbial binding due to ionic strength was also observed at pH 6.0. Even small modifications could result in microenvironmental changes which would affect charges on cell or support surface, ion-ion interaction, or support cell partial covalent bond formation, thereby modifying the adsorption.
- Studies have done (Vijayalakshmi et.al.) suspending the support material in 0.5M FeCl₃ solution at a constant pH for 24 hrs. Then the support is washed. It has been proved that the carrier with Fe³⁺ retains almost 50% of cells. It is clear that the addition of inorganic metal ions to organic carriers greatly influences the support capacity for the cell adsorption.
- Surface attachment in bioreactors makes laboratory data inaccurate and scale-up difficult. Even the bioadhesion can be voluminous, the quantitative analysis of these process and mechanism has been complicated by the nonideality of living cells.

Degradation tests

From the separated flask for the inoculum of the columns the microbial growth was monitored plating the microorganisms daily. With this data it was possible to observe the growth phases of the microorganisms and to predict when MSM should be added in order to maintain a constant concentration of microorganisms.

The experiments of degradation with an amount of diesel of 2000 mg/L with a level of MSM of C:N:P (100:5:0.5), inoculum and no xylite needed around 15 to 16 days to be almost degraded. During this degradation the microbial growth was monitored the microorganisms in agar plates in the same moment when the samples for the analysis were taken.

Data plots of first order versus time, presents the best description for the model since the coefficient of correlation is of 0.926, this means that the reaction rate is dependent of the concentration. But in this study it is not only important the chemical reaction engineering but also the biochemical reactions, which are characterized by their use of enzyme or whole cells to carry out specific conversions. Therefore, it is impossible to determine the order of reaction without the study of the kinetic microbial growth.

The Kinetic microbial growth represents graphically the equation of Monod. The constant K_s for the reaction is the concentration of the substrate was 60 mg/L. This is the concentration required to give half the maximum rate. The experiments were repeated several times, the biodegradation duration in the separated glass was always between 15 and 16 days. It can be concluded that with a specific growth rate of 0.084 hr^{-1} an almost complete biodegradation can be reached.

At high concentrations of diesel (2000 mg/L) the growth rate was not inhibit. When the substrate concentration is low the growth is dependent on the substrate concentration. As the substrate concentration decrease, the rate of growth will also decrease. This type of growth is typically found in a batch flask as the one that was used for this experiment and which is very helpful to simulate the behaviour of the microorganisms inside the columns. With this explanation is possible to understand why the best order of reaction was of one and not of zero order even the concentration was very high.

The *microbial activity* measured by the carbon dioxide generation of the bacteria in a closed system. as an indicator of the degradation rates of the contaminant, is an informative parameter of the diesel biodegradation. A higher percentage of CO_2 was observed in the first column, this could be due the highest amount of diesel during the first steps of the biodegradation that takes part in this column.

The authors, R. Barry King, Gilbert M. Long, John K. Sheldon, affirm that groundwater contaminated by organic solvents or fuel hydrocarbons should always be assessed in terms of in situ bioremediation prior to implementation of any other

alternative. But they mention too that if a standard-pump-and-treat method with surface treatment will be employed, simultaneous nutrient injection of a portion or all of the produced water will: (1) speed the time to completion of the project, (2) ensure a clean closure, and (3) conserve precious groundwater resources. In addition, surface biotreatment of extracted groundwater could prove to be more cost effective than other surface treatment alternatives. Therefore, they suggest that a combination of surface and in situ biotreatment simultaneously is the best option. For the objective of the project there are enough reasons to think that a bioreactor is the best option, since drink water is basic for living.

Since the concentrations of the three samples were different and one of them had very high amount of diesel (2000 mg/L) present as an emulsion, some Literature Study was done and a modification in the *columns* was necessary. A combination of suspended – growth and fixed-film reactor designs was constructed. In this unit the packed material is submerged in the water in the reactor tank. The bacteria grow on the packed material as in the fixed bed system; however. the water is in contact with the film, as opposed to passing through the thin films. This design mode can accommodate an influent with an organic content ranging from 50 to 5000 mg/l. This range covers two of the samples 2000 mg/L and 63.2 mg/L. For the Sample with a concentration of 35.8 mg/L the columns can work as a Tickled Fixed Film Reactor.

When the monitoring of the samples of the reactor indicates that the remediation target concentrations have been reached or are almost reached, the type of analysis may be more detail, because the objective is to determine the final concentration of all the target contaminants. In this case a more intensive study was done for Benzene due to the limitation of the Gas Chromatograph (FID), the samples were sent to a special Laboratory.

Constrains of the GC Method

- The GC-FID method is limited to reporting compounds with retention times between those of n-decane ($C_{10}H_{24}$) and n-tetracontane ($C_{40}H_{82}$). From this it is seen that dissolved gas and volatile aromatics. and dispersed light hydrocarbons and very heavy hydrocarbons are not detected by the GC method

- The Method that was used (Method using solvent extraction and gas chromatography ISO 9377-2:2000 previously described) is convenient for the determination of hydrocarbons in drinking water and surface water with concentrations higher than 0.1mg/L.

Benzene Biodegradation

The release of petroleum hydrocarbons in the environment which a widespread occurrence, on particular concern is the contamination of drinking water sources by the toxic, water soluble, and mobile petroleum components benzene, toluene and xylene (BTEX) (Barker, J.F. 1987. Chiang, C.Y., 1989. Hutchins, S. R. 1989. Lee, M.D., 1988, Rifai. H.S., 1988, Thomas, J.M. 1990, Verheul, J.H.. 1988).

High amount of benzene was lost by the adding of oxygen to the system therefore it was necessary to go in more detail to the best conditions in which oxygen can be degraded trying to avoid as much as possible the lost of benzene, another Literature study was done:

Controversy exists as to whether the presence of oxygen is a necessary precursor in the biodegradation of non-substituted aromatic hydrocarbons. Some researchers have proposed that the initial steps in the biotransformation of non-substituted aromatic hydrocarbons require attack by oxygenases, thus necessitating the presence of oxygen (Cerniglia. 1992). However anaerobic biodegradation of benzene has been reported under denitrifying (Mayor *et al.* 1998), sulphate reducing (Edwards and Grbic-Galic. 1992), and methanogenic conditions (Grbic-Galic and Vogel. 1987). Biodegradation of substituted aromatic hydrocarbons (e.g. toluene) has also been reported to be feasible under anaerobic conditions, including denitrifying, sulphate reducing and methanogenic conditions (Edwards et al. 1992; Hutchins. 1991; and Grbic-Galic and Vogel. 1987). A common finding from most studies on biodegradation of aromatic hydrocarbons is that, transformation under aerobic conditions.

Interest is growing in bacteria metabolism under microaerophilic conditions (dissolved oxygen < 2mg/L), particularly in the presence of significant quantities of nitrate. A combination of oxygen and nitrate may lead to complete mineralization of certain aromatic hydrocarbons. Once the concentration of oxygen becomes limiting, between 0.1 and 1 mg/L. The microorganisms begin using nitrate and continue using any oxygen that enters the region.

The next step would be to rely try to depict the actual field experience that is really necessary and can only be approach in an actual *Pilot Test* on the actual field site. in this case the columns were just constructed in the Laboratory. Various modifications can be made during the pilot test period to determine the best operating conditions for the system. Employment of a stringent analytical protocol is highly beneficial during the pilot test in order to thoroughly document treatment efficiency. The pilot plant test is most often conducted when the owners or regulators are inexperienced in dealing with bioremediation technology and required a confidence boost. Pilot test are also conducted when there are technical issues which need to be resolved in large projects before proceeding to full-scale operations. The resolution of these issues can greatly affect the total amount of money spent by the owner. At this point, the system design is sufficient complete to provide predictions about a cost estimate and remediation time requirement with some degree of confidence.

The process of Monitoring and Operation will consist in checking at regular intervals for the following:

1. Microbial health as measured by population counts or relative toxicity
2. Water conditions as determine by dissolve oxygen. pH, conductivity, oxidation/reduction potential, and dissolve ammonia nitrogen and o-phosphate content.
3. The contaminant concentrations will normally be monitored on a regular schedule, with frequency ranging depending on the results previously obtained in the previously results obtained in the laboratory.
4. Nutrients and oxygen will need to be added on a schedule initially determine by the feaseability testing and made part of site work plan. Adjustment to pH may also be required based on the data obtained above.

9 Conclusion

- Mexico still working in the new regulation for drinking water. For this reason, the limits for drinking water will be taken from the German Regulations as a reference.
- *Bioremediation* does not work at every site, is not necessarily the least expensive method at every site may not meet the remediation timetable at every site and may not achieve the necessary cleanup standards at every site.
- *The Biofeasibility testing* using plate count techniques has some constrains, 1-10% of the number of cells observed with direct microscopic counts can be recovered as viable bacteria using plate count techniques. This may be due viable organisms that may become nonculturable because of stress imposed on them during the extraction and dilution process. Another reason is that competition that occurs among bacteria to form colonies may suppress the growth of some microbes. In addition all microbes have different optimal minimal growth conditions with respect to nutrient and electron acceptor requirements. Thus, some microbes grow very slowly or not at all on the plating medium.
- The Monod equation is the best way to describe the dependence of microbial growth rate on feed concentration, first because the chemical reactions occurring inside a microbial cell are generally mediated by enzymes, and it would be reasonable to suppose that one of these reactions is for some reason slower than the others. Another reason is that the rate determining step may be controlled by the transport of the feed through the boundary layers to microorganism or through the membranes forming the cell wall itself. Even if the transport is active the rate equation will be of the same general form and results in the Monod type equation (Coulson and Richardson. 2003).
- The Submerged Fixed Film reactor is able to biodegrade the diesel from a concentration of 2000 mg/L to 0.5mg/L. Concentration required by the German Limits of drinking water.

- The Trickled Fixed Film Reactor working in series with recirculation and a combination of oxygen and nitrate as a source of electron acceptor may lead to complete mineralization of Benzene, reaching a concentration of 0.001 mg/L required by the German Limits of drinking water.
- The solubility of organics compounds play a very important role in the decision of the type of reactor that will be used.
- The equilibrium in the columns was impossible to be reached at high concentrations of diesel due to low solubilities of organics in water. The insoluble part of the organics is trapped in the xylite instead of being degraded.
- At lower concentrations of diesel (1-2 mg/L) and higher concentrations of Benzene the columns can work efficiently as a trickled Fixed Bed Reactor, because solubility is not a limiting factor.
- In the Laboratory a modification in the reactor was done for the Sample with high concentration but in a real case a study cost should be done and maybe in this case where two phases are present is better to remove the free-phase of LNAPL because it is the most concentrated source of hydrocarbon material. These hydrocarbon materials in high concentrations can pose a threat of recontamination. The recovery liquid can sometimes be reused as a fuel or for product blending material. The water pumped from the well almost always requires treatment to remove the soluble organic materials prior to its disposal or reinjection, in this case the alternative will be the trickled film reactor. This decision can be taken in the Pilot Test. The advantage of the Laboratory study is that it can give all the possible alternatives to solve a problem because in such small scale is easy to have the control of all the variables. Not all the possibilities obtained in the Laboratory are possible in the real case but they give the experience necessary to have a better decision in the Pilot Plant

10 Bibliography

A. Braithwaite and F.J. Smith, 1997. *Chromatographic methods* (Fifth Edition), Blackie Academic & Profesional.

A. Massol-Deyá, R. Weller, L. Rios-Hernández, J.Z. Zhou, R.F. Hickey and J.M. Tiedje, (1997). Succession and Convergence of Biofilm Community in Fixed-Film Reactor Treating Aromatic Hydrocarbons in Groundwater. *Appl. Environ. Microbiol.* Vol. 63 pp.270-276.

A.Paschke. P.Poop. 2004. Difussion-based calibration for solid-phase microextraction of benzene, Toluene, ethylbenzene, p-xylene and chlorobenzenes from aqueous samples, *Journal of Chromatography*.

Alexander M., (1977). *Introduction to Soil Microbiology*, 1st edn. John Wiley & Sons. New York.

A. Hess, Boris Zarda, Ditmar Hahn, Andreas Häner, Dietmar Stax, Patrick Höner and Josef Zeyer, 1997. *In Situ Analysis of Denitrifying Toluene and m-Xylene-Degrading*

Anderson M.R., R.L. Johson, and J.P. Pankow, 1987. The dissolution of dense non-aqueous phase liquid (DNPL) from a saturated porous medium, of Petroleum Hydrocarbon and Organic Chemicals in Groundwater: Prevention, Detection and Restoration. *National Ground Water Assoc.* Columbus, Ohio, p. 409-428.

Anon, (1989) *Proceedings of Beach and Nearshore Workshop for Prince William Sound Bioremediation Project*, june 15-16, ed. McCutcheon, S.C. Seattle, WA.

Atlas, R.M., 1981 *Microbial degradation of petroleum hydrocarbons: an environmental perspective.* *Microbial, Rev.* 45. 180-209.

Altas, R.M., and Bartha. R., 1993 “*Microbial Ecology*” Benjamin Cummings. New York. *Bacteria in a Diesel Fuel-Contaminated Laboratory Aquifer Column.* *Applied and Environmental Microbiology* Vol. 63 No.6. p. 2136-2141.

Bauer. E.J., and Capone D:G., 1988. *Appl. Envriron. Microbiol.* 54. 1649-1655

Barker, J.F. G.C. Patrick, and D. Major, 1987. Natural attenuation of aromatic hydrocarbons in a shallow sand aquifer. *Ground Water Monit. Rev.* Winter:64-71

Bear. F. E., 1964. *Chemistry of Soil.* Reinhold Publishing Corporation N.Y.

Bouwer, E.J., 1992 *Bioremediation of organic contaminants in the subsurface.* *Environmental Microbiology* (Mitchell. R., ed.). pp. 287-318, John Wiley & Sons.

Brock T.D. & Madigan M.T., 1988. *Biology of Microorganisms*, 5th edn. Prentince Hall. Englewood Cliffs.

Cerniglia, C.E., 1992. Biodegradation of polycyclic aromatic hydrocarbons. *Biodegradation*, (3) 351-368.

Characklis W.G., K.C. Marshall, 1990. *Biofilms*, J. Wiley & sons. New York, USA

Charles G. Hill. Jr., 1977. *An introduction to Chemical Engineering Kinetics and Reactor design*. ISBN 0-471-39609-5.

Chiang C.Y., J.P. Salnitro, E.Y. Chai, J.D. Colthart and C.L. Klein, 1989. Aerobic biodegradation of benzene, toluene, and xylene in a sandy aquifer-data analysis and computer modelling. *Ground Water* 27:823-834.

Claire Joannis –Cassan. Marie Delia and Jan Pierre Riba, 2005. Limitation phenomena induced by biofilm formation during hydrocarbon degradation, *J Chem Technol Biotechnol*. 80:99-106.

C.W. Fetter. 1999. *Contaminant Hydrogeology*. Prentice Hall.

Costerton J.W., K.J. Cheng, G.G. Geesey, T.I. Ladd. J.C. Nickel, M. Desgupta and T.J. Marrie, 1987. Bacterial biofilm in nature and disease. *Revue of Microbiology*. 41:435-505.

De Beer D. and P. Stoodley, 1995. Relation between the structure of aerobic biofilm and mass transport phenomena. Proceedings of the Conference workshop “Biofilm structure. growth and dynamics.” Noordwijkerhout. The Netherlands

Donald G. Crossby. 1998. *Environmental Toxicology and Chemistry*. Oxford University Press.

Durand. J.P., Béboulène. J.J.and Ducrozet. A., 1995. Detailed characterization of petroleum products with capillary analysers. *Analisis*. 23. 481-483

Ebbing, Darrell D., *General Chemistry*, 3rd ed. Houghton Mifflin, 1990.
<http://www.aehs.com/publications/catalog/contents/Volume2.pdf>

Edel H-G. Meyer-Murlowsky T., 2000. *Groundwater Remediation Using Biofilm Reactors*. ZÜBLING Umwelttechnik GmbH.. Albstadtweg. Stuttgart Germany

Edwards. E.A., Will. L.E., Reinhard. M. and Grbic-Galic, D., 1992. Anaerobic degradation of toluene and xylene by aquifer microorganisms under sulphate reducing conditions. *App. Environ. Microbiol.* (58) 794-800.

EPA 542-F-96-007 United States Environmental Protection Agency,1996. *A Citizen’s Guide to Bioremediation*.

Evan K. Nyer, 1998. *Groundwater and Soil Remediation. Practical Methods and Strategies*.

Fabrizio Bruner, 1993. *Gas Chromatographic Environmental Analysis. Principles. Techniques and Instrumentation*. VCH Publishers. Inc.

- Farmer V.E., 1993. Behaviour of petroleum contaminants in an underground environment. Proc. Seminar on Groundwater and Petroleum Hydrocarbons. Protection Detection. Restoration. Petroleum Assc. for Conservation of the Canadian Environment. Ottawa. II-I-II.16.
- Flemming H.C., 1993. Biofilms and environmental protection. *Water Science and Technology*, 27(7-8):1-10
- Francis H. Chapelle, 2001. Groundwater Microbiology and Geochemistry. John Wiley & Sons.
- Frankling W., Schwartz, Zhang, 2002. Fundamentals of groundwater. J. Wiley & Sons.
- Gerhard Schomburg, 1990 Gas Chromatography A practical Course. Weinheim VCH. ISBN 3-527-27879-6.
- Grbic-Galic, D. and Vogel. T.M., 1987. Transformation of toluene by mixed methanogenic cultures. *Appl. Environ. Microbiol.* (53) 254-260.
- Henis Y., 1987. Survival and Dormancy of Microorganisms. John Wiley & Sons.
- Ian A. Fowils, 1994. Gas Chromatography. Second Edition. John Wiley & Sons.
- Jack Cazes, 2001. Encyclopedia of Chromatography, Marcel Dekker. Inc. ISBN:08247-0511-4
- J. W. Delleur, 1999. The Handbook of Groundwater Engineering. CRC Press LLC.
- Jean-Pierre Arcangeli and Erik Arvin, 1995. Biodegradation rates of aromatic contaminants in Biofilm Reactors Vol.31, pp. 117-128.
- JF Richardson. DG Peacock, 2003. Chemical Engineering. Third Edition Chemical and Biochemical Reactors and Process Control Volume 3.
- Joseph V. Rodricks, 1992. Calculated Risks. The toxicity and human health risk of chemicals in our environment. Cambridge University Press.
- Kay Winkelmann, Joachim Venus, Wolfgang Spyra, 2003. Untersuchung eines Kerosin-Grünwasserschadens unter dem Aspekt „Natural Attenuation“- natürliche (microbiologische) Selbstreinigung in BTU. *Forum der Forschung*. 8 Jahrgang. 2003. Heft 15. Seite 107-111.
- Kevin J. Johnson, Susan L. Rose-Pherson and Robert E. Morris, 2004. Monitoring Diesel Fuel Degradation by Gas Chromatography-Mass Spectroscopy and Chemometric Analysis. *Energy & Fuel*. 18. 844-850.
- Leahy. J.G. and Colwell, R.R., 1990. Microbial degradation of hydrocarbons in the environment. *Microbiology Reviews* 54. 305-315.

- Lazarova V.Z. and J. Manem, 1995. Biofilm characterization and biofilm analysis in water and wastewater treatment. *Water Research*. 29:2227-2245.
- Leahy, J.G. and Colwell, R.R., 1990. Microbial degradation of hydrocarbons in the environment. *Microbial Rev.* 54. 304-315.
- Lee. M.D., Thomas. J.M., Borden. R.C., Bedient P.B. and Ward C:H., 1988. Bioremediation of aquifers contaminated with organic compounds. *CRC Critical Reviews in Env. Cont.*, 18(1). 29-89.
- Marcipar A., Cochet. N., Brackenridge. L., Lebeault.J:M., 1978. Immobilization of yeast on ceramic supports. *Biotechnol. Lett.* 1.65.
- Marshall K.C., 1994. Microbial adhesion in biotechnological process. *Current opinion in Biotechnology*. 5:296-301
- Martin N. Sara, 2003. *Site Assessment and Remediation Handbook*. Lewis Publishers
- Martin Alexander, 1999. *Biodegradation and Bioremediation*. 2nd, Academic Press.
- Mayor D.W., Mayfield, C.I. and Baker. J.F., 1998. Biotransformation of benzene by denitrification in aquifer sand. *Groundwater*, (26) 8-14.
- Mejia Juan Angel¹. Rodriguez Ramiro and Berlin Joel². 2000. "Hydrodynamic and Pollution of the Urban Aquifer System of Salamanca Qro³". Consejo Técnico de Aguas Irapuato - Valle de Santiago¹. Instituto de Geofísica UNAM². Dir. de Ecología Municipio Salamanca³.
- Mendoza, C.A. and T.A. McAlary, 1990. Modeling of groundwater contamination caused by organic solvent vapors. *Groundwater* V.28. No.2. p.199-206.
- Miller, R.M., 1995. Surfactant-Enhanced Bioavailability of Slightly Soluble Organic Compounds. In "Bioremediation-Science & Applications" Soil Science Society of America Special Publication Number 43. Madison. WI. pp.33-45.
- Murray Moo- Young, 1998. *Bioreactor immobilized Enzymes and Cells. Fundamentals and Applications*. Elsevier Applied Science.
- Navarro, J.M. and Durand, G. Modifications de la croissance de *Saccharomyces*. 1980 *cerevisiae* sur support solide. *C.R. Acad. Sci. Ser. D*. 290. 453.
- N.F. Gray, 1994. *Drinking Water Quality. Problems and Solutions*. J. Wiles & Sons.
- N.G. Wilson and G. Bradley, 1996. Enhanced degradation of petrol (Slovene diesel) in an aqueous system by immobilized *Pseudomonas fluorescens*. *The Society of Applied Bacteriology*. Vol. 80 pp. 99-104.
- Olson. J.J., Mills. G.L.. Herbert, B.E. and Morris . P.J., 1999. Biodegradation rates of separated diesel components . *Env. Toxicol. Chem.* 18. 2448-2453

- Paul E. A. and Clark F.E., 1989. "Soil Microbiology and Biochemistry". Academic Press. San Diego, p.76.
- Pedro J.J. Alvarez and Timothy M. Vogel, 1991. Substrate Interactions of Benzene, Toluene and para-Xylene during Microbial Degradation by Pure Cultures and Mixed Culture Aquifer Slurries. *Appl. Environ. Microbiol.* Vol.57. pp. 2981-2985.
- Pedro J.J. Alvarez and Timothy M. Vogel, 1995. Degradation of BTEX and their Aerobic Metabolites by Indigenous Microorganisms under Nitrate Reducing Conditions. *Applied and Environmental Microbiology* Vol.31. pp. 15-28.
- Perry. J.J., 1984. Microbial metabolism of cyclic alkanes. In "Petroleum Microbiology" (R. Atlas. ed.) Macmillan, New York., pp.61-97.
- Phelps & White D.C., 1991. Activities of microorganisms in deep unconsolidated eastern Coastal Plain sediments. *Proceeding of the First International Symposium on Microbiology of Deep Surface*, pp 4-125 .
- Prescot, L.M., Harley. J.P. and Klein, D.A., 1993. *Microbiology*, 2nd ed., Wm. C. Brown. Dubuque, IA.
- Raina M Maier, Ian L. Pepper and Charles P. Gerba, 2000. *Environmental Microbiology*. Academic Press.
- R. Barry King, Gilbert M. Long, John K Sheldon, 2000. *Practical Environmental Bioremediation, The field guide*.
- R. Marchal, S. Penet, F. Solano-Serena and J.P. Vandecastelle, 2003. "Gasoline and Diesel Oil Biodegradation". *Oil & Gas Science and Technology* Vol. 58. p.441-448.
- Rosevear, A., Kennedy, J.F. and Cabral, J.M.S., 1987. *Immobilized Enzymes and Cells* ed. Gaylarde, C. Bristol:IOP Publishing Ltd.
- Siebel M. A., 1987. Binary population biofilms. Ph.D. thesis Montana State University, Bozeman. USA. Solomon B.O., V. Hecht, C. Posten and W.-D Decwer, 1995.
- Snoeyink, V.L., Jenkins. D., 1980. *Water Chemistry*. Wiley, New York.
- Solano-Serena, F.R. Marchall, D. Blanchet and J.P. Vandecasteele, 1998. Intrinsic capacities of soil microflorae for gasoline degradation. *Biodegradation* 9:319-326.
- Stephen M. Testa, Duane L. Winegardner, 2000. *Restoration of Contaminated Aquifes, Petroleum Hydrocarbons and Organic Compounds*. Lewis Publishers, 2nd Edition.
- Stephen R. Hutchins, 1999. Nitrate as an Alternate Electron Acceptor for Bioremediation of Fuel- Contaminated Aquifers.

- Suthan S. Suthersan, 2002. Natural and Enhanced Remediation Systems. Lewis Publishers
- Tagger, S., Bianchi, A. and Roux, B., 1993. Effect of microbial seeding of crude oil in seawater in a model system. *Marine Biology* (78) 13-20.
- Tibor Cserháti, Esther Forgács, 2001. *Chromatography in Environmental Protection* Volume 3, pp.3.4.
- Timothy Edgcumbe Ford, 1993. *Aquatic Microbiology. An ecological approach*, Blackwell Scientific Publication. Inc.
- Ting, Y.P., Hu. H.L., Tan. H.M., 1999. Bioremediation of petroleum hydrocarbons in soil microcosms. *Resource and Environmental Biotechnology* 2. 197-218.
- Vasudevan, N., Rajaram, P., 2001. Bioremediation of oil sludge contaminated soil. *Environment International* (26) 409-411.
- Venus, J.; Spyra, W., 2003. Biologische Behandlung von organisch kontaminierten Wässern. *BTU Forum der Forschung* 8, Jahrgang, 2003. Heft 15. Seite 103-106.
- Venus, J; Beitz, H.; Spyra (2000). Microbial regeneration of the adsorbents for the cleaning of triazine-contaminated groundwater. *Chemical Engineering Technology*, Vol. 23. 2000. Issue 1. pp. 26-29.
- William C. Anderson, 1995. *Innovative Site Remediation technology*, Bioremediation, Water Environment Federation
- W. Zhang, E. Bouwer, L. Wilson and N. Durant, 1995. Biotransformation of Aromatic Hydrocarbons in subsurface Biofilms. *Wat. Sci. Tech.* Vol. 31 No. 1pp.1-14
- Wilfred F.M. Röling, Michael G. Milner, D. Martin Jones, Kenneth Lee, Fabien Daniel, Richard J.P. Swannell and Ian M. Head, 2002. Robust Hydrocarbon Degradation and Dynamics of Bacterial Communities during Nutrient Enhanced Oil spill Bioremediation. *Appl. and Environ. Microbiol.* Vol.68. pp. 5537-5548
- Wilson, J., L. Leach, J. Michalowski, S. Vandergrift and R. Callaway, 1990. In situ reclamation of spills from underground storage tanks: new approaches for site characterization, project design and evaluation of performance pp. 30-1-30-16.
- Zhang, Y., and Miller, R. M., 1994. Effect of a *Pseudomonas* Rhamnolipid Bisurfactant on Cell Hydrophobicity and Biodegradation of Octadecane. *App. Environ. Microbiol.* 60. 2101-2106.

List of Figures and Tables

Figures	page
Figure 1 Mexican Refineries Infrastructure	6
Figure 2 National Production of oil for Refinery Include: gasoline, combustible, diesel, turbosine and petroleum coke	8
Figure 3 Percentage of BTEX in gasoline	22
Figure 4 BTEX components of the gasoline (% weight)	22
Figure 5 Saturated and unsaturated groundwater zone	30
Figure 6 Groundwater Strata	31
Figure 7 Schematic showing general distribution of LNAPL and DNAPL in the subsurface	33
Figure 8 Downward percolation pf a NAPL in the unsaturated zone	34
Figure 9 Presence of zones of low hydraulic conductivity within the unsaturated zone can cause NAPLs to mound and spread laterally	35
Figure 9.1 Pattern of flow is determined by the nature of the spill. In a) a sudden. large volume. b) a slow leak	35
Figure 10 NAPLs in the vadose zone as a source of groundwater contamination	37
Figure 11 Relative Solubilities of BTEX. MTBE and others	40
Figure 12 Classification within the kingdom of the Protists	43
Figure 13 Configuration of a) gram-negative and b) gram positive cell wall	44
Figure 14 Cellular structure of bacteria	45
Figure 15 Common shapes of bacteria cells	45
Figure 16 Representation of soil horizons	55
Figure 17 Formation of ATP from ADP with the storage of energy	57
Figure 18 The inner-relationship between metabolism. energy and redox process	58
Figure 19 Biodegradation of Alkanes	62
Figure 20 Biodegradation of Alkenes	63
Figure 21 Degradation of cyclohexane	63
Figure 22 Incorporation of oxygen into the aromatic ring by the dioxygenase enzyme. followed by meta or ortho cleavage	64
Figure 23 Phases of grow of a microbial culture	72
Figure 24 The general form of Monod Equation	76
Figure 25 Dependence of the specific growth rate μ on the substrate concentration	77
Figure 26 Groundwater sparging with optional in situ vapour	82
Figure 27 Activated Sludge	85

Figure 28 Sequencing Batch Reactor Treatment Stages	86
Figure 29 Rotating Biological Contactor	86
Figure 30 Trickling Filter	87
Figure 31 Submerged Fixed Film	90
Figure 32 Split injector	99
Figure 33 Schematic view of a Flame ionisation detector	101
Figure 34 Gas Chromatograph 1-4 Sichromat	102
Figure 35 Extraction process	104
Figure 36 Diagram of adsorption columns	104
Figure 37 Calibration curve Heptane	115
Figure 38 Gas Chromatogram maximum concentration of heptane	116
Figure 39 Gas Chromatogram minimum concentration of heptane	116
Figure 40 Diesel Calibration Curve	127
Figure 41 Gas chromatogram; extraction (1:20); Standard Heptane:Hexane (1:20,000) dilution a) Calibration 0.1 mg/L	119
Figure 42 Gas chromatogram; extraction (1:20); Standard Heptane:Hexane (1:20,000) dilution b) Calibration 0.5 mg/L	119
Figure 43 Gas chromatogram; extraction (1:20); Standard Heptane:Hexane (1:20,000) dilution c) Calibration 1 mg/L	119
Figure 44 Gas chromatogram; extraction (1:20); Standard Heptane:Hexane (1:20,000) dilution d) Calibration 5 mg/L	119
Figure 45 Gas chromatogram; extraction (1:80); Standard Heptane:Hexane (1:20,000) dilution a) Standard Solution 2000 mg/L	121
Figure 46 Gas chromatogram; extraction (1:44); Standard Heptane:Hexane (1:20,000) dilution b) Standard Solution 200 mg/L	121
Figure 47 Gas chromatogram; extraction (1:20); Standard Heptane:Hexane (1:20,000) dilution c) Standard Solution 20 mg/L	121
Figure 48 Gas chromatogram; extraction (1:88); Standard Heptane:Hexane (1:20,000) dilution; Sample 1 Original Mexican Sample 2000 mg/L	123
Figure 49 Gas chromatogram extraction (1:44); Standard Heptane:Hexane (1:20,000) dilution; Sample 2 Original Mexican Sample 63.24 mg/L	123
Figure 50 Gas chromatogram extraction (1:44); Standard Heptane:Hexane (1:20,000) dilution; Sample 3 Original Mexican Sample 35.8 mg/L	123
Figure 51 Diesel biodegradation vs. days; (1:50) dilution groundwater:MSM	126
Figures 52 Comparison of the results of three experiments with different salts and N:P 10:1 a) 1000 mg/L	136
Figure 53 Comparison of the results of three experiments with different salts and N:P 10:1 b) 2000 mg/L	136
Figure 54 Comparison of the results of three experiments with different salts and N:P 10:1 c) 4000 mg/L	136
Figure 55 Comparison of the results of three experiments with different salts and N:P 20:2 a) 1000 mg/L	137
Figure 56 Comparison of the results of three experiments with different salts and N:P 20:2 b) 2000 mg/L	137

Figure 58 Comparison of the results of three experiments with different salts, and N:P 5:0.5 a) 1000 mg/L	138
Figure 59 Comparison of the results of three experiments with different salts, and N:P 5:0.5 b) 2000 mg/L	138
Figure 60 Comparison of the results of three experiments with different salts, and N:P 5:0.5 c) 4000 mg/L	138
Figure 61 New comparisons of the results of three experiments with different MSM, all of them with 2000 mg/L of diesel and N:P 5:0.5	141
Figure 62 Xylite adsorption vs. hours; 2000 mg/L of diesel Experiment 1 and Experiment 2	142
Figure 63 Soil adsorption vs. time; 2000 mg/L diesel MSM, soil and NaN_3	143
Figure 64 Xylite and soil adsorption vs. time; 2000 mg/L diesel MSM, soil, xylite and NaN_3	144
Figure 65 Adsorption and desorption of diesel vs. time in a column with xylite	146
Figure 66 Gas chromatogram; extraction (1:44); Standard Heptane:Hexane (1:20,000) dilution a) Standard Solution 200 mg/L	147
Figure 67 Gas chromatogram; extraction (1:44); Standard Heptane:Hexane (1:20,000) dilution b) Measurement of adsorption after 2 minutes	147
Figure 68 Gas chromatogram extraction (1:44); Standard Heptane:Hexane (1:20,000) dilution c) Measurement of adsorption after 4 days	148
Figure 69 Gas chromatogram extraction (1:44); Standard Heptane:Hexane (1:20,000) dilution d) Measurement of adsorption after 9 days	148
Figure 70 Gas chromatogram extraction (1:44); Standard Heptane:Hexane (1:20,000) dilution e) Measurement of adsorption after 29 days	149
Figure 71 Adsorption and desorption of diesel vs. time in a column with xylite	150
Figure 72 Microorganisms growth in a separated glass. Amount of diesel 2000 mg/L, MSM+Agar logarithmic scale	151
Figure 73 Gas chromatogram; extraction (1:88); Standard Heptane:Hexane (1:20,000) dilution a) Standard Solution 2000 mg/L	155
Figure 74 Gas chromatogram; extraction (1:88); Standard Heptane:Hexane (1:20,000) dilution; b) Concentration Measurement after 3 days	155
Figure 75 Gas chromatogram; extraction (1:44); Standard Heptane:Hexane (1:20,000) dilution. a) Concentration Measurement after 5 days	156
Figure 77 Gas chromatogram; extraction (1:44); Standard Heptane:Hexane (1:20,000) dilution. b) Concentration Measurement after 6 days	156
Figure 78 Gas chromatogram; extraction (1:44); Standard Heptane:Hexane (1:20,000) dilution. c) Concentration Measurement after 7 days	156
Figure 79 Gas chromatogram; extraction (1:44); Standard Heptane:Hexane (1:20,000) dilution. a) Concentration Measurement after 8 days	157
Figure 80 Gas chromatogram; extraction (1:44); Standard Heptane:Hexane (1:20,000) dilution. b) Concentration Measurement after 11 days	157
Figure 81 Gas chromatogram; extraction (1:44); Standard Heptane:Hexane (1:20,000) dilution. c) Concentration Measurement after 13 days	157
Figure 82 Gas chromatogram; extraction (1:44); Standard dilution. d) Concentration Measurement after 15 days	157
Figure 83 Diesel amount vs. time (Experiment 1 and Experiment 2)	158
Figure 84 Diesel amount vs. time (Experiment 1 and Experiment 2)	158
Figure 85 Diesel amount vs. time (Experiment 1 and Experiment 2)	159
Figure 86 Growth rate versus amount of diesel	161

Figure 87 Microorganisms growth within the columns CFU/ml vs time	166
Figure 88 Gas chromatogram extraction (1:20); Standard Heptane:Hexane (1:20,000) dilution. Solubility Test at different concentrations a) 1.35 mg/L	168
Figure 89 Gas chromatogram extraction (1:20); Standard Heptane:Hexane (1:20,000) dilution. Solubility Test at different concentrations b) 0.70 mg/L	168
Figure 90 Gas chromatogram extraction (1:20); Standard Heptane:Hexane (1:20,000) dilution. Solubility Test at different concentrations c) 0.79 mg/L	168
Figure 91 Gas chromatogram extraction (1:20); Standard Heptane:Hexane (1:20,000) dilution. Solubility Test at different concentrations d) 0.79 mg/L after 10 minutes	168
Figure 92 Gas chromatogram extraction (1:20); Standard Heptane:Hexane (1:20,000) dilution. Solubility Test at different concentrations a) 0.75 mg/L after 30 minutes	169
Figure 93 Gas chromatogram extraction (1:20); Standard Heptane:Hexane (1:20,000) dilution Solubility Test at different concentrations b) 0.77 mg/L after 60 minutes	169
Figure 94 Gas chromatogram extraction (1:20); Standard Heptane:Hexane (1:20,000) dilution Solubility Test at different concentrations c) 0.77 mg/L after 120 minutes	169
Figure 95 Gas chromatogram extraction (1:20); Standard Heptane:Hexane (1:20,000) dilution. Solubility Test at different concentrations d) 0.77 mg/L after 240 minutes	169
Figure. 96 Measurement of microbial activity CO ₂ vs. minutes; velocity 19 L/day Column 1	170
Figure 97 Measurement of microbial activity CO ₂ vs. minutes velocity 19.2 L/day Column 3	170
Figure 98 Measurement of microbial activity CO ₂ vs. minutes; velocity 19.2 L/day Column 4	170
Figure 99 Gas chromatogram; extraction (1:80); Standard Heptane:Hexane (1:20,000) dilution a) Standard Solution 2000 mg/L	173
Figure 100 Gas chromatogram; extraction (1:80); Standard Heptane:Hexane (1:20,000) dilution b) Measurement after 2 days	173
Figure 101 Gas chromatogram; extraction; (1:80); Standard Heptane:Hexane (1:20,000) dilution a) Measurement after 3 days	174
Figure 102 Gas chromatogram; extraction (1:80); Standard Heptane:Hexane (1:20,000) dilution b) Measurement after 4 days	174
Figure 103 Gas chromatogram; extraction (1:44); Standard Heptane:Hexane (1:20,000) dilution a) Measurement after 7 days	174
Figure 104 Gas chromatogram; extraction (1:44); Standard Heptane:Hexane (1:20,000) dilution b) Measurement after 8 days	174
Figure 105 Growth rate (h ⁻¹) versus amount of diesel mg/L	176
Figure 106 Gas chromatogram; extraction (1:80); Standard Heptane:Hexane (1:20,000) dilution a) Standard Solution 2000 mg/L	178
Figure 107 Gas chromatogram; extraction (1:80); Standard Heptane:Hexane (1:20,000) dilution b) Measurement after 1day Column 1	179
Figure 108 Gas chromatogram; extraction (1:80); Standard Heptane:Hexane (1:20,000) dilution c) Measurement after 1day Column 2	179
Figure 109 Gas chromatogram; extraction (1:80); Standard Heptane:Hexane (1:20,000) dilution d) Measurement after 1day Column 3	179
Figure 110 Gas chromatogram; extraction (1:80); Standard Heptane:Hexane (1:20,000) dilution e) Measurement after 1day Column 4	179
Figure 111 Gas chromatogram; extraction (1:80); Standard Heptane:Hexane (1:20,000) dilution a) Measurement after 2 days Column 1	180
Figure 112 Gas chromatogram; extraction (1:80); Standard Heptane:Hexane (1:20,000) dilution b) Measurement after 1days Column 2	180
Figure 113 Gas chromatogram; extraction (1:80); Standard Heptane:Hexane (1:20,000) dilution c) Measurement after 2days Column 3	180

Figure 114 Gas chromatogram; extraction (1:80); Standard Heptane:Hexane (1:20,000) dilution d) Measurement after 2 days Column 4	180
Figure 115 Gas chromatogram; extraction (1:44); Standard Heptane:Hexane (1:20,000) dilution a) Measurement after 3 days Column 1	181
Figure 116 Gas chromatogram; extraction (1:44); Standard Heptane:Hexane (1:20,000) dilution b) Measurement after 3 days Column 2	181
Figure 117 Gas chromatogram; extraction (1:44); Standard Heptane:Hexane (1:20,000) dilution c) Measurement after 3 days Column 3	181
Figure 118 Gas chromatogram; extraction (1:44); Standard Heptane:Hexane (1:20,000) dilution d) Measurement after 3 days Column 4	181
Figure 119 Gas chromatogram; extraction (1:44); Standard Heptane:Hexane (1:20,000) dilution a) Measurement after 4 days Column 1	182
Figure 120 Gas chromatogram; extraction (1:44); Standard Heptane:Hexane (1:20,000) dilution b) Measurement after 4 days Column 2	182
Figure 121 Gas chromatogram; extraction (1:44); Standard Heptane:Hexane (1:20,000) dilution c) Measurement after 4 days Column 3	182
Figure 122 Gas chromatogram; extraction (1:44); Standard Heptane:Hexane (1:20,000) dilution d) Measurement after 4 days Column 4	182
Figure 123 Gas chromatogram; extraction (1:22); Standard Heptane:Hexane (1:20,000) dilution a) Measurement after 7 days Column 1	186
Figure 124 Gas chromatogram extraction (1:22); Standard Heptane:Hexane (1:20,000) dilution b) Measurement after 4 days Column 2	186
Figure 125 Gas chromatogram extraction (1:22); Standard Heptane:Hexane (1:20,000) dilution c) Measurement after 7 days Column 3	186
Figure 126 Gas chromatogram extraction (1:22); Standard Heptane:Hexane (1:20,000) dilution d) Measurement after 4 days Column 4	186
Figure 127 Gas chromatogram extraction (1:22); Standard Heptane:Hexane (1:20,000) dilution a) Measurement after 8 days Column 3	184
Figure 128 Gas chromatogram extraction (1:22); Standard Heptane:Hexane (1:20,000) dilution b) Measurement after 4 days Column 4	184
Figure 129 Gas chromatogram; extraction (1:88); Standard Heptane:Hexane (1:20,000) dilution Measurement after 2 days Column 1	186
Figure 130 Gas chromatogram extraction (1:44); Standard Heptane:Hexane (1:20,000) dilution Measurement after 3 days outlet	186
Figure 131 Gas chromatogram; extraction (1:22); Standard Heptane:Hexane (1:20,000) dilution Measurement after 4 days outlet	186
Figure 132 Gas chromatogram; extraction (1:80); Standard Heptane:Hexane (1:20,000) dilution Measurement after 1 day Column 1	187
Figure 133 Gas chromatogram; extraction (1:80); Standard Heptane:Hexane (1:20,000) dilution Measurement after 1 day Column 1	188
Figure 134 Microbial Growth 1 st and 2 nd experiment with constant O ₂ and 3 rd experiment with no constant oxygen; 4 th experiment optimised	192
Figure 135 Scheme of the construction of the Columns	195
Figure 136 Scheme of the Columns in Equilibrium	196

Table	page
Table 1 Limits for drinking water in Germany	4
Table 2 Total World Oil Producer	6
Table 3 Crude yields in the production of oils	6
Table 4 Volume of water granted in concession for off stream water use (Cumulative figures as of december. (2002) (km ³ per year)	8
Table 5 Petrohydrocarbons typical properties and structures	16
Table 6 Major Petroleum Distillation Products	20
Table 7 Groundwater parameters	84
Table 8 Soil parameters	84
Table 9 Comparison between the Mexican and German diesel and gasoline	96
Table 10 Experiments with different amounts of diesel. different level of N:P and different groups of salts	100
Table 11 Diesel solubility and its compounds in water	103
Table 12 Groundwater chemical and physical characteristics	113
Table 13 Soil chemical and physical characteristics	113
Table 14 Quantification of TPH of Mexican contaminated groundwater using a Horriba oil Counter Analyzer, (Sample 1)	113
Table 15 Quantification of TPH of Mexican contaminated groundwater using a Horriba oil Counter Analyzer, (Sample 2)	114
Table 16 Quantification of TPH of Mexican contaminated groundwater using a Horriba oil Counter Analyzer, (Sample 3)	114
Table 17 PAHs concentrations in soil	114
Table 18 Range of detection of Heptane	114
Table 19 Diesel calibration curve data	117
Table 20 Analysis of different amounts of diesel to prepare a diesel calibration curve using a Gas Chromatograph (FID)	118
Table 21 Analysis of different amounts of diesel in the Original Mexican Samples using a Gas Chromatograph (FID)	122
Table 22 Cell concentrations in the soil	124
Table 23 Cell concentrations in groundwater	124
Table 24 Soil plating calculations	124
Table 25 Groundwater plating calculations	125
Table 26 Mineral Salts Medium (100:10:1)	125
Table 27 TPH bioremediation results (daily measurements)	126
Table 28 Nutrients for the preparation of MSM	130
Table 29 Calculations C:N:P 100:10:1	132
Table 30 Calculations C:N:P 100:20:2	133
Table 31 Calculations 100:5:0.5	134

Table 32 Results of the last experiment 18 days	140
Table 33 Xylite Adsorption	142
Table 34 Mineral Salt Medium+soil+NaN ₃ ; Mineral Salt Medium+soil	143
Table 35 Mineral Salt Medium+soil+xylite; Mineral Salt Medium+soil+xylite+NaN ₃	144
Table 36 Adsorption and Bioremediation percentage	145
Table 37 CFU/ml vs. days (control)	151
Table 38 Test Analysis of different amounts of diesel using Gas Chromatograph (FID)	153
Table 39 Data zero order reaction	158
Table 40 Data first order reaction	158
Table 41 Data second order reaction	159
Table 42 Microbial growth in a separated flask	160
Table 43 Data necessary for the design of the Trickle bed reactor	162
Table 44 Theoretical residence time	164
Table 45 Monitoring of the growth of microorganisms in the column	165
Table 46 CO ₂ Measurement	171
Table 47 Determination of diesel concentration using a Gas chromatograph (FID) one column	172
Table 48 Microbial growth of the microorganisms in one column	175
Table 49 Determination of diesel concentration in four columns using a Gas chromatograph (FID)	177
Table 50 Determination of diesel amount with a retention time of 1 day in Column 1 and after the second day three columns in series using a Gas chromatograph (FID)	185
Table 51 Second determination of diesel amount with a retention time of 2 days in Column 1 and on the third day three columns in series using a Gas chromatograph (FID)	187
Table 52 Determination of diesel amount four columns in series using a Gas chromatograph (FID)	188
Table 53 Optimisation of microbial growth	191
Table 54 Benzene concentration after 24 hours; oxygen flow	193
Table 55 Benzene concentration after 11 days	193
Table 56 Benzene biodegradation	194
Table 57 Benzene biodegradation in the four columns	194

11 Appendix

Appendix 1 Crude Oil Composition

Crude oil composition (mixture of hydrocarbons)	84.5% carbon 13% hydrogen 1.5% sulphur 0.5% nitrogen and 0.5% oxygen
Crude oil consist of	25% alkanes (paraffins) 50% cycloalkanes (naphthenes) 17% aromatics (incl. polycyclic aromatics) 8% asphaltics

Appendix 2 PAH: Properties

melting point	>80°C
boiling point	300-500°C
density	>1 g/cm ³
water solubility	very low
log K _{ow}	3-8
vapor pressure	10 ⁻² – 10 ⁻⁸ Pa
viscosity	Viscose up to high-viscous

Quellen: Schwarzenbach et al.1993 und Hazardous Substances Database 2000

Appendix 3 Typical API Gravities

Product Type	Specific Gravity	API Gravity. °
Gasoline	0.74	60
Light Crude	0.84	36
Heavy Crude	0.95	18
Asphalt	0.99	11

Source: Stephen M. Testa. Duane L. Winegardner. 2000

Appendix 4 Typical Fluorescence Color for Varying API Gravities

API Gravity	Color of Fluorescence
Below 15	Brown
15-25	Orange
25-35	Yellow to cream
35-45	White
Over 45	Blue-white to violet

Source: Stephen M. Testa. Duane L. Winegardner. 2000

Appendix 5 Chemical and Physical Properties of Common Normal Paraffin and Branched-Chain Paraffins

Compound	Chemical Formula	Molecular Weight (g/mol)	Density (g/cm ³)	Solubility (g/m ³)	Viscosity (mP)	Boiling Point (°C)	Vapor Pressure (mm)
Normal Paraffins							
Methane	CH ₄	16	0.554	---	108.7@20°C	-161	400@-168.8°C
Ethane	C ₂ H ₆	30	0.446	---	98.7@17°C	-89	400@-99.7°C
Propane	C ₃ H ₈	44	0.582	62.4 ± 2.1	79.5@17.9°C	-42	400@-55.6°C
Butane	C ₄ H ₁₀	58	0.599	61.4 ± 2.6	---	-0.5	400@16.3°C
Pentane	C ₅ H ₁₂	72	0.626	38.5 ± 2.0	676.000@25°C	36	426
Hexane	C ₆ H ₁₄	86	0.659	9.5 ± 13	3.260@2°C	69	124
Branched-Chain Paraffins							
Isobutane	C ₄ H ₁₀	58	----	48.9 ± 2.1	---	-12	---
2,2-Dimethylbutane	C ₆ H ₁₄	86	0.649	18.4 ± 1.3	---	50	400
2,3-Dimethylbutane	C ₆ H ₁₄	86	0.668	22.5 ± 0.4	---	58	400
2-Methylpentane	C ₆ H ₁₄	86	0.669	13.8 ± 0.9	---	60	400@41.6°C
2-Methylhexane	C ₇ H ₁₆	100	0.6789	2.54 ± 0.0	---	90	40
3-Methylhexane	C ₇ H ₁₆	100	---	4.95 ± 0.08	---	92	---
2,2,4-Trimethylpentane	C ₈ H ₁₈	114	0.692	2.44 ± 0.12	---	99	40.6

Source: Stephen M. Testa. Duane L. Winegardner. 2000

Appendix 6 Chemical and Physical Properties of Common Naphthenes

Compound	Chemical formula	Molecular Weight (g/mol)	Density (g/cm ³)	Solubility (g/m ³)	Viscosity (mP)	Boiling Point (°C)	Vapor Pressure (mm)
Methylcyclopentane	C ₆ H ₁₂	84	0.749	42 ± 1.6	---	72	---
Cyclohexane	C ₆ H ₁₂	84	0.778	55 ± 2.3	1.02@17°C	81	95
Ethylcyclohexane	C ₈ H ₁₆	112	---	3.29 ± 0.46	---	132	---
1.1.3-Trimethyl-cyclohexane	C ₉ H ₁₈	126	---	1.77 ± 0.05	---	137	---

Source: Stephen M. Testa. Duane L. Winegardner. 2000

Appendix 5 Chemical and Physical Properties for Aromatics

Compound	Chemical Formula	Molecular Weight (g/mol)	Specific Gravity @25°C	Solubility (g/m ³)	Viscosity (mP)	Boiling Point (°C)	Vapor Pressure (mm)	K _{OK}
Benzene	C ₆ H ₆	78.11	0.878	1780 ± 45	0.652	80	76@20°C	1.69-2.00
Toluene	C ₇ H ₈	92.14	0.867	515 ± 17	0.590	111	22@20°C	2.06-2.18
Ethylbenzene	C ₈ H ₁₀	106.17	0.867	161 mg/l@25°C	---	136.2	4.53@25°C	3.05-3.15
Orthoxylene	C ₈ H ₁₀	106.17	0.880	1.75 ± 8	0.810	142	10@25.9°C	2.11
Metaxylene	C ₈ H ₁₀	106	0.867	146 ± 1.6	0.620	138.9	10@28.3°C	3.20
Paraxylene	C ₉ H ₁₂	120	0.860	156 ± 1.6	0.648	138	10@27.3°C	2.31
Isopropylbenzene	C ₉ H ₁₂	120	---	50 ± 5	---	152	---	---
3.4-Benzpyrene	C ₂₀ H ₁₂	252	1.351	0.003	---	495	5.49x10 ⁻⁹ @25°C	5.81-6.50
MTBE		88.15	0.744	42.000 mg/l	---	---	245	1.035-1.91

Source: Stephen M. Testa. Duane L. Winegardner. 2000

Appendix 8 Typical Residual Saturation Data for various LNAPL and DNAPL Types

Residual Fluid Type	Hydrogeologic Conditions ^a	Media	Residual Saturation (S _r) or Retention Factor (R _f) (l/m ³)	
			S _r	R _f
Water	Unsaturated	Sand	0.01	
		Silt	0.07	
		Sandy clay	0.26	
		Silty clay	0.19	
		Clay	0.18	
LNAPLs				
Gasoline	Unsaturated	Coarse gravel		2.5
		Coarse sand and gravel		4.0
		Medium to coarse sand		7.5
		Fine medium sand		12.5
		Silt to fine sand		20
		Coarse sand	0.15-0.19	
		Medium sand	0.12-0.27	
		Fine to coarse sand	0.19-0.60	
Kerosene		Stone. coarse sand	0.46-0.59	
		Gravel. coarse sand	5	
		Fine to medium sand	8	
		Coarse and medium sand	15	
		Fine sand and silt	25	
Diesel and light fuel oil		Soil	40	
Light oil and gasoline		Soil	0.18	
Lube and heavy fuel oils		Soil	10.18	
			0.15	
Middle distillates	Unsaturated	Coarse gravel		5.0
		Coarse sand and gravel		8.0
		Medium to coarse sand		15
		Fine to medium sand		25
		Silt to fine sand		40
Fuel oils	Unsaturated	Coarse gravel		10
		Coarse sand gravel		16
		Medium to coarse sand		30
		Fine to medium sand		50
		Silt and fine sand		80
Crude oils	Saturated	Sandstone	0.35-0.43	
		Sandstone	0.16-0.47	
		Sandstone	0.26-0.43	
DNAPLs				
Benzene	Saturated	Sand (92% sand. 5% silt. 3% clay)	0.24	
Tetrachloroethane	Saturated	Fracture (0.2 aperture)		0.05 l/m ²
Tetrachloroethene	Unsaturated	Coarse Ottawa sand	0.15-0.25	

Appendix 9 Standard gas chromatographs for gasoline. naphta. kerosene. JP-5 jet fuel. diesel fuel and crude oil.

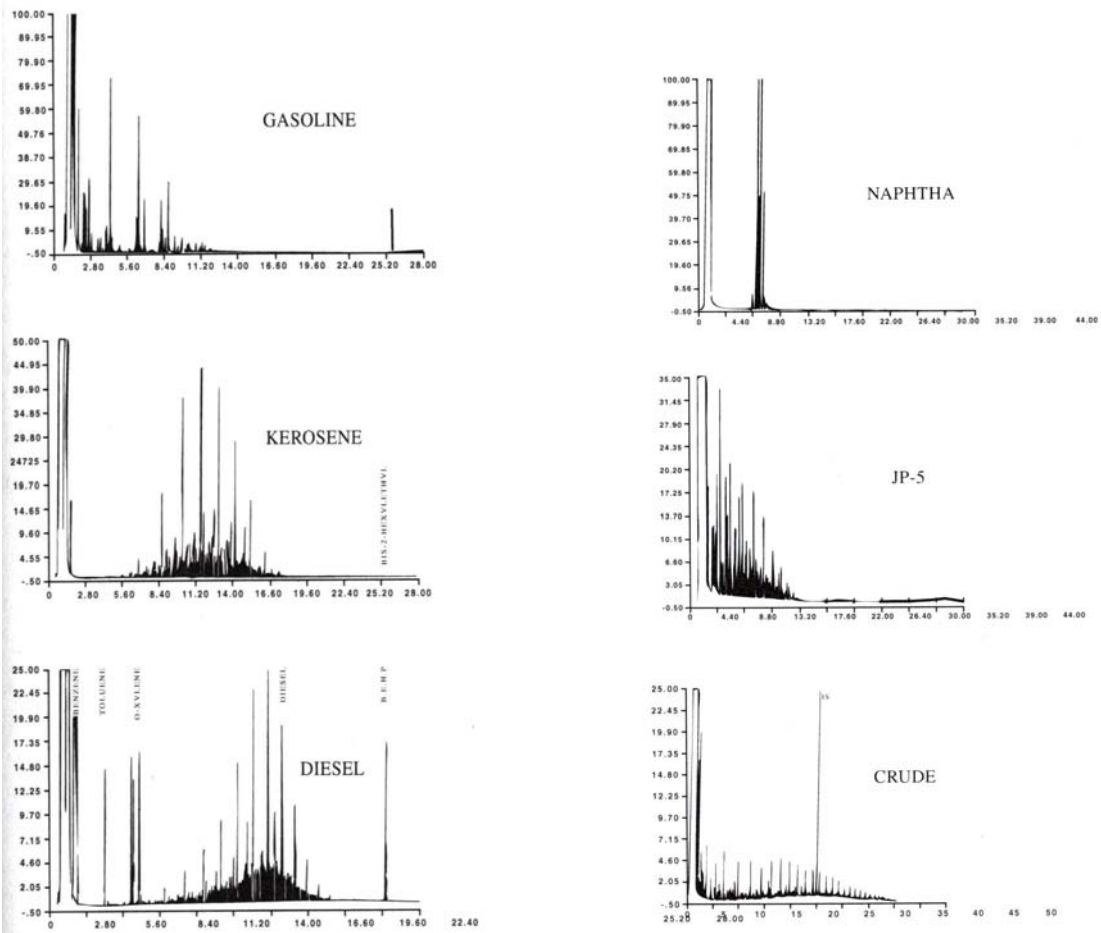

Appendix 10 Characteristics of Xylite

General Data	Unit	Value
grain size	mm	0-200
density	g/cm ³	0.2-0.4
Brief analysis of Delivery conditions		
Content of water	% weight	45-55
Content of ashes	% weight	0.5-2
Volatility	% weight	29-43
Specific Carbon	% weight	15-24
Calorific capacity	KJ/Kg	8500-12000
Elemental Analysis of Delivery conditions		
Carbon	% weight	25-36
Hydrocarbon	% weight	2.4-3.5
Oxygen	% weight	14-18
Nitrogen	% weight	0.1-0.3
Total Sulphur	% weight	0.2-0.4
Components		
Silicium	% weight	250-980
Aluminium	% weight	150-580
Iron	% weight	822-3300
Calcium	% weight	860-3400
Magnesium	% weight	230-900
Sulphate	% weight	490-1900
Sodium	% weight	1-27
Potassium	% weight	10-170
Titanium	% weight	1-18
Phosphorous	% weight	1-26
Manganese	% weight	10-38
Chlorine	% weight	50-60
Flourine	% weight	5-6
Content of Humid of delivery conditions		
Content of Humic	% weight	4-10
bounded Humic acid	% weight	0.1-0.3
Humic acid free	% weight	5-12

Source: Lausitzer Braunkohle Aktiengesellschaft

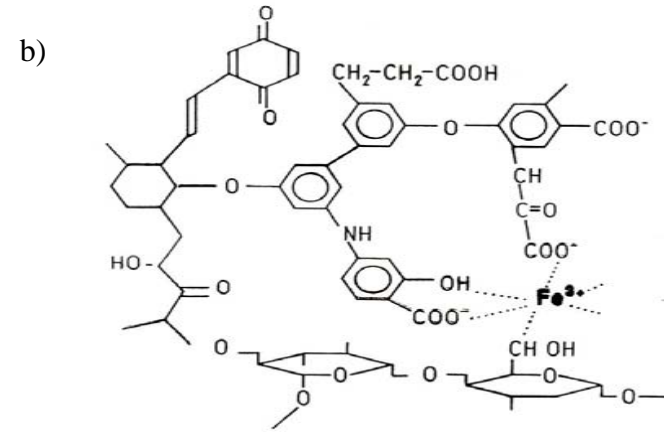
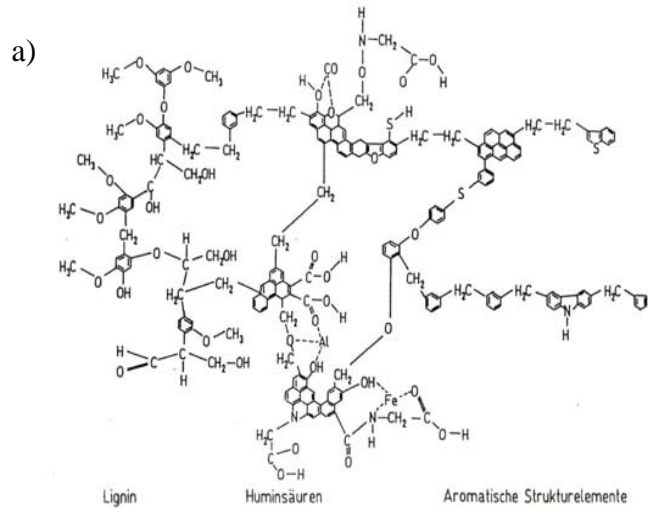

Appendix 11

a) Model of a Macro molecule of Lignite

b) Model Structure of the Humic acid

c) Important Lignite Functional Groups

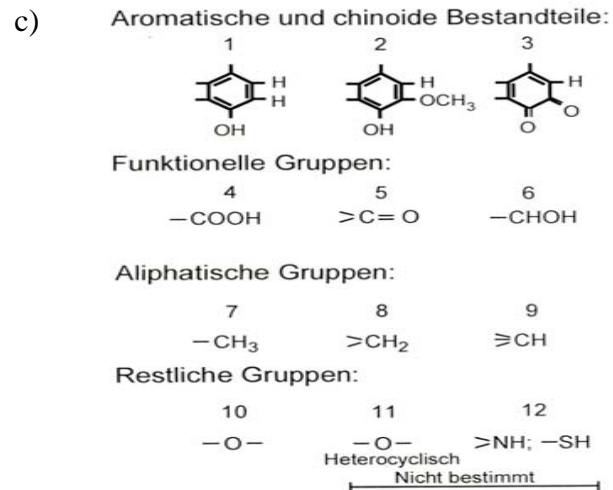

TU Bergakademie Freiberg
 Professur Agglomerationstechnik und Luftreinhaltung

