

Integration of available regenerative energy sources in community networks for both electricity and heating

Von der Fakultät für Maschinenbau, Elektrotechnik und
Wirtschaftsingenieurwesen der Brandenburgischen Technischen Universität
Cottbus zur Erlangung des akademischen Grades eines Doktor-Ingenieur
genehmigte Dissertation

vorgelegt von

M.Sc. Henrique Alcalde Melo

Geboren am 31.03.1981 in Belo Horizonte, Brasilien

Vorsitzender: Prof. Dr.-Ing. G. Lappus

Gutachter: Prof. Dr.-Ing. H. Schwarz

Gutachter: Prof. Dr. rer. nat. habil. G. Seibold

Gutachter: Dr.-Ing. C. Heinrich

Tag der mündlichen Prüfung: 6. März 2013

Summary

In the last years, energy prices for German households have been increasing constantly. Some reasons for that include: the dependency of Germany on external fossil fuels to supply its energy demand, the decision to invest in renewable energy generation and to shut down all its nuclear power plants. Nowadays households are already able to generate energy on-site, however the generation potential depends on climatic conditions as well as the specific location and the type of the building.

The aim of this work is to evaluate whether a community of new efficient single-family houses can generate enough energy on-site to supply its electricity and heating demand over the year based on renewable energy sources and with the support of energy storage systems, including electric vehicles.

The theoretical community is situated in the city of Cottbus, Germany. For this community, an electricity load profile was designed based on the use of common devices and separated in controllable and uncontrollable loads. Electricity is generated on-site through photovoltaic panels and small wind turbines, and the electricity generation potential is evaluated based on the community's available space, which is rather limited, and the actual regulations in the State of Brandenburg. A comparison of the available technologies to supply the heating demand as well as to store energy in the household sector is presented and discussed. It is assumed that each household has an electric vehicle that can be charged and also discharged in the community as an extra energy storage system. A software simulation system was designed with which an energy balance analysis is carried out based on hourly values of supply and demand.

Under the assumptions taken for this study, the results of the simulation show that the community is able to generate more energy than consumed throughout a year, however in a few occasions there is not enough energy available to supply the community's energy demand. Water can be heated up to 70°C at least once a week preventing the bacterium *Legionella* to grow. The community is able to supply 99% of the uncontrollable load group demand and 97% of the controllable load group demand. There is enough energy available to heat space during the cold months, if heat pumps with a coefficient of performance greater

than two are used. The electric vehicles can be charged using the energy generated in the community via grid or extra battery banks.

If energy prices continue to increase, German households will try to find solutions to reduce their energy bills. The integration of several households forming a community network is a solution that optimizes the energy use and space (especially taking wind turbines in consideration), and reduces investments. However, the implementation of such a community still depends on the availability of space, improvement and price reduction of energy storage systems, regulations for energy exchange as well as willingness of the people living in such a community to adapt their daily routine according to the availability of energy.

Zusammenfassung

In den letzten Jahren sind die Energiepreise für Haushalte in Deutschland stetig gestiegen. Einige Gründe dafür sind: die Abhängigkeit Deutschlands von externen fossilen Brennstoffen zur Deckung des eigenen Energiebedarf, die Förderungen von Energieerzeugung aus erneuerbaren Energien sowie die sukzessive Abschaltung aller Kernkraftwerke. Heutzutage sind Haushalte bereits in der Lage, dezentral Energie zu erzeugen. Das Potential zur Energieerzeugung hängt jedoch von den klimatischen Bedingungen sowie der konkreten Lage und Art des Gebäudes ab.

Das Ziel dieser Arbeit ist es zu analysieren, ob eine Gemeinschaft bestehend aus energieeffizienten Passiv-Einfamilienhäusern genügend Energie auf Basis von erneuerbaren Energien dezentral erzeugen kann, um ihren gesamten Strom- und Wärmebedarf mit der Unterstützung von Energiespeichern im Laufe eines Jahres zu decken (einschließlich von Elektrofahrzeugen).

Die theoretische Gebäudegemeinschaft befindet sich in der Stadt Cottbus, Deutschland. Für diese Gemeinschaft wurde ein Stromlastprofil, bestehend aus kontrollierbaren und unkontrollierbaren Belastungen, erstellt. Das Potential zur dezentralen Energieerzeugung basierend auf Photovoltaik- und kleinen Windkraftanlagen wird anhand der zur Verfügung stehenden Flächen sowie den gegenwärtigen gesetzlichen Vorschriften untersucht. Verfügbare Technologien zur Bereitstellung des Wärmebedarfs sowie aktuelle Speichertechnologien für Haushalte werden vergleichend vorgestellt und diskutiert. Es wird angenommen, dass jeder Haushalt ein elektrisches Fahrzeug besitzt, welches im Gemeinschaftsnetz auf- und entladen werden kann und somit auch als zusätzlicher Energiespeicher dienen kann. Um zu untersuchen, ob sich Energiebedarf und -erzeugung im stündlichen Zeitschritt decken, wurde eine Simulationssoftware entwickelt.

Basierend auf den getroffenen Annahmen zeigen die Simulationsergebnisse, dass die dezentrale Energieerzeugung aus erneuerbaren Energien den Bedarf über den Zeitraum eines Jahres übersteigt. Es gibt jedoch einige wenige Zeitschritte, an denen der Bedarf größer als die Erzeugung ist. Es ist außerdem genug Energie vorhanden, um den Wassertank der Gemeinschaft einmal wöchentlich auf 70 °C zu erhitzen, um das Wachstum der Legionellen Bakterien zu verhindern. Die statistische Auswertung ergab, dass die Gemeinschaft 99 % der kontrollierbaren sowie 97 % der unkontrollierbaren Energiebedarfe decken kann. Außerdem

steht genug Energie zu Verfügung um den Wärmebedarf während der kalten Wintermonate, unter Verwendung von Wärmepumpen mit einer Leistungszahl größer als zwei, zu decken. Die elektrischen Autos können sowohl mit der zur Verfügung stehenden Energie über das Gemeinschaftsnetz als auch über die Speichersysteme aufgeladen werden.

Sollten die Energiepreise in Deutschland weiter ansteigen, werden Haushalte nach Möglichkeiten suchen ihre Stromrechnungen zu reduzieren. Die Integration von mehreren Haushalten zu einem Gemeinschaftsnetz könnte eine Lösung darstellen, welche sowohl die Energienutzung als auch den verfügbaren Platz (insbesondere unter Berücksichtigung von Windkraftanlagen) optimiert und Investitionen reduziert. Die Umsetzung einer solchen Gemeinschaft hängt jedoch vom verfügbaren Platz, der Weiterentwicklung und Kostenverringerung von Energiespeichersystemen, der Regulierung von Energieaustausch sowie der Bereitschaft der Gemeinschaft ab, ihre täglichen Abläufe an die Verfügbarkeit von Energie anzupassen.

Contents

Summary	ii
Zusammenfassung	iv
List of figures	viii
List of tables	x
1. Introduction	1
1.1. Objective and structure of the thesis.....	2
2. Evolution of world energy use	3
2.1. Primary energy consumption.....	3
2.2. Fossil fuels countdown	5
2.3. Carbon dioxide emissions.....	6
2.4. The era of renewables.....	8
3. Germany.....	11
3.1. Energy consumption	11
3.2. The transformation of the energy system	12
3.3. Household sector	15
3.3.1 Examples of on-site energy generation (Germany and USA).....	18
3.4. Smart grid	20
3.5. Electric vehicles.....	22
4. The path to renewable energy communities.....	25
4.1. Definition.....	25
4.2. Passive houses	26
4.3. Electricity generation from renewable sources	27
4.3.1. Photovoltaics	28
4.3.1.1. Photovoltaic potential in the renewable energy community.....	30
4.3.2. Wind turbine.....	33
4.3.2.1. Wind turbine potential in the renewable energy community	36
4.3.3. Achieving grid parity	40
4.4. Heating generation from renewable sources	41
4.4.1. Electric heater.....	41
4.4.2. Solar thermal collector	42
4.4.2.1. Flat-plate collector	44
4.4.2.2. Evacuated tube collector	45
4.4.3. Heat pump	45

4.4.4.	Water storage tank.....	47
4.5.	Energy storage systems	48
4.5.1.	Lead-acid battery	49
4.5.2.	Lithium-ion battery	51
4.5.3.	Vanadium redox-flow battery	54
4.5.4.	Hydrogen storage system	55
4.5.5.	Energy storage systems comparison	57
5.	Case study	59
5.1.	Renewable energy community overview	59
5.2.	Electricity load profile	59
5.3.	Electricity generation.....	62
5.4.	Heating demand.....	63
5.5.	Energy storage system	65
5.6.	Electric vehicle as stationary energy system	66
5.7.	Energy balance simulation.....	67
5.8.	Results of the simulation	72
5.8.1.	Domestic hot water demand.....	72
5.8.2.	Uncontrollable load group.....	74
5.8.3.	Controllable load group.....	75
5.8.4.	Waste of energy and space heating demand.....	76
5.8.5.	Performance of the stationary battery bank.....	79
5.8.6.	Performance of the electric vehicles	82
5.8.7.	Resume of the simulation results and final considerations	84
6.	Conclusions	85
7.	Abbreviations	88
8.	References	90

List of figures

Figure 2.1: Primary energy consumption per region [1]	4
Figure 2.2: Primary energy consumption per source [1].....	4
Figure 2.3: Total U.S. natural gas production, consumption, and net imports, 1990-2035 (trillion cubic feet) [2]	5
Figure 2.4: Carbon dioxide emissions per region [1].....	7
Figure 2.5: Primary energy consumption in Europe & Eurasia per fossil fuel source [1]	8
Figure 2.6: Primary energy consumption from renewables per region (excluding Hydroelectricity) [1].....	9
Figure 2.7: Energy storage technologies [9]	10
Figure 3.1: Primary energy consumption by fuel in Germany (2011) [1]	11
Figure 3.2: Renewables installed capacity for electricity generation in Germany [18].....	13
Figure 3.3: Electricity production from renewables in Germany (2010) [18]	14
Figure 3.4: Example of zero-energy houses in Freiburg im Breisgau [22].....	15
Figure 3.5: Energy sources for the heating demand in Brandenburg (2008) - Households and services sectors [27]	17
Figure 3.6: Energy prices evolution for private households in Germany [12].....	18
Figure 3.7: Efficient house plus in Berlin [30].....	19
Figure 3.8: Integrated photovoltaics and small wind turbines in Lexington Farms Community in Jerseyville [32]	20
Figure 3.9: Illustration of variable tariffs in the smart grid [34]	21
Figure 3.10: Temporal development of global oil production, consumption and price [36] ...	22
Figure 3.11: Fuel prices evolution in the German gas stations [37]	23
Figure 3.12: Electric vehicles being charged (a) based on cable and (b) based on wireless inductive charging [42]	24
Figure 4.1: Ventilation system with heat exchanger [46]	27
Figure 4.2: Exponential growth of photovoltaic installations in Germany [50]	29
Figure 4.3: Daily average irradiation in Cottbus [54]	31
Figure 4.4: Electricity generated from photovoltaics per month	32
Figure 4.5: Idealized change of wind speed at a wind turbine [51]	34
Figure 4.6: Evolution of the wind turbine over the years [57]	35
Figure 4.7: Average wind speed in Cottbus (1997-2001) [59]	36
Figure 4.8: Distance space of wind turbines [61].....	38
Figure 4.9: Electricity generated from small wind turbines per month.....	39

Figure 4.10: Electricity price for households in Germany [39]	40
Figure 4.11: Examples of electrical resistors to heat water [65], [66]	42
Figure 4.12: Examples of electrical resistors to heat space [67], [68], [69], [70]	42
Figure 4.13: Solar thermal system main components [51].....	43
Figure 4.14: Example of a flat-plate collector [73]	44
Figure 4.15: Example of an evacuated tube collector [73]	45
Figure 4.16: Operating principle of a heat pump [6].....	46
Figure 4.17: Storage temperature reduction without loading or unloading [6].....	48
Figure 4.18: Discharging and charging a lead-acid battery [6].....	49
Figure 4.19: Charge stages of a lead-acid battery [81].....	51
Figure 4.20: Ion flow in lithium-ion battery [85].....	52
Figure 4.21: Capacity as a function of charge voltage on a lithium-ion battery [87]	53
Figure 4.22: Estimates of electric vehicle battery costs [90]	54
Figure 4.23: Operating principle of a vanadium redox-flow battery [91].....	55
Figure 4.24: Operating principle of a PEM fuel cell [99]	57
Figure 5.1: Example of the electricity load profile on a winter Sunday	61
Figure 5.2: Total electricity production (kWh) per season	62
Figure 5.3: Illustration of the simulation steps in LabVIEW	67
Figure 5.4: Flow chart to supply energy to the uncontrollable load group	68
Figure 5.5: Flow chart to supply energy to the hot water demand.....	69
Figure 5.6: Flow chart to supply energy to the controllable load group	70
Figure 5.7: Flow chart to charge the energy storage systems	71
Figure 5.8: Battery bank energy capacity histogram.....	81
Figure 5.9: How many times the electric vehicles are completely charged in the community	83

List of tables

Table 2.1: Ratio of fossil fuels proved reserves and production per region in 2011 [1].....	6
Table 3.1: Average electricity consumption per year in the new states of Germany [23]	16
Table 3.2: Ratio of fossil fuels proved reserves and production in Russia, Norway and Netherlands [1].....	17
Table 3.3: Comparison between conventional and electric vehicles [37], [39], [40].....	23
Table 4.1: Maximum efficiency and needed area of different photovoltaic technologies [51]	30
Table 4.2: Main photovoltaic components costs [6], [55].....	32
Table 4.3: Values of surface roughness length for various types of terrain [58]	36
Table 4.4: Heat pump coefficient of performance for space heating [51]	47
Table 4.5: Cycle performance of lead-acid batteries [77], [80]	50
Table 4.6: Cycle performance of lithium-ion batteries [86].....	53
Table 4.7: Comparison of fuel cell technologies [98], [99]	56
Table 4.8: Comparison of different energy storage systems for the household sector	58
Table 5.1: Group of houses in the community	59
Table 5.2: Electrical appliances per load group	60
Table 5.3: Electricity consumption (kWh) per season	61
Table 5.4: Period when people take a shower per house group	63
Table 5.5: How water temperatures affect Legionella [102].....	64
Table 5.6: Period when the electric vehicles are parked in the community.....	66
Table 5.7: Examples of charge and discharge of electric vehicles.....	66
Table 5.8: Number of times that water is heated up to 70°C	72
Table 5.9: Number of times that water is demanded but there is not enough energy supply ..	73
Table 5.10: Energy consumed to heat water up to 40°C	73
Table 5.11: Lack of energy (kWh) to supply the load demand of the ULG	74
Table 5.12: Lack of energy (kWh) to supply the load demand of the CLG.....	76
Table 5.13: Space heating demand per month	77
Table 5.14: Waste of energy (kWh)	78
Table 5.15: Excess of electricity per month	79
Table 5.16: Charged and discharged energy	80
Table 5.17: Electric vehicles charge and discharge in the community	82
Table 5.18: Electric vehicles energy consumption outside the community.....	83

1. Introduction

The global primary energy consumption is currently mainly based on fossil fuels, which are finite and globally unequally distributed. During the last decades, energy prices have been increasing due to the scarcity of fossil fuel reserves and the increase of energy consumption globally. Since the oil crisis in the 1970s, a lot of effort has been put into developing and improving technologies that generate energy from renewable energy sources. It is very likely that in the twenty-first century these technologies will gradually substitute the use of finite fossil fuels in countries with little or no reserves.

Germany heavily depends on external resources to supply its energy demand. In order to reduce its dependency on other countries and to reduce its emission of climate damaging gases, Germany has attempted to reduce its energy consumption and increase the share of renewables for many years. The household sector, which is currently still responsible for a great share of energy consumption in Germany, has a great potential to reduce its energy consumption by improving the thermal insulation of buildings and substituting old heating systems by more efficient ones. Due to the rapid development of renewable energies, households are no longer only energy consumers but can also be decentralized energy producers, which helps reducing transmission and distribution losses and also Germany's dependence on imported fossil fuels. In addition to that, if electricity is consumed where it is generated, there is no need to upgrade the existing networks.

New buildings constructed in one of the European Union members must consume “nearly zero” energy by 2020 and the low amount of energy required should be covered by energy from renewable sources generated on-site or nearby. This target might be difficult to be achieved in central areas of big cities where free space is not available in abundance to produce energy on-site. However, communities of single-family houses constructed in suburban areas have more chances to succeed, in particular if a mix of different renewable energy sources is used.

The transportation sector will likewise pass through a transformation when electric vehicles gradually substitute conventional vehicles operating on fossil fuels. In that case, households will have the possibility of charging their vehicles at home using the excess of electricity generated on-site, and also use the energy from the vehicles as a storage system to supply domestic loads.

1.1.Objective and structure of the thesis

The main target of this work is to evaluate if a community of new efficient single-family houses can generate enough energy on-site to supply its electricity and heating demand over the year from renewable energy sources and with the support of energy storage systems. This evaluation shall be based on current technologies which are already available or expected to be available soon. The thesis outlines the opportunities and limits of various technologies, the balance between availability and demand and describes the main design criteria for a sustainable community.

The study is based on simulations with the software HOMER and LabVIEW to evaluate if energy balance can be achieved in every hour of the year. HOMER is used to assess the electricity generation potential of photovoltaics and wind turbines. LabVIEW is applied to integrate the outputs from HOMER with the electricity load profile, heat generators, electric vehicles and storage systems. The case study is based in the city of Cottbus in Brandenburg (Germany), for which the necessary input data were available.

An analysis of the primary energy consumption is presented in Chapter 2 for different regions of the world. Emphasis is given on the use of fossil fuels and their impact on the environment as well as on the increasing share of renewables, especially in the regions that heavily depend on external resources.

Chapter 3 describes how the energy system in Germany has been changing since the oil crisis in the 1970s and how the household sector has been being affected by the increase of energy prices.

The concept of the renewable energy community is introduced in Chapter 4 along with the importance of constructing buildings that consume less energy by maximizing passive energy gains. Furthermore, the technologies mostly used to generate electricity and heat on-site from renewable energy sources are presented. This chapter also includes a comparison among different energy storage systems that can be applied in the household sector.

In Chapter 5, the results of the software simulations are shown and discussed in order to determine if the theoretical community can supply its energy demand over the year. The last chapter contains the conclusion and future prospects.

2. Evolution of world energy use

2.1. Primary energy consumption

The twentieth century was characterized by the most rapid technological development ever experienced in human history. Consequently, the way of living and working has changed drastically for many people worldwide leading to an increase in quality of life and life expectancy. In the modern globalized world, computers, machines and robots have made the industry and agriculture sectors more efficient. The transportation sector, due to invention and commercialization of vehicles, trains and airplanes facilitates the exchange of goods and allows people and cultures to meet and exchange ideas faster. And in the household sector, domestic appliances are a great help for families with cooking, washing and cleaning. However machines demand energy to operate and even with the development of new and more efficient technologies humans are consuming more energy every year. Despite the fact that most devices on its own consume less energy than years before, the amount of devices including communication and entertain equipment has increased and overcompensates the savings. Furthermore, in most western countries the standard of living has increased leading to larger homes which also needs to be heated.

The primary energy consumption has increased over the decades almost everywhere in the world, except in Europe & Eurasia after the fall of the Soviet Union in the beginning of the 1990s, as depicted in Figure 2.1. It is important to mention that between 1965 and 1984, there is no data available for the former Soviet Union. In 2011, the total consumption was 12,274 Mtoe, 2.5% higher than the year before. The Asia Pacific region is the biggest consumer driven by developing countries, such as China, with 39% share in 2011.

2 Evolution of world energy use

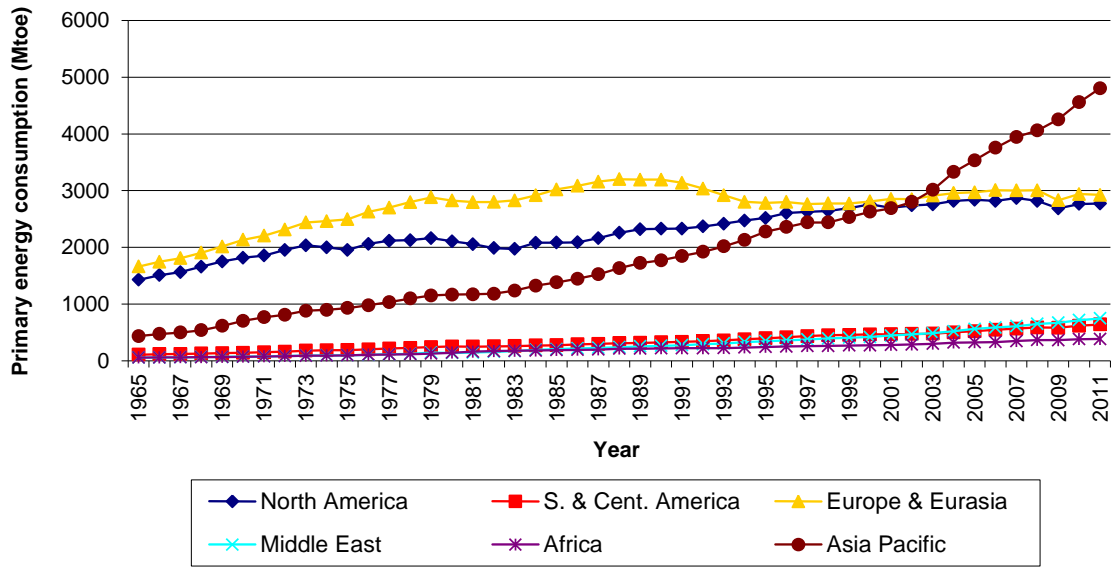

Figure 2.1: Primary energy consumption per region [1]

The main sources of primary energy are finite fossil fuels: oil, coal and natural gas. They are not equally distributed in the world and therefore local conflicts can affect their prices and their supply. As shown in Figure 2.2, oil has always had the highest share from all sources since 1965. The use of coal has been increasing significantly in the last years, on average 4.2% in the last ten years. In 2011, only China consumed almost half of the coal used as primary energy. The share of nuclear energy reduced 5.6% from 2006 to 2011, while the renewables (wind, geothermal, solar, biomass and waste) increased 107% in the same period.

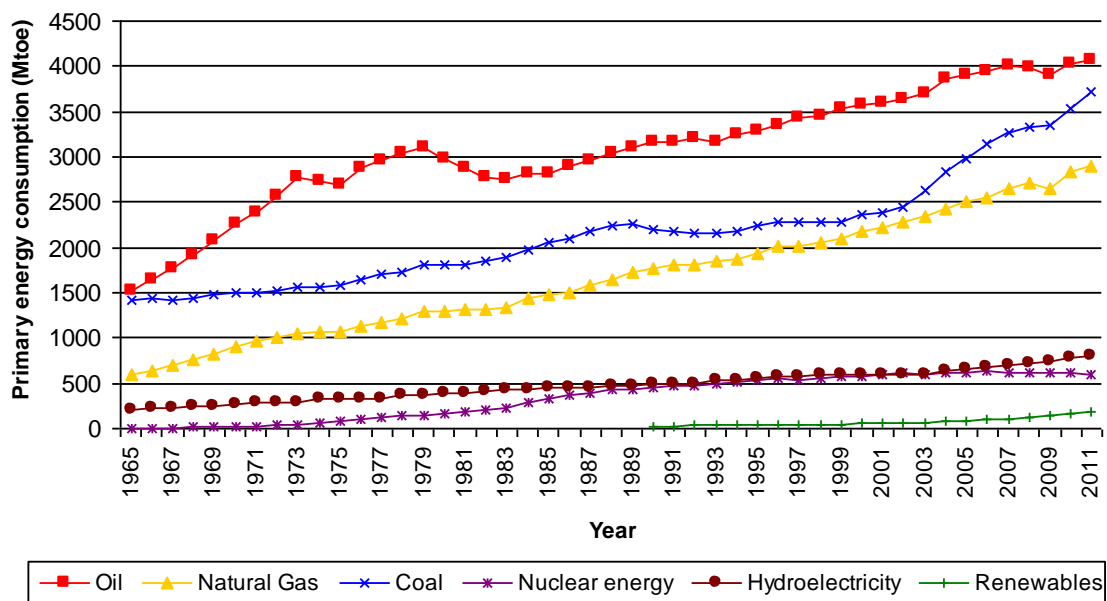

Figure 2.2: Primary energy consumption per source [1]

The share of each source of primary energy is expected to change in the next decades because oil reserves are diminishing, while new techniques like hydraulic fracturing to extract natural gas from shale formations have become economically viable. In the last years, the price of natural gas in the United States had dropped to the level of the beginning of the century, while in other parts of the world it has more than double [1]. The Energy Information Administration (EIA) projects that the United States will increase the production and consumption of natural gas in the next years, starting even to export it after 2020, as shown in Figure 2.3.

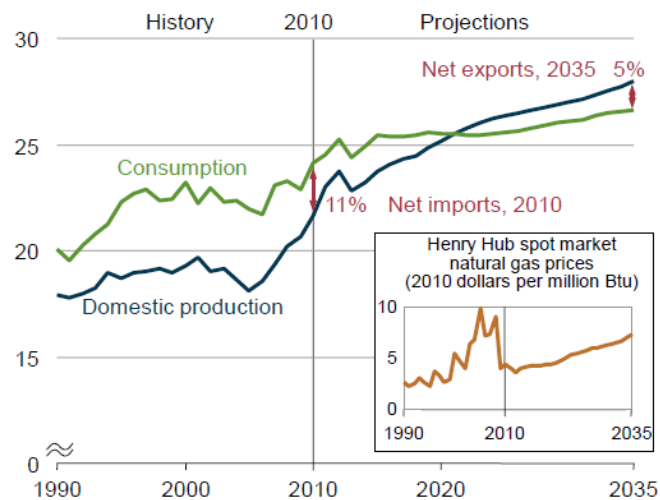

Figure 2.3: Total U.S. natural gas production, consumption, and net imports, 1990-2035 (trillion cubic feet) [2]

2.2.Fossil fuels countdown

Fossil fuels are the main sources of primary energy in the world. They are however finite and irregularly distributed throughout the world. Table 2.1 presents the remaining years of the different fossil fuels based on the ratio of proved reserves and production per region in the year 2011. As presented in Figure 2.2, oil has been the source of primary energy mostly used for decades. The oil proved reserves may last for about 60 years and are mainly concentrated in the Middle East region. Most of the natural gas proved reserves are located in the Middle East region and Europe & Eurasia which are predicted to also only last for around six decades. Coal on the contrary is more abundantly available and the proved reserves are distributed more evenly throughout the world, mainly in Europe & Eurasia followed by Asia Pacific and North America.

Table 2.1: Ratio of fossil fuels proved reserves and production per region in 2011 [1]

Fossil Fuel		North America	S. & Cent. America	Europe & Eurasia	Middle East	Africa	Asia Pacific	World
Oil (*)	Proved reserves	33,529	50,477	19,024	108,193	17,563	5,463	234,249
	Production	670	379	838	1,301	417	388	3,993
	Years left	50	133	23	83	42	14	59
Natural Gas (#)	Proved reserves	10,826	7,581	78,687	80,031	14,531	16,777	208,433
	Production	864	167	1,036	526	202	479	3,274
	Years left	13	45	76	152	72	35	64
Coal (+)	Proved reserves	245,088	12,508	304,604		32,895	265,843	860,938
	Production	1,076	101	1,256		260	5,000	7,693
	Years left	228	124	243		127	53	112

* million tonnes oil equivalent
 # billion cubic meters
 + million tones

As shown in Table 2.1, the proved reserves may last for about a century in case production is kept constant. According to [3] however, there are 590,003 EJ of resources in the planet which can still be used in the future. With the development of new technologies, both proved reserves and resources might increase [4]. Nevertheless, the use of fossil fuels should be reduced not only to preserve them for future generations but also to diminish the emissions of climate damaging gases [5].

2.3. Carbon dioxide emissions

The intensive use of fossil fuels since the industrial revolution, has affected the balance of the natural greenhouse effect. When fossil fuels are burned, carbon dioxide (CO₂) is released in the environment and remains in the atmosphere for many years. According to [6], the carbon dioxide contribution to the greenhouse effect is about 60%, which makes it the most relevant greenhouse gas. The total CO₂ emission has been increasing over the years, as depicted in Figure 2.4. In 2011 the total amount of CO₂ emitted was 34 billion tones. The Asia Pacific region has been emitting most CO₂ since 1996, especially due to China’s and India’s fast development. Europe & Eurasia regions have reduced their emissions since the end of the 1990s. Although not so relevant in the global context, the Middle East, Africa and South & Central America regions have also increased their emissions in the last ten years by 64%, 34% and 34% respectively.

2 Evolution of world energy use

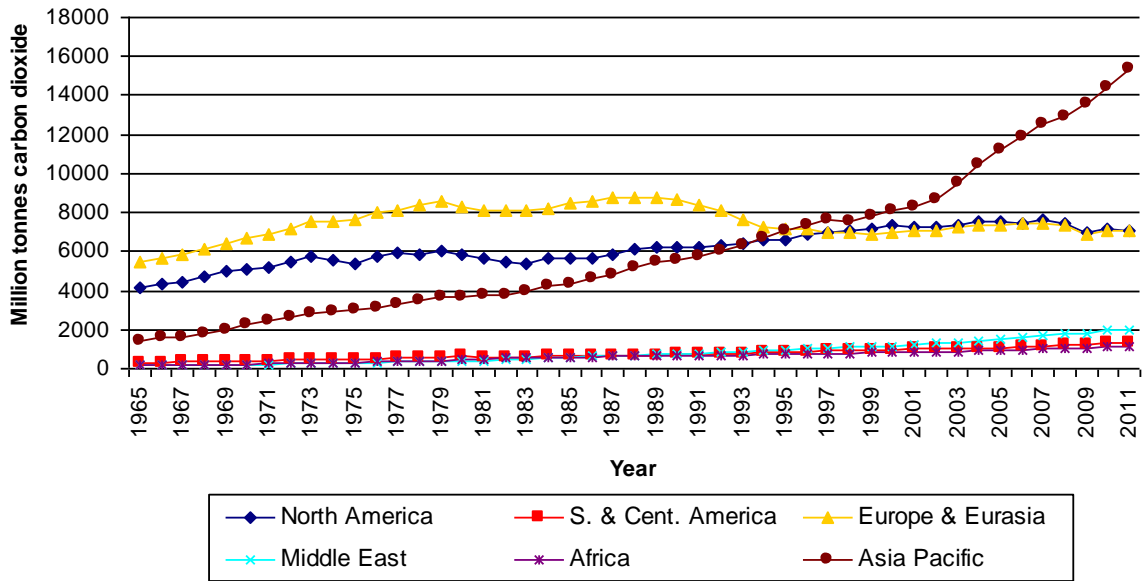

Figure 2.4: Carbon dioxide emissions per region [1]

From the three fossil fuels, the burning of coal causes most CO₂ emissions (0.34 – 0.36 kg/kWh), followed by oil (0.25 – 0.28 kg/kWh) and natural gas (0.20 kg/kWh) [6]. Europe & Eurasia are the only regions that significantly reduced their CO₂ emissions during the last 20 years. This is due to the fact that the primary energy consumption reduced and more natural gas started to be used instead of coal and oil, as shown in Figure 2.5. In the near future, the United States may also reduce their emissions in case the EIA projection is confirmed and less coal and oil are used. This however will not cause a significant effect on the global scale if the countries in Asia Pacific continue using coal as the main primary energy source.

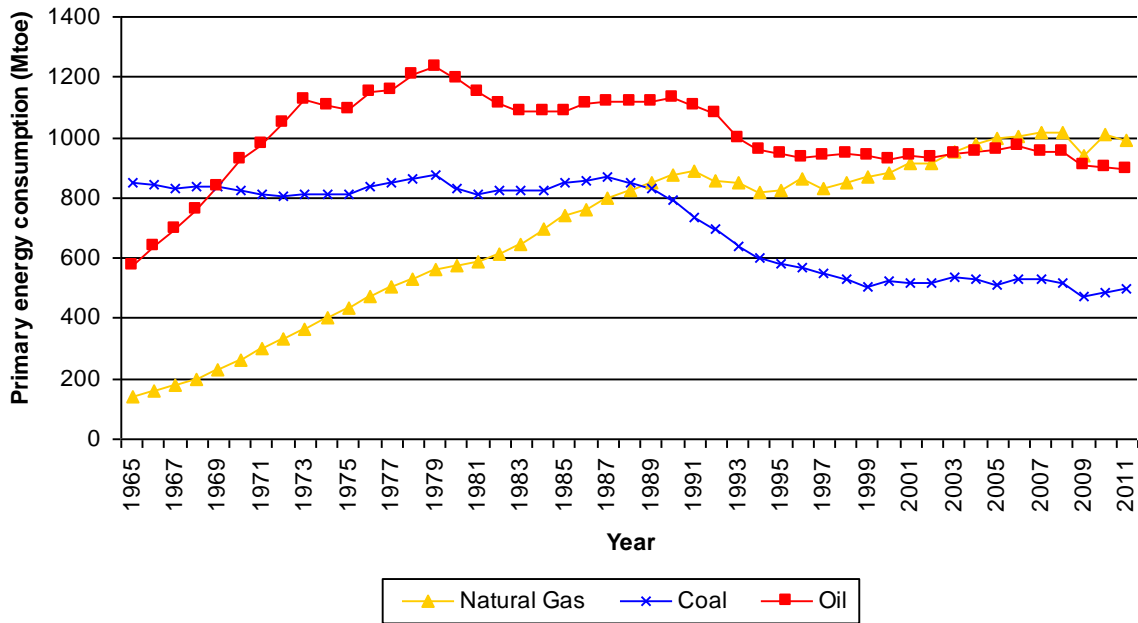

Figure 2.5: Primary energy consumption in Europe & Eurasia per fossil fuel source [1]

2.4. The era of renewables

Energy provided from renewable sources is naturally replenished and therefore considered inexhaustible, such as solar energy, geothermal energy and planetary energy (gravitation). Only the sun delivers 3,900,000,000 PJ/year, which is more than enough to supply the global energy demand [6].

Throughout history, humans have used renewable energy to facilitate work, for instance through windmills and water wheels. The use of fossil fuels has been however predominant because the energy generated from them was still very cheap until some decades ago. After the oil crisis in the 1970s, the countries dependent on external fuels started to use more their renewable sources to produce energy, and new technologies like photovoltaics and wind turbines started to be developed and were improved for electricity production. Germany was the first European country to adopt feed-in tariffs in 2000 for new renewable installations. Based on [7], due to the success of the implementation in Germany, several other countries started to adopt similar feed-in schemes. As a consequence the share of renewables in the primary energy consumption has increased in many regions of the world, as depicted in Figure 2.6.

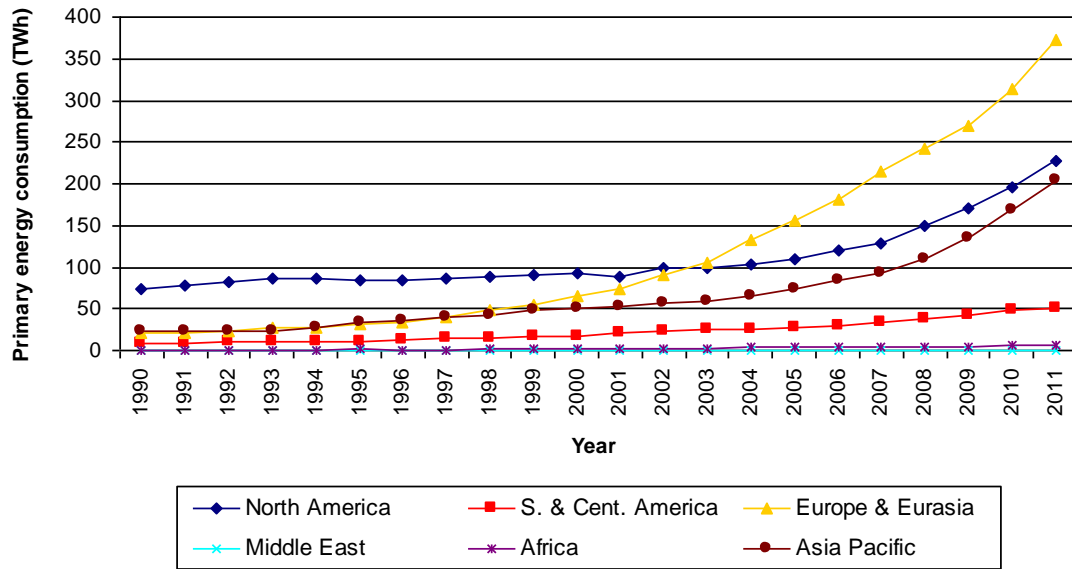

Figure 2.6: Primary energy consumption from renewables per region (excluding Hydroelectricity) [1]

Although the renewable energy generation has fewer impacts on the environment, it also has some disadvantages. Sun and wind are not constantly available, thus the energy generation is sometimes instable causing for example voltage fluctuations. The existing transmission lines were not designed to integrate extra generators and therefore they must be upgraded. Otherwise the energy that is produced and not transmitted to a consumer is wasted and at the same time paid because it was produced. Some possibilities to optimize the use of renewable energy sources are:

- Build new transmission lines and/or pipelines connecting the regions more favorable for energy generation to main consumers
- Change habits and adapt the consumption of energy according to the availability of resources
- Store excess of energy locally to be used at moments of high demand
- Consume the energy produced on-site or nearby

New transmission lines and/or pipelines are however very costly and free space is sometimes not available. In the short term it is likely that load management and local energy storage systems (ESSs) can play a role. Switching the use of certain loads from peak times to low demand hours does not necessarily mean that habits and routines must be changed. It is therefore the easiest solution depending only on the availability and cost of technologies to control the loads. However not all the loads can be used at other times, and for these cases energy storage systems are necessary. The most common storage systems are depicted in

Figure 2.7. They vary depending on the rated power as well as the discharge time. Some are already mature and used for several years like pumped-storage hydro, while others are still in the development phase such as lithium-ion batteries. With the projected increase in the use of renewables in the future, the importance of energy storage systems will also increase. As described in [8], there is no single ESS that meets the requirements of all applications and therefore the characteristics of the technologies, such as efficiency, specific energy, cycle life and costs must be analyzed and compared for each situation. In case the energy consumption is not so high, like in the household sector, the energy can be produced and consumed on-site or nearby. Moreover, if load management and energy storage systems are also applied, small energy consumers can reduce their dependency on external energy.

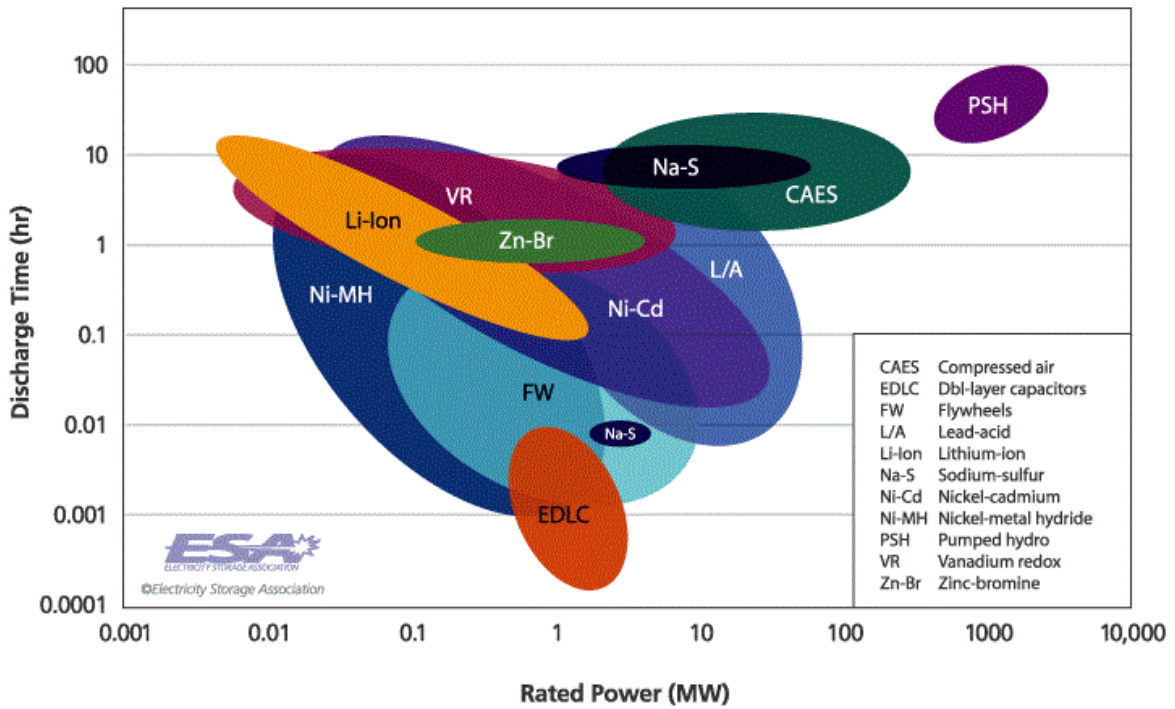

Figure 2.7: Energy storage technologies [9]

3. Germany

This chapter describes the energy system in Germany and its transformation with a special focus on the household sector. In addition, it is discussed future challenges such as the implementation of the smart grid and the integration of electric vehicles (EVs) based on the integration of decentralized renewable generation. Germany has been chosen because of the close proximity and the advanced status of renewable generation in combination with the above mentioned problems.

3.1. Energy consumption

Germany is one of the most industrialized countries not only in Europe but also in the world. With a population of 82 million, it is the most populous country within Europe [10]. The country is the seventh main consumer of primary energy in the world and the biggest in Europe [1]. In 2011, the primary energy consumption was 12,829 PJ in Germany [1]. The main energy sources are oil (37%), followed by coal (25%) and natural gas (21%), as depicted in Figure 3.1. Nuclear energy and renewables contribute each 8% and hydroelectricity 1%.

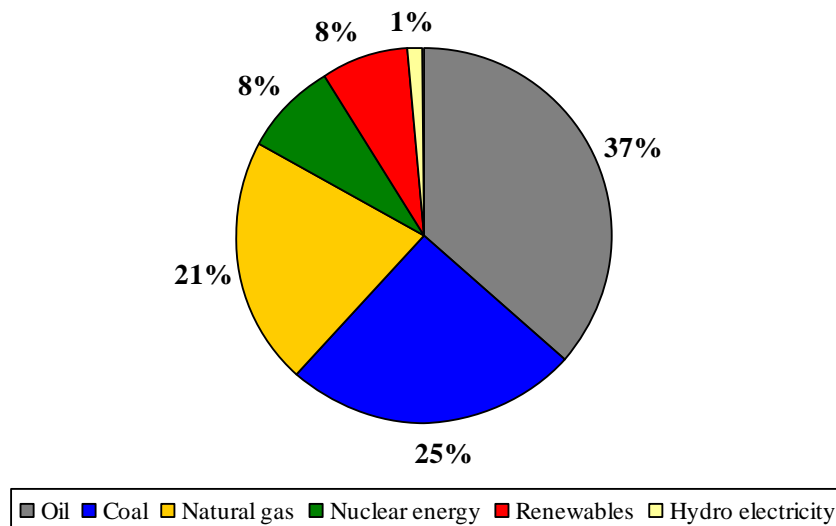

Figure 3.1: Primary energy consumption by fuel in Germany (2011) [1]

Germany is dependent on imported fossil fuels to supply its energy demand, especially oil and natural gas [11]. The ratio between imported energy and primary energy consumption was 84% in 2009 [12]. In addition, the country is the main emitter of CO₂ in Europe and the sixth largest emitter in the world. In 2011, Germany emitted approximately 800 million tonnes of carbon dioxide [1].

3.2. The transformation of the energy system

The energy system in Germany is passing through a transformation, where energy generated from renewable sources is gradually substituting the use of fossil fuels and nuclear power [13]. Some decades ago, when new technologies that generate energy from renewable sources were still under development, energy generation from nuclear power and domestic coal were supported by the government in order to reduce the dependency on external primary energy resources. Nuclear power has however never been well accepted by parts of the population, due to safety issues as well as the unanswered question of the disposal of the nuclear waste. Many people wanted that the investments and efforts should rather be given to renewable energy. In the beginning of the 1980s, wind turbines and solar cells started to receive financial support from the government and a set of demonstration projects were implemented. After the nuclear disaster in Chernobyl in 1986, the opposition against nuclear power further increased. In 1990, the Feed-in Law (in German “Stromeinspeisungsgesetz-StrEG”) was adopted and utilities were obligated to buy the electricity generated from renewables. In 2000, the Feed-in Law was replaced by the Renewable Energy Source Act (in German “Erneuerbare-Energien-Gesetz-EEG”), which is still in force and is the main policy to develop the renewable energy sector in the country and to reduce CO₂ emissions [7]. Figure 3.2 shows the temporal development of the renewables installed capacity for electricity generation in Germany from 1990 to 2010. Since 2000 the installation capacity of wind turbines has constantly increased. The photovoltaic installation presents an exponential growth driven by the decrease of the solar modules price in the last decade [14]. Onshore wind parks are close to achieve their limit of installations [15]. Offshore wind parks on the contrary have still high potential, but new transmission and distribution (T&D) lines are needed to transport the electricity from the North to the main industrial consumers in the South [16]. This requires huge investments, which have to be paid by consumers of energy. As part of the European Union, Germany is committed to achieve the “20-20-20” targets set in 2007. According to [17], the three key objectives for 2020 are:

- A 20% reduction in EU greenhouse gas emissions from 1990 levels,
- Raising the share of EU energy consumption produced from renewable resources to 20%;
- A 20% improvement in the EU’s energy efficiency.

In order to contribute with the achievement of these goals, Germany must continue its efforts to increase the share of renewables and reduce the use of fossil fuels as primary energy sources.

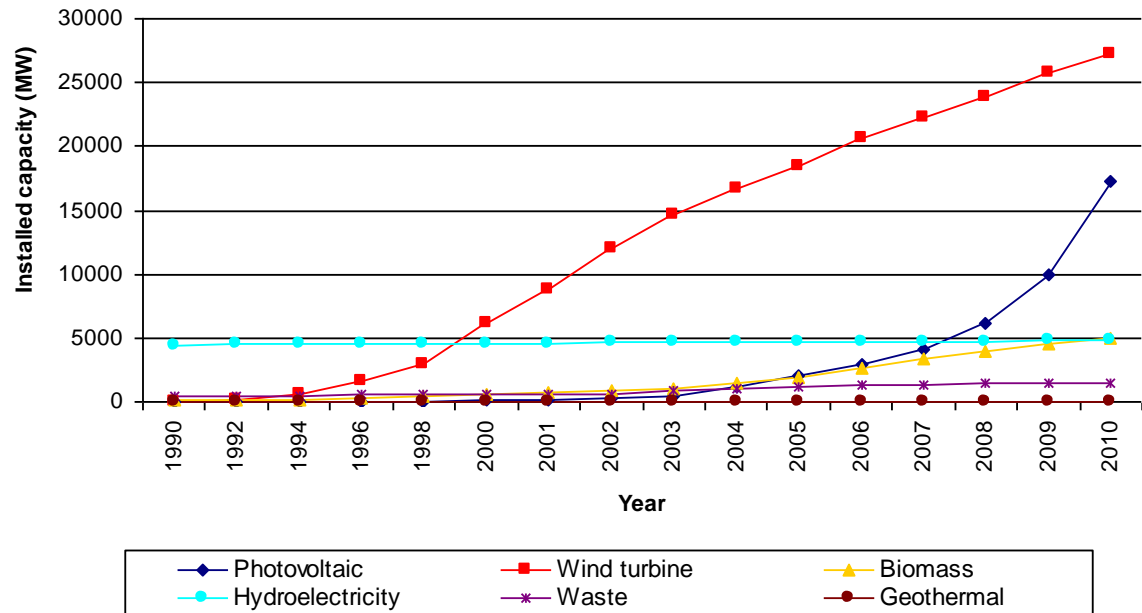

Figure 3.2: Renewables installed capacity for electricity generation in Germany [18]

After the tsunami disaster in Fukushima in 2011, Germany decided to shut down all its 17 nuclear power plants until 2022, approximately 21.5 GW installed power [16]. Renewable energy is supposed to replace this lack of power in order to avoid an increase in imported fossil fuels. But because electricity generated from renewables is discontinuous, the total power of the new installations must be higher than the actual nuclear power plants if the same amount of electricity is expected to be produced.

Since the release of the Renewable Energy Source Act, Germany has achieved one of the leading positions worldwide in installed capacity of photovoltaics and wind turbines [1]. Figure 3.3 shows that the share of these two energy sources is equivalent to almost 50% of the total electricity produced from renewables in the country. In 2010, the share of renewables increased to 9.4% in the primary energy consumption and 16.6% in the electricity generation [12].

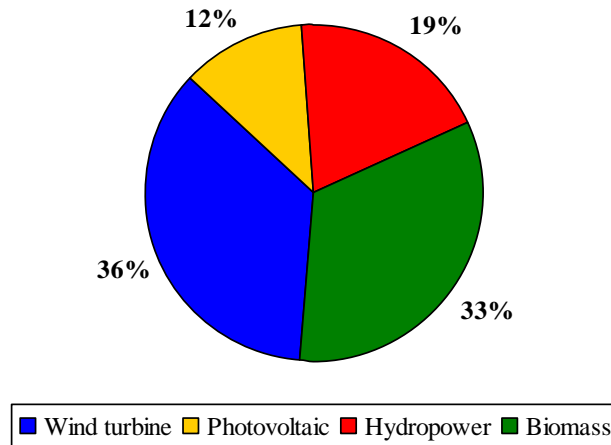

Figure 3.3: Electricity production from renewables in Germany (2010) [18]

Electricity makes up only one part of the transformation of the energy sector. According to the Federal Ministry of Transport, Building and Urban Development, approximately 40% of the energy consumed in Germany is used to heat space and water and two thirds of that is used in private households [19]. And just like for electricity, the main sources of heat supply are fossil fuels. Even if the country installs enough renewables to supply 100% of the electricity demand, investments in heating systems based on electricity would still be required. One measure taken in the last years to reduce the energy consumption for space heating is the renovation of old buildings in order to improve thermal insulation. Although it is probably the fastest and cheapest alternative to improve the energy efficiency of these buildings, it is also not easy to renovate heritage ones. Nevertheless, the primary energy consumption in the country is decreasing due to increasing energy efficiency, i.e. the measures applied are producing a positive effect which might continue into the future [12].

According to the European Parliament and the council of the European Union (EU), the Member States of the EU shall ensure that all new buildings are nearly zero-energy buildings by 2020 [20]. Moreover, the low amount of energy required should be covered by energy from renewable sources generated on-site or nearby. Nowadays some zero-energy houses already exist in Europe [21]. One example is shown in Figure 3.4.



Figure 3.4: Example of zero-energy houses in Freiburg im Breisgau [22]

This community in Freiburg im Breisgau, which is connected to the grid, generates via photovoltaic modules more energy, over the course of a year than needed benefiting from the feed-in tariffs of the Renewable Energy Source Act. The community however is dependent on external sources to supply its electricity demand at night as well as the heating demand in the winter. In the future if the financial support is reduced or cut, similar communities might not profit anymore financially. The solution to this case might be using and storing the electricity generated on-site, which may work well in the hot seasons but not in the cold ones when the electricity demand is higher, space heating is demanded and less sun hours are available.

3.3. Household sector

The household is with around twenty-eight percent one of the sectors that consumes most final energy in Germany [12]. In the modern society, people use many different domestic appliances to facilitate the tasks of cooking, washing and cleaning. Furthermore, the amount of electrical devices for entertainment is constantly increasing, e.g. TV, internet, personal computers and mobile phones. It is unlikely that people will stop using these devices once they are part of their routine and therefore electricity consumption is expected to decline only if the devices get more efficient over time.

The electricity consumption in the household sector varies depending on the number of persons living in the house. Table 3.1 presents the average electricity consumption per year in selected states of Germany, which is the result of the study described in [23]. It can be seen

that the electricity consumption increases with the number of persons, but not proportionally. Moreover, the type and size of the building also influence the final consumption. On the one hand, households living in single-family houses consume more electricity because they have in general more rooms and as consequence more electrical appliances [23]. On the other hand, these houses have more space for on-site renewable integration.

Table 3.1: Average electricity consumption per year in the new states of Germany [23]

Number of persons	Electricity consumption (kWh/a)
2	2,270
3	3,138
4	3,652
5	4,573

As mentioned in Section 3.2, electricity is just a part of the energy consumed by households. The demand for space heating and hot water can be higher than electricity, depending on the insulation of the building. Old constructions may consume more than 100 kWh/m² to heat space during one year [23], [24], [25], and in most cases fossil fuels are still the main energy sources. In the state Brandenburg, 95% of the heating demand in the household and services sectors is supplied by fossil fuels, as depicted in Figure 3.5. Electricity has only 3% share and biomass 2%. According to the Federal Ministry for the Environment, Nature Conservation and Nuclear Safety: “*three quarters of the existing buildings in Germany were built before the 1st Thermal Insulation Ordinance of 1979 (in German “Wärmeschutzverordnung”) and have seen little or no energy efficiency upgrades*” [26]. Therefore, there is still a great potential to reduce energy consumption by improving insulation and substituting old heating systems by more efficient ones. In 2008, the German government created the Renewable Energies Heat Act (in German “Erneuerbare-Energien-Wärmegesetz – EEWärmeG”) which defines that new buildings must incorporate renewables to cover part of the heat demand, such as solar energy, biomass and heat pumps [24]. This is an important measure to increase the renewables share, however renovation and improvements in old buildings must continue.

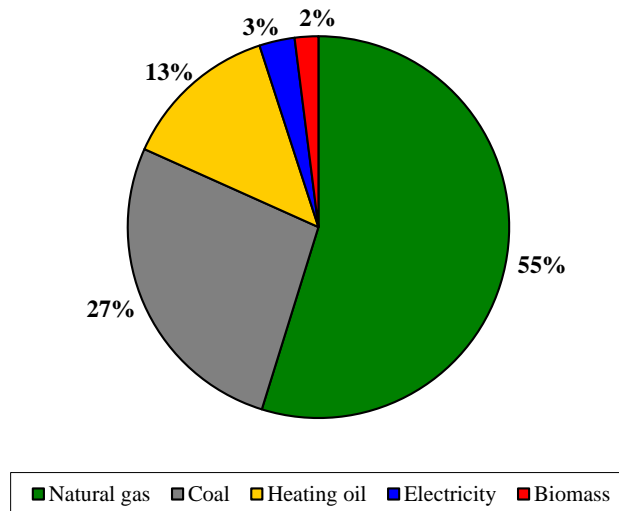

Figure 3.5: Energy sources for the heating demand in Brandenburg (2008) - Households and services sectors [27]

As shown in Figure 3.5, natural gas is the main fuel used to supply the heating demand in Brandenburg in the households and services sectors, which is justified by its low price, being approximately 5.5 €-Cent/kWh in 2011 [12]. On the one hand its burning emits less greenhouse gases than oil and coal. On the other hand, Germany is nowadays dependent on three natural gas suppliers: Russia, Norway and Netherlands [1]. The proved reserves of these countries will not last for more than few decades if production remains at the same level, as shown in Table 3.2. When the reserves of Norway and Netherlands are exhausted, the reserves of Russia will probably decrease in a faster pace to keep provision for other countries. In this case, the price of natural gas might increase if there are no new suppliers.

Table 3.2: Ratio of fossil fuels proved reserves and production in Russia, Norway and Netherlands [1]

Country	Proved reserves (billion cubic meters)	Production (billion cubic meters)	Reserves/Production ratio (years)
Russia	44,598	607	73
Norway	2,069	101	20
Netherlands	1,101	64	17

Energy prices for private households are increasing every year, as depicted in Figure 3.6. For instance, since the introduction of the Renewable Energy Source Act in 2000 the electricity price increased more than 50% for two reasons:

- increased prices of fossil fuels
- additional charge to all consumers in order to compensate the high pay-out for renewable energies

Due to the fact that the transformation of the energy sector is still continuing, it is likely that the electricity price will keep rising in the future. Fossil fuel prices may vary in the short term depending on the demand and supply situation, and also on the market speculations. But because they are finite, it is likely that their prices will increase in the long term. According to [28], the prices of gas, district heating and electricity have increased 9%, 8% and 4.5% respectively from 2011 to 2012 in Brandenburg.

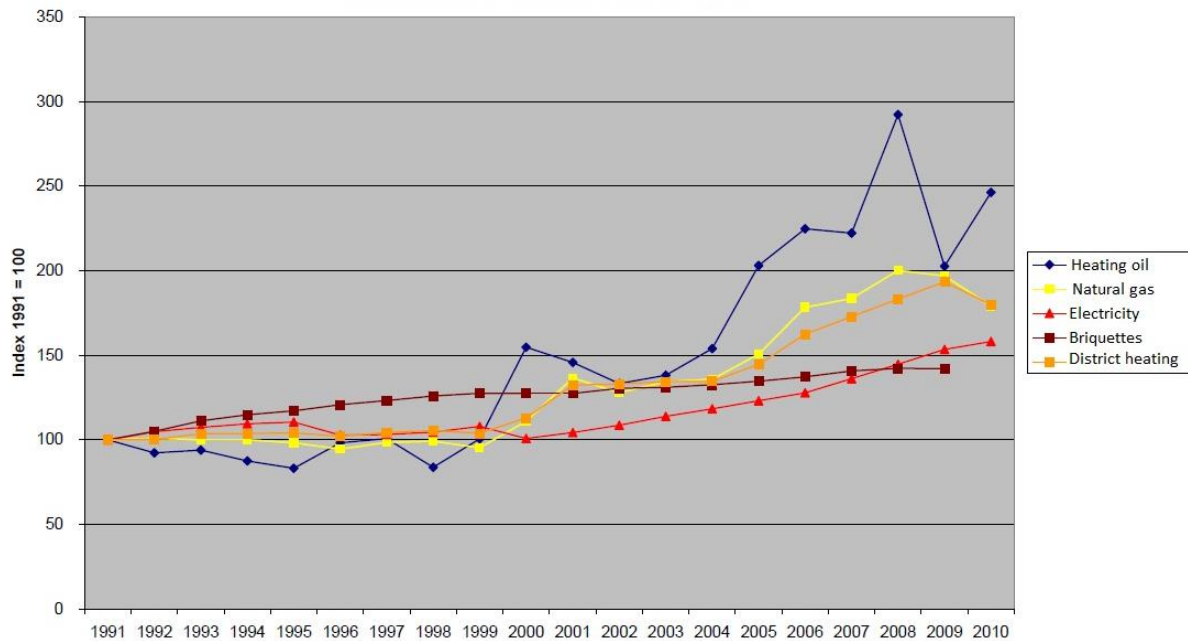

Figure 3.6: Energy prices evolution for private households in Germany [12]

Especially households living in single-family houses have nowadays the possibility to generate their own energy on-site based on renewable energy. The term on-site generation can have a dual interpretation. One may think that the generators are installed in the property area (on the roof or nearby the house) or in the vicinity (from several meters up to few kilometers away from the house). In this study, only the first case is assumed.

3.3.1 Examples of on-site energy generation (Germany and USA)

Since the end of 2011, a project called efficient house plus (in German “Effizienzhaus Plus”) is being conducted in Berlin by the Federal Ministry of Transport, Building and Urban Development to evaluate whether the house can produce more energy than consumed over the year [29]. The electricity is generated from 23 kW_p photovoltaic panels installed on the roof and side of the house, as depicted in Figure 3.7. The use of stationary batteries, the performance of the solar panels and the charge of electric vehicles are also a focus of this

experimental study. Furthermore, the results of the project will show how dependent a modern house is on the grid. Figure 3.7 shows that the house demands a lot of space to receive the solar rays and this is not available in most of the old main European cities, at least in central areas. Therefore, it is more likely that the zero-energy buildings of the future will be constructed in suburban areas, where more space is available and fewer obstacles (such as high buildings) exist. Last but not least, it is improbable that wind turbines will be an important player to generate electricity for single-family houses in urban areas. That is because they require a lot of space for the installation and can cause visual and noise pollution.



Figure 3.7: Efficient house plus in Berlin [30]

In some parts of the world however, new planned household communities are already being constructed in suburban areas based on renewable technologies, as illustrated in Figure 3.8. This community is located in the United States of America (USA) and each house has 1 kW wind turbine and 7.2 kW_p photovoltaics [31]. In such case, the whole community was previously planned, which reduces the chances that a dweller complains about the shadow or noise from the wind turbine of a neighbor. Moreover, with the integration of wind turbines, the community is able to generate electricity also at night minimizing the dependence of grid. This is an example that can also be applied in the suburban areas in Germany.



Figure 3.8: Integrated photovoltaics and small wind turbines in Lexington Farms Community in Jerseyville [32]

3.4. Smart grid

In the past, electricity was generated mainly in centralized power plants and from there it was transported until the final consumers via transmission and distribution lines. With the increase of decentralized generation systems, the energy system is becoming more complex. Therefore, the grid must be adapted to this new reality. The industry, government and utilities are aware of this trend and they are preparing the so called smart grid to be implemented. According to Momoh [33], “*a smart grid is an electrical grid that can monitor, predict, and intelligently respond to the behavior of all power suppliers and consumers connected to it in order to deliver reliable and sustainable electricity services as efficiently as possible*”. In the smart grid, information will be shared between electricity suppliers and consumers and it is expected that all parts benefit. Utilities have more control of the current status of the grid, being able to react faster to unexpected or emergency situations. The consumers have the possibility to pay different tariffs over the day, as illustrated in Figure 3.9, and follow their consumption instantaneously via internet and mobile phones.

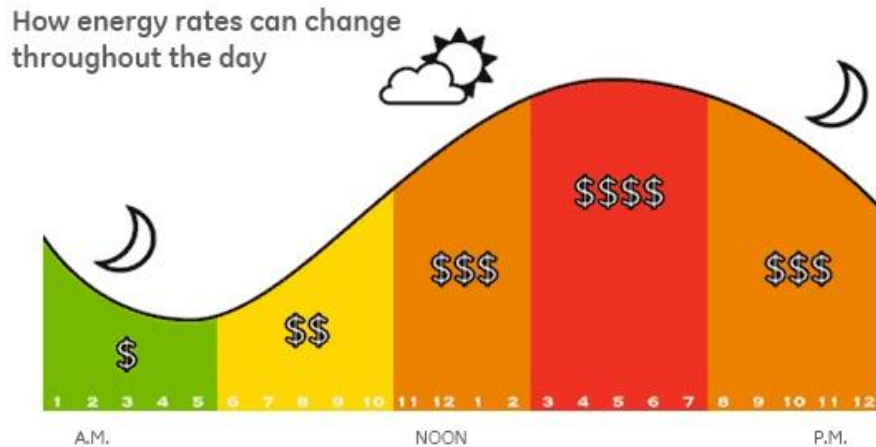

Figure 3.9: Illustration of variable tariffs in the smart grid [34]

The smart grid demands new regulations and investments in infrastructure for communication. Smart meters are required to exchange data between utility and consumers. In addition, because the lowest electricity price will be probably in some period of the night, consumers will have to purchase smart appliances that can be programmed to work when demanded by the user or the utility, or use an energy storage system to store electricity during the low tariff period and then use the stored energy as usual with normal appliances. The period of the different tariffs and their prices must be fixed or customers must be informed in advance of at least a day before tariffs change. Otherwise the users will not have the necessary time to prepare for example their washing machines to operate over night. And last but not least, the investment in these new devices or energy storage systems should pay themselves off. Some people may not like the idea of being controlled by the utility or providing their consumption profile periodically, even if their electricity bill is reduced. Therefore, “being smart” must be an option and not be mandatory, just like an extra service.

An interesting case reporting what can happen in reality in the future was published in the Photon magazine [35]. In the state of Alabama in the United States, a household decided to invest in photovoltaic panels to reduce its electricity bill, but connection with the grid was still necessary. The local utility reacted allocating the household in a new tariff category, making the total electricity costs higher than before without self-generation. The solution found by the household was to invest in batteries and reduce the contract of demand with the utility just to charge the batteries when demand is low. The future plans are to increase the storage energy capacity and be independent from the grid. This example clearly shows that utilities may start losing customers that start producing their own energy on-site from renewables at lower costs and that new regulations need to be adopted.

3.5. Electric vehicles

Due to the increase in global oil consumption and price, vehicles based on conventional fossil fuels will most probably be replaced by electric and hybrid ones in the future. In the United States it is expected that they take 10% of the market share in 2015 and 50% by 2025 [33]. In the last years it has become common to see the oil price breaking records, excluding the period after the financial crisis in 2008, as depicted in Figure 3.10.

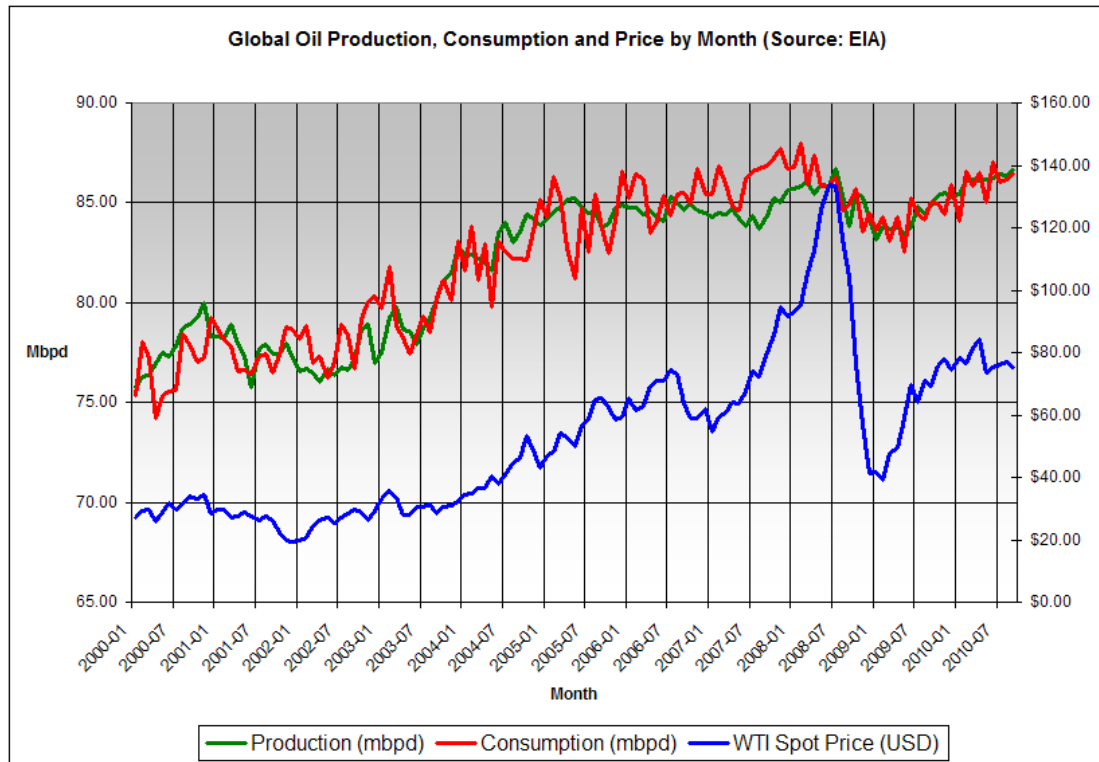

Figure 3.10: Temporal development of global oil production, consumption and price [36]

According to [1], Germany totally depends on imported fuel to supply its vehicles. The extraction of petroleum is getting more and more challenging and expensive, and with high risk of ecological disasters like the one in the Gulf of Mexico in 2010. Figure 3.11 shows that the fuel prices increased more than 50% in the German gas stations in the last ten years.

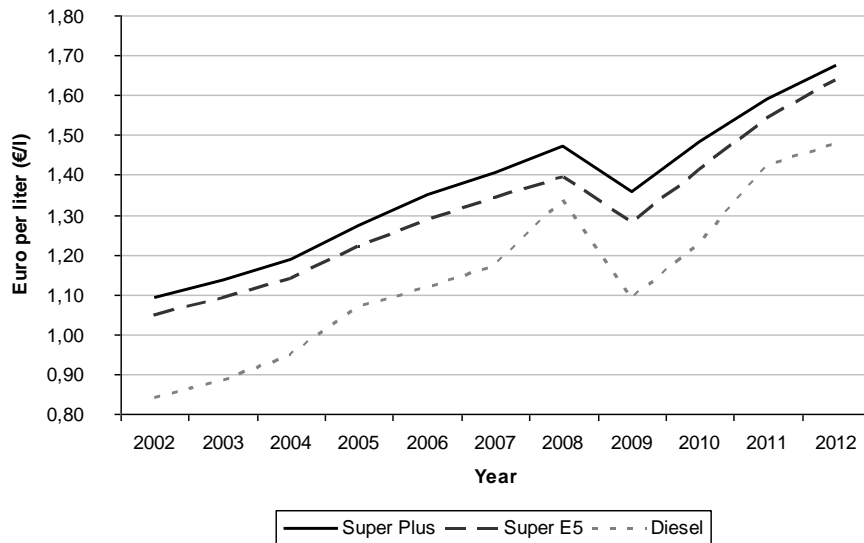

Figure 3.11: Fuel prices evolution in the German gas stations [37]

In 2008, Germany has set the target of having one million electric vehicles on its roads by 2020 [38]. In order to achieve this goal, the following issues must be solved until then:

- Increase the driving range
- Reduce the battery costs
- Build enough charging stations for all vehicles
- Increase the share of renewable generation exclusively for the transportation sector

At the moment, only few car manufactures are producing electric vehicles. Nissan is one example of a manufacture which already sells EVs. A comparison of few features of two cars from Nissan is presented in Table 3.3. Based on the actual prices of diesel and electricity, it is already cheaper to drive 100 km with the electric model than with the conventional. The major disadvantages of the electric model however are the high initial price and the still low maximum driving range.

Table 3.3: Comparison between conventional and electric vehicles [37], [39], [40]

Model	Capacity	Consumption per 100 km	Price of "fuel"	Total "fuel" price	Lowest price (€)
Leaf (electric)	24 kWh	17.3 kWh	0.255 €/kWh	4.41 €	36.990
Note (diesel)	46 liters	3.7 – 5 liters	1.48 €/l	5.78 – 7.4 €	14.180

According to [41], the battery of an electric vehicle costs around one third of the total price. Its lifetime is influenced by several factors, like temperature, charge/discharge cycles and of course the way the driver conduces the vehicle. Nowadays it is possible to drive more than

100 kilometers with one charge, which is satisfactory for short distances destinations but far from substituting all conventional vehicles. Therefore, enough charging stations will have to be built. Moreover, the charging stations must provide green electricity at all times of the day during the whole year in order to reduce greenhouse gases emissions. All these requirements may lead the electricity price to increase.

Besides the obvious purpose of transportation, it is expected that the electric vehicle also interacts with the smart grid as a storage system of renewable energy, known as vehicle-to-grid. Depending on the electricity prices, the energy stored in the battery can be sold to the grid during peak times or be used at home to power electrical devices. This system will probably work better for the household use, because the owner has total control of its loads and storage system. Utilities on the contrary cannot expect that the vehicles will be connected to the grid whenever they require, especially during the day if a charging station is not available in the vicinity. In the future, if electricity is sold cheaper at night, owners will certainly just charge the cars during this period. Therefore, there must be an incentive to convince owners to let their vehicles always connected to the grid during the day to store excess electricity from renewables. In addition, the amount of energy sent to the grid must be limited by the owner. Otherwise, the grid might take all the energy from the vehicle and the owner has to wait for another charging. Electric vehicles must be equipped with at least one option of charging systems. The most common is based on cable connections, but wireless inductive charging is also a possibility, as shown in Figure 3.12. The charging time varies with the electrical system (one/three phases AC or DC). It can take from few minutes to several hours depending on the power supply.



Figure 3.12: Electric vehicles being charged (a) based on cable and (b) based on wireless inductive charging [42]

4. The path to renewable energy communities

After describing the energy system in Germany and how it has been transforming in the last decades, Chapter 4 presents how households can produce electricity and heating on-site from renewable energy technologies as well as possible stationary energy storage systems for residential use. Focus is given on photovoltaics and small wind turbines for electricity generation, and on solar collectors and heat pumps for heat production. The analysis is based on a theoretical renewable energy community in the city of Cottbus, Germany.

4.1. Definition

The renewable energy community (REC) is a concept created by the National Renewable Energy Laboratory (NREL), which is defined as “*a state-of-the-art community in which integrated, renewable energy technologies play the primary role in meeting the energy supply and demand needs of its residents, with the possibility of providing excess energy back to the grid or other communities*” [43]. The community is based on on-site renewable energy technologies, environment friendly transportation and zero-energy buildings. The advantages of the REC are:

- Independent of imported fossil fuels
- Less transmission and distribution losses
- Zero emission of greenhouse gases during operation
- Reduced need for distribution network enhancement due to generation on-site
- No need to disclose load data to distribution utility

According to [43], to date there is no renewable energy community in the world. Due to the fact that new buildings in Germany must be nearly zero-energy by 2020, if it becomes more cost-effective to generate and store energy on-site from renewable sources, at least in suburban areas renewable energy communities may start to be constructed. Taking that into account, a theoretical REC of 50 single-family houses located in the suburban area of the city Cottbus (Brandenburg) is considered in order to evaluate if energy balance can be achieved over the year. The exact location where the REC could be built is not defined, but a potential place is the old airport Cottbus-North, which is currently not in operation and has an area of 327 hectares [44]. The airport is located near downtown, but at the same time far enough from

other residences. This is important to avoid conflicts regarding the visual and noise pollution of wind turbines.

Cottbus is located close to the open cast lignite mining district of Lusatia where currently 5 active mines exist [45]. As these mines move spatially with time, villages must be relocated. In some cases, this leads to historical and cultural values being lost and the separation of the village community. Despite the conflicts generated by the use of land and the fact that the burning of coal emits large amounts of CO₂, the activities related to the extraction and use of coal to generate energy employ thousands of people in the region and is therefore the most important industrial sector in the otherwise structurally poor area. In addition to that, coal is the only fossil fuel that Germany has plenty of reserves and it is unlikely that the country will stop using coal in the near future. New renewable energy communities can be an environment friendly solution for the relocation of villages. It is an opportunity to build new efficient houses that generate their own energy on-site from renewable energy sources.

4.2. Passive houses

In Germany, even zero-energy or energy-plus buildings consume energy for space heating. The energy consumption can be reduced depending on the standards under which the building is constructed. About two decades ago, the passive house standard was originated. Such a house works with the principle of minimizing heat losses and maximizing passive heat gains. Minimizing heat losses means keeping the heat inside the house and eliminating thermal bridges. This is done by building the floor, walls and roof with thick insulation and applying triple glazed windows. Especially in the cold season, the windows and doors must be kept closed to avoid heat losses. Maximizing heat gains means facing windows towards the sun to benefit from passive solar energy. Additional heat sources are electrical devices and people. As a result, the passive house demands less than 15 kWh/m².a for space heating and less than 120 kWh/m².a as total primary energy consumption [46].

The disadvantages of passive houses are the higher construction costs (about 10% higher) [25], [46], additional shadowing for windows during the summer to avoid overheating and need for a ventilation system with heat exchanger. A ventilation system with heat exchanger is used to change the inside air and maintain the air quality inside the house, as illustrated in Figure 4.1. The heat exchanger takes the heat from the air inside the house and transfers it to the fresh incoming air. Indeed, the system works during the whole year to prevent the

proliferation of diseases, e.g. mold. Although operating all the time, it does not consume too much electricity. According to [47], the ventilation system consumes around 0.55 Wh/m^2 . Despite the disadvantages, the thick insulation applied in passive houses can help filtering the noise from outside. Because of that and the low space heating demand, the houses considered in the REC are passive houses.

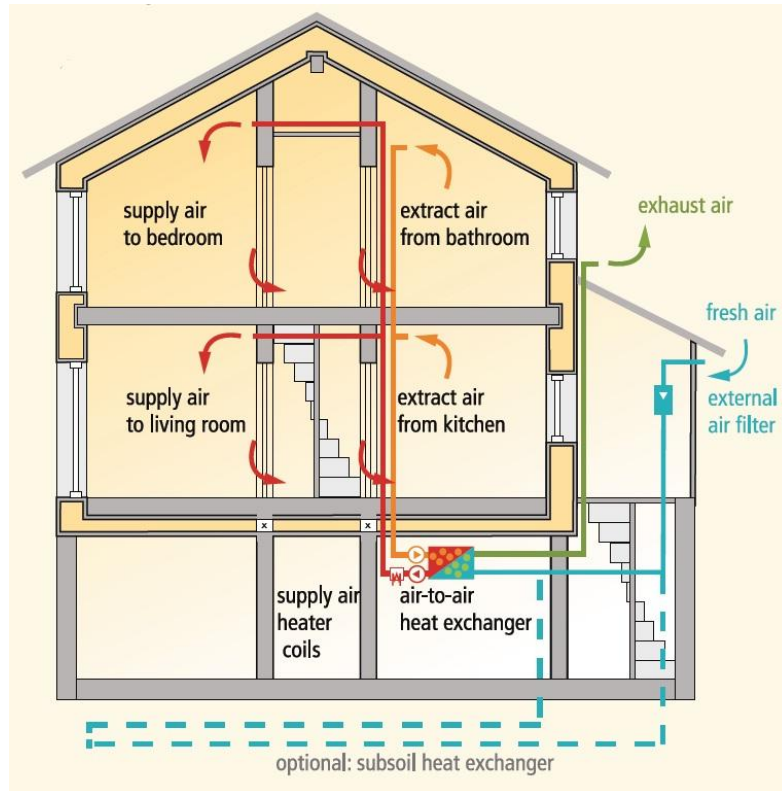

Figure 4.1: Ventilation system with heat exchanger [46]

4.3. Electricity generation from renewable sources

In the beginning of the last century, big centralized power plants were dominant in order to generate cheap electricity. In many cases, the resources were located far from the consumers and therefore T&D lines were built to transport energy over long distances. Nowadays, electricity can be generated on-site using photovoltaics or wind turbines near the final consumers, reducing for example the need of new lines and T&D losses.

Due to the German Renewable Energy Source Act, the share of renewable energy is increasing in the country. Considering the household sector there is still a lot of development potential, especially for photovoltaics and small wind turbines. As the sun does not shine at night and the wind blows inconstantly, the use of only one technology is insufficient to supply the daily energy demand of a household without grid support or energy storage system. In

Germany, photovoltaic modules generate more electricity in the hot seasons and wind turbine in the cold seasons. Therefore combining both technologies implies a more stable energy supply over the year.

In this chapter, the software HOMER is applied to access the electricity generation potential of photovoltaics and wind turbine in the city of Cottbus. HOMER (Hybrid Optimization Model for Electric Renewables) is a software developed by the National Renewable Energy Laboratory (NREL) that is used to evaluate and compare different power systems [48]. HOMER simulates the operation of a system by making energy balance calculations for each of the 8,760 hour in a year [49].

4.3.1. Photovoltaics

The term photovoltaics (PV) means the generation of electricity from the sunlight. The device used to convert the sunlight into electricity is called solar cell, which was first produced in 1954 at Bell Laboratories. At that time, PV had very low efficiency and it was very costly [6]. In the following decades, it was put a lot of efforts into improving the efficiency of the solar cells and reducing the production costs. Since governments have started to financially support the use of decentralized power generation, the installed photovoltaic capacity has increased in many countries. In Germany, the growth is exponential as depicted in Figure 4.2. Due to the improvement of the solar cells, the average cost of solar panels has reduced from \$ 108/W_p in 1975 to \$ 1.3/W_p in 2010 [14].

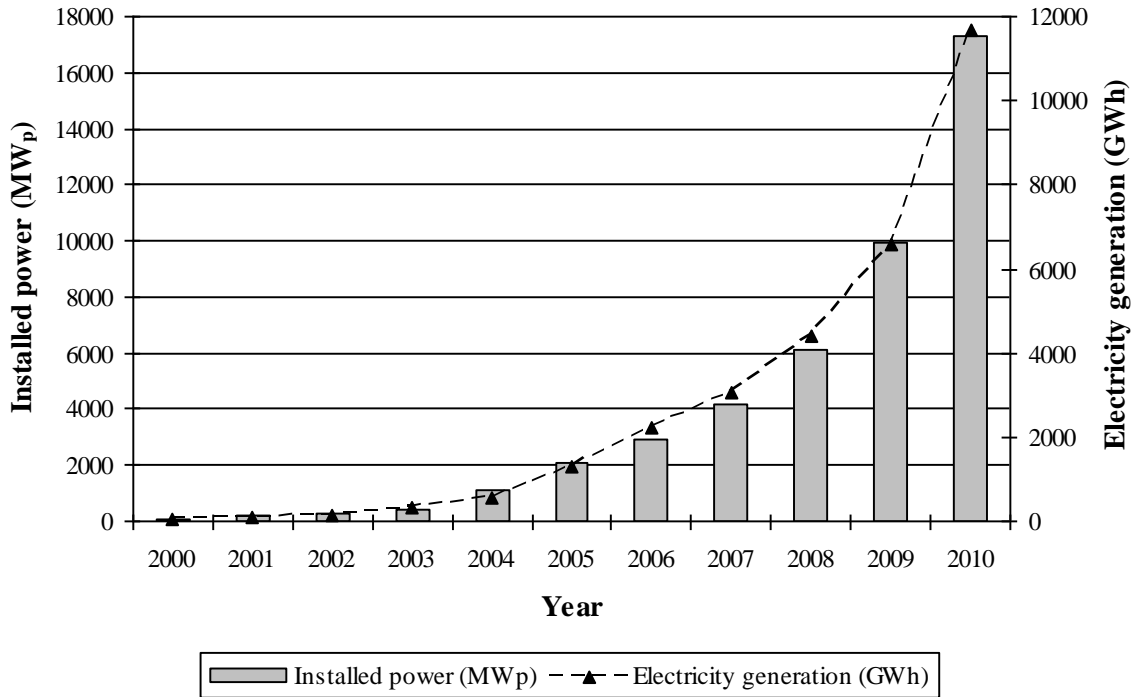

Figure 4.2: Exponential growth of photovoltaic installations in Germany [50]

Solar cells are made of semiconductor elements, mostly silicon because it is available in abundance. Monocrystalline (Mono-Si) and polycrystalline (Poly-Si) silicon are the dominant technologies in the solar market, due to their high efficiency. Other materials like cadmium telluride (CdTe) or amorphous silicon (a-Si), referred as thin film modules, also hold a small market share. However, a-Si modules have low efficiency and tellurium is an extremely rare element [6].

The efficiency (η) of a PV module can be calculated based on Equation (4.1).

$$\eta = \frac{Y_{PV}}{E_{STC} \times A} \quad (4.1)$$

where Y_{PV} is the rated power output of the PV module under standard test conditions (STC) [kW], E_{STC} is the irradiance at standard test conditions [1 kW/m^2] and A is the surface area of the PV module [m^2].

Comparing modules that have the same area, the most efficient are the ones that generate more power. Table 4.1 presents the maximum efficiency achieved by different PV modules and the area needed for the installation of 1 kW_p .

Table 4.1: Maximum efficiency and needed area of different photovoltaic technologies [51]

Technology	η_{\max} of a module (%)	Area (m ²)
Mono-Si	19.3	5.2
Poly-Si	15.2	6.6
CdTe	11.1	9.0
a-Si	6.6	15.2

4.3.1.1. Photovoltaic potential in the renewable energy community

The renewable energy community theoretically designed in this study has 50 houses. It is assumed that the total roof area available for PV installation is 3,000 m², or 60 m² per house. The area for PV installation is limited and therefore the REC must utilize all the potential to generate as much energy as possible. That means that Mono-Si or Poly-Si modules with high peak power should be chosen. In this study, the solar module JAM6-320Watts of JA Solar is investigated, which has an area of 2 m² and an efficiency of 16% [52]. Thus, the power capacity of the REC is 480 kW_p or 9.6 kW_p per house. This module was selected because it presented the highest rated power from the five main PV manufactures in 2011 [53]. The software HOMER is used to evaluate how much energy can be generated in the community using this solar module. HOMER calculates the PV power output based on Equation (4.2).

$$P_{PV} = Y_{PV} f_{PV} \left(\frac{\overline{G}_T}{\overline{G}_{T, STC}} \right) \left[1 + \alpha_p (T_c - T_{c, STC}) \right] \quad (4.2)$$

where:

- P_{PV} is the PV power output
- Y_{PV} is the rated capacity of the PV array, meaning its power output under standard test conditions [kW]
- f_{PV} is the PV derating factor [%]
- \overline{G}_T is the irradiance on the PV array in the current time step [kW/m²]
- $\overline{G}_{T, STC}$ is the irradiance at standard test conditions [1 kW/ m²]
- α_p is the temperature coefficient of power [%/°C]
- T_c is the PV cell temperature in the current time step [°C]
- $T_{c, STC}$ is the PV cell temperature under standard test conditions [25 °C]

The temperature coefficient of power α_p of the chosen module is $-0.47\%/^{\circ}\text{C}$. The derating factor considered in the simulation is 80%. This factor accounts for reduced output due to for instance wiring losses, shading, snow cover and aging. For the simulation, the solar modules face south and have 60° slope angle in order to maximize the energy generation during the winter. Furthermore, ten percent losses are considered during conversion of power.

From [54], HOMER obtains the irradiance data from 1998 of a determined location via internet. The annual global irradiation on a horizontal surface in Cottbus is $1,015 \text{ kWh/m}^2$ and the daily average irradiation per month is presented in Figure 4.3.

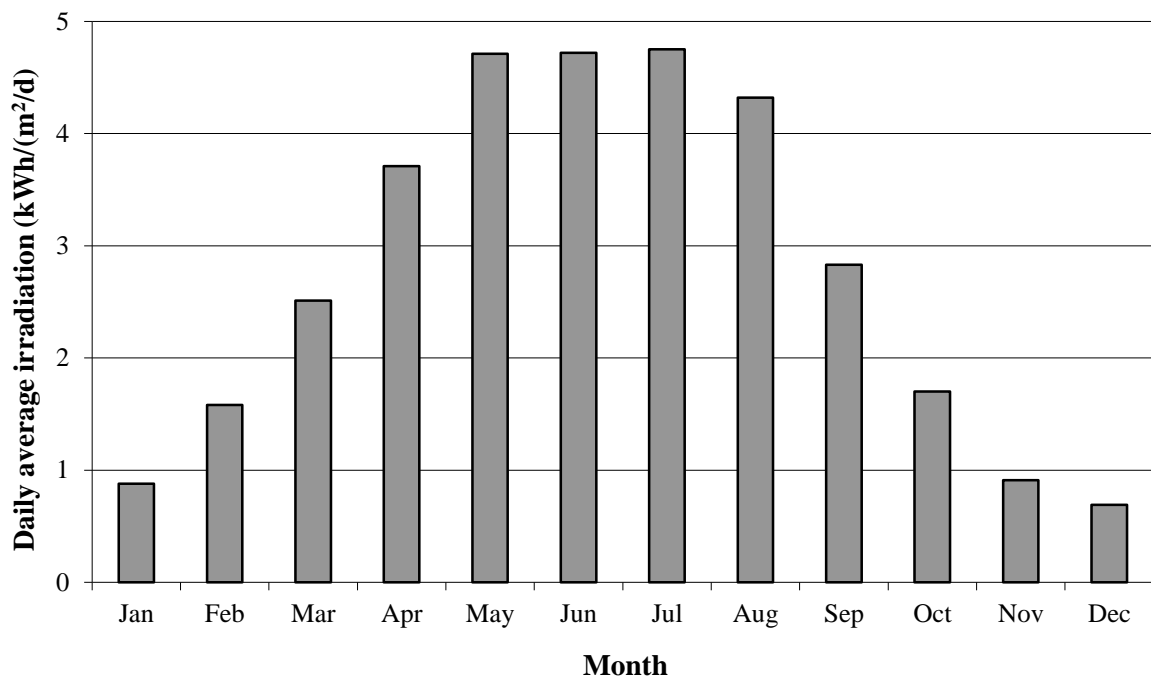

Figure 4.3: Daily average irradiation in Cottbus [54]

The result of the simulation shows that the annual energy production is 411.3 MWh. The electricity generated per month is depicted in Figure 4.4. It can be seen that in the spring and summer more electricity is produced, about 60% of the annual generation. In the cold seasons when space heating is demanded, the photovoltaic system has low performance.

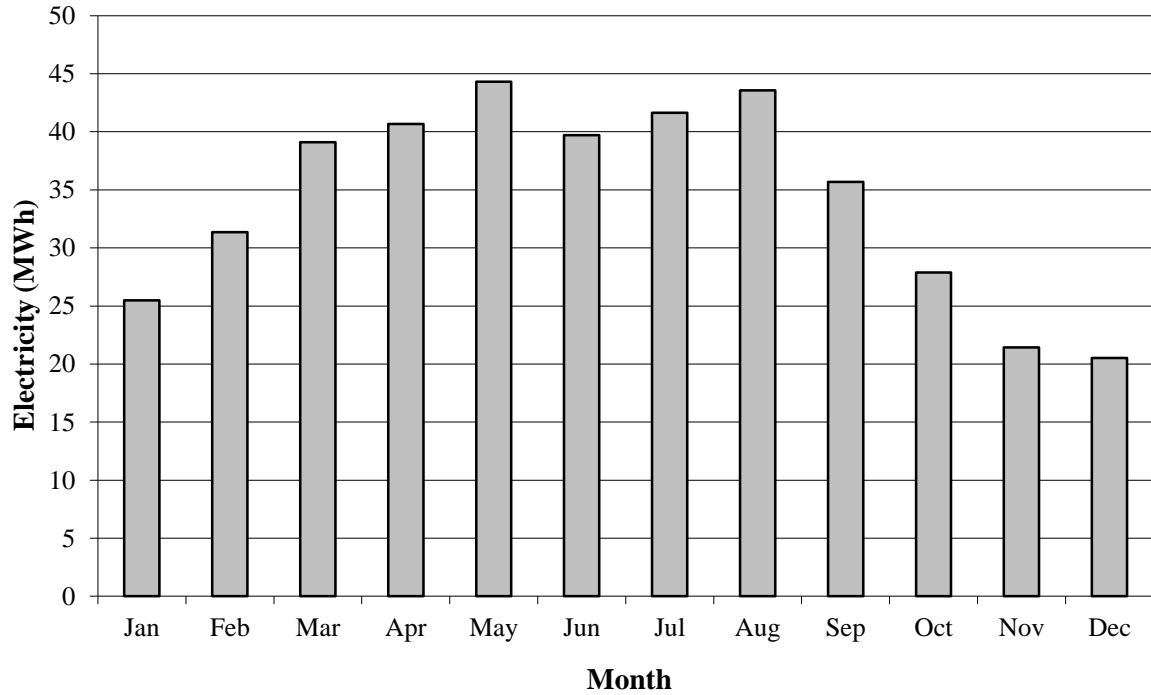

Figure 4.4: Electricity generated from photovoltaics per month

The photovoltaic system comprises not only the solar panels, but also inverter, cables and installation costs (balance of system components – BOS). In order to evaluate the cost of electricity from photovoltaics, the costs of the main components are taken into account as presented in Table 4.2. For this calculation, it is considered only the capacity of one household (9.6 kW_p).

Table 4.2: Main photovoltaic components costs [6], [55]

Component	Manufacture	Costs (per household)
Photovoltaic module	JA Solar (JAM6-320Watts)	10,350 €
Inverter	Kaco New Energy (Powadro 9600)	1,543 €
BOS	-	32% of PV module = 3,312 €

The cost of electricity (C_e) is calculated by dividing the annual costs (A_c) by the energy produced per year (E_p), as presented in Equation (4.3).

$$C_e = \frac{A_c}{E_p} \quad (4.3)$$

The annual costs (A_c) can be calculated taken into account the capital costs (C_c), the lifetime of the system (N) and the rate of return (R), as shown in Equation (4.4).

$$A_c = \frac{R \times C_c}{1 - (1 + R)^{-N}} \quad (4.4)$$

To calculate the capital costs, the costs of the PV modules, inverter and BOS are added.

$$C_c = 10,350\text{€} + 1,543\text{€} + 3,312\text{€} = 15,205\text{€}$$

Considering twenty years lifetime and six percent rate of return, the annual costs of the photovoltaic system are 1,326 €.

$$A_c = \frac{0.06 \times 15,205}{1 - (1 + 0,06)^{-20}} = 1,326\text{€}$$

As the energy produced per year per household is equal to 8,227 kWh, the cost of electricity is 0.161 €/kWh, which is well below the electricity price of the grid 0.255 €/kWh [39].

$$C_e = \frac{1,326\text{€}}{8,227 \text{ kWh}} = 0.161\text{€/kWh}$$

4.3.2. Wind turbine

Wind is a free renewable energy source which has been used by humans to facilitate mechanical work as well as to generate electricity. A wind turbine (WT) is the device responsible to generate electrical energy using the kinetic energy of the wind. It was first used in the end of the 19th century by James Blyth in Scotland [56]. The power of the wind is calculated based on Equation (4.5).

$$P = \frac{1}{2} \times p \times A \times v^3 \quad (4.5)$$

where p is the air density (kg/m^3), A is the area (m^2) and v is the wind speed (m/s).

As the wind passes through the blades of the turbine the wind speed v_1 is reduced to v_2 as depicted in Figure 4.5. Because the air flow before and after the turbine is constant, the area A_1 is increased to A_2 .

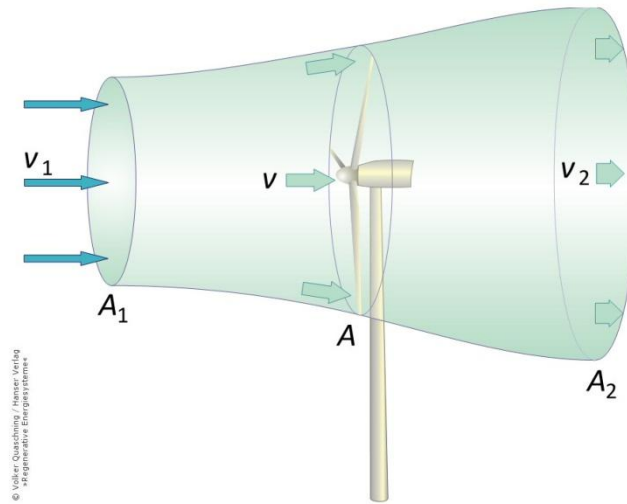

Figure 4.5: Idealized change of wind speed at a wind turbine [51]

In the beginning of last century, the German physicist Albert Betz calculated the maximum power that a wind turbine can extract from the wind. The relation is called power coefficient, as presented in Equation (4.6), and its maximum is 59.3%.

$$c_p = \frac{P_N}{P_0} \quad (4.6)$$

where P_N is the power of the wind that reaches the wind turbine and P_0 is the power of the wind before the wind turbine.

Depending on the rotor axis position, wind turbines are classified as vertical or horizontal. Horizontal axis wind turbines reach power coefficients of 0.5 and vertical wind turbines 0.375 [51]. Because of that, the majority of the modern wind turbines are horizontal.

The wind speed is normally measured at 10 meters height. The velocity tends to increase with the height above ground because there are fewer obstacles to slow down the wind. Therefore, one of the main efforts of the wind turbine manufacturers is to increase the energy production of the turbine by increasing the tower height as well as the area of the blades, maintaining the stability of the turbine. Furthermore, the blade material is in constant development to keep the total mass as low as possible. Figure 4.6 depicts the evolution of the wind turbine over the years.

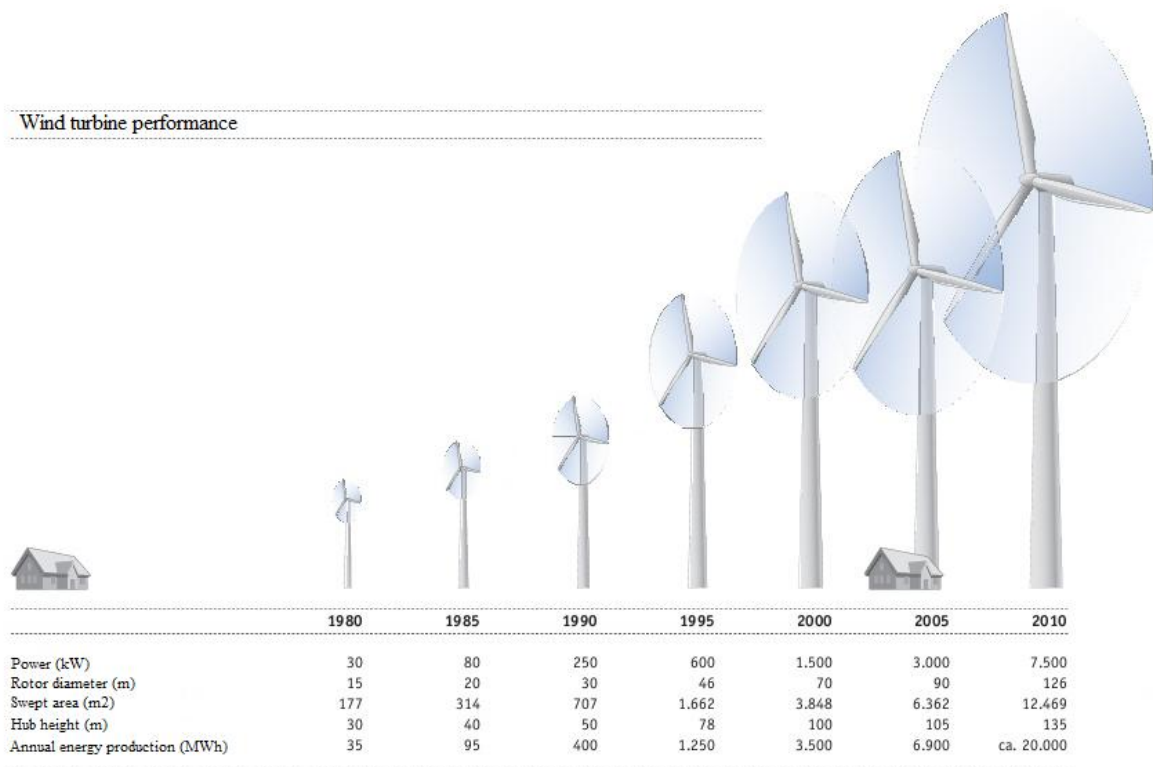

Figure 4.6: Evolution of the wind turbine over the years [57]

In order to calculate the wind speed at different heights, a method called logarithmic profile can be applied as shown in Equation (4.7).

$$V = V_{ref} \frac{\ln\left(\frac{z}{z_0}\right)}{\ln\left(\frac{z_{ref}}{z_0}\right)} \quad (4.7)$$

where v is the wind speed at height z above ground level, v_{ref} is the reference speed, z is the height above ground level for the desired wind speed, z_0 is the roughness length in the wind direction and z_{ref} is the reference height.

The roughness length is a parameter that characterizes the roughness of the surrounding terrain. Table 4.3 presents the different roughness classes based on the types of surfaces.

Table 4.3: Values of surface roughness length for various types of terrain [58]

Types of surfaces	Surface roughness length Z_0 [m]
Very smooth, ice or mud	0.00001
Calm open sea	0.0002
Blown sea	0.0005
Snow surface	0.003
Lawn grass	0.008
Rough pasture	0.010
Fallow field	0.03
Crops	0.05
Few trees	0.10
Many trees, few buildings	0.25
Forest and woodlands	0.5
Suburbs	1.5
City center, tall buildings	3.0

4.3.2.1. Wind turbine potential in the renewable energy community

In the household sector, electricity and heating demands are higher in the cold seasons. As depicted in Figure 4.7, the wind speed in Cottbus is also higher in these periods. Therefore, wind turbines can play an important role to cover the energy demand in the months when the photovoltaic modules generate less energy.

Average wind speed (1997-2001)

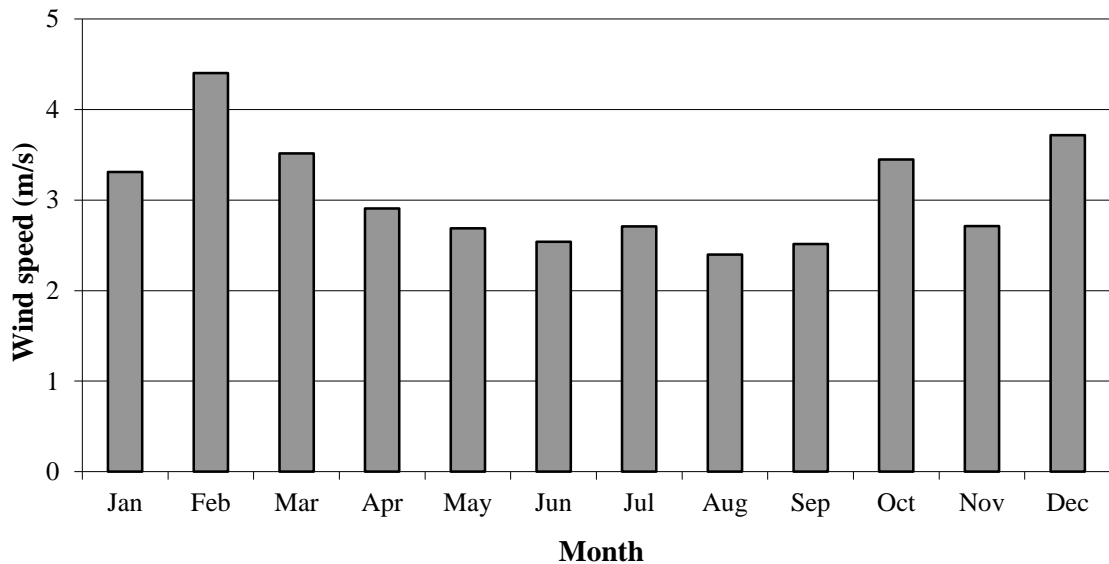

Figure 4.7: Average wind speed in Cottbus (1997-2001) [59]

Before installing a wind turbine, the following aspects must be taken into account:

- Site conditions (wind intensity and direction)
- Permission for installation
- Obstacles in the vicinity (trees or buildings)
- Noise level
- Shadow impact of the blades
- Economical

In the case of new planned communities, the issues of noise, obstacles and shadowing can be minimized. In Cottbus the average wind speed amounts to 3 m/s (measured at 10 meters height). To harvest the maximum of the wind power, the tower height of the wind turbine must be higher than the obstacles in the vicinity. A two floors single-family house with sloped roof has approximately 10 meters height. Therefore, the wind turbine tower should be higher than that. According to the building regulations in Brandenburg (in German “Bauordnungsrecht in Brandenburg”) [60], the distance of a wind turbine to a building is calculated based on Equation (4.8) and Equation (4.9).

$$A = \frac{1}{2} \times H_N + 1.11804 \times R_A \quad (4.8)$$

$$R_A = \sqrt{R_R^2 + e^2} \quad (4.9)$$

where A is the distance between the tower and the building, H_N is the hub height, R_A is the radius of the fictitious sphere, R_R is the radius of the rotor blades and e is the eccentricity of the rotor, as illustrated in Figure 4.8.

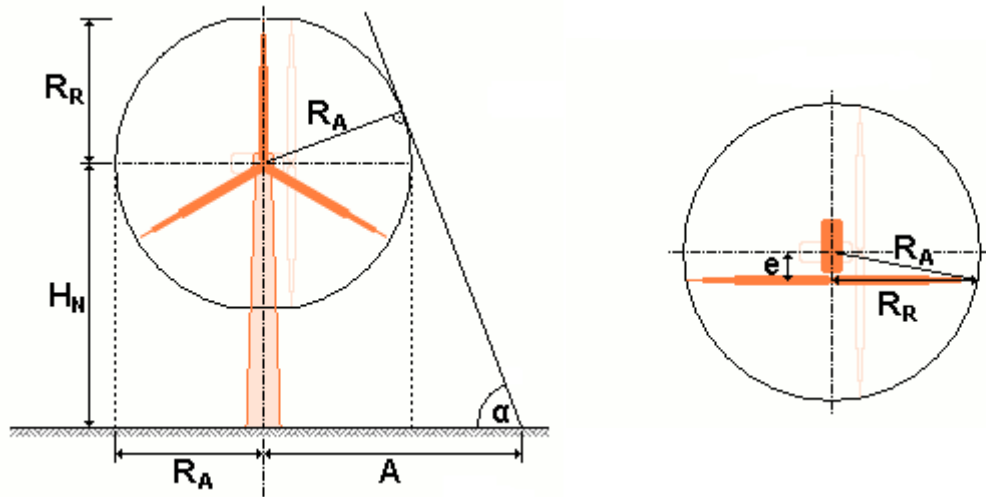

Figure 4.8: Distance space of wind turbines [61]

The optimum wind turbine for a small community of houses would be a medium scale one (100 to 500 kW) with a tower of more than 50 meters. With this solution, the costs of the wind turbine can be reduced, more electricity generated and problems with visual and noise pollution avoided. The main disadvantages are however that the turbine must be installed far from the community increasing land costs, and the houses rely on only one generator. To date the market is focusing on large scale wind turbines (> 1 MW), and therefore it is difficult to find and evaluate medium size wind turbines. However, small wind turbines (SWT) still have a lot of potential especially if installed in suburban areas. Because there are many types of small wind turbines with different rated power and varied tower height, and being produced in many countries, a comparison among them is not easily conducted. Therefore the German small wind turbine S&W 20 kW is chosen in this study for evaluation [62]. Some turbines are already in operation in the country and information about its power curve and price are available. This turbine has a tower of 24 meters which is higher than common obstacles (houses and trees), and the length of each blade is 4.45 meters. Based on Equation (4.8) and Equation (4.9) and considering R_A equal to 4.45, the minimum distance A is then 17 meters.

$$A = \frac{1}{2} \times 24 + 1.11804 \times 4.45 \approx 17 \text{ m}$$

The software HOMER is used to access how much electricity a small wind turbine can produce per year. In the simulation, the roughness length is 0.5 m and ten percent losses are considered due to power conversion. The result of the simulation shows that the annual electricity production is 16,771 kWh, which is equivalent to the same amount of electricity generated by photovoltaics in two houses. Therefore, in order to maximize the use of space in

the community, it is assumed that one wind turbine supplies electricity for two households. Thus the community has 25 small wind turbines in total that generate 419.2 MWh per year. The electricity generation per month is depicted in Figure 4.9. It can be seen that in the winter and autumn more electricity is produced, except in November. Compared to the photovoltaic energy generation, the wind turbines can have a higher contribution to supply the space heating demand in the cold seasons. Adding the PV and WT annual potential, the total electricity generation is 830.6 MWh/a.

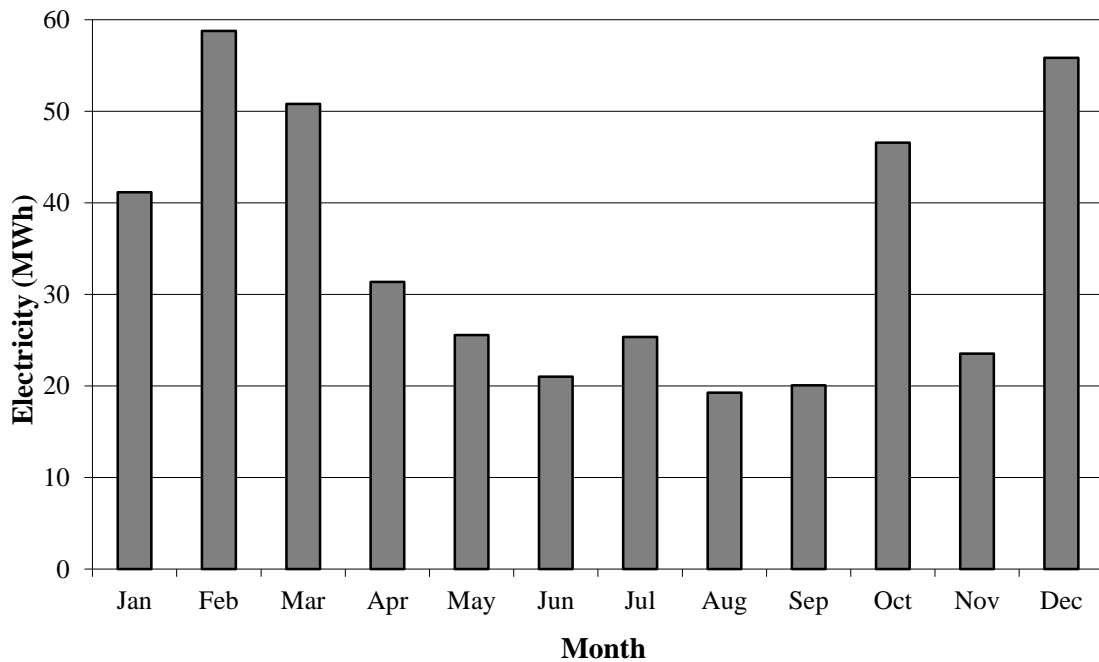

Figure 4.9: Electricity generated from small wind turbines per month

Based on [63], the capital costs of the S&W 20 kW wind turbine are 45,000 €. Considering 20 years lifetime and 6% of rate of return, it is possible to estimate the cost of electricity from each turbine using the Equation (4.3) and Equation (4.4).

$$A_c = \frac{0.06 \times 45,000}{1 - (1 + 0,06)^{-20}} = 3,923\text{€}$$

$$C_e = \frac{3,923\text{€}}{16,771 \text{ kWh}} = 0.234\text{€/kWh}$$

The annual costs are 3,923 € and thus the cost of electricity is 0.234 €/kWh, which is also below the electricity price of the grid 0.255 €/kWh [39].

4.3.3. Achieving grid parity

In Section 4.3.1.1 and Section 4.3.2.1, the cost of electricity from photovoltaics and wind turbine were calculated and compared with the price of the grid. The calculations do not include possible changes of components during the lifetime or any maintenance costs. In addition, it was considered that all the electricity generated on-site is used or sold to the grid. In reality the situation is different because supply and demand are not always balanced, the grid might not support every excess of energy from decentralized units, and feed-in tariffs are not so high as the price paid by households to grid. Nevertheless, the intention is to show that grid parity is close to be achieved. With the increase of fossil fuel prices and the necessity of building new T&D lines to integrate more renewable energy, the electricity price of the grid tends also to increase. The electricity price for households increased 28% in the last five years, as depicted in Figure 4.10. If the price continues to increase on average 5% per year, households will pay 39 €-Cent/kWh in 2020.

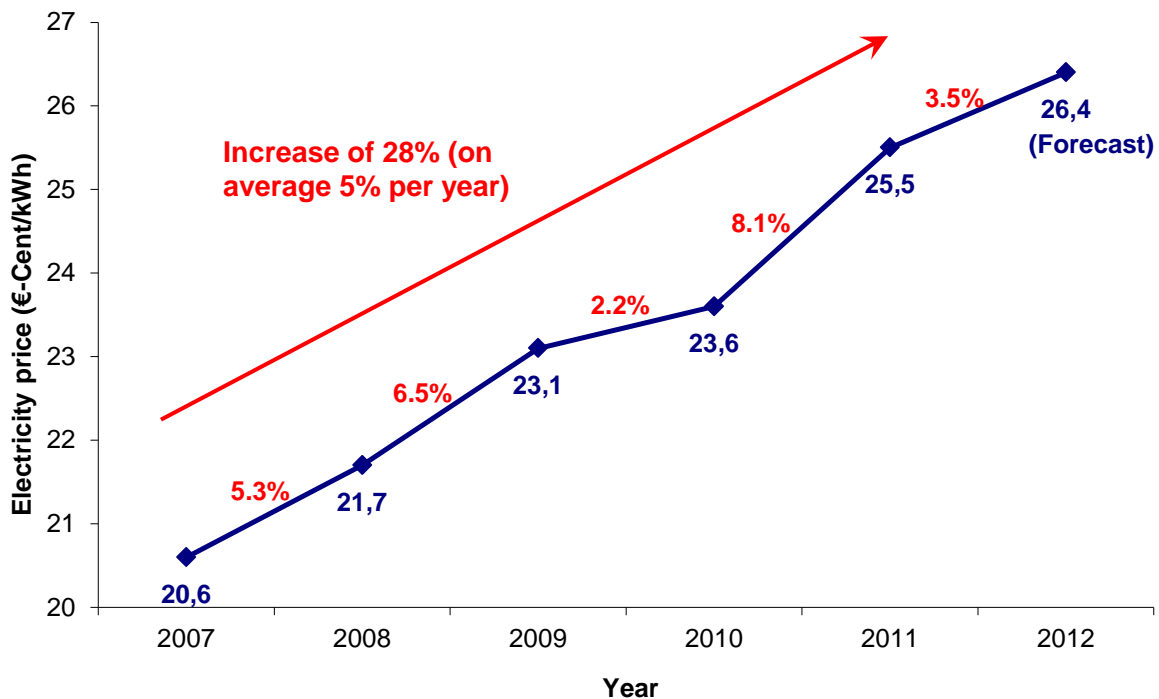

Figure 4.10: Electricity price for households in Germany [39]

In the case of small wind turbines, it is easy to understand why there are not so many installations. Besides the fact that the wind turbine must be built respecting a certain limit to other buildings as well as the issues with noise and visual pollution, the feed-in tariff paid nowadays is not sufficient to pay for the turbine if all the energy produced is sold to the grid. According to the amendment of the Renewable Energy Source Act of 2011 [64], onshore small wind turbines (< 50 kW) receive a fix tariff of 8.93 €-Cent/kWh for 20 years, if the year of commissioning is 2012. Taking into account that the S&W 20 kW turbine produces 16,771 kWh annually, after 20 years one would receive approximately 30,000 € which is not sufficient to cover the capital costs. Therefore, it is rather recommendable to install small wind turbines if the electricity generated is consumed by the user instead of feeding it into the grid and buying back at a higher price.

4.4. Heating generation from renewable sources

In a renewable energy community, space and water heating demand should also be supplied by on-site renewable sources. Technologies frequently used for this purpose are solar collectors, heat pumps and electric heaters. Solar collectors directly convert the solar radiation into useful heat. Heat pumps and electric heaters are electrical devices that can only produce “clean” heat if the electricity is generated from renewables. This section presents these three technologies and also how heat is stored in water tanks.

4.4.1. Electric heater

An electric heater is the simplest device used to convert electricity into heat to supply both hot water and space heating demands. Common devices are electrical resistors, oil heaters and radiative heaters. The electrical resistor can be in direct contact with water, such as in water storage tanks or electric showers as shown in Figure 4.11.



Figure 4.11: Examples of electrical resistors to heat water [65], [66]

To supply space heating, the electrical resistor can be installed under the floor or as a portable device as depicted in Figure 4.12.



Figure 4.12: Examples of electrical resistors to heat space [67], [68], [69], [70]

Electric heaters need electricity to operate. They are not able to produce more energy than consumed due to internal losses implying that their efficiency is always less than 100%. In passive houses, where space heating demand is reduced, portable heaters can be used to supply heat in specific rooms avoiding extra costs with traditional radiators or underfloor heating. The domestic hot water demand can be supplied using electrical resistors, solar collectors or heat pumps.

4.4.2. Solar thermal collector

Solar thermal collectors, differently from photovoltaics, transform solar radiation into heat. Depending on the geographic location and the heating demands, different systems can be designed. In Germany, solar collectors can be used in the household sector to heat space and

water. The most used technologies are flat-plate collectors and evacuated tube collectors. The solar thermal system and its main components for domestic hot water are depicted in Figure 4.13.

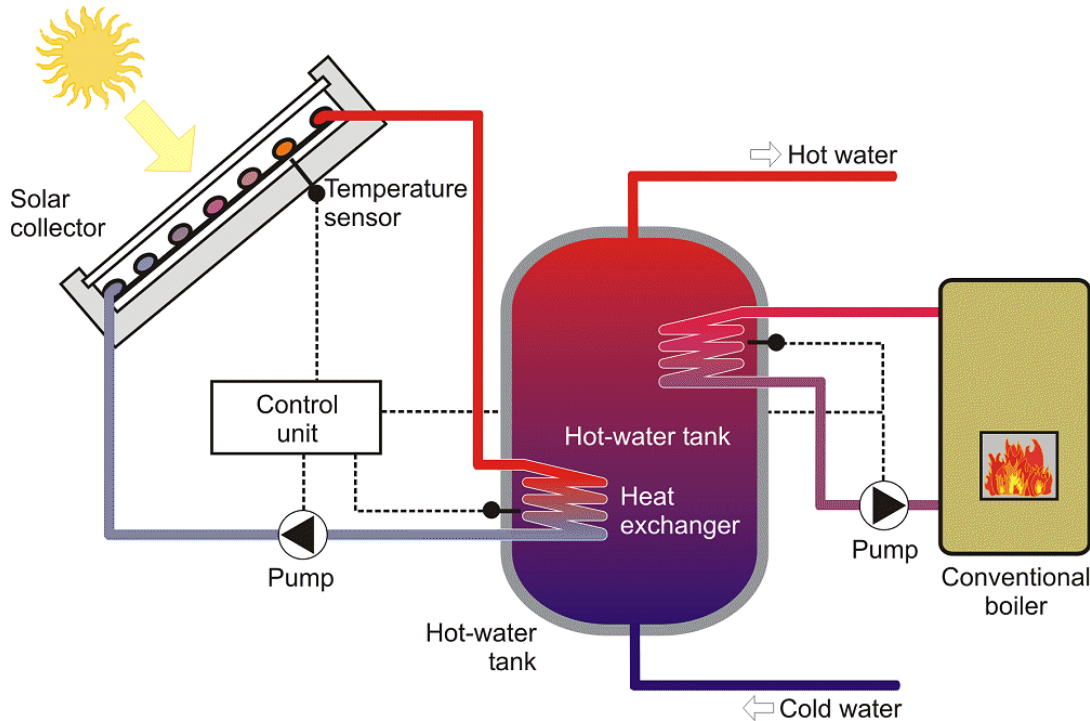

Figure 4.13: Solar thermal system main components [51]

The solar collector is the component responsible to absorb the solar energy and to heat up a transport fluid (like water, air or antifreeze). The heated fluid circulates through the system driven by an electric pump. Inside the storage tank heat is exchanged, the transport fluid cooled and sent back to the collector. The process continues depending on the ambient, solar collector and water storage tank temperatures. The backup heater, which can be an electric heater or based on burning oil, gas or biomass, is used when the set up temperature is not reached.

The daily average irradiation in Cottbus varies among the seasons as shown in Figure 4.3. In the summer it is four times higher than in the winter. Seasonal storage systems can be used to store heat from the hot to the cold seasons. However this technology is not yet mature but in its research phase and so far the solar fraction amounts to only 50% of the annual heat demand for space heating and domestic hot water [71], [72]. This implies that the solar collector system always depends on a backup heater, increasing the costs and the complexity of the system. Another disadvantage of seasonal storage is that several solar collectors must be installed occupying most of the available roof space and leaving no area for photovoltaics.

If the solar collector is used only to supply domestic hot water, then photovoltaic panels can also be installed on the roof. In this case, portable electric heaters can be used to heat space as mentioned in the last section. The backup heater is however still necessary because the maximum solar fraction for domestic hot water is 88% [51].

4.4.2.1. Flat-plate collector

The shape and appearance of a flat-plate collector is very similar to a photovoltaic module. However, the components are different as well as the working principle. The main parts of a flat-plate collector are shown in Figure 4.14.

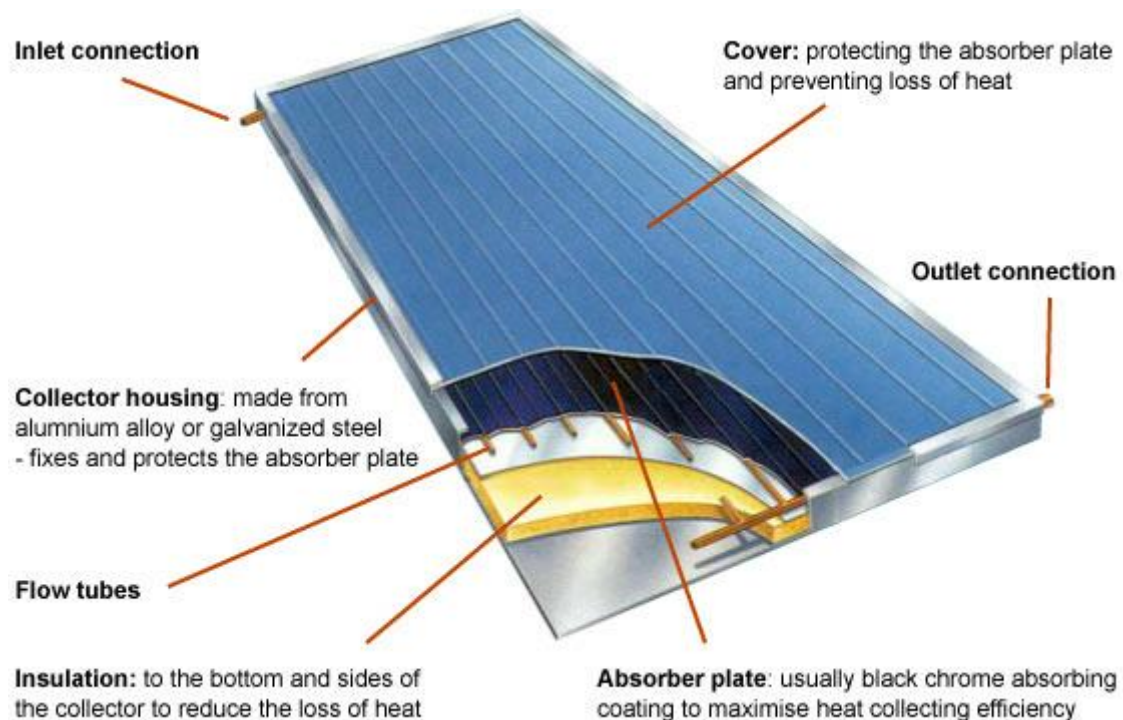

Figure 4.14: Example of a flat-plate collector [73]

The transparent cover protects the inner parts and prevents convection losses caused by air movements. In addition, it inhibits the absorber to radiate heat to the environment. The collector housing fixes and protects the absorber plate. The absorber is made of copper or steel to withstand high temperatures and it is coated with specific selective coating materials that re-emit less heat radiation. The transport fluid inside the flow tubes collects the heat from the absorber and transfers it to the water storage tank [6].

4.4.2.2. Evacuated tube collector

An evacuated tube collector is a glass tube with high vacuum. The tube has a selectively coated absorber sheet with a heat pipe inside. The heat pipe contains a special fluid, like methanol, which vaporizes at low temperatures. The vapor rises to the top of the tube, where it condenses by transferring the heat to the heat carrier in the main pipe. The heat pipe fluid returns then to the bottom of the tube and the process starts again. The evacuated tube collector is more efficient than the flat-plate collector over the year; therefore it needs less area for installation [6]. Figure 4.15 shows the working principle of an evacuated tube collector.

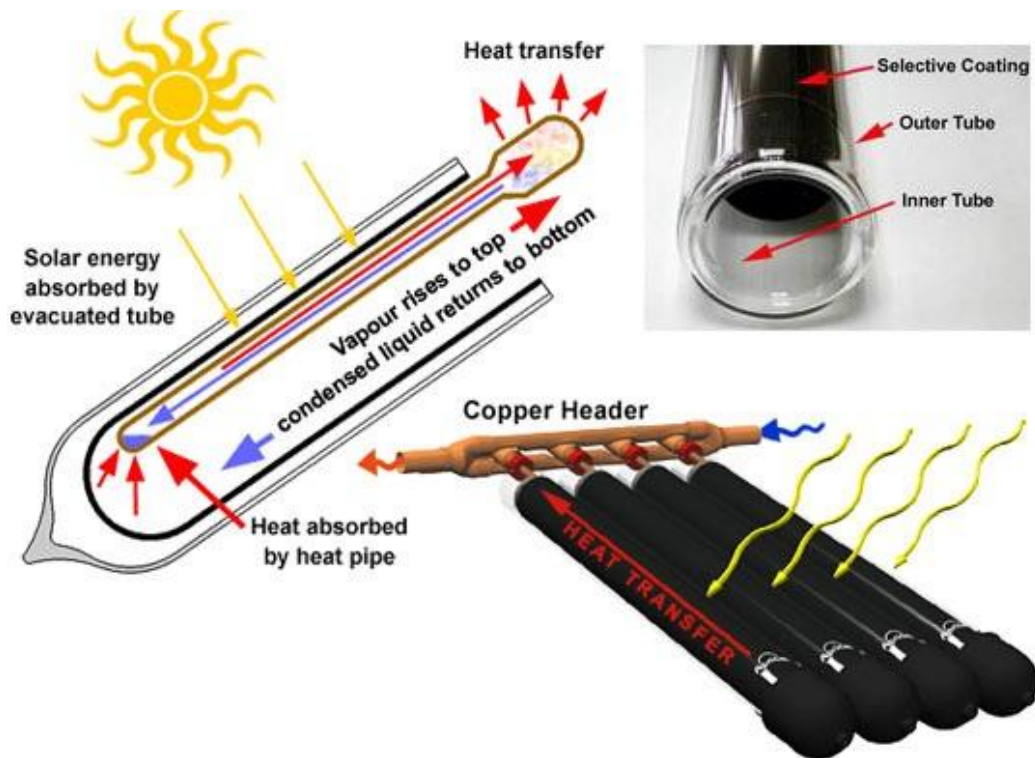

Figure 4.15: Example of an evacuated tube collector [73]

Over the time, hydrogen atoms can enter the tube destroying the vacuum. In order to avoid that, a barium getter is used to absorb the gas during operation. Moreover, the barium layer at the bottom of the tube is silver and in case the vacuum is lost, it turns to white. It is therefore an easy visual indication of the actual status of the tube [74].

4.4.3. Heat pump

A heat pump is a system that extracts heat from a source and transfers it to another environment to increase its temperature. The heat source can be the ambient air, groundwater

or soil. The operating principle of the heat pump is illustrated in Figure 4.16. There are basically two heat exchangers and a working fluid/refrigerant (such as ammonia, carbon dioxide and propane) that circulates through the system transferring heat from the heat source to the heating system. The working fluid takes heat from the source and vaporizes. The vaporous working medium is then compressed and consequently its temperature increases as well as its pressure. The working medium gives then heat away to the heating system and condenses. At this point the heat can be used for space heating or for domestic hot water. Finally, the working medium passes through an expansion valve, where its pressure is reduced and the process starts again. Because a heat pump consumes electricity during operation, it can only be considered a clean heat supplier if the electricity is generated from renewable sources.

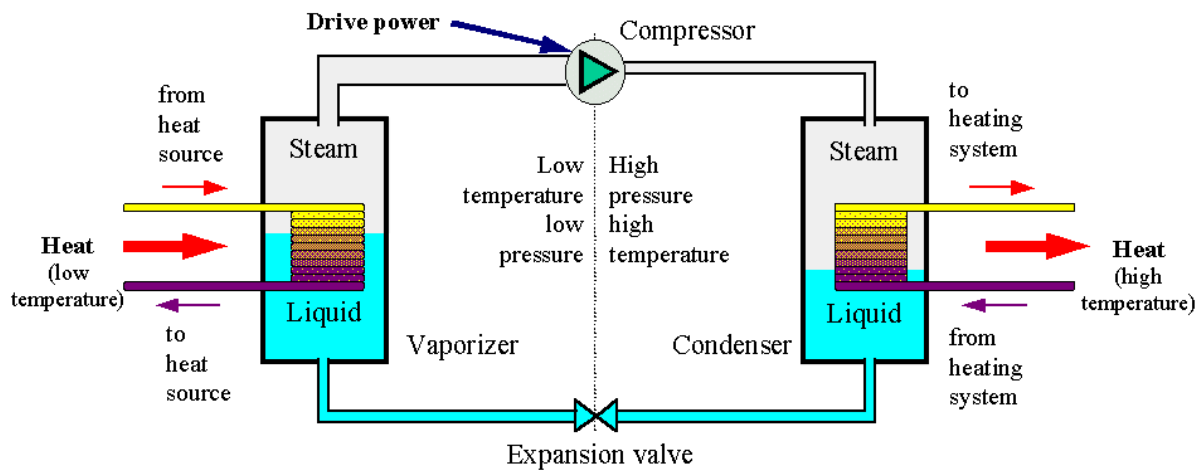

Figure 4.16: Operating principle of a heat pump [6]

In order to compare the performance of different types of heat pumps, the so called coefficient of performance (COP) is used, as presented in Equation (4.10).

$$COP = \frac{Q_{out}}{W} \quad (4.10)$$

where Q_{out} is the useful heat and W is the energy consumed by the compressor.

Generally, the coefficient of performance of a heat pump is bigger than one (2-4). This means that a heat pump can generate up to 4 kWh of heat consuming only 1 kWh of electrical energy. The COP is not fixed, but it varies during the year depending on the source temperature. Because the temperatures underground are more stable, ground-sourced heat pumps achieve the highest coefficient of performance, as shown in Table 4.4.

Table 4.4: Heat pump coefficient of performance for space heating [51]

Heat pump	COP with underfloor heating	COP with conventional radiator
Ground-source (vertical)	3.6	3.2
Water-source	3.4	3.0
Air-source	3.0	2.3

The most common types of heat pumps used in Germany are air and ground-source heat pumps [75]. Air-source heat pumps take heat from the incoming fresh air and produce cooled air as output. The evaporator can be installed outside or inside the house. If it is installed inside the house, the input air must be replaced continuously. If it is installed outside and close to neighboring houses, the device can produce noise which may cause undesirable conflicts. Moreover, during winter the air heat pump is less efficient because air temperature is lower and heating demand higher. The ground-source heat pump on the contrary does not produce any undesirable noise and it is more efficient. The drawback is that the installation is more complex and expensive. In order to extract heat from underground, long pipes have to be buried in a depth varying from a few meters up to 100 meters. The pipes can be placed in two types of arrangements: horizontal or vertical. The horizontal is more common for large properties, and can mostly be found in suburban/rural areas. The vertical is more adequate in areas where space is limited. Compared to electric heaters and solar thermal collectors, the heat pump is the most efficient technology to generate heat all over the year, but the electricity consumed by the heat pump should be produced from renewables.

4.4.4. Water storage tank

Solar thermal collectors and heat pumps use water storage tanks to transfer and store the thermal energy from the working fluids to the water that will be consumed. The tank can have different sizes depending on the hot water consumption and the desired period for storage. On average, a German citizen consumes approximately 50 liters of hot water per day [6], [76]. This means that the size of the tank for a family of four persons should be at least 200 liters. The amount of heat needed to increase the temperature of a determined mass of water is defined as:

$$Q = c \times m \times \Delta t \quad (4.11)$$

where Q is the amount of heat (kJ), c is the heat capacity (kJ/kg.K), m is the mass (kg) and Δt is the temperature difference (K).

The density of water reduces with increasing temperature. At 20°C the density of water is 998.3 kg/m³ or 0.9983 kg/liter and the heat capacity 4.182 KJ/kg.K = 1.161 Wh/kg.K [6]. In this thesis, the density of water is considered as 1,000 kg/m³ and the heat capacity equal to 1.161 Wh/kg.K, independent of the temperature.

The temperature of the water inside the tank reduces with time, i.e. it loses heat to the environment. Figure 4.17 shows that after a day the temperature reduces 5°C (on average 0.21°C/hour), and after a month the temperature of the water inside the tank is almost the same as the ambient temperature. That helps clarifying why it is difficult to implement seasonal storage with solar thermal collectors.

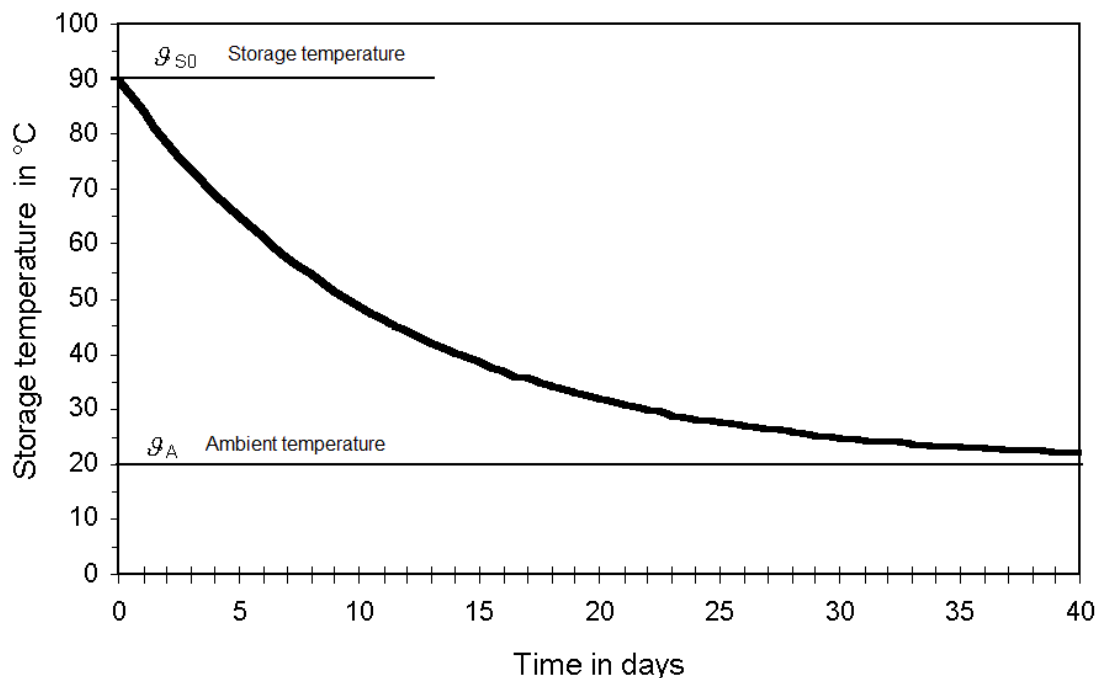

Figure 4.17: Storage temperature reduction without loading or unloading [6]

4.5. Energy storage systems

Electricity generated from photovoltaics and wind turbines fluctuates over time depending on the weather conditions, such as shadows on the solar panels and variations in the wind speed. Energy storage systems can be used to stabilize the fluctuating generation and to supply the demand when there is no or insufficient generation. In a household community, the ideal storage system is suitable for daily charge and discharge cycle, and can operate under severe conditions, i.e. no charge for few days and frequent discharges with incomplete charge. This section will present four technologies that may be used in the future as stationary storage applications by households in combination with decentralized electricity generators.

4.5.1. Lead-acid battery

The lead-acid battery was invented by Gaston Planté in 1860 [77]. It is a mature technology, which is applied in a variety of applications such as in vehicles and stationary backup systems. There are mainly two types of lead-acid batteries: flooded or vented lead-acid batteries (VLA) and sealed or valve-regulated lead-acid batteries (VRLA). The basic difference between VLA and VRLA batteries is that VLA loses water during operation, which makes refilling necessary [78].

The battery is composed of a positive electrode (PbO_2) and a negative electrode (Pb) that are immersed in a electrolyte of sulfuric acid (H_2SO_4), as depicted in Figure 4.18.

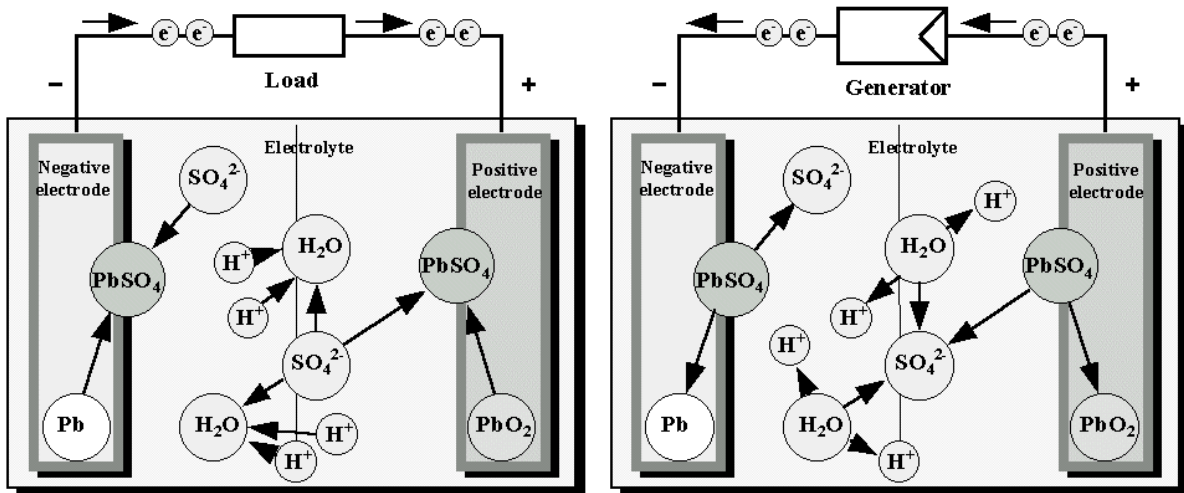
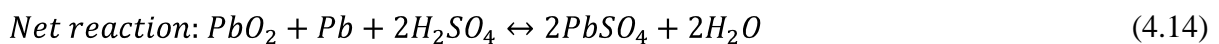
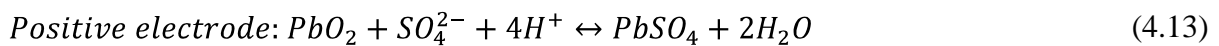
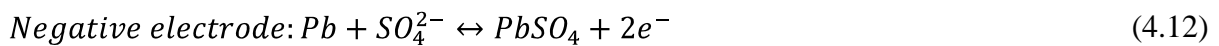

Figure 4.18: Discharging and charging a lead-acid battery [6]

The nominal voltage of a lead-acid battery is 2 V [79]. The chemical reactions that occur inside the battery during discharge and charge are shown in the following equations:



During discharge lead sulfate (PbSO_4) is formed. It is reverted into lead (Pb), lead dioxide (PbO_2) and sulfuric acid (H_2SO_4) when the battery is charged. If the battery is not immediately recharged after its discharge, the lead sulfate will begin to form crystals (sulfation), which can reduce the energy storage capacity of the battery and its performance [78].

Nowadays lead-acid is the most used battery technology for stationary applications. It is relatively inexpensive (approx. 150 €/kWh), reliable, has fast start up and high efficiency (more than 80%). However, it has low specific energy (20-40 Wh/kg) and low cycle life (250-500 cycles), especially when it is frequently deep discharged [79]. Table 4.5 shows that the lead-acid battery only achieves high cycle life if it is discharged to 30% of its energy storage capacity. That means that the total energy capacity of the battery must be larger under constant deep discharge or the batteries must be replaced more often. In either case, costs are increased.

Table 4.5: Cycle performance of lead-acid batteries [77], [80]

Depth of discharge (%)	Deep-cycle lead-acid battery (cycles)
100	150 - 200
50	400 - 500
30	1,000 and more cycles

Depending on the recharge method, state of charge and battery type, the lead-acid battery may need more than 10 hours to recharge [77], [81]. A conventional method of charging is illustrated in Figure 4.19. In the first stage the current is kept constant while the voltage rises to approximately 2.4 V. Then the voltage is kept constant and the current decreases until it reaches a threshold value, typically below 1% of the ampere-hour capacity of the battery. In the last stage, the voltage is reduced and the battery is kept fully charged.

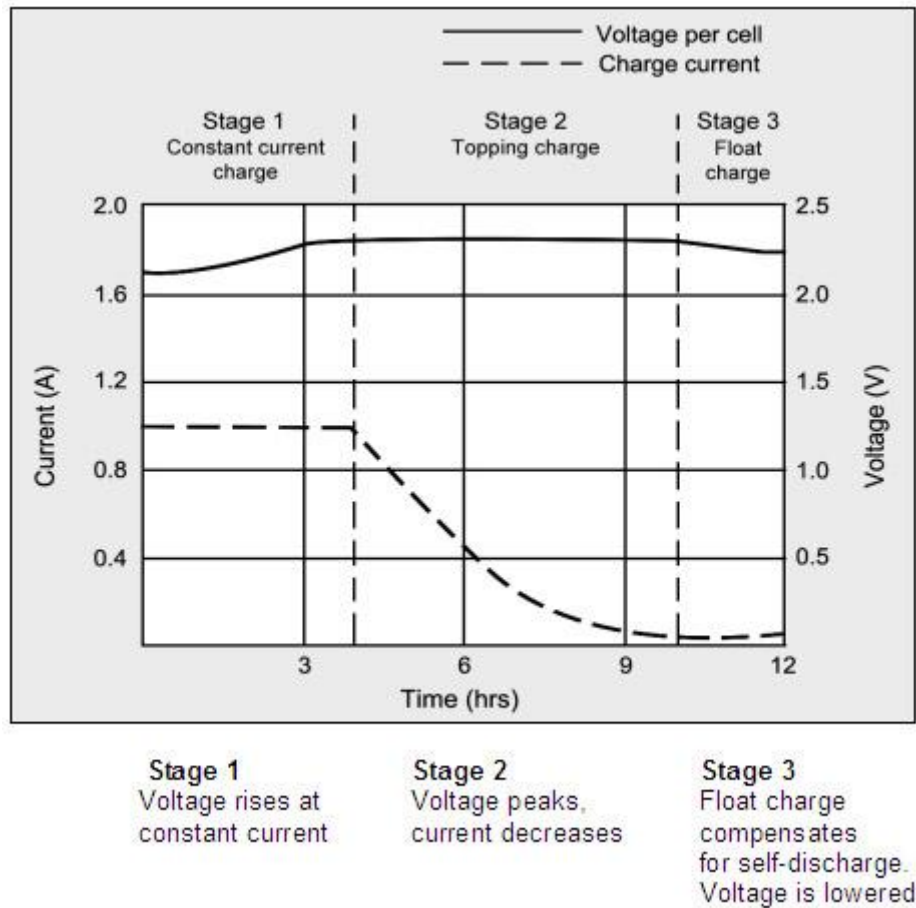

Figure 4.19: Charge stages of a lead-acid battery [81]

The lead-acid battery will continue to be the most applied energy storage technology in stationary applications because of its reliability and low costs. In a renewable energy community however it might not be the best choice due to the low cycle life under constant deep discharges. In addition to that, if the battery is kept discharged for long periods and sulfation occurs, the battery's capacity might be reduced.

4.5.2. Lithium-ion battery

The rechargeable lithium-ion (Li-ion) battery started to be commercialized by Sony in the beginning of the 1990s. Since then, it is the technology that developed most, being nowadays the main energy storage medium for the majority of portable devices as well as electric vehicles [82]. Because of the limitations of lead-acid batteries and the increasing interest in storing energy from renewables, in the last years the lithium-ion batteries started to be tested in residences for stationary applications [83], [84].

The principle of operation is based on the migration of lithium ions (Li^+) between the positive and negative electrode, as depicted in Figure 4.20.

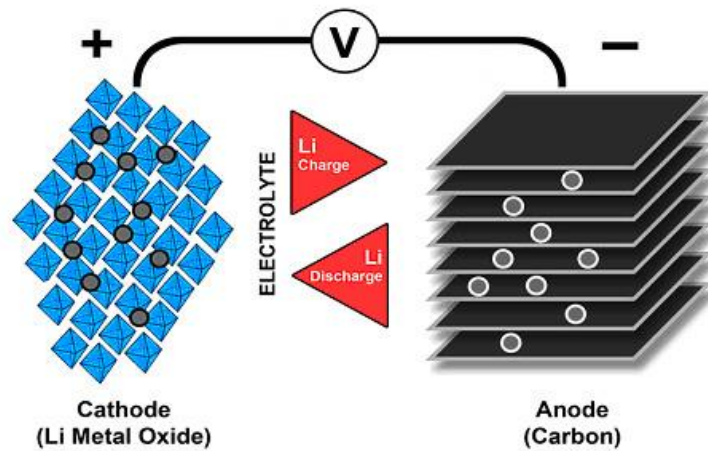
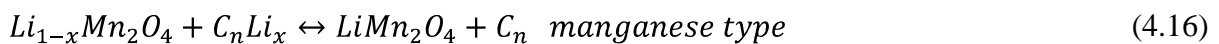
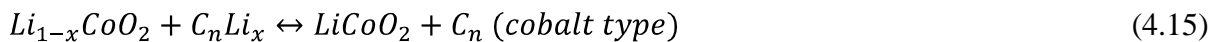

Figure 4.20: Ion flow in lithium-ion battery [85]

The positive electrode material is normally a lithiated metal oxide, like lithium cobalt oxide (LiCoO_2) or lithium manganese oxide (LiMn_2O_4), and the negative electrode is typically lithiated carbon. Li-ion batteries mainly use liquid or gel electrolytes, which are composed of a salt (normally LiPF_6) and organic solvents [82]. The reactions occurring during charge and discharge in a lithium-ion battery are presented in the following equations:



The nominal voltage of the lithium-ion battery is 3.6 V [79]. It has high efficiency (more than 90%), high specific energy (90-150 Wh/kg) and high cycle life (500-1,000 cycles) [79]. The drawback of the battery is that it cannot tolerate overcharge and overvoltage. Therefore, a protection circuit is required to monitor the operation of the battery [77]. Like the lead-acid battery, the lithium-ion battery achieves higher cycle life if the depth of discharge is reduced. Table 4.6 presents the number of discharge cycles at different depth of discharge levels.

Table 4.6: Cycle performance of lithium-ion batteries [86]

Depth of discharge (%)	Discharge cycles
100	300 - 500
50	1,200 - 1,500
25	2,000 - 2,500
10	3,750 - 4,700

The charging stages of the lithium-ion battery are shown in Figure 4.21. At first the current is kept constant while the voltage rises until it reaches 4.2V. Then the voltage is hold at 4.2V until the current reaches about 3% of the initial charge rate, which is when the battery is charged [87].

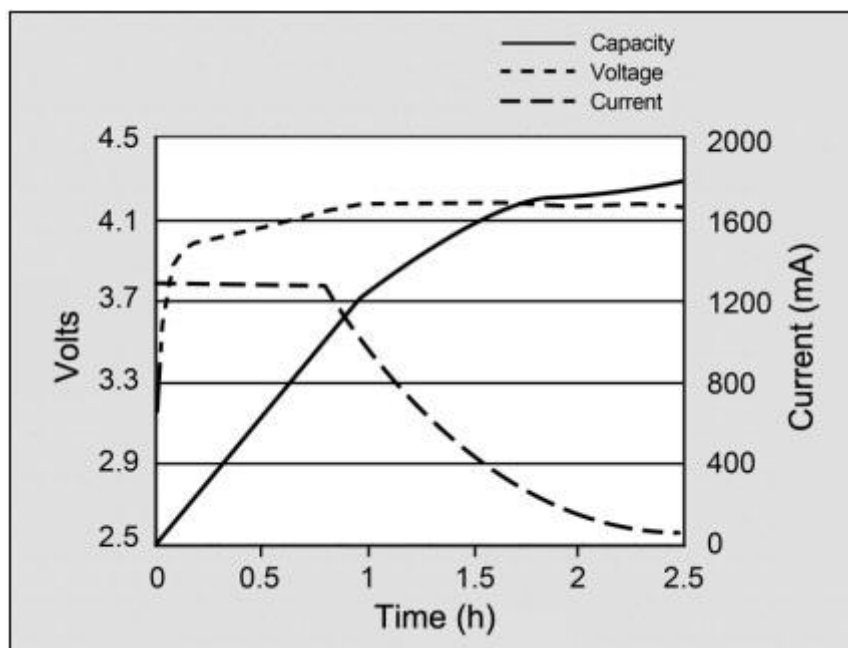

Figure 4.21: Capacity as a function of charge voltage on a lithium-ion battery [87]

The lithium-ion battery will probably remain the market leader in portable devices until a better technology is released. Its high costs still impose some restrictions in stationary applications. In the near future however due to the development and improvement of electric vehicles the costs of the battery is supposed to decline, as depicted in Figure 4.22. At the moment there are some studies investigating the secondary use of lithium-ion batteries from electric vehicles [84], [88], [89].

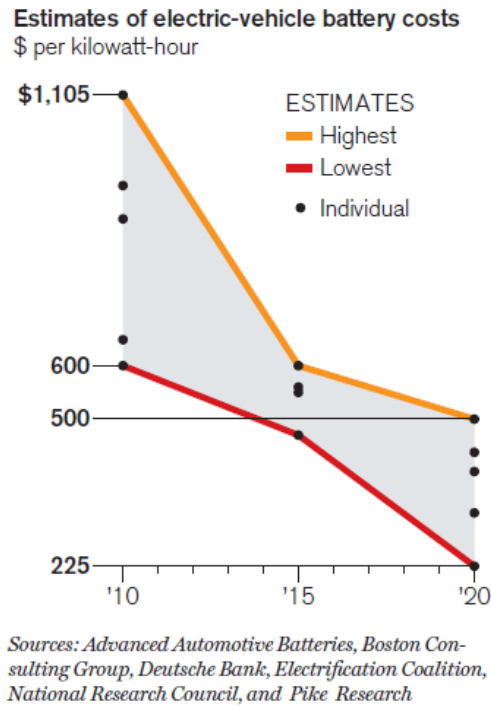
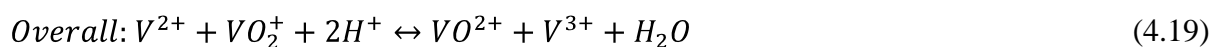

Figure 4.22: Estimates of electric vehicle battery costs [90]

4.5.3. Vanadium redox-flow battery

The vanadium redox-flow battery (VRFB) is a kind of rechargeable flow battery developed by the University of New South Wales in the late 1980s [77]. The VRFB works with two tanks that store vanadium in different oxidation states and a proton exchange membrane that separates the electrolytes. The membrane allows protons to pass through, but no electrons. The power of the battery is determined by the sum of cell stacks, where the chemical energy is converted into electricity. The total energy is dictated by the quantity of electrolyte in the tanks. Electrode materials are polymer-impregnated graphite plates, conductive carbon-polymer composites and polymer-impregnated flexible graphite [91]. The chemical reactions are presented as follows:



where the vanadium oxide ions VO^{2+} and VO_2^+ are in fact the vanadium ions V^{4+} and V^{5+} respectively [92].

In a VRFB, the catholyte and anolyte flow by two pumps as shown in Figure 4.23.

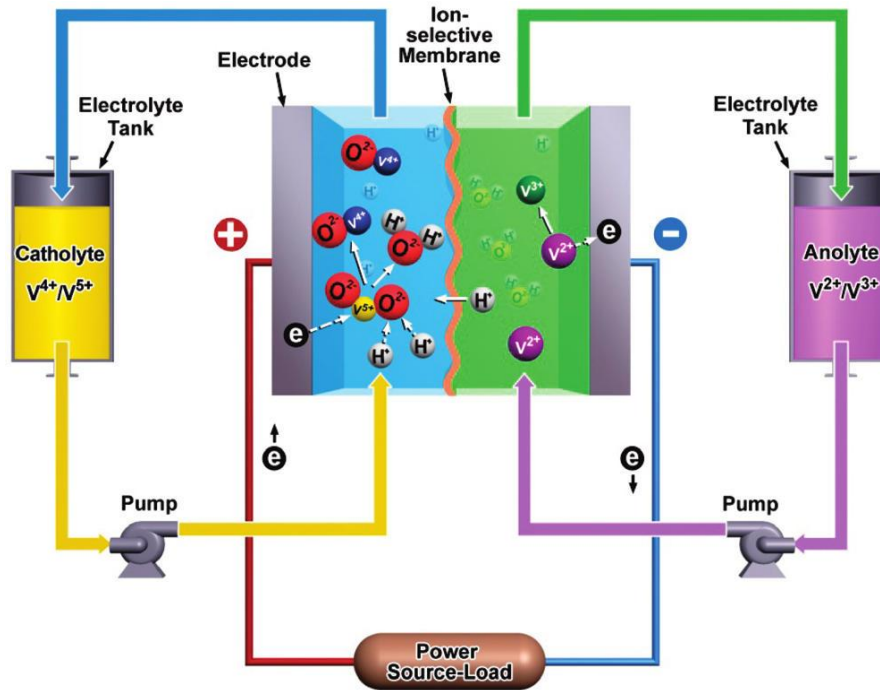

Figure 4.23: Operating principle of a vanadium redox-flow battery [91]

The vanadium redox-flow battery has several advantages such as fast response to changing load, high charge/discharge ratio 1.5:1 and high cycle life (greater than 10,000 cycles) [93], [94]. The drawbacks however, are the low specific energy (10-20 Wh/kg) and the need for pumps during operation, which demands more space and increases the complexity of the system. Moreover, the pumps require regular maintenance, reduce the overall efficiency to around 75%, and have an expected lifetime of only ten years [95]. The cell stacks can also degrade over time and need to be replaced [96]. Although VRFB is commercialized and presented in several projects all over the world, there is no indication that the battery will be used soon in the household sector [82]. However, it may compete in the future with lead-acid and lithium-ion batteries in stationary applications with frequent deep discharge depending on the capital and operating costs.

4.5.4. Hydrogen storage system

The hydrogen storage system is composed basically of three components: electrolyser, storage tank and fuel cell. Electrolysis of water is a method that separates water (H_2O) into oxygen (O_2) and hydrogen gas (H_2) using electricity.

The overall reaction of electrolysis is presented as follows:



Hydrogen can be compressed and stored in tanks at the pressure of 200-800 bar. As compression requires extra energy, the efficiency of the system is reduced [79]. The stored hydrogen is used by fuel cells to generate electricity. The fuel cell was invented by William Grove in 1839. However, its practical use only started in the 1960s with the NASA space programs [97]. A fuel cell is made up of anode, cathode and electrolyte. There are several types of fuel cells, as presented in Table 4.7. They are defined by their electrolyte substance.

Table 4.7: Comparison of fuel cell technologies [98], [99]

Fuel cell	Electrolyte	Temperature (°C)	Electrical efficiency (%)	Power range (kW)	Power density (mW/cm ²)
PEMFC (polymer electrolyte membrane fuel cell)	Solid organic polymer poly-perfluoro-sulfonic acid	60-100	40-50	0.001-1000	300-1000
AFC (alkaline fuel cell)	Aqueous solution of potassium hydroxide soaked in matrix	90-100	50	1-100	150-400
PAFC (phosphoric acid fuel cell)	Liquid phosphoric acid soaked in a matrix	175-200	40	50-1000	150-300
MCFC (molten carbonate fuel cell)	Liquid solution of lithium, sodium/potassium carbonates, soaked in a matrix	600-1000	45-55	100-100,000	100-300
SOFC (solid oxide fuel cell)	Solid zirconium oxide to which a small amount of yttria is added	600-1000	50-60	10-100,000	250-350

The most dominant fuel cell type is the PEMFC. It has the highest power density of all types and because of that it is used for example in fuel cell vehicles. The main disadvantages however are the expensive components, like platinum catalyst and the polymer membrane [98]. The equations of reactions in its anode and cathode are described as follows:



In the fuel cell, oxidation of hydrogen by oxygen occurs as depicted in Figure 4.24.

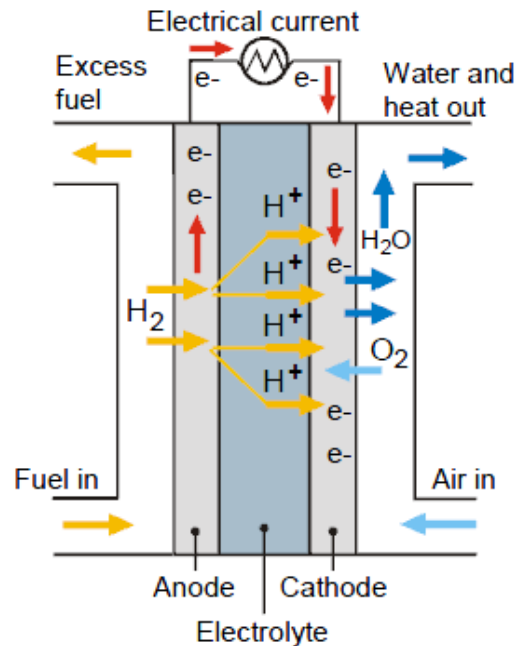

Figure 4.24: Operating principle of a PEM fuel cell [99]

Water and heat are the output products of the PEMFC. In theory, the system can cogenerate electricity and heating in residential applications. However, it is still very complex, expensive and inefficient. Based on [100], the electrolyser consumes 6 kWh to generate only 1 kWh using PEMFC, which gives a low efficiency of only 16.6%. Additionally, the experiment in [101] has proved that the system temperature needs about two hours to achieve its steady state, i.e. it consumes too much fuel before starting to generate heat, reducing the efficiency even further. Based on these facts, it is unlikely that the hydrogen system will compete in the near future with other storage technologies in the household sector before improvements in the overall efficiency are achieved.

4.5.5. Energy storage systems comparison

In this section, four types of energy storage systems were presented focusing the household sector. All technologies have advantages and disadvantages, which are summarized in Table 4.8. In the short-term the lead-acid battery might continue being the most used technology in stationary applications due to its low costs. Lithium-ion battery and vanadium redox-flow battery may play a role in the future because they are characterized by higher cycle life. On the one hand however, the operation of VRFB must be simplified and its specific energy improved. On the other hand, the costs of lithium-ion batteries must be

reduced in order to be competitive, which will probably occur as they are the technology used to power electric vehicles. The hydrogen storage system might be used in large scale power systems, but unlikely in the household sector due to the complexity and inefficiency of the system.

Table 4.8: Comparison of different energy storage systems for the household sector

Storage	Advantages	Disadvantages
Lead-acid battery	<ul style="list-style-type: none"> • Mature technology • Inexpensive • Fast start up • High efficiency 	<ul style="list-style-type: none"> • Low specific energy • Low cycle life • Long time for charging
Lithium-ion battery	<ul style="list-style-type: none"> • High specific energy • Fast charge time • Fast start up • High efficiency 	<ul style="list-style-type: none"> • High cost • Low cycle life
Vanadium redox-flow battery	<ul style="list-style-type: none"> • High cycle life • Good efficiency • Fast charge time 	<ul style="list-style-type: none"> • Low specific energy • Need pumps for operation
Hydrogen storage system	<ul style="list-style-type: none"> • Cogeneration potential • Energy can be stored for long periods 	<ul style="list-style-type: none"> • Complex operation • Inefficient • Low start up for cogeneration

5. Case study

In the previous chapters, the main technologies used to generate electricity and heating on-site from renewable sources as well as energy storage systems were analyzed. This chapter presents a case study of a simulated renewable energy community to determine if and how it can supply its energy demand over the year based on the existing technologies.

5.1. Renewable energy community overview

The community consists of 50 single-family houses, where in total 175 persons live. The houses are grouped as presented in Table 5.1 to facilitate the creation of the electricity load profile as well as to simplify the simulations. All the houses are purposely built facing south and passive to maximize solar gains and reduce space heating demand.

Table 5.1: Group of houses in the community

Persons per house	Number of houses	House group
2	5	HG23
3	20	
4	20	HG45
5	5	

Electricity is generated from photovoltaic panels installed on the garages and houses roofs, and small wind turbines located near the houses. Stationary energy storage batteries are used to stabilize the fluctuating generation and to supply the demand when there is no or insufficient generation. On average each household has an electric vehicle, which is used not only for transportation but also as an extra storage system.

5.2. Electricity load profile

Cottbus is situated in the state Brandenburg, one of the new federal states of Germany. As mentioned in Section 3.3, the average electricity consumption per year in this region is 3.4 MWh. Traditionally when one analyzes the electricity consumption over short periods, the most accurate data is obtained from the load curve. Although it is a very useful chart, the information of which electrical appliance is being used at a certain time is missing. Therefore, in order to simulate the load management, the hourly electricity profile of the REC is built based on the German daily routine and on the use of common devices, as mentioned in [23].

Households use appliances according to their necessities. When electricity is supplied by utilities, consumers use their electrical devices at any time without restrictions and expect that the electricity supply is never interrupted. In the REC however, the families should use their appliances when there is enough energy available. Taking that into consideration, the load profile is separated into two load groups: uncontrollable (ULG) and controllable (CLG). The uncontrollable loads run whenever they are demanded, while the controllable loads are used at times when there is less demand or more generation (for instance at night and afternoon respectively). Some controllable loads can be programmed to start working at any time without the presence of somebody at home or be used at another time in case there is not sufficient energy available. Table 5.2 shows the amount of devices depending on the number of persons per house.

Table 5.2: Electrical appliances per load group

Load group	Electrical appliances	Power or Energy (W or Wh)	Persons per house			
			2	3	4	5
Controllable	Dish washer ^a	2,400 W 920 Wh in 185 minutes	1	1	1	1
	Iron	2,400 W	1	1	1	1
	Vacuum cleaner	1,200 W	1	1	1	1
	Washing and dryer machine ^b	2,200 W 4,760 Wh in 480 minutes	1	1	1	1
	Water heater	2,400 W	1	1	1	1
Uncontrollable	Alarm clock	5 W	2	3	3	4
	Blu-ray	12 W 0,3 W standby	1	1	1	1
	Coffee machine	1,100 W	1	1	1	1
	Electric oven ^c	11,200 W 4,600 W (2 large cooking zones)	1	1	1	1
	Hair dryer	2,000 W	1	1	2	2
	Internet	5 W	1	1	1	1
	Light	40 W	10	11	12	13
	Microwave	800 W	1	1	1	1
	PC	90 W	2	2	3	4
	Printer	10 W 2.3 W standby	1	1	1	1
	Radio	30 W	3	4	4	5
	Refrigerator ^d	160 W 30 Wh	1	1	1	1
	Small oven	1,500 W	1	1	1	1
	Telephone	2 W	3	4	4	5
	TV	120 W maximum 0.3 W standby	2	3	3	3
Ventilation system with heat exchanger	100 W	1	1	1	1	

^a Model Siemens SN28N268DE – Program “3 Eco”

^b Model Siemens WD14H540 – Program “Cottons 60°C + Intensive dry”

^c Model Siemens EA645GH11M – only the cooking zones 2 and 4 are considered

^d Model Siemens KG39NEI32 – energy consumption 260 kWh/year

The electricity load profile normally does not change every week. Families have defined routines to go to work, school, eat, etc. In order to simplify the calculations and analysis, the year is divided into seasons. The winter is the first season occurring in the first three months of the year. The other seasons are spring, summer and autumn, each one having three months. Table 5.3 presents the electricity consumption in the REC per season and per load group.

Table 5.3: Electricity consumption (kWh) per season

Load Group	Season				
	Winter	Spring	Summer	Autumn	Total
Controllable	12,311	11,664	10,478	12,311	46,764
Uncontrollable	44,886	42,553	40,231	43,312	170,982
Total	57,197	54,217	50,709	55,623	217,746

The annual electricity consumption in the community is 217.7 MWh, which gives an average of 4.3 MWh per house. The amount is higher than the previous mentioned average of 3.4 MWh because the ventilation system of the passive house is included in the load profile. Figure 5.1 shows an example of the load profile in a house of five persons on a winter Sunday. It can be seen that the peak occurs around noon when people are more active using several electrical devices for cleaning, cooking and entertainment.

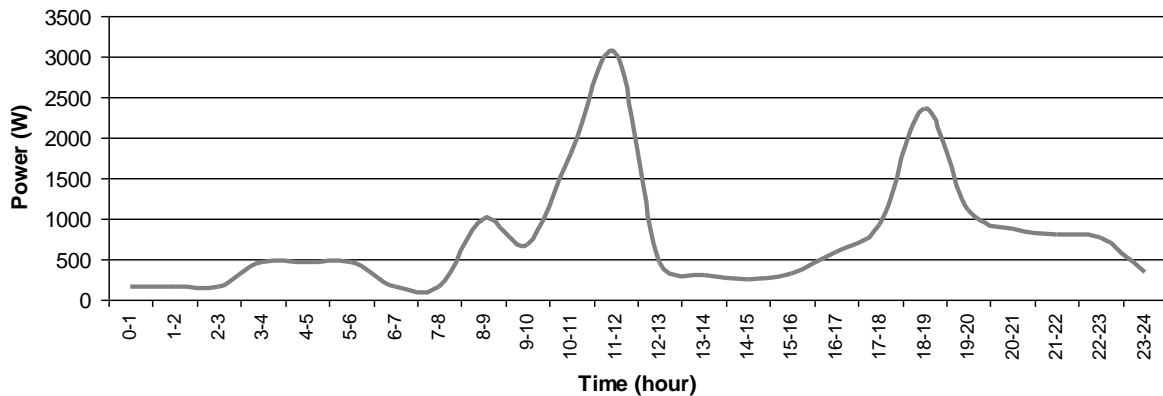

Figure 5.1: Example of the electricity load profile on a winter Sunday

5.3. Electricity generation

Electricity is generated on-site from PV panels and small wind turbines. The installed total power capacity is composed of 480 kW_p PV panels and 500 kW SWT, as introduced in Section 4.3.1.1 and Section 4.3.2.1. The software HOMER is used to calculate how much electricity can be generated per hour over the year. Based on hourly values, a comparison between electricity production and energy consumption can be realized. Figure 5.2 presents the electricity generation potential per season.

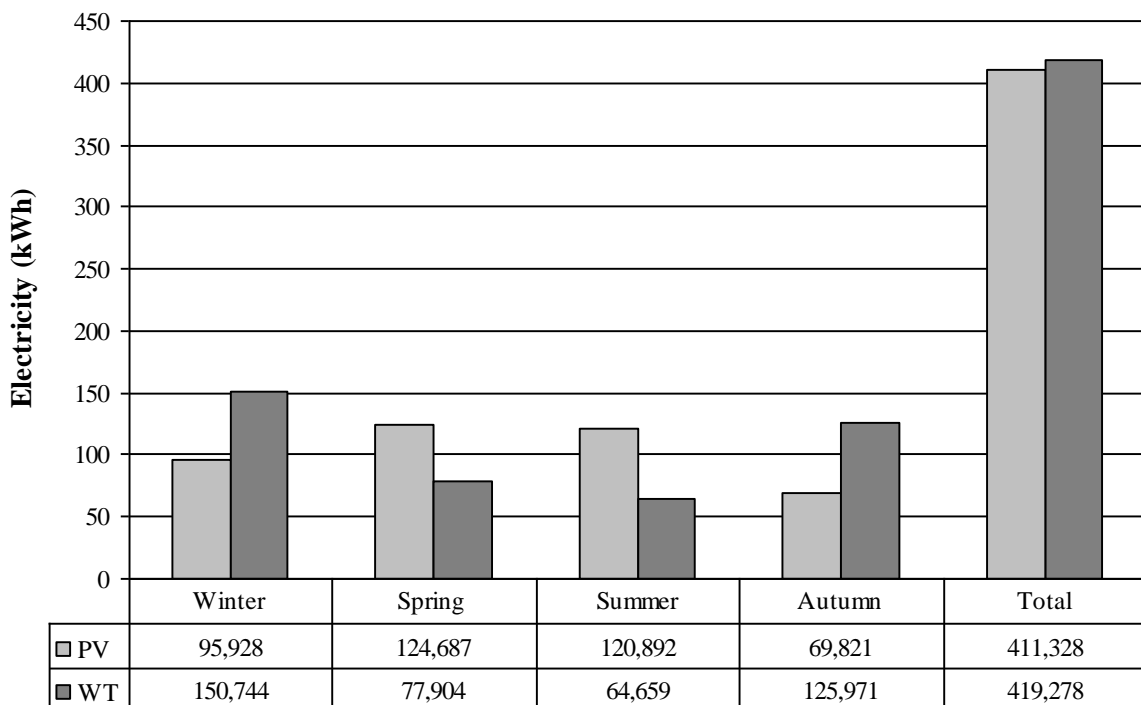

Figure 5.2: Total electricity production (kWh) per season

The total electricity production is 830.5 MWh/a, which gives an average of 16.6 MWh/a per household. Figure 5.2 shows that the photovoltaic modules produce more electricity in the spring and summer, while the wind turbines in the winter and autumn. With such a mix of generation, the investments in energy storage systems can be reduced as well as the energy purchased from the grid. Also important to notice is that most of the energy is produced in the winter, when space heating is demanded.

5.4. Heating demand

The heating profile in the household sector can be divided into hot water and space heating demand. The hot water demand is somehow predictable, because people consume water based on their daily routines and the temperature is more or less standard, around 40°C. The space heating demand is on the contrary more complex to be analyzed. It depends on the external and internal temperatures, and the thermal sensitivity of people. In order to avoid any wrong assumption, the space heating demand is not taken into account at first in the simulations. In the end, the excess of electricity will be considered as the available energy to heat space.

In Chapter 4.4, the main technologies used to generate heat on-site using renewable sources were presented. For the case study, a heat pump with COP equal two is considered, i.e. the heat pump produces 2 kWh of heat consuming 1 kWh of electricity. The heat pump system has a water storage tank where heat is transferred and stored. The capacity of the tank is based on the average hot water consumption per day, 50 liters/person. In the simulations, hot water is consumed every day but only to take a shower. The water temperature inside the tanks is reduced by 0.5 °C/hour to simulate energy losses and to consider short demands, such as washing hands. As each person prefers to take a shower at a certain time (some in the morning and others in the evening), it is assumed that 50% of the water of the storage tank is used in one period of the day and 50% in the other period, as shown in Table 5.4

Table 5.4: Period when people take a shower per house group

House group	Morning	Evening
HG23	06:00 to 07:00	17:00 to 18:00
HG45	06:00 to 07:00	18:00 to 19:00

It is known that the bacterium *Legionella* can multiply itself in water storage tanks depending on the water temperature and on the frequency of use [102]. Based on Table 5.5, it can be seen that the optimum temperature to take a shower is in a dangerous range. That means that if the water is stored at 40°C, there might be a chance of proliferation and contamination by *Legionella*. Above 70°C the bacterium dies instantly. In order to prevent the spread of diseases, the water inside the storage tank is heated up to 70°C. The simulations will show if there is enough energy available to reach this limit at least once a week.

Table 5.5: How water temperatures affect Legionella [102]

Temperature (°C)	Status
20	It can survive but it is dormant
20 to 50	Ideal growth range
55	It dies within 5 to 6 hours
60	It dies within 32 minutes
66	It dies within 2 minutes
70 to 80	Disinfection range

In the simulation, the hot water consumption is 50% of the tank capacity only if the temperature of the water is 40°C, i.e. no cold water is consumed. In case the water temperature inside the storage tank is higher than 40°C, the hot water consumption is less than 50% and cold water is consumed. Based on Equation (5.1) [103], it is possible to calculate the consumption of hot and cold water fixing the final temperature (T_f) at 40°C and the total water consumption (m_1+m_2) at 50% of the storage tank capacity.

$$T_f = \frac{m_1 \times T_1 + (m_2 \times T_2)}{(m_1 + m_2)} \quad (5.1)$$

where T_f is the final temperature (°C), m_1 is the mass of cold water (kg), T_1 is the cold water temperature (°C), m_2 is the mass of hot water (kg) and T_2 is the hot water temperature (°C).

The following example shows how the hot water temperature and consumption are calculated in the simulation. A house with four persons has a storage tank of 200 liters capacity. The cold water temperature (T_1) is 10°C and the final temperature (T_f) 40°C. It is evening and two persons will take a shower, i.e. 100 liters of water will be consumed. The temperature of the water inside the storage tank (T_2) is 60°C. Inputting all the values in Equation (5.1), it is possible to find how much cold and hot water are consumed.

$$m_1 + m_2 = 100 \text{ liters}$$

$$40^\circ\text{C} = \frac{m_1 \times 10^\circ\text{C} + [100\text{l} - m_1) \times 60^\circ\text{C}]}{100 \text{ l}}$$

$$m_1 = 40 \text{ liters and } m_2 = 60 \text{ liters}$$

The two persons consume 40 liters of cold water and 60 liters of hot water. In the end, there will be still 140 liters of water inside the storage tank at 60°C. Filling up the tank with 60 liters of cold water at 10°C, the new temperature of the 200 liters of water will be 45°C.

$$T_f = \frac{60l \times 10^\circ C + 140l \times 60^\circ C}{200 l} = 45^\circ C$$

5.5. Energy storage system

An energy storage system is essential to stabilize the fluctuating electricity generated from PV and SWT, and to supply the demand when there is no or insufficient generation. In the future, lithium-ion and vanadium redox-flow batteries may compete with lead-acid batteries in stationary applications, as presented in Section 4.5. Lithium-ion batteries have better chances to gain market due to the development of electric vehicles. Because of that, the storage system simulated in the case study is based on the lithium-ion battery. The energy storage capacity is calculated taking into account the daily average electricity consumption and hot water consumption. The daily average electricity consumption is found by dividing the annual electricity consumption per the number of days in a year, as shown in Equation (5.2).

$$\text{Daily average electricity consumption} = \frac{\text{Annual electricity consumption}}{\text{Number of days}} \quad (5.2)$$

$$\text{Daily average electricity consumption} = \frac{4,354 \text{ kWh}}{365 \text{ days}} = 11.92 \text{ kWh/day}$$

To calculate the daily average hot water consumption, Equation (4.11) is applied. It is assumed that the temperature of the input cold water is $10^\circ C$ and it is heated up to $40^\circ C$. Because the water storage tanks have different capacities, the average amount of water consumed in the community is found by dividing the total capacity of the water storage tanks by the number of houses.

$$\text{Daily average hot water consumption} = \frac{1.161 \text{ Wh}}{l.K} \times \frac{8750l}{50 \text{ houses}} \times 40^\circ C - 10^\circ C$$

$$\text{Daily average hot water consumption} = 6.09 \text{ kWh/day}$$

$$\text{Total} = 11.92 \text{ kWh} + 6.09 \text{ kWh} = 18.01 \text{ kWh}$$

The assumed total energy storage capacity is 19.8 kWh per household based on nine Synerion 48E lithium-ion batteries of 2.2 kWh from Saft [104]. Based on the manufacture datasheet, the cycle efficiency is 96%, which corresponds approximately to 98% to charge and 98% to discharge. The maximum continuous discharge power is 2.5 kW per battery and the maximum

continuous charge power is 1.15 kW. In the simulation, ten percent losses are assumed during power conversion.

5.6. Electric vehicle as stationary energy system

As introduced in Section 3.5, Germany has set a target to have one million electric vehicles operating in practice by 2020. Based on that, it is considered that each household in the community has an electric vehicle driven by lithium-ion batteries. The batteries are seen as electrical loads or as part of the stationary energy system and have cycle efficiency of 96%. The energy storage capacity of each vehicle is assumed to be 20 kWh and ten percent losses are assumed during power conversion. Unlike the stationary system, the main function of the EVs batteries is to power the car. Therefore, the batteries should not be completely discharged in the community. In the simulations, the vehicles can provide energy only if the batteries are charged over 12 kWh. The period when the vehicles are parked in the community and are available for charge or discharge is presented in Table 5.6.

Table 5.6: Period when the electric vehicles are parked in the community

House group	Period
HG23	From 17:00 to 07:00
HG45	From 18:00 to 07:00

Because the area of Cottbus is not very big (approximately 164 km²), it is assumed that people drive on average 15 km from home to work and the same distance back. Based on the condition that 20 kWh is sufficient to travel 100 km, 15 km is then equal to 3 kWh. It is assumed that the cars arrive in the community with a charge of 14 kWh every day. This means that if the batteries are completely charged when the vehicle leaves the community, then no charge outside the REC is considered. Table 5.7 presents three examples to illustrate the routine of charge/discharge of the electric vehicles depending on the initial charge capacity.

Table 5.7: Examples of charge and discharge of electric vehicles

Examples	1	2	3	Unit
Energy capacity before leaving the REC	20 (100%)	16 (80%)	12 (60%)	kWh
Energy used to go to work	3	3	3	
Energy capacity arriving at work	17	13	9	
Charge during the day at work	0	4	8	
Energy capacity leaving work	17	17	17	
Energy used to go to the REC	3	3	3	
Energy capacity arriving at the REC	14	14	14	
Energy available to be used in the REC	2	2	2	

5.7. Energy balance simulation

To build a system that evaluates the energy balance in the Renewable Energy Community, the software HOMER and LabVIEW [105] are employed. HOMER is used to estimate how much electricity can be generated per hour from PV and SWT over the year as introduced in Section 5.3. LabVIEW is a software developed by National Instruments which is used for example to automate testing and data gathering. In this thesis LabVIEW is applied to integrate the outputs from HOMER with the electrical loads, heat pumps, electric vehicles and storage systems. As HOMER restricts its result of electricity generation in hourly values, the simulation in LabVIEW has to follow the same principle. In the model, hourly values are inputted, processed and collected in the output, i.e. 8,760 iterations are processed in order to simulate each hour of the year. Figure 5.3 illustrates the four main parts of the algorithm created in LabVIEW. The inputs are electricity generation, load demand, storage capacity, temperature of the water inside the storage tanks and temperature of the input water (4°C in winter, 8°C in spring and autumn and 12°C in summer). The arrow connecting the outputs and the inputs indicates that some outputs become new inputs in the next iteration.

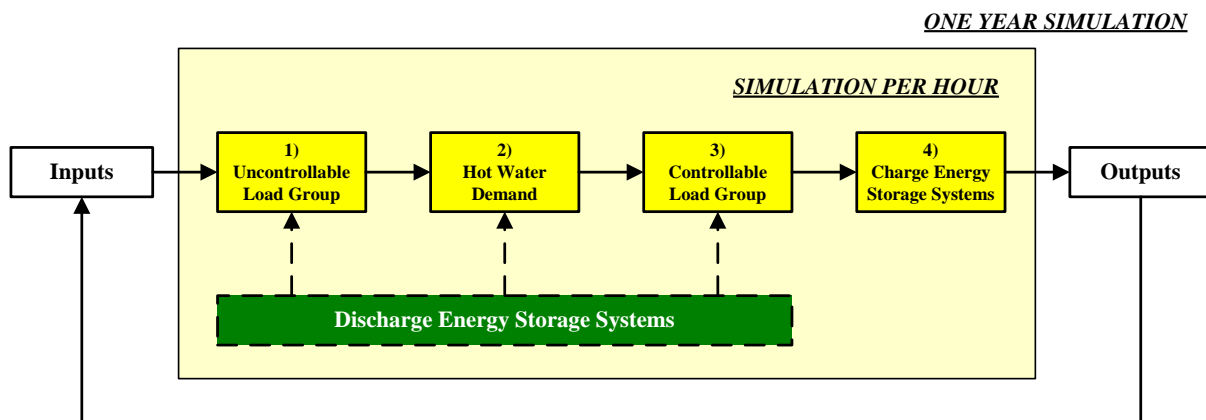

Figure 5.3: Illustration of the simulation steps in LabVIEW

The next four figures present in more detail each part of the energy balance simulation in LabVIEW. In the first part, the electricity generated by photovoltaics and wind turbines supplies the demand of the uncontrollable load group (Section 5.2, Table 5.2). As presented in Figure 5.4, in case there is no load demand, the part two of the simulation starts. If there is load demand, then the generators and batteries supply it. If the load demand is greater than the energy available, then the loads are turned off and the part two starts.

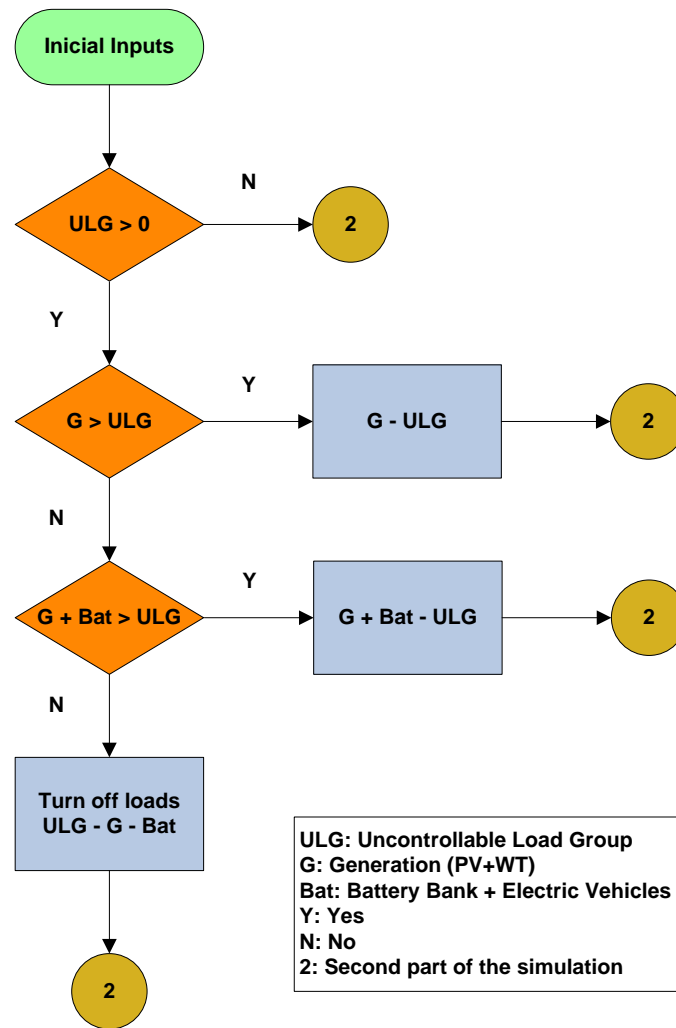

Figure 5.4: Flow chart to supply energy to the uncontrollable load group

The second part receives the outputs of the first part to supply domestic hot water demand. The left side of Figure 5.5 shows what happens if all the households (from HG23 and HG45) demand hot water at the same hour, while the middle and right side presents what happens if only one of the house groups demands hot water. In all the cases, if the temperature of the water inside the storage tanks is higher than 40°C, then no extra energy is needed. Otherwise, the water is heated up to 40°C using the energy from the generators and/or batteries. If there is not enough energy available, then the water cannot be heated up at that hour.

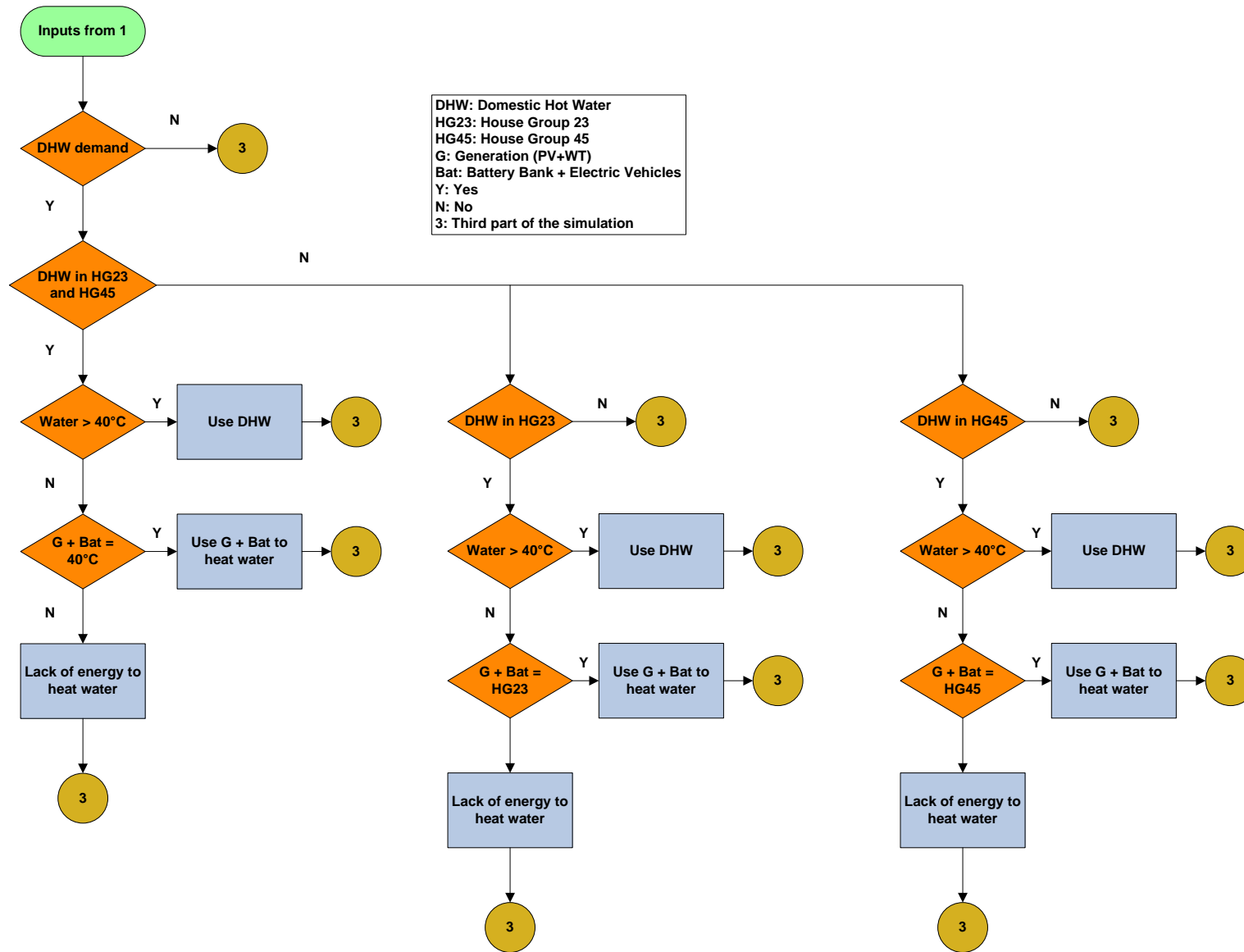

Figure 5.5: Flow chart to supply energy to the hot water demand

In the third part, the outputs of the second part are used to supply the demand of the controllable load group (Section 5.2, Table 5.2). The logic is the same as the first part, but now more restrictions are imposed if the load demand is greater than the electricity generation. That means that in this case, the controllable loads can only take energy from the battery bank if they demand half of the energy available at that hour. In addition, the CLG cannot take energy from the electric vehicles.

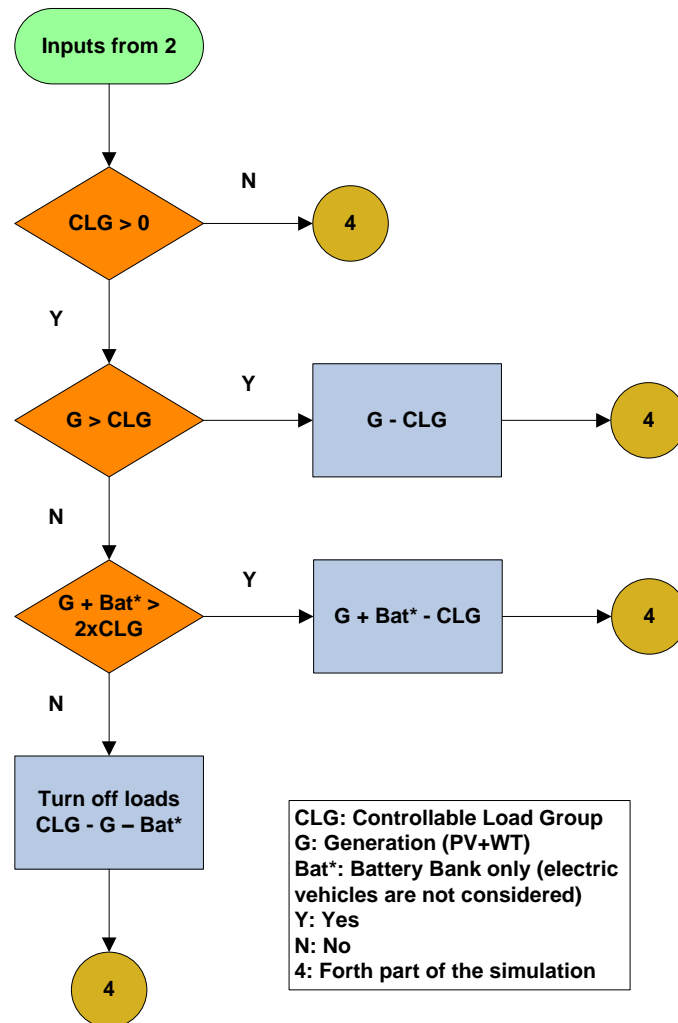

Figure 5.6: Flow chart to supply energy to the controllable load group

In the fourth and last part, the excess of electricity (output of part 3) is used to charge the battery bank, electric vehicles batteries and to heat the water inside the storage tanks. In the end of part four, the outputs battery bank and vehicles batteries capacity and water temperature of storage tanks become inputs of the next hour.

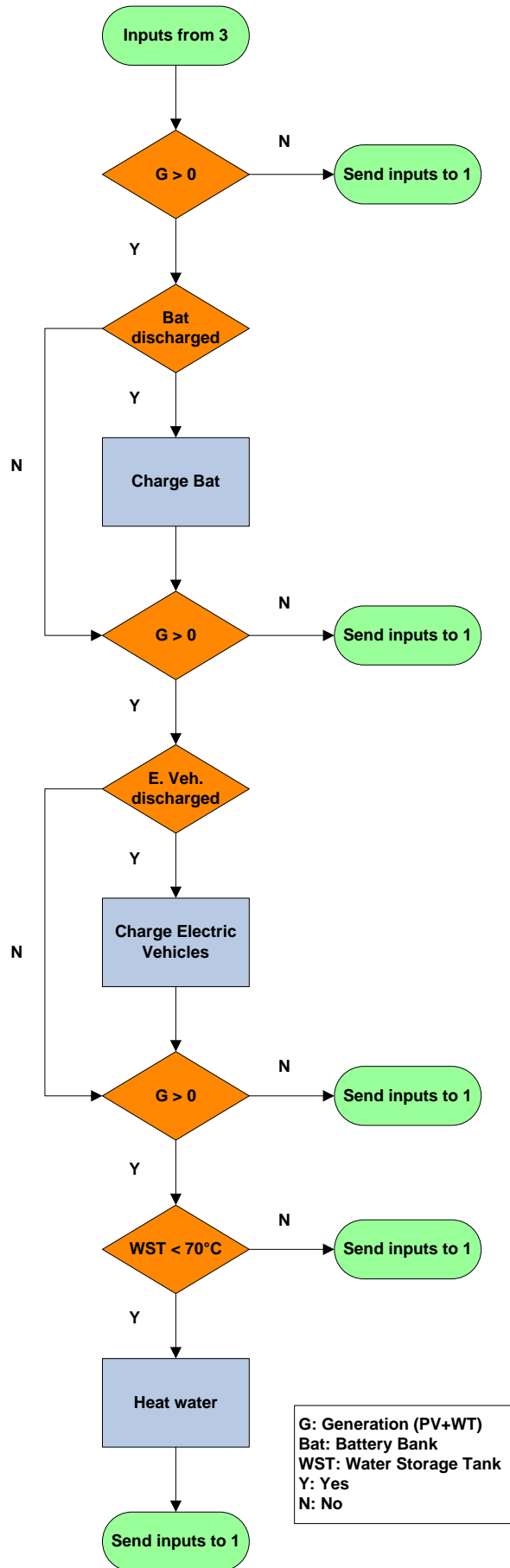

Figure 5.7: Flow chart to charge the energy storage systems

5.8. Results of the simulation

By simulating the energy balance in LabVIEW, it is analyzed whether or not the renewable energy community can achieve energy balance over the year based on hourly values of generation and demand. The main results involving the load groups, hot water demand, temperature of the stored water, and the performance of the batteries are presented in this section. It is important to mention that no holidays or vacations are considered. It is assumed that while some people stay at home and consume more energy, others go on holiday leading to reduced energy consumption.

5.8.1. Domestic hot water demand

The first investigation aims to show if the water in the storage tanks can be heated up to 70°C at least once a week to prevent the bacterium *Legionella* to grow. Table 5.8 shows that the water can be heated up in all weeks of the year for both house groups. In fact, in several weeks, the target is achieved in more than one day. This result indicates that the risk of water contamination is low. In addition to that, achieving high temperatures means that no extra energy is used when hot water is demanded.

Table 5.8: Number of times that water is heated up to 70°C

Number of days in a week	Number of weeks that the result is achieved per house group	
	HG 23	HG 45
1	1	1
2	4	4
3	6	6
4	11	11
5	8	9
6	12	12
7	10	9

Although the first result is positive in the sense that health problems are avoided, there are some days when the households do not have access to hot water due to lack of energy. Table 5.9 presents how many times hot water is demanded but there is not enough energy to heat the water up to 40°C. Here it is important to emphasize that in the simulations hot water is demanded twice a day per household, i.e. 730 times per year. The result shows that the HG45 uses less hot water than HG23. That is because the houses of the HG45 demand more water than HG23. In addition to that, it is assumed that the households from HG23 use hot water first in the evening. In reality however this result could be different if people consume

less hot water when they take a shower for instance. In case some households are absent, then more energy would be available for the others.

Table 5.9: Number of times that water is demanded but there is not enough energy supply

Month	HG23	HG45
January	8	11
February	0	0
March	4	4
April	5	5
May	3	3
June	8	8
July	2	4
August	7	9
September	10	12
October	4	4
November	16	19
December	3	4
Total	70	83

The last analysis regarding domestic hot water demand shows how much energy is consumed to heat water up to 40°C when there is enough energy available in the community. Table 5.10 shows that HG45 consumes approximately 59.1% more energy than HG23. The water storage tanks capacity of the HG45 is however 50% bigger than the ones of the HG23, which explains the higher consumption in HG45. The last line of the table shows that proportionally both house groups consume the same energy in the two periods for hot water demand.

Table 5.10: Energy consumed to heat water up to 40°C

Month	HG23		HG45	
	From 06:00 to 07:00	From 17:00 to 18:00	From 06:00 to 07:00	From 18:00 to 19:00
January	181	406	266	354
February	0	0	7	0
March	241	359	358	610
April	45	220	77	402
May	83	43	164	224
June	83	204	133	560
July	134	39	261	157
August	52	248	69	436
September	91	301	174	433
October	45	153	66	286
November	195	708	262	901
December	223	229	328	287
Subtotal	1,373	2,909	2,163	4,652
Total	4,282		6,814	
Ratio (Subtotal/Total)	32%	68%	32%	68%

5.8.2. Uncontrollable load group

The aim of the second investigation is to show how much energy is missing to supply the demand of the uncontrollable loads. Or in other words, this result shows for instance how much energy the community would have to purchase from the grid if the households wish to keep their loads working. Table 5.11 shows that the annual lack of energy in the community is 1.5 MWh. On average it corresponds to 31.1 kWh/a per household, or 0.91% of the annual electricity demand of the ULG. Based on the actual electricity price of 0.255 €/kWh, each household could pay 7.93 € to the grid in the end of the year to avoid this situation (not including any fixed tariff paid independent of the consumption).

Table 5.11: Lack of energy (kWh) to supply the load demand of the ULG

Hour	Month								Total
	Jan	Mar	Apr	Aug	Sep	Oct	Nov	Dec	
00:00-01:00	7.04	-	-	7.97	4.44	-	6.52	7.97	33.93
01:00-02:00	7.97	-	-	7.97	3.57	-	0.11	7.04	26.65
02:00-03:00	3.92	-	0.93	7.97	7.04	-	-	4.44	24.30
03:00-04:00	-	-	7.97	7.97	6.52	-	-	7.97	30.42
04:00-05:00	-	-	7.97	7.97	10.30	-	-	7.97	34.19
05:00-06:00	-	3.70	13.23	7.97	8.97	-	-	3.57	37.44
06:00-07:00	16.47	53.12	127.02	3.47	36.96	41.30	70.43	6.52	355.28
07:00-08:00	-	6.63	-	-	4.60	3.85	5.97	6.18	27.24
08:00-09:00	-	-	-	-	-	-	25.04	29.92	54.96
09:00-10:00	-	-	-	-	-	-	15.56	14.84	30.40
10:00-11:00	-	-	-	-	-	-	-	4.91	4.91
11:00-12:00	6.67	-	-	-	-	-	0.72	95.83	103.21
12:00-13:00	-	-	-	-	-	-	-	-	-
13:00-14:00	-	-	-	-	-	-	-	-	-
14:00-15:00	-	-	-	-	-	-	-	-	-
15:00-16:00	-	-	-	-	-	-	-	1.19	1.19
16:00-17:00	-	-	-	-	-	-	-	19.79	19.79
17:00-18:00	-	-	-	-	-	-	-	47.49	47.49
18:00-19:00	-	-	-	-	-	-	14.80	58.21	73.00
19:00-20:00	-	-	-	8.92	22.82	-	32.12	34.98	98.84
20:00-21:00	-	-	-	28.14	18.20	-	52.81	24.94	124.09
21:00-22:00	18.46	-	-	28.22	44.67	-	46.53	19.04	156.91
22:00-23:00	45.39	-	-	28.05	52.38	-	50.54	20.92	197.28
23:00-24:00	15.68	-	-	15.45	15.45	-	13.27	13.83	73.68
Total	121.58	63.46	157.11	160.04	235.92	45.15	334.42	437.53	1,555.20
N° days	5	1	4	3	4	1	6	2	26

It can be seen that in eight of twelve months the energy demand of the community is not met, and that in the last month of the year the situation is the most critical. From 06:00 to 07:00 occurs the morning peak demand, i.e. all the households wake up and prepare to go to work/school during the week. The result shows that 22% of the lack of energy occurs during this hour. Unfortunately this situation can only be avoided if people have different schedules, which is not easy if the parents must bring their kids to school for instance. The lack of energy in the evening period could be reduced if the families use less electrical appliances and turn off the ones that are not being used. In the simulation it is assumed that between 20:00 and 24:00 several TVs and PCs are turned on, but it does not mean that someone is really using them. The last line of Table 5.11 shows that in March, October and December the lack of energy occurs only in a few days. In these cases people could change their habits and use less electrical appliances without influencing their quality of life.

5.8.3. Controllable load group

The aim of the third investigation is to show how much energy is missing to supply the demand of the controllable loads. Differently from the uncontrollable load group, the controllable loads can be used at other times when more energy is available, or for instance people can wash dishes by hand instead of using the machine. Table 5.12 shows that the annual lack of energy in the community is 1.3 MWh. On average it corresponds to 27.4 kWh/a per household, or 2.94% of the annual electricity demand of the CLG. Based on the actual electricity price of 0.255 €/kWh, each household could pay 7 € to the grid in the end of the year to avoid this situation (not including any fixed tariff paid independent of the consumption).

Table 5.12: Lack of energy (kWh) to supply the load demand of the CLG

Hour	Month							Total
	Jan	Mar	Apr	Sep	Oct	Nov	Dec	
00:00-01:00	7.50	-	-	7.50	-	3.62	7.50	26.12
01:00-02:00	7.50	-	-	7.50	-	2.33	7.50	24.83
02:00-03:00	7.50	-	-	13.97	-	5.00	7.50	33.97
03:00-04:00	-	-	-	7.50	-	-	7.50	15.00
04:00-05:00	-	-	-	7.50	-	-	7.50	15.00
05:00-06:00	-	-	-	5.35	-	-	7.50	12.85
06:00-07:00	6.00	6.00	16.00	-	6.00	12.00	-	46.00
07:00-08:00	-	3.00	1.94	7.76	3.00	50.57	-	66.26
08:00-09:00	-	-	-	21.93	8.52	66.00	41.67	138.11
09:00-10:00	13.46	60.35	-	33.40	8.81	9.14	22.13	147.29
10:00-11:00	29.97	-	35.72	6.15	-	118.31	147.35	337.49
11:00-12:00	60.00	-	5.21	57.84	10.48	113.81	99.71	347.05
12:00-13:00	-	-	-	-	-	-	25.11	25.11
13:00-14:00	-	-	-	-	-	-	22.99	22.99
14:00-15:00	-	-	-	-	-	-	24.22	24.22
15:00-16:00	-	-	-	-	-	-	60.00	60.00
16:00-17:00	-	-	-	-	-	-	-	-
17:00-18:00	-	-	-	-	-	-	6.00	6.00
18:00-19:00	-	-	-	-	-	-	-	-
19:00-20:00	-	-	-	-	-	6.00	6.00	12.00
20:00-21:00	0.47	-	-	-	-	12.00	-	12.47
21:00-22:00	-	-	-	-	-	-	-	-
22:00-23:00	-	-	-	-	-	-	-	-
23:00-24:00	-	-	-	-	-	-	-	-
Total	132.40	69.35	58.86	176.40	36.81	398.77	500.17	1372.75
N° days	4	2	5	4	2	7	3	27

It can be seen that in seven of twelve months some energy is missing, especially in the period between 06:00 and 16:00. At these hours the washing machine is used. In the simulation, only the washing program “Cottons 60°C + Intensive dry” is considered, which consumes 4.7 kWh in eight hours. In reality however people can choose faster and less energy consuming programs that only wash the clothes at lower temperatures. In the period between 00:00 and 06:00 the dish washer is used and, as already mentioned, the households can wash their dishes by hand once in a while. As a conclusion, this result shows that the community can easily solve the issue of the controllable loads by slightly changing the use of certain appliances.

5.8.4. Waste of energy and space heating demand

The waste of energy in the community is the excess of electricity that is not used at a certain hour, meaning that the energy storage systems are completely charged and the temperature of the water in the storage tanks is 70°C. The excess of energy presented in this section could be used to supply the space heating demand or to charge the electric vehicles via connection with the grid.

As mentioned in Section 4.2, the houses of the community are passive and therefore consume a maximum of 15 kWh/m².a to heat space. The average area of each house is approximately 140 m², as presented in Section 4.3.2.1. Thus the annual energy consumption for space heating in the REC is 105 MWh. It is assumed that space heating demand occurs only in the first and last four months of the year as shown in Table 5.13.

Table 5.13: Space heating demand per month

Month	Demand (%)	Demand (kWh)
January	20	21,000
February	15	15,750
March	10	10,500
April	5	5,250
May	-	-
June	-	-
July	-	-
August	-	-
September	5	5,250
October	10	10,500
November	15	15,750
December	20	21,000
Total	100	105,000

Table 5.14 presents the waste of energy per month and hour in the community. In the period between 10:00 and 17:00 is when there is more surplus of electricity. Comparing Table 5.13 and Table 5.14, it can be seen that there is enough energy to supply the space heating demand if heat pumps (with COP > 2) are used. If electric heaters are employed, then there will be a lack of energy in November. In this case the households could purchase electricity from the grid, turn off other electrical appliances or let the internal temperature reduce by a few degrees.

5 Case study

Table 5.14: Waste of energy (kWh)

Hour	Month												Total
	Jan	Feb	Mar	Apr	May	Jun	Jul	Aug	Sep	Oct	Nov	Dec	
00:00-01:00	107	703	697	55	76	-	-	-	-	313	-	793	2,745
01:00-02:00	289	918	769	64	65	-	8	-	-	508	-	860	3,480
02:00-03:00	453	951	765	78	72	-	26	-	-	635	-	1,110	4,090
03:00-04:00	422	1,019	797	73	66	-	30	-	-	720	29	1,114	4,270
04:00-05:00	458	1,009	927	57	56	-	32	1	-	733	151	1,157	4,579
05:00-06:00	504	1,287	940	53	81	-	42	6	-	730	155	1,271	5,069
06:00-07:00	-	77	86	-	-	-	20	-	-	36	-	121	340
07:00-08:00	273	619	385	10	76	-	118	-	-	408	42	860	2,790
08:00-09:00	420	1,045	820	387	271	-	205	-	-	841	148	1,021	5,158
09:00-10:00	588	2,112	2,105	807	464	7	441	-	10	1,586	192	1,367	9,679
10:00-11:00	1,641	3,463	3,649	1,957	782	402	740	233	507	2,305	518	2,594	18,791
11:00-12:00	2,832	4,523	4,287	2,754	1,455	451	1,237	383	962	2,854	821	3,370	25,929
12:00-13:00	3,914	6,637	5,727	3,466	2,153	1,299	2,462	1,784	1,475	4,380	884	4,493	38,673
13:00-14:00	4,657	7,320	5,988	4,567	2,960	3,177	3,344	3,560	2,001	4,948	1,405	5,282	49,210
14:00-15:00	4,325	6,617	6,649	5,123	4,027	3,583	4,325	4,579	3,294	4,858	2,060	4,703	54,145
15:00-16:00	3,891	6,241	5,953	5,035	4,725	3,423	4,119	4,207	3,442	4,272	2,188	4,130	51,626
16:00-17:00	2,383	5,154	4,855	4,497	4,407	3,292	3,502	3,541	2,893	3,842	1,332	2,376	42,074
17:00-18:00	8	429	644	567	496	322	488	477	250	117	-	79	3,875
18:00-19:00	-	-	-	-	-	-	-	-	-	-	-	-	-
19:00-20:00	-	-	54	1	-	-	-	-	-	-	-	21	76
20:00-21:00	-	81	203	14	14	-	-	-	-	-	-	118	429
21:00-22:00	-	187	301	3	9	-	-	-	-	2	-	259	761
22:00-23:00	14	315	442	-	19	-	-	-	-	54	-	441	1,285
23:00-24:00	86	642	574	18	51	-	-	-	-	138	-	618	2,128
Total	27,266	51,348	47,616	29,586	22,324	15,957	21,140	18,772	14,835	34,277	9,924	38,158	331,202

The real excess of electricity can be determined subtracting the space heating demand from the waste of energy. The community generates a surplus of 226.2 MWh, as shown in Table 5.15. This energy can be used to charge the electric vehicles via grid or drive extra loads.

Table 5.15: Excess of electricity per month

Month	Waste of energy (kWh)	Demand (kWh)	Excess of electricity (kWh)
January	27,266	21,000	6,266
February	51,348	15,750	35,598
March	47,616	10,500	37,116
April	29,586	5,250	24,336
May	22,324	-	22,324
June	15,957	-	15,957
July	21,140	-	21,140
August	18,772	-	18,772
September	14,835	5,250	9,585
October	34,277	10,500	23,777
November	9,924	15,750	-5,826
December	38,158	21,000	17,158
Total	331,202	105,000	226,202

5.8.5. Performance of the stationary battery bank

The simulation result indicates that the stationary battery bank is frequently used in the REC. That was already expected as the electricity generation is based on intermittent renewable energy sources. In the end of the simulated year, the battery bank discharged a total of 185.2 MWh (on average 507.4 kWh/day or 10.1 kWh/day per household). Table 5.16 presents the total charged and discharged energy per hour over the year. It can be seen that the period when the battery is mostly charged is between 08:00 and 15:00, i.e. when PV generates more electricity. On the other hand, the battery is mainly used when people are at home using several electrical devices, which happens between 06:00 to 07:00 and from 17:00 to 24:00.

Table 5.16: Charged and discharged energy

Hour	Charge (kWh)	Discharge (kWh)
00:00-01:00	2,530	7,282
01:00-02:00	2,173	7,332
02:00-03:00	2,173	6,272
03:00-04:00	2,210	5,390
04:00-05:00	2,096	4,495
05:00-06:00	2,209	3,879
06:00-07:00	1,001	19,914
07:00-08:00	6,672	2,528
08:00-09:00	14,666	2,063
09:00-10:00	23,441	689
10:00-11:00	27,160	814
11:00-12:00	21,615	2,389
12:00-13:00	25,896	-
13:00-14:00	18,209	-
14:00-15:00	12,070	22
15:00-16:00	8,123	361
16:00-17:00	5,143	16
17:00-18:00	570	12,050
18:00-19:00	123	23,035
19:00-20:00	935	17,542
20:00-21:00	949	22,055
21:00-22:00	1,208	19,498
22:00-23:00	1,354	17,290
23:00-24:00	2,455	10,301
Total	184,981	185,216

It is interesting to note that between 12:00 and 14:00 the battery is never discharged. As shown in Table 5.14, at these hours there is excess of electricity in all months. Therefore, in order to improve the balance of energy in the community, the households could program more controllable loads to operate during this period, especially dish washers and washing machines. Furthermore, the cycle life of the batteries can be improved if the energy is used when generated.

The average charge level of the battery bank in one year simulation is 662 kWh (67% of the total energy capacity). Figure 5.8 depicts that the battery energy capacity is over 890 kWh in 40% of the 8,760 hours of the year. In addition, the capacity of the battery bank is below 90 kWh in only 522 hours. This is an indication that the batteries are not often being deeply discharged and that their lifetime might be high.

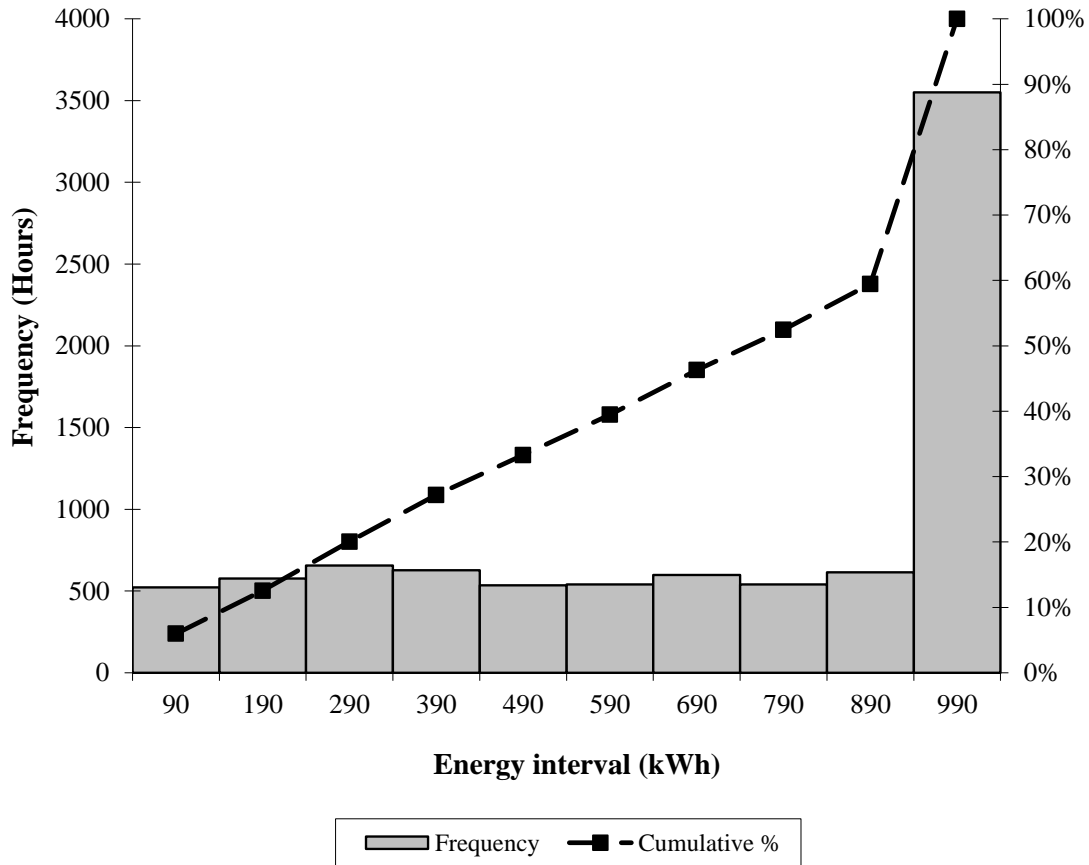

Figure 5.8: Battery bank energy capacity histogram

As presented in Section 4.5.2, the costs of the lithium-ion battery are estimated to decline up to \$ 225/kWh (180 €/kWh – 1 €=\$ 1.25) by 2020. Assuming these costs and the total energy capacity of the community to be 990 kWh, the households would spend 178,200 € with the storage system. If the batteries last for five years and not taking into account any rate of return or maintenance costs, the battery costs can be assumed to be 35,640 €/year.

$$\text{Battery costs} = \frac{180 \text{ € kWh} \times 990 \text{ kWh}}{5 \text{ years}} = 35,640 \text{ €/year}$$

As the total energy discharged by the batteries in the community is 185,216 kWh/year (Table 5.16), the minimum difference between the electricity price of the grid and the generated energy on-site to pay back the investment in batteries is 0.19 €/kWh.

$$\text{Cost of electricity} = \frac{35,640 \text{ € year}}{185,216 \text{ kWh year}} = 0.19 \text{ €/kWh}$$

This situation can already be achieved if the electricity price increases on average more than 5% per year until 2020, as discussed in Section 4.3.3. This scenario is not unrealistic based on the fact that new T&D lines must be built in the next years to transport the electricity from offshore wind parks to the main consumers. The biggest challenge however is to reduce the costs of the lithium-ion battery to the estimated level or improve its performance and lifetime.

5.8.6. Performance of the electric vehicles

The batteries of the electric vehicles are charged and discharged in the community based on the period that they are parked. In total, both HG23 and HG45 charge more than discharge as presented in Table 5.17. The vehicles from HG23 charge and discharge more energy because in the simulation it is assumed that they arrive one hour earlier than the vehicles from HG45.

Table 5.17: Electric vehicles charge and discharge in the community

Month	HG23		HG45	
	Charge (kWh)	Discharge (kWh)	Charge (kWh)	Discharge (kWh)
Jan	1,832	1,186	1,789	1,151
Feb	3,886	995	3,515	719
Mar	2,260	1,336	1,907	1,034
Apr	2,092	2,241	1,141	1,577
May	1,808	2,298	871	1,387
Jun	1,398	2,473	536	1,487
Jul	1,976	2,558	934	1,648
Aug	1,367	2,294	469	1,399
Sep	846	1,727	201	1,233
Oct	2,274	1,149	2,113	1,125
Nov	318	1,248	329	1,269
Dec	2,696	923	2,674	885
Total	22,754	20,427	16,481	14,914

Figure 5.9 depicts how many times it was possible to completely charge the vehicles in the community. The HG23 achieves it sixty-four times and the HG45 sixty-two times throughout the year. During the months of the cold season, when the wind turbines generate more electricity, the electric vehicles could be more often fully charged.

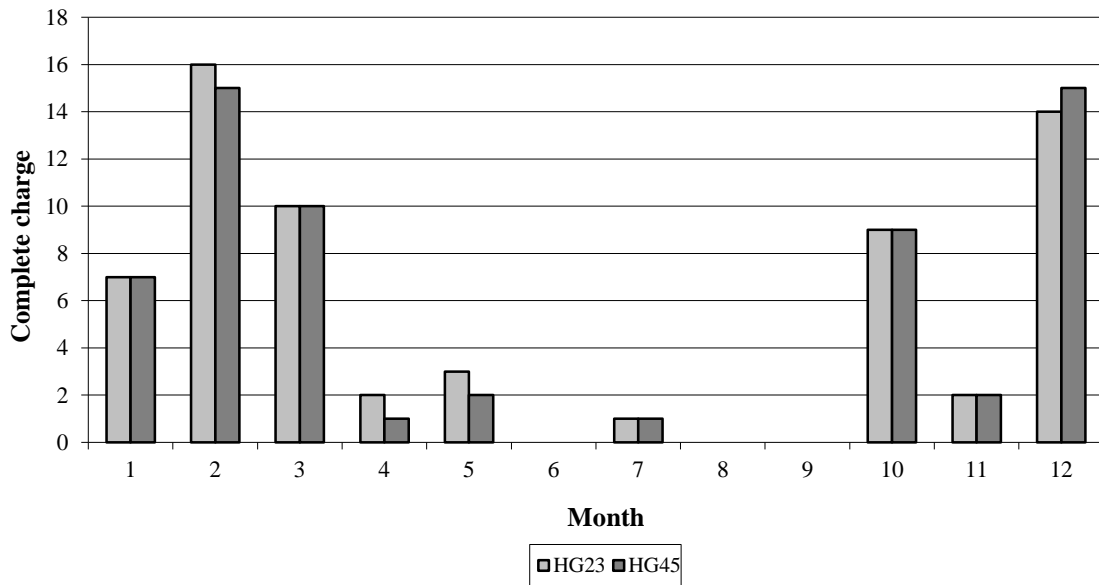

Figure 5.9: How many times the electric vehicles are completely charged in the community

Although the electric vehicles are charged in the community, they must also be charged during the day. Table 5.18 presents how much energy is consumed per month outside the community to charge each vehicle to 17 kWh, as explained in Section 5.6. The HG45 consumes more energy because they have one hour less to charge its vehicles in the community. Based on the fact that each vehicle has an energy capacity of 20 kWh, on average each EV charges completely approximately twice a week outside the REC.

Table 5.18: Electric vehicles energy consumption outside the community

Month	Charge outside the community (kWh)	
	HG23	HG45
January	3,977	3,971
February	1,485	1,596
March	3,539	3,585
April	4,671	4,953
May	5,114	5,149
June	5,576	5,466
July	5,253	5,355
August	5,555	5,571
September	5,572	5,690
October	3,525	3,676
November	5,238	5,269
December	2,876	2,860
Total	52,381	53,140

As presented in Section 5.8.4, the community generates an excess of electricity of 226.2 MWh/year (Table 5.15), mainly in the period from 10.00 to 17:00 (Table 5.14). This energy can be used to charge the EVs via grid. The electric vehicles consume a total of

105.5 MWh/year outside the community, which is around half of the excess of electricity available in the REC. The other possibility is to increase the stationary battery bank capacity and then charge the vehicles during the night using the energy stored during the day.

5.8.7. Resume of the simulation results and final considerations

The results of the simulation have shown that the REC is able to supply its energy demand in most of the hours of the year. Even considering the charging of the electric vehicles using the energy generated in the community, there is approximately 120 MWh excess of electricity that can be exchanged with other consumers or the grid. Nevertheless, it is important to stress that the result of this study is based on the inputted data, like the input water temperature, solar irradiation and wind speed. These values can vary each year changing the performance of the community. Moreover, several assumptions were taken into account, which might affect the results in reality:

- Roughness length of 0.5 m
- No influence of a wind turbine on the wind speed and direction
- Fixed coefficient of performance for the heat pump (COP=2)
- Hourly reduction of the water temperature inside the storage tanks (0.5 °C/hour)
- Performance of batteries is independent of ambient conditions (like temperature) and also on the state of charge

The costs of energy storage systems are a critical point that will define in the future if households, that generate energy on-site, will still depend on the electricity produced from utilities. Transmission and distribution lines will however always be required for energy exchange and it is fundamental the existence of regulations between energy producers and consumers.

The energy system presented in this thesis is just one example that can be applied in the future in case households must generate their energy on-site. In practice, probably only few cities will develop renewable energy communities because space is not available in abundance in Germany, especially when one considers the installation of small wind turbines. In central areas of big cities it is unlikely that WTs will ever play an important role. Photovoltaics will be the main technology to generate energy on-site, and in the future it will be a fundamental part of zero-energy houses.

6. Conclusions

The household is one of the sectors that consume most final energy in Germany. The country is dependent on external fossil fuels to supply its energy demand, which are finite and harm the environment. The share of renewables to produce energy is increasing based on the decision of transforming the energy system, and household sector is an important part in this transition. The increase of energy prices is driving households to find alternatives to reduce their energy consumption and their energy bill. There are different solutions depending on the type of building, the available space and the financial situation. The integration of households forming a renewable energy community is one possibility to optimize the use of energy and space, and minimize investments with generators and storage systems. It also relieves the utility from upgrading the network as there will be less energy needed to be transmitted through the grid.

The concept of a renewable energy community was introduced in Chapter 4 as well as the importance of passive houses to reduce space heating demand by maximizing heat gains. In addition to that the technologies mostly used to generate electricity and heating on-site in the household sector were presented, and four types of energy storage systems were compared.

In Germany photovoltaic modules generate more electricity during the hot seasons while small wind turbines during the cold ones. The combination of both technologies is essential in order to achieve energy balance over the year. Differently from photovoltaics, small wind turbines installations may cause conflicts among neighbors due to noise and visual pollution. Moreover, the turbine must be installed respecting a minimum distance from buildings, which is based on local/regional regulations. These issues can be minimized or eliminated in a new planned community of similar houses.

Domestic hot water and space heating demand can be supplied by electric heaters, solar collectors or heat pumps. Electric heaters are the simplest and cheapest solution, but they require electricity to work and cannot generate more energy than consumed. In Germany, solar collectors work well during the hot season but they need a backup heater during the cold seasons when there is space heating demand and only a few hours of sunlight. Seasonal storage systems could solve this issue, but they are still a focus of research. In addition, the solar collectors may take the space from the photovoltaic modules. Heat pumps are able to produce up to four times more energy than the amount consumed. They can extract heat from

the ambient air, groundwater or soil. Ground-source heat pumps are more efficient because the temperatures underground are more stable. However the installation is more costly, especially if vertical pipes are applied.

Electricity generated from photovoltaics and wind turbines temporally fluctuates. Energy storage systems can be used to stabilize the fluctuating generation and to supply the energy demand when there is no or insufficient generation. The lead-acid battery will continue being the technology mostly used in the short term because it is the cheapest one and well established worldwide. In the future, with the development of electric vehicles the lithium-ion battery may start being used in stationary applications competing with lead-acid batteries. The vanadium redox-flow battery and hydrogen storage systems are still in their infancy phase and it is unlikely that they will play any role in the household sector within the next years.

Chapter 5 presented a case study of a theoretical renewable energy community in the city of Cottbus. Based on software simulations, it was analyzed whether or not the community can achieve energy balance over the year based on hourly values of generation and demand. The results of the simulation show that the community is able to generate more energy than consumed throughout a year, but in few occasions there is not enough energy available to supply the community's demand. Focus was given on the domestic hot water demand, controllable and uncontrollable load groups, excess of energy, performance of batteries, and controllable and uncontrollable loads. The main results of the simulations are:

- With the use of heat pumps, water stored in tanks can be heated up to 70°C at least once a week preventing the bacterium Legionella to grow.
- In some days of the year, there is not enough energy available to heat water up to 40°C in order to take a shower. However if people consume less hot water or reduce the frequency of demand, this deficit could be avoided.
- The community is able to supply 99.1% of the uncontrollable load group demand. This result could be further improved if some devices are turned off when they are not in use.
- The community is able to supply 97.1% of the controllable load group demand. This result could be further improved, if for example different programs that consume less energy are used to wash clothes.
- There is enough energy available to heat space in case the houses consume a maximum of 15 kWh/m² and apply heat pumps.

- Although the stationary battery bank is used every day, the annual average charge level is 67% of the total energy capacity, which indicates that the lifetime of the batteries might be high.
- Electric vehicles will be an extra load for households in the future, but they will play an important role by storing excess of energy from renewables during low demand periods and supplying the load demand when there is less energy available. The community generates enough energy to charge its vehicles via grid during the day (most efficient solution but depends on regulations) or via extra energy storage systems (less efficient solution and probably more costly, but the community is more energy independent).

This thesis could proof the feasibility of a renewable energy community to produce its own energy on-site to supply its energy demand under the assumptions taken. Consequently, the author believes that renewable energy communities may become reality in the future if energy prices continue to increase and technologies are further improved. More investigations should be done to verify the assumptions taken in a practical environment. Some future research based on the topics investigated in this thesis could be:

- Analysis of the real performance of different small wind turbines in suburban areas.
- Investigating the noise pollution impact of small wind turbines on the vicinity as well as possibilities of noise pollution reduction.
- Investigation of the pros and cons of using electric vehicles as stationary energy systems in the household sector.
- Evaluation of the acceptance of a real renewable energy community in Cottbus based on surveys with the local habitants.

Households that are conscious about their energy consumption and are able to adapt their demand with the availability of energy will certainly be more interested to live in such a community. However, even though all the technical and economic feasibility can be proven, in the end it will certainly depend on the people's willingness to live in such a community, share the energy produced with the other members in a fair/balanced way and also to accept that there might be times/situations where no energy is available. Therefore, after all, a change of thinking throughout our societies and their attitude towards always having energy for a cheap price available is needed, in order to put a successful renewable energy community into practice.

7. Abbreviations

AC	Alternating current
AFC	Alkaline fuel cell
a-Si	Amorphous silicon
BOS	Balance of system
CdTe	Cadmium telluride
CLG	Controllable load group
COP	Coefficient of performance
d	Day
DC	Direct current
E5	5% ethanol
EIA	Energy information administration
ESS	Energy storage system
EU	European Union
EV	Electric vehicle
HG	House group
HOMER	Hybrid optimization model for electric renewables
kWh/a	Kilo watt hour per year
kW _p	Kilo watt peak
l	Liter
Li-ion	Lithium-ion

7 Abbreviations

mbpd	Millions of barrels per day
MCFC	Molten carbonate fuel cell
Mono-Si	Monocrystalline silicon
Mtoe	Million tonnes oil equivalent (1 toe = 11,630 kWh)
NASA	National aeronautics and space administration
NREL	National renewable energy laboratory
PAFC	Phosphoric acid fuel cell
PEMFC	Polymer electrolyte membrane fuel cell
Poly-Si	Polycrystalline silicon
PV	Photovoltaics
REC	Renewable energy community
SOFC	Solid oxide fuel cell
STC	Standard test conditions
SWT	Small wind turbine
T&D	Transmission and distribution
ULG	Uncontrollable load group
USD	United States Dollar
VLA	Vented lead-acid batteries
VRFB	Vanadium redox-flow battery
VRLA	Valve-regulated lead-acid batteries
WT	Wind turbine
WTI	West Texas intermediate

8. References

- [1] BP, "BP Statistical Review of World Energy June 2012," June 2012. [Online]. Available: http://www.bp.com/assets/bp_internet/globalbp/globalbp_uk_english/reports_and_publications/statistical_energy_review_2011/STAGING/local_assets/spreadsheets/statistical_review_of_world_energy_full_report_2012.xlsx. [Accessed September 2012].
- [2] U.S. Energy Information Administration (EIA), "Annual Energy Outlook 2012 with projections to 2035," 2012.
- [3] Andrleit H., Babies H.G., Meßner J., Rehder S., Schauer M. and Schmidt S., "Kurzstudie: Reserven, Ressourcen und Verfügbarkeit von Energierohstoffen 2011," Deutsche Rohstoffagentur (DERA), Hannover, 2011.
- [4] Bundesministerium für Wirtschaft und Technologie (BMWi), "Energie in Deutschland: Trends und Hintergründe zur Energieversorgung," Bundesministerium für Wirtschaft und Technologie (BMWi), Berlin, 2010.
- [5] Lau L.C., Lee K.T. and Mohamed A.R., "Global warming mitigation and renewable energy policy development from the Kyoto Protocol to the Copenhagen Accord-A comment," *Renewable and Sustainable Energy Reviews*, vol. 16, p. 5280–5284, 2012.
- [6] Quaschnig V., *Understanding renewable energy systems*, Earthscan, 2010.
- [7] Büsgen U. and Dürrschmidt W., "The expansion of electricity generation from renewable energies in Germany: A review based on the Renewable Energy Sources Act Progress Report 2007 and the new German feed-in legislation," *Energy Policy*, vol. 37, p. 2536–2545, 2009.
- [8] Beaudin M., Zareipour H., Schellenbergglabe A. and Rosehart W., "Energy storage for mitigating the variability of renewable electricity sources: An updated review," *Energy for Sustainable Development*, vol. 14, p. 302–314, 2010.
- [9] Electricity Storage Association, "Technology Comparison," 2008. [Online]. Available: http://www.electricitystorage.org/images/uploads/static_content/technology/technology_resources/ratings_large.gif. [Accessed September 2012].
- [10] União Européia, "Alemanha," [Online]. Available: http://europa.eu/about-eu/countries/member-countries/germany/index_pt.htm. [Accessed September 2012].
- [11] DEBRIV Bundesverband Braunkohle, "Energiewirtschaft Deutschland," February 2012. [Online]. Available: <http://www.braunkohle.de/pages/grafiken.php?page=263>. [Accessed September 2012].

- [12] Bundesministerium für Wirtschaft und Technologie (BMWi), "Energiedaten: ausgewählte Grafiken," 2012.
- [13] Jacobsson S. and Lauber V., "The politics and policy of energy system transformation—explaining the German diffusion of renewable energy technology," *Energy Policy*, vol. 34, p. 256–276, 2006.
- [14] Randers J., 2052: A global forecast for the next forty years, Chelsea Green, 2012.
- [15] DEWI; E.ON Grid; EWI; RWE Transport Grid; Electricity; VE Transmission, "Energy Management Planning for the Integration of Wind Energy into the grid in Germany, onshore and offshore by 2020," Cologne, 2005.
- [16] Federal Ministry for the Environment, Nature Conservation and Nuclear Safety (BMU), "The Energy Concept and its accelerated implementation," October 2011. [Online]. Available: http://www.bmu.de/english/transformation_of_the_energy_system/resolutions_and_measures/doc/48054.php. [Accessed September 2012].
- [17] European Commission, „The EU climate and energy package,“ Climate Action, 10 September 2012. [Online]. Available: http://ec.europa.eu/clima/policies/package/index_en.htm. [Zugriff am September 2012].
- [18] Federal Ministry for the Environment, Nature Conservation and Nuclear Safety (BMU), "Renewable energy sources 2010," Federal Ministry for the Environment, Nature Conservation and Nuclear Safety (BMU), 2011.
- [19] Federal Ministry of Transport, Building and Urban Development (BMVBS), "Transforming our energy system: a safe bet," [Online]. Available: <http://www.bmvbs.de/SharedDocs/EN/Artikel/SW/shifting-to-renewable-energy-a-safe-bet.html>. [Accessed September 2012].
- [20] Council of the European Union, *Position of the Council at first reading with a view to the adoption of a DIRECTIVE OF THE EUROPEAN PARLIAMENT AND OF THE COUNCIL on the energy performance of buildings (Recast)*, Brussels, 2010.
- [21] Mlecnik E., Schütze T., Jansen S.J.T., de Vries G., Visscher H.J. and van Hal A., "End-user experiences in nearly zero-energy houses," *Energy and Buildings*, vol. 49, p. 471–478, 2012.
- [22] Solarsiedlung am Schlierberg, "Bildmaterial," [Online]. Available: <http://www.solarsiedlung.de/default.asp?id=26>. [Accessed September 2012].
- [23] Schlomann B., Gruber E., Eichhammer W., Kling N., Diekmann J., Ziesing H.J., Rieke H., Wittke F., Herzog T., Barbosa M., Lutz S., Broeske U., Merten D., Falkenberg D., Nill M., Kaltschmitt M., Geiger B., Kleeberger H. and Eckl R., "Energieverbrauch der privaten Haushalte und des Sektors Gewerbe, Handel, Dienstleistungen (GHD)," Karlsruhe, Berlin, Nürnberg, Leipzig, München, 2004.

- [24] Schmischar S., Blok K., Boermans T. and Hermelink A., "Germany's path towards nearly zero-energy buildings—Enabling the greenhouse gas mitigation potential in the building stock," *Energy Policy*, vol. 39, p. 3346–3360, 2011.
- [25] Schnieders J. and Hermeling A., "CEPHEUS results: measurements and occupants' satisfaction provide evidence for Passive Houses being an option for sustainable building," *Energy Policy*, vol. 34, p. 151–171, 2006.
- [26] Federal Ministry for the Environment, Nature Conservation and Nuclear Safety (BMU), "Energy Concept 2050 - Milestones and Assessments," October 2010. [Online]. Available: http://www.bmu.de/english/energy_efficiency/doc/46733.php. [Accessed September 2012].
- [27] Twele J., "Wärmeversorgung der Region Brandenburg-Berlin auf Basis Erneuerbarer Energien," Reiner Lemoine Institut, 2012, 2012.
- [28] Maren K., "Pressegespräch BBU-Preisdatenbank 2012: Energie immer teurer," Verband Berlin-Brandenburgischer Wohnungsunternehmen e.V. (BBU), 30 August 2012. [Online]. Available: http://web1.bbu.de/publicity/bbu/internet.nsf/index/de_pm2012.htm?OpenDocument&69383FA1FE8D47A2C1257A6A0022E26B. [Accessed September 2012].
- [29] Bundesministerium für Verkehr, Bau und Stadtentwicklung (BMVBS), "Effizienzhaus Plus," [Online]. Available: http://www.bmvbs.de/DE/EffizienzhausPlus/effizienzhaus-plus_node.html. [Accessed September 2012].
- [30] Baulinks, "Dreistufige Wärmerückgewinnung im Effizienzhaus Plus in Berlin," 27 July 2012. [Online]. Available: <http://www.baulinks.de/webplugin/2012/1259.php4>. [Accessed September 2012].
- [31] Marchetti N., "Wind, solar aim affordable homes at net zero," Earth Techling, 30 June 2011. [Online]. Available: <http://www.earthtechling.com/2011/06/wind-solar-aim-affordable-homes-at-net-zero/>. [Accessed September 2012].
- [32] Urban Green Energy, *UGEmail: 32 eddyGTs in St. Louis Subdivision!*, 2011.
- [33] Momoh J., *Smart grid: Fundamentals of Design and Analysis*, New Jersey: Wiley, 2012.
- [34] GE, "Smart Energy: Understanding smart grids & smart meters," [Online]. Available: <http://www.geappliances.com/home-energy-manager/monitoring-energy.htm>. [Accessed September 2012].
- [35] Bosworth M., "Absurd: Mit Solarstrom teurer," *Photon das Solarstrom – Magazin*, pp. 90-91, April 2012.

- [36] McGreal R., "Rising gas prices and the unnameable cause," Raise the hammer, 17 November 2010. [Online]. Available: http://raisethehammer.org/article/1234/rising_gas_prices_and_the_unnameable_cause. [Accessed September 2012].
- [37] Aral, "Preis-Datenbank," [Online]. Available: <http://www.aral.de/toolserver/retaileurope/histFuelPrice.do?categoryId=4001137&contentId=58611>. [Accessed July 2012].
- [38] Grünig M., Witte M., Marcellino D., Selig J. and van Essen H., "An overview of electric vehicles on the market and in development," CE Delft, 2011.
- [39] Agentur für Erneuerbare Energien, "Grafik-Dossier: Strompreis 2012 und Stromkosten privater Haushalte," [Online]. Available: <http://www.unendlich-viel-energie.de/de/wirtschaft/detailansicht/browse/1/article/135/grafik-dossier-strompreis-2012-und-stromkosten-privater-haushalte.html>. [Accessed September 2012].
- [40] Nissan, "Nissan," [Online]. Available: www.nissan.de. [Accessed July 2012].
- [41] Ramsey M., "Ford reveals how much electric-car batteries cost," The wall street journal, 17 April 2012. [Online]. Available: <http://blogs.wsj.com/drivers-seat/2012/04/17/ford-reveals-how-much-electric-car-batteries-cost/>. [Accessed September 2012].
- [42] Bulmer G., "Nissan Leaf goes wireless - charged by electromagnetic induction from floor pad," Herald Sun, 1 December 2011. [Online]. Available: <http://www.heraldsun.com.au/technology/electric-car-is-going-wireless/story-fn7celvh-1226210839878>. [Accessed September 2012].
- [43] Carlisle N., Elling J. and Penney T., "A renewable energy community: Key elements," National Renewable Energy Laboratory (NREL), Colorado, 2008.
- [44] Becker J., "Auf Ex-Flugplatz Cottbus-Nord sollen 1000 Jobs entstehen," Lausitzer Rundschau, 25 July 2007. [Online]. Available: <http://www.lr-online.de/regionen/cottbus/Auf-Ex-Flugplatz-Cottbus-Nord-sollen-1000-Jobs-entstehen;art1049,1719722>. [Accessed September 2012].
- [45] Vattenfall, „Das Lausitzer Braunkohlenrevier,“ [Online]. Available: http://www.vattenfall.de/de/file/Revierkarte-1_13592467.pdf. [Zugriff am September 2012].
- [46] International Passive House Association (iPHA), *Active for more comfort: The Passive House*, Darmstadt: International Passive House Association (iPHA), 2010.
- [47] Passivhaus Vauban, "Passivhaus Vauban," [Online]. Available: www.passivhaus-vauban.de. [Accessed September 2012].
- [48] HOMER, "HOMER Energy," [Online]. Available: www.homerenergy.com. [Accessed September 2012].

- [49] National Renewable Energy Laboratory, "NREL," April 2005. [Online]. Available: <https://analysis.nrel.gov/homer/includes/downloads/HOMERGettingStarted210.pdf>. [Accessed September 2012].
- [50] Bundesministerium für Umwelt, Naturschutz und Reaktorsicherheit (BMU), "Erneuerbare Energien in Zahlen," Berlin, 2011.
- [51] Quaschnig V., Regenerative Energiesysteme, Hanser, 2009.
- [52] JA Solar, "JA Solar," [Online]. Available: <http://www.jasolar.com>. [Accessed April 2011].
- [53] Photon, "Die Top 20 der größten Zellhersteller 2011 (2010)," *Photon das Solarstrom – Magazin*, p. 44, April 2012.
- [54] Surface meteorology and Solar Energy, "Surface meteorology and Solar Energy," [Online]. Available: <http://eosweb.larc.nasa.gov/sse/>. [Accessed September 2012].
- [55] Trikkis Energy, "Trikkis Energy," [Online]. Available: <http://www.trikkisenergy.com>. [Accessed September 2012].
- [56] Khaligh A. and Onar O.C., Energy harvesting solar, wind, and ocean energy conversion systems, CRC Press, 2010.
- [57] Bundesverband WindEnergie (BWE), "Leistungssteigerung der Windkraftanlagen," [Online]. Available: <http://www.windenergie.de/sites/default/files/images/page/2011/technik/2012-02-17-groessenwachstum.jpg>. [Accessed September 2012].
- [58] Manwell J.F., MCGowan J.G. and Rogers A.L., Wind energy explained theory, design and application, Wiley, 2010.
- [59] Deutscher Wetterdienst (DWD).
- [60] Ministerium für Infrastruktur und Raumordnung, *Das aktuelle Bauordnungsrecht in Brandenburg*, Potsdam, 2009.
- [61] Schröder J., "Abstandsflächenrecht in Brandenburg," [Online]. Available: <http://www.vermessung-wolf.de/wissen/abstandsflaechen.html>. [Accessed September 2012].
- [62] S&W Energiesysteme, "S&W Energiesysteme," [Online]. Available: <http://www.s-und-w-energie.de/wind.html>. [Accessed September 2012].
- [63] Sponholz G., "Windkraft eine Nummer kleiner," Kreis Segeberg, 11 April 2012. [Online]. Available: <http://www.s-und-w-energie.de/Teegen.pdf>. [Accessed September 2012].

- [64] Federal Ministry for the Environment, Nature Conservation and Nuclear Safety (BMU), "Tariffs, degression and sample calculations pursuant to the new Renewable Energy Sources Act (Erneuerbare-Energien-Gesetz - EEG) of 4 August 2011 ('EEG 2012')," January 2012. [Online]. Available: http://www.bmu.de/files/english/pdf/application/pdf/eeg_2012_verguetungsdegression_en_bf.pdf. [Accessed September 2012].
- [65] Whirlpool Water Heaters, "Whirlpool Water Heaters," [Online]. Available: http://www.whirlpoolwaterheaters.com/images/learn_more/standardelectriccutaway.jpg. [Accessed September 2012].
- [66] The Bathroom Shop, "The Bathroom Shop," [Online]. Available: <http://www.the-bathroom-shop.co.uk/images2/redring-california-electric-shower.jpg>. [Accessed September 2012].
- [67] Danfoss Electric Heating Systems, "Danfoss Electric Heating Systems," [Online]. Available: <http://devi.danfoss.com/Consumer/FloorHeatingForHome/Postings+Why+Floor+Heating/Electric+vs+Hydronic.htm>. [Accessed September 2012].
- [68] Wikipedia, "Fan heater," 20 April 2011. [Online]. Available: http://en.wikipedia.org/wiki/File:Fan_heater_innards_4989-2.jpg#. [Accessed September 2012].
- [69] Skec S., "Stephen Skec," 2012 April 2012. [Online]. Available: http://stephenskec.com/electrician-melbourne-blog/wp-content/uploads/2012/04/electric_heater.jpg. [Accessed September 2012].
- [70] Steam boilers, "Oil heater," [Online]. Available: <http://www.steam-boilers.net/oil-heater/>. [Accessed September 2012].
- [71] Schmidt T. and Mangold D., "New steps in seasonal thermal energy storage in Germany," in *Ecstock 2006, Tenth International Conference on Thermal Energy Storage*, Pomona, 2006.
- [72] Lottner V. and Mangold D., "Status of seasonal thermal energy storage in Germany," in *Terrastock 2000*, Stuttgart, 2000.
- [73] GreenSpec, "Solar hot water collectors," [Online]. Available: <http://www.greenspec.co.uk/solar-collectors.php>. [Accessed September 2012].
- [74] Apricus, "What is an Evacuated Tube?," [Online]. Available: <http://www.apricus.com/en/europe/solar-information/solar-basics/what-is-an-evacuated-tube/>. [Accessed September 2012].
- [75] Bundesverband Wärmepumpe e.V. (BWP), "Absatzzahlen von Heizungswärmepumpen in Deutschland von 2006 bis 2011," [Online]. Available: http://www.waermepumpe.de/uploads/tx_bwppublication/Grafik_Absatzzahlen_2006-2011_gross.jpg. [Accessed September 2012].

- [76] Krause F., Bossel H. and Müller-Reißmann K.F., *Energiewende: Wachstum und Wohlstand ohne Erdöl und Uran*, S. Fischer, 1980.
- [77] Linden D. and Reddy T.B., *Handbook of Batteries*, McGraw-Hill Handbooks, 2002.
- [78] Luque A. und Hegedus S., *Handbook of Photovoltaic Science and Engineering*, John Wiley and Sons, Ltd., 2011.
- [79] Strzelecki R. and Benysek G., *Power Electronics in Smart Electrical Energy Networks*, Springer, 2008.
- [80] Buchmann I., "Lead-based Batteries," Battery University, [Online]. Available: http://batteryuniversity.com/learn/article/lead_based_batteries. [Accessed September 2012].
- [81] Buchmann I., "Charging lead acid," Battery University, [Online]. Available: www.batteryuniversity.com/learn/article/charging_the_lead_acid_battery. [Accessed September 2012].
- [82] D. Linden and T. Reddy, *Linden's Handbook of Batteries*, McGraw Hill, 2011.
- [83] Zentrum für Sonnenenergie und Wasserstoff Forschung Baden-Württemberg (ZSW), "Den lukrativen Eigenverbrauch von Solarstrom mit Lithium-Ionen-Batterien erhöhen," 2 May 2012. [Online]. Available: http://www.zsw-bw.de/fileadmin/ZSW_files/Infoportal/Presseinformationen/docs/pi06-2012-ZSW-Sol-Ion.pdf. [Accessed September 2012].
- [84] Hellpoldt D., "Zukunftstechnologie zum Wohnen: Was steckt im "Effizienzhaus Plus"?, " Rundfunk Berlin-Brandenburg, 2 April 2012. [Online]. Available: http://www.rbb-online.de/stadt_land/dossiers/energie/effizienzhaus_plus/zukunftstechnologie.pagenumber.0.html. [Accessed September 2012].
- [85] Buchmann I., "Lithium-based Batteries," Battery University, [Online]. Available: http://batteryuniversity.com/learn/article/lithium_based_batteries. [Accessed September 2012].
- [86] Buchmann I., "How to Prolong Lithium-based Batteries," Battery University, [Online]. Available: http://batteryuniversity.com/learn/article/how_to_prolong_lithium_based_batteries. [Accessed September 2012].
- [87] Buchmann I., "Charging Lithium-ion," Battery University, [Online]. Available: http://batteryuniversity.com/learn/article/charging_lithium_ion_batteries/. [Accessed September 2012].
- [88] Colgan C., "Second Life for EV Batteries," California Center for Sustainable Energy (CCSE), 19 April 2011. [Online]. Available: <http://energycenter.org/index.php/news-a-media/latest-news/2527-second-life-for-ev-batteries>. [Accessed September 2012].

- [89] ABB, "ABB and partners to evaluate the reuse of the Nissan LEAF battery for commercial purposes," 8 January 2012. [Online]. Available: <http://www.abb.com/cawp/seitp202/a2b2d2aff96520bec1257989004e62ae.aspx>. [Accessed September 2012].
- [90] McCall T., "The price of batteries: Although costs are uncertain, they will be key to the success of electric cars," Technology review, January 2011. [Online]. Available: <http://www.technologyreview.com/files/49959/Jan11%20Feature%20Electric%20Cars%20p61.pdf>. [Accessed September 2012].
- [91] Yang Z., Zhang J., Kintner-Meyer M.C.W., Lu X., Choi D. and Lemmon J.P., "Electrochemical energy storage for green grid," *Chemical reviews*, vol. 111, no. 5, pp. 3577-3613, 2011.
- [92] Nathwani J. and Ng A.W., Paths to sustainable energy, InTech, 2010.
- [93] Renewable Energy Dynamics Technology Ltd. (REDT), "Renewable Energy Dynamics Technology Ltd. (REDT)," [Online]. Available: <http://www.poweringnow.com/products>. [Accessed September 2012].
- [94] Skyllas-Kazacos M., "Secondary batteries - flow systems: Vanadium redox-flow batteries," in *Encyclopedia of Electrochemical Power Sources*, Elsevier, 2009, pp. 444-453.
- [95] Sharman H., *Storage for a sustainable future*, Prudent energy, 2010.
- [96] EPRI, "EPRI-DOE Handbook of Energy Storage for Transmission & Distribution Applications," Palo Alto, CA and Washington, DC, 2003.
- [97] Andrews J. and Jelley N., *Energy science: principles, technologies, and impacts*, Oxford, 2007.
- [98] O'Hayre R., Cha S.W., Colella W. and Prinz F.B., *Fuel Cell Fundamentals*, John Wiley & Sons, 2006.
- [99] OPET Finland, *Fuel cells using renewable energy sources - a leap to hydrogen economy*, 2004.
- [100] Siehl N., *New Energy Lab (Basic/Advanced)*, Heliocentris, 2010.
- [101] Chu H.S., Tsau F., Yan Y.Y., Hsueh K.L. and Chen F.L., "The development of a small PEMFC combined heat and power system," *Journal of Power Sources*, vol. 176, p. 499-514, 2008.
- [102] Armstrong International, Inc., *Controlling Legionella in Domestic Hot Water Systems*, Michigan, 2003.
- [103] Zanker, *Technische Information für Fachhandel und Planer*, 2008.

8 References

- [104] Saft, "Synerion 48E," April 2012. [Online]. Available: http://www.saftbatteries.com/doc/Documents/aviation/Cube946/4113_Synerion%2048E_PROTECTED.d3680d10-19ca-4a4f-9587-5e7b2c9d6b6a.pdf. [Accessed September 2012].
- [105] LabVIEW, [Online]. Available: <http://www.ni.com/labview/>. [Accessed September 2012].