

An aerial photograph of a rugged, rocky cliffside. The rock face is characterized by distinct horizontal layers and deep shadows. In the lower portion of the image, several ancient stone structures are visible, including a prominent rectangular wall and a smaller, more complex structure. The overall scene is arid and historical.

**STONE
AND
ARCHITECTURE**



STONE AND ARCHITECTURE

in the mountainous regions of Jordan and Syria

Juliane Jäger

Ingo Helmedag

Thomas Maria Weber

Nizar Abu-Jaber

Abdulhamid Suleiman

Berthold Burkhardt

Olaf Reiter

Margaret Louderback

Ammar Khammash

© 2012

Amman - Damascus - Berlin

ISBN: 978-3-9811040-9-7

editors in chief

Ingo Helmedag, Juliane Jäger

text & layout editor

Margaret Louderback

photographs and illustrations

All photographs and illustrations were taken by the authors, unless otherwise mentioned.
All rights reserved.

This publication has been generously funded and supported by

DAAD

German Academic Exchange Service

[Deutscher Akademischer Austausch Dienst]

Special thanks to Dr. Christian Hülshörster and Dr. Renate Dieterich for their help and ongoing motivation as the DAAD representatives for North Africa and the Middle East.

For their cooperative spirit, we would like to thank the experts who contributed to this book, the German-Jordanian University and Damascus University.

Front cover and inside photographs: panoramic views taken from Schobak Castle, Jordan.



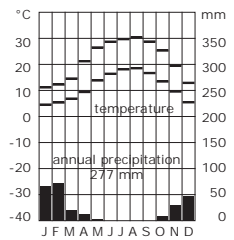
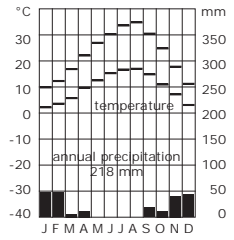
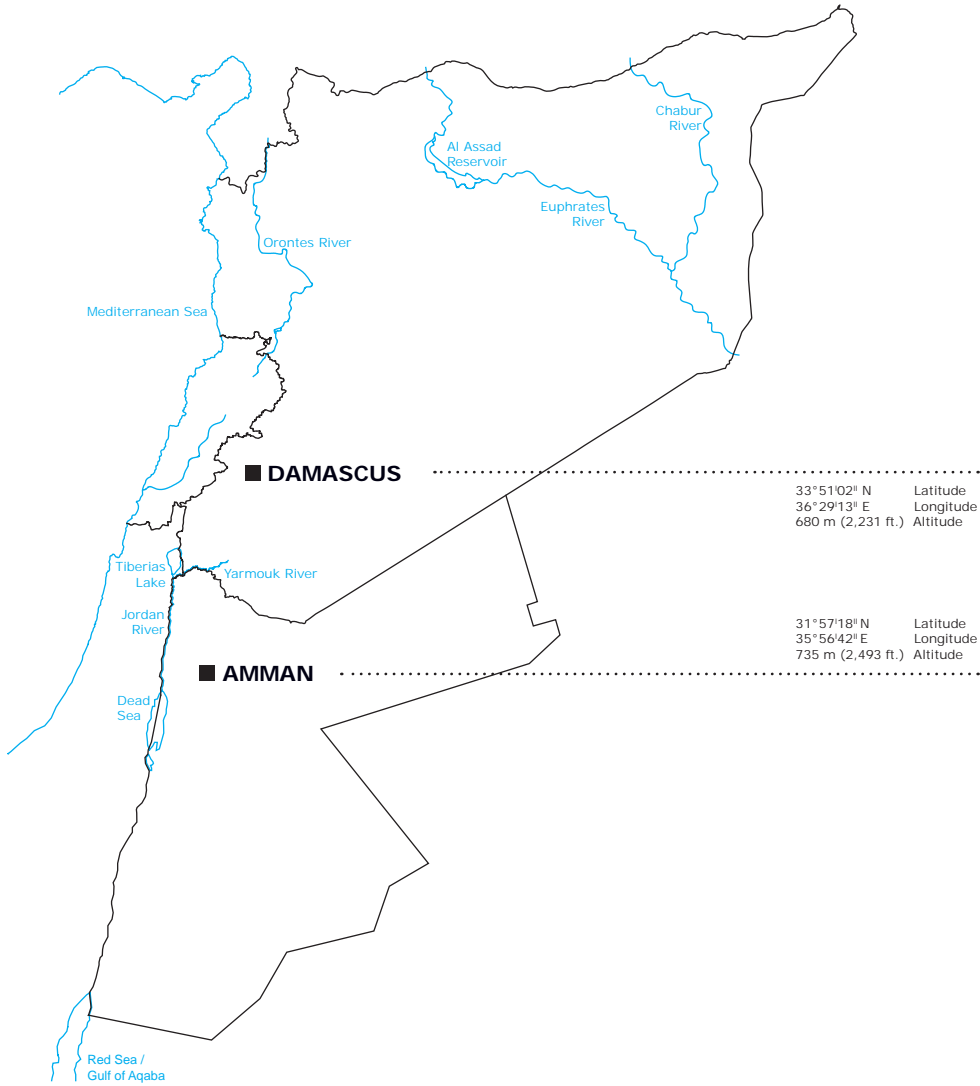

TABLE OF CONTENTS

8	Ingo Helmedag & Juliane Jäger	Preface
10		Introduction of the authors
13	Juliane Jäger	Describing traditional architecture in rural areas, examples from Syria and Jordan
61	Ingo Helmedag	Contemplations on contemporary construction routines, examples from Amman
121	Thomas Maria Weber	Rock and order stone masonry in a historical context
157	Nizar Abu-Jaber	Geological outline of Syria and Jordan
171	Abdulhamid Suleiman	Accumulative architecture as a sustainable process at the Deir Mar Mousa monastery
181	Berthold Burkhardt	The sight behind the façade contemporary stone façades and surfaces
195	Olaf Reiter	Passive housing projects in Germany
213	Margaret Louderback	Waiting for the rain a phenomenological perspective on site analysis
225	Ammar Khammash	The stone man of the third millennium architecture from material to non-material
232	Ingo Helmedag & Juliane Jäger	Impressions of Syria and Jordan



PREFACE

From its earliest beginnings as a naturally found building material to current construction, stone is a material frequently used in the arid and mountainous regions spanning the nation states of Jordan and Syria.

While the extensive use of stone for early human sheltering was substantiated by simple necessity, influenced by prevailing environmental conditions and a lack of choices, present-day applications unfortunately have been widely reduced to surface refinements. Stone used in cladding and pavement, most often in repetitive and monotonous ways, prevails in contemporary building contexts through out Syria and Jordan. Acknowledging the inherently rich qualities of stone, its architectural potential is currently not being realized in either an aesthetic or a technical sense. For example, as a result of restrictive building codes, Amman's contemporary architecture is perceived as made of solid white stone. In reality surface cladding exists generating similarity of urban elevations and proliferating uniformity. The architecture of the city is less personalized, showing only a few nondescript faces and landmarks. As a consequence people find it hard to orientate themselves in this urban sameness. Quality sense of place is lacking.

In contrast to the standardized and monotonous placelessness of Amman, stone naturally occurs in an immense variety of colors and shapes with numerous technical building properties from Aleppo to Petra. In this wide region one can find stone's different material properties meaningfully applied in traditional buildings. As concerned architects, we find that both natural and traditional aspects are sources of inspiration when contextually applied in the building of new environments.

Following this enthusiasm to demonstrate the technical and aesthetic possibilities of stone as a material with abundant untapped potential, the idea of a comprehensive contemplation on the material's use was conceived. Developing this idea, it became important to address the topic from different perspectives, which it is hoped will encourage continued critical investigation. We maintain that the use of local building materials, like stone, is an important part in forwarding sustainable and meaningful architecture. Included in this realization is the utmost importance of energy discussions in these environmentally and financially conscious times. In examining the energy question contributions

have been included, which are currently approved and widely used, as well as upcoming methods to forward efficiency and sustainability in the building of quality environments. There is an awareness of the wide-ranging scope opened by these different topics, and the intentional sentiment to connect local stone architecture with modern, environmentally friendly design and energy efficient techniques. It is believed that stone as a native building material should be used neither in an unreflected historicizing way nor as a more or less fashionable dressing for built environment design solutions. Instead we propose a meaningful interaction with resources and possibilities of place that forwards a new environmentally aware architecture which addresses energy issues.
"Tradition is to pass on the fire, and not to worship the ashes." Gustav Mahler.

Architectural quality is a process that starts by analyzing the specific characteristics of a certain location as a base for design interlinked with the technical possibilities of our time. Through the production of this book it is hoped to communicate this architectural attitude. The book at hand stands as a thematically wide spread reading for students

and other interested persons, intentionally initiating critical thinking on contemporary architecture and prevailing local building practices. *"Learn from yesterday, live for today, hope for tomorrow. The important thing is not to stop questioning." Albert Einstein.* To be prompted are thoughts concerning urgent energy questions and a visible progressive destruction of authentic regional landscapes. As a collection of observations and insights on the topic of stone architecture in Jordan and Syria, this publication reflects on energy efficient methodology for buildings without claiming to be exhaustive or purely scientific, but with a relatedness to the region, its people and culture...

Juliane Jäger & Ingo Helmedag



INTRODUCTION OF THE AUTHORS

Juliane Jäger began teaching Architecture in 2005 at Brandenburg University of Technology in Cottbus, Germany. In 2007 she became a lecturer for the German Academic Exchange Service (DAAD) at Wadi International University and Damascus University in Syria. In the first article she describes traditional stone architecture in the rural areas of Syria and Jordan. Currently, she is working on a PhD extending these ideas into contemporary applications at the Technical University in Braunschweig, Germany.

Working under the umbrella of DAAD since 2008, **Ingo Helmedag** is a professor at the German Jordanian University in Amman. Focusing on building technique and design, he began teaching at the Technical University in Dresden in 1993 where he also organized academic contacts and exchange programs world-wide. Prior to running his own office as a licensed architect in Dresden, he worked at well-known offices in Graz, Austria. Continued travel affords opportunities to follow his cultural interests and their respective architectural approaches. The article on construction routines highlights observations on contemporary architecture in Amman, and points out resulting problems from urban scale to building techniques.

Dr. Thomas Maria Weber is an archaeologist with extensive research and field experience in the Middle East and North Africa. As a professor at the University of Mainz, he became the director of the German Protestant Institute of Archaeology in Amman in 1985. Currently, he is teaching at the University of Jordan in Amman as a professor for DAAD. His research focuses on the Classical periods. In his article, *Rock and order*, he concentrates on stone building techniques from prehistoric to Roman times.

Dr. Nizar Abu-Jaber is a geologist with much international experience, a professor and currently the Dean of Scientific Research at the German Jordanian University. His article focuses on the geological outline of Syria and Jordan, concentrating mainly on stone occurrences and material properties in terms of architectural usage.

Abdulhamid Suleiman is an architecture student at Damascus University. During university studies he lived at Deir Mar Mousa, Syria as part of the monastic community. His article describes on-going construction at the monastery.

Berthold Burkhardt held the chair of Statics and Structural Design at the Technical University in Braunschweig. His academic career started at the Technical University in Stuttgart as a collaborator of Frei Otto, who inspired his special interest in tensile structures and tents. In the course of continuous historical research he has assimilated a unique collection of tents. As a member of DOCOMOMO and ICOMOS he concentrates on the protection and status of existing modern architecture. His professional practice focuses on rehabilitation projects. *The sight behind the façade* discusses material properties and techniques of stone façades.

Olaf Reiter is a highly experienced *Passive House* architect in Dresden, Germany. Traveling for the first time to Jordan in 2010 as an invited critic for a Jordanian-Syrian workshop on Architecture, he initiated fruitful discussions on the adapted use of *Passive House* architecture in the region. In addition to his professional practice in Dresden, he teaches sustainable architecture and design at Krems University, Austria and at the Technical University in Dresden, Germany, and lectures at other universities world-wide. His contribution reviews three *Passive House* projects from his personal practice.

Motivated by a love for landscape architecture in arid regions, **Margaret Louderback**, a residential landscape designer from Arizona, USA, has traveled extensively in the Middle East and North Africa. She taught at the German Jordanian University for two years, before beginning current work on a PhD concerning phenomenology and landscape architecture theory at the University of Malta. Her article, *Waiting for the rain*, addresses this interest. She continues to be engaged in regional landscape architecture projects.

Ammar Khammash as a prize winning Jordanian architect and artist, is well known for eco-tourism concepts and hotel designs through out Jordan. He has taught at several universities, including Columbia University in New York, and his artwork has been exhibited in selected galleries. In an early publication, *Notes on Village Architecture in Jordan*, he documented vernacular stone architecture in his beloved home country. *The Stone Man of the Third Millennium* philosophizes on the interaction of natural and built environments.

January 2012



DESCRIBING TRADITIONAL ARCHITECTURE IN RURAL AREAS EXAMPLES FROM SYRIA AND JORDAN

Similar environments and naturally available building materials, such as stone, earth and limited amounts of timber, as well as the social and economic needs of sedentary farmers, have shaped the appearance of traditional houses in the mountainous regions of Syria and Jordan.

Influences from previously static dwellings, like natural or modified caves, and temporarily used or nomadic accommodations, like earth houses, twig huts and tents, are obvious. From these beginnings until the early 20th century, the typical farmstead was built maintaining the standard typology of a compact, single story volume made of heavy stone-walls with a flat earth-covered roof (JJ02).

The simplest housing styles connected living and working spaces, stables and storage in one big hall. Commonly, walled courtyards and roof-scapes were used as integrated functional parts extending outdoor units for daily routines. In response to topography, the practice of terracing was not just used for agricultural cultivation. Building sites were divided into flat plateaus of differing heights for courtyard, garden and house as these structures were embedded in mountainous slopes (JJ01).



JJ01

JJ01 Remains of a typical farmstead embedded in the mountainous slope.

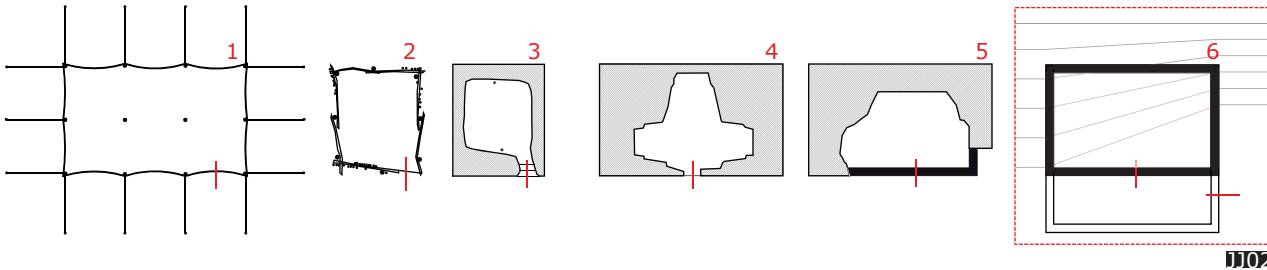

JJ02

Nevertheless, during the late 18th, 19th and early 20th centuries transformation and evolution processes, accompanied by complex changes in social, economic and technical developments stimulated adaptations. Following the above mentioned basic organization scheme five types of dwellings appeared; the *Basic or Closed Rectangular House*, the *Liwān House*, the *Courtyard House*, the *Riwāq or Gallery House*, and the *Central Hall* or so called *Lebanese House* (JJ03).

Although all of the housing types coexisted isochronally, a steady enhancement of spatial and functional differentiation and an increasing approach of visual representation can be observed. Building typology often mirrors social status and the changing living conditions of its inhabitants. In addition to typological distinctions, research on major construction elements and utilities has shed light on changing building standards and technical progress. Exemplarily are simple cobblestone farmhouses with timber ceilings and supports, and the homes of wealthy families, which consist of arches and vaults in accurately shaped ashlar with extensive ornamentation.

JJ02 Illustrated classification of primary dwelling types.

- 1 tent, a nomadic accommodation, *baīt š'ar*
- 2 twig hut, *shībāt*, respectively summer hut
- 3 earth hut, *debābe*
- 4 triple concha cave as used in Roman tombs and subsequently used for temporary accommodation
- 5 naturally found and extended cave
- 6 basic house form of sedentary farmers

JJ03 A classification of traditional residential buildings of sedentary farmers.

- 1 *Basic or Closed Rectangular House*
- 2 *Liwān House*, *liwān*, central hall element, opened to the exterior through an arched passage
- 3 *Courtyard House*
- 4 *Riwāq or Gallery House*, *riwāq*, roof covered space opened to the outside through a colonnade or arcade
- 5 *Central Hall* or so called *Lebanese House*

In literature, the classification of houses and their titles are used in a non-uniform manner. The chosen structure is based on Ragette, F. (1974) one of the first to describe traditional stone houses in the Lebanese mountains. Adaptations were made accordingly by Liger-Belair, J. (2000) and Davie, M. (2007), both referring to Lebanon, Pütt, K. (2003) referring to northern Syria and the study of CORPUS-Levant (2004) referring generally to Syria and Lebanon. Khammash, A. (1987) reported on a number of Jordanian villages.

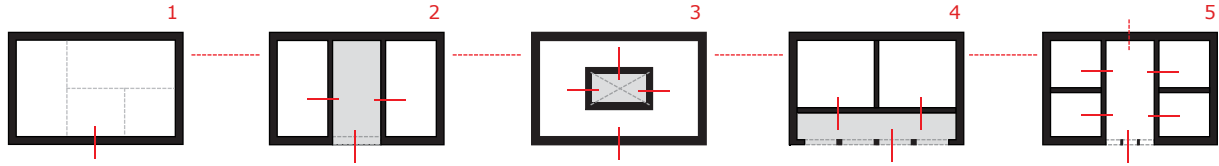

003

At present, in the rural areas of Syria and Jordan traditional residential architecture has not been widely noticed and explored. Due to its programmatically inscribed continuity of change, its respectively young age and the lack of monumental presence, a shortage of public and private interest and an increasing rate of deterioration persists.

In addition accelerated modern concrete building has displaced former stone house architecture. Traditional craftsmanship has almost disappeared. The majority of traditional houses are contemporarily out of use, inappropriately repaired or otherwise extended by means of concrete. Professional adaptations are rare and costly. Requests are not often responded to by offers within the local building industry, nor is continued education of experts and craftsmen available.

As newly built houses adopt single traditional elements or concepts, proving the timeliness and sustainable content, and as locally first heritage saving interests appear, the following article provides research and documentation of vernacular architecture as a first approach in passing on identity and tradition to future generations.

Outline of architectural features

TYPOLOGIES

Basic or Closed Rectangular House
 Liwān House
 Courtyard House
 Riwāq or Gallery House
 Central Hall or Lebanese House

MAJOR CONSTRUCTION ELEMENTS

Walls & Masonry
 Floors
 Structures
 Roofs
 Openings
 Stairs
 Corbel Stones

UTILITIES

Heating
 Ventilation
 Water & Sewage System

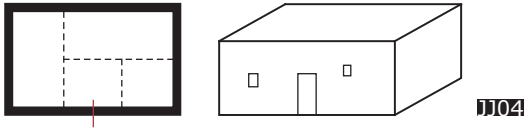

Basic or Closed Rectangular House

The simplest and most common type of traditional building is the *Basic* or *Closed Rectangular House*. Typically, it hosts a peasant family and their livestock under one roof. This house type groups all living and working functions into one space.

The name results from the prevailing rectangular house plans and the relatively closed façade. This façade is broken only by the door, small windows and ventilation openings to extract smoke from the open interior fireplace (JJ04).

The close contact between man and animal, as well as the continuing building envelope, satisfied the need for security, suitable shelter in all weathers and allowed for the beneficial use of animal warmth in winter. Massive exterior double-layered walls were built as dry masonry from cobblestones collected from the surroundings, or as quarry stone masonry supplied from nearby stone pits. Stone façades were kept visible as a decorative element, while the inside walls were plastered and whitewashed.

Niches in the inner wall layer served as furniture and storage.

Regularly several levels differentiated the interior space. The entrance and stable were placed at the lowest level. The area for cooking and daily works, the place for guests, sleeping and the storage of goods were organized a few steps above. In addition to the sense of privacy, the practical aspect of keeping the house clean was implemented in this leveled layout. All succeeding types of traditional houses preserved the lower entrance zone.

More sophisticated designs separated functional units via interior walls, or increased the number and size of windows and doors (JJ05). Structural items co-determined the interior organization. From a single space with various wooden columns, the house floor plan developed in a repetition of identical units based on the grid of transverse arches or vaults. Openings were often decorated with masonry work of framing stone panels or highlighted by different types of stone.

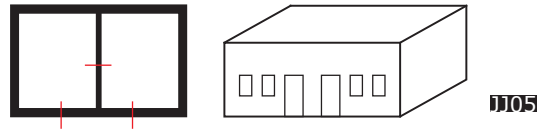

Generally, outdoor spaces functioned as washing, toilet, food preparation and cooking areas. Adjoining buildings, like a baking house, cisterns, cattle stands, and the walled courtyard completed the traditional farmstead. External staircases emphasized the close relation of interior and exterior spaces. Flat earth covered house roofs, accessed by these stairs, were used in summer as sleeping places and platforms to dry fruits and vegetables.

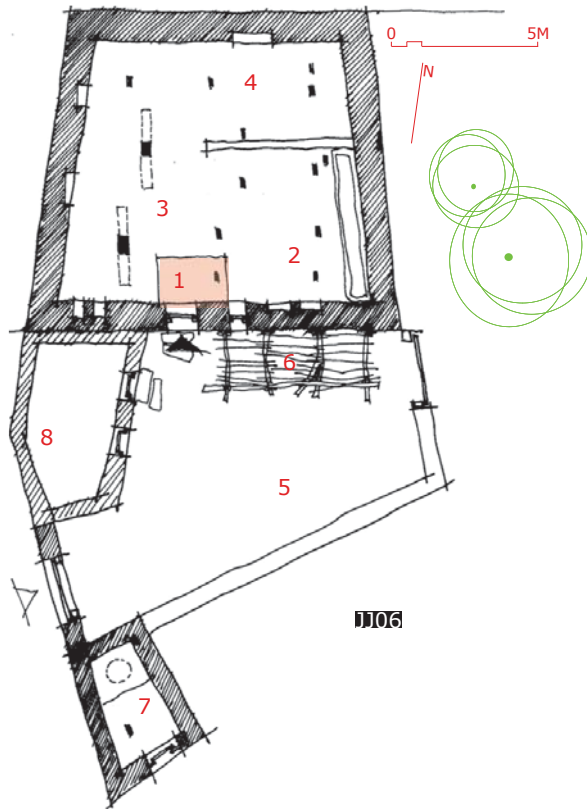

JJ06 Plan of a simple *Closed Rectangular House* showing masonry from basalt cobblestones and an interior timber and beam structure, Al Kaimeh, Syria.

- 1 entrance, *madūra*
- 2 stable, *'istabl*
- 3 raised platform
with fireplace and spaces for living and working
- 4 sleeping and storage area
- 5 walled courtyard
- 6 cattle stand
- 7 external bakery house, *tannūr*
- 8 later added workshop building

JJ07 Main elevation of the *Closed Rectangular House* in JJ06.

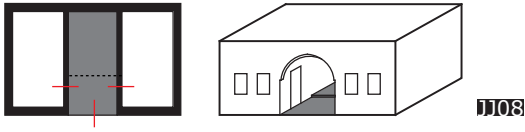

Liwān House

Liwān Houses are found to a much lesser extent than the other traditional building types. But their characteristic element, the central hall opened to the exterior through an arched passage or *liwān*, generates very impressive elevations and interesting dual functions. *Liwān* or *iwān* of Persian origin, means open hall.

In its initial arrangement, the *Liwān House* is a free standing building accessible from the central open space. From this middle position, flanking rooms right and left of the *liwān* can be reached (JJ08). Entryways or doors face each other in symmetrical balance, and are commonly located on the first third of the *liwān* plan. This outdoor strip generates a circulation zone that works similarly to the entrance of *Closed Rectangular Houses*.

In addition to its utilisation for access and circulation, the *liwān* also serves as a roof-covered terrace, an outdoor living room for the family and a representative area for reception. Accordingly, the rear two thirds of its space are often raised in height, and furnished with revolving seating accommodations.

The flanking rooms, with few or small windows, commonly contain living, working, sleeping and storage functions.

As a result of later additions, or because of an adopted organization scheme, asymmetrically partitioned *Liwān Houses* appeared. They may have taken on a linear, L- or U-shape or even the perimeter frame of a courtyard.

Similar to *Closed Rectangular Houses* numerous functions like the cooking area, bath and toilet, were originally organized outside the house or as an extension annexed to the flanking rooms. Increasingly, man and animal became spatially separate.

In the Syrian and Jordanian mountain villages *Liwān Houses* are typically oriented south. In winter, low sunrays can enter the wind protected open hall. Steep sunrays just reach the frontal part of the *liwān* in summer. Due to the arched lintel and the comparably large depth of the hall a greater part of the *liwān* stays shaded. This orientation speciality appears in contradiction to most of the urban *Liwān Houses*. For example in Damascus, the northern orientation of the *liwān* opening is predominant avoiding the access of sunrays all together. The application of the *Liwān House* style makes sense in warm climates, protecting its inhabitants from sun in summer and wind and rain in winter.

It also implies a certain luxury; the loss of a good portion of space for utilization as an interior room. Accordingly and responding to the need of additional living space, various liwāns were reduced to entrance and circulation functions, and were partly or fully closed.

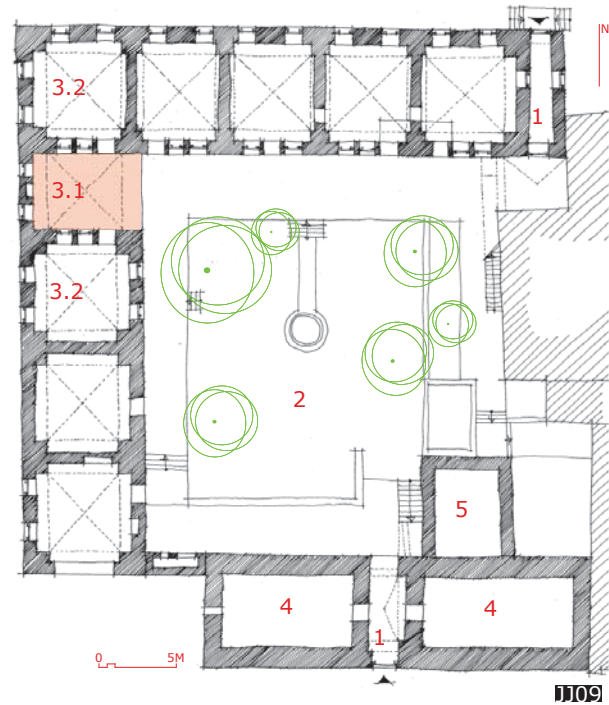

JJ09 *Liwān House* illustrating an asymmetrical L-shaped plan, Al Kaimeh, Syria.

- 1 entrances
- 2 courtyard
- 3 liwān unit
- 3.1 liwān. Notice the uncommon east-facing opening orientation.
- 3.2 living and sleeping rooms. Other annexed rooms were used as living or storage space.
- 4 stable from an earlier building period
- 5 property from an earlier building period

JJ10 A courtyard elevation facing the liwān opening of the *Liwān House* in JJ09.

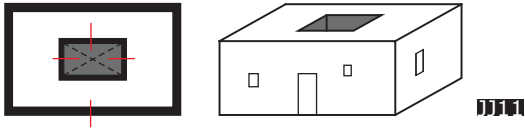

Courtyard House

Courtyard Houses, less widespread in mountain villages, are typically found in the Jordanian and Syrian plateaus. For instance, on the Hauran plains the *Courtyard House* stands as the primary traditional building type, while in other areas it constitutes an exception.

Most commonly, *Courtyard Houses* were not planned from the beginning to a final shape. Several steps of accumulative additions turned a formerly walled courtyard into a belt of buildings. Due to this metamorphosing process, *Courtyard Houses* often combine several building types in one.

Generally, their contour follows irregular outlines of property boundaries, in an attempt to encircle and maximize the farmstead. In contradiction, the inner courtyard is commonly found in a regular geometric form.

In the urban context or in terms of extensively connected buildings, this traditional building type may contain not just a single courtyard, but several. Each courtyard is

differentiated to meet varying functional and spatial needs.

In any case, courtyards serve as circulation zones. All building parts and major openings are oriented towards this central element of the house, which is also used as outdoor living and working space.

Commonly shade trees, tiny gardens, wells or water basins are integrated to the courtyard space. The representative façades and the charm of the house can only be experienced from the inside. From the exterior *Courtyard Houses* appear very simple.

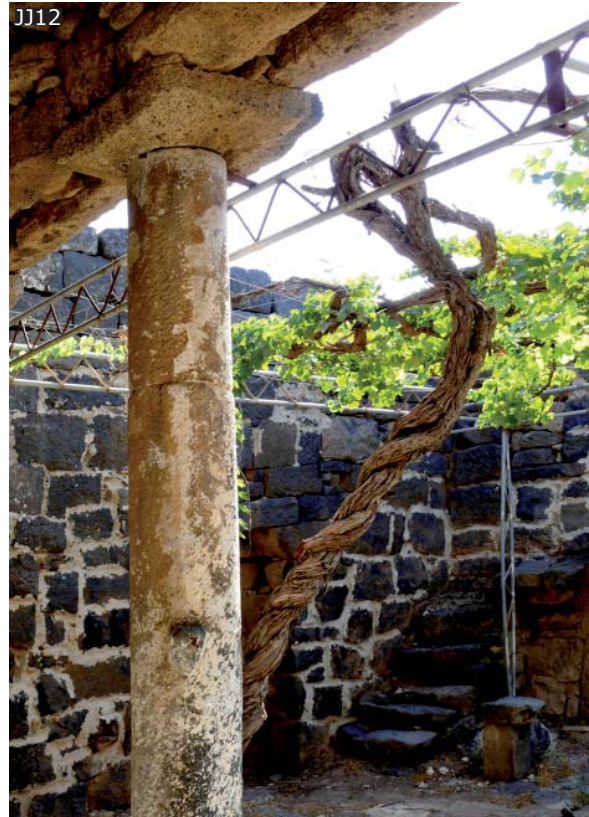



JJ13

JJ12 The courtyard acts as a central circulation zone.

JJ13 Planted with shade trees, grapevines and flowers, the courtyard is protected from sun in summer and from harsh winter winds. Through out the year it stands as a vibrant core and social meeting point.

JJ14 A *Courtyard House* consisting of four buildings from different building periods frames the current courtyard, Shakra, Syria.

- 1 entrance zone
- 2 courtyard, partly paved and partly used as a garden
- 3 framing buildings
- 3.1 *Riwāq House* with colonnade, actually used as an atelier and storage
- 3.2 a collection of rooms, including an interior colonnade, that are currently out of use.
- 3.3 two-story collection of rooms, partly used as storage and a workshop with an annexed addition, formerly used as a stable
- 3.4 modern concrete building extensions including kitchen, bath and toilet. (These are typically missing in the traditional parts of an original *Courtyard House*.)

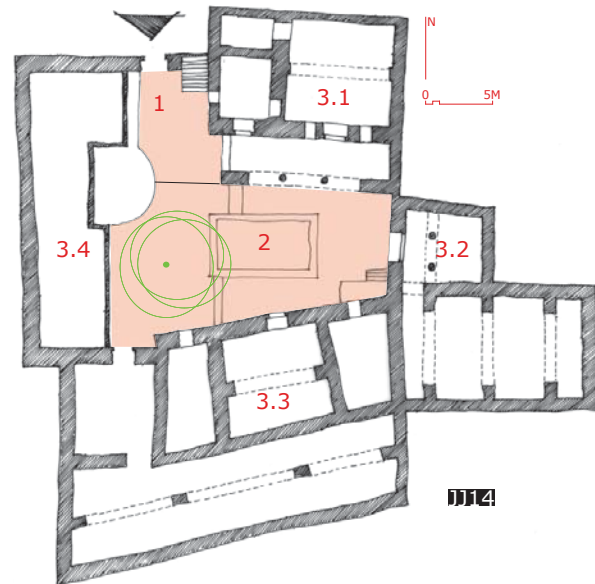

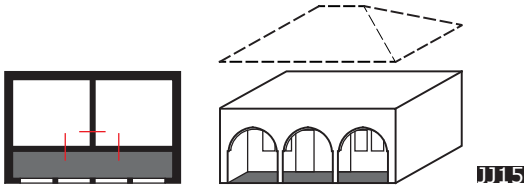

Riwāq or Gallery House

The traditional building type of *Riwāq* or *Gallery House* is frequently used in Syria and Jordan. It is either found as a single story building or as an upper floor addition on top of the *Closed Rectangular* or *Liwān Houses*. In this latter case, the upper level is reached by a cantilevered external stairway.

The *riwāq*, a roof covered space, open to the outside through a series of supports, is the major circulation and decorative element. Usually shaped longer in length than in depth, it forms an open corridor or gallery, contains the entrance and services a row of rooms (JJ15). The *riwāq* is not to be understood as a porch roof or peristyle attached to the building volume. Instead, it is an integrated part of the original design as its massive flanking walls suggest.

The major *riwāq* façade, either configured by a colonnade or an arcade of mason worked stones, represents the most structured, airy and sophisticated façade design of all traditional building types. Mason worked framing stones around the doors and windows of the

adjoining rooms, ventilation holes or niches, for lamps and the like, decorate inner *riwāq* walls.

In its formal expression the *Riwāq* or *Gallery House* marks the widest contrast in relation to the *Closed Rectangular House*. The *Gallery House* physically represents a process of social change spanning from a major need of security, to the wish for visual representation and extraversion.

Similar to the *liwān* element, the *riwāq* defines an intermediary zone between inside and outside. It is used as a multifunctional entrance and as a terrace protected from the weather creating a temporarily used recreation and family space. All attached rooms that contain either living, sleeping or working functions are split into cells. The bathroom, toilet and even the kitchen still remain organized outside in annexed rooms or separated buildings.

The increasing internal subdivision of rooms expresses a desire for greater privacy, but implies the disadvantage of losing a clearly defined central living area for the whole family. In terms of subsequent building modifications, the former open gallery was often closed completely changing the circulation concept.

Riwāq Houses foster an increase in vertical building extensions with their comparatively low weight. Paralleled with flat earth-covered roofs, the flat concrete roof and

the hipped red-tiled roof began to appear. Representative of new building fashions, they illustrate an idea exchange between neighbouring countries. These changes can mainly be seen in the coastal areas.

JJ16 Upper floor of *Riwāq House*, Al Kaimeh, Syria.

- 1 *Closed Rectangular House* on the ground floor, arranged as two cross vaulted units
- 2 cantilevered exterior staircase
- 3 *riwāq*, *Riwāq House* in the upper floor
- 4 adjoining rooms used as living and sleeping space

JJ17 Main house elevation mentioned in JJ16.

JJ18 Upper floor of *Riwāq House* with an unusually stretched linear gallery and numerous adjoining rooms in Ezra'a, Syria.

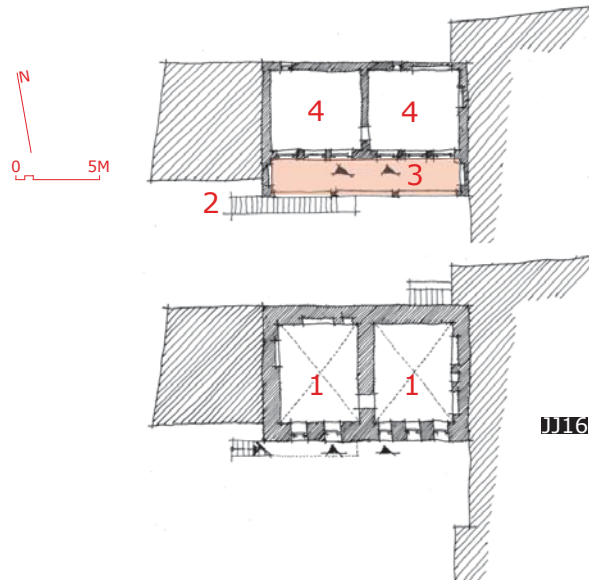

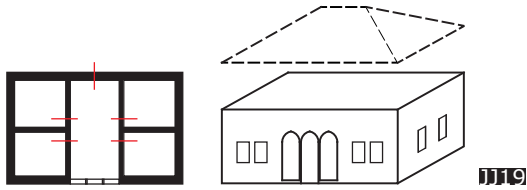

Central Hall House

The *Central Hall House* appears in Syria and Jordan to a moderate extent, and at a later date than the types so far described. It is the most prevalent traditional building type in the coastal mountains of Lebanon and, as it attained the highest degree of identity there, often entitled the *Lebanese House*.

As the most popular building type in the civil society of merchants and traders during the late Ottoman period, examples of *Central Hall Houses* are often found in urban centers. For example, the city of Salt in Jordan has numerous buildings of this housing type, which define the traditional character of the town.

In rural areas, mainly during the late 19th and early 20th century, wealthy peasant families copied the fashionably new style designing their villas or country houses according to the urban prototype.

Major elements included in this building type are the characteristic central hall with an arcade from an uneven number of open-

ings on its main elevation, a widely symmetrical plan and façade organization and the common red-tile pitched or flat concrete roof.

Central Hall Houses are found in the rural areas as single or two-story. The first story is regularly accessible from the front, while the upper story acts mainly as a vertical extension of former buildings accessible from the rear.

The central hall can be seen as a successor of the *liwān* and *riwāq* element. It either spans the full depth of the house or is subdivided into sections. The central hall serves as an entrance, and a family and reception room. From this core space, facing doors lead to sleeping rooms and, in highly developed models, to the kitchen and bath. Modern living standards are fully reached in this building type. These include the full separation of work and living units, the inclusion of kitchen and sanitary units and the responding increased need of privacy on the one hand, and extraversion on the other.

In addition to these sophisticated typological aspects, the quality of masonry work and decoration is remarkable. The arcade of each central hall stands as the most impressively decorated object. Balconies, verandas or porch roofs in front of the central hall are often used to underline the axial symmetry.



JJ20



JJ21

JJ20 *Central Hall House II* interior central hall showing triple horseshoe-shaped arcade, Mishtayeh, Syria.

JJ21 Elevation of *Central Hall House I* with pitched roof as mentioned in JJ22.

JJ22 *Central Hall House I* with pitched roof, Mishtayeh, Syria.

- 1 entrance with walled south-facing courtyard
- 2 *Liwān House* on the lower level. The *liwān* is partly closed.
- 3 entrance with walled north-facing courtyard
- 4 *Central Hall House* on the upper level showing the hall with triple arcade, balcony in front and a pitched roof.
- 5 similar units for living and sleeping functions
- 6 kitchen, toilet, storage arranged in one cell
- 7 modern building extension

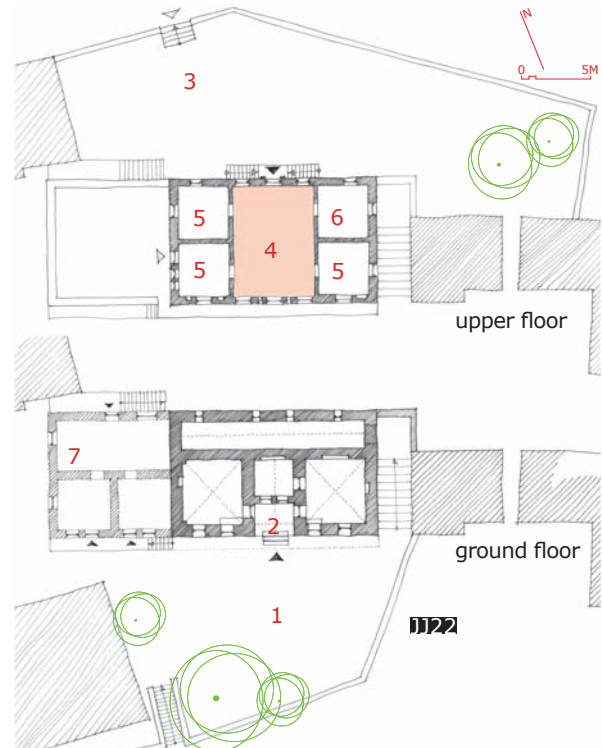

Walls & Masonry

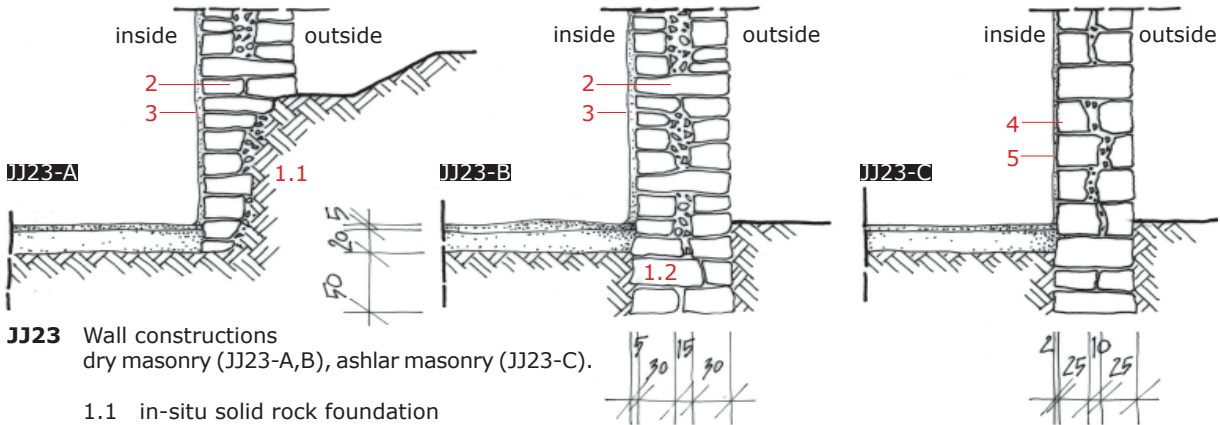

JJ23 Wall constructions
dry masonry (JJ23-A,B), ashlar masonry (JJ23-C).

- 1.1 in-situ solid rock foundation
- 1.2 rough foundation masonry (*byiftahu al-'asas*)
- 2 double-walled dry masonry made of natural stone, mainly field stones of basalt or limestone filled with rubble, earth and scattered interlocking stones
- 3 interior plastering of loamy earth (*tīn*), chaff (*qasrīne*), chalk whitewash (*ğis*)
- 4 double-walled ashlar masonry made of natural stone (dressed stones of basalt or limestone), mortar filled with rubble and scattered with interlocking stones
- 5 interior plastering: loam rendering, chalk whitewash (*ğis*) and optional paint coating

JJ24 Stone masonry techniques.

- 1 irregular quarry-stone masonry
- 2 herring bone masonry
- 3 layered quarry-stone masonry
- 4 masonry technique as punched window façade
- 5 ashlar masonry

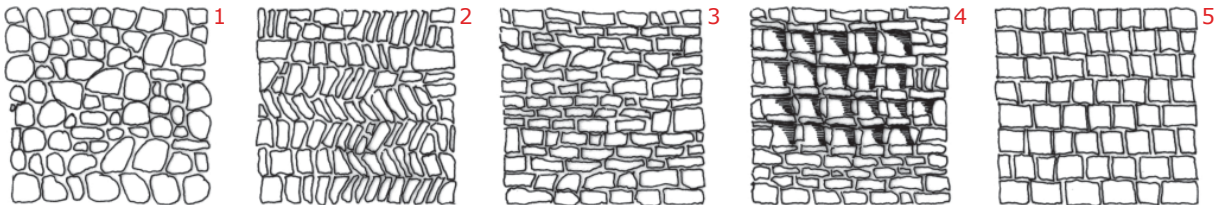



JJ25



JJ26



JJ27

JJ25 Double-walled quarry stone masonry of limestone, Dana, Jordan.

JJ26 Double-walled dry masonry of basalt field stones, Al Kalatiah, Syria.

JJ27 Detail of interior plastering; a mixture of loamy earth, hay and chalk whitewash, Dana, Jordan.

JJ28-30 Masonry façades Kalatiah, Syria (JJ28), Salt, Jordan (JJ29) and Marmarita, Syria (JJ30).



JJ28



JJ29



JJ30

Wall Niches

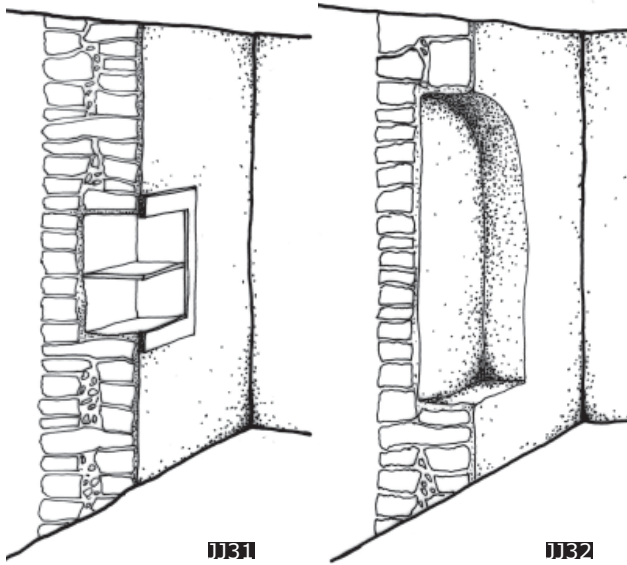

Niches of different sizes were designed in double-walled masonry as a type of furniture inside traditional houses.

Using half the thickness of the wall, they appeared in various versions; as untreated openings or with wooden frames, with or without wooden shutters and shelves or screened with decorated textiles.

Either stone blocks or beams of wood were used as plane lintels, or the opening was covered by segmental or semi-circular arches.

JJ31 Smaller types of niches served as depositories for domestic appliances, as places to store food and other goods, as book shelves (*kutbieh*) or closets (*kerestani*).

JJ32 The largest niche inside the house was used to store mattresses and bedding implements (*yūk*). Regularly the opening was bridged with a semi-circular or segmental arch.

In addition to internal niches, small external ones used for decorative purposes or as candle stands appeared occasionally.



JJ33-35 Different versions of small internal niches in double-walled masonry, Wadi Al Nadarah, Syria.

JJ36 Example of a simple yūk, a large internal niche with a segmental arch, Habnimra, Syria.



Floors

JJ37 Floor construction I.

- 1 foundation on earth or in-situ solid rock
- 2 packed earth layer
- 3 packed earth floor (*trāb*) or floor covering from screed

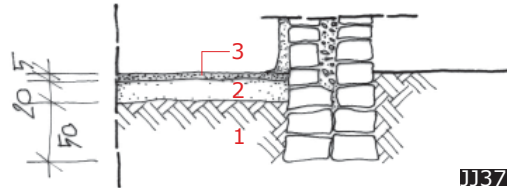

JJ38 Floor construction II.

- 1 foundation on earth or in-situ solid rock
- 2 packed earth layer
- 3 screed layer or mortar bed
- 4 floor covering in different versions
packed gravel (*ghorzeh*)
untreated natural stone plates (*daff*)
dressed stone plates with rough rear sides
plane surfaces (*haschr maqsub*)
or varying kinds of tile

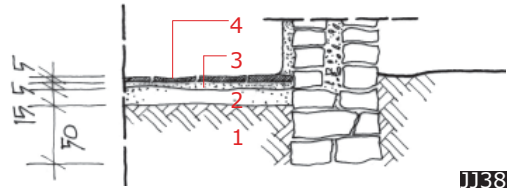



JJ39

JJ39 Example floor construction I, surface of packed earth, Mistayeh, Syria.

JJ40 Example floor construction II, floor tiling, Al Kaimeh, Syria.

JJ41 Example floor construction II, surface of dressed stone plates, 'Amar Al Hosn, Syria.



JJ40



JJ41

Structures I

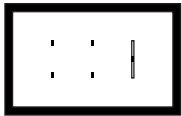
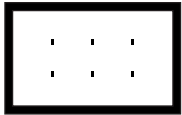

JJ42

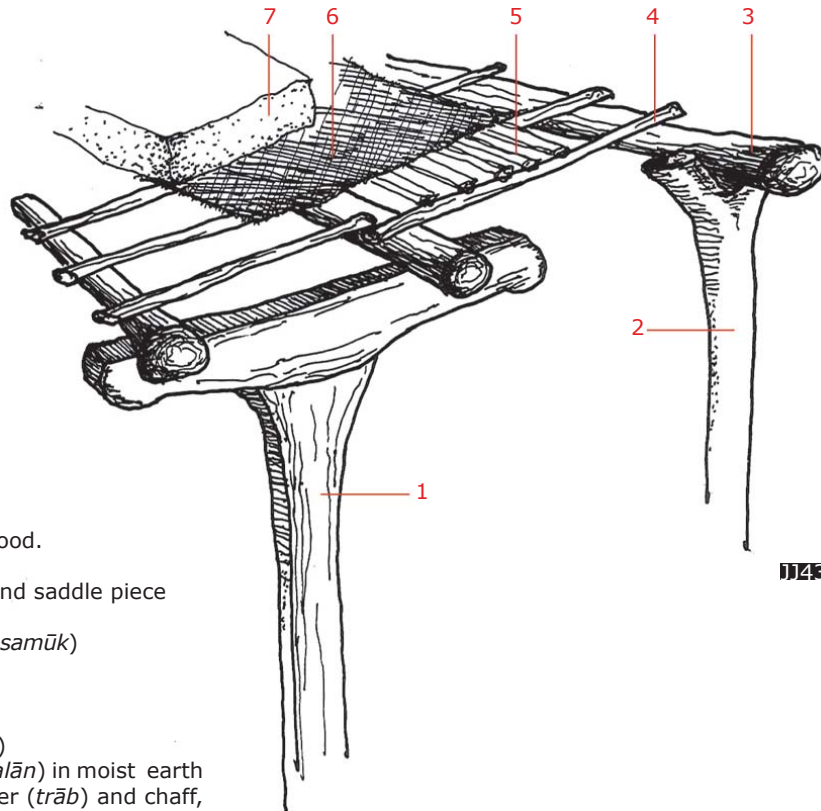

JJ43

JJ42 Subdivided spatial plan via different pillars types.

JJ43 Rafted ceiling on pillars of wood.

- 1 pillar using timber post and saddle piece (*mnārah*)
- 2 pillar using branched log (*samūk*) of mulberry trees
- 3 timber beam (*arka*)
- 4 timber cross beam (*bid*)
- 5 reeds or branches (*qas'a*)
- 6 thorny shrubs (*rukāza, balān*) in moist earth
- 7 20-25 cm thick earth layer (*trāb*) and chaff, with lime chaff screed used as a finishing

JJ44 Pillar variations.

- 1 branching log approximately 10-20 cm in diameter
- 2 timber plank approximately 7 by 15 cm
- 3 timber post and saddle piece approximately 15 by 15 cm
- 4 dressed stone post and saddle piece approximately 20 by 20 cm

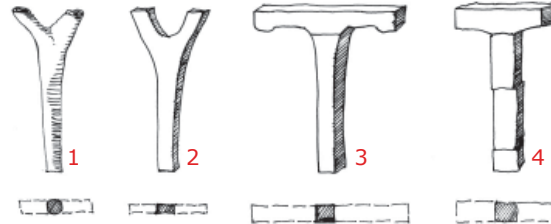

JJ44



JJ45

JJ45 Rafted ceiling on wooden pillars, 'Anaz, Syria.

JJ46 Timber plank pillar lifted from soil floor with a foot stone, 'Anaz, Syria.

JJ47 Detail post and saddle piece of dressed stone, 'Azer, Syria.

JJ48 Structural remains of a formerly earth-covered rafted ceiling on wooden pillars, Muqabara, Syria.



JJ46



JJ47



JJ48

Structures II

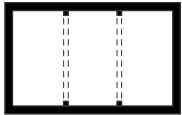

JJ49

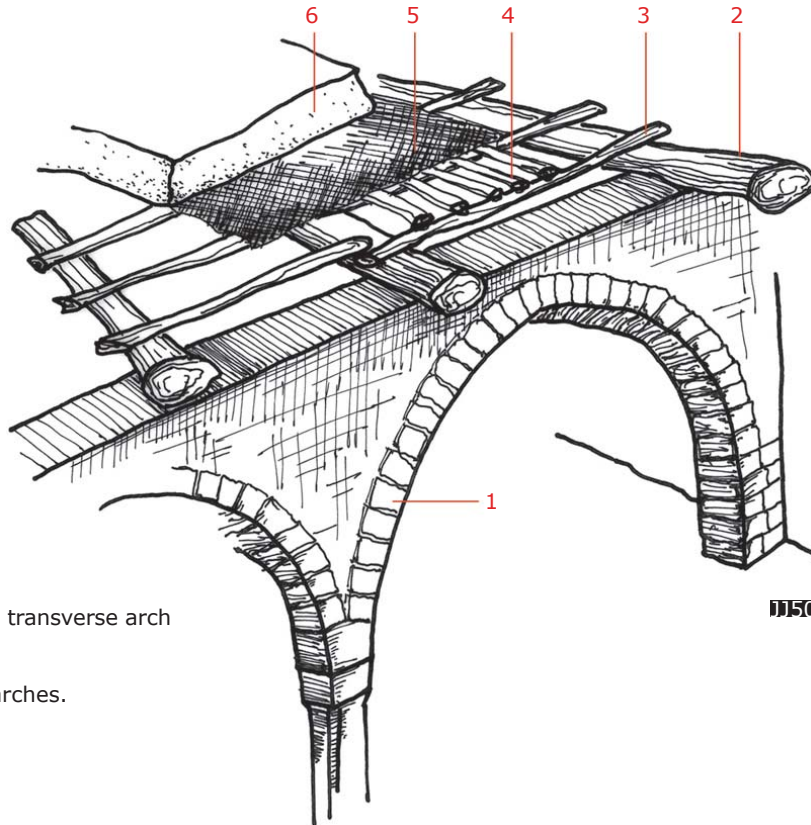

JJ50

JJ49 Spatial plan subdivided according to parallel rows of a transverse arch or an inner arcade.

JJ50 Rafted ceiling on transverse arches.

- 1 transverse arch (*qantara*)
- 2 timber beam (*arka*)
- 3 timber cross beam (*bid*)
- 4 reeds or branches (*qas'a*)
- 5 thorny shrubs (*rukāza*, *balān*) in moist earth
- 6 20-25 cm thick earth layer (*trāb*) and chaff, with lime chaff screed used as a finishing

JJ51 Transverse arch variations.

- 1 transverse arch, single or parallel in row, mainly used as segmental or slightly pointed arch
- 2 transverse arch in line as an inner arcade

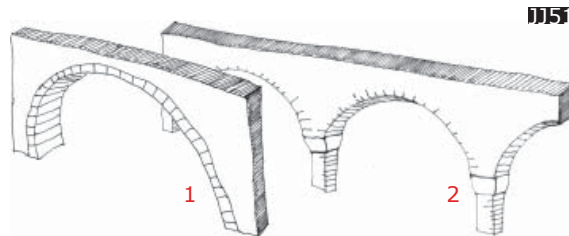

JJ51



JJ52

- JJ52** Rafted ceiling on transverse arch, Kafra-Wadi Al Nadarah, Syria. The dressed stones of the arch are plastered.
JJ53 Interior arcade of basalt stones, 'Azer, Syria. The formerly rafted ceiling was later replaced by a concrete slab.
JJ54 Limestone transverse arch in an abandoned house, Wadi Al Nadarah, Syria.



JJ53



JJ54

Structures III

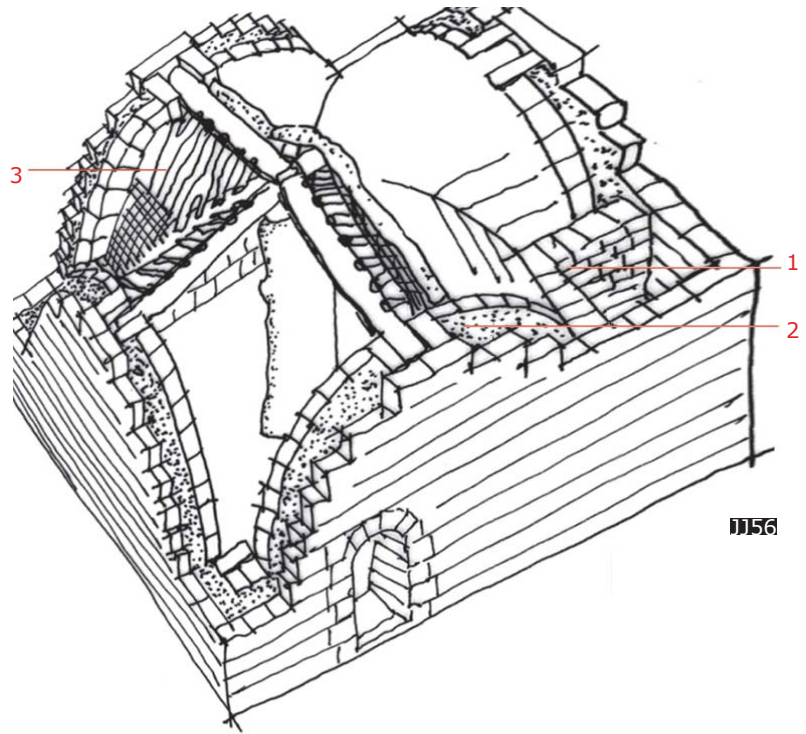
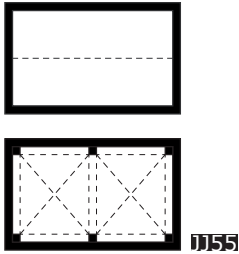

JJ55 Subdivision of space utilizing barrel vaults (top) or cross vaults (bottom).

JJ56 Cross vault construction.

- 1 pillars (*da'meh*), made from quarry-stone masonry, filled with rubble and earth
- 2 side wall / buckler
- 3 sub-structure illustrating the intrados curve, covered with layers of earth (*trāb*) and chaff, with a lime chaff screed used as a finishing

JJ57 Commonly used vault constructions.

- 1 barrel vault, less common
- 2 cross vault, most commonly used
- 3 cupola, rarely found

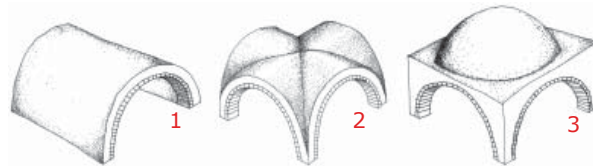



JJ58

JJ58 Limestone cross vault construction, Tannurīn, Syria.
The masonry of formerly plastered ceiling and walls was left visible after refurbishment.

JJ59 Plastered cross vault construction in a currently abandoned house, Kafra, Syria.

JJ60 Remains of cross vault construction offering a view inside the pillar, Al Kaimeh, Syria.



JJ59



JJ60

Structures IV

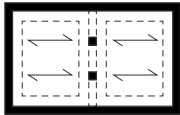
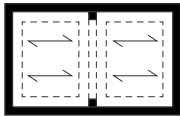
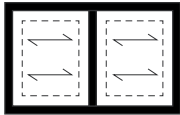

JJ61

JJ61 Subdivision of space using supports such as walls, transverse arch or pillars.

JJ62 Linear corbel stone ceiling.

- 1 transverse arch (*qantara/qaus*) or other supporting structures (*hamel* = load-bearing), such as walls or pillars
- 2 corbel stone (*mizan* = balance)
- 3 stone block (*mahmul/rabad* = beam)
- 4 super-imposed load of framing stones
- 5 thorny shrubs (*rukāza, balān*) in moist earth
- 6 20-25 cm thick earth layer (*trāb*) and chaff with lime chaff screed finishing

JJ63 Commonly used support variations.

- 1 pillars or columns
- 2 transverse arches; single standing, as inner arcade or paralleled in rows
- 3 walls

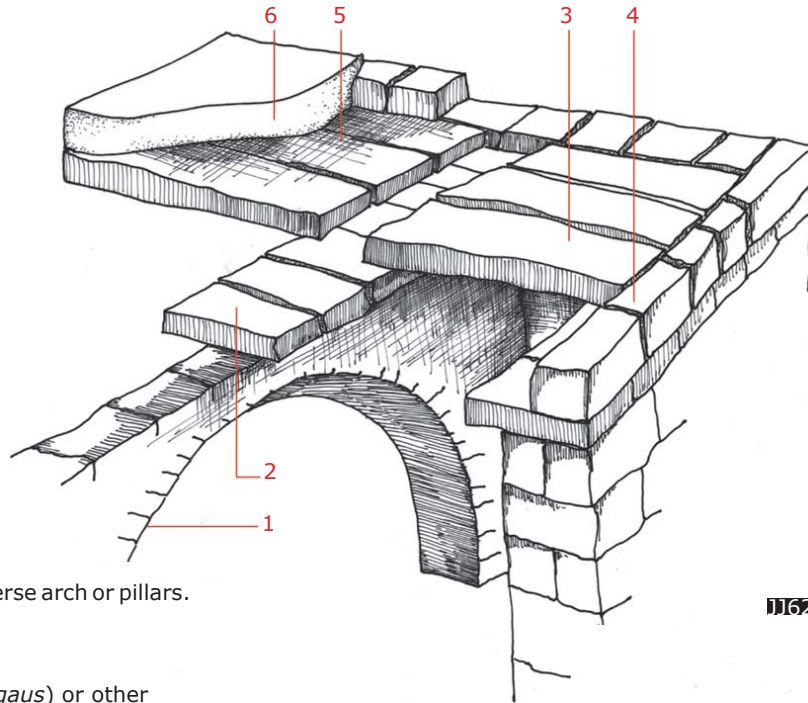

JJ62

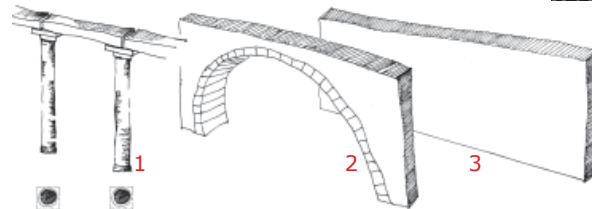

JJ63



JJ64

JJ64 Linear corbel stone ceiling of basalt stones on transverse arch and wall supports, Ezraa, Syria.

JJ65 Similar construction on transverse arch and columns, Shakra, Syria.

JJ66 Similar construction with rendered and whitewashed surface, Khabah, Syria.



JJ65



JJ66

ROOFS

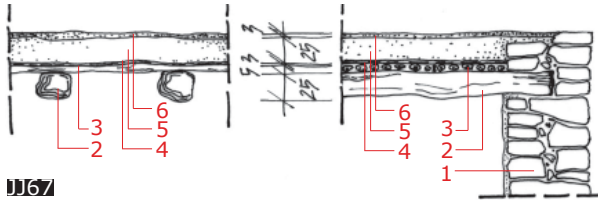

JJ67

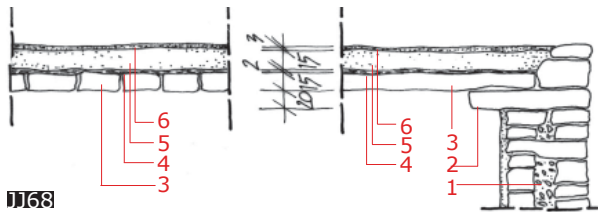

JJ68

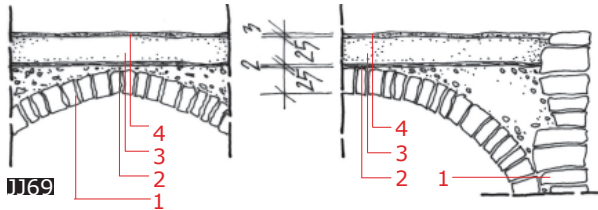

JJ69

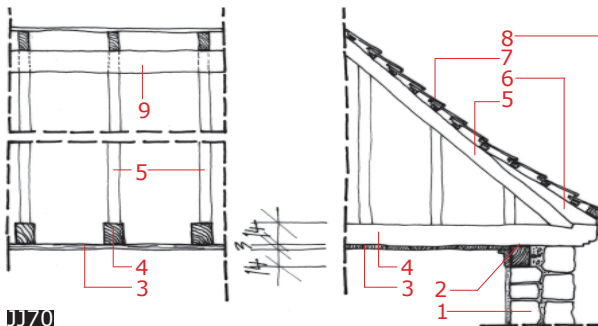

JJ70

Commonly used roof constructions, vertical sections.

JJ67 Rafted timber ceiling.

- 1 double-leafed exterior wall
- 2 timber beam (*arka*)
- 3 timber cross beam (*bid*)
- 4 reeds or branches (*qas'a*) and thorny shrubs (*rukāza, balān*) laid in moist earth
- 5 20-25cm thick earth layer (*trāb*) and chaff
- 6 lime chaff screed finishing

JJ68 Linear corbel stone ceiling.

- 1 double-leafed exterior wall
- 2 corbel stone (*mizan* = balance)
- 3 stone block (*mahmul/rabad* = beam)
- 4 reeds or branches (*qas'a*) and thorny shrubs (*rukāza, balān*) laid in moist earth
- 5 20-25cm thick earth layer (*trāb*) and chaff
- 6 lime chaff screed finishing

JJ69 Cross vault construction.

- 1 pillars (*da'me*) made from quarry stone masonry, filled with rubble and earth
- 2 reeds or branches (*qas'a*) and thorny shrubs (*rukāza, balān*) laid in moist earth
- 3 20-25cm thick earth layer (*trāb*) and chaff
- 4 lime chaff screed finishing

JJ70 Hipped roof.

- 1 double-leafed exterior wall
- 2 top girt
- 3 wooden lagging decorated on its primary view
- 4 ceiling beam
- 5 rafter
- 6 sprocket
- 7 red roof tiles on battens
- 8 roof ledge and rain gutter, originally both as timber constructions, often slightly decorated
- 9 pole beam



JJ71



JJ72

JJ71 Characteristic roofscape of red-tiled hipped roofs, Al Kaimeh-Wadi Al Nadarah, Syria.

JJ72 Characteristic roofscape of earth-covered flat roofs, Al Msekeh-Hauran, Syria.

Ceilings viewed from below in traditional houses.

JJ73 Linear corbel stone ceiling, Hauran, Syria.

JJ74 Rafted timber ceiling, Wadi Al Nadarah, Syria.

JJ75 Wooden lagging, Wadi Al Nadarah, Syria.



JJ73



JJ74



JJ75

OPENINGS

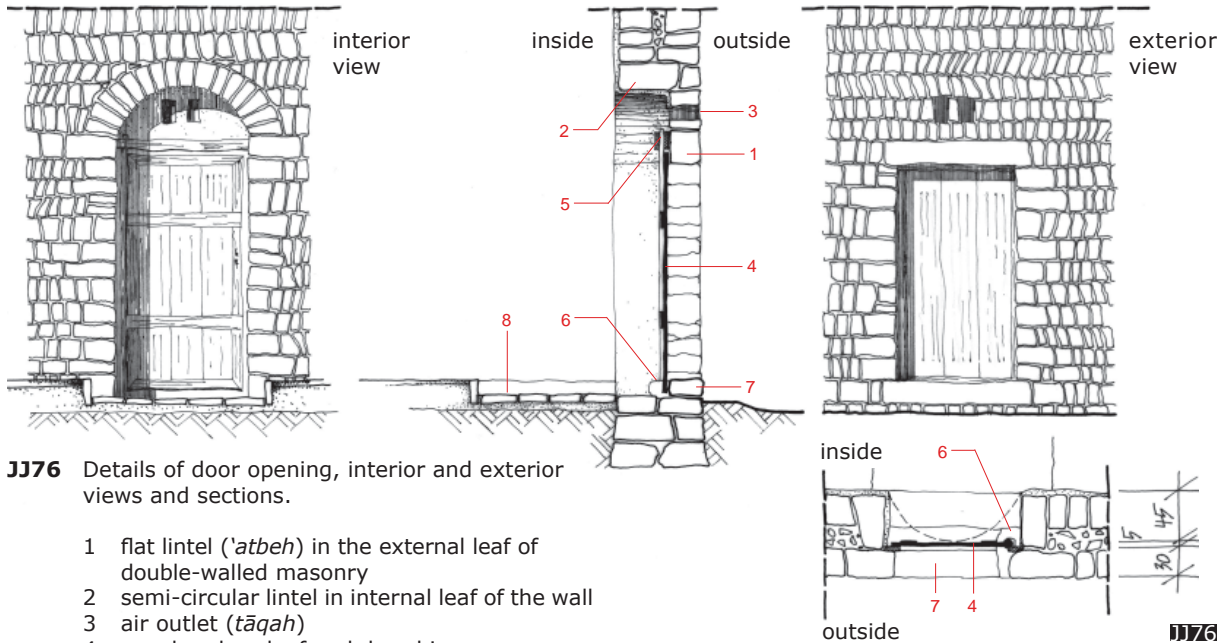

JJ76 Details of door opening, interior and exterior views and sections.

- 1 flat lintel (*'atbeh*) in the external leaf of double-walled masonry
- 2 semi-circular lintel in internal leaf of the wall
- 3 air outlet (*tāqah*)
- 4 wooden door leaf and door hinge
- 5 timber clamps or metal ring used as upper guide track of a door
- 6 perforated stone as lower guide track
- 7 stone threshold (*bertāsh*)
- 8 paved inner service space (*madura*)

JJ77 Common door opening showing a flat lintel outside and semi-circular inside arch, Anaz, Syria.

JJ78 Door leaf and door hinge of wood.

JJ79 Detail lower guide track of the door facing the paved inner service space (*madura*).

JJ80 Detail lower stone guide track of the door made of perforated stone.

The door opening, with a flat lintel outside and a semi-circular arch inside, is commonly used in traditional houses.

Occasionally found are flat lintels, inside and outside (either of stone, timber or with embedded timber beams between the stones), or an arch in both leafs of the wall.

Furthermore, a rich variety of lintel types appeared. These combined original forms and followed constructive and aesthetic aspects.



OPENINGS

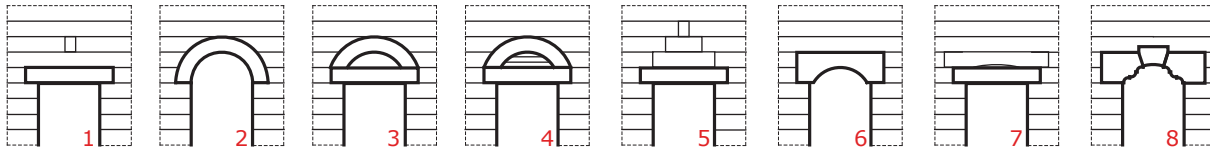

JJ81 Lintel types.

JJ81

- 1 flat lintel
- 2 semi-circular lintel
- 3 combination of flat and semi-circular lintel
The latter seen as an arch in relief with integrated air outlet.
- 4 combination of flat and semi-circular lintel with masonry filling
- 5 flat lintel with plane stone pyramid in relief
- 6 combination of flat lintel and segmented solid block arch
- 7 overlapping flat lintels with incised air outlet
- 8 combination of flat lintel and shouldered arch composed of three pieces

JJ82-86 Varying examples of lintel types from Syria and Jordan.

JJ87 Impressive door made completely from single stone slabs including the door leaf, hinge, upper and lower guide track and the flat lintel, Al Msekeh-Hauran, Syria.

JJ88-93 Lintel pairs; inner and outer leaf in walls of door openings, Wadi Al Nadarah, Syria.





OPENINGS

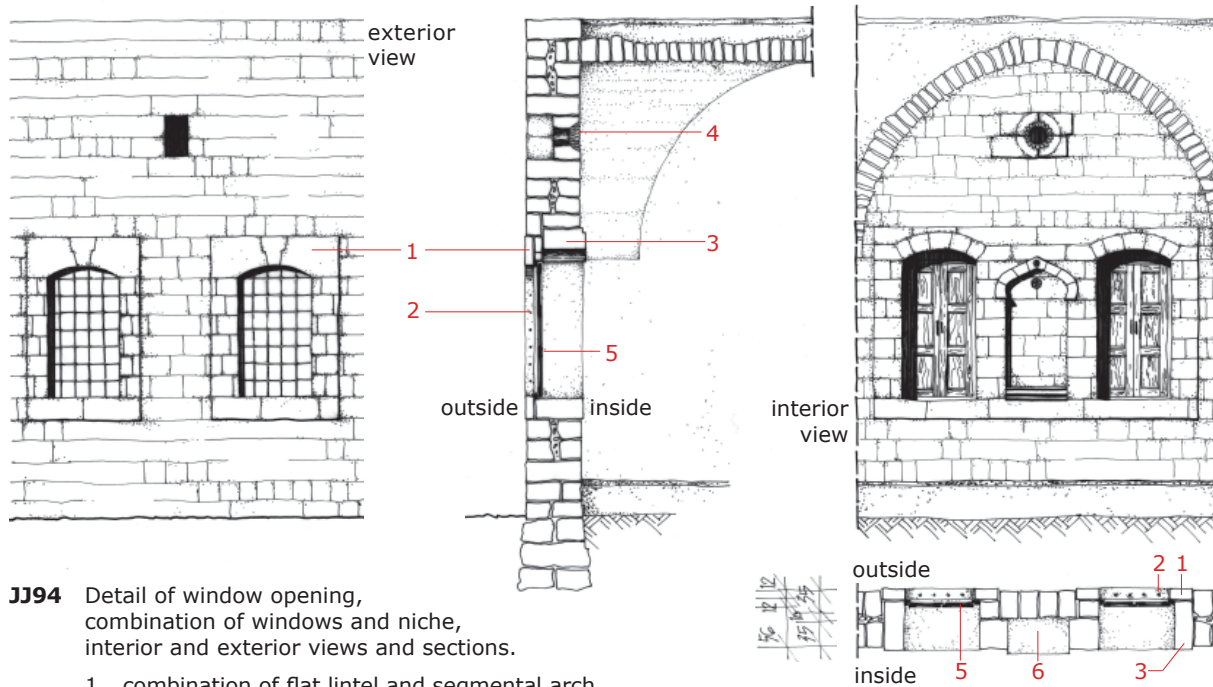

JJ94 Detail of window opening, combination of windows and niche, interior and exterior views and sections.

- 1 combination of flat lintel and segmental arch
The arch is composed of three pieces including window framing stones slightly emerging from the external leaf of double-walled masonry.
- 2 steel bars
- 3 internal leaf of double-walled masonry with slightly emerging stone frieze combining two windows with segmental lintels and a niche within a horseshoe shaped arch
- 4 air outlet with decorated wall rosette inside, and in a simple rectangular shape outside
- 5 double-winged wooden windows
- 6 interior decorative niche

JJ94



JJ95

JJ95 Window openings and internal niche, Al Kaimeh, Syria (see JJ94).



JJ96

JJ96 Remains of an opening consisting of windows and door as often used in *Central Hall Houses*. The openings are spanned with horseshoe shaped arches, Tell Kalakh, Syria.

JJ97 Commonly used arch types.

- 1 pointed, lancet or Gothic arch (*ra'siya* literally meaning pointed or *murabab* meaning pointed nose)
- 2 pointed version of a horseshoe arch (*mughrabi*, from the Maghreb, i.e. North Africa and Spain)
- 3 semi-circular arch (*rūmani/rūmi*, Roman arch)
- 4 segmental arch (*hilāliya*, literally translated as a crescent with different relations from arch to chord, e.g. *nusf rūmi* = $\frac{1}{4}$ arch rise or half a Roman arch; *mahmūs* = $\frac{1}{5}$ arch rise)
- 5 ogee arch literally translated as shouldered segmental arch (*madaniya*, referring to Medina)
- 6 trefoil arch

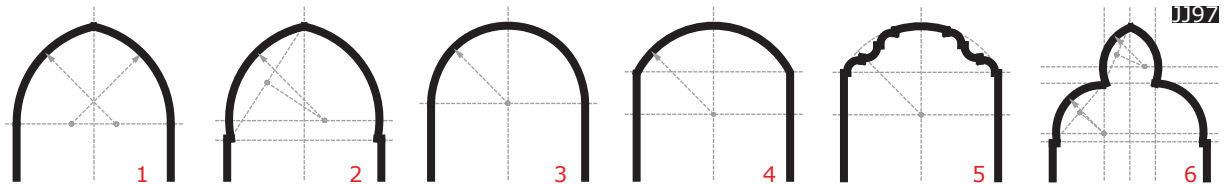

STAIRS

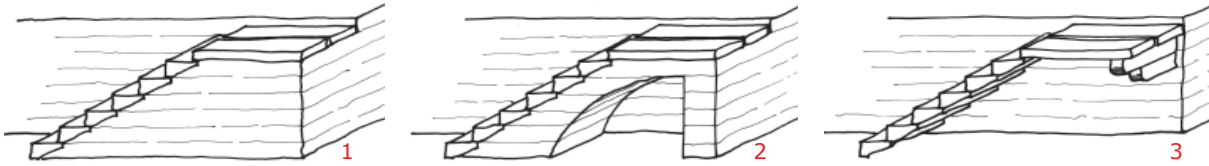

JJ98 Commonly used staircase types.

JJ98

- 1 staircase resting on massive masonry block
- 2 staircase resting on a vaulted construction
- 3 cantilevered staircase built with stone blocks integrated into double-walled masonry either as steps or as corbel stones supporting a stair platform or a balcony of stone plates

Traditionally, staircases were built externally and commonly added to the main elevation. They either were built as a single run or with a 1/4 winding. In addition to providing roof access, staircases, mainly cantilevered, were also useful for weather protection spanning windows and doors.





JJ99 Simple staircase constructed of basalt field stones resting on a vaulted construction, Al Kaimeh, Syria.

JJ100 Cantilevered stone block staircase, Marmarita, Syria.

JJ102 Staircase resting on a vaulted construction, former silk mill in Mashta Helou, Syria.

JJ101 A sophisticated version of the *Closed Rectangular House* in Marmarita, Syria. The first missing steps of the cantilevered staircase represent a simple safety measure protecting the summer rooftop sleeping space from unwelcome guests. A portable wooden ladder, *sellom*, helps to climb the first heights and is taken along to the roof.



CORBEL STONES

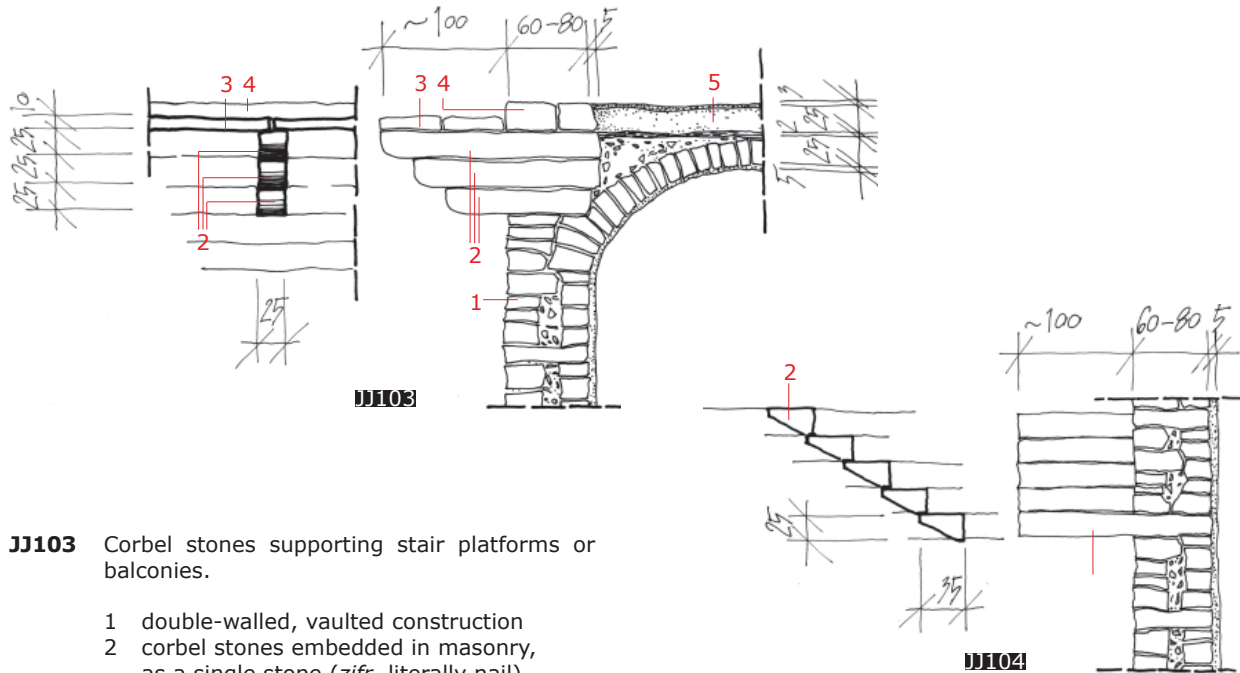

JJ103 Corbel stones supporting stair platforms or balconies.

- 1 double-walled, vaulted construction
- 2 corbel stones embedded in masonry, as a single stone (*zifr*, literally nail), or stacked with other stones (*tunūf*)
- 3 stone plates as landing or platform
- 4 roof framing stones as super-imposed load
- 5 flat earth-covered roof construction

JJ104 Corbel stones forming cantilevered staircases.

- 1 double-walled masonry
- 2 corbel stones embedded in the masonry, as modular, mason-worked elements with a rear rectangular cross section and tapered front, 1/3 its length as anchoring depth





JJ106

JJ105 Triple corbel stones embedded in ablaq decorated masonry, Marmarita , Syria.

JJ106 Similar construction embedded in masonry, Zuwetīna, Syria.

JJ107 Corbel stones forming external single run cantilevered staircase, and double-layered support for stair platform and balcony, Marmarita, Syria.



JJ107

HEATING

In traditional houses the massively constructed walls and roofs provide good thermal insulation and thus, a comfortable internal climate in summer heat and winter cold.

For heating purposes open fireplaces, burning charcoal, dried manure or brushwood are utilized.

The smoke dissipates through small openings situated slightly under the roof, hence these houses can also be referred to as *smoke houses*.

If a stable opens into the living space, the animals warmth also affords an additional heating source.

Varying types of open fireplaces and heating tools.

- small clay stove (*maw'ad*), consisting of a lower clay part with a ventilation opening and some pots for cooking
- small clay fire pot (*manqal*), consisting of a lower metal frame and an upper clay pot
- chimneys on outer walls, less frequently used
- oil stoves (*sūbiya*), consisting of a stove with small oil tank and fire tubes. Located inside the living space, the oil stove subsequently replaced the above-mentioned fireplace types.

Varying types of baking tools.

- curved metal plates (*saj*) used as stove covers or over an open fire
- baking oven (*tannūr*)
built of stone (*tannūr haschr*)
or more commonly from clay (*tannūr shūsheh*)

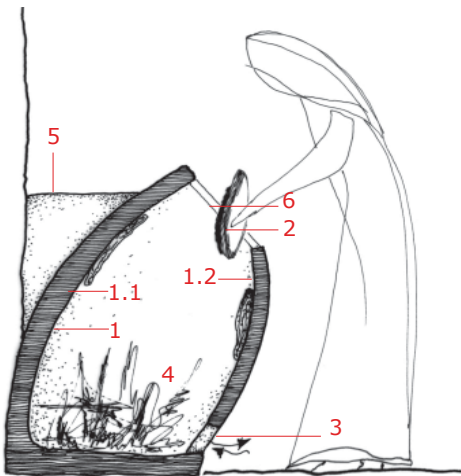

JJ108

JJ108 Clay baking oven.

- 1 mixture of clay, goat hair and tamped bits of broken glass (or silica) for inclining *tannūr* walls
- 1.1 less inclined wall providing a heated side for baking flat bread
- 1.2 more inclined wall affording a less heated side for baking thick bread
- 2 upper *tannūr* opening
- 3 lower *tannūr* opening showing ventilation and a slag outlet
- 4 fireplace
- 5 warmed surface for dough preparation
- 6 leather glove used to place the bread dough on the oven walls and to fetch the baked breads

- JJ109** Detail of a baking oven, *tannūr*, local history museum, Deir Atiyeh, Syria.
JJ110 Interior view of a baking house with ovens in two corners, Dana, Jordan.



VENTILATION



In traditional houses, continuous ventilation is maintained through various small openings, and various windows and doors that are not completely sealed.

In the walls, smoke outlets are constructed as tiny openings (*tāqah*) or larger ones (*nafizah*). They are either simply rectangular in shape or decorated with masonry worked stone pieces. Regularly they are situated slightly below the ceiling to avoid drafts, and often centered above the door to emphasize the main entrance.

Smoke outlets are less commonly situated within the roof structure. More commonly, these openings are used as filler holes (*rozannah*) pouring grains or other goods into clay storage bins (*sandug*).

In summer, the massiveness of the house construction and continuous ventilation provides a cool breeze. Additional elements, such as the *Liwān*, or the *Riwāq* and shady courtyards planted with trees intensify this constant air exchange. Conversely in winter, ventilation holes are plugged with rags.



JJ111-112 Smoke outlets inside flat earth-covered roofs.
 JJ111 Anaz, Syria
 JJ112 Dana, Jordan

JJ113-115 Smoke outlets inside walls, examples from Syria and Jordan.

JJ116-117 Inner and outer leaf of a wall with smoke outlets integrated into decoration,
 Wadi Al Nadarah, Syria.



WATER & SEWAGE SYSTEM

Traditionally, fresh drinking water was fetched from the village fountain (*'aīn*), transported in big jars and stored near the house entrance. Occasionally, channel systems organized water distribution and field irrigation. In contradiction, individual wells (*bīr*) or running water supplies were very rarely found.

Slope and sewage water was transported from a service zone (*madura*) at the house entrance out through an opening under the threshold. From there it was guided via stone channels from courtyards to the garden or further away.

Inside traditional houses, sanitary installations were unusual. There might have been a floor toilet in a corner of the yard, but since the houses were situated next to open land there was not necessarily a need to implement any kind of extensive sanitation system.

Rainwater was collected on the roofs in drip mouldings (*mozrab*) made from clay, mud or stones or constructed of timber or metal. Most commonly, cisterns were used to catch rainwater as a secondary reservoir.

After heavy rains, and as a regular maintenance activity, flat earth-covered roofs and their lime chaff screed finishing had to be compressed. For this purpose a stone roller (*madafeh*) was regularly used.



JJ118

JJ118 Channel system, Danaa, Jordan.

JJ119 Water jars used to collect and organize fresh water supplies, 'Amar Al Hosn, Syria.

JJ120 Roof maintenance via stone roller, Al Kaimeh, Syria.



Aljundi, Ghiyas. L'architecture traditionnelle en Syrie. UNESCO Établissements humains et environnement socio-culturel, No. 33, 1984

Amiry, Suad. Tamari, Vera. The Palestinian Village Home. Trustees of the British Museum, BM Ass., London, 1989

Davie, Michael F. La Maison Beyrouthine Aux Trois Arcs: une architecture bourgeoise du Levant. Editions Alba, Beirut, 2003

Kfoury, Semaan. Maisons Libanaises. Editions Alba, Academie Libanaise des Beaux Arts, Beirut, 1999

Khammash, Ammar. Notes on Village Architecture in Jordan. Arabesque, Amman, 1995

Liger-Belair, Jacques. L'habitation au Liban. Société Nouvelle, Librairie Orientaliste Paul Geuthner, Paris, 2000

Pütt, Karin. Zelte, Kuppeln und Hallenhäuser. Wohnen und Bauen im ländlichen Syrien. Imhof Verlag, Petersberg, 2005

Ragette, Friedrich. Architecture in Lebanon: The Lebanese House during the 18th and 19th Centuries. American University of Beirut, Beirut, 1974

Ragette, Friedrich. Traditional Domestic Architecture of the Arab Region. Edition Axel Menges, Stuttgart, 2003

Sinjab, Kamil. Das Arabische Wohnhaus des 17. bis 19. Jahrhunderts in Syrien. RWTH Aachen, Aachen, 1995

Thoumin, Richard. La Maison Syrienne dans la Plaine Hauranaise, le Bassin du Baradah et sur les Plateaux du Qalamun, in Melanges Géographiques offerts par ses élèves à Raoul Blanchard. Paris, 1932

CORPUS-Levant. Handbook for the Maintenance and Rehabilitation of Traditional Syrian Architecture.
<http://www.meda-corpus.net>, 2004

CORPUS-Network. Nourissier, Gilles. Reguant, Joan. Casanovas, Xavier. Graz, Christophe. Traditional Mediterranean Architecture. Barcelona, 2002



CONTEMPLATIONS ON CONTEMPORARY CONSTRUCTION ROUTINES, EXAMPLES FROM AMMAN

West-Amman exemplifies a unique and prosperous modern city development, which has grown over the past six decades and continues to expand in the twenty-first century. An examination of West-Amman's growth provides opportunities to explore an unbridled city development that has taken place in a region where stone is the predominant natural building material.

Within a mostly tribal society of Bedouin origin, and with only a few historic architectural examples as cultural reference, West-Amman reflects the images and ideas of a young emerging nation seeking what it believes is identification with the modern world.

This article contemplates the building activities in West-Amman in terms of unity of design and building techniques. Focusing on standard housing and office buildings, underlying premises of sustainability and local traditions will be addressed. While one can find good architects and amazing local building examples, the majority of building activity is purely investment oriented and shows a lack of detail refinement.

This is not due solely to a shortage of money, but is founded as well on a lack of understanding among planners and buyers, insufficient regulations and control systems, and an untrained labour force. Nevertheless, as problems become increasingly evident, there is hope for buildings which are better adapted to the environmentally predominant living conditions in Jordan for the sake of *all* Jordanians.

This article lives on its images, which are, if not otherwise mentioned, taken from the developing districts of Dahit El-Rashid and Jubeiha in West-Amman.



IH01 Amman panoramic view



Table of Content

THE URBAN FABRIC

History
Approaching Amman Today
Street Space
Residential Buildings
Apartment Blocks
Houses and Villas
Office and Commercial Buildings

BUILDING CONSTRUCTION

Setting
Structure and Materials
Stone as Building Material
Stone Surfaces
Walls
Wall Mounting
Glass Fronts
Openings - Windows and Doors
Floors and Roofs
Balconies
Stairs
Building Construction Cycle

UTILITIES

Water Supply
Supply and Disposal Lines
Electrical Circuitry
Energies



History

Amman has a long history evidenced by the early Neolithic site *Ain Ghazal* situated in the outskirts of Amman, which ranks as one of the largest known prehistoric settlements in the Middle East. From ancient to Islamic times the city has attracted different cultures. Its heyday began after it was annexed into the Roman frontier province of Arabia by the emperor Trajan. In 635 AD the Arabs conquered and occupied the city. Only after 750 AD, when the Omayyads made Damascus their capital, did the city gradually decline. Contributing to its downfall later centuries witnessed earthquakes and natural disasters

leaving a small village and a pile of ruins. At the end of the 19th century a Circassian settlement revived Amman. King Abdullah I chose Amman as seat of government for his newly created state in 1921, which later became the capital of the Hashemite Kingdom of Jordan. Still being a small city, its population expanded considerably due to several waves of refugees from Palestine, Kuwait and Iraq (1948 from the Arab-Israeli War, 1967 from the Six-Day War, 1990 from the Gulf War and 2003 from the Iraq War). As a result Amman has grown rapidly to become the modern capital of the Kingdom of Jordan, a hub for the Middle East in general,



IH03

and is often referred to as the most western oriented city in the Middle East. It is said that in biblical times the city stretched over seven hills. Presently much more land has been included within the cities boundaries.

IH02 Historical map, presenting Amman in the 1930's, showing mainly Circassian properties (source: Ali Maher, Amman).

IH03 Historic Amman and the monuments of Jabal al Qal'a, which is the Citadel Hill, with the Temple of Hercules and ruins of the Umayyad palace.

IH04 The vision of a new downtown in the Abdali district of Amman (source: en.wikipedia, CC-BY-SA-3.0.2008-12-11, Joeyzaza).



IH04

Approaching Amman Today

IH05 The Street map demonstrates the importance of the circles for orientation in the city, which is difficult due to the uniformity of street spaces and buildings. The main east-west running artery is called the *Circle Road* (source: en.wikipedia Amman).

IH06 Airport Road to West Amman.

IH07 Sprawling West Amman.



Amman continues to grow. Whole new districts crop up on its southern and western edges. This nondescript urban sprawl rolls far into the hilly, and once agriculturally prolific countryside. Consumption of fertile land is immense with no vested interest in controlling it. This issue deserves consideration especially when food production is essential to a country with a growing population. In these new city areas one mainly finds tall apartment blocks for the upper middle class as well as private castles of the rich.

Coming from the Queen Alia International Airport, which is about 30 km south of the city, the currently extended airport highway passes by this new urbanisation and connects with the inner city's main traffic artery, the so-called *Circle Road*. The *Circle Road* stretches east to west, from the 1st circle at Jabal Amman to the 8th circle in West-Amman. The eight circles, making up the *Circle Road*, are important for orientation, and counter the uniformity of street spaces and buildings found in the present-day urban sprawl.



Approaching Amman Today



The city extends almost uncontrollably into the landscape. Thus fertile land is diminished. Instead of establishing drought tolerant low water use plants arid land is often made green by unsustainable planting (IH08 refers to Margaret Louderback's article *Waiting for the rain*).

- IH08** Villa along the Desert Highway south of Amman.
- IH09 and 11** Southwest edges of Amman.
- IH10** Villa along the Amman-Madaba Road.





IH10



IH11

Street Space

Mainly adapted for cars, street space often appears too wide and open for pedestrians. There are insufficient wind barriers for the cold, and lack of shading devices for the hot season. Sidewalks are preferably used for planting trees, mainly olives and palms, which hinder pedestrian movement. Private tree planting in sidewalk areas has been explained as a resident's claim to street property, thereby taken away from the public. The possibility of comfortable walking does not exist, creating a conceptual city layout more closely aligned to the classic American car-city. What is to be strived for is a mixed-use concept where pedestrian and public traffic work in harmony with each other.





IH14



IH15

IH12 and 13 Al Radwan Street.

IH14 and 15 Olive trees
planted in pedestrian walkways.

Residential Buildings

The licensed area for construction in Jordan has more than doubled from the year 2000 to 2007. Residential buildings, mainly in the cities of Amman and Aqaba, have attributed significantly to this statistical fact.¹ The trend seems to continue in 2011, even during the slow down due to the world financial crisis.

The most common house type is a relatively high standard apartment block, followed by popular family houses called *dar*, and villas.² Apartment buildings more often differ by applications of stucco work than from the architectural design itself. While in family

houses or private villas one can find more authentic architectural design (IH17-18), often façades and exterior designs are lacking sophistication.

Design ideas coming as a matter of course from the site and the climate are rare. It seems less common to design houses according to the sun's trajectory. This consideration is not evident in floor plans or in window sizes and positions, a primary first step towards energy efficiency and sustainability. More emphasis is given to the cloth or building envelope resulting in an image projection of street façades only.



IH16 Apartment block. It seems that a lack of self-evident architectural development needs to be varnished by cosmetic applications.

IH17 Villa by architect Rasan Badran.

IH18 Family House.



IH17



IH18

Apartment Blocks

Same, same, yet cosmetically different.

These buildings rarely contribute to a sense of place. They do not understand the changing climate conditions due to the yearly solar cycle, and they do not talk to the neighbours, as there is no understood and defined neighbourhood context. The standard middle class apartment blocks are not individualised in floor plans and orientations for the needs of the owners. Distinction occurs in exterior decorations mainly devised for expression toward the street.

IH19-21 Apartment block on Hashem Ahmad Adabas Street.

IH21 A back-alley showing a lower level used for parking and utilities such as water and oil-tanks and burners for individual apartments.

IH21-25 Standard middle class apartment blocks. The stairway splits the houses into mirrored halves.



IH19

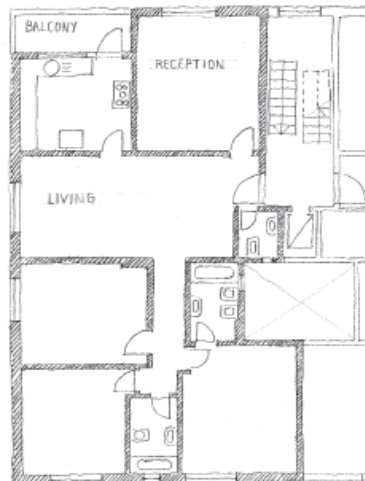



Houses and Villas

Many houses seemingly want to impress the beholder, often with an imported image of great iconic architecture. Unfortunately this preconceived greatness often has nothing to do with the site or tradition, instead demonstrating a lack of confidence and understanding of architectural form generation.





IH29



IH32



IH30

**IH26-29
and IH32**

The villas pictured do not contribute to spatial neighbourhood context. Unity is sacrificed to individual surface impressions with no core of authentic architectural origin.

IH30 and 31

The modest and local character of the house pictured in IH30, with an inner loggia and courtyard, is best adapted to the site. The classic modern villa in IH31 stands with authenticity.



IH31

Office and Commercial Buildings

Most office and commercial buildings in Amman try to copy an image that is thought to be modern and international translated for many into glass fronts or façades. Solar glasses are used to reduce light transmission. This is achieved either with a special noble metal coating or through tinting. The resulting reduced light transmission not only diminishes the heat input in summer (and winter, when it might be needed), but it also decreases the daylight factor through out the year. The first solar glasses, used in the seventies, were dark-ish coloured creating a mirror-glass effect on the outside and a resultant colour shift inside. This contradicts the modern idea of transparency through glass, nevertheless it is widely used in Amman (IH36). Solar glass does not provide a glare shield.

It does not allow passive solar energy use, and it diminishes the possible thermal storage mass of the building. Resulting problems are an uncomfortable indoor climate, and a high-energy demand for air conditioning. For good sun protection, consideration for windows and glass front orientations, which correspond to daily and yearly sun trajectories, is needed. It is crucial to understand that on east and west sides the sun's position is low and the sun-hours, especially in summer, are long. Therefore, while it is best to avoid excessive openings towards east and western exposures, an outer sun protection system that is more vertical than horizontal can be utilized. Accomodating the sun's high position in the south it is easy to add additional horizontal sun protection or planned overhangs. In winter, when the sun's energy is advantageous, the lower sun position would not be blocked by these horizontal protections.



IH34-37 Typical glass front buildings situated through out the city.

IH34 Medina Street
IH35 Airport Road
IH36 Abdoun
IH37 4th circle

IH38 A design exception where possible massive thermal active walls are combined with a glass front.



IH36

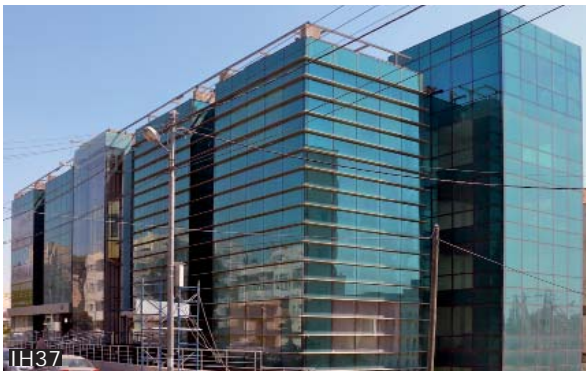

IH37



IH38

Setting

Not many buildings in West-Amman follow the existing topography. It is more common to cut a hole in the prevailing rocky ground inserting a building unit. Due to this practice buildings often become generic blocks, which are not referenced to a specific site. High retaining walls and sunken gardens or terrace spaces are a result of this practice. Excessive rainfall in winter can create flooding in these areas if there is not good drainage.

Very often the basement of these buildings is used like cellar rooms for utilities, oil burners, oil and water tanks.





- IH39-40** Houses with sunken terraces and gardens.
IH41-42 Earthwork and foundations for housing.
IH43 Retaining wall.
IH44 Skeleton of a house inserted in a cut hole on University Street.



Structure and Materials

The Jordan Valley, like the Dead Sea and the Gulf of Aqaba, is situated between two continental plates creating an earthquake fault line. Reinforced concrete skeleton structures, pervasive in Jordan, provide an earthquake deterrent solution, and are economically feasible. Walls are usually non-structural and consist of concrete hollow blocks, in-situ poured concrete and treated natural stones, referenced inside to outside. Concrete hollow-block stone is one of the most important wall building materials used in Amman.



- IH45** Concrete hollow blocks are used to accommodate temporary workers on a building site.
- IH46** Concrete skeleton structure, University Street.
- IH47** The Wild Jordan Center in Jabal Amman designed by architect A. Khammash, uses a concrete skeleton as a scaffold, which becomes rooms and terraces overlooking the downtown area.
- IH48** An ordinary house structure built of reinforced concrete and filled with hollow cement blocks around the window holes in the upscale district of Abdoun.



IH48



Stone as Building Material

Natural stone comes in machine-sliced blocks to small local factories where the stone slices are cut into stone panels of different sizes. Many natural stones used for building purposes are found in Jordan

(see Nizar Abu-Jaber's article), but increasingly stone is being imported from other countries like Turkey. Very often the surface treatment of the stone is still done traditionally by hand at the building site.





IH50

IH49 Machine-sliced natural stone being cut into panels for building purposes. Jordan Valley workshop.

IH50-51 Stone surface treatment done on site.



IH51

Stone Surfaces



A large variety of stone formations can be found in Jordan, but limestone is the one most quarried and used for building purposes. While older houses were built from whole stone blocks, presently natural stone is almost entirely used as cladding material. It is still common to manually work the surface of stone with a variety of tools, even as machine-dressed stone surfaces are gaining popularity. It is not only the colors and different surface treatments, which vary in stone façades. The arrangement and the size of the stone courses also create variation.

IH52 Modern house in Jabal Webdeh with *Tubzeh* (local Arabic term) stone dressing. Usually houses in the 1920's and 30's were dressed in the rougher *Tubzeh* manner.

IH53 *Mufajjar* stone surfaces were widespread in the 1980's with a medium roughness between *Musamsam* and *Tubzeh*.

IH54 House in Jabal Amman dressed in the *Musamsam* manner of more even surfaces. This method gained popularity in the 1940's.

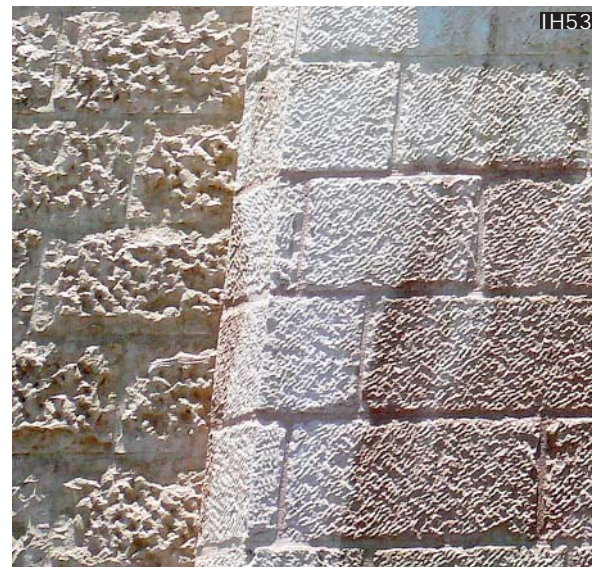

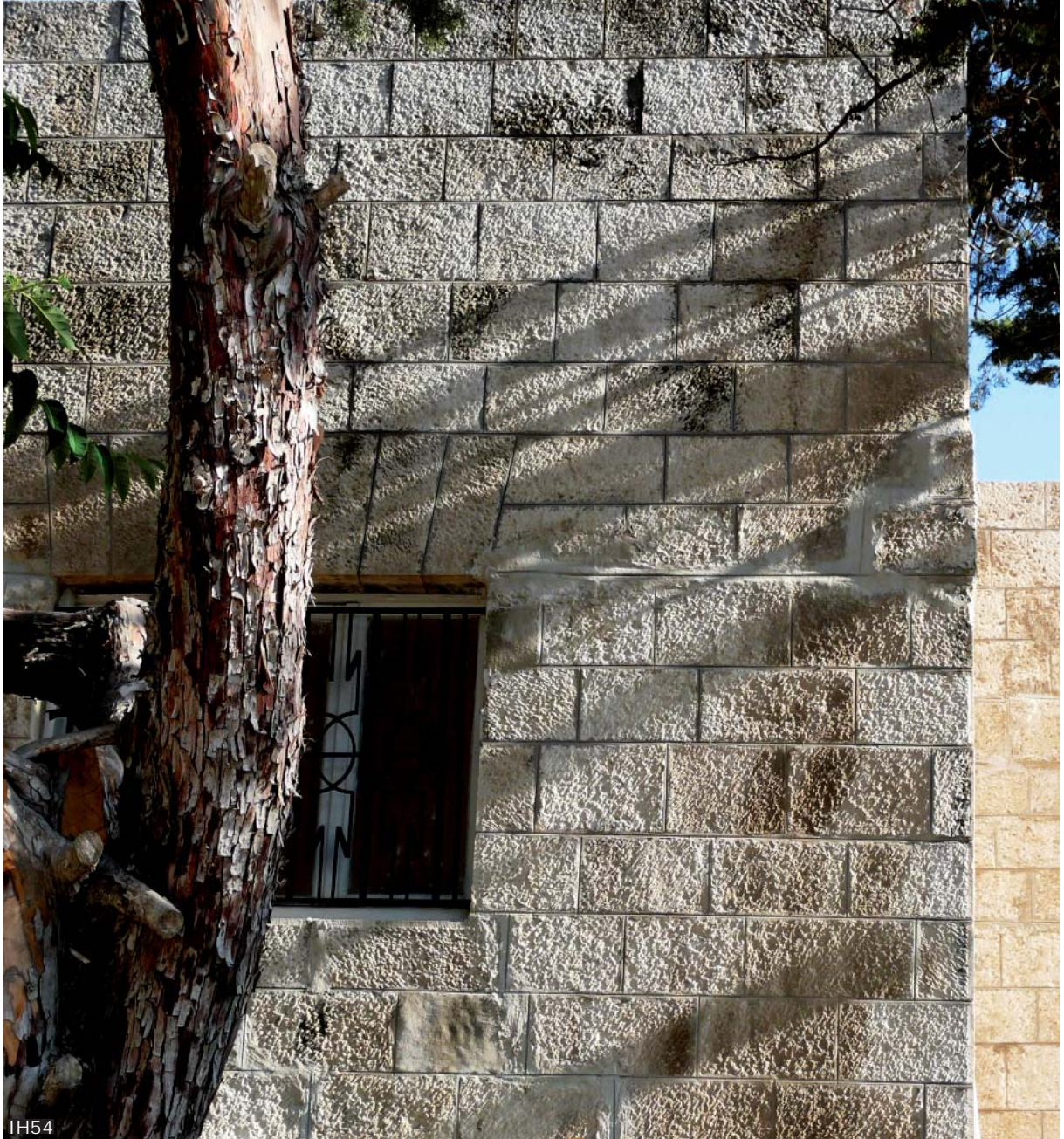

IH54

Walls

In Amman a general building code requires light stone façades for the outside of buildings. But what appears as a massive wall of stone to the untrained eye proves to be only a thin stone cladding. During construction wooden wedges keep the stone panels in place until the cast concrete behind them hardens and connects with the stone.



IH55-58 Stone panels kept in place with wooden wedges until the concrete behind hardens and connects with the stone.

IH58 House façade in Tla' Al Ali.

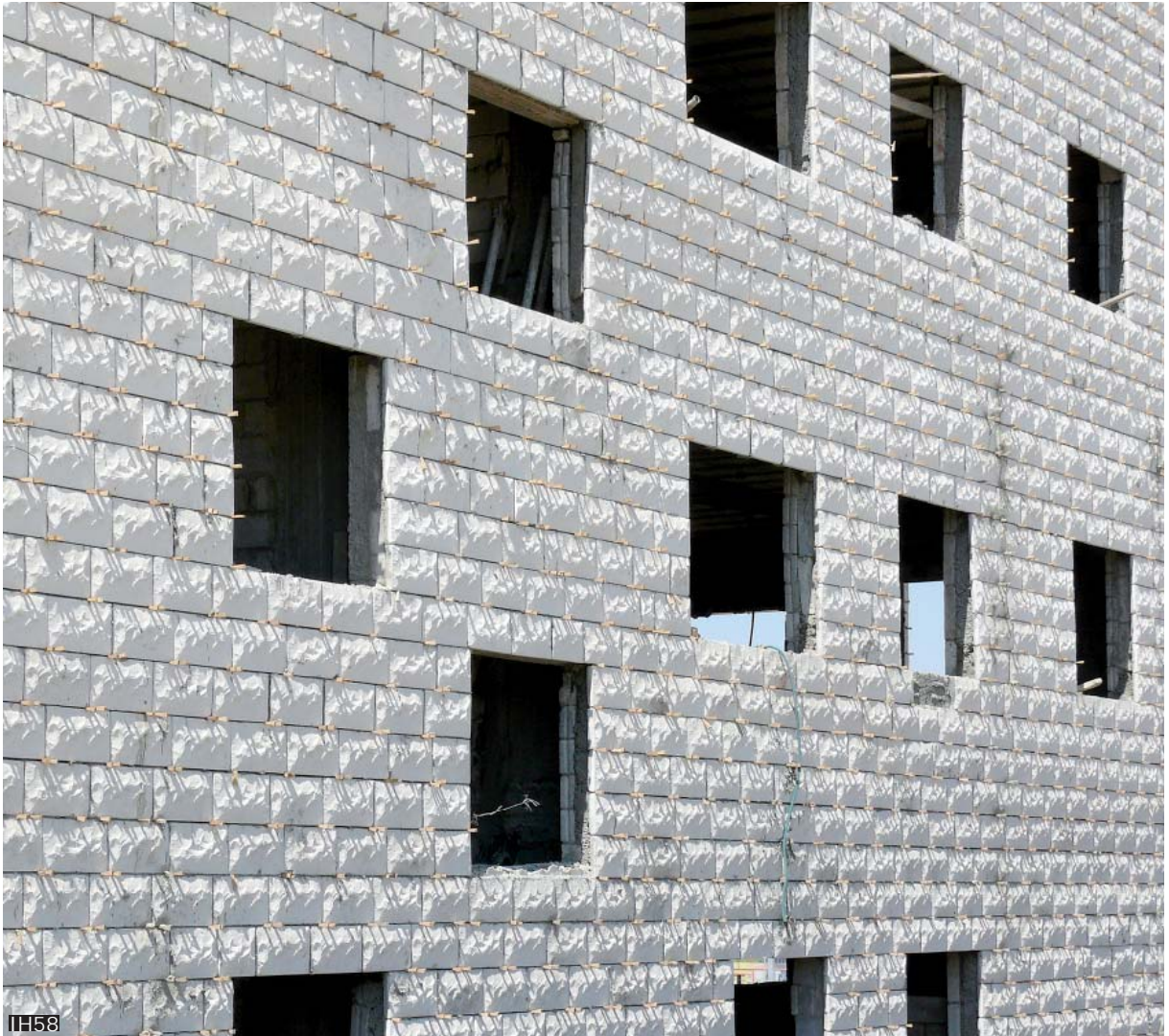

IH58

Wall Mounting

The prevailing wall section for housing is made of hollow block stones, cast concrete and natural stone (from inside to outside). A thin layer of thermal insulation, usually polystyrene, is becoming more widely used (IH62).

Generally speaking the thickness of the insulation layer is not enough to reach sufficient low heat transmissions (U-value) through the wall, and the position of the insulation layer is also problematic. Common thermal bridges, such as concrete columns and slabs, are not protected by the insulation layer, which is usually positioned between them.

Therefore they transmit the heat easily outside in winter and inside in summer. In addition there is not enough thermal mass, normally a heavy material, added to the inside of the building. Thermal mass is required to balance timely temperature differences for good indoor climate. The fixing of the stone cladding with cast concrete brings a possible thermal active material to the outside of the building. A technical solution for this problem would be an anchoring system to fix the stone cladding. This would also allow air circulation behind the cladding to keep the wall dry and humidity free. Humidity in the wall diminishes the U-value, and is a frequent problem of buildings in Amman.

Vertical
Wall Section

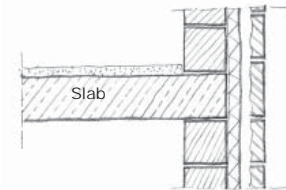
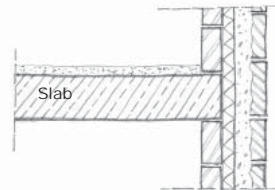
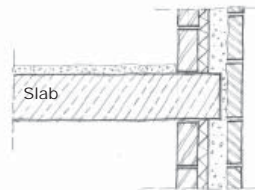

Horizontal
Wall Section

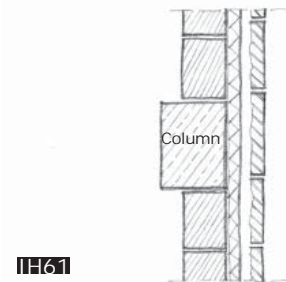
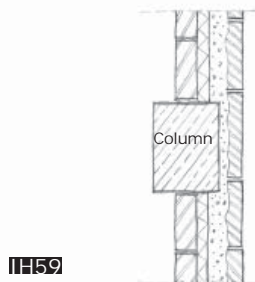

Reportedly this problem has increased due to a lower quality of the stone currently used for the cladding panels. This newly used stone has a higher porosity allowing humidity to penetrate more easily.

- IH59** Wall section, from inside to outside; 10 cm concrete hollow block, 3-5 cm heat insulation, 8 cm cast concrete, 5-7 cm stone cladding.
- IH60** Same section as IH59 but without thermal bridges. The insulation is covering the skeleton structure including the concrete floor.
- IH61** Hollow block stone is replaced by a heavy brick or concrete block for better thermal storage capacity towards the inside.
- IH62-64** The building process of a wall. The outer thin stone panels are erected together with the inner hollow block wall in a step-by-step process (IH64). The insulation layer is then placed and concrete poured in between.



Glass Fronts

Structural glazing allows for the complete glass covering of a building without a visible supporting structure. The effect is a homogeneous glass surface. One can find examples on many buildings, but the inherent promise of transparency and large open spaces is rarely kept. Hidden behind the tinted glass and due to the mirror glass effect one might not see the usual skeleton structure from the outside, but it will be experienced once a person enters the building. Additional to the usual heat gain through the glass façade (see also office and commercial buildings) the unprotected skeleton structure, mainly the slab, will absorb sun energy leading to extra cooling needs in summer. To solve these problems it is recommended to use an insulating panel façade separating the structure from the opening (IH65).



IH66 shows a well-designed glass front where the levels of the building are still readable. Nevertheless the question of sun protection has to be resolved, even more so in buildings with clear-glass fronts. A double glass façade system with two layers of glazing and wide air space in between can be used for sun, sound and wind protection, and for naturally tempered indoor ventilation (by using the pre-warmed air in between the two glass layers for inner air exchange). Of course there has to be a well-planned closed system of sophisticated ventilation and sun protection in between the two glass layers. If not, the result becomes just an expensive design decision without offering any advantage to the normal glass façade with double glazing (IH67).

IH65 and 68 Medina Street.

IH66 and 67 7th circle.

IH69 and 70 Jordan Gate Towers at the 6th circle.





IH67



IH69



IH68



IH70

Openings - Windows and Doors



The window shutter in the Pella restaurant wall (IH71) might have been inspired by traditional stone doors as they are found in the region of the Hauran, but the traditional reminiscence is casted in a modern building material, concrete. The steel-glass door in the same restaurant (IH72) supports an inside outside connection while not interfering with the expression of the vault.

- IH71** Window, Pella restaurant.
- IH72** Terrace door, Pella restaurant, architect: A. Khammash.

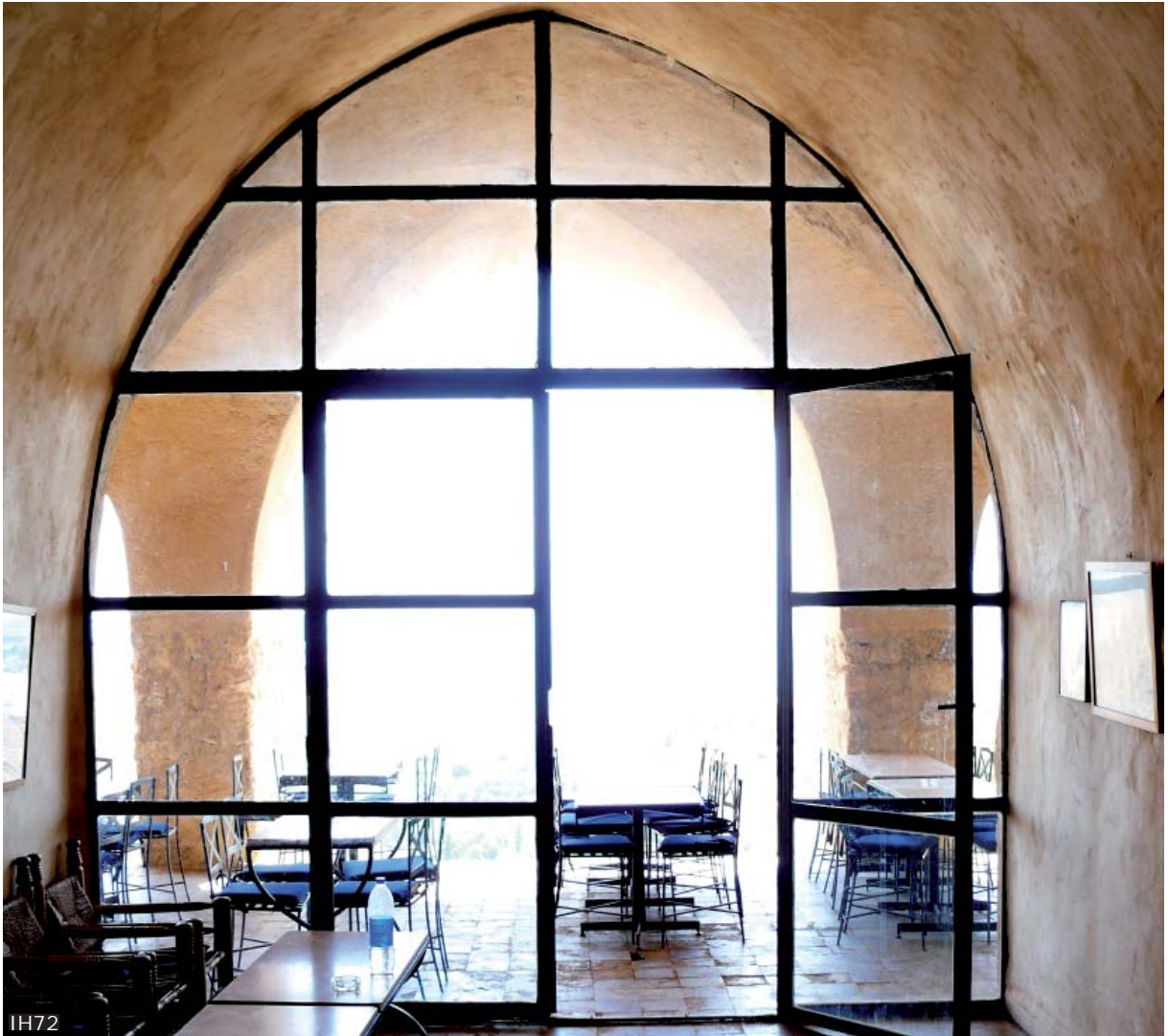

IH72

Openings - Windows and Doors

Openings, such as windows and entrance doors, are important design elements. Very often used as pure decorative elements and exaggerated with symbolism, they lose their deeper meaning as a transitional element connecting outside and inside. The functional rectangular window glass opening is frequently overridden by symbolic decoration done in stone. In IH73 the Greek-antic entrance symbol is set like a triumphal arch in front of the entrance door. Here is an example of symbolism overriding a transitional experience.





IH73-76 Opening decoration of new middle-class housing projects.

IH77 Opening in the Mövenpick Resort & Spa Dead Hotel, designed by architect A. Khammash, might have been inspired by cut stone façades.

IH78 Cut stone façade in Wadi As Seer, assumed to be a pigeonry.



Openings - Windows and Doors

The majority of windows in Amman still come with single glazing and a simple rectangular hollow aluminium profile. Both are highly conductive. Heat transmission through the frame and the glass is already high, and in addition the normally used sliding windows are in no way airtight. European style windows with staggered frame profiles against the airflow are rare and expensive. As if this is not bad enough, the wooden boxes for roller shutters, thought to be helpful against the winter cold and summer heat as well as for privacy, are not insulated. Like long holes in the wall they create energy waste. In older houses one can still find iron shutters that demonstrate expert ironworking skills, a craft worthy of revival. IH85 shows an example of iron-sliding shutters.





IH83

- IH79 and 82** Sliding windows, bottom and top.
IH80 Hole for the shutter box.
IH81 Assembled shutter boxes.
IH83 and 84 Multi-functional iron shutters on old houses in Jabal Weibdeh and Jabal Amman.
IH85 Inspired new sliding iron shutter at a house in Jabal Amman.



IH84

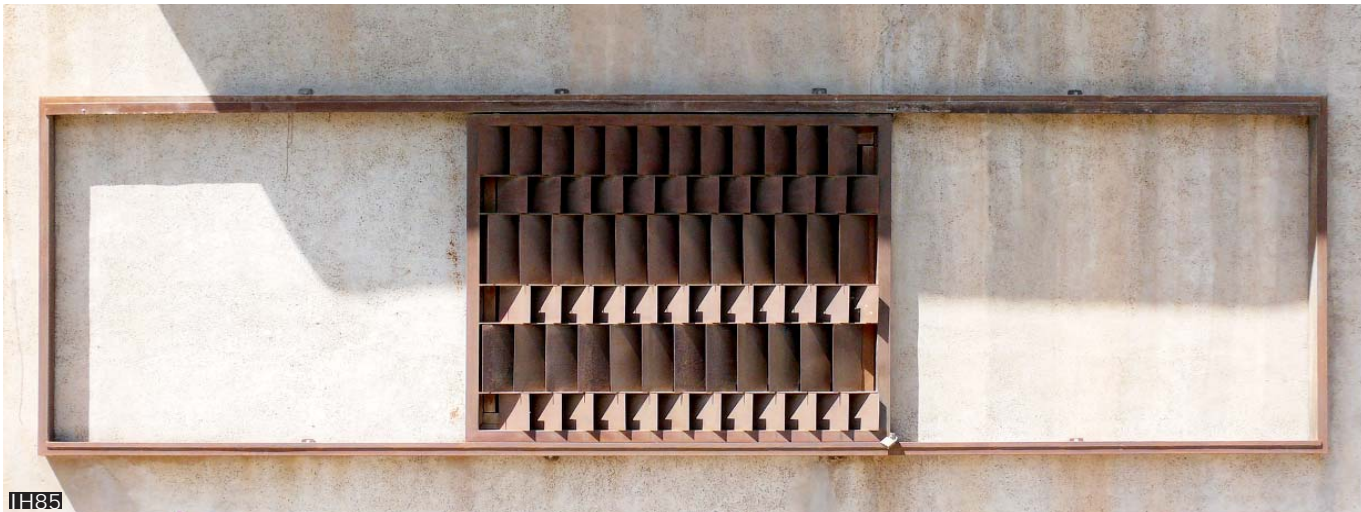

IH85

Floors and Roofs

Floors are commonly built as a linked system of concrete steel bars and hollow cement stone blocks. The slab, casted on site, is carried by simple timber formwork. Screed, on top of the floor slab, levels the surface area. Tiles as a widely used flooring material cover this surface. Resting the screed on a layer of insulation material (floating screed), which works against footfall sound and thermal transmissions, is not common.

For the roof construction, which traditionally is a flat slab, an insulation layer inserted against heat transmissions is even more important than the vertical wall construction, as hot air rises. Typically in Amman an insulation layer on the roof is even less common than for the walls.

Another issue related to roofs is rainfall water. Flat roofs often show water problems in the rainy season. To direct the water outflow it is necessary to have a minimal decline of 2% or more along with a waterproofing layer. Most often neither exists. Hence the rooms under the roof of a building are often too cold in winter and too hot in summer, and frequently leak in some areas after heavy and long rains. Utilities on top of the flat roof (water tanks, satellite dishes or thermal collectors) are often dominant in the appearance of the whole house. It is the design task of skilled architects to find solutions to integrate them within the overall building image.





IH89



IH92



IH90

- IH86** Plastic foil over a shelter blocks wind and rain.
- IH87** Puddle after rainfall on a flat roof.
- IH88** Ceiling water damage under the flat roof of an apartment building.
- IH89-93** Concrete slabs in various stages of construction.



IH91



IH93

Balconies

There is no tradition for balconies in the Arab world where one would rather find comfort in courtyards, terraces or loggias as private outdoor areas. Balconies, mainly found in modern apartment buildings, are more for representation as they seem to be rarely used. Often they are transformed into glazed indoor rooms, which offer more privacy and are better protected from sun, wind, noise or dirt.

Construction-wise, balconies are essentially cantilevered floor slabs. They are not thermally separated from the indoor slab and are not insulated. This makes them thermal bridges par excellence. Techniques for a thermal separation of the slab (indoor-outdoor), extra insulation or extra stilts to rest the balconies on, are not common. Balconies, like windows or doors, are often protected with iron latticework. This can lead to a cage-like expression that also affects interior spaces.



IH94 and IH95 Rarely used balconies on a modern apartment block are very often protected with iron lattice-work.

IH96 Glazed balconies used as an indoor room extension on a modern apartment block. An iron fence is hiding water tanks and satellite dishes.

IH97 Balcony on a historic house in Jabal Amman.



Stairs

Stairways in average apartment buildings are typically built of concrete poured in-situ. Lacking precision and poor workmanship results in first step and stair heads at landings, which often do not match, creating the uneven endings of handrails. The thickness of the stairs can frequently be seen as oversized inconsistent or unproportional to the step height.



IH98 Formwork for a stairway in an apartment block. The upright timber boards form the rising concrete steps while the lower inclined boards form the stairs plate.

IH99 In-situ casted concrete stairway.
IH100 Staiway in an apartment block. The handrails do not form a continious railing system.





IH101



IH102

- IH101** Stairway in Salt.
IH102 Stairway in Jabal Weibdeh.
IH103 Stairway at the Wild Jordan Foundation, Jabal Amman, architect A. Khammash.



IH103



IH104

Building Construction Cycle

IH104-115 Construction cycle of an apartment block on Al Radwan Street, Amman, May 2010 - June 2011.



IH107



IH105



IH108



IH106



IH109

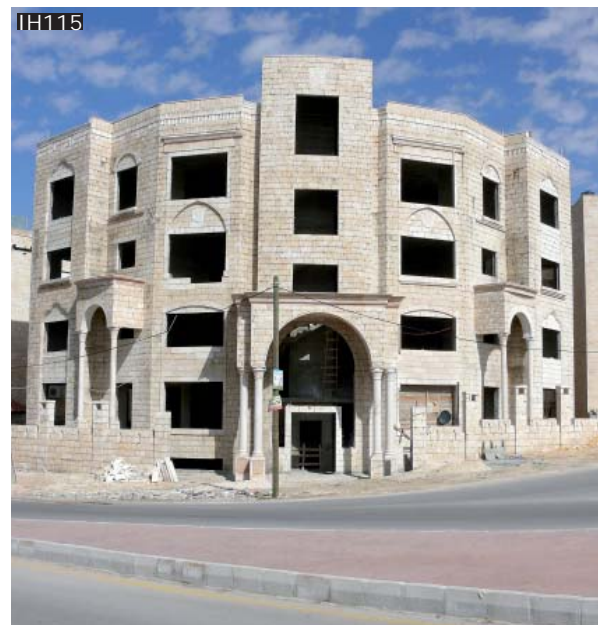



IH116

- IH116** Wadi Mujib reservoir.
IH117 and IH118 Wadi Walla water spring.
IH119 Pipeline from the Disi aquifer along the Desert Highway near Wadi Rum.
IH120 Nabatean aqueduct at the entry Siq in Petra.

Water Supply

Water is a rare commodity in Jordan. The country is considered one of the four most water scarce countries in the world. Currently there is a combination of viable water resources and projects in process to remedy the situation. Rainfall in Amman and the surrounding mountainous areas amounts to an average of 277 mm per year. Short periods of snowfall in Amman are included in this average. Water from the Jordan and Yarmouk rivers contributes to the national average. But because this water is shared between Jordan, Israel and Syria, only a small proportion finds its way



IH117



IH118

to Jordan, and this water is vastly needed for agricultural purposes. Rainwater collected in huge reservoirs in the wadis contributes to the naturally available water resources.

Against the background of future population growth and a strongly growing population concentration in the capital of Amman, it is planned to use desalinated water through the implementation of Red Sea - Dead Sea Canal Project. This project is not without environmental concerns. And finally under current construction is a 300 km long pipeline from the Disi aquifer close to Aqaba and the Saudi border, which is scheduled to bring non-renewable water to Amman.



IH119



IH120

Water Supply

Nevertheless there is a good water supply in Amman although intermittent. The continuity of water supply is, depending on the area, only once or twice a week, and it is common to store this weekly supplied water in individual tanks for each household. Typically every household has one tank on the ground for the main water supply and another on the roof of the building. (It is prudently conscientious to have the roof tank full when the main supply water is running, never knowing if there will be an adequate supply between weekly delivery times.) The roof tank storage guarantees the water pressure in bathrooms and kitchens unless there is an intermediary water pump. Concerning the design, water tanks on roofs are rarely seen as an integral part of the building design adding to the architectural image problem of exposed satellite dishes and thermal collectors.



IH121 and 123 New plastic water storage tanks.

IH122 Meters for counting the water consumption are usually in steel boxes outside the buildings along the streets (see also IH128).

IH124 and 126 Water tanks, satellite dishes and thermal water heating appliances placed on rooftops.

IH125 Water storage tanks in the basement of an apartment block.





IH124



IH125



IH126

Supply and Disposal Lines

Pipes for the water supply, or even bigger pipes for the toilet or rainwater sewage systems, are not always an integral part of the house design. All too often one finds various pipes running inside the exterior walls or even through the concrete structure. This configuration weakens the building's construction, creates noise problems and is hard to control or to repair in cases of damage. Disposal lines may buckle creating a fault location where waste can easily jam pipes. A suggested solution would be to place these systems in shafts or behind pre-wall constructions.



IH127 and 128 Supply and disposal pipes running along the façades of newly built apartment blocks. The lines could be better organized running in ducts.





IH129

IH129 Plastic pipes for water running under a basement ceiling.

IH130 and 132 Pipes running in construction walls are problematic for various reasons.

IH131 A buckle creates a fault location.



IH131



IH130



IH132

Electrical Circuitry

Electrical circuitry, including sockets and plugs, comes in assorted sizes. This creates not only frustrating appliance connection problems, but also introduces unwanted safety issues. Often the connecting parts are not precise in their fittings resulting in faulty currents. The same happens when different equipments, hanging on the same line and socket, use more power than is suitable for the appliance, resulting in an override in the net electricity available. Plastic parts may melt from overheating resulting in fire hazards. Standardization of electrical circuitry, appliances and coding rules could alleviate potential and hazardous problems.



- IH133** Different electrical appliances.
- IH134** Melted plastic socket resulting from an override in the net electrical capacity.
- IH135** Repairing electric cables and power distribution lines.



Energies

Sun energy is plentiful in Jordan amounting to approximately 2.100 kWh/m² a year. This free and environmentally harmless energy potential is not used to a noteworthy extent. One may find solar collectors used for water heating, which have better pay-offs than solar cells used to produce electricity. Instead, gas, stored in metal cylinders, is used for cooking and heating purposes as it is cheap. As a governmentally subsidized energy it currently costs 6.5 JD per cylinder and usually is imported from Egypt. Disputes over a fair gas prize arose after the revolution in Egypt.

Water in general is heated electricly in boilers, which are predominantly not insulated. The heated water cools quickly and often the boilers are turned on for a specific time-close usage only. Public buildings or richer households use oil for heating purposes, which is much more expensive because it is no longer subsidized.

To encourage the use of sun energies much more can be done. Architects, engineers, builders and construction workers could be trained to implement better planning and construction methods. Highest priority must be given to save energy and not necessarily to concentrate on generating more energy. Proper window orientations and sizes, sun shadings and the right use of insulating materials, are needed.



Active devices like thermal collectors and photovoltaic cells could also become integrated architectural solutions, meaning that panels and techniques become part of the architecture and not just an application.



IH139

IH136 For office and commercial buildings necessary cooling loads in summer time might exceed the heating loads in winter time. Through a proper planning and construction process, providing good shade devices for glazed openings and sufficient thermal masses on the inside of buildings, air conditioning could be dispensable.

IH137 Gas, coming in cylinders, is used for cooking and heating purposes. Only with richer families and in public buildings is oil used for room heating.

IH138-140 Thermal and photovoltaic collectors catching sun energy in the Feynan Eco-lodge (architect: A. Khammash). Gained electric power from photovoltaic panels is stored in batteries, still a weak point in the usage of PV cells. The immense potential of free sun energy available in Jordan is widely neglected. It could guarantee future sustainable energy.



IH140

- 1 Johansson and Ouahrani (2009), p. 21 and 26
2 Ibid

Center for the Study of the Built Environment.

www.csbe.org/e-publications

Hönger, Ch., Brunner, R., Menti, U.-P. and Wieser, Ch. Das Klima als Entwurfsfaktor. Climate as a Design Factor, Quart Verlag, Luzern, 2009

Hegger, M., Fuchs, M., Stark, Th. and Zeumer, M. Energy Manual Sustainable Architecture. Birkhäuser, Edition Detail, 2008

Hindrichs, D. (eds.). Plusminus 20°/40° latitude. Sustainable building design in tropical and subtropical regions. Edition Axel Menges, Stuttgart-London, 2007

Johansson, E. and Ouahrani, Dj. (eds.). Climate Conscious Architecture and Urban Design in Jordan. Housing Development & Management, Lund University, Sweden and Building Research Center, Royal Scientific Society, Jordan, Lund, 2009

Hausladen, G., Saldanha, de M., Liedl, P. and Sager, C. ClimateDesign. Solutions for buildings that can do more with less technology. Callwey, München, 2005

Ragette, F. Traditional Domestic Architecture of the Arab Region. Edition Axel Menges, Stuttgart, 2003

Shaer, M. Stone as Wall paper: the Evolution of Stone as a Sheathing Material in Twentieth-Century Amman. www.csbe.org/e-publications



Thomas Maria Weber

ROCK AND ORDER

STONE MASONRY IN A HISTORICAL CONTEXT

Introduction *Aims and Methods*

This contribution deals with stone as a building material through out human history focusing on the land east of the river Jordan. It is the endeavor of the present article to provide an introductory outline on stone construction techniques starting from prehistoric periods to main developments leading up to the rise of Islam. The methodological approach relies on historical monuments prior to AD 1750, defined by the legislation of the Hashemite Kingdom of Jordan as *immovable antiquities*. The present comparative survey focuses on selected monuments well dated either by archaeological data such as stratigraphy or typology, or by historical sources such as descriptions in ancient literature or inscriptions. It is the aim of this author to present a reciprocal process of intercultural exchange between the Levantine Orient and the central Mediterranean, two regions today called Middle East and (southeastern) Europe. It is to be demonstrated that the Orient during the 10th millennia, before the Christian era, contributed to cultural achievements.

This influential direction was inverted in the second half of the 1st millennium BC due to the historical event of the Macedonian conquest. From that time onward, the Oriental provinces – always remaining aware of the splendor of their own cultural heritage – could be characterized as the receiving part in the network of intercultural tensions.

The period of this investigation spans from the Neolithic, i.e. 10th century BC, to the rise of Islam in AD 636. The wide breath of the present contribution, in terms of geography as well as chronology, does not allow for a detailed discussion of problems under actual research. A handbook on the ancient building techniques of Palestine and Jordan has not yet been written. The scope of the present article thus cannot go beyond a rough sketch of the main lines of development.

The majority of sources concerning the brief survey of rock as a building material in historical context is principally based on two standard publications.

These are the handbook of the renown Greek architect Anastasios K. Orlandos, still irreplaceable for any study on the building materials of the ancient Greeks¹, and secondly, the methodic dictionary on Greek and Roman architecture by René Ginouvès and Roland Martin.² The first volume of this reference deals with all varieties of raw and dressed stone in the architectural construction process, and is of great help in respective terminology. It provides the vocabulary of petrographic and architectural terms in French, English, Italian and Greek. For the native German reader the architectural dictionary by Hans Koepf and Günther Binding (2005) might be of help in this respect as it provides translations of technical terms. The Arab student may be advised to use the handbook by A. Bahnassi (1995) for a circumstantial English/French – Arabic vocabulary of architecture and the arts.

The Dawn of Architecture

Nomadic tents versus sedentary mud bricks of prehistory

The general development of stone use for the construction of dwellings can best be described as *giant to miniature* in respect to size. The earliest representatives of mankind adapted natural caves or fissures as shelters. The invention of architecture may be considered as an Oriental achievement closely linked to sedentary activity which took place during

the Neolithic age (ca. 9500–5000 BC)³ within the Fertile Crescent, a sickle shaped territory spanning from Mesopotamia to northwestern Syria down to Palestine. The composite term *architecture*, originating in Greek language, precisely describes this process. The noun *archê* or *archî* (= origin, begin) plus the verb *ktizein* (= to found, to construct) refers to the initial stage of construction – metaphorically applied to the individual *architect* as the planner, inventor and creator of a city, village or a single building.

Thus the profession of the architect goes back to the 10th millennium. The two basic elements of his activity are the uncurbed power of nature and the human rational act, *rock and order*, or even more correct when referring to the architect's product – *rock in order*. The sorts of rock available and suitable for this activity in the Levant are the subject of another contribution to the present volume. Those workmen realizing the planning process of the architects are subsequently called the *stone workers* or the *masons*.

Nomads continued to employ traditional materials such as animal skins and wooden beams for their itinerant housing. Early settlers, however, inherited from their nomad ancestors the stone foundation, as necessary protection from strong winds. Mud brick, a mixture of mud with cane as a building material, is first attested in Neolithic Mesopotamia from mid 10th millennium BC onward.

Mud walls commonly rose on a massive layer of stone, which prevented humidity from penetrating the wall. The first hand-modeled mud bricks appeared in this area about 8000 BC, and an *industrial* production of mould made bricks started in the second half of the subsequent millennium.⁴ In regions further west, where large rock slabs were naturally available and broken into manageable formats by natural erosion, early man made use of them in order to defend themselves from enemies or wild animals. This early stage of the employment of rock has two aspects closely inter-related to each other; a transcendent and a more practical one. In both instances the owners of these dwellings possessed a high social status since the technical aspect of this prehistoric architecture required a considerable engagement of human manpower.

Mythic Rock Architects in the Levant

The Biblical Giants and Megalithic masonry

The oldest references to megalithic phenomena in the Levant are found in the Bible.⁵ *Their altars shall be heaps in the furrows of the fields*, as prophet Hosea (12: 11) wrote. Searching for an explanation of the early appearance of megalithic masonry, difficult to be comprehended by rationalism of later populations, the assumption of giants as constructors provided a plausible possibility.

As it will be shown, the folks of the Orient shared this intellectual process with their neighbors in the Pre-Hellenic Mediterranean. Only assumed giants of supernatural power like those of Gilead, Bashan, Amman and Moab, most renown in the Old Testament tradition as the mysterious King Og with his huge iron bed, were capable of heaping stone blocks of immeasurable weights on each other. But what did Prophet Hosea mean by *their altars*?

In an effort to take care of the material remnants of their deceased antecessors, pre-historic people constructed protective shelters out of huge rock slabs which archaeologists customarily call *dolmens*. Dolmens can be found in a wide spread line along the slopes of the Jordan rift valley (TMW01) with concentrations in the areas of Ghassul and Damiyah. These are simple structures, normally composed of two vertical stone slabs set approximately one meter apart from each other and covered by a larger third slab. Sometimes, the short sides of these buildings are closed by a fourth and fifth slab with a door-shaped opening on one of the short sides. Normally, the stone slabs were used as they were found in nature in an undressed form. Work by chisel was nevertheless attested in this early stage by elaborately dressed door openings. Some examples provide stone boxes underneath their floors.

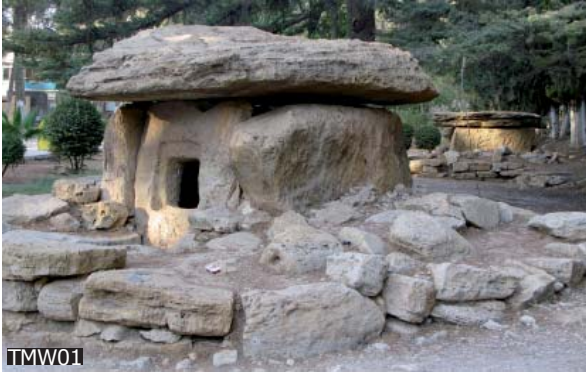

TMW01 Reconstruction of a dolmen from the Jordan Valley, University of Jordan campus, Amman.

TMW02 The citadel of Jawa.

These were considered as their direct antecessors serving the same purpose as the over ground parts of the buildings. In many cases, a circular setting of raw stones comparable to the foundations of the burial tumuli in other parts of the Mediterranean world augment the monumentality and the noble appearance of these structures.

Evidence regarding the purpose and chronology of these megalithic constructions was retrieved by the excavation of one specimen in the Damiyah dolmen field, executed in the 1980s by the University of Jordan.⁶ The unusual large amount of pottery found inside and in the vicinity of these buildings dates to the first phase of the early Bronze Age (EB I).

The absolute chronological terms are under dispute, but one might approximate the period between 3600 and 3000 BC as an orientation. Human skeletal remains, collected inside the dolmens, point to a funerary purpose. Both the rising parts as well as the underground boxes did not serve for the burial of distinguished individuals, but as collective graves of a community, most probably in a continuous sequence of several hundred years.

There is still not much information about the cultural background of the would-be architects and masons of these early monumental buildings. It is unclear if they followed a pastoral, hunting or an early food storing way of life. The most probable aim of these huge constructions was to gain a maximum of protection for the vulnerable situation of the dead.

About the same time during the early Bronze Age, megalithic masonry was also employed for the protection of the living.⁷ As site par excellence in northeastern Jordan, one may quote Jawa⁸ in the Mafraq district, located on a rocky spur in the southern outskirts of the Syrian lava fields. This site, located in the semi-arid steppe of volcanic origin of the southern Levant, witnessed astonishing skills of water-management by early mankind, starting from the Upper Paleolithic (ca. 1.7 million to 21.000 BC), with interruptions, to the present day. The main phases of per-

manent occupation focuses on two periods. For only a short but very intensive time Jawa was settled during the 4th millennium BC. The second period was from the Early Bronze Age phase IV to the Middle Bronze Age phase IIa (ca. 2300-1800 BC). These earlier ramparts protected domestic installations and water systems on and around the site. A monumental entrance gate of a rampart has been reconstructed in a showroom of the Jordan National Museum in Amman. The huge blocks kept their raw surface as they were broken by the stone workers and set by the masons. In the later phase of this second occupational period (EB IV), a fortified citadel (TMW 02) on the summit of the site, resembling the younger Hellenic acropolis, supplemented older fortifications going back to the Early Bronze Age phase IA (ca. 3600 BC).

The attached younger structure shows a stark militarized blend to the large nuclear settlement, which is in sharp contrast to what went on there before. The large blocks of the acropolis had been set in curved registers, following the relief of the rocky ground, producing by their smoothed outer surfaces an irregular polygonal mosaic. Regarding this stone masonry of the 4th millennium BC at Jawa, it should be emphasized that comparable constructions at other sites in the Levant and Anatolia such as Jericho, Jerf el-Ahmar and Göbekli Tepe date to considerably older periods.

There is an essential difference between the masonry of the dolmens and that of the Jawa ramparts and citadel even though there is not a big chronological distance between them. The walls and the roofs of the Early Bronze Age giant-buildings consist of large monolithic slabs. The architects of the Jawa ramparts in contrast *invented* polyolithic masonry. This achievement would write construction history down to the present day. The raw blocks are the immediate antecessors of the later cubic ashlar, which have the canonical features of Oriental and Greek masonries of the Archaic or Iron Age periods (1st millennium BC). This is a first step in the development, which is described as the splintering or atomization of natural grown virgin rock as building material.



It is somehow peculiar to state that it took some 2000 years until comparable phenomena of stone construction occurred in the central Mediterranean. Egypt, where stone masonry achieved a high level of quality within a few generations around the 27th century BC, must have been an important mediator.⁹ The reasons for this retarded development, as well as the mechanism of adaptation, remains obscure. That both historically existed is indisputable. There are no gaps in history, but only gaps in our knowledge.

From Cyclopic to Polygonal Masonry

Pelasgan-Helladic

to Greek Archaic Architecture

Stimulated by their Oriental neighbors, Greeks explained earliest appearances of human works of art and architecture through myths. Admiring the giant size of blocks heaped into walls, they attributed the earliest examples of monumental stone masonry to the *daemons of art*. The Roman geographer Strabon¹⁰ assigned the walls of the pre-Greek or Late Helladic palaces of Mycene and Tiryns (TMW 03) as well as the labyrinths in the caves of Nauplion as works of the Cyclopes, the three titanic single-round-eyed sons¹¹ of Uranos and Gaia. These daemons were related to the Titans, and were reputed as blacksmiths who produced the thunderbolt of the supreme Olympian god Zeus.

As constructors they were believed to have been assisted by the *gasterocheires* or *belly-handers*.¹² Byzantine commentators and lexicographers claim these daemonic masons came from Lycia in southwestern Asia Minor, while the Cyclopes were assumed to have originated in northern-Greek Thrace.¹³ The fortified structures of the Mycenean palaces display *cyclopic* masonries. They consist of huge stones in their raw, broken shape set in registers on top of each other. Not only at the renown Late Helladic sites in the Peloponnesian Argolid, but also on the Athenian Acropolis at the Pelargikon the same construction technique occurs.¹⁴

At the same time the skill of stone dressing is attested by the relief of heraldic Sphinxes on both sides of a column, which from the time of Pausanias¹⁵ onward were mistakenly assigned as lions, on a triangular stone slap crowning the main gate. Other fine stonework is preserved in the circular tomb of Atreus where the re-cutting of overlapping stone courses produced a semi-globular dome of perfect appearance.¹⁶ This construction technique was applied to other types of vaulting such as the Syringes and the casemates of the Tiryns palace (TMW 04). It should be pointed out that this type of rock construction was limited to the prestigious residences of monarchic rulers, while the *hoi polloi* of citizens and farmers dwelled in more humble buildings made of mud brick framework constructions.

The exquisite appearance of Greek stonework dawned at the end of the orientalizing and early Archaic periods (late 7th to early 6th centuries BC), after a rupture of the Late Helladic traditions in the Dark Age (10th to early 9th centuries BC). At this time rock gradually replaces the hitherto predominant building materials, mud brick and wood. Wood architecture of the preceding times has rather close relations to Egypt where stone had been employed centuries earlier in monumental buildings.¹⁷

TMMW03 Sample of Cyclopic masonry at the palace in Tiryns, Argolis, Greece.

TMMW04 Pseudo-vaults in the casemates at Tiryns.



The innovative trend was to replace columns and entablatures that were formerly fashioned out of wood by dressed stones. At the beginning *póros*, a yellowish-brown tuff quarried at various locations in southern Italy, Sicily, the Aegean and continental Greece was given preference in addition to the various types of conglomerates, sandstone and limestone. The noble rock of Greek construction material was the bright white marble employed from the early 6th century BC in monumental architecture as well as in sculpture. Through out the ages it epitomized the Hellenic blend to an extent that Oriental religions, Judaism in particular, classified it as a medium suspect of pagan impurity.¹⁸ Extracting, transport, chiseling and building with these stone materials required a number of iron tools such as hammers, drills and chisels (TMW05), plumps, scales, calipers and meters, ropes and wooden supports as well as a platoon of ingenious transport and lifting machinery, such as charts, cranes and pulleys.¹⁹

Greek stone cutters of this period achieved in taming the elemental nature of rock into canonized orders dictated by human intellect and ratio. They translated the archetypes of timberwork into stone, leading to distinct building orders with a specific combination of ornate decors. Two of the three Classical orders, the Dorian and the Ionian, are an immediate result of this process.

(The Ionian was most probably a derivative of the so-called Aeolic style which originated in the Egypto-Levantine realm²⁰.)

Architects soon understood the advantages of dressed large orthogonal blocks set upside down in rows (Greek *orthostades*) or laid horizontally in bands (*parastades*) often joined to each other by swallow-tail-shaped iron clamps. In order to lift and position the heavy blocks, protruding bosses or holes were needed in order to fix the loops of ropes or iron scissors.

Apart from static and constructional necessities, the external appearance of stone masonry achieved a high esthetic value in Greece. The 7th and 6th centuries BC form the époque when masonry, consisting of dressed cubic stone ashlar, arranged in a system of orthogonal registers (*isodome*) became common in the central Mediterranean. Antecedent stages of this mature Classical mode of ashlar construction were the so-called Lesbian and polygonal systems. These systems joined irregularly cut stones with smoothly dressed faces with admirable precision, commonly leaving not even space to insert the blade of a knife between joints. These antecedents of Classical isodome constructions have been dated to the earlier 6th century BC, and found widely spread over mainland Greece from Attica to Thessaly, over the Aegean islands and toward the cities along the western littoral of Asia Minor.

As fine examples of both systems one may quote the Peistratian wall at Euleusis, the early temple in the Nemesis shrine at Rhamnous and sections of the retaining walls of the temple of Apollon and the lower terrace at Delphi (TMW06).²¹

The transition to the trend-setting isodomic systems of the later periods is seen in the tendency to line the blocks into horizontal rows by dressing them in trapezoid forms with horizontally leveled upper and lower, and oblique lateral joints. This is impressively seen at the walls of the hypostyle or the Aphrodision at Delos or the ramparts of the Attic-Boeotian frontier fortress of Panakton-Eleutherai. Trapezoid and pseudo-isodome masonry systems continued through out the late Archaic to the Hellenistic periods.

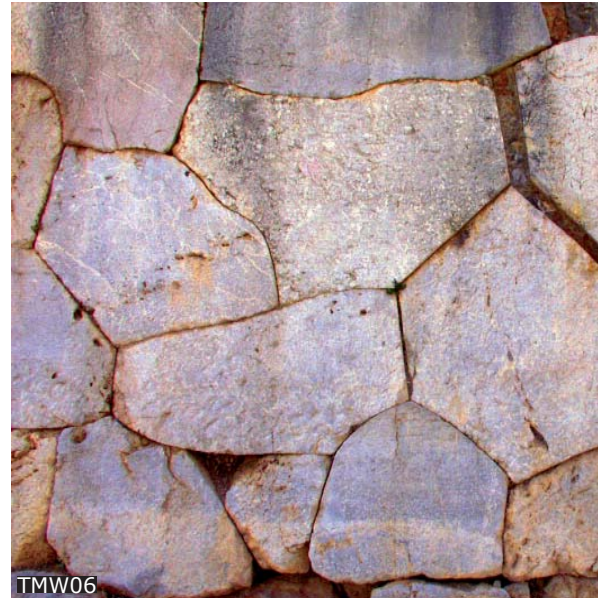

TMW05 Set of contemporary stoneworker's tools; hammers, chisels and drill (after Orlandos 1955: p. 118, fig. 36).

TMW06 Archaic masonry of the polygonal system in the retaining wall of the sanctuary of Apollon at Delphi.

TMW05

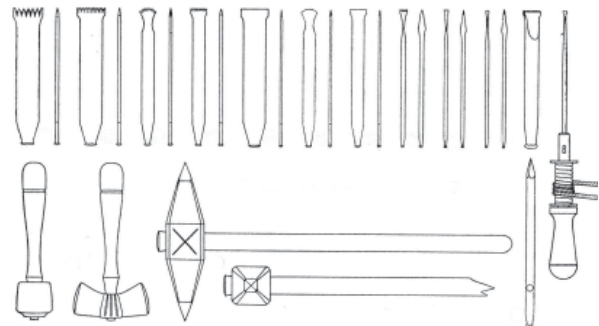



A Levantine Iron Age Prelude

The Aeolian Capitals

As already mentioned, Egypt and the Levantine Orient were sources of inspiration for Greek architects. This cultural dependence of the central Mediterranean realm began in prehistory and continued at least to the time of the Greco-Persian wars (499-449 BC). The unexpected successful result of this conflict with the Oriental super-power represented a new self-awareness.

It increased consciousness of Hellenic values in political as well as cultural terms resulting in the Macedonian campaign and the disastrous end of the Great Persian Empire two centuries later. An element of considerable importance, which sheds light on the penetration of Egypto-Levantine decorative elements into the architectural style of early Archaic Greece, is the Aeolic capital (TMW07-08).

Aeolic capitals are named after the region Aeolis in the northwestern littoral of Asia Minor where the first specimen was found in the 19th century.²² As an element intermediating between the perpendicular column shaft and the horizontal entablature, the Aeolic capital consists of a set of paired volutes. These mirror-like structures rise from the bottom and scroll upward to the lateral portions of the block. A multi-petalled upright standing palmetto commonly fills the triangular spandrel between them.

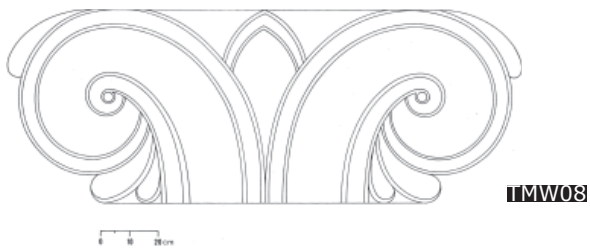

TMW07 Fragment of a limestone Aeolic capital found in front of the Amman citadell. The left part was restored in modern times.

TMW08 Aeolic capital, limestone, from Hazor (after EAA atlante pl. 307,1).

The earliest stone specimen of this type of capital comes from Palestinian Shechem, Hazor (TMW08) and Megiddo dating from the 10th and 9th centuries BC.²³ They go back to a far older development of architectural decor which took place in Pharaonic Egypt since the 25th century BC. The oldest known architectural columns with Aeolic-like designs can be seen on Theban tombs dating to the second half of the 18th dynasty.²⁴ Their volutes sometimes rise from simple upwardly directed triangles as paralleled in the later Palestine or Cypriote series. Apart from Palestine, capitals of this sort are also known in various locations east of the river Jordan.²⁵ Fragments can be seen today at the entrances of the Amman citadel and of the Karak castle (TMW07). Their exact position within the architectural masonry context is not always clear. Some capitals were partly set into the walls concluded by differences in workmanship along both sides. Sometimes they seem to have capped decorative doorjambs. Others fronted courtyards forming ornamental façades, probably crowning protruding wall-pillars. Independently, and probably influenced by Phoenician wood carpentry or minor Syrian arts out of metal and ivory, the column-capital as a support was developed as an innovative tectonic element in the Levantine Iron Age culture. As another structural part, the bulky base adorned with floral motives was added. A fragment of an elaborate specimen of the latter, belonging to the Achaemenid type and chiseled

out of local Transjordan limestone, is preserved in the lapidary of the Amman citadel museum, unfortunately without provenance.

The interrelation between the Aeolic style and the Ionic order has been controversially discussed in scholarship.²⁶ There are striking differences between both with an important difference in its degree of informality.

*"While still conforming to the broad tenets of the style, each Aeolic structure was a highly individualistic monument. Freedom from the restraints of a tight canon was even extended to the design of specific elements, and Aeolic details (such as capitals or bases) admitted far more variation within a single building than was usual in Ionic architecture."*²⁷

With its Oriental influence, the Aeolic capital chronologically antecedes the Ionic one. This fact alone seems to the present writer fairly indicative, even though structural differences must be admitted. By the time of the Persian Wars, the Ionic capital emerged as the dominant East Greek fashion that was to survive into the Late Roman period. In contrast to this, the Aeolic style declined at the end of the Archaic period, at least in monumental architecture. Pieces of evidence, including representations in Athenian vase-painting and Archaistic reliefs dating to the Roman period, evidence that it did not end completely in the Greek areas.²⁸ However its *Golden Age* was gone forever.

The Climax of Order

Isodome Masonry and the three standard Orders of Greek Architectures

As previously mentioned, the arrangement of cubic blocks into horizontal layers appears in the Greek Archaic period and proved to be trend-setting for the subsequent centuries of the Classic, Hellenistic and Roman periods. The calibrated *Attic foot*, ell and dactyl from the 5th century BC onward, exactly defined the sizes of the ashlar and achieved a never more-regained elegance of proportions. Careful stone dressing reached a precision admired by craftsmen in the subsequent eras, and continues until today.

Classical architects and their masons refined the isodomic system by the solid construction mode of posing the cubic blocks in variations (TMW09), among which the *headers-and-stretcher* technique (TMW09-3,5) became the most prominent and persistent.²⁹

The header is a cubic block bound with its long sides perpendicularly into the wall, while the stretcher runs parallel to the alignment of the wall. This arrangement was cleverly repeated in the registered layers of the masonry. The insertion of horizontal rows consisting of ashlar with lower heights created the variant of pseudo-isodome masonry.³⁰ Mortar and concrete for stabilizing the hori-

zontal and vertical joints was still unknown. Iron clamps at both ends of the horizontal joints held the blocks together, often in the shape of double swallow-tails. In order to prevent corrosion, the iron parts were commonly coated with lead.

The standardization bore three canonical Classical building orders which are the Doric (TMW10, TMW11-A), the Ionic (TMW11-B) and the Corinthian (TMW11-C).

The first two originated in the early Archaic period. However, the third, derived from the Ionian order, is an invention of the late 5th century and commonly named Corinthian. Distinctive elements of all three orders can be seen in the performances of the entablatures and the capitals. The Corinthian order introduced the acanthus leaf as the main decorative element of the capital. It is arranged in two superimposed registers like a basket (Greek *kalathos*) upon the upper end of the fluted column shaft in order to stem the architrave.

Corinthian capitals are first attested in monumental architecture as crowning elements of the semi-columns along the cella-walls of the temple of Apollon at Bassai-Phigaleia, dated to 410 BC.

Pausanias praised this temple due to the *harmonia* of its masonry and attributed its design to the famous Athenian architect, called Iktinos.³¹

All these three orders survived, with alterations, the whole of antiquity. One of the finest examples of Greek Classical architecture in the Levant is the temple of Eschmun north of Sidon in modern Saida, Lebanon. This example adopted many features from the shrine of Erechtheus on the Athenian Acropolis.

Many lavish buildings in public and private places all over the Roman Empire retrieved the Ionian and Corinthian order, sometimes in a hybrid combination with elements of the Dorian entablature. The Classical orders suffered a certain decline during the medieval ages east and west, but they were revived and codified in Europe by Italian architects and scholars such as Giacomo da Vignola (1507-1573) or Andrea Palladio (1508-1580) during the Renaissance.

In central Europe they were en vogue during the era of historicism in the 19th century. They also found an unexpected come back in the Orient. Elements inspired by classical architecture, and sometimes combined in a rather hybrid manner with elongated proportions, can be found in several modern villas in the western quarters of Amman.

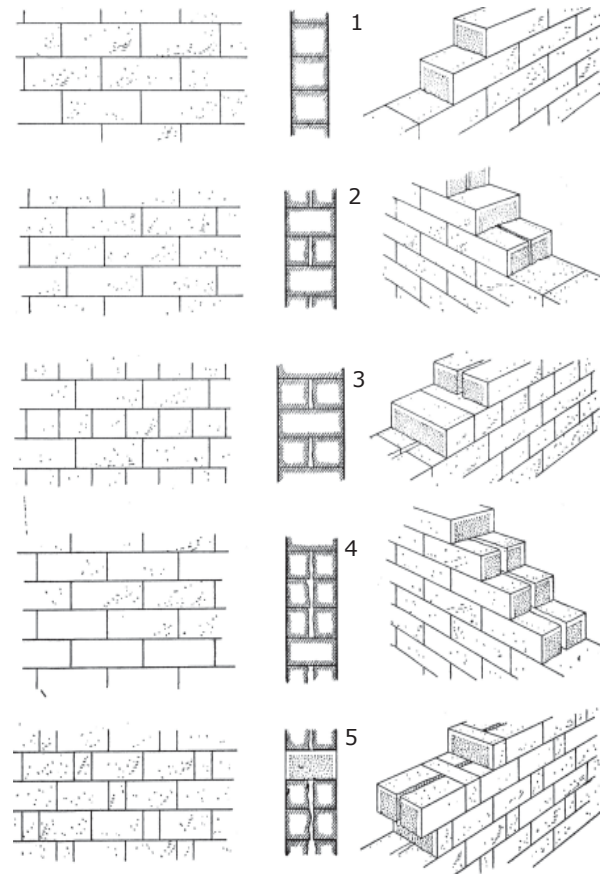

TW09

TW09 Variants of rectangular (isodomic) masonry (after Orlandos 1955: p. 227, fig. 182).

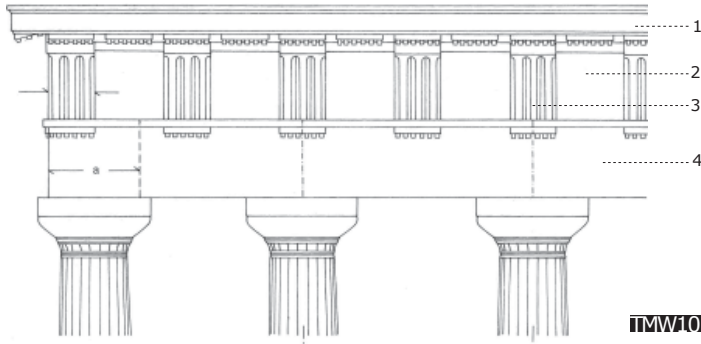

TMW10 Significant parts of the Doric order (after EAA atlante pl. 302C).

The entablature consisting of

- 1 the sima
- 2 the metopes
- 3 the triglypha
- 4 the architrave

TMW11-A Significant parts of the Doric order (after EAA atlante pl. 290).

Capital consisting of
(from above)

- 1 the abacus
- 2 the echinus
- 3 the hypotrachelium

Basement consisting of

- 4 the stylobate
- 5 the krepis or krepidoma
- 6 the euthyteria

TMW11-B Significant parts of the Ionic order (after EAA atlante pl. 311, 312).

Capital consisting of

- 1 the plinth
- 2 the canalis
- 3 the volute or helix, plural helices
- 4 with central knob or oculus
- 5 the echinus with cymation
- 6 the astragalus
- 7 the pulvinus, plural pulvini
- 8 the balteus, plural baltei

Base consisting of

- 9 the plinth
- 10 the torus, plural tori
- 11 the trochylus or scotia,
plural trochyli or scotiae

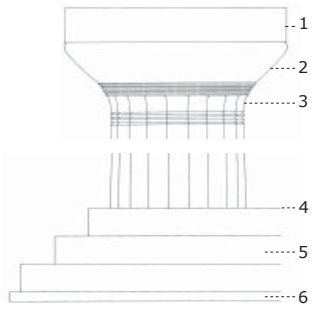

TMW11-A

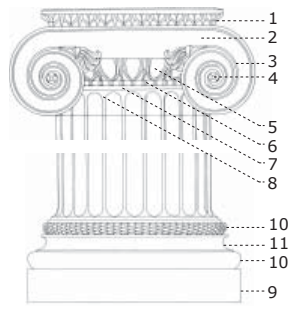

TMW11-B

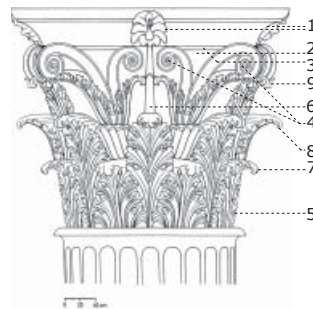

TMW11-C



TMW11-D

TMW11-C Significant parts of the Corinthian order (after EAA atlante pl. 357).

Corinthian standard capital consisting of

- 1 the abacus with the abacus flower
- 2 the ovulus
- 3 the cavetto
- 4 the volute or helix, plural helices
- 5 the base of the basket or calathus
- 6 the stem of the abacus flower

The main part of the Corinthian order is the acanthus basket or calathus consisting of two rows of leaves

- 7 lower row of leaves: *ima folia*
- 8 upper row of leaves: *secunda folia*
- 9 and caulices, singular: *caulix*, or *cauliculus*, supporting the volutes

TMW11-D Corinthian composite capital with only one row of acanthus leaves and large volutes derived from Ionic order (after EAA atlante pl. 380).

TMW12 Temple on the Citadel in Amman showing the Corinthian order (source: OR).



TMW12

The Challenge of Weights and Static

The Trilithon, the true vault and the venue of mortar & plaster in Hellenistic architecture

The Hellenistic period starts with an event of outrageous range that radically changed the hitherto constellation of political and cultural power in the eastern Mediterranean basin. It opened new tracks to cultures in the heart of Asia formerly known only by hearsay. The Macedonian troops under the command of their king Alexander III, called *the Great*, defeated the army of the great Persian King Dareios, and conquered the territory of his Achaemenid Empire extending from the coast of Asia Minor to the foothills of the Himalayas. Koine Greek became the lingua franca, and Hellenic culture merged into a peculiar biotope with Oriental traditions. The overwhelming military success of the Greeks furnished them with supernatural ideas and skills in art.

Hellenistic and Roman architecture dared to undertake audacious enterprises to tame nature. The task to model the complete mount Athos (in the middle peninsula of northern Greek Chalkidiki) into a giant statue portraying Alexander³² is probably not a mere anecdote. It does nonetheless impressively betray the huge dimensions of imagination, thought and ideas. In order to construct sophisticated instruments and architectural elements (such as siege machinery and half cylindrical vaults

as space covers), statics and the laws of gravity were thoroughly studied by scientists. The employment of heavy catapults and artillery in military conflicts demanded strength and at the same time provided elasticity for the masonry of platforms and defensive walls. East of the Jordan River impressive examples of Hellenistic fortification architecture can be found in the ramparts of the Gadarene acropolis at Umm Qais (TMW13), or in parts of the retaining wall of the Amman citadel. The limestone blocks at the Umm Qais monument are carefully set in isodome registers according to the headers-and-stretchers arrangement. Each one is chiseled with great precision and adjusted in their joints by a flimsy layer of mortar. Each cubic ashlar appears carefully smoothed on all six sides, and its dimensions seem to have been standardized by the stonecutters. To emphasize the orthogonal appearance of the blocks and as a decorative element, recessed margins were introduced.³³



The Tobiad palace at Iraq al-Amir (TMW14-16)³⁴, dated to the 2nd century BC, displays in its elevations huge cubical blocks with such recesses. These can be seen especially on the southern and northern elevations. The dignity and aristocratic power of the building's owner is indicated by monumental animal sculptures. Lionesses with their youngsters are found on the corners of the second floor elevations and leopards as fountain spouts found at the base. Noteworthy is the use of a conglomerate stained rock in order to indicate the fur of the felines. Not only the masonry and the decoration of this building, but its topographical placement shed light on the fancy boldness of the planners. The palace rises in the center of an artificial lake, which was formed by accumulating water retained by a dam, in alluding to the luxury Nile ships (Greek *bareis*)³⁵ of the Ptolemaean servants of the Tobiad tribe.



TMW14



TMW16



TMW15

TMW13 Limestone blocks in the Umm Qais Hellenistic rampart.

TMW14-16

The palace (*Qasr al-'Abd*) of Hyrcanus the Tobiade was situated in an artificial lake, imitating a luxurious Ptolemean Nile ship (Greek *bareis*), Iraq al-Amir, Jordan, 2nd century BC.

TMW14 Panoramic view.

TMW15 Megalithic ashlar with recessed margins at the southern elevations.

TMW16 Fountain in the shape of a leopard made of colored conglomerate rock.

Another exemplary monument in the Orient, illuminating the challenging tasks of pre-Roman architects to wrestle with the power of rock, is the foundation podium of the temple of Jupiter Heliopolitanus in Baalbek, Lebanon. It measures 12m in height and consists of only three lines of giant blocks, thus called the *Trilithon* by the Greeks.³⁶ The lower and upper layers, 4m each in height, are constructed as headers. Due to aesthetic rules of Greek masonry, the middle stone layer, again 4m in height, had to be laid out orthogonally as stretchers. Each of these blocks thus had to be a multiple proportion of length in comparison to height. In the total length of the podium, spanning over 60m, each of the three blocks needed a length of 20m. One of these giant stones, obviously abandoned for unknown reason, can still be admired today in the ancient quarries of Baalbek (TMW17). Taken into consideration the height and a depth of 4m, each of these blocks weights 700 to 800 tons. These are the heaviest weights ever moved by humans during antiquity.



Macedonian architects of the late 4th century BC were the first in the Mediterranean realm to adopt the *true* vault, which was constructed of wedge-shaped stones on a wooden form, semi-circular or segmental in section and supported on scaffold between the long sides of the walls. The weight of the ceiling, loaded on the lateral retaining walls of the rectangular space and the semi-circular array of the stone wedges, were kept in a stable position by the insertion of a keystone in the climax of the arch. The *fellahin* constructors of southern Syria and Jordan practiced this technique with simplified scaffolding until recent times (TMW18).

The invention goes back to 2nd millennium Mesopotamia where similar mud brick construction occurred at Assur. The Achaemenid underground tombs in the Sakara cemetery of Egypt, add to the conclusion that the Macedons learned this ingenious construction technique from Persian engineers.³⁷ From the early Roman to the Ottoman period the static principle was re-introduced in Oriental architecture for the roofing of broad rectangular spaces. Especially in the volcanic zones of southern Syria transversal arches supported by wall pillars resume this early Hellenistic constructional invention. A fine specimen is the Roman cistern of rectangular plan in front of the temple of Zeus Megistos in Qanawat, Syria (TMW19).

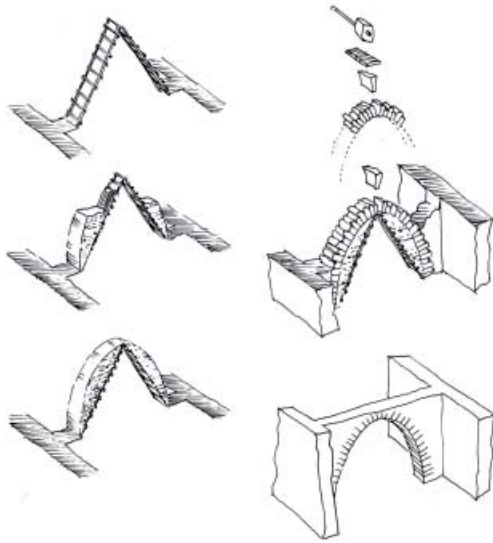

TMW18

Even in very humble dwellings like stables or barns, these arches carried the roofs made from cane mats on oak beams covered by earth packages. In arid woodless zones organic materials were replaced by long stone slabs.



TMW19

TMW17 The Temple of Jupiter Heliopolitanus in Baalbek, Lebanon. Stone in the quarry.

TMW18 Semi-barrel roofs constructed by the *true*-vault-technique. Construction technique of a transversal arch as applied by Jordanian *fellahin* in the Ottoman and early Hashemite periods (after A. Khammash 1986: p. 77).

TMW19 Transversal arches using the Hellenistic principle of the *true* vault serving as supports for the flat roof of a Roman water tank in the sanctuary of Zeus Megistos in Qanawat, Syria.

Hellenistic architecture can be characterized by the introduction of mortar and plaster in order to join the ashlar and to achieve illusionistic effects. Imitating the appearance of marble, the limestone walls of barrel-vaulted underground tombs in Macedonia³⁸ were covered by a whitish plaster. Parts of the exterior and interior walls of these aristocratic funeral buildings were lavishly decorated with polychrome frescoes.

Sometimes architectural elements such as pillars, columns, metopes or mouldings, like dentils and astragals, were executed in applied fine white stucco or in wall paintings.

The interior of the mausoleum of Lyson and Kallikles at Lefkadia, Macedonia³⁹ displays the armors of the deceased in the semi-circular *tondi* of the vault in colored frescoes. The pilasters carrying the architrave of the chamber, adorned by a continuous garland, are painted with indication of shades in order to achieve three-dimensional illusion. The entrance corridor (Greek *dromos*) to the Macedonian tomb at Pydna⁴⁰, as another example for illusionism in Hellenistic architecture, displays an ashlar masonry with recessed margins illusively executed in stucco, similar to what was found in Italy during the Second Pompeian Style. Similar features can be seen in the Nabatean banquet hall at Siq al-Barid near Petra.

Mortar is basically a mixture of chalk, lime and sand. It serves the practical purpose of joining the ashlar, as it has already been observed above at the ramparts of Gadara.

In Italy the earliest evidence of mortar as a medium to consolidate stone-masonry dates to the 3rd century BC. It can be found in the colonial cities of Cosa and Alba Fucens in the Abruzzi mountains. It is generally accepted that in Rome it was widely used in the same century.⁴¹

Alexandria, the eastern Mediterranean Egyptian capital of the Ptolemean kingdom, seems to have been a protagonist for these trends. Here again, the illusive ashlar masonry made of plaster is attested in funeral architecture of the Anfushy cemetery tomb 1 dating to the mid or second half of the 2nd century BC.⁴² Illusive wall decorations consisting of double story porticoes with segmental and broken pediments and curved entablature round temples of the *monopteros* (or *tholos*)-type, all executed in stucco or fresco, adorn the walls of houses and underground tombs.

Such Alexandrian illusive wall decoration systems have been considered as prototypes for some of the elaborated tomb façades in Arabia Petraea, there, translated into monumental rock-carvings.⁴³

Concrete, Pseudo-Ashlars, and Marble
Roman Imperial Architecture in the Oriental Provinces

The audacious attempt to demonstrate their political power by dominating nature is a specific trait of late-Hellenistic Oriental kings, who were clients of the Romans. With this attitude, they proved to be true heirs of their Macedonian royal ancestors. The task to change virgin rock into man-made architecture can be best understood in the Nabataean tomb façades in Petra, Jordan, and Hegra / Madain Salih, Saudi Arabia. The Khazneh al-Fira'un is still the finest and most elaborate example (TMW20).

Palaces with luxurious bathing installations were set on the top of steep mountains, best exemplified by the royal Nabataean court on top of the Umm al-Biyara-massive in Petra or the Herodian villa found in the steep rock face of Masada.

Both the Nabataean King Areathas IV as well as Herod, the founder of the Jewish-Idumaeon dynasty, maintained close relations to the imperial capital of Rome, which they personally knew by various visits. This fact may explain the transfer of central Italian plans and construction techniques to their Oriental homelands.

TMW20 Khazneh al-Fira'un in Petra, Jordan (photograph I. Helmedag).

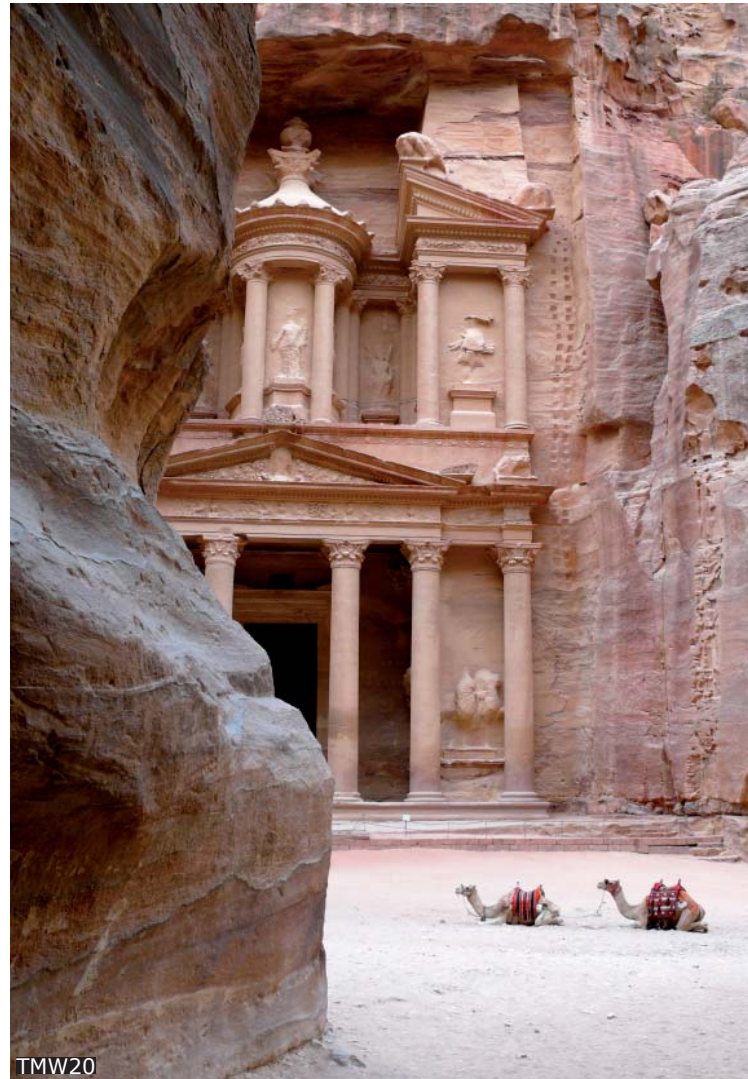

Opus reticulatum, for instance, a net-shaped masonry of obliquely set baked bricks in concrete⁴⁴ typical of the Late Republican and Augustean architecture in Rome (TMW21), occurs in the eastern dining room (*triclinium*) of the Herodian winter palace at Jericho.⁴⁵

With a certain emphasis on architectural monuments, inaugurated by the Herodian dynasty, isodome ashlar with recessed margins achieved an esthetic effect by emphasizing the supposed strength of walls in illusive plaster variants. This can be found in the western palace in Masada.⁴⁶

TMW21 Funeral building executed in *opus reticulatum*, found in Roman cemetery of Isola Sacra near Ostia, Italy.



One of the greatest achievements of Roman architecture was the invention of concrete⁴⁷, *opus caementitium*.

Opus incertum, a reinforced mix of broken brick or stone, was an additional type of concrete. The use of this material opened new dimensions of constructing durable walls and vaults, which disregarded the laws of statics. With this invention, nature was dominated to such an extent that some Roman intellectuals issued doubts as to whether such a behavior of mortals trespassed divine law. Apart from sun dried or burned brick, the construction materials on the Apennine peninsula in the pre-Augustean period were local rocks such as Grotta-Oscura-Tuffo, Travertine and Peperine. These indigenous rocks basically served as a coating material on exterior walls consisting of cores made from casted *opus caementitium*.

Such a technique provided an economic advantage in that the walls did not need to be constructed of massive cubic stone blocks. They were stabilized by casted-concrete cores. The exterior appearance of mason stonewalls gradually became more misleading, since only the visible front part of the ashlar needed to be shaped orthogonally, while the invisible rear remained as a raw broken wedge.

Literally these walls now consisted of two opposite linings of pseudo-ashlars hiding the massive concrete core.

Another important innovation of the Roman Imperial period was the revival of marble as a decorative and precious building material, originally employed in large scale building programs in Classical Athens. In a famous passage from the biography by Suetonius⁴⁸, Augustus, the first emperor, was claimed to have found the capital Rome clothed in brick, but left it by his death clad in marble.

The emperor's preference for this exquisite building material certainly came from his personal admiration of the leading Hellenic city, widely considered as the seat of wisdom and arts. Augustus converted this city into a kind of open-air museum by rebuilding destroyed temples of Attica on new foundations at the Athenian *agora* such as those found in Athena at Sounion, Ares at Acharnai or in Demeter at Thorikos.⁴⁹

White marbles were quarried in the vicinity of Athens at Mounts Pentelis and Hymettos, as well as on the islands of the Aegean archipelago, such as Thasos, Naxos and Paros. White marbles for the supply of the Roman capital were extracted in Asia Minor and from mainland Italy, the latter abundantly available nearby Luni in Toscana known as Carrara.

In order to achieve polychromic effects, colored marbles were imported from the Greek island Euboea (or *Cippolino*, an Italian word meaning small onion due to

its green and white texture), from northern Africa (*Pavonazetto*, *giallo* and *rosso antico*, and *Africano*) and extraordinary noble rocks like Porphyry and Assuan rose granites from Egypt.

All these quarries were added to the emperor's monopoly by the early 2nd century AD.⁵⁰

The climax of variegation achieved by the use of colored rocks can be found in the interior refurbishment of Hadrian's Pantheon in Rome (TMW22). Revetments of niches, entablatures and buttresses form a multi-colored kaleidoscope to impress the visitor of this shrine made for the common wealth of the Roman Empire. The following quote by J. B. Ward-Perkins, found in his famous article on Roman marble trade in the Libyan Tripolitania, gives a more detailed account of the extravagant use of different colored rocks.

The Pantheon is typical of the new age. The columns of the porch are of red and of grey Egyptian granite; the bases, the great fluted pilasters, and a part of the entablature of Pentelic; the capitals, the rest of the entablature and the door-frame of Luna; the door-sill of Africano; the columns in the four exedrae of Numidian; and the whole of the interior veneered and paved in colored marble, some of it in slabs cut from very large blocks.⁵¹ The choice of varied and costly stone became part of the vocabulary of power.⁵²



- TMW22 - 23** Colored stone used for geometric wall and floor ornaments (*opus sectile*) in the Roman, Byzantine and Islamic periods.
- TMW22** Interior elevation of niches and pilaster architecture made from multi-colored marbles, Pantheon, 118-125 AD, Rome.
- TMW23** Revetment of the eastern interior wall of the large courtyard (*riwaq*) made from black-bluish white marble with partial natural veining and sprinkling, Ummayyad Mosque, Damascus.

It was certainly the visit of Hadrian to the Oriental provinces in 129/130 AD that leveraged the trade of marble and the standardization of town planning and architecture in the Levant. The chessboard-patterned layout of the city settlement grounds (based on the orthogonal so-called *Hippodamian system* developed in 5th century BC Greece and Asia Minor and employed in the royal Hellenistic metropoleis of Antioch and Alexandria) became a planning rule in the Greek-speaking east.

Due to the long urban tradition, which was lacking in the western provinces, the colonnaded street axis became the distinctive element of Roman Levantine visual urbanism during the Roman imperial period.⁵³ It must be noted that there is no indigenous source of the crystalline marble available either in Syria, Palestine or Arabia. Import of this material from the Mediterranean overseas required skilled logistics for the shipment, profound financial funds to cover the expenses, as well as thorough training for its treatment. All this was made possible by the long period of political stability and economic prosperity under the augurs of Rome, the *Pax Romana*. According to the statistics of marble finds, it is obvious that incoming raw blocks and finished or semi-finished objects, were stockpiled in the Levantine ports. By on-sale commerce they were then distributed to the coastal cities and the hinterlands.

*The marble trade had a profound effect upon the material culture of Syria and the Near East. Cities could acquire prefabricated elements for buildings, or, if they could not afford these, they might be able to have competent copies made in local materials. Temples and other public buildings could be decorated with sculpture, either mass-produced or specially commissioned. Individuals could have statues and portraits produced by craftsmen skilled in classical styles, and they could be buried in imported sarcophagi. The uniformity of this cultural material speaks of a desire for regularity, but it should be noted that this desire was mainly that of the elites who could afford to pay for such expensive objects, and who had the most to gain by aligning themselves with the international overlay culture of the Roman Mediterranean.*⁵⁴

Spolia, Stones and Bricks

*Early Christian
to Byzantine Stone Architecture*

With the rise of Christianity, politically sealed by the Constantinian edicts of the early 4th century AD, a new chapter of Oriental architecture opened. Written sources from the extensive literary heritage by Eusebius Caesarensis (ca. 260-339 AD), author of *A History of the Early Church at Palestine* and of *A Panegyric Biography of Emperor Constantine I* prove most valuable.

The emperor in person initiated the commemorative buildings in Palestine, which related to the life and death of Jesus of Nazareth and were furnished in greatest splendor in plan and chosen materials. With the spread of early Christian communities beyond the borders of the river Jordan, intensive building activity started in towns and countryside alike. This building frenzy resulted in lavishly embellished churches and chapels, monasteries and residences of Arab and Aramaean communities all adhering to the new confession. This tendency climaxed during the reign of emperor Justinian early in the 6th century AD when mosaic schools such as that of Madaba created their most celebrated works of art. The most impressive works preserved today are the mosaic floors jigsaw puzzled out small square stone and glass tesserae. The tradition of mosaic art can be followed back in the Orient to the late Hellenistic period and was later bequeathed to the craftsmen working on command by the Umayyad caliphs (TMW24, TMW25).





Besides the continuation of Roman concrete and pseudo-ashlar masonry, the attentive visitor of archaeological sites in the Levant may observe a new construction custom typical of the Late Antiquity; the recycling of older building material as spoils.⁵⁵ Recycling is predominantly of stone in all its varieties and qualities, dressed in Roman times for the construction of private or public constructions, delicately adorned with abstract or floral decorations, and/or partly inscribed with Greek, Nabataean or Jewish characters. An impressive and early example is the portal of the Byzantine church in the Serayl of Qanawat, Syria showing the frame and lintel, which consists of a badly battered Roman frieze of acanthus scrolls. The intentions for the use of spoils seem to be threefold; economic to save money by re-using existing older elements, decorative to enjoy them as pieces of sculptural art, and ideological in displaying them as grand trophies of the victory of Christianity over the power and wealth of Roman paganism.

The masons of the Ghassanid monastic *praetorium* at Hallabat made use of basalt blocks transported from elsewhere containing long portions of a Greek inscription identified as an edict by Emperor Theodosius for organizing the defense of desert borders (TMW26). In some remote areas of Syria complete ancient structures are still lived in today.

TMW24 -25 Colored stone and glass cubes (*tesserae*) used for figural and floral painting (*mosaics*) in the Hellenistic, Roman, Byzantine and Islamic periods.

TMW24 Detail of a geometric mosaic made of dark brown and white tesserae from the Herodian palace in Machairos at Muqawir, Jordan, late 1st century BC. It is the oldest mosaic found in Jordan, represented at the Madaba visitors center.

TMW25 Polychrome floor mosaic representing a wind god, from a villa in Philippopolis, Syria, early 4th century AD, Shahba, Museum.



TMW26 -27 Re-use of older ornamented or inscribed stones (*spolia*) in late-antique, Islamic and modern masonry.

TMW26 Small ancient sanctuary of the 3rd century AD inhabited by a Druze family, Umm Zaytoun, Syria.

TMW27 Façade of a late-Ottoman *fellahin*-house with bi-chrome masonry out of white limestone and dark-blue basalt ashlar arranged in horizontal bands. On both sides of the entrance basalt fragments of a Roman tomb door have been ornamentally re-used. Bait Husban, al-Melab, Umm Qais, Jordan.





In addition to the art of mosaics, the Muslim world inherited the spoils of masonry, as well as another type of construction technique, which may be called *composite*.

This technique employed two inorganic materials in a practical and decorative manner, that of stone and brick (TMW28). Both stone and bricks are embedded into horizontal and vertical joints made from wet mortar. Burned or sun-dried bricks, having a long tradition in the Orient, could easily have been mass-produced by using moulds. They also fulfilled two further practical purposes as insulation which prevents thermal bridges and as elastical cushioning which stops the seismic strokes of earthquakes. Laid in alternating bands with rows of dressed ashlars, such a composite masonry, achieves a high aesthetic value as best represented by the buildings at Qasr Ibn Wardane in central Syria. Some of them are dated by inscriptions back to 564 AD. Byzantine churches in Greece dating to the 10th century AD preserve a developed variant of such composite masonry by coating each single ashlar along all joints with a flat slab of burned brick. Some include brick bands with pseudo-Coufic inscriptions betraying the provenance of the idea of composite masonry from the East.

TMW28 Composite masonry combining stone ashlar with bricks in Byzantine architecture. Alternating brick and basalt masonry lines at Qasr Ibn Wardane, Syria, 564 AD.

Revival of the brick and glazed tile

An Islamic epilogue

A full account of the present narrative on the following era of Islam would go beyond the scope of the present survey and the competence of its author. A conclusion and perspective of the history of stone used in architectural contexts should be merely considered as a sketch. As the above considerations and observations already addressed, the Muslim religion was the natural heir of all its antecessors in the Levant. The mosaics and *opus sectile* revetments of the Umayyad mosque in Damascus are not understandable without the works of art from the eastern regions of the Byzantine Empire, themselves based on Greco-Roman foundations. At any rate, the Muslim period is often falsely and tendentiously assigned as a time of decline by western scholars and media. Certainly, the eternity of Roman and Byzantine marble is a futile supposition since this rock could be recycled by burning it in furnaces or kilns to produce lime.

In addition, many features invented and maintained by Greco-Roman and Byzantine architecture have been adopted and transformed by Muslim artists and scholars.

Compared with the medieval west, the Orient achieved predominance in the arts and sciences until open-minded western intellectual rulers such as Frederic II of Hohenstauffen began a profitable dialogue. In Mesopotamia, Iran and Egypt, along the northern African coast and up into southern Spain a renaissance of the uncoated brick, sometimes composed to Arabesque ornaments, can be traced. The glazed tile, colored by minerals, was once invented in Mesopotamian Sumer and Babylon during the 2nd millennium BC. It not only was revived during the Muslim period, but celebrated a campaign of victory through out Arabian and Persian countries and societies.

Rock, however, lost its privilege as the guardian of order and power. But, it entered into a new dimension; the dimension of holiness. As one can read in the tractate on the idols by the Abbasid scholar Ibn al-Qalbi, pre-Islamic Arabs already venerated stones as the seat of gods. Nabataean caravan merchants prayed to their divine patrons on fissured rocky high-places. The lithic aspect of religion was still maintained by Islam, a fact witnessed by its two most important sanctuaries, the meteorite in the Kaba of Meqqa and the Dome of the Rock in Jerusalem.

- 1 First published in Greek (1955) and subsequently translated into French (Vol. I-II, 1966-1968)
2 II. 1985, pp. 29-63
3 All prehistoric chronological dates subsequently given refer to Scheltema 2009, p. 6
4 Sievertsen 1997, col. 512
5 Scheltema 2009, pp. 27-31
6 Yassine 1985
7 Sievertsen 1997, col. 512 points out that stone masonry in the ancient Near East was first applied in Neo-Assyrian monumental architecture from the 8th century BC onward under Syro-Phoenician and Hethite influence. But his point of view focuses mainly on Mesopotamia, which takes a different development compared to the Levant due to the wide lack of stone.
8 S. W. Helms, in Homès-Frederic – Hennessy I., 1989, pp. 310-316
9 For Egyptian Pharaonic architecture of fundamental importance are Arnold 1991; Goyon et alii 2004.
10 Geography VIII, Overbeck 1868, 3 No. 1-2, pp. 369, 373
11 Called Argos (*the one who beams*), Brontes (*the one who thunders*) and Stereopes (*the one who flashes*), cf. H. von Geisau, in KP III, col. 393
12 Also alternatively named engasterocheires or cheirogastores
13 Eustathios, Commentary in Odyssey p. 1622, 54; Scholion on Eurypides, Orestide 965; Scholion in Aristides, Rhetorical Art I, p 52, etc. Overbeck 1868, nos. 3-5, pp. 3-4
14 Travlos 1971, no. 101, pp. 52, 54, figs. 66, 67
15 Periegisis II.16.5, Overbeck 1868, no. 25, p. 5
16 Orlandos 1955, p. 294, fig. 271; Orlandos 1968, p. 200, fig. 244
17 Orlandos 1955, p. 67; Orlandos 1968, p. 1
18 Löw 1936, pp. 374-379
19 Orlandos 1955, pp. 107-140; Orlandos 1968, pp. 21-69
20 For the development of the Greek Aeolic capital and its relation to Oriental architectural prototypes see Wesenberg 1971, pp. 74-87 (Wesenberg is more hesitant about the Oriental origin of the Aeolian capital. He assumes an independent development under comparable external conditions); Betancourt 1977, pp. 115-133, esp. p. 117, *It is most likely that the Greeks borrowed the volute capital from some nearby region in Anatolia or North Syria, although an Assyrian origin cannot be completely ruled out.* Yigal 1979; Negueruela 1982, pp. 395-401
21 Orlandos 1955, pp. 207-216; Orlandos II. 1968, pp. 127-134
22 Betancourt 1977, pp. 50-55; cf. Baran 2011
23 Betancourt 1977, p. 27-35, pl. 4-6, 9
24 Betancourt 1977, p. 19 with note 12
25 Negueruela, I., 1982, pp. 395-401
26 Betancourt 1977, p. 122 with notes 1-2
27 Betancourt 1977, p. 129
28 Betancourt 1977, p. 132
29 An excellent overview on the Greek architects of the Archaic and Classical periods is provided by Svenson-Evers 1996
30 Orlandos 1955, p. 232, fig. 187; Orlandos 1968, p. 148, fig. 165
31 Pausanias, Periegisis VIII 30,2; For justified criticism on Pausanias cf. Svenson-Evers 1996, p. 160 with note 3

- 32 Relevant literary sources quoted in RE II. 1896, col. 2068 s.v. Athos 1 (Oberhummer)
33 Orlandos 1955, 251-256; Orlandos 1968, pp. 175-178
34 Will – Larché 1991
35 Will 1987
36 Will 1966; Adam 1977; F. Ragette, in Van Ess – Weber 1999, p. 59-61, fig.55
37 Wesenberg 1991. For the adoptions of Achaemenid elements by Philipp II of Macedonia cf. Kienast 1973
38 For this important group of Hellenistic funeral monuments see now Huguenot 2008
39 Miller 1993
40 Huguenot 2008, p. 34, no. 27D
41 von Hesberg 2005, pp. 20-21
42 Venit 2002, p. 74-77, color pl. I
43 McKenzie 1990, pp. 85-104
44 von Hesberg 2005, p. 24, fig. 4 g
45 Förtsch 1988, p. 80, fig. 63
46 Förtsch 1996, p. 114, fig. 59
47 For Roman cement in general see Ringbom – Hohlfelder 2011,
For its employment in the East see Deichman 1979
48 De Vita Caesarum, Augustus 28
49 Travlos 1971, p. 104-111
50 Ward-Perkins 1951, p. 79
51 Ward-Perkins 1951, p. 99; Burns 2011 (unpublished), p. 170
52 Taylor 2003, p. 19; Burns 2011 (unpublished), p. 170
53 Burns 2011 (unpublished)
54 Butcher 2003, p. 211
55 Deichmann 1975

- Adam, J.P.** A propos du trilithon de Baalbek. Le transport et la mise en oeuvre des mégalithes. *Syria* 54, 1977, pp. 31-63
- Arnold, D.** Building in Egypt. Pharaonic stonemasonry. New York – Oxford etc., Oxford University Press, 1991
- Aurenche, O.** La Maison Orientale. 1981
- Bahnassi, A.** A Dictionary of Architecture and Arts. Arabic-English and English-Arabic, with an English-French glossary. Beirut, Librairie du Liban, 1995
- Baran, A.** New Thoughts on the Aeolic Style in Architecture. In SOMA 15th Symposium on Mediterranean Archaeology. Catania University, 2011, unpublished, http://docs.google.com/viewer?a=v&q=cache:LhaNCO5I02YJ:ww.genama.info/images/SOMA2011_ABSTARCTS.pdf+Abdulkadir+Baran+Aeolic+Style&hl=de&gl=de&pid=bl&srcid=ADGEESjVWFv9I_nH1mQX6L-IufKgzzT4aY86acS4pu1Ao3u1hhY1JL_zt2MvisOOBMuC8Ni6jMPPC29OihHoUWoqUvym4lctm9Mefn9KDC5871-BgRYotcTzhg7JzxnP6jHEt64Hsy9q&sig=AHIEtbTelDv2otP863p5akziKHhV7Fvxww
- Betancourt, P. P.** The Aeolic Style in Architecture. A Survey of its Development in Palestine, the Halikarnassos Peninsula, and Greece, 1000-500 BC. Princeton, N. J., Princeton University Press, 1977.
- Burns, R. A.** Colonnaded Streets in the Cities of the East under Rome, unpublished PhD-thesis, Sydney: Macquarie University Department of Ancient History, 2011
- Butcher, K.** Roman Syria and the Near East. London, The British Museum, 2003
- Coarelli, F.** Rom. Ein archäologischer Führer. Freiburg-Basel-Wien, Herder, 1975
- Deichmann, F. W.** Die Spolien in der spätantiken Architektur. Sitzungsberichte der Bayerischen Akademie der Wissenschaften, Phil.-Hist. Klasse Heft 6, Munich, Bayerische Akademie der Wissenschaften, 1975
- Deichman, F. W.** Westliche Bautechnik im römischen und rhomäischen Osten, in Mitteilungen des Deutschen Archäologischen Instituts. Römische Abteilung, 86, 1979, pp. 437-527
- EAA atlante.** Enciclopedia dell'Arte Antica Classica e Orientale, Atlante dei Complessi Figurati, ed. G. Becatti. Rome, Istituto della Enciclopedia Italiana, 1973
- Förtsch, R.** The Residences of King Herod and their Relations to Roman Villa Architecture, in Judaea and the Greco-Roman World in the Time of Herod in the Light of Archaeological Evidence. Abhandlungen der Akademie der Wissenschaften in Göttingen, philologisch-historische Klasse, dritte Folge Nr. 215, Göttingen, Vandenhoeck & Ruprecht, 1996, pp. 73-120
- Gebel, H.-G.** Das Akeramische Neolithikum Vorderasiens: Subsistenzformen und Siedlungsweisen; tabellarische Material- und Befundpräsentation zu Fundorten des Protoneolithikums und des Akeramischen Neolithikums. 1984
- Ginouvès, R., Martin, R., I.** Dictionnaire méthodique de l'architecture Grecque et Romaine I: Matériaux, techniques de construction, techniques et formes du décor. Collection de l'École Française de Rome, Vol. 84. Athens-Rome, 1985

- Goyon, J.-C., et alii.** La construction Pharaonique du Moyen Empire à l'époque gréco-romaine. Contexte et principes technologues. Paris, Picard, 2004
- Homès-Frederic, D., Hennessy, J. B.** The Archaeology of Jordan I-II. Akkadika Supplements VII.***, Leuven, Peeters 1989, 2010
- Huguenot, C.** La tombe aus Érotés et la tombe d'Amarynthos. Eretria XIX, Gollion, Infolia éditions, 2008
- Khammash, A.** Notes on Village Architecture in Jordan. Lafayette, LA, University of Southwestern Louisiana Art Museum, 1986
- Kienast, D.** Philipp II. und das Reich der Achaimeniden. Abhandlungen der Marburger Gelehrten Gesellschaft, 1971, Nr. 6, Munich, W. Fink, 1973
- Kopf, H., Binding, G.** Bildwörterbuch der Architektur mit englischem, französischem, italienischem und spanischem Fachglossar. 4th edition, Stuttgart, Alfred Kröner Verlag, 2005
- KP. Der Kleine Pauly.** Lexikon der Antike, Vols. I-V. Ed. K. Ziegler – W. Sontheimer. Munich, Deutscher Taschenbuch-Verlag, 1979
- Löw, I.** Marmor. Ein Kapitel aus meinem: Mineralien der Juden, in Occident and Orient. In Honour of Haham Dr. Moses Gaster's 80th birthday. Gaster Anniversary Volume. ed. B. Schindler, London,*****, 1936, pp. 374-379
- Macaulay, D.** City, A Story of Roman Planning and Construction. Boston, MA, Boughton Mifflin Company, 1974
- Miller, S. G.** The Tomb of Lyson and Kallikles: A Painted Macedonian Tomb. Mainz, Philipp von Zabern, 1993
- Naumann, R.** Architektur Kleinasiens von ihren Anfängen bis zum Ende der hethitischen Zeit. Deutsches Archäologisches Institut, Tübingen, Verlag Ernst Wasmuth, 1955
- Negueruela, I.** The Proto-Aeolic Capitals from Mudeibi'a, Moab, in Annuals of the Department of Antiquities of Jordan, 26, pp. 395-401, 1982
- Orlandos, A.** Les matériaux de construction et la technique architecturale des anciens Grecs, I-II. Travaux et Mémoires, École Francaise d'Athènes Fasc. XVI-XVIIbis. Paris, Éditions E. de Boccard, 1966, 1968
- Overbeck, J.** Die antiken Schriftquellen zur Geschichte der bildenden Künste bei den Griechen. Leipzig, Verlag von Wilhelm Engelmann, 1868
- RE.** Pauly's Real-Encyclopädie der Classischen Altertumswissenschaft ed. G. Wissowa. Stuttgart, J. R. Metzlerscher Verlag
- Scheltema, G.** Megalithic Jordan. An Introduction and Field Guide. Amman, American Center of Oriental Research, 2008

- Sievertsen, U.** Article Bautechnik I.: Vorderer Orient und Ägypten, in *Der Neue Pauly – Enzyklopädie der Antike*. Cancik, H., Schneider, H.(eds.), Vol. II, Stuttgart-Weimar, Verlag J. Metzler, 1997
- Svenson-Evers, H.** Die Griechischen Architekten archaischer und klassischer Zeit. *Archäologische Studien 11*. Frankfurt/M.-Berlin-Bern-New York-Paris-Wien, Peter Lang, 1996
- Taylor, R. M.** *Roman Builders: A Study in Architectural Process*. Cambridge University Press, 2003
- Travlos, J.** *Bildlexikon zur Topographie des antiken Athen*. Tübingen, Verlag Ernst Wasmuth, 1971
- Van Ess, M., Weber, Th.** *Baalbek – Im Bann Römischer Monumentalarchitektur*. Mainz, Philipp von Zabern, 1999
- Venit, M. S.** *Monumental Tombs of Ancient Alexandria*. Cambridge, Mass., University Press, 2002
- von Hesberg, H.** *Römische Baukunst*. München, Verlag C.H. Beck, 2005
- Ward-Perkins, J. B.** Tripolitania and the Marble Trade. *Journal of Roman Studies*, 1951, 41, no. 1-2, pp. 89-104
- Wesenberg, B.** Kapitelle und Basen. Beobachtungen zur Entstehung der griechischen Säulenformen. Beihefte der Bonner Jahrbücher, Vol. XXXII, Düsseldorf, Rheinland-Verlag, 1971
- Wesenberg, B.** Zur Entstehung des griechischen Keilsteingewölbes, in *Bautechnik der Antike: internationales Kolloquium in Berlin vom 15.-17.2.1990*, veranstaltet vom Architekturreferat des DAI in Zus.-arbeit mit dem Seminar für Klassische Archäologie der FU Berlin. Hoffmann, A. (et alii), Philipp von Zabern, Mainz, 1991, pp. 252-258
- Will, E.** Du trilithon de Baalbek et d'autres appareils colossaux, in *Mélanges offerts à Kazimierz Michałowski*. Warszawa, Państwowe Wydawnictwo Nauk, 1966
- Will, E.** Qu'uest-ce qu'une „baris“?, in *Syria* 64. 1987, pp. 253-259
- Will, E., Larché, F.** 'Iraq al Amir: le château du Tobiade Hyrcan. *Bibliothèque Archéologique et Historique*, Vol. 132, P. Geuthner, Paris, 1991
- Wright, G. R. H.** *Ancient building in south Syria and Palestine*. 1986
- Yassine, Kh.** The Dolmens: Construction and Dating Reconsidered, in *Bulletin of the American Schools of Oriental Research*. no. 259, 1985, pp. 63-69
- Yigal, S.** *The Proto-Aeolic Capital and Israelite Ashlar Masonry*. Qedem 11, Jerusalem, The Hebrew University, 1979



GEOLOGICAL OUTLINE OF SYRIA AND JORDAN

The evolution of architecture, and any given built environment, is clearly a function of the needs of the people and the resources available for construction. In the Mediterranean region, needs include shelter from the elements (heat, cold, humidity and wild animals), which differs little from most climatic settings. On the other hand, the bulk of useable natural materials consists of stone, except in limited settings where mud brick has been used as a prime building material when suitable stone resources were not available¹. Wood was sparingly used due to its limited availability in arid climates.

Stone is a bulky material, which is expensive and difficult to move. Therefore, it is not surprising that in any given area, most of the stone used consisted of material which was locally available, irrespective of the quality of that material.

In modern architecture, and with the use of heavy equipment for extraction and transport, it has become more common to move stone from more distant sources. This provides opportunities for stone use

most appropriate to the function. In fact, modern building has departed significantly from traditional architecture in terms of the materials used, and the form, function and technology of the usage. However, in some aspects modern architecture in Jordan and to a lesser extent in Syria does retain the use of stone, while changing the function of this material as well as its sources. Specifically, stone is now being used as decorative cladding rather than a material for structural support. This has had the effect of lowering the volume of the stone needed per building, and lowering transportation costs.

The use of imported stone for decoration is not new. During the Classical periods of the Greek, Roman and Nabatean empires, marble transported from Greece and Anatolia was used for flooring and wall cladding in public buildings and private residences. These have been found in Jarash, Umm Qais and Petra. While these are notable examples, they are none the less a departure from the more mundane trend of using local stone, which was a more economically feasible choice.

Geologically, rock is classified as being either igneous (formed from cooling melted rock known as magma or lava), sedimentary (derived from the weathering, erosion, transport, sedimentation and lithification of previously existing rock) or metamorphic (formed from a previously existing rock subjected to high pressures, temperatures and/or interaction with thermal water). Thus, the types of rocks present reflect the geological history of an area. Most common examples of igneous rocks include granite and basalt. Sedimentary rocks include sandstone and limestone, and metamorphic rock is marble and slate².

In this chapter, I will describe how geology has dictated the nature of building materials in Jordan and Syria. Also to be considered is how modern architecture has adopted the use of stone increasingly as a decorative element, changing the economic drivers related to how it is used, the volume needed, and the qualities that are deemed desirable when choosing this material. These imperatives have thus led to the use of selected sources that provide the desired properties in balance with the cost of extracting and transporting stone. In addition, I will add a few notes on the use of imported stone that has been found in ancient structures, specifically in buildings of the Classical Period (Greek, Roman and Nabataean civilizations). These represent a

unique case that deserves at least a short mention in this context.

Brief Geology

The region of Jordan and Syria, geologically speaking, has long represented what is known as a stable shelf margin, where a continent with a core at the Arabian-Nubian Shield (in what is now the western part of Saudi Arabia and the eastern parts of Egypt and Sudan) interacted with the Tethys Sea in the area around this core. As the sea rose and receded, the boundary between continental sediments surrounding the shield and the marine sediments deposited by the Tethys fluctuated. From 350 million ago until 30 million years ago, it can be seen that sedimentary rocks tend to grade from continental sandstone in the south (where the Arabian Nubian shield is found) to clay rich limestone (known as marl and marly limestone) and cleaner white limestone in the north where marine environments dominated. While this oversimplified view of the area's paleogeography would make a geologist wince, it does provide a starting point in understanding the distribution of the sedimentary rocks that characterize the region.

Drastic changes in the paleogeography began to occur about 30 million years ago, when the Tethys ocean began to disappear

as the Arabian Continental Plate began to collide with the Eurasian Plate. This led to the formation of the Taurus and Zagros mountains in Turkey, Iraq and Iran, the beginning of the Mediterranean Sea, the Red Sea and the Dead Sea rift valley, and a number of other features that now dominate the geomorphology of the region. In addition, massive volcanism at this time led to significant basalt flows seen in central Jordan as well as in the boundary area covering northern Jordan and southern Syria.

From south to north the dominant rock outcrops start from Paleozoic continental sandstones in southern Jordan to Mesozoic and Early Cenozoic limestone in central to northern Jordan and southern Syria (This limestone sometimes contains marly limestone, phosphatic and cherty limestone.) Basalt outcroppings span from southern Syria reaching into northern Jordan³. The basalt is Cenozoic in age, and is mostly from the Eocene period. While other types of lithologies are present (such as Precambrian granite in the Aqaba area and Cenozoic travertine in the Jordan Valley), these have rarely been used in the past, and their modern uses are for decorative purposes. They are rarely used as building stone.

Following is a brief synopsis of the major stones used for building in the past and the present.

Limestone

Limestone is by far the most common building stone used in Jordan and Syria. Specifically, the Middle and Upper Cretaceous and Eocene limestone found in northern Jordan and southern Syria has long been the favored building stone. Aside from its abundance, this limestone provides a suitable building material that is both mechanically and chemically stable as well as aesthetically desirable.

The Middle and Upper Cretaceous and Eocene sequence in northern Jordan is divided into two distinct groups. The Middle Cretaceous is known as the Ajloun Group and the Upper Cretaceous-Eocene Group is known as the Balqa Group. The Ajloun Group is divided into five formations, from older (lower) to younger known as the Naur, Wadi Shueib, Hummar, Fuheis and Wadi Sir formations. These vary in physical qualities and thus in their desirability as building materials. For example, the Naur and Wadi Shueib formations are thinly bedded and rich in clay material known as marl. These formations tend to be ignored because their thin bedding does not lend to the extraction of large enough stones for building purposes. Their clay content makes them generally weak stones that do not endure weathering, and their yellow color is not considered to be aesthetically pleasing.

This is not to say that these stones have not been used in traditional architecture. The traditional buildings in Salt have almost exclusively been extracted from the Wadi Shueib formation, giving the old city a distinctive and beautiful yellowish hue.

But most stone from the Ajloun group has been extracted from the thicker, cleaner and whiter Fuheis and Wadi Sir formations⁴. These formations have provided the bulk of architectural building stones found both in classical archaeological sites as well as more recent traditional architecture. The quarries of ancient Gerasa (Jarash), for example, were opened by the Romans providing the bulk of the building stone used in the construction of their monumental city. These quarries were generally opened in the outcrops of the Fuheis and to a lesser extent the Wadi Sir formations. They provided stone that was large enough to carve large drums for the colonnaded streets as well as blocks that were needed for the construction of palaces, temples, baths and houses that graced the Decapolis city of Gerasa.

Quarries deriving from the Fuheis and Wadi Sir formations are ubiquitous in northern Jordan, both as a result of the desirability of this stone as well as its prevalence in the region⁵. The stone is hard yet easily shaped. Large blocks can be extracted, and have a desirable white color.

The Wadi Sir formation has been exploited extensively in Ajloun, Ishtafaina, Anjara and Dair Yousef in the Ajloun and Irbid governorates. A highly sought after stone for building in modern times, it is hard and dense and comes in subtle pink, yellow and grey hues. But because these quarries exist in forested areas in a country sorely devoid of trees, permits to quarry there have been revoked for environmental reasons.

The Wadi Sir formation, is also extracted extensively in the northwestern Mafrq governorate, most notably in Hayyan. While the Wadi Sir formation is the same, the quality of stone is notably lower in this area, as it has not undergone the extensive recrystallization which characterizes the limestone found in the more humid Irbid and Ajloun governorates. The softer Hayyan limestone is easier to extract, and the area where it is found does not have the same environmental concerns that limit the extractability of stone from Irbid and Ajloun.

The Hellenistic Temple of Qasr al Abd at Iraq al Amir west of Amman is an interesting example where massive blocks of the Wadi Sir limestone were used in construction. The sizes of the blocks used are impressive, and clearly show the possibilities of utilizing local stone resources in astounding ways. The Upper Cretaceous and Lower Tertiary Balqa Group is not as prevalent in northern Jordan.

It consists of four formations known as the Amman Silicified Limestone, the Hassa Phosphorite, the Muwaqqar Chalk Marl and the Umm Rijam Chalk Marl formations.

The Amman Silicified Limestone (ASL) is a formation consisting of alternating layers of chert and limestone that are difficult to separate, brittle and are relatively thin. This stone was seldom used as a building stone, with notable exceptions seen at Rujm al Malfuf, where an Iron Age fortification in the form of a round tower has been built exclusively out of flat stones from this formation. A series of these fortifications were built from the Amman formation silicified limestone during that time.

Other structures known as dolmens are found throughout the north of Jordan, which are Bronze Age structures consisting of two flat supporting walls and a ceiling made up of large slabs of stone extracted from the ASL. Generally speaking builders have long ignored this stone as a building material despite its abundance. It is difficult to shape because it is hard and brittle, and thus stonemasons tended to avoid it.

The Hassa phosphorite unit is soft and thin bedded, and thus does not lend itself to use as a building stone. Some phosphatic limestone can be recognized in older buildings in northern Jordan (from their distinctive peloidal textures and grayish coloration), but these are rare.



NAJ01

NAJ01 Massive limestone blocks used in the construction of Qasr al 'Abd at Iraq al Amir. Stone is from the Wadi Sir formation.

NAJ02 Amman formation building stone at Rujm al Malfuf (photograph T.M. Weber).



NAJ02

Localized metamorphism of the phosphatic formation at Daba south of Amman has led to the formation of colorful reddish, purple and green marbles that are frequently used as fragments imbedded in concrete tile flooring material. This marble is not extracted in large blocks, nor is it used as a building stone for structure or cladding. The Um Rijam formation is a sequence of hard limestone and chert beds of the Late Eocene age. Thick beds and large carbonate concretions within this formation provide some of the most desirable building stone in Jordan. Specifically, the Um Rijam formation in Ma'an is highly desired for modern buildings (Sateh Ma'an and Jazeera stone). It is the most expensive due to its high quality and the distance that is needed to transport it to the urban areas in the north and center of the country. The Um Rijam is also quarried in the northeast of the country in Ruwaishid in the Mafraq governorate. The Ruwaishid stone is of lower quality than its counterpart in the south, and is mostly used as a low cost alternative.

Basalt

Cenozoic volcanism in the west and north of Jordan and southern Syria has led to extensive basalt flows in these areas. Over the last 30 million years, thick deposits of basalt as well as pyroclastic cones have marked large areas in both countries.



On the face of it, basalt is an ideal building material as it is durable and hard. However, because it is difficult to work and to move, it has not been used much in the past except in areas where it is near the source. Thus, the builders of the Nabatean city of Umm Jimal in the Mafraq area and the Greek-Roman city of Gadara (Umm

Qais) in the Irbid governorate as well as the city Bosra (Nabatean, later Roman) in southern Syria used this stone extensively, as it is local and thus costs little to transport. More recent Ottoman and 20th century buildings in Damascus and Irbid have also used basalt, mostly intermingled with limestone. Current building codes discourage the use of basalt. The material is difficult to extract and dress because of its hardness. There is also an aversion to using it as owning a black house might be considered bad luck by many. Basalt is less commonly used in modern times.

NAJ03 Basalt cladding on a contemporary church designed by the architect Josef Abu-Hadid in the Hauran region, Syria (photograph J. Jäger).

NAJ04 Travertine block handrail at Kempinsky Ishtar Dead Sea, Jordan (photograph I. Helmedag).



NAJ04

Travertine

In the late 1990's the use of travertine extracted from the Jordan valley became somewhat fashionable, mostly to add a rough yellowish touch to parts of the exteriors of buildings.

The use of travertine in the past has been limited, although there are occurrences. For example, there is at least one travertine column in the ancient city of Gerasa (Jerash), despite the fact that most of the columns used in building the Greco-Roman city were extracted from local limestone. In addition, there is a granite column in the city. This occurrence is interesting to note, because the nearest source of granite was about 400 km away. Most probably stone used for this column was brought from Aswan in Egypt. Travertine is a carbonate deposit formed due to precipitation near springs of both cold but mostly hot water. It tends to contain large voids from areas where bubbling water penetrated when the stone was deposited. Low porosity stones, particularly limestone, tend to be considered of higher quality and desirability than high porosity ones, as shall be discussed later.

Under most contexts travertine would be considered a low quality building stone. However, its aesthetic value overcomes its technical characteristics in some cases.

This is somewhat ironic because the Wadi Shueib formation stone used extensively in traditional Salt has been deemed undesirable, even as the travertine has come into use to achieve a similar effect.

Granite

Extensive outcrops of granite are found in the south of Jordan near the city of Aqaba. The granite is very old, and has been subjected to extensive tectonic deformation and to a lesser extent mechanical weathering.

Quarrying for large blocks has not occurred in this region, because the size of the blocks that can be extracted would generally be small. Nonetheless, some small operators look for large granite boulders in the stream beds in the area.

Using jackhammers and small equipment, these operators carve cubes out of such boulders and transport them to saw mills where they are cut into sheets, polished and used for kitchen tops and occasionally flooring material.

Granite is not used as a building material although it has been used in a few old buildings in Aqaba, notably the Mamlouk fort, where modern renovations utilized this material.

Marble

Besides the Daba' marble mentioned previously, there are no native marble sources in Jordan. Some hard fossiliferous white, grey and reddish limestone is extracted from the Hallabat area near Azraq (from the Wadi Sir Formation), and is polished and marketed as marble for local use. From a scientific view point these are sedimentary rocks and not metamorphic, which is a requirement for any stone to be termed a marble.

Imported marble is extensively used in modern architecture, mostly as flooring but sometimes on exterior walls. Distinctive marbles from the northern Mediterranean (Italy, Turkey and Greece) are quite popular, with their white, bluish and greyish colors. Interestingly, this is not a new phenomenon.

Similar marble (mostly from modern Greece and Turkey) was generously used in classical architecture (Greek, Roman and Nabatean) from Gadara in the north of Jordan all the way down to Petra in the south. Statues, columns, floors and light cladding of walls have been found using this material. Its provenance has been authenticated using standard petrographical and isotopic techniques. The volume was constrained by the ability to move the material, as the logistics were certainly a consideration at that time.



NAJ05 Petra Treasury made of sandstone (photograph I. Helmedag).

Sandstone

The most outstanding example of the use of sandstone in Jordanian architecture is in the Nabatean city of Petra. While the city is renowned for its façades carved into the sandstone cliffs of the city, built architecture is a significant component of the city, although now less prominent as a result of selective preservation. It should be noted that the spectacular façades seen today were mostly tombs with little functional value for the inhabitants of the ancient city.

Large monumental buildings (such as Qasr al Bint and the Great Temple) were built from sandstone quarried from the cliffs of the city and the surrounding area⁷. Smaller structures such as homes and shops were also built structures in which locally quarried sandstone was the primary material used. There are two geological units of sandstone in Petra; a lower, older unit known as the Umm Ishrin formation, which is of Cambrian age, and an upper white unit known as the Disiformation, which is of Ordovician age.

Most of the well-known façades of Petra, such as the treasury and the monastery, were in fact carved into the Umm Ishrin formation sandstone, which is easily recognized by its red and variegated colors.

The sandstone's multiple colors give it beauty, but in many cases is also a source of weakness. Hematite and limonite inclusions in the stone tend to be source points of deterioration. One outcrop, the Umm Ishrin sandstone, is identifiable not only by its reddish and variable color, but by its weathering and erosional patterns, as it is characterized by steep cliffs and angular edges. The overlying Disi formation, on the other hand, is whitish in color and tends to form more gentle slopes and more rounded edges. Generally, it is more brittle and less consolidated than Umm Ishrin sandstone.



NAJ06 Free-standing sandstone structure, Qasr El Bint in Petra.

Both the Umm Ishrin and the Disi sandstones have been quarried and used as building stones in Petra.

The Nabateans also built the settlement of Khirbat Al Dharih to the north of Petra from local sandstone. Other notable sandstone architecture is seen at Herodus' palace on the eastern shore of the Dead Sea.

This Roman complex, with an associated port, was also built from the local Paleozoic sandstone, probably Cambrian as well, which was present in the area.

Younger sandstone of the Early Cretaceous, known geologically as Kurnub sandstone and more popularly as *Ramil Sweileh*, is present in a few locations in northern Jordan.

However, it tends to be more friable than the Paleozoic sandstone in the south, and has not been employed in traditional or modern architecture as a building stone. It is used as an aggregate material in modern concrete.

The weak nature of the sandstone and the more humid climate found in the north have led to the prevalent use of the abundant limestone resources in these areas. Limestone is the dominant building stone found in both Jordan and Syria.

What makes a good building stone?

In the last 25 years the function of stone has changed from a supporting structural material to a decorative cladding material. As such, the requirements for a good building stone have changed from that of strength and durability to that of what is perceived as aesthetically pleasing. The general requirement is that the stone be void of any clay inclusions, stylolites, fossils or crystalline veins. Moreover, the color of the stone should be white and more or less uniform.

In short, the unfortunate trend is that the stone should look more like a factory produced industrial material than a natural material with all that is entailed regarding heterogeneity. Ironically, the chalky limestone that meets these requirements often has poor strength and porosity characteristics.

Other functional traits require that the stone has low porosity. As it turns out, the strength of the material is well correlated with low porosity⁶, and so good stone has both the characteristics of strength and low porosity.

Low porosity helps to insulate buildings from humidity, and thus lowers dampness on the inner walls, the formation of mildew and blistering of paint. In the long run, good stone lowers the heating and maintenance costs of buildings, because it minimizes the damage that dampness causes.

The exteriors of buildings also tend to degrade with time when high porosity stone is used. Areas of moisture in the stone may encourage the growth of moss. While this may be viewed as quaint in older buildings, it is undesirable in modern structures. In areas where pollution is high, soot particles from automobiles tend to become embedded in the pores, causing ugly discoloration that can only be remedied with sand blasting. While this solution can be resorted to occasionally, it is a nuisance to neighbors

and causes the erosion of the façade with time. This is a particular problem because the stones currently used are not thick. The decorative mortar between the stones, which consists of white cement with a black line (*kuhleh*), also erodes due to sand blasting and may require additional maintenance.

Buildings exteriors look similar to the untrained eye when the building is new.

It is common for commercial builders to use low quality stone, as the problems relating to stone permeability do not appear for a number of years after the building has been finished and apartments sold.

- 1 Nourisier et al., 2002
- 2 Lutgens and Tarbuck, 2005
- 3 Abu-Jaber et al., 1989
- 4 Abu-Jaber et al., 2009
- 5 Nawasreh et al., 2007
- 6 Naghoj et al., 2010
- 7 Al Saad et al., 2007

Abu-Jaber, N., Kimberley, M. and Cavaroc, V. Mesozoic-Paleogene basin development within the eastern Mediterranean borderland. *J. Petrol. Geol.*, 12, pp. 419-436, 1989

Abu-Jaber, N., Al-Saad, Z. and Smadi, N. The Quarryscapes of Gerasa (Jarash), Jordan, in Abu-Jaber, N., Bloxam, E.G., Degryse, P. and Heldal, T. (eds.). *Quarryscapes: ancient stone-quarry landscapes in the Eastern Mediterranean*. Geological Survey of Norway Special Publication 12, pp. 67-75, 2009

Al-Saad, Z., Abu-Jaber, N. and Zoubi, A. Petra, p. 99-170, in *Quarryscapes Report: Landscape, provenance and conservation of stone sources from selected archaeological sites in Jordan* (ed. Nizar Abu-Jaber, Ziad Al-Saad), 2007 http://www.quarryscapes.no/text/publications/del1_report.pdf

Lutgens, F. and Tarbuck, E. *Foundations of Earth Science*, 4th edition. Pearson Educational International, NJ, USA, 2005

Naghoj, N., Youssef, N. and Maiaatah, O. Mechanical Properties of Natural Building Stone: Jordanian Building Limestone as an Example. *Jordan Journal of Earth and Environmental Sciences* 3, pp. 37-48, 2010

Nawasreh, M., Abu Qubu, J. and Mdanat, M. *Building Stones*. Report on the Natural Resources Authority of Jordan, 2007 <http://www.nra.gov.jo>.

Nourissier, G., Reguant, J., Casanovas, X., and Graz, C. (eds.). *Traditional Mediterranean Architecture*. The Corpus Network, Ecole d'Avignon, 2007 www.meda-corpus.net.



ACCUMULATIVE ARCHITECTURE AS A SUSTAINABLE PROCESS AT THE DEIR MAR MUSA MONASTERY

Retrospection *Geography and History*

The Syrian monastery of Saint Moses the Abyssinian (Deir Mar Musa el-Habashi) is situated near the town of An-Nabk, about 80 km north of Damascus.

Built into the extended cliffs of the Anti-Lebanon mountain range approximately 1,320 m above sea level, the monastery overlooks a barren valley in the Badiat Asham desert.

Attracted by natural cisterns and grazing, prehistoric hunters and shepherds once inhabited the region surrounding the monastery. The Romans or Palmyrans are thought to have begun settlement evidenced by a watchtower built on a rock spur in the mountainous cliff side. Christian hermits (among them Moses the Abyssinian, son of the King of Ethiopia, who was martyred by Byzantine soldiers) used cliff caves in this mountain-side for meditation. Thus were the beginnings of a monastic center.

Archaeological and historical evidence confirms the existence of the monastery be-

longing to the Syrian Antiochian Rite since the middle of the 6th century. According to Arabic inscriptions on the walls, the present church in the monastery complex was built in the Islamic year 450 (1058 AD).

In the 15th century the monastery was partly rebuilt and enlarged, but by the first half of the 19th century it was completely abandoned, and slowly fell into ruin. Nevertheless, remaining under the ownership of the Syrian Catholic diocese of Homs, Hama and Nabk, the inhabitants of Nabk devotedly visited the monastery, even as the local parish struggled to maintain it.

In 1984 with the help of the Syrian government, together with the local church and a group of Arabic and European volunteers (led by the Italian Jesuit Father Paolo Dell'Oglio) archaeological conservation began on church frescoes dating back to the 11th and 12th century. At the present time, the monastery hosts a Syrian-Italian school, which is actively restoring these frescos according to a Syrian-European cooperative agreement.



AS01 The monastery Deir Mar Musa, Syria, built on cliffs (photograph I. Helmedag).

In addition to conservation activities, in 1991 a new monastic community was founded. Currently five monks and two nuns, as well as temporarily volunteers and guests, live at Deir Mar Musa under the direction of Father Paolo. Representing different religions they live together in a life of prayer. Their mission includes producing handicraft work and extending hospitality, which for the Semitic, Arabic, and nomadic worlds represents the highest form of virtue.

Building Process

Deir Mar Musa, Deir Al Huqab, Deir Al Hayek

The church is the main building at the Deir Mar Musa monastery. Built in 1058 AD, it has been continuously extended. Presently this small church of about 10 x 10 m is divided into two sections. The larger section consists of a nave and two aisles, which are illuminated by a high eastern window. The second section, the sanctuary, contains the altar and apse. This section is separated from the rest of the church by a stone and wooden chancel screen.

In addition to the church, the monastic complex hosts different spatial functions, including a library, a kitchen, a large platform supporting a traditional goat's hair tent, and a tourist reception area. It has become increasingly apparent that the existing structures are insufficient for a growing community and their guests. Of particular concern is the respected need for separation of male and female accommodations, which are required for monastic life.

In order to accommodate these needs, natural caves a short distance north of the church were transformed into rooms for monks and male guests. Built in a step-by-step pragmatic process modern and traditional construction methods were utilized with the aim to keep the traditional appearance of a

unified complex. This part of the complex is called Deir Al Huqab, and continues to have new rooms added whenever the community is in need of additional space.

A second need led to the building of a complimentary compound at the monastery. This compound became an important extension offering space for cultural activities, spiritual retreats and accommodations for nuns and female guests. Design decisions, such as the choice of the building site, were made by the monastic community and handled as a spontaneous rather than master-planned building process.

Several sites had been suggested for this new building project. Eventually the foot of the mountain facing southeast of the old monastery was selected. Here, a famous ancient cave used by monks for spiritual matters was located. According to local rumour, pieces of an old loom were found inside, leading to naming the cave Al-Hayek (weaver/weaving). Al-Hayek is a common family name in the region as well, and accordingly, the new building was named Deir Al Hayek.

Structure and design of Deir Al Hayek follows the mountain topography. The stairs, affording the vertical movement through the building, are aligned with the steep slope of the mountain. These stairways became a decisive element influencing the overall building design. Providing needed circulation

the stairs are form and order generators. Other form generators include the utilization of traditional construction methods and masonry techniques, such as arches, vaults, and double-layered stonewalls. There is an inner layer of concrete, which is not traditional, but allows for structural support and an outer exposed layer of stone as a masonry façade.

In 1998 building of Deir Al Hayek began with the establishment of a basement that consists of three independent levels accommodating the slope. Extending upward from the basement, walls and columns were erected, starting with a colonnade framing a cave or grotto entrance. This colonnaded entrance is metaphorically seen as a buffer zone between the sacred and secular world. In a later building stage, an exact copy of the eastern building mass was erected west of the colonnade on the next higher level. A bell tower or campanile works as a landmark and an elevator. The elevator is used for circulation inside the building unit.

In principle, all building parts follow the mountain slope along the stairs. Thus the integration of the site and the surrounding environment, as well as the use of traditional building techniques have led to the final appearance of Deir Al Hayek. It has taken nine years to reach its current state, divided into several building phases and motivated by spatial requirements. To quote Father Paolo: "*...we build what we need*".

In addition to the mentioned projects several smaller multifunctional buildings and necessary infrastructure have been completed over the years. These include the visitor center, a nature reserve park, the staircase winding up to the monastery, an iron bridge that connects the old monastery and Deir Al Hayek, an irrigation and sewage system, and facilities for water harvesting. Combined these form the present day complex of Deir Mar Musa.

AS02 This stairway affords the only passage to reach the monastery (photograph J. Jäger).

AS03 The monastic complex of Deir Mar Musa, Syria (photograph I. Helmedag).



AS02



Deir Al Hayek

AS03



Deir Mar Musa

Deir Al Huqab

Sustainability

The arid Mar Musa valley is home to several thousand farmers and shepherds. With decreased rainfall in recent years they have faced severe difficulties, as other job opportunities are limited. Low rainfall is also a major threat to the environment. Few people had heard of Deir Mar Musa until just a few years ago. But with the foresight of Father Paolo, supported by the monastic community and several other partners, new optimism centered on ideas of eco-tourism and biodiversity have budded. Utilizing these sustainable concepts has helped in preserving the environment, reviving the local economy and promoting a dialogue between religions.

Many positive impacts have occurred as villagers from the surrounding community have vigorously participated in various projects. For example, the aforementioned building activities created work for the locals. Although it was difficult in the beginning to find skilled workers capable of building in traditional ways demanded by the regional architecture, training courses were offered to help in re-establishing qualified knowledge for masonry and other building techniques. The growing number of visitors to the monastery has generated business for restaurants and shops in the nearby town Nabk, and furthered job opportunities in the transportation and guidance sector. Tourists, both Syrian and international, participate in the recycling

of garbage, water and sewage at the monastery - one of many activities Deir Mar Musa uses to educate guests of environmental issues. With an architectural design statement that follows local conditions sustainability has been addressed through site interaction. Building at Deir Mar Musa reflects the unique topography of the area. Major materials for added structures are rocks and rough-cut local stone extracted, prepared and used in-situ. Numerous construction methods, like the detailing of openings, lintels and cantilevering stairs recite local building traditions, utilizing and combining them with modern construction techniques. Convenient parts of ruined neighbouring houses have been revitalized as decorative elements, and are vivid witnesses of the past. As a result architecture and landscape at Deir Mar Musa have merged and accent the preservation of the valley's natural beauty.



AS04



AS04-AS06 Utilization of locally available building materials and traditions combined with modern building techniques. For example, note a hidden load bearing structure of concrete at the Deir Al Huqab complimentary compound (photographs I. Helmedag).

Folkesson, Annika. Making the Desert Bloom at Deir Mar Musa. United Nations Report, 2008-10-29
www.un.org.sy/forms/stories/viewStories.php?id=17&pageLang=en (downloaded: 2011-06-05)

Fuchs, Christian. Dair Mar Musa al-Habaschi. Spiegel Online,
www.spiegel.de/reise/fernweh/0,1518,druck-653305,00.html (downloaded: 2011-06-02)

Saglietti, Ivo. Sotto la tenda di Abramo - Deir Mar Musa el-Habaschi. Rome, 2004

Saglietti, Ivo. Deir Mar Musa el-Habashi - Dialog between Islam and Christianity. Rome, 2003
www.prospekt.it/reportage.php?id=184&select=8 (downloaded: 2011-06-05)

Deir Mar Musa's green activities started as far back as 20 years ago, but with the funding of the GEF Small Grants Program (SGP), the eco-tourism project has expanded significantly. SGP, which started its Syrian program in 2005, is funded by the Global Environment Facility (GEF) as a corporate program, and implemented by the United Nations Development Programme (UNDP) on behalf of the GEF partnership and is executed by the United Nations Office for Project Services (UNOPS). SGP supports activities of non-governmental and community-based organizations with the objective of solving environmental problems. In 2006, SGP awarded the monastery with a financial grant. Although SGP today is one of several financiers, this grant was the first. And as such, it opened the doors to additional funding for the monastery as other contributors became interested and decided to support the project.

Mention should be given for the architectural competition *Sham Spiritual Oasis* launched in March 2008 by the monastery community, COSV (Comitato di Coordinamento delle Organizzazioni per il Servizio Volontario, Milan-Italy) and Tanween Arabian Cultural Centre (Prague-Czech Republic) funded by the European Union as a contribution to the celebration of *Damascus as the Cultural Capital of the Arab World*.



THE SIGHT BEHIND THE FAÇADE CONTEMPORARY STONE FAÇADES AND SURFACES

Natural stone façades

Building with natural stone is among the oldest construction techniques of settled man. Almost everywhere on earth one can find natural stones formed into walls and vaults in more or less sophisticated constructions. In the earliest natural stone buildings the outer layer of stones making up façades offered protection against weathering for the building. Individual detailing of surfaces and special stone formats created distinctive appearances.

As time past new complementary surfaces of masonry appeared, for example plastering from mud and chalk, which simplified the laborious processing of masonry surfaces. Unfortunately this added surface application was not equal to the durability of natural stones. The principle of facing masonry or brick was only brought into use for natural flagstones, bricks, earthenware slabs or tiles - a rediscovered yet new building technique for façades of all building types from housing to administration buildings. Meanwhile rear ventilated flagstone façades replaced masonry lining for natural stone façades.



BB01 Detail at the Getty Museum, Los Angeles, USA (photograph I. Helmedag).

Genesis of natural stone material

All over the world there are natural stones of local geological origin. In many places man has quarried natural stone economically providing worthwhile material for building houses, streets, walls, bridges and other structures. There is a huge amount of natural stones available, differing considerably in mineralogical compositions, structure, density and coloring. These differences are explained by their geological genesis (reference Nizar Abu Jaber's article *Geological outline of Syria and Jordan*).

Pyrogenic Rock

Granite and diorite (or syenite) are pyrogenic rock types, formed by the solidification of magma under pressure in the depths under the earth's crust. Resulting from this process is a highly density and resistance rock. Pyrogenic rocks are found on all continents. Characteristically they have a relatively subtle structure and a red to grey chromaticity.

density	2.6-3.0 g/cm ³
compression strength	130-300 N/mm ²
bending tensile strength	5-22 N/mm ²
water absorption	0.2-0.9 mass %
predominantly frost resistant	

Extrusive Rock

Porphyry, basalt, lava flows or volcanic tuff arise when liquid flowing magma reaches the earth's surface and cools down. The fast cooling process produces a generally subtle crystalline structure. As the lava flows escaping gases produce porosity in the rocks' structures.

Almost all extrusive rocks are suited for façades. The strongest rock of this group, basalt, is well suited for construction of heavy walls, flooring, and road pavement. The color range of these extrusive rocks is varied due to the build-up of the magma, producing colors from light white to black.

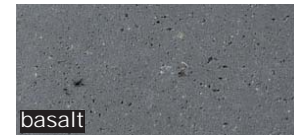

density	1.8-3.0 g/cm ³
compression strength	up to 400 N/mm ²
bending tensile strength	up to 25 N/mm ²
water absorption	0.5 mass %
(in porous rocks	6-15 mass %)
of the extrusive rock types basalt is frost resistant, others predominantly frost resistant	

Sedimentary Rock

Sandstone is the most frequently occurring and processed natural stone. It results from the bonding of fine sand grains (up to 3 mm in size) under pressure. The sand normally originates from erosion. Limestone, which is also included in the sedimentary rock category, develops in oceans (dolomite) and in continental waters (travertine). The rock develops through small-fossil accumulation under pressure in combination with physico-chemical processes in the water. Most sandstones can be used for natural stone façades, but there are big differences in densities, resistances and structures. Travertine and shell limestone have a high porosity. Colors of sedimentary rocks are rather uniform, ranging from light yellow to grey.



density	up to 2.9 g/cm ³
compression strength	up to 60 N/mm ² (travertine)
compression strength	up to 240 N/mm ² (dolomite)
most of these rocks are frost resistant	

Metamorphic Rock

Existing rocks, altered under very high pressure and partly in combination with high temperatures, form a completely new metamorphic rock. The most commonly identified of these natural stones are gneissic rock, schist, quartzite or marble. Metamorphic rocks are found in mountain ranges originating from these processes. The structures are very different. Colors vary from very light white (quartzite) to grey, striped or blurred patterns (marble).

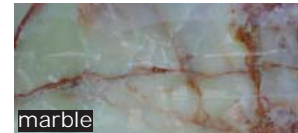

density	2.5-3.0 g/cm ³
compression strength	up to 300 N/mm ²
bending tensile strength	up to 25 N/mm ²
water absorption	up to 0.5 mass %
predominantly frost resistant	

BB02 Multipurpose center and shopping mall (so-called *Aachener Fenster*) in the city of Aachen, Germany, built in 1994, designed by E. Kasper & K. Klever architects. The façade is structured with granite panels in bichromatic color exchange.

BB03 Cladding detail.



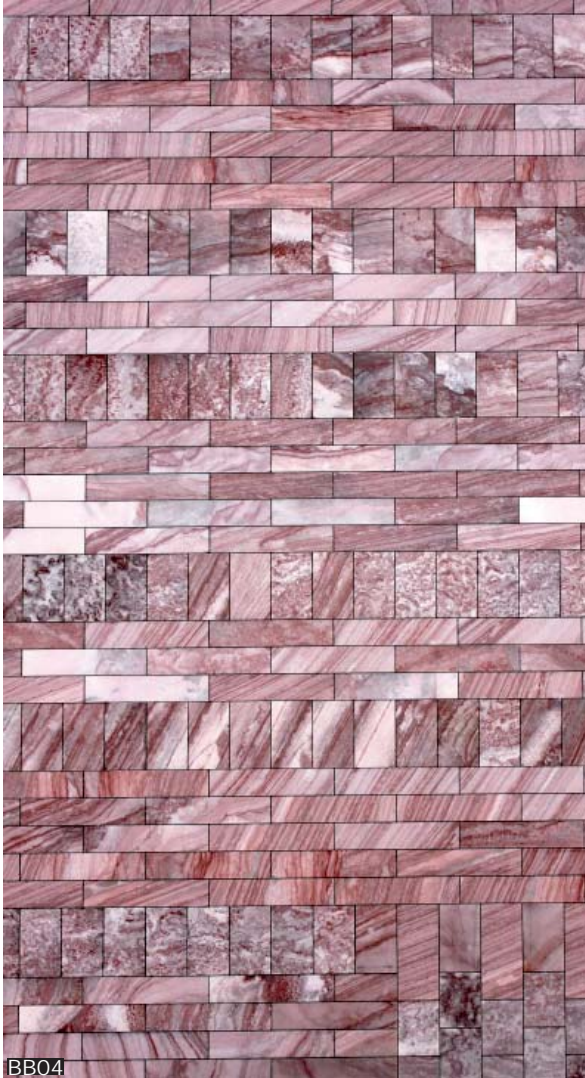

BB05 Central library in Dortmund, Germany, built in 1999, designed by the architect Mario Botta. The regularly perforated façade is characterized by vividly colored sandstone panels.

BB04 Cladding detail.



BB06

BB07 Shell House in Berlin, Germany, built 1930-32, reconstructed 1998-2000, designed by Emil Fahrenkamp, and reconstructed under the aegis of the architect Meinhard von Gerkan.

The Shell House is listed as historical heritage. Its elegant wavy façade is covered with Roman travertine panels, in parts moulded elaborately in convex and concave shapes (photographs J. Jäger).

BB06 Cladding detail.



BB07

The natural stone façade

In addition to the use of natural stone for exposed masonry, natural stone façades can be achieved in three basic variations; first by fixing flagstones with mortar (mortar fixing is extended over the complete area), second with a masonry lining or finally as a rain-screen façade with rear ventilation.

Structurally engineered and structural-physical aspects effect the selection of natural stone, as well as aesthetic aspects like color and structure. Specific values of construction materials, like strength, structure, water absorption and frost resistance, are as important to consider as the different form and configuration possibilities of natural flagstone.

Exposed masonry from natural stone

The oldest way to build a natural stone façade is to construct a masonry wall from natural stones, which are individually treated on the surface. Wall construction methods must follow prescribed building codes for masonry construction. The façade is part of the engineered and physical load bearing structure.

Walls can be achieved in a single or double-leafed construction method where the outside façade may have a different surface treatment from the inner wall.

Due to the advance of new façade construction systems (the feasibilities of machine processed workmanship and various anchoring methods) the façade is being developed as a separate part. But, if connected adequately it will remain part of the load-bearing wall in surface masonry or mixed stonework.

The mortar fixed façade

Mortar fixed façades, where flagstones are symmetrically fixed with mortar to a supporting background layer (similar to tiles in the so-called thick-set application), are no longer common in natural stone applications.

Building techniques with corresponding codes and rules have continuously developed. In repairing or supplementing historical façades, for example in the use of travertine, the technique of a symmetrically mortared stone is still used. Additionally this system of mortar application and/or glued fixation is used with small sized tiles of ceramic or terracotta, and from natural stone.

The mortaring depends on the ground. If the surface of the body shell is even, as on a plastering or an insulation layer, the mortar layer can be added directly but without cavities. If the material is uneven, an armoring in the mortar may become necessary. Joints will be closed completely.

Exemplary wall construction details
(drawings J. Jäger, based on *Detail* review of architecture)

- BB08** Façade as a masonry lining.
- BB09** Exposed masonry from natural stone.
- BB10** Rain-screen cladding.
- BB11** Mortar fixed façade.

Building up a rain-screen cladding
(photographs I. Helmedag)

- BB12** Thermal insulation between concrete wall and flagstones.
- BB13** Panel anchors fix flagstones on the concrete wall.

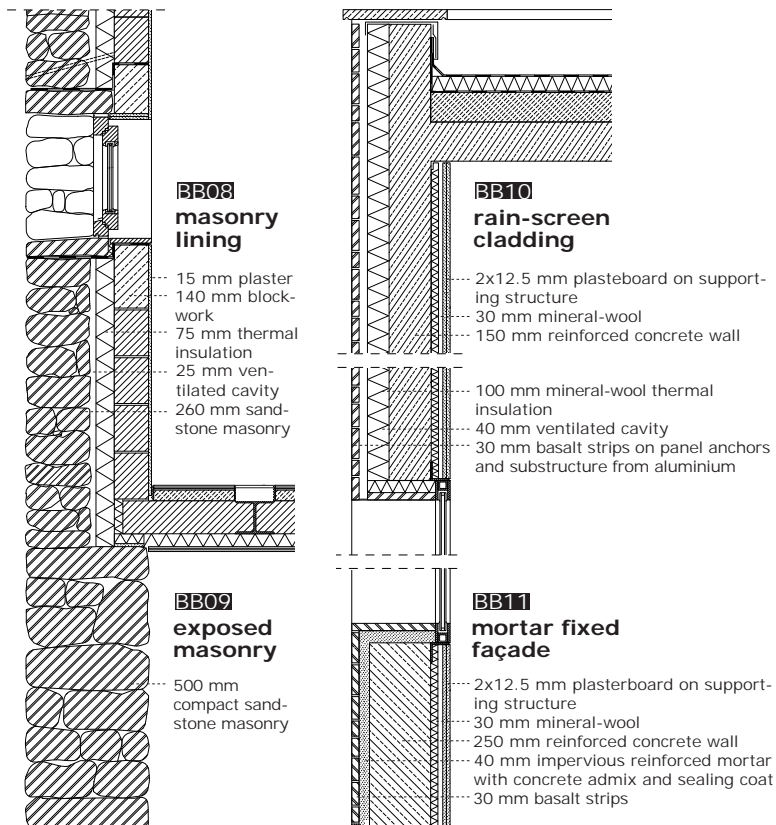

A maximum flagstone size of 0.12 m², from 0.10 m² on fixations of stainless steel is compulsory. Mortar fixed façades are still the commonly prevalent way to construct natural stone façades in Jordan and Syria (see Ingo Helmedag's article *Contemplations on contemporary construction routines, examples from Amman, Jordan*).

The façade as a masonry lining

A façade of masonry lining is exclusively used for covering the shell of a building. It is not part of the load-bearing structure. But the masonry lining is self-supporting, and therefore is subject to the codes for masonry or stonework. Openings for doors or windows are either build as arches or require the addition of lintels.

The loads of the lining shell must be safely supported on foundations or slabs. A minimum of 5 fixations per square meter of stainless steel is needed. Wind loads and dead loads must be counted. With large wall heights the increasing load at the bottom can lead to edge pressure and therefore to spalling. Thickness of the shell ranges between 55 and 90 mm. Joints are closed with mortar. The façade can be built as two-sided masonry, where in between the main load-bearing shell and the lining shell an air layer for ventilation can be located. Small air gaps in the butt joints of the lining shell in the plinth area allow for the ventilation.

Rain-screen cladding

The most commonly constructed natural stone façades are rain-screen claddings; a façade type with an outer skin of rear-ventilated cladding. The outer layer is the actual façade cladding and mainly protects against driving rain. Behind this layer of natural stone are the ventilation and insulation layers within the substructure. Ventilated façades (such as rain-screen cladding) are more costly and time-consuming to implement, but they offer high adaptability forwarding individual needs respective of design and structural-physical demands. They also provide good thermal insulation capacity as the cavity space, acting as an insulation layer, adds to the insulation layer itself. Problems with thermal bridging and humidity development are being resolved with rain-screen cladding. The elements of the façade are fixed in a self-supporting method with steel anchors or anchoring rails in the structural wall behind. Also applied are prefabricated industrial systems made from light metal profiles. The cavity (generally 20 mm) has to be ventilated and drained at its base point.

The joints of natural flagstones remain open; therefore expansion joints in this system are not needed. As natural flagstones are fixed separate from each other, flags, inclined walls and inclined joints can be realised. Vertical standing flagstones need a minimum thickness of 30 mm.

Flagstone forms

Natural stone façades in an exposed outer leaf configuration show rather small flagstone dimensions. Elements for rain-screen cladding can be larger. In this construction application the image of the elevation has to be developed in a joint and stone-cut plan. As in the rain-screen façade with its elements fixed to a substructure, a joint pattern, using different sizes and different natural stone materials, can be creatively designed. Not only rectangular but also inclined or even circular formats are possible. Flagstones for closed façades can also be perforated therefore becoming light transmissive. All constructions have to be proved suitable for statics and in terms of material engineering.

Anchoring of flagstones

Natural stone façades can be fixed visibly or concealed. Each flagstone piece must be fixed with at least 4 anchor bolts, which are drilled in the flagstone. Each piece of flagstone is adhered to surfaces with a fixed bearing and with an expansion bearing necessary for thermal reasons. Temperatures of more than 80°C are possible for façades. The anchor bolt is glued or mortared in. The joints of the rain-screen façade remain open. If the joint is about 10 mm wide adjusted dimensional allowances can be made. Anchors and substructural rails are constructed of anti-rusting

stainless steel or can be galvanized. The durability of the substructure, which is usually hidden, has to be ensured with an appropriate quality of material or material protection.

Static calculation of the façade

With self-supporting natural stone façades a static proof is needed. The proof relates to the strength of the flagstone itself, and to the fixation with anchor bolts or anchoring rails. Through this method wind and dead loads are channeled into the load-bearing structure of the building.

Surface treatment

The surface treatment depends on the structure of the natural stone. Very dense and small stones, like gneissic rock or basalt, allow for flexibility of surface treatments more than porous shell limestone or travertine. Surfaces of flagstone can be created mechanically or manually manipulated. In tradition surfacing methods natural stone is treated manually (by various types of dressing, bossing, charring). Through the sawing process, which is commonly used today, flagstones are perceived as even but rough surfaces. These rough surfaces can receive further embellishment as furrowed, grounded or evenly polished textures. With three-dimensional milling machines signs or lettering can be cut into natural flagstone.

Cleaning of natural stone façades

All natural stones undergo an ageing process, which shows on natural stone surface layers. Natural patinas may be welcomed, but stone façades can become contaminated or visually blemished. Reasons for unwanted surface disfiguring include environmental influences, such as corrosion from ferrous elements and salt, or organic contamination. Unwelcomed color applications such as graffiti, may also occur on stone surfaces. In addition, chemical reactions can alter the surface layer in terms of color, a process that is unavoidable with certain natural stones.

In cleaning stone surfaces gentle procedures are recommended. The structure of the stone must not be disturbed, especially in its vapour diffusion and water absorption abilities. High pressure sand-blasting damages stone façades. Gentle procedures include brush cleaning with water combined with chemical or mechanical applications. Newer methods use laser techniques or dry ice for cleaning purposes. Careful consultation with experts is necessary when considering the possible kinds of damage that may occur as a result of unsanctioned cleaning methods. Non-visible washable coats of paint (treacle) can protect against unwanted color change, but this application must be renewed after every cleaning.

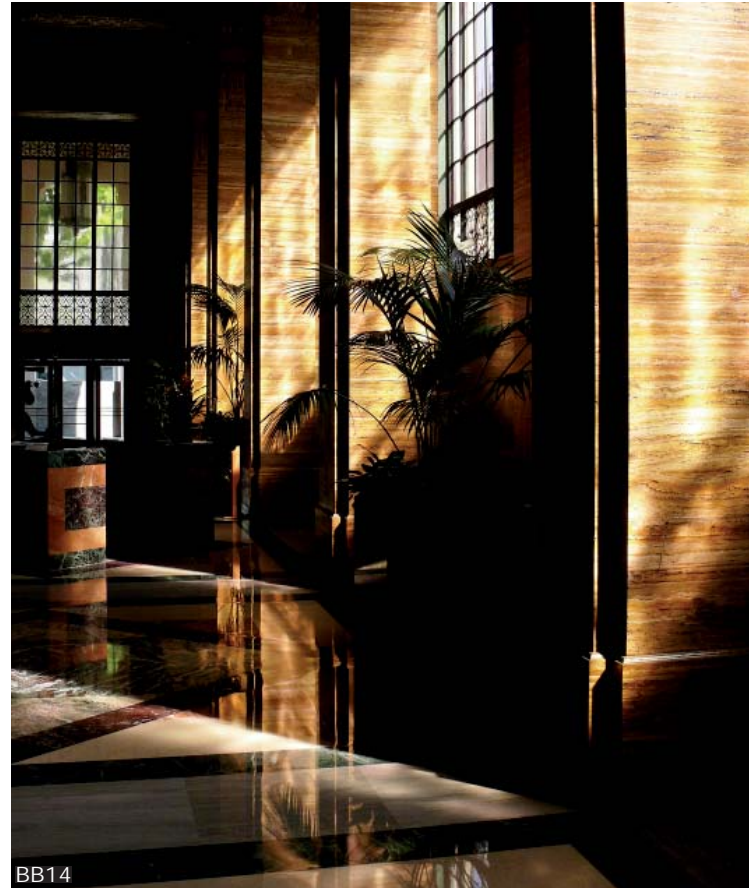

BB14

- BB14** Natural stone is not just found on exterior façades, but used as sophisticated interior material for cladding sheets, paving tiles and even furniture. In the picture, a lobby with travertine cladding and marble pavement, downtown Los Angeles, USA, is shown (photograph I. Helmedag).

Herzog, Thomas. Krippner, Roland. Lang, Werner. Fassaden Atlas. Basel, 2004

Hugues, Theodor. Steiger, Ludwig. Weber, Johann. Detail Praxis. Naturwerkstein: Gesteinsarten. Details. Beispiele. Edition Detail, München, 2002 (2008); respectively: Detail Practice. Dressed Stone: Types of Stone. Details. Examples. Detail Edition, Munich, 2005

Mäckler, Christoph. Werkstoff Stein. Material, Konstruktion, zeitgenössische Architektur. Birkhäuser. Basel, Berlin, Boston, 2004

Schittich, Christian. Im Detail: Gebäudehüllen: Konzepte. Schichten. Material. Birkhäuser (Edition Detail), Basel, Berlin, Boston, 2001

Stein, Alfred. Fassaden aus Natur- und Betonwerkstein, Konstruktion und Bemessung. München, 2000

DETAIL. Zeitschrift für Architektur und Baudetail - Review of Architecture. Bauen mit Naturstein - Natural stone construction. 06/1999, 11/2003

<http://www.naturstein-datenbank.de>

<http://www.halfen.de> (Referring to various systems and drawing details concerning the anchoring of flagstones. English version available.)



PASSIVE HOUSING PROJECTS IN GERMANY

with an introduction by Ingo Helmedag

Realizing that fossil energies are depleting, and that CO₂ reduction is necessary to protect our environment, energy efficiency has become a key issue in resolving these problems in Germany and other countries. *Passive Houses* have a very low energy consumption, and provide an important energy-saving solution for buildings, especially in housing where up to 40% of all energies are used.

To achieve low energy consumption, *Passive Houses* require a certain building standard, which guarantees high energy efficiency and comfortable living. It is important to understand that they are not built in a specific construction method. *Passive Houses* use less than 15 kWh per year and square meter of living area, which is the energy equivalent of 1.5 litres of oil or 1.5 cubic meter of gas, less than 10% of average consumption in a common house. Simply heating the supply air required for good indoor air quality can cover the small amount of remaining energy. Technically low energy consumption is achieved by exceptional high thermal insulation, including well-insulated windows and window frames. Thermal bridges in the building envelope are not allowed. The building

envelope must be airtight, therefore requiring a controlled ventilation system, usually in combination with an efficient heat recovery system. Heating can be done over controlled fresh air flow only, thus a steady comfort zone is guaranteed. *Passive Houses* are not restricted to certain climate zones. They work in hot and cold climates alike. Necessary heating and cooling demands are very low due to the high thermal insulation and sufficiently controlled ventilation.

As *Passive Houses* are not built according to a certain construction method or specified building materials, they could easily be adapted to local requirements. Energy gains through sustainable planning methods and techniques to cover the rest of needed energies are encouraged, but not demanded. The standards for *Passive Houses* are convincingly clear, easy to understand and can be universally adapted to locally prevalent possibilities. The quality requirements of individual components may be adapted to the prevailing local climate. For example double low-e glazing with noble gas filling might be a sufficient choice for hotter climates where shading systems become a necessity.

Housing project in Dresden Pillnitz, Germany

The *Nestwerk Pillnitz* housing project concept began in 2000 with 9 families totaling 39 members as a self-organised group who decided to build and live together in an ecologically sound manner. A site was found on a sunny south-facing slope near the river Elbe and the park of the former royal palace in Pillnitz. It was an urban location, yet in a green setting. Two *Passive Houses* with a total of 9 apartments were constructed using ecologically sound materials and technology.

Two buildings, each consisting of three terraced houses and three loft apartments, were built around a shared atrium providing an ideal space for community life. Every apartment also had an adjacent garden as private space. The apartments are sized from 52m² to 144m². Varying levels allow the buildings to follow the form of the slope. The ground floor is thus made up of a kitchen and spacious living room comprising two levels with generous room heights. Bedrooms and bathroom are located in the upper story. Loft apartments are reached by covered stairs standing separately and extend over one level. Decisions during the planning stage, as well as during actual construction, were reached in discussions involving the ownership community, the architects and the engineers.

A main aim of the owners was to create an ecologically sound and healthy living environment. The energy consumption was to be minimized as much as possible without compromising quality of life. To achieve that, a low energy house concept was used in a more developed form.

The buildings are built of timber-frame construction with healthy building materials. The walls are constructed with *Doka* studwork (timber T profiles at 1,28m centers) as well as oriented-strand-board, which guarantee stiffness and air tightness. The outer walls (three stories high) were made in one piece and then raised to be subsequently attached to inner walls and floors, thus guaranteeing an air-tight façade. The walls were then insulated with cellulose (over a width of 37cm) which is a product of recycled newspapers and achieves $u=0,11\text{W/m}^2\text{K}$. The green roof was insulated with 34cm of cellulose ($u=0,12\text{W/m}^2\text{K}$). Deepened roof battens form the protruding eaves.

The required energy conservation in the partial basement (or ground level) is achieved by crossing boards with an insulation of 30cm. The total area of windows surface was reduced to 30% to avoid overheating the buildings in summer. The wood windows have three pane energy-efficient glazing and insulated frames, which achieve $u=0,85\text{W/m}^2\text{K}$ and $g=44\%$. Only the timber of the sill is chemically treated.



OR01 Multi-family residence,
Dresden-Pillnitz, Germany.

OR02 Site plan / ground floor plan,
multi-family residence,
Dresden-Pillnitz, Germany.

The materials to complete the structure were chosen to meet high ecological standards. Almost no chemical wood protection was used. Painting inside as well as outside was done using natural colors. Pigment joints were sealed with cotton, wool and flaxes. Clay was added in places to enhance the timber construction. The utilization of green roof and rain-water-use complete the concept.

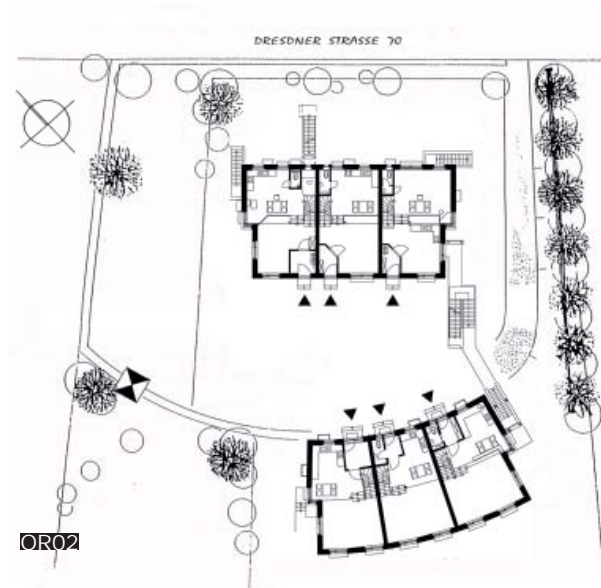

Energy

The elements of the energy concept are an automatic ventilation system with air heating in every apartment, solar panels (12m²) on every house with interim storage of a thousand litres and gas central heating. The legal division of the apartments and the individual floor layouts account for the decision to install separate ventilation systems (with attached ground heat exchanger) in each apartment. Additionally, a heated towel rail was installed in the bathrooms, as well as 3m² of heating pipes embedded in the living room wall. These were installed solely for comfort, to allow the users to feel warmth on cold and unpleasant days.

The heating is distributed in insulated double pipe assemblies that are commonly employed in solar technology. The interim storage takes heating from both solar panels and the community gas boiler. The gas boiler with a performance of 36kW was designed for warm water heating. The times required to heat up the water were considered. The total remaining required energy of both houses is 8kW, calculated on the basis of PhPP. The remaining required heating energy of the apartments lies between 650W and 1600A. There are performance reserves for higher temperatures. As per the wish of some owners, a solution was to disconnect the master bedroom from the air circulation.

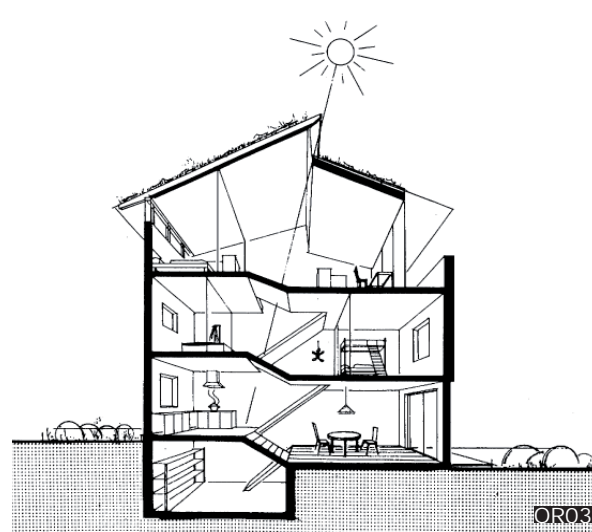

OR03 Section / energy concept.

In response, doors were sealed on four sides. The incoming air and soundproofed overflow openings can be separately locked. Thus the room temperature can vary, and an open window at night does not cool the apartment.

Building costs

The building costs with connecting media and earth exchange, were 1,345 EUR/m². The technological installations (sanitary, electric, heating, air circulation) comprise about 17%. Regarding heating and air circulation, this part is about 9% (OR04). Based on these figures, a comparison with a low-energy house and the project's dynamic rentability was calculated. A comparable user comfort was assumed, in this case solar collectors and ventilation system. The running costs were based on an offer by the install company. Per year and apartment, the costs are 316 EUR with the different maintenance cycles considered.

Costs of 75% are due to the ventilation system. The largest portion, 118 EUR, is the exchange of the filter in the outside air filter box where a lifetime of one year was assumed. As listed in OR05, the running costs are 1.60 EUR/m²a. The rentability calculation takes the installation costs of the energy technology and the increased construction costs of a *Passive House* (wood construction, insulation, windows and doors) into account. The increased building costs are about 5% of total costs. Over a period of 20 years, taking a capital increase of 10% p.a. into account, the *Passive House* has a cost balance compared to the low-energy house.

Building costs	EP [Euro]	GP [Euro]
Site preparation		6,800
Building: labor and material		1,043,500
Building: technology		208,500
Heating, solar installation	52,900	
Sanitary installments	59,900	
Air circulation	59,300	
Electric installments	27,100	
Earth warmth exchange	9,300	
Total costs		1,258,800
Specific costs	Euro/m²	1,345
Percentage technology		17 %
Percentage of heating, solar Air circulation installments		9 %

OR04 Building costs (EP-price per craft, GP-total price).

Running costs	Costs per year for a flat	Costs per year and m ²
Heating and Solar	78,37	0,75
Ventilation system	238,00	2,29
Usages costs	166,11	1,60
Sum	482,48	4,64
Living unit of 100 m²		464,00

OR05 Running costs.

Conclusion

Further development of the *Passive House* should in our opinion aim to be a complete ecological concept. Only saving energy is not sufficient. Architectural ambitions of owners, such as a beautiful, comfortable house with little energy consumption, are not hampered by the idea of the *Passive House*. Eaves, the composition of structures, large window openings in the living area, even round buildings are easily realized. The amount of design does increase. Eighty details were drawn for this building including invisible air circulation ducts. After initial scepticism, the owners were delighted with the living qualities of *Passive Houses*. Combining individual satisfaction with community emphasis has proved to be practicable. In the next two years the structures will be measured to chart the energy consumption, as user behaviour remains the key determining factor.

Kindergarten in Döbeln, Germany

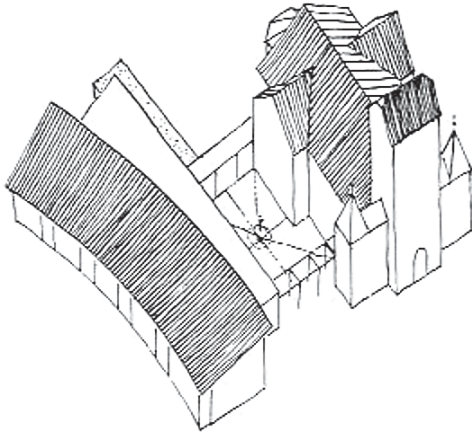

OR06

OR06 Perspective and concept connecting cloister, 19th century church and kindergarten.

OR07 Kindergarten Döbeln, Germany.

Directly by the Jakob Church in Döbeln the Lutheran church commissioned a new kindergarten. Similar to a monastery, the original kindergarten St. Florian was intimately connected to the church by means of a cloister. However, due to severe flooding in 2002 a replacement kindergarten was required and an architectural competition was announced. Architects Reiter Rentzsch won the competition with the concept of

recreating a cloister and an inherent relationship with the church. It was immediately apparent that the proposed modern timber building would require sensitive treatment when placed next to a 19th century church.

When entering the enclosed kindergarten from the street into the foyer, a person's gaze is immediately drawn to the church via an expanse of north facing glazing. A curved earthen wall, polished carmine red, with built-in wardrobe, separates the circulation space from the south facing group rooms. Stepping through the doors with large glazed elements, the children enter a play space complete with timber galleries and bathrooms. From the group rooms it is possible for four groups of sixty-eight nursery and kindergarten children to directly access the garden.

The building has the pleasant aroma of natural materials, such as earth and timber. This combined with controlled mechanical ventilation results in fresh and healthy air quality. The ventilation and heat recovery unit, located above the north wing of ancillary rooms, is expressed and visible through a glass wall.

The ecological and *Passive House* concepts were very well received by the children and clients.



Timber frame construction with engineered beams

All external walls and roof are of timber frame construction utilizing engineered timber I-beams (360mm *Doka*), stiffened with OSB panels. A $u=0.11\text{W/m}^2\text{K}$ is achieved by filling between the timbers with cellulose insulation. Additionally 4cm of wood fibreboard encloses the structure to achieve thirty-minute fire resistance and to ensure the construction is free of thermal bridges. This is vital for *Passive House* construction as thermal bridges must be minimized. This is particularly difficult at the corners of timber construction (OR08).

The floor plate is of warm construction, and is insulated on the underside ($u=0.13\text{W/m}^2\text{K}$). Additionally, the whole of the timber frame is raised on foam glass footings, which protects the construction and minimizes the thermal bridging. The internal walls of the group rooms are of timber frame construction with solid timber joists. Children and parents were capable of building the infill elements of unfired clay bricks. Over this were installed areas of wall heating tubes covered by a clay plaster and finished in breathable natural paint. The earthen construction provides high thermal mass for the building, and regulates not only the temperature swings, but also the internal moisture levels.

The gallery and ancillary room ceilings are solid glue laminated timber. For the glazed façades a *Passive House* glazing system ($u=0.85 \text{ W/m}^2\text{K}$, $g=55\%$) was installed on the load-bearing timber elements. The external cladding consisted of painted larch timber cladding for the walls, a rear ventilated green roof and timber window complete with material blinds for solar shading. The application of a vapour barrier or waterproof membrane was intentionally excluded, therefore allowing the walls and roof to be breathable, which is highly desirable for healthy construction. A *blower door test* achieved the air tightness $n50$ requirements of a *Passive House* (0.5 internal volume air changes per hour at 50 pascals). The timber construction, including glazing, was completed in two weeks. The clients were impressed by the quality and the finish of the construction. The winter erection of a timber building encountered no problems.

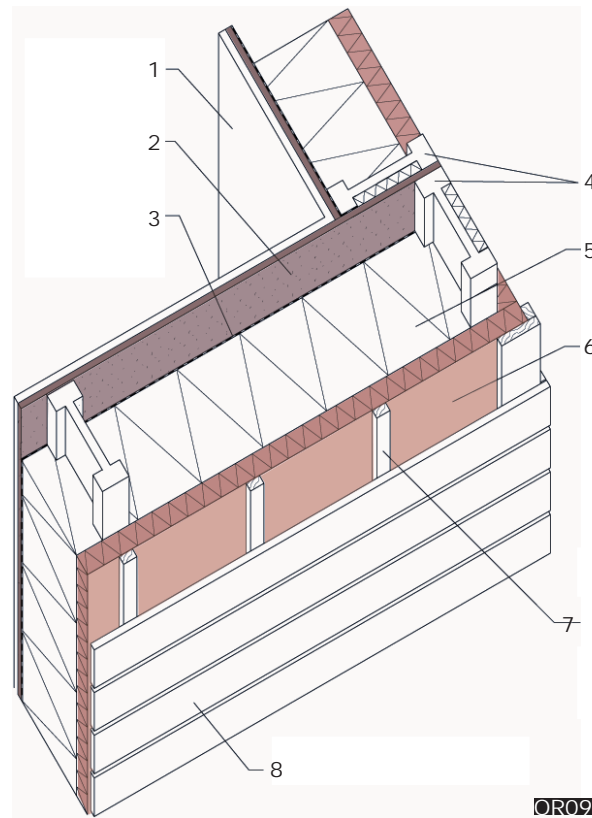

OR09



OR08

OR08 Timber frame on foam glass footing.

OR09 *Passive House* external wall build section.

- 1 clay plaster adhered to gridded reed layer
- 2 sheetrock, 2.2cm
- 3 water proof insulating layer
- 4 Doka I-beam, 360mm
- 5 cellulose insulation layer
- 6 MDF-board, 4cm
- 7 lattice framework
(battens and counter battens, 3/5cm)
- 8 colored larch timber cladding, 2.5/12cm

OR10 Foyer with interior planting.

Sixty percent north facing glazed façade – is that possible?

With *Passive House* design it is desirable to have the majority of glazing in a south facing orientation in order to optimise solar gains. However, central to the architectural concept was a strong visual connection between the church and kindergarten, therefore a highly glazed north facade was essential. The first PHPP (*Passive House Project Package*) calculated that the building was a little over the required 15kWh/m²a heating load. Through the inclusion of a small windowsill and additional insulation on the external walls, the building was able to achieve the *Passive House* standard. After several years of use it has been demonstrated that *Passive House* designs can function effectively as part of the urban fabric.

Interior planting to remedy dry air

A child requires a minimum of 15m³/h supply of fresh air. With a relatively high occupation of one child per 2.5m², the group rooms require 300m³/h for the eighteen children and one adult. Therefore the group rooms with an internal volume of 185m³ require 1.6 air changes per hour. In winter this could result in low moisture levels and uncomfortably dry air. To remedy the situation, architects Reiter Rentzsch worked in collaboration with a horticultural expert

from Tübingen Botanical Gardens to design a scheme that would enable them to use internal planting as a means of providing ideal moisture levels.

For example a 2m high *Ficus alii* can increase moisture levels by transpiring around 1.5 litres per 24 hours. Two large planting troughs were built directly into the floor slab. To ensure air tightness 20cm of a special clay, peat and clay granule mix was added. The natural habitat of the selected plants are tropical rainforests, one trough contains African species and the second Asian. The children water the plants themselves and are fascinated by the rate at which they grow.



Environmental Strategy and Servicing

The fundamental concept of a *Passive House* is that heat losses are minimized through high insulation and tightness. Passive heat gains, people, lighting, solar transmittance etc. are optimized so that no active heating system is required in order to achieve thermal comfort. However, after a weekend or a holiday when the building is missing the heat gains from the occupants and use, internal temperatures can become unsatisfactory.



OR11 Ventilation as visible architectural component.

To ensure that the building could deal with these occasions and future energy demands, an auxiliary heating system was devised. These additional heating loads are provided by solar thermal collectors in combination with the excess capacity of the existing low temperature gas boiler located in the Jacob Church. This auxiliary heating is delivered to the group rooms by wall heating as narrow metal tubes laid beneath the clay plaster. As this employs a relatively large area, it pro-

duces comfortable radiant heat in addition to removing the need for cumbersome radiators. The ventilation system is designed to require a minimum amount of energy, while operating at the optimum. Heat recovery is central to this concept, whereby the heat from the stale extracted air is recovered by a rotating heat exchange plate, which is then transferred to heat the fresh supply air. This ensures that optimal levels of fresh air per person are supplied while minimizing the heat loss usually associated with ventilation. As mentioned in the previous section, the pre-heating of air supply can result in low moisture levels, however the strategic inclusion of internal planting mitigated this potential problem. Additionally as the incoming fresh air is filtered the air quality is further improved by the removal of fine particles and pollen.

The air is distributed via a canal system and is supplied to the group rooms and the multiple purpose hall. It is supplied at a high level in the galleries above the foyer and extracted from the bathrooms and ancillary areas. This results in *Passive House* buildings having very high air quality in addition to good hygiene. The project is located in Saxony where the building regulations require natural ventilation in kindergartens. Because the windows in the buildings are always operable, allowing for potential natural ventilation in conjunction with the mechanical system, a regulatory issue is mitigated.

Play in the *Passive House* Hill Kindergarten in Heidenau, Germany

Before 1995 there was a nursery situated on Diesterwegstraße in Heidenau. The building was in such bad condition that it was demolished. It was replaced with a municipal park. A children's nursery was situated next door in the grammar school.

In 2007 the town of Heidenau decided to build a new nursery for seventy-two children on the north side of the park. At this time it was planned to locate the nursery on a hill. We used this geographical feature to develop the initial idea, which was to integrate the building into the hill. The construction of the nursery fit perfectly into the scenery resulting in an organic architectural expression experienced at all levels of the design.

The plan follows a curved line, and the undulating wave of the roof, which appears to be *growing*, fits perfectly into the landscape. The building is sympathetic to the surrounding area and integrates well with the existing park. This design also allows for the preservation of trees to the south and the west of the site.

- OR12** Site plan.
OR13 Aerial view.



Plan Design

The site of the nursery lies directly on the Diesterwegstraße and opens up to the south. It is a single story building designed to have a minimal barrier to the outside thus increasing the connection to external space. In addition, fire protection is kept to a minimum, and the disabled can easily access the nursery.

The entrance is found under the highest point of the undulating roof. On the opposite side of the nursery is the children's play area. From the entrance one can reach the foyer and a multi-functional space. The importance of this exposed space emphasizes that the head of the building can be felt. The room, which can be used for sport, dance and theatre, is 5.6m high and is mostly glazed affording a view to the park. The plan layout offers interesting and flexible spatial options.

The multi-functional space together with the foyer, vestibule, storeroom, toilet and kitchen form their own separate unit. Therefore this unit can be used independent of the nursery by inhabitants of the surrounding area. As well as the multi-functional space, there are four south facing group rooms. They are extensively glazed and each has a large door to the outside terrace. The four rooms follow the same basic module; a group space with an attached sanitary space built for children.

Next to the toilet is a gallery, which can serve as play area. Secondary rooms run like a spine along the northern side of the nursery. The inner use is reflected in the outwardly visible façade. The north view, with the functional areas lying behind it, appears closed. However, the south façade appears very open with its big glass windows. Timber sliding elements provide solar protection for these windows.

Building Construction

The nursery is an ecological *Passive House*. Only building materials that were recommended by the Federal Ministry of Environment have been used. In some areas non-ecological materials were used with the owners consent to compromise.

The walls, roof and floor have very good insulation ($u=0.11\text{W/m}^2\text{K}$). The outer walls are built in brick filled with perlite. On top of this is a vapour permeable structure made of mineral wool insulation which is covered by a colourful scumble larch timber facade. In between these two materials is a ventilation layer. This wall construction qualifies as suitable for a *Passive House*, and has a u-value of $0.11\text{W/m}^2\text{K}$. All wooden windows and the curtain wall system are triple glazed which again qualifies for use in a *Passive House*. The corrugated roof is flat with a 3% slope to the north. A structure of timber purlins,

insulation made from cellulose and a green roof construction as the top layer, complete the roof structure. The extensive green roof holds approximately 50% of the rainwater on the roof and contributes to the improvement of the microclimate of the property. Hemp as a material for sound absorption and flax or coconut palm fibres for the fastenings of joints, complete the whole ecological concept.

- OR14** Brick wall and timber roof under construction.
OR15 Elevation showing undulating roof and landscape integration.





Energy concept and house technology

The thermal quality of the house corresponds to the quality of a *Passive House*. It has the very low energy consumption of 15kWh/m².

In addition to natural ventilation by windows, a ventilation system was inserted which has a heat recovery system. It provides fresh warm air in winter. The fresh air is sucked into the house under the roof from the north side and passed through a heat exchanger. The exchanger has an efficiency of 90%. The incoming fresh air is warmed by the exhaust air before being distributed in air channels. The air channels are hidden from view in a false ceiling. Fresh air is continuously circulated within the house environment.

The air supply, and therefore also the exhaust air streams, in the main stay areas (multi-function room, foyer, group rooms) are variable and adjustable. The regulation occurs as a function of the CO₂ value in the rooms or ambient temperature in comparison to allowed maximum or minimum value. The ventilation system has several steps, from the basic ventilation of 510m³/h to the maximum ventilation of 1,270m³/h. The supplied air has a maximum temperature of 45°C, and a minimum of 17°C.

To reheat the building after the ventilation system has been switched off takes one to two hours, and therefore automatically starts before the children arrive to the nursery. All of the building is ventilated at the same time. During the summer when the outside temperature is over 18°C, the air inlet into the nursery is closed. But air is allowed to leave from the sanitary rooms and the kitchen. The ventilation and heating technology is accommodated above the secondary rooms on the functional northern wall and can be seen from the hall. The kind of warm delivery system in the space is adapted to the respective requirements of that space. The four group rooms have wall surface heating. In personal rooms there are flat radiators and in the multi-functional space there is a skirting board heater. All the systems are thermostatically adjustable and have a low surface temperature so that the children will not burn themselves.

A thermal solar-energy collector with a cover rate of 70% provides the hot water. The main components of the collectors are the flat collectors (12m²) on the roof and a storage tank (750l). With an ecological construction method and the technology of a passive house this nursery provides high quality living conditions for the children as well as being environmentally friendly.

- OR16** Interior group room.
- OR17** North facing glazed façade under construction.
- OR18** Multi-purpose hall showing the completed north facing glazed façade.



Schnieders. J. Passive Houses in South West Europe. A quantitative investigation of some passive and active space conditioning techniques for highly energy efficient dwellings in the South West European region. 2nd corrected edition, Darmstadt, Passivhaus Institut, 2009

<http://www.passiv.de>

<http://www.passivehouse-international.org>



Margaret Louderback

WAITING FOR THE RAIN **A PHENOMENOLOGICAL PERSPECTIVE ON SITE ANALYSIS**

Landscape architecture is a melding of varied contexts discovered and revealed as design processes move through layered understanding of existing and potential surrounds. Understanding context leads to responsible design solutions. Sustainable design decisions come from understanding the particular context of a particular environment. A "*landscape is an environment with particular features*"¹. Landscape architects experiencing these particular features find design inspiration. The contextual landscape motivates and directs design decisions.

Landscape and phenomenology a roundness of being

Landscape is roundness of being. Landscape "*is not seen according to its exterior envelope; I live in it from the inside. I am immersed in it, after all, the world is around me, not in front of me*"².

Defined in the roundness of being is an inclusion of all the senses in the experience of landscape. This definition introduces the phenomenological perspective. By way of

phenomenology there is a shift from an abstracted scientific perspective, where things are pulled apart toward holistic, qualitative and human centered experience. Different from the scientist, a phenomenologist "*takes experience just as it is, and tries to make it his own*"³.

Experiencing landscape as a verb, a dynamic and personal process occurs. Landscaping brings one into a close interpersonal experience of self-space. With conscious awareness, there is an automatic gathering together; a surrounded experience of immediacy brought home to the personal self.

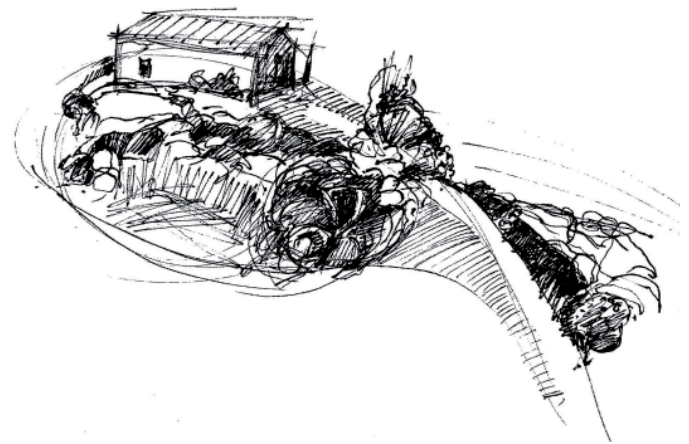



The experience is immediate and primitive in the sense that it occurs before thoughts or words are formed and attached. "*In fact, we are counting on the wordlessness to comfort us*"⁴ explains artist Agnes Martin who poetizes landscape in her paintings. The power of awareness lies not in the ability to describe, but in the felt process of absorbing oneself into a landscape.

This experience is a working description of phenomenology, an unguided direct connection of what is surrounding and inside oneself as a whole unit. A landscape designer can translate personal landscape experiences into a design context. Viewpoints rooted in the human senses guide the designer in the creation of new *meaningful* human places.

Landscape and existential meaning

What is meant by meaningful places? To answer this question, a series of questions must be posed. Why is meaningful significant? "*What must be demanded from architectural space (the space of built environments which includes landscape architectural space) in order that man may still remain human?*"⁵ What is the definition of architectural space?

Architectural space in simple terms can be divided into two categories. Euclidean space is a systemized concept of space based on geometric relationships.

A second category of architectural space is existential space. This theory of space is

centered around ideas, which include man and his emotions, or personal connections. It is deeply reliant on phenomenological theory. Phenomenology is basic to the definition of existential space because primary sensory perceptions are how man initially defines and identifies himself the space in which he lives.

In existential space, the particular environment or landscape shifts position from external and separate to a holistic continuum of inside and outside, a definition of roundness, with man himself as the author. Landscape becomes through man's abilities to perceive it.

The emphasis is on man's interaction and interconnectedness with the environment of which he is a part. "*Space becomes a dimension of man's human existence*"⁶ or his beingness in the world. This beingness is man's ability to grasp spatial dimensions that are then assimilated as meaningful experiences in one's life. Martin Heidegger calls this dwelling. Dwelling suggests, "*that the space where life occurs is place*"⁷. Through the act of being, which is perception based, man makes "*spaces into places*"⁸.

In the natural landscape essential meaningfulness can be found and applied to man's sense of self-identity, his roundness of being. "*Landscape is not a mere flux of phenomena. It has structure and embodies meanings, which give rise to cosmologies,*

forming the basis of dwelling"⁹. An understanding of a natural environment (a particular landscape or region) grows out of "*a primeval experience of nature as a multitude of living forces*"¹⁰.

These living forces fused with man's perceptual abilities define existential space, the space of man's beingness. All are essentially manifest in the landscape, or to quote Willy Hellpach, "*existential contents have their source in the landscape*"¹¹.

Existential contents in landscape

Existential contents found in the landscape are categorically defined as "*things, order, character, light and time*"¹². Theoretically applied they form a foundation for understanding what makes space into meaningful place.

Between earth and sky primary natural things exist. Among them is the materiality of stone, further defined as mountains, which can be understood existentially to represent a state of permanence or closeness to a culturally defined god or higher power. Considering mountains, one recalls symbolic architectural examples like the ziggurat, a mountain-like structure built in ancient Babylon. Man may conceptually draw from physical nature, or its processes to serve his existentially defined needs.

Things also consist of vegetation. For example, different cultures have metaphorically structured cosmologies around the tree. Used as a symbol for the tree of life, the palm tree affords not only food and shelter, but is grounded in the earth, growing toward the sky providing a cosmic link.

In the contemporary culture of sustainability a plant's morphology may be considered as a design concept. Plants, one of the five basic design elements in landscape architecture, are living design materials. (Landscape design elements include plants, hardscapes, lighting, site furniture and water features.) As sustainable issues gain deeper understanding, a built environment may be thought of conceptually as a plant in terms of its flexibility, adaptability and ability to integrate with the natural forces in which it is situated. Built environments can be conceptually approached as living through contextual connection with natural landscape forces. Adaptability and flexibility can be brought into sustainable design contexts physically and metaphorically.

Water is included in the category of things. Water symbolizes generosity in arid climates. A generously flowing fountain in a hot desert climate is a welcoming relief. Water is used in cleansing before ritual performance in the Islamic tradition. Places are made manifest by water sources forming gathering points

that allow for settlement and permanence. The primary acknowledgment of things like the presence of water combine to make centers or places where man can settle in a self-identified home.

A "*cosmic order*"¹³ is established each day as the sun moves across the sky. In its movement, directions or the cardinal points are defined which orient man in the space of landscape. Man establishes a sense of where he is on earth. He locates himself in the space that surrounds him. In Islam, direction toward Mecca is found in every mosque. An integral consideration of landscape architects, and significantly related to sustainability, requires paying attention to sun exposures. An area designed to take advantage of sunrise or sunset views affords meaningful and universally felt satisfaction.

Man further defines his position integrated between earth and sky by relating with the character of spaces in the natural world. The character, partly a combination of topographical elements and climate, may generate feelings of safety or danger, openness or enclosure, closeness to the grounding of earth or piety in a high place. A specific character in a landscape context may connect man to his own personal nature, feelings and self-identification. Man recognizes some sense of humanness in a natural place that surrounds him as he resonates

with a particular landscape. In this sense a particular landscape setting extends beyond cultural familiarity into personal identity. Desert landscapes generate feelings of spaciousness. Their character is open and expansive encouraging clear simple thoughts. Uncomplicated perceptions may forward a deeper connection to beingness.

Things and the character of a place are a combination of forms defined by light. Light, direct or diffused, defines space. In the Christian religion god is metaphorically symbolized as light. God is divine light, and a manifestation of spirit central to man's existential being. In much church architecture the capturing of light is part of the design concept. Light and its requisite opposite, shadow, are important design considerations in making a space become a place.

Light by its changing nature connects man to temporality or time, temporal rhythms, and seasonality. Light defines time in man's daily human scale existence and in the cycle of seasons.

Time has the dimension of constancy and change. Like in a human being many things change in a person's lifetime, but an essential core of being remains. The capturing of light aligns man with this basic central core in the roundness of evolving life.

These existential contents are interrelated and not realistically separate. One category is used in the definition of the others, all supporting the idea that the landscape holds existential meaning. Landscape is basic and integral to man's presence. Respect for natural elements within a particular landscape, brought to the fore by sustainable application, reinforces man's ability and vibrancy to dwell. A simple ordered understanding of the natural world has been highlighted through these five categories; things, orientation, character, light, and time.

Coming together they define the sense of a particular place, the genius loci, which can be discovered and revealed by the perceptive awareness of a designer.

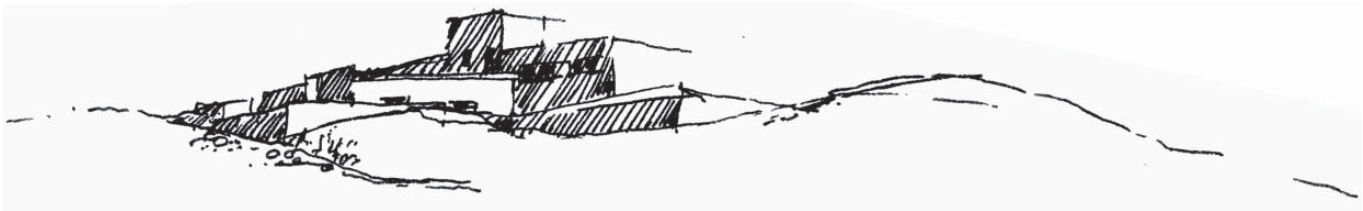



Critical Regionalism

In the design context respect for regional landscapes forwards the feeling of dwelling. Dwelling holds to a phenomenological perspective and supports underlying theories of Critical Regionalism. Drawing from Martin Heidegger's philosophy, Kenneth Frampton, an architectural critic and theorist, articulated six points of Critical Regionalism. As "*phenomenology provides a theoretical basis for contextualism*"¹⁴ these points used as guidelines emphasize the building of meaningful places within the context of a particular landscape or region. The theories formulated in the six points of Critical Regionalism (attention to climate, topography, time, light, tectonic form and emphasis on the tactile over the visual sense) assist concept building resulting in a quality of space enriching man's life experience.

In the arid context of Jordan and Syria surroundings are absolute and elemental particularly in the desert regions. There is a natural call for limits; limitations brought on by climate, seasonal rains, and rugged isolated topography. Acknowledgment of these conditions directs flexibility of design, seasonal adaptability and human adjustment necessary for living in this region's demanding and ever changing nature.

Flexibility is part of the new paradigm. Recognizing a consistent but changing dynamic is inherent in sustainable design. A landscape design has the capability of integrating with the natural forces present in the environment. Nature has always been flexible, man is learning to become more so.

Environmental acknowledgement understands designing with plant species, ornamental or otherwise, that are suited for arid and mountainous climates. Plants found existing in the context, for example the surrounding wheat fields of the Hauran, may be useful in forming a design concept. When organized in a graphic unit and brought into public places, mass plantings of wheat may act as cultural reminders or celebrations of the sustenance that they provide and have provided over time. Additional plants introduced in the design context should support sustainable requirements and aesthetic sensibilities, both adding to a sense of place.

Time has the dimension of constancy and change. Light defines time and particularly the cycle of seasons. Seasons change the appearance of places. Again an example of this can be seen in the altering appearance of bare soil newly seeded to the full green maturity of wheat fields through out the region. Passage of time can be understood in other examples like the signs of decay seen in fading façades, worn paving or the knotted trunks of older trees.

More specific to the construction of meaningful place is Frampton's articulation of tectonic form. Tectonic form, the "*art of construction*"¹⁵, is an understanding of the language of materials, the medium which designers of built environments use as a means of spatial communication. Materials are tools of expression. The melding of medium and concept creates a sense of place. A built environment becomes a clearly felt statement or a fabricated imitation based on an integral understanding of tectonic form and context.

Scott Patterson explains the danger of mimicking vernacular settings as "*a kind of reduction of architecture to a scenography which makes a very gratuitous, or parodied use of historicist motifs*"¹⁶. Structure creation is thinking about materials that accentuate regional identity, are appropriate to the context and forward the creation of an "*iconic expression of sense of place*"¹⁷.

An understanding of the authentic working essence found in local materials, and the formal concepts found in vernacular architecture combined with new technological sensibilities can make meaningful felt places. The use of new technologies, sustainable in orientation or environmentally appropriate in choice, combined with a clear understanding of local mediums and concepts supports sense of place building.

Critical Regionalism stresses the importance of tactile over the visual sense. The position of landscape architecture has shifted in importance from scenery, the cosmetics of built environments supported by vision, to an integration of full-bodied experience in the design of meaningful and livable places.

In his seminal work *The Eyes of the Skin*, Juhani Pallasmaa includes a quote by Johann Wolfgang von Goethe "*The hands want to see, the eyes want to caress*"¹⁸, poetically defining phenomenology in the spatial context. By downplaying the current cultural emphasis on the visual sense, Pallasmaa opens spatial design to expanding full body peripheral experience. "*The very essence of the lived experience is molded by hapticity and peripheral unfocused vision. Focused vision confronts us with the world whereas peripheral vision envelops us in the flesh of the world*"¹⁹.

A full-bodied phenomenological approach used in environment building reduces the poverty of environmental separation, and forwards quality life experience. Just as sound comes into the ever-present world of silence, peripheral space holds the potential perceptive abilities of all the senses. One can almost taste the coming of desert rains.



There is a shift toward process as an ecological concept. Similar to the phenomenological approach, ecological mindfulness encompasses a shifting toward full body sensory involvement emphasized in dynamic states of experience. There is a stepping into process where full-bodied experiences are engagement detectors within the surroundings. Acknowledging this process oriented engagement as the dwelling aspect man begins to gain an existential understanding of the world in which he lives.

Landscape and aesthetics

In these contemporary times, the importance of landscape is shifting position from a source of natural resources for commercial gain, toward a focusing on the relevance of environmental context. Value is placed on quality environments where one can feel at home. The creation of "*existential footholds*"²⁰ is the forwarding aim as relationship with landscape is redefined as connected, ecological, and contextual rather than detached and separate. There is a renewed appreciation of experience in context. Appreciation introduces an aesthetic component. *"To the unreflective eye no two interests must appear less related. The one, aesthetics, is an esoteric discipline, an inquiry into the nature and meaning of the arts. And the arts, whatever they may be, stand in the minds of most people as the epitome of contrivance, a manipulation of materials beyond their ordinary appearances. Nothing seems further removed from environment than this, for environment in its purest form connotes the natural world, while art represent the height of artificiality."*²¹

But environment and aesthetics support each other. There is a provocative connection between the two. Environments offer rich opportunities for stimulating aesthetic experience that goes beyond mere appreciation. As particular qualities of the

environment are perceived, yielding existential understanding, self-identification follows. *"The order of nature is explicate (explainable), the order of landscape is implicate (a personal connection)"*²². Personal connections experienced through interaction with art imply self-knowledge gathering and leads to further self-identification. Landscaping as a verb is another means of self-identification. Phenomenology is a link between aesthetics and environment. Vital to human existence the link between environment and aesthetics is the ability to insight personal connections, which may translate into findings meaningful in man's life. Environmental aesthetics is more than appreciation and appearance. It defines a way of self-knowing which is poetic and humanistic. The landscape perceived by humans is where it all starts... not as egotistical but experiential. Art and environment both have components of self-identification or making life meaningful. The well-known architectural theorist, Norgberg-Schultz substantiates the necessity of artful environment building in stating *"It is one of the basic needs of man to experience his life-situations as meaningful, and the purpose of art is to keep and transmit meaning"*²³.

Conclusion

In these times there is a desperate search for meaning and rediscovery of the landscape.

Not only are environmental issues at the fore, but also questions of identity loss, or the destruction of environmental *"realms of possibilities"*²⁴. The disappearing richness of perceivable contexts holding human meaning is of great concern. Thomas Moore states, the soul has a need *"for vernacular life - a relationship to a local place and culture. It has a preference for details and particulars, intimacy and involvement, attachment and rootedness. Like an animal, the soul feeds on whatever life grows in its immediate environment"*²⁵.

The designer's intention is to strengthen sense of place, which can be existential, poetic and body centered in approach. The critical criteria and skill of a designer is to communicate these findings into spaces, which then become places for quality living. This requires playing by the rules dictated by the land, an applied understanding of the landscape's presence and the perceived dynamics that reinforce connection to place. Successful design decision-making results in built environments that are tied to the designer's depth of contextual understanding ultimately leading to the question... what am I as a landscape designer? I went to change the landscape, but the landscape changed me.



- 1** Ingold, 2000
- 2** Berleant, 2005, p. 7
- 3** Bachelard 1964, p. 227
- 4** Doyle, 2008, Internet source
- 5** AL'Saigh, Internet source
- 6** Ibid
- 7** Norberg-Schultz, 1980, p. 5
- 8** Ibid, p. 5
- 9** Ibid, p. 23
- 10** Ibid, p. 23
- 11** Ibid, p. 32
- 12** Ibid, p. 32
- 13** Ibid, p. 28
- 14** Clare, 2011
- 15** Ibid
- 16** Patterson, Internet source
- 17** Clare, 2011
- 18** Pallasmaa, 2005, p. 2
- 19** Ibid, p. 17
- 20** Norberg-Schultz, 1980, p. 5
- 21** Berleant, 2005
- 22** Bohm, 1980
- 23** Norberg-Schultz, 1980, p. 5
- 24** Bachelard, 1964, p. 218
- 25** Moore, 2008, p. 203

Drawings by Margaret Louderback, 2009-2011.

AL'Saigh, Mariam Y. book review *Norgberg-Schultz, Existence, Space and Architecture*. Studio Vista, London, 1971, book review, Internet source http://www.biblioteca.dpa.polimi.it/interni/lectures/05-norberg_schulz.htm, June 2011

Bachelard, Gaston. *The Poetics of Space*. Orion Press, New York, 1964

Berleant, Arnold. *Aesthetics and Environment, Variations on a Theme*. Ashgate Publishing Limited, England, 2005

Bohm, David. *Wholeness and the Implicate Order*. Routledge, London, 1980

Clare, Kerry and Lindsay. *Sustainability in Australia*. Kamra tal-Perit Architecture Nights lecture series, Aula magna, University of Malta, Valletta, Malta, May 31, 2011

Doyle, Nancy. Artist Profile: Agnes Martin. Internet source, www.ndoylefineart.com/martin.html, February 2011

Frampton, Kenneth. *Modern Architecture, A Critical History*. Thames and Hudson, London, 1987

Ingold, Tim. *The Perception of the Environment, Essays in Livelihood, Dwelling and Skill*. Routledge, London and New York, 2000

Larice, Micheal. Macdonald, Elizabeth. (eds.) *The Phenomenon of Place*, a book review. Routledge Taylor and Francis Group, London and New York, 1976

Matter, S. Fred. *Critical Regionalism from a Desert Dweller's Perspective*. Arid lands newsletter, University of Arizona, Tucson, Arizona, no. 28, spring/summer 1989

Merleau-Ponty, Maurice. *Phenomenology of Perception*. Routledge, London, 1962

Moore, Thomas. *Care of the Soul*. Piatkus, Great Britain, 2008

Norberg-Schultz, Christian. *Genius Loci, Toward a Phenomenology of Architecture*. Academy Editions, London, 1980

Pallasmaa, Juhani. *Touching the World – architecture, hapticity and the emancipation of the eye*. Internet source http://www.Arquitectura-ucp.cpm/images/Pallasmaa_TW.pdf, September 2011

Patterson, Scott. *Critical Analysis of Towards a Critical Regionalism* by Kenneth Frampton. Internet source <http://home.earthlink.net/~aisgp/texts/regionalism/regionalism.html>, June 2011



THE STONE MAN OF THE THIRD MILLENNIUM ARCHITECTURE FROM MATERIAL TO NON-MATERIAL

With the first development of architecture, man's relationship to material began an irreversible course forwarding the infinite opportunities found in the human value of *the idea*. The beginning of architecture, as a natural result of agriculture and settlement, was second in importance to the initial human use of tools. As tools became simply an extension of the hand and fingers, architecture became the expansion of the entire body. This included not only of the individual, but also extended into small groups, especially during critical productive periods experienced in the making of a nucleus family.

Design above all is a total and mutual union between matter and idea. What life on earth has realized out of matter are ideas upon ideas in an evolutionary line for the past half a billion years. As time passed humans became idea-originating creatures par excellence, taking design into new orbits outside the realm of life itself.

The evolutionary *idea* cycle was extended by humans into a spiral, a tangent built on exploring new possibilities for shaping matter. Among original construction materials that early humans experimented with,

stone, especially limestone appears to have been the most important. (Sun-dried mud brick, a later invention, required a more complex process of manufacturing.) Stones were naturally found on the ground, ready for use and requiring only minimal selection efforts. Unlike the common impression, limestone was not only the product of chemistry and physics in the geological sedimentation process, but in fact its formation was largely dependent on biology, on design by process of *life*.

Almost the entire exposed limestone landscape of Jordan and the East Mediterranean tableland is of the Cretaceous period, formed in the sedimentation floor of the Tethys Sea some 100 million years ago. During this period biology seems to have made a major impact in the sedimentation process resulting in a *period of lime*. This was different from earlier periods where layers of sand and materials closer to the lifeless plutonic rocks were formed during the time of the earth's cooling process. Life, or biology added before humans, a new layer of complexity to geological processes that otherwise would have depended only on physics and chemistry.

The beginning of architecture can be linked to the specific characteristics of this Cretaceous rock stratum. Beginning with hydrology, as in the location and nature of water springs related to issues like karst systems and retention, to the morphology that allowed for topsoil to form meadows for rain-fed grain concentrations of early farming. Specific rock strata of the Upper Cretaceous Jordan, such as the folded plates of the Amman Silicified Limestone Formation (visible in Ain Ghazal and along hillsides of the Amman ravine) provided natural caves. These caves were easy to expand and finish with minimal architectural intervention. This specific geological layer inspired early builders by providing natural half houses easy to enclose or expand; thus the origins of architecture. It could be said that the beginnings of architecture were extensions or adaptations of an earlier nature-made architecture, which was *found* naturally ready to be used as a shelter with some extension and improvement. The Upper Cretaceous layer also provided the flint that could be shaped into sharp implements satisfying needs associated with the development of animal and plant domestication.

Specific geological features mostly related to layers of the Cretaceous Period can explain the entire beginning of agriculture and architecture. This layer is found in Jordan along the Great Rift Valley that extends out of Africa and into the eastern Mediterranean region in what is often called the *Levantine Bridge*.

Over the last ten thousand years stone-wall architecture, found in the present day landscape of Jordan, has witnessed minimal change. The majority of stonewalls were built with two main layers; the better and bigger stones on the outside, the second best on the inside, and the rest in the middle as a mixture of earth, pebbles and water. In addition, there must have been some use for walls of single stone layer. This can be intuited in village architecture of the recent past by what seems to be informal additions next to main structures, such as chicken sheds and boundary walls. These features were relatively fragile leaving little record in the face of gravity and time.

At the very beginnings, the beginnings that have left something for archaeology to record, such as the pre-pottery Neolithic site of Ain Ghazal in Amman or Baida in Petra, stones were simply gathered on site and used in their natural state. Only during the Iron Age (around 700 BC) did dressed stones begin to appear. Dressed stone, which is shaped into geometric building blocks, was the direct result of major technological achievements in the area of metallurgy. These achievements expanded man's ability to reach higher temperatures for smelting, and thus resulted in the manufacturing of pivotal iron stone-shaping tools. Following the Iron Age, the Hellenistic period evidenced elaborate limestone structures such as Qasr al Abd at Iraq al Amir.

At this site, stone building blocks of impressive sizes demonstrate the advancement of the technology related to the new power of iron tools.

During the Roman period, Jordan witnessed the largest scale of stone quarrying and dressing in antiquity. The scale of building block production was so large that one can assume that all the following periods (Byzantine, Islamic, Ottoman and even Early Hashemite) did very little quarrying, finding it more convenient to recycle the pre-shaped Roman building blocks. Generally speaking the size of building blocks of masonry walls was most profound in the Hellenistic period, and gradually reduced in size until the Late Ottoman building of town of Salt. During this building period (1890s-1930s) stone courses were only around 20 cm in height, one tenth the size of the blocks at Iraq al Amir.

Throughout the ten thousand year expanse of stone architecture, a line of rubble-stone building technique must have continued parallel to the architecture of dressed stone. Rubble stone building techniques survived with no change, providing retaining walls for cultivation and terraces as well as walls for the architecture of the poor. This building technique can be seen through the present. Rubble stone building remains common, particularly in times of man-made or natural disasters when the elaborate line of

technical evolution partially yields or totally collapses. An interesting observation can be made on how the stonewalls of village architecture of the Late Ottoman period are in fact almost identical to walls at one of the world's early architecture sites at Ain Ghazal built almost ten thousand years ago.

Late Ottoman urban architecture in towns like Salt, Irbid, Madaba and Amman, along with some mansions, was a natural continuation of the Mamluk and earlier Islamic periods' way of wall-building. After the Ottoman period, stonewalls saw the first development under the tide of the industrial revolution with the arrival of manufactured Portland cement in the early 1920s. The use of cement, on the one hand, is nothing new. Good examples of cement can be found from the Hellenistic through the Late Islamic times, still strong and relatively water-resistant until this day. The marked difference is that during the Industrial Revolution cement was manufactured using machines, which resulted in better strength, consistency, and quantities. The Industrial Revolution also laid down the foundation of *scientific specification* continuously monitored by tests and analysis secured by the solid infrastructure of laboratories and testing technologies and procedures. During the last century, cement research and development became one of the most important fields of modern life.

A whole branch of science has been devoted to understanding and further exploiting the fascinating properties of cement. The magical role in the making of concrete, reinforced by the addition of steel, has resulted in a technology that has opened up structural possibilities never before possible. In a nutshell, cement technology followed a parallel line similar to the story of biology, which made new compositions out of elemental matter by transforming earth, air and water into the building blocks of trees or animals.

Like in the making of the ancient lime, cement is simply the *liquidation* of limestone. Man took the building blocks of mountains, crushed them, roasted them, refined the powder, enhanced its properties with additives, filled the powder in bags or pumped it into tanks and called it *Portland cement*. This cement, then remixed with aggregates and sand, produces a liquid conglomerate stone (concrete) that can be molded into any form or size. Once man learned to turn stone into liquid, a bright new page opened for architecture. The abundance of stone as a geological material could now be formed to materialize both the massive and the intricate pieces of a new virtual world evolving in human imagination. The process of liquidating stone can be compared to the metabolism in zoology. Calcium, iron and other elements of matter, turns into the functional

bones in the living body, slowly cast into place by liquid blood as the body grows. There is no better example of the architectural achievement of biology than the way birds swallow small limestone pebbles to provide for construction material of the eggshell, the temporary architecture of their unhatched chicks. The shell of an egg is an amazing example of structural-architectural design.

Liquid stone is now flowing in the veins of cities that are growing like a giant living body reminiscent of the plant or animal kingdom. Looking at the earth from afar, overwhelming urbanism now appears like expanding gray matter. From the viewpoint of space, this sprawling urbanism appears like some biological growth, something like a germ culture that has proven to be invasive and advantageously healthy. Our cities are the latest shell of all organisms on this earth, manipulated by one species that learned to mimic the design process of biology, but at a much faster pace than that of evolution. Man-made structures on earth are the creation of biology. They are the trace-fossils of one species that managed to take advantage of all others with the obsession of breaking out of what has been achieved, and traveling into the unknown. Not to fall into an exclusive human-centered view, the fact remains that humans could only achieve this *design big-bang* with the help and manipulation of the rest of the plant and animal kingdom.

The future of stone may best be predicted by reviewing the projection of its past. At this point, the irrelevant lines of the *decorative, nostalgic, rustic, artistic* expressions in stone should be skipped. Concentration should be put on the non-fashion bulk housing of the mass population, infrastructure, and the industrial and public structures of modern needs. Reflecting on the trends of the past, it is predictable that stone will be further crushed into even smaller particles, made into better-designed liquids, and pumped into finer forms and in more far-away locations. The further liquidation of stone will continue to incorporate new reinforcement, tension-handling materials, such as carbon fiber, fiberglass, and new materials that have not yet been made. There may be a time when tension might even be achieved by non-material elements such as gravity and magnetism. This imagined innovation would allow better concrete reinforcement options, since gravity itself has no weight and does not rust.

It can be imagined that one day, stone will be rearranged on the molecular level in great quantities for better delivery, constructibility and fidelity of form, addressing the urgent need to comply with the pressing issues of environmental compatibility. With the development of nano-technology for use in architecture, stone could be rebuilt into an *intelligent* element for architectural finish.

Living walls with *good* biology that breathe like a tree (giving oxygen and trapping carbon), possibly the harvesting of water and energy, and production of food for humans and for the passing bird are viable potentials.

Stone was the idea of nature. One day man may outgrow the borrowing of nature's ideas, through the efforts of the human brain, the most advanced product of nature. At this time all brains conceivably could be connected by nerve fibers, or some sort of intangible communication lines that extend outside the skull of the individual, making the entire earth one single mass of real-time thinking entanglement. This is partially happening right now.

Man may outgrow the need of physical architecture altogether. Architecture could become a relic of the past's endless line of evolution. Humans may outgrow the need of matter altogether by finding the missing link that can make a virtual world *temporarily* tangible, usable, and able to shelter us without the environmentally-destructive use of stone or cement.

Design is the collaboration of matter and idea. Life is designs in evolution. Design can evolve to outsmart matter ultimately using matter's properties as a springboard to snap out of matter's material use.

From the beginning, matter is an *idea*.



AK01

AK01 Painting by Ammar Khammash entitled *Gardens and the Great Mosque*, 180 x 240 cm, oil on canvas, 2004.

<http://www.khammash.com>

Wadi Mujib, Jordan.

Wadi El Feynan, Jordan.





Approaching Karak Castle, Jordan.

Stone quarry
Wadi Mujib, Jordan.





Sandstone formation
Wadi Rum, Jordan.

Shading device
Feynan Eco-Lodge, Jordan.





Wadi Mujib, Jordan.

Rainbow street pavement
Amman, Jordan.





Sandstone formation
Petra, Jordan.

Mosaic
Madaba, Jordan.





Abandoned village
between the Dead Sea and Al Karak, Jordan.

Water reservoir staircase
Amman Citadel, Jordan.





Oak trees in limestone formation
near Ajloun, Jordan.

Green valley
near Ajloun, Jordan.





Abandoned basalt stone village of Al Msekeh
Hauran, Syria.

The Tree and the Sky

There's a tree walking around in the rain,
it rushes past us in the pouring grey.
It has an errand. It gathers life
out of the rain like a blackbird in an orchard.
When the rain stops so does the tree.
There it is, quiet on clear nights
waiting as we do for the moment
when the snowflakes blossom in space.

Tomas Gösta Transströmer
Nobel Prize in Literature, 2011.





Stone pavement
Kempinski Ishtar Dead Sea Hotel, Jordan.

Remains of basalt stone rotary querns
Jerash, Jordan.





Illuminated stone
Petra Guest House, Jordan.

Basalt stone door leaves
Umm Qais Museum, Jordan.



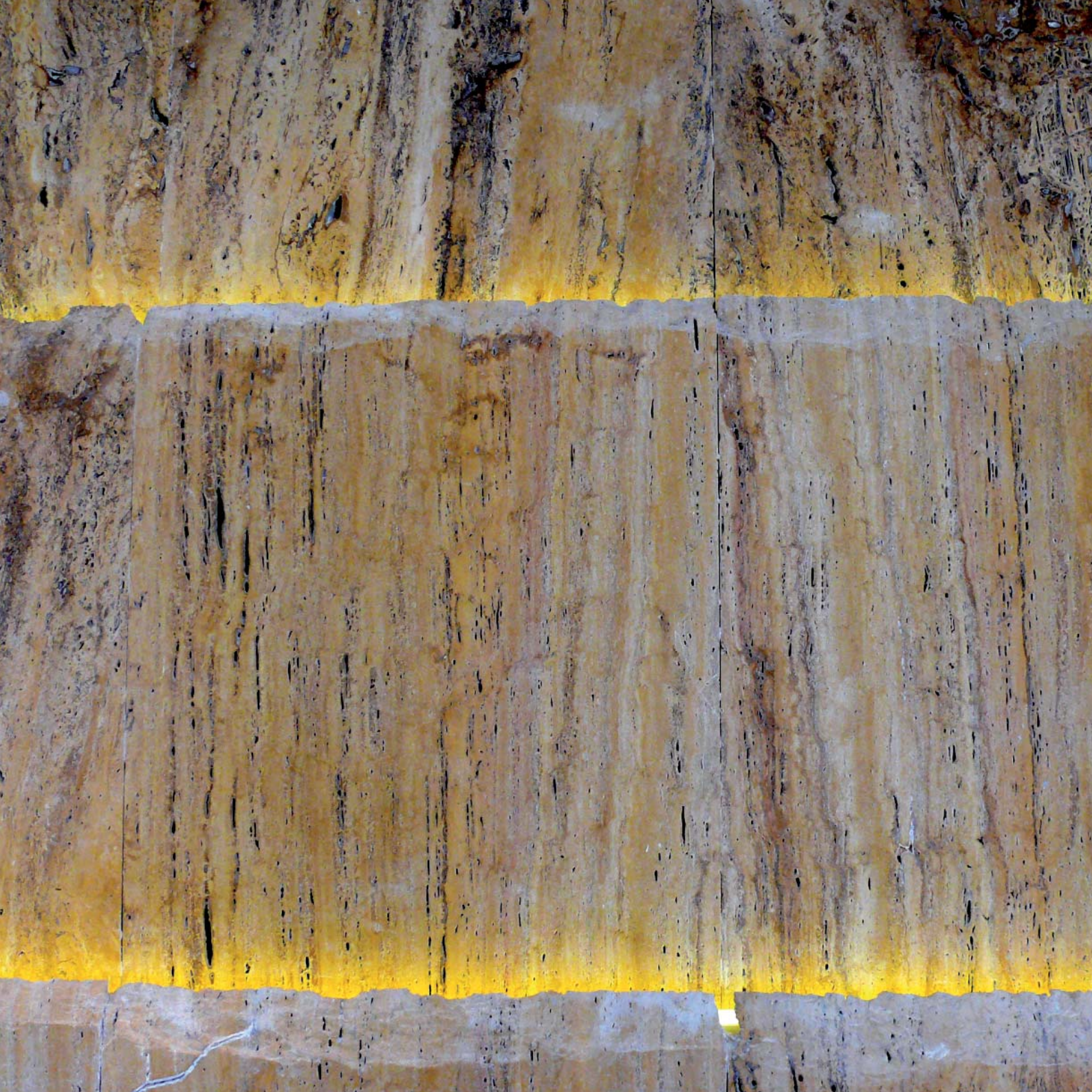

Interior facade
possibly a pigeonry
Wadi Al Seer, Jordan.

Interior facade
possibly a pigeonry
Petra, Jordan.





Alabaster window
Madaba, Jordan.

Further In

On the main road into the city
when the sun is low.
The traffic thickens, crawls.
It is a sluggish dragon glittering.
I am one of the dragon's scales.
Suddenly the red sun is
right in the middle of the windscreen
streaming in.
I am transparent
and writing becomes visible
inside me
words in invisible ink
which appear
when the paper is held to the fire!
I know I must get far away
straight through the city and then
further until it is time to go out
and walk far in the forest.
Walk in the footprints of the badger.
It gets dark, difficult to see.
In there on the moss lie stones.
One of the stones is precious.
It can change everything
it can make the darkness shine.
It is a switch for the whole country.
Everything depends on it.
Look at it, touch it...

Tomas Gösta Transströmer
Nobel Prize in Literature, 2011.







STONE AND ARCHITECTURE
in the mountainous regions of Jordan and Syria

INGO HELMEDAG
JULIANE JÄGER

DAAD