

*Application of Life Cycle Assessment  
in the Context of Classical Environmental Management System  
and with Respect to the Implementation of the EuP Directive*

**Volume 2**

Von der Fakultät für Umweltwissenschaften und Verfahrenstechnik  
der Brandenburgischen Technischen Universität Cottbus  
zur Erlangung des akademischen Grades eines Doktor-Ingenieurs  
genehmigte Dissertation

vorgelegt von

M.Sc.

Marek Gawor

aus Kowary, Polen

Gutachter:	Prof. Dr. Jürgen Ertel
Gutachter:	Prof. Dr.-Ing. Gerhard Lappus
Tag der mündlichen Prüfung:	03.12.2009

---

**Table of content**

<b>LIST OF TABLES</b> .....	<b>4</b>
-----------------------------	----------

<b>LIST OF FIGURES</b> .....	<b>5</b>
------------------------------	----------

**APPENDIX I**

<b>LCIA METHODS USED IN THE STUDY</b> .....	<b>9</b>
---	----------

1. <i>CML 1992 and CML 2 Baseline 2000</i> .....	9
2. <i>Cumulative Energy Demand</i> .....	11
3. <i>Ecopoints 97</i> .....	12
4. <i>EDIP/UMIP</i> .....	14
5. <i>EPS 2000</i> .....	15
6. <i>IPCC 2001</i> .....	17
7. <i>Other methods</i> .....	18

**APPENDIX II**

<b>MATERIAL COMPOSITION AND SUBASSEMBLY WEIGHTS FOR THE KGE 3490X</b> .....	<b>19</b>
---	-----------

**APPENDIX III**

<b>QUESTIONNAIRE – COOKING HABITS IN THE POLISH HOUSEHOLDS</b> .....	<b>21</b>
--	-----------

1. <i>Original questionnaire in Polish</i> .....	21
2. <i>English version of the questionnaire</i> .....	30
3. <i>Summary of answers to the general questions</i> .....	34
4. <i>Example of filled questionnaire (No. 38)</i> .....	38

**APPENDIX IV**

<b>USE PHASE PROCESSES CREATED IN THE SIMAPRO</b> .....	<b>42</b>
---	-----------

**APPENDIX V**

<b>GAS AND ELECTRICITY CONSUMPTION AND CONVERSION FACTORS USED IN THE MODELLING</b> .....	<b>46</b>
---	-----------

**APPENDIX VI**

<b>END OF LIFE SCENARIOS USED IN COOKER MODELLING</b> .....	<b>47</b>
---	-----------

**APPENDIX VII**

<b>END OF LIFE PROCESSES USED IN COOKER MODELLING</b> .....	<b>51</b>
---	-----------

**APPENDIX VIII****NETWORK DIAGRAMS, KGE 3490X WITHOUT EOL AND WITHOUT USE PHASE----- 55**

1.	<i>CML 2 Baseline 2000</i>	55
2.	<i>Cumulative Energy Demand</i>	57
3.	<i>Ecopoints 97</i>	58
4.	<i>EDIP/UMIP</i>	60
5.	<i>Eco-Indicator 99</i>	62
6.	<i>EPS 2000</i>	67
7.	<i>IPCC</i>	69

**APPENDIX IX****NETWORK DIAGRAMS, KGE 3490X WITH RECYCLING AND LANDFILLING EOL ----- 70**

1.	<i>CML 2 Baseline 2000</i>	70
2.	<i>Cumulative Energy Demand</i>	71
3.	<i>Ecopoints 97</i>	72
4.	<i>EDIP/UMIP</i>	74
5.	<i>Eco-Indicator 99</i>	76
6.	<i>EPS 2000</i>	80
7.	<i>IPCC</i>	82

**APPENDIX X****DESCRIPTION OF THE MODELLING VARIABLES IN THE SMPV----- 83****APPENDIX XI****EFFECT DIAGRAMS FOR THE VARIABLES IN THE SIMULATION MODULE OF THE SMPV----- 91**

1.	<i>Stable policy scenario</i>	91
2.	<i>Fluctuating policy scenario</i>	99

**APPENDIX XII****RESULTS OF SIMULATION IN THE SMPV -----104**

1.	<i>Stable policy scenario, modelling results</i>	104
2.	<i>Fluctuating policy scenario, modelling results</i>	114

**INDEX----- 117****DECLARATION ----- 118**

---

**List of tables**

TABLE 1 SIMPLIFIED INVENTORY ANALYSIS RESULTS WITH RESPECT TO MATERIALS USED. PERCENTAGES RELATE TO ALL MATERIALS, WITHOUT SHEET ROLLING.....	19
TABLE 2 INVENTORY ANALYSIS RESULTS. SUBASSEMBLIES OF KGE3490X.....	20
TABLE 3 CZĘSTOTLIWOŚĆ PRZYGOTOWYWANIA POTRAW.....	23
TABLE 4 GOTOWANIE – GÓRNA CZĘŚĆ KUCHENKI.....	27
TABLE 5 CIASTA LUB INNE POTRAWY – PIEKARNIK.....	28
TABLE 6 INNE POTRAWY. ....	29
TABLE 7 FREQUENCY OF PREPARING THE MEALS .....	32
TABLE 8 COOKING – UPPER PART OF THE COOKER .....	33
TABLE 9 CAKES OR OTHER MEALS – OVEN. ....	33
TABLE 10 OTHER MEALS. ....	33
TABLE 11 ANSWERS TO THE QUESTIONNAIRE – GENERAL DATA.. ....	34
TABLE 12 ANSWERS TO THE QUESTIONNAIRE – GENERAL DATA. ....	36
TABLE 13 FREQUENCY OF PREPARATION OF MEALS: QUESTIONNAIRE NO 38.....	39
TABLE 14 COOKING – UPPER PART OF THE COOKER. QUESTIONNAIRE NO 38.....	41
TABLE 15 CAKES OR OTHER MEALS – OVEN. QUESTIONNAIRE NO 38.....	41
TABLE 16 OTHER MEALS. QUESTIONNAIRE NO 38.....	41
TABLE 17 MEALS PREPARED ON THE TOP OF THE GAS-ELECTRO COOKER (GAS BURNERS).....	42
TABLE 18 MEALS/CAKES PREPARED IN THE OVEN.....	45
TABLE 19 NATURAL GAS CONSUMPTION. ....	46
TABLE 20 MULTIPLICATION FACTORS USED IN TABLE 7.18 FOR THE CALCULATION OF THE ELECTRICITY CONSUMPTION.....	46
TABLE 21 ASSUMPTIONS MADE FOR THE ELECTRICITY CONSUMPTION DURING THE USE OF OVEN IN THE TIME OF 60 MINUTES.....	46
TABLE 22 END-OF-LIFE SCENARIOS AND THE FATE OF MATERIALS. R – RECYCLING, I – INCINERATION, WWTP – WASTE WATER TREATMENT PLANT, L – LANDFILLING. ....	47
TABLE 23 END-OF-LIFE PROCESSES USED IN THE SIMAPRO MODELLING. R – RECYCLING, I – INCINERATION, WWTP – WASTE WATER TREATMENT PLANT, L – LANDFILLING .....	51
TABLE 24 VARIABLES AND THEIR DESCRIPTION IN THE SYSTEM MODEL “POLISH ENTERPRISE” .....	83
TABLE 25 VARIABLES AND THEIR INSCRIPTION IN THE SCALE OF VALUES.....	87

## List of figures

FIGURE 1 WORLD MARKETED ENERGY USE BY FUEL TYPE, 1990 – 2030. SOURCE: <a href="http://www.eia.doe.gov/oiaf/ieo/world.html">HTTP://WWW.EIA.DOE.GOV/OIAF/IEO/WORLD.HTML</a> (LAST ACCESSED ON 20.03.2009), MODIFIED.....	12
FIGURE 2 COAL CONSUMPTION IN THE SELECTED WORLD REGIONS, 1980 – 2030. SOURCE: <a href="http://www.eia.doe.gov/oiaf/ieo/world.html">HTTP://WWW.EIA.DOE.GOV/OIAF/IEO/WORLD.HTML</a> (LAST ACCESSED ON 20.03.2009), MODIFIED.....	13
FIGURE 3 CHARACTERIZATION, CML 2 2000, WITH RESPECT TO MARINE AQUATIC ECOTOXICITY, KGE 3490X WITHOUT EoL AND WITHOUT USE PHASE. UNITS: PERCENTAGE, CUT-OFF LEVEL 6.1%. ....	55
FIGURE 4 NORMALIZATION, CML 2 2000, WITH RESPECT TO ACIDIFICATION, COOKER WITHOUT EoL AND WITHOUT USE PHASE. UNITS: PERCENTAGE, 6% CUT-OFF. ....	56
FIGURE 5 CHARACTERIZATION, CUMULATIVE ENERGY DEMAND, WITH RESPECT TO NON-RENEWABLE FOSSIL FUELS, COOKER WITHOUT EoL AND WITHOUT USE PHASE. UNITS: MJ-EQ., 6% CUT-OFF. ....	57
FIGURE 6 WEIGHTING RESULTS, ECOPOINTS 97, WITH RESPECT TO SO <sub>x</sub> G EQ. KGE 3490X WITHOUT EoL AND WITHOUT USE PHASE. UNITS: POINTS, 6% CUT-OFF. ....	58
FIGURE 7 SINGLE SCORE RESULTS, ECOPOINTS 97, KGE 3490X WITHOUT EoL AND WITHOUT USE PHASE. UNITS: POINTS, CUT-OFF 6%. ....	59
FIGURE 8 CHARACTERIZATION RESULTS, EDIP/UMIP, WITH RESPECT TO GLOBAL WARMING POTENTIAL 100, KGE 3490X WITHOUT EoL AND WITHOUT USE PHASE . UNITS: G CO <sub>2</sub> , CUT-OFF 6%. ....	60
FIGURE 9 NORMALIZATION RESULTS, EDIP/UMIP, WITH RESPECT TO ECOTOXICITY SOIL CHRONIC. KGE 3490X WITHOUT EoL AND WITHOUT USE PHASE. UNITS: PERCENTAGE. ....	61
FIGURE 10 CHARACTERIZATION, ECO-INDICATOR 99, WITH RESPECT TO RESPIRATORY INORGANICS. KGE 3490X WITHOUT EoL AND WITHOUT USE PHASE. UNITS: PERCENTAGE, 6% CUT-OFF. ....	62
FIGURE 11 DAMAGE ASSESSMENT, ECO-INDICATOR 99, WITH RESPECT TO HUMAN HEALTH. KGE 3490X WITHOUT EoL AND WITHOUT USE PHASE UNITS: PERCENTAGE, 6% CUT-OFF. ....	63
FIGURE 12 NORMALIZATION, ECO-INDICATOR 99, WITH RESPECT TO RESOURCES. KGE 3490X WITHOUT EoL AND WITHOUT USE PHASE. UNITS: PERCENTAGE, 6% CUT-OFF. ....	64
FIGURE 13 WEIGHTING, ECO-INDICATOR 99, WITH RESPECT TO ECOSYSTEM QUALITY. KGE 3490X WITHOUT EoL AND WITHOUT USE PHASE. UNITS: PERCENTAGE, 6% CUT-OFF. ....	65
FIGURE 14 SINGLE SCORE, ECO-INDICATOR 99. KGE 3490X WITHOUT EoL AND WITHOUT USE PHASE.. UNITS: POINTS, 6% CUT-OFF. ....	66
FIGURE 15 DAMAGE ASSESSMENT, EPS 2000, WITH RESPECT TO ECOSYSTEM PRODUCTION CAPACITY. KGE 3490X WITHOUT EoL AND WITHOUT USE PHASE. UNITS: PERCENTAGE, 6% CUT-OFF. ....	67
FIGURE 16 WEIGHTING, EPS 2000, WITH RESPECT TO HUMAN HEALTH. KGE 3490X WITHOUT EoL AND WITHOUT USE PHASE. UNITS: POINTS, 6% CUT-OFF. ....	68
FIGURE 17 CHARACTERIZATION, IPCC METHOD, TIME SPAN 100 YEARS. KGE 3490X WITHOUT EoL AND WITHOUT USE PHASE. UNITS: KG CO <sub>2</sub> EQ., 6% CUT-OFF. ....	69
FIGURE 18 NORMALIZATION, CML 2 2000, WITH RESPECT TO ACIDIFICATION, 4% CUT-OFF. UNITS: PERCENTAGE. ....	70
FIGURE 19 CHARACTERIZATION, CUMULATIVE ENERGY DEMAND, WITH RESPECT TO NON-RENEWABLE FOSSIL FUELS. UNITS: MJ-EQ., 3% CUT-OFF. ....	71
FIGURE 20 SINGLE SCORE RESULTS, CUMULATIVE ENERGY DEMAND, UNITS: POINTS. 3% CUT-OFF. ....	71

---

FIGURE 21 WEIGHTING RESULTS, ECOPOINTS 97, WITH RESPECT TO SO <sub>x</sub> G EQ. UNITS: PERCENTAGE, 4% CUT-OFF. ....	72
FIGURE 22 SINGLE SCORE RESULTS, ECOPOINTS 97, UNITS: POINTS. 4% CUT-OFF. ....	73
FIGURE 23 CHARACTERIZATION RESULTS, EDIP/UMIP, WITH RESPECT TO ECOTOXICITY SOIL CHRONIC. UNITS: PERCENTAGE. 4% CUT-OFF. ....	74
FIGURE 24 SINGLE SCORE RESULTS, EDIP/UMIP. UNITS: PERCENTAGE, 6 % CUT-OFF. ....	75
FIGURE 25 CHARACTERIZATION, ECO-INDICATOR 99, WITH RESPECT TO ECOTOXICITY. UNITS: PERCENTAGE, 6% CUT-OFF. ....	76
FIGURE 26 DAMAGE ASSESSMENT, ECO-INDICATOR 99, WITH RESPECT TO HUMAN HEALTH. UNITS: PERCENTAGE, 5% CUT-OFF. ....	77
FIGURE 27 NORMALIZATION, ECO-INDICATOR 99, WITH RESPECT TO RESOURCES. UNITS: PERCENTAGE, 2% CUT-OFF. ....	78
FIGURE 28 SINGLE SCORE, ECO-INDICATOR 99. UNITS: POINTS, 2.5% CUT-OFF. ....	79
FIGURE 29 DAMAGE ASSESSMENT, EPS 2000, WITH RESPECT TO BIODIVERSITY. UNITS: PERCENTAGE, 4% CUT-OFF. ....	80
FIGURE 30 SINGLE SCORE, EPS 2000. UNITS: POINTS, 4.3% CUT-OFF. ....	81
FIGURE 31 CHARACTERIZATION, IPCC METHOD, TIME SPAN 500 YEARS. UNITS: KG CO <sub>2</sub> -EQ., 4% CUT-OFF. ....	82
FIGURE 32 INFLUENCE OF VARIABLE AUTHORITIES ON VARIABLE EMPLOYEES. SIMILAR INTERRELATION DETERMINED FOR THE RELATIONSHIPS CUSTOMERS – FINANCIAL RESULTS, EMPLOYEES – FINANCIAL RESULTS, LCA + EMS – FINANCIAL RESULTS, QUALITY – FINANCIAL RESULTS. ....	91
FIGURE 33 INFLUENCE OF VARIABLE AUTHORITIES ON VARIABLE ENVIRONMENT. SIMILAR INTERRELATION DETERMINED FOR THE RELATIONSHIPS COMPETITORS – PRICE, LCA + EMS – AUTHORITIES, LCA + EMS – ENVIRONMENT, OWNER – AUTHORITIES, QUALITY – COMPETITORS, QUALITY – ENVIRONMENT. ....	91
FIGURE 34 INFLUENCE OF VARIABLE AUTHORITIES ON VARIABLE FINANCIAL RESULTS. ....	92
FIGURE 35 INFLUENCE OF VARIABLE AUTHORITIES ON VARIABLE OWNER. ....	92
FIGURE 36 INFLUENCE OF VARIABLE AUTHORITIES ON VARIABLE PRICE. SIMILAR INTERRELATION DETERMINED FOR THE RELATIONSHIPS EMPLOYEES – PRICE, FINANCIAL RESULTS – LCA + EMS, LCA + EMS – QUALITY, QUALITY – CUSTOMERS, QUALITY – LCA + EMS, QUALITY – PRICE. ....	93
FIGURE 37 INFLUENCE OF VARIABLE COMPETITORS ON VARIABLE AUTHORITIES. ....	93
FIGURE 38 INFLUENCE OF VARIABLE COMPETITORS ON VARIABLE CUSTOMERS. ....	94
FIGURE 39 INFLUENCE OF VARIABLE COMPETITORS ON VARIABLE FINANCIAL RESULTS. ....	94
FIGURE 40 INFLUENCE OF VARIABLE CUSTOMERS ON VARIABLE COMPETITORS. SIMILAR INTERRELATION DETERMINED FOR THE RELATIONSHIPS CUSTOMERS – EMPLOYEES AND FINANCIAL RESULTS – EMPLOYEES. ....	95
FIGURE 41 TECHNICAL FEEDBACK FOR THE VARIABLE EMPLOYEES. ....	95
FIGURE 42 INFLUENCE OF VARIABLE ENVIRONMENT ON VARIABLE FINANCIAL RESULTS. SIMILAR INTERRELATION DETERMINED FOR THE RELATIONSHIP FINANCIAL RESULTS – PRICE. ....	96
FIGURE 43 INFLUENCE OF VARIABLE ENVIRONMENT ON VARIABLE PRICE. ....	96
FIGURE 44 TECHNICAL FEEDBACK FOR THE VARIABLE FINANCIAL RESULTS. ....	97
FIGURE 45 INFLUENCE OF VARIABLE OWNER ON VARIABLE FINANCIAL RESULTS. ....	97
FIGURE 46 INFLUENCE OF VARIABLE OWNER ON VARIABLE PRICE. ....	98

---

---

FIGURE 47 INFLUENCE OF VARIABLE PRICE ON VARIABLE CUSTOMERS. ....	98
FIGURE 48 TECHNICAL FEEDBACK FOR THE VARIABLE PRICE . ....	99
FIGURE 49 INFLUENCE OF VARIABLE AUTHORITIES ON VARIABLE EMPLOYEES. SIMILAR INTERRELATION DETERMINED FOR THE RELATIONSHIPS AUTHORITIES – FINANCIAL RESULTS, AUTHORITIES – OWNER, FINANCIAL RESULTS – EMPLOYEES, FINANCIAL RESULTS – PRICE, QUALITY – FINANCIAL RESULTS....	99
FIGURE 50 INFLUENCE OF VARIABLE AUTHORITIES ON VARIABLE ENVIRONMENT. SIMILAR INTERRELATION DETERMINED FOR THE RELATIONSHIPS COMPETITORS – CUSTOMERS, COMPETITORS – FINANCIAL RESULTS, COMPETITORS – PRICE, LCA + EMS – AUTHORITIES, LCA + EMS – ENVIRONMENT, OWNER – AUTHORITIES, OWNER – PRICE, QUALITY – COMPETITORS, QUALITY – ENVIRONMENT. ....	100
FIGURE 51 INFLUENCE OF VARIABLE AUTHORITIES ON VARIABLE PRICE. SIMILAR INTERRELATION DETERMINED FOR THE RELATIONSHIPS EMPLOYEES – PRICE, FINANCIAL RESULTS – LCA + EMS, LCA + EMS – QUALITY, OWNER – FINANCIAL RESULTS, QUALITY – CONSUMERS, QUALITY – LCA + EMS, QUALITY – PRICE. ....	100
FIGURE 52 INFLUENCE OF VARIABLE COMPETITORS ON VARIABLE AUTHORITIES. ....	101
FIGURE 53 INFLUENCE OF VARIABLE CUSTOMERS ON VARIABLE COMPETITORS. SIMILAR INTERRELATION DETERMINED FOR THE RELATIONSHIPS CUSTOMERS – EMPLOYEES, EMPLOYEES – FINANCIAL RESULTS, FINANCIAL RESULTS – EMPLOYEES, LCA + EMS – FINANCIAL RESULTS. ....	101
FIGURE 54 INFLUENCE OF VARIABLE CUSTOMERS ON VARIABLE FINANCIAL RESULTS. ....	102
FIGURE 55 INFLUENCE OF VARIABLE ENVIRONMENT ON VARIABLE FINANCIAL RESULTS. ....	102
FIGURE 56 INFLUENCE OF VARIABLE ENVIRONMENT ON VARIABLE PRICE. ....	103
FIGURE 57 INFLUENCE OF VARIABLE PRICE ON VARIABLE CUSTOMERS. ....	103
FIGURE 58 SIMULATION RESULTS, CRITICAL VARIABLES WITHOUT SELF-CONTROLLING FEEDBACK, STABLE POLICY TEST, SIMULTANEOUS INTERACTIONS. ....	104
FIGURE 59 SIMULATION RESULTS, CRITICAL VARIABLES WITHOUT SELF-CONTROLLING FEEDBACK, POLICY TEST FOCUSING ON INNER-ENTERPRISE VARIABLES. ....	105
FIGURE 60 SIMULATION RESULTS, CRITICAL VARIABLES WITHOUT SELF-CONTROLLING FEEDBACK, POLICY TEST FOCUSING ON OUTER-ENTERPRISE VARIABLES. ....	105
FIGURE 61 SIMULATION RESULTS, CRITICAL VARIABLES WITH SELF-CONTROLLING FEEDBACK, STABLE POLICY TEST, SIMULTANEOUS INTERACTIONS. ....	106
FIGURE 62 SIMULATION RESULTS, CRITICAL VARIABLES WITH SELF-CONTROLLING FEEDBACK, STABLE POLICY TEST FOCUSING ON INNER-ENTERPRISE VARIABLES. ....	107
FIGURE 63 SIMULATION RESULTS, CRITICAL VARIABLES WITH SELF-CONTROLLING FEEDBACK, STABLE POLICY TEST FOCUSING ON OUTER-ENTERPRISE VARIABLES. ....	108
FIGURE 64 SIMULATION RESULTS, CORE VARIABLES WITHOUT SELF-CONTROLLING FEEDBACK, STABLE POLICY TEST, SIMULTANEOUS INTERACTIONS. ....	109
FIGURE 65 SIMULATION RESULTS, CORE VARIABLES WITHOUT SELF-CONTROLLING FEEDBACK, POLICY TEST FOCUSING ON INNER-ENTERPRISE VARIABLES. ....	109
FIGURE 66 SIMULATION RESULTS, CORE VARIABLES WITHOUT SELF-CONTROLLING FEEDBACK, POLICY TEST FOCUSING ON OUTER-ENTERPRISE VARIABLES. ....	110
FIGURE 67 SIMULATION RESULTS, CORE VARIABLES WITH SELF-CONTROLLING FEEDBACK, STABLE POLICY TEST, SIMULTANEOUS INTERACTIONS. ....	111
FIGURE 68 SIMULATION RESULTS, CORE VARIABLES WITH SELF-CONTROLLING FEEDBACK, STABLE POLICY TEST FOCUSING ON INNER-ENTERPRISE VARIABLES. ....	112

---

FIGURE 69 SIMULATION RESULTS, CORE VARIABLES WITH SELF-CONTROLLING FEEDBACK, STABLE POLICY TEST FOCUSING ON OUTER-ENTERPRISE VARIABLES. ....	113
FIGURE 70 SIMULATION RESULTS, CRITICAL VARIABLES WITHOUT SELF-CONTROLLING FEEDBACK, FLUCTUATING POLICY TEST, SIMULTANEOUS INTERACTIONS. ....	114
FIGURE 71 SIMULATION RESULTS, CRITICAL VARIABLES WITHOUT SELF-CONTROLLING FEEDBACK, POLICY TEST FOCUSING ON INNER-ENTERPRISE VARIABLES. ....	114
FIGURE 72 SIMULATION RESULTS, CRITICAL VARIABLES WITHOUT SELF-CONTROLLING FEEDBACK, POLICY TEST FOCUSING ON OUTER-ENTERPRISE VARIABLES. ....	115
FIGURE 73 SIMULATION RESULTS, CORE VARIABLES WITHOUT SELF-CONTROLLING FEEDBACK, FLUCTUATING POLICY TEST, SIMULTANEOUS INTERACTIONS. ....	115
FIGURE 74 SIMULATION RESULTS, CORE VARIABLES WITHOUT SELF-CONTROLLING FEEDBACK, POLICY TEST FOCUSING ON INNER-ENTERPRISE VARIABLES. ....	116
FIGURE 75 FIGURE 76 SIMULATION RESULTS, CORE VARIABLES WITHOUT SELF-CONTROLLING FEEDBACK, POLICY TEST FOCUSING ON OUTER-ENTERPRISE VARIABLES. ....	116



## Appendix I

### LCIA methods used in the study<sup>1</sup>

#### 1. CML 1992 and CML 2 Baseline 2000

CML method has been developed and published by the University of Leiden in October 1992. Method consists of characterisation, normalisation, and evaluation steps.

In characterisation, “grouped substances or sum parameters have been defined in a number of classes. This has been done because the emissions are not always specified separately in the data sources for the processes concerned. Emissions are often specified under a collective name, e.g. aromatic hydrocarbons. Since the different substances within such a group can have considerable variation in their environmental impact, the resulting effect score may not be completely reliable” (Goedkoop, Oele, Effting 2004).

Two main classes of the environmental impact recognized by the CML 1992 method are the exhaustion of raw materials and energy (referred to abiotic and biotic resources) and pollution (focusing on greenhouse effect, ozone layer depletion, human toxicity, ecotoxicity, smog, acidification, eutrophication, solids).

Greenhouse effect is measured and calculated by the means of the Global Warming Potential (GWP). The value is calculated over the period of 100 years, because that is the most common choice of the Life Cycle practitioners. Additionally, SimaPro developers added values for CFC (hard) and for CFC (soft) to the CML (1992) method, since it is not always known which CFC is released.

Ozone layer depletion calculation is based on the Ozone Depletion Potential (ODP) values established for hydrocarbons containing combined bromine, fluorine and chlorine, or CFCs.

Human toxicity values have to combine scores for emissions to air, water and soil. The CML 1992 method uses Human-toxicological classification value for air (HCA), Human-toxicological classification value for water (HCW), and Human-toxicological classification values for soil (HCS). SimaPro does not support soil emissions; therefore, this impact has been excluded from the calculation. The soil emissions were included as a part of the groundwater pollution.

Ecotoxicity for flora and fauna are elaborated in the aquatic (ECA) and terrestrial ecotoxicity (ECT) categories, respectively. Practically, only the ECA values have been included in the CML 92

---

<sup>1</sup> Unless otherwise specified, methods' description is based on: Goedkoop, M., Oele, M., Effting, S. (2004): SimaPro database manual. Methods library. PRé Consultants, the Netherlands. <http://www.pre.nl> (last accessed on 15.02.2007).

method because emissions to soil eventually appear in the groundwater and are thus already covered.

As for the smog, the photochemical ozone creation potential (POCP) is used for the calculation of the potential capacity of a volatile organic substance to produce ozone.

For the acidification, CML 1992 calculates the results on the basis of the Acidification Potential (AP), which is expressed relative to the acidifying effect of SO<sub>2</sub>.

The Nutriphication Potential (NP) is the basis for the eutrophication impact category. Odour category (included in the SimaPro package) is not included in the original CML 92 method because it is a highly localized environmental effect, and the degree of stench nuisance depends largely on local circumstances. Another class added by the SimaPro developers is solids.

In the normalization step, CML 2 recognizes 3 levels:

- Dutch territory. All emissions registered emitted within the Netherlands and all raw materials consumed by the Dutch economy;
- Dutch consumer. The effect of imports have been added, the effects of exports have been subtracted. The calculation was performed using the Dutch input-output matrix;
- European territory (EC, Switzerland, Austria and Norway). Most data are from original European data. In some cases data were extrapolated from Dutch and Swiss data. The energy consumption within a region was taken as a basis for extrapolation.

CML 2 Baseline 2000 method is an update from the method CML 1992. It elaborates the problem-oriented (midpoint) approach.

In CML 2 impact assessment categories grouped into A: Obligatory impact categories (category indicators used in most LCAs), B: Additional impact categories (operational indicators exist, but are not often included in LCA studies), and C: Other impact categories (no operational indicators available, therefore impossible to include quantitatively in LCA).

As Goedkoop, Oele, Effting (2004) indicate, “In case several methods are available for obligatory impact categories, a baseline indicator is selected, based on the principle of best available practice. These baseline indicators are category indicators at “mid-point level” (problem oriented approach). Baseline indicators are recommended for simplified studies. The guide provides guidelines for inclusion of other methods and impact category indicators in case of detailed studies and extended studies”.

The impact categories are very similar to those used in the CML 1992 method. Here, the environmental load is divided into:

- Depletion of abiotic resources;
- Climate change;
- Stratospheric ozone depletion;
- Human toxicity;
- Fresh water aquatic toxicity;
- Marine ecotoxicity;
- Terrestrial ecotoxicity;
- Photooxidant formation;
- Acidification;
- and eutrophication.

Most of these impact categories have a global geographic scope (i.e. depletion of abiotic resources, climate change, ozone depletion, etc.). Some of them (like i.e. human toxicity, aquatic toxicity) have scopes varying between local, regional, continental and global scales.

Grouping and weighting, as the optional step, were not included in the CML 2 method.

As for the normalization, scores are calculated for each baseline indicator. This calculation takes into account the reference situations in the World in 1990, Europe in 1995 and the Netherlands in 1997 (with respect to the territory and the number of inhabitants).

## 2. Cumulative Energy Demand

The Cumulative Energy Demand (CED) was introduced and developed by the Swiss Centre for LCI. It consists of characterisation and weighting steps. Normalization is not part of this method.

Characterisation factors for energy resources are divided into 5 major categories:

- Non renewable, fossil;
- Non renewable, nuclear;
- Renewable, biomass;
- Renewable, wind, solar, geothermal;
- Renewable, water (Frischknecht and Jungbluth 2003).

SimaPro developers have made some changes and updates, but the method in its substantial part is identical to this published by Ecoinvent. To analyse the LCA results according to the CED methodology, one may refer to the current structure of energy production capacity in Poland:

- Hard coal power plants – 57.82%;
- Lignite power plants – 25.55%;
- Natural gas power plants – 2.18%;
- Water power plants – 6.25%;
- Industrial power plants – 7.22%;
- Renewable energies – 0.99% (data as for 31.12.2008; source: <http://www.pse-operator.pl/>).

These values may be compared with the world marketed energy use, and the example of coal consumption in the selected world regions (fig. 1 and fig. 2).

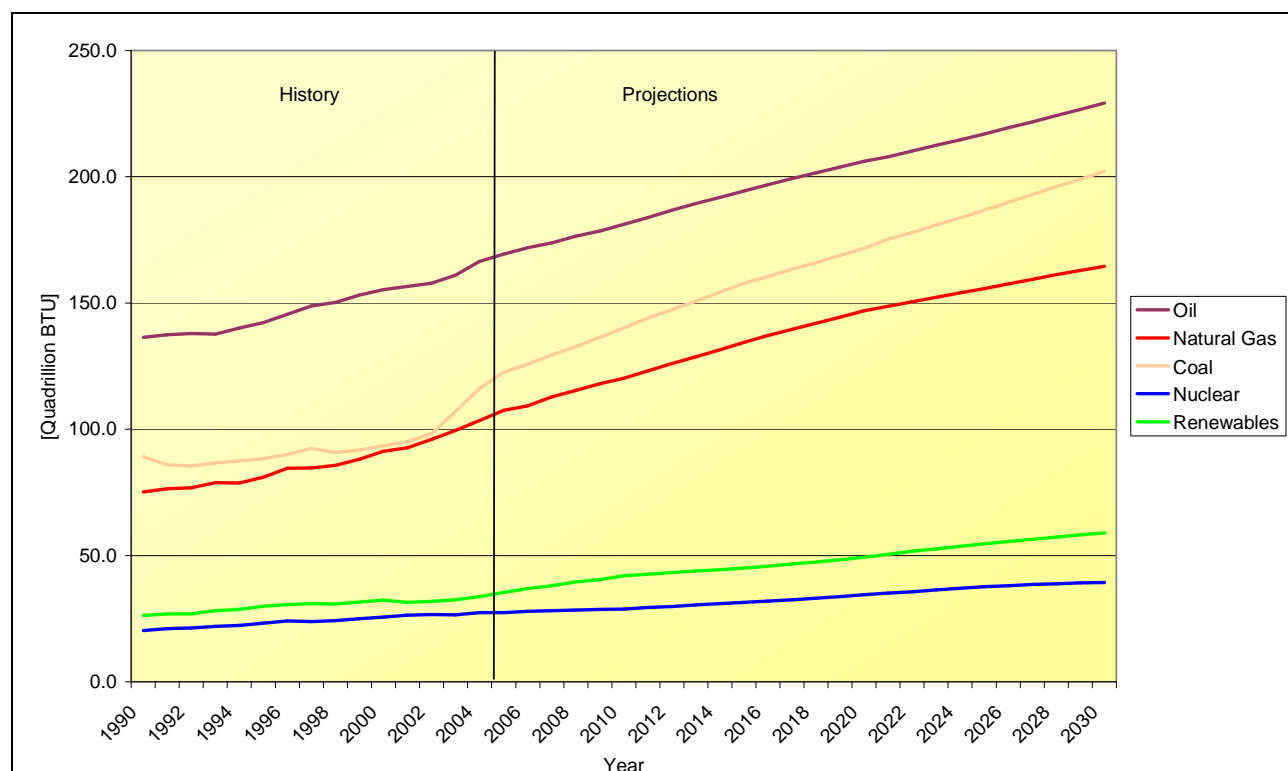

**Figure 1** World marketed energy use by fuel type, 1990 – 2030. Source: <http://www.eia.doe.gov/oiaf/ieo/world.html> (last accessed on 20.03.2009), modified.

### 3. Ecopoints 97

Ecopoints 97 method was developed by the BUWAL – Bundesamt für Umwelt, Wald und Landschaft (Swiss Agency for the Environment, Forests and Landscape). It is based on the critical targets derived from the Swiss policy, and calculates the impact assessment with a single score. Furthermore, as Eco-Indicator 99, it is based on the distance-to-target evaluation (Goedkoop, Oele, Effting 2004).

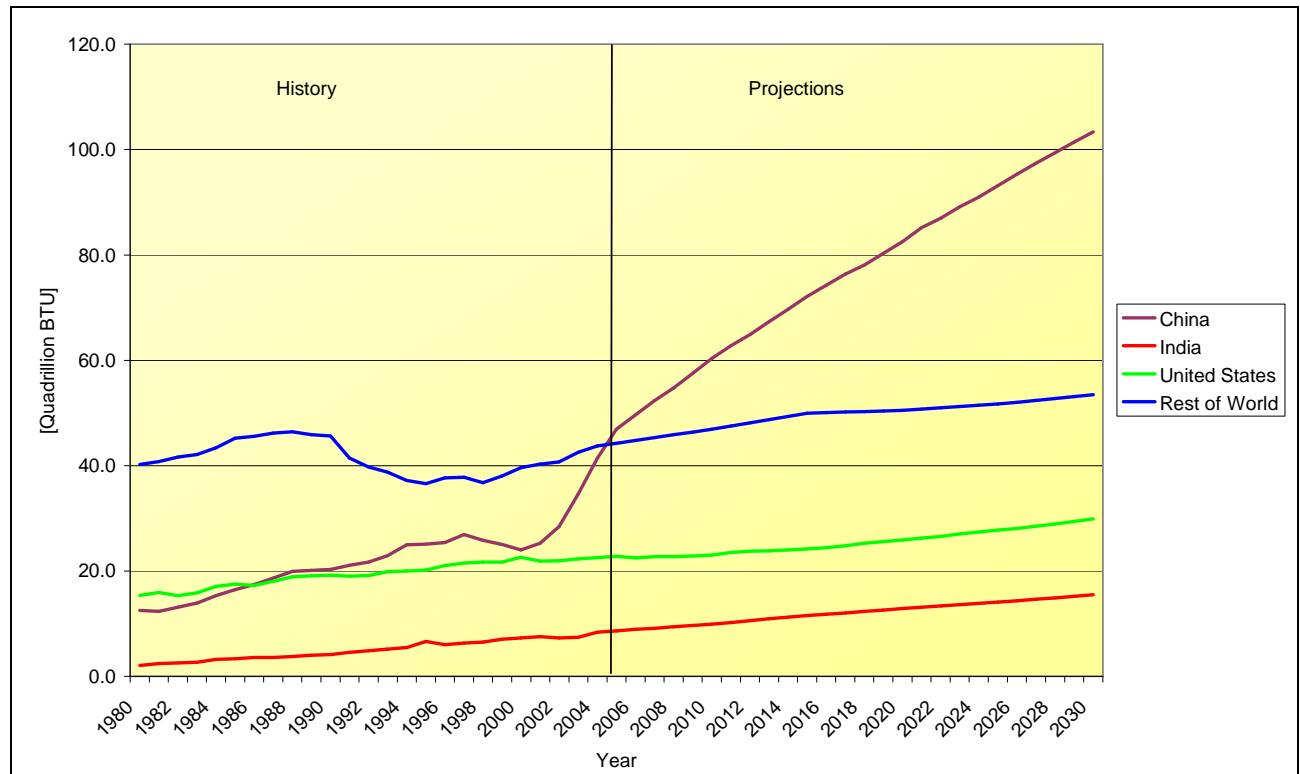

**Figure 2 Coal consumption in the selected world regions, 1980 – 2030. Source: <http://www.eia.doe.gov/oiaf/ieo/world.html> (last accessed on 20.03.2009), modified.**

According to Goedkoop, Oele and Effting (2004), several points have to be taken into consideration when discussing Ecopoints 97 method. First, this method does not use a classification. It assesses impacts individually. Although this allows for a detailed and very substance-specific method, it has the disadvantage that only a few impacts are assessed. Secondly, for the normalization step, Ecopoints 97 uses target values rather than current values. Finally, the Ecopoint system is based on policy levels instead of sustainability levels. The former ones are usually a compromise between political and environmental considerations.

As for the weighting, Ecopoints 97 calculates so-called Ecofactors (weighting factors). The calculation is being made according to the general formula:

$$f = \frac{1}{F_k} \times \frac{F}{F_k} \times 10^{12} = \frac{F}{F_k^2},$$

where  $f$  is the ecofactor and  $F$  is the actual total load,  $F_k$  is a target norm for total load, and  $10^{12}$  is a constant. The first term ( $1/F_k$ ) expresses the relative contribution of the load to the exceeding of the target norm. It is the normalisation step. The second term ( $F/F_k$ ) expresses the extent to which the target norm is already being exceeded (Goedkoop, Oele, Effting 2004).

For the calculation of the single score in the Ecopoints, the following input data are necessary:

- Quantified impacts of a product;
- Total environmental load for each impact type in a particular geographical area;
- Maximum acceptable environmental load for each impact type in that particular geographical area.

SimaPro developers provided 3 versions of the method that give identical evaluation and indicator values. The difference is caused by the choice of normalisation factor (Goedkoop, Oele, Effting 2004). One can choose between Normalisation on Target Value or Critical Emission (N=Target), Normalisation based on Actual Emission (N= Actual), and finally Ecopoints (Ecofactors given in the evaluation step, normalisation factors=1). Actually, last option means no normalization applied.

In the first case, the original general formula is used for the calculation. If normalisation is based on actual emissions, it is adapted to the following form:

$$f = \frac{1}{F} \times \frac{F}{F_k} \times \frac{F}{F_k} \times const.$$

where  $f$  is the ecofactor and  $F$  is the actual total current load,  $F_k$  is a target norm for total load (here: Critical Swiss emission per year), and constant is  $1E^{12}$ /year (BUWAL 1990, Braunschweig *et al.* 1998).

As in other SimaPro methods, some necessary technical changes and updates have been made.

#### 4. EDIP/UMIP

The Environmental Design of Industrial Products (EDIP, in Danish UMIP) method was developed in 1996 by Michael Hauschild, Henrik Wenzel, and Leo Alting (Hauschild, Wenzel and Alting 1997, 1998). It was created in close collaboration between the Danish Environmental Protection Agency, the Technical University of Denmark (Institute for Product Development and Department of Technology and Social Sciences), Confederation of Danish Industries and Danish companies. The method consists of characterisation, normalisation, and weighting steps.

As for the characterisation, most important impact group categories are global warming, acidification, eutrophication, ecotoxicity, human toxicity and resources.

Global warming assessment is based on the results from various scientific reports, such as i.e. IPCC results or reports of United Nations Economic Commission for Europe (UNECE 1991). SimaPro takes into consideration infinite time for stratospheric ozone depletion and 100 year perspective for the Global Warming Potential.

According to Goedkoop, Oele and Effting (2004), “acidification is based on the number of hydrogen ions ( $H^+$ ) that can be released. Eutrophication potential is based on nitrogen and phosphorus content in organisms. Waste streams are divided in 4 categories, bulk waste (not hazardous), hazardous waste, radioactive waste, slags, and ashes. All wastes are reported on a mass basis”.

Chemical hazard screening method serves as a basis for the ecotoxicity and human toxicity assessment. It takes into account toxicity, persistency and bioconcentration of the chemical, as well as fate or the distribution of substances into various environmental compartments. The method distinguishes also between acute and chronic ecotoxicity to water and chronic ecotoxicity for soil. For the human toxicity, potentials are calculated for exposure via air, soil, and surface water.

Resources impact category, although added to other categories, should be analyzed with care in this method. It gives only general results, because it uses different weighting factors and procedure in comparison to other categories. For detailed results, one has to apply “EDIP/UMIP resources only” method.

In the normalization step, SimaPro calculates the results on the basis on person equivalents (proven resources per person) for 1990. For resources, normalisation and weighing are already included in the characterisation factor and therefore set at zero. The weighting factors are set according to the politically set target emissions per person in the year 2000.

As the authors of the method suggest, presenting the EDIP method as a single score (addition) is allowed, however it is not recommended. Furthermore, due to a different weighting method for resources (based on reserves rather than political targets), resources may never be included in a single score. This is the reason that the weighting factor for resources is set at zero.

Various adaptations of the method were applied by the SimaPro developers.

## **5. EPS 2000**

The Environmental Priority Strategies in product design (EPS) is an assisting tool for designers and product developers for a company’s internal product development process. As Goedkoop, Oele and Effting (2004) specify, “The models and data in EPS are intended to improve environmental performance of products. The choice and design of the models and data are made from an anticipated utility perspective of a product developer. They are, for instance not intended to be used as a basis for environmental protection strategies for single substances, or as a sole basis for

environmental product declarations. In most of those cases additional site-specific information and modelling is necessary”.

The method itself is damage-oriented. It uses the Environmental Load Unit (ELU) as the indicator in the calculation of classification, characterisation and weighting steps. Normalization is not included in the methodology of EPS 2000. Calculation is done in five major impact categories: human health, ecosystem production capacity, abiotic stock resource, biodiversity and cultural and recreational values.

One has to mention very interesting top-down structure of the method. It implies the following hierarchy among its principles and rules, namely:

- “The top-down principle (highest priority is given to the usefulness of the system);
- The index principle (ready made indices represent weighted and aggregated impacts);
- The default principle (an operative method as default is required);
- The uncertainty principle (uncertainty of input data has to be estimated);
- Choice of default data and models to determine them.” (Steen 1999a and Steen 1999b).

In classification LCIA step, emissions and resources are assigned to impact categories. The classification is based on likely exposure of effects in the environment.

Characterisation values are calculated on the basis of empirical, equivalency and mechanistic models. The following weighting factors and indicators are used for various impact categories (brackets show the used unit):

- Human Health:
  - Life expectancy: Years of life lost [person year];
  - Severe morbidity and suffering, including starvation: [person year];
  - Morbidity (i.e. cold or flue): [person year];
  - Severe nuisance, which would normally cause a reaction to avoid the nuisance: [person year];
  - Nuisance, irritating, but not causing any direct action: [person year];
- Ecosystem production capacity:
  - Crop production capacity: [kg weight at harvest];
  - Wood production capacity: [kg dry weight];



- Fish and meat production capacity: [kg full weight of animals];
  - Base cation capacity, used only when models including the other indicators are not available: [ $H^+$  mole equivalents];
  - Production capacity of (irrigation) water, with respect to persistent toxic substances: [kg acceptable for irrigation];
  - Production capacity of (drinking) water: [kg of water fulfilling WHO criteria on drinking water];
- Abiotic stock resources (values resulting from both the impact of depletion and impacts due to extraction of the element/mineral or resource):
    - Depletion of elemental or mineral reserves;
    - Depletion of fossil reserves;
  - Biodiversity:
    - Extinction of species: [Normalised Extinction of species, NEX];
  - Cultural and recreational values: since highly specific and qualitative in nature, indicators are difficult to describe. Therefore, they are not included in the SimaPro.

As for the weighting, EPS 2000 uses valuation procedure, namely weighting factors represent the willingness to pay to avoid changes. The present state of the environment serves as a basis for the environmental reference. As mentioned before, the indicator unit is ELU.

The SimaPro developers made some changes and adjustments in the original EPS methodology. Changes include i.e. addition of carbon dioxide, biogenic and uptake from carbon dioxide from air (carbon dioxide, in air) to the calculation, or updating characterisation factors for Benzo(a)pyrene and for polychlorinated biphenyls.

## 6. IPCC 2001

The IPCC method is based on the results from Intergovernmental Panel for Climate Change. It assesses damage to the environment based on time perspectives of 20, 100, and 500 years. This assessment is based on characterisation factors for the direct global warming potential of air emissions.

According to Goedkoop, Oele and Effting (2004), these factors are:

- Not including indirect formation of dinitrogen monoxide from nitrogen emissions;

- Not accounting for radiative forcing due to emissions of NO<sub>x</sub>, water, sulphate, etc. in the lower stratosphere and upper troposphere;
- Not considering the range of indirect effects given by IPCC;
- Including CO<sub>2</sub> formation from CO emissions;
- Considering biogenic CO<sub>2</sub> uptake as negative impact.

Some modelling factors were updated by SimaPro developers (i.e. characterisation value 'Methane, difluoro-, HFC-32' has been corrected).

### **7. Other methods**

The SimaPro package contains two additional methods that were not used in the study, namely Impact 2002+ and TRACI. These methods were excluded from the research, since they are still under development. As the results, modelling data and official documentation are not available yet.

IMPACT 2002+ was created as a combination between IMPACT 2002, Eco-indicator 99, CML and IPCC methods.

TRACI 2.0 method is still under development by US Environmental Protection Agency.

## Appendix II

## Material composition and subassembly weights for the KGE 3490X

**Table 1 Simplified inventory analysis results with respect to materials used. Percentages relate to all materials, without sheet rolling.**

No.	Name	Amount [kg]	[%]
1.	X6CrNi18 (~304) I	17.0878	26.9
2.	Steel low alloy ETH U	15.5245	23.88
3.	Sheet rolling, steel/RER U	14.4294	-
4.	Float glass coated ETH U	10.9150	16.79
5.	Glass fibre, at plant/RER U	9.3522	14.39
6.	Soap, at plant/RER U	2.8361	4.36
7.	Glass wool mat, at plant/CH U	1.4914	2.29
8.	Polystyrene foam slab, at plant/RER U	0.9711	1.49
9.	X6Cr17 (430) I	0.8520	1.31
10.	Silica sand, at plant/DE U	0.8238	1.27
11.	Steel high alloy ETH U	0.7905	1.22
12.	Clay, at mine/CH U	0.5047	0.78
13.	St13 I	0.4994	0.77
14.	Corrugated board base paper, kraftliner at plant/RER U	0.3225	0.50
15.	PP ETH U	0.3000	0.46
16.	Packaging film, LDPE, at plant/RER U	0.2740	0.42
17.	13CrMo4 5 (1.7335) I	0.2690	0.41
18.	PB B250 (1998)	0.2428	0.37
19.	Electronics for control units/RER U	0.2262	0.35
20.	PVC B250	0.1920	0.30
21.	Fe 360 I	0.1787	0.27
22.	Pigments (general) I	0.1624	0.25
23.	Paper, woodfree, coated, at non-integrated mill/RER U	0.1503	0.23
24.	Silicone product, at plant/RER U	0.1500	0.23
25.	Packaging carton ETH U	0.1360	0.21
26.	Cotton fabric I	0.1133	0.17
27.	AlCuMg2 (2024) I	0.1095	0.17
28.	AlMgSi0.5 (6060) I	0.0800	0.12
29.	Tube insulation, elastomere, at plant/DE U	0.0800	0.12
30.	AlCuMg1 (2017) I	0.0777	0.12
31.	Chemicals inorganic, at plant/GLO U	0.0751	0.12
32.	Silicon carbide, at plant/RER U	0.0644	0.10
33.	Synthetic rubber, at plant/RER U	0.0595	0.09
34.	Fatty alcohol, petrochemical, at plant/RER U	0.0575	0.09
35.	LDPE ETH U	0.0500	0.08
36.	Borax, anhydrous, powder, at plant/RER U	0.0335	0.05
37.	Aluminium foil B250	0.0312	0.05
38.	Lubricating oil, at plant/RER U	0.0301	0.05
39.	Potassium chloride, as K2O, at regional storehouse/RER U	0.0290	0.04
40.	PA 6 GF30 I	0.0240	0.04

No.	Name	Amount [kg]	[%]
41.	Boric acid, anhydrous, powder, at plant/RER U	0.0224	0.03
42.	PE expanded I	0.0217	0.03
43.	Solvent, organic, unspecified, GLO U	0.0202	0.03
44.	Core board, at plant/RER U	0.0200	0.03
45.	Sodium phosphate, at plant, RER U	0.0138	0.02
46.	HCl (100%) B250	0.0101	0.02
47.	CuNi10Fe I	0.0100	0.02
48.	Acrylic varnish, 87.5% in H <sub>2</sub> O, at plant/RER U	0.0089	0.01
49.	13CrMo4 5 (1.7335) I	0.0080	0.01
50.	Argon ETH U 10%, CO at plant/RER U 90%	0.0050	0.01
51.	Soda ETH U	0.0045	0.01
52.	Brazing solder, cadmium free, at plant/RER U	0.0036	0.01
53.	Coating powder, at plant/RER U	0.0033	0.01
54.	Chemicals organic ETH U	0.0033	0.01
55.	Sand ETH U	0.0018	less than 0.01
56.	HDPE B250	0.0010	less than 0.01
57.	Sodium tripolyphosphate, at plant/RER U	0.0005	less than 0.01
58.	Sodium hydroxide, 50% in H <sub>2</sub> O, production mix, at plant/RER U	0.0001	less than 0.01
59.	Bentonite, at processing/DE U	0.00004	less than 0.01
60.	Lime, hydrated, loose, at plant/CH U	0.00002	less than 0.01

Table 2 Inventory analysis results. Subassemblies of KGE 3490X.

No.	Name	Amount [kg]	[%]
1.	405 Oven	21.8008	27.25
2.	006 Glass plate	15.2908	19.11
3.	196 Door	12.2395	15.30
4.	263 Drawer	5.2151	6.52
5.	593 Equipment	5.0628	6.33
6.	133 Side wall	4.7799	5.97
7.	183 Electrical system screen	3.6731	4.59
8.	630 Decorative angle	3.2789	4.10
9.	105 Packaging	1.7593	2.20
10.	295 Gas installation	1.7302	2.16
11.	001 Insulation	1.5226	1.90
12.	286 Black base	1.3250	1.66
13.	390 Back wall	1.1712	1.46
14.	403 Shelf	0.2000	0.25
15.	358 Trade fasteners	0.1790	0.22
16.	131 Grill	0.1240	0.16
17.	570 Nomenclature	0.1173	0.15
18.	195 Electrical chimney	0.1110	0.14
19.	99 Control knobs	0.0800	0.10
20.	354 Ignition packet	0.0630	0.08
21.	676 Cardboard pad	0.0200	0.03
22.	375 Special fasteners	0.0097	0.01
23.	005 Protective wiring harness	0.0012	less than 0.01

## Appendix III

### Questionnaire – cooking habits in the Polish households

#### 1. Original questionnaire in Polish

#### Wprowadzenie

Szanowni Państwo,

Nazywam się Marek Gawor i jestem doktorantem na Politechnice Brandenburskiej w Cottbus. W ramach pracy doktorskiej badam wpływ na środowisko kuchenki gazowo-elektrycznej.

Aby w pełni poznać wszelkie aspekty środowiskowe związane ze zużyciem gazu i energii elektrycznej w procesie gotowania, konieczne jest poznanie nawyków kulinarnych w polskich domach. Przedstawiona poniżej ankieta służy temu właśnie celowi.

W pierwszej części ankiety pytania dotyczą ogólnych danych statystycznych dotyczących danego gospodarstwa, jak i przygotowywanych potraw. Druga część ankiety składa się z 3 tabel. W tabelach tych proszę o dokładniejsze opisanie czasu, jak i sposobu przygotowywania poszczególnych potraw.

Chciałbym zaznaczyć, iż ankieta ma charakter anonimowy. Zebrane dane posłużą wyłącznie do pisania pracy doktorskiej.

W przypadku jakichkolwiek pytań lub wątpliwości, proszę o kontakt telefoniczny, listowny lub e-mailowy:

Marek Gawor

Ul. Długosza 5/5

58-420 Lubawka

Tel. Niemcy 00491788396019

E-mail: [marekgawor@yahoo.com](mailto:marekgawor@yahoo.com)

Z góry dziękuję za czas poświęcony na wypełnienie ankiety,

Z poważaniem,

Marek Gawor

**Część 1. Dane ogólne**

- a) Wiek: .....
- b) Płeć:.....
- c) Wykształcenie:.....
- d) Ilość osób w gospodarstwie domowym:.....
- e) Wykonywane obecnie zajęcie: .....
- f) Częstotliwość wyjazdów/przebywanie poza domem:.....<sup>2</sup>
- g) Przyjazdy rodziny lub znajomych/ jak często, ile osób, na jak długo?  
.....<sup>3</sup>
- h) Rodzaj używanego piekarnika (właściwe zakreślić):
- i) Gazowy,
  - ii) Elektryczny,
  - iii) Gazowo-elektryczny,
  - iv) Prodiż,
  - v) Piec na węgiel,
  - vi) Piec na drewno,
- i) Rodzaj kuchenki Firma:.....Typ/model:.....  
Przybliżony rok produkcji/wiek: .....
- j) Jak często gotujesz obiady?.....
- k) Średni rachunek lub zużycie z ostatnich 12 miesięcy za:
- i) Prąd:.....
  - ii) Gaz:.....
- l) Mieszkasz w dużym mieście/małym/wieś (przybliżona liczba mieszkańców):  
.....
- m) Potrawy – częstotliwość przygotowania (skala 0-10)<sup>4</sup>

<sup>2</sup> 0 wcale, 1 raz do roku lub rzadziej, 2 raz na pół roku lub rzadziej, 3 raz na trzy miesiące, 4 raz na dwa miesiące, 5 raz na miesiąc lub częściej;

<sup>3</sup> J.w.

**Table 3 Częstotliwość przygotowywania potraw.**

Lp.	Rodzaj potrawy	0	1	2	3	4	5	6	7	8	9	10
1.	Ziemniaki											
2.	Ryż											
3.	Frytki											
4.	Pyzy											
5.	Pierogi											
6.	Makaron											
7.	Kopytka											
8.	Kluski											
9.	Naleśniki											
10.	Knedle											
11.	Placki ziemniaczane											
12.	Kasza gryczana/jęczmienna											
13.	Schabowe/pierś z kurczaka											
14.	Pulpety/klopsy											
15.	Kotlety mielone											
16.	Pieczeń											
17.	Kurczak pieczony											
18.	Steki											

<sup>4</sup> 0 wcale, 1 raz do roku lub rzadziej, 2 raz na pół roku lub rzadziej, 3 raz na trzy miesiące, 4 raz na dwa miesiące, 5 raz na miesiąc 6 2x na miesiąc, 7 Co tydzień, 8 2 razy w tygodniu, 9 3 razy w tygodniu lub częściej, 10 Codziennie.

Lp.	Rodzaj potrawy	0	1	2	3	4	5	6	7	8	9	10
19.	Zrazy											
20.	Żeberka											
21.	Wątróbki											
22.	Ryba smażona											
23.	Kiełbasa smażona											
24.	Kaszanka											
25.	Cebula smażona											
26.	Jajecznica											
27.	Jajko na miękko											
28.	Jajko na twardo											
29.	Gołąbki											
30.	Rosół											
31.	Żurek											
32.	Zupa jarzynowa											
33.	Zupa grzybowa											
34.	Zupa ogórkowa											
35.	Zupa koperkowa											
36.	Zupa pomidorowa											
37.	Zupa grzybowa											
38.	Barszcz czerwony											



Lp.	Rodzaj potrawy	0	1	2	3	4	5	6	7	8	9	10
39.	Barszcz biały											
40.	Flaki											
41.	Grochowa											
42.	Kapuśniak											
43.	Krupnik											
44.	Bigos											
45.	Kapusta zasmażana											
46.	Leczo											
47.	Gulasz											
48.	Fasolka po bretońsku											
49.	Gotowanie przetworów											
50.	Mrożonki: pierogi											
51.	Mrożonki: warzywa na patelnię											
52.	Mrożonki: pyzy											
53.	Mrożonki: zapiekanki											
54.	Mrożonki: pizza											
55.	Woda (herbata, kawa)											
56.	Ciasta i ciastka											
57.	Galaretka											
58.	Polewa czekoladowa											

Lp.	Rodzaj potrawy	0	1	2	3	4	5	6	7	8	9	10
59.	Pączki											
60.	Sernik											
61.	Makowiec											
62.	Drożdżowe											
63.	Szarlotka											
64.	Inne:											
65.	Inne:											
66.	Inne:											
67.	Inne:											
68.	Inne:											
69.	Inne:											
70.	Inne:											
71.	Inne:											
72.	Inne:											
73.	Inne:											
74.	Inne:											
75.	Inne:											
76.	Inne:											

**Część 2. Dane szczegółowe****Table 4 Gotowanie – górna część kuchenki.**

<b>Lp.</b>	<b>Rodzaj potrawy</b>	<b>Całkowity czas przygotowania</b>	<b>Rodzaj palnika (duży, średni, mały)</b>	<b>Ustawienie pokrętła (duży, średni, mały płomień)</b>	<b>Uwagi</b>
1.					
2.					
3.					
4.					
5.					
6.					
7.					
8.					
9.					
10.					

**Table 5 Ciasta lub inne potrawy – piekarnik.**

<b>Lp.</b>	<b>Rodzaj</b>	<b>Całkowity czas przygotowania</b>	<b>Ustawienie temperatury</b>	<b>Funkcje dodatkowe (termoobieg, grzałka dolna lub górna)</b>	<b>Uwagi</b>
1.					
2.					
3.					
4.					
5.					
6.					
7.					
8.					
9.					
10.					

**Table 6** Inne potrawy.

Lp.	Rodzaj	Całkowity czas przygotowania (min)	Palnik/ piekarnik	Temperatura/ ustawienie	Funkcje dodatkowe	Częstotliwość przygotowania	Uwagi
1.							
2.							
3.							
4.							
5.							
6.							
7.							
8.							
9.							
10.							
11.							

## 2. English version of the questionnaire

### **Introduction**

Dear Madame, Dear Sir,

My name is Marek Gawor and I am a PhD student of the Brandenburg University of Technology Cottbus. In the framework of my Doctoral Thesis I am investigating environmental impact of the gas-electro cooker.

This questionnaire aims to know the cooking habits in the Polish households. That is necessary for the assessment of environmental aspects connected to the consumption of the gas and the electricity in the use phase.

In the first part of the questionnaire, some general questions are asked about statistical data related to your household, as well as frequency of preparation of your preferred meals. Second part of the questionnaire consists of three tables. I am kindly asking you to fill in the detailed procedure of cooking, including time and preparation way of the meal.

I would like to underline, that this questionnaire is anonymous. Collected data will be used only for the purposes of the Doctoral Thesis.

In case you would have any question or doubts, please do not hesitate to contact me by mail, email or telephone.

Marek Gawor

Ul. Długosza 5/5

58-420 Lubawka

Tel. Germany 00491788396019

E-mail: [marekgawor@yahoo.com](mailto:marekgawor@yahoo.com)

Thank you in advance for the time spent on the questionnaire.

Yours truthfully,

Marek Gawor

**Part 1. General data**

- a) Age: .....
- b) Sex:.....
- c) Education:.....
- d) Number of people in the household:.....
- e) Job: .....
- f) Frequency and length of time spent outside home (holidays, etc.):.....<sup>5</sup>
- g) Family or friend visits: How often, for how long, average time?  
.....<sup>6</sup>
- h) Type of cooker used:
- i) Gas,
  - ii) Electric,
  - iii) Gas-electric,
  - iv) Electric oven,
  - v) Coal stove,
  - vi) Wood stove,
- i) Cooker:      Company:.....Type/model:.....  
Estimated production year/age: .....
- j) How often do you prepare lunch/dinner?.....
- k) Average monthly bill from the last 12 months for:
- iii) Electricity.....
  - iv) Gas:.....
- l) Where do you live? (Small town, city, village, estimated number of inhabitants):  
.....
- m) Meals/frequency (scale 0-10)<sup>7</sup>

<sup>5</sup> 0 Not at all, 1 once per year or less, 2 twice per year or less, 3 every three months, 4 every two months, 5 once per month or more;

<sup>6</sup> See above.

**Table 7 Frequency of preparing the meals.**

No.	Type of meal	0	1	2	3	4	5	6	7	8	9	10
1.												
2.												

---

<sup>7</sup> 0 Not at all, 1 once per year or less, 2 twice per year or less, 3 every three months, 4 every two months, 5 once per month, 6 Twice per month, 7 Every week, 8 Twice per week, 9 Three times per week or more, 10 Everyday.



**Part 2. Detailed data****Table 8 Cooking – upper part of the cooker.**

Lp.	Type of meal	Total preparation time	Burner type	Knob setting, %	Remarks
1.					
2.					

**Table 9 Cakes or other meals – oven.**

Lp.	Type	Total preparation time	Temperature	Additional functions (fan, upper or lower heater)	Remarks
1.					
2.					

**Table 10 Other meals.**

Lp.	Type	Total preparation time	Burner/oven	Temperature	Additional functions	Remarks
1.						

## 3. Summary of answers to the general questions

**Table 11 Answers to the questionnaire – general data. If no answer was given, the assigned number was 0. Otherwise frequencies as described in footnote No. 6 or in headers of the specific column. Education: 1-primary, 2-secondary, 3-higher.**

Number of questionnaire	Age	Sex (0 Male, 1 Female)	Education	People in household	Occupation	Absences	Visitors
1	50	1	2	3	Office work	2	2
2	45	1	2	2	Housewife	5	5
3	37	1	2	4	Businesswoman	5	3.5
4	40	1	2	3	Nurse	5	5
5	65	1	1	2	Retired	1	4
6	29	1	3	2	Secretary	5	5
7	35	1	3	4	Teacher	5	5
8	55	1	2	4	Social worker	1	5
9	36	1	2	3	Office work	1	2
10	50	1	2	3	-	1	1
11	52	1	2	3	Office work	0	1
12	45	1	2	5	Office work	0	0
13	78	1	3	3	Housewife	5	3
14	38	0	3	5	Farmer	3	4
15	78	0	3	2	Retired	4	4
16	36	1	3	4	Physiotherapy	1	1
17	35	1	3	4	-	0	2
18	13	1	1	5	Pupil	5	1
19	32	1	2	3	Industry worker	5	4
20	43	0	0	5	Retired	5	5
21	35	1	2	6	Housewife	1	1
22	13	1	1	3	-	5	4
23	32	1	2	5	Seller	2	3
24	36	1	3	4	Clerk	2	5
25	13	0	1	5	Pupil	1	1
26	12	1		5	-	1	1
27	31	1	2	4	Seller	5	5
28	12	1	1	4	Pupil	3	3
29	35	1	2	5	Nurse	1	1
30	45	1	2	5	Retired teacher	2	2

Number of questionnaire	Age	Sex (0 Male, 1 Female)	Education	People in household	Occupation	Absences	Visitors
31	38	1	2	4	Tailor	1	1
32	21	1		4			
33	54	0	2	3	Retired	5	5
34	38	1	2	4	House work	1	0
35	13	1	1	4	Pupil	0	0
36	40	1	2	4	Industry worker	3	5
37	50	1	2	3	Housewife	1	5
38	32	1	2	3	Restaurant worker	0	2
39	37	1	2	4	Tailor	0	5
40	40	1	2	4	Tailor	2	1
41	45	0	2	4	Construction industry	1	1
42	33	1	2	5	Housewife	1	1
43	43	1	3	5		2	2
44	29	0	2	5	Physical work	5	
45	42	1	0	6	Tailor	1	3
46	12	1	1	3	Pupil	2.5	2
47	33	1	2	4	Quality controller	1	5
48	33	1	2	4	Czech republic	1	1
49	32	1	Student	3	Secretary		5
50	13	1	0	4	Pupil	3	1
51	13	0	1	6	Pupil		
52	12	1	0	4	Pupil	1	5
53	48	1	2	4	Industry worker	1	5
<b>Median</b>	<b>36</b>	<b>1</b>	<b>2</b>	<b>4</b>		<b>2</b>	<b>3</b>
<b>Min</b>	<b>12</b>	<b>0</b>	<b>0</b>	<b>2</b>		<b>0</b>	<b>0</b>
<b>Max</b>	<b>78</b>	<b>1</b>	<b>3</b>	<b>6</b>		<b>5</b>	<b>5</b>
<b>1<sup>st</sup> quartile</b>	<b>31</b>	<b>1</b>	<b>2</b>	<b>3</b>		<b>1</b>	<b>1</b>
<b>3<sup>rd</sup> quartile</b>	<b>45</b>	<b>1</b>	<b>2</b>	<b>5</b>		<b>5</b>	<b>5</b>
<b>Average</b>	<b>35.98</b>	<b>0.85</b>	<b>1.86</b>	<b>3.94</b>		<b>2.37</b>	<b>2.87</b>
<b>St. Deviation</b>	15.49	0.36	0.81	1.01		1.82	1.80

**Table 12** Answers to the questionnaire – general data. If no answer was given, the assigned number was 0. Otherwise frequencies as described in footnote No. 6 or in headers of the specific column. Type of cooker: 1 – Gas, 2 – Electrical, 3 – Gas+Electro, 4 – Small electrical oven, 5 – Coal oven, 6 – Wood oven. Inhabitants in the city: alternatively: 0 – village, 1 – small, 2 – middle, 3 – big city.

Number of questionnaire	Type of cooker	Produced by:	Type/model:	Age of the appliance:	Production year:	Frequency of preparing diners?	Electricity: monthly bill	Gas: monthly bill	Inhabitants in the city
1	1	-	-		0	10	80	30	12000
2	1	Wrozamet	Ewa	12	1996	10	130	28.5	2
3	2	Amica	-	9	1999	10	225	158.3333	30000
4	3	Wrozamet	Ewa	10	1998	10	125	125	30000
5	1	Amica	-	3	2005	10	70	100	30000
6	3	Fagor	Mastercook	4	2004	9	60	70	30000
7	1	Fagor	Mastercook	0	2008	10	140	120	30000
8	2	Fagor	Mastercook	3	2005	10	180	250	12000
9	2	Amica	-	9	1999	10	180	150	12000
10	2,4	Ardo	-	8	2000	10	130	25	13000
11	2	Fagor	Future KGE 3485x	1	2007	10	80	70	12500
12	3	Fagor	Mastercook	5	2003	9	90	110	12000
13	5	-	-	0	0	10	40	-	700
14	3	Wrozamet	Ewa	13	1995	10	200	48	500
15	1	-	Jola	38	1970	10	15	20	2500000
16	1	Amica	Family	10	1998	10	190	180	7000
17	5,6	-	-	4	2004	10	300	0	8000
18	4	-	-	20	1988	8	333	42	200
19	3,5	Amica	-	1	2007	10	75	25	12000
20	1	Wrozamet	Ewa	-	-	10	88	66.5	3
21	2	Fagor	Mastercook	4	2004	10	60	40	250
22		Amica	-	-	-	7	-	-	10000
23	3	Fagor	Mastercook	1	2007	10	110	50	9000
24	3	Beko	-	3	2005	9	150	300	6000
25	1, 5, 6	Fagor	Mastercook	5	2003	8	80	40	50
26	2	Fagor	Mastercook 3400	3	2005	10	360	75	8000
27	2	Amica	-	10	1998	10	70	80	1
28	1	Amica	-	-	-	10	60	250	7500
29	1	Wrozamet	-	20	1988	10	84	150	8000

Number of questionnaire	Type of cooker	Produced by:	Type/model:	Age of the appliance:	Production year:	Frequency of preparing diners?	Electricity: monthly bill	Gas: monthly bill	Inhabitants in the city
30	2,5,6	Fagor	Mastercook	3	2005	10	84	84	5000
31	2	Amica	-	18	1990	10	84	25	1
32	1.2	Amica	-	3	2005	6	66	42	1
33	3	Fagor	Mastercook	3	2005	10	200	100	7000
34	2	Amica	-	13	1995	10	60	42	6000
35	2	First	-	3	2005	10	210	0	-
36	2	Wrozamet	Magda	18	1990	10	160	48	7000
37	1	Wrozamet	Mastercook	9	1999	10	108	50	7000
38	2	Amica	-	7	2001	10	100	50	10000
39	1	Zanussi	ZCG 5060	5	2003	10	52.5	34	1
40	2	Amica	-	-	-	10	-	-	1
41	2	Amica	-	5	2003	10	75	40	7200
42	2	-	-	12	1996	10	-	-	9000
43	3	Amica	-	-	-	10	100	10	7500
44	2	Zanussi	Mora	9	1999	10	250	70	6000
45	2	Wrozamet	-	18	1990	10	185	175	6500
46	1	Wrozamet	-	10	1998	9	167	75	7000
47	2	Fagor	Mastercook 2400	11	1997	9.5	209	0	10000
48	2	Mora	2275	8	2000	10	59	100	7000
49	3	-	-	3	2005	10	53.5	37.25	3000
50	1	Primo super	K-04 s	1	2007	3	80	42	240
51	3	Indesit	K3G55	8	2000	0	600	450	300
52	1	-	-	-	-	7	50	60	7000
53	1	Amica	-	3	2005	10	60	40	-
<b>Median</b>				<b>7</b>	<b>2000.5</b>	<b>10</b>	<b>95</b>	<b>50</b>	
<b>Min</b>				<b>0</b>	<b>0</b>	<b>0</b>	<b>15</b>	<b>0</b>	
<b>Max</b>				<b>38</b>	<b>2008</b>	<b>10</b>	<b>600</b>	<b>450</b>	
<b>1<sup>st</sup> quartile</b>				<b>3</b>	<b>1997.25</b>	<b>10</b>	<b>70</b>	<b>40</b>	
<b>3<sup>rd</sup> quartile</b>				<b>10</b>	<b>2005</b>	<b>10</b>	<b>180</b>	<b>100</b>	
<b>Average</b>				<b>8.13</b>	<b>1956.39</b>	<b>9.33</b>	<b>134.36</b>	<b>85.26</b>	
<b>St. Deviation</b>				<b>7.06</b>	<b>294.95</b>	<b>1.82</b>	<b>102.23</b>	<b>84.92</b>	

## 4. Example of filled questionnaire (No. 38)

**Part 1. General data**

- a) Age: 32
- b) Sex: Female
- c) Education: Secondary
- d) Number of people in the household: 4
- e) Job: Restaurant worker
- f) Frequency and length of time spent outside home (holidays, etc.): -<sup>8</sup>
- g) Family or friend visits: How often, for how long, average time? Twice a year.<sup>9</sup>
- h) Type of cooker used:
  - i) Gas,
  - ~~ii) Electric,~~
  - iii) Gas-electric,
  - iv) Electric oven,
  - v) Coal stove,
  - vi) Wood stove,
- i) Cooker: Company: Amica Type/model: - Estimated production year/age: 2001
- j) How often do you prepare lunch/dinner? Everyday
- k) Average monthly bill from the last 12 months for:
  - i) Electricity: 1200 zł
  - ii) Gas: 600 zł
- l) Where do you live? (Small town, city, village, estimated number of inhabitants):  
Approximately 10000
- m) Meals/frequency (scale 0-10)<sup>10</sup>

---

<sup>8</sup> 0 Not at all, 1 once per year or less, 2 twice per year or less, 3 every three months, 4 every two months, 5 once per month or more;

<sup>9</sup> See above.

<sup>10</sup> 0 Not at all, 1 once per year or less, 2 twice per year or less, 3 every three months, 4 every two months, 5 once per month, 6 Twice per month, 7 Every week, 8 Twice per week, 9 Three times per week or more, 10 Everyday.

**Table 13 Frequency of preparation of meals: questionnaire no 38.**

No. of meal	Polish name	English name	Frequency of preparation
1	Ziemniaki	Potatoes	7
2	Ryż	Rice	3
3	Frytki	French frites	5
4	Pyzy	Potato dumplings	1
5	Pierogi	Boiled dough pockets	2
6	Makaron	Pasta	3
7	Kopytka	Hoof-shaped dumplings	1
8	Kluski	Silesian dumplings	1
9	Naleśniki	Creps/crepes	1
10	Knedle	Potato dumplings 2	1
11	Placki ziemniaczane	Potato pancakes	1
12	Kasza gryczana/jęczmienna	Buckwheat/Barley groats	4
13	Schabowe	Breaded pork chop	8
14	Pulpety, klopsy	Meatballs	5
15	Mielone	Minced cutlet	5
16	Pieczeń	Roast	5
17	Kurczak	Chicken	3
18	Steki	Steaks	2
19	Zrazy	Stuffed beef rolls	3
20	Żeberka	Spare ribs	4
21	Wątróbki	Livers	0
22	Ryba smażona	Fried fish	3
23	Kiełbasa smażona	Fried sausage	3
24	Kaszanka	Blood sausage	0
25	Cebula smażona	Fried onion	3
26	Jajecznica	Fried eggs	8
27	Jajka na miękko	Soft-boiled eggs	8
28	Jajka na twardo	Hard-boiled eggs	7
29a	Gołąbki burner	Cabbage rolls burner	6
29b	Gołąbki oven	Cabbage rolls oven	6
30	Rosół	Clear chicken soup	10
31	Żurek	Sour soup	5
32	Zupa jarzynowa	Vegetable soup	6
33	Zupa grzybowa	Mushroom soup	6
34	Zupa ogórkowa	Cucumber soup	4
35	Zupa koperkowa	Dill soup	0
36	Zupa pomidorowa	Tomato soup	6
37	Zupa grzybowa	Wild-mushroom soup	6
38	Barszcz czerwony	Red beetroot soup	4

No. of meal	Polish name	English name	Frequency of preparation
39	Barszcz biały	Sour thick wheat and potato starch soup	3
40	Flaki	Beef/pork tripe stew	0
41	Grochowa	Pea soup	1
42	Kapuśniak	Sour cabbage soup	4
43	Krupnik	Chicken/vegetable soup	2
44	Bigos	Sauerkraut/meat stew	6
45	Kapusta smażona	Cabbage fried	5
46	Leczo	Letcho	2
47	Gulasz	Goulash	6
48	Fasolka po bretońsku	Bean and sausage stew	3
49	Przetwory	Fruit/vegetable products	2
50	Pierogi mrożone	Frozen dough pockets	1
51	Warzywa mrożone	Frozen vegetables	4
52	Pyzy mrożone	Frozen potato dumplings	1
53	Zapiekanki mrożone	Toasts frozen	1
54a	Pizza mrożona	Pizza frozen	1
54b	Pizza zwykła	Pizza standard	1
55	Woda, kawa, herbata	Water, coffee, tee	10
56	Ciastka	Cookies	6
57	Galaretka	Jelly	3
58	Polewa czekoladowa	Chocolate dressing	0
59	Pączki	Donuts	6
60	Sernik	Cheesecake	5
61	Makowiec	Poppyseed cake	1
62	Drożdżowe	Yeast cake	0
63	Szarlotka	Apple pie	5
64	Biskopt	Biscuit	-
65	Babka	Sweatbread/Easter bread	-
66	Miodownik	Honey pie	-
67	Piernik	Gingerbread	-
68	Inne ciasta	Other cakes	-
69	Spaghetti	Spaghetti	-
70	Mleko	Milk	-
71a	Zapiekanki piekarnik	Toasts oven	-
71b	Zapiekanki np. ziemniaczane	Casserole	-
72	Sosy	Sauces	-



**Part 2. Detailed data****Table 14 Cooking – upper part of the cooker. Questionnaire no 38.**

Lp.	Type of meal	Total preparation time	Burner type	Knob setting, flame	Remarks
1.	Tomato soup	1 h	standard	middle	
2.	Potatoes	35 min	standard	small	
3.	Cutlets	15 min	large	middle	
4.	Potato pancakes	20 min	large	middle	
5.	Goulash	1.5 h	standard	small	
6.	Crepes	40 min	standard	middle	
7.	Vegetables on steam	25 min	large	middle	

**Table 15 Cakes or other meals – oven. Questionnaire no 38.**

Lp.	Type	Total preparation time	Temperature	Additional functions (fan, upper or lower heater)	Remarks
1.	Apple pie	40 min	150°C	lower heater	
2.	Pizza	30 min	160°C	convection	
3.	Roasted beef	1.5 h	180°C	convection	
4.	Cheesecake	1.5 h	180°C	convection	
5.	Toasts oven	20 min	150°C	upper heater	

**Table 16 Other meals. Questionnaire no 38.**

Lp.	Type	Total preparation time	Burner/oven	Temperature	Additional functions	Remarks
1.	Bean and sausage stew	2 h	burner	middle	-	once per two months
2.	Cabbage rolls	1 h	oven	150°C	convection	once per two months
3.	Fried fish	30 min	burner	middle	-	twice per month
4.	Casserole with potatoes	40 min	oven	150°C	convection	once per month
5.	Mushroom soup	1 h	burner	middle	-	twice per month
6.	Dough pockets	25 min	burner	middle	-	once per month

## Appendix IV

## Use phase processes created in the SimaPro

Table 17 Meals prepared on the top of the gas-electro cooker (gas burners).

Number of meal	Polish name	English name	Burner type (1-large, 2-standard, 3-auxiliary)	Flame (1-big, 2-middle, 3-small)	Time of preparation [min]	Gas consumption burner/flame [m <sup>3</sup> /min]	Frequency [a <sup>-1</sup> ]	Gas consumption per year [m <sup>3</sup> ]
1	Ziemniaki	Potatoes	2	2	30	0.0014	156	<b>6.70</b>
2	Ryż	Rice	2	2	20	0.0014	24	<b>0.69</b>
3	Frytki	French fries	2	2	20	0.0014	12	<b>0.34</b>
4	Pyzy	Potato dumplings	1	1	20	0.0046	2	<b>0.18</b>
5	Pierogi	Boiled dough pockets	2	2	25	0.0014	12	<b>0.43</b>
6	Makaron	Pasta	2	2	20	0.0014	52	<b>1.49</b>
7	Kopytka	Hoof-shaped dumplings	1	2	60	0.0023	6	<b>0.83</b>
8	Kluski	Silesian dumplings	2	2	45	0.0014	4	<b>0.26</b>
9	Naleśniki	Crepes/crepes	2	2	30	0.0014	24	<b>1.03</b>
10	Knedle	Potato dumplings 2	1	1	20	0.0046	2	<b>0.18</b>
11	Placki ziemniaczane	Potato pancakes	1	2	30	0.0023	6	<b>0.41</b>
12	Kasza gryczana/jęczmienna	Buckwheat/Barley groats	2	2	30	0.0014	6	<b>0.26</b>
13	Schabowe	Breaded pork chop	2	2	30	0.0014	52	<b>2.23</b>
14	Pulpety, klopsy	Meatballs	2	2	30	0.0014	6	<b>0.26</b>
15	Mielone	Minced cutlet	2	2	30	0.0014	24	<b>1.03</b>
18	Steki	Steaks	2	3	30	0.0007	1	<b>0.02</b>
19	Zrazy	Stuffed beef rolls	2	3	30	0.0007	1	<b>0.02</b>
21	Wątróbki	Livers	2	2	30	0.0014	4	<b>0.17</b>
22	Ryba smażona	Fried fish	2	2	25	0.0014	24	<b>0.86</b>
23	Kiełbasa smażona	Fried sausage	2	2	30	0.0014	12	<b>0.52</b>
24	Kaszanka	Blood sausage	2	2	30	0.0014	2	<b>0.09</b>
25	Cebula smażona	Fried onion	2	2	15	0.0014	2	<b>0.04</b>
26	Jajecznicza	Fried eggs	3	3	7,5	0.0004	52	<b>0.16</b>
27	Jajka na miękko	Soft-boiled eggs	3	3	3	0.0004	24	<b>0.03</b>

Number of meal	Polish name	English name	Burner type (1-large, 2-standard, 3-auxiliary)	Flame (1-big, 2-middle, 3-small)	Time of preparation [min]	Gas consumption burner/flame [m <sup>3</sup> /min]	Frequency [a <sup>-1</sup> ]	Gas consumption per year [m <sup>3</sup> ]
28	Jajka na twardo	Hard-boiled eggs	3	3	10	0.0004	24	<b>0.10</b>
29a	Gołąbki burner	Cabbage rolls burner	2	2	120	0.0014	4	<b>0.69</b>
30	Rosół	Clear chicken soup	2	2	60	0.0014	52	<b>4.46</b>
31	Żurek	Sour soup	2	2	60	0.0014	12	<b>1.03</b>
32	Zupa jarzynowa	Vegetable soup	2	2	60	0.0014	52	<b>4.46</b>
33	Zupa grzybowa	Mushroom soup	2	2	60	0.0014	6	<b>0.52</b>
34	Zupa ogórkowa	Cucumber soup	2	2	60	0.0014	12	<b>1.03</b>
35	Zupa koperkowa	Dill soup	2	2	60	0.0014	1	<b>0.09</b>
36	Zupa pomidorowa	Tomato soup	2	2	60	0.0014	52	<b>4.46</b>
37	Zupa grzybowa	Wild-mushroom soup	2	2	60	0.0014	0	<b>0.00</b>
38	Barszcz czerwony	Red beetroot soup	2	2	60	0.0014	12	<b>1.03</b>
39	Barszcz biały	Sour thick wheat and potato starch soup	2	2	60	0.0014	6	<b>0.52</b>
40	Flaki	Beef/pork tripe stew	2	2	60	0.0014	1	<b>0.09</b>
41	Grochowa	Pea soup	2	2	60	0.0014	4	<b>0.34</b>
42	Kapuśniak	Sour cabbage soup	2	2	60	0.0014	12	<b>1.03</b>
43	Krupnik	Chicken/vegetable soup with kasha	2	2	60	0.0014	12	<b>1.03</b>
44	Bigos	Sauerkraut/meat stew	2	2	120	0.0014	6	<b>1.03</b>
45	Kapusta smażona	Cabbage fried	2	2	75	0.0014	6	<b>0.64</b>
46	Leczo	Letcho	2	3	40	0.0007	4	<b>0.11</b>
47	Gulasz	Goulash	2	3	60	0.0007	12	<b>0.52</b>
48	Fasolka po bretońsku	Cheap bean and sausage stew	2	3	105	0.0007	6	<b>0.45</b>
49	Przetwory	Fruit/vegetable products	1	3	900	0.0011	1	<b>1.03</b>
50	Pierogi mrożone	Frozen dough pockets	2	2	30	0.0014	1	<b>0.04</b>
51	Warzywa mrożone	Frozen vegetables	1	2	25	0.0023	2	<b>0.11</b>
52	Pyzy mrożone	Frozen potato dumplings	2	2	30	0.0014	1	<b>0.04</b>
55	Woda, kawa, herbata	Water, coffee, tee	1	1	10	0.0046	1460	<b>67.10</b>
57	Galaretką	Jelly	1	1	10	0.0046	6	<b>0.28</b>

<b>Number of meal</b>	<b>Polish name</b>	<b>English name</b>	<b>Burner type (1-large, 2-standard, 3-auxiliary)</b>	<b>Flame (1-big, 2-middle, 3-small)</b>	<b>Time of preparation [min]</b>	<b>Gas consumption burner/flame [m<sup>3</sup>/min]</b>	<b>Frequency [a<sup>-1</sup>]</b>	<b>Gas consumption per year [m<sup>3</sup>]</b>
<b>58</b>	Polewa czekoladowa	Chocolate dressing	1	1	10	0.0046	2	<b>0.09</b>
<b>69</b>	Spaghetti	Spaghetti	2	2	35	0.0014	12	<b>0.60</b>
<b>70</b>	Mleko	Milk	2	2	15	0.0014	52	<b>1.12</b>
<b>72</b>	Sosy	Sauces	2	3	20	0.0007	52	<b>0.74</b>

Table 18 Meals/cakes prepared in the oven.

Number of meal	Polish name	English name	Temperature [°C]	Additional functions (c-convection)	Time of preparation [min]	Multiplication factor [-]	Frequency [a <sup>-1</sup> ]	Electricity consumption [kWh]	Electricity consumption per year [kWh]
16	Pieczeń	Roast	200		90	1.5	12	0.97	17.54
17	Kurczak	Chicken	190		60	1	24	0.92	22.13
20	Żeberka	Spare ribs	200		90	1.5	6	0.97	8.77
29b	Gołąbki oven	Cabbage rolls oven	170		90	1.5	2	0.82	2.45
53	Zapiekanki mrożone	Toasts frozen	180	c	20	0.33	1	0.79	0.26
54a	Pizza mrożona	Pizza frozen	170	c	15	0.25	2	0.74	0.37
54b	Pizza zwykła	Pizza standard	180		45	0.75	12	0.87	7.83
56	Ciastka	Cookies	190		30	0.5	52	0.92	23.98
59	Pączki	Donuts	200	c	60	1	2	0.88	1.77
60	Sernik	Cheesecake	190		75	1.25	6	0.92	6.92
61	Makowiec	Poppyseed cake	190		60	1	2	0.92	1.84
62	Drożdżowe	Yeast cake	190		60	1	4	0.92	3.69
63	Szarlotka	Apple pie	190		60	1	6	0.92	5.53
64	Biszkopt	Biscuit	180		40	0.67	12	0.87	6.99
65	Babka	Sweatbread/Easter bread	180		45	0.75	12	0.87	7.83
66	Miodownik	Honey pie	200		45	0.75	6	0.97	4.38
67	Piernik	Gingerbread	180		60	1	2	0.87	1.74
68	Inne ciasta	Other cakes	180		55	0.92	6	0.87	4.80
71a	Zapiekanki piekarnik	Toasts oven	190		15	0.25	12	0.92	2.77
71b	Zapiekanki np. ziemniaczane	Casserole	180		60	1	12	0.87	10.44

## Appendix V

## Gas and electricity consumption and conversion factors used in the modelling

**Table 19 Natural gas consumption, assumption: middle flame= approximately 50% of big flame gas consumption, small flame= approximately 25% of big flame gas consumption.**

Burner	Valve/Flame	Consumption m <sup>3</sup> /min
Large	Big	0,0046
	Middle	0,0023
	Small	0,0011
Standard	Big	0,0029
	Middle	0,0014
	Small	0,0007
Auxiliary	Big	0,0016
	Middle	0,0008
	Small	0,0004

**Table 20 Multiplication factors used in table 7.18 for the calculation of the electricity consumption.**

Min	Factor
30	0.50
35	0.58
40	0.67
45	0.75
50	0.83
55	0.92
60	1.00
65	1.08
70	1.17
75	1.25
80	1.33
85	1.42
90	1.50

**Table 21 Assumptions made for the electricity consumption during the use of oven in the time of 60 minutes. 10°C = 6% change in electricity consumption with respect to the reference value.**

Oven	170°C	180°C	190°C	200°C	Units
No convection	0.82	0.87	0.92	0.97	kWh
Convection	0.74	0.79	0.84	0.88	kWh

## Appendix VI

## End of Life scenarios used in cooker modelling

Table 22 End-of-Life scenarios and the fate of materials. R – recycling, I – incineration, WWTP – waste water treatment plant, L – landfilling.

No.	Part/material	Database	Material type	Recycling	Incineration	Recycling and landfilling	Remarks
1.	Boric acid, anhydrous, powder, at plant/RER U	Ecoinvent	Chemicals, acids, inorganic	R	WWTP	WWTP	Acid
2.	HCl (100%) B250	BUWAL 250	Chemicals, acids, inorganic	R	WWTP	WWTP	Acid
3.	Potassium chloride, as K <sub>2</sub> O, at regional storehouse/RER U	Ecoinvent	Chemicals, fertilizers, inorganic	R	90% I, 10% WWTP	99%R, 1% WWTP	Enamel
4.	Argon ETH U 10%, CO at plant/RER U 90%	ETH-ESU 96, Ecoinvent	Chemicals, gases	I	I	I	Welding
5.	Bentonite, at processing/DE U	Ecoinvent	Chemicals, inorganic	R	90% I, 10% WWTP	99%R, 1% WWTP	Enamel
6.	Borax, anhydrous, powder, at plant/RER U	Ecoinvent	Chemicals, inorganic	R	90% I, 10% WWTP	99%R, 1% WWTP	Enamel
7.	Chemicals inorganic, at plant/GLO U	Ecoinvent	Chemicals, inorganic	R	90% I, 10% WWTP	99%R, 1% WWTP	
8.	Lime, hydrated, loose, at plant/CH U	Ecoinvent	Chemicals, inorganic	R	90% I, 10% WWTP	99%R, 1% WWTP	Enamel
9.	Silica sand, at plant/DE U	Ecoinvent	Chemicals, inorganic	R	90% I, 10% WWTP	99%R, 1% WWTP	Enamel
10.	Silicon carbide, at plant/RER U	Ecoinvent	Chemicals, inorganic	R	90% I, 10% WWTP	99%R, 1% WWTP	Enamel
11.	Silicone product, at plant/RER U	Ecoinvent	Chemicals, inorganic	R	90% I, 10% WWTP	99%R, 1% WWTP	
12.	Soda ETH U	ETH-ESU 96	Chemicals, inorganic	R	90% I, 10% WWTP	99%R, 1% WWTP	Enamel
13.	Sodium hydroxide, 50% in H <sub>2</sub> O, production mix, at plant/RER U	Ecoinvent	Chemicals, inorganic	R	90% I, 10% WWTP	99%R, 1% WWTP	Enamel

No.	Part/material	Database	Material type	Recycling	Incineration	Recycling and landfilling	Remarks
14.	Sodium phosphate, at plant, RER U	Ecoinvent	Chemicals, inorganic	R	90% I, 10% WWTP	99%R, 1% WWTP	Enamel
15.	Chemicals organic ETH U	ETH-ESU 96	Chemicals, organic	R	90% I, 10% WWTP	99%R, 1% WWTP	
16.	Fatty alcohol, petrochemical, at plant/RER U	Ecoinvent	Chemicals, organic	R	90% I, 10% WWTP	99%R, 1% WWTP	
17.	Solvent, organic, unspecified, GLO U	Ecoinvent	Chemicals, organic	R	90% I, 10% WWTP	99%R, 1% WWTP	
18.	Coating powder, at plant/RER U	Ecoinvent	Chemicals, others	R	90% I, 10% WWTP	99%R, 1% WWTP	Enamel
19.	Lubricating oil, at plant/RER U	Ecoinvent	Chemicals, others	R	90% I, 10% WWTP	99%R, 1% WWTP	
20.	Pigments (general) I	IDEMAT 2001	Chemicals, others	R	90% I, 10% WWTP	99%R, 1% WWTP	Enamel
21.	Sodium tripolyphosphate, at plant/RER U	Ecoinvent	Chemicals, washing agents, builders	R	90% I, 10% WWTP	99%R, 1% WWTP	Enamel
22.	Soap, at plant/RER U	Ecoinvent	Chemicals, washing agents, tensides	R	90% I, 10% WWTP	99%R, 1% WWTP	
23.	Glass wool mat, at plant/CH U	Ecoinvent	Construction, insulation	R	I	L	
24.	Polystyrene foam slab, at plant/RER U	Ecoinvent	Construction, insulation	R	I	L	
25.	Tube insulation, elastomere, at plant/DE U	Ecoinvent	Construction, insulation	R	I	L	
26.	Acrylic varnish, 87.5% in H <sub>2</sub> O, at plant/RER U	Ecoinvent	Construction, paints	R	90% I, 10% WWTP	99%R, 1% WWTP	Enamel
27.	Electronics for control units/RER U	Ecoinvent	Electronics	R	I	L	
28.	Float glass coated ETH U	ETH-ESU 96	Glass, construction	R	I	L	
29.	Glass fibre, at plant/RER U	Ecoinvent-	Glass, construction	R	90% I, 10% WWTP	99%R, 1% WWTP	



No.	Part/material	Database	Material type	Recycling	Incineration	Recycling and landfilling	Remarks
30.	Brazing solder, at plant/RER U	Ecoinvent	Metals, alloys	R	I	90% R, 10% L	
31.	Steel high alloy ETH U	ETH-ESU 96	Metals, ferro	R	I	90% R, 10 % L	
32.	St13 I	IDEMAT 2001	Metals, ferro, construction	R	I	90% R, 10 % L	
33.	Austenitic steel, X6CrNi18 (~304) I	IDEMAT 2001	Metals, ferro, stainless	R	I	90% R, 10 % L	
34.	X6Cr17 (430) I	IDEMAT 2001	Metals, ferro, stainless	R	I	90% R, 10 % L	
35.	Fe360 I	IDEMAT 2001	Metals, ferro, steel construction	R	I	90% R, 10 % L	
36.	13CrMo4 5 (1.7335) I	IDEMAT 2001	Metals, ferro, steel high temperature	R	I	90% R, 10 % L	
37.	38Si6 I	IDEMAT 2001	Metals, ferro, steel spring	R	I	90% R, 10 % L	
38.	Aluminium foil B250	BUWAL 250	Metals, non ferro	R	I	90% R, 10 % L	
39.	AlCuMg1 (2017) I	IDEMAT 2001	Metals, non ferro, aluminiums	R	I	90% R, 10 % L	
40.	AlCuMg2 (2024) I	IDEMAT 2001	Metals, non ferro, aluminiums	R	I	90% R, 10 % L	
41.	AlMgSi0.5 (6060) I	IDEMAT 2001	Metals, non ferro, aluminiums	R	I	90% R, 10 % L	
42.	CuNi10Fe I	IDEMAT 2001	Metals, non ferro, copper	R	I	90% R, 10 % L	
43.	Clay, at mine/CH U	Ecoinvent	Minerals	R	90% I, 10% WWTP	99%R, 1% WWTP	Enamel
44.	Sand ETH U	ETH-ESU 96	Minerals	R	90% I, 10% WWTP	99%R, 1% WWTP	Enamel

No.	Part/material	Database	Material type	Recycling	Incineration	Recycling and landfilling	Remarks
45.	Core board, at plant/RER U	Ecoinvent	Paper + board, board	R	I	L	
46.	Corrugated board base paper, kraftliner, at plant/RER U	Ecoinvent	Paper + board, corrugated board	R	I	L	
47.	Paper, woodfree, coated, at non-integrated mill/RER U	Ecoinvent	Paper + board, graphic paper	R	I	L	
48.	Packaging carton ETH U	ETH-ESU 96	Paper + board, packagings	R	I	L	
49.	Synthetic rubber, at plant/RER U	Ecoinvent	Plastics, rubbers	R	I	L	
50.	HDPE B250	BUWAL 250	Plastics, thermoplasts	R	I	L	
51.	LDPE ETH U	ETH-ESU 96	Plastics, thermoplasts	R	I	L	
52.	PA 6 GF30 I	IDEMAT 2001	Plastics, thermoplasts	R	I	L	
53.	Packaging film, LDPE, at plant/RER U	Ecoinvent	Plastics, thermoplasts	R	I	L	
54.	PB B250 (1998)	BUWAL 250	Plastics, thermoplasts	R	I	L	
55.	PE expanded I	IDEMAT 2001	Plastics, thermoplasts	R	I	L	
56.	PP ETH U	ETH-ESU 96	Plastics, thermoplasts	R	I	L	
57.	PVC B250	BUWAL 250	Plastics, thermoplasts	R	I	L	
58.	Cotton fabric I	IDEMAT 2001	Textiles	L	I	L	

## Appendix VII

## End of Life processes used in cooker modelling

Table 23 End-of-Life processes used in the SimaPro modelling. R – recycling, I – incineration, WWTP – waste water treatment plant, L – landfilling.

No.	Material type	Processing type	Process in SimaPro	Database	Remarks
1.	Chemicals, acids, inorganic	WWTP	Treatment, ceramic production effluent, to wastewater treatment, class 3/CH U	Ecoinvent	
		R	Recycling steel and iron/RER U	Ecoinvent	
2.	Chemicals, fertilizers, inorganic	R	Recycling steel and iron/RER U	Ecoinvent	
		I	Disposal, paint remains, 0% water, to hazardous waste incineration/CH U	Ecoinvent	
3.	Chemicals, gases	I	Process-specific burdens, hazardous waste incineration plant/CH U	Ecoinvent	
4.	Chemicals, inorganic	R	Recycling steel and iron/RER U	Ecoinvent	
		I	Disposal, paint remains, 0% water, to hazardous waste incineration/CH U	Ecoinvent	
5.	Chemicals, organic	R	Recycling steel and iron/RER U	Ecoinvent	
		I	Disposal, hazardous waste, 25% water, to hazardous waste incineration/CH U	Ecoinvent	
6.	Chemicals, others	R	Recycling steel and iron/RER U	Ecoinvent	
		I	Disposal, paint remains, 0% water, to hazardous waste incineration/CH U	Ecoinvent	Paint and enamel remains
		I	Disposal, hazardous waste, 25% water, to hazardous waste incineration/CH U	Ecoinvent	Oil, degreaser
7.	Chemicals, washing agents, builders and tensides	R	Recycling steel and iron/RER U	Ecoinvent	
		I	Disposal, hazardous waste, 25% water, to hazardous waste incineration/CH U	Ecoinvent	
		WWTP	Treatment, ceramic production effluent, to wastewater treatment, class 3/CH U	Ecoinvent	

No.	Material type	Processing type	Process in SimaPro	Database	Remarks
8.	Construction, insulation	R	Recycling mixed plastics/RER U	Ecoinvent	
		I	Incin. PS 2000 B250 avoided	BUWAL 250	Polystyrene
		I	Incin. Glass 2000 B250	BUWAL 250	Glass wool
		I	Disposal, plastics, mixture, 15.3% water, to municipal incineration/CH S	Ecoinvent	Others
		L	Disposal, mineral wool, 0% water, to inert material landfill/CH U	Ecoinvent	Glass wool
		L	Waste (inert) to landfill U	ETH-ESU 96	Others
9.	Construction, paints	R	Recycling steel and iron/RER U	Ecoinvent	
		I	Disposal, paint remains, 0% water, to hazardous waste incineration/CH U	Ecoinvent	
10.	Electronics	R	Recycling steel and iron/RER U 50%, Recycling mixed plastics/RER U 50%	Ecoinvent	
		L	Waste (inert) to landfill U	ETH-ESU 96	
11.	Glass, construction	R	Recycling glass/RER U	Ecoinvent	
		L	Disposal, glass, 0% water, to inert material landfill/CH U	Ecoinvent	Float glass coated
		I	Disposal, glass, 0% water, to municipal incineration/CH U	Ecoinvent	Float glass coated
		I	Disposal, paint remains, 0% water, to hazardous waste incineration/CH U	Ecoinvent	Glass frit
12.	Metals	R	Recycling steel and iron/RER U	Ecoinvent	
		I	Steel to MWI U	ETH-ESU 96	Welding wire only
		L	Disposal, steel, 0% water, to inert material landfill/CH U	Ecoinvent	
13.	Minerals	R	Recycling steel and iron/RER U	Ecoinvent	
		I	Disposal, paint remains, 0% water, to hazardous waste incineration/CH U	Ecoinvent	
14.	Paper + board, corrugated board	R	Recycling cardboard/RER U	Ecoinvent	Cardboard, paper-board

No.	Material type	Processing type	Process in SimaPro	Database	Remarks
	and board	I	Disposal, packaging cardboard, 19.6% water, to municipal incineration/CH U	Ecoinvent	
		L	Disposal, packaging cardboard, 19.6% water, to inert material landfill/CH U	Ecoinvent	
15.	Paper + board, graphic paper	R	Recycling paper/RER U	Ecoinvent	Special paper etc.
		I	Disposal, paper, 11.2% water, to municipal incineration/CH U	Ecoinvent	
		L	Disposal, paper, 11.2% water, to sanitary landfill/CH U	Ecoinvent	
16.	Plastics, rubbers	R	Recycling mixed plastics/RER U	Ecoinvent	Synthetic rubber
		I	Disposal, rubber, unspecified, 0% water, to municipal incineration/CH U	Ecoinvent	
		L	Disposal, plastics, mixture, 15.3% water, to sanitary landfill/CH U	Ecoinvent	
17.	Plastics, thermoplasts	R	Recycling Plastics (excl. PVC) B250	BUWAL 250	HDPE B250
		I	Disposal, plastic, consumer electronics, 15.3% water, to municipal incineration/CH U	Ecoinvent	
		L	Disposal, plastics, mixture, 15.3% water, to sanitary landfill/CH U	Ecoinvent	
18.	Plastics, thermoplasts	R	Recycling mixed plastics/RER U	Ecoinvent	LDPE ETH U
		I	Disposal, plastic, consumer electronics, 15.3% water, to municipal incineration/CH U	Ecoinvent	
		L	Disposal, plastics, mixture, 15.3% water, to sanitary landfill/CH U	Ecoinvent	
19.	Plastics, thermoplasts	R	Recycling mixed plastics/RER U	Ecoinvent	PA 6 GF 30 I
		I	Disposal, plastic, consumer electronics, 15.3% water, to municipal incineration/CH U	Ecoinvent	
		L	Disposal, plastics, mixture, 15.3% water, to sanitary landfill/CH U	Ecoinvent	
20.	Plastics, thermoplasts	R	Recycling mixed plastics/RER U	Ecoinvent	Packaging film LDPE
		I	Disposal, plastics, mixture, 15.3% water, to municipal incineration/CH U	Ecoinvent	

No.	Material type	Processing type	Process in SimaPro	Database	Remarks
		L	Disposal, plastics, mixture, 15.3% water, to sanitary landfill/CH U	Ecoinvent	
21.	Plastics, thermoplasts	R	Recycling Plastics (excl. PVC) B250	BUWAL 250	PB B250
		I	Disposal, plastic, consumer electronics, 15.3% water, to municipal incineration/CH U	Ecoinvent	
		L	Disposal, plastics, mixture, 15.3% water, to sanitary landfill/CH U	Ecoinvent	
22.	Plastics, thermoplasts	R	Recycling PE/RER U	Ecoinvent	PE expanded I
		I	Disposal, polyethylene, 0.4% water, to municipal incineration/CH U	Ecoinvent	
		L	Disposal, polyethylene, 0.4% water, to sanitary landfill/CH U	Ecoinvent	
23.	Plastics, thermoplasts	R	Recycling PP/RER U	Ecoinvent	PP ETH U
		I	Disposal, polypropylene, 15.9% water, to municipal incineration/CH U	Ecoinvent	
		L	Disposal, polypropylene, 15.9% water, to sanitary landfill/CH U	Ecoinvent	
24.	Plastics, thermoplasts	R	Recycling PVC B250	BUWAL 250	PVC B250
		I	Incin. PVC 2000 B250 avoided	BUWAL 250	
		L	Landfill PVC B250	BUWAL 250	
25.	Textiles	L	Waste (inert) to landfill U	ETH-ESU 96	
		I	Municipal waste to MWI U	ETH-ESU 96	

## Appendix VIII

## Network diagrams, KGE 3490X without EoL and without use phase

## 1. CML 2 Baseline 2000

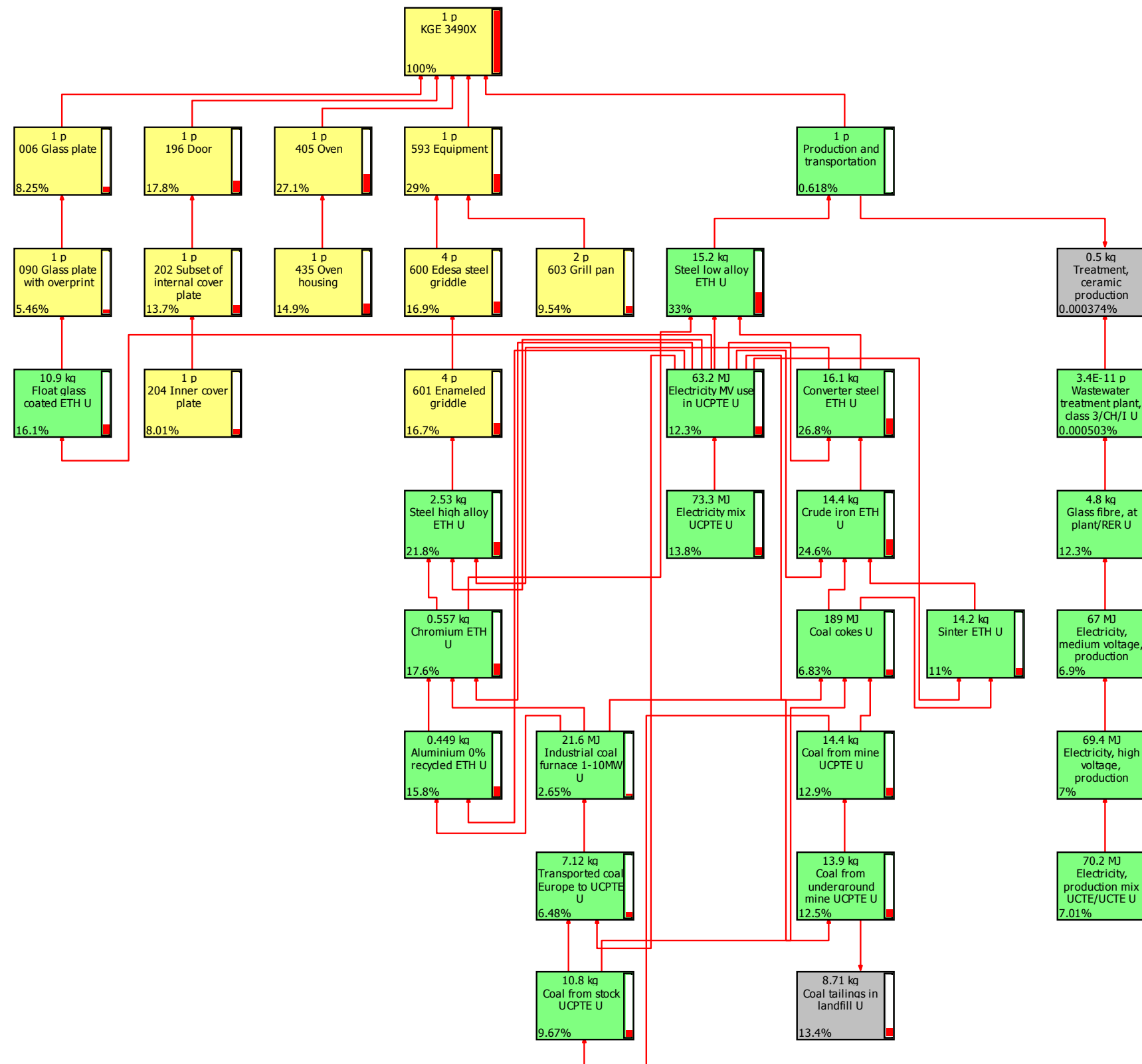

Figure 3 Characterization, CML 2 2000, with respect to marine aquatic ecotoxicity, KGE 3490X without EoL and without use phase. Units: percentage, cut-off level 6.1%.



Figure 4 Normalization, CML 2 2000, with respect to acidification, cooker without EoL and without use phase. Units: percentage, 6% cut-off.



## 2. Cumulative Energy Demand

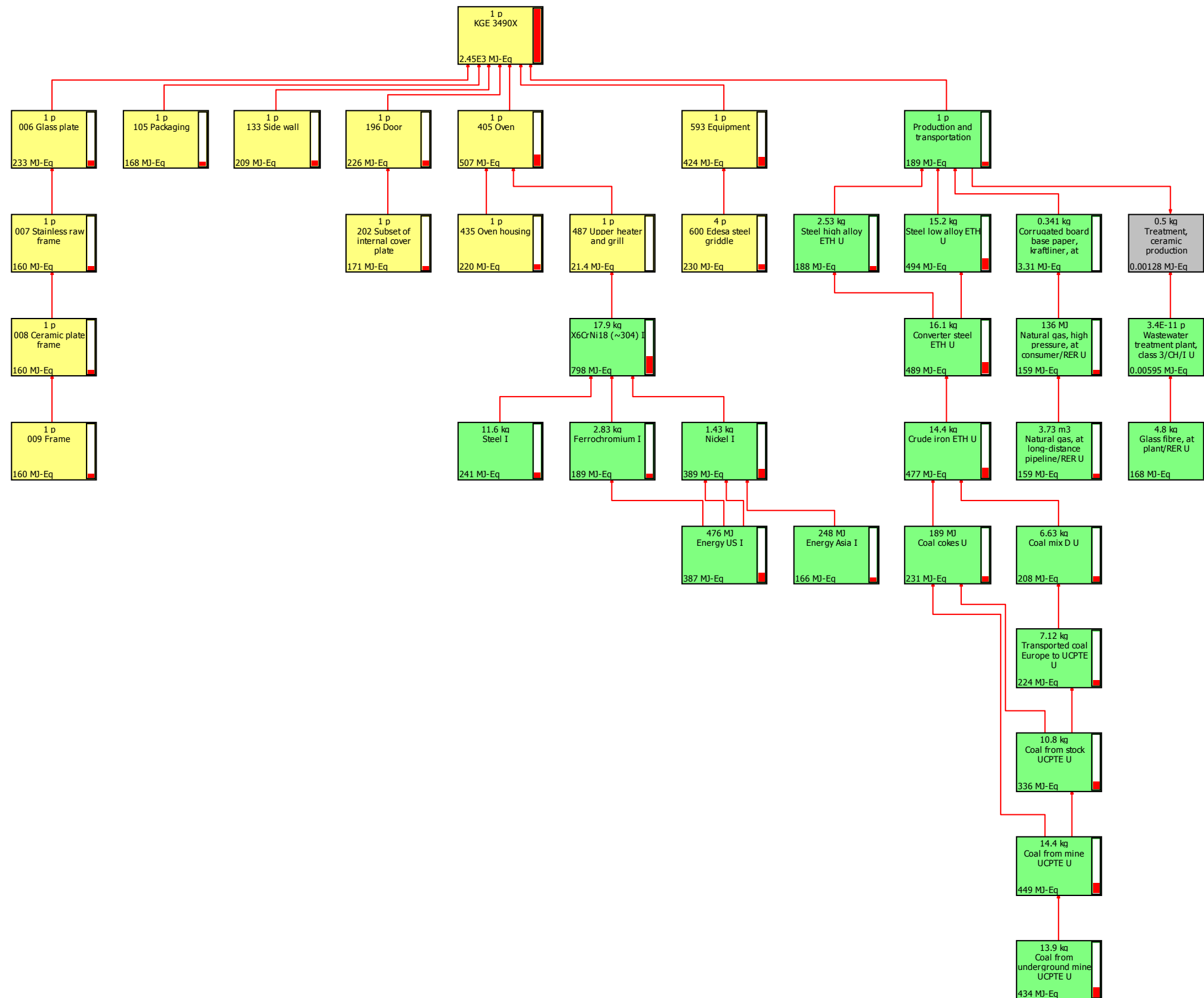

Figure 5 Characterization, Cumulative Energy Demand, with respect to non-renewable fossil fuels, cooker without EoL and without use phase. Units: MJ-Eq., 6% cut-off.

### 3. Ecopoints 97

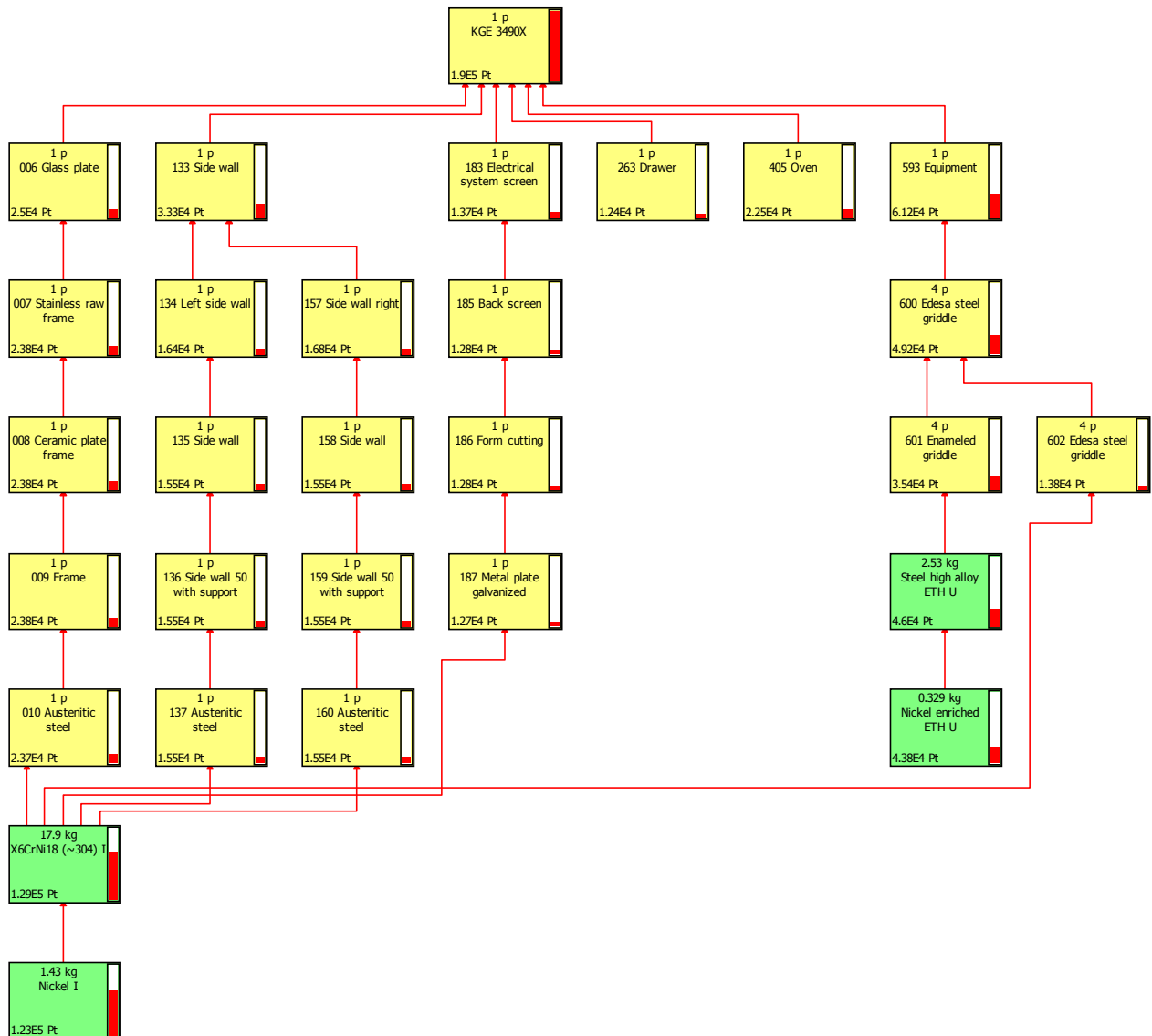
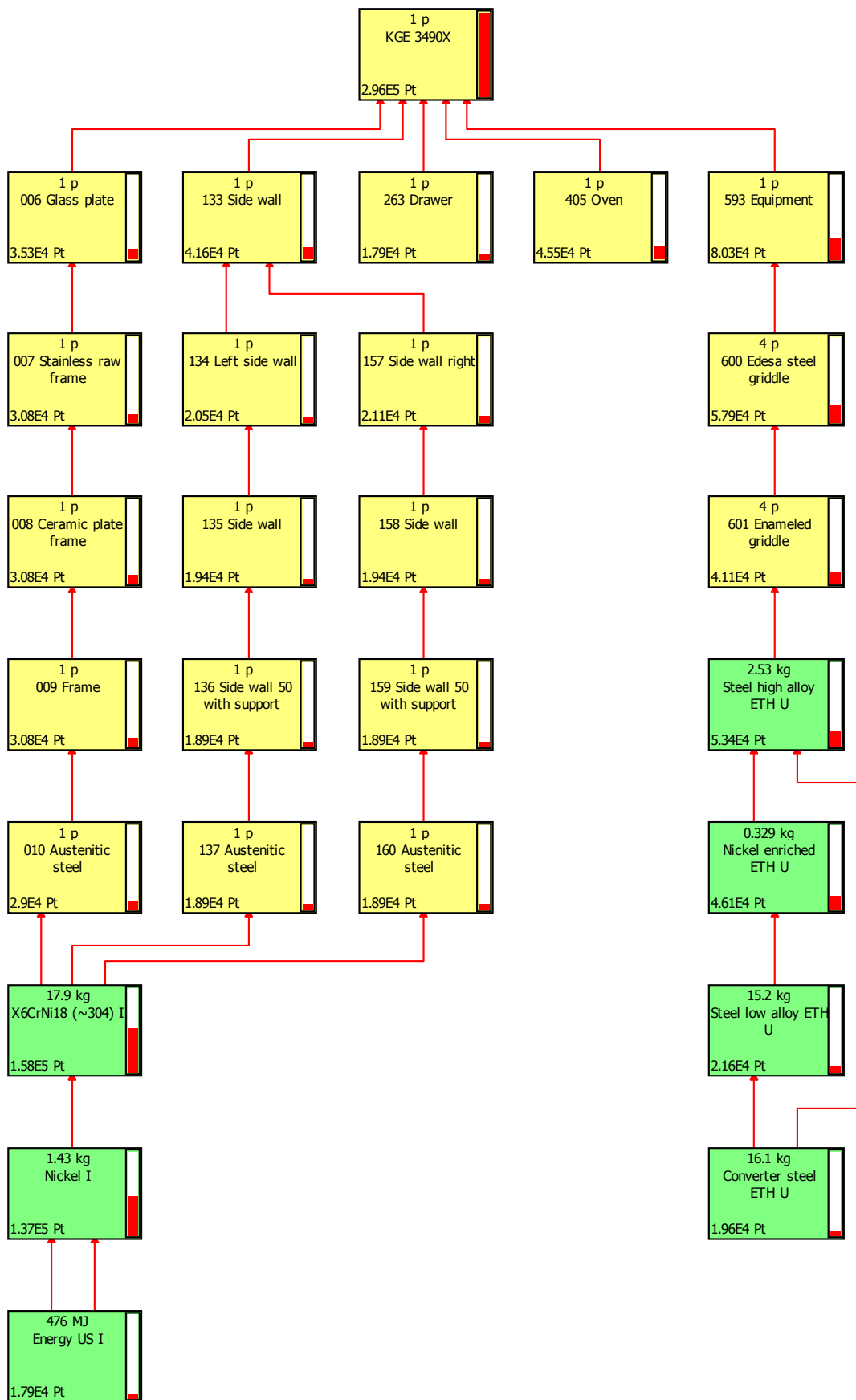

Figure 6 Weighting results, Ecopoints 97, with respect to  $\text{SO}_x$  g eq. KGE 3490X without EoL and without use phase. Units: points, 6% cut-off.



**Figure 7 Single Score results, Ecopoints 97, KGE 3490X without EoL and without use phase. Units: points, cut-off 6%.**

Marek Gawor

*Application of Life Cycle Assessment in the Context of Classical Environmental Management System and with Respect to the Implementation of the EuP Directive*

#### 4. EDIP/UMIP

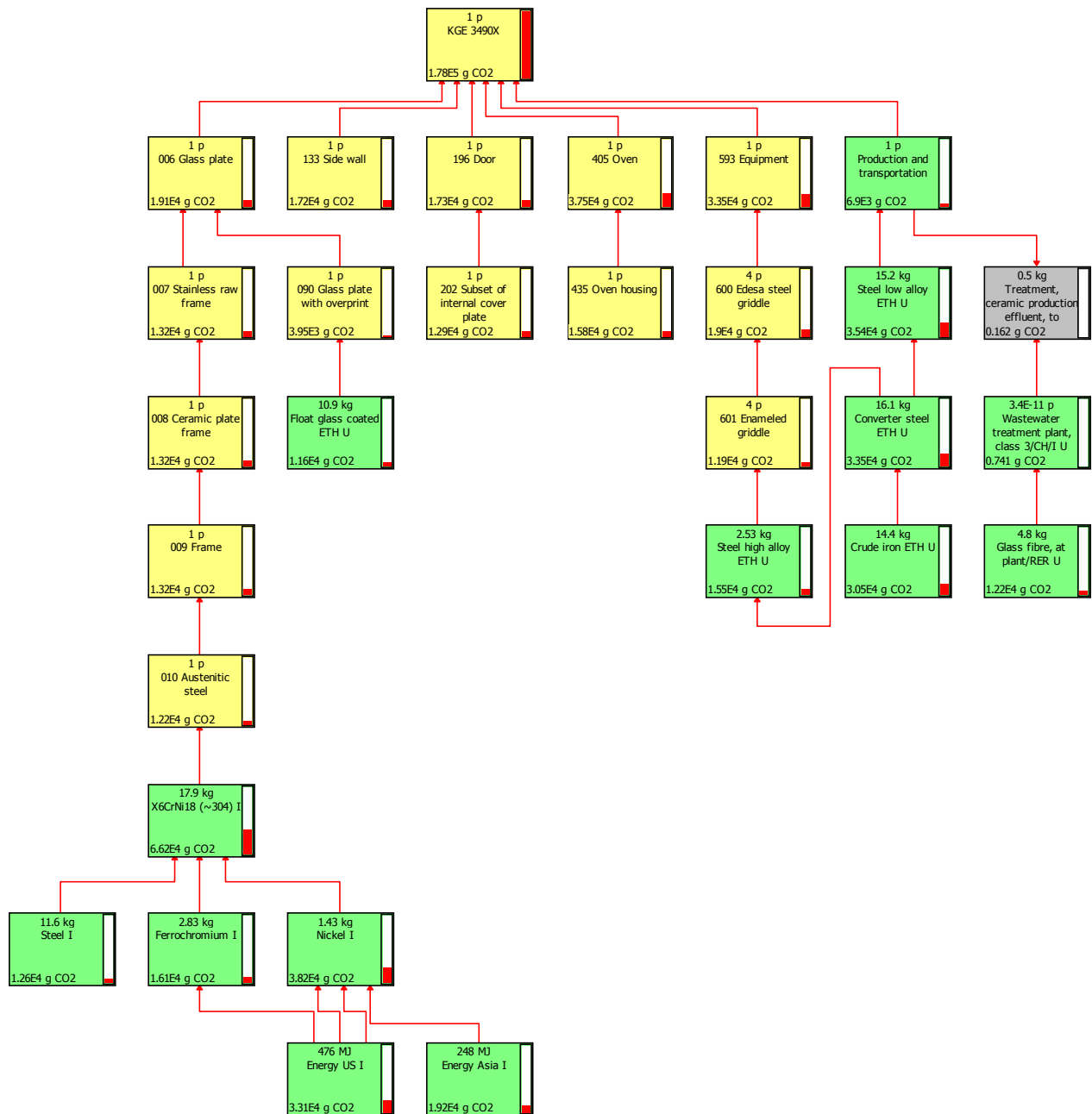

Figure 8 Characterization results, EDIP/UMIP, with respect to Global Warming Potential 100, KGE 3490X without EoL and without use phase. Units: g CO<sub>2</sub>, cut-off 6%.

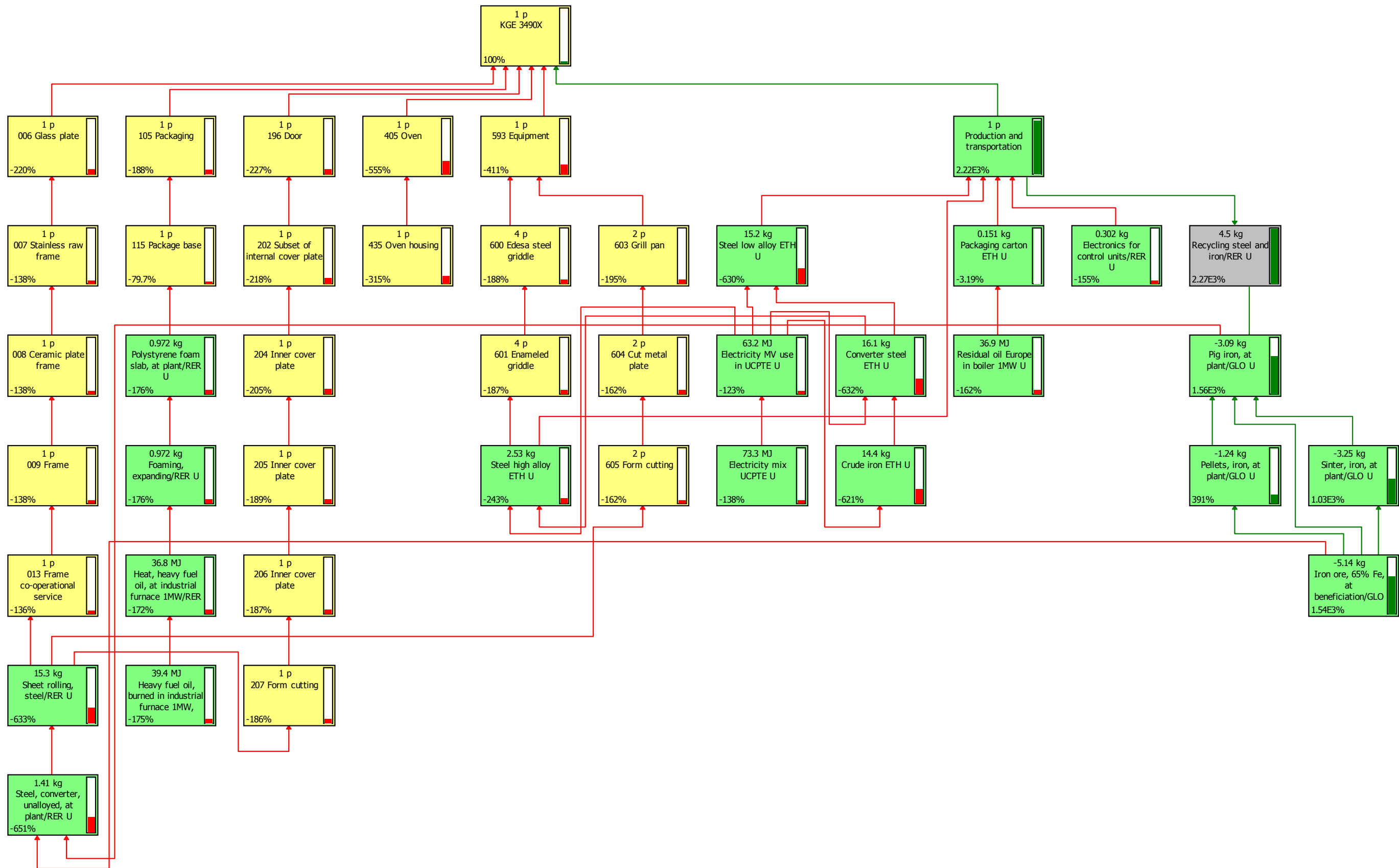

Figure 9 Normalization results, EDIP/UMIP, with respect to ecotoxicity soil chronic. KGE 3490X without EoL and without use phase. Units: percentage, cut-off 6%.

5. Eco-Indicator 99

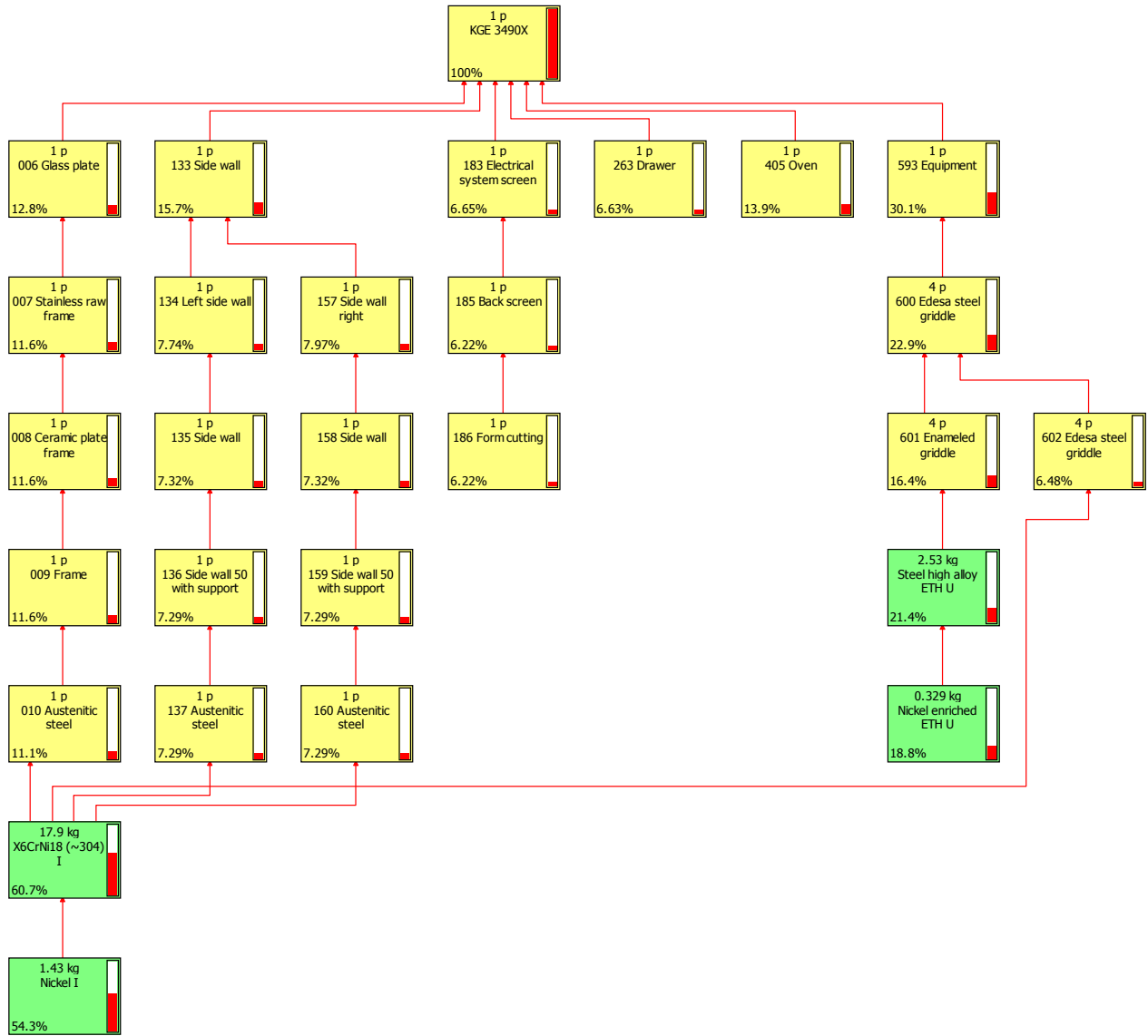
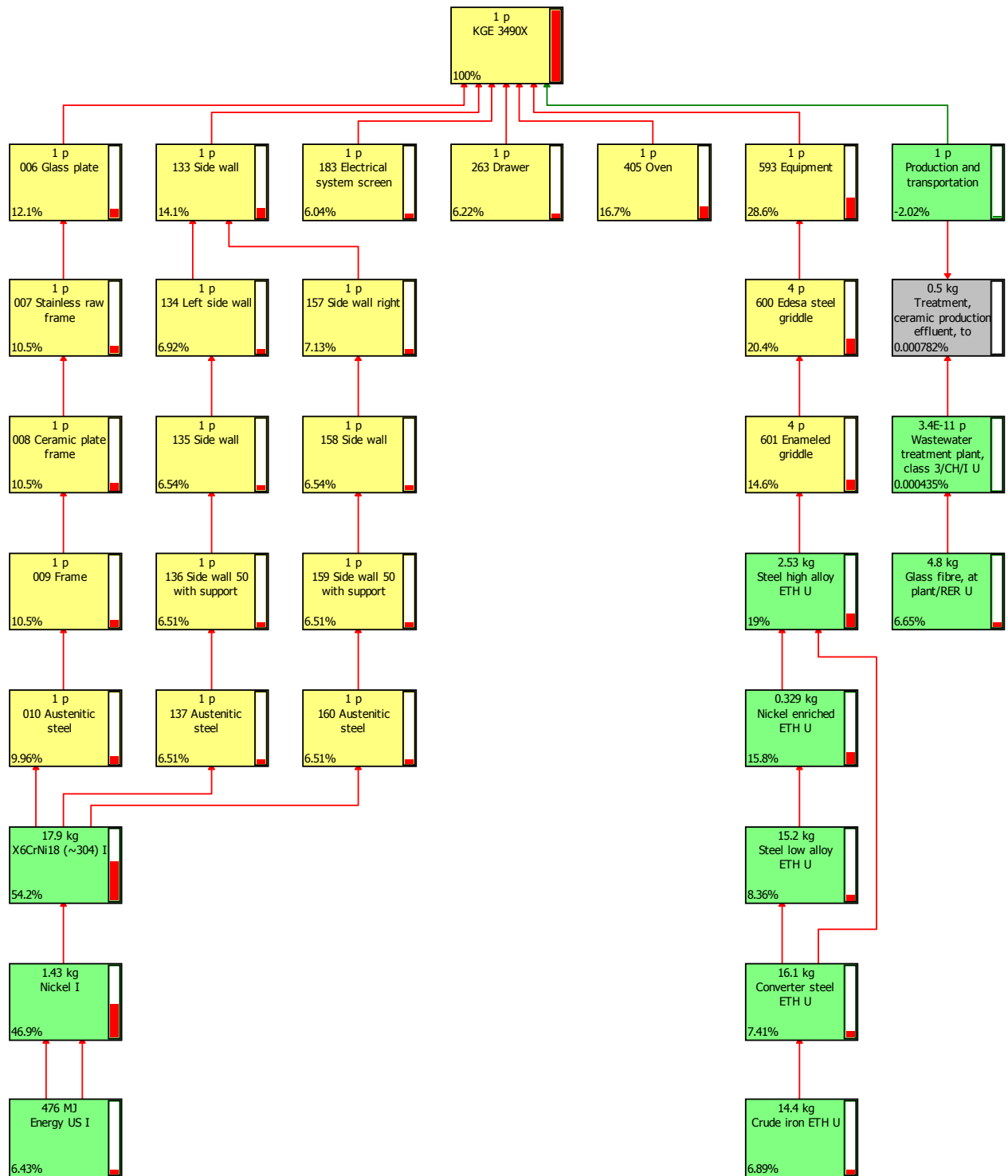

Figure 10 Characterization, Eco-Indicator 99, with respect to respiratory inorganics. KGE 3490X without EoL and without use phase. Units: percentage, 6% cut-off.



**Figure 11** Damage assessment, Eco-Indicator 99, with respect to human health. KGE 3490X without EoL and without use phase. Units: percentage, 6% cut-off.

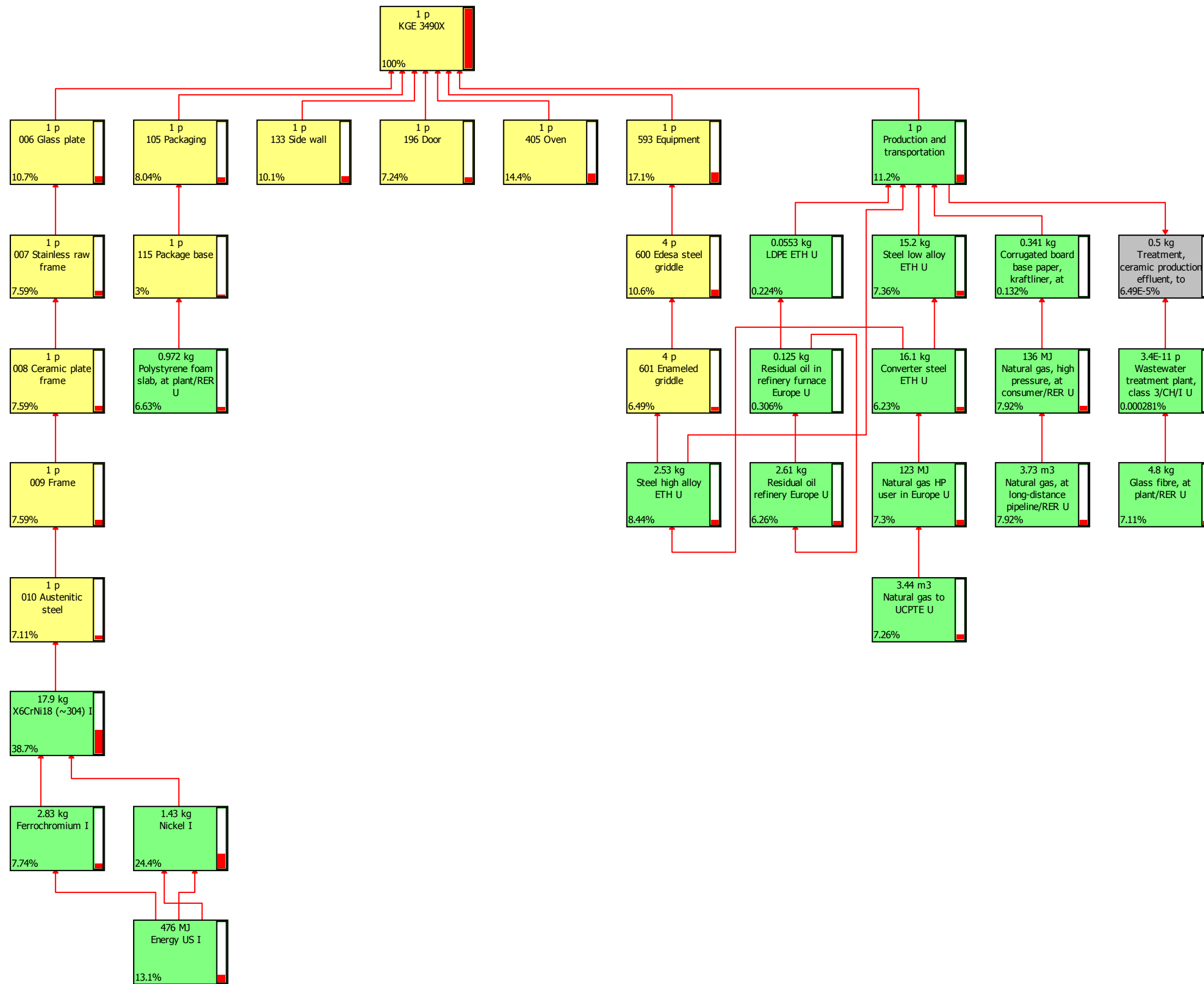

Figure 12 Normalization, Eco-Indicator 99, with respect to resources. KGE 3490X without EoL and without use phase. Units: percentage, 6% cut-off.



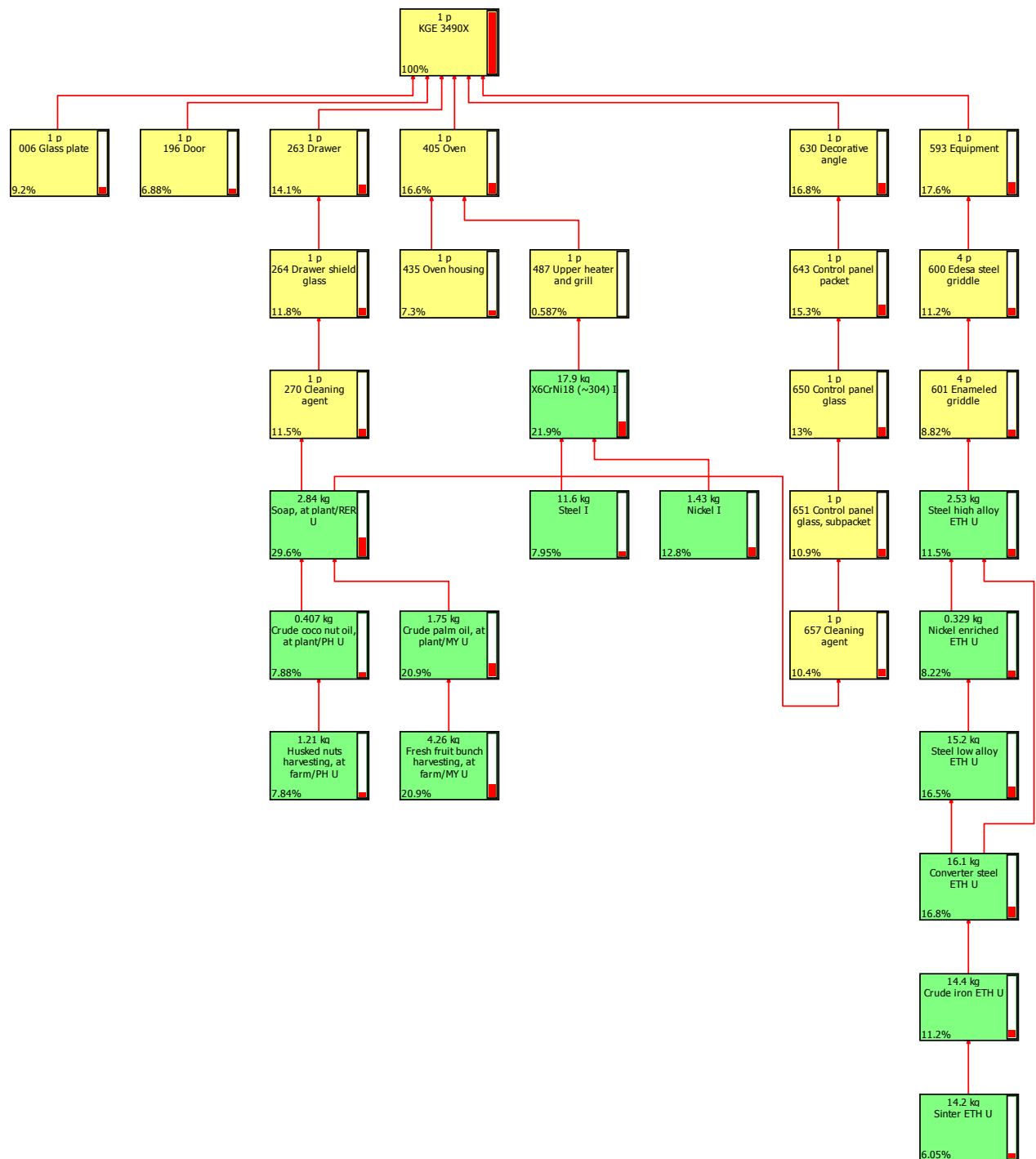

Figure 13 Weighting, Eco-Indicator 99, with respect to ecosystem quality. KGE 3490X without EoL and without use phase. Units: percentage, 6% cut-off.

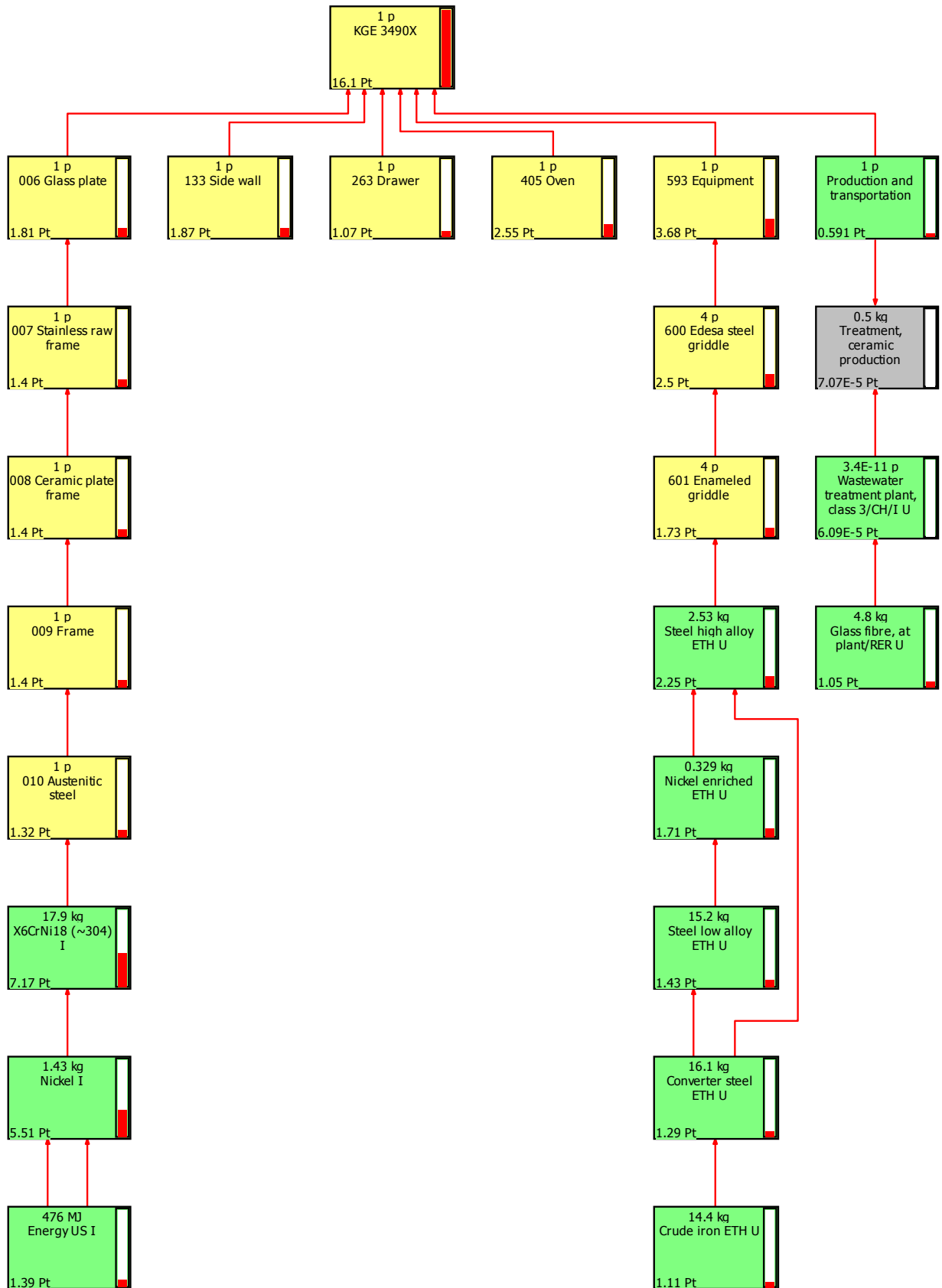

Figure 14 Single Score, Eco-Indicator 99. KGE 3490X without EoL and without use phase. Units: points, 6% cut-off.

6. EPS 2000

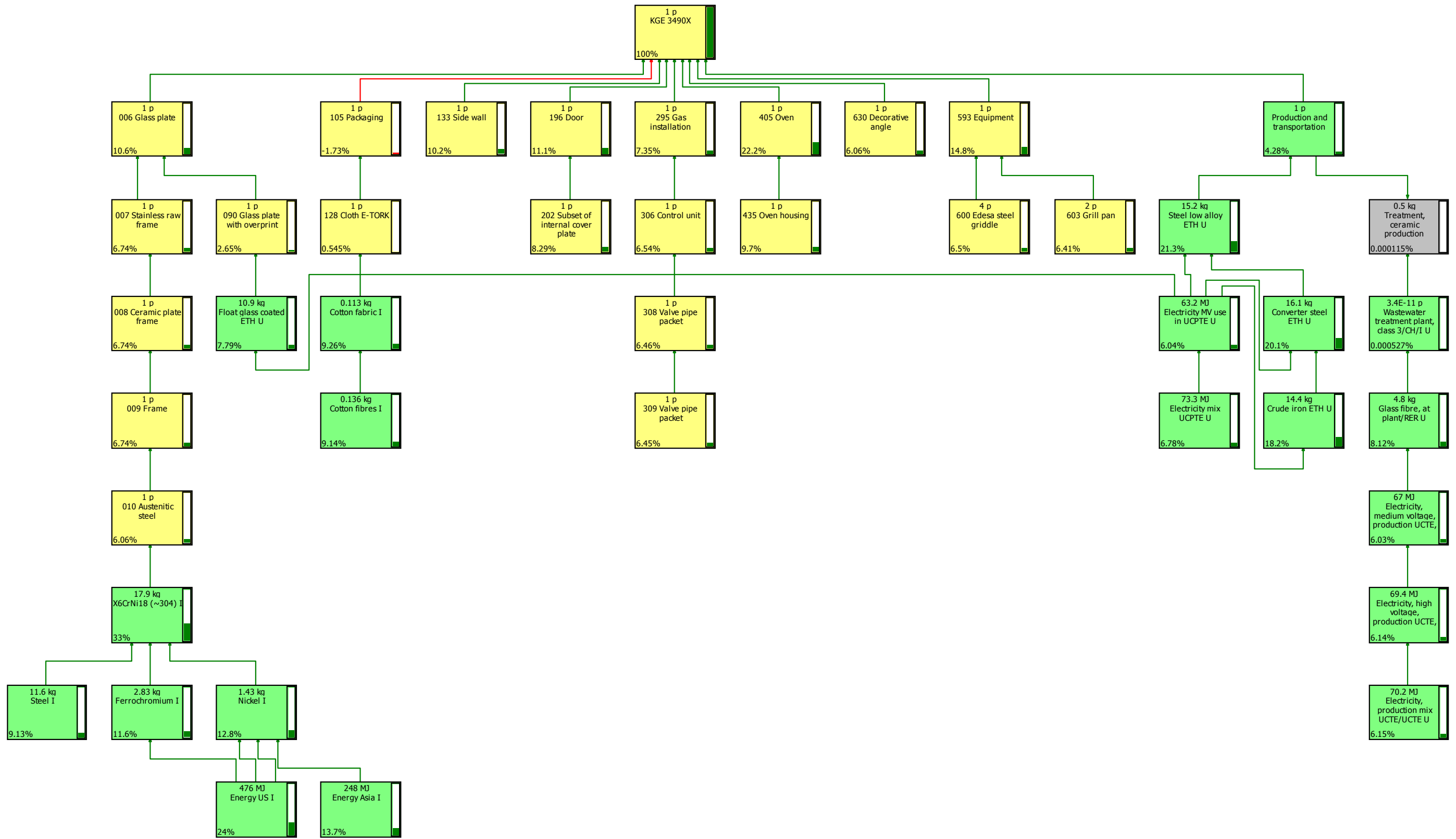
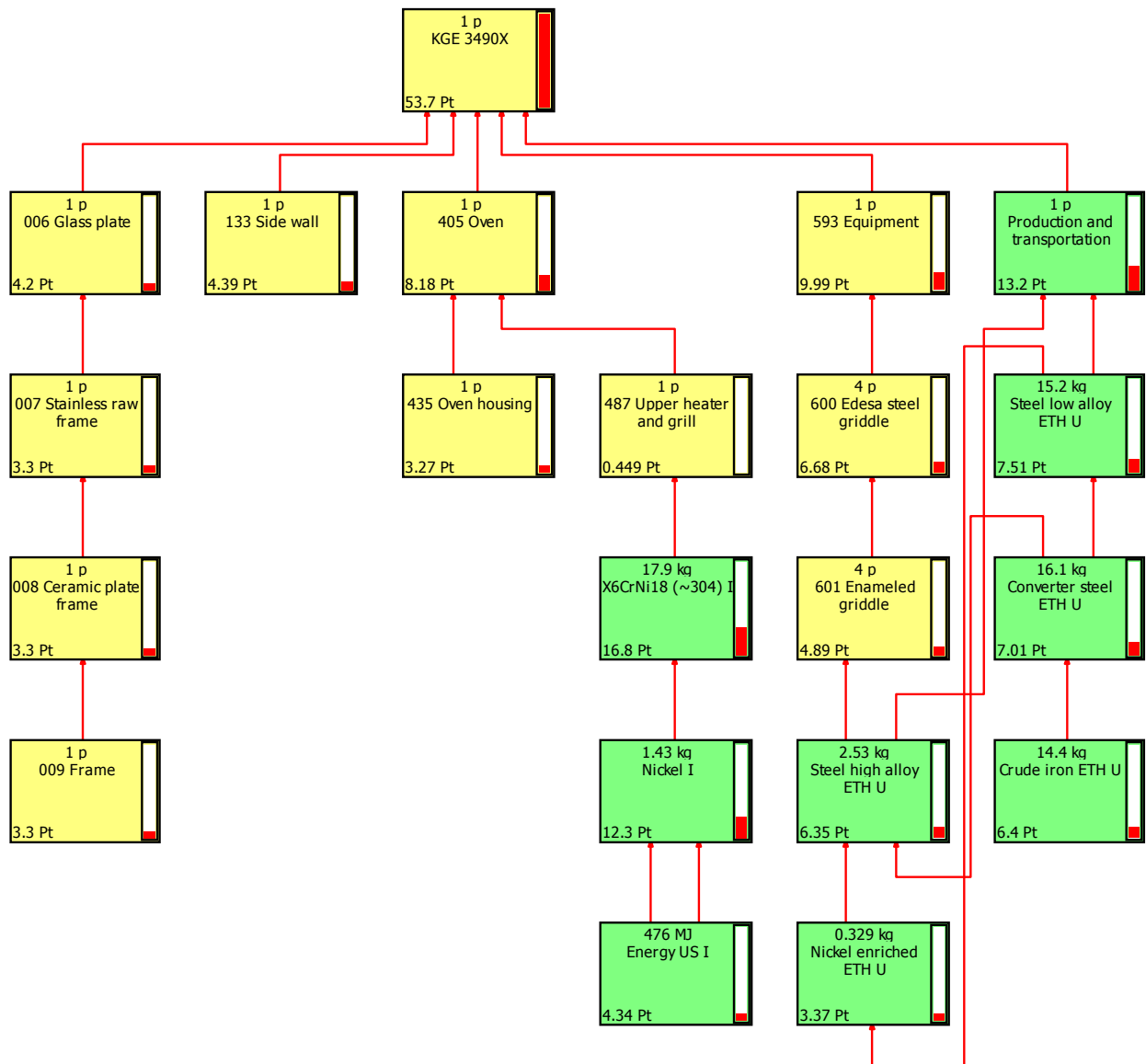
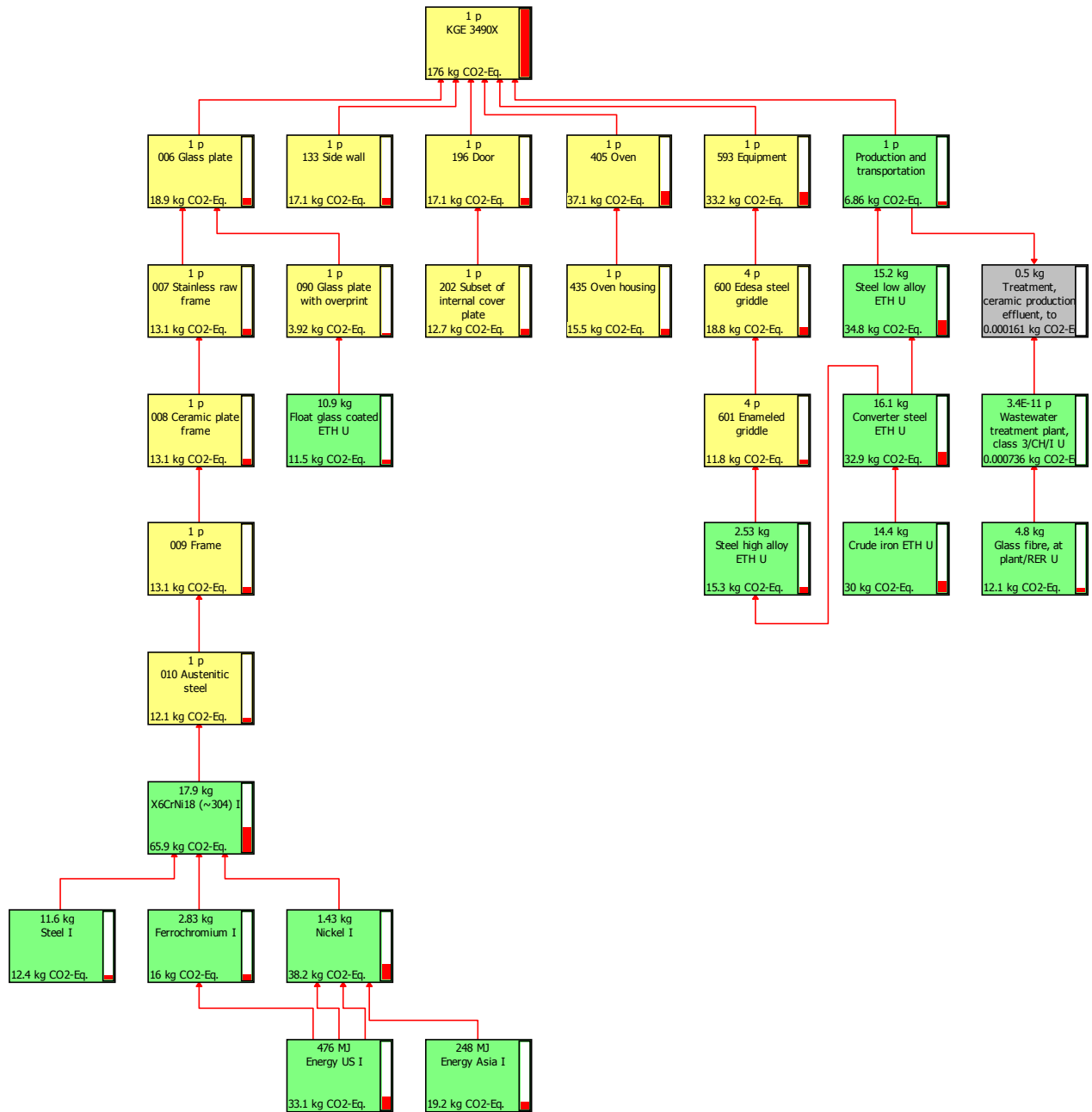

Figure 15 Damage Assessment, EPS 2000, with respect to ecosystem production capacity. KGE 3490X without EoL and without use phase. Units: percentage, 6% cut-off.



**Figure 16 Weighting, EPS 2000, with respect to human health. KGE 3490X without EoL and without use phase. Units: points, 6% cut-off.**

## 7. IPCC

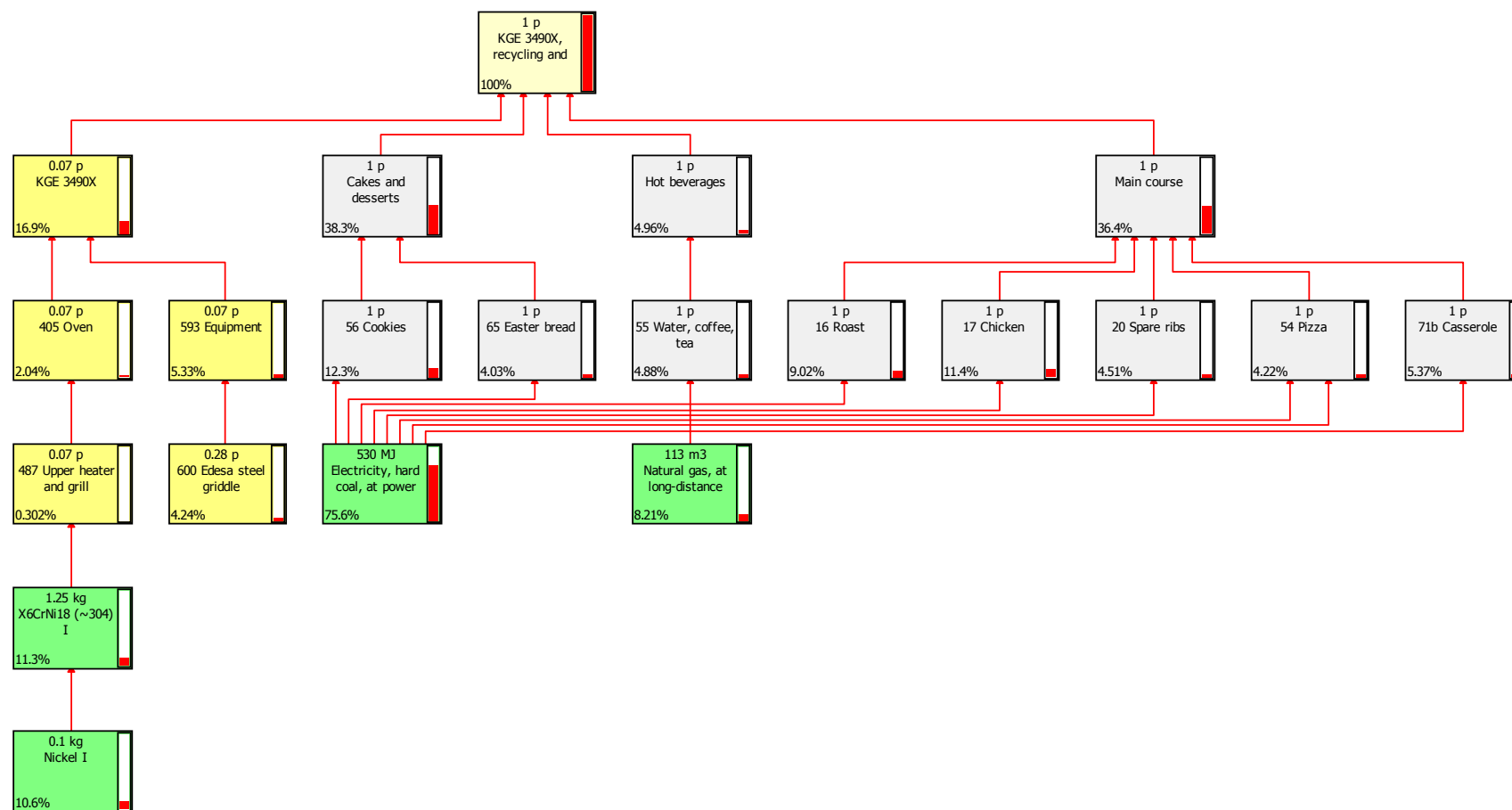

**Figure 17** Characterization, IPCC method, time span 100 years. KGE 3490X without EoL and without use phase. Units: kg CO<sub>2</sub> eq., 6% cut-off.

**Appendix IX**

**Network diagrams, KGE 3490X with recycling and landfilling EoL**

**1. CML 2 Baseline 2000**



**Figure 18 Normalization, CML 2 2000, with respect to acidification, 4% cut-off. Units: percentage.**

## 2. Cumulative Energy Demand

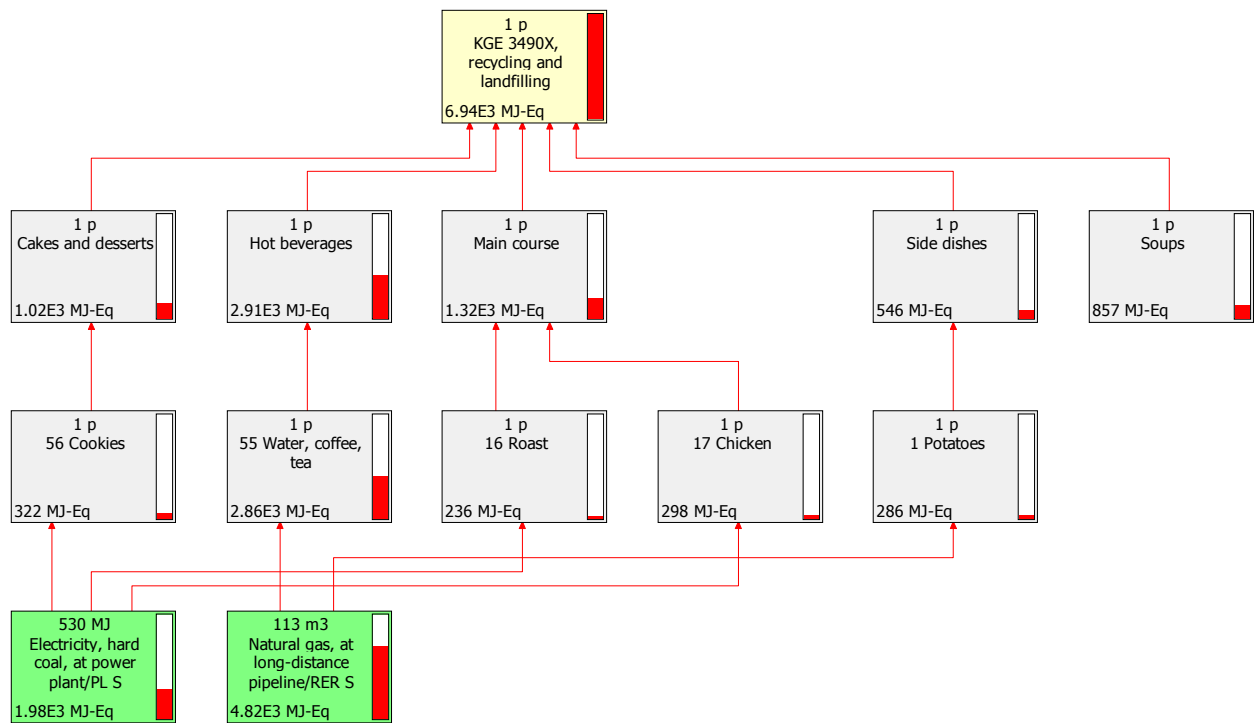

Figure 19 Characterization, Cumulative Energy Demand, with respect to non-renewable fossil fuels. Units: MJ-Eq., 3% cut-off.

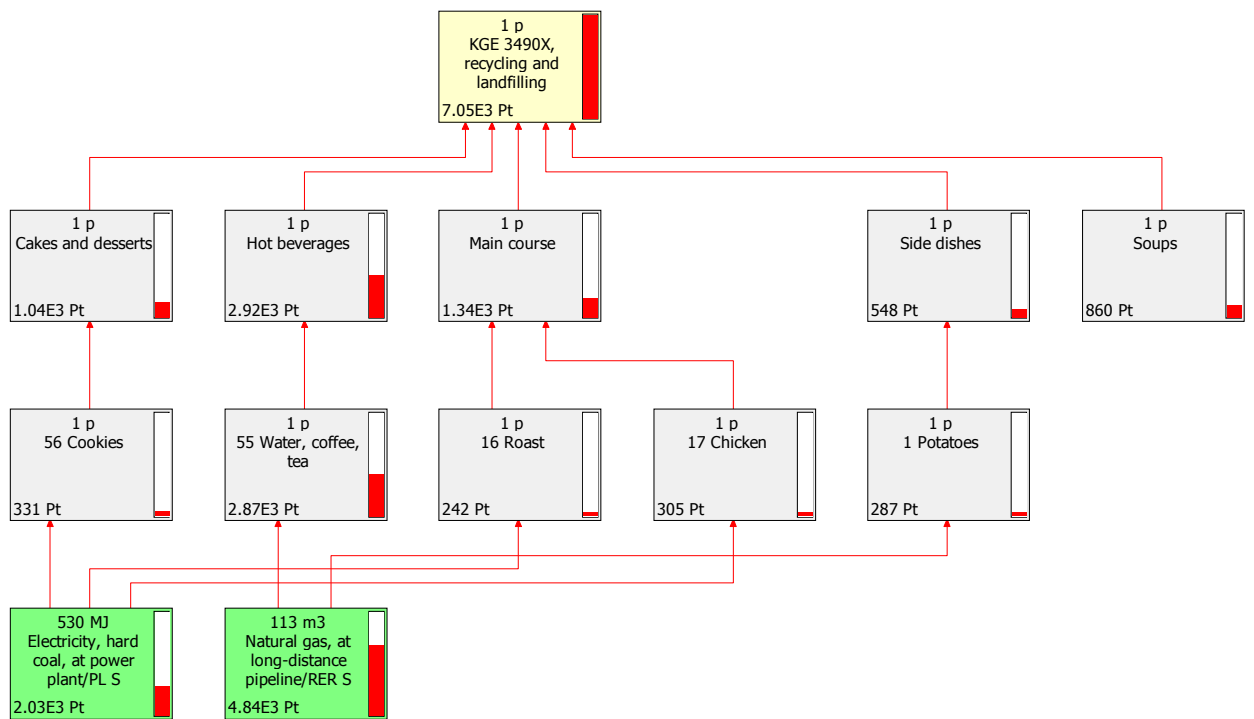

Figure 20 Single Score results, Cumulative Energy Demand, units: points. 3% cut-off.

### 3. Ecopoints 97

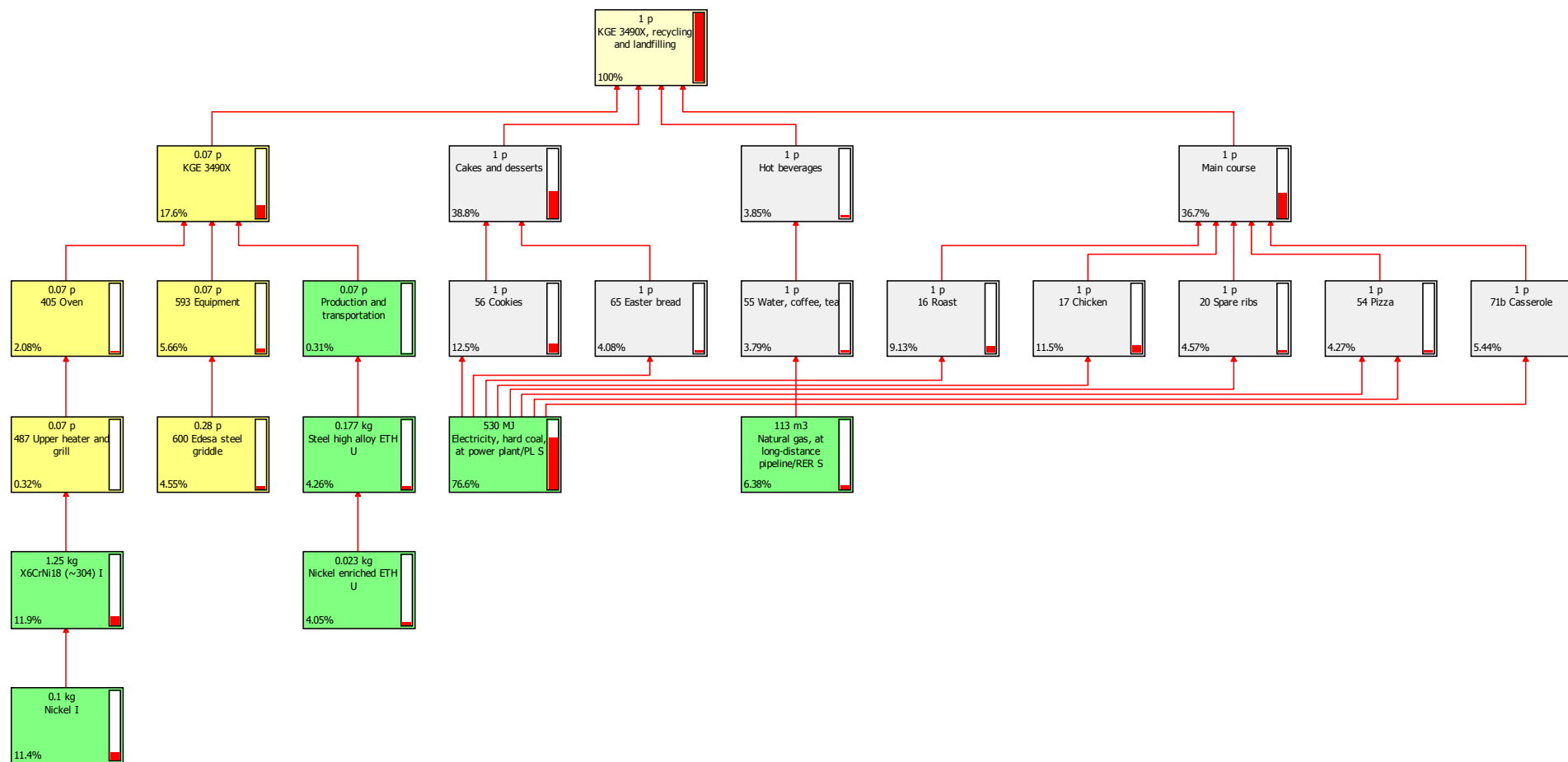

Figure 21 Weighting results, Ecopoints 97, with respect to SO<sub>x</sub> g eq. Units: percentage, 4% cut-off.



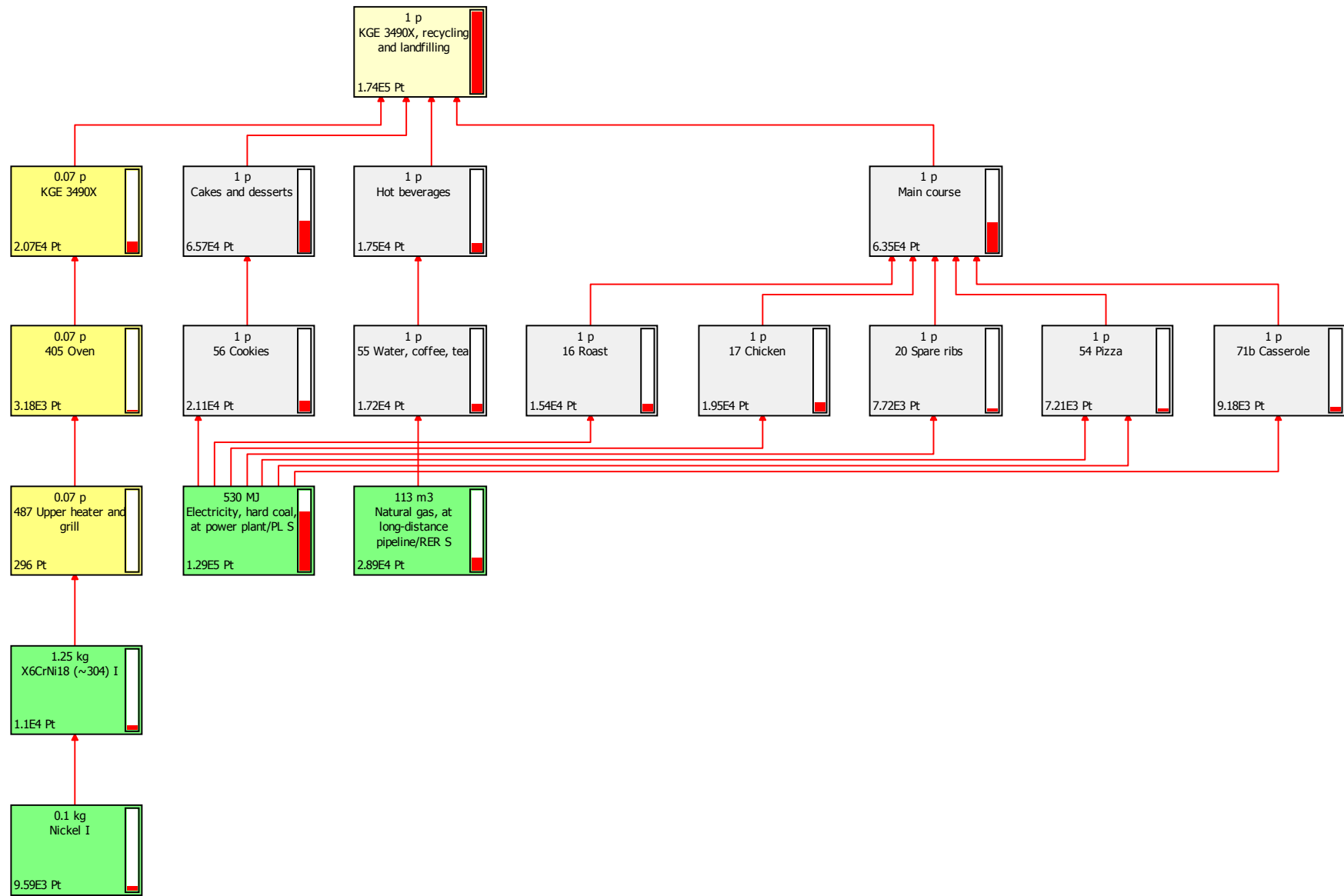

Figure 22 Single Score results, Ecopoints 97, units: points. 4% cut-off.

4. EDIP/UMIP

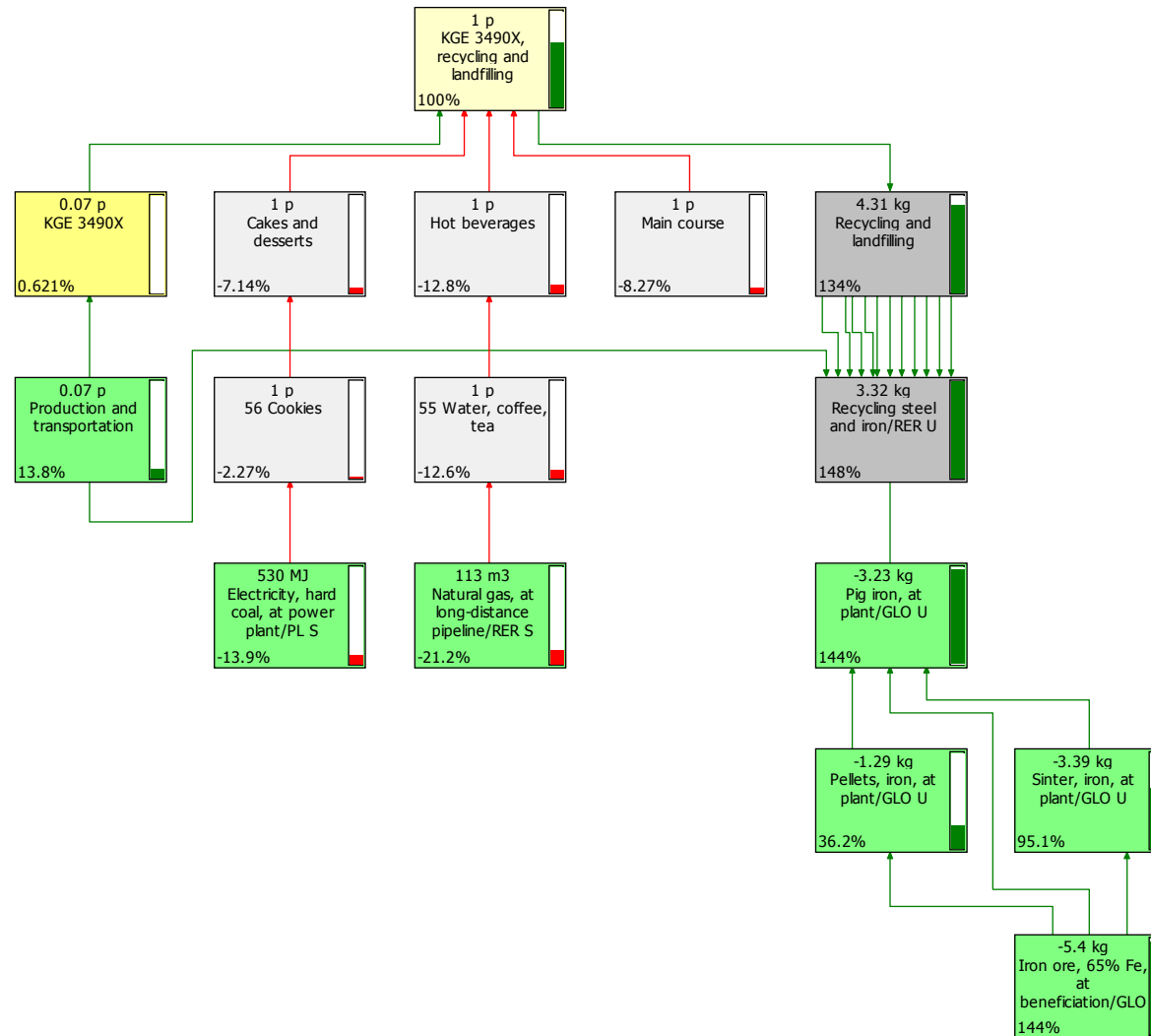

Figure 23 Characterization results, EDIP/UMIP, with respect to ecotoxicity soil chronic. Units: percentage. 4% cut-off.

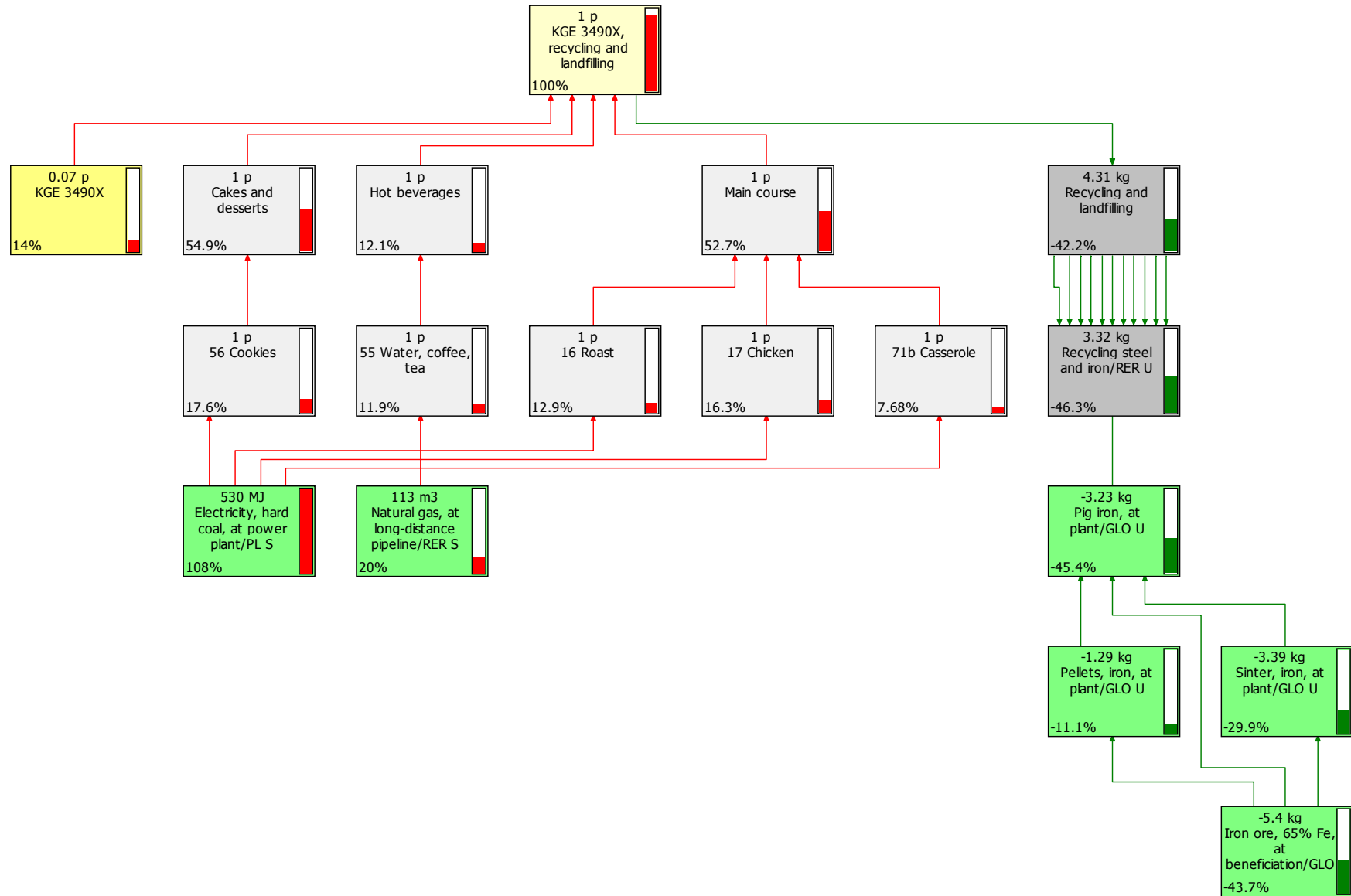

Figure 24 Single Score results, EDIP/UMIP. Units: percentage, 6% cut-off.

5. Eco-Indicator 99

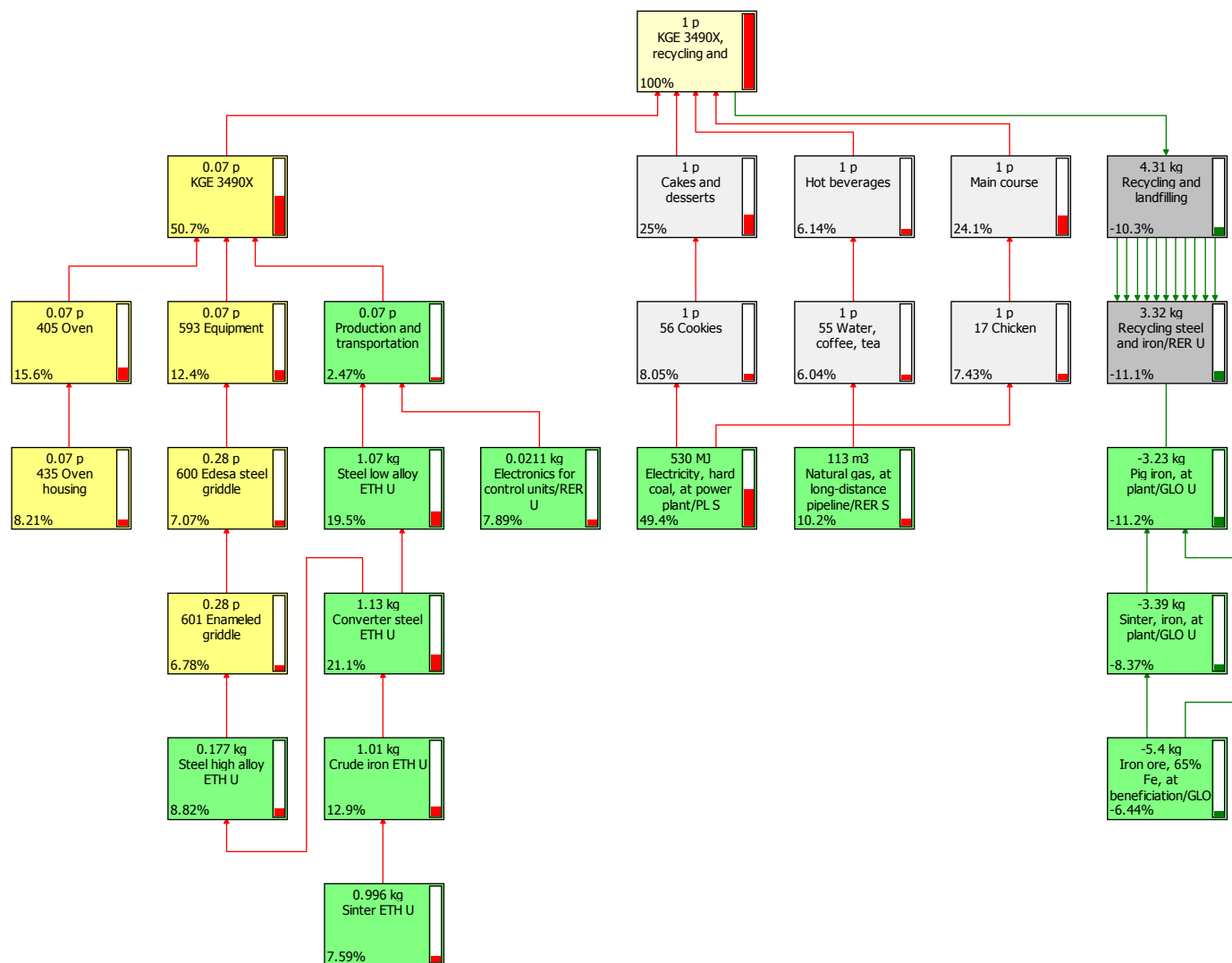

Figure 25 Characterization, Eco-Indicator 99, with respect to ecotoxicity. Units: percentage, 6% cut-off.

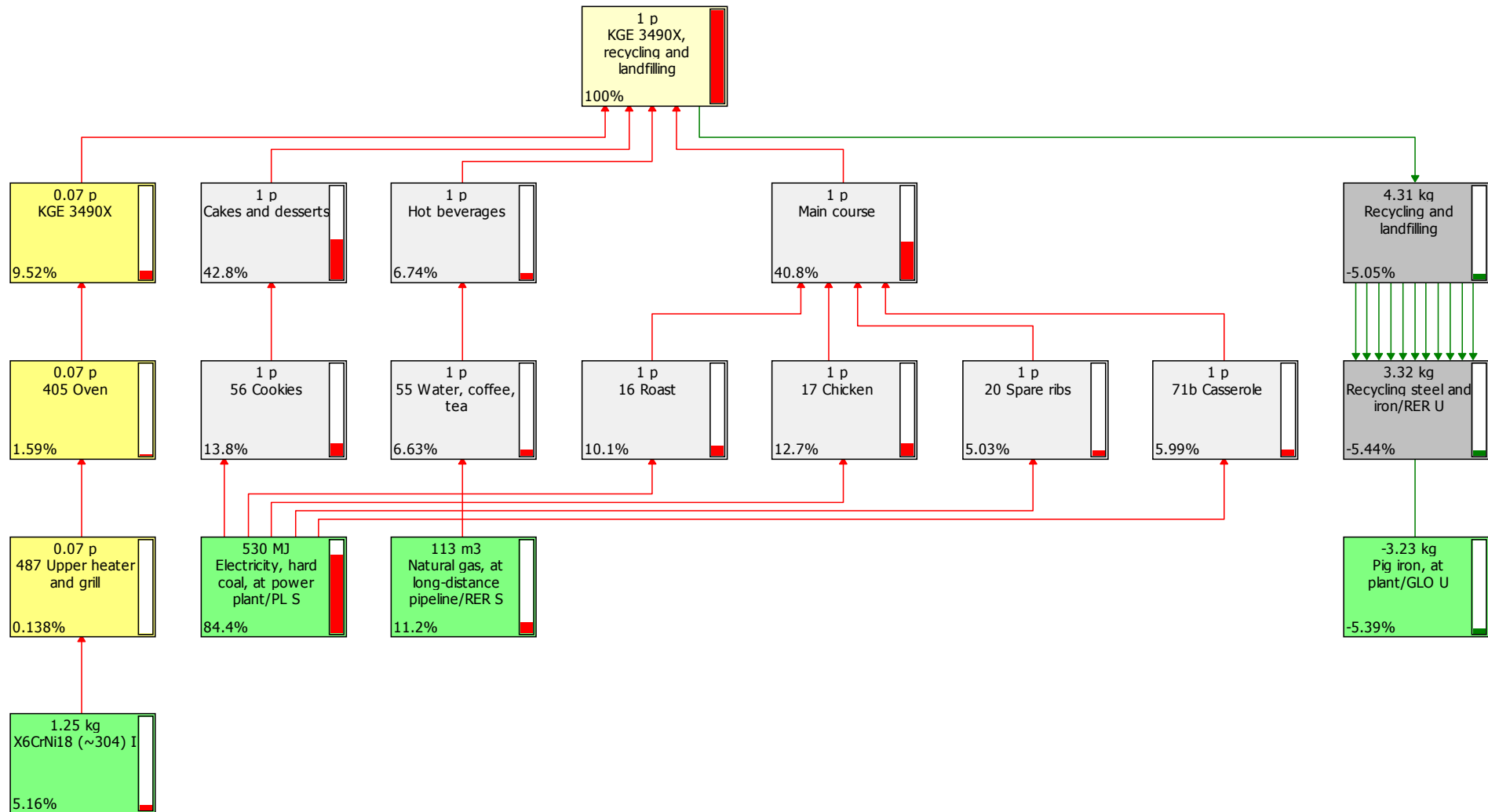

Figure 26 Damage assessment, Eco-Indicator 99, with respect to human health. Units: percentage, 5% cut-off.

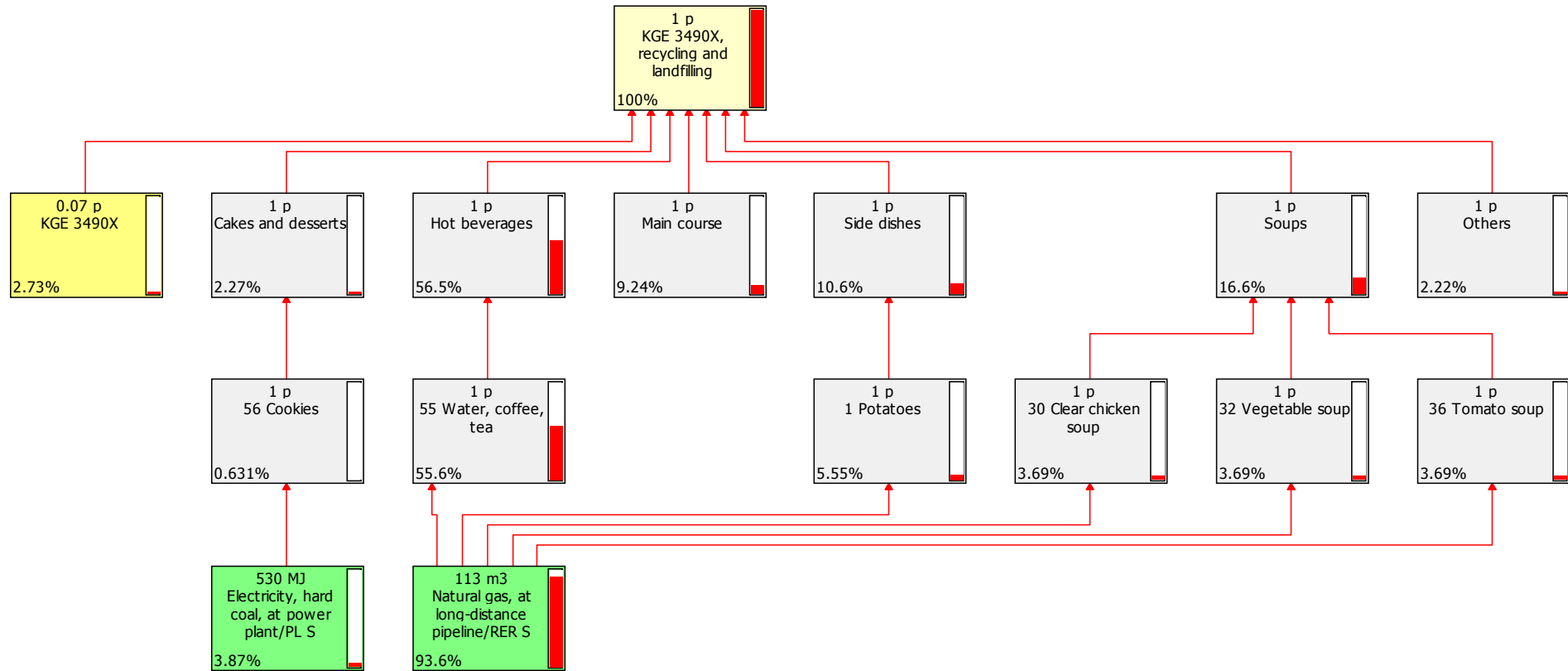

Figure 27 Normalization, Eco-Indicator 99, with respect to resources. Units: percentage, 2% cut-off.

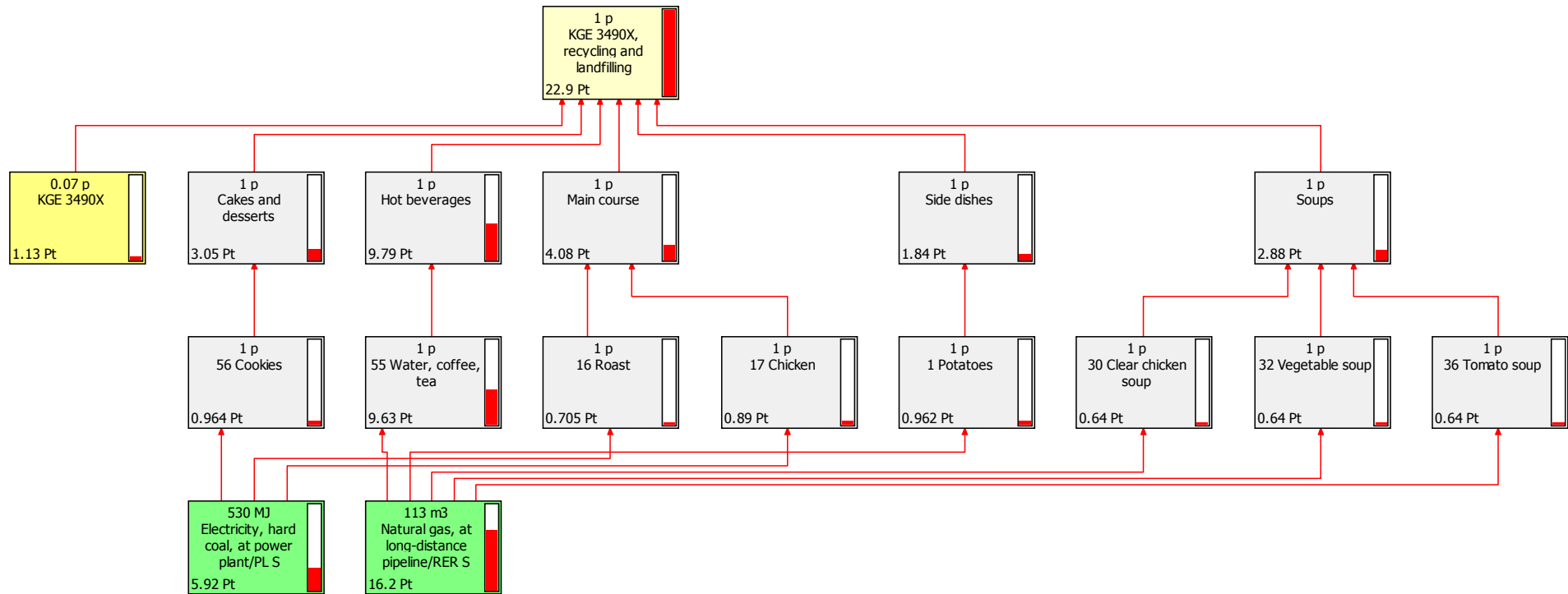

Figure 28 Single Score, Eco-Indicator 99. Units: points, 2.5% cut-off.

6. EPS 2000

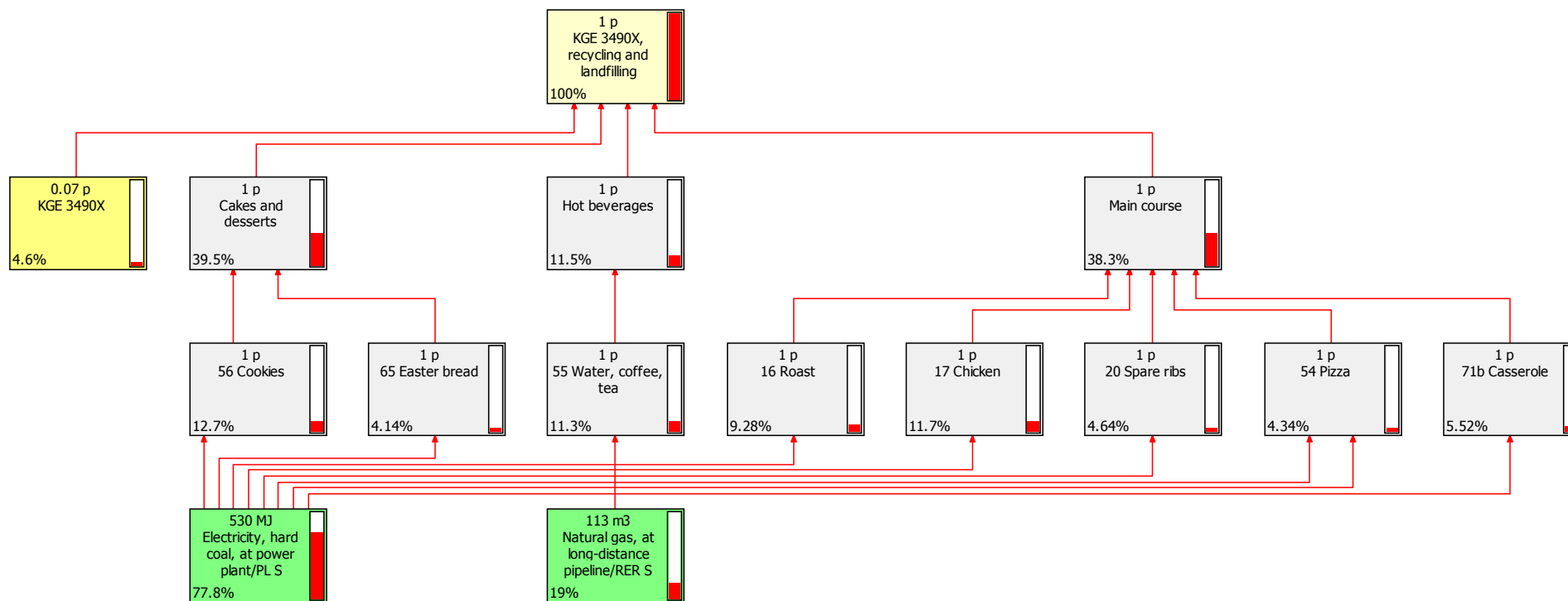

Figure 29 Damage Assessment, EPS 2000, with respect to biodiversity. Units: percentage, 4% cut-off.



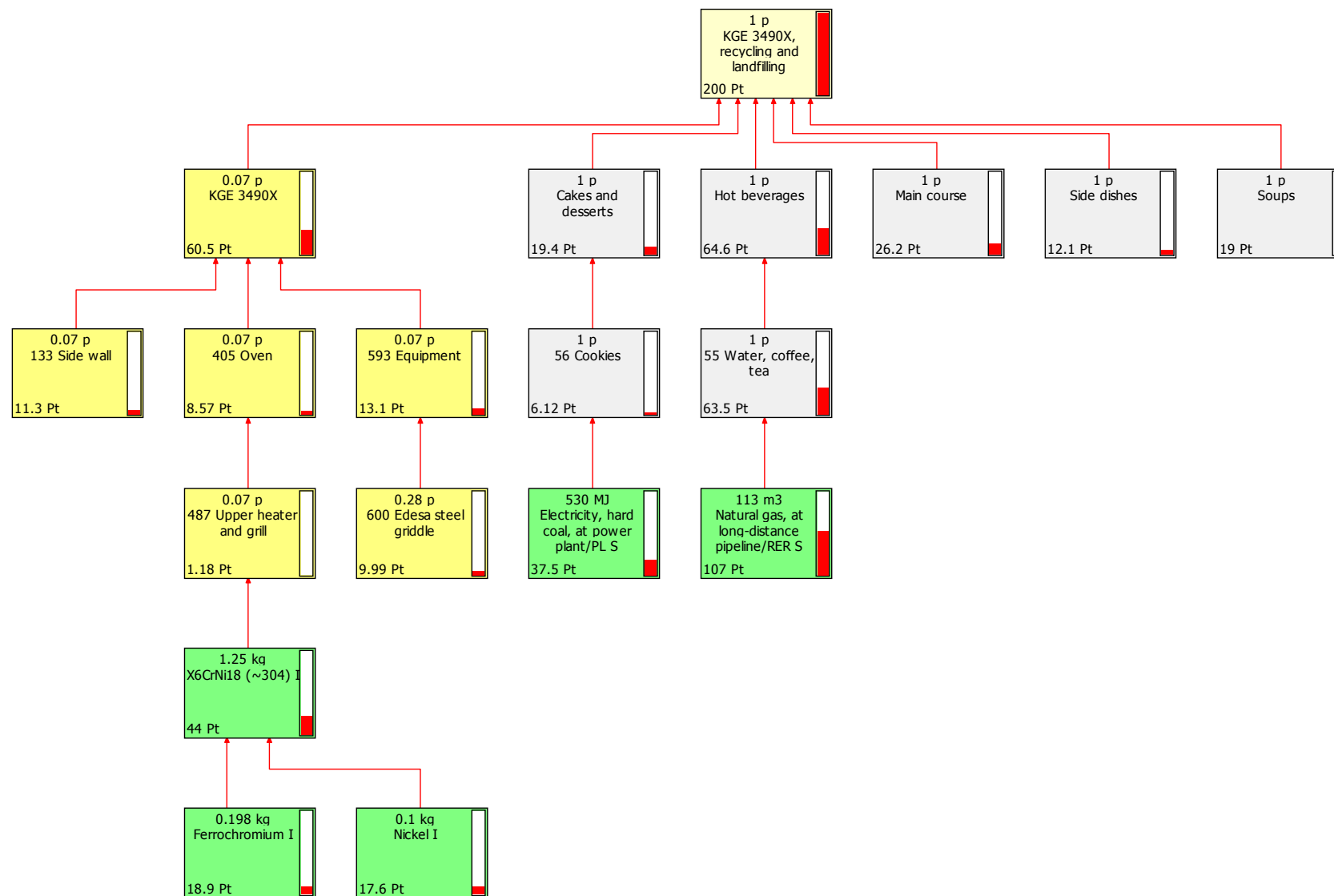

Figure 30 Single Score, EPS 2000. Units: points, 4.3% cut-off.

7. IPCC

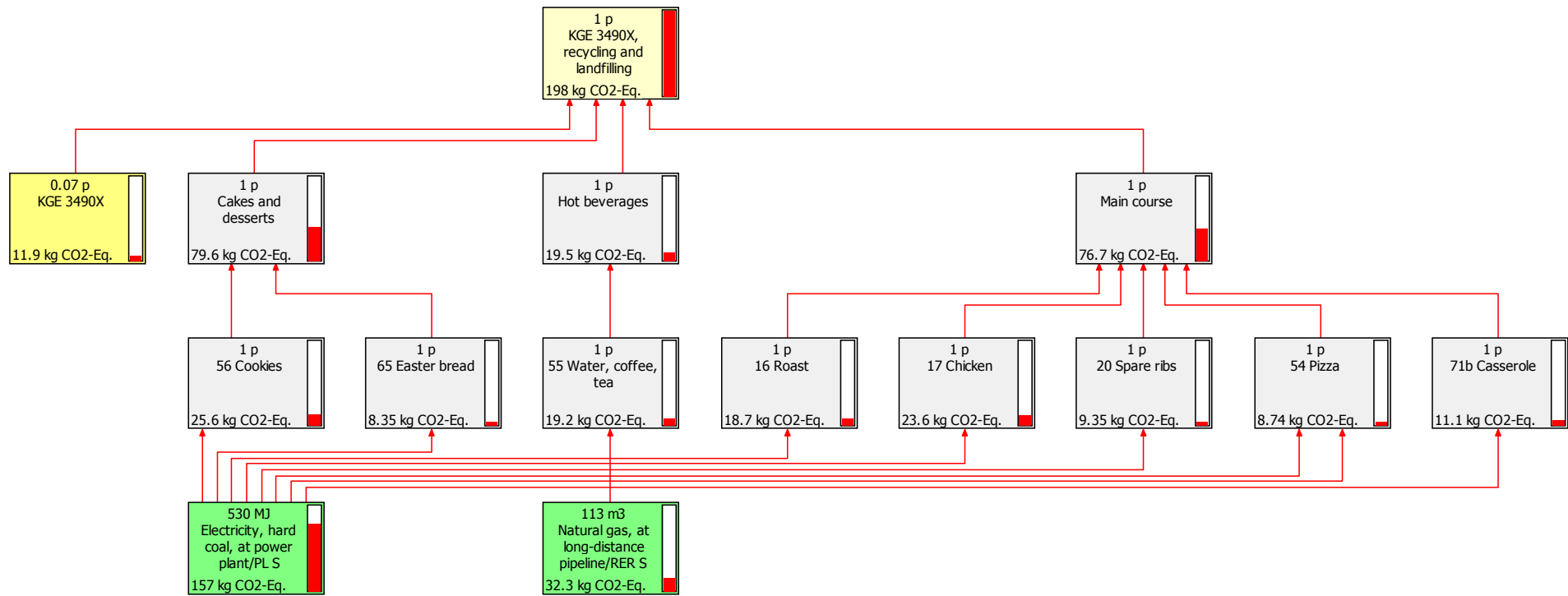

Figure 31 Characterization, IPCC method, time span 500 years. Units: kg CO<sub>2</sub>-eq., 4% cut-off.

**Appendix X****Description of the modelling variables in the SMPV****Table 24 Variables and their description in the system model “Polish Enterprise”.**

No.	Name	Definition	Variables influenced	Most important relationships	Strength of influence
1.	<b>Owner</b>	Person or corporation that owns the company. May be a private person, a legal person, the state or corporation	Financial results, Wages, EMS, Price, Employees, Trade unions, Authorities, Customers, Competitors, Politicians, Subassembly deliverers, Job centres, Health and social care, TV/radio stations	Financial results	Very high
2.	<b>Financial results</b>	General financial results, including profit and economic efficiency, etc.	Owner, Wages, Quality, Price, Employees, Trade unions, Authorities, Customers, Competitors, Subassembly deliverers, Resources/Global market, Local infrastructure, Educational institutions, Health and social care, Property market, Financial institutions, Politicians	Owner, Wages, Financial results, Price, Employees, Competitors	Very high
3.	<b>Wages</b>	Amount of money paid monthly by the company to the employees	Owner, Financial results, Price, Employees, Trade unions, Customers, Competitors, Educational institutions, Health and social care, Inhabitants of city, Property market, TV/radio stations	Financial results, Employees	High
4.	<b>LCA</b>	Life Cycle Assessment, early identification of the product impacts in the cradle-to-grave approach	Financial results, EMS, Quality, Price, Authorities, Customers, Competitors, Educational institutions, EU, Environment, Resources/global market, Health and social care, Inhabitants of the city, International organizations	EMS, Financial results, Quality and Price, Environment	Moderately low
5.	<b>EMS</b>	Environmental Management System – system for ensuring maximum environmental performance of the enterprise, including proper documentation, environmental awareness, etc.	Owner, Financial Results, LCA, Quality, Employees, Authorities, Trade unions, Customers, Environment, Subassembly deliverers, Competitors, Inhabitants of the city, International organizations	LCA, Customers, Environment, Competitors	Moderate

No.	Name	Definition	Variables influenced	Most important relationships	Strength of influence
6.	<b>Quality</b>	General quality of the products (robustness, lifetime, etc.)	Financial results, LCA, Price, Customers, Competitors, Environment, Subassembly deliverers, Resources/Global Market	Financial results, Customers, Competitors	Moderately high
7.	<b>Price</b>	Price of the products on the internal (Polish) and external (European and non-European) market	Owner, Financial results, Wages, Quality, Customers, Competitors, Subassembly deliverers	Financial results, Customers, Competitors	Moderate
8.	<b>Employees</b>	People working in the enterprise. This term refers to both production and administration workers	Owner, Financial results, Wages, EMS, Quality, Price, Trade unions, Authorities, Customers, Competitors, Job centres, Educational Institutions, Politicians, Health and Social care, Inhabitants of the city, Property market, TV/Radio stations	Wages, Quality, Customers, Financial results	Extremely high
9.	<b>Trade unions</b>	Associations recognized by law, with main aim – to support the workers in relationship with the owner and the administration	Owner, Financial results, Wages, Quality, Price, Employees, Authorities, Health and social care	Owner, Wages, Price, Employees	Moderate to high
10.	<b>Authorities</b>	Local authorities and administration of the city, as well as national authorities (statistical, environmental, health and safety, financial, fiscal, etc.)	Owner, Financial results, Wages, LCA, Quality, Price	Financial results, Price, Environment	Extremely high
11.	<b>Customers</b>	People purchasing and using products of the company	Financial results, LCA, Price, Environment, Resources/Global market, Competitors	Financial results, LCA, Competitors	Very high
12.	<b>Competitors</b>	Companies selling the same or similar products on the national market. Examples: Polar/Whirlpool, Indesit, Electrolux	Owner, Financial results, Wages, Price, Employees, Customers, Subassembly deliverers, Job centres, Health and social care, Inhabitants, Property market	Financial results, Price, Customers	Very high

No.	Name	Definition	Variables influenced	Most important relationships	Strength of influence
13.	<b>Educational institutions</b>	Institutions (mostly state-owned, but also private ones) with target to educate the people to become managers/engineers and physical/production workers. Universities, schools, etc.	Financial results, Wages, LCA and EMS, Quality, Price, Employees, Authorities, Competitors, EU, Politicians, Environment, Subassembly deliverers, Local Infrastructure, Job centres, Health and social care, Financial Institutions, International organizations	Financial results, Employees	Very high
14.	<b>Politicians</b>	Parliament (upper and lower chamber), local politicians in the voivodship; setting laws, taxes, etc.	Owner, Financial results, Wages, LCA and EMS, Quality, Price, Employees, Trade Unions, Authorities, Customers, Competitors, Educational institutions, Environment, Subassembly deliverers, Local infrastructure, Transportation network, Job centres, etc.	Financial results	Extremely high
15.	<b>EU</b>	European Union institutions, setting laws, standards and requirements; also used in the meaning of the standards and laws itself, such as i.e. EuP Directive	Owner, Financial results, LCA, EMS, Quality, Price, Employees, Trade unions, Authorities, Customers, Competitors, Educational institutions, Environment, Transportation network, Politicians, TV/radio stations	Financial results, LCA, Quality, Environment	Extremely high
16.	<b>Environment</b>	State of the environment, partially connected with the activities of the company as well as inhabitants; with respect to water, air, soil quality	LCA, EMS, Authorities, Customers, Resources, Educational Institutions, Health and social care, Inhabitants of the city, EU, international organizations, TV/radio stations	LCA, EMS, Customers, Resources	Moderate
17.	<b>Subassembly deliverers</b>	Companies/enterprises delivering subassemblies/parts/materials for the production. Excluded: local infrastructure of energy and water delivery, and waste removal (wastewater treatment, solid waste)	Financial results, LCA, EMS, Quality, Price, Environment, Resources, Competitors	Financial results, Quality, Price, Environment	Moderate

No.	Name	Definition	Variables influenced	Most important relationships	Strength of influence
18.	<b>Resources/Global market</b>	General situation on the global market with respect to resource availability and prices (i.e. price of steel etc.)	Financial results, Quality, Price, Customers, Competitors, Environment, Subassembly deliverers	Financial results, Price, Customers	Low to moderate
19.	<b>Local infrastructure</b>	Water and energy supply, including city-owned companies. The variable includes also waste removal/sludge network, and private companies – recycling/reuse	Financial results, LCA and EMS, Price, Authorities, Environment, Inhabitants of the city	Financial results, Environment	Low
20.	<b>Transportation network</b>	Transportation network (rail, road, air) for products, subassemblies, and materials	Financial results, LCA, Price, Environment, Subassembly deliverers, Inhabitants of the city	Financial results, Environment, Inhabitants	Low to moderate
21.	<b>Job centres</b>	State-owned and private companies helping the enterprises to find a proper worker. Job centres are mostly part of the national authorities.	Financial results, Employees, Subassembly deliverers, Competitors, Educational institutions, Inhabitants of the city	Financial results, Employees	Low
22.	<b>Health and social care</b>	Health and social care system; paid by employer and employees; mostly state-owned hospitals, social care centres, etc.	Employees, Authorities, Inhabitants of the city, Politicians, TV/radio stations	Employees	Low
23.	<b>Inhabitants of the city</b>	People living in the city where the company/factory is located. Excluded: Company workers (variable Employees)	Employees, Trade unions, Authorities, Customers, Environment, Local infrastructure, Competitors, Job centres, Health and social care, Property market, TV/radio stations	Employees	Moderate
24.	<b>Property market</b>	Availability of accommodation for company employees; property prices	Wages, Employees, Competitors, Job centres, Inhabitants of the city	Wages, Employees	Low to moderate

No.	Name	Definition	Variables influenced	Most important relationships	Strength of influence
25.	<b>Financial institutions</b>	Mainly banks; loans	Owner, Financial results, Price	Financial results	Very low
26.	<b>International organizations</b>	NGOs, Trade Associations, etc.: 1. setting standards for products, i.e. ISO 14001, EMAS 2. Ecological, i.e. Greenpeace	Variables influenced: Owner, LCA and EMS, Quality, Customers, Environment, Educational Institutions	LCA and EMS, Customers	Low to moderate
27.	<b>TV/radio stations</b>	Local and national TV and radio stations/channels, news and advertisements	Owner, Financial results, Wages, Price, Employees, Trade unions, Customers, Competitors	Financial results, Customers	Low to moderate

Table 25 Variables and their inscription in the scale of values.

Variable	Optimum	Maximum	Middle range	Minimum	Actual situation
<b>1. Owner</b>	At the top	Making profits, but also taking care of employees well-being, health and social care, Corporate Social Responsibility, environment, future development of the company	Focused mainly on making profits, obeying laws and standards if necessary, no special commitment in health and safety, as well as environmental issues	Disobeying laws and standards, no commitment towards development of the company, wrong management without making profits	Upper middle range
<b>2. Financial results</b>	At the top	Very high profit, divided "equally" between owner and employees, plus new investments	Moderate profit, returned mainly to the owner of the company, with little investments and little share of employees	No profits or losses	Between upper middle range and maximum. High investments, high profit, little share with the employees
<b>3. Wages</b>	In the middle range	Very high wages, lowering of the economic efficiency, low profit for investments and non-competitiveness of the products on the market	Moderate wages, level of product prices acceptable for consumers; positive financial results	Very low wages, low level of employee satisfaction, outflow of employees to other companies. Question of the product quality	Between minimum and lower middle range

Variable	Optimum	Maximum	Middle range	Minimum	Actual situation
<b>4. LCA</b>	At the top	Implemented in the EMS, not influencing the profit significantly, high quality and low price products, low environmental impacts	Implemented in the EMS, moderately influencing the profit, quality and price	Not implemented in the EMS, low quality of products or high environmental impact	Between lower and middle range
<b>5. EMS</b>	At the top	EMS implemented, LCA included, communicated to customers, competitiveness strengthened, lower impact to the environment	EMS implemented, LCA not included, partially communicated to customers, unchanged impact on the environment	EMS not implemented, LCA not included, no communication to customers, low competitiveness, high or unknown impact to the environment	Middle range
<b>6. Quality</b>	At the top	Very good quality excellent economical results, satisfied customers, much better performance than competitors	Moderate quality and economical results, fluctuating customer satisfaction, average overall performance	Very bad quality, miserable economical results, dissatisfied customers, much worse performance than competitors	Between middle and upper middle range
<b>7. Price</b>	In the middle range	Very high price, customers satisfied with quality, worse position vs. competitors	Moderate price, customers satisfied with price-to-quality ratio, keeping the products competitive vs. competitors	Low price, customers dissatisfied with quality, problems with keeping the products competitive	Middle range
<b>8. Employees</b>	At the top	Low wage, high quality work, creating product that satisfies customers (including service), contributing to the positive financial results	Moderate wage, moderate quality work, creating product that generally satisfies customers (including service), moderate financial results	High wage, bad quality work, creating product that does not satisfy customers (including service), poor financial results	Upper middle range
<b>9. Trade unions</b>	In the middle range	Taking care of employees' interests, blocking of key company functions and economy results i.e. by strikes	Taking care of employees' interests, but no blocking of key company functions	No trade unions, nobody taking care of employees interests	Between lower middle range and middle range
<b>10. Authorities</b>	In the middle range	Too high influence on the company, by checking its functioning, causing severe disturbances	Moderate and positive influence on the company, by checking its functioning, but without disturbance	No influence on the company, by checking its functioning, without disturbances, but laws and standards not obeyed	Upper middle range



Variable	Optimum	Maximum	Middle range	Minimum	Actual situation
<b>11. Customers</b>	At the top	Buying many products of the company, saving energy and resources by the proper usage of the product	Moderate choice of the products of the company, moderate interest in saving energy and resources by the proper usage of the product	Not buying products of the company, wasting energy and resources by the improper usage of the product	Between lower and middle range
<b>12. Competitors</b>	At the bottom	Creating products that are more competitive, cheaper and of better quality; more often chosen by customers	Creating products that are similarly competitive, at the same level of price and quality; similar sale level	Creating products that are less competitive, more expensive and of worse quality; less often chosen by customers	Lower middle range to middle range
<b>13. Educational institutions</b>	At the top	Providing well-educated workers, prepared for the challenges, with up-to-date knowledge and skills	Problems with providing well-educated workers, prepared for the challenges, with up-to-date knowledge and skills; partially inadequate education	Not providing well-educated workers, prepared for the challenges, with up-to-date knowledge and skills; Inadequate education	Between middle and upper-middle range
<b>14. Politicians</b>	In the middle range	Too many laws introduced to protect the environment; excessive administrative burden put on the company	Laws introduced helping to protect the environment; not too much administrative burden put on the company	Too little laws introduced to protect the environment; no administrative burden put on the company	Upper middle range
<b>15. EU</b>	In the middle range	Too many laws introduced to protect the environment; excessive administrative burden put on the company	Laws introduced helping to protect the environment; not too much administrative burden put on the company	Too little laws introduced to protect the environment; no administrative burden put on the company	Between middle and upper middle range
<b>16. Environment</b>	At the bottom	Very high impact on the environment by the product and company; high amount of waste and emissions	Average impact on the environment by the product and company; average amount of waste and emissions	Very low impact on the environment by the product and company; low amount of waste and emissions	Lower middle range
<b>17. Subassembly deliverers</b>	At the top	Delivering high quality and low price parts/materials, minimum impact on the environment	Delivering moderate quality and moderate price parts/materials, impact on the environment non-negligible	Delivering low quality and high price parts/materials, with significant impact on the environment	Upper middle range
<b>18. Resources</b>	At the bottom	High prices with low price stability, high influence the environment	Moderate price level with varying price stability, moderate or unknown impact on the environment	Low prices with high price stability, low impact on the environment	Between lower and middle range

Variable	Optimum	Maximum	Middle range	Minimum	Actual situation
<b>19. Local infrastruct.</b>	At the top	Reliable network and low cost of maintenance, low impact on environment and low influence on the company's activities	Problems with reliability, costs of maintenance non-negligible, moderate impact on environment, influence on the company's activities	Non-reliable and high cost of maintenance network, high impact on environment and high influence on the company's activities	Between upper middle range and maximum
<b>20. Transp. network</b>	At the top	Well developed transportation network, minimising impact on the environment i.e. highways	Moderately developed network, increased impact on the environment	Poorly developed transportation network, high impact on the environment	Middle range
<b>21. Job centres</b>	At the top	Able to find appropriate workers for the company in case any employment gaps are recognized	Moderate difficulties in finding appropriate workers for the company	Unable to find appropriate workers for the company	Middle range
<b>22. Health and social care</b>	At the top	Providing the appropriate health and social care for employees	Moderate problems with providing the appropriate health and social care for employees	Not providing the appropriate health and social care for employees/Severe problems	Lower middle range
<b>23. Inhabitants of the city</b>	At the top	Smooth co-operation and co-existence of company and the inhabitants	Problems with co-operation and co-existence of company and the inhabitants	Lack of co-operation and difficult co-existence of company and the inhabitants	Maximum
<b>24. Property market</b>	At the top	Accommodation easily available for affordable prices	Increased property prices, moderate availability	Expensive accommodation, problems with availability	Lower middle range
<b>25. Financial institutions</b>	At the bottom	Loans necessary for the company activities; high interest rates, low availability	Loans generally not necessary for the company activities; affordable interest rates, satisfying availability	Loans not necessary for the company activities; low interest rates, high availability	Between lower middle range and minimum
<b>26. International organizations</b>	In the middle range	Too much pressure put on the company, too detailed standards, distortion of the company's functioning	Moderate pressure put on the company, clear standards	Too less pressure put on the company, too general standards, lack of guidelines for company's functioning	Middle range
<b>27. TV and radio stations</b>	No optimum; depending on other variables	Many advertisements and information on the company's profile, products, and current situation	Moderate frequency of advertisements and information on the company's profile, products, and current situation	No advertisements and information on the company's profile, products, and current situation	Lower middle range

## Appendix XI

## Effect diagrams for the variables in the simulation module of the SMPV

## 1. Stable policy scenario

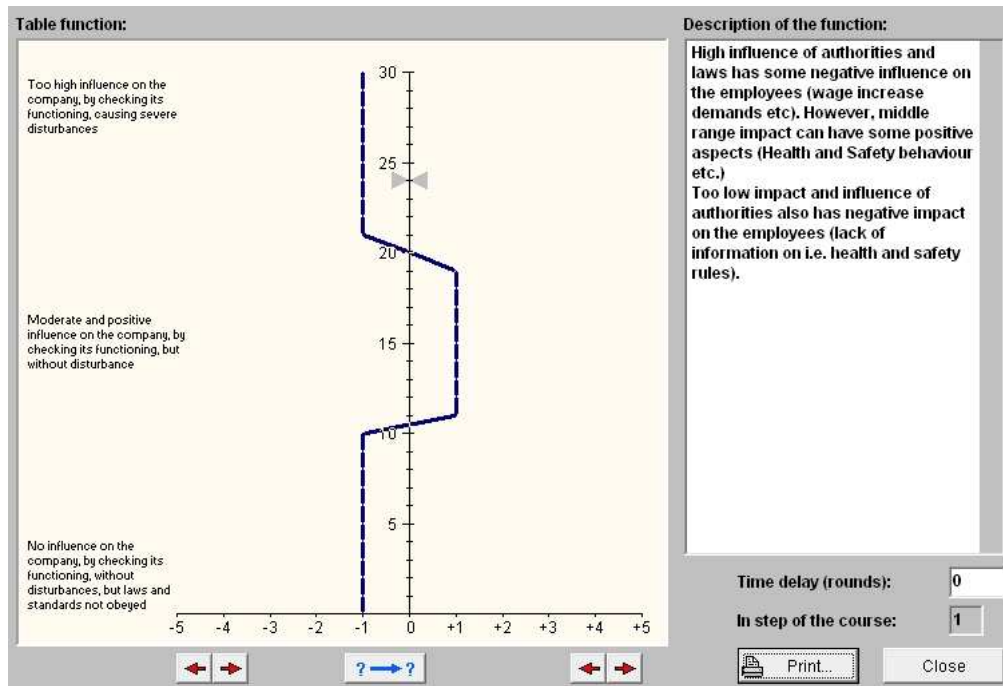

**Figure 32 Influence of variable Authorities on variable Employees. Similar interrelation determined for the relationships Customers – Financial Results, Employees – Financial Results, LCA + EMS – Financial Results, Quality – Financial results.**

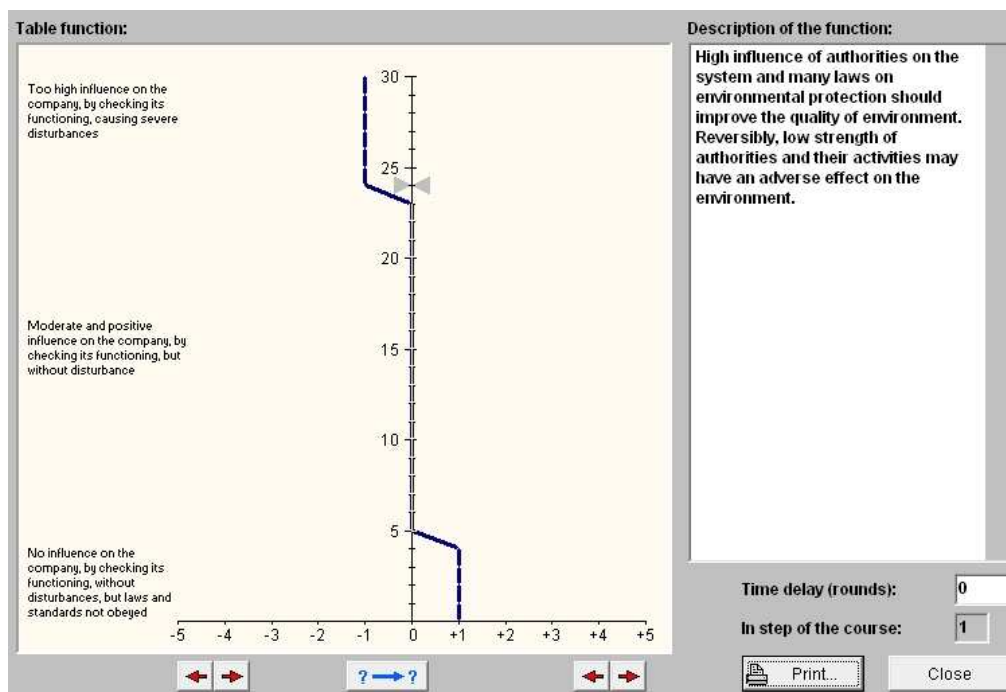

**Figure 33 Influence of variable Authorities on variable Environment. Similar interrelation determined for the relationships Competitors – Price, LCA + EMS – Authorities, LCA + EMS – Environment, Owner – Authorities, Quality – Competitors, Quality – Environment.**

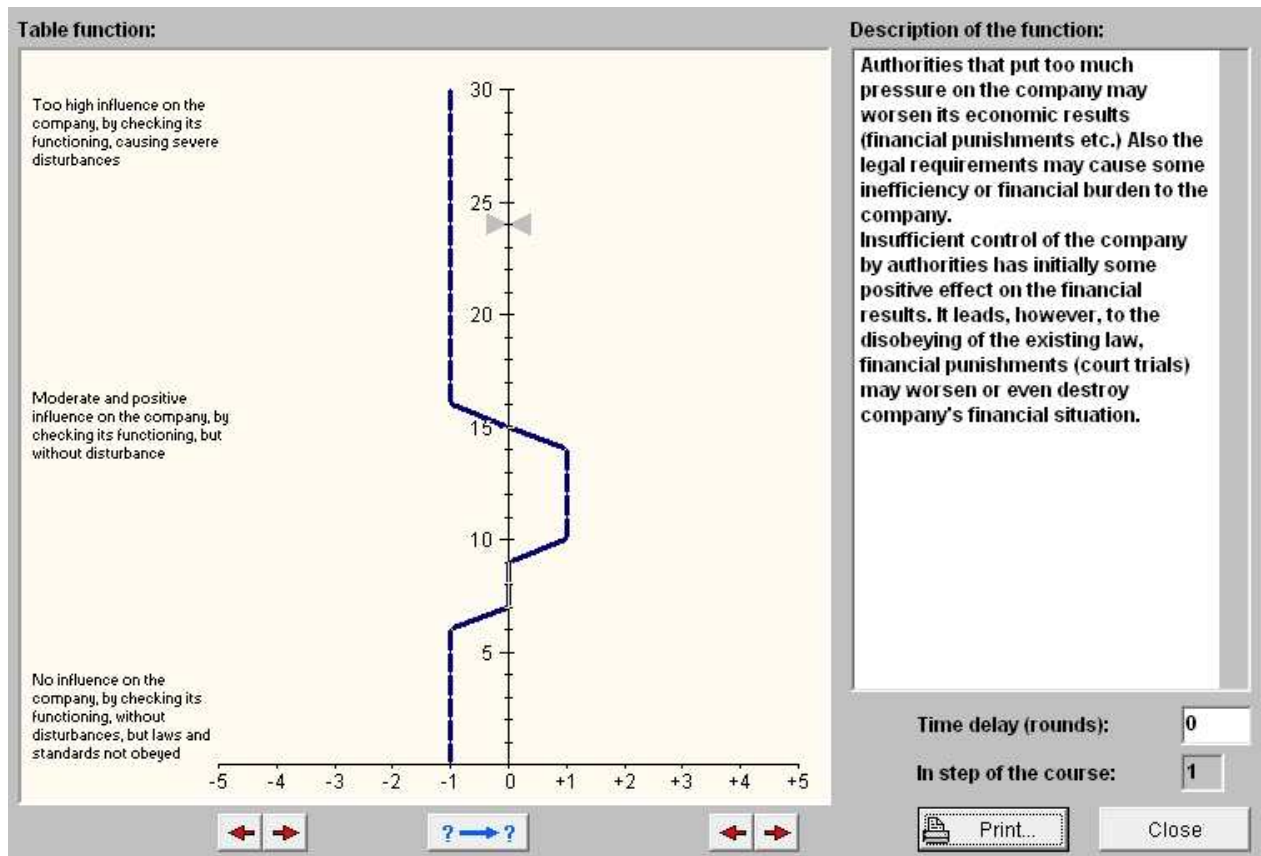

Figure 34 Influence of variable Authorities on variable Financial results.

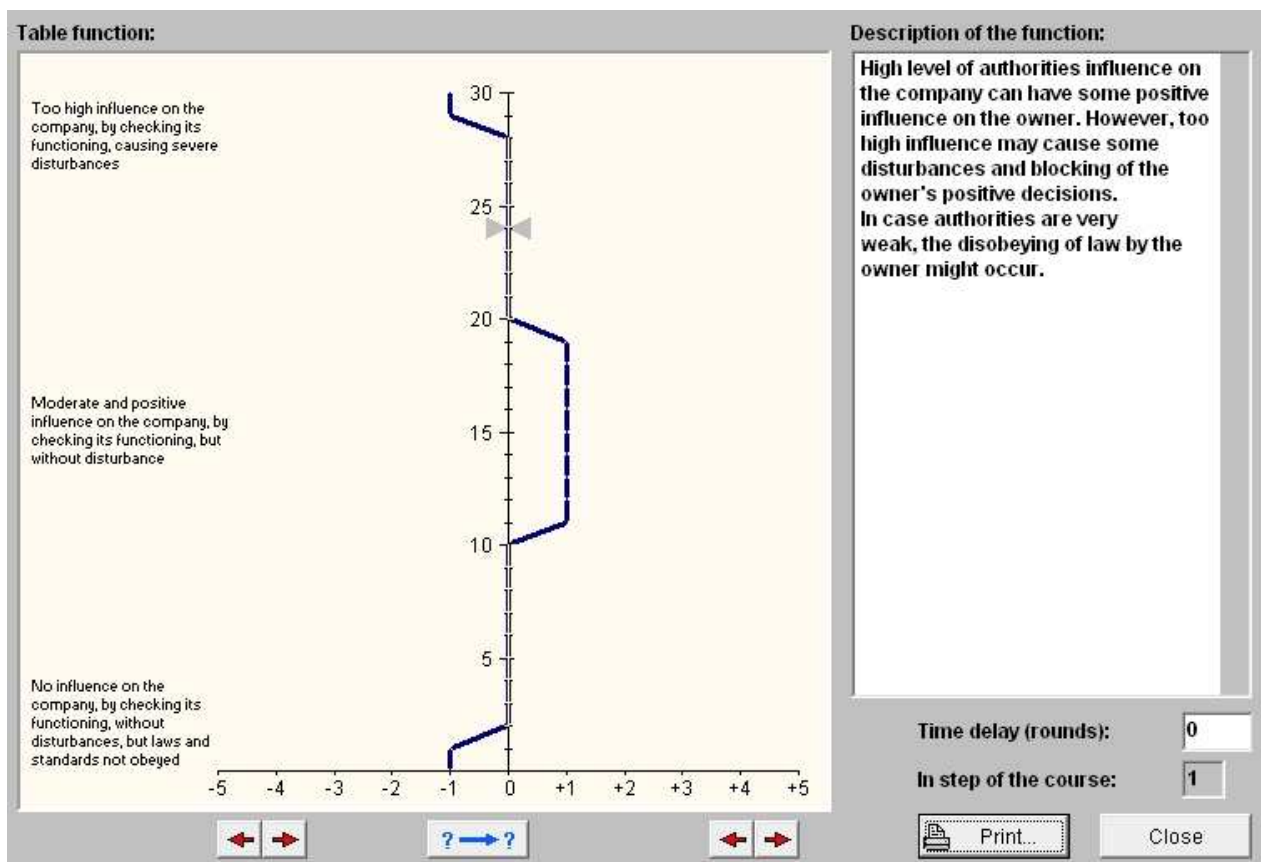
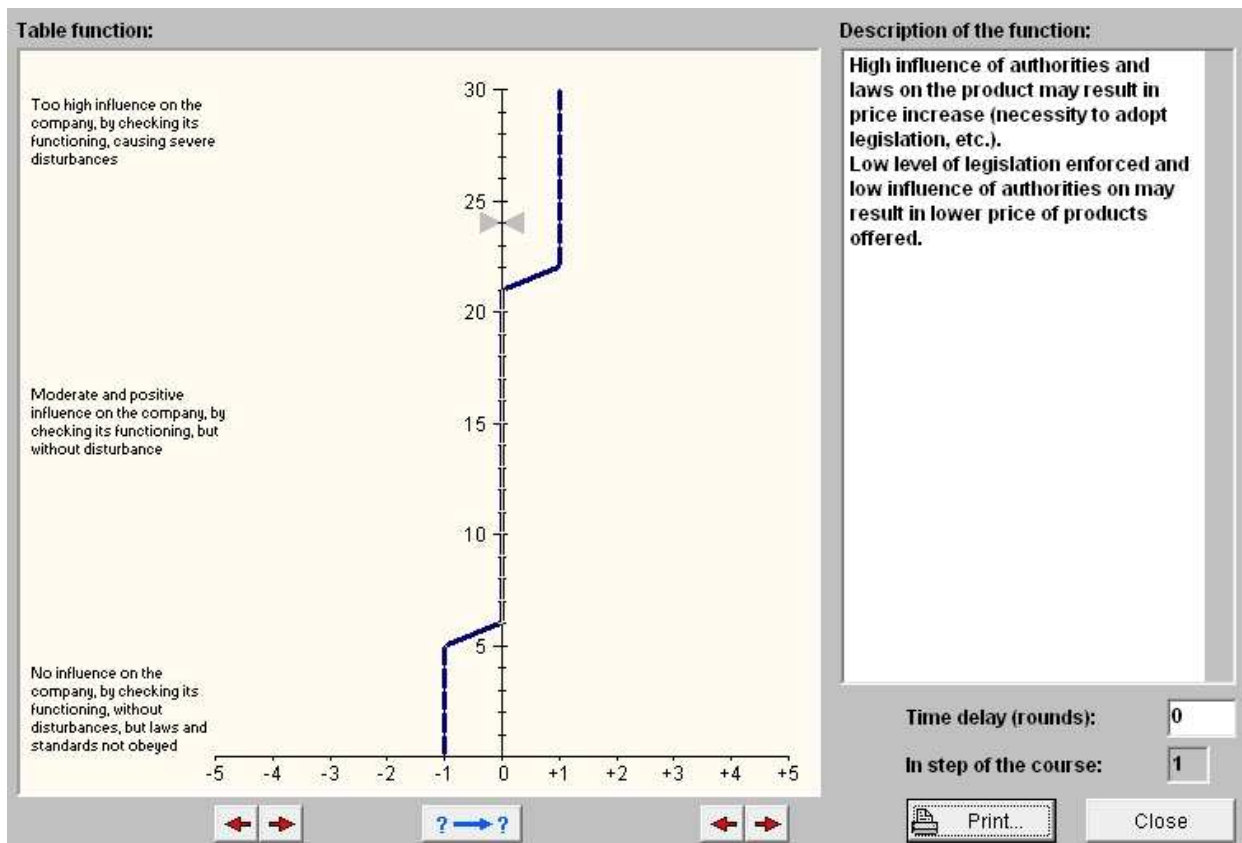
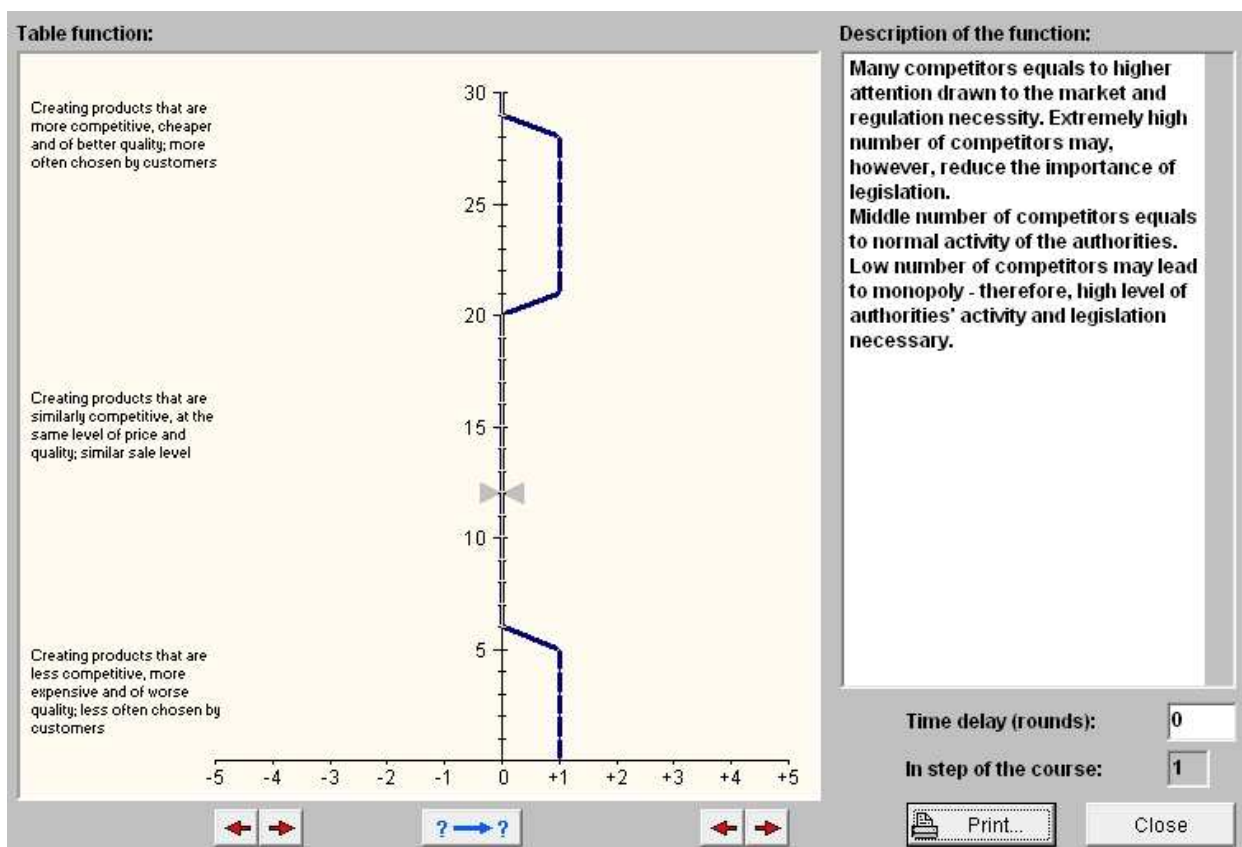

Figure 35 Influence of variable Authorities on variable Owner.



**Figure 36 Influence of variable Authorities on variable Price. Similar interrelation determined for the relationships Employees – Price, Financial results – LCA + EMS, LCA + EMS – Quality, Quality – Customers, Quality – LCA + EMS, Quality – Price.**



**Figure 37 Influence of variable Competitors on variable Authorities.**

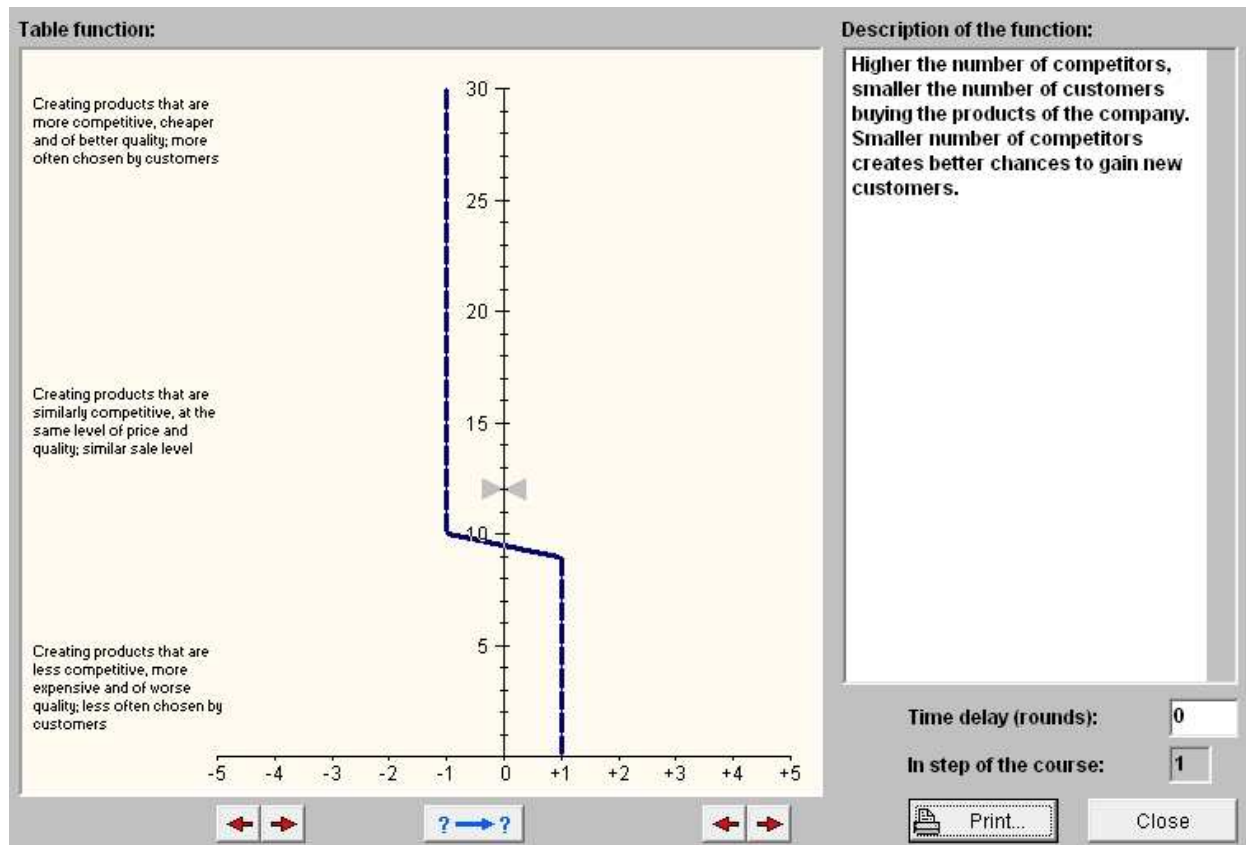

**Figure 38 Influence of variable Competitors on variable Customers.**

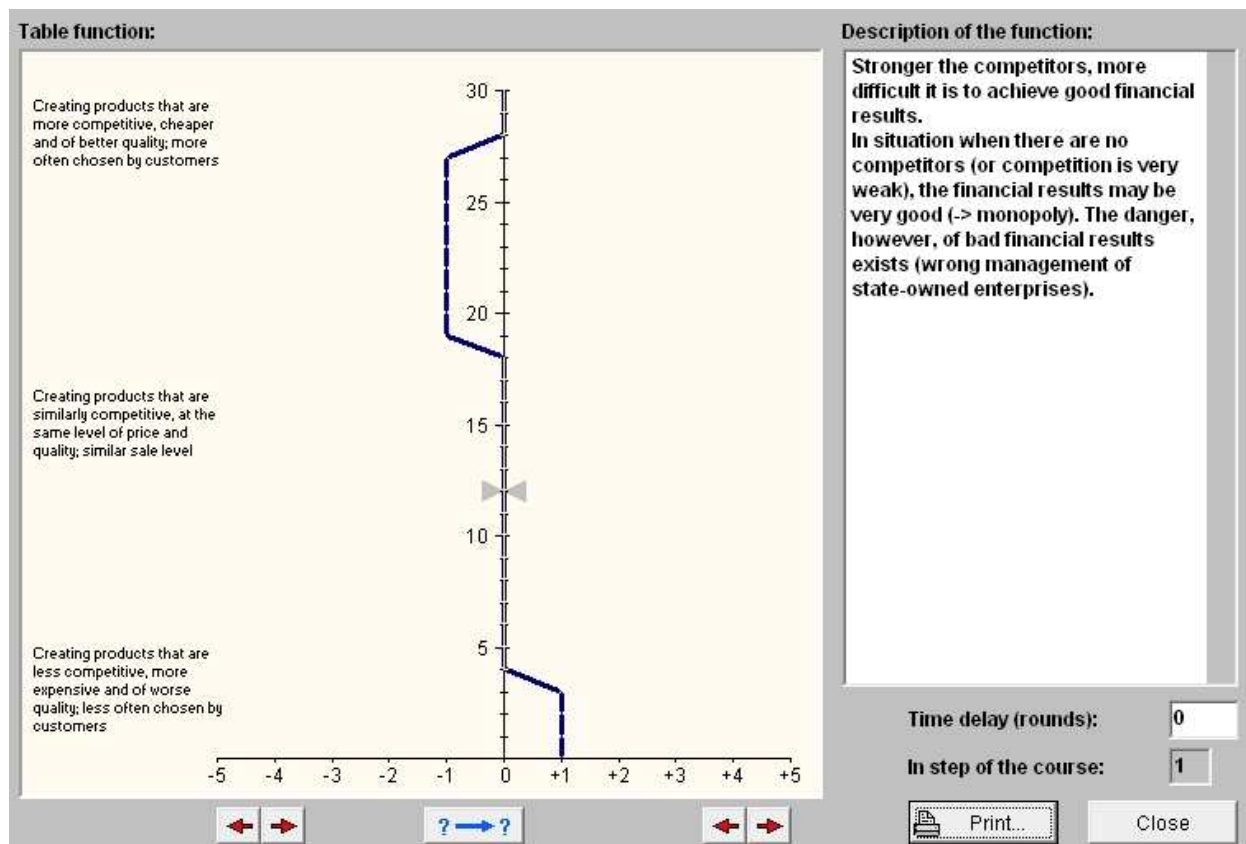

**Figure 39 Influence of variable Competitors on variable Financial results.**

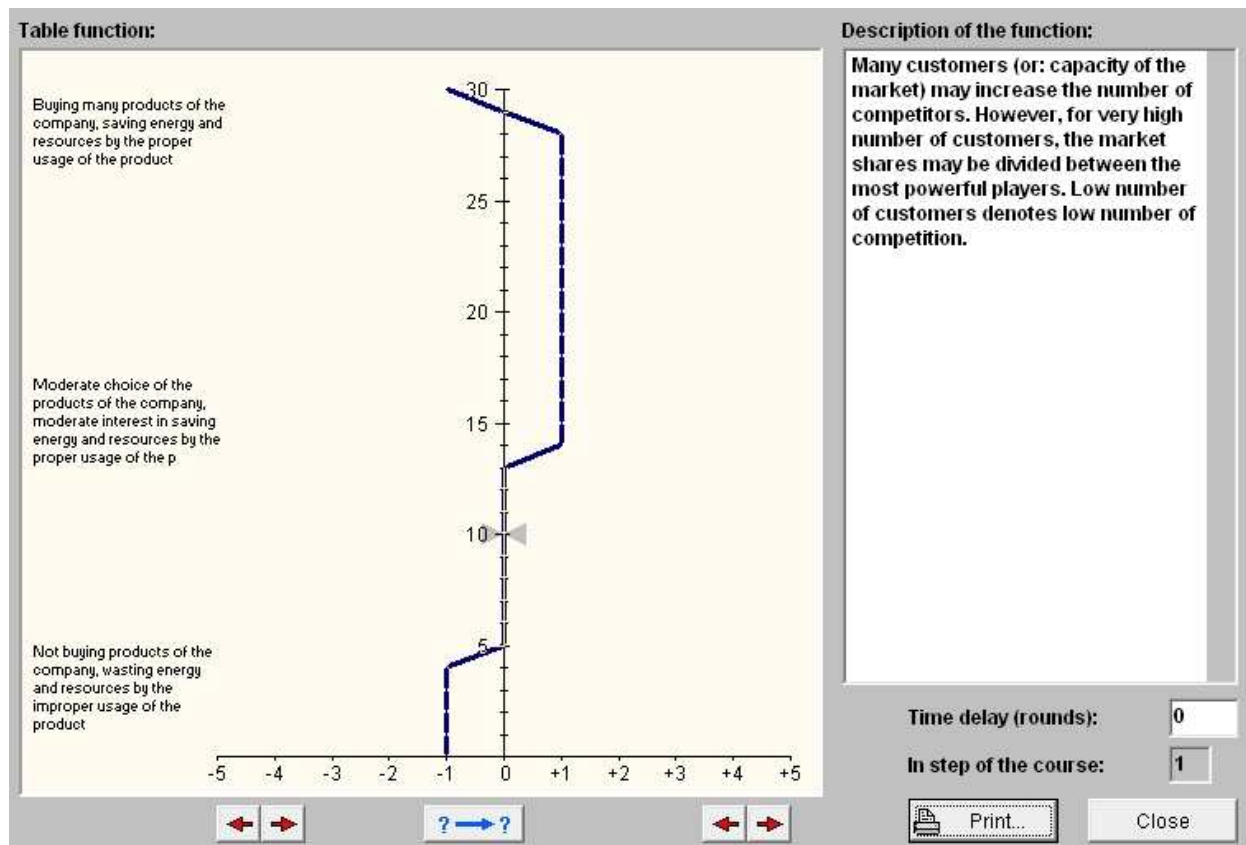

**Figure 40 Influence of variable Customers on variable Competitors. Similar interrelation determined for the relationships Customers – Employees and Financial Results – Employees.**

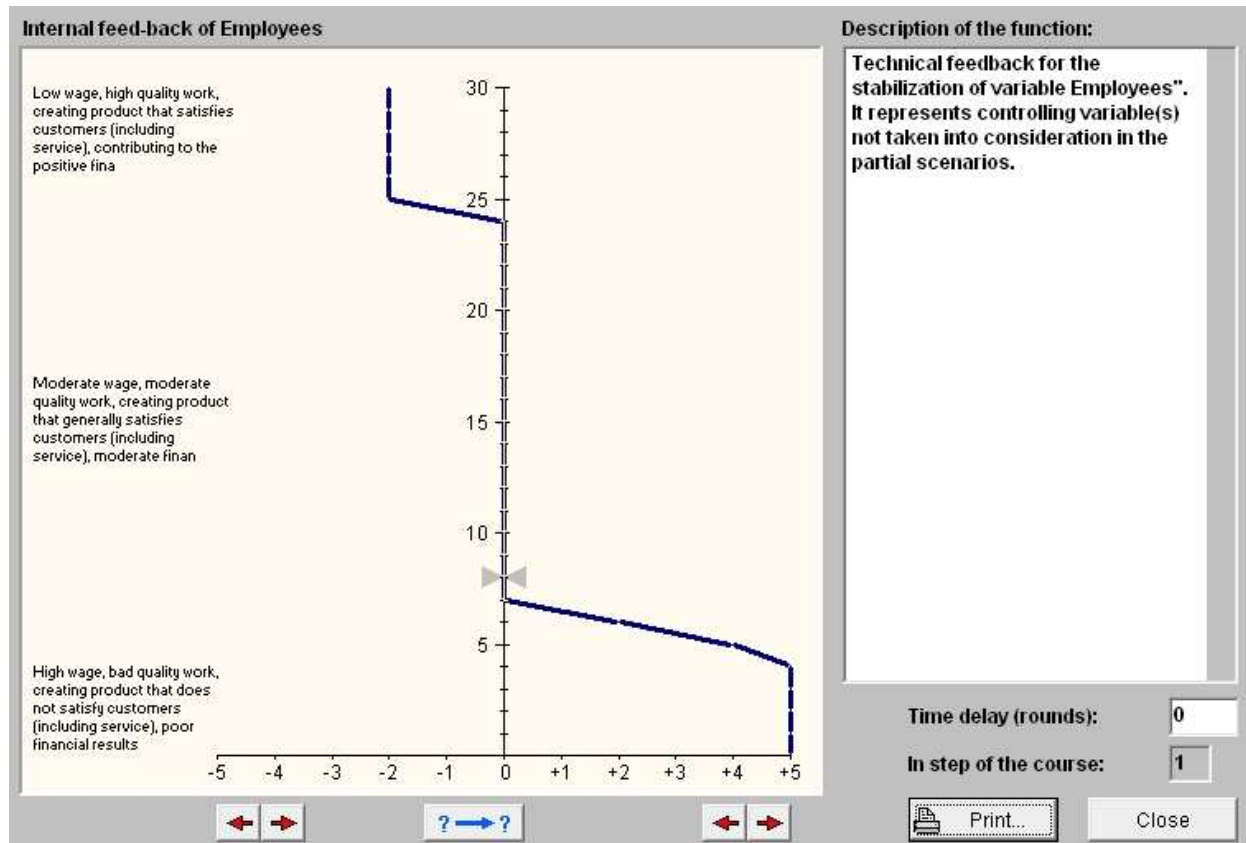

**Figure 41 Technical feedback for the variable Employees.**

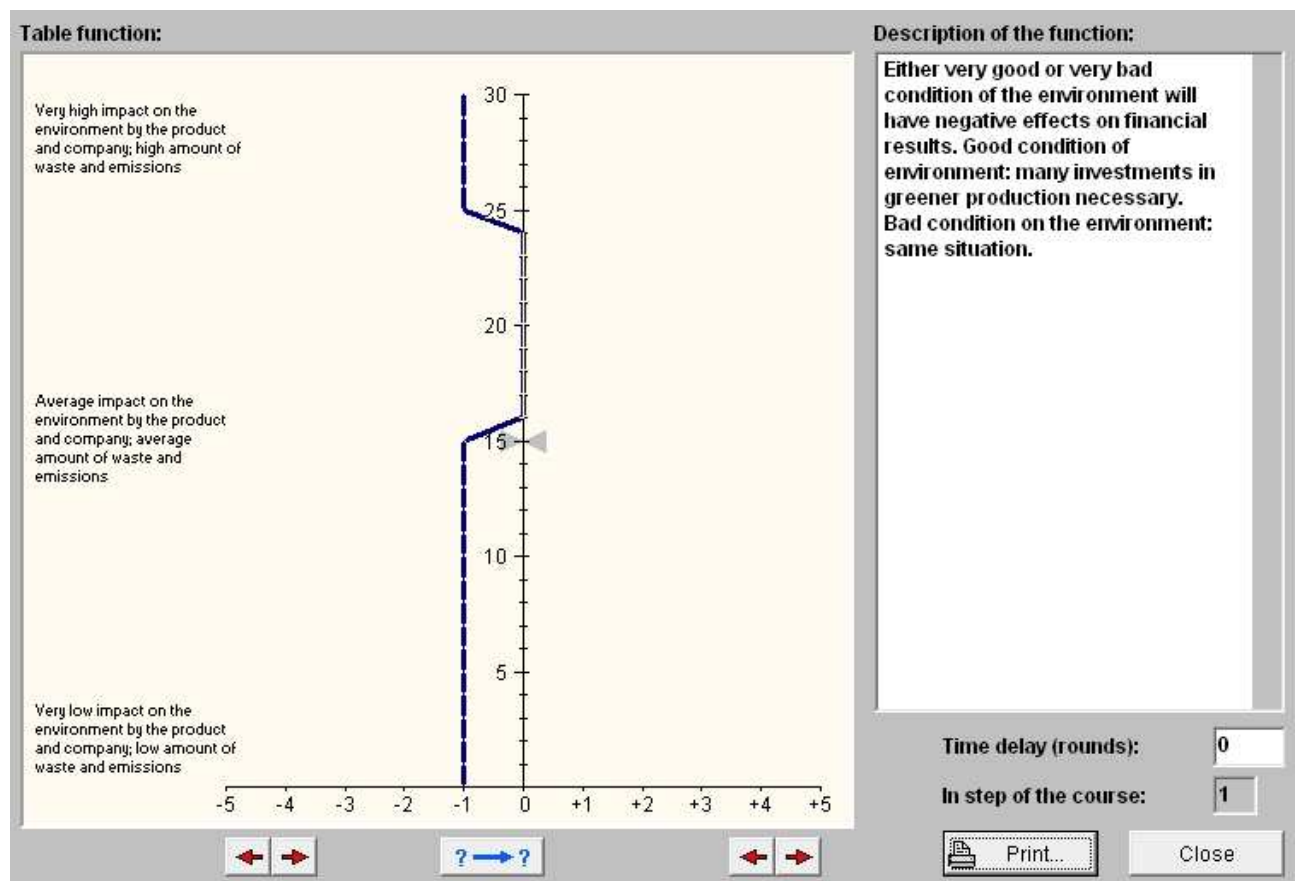

**Figure 42 Influence of variable Environment on variable Financial results. Similar interrelation determined for the relationship Financial results – Price.**

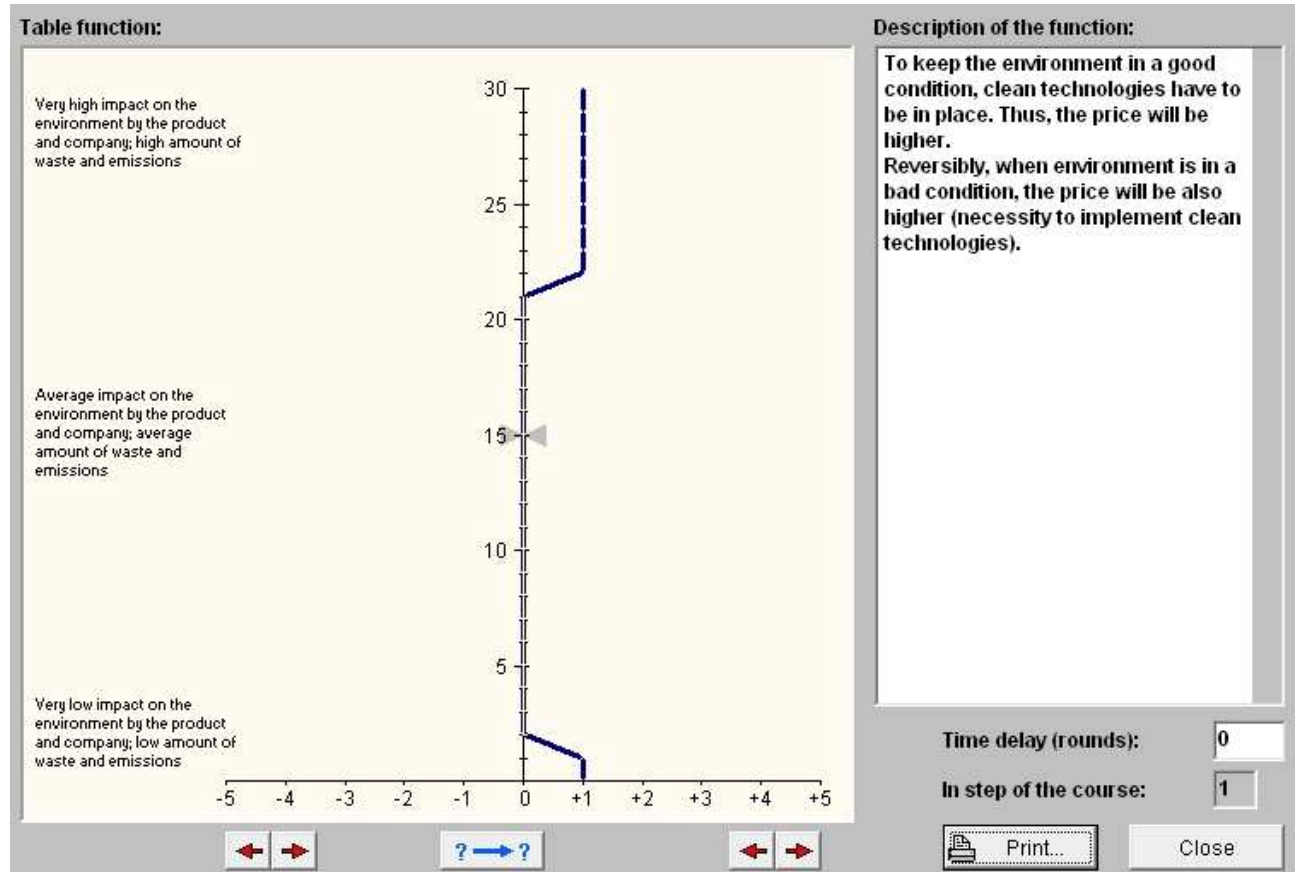

**Figure 43 Influence of variable Environment on variable Price.**



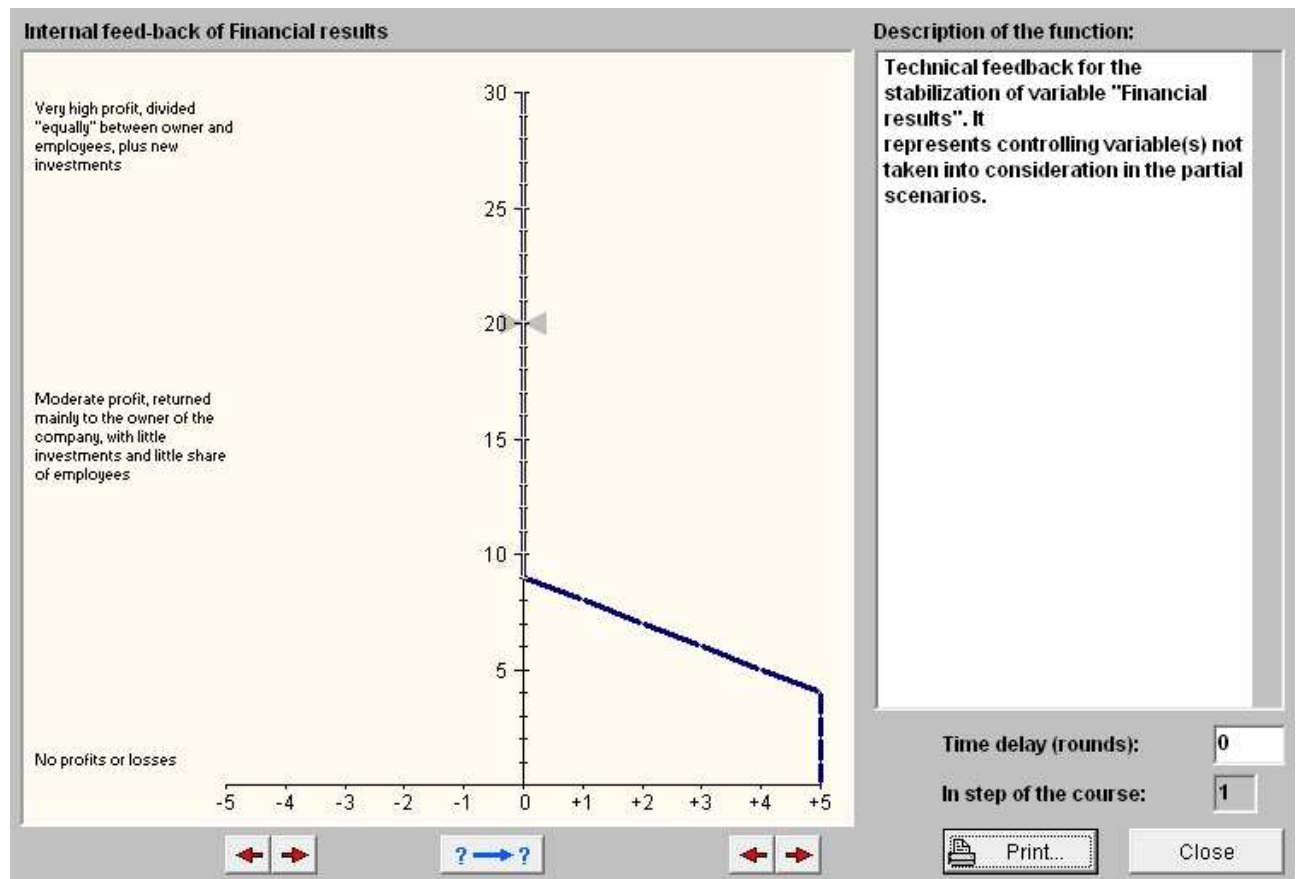

Figure 44 Technical feedback for the variable Financial results.

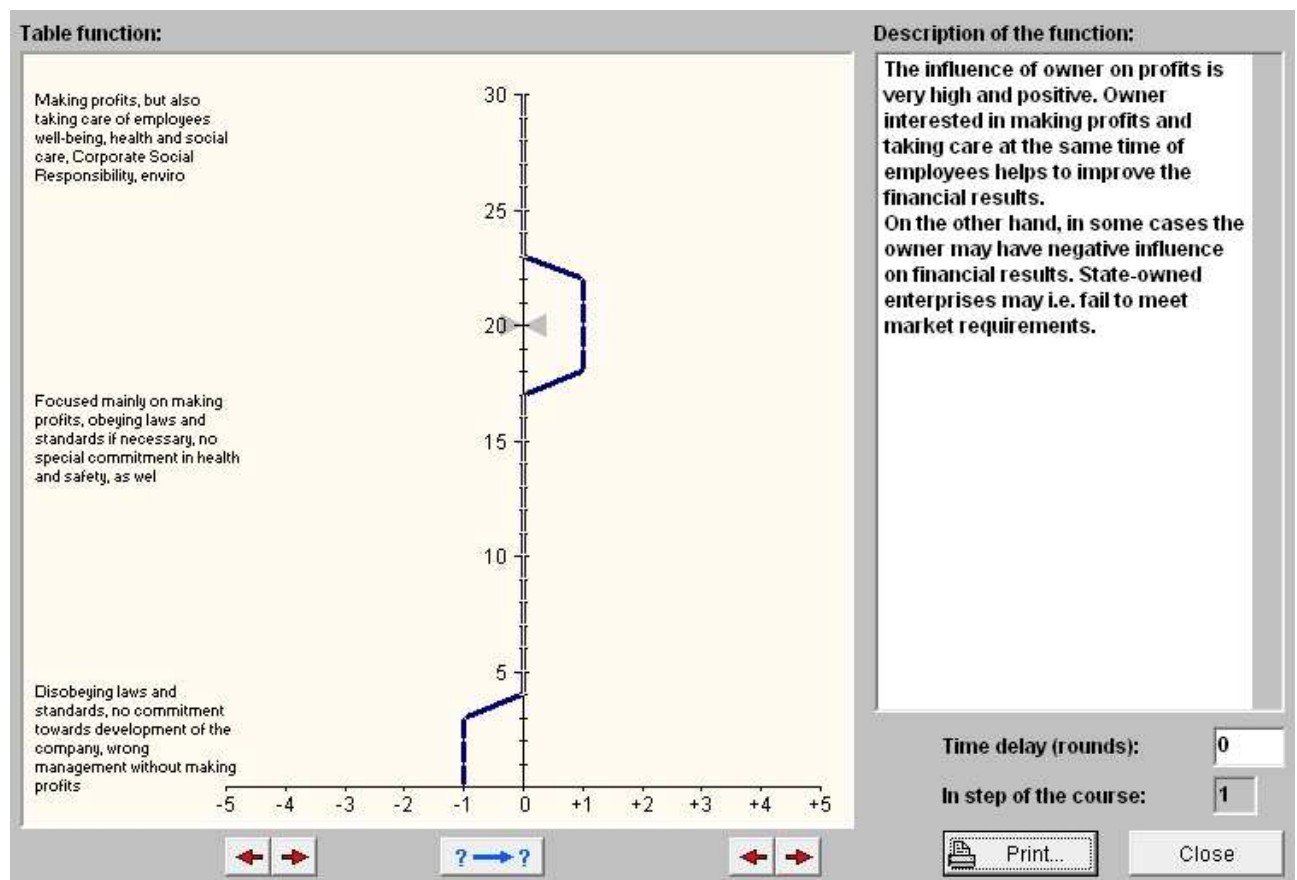

Figure 45 Influence of variable Owner on variable Financial results.

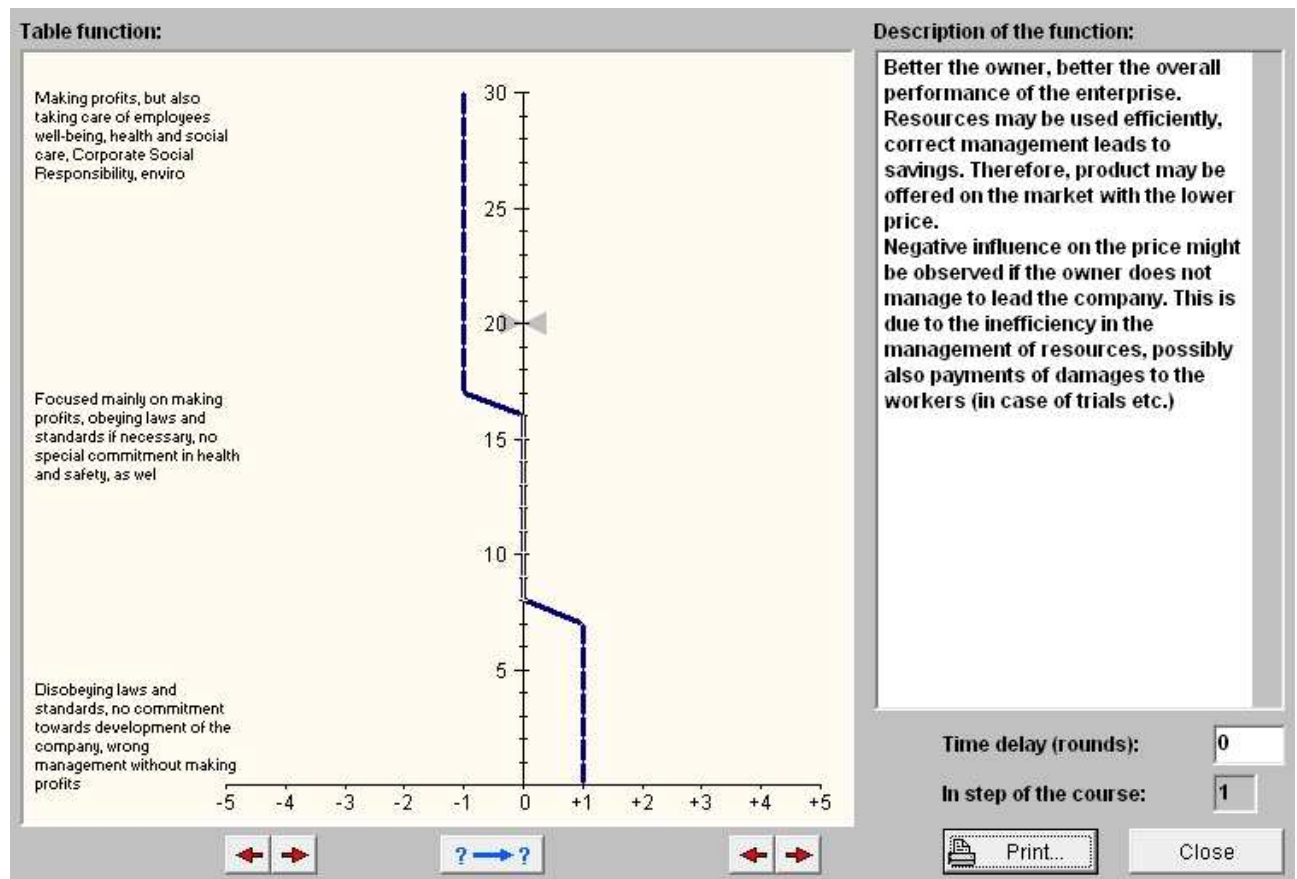

Figure 46 Influence of variable Owner on variable Price.

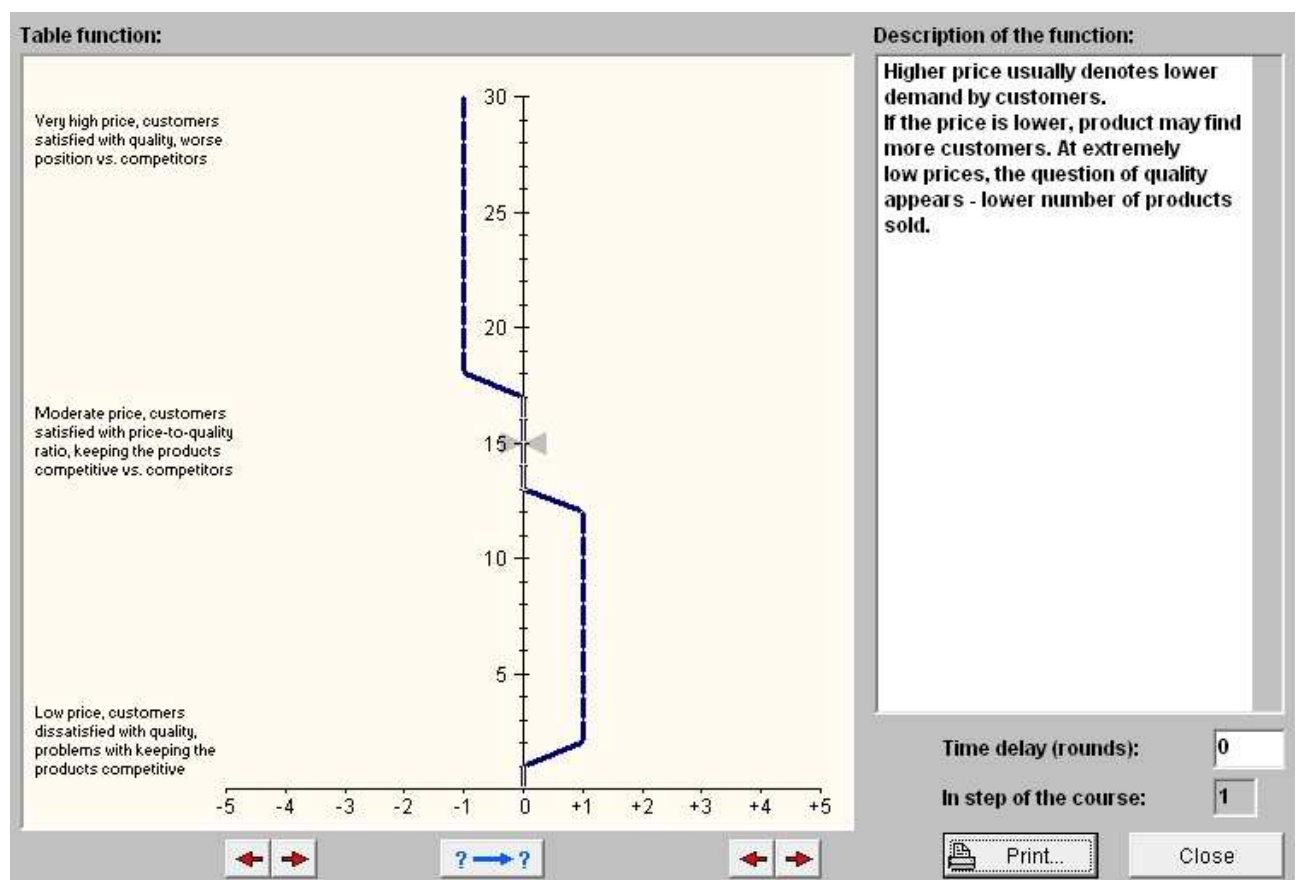

Figure 47 Influence of variable Price on variable Customers.

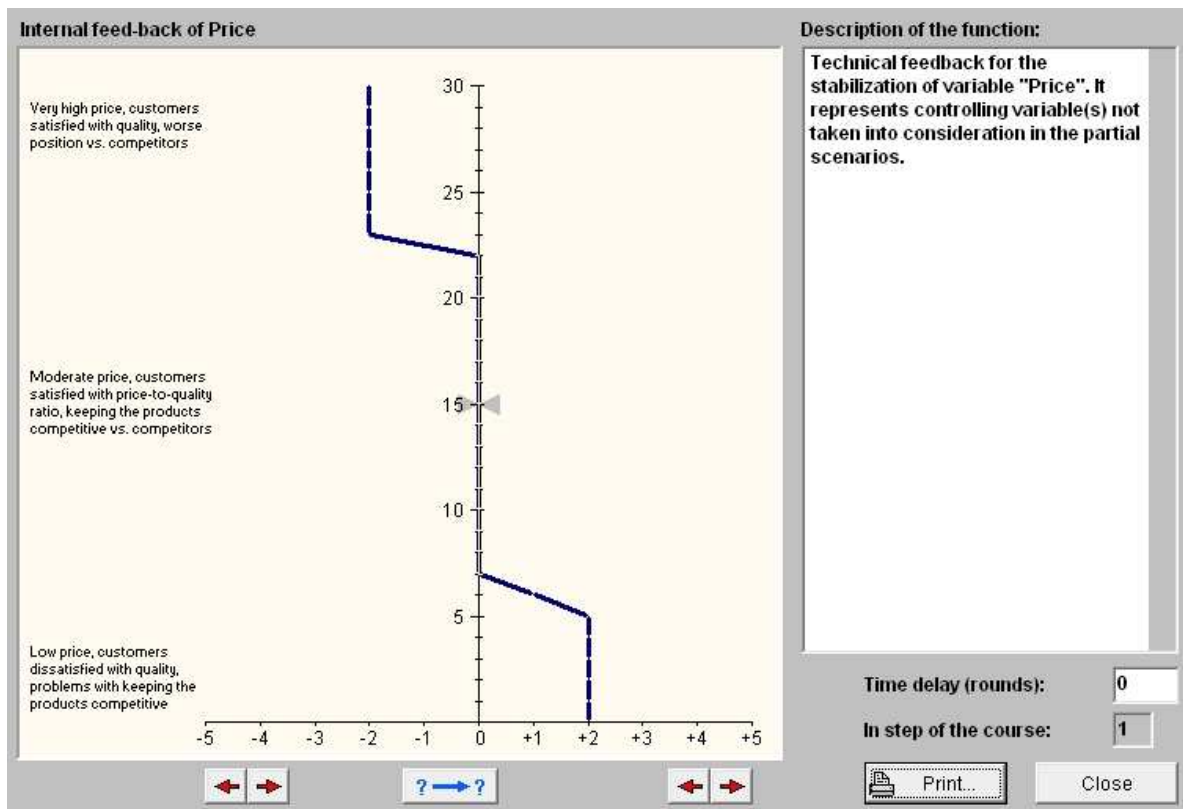

Figure 48 Technical feedback for the variable Price.

2. Fluctuating policy scenario

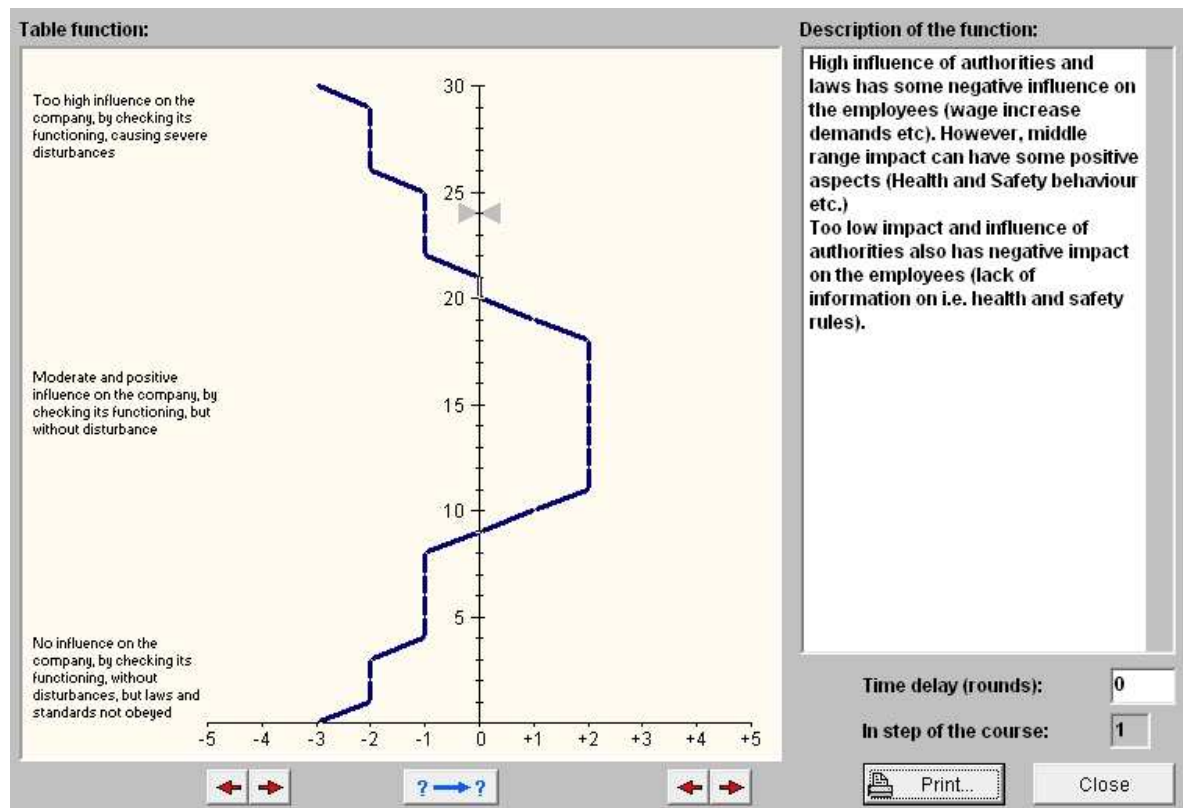
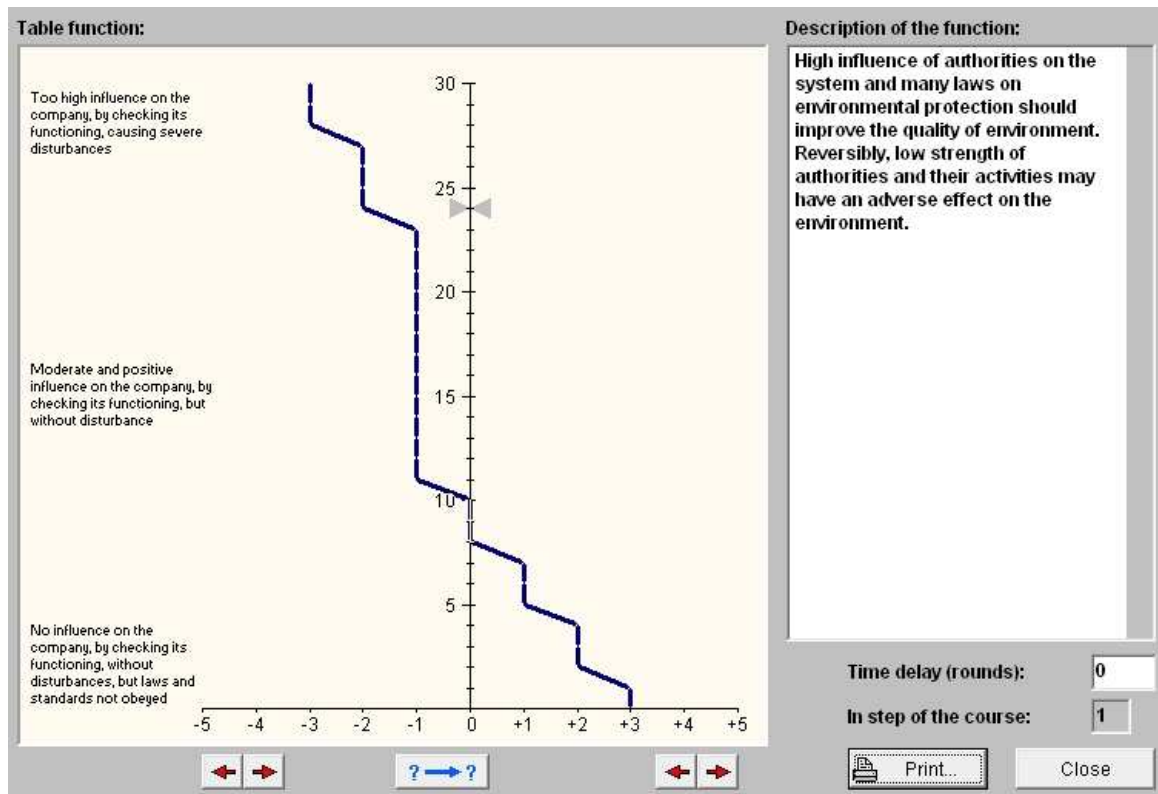
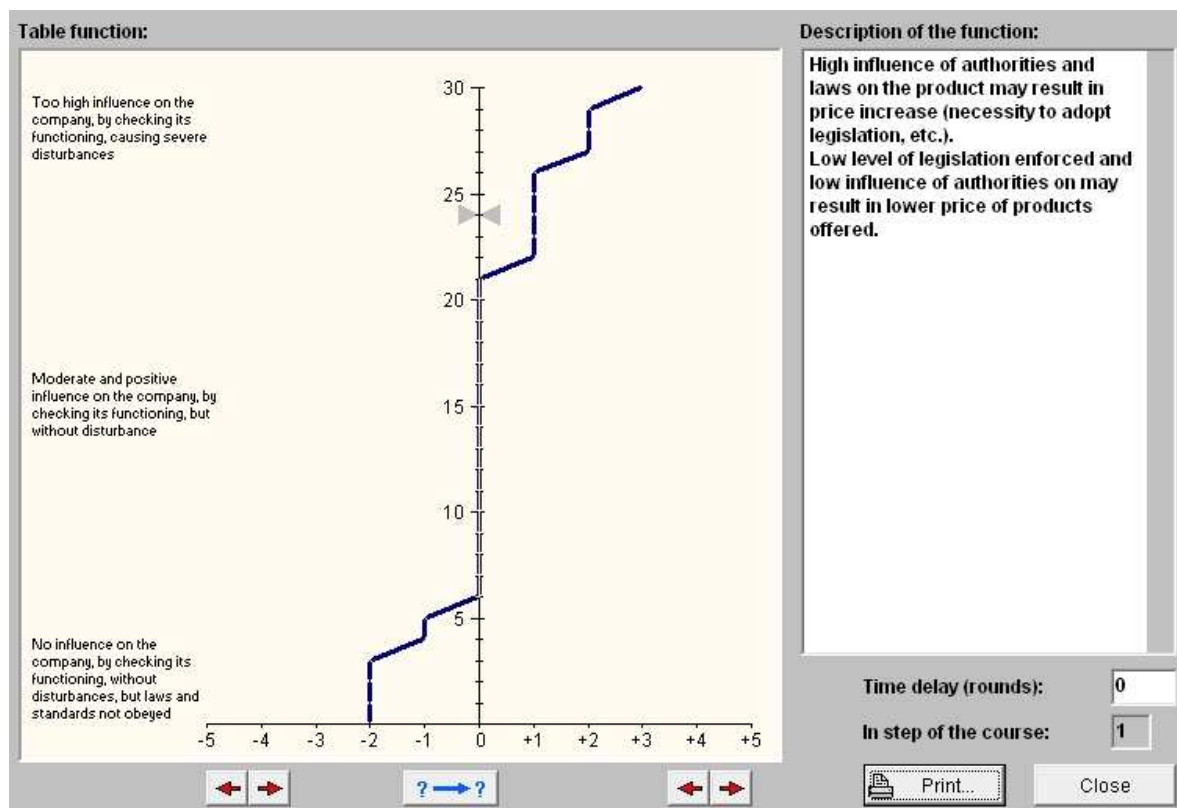

Figure 49 Influence of variable Authorities on variable Employees. Similar interrelation determined for the relationships Authorities – Financial results, Authorities – Owner, Financial results – Employees, Financial results – Price, Quality – Financial results.



**Figure 50 Influence of variable Authorities on variable Environment. Similar interrelation determined for the relationships Competitors – Customers, Competitors – Financial results, Competitors – Price, LCA + EMS – Authorities, LCA + EMS – Environment, Owner – Authorities, Owner – Price, Quality – Competitors, Quality – Environment.**



**Figure 51 Influence of variable Authorities on variable Price. Similar interrelation determined for the relationships Employees – Price, Financial results – LCA + EMS, LCA + EMS – Quality, Owner – Financial results, Quality – Consumers, Quality – LCA + EMS, Quality – Price.**

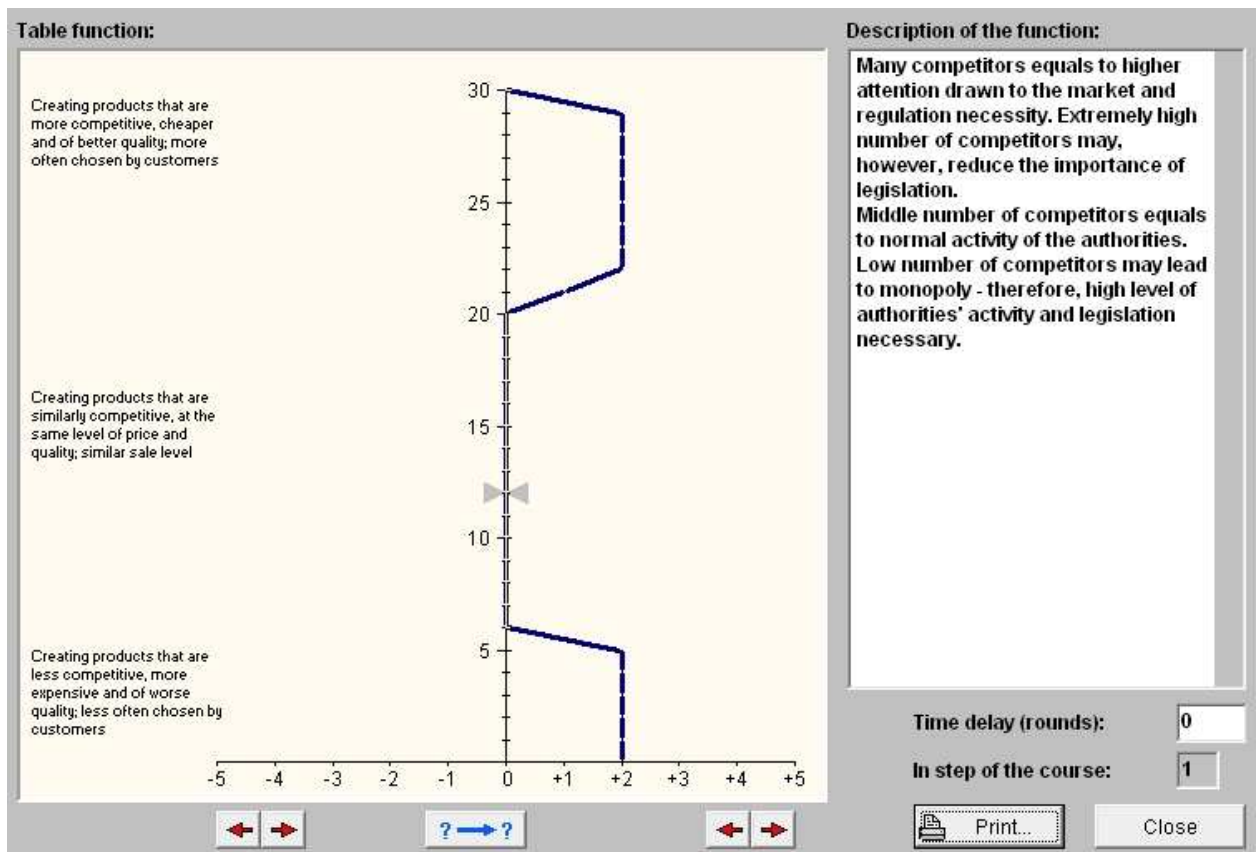

Figure 52 Influence of variable Competitors on variable Authorities.

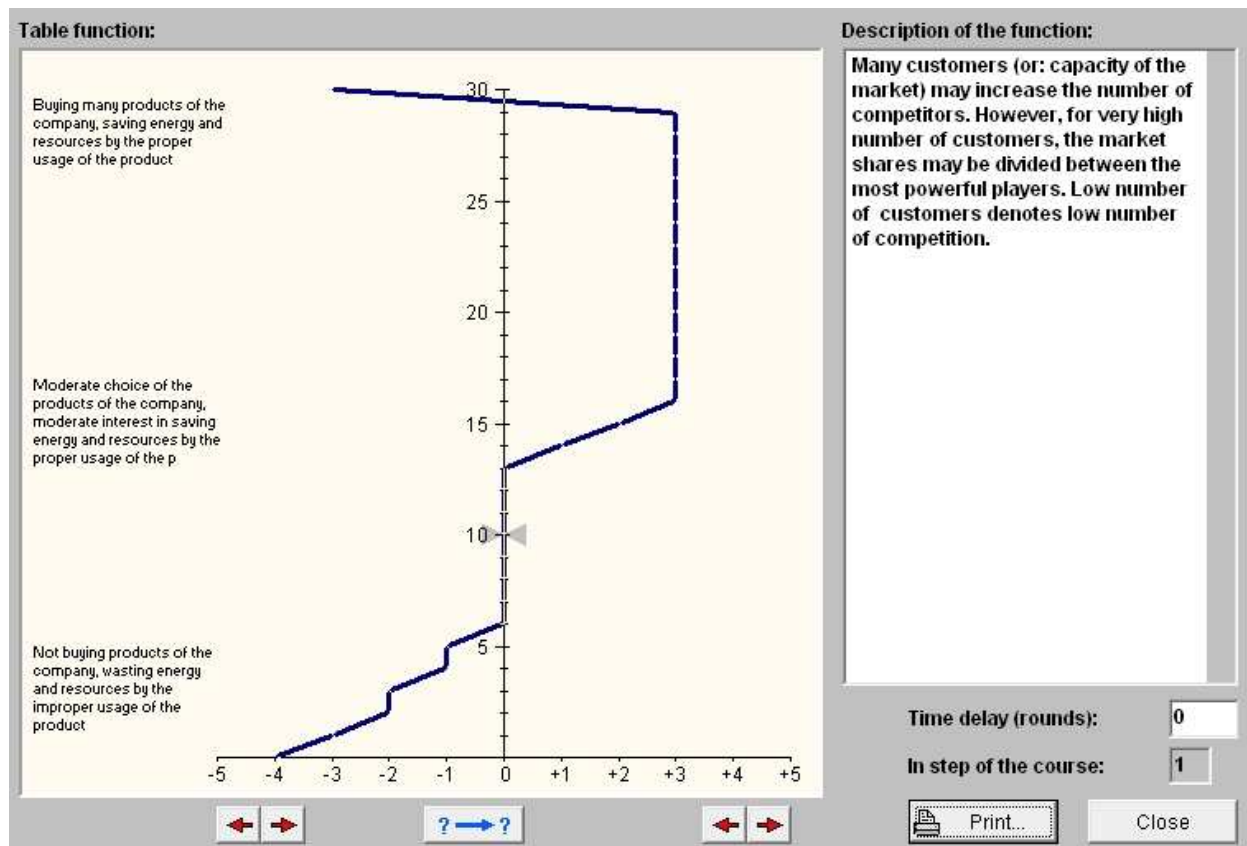

Figure 53 Influence of variable Customers on variable Competitors. Similar interrelation determined for the relationships Customers – Employees, Employees – Financial results, Financial results – Employees, LCA + EMS – Financial results.

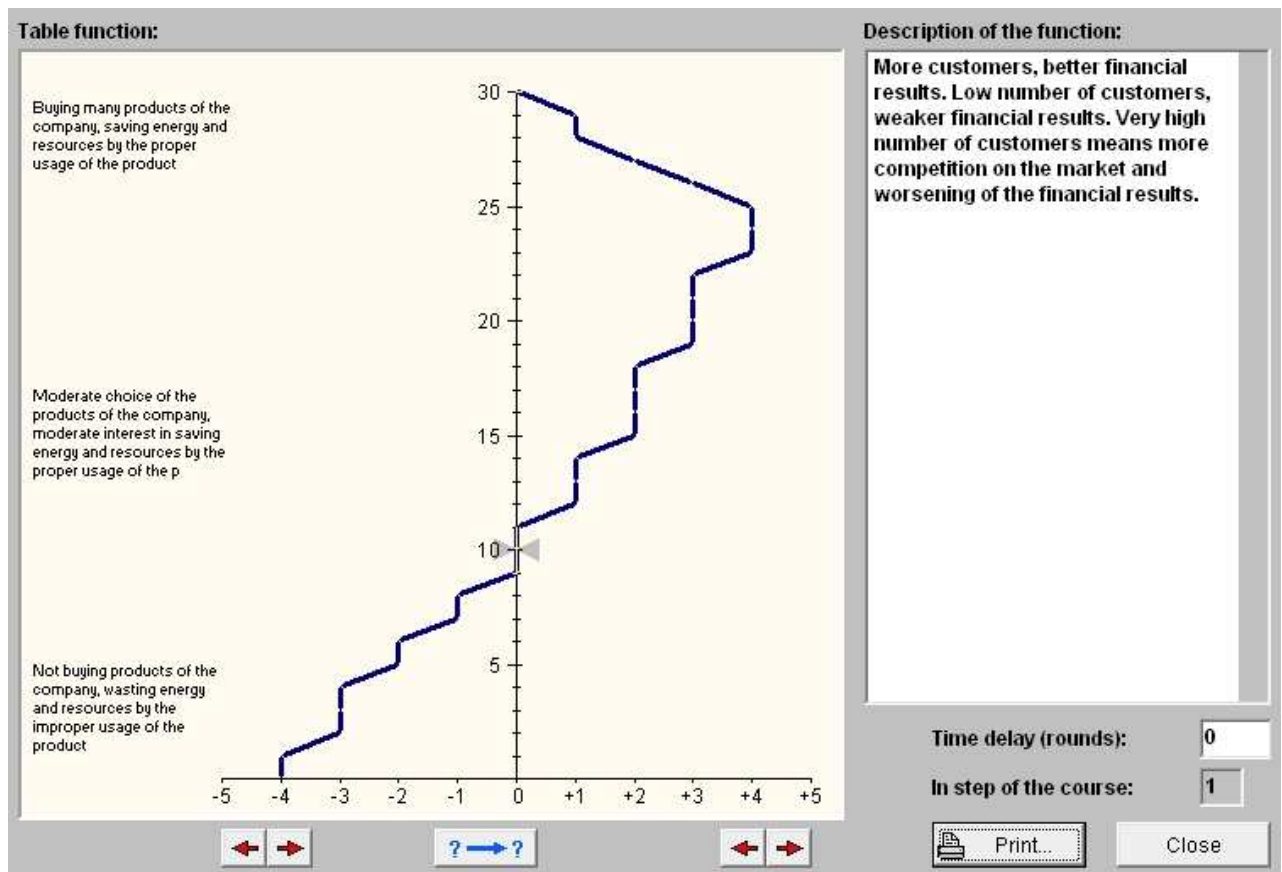

Figure 54 Influence of variable Customers on variable Financial results.

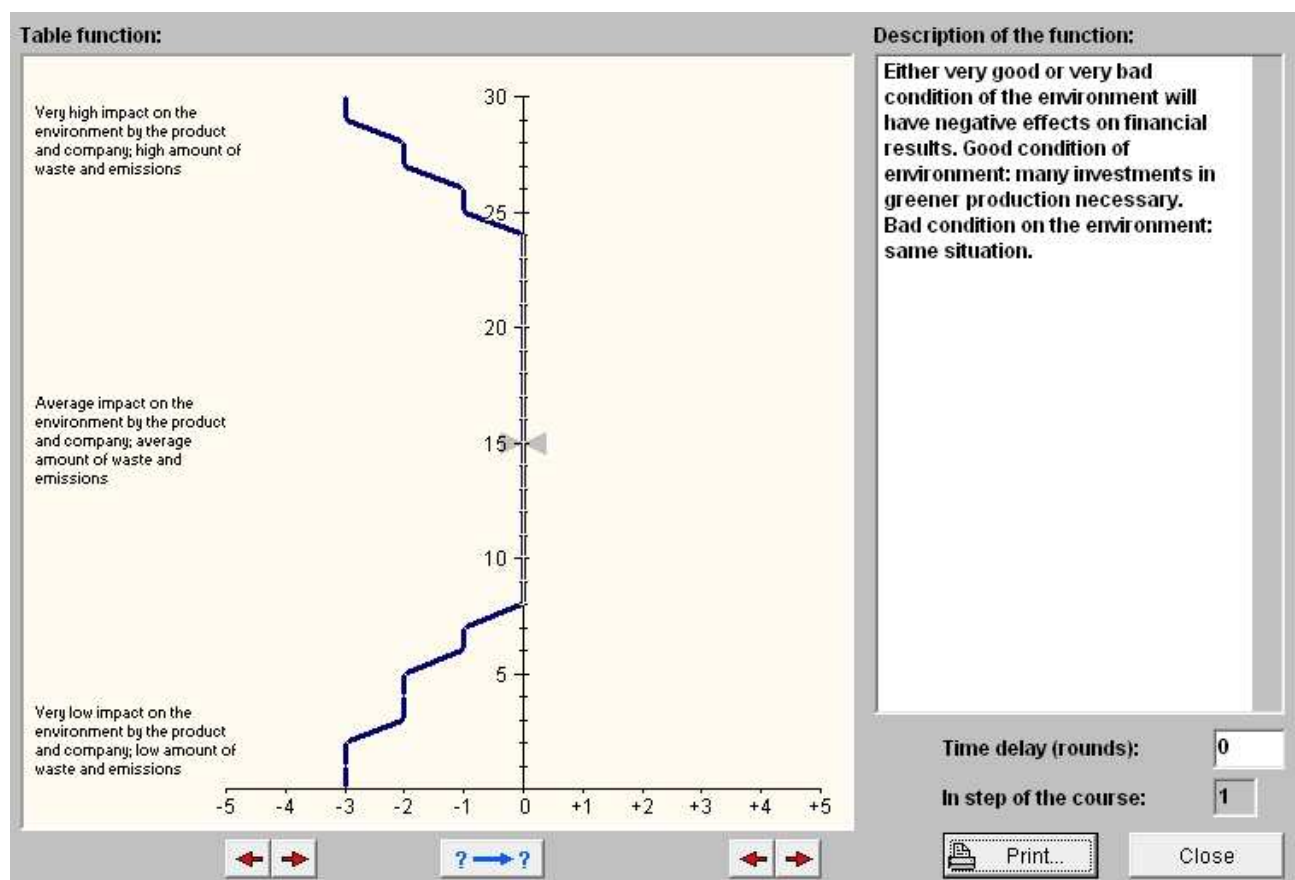

Figure 55 Influence of variable Environment on variable Financial results.

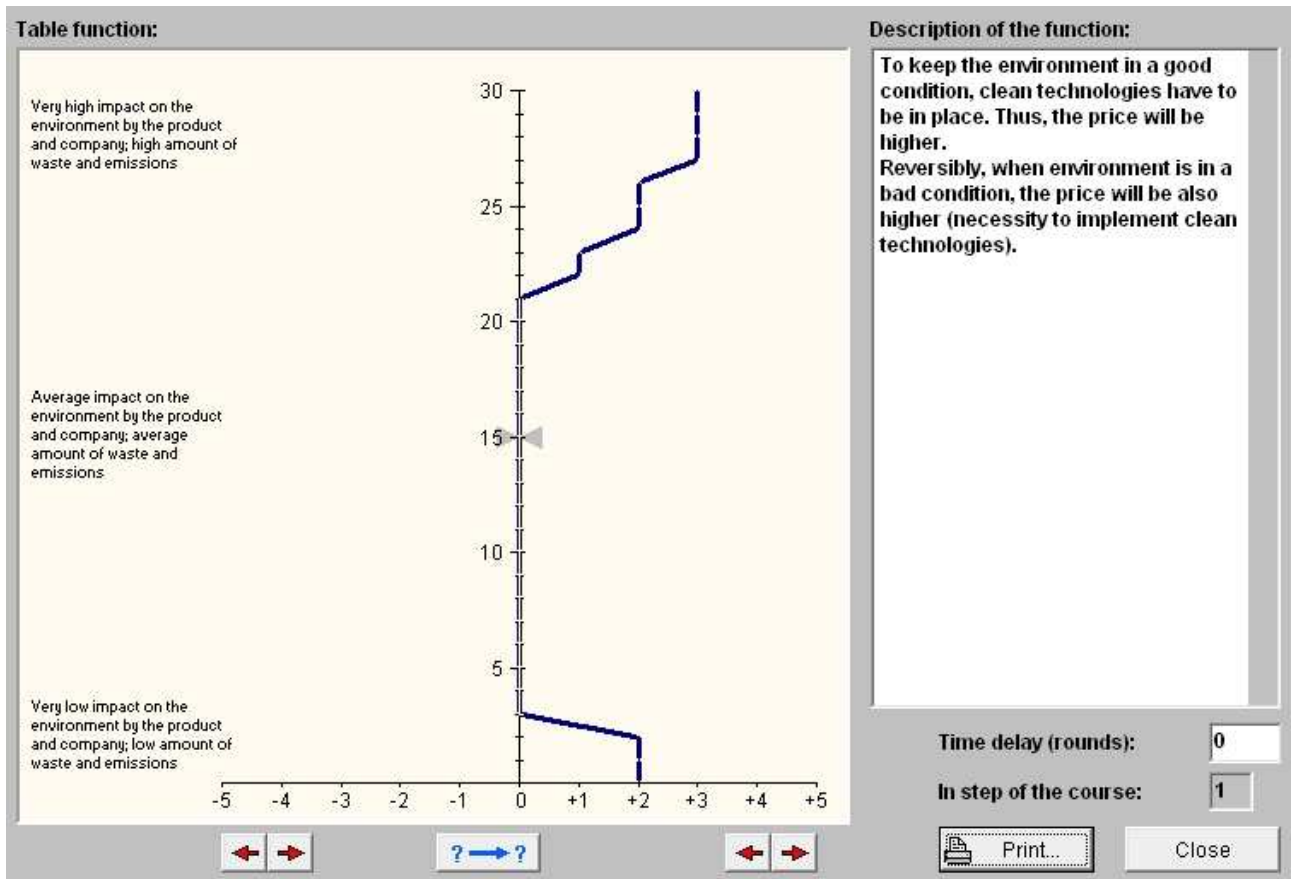

Figure 56 Influence of variable Environment on variable Price.

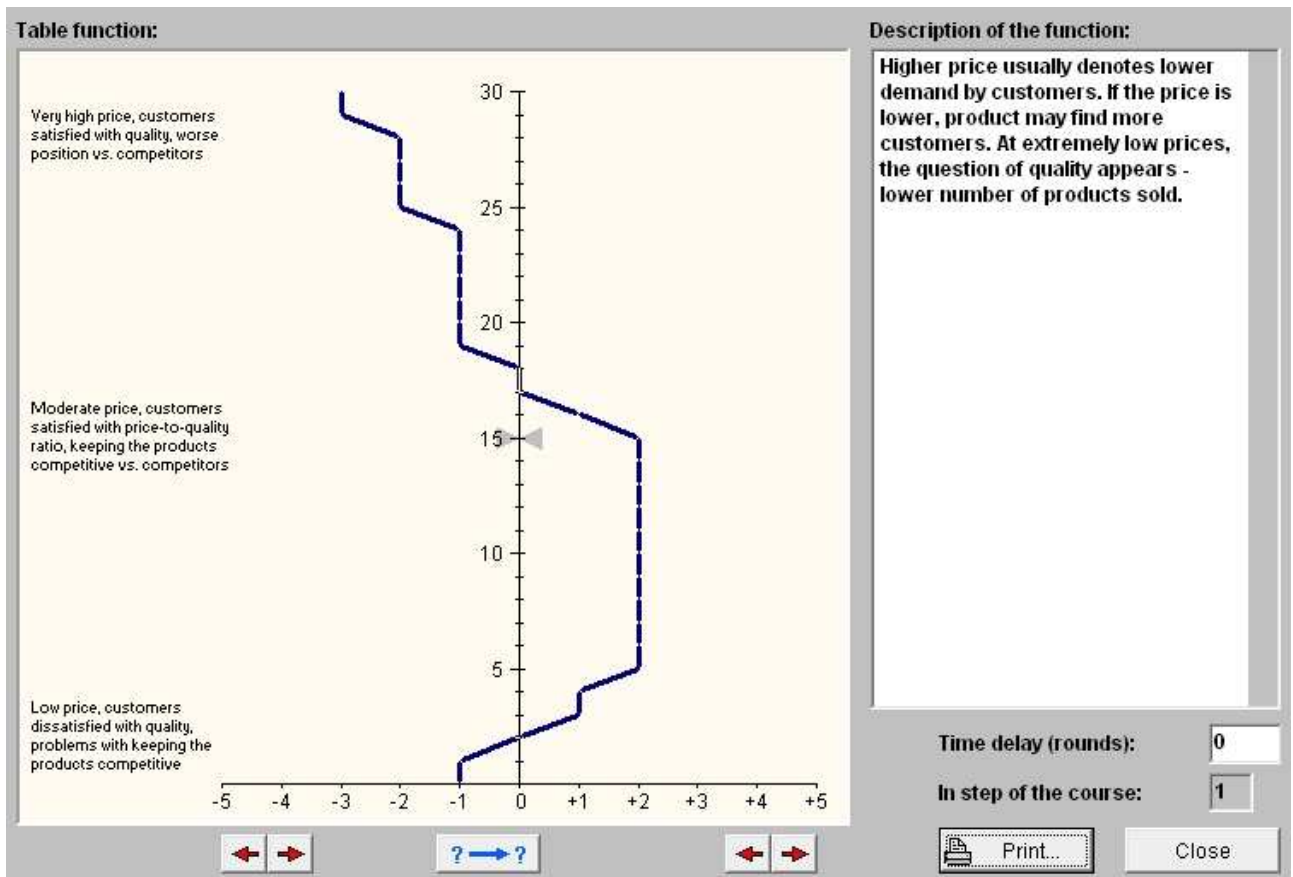
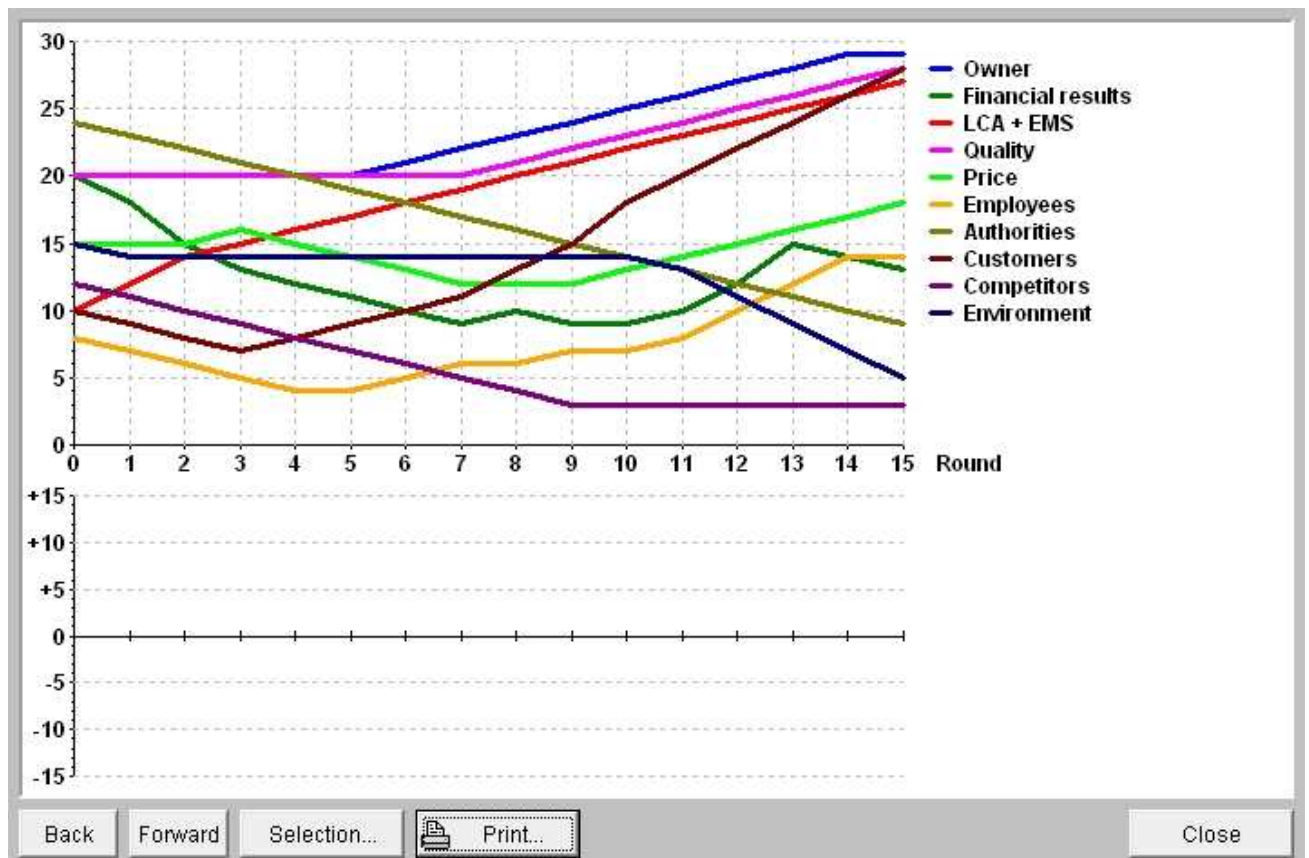

Figure 57 Influence of variable Price on variable Customers.

## Appendix XII

## Results of simulation in the SMPV

## 1. Stable policy scenario, modelling results



**Figure 58** Simulation results, critical variables without self-controlling feedback, stable policy test, simultaneous interactions.



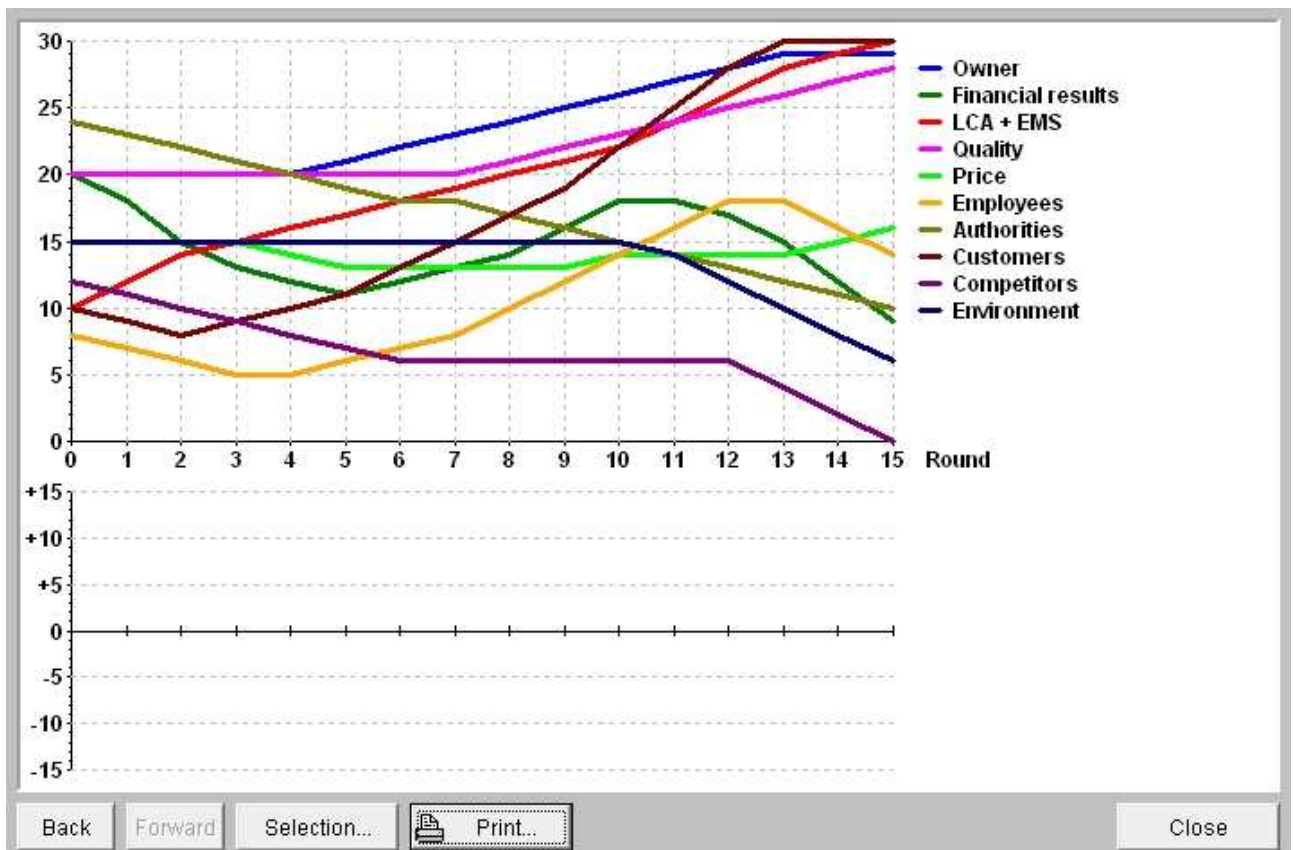

Figure 59 Simulation results, critical variables without self-controlling feedback, policy test focusing on inner-enterprise variables.

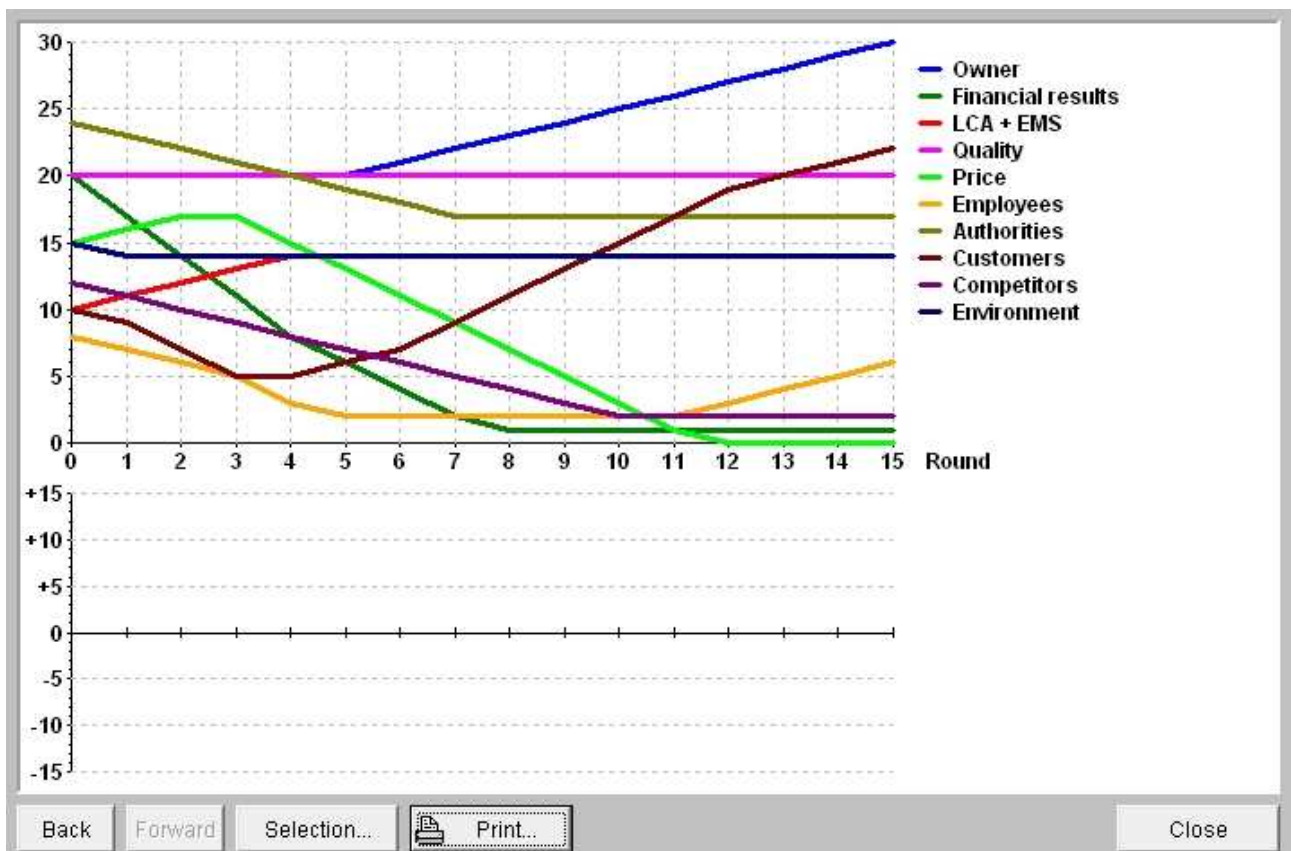
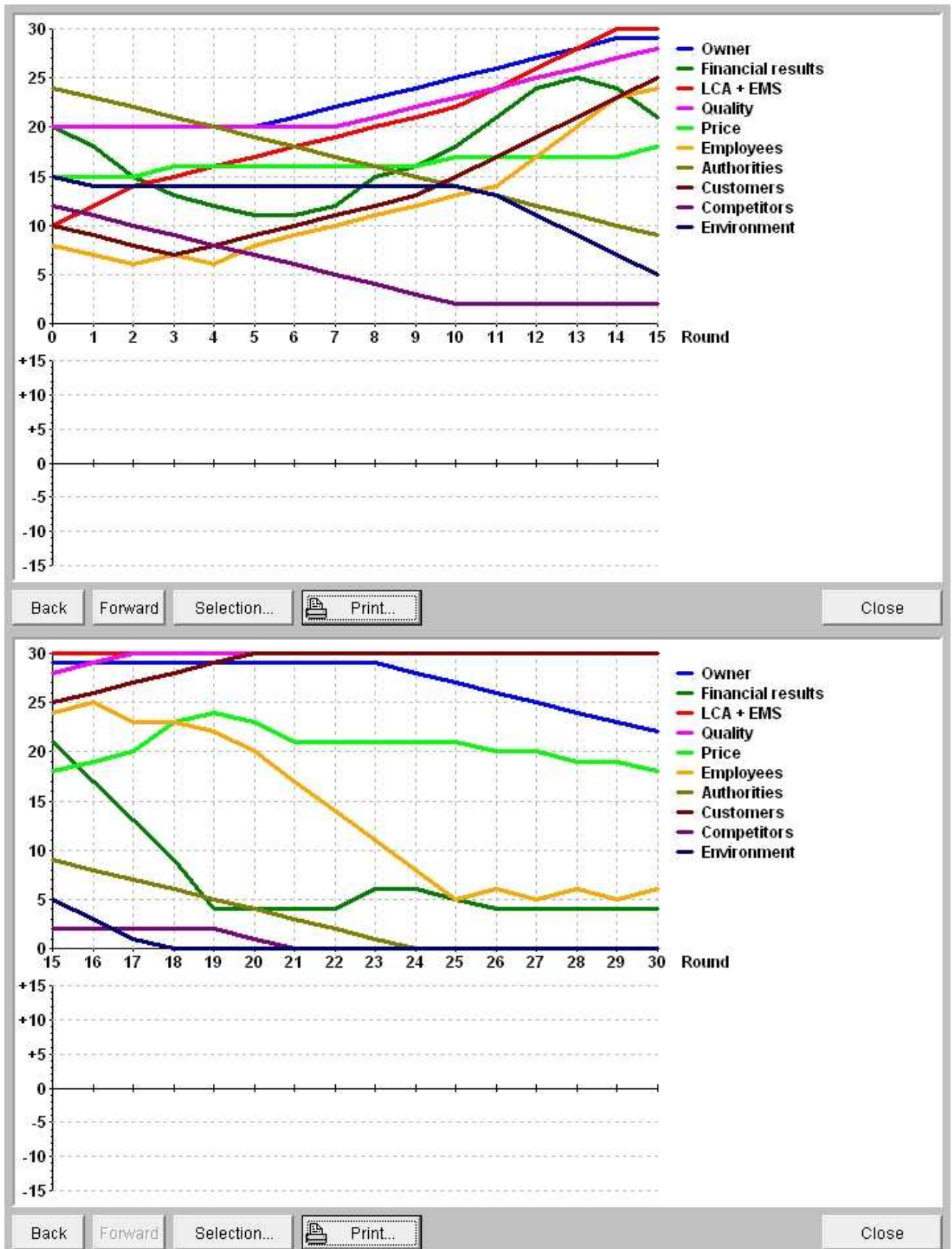
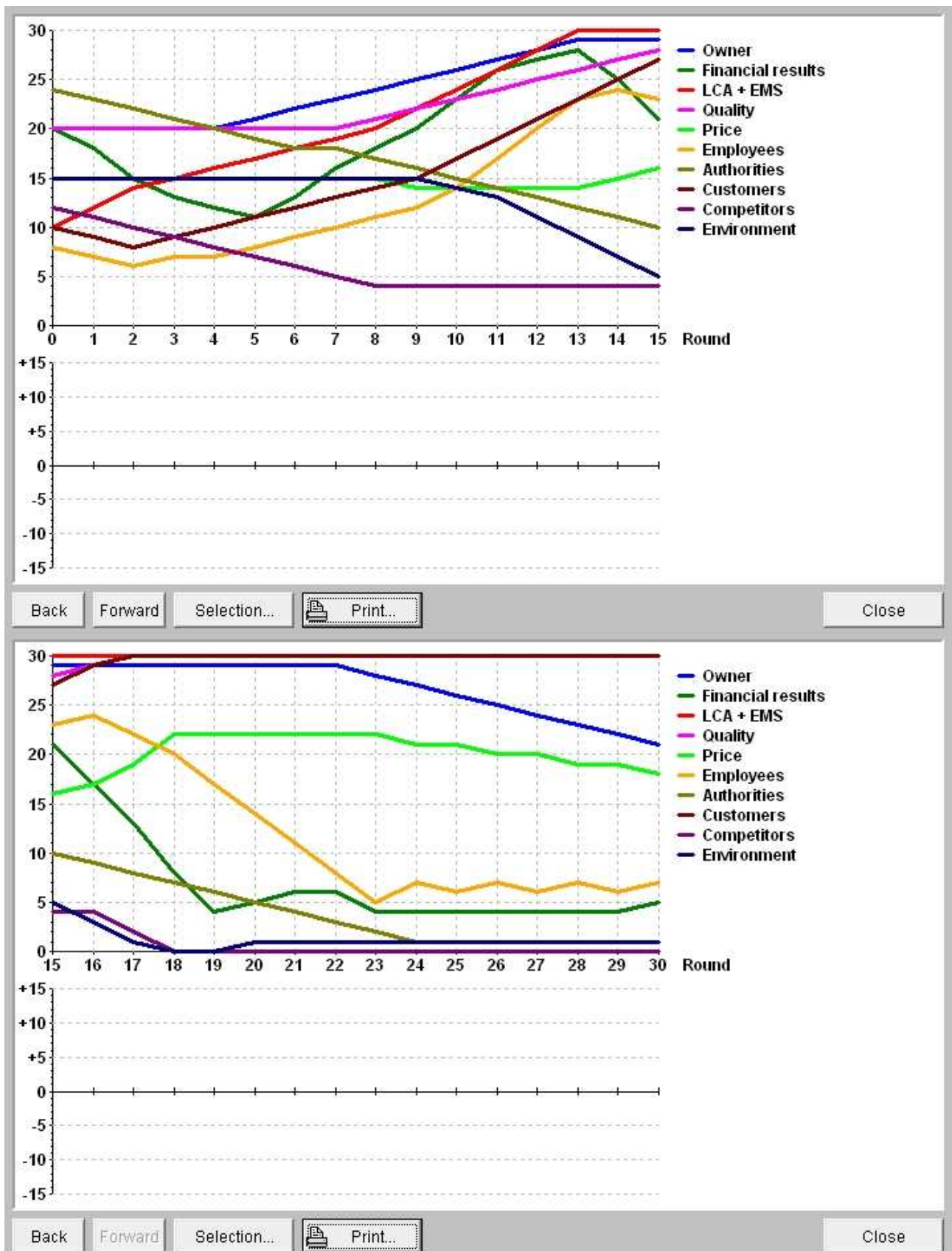

Figure 60 Simulation results, critical variables without self-controlling feedback, policy test focusing on outer-enterprise variables.



**Figure 61** Simulation results, critical variables with self-controlling feedback, stable policy test, simultaneous interactions.



**Figure 62** Simulation results, critical variables with self-controlling feedback, stable policy test focusing on inner-enterprise variables.

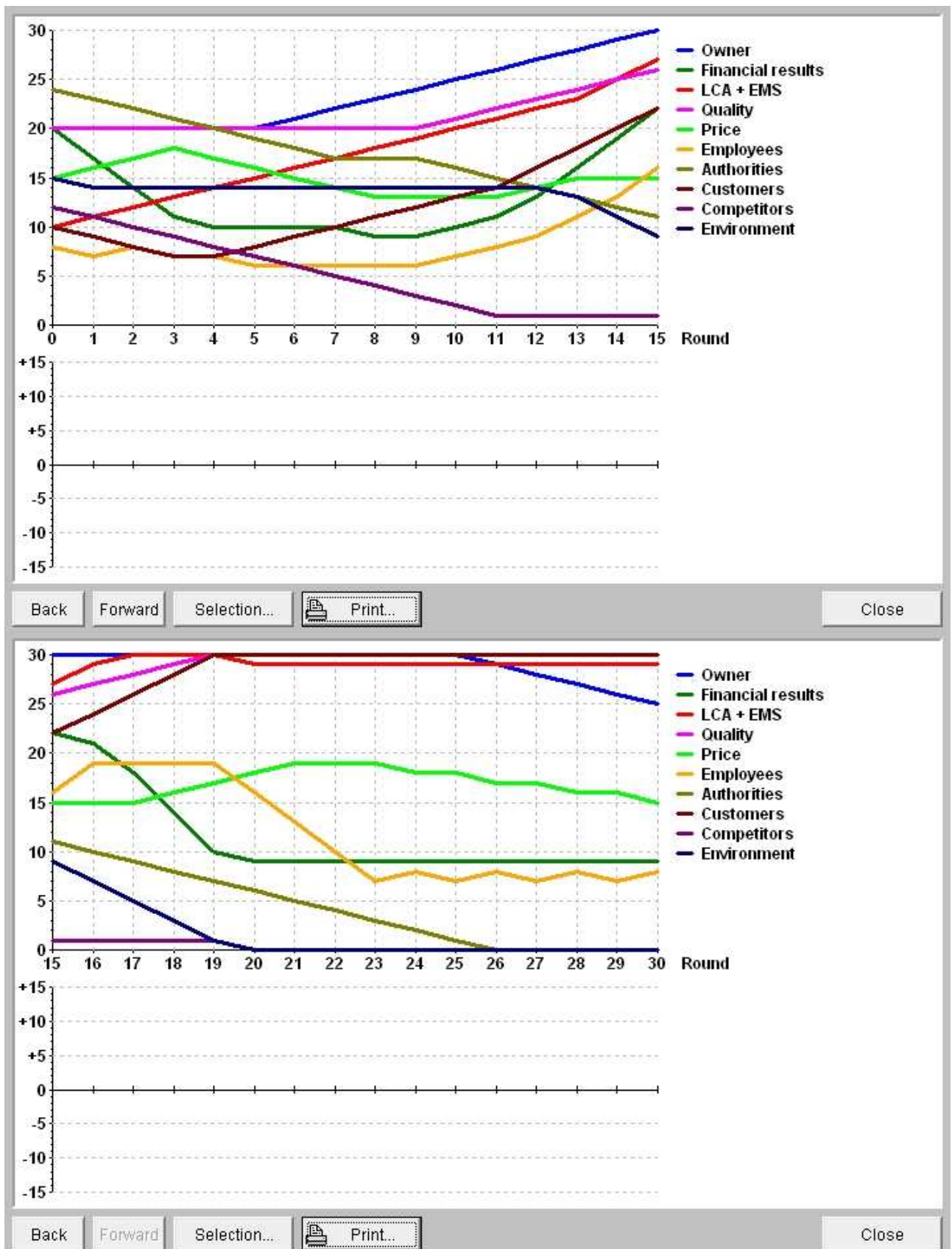

Figure 63 Simulation results, critical variables with self-controlling feedback, stable policy test focusing on outer-enterprise variables.

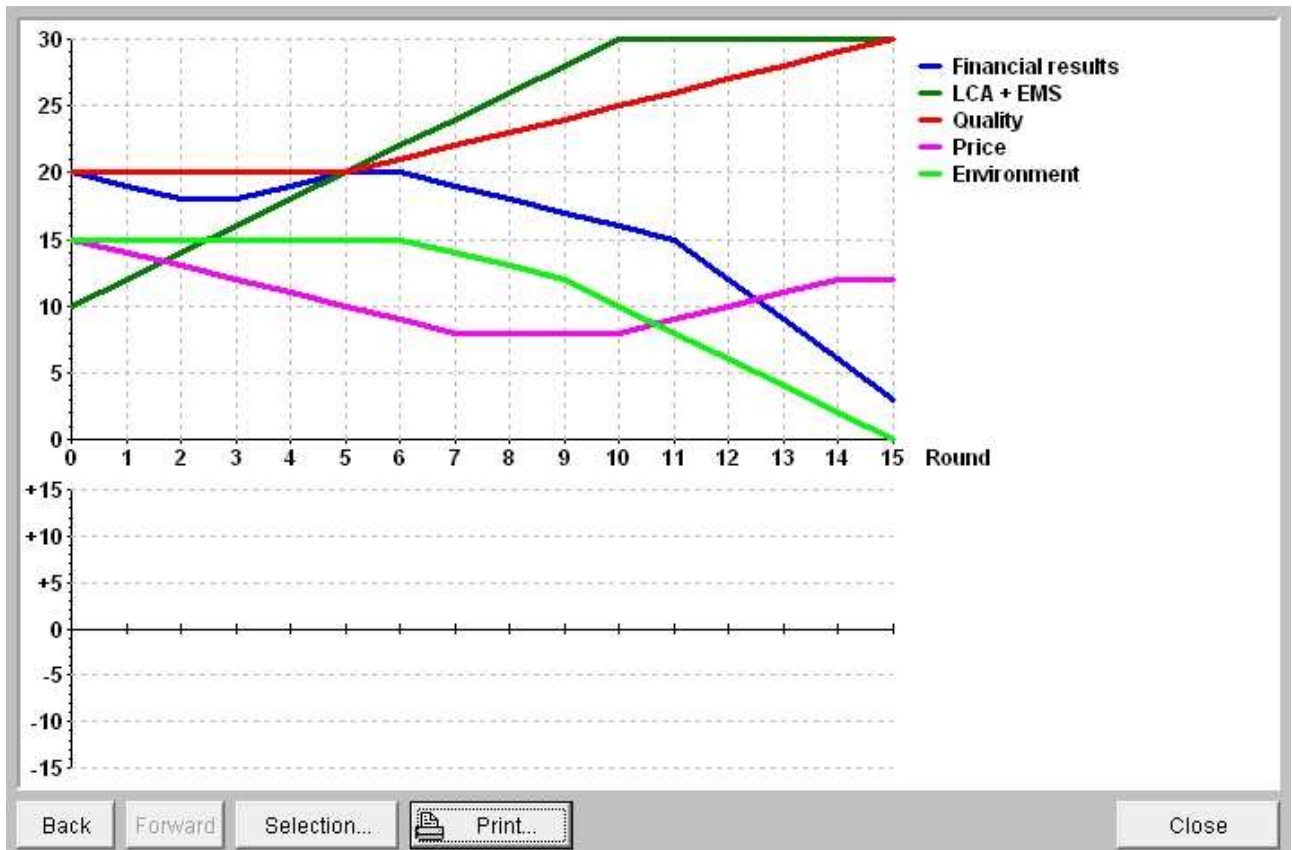

Figure 64 Simulation results, core variables without self-controlling feedback, stable policy test, simultaneous interactions.

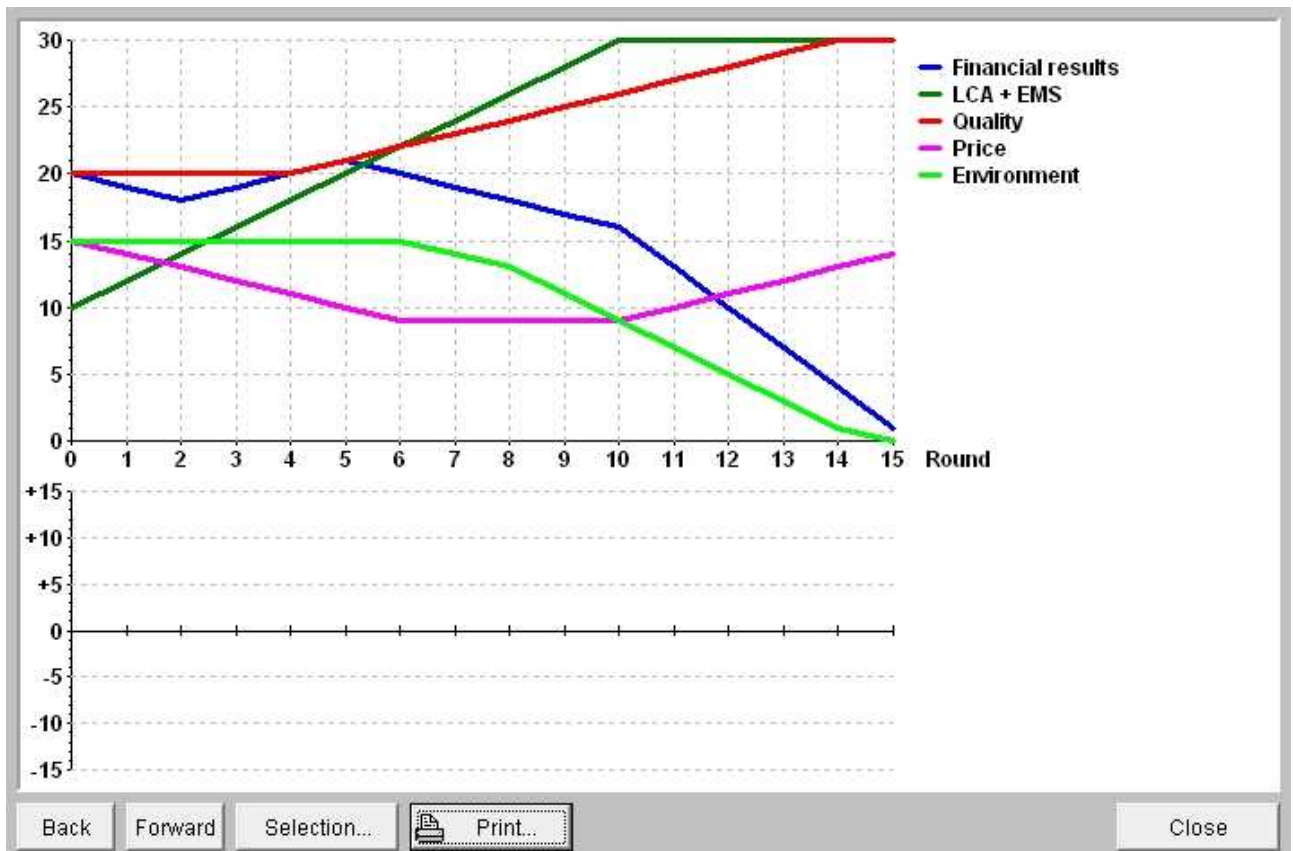
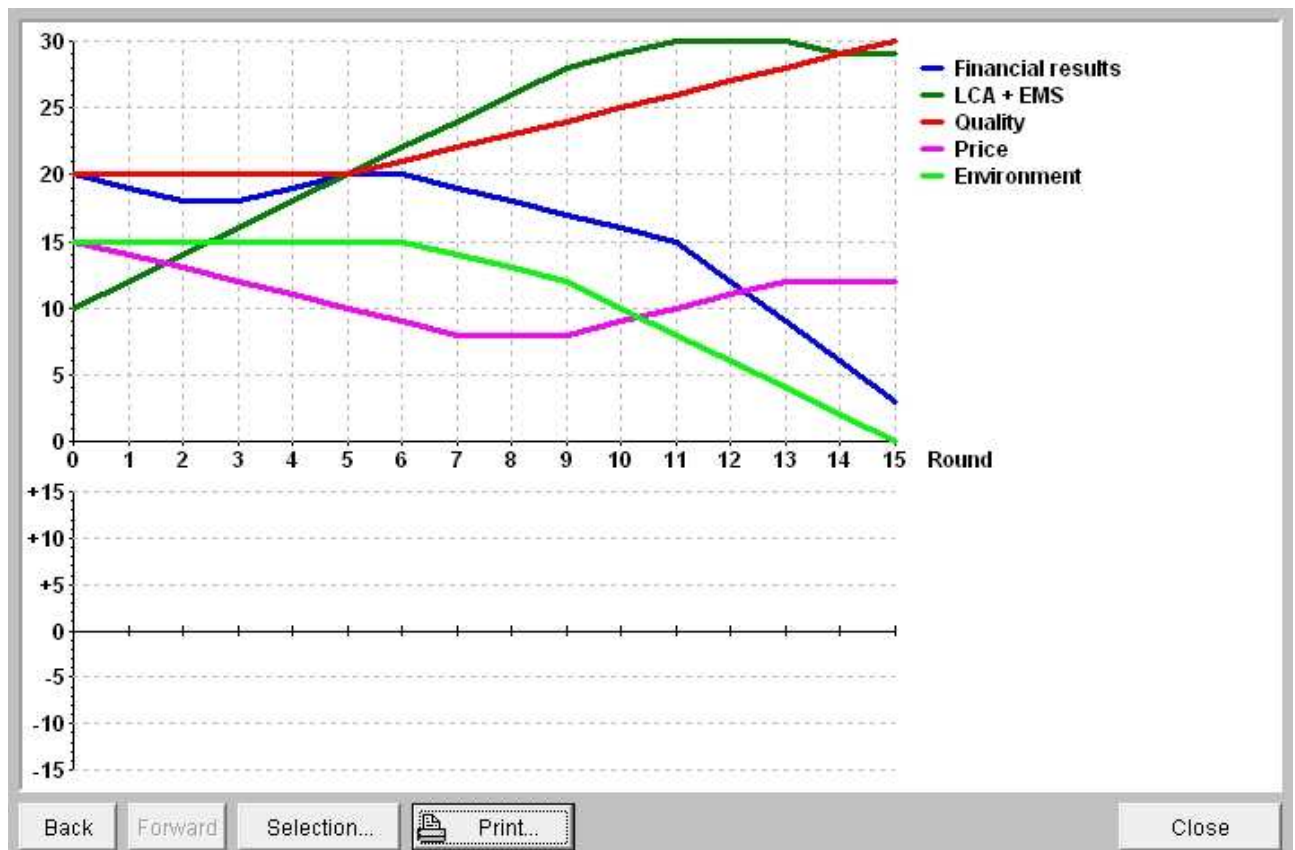

Figure 65 Simulation results, core variables without self-controlling feedback, policy test focusing on inner-enterprise variables.



**Figure 66** Simulation results, core variables without self-controlling feedback, policy test focusing on outer-enterprise variables.

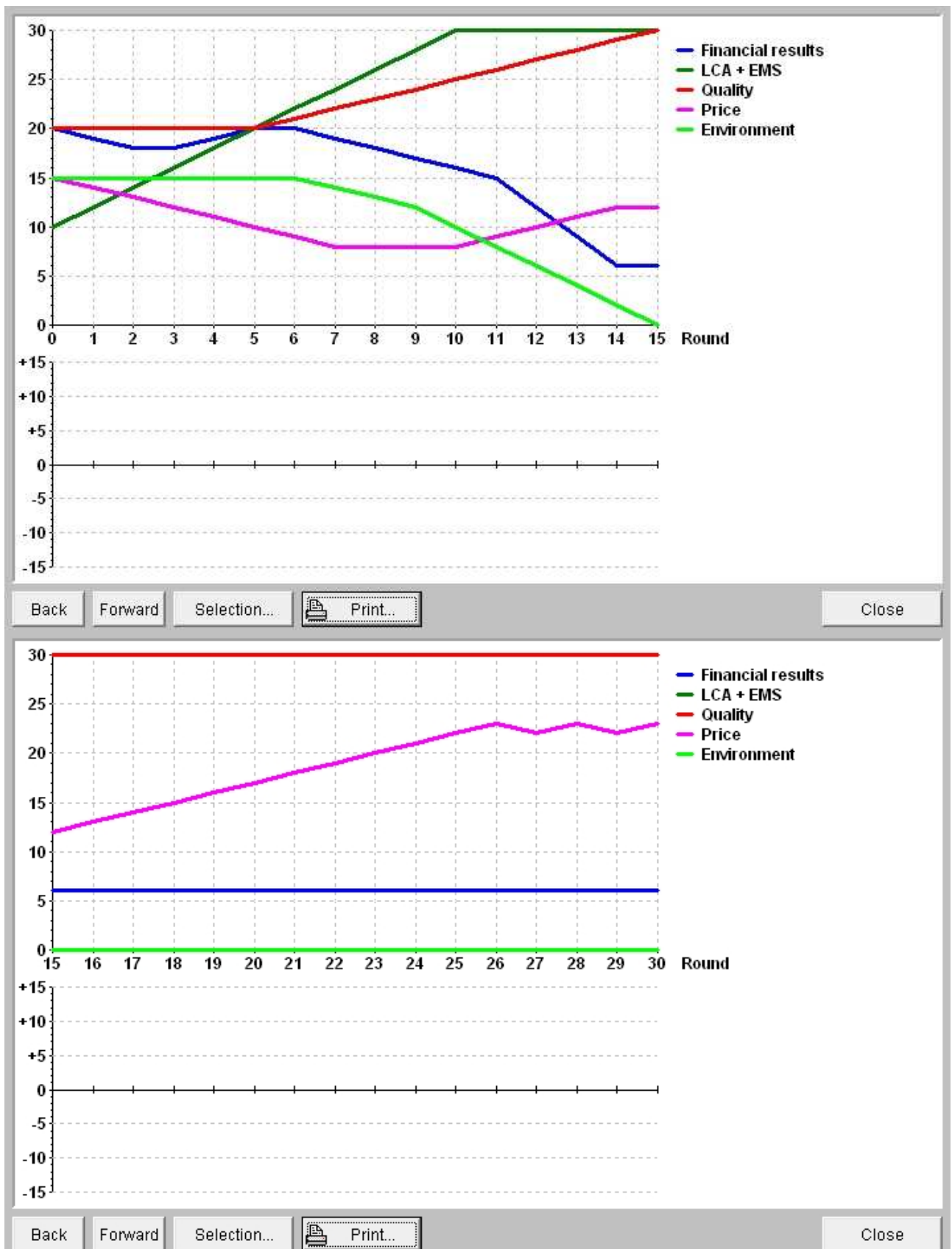
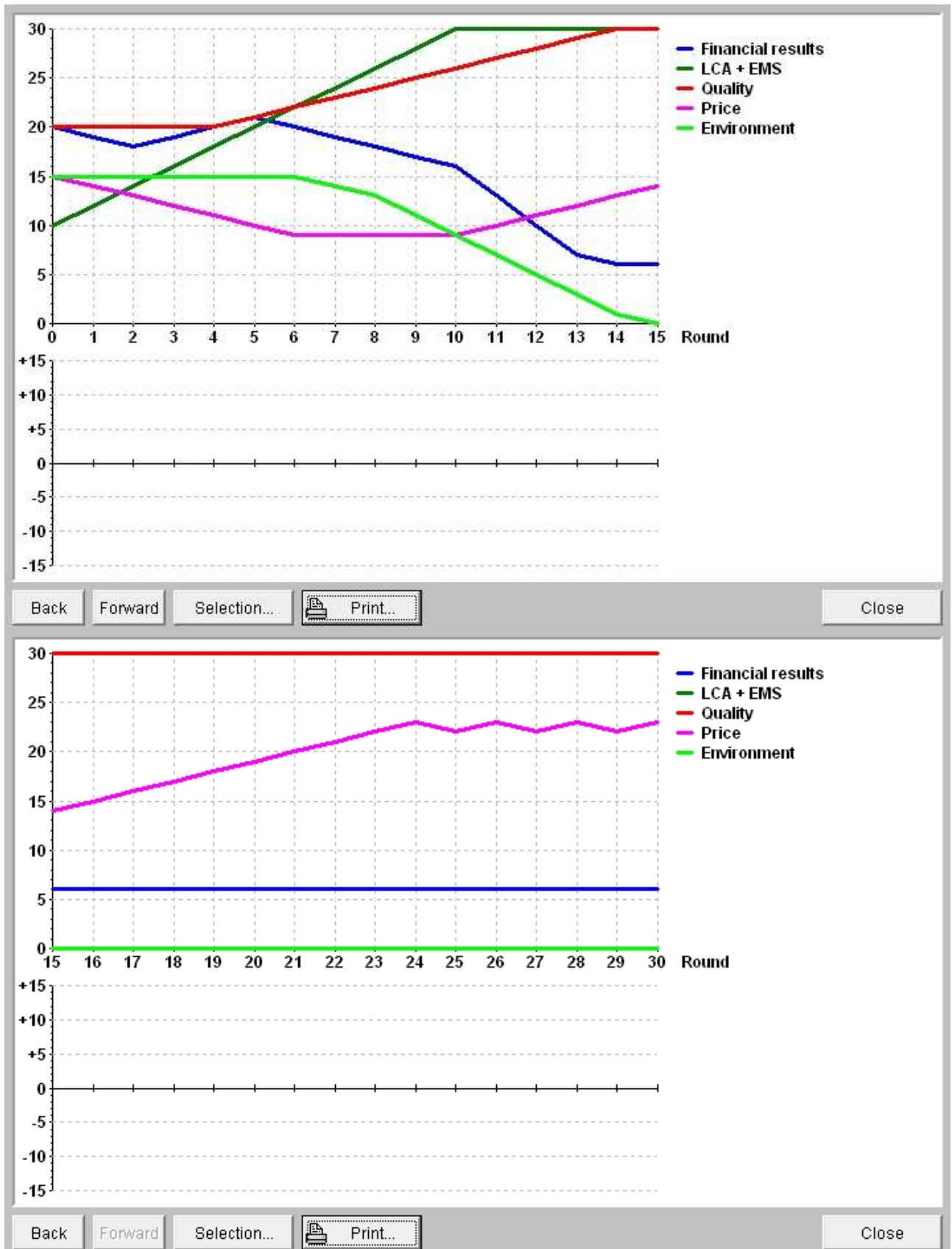

Figure 67 Simulation results, core variables with self-controlling feedback, stable policy test, simultaneous interactions.



**Figure 68 Simulation results, core variables with self-controlling feedback, stable policy test focusing on inner-enterprise variables.**



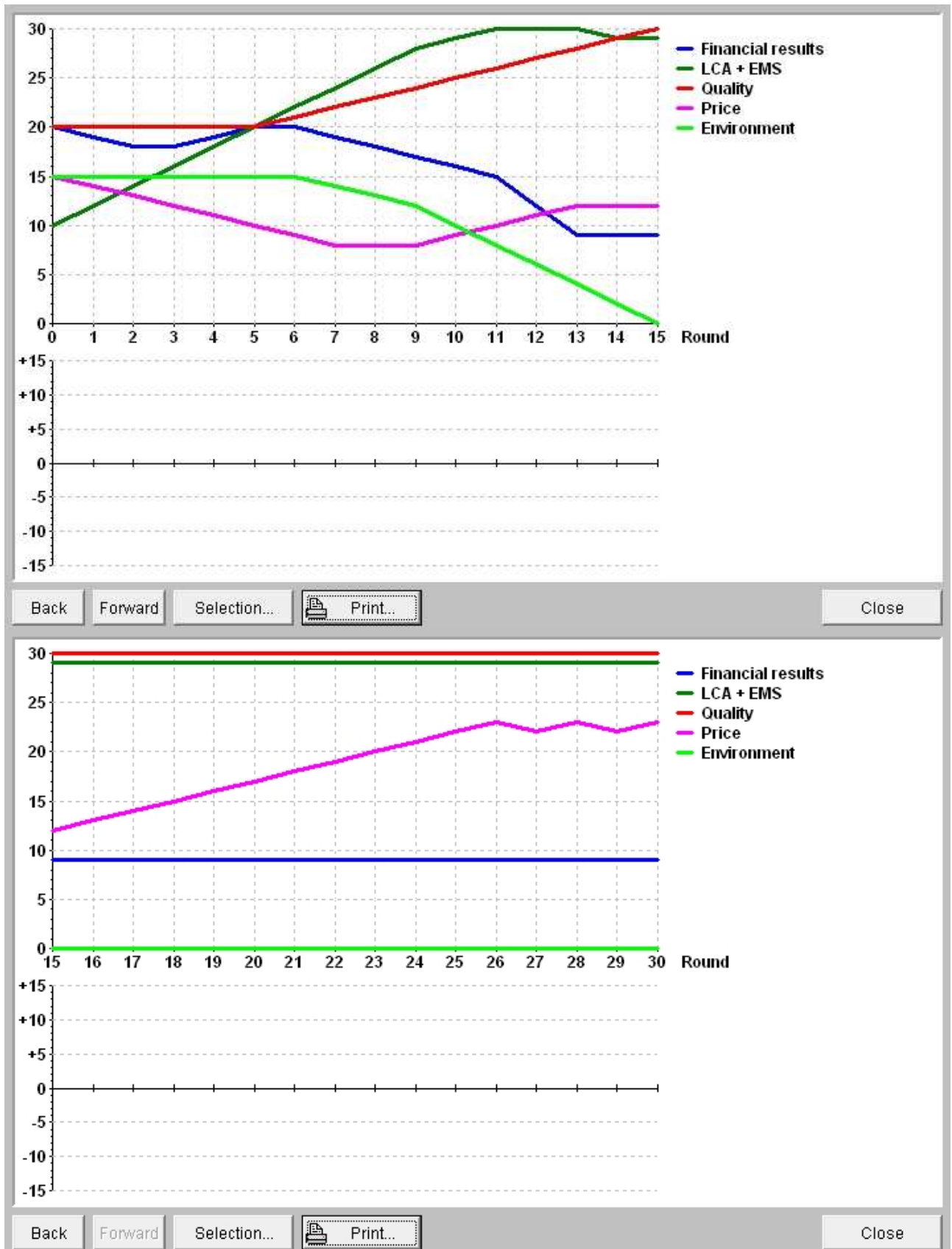
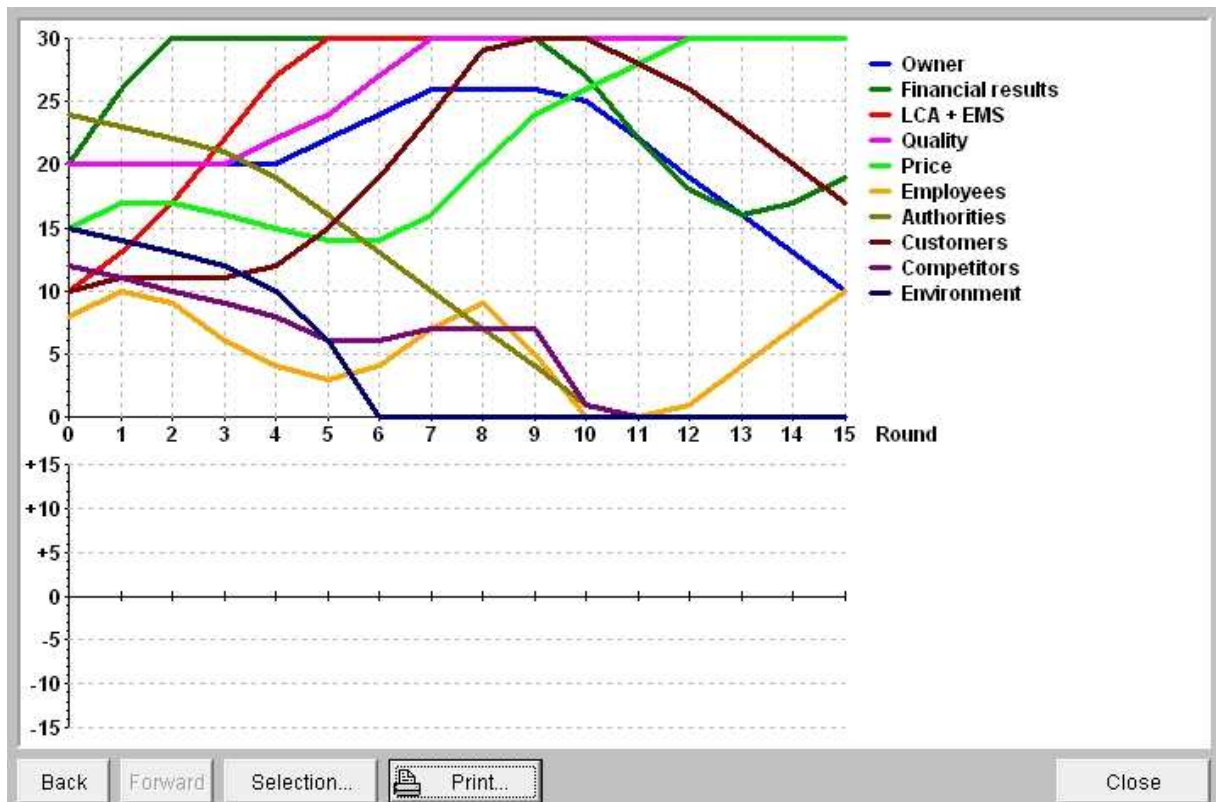
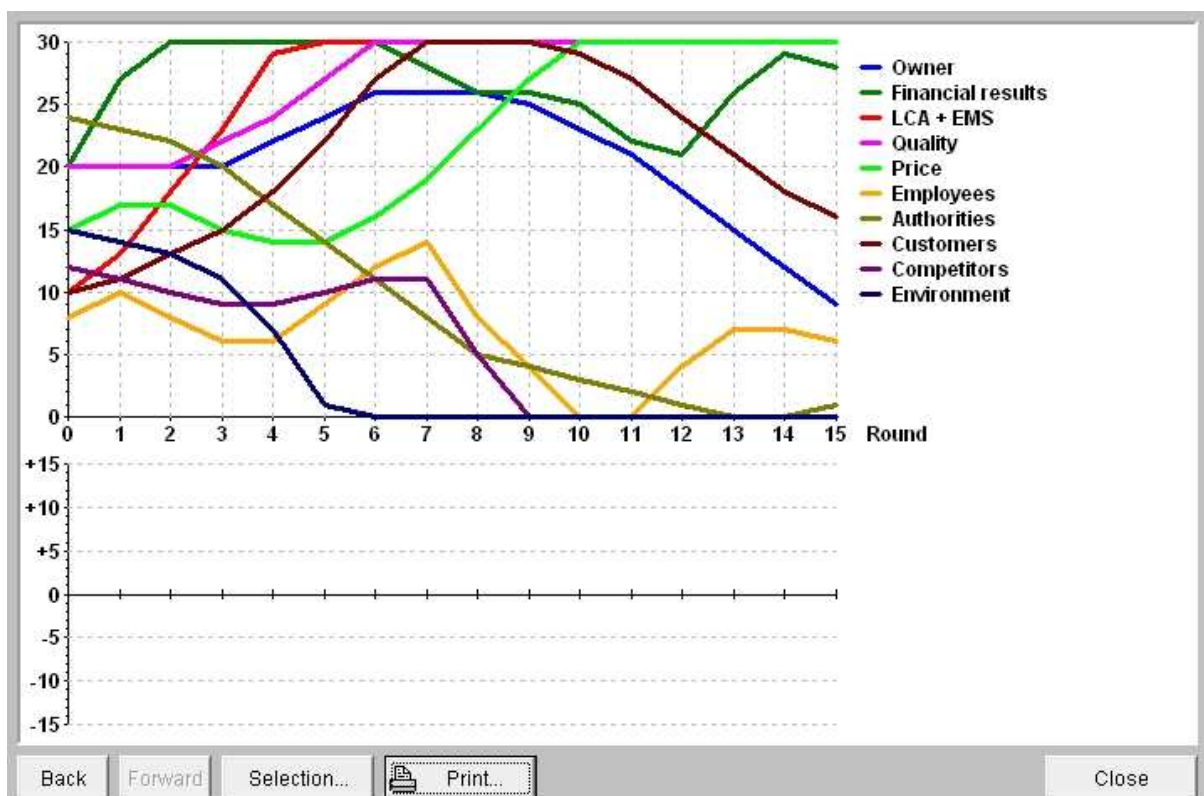

Figure 69 Simulation results, core variables with self-controlling feedback, stable policy test focusing on outer-enterprise variables.

## 2. Fluctuating policy scenario, modelling results



**Figure 70** Simulation results, critical variables without self-controlling feedback, fluctuating policy test, simultaneous interactions.



**Figure 71** Simulation results, critical variables without self-controlling feedback, policy test focusing on inner-enterprise variables.

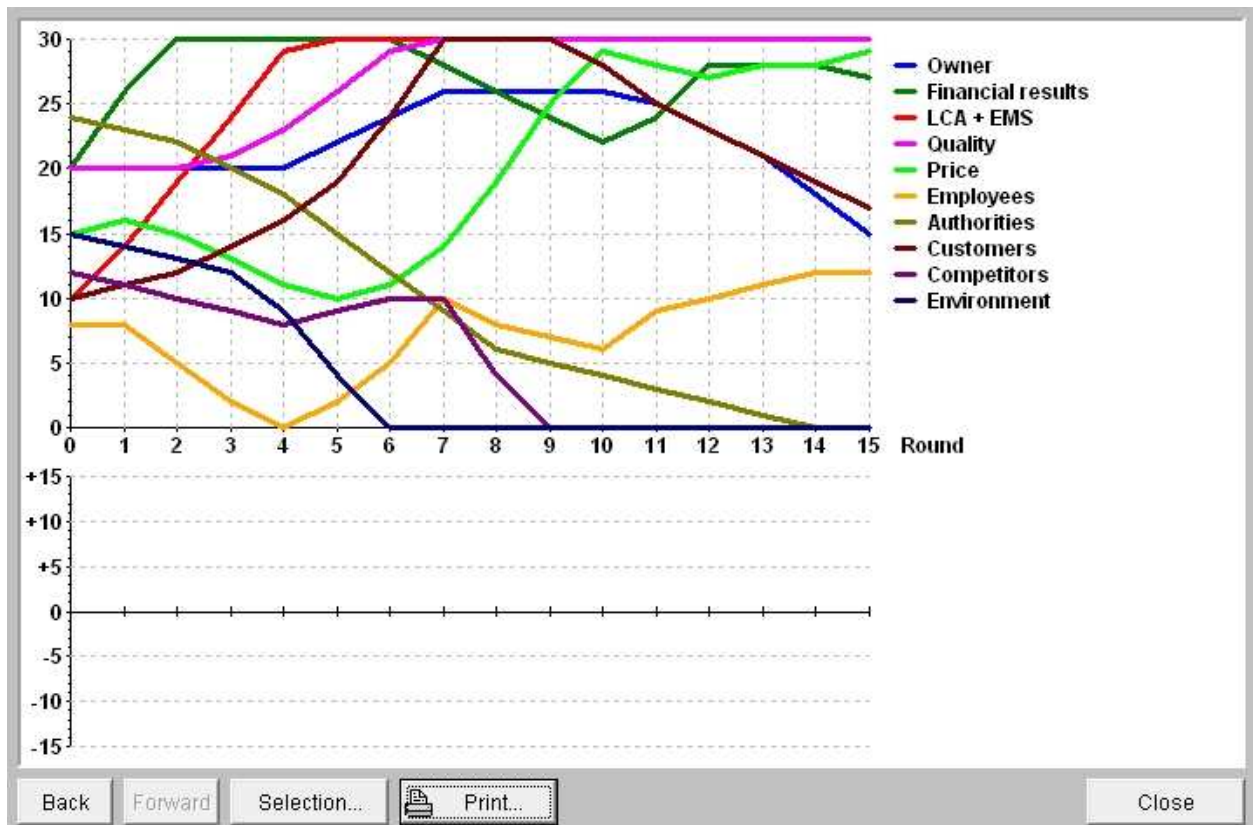

Figure 72 Simulation results, critical variables without self-controlling feedback, policy test focusing on outer-enterprise variables.

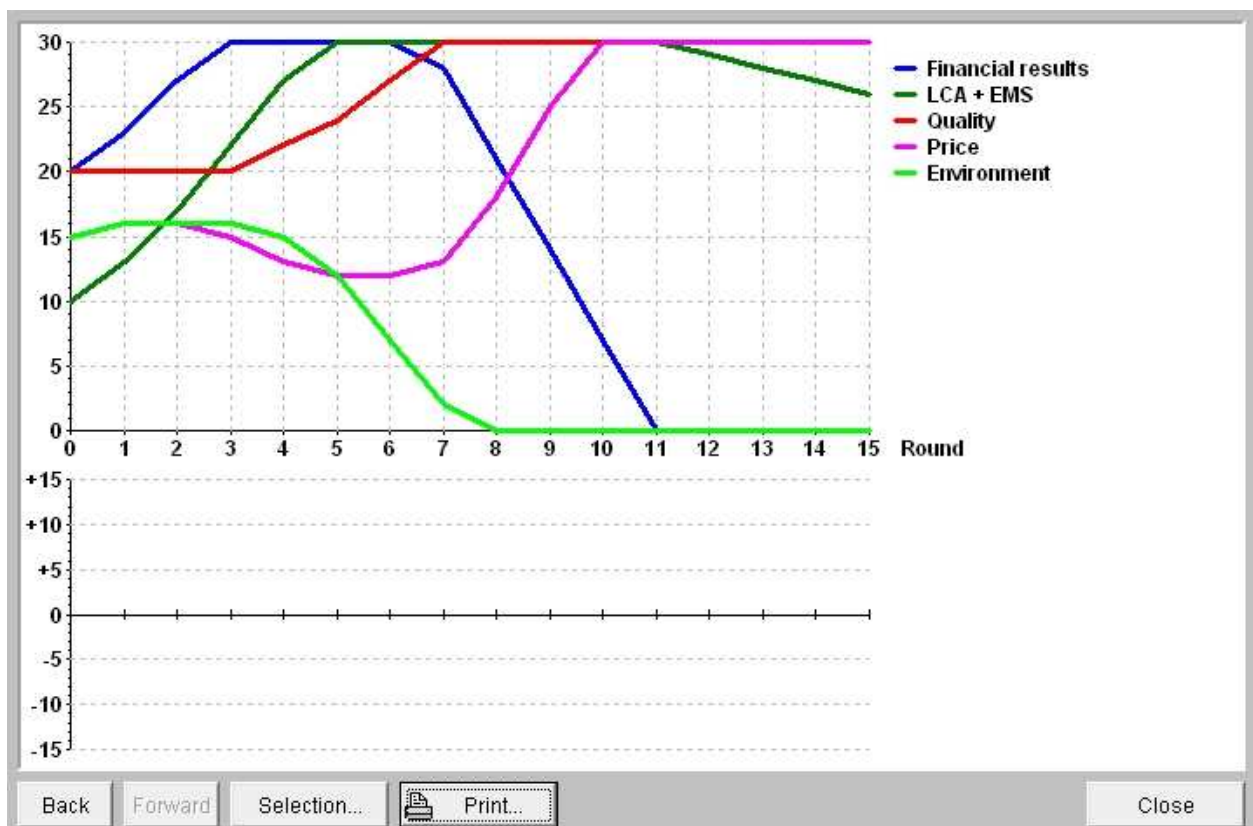

Figure 73 Simulation results, core variables without self-controlling feedback, fluctuating policy test, simultaneous interactions.

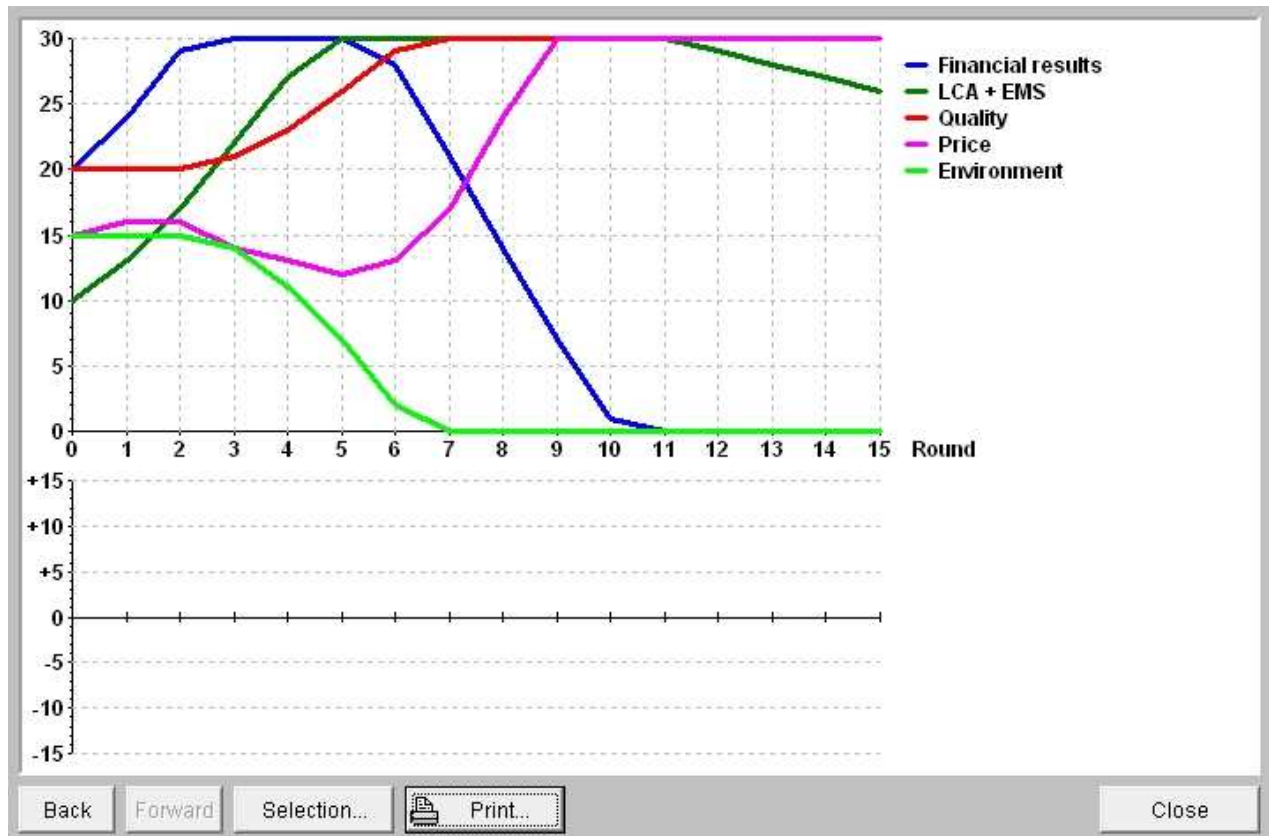

Figure 74 Simulation results, core variables without self-controlling feedback, policy test focusing on inner-enterprise variables.

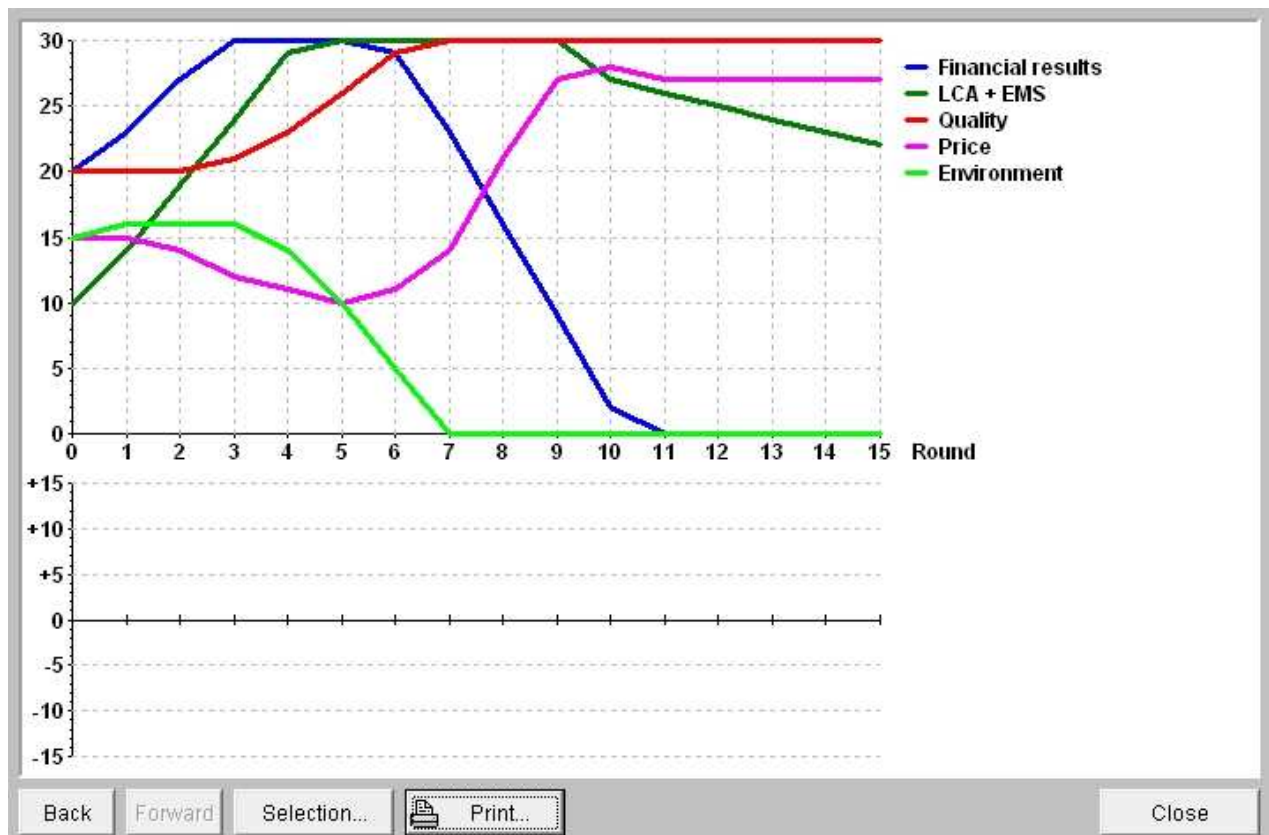

Figure 75 Figure 76 Simulation results, core variables without self-controlling feedback, policy test focusing on outer-enterprise variables.

## Index

<b>B</b>	
BUWAL .....	12, 14, 47, 49, 50, 52, 53, 54
<b>C</b>	
Characterization .....	55, 57, 60, 62, 69, 71, 74, 76, 82
CML 1992 .....	2, 9, 10
CML 2 Baseline 2000.....	2, 3, 9, 10, 55, 70
Cumulative Energy Demand .....	11, 57, 71
<b>D</b>	
Damage assessment.....	63, 77
<b>E</b>	
Eco-Indicator .....	13, 62, 63, 64, 65, 66, 76, 77, 78, 79
Ecopoints .....	2, 3, 5, 6, 12, 13, 58, 59, 72, 73
EDIP/UMIP .....	14, 15, 60, 61, 74, 75
EMS.....	83, 84, 85, 86, 87, 88, 91, 93, 100, 101
End of Life .....	47, 51
EPS .....	15, 16, 17, 67, 68, 80, 81
<b>G</b>	
Global Warming Potential.....	5, 9, 15, 60
<b>I</b>	
IMPACT 2002+.....	18
<b>K</b>	
Inventory analysis.....	20
IPCC 2001 .....	2, 3, 5, 6, 15, 17, 18, 69, 82
ISO.....	87
<b>L</b>	
KGE 3490X .....	2, 3, 5, 19, 55, 58, 59, 60, 61, 62, 63, 64, 65, 66, 67, 68, 69, 70
<b>L</b>	
LCA .....	10, 11, 83, 84, 85, 86, 87, 88, 91, 93, 100, 101
LCI.....	11
LCIA.....	9, 16
<b>N</b>	
Normalization .....	11, 16, 56, 61, 64, 70, 78
<b>S</b>	
SimaPro .....	9, 10, 11, 14, 15, 17, 18, 42, 51
Single Score.....	59, 66, 71, 73, 75, 79, 81
<b>T</b>	
TRACI .....	18
<b>W</b>	
Weighting .....	58, 65, 68, 72
Wrozamet .....	36, 37

---

## Declaration

### Declaration in lieu of an oath

Herewith I declare in lieu of an oath that I prepared this work on my own and without using any other as the quoted aids. The thoughts taken directly or indirectly from foreign sources are marked as such. Till now this work was not presented neither in the same nor in similar form to any other examining authority and has also not been published.

Cottbus, the 18.01.2010

---

Marek Gawor