

M. Sc. Ranjit Sharad Joshi

**Polymer surface modification using
novel underwater plasma (UWP) technique**

Die vorliegende Arbeit entstand an der BAM Bundesanstalt für Materialforschung und -prüfung und wurde vom VDI-TZ (BMBF) finanziert.

Impressum

**Polymer surface modification using
novel underwater plasma (UWP) technique**

2010

Herausgeber:

BAM Bundesanstalt für Materialforschung und -prüfung
Unter den Eichen 87

12205 Berlin

Telefon: +49 30 8104-0

Telefax: +49 30 8112029

E-Mail: info@bam.de

Internet: www.bam.de

Copyright © 2010 by

BAM Bundesanstalt für Materialforschung und -prüfung

Layout: BAM-Arbeitsgruppe Z.64

ISSN 1613-4249

ISBN 978-3-9813550-2-4

Polymer surface modification using novel underwater plasma (UWP) technique

vorgelegt von

M. Sc. Ranjit Sharad Joshi

aus Nanded, Indien

Inaugural-Dissertation

Zur Erlangung des akademischen Grades des
Doktors der Naturwissenschaften (Dr. rer. nat.)

eingereicht bei Fakultät III

Institut für Werkstoffwissenschaften und -technologien

Fachgebiet Polymertechnik und Polymerphysik

der Technische Universität Berlin

- 1. Gutachter:** Prof. Dr. rer. nat. Jörg F. Friedrich
- 2. Gutachter:** Prof. Dr.-Ing. Manfred H. Wagner

Disputation am: 23rd April 2010

ॐ



*When I asked god for strength, He gave me difficult situations to face
When I asked god for brain & brawn, He gave me puzzle in life to solve
When I asked god for happiness, He showed me some unhappy people
When I asked god for wealth, He showed me how to work hard,
When I asked god for favors, He showed me opportunities to work hard
When I asked god for peace, He showed me how to help others,
God gave me nothing I wanted; He gave me everything I needed*

-Swami Vivekanand

Dedicated to the memory of my holy ancestors

Abstract

Plasma chemical methods are well suited for introducing functional groups to the surface of chemically inert polymers such as polyolefins. However, a broad variety of functional groups is often formed. Unfortunately, for further chemical processing such as grafting of molecules for advanced applications a highly dense and monotype functionalized polyolefin surface is needed. Therefore, the main task was to develop a selective surface functionalization process, which forms preferably one type of functional groups at the surface in high and variable concentration. Amongst the novel plasma methods, the under-water plasma process (UWP) is one of most attractive to solve the problem of monotype functionalization. Such plasma is an efficient source of ions, electrons, UV-radiation, high frequency shock waves, radicals such as hydroxyl radical and reactive neutral molecules such as hydrogen peroxide, hydrogen and oxygen. It was found that underwater plasma and the closely related glow discharge electrolysis are interesting new methods for polymer surface functionalization. An effective modification into the topmost surface chemistry of polymer layer was observed by the collective effect of wet-chemistry, electrochemistry, atmospheric gas discharges, irradiation, and shock waves. Underwater capillary discharge was seen more effective in -OH functionalization and was largely seen as a flow dominated process because of the shock wave turbulences. Using such water-based plasma a fraction of 25-40% of all O-functional groups was produced as OH-groups in comparison to <10% OH produced in the oxygen low-pressure plasma. The exact concentration of the OH functionality was studied by TFAA gas phase derivatization and measuring the respective fluorine concentration by photoelectron spectroscopy (XPS).

In contrast to established gas phase glow discharge processes, the water phase absorbs and therefore limits the particle and radiation energy and thus the energy input into the polymer. Extensive oxidation, degradation, cross-linking and radical formation in the polymer is more limited than under gas plasma exposure because of the liquid water environment, which moderates high energetic plasma species. The variety of plasma produced species in the water

phase is also much smaller because of the limited reaction possibilities of the plasma with water. The possibility to admix a broad variety of chemical additives makes underwater plasma additionally highly attractive for the chemist. At last, the water removes all low-molecular weight oxidized products formed by plasma-induced polymer degradation.

Hydrogen peroxide and the catalyst (Fe-ZSM5) should influence or increase the equilibrium concentration of OH radicals in the underwater process. It was supposed that these radicals play the most important role for OH functionalization of polyolefin surfaces. Hydrogen peroxide was believed to be the most prominent precursor for OH group formation in the UWP. The catalyst should modulate the steady state of OH group formation and recombination, and thus accelerate the functionalization. This was confirmed by an increased oxidation rate. Owing to the detection limit of XPS the C-O bond selectivity was defined as clearly resolvable subpeak within the C1s signal assigned to C-OH, C-O-C and other singly C-O bonded species. This bond amounts 47 C-O bonds/100 O atoms with pure UWP system and enhances to a maximum of the 81 C-O bonds/100 O atoms using the Fe-ZSM5 catalyst system. Therefore, this method exhibits a great progress for a start. However, after TFAA derivatization the fraction of desired OH groups could not be significantly increased.

In the continuation acetic acid, acrylic acid, maleic and itaconic acid were used as additive monomers. The chemical selectivity in -COOH bond formation using bi-carboxylic additives was seen inferior. Acetic acid is not a chemically polymerizing monomer but it could polymerize by monomer/molecular fragmentation and recombination to a cross linked layer. The other monomers form preferably water-soluble polymers on a preferred chemical way. Only the fragmented fraction of these monomers could form an insoluble coating by cross linking to substrate. The XPS analysis was used to track the alterations in COO- bond percentage on the PP surface. To identify the -COOH groups on substrate surface unambiguously, which have survived the plasma polymerization process, the gas phase derivatization with trifluoroethanol

was performed. A much higher yield in COOH groups was achieved using the glow discharge electrolysis and acrylic acid.

Zusammenfassung

Plasmachemische Methoden sind geeignet, um chemisch inerte Polyolefinoberflächen zu funktionalisieren. Meist entsteht jedoch dabei eine große Vielfalt verschiedener funktioneller Gruppen. Für Pfropfreaktionen an diesen Gruppen, aber auch für höherwertige Anwendungen ist die Existenz einer hochdicht mit einer einzigen Sorte funktioneller Gruppen versehenen Polymeroberfläche Voraussetzung. Dementsprechend sollte in dieser Arbeit versucht werden, einen solch einen selektiven Funktionalisierungsprozeß zu entwickeln, der möglichst nur eine Art funktioneller Gruppe in hoher Konzentration liefert. Innerhalb mehrerer neuentwickelter selektiver Plasmaprozesse erschien das Unterwasserplasma (UWP) besonders aus technischer Sicht zur Lösung dieses Problems geeignet.

Das UWP ist Quelle von Ionen, Elektronen, UV-Strahlung, Schockwellen, Radikalen, wie Hydroxyl-, sowie reaktiven Neutralkmolekülen, wie Wasserstoffperoxid, Wasserstoff und Sauerstoff. Das UWP und die nahverwandte Glimmentladungselektrolyse (GDE) stellen interessante neue Methoden für die Polymeroberflächenmodifizierung dar. Die Polymeroberfläche wird durch Wirken von Elektrochemie, Naßchemie, Plasma- und Strahlenchemie sowie durch Schockwellen umgestaltet. Das UWP ist naheliegenderweise besonders zur Polymeroberflächenmodifizierung mit OH-Gruppen geeignet. Es ist wegen der Art der Erzeugung (Kapillarentladung und Schockwellenerzeugung) ein strömungsbestimmtes Plasma. Je nach Entladungsbedingungen hatten die OH-Gruppen einen Anteil von 25-40% von allen durch das Plasma eingeführten sauerstoffhaltigen Gruppen. Dieser Anteil reicht nicht aus, um von einem selektiven Plasma zu sprechen, ist aber deutlich höher als bei der Modifizierung im Sauerstoffniederdruckplasma, wo weniger als 10% aller O-Funktionalitäten OH-Gruppen sind. Die genaue Bestimmung der OH-Gruppenkonzentration erfordert deren Derivatisierung mit Trifluoressigsäureanhydrid (TFAA), um über die Fluorbestimmung mit Photoelektronenspektroskopie (XPS) diese Konzentration berechnen zu können.

Im Unterschied zu der etablierten Niederdruckplasmatechnik moderiert die Wasserphase

im UWP die hochenergetischen Spezies sehr schnell auf ein energetisch niedriges Niveau, was den Energieeintrag und die damit verbundenen Veränderungen im Polymer begrenzt. Intensive Oxidation, starker Abbau, Vernetzung und Radikalbildung im Polymer werden weitgehend zurückgedrängt. Möglicherweise dennoch entstehende Abbauprodukte werden durch die umgebende Wasserphase sofort aufgelöst. Die Produktpalette an funktionellen Gruppen auf der im UWP modifizierten Polypropylenfolie beschränkt sich auf C-O-Spezies mit einer Sauerstoffeinfachbindung und wenigen mit zwei Sauerstoffbindungen. Ein weiterer interessanter Gesichtspunkt ist, daß eine Vielfalt an chemischen Additiven zum UWP zumischbar ist, wodurch sich die Reaktionsrichtung beeinflussen läßt.

Wasserstoffperoxid- und Katalysatorzugabe (Fe-ZSM5) sollten die Reaktivität des UWP beeinflussen, indem die Konzentration der für die OH-Funktionalisierung verantwortlich gemachten OH-Radikale als Produkte der homolytischen Wasserstoffperoxiddissoziation erhöht wird. Der Katalysator beschleunigte die Gleichgewichtseinstellung zwischen OH-Gruppenbildung durch Dissoziation und Rekombination, was sich vor allem in einer erhöhten Oxidationsrate widerspiegelte. Entsprechend den analytischen Möglichkeiten der XPS konnten als Schnellbestimmung lediglich die Summe aller C-O einfach gebundenen Spezies gemessen werden, wie C-OH, C-O-C oder Hydroperoxide. Diese „C-O-Selektivität“ betrug im UWP 47 C-O/100 O-Atome und konnte durch Mitwirkung des Katalysators (Fe-ZSM5) auf 81 C-O/100 O-Atome verbessert werden, was zunächst einen bemerkenswerten Fortschritt darstellte. Die TFAA-Derivatisierung ergab jedoch, daß der Anteil an OH-Gruppen innerhalb der C-O-Spezies nicht erhöht werden konnte.

Eine andere Möglichkeit bestand in der Erzeugung von Carboxylgruppen an der Polypropylenoberfläche. Dazu wurden Essigsäure, Acryl-, Malein- und Itaconsäure als Modifikatoren bzw. Monomere für die Polymerbildung eingesetzt. Die erwartete bevorzugte Bildung von COOH-Gruppen an der Polymeroberfläche war jedoch niedrig bei Einsatz polymerbildender Säuren. Diese Tatsache war nicht weiter verwunderlich, weil die gebildeten

COOH- enthaltenden Polymere wasserlöslich sind. Nur die durch das UWP fragmentierten Monomere konnten eine im Wasser nicht lösliche Polymerabscheidung ergeben, die aber nur noch einen gewissen Bruchteil der ursprünglichen COOH-Gruppen besaß. Essigsäure muß diesen Fragmentierungsweg gehen, wobei gehofft wurde, daß überlebende COOH-Spezies an der Polypropylenoberfläche die gewünschten Säuregruppen in der vernetzten Schicht bilden würden. Die XPS wurde zur Identifizierung und Konzentrationsbestimmung der COOH(R)-Spezies benutzt. Zur zweifelsfreien Konzentrationsbestimmung wurde die Gasphasenderivatisierung mit Trifluorethanol eingesetzt. Eine wesentlich höhere COOH-Ausbeute ergab der Einsatz von Acrylsäure in der GDE.

Abbreviations

| | |
|-------|--|
| UWP | underwater plasma |
| UW | underwater |
| GDE | glow discharge electrolysis |
| APGD | atmospheric pressure glow discharge |
| DBD | dielectric barrier discharge |
| AeDBD | Aerosol dielectric barrier discharge |
| ESI | electro spray ionization |
| cps | counts per second |
| eV | electron volt (1 eV = 1.6022×10^{-19} J) |
| cw | continuous wave |
| r. f. | radio frequency |
| Pa | Pascal (1 Pa = 1 N/m ²) |
| W | Watt (W = 1 J/s) |
| UV | ultra violet |
| kJ | kilo joules (1 joule = 10^7 ergs = 0.2388 calorie) |
| VOC's | volatile organic compounds |
| AC | alternating current |
| DC | direct current |
| HV | high voltage |
| XPS | X-ray photoelectron spectroscopy |
| ESCA | electron spectroscopy for chemical analysis |
| PP | Polypropylene |
| PE | Polyethylene |
| PAA | Poly (acrylic acid) |
| AA | acrylic acid |

| | |
|------|------------------------------|
| IA | itaconic acid |
| S | seconds |
| TFAA | tri fluoroacetic anhydride |
| TFE | 2,2,2-Trifluoroethanol |
| THF | Tetrahydrofuran |
| SEM | scanning electron microscope |
| NMR | nuclear magnetic resonance |

| | |
|--|-----------|
| 1. Introduction | 1 |
| 1.1 Background and Basics | 1 |
| 1.1.1 Known surface functionalization methods | 2 |
| 1.1.2 Relevance of plasma for polymer surface modification | 5 |
| 1.2 Motivation | 7 |
| 1.2.1 History of atmospheric underwater discharges (plasma) | 12 |
| 1.2.1.1 Glow discharge electrolysis | 12 |
| 1.2.1.2 Underwater capillary discharge | 14 |
| 1.2.1.3 Underwater corona discharge | 17 |
| 1.2.1.4 Atmospheric-Pressure Glow discharge (APGD) electrolysis using Liquid-Electrode | 17 |
| 1.2.2 Comparison of APGD electrolysis (liquid electrode) and capillary discharge approach | 19 |
| 1.3 Underwater plasma reaction pathways and kinetics | 22 |
| 1.3.1 Surface functionalization by oxygen functionalities | 22 |
| 1.3.1.1 Hydroxyl (OH) functionalization | 22 |
| 1.3.1.2 Role of H ₂ O ₂ and R-O-OH in UWP processes | 26 |
| 1.3.1.3 Enrichment of the carboxylic (-COOH) functionality at PP surface | 29 |
| 1.4 Approach and perspective of the work | 32 |
| 1.4.1 Brief overview of proposed work | 33 |
| | |
| 2. Experimental | 34 |
| 2.1 Underwater plasma assembly construction | 34 |
| 2.2 Materials and characterization | 37 |

| | | |
|------------|--|-----------|
| 2.2.1 | Surface analysis technique by XPS | 38 |
| 2.3 | Derivatization of functional groups for improved XPS analysis | 39 |
| 2.3.1 | Hydroxyl (-OH) group derivatization | 39 |
| 2.3.2 | Carboxylic (-COOH) group derivatization | 40 |
| 2.3.3 | Hydroperoxyl (-O-OH) group derivatization | 40 |
| 2.4 | Analysis of UWP exposed olefinic monomer (Acrylic Acid) | 41 |
| | | |
| 3. | Results | 43 |
| | | |
| 3.1 | Underwater Capillary Discharge – visual observations | 43 |
| 3.2 | Oxygen bonding efficiency, selectivity and related parameters definitions | 48 |
| 3.2.1 | Functionalization with hydroxyl groups (OH) | 48 |
| 3.2.2 | Functionalization with carboxylic groups (COOH) | 48 |
| 3.3 | Dependence of polymer surface functionalization on plasma generation parameters | 49 |
| 3.3.1 | Electrolyte concentration (sodium chloride) | 49 |
| 3.3.2 | Distance of polymer film from plasma source | 51 |
| 3.3.3 | Influence of solution temperature on selectivity | 57 |
| 3.3.4 | Influence of solution pH on selectivity | 58 |
| 3.4 | Selectivity and yield in OH-group formation | 60 |
| 3.5 | Post-UW plasma treatment using reducing agents | 62 |
| 3.6 | Hydrogen peroxide incursion experiment | 65 |
| 3.6.1 | Qualitative effects of hydrogen peroxide addition on hydroxyl (-OH) group functionalization | 65 |
| 3.6.2 | Quantitative effects of hydrogen peroxide addition on hydroxyl (-OH) group functionalization | 67 |

| | | |
|-----------|---|-----------|
| 3.7 | Hydroxyl (-OH) functionalization using the Fe-ZSM5 catalyst system | 68 |
| 3.8 | Qualitative interpretation and results comparison obtained by addition of hydrogen peroxide and Fe-ZSM5 catalysts to the UWP system | 70 |
| 3.9 | Study of hydroperoxide (-O-OH) functionality generated by the UWP process | 71 |
| 3.10 | Possibilities to produce other functional groups | 75 |
| 3.10.1 | Carboxylic (-COOH/-COO-) functionalization of PP-surface | 75 |
| 3.11 | Plasma polymerization of acrylic acid in the UWP | 86 |
| 3.11.1 | Carboxylic (-COOH/-COO-) group derivatization results | 89 |
| 3.12 | APGD electrolysis using liquid electrode | 91 |
| 3.12.1 | Polymer surface modification by deposition of OH and COOH groups containing polymers using the GDE | 91 |
| | ○ Acrylic acid, | |
| | ○ Ethylene glycol, | |
| | ○ Allyl alcohol | |
| 4. | Discussion | 94 |
| 4.1 | Underwater plasma and selectivity in surface functionalization (-OH) process | 94 |
| 4.2 | Factors affecting the selectivity of functionalization | 97 |
| 4.3 | Interrelation of OH and O-OH functionalization | 100 |
| 4.4 | Comparison of bond selectivity obtained by atmospheric/reduced pressure discharges with UWP (XPS perspective) | 103 |

| | |
|---|------------|
| 5. Application of capillary diaphragm discharge to the contact lens material | 107 |
| 6. Conclusions | 110 |
| 7. References | 113 |
| 8. List of publications from this work | 123 |
| 8.1 Peer reviewed journal articles | 123 |
| 8.2 Oral presentations | 123 |
| 8.2.1 Self delivered | 123 |
| 8.2.2 Contribution into the confere's orals | 124 |
| 8.3 Poster presentations | 125 |
| 9. Acknowledgements | 126 |

1. Introduction

1.1 Background and Basics

The chemistry of polymer surfaces plays a decisive role in stipulating the properties of polymers such as surface energy, wettability with polar liquids as water and bonding ability to coatings, adhesives or metals. Repercussion of absence of any functional groups and the chemical inertness of all polyolefin is evident in its very low surface energy, insignificant wettability with polar liquids as water and weak bond-ability to coatings, adhesives or metals. Thus science behind surfaces of organic polymer has remained an intensively studied and investigated area because of continued advance innovations in the polymer academics and relevant application industry. Polyethylene and polypropylene for its very good recycling abilities within the existing

| Bulk properties of polymers | Surface properties of polymers |
|--|---|
| <ul style="list-style-type: none">• chemical structure• molecular mass• polymer morphology | <ul style="list-style-type: none">• surface energy• optical• biocompatible• electrical/magnetic• morphology/texture |

Table 1 : Properties of polymers, which may be affected by the method of polymer surface modification

commercial engineering plastics remained a prominent object of intense studies for improvement of their interactions to other solids and liquids [1]. The majority of its technical applications are connected with a highly adherent bonding to other materials. Diverse new applications for engineering polymers have therefore made polymer surface modification methods to a subject of intense research. It is seldom to find a suitable polymer which perfectly suits an intended application. Mostly an engineering polymer is selected for an application primarily because of its favorable bulk properties such as thermal stability, mechanical strength and solvent resistance. Copolymerization, blending and additives can help to tailor the desired application properties.

The polymer bulk communicates, interacts with its surrounding via its surface. Therefore, the utility of the polymer could be enhanced when the polymer is processed and its surface is chemically modified. Modification of surface properties without changing the properties of bulk properties is one of the main tasks [2]. Various physical and chemical pretreatments for modifying important surface properties of polymer materials are summarized in the Table 1. A few major techniques should be mentioned [3, 4]:

1.1.1 Known surface functionalization methods

Copolymerization of monomer forming an inert polymer segment and a monomer carrying functional groups. Several types of copolymers of inert and reactive units can be formed as graft, block, random or alternating copolymer. Thus, the resulting copolymer can undergo interactions to other materials or reactions on its surface as well as into the polymer bulk. Prominent examples are copolymers with vinyl alcohol, acrylic acid, maleic acid etc.

Surface functionalization by a well defined classic organic chemistry involves essentially suitable polymers vulnerable for electrophilic or nucleophilic attack. Polymers containing most preferred sites for changing the wettability and bond ability like benzene nucleus, hydroxyl groups, double bonds and halogens can be grafted by adhesion-promoting groups.

Wet chemical oxidation treatments are one of the most classical and widely accepted techniques for the process of surface treatment of inert class of polymers like polyethylene, polypropylene and polyester cords, fibers and films. It is carried out by strong oxidizing agents such as chromic acid, nitric acid, potassium permanganate, hydrogen peroxide and peroxidisulfuric acid. A strong oxidizing agent tends to introduce oxygen in all possible chemical combinations like carbonyls, hydroxyl and carboxylic acid groups on and into the polymer surfaces. Introduction of all such combinations in the form of oxygen is often sufficient to improve wettability and adhesion of such inert polymer surfaces. However, waste water and ecological problems hinder the further use of these oxidations.

Reductive treatment is applied to promote the adhesion property of per-fluorinated polymers as poly (tetrafluoroethylene) (PTFE). Sodium dissolved in naphthalene or ammonia is known as reducing agent for Teflon and forms a reasonable bondability.

Plasma treatment is finally the most often used and very viable method for polymer surface activation, the topic and the point of this study [5]. A method with a maximum power and versatility, which can be used for cleaning or etching of polymer surface by removing some of its topmost surface layers, introducing functional groups as well as depositing a thin polymer coatings on the polymer substrate.

However, modification is a generic term used for all chemical and physical changes that are introduced to the surfaces of organic and inorganic materials. It can be roughening, coating, oxidizing etc. Functionalization means the introduction of functional groups onto the polymer surface. The process which introduces chemically different types of functional groups a term of unspecific functionalization is used. Specific functionalization stands for monosort functional groups, e.g. only one type of functional groups exists. Usual functional groups are OH, COOH,

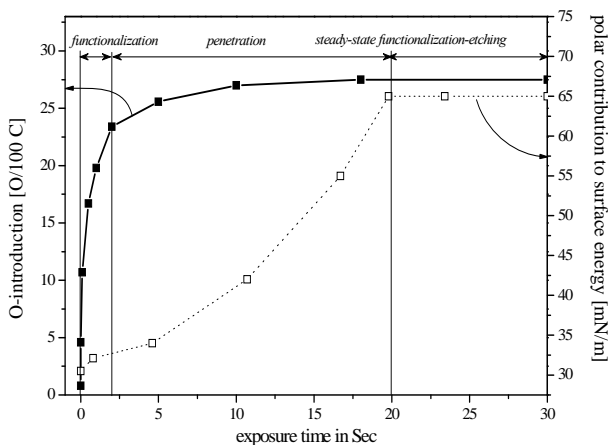
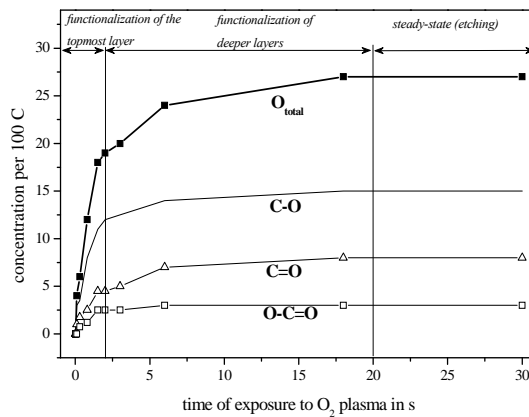

Figure 1
Typical exponential increase of introduced oxygen onto polyethylene surfaces if exposed to the O₂ plasma (c.w. -r.f., 6 Pa, 100 W) and increasing of polar component of surface energy

epoxy, NH₂, SH etc.

Using the low-pressure oxygen plasma treatment the surface was functionalized within ca. 2 s followed by oxidation of carbon atoms below the top most carbon layer but within the information depth of the photoelectron spectroscopy method (XPS). After about 20 s a steady-state of formation, further oxidation and splitting off the functional groups and forming gaseous degradation products (CO_2 , CO , H_2O) occurs (Fig. 1) [6].

Figure 2
Oxygen introduction and fitted C1s on polypropylene surfaces in dependence on exposure to the cw r.f. plasma (100 W, 6 Pa)



Most often unspecific functionalization dominates, i.e. different types of functional groups are formed simultaneously as singly, doubly and triply bonded oxygen to carbon (Fig. 2). The monotype functionalization is achieved by polymerization or copolymerization of monomers bearing functional groups, thus, the resulting polymer also carries the same functional group as the monomer and forms a top-coating at the surface of the polymer substrate.

The same strategy was used to form monotype functional-group carrying deposits by electrospray ionisation (ESI) [7]. The method ESI works at atmospheric pressure and deposits via a special mechanism, single macromolecules at the substrate surface without any degradation, thus forming an ultra-thin polymer layer [8].

Moreover, also under low-pressure conditions monotype functional groups at polyolefin surface can be produced by plasma bromination with high yield and high selectivity [9]. However, it is easy to understand that thin polymer topcoats bear problems with their adhesion to the

polyolefin substrate and the low-pressure plasma bromination is handicapped by the need of vacuum.

Subsequent post-polymerization functionalization processes at polymer surface whether it's chemical, physical or plasma basis are always connected with unspecific functionalization. In the case of chemically inert structures such as for polyolefin's, the structure can only be attacked by oxidative processes; however, they are generally not selective. Further complications are also due to the fact that the functionalization does not stop automatically at the topmost surface layer, therefore, the subjacent layers are also influenced, either functionalized or degraded as shown in Fig. 2. Desorption of adsorbates or contamination of layers at the surface occurs firstly, activation of the surface molecules follows, attachment of the plasma gas or activated liquid under formation of functional groups is the next, then the oxidation proceeds to degradation and etching as well as UV light from the plasma crosslink's, forms radicals or degrades the polymer.

1.1.2 Relevance of plasma for polymer surface modification:

Plasma is an ionized gas comprising a dynamic mix of electrons, ions, neutrons photons, free radicals, meta-stable excited species, neutral atoms and molecules, also called as fourth state of matter. More than 90% of all matter in the universe exists in this plasma state [10]. Under the action of an electromagnetic field high energy species were produced by collisions (or radiative processes). They were accelerated under the influence of the electromagnetic field, collide with other species and loose its energy and transfer it to the other particle or to the wall. Elastic collisions of equiponderate particles equilibrate the energy within the plasma system and collisions of light electrons with heavy particle produce excitation, ionization, dissociation, re-charging, charge transfer, recombination radiation etc. [11]. The energy from the electromagnetic field is mainly acquired by plasma electrons because of its swift spur within the electrical field. Their inelastic collisions gas molecules leading to ionization and the appearance of the ion avalanche as the basic process of ignition and sustain the plasma. Recombination and quenching

at the walls limit the ion avalanche and produce a steady state of the plasma. Electrons and ions generate the plasma conductivity. The broad distribution of energy over all species in the plasma is reflected in the electron energy distribution function. In ordinary gas plasmas (glow discharges) under low-pressure the range of energetic species also involves components with energies much higher than those of chemical bonds in polymers. It must be considered, that the supply of (electrical) energy is continuous. The transfer of energy leads to a variety of new species which are chemically active and thus can serve as precursor for the new stable compounds. Thus, by an elaborated choice of the precursor the resulting functional group can be roughly predetermined. However, numerous by-products and side-products are also formed. The plasma initiated energy rich species and their collision with the other neutrals initiates a new chemical processes giving rise to a phenomenon known as plasma chemistry. Chemists have always been fascinated by the various electric discharges they have observed in nature and into experimental studies. Their expectation was to possess a new convenient, clean, waste-free, one-step, powerful universal chemical tool. As and when these techniques were available for producing discharges in the laboratory, they attempted to use them for chemical synthesis. There are several reported attempts to maneuver the organic chemical reaction for the synthetic purpose using the plasma as a tool [12-21]. In comparison with the classic and wet chemical oxidation processes, use of plasma was always considered suitable convenient and eco-friendly process for the polymer surface energy alteration. A few reactions are only possible by plasma assistance, such as production of noble gas compounds or artificial diamond layers (DLC) [22].

Chemist's perspective provides that plasma is a new way of transferring energy to molecules. This phenomenon is very successfully maneuvered into atmosphere, vacuum as well as into the water phases depending upon the utility and the feasibility of the techniques [1, 23]. The genesis of life on earth was an interaction of gases, water, heat and plasma as shown by S. L. Miller and H. C. Urey simulating the urea under atmospheric plasma conditions. Using ammonia, water, carbon dioxide etc. amino acids were formed under exposure to plasma [24, 25].

The most interesting, essential and desired feature of this plasma tool is its ability to modify polymer substrates without affecting the bulk properties of the polymer. Here, all low-and atmospheric pressure glow discharges, corona and dielectric barrier discharges as well as the underwater plasma possess an important advantage for processing of temperature-sensitive materials, such as organic substances but above all polymers. These plasmas are not in the thermodynamic equilibrium, e.g. only the electrons have high energy. Heavy particles transfer their energy efficiently to the walls and cool down. Thus, the gas temperature in such plasma is commonly below 50°C. Therefore, they are also called as “cold” plasmas, well suited for polymer modification. Therefore, they accumulate the absorbed electrical energy as high kinetic energy. The limitless growing of electron energy is stopped only by the inelastic collisions as mentioned before. Thus, cold plasmas are chemically powerful but thermally soft.

However, also “hot” plasmas of a few thousand Kelvin may be useful for polymer surface modification if ignited under water, thus cooled down, and applied indirectly. Indirectly means the plasma produces energetic species in the surrounding water phase, which activate the polymer surface. However, the hot plasma itself does not touch the polymer. Thus, the underwater plasma may be a combination of plasma-chemical, electrochemical and wet-chemical processes offering several parameters for managing the functionalization process of polyolefin surfaces.

1.2 Motivation

The production of a radical needs higher energy as shown in scheme 1 by hemolytic cleavage. The process of radical formation is as follows:

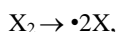

As seen earlier, plasma is relevant for this type of processes for generating radicals which are utilized to modify the polymer surfaces,

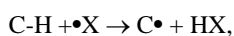

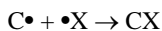

The low-pressure glow discharge plasma technique also referred as vacuum plasma technology has its origin in processing of semiconductor materials and printed circuit boards (PCB) which was successively and successfully adapted by automotive, biomedical sects of the industry [26]. The technique can bring several important effects to substrates depending on the plasma mode and processes gases used; most important of them are surface activation, coating deposition, cross-linking and etching. In short very high chemical activity of such plasmas (continuous flow of energy and enthalpy) is a very important tool to alter the chemistry and the surface energy on polymer surfaces.

The most important problem of plasma exposure to polymers is the excess of energy delivered by the plasma. The energy is consumed by the particle bombardment and the UV-irradiation. These two processes provoke random chain scissions, H abstraction, C-radical formation, auto-oxidation, degradation, cross linking etc. in polymers [27, 31, 35, 39]. For attaching plasma

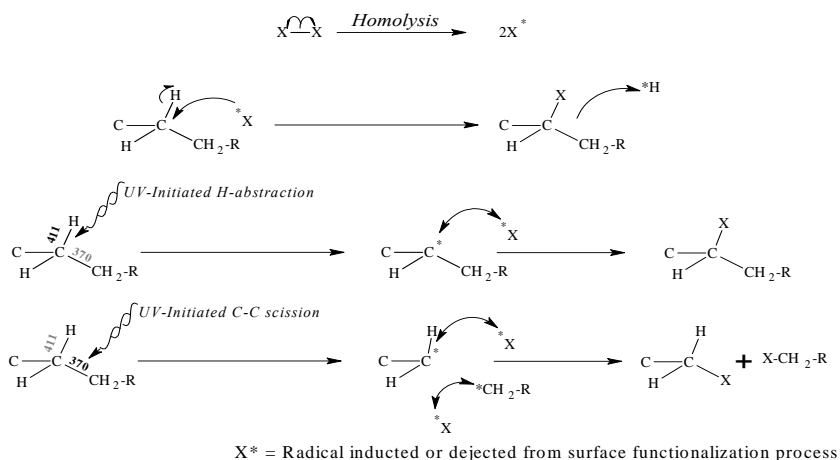

Scheme. 1: Schematic presentation of attaching plasma fragments onto polymer surfaces

(numbers give energies in kJ/mole)

atoms or fragments as (plasma gas-specific) functional groups onto polymer surfaces only a

small amount of energy is useful for replacing hydrogen atoms by plasma fragments (functional groups) (cf. Scheme. 1). The replacement of hydrogen from the C atom may be possible either by nucleophilic substitution or by radical-radical recombination. Substitution reactions are more selective, however, implausible. Recombination reactions are probable because of the high rate of radical formation but unselective. The very high chemical activity of such plasmas (continuous flow of energy and enthalpy) alter the surface energy and the chemistry on polymer materials surface. The typical binding energies in polyolefin as present in the prototype of polyolefin, the aliphatic polyethylene are 375 kJ/mole for the H₂C-CH₂ bond and 395 kJ/mole for the CH-H bond. It is lowered for the tertiary C-H bond in polypropylene to C-H=385 kJ/mole and improved for primary ones to CH₂-H=411 kJ/mole [28]. This energy, necessary to produce C-H scissions at polymer surfaces, can be delivered on a chemical way only by use of the strongest oxidation agents as oxygen at elevated temperatures, chromic acid or elemental fluorine [29, 30]. Because of the similar dissociation energies of the C-H and C-C bonds the C-C bond dissociation is simultaneously expected with the formation of weakly adherent chain fragments, oligomers (“molecular debris”) resulting in a weak boundary layer [28]. A second source of degradation is the bombardment of the polymer surface with energy-rich neutrals, ions and electrons from the plasma causes unspecific, random chain-scissions in the polymer. A third source of degradation and side-reactions is the UV-irradiation from the plasma itself that also penetrates layers under and fairly deep into the surface. There, the polymer chains are imbedded in crystalline or stretched-oriented domains or surrounded by amorphous matrix. Thus, the mobility of chains in the solid phase is limited, thus, formation of double bonds and radical recombination (cross linking) are preferred [32, 33]. Nevertheless, a high concentration of trapped radicals within polymer surface layers remains and can undergo auto-oxidations [34].

These polymer damaging processes, caused by irradiation and bombardment, result in C-radical sites formation. The radical recombination leads to cross linking of neighboured chains but the reaction with singlet molecular oxygen from air is in competition to the cross linking and

the dehydrogenation to double bonds. The attachment of oxygen and formation of peroxy radicals is followed by auto-oxidation to a broad variety of oxygen-containing functional groups in high quantity [35]. Thus, such plasma processing with polymers is automatically accompanied by insufficient selectivity, irregular, and exotic products of highly energetic chemical processes.

Commonly, the plasma process is not adjustable to the needed low energy consumption, necessary for selective substitution reactions onto polymer backbones. This limitation of wattage lowering is caused by the needed power-input for sustaining the plasma. Going below this limit, the plasma expires. To overcome these general and basic limitations of the plasma process new and tricky solutions were developed. Our group is working on a range of such novel and interesting plasma processes imparting selective surface modification of polymers as discussed in details earlier [7]. Among these new types of plasma processes the underwater plasma is one of the most interesting new methods for polymer surface functionalization. Primary feature of such plasma processes is that it generates plasma well below the water surface or in contact with liquid surface and using such plasma moderated liquid for modifying the surface of the polymer. One of the most prominent features of such plasma solution system are the material surfaces to be modified remain in contact with the plasma moderated solution. The underwater plasma (UWP) also gives the possibility to combine plasma-chemical activity with the selectivity of chemical and electrochemical processes in solutions. The role of plasma moderated liquids, allows, the reach of the reactive species through solution onto the geometrically hindered sites. The UV-radiation produced in plasma formation helps in moderating the reaction solution further by producing additional excited, ionized/dissociated molecules. Interesting feature of the technique also remains in its flexibility to use a wide variety of chemically active additives as or in-solution system. Outcome of such processes were theoretically assumed for creating monosort functional groups (especially hydroxyl). The plasma is surrounded by water, thus, plasma-produced species with excess energies were equilibrated by water as moderator much faster than under low-pressure conditions because of much higher collision probability. Water also cools the

sample surface. Moreover, water is open for a broad variety of additives, which may help to tune the chemical reactions at polymer surfaces.

An engineering polymer is selected for a given application primarily because of its favorable bulk properties such as thermal stability, mechanical strength or solvent resistance. In plastic industry, generally, the driving forces to choose the correct and appropriate polymer for a specific application such as in automotive and home appliances remains ecological, aesthetical and economical aspects. Since the 1990ies there has been a definite trend to replace some established plastics such as polyvinyl chloride (PVC), and acrylonitrile-butadiene-styrene (ABS) resin by polypropylene (PP) for the reason of recyclability or Cl-enrichment in human liver [3, 26]. However, PP has much lower surface energy, typically 30 mN/m or even less as compared to PVC or ABS and, hence, it is more difficult to glue, to bond, to print or to paint. An appropriate common example is the problem of modifying packing materials like polypropylene or polyethylene, which must be inexpensive and very fast. It's quite evident that the use of vacuum equipment raises the cost of the finished product. The products with high economic inputs to produce the finished good with certain specialty applications are seldom or infrequently required from the industry. It is also expected that the processes can be functioned batch wise and not continuous.

Desired functionalities are developed on the uppermost surface of the films within few seconds using conventional plasma treatment accompanied by the gas discharge plasma under reduced or atmospheric pressure. In case of oxygen plasma this exposure time is less than two seconds and produces sufficient functionalized surface. Important O-functional groups cannot be formed directly using this plasma process. The formation of OH and COOH groups demand the existence of hydrogen in the plasma phase, however, it is absent in oxygen or air atmosphere. Excessive exposure to the plasma increases the oxygen percentage slightly or more often accompanied by the degradation, etching and damaging the bulk of the polymer. Another

important problematic aspect of vacuum plasma modification is that it loses its efficiency in treating deep narrow or micro/nano-pores [36].

1.2.1 History of atmospheric Underwater discharges (plasma)

1.2.1.1 Glow Discharge Electrolysis

Taking a look into the history and evolution of such liquid-based plasma processes It has been known from over a century that some organic compounds or polymers can be formed in plasma (ionized gas) generated by some kinds of electric discharge [13]. It was recently in the 1950's seen that the application established with a generic term of "plasma electrolysis" or "glow-discharge electrolysis" [37-39] were successfully applied to metals and polymer processing, especially to mention the deposition of metals with metal oxides in liquid (see Picture 1). Monomers were used for the production of polymers with ultra-high molar masses without using any initiators [40].



Picture 1
Plasma generated on the metal coil
as substrate for electro-deposition
application of metal

*Picture cordially received from
Innovent-Technologies, Jena
Germany*

The gas plasma process was firstly used in 1956 by K. Rossman to introduce polar oxygen-containing groups onto the polyolefin surface [41]. Thus, it was demonstrated that the plasma is a well-suited tool for modifying polymer surfaces [42].

The liquid-based plasma processes were introduced by Hickling, Ingram, Hollahan and Venugopalan [43-46]. Most often the plasma burns in the gas phase and interacts with the liquid surface (glow discharge electrolysis), thus, reactive species formed at this interaction must diffuse into the liquid. The highly reactive nature of plasmas makes them very useful to use them into VOC's and waste water treatments/purification from the wastes of the chemical industry; which is unambiguously one of the most successful applications of underwater discharges. The same application gave the stimulation to apply underwater plasmas to natural and synthetic yarns [47, 48]. Another traditional application of underwater plasmas is the passivation of magnesium (or other metal) assemblies [37, 44, 49]

From the historical point of view the synthesis of amino acids by plasma exposure to a liquid mixture of inorganic precursors by Miller and Urey must be mentioned again [24, 25].

A broad range of assemblies were studied until now for generation of these kinds of non-thermal discharges, well below the surface of liquid and liquid in contact with atmospheric discharges and closely reviewed [50].

From the dissertation point of concern the visualization of underwater discharge can be realized with an assembly comprising electrochemical cell. The term of glow discharge electrolysis also known as plasma electrolysis is used to describe a variety of high voltage electrochemical processes, which features plasma discharge phenomena occurring at an electrode-electrolyte interface.

The plasma discharge occurs at the metal/electrolyte interface when the applied voltage exceeds a certain critical breakdown value (typically several hundreds of volts).

However, the simple electrochemistry in neutral water (pH = 7) needs only low voltage. The electrolysis of water produces ions and finally neutral gases ($2\text{H}_2\text{O} \rightarrow 2\text{H}_2 + \text{O}_2$), see Table 2. In the process the O-H bond in the water molecule undergoes scission heterolytically. The both important standard potentials of water are $E^0(\text{H}_3\text{O}^+/\text{H}_2) = -0.42 \text{ V}$ (cathode) and

$E^0(\text{O}_2/\text{OH}^-) = +0.82 \text{ V}$ (anode) [51]. Thus, applying more than 1.24 V, in reality more than 1.8 V (overpotential), H_2 and O_2 is produced. The processes at electrodes are following:

| | |
|------------|---|
| At cathode | $2 \text{H}_2\text{O} + 2 \text{e}^- \rightarrow \text{H}_2\uparrow + 2 \text{OH}^-$ |
| At anode | $6 \text{H}_2\text{O} \rightarrow \text{O}_2\uparrow + 4 \text{H}_3\text{O}^+ + 4 \text{e}^-$ |
| Sum | $2 \text{H}_2\text{O} \rightarrow 2 \text{H}_2 + \text{O}_2$ |

Table 2: Elemental process during water electrolysis

In contrast to that, high voltage and kHz current enforce the electrochemical processes. However, the UWP capillary discharge consists of an arc-like discharge and therefore plasma in the capillary (water vapour and liquid water) and the stream of energy-rich plasma produces bubbles, supersonic shock waves, irradiation and supercritical conditions. Thus, it is manifested that the UWP has another mechanism than that of water electrolysis. In particular, the O-H bond in the water molecule scission homolytically but not heterolytically. Now, atomic hydrogen, OH radicals and other energy-rich neutral are predominantly produced.

It is theoretical and experimentally known, such plasma electrolytic process leads to metal erosion. The eroded metal/electrode may alter the pH and conductivity of electrolyte significantly [52]. Such phenomenons are prominent when one of the electrodes is in air.

When plasma is ignited between the electrode gap, ions and activated species enter the plasma zone thereby affects the pH of the solution.

Additionally from the polymer processing point of view these metals perhaps significantly alter and interfere in the rates of plasma initiated chemical processes.

1.2.1.2 Underwater Capillary discharge (UWP)

Amongst a broad variety of configurations earlier proposed to generate plasma in electrically conductive liquids only diaphragm and capillary discharge schemes allow to generate plasma, which is **not** in contact with the electrode systems [53]. Electrical discharges under water can be generated in several ways, e.g., with short or low rising voltage pulses and by using various electrode geometries. Earlier approach, which permits AC and DC pulses, is generically known

as underwater diaphragm/capillary discharge. Periodic electrical breakdown inside the capillary results in a net flow of aqueous plasma moderated solution though/from the capillary without using any moving parts such as valves or diaphragms.

The principle is based on the underwater plasma equipment, see scheme. 6 typically composed similar to that of an electrochemical cell [54]. However, the electrodes in the electrochemical cells are separated by a dielectric barrier and connected via a capillary. When a sufficiently high current is forced through the capillary the water locally evaporates resulting in a (big) vapor bubble. The complete potential difference applied to the electrodes is applied across the expanding bubble. For a critical combination of voltage and bubble diameter the vapor bubble undergoes an electrical breakdown. The resulting plasma bubble expands and eventually collapses to produce arc-like plasma. A subsequent jet burst is surged inside water on the both sides of the electrochemical cell (cf. Picture 2). Such discharges can be generated in aqueous solutions of adequate conductivity at relatively lower voltages.

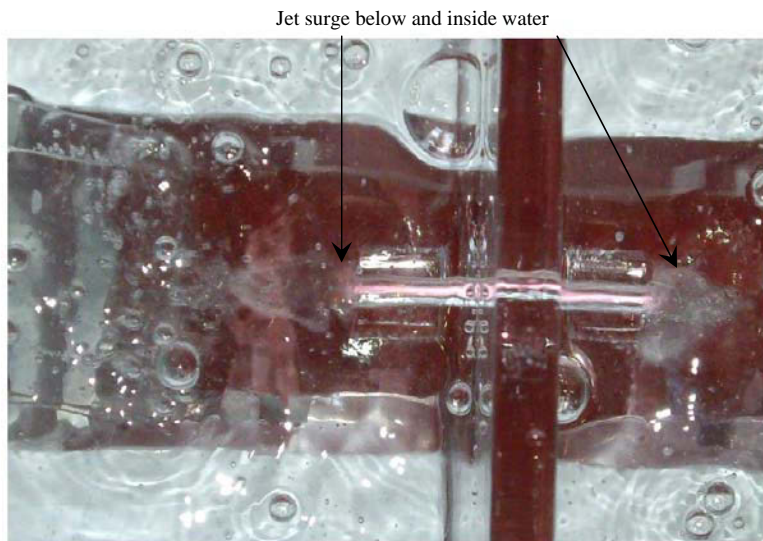

Picture 2: Underwater capillary discharge

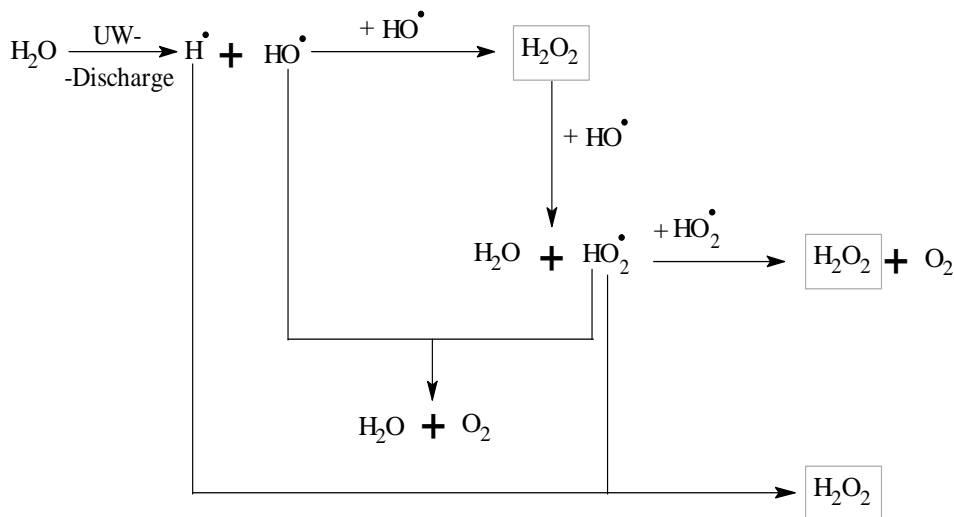

Scheme 2: Most important reactions taking place in the underwater discharges process

The discharge is not in contact with the electrodes and thus the problem of electrode erosion and destruction does not arise. These characteristics make the capillary discharge concept to an attractive and most interesting tool amongst all available underwater discharge tools for surface chemistry alterations of synthetic polymers. Very recently growing interests have been seen to study such processes for polymer surface treatments [48, 55].

The reactions provoked by the underwater discharges inside water are studied exclusively earlier [56, 57]. These discharges are known to generate chemically active species like H_2O_2 , O^\bullet , HO^\bullet , HO_2^\bullet , O_3 , e^-_{aq} , O_2^- , O^- , O . Theoretical and practical facts suggests that the hydroxyl radical and hydrogen peroxide are the most important products of such reactions. More than 30 reactions have been suggested inside the literature for the production of primary active particles and intermediate products. On the basis of this literature a simplified scheme (see scheme 2) for hydrogen peroxide formation was summarised [58]. A number of different types of plasma-solution systems were studied for the production of hydrogen peroxide which is always considered as the hydroxyl OH radical generation indicator of the system. Capillary discharge was found an efficient source of generation of these highly reactive and oxidative species [58].

1.2.1.3 Underwater corona discharge

In concurrence to the capillary UWP discharge also a corona discharge was developed working beneath the water surface. Such an assembly shows cold and more homogeneous plasma within water. Using a well suited corona bunch electrode also samples with greater surface area can be more homogeneously modified (Scheme 3).

The main disadvantage of the corona equipment, the electrode tip corrosion, makes it not applicable to polymer surface modification. A thick metal oxide layer becomes deposited onto the polymer surface. Therefore, the quasi-electrode less capillary system was favoured.

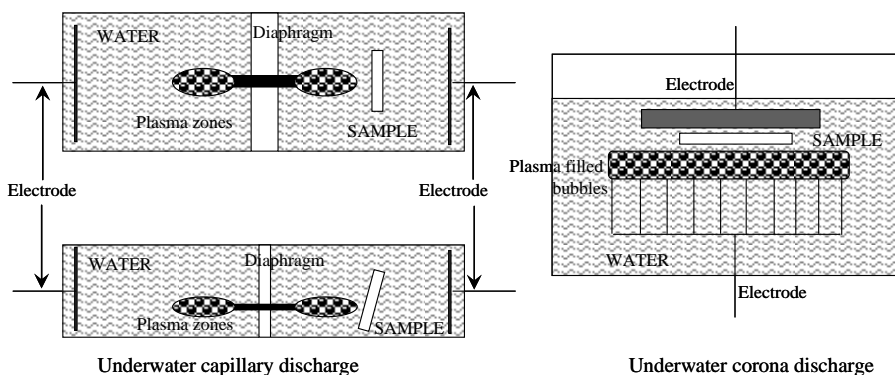

Scheme 3: Underwater capillary and corona discharge

1.2.1.4 Atmospheric-Pressure Glow discharge electrolysis using Liquid Electrode(APGD)

It was shown earlier in 1960's that polymers when exposed to corona discharges loose weight due to oxidation of the surface to volatile products (mostly CO_2 and H_2O). The weight loss is time dependent and independent of film thickness [59]. Prominent functionalities contain the carbonyl unit found near surface regions of depths of LDPE thin film. Carbonyl groups are also formed in film which was not in discharge area. The reason attributed to the finding was the ozone produced by the glow discharge may affect the surface area just outside the discharge

zone. It is less probable that ozone can attack polyethylene but only C=C double bonds and may be irregularity in PE surface morphology can be attacked. It was presumed that the plasma

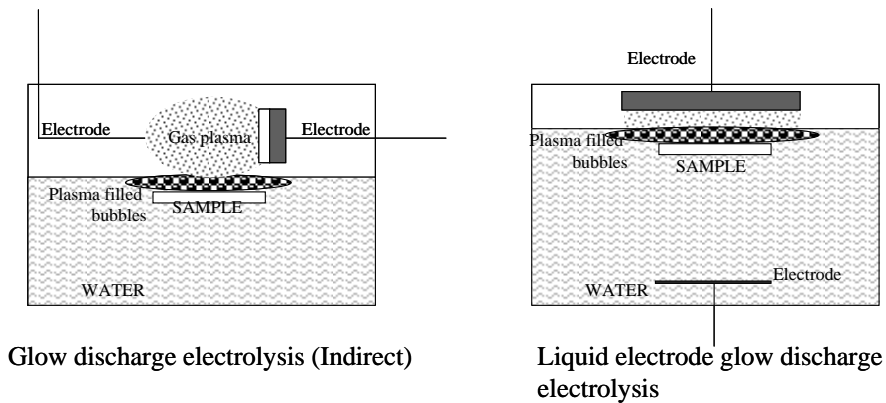

Scheme 4: Glow-discharge electrolysis equipment

activation effect emerged out as energetic radiations may cause such reaction. One more possibility may be the surface reconstruction effect which may generates and propagates a fence of functionalities within the adjacent layers of the polymers and within its bulk, exposed to such glow discharges [32, 60, 61].

A barrier discharge was created between two electrodes, one being the electrolytic liquid and other held in ambient air. A limited work and data is presented in the dissertation, nevertheless, it was interesting to take into account the literature available in two different liquid plasma systems distinctly in contact with the liquid and thereafter used for the surface modification. The assembly adopted for executing such plasma-liquid system is presented in Scheme 4.

The plasma zone remains between the two electrodes in the vicinity of ambient air. The system feature is that active species are exclusively formed by the bombardment of charged ions on the electrolyte surface. This bombardment generates H, OH radicals and solvated electrons as discussed earlier in the introduction. Action of atmospheric-pressure glow discharge (APGD) electrolysis has shown to cause an increase in solution acidity. One of the best advantages as

discussed earlier of these processes is for UWP systems that functionalization starts with abstraction of hydrogen by OH radical followed by all above introductory reactions. It was seen from the literature that such APGD systems such remained of keen interests for researchers modifying different polymer substrates [62]. Both systems depicted in Scheme 4, glow discharge indirect electrolysis as well as liquid electrode glow discharge electrolysis, have a significant disadvantage for the polymer surface modification. The operating distance between water and sample surface is a few millimetres and, therefore, far from the zone of highly reactive species at the water surface. Their life-time and diffusion rates determine their operating distance. Therefore, the functionalization rate of polymer surfaces is very low.

It must be appended that glow discharge electrolysis systems were created working under low pressure conditions with [59] and without using organic liquids. Such a system was used by Osada, who investigated the initiation of a liquid-phase polymerisation by exposing the liquid monomer to a glow discharge in the vapour phase. It was also tested to initiate such polymerisation in the frozen phase of the monomer exposing it to an argon glow discharge [63].

1.2.2. Comparison of APGD electrolysis (liquid electrode) and capillary discharge approach

Growing interests in underwater discharges for surface treatment application has led to find the most suitable and efficient system for bringing out required changes on the materials surfaces. Both systems plasma generated above (scheme 4) and below (scheme 3) the liquid surface is interesting for the purpose of polymer surface modification. Though it is said about basic difference between the two methods of generation plasma with one in water other over its surface nevertheless the motivation for using such type of system remains the same. One of the basic products that are obtained by these underwater discharge processes are the OH radical and hydrogen peroxide H_2O_2 thereof. The capillary discharge is a flow dominated technique well suited for high yields in OH radicals and molecular hydrogen peroxide. [47, 53, 58].

An ample study has been done to compare generation and kinetic nature of these oxidative species by the different techniques [64, 65]. Spectroscopic analysis of OH radicals supported by titrimetric yields obtained for H₂O₂ by the method of underwater capillary discharge have found superior to some of other underwater plasma and electrolysis processes was studied by Nikiforov and Maximov earlier. A similar fact was seen in an application study which confirms the optimal sterilization time of E-coli by the UWP treatment. An application study confirms the optimal sterilization time of E-coli by the UWP treatment. At lower concentrations of E-Coli ($\approx 10^4$ colonies/ml), glow discharge electrolysis takes 15 min in comparison to the 3 min. using underwater capillary discharge; at higher concentration ($\approx 10^7$ colonies/ml) same was found 20 and 12 min. respectively.

It is reported that the glow discharge treatment of an electrolyte is always accompanied by change in the pH of the solution. The available data suggests that variations in the pH are affected by the transfer processes: such as intrusion of nitrogen, oxides, injected foreign ions from the plasma zone followed by their solvation together with hydroxonium and hydroxyl species from solution [52, 65]. Such pH fluctuations are not evident in capillary discharges [65, 66].

The mechanism of H₂O₂ formation is thought to be mainly the recombination of OH radicals that are formed by electron impact dissociation of water molecules in the plasma discharge zone [67, 68]. It was seen earlier that the emission intensity of the UV-radiation markedly increases with increasing solution conductivity [69]. Production rate of hydrogen peroxide was observed to decrease with increasing solution conductivity due to increasing photolysis of H₂O₂.molecules. Conductivity and pH are physical parameters which are strongly dependent on the chemical characteristics of an aqueous solution. Taking into account all these factors will obviously to affect the production of hydrogen peroxide.

One more experimental fact that came to notice in this work was that the use of APGD using liquid electrode needs precise control of the distances between electrode in air and liquid

surface as well as that between water surface and sample surface is very essential and is technologically inconvenient [64]. Both the techniques have some common parameter like applied voltage, solution conductivity; temperature etc., capillary discharges provides an additional and technologically convenient parameter of capillary geometry which also affects the production of hydroxyl radicals and hydrogen peroxide. More importantly taking into the account the life of OH radical which is considered very small (10^{-6} s), the jet burst provides a most required flow action to the plasma affected solution such that the radicals of interests can effectively be used to modify the substrate surface.

One of the major disadvantages of capillary discharge process is the small area of polymer surface that can be treated by the capillary discharged plasma and the in-homogeneity of treatment in this area. Thus, the technique lacks in treating larger areas of polymer surfaces. This problem can be resolved by generating increasing number of capillary discharge sites on the electrochemical cell diaphragm. Though a couple of or a handful of attempts were reported to construct such type of underwater plasma discharge reactors. [70].

Eventuality of the drawback the capillary discharge was seen very useful and effective for introducing oxygen functionalities on polymers of biomedical interests in the cases where the area of treatment is substantially smaller, such as contact lens. The materials was supplied by CIBA Vision Corporation, Duluth, GA, USA, and cyclic olefin copolymer supplied by PolyAn GmbH, Berlin, Germany.

Taking into considerations all parameters, the technique of capillary discharges was exclusively studied and applied for altering the chemistry of the polypropylene surface.

1.3 Underwater plasma reaction pathways and kinetics

1.3.1 Surface functionalization of polypropylene by oxygen functionalities

1.3.1.1 Hydroxyl functionalization

Most often oxygen functional groups such as OH groups are essential at the polyolefin surface for many subsequent industrial application processes such as adhesion, coating, printing, metallization etc [7, 71, 72]. For this purpose, the CH_x groups of the polyolefin surface must be selectively oxidized to preferentially OH groups [73]. The exposure of the aliphatic polymer to an underwater plasma (UWP) that is enriched with OH features ($\dot{\text{O}}\text{H}$, $\dot{\text{O}}\text{-OH}$) pertains greater possibilities to introduce OH groups onto the polymer surface in much higher concentration and with higher (OH) selectivity [7] than the treatment in oxygen gas plasma [74]. The introduction of OH groups is possible as nucleophilic substitution via a two-step process:

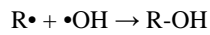
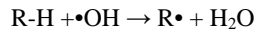

and in sum,



This process is exothermic ($\Delta_R H_{298}^{\ominus} = \Delta_R H_{\text{R-H}}^{\ominus} - \Delta_R H_{\text{H-OH}}^{\ominus} = (396-499) \text{ kJ/mole} = -103 \text{ kJ/mole}$). The (standard) reaction enthalpy (R) of the addition reaction is given as difference of (standard) heats of formation (B) of the end (E) and start product (S):

$\Delta_R H^0 = \Delta_B H_E^0 - \Delta_B H_S^0$. Using Hess rule $\Delta_R H^0$ is the difference of dissociation enthalpies of the scissioned (S) and formed (F) bonds: $\Delta_R H^0 = \Sigma^S \Delta_D H^0 - \Sigma^F \Delta_D H^0$.

Therefore, for a raw estimation, the heat of formations can be replaced by dissociation enthalpies. Because of the gas-solid type of reaction, the entropy must be considered (Gibbs-Helmholtz): $\Delta_R G^0 = \Delta_R H^0 - T\Delta S$. The entropy term $\Delta_R S^0$ shows ambivalent behaviour. This term becomes negative when two (three) species form one species.

In the case of PP the tertiary C-H bond is the weakest one and the target of OH attack. Then, the overall reaction may be written as:

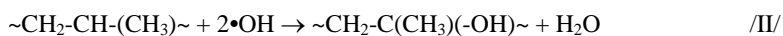

Precondition is the homolytic dissociation of water molecules:



However, other plasma species or radiation can also dissociate a C-H bond at the polymer molecule; thus, a C radical site is produced:

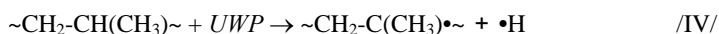

Either OH radicals recombine with the tertiary radicals as shown before or it can attach molecular oxygen dissolved in the water:

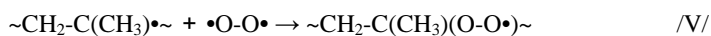

followed by the auto-oxidation process [75]. This process is followed by hydroperoxide formation and its decay to different oxidation products [27].

As mentioned before, the underwater plasma is the source of different reaction species, solvated electrons, ozone, UV-radiation, shock waves etc. [69, 71, 76]. Therefore, it was emphasized earlier that UWP chemistry of polymer surface oxidation is similar to that of chemical or thermo-chemical liquid phase oxidation, and only differs in the primary reaction step [32].

Hydroxyl radicals are often referred to as the "detergent" of the troposphere because it reacts with pollutants, often acting as the first step to their removal. It also has an important role in eliminating some greenhouse gases like methane and ozone [77, 78]. Methane is also an alkane as polyethylene and polypropylene, therefore, the same basic processes were found.

The hydroperoxyl radical does not possess much energy ($\Delta_D H^0_{\text{HO-O-H}}=375$ kJ/mole) [28]. Thus, only activated H-atoms can be removed by it (neighbouring to rings, allyl bonds, tert. C-H, C-O etc.). Looking at the standard redox potentials of $\bullet\text{OH}$ ($E^0_{\text{redox}}\approx 2,8$ V), $\bullet\text{O}^{\text{I}}$ ($E^0_{\text{redox}}\approx 2,4$ V), H_2O_2 ($E^0_{\text{redox}}\approx 1,8$ V) and $\bullet\text{O-OH}$ ($E^0_{\text{redox}}\approx 1,7$ V) species, it must be understood that these species

are very strong oxidizing agents leading to a formation of O-functional groups of different oxidation states [79, 80]. Moreover, molar mass degradation occurs during the decay of hydroperoxides [27, 60, 75, 81].



decay products = (R-OH, RR'C=O, R-CHO, R-COOH, R(O)OOH; R-O-O-R') or on a direct way.

Thus, any oxidation of alkanes leads to all kinds of oxygen-containing products (ketones, aldehydes, fatty acids, peroxy acids, ethers, peroxy links etc.) of lower molar mass [27, 75].

A strong concurrent reaction to eq. /I/ exists because of the lower dissociation energy of the H₂C-CH₂ bond (370 kJ/mole) in comparison to that of the C(CH₃)-H bond (385 kJ/mole):

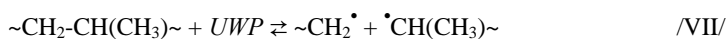

or CH-H (396 kJ/mole) and CH₂-H (411 kJ/mole). The C-C bond dissociation (cf. eq. /VII/) may be partially reversible (recombination) because of the fast back reaction and the slow moving of radicals within the polymer bulk, if the energy can be dissipated rapidly enough [82]. Another alternative is the abstraction of hydrogen from neighbouring macromolecule thus producing alkyl radical within the chain:

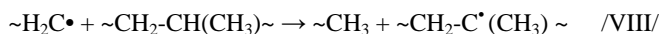

Established gas plasma techniques like low-pressure and atmospheric discharges working with pure oxygen have much more limitations due to the lack of hydrogen. For OH formation, hydrogen must be abstracted from the polymer chain initially (or from contaminations). Only after formation of OH species in the plasma phase by O and H recombination to OH in a three-body reaction



Hydroxyl groups could be introduced into the polymer surface. As shown in Scheme 1, the incoming functionalization moiety X=OH radical is not readily available for direct attachment to the substrate surface. In contrast to that, the water-based plasmas produce OH species directly

(eq. /II/). Therefore, the underwater plasma is more predestinated to generate more selective hydroxyl functionalized polymer surfaces. One of the most important aspects of this process is that the oxidation of polypropylene ends in gaseous and water-soluble degradation products, e.g. the polymer surface will be etched. Therefore, these volatile and soluble products lower the fraction of highly over oxidized species ($C^{>1+}$) at the polypropylene surface. Net result presumed the dominance of single C-O bonded features [C-OH, -C-O-C-, -C-O-OH(R)] on the polymer surface.

The UV radiation emitted from the plasma inside any liquid may support the polymer surface modification [83]. Whilst traversing through the liquid media, which is comparatively dense, plasma-originated UV radiation generates also active species in the liquid:



A neutral energetic key intermediate is hydrogen peroxide formed by recombination of 2 OH or other radicals and ions [50]. Along with the plasma and UV effect, in the case of the underwater plasma, the process is also accompanied by the generation of shockwaves although it is yet not clear to what extent plasma, UV-radiations and shockwaves contribute to the formation of active species in the liquid medium [50]. Partially and locally, it may be existing also supercritical conditions in the vicinity of the capillary, which support also any chemical modification. Nevertheless, the underwater and the solution-plasmas present a promising chance for achieving a more selective surface modification. Some of above mentioned drawbacks or demerits in established plasma surface modification techniques can be resolved by exposure of surfaces to this kind of plasma-liquid systems at ambient temperature and pressure conditions.

In this dissertation topic, the methods of capillary discharge and glow discharge electrolysis for surface modification of polypropylene films were evaluated for their efficacy to introduce oxygen and especially hydroxyl groups onto the PP surface.

Wet-chemical reduction technique was an additional tool to assist the plasma modification by post-plasma reduction of all possible oxygen functional groups to the required

hydroxyl functionality and thus to achieve a highly mono-functionalized polypropylene surface. The reduction technique introduced by Nuzzo and Smolinsky [84], who used diborane to reduce oxygen functionality to hydroxyl groups in 1984, was further improved by Kühn. [74]. Therefore, using the mild reducing agent sodium borohydride the plasma oxidized polymer surfaces were reduced in a second post plasma wet-chemical process for increasing the yield in OH groups:

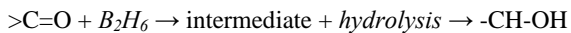

C=C double bonds can be hydroborated in presence of hydrogen peroxide:

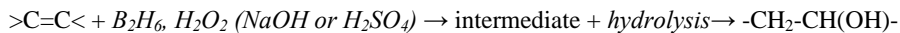

1.3.1.2 Role of H₂O₂ and R-O-OH generation in UWP processes

It must be emphasized that the UWP process under study is an efficient source of *in situ* formed hydrogen peroxide. Hydrogen peroxide is generated under the action of the UWP up to steady-state equilibrium, where the rates of formation and decay of hydrogen peroxide are equal. The steady-state equilibrium was shown to be altered by the addition of hydroxyl radical scavengers [69, 76, 85]. The formation of H₂O₂ has a standard formation enthalpy of -214 kJ/mole. Most often the production of hydrogen peroxide is discussed by recombination of two OH radicals:



The decay of pure hydrogen peroxide produces -98 kJ/mole:

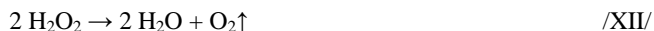

The OH radicals have average life times in the order of nanoseconds as mentioned before [86, 87]. The equilibrium concentration of H₂O₂ is 2.5 mmole/l [88]. The decomposition mechanism is assumed to be as follows:

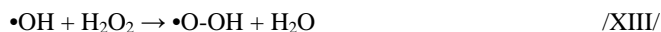

The hydrogen peroxide formation in the water vapor phase using a glow discharge process was discussed earlier [89]:



In analogy to the ionic formation of H_2O_2 [76] OH radicals can react by singlet excited water molecules [47] and solvated electrons, atomic oxygen are discussed in literature [56, 90].

Ozone may also contribute to the polymer surface modification because of its high standard redox potential (2.07 V) is close to that of OH radicals (2.80 V) [56]:



However, ozone reacts predominantly with olefinic double bonds only present in low concentrations in polypropylene after exposure to the plasma [6]

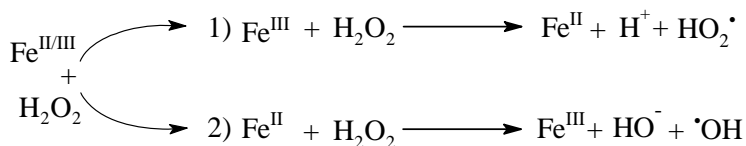

Scheme 5: Fenton Chemistry

Most notably hydroxyl radicals are produced from the decomposition of hydroperoxides (RO-OH) [91]:



Therefore, the existence of hydrogen peroxide, OH radicals and hydroperoxy radicals in the UWP and their interdependence is the key factor for understanding the polymer surface functionalization. Hydroxy groups, peroxides and hydroperoxids cannot clearly be distinguished by means of X-ray photoelectron spectroscopy (XPS). Gas phase chemical derivatizations of OH

and O-OH groups, using trifluoroacetic anhydride (TFAA) and SO₂ respectively, must be applied for quantification of these groups by XPS [92-94].

It was studied[48] earlier that the hydrogen peroxide generated during the underwater discharge process works as hydroxyl radical scavenger and reduces significantly the OH radical concentration within the plasma affected liquid process (see eq. /XI/, /XIII/ and /XIV/) [85, 95]. It was also noticed that this may reduce the efficiency of -OH surface functionalization process using the UWP technique.

The hydrogen peroxide can be brought back to hydroxyl radical status by using Fenton's catalytic systems [97, 128, 148]. The motive of the experiment was to increase the concentration of hydroxyl radicals in the plasma affected liquid thereby increasing the OH functionalization process. Addition of zeolite based heterogeneous catalyst Fe-ZSM5 is believed to form a Fenton-like [79, 96] system. The following reaction is assumed to be responsible for possibly increased concentration of OH species [50]:

The in-situ formed Fenton-type reagent was added to the UWP system and its effect on the hydroxyl functionalization of PP-surface was studied. Fenton's reaction can also be assisted by UWP emitted light (Photo-Fenton), which generally enhances the oxidation power of the overall process [97]. In this work the selectivity in OH group formation at the polypropylene surface was influenced by introduction of a heterogeneous catalyst and the addition of hydrogen peroxide thus triggering the formation of OH radicals, which were assumed to be the main source of OH group formation at the polymer surface [76, 87]. Hydrogen peroxide and catalyst additions should influence the kinetics strongly. Also the polymer surface itself acts as an OH radical scavenger by bonding OH groups at the surface [85, 95, 98]. In this work the focus is directed to maximize the OH-specific surface functionalization of polypropylene. OH groups at polypropylene surfaces are necessary to establish strong adhesion of organic coatings promoted exclusively by covalent bonds; to graft special molecular architectures onto the polypropylene for the production of biosensors, biochips or for the generation of special tribology properties of

biomaterials. To establish such chemical structures at the polyolefin surface OH groups can be consumed easily by reaction with isocyanates, silanes, alkyl halogenids or carboxylic acids under formation of covalent bonds to the polymer.

1.3.1.3 Enrichment of the carboxylic (COOH) functionality at PP-surface

For specific applications such as medical engineering, biotechnology, optimized adhesion and for any post-plasma chemical processing (grafting) homo-functionalized polymer surfaces are required as explained discussing the introduction of OH groups. The same is true for COOH groups produced by plasma-polymerization of acrylic or maleic acid. This group can be consumed by esterification [74, 99] or by forming salts. Atmospheric plasmas as well as the modification in low-pressure glow discharge do not fulfil this selectivity requirement completely [76 100]. To serve this purpose the monomers like allyl alcohol, acrylic acid, allyl amine polymerization were attempted with the aid of low-pressure pulse plasma yields high selectivity was reported recently [99, 101-104]. The numerous species and the broad energy distribution from APGD and dielectric barrier discharge plasmas hinder any dominance of chemical reaction pathways as available from organic chemistry [105]. Therefore, organic chemists disrespectfully comment all plasma chemical activities. As discussed earlier high kinetic energy particles, highly excited atoms- molecules, intense and energy-rich vacuum-ultra violet radiation, which are responsible for the exotic character of gas plasmas, should be dramatically quenched in presence of water. A similar experimental set up and methodology as in the case of –OH functionalization experiment was applied for studying carboxylic or ester function enrichments. Polymer surface equipment with dense populated carboxylic functionalities using the direct functionalization of the substrate still remains a daunting task for plasma chemist.

The simplest way to the surface modification of polyolefins with COOH groups is presented by Badyal and Poncin-Epaillard [106, 107]. They postulate that carbon dioxide can form carboxylic groups by the following sum process: $C-H + CO_2 \rightarrow C-OOH$.

Kokufuta et al. [108, 109] have subjected organic acids such as acetic acid, acrylic acid, maleic and itaconic acid to such glow discharge electrolysis systems. Such liquid based plasma systems generating the OH and H radical in the GDE shown to have been responsible for the further reactions. Acetic acid can undergo de-hydroxylation (-OH), de-hydration (-H₂O), de-carbonylation (-CO), de-carboxylation (-CO₂) and de-hydrogenation (-H, H₂) under the exposure to the glow discharge electrolysis in aqueous media. Study has suggested coupling of OH and H radicals with the CH₂COOH radical during the course of glow discharge electrolysis. It was also proposed in the same study that the unsaturated acid may undergo to hydroxylation, hydration by the same set of radicals. Surface functionalization of polypropylene with carboxylic functionality using underwater capillary discharges was recently published [110]

As a first step, our present work is focused on the behavior and the chemical conversions of a number of organic acids exposed to the underwater capillary discharge. The first goal was to initiate a plasma polymerization of unsaturated organic acids containing polymerizable double bonds such as acrylic, fumaric, maleic and itaconic acid. It was expected that polymerization occur under the effect of reactive species generated during the underwater plasma system. The nature of poly-acids should be analyzed as retention of carboxylic groups in the corresponding polymer, molar masses, branching, cross linking or other deviations from the classic structure of unsaturated acid polymers. The second goal was to precipitate such a polymer onto a polypropylene film as coating. Such acid-modified polypropylene surface should possess improved adhesion properties caused by the -COOH groups. However, all these polymers are water-soluble and do not coat any substrate, on the other hand, thus showing the pure chemical nature of polymerization, not achieved at any time using the gas plasma polymerization technique. Nevertheless, the partial cross linking, characteristic for each plasma process should

help to deposit a coating. In such a case it could be expected that the structure of this acid polymer coating is different from that of the soluble polymer fraction.

For this coating process the most important question was, how much -COOH groups have retained the polymerization process and what is the resulting -COOH group density. This can be checked roughly by C1s peak fitting of the XP (X-ray Photoelectron) spectra. The carboxylic group appears at a characteristic binding energy between 288.9 eV – 289.3 eV [111]. However, this binding energy region is also simultaneously attributed to the ester group or O=C-OR bonded carbon. Unambiguous specific identification of -COOH groups needs the derivatization of this group by 2, 2, 2-trifluoroethanol (TFE) in presence of a carbodiimide and measuring thus the introduced fluorine concentration by means of XPS [112].

Simultaneously, the deposited cross linked polymer layer may be further modified by the plasma exposure [74]. The thus produced functionalities or those which are rearranged during the deposition process may be hydroxyl, ether, epoxy, ketone, aldehyde, acids, esters, peroxy acids and carbonates. The XPS measurement was used to identify such functional groups as hydroxyl, ether, epoxy (286.1-286.7 eV), ketone, aldehyde (287.2-288.2 eV), acid, ester (288.9-289.3 eV), peroxy acids (ca. 290 eV) and carbonates (290.3-290.5 eV). The carbon attached to the ester or the carboxylic group $\text{>}\underline{\text{C}}\text{H-COOR}$ or $\text{>}\underline{\text{C}}\text{H-COOH}$ is assigned between 285.4-285.8 eV which is obviously a part of C1s curve for C-H at 285 eV. The carbon R of the ester group COOR (C-O-C) is situated in the range of 286.1 to 286.7 eV. The data obtained after X-ray photoelectron spectroscopic analysis was processed using the software CASA-XPS. It was expected that -COOH groups may not survive the polymerization process (decarbonylation, decarboxylation) and a large fraction of the survived -COOH groups were esterified. The total oxygen percentage (all oxygen containing groups) may also reflect the process of -COOH group destruction because the decarboxylation as well as the decarbonylation decreases the total bonded oxygen percentage. On the other hand the simultaneous surface oxidation increases the oxygen content. Anhydride formation is not possible in presence of water.

1.4 Approach and perspective of the work

The functionalization of the outermost surface with O containing groups involves OH, C-O-C, C-O-OH, CHO, $R_1R_2C=O$, COOH, COOR, CO-O-OH, CO_3 , C=C etc. These functional groups are capable of improving strongly adhesion properties of polymers to metals, other polymers, fibers or adhesives. For advanced future applications and basic research on the adhesion mechanism it is desirable to produce a mono-sort functionalization, i.e. the existence of only one type of functional groups at the polymer surface.

With regard to biomedical applications OH, COOH, CHO and NH_2 groups are of special interest. These polar groups are reactive and can be used as the starting-point for subsequent highly selective chemical graft reactions. Biochemically modified polymer surfaces are important in new fields like nucleotide synthesis, DNA chips, and tissue engineering.

More recently the ESCA studies stated, oxygen gas plasma treatments induces some modification of surface chemistry at short treatment time but at longer treatment times the only effect that is obtained is etching (and roughening), also confirms SEM analysis [120]. A majority of processes for the plasma surface modification of polymer materials in the industry are based on the alteration of physicochemical properties of the surfaces, mostly surface energy. However, surface energy is an integral message of the polymer structure on the surface and does not give detailed information of the surface chemistry. Because of the stringent requirement for the mono functional surface can only be brought out by using strictly selective processes and can only characterized by an exact surface analysis method [123].

On the foregrounds of all the facts introduced and described, use of underwater plasma accompanied by its water-born auto-oxidation processes are assumed to introduce relatively dense population of singly bonded oxygen atoms to the PP-surface and consequently highly dense hydroxyl functionalities could be manifested. The same will remain the intention in this dissertation.

1.4.1 Brief overview of proposed work

This work will focus on:

1. Surface modification of polymers from polyolefin class of polymers.
2. Advanced oxidation processes (AOP's) caused by underwater discharges will be briefly reviewed to use them as a tool for surface oxidation of PP-surface.
3. Theory and literature support assumption that the AOP's such as underwater discharges can be a niche device to introduce predominantly hydroxyl functionality on polymer surfaces unlike the existing plasma processes; the assumption was validated using the XPS technique.
4. Factors which may affect such introduction of hydroxyl groups (-OH selective) to polypropylene surface was experimentally verified.
5. To check the efficacies of the UWP system using different additives and to evaluate its effect on surface modification of polypropylene film.
6. To look for possible applications of the UWP system to the potential industries.

2. Experimental

2.1 Underwater plasma assembly construction

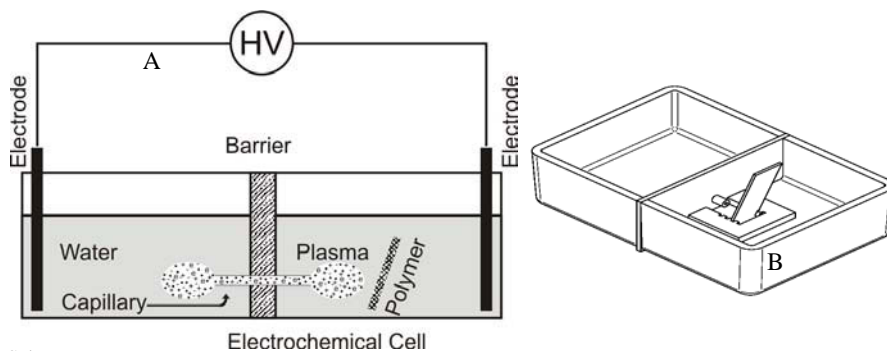

Scheme 6:

A) Schematic sketch of electrochemical cell used for underwater plasma generation

B) Perspective drawing of the underwater plasma reactor assembly

The experimental setup consists of two electrodes submerged in an electrochemical cell separated by a dielectric wall with a diaphragm. The assembly together with the capillary was manufactured from quartz glass in order to avoid contaminations on the polymer surface. The scheme 6 and 7 depict an idea on the underwater plasma and glow discharge electrolysis reactor setup respectively and the power input scheme, respectively. A more perspective view on the underwater plasma is shown in scheme 7.

The rearrangement in scheme 7 is gas phase atmospheric plasma in contact to any liquid (gas-to-liquid plasma). At the same time the polymer sample is positioned under water surface. The plasma glow touches the water (liquid) surface. Plasma particles and plasma radiation produce a broad collection of ions, solvated electrons, energy-rich neutrals such as radicals and energy-rich complexes. These species are usually present also under conditions of electrolysis; however, their potential energy is higher because of additional electronic and vibration excitations as reproduced principally in Fig. 3.

The underwater plasma is also schematically depicted in scheme 6 and more realistic in picture 2. The core of this underwater assembly is the capillary in the barrier between the two

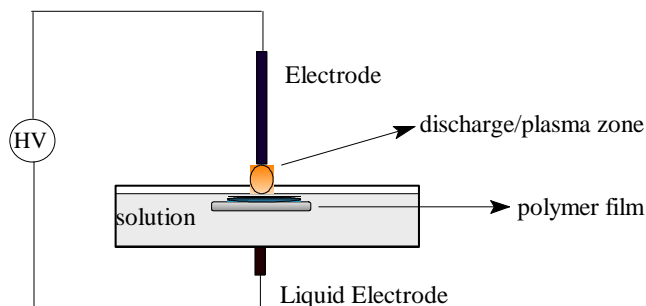

Scheme 7: Schematic sketch-up of used APGD electrolysis (liquid electrode) plasma in contact with water in ambient air

water-filled chambers completed by graphite or metallic electrodes. The capillary had an inner

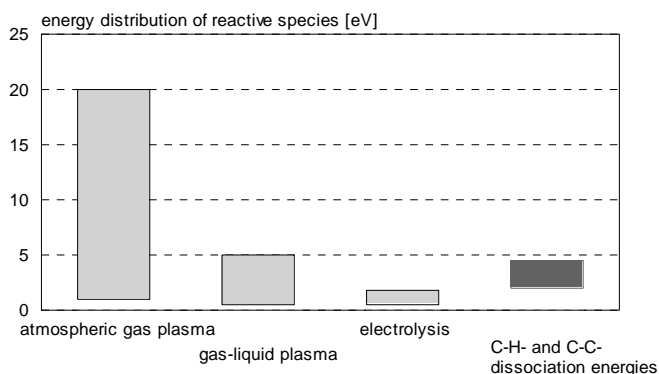

Fig. 3 Energy range of chemically active species in liquid phase

diameter of $2.5\text{mm} \pm 0.1\text{ mm}$ and a length $25.0\text{mm} \pm 0.5\text{mm}$. The reproducibility of the plasma critically relies on the capillary dimensions [58]. During the experiment an ablation of the inner surface of the capillary was observed due to high current densities. The diaphragm thickness was 4 mm. The sample was placed facing the capillary, with vertically inclined angle such that the capillary firing out the plasma and its affected solution should whirl along the surface of the polymer as seen in scheme 6.

A few years ago, researchers have used a moderately smaller [47, 48, 53, 58] dimensions of the capillaries for the plasma studies, among others, for pretreatment of natural and synthetic fibers [47, 48,] by using a similar type of underwater discharge. The present work is the first reported attempt to study the surface modification efficacies using underwater capillary discharge technique on a planar polymer.

For achieving reproducibility and an unambiguous modification results, it is important to use a reactor setup which allows in creating non-contaminated modified polymer surface. It was achieved by the use of high purity graphite foils as electrodes and a complete glass reactor setup. Electrodes made up of other metals like aluminium, copper, or stainless steel lead to a substantial deposition of metal oxide on the polymer substrate.

Graphite electrodes were kept at a distance of 25 cm to 45 cm apart. Alternating current of 20 kHz was applied with a voltage ranging from 12 to 15 kV. The circuit scheme of the underwater discharge is shown in Fig. 4.

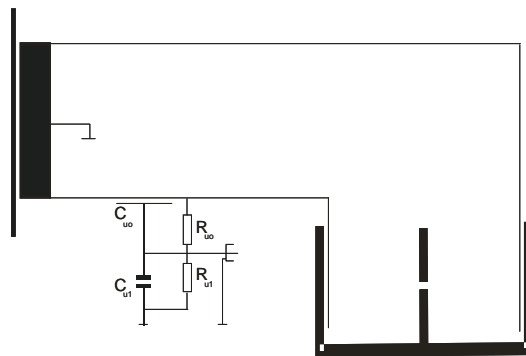

Figure 4: Power input scheme

The Figure 5 is a self-explanatory curve elaborating the behavior of current and voltage after plasma ignition within the capillary. The discharge was generated using sodium chloride as electrolyte imparting initial conductivities ranging from $400\mu\text{S}/\text{cm}$ to $650\mu\text{S}/\text{cm}$.

The maximal current flows after full formation of the plasma arc following the voltage maximum. After full ignition of the arc the voltage can be decreased for maintenance of the

plasma. Very basic of electrical and optical characteristics of such system are studied earlier [54, 113, 114].

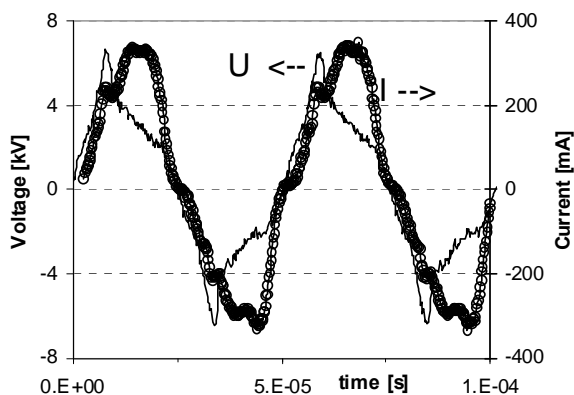

Figure 5
Current-voltage characteristics
of the underwater plasma

It was observed that the conductivity of solution alters during the experiment due to the increasing temperature and the plasma conditions inside the reactor in course and after the plasma discharge. Solution conductivity plays a decisive role in plasma ignition. Thus the initial conductivities are most vital parameter from the plasma ignition point of view [54, 113].

2.2 Materials and characterization

Polypropylene film of 100 μm thickness was supplied by Goodfellow Cambridge Ltd., UK. A (PP) swatch of 25 mm \times 75 mm size and of 0.1 mm thickness mounted on a glass support in front of the underwater capillary holding the plasma. The sample distance was varied systematically. A symmetric setup allowed to treat two samples simultaneously- one for subsequent bonded oxygen studies by XPS and another for TFAA derivatization studies for process selectivity evaluation.

Zeolite ZSM5 was cordially received from Süd Chemie, India Ltd., Baroda, India. Ferrous sulphate was used for the ion exchange process with the zeolite for preparation of the catalyst. The catalyst Fe-ZSM5 was prepared in the laboratory as follows:

To the solution, comprising of 15 mg ferrous sulphate diluted in 100 ml bi-distilled water, 11.5 mg ZSM-5 powder was added. The mixture was heated to 80°C and kept at this temperature while stirring for 4-6 h. After 6 h of stirring the mixture was filtered and washed thoroughly with distilled water 3-4 times (with 150-200 ml water each time). The filtered cake was heated at 90-120°C for 2 h and then underwent calcination between 520-550°C for 6 h. The temperature for calcinations was attained slowly from 120 to 520 °C in a period of 2-3 h. The material recovered was analysed by Mössbauer spectroscopy to detect the active ferrous and ferric sites on and within the zeolite ZSM5. The spectroscopic analysis suggests that the synthesized catalyst contains less than 0.2% ferrous Fe²⁺ and at least 1.8 to 2.0 ferric Fe³⁺ sites per 100gm of Fe-ZSM5 sample. A concentration of 0.2gm/lit of thus prepared catalyst was used for the experiment.

Hydrogen peroxide with 30% concentration in water was supplied by Fluka Chemicals.

2.2.1 Surface Analysis by XPS

For investigation of structure and bonding of plasma-polymerized material, the techniques such as infra-red spectroscopy, electron spectroscopy for chemical analysis (ESCA) are used where as the technique electron spin resonance (ESR) can provide information about the radical sites within polymer framework. The contact angle measurement provides complimentary data to ESCA with regards to outermost sample surface [2].

As mentioned in introduction section the area of polymer that was exposed is limited and thus not sufficient to see reproducible contact angle measurement analysis. This analysis was done eventually, and the X-Ray Photoelectron Spectroscopy (XPS) was used exclusively to study and track the changes in the chemistry of the modified polymer surface. The introduction of oxygen and OH-groups was controlled by photoelectron spectroscopy (XPS) and measuring the C1s, O1s and N1s peaks (or the F1s peak if the OH-groups were derivatized with TFAA. The spectrometer used was a SAGE150 (Specs, Berlin, Germany) equipped with channeltrons and

working with non-monochromatized MgK α radiation with 11 kV and 250 W settings at a pressure $\approx 1 \cdot 10^{-7}$ Pa in the analysis chamber. XPS spectra were acquired in the constant analyser energy (CAE) mode at 90° take-off angle. Peak analysis was performed using the peak fit routine from Specs.

2.3 Derivatization of functional groups for improved XPS analysis

2.3.1 Hydroxyl group derivatization

The derivatization of OH groups was selective in high yield by using TFAA in the vapor phase [115, 116]: The TFAA derivatization of hydroxyl functional group for improved XPS analysis was highly selective in the absence of any amino groups, and showed a high yield by using it in the vapor phase. Scheme 8 represents this gas phase reaction.

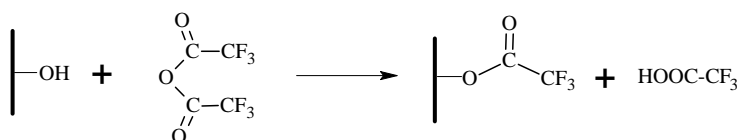

Scheme 8: Gas phase derivatization of hydroxyl functionality

The F1s peaks were used for quantifying the presence of –OH groups among all other singly-oxygen to carbon bonded (C-O) species (C-OH-alcohols, C-O-C-ethers and hydroperoxides-C-O-OH), by derivatizing them with trifluoroacetic anhydride (TFAA). Trifluoroacetic anhydride was supplied by Merck, Germany.

Wet-chemical post-plasma reductions or post plasma wet treatments were carried out by diborane [84, 116-118] and sodium borohydride in dry tetrahydrofuran and distilled water respectively as the solvents with the objective to produce OH-groups:

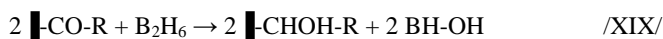

Reduction with diborane was carried out under nitrogen and dry conditions with 5 to 10% diborane quantity to the total quantity of THF taken. The total reaction duration for the reaction was 24 h. The sodium borohydride reduction was carried out for 12 hours with 0.1% wt/vol. concentration of sodium borohydride to water. Trifluoroacetic anhydride, diborane (B₂H₆) and sodium borohydride (NaBH₄) were provided by Aldrich.

2.3.2 Carboxylic group derivatization

To distinguish between carboxylic acid and ester group formation on the PP-surface in context with the scheme of gas phase derivatization from scheme 9, chemical derivatization with

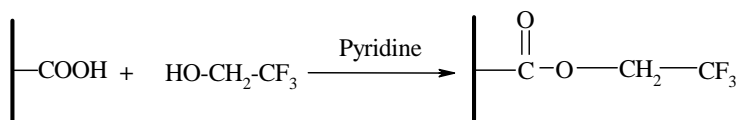

Scheme 9: Gas phase fluorine derivatization of carboxylic group reaction

trifluoroethanol (TFE) [112]. Derivatization proves the chemical presence of -COOH functionalities retained within the (288.9-289.3 eV region). The reaction is carried out at room temperature in gaseous phase.

2.3.3 Hydroperoxyl (-O-OH) group derivatization

The introduction of total oxygen, and among all singly bonded oxygen to carbon groups (C-O) species (C-OH-alcohols, C-O-C-ethers and hydroperoxides-C-O-OH), that of the OH-groups, was quantified and controlled by measuring the C1s and O1s peaks.

The presence of hydroperoxy functionalities was shown by XPS studies. The quantity of such functionalities though found feeble nevertheless could be effectively tracked by the gas

phase derivatization using sulphur dioxide reagent according see reaction in scheme 10 [94, 119].



Scheme 10: sulfur derivatization of hydroperoxyl functionality

The F1s and S2p peaks were used for quantifying the presence of $-\text{OH}$ and $-\text{O-OH}$ groups among all other singly-oxygen to carbon bonded (C-O) species (C-OH-alcohols, C-O-C-ethers and hydroperoxides-C-O-OH), by derivatizing them with trifluoroacetic anhydride (TFAA) and sulphur dioxide (SO_2) gas respectively.

A sulfur dioxide gas lecture bottle was used, supplied by Air Liquide, Germany, for the derivatization of hydroperoxy groups at the polymer surface.

2.4 Analysis of UWP exposed olefinic monomer (Acrylic Acid)

For investigation of structure and bonding of plasma-polymerized material, the techniques such nuclear magnetic resonance spectroscopy was used. The data presented in the work is limited to the polymerization of acrylic acid monomer.

The plasma polymerized acrylic acid was separated from water using high vacuum under slow heating to about 30-40°C using a rotary evaporator. Dried sample was subjected to the ^1H -NMR and ^{13}C -NMR analyses. The spectroscopy pertained information of ^1H and ^{13}C - environments observed after UWP exposure to the acrylic acid.

Spectrometer BRUKER Avance 600 with 600.2 MHz for ^1H was used. Solvent D_2O supplied by Sigma-Aldrich 99.9% D purity was used. Further parameters: 9616 Hz sweep width, 6.81 s acquisition time, and 30 s relaxation time was used during the analysis.

^{13}C -NMR-measurement: frequency 150.93 MHz, sweep width 30.3 KHZ, acquisition time 2.16 s, relaxation delay 30 s were followed during the analysis. Analysis of the sample and the

reports were cordially received from division I.3, Structure Analysis; Polymer Analysis, working group NMR Spectroscopy (BAM reference I093).

3. Results

3.1 Underwater Capillary Discharge – visual observations

The technique of capillary discharge consists of two electrodes submerged in a well separated chamber containing water and any salt (here: NaCl) for production of sufficient conductivity as described in the Section Experimental. The separating barrier between the two compartments is perforated by a 25 mm long silica capillary with an inner diameter of 2.5 mm (see Fig. 1 and Picture 2). When a sufficiently high voltage is applied (>10 kV, 20 kHz) an electrical glowing discharge propagates within and 10 to 15 mm far from the tips of capillary into water. The commencement of such discharge is assumed to be the electrolysis; when a sufficient high current is forced to flow through a narrow capillary hole, water inside capillary evaporates and generates bubbles in the water phase due to Joule heating, similar to the process of electrolysis of water into an electrochemical cell on the surface of its electrode. However, in this case alternating current of high voltage is used. It must be noted that the highest current density is not situated at the surface of electrodes but within the 2.5 mm of the capillary. Joule heating causes heating of the local water inside capillary and leads to nucleation of toroidal bubble. This ever expanding bubble reaches at a critical voltage-diameter combination and breaks down to generate plasma and consequently UV-radiations and shockwaves. Theoretical aspects of this bubble collapse were confirmed experimentally by researchers earlier [114, 121, 122]. The expansion of each bubble interrupts the current, while its collapse switches the current on and leads to a cycle of such processes breakdown. Bubble breakdown process develops along the perimeter of the boundary of the bubble [122]. It was presumed that this is the place of ignition of the arc discharge.

It should be added principally that the uniform diameter of the used capillary produces an equivalent discharge on both ends of the capillary. Using conic capillaries it is possible to suppress the discharge glow on the side of higher diameter and enhance the plasma on the other end of the capillary.

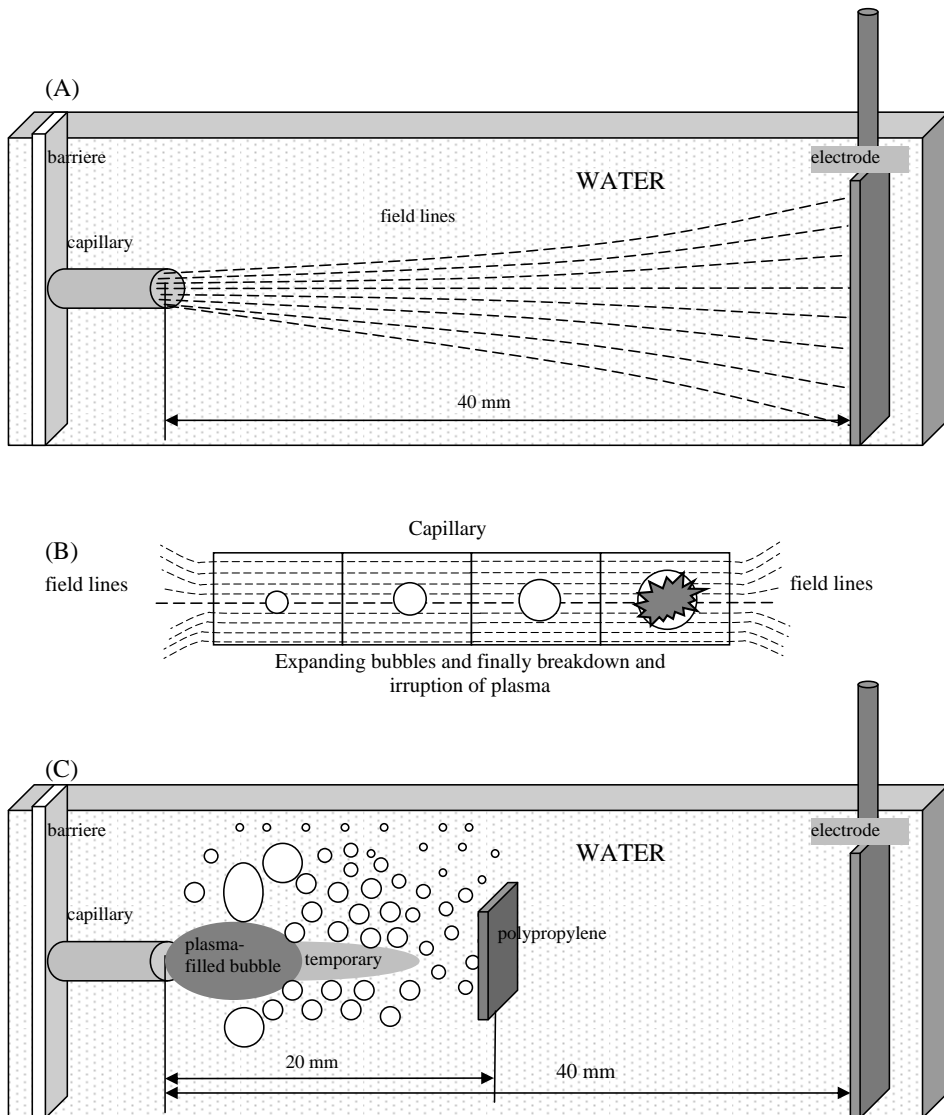

Figure 6:

Sketch (A): Depiction of assumed distribution of field lines going out from the capillary to the electrode

Sketch (B): Depiction of gradual growth of bubble in dense current field lines within capillary

Sketch (C): Visual effects caused after outburst of discharge from capillary

A schematic visualization of this situation is presented (see scheme 6 and Figure 6).

The immediate vicinity of the capillary tip (0 to 10 mm) was found to be inappropriate for any polymer treatment because of the direct contact of polymer surface to the plasma and its high temperature. The operating range of the arc discharge far from the capillary tip periodically varies from <10 to 15 mm. In this region all plasma-induced polymer surface modifications are much faster and proceed within few seconds. However, thermo-oxidative degradation and thermally-induced shrinking of foils were observed several times. Moreover, the polymer surfaces could not be modified homogeneously, what was seen by recorded high-speed movies. Thus, to attain a more homogeneous treatment and to avoid high temperature and shock wave-induced (plasma and bubble) fluctuations of the plasma a safe distance of at least 15 mm is needed; however, exposure time in the range of a few minutes and slower oxidation rates must be accepted. Near the tip of capillary big pulsating bubbles are visible as seen by the high-speed movies of the process (cf. Figure 6). The following process description may be illustrated by these snap-shots.

The plasma-plume shrinks and expands periodically up to about 15 mm distance as shown by a grey-colored region in Figure 6. Long grey colored temporary area represents the cavitation-region accrued by the shock-wave as well as the high temperature of plasma discharge. Similar was validated using the high speed camera photography presented in picture 3 in A, B, C and D. Snap shots A and B being pictured at initial jet burst of plasma inside water photographed in dark room conditions. A dark grey zone is a region which is relatively illuminated more prolonged period of time with plasma discharge. The same is evident from the snap shots E & F from picture 3. Polymer sample kept in its vicinity causes burning and melting of the polymers (5 to 7 mm from capillary tip). The blue marked square in picture D depicts the outer boundary of capillary in the respective side of the reactor. Smaller plasma-free bubbles, as was seen with the naked eye, dominate at 20 mm and myriads of fine water vapor bubbles are present at 25 and 30 mm with its tendency to move upward to the water surface (see snap shots E & F). Thus, it is believed that the minima and maxima in Figure 9 and 16 from *distance-*

plasma-polymer section are probably caused by periodic bubble pulsation and consequently different coverage for the sample surface at each position. Analyzing the movies (picture 3 snapshots), it looks like that expanding, shrinking of bubbles and reflection of ultrasonic waves from the walls of the UWP cell and from the sample surface produce “standing waves” within the UWP cell.



A



B

Picture A & B: Top view of reactor vessel:

Photographed from using high speed camera under dark room conditions. Initial breakdown of plasma from the capillary.



C



D

C, D, E & F: Side view of reactor vessel



E



F

Picture 3: Photographed from using high speed camera under day light conditions during different time periods of plasma discharge.

It is important to note that the reactive species are packed very closely together in the primary reaction zone around the arc [44]. The radicals and the reactive molecular products were

convectively driven and diffuse into the solution and interact there with water molecules, produce secondary energy-rich products, which react with the substrate surface [44].

The processing of the polypropylene surface at a distance of 15-30 mm from the end of the capillary implies that the polymer was not in continuous or temporary contact with the plasma, only with secondary products within the plasma-affected solution and bubbles.

Another important observation is related to the temperature of the UWP-cell solution.

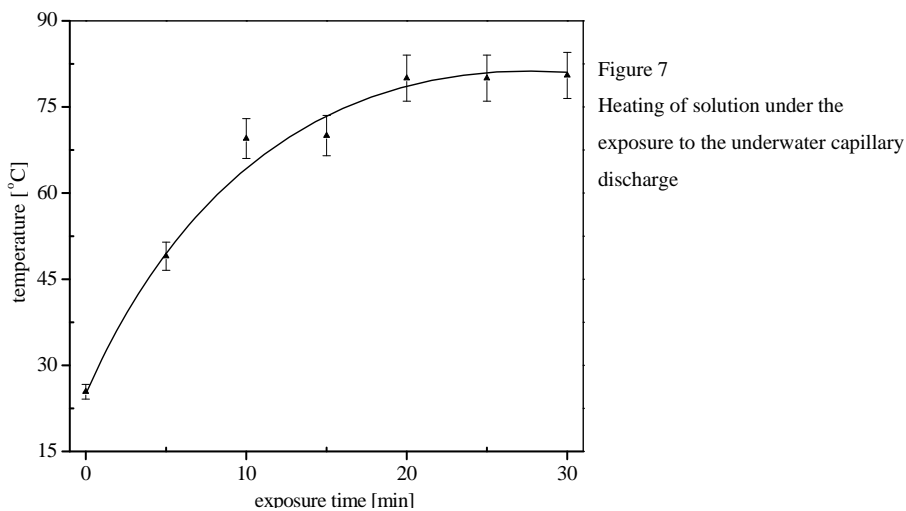

The UWP exposure increases significantly the solution. When plasma exposure is run continuously for 30 min of time almost 80°C to 85°C was reached where a fast steaming of water surface was observed. This temperature growth for is evident in the Figure 7. A steep temperature rise from 25°C to 65 °C was observed during the initial 10 minutes of time after plasma ignition, see Figure 7, followed by a much slower rise from 70 °C to 85 °C in the following 10 minutes plasma exposure.

The generated heat by the high-pressure and high-temperature arc plasma within the capillary is distributed within its surrounding aqueous medium using a magnetic stirring needle. Rise in temperature of the aqueous system is the consequence. To a certain extent, the electrical

resistance of the volume of aqueous solution from the tip of the capillary to the electrode also has a role in elevation of temperature (Joule-heating).

3.2 Oxygen bonding efficiency, selectivity and related parameters definitions

3.2.1 Functionalization with hydroxyl groups (OH)

This work is focused on the evaluation of four crucial process characteristics, which have to be defined:

- The *efficiency* in total oxygen introduction onto the polymer surface measured by the elemental composition using the XPS method (calculated from the survey scan) in O per 100 C atoms, labeled as O_{total}
- The *selectivity in C-O formation* derived from peak fitting of the C1s signal representing singly bonded carbon to oxygen groups (binding energy ≈ 286.3 eV), e.g. the sum of ether and hydroxyl groups given in C-O per CO_x , labeled as C-O/100 C. CO_x means the sum of all fitted CO species within the C1s peak, i.e. C-O, (O-C-O and C=O), (O-C=O and O-C(-O)-O) and O-C(=O)-O. CO_x should be roughly equivalent to O_{total} .
- The *selectivity in OH group formation* among all types of other oxygen-functional groups measured after derivatization of the C-OH groups with trifluoroacetic anhydride (TFAA) and measuring the fluorine content at the sample surface given in OH per 100-Oxygen atoms. (cf. Scheme 8), indicated by OH/100 CO_x ($\approx O_{\text{total}}$)
- The *yield* in OH group formation among all types of other oxygen-functional groups measured after derivatization of the C-OH groups with trifluoroacetic anhydride (TFAA) and measuring the fluorine content at the sample surface given in OH per 100 carbon atoms, OH/100 C.

3.2.2 Functionalization with carboxylic groups (COOH)

The selectivity and the yield in COOH group formation are defined in a similar manner as with OH groups:

- The *selectivity in COOH (O=C-OH) bond formation* derived from peak fitting of the C1s signal representing triply bonded carbon to oxygen (binding energy 288.9 – 289.3 eV) is defined as the sum of ester (-COOR) and carboxylic (COOH) groups given as $\frac{-\text{COOH}}{(\text{COOH} + \text{COOR})}$
- The *selectivity in COOH group formation* among all types of other oxygen-functional groups measured after derivatization of the COOH groups with trifluoroethanol (TFE) to the corresponding trifluoroethylester, measuring the fluorine content at the sample surface and calculating with this, a value for the original COOH content, given in $\frac{\text{COOH}}{100 \text{ O}}$ (or CO_x) (cf. Scheme 9)

3.3 Dependence of polymer surface functionalization on plasma generation parameters

3.3.1 Electrolyte concentration (sodium chloride)

The electrolyte (NaCl) concentration has an important influence on the introduction of oxygen (O_{total} resp. CO_x) onto the polypropylene surface and the OH selectivity ($\frac{\text{OH}}{\text{O}_{\text{total}}}$) as shown in Figure 8. The efficiency of oxygen introduction decreases with growing NaCl concentration (presumably increased Joule-heating) but the OH selectivity increases strongly. The NaCl concentration was varied from 0.002 mol/l to 0.012 mol/l giving rise to the initial conductivities of the solution from 200 $\mu\text{S}/\text{cm}$ to 1400 $\mu\text{S}/\text{cm}$ at room temperature. A good compromise was found to keep the electrolyte concentration at 0.005 mol/l.

Lower electrolyte concentrations cause the problem of shock waves generated by the system in the plasma ignition phase, which was destructive for the plasma-glass vessel. A higher electrolyte concentration than 0.012 mol/l reduces the resistance to a level at which the plasma generation becomes impossible for the available power supply and chosen conditions [66].

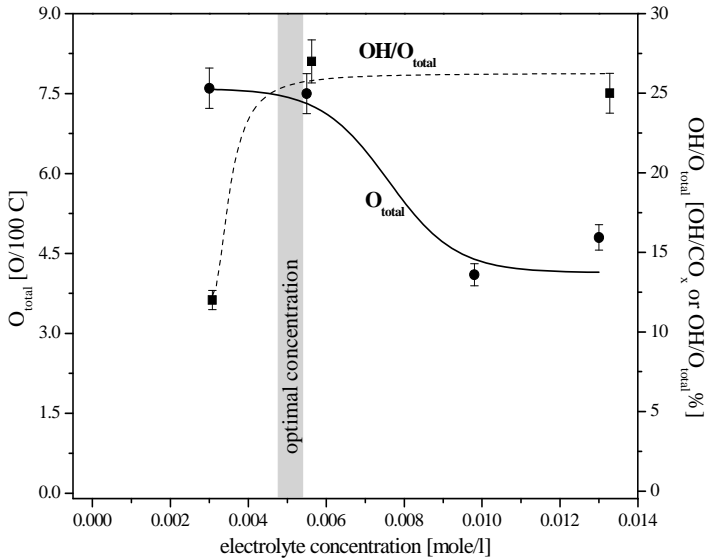

Figure 8
 O_{total} and selectivity in
 OH introduction to the
 PP surface depending
 on the electrolyte
 (NaCl) concentration

It was seen from the earlier work that there are different opinions on the conductivity dependence for generation of energetic species such as hydroxyl, hydrogen radical generation during such or other types of discharges [67, 124].

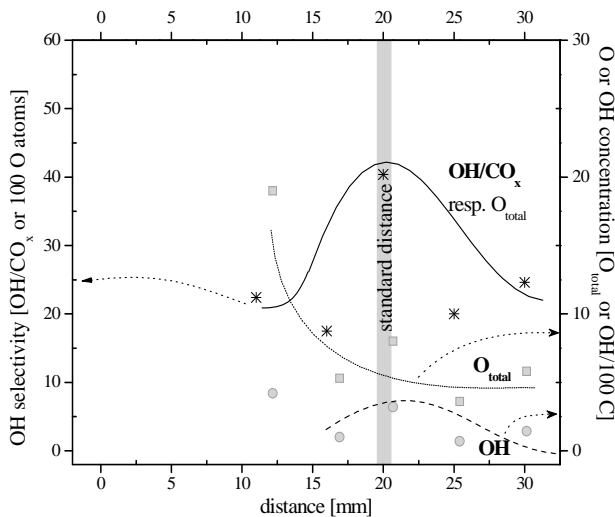

Figure 9
 A set of OH selectivity
 (OH/O_{total}) curves for
 different treatment time
 (1 to 30 min), OH and O_{total}
 concentration for 3 min
 treatment at polypropylene
 surfaces against the distance
 between sample and capillary

3.3.2 Distance of polymer film from plasma source

It was mentioned earlier that immediate vicinity of the capillary tip (0 to 10 mm) was found inappropriate for polymer treatment because of the direct contact of polymer surface to the plasma and its high temperature. To understand the oxidation and selectivity results it is equally

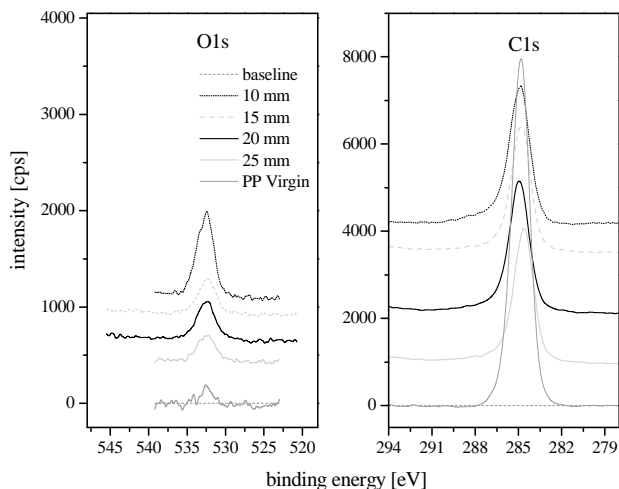

Figure 10
C1s and O1s peaks of
underwaterplasma-treated
polypropylene

important to take into account visual observations mentioned in the section 3.1.

The maximum selectivity in hydroxyl group formation, measured by TFAA derivatization and XPS analysis, was found at exposure times of 3 min among a set of curves with similar values, published more recently, at a distance of 20 mm from the plasma source (Figure 9) [85, 98].

The OH selectivity ranged from about 18 to 41 OH groups per 100 CO_x as measured for all C-O bonded species in the C1s peak or alternatively per 100 oxygen atoms (O_{total}). This result should be compared to the fact that low-pressure oxygen plasma introduces maximal about 28 O per 100 C atoms to the polypropylene surface, and among them 1-3 OH/100 C or expressed in terms of OH selectivity 5 to 10 OH groups per 100 O_{total} atoms may be found [74].

Normally, one had expected an exponential decrease of the $O_{\text{total}}=f(t)$ function as fitted for CO_x in Figure 9.

Thus, it is believed that maxima in Figure 9 are probably caused by periodic bubble pulsation and consequently sample surface at each position. Analyzing the movies, it looks like that expanding, shrinking of bubbles and reflection of ultrasonic waves from the walls of the UWP cell and from the sample surface produce “standing waves” within the UWP cell.

Taking into account the visual observations the discharge filament touching the film position at 15 mm experiences a continual plasma activation and quenching effect due to bubble pulsation effect.

In contrast to gas plasmas, underwater plasma processes are related with electrochemical processes, thus, charging of polymers surface may play a more important role than in gas plasmas. Solvation effect for charged particles such as electrons, ions and as well as radicals is most favored possibility with such an electrochemical system; consequently the charges are more effectively stabilized. The polypropylene material is non-polar and initially charge-free. The electrical conductivity of polymers such as polypropylene increases markedly under plasma irradiation; it does not fall off immediately to its original value after irradiation, but remains over a period of long time [125]. It was assumed that the charge is also deposited ‘instantaneously’ at zero time by irradiation before the plasma touches the surface [126]. Instantaneous charging requires that the charge be deposited before significant movement from the surface to the bulk occurs [127].

It was apparent by the high speed photography (cf. picture C, D, E, F) that during the backward pulsation (bubble pulsation) of plasma filament the generated radical sites may be quenched by surrounding aqueous medium, giving rise to polar oxygen functionalities at activated sites. Polymers which normally cross link under irradiation are degraded if irradiated in the presence of oxygen in a divided form, i.e. with a large surface to volume ratio, oxidative degradation of main chain [125]. It has established a steady-state between formation and decay

of oxygen functional groups. The decay is connected with formation of highly-oxidized gaseous degradation products such as carbon dioxide or water. Formation of carbon mono and dioxide needs the participation of carbon from the polymer thus polymer etching occurs. Such a continual etching of polymer surface at such tricky position reduces substantially the oxygen content at 15 mm distance. This may be one of the reasons of having very low oxygen and hydroxyl group at 15 mm distance from capillary plasma source.

The processing of the polypropylene surface at a distance of 15-30 mm, preferably at 20 mm from the end of capillary implies that the polymer was not in continuous or temporary contact with the plasma, only with secondary products within the plasma-affected solution and bubbles.

Figure 10 contains the C1s and O1s XPS graphs showing dependence of intensity of oxidation

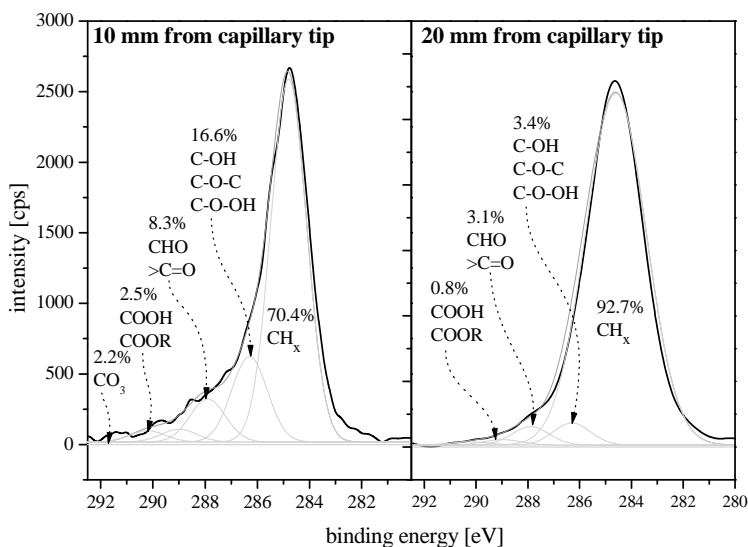

Figure 11
Details of the C1s peaks at distances of 10 and 20 mm from the plasma source

on the distance of the polymer foil from the plasma source, e.g from the tip of capillary. Treatments at distances of 5 and 10 mm have shown the thermal and thermo-oxidative damaging of polymer foils. In some experiments even melting of the polymer film was observed, although

these shorter distances have efficiently introduced oxygen in the range about 15 to 20 O/100C within 3 to 5 minutes as shown in Figure 9.

Broadening of the C1s-peak and forming a shoulder towards the higher binding energy side of the 10 mm sample distance depicted in Figure 11 between binding energies of 287.5 eV to 290 eV is obvious. The introduction of O functional groups as singly (hydroxyl, ether, epoxy, hydroperoxide - 286.1-286.7 eV), doubly (keton, aldehyde-287.2-288.2 eV), triply (acid, ester-288.9-289.3 eV) and (peroxyacids-ca. 290 eV) as well as quarterly bonded carbon to oxygen species (carbonate-290.3-290.5 eV) causes this significant broadening. The more doubly, triply and quarterly C-O bonded species are present the lower will be the yield in desired OH-groups. Additionally, their coexistence within the singly bonded C-O species with other groups also lowers the selectivity of OH-formation (here, C-O selectivity exactly represents, OH + C-O-C + hydroperoxides). All C-O singly bonded species amounts 56 C-O/100 CO_x (O_{total}), among them the fraction of OH groups is existing.

At 20 mm distance from the capillary tip, the sample shows a lower concentration of oxygen (about 8 O per 100 C) and a comparatively lower C-O-selectivity (sum of OH + C-O-C + hydroperoxides) of 45 C-O/100 O_{total}, cf. Fig. 11) in comparison to about 20 O/100 C at 10 mm distance as mentioned before.

The time-dependences of polymer surface oxidation at 10 and 20 mm distance from the capillary tip are shown in Fig. 12. For 20 mm distance a clearly defined point of saturation just below 8 O per 100 C was obviously. At the closer distance of 10 mm, a nearly linear growth in overall oxidation of polymer surface with respect to the time was observed. More than 25 O per 100 C were measured nevertheless a much higher error margin or fluctuations in total introduced oxygen for such long duration plasma exposure was frequently observed. This continuous increasing in O concentration may be due to the thermal oxidation at this position within the fluctuation plasma.

A comparison is well depicted by C1s curves for 10 min and 25 min UWP exposed PP-films

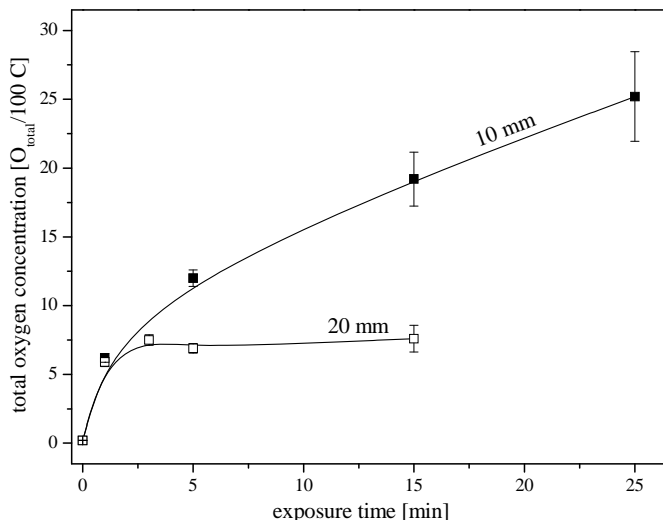

Figure 12
XPS-measured oxygen
introduction at two different
distances onto PP- surfaces
after UWP exposure

(Fig. 13). Prolonged exposure introduces oxygen to the surface in a variety of single (C-O), double (>C=O) and triple bonded (COO-) features.

It may be noted at this point that treating the polymer surfaces out of the plasma zone has a problem of efficient oxygen introduction onto the surface. Treating surface inside plasma zone had deteriorating effects for the surface and the polymer as seen on position 10 and 15 mm from capillary plasma source. This study was emphasized to modulate a precise and reproducible position of polymer sample such that a better oxidation could be attained without the danger of thermal damaging the sample surface.

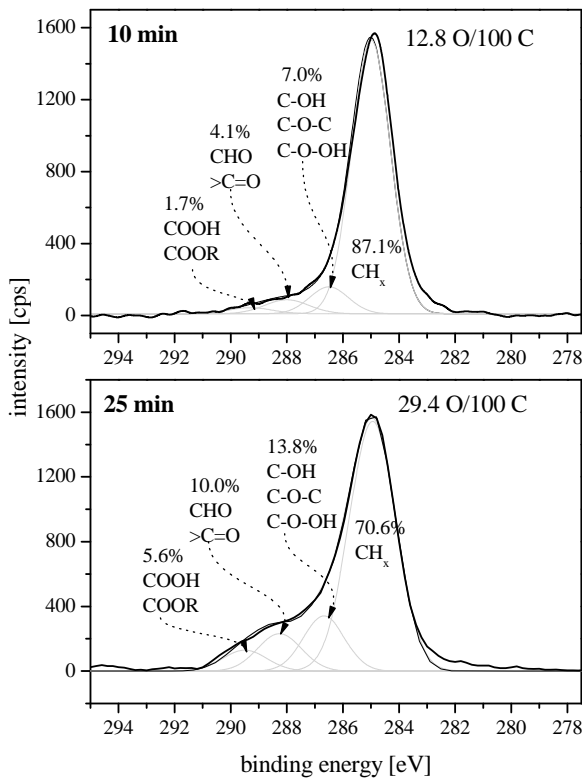

Figure 13
Changes in the C1s-peak of underwater plasma treated polypropylene foils (distance 10 and 25 mm)

3.3.3 Influence of solution temperature on selectivity

Due to the heating effect of the underwater capillary discharge, the temperature elevation at the film position (20 mm far from the capillary) was rapid within the initial 10 min, followed by a slow rise to an equilibrium temperature of 75-85°C. To study the effects of temperature on the selectivity of OH functionalization, the water solution was heated to different temperature ranges of 40-60 °C and 60-80 °C using the underwater plasma source as an internal heater or using an external heating source to adjust 80°C. The polymer samples were dipped and subsequently exposed to the UWP when the desired temperature of the well stirred solution in the electrochemical cell was attained. The OH selectivity ($\text{OH}/100 \text{ O}_{\text{total}}$) was determined as a function of the exposure to the UWP at the two distinct temperature levels. The difference between the two heating modes was that the UWP starts from room temperature, i.e. 20°C (Figure 14), to heat the water solution to 40-60 or 70-80°C. The time needed for heating was about 5 or 20 min.

The lowest possible temperature range of 40-60°C, established by burning UWP, produced the maximal OH-selectivity with 30-40 OH groups/100 O_{total} atoms (Figure 14). Using external pre-heating to 80°C, the OH selectivity was limited to 12-16 OH groups per 100 O_{total} atoms (cf. Figure 14). Changing the heating source for the UWP cell from an external heating device to the capillary discharge itself and the subsequent dissipation of thermal energy, a slight elevation in the OH selectivity was observed (cf. Fig. 14). The interpretation is as follows. It is well known that the reaction rate is improved by increasing temperature but the selectivity of a distinct reaction is lowered. At higher temperatures the decomposition of hydrogen peroxide begins to dominate under formation of molecular oxygen (cf. /XI/), as also depicted in the Section Introduction.

Thus in the lower temperature regime, more OH and O-OH group forming species are present and are available for the desired functionalization.

It may be assumed that the decay of intermediary produced hydrogen peroxide at

Figure 14

Temperature as a function of selectivity:

in-situ heating of solution using underwater discharge to 40-60°C;

in-situ heating of solution using underwater discharge to 60-80°C;

heating of solution using an external heating device to 60-80°C

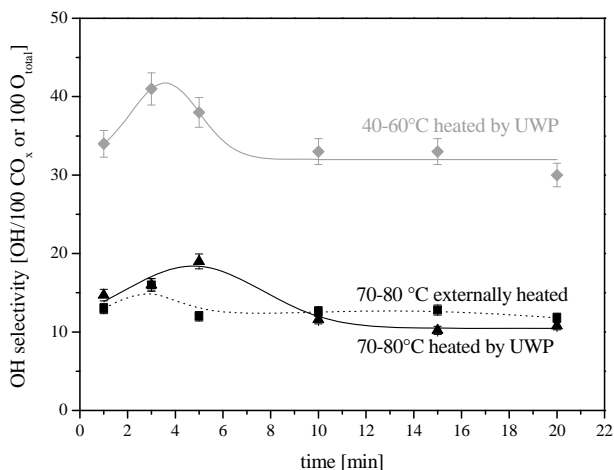

elevated temperatures (40-60°C) preferably follows the reactions: $\text{HOOH} \rightarrow \text{H}\cdot + \cdot\text{OOH}$ ($\Delta\text{H}_0=375$ kJ/mole) and $\text{HOOH} \rightarrow 2 \cdot\text{OH}$ ($\Delta\text{H}_0=214$ kJ/mole). At higher temperatures (70-80°C) the decomposition of hydrogen peroxide under formation of oxygen gas dominates: $\text{H}_2\text{O}_2 \rightarrow \text{H}_2\text{O} + \frac{1}{2}\text{O}_2\uparrow$; $\Delta\text{H}_0= -98.2$ kJ/mole, as also depicted in the Introduction section.

3.3.4 Influence of solution pH on selectivity

The pH value of the water phase has a significant consequence on the OH selectivity as demonstrated in Figure 15.

Using neutral water systems (pH 6-7) in the underwater plasma generating electrochemical cell, a maximum selectivity in OH formation at polypropylene surfaces of more than 40% is achieved at the beginning of the plasma process, at about 3 min. It is followed by a decrease and then by a constant steady state, which is argued to be due to an increased recombination of OH radicals.

It must be understood that in this period also a strong heating of the underwater plasma occurs. Thus, the dissociation of hydrogen peroxide into OH radicals may be accelerated and therefore the attachment of these hydroxyl radicals onto the polymer surface as measured with XPS and derivatization. Acidic systems (pH range 2, H₂SO₄) show the opposite behaviour. A minimum OH selectivity was seen in the range of 1-3 min exposure. A simple, plausible and well grounded explanation cannot be presented yet. However, one explanation may be the dissociation of water molecules into positively charged water ions and solvated electron [79]. The solvated electrons react with water molecules, OH radicals, hydrogen peroxide etc. and form hydroxyl anions. These anions may be reacting with solvated protons at low pH value to form

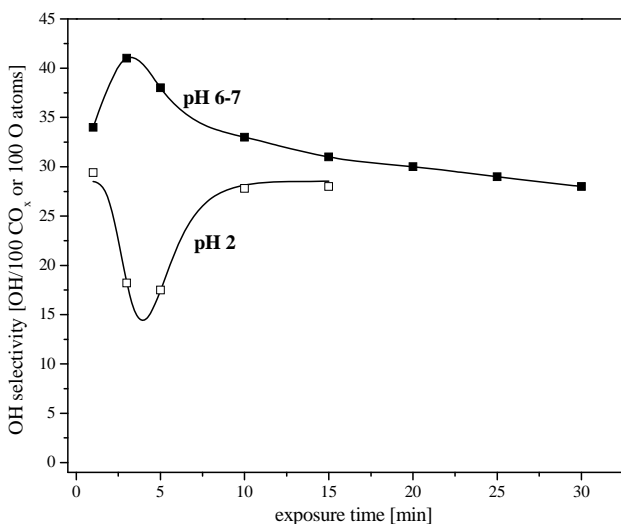
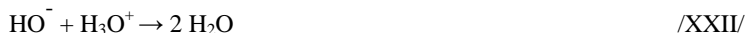

Figure 15
OH selectivity vs. time
at distinct pH value

water, thus lowering the possibility of OH group attachment at the polymer surface as shown by equations /XXI/ and /XXII/ [128]. Electrons may also react with protons and form gaseous hydrogen and hydroxyl anions remain and may alter the pH of the solution. It was earlier mentioned that the UWP process are also a source of solvated electrons and may contribute to the production of OH species [90]:



On the basis of equations /XXI/ and /XXII/ it may be assumed that highly acidic conditions generally deactivate OH radicals as from thus affecting the selectivity of the process [81].

3.4 Selectivity and yield in OH group formation

The oxidation efficiency is the number of introduced oxygen atoms per 100 carbon atoms using XPS. Referencing to 100 C was chosen because of the (non-stoichiometric) statistical process of oxidation.

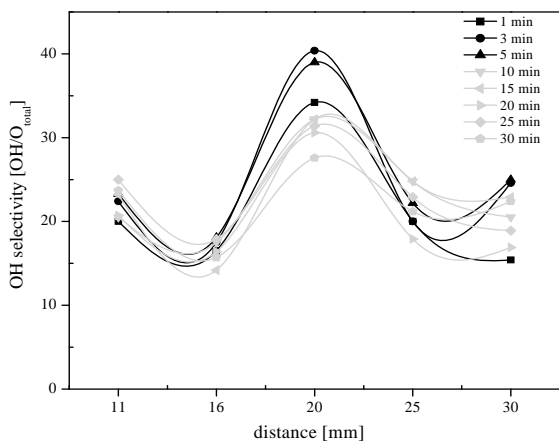

Figure 16
Selectivity in OH-group formation in dependence on distance to the underwater plasma after 5 min treatment

Since hydroxyl oxygen cannot be clearly distinguished from other singly oxygen to carbon bonded species by XPS, a chemical derivatization reaction with trifluoroacetic anhydride (TFAA) was used (cf. Scheme 8) to label them with a threefold amount of fluorine atoms [129]. It was used to find the optimal distance between the capillary tip and the polymer sample with respect to the highest OH selectivity (OH/O_{total}) in the underwater plasma system (Fig. 16).

The manifest dissociation of water in the underwater plasma into OH radicals and hydrogen atoms should enhance the OH selectivity in contrast to the oxygen low-pressure gas plasma, where the formation of OH is not possible because of missing hydrogen atoms in this plasma. Therefore, the OH-selectivity is very low (<10%). Only secondary produced hydrogen, abstracted from the polymer or originating from humidity traces, may occur and thus produce OH groups in the oxygen gas plasma. This primary OH groups formed in the oxygen plasma have to be distinguished from secondary formed OH groups within the auto-oxidation process at long-time exposure of the plasma-treated polymer to the ambient air. The auto-oxidation needs trapped C radical sites within the polymer produced by plasma irradiation [35]. The underwater plasma emits radiation with lower energy and is less likely to produce trapped C radicals in near-surface layers. Moreover, such radicals situated in the topmost surface layer are immediately

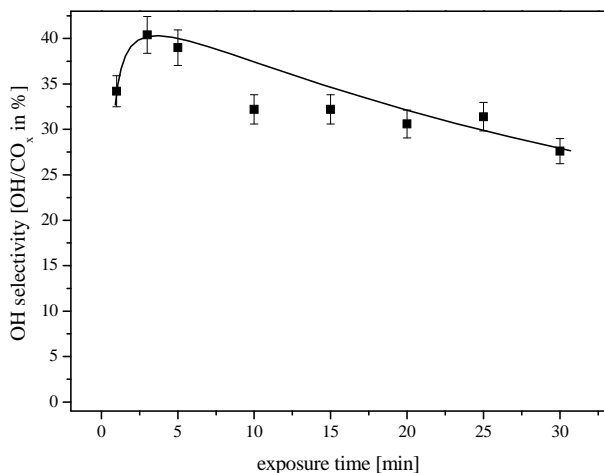

Figure 17
OH selectivity as function of UWP exposure time at a distance of 20 mm from the capillary tip

quenched when they get in contact with water.

In contrast to the point of highest efficiency in O_{total} introduction onto the polymer surface at 5 to 10 mm distance from the plasma source with a low OH selectivity (cf. Fig. 8) the

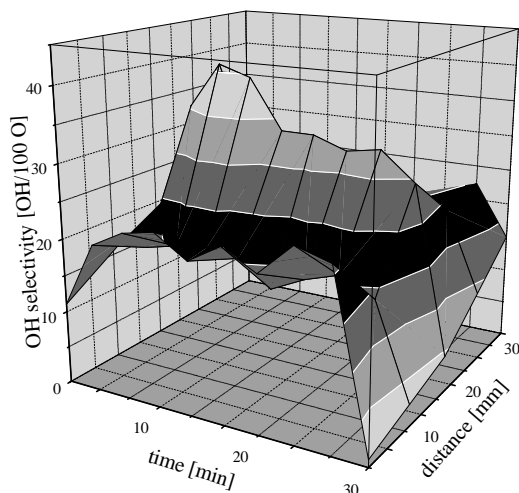

Figure 18
3d plot of OH
selectivity vs. time and
distance

maximal yield in OH formation was found at a distance of 20 mm accompanied by lower O_{total} introduction. Maximal more than 40 OH among 100 O atoms were detected (cf. Fig. 16).

Processing the polypropylene substrate at 20 mm distance from the plasma source the time-dependence of OH selectivity was determined. The maximum selectivity in hydroxyl group formation, measured by TFAA derivatization and XPS-analysis, was situated between 3 to 5 min exposures to the underwater plasma as shown also in Fig. 17.

The complete field of parameter dependence is visualized as 3d-plot in Fig. 18, clearly confirming that 3 min treatment time and 20 mm distance to the capillary tip are the optimum UWP conditions to establish the maximum OH selectivity, for this set of applied experimental condition, seen as red colored top.

3.5 Post-UW plasma treatment using reducing agents

As evident from the present data the complexity of plasma-chemical surface processing generally involves the formation of a broad range of oxygen-containing functionalities. The gas discharges in atmosphere or in vacuum using the oxygen plasma processes are always

accompanied by formation of other functionalities like ethers, ketones, aldehydes, epoxy, acids or esters and carbonates. These overall functionalities can be broadly divided as reducible (carbonyl features) and non-reducible functional groups (ethers) with soft reducing agents as diborane. Moreover, olefinic double bonds can be added by OH groups also using diborane (B_2H_6) and basic or acidic hydrolyzation of borane complexes [84, 117, 118, 130].

All carbonyl functionalities are reduced to OH. This requires a wet chemical reduction of such sort of functionalities [84, 117, 118]. For the present study diborane (B_2H_6) and sodium borohydride ($NaBH_4$) were used. Reductions were carried out as explained in the experimental section. As it should be mentioned hydroboration of gas-plasma produced olefinic double bonds is additionally possible [74]. However, any yellowing of polymer samples was absent using the

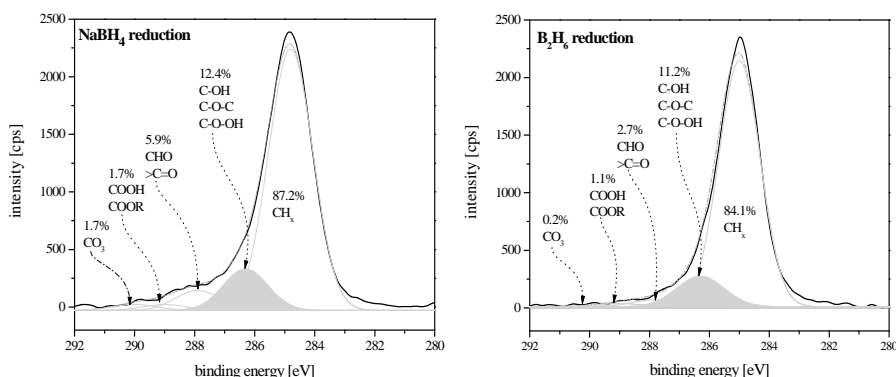

Figure 19: Underwater plasma treated PP followed by $NaBH_4$ or B_2H_6 reduction

UWP, therefore, hydroboration was not used.

The comparative $C1s$ peak fitting from Figures 19 gives results for the post-plasma chemically reduced substrates.

In comparison to the underwater plasma treated sample a noticeable and significant growth in carbon-oxygen percentage (C-O selectivity) of post plasma treated sample was observed using the diborane post-plasma reduction. The carbonyl-related $C1s$ subpeaks (for CHO, $>C=O$, COOR, COOH, CO_3) were significantly reduced applying the diborane

reduction (Fig. 19b). Using the C1s-peak after fitting as depicted in Fig. 19 the C-O percentage (OH + ethers) rises from 47 (cf. Fig. 13, not post-plasma treated) to 57 (NaBH₄) and 74 (B₂H₆) C-O features per 100 introduced O atoms. This fact was again cross-verified by the fluorine derivatization reaction which gives selectivity's of about 40 OH groups per 100 O atoms for both kinds of reduction, e.g. the difference to the C-O concentration is due to existence of ether links (C-O-C). There is a not understandable difference between 57 C-O and 74 C-O per 100 O atoms for NaBH₄ and B₂H₆ respectively. The earlier shown higher oxidation though less selectivity in C-O formation. In later case lower oxidation with higher C-O bond formation was. The following reason was found appropriate for this result obtained using different reducing agents:

As mentioned in experimental section the post plasma treatments by NaBH₄ (12 h) and B₂H₆ (24 h) were carried out using distilled water and dry THF respectively. Aqueous NaBH₄ solution exhibits higher pH of resulting solution. Swelling of polypropylene after a prolonged dip is obviously expected. Swelling effect in polymer in contact with aqueous solutions occurs as a result of diffusion of pure water and its solution which is governed by the partial vapour pressure of water above the solution [131]. Additives such as acids, alkali and salts can reasonably alter this pressure. If the external pressure on liquid is increased, its vapour pressure is raised [132]. External pressure in this case is exerted by the capillary discharge process on the polymer film via the liquid in its vicinity. Swollen polymers allow more diffusion of reducing solution into its matrix. Such type of diffusion phenomenon is less expected in the THF solvent which promotes more effective reduction of carbonyls at polymer surface unlike NaBH₄. Evidently it was seen that the NaBH₄ reduction pertains more O_{total} per 100 C and less CO_x composition inside C1s peak and vice versa in case of diborane was observed.

This conversion rate is not so significantly high as compared to the selectivity obtained after direct plasma processing of the substrate [133]. Sodium borohydride was not able to convert all carbonyl functionalities to OH as shown for LiAlH₄ [133].

Thus, concluding from these experiments the hydroxyl group yield should be increased by using of an additional supplier of OH groups under exposure to the plasma.

3.6 Hydrogen peroxide incursion experiment

3.6.1 Qualitative effects of hydrogen peroxide addition on hydroxyl

(-OH) group functionalization

Hydrogen peroxide seems to be a key intermediate in the UWP as shown by eqs. /X/-/XV/ and its presence in the water phase should influence the yield and selectivity in OH group formation on polyolefin surfaces. Therefore, it was of interest to investigate whether the external addition of hydrogen peroxide to the system would increase the hydroxyl group formation further. Then, the next prediction or assumption, higher concentrations of hydroxyl radicals in the UWP also increases the yield in OH group formation at the polymer surface. Hence, hydrogen peroxide was added externally to the electrolyte solution maintaining all other experimental conditions constant. A significant growth in the oxygen signal could be seen in Figure 17 after the addition of 5-6% hydrogen peroxide to the existing UWP system. Assuming the steady-state concentration of hydrogen peroxide, its decay and formation, an increased OH radical concentration could be expected after its addition to the UWP and thus consequently an enhanced decay into OH radicals, thus, the OH group functionalization efficacy of the surface should be increased. As described in the introduction, any excess of hydrogen peroxide will be decomposed during the UWP and reduced to the steady-state concentration at equilibrium. Thus, within a short range of time, the probability of higher OH radical concentrations in the solution and, consequently a better chance of selectively OH functionalized polymer surface may exist.

The introduction of molar concentrations of hydrogen peroxide in the range of 100 to 150 mol/l to the aqueous plasma-system certainly increased the total oxygen introduction per 100 carbons on the polypropylene surface. In accordance with Figures 20 and 21 represent the increase in efficiency of oxidation with hydrogen peroxide addition. Exposure time (5 min) and distance of the film to the plasma source (20 mm) were kept constant.

It was interesting to note comparing Fig. 10 (curve 20 min) and Fig. 21 that the addition of H_2O_2 leads to a distinct increase of the C-O sub-peak (hatched) at the polypropylene surface, within the binding energy region of 286.0 to 286.6 eV. This C1s sub-peak was assigned as

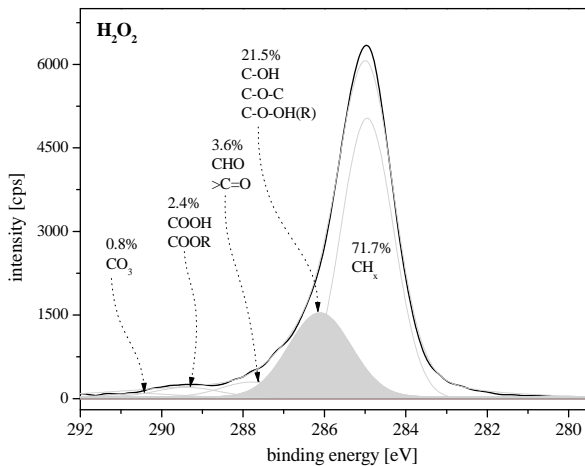

Figure 20
XPS C1s peak of PP surface exposed to 5% H_2O_2 solution plasma for 5 min at 20 mm distance to the capillary

repeatedly mentioned to C-OH, epoxy, C-O-C and aliphatic peroxides [111].

The XP-spectrum shown in Figure 20 exhibits the C-O sub peak with 76% of the total amount of UWP-introduced oxygen.

3.6.2 Quantitative effects of hydrogen peroxide addition on (-OH) group hydroxyl functionalization

Interpreting the recorded XP spectra, it was found that the added H_2O_2 suddenly slumped down the yield in hydroxyl groups referenced to all oxygen functionalities from 30 to 10- 12 OH

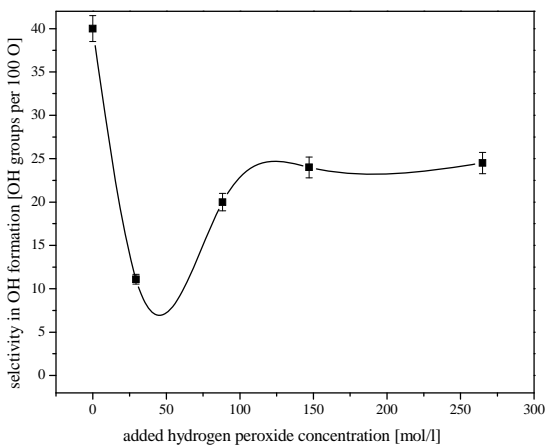

Figure 21
Selectivity in OH group formation at PP surfaces vs. the dosage of hydrogen peroxide to the underwater plasma (3 min, 25°C, 20 mm)

groups/100 oxygen atom [cf. Fig. 21]. At higher dosage of H_2O_2 , an increase to about 25 OH/100 O was observed. It is believed that the addition of H_2O_2 to the plasma system results in deactivating the OH radical formation by the mechanism represented by the equations /XI-XIV/ as described in the Section Introduction. Consequently, the OH group formation within the plasma-initiated processes decreases significantly.

Interpreting the results with and without hydrogen peroxide it can be concluded that the intermediately formed hydrogen peroxide concentration is the key factor for the selective formation of OH groups at polyolefin surfaces as seen in Fig. 3. It must be conceded that the temperature dependence of hydrogen peroxide formation and decay additionally superposes its extra-addition to the UWP. Higher temperature enhances the hydrogen peroxide decay to OH and provokes strong oxidation reaction.

3.7 Hydroxyl (-OH) functionalization using the Fe-ZSM5 catalyst system

The heterogeneous Fenton's catalyst system comprises iron (II and III) at a lower pH range of 2-3. Applying this catalyst system it should be more easily possible to decompose hydrogen peroxide molecules to hydroxy or hydroperoxy radicals (cf. scheme 5). The use of the heterogeneous catalyst system was preferred instead of the application of a water-soluble iron salt, such as FeSO₄, to avoid plausible contamination of the polymer surface by traces or excess of iron and its complexes. In an experiment with 0.05 mg Fe-ZSM5 per 1000 ml distilled water with a pH ranging between 2-3, the PP-films were exposed to this UWP + catalyst from 1 min to 15 min. Results of UWP processes (at neutral pH) with and without catalyst at two pH values are summarized in Fig. 22. The catalyst system increases the selectivity in OH group formation exponentially to the same level as with hydrogen peroxide addition using a pH 2 (Fig. 22). The OH selectivity amounted to 15 OH groups/100 oxygen atoms after 1 min of exposure, and increases in the next 5-10 min to 25-27 OH groups/100 oxygen atoms. The used two pH values

| | maximum total oxygen /100-carbon atoms | C1s peak [bonds/100 carbon atom] | | | C-O bond selectivity [C-O/100 oxygen bonds in C1s peak] | OH groups per 100 within O _{total} [TFAA-derivatisation] |
|----------------------------|--|----------------------------------|------|--------|---|---|
| | | C-O% | C=O% | O=C-O% | | |
| pure UW-plasma | 4-6 | 3.4 | 3.1 | 0.8 | 47.0 | 25-40 |
| UWP with hydrogen peroxide | 7-9 | 21,5 | 3.6 | 3.2 | 76.0 | 12-25 |
| UWP with Fenton's catalyst | 9.5 | 18.1 | 3.2 | 1.1 | 81.0 | 15-27 |

Table 3: comparative bond selectivity obtained by XPS measurement

with catalyst Fe-ZSM5 show a constant OH selectivity at longer treatment times, but at different levels. While the OH selectivity at pH 2 yields an exponential growth as mentioned above

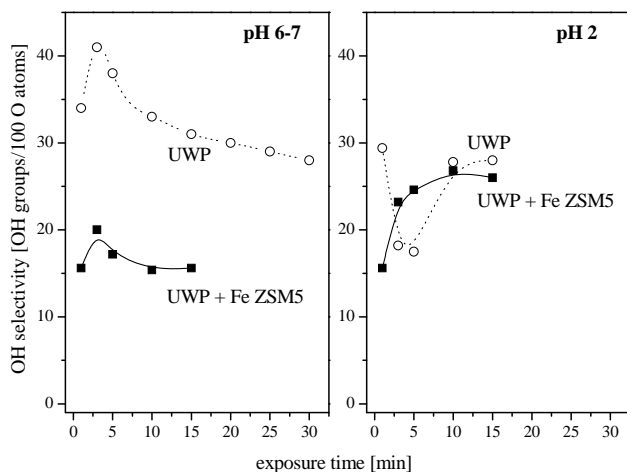

Figure 22
Comparison of OH selectivity using UWP and UWP+Fe ZSM5 at two pH values

(Fig. 22), the curve at pH 6-7 shows the reverse behavior on a much lower level. Curve fitting of the C1s signal shows that the C-O bonds fraction in the C1s spectra was 21.5% (UWP+H₂O₂, cf.

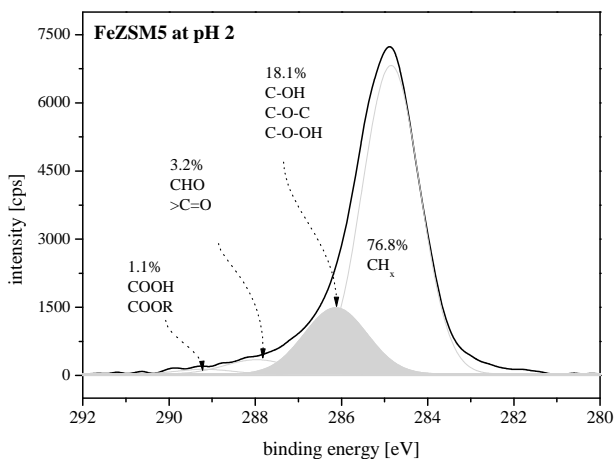

Figure 23
C1s curve of PP-surface Fe-ZSM5 catalysts or Fenton's catalysts system

Fig. 20) and 18.0% (UWP + Fenton, cf. Fig. 23). Table 3 depicts the percentage of C-O bond selectivity [98] (all singly bonded C-O features). Using the Fenton's catalyst system, the C-O selectivity (C-OH, C-O-O, C-O-C) was slightly improved.

3.8 Qualitative interpretation and results comparison obtained by addition of hydrogen peroxide and Fe-ZSM5 catalysts to UWP system

The heterogeneous Fenton's catalyst system comprises Fe(II) and Fe(III) at a lower pH range of 2-4 is known to decompose hydrogen peroxide to OH radicals as shown in scheme 5 [58]. The thus increased concentration of OH radicals inside the solution should effectively improve the oxygen introduction and hydroxyl functionalization of polymer surfaces.

In an experiment with 0.05 mg Fe-ZSM5 per 1000 ml distilled water within a pH range of 2-3, the PP-films were exposed to this UWP + catalyst from 1 min to 15 min. The total oxygen concentration growth was almost linear with the aid of the Fenton catalyst system (Fig.24).

The underwater plasma achieves a steady state of oxygen introduction after 1 to 2 min

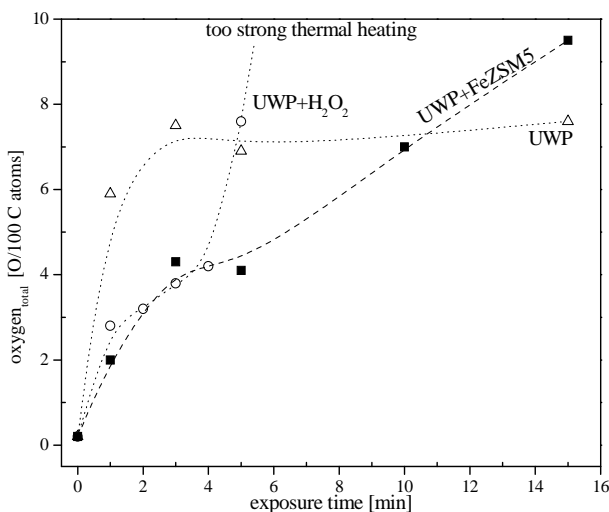

Figure 24
Total oxygen introduction onto polypropylene surfaces as function of exposure time using:
 Δ-UWP (underwater plasma),
 ○-UWP + H₂O₂, and
 ■-UWP + Fe ZSM5 catalyst

exposure time in the range of about 7 O/100 C. 70% of this O_{total} (all CO_x species in the C1s peak) occurs as C-O singly bonded species (Table 3). 40% of these singly bonded C-O species are linked as OH groups at the polypropylene surface. Hydrogen peroxide induces the oxidation slower, nevertheless, after 5 min a strong thermal heating of the water solution occurs so that the experiment must be stopped, thus not exploiting the full oxidation capability. More than 75% of all oxygen atoms were found as C-O singly bonded species among them 15 to 35% OH groups. After catalyst addition the fraction of singly C-O bonded species within the C1s peak amounts about 80%; however, 15 to 28% of these C-O species are bound as OH groups (cf. Fig. 22).

The OH selectivity of the UWP processes with and without addition of the catalyst at two pH values is shown in more detail, as function of the exposure time (Fig. 22). Comparing Figures 22 and 24 it is evident that the O_{total} and the OH selectivity as function of exposure time have different characteristics. Thus, it is obvious that the catalyst influences strongly the UWP composition and, therefore, the selectivity in OH group formation. It can be resumed, approximately, the higher the oxidation rate the lower the OH selectivity.

3.9 Study of the hydroperoxide (-O-OH) functionality generated by the UWP process

During the underwater plasma processes, the formation of a new component, the hydroperoxyl radical, was also expected as shown in eqn. /V/. Peak fitting results for the O1s curve support this theoretical assumption (Fig. 23). The O1s signal was fitted into two components at 532.8 to 532.2eV ($>C=O$) and 533.5eV (C-OH). The hydroperoxyl functionality allocation was given at 535.5eV [93, 111]. A significant portion of about (9.3% in Fig. 25) of all oxygen were designated to hydroperoxyl groups, which further increases with the addition of hydrogen peroxide to (8.0%)-O-OH within 100 oxygen atoms. Evidently, it was seen that this percentage decreases further to 10.3% with the addition of Fe-ZSM5 catalyst. However, these values are within the XPS variability.

These detected hydroperoxy moieties may be another key product in the OH surface functionalization process besides H₂O₂ and OH radicals as confirmed by the XPS analysis and shown in Fig. 25. They are meta-stable and are vicious for overall selectivity of the processes. The auto-oxidation chain-reaction may be one source of this type of functional groups, starting with the peroxy radical formation with O₂, the abstraction of H from a neighbored polymer chain and the following slow auto-decay of the thereby formed hydroperoxide to the mentioned broad variety of O-functional groups [93, 134]:



and



and finally



The concurrent mechanism may be the direct attachment of hydroperoxy radicals onto radical sites at the polyolefin surface according to:



The thus formed meta-stable hydroperoxides were quantified by derivatization with SO₂ [93]. During the underwater plasma processes the formation of a further component, the hydroperoxyl radical, was also expected as shown in eqn. /XV/. The O1s curve fitting results may support this theoretical assumption (Figure 25).

The O1s signal was fitted into three components: 531.7 eV (>C=O) and 533.1 eV (C-OH + C-O-C). The hydroperoxyl (-C-O-OH) functionality allocation was given at 535.5 eV [111].

It must be added that these results are received from strongly vacuum-dried polypropylene samples; however, traces of adsorbed/trapped water may superpose this signal.

Within the same series of comparisons with and without the addition of hydrogen peroxide into the UWP system, it was seen that in the O1s curve the singly bonded C-O species

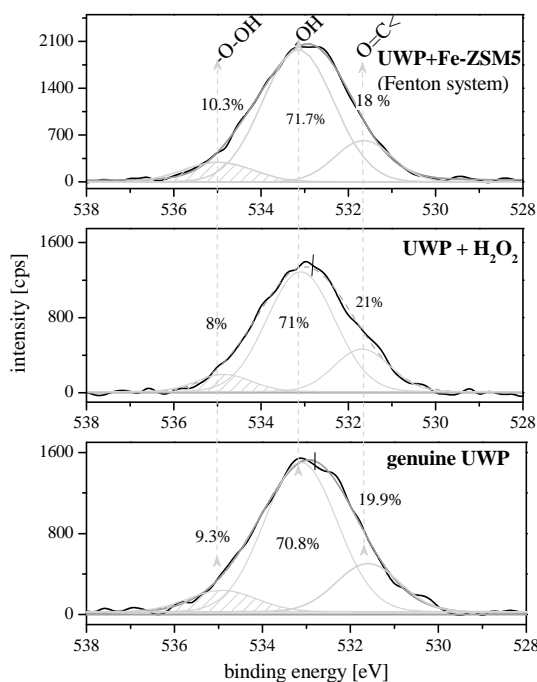

Figure 25
O1s curve fit comparison of genuine UW-plasma system to that with the additives H₂O₂ and Fe-ZSM5

dominated as in the case of the C1s peak fitting. For these fitting comparisons the binding energies were fixed for each treatment to values as mentioned before and given in a reference [101].

The accumulation of hydroperoxides on the polymer film is presented in Figure 26 as a parabolic function with an intermediate maximum in dependence on exposure time of PP films

to the UWP. A similar behavior was sighted earlier for the thermo-oxidation process of low-density polyethylene films [60, 61].

Hydrogen peroxide addition (5%) only increases the O-OH formation at the polymer surface within the first two seconds. Moreover, it was interesting to study the localization of hydroperoxide groups using the angle-resolved XPS, either at the topmost polymer layers or in the near-surface layer, in an environment that shields the C radicals from early deactivation by molecular oxygen (cf. Fig. 26) [134].

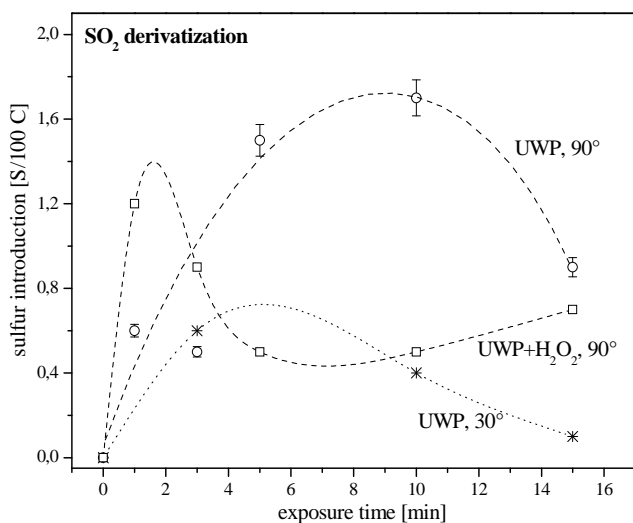

Figure 26
SO₂-derivatization of UWP and UWP + hydrogen peroxide (5%) modified polypropylene films as well as using two distinct take off angles for the XP- spectral analysis

It may be concluded from Fig. 26 that the preferred locus of C-O-OH groups moves from the topmost surface to the near-surface layer below. These meta-stable hydroperoxides can be traced by using the chemical derivatization of hydroperoxy moieties as shown in the reaction Scheme 10.

It is quite clear from the scheme 10 (SO₂ derivatisation) that one hydroperoxy moiety corresponds to one sulfur atom detected by XPS. The Fig. 27 depicts the XPS data of the sulfur

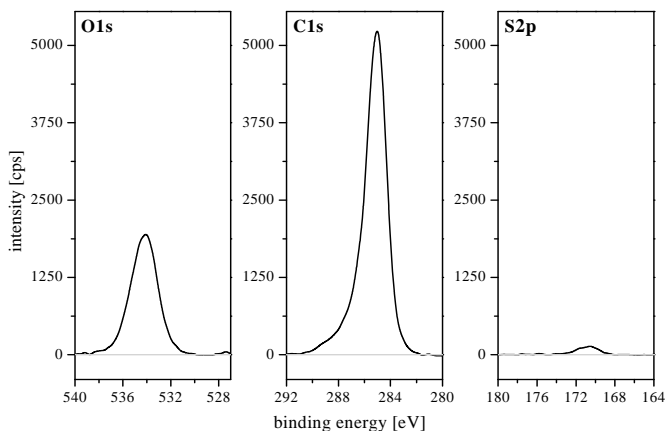

Figure 27
XPS-peaks of
SO₂-derivatized
PP-surface exposed
to UW-plasma for
10 min

dioxide derivatized PP-film. The sulfur signal was detected at 169.4-170.5 eV [93]. Results obtained by the gas phase derivatization are summarized in Fig. 26.

3.10 Possibilities to produce other functional groups

3.10.1 Carboxylic (-COOH/-COO-) functionalization of PP surface

Three general possibilities were considered to attach COOH groups onto polypropylene surfaces:

- a) decomposition of carboxylic acids and formation of COOH species which can attach to the polymer surface as:

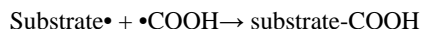
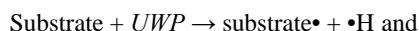

however, the chance of fragmentation without decomposition of the COOH group is very small

- b) Decomposition of carboxylic acid to some extent and formation of a cross-linked plasma polymer layer with (partially) retained COOH functional groups; the chance of COOH retention is small

- c) Initiation of the chemical polymerization of acrylic acid to poly (acrylic acid) (PAA) in the UWP; however, because of the solubility of PAA the deposition of a COOH group-containing polymer layer is not expected
- d) Though it is not investigated here, the saturation of water with CO₂, and formation of carboxylic groups:

$C_{\text{substrate}}\text{-H} + \text{CO}_2 \rightarrow C_{\text{substrate}}\text{-COOH}$ as demonstrated by for low-pressure glow-discharge treatment of polypropylene [107].

Formic and acetic acid may be representatives for processes a) and b). In this case, the COOH group retention has lower chances; however, the formation of a plasma polymer in the UWP is possible because of the cross-linked nature of all plasma polymerized organic deposits. Maleic acid, itaconic acid and acrylic acid possess a polymerizable double bond within its molecule, thus, a chemical polymerization may be initiated by the UWP (process c). The problem of process c) is that regular and defined poly (acrylic acid) is completely soluble and cannot be deposited as layer. If the plasma conditions are intensified this chemical polymerization is changing to the monomer fragmentation and poly-recombination of fragments as cross-linked deposit. However, the number of survived COOH groups should be drastically decreased.

A simultaneous hydroxyl functionalization of PP-surfaces can also be predicted in the same process.

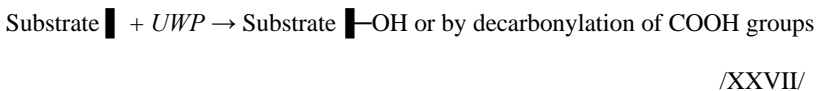

Thus generated –OH functionality provides a classical plausibility of esterification reacting with the added monomer forming an ester linkage with the surface with a terminal olefinic linkage for vertical polymerization.

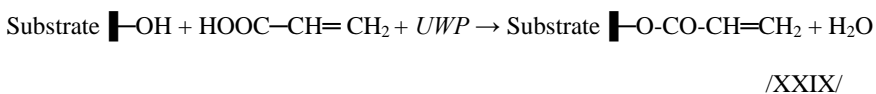

In Fig. 29 the total XPS-measured oxygen concentration is plotted vs. the molar concentration of added acetic acid. It must be appended here that the generation of continuous discharge from the capillary is conductivity and hydrogen ion capacities dependent phenomenon for the various organic acids used. This is always different for different additives that are used in this series of experiment.

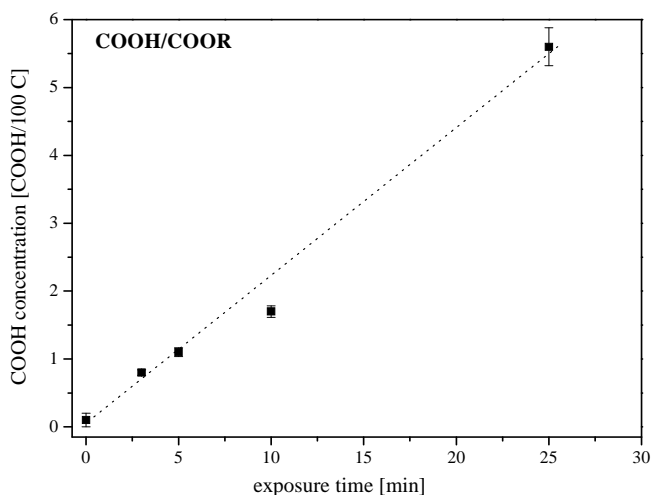

Figure 28
COO functionalities vs. time
using pure UWP system

At lowest concentrations of added acetic acid higher amounts of introduced oxygen were found at the surface of the polypropylene foil (film for spin coating, not for foil). It is clear that UWP exposure also facilitates the COO functional groups on PP-surface. XPS analysis of pure UWP exposed PP-films shows an exponential growth in COO groups with time of exposure was observed (cf. Fig. 28).

More than 5.5 -COOH groups per 100 carbon atoms after 25 min of UWP exposure were found. For 3 min of exposure the same was found 0.7 to 0.8 COOH per 100 C at 20 mm from the capillary tip. Thus the zero-value must be taken into consideration before looking into the COOH

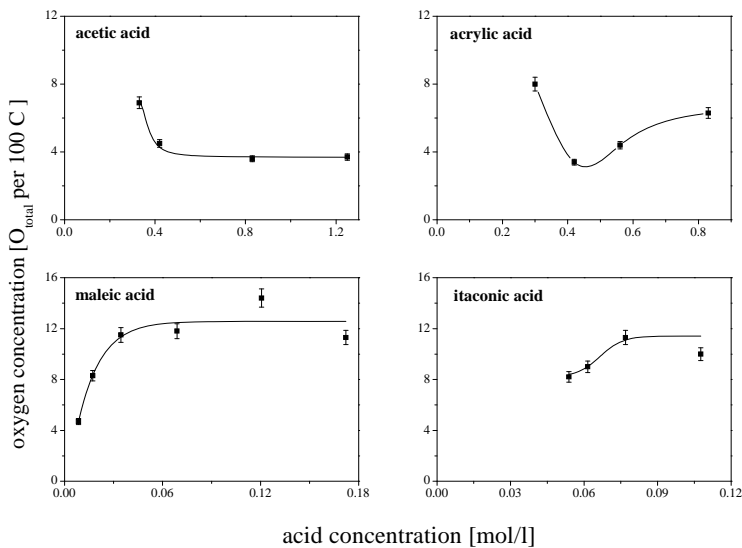

Figure 29
Total oxygen concentration measured by XPS on PP-surface after addition of
A: acetic acid
B: acrylic acid
C: maleic acid
D: itaconic acid

functionalization results using different additives.

The carboxylic group concentration obtained by XPS curve fitting analysis of the corresponding C1s curve was studied at varied distances from plasma source. It was found that the distances other than 15 and 20 mm from tip of capillary (plasma source) were uninteresting for introduction of carboxylic bonds. Moreover, it was evident experimentally that the concentration of these bonds reduces with increasing concentration of added acetic acid inside the solution as seen in Fig. 29. It was noted that the carboxylic/ester (COOH(R)) bond percentage obtained on PP-surface in the near (10 mm) and far (25 mm) region of the plasma capillary source was very low as proposed before (see Fig. 30).

In Fig. 29 the total oxygen concentration is plotted vs. the amount of added acetic acid. Here, it

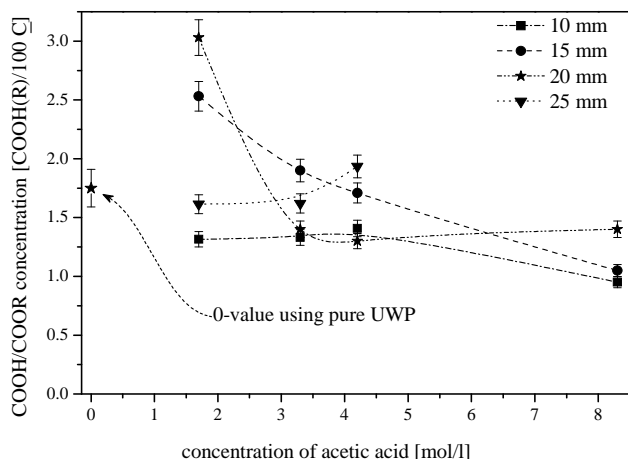

Figure 30
Change in
COOH/COOR bond
percentage (by XPS)
with respect to change in
molar concentration of
acetic acid at different
distances from the
capillary source

must be appended that the generation of continuous discharge from the capillary is dependent on conductivity and hydrogen ion capacities of the various organic acids used as an electrolyte. This is always different for different additives that are used in this series of experiment.

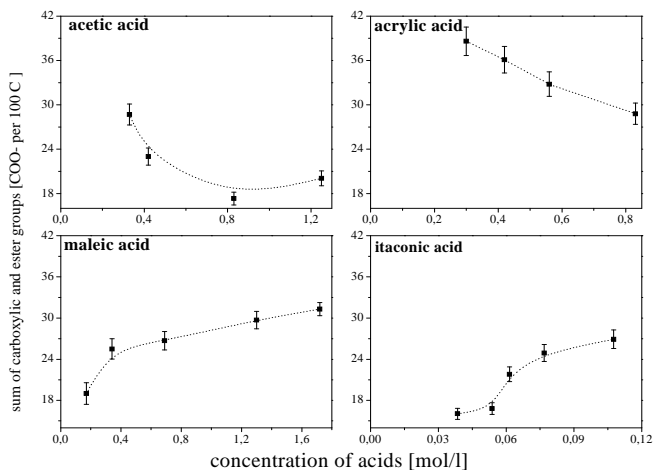

Figure 31
COO- group selectivity
(COO- bonds/100 oxygen
atoms) in dependence on molar
concentration of added acids
measured by XPS on
PP-surfaces

In the case of acrylic acid, see the Figs. 28 and 30, the oxygen and COOH group percentage on the PP-surface increases respectively, when the concentration of the monomer is reduced. Increased concentration initiates more reactions inside the plasma affected solution than on the PP-surface. An increased concentration of monomer inside water phase promotes possibility of reaction inside water than on the polymer substrate. Plasma polymerization of acrylic acid

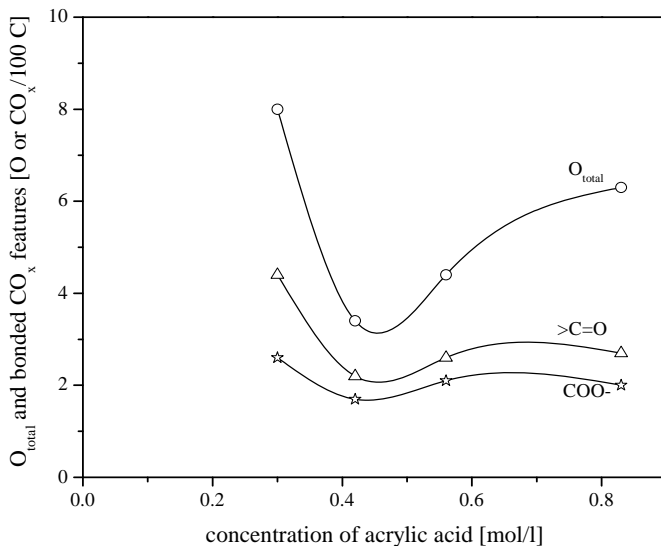

Figure 32
Changing of the XPS fitted CO_x groups and O detected on polypropylene substrates after exposure to the underwater plasma with addition of acrylic acid

monomer is favored. Results concerning this topic are elaborately discussed later in the dissertation. Acrylic acid is one of the most interesting acids in this series of additives used because of its chemical reactivity towards genuine chemical polymerization. When the XPS data of C1s spectrum is resolved different percentage for single (C-O), double (>C=O) & triple (-COO-) bonded features within the C1s peak measured can be obtained. It was quite clear and anticipated in the UWP treatment the high C-O bond percentage followed by carbonyl and ester. (cf. Fig. 32). It must be kept in mind here that $O_{total} = C-O + C=O + COO^-$; as mentioned in introduction section. Moreover, CO_x features are not related to 100 C. It is the sum of C-O + C=O + COO⁻ + CH_x. It was mentioned earlier that CO_x should be roughly equivalent to O_{total}.

Fig. 32 depicts the quantities, based on C1s peak fitting calculation; $\underline{\text{C}}\text{H-COOH}$ has BE= 285.4 eV, apparently mixed with the BE signal of C-O+C-O-C +C-O-O-H(R) at 286.0-286.6eV. It can be best resolved by XPS instrument with higher resolution capacities than such used in this study. It may be that C-O- (singly C-O) bonded groups are formed because of the decay of COOH groups.

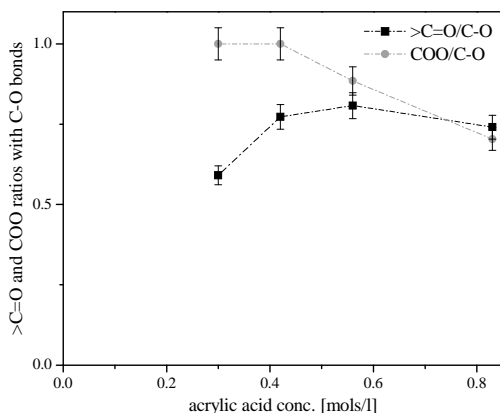

Figure 33
Bond percent ratio of
>C=O and COO- (O-CO-)
per 100 C atoms with
respect to C-O bond
obtained from C1s peak

It must be added to Fig. 32 that CO_x features are not related to 100 C. CO_x is the sum of C-O- + C=O + COO- + CH_x . O_{total} is determined by the survey scan and it is referenced to 100 C atoms. The same data of carbonyl and ester with respect to the C-O bond percent an interesting observation was apparent (see Fig. 33). The ratio of ester (COO-) to C-O bond was found better than the carbonyl (>C=O) to C-O bond ration. The earlier ratio, recess with increasing acrylic acid concentration in the solution where as the later gradually increasing with monomer concentration.

The strong tendency of chemical polymerization of acrylic acid is well known. Vinyl and acrylic monomers are the easiest polymerizable substances [135]. The crux is that well defined PAA (poly-acrylic acid) is soluble in water and does not form a deposit on polypropylene. The main task was to find UWP conditions with deposition of a crosslinked polymer under harsh plasma

conditions but at the same time without too strong destruction of carboxylic groups. However, to fulfill both contradictory needs are impossible; therefore, a good compromise should be found. Using acrylic acid the polypropylene functionalization is achieved exclusively by coating with COOH group-containing PAA and not by COOH functionalization of the polypropylene

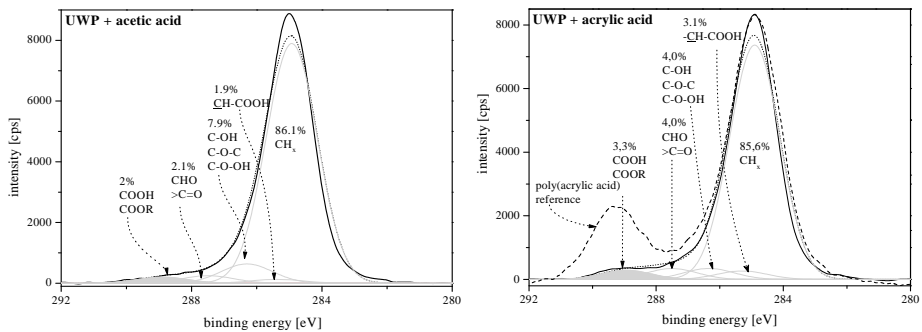
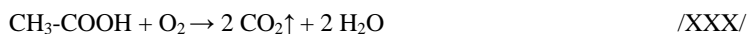

Figure 34: C1s peaks of UWP exposed PP foil after addition of acetic acid and acrylic acid

substrate itself. It was observed using acrylic and acetic acid that reducing the monomer concentration causes a better (bond-) selective functionalization of PP-surface (Figs. 28-30). Using this acrylic acid UWP as functionalization tool it is obvious to expect triply ($O=C-OH$) and β -shifted ($CH-COOH$) features in the respective C1s peak of the PAA deposited on the surface. Figure 34 depicts the formation of three different functionalities ($C-O$, $>C=O$ and $COO-$ ($-O-C=O-$)) measured by XPS. The $C-O$ single bond may be the follow of the decay of carboxylic groups as well as the formation of ketones and aldehydes. It is obvious that in the UWP the acrylic acid polymer deposits have only marginal similarity to the commercial poly-(acrylic acid) reference material. It can be appreciated that about 10% of the original COOH groups in the monomer have survived the plasma deposition process. The quantitatively dominating soluble fraction of UWP-produced PAA may be agree in its structure to a much larger extent with the commercial PAA, otherwise it is not soluble. Unfortunately, it was not measured.

It is not surprising that acetic acid as a “monomer” demands stronger fragmentation of the molecule for its polymerization and cross linking as also seen in Fig. 34. Only a very small quantity (4%) of the original COOH groups was found in the deposit. The intermediates of the acetic acid polymerization must be stronger dehydrogenated, or much more possible, must be partially decarbonylated or decarboxylated. The final stage is the decomposition into carbon monoxide, carbon dioxide and water:



This is not necessary in the case of acrylic acid. As acrylic-type monomer it can easily be polymerized on a chemical way:



However, under exposure to the UWP decomposition of acrylic acid is also possible using on similar pathways.

Acrylic acid forms unambiguously soluble polymer films during the pulse-plasma polymerization [102, 135]. Side reactions were assumed to be present, the self-condensation to poly-(β-propionic acid) as equation below:



It was clear from the results obtained (cf. Fig. 32) that in presence of monomers such a reaction may occur. This single bonded C-O feature in C1s (Fig. 34) may be ethers (C-O-C), hydroperoxy (C-O-OH) or hydroxyl (OH).

Exposure of acetic acid to glow discharge electrolysis also leads to the formation of •CH₂COOH radical species, which further decompose to carbon dioxide and water [108, 109]. The C1s fits (cf. Fig. 34) showing the presence of β-shifted carbon, >C̄H-COO-(H)-, characteristic for the neighborhoods of ester or carboxylic group in both the cases near the region 285.4-285.6 eV [111].

C1s curve fittings of maleic and itaconic acid deposits produced in the underwater plasma are shown in Fig. 35.

Unlike acrylic acid, maleic and itaconic acid have moderate or behave with reluctant tendency towards chemical homo-polymerization. Additionally, these dicarboxylic acids tend to form β -keto acids capable to decarboxylate further to β -ketones or cyclic ketones as proposed earlier. Decarboxylation could be enhanced considering the plasma produced UV-radiation. The reaction pathway for these reaction equations was discussed in details earlier [36]. It was observed that formation of aldehydes and ketones was significant because the C1s signal could only be fitted with a distinct fit at 287.5 eV which is prominent for itaconic and also maleic acid [cf. Fig. 35].

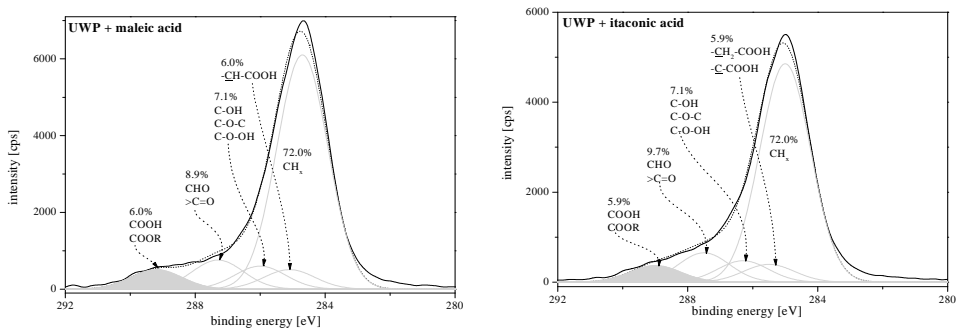

Figure 35: C1s peak fitting of UWP exposed polypropylene foils after addition of maleic acid (0.17 mol/l) and itaconic acid (0.08 mol/l)

Increasing the concentration of bi-functional organic acids overall the oxygen (O_{total}) percentage of on the PP-surface was also increased (cf. Figs. 28) and the COO- bond formation (cf. Fig. 31). The COO- ($-O-C=O$) bond percentages after UWP or low-pressure glow discharge gas plasma treatment are compared with those of acetic (14.5 COO- among 100 O), acrylic (23 COO- among 100 O), maleic (21 COO- among 100 O) and itaconic acid (21 COO- among 100 O) (cf. Fig. 36). The underwater plasma has generally produced about 10-25% COO- ($-O-C=O$) bonds among all other C-O features or O_{total} (cf. Table 3 and Fig. 36). This COO- ($-O-C=O$) functionality was further diminished with addition of hydrogen peroxide. This series of experiments with hydrogen peroxide addition was focused on maximizing the yield in hydroxyl functionalities [85, 98]. In continuation, the addition of acetic acid, itaconic acid, maleic acid and

acrylic acid have shown to be also imparting an increasing trend in selective COO- (-O-C=O) bond formation on PP film surfaces, however, on a distinct way, that of surface coverage with a COOH group containing UWP polymer. In contrast to that, the direct attachment of •COOH radicals in the sense of the functionalization of the PP substrate with carboxylic groups could not be evidenced. As mentioned before CO₂ or Na₂CO₃/NaHCO₃ shall be tested for direct functionalization of polypropylene in the UWP with COOH groups in future work.

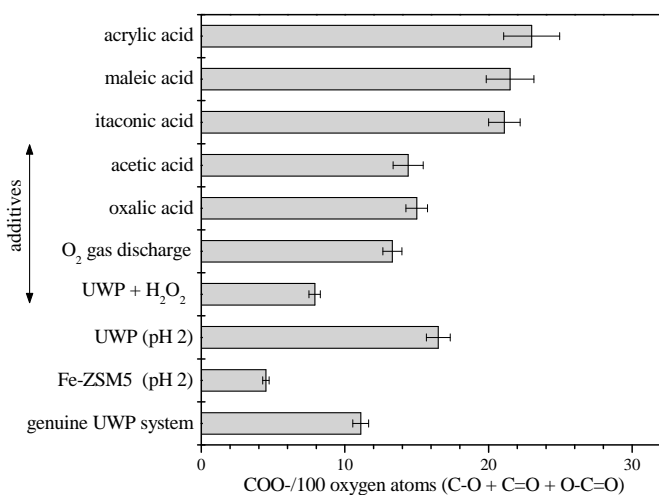

Figure 36
Bond selectivity
observed after
addition of
various additives

Comparing the UWP polymerization of acrylic acid with those under low-pressure glow discharge conditions similar selectivity was achieved. The gas plasma polymerization yielded in about 75 COOH groups among 100 oxygen atoms [101]. The soluble fraction of the poly(acrylic acid) produced in the UWP should be also very near to the commercial reference poly(acrylic acid). However, as mentioned before, the investigation of this soluble fraction is planned in future. Additionally to the soluble fraction a very small insoluble fraction also exists. This insignificant fraction consists of a crosslinked product of the strongly decomposed acrylic acid molecule, thus, forming the deposited layer. The deposition rate was very low, the maximum layer so thin that the resulting layer was partially transparent for photoelectrons from the

polypropylene. The observed selectivity in COO- (-O-C=O) bond formation was found up to 23 COOH within 100 of all oxygen functionalities. It can be concluded that the layer deposition by plasma polymerization under UWP conditions is inefficient. Therefore, it is planned a copolymerization with a chemical crosslinker (two or three functional groups) to develop with much higher deposition efficiency.

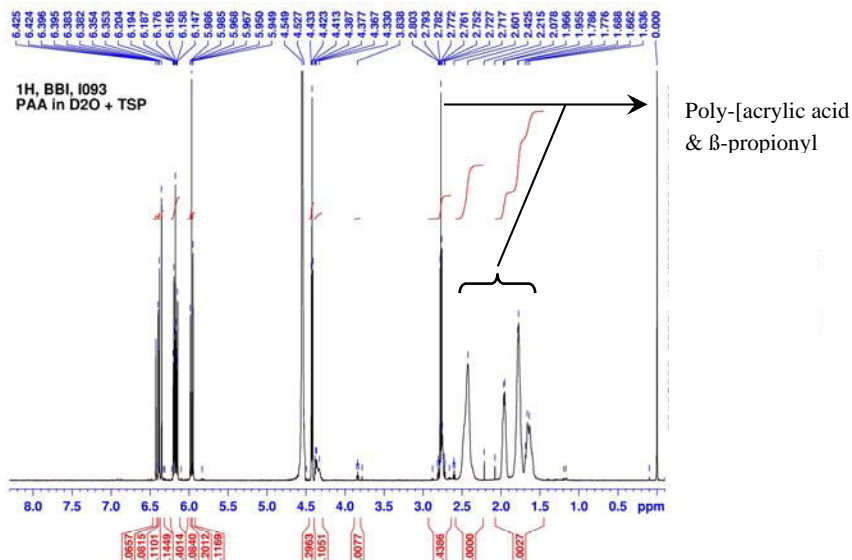

Figure 37: ¹H-NMR spectra of water dissolved acrylic acid fraction

3.11 Plasma polymerization of acrylic acid in the UWP

Only a few closely cross-linked networks with a few survived (or newly formed, not original) COOH groups are responsible for the deposition of a polymer layer in the few-nanometer region. ¹H-NMR investigations explain a prominent reaction pathway to crosslinked products by self-condensation using the COOH groups, thus, additionally lowering the remaining COOH group concentration.

¹H-NMR spectroscopy indicates the formation of poly-acrylic acid & β-propionyl ether type of linkages. Protons characteristic for ether bonds were found at 1.5-2.8 ppm of NMR spectra.

More recently, Kokafuta et al. have experimentally predicted the possibilities of various types of products which can be obtained by glow discharge electrolysis of mono and dicarboxylic acids.

[108, 109] (cf. Scheme 11). Thus, formation of β -propionyl ether

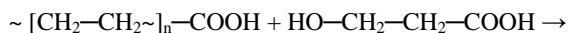
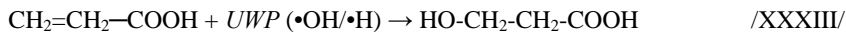

Commercial poly (acrylic acid) was compared with the UWP product deposited onto the polypropylene substrate as shown in Fig. 34. However, when the soluble fraction of the

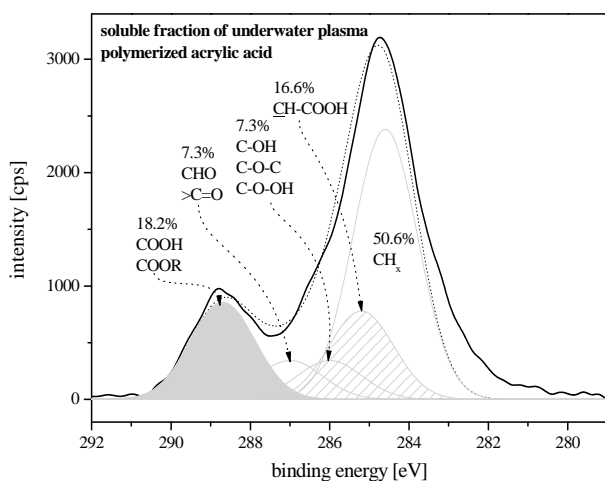

Figure 38
C1s peak of
underwater plasma
polymerized acrylic
acid isolated in the
water soluble fraction

underwater plasma polymerized acrylic acid was analyzed a good accordance as depicted in Fig. 38. The C1s curve fitting shows that more than 80% of the original carboxylic groups (or as side-reaction ester groups) (-O-CO-) were found. Additionally, singly and doubly bonded C-O groups are formed. It can be concluded that these groups are formed by decomposition of COOH groups but also by oxidation of CH₂ and CH groups in the polymer.

A substantial C-O bond percentage seen in XPS studies are interestingly sited in of β -propionyl ether type of linkages seen in ¹H-NMR. XPS study shows 50 oxygen atoms per

100 C atoms were evident for the UWP polymerized acrylic acid material. The same was found 13 to-15% more than commercial PAA sample.

At this point, it should be remembered that the carboxylic group retention was twice using monomer acrylic acid with the help of Glow Discharge Electrolysis (GDE) technique [98]. It will be discussed in detail in the section AGDE.

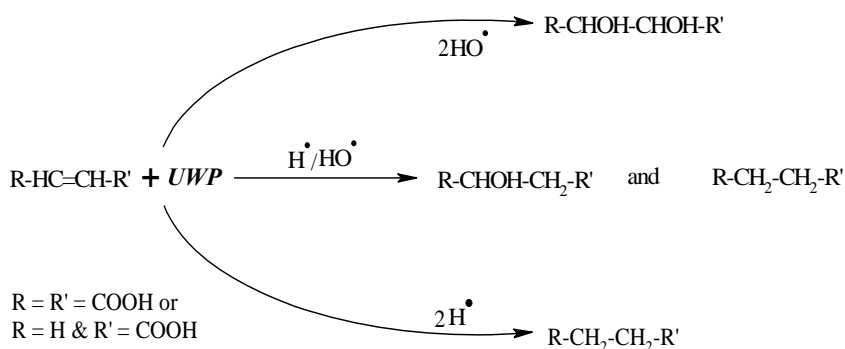

Scheme 11
Decomposition of mono and dicarboxylic groups at exposure to the glow discharge electrolysis

The oxidation by UWP has obviously formed new C-O and CHO/>C=O features. Additionally it has degraded the original PAA and retained 60-65 % structure (cf. Table 4). Furthermore, the survival of classical PAA structure seen lowered in UWP-polymerized acrylic acid material may be because of ester formation involved within CH-COOH and COOH peaks. The occurrence of ester formation in real UWP was demonstrated by NMR, thus, the yield in PAA formed with original/classic structure is further lowered.

3.11.1 Carboxylic (-COOH/-COO-) group derivatization results

To distinguish between carboxylic acid and ester groups on the PP surface a gas or liquid phase derivatization with trifluoroethanol (TFE) [112] was carried out as described in Section (see Scheme 9) for labeling the COOH groups.

In Fig. 39 the survey scans of all reactions during the labeling are presented. For the UWP produced deposit it is indicative with respect to blank polypropylene XPS spectra that sparse quantities of COOH groups are present as also proposed by the peak fitting of the respective C1s signal. Above results and the fluorine atom presence comparison is perhaps an indication of the

| | Standard poly-acrylic acid [per 100 C atoms] | UW-plasma polymerized acrylic acid monomer [per 100 C atoms] |
|---|---|--|
| $\underline{\text{C}}\text{H}_2\text{-}$ | 42 | 50.6 |
| $\underline{\text{C}}\text{H}_2\text{-COOH}$ | 29 | 16.6 |
| $\underline{\text{C}}\text{-O}$ | - | 7.3 |
| $\text{H-}\underline{\text{C}}\text{=O} / >\underline{\text{C}}\text{=O}$ | - | 7.3 |
| $\underline{\text{C}}\text{OOR} / \underline{\text{C}}\text{OOH}$ | 29 | 18.2 |

Table 4: Comparison of standard PAA XPS spectra with poly-acrylic acid obtained by UW-plasma polymerization

disagreement between COOH and COOR bond formation. Polypropylene without any treatment and with UW-plasma processing doesn't show significant change in formation of COOH groups (Fig. 40). Itaconic acid has lowest score amongst the series of organic acids for fluorine atoms presence on PP, about 3.0 to 3.5 F atoms 100 C atoms were found (see UWP+IA in Fig. 40). The concentration of itaconic acid used was 0.08 mol/l.

Acrylic acid and acetic acid account for 4.5 to 5 fluorine atoms per 100 C atoms (see UWP+AA in Fig. 40). Improved results were achieved in the concentration range of 40 to 60% of acrylic acid solution.

It is important to mention here that the reproducibility for fluorine derivatization experiment in the case of acetic acid was cumbersome.

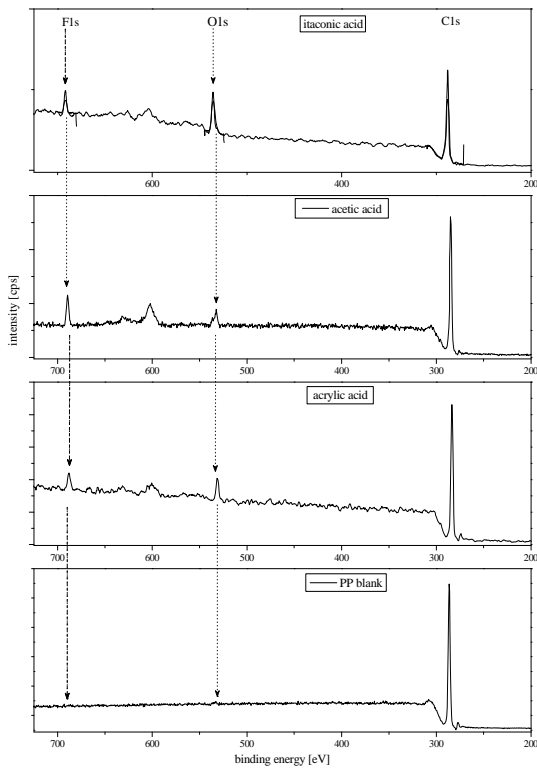

Figure 39
XPS of fluorine-
labeled PP-surfaces
for different
organic additive

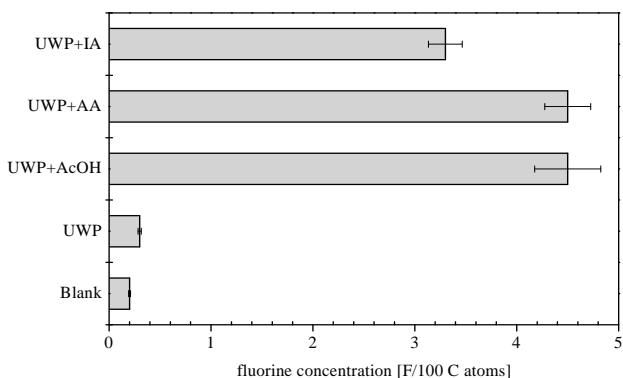

Figure 40
Derivatization result of
UWP-modified PP surfaces
after using the various
organic additives depicting
XPS analysis for fluorine
atoms analyzed per 100 C
atoms

3.12 Atmospheric Glow Discharge Electrolysis using liquid electrode

3.12.1 Polymer surface modification by deposition of OH and COOH groups containing polymers using the GDE

It should be repeated that the deposition of polymer layers bearing functional groups is an alternative way to modify polymer substrate surfaces. Therefore, the plasma polymerization was also investigated under the conditions of Glow Discharge Electrolysis (GDE). This plasma polymerization offers the advantage of establishing the desired monosort surface functionalization by coating the substrate with a 50 to 100 nm thick polymer layer [38, 39] (cf. Fig. 2). However, the problem of solubility of the resulting polymers also persists. Using allyl alcohol as monomer OH groups bearing surfaces and using acrylic acid COOH groups can be produced [104]. Here, two examples are presented. First, the polymerization of the easily polymerizable acrylic acid was performed.

The polymerization proceeds chemically on a radical mechanism in water solutions or emulsions [138]. The formed poly (acrylic acid) is soluble in water. Therefore, the precipitated coating at the polypropylene substrates was cross linked. The C1s signal of this polymer shows a small fraction of side-products indicated by the C1s-subpeak at 287.5 eV (ketone, aldehyde) (Fig. 41).

The overall C1s signal indicates a more or less regularly formed polymer as shown by the equivalence of the two C1s components at 286 and 289 eV as well as the O1s features at 532 and 533.5 eV (not presented). The measured value of 21 COOH per 100 C amounts 65% of the

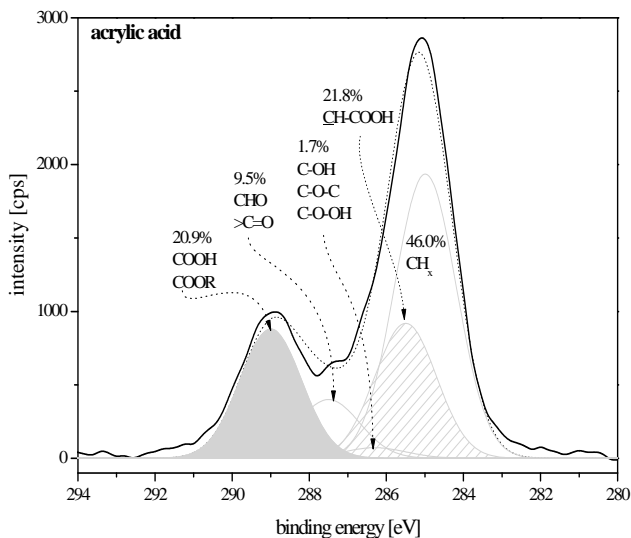

Figure 41
C1s signal of poly(acrylic acid) that was polymerized using the glow discharge electrolysis

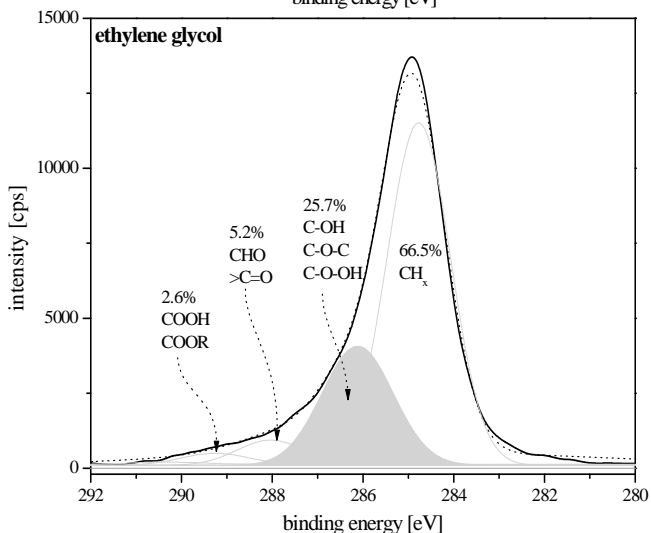

Figure 42
C1s-signal of GDE-polymerized poly(ethylene glycol) (10 % ethylene glycol in water) at the surface of the PP foil

theoretical composition of pure poly(acrylic acid) (33 COOH per 100 C) [111]. The majority of formed poly (acrylic acid) was dissolved as clear solution in water. This polymer fraction consists of linear or branched macromolecules because of their solubility. The second type of

polymerization under the conditions of glow discharge electrolysis has the character of monomer fragmenting and polyrecombination of fragments as random structured polymer. This typical plasma fragmentation-polyrecombination polymerization process is the only way for

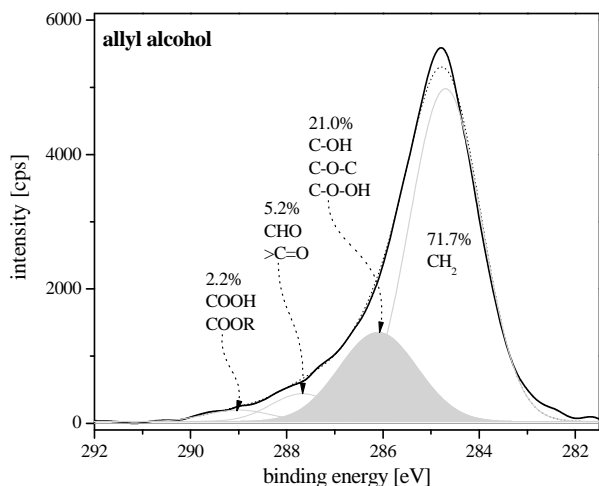

Figure 43
C1s signal of allyl alcohol polymerized on PP surfaces using the glow discharge electrolysis

“monomers” without chemically polymerizable double bonds to form a (non-classic) polymer [104], (Fig. 42). For deposition as plasma polymer layer the ethylene glycol must be fragmented and then the fragments are able to randomly recombine and form an irregularly structured and composed plasma polymers.

However, as shown in Fig. 42, ethylene glycol was polymerized under glow discharge electrolysis conditions. The C-O/100 O selectivity (OH + C-O-C + C-O-OH) amounts only 58 compared to theoretically 100 (all oxygen is bonded in OH groups). It can be assumed that the majority of functional groups among this 58 C-O features are the survived hydroxyl groups of the ethylene glycol.

In order to polymerize allyl alcohol, 10% solution was used for processing in the glow discharge electrolysis. Fig. 43 depicts the surface of the allyl alcohol deposit at the PP-foil. Unlike acrylic acid the C1s peak in Fig. 43 shows an intense signal for singly C to O bonded species in the region of 286.0-286.5 eV, where the C-O- species dominate by about 74.0%.

4. Discussion

4.1 Underwater plasma and selectivity in surface functionalization (-OH) process

Water vapor plasmas are well-known for the production of OH radicals [139, 46]. Also ozone plays an important role [140].

It is evident that the use of vacuum equipment increases the costs of the end product. An appropriate common example can be the problem of modifying packing materials like polypropylene or polyethylene, which must be inexpensive. Thus, the tool of underwater plasma is an alternative to reduce costs by operating under atmospheric pressure or even in vacuum. Here, two types of water-related plasmas were applied, the gas-liquid glow discharge electrolysis and the liquid underwater capillary plasma. The underwater capillary discharge is a source of chemically active species and radicals like electrons (e^-_{aq}), radicals ($H\bullet$, $O\bullet$, $\bullet OH$), ions H^+ , \bar{OH} and molecules like H_2 , O_2 , H_2O_2 and O_3 additionally to the physical processes as production of plasma bubbles, shock waves or explosive surface impacts [50, 56]. A plausible mechanism of its formation was discussed earlier [49, 56]. The bubble collapse to generate plasma also gives rise to high frequency shock waves.

Consequently, the plasma discharge, surrounded with the liquid, appears as a plasma jet. Thus, the generated OH radicals are assumed to get sufficient time within such a shock wave to reach the desired substrate surface effectively. The Mach number associated with that of compression waves produced by commonly available pulse discharges in water are in the range of 0.1-0.7 [70, 141].

The average lifetime of radicals in plasma solutions is in the range of 10^{-6} s [86, 87]. In the gas plasma, radiation diffusion is possible by (energy) $h\nu$ transfer from atom to atom or molecule to molecule. Side reactions decrease the amount of diffusing photons; however, the residue of diffusing photons is able to dissociate water molecules to hydroxyl radicals also far from the plasma source. Such a mechanism may also contribute to the polymer surface modification and may remain independent on the lifetime of OH radicals. Organic molecules

show a similar effect, adsorption of UV radiation and emission of resonance and fluorescence radiation (Jablonski Scheme) [142, 143]. This may help the desired reactive species to reach the substrate surface. Thus, flow rates determined for geometry of capillary has an effect over the delivery of active species to the desired sites [53].

Based on the knowledge of oxygen low-pressure glow discharge plasma treatment of polymer surfaces the presented XPS data can be summarized schematically in a tentative model of reaction products (Scheme 12).

Post-plasma oxidation is caused by unsaturated carbon and carbon radicals sites which can react at exposure to oxygen from air by peroxy radical and hydroperoxide intermediates and finally to auto-oxidation. However, it was not observed in the cases of UWP and GDE because of the immediately saturation of C radicals by the surrounding water.

Optical measurements suggest that most of the species responsible for emission of radiation are produced immediately after discharge during the first few hundreds of nanosecond of plasma generation [114]. Then, a stationary regime of reactive or excited species is established by quenching and production of new energetic species. These UWP and GDE discharges generate some of the strongest oxidants available in water. The most reactive species are hydroxy radicals. They are able to oxidize aliphatic chains by H-abstraction and OH attachment [144]. When the compressibility effect of plasma gases (inside capillary) are neglected and such underwater discharge affected flow is simulated with the help of software Ansys CFX-11 from division Reactive Substances and Systems (II.2); it takes approximately 125-150 nanoseconds to reach the polymer surface placed at a distance 20 mm away from the capillary tip [145].

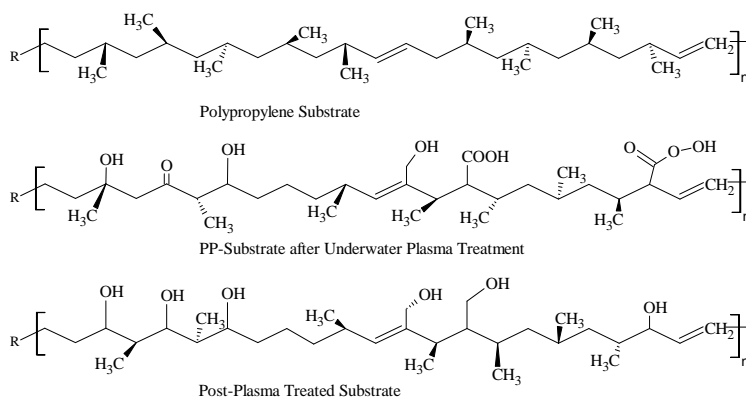

Scheme 12: Modification of PP with O-functional groups hydroxyl group by exposure to underwater plasma followed by the reduction with diborane

Taking into account these model calculations it may be assumed that the maximum surface functionalization could possibly be already achieved in very early stages of plasma discharge (within *nano* to *micro*-seconds regime of post discharge phase) followed by the stationary (steady-state) regime. Such a stationary principle is also valid for the formation of O functional groups in the UWP and their split-off, their decomposition or their further oxidation, which is related with the etching of polymer. Following oxidation rates are passed through approximately: $\text{CH}_2 (\text{C}^0) \rightarrow \text{C-OH} (\text{C}^{1+}) \rightarrow \text{CHO}$ or $\text{CO} \uparrow (\text{C}^{2+}) \rightarrow \text{COOH} (\text{C}^{3+}) \rightarrow \text{CO}_3$ or $\text{CO}_2 \uparrow (\text{C}^{4+})$ and $\text{H}_2\text{O} \uparrow$. The measured O functional groups after UWP treatment are those of the steady state between formation and destruction.

The underwater capillary discharge is a promising technique for more efficient and selective functionalization of the polymer surface. The functionalization results, being affected by the liquid flow profile, show a strong dependence on the distance between the polymer surface and the plasma capillary source.

High resolution XPS data confirm that this method produces 70 C-O- features (ethers and hydroxyl groups) per 100 introduced O atoms formation among them the preferred hydroxyl groups take up 40% as evidenced by TFAA derivatization and using XPS. Thus, the

derivatization results confirm that from the C-O bond formation by this technique selectively creates hydroxyl functionality from 25-41 of all oxygen functionalities. It was also revealed that using this method or technique any post-plasma plasma treatment to create a homo-functional (monosort) polymer surface can be dispensed, especially, if using additional chemicals in the liquid phase to support the plasma modification process. In comparison to the polymer functionalization in the UWP, the oxygen low-pressure plasma produced about 50 C-O-/100 O among them about 5 OH/100 O [74]. Referencing it to 100 C and a maximal total oxygen introduction of 28 O about 14 C-O- species and 1.5 OH groups exist produced [74]. Using the UWP and introduce 10 O/100 C onto the polypropylene surface 7 C-O-/100 C and about 3 OH/100 C were produced [74]. The selectivity in OH group formation in the gas plasma is ca. 5% and is improved in the UWP to >40%. Besides the improved OH selectivity the post-plasma oxidation of the polymer is minimized or absent during the storage of samples under the ambient air. Another advantage is the absence of degradation products at the polymer surface and, thus, any Weak Boundary Layer cannot be formed.

Preliminary results with incursion of hydrogen peroxide (standard redox potential 1.7 V [54, 79]) into the plasma-solution system show encouraging possibility to improve the present oxidation of polypropylene and to influence the selectivity range in the underwater plasma to a greater extent. However, the hydrogen peroxide formation and its dissociation to OH radicals is an equilibrium reaction (steady-state process), thus, the production of OH radicals cannot be increased further by addition of H₂O₂ [54, 79].

4.2 Factors affecting the selectivity of functionalization

It was clear from earlier studies that functionalities such as alkyl hydroperoxyl (R-COOH) and alkyl hydroperoxide (R-COO•) radicals play a decisive role in the complex surface reaction on and within the bulk of polymers [32, 35, 96 146].

Generation and removal of molecular hydrogen peroxide in the underwater plasma processes is a vital key process as it gives rise to the hydroxyl radical scavenging activities within the plasma affected solution. As a result, hydroperoxy moieties on the polymer surfaces were formed by the substitution reaction of OH radicals onto polymer molecules as C-OH group (see equation /I/ to /V/).

The hydroxyl radical has the highest oxidation potential (2.9 V) of all formed species within the UWP process as reviewed in the section *introduction*. A direct contact or touch of the plasma to the polymer surface can produce a stronger oxidation as it is necessary for simple attachment (H substitution by OH) of OH groups onto the polymer surface. This may validate or support the hypothesis that OH radicals are responsible for the majority of oxidation processes at the polypropylene surface. Also other products were predominantly formed in the C⁺¹ oxidation state as C-O-C, epoxy (unstable under hydrous conditions and rapidly hydrolyzing to OH groups) as well as C-O-O• and C-O-OH (peroxides and hydroperoxides) demonstrated by C1s and O1s peak fitting supplemented by OH and O-OH group labeling. However, also higher oxidation states (C^{+2 to +4}) >C=O and CHO (C⁺²) and in smaller quantities -COOH, -COOR (C⁺³) and possibly -O-CO-O- (CO₃, C⁺⁴) are formed [72, 60, 61].

It was assumed that the equilibrium between OH radical formation and its dimerization to hydrogen peroxide can be shifted towards the hydroxyl radical side of the equation using Fenton's process [cf. scheme 5]. However, the pH of water solution determines the existence conditions of H₂O₂. At alkaline pH, H₂O₂ is unstable and loses its oxidizing potential. A significant moderation in pH values of the solution affects the generation of UV-radiation, OH radicals and consequently hydrogen peroxide after underwater capillary discharge [66]. Therefore, an optimized pH range of 2-3 was found, where most of the Fe³⁺ exists in its ferric state and at pH higher than 2, the Fe³⁺ precipitates as oxy hydroxides [128, 147]. Fenton's reaction can be initiated either by iron in its ferrous or ferric state though it must be noted that such reactions are reported to be faster in the case of ferrous ions [97].

Pure UWP process clearly yields highest selective functionalization of the PP-surface with at maximal 3 min exposure. Thereafter, it decreases as seen in Fig. 20, pH 6-7. Using the heterogeneous catalyst (FeZSM5), without Fenton's conditions [148], a significant drop in the selectivity was observed, see curve UWP+FeZSM5 (Fig. 20, pH 6-7) with a maximum at a plasma exposure time of 3 min. Use of lower H_2O_2 to $\text{Fe}^{\text{II/III}}$ ratio was suggested [85,128] to avoid scavenging of OH radicals. Using the Fenton's conditions, the selectivity, was seen increasing exponentially, see curve UWP+FeZSM5 in Fig. 20, pH 2-3. It was interesting to note that the increase significantly started after 3 min of time of exposure of PP films. It was believed that the UWP process provides necessary quantity of hydrogen peroxide to function as a Fenton's catalytic system and accelerates the OH radical regeneration as seen from scheme 5. The derivatization confirms the introduction of C-O-OH (hydroperoxy) groups to the polymer surface, does not start immediately after discharge ignition. After a 3 min of plasma initiation phase a sharp increase in the C-O-OH formation was found. It is also significant that the O_{total} and the highest share in OH group production remain maximal within the initial 1-5 minutes of UWP exposure. The same regime is also accompanied by minimal concentration of sulfur atom till 3 min of time of exposure of PP foil. These experimental observations are well supported by earlier research carried out in DBD on PP foil and the peroxy functionalities were traced [61]. The here obtained results indicate the establishing of two regimes wherein the first regime characterized by highly selective OH surface and an underwater plasma regime where OH radical presence is dominating. To understand these processes closely, it was found helpful to assimilate the derivatization results obtained in quantifying the hydroxyl and identifying the hydroperoxyl groups. All these results are brought together schematically irrespective of its quantities obtained in its XPS analysis (see Sketch 7).

4.3 Interrelation of OH and O-OH functionalization

Hydroxyl and hydroperoxyl functional group derivatization results of XPS indicate a specific pattern of functionality formation with respect to the time. Theoretically overall functionalization process may be divided into three distinct regimes.

1. The first one being the one minute regime; that is functionalization process between 0 min to about 1 min of UW-plasma exposure of the polymer film which was not investigated in this work. To simplify let us nominate it as “*zero regime*”
2. Second regime resides between the time periods 1 min to 5 min after UWP exposure to of the PP-film. *Regime I*
3. *Regime II* is from the 5 min and onward time regime of exposure of PP-film.

It was reported earlier that hydroperoxides are formed almost quantitatively from the oxygen absorbed by the polymer during its induction period [149,150]. Decomposition of such unstable moieties often accompanied by free radical formation is widely believed to be critical intermediates in the oxidative degradation of many polymers, especially engineering plastics such as polyolefin.

Formation of such groups on PP-surface represented by two parabolic curves, hatched line for UWP process and dotted line UWP process carried out with hydrogen peroxide (cf. Fig. 26) Hatched line shows a rapid growth in –O-OH formation on PP initially which reaches maximum during the time 5 min to 10 min after the UW discharge. The dotted line (UWP+H₂O₂) indicate an opposite behaviors with the vertex of the parabolic locus between the same time period. As hatched line indicates dominance of –O-OH in this time period which was interestingly suppressed by addition of hydrogen peroxide into the same system.

Black colored curve shows OH group dominance on the polymer surface in the time period 1 min to 5 min after the UW-discharge. It was discussed earlier that the –OH formation on PP-surface in later part recess due to the hydrogen peroxide generation in UW discharge processes after 3 to 5 min of time after UW-discharge initiation. Due to incorporation of

FeZSM5 heterogeneous catalyst the decrease in selectivity was almost stabilized to a certain value. All such fact indicates this regime for (*regime II*) hydrogen peroxide or –O-OH inside plasma affected solution and thereby affecting the PP surface functionalization process.

The similar process without use of the Fe-ZSM5 catalyst, when driven within the pH range 2-3, shows a significant drop in the selectivity during the initial 1 to 3 min of plasma exposure. Concentrated sulfuric acid was used to reduce the pH of the solution as the sulfate ions are relatively less reactive towards attack of OH radicals [128].

Clearly, from 1 min to 5 min maximum –OH formation was repeatedly observed. A typical spike in this time zone for hydroxyl functionalization was repeatedly observed with or without a specific additive in this time region, the time zone of 1 min to 5 min thus was identified as *regime I* for –OH functionalization dominance on PP-surfaces.

Taking into account the effects those may arise from UWP processes during initial 0 min to 1 min of UWP exposure of films would also be interesting. This was denoted as “zero regime”. No focus was unfortunately addressed to this regime and no experimental outcomes were verified in this work. It was believed that due to intense UW discharge activities and chemistry emerged by UV-radiation inside solution as well as on the surface a substantial amount of functionalization of polymer surface maybe induced. Due to continual UWP process these are attached functionalities are repeatedly go through make and break process. Nevertheless, it was believed that if the time is further reduced to less than 1 min a higher –OH selectivity in surface functionalization may be expected.

It was earlier mentioned that the UWP processes are also a source of solvated electrons and may contribute to the production of OH species [90]:



On the basis of equation /XXXVI/ and /XXXVII/ it may be assumed that highly acidic condition during the primary plasma process leads to deactivate OH radicals as from thus

affecting the selectivity of the process [81]. The concentration of hydrogenperoxide, OH and hydroperoxyl radicals is interdependent as shown by the set of eqs. /X/-/XV/. These reactions in water are also affecting the surface functionalization process as seen by the XPS studies. Two different ways of hydroperoxide formation at polypropylene surface were discussed based on the eqs. /XII/-/XV/. Verification of such functionality was done by SO₂ derivatization (cf. Figure 26, curve UWP, 90°). It confirms the favoured introduction of C-O-OH group below the polymer surface and their accelerated consumption at the top most surface during the UWP, indicated by much lower concentration (cf. Fig. 26, curve UWP, 30°). Thus, the (plasma) irradiation initiated auto-oxidation in region below the surface seems to be the dominating process for hydroxyl formation, because the survival of hydroperoxyl radicals during its diffusion into deeper layers is improbable. Experiments with D₂O should help to solve definitely this problem in the future.

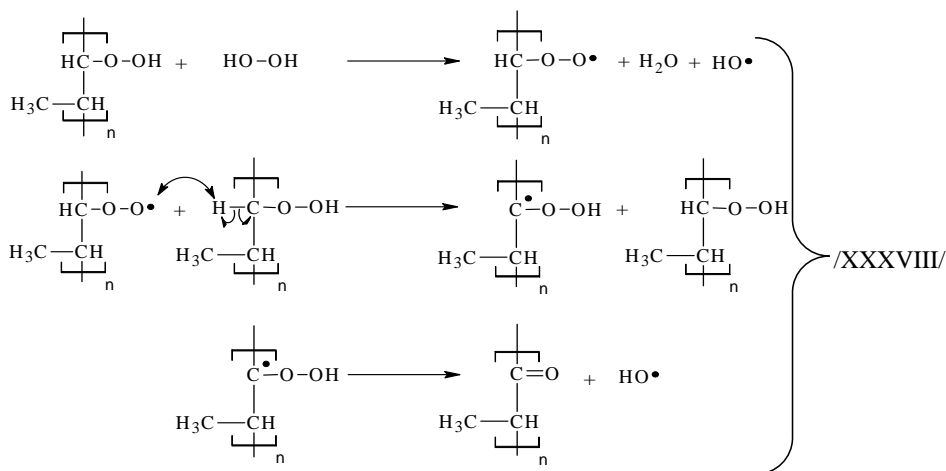

Alkyl hydroperoxyl moieties in polypropylene under acidic conditions undergo chain scission by an intramolecular decomposition mechanism [75, 81]. A mechanism was suggested for the formation of ketones from these alkyl peroxide generated on the polymer chain (see equation /XXXVIII/) [61].

The above discussed facts are conclusively suggesting that the presence of hydroperoxyl moieties could be erratic due to its unreasonable decay behavior to form decomposition products. It obviously causes deleterious effects for desired hydroxyl functionalization process. To

overcome formation of such species, Fenton-like processes, as discussed earlier, can be also employed into the underwater plasma process:

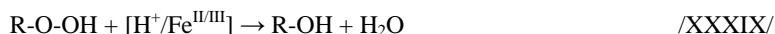

Alkyl hydroperoxyl moieties in polypropylene under acidic conditions undergo chain scission by an intramolecular decomposition mechanism [75, 81]. Another study on the polyethylene substrate suggests that generated hydroperoxyl moieties begin their decay due to the hydrogen peroxide generated in the underwater discharge process. A mechanism was suggested earlier for the formation of ketones from these alkyl peroxide generated on the polymer chain [61] (see equation /XXXVIII/). As the UWP processes generates substantial concentrations of hydrogen peroxides and hydroperoxyl functionality, it is essential to take a keen note or possibly an account of such species. A detail study focusing this topic was recently completed [137]

4.4 Comparison of bond selectivity obtained by atmospheric/reduced pressure discharges with underwater plasma (XPS perspective)

The concept and definition of the bond selectivity was described elaborately in the Section Results. The permanence of hydrophilic modification is a direct result of covalently bound OH, COOH and other CO_x groups introduced by H₂O plasma treatment [144]. The dominance of singly C-O bonded hydroxyl groups (C-OH), (see Fig. 25) within the spectrum of all 70-79 (C-O-) singly bonded C-O functions per 100-oxygen atoms (O_{total}) is obvious (>40 C-OH/O_{total} or 57% OH of all C-O- singly bonded species). The same can be compared with the O1s deconvolution analysis of established plasma assisted surface oxidation processes like oxygen low pressure-glow discharge (LPGD) with about 1.5 OH/100 C and with diborane reduction about 11-14 OH/100 C, dielectric barrier discharge (DBD) with 2-5 OH/100 C and aerosol plasma systems (AeDBD) with 5-10 OH/100 C [151] (see Fig. 44). Using the pulsed plasma polymerization (PPP) about 30 OH functions per 100-oxygen atoms were found at the surface of plasma polymers.

Generation and degeneration processes of such functionalities at the polymer surface are of utter

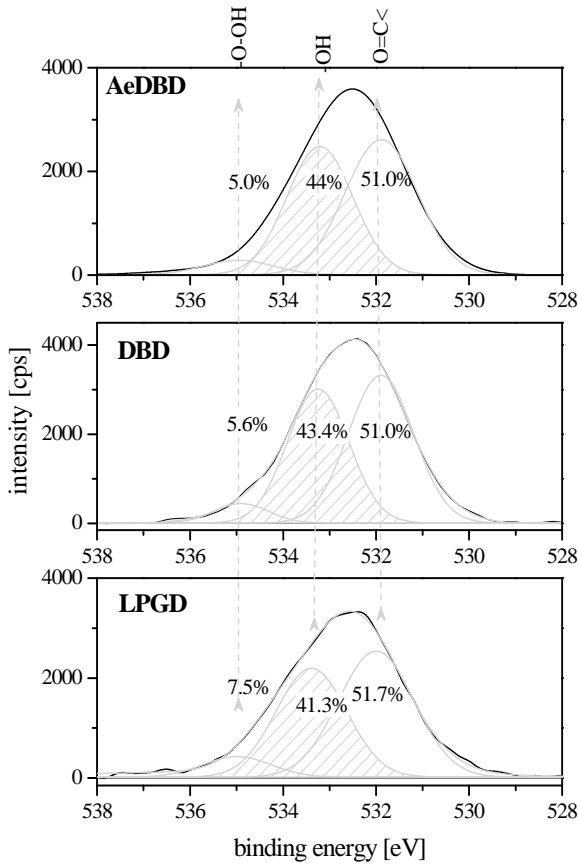

Figure 44
Comparison of O1s peak fits of established plasma processes: oxygen low pressure glow discharge (LPGD,) dielectric barrier discharge (DBD) and aerosol-DBD (AeDBD) treatments of polyolefin surfaces

interests for polymer aging processes. Thus, it was apparent from the XPS studies that the percent bond selectivity for single bonded, most interestingly C-O features (C-O, C-O-C, C-O-OH) in established processes are substantially affected by its companion, doubly bonded (aldehyde and ketone) $>C=O$, $COO(R)$, $COOH$ oxygen functions. It is yet not clear the exact pathway for such degenerate polymer aging process and their products. Nevertheless, understanding the accurate reaction pathways of such processes would certainly help in maximizing the selective functionalization of polymer surfaces. The same perhaps also beneficial for polymer aging studies as hydroperoxide groups are widely believed to be critical

intermediates in oxidative degradation of many polymers especially commodity polyolefins [152-154].

The alternative way of polymer surface functionalization is that of coating the polymer substrates with thin plasma polymer layers carrying functional groups in the UWP shows comparable results to the low-pressure glow discharge deposition. Polymerizing acrylic acid the chemical polymerization dominates and produces predominantly a water-soluble poly (acrylic acid) with more than 65% congruence to the reference polymer applying the glow discharge electrolysis process. The typical energy excess character of the plasma is evident when non-polymerizable organic substances form a polymer film as demonstrated using ethylene glycol. Thus, the liquid-plasma system also shows the disadvantages of the high energy and high enthalpy chemistry as well occurring in the gas liquid-plasma systems. They produce fragmentations and therefore irregular structures, cause degradation and etching. As it could shown the influence of chemistry and its promotion by any additives improves gradually the selectivity of chemical processes in comparison to low-pressure glow discharge processes.

Our working group is very much active in a broad variety of various surface functionalization processes. Various organic groups such as hydroxyl, carboxylic or amines are introduced to the surface by direct plasma functionalization process or by plasma polymerization.

Figure 44 gives a broader picture of comparative status of the various plasma processes used to generate mono-sort functionalized surface. Undoubtedly, the 'depositing' polymer on the substrate surface has higher chances of creating such mono-sort surface by burying the parent surface with the desired coat of polymer. It gave rise to new type of complicated scientific topic of interfacial studies. The new functionalization sites in such cases are indirectly attached (not covalently) to the substrate surface. Although using phenomenon such as pulse, corona aerosol and underwater plasma functionalized surface reasonably has covalently bonded functionalities directly attached to the substrate surface and such functional surfaces are of more interests to the

industry application and academia. Moreover, it was interesting to see the percent of such desired functionalities can be increased or altered using external heterogeneous catalyst system such as Fenton's used in this case and overall selectivity of the process could be enhanced.

5. Application of capillary diaphragm discharge to the contact lens material

Surface properties of contact lenses provided by CIBA Vision were exposed to the underwater plasma. This was modified using the underwater plasma generated by the capillary technique. Principally, this assembly with a fixed sample holder made of glass was designed to hold flat film-like substrates. Therefore, a special lens holder material was designed to hold the lens.



Picture 4: Sample holder for holding the lens curvatures in front of the capillary discharge site

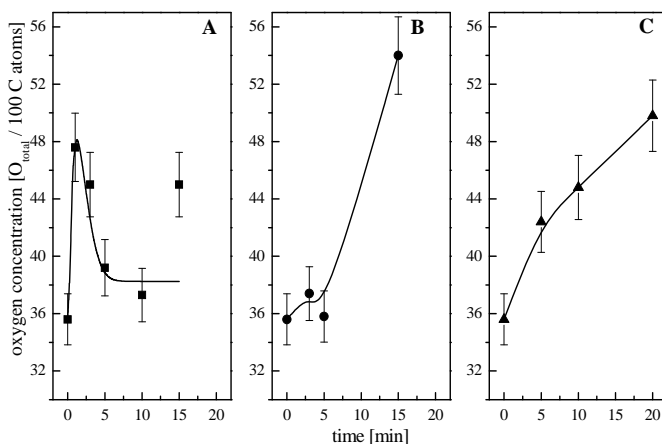

Figure 45
Oxygen introduction onto lens surfaces as measured by XPS analysis
A: UWP exposed lens
B: UWP + allyl alcohol
C: UWP + DADMAC

Picture 4 shows the sample holder mold with a plastic rubber bed for lens with a cap to hold the lens geometry tightly in front of the capillary discharge. The holder mould was supplied by CIBA Vision.

Additives or the chemicals are chosen from the set of additives available and had an experience of its handling into the UWP system earlier.

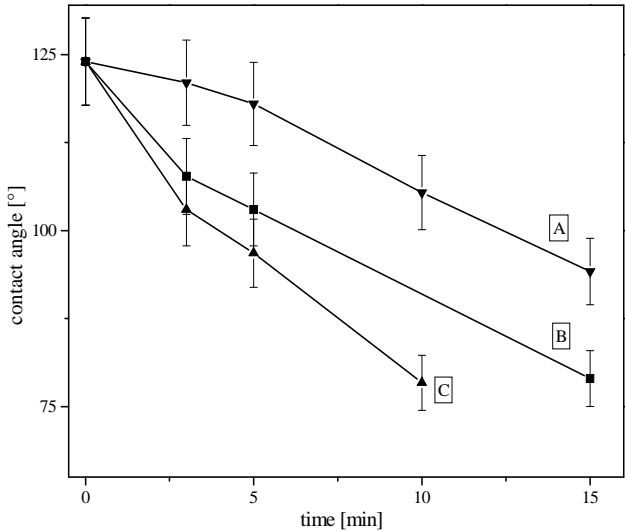

Figure 46
 Static contact angle using the sessile drop method on lens surface after
 A: Pure UWP exposure
 B: UWP +Allyl alcohol
 C: UWP + DADMAC

The contact lens material, a silicon hydrogel was exposed to underwater capillary discharges for a varied period of time. As per the specifications provided by the lens supplier the uncoated lenses have following surface composition by XPS: C ~52%, O ~25%, Si ~12%, N 4~5%, F 6~7%. Alterations in the oxygen concentration of the topmost surface of lenses after UWP exposure were studied for the genuine water based system as well as for admixing additives such as allyl alcohol and di-allyl dimethyl ammonium chloride as precursor for polymer layers with ionic groups.

Figure 45 shows the oxygen growth on the lens surface analyzed by X-ray photoelectron spectroscopic analysis after exposure to genuine underwater plasma system [A] with pure UWP processing, [B] allyl alcohol and [C] diallyl dimethylammonium chloride (DADMAC). The curve patterns for the oxygen deposition were almost reproducible as it was studied earlier in the case of surface functionalization of polypropylene.

In Figure 46 the contact angles of the lens material are altered by the underwater plasma and allyl alcohol and di-allyl dimethyl ammonium chloride are compared. Contact angles for each exposure were measured using the described goniometer, water as test liquid and the sessile drop method.

As mentioned earlier the surface changes being the subject to the instrument and capillary dimensions it was believed that a tending value of 60° for the contact angle for silicon hydrogel materials (contact lens material) could be achieved with appropriate modification into the existing assembly.

It must be added that the principal treatment time can extremely be shortened by new equipments acquisition, the optimization as well as attuning the UWP process of the polymer material. The extent of hydrophilization can be enhanced by applying stronger acidic monomers to produce polymer coatings with COOH groups from acrylic acid provided that they remain body tissue-compatible after the process. Taking into account the main elements in the silicon polymer are carbon, oxygen and silicon. It will be a lucrative proposal to use vinyl and amino silane chemistry after UWP to functionalize or coat the lens material. Summarizing all possibilities of UWP treatment, it can be stated that it is theoretically and also practically the most efficient surface modification method because of the possibilities to tune the reaction by additives, to quench all radicals, the automatic dissolution and removing of all degradation products, the relatively selective functionalization etc.

The lens holder assembly provided by CIBA Vision was a temporary adjustment to the existing assembly. Taking into account the effect of distance of the film from plasma source and the area exposed to the plasma, precise developments and much more sophistication in the assembly could enhance the results further.

6. Conclusions

In the dissertation equipping of polyolefin surfaces with a dense and covalently bonded monolayer of hydroxyl groups were investigated. Underwater plasmas generated by underwater capillary discharges were found to be a very useful tool for such a polymer surface functionalization, with exclusively monosort -OH groups. Important aspects of such process are the simple equipment and the processing at atmospheric pressure, thus avoiding expensive vacuum equipment as used for other plasma processes. Using this water-based plasma 25-40% of all O-functional groups was produced as OH-groups. In comparison to <10% OH produced in the gaseous oxygen low-pressure plasma. Therefore, this method exhibits a great progress.

Earlier studies as well as experimental results suggest that the underwater discharge is a flow controlled process. The flow parameter is dominated by the capillary geometry and the power input into the electrochemical cell. In case of this study with the given parameter 20 mm distance of the polymer sample from capillary tip and therefore from the origin of the plasma jet a steady-state temperature of 40-60°C was measured as optimal for polymer treatment. Moreover, this position was seen to be most effective for a selective oxidation to highest percentage of OH groups at the surface of PP foils.

The role of hydrogen peroxide generated during the underwater plasma process or externally added was studied in presence of a heterogeneous (Fenton's) catalyst system with regard to predominant OH group formation on polymer surfaces. Hydrogen peroxide addition to the UWP has increased the overall efficiency of the polypropylene surface oxidation. On the other hand, the hydrogen peroxide addition to the underwater plasma process has scavenged the selectivity in OH functionalization of the polymer surface by consuming the hydroxyl radicals.

The incursion of the heterogeneous Fe-ZSM5 catalyst has also accelerated the surface oxidation. It was concluded that Fenton's redox system has accelerated the decay of hydrogen peroxide to OH radicals. Bond selectivity which was found 47 C-O bonds/100 O atoms with pure UWP system rises to 76 C-O bonds/100 O atoms using hydrogen peroxide as an additive,

Moreover using the Fenton's catalyst same enhances to a maximum of the 81 C-O bonds/100 O atoms. In contrast to the improved oxidation the selective OH group formation at polymer surfaces could not be improved in comparison to the genuine UWP, which was found to be the most efficient system.

It could be shown that the UWP process also generates the hydroperoxyl functionality into the PP-surface. Its preferred localization was seen by XPS to be below the uppermost polymer surface region.

Kinetic studies have clearly shown that the underwater plasma treatment can be divided into two regimes with respect to the selectivity in OH functionalization in the initiation and the stabilization (steady-state, equilibrium) phase of the UWP process. The initiation phase is characterized by the weakest oxidation of carbon atoms to hydroxyl groups onto the polymer surface (≥ 40 OH/100 O_{total}). OH groups are the lowest oxidation state of C atoms (C^{+1}) interpreted as a regime with maximal concentration of OH species in the process. The subsequent stabilization period is dominated by oxidation also to higher oxidation states ($C^{+2,+3}$). It is characterized by hydroxyl radical scavengers such as hydrogen peroxide.

A broad variety of supporting chemicals as additive, such as organic acids, bases and salts were found useful for the aqueous system under study. Nevertheless of all sorts, the underwater plasma-polymerization shows a new interesting branch and any further progress using this technique still required.

Polymer surface could be effectively functionalized or equipped with carboxylic functionalities using the underwater plasma technique. Various additives were tested such as maleic and itaconic acid, showing destruction of the carboxylic functionality during its introduction on the surface under formation of other, carbonyl and ester species formation. The chemical selectivity in -COOH bond formation using bi-carboxylic additives was seen inferior.

Acrylic acid has shown an effective COOH group survival during its polymerization ranging between 25–40% of all CO bonds. Acetic acid showed very low -COO- bond formation

ranging between 15–25% of overall C-O bond introductions, lowest in the series of organic additives used in this study. The COO- bond percent selectivity using acetic acid was seen to be far inferior as compared to acrylic acid. Nevertheless, derivatization studies using the usual fluorine labeling agent trifluoroethanol for XP-spectroscopy suggests that acetic acid has introduced carboxylic functionalities onto PP-surface. The atomic fluorine percentages observed after derivatization were almost comparable for acrylic and acetic acid results, 3.5–5% fluorine in the overall XPS signal. This COOH functionalization needs the deposition of an insoluble plasma polymer layer onto the substrate. However, insolubility was only achieved by drastic plasma conditions needed for crosslinking. Unfortunately, this extreme condition is characterized by a strong decay in COOH groups. A detail investigation on process optimization is required for the acetic acid and is a subject of an ongoing study and research.

7. References

1. G. Habenicht, *Kleben*, 6th ed., Springer, Berlin, 2009
2. D. T. Clark, A. Dilks, D. Shuttleworth in: *Polymer Surfaces*, Edited by D. T Clark, W. J. Feast, Chapter 9, John Wiley and Sons. 1978
3. L. Penn, H. Wang; *Polymers for Advanced Technologies*; **1994**, 5, 809-817
4. T. C. Chung, *Functionalization of Polyolefins*, Academic Press, 2002
5. M. Ozdemir, C. Yurteri, H. Sadikoglu, *Critical Reviews in Food Science and Nutrition*, **1999**, 39, 5, 457-477
6. J. Friedrich, W. Unger, A. Lippitz, I. Koprinarov, St. Weidner, G. Kühn, L. Vogel, in: *Metallized Plastics 5 & 6: Fundamental and Applied Aspects*, K. Mittal., (ed.): VSP, Utrecht, 1998, pp. 271-293
7. J. Friedrich, R. Mix, R.-D. Schulze, A. Meyer-Plath, R. Joshi, S. Wettmarshausen, *Plasma Processing and Polymers*, **2008**, 5, 407-423
8. J. Friedrich, R. Mix, R.-D. Schulze, A. Rau, *J. Adhes. Sci. Technol.*, in press
9. J. Friedrich, S. Wettmarshausen, M. Hennecke, *Surf. Coat. Technol.*, **2009**, 203, 3647-3655
10. W. Crookes, *Nature*, **1879**, 20, 439
11. G. Hertz, R. Rompe, Akademie-Verlag, Berlin, 1973
12. P. L. Spedding, *Nature*, **1967**, 214, 124-126
13. H. Yasuda, *Journal of Polymer Science: Macromolecular Reviews*, **1981**, 16, 199-293
14. Na Na, Yu Xia, Z. Zhu, X. Zhang, R. Cooks, *Angew. Chem. Int. Ed.*, **2009**, 48, 2017 – 2019
15. E. Linder, A. Davis, *J. Phys. Chem.*, **1931**, 35, 3649-3672
16. Bondt, Deimann, Paets van Trostwijk, Lauwerenburg, in: *J. Fourcroy, Ann. Chem.*, **1796**, 21, 58

17. M. Berthelot, *Ann. Chim. Phys.* **1863**, 6/7, 53; **1866**, 9, 413; **1867**, 12, 5
18. M. Berthelot, *Compt. Rend.*, **1869**, 67, 1141; **1876**, 62, 1283
 - a. P. de Wilde, *Ber.*, **1874**, 7, 352
19. P. u. A. Thenard, *Compt. Rend.*, **1874**, 78, 219
20. H. Schüler, L. Reinebeck, *Z. Naturforsch.*, **1951**, 6a, 271; **1952**, 7a, 285; **1954**, 9a 350
21. H. Schüler, M. Stockburger, *Z. Naturforsch* **1959**, 14a, 981
22. H. O. Pierson, *Handbook of Carbon, Graphite, Diamond and Fullerene: Properties, processing and applications*, Ch. 14, Noyes Publication New Jersey, 1993
23. A. T. Bell in: *Techniques and Applications of Plasma Chemistry*, Edited by J. R. Hollahan, A. T. Bell, Chapter 1, John Wiley & sons New York, 1974
24. S. L. Miller, *Science*, **1953**, 117, 3046
25. S. L. Miller, H. C. Urey, *Science*, **1959**, 130, 245
26. P. Lippens in: *Plasma technologies for textiles*, edited by R. Shishoo, Woodhead Publishing Ltd. Cambridge England, Chapter 3, p. 64-78, 2007
27. M. Hudis, *Journal of Applied Polymer Science*, **1972**, 16, 9, 2397-2415
28. E. Fanghänel, R. Beckert, W. D. Habicher, P. Metz, D. Pavel, K. Schwetlick, *Organikum*, 22nd ed., Wiley-VCH, Weinheim, 2004
29. A. N. Bashkirov, I. B. Chertkov, *Dokl. Akad. Nauk*, **1947**, 817-824
30. J. Friedrich, L. Wigant, W. Unger, A. Lippitz, J. Erdmann, H.-V. Gorsler, D. Prescher, H. Wittrich, *Surf. Coat. Technol.*, **1995**, 74-75, 910
31. R. Hansen, H. Schonhorn, *J. Polym. Sci. B4*, **1966**, 4, 203
32. A. L. Buchachenko, *J. Polymer Sci. Symposium*, **1976**, 57, 299-310
33. A. Holländer, J. Klemberg-Sapieha, M. R. Wertheimer, *J. Polym. Sci.: Part A, Polym. Chem.* **1995**, 33, 2013-2025
34. M. Kuzuya, T. Sawa, M. Mouria, S.-I. Kondo, O. Takai, *Surf. Coatings Technol.* **2003**, 169 –170, 587–591

35. J. Friedrich, G. Kühn, J. Gähde, *Acta Polymerica*, **1979**, 30, 470-477
36. A. I. Maximov, *Fiber Chemistry*, **2004**, 36, 5
37. H. Kellogg, *J. Electrochemical Society*; **1950**, 97, 133
38. A. Hickling, M. Ingram, *J. Electroanal. Chem.* **1964**, 8, 65-70
39. A. Denaro, K. Hough, *Electrochim. Acta*, **1973**, 18, 863-869
40. D. R. Johnson, Y. Osada, A. T. Bell, M. Shen, *Macromolecules*, **1981**, 14, 118
41. K. Rossmann, *J. Polym. Sci.* **1956**, 19, 141-144
42. N. Inagaki, *Plasma surface modification and plasma polymerization*, Technomic Publication, Lancaster, Pennsylvania, 1996
43. R. A. Davies and A. Hickling, *J. Chem. Soc.* **1952**, 3595-3602
44. A. Hickling, *Electrochemical Processes in Glow Discharge at the Gas-Solution Interface in Modern Aspects of Electrochemistry*, J. O. M. Bockris, B. Conway, E., Eds.; Plenum Press: New York, Vol. 6, p. 329-373, 1971
45. A. Hickling, M. Ingram, *J. Electroanal. Chem.* **1964**, 8, 1, 65-81
46. K-J. Choi, J. E. Cook M. Venugopalan; *Z. Anorg. allg. Chem.*, **1971**, 384, 287-296
47. A. Nikiforov, C. Leys, *Plasma Chem Plasma Process*, **2006**, 26, 415-423
48. A. Brablec, P. Slavicek, P. Stahel, T. Cizmar, D. Trunec, M. Simor, M Cernak, *Czech J. Physics*, **2002**, 52, Suppl. D, 491-500
49. P. Gupta, G. Tenhundfeld, E. Daigle, D. Ryabkov, *Surf. Coat. Technol.* **2007**, 201, 8746
50. B. R. Locke, M. Sato, P. Sunka, M. R. Hoffmann, J.-S. Chang; *Ind. Eng. Chem. Res.* **2006**, 45, 882-905
51. R. Brdicka, *Grundlagen der Physikalischen Chemie*, VEB Deutscher Verlag der Wissenschaften, Berlin, 1965
52. J. Brisset, J. Lelievre, A. Doubla, J. Amouroux, *Revue de Physique appliquee*, **1990**, 25, 535-543

53. F.-de Baerdemaeker, M. Simek, C. Leys, W. Verstraete, *Plasma Chem. Plasma Process* **2007**, 27, 473-485
54. P. Sunka, V. Babicky, M. Clupek, P. Lukes, M. Simek, J. Schmidt, M. Cernak, *Plasma Sources Sci. Technol.*, **1999**, 8, 258-265
55. H. Corcoran, D-J. Sung, S. Banerjee, *Ind. Eng. Chem. Res.*, **2001**, 40, 152-155
56. M. Malik, A. Ghaffar, S. Malik; *Plasma Sources Sci. Technol.*, **2001**, 10, 82-91
57. D. R. Grymonpre, A. K. Sharma, W. C. Finney, B. R. Locke, *Chem. Eng. J.*, **2001**, 82, 189-207
58. A. Y. Nikiforov, C. Leys, *Plasma Sources Sci. Technol.* **2007**, 16, 273-280
59. G. Cooper, M. Prober; *Journal of Polymer Science*, **1960**, 44/144, 397-409
60. N. Emanuel, E. Denisov, Z. Maizus, *Liquid phase oxidation of hydrocarbons* (Translated from Russian) Plenum press New York, 1967
61. J. Petruj, J. Marchal, *Radiat. Phys. Chem.*, **1980**, 16, 27-36
62. H. Choi, T. Shikova, V. Titov, V. Rybkin, *J. Colloid Interf. Sci.*, 2006, 300, 640-647
63. T. Wydeven, J. Hollahan: in, *Techniques and Applications of Plasma Chemistry*, chapter 6, page 215, edited by Hollahan and Bell, John Wiley & sons USA 1974
64. A. Nikiforov, *Surface Engineering and Applied Electrochemistry*; **2006**, 4, 51-56
65. A. Maximov, *Contrib. Plasma Phys.* **2007**, 47, No. 1-2, 111-118
66. S. Zdenka, PhD Thesis, Brno, 2005
67. M. Sato, T. Ohgiyama, J. Clements, *IEEE Trans. Ind. Appl.* **1996**, 32, 106-112
68. M. Sahni and B. Locke, *Ind. Eng. Chem. Res.* **2006**, 45, 5819-25
69. P. Lukes, M. Clupek, V. Babicky P. Sunka, *Plasma Sources Sci. Technol.*, **2008**, 17, 024012
70. G. N. Sankin, A. P. Drozhzhin, K. A. Lomanovich, V. S. Teslenko, *Instruments and Experimental Techniques*, **2004**, 47, 4, 525-528

71. A. Maximov, L. Kuzmicheva, A. Nikiforov, J. Titova, *Plasma Chem. Plasma Process.*, **2006**, 26, 205-209
72. D. Briggs, C. Kendall, *Int. J. Adhesion and Adhesives*, **1982**, 2, 1, 13-17
73. A. Sharma, B. Locke, R. Arce, W. Finney, *Hazard. Waste Hazard. Mater.* **1993**, 10, 209-215
74. G. Kühn, St. Weidner, R. Decker, A. Ghode, J. Friedrich, *Surf. Coat. Technol.*, **1999**, 116-119, 796-801
75. J. Rabek, *Polymers Photodegradation*, Chapman & Hall, New York, 1996
76. F.-de Baerdemaeker, M. Simek, C. Leys, *J. Phys. D: Appl. Phys.*, **2007**, 40, 2801-2809
77. R. Atkinson, *Chem. Rev.* **1986**, 86, 69
78. E. Uherek, in: *ESPERE Climate Encyclopedia*, 2006
79. A. Joshi, B. Locke, P. Arce, W. Finney, *Journal of Hazardous Materials* **1995**, 41, 3-30
80. V. V. Rybkin, T. G. Shibaeva, V. A. Titov, *High Energy Chemistry*, **2008**, 42, 485-487
81. Daniel Swern, *Organic Peroxides*, vol. 1, Wiley- Interscience, New York 1970
82. A. Holländer, J. Klemberg-Sapieha, M. Wertheimer, *J. Polym. Sci.: Part A, Polym. Chem.*, **1995**, 33, 2013-2025
83. P. Yang, J. Deng, W.-Tai Yang, *Polymer*, **2003**, 44, 7157-7164
84. R. Nuzzo, G. Smolinsky, *Macromolecules* **1984**, 17, 1013-1019
85. R. Joshi, R-D. Schulze, A. Meyer-Plath, M. Wagner, J. Friedrich, *Plasma Process. Polym.*, **2009**, 6, 5, S218–S222
86. J. Fossey, D. Lefort, S. Sorba, *Free Radicals in Organic Chemistry*, John Wiley & sons, Paris, 1995
87. M. Sato, T. Ohgiyama, J. Clements, *J. Electrostat.*, **1997**, 39, 106-112
88. M. J. Kirkpatrick, B. R. Locke, *Ind. Eng. Chem. Res.*, **2005**, 44, 4243-4248
89. K.-J. Choi, J. Cook, M. Venugopalan, *Z. Anorg. Allg. Chem.*, **1971**, 384, 287-296

90. A. J. Elliott, D. R. Cracken, G. V. Buxton, N. D. Wood, *J. Chem. Soc. Faraday Trans.*, **1990**, 86, 1539-1548
91. G. Geuskens, D. Baeyens-Volant, G. Delaunois, Q. Vinh, W. Piret, C. David, *Eur. Polym. J.*, **1978**, 14, 299-303
92. D. E. Everhart, C. N. Reilley, *Anal. Chem.*, **1981**, 53, 665-676
93. D. T. Clark, *Pure Appl. Chem.* **1982**, 54, 415-438
94. J. Scheirs, D. Carlsson, S. Bigger, *Polymer-Plastics Technology and Engineering*, **1995**, 34, 1, 97-116
95. P. Lukes, *Proceedings of Hakone XI*; Oleron Island, France, 2008
96. A. Swallow, *Radiation Chemistry of Organic Compound*, Pergamon Press, Oxford, 1960
97. S. Wadley, T. Waite, in: *Advanced Oxidation Processes for waste water treatment*, edited by Simon Parsons, 2004, Chapter 5, p 111-136
98. R. Joshi, R-D. Schulze, A. Meyer-Plath, J. Friedrich; *Plasma Processes and Polymers*, **2008**, 5, 695-707
99. C. Oehr, M. Müller, B. Elkin, D. Hegemann, U. Vohrer, *Surf. Coat. Technol.*, **1999**, 116-119, 25-35
100. I. Koprinarov, A. Lippitz, J. F. Friedrich, W. E. S. Unger, Ch. Wöll, *Polymer*, **1998**, 39, 3001-3009
101. J. Friedrich, G. Kühn., R. Mix, A. Fritz, A. Schönhals, *J. Adhesion Sci. Technol.*, **2003**, 17, 12, 1591-1617
102. G. Kühn, I. Retzko, A. Lippitz, W. Unger, J. Friedrich; *Surface and Coatings Technology*, **2001**, 142-144, 494-500
103. J. Friedrich, G Kühn, R. Mix, W. Unger, *Plasma Processes and Polymers*; **2004**, 1, 1, 28-50

104. J. Friedrich, G. Kühn, R. Mix in: *Plasma processes and polymers*, edited by R. d'Agostino, P. Favia, C. Oehr, M. Wertheimer, Wiley-VCH, Weinheim, Page 1-21, 2005
105. M. Noeske, J. Degenhardt, S. Strudthoff, U. Lommatzsch, *International Journal of Adhesion & Adhesives*, **2004**, 24, 171–177
106. A. G. Shard, J. P. S. Badyal, *J. Phys. Chem.*, **1991**, 95, 9438
107. N. Medard, J.-C. Soutif, F. Poncin-Epaillard, *Surf. Coatings Technol.*, **2002**, 160, 197
108. E. Kokufuta, T. Sodeyama, K. Fujimori, K. Harada, L. Nakamura, *J. Chem. Soc., Chem. Comm.* **1984**, 5, 269-270
109. E. Kokufuta, T. Shibasaki, T. Sodeyama, K. Harada, *Chemistry Letters*, **1985**, 14, 10, 1569-1572
110. R. Joshi, J. Friedrich, M. Wagner, *European Physical Journal D*, **2009**, 54, 249–258
111. G. Beamson, D. Briggs, *High Resolution XPS of Organic Polymers*, John Wiley & Sons, Chichester, 1992
112. M. R. Alexander, P. V. Wright, B. D. Ratner, *Surf. Interf. Anal.*, **1996**, 24, 217-220
113. P. Sunka, *Physics of Plasmas*, **2001**, 8, 5, 2587-2594
114. F.-de Baerdemaeker, M. Simek, J. Schmidt C. Leys, *Plasma Sources Sci. Technol.*; **2007**, 16, 341–354
115. R. A. Dickie, J. S. Hammond, J. E-de Vries, J. W. Holubka; *Analytical Chemistry*, **1982**, 54, 12, 2045-2049
116. J. Friedrich, W. Unger, A. Lippitz, I. Koprinarov, G. Kühn, St. Weidner, L. Vogel, *Surf. Coat. Technol.*, **1992**, 59, 371
117. H. C. Brown, H. Schlesinger, A. Burg, *J. Amer. Chem. Soc.* **1939**, 61, 673-677
118. H. C. Brown, B. Subbarao, *J. Amer. Chem. Soc.*, **1960**, 82, 3866
119. J. M. Pochan, L. J. Gerenser, J. F. Elman; *Polymer*, **1986**, 27, 1058-1062
120. M. Morra, E. Occhiello, F. Garbassi, **1989**, *Langmuir*, 5, 3, 873

121. V. Teslenko, A. Drozhzhin, G. Sankin; *Technical Physics Letters*, **2006**, 32, 2, 149–152
122. P. Bruggeman, J. Degroote, C. Leys, J. Vierendeels; *J. Phys. D: Appl. Phys.*, **2008**, 41, 194007
123. A. Kutepov, A. Zacharov A. Maksimov, A. Titov, *High Energy Chemistry*, **2003**, 37, 5, 317-321
124. G. Jinzhang, W. Aixiang, F. Yan, W. Jianlin, M. Dongping, G. Xiao, L. Yan, Y. Wu, *Plasma Science & Technology*, **2008**, 10, 30-38
125. Adolphe Chapiro, *Radiation chemistry of polymeric systems*, Chapter VIII, Interscience Publishers John Wiley & Sons 1962
126. R. Toomer T. Lewis, *J. Phys. D: Appl. Phys.*, **1980**, 13, 1343-56
127. T. J. Lewis in: *Polymer Surfaces*, Edited by D. T. Clark and W. J. Feast, p. 65 John Wiley & Sons 1978
128. J. J. Pignatello, *Environ. Sci. Technol.*, **1992**, 26, 944-951
129. A. Chilkoti,; B. Ratner, in: *Surface Characterization of Advanced Polymers*, L. Sabbattini, P. Zambonin, (eds.), VCH Publishers, Weinheim, Germany (1996), pp. 221-256
130. G. Kühn, A. Ghode, S. Weidner, I. Retzko, W. E. S. Unger, J. F. Friedrich, in: *Polymer Surface Modification: Relevance to Adhesion*, Edited by K. L. Mittal, vol. 2, VSP, Utrecht 2000, p. 45
131. J. Crank, G. park in: *Diffusion in Polymers*, Edited by J. Crank, G. Park, chapter 1, 1968, Academic press Inc. (London) Ltd. London
132. W. J. Moore *Physical Chemistry*, Chapter 6, Fifth Edition Longman Group London 1972
133. J. Friedrich, W. Unger, A. Lippitz, I. Koprinarov, A. Ghode, Sh. Geng, G. Kühn, *Composite Interface*, **2003**, 10, 139-172

134. L. J. Gerenser, J. F. Elman, M. G. Mason, J. M. Pochan, *Polymer*, **1985**, 26, 1162-1166
135. Hans-Georg Elias, *Makromoleküle*, vol. 1, Hüthig & Wepf, 1990
136. B. Tate, *Die Makromolekulare Chemie*, **1967**, 109, 176-193
137. R. Joshi, J. Friedrich, M. Wagner; *communicated* '2010
138. Thieme Chemistry, *Römpp online* (www.roempp.com)
139. G. I. Lavin, F. B. Stewart, *Proceedings of the National Academy of Sciences of the United States of America*, **1929**, 15, 11, 829-832
140. P. Lukes, M. Clupek, V. Babicky, V. Janda, P. Sunka, *J. Phys. D: Appl. Phys.*, **2005**, 38, 409-416
141. M. Mikula, J. Panak, V. Dvonka, *Plasma Sources Sci. Technol.*, **1997**, 6, 179-184
142. P. A. Leermakers in: *Techniques of organic chemistry*, vol. XIV, Ch. I, Edited by A. A. Lamola and N. Turro, Interscience Publishers, John Wiley & sons 1969
143. J. G. Calvert, J. N. Pitts, *Photochemistry*, New York: John Wiley & Sons, Inc 1966
144. M. Steen, C. Butoi, E. Fisher; *Langmuir*, **2001**, 17, 8156-8166
145. R. Joshi, K. Mishra, J. Friedrich; underwater capillary discharge 2d-simulation, unpublished data
146. A. Tobolosky, P. Norling, N. Frick, H. Yu, *J. Amer. Chem. Soc.*, **1964**, 86, 3925-3930
147. K. Swaminathan, S. Sandhya, A. Carmalin-Sophia, K. Pachhade, Y. Subrahmanyam, *Chemosphere*, **2003**, 50, 619-625
148. H. J. H. Fenton, *J. Chem. Soc.*, **1894**, 65, 899-901; **1899**, 75, 1-11
149. C. Decker, F. Mayo, *Journal of Polymer Science: Polymer Chemistry Edition*, **1973**, 11, 2847-2877
150. C. Decker, F. Mayo, H. Richardson, *Journal of Polymer Science: Polymer Chemistry Edition*, **1973**, 11, 2879-2898

151. R. Mix, J Friedrich, Unpublished results
152. J.-L. Gardette, J. Lemaire, *Polymer degradation and stability*, **1986**,7,5, 409-416
153. J. Lacoste', D. Vaillant', D. Carlson, *Journal of Polymer Science: Part A Polymer Chemistry*, **1993**, 31, 715-722
154. J. Lacoste', D. Carwon, *Journal of Polymer Science: Part A: Polymer Chemistry*, **1992**, 30, 493-500

8. List of publications from this work

8.1 Peer reviewed journal articles

- 1) J. Friedrich, R. Mix, R-D. Schulze, A. M-Plath, R. Joshi, S. Wettmarshausen; *Plasma Process. Polymer*; 5, 5, 407–423, **2008**
- 2) R. Joshi, R-D. Schulze, A. M-Plath, J. Friedrich; *Plasma Process Polymers*; 5, 695–707, **2008**
- 3) R. Joshi, J. Friedrich, M. Wagner, *European Physical Journal D*; 54, 249–258, **2009**
- 4) R. Joshi, R-D. Schulze, A. M-Plath, M. Wagner, J. Friedrich; *Plasma Process. Polymer*; 6, 1, S218-S222, **2009**
- 5) R. Joshi, J. Friedrich, M. Wagner, [Role of hydrogen peroxide in selective OH group functionalization of polypropylene surfaces using underwater capillary discharge] *Accepted Journal of Adhesion Sci. Technol.*, **2010**

8.2 Oral presentations

8.2.1. Self delivered:

- 1) Ranjit Joshi, Jörg Friedrich; Title: *Modifying Polymer Surface using the plasma solution technique* at XV - Oberflächentechnologie mit Plasma- und Ionenstrahlprozessen, Klingenthal, Germany on 4-6 March **2008**.
- 2) Ranjit Joshi, Manfred Wagner, Jörg Friedrich; Title: *Polymer surface treatment studies for ester bond generation using solution plasma technique and its relevance to surface modification with carboxylic functionality*, in 23rd Symposium on Plasma Physics and Technology, Prague, Czech Republic, 16-19 June, **2008**
- 3) Ranjit Joshi, Rolf-Dieter Schulze, Asmus M-Plath, Manfred Wagner, Jörg Friedrich; Title: *Selective surface modification of polypropylene using underwater plasma technique or underwater capillary discharge*, in 11th International Conference on

Plasma Surface Engineering (PSE 2008), Garmisch-Partenkirchen, Germany 15 -19 September, **2008**

- 4) Ranjit Joshi, Jörg Friedrich; Title: *Influence of hydroperoxy functionality and hydrogen peroxide on selective surface functionalization of PP-surface*, in 4th International Congress on Cold Atmospheric Pressure Plasmas: Sources and Applications [CAPPSA 2009] Gent, Belgium, 22-24 June, **2009**
- 5) Ranjit Joshi, Jörg Friedrich; Title: *Influence of H₂O₂ and hydroperoxy (-O-OH) on selective functionalization of PP-surface*, at 7th International Symposium on Polymer Surface Modification Orono, Maine, United States of America (USA) 12-15th July, **2009**
- 6) Ranjit Joshi, Jörg Friedrich; Title: *Effects of H₂O₂ generated during underwater discharges and hydroperoxyl functionality (-O-OH) formed on the selective (-OH) hydroxyl functionalization of PP-surface using underwater plasma technique*, in 19th International Symposium on Plasma Chemistry [ISPC' 19] Bochum, Germany 26-31 July, **2009**

8.2.2 Contribution into the confere's orals:

- 7) Renate Mix, Ranjit Joshi, Rolf-Dieter Schulze, Asmus Meyer-Plath, Jörg F Friedrich; *Aerosol and underwater plasma for polymer surface functionalization*, published in Proceedings of the 18th international symposium on plasma chemistry, page 27P/80, 1-4, at Kyoto Japan, 26-31 August **2007**
- 8) Jörg Friedrich, Asmus Meyer-Plath, Renate Mix, Rolf-Dieter Schulze, Ranjit Joshi; Contribution to a collection: Proceedings of the 18th international symposium on plasma chemistry; page 424, 29A/a8, 1-4, Kyoto Japan, 26-31 August **2007**

- 9) Jörg Friedrich, Renate Mix, Rolf-Dieter Schulze, Asmus Meyer-Plath, Ranjit Joshi;
Title: *New plasmas for polymer surface functionalization* at Karls-Universität Prag,
28th January, **2008**
- 10) Jörg Friedrich Renate Mix, Rolf-Dieter Schulze, Asmus Meyer-Plath, Ranjit Joshi at
The 11th International Conference on Plasma Surface Engineering (PSE 2008), Title:
New plasmas for polymer surface functionalization Garmisch-Partenkirchen,
Germany 15 -19 September, **2008**
- 11) Ranjit Joshi, Jörg Friedrich, Title: *Unterwasserplasma zur Funktionalisierung oder
Beschichtung von Polymeroberflächen* Contribution to a collection: Neues Dresdner
Vakuumtechnisches Kolloquium - Beschichtung, Modifizierung und
Charakterisierung von Polymeroberflächen, page 44-52, Dresden, Germany,
16.- 17. October **2008**

8.3 Poster Presentations

- 1) Ranjit Joshi, Asmus Meyer-Plath, Rolf-Dieter Schulze, Jörg Friedrich, title: *Surface
modification studies of polypropylene films using underwater capillary discharge* in
3rd International Congress on Cold Atmospheric Pressure Plasmas: Sources and
Application at Ghent, Belgium, 10-13 July **2007**
- 2) Ranjit Joshi, Rolf-Dieter Schulze, Asmus M-Plath, Jörg Friedrich; Title: *Selective
surface functionalization of polypropylene films using the underwater capillary
discharges* at 18th international symposium on plasma chemistry; Kyoto Japan, 26-31
August **2007**

9. Acknowledgements

I take this opportunity to express first and foremost gratitude towards my supervisor, Professor Dr. Jörg Friedrich for giving me an excitingly challenging opportunity to work on the topic of polymer surface modification using underwater plasmas. I am obliged to learn a trifle of surface chemistry and relevant analytical studies during a cheerful interpersonal interaction and communications with him during the course of this work. This thesis would not have been possible without his supervision, guidance, generosity towards sparing time during the course of the work and compilation of this dissertation.

It was an honor to get the guidance of Professor Dr. Manfred Wagner at Technical University Berlin. I am grateful to him for accepting my request to be reviewer of this dissertation.

I am indebted to many of my colleagues from division VI.5 who supported me during the course of work of this dissertation. I am grateful and would like to thank Dr. Rolf-Dieter Schulze for his amicable cordial help with knowledge has he extended during course of this work. I would also like to thank Dr. Asmus Meyer-Plath for his encouragements during occasional discussions. In fact, I am obliged to receive help and suggestions at couple of occasions in some of my non-academic or non scientific problems from both of my senior colleagues.

I would like to show my gratitude to Dr. Renate Mix and Dr Reinhardt Mach for all their help and support at numerous technical or scientific problems.

It is my pleasant duty to thank my confreres Ms Gundula Hidde for her support and understanding in doing ESCA studies of samples and most importantly introducing and teaching me experiments concerning the XPS instrument. I thank Frank Milczewski for his friendly and cheerful laboratory support and also want to acknowledge my senior colleague Ms Renate Decker towards training I received from her towards various *in-laboratory* techniques during my induction time into the laboratory. I would like to thank ours department secretary Ms Haske and Ms Schulz for their understanding support and help at numerous times.

I would like to show gratitude to Dr. Dietmar Pfeifer and Professor Dr. Christian Jäger (Division I.3, BAM NMR facility) supporting with NMR spectroscopic studies and Dr Michael Menzel for Mössbauer spectroscopic analysis of catalyst. I also want to thank Dr. Jana Falkenhagen and Dr. Steffen Weidner for the polymer analysis of UWP polymerized monomers.

I would like to thank my colleagues Mr. Pott and Mr. Schneider from workshop. Their unconditional and jolly support helped me to design my experimental set up at beginning of my work at BAM.

I would like to recall cordial and kind help extended by Dr. Anton Nikiforov and Professor A. Maximov (from Institute of Solution Chemistry RAS, Ivanovo, Russia) for providing with initial literature on underwater discharges and its understanding when was a new comer into underwater plasma research.

I thank my friend Kirti for an informal refreshing discussion with topics '*anything under the sun*'.

I sincerely thank the companies VDI-TZ (BMBF) Düsseldorf, COTEC, Ahlbrandt, and PolyAn for financing this work.

Last but not the least thanks are to parents and my family for the moral support and encouragement I received during the course of my work and studies. I could not have concentrate and focus on my studies without enduring patient support from my wife Ashwini and ours wonderful son Malhar. In fact I owe special thanks to her towards understanding my working habits and allowing me to remain involved with my studies at maximal.