

Dipl.-Ing. Petra Weißhaupt

**Nitrogen uptake
of saprotrophic basidiomycetes
and bacteria**

Die vorliegende Arbeit entstand an der BAM Bundesanstalt für Materialforschung und -prüfung.

Impressum

**Nitrogen uptake of
saprotrophic basidiomycetes
and bacteria**

2012

Herausgeber:

BAM Bundesanstalt für Materialforschung und -prüfung

Unter den Eichen 87

12205 Berlin

Telefon: +49 30 8104-0

Telefax: +49 30 8112029

E-Mail: info@bam.de

Internet: www.bam.de

Copyright © 2012 by

BAM Bundesanstalt für Materialforschung und -prüfung

Layout: BAM-Referat Z.8

ISSN 1613-4249

ISBN 978-3-9815134-2-4

Nitrogen uptake of saprotrophic basidiomycetes
and bacteria

vorgelegt von
Diplom-Biotechnologin
Petra Weißhaupt
aus Aachen

von der Fakultät III – Prozesswissenschaften
der Technischen Universität Berlin
zur Erlangung des akademischen Grades

Doktorin der Naturwissenschaften
- Dr. rer. nat. -

genehmigte Dissertation

Promotionsausschuss:

Vorsitzender: Prof. Dr. Sven-Uwe Geißen
Berichter: Prof. Dr. Ulrich Szewzyk
Berichter: Prof. Dr. Wolfgang Rotard
Berichter: Prof. Dr. Matthias Noll

Tag der wissenschaftlichen Aussprache: 29.05.2012

Berlin 2012
D 83

Zusammenfassung

Saprotrophe Basidiomyceten können unter aeroben Bedingungen Holz abbauen und wirtschaftliche Schäden verursachen. Die Stickstoffverfügbarkeit ist für diesen Abbau entscheidend, und diazotrophe Bakterien können durch Fixierung von atmosphärischem N_2 Stickstoff auf Holz anreichern. Der gemeinsame Abbau durch Basidiomyceten und Diazotrophe könnte zu hohen Abbauraten führen, da N_2 -Fixierung große Mengen an ATP benötigt, welche durch Celluloseabbau regeneriert werden. In dieser Arbeit wurde diese Interaktion durch Messungen des Stickstoffanteils sowie der $\delta^{15}N$ -Werte in der Biomasse untersucht. Außerdem wurde die Aktivität der Basidiomyceten unter Einfluss unterschiedlicher Stickstoffquellen bestimmt.

Die Messungen des Stickstoffanteils in der Biomasse der Basidiomyceten *Oligoporus placenta* und *Trametes versicolor* bewiesen die Aufnahme organischen Stickstoffs, sogar wenn nur Spuren verfügbar waren. Darüber hinaus förderten Harnstoff und Ammoniumchlorid das Wachstum von *T. versicolor*. In Experimenten unter einer $^{15}N_2/O_2$ -Atmosphäre wurde ermittelt, dass die diazotrophen Bakterien *Azotobacter croococcum*, *Beijerinckia acida* und *Novosphingobium nitrogenifigens* etwa 1–13% ihres Stickstoffbedarfs durch N_2 -Fixierung decken. Wurden Diazotrophe und Basidiomyceten gemeinsam kultiviert, konnte nur von *B. acida* N_2 fixiert und an beide Basidiomyceten übertragen werden. *A. croococcum* und *N. nitrogenifigens* wiesen keine Aktivität auf.

Die Effekte der drei Stickstoffquellen, organischer Stickstoff im Medium, organischer Stickstoff in Splintholz sowie N_2 aus der Luft, auf die Biomasse der Basidiomyceten wurden in Experimenten nach einem statistischen Versuchsplan bestimmt. Organischer Stickstoff als Medienbestandteil förderte das Wachstum beider Basidiomyceten signifikant. In zwei weiteren Versuchsreihen wurde die Stickstoffquelle im Medium durch das Bakterium *B. acida* ersetzt. Luftstickstoff begünstigte das Bakterienwachstum, so dass die Biomassen der Basidiomyceten gegenüber N_2 -freien Bedingungen verringert wurden. Das Vorhandensein von *B. acida* hatte einen geringfügig fördernden Effekt auf die Biomasse von *T. versicolor* aber keinen Effekt auf die Biomasse von *O. placenta*.

Im Gegensatz zu den zuvor genannten Organismen kommen *Hypholoma fasciculare* und einige, teils isolierte und charakterisierte Proteobakterien gemeinsam in der Natur vor. Das Wachstum der Biomasse von *H. fasciculare* und von Proteobakterien wurde durch organischen Stickstoff, Harnstoff und Ammoniumchlorid gefördert. Die N_2 -Fixierung der Proteobakterien war zwar signifikant jedoch geringfügig, so dass sie mit Adsorption an Stelle von Nitrogenaseaktivität interpretiert wurde. Die Konkurrenz von *H. fasciculare* und Proteobakterien um die gleichen Stickstoffquellen wurde als wahrscheinlicher betrachtet als die Stickstoffanreicherung durch Diazotrophie.

Summary

Saprotrophic basidiomycetes decompose wood in aerobic environments and can cause economic damage. The availability of nitrogen is determining for decomposition, and diazotrophic bacteria might enhance the nitrogen availability by fixation of atmospheric N₂. Simultaneous decomposition by basidiomycetes and diazotrophs may intensify decomposition, because N₂ fixation requires ATP, which could be provided during cellulose decomposition. In this study, the interaction was analysed by measurements of the nitrogen content and the $\delta^{15}\text{N}$ values in biomass. Besides, the activity of basidiomycetes, influenced by different nitrogen sources, was determined.

The analysis of the nitrogen content in biomass of *Oligoporus placenta* and *Trametes versicolor* proved the efficient uptake of organic nitrogen by wood-decomposing fungi even if only traces were available. In the presence of urea and ammonium chloride, the growth of *T. versicolor* was intensified. At cultivations in a ¹⁵N₂/O₂ atmosphere, the diazotrophic bacteria *Azotobacter croococcum*, *Beijerinckia acida* and *Novosphingobium nitrogenifigens* covered 1 to 13% of the nitrogen in their biomass by N₂ fixation. If basidiomycetes and diazotrophs were co-cultivated, only *B. acida* fixed N₂ and transferred it to both fungi. *A. croococcum* and *N. nitrogenifigens* did not coexist with the fungi.

The effects of the nitrogen sources, i.e., organic nitrogen in the medium, organic nitrogen in sapwood and N₂ from air, on the biomass of the mentioned basidiomycetes were determined in experiments according to full-factorial experimental plans. Organic nitrogen in the medium increased the growth of both basidiomycetes significantly. In additional experiments, the nitrogen source in the medium was replaced by an inoculum of *B. acida*. Then, atmospheric N₂ supported the bacterial growth, which caused a significant decrease of basidiomycetal biomass compared to N₂-free conditions. The presence of *B. acida* increased the biomass of *T. versicolor* to a low extent, but had no effect on the biomass of *O. placenta*.

In contrast to the previously mentioned organisms, *Hypholoma fasciculare* and proteobacteria occur together in nature. In experiments, the growth of biomass of *H. fasciculare* and proteobacteria was supported by organic nitrogen, urea and ammonium chloride. The N₂ fixation of the bacteria was significant but amounted to a low extent and was therefore explained by adsorption and not by nitrogenase activity. Competition between *H. fasciculare* and proteobacteria for the same nitrogen sources appeared more probable than N enrichment by diazotrophic activity.

Table of contents

Abbreviations	IX
List of figures	XI
List of tables	XIII
1. Introduction	1
1.1. Wood decomposition by basidiomycetes	1
1.2. Diazotrophs in forest ecosystems and wood-decomposing bacteria	2
1.3. Symbiosis and interaction	4
1.4. Isotope ratio mass spectrometry in environmental sciences	5
1.5. Natural ¹⁵ N abundance and fractionation	7
1.6. Design of experiments (DOE)	8
1.7. Objectives	9
2. Materials and Methods	12
2.1. Sterilisation	12
2.2. Cultivation of basidiomycetes	12
2.3. Cultivation of bacteria	13
2.4. Fungal-bacterial co-cultivations under ¹⁵ N ₂ /O ₂ atmosphere	18
2.5. Cultivations according to full-factorial experimental plans	19
2.6. Aqueous soil and wood extracts	21
2.7. Measurement of biomass and enzyme activities	21
2.8. Elemental analysis isotope ratio mass spectrometry (IRMS)	22
2.9. Gas analysis of O ₂ , N ₂ and CO ₂	23
2.10. Statistical analysis	24
3. Results	27
3.1. Wood decomposition by <i>O. placenta</i> and <i>T. versicolor</i>	27
3.2. Elemental analysis of medium compounds	27
3.3. Elemental analysis of basidiomycetes and of aqueous wood and soil extracts	29
3.4. Nitrogen uptake of <i>O. placenta</i> , <i>T. versicolor</i> and <i>H. fasciculare</i>	30
3.5. Nitrogen uptake of bacterial isolates coexisting with <i>H. fasciculare</i>	33
3.6. N ₂ fixation by <i>A. croococcum</i> , <i>B. acida</i> and <i>N. nitrogenifigens</i> as well as bacterial isolates coexisting with <i>H. fasciculare</i>	35
3.7. N ₂ fixation of bacteria in co-cultivation with basidiomycetes	39
3.8. Cultivation of <i>O. placenta</i> and <i>T. versicolor</i> at different N sources	42

Table of contents

3.9. Co-cultivation of <i>O. placenta</i> and <i>T. versicolor</i> with the diazotroph <i>B. acida</i>	47
4. Discussion	53
4.1. Ecology of wood decomposition	53
4.2. Sapwood decomposition and elemental composition of microbial biomass	53
4.3. Nitrogen uptake of saprotrophic basidiomycetes	55
4.4. Nitrogen uptake of diazotrophs	57
4.5. Fungal-bacterial interactions investigated by ¹⁵ N tracing	59
4.6. Nitrogen uptake of <i>O. placenta</i> and <i>T. versicolor</i> determined by DOE	62
4.7. Fungal-bacterial interactions determined by DOE	64
4.8. Fungal-bacterial interactions in wood decomposition	66
4.9. Uncertainty treatment	69
4.10. Implications for applied wood protection	71
5. Conclusion	72
6. Outlook	74
7. References	75
8. Acknowledgements	84

Abbreviations

ABTS	2,2'-azino-bis-(3-ethylbenzthiazoline)-6-sulphonate
ANOVA	analysis of variance
ADP	adenosine-5'-diphosphate
ATP	adenosine-5'-triphosphate
ATR	attenuated total reflection
CRM	certified reference material
CTB	Centre Technique du Bois
DSM	German Collection of Microorganisms
DSMZ	German Collection of Microorganisms and Cell Cultures
DIN	German Institute for Standardization
DOE	design of experiments
EA	elemental analysis
EN	European Norm
<i>F</i> -value	Parameter of F-distribution test ($F = \text{between-group variability} / \text{within-group variability}$)
FTIR	Fourier transformed infrared spectroscopy
FPRL	Forest Products Research Laboratory
GC	gas chromatography
IAEA	International Atomic Agency
ID	isotope dilution
IRMS	isotope ratio mass spectrometry
ISO	International Standardization Organization
JCGM	Joint Committee for Guides in Metrology
LC	liquid chromatography
MEA	5%-malt-extract medium
MES	2-(<i>N</i> -morpholino)ethanesulfonic acid
<i>n</i>	number of replicates
<i>N</i>	number of experiments
<i>nifH</i>	gene encoding nitrogen fixation
Pi	phosphate
pH	pondus hydrogenii
<i>P</i> -value	probability between 0 and 1 (null hypothesis), significance if $P < 0.05$
PCR	polymerase chain reaction
R^2	coefficient of determination
RBA	diazotrophic medium

Abbreviations

rpm	rounds per minute
SD	experimental standard deviation of the mean
TSB	tryptone soy broth
TCD	thermal conductivity detector
UV-Vis	ultraviolet-visible spectroscopy
VPDB	Vienna Pee Dee Belemnite
°C	degree Celsius
d	days
g	gram
g L ⁻¹	gram per litre
L	litre
mL	millilitre
mM	millimol
mm	millimetre
m z ⁻¹	mass to charge ratio
MW	molecular weight
U	Unit, i.e., enzyme activity (μmol substrate · min ⁻¹)
C	carbon
Fe	iron
N	nitrogen
S	sulphur
O	oxygen
δ ¹⁵ N	¹⁴ N/ ¹⁵ N ratio referred to the standard air N ₂ in ‰
δ ¹³ C	¹² C/ ¹³ C ratio referred to the standard VPDB in ‰

List of figures

- Fig. 1:** Elemental analysis (1) combined with isotope ratio mass spectrometry (2) (Hoefs 2009). 6
- Fig. 2:** Hypothesis of increased wood decomposition during fungal-bacterial interaction. 10
- Fig. 3:** Cultivation of *A. croococcum*, *B. acida* and *N. nitrogenifigens* as well as bacterial isolates coexisting with *H. fasciculare* under a $^{15}\text{N}_2/\text{O}_2$ atmosphere and under air. Under both atmospheres, bacteria were cultivated on RBA and on recommended medium. 16
- Fig. 4:** Co-cultivations of *A. croococcum*, *B. acida* and *N. nitrogenifigens* with *O. placenta* and *T. versicolor* under a $^{15}\text{N}_2/\text{O}_2$ atmosphere and under air. 18
- Fig. 5:** Wood and wood decomposed by fungi: (A) sapwood of *P. sylvestris*, (B) sapwood of *P. sylvestris* decomposed by *O. placenta*, (C) sapwood of *F. sylvatica*, (D) sapwood of *F. sylvatica* decomposed by *T. versicolor*. 27
- Fig. 6:** Biomass of *O. placenta* and *T. versicolor* cultivated on RBA amended with 10 mM N of urea (\blacktriangle), NH_4Cl (\circ), NaNO_3 (Δ) or deionised water as reference cultivation (\bullet). Linear approximations of the measured values are indicated. 30
- Fig. 7:** Biomass of *H. fasciculare* cultivated on RBA amended with 10 mM N from urea (\blacktriangle), NH_4Cl (\circ), NaNO_3 (Δ) or deionised water as reference cultivation (\bullet). Linear approximations of the measured values are indicated. 32
- Fig. 8:** C/N ratio (grey), N content in % (m/m) (dark grey) and ^{15}N abundance in % (black) in biomass of *A. croococcum* after 14 d of incubation ($n = 9$, mean values \pm SD). The results of the two-way ANOVA are given in the table. 35
- Fig. 9:** C/N ratio (grey), N content in % (m/m) (dark grey) and ^{15}N abundance in % (black) in biomass of *B. acida* after 14 d of incubation ($n = 9$, mean values \pm SD). The results of the two-way ANOVA are given in the table. 36
- Fig. 10:** C/N ratio (grey), N content in % (m/m) (dark grey) and ^{15}N abundance in % (black) in biomass of *N. nitrogenifigens* after 14 d of incubation ($n = 9$, mean values \pm SD). The results of the two-way ANOVA are given in the table. 37
- Fig. 11:** N contents and $\delta^{15}\text{N}$ values of biomass of bacterial isolates coexisting with *H. fasciculare*. The 27 bacteria were cultivated on RBA and on TSB under air and under a $^{15}\text{N}_2/\text{O}_2$ atmosphere ($n = 1$). Significances of the effects of medium and $^{15}\text{N}_2/\text{O}_2$ treatment were calculated by two-way ANOVA (0.05 level). 38
- Fig. 12:** Effects of the factors (peptone (x_1), wood of *P. sylvestris* (x_2), N_2 in air (x_3)) and their linear combination (x_1x_2 , x_1x_3 , x_2x_3 and $x_1x_2x_3$) on the indicators of fungal activity of *O. placenta*. Effects on six indicators are outlined in bars in different designs. The confidence

intervals of the indicators of fungal activity were determined according to the 95% criterion and are given in the legend. 43

Fig. 13: Effects of the factors (peptone (x_1), wood of *F. sylvatica* (x_2), N_2 in air (x_3)) and their linear combination (x_1x_2 , x_1x_3 , x_2x_3 and $x_1x_2x_3$) on the indicators of fungal activity of *T. versicolor*. Effects on seven indicators are outlined as bars in different designs. The confidence intervals of the indicators of fungal activity were determined according to the 95% criterion and are given in the legend. 45

Fig. 14: Effects in % of the factors (*B. acida* (x_1), wood of *P. sylvestris* (x_2), N_2 in air (x_3)) and their linear combination (x_1x_2 , x_1x_3 , x_2x_3 and $x_1x_2x_3$) on the indicators of fungal activity of *O. placenta*. Effects on six indicators are outlined as bars in different designs. The confidence intervals of the indicators of fungal activity were determined according to the 95% criterion and are given in the legend. 49

Fig. 15: Effects in % of the factors (*B. acida* (x_1), wood of *F. sylvatica* (x_2), N_2 in air (x_3)) and their linear combination (x_1x_2 , x_1x_3 , x_2x_3 and $x_1x_2x_3$) on the indicators of fungal activity of *T. versicolor*. Effects on seven indicators are outlined as bars in different designs. The confidence intervals of the indicators of fungal activity were determined according to the 95% criterion and are given in the legend. 51

List of tables

- Tab. 1:** Composition of media applied for the cultivation of bacteria in the present study (Atlas 1997). 14
- Tab. 2:** An example of an experiment and a 2³ experimental plan with eight experiments. Each experiment was inoculated with *O. placenta* or *T. versicolor*. *P. sylvestris* was used if *O. placenta* was cultivated in the eight experiments, and *F. sylvatica* was used if *T. versicolor* was analysed. 19
- Tab. 3:** Test of fungal and bacterial viability and of the quality of gas-exchange procedure (n = 3, mean values ± SD if RBA was used; n = 6, mean values ± SD if MEA was used). 20
- Tab. 4:** Elemental composition, δ¹⁵N and δ¹³C values of dry media and medium compounds frequently used for the cultivation of microorganisms (n = 3, mean values ± SD). 28
- Tab. 5:** C content, N content, C/N, δ¹⁵N and δ¹³C values of basidiomycetes cultivated in 5%-malt-extract medium after 28 d of incubation (n = 3, mean values ± SD). 29
- Tab. 6:** Elemental analysis and δ¹⁵N and δ¹³C values of wood, bark and soil extract samples (n = 3: three measurements of biomass from one extraction, mean values ± SD). 30
- Tab. 7:** C content, N content, C/N, δ¹⁵N and δ¹³C values of biomass of *O. placenta* and *T. versicolor* cultivated at different N substrates (n = 3, mean values ± SD). 31
- Tab. 8:** C content, N content, C/N, δ¹⁵N and δ¹³C values of dry biomass of *H. fasciculare* cultivated on RBA and RBA amended with 10 mM urea, NH₄Cl or NaNO₃ for 28 and 56 d (n = 6, mean values ± SD). 33
- Tab. 9:** Growth of bacterial strains with different N sources (n = 3). The averages of replicate growth curves were determined and categorised according to the increase from an initial OD of 0.2 to a maximum OD of a) OD_{max} > 0.25 (+), b) OD_{max} > 0.5 (++), c) OD_{max} > 0.75 (+++), d) OD_{max} > 1 (++++). No OD increase was indicated by the symbol (o). 34
- Tab. 10:** Co-cultivations of *O. placenta* and N₂-fixing bacteria on RBA medium under air and under ¹⁵N₂/O₂ atmosphere. Fungal control cultures (A) and consecutively listed pairs of organisms (B, C and D) were co-cultivated under the gas atmosphere outlined. The results are the biomass per batch after separation and the results of the IRMS analysis (n = 3, mean values ± SD). 40
- Tab. 11:** Co-cultivations of *T. versicolor* and N₂-fixing bacteria on RBA medium under air and under ¹⁵N₂/O₂ atmosphere. Fungal control cultures (A) and consecutively listed pairs of organisms (B, C and D) were co-cultivated under the gas atmosphere outlined. The results are the biomass per batch after separation and the results of the IRMS analysis (n = 3, mean values ± SD). 41

- Tab. 12:** Investigation of the N sources (peptone (x_1), wood of *P. sylvestris* (x_2), N_2 in air (x_3)) of *O. placenta* in a 2^3 experimental plan. The indicators of fungal activity were determined after 14 d of cultivation ($n = 3$, mean values \pm SD). 42
- Tab. 13:** Investigation of the N sources (peptone (x_1), wood of *F. sylvatica* (x_2), N_2 in air (x_3)) of *T. versicolor* in experiments of a 2^3 experimental plan ($n = 3$, mean values \pm SD). 44
- Tab. 14:** Investigation of the N sources (*B. acida* (x_1), wood of *P. sylvestris* (x_2), N_2 in air (x_3)) of *O. placenta* in coexistence with *B. acida* in a 2^3 experimental plan ($n = 3$, mean values \pm SD). 48
- Tab. 15:** Investigation of the N sources (*B. acida* (x_1), wood of *F. sylvatica* (x_2), N_2 in air (x_3)) of *T. versicolor* in coexistence with *B. acida* in experiments of a 2^3 experimental plan ($n = 3$, mean values \pm SD). 50

1. Introduction

1.1. Wood decomposition by basidiomycetes

Fungi are important decomposers, plant-associated symbionts and spoilage organisms of manufactured materials (Gadd 2007). Ascomycetes and basidiomycetes decompose wood and plant litter, and their activity is essential for the functioning of forest ecosystems (Boddy *et al.* 2008). Fungal timber decomposition, which is described as white rot or brown rot, needs to be prevented for reasons of stability (Jakobs-Schönwandt *et al.* 2010, Schmidt 2006). Several fungal species can infect sapwood and decrease the stability of construction elements (Schmidt 2006). The initial durability, temperature, moisture and nutrient availability of wood affect the decomposition (Lilly and Barnett 1951). In particular, the availability of nitrogen (N), which occurs in soils but only to a limited amount in sapwood, is a prerequisite for microbial decomposition (Watkinson *et al.* 2006, Boyle 1998). Freshly felled sapwood has a C/N ratio of approximately 350 to 500 (Boddy and Jones 2008), and a C/N ratio of 40 was found as being critical for fungal development in *in vitro* cultivations using low-molecular weight carbon (C) and N sources (Levi and Cowling 1969). During wood decomposition, basidiomycetes recycle N from wood and plant litter and this N capture results in an N enrichment in the residual biomass after decay (Watkinson *et al.* 2006, 1981). Spatially inhomogeneous N availability may be bridged by mycelial transport (Lindahnl and Olsson 2004, Tlalka *et al.* 2002), efficiency of uptake (Read and Perez-Moreno 2003), local and temporal changes in nutrient addition, e.g., by plant material such as pollen or leaves (Perez-Moreno and Read 2001) or by symbiotic partners (Ahmadjian 1993). Apart from the multiple parameters determining wood decomposition, the combination of parameters may determine fungal growth. Since the assimilation of N by saprotrophic fungi is very efficient, fungal growth can already occur at a low availability of N. A similar efficiency in N uptake is described for mycorrhiza fungi (Read and Perez-Moreno 2003).

On wood, decomposition is traceable by visual detection of mycelium or by a typical decomposition pattern, such as brown rot accompanied with cubic rot, white rot or soft rot (Schmidt 2006). In experiments with defined specimens, wood decomposition can be quantified by mass loss (DIN EN 113), bending elasticity (DIN 52186, Stephan *et al.* 2000) and FTIR spectroscopy with an attenuated-total-reflection (ATR) device (Naumann *et al.* 2005). Fungal activity is investigated by measurements of spatial growth, i.e., radial or linear expansion (Lilly and Barnett 1951, Ryan *et al.* 1943) or by measurements of dry biomass if the fungal biomass is separable from the medium. Other indicators of fungal activity are CO₂ formation and O₂ consumption (White and Boddy 1992), a pH decrease in the reaction medium (Schmidt 2006) and specific enzyme activities (Baldrian 2008). These indicators are

measured by gas chromatography, pH measurements or by chemical analysis combined with UV-VIS spectroscopy. Wood-decomposing enzyme activities are either oxidative, i.e., laccase, manganese peroxidase and phenoloxidase activity (Elisashvili and Kachlishvili 2009, Baldrian 2008, Hofrichter 2002, Kirk 1987) or hydrolytic, i.e., cellulase and cellulbiohydrolase activity (Baldrian and Valášková 2008). Alternatively, decomposition is caused by the Fenton reaction (Eastwood *et al.* 2011, Martínez *et al.* 2009). If oxidative activities prevail, lignin in wood is decomposed, and the visual appearance of decomposition is white rot. Hydrolytic activities or Fenton reactions predominantly attack cellulose and cause brown rot.

The basidiomycetes *Trametes versicolor* and *Oligoporus placenta* are examples for a white-rot and a brown-rot causing fungus, respectively. *T. versicolor* occurs on soft- and hardwood and decomposes wood by a set of oxidative enzymes (Valášková and Baldrian 2006). *O. placenta* more frequently occurs on softwood and causes decomposition by Fenton reaction (Martínez *et al.* 2009). Nevertheless, both fungi decompose wood completely. The third fungus *Hypholoma fasciculare* (Blaich and Esser 1975) occurs on hard- and softwood in natural ecosystems, but is neither a frequently-found spoilage organism on manufactured materials nor used as test organism for standardised materials testing (e.g., DIN EN 113, DIN 839). It is a white-rot fungus with oxidative activity and was described to coexist with defined proteobacteria (Valášková *et al.* 2009).

1.2. Diazotrophs in forest ecosystems and wood-decomposing bacteria

Forest soil comprises a broad diversity of bacteria, and some of these bacteria are diazotrophs with the ability of atmospheric N₂ fixation. The importance of bacterial N₂ fixation in forest ecosystems is still under investigation and was recently evaluated in a global modelling approach (Houlton *et al.* 2008). In temperate regions, diazotrophs were discussed as soil-fertilising mycorrhiza helper bacteria (MHB) with antagonistic effects on bacterial phytopathogens (Frey-Klett *et al.* 2007, Garbaye 1994). Diazotrophs are more frequently found in ecosystems of a warm climate, such as tropical forests or warm deserts (Houlton *et al.* 2008, Virginia *et al.* 1988). Atmospheric N₂-fixing bacteria occur in decomposing plant litter (Streichan and Schink 1986, Aho *et al.* 1974), are described as cyanobionts in lichens (Bates *et al.* 2011, Antoine 2004, Ahmadjian 1993) or are associated to mycorrhizae. Fungal-bacterial interactions including diazotrophic bacteria and saprotrophic basidiomycetes were reviewed (de Boer and van der Wal 2008, de Boer *et al.* 2005).

Aho *et al.* investigated an interaction between wood-decomposing fungi and diazotrophs *in situ* by testing the acetylene-reduction activity (Aho *et al.* 1974, Hardy *et al.* 1968). Acetylene-reduction activity was frequently found in the vicinity of white-rot (Jurgensen *et al.*

1989), and bacteria affiliated to *Azospirillum* sp. were identified. Consequently, the soil bacterium *Azospirillum* was explored in more detail (e.g., de Boer and van der Wal 2008, Jurgensen *et al.* 1984). Following studies focused on a *nifH* gene screening in soil and plant litter in forests. The *nifH* genes are key-genes, which encode for nitrogenase enzymes that are essential for diazotrophic activity. A great variety of *nifH* gene-comprising bacterial species occurred in Douglas fir forest soils (Widmer *et al.* 1999, Li *et al.* 1992). The N₂-fixing species in plant litter included members of the genera *Rhizobium*, *Sinorhizobium* and *Azospirillum* and differed from the soil-inhabiting N₂-fixing bacteria, which include members of the genera *Bradyrhizobium*, *Azorhizobium*, *Herbaspirillum* and *Thiobacillus* (Widmer *et al.* 1999). The detection method could be optimised by nested PCR (Duc *et al.* 2009, Bürgmann *et al.* 2004). In the soil of a European forest, diazotrophs were found to a similar extent like denitrifying bacteria (Rösch and Bothe 2005). Cellulytic or lignolytic activity of the diazotrophs was not described. Further *nifH* gene-containing bacteria were found on *P. sylvestris* ectomycorrhiza (Timonen and Hurek 2006). The association of diazotrophs on saprotrophs was not described, but a detailed description of the bacterial community in the mycosphere of the white-rot fungus *Hypholoma fasciculare* exists (Valášková *et al.* 2009). These bacteria were predominantly affiliated to the *Alpha*-, *Beta*- and *Gammaproteobacteria*, and their C sources were investigated (de Boer *et al.* 2010, Valášková *et al.* 2009, Folman *et al.* 2008). Further, these bacteria were not able to decompose cellulose, but they metabolised wood-decomposition products provided by the fungus. Interestingly, the bacterial number increased after prolonged wood decomposition (Valášková *et al.* 2009), which parallels to the increased N availability created by N-recycling basidiomycetes in the late stage of decomposition (Watkinson *et al.* 2006, 1981).

In N-limited environments, N₂ fixation could increase the concentration of biologically available N and support fungal growth. On the one hand, the presence of N₂-fixing bacteria could explain why saprotrophs exist even on N-deficient sapwood without soil or litter contact, on the other hand, their mere existence could increase fungal wood decomposition. The latter could bring N₂-fixing bacteria in the focus of materials protection. The increase in wood decomposition is probable, because N₂ fixation requires considerable amounts of adenosine-5'-triphosphate (ATP, Burgess and Lowe 1996). The reduction of N₂ to NH₄⁺ is catalysed by the nitrogenase enzyme and the hydrolysis of 16 mol ATP per one mol N₂. The postulated N₂ reduction in an eight-electron reaction (Burgess and Lowe 1996, Thorneley and Lowe 1985, Lowe and Thorneley 1984) was proven by detecting the intermediates diazene and hydrazine but no N oxides (Hoffman *et al.* 2009, Barney *et al.* 2007). Consequently, regeneration of ATP by glucose catabolism could intensify cellulose decomposition. Moreover, further inorganic trace elements are needed, since the catalytic

centre of the nitrogenase enzyme consists of a Fe-S cluster with a molybdenum or vanadium atom in the centre. So far, it is not known if wood provides these elements. Separated nitrogenase enzymes cannot catalyse N₂ reduction.

Living bacterial cells are a prerequisite for nitrogenase activity. In addition, diazotrophic bacteria are not described to have lignolytic or cellulolytic activity. For these reasons, there are many open questions on the mechanism of saprotrophic-diazotrophic interactions during wood decomposition.

Lignolytic or cellulolytic bacteria without nitrogenase activity were found on archaeological wood stored under humid, anoxic conditions in soil (Blanchette 2000, Pajanen and Viitanen 1988), on waterlogged timber (Jordan and Schmidt 2000) or on wood piles in soils with a varying groundwater level (Grinda 1997). These bacteria live predominantly under anoxic conditions. The appearance of these bacteria on wood was classified according to the type of damage (Clausen 1996, Nilsson and Daniel 1983, Greaves 1971). The damage was visualised using light microscopy (Gelbrich *et al.* 2008), scanning and transmission electron microscopy (Blanchette 2000, Daniel and Nilsson 1986) and FTIR spectroscopy (Gelbrich *et al.* 2008). Particular organisms were isolated separately by laser techniques (Nilsson *et al.* 2008); some were identified (Landy *et al.* 2008). Other bacteria were described as decomposers of natural and artificial compounds, which have inhibitory effects on fungal decomposers (Jakobs-Schönwandt *et al.* 2010, Gelbrich *et al.* 2008).

In the present approach on tracing N₂-fixation by instrumental means, diazotrophs from strain collections were investigated. These well-described bacteria were supposed as suitable for achieving first data by instrumental measurements. The diazotrophs *Azotobacter croococcum* (Claus and Hempel 1970) and *Beijerinckia acida* (Hilger 1964) are examples of free-living soil bacteria with diazotrophic activity. In soil, the bacteria coexist with fungi. *Novosphingobium nitrogenifigens* was isolated from pulp and paper wastewater, which is a substrate with a high C/N ratio. The bacterium contains *nifH* genes (Addison *et al.* 2007). In this study, the fixation of atmospheric N₂ of the bacteria was quantified by tracing the uptake of N₂, which was artificially enriched with the isotope ¹⁵N. In addition, the bacterial isolates coexisting with *Hypholoma fasciculare* (Valášková *et al.* 2009) were analysed by the same method.

1.3. Symbiosis and interaction

The term symbiosis was originally defined as “the living together of differently named organisms” (de Bary 1879) that comprises mutualism, commensalism, competition and antagonism (Ahmadjian 1986). Sometimes, these types of symbiosis cannot be distinguished, because their morphologies are similar. Competition and mutualism may be characterised by

similar physiological effects, e.g., the bacterially induced protein expression during nodulation of legumes partly coincides with the protein release after pathogenic infections (Deakin and Broughton 2009), and commensalism can change to antagonism (Kaldorf *et al.* 2006) and vice versa. The environmental conditions can also influence the kind of interaction, but the exact interrelations are manifold and a wild field for environmental studies. Although the original definition of symbiosis includes all types of living together, the term often appears as a synonym for mutualism. Therefore, the neutral term “interaction” was preferred in several recent studies on fungal-bacterial coexistence (Frey-Klett *et al.* 2011, Miransari 2011, de Boer and van der Wal 2008).

In many environments, fungal-bacterial interactions have important effects on the biology of both partners (Frey-Klett *et al.* 2011). Mycorrhiza-fungi may benefit from ectomycelial associations of bacteria, which compete with pathogens or provide additional nutrients (Frey-Klett *et al.* 2007), and endomycelial associations of bacteria are a prerequisite for the existence of lichens (Ahmadjian 1993). Bacteria living within the fungal hyphae are protected in the mycelium, and these fungal-bacterial interactions imply a very close association. Similar to mycorrhiza fungi, saprotrophic fungi may be affected by bacterial partners as well (de Boer and van der Wal 2008). Fungal-bacterial studies include bacteria with the ability to suppress fungi (de Boer *et al.* 2004) as well as fungi with the ability to reduce the number of bacteria (Folman *et al.* 2008).

1.4. Isotope ratio mass spectrometry in environmental sciences

Isotopes are atoms with nuclei of the same number of protons but a different number of neutrons. In nature, N occurs as two stable isotopes: ^{14}N and ^{15}N . Approximately 99% of the global N is present as atmospheric N_2 with a composition of 99.63% ^{14}N and 0.37% ^{15}N (De Laeter *et al.* 2003, Junk and Svec 1958). Solid N occurs predominately as inorganic ions (NH_4^+ , NO_3^- or NO_2^-), as NH_3 or as organic N in biomass, e.g., amino acids, aminated carbohydrates and nucleotides. The variances in natural relative isotope abundance in biomass or salts can be analysed by isotope ratio mass spectrometry (IRMS).

Isotope ratio mass spectrometry combined with elemental analysis (EA, Fig. 1) allows C, N, S and H to be analysed simultaneously. Dried samples are combusted under O_2 , reduced by Cu^{2+} and desiccated. While N_2 directly passes the instrument, CO_2 and SO_2 are retarded at purge-and-trap columns and heated out consecutively. The gases are quantified by a thermal conductivity detector, which is a Wheatstone bridge (Fig. 1, 1), and further analysed in a magnetic sector-field mass spectrometer (Fig. 1, 2). N is detected as N_2 with a mass to charge ratio ($m z^{-1}$) of 28 and 29 (Hoefs 2009).

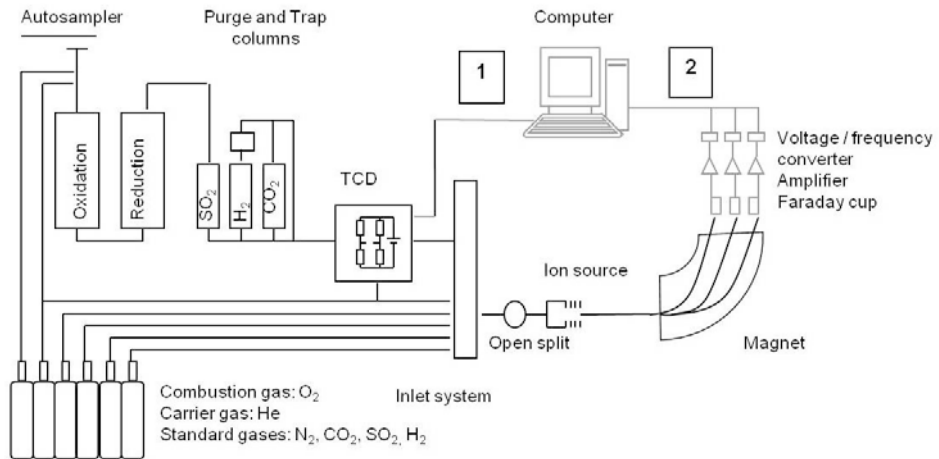

Fig. 1: Elemental analysis (1) combined with isotope ratio mass spectrometry (2) (Hoefs 2009).

The challenges of instrumental N measurements are the low natural abundance of N isotopes in organic compounds, N oxides as minor products of combustion and contamination by atmospheric N₂ during measurements. Nitrogen oxides are removed during the reduction at Cu²⁺, and the carrier gas helium prevents disturbances by N₂ (Meier-Augenstein 1999). The isotope ratio at low N abundances was quantified by using optimised sample sizes, which may also include separate measurements for the different elements, i.e., C, N, S, H. Alternatively, isotopes of different quantities can be quantified by isotope dilution (ID) in a single measurement. Hence, the addition of a spike with a known isotope ratio adjusts the abundances of the isotopes in a sample to similar concentrations. Then, both isotope peaks are measurable at the same time, and the abundances of the isotopes in the initial sample become calculable (Vogl and Pritzkow 2010, Vogl 2007, Wolff *et al.* 1996).

As an alternative to elemental analysis, isotope ratio mass spectrometry was combined with gas chromatography including a combustion interface (GC-C-IRMS, Petzke *et al.* 2005, Meier-Augenstein 1999, Metges *et al.* 1996) or with high-pressure liquid chromatography (HPLC-C-IRMS, Godin *et al.* 2007). With both methods, isotope ratios of separated molecules were determined, but the methods were limited by the amount of N in the molecules. Dilution during chromatography further curbs the detection limit of different isotopes in molecules. Particularly, methods using HPLC-C-IRMS are restricted to the analysis of C isotopes, since the dilution during chromatography reduces the N to a non-measurable concentration. If the mass of amino acids (Zhang *et al.* 2007, Macko *et al.* 1997) and aminated carbohydrates (He *et al.* 2006, Zhang and Amelung 1996) artificially enriched in ¹⁵N were analysed, gas chromatography and quadrupole mass spectrometry were applied.

The molecules were ionised by electron impact ionisation (EI) or chemical ionisation (CI). HPLC combined with electro-spray ionisation triple quadrupole mass spectrometry (ESI-MS-MS) was used as well (Thiele *et al.* 2008). Proteins labelled with ^{15}N were separated by two-dimensional gel electrophoresis, trypsin digested and finally analysed with matrix-assisted laser desorption ionisation time-of-flight mass spectrometry (MALDI-TOF), similar to peptide sequencing approaches. As a result, mass spectra from ^{15}N -labelled peptides slightly differed from non-labelled control experiments (Jehmlich *et al.* 2008). The proteome of the N_2 -fixing lichen *Lobaria pulmonaria* was investigated by a similar instrumental approach: Isolated peptides without any labelling were analysed by one-dimensional gel electrophoresis combined with LC-MS-MS (Schneider *et al.* 2011).

N analysis in biomass by EA-IRMS included the determination of the natural isotope ratio and the recovering of substances artificially enriched in the isotope ^{15}N . The natural isotope ratio was determined for biomass from laboratory cultivations and N substrates as well as for environmental samples. Tracing experiments of substances artificially enriched in ^{15}N have been frequently used to investigate the effect of artificial fertilisers or of bacterial N_2 fixation on plant roots (Shearer and Kohl 1993, Hardarson *et al.* 1984). The IRMS approach was supposed to be the best available method to directly quantify the $^{15}\text{N}_2$ fixation by root-associated bacteria (Warembourg 1993). However, there are limitations regarding the experimental setup and the time of exposure of biomass to $^{15}\text{N}_2$. Particularly, the measurement of low levels of N is accompanied with a high uncertainty (Danso *et al.* 1993).

1.5. Natural ^{15}N abundance and fractionation

The natural $\delta^{15}\text{N}$ values vary between -20 and $+20\%$ (Hoefs 2009). The variance of N isotopes in biogeochemical matter is a result of fractionation, which occurs during physical or chemical reactions (Hoefs 2009, Shearer and Kohl 1989). Since the reaction rates of the N isotopes differ to a low extent, reactions discriminate against heavier isotopes. A fractionation by atomic decay is negligible for stable N isotopes. Isotope fractionation is predominantly caused by equilibrium exchange reactions, e.g., ammonia volatilisation (equation (1)). In the process of volatilisation, the gaseous ammonia becomes ^{15}N -depleted compared to the aqueous ammonia (Hoefs 2009).



Accordingly, temperature and climate are the most important parameters determining fractionation. The measurable $\delta^{15}\text{N}$ values in biomass comprise the sum of fractionation from subsequent physical and chemical reactions. Additionally, the molecular weight of the N source effects fractionation. In experiments, fractionation was more pronounced during

uptake of ammonia (NH_4^+) than of amino acids. The N-fractionation rate of nitrate NO_3^- in biochemical reactions is usually lower than the fractionation of NH_4^+ (Hoefs 2009).

N transfer in mycorrhiza fungi in forests soils was investigated (Hobbie and Hobbie 2008). In studies on soil, plants and fungi of the same ecosystem, fungi discriminated against ^{15}N if they transferred N into the plants. Thus, mycorrhiza plants are depleted whereas mycorrhiza fungi are enriched in ^{15}N (Högberg *et al.* 2011, Hobbie and Hobbie 2008, Högberg 1997). For example, roots of *F. sylvatica* were depleted in ^{15}N by almost 6.4‰ compared to the ectomycorrhiza mantle (Högberg *et al.* 1999, Högberg *et al.* 1996). Non-mycorrhiza plants had $\delta^{15}\text{N}$ values similar to soil (Hobbie and Hobbie 2006). Interestingly, in ericoid mycorrhiza penetrating the plant cell wall, the difference in $\delta^{15}\text{N}$ values between fungi and plants was less significant than in ectomycorrhiza plants and fungi (Emmertson *et al.* 2001a). Particularly, plants and fungi of arctic ecosystems have been frequently used for studies on isotope fractionation in biological reactions, since fractionation by equilibrium exchange is reduced at low and constant temperatures (Emmertson *et al.* 2001a, b).

In biomass of saprotrophic basidiomycetes, higher N contents and $\delta^{15}\text{N}$ values were found than in wood, but both were lower than the $\delta^{15}\text{N}$ values in soil of the particular ecosystem (Gebauer and Taylor 1999). The $\delta^{15}\text{N}$ values of soil differ according to soil origin and usually increase in deeper soil horizons (Högberg *et al.* 1996). In several tested ecosystems, mycelia were depleted in ^{15}N compared to their fruiting bodies (Zeller *et al.* 2007), and within fruiting bodies proteins usually had higher $\delta^{15}\text{N}$ values than chitin (Taylor *et al.* 1997). Additionally, fruiting bodies of ectomycorrhiza fungi were enriched in ^{15}N compared to saprotrophic fungi (Gebauer and Taylor 1999, Hobbie *et al.* 1999, Taylor *et al.* 1997, Högberg *et al.* 1996). In laboratory studies, saprotrophic and mycorrhiza fungi fractionated N to a similar extent, and the $\delta^{15}\text{N}$ values of the substrates were determining for the final $\delta^{15}\text{N}$ values in biomass (Hobbie *et al.* 2004). In nature, differences among mycorrhiza and saprotrophic fungi result from the uptake of ^{15}N -rich N from soil or ^{15}N -depleted N from plant material. The $\delta^{15}\text{N}$ values of the substrates determine the $\delta^{15}\text{N}$ values in the fungal biomass to a greater extent than strain specific fractionation.

1.6. Design of experiments (DOE)

To determine multiple factors of fungal wood decomposition, full-factorial experimental plans were implemented. Experimental plans comprise a set of parallel experiments, which allow the calculation of effects of different factors and their linear combinations (Kleppmann 2008, Retzlaff *et al.* 1978). This design of experiments was invented by R. A. Fisher (Fisher 1935) and was later optimised for a randomised parameter screening at a high number of factors (Plackett and Burman 1946). Recently, experimental plans were used in biological studies for

parameter evaluation (White and Gadd 1996), optimisation of analytical tests (Olsson *et al.* 2006) and processes in applied microbiology (Jacques *et al.* 1999).

A full-factorial experimental plan comprises experiments for all factor combinations, which determine the measured value, and can be designed in a matrix of the type of Hadamard matrices (Hedayat and Wallis 1978). The initial factors have to be chosen by a sound guess. Microbial interactions can be analysed under a small number of different conditions. Fractional-factorial plans (Plackett and Burman 1946) are useful if a high number of factors has to be considered. Hence, the matrix of factor combinations is established as well, but only a randomised fraction is carried out experimentally. The randomisation is realised by software packages such as Statistica (StatSoft GmbH, Hamburg) or Minitab (Additive GmbH, Friedrichsdorf).

In this study, the N sources of wood-decomposing basidiomycetes and the symbiosis with the diazotroph *B. acida* were investigated in four full-factorial experimental plans. The test organisms were *T. versicolor* and *O. placenta* in the vegetative growth phase, which is generally regarded as the stage of wood decomposition. *B. acida* was found in the vicinity of decomposing coniferous wood (Streichan and Schink 1986), was able to coexist with both fungi and transferred fixed N₂ to them (Weißhaupt *et al.* 2011). Experimental plans were applied to quantify and compare the effects of different N sources and to evaluate if particular combinations of parameters are determining. The intention was to reveal if different N sources affect fungal activity and if fungi benefit from fungal-bacterial interactions. Two full-factorial experimental plans were applied to investigate the effects of organic N from peptone, N₂ from air and ultimately N from wood on the growth of *O. placenta* and *T. versicolor*. In two further plans, peptone was replaced by an inoculum of *B. acida*, and the growth of the fungi was investigated again. The indicators of fungal activity were the biomass, O₂ consumption, CO₂ formation, the elemental composition of the biomass and laccase activity (Weißhaupt *et al.* 2012).

1.7. Objectives

Wood is decomposed by diverse organisms including fungi and bacteria. Since sapwood is an N-deficient substrate, N amendment is a prerequisite for decomposition. Initial N could be provided by minor spoilage with anthropogenic N or by diazotrophic bacteria. Both aspects could be of interest for materials protection. This study focused on the microbial N assimilation and on the relevance of diazotrophs, i.e., bacteria with the ability to assimilate N₂. If glucose from cellulose is the main C and energy source and if the bacterial nitrogenase reaction is the bottleneck of N availability on wood, an increase in decomposition activity is possible. Bacterial N₂ fixation is energy demanding, and in microbial cells energy is provided

by the hydrolysis of adenosine-5'-triphosphate (ATP). The regeneration of ATP could be provided by glucose catabolism and could accelerate cellulose decomposition by fungi (Fig. 2). So far, this is a hypothesis, which has not been approved. The objective was to establish a quantitative method for the determination of N isotopes in biomass, to trace $^{15}\text{N}_2$ fixation by bacteria and to follow the ^{15}N transfer into decomposing fungi. Since $^{15}\text{N}_2$ tracing studies depend on reference data with appropriate organisms (Danso 1993), diazotrophs and wood-decomposing basidiomycetes from strain collections were used in this study. Experimental results were employed to approve or disapprove the hypothesis of increased decomposition.

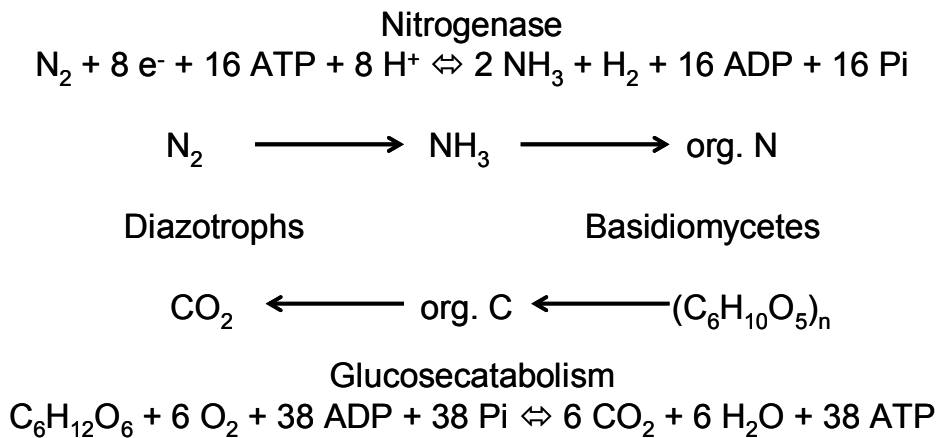

Fig. 2: Hypothesis of increased wood decomposition during fungal-bacterial interaction.

The thesis consists of three parts, in which the hypothesis is investigated by different approaches:

Firstly, the preferred N sources of basidiomycetes from strain collections were investigated, and the N_2 fixation of diazotrophs was quantified and compared. Cultivation experiments with basidiomycetes with N sources of different natural $\delta^{15}\text{N}$ values proved the N uptake by brown- and white-rot fungi. In experiments with N_2 artificially enriched with ^{15}N , the N_2 uptake was quantified. The basidiomycetes *T. versicolor* and *O. placenta* and the diazotrophs *A. croococcum*, *B. acida* and *N. nitrogenifigens* were investigated both individually and in combination. It was investigated, whether $^{15}\text{N}_2$ is fixed and reduced by diazotrophic bacteria and afterwards transferred into fungal biomass (Weißhaupt *et al.* 2011).

Secondly, the effects of peptone as medium compound, of N_2 from air and of N traces in wood on *T. versicolor* and *O. placenta* were investigated by experiments according to full-factorial plans. In contrast to the previous experiments with air and $^{15}\text{N}_2/\text{O}_2$, air and a N_2 -free

O₂/Ar atmosphere were applied. In addition, the experiments of the experimental plan included wood as a substrate. Since *B. acida* transferred fixed N into fungi, this bacterium was chosen for further tests of fungal-bacterial interaction. The indicators of fungal activity were biomass formation, CO₂ formation, O₂ consumption, C and N contents, δ¹⁵N values in the biomass and laccase activity. These indicators were measured in order to show if fungal growth and the increase of decomposition activity are affected in the same way by the N sources. Moreover, gas measurements ensured the quality of the experimental conditions after gas-replacement, and IRMS measurements proved the uptake of N sources (Weißhaupt *et al.* 2012).

Thirdly, the results of the previous studies were compared to the N uptake of *Hypholoma fasciculare* and coexisting bacterial isolates, which occurred together on decomposing wood in nature. The bacteria were isolated, identified, and their C utilisation was investigated in another study (Valášková *et al.* 2009). *H. fasciculare* and coexisting bacterial isolates were cultivated with different N sources, and the ¹⁵N₂-tracing methods were applied. The preferred N species were determined, and the bacterial ¹⁵N₂ fixation was quantified. Analysis was conducted to determine if bacteria increase the N availability and affect wood decomposition.

The three approaches focused on different methods and aspects of fungal-bacterial interactions during decomposition. Two experimental approaches were applied and compared: stable-isotope tracing by means of ¹⁵N₂ and experimental plans including an N-free O₂/Ar atmosphere. The results of both approaches were critically reviewed by statistical means to exclude artefacts and to test the significance of experimental datasets. Firstly, wood decomposers and diazotrophs from strain collections were used to obtain basic information on N concentrations in microbial biomass and N₂-fixation rates. Secondly, the comparison with the natural-occurring community gave evidence on the role of bacteria *in situ*.

2. Materials and Methods

2.1. Sterilisation

All experiments were carried out under sterile conditions. Tools, media and also wastes were steam sterilised according to a standardised method (DIN EN ISO 17665), i.e., 20 min at 2×10^5 Pa and 120 °C in a laboratory autoclave (Varioklav Dampfsterilisator, H + P Labortechnik GmbH, Oberschleißheim). Wood specimens were steam sterilised at 100 °C for 20 min on two consecutive days in a steam-raising unit (Fritz Gössner GmbH, Hamburg). During sterilisation, the specimens were placed either on Petri dishes or in bags. Afterwards, all tools or wood samples were dried at 60 °C in a drying cabinet (Heraeus 6000, Thermo Fisher Scientific GmbH, Bremen). Microorganisms were transferred under sterile conditions in laminar airflow cabinets (Nalgene Nunc International GmbH, Wiesbaden).

2.2. Cultivation of basidiomycetes

2.2.1. Cultivation media

Basidiomycetes are usually cultivated on 5%-barley-malt-extract medium (MEA, Villa Natura Gesundprodukte, Kirn). Occasionally, the medium was amended with 15 or 20 g L⁻¹ agar (Merck KGaA). This medium was also used for long-term cultivations.

In most of the experiments of this study, the basidiomycetes were cultivated on diazotrophic medium (RBA, Tab. 1, Atlas 1997). This N-free medium was modified according to experimental requirements (see 2.2.2. and 2.2.3. as well as 2.4. and 2.5.). Generally, the vitamin solution (solution D) was not added as recommended (Atlas 1997) to prevent the dilution of N isotopes.

2.2.2. Long-term cultivations and cultivations on complex substrates

Trametes versicolor (CTB 863A, Centre Technique du Bois, Paris, France), *Oligoporus placenta* (FPRL 280, Forest Products Research Laboratory, Watford, United Kingdom) and *Hypholoma fasciculare* (DSM 1010, German Collection of Microorganisms and Cell Cultures GmbH, Brunswick) were used. In preliminary experiments, *Serpula lacrimans* (BAM Ebw. 315, BAM Federal Institute for Materials Research and Testing, Berlin), *Coniophora puteana* (BAM Ebw. 15) and *Antrrodia vaillantii* (BAM h2) were investigated. For pre-cultures and long-term cultivations on Petri dishes (94/16, PS, w/vents, Paul Boettger OHG, Bodenmais) with MEA were used. Fungal inocula (excisions of 5 mm × 5 mm) were monthly transferred to new medium. To maintain the virulence, i.e., the wood-decomposing activity, fungi were cultivated on MEA with two wood blocks (sapwood, 5 mm × 10 mm × 32.5 mm). *O. placenta* was cultivated on wood of *Pinus sylvestris*. *T. versicolor* and *H. fasciculare* were

cultivated on wood of *Fagus sylvatica*. Hence, the wood blocks were co-transferred to the new media. Before conducting the experiments, fungi were pre-cultivated without wood on 5%-barley-malt-extract medium or RBA medium for 14 d.

In preliminary cultivation experiments, the basidiomycetes were grown in 50 mL MEA without agar in Erlenmeyer flasks. The fungal inocula were excisions of 5 mm × 5 mm of each basidiomycete, which was pre-cultivated in solid medium. Cultivations proceeded in a dark room with a constant temperature of 21 ± 2 °C at a humidity of 70 (± 5)%. The cultivations were not shaken to prevent any pellet formation.

2.2.3. Cultivations at defined N sources

If the uptake of specific N sources by fungi was tested, N-free RBA medium (without solution D, Atlas 1997) was applied. For these experiments, fungi were pre-cultivated on agar-containing RBA medium on Petri dishes and transferred twice on new RBA medium to prohibit the transfer of N from residual MEA in the inoculum. For experiments in Erlenmeyer flasks, 50 mL agar-free RBA was amended with 1 mL of 50% D-glucose solution and 250 μ L of (a) 60 g L⁻¹ urea, (b) 117 g L⁻¹ NaNO₃, (c) 107 g L⁻¹ NH₄Cl or (d) deionised water as N-free control. The final N concentration of (a)–(c) was adjusted to 10 mM N, and each of the experiments was carried out three times (Weißhaupt *et al.* 2011). The cultivation was carried out at 21 ± 2 °C at a humidity of 70 (± 5)%. *O. placenta* and *T. versicolor* were cultivated for 7, 14, 21, 28 and 35 d with each of the N sources (a)–(d). *H. fasciculare* was cultivated for 14, 28, 42, 56 and 70 d with each of the N sources (a)–(d). After cultivation, fungal biomass was separated from the medium by filtration (No. 1, Whatman International Ltd., Maidstone, United Kingdom), rinsed with sterile, deionised water and lyophilised (as mentioned in section 2.7.). Dried samples of biomass were analysed by EA and IRMS (section 2.8.).

2.3. Cultivation of bacteria

2.3.1. Cultivation media

RBA (without solution D, Atlas 1997) was used for the cultivation of diazotrophs, bacterial isolates coexisting with *H. fasciculare* and for fungal-bacterial co-cultivations. The medium is supposed to be suitable for the cultivation of a broad diversity of diazotrophs. It contains several C-sources and trace elements that are necessary for the nitrogenase reaction. The recommended vitamin solution (Solution D) was not added to prevent N isotope dilution. RBA medium contained 0.005 g L⁻¹ N, which can be traced back to yeast extract (0.05 g L⁻¹ with an N content of 11.16 (± 0.1)%). If agar (15 g L⁻¹ with an N content of 0.28 (± 0.01)%) was applied, the N content was approximately 0.05 g L⁻¹.

Materials and Methods

In addition, the purchased bacteria were cultivated on recommended media. The specific media were Azotobacter medium for *A. croococcum*, Beijerinckia medium for *B. acida* and nutrient medium for *N. nitrogenifigens* (recommendation by DSMZ, Atlas 1997; Tab. 1).

Tab. 1: Composition of media applied for the cultivation of bacteria in the present study (Atlas 1997).

Diazotrophic medium pH 7.3	Azotobacter medium pH 7.3	Beijerinckia medium pH 6.5	Nutrient medium pH 7.0	Tryptone soy broth (1:10) pH 5
D-Glucose 2.0 g L ⁻¹	D-Glucose 5.0 g L ⁻¹	D-Glucose 10.0 g L ⁻¹	Peptone (casein) 5 g L ⁻¹	D-Glucose 0.25 g L ⁻¹
D-Mannitol 2.0 g L ⁻¹	D-Mannitol 5.0 g L ⁻¹		Meat extract 3 g L ⁻¹	MES 1.95 g L ⁻¹
K ₂ HPO ₄ 0.9 g L ⁻¹	K ₂ HPO ₄ 0.9 g L ⁻¹	K ₂ HPO ₄ 0.8 g L ⁻¹		K ₂ HPO ₄ 0.25 g L ⁻¹
KH ₂ PO ₄ 0.1 g L ⁻¹	KH ₂ PO ₄ 0.1 g L ⁻¹	KH ₂ PO ₄ 0.2 g L ⁻¹		NaCl 1.5 g L ⁻¹
MgSO ₄ x 7 H ₂ O 0.1 g L ⁻¹	MgSO ₄ x 7 H ₂ O 0.1 g L ⁻¹	MgSO ₄ x 7 H ₂ O 0.1 g L ⁻¹		Peptone (casein) 1.7 g L ⁻¹
FeSO ₄ x 7 H ₂ O 0.01 g L ⁻¹	FeSO ₄ x 7 H ₂ O 0.01 g L ⁻¹	FeSO ₄ x 7 H ₂ O 0.02 g L ⁻¹		Peptone (soy meal) 0.3 g L ⁻¹
MnSO ₄ x H ₂ O 0.005 g L ⁻¹		MnSO ₄ x 6 H ₂ O 0.002 g L ⁻¹		
Na ₂ MoO ₄ x 2 H ₂ O 0.005 g L ⁻¹	Na ₂ MoO ₄ x 2 H ₂ O 0.005 g L ⁻¹	Na ₂ MoO ₄ x 2 H ₂ O 0.005 g L ⁻¹		
NaVO ₃ x H ₂ O 0.005 g L ⁻¹		ZnSO ₄ x 6 H ₂ O 0.005 g L ⁻¹		
CaCl ₂ x 2 H ₂ O 0.10 g L ⁻¹	CaCl ₂ x 2 H ₂ O 0.10 g L ⁻¹	CuSO ₄ x 6 H ₂ O 0.004 g L ⁻¹		
NaCl 0.1 g L ⁻¹	CaCO ₃ 5 g L ⁻¹			
Na-pyruvate 1.0 g L ⁻¹				
DL-malate 2.0 g L ⁻¹				
Na ₂ -succinate 1.0 g L ⁻¹				
Yeast extract 0.05 g L ⁻¹				
Trace elements				
0.005 g L⁻¹	No N	No N	1.1 g L⁻¹	0.28 g L⁻¹

Azotobacter medium and Beijerinckia medium are N-free. Nutrient medium contains organic N from complex sources, i.e., peptone and meat extract. TSB, which also contains N, was used for the cultivation of bacteria coexisting with *H. fasciculare* (Valášková *et al.* 2009, Folman *et al.* 2008). It was diluted 1:10 and adjusted to pH 5 by adding 2-(*N*-morpholino)ethanesulfonic acid (MES) and NaCl (Folman *et al.* 2008). TSB medium comprised 0.33 g L^{-1} N, which was provided by peptone from casein (1.7 g L^{-1} with an N content of $14.88 (\pm 0.01)\%$), peptone from soy meal (0.3 g L^{-1} with an N content of $10.34 (\pm 0.01)\%$) and agar (15 g L^{-1} with an N content of $0.28 (\pm 0.01)\%$). The N concentrations of each medium were calculated after measuring the medium ingredients by elemental analysis.

2.3.2. Cultivation of diazotrophic bacteria and bacterial isolates coexisting with *H. fasciculare*

Azotobacter croococcum (DSM 281), *Beijerinckia acida* (DSM 1714) and *Novosphingobium nitrogenifigens* (DSM 19370) were cultivated on recommended media and on RBA amended with 15 g L^{-1} agar (Tab. 1). Bacteria were cultivated on Petri dishes (94/16, PS, w/vents, Paul Boettger OHG) containing 20 mL medium or in glass reaction tubes containing either 10 mL or 20 mL solidified or liquid medium. The cultivation proceeded at room temperature in a sterile box or at $30 \pm 3 \text{ }^\circ\text{C}$ in an incubation room. For long-term storage, bacteria were cultivated in Erlenmeyer flasks for 21 d, harvested by centrifugation in 1.5 mL-reaction-tubes (10000 rpm, 3 min, Model 5424, Eppendorf AG, Hamburg) and stored at $-20 \text{ }^\circ\text{C}$.

The proteobacterial isolates coexisting with *H. fasciculare* (Netherlands Institute of Ecology NIOO-KNAW, Heteren, The Netherlands) were affiliated to *Sphingomonas sp.* (WH 5, 6 and 29), *Acetobacteraceae b.* (WH 150), *Burkholderia sp.* (WH 27, 10, 11, 12, 20, 22, 24, 25, 26 and 8), *Dyella sp.* (WH 3, 32, 33, 34 and 35), *Xanthomonadaceae b.* (WH 1, 2, 7, 30 and 38), *Rahnella sp.* (WH 9 and 28) and *Pedobacter sp.* (WH 4, Valášková *et al.* 2009). The bacterial isolates were cultivated on 20 mL agar-containing tryptone soy broth (TSB) at pH 5 (Folman *et al.* 2008; Atlas 1997) or on RBA at pH 5 (Atlas 1997) on Petri dishes (94/16, PS, w/vents, Paul Boettger OHG). The initial pH of RBA was adjusted by changing the amounts of KH_2PO_4 to 0.6 g L^{-1} and K_2HPO_4 to 0.4 g L^{-1} (Sørensen 1909). The cultivations proceeded either at $30 \pm 3 \text{ }^\circ\text{C}$ and a humidity of $70 \pm 5\%$ or at room temperature of $21 \pm 3 \text{ }^\circ\text{C}$ in the dark. Cultures at TSB medium were stored at $8 \pm 2 \text{ }^\circ\text{C}$ in a refrigerator.

2.3.3. Cultivation on micro plates with different N sources

The preferences of bacteria towards N species were tested on micro plates (96-well, pure Grade™, Brand GmbH & Co KG, Wertheim) in 250 μL RBA at pH 7 or RBA at pH 7 amended

with 10 mM N from urea, NH_4Cl or NaNO_3 . The medium suspensions with different N sources were prepared in 50 mL RBA in Erlenmeyer flasks (as mentioned in section 2.2.2. but without additional glucose), and then 250 μL of the suspension were transferred into the wells of the micro plate. The inocula were 50 μL of a pre-culture of bacteria in 1.5 mL-reaction-tubes in RBA. Optical density at 600 nm was determined in a plate reader (30 °C, every 2 h, for 72 h, Synergy HT, BioTek Instruments GmbH, Bad Friedrichshall). Growth curves were monitored by the instrument's Software. Three replicate growth curves for each of the 27 bacterial isolates coexisting with *H. fasciculare* on each N source were monitored, and Excel Software (Microsoft GmbH, Unterschleißheim) was used to determine the mean curves. The averages of replicate growth curves were determined and categorised according to the increase from an initial OD of 0.2 to a maximum OD of a) $\text{OD}_{\text{max}} > 0.25$ (+), b) $\text{OD}_{\text{max}} > 0.5$ (++), c) $\text{OD}_{\text{max}} > 0.75$ (+++), d) $\text{OD}_{\text{max}} > 1$ (++++). No OD increase was indicated by the symbol (o).

2.3.4. Cultivation of bacteria under a $^{15}\text{N}_2/\text{O}_2$ atmosphere

The diazotrophs *A. croococcum* (DSM 281), *B. acida* (DSM 1714) and *N. nitrogenifigens* (DSM 19370) as well as the bacterial isolates coexisting with *H. fasciculare* were cultivated under an atmosphere of $^{15}\text{N}_2/\text{O}_2$ and under air. The cultivations proceeded in two parallel batches in desiccators (6071, with a volume of approximately 6 L and tested to 2×10^5 Pa, Glaswerke Wertheim, Wertheim). The first desiccator was filled with $^{15}\text{N}_2/\text{O}_2$, and the second desiccator was filled with air. Each desiccator contained a glass vial with 10 mL of sterile water to maintain humid conditions during cultivation (Fig. 3). The experiment included cultivations of each bacterium under four conditions: (a) RBA under $^{15}\text{N}_2/\text{O}_2$ atmosphere, (b) respective media in Tab. 1 under $^{15}\text{N}_2/\text{O}_2$ atmosphere, (c) RBA under air and (d) respective media in Tab. 1 under air.

$^{15}\text{N}_2$ fixation by bacteria

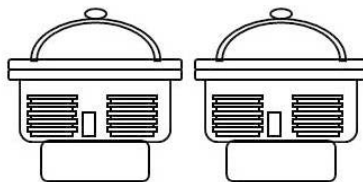

$^{15}\text{N}_2/\text{O}_2$ (75:25) or air on RBA or recommended medium

Fig. 3: Cultivation of *A. croococcum*, *B. acida* and *N. nitrogenifigens* as well as bacterial isolates coexisting with *H. fasciculare* under a $^{15}\text{N}_2/\text{O}_2$ atmosphere and under air. Under both atmospheres, bacteria were cultivated on RBA and on recommended medium.

Each of the two batches included the three diazotrophs cultivated on the recommended medium (two replicates of *A. crococcum* on Azotobacter medium, two replicates of *B. acida* on Beierinckia medium and two replicates of *N. nitrogenifigens* on nutrient medium) and on RBA medium (two replicates of *A. crococcum*, *B. acida* and *N. nitrogenifigens*). The bacterial isolates coexisting with *H. fasciculare* were cultivated on TSB (Folman *et al.* 2008) and RBA medium at pH 5. Three strains of the 27 isolates (described in 2.3.2) were cultivated together on one Petri dish, and each strain was distributed on a third of the medium's surface. Cultivations were carried out on Petri dishes (94/16, PS, w/vents, Paul Boettger OHG) containing 20 mL medium with 15 g L⁻¹ agar. The Petri dishes had to be equipped with vents to stand the gas-replacement procedure (see below). Finally, each desiccator included 31 Petri dishes.

The bacterial isolates coexisting with *H. fasciculare* were pre-cultured on TSB at pH 5 (Atlas 1997; 1:10 diluted according to Folman *et al.* 2008) and transferred with an inoculation loop. Each diazotroph was pre-cultured in RBA medium. During transfer, the co-transfer of medium was prevented as far as possible. The Petri dishes were then transferred into the two sterilised desiccators. The transfer proceeded under a laminar-flow working bench.

For gas-replacement, the desiccators were evacuated for 15 min with a vacuum pump (CVC 2000II, Vacuubrand GmbH & Co. KG, Wertheim) to 4×10^3 Pa and then refilled with sterile-filtered air or a gas mixture of 75 vol.-% ¹⁵N₂ (98 atom-% ¹⁵N) and 25 vol.-% O₂ (672793-SPEC, Sigma-Aldrich Chemie GmbH). The equipment was surface-sterilised (Meliseptol®, B. Braun Melsungen AG, Melsungen). The gas bottle, the vacuum-pump and the desiccator were connected by a three-way valve (glass, NS 18, D = 2.5 mm, Duran Group GmbH, Wertheim) and with silicone and PVC tubes. The connections were made gastight by interference-fit and hose clamps. After evacuation, the valve was switched to connect the gas bottle, the pump was switched off, and the valve of the gas bottle was carefully opened in exactly this order. The complete refilling was indicated by a movement of the desiccator lid. After that step, a gas container of 5 L of the mentioned gas (672793-SPEC, Sigma-Aldrich Chemie GmbH) was empty. The desiccator was disconnected, and the connection-opening was immediately sealed with rubber.

Consecutively, the incubation at 21 ± 3 °C proceeded for 21 d. The increase of bacterial biomass was observed, and the bacteria were harvested from the surface with a spatula. The samples were transferred to 1.5 mL-reaction-tubes, lyophilised (as mentioned in section 2.7.) and analysed by IRMS (as mentioned in section 2.8.).

2.4. Fungal-bacterial co-cultivations under $^{15}\text{N}_2/\text{O}_2$ atmosphere

Each of the two basidiomycetes *O. placenta* and *T. versicolor* was co-cultivated with each of the three diazotrophs *A. croococcum*, *B. acida* and *N. nitrogenifigens* in 20 mL liquid RBA medium on Petri dishes (94/16, PS, w/vents, Paul Boettger OHG) for 21 d and in three replicate cultivations, i.e., two basidiomycetes \times three diazotrophs \times three replicates = 18 cultivations. Moreover, the fungi were cultivated individually under both atmospheres (three replicates). The bacterial inocula consisted of approximately 20 mg cells harvested from pre-cultures on favoured solid media as mentioned above. The co-cultivations were carried out in two desiccators: one was filled with air and the other one was filled with a gas mixture of $^{15}\text{N}_2/\text{O}_2$ (Fig. 4). The experiment included the following co-cultivations on RBA: (a) three individual cultivations of *T. versicolor* and nine co-cultivations with *T. versicolor* under $^{15}\text{N}_2/\text{O}_2$ atmosphere, (b) three individual cultivations of *O. placenta* and nine co-cultivations with *O. placenta* under $^{15}\text{N}_2/\text{O}_2$ atmosphere, (c) three individual cultivations of *T. versicolor* and nine co-cultivations with *T. versicolor* under air, (d) three individual cultivations of *O. placenta* and nine co-cultivations with *O. placenta* under air.

Co-cultivation of basidiomycetes and diazotrophs

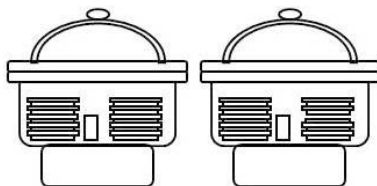

$^{15}\text{N}_2/\text{O}_2$ (75:25) or air, co-cultivations with *O. placenta* and *T. versicolor*

Fig. 4: Co-cultivations of *A. croococcum*, *B. acida* and *N. nitrogenifigens* with *O. placenta* and *T. versicolor* under a $^{15}\text{N}_2/\text{O}_2$ atmosphere and under air.

At the beginning of the incubation time, the desiccator was evacuated for 15 min with a vacuum pump (CVC 2000II) to 4×10^3 Pa and then refilled with air or a gas mixture of 75 vol.-% $^{15}\text{N}_2$ (98 atom-% ^{15}N) and 25 vol.-% O_2 (672793-SPEC, as mentioned in section 2.3.4.). After incubation, each mycelium was separately removed with a spatula and rinsed with sterile deionised water to separate attached bacteria. The mycelium was put into a reaction vial, while the medium suspension and the washing water were centrifuged at 8000 rpm for 10 min (Labofuge M, Heraeus Instruments GmbH, Berlin) to collect the bacterial biomass. The resulting biomass samples (bacterial and fungal) were lyophilised, weighed and analysed by IRMS (as mentioned in section 2.7. and 2.8.).

2.5. Cultivations according to full-factorial experimental plans

Two full-factorial experimental plans were designed to test the growth of *O. placenta* and *T. versicolor* at varying N sources (Weißhaupt *et al.* 2012). The factors were x_1 : organic N as part of the medium (1.9 g L^{-1} peptone or no N source), x_2 : N traces in a wood specimen (presence or absence of sapwood, $5 \text{ mm} \times 32.5 \text{ mm} \times 10 \text{ mm}$) and x_3 : N_2 content in the gas atmosphere (air or O_2/Ar atmosphere, Tab. 2). *O. placenta* was tested on wood of *P. sylvestris*, and in experiments with *T. versicolor* wood of *F. sylvatica* was applied. All experiments comprised 20 mL of liquid RBA (without solution D and without agar, Atlas 1997). To prevent any bacterial growth, $100 \mu\text{L}$ antibiotics solution (2 g L^{-1} tetracycline and 8 g L^{-1} streptomycin, Merck KGaA) was added to 20 mL of RBA medium. Peptone from casein (Merck KGaA) was added to RBA medium in an amount of 1.9 g L^{-1} ($380 \mu\text{L}$ of a sterile solution of 0.1 g mL^{-1}) which was approximately the protein concentration in 5%-malt-extract medium, since a protein content of 3.8% was outlined in the nutrition panel of malt extract (Villa Natura Gesundheitsprodukte GmbH).

Tab. 2: An example of an experiment and a 2^3 experimental plan with eight experiments. Each experiment was inoculated with *O. placenta* or *T. versicolor*. *P. sylvestris* was used if *O. placenta* was cultivated in the eight experiments, and *F. sylvatica* was used if *T. versicolor* was analysed.



	Organic N	Wood	Gas
1	RBA	none	O_2/Ar
2	RBA + Peptone	none	O_2/Ar
3	RBA	<i>F. sylvatica</i> or <i>P. sylvestris</i>	O_2/Ar
4	RBA + Peptone	<i>F. sylvatica</i> or <i>P. sylvestris</i>	O_2/Ar
5	RBA	none	air
6	RBA + Peptone	none	air
7	RBA	<i>F. sylvatica</i> or <i>P. sylvestris</i>	air
8	RBA + Peptone	<i>F. sylvatica</i> or <i>P. sylvestris</i>	air

In experiments of two further experimental plans, the interaction of *O. placenta* and *T. versicolor* with *B. acida* (DSM 1714) was investigated. For this purpose, peptone was replaced by inocula of *B. acida*, and no antibiotics were applied.

The experiments according to the eight factor combinations of the four plans were examined three times, and mean values, standard deviations and variances were determined. All experiments were conducted in butyl-rubber-sealed glass bottles (100 mL, Kavalierglass, Co. Ltd., Prague, Czech Republic, Weißhaupt *et al.* 2012).

Sterilised sapwood blocks were placed on spacers (netting wire, mesh 10 mm², wire diameter 1 mm, X5CrNi18-10, Kaldenbach KG, Berlin) at the gas-liquid interface. The fungal and bacterial inocula were pre-cultivated on solid RBA. The atmosphere was sterile air or a mixture of 20.23 mol-% O₂ in Ar (CRM No.: BAM-G035, BAM Federal Institute for Materials Research and Testing, Berlin).

For gas-replacement, the bottles were evacuated three times for 10 min to 1000 Pa with a vacuum pump (CVC 2000II) and refilled with the respective gas mixture. The gastightness and the reproducibility of gas-replacement procedure were tested in pre-experiments without inocula (Tab. 3). After 14 d of incubation at 21 °C, the gas phase was investigated by gas chromatography (section 2.9.). Then, the fungus was separated from the medium by filtration (Whatman No. 1, Whatman International Ltd.). Fungal biomass of experiments containing *B. acida* was separated with a spatula and washed with deionised water. The washing suspensions and the residual medium was centrifuged (10 min, 8000 rpm, Labofuge M) to collect the bacterial biomass. Biomass was lyophilised and weighed immediately. Afterwards, the biomass was analysed by IRMS (section 2.8.).

Tab. 3: Test of fungal and bacterial viability and of the quality of gas-exchange procedure (n = 3, mean values ± SD if RBA was used; n = 6, mean values ± SD if MEA was used).

medium wood gas			O ₂ /Ar	N ₂	CO ₂	organism	biomass	C	N	δ ¹⁵ N
			in %	in %	in %		in mg	in %	in %	in ‰
MEA	none	O ₂ /Ar	70.33 (± 4.1)	0.90 (± 0.6)	28.77 (± 4.5)	<i>O. placenta</i>	52.37 (± 9.2)	47.63 (± 14.6)	5.18 (± 2.0)	4.29 (± 0.4)
MEA	none	air	2.91 (± 2.0)	78.15 (± 1.5)	18.94 (± 0.9)	<i>O. placenta</i>	43.45 (± 3.4)	42.54 (± 0.7)	3.34 (± 0.2)	4.61 (± 1.4)
MEA	none	O ₂ /Ar	68.13 (± 15.0)	1.35 (± 0.8)	30.52 (± 14.8)	<i>T. versicolor</i>	58.17 (± 4.1)	48.09 (± 11.7)	4.00 (± 1.9)	4.29 (± 0.5)
MEA	none	air	0.84 (± 0.1)	64.20 (± 1.6)	34.96 (± 1.6)	<i>T. versicolor</i>	42.08 (± 7.5)	44.77 (± 0.9)	4.53 (± 0.5)	4.21 (± 0.5)
RBA	none	O ₂ /Ar	99.55 (± 0.1)	0.39 (± 0.1)	0.04 (± 0.1)	no inoculum and no biomass analysis				
RBA	none	air	20.15 (± 0.1)	79.79 (± 0.1)	0.07 (± 0.1)	no inoculum and no biomass analysis				
RBA + <i>B. acida</i>	none	O ₂ /Ar	94.86 (± 0.4)	0.34 (± 0.1)	4.80 (± 0.4)	<i>B. acida</i>	1.23 (± 0.1)	32.26 ¹⁾	2.12 ¹⁾	1.19 ¹⁾
RBA + <i>B. acida</i>	none	air	11.26 (± 2.0)	76.16 (± 1.6)	12.59 (± 0.5)	<i>B. acida</i>	4.6 (± 1.4)	33.93 ¹⁾	2.94 ¹⁾	-0.06 ¹⁾

¹⁾ One measurement of the biomass collected from three replicates.

In preliminary experiments, the fungal viability was tested by cultivating *T. versicolor* and *O. placenta* in 20 mL of a 5%-malt-extract medium without agar (Atlas 1997) and by determining the indicators of fungal activity (Tab. 3). Bacterial viability of *B. acida* was investigated on

RBA and unravelled a positive but not mandatory effect of N₂ (Tab. 3). Gas analysis and IRMS analysis were conducted as described (sections 2.8. and 2.9.). The results (in Tab. 3) are a reference for the results of the experiments in section 3.8. and 3.9. and underline that the organisms are cultivable under the chosen conditions and that the glass bottles were gastight during experiments.

2.6. Aqueous soil and wood extracts

Deionised water was added to a volume of 500 mL soil (collected from BAM Test Site Technical Safety, Baruth/Mark), 500 mL bark fragments from *Betula pendula* and 500 mL sawdust from *P. sylvestris* to a final volume of 800 mL. The mixtures were put into an autoclave for optimised aqueous extraction (sterilisation procedure as mentioned in section 2.1.). Afterwards, the solid particles were separated by filtration. The permeate was collected, and 40 mL permeate were filled in round bottom flasks, which were dipped in liquid N₂ until the content was frozen. Subsequently, the samples were freeze-died in a lyophilisation unit (section 2.7.). Approximately 2 to 15 mg of each sample was analysed by IRMS.

2.7. Measurement of biomass and enzyme activities

Microbial growth was analysed by measurements of dry biomass. Therefore, fungi were cultivated in liquid medium, then separated by filtration (Whatman No 1), rinsed with sterile, deionised water and finally dried (20 h at 10 Pa plus 4 h at 1 Pa, Lyophilisator Alpha 2-4, Martin Christ Gefriertrocknungsanlagen GmbH, Osterode). Bacterial suspensions were either centrifuged (10 min, 8000 rpm, Labofuge M) or harvested from the medium's surface with a spatula. Fungal-bacterial co-cultivations in liquid medium were separated by removing the fungal biomass with a spatula and by centrifugation of bacterial suspensions. For lyophilisation, samples were either filled in round bottom flasks or in 1.5 mL-reaction tubes. These samples were frozen in liquid N and immediately connected to the lyophilisator. Afterwards, the lyophilised samples were weighed (PM 4000, Mettler Instrumente AG, Greifensee, Switzerland) and stored in a glass desiccator amended with silica gel (Merck KGaA) to prevent intrusion of moisture.

The pH decrease in the media during cultivation and on infested wood surfaces was measured with pH indicator paper (Acilit, Merck KGaA) and by surface pH measurements (InLab 426, Knick Elektronische Messgeräte GmbH & Co. KG, Berlin), respectively.

Laccase activity, i.e., the sum of all peroxidative enzyme activity, was quantified by the oxidation of 2,2'-azino-bis-(3-ethylbenzthiazoline)-6-sulphonate (ABTS, Sigma-Aldrich Chemie GmbH) in 100 mM sodium acetate buffer (Merck KGaA) at pH 5 (Bourbonnais and Paice 1990, Wolfenden and Willson 1982). These experiments were realised on micro plates

(96-well, pureGrade™, Brand GmbH & Co KG) and analysed in a micro plate reader (Synergy HT, BioTek Instruments GmbH). Each well contained 160 µL sodium acetate buffer, 20 µL sample, i.e., cultivation medium after the organisms were removed, and 20 µL 50 mM ABTS in sodium acetate buffer. The extinction at 420 nm increased according to laccase-catalysed oxidation of ABTS and was measured every 10 min during a period of 8 h. After linear approximation of the exponential curves, the gradient was determined and used to calculate the increase in concentration according to Lambert-Beer's law. The molar extinction coefficient for ABTS was $\epsilon_{\lambda} = 36000 \text{ L mol}^{-1} \text{ cm}^{-1}$, and d was determined as 0.33 cm. The enzyme activity is determined in enzyme unit per litre (U L^{-1}), which is defined as μmol substrate per min and litre.

2.8. Elemental analysis isotope ratio mass spectrometry (IRMS)

The C and N contents as well as the $\delta^{13}\text{C}$ and the $\delta^{15}\text{N}$ values of fungal and bacterial biomass were investigated by elemental analysis (Vario EL III, Elementar Analysensysteme GmbH) combined with isotope ratio mass spectrometry (Isoprime, GV Instruments Ltd., Manchester, United Kingdom). Lyophilised samples were weighed in tin cases (Elementar Analysensysteme GmbH, Hanau) on a microbalance (XP6, Mettler-Toledo GmbH, Giessen). The tin cases were closed tightly to prevent the enclosure of residual N_2 . The exact mass of the sample was written manually into working sheets of the instrument's software and used to calculate mass related values, i.e., C, N, S, H contents in %. The sample sizes were optimised for N measurements. If bacterial biomass was measured, the sample size was 0.5 to 3 mg depending on the labelling with ^{15}N . If fungal biomass was focused, 3 to 10 mg was used, and 10 to 15 mg biomass was measured if the fungal biomass was grown under limited conditions or if aqueous wood extracts were analysed.

In a measurement, the combustion proceeded in O_2 (purity: 99.9999 vol.-%, AirLiquide Deutschland GmbH, Düsseldorf) for 90 s, and the carrier gas was He (purity: 99.9999 vol.-%, AirLiquide). The reference gases CO_2 (purity: 99.998 vol.-%, AirLiquide) and N_2 (purity: 99.9999 vol.-%, AirLiquide) were used as gas standards for IRMS. If samples enriched in ^{15}N are measured, the $m z^{-1} = 29$ is difficult to determine, because the relevant Faraday cup is adjusted to a low ion current. That problem was solved by low sample sizes. Reducing the amplifier resistance of the Faraday cup or isotope dilution are further alternatives.

The elemental analyser was calibrated with sulphanilic acid ($\text{C}_6\text{H}_7\text{NO}_2\text{S}$, MW: $173.18 \text{ g mol}^{-1}$, 41.6% C, 8.1% N, Merck KGaA) for C and N in the range of 0.1 to 20.0 mg, and the mass spectrometer was calibrated with an IAEA secondary standard (L-glutamic acid with $\delta^{13}\text{C}_{\text{VPDB}} = 26.39 (\pm 0.04)\text{‰}$ and $\delta^{15}\text{N}_{\text{AIR N}_2} = -4.5 (\pm 0.1)\text{‰}$, USGS 40, International Atomic Agency, Vienna, Austria; Qi *et al.* 2003). The $\delta^{13}\text{C}$ and $\delta^{15}\text{N}$ values were referred to

the international standards Vienna Pee Dee Belemnite (VPDB) and air N₂, respectively. Casein (Merck KGaA) was used as working standard, and 2 to 2.5 mg were measured 3 to 5 times before and after a set of measurements and after every sixth sample. The working standard indicated the instrumental reproducibility of the measurements. In casein, N contents of 14.42 (± 0.1)%, C contents of 49.14 (± 0.6)%, C/N ratios of 3.41 (± 0.6)%, δ¹⁵N values of 6.29 (± 0.1)‰ and δ¹³C values of -21.97 (± 0.1)‰ were measured.

The difference of the ion current ratios between sample and reference was denoted as δ value. The δ¹⁵N value in ‰ is determined according to eq. (2) considering the international standard air N₂ as reference. N is measured as N₂ with m z⁻¹ = 28 (¹⁴N₂) and 29 (¹⁴N¹⁵N). The δ¹³C values in ‰ are calculated using an equation, which is an analogue to eq. (2) with Vienna Pee Dee Belemnite (VPDB) as international standard. Carbon is detected as carbon dioxide, with four natural isotopes with the m z⁻¹ = 44 (¹²C¹⁶O¹⁶O), 45 (¹³C¹⁶O¹⁶O or ¹²C¹⁷O¹⁶O) and 46 (¹²C¹⁶O¹⁸O).

$$\delta^{15}\text{N}_{\text{Sample}} = \left[\frac{\left(\frac{^{15}\text{N}}{^{14}\text{N}} \right)_{\text{Sample}}}{\left(\frac{^{15}\text{N}}{^{14}\text{N}} \right)_{\text{AIR N}_2}} - 1 \right] \times 1000 \quad (2)$$

In tracing experiments with ¹⁵N₂, the ¹⁵N abundance of the biomass in % was calculated, too (eq. (3)).

$$^{15}\text{N}_{\text{Sample}} = \frac{100}{\frac{1}{\left(\frac{\delta^{15}\text{N}_{\text{Sample}}}{1000} + 1 \right) \times \left(\frac{^{15}\text{N}}{^{14}\text{N}} \right)_{\text{AIR N}_2}} + 1} \quad (3)$$

2.9. Gas analysis of O₂, N₂ and CO₂

The gases N₂, O₂ and CO₂ were measured by gas chromatography in two independent procedures (Weißhaupt *et al.* 2012). Each of the samples, i.e., rubber-sealed bottles with the exhaust gases from a 14-days cultivation of fungi and bacteria (as described in section 2.5.), was measured twice to determine the composition of the gas phase. Prior to the measurements, each bottle was carefully shaken to avoid inhomogenic gas sampling. Gas samples were taken by a glass syringe (10 mL, removable Luer-Lock with valve, SGE Analytical Science Pty Ltd., Melbourne, Australia) with removable needles (G23, side hole, ILS Innovative Labor Systeme GmbH, Stützerbach).

The concentration of O₂/Ar and N₂ in the gas phase was measured by a gas chromatograph (6890 Series, Agilent Technologies GmbH, Böblingen) equipped with a

molecular-sieve column (molecular sieve, 60–80 mesh, 4 m, 1/8 inch, Perkin Elmer GmbH, Rodgau) and a thermal conductivity detector. The analysis parameters were 20 min at 60 °C with helium as carrier gas (Alphagaz 2, purity: 99.9999 vol.-%, AirLiquide). O₂ and Ar were not separable and measured as a single peak. The mean values and standard deviations of three replicate samples were determined. The N₂ as well as O₂ measurement was calibrated with air, and the abundances of the gases were given as ratio in vol.-%.

CO₂ analysis was carried out with the same gas chromatograph equipped with a second molecular-sieve column (GC Porapak R, 100–120 mesh, 2 m, 1/8 inch, Perkin Elmer). These measurements were carried out at 60 °C and a total analysis time of 7 min. CO₂ calibration included the measurement of two reference gases containing 10.006 mol-% and 25.021 mol-% CO₂ in N₂ (CRM No.: BAM-G050, BAM). A thermal conductivity detector (TCD) was applied for the analysis of both measurements.

The ratio of N₂ and O₂ was applied to the difference between the CO₂ concentration in mol-% and 100 mol-%. With this calculation, the content of O₂ and N₂ in mol-% was approximated. So, the sum of O₂/Ar, N₂ and CO₂ amounted to 100 mol-%. This result allowed comparing the experiments of the experimental plans.

2.10. Statistical analysis

2.10.1. Mean value and experimental standard deviation of the means

All fungal or bacterial cultivations were conducted three times. Subsequently, the analysis of biomass by IRMS or medium suspensions in enzyme tests included two or three replicates. The arithmetical averages were determined for the replicate tests and replicate cultivations.

The experimental standard deviations of the means (SD) were calculated to reflect the uncertainty of measurements and sample preparation. This particular standard deviation does not correspond to the standard error of the means (SE), which is the experimental standard deviation divided by \sqrt{n} (for a detailed discussion see JCGM 100: 2008).

2.10.2. Two-way ANOVA, mean value comparison and linear approximation

In the present study, it was of particular importance to find out if a measured difference was significant. In most cases, two factors affected the measured values, and therefore, the two-way analysis of variance (two-way ANOVA) was applied. The 0.05 level, which is the level that includes 95% of the results of replicate measurements, was the criterion for significance (Origin software, Additive GmbH, Friedrichsdorf). Parameters of growth curves of the fungal biomass were determined by linear approximation of the measured biomass in a logarithmic plot. The variability was tested by the coefficient of determination R² (Origin software).

2.10.3. Design of experiments DOE

According to the four experimental plans (cultivation of *O. placenta* and *T. versicolor* at different N sources and co-cultivation of *O. placenta* and *T. versicolor* with the diazotroph *B. acida*), the indicators of fungal activity were measured in three independent replicate measurements, i.e., 96 experiments = four experimental plans à eight experiments and three replicates. Seven indicators of fungal activity were investigated, and mean values (\bar{y}), variances (v) and standard deviations (s) of the three replicates were determined. The indicators of fungal activity were the biomass ($\bar{y}_{11} - \bar{y}_{18}$), O_2 ($\bar{y}_{21} - \bar{y}_{28}$) as well as CO_2 content ($\bar{y}_{31} - \bar{y}_{38}$) in the gas phase, N content ($\bar{y}_{41} - \bar{y}_{48}$), C content ($\bar{y}_{51} - \bar{y}_{58}$) and $\delta^{15}N$ value ($\bar{y}_{61} - \bar{y}_{68}$) of the biomass and finally the laccase activity ($\bar{y}_{71} - \bar{y}_{78}$).

In addition, the mean value of the variances of the eight factor combinations of each experimental plan was determined. The mean variances (\bar{v}) were used to determine the 95% confidence intervals according to *t*-test recommendation. The mean standard deviation was determined by equation (4), considering $N = 24$ samples (eight factor combinations, three replicates) and a factor multiplicity of four (Kleppmann 2008).

$$\bar{s}_d = \sqrt{\frac{4}{N} \times \bar{v}^2} \quad (4)$$

For 16 degrees of freedom, *t*-factor tables recommend $t = 2.21$ according to the 95% criterion (DIN 1319-3). The two sided confidence interval (c_i) was calculated by equation (5).

$$c_i = t \times \bar{s} \quad (5)$$

Since the effects on all indicators of fungal activity had to be considered, matrix notation was useful. The result matrix **Y** had seven rows according to seven indicators and eight columns for the results of the eight factor combinations (equation (6)).

$$\mathbf{Y} = \begin{pmatrix} \bar{y}_{11} & \bar{y}_{12} & \bar{y}_{13} & \bar{y}_{14} & \bar{y}_{15} & \bar{y}_{16} & \bar{y}_{17} & \bar{y}_{18} \\ \bar{y}_{21} & \bar{y}_{22} & \bar{y}_{23} & \bar{y}_{24} & \bar{y}_{25} & \bar{y}_{26} & \bar{y}_{27} & \bar{y}_{28} \\ \bar{y}_{31} & \bar{y}_{32} & \bar{y}_{33} & \bar{y}_{34} & \bar{y}_{35} & \bar{y}_{36} & \bar{y}_{37} & \bar{y}_{38} \\ \bar{y}_{41} & \bar{y}_{42} & \bar{y}_{43} & \bar{y}_{44} & \bar{y}_{45} & \bar{y}_{46} & \bar{y}_{47} & \bar{y}_{48} \\ \bar{y}_{51} & \bar{y}_{52} & \bar{y}_{53} & \bar{y}_{54} & \bar{y}_{55} & \bar{y}_{56} & \bar{y}_{57} & \bar{y}_{58} \\ \bar{y}_{61} & \bar{y}_{62} & \bar{y}_{63} & \bar{y}_{64} & \bar{y}_{65} & \bar{y}_{66} & \bar{y}_{67} & \bar{y}_{68} \\ \bar{y}_{71} & \bar{y}_{72} & \bar{y}_{73} & \bar{y}_{74} & \bar{y}_{75} & \bar{y}_{76} & \bar{y}_{77} & \bar{y}_{78} \end{pmatrix} \quad (6)$$

The matrix of factor combinations X (equation (7)) comprised the experimental plan in the first three columns. The presence of the factors x_1 , x_2 or x_3 was indicated by 1 and absence by -1 . The interaction of the factors x_1x_2 , x_1x_3 , x_2x_3 and $x_1x_2x_3$ were the linear combinations of the factors from the same line and were listed in the columns 4 to 7. The last column allowed the determination of the blank value or the indicator performance, which was not dependent of the chosen influencing factors x_1 , x_2 and x_3 in equation (7). In column number eight, 1 is replaced by 0.5 as the factor multiplicity amounts to eight instead of four.

$$X = \begin{pmatrix} -1 & -1 & -1 & 1 & 1 & 1 & -1 & 0.5 \\ 1 & -1 & -1 & -1 & -1 & 1 & 1 & 0.5 \\ -1 & 1 & -1 & -1 & 1 & -1 & 1 & 0.5 \\ 1 & 1 & -1 & -1 & -1 & -1 & -1 & 0.5 \\ -1 & -1 & 1 & -1 & -1 & -1 & 1 & 0.5 \\ 1 & -1 & 1 & 1 & 1 & -1 & -1 & 0.5 \\ -1 & 1 & 1 & -1 & -1 & 1 & -1 & 0.5 \\ 1 & 1 & 1 & 1 & 1 & 1 & 1 & 0.5 \end{pmatrix} \quad (7)$$

The effects of the influencing factors X on the indicators of fungal activity Y is calculated by equation (8).

$$A = \frac{1}{4} YX \quad (8)$$

The factor 0.25 resulted from the factor multiplicity of four. A is the matrix of effects and permitted an approximation of the indicator performance. All calculations regarding the 2^3 experimental plans were implemented in Excel Software.

3. Results

3.1. Wood decomposition by *O. placenta* and *T. versicolor*

Wood specimens were incubated with *T. versicolor* and *O. placenta* for ten months and transferred once per month to new malt-extract medium. If wood of *P. sylvestris* (Fig. 5A) was decomposed by *O. placenta*, the colour turned into dark brown and cracks right-angle to the wood fibre appeared (Fig. 5B). Wood of *F. sylvatica* (Fig. 5C) displayed white rot after decomposition by *T. versicolor* (Fig. 5D). The colour of the wood faded, and the structure disintegrated. The types of wood rot can be distinguished by visual analysis.

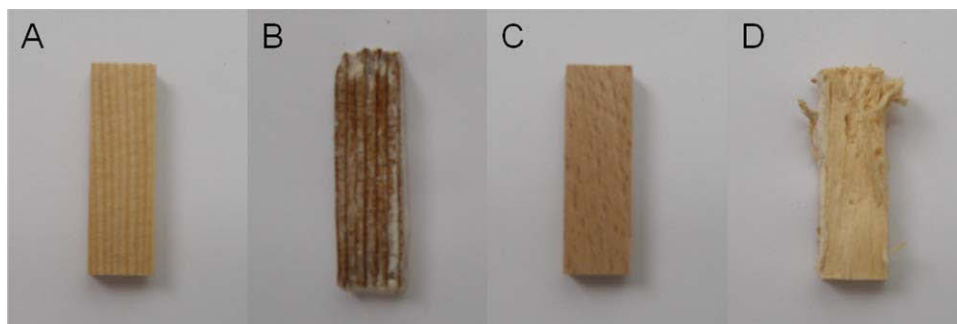

Fig. 5: Wood and wood decomposed by fungi: (A) sapwood of *P. sylvestris*, (B) sapwood of *P. sylvestris* decomposed by *O. placenta*, (C) sapwood of *F. sylvatica*, (D) sapwood of *F. sylvatica* decomposed by *T. versicolor*.

3.2. Elemental analysis of medium compounds

Media preparations and compounds, which were used for cultivation of fungi and bacteria, were investigated by IRMS (Tab. 4). The N contents of dry medium components allowed to calculate the N contents in suspended media even if just N traces were prevalent (see also Tab. 1). However, only the substances from the particular charges, which were used in this study, were investigated, which means that the elemental composition of the same compounds but from other sources, production lots or manufacturers can differ. Low amounts of N were found in agar. If agar is amended to the medium, it is a source of N traces, and isotope dilution in the cultivated biomass has to be expected. Therefore, agar-free medium was favoured in experiments with subsequent isotope analysis. Yeast extract, which is a component of RBA medium, comprised 11.16% N. Hence, agar-free RBA medium comprised approximately 0.005 g L⁻¹ N (see also Tab. 1).

Tab. 4: Elemental composition, $\delta^{15}\text{N}$ and $\delta^{13}\text{C}$ values of dry media and medium compounds frequently used for the cultivation of microorganisms ($n = 3$, mean values \pm SD).

Medium compounds	N in %	C in %	S in %	C/N	$\delta^{15}\text{N}_{\text{AIR N}_2}$ in ‰	$\delta^{13}\text{C}_{\text{VPDB}}$ in ‰
Gelatine	17.07 (± 0.1)	44.40 (± 0.7)	0.33 (± 0.3)	2.60 (± 0.1)	4.47 (± 0.1)	-21.58 (± 0.1)
Peptone from casein	15.36 (± 0.1)	44.22 (± 0.4)	1.39 (± 0.5)	2.88 (± 0.1)	4.56 (± 0.1)	-27.25 (± 0.1)
Casein (Hammarsten)	14.88 (± 0.1)	49.92 (± 0.2)	0.08 (± 0.1)	3.35 (± 0.1)	5.96 (± 0.1)	-22.19 (± 0.1)
Lab Lemco Broth	13.62 (± 0.1)	40.86 (± 0.1)	0.17 (± 0.1)	3.00 (± 0.1)	5.42 (± 0.1)	-14.55 (± 0.1)
Meat extract	12.38 (± 0.1)	40.95 (± 0.4)	0.32 (± 0.2)	3.31 (± 0.1)	3.76 (± 0.1)	-25.28 (± 0.1)
Yeast extract	11.16 (± 0.1)	40.73 (± 0.3)	0.37 (± 0.1)	3.65 (± 0.1)	-0.71 (± 0.1)	-25.27 (± 0.1)
Peptone from meat	10.87 (± 3.0)	34.97 (± 9.6)	0.58 (± 0.1)	3.22 (± 0.1)	16.40 (± 11.3)	-22.93 (± 0.1)
Peptone from soy	10.34 (± 0.1)	40.74 (± 1.4)	1.14 (± 0.4)	3.94 (± 0.1)	6.46 (± 7.0)	-24.27 (± 0.1)
Caseinpeptone lecithin polysorbat B	10.51 (± 0.2)	48.03 (± 0.2)	0.14 (± 0.1)	4.57 (± 0.1)	5.54 (± 0.1)	-27.61 (± 0.1)
Tryptone soy broth	7.71 (± 0.3)	29.99 (± 1.3)	0.27 (± 0.2)	3.89 (± 0.1)	1.58 (± 0.1)	-23.57 (± 0.1)
Tryptone soy agar	6.23 (± 0.3)	37.10 (± 1.3)	0.18 (± 0.2)	5.96 (± 0.1)	1.65 (± 0.1)	-22.30 (± 0.1)
Standard medium	5.40 (± 0.2)	34.27 (± 0.8)	0.41 (± 0.1)	6.35 (± 0.1)	1.94 (± 0.3)	-22.42 (± 0.1)
Malt extract agar	1.61 (± 0.1)	41.02 (± 0.1)	0.13 (± 0.1)	25.45 (± 0.3)	0.83 (± 0.1)	-16.63 (± 0.1)
Malt extract	1.41 (± 0.1)	40.48 (± 0.5)	0.09 (± 0.2)	28.79 (± 1.3)	0.68 (± 0.7)	-20.60 (± 0.1)
Potato glucose agar	0.83 (± 0.1)	37.59 (± 1.2)	0.10 (± 0.1)	45.13 (± 1.1)	-0.30 (± 0.4)	-17.22 (± 0.1)
Agar	0.28 (± 0.1)	41.21 (± 0.2)	0.34 (± 0.1)	144.7 (± 1.1)	4.20 (± 0.6)	-18.96 (± 0.1)

3.3. Elemental analysis of basidiomycetes and of aqueous wood and soil extracts

Five wood-decomposing basidiomycetes from strain collections were cultivated in malt-extract medium and measured by IRMS (Tab. 5). The N and C contents in the dry biomass amounted to 2 to 5% and 38 to 40%, respectively. The sulphur and hydrogen content was less than 1%. The rest of the dry biomass was supposed to be oxygen, e.g., in carbohydrates, or trace elements with a low molecular abundance but a comparatively high molecular weight. The elemental composition of the biomass of the tested basidiomycetes was similar. However, growth dynamics differed, and *T. versicolor* and *O. placenta* yielded most biomass at the same cultivation interval than the other tested basidiomycetes. Isotope-fractionation phenomena were negligible during *in vitro* experiments.

Tab. 5: C content, N content, C/N, $\delta^{15}\text{N}$ and $\delta^{13}\text{C}$ values of basidiomycetes cultivated in 5%-malt-extract medium after 28 d of incubation (n = 3, mean values \pm SD).

Basidiomycetes	N in %	C in %	C/N	$\delta^{15}\text{N}_{\text{AIR N}_2}$ in ‰	$\delta^{13}\text{C}_{\text{VPDB}}$ in ‰
<i>Oligoporus placenta</i>	2.15 (\pm 0.3)	40.76 (\pm 0.7)	19.18 (\pm 2.3)	5.69 (\pm 0.4)	-27.09 (\pm 0.1)
<i>Trametes versicolor</i>	3.32 (\pm 0.6)	40.45 (\pm 4.9)	12.33 (\pm 1.6)	4.35 (\pm 0.4)	-26.86 (\pm 0.2)
<i>Anthrodia vaillantii</i>	2.66 (\pm 0.2)	40.74 (\pm 0.5)	15.35 (\pm 0.7)	4.13 (\pm 0.1)	-27.01 (\pm 0.1)
<i>Serpula lacrimans</i>	4.13 (\pm 1.0)	38.51 (\pm 8.1)	9.37 (\pm 0.3)	4.82 (\pm 0.3)	-27.38 (\pm 0.1)
<i>Coniophora puteana</i>	3.96 (\pm 0.3)	44.46 (\pm 0.9)	11.27 (\pm 0.8)	3.85 (\pm 0.5)	-27.90 (\pm 0.1)

To estimate the concentration of bio-available N in the biomass of organic matrices, aqueous extracts of sample matrices typical of fungal environments were investigated (Tab. 6). Aqueous extracts were focused, because the solubility in water is regarded as a prerequisite for further uptake by microorganisms. In addition, a concentration of N containing compounds during the extraction is expected. In dried biomass of aqueous extracts of sapwood, N was found in a concentration of 0.37%. The N content in sapwood extract was significantly lower than in bark extract with an N content of 1.15%. In soil, the N content amounted to 2.33%. The C content was highest in wood extract but lowest in soil extract, and the corresponding C/N ratio varied accordingly. The δ values are not meaningful, since the samples were considered irrespective of their origin. Nevertheless, the ^{15}N enrichment in soil material ($\delta^{15}\text{N}$ value of -6.98‰) compared to plant material ($\delta^{15}\text{N}$ value of 4.26‰) was affirmed.

Results

Tab. 6: Elemental analysis and $\delta^{15}\text{N}$ and $\delta^{13}\text{C}$ values of wood, bark and soil extract samples (n = 3: three measurements of biomass from one extraction, mean values \pm SD).

Organic sample	N in %	C in %	C/N	$\delta^{15}\text{N}_{\text{AIR N}_2}$ in ‰	$\delta^{13}\text{C}_{\text{VPDB}}$ in ‰
Pine wood extract	0.37 (\pm 0.1)	49.48 (\pm 0.5)	133.73 (\pm 10.5)	nm ¹⁾	-25.74 (\pm 0.1)
Birch bark extract	1.18 (\pm 0.1)	43.08 (\pm 0.4)	36.51 (\pm 0.2)	4.26 (\pm 0.4)	-26.48 (\pm 0.1)
Soil extract	2.33 (\pm 0.1)	15.69 (\pm 0.3)	6.73 (\pm 0.2)	-6.98 (\pm 0.2)	-26.19 (\pm 0.1)

¹⁾ nm: not measurable, value below the detection limit

3.4. Nitrogen uptake of *O. placenta*, *T. versicolor* and *H. fasciculare*

The brown-rot fungus *O. placenta* and the white-rot fungus *T. versicolor* were cultivated on RBA medium amended with 10 mM N from urea, NH_4Cl , NaNO_3 or without additional N (Weißhaupt *et al.* 2011). Interestingly, both of the tested basidiomycetes developed a low amount of biomass in medium without N addition. Therefore, efficient uptake of N traces was assumed. In RBA medium, the medium component yeast extract may be the source for N traces. On NaNO_3 , the growth rates were low compared to other N-enriched media, and therefore, NaNO_3 was regarded as a non-favourite N substrate for both fungi. In the presence of urea or NH_4Cl , *T. versicolor* produced more biomass compared to cultivation on RBA without N addition. *O. placenta* had a similar biomass production over time at all tested N sources (Fig. 6).

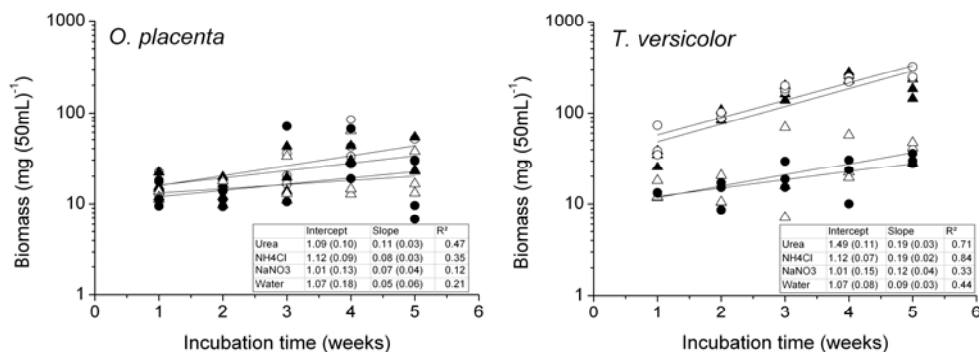

Fig. 6: Biomass of *O. placenta* and *T. versicolor* cultivated on RBA amended with 10 mM N of urea (\blacktriangle), NH_4Cl (\circ), NaNO_3 (\triangle) or deionised water as reference cultivation (\bullet). Linear approximations of the measured values are indicated.

To test the effect of yeast extract, the previously mentioned set of experiments was repeated with RBA that contained no yeast extract. While *T. versicolor* did not grow after 70 d of incubation, biomass of *O. placenta* developed very weak on all added N substrates but also in the N-free control culture (data not shown).

In addition to the biomass itself (Fig. 6), the elemental composition of the fungal biomass was measured after 14 and 28 d of cultivation (Tab. 7). The C content was almost constant at all cultivations and in both fungi. The N content of the mycelia of both fungi was lower if they were cultivated on RBA instead of a medium containing bio-available N. These results underlined that both basidiomycetes adjusted their metabolism to N-limited conditions, which was also mirrored in the C/N ratios. In addition, the N content decreased over time (compare the N contents after 14 and 28 d), indicating N-limitation after prolonged cultivation.

Tab. 7: C content, N content, C/N, $\delta^{15}\text{N}$ and $\delta^{13}\text{C}$ values of biomass of *O. placenta* and *T. versicolor* cultivated at different N substrates (n = 3, mean values \pm SD).

N substrate ¹⁾	<i>O. placenta</i>					<i>T. versicolor</i>				
	N in %	C in %	C/N	$\delta^{15}\text{N}_{\text{AIR N}_2}$ in ‰	$\delta^{13}\text{C}_{\text{VPDB}}$ in ‰	N in %	C in %	C/N	$\delta^{15}\text{N}_{\text{AIR N}_2}$ in ‰	$\delta^{13}\text{C}_{\text{VPDB}}$ in ‰
	14 d of incubation					14 d of incubation				
N traces -0.71 (\pm 0.01)	1.66 (\pm 0.1)	35.70 (\pm 0.9)	21.51 (\pm 3.1)	-0.05 (\pm 0.1)	-16.14 (\pm 0.2)	1.75 (\pm 0.4)	41.17 (\pm 0.9)	23.53 (\pm 5.3)	-0.40 (\pm 0.4)	-16.02 (\pm 0.3)
urea 2.55 (\pm 0.01)	2.98 (\pm 0.1)	36.81 (\pm 0.7)	12.35 (\pm 0.4)	1.29 (\pm 2.0)	-15.53 (\pm 0.1)	3.26 (\pm 0.9)	41.18 (\pm 1.4)	12.63 (\pm 3.2)	1.60 (\pm 1.1)	-13.93 (\pm 0.5)
NH ₄ Cl -0.59 (\pm 0.1)	2.79 (\pm 0.2)	38.53 (\pm 1.6)	13.81 (\pm 0.4)	-2.89 (\pm 0.5)	-15.84 (\pm 0.1)	4.61 (\pm 0.5)	41.04 (\pm 0.8)	8.09 (\pm 0.9)	-4.48 (\pm 0.1)	-13.08 (\pm 0.3)
NaNO ₃ 1.39 (\pm 0.4)	2.20 (\pm 0.4)	34.95 (\pm 0.6)	15.89 (\pm 2.3)	-1.71 (\pm 0.2)	-16.04 (\pm 0.2)	1.99 (\pm 0.3)	40.51 (\pm 0.7)	20.36 (\pm 3.4)	-1.90 (\pm 0.2)	-15.81 (\pm 0.3)
	28 d of incubation					28 d of incubation				
N traces -0.71 (\pm 0.01)	0.98 (\pm 0.3)	36.01 (\pm 1.1)	36.74 (\pm 9.7)	-0.12 (\pm 0.3)	-15.92 (\pm 0.2)	0.56 (\pm 0.5)	36.17 (\pm 0.8)	64.59 (\pm 5.8)	0.23 (\pm 1.0)	-16.12 (\pm 0.4)
urea 2.55 (\pm 0.01)	2.47 (\pm 1.0)	36.87 (\pm 0.4)	14.93 (\pm 10.6)	1.97 (\pm 1.9)	-15.43 (\pm 0.1)	2.48 (\pm 0.4)	39.03 (\pm 1.4)	15.74 (\pm 3.0)	3.10 (\pm 1.1)	-12.95 (\pm 0.6)
NH ₄ Cl -0.59 (\pm 0.1)	2.18 (\pm 0.2)	36.63 (\pm 0.4)	16.80 (\pm 1.7)	-0.88 (\pm 1.0)	-15.62 (\pm 0.1)	2.82 (\pm 0.3)	39.75 (\pm 0.5)	14.10 (\pm 1.2)	-0.22 (\pm 0.9)	-13.39 (\pm 0.2)
NaNO ₃ 1.39 (\pm 0.4)	1.82 (\pm 0.4)	34.73 (\pm 0.5)	19.08 (\pm 4.2)	-2.22 (\pm 0.6)	-16.10 (\pm 0.2)	1.79 (\pm 0.3)	37.03 (\pm 1.5)	20.69 (\pm 3.6)	-2.23 (\pm 0.1)	-15.24 (\pm 0.2)

¹⁾ Amended N substrates in RBA were adjusted to 10 mM N. The $\delta^{15}\text{N}$ values of the amended N substrates and N traces are listed below.

Results

The $\delta^{15}\text{N}$ values of the basidiomycetal biomass, after growth on the respective substrates, and the substrates prior usage were measured and compared. The $\delta^{15}\text{N}$ values of the biomass were very similar to those of the respective N source. However, the uptake of the source cannot be approved, since the differences in the $\delta^{15}\text{N}$ values among the biomass of different cultivations were not significant. If the $\delta^{15}\text{N}$ values of the biomass differed from the N substrates (Tab. 7), this difference indicated that a mix of N sources from urea or ammonia and yeast extract from the RBA were metabolised.

The white-rot fungus *H. fasciculare* was also cultivated on different N sources. Biomass production of *H. fasciculare* was significantly enhanced by urea or NH_4Cl but not by NaNO_3 (Fig. 7). Biomass formation was consistent with exponential growth. In RBA medium, a low amount of biomass was produced. Growth curves of *H. fasciculare* in RBA without and with NaNO_3 amendment were visually identical after linear approximation (Fig. 7).

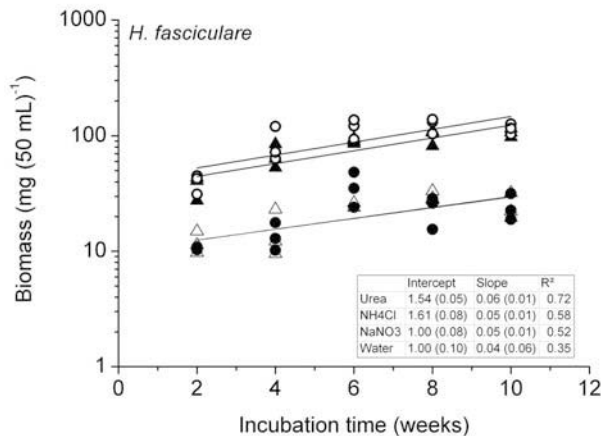

Fig. 7: Biomass of *H. fasciculare* cultivated on RBA amended with 10 mM N from urea (\blacktriangle), NH_4Cl (\circ), NaNO_3 (\triangle) or deionised water as reference cultivation (\bullet). Linear approximations of the measured values are indicated.

The elemental composition of biomass cultivated with different N sources showed that the N content increased if urea or NH_4Cl was fed. The C content increased as well but to a lower extent. Accordingly, the C/N ratio decreased (Tab. 8). Unlike NaNO_3 , the presence of urea and NH_4Cl in the medium significantly affected the N contents, C contents, C/N ratios and $\delta^{15}\text{N}$ values in fungal biomass. The effect of the incubation time between the interval of 28 and 56 d was marginal for all N sources.

Tab. 8: C content, N content, C/N, $\delta^{15}\text{N}$ and $\delta^{13}\text{C}$ values of dry biomass of *H. fasciculare* cultivated on RBA and RBA amended with 10 mM urea, NH_4Cl or NaNO_3 for 28 and 56 d (n = 6, mean values \pm SD).

N substrate ¹⁾	N	C	C/N	$\delta^{15}\text{N}_{\text{AIRN}_2}$	N	C	C/N	$\delta^{15}\text{N}_{\text{AIRN}_2}$
	in %	in %	ratio	in ‰	in %	in %	ratio	in ‰
	28 d of incubation				56 d of incubation			
N traces -0.71 (\pm 0.01)	1.21 (\pm 0.6)	35.60 (\pm 2.2)	39.0 (\pm 18.4)	1.50 (\pm 0.1)	1.74 (\pm 0.8)	36.64 (\pm 2.1)	25.44 (\pm 13.6)	1.70 (\pm 1.5)
urea 2.55 (\pm 0.01)	5.35 (\pm 0.2)	41.92 (\pm 1.5)	7.94 (\pm 0.4)	2.24 (\pm 1.1)	5.38 (\pm 0.2)	44.79 (\pm 2.4)	8.41 (\pm 0.7)	4.69 (\pm 1.7)
NH_4Cl -0.59 (\pm 0.1)	5.24 (\pm 0.8)	42.92 (\pm 1.4)	8.31 (\pm 1.2)	-5.71 (\pm 2.6)	5.57 (\pm 0.3)	45.04 (\pm 0.7)	8.10 (\pm 0.4)	-1.99 (\pm 0.5)
NaNO_3 1.39 (\pm 0.4)	2.29 (\pm 0.8)	33.55 (\pm 3.0)	16.04 (\pm 5.6)	0.31 (\pm 1.3)	1.28 (\pm 0.1)	34.06 (\pm 1.7)	26.90 (\pm 3.7)	1.90 (\pm 0.7)

¹⁾ Amended N substrates in RBA were adjusted to 10 mM N. The $\delta^{15}\text{N}$ values of the amended N substrates and N traces are listed below.

Interestingly, all of the tested basidiomycetes developed a low amount of biomass in a medium without N addition. Again, an efficient uptake of organic N traces from the medium by the fungus was observed. All three fungi developed a mycelium of thin hyphae, which is supposed to be advantageous for the uptake of nutrient traces. Biomass formation of the white-rot fungi *T. versicolor* and *H. fasciculare* was intensified by amendment of urea and NH_4Cl . However, growth rates for *H. fasciculare* remained lower than for *T. versicolor*. Growth of *O. placenta* was not affected by the amendment of N sources. If N was accumulated in the mycelium, the N content of the biomass increased compared to control experiment without N amendment. At the same time, the N addition affected the C content to a low extent. If the N content increased, the C/N ratio decreased. The $\delta^{15}\text{N}$ values of the N sources affected the $\delta^{15}\text{N}$ values of biomass.

3.5. Nitrogen uptake of bacterial isolates coexisting with *H. fasciculare*

In addition to the experiments with saprotrophic basidiomycetes, the uptake of N sources was also tested in growth experiments with bacterial isolates coexisting with *H. fasciculare*. The growth of more than 50% of the bacterial strains was increased by urea or NH_4Cl . Only 11% of the bacterial strains metabolised NaNO_3 , and 7% developed equally on both RBA amended with NaNO_3 and without N addition (Tab. 9). Thus, the bacterial preferences for N species were similar to those of *H. fasciculare*. Some of the bacterial isolates were not cultivable on RBA medium. Those bacteria were members of the *Dyella* sp., *Xanthomonadaceae* sp. and *Rahnella* sp.

Results

Tab. 9: Growth of bacterial strains with different N sources (n = 3). The averages of replicate growth curves were determined and categorised according to the increase from an initial OD of 0.2 to a maximum OD of a) $OD_{max} > 0.25$ (+), b) $OD_{max} > 0.5$ (++) , c) $OD_{max} > 0.75$ (+++) , d) $OD_{max} > 1$ (++++). No OD increase was indicated by the symbol (o).

Name		Bacterial growth on 10 mM N of different N sources in RBA			
No.	species	Urea	NH ₄ Cl	NaNO ₃	Water
<i>Alphaproteobacteria</i>					
WH5	<i>Sphingomonas sp.</i>	++++	++++	+	+
WH6	<i>Sphingomonas sp.</i>	++	+	+	++
WH29	<i>Sphingomonas sp.</i>	+	+	o	o
<i>Betaproteobacteria</i>					
WH27	<i>Burkholderia glathei</i>	++	++	+	+
WH10	<i>Burkholderia sp.</i>	+++	+++	+	+
WH11	<i>Burkholderia sp.</i>	++	+	++	+
WH12	<i>Burkholderia sp.</i>	++	++	+	+
WH20	<i>Burkholderia sp.</i>	++	++	++	+
WH22	<i>Burkholderia sp.</i>	+	+	+	+
WH24	<i>Burkholderia sp.</i>	++	+++	++	++
WH25	<i>Burkholderia sp.</i>	+	+	o	o
WH26	<i>Burkholderia sp.</i>	++	++	+	+
WH8	<i>Burkholderia sp.</i>	+++	++	+	+
<i>Gammaproteobacteria</i>					
WH3	<i>Dyella sp.</i>	++++	+++	++++	o
WH32	<i>Dyella sp.</i>	++	+	+	+
WH33	<i>Dyella sp.</i>	o	o	o	o
WH34	<i>Dyella sp.</i>	o	o	o	o
WH35	<i>Dyella sp.</i>	+	+	+	+
WH1	<i>Xanthomonadaceae b.</i>	++	++++	+	+
WH2	<i>Xanthomonadaceae b.</i>	++	+++	+	+
WH7	<i>Xanthomonadaceae b.</i>	+++	+++	+	+
WH30	<i>Xanthomonadaceae b.</i>	++++	++++	+++	+++
WH38	<i>Xanthomonadaceae b.</i>	o	o	o	o
WH9	<i>Rahnella sp.</i>	o	o	o	o
WH28	<i>Rahnella sp.</i>	+	+	+	+
<i>Bacteroidetes</i>					
WH4	<i>Pedobacter sp.</i>	++	++++	o	o

3.6. N₂ fixation by *A. croococcum*, *B. acida* and *N. nitrogenifigens* as well as bacterial isolates coexisting with *H. fasciculare*

The diazotrophs *A. croococcum*, *B. acida* and *N. nitrogenifigens* (Weißhaupt *et al.* 2011) as well as the bacteria coexisting with *H. fasciculare* were cultivated on solid RBA medium and on recommended media (Tab. 1) under air and under a ¹⁵N₂/O₂ atmosphere (Figs. 8 to 11).

A. croococcum was cultivated on RBA as well as on Azotobacter medium (Fig. 8). Under all conditions, the bacteria developed separated, round colonies. The N content of the dry bacterial biomass was in both media and under both atmospheres approximately 10% with a C/N ratio of 4 to 5. Under air, the ¹⁵N abundance was in the range of the natural ¹⁵N abundance. If the bacterium was cultivated under a gas mixture of ¹⁵N₂/O₂, the ¹⁵N abundance in the bacterial biomass was 12 to 13%, indicating bacterial fixation of N₂. The effect of the gas atmosphere on the ¹⁵N abundance in the bacterial biomass was significant (see ANOVA in Fig. 8). The effects of medium, gas atmosphere and the combination of both on C/N and N content of the biomass were not significant. The diazotrophic activity of *A. croococcum* was approved, and effects of the medium on the biomass were not detected. Azotobacter medium and RBA medium were supposed to comprise a similar amount of N traces (Tab. 3).

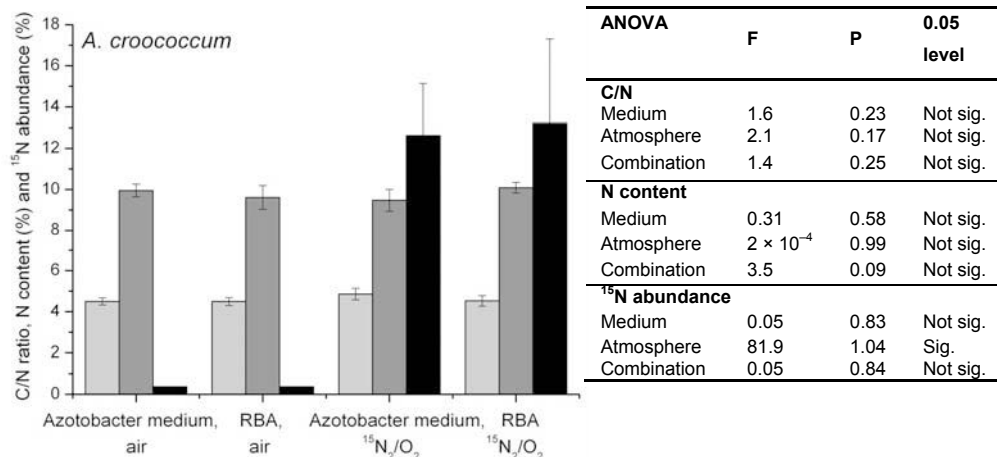
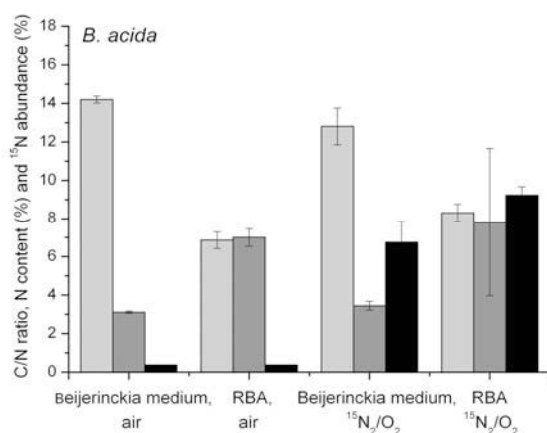

Fig. 8: C/N ratio (grey), N content in % (m/m) (dark grey) and ¹⁵N abundance in % (black) in biomass of *A. croococcum* after 14 d of incubation (n = 9, mean values ± SD). The results of the two-way ANOVA are given in the table.

Results

B. acida was cultivated on Beijerinckia medium and on RBA medium (Fig. 9). On both media and under both atmospheres, it developed a sort of mucilage that covered the entire mediums' surface. On RBA medium, *B. acida* developed a biomass with an N content of 7 to 8%, and on Beijerinckia medium the bacterial biomass had an N content of 3 to 4%. The ^{15}N abundance in biomass produced under $^{15}\text{N}_2/\text{O}_2$ atmosphere was 7 to 9% indicating a significant fixation of atmospheric N_2 . However, the fixation rates were lower than at *A. croococcum* cultivated under $^{15}\text{N}_2/\text{O}_2$. The effects of the medium on the C/N ratio, the N content and the ^{15}N abundance were significant. Besides, the combination of medium and atmosphere also affected the C/N ratio, N content and $\delta^{15}\text{N}$ value. However, the effect of the atmosphere on the C/N ratio was not significant. The diazotrophic activity of *B. acida* was approved, and an effect of the medium was detected. Beijerinckia medium was supposed to contain less N traces than RBA (Tab. 3).



ANOVA	F	P	0.05 level
C/N			
Medium	315.2	5.6×10^{-10}	Sig.
Atmosphere	0.006	0.938	Not sig.
Combination	18.06	0.001	Sig.
N content			
Medium	171.7	1.8×10^{-8}	Sig.
Atmosphere	9.42	0.01	Sig.
Combination	21.23	6.0×10^{-4}	Sig.
^{15}N abundance			
Medium	13.52	3.6×10^{-3}	Sig.
Atmosphere	511.4	3.3×10^{-11}	Sig.
Combination	13.54	3.5×10^{-3}	Sig.

Fig. 9: C/N ratio (grey), N content in % (m/m) (dark grey) and ^{15}N abundance in % (black) in biomass of *B. acida* after 14 d of incubation ($n = 9$, mean values \pm SD). The results of the two-way ANOVA are given in the table.

N. nitrogenifigens was cultivated on RBA and nutrient medium (Fig. 10). In cultivation experiments, *N. nitrogenifigens* had a higher N content if it was cultivated on nutrient medium than on RBA. The N content in the bacterial biomass amounted to 10 to 12% and 4% on nutrient medium and on RBA, respectively. If the biomass of *N. nitrogenifigens* was cultivated on RBA medium and under a gas mixture of $^{15}\text{N}_2/\text{O}_2$, the ^{15}N abundance in the bacterium was generally less than 2%. If nutrient medium was applied instead of RBA, the ^{15}N abundance increased only to 0.38%. The effect of the medium was significant on the C/N ratio and the ^{15}N abundance in the biomass. The atmosphere affected the N content and the

^{15}N abundance but not the C/N ratio. Nutrient medium contained approximately 1.1 g L^{-1} N from organic sources (Tab. 3).

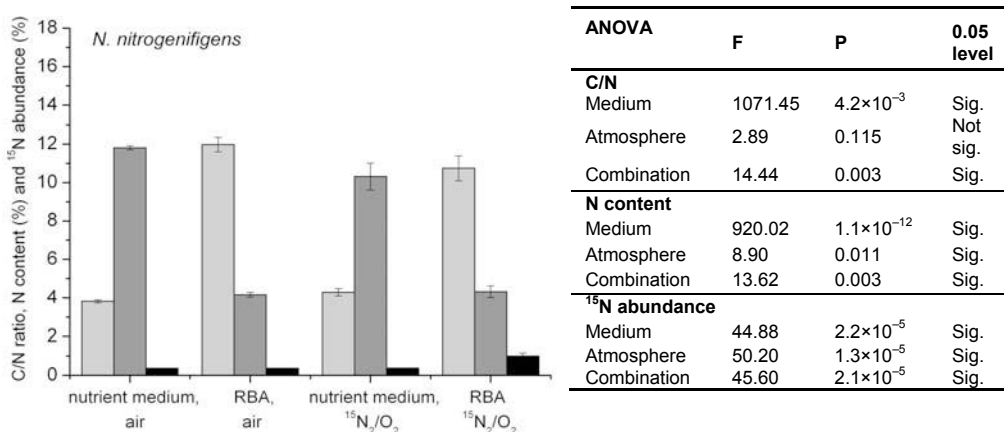

Fig. 10: C/N ratio (grey), N content in % (m/m) (dark grey) and ^{15}N abundance in % (black) in biomass of *N. nitrogenifigens* after 14 d of incubation ($n = 9$, mean values \pm SD). The results of the two-way ANOVA are given in the table.

IRMS results confirmed that all tested diazotrophs fixed atmospheric N_2 , although their fixation rates differed depending on species and media. None of the bacteria assimilated 100% of its N content from the gas atmosphere. Therefore, the availability of additional N sources is essential for the growth of diazotrophic bacteria. Traces of N in the medium can provide enough initial N for the growth of diazotrophs. In addition, at higher concentrations of organic N, such as in nutrient medium, the N_2 -fixation activity is inhibited. *In situ*, environmental conditions and particularly N concentrations determine bacterial N_2 fixation.

Similar to the diazotrophic bacteria, bacterial isolates coexisting with *H. fasciculare* were cultivated on RBA and on TSB medium under $^{15}\text{N}_2/\text{O}_2$ atmosphere and under air (Fig. 11). The N contents of bacterial biomass cultivated on TSB medium (N concentration of the medium of 0.33 g L^{-1}) differed significantly from the N content in bacterial biomass cultivated on RBA medium (N concentration of the medium of 0.05 g L^{-1}). The N contents amounted to 1 to 8% and 7 to 13% on RBA and TSB, respectively. The effect of the medium on the N content in the bacterial biomass was significant.

Results

The $\delta^{15}\text{N}$ values of bacterial biomass were significantly affected by the $^{15}\text{N}_2/\text{O}_2$ atmosphere. This was found on both media but the effect was more pronounced if RBA and $^{15}\text{N}_2/\text{O}_2$ atmosphere were combined (Fig. 11). Nevertheless, the $\delta^{15}\text{N}$ values had a maximum of 30‰ for the majority of the bacteria, and diazotrophic activity was low compared to the previous results (Figs. 8 to 10). Exceptionally, the $\delta^{15}\text{N}$ values of some isolates affiliated to the *Betaproteobacteria*, i.e., *Burkholderia sp.* WH 11, WH 12 and WH 8, were enhanced to values above 40‰ in case of cultivation on RBA under $^{15}\text{N}_2/\text{O}_2$ atmosphere. The effects of the atmosphere and the combination of atmosphere and medium were significant.

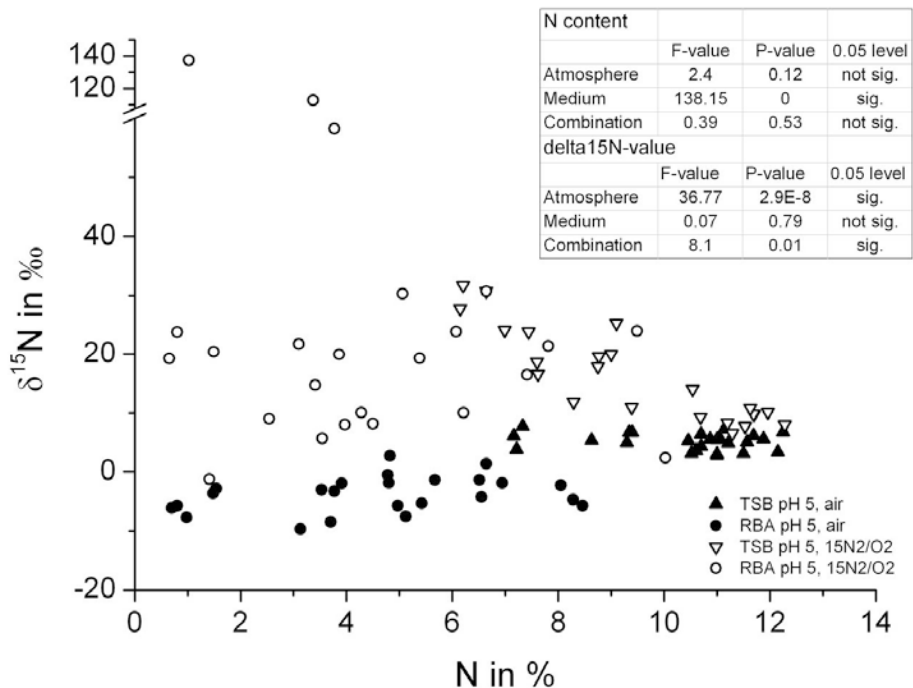

Fig. 11: N contents and $\delta^{15}\text{N}$ values of biomass of bacterial isolates coexisting with *H. fasciculare*. The 27 bacteria were cultivated on RBA and on TSB under air and under a $^{15}\text{N}_2/\text{O}_2$ atmosphere ($n = 1$). Significances of the effects of medium and $^{15}\text{N}_2/\text{O}_2$ treatment were calculated by two-way ANOVA (0.05 level).

If the bacteria were cultivated on TSB medium, the variance of the N content as well as the $\delta^{15}\text{N}$ value of some bacteria were remarkably low (triangles in Fig. 11). Bacteria, which were characterised by high N contents of 10 to 13% and average $\delta^{15}\text{N}$ values from 0 to 10‰, were predominantly affiliated to the *Gammaproteobacteria* (WH 32, WH 33, WH 34, WH 1, WH 28, WH 38 and WH 9) and to *Sphingomonas sp.* and *Burkholderia sp.* (WH 6, WH 11 and WH 12). Interestingly, the $\delta^{15}\text{N}$ values increased less if the bacteria were cultivated on

TSB. Obviously, the presence of N in the medium suppressed the $^{15}\text{N}_2$ fixation. On RBA medium, most of the bacteria suffered from N limitation and produced a biomass with a reduced N content. Most of the bacteria adsorbed $^{15}\text{N}_2$ particularly at N-limited conditions.

3.7. N_2 fixation of bacteria in co-cultivation with basidiomycetes

Bacterial N_2 fixation and the N transfer to fungi were tested by co-cultivating *O. placenta* (Tab. 10, A) and *T. versicolor* (Tab. 11, A) with each of the diazotrophs *A. croococcum* (B), *B. acida* (C) and *N. nitrogenifigens* (D) under air and under a $^{15}\text{N}_2/\text{O}_2$ atmosphere. The cultivations proceeded on RBA medium without additional N or C sources. This medium was chosen to provide optimal conditions for bacterial N_2 fixation. These conditions include the presence of trace-elements and the absence of N sources. After cultivation, fungal biomass was recoverable at all co-cultivations and yielded enough biomass for IRMS measurements. Biomass of *A. croococcum* and of *N. nitrogenifigens* was difficult to recover, whereas biomass of *B. acida* was found at high abundances in both co-cultivations (Tabs. 10 and 11; Weißhaupt *et al.* 2011).

Firstly, *O. placenta* was cultivated alone (A) and with each of the bacteria (B, C and D) under air and under $^{15}\text{N}_2/\text{O}_2$ atmosphere (Tab. 10). The fungal biomass amounted 6.3 to 15.8 mg in 20 mL cultivation medium cultivated for 21 d. In all co-cultivations, more fungal than bacterial biomass was harvested, and the bacterial biomass of *A. croococcum* and *N. nitrogenifigens* was low compared to the biomass of *B. acida*. The last mentioned bacterium was able to compete with *O. placenta*, and the bacterium reduced the biomass of *O. placenta* compared to cultivations without bacteria.

In all co-cultivations with *O. placenta*, the fungal biomass had a remarkable low N content (Tab. 10). In the biomass of *O. placenta*, the N content was lower than in biomass from cultivations on medium which contained an N source, e.g., malt-extract, urea, NH_4Cl (Tabs. 5 and 7). The presence of bacteria affected the fungal N content to a low extent. The N content in bacterial biomass was between 2 and 2.5% and between 7 and 9% in the biomass of *A. croococcum* (B) as well as *N. nitrogenifigens* (D) and *B. acida* (C), respectively.

The $\delta^{15}\text{N}$ values in fungal and bacterial biomass were increased at cultivations under a $^{15}\text{N}_2/\text{O}_2$ atmosphere compared to air (Tab. 10). However, in biomass of *O. placenta*, *A. croococcum* and *N. nitrogenifigens* the $\delta^{15}\text{N}$ values increased only to a low extent (Tab. 10, A, B and D). In biomass of *B. acida* and *O. placenta* in co-cultivation, the $\delta^{15}\text{N}$ values increased significantly, which indicated $^{15}\text{N}_2$ fixation and transfer into fungal biomass (Tab. 10, C).

In addition to the $\delta^{15}\text{N}$ values, the ^{15}N abundances were calculated (Tab. 10). In most samples, the ^{15}N abundance amounted to 0.37% and just increased the natural ^{15}N abundance to a low extent. If *O. placenta* and *B. acida* were co-cultivated under $^{15}\text{N}_2/\text{O}_2$

Results

atmosphere, the ^{15}N abundance amounted to 9 and 13.5%, respectively (C). ^{15}N uptake and transfer to the fungus was approved.

Tab. 10: Co-cultivations of *O. placenta* and N_2 -fixing bacteria on RBA medium under air and under $^{15}\text{N}_2/\text{O}_2$ atmosphere. Fungal control cultures (A) and consecutively listed pairs of organisms (B, C and D) were co-cultivated under the gas atmosphere outlined. The results are the biomass per batch after separation and the results of the IRMS analysis ($n = 3$, mean values \pm SD).

Gas atmosphere	Organism	Biomass in mg (20 mL)^{-1}	N content in %	$\delta^{15}\text{N}_{\text{AIR N}_2}$ in ‰	^{15}N abundance in %	
A	air	<i>O. placenta</i>	7.43 (\pm 0.5)	0.16 (\pm 0.01)	3.21 (\pm 2.3)	0.37 (\pm $3 \cdot 10^{-3}$)
	$^{15}\text{N}_2/\text{O}_2$	<i>O. placenta</i>	13.10 (\pm 2.4)	0.06 (\pm 0.002)	8.66 (\pm 6.0)	0.37 (\pm $2 \cdot 10^{-3}$)
B	air	<i>O. placenta</i>	8.70 (\pm 0.7)	0.48 (\pm 0.3)	5.54 (\pm 4.8)	0.37 (\pm $2 \cdot 10^{-3}$)
		<i>A. croococcum</i>	8.50 (\pm 0.3)	2.05 (\pm 0.12)	4.76 (\pm 2.1)	0.37 (\pm $1 \cdot 10^{-3}$)
	$^{15}\text{N}_2/\text{O}_2$	<i>O. placenta</i>	9.10 (\pm 0.0)	1.03 (\pm 0.71)	362.8 (\pm 283.2)	0.50 (\pm 0.1)
		<i>A. croococcum</i>	1.40 ¹⁾	2.83 ¹⁾	56.79 ¹⁾	0.36 ¹⁾
C	air	<i>O. placenta</i>	7.17 (\pm 0.3)	0.29 (\pm 0.07)	6.09 (\pm 2.1)	0.37 (\pm 0.01)
		<i>B. acida</i>	13.47 (\pm 1.4)	7.04 (\pm 0.63)	-0.19 (\pm 2.1)	0.37 (\pm $3 \cdot 10^{-5}$)
	$^{15}\text{N}_2/\text{O}_2$	<i>O. placenta</i>	6.3 (\pm 0.5)	0.27 (\pm 0.15)	26335.50 (\pm 9664.7)	9.13 (\pm 2.9)
		<i>B. acida</i>	12.67 (\pm 1.4)	9.14 (\pm 1.16)	40989.26 (\pm 7376.8)	13.37 (\pm 2.1)
D	air	<i>O. placenta</i>	8.75 (\pm 0.1)	0.46 (\pm 0.2)	14.86 (\pm 1.6)	0.37 (\pm $1 \cdot 10^{-3}$)
		<i>N. nitrogenifigens</i>	2.55 (\pm 0.1)	1.71 (\pm 0.1)	13.24 (\pm 4.0)	0.37 (\pm $1 \cdot 10^{-3}$)
	$^{15}\text{N}_2/\text{O}_2$	<i>O. placenta</i>	15.83 (\pm 1.6)	2.34 (\pm 0.4)	241.6 (\pm 137.5)	0.45 (\pm 0.1)
		<i>N. nitrogenifigens</i>	too less biomass for a measurement			

¹⁾ The biomass from three cultivations was collected for a single measurement.

Secondly, *T. versicolor* was co-cultivated with each of the bacteria under air and under $^{15}\text{N}_2/\text{O}_2$ atmosphere (Tab. 11). The fungal biomass amounted to 6.3 to 16.8 mg in 20 mL cultivation medium at comparatively high standard deviations similar to experiments with *O. placenta*. The bacterial biomass of *A. croococcum* (Tab. 11, B) and *N. nitrogenifigens* (0.5 to 6.3 mg (20 mL)^{-1} ; B and D) was low compared to biomass of *B. acida* (11.1 to 13.8 mg (20 mL)^{-1} ; C).

The N content in biomass of *T. versicolor* was particularly low compared to cultivations at non-limited conditions (see results in sections 3.3. and 3.4.). The bacterial N content was usually higher than the fungal N content (Tab. 11 B, C, D), but low compared to pure bacterial cultivations (see results in section 3.6.). This result may indicate N limitations regarding bacterial growth. The highest N contents were found in biomass of *B. acida* (C). If the cultivations proceeded under $^{15}\text{N}_2/\text{O}_2$ atmosphere, the $\delta^{15}\text{N}$ value in the biomass increased compared to cultivations under air. The $\delta^{15}\text{N}$ value just increased to a low extent in co-cultivations with *A. croococcum* (Tab. 11, B) and *N. nitrogenifigens* (Tab. 11, D). A

significant increase of the $\delta^{15}\text{N}$ value was found in co-cultivation with *B. acida* and included fungal and bacterial biomass. So, N_2 fixation and transfer into fungal biomass was approved for *B. acida* but not for the other diazotrophs.

If the ^{15}N abundance was calculated, 12.5 to 13.1% of the total N in the biomass of *B. acida* and *T. versicolor*, respectively, was initially fixed from $^{15}\text{N}_2$ (Tab. 11, C). The ^{15}N abundances increased only to a low extent in the other co-cultivations under $^{15}\text{N}_2/\text{O}_2$ atmosphere (Tab. 11, B and D).

Tab. 11: Co-cultivations of *T. versicolor* and N_2 -fixing bacteria on RBA medium under air and under $^{15}\text{N}_2/\text{O}_2$ atmosphere. Fungal control cultures (A) and consecutively listed pairs of organisms (B, C and D) were co-cultivated under the gas atmosphere outlined. The results are the biomass per batch after separation and the results of the IRMS analysis ($n = 3$, mean values \pm SD).

	Gas atmosphere	organism	Biomass in mg (20 mL)^{-1}	N content in %	$\delta^{15}\text{N}$ in ‰	^{15}N abundance in %
A	air	<i>T. versicolor</i>	16.80 (\pm 0.8)	0.09 (0.006)	4.37 (\pm 4.4)	0.37 (\pm $1 \cdot 10^{-3}$)
	$^{15}\text{N}_2/\text{O}_2$	<i>T. versicolor</i>	15.50 (\pm 3.0)	0.16 (0.001)	1.57 (\pm 0.8)	0.37 (\pm $3 \cdot 10^{-4}$)
B	air	<i>T. versicolor</i>	16.23 (\pm 1.4)	1.72 (\pm 0.1)	-0.15 (\pm 0.6)	0.37 (\pm $4 \cdot 10^{-4}$)
		<i>A. croococcum</i>	3.73 (\pm 1.0)	2.51 (\pm 0.3)	7.39 (\pm 4.5)	0.39 (\pm $2 \cdot 10^{-3}$)
	$^{15}\text{N}_2/\text{O}_2$	<i>T. versicolor</i>	7.77 (\pm 0.3)	1.62 (\pm 0.6)	101.40 (\pm 92.8)	0.40 (\pm $3.4 \cdot 10^{-2}$)
		<i>A. croococcum</i>	6.30 (\pm 0.9)	2.54 (\pm 0.1)	22.66 (\pm 6.1)	0.37 (\pm $2 \cdot 10^{-3}$)
C	air	<i>T. versicolor</i>	6.93 (\pm 1.6)	1.43 (\pm 0.5)	6.20 (\pm 2.5)	0.37 (\pm $9 \cdot 10^{-4}$)
		<i>B. acida</i>	13.80 (\pm 1.2)	6.41 (\pm 0.7)	-0.17 (\pm 2.3)	0.37 (\pm $6 \cdot 10^{-5}$)
	$^{15}\text{N}_2/\text{O}_2$	<i>T. versicolor</i>	8.07 (\pm 0.4)	0.83 (\pm 0.5)	40291.08 (\pm 5935.1)	13.18 (\pm 1.6)
		<i>B. acida</i>	11.13 (\pm 0.4)	8.91 (\pm 1.2)	37922.17 (\pm 10024.7)	12.52 (\pm 2.8)
D	air	<i>T. versicolor</i>	15.23 (\pm 0.6)	0.78 (\pm 0.2)	6.19 (\pm 1.1)	0.37 (\pm $4 \cdot 10^{-4}$)
		<i>N. nitrogenifigens</i>	too less biomass for a mesurement			
	$^{15}\text{N}_2/\text{O}_2$	<i>T. versicolor</i>	16.13 (\pm 1.1)	1.15 (\pm 0.3)	14.80 (\pm 6.4)	0.37 (\pm $4 \cdot 10^{-4}$)
		<i>N. nitrogenifigens</i>	3.03 (\pm 0.9)	2.27 (\pm 1.3)	103.40 (\pm 50.0)	0.40 (\pm $4 \cdot 10^{-4}$)

In experiments with both fungi, i.e., *O. placenta* (Tab. 10) and *T. versicolor* (Tab. 11), the $\delta^{15}\text{N}$ values increased at all co-cultivations with bacteria under $^{15}\text{N}_2/\text{O}_2$ atmosphere. In co-cultivation with *A. croococcum* (B) and *N. nitrogenifigens* (D), the increase in $\delta^{15}\text{N}$ values in the fungal and bacterial biomass was marginally due to high standard deviations. The small increase in $\delta^{15}\text{N}$ values was either explained by strongly reduced diazotrophic activity (compared to the results in Figs. 8, 9 and 10) or by adsorption of $^{15}\text{N}_2$. Only in case of *B. acida* (C), the bacterium coexisted with both fungi, and diazotrophic activity was approved as well as the transfer of fixed ^{15}N into fungal biomass. The $\delta^{15}\text{N}$ values increased significantly in fungal and bacterial biomass if it was co-cultivated under $^{15}\text{N}_2/\text{O}_2$ atmosphere.

3.8. Cultivation of *O. placenta* and *T. versicolor* at different N sources

The effects of different N sources on *T. versicolor* as well as on *O. placenta* were investigated in experiments according to experimental plans (Weißhaupt *et al.* 2012). The effects of the organic N source peptone (x_1), of the residual N in sapwood (x_2) and N_2 in air (x_3) as well as their synergistic effects (x_1x_2 , x_1x_3 , x_2x_3 and $x_1x_2x_3$) on the fungal activity were determined. After 14 d of incubation in closed bottles (Fig. 2), the concentration of O_2/Ar (gas chromatography gave one peak, since O_2 and Ar were not separable with the employed method), N_2 and ultimately CO_2 in the gas phase was measured. Afterwards, the fungal biomass was determined. Finally, the C content, N content and $\delta^{15}N$ value of dried biomass were measured (Tabs. 12 and 13).

Tab. 12: Investigation of the N sources (peptone (x_1), wood of *P. sylvestris* (x_2), N_2 in air (x_3)) of *O. placenta* in a 2^3 experimental plan. The indicators of fungal activity were determined after 14 d of cultivation ($n = 3$, mean values \pm SD).

no.	medium x_1	wood x_2	gas x_3	O_2/Ar in vol.-%	N_2 in vol.-%	CO_2 in vol.-%	biomass in $mg (20 mL)^{-1}$	C in %	N in %	$\delta^{15}N_{AIR}$ in ‰
1	RBA	none	O_2 /Ar	92.30 (± 2.1)	1.42 (± 0.1)	6.29 (± 2.1)	8.07 (± 2.7)	35.08 (± 0.4)	0.40 (± 0.1)	1.59 (± 0.8)
2	RBA + Peptone	none	O_2 /Ar	80.00 (± 0.4)	1.26 (± 0.4)	18.74 (± 0.2)	11.47 (± 3.6)	37.55 (± 1.3)	2.02 (± 0.4)	4.93 (± 0.4)
3	RBA	<i>P.</i> <i>sylvestris</i>	O_2 /Ar	93.99 (± 1.3)	0.85 (± 0.3)	5.16 (± 0.9)	8.27 (± 0.6)	38.79 (± 1.0)	0.67 (± 0.3)	-1.89 (± 0.4)
4	RBA + Peptone	<i>P.</i> <i>sylvestris</i>	O_2 /Ar	89.39 (± 5.7)	0.58 (± 0.1)	10.03 (± 5.7)	15.47 (± 6.8)	42.04 (± 0.2)	6.28 (± 0.1)	3.43 (± 0.6)
5	RBA	none	air	14.12 (± 0.1)	82.60 (± 0.1)	3.28 (± 0.1)	5.07 (± 1.4)	37.44 (± 0.6)	0.88 (± 0.4)	-0.58 (± 0.4)
6	RBA + Peptone	none	air	1.27 (± 0.3)	84.44 (± 0.4)	14.29 (± 0.5)	15.4 (± 1.8)	42.51 (± 0.4)	3.81 (± 0.7)	6.40 (± 0.6)
7	RBA	<i>P.</i> <i>sylvestris</i>	air	8.25 (± 0.3)	86.63 (± 0.8)	5.12 (± 1.1)	4.43 (± 0.6)	37.06 (± 0.6)	0.82 (± 0.2)	-2.93 (± 0.6)
8	RBA + Peptone	<i>P.</i> <i>sylvestris</i>	air	1.07 (± 0.1)	80.79 (± 0.1)	18.14 (± 0.1)	10.67 (± 0.7)	42.50 (± 1.3)	2.96 (± 0.9)	3.61 (± 0.9)

In the experiments of the first experimental plan, *O. placenta* was cultivated at different N sources (peptone (x_1), wood of *P. sylvestris* (x_2), N_2 in air (x_3)). In experiments containing peptone (Tab. 12, nos. 2, 4, 6 and 8), fungal biomass increased compared to cultivations on pure RBA medium (Tab. 12, nos. 1, 3, 5 and 7). However, the biomass was less than at similar cultivations on MEA medium (Tab. 3). The addition of wood marginally influenced the

biomass, and N_2 had no effect (Tab. 12, nos. 3, 4, 7 and 8). CO_2 formation and O_2 consumption paralleled the biomass development. If peptone was in the medium, the N content in fungal biomass increased. In addition, the $\delta^{15}N$ value was similar to the one of peptone, which was $4.56 (\pm 0.1)\%$. In the presence of wood, the C content marginally increased, but not the N content, indicating that N traces in wood only marginally affected the biomass formation. After 14 d of incubation, the pH value decreased from 7 to 3.5.

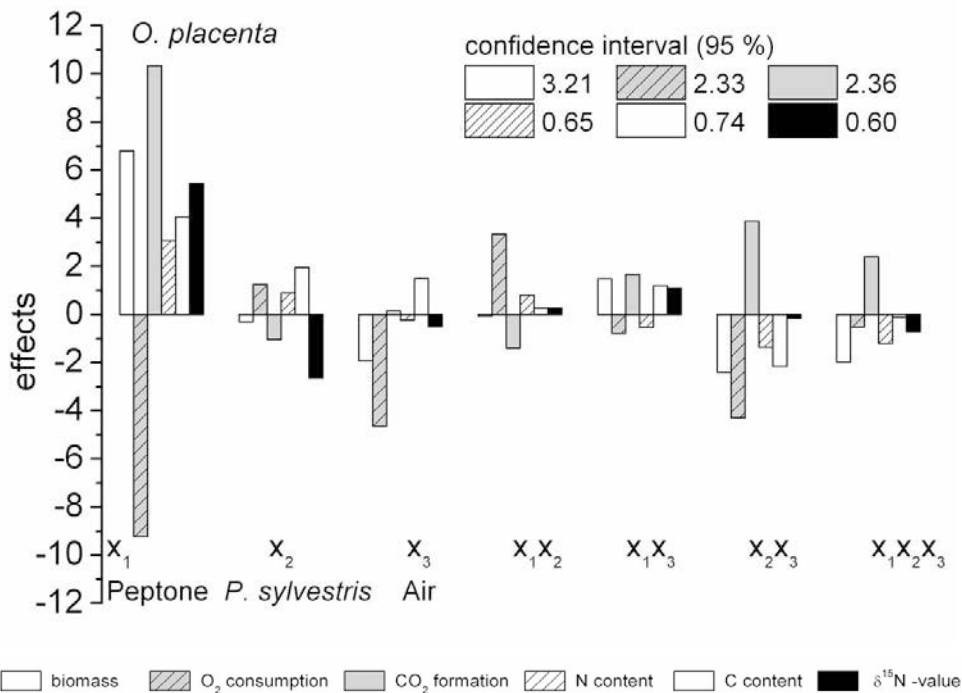

Fig. 12: Effects of the factors (peptone (x_1), wood of *P. sylvestris* (x_2), N_2 in air (x_3)) and their linear combination (x_1x_2 , x_1x_3 , x_2x_3 and $x_1x_2x_3$) on the indicators of fungal activity of *O. placenta*. Effects on six indicators are outlined in bars in different designs. The confidence intervals of the indicators of fungal activity were determined according to the 95% criterion and are given in the legend.

Based on the measured values (Tab. 12), the effects of the N sources were calculated (Fig. 12). The effects of the factors x_1 , x_2 and x_3 as well as factor combinations on the indicators of fungal activity are displayed in bars. The indicators and their specific confidence intervals are listed in the legend. If an effect is within the two-sided confidence interval (specific values are given in the legend), it is not significant. Consequently, the factor does not affect the indicator of fungal activity.

Firstly, the effects on *O. placenta* were investigated (Fig. 12). If the biomass is targeted, the confidence level is ± 3.21 mg. If the first factor peptone (x_1) is analysed, the effect amounts to almost 7 mg and is significant. The effects of *P. sylvestris* (x_2), N_2 in air (x_3) and the linear combinations (x_1x_2 , x_1x_3 , x_2x_3 and $x_1x_2x_3$) on the biomass formation of *O. placenta* are not significant.

The effect of peptone (x_1) on O_2 consumption and CO_2 formation is significant as well. The effects of peptone go beyond the confidence intervals of 2.33 and 2.36%, respectively. Moreover, the CO_2 formation is significantly affected by the combination of *P. sylvestris* and air (x_2x_3). If both factors occur together, the CO_2 formation increases significantly, although the fungal biomass does not increase. This could imply increased decomposition activity without biomass development. In addition, the atmosphere has an effect on O_2 consumption, which means that in air the O_2 consumption is more pronounced than in O_2/Ar atmosphere.

The indicators C content, N content and $\delta^{15}N$ value were all significantly affected by peptone (x_1). The other factors, i.e., *P. sylvestris* (x_2), air (x_3) and the combinations (x_1x_2 , x_1x_3 , x_2x_3 and $x_1x_2x_3$) had minor effects on the elemental composition of the biomass. The addition of wood of *P. sylvestris* affected the C content and $\delta^{15}N$ value in the fungal biomass significantly, which indicates that wood was used as a substrate, although it did not increase fungal growth immediately.

Tab. 13: Investigation of the N sources (peptone (x_1), wood of *F. sylvatica* (x_2), N_2 in air (x_3)) of *T. versicolor* in experiments of a 2^2 experimental plan. The indicators of fungal activity were determined after 14 d of cultivation (n = 3, mean values \pm SD).

no.	medium x_1	wood x_2	gas x_3	O_2/Ar in vol.-%	N_2 in vol.-%	CO_2 in vol.-%	laccase in $U L^{-1}$	biomass in $mg (20 mL)^{-1}$	C in %	N in %	$\delta^{15}N$ in ‰
1	RBA	none	O_2 /Ar	86.10 (± 5.7)	1.37 (± 0.8)	8.36 (± 0.3)	0.18 (± 0.1)	7.00 (± 1.0)	38.44 (± 2.5)	2.24 (± 1.2)	2.37 (± 2.3)
2	RBA + Peptone	none	O_2 /Ar	83.18 (± 4.9)	1.04 (± 0.1)	12.33 (± 0.1)	0.50 (± 0.7)	5.35 (± 0.6)	39.64 (± 0.8)	3.63 (± 0.3)	3.70 (± 0.3)
3	RBA	<i>F.</i> <i>sylvatica</i>	O_2 /Ar	87.36 (± 0.5)	0.45 (± 0.1)	12.18 (± 0.6)	15.12 (± 2.5)	4.23 (± 0.2)	41.75 (± 2.1)	0.67 (± 0.3)	nm
4	RBA + Peptone	<i>F.</i> <i>sylvatica</i>	O_2 /Ar	78.32 (± 1.6)	0.79 (± 0.8)	20.89 (± 0.9)	45.07 (± 9.4)	23.27 (± 1.4)	46.29 (± 0.4)	8.36 (± 0.3)	3.75 (± 0.1)
5	RBA	none	air	6.94 (± 3.4)	77.27 (± 0.7)	15.79 (± 4.1)	0.19 (± 0.2)	5.73 (± 0.5)	40.57 (± 0.5)	1.46 (± 0.4)	-0.51 (± 0.3)
6	RBA + Peptone	none	air	1.02 (± 0.1)	77.97 (± 0.1)	21.01 (± 0.1)	2.25 (± 0.4)	13.90 (± 1.1)	42.21 (± 0.9)	3.57 (± 0.8)	3.73 (± 0.3)
7	RBA	<i>F.</i> <i>sylvatica</i>	air	6.25 (± 0.7)	78.55 (± 0.1)	15.20 (± 0.6)	2.59 (± 0.4)	4.60 (± 0.2)	39.91 (± 0.7)	0.56 (± 0.4)	-2.91 (± 0.7)
8	RBA + Peptone	<i>F.</i> <i>sylvatica</i>	air	1.01 (± 0.1)	77.13 (± 0.1)	21.87 (± 0.1)	9.32 (± 2.4)	14.53 (± 3.7)	45.33 (± 1.8)	5.28 (± 1.4)	3.02 (± 0.4)

In experiments of a second experimental plan, *T. versicolor* was investigated at different N sources (peptone (x_1), wood of *F. sylvatica* (x_2), N_2 in air (x_3); Tab. 13). The presence of peptone (nos. 2, 4, 6 and 8) enhanced the formation of fungal biomass significantly, but sapwood (nos. 3, 4, 7 and 8) increased the biomass only to a low extent. The fungal laccase activity was activated by wood (Tab. 13, nos. 3, 4, 7 and 8) and increased threefold on sapwood plus peptone (Tab. 13, nos. 4, 8) indicating a synergistic effect. Interestingly, this effect was not as intensive under air as under the O_2/Ar atmosphere.

CO_2 formation and O_2 consumption also increased on sapwood (x_2) and peptone (x_1), and CO_2 formation was highest in the presence of air. The N_2 concentration did not change during incubation. In experiments under O_2/Ar atmosphere, a residual N concentration of a maximum of 1.4 vol.-% N_2 was measured, while zero vol.-% was expected. In experiments under air, the expected N_2 concentration corresponded to the N_2 concentration in air. However, the measured values differ from the N_2 concentration of 78.8 vol.-% (DIN ISO 2533), because the results of the CO_2 and O_2 as well as N_2 measurement were combined (as described in section 2.9.).

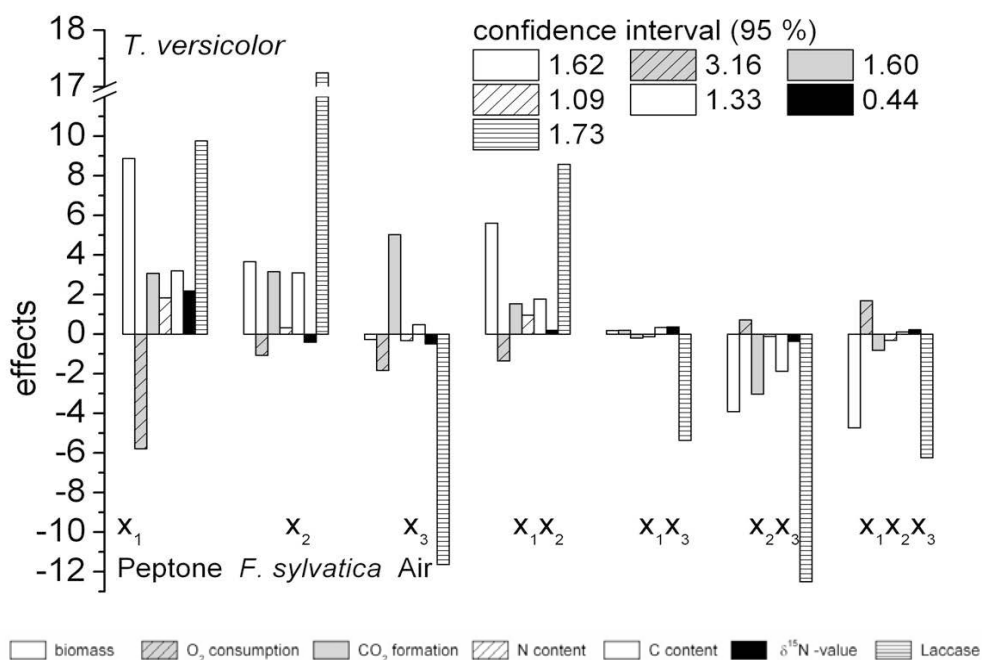

Fig. 13: Effects of the factors (peptone (x_1), wood of *F. sylvatica* (x_2), N_2 in air (x_3)) and their linear combination (x_1x_2 , x_1x_3 , x_2x_3 and $x_1x_2x_3$) on the indicators of fungal activity of *T. versicolor*. Effects on seven indicators are outlined as bars in different designs. The confidence intervals of the indicators of fungal activity were determined according to the 95% criterion and are given in the legend.

If wood (Tab. 13, nos. 3, 4, 7 and 8) and peptone (nos. 2, 4, 6 and 8) were added, the C and N contents in fungal biomass increased, and the $\delta^{15}\text{N}$ values indicated the uptake of peptone. N contents in the fungal biomass remained low if peptone was not added (Tab. 13).

The results summarised in Tab. 13 were used to calculate the effects of the factors on the indicators of fungal activity (Fig. 13). The biomass of *T. versicolor* was significantly affected by peptone (x_1), *F. sylvatica* (x_2) and the combination of both (x_1x_2). Consequently, wood amendment as well as peptone amendment increased the growth of this fungus, and in particular, if both factors occur at the same time, the growth of *T. versicolor* is pronounced. In contrast to *O. placenta* (Fig. 12), the effect of wood on biomass formation of *T. versicolor* (Fig. 13) is significant. However, if wood is combined with N_2 in the gas phase (x_2x_3 and $x_1x_2x_3$), the biomass is rather reduced.

If the effect on the laccase activity was measured, it was found that peptone (x_1) and wood of *F. sylvatica* (x_2) significantly enhanced that particular enzyme activity. In addition, the combination of peptone and wood (x_1x_2) resulted in high laccase activity. Interestingly, the presence of air N_2 (x_3) reduced this activity. The reduction of activity was also found for combinatory effects including air N_2 (x_1x_3 , x_2x_3 and $x_1x_2x_3$). Since the enzyme test itself was done under air, this result shows that the presence of N_2 reduces the production of the laccase enzyme. The inhibitory effects of N_2 on biomass and laccase activity are remarkable, since they were not described before.

If the O_2 consumption and CO_2 formation were examined, peptone significantly affected the O_2 consumption. The CO_2 formation was increased by all factors (x_1 peptone, x_2 *F. sylvatica*, x_3 air N_2), but not by the factor combinations (x_1x_2 , x_1x_3 , x_2x_3 and $x_1x_2x_3$). The elemental composition of the fungal biomass was affected only to a low extent by the factors and factor combinations. The C content increased after amendment of peptone (x_1) as well as wood (x_2). Peptone (x_1) affected the N content in *T. versicolor* and increased the $\delta^{15}\text{N}$ value. Thus, N was assimilated not only from peptone but also from wood.

Consequently, the results of the full-factorial experimental plans indicated that peptone amendment (x_1) increased the activity of *O. placenta* and *T. versicolor*, and that wood amendment (x_2) increased the laccase activity of *T. versicolor*. The effects of N_2 in air (x_3) and wood (x_2) on the biomass formation and their factor combinations were not significant or of minor intensity. The effect of N_2 of the activity of *T. versicolor* was rather inhibitory. The N content and the $\delta^{15}\text{N}$ values in the biomass of *T. versicolor* and *O. placenta* increased if peptone was amended to the cultivation medium. It can be concluded that in RBA and in RBA amended with wood the limitation in N limits fungal activity. The limitation is more pronounced if wood of *P. sylvestris* is applied, while wood of *F. sylvatica* seems to contain a higher initial N content. Peptone bridges the N-limitation, which prevails in both cases.

3.9. Co-cultivation of *O. placenta* and *T. versicolor* with the diazotroph *B. acida*

In a third and in a fourth experimental plan, the activities of *O. placenta* and *T. versicolor* were investigated in combination with *B. acida* (*B. acida* (x_1), *P. sylvestris* or *F. sylvatica* (x_2) and N_2 in air (x_3)). In contrast to the previous experiments (section 3.8.), the experiments did not include peptone but inoculums of the diazotrophic bacterium *B. acida*, and antibiotics were omitted. Apart from these differences, the experimental setup and incubation time were similar. Therefore, the results of the experiments are comparable with each other and to those of the experimental plans in section 3.8. After incubation, the same indicators of fungal activity were investigated as in 3.8.

In the experiments of the third experimental plan, *O. placenta* was analysed (Tab. 14). Fungal biomass increased in the presence of *B. acida* (nos. 2, 4, 6 and 8) or wood (nos. 3, 4, 7 and 8), and if both factors were combined (nos. 4 and 8). The biomass of *B. acida* increased under air compared to an O_2/Ar atmosphere (Tab. 3). However, this was only partly mirrored in the experiments of the experimental plan (Tab. 14).

If CO_2 and O_2/Ar were analysed, the CO_2 and O_2/Ar concentration was a result of fungal and bacterial respiration. Therefore, the results do not only reflect the fungal activity, which was analysed in 3.8. In experiments including *B. acida*, higher CO_2 concentrations were measured than in experiments without the bacterium, indicating additional bacterial activity. Wood amendment further increased the CO_2 concentration under O_2/Ar atmosphere. In absence of *B. acida*, the formation of CO_2 was similar in both atmospheres. The O_2/Ar content decreased according to the CO_2 increase, although the different Ar concentrations had to be considered. So, the O_2/Ar concentration decreased towards 79.77 vol.-% in O_2/Ar atmosphere, which is the Ar concentration of the applied gas mixture. In experiments under air, the O_2 plus Ar concentration declined and towards 0.93 vol.-% which is the Ar content in air (DIN ISO 2533). The N_2 concentration in the air atmosphere was affected. However, the strong deviation from the value of N_2 in air in literature (78.8 vol.-% N, DIN ISO 2533) suggests that the combination of the results from two measurements is not suitable to determine the exact composition in the atmospheres. The differences in N_2 concentrations result from bacterial N_2 consumption as well as from the treatment of the measured values. In addition, the different starting concentrations on N_2 have to be considered. In the experiments 1 to 4, an N_2 concentration of zero vol.-% was expected and in the experiments 5 to 8 a constant concentration of 78.8 vol.-%.

Results

Tab. 14: Investigation of the N sources (*B. acida* (x_1), wood of *P. sylvestris* (x_2), N_2 in air (x_3)) of *O. placenta* in coexistence with *B. acida* in a 2^3 experimental plan. The indicators of fungal activity were determined after 14 d of cultivation ($n = 3$, mean values \pm SD).

no.	medium x_1	wood x_2	gas x_3	O_2/Ar	N_2	CO_2	micro- organism	biomass in mg (20 mL) ⁻¹	C in %	N in %	$\delta^{15}N$ in ‰
				in vol.-%	in vol.-%	in vol.-%					
1	RBA	none	O_2 /Ar	94.35 (\pm 4.3)	3.31 (\pm 4.2)	2.34 (\pm 0.1)	<i>O. placenta</i>	6.97 (\pm 0.5)	34.82 (\pm 0.3)	1.92 (\pm 0.1)	2.27 (\pm 0.1)
2	RBA + <i>B. acida</i>	none	O_2 /Ar	91.69 (\pm 1.6)	1.63 (\pm 0.1)	6.68 (\pm 0.3)	<i>O. placenta</i> <i>B. acida</i>	14.63 (\pm 1.2) 7.10 (\pm 3.2)	31.76 (\pm 0.3) 29.58 ¹⁾	1.14 (\pm 0.1) 0.20 ¹⁾	0.72 (\pm 0.6) nm
3	RBA	<i>P. sylvestris</i>	O_2 /Ar	92.87 (\pm 0.8)	1.52 (\pm 0.8)	5.62 (\pm 0.9)	<i>O. placenta</i>	14.50 (\pm 2.5)	32.63 (\pm 0.9)	0.90 (\pm 0.4)	2.58 (\pm 1.2)
4	RBA + <i>B. acida</i>	<i>P. sylvestris</i>	O_2 /Ar	89.31 (\pm 0.5)	0.63 (\pm 0.2)	10.06 (\pm 0.4)	<i>O. placenta</i> <i>B. acida</i>	10.20 (\pm 2.7) 4.53 (\pm 1.5)	33.86 (\pm 0.2) 29.75 ¹⁾	1.32 (\pm 0.5) 0.69 ¹⁾	1.31 (\pm 0.7) 1.61 ¹⁾
5	RBA	none	air	15.61 (\pm 0.1)	82.84 (\pm 0.3)	1.55 (\pm 0.2)	<i>O. placenta</i>	4.04 (\pm 1.0)	34.19 (\pm 1.8)	2.0 (\pm 0.6)	1.77 (\pm 0.8)
6	RBA + <i>B. acida</i>	none	air	10.74 (\pm 0.5)	77.28 (\pm 0.4)	11.98 (\pm 0.7)	<i>O. placenta</i> <i>B. acida</i>	5.93 (\pm 1.3) 2.97 (\pm 0.2)	33.25 (\pm 0.1) 43.64 ¹⁾	0.55 (\pm 0.4) 8.49 ¹⁾	1.10 (\pm 0.1) -0.04 ¹⁾
7	RBA	<i>P. sylvestris</i>	air	4.80 (\pm 1.0)	89.75 (\pm 1.6)	5.45 (\pm 1.4)	<i>O. placenta</i>	5.27 (\pm 0.9)	36.63 (\pm 0.7)	1.09 (\pm 0.3)	0.53 (\pm 2.4)
8	RBA + <i>B. acida</i>	<i>P. sylvestris</i>	air	2.43 (\pm 0.9)	79.45 (\pm 1.4)	18.12 (\pm 0.5)	<i>O. placenta</i> <i>B. acida</i>	6.37 (\pm 1.9) 7.53 (\pm 1.0)	33.75 (\pm 1.0) 32.56 ¹⁾	0.76 (\pm 0.4) 2.06 ¹⁾	4.25 (\pm 2.4) 7.49 ¹⁾

¹⁾The biomass of three cultivations was collected for a single measurement. nm = not measurable

In addition, the elemental composition of fungal and bacterial biomass was determined. The C contents of fungal biomass were similar in all experiments of the experimental plan (Tab. 14). The bacterial biomass usually had lower C content than the fungal biomass. The N contents as well as the $\delta^{15}N$ value in fungal biomass indicated that bacterial N_2 fixation and N transfer into fungal biomass occurred to a limited amount. If *O. placenta* and *B. acida* were co-cultivated, the fungal N content rather decreased. The biomass of *B. acida* had a lower N content in the O_2/Ar atmosphere than under air (Tab. 14), indicating that atmospheric N_2 supported the growth of the diazotroph. The $\delta^{15}N$ values just differed to a low extent. Generally, $\delta^{15}N$ values of 0‰ are expected if N_2 from air was used as the N source, since the natural $\delta^{15}N$ value of air is defined as 0‰ (De Laeter *et al.* 2003).

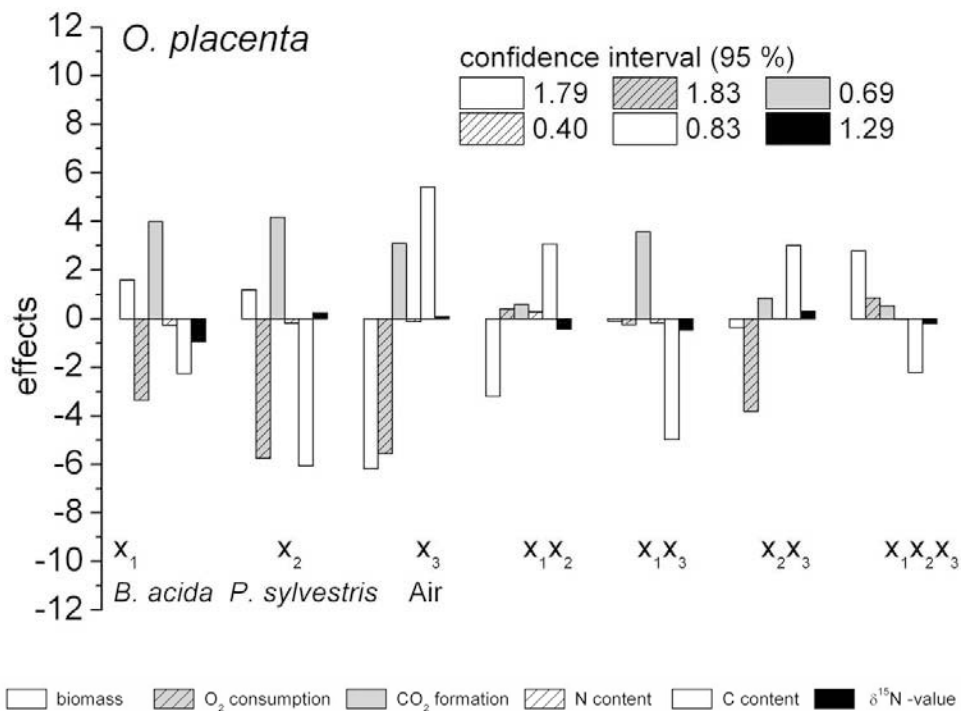

Fig. 14: Effects in % of the factors (*B. acidia* (x_1), wood of *P. sylvestris* (x_2), N₂ in air (x_3)) and their linear combination (x_1x_2 , x_1x_3 , x_2x_3 and $x_1x_2x_3$) on the indicators of fungal activity of *O. placenta*. Effects on six indicators are outlined as bars in different designs. The confidence intervals of the indicators of fungal activity were determined according to the 95% criterion and are given in the legend.

The results in Tab. 14 were used to calculate the effects of the factors on the indicators of activity of *O. placenta* (Fig. 14). *B. acidia* (x_1) and wood (x_2) did not have a significant effect on biomass production. In contrast, N₂ in air (x_3) had a significant effect and reduced the biomass formation. The latter effect may be explained with the competition between *B. acidia* and *O. placenta*. If N₂ was available in the experiment, the growth of the N₂-fixing *B. acidia* is intensified. Since also additional N sources, i.e., N traces, are used, fungal-bacterial competition occurs.

O₂ consumption and CO₂ formation significantly increased in the presence of *B. acidia* (x_1), *P. sylvestris* (x_2) and air (x_3). All three factors lead to high respiration coefficients, which include fungal and bacterial activity. In contrast to the experiments without *B. acidia* (Fig. 12), the results of experiments including the bacterium (Fig. 14) are the sum of fungal and bacterial respiration. However, the summarised respiration increased at the amendment of the N sources, indicating that the source was metabolised.

Results

The effects on elemental composition of the fungal biomass were also investigated. The N content and $\delta^{15}\text{N}$ values of the biomass were not affected by any factor or factor combination. Thus, N transfer did not occur. Nevertheless, the fungal C content was minored if *B. acida* (x_1) or *P. sylvestris* (x_2) was added, which may hint to fungal-bacterial competition. The fungal C content increased in the presence of air compared to O_2/Ar .

Tab. 15: Investigation of the N sources (*B. acida* (x_1), wood of *F. sylvatica* (x_2), N_2 in air (x_3)) of *T. versicolor* in coexistence with *B. acida* in experiments of a 2^3 experimental plan. The indicators of fungal activity were determined after 14 d of cultivation ($n = 3$, mean values \pm SD).

no	medium x_1	wood x_2	gas x_3	O_2/Ar in vol.- %	N_2 in vol.- %	CO_2 in vol.- %	laccase in U L^{-1}	micro- organism	biomass in mg (20 mL)^{-1}	C in %	N in %	$\delta^{15}\text{N}$ in ‰
1	RBA	none	O_2 /Ar	87.54 (± 0.7)	0.40 (± 0.1)	12.03 (± 0.7)	4.67 (± 0.2)	<i>T. versicolor</i>	6.87 (± 0.6)	37.51 (± 0.5)	2.51 (± 0.4)	1.08 (± 0.9)
2	RBA + <i>B. acida</i>	none	O_2 /Ar	86.78 (± 2.5)	0.26 (± 0.1)	12.96 (± 2.4)	3.51 (± 0.5)	<i>T. versicolor</i> <i>B. acida</i>	12.03 (± 5.1) 2.87 ¹⁾ (± 1.8)	34.93 (± 2.3) 29.3 ¹⁾ (± 1.8)	1.68 (± 0.5) 0.7 ¹⁾	1.02 (± 0.6) nm
3	RBA	<i>F. sylvatica</i>	O_2 /Ar	83.34 (± 1.4)	0.26 (± 0.1)	16.41 (± 1.3)	27.67 (± 3.9)	<i>T. versicolor</i>	16.93 (± 2.0)	32.16 (± 0.3)	0.70 (± 0.1)	1.83 (± 0.4)
4	RBA + <i>B. acida</i>	<i>F. sylvatica</i>	O_2 /Ar	80.62 (± 0.6)	0.24 (± 0.1)	19.14 (± 0.5)	32.36 (± 6.7)	<i>T. versicolor</i> <i>B. acida</i>	13.70 (± 1.8) 7.97 (± 4.8)	31.15 (± 0.8) 28.9 (± 1.3)	0.95 (± 0.1) 0.64 (± 0.2)	0.45 (± 0.1) 3.8 (± 2.3)
5	RBA	none	air	12.37 (± 0.5)	78.39 (± 0.3)	9.24 (± 0.7)	0.08 (± 0.1)	<i>T. versicolor</i>	4.53 (± 1.1)	42.71 (± 1.0)	2.09 (± 0.4)	1.60 (± 1.0)
6	RBA + <i>B. acida</i>	none	air	11.76 (± 0.2)	76.71 (± 0.4)	11.54 (± 0.7)	0.67 (± 0.1)	<i>T. versicolor</i> <i>B. acida</i>	3.77 (± 0.8) 1.70 (± 1.3)	34.59 (± 0.6) 42.7 ¹⁾ (± 1.3)	0.75 (± 0.1) 7.42 ¹⁾	nm -0.8 ¹⁾
7	RBA	<i>F. sylvatica</i>	air	7.79 (± 0.3)	77.88 (± 0.1)	14.33 (± 0.3)	4.80 (± 0.6)	<i>T. versicolor</i>	4.2 (± 0.4)	38.79 (± 0.6)	1.03 (± 0.1)	3.94 (± 0.8)
8	RBA + <i>B. acida</i>	<i>F. sylvatica</i>	air	2.08 (± 1.3)	77.49 (± 0.6)	20.43 (± 1.8)	17.75 (± 1.2)	<i>T. versicolor</i> <i>B. acida</i>	16.57 (± 2.0) 4.27 (± 3.2)	32.41 (± 2.8) 30.01 ¹⁾	1.05 (± 0.3) 0.87 ¹⁾	-0.12 (± 0.1) nm

¹⁾ The biomass of three cultivations was collected for a single measurement. nm = not measurable

In the fourth experimental plan, *T. versicolor* was investigated in combination with *B. acida* (*B. acida* (x_1), wood of *F. sylvatica* (x_2), N_2 in air (x_3)). The experiments revealed that biomass of *T. versicolor* increased in the presence of wood (Tab. 15, nos. 3, 4, 7 and 8) or *B. acida* (Tab. 15, nos. 2, 4, 6 and 8). The laccase activity increased after addition of wood (nos. 3, 4, 7 and 8), while the presence of *B. acida* (nos. 2, 4, 6 and 8) did rather not affected the

enzyme activity. Under air, lower activities were found compared to an O₂/Ar atmosphere. The formation of CO₂ increased in the presence of *B. acidia* (x₁) and was more pronounced after addition of *P. sylvestris* (x₂). In the presence of both factors (x₁x₂), the formation of CO₂ was highest. The O₂/Ar concentration decreased according to the CO₂ increase, and the N₂ concentrations fitted well to the expectations regarding the applied gas and the literature values of the standard atmosphere (DIN ISO 2533).

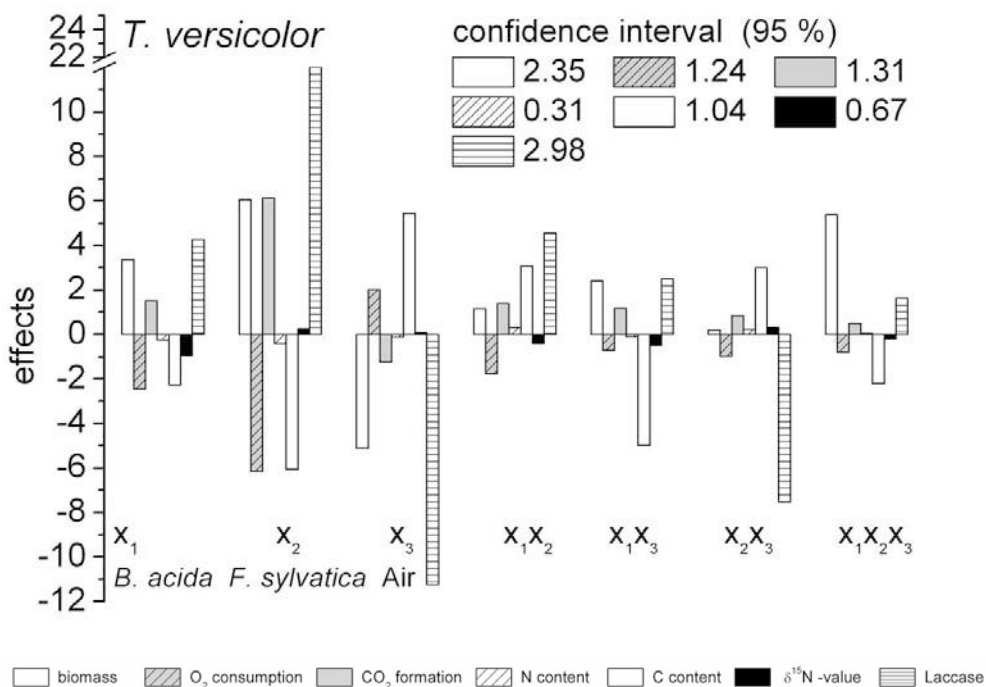

Fig. 15: Effects in % of the factors (*B. acidia* (x₁), wood of *F. sylvatica* (x₂), N₂ in air (x₃)) and their linear combination (x₁x₂, x₁x₃, x₂x₃ and x₁x₂x₃) on the indicators of fungal activity of *T. versicolor*. Effects on seven indicators are outlined as bars in different designs. The confidence intervals of the indicators of fungal activity were determined according to the 95% criterion and are given in the legend.

The C content of fungal biomass was similar after all incubations and only marginally lower in the presence of *B. acidia*. The C content in the bacterial biomass was lower than in the fungal biomass. The fungal N content decreased if *B. acidia* was present, and if wood was amended, the fungal N content was at a similarly low level with and without *B. acidia* (Tab. 15). Interestingly, the N content of fungal biomass in co-cultivations was higher under air compared to an O₂/Ar atmosphere. The δ¹⁵N values of fungal biomass underlined this finding and decreased in the presence of *B. acidia* to values of atmospheric N₂, i.e., 0‰. The

$\delta^{15}\text{N}$ values in the biomass of *B. acida* were not measurable due to the low biomass formation and the low N content in the biomass. Occasionally, the measured values were below the detection limit of the IRMS instrument (Tab. 15, no. 2, 6 and 8).

The measured values (Tab. 15) were used to calculate the effects on the indicators of fungal activity (Fig. 15). The biomass of *T. versicolor* increased if wood was added (x_2) and decreased under air containing N_2 (x_3). If all factors were combined ($x_1x_2x_3$), the fungal biomass increased. This increase in fungal biomass was not found for *O. placenta*. Therefore, the positive effect of diazotrophs on fungal growth is more probable for the white-rot fungus *T. versicolor* than for the brown-rot fungus *O. placenta*. The laccase activity increased significantly if wood (x_2) was added and decreased if the atmosphere contained N_2 (x_3). Wood (x_2) induced the enzyme formation, but N_2 (x_3) reduced it. The latter effect of N_2 was also found in the results in section 3.8. (see Tab. 13 and Fig. 13), and it is regarded as a physiological effect rather than an artefact of this particular experimental setup. In combination of wood and N_2 (x_2x_3), the enzyme activity was rather reduced. The presence of *B. acida* increased the laccase activity significantly but to a low extent (x_1 , x_1x_2 and x_1x_3).

In addition, the effects of the CO_2 formation and O_2 consumption were determined. O_2 consumption and CO_2 formation increased if *F. sylvatica* was added (x_2), which indicates that *T. versicolor* used wood as a nutrient source. The other factors (x_1 and x_3) as well as the factor combinations (x_1x_2 , x_1x_3 , x_2x_3 and $x_1x_2x_3$) marginally effected CO_2 formation and O_2 consumption. The elemental composition showed that the N content and $\delta^{15}\text{N}$ value were not affected by any factor or factor combination. Interestingly, the C content was decreased by wood (x_2), increased by air N_2 (x_3) and decreased by the combination of *B. acida* and air (x_1x_3). A reduction of the C content can be regarded as a consequence of limited nutrient conditions including N limitation.

In the experiments of the experimental plans including *B. acida*, the effects of the N sources on the indicators of fungal activity were low. *B. acida*, wood and N_2 in air affected the indicators of fungal activity less than organic N sources like peptone, which was investigated before (see section 3.8.). The bacterial biomass increased in the presence of air, whereas the diazotroph was suppressed if an O_2/Ar atmosphere replaced air. Therefore, the presence of air had a rather negative effect on fungal biomass, whereas the presence of the bacterium was not determining. Under air, *O. placenta* and *B. acida* competed for the same N sources in wood and RBA medium, whereas *T. versicolor* and *B. acida* partly shared the N_2 fixed by *B. acida*. The positive effect of the addition of *B. acida* on the biomass of *T. versicolor* was low but significant.

4. Discussion

4.1. Ecology of wood decomposition

Sapwood and timber are ecosystems with a lower nutrient availability than plant litter on forest grounds (Schmidt 2006), and therefore, decomposition proceeds in different intensities and at different rates. If wood is in contact with soil or plant litter, a higher abundance and diversity of microorganisms is expected, and wood is decomposed faster than wood without any contact except exposition to air (Schmidt 2006). In addition, soil and litter can provide N, and the individual types of soil affect microbial decomposition rates. For example, decomposition usually proceeds faster in N-rich arable soils than in podzolic soils (van der Wal *et al.* 2007). Limitations of organic N predominantly occur on sapwood without any contact except to air. If N₂ is the only N source, diazotrophic activity could provide fixed N, which is a prerequisite for the development of saprotrophic fungi. So far, rather little is known about the importance of diazotrophs on wood without soil contact. In addition, it is not known if pure sapwood provides the nutrient and cofactors for diazotrophic activity and if diazotrophs can exist in the environment of fungi.

If diazotrophs immediately intensified decomposition, the inhibition of this interaction would be a target for new wood preservatives and possibilities for protection. To estimate the impact of diazotrophic bacteria on wood-decomposing basidiomycetes, the fungal-bacterial interaction was investigated by quantitative, instrumental means. The focus was on *in vitro* studies on material spoilage organisms from strain collections (Weißhaupt *et al.* 2011, 2012), which are of economic interest and applied for material-testing procedures (Schmidt 2006). Moreover, a fungal-bacterial community which occurs in natural forest ecosystems was investigated. The experimental results were compared with findings from environmental studies published earlier and allowed to estimate the impact of cooperative decomposition.

4.2. Sapwood decomposition and elemental composition of microbial biomass and media

The brown-rot fungus *O. placenta* and the white-rot fungus *T. versicolor* were cultivated on 5%-malt-extract medium amended with wood specimens. After cultivation of *O. placenta* on specimens of *P. sylvestris*, the wood structure corresponded to brown and cubic rot, because cellulose was decomposed and other wood components remained. If wood of *F. sylvatica* was incubated with *T. versicolor*, white rot of the wood was visible. Decomposition by *H. fasciculare* also caused white rot, but the decomposition did not proceed as fast as with *T. versicolor*. Since oxidative decomposition targets the lignin structure, cellulose fibres disintegrate, become visible, and the volume of the wood block increases. The appearance

of decomposition by the same basidiomycetes differs if the incubation time changes or if additional nutrient sources are provided. The intensity of decomposition may change and may be accompanied with fungal fruiting-bodies in the late stage of decomposition.

In further experiments, five basidiomycetes were cultivated on malt-extract medium, prior to IRMS analysis. In the biomass of the basidiomycetes, the C and N contents as well as $\delta^{15}\text{N}$ and $\delta^{13}\text{C}$ values were similar to each other. Thus, the basidiomycetes were supposed to have a similar demand in N and to cause negligible N isotope fractionation during growth in *in vitro* cultivations. The $\delta^{15}\text{N}$ value of the substrates determined the $\delta^{15}\text{N}$ value in the fungal biomass. Nevertheless, growth dynamics differed, and the fast-growing fungi *O. placenta* and *T. versicolor* were employed in further experiments. In further experiments on RBA, the biomass had a lower N content than in these pre-experiments. Therefore, in all further tested media, i.e., RBA and RBA amended with urea, NH_4Cl , NaNO_3 or peptone, the N supply was worse than in the complex medium.

Since the medium composition affects the composition of laboratory-grown microbial biomass, the analysis of the media compounds is a prerequisite for further investigations by elemental analysis and IRMS (Weißhaupt *et al.* 2011). Several frequently used media and medium components were analysed for their elemental compositions and $\delta^{15}\text{N}$ values. The same production lots of the analysed substances were applied in this study. The elemental composition of each of the substances can further differ according to production lots and manufacturer. Since most of the components are products of plants or animals, their composition and δ values differ according to cultivation or breeding conditions. Differences in N contents and $\delta^{15}\text{N}$ values beyond the given standard deviations (Tab. 3) are possible. If the N content of a medium preparation is analysed, it is recommended to analyse the individual components instead of the suspensions. Drying of suspended media for elemental analysis was also disadvantageous. The lyophilised material was hygroscopic, and the water content affected the measurement. In addition, N traces in RBA were below the detection limit if they were mixed with the other medium compounds and subsequently dried. If the medium components were measured separately, the N contents in the single compounds were measurable, and the N concentration was calculable. In yeast extract and agar, N was measured as well. Both substances provide N traces in prepared media.

With regard to the N sources in the natural environment of saprotrophic fungi, examples of prevalent matrices were analysed. The N content in aqueous extracts of soil, bark and sawdust showed that these matrices are not completely N-free. The highest N concentrations were found in soil extract, which is a frequently used N source for saprotrophic fungi in nature. The N content in bark extract underlined that plant litter is another N source in the environment of sapwood, although sapwood itself comprises only traces of N. It is denied that the initial N content in sapwood provides enough N for fungal development. The result

further showed that the N-containing substances, such as functional enzymes of a tree, are rather in the bark than in the sapwood.

4.3. Nitrogen uptake of saprotrophic basidiomycetes

The uptake of different N sources by *T. versicolor*, *O. placenta* and *H. fasciculare* was analysed by elemental analysis and IRMS (Weißhaupt *et al.* 2011). In parallel cultivations, the fungi were exposed to different N species and after cultivation, the biomass was harvested, dried and weighed. Elemental analysis by means of an elemental analyser was preferred to the Kjeldahl method (e.g., DIN EN ISO 3188), because it allows low sample sizes of 1.5 to 10 mg to be analysed, and because it is directly combined to IRMS. The biomass measurements revealed that all tested fungi showed a strong preference to organic N species, and N traces at an amount of 0.005 g L^{-1} N were mandatory for any fungal growth. The biomass formation in laboratory experiments and the elemental composition further proved the uptake of urea and NH_4Cl by *T. versicolor* and *H. fasciculare*. *O. placenta* did not assimilate the added N sources. Preferences for particular N sources were partly explained by the size and molecular weight of the N substrates, e.g., NH_4^+ is smaller than NO_3^- and could more easily pass the cell membrane. Besides, several basidiomycetes contain ammonia transporter proteins (Lucic *et al.* 2008), but the described organisms did not include the fungi tested in this study. The presence of such transporter proteins could explain the uptake of ammonia by *T. versicolor* and *H. fasciculare* in contrast to *O. placenta*. The uptake of amino acids and their transport along the mycelium of saprotrophic fungi was described as well (Lindahl and Olsson 2004, Tlalka *et al.* 2002, Emmerton *et al.* 2001a). In early studies, the differences in N utilisation among fungi were even used to categorise ascomycetes (Robbins 1937, cited in Lilly and Barnett 1951). Organic N was consumed by the majority of fungi, whereas NH_4^+ and NO_3^- were used with decreasing frequency. The high affinity to organic N and reduced N of NH_4Cl and urea of the tested basidiomycetes corresponded to these results. The uptake of traces of organic N was supported by the surface-optimised growth in a mycelium of thin hyphae. With this mycelium, fungi cover the substrate without producing much biomass and collect N traces from a wide surface. As a result of simultaneous transformation of organic C to CO_2 , decomposing fungi create an N-enriched environment in the late stage of decomposition *in situ* (Watkinson *et al.* 2009). The $\delta^{15}\text{N}$ values in fungal biomass usually mirrored the $\delta^{15}\text{N}$ values of substrates. However, in the experiments of this study, the $\delta^{15}\text{N}$ values could not prove the uptake of an N source, since N traces with different $\delta^{15}\text{N}$ values may dilute the isotope ratio. This is indeed a phenomenon that occurs in fungal biomass with a low N content. In addition, $\delta^{15}\text{N}$ values differed according to incubation time. Generally, it is recommended to use the biomass of the

late phase of the logarithmic part of the growth curve for isotope studies. The cultivation volume of 50 mL medium was appropriate. At smaller volumes, the problem of isotope dilution by N traces and variable $\delta^{15}\text{N}$ values could increase. Fractionation was supposed to be negligible during cultivations of a maximum of 70 d. Previous studies on fractionation suggested that more detailed experiments with variable cultivation times and N concentrations have to be applied to distinguish strain specific isotope fractionation from interference of different N sources.

The mycelia of saprotrophic basidiomycetes have been previously investigated by IRMS. In these studies, the N contents amounted to 1 to 6% (Taylor 1997) with a comparatively high variation between fungal origin and species. The biomass produced in the present study had a similar N content including variations according to nutrient conditions. The comparison with the natural samples showed that the N concentrations in the *in vitro* experiments were similar to those in nature. Therefore, the tested N concentrations in the substrate were appropriate and the results were meaningful. In several studies on N isotopes in biomass, e.g., some of those mentioned in section 1.4. and 1.5., the N content in the biomass neglected and just the $\delta^{15}\text{N}$ values were discussed. This is explained with the high uncertainty in the measurements of the N content. Firstly, the natural N content in the same species of fungi or bacteria can differ according to nutrient conditions. This was also found in experiments on N-containing and N-limited medium (Weißhaupt *et al.* 2012). Secondly, the water content in the samples may differ significantly, and different drying procedures may also affect the residual water contents. In the experiments of the present study, the cultivation and drying procedure followed the same method. So, the results are comparable with each other, but in other studies and under other flaking conditions different N contents may be measured. If only the $\delta^{15}\text{N}$ values are considered, the ratio of ^{15}N and ^{14}N is focused irrespective of the absolute N concentration. This information is sufficient to trace N transfer (Hobbie and Hobbie 2008), but if the increase of biomass formation as a consequence of N addition is focused, the absolute N content includes additional information. However, exact mass balance studies require defined experimental conditions and therefore, laboratory studies are regarded as appropriate tool to investigate fungal responses on N amendment. The $\delta^{15}\text{N}$ values of fungal mycelia usually varied between -10 to 10‰ (Hobbie and Hobbie 2006, Högberg 1999, Gebauer and Taylor 1999 etc.). The natural $\delta^{15}\text{N}$ values in all types of natural matter are between -20 to 20‰ , and air N_2 has a $\delta^{15}\text{N}$ value of 0‰ (Hoefs 2009). In most studies, the $\delta^{15}\text{N}$ values of fungal mycelia were compared with the $\delta^{15}\text{N}$ values of soil and plants of the same ecosystem or between different compartments of the fungi, such as fruit bodies vs. mycelium (Zeller *et al.* 2007) or protein vs. chitin (Taylor *et al.* 1997). Comparisons between different ecosystems are rare and the results are not comparable. Unlike $\delta^{13}\text{C}$ values, $\delta^{15}\text{N}$

values differ on a small scale, and differences of biomass from different ecosystems are not always significant (Hoefs 2009).

4.4. Nitrogen uptake of diazotrophs

The diazotrophic activity of *A. croococcum*, *B. acida* and *N. nitrogenifigens* was quantified by ^{15}N measurements in bacterial biomass, which was cultivated under a $^{15}\text{N}_2/\text{O}_2$ atmosphere (Weißhaupt *et al.* 2011). The ^{15}N abundance of 1 to 13% of the N content in biomass proved the fixation of atmospheric N_2 . Nevertheless, the result implied that most of the N in biomass was not assimilated by N_2 fixation, but by the uptake of N sources from the medium. Further N sources were presumably provided by the media ingredients, impurities or by the inoculum. The main sources for N contaminations were supposed to be agar in all media, yeast extract in RBA medium and CaCO_3 in Azotobacter medium. Agar must be considered as a source, since it is added in high amount to the medium. In CaCO_3 , the N traces were below the detection limit of the EA. However, this compound was added in a high concentration of 5 g L^{-1} to the medium and was presumably a source of N traces.

A prerequisite for N_2 fixation and N_2 reduction by free-living diazotrophs is the ability to provide ATP for the nitrogenase reaction (Burgess and Lowe 1996). If the full demand in N was provided by N_2 fixation, ATP regeneration implied a high carbon, e.g., a high glucose consumption. This dependence on ATP may explain why the full bacterial demand in N is usually not provided by diazotrophic activity. Atmospheric N_2 is usually only an additional N source for diazotrophs. In parallel experiments, different species of diazotrophs exhibited different $^{15}\text{N}_2$ fixation rates. The $^{15}\text{N}_2$ -fixation rates were higher in biomass of *A. croococcum* than in biomass of *B. acida*, but the latter bacterium developed a kind of mucilage, which optimised spatial growth. This surface-optimised growth supported the nutrient uptake and transport into bacterial cells. Presumably, N traces were used more efficiently, and the ATP-demanding N_2 fixation was not as intensive as found in *A. croococcum*. The spatial growth on mucilage is regarded as a possibility to deal with limited N availability and is an alternative to the uptake via the mycelium of fungi. Just the kind of mass transport differs: In fungal mycelium, transport is driven by the turgor in the fungal mycelium (Lindahl and Olsson 2004, Tlalka *et al.* 2002), whereas nutrient diffusion prevails in mucilage. In biomass of *N. nitrogenifigens*, the $^{15}\text{N}_2$ uptake was significant, but amounted to less than 1.5% if it was cultivated on RBA medium under $^{15}\text{N}_2/\text{O}_2$ atmosphere. Although the presence of *nifH* genes was described (Addison *et al.* 2007), diazotrophic activity is of minor relevance for N fixation of this particular bacterium. This bacterium further reduced biomass production at N-limited environments, and if *N. nitrogenifigens* was cultivated on N-containing nutrient medium, diazotrophic activity was suppressed to 0.39%.

Proteobacteria coexisting with *H. fasciculare* were also tested for their N₂ fixation rates. In all incubations under ¹⁵N₂/O₂, the δ¹⁵N values increased significantly but to a low extent. The ¹⁵N abundances were lower than 0.39%, while the natural average ¹⁵N abundance is 0.364% (De Laeter *et al.* 2003). The increase in ¹⁵N abundance in the tested proteobacteria cultivated under ¹⁵N₂/O₂ compared to the same bacteria cultivated under air was explained by adsorption phenomena. Low amounts of N₂ were fixed in the bacterial matrix, which is supposed to provide enough electron negativity for N₂ capture. However, the reduction of N₂, which is catalysed by nitrogenase reaction, did not occur. This artefact was reproducible and resulted in a significant difference if biomass was cultivated at ¹⁵N₂/O₂ compared to air, but it was not referred to diazotrophic activity.

At low N₂-fixation rates, nitrogenase activity cannot be distinguished from adsorption of N₂. Therefore, the method of ¹⁵N₂ tracing is suitable at high assimilation rates, but it must be accompanied with further molecular biological studies to clearly distinguish weak nitrogenase activity from adsorption at low ¹⁵N₂ assimilation rates. The increase in δ¹⁵N values found in the biomass of the bacterial isolates coexisting with *H. fasciculare* was regarded as an artefact and was explained by ¹⁵N₂ adsorption phenomena. It is assumed that the concentration of ions in the bacterial biomass can provide enough electronegativity to fix a limited amount of N₂, which is not reduced to ammonia. In addition, it cannot be excluded that the purchased ¹⁵N₂/O₂ gas contained traces of ammonia that was enriched in ¹⁵N. These traces could be easily absorbed by biomass and may also explain the artefact found in the experiments with the bacterial isolates coexisting with *H. fasciculare*. The presence of ammonia traces in ¹⁵N₂ gas preparation is regarded as possible. Usually, ¹⁵N₂ gas is produced by oxidation of an ammonium salt, e.g., (NH₄)₂SO₄, which is either realised by oxidation on hot copper oxide after generation with sodium hydroxide (Bergersen 1980, cited in Warembourg 1993) or with alkaline hypobromide (Ohyama and Kumazawa 1981, cited in Warembourg 1993). Although purification steps are described, e.g., passing the ¹⁵N₂ gas through a liquid air trap or solutions of KMnO₄-KOH and H₂SO₄, residual traces of ammonia cannot be excluded. The information on the purchased gas mixture did neither contain information on ammonia traces nor on the exact preparation procedure.

Since the diazotrophs (*A. croococcum*, *B. acida* and *N. nitrogenifigens*) as well as the bacterial isolates coexisting with *H. fasciculare* were cultivated in parallel experiments under the same ¹⁵N₂/O₂ atmosphere, equal conditions can be assumed. It can be concluded that the importance of N₂ fixation differs among species, and that there is a gap between the presence of functional genes and the appearance of N₂ fixation. However, even if the small increase in ¹⁵N abundances indicated weak nitrogenase activity, N₂ fixation contributed to a low extent to the N supply of the bacterial isolates. Presumably, the competition for mineralised N sources prevails *in situ*. Regarding the assumption of enhanced wood

decomposition during diazotrophic-basidiomycetal interaction, it is concluded that the impact of diazotrophs is lower than expected. The ATP-consuming N_2 -reduction reaction occurs to a lower extent than the N content suggests. Similar to fungal growth, growth of diazotrophs depended on initial solid N sources, and the problem of limitation on wood surface is similar. Therefore, the ATP regeneration and cellulose decomposition is triggered to a lower extent than assumed in section 1.7.

4.5. Fungal-bacterial interactions investigated by ^{15}N tracing

The experiments on the N uptake of basidiomycetes and diazotrophs (Weißhaupt *et al.* 2011) and of *H. fasciculare* and its coexisting bacteria showed that the demand in N of fungi is low, and that the $^{15}N_2$ fixation rates of diazotrophs are limited. In further experiments, the $^{15}N_2$ fixation in coexistence of basidiomycetes and diazotrophs was tested. Either *O. placenta* or *T. versicolor* was co-cultivated with each of the three diazotrophs under air and $^{15}N_2/O_2$ atmosphere (Weißhaupt *et al.* 2011). As a result, bacterial growth of *A. crococcum* and *N. nitrogenifigens* was reduced in the acidic and oxidative conditions in the mycosphere. *B. acida* developed biomass in co-cultivation and fixed and transferred $^{15}N_2$ into both fungi under $^{15}N_2/O_2$ atmosphere. However, the fungal biomass was minored compared to cultivations without bacteria. This growth-limiting interaction rejects the hypothesis of intensified decomposition by basidiomycetes combined with diazotrophs.

The results of the co-cultivation experiments are ambiguous. On the one hand, the transfer of N from diazotrophs to basidiomycetes was approved, but on the other hand, the experiments underlined that the fungal-bacterial coexistence is limited. For this reason, *H. fasciculare* and the coexisting bacterial isolates were considered as well. The mycosphere of *H. fasciculare* was supposed to be more suitable for coexisting bacteria. It was less acidic than the mycosphere of *O. placenta* and not as oxidative as the mycosphere of *T. versicolor*. However, *H. fasciculare* also reduced the bacterial number on pre-colonised wood (Folman *et al.* 2008, Valášková *et al.* 2009), but the bacterial number increased again at prolonged time of decomposition. This alternating community structure suggested a competitive interaction. Since the ^{15}N assimilation rates were low among the bacteria coexisting with *H. fasciculare*, fungal wood decomposition is rather not triggered by diazotrophic N enrichment. In addition, organic sources, urea and NH_4Cl were metabolised by most of the bacteria. These results suggest that *H. fasciculare* and bacteria use the same N sources *in situ*. Further co-cultivating experiments of *H. fasciculare* and coexisting bacterial isolates under $^{15}N_2/O_2$ atmosphere were not examined, since the low N_2 assimilation rates were already approved.

The experimental approach of direct quantification of $^{15}\text{N}_2$ fixation was suitable for tracing the uptake of N_2 and transfer into both fungi. The experiments approved that some diazotrophs maintain their diazotrophic activity in co-cultivation with fungi. However, there is a high uncertainty regarding the detection limit of N_2 -fixation activity. On account of the description in section 4.4., low adsorption rates cannot be distinguished from experimental artefacts. This problem even increases in co-cultivation or *in situ* studies, where also dilution phenomena have to be considered (Danso *et al.* 1993). Nevertheless, bacterial N_2 fixation in association to plants, fungi or lichens has been frequently analysed by $^{15}\text{N}_2$ -tracing, and several methods and experimental setups were suggested. First tracing experiments were applied by Burris and Miller (1941). This direct and quantitative $^{15}\text{N}_2$ -tracing method is regarded as the method to which all other methods, e.g., acetylene-reduction assays or N enrichment studies focusing on the N content, should be referred to (Warembourg 1993, Shearer and Kohl 1993). The method was preferred to the acetylene-reduction assay, in which the reduction of acetylene to ethene is quantified and related to the N_2 reduction (Hardy *et al.* 1968). Similar to the advantages, the limitations of the $^{15}\text{N}_2$ -tracing method were discussed as well (Danso *et al.* 1993). The particular experimental setup during $^{15}\text{N}_2$ exposure and the reaction time affect the results. One difficulty is to find an appropriate chamber which allows the cultivation and the gas-replacement at the same time. That chamber must have an optimised volume to cover the whole experimental setup, to minimise the costs of $^{15}\text{N}_2$ gas, but to ensure sample supply with gases for gas reactions, such as respiration or CO_2 fixation. In addition, the chamber must be gastight to prevent the loss or dilution of $^{15}\text{N}_2$ and must stand the gas-replacement procedure. In the present study, a desiccator was used, cultivations were carried out on Petri dishes, and many Petri dishes (30 dishes) were put into the same desiccators before ^{15}N -enriched gas was applied. The method was appropriate for the parallel cultivation of the tested fungi and bacteria. The gas in the desiccator was replaceable, and the gastight sealing was provided by the grinding of the lid and a rubber-sealing. Besides, it was possible to treat the desiccator in a laboratory autoclave to provide sterile cultivation conditions. The Petri dishes provided a huge surface compared to other cultivation flasks, which ensured optimised exposure of the microorganisms to the gas phase. Petri dishes were used including their lids, which had to be equipped with vents to ensure the gas-replacement in the Petri dishes. For the purpose of bacterial and fungal cultivations on different media, this method was suitable. It allowed isotope tracing experiments at comparatively low expenses.

It is particularly recommended to use a single batch for experiments that are intended to be compared. The gas-replacement and the gastightness of the desiccator were regarded as most critical issues during the entire procedure. Parallel cultivations in the same desiccator and at the same time were the easiest way to provide equal conditions. In this study, only two

batches with a $^{15}\text{N}_2/\text{O}_2$ atmosphere were investigated: Firstly, all bacteria were cultivated in the same desiccator (results section 3.6.), and secondly, all fungal-bacterial co-cultivations were carried out in another desiccator (results section 3.7.). So, the comparisons of the experiments in this study are feasible, although the results may differ from other studies. Nevertheless, the presence of N_2 -fixing organisms in both batches was a positive control and approved the presence of the $^{15}\text{N}_2$ gas. (In the first batch, *A. croococcum* and *B. acida* fixed $^{15}\text{N}_2$ and gave evidence for the presence of ^{15}N gas in the desiccator. In the second batch, *B. acida* in co-cultivation with both fungi assimilated ^{15}N .) All experiments under $^{15}\text{N}_2/\text{O}_2$ atmosphere were also done under air. These experiments are important control experiments, which cover all disturbances that may affect the experiments apart from the gas atmosphere. These disturbances may include variations in the temperature during the cultivation time, small differences in the elemental composition of media, the resistance of the microorganisms towards the gas-replacement procedure etc. The control experiments helped to find out if other N sources than N_2 affected the growth of fungi and bacteria. The disadvantages of the setup in desiccators are the uncertainty of the composition of the gas phase and the inconvenience with placing the dishes in the desiccators under sterile conditions. Therefore, further containers, i.e., rubber-sealed reaction bottles were applied in experiments under O_2/Ar atmosphere (sections 3.8. and 3.9.). In these flasks, the gas phase can be replaced several times to ensure that air is completely removed. This procedure is not applicable to $^{15}\text{N}_2$ -enriched gas, since a high volume of gas would be required.

The experimental setup in this study was much simpler than the experiments on living plants (Warembourg 1993, Shearer and Kohl 1993) or lichens (Millbank and Olsen 1981). Since plants or lichens have to be cultivated in soil for a long period, tracing experiments under $^{15}\text{N}_2$ gas are challenging. In several approaches, plants were cultivated in soil, taken out from the soil and then exposed to a $^{15}\text{N}_2$ -containing atmosphere or just the root ball was exposed to $^{15}\text{N}_2$. Then, the bacteria on the root surface assimilated traceable amounts of ^{15}N . However, in these experiments, the previously mentioned artefacts as a result of adsorption can occur as well (Danso *et al.* 1993). Another difficulty is to find appropriate reference plants, to which the measured values can be referred to. Considering the problem of appropriate reference data, laboratory experiments under defined conditions are a prerequisite and should accompany all environmental studies. Since almost all $^{15}\text{N}_2$ -tracing methods have limitations at low N_2 -fixation rates, an alternative method was developed, and the co-cultivations proceeded under an N_2 -free O_2/Ar atmosphere (sections 3.8. and 3.9.). In these experiments, the fungal activity at different conditions was measured. The method is not transferable to *in situ* studies, which is a disadvantage compared to the $^{15}\text{N}_2$ -tracing method.

4.6. Nitrogen uptake of *O. placenta* and *T. versicolor* determined by DOE

The N uptake of *O. placenta* and *T. versicolor* was further analysed in experiments of full-factorial experimental plans (Weißhaupt *et al.* 2012). The effects of the most frequent N sources, namely organic N in the medium (x_1), N traces in wood (x_2) and N_2 in air (x_3), were tested. Since fungal growth and decomposition activity responded in different magnitude to the amendment of the N sources, several indicators of fungal activity were investigated. This approach enabled a detailed evaluation of the effects (Figs. 12 and 13). Combinations of factors (x_1x_2 , x_1x_3 , x_2x_3 and $x_1x_2x_3$) revealed synergistic effects, which occur if the effect of combined factors was higher than the sum of the individual factor's effects. The 95% confidence interval was used to determine whether an effect was significant or negligible. The indicators were the fungal biomass, the O_2 , N_2 and CO_2 content in the gas phase, the elemental composition of the fungal biomass and the laccase activity in case of *T. versicolor*.

The growth of biomass of *O. placenta* was triggered by the presence of peptone (x_1), whereas the effects of N from sapwood of *P. sylvestris* (x_2) and gaseous N_2 (x_3) were within the confidence interval (Fig. 12). Linear combinations of these factors were not significant, indicating no synergistic effects. The C sources in RBA, i.e., glucose, mannitol, malate, pyruvate and succinate, were supposed to be preferred to the C polymers of wood, i.e., cellulose, hemicelluloses, lignin. Therefore, the C addition by wood amendment did not cause the increase in fungal biomass. If wood amendment had increased the biomass, this would have approved that wood provides enough N for fungal development. However, the latter was not approved in the experiments, and therefore, the initial N in wood did not support fungal growth under these conditions. In contrast, peptone decreased the C/N ratio in the medium and enhanced fungal growth. This fact approves that N limitation in the experiments prevailed, and that this limitation was coverable by the amendment of an organic N source. Nevertheless, peptone had to be considered as an additional C source. Elemental analysis of peptone revealed a C content of 44.06 (± 0.5)% and an N content of 15.24 (± 0.1)%. Anyway, the amendment of C was not determining, since the initial RBA was not C-limited. Further indicators, such as the CO_2 formation and O_2 consumption as well as the C content, N content and the $\delta^{15}N$ value in the fungal biomass, affirmed the enhancing effect of peptone on fungal activity. Since O_2 and Ar are not separable by the gas chromatographic method, both gases were measured as one peak. The Ar/ O_2 peak declined towards a minimum of 0.93%, which is the natural abundance of Ar in air (DIN ISO 2533). If the air atmosphere was replaced by the O_2 /Ar mixture, the O_2 /Ar peak declined towards 79.77 vol.-%, which resembled the Ar content of the mixture. The O_2 consumption and CO_2 production increased after peptone amendment, but not after amendment of wood or N_2 in air, and this showed that wood and N_2 did not intensify fungal activity. In experiments with *O.*

placenta, laccase activity was not representative, since *O. placenta* decomposes wood by oxalic acid and Fenton reaction (Martinez *et al.* 2009). Consequently, after 14 d of incubation, the pH value decreased significantly, and the laccase activity was below the detection limit.

The biomass of *T. versicolor* was significantly enhanced by peptone (x_1), by wood of *F. sylvatica* (x_2), and the combination of both (x_1x_2) was synergistic (Fig. 13). In contrast, the combination of wood and air (x_2x_3) and of wood, air and peptone ($x_1x_2x_3$) suppressed the formation of biomass significantly. These findings paralleled the findings from applied timber protection, where clean and aerated sapwood is supposed to be more resistant to microbial attack than wood in soil contact (Schmidt 2006). Interestingly, wood of *F. sylvatica* in contrast to *P. sylvestris* provided initial N and activated the fungus to a low extent. The CO₂ formation paralleled the development of biomass. Wood (x_2) and peptone (x_1) further enhanced laccase activity significantly, whereas the presence of N₂ (x_3) and the combinations of air and wood (x_2x_3) and of air and peptone (x_1x_2) inhibited the enzyme activities (Fig. 13). Previous studies affirmed these results, since laccase was found to be activated by plant litter (Elisashvili and Kachlishvili 2009) or organic N sources, such as peptone (Mikiashvili *et al.* 2005). Less is known about inhibiting effects of N₂ on laccase production. A similar increasing effect on laccase activities was found if N₂ in the cultivation atmosphere was replaced by O₂ and CO₂ (White and Boddy 1992). This finding was not further explained or investigated in literature. The C and N contents in the fungal biomass were marginally affected by the different N sources, but the $\delta^{15}\text{N}$ value in biomass of *T. versicolor* increased in the presence of peptone (x_1) and wood (x_2), indicating N uptake from these sources.

The activity (growth and decomposition activity) of both basidiomycetes increased if peptone was added to the medium. The presence of N₂ and N traces in wood affected the fungal biomass formation marginally. Previous studies on *O. placenta* and *Gloeophyllum trabeum* confirmed that CO₂ formation was enhanced as a result of the addition of N sources (Niemenmaa *et al.* 2008). It was further suggested that low amounts of N are scavenged from substrate (Watkinson *et al.* 2006, Bebbler *et al.* 2011) or from N-containing organic matter (Perez-Moreno and Read 2001). Considering the indicators of fungal activity, which were measured apart from biomass, the results found for the biomass production were supported. Moreover, the amendment of wood significantly increased the laccase activity of *T. versicolor*. In contrast, laccase activity was significantly minored in experiments containing atmospheric N₂. The activity of the enzyme was tested in separate tests with samples of the medium after cultivation. All tests were carried out under air atmosphere. Therefore, enzyme inhibition by N₂ did not cause the reduction in enzyme activity. Instead, the production of the enzymes during growth under air was reduced. This is a new finding, which has not been described in detail in literature.

4.7. Fungal-bacterial interactions determined by DOE

The impact of *B. acida* (x_1) on both fungi (*O. placenta* and *T. versicolor*) was investigated in experiments of two further experimental plans. *B. acida* was chosen according to the results of the co-cultivation experiments under $^{15}\text{N}_2/\text{O}_2$ atmosphere. In contrast to *A. crococcum* and *N. nitrogenifigens*, this bacterium fixed $^{15}\text{N}_2$, coexisted with both fungi and transferred ^{15}N to the fungal biomass all at the same time (Weißhaupt *et al.* 2011). Atmospheric N_2 in the gas phase positively affected the growth of the diazotroph *B. acida*, but N_2 was not mandatory for the development of bacterial biomass. Even under O_2/Ar atmosphere the bacterium developed biomass, which fitted well to the results from the cultivation experiments under $^{15}\text{N}_2/\text{O}_2$ atmosphere that also suggested that further sources were used. On account of the results of the experiments of the experimental plan, N_2 had a significant negative effect on fungal biomass, which underlines the fungal-bacterial competition. Interestingly, the presence of N_2 , but not of *B. acida* itself, was the significant factor, and the combination of both did not affect fungal growth significantly either.

Fungal activity was different in co-cultivation of *O. placenta* and *B. acida* (Fig. 14) compared to experiments including peptone (Fig. 12). The biomass of *O. placenta* was only marginally affected by *B. acida* (x_1) and sapwood (x_2) under O_2/Ar atmosphere, but it was significantly negatively affected by the presence of N_2 (x_3 , Tab. 14). If gaseous N_2 was present, the diazotroph prevailed in the co-cultivation and caused reduced fungal biomass, while in an O_2/Ar atmosphere *O. placenta* prevailed. CO_2 formation and O_2 consumption were not as representative as in experiments without *B. acida*, because *B. acida* contributed significantly to CO_2 formation. Nevertheless, the experiments revealed that all three influencing factors positively affected CO_2 formation. The effect of bacteria as nutrient source was not discussed, but glucose, amended or as mineralisation product of cellulose, allowed respiration of both *B. acida* and *O. placenta*. The combination of air and *B. acida* (x_1x_3) was synergistic in terms of CO_2 formation and can be traced back to a better N availability after bacterial N_2 fixation (Fig. 14). However, enhanced wood decomposition is questionable, because other indicators did not confirm this synergistic effect. During the initial stage of wood decomposition, the C sources from the medium were more frequently used than wood (Tab. 14), which was similar to findings on decomposition of flakes of *P. sylvestris* (Jin *et al.* 1990). If *O. placenta* was employed, the addition of wood of *P. sylvestris* and *B. acida* affected fungal growth marginally. Further indicators revealed that except for CO_2 formation none of the effects was significant and, since CO_2 was also produced by the bacterium, *B. acida* did not increase fungal activity. *B. acida* competed with *O. placenta* for the N sources in the cultivation medium. If *T. versicolor* was combined with *B. acida*, the bacterium increased the biomass production of the fungus (Fig. 15). This effect on the fungal biomass

was higher than the confidence interval, which was not found for the biomass of *O. placenta* in combination with *B. acida* (Fig. 14). In addition, wood positively affected the formation of fungal biomass, whereas air inhibited fungal biomass (Fig. 15). Air N₂ (x₃) supported the growth of *B. acida* in such a way that both organisms coexisted. The combinations of factors marginally affect biomass production except if all factors were combined. In that case, the fungal biomass was increased. These results were also mirrored in an increasing formation of CO₂ and consumption of O₂. In addition, the fungal laccase activity was enhanced by *B. acida* (x₁) and indeed increased by sapwood (x₂). However, air (x₃) inhibited the laccase activity, which was also found in the experiments of the experimental plan excluding *B. acida* (see section 4.6.). Combinations of air and sapwood (x₂x₃) rather reduced the laccase activity. Effects on the elemental composition were not significant. The results in co-cultivations displayed high standard deviations probably caused by insufficient separation of fungal and bacterial biomass. Maybe the spatial heterogeneity of fungal and bacterial species on wood caused different patterns of fungal-bacterial interactions. A positive effect of bacteria on white rot rather than on brown rot was expected, because *T. versicolor* increased in the presence of NH₄Cl (Weißhaupt *et al.* 2011), and because NH₄⁺ is a product of nitrogenase-catalysed N₂ fixation (Burgess and Lowe 1996).

The significance of the effects was estimated by the confidence intervals. These confidence intervals were calculated for all indicators of fungal activity, and effects within these limits were insignificant. However, the tested parameters are not the only factors for fungal activity. In order to reveal any effects of N, deviations were minimised by using chemicals from the same purchased charge. This enabled effects to be measured, because all experiments contained exactly the same medium. This was of particular importance regarding IRMS measurements. As a result of initial C sources, the effect of wood amendment on fungal growth may be underestimated, but an inducing effect of wood on laccase activity was found. Peptone is also an additional C source, and an impact of C on the effect attributed to organic N cannot be excluded. The N contents in fungal biomass and the δ¹⁵N values proved the utilisation of peptone as N source. Moreover, experiments without peptone are not C-limited due to RBA medium. The similar C contents in fungal biomass in all experiments of the experimental plan approved the C supply. In addition to the C and N content in biomass, the C/N ratio is discussed. The C/N ratio underlines the close association of C and N, but it does not give any evidence of the absolute contents of the elements. If the C content is almost constant, the discussion of the N content gives evidence on the effects.

In conclusion, the experiments of the experimental plans revealed that organic N rather than N from sapwood determined fungal activity. This result underlined that sapwood decomposition increased after addition of organic N. In case of decomposition of *P. sylvestris*, N addition even seemed to be mandatory. Diazotrophic activity of *B. acida*

marginally affected the initial phase of wood decomposition by *O. placenta*, and the bacterium even inhibited fungal growth if gaseous N₂ was present. In contrast, the activity of *T. versicolor* was enhanced in the presence of *B. acida*. Biomass formation of *B. acida* was supported in the presence of wood and gaseous N₂. Therefore, this bacterium was able to compete with *O. placenta* and to coexist with *T. versicolor*. Moreover, the presence of gaseous N₂ reduced laccase activity significantly and affected wood decomposition negatively. These results affirmed that aeration combined with dry and clean storage of wood is advantageous for timber durability. Interestingly, wood of *F. sylvatica* was an N source for *T. versicolor*, while wood of *P. sylvestris* was not an N source for *O. placenta*. It is assumed that the wood of *F. sylvatica* contains a higher initial N concentration than the wood of *P. sylvestris*.

4.8. Fungal-bacterial interactions in wood decomposition

The amendment of urea or NH₄Cl supported white rot, and organic N increased brown- and white-rot fungi. The effect of N on the biomass of saprotrophic basidiomycetes was found for a concentration of 10 mM N in both experimental approaches: the IRMS measurements (Weißhaupt *et al.* 2011) and the experiments according to experimental plans (Weißhaupt *et al.* 2012). In preliminary experiments, growth on RBA medium amended with 1 to 100 mM N was tested, and the growth increase was most pronounced at 100 mM (data not shown). If the N concentration was further increased, a further increase in growth rates is expected. However, at very high concentrations, an inhibition of growth rates is expected as well. The concentration for maximum growth rates was not determined, because it depends on the availability of further nutrient conditions and is not a constant value. The growth of bacteria was also increased in N-containing media, but the N₂ assimilation was reduced if organic or reduced N was available. These results of experiments on fungal growth underlined that the demand in N of saprotrophs is very low. The effect of bacteria was ambiguous. On the one hand, it was approved that N₂ can be fixed and transferred to saprotrophs, but on the other hand, growth limitations during fungal-bacterial interactions were observed. So, bacteria seemed not to be mandatory for fungal wood decomposition.

The initial existence of endosymbiotic or ectosymbiotic bacteria in basidiomycetes from strain collections was neither approved nor disapproved in experiments of this study. Fungal growth in experiments with and without antibiotics (streptomycin, tetracycline) was similar, and fungal growth was not minored in experiments without N₂. The presence of ectosymbiotic bacteria in the outer mycosphere of the fungus was not probable, because the treatment with antibiotics had no effect. Endomycelial bacteria within the hyphae would be protected against antibiotics. Their presence cannot be excluded, but they are probably not

diazotrophs, because the absence of N₂ during cultivation had no effect and because in ¹⁵N₂-tracing experiments, ¹⁵N₂ was not assimilated. Therefore, the cultures of *O. placenta* and *T. versicolor* from strain collections did rather not contain diazotrophs.

The impact of N₂-assimilating bacteria on fungal growth was analysed with two independent methods: ¹⁵N₂-tracing (Weißhaupt *et al.* 2011) and cultivation with and without atmospheric N₂ (Weißhaupt *et al.* 2012). The results of the experiments with both methods suggested that apart from N₂ fixation fungal-bacterial competition for the same N-containing substrates in the cultivation media prevailed. In particular, organic N was used which underlined the importance of microbial amino acid transfer. While N oxidation, nitrification, denitrification and N₂-fixation are in the focus of the bacterial N cycle (Jetten 2008), terrestrial ecosystems including plants and fungi are affected by transfer reactions of amino acids, amino sugars and small peptides. These reactions are supposed to control the C and N mineralisation in soil (Gärdenäs *et al.* 2011). Atmospheric N₂-fixation by bacteria and transfer into fungi proceeded in co-cultivation with *B. acida* (Weißhaupt *et al.* 2011). However, the postulated effect of increased wood decomposition as a consequence of mutualism between basidiomycetes and diazotrophs was not affirmed. Fungal-bacterial cooperation which intensifies wood decomposition could occur during decomposition in natural ecosystems and could explain high decomposition rates in soil. On pure sapwood, the association of diazotrophs to saprotrophic basidiomycetes is questionable. Sapwood combined with minor spoilage can provide enough N for the growth of decomposing saprotrophs. Spoilage may be caused by N-containing particles from air, e.g., bacteria, spores, pollen or dust, since saprotrophic fungi collect and scavenge N.

The high number of studies describing fungi in temperate regions suggested two principles of efficient N assimilation during wood decomposition in forest ecosystems. Firstly, fungi collect and recycle organic N from substrates in temperate forests. Even traces of organic N are captured in the soil organic matter and protected against wash-out. Secondly, bacteria fix N₂, but they require high amounts of ATP. Interestingly, diazotrophs occurred more frequently in tropical forests (Houlton *et al.* 2008). Presumably, high temperature and diurnal climate with a constant amount of C-rich plant litter throughout the whole year support the bacterial fixation of atmospheric N₂. Mandatory associations of ascomycetes and diazotrophs related to wood were only found among lichens, such as *Lobaria* lichens (Bates *et al.* 2011, Antoine 2004). These lichens are not cultivable and have not been described as spoilage organism on materials. It occurs on trees affiliated to *Pseudotsuga* in natural environments that are protected against pollution. The lichens usually grow very slowly, but their existence on the wood of *Pseudotsuga* indicates that they can even mineralise the structure of very persistent wood. Decomposition of wood by basidiomycetal-diazotrophic interactions cannot be exactly predicted. The results suggest the growth-enhancing effect of

fixed N sources on both bacteria and fungi. However, a mandatory association of diazotrophs and saprotrophs is estimated to occur rarely. On sapwood, fungal species and flanking nutrient conditions determine decomposition rates. Further factors include physical properties, i.e., temperature, texture, as well as chemical properties, such as moisture, aeration and nutrient availability.

Previous studies showed that the amendment of N to forest soils can activate enzyme activities for plant litter decomposition (Waldrop *et al.* 2004, Sinsabaugh *et al.* 2002, Carreiro *et al.* 2000). However, the amendment of NH_4NO_3 led to increased cellulose decomposition in cellulose-rich material, but to reduced phenol oxidase activity in lignine-rich oak litter (Waldrop *et al.* 2004, Carreiro *et al.* 2000, Fog 1988). The second finding contrasts to our result of laccase activation after amendment of organic N (Weißhaupt *et al.* 2012). Since natural ecosystems are multi-factorial systems, the effects of N amendment on litter decomposition cannot be predicted and generalized. It has to be considered that N amendment can lead to a community shift in soil and may support organisms which are not lignolytic. So, N deposition can explain both increased and decreased decomposition activity (Carreiro *et al.* 2000). These experiments on enzyme activities reveal the effects of deposition of anthropogenic N to forest ecosystems. Since the increased deposition of anthropogenic N is one of the most frequently discussed environmental risks of the present time (Galloway *et al.* 2004), several approaches tried to estimate the impact on forest ecosystems (Aber and Magill 2004, Gundersen *et al.* 1998). Apart from the mentioned changes in the soil enzyme activity, changes in the community structure were observed (Frey *et al.* 2004). In N-rich soil, the fungal-bacterial biomass ratio was lower than in soils without N amendment. This finding fits well to the fact that bacterial biomass usually has a higher N content than fungal biomass (referred to the dry weight). Since fungal biomass is decreased as a consequence of N amendment in environmental studies (Frey *et al.* 2004), increased decomposition rates do rather not occur. This contrasts to the finding that N addition to sapwood is a prerequisite for its decomposition (Bebber *et al.* 2011, Boddy *et al.* 2008, Watkinson *et al.* 2006). The latter results correspond to the results of the experiments according to experimental plans (section 4.6. and 4.8.) and the increased fungal growth on N amendment. Considering the inhibition and activation of decomposing organisms, we can conclude that there exists a narrow range in N concentrations that increases fungal growth on wood. If soil or plant litter is present, these substances provide so much N that the further amendment of N can lead to an N concentration that suppresses decomposing saprotrophs. High N concentrations support different fungal and bacterial species which are not lignolytic. This could explain the suppression of decomposition by N amendment, but does not give evidence on the ecological relevance. Even if wood decomposition is reduced, this may be disadvantageous if the C cycle is blocked. The results showed that it is very difficult to

estimate consequences of anthropogenic N deposition in forests. Besides, there is certainly a gap between deposition experiments and N amendment as a result of pollution. If pollution prevails, the episodic amendment over a longer period must be considered. Corresponding experiments are difficult to design. This difficulty includes wood litter decomposition in forests as well as wooden materials exposed to N deposition.

4.9. Uncertainty treatment

Measurements by instrumental means are affected by several parameters, which include the calibration of the instrument, the parameters during a measurement and further operating conditions. Measured values are usually not identical, and the uncertainty must be minimized and at least described. Moreover, the sample preparations, e.g., the microbiological experiments, bear the risk of further variations. Therefore, careful considerations on the uncertainty and detailed information on its treatment are mandatory to distinguish effects from artefacts. Reliable measurements must include information which parameters were considered and were excluded. Generally, the Guide to the Expression of Uncertainty in Measurement (JCGM 100: 2008) recommends how to treat measured values, but the applied uncertainty expression usually varies according to the particular method and subject.

In this study, arithmetical averages and standard deviations of replicate tests were calculated. For fungal and bacterial cultivation-tests, usually three replicates were carried out, and the elemental composition of each biomass was measured one to three times. The standard deviations reflected minor disturbances during cultivation, biomass recovering, lyophilisation and instrumental measurements. These deviations were calculated from measured values of biomass and elemental analysis but did not comprise the differences in $\delta^{15}\text{N}$ and $\delta^{13}\text{C}$ values that result if different compounds for media preparation were applied. Replicate EA and IRMS measurements of the same sample of biomass usually had a lower standard deviation than measurements of biomass from replicate cultivations under the same conditions, which ensured the reproducibility of the methods. The reproducibility of the instrumental measurement was supported by the standard deviations of the working standard casein, which were usually the lowest.

In this study, the uncertainty was predominantly described by the SD of the measured values. This was regarded as the most suitable treatment, since the parallel experiments were focused and a comparison with results from further studies was not intended. Under the chosen laboratorial conditions, many sources of uncertainty were suppressed and did not enter the uncertainty treatment. However, this applied uncertainty treatment does not correspond to metrological recommendations to determine the standard deviation of each parameter and to summarise these standard deviations to estimate the full uncertainty of a pro-

cedure (JCGM 100: 2008). In the present example of consecutive cultivating, harvesting, drying and measuring, the summarised deviations would correspond to more pronounced uncertainties than the simple calculation of the standard deviation from measurements of replicates. If all uncertainties were summarised, some of the investigated physiological effects could be no longer significant. To detect morphological differences as a result of different cultivation conditions, disturbances were minimised, and appropriate control experiments were of particular importance. The experiments in this study and in particular the experiments of the experimental plans provided all necessary control experiments to approve the conclusions.

Apart from the standard deviations, the significances and confidence intervals were calculated. Firstly, confidence intervals were calculated using the variances and tabulated *t*-values. Secondly, the computer-based *P*-value approach and two-way ANOVA was applied. For these calculations, a normal distribution of the values was assumed. Both approaches helped to determine significances of effects on the performance of the bacterium under laboratory conditions. However, even if the significance of an effect is calculable, the effect may still be an artefact. In case of an artefact, the experimental setup was not appropriate. For example, the bacteria coexisting with *H. fasciculare* assimilated $^{15}\text{N}_2$ significantly but only to a low extent. These bacteria were supposed to adsorb $^{15}\text{N}_2$ but not to fix and reduce $^{15}\text{N}_2$ to ammonia by nitrogenase reaction. Significant ^{15}N enrichment was prevalent, since the adsorption was reproducible in the experiments. At low N_2 assimilation rates, molecular biological studies are mandatory to distinguish weak diazotrophic activity from adsorption.

$^{15}\text{N}_2$ -tracing experiments and experiments of the experimental plans were suitable approaches and resulted in similar conclusions. The quality and reproducibility of the results were almost the same at similar operating expenses. However, many of the measured effects in this study were low and thus difficult to approve. The conclusions from the two approaches were similar, which underlines again that the conclusions are sound. Regarding the experiments of the experimental plans, many results were gained from the biomass as the only measured indicator of fungal activity. Nevertheless, it was advantageous to consider several indicators, since decomposition activity does not necessarily increase under the same conditions like fungal growth. The intention was to find characteristics as a result of different cultivation conditions. The data are a reference for any *in situ* studies using stable N isotopes. Under laboratory conditions in limited medium, the ^{15}N fixation rates of well-described organisms from strain collection can be regarded as a positive control. These data ensured that the experimental setup was appropriate.

4.10. Implications for applied wood protection

Experiments revealed that the N availability is a critical issue for the development of saprotrophs and bacteria on wood. Nevertheless, it is not the only factor that affects the development of spoilage organisms. Further nutrients and in particular moisture determine decomposition. Generally, the protection of wood from N and nutrient sources is recommended. This conclusion is drawn, since the addition of organic N, e.g., peptone (Fig. 12 to 15) or yeast extract (Fig. 9 to 11), supported the growth of the tested saprotrophs. The preferences for N sources may differ according to fungal species. Besides, wood initially comprises traces of N, which was approved by the elemental composition of aqueous wood extracts.

The tested basidiomycetes had a low N content compared to bacteria. This underlines, that the specific N demand of wood-decomposing fungi is low. The amount of N, which is required for growth, can be provided by minor spoilage after a prolonged time of usage or exposure to N sources. Numerous sources can be imagined. To protect wood from spoilage with N, an appropriate surface treatment could be advantageous. Aeration may further be advantageous for wood protection, since the experiments showed that N₂ in the gas atmosphere reduced the laccase activity of *T. versicolor*, but aeration may also be disadvantageous, because the exposure to air may include exposure to N-containing particles, such as dust or pollen. Another important parameter for the growth of fungi on wood is the moisture. In experiments, equal and high moisture was provided, but *in situ* the moisture could affect the fungal activity significantly independent of the N concentration.

Although several bacteria species can decompose wood, the present study did not approve the particular importance of diazotrophic bacteria. The hypothesis of enhanced wood decomposition during fungal-bacterial co-existence was not supported. There are several reasons: Firstly, fungi and bacteria use several N sources, and N₂ is usually not the only source. Thus, fungal-bacterial competition is prevalent. Secondly, the environment of fungi usually reduces the number of bacteria, and therefore bacteria need a sort of protection if they coexist with fungi. Diazotrophs could be protected within the hyphae of the fungal mycelium. So far, such endomycelial bacteria have not been found for the chosen organisms from strain collections. Since the effect of diazotrophs was only marginally in the test experiments, the protection against bacteria is not recommended. It can be denied that the durability of wood is improved if bacterial decomposition is prevented. Antibacterial wood repellents can prevent any bacterial growth, but they can also support bacteria with resistance to antibiotics including those that are prevalent but not relevant for the material's decomposition. These resistant bacteria must be considered as a risk for human health. Therefore, the treatment of wood with antibacterial repellents includes disadvantages apart from the protection against decay.

5. Conclusion

In this work, the N uptake during fungal-bacterial interactions was investigated. Saprotrophic basidiomycetes and diazotrophic bacteria from strain collections were analysed to gain elementary information on microbial N uptake. Elemental analysis combined with isotope ratio mass spectrometry allowed to quantify N isotopes in dry biomass and to determine $\delta^{15}\text{N}$ values. Such reference data from laboratory studies are useful for any environmental ^{15}N tracing studies, including more advanced instrumental approaches. In addition, experiments according to experimental plans revealed the effects of different N sources which occur at the same time. With both approaches, the N sources of fungi were investigated, and the impact of diazotrophs on fungi was estimated.

The first finding was that the N content in fungal biomass is usually low compared to bacterial biomass and variable according to the nutrient availability. Regarding ^{15}N -tracing experiments, these low N concentrations in fungal biomass are challenging. The applied method of elemental analysis and subsequent IRMS was optimised for correct isotope quantification in fungal biomass. Methods which include more purification steps bear the risk of isotope dilution. Secondly, diazotrophic bacteria fixed N_2 at different rates and used N sources in addition to N_2 . If organic N is available, N_2 fixation is usually reduced compared to N-limited conditions. Consequently, the bacterial N_2 fixation contributes less to the bioavailability of N on decomposing wood than expected according to the hypothesis described (Fig. 1). *In situ* further N sources may be provided by soil, plant litter spoilage or by initial N of particular wood species. Thirdly, diazotrophic-saprotrophic interactions just occurred under particular conditions, and the interaction was not mandatory for both species. Although bacterial N_2 fixation and transfer into fungal biomass was possible, a significant increase in fungal activity and wood decomposition was not affirmed. A prerequisite for fungal-bacterial interactions is the physiological ability of bacteria to survive in the acidic and oxidative environment of fungi. For example, the bacterium *B. acida* developed biomass in the presence of either *O. placenta* or *T. versicolor* and transferred fixed N_2 to both fungi. Because of its strong spatial growth, the fungal growth was inhibited and the increase of wood decomposition was not approved.

Environmental studies suggested that diazotrophic bacteria predominantly coexist with white-rot fungi and in particular, the bacterial community, which coexisted with *H. fasciculare*, was analysed. *H. fasciculare* and the coexisting bacteria were well adjusted to N-limited environments and even developed biomass on traces of organic N in RBA medium. Interestingly, *H. fasciculare* and coexisting bacteria preferred the same N sources for the formation of their biomass, and the bacteria fixed atmospheric N_2 only to a low extent without further reduction to ammonia. Thus, fungal-bacterial competition for the same N sources is

supposed to prevail in nature. As a consequence, wood decomposition is not intensified at coexistence of fungi and bacteria.

If bacteria with strong diazotrophic activity existed in the environment of saprotrophs, acceleration of decomposition was possible. In *in vitro* experiments, the composition of the media determined the N content in bacteria and the N₂-fixation activity of diazotrophs. Even in diazotrophs with high N₂-assimilation rates, the abundance of N assimilated from atmospheric N₂ did not exceed 13% of the N in the bacterial biomass. So, the hypothesis of an increase of wood decomposition by fungal-bacterial interaction was not approved. The effect of the increased demand in ATP was smaller than expected, since further N sources were assimilated. The high demand in ATP, which is needed for the nitrogenase-catalysed reaction, explains why N₂ fixation usually does not cover the full bacterial demand in N. In addition, the mycosphere of strong decomposers limited bacterial growth, and an exomycelial association is improbable. Therefore, a stable interaction of wood-decomposing fungi and diazotrophs would require endomycelial diazotrophs. Such associations occur among lichen, e.g., *Lobaria sp.*, and isotope tracing techniques would be appropriate to quantify the N₂ fixation by endomycelial diazotrophs if an appropriate experimental setup for the exposure to ¹⁵N was found (e.g., Millbank and Olsen 1981).

In conclusion, the impact of diazotrophs on saprotrophic fungi might be of particular importance in natural ecosystems and forest soils, but it is of minor relevance for applied sapwood or timber protection. Frequently found material spoilage organisms are adapted to N traces, which can be provided by minor spoilage. The fixation of atmospheric N₂ is thus of minor relevance for the N supply in domestic environments and on materials. Regarding applied timber protection, the exposure of wood to N is usually one of several conditions that determine the decomposability. Generally, it is advantageous to protect wood against N sources, such as soil, plant litter, contaminated water or atmospheric deposition. Since N from several sources is assimilated, the critical concentration for the initiation of decomposition is very low. Appropriate surface treatments are advantageous if they prevent nutrient enrichment but do not capture humidity. A protection against bacteria is not recommended for wood without contact to soil, since the decomposition activity by bacteria is marginal, and a strong effect of bacteria on wood decomposition by fungi was not approved in experiments.

6. Outlook

This study underlined that the elemental composition and isotope ratios in microbial biomass can provide information that are not available by molecular biological analysis. The results allow to study ecological food webs and to identify nutrient sources. Elemental analysis and isotope ratio mass spectrometry are applicable to any kind of biomass, and experiments can be further supported by the utilization of ^{15}N -labelled substrates. EA combined with IRMS is optimised for the correct quantification of N isotopes in biomass. If more detailed information on the target molecules in fungal or bacterial biomass was of interest, chromatographic methods could provide the necessary separation. The combination of gas chromatography or high-pressure liquid chromatography to IRMS via a combustion interface allows determining $\delta^{15}\text{N}$ values of molecules. Nevertheless, limitations must be considered, since N occurs in low quantities in microbial biomass and biomolecules. N-tracing methods could target on amino acids or amino carbohydrates, such as chitin.

Applied wood or materials protection could benefit from measurements on the N contents on and in materials if the N source can be identified. Materials which provide nutrients and high N concentrations must be considered as susceptible to microbial decomposition. The decomposability should be taken into consideration during the choice of the raw material, since fast decomposing materials are not suitable for many applications. If necessary, appropriate ways of materials protection should be considered or more durable materials should be applied.

Regarding forest ecosystems and forest soil quality, further investigations of fungal-bacterial interactions could be of high value for understanding the N cycle in natural ecosystems. Since forests are of high ecologic and economic value, a detailed knowledge on the soil quality could help to ensure the functioning of ecosystems on the background of increasing deposition of anthropogenic N. Further studies could target on the identification of relevant bacterial species, changes in the microbial structure or by applying the ^{15}N -tracing technique to environmental samples. Derelict land becoming a forest ecosystem could be another interesting site for N-tracing studies. In particular, studies on diazotrophic, soil-fertilising bacteria as part of diverse fungal-bacterial communities could be of interest.

7. References

- Aber, J.D., Magill, A.H., 2004. Chronic nitrogen additions at the Harvard Forest (USA): the first 15 years of a nitrogen saturation experiment. *Forest Ecology and Management*, **196**, 1–5.
- Addison, S.L., Foote, S.M., Reid, N.M., Lloyd-Jones, G., 2007. *Novosphingobium nitrogenifigens* sp. nov., a polyhydroxyalkanoate-accumulating diazotroph isolated from a New Zealand pulp and paper wastewater. *International Journal of Systematic and Evolutionary Microbiology*, **57**, 2467–2471.
- Ahmadjian, V., 1993. *The Lichen Symbiosis*. Wiley, New York.
- Ahmadjian, V., Paracer, S., 1986. *Symbiosis - An Introduction to Biological Associations*. University Press of New England, London.
- Aho, P.E., Seidler, R.J., Evans, H.J., Raju, P.N., 1974. Distribution, enumeration, and identification of nitrogen-fixing bacteria associated with decay in living white fir trees. *Phytopathology*, **64**, 1413–1974.
- Antoine, M.E., 2004. An ecophysiological approach to quantifying nitrogen fixation by *Lobaria oregana*. *Bryologist*, **107**, 82–87.
- Atlas, R.M., (ed.), 1997. *Handbook of microbiological media*. 2nd ed. CRC Press, New York.
- Baldrian, P., 2008. Enzymes of saprotrophic basidiomycetes. In: Boddy, L., Frankland, J.C., van West, P. (eds.), *Ecology of saprotrophic basidiomycetes*, 1st ed. Elsevier, Amsterdam, pp. 143–153.
- Baldrian, P., Valášková, V., 2008. Degradation of cellulose by basidiomycetous fungi. *FEMS Microbiological Reviews*, **32**, 501–521.
- Barney, B.M., McClead, J., Lukoyanov, D., Laryukhin, M., Yang, T.-C., Dean, D.R., Hoffmann, B.M., Seefeldt, L.C., 2007. Diazene (HN=NH) is a substrate for nitrogenase: Insights into the pathway of N₂ reduction. *Biochemistry*, **46**, 6784–6794.
- Bates, S.T., Cropsey, G.W.G., Caporaso, J.G., Knight, R., Fierer, N., 2011. Bacterial communities associated with the lichen symbiosis. *Applied and Environmental Microbiology*, **77**, 1309–1314.
- Bebber, D.P., Watkinson, S.C., Boddy, L., Darrah, P.R., 2011. Simulated nitrogen deposition affects wood decomposition by cord-forming fungi. *Oecologia*, **167**, 1177–1184.
- Bergersen, F.J., 1980. Measurement of nitrogen fixation by direct means. In: Bergersen, F.J. (ed.), *Methods for evaluating Biological Nitrogen Fixation*. John Wiley and Sons, Chichester, pp. 65–110.
- Blaich, R., Esser, K., 1975. Function of enzymes in wood destroying fungi. II. Multiple forms of laccase in white rot fungi. *Archives of Microbiology*, **103**, 271–277.
- Blanchette, R.A., 2000. A review of microbial deterioration found in archaeological wood from different environments. *International Biodeterioration and Biodegradation*, **46**, 189–204.
- Boddy, L., Frankland, J.C., van West, P., 2008. *Ecology of saprotrophic basidiomycetes*, 1st ed. Elsevier, Amsterdam.
- Boddy, L., Jones, T.H., 2008. Interactions between basidiomycota and invertebrates. In: Boddy, L., Frankland, J.C., van West, P. (eds.), *Ecology of saprotrophic basidiomycetes*, 1st ed. Elsevier, Amsterdam, pp. 155–179.
- Bourbonnais, R., Paice, M.G., 1990. Oxidation of non-phenolic substrates. An expanded role for laccase in lignin biodegradation. *FEBS Letters*, **267**, 99–102.
- Boyle, D., 1998. Nutritional factors limiting the growth of *Lentinula edodes* and other white-rot fungi in wood. *Soil Biology and Biochemistry*, **30**, 817–823.

- JCGM 100, 2008. Evaluation of measurement data – Guide to the expression of uncertainty in measurement (GUM). Bureau International des Poids et Mesures (BIPM), Paris.
- Burgess, B.K., Lowe, D.J., 1996. Mechanism of molybdenum nitrogenase. *Chemical Reviews*, **96**, 2983–3011.
- Bürgmann, H., Widmer, F., von Sigler, W., Zeyer, J., 2004. New molecular screening tools for analysis of free-living diazotrophs in soil. *Applied Environmental Microbiology*, **70**, 240–247.
- Burris, R.H., Miller, C.E., 1941. Application of ^{15}N to the study of biological nitrogen fixation. *Science*, **93**, 114–115.
- Carreiro, M.M., Sinsabaugh, R.L., Repert, D.A., Parkhurst, D.F., 2000. Microbial enzyme shifts explain litter decay responses to simulated nitrogen deposition. *Ecology*, **81**, 2359–2365.
- Claus, D., Hempel, W., 1970. Specific substrates for isolation and differentiation of *Azotobacter vinelandii*. *Archives of Microbiology*, **73**, 90–96.
- Clausen, C.A., 1996. Bacterial associations with decaying wood: a Review. *International Biodeterioration and Biodegradation*, **37**, 101–107.
- Daniel, G., Nilsson, T., 1986. Ultrastructural observations on wood – degrading erosion bacteria. *The International Research Group on Wood Preservation*, Document No.: IRG/WP 86–1283.
- Danso, S.K.A., Hardarson, G., Zapata, F., 1993. Misconceptions and practical problems in the use of ^{15}N soil enrichment techniques for estimating N_2 fixation. *Plant and Soil*, **152**, 25–52.
- Deakin, W.J., Broughton, W.J., 2009. Symbiotic use of pathogenic strategies: rhizobial protein secretion systems. *Nature Reviews Microbiology*, **7**, 312–320.
- de Bary, A.H., 1879. Die Erscheinung der Symbiose, Verlag Karl J. Trubner, Strasbourg.
- de Boer, W., Folman, L.B., Klein Gunnewiek, P.J.A., Svensson, T., Bastviken, D., Oeberg, G., del Rio, J.C., Boddy, L., 2010. Mechanism of antibacterial activity of the white-rot fungus *Hypholoma fasciculare* colonizing wood. *Canadian Journal of Microbiology*, **56**, 380–388.
- de Boer, W., Folman, L.B., Summerbell, R.C., Boddy, L., 2005. Living in a fungal world: impact on fungi on soil bacterial niche development. *FEMS Microbiology Reviews*, **29**, 795–811.
- de Boer, W., van der Wal, A., 2008. Interactions between saprotrophic basidiomycetes and bacteria. In: Boddy, L., Frankland, J.C., van West, P. (eds.), *Ecology of saprotrophic basidiomycetes*, 1st ed. Elsevier, Amsterdam, pp. 143–153.
- De Laeter, J.R., Böhlke, J.K., De Bièvre, P., Hidaka, H., Peiser, H.S., Rosman, K.J.R., Taylor, P.D.P., 2003. Atomic weights of the elements: Review 2000 (IUPAC Technical Report). *Pure and Applied Chemistry*, **75**, 683–800.
- Deutsches Institut für Normung e.V., 1996. DIN EN 113 Wood preservatives - Method of test for determining the protective effectiveness against wood destroying basidiomycetes - Determination of the toxic values. Beuth Verlag GmbH, Berlin.
- Deutsches Institut für Normung e.V., 2008. DIN CEN/TS 839 Wood preservatives - Determination of the protective effectiveness against wood destroying basidiomycetes - Application by surface treatment. Beuth Verlag GmbH, Berlin.
- Deutsches Institut für Normung e.V., 1996. DIN 1319-3 Fundamentals of metrology - Part 3: Evaluation of measurements of a single measurand, measurement uncertainty. NATG 152 Normenausschuss Technische Grundlagen (eds.), Beuth Verlag GmbH, Berlin.
- Deutsches Institut für Normung e.V., 1979. DIN ISO 2533 Standard Atmosphere. Beuth Verlag GmbH, Berlin.

- Deutsches Institut für Normung e.V., 1979. DIN EN ISO 3188 Starches and derived products - Determination of nitrogen content by the Kjeldahl method - Titrimetric method (ISO 3188:1978), Beuth Verlag GmbH, Berlin.
- Deutsches Institut für Normung e.V., 2006. DIN EN ISO 17665-1 Sterilization of health care products - Moist heat - Part 1: Requirements for the development, validation and routine control of a sterilization process for medical devices, Beuth Verlag GmbH, Berlin.
- Deutsches Institut für Normung e.V., 1978. DIN 52186 Testing of wood; bending test. Fachnormenausschuss Materialprüfung (FNM) im DIN, Beuth Verlag GmbH, Berlin.
- Duc, L., Noll, M., Meier, B.E., Bürgmann, H., Zeyer, J., 2009. High diversity of diazotrophs in the forefield of a receding alpine glacier. *Microbiology Ecology*, **57**, 179–190.
- Eastwood, D.C., Floudas, D., Binder, M., Majcherczyk, A., Schneider, P., Aerts, A., Asiegbu, F.O., Baker, S.E., Barry, K., Bendiksby, M., Blumentritt, M., Coutinho, P.M., Cullen, D., de Vries, R.P., Gathman, A., Goodell, B., Henrissat, P.M., Ihrmark, K., Kauserud, H., Kohler, A., LaButti, K., Lapidus, A., Lavin, J.L., Lee, Y.-H., Linquist, E., Lilly, W., Lucas, S., Morin, E., Murat, C., Oguiza, J.A., Park, J., Pisabarro, A.G., Riley, R., Rosling, A., Salamov, A., Schmidt, O., Schmutz, J., Skrede, J., Stenlid, J., Wiebenga, A., Xie, X., Kues, U., Hibbett, D.S., Hoffmeister, D., Högberg, N., Martin, F., Grigoriev, I.V., Watkinson, S.C., 2011. The plant cell wall-decomposing machinery underlies the functional diversity of forest fungi, *Science*, **333**, 762–765.
- Elisashvili, V., Kachlishvili, E., 2009. Physiological regulation of laccase and manganese peroxidase production by white-rot basidiomycetes. *Journal of Biotechnology*, **144**, 37–42.
- Emmerton, K.S., Callaghan, T.V., Jones, H.E., Leake, J.R., Michelsen, A., Read, D.J., 2001a. Assimilation and isotopic fractionation of nitrogen by mycorrhizal fungi. *New Phytologist*, **151**, 503–511.
- Emmerton, K.S., Callaghan, T.V., Jones, H.E., Leake, J.R., Michelsen, A., Read, D.J., 2001b. Assimilation and isotopic fractionation of nitrogen by mycorrhizal and nonmycorrhizal subarctic plants. *New Phytologist*, **151**, 513–524.
- Fisher, R.A., 1935. *The Design of Experiments*. Oliver and Boyd, Edinburgh.
- Folman, L.B., Klein Gunnewiek, P.J.A., Boddy, L., de Boer, W., 2008. Impact of white-rot fungi on numbers and community composition of bacteria colonizing beech wood from forest soil. *FEMS Microbiology Ecology*, **63**, 181–191.
- Fog, K., 1988. The effect of added nitrogen on the rate of decomposition of organic-matter. *Biological Reviews of the Cambridge Philosophical Society*, **63**, 433–462.
- Frey, S.D., Knorr, M., Parrent, J.L., Simpson, R.T., 2004. Chronic nitrogen enrichment affects the structure and function of the soil microbial community in temperate hardwood and pine forests, *Forest Ecology and Management*, **196**, 159–171.
- Frey-Klett, P., Garbaye, J., Tarkka, M., 2007. The mycorrhiza helper bacteria revisited. *New Phytologist*, **176**, 22–36.
- Frey-Klett, P., Burlinson, P., Deveau, A., Barret, M., Tarkka, M., Sarniguet, A., 2011. Bacterial-fungal interactions: Hyphens between agricultural, clinical, environmental, and food microbiologists. *Microbiology and Molecular Biological Research*, **75**, 583–609.
- Gadd, G.M., 2007. Geomycology: biogeochemical transformations of rocks, minerals, metals and radionuclides by fungi, bioweathering and bioremediation. *Mycological Research*, **111**, 3–49.
- Galloway, J.N., Dentener, F.J., Capone, D.G., Boyer, E.W., Howarth, R.W., Seitzinger, S.P., Asner, G.P., Cleveland, C.C., Green, P.A., Holland, E.A., Karl, D.M., Michaels, A.F., Porter, J.H., Townsend, A.R., Vörösmarty, C.J., 2004. Nitrogen cycles: past, present, and future *Biogeochemistry*, **70**, 153–226.

- Garbaye, J., 1994. Tansley Review No. 76 Helper bacteria: a new dimension to the mycorrhizal symbiosis. *New Phytologist*, **128**, 197–210.
- Gårdenäs, A.I., Ågren, G.I., Bird, J.A., Clarholm, M., Hallin, S., Ineson, P., Kätterer, T., Knicker, H., Nilsson, S.I., Näsholm, T., Ogle, S., Paustian, K., Persson, T., Stendahl, J., 2011. Knowledge gaps in soil carbon and nitrogen interactions – From molecular to global scale. *Soil Biology and Biochemistry*, **43**, 702–717.
- Gebauer, G., Taylor, A.F.S., 1999. ¹⁵N natural abundance in fruit bodies of different functional groups of fungi in relation to substrate utilization. *New Phytologist*, **142**, 93–101.
- Gelbrich, J., Mai, C., Militz, H., 2008. Chemical changes in wood degraded by bacteria. *International Biodeterioration and Biodegradation*, **61**, 24–32.
- Godin, J.-P., Fay, L.-B., Hopfgartner, G., 2007. Liquid chromatography combined with mass Spectrometry for ¹³C isotopic analysis in life science research. *Mass Spectrometry Reviews*, **26**, 751–774.
- Greaves, H., 1971. The bacterial factor in wood decay. *Wood Science and Technology*, **5**, 6–16.
- Grinda, M., 1997. Some experiences with attack of microorganisms on wooden constructions supporting foundations of houses and bridges, *The International Research Group on Wood Preservation*. Document No.: IRG/WP 97-10232.
- Gundersen, P., Emmet, B.A., Kjønås, O.J., Koopmans, C.J., Tietema, A., 1998. Impact of nitrogen deposition on nitrogen cycling in forests: a synthesis of NITREX data. *Forest Ecology Management*, **101**, 37–55.
- Hardarson, G., Zapata, F., Danso, S.K.A., 1984. Effect of plant genotype and nitrogen fertilizer on symbiotic nitrogen fixation by soybean cultivars. *Plant and Soil*, **82**, 397–405.
- Hardy, R.W.F., Holsten, R.D., Jackson, E.K., Burns, R.C., 1968. The acetylene-ethylene assay for N₂ fixation: Laboratory and field evaluation. *Plant Physiology*, **43**, 1185–1207.
- He, H., Xie, H., Zhang, X., 2006. A novel GC/MS technique to assess ¹⁵N and ¹³C incorporation into soil amino sugars. *Soil Biology and Biochemistry*, **38**, 1083–1091.
- Hedayat, A., Wallis, W.D., 1978. Hadamard matrices and their applications. *The Annals of Statistics*, **6**, 1184–1238.
- Hilger, F., 1964. Comportement des bactéries fixatrices d'azote du genre *Beijerinckia* a l'égard du pH et du calcium. *Annals Institute Pasteur (Paris)*, **106**, 279–291.
- Hobbie, E.A., Hobbie, J.E., 2008. Natural abundance of ¹⁵N in nitrogen-limited forests and tundra can estimate nitrogen cycling through mycorrhizal fungi: A Review. *Ecosystems*, **11**, 815–830.
- Hobbie, E.A., Macko, S.A., Shugart, H.H., 1999. Insights into nitrogen and carbon dynamics of ectomycorrhizal and saprotrophic fungi from isotopic evidence. *Oecologia*, **118**, 353–360.
- Hobbie, E.A., Sánchez, F.S., Rygielwicz, P.T., 2004. Carbon use, nitrogen use, and isotopic fractionation of ectomycorrhizal and saprotrophic fungi in natural abundance and ¹³C-labelled cultures. *Mycological Research*, **108**, 725–736.
- Hobbie, J.E., Hobbie, E.A., 2006. ¹⁵N in symbiotic fungi and plants estimates nitrogen and carbon flux rates in arctic tundra. *Ecology*, **87**, 816–822.
- Hoefs, J., 2009. *Stable Isotope Geochemistry*, 6th ed. Springer, Heidelberg.
- Hoffmann, B.M., Dean, D.R., Seefeldt, L.C., 2009. Climbing nitrogenase: Toward a mechanism of enzymatic nitrogen fixation. *Accounts of Chemical Research*, **42**, 609–619.
- Hofrichter, M., 2002. Review: lignin conversion by manganese peroxidase (MnP). *Enzyme and Microbial Technology*, **30**, 454–466.

- Högberg, P., 1997. Tansley Review No. 95 - ^{15}N natural abundance in soil-plant systems. *New Phytologist*, **137**, 179–203.
- Högberg, P., Högberg, M.N., Quist, M.E., Ekblad, A., Näsholm, T., 1999. Nitrogen isotope fractionation during nitrogen uptake by ectomycorrhizal and non-mycorrhizal *Pinus sylvestris*. *New Phytologist*, **142**, 569–576.
- Högberg, P., Högbom, L., Schinkel, H., Högberg, M., Johannisson, C., Wallmark, H., 1996. ^{15}N abundance of surface soils, roots and mycorrhizas in profiles of European forest soils. *Oecologia*, **108**, 207–214.
- Högberg, P., Johannisson, C., Yarwood, S., Callesen, I., Näsholm, T., Myrold, D.D., Högberg, M.N., 2011. Recovery of ectomycorrhiza after 'nitrogen saturation' of a conifer forest. *New Phytologist*, **189**, 515–525.
- Högberg, P., Näsholm, T., Högbom, L., Stahl, L., 1994. Use of ^{15}N labelling and ^{15}N natural abundance to quantify the role of mycorrhizas in N uptake by plants: importance of seed N and of changes in the ^{15}N labelling of available N. *New Phytologist*, **127**, 515–519.
- Houlton, B.Z., Wang, Y.-P., Vitousek, P.M., Field, C.B., 2008. A unifying framework for dinitrogen fixation in the terrestrial biosphere. *Nature*, **454**, 327–331.
- Jacques, P., Hbid, C., Destain, J., Razafindralambo, H., Paquot, M., De Pauw, E., Thonart, P., 1999. Optimization of biosurfactant lipopeptide production from *Bacillus subtilis* S499 by Plackett-Burman Design. *Applied Biochemistry and Biotechnology*, **77**, 223–233.
- Jakobs-Schönwandt, D., Mathies, H., Abraham, W.-R., Pritzkow, W., Stephan, I., Noll, M., 2010. Biodegradation of a biocide (Cu-N-Cyclohexyldiazonium Dioxide) component of a wood preservative by a defined soil bacterial community. *Applied and Environmental Microbiology*, **76**, 8076–8083.
- Jehmlich, N., Schmidt, F., von Bergen, M., Richnow, H.-H., Vogt, C., 2008. Protein-based stable isotope probing (Protein-SIP) reveals active species within anoxic mixed cultures. *The ISME Journal*, **2**, 1122–1133.
- Jetten, M.S.M., 2008. The microbial nitrogen cycle. *Environmental Microbiology*, **10**, 2903–2909.
- Jin, I., Nicholas, D.D., Kirk, T.K., 1990. Mineralization of the methoxyl carbon of isolated lignin by brown-rot fungi under solid substrate conditions. *Wood Science and Technology*, **24**, 263–276.
- Jordan, B.A., Schmidt, E.L., 2000. Site characteristics impacting historic waterlogged wood: A review. *The International Research Group on Wood Preservation*, Document No.: IRG/WP 00-10344.
- Junk, G., Svec, H.J., 1958. The absolute abundance of the nitrogen isotopes in the atmosphere and compressed gas from various sources. *Geochimica et Cosmochimica Acta*, **14**, 234–243.
- Jurgensen, M.F., Larsen, M.J., Spano, S.D., Harvey, A.E., Gale, M.R., 1984. Nitrogen fixation associated with increased wood decay in Douglas-fir residue. *Forest Science*, **30**, 1038–44.
- Jurgensen, M.F., Larsen, M.J., Wolosiewicz, M., Harvey, A.E., 1989. A comparison of dinitrogen fixation rates in wood litter decayed by white-rot and brown-rot fungi. *Plant and Soil*, **115**, 117–122.
- Kaldorf, M., Koch, B., Rexer, K.H., Kost, G., Varma, A., 2005. Patterns of interaction between *Populus* Esch5 and *Piriformospora indica*: A Transition from mutualism to antagonism. *Plant Biology*, **7**, 210–218.
- Kirk, T.K., 1987. Enzymatic "combustion": The microbial degradation of lignin. *Annual Reviews of Microbiology*, **41**, 465–505.

- Kleppmann, W., 2008. *Taschenbuch Versuchsplanung - Produkte und Prozesse optimieren*, 5th ed. Carl Hanser Verlag, München.
- Landy, E.T., Mitchell, J.I., Hotchkiss, S., Eaton, R.A., 2008. Bacterial diversity associated with archaeological waterlogged wood: Ribosomal RNA clone libraries and denaturing gradient gel electrophoresis (DGGE). *International Biodeterioration and Biodegradation*, **61**, 106–116.
- Levi, M.P., Cowling, E.B., 1969. Role of nitrogen in wood deterioration VII. Physiological adaptation of wood-destroying and other fungi to substrates deficient in nitrogen. *Phytopathology*, **59**, 460–468.
- Li, C.Y., Massicoté, H.B., Moore, L.V.H., 1992. Nitrogen-fixing *Bacillus* sp. associated with Douglas-fir tuberculate ectomycorrhizae. *Plant and Soil*, **140**, 35–40.
- Lilly, V.G., Barnett, H.L., 1951. *Physiology of the fungi*. McGraw-Hill Book Company, New York.
- Lindahl, B.D., Olsson, S., 2004. Fungal translocation – creating and responding to environmental heterogeneity. *Mycologist*, **18**, 79–88.
- Lowe, D.J., Thorneley, R.N.F., 1984. The mechanism of *Klebsiella pneumoniae* nitrogenase action, Pre-steady-state kinetics of H₂ formation. *Biochemical Journal*, **224**, 877–886.
- Lucic, E., Fourrey, C., Kohler, A., Martin, F., Chalot, M., Brun-Jacob, A., 2008. A gene repertoire for nitrogen transporters in *Laccaria bicolor*. *New Phytologist*, **180**, 343–364.
- Macko, S.A., Uhle, M.E., Engel, M.H., Andrusevich, V., 1997. Stable nitrogen isotope analysis of amino acid enantiomers by gas chromatography/combustion/isotope ratio mass spectrometry. *Analytical Chemistry*, **69**, 926–929.
- Martínez, D., Challacombe, J., Morgenstern, I., Hibbett, D., Schmoll, M., Kubicek, C.P., Ferreira, P., Ruiz-Dueñas, F.J., Martínez, A.T., Kersten, P., Hammel, K.E., Van den Wymelenberg, A., Gaskell, J., Lindquist, E., Sabat, G., Splinter BonDurant, S., Larrondo, L.F., Canessa, P., Vicuña, R., Yadav, J., Doddapaneni, H., Subramanian, V., Pisabarro, A.G., Lavín, J.L., Oguiza, J.A., Master, M., Henrissat, B., Coutinho, P.M., Harris, P., Magnuson, J.K., Baker, S.E., Bruno, K., Kenealy, W., Hoegger, P.J., Kües, U., Ramaiya, P., Lucas, S., Salamov, A., Shapiro, H., Tu, H., Chee, C.L., Misra, M., Xie, G., Teter, S., Yaver, D., James, T., Mokrejs, M., Pospíšek, M., Grigoriev, I.V., Brettin, T., Rokhsar, D., Berka, R., Cullen, D., 2009. Genome, transcriptome, and secretome analysis of wood decay fungus *Postia placenta* supports unique mechanisms of lignocelluloses conversion. *Proceedings of the National Academy of Science of the United States of America*, **106**, 1954–1959.
- Meier-Augenstein, W., 1999. Applied gas chromatography coupled to isotope ratio mass spectrometry. *Journal of Chromatography A*, **842**, 351–371.
- Metges, C.C., Petzke, K.-J., Hennig, U., 1996. Gas chromatography combustion isotope ratio mass spectrometric comparison of *N*-acetyl- and *N*-pivaloyl amino acid esters to measure ¹⁵N isotopic abundances in physiological samples: A pilot study on amino acid synthesis in the upper gastro-intestinal tract of minipigs. *Journal of Mass Spectrometry*, **31**, 367–376.
- Mikiashvili, N., Elisashvili, V., Wasser, S., Nevo, E., 2005. Carbon and nitrogen sources influence the ligninolytic enzyme activity of *Trametes versicolor*. *Biotechnology Letters*, **27**, 955–959.
- Miransari, M., 2011. Interactions between arbuscular mycorrhizal fungi and soil bacteria. *Applied Microbiology Biotechnology*, **89**, 917–930.
- Millbank, J.W., Olsen, J.D., 1981. The assessment of nitrogen fixation and throughput by lichen II. Construction of an enclosed growth chamber for the use of ¹⁵N₂. *New Phytologist*, **89**, 657–665.

- Naumann, A., Navarro-González, M., Peddireddi, S., Kües, U., Polle, A., 2005. Fourier transform infrared microscopy and imaging: Detection of fungi in wood. *Fungal Genetics and Biology*, **42**, 829–835.
- Niemenmaa, O., Uusi-Rauva, A., Hatakka, A., 2008. Demethoxylation of [O¹⁴CH₃]-labelled lignin model compounds by the brown-rot fungi *Gloeophyllum trabeum* and *Poria (Postia) placenta*. *Biodegradation*, **19**, 555–565.
- Nilsson, T., Björdal, C., Fällman, E., 2008. Culturing erosion bacteria: Procedures for obtaining purer cultures and pure strains. *International Biodeterioration and Biodegradation*, **61**, 17–23.
- Nilsson, T., Daniel, G., 1983. Tunnelling bacteria. *The International Research Group on Wood Preservation*. Document No.: IRG/WP 83–1183.
- Ohyama, T., Kumazawa, K., 1981. A simple method for the preparation, purification and storage of (N₂)-N-15 gas for biological nitrogen-fixation studies. *Soil Science and Plant Nutrition*, **27**, 263–265.
- Olsson, I.-M., Johansson, E., Berntsson, M., Eriksson, L., Gottfries, J., Wold, S., 2006. Rational DOE protocols for 96-well plates. *Chemometrics and Intelligent Laboratory Systems*, **83**, 66–74.
- Paajanen, L., Viitanen, H., 1988. Microbial degradation of wooden piles in building foundations. *The International Research Group on Wood Preservation*. Document No.: IRG/WP/88–1370.
- Perez-Moreno, J., Read, D.J., 2001. Exploitation of pollen by mycorrhizal mycelia systems with special reference to nutrient recycling in boreal forests. *Proceedings of the Royal Society B*, **268**, 1329–1335.
- Petzke, K.J., Boeing, H., Metges, C.C., 2005. Choice of dietary protein of vegetarians and omnivores is reflected in their hair protein ¹³C and ¹⁵N abundance. *Rapid Communication in Mass Spectrometry*, **19**, 1392–1400.
- Plackett, R.L., Burman, J.P., 1946. The design of optimal multifactorial experiments. *Biometrika*, **33**, 305–325.
- Qi, H., Coplen, T.B., Geilmann, H., Brand, W.A., Böhlke, J.K., 2003. Two new organic reference materials for δ¹³C and δ¹⁵N measurements and a new value for the δ¹³C of NBS 22 oil. *Rapid Communication in Mass Spectrometry*, **17**, 2483–2487.
- Read, D.J., Perez-Moreno, J., 2003. Mycorrhizas and nutrient cycling in ecosystems – a journey towards relevance? *New Phytologist*, **157**, 475–429.
- Retzlaff, G., Rust, G., Waibel, J., 1978. *Statistische Versuchsplanung – Planung naturwissenschaftlicher Experimente und ihre Auswertung mit statistischen Methoden*, 2nd ed. Verlag Chemie, Weinheim.
- Robbins, W.J., 1937. The assimilation by plants of various forms of nitrogen. *American Journal of Botany*, **24**, 243–250.
- Rösch, C., Bothe, H., 2005. Improved assessment of denitrifying, N₂-fixing, and total-community bacteria by Terminal Restriction Fragment Length Polymorphism analysis using multiple restriction enzymes. *Applied and Environmental Microbiology*, **71**, 2026–2035.
- Ryan, F.J., Beadle, G.W., Tatum, E.L., 1943. The tube method of measuring the growth rate of neurospora. *American Journal of Botany*, **30**, 784–799.
- Saiya-Cork, K.R., Sinsabaugh, R.L., Zak, D.R., 2002. The effects of long term nitrogen deposition on extracellular enzyme activity in an *Acer saccharum* forest soil. *Soil Biology and Biochemistry*, **34**, 1309–1315.

- Schneider, T., Schmid, E., de Castro Jr., J.V., Cardinale, M., Eberl, L., Grube, M., Berg, G., Riedel, K., 2011. Structure and function of the symbiosis partners of the lung lichen (*Lobaria pulmonaria* L. Hoffm.) analyzed by metaproteomics. *Proteomics*, **11**, 2752–2756.
- Schmidt, O., 2006. *Wood and Tree Fungi: Biology, Damage, Protection, and Use*. Springer, Berlin.
- Shearer, G., Kohl, D.H., 1989. Estimates of N₂ fixation in ecosystems: The need for and basis of the ¹⁵N natural abundance method. In: Rundel, P.W., Ehleringer, J.R., Nagy, K.A., (eds.), *Stable Isotopes in Ecological Research*, Springer, Berlin, pp. 343–374.
- Shearer, G., Kohl, D.H., 1993. Natural abundance of ¹⁵N: Fractional contribution of two sources to a common sink and use of isotope discrimination. In: Knowles, R., Blackburn, T.H., (eds.), *Nitrogen Isotope Techniques*, Academic Press Inc., San Diego, pp. 89–125.
- Sinsabaugh, R.L., Carreiro, M., Repert, D., 2002. Allocation of extracellular enzymatic activity in relation to litter composition, N deposition, and mass loss. *Biogeochemistry*, **60**, 1–24.
- Stephan, I., Göller, S., Rudolph, D., 2000. Improvements of monitoring the effects of soil organisms on wood in ground contact. *European Journal of Wood and Wood Products*, **58**, 115–119.
- Streichan, M., Schink, B., 1986. Microbial populations in wet wood of European white-fir (*Abies alba* Mill.). *FEMS Microbiology Ecology*, **38**, 141–150.
- Sørensen, S.P.L., 1909. Enzymstudien. II: Mitteilung. Über die Messung und die Bedeutung der Wasserstoffionenkonzentration bei enzymatischen Prozessen. *Biochemische Zeitschrift*, **21**, 131–304.
- Taylor, A.F.S., Högbom, L., Högberg, M., Lyon, A.J.E., Näsholm, T., Högberg, P., 1997. Natural ¹⁵N abundance in fruit bodies of ectomycorrhizal fungi from boreal forests. *New Phytologist*, **136**, 713–720.
- Thiele, B., Füllner, K., Stein, N., Oldiges, M., Kuhn, A.J., Hofmann, D., 2008. Analysis of amino acids without derivatization in barley extracts by LC-MS-MS. *Analytical and Bioanalytical Chemistry*, **391**, 2663–2672.
- Thorneley, R.N.F., Lowe, D.J., 1985. In: Spiro, T.G., (ed.), *Molybdenum Enzymes*. Wiley-Interscience, New York, p. 221.
- Timonen, S., Hurek, T., 2006. Characterization of culturable bacterial populations associating with *Pinus sylvestris*-*Suillus bovinus* mycorrhizospheres. *Canadian Journal of Microbiology*, **52**, 769–778.
- Tlalka, M., Watkinson, S.C., Darrah, P.R., Fricker, M.D., 2002. Continuous imaging of amino-acid translocation in intact mycelia of *Phanerochaete velutina* reveals rapid, pulsatile fluxes. *New Phytologist*, **153**, 173–184.
- Valášková, V., de Boer, W., Klein Gunnewiek, P.J.A., Pospíšek, M., Baldrian, P., 2009. Phylogenetic composition and properties of bacteria coexisting with the fungus *Hypholoma fasciculare* in decaying wood. *ISME Journal*, **3**, 1218–1221.
- Valášková, V., Baldrian, P., 2006. Estimation of bound and free fractions of lignocellulose-degrading enzymes of wood-rotting fungi *Pleurotus ostreatus*, *Trametes versicolor* and *Piptoporus betulinus*. *Research in Microbiology*, **157**, 119–124.
- van der Wal, A., de Boer, W., Smant, W., van Veen, J.A., 2007. Initial decay of woody fragments in soil is influenced by size, vertical position, nitrogen availability and soil origin. *Plant and Soil*, **301**, 189–201.
- Virginia, R.A., Jarrell, W.M., Rundel, P.W., Shearer, G., Kohl, D.H., 1988. The use of variation in the natural abundance of ¹⁵N to assess symbiotic nitrogen fixation by woody plants. In: Rundel, P.W., Ehleringer, J.R., Nagy, K.A., (eds.), *Stable Isotopes in Ecological Research*, 1st ed. Springer-Verlag, Berlin, pp. 375–394.

- Vogl, J., 2007. Characterization of reference materials by isotope dilution mass spectrometry. *Journal of Analytical Atomic Spectrometry*, **22**, 475–492.
- Vogl, J., Pritzkow, W., 2010. Isotope dilution mass spectrometry – A primary method of measurement and its role for RM certification. *Mapan - Journal of Metrology Society of India*, **25**, 135–164.
- Waldrop, M.P., Zak, D.R., Sinsabaugh, R.L., 2004. Microbial community response to nitrogen deposition in northern forest ecosystems. *Soil Biology and Biochemistry*, **36**, 1443–1451.
- Warembourg, F.R., 1993. Nitrogen Fixation in Soil and Plant Systems. In: Knowles, R., Blackburn, T.H., (eds.), *Nitrogen Isotope Techniques*, Academic Press, Inc., San Diego, pp. 127–155.
- Watkinson, S., Bebber, D., Darrah, P., Fricker, M., Tlalka, M., Boddy, L., 2006. The role of wood decay fungi in the carbon and nitrogen dynamics of the forest floor. In: Gadd, G.M., (ed.), *Fungi in Biogeochemical Cycles*, Cambridge University Press, Cambridge, pp. 151–181.
- Watkinson, S.C., Davison, E.M., Bramah, J., 1981. The effect of nitrogen availability on growth and cellulolysis by *Serpula lacrimans*. *New Phytologist*, **89**, 295–305.
- Weand, M.P., Arthur, M.A., Lovett, G.M., McCulley, R.L., Weathers, K.C., 2010. Effects of tree species and N additions on forest floor microbial communities and extracellular enzyme activities. *Soil Biology and Biochemistry*, **42**, 2161–2173.
- Weißhaupt, P., Pritzkow, W., Noll, M., 2011. Nitrogen metabolism of wood decomposing basidiomycetes and their interaction with diazotrophs as revealed by IRMS. *International Journal of Mass Spectrometry*, **307**, 225–231.
- Weißhaupt, P., Pritzkow, W., Noll, M., 2012. Nitrogen sources of *Oligoporus placenta* and *Trametes versicolor* evaluated in a 2³ experimental plan. *Fungal Biology*, **116**, 81–89.
- White, C., Gadd, G.M., 1996. Mixed sulphate-reducing bacterial cultures for bioprecipitation of toxic metals: factorial and response-surface analysis of the effects of dilution rate, sulphate and substrate concentration. *Microbiology*, **142**, 2197–2205.
- White, N.A., Boddy, L., 1992. Differential extracellular enzyme production in colonies of *Coriolus versicolor*, *Phlebia radiata* and *Phlebia rufa*: effect of gaseous regime. *Journal of General Microbiology*, **138**, 2589–2598.
- Wolfenden, B.S., Willson, R.L., 1982. Radical-cations as reference chromogens in kinetic Studies of one-electron transfer reactions: Pulse radiolysis studies of 2,2'-azinobis-(3-ethylbenzthiazoline-6-sulphonate). *Journal of the Chemical Society, Perkin Transactions 2*, **7**, 805–812.
- Wolff, J.-C., Dyckmans, B., Taylor, P.D.P., De Bièvre, P., 1996. Certification of a ¹⁵N-enriched nitrate species-specific spike isotope reference material IRMM-627. *International Journal of Mass Spectrometry and Ion Processes*, **156**, 67–75.
- Zeller, B., Brechet, C., Maurice, J.-P., Le Tacon, F., 2007. ¹³C and ¹⁵N isotopic fractionation in trees, soils and fungi in a natural forest stand and a Norway spruce plantation. *Annals of Forest Science*, **64**, 419–429.
- Zhang, X., Amelung, W., 1996. Gas chromatographic determination of muramic acid, glucosamine, mannosamine, and galactosamine in soils. *Soil Biology and Biochemistry*, **28**, 1201–1206.
- Zhang, X., He, H., Amelung, W., 2007. A GC/MS method for the assessment of ¹⁵N and ¹³C incorporation into soil amino acid enantiomers. *Soil Biology and Biochemistry*, **39**, 2785–2796.

8. Acknowledgements

This thesis was part of the BAM Federal Institute for Materials Research and Testing Innovation Program. The financial, structural and professional support is highly appreciated.

Prof. Dr. Ulrich Szewzyk, Technical University of Berlin, is acknowledged for supervising my thesis. I would like to thank him and Prof. Dr. Wolfgang Rotard for surveying the dissertation.

In addition, I would like to express my gratitude to the chairman of the examination board, Prof. Dr. Sven-Uwe Geißen.

I wish to offer my sincere thanks to Prof. Dr. Matthias Noll and Dr. Wolfgang Pritzkow for their mentorship, and also to Dr. Annette Naumann for her support in the later stage of my studies.

Furthermore, I would like to thank Dr. Ina Stephan, Dr. Jochen Vogl and their working groups for their cooperation and for providing equipment. It was a great experience for me to join both groups.

I wish to express my gratitude to Dr. Dirk Tuma for his excellent support with the gas measurements and mixtures and for fruitful discussions and comments to the manuscript.

To Dr. Wietse de Boer, The Netherlands Institute of Ecology (NIOO-KNAW), I am also grateful for his contributions to this work by bacterial strains, his expertise and the experimental results of *nifH*-gene analysis.

Many thanks are offered to Leonie Lang, Lisa Kersting and Dipl.-Ing. Andreas Litzba. They participated in this project during internships.

Finally, I would like to thank my family for their patience and support during many years of studies and my doctorate.