



## False-positive results of UN test O.2 liquid oxidizer test of polychlorosilanes

C. Kroesche<sup>a,\*</sup>, K. Budde<sup>b</sup>, M. Malow<sup>c</sup>

<sup>a</sup> Evonik Resource Efficiency GmbH, Product Safety Department, 63457, Hanau, Germany

<sup>b</sup> BSC Budde Safety Consulting GmbH, Chemical Process and Plant Safety, 46284, Dorsten, Germany

<sup>c</sup> Bundesanstalt für Materialforschung und -prüfung (BAM), 12205, Berlin, Germany

### ARTICLE INFO

#### Keywords:

Polychlorosilanes  
UN Test O.2  
Hexachlorodisilane  
Octachlorotrisilane  
Decachlorotetrasilane  
False-positive results

### ABSTRACT

According to UN Test O.2, surprisingly, the polychlorosilanes hexachlorodisilane (HCDS), octachlorotrisilane (OCTS) and decachlorotetrasilane (DCTS) formally fulfill the criteria of the “test for oxidizing liquids”. This result is in contrast to the properties of polychlorosilanes that are described in the literature and those we have experienced in our own production.

By investigating the reaction products from the UN O.2 test reactor, using IR, Raman and XPS spectroscopy, it was shown that the results are not due to oxidizing properties of HCDS, OCTS or DCTS, but are caused by the specified test substance cellulose. To our knowledge, this is the very first substance class in which the reference substance oxidizes the test sample, instead of vice versa. This represents an important limitation of the internationally used UN Test O.2 for this substance class. The cause for this false-positive result is the known high degree of affinity of oxygen to silicon.

It is shown that the correctly executed UN Test O.2 produces false-positive results and that the polychlorosilanes do not have an oxidizing effect and, therefore, do not have to be classified as “oxidizing substances”.

### 1. Introduction

Hexachlorodisilane (HCDS), octachlorotrisilane (OCTS), and decachlorotetrasilane (DCTS) are specialty chemicals, used as precursors for low temperature chemical vapour deposition of thin film layers of SiN, SiON, or epitaxial Si in the semiconductor and solar cell industry (Koleske, D. D.; Gates, S. M., 1994; Taylor, R. C.; Scott, B. A., 1989; Carlson, D.K., Comita, P.B, 2005), as well as in fibreglass production have found particular interest.

A characteristic, shared property of all chlorosilanes (including dichlorosilane, trichlorosilane, and tetrachlorosilane) is the immediate release of hydrogen chloride upon contact with water or moisture in the air, with precipitation of silicon hydroxides. The complexly structured precipitates of chlorosilanes with more than one Si atom, are explosive after drying (“poppy gels”) and have been identified as the cause for a serious accident in Japan in the year 2014 (Masamitsu Tamura, Hirota Akatsuka et al., 2014; Yu-Jhen Lin, Chien-Ho Liu et al., 2019).

These dried hydrolysates are friction-sensitive impact-sensitive (1–10 J, “BAM drop hammer test”) (EVONIK, 2016; Yu-Jhen Lin, Chien-Ho Liu et al., 2019). In contrast, the polychlorosilanes themselves

are neither impact-sensitive nor pyrophoric (UN test N.3), nor thermally sensitive under partial confinement (“Koenen test”) (EVONIK, 2016).

In the course of an overall safety analysis, the polychlorosilanes HCDS, OCTS, and DCTS were examined for their potential as oxidation agents.

In UN tests O.2, chlorosilanes with one Si atom (e.g. tetrachlorosilane) showed no oxidizing properties, but the products hexachlorodisilane (HCDS), octachlorotrisilane (OCTS) and decachlorotetrasilane (DCTS) surprisingly exhibited what appeared to be oxidizing properties. This was an unexpected finding, as from a structural aspect and from own experience in production, there had been no indications of potential oxidizing properties of this substance group. Neither the classical chemical literature (e.g. Greenwood and Earnshaw, 1995; Gmelin Handbuch der Anorganischen Chemie, 1959; Remy, 1970) nor modern publication that was evaluated (e.g. Yu-Jhen Lin, Chien-Ho Liu et al., 2019; Xiaobing Zhou, Mark A. Wanous et al., 2018) contained no corresponding information about potential oxidative properties of polychlorosilanes.

If these test results were to be applied formally, the substances would be classified and labeled as “oxidizing substances”, which would have

\* Corresponding author.

E-mail address: [christoph.kroesche@evonik.com](mailto:christoph.kroesche@evonik.com) (C. Kroesche).

<https://doi.org/10.1016/j.jlp.2021.104434>

Received 21 May 2020; Received in revised form 27 November 2020; Accepted 11 February 2021

0950-4230/© 2021 The Authors. Published by Elsevier Ltd. This is an open access article under the CC BY license (<http://creativecommons.org/licenses/by/4.0/>).

considerable effects on storage and transportation.

To determine the oxidative properties of a substance, the so-called "UN Test O.2" has been in use internationally since the early 90s (UN-GHS, 2019; Antoni et al., 2011). Considering the significance of this important test method for hazardous goods, the limits of the method must be demonstrated, and substances with structural elements that provide false results must be made known.

Unfortunately, there have been few publications dealing with the problem of the oxidizing properties of materials under transport law or GHS (Babrauskas, 2016; Koseki, 2001). We are not familiar with any literature that deal particularly with liquid oxidizers.

Considering these unexpected findings and their significance for this internationally used testing method, we investigated the cause of this reaction in more detail.

## 2. Material

Hexachlorodisilane (Siridion® HCDS, purity > 99.5%, CAS 13465-77-5), octachlorotrisilane (Siridion® OCTS, purity 97.5%, CAS 13596-23-1), decachlorotetrasilane (Siridion® DCTS, purity 98.1%, CAS 13763-19-4), tetrachlorosilane (Siridion® STC, purity > 99%, CAS 10026-04-7). All products are from the production facilities of EVONIK Industries AG in Rheinfelden (Baden), Germany. The substances are colorless liquids that were distilled for purification.

Reference substances used:

Nitric acid (65% aqueous solution), batch: K48498656648, Merck  
Sodium chlorate (40% aqueous solution), batch: MKBT4627V, Aldrich

Perchloric acid (50% aqueous solution), batch: SHBG2241V, Aldrich  
Cellulose: Technocel 75 batch G03001247, CFF; before being used, the cellulose was dried for 8 h at 105 °C

Activated carbon, batch K47378386645, Aldrich  
Diatomite (calcined), batch BCBW9472, Supelco

### 2.1. Instruments

Fourier transformation infrared spectra (FT-IR) were recorded on a Vertex-70, Bruker Optics (Ettlingen, Germany); measuring range: 7500–380 cm<sup>-1</sup> combined with an attenuated total reflection (ATR) diamond unit; measuring range: 6500–550 cm<sup>-1</sup>

Raman spectra had been recorded with a grating spectrometer LabRam-HR, Horiba (Bensheim, Germany); Laser 532 nm/50×-LWD-Objective; 100 accumulations.

## 3. Experimental method for testing for oxidizing properties

Pre-investigations for substances that could be oxidizing usually consist of a combination of theoretical assessment and/or screening tests. In many cases, an assessment can be made on this basis which means that no comprehensive classification test is required. In the case of organic compounds, there is no requirement to carry out a classification procedure according to UN test O.2 if the substance under consideration does not contain oxygen, chlorine, or fluorine or, if one of these elements is present, only a chemical bond to carbon or hydrogen is present (UN-TDG, 2015). These exclusion criteria do not exist for polychlorosilanes.

### 3.1. UN test O.2

The UN Test O.2 (UN-TDG, 2015) describes a method to test liquids for oxidizing properties. A substance that is assessed as oxidizing according to this test method is classified in the UN transportation class 5.1 "Oxidizing substances" (UN-MR, 2017). Within transportation class 5.1, substances are assigned to a packing group PG I, PG II, or PG III (strong,

medium or weak oxidizers, resp.) by comparing the relative oxidation strength with known oxidizing agents.

Reference oxidizing agents are 50% perchloric acid, 40% aqueous sodium chlorate solution, and 65% aqueous nitric acid, which are mixed with a defined cellulose in a mass ratio of 1:1 (reference mixtures for PG I, PG II, and PG III).

For the experiments, a pressure vessel with specified dimensions is used. The vessel is equipped with a rupture disk, a pressure transducer, and an ignition device.

The mixture of the respective test substance with cellulose or the individual reference substances with cellulose are placed in the pressure vessel. When the ignition source is activated, the time required for the pressure to change from 690 kPa to 2070 kPa is measured. This pressure increase for the mixture of polychlorosilane and cellulose is compared with the pressure increase times for the reference mixtures (UN-TDG, 2015). For classification according to the category "Oxidizing liquids" of the Globally Harmonized System of Classification and Labelling of Chemicals (UN-GHS, 2019), UN Test O.2 is also used, in which case GHS categories 1, 2, and 3 correspond to packing groups I, II, or III in transportation law. For the sake of simplicity, we use only the transportation nomenclature below.

Test method A.21 according to the Regulation EC No 440/2008 (European Union, 2008), was not used, as the test according to UN Test O.2 provides more detailed results.

### 3.2. Equipment and experiments

The figure below shows the setup of the test reactor (Fig. 1). The pressure measurement system consisted of a piezo-resistive pressure transducer (Kulite, MB 0 bar–50 bar) and a high-speed data recording device (10 kHz).

Test equipment, coiled filament, ignition device, and rupture disk corresponded to the test specification for UN Test O.2 (UN-TDG, 2015).

The polychlorosilanes HCDS, OCTS, DCTS, and STC were investigated. In additional investigations, as an alternative test substance to cellulose, activated carbon, diatomite, and calcium carbonate were also used.

### 3.3. Preparing the reference and test mixtures

The reference mixtures were prepared in the laboratory and placed in the reactor.

The test mixtures containing chlorosilanes and the reactor filling for the individual tests were carried out in a dry N<sub>2</sub> atmosphere in a glove box (measured O<sub>2</sub> concentration: 1–2%), as the chlorosilanes react immediately with moisture in the air and form hydrochloric acid (Fig. 2). The UN O.2 specification does not describe or require that the reactor be filled under inert gas, but that is important here, in order to exclude a reaction with oxygen.

The mass ratio of the respective reference substance: cellulose and the respective test substance: cellulose was 1:1. In all cases, the total mass of a single mixture was 5 g.

## 4. Results and discussions

To assess the results, the average of the pressure increase time for the pressure range 690 kPa–2070 kPa with the test substance was compared to the respective average of five single tests with each reference mixture (see Table 1). No measurement deviated from the average by more than 30%.

Fig. 3 shows a chart of the results of the experiments where the values for 50% perchloric acid, 40% sodium perchlorate solution, and 65% nitric acid represent the respective limit values for packing groups PG I, PG II, and PG III (strong, medium or weak oxidizers, resp.).

Based on these results, from a purely formal aspect, DCTS and OCTS would be classified in transportation class 5.1 in packing group II, while

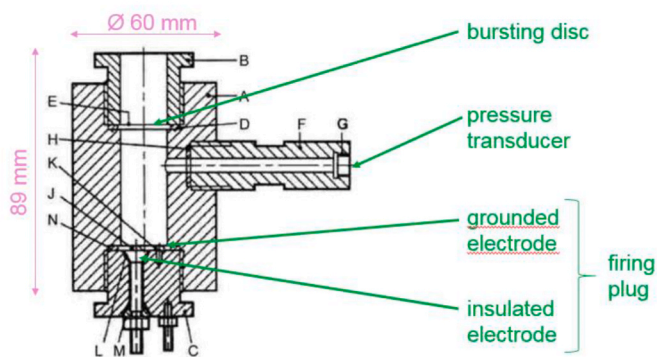

Fig. 1. Schematic view (left, picture adapted from European Union (2008)) and photo (right) of the test reactor.



Fig. 2. N<sub>2</sub>-inertized glove box with test reactor.

Table 1

Average pressure increase times from 5 experiments each [ms].

STC	HCDS	OCTS	DCTS	65% nitric acid	40% sod. Chlorate	50% perchlor. Acid
6228	2106	531	220	5153	636	67

HCDS would be classified in packing group III. This is a surprising result.

The silicon in STC is already in the highest oxidation state (+IV), therefore no further oxidation of Si is possible. The result of the investigation of STC shows that in comparison with the pressure increase times of the reference substances, there was also no reaction acceleration (Fig. 3). Consequently, STC cannot be classified in transportation class 5.1. This was an expected result.

#### 4.1. Results of the test verification

According to UN-TDG (2015) sub-section 34.4.2, the test shall be repeated with an inert substance, such as diatomite (kieselgur) in place of the cellulose, if in the main test with the cellulose a pressure rise (too high or too low) is measured which may not be caused by the oxidizing properties of the substance to be tested and thus, would constitute a false-positive result. Additionally, tests with chalk and charcoal had been performed to investigate the reactivity with polychlorosilanes. To testing for possible formation of hydrogen the UN N.5 had been applied.

##### 4.1.1. Investigation of DCTS with diatomite

DCTS – as the most reactive substance of the chlorosilanes considered here – was mixed 1:1 with the inert substance ‘diatomite’ (= SiO<sub>2</sub>) and investigated in the test reactor.

In two experiments, after about 2 s–3 s (<3000 ms) the coiled filament had melted through (Fig. 4), with a one-sided break of the coil and melting (see blue arrows in Fig. 4). During this time, no significant pressure increase was determined.

##### 4.1.2. Investigation of DCTS with calcium carbonate

To back up the ‘diatomite’ experiments, DCTS was tested with CaCO<sub>3</sub>, which can be considered inert with regard to oxidation.

Deviating from UN-TDG (2015), a mass ratio of: 1:2.5 had to be chosen rather than 1:1 DCTS:CaCO<sub>3</sub>, as otherwise no powder test mixture was obtained (in a 1:1 mixture the sample remained “slushy”).

After approximately 180 s, the measurement was stopped, as no pressure increase occurred; in other words, as expected, no reaction took place.

##### 4.1.3. Reaction with an alternative combustible substance

To investigate whether the polychlorosilanes react with a combustible substance that can be oxidized but that does not have any significant functional groups containing oxygen, the test was carried out with activated carbon as a combustible substance instead of cellulose.

First, the oxidizability of activated carbon was tested using nitric acid, sodium chlorate solution, and perchloric acid as oxidizing agents. The investigations showed that the reference oxidizing agents can oxidize activated carbon (see Table 2).

The reaction of the polychlorosilanes with the activated carbon produced the following:

The rupture disk did not respond in any of the three batches with HCDS, OCTS and DCTS, since in all three cases the coiled filament melted soon after the start before a reaction could be detected. Consequently, no direct evaluation of the experiments was possible. Problems with wires breaking had already been described in the literature (Koseki (2001), underscoring the need for new wire materials to be tested for this method.

The times until the coiled filament melted through were approx. 7 s–9 s (HCDS), 4 s–5 s (OCTS), and 3 s–4 s (DCTS).

In other words, the time between the current flow to when the filament melted decreased in the following order: HCDS > OCTS > DCTS.

While the pressure vessel was being emptied and cleaned, there was a mist that clearly smelled of hydrochloric acid. When the content was emptied into a Petri dish, there were small “fire clusters” in the DCTS/activated carbon mixture. Both prove the presence of unchanged DCTS which shows that no (oxidation) reactions had taken place with the activated carbon.

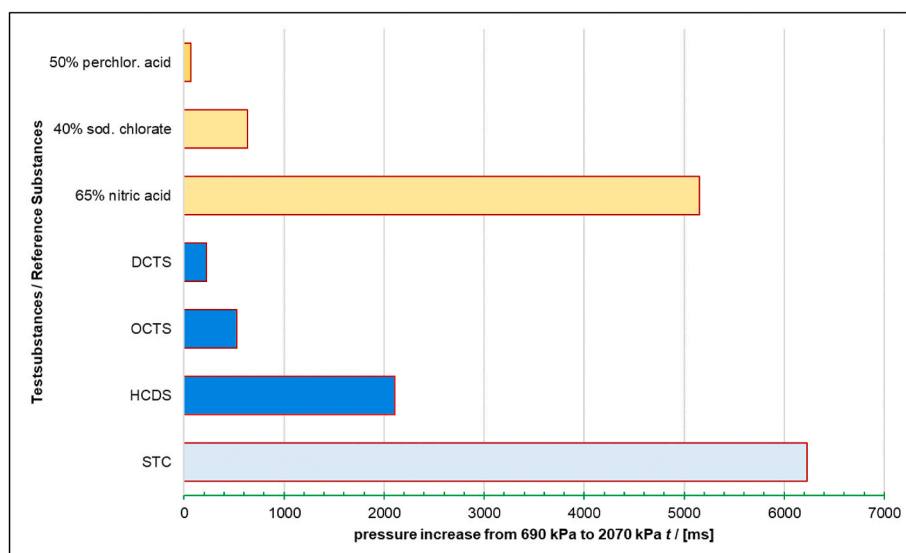

Fig. 3. Graphical illustration of the mean pressure increase time from UN Test O.2 for the reference substances and the chlorosilanes.

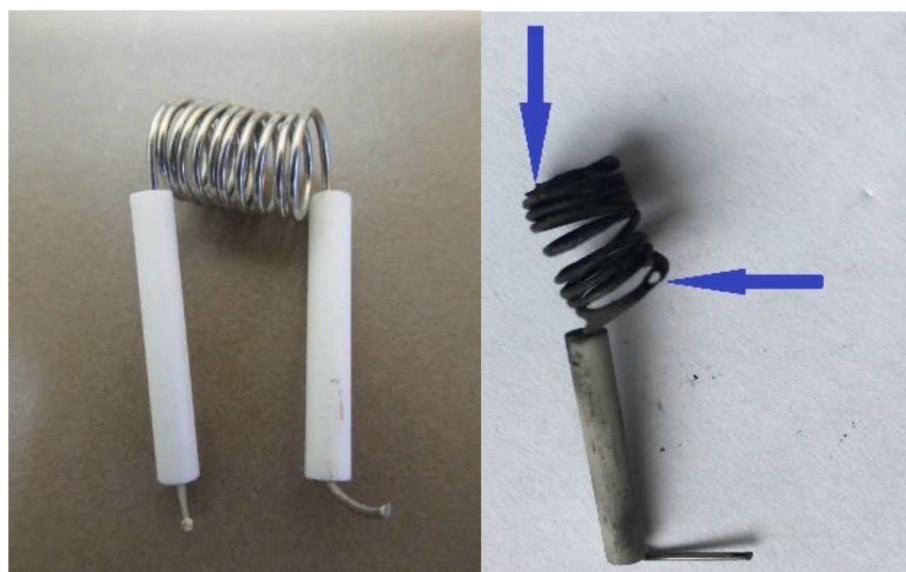

Fig. 4. New coil (left) and melted and broken coiled filament (right) (photo: Tim Krösche®).

Table 2

Averages of the pressure increase times of the substance to be oxidized.

Oxidizing agent	Cellulose	Activated carbon <sup>a</sup>
Nitric acid (65%)	5153 ms	11,000 ms
Na chlorate (40%)	636 ms	3000 ms
Perchloric acid (50%)	67 ms	10 ms

<sup>a</sup> No fivefold determination, double determination (rounded values).

#### 4.1.4. Testing for possible formation of hydrogen

It has long been known in the literature that in an alkaline milieu Si-Si compounds are split quantitatively while producing hydrogen (Steward, W., William, J. (1988) and the literature cited there). It was considered whether, during the reaction, H<sub>2</sub> is formed, which could cause the high reactivity of the reaction after the coiled filaments were started. But this hypothesis was rejected, as the entire sample preparation and the experiment itself were carried out in an N<sub>2</sub> atmosphere so that no significant quantities of O<sub>2</sub> (from the air) could be available as a reaction partner for H<sub>2</sub>.

In accordance with UN Test N.5 (UN-TDG, 2015), for HCDS and DCTS it was checked whether a flammable gas forms when water is added to the test substances.

In the reaction of chlorosilanes with water, considerable amounts of HCl was formed.

Deviating from the procedure for UN Test N.5, the gas occurring during the test was fed through water in a wash bottle to reduce dilution of a possible occurring flammable gas by HCl. But the occurring gas could not be ignited by an external ignition source. No further investigations (e.g. according to EC 440/2008, A.11) were carried out here.

The substance does not form a flammable gas when it comes into contact with water, at least not at ambient temperature. A reaction acceleration due to H<sub>2</sub> is deemed to be unlikely.

#### 4.2. Results of spectroscopic investigations

It is known that elemental silicon and silicon compounds have a high affinity to oxygen and that the cleavage of the Si-Si bond to give two

Si–O bonds is highly thermodynamically-favored (Greenwood and Earnshaw, 1995; Gmelin Handbuch der Anorganischen Chemie, 1959; Remy, 1970). Use of, for example, HCDS as an oxophilic agent in the reduction of phosphorous and sulfur oxides is described often in the literature (Evonik (2016a); Houben-Weyl “Methods of Organic Chemistry” (2014); Auner et al. (2009); Naumann et al. (1969); Handbook of Reagents for Organic Synthesis (2011)) where this property is utilized.

Cellulose is an oxygen-rich macromolecule (see Fig. 5) so that we can assume that in the reaction of cellulose with polychlorosilane – especially when energy is added – SiO<sub>2</sub> forms in significant quantities.

But this would then mean that cellulose reacted as an oxidizing agent for the polychlorosilane and not the other way around. With consideration of the significance of this hypothesis, this should be tested by investigating the reaction products from the UN Test O.2.

The following summary reactions are theoretically conceivable (explained here using DCTS as an example):

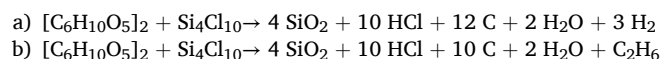

If we use the formal concept of oxidation numbers for the above reactions, we see that the silicon from the polychlorosilane is oxidized to SiO<sub>2</sub> and hence, formally acts as a reducing agent.

To check the plausibility of the above reactions a and b, the reaction mixture obtained from the UN Test O.2 was collected after completion of the test and a representative sample of different particles was separated and analysed under a microscope. Black, gray, whitely, fiber-shaped and white particles were discovered.

#### 4.2.1. IR investigation of the light particles

The white particles and the fiber agglomerates (Fig. 6) were investigated using IR spectroscopy.

In Fig. 7 the IR spectrum of the test substance cellulose was superimposed with the spectrum of the particles.

The characteristic bands of the cellulose are easily recognizable in the spectrum of the whitish particles. The dried cellulose (red line) shows no signal at approx. 1620 cm<sup>-1</sup>; after the reaction (black line), a clear signal can be seen at 1620 cm<sup>-1</sup>. This is the typical region of absorbed “hydrate” water (Das, S. K., Mukherjee, S, 2014; Kampa, G., 2016; personal communication). At present, it is not clear whether this water is from the reaction or from moisture in the air during handling procedures. Besides the cellulose signals, there are no other recognizable structured and allocatable bands. In the spectrum shown, the range was measured down to 550 cm<sup>-1</sup>. Characteristic Si–Cl bands are expected here at about 600 and < 600 cm<sup>-1</sup> (Hassler, K., Hengge, E. 1980), but cannot be seen here.

#### 4.2.2. IR investigation of the black particles

With the attenuated total reflection-Fourier transform infrared spectrometry (ATR-FT-IR) only the upper few μm of a sample layer is analysed. Therefore, all measurements were done on multiple particles, in order to get a representative picture. The IR spectrum of the black

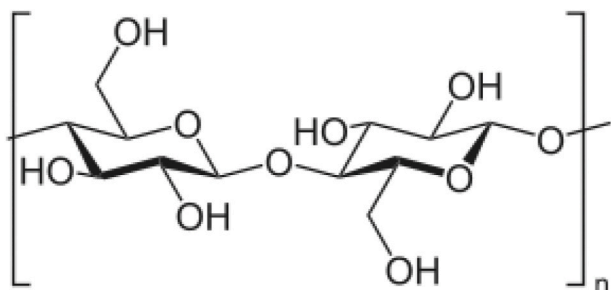

Fig. 5. Structural section of cellulose.

particles (Fig. 8) is showing a very good match with the IR image of a precipitated silica, “SiO<sub>2</sub>”. The bands at 1060 cm<sup>-1</sup> are attributable to the antisymmetric stretching vibration of Si–O–Si in the tetrahedral SiO<sub>4</sub> units, and the bands at 820 cm<sup>-1</sup> are attributable to the symmetrical Si–O vibration. In the range of 3000–3400 cm<sup>-1</sup>, no intensive signals are detected; therefore, no significant portions of Si–OH groups can be present in the particles (Das, S. K., Mukherjee, S, 2014; Yu-Jhen Lin, Chien-Ho Liu, 2019).

Since no other signals can be detected in the range of >1400 to 3000 cm<sup>-1</sup>, no organic components can be expected in the black particles that would be able to provide evidence regarding any possible intermediate products and thus provide information on the reaction mechanism.

#### 4.2.3. Raman spectroscopy investigation of the black particles

Due to the color of the black particles (Fig. 6), the presence of elemental carbon was assumed. Since elemental carbon is IR-inactive, a Raman spectrum was recorded and the presence of carbon was confirmed through the characteristic Peak at 1585 cm<sup>-1</sup> (so-called “G-band”) (Hodkiewicz, J. (2010)) and comparison with a graphite spectrum (Fig. 9).

The presence of significant amounts of carbon clearly underpins the fact that cellulose acted as an oxidizing agent and was reduced.

In the Raman spectrum, signals from elemental Si would be expected at 520 cm<sup>-1</sup> (Hodkiewicz, J. (2010)). In the case of highly amorphous Si, a broad band would occur at 480 cm<sup>-1</sup> (Deschaines, T., Hodkiewicz, J., Henson, P., 2009). In other words, the presence of significant amounts of elemental silicon can be ruled out. This was confirmed through XPS/ESCA investigations (EVONIK 2016).

If the polychlorosilane was to have an oxidizing effect, indications of elemental silicon should be found, since as an oxidizing agent, it would have to be reduced.

The signal spread at approx. 1250 and 2500 cm<sup>-1</sup> to 3500 cm<sup>-1</sup> is essentially caused by cellulose residues, which was determined by the corresponding spectra comparisons (not shown).

## 5. Summary and conclusions

According to the results from the UN Test O.2, the higher polychlorosilanes HCDS, OCTS and DCTS formally fulfill the criteria of an oxidizing agent. False-positive results or a reaction acceleration due to the formation of H<sub>2</sub> were ruled out. Nevertheless, there remains strong, justified doubt as to whether it is actually possible to reach the conclusion that these three substances possess oxidizing properties. Research in literature, evaluation of material safety data sheets from worldwide suppliers of HCDS, and our own production experience show no indication of potential oxidizing properties, which reinforces this doubt.

The analytical tests described and conducted showed that the reaction residues consist essentially of SiO<sub>2</sub> and elemental carbon, along with portions of undecomposed cellulose. That means that the Si–Si compounds were oxidized in the polychlorosilanes. Since the entire reactor charging was done in a glove box in an N<sub>2</sub> atmosphere, the only possible source of oxygen for the formation of SiO<sub>2</sub> in the reactor is the test cellulose that was used. In addition, if the polychlorosilanes had an oxidizing effect, no elemental carbon would be expected, because it would have been oxidized to carbon dioxide and would no longer be detectable.

There were no indications of elemental silicon in any of the investigations, which would be expected if the polychlorosilane had an oxidizing effect (Si in polychlorosilanes should had been reduced).

To verify the results of IR- and Raman-Investigation, an XPS analysis (electron spectroscopy for chemical analysis, ESCA) of the particles was carried out to investigate the chemical bonding states of various elements. These investigations confirm the results from the IR- and the Raman investigation with SiO<sub>2</sub> and elemental carbon as the main components along with still undecomposed cellulose. Neither elemental

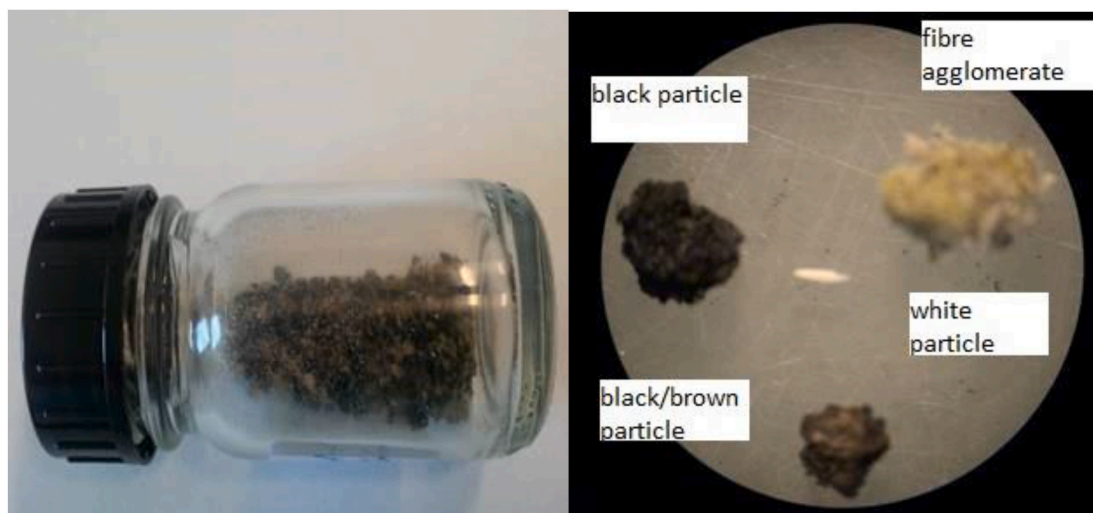

Fig. 6. Reaction residue (left) and microscopic picture of representative particles (right).

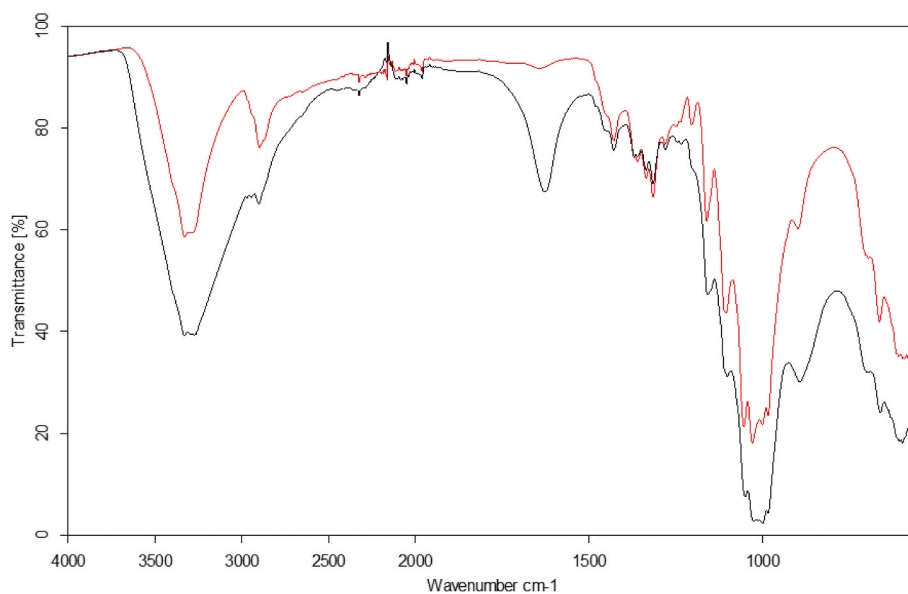

Fig. 7. Black line: IR spectrum of the whitish particles. Red line: test substance cellulose. (For interpretation of the references to color in this figure legend, the reader is referred to the Web version of this article.)

silicon nor low-valency Si components were detected in the ESCA analysis (EVONIK 2016).

Additional experiments were designed to check whether the polychlorosilanes are able to oxidize pure carbon. Preliminary tests showed that the reference oxidation agents oxidize the activated charcoal in the UN O.2 reactor. However, the tests with the polychlorosilanes could not be analysed, because the filament melted through before the bursting disc was activated. Remarkably, the speed at which it melted through increased with the number of Si atoms in the molecule. Whether this was due to an increasing, corrosive chloride concentration or to a reaction of the silicon contained in the polychlorosilanes with the metal wire, or to other reasons, remains a matter of speculation.

It is obvious that the polychlorosilanes HCDS, OCTS and DCTS react faster with cellulose than the reference substances used in the UN Test O.2 (nitric acid, sodium perchlorate and perchloric acid) and, consequently, lead to a faster pressure increase in the UN test O.2.

However, all these investigations prove that there is no oxidation of the cellulose by HCDS, OCTS or DCTS, but rather, the cellulose acts as an “oxygen supplier” (oxidizing agent) to the polychlorosilanes.

In the UN-TDG (2015) it states:

“In the event of divergence between test results and known experience in the handling and use of substances or mixtures which shows them to be oxidizing, judgments based on known experience shall take precedence over test results”

This is to emphasize the fact that, if there is justified doubt regarding the UN O.2 test results, known empirical values have clear priority with regard to the assessment.

Therefore, with the investigations described here, the result of UN Test O.2 for the polychlorosilanes DCTS, HSDS and OCTS is assessed as “false-positive” and they will not be classified as “oxidizing substances” (UN-TDG, 2015) in UN transportation class 5.1 (Kroesche, 2018).

This means that the test for oxidizing properties prescribed in international transport law and in the CLP regulations cannot be used for this substance class. At the current time, conclusions regarding the mechanism and the details of the reaction remain speculative.

It is of concern that we found only very few information in the peer-reviewed, scientific literature demonstrating the soundness of the

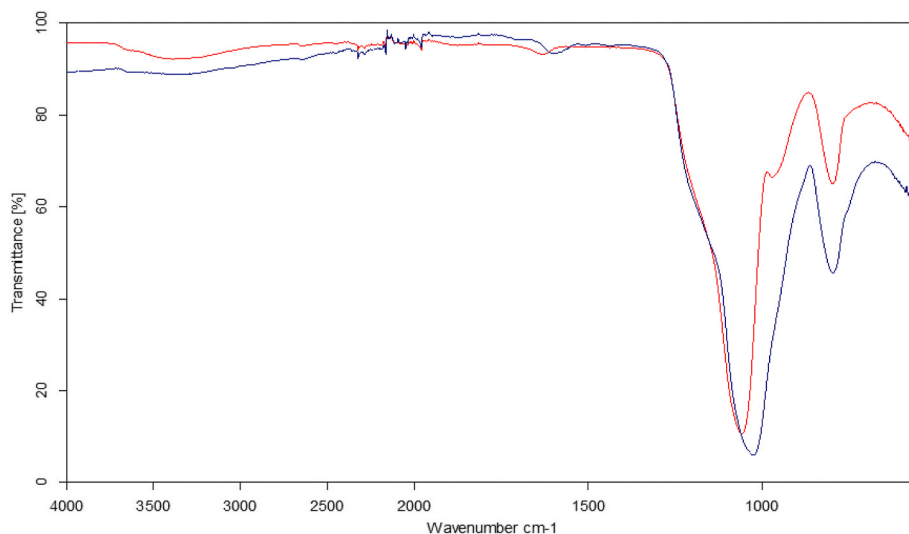

**Fig. 8.** IR spectrum of a black particle (blue: black particle; red: precipitated silica). (For interpretation of the references to color in this figure legend, the reader is referred to the Web version of this article.)

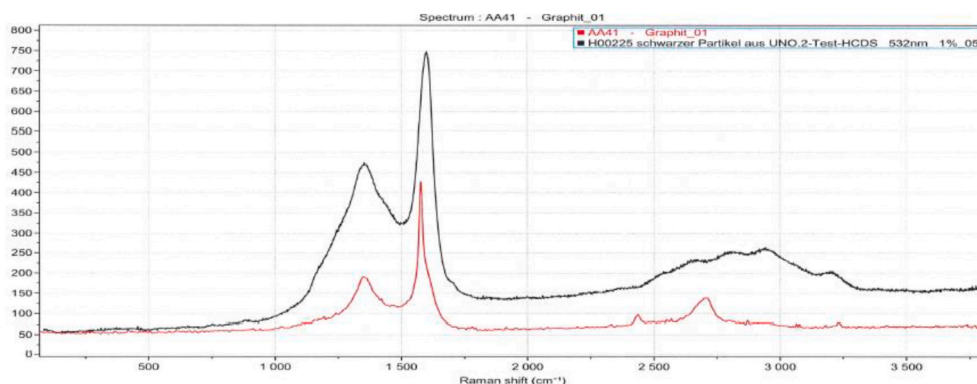

**Fig. 9.** Raman spectrum – comparison of sample particles (black) with pure carbon (red). (For interpretation of the references to color in this figure legend, the reader is referred to the Web version of this article.)

globally used UN O.2 method and its classifications. It seemed this method is based either on ancient work, or on undocumented development in the past. This should be corrected. The UN test should be reexamined, their propensity for false-positive or false-negative classifications studied, and the results published in the peer-reviewed scientific literature.

#### Authors statement

Ch. Krösche: Conceptualization, initiator and coordinator of the scientific work and measurements, Writing: Writing – original draft; K. Budde: supervising and evaluation of all UN O.2 test relevant measurements at the Safety Test Center of Evonik, Writing: UN O.2 relevant part; M. Malow: Reviewing and evaluation as external expert; Writing: reviewing and editing.

#### Funding

All investigations were carried out in the laboratories of Evonik Industries in Hanau, Germany.

#### Declaration of competing interest

The authors declare that they have no known competing financial interests or personal relationships that could have appeared to influence

the work reported in this paper.

#### Acknowledgment

The authors would like to thank Mathias Vorwinkel for the carefully conducted tests and his patience in dealing with many special wishes.

We thank Gerhard Kampa for the images and evaluation of the IR and Raman spectra.

#### Symbols used

HCl	Hydrogen chloride
DCTS	Decachlorotetrasilane
ESCA	Electron Spectroscopy for Chemical Analysis
HCDS	Hexachlorodisilane
OCTS	Octachlorotrisilane
STC	Tetrachlorosilane
XPS	X-ray photoelectron spectroscopy

#### References

- Antoni, S., Kunath, K., Lüth, P., Simon, K., Uhlig, S., 2011. "Evaluation of the Interlaboratory Test on the Method UN O.2//EC A.21 "Test for Oxidising Liquids". BAM – Federal Institute for Materials Research and Testing, Berlin, Germany. Final Report 31.10.2011.

- Auner, G., Bauch, C., Lippold, G., Deltschew, R., 2009. Patent Application Publication US 2009/0169457 A1.
- Babrauskas, V., 2016. UN test O.1 errors in quantifying the behavior of solid oxidizers. *J. Loss Prev. Process. Ind.* 39, 1–6.
- Carlson, D.K., Comita, P.B., Scudder, L.A., Singh, K.K., 2005. European Patent Office. EP1563529A2.
- Das, S.K., Mukherjee, S., Lopes, L.M.F., Ilharco, L.M., Ferraria, A.M., Botelho do Rego, A. M., Pombeiro, A.J.L., 2014. *Dalton Trans.* 43, 3215.
- Deschaines, T., Hodkiewicz, J., Henson, P., 2009. Characterization of Amorphous and Microcrystalline Silicon Using Raman Spectroscopy. Thermo Fisher Scientific, Madison, WI, USA, Application Note, p. 51735.
- European Union, 2008. Commission Regulation (EC) No 440/2008, 2008. A.21. Oxidising Properties (Liquids).
- EVONIK, 2016. Nicht Veröffentlichte Forschungsergebnisse.
- EVONIK, 2016a. Product Information "SIRIDION HCDS".
- Gmelin Handbuch der Anorganischen Chemie, 1959. Silicium, eighth ed., vol. 15. Verlag Chemie, Weinheim. Part B.
- Greenwood, N., Earnshaw, A., 1995. Chemistry of the Elements. Butterworth-Heinemann.
- Handbook of Reagents for Organic Synthesis, 2011. In: Fuchs, P.L. (Ed.), Reagents for Silicon-Mediated Organic Synthesis. Wiley, pp. 309–310.
- Hassler, K., Hengge, E., Raml, W., 1980. The vibrational spectra of linear and branched Perchlorosilanes and their simulation using a local symmetry force field. *Monatsh. Chem.* 111, 581–590.
- Hodkiewicz, J., 2010. Characterizing Carbon Materials with Raman Spectroscopy. Thermo Fisher Scientific. Madison, WI, USA, Application Note: 51901.
- Houben, Weyl, 2014. Methods of organic chemistry. In: Reduktion von Phosphinoxiden mit HCDS, fourth ed., E 21f (chapter 8.1.1.1).
- Koleske, D.D., Gates, S.M., 1994. Atomic Layer Epitaxy of Si on Ge(100) using Si<sub>2</sub>Cl<sub>6</sub> and atomic hydrogen. *Appl. Phys. Lett.* 64 (7), 884–886.
- Koseki, H., 2001. Study on test methods for oxidizing solids in the UN recommendations. *J. Loss Prev. Process. Ind.* 14, 431–434.
- Kroesche, C., 2018. 9th European Silicon Days (Saarbrücken, Germany).
- Lin, Yu-Jhen, Liu, Chien-Ho, Chin, Mo-Geng, Wang, Cheng-Chieh, Wang, Sheng-Hsun, Tsai, Hsiao-Yun, Chen, Jenq-Renn, Ngai, Eugene Y., Ramachandran, Ram, 2019. Characterization of shock-sensitive deposits from the hydrolysis of hexachlorodisilane. *ACS Omega* 4, 1416–1424.
- Naumann, K., Zon, G., Mislow, K., 1969. The use of hexachlorodisilane as a reducing agent. Stereospecific deoxygenation of acyclic phosphine oxides. *J. Am. Chem. Soc.* 91 (25), 7012–7023.
- Remy, H., 1970. Lehrbuch der Anorganischen Chemie, thirteenth ed., vol. 1. Akademische Verlagsgesellschaft Geest & Portig, Leipzig, Germany.
- Steward, W., William, J., 1988. New mechanism for the base-catalyzed cleavage of Si-Si bonds in organopolysilanes. *J. Organomet. Chem.* 341, 199–211.
- Tamura, Masamitsu, Akatsuka, Hirotsuka, Suzuki, Yasuyuki, Mochida, Kunio, Iida, Osamu, Saiki, Wataru, 2014. Investigative report by the accident investigation committee for the explosion & fire accident occurred in the high-purity polycrystalline silicon manufacturing facility at yokkaichi plant of mitsubishi materials corporation. In: June 12, 2014; Mitsubishi Materials Corporation Yokkaichi Plant Accident Investigation Committee. Mitsubishi Materials Corporation (in English).
- Taylor, R.C., Scott, B.A., 1989. Hexachlorodisilane as A Precursor in the LPCVD of silicon dioxide and silicon oxynitride films. *J. Electrochem. Soc.* 136 (8), 2382–2386.
- Un-Ghs, 2019. Globally Harmonized System of Classification and Labelling of Chemicals, 8th revised ed. United Nations, New York and Geneva (Chapter 2).13. Oxidizing liquids.
- Un-Mr, 2017. UN Recommendations on the Transport of Dangerous Goods, Model Regulations, 20th revised ed. United Nations, New York and Geneva (Chapter 2).5. CLASS 5 - OXIDIZING SUBSTANCES AND ORGANIC PEROXIDES.
- Un-Tdg, 2015. UN Recommendations on the Transport of Dangerous Goods, Manual of Tests & Criteria, 6th revised ed. United Nations, New York and Geneva. Section 34, CLASSIFICATION PROCEDURES; TEST METHODS AND CRITERIA RELATING TO OXIDISING SUBSTANCES OF DIVISION 5.1.
- Zhou, Xiaobing, Wanous, Mark A., Wang, Xianghuai, Eldred, Donald V., Thomas, L., Sanders Jr., 2018. Study on the shock sensitivity of the hydrolysis products of hexachlorodisilane. *Ind. Eng. Chem. Res.* 57, 10354–10364.