

Comparative study on standardized ignition sources used for explosion testing

Stefan Spitzer, Enis Askar, Arne Krietsch & Volkmar Schröder

Bundesanstalt für Materialforschung und -prüfung, Berlin, Germany

E-Mail: stefan.spitzer@bam.de

Abstract

For the determination of safety characteristics of gases, vapors and dusts different types of ignition sources are used in international standards and guidelines. Table 1 compares technical relevant ignition sources with their main features. The paper presents test results of a comparative calorimetric and visual study between four different types of ignition sources. The ignition procedures were analyzed visually with a high-speed camera and electric recordings. In addition to that, the influence of the electrode-orientation, -distance as well as ignition energy on the reproducibility of the exploding wire igniter was tested.

The exploding wire is already in use for standardized determination of safety characteristics of gases [1], first tests on the suitability of the exploding wire igniter for dust testing have been carried out by Scheid et al. [2]. Using the exploding wire, the ignition energy can be varied from 2 to 10 000 J (2 x 5 000 J) and thus it could be used for gases, vapors, dusts and hybrid mixtures. Moreover it can be used at high initial pressures and it is the only ignition source with an easily measurable ignition energy release. Furthermore, it does not introduce another chemical reaction into the system.

Finally, a proposal for a standard ignition source for explosion tests on hybrid mixtures is derived from the test results.

Keywords: *Ignition source, Exploding Wire, hybrid mixtures, safety characteristics determination*

Table 1: Technical relevant ignition sources

Ignition source	Energy range [J]	Adjustable Energy	Application (example)	Used/Found in	Affecting chemical reaction	Suitable for high pressures
Exploding wire	Low to high, 2 – 5 000	Yes	Determination of LEL and UEL of gases and vapors	EN 1839 B, ASTM E918, EN ISO 10156	No	Yes, Tested up to 100 bar
Chemical igniter	Moderate to high, 100 – 10 000	No, Stepwise	Determination of LEL, p_{max} , $(dp/dt)_{max}$, (K_{St}) of dusts	EN 14034 series	Yes	Yes
Induction spark	Low, < 10 J	Yes	Determination of LEL and UEL of gases and vapors	EN 1839, ASTM E681	No	No, Just up to 5 bar
Surface-gap spark	Low, 10 – 40	Yes	Determination of LOC of gases and vapors under non-atmospheric conditions	ASTM 2079	No	No, Just up to 25 bar

1. Introduction

Safety characteristics of gases, vapors and dusts are often investigated without considering the influence of the ignition source in more detail, even though it is found to have an impact on them [3, 4]. Other standards say, that the “delivered ignition energy” (= net energy) must be specified in the test report but don't give a hint how to measure it [5]. This is caused by the fact, that for most ignition sources it is hard to measure the real energy and burning duration under laboratory conditions and almost impossible during tests. Rough estimates such as the gross energy for all electrical igniters based on capacitors ($E[\text{J}] = 0.5 * C[\text{F}] * U[\text{V}]^2$ with E: Energy (Joule), C: Capacitance (Farad) and U: Voltage (Volts)) are known to be unprecise [3, 6] but are still widely used. The net energy therefore is, because of the dependence on cable resistance and length, burning duration and other technical parameters, unknown and varies between 20% to 80% of the gross energy for electrical igniters [3].

Additionally to the ignition energy that is actually introduced into a system, there are several other specifications of the ignition source that might influence the effectivity of an ignition source, particularly the ignition duration and the initial volume that is affected by the ignition source, which is also dependent from the distance and the orientation of the electrodes.

For explosion tests on dusts mainly chemical igniters are used [7]. There are standardized chemical igniters with defined energies varying from 100 J up to 10 000 J but with them the energy cannot be adjusted fluently, and the net energy that is introduced into the system (and their variation) as well as the burning duration are unknown.

For gas explosion tests, typical ignition sources are the induction spark and the exploding wire [1]. The spark ignition is probably the most common ignition source for gas explosions. It is characterized by a rather low ignition energy (< 10 J) and long ignition duration of (200 – 400) ms. Measuring the actual net ignition energy of the spark igniter is not directly possible. Contrary to the exploding wire igniter it can only be used at atmospheric or slightly elevated pressure. Using the exploding wire igniter much higher ignition energies can be realized and it is possible to calculate the actual net ignition energy in each test by measuring the ignition current and voltage, whereas the ignition duration of around 5 ms is much shorter compared to the spark ignition. The surface gap spark is another alternative ignition source mainly for gas explosion tests [5]. Considering the ignition energy, that can be realized, it is stronger, than the spark ignition, but not as strong as the exploding wire igniter. However, the ignition duration is much shorter than all other ignition sources that are considered. In this work the four types of ignition source mentioned above should be characterized experimentally. The net ignition energy introduced into the system as well as the reproducibility was compared by calorimetric measurements. The burning duration has been compared by high-speed-recordings. Finally, the influence of the orientation of the electrodes was studied for the exploding wire igniter. Based on the test results a standardized ignition source for the determination of safety characteristics of hybrid mixtures of gases and dusts is proposed.

2. Experiments

The induction spark (Fig. 1) is the most common ignition source for gas testing. It consists of a high voltage transformer with an open-circuit voltage of 15 kV and a short circuit current of 30 mA. The electrodes have a distance of 5 ± 1 mm and the burning duration is set to 200 ms [1].

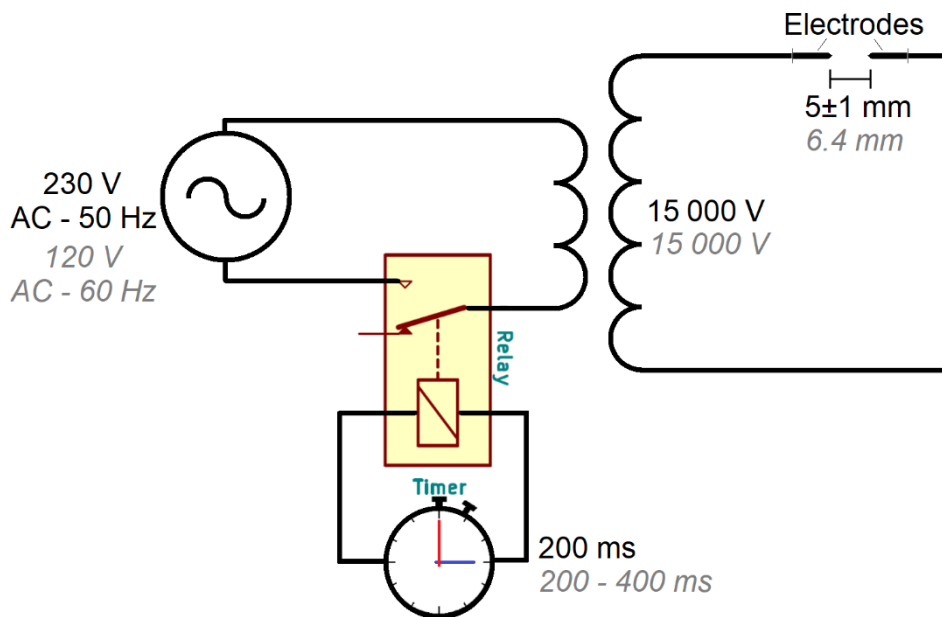

Fig. 1. Schematic of the Induction spark with specifications according to DIN 1839:2017 [1] and ASTM E-681 [8] in italic

The chemical igniters (Fig. 2) consist of small plastic or aluminum buckets filled with a firing charge of 40% zirconium, 30% barium nitrate and 30% barium peroxide. A sealing cap keeps the firing charge inside. An electrical fuse head is connected to two wires for a precise electrically controlled ignition from the outside of the apparatus.

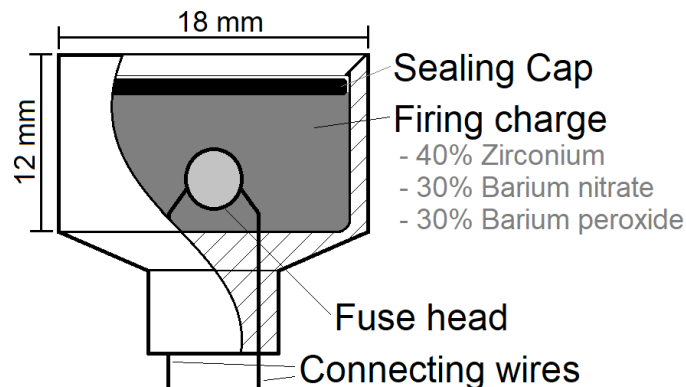

Fig. 2. Structure of a chemical igniter

The surface-gap spark (Fig. 3) is made of two electrodes, separated by a pencil lead mainly consisting of graphite with 6 to 10 mm in length and an electrical power supply. The emerging discrete spark is a surface discharge on the outside of the pencil lead.

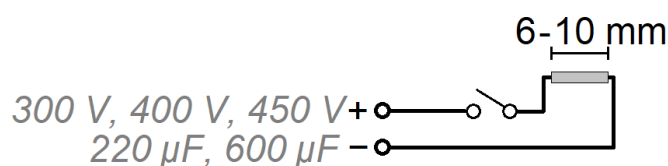

Fig. 3 Schematic of the surface-gap spark, listed values in italic are typical but not specified

The exploding wire consists of a copper nickel manganese alloy (CuNi30Mn) wire that is mounted between two metal rods and a power supply. An electric current is passed through the wire, melting it and generating an electric arc. Typical values specified in standards for the determination of safety characteristics of gases are an electrode diameter greater than 3 mm and an electrode distance of (5 ± 1) mm. The diameter of the connecting alloy wire shall be between 0.05 mm and 0.2 mm (typical: 0.12 mm). The electrical power for melting the wire and generating the arc is typically supplied by an alternating current isolating transformer with a power of 700 VA to 3 500 VA and a secondary voltage 230 V. The secondary winding of the transformer shall be switched by thyristors to control the time the voltage passes through the rods and the wire for adjustment of the ignition energy between 10 J and 20 J [1, 9].

For higher delivered energies of up to 2 000 J capacitors with an operating voltage of 450 V and a capacity of up to 21 000 μF are used. To achieve a comparable burning duration of 4 – 10 ms an inductor is introduced to the circuit (see Fig. 4).

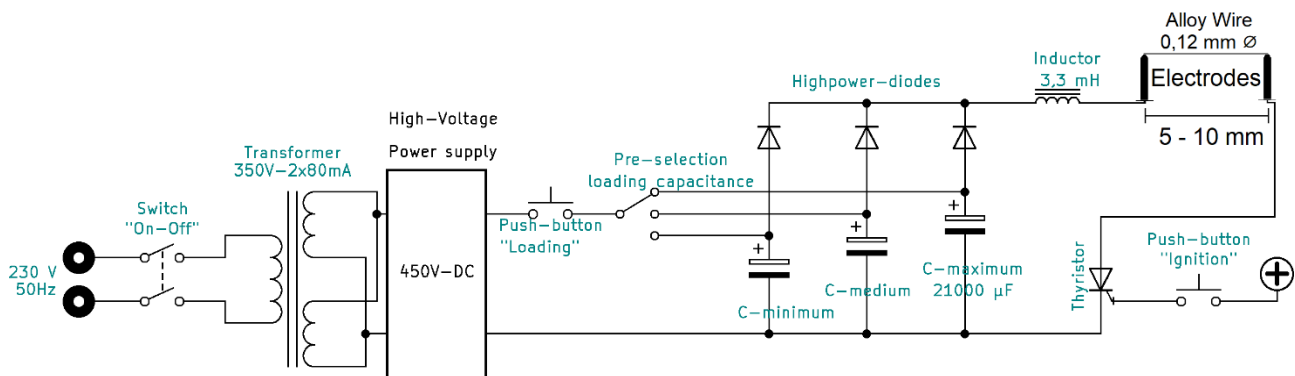

Fig. 4. Schematic of a high-energy exploding wire ignition source

Two test set-ups were built for the results presented in this paper. The first was a quasi-adiabatic calorimeter to measure the net energy and comparing it to the specified values and the electrical recordings (if available). The second was a fire-proof chamber equipped with different high-speed cameras and electrical measurement devices to capture the ignition procedures on video and measure the burning duration and net energy.

2.1 Calorimetric measurements of the net energy of different ignition sources

The calorimeter is made of brass and has an inner diameter of 2 cm, outer diameter of 6.5 cm and a total height of 7 cm. It was isolated by foamed polystyrene with a thickness of at least 90 mm. The temperature increase of the calorimeter was measured with a high precision semiconductor thermistor, TS-NTC-203, Hygrosens Instruments GmbH, and a self-designed circuit board transferring the changing resistance into a changing voltage. The recorded voltage signal is proportional to the temperature increase and thus to the released energy (see Fig. 6).

The calorimeter was calibrated with a 100 Watt lamp, a 12.5 Volt DC power source adjusted to an output of 8 Ampere and a timed relay that was set to several switching times to get a calibration curve according to the formula $E[J] = U[V] * I[A] * t[s]$ (E: Energy (Joule), U: Voltage (Volts), I: Current (Ampere), t: time (seconds)). By means of the calibration a sensitivity of 0.0698 mV/J and a mean variation of 1.63% (max 4%) was obtained. In Fig. 5 the calibration curve is shown together with the results of several validation tests.

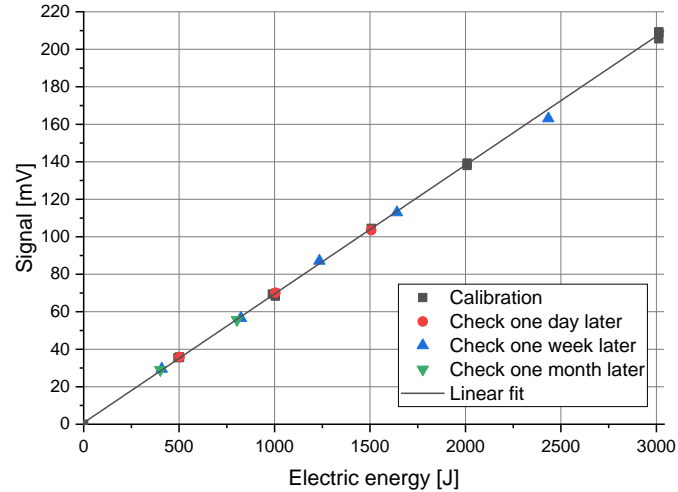

Fig. 5. Calibration line and three verification tests with a variation of less than 4%

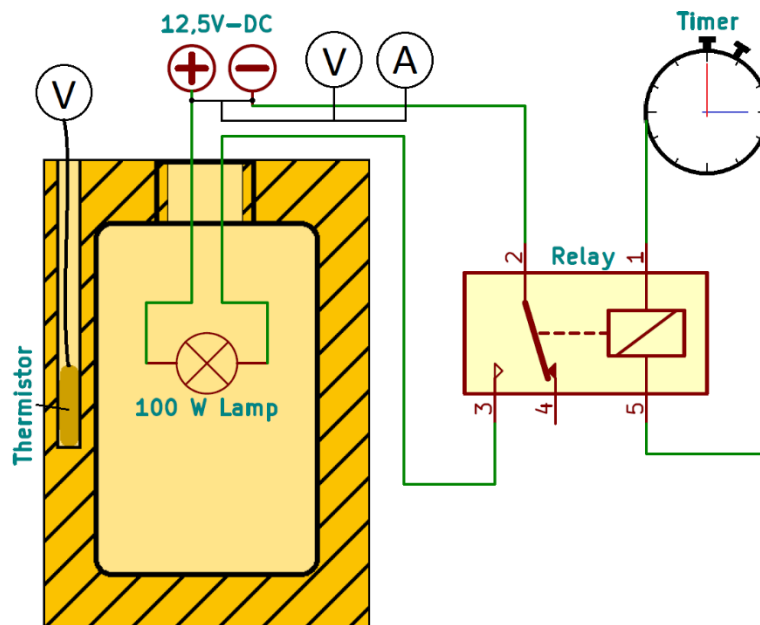

Fig. 6. Adiabatic brass calorimeter in the calibration set-up

2.2 Highspeed camera and electrical recordings

Three different high-speed cameras (MotionCorder Analyzer Model SR-1000 from Kodak, FASTCAM APX RS from Photron and HPV-1 from Shimadzu) were used for filming with maximum framerates of 1 000, 20 000 and 1 000 000 frames per second. The electrical recordings of the ignition current and ignition voltage of the exploding wire were measured with a frequency of 30 kHz.

3. Results and discussion

3.1 Results of the calorimetric measurements

Ten tests with different ignition times of the induction spark and an electrode distance of 6 mm showed a power of 11.9 W with a mean variance of 4.4%. This matches DIN EN 1839 in which the power of this ignition source is specified with circa 10 W. In the standard gas explosion tests the burning duration is adjusted to 200 ms [1] or respectively 200 – 400 ms [8] so the net energy released by the induction spark is between 2.2 J and 5.0 J ($E(J)=P(W)*t(s)$; variance included). Other standards

that included the same ignition source with 15 kV and 30 mA differ by specifying a delivered energy instead of power of 10 J in 200 – 500 ms [9]. The energy can only be increased by a longer burning duration. Higher energies for dust explosions of at least a few hundred joules cannot be provided in a reasonable time span.

Twenty-two tests with a surface-gap spark igniter were carried out. The energy was provided by capacitors with a operating voltage of 450 V and a capacitance of 220 μF . In the tests an average net ignition energy of 7.9 J with a mean variance of 4.5% was measured. The efficiency in this set-up is 35% compared to the gross energy of 22.75 J.

Another test with a capacitance of 600 μF and different loading voltages led to the results shown in the following diagram (see Fig. 7). The efficiency was between 41% and 29% with the trend of decreasing with higher voltages.

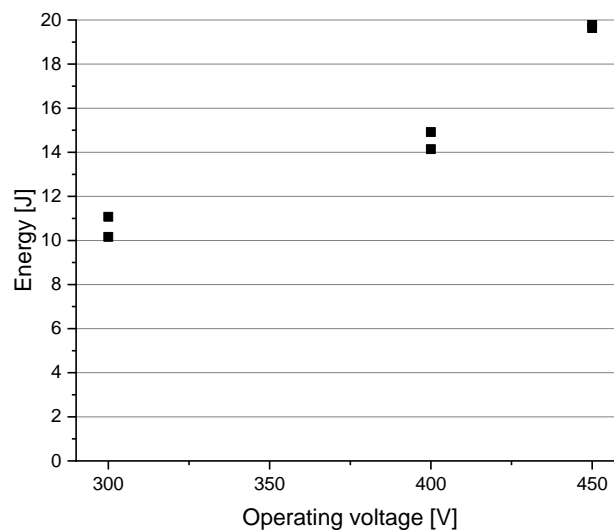

Fig. 7. Calorimetric measurements of a surface-gap spark igniter with a capacitance of 600 μF , calorimetric measured energy against operating voltage

The influence of the cable length was also measured with two cables of the same cross section of 4 mm^2 and a length of 3.2 m and 21,7 m. The efficiency decreased with the longer cable from 40% on average to 32% on average. Another influencing factor is the number of the ignitions carried out with one pencil lead mainly consisting of graphite. In the first few ignitions the released energy is decreasing from test to test, then after about 5 ignitions the released net energy is constant (see Fig. 8). This may be because of the lacquer or something else that is burned from the surface at the first ignition. The resistance of the pencil lead was measured in an additional test showing the dropping resistance over the first three ignitions.

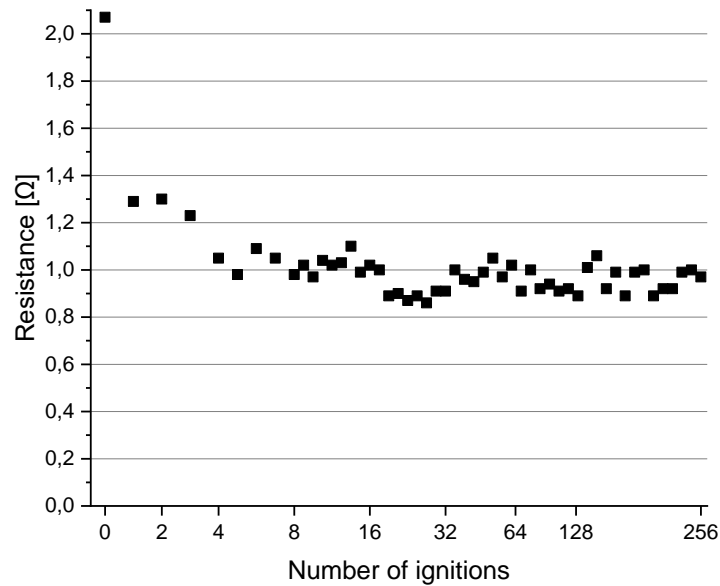

Fig. 8. Resistance of the 10 mm (length) * 2 mm (\varnothing) pencil lead against the number of ignitions

The surface-gap spark has many parameters influencing the energy and the efficiency. For every set-up, calorimetric tests should be made or the set-up conditions (cable length, cable cross-section, number of ignitions, resistance and length of pencil lead) should be described precisely to have a chance to check the net energies in subsequent tests.

Three tested chemical igniters with a specified energy of 1 000 J had a calorimetric energy of $1\ 090\ \text{J} \pm 24\ \text{J}$. For the igniters with smaller specified energies (three tests each) the difference between the specified and the measured ignition energy was higher. The calorimetric measured energies were $660\ \text{J} \pm 32\ \text{J}$ instead of 500 J, $477\ \text{J} \pm 35\ \text{J}$ instead of 250 J and $425\ \text{J} \pm 51\ \text{J}$ instead of 100 J. The chemical igniters consist of an explosive and an igniting pill. It was assumed, that the weight of the explosive is adjusted, and the igniting pill is disregarded. To prove this, chemical igniters of different specified energies were disassembled, and the explosive weight measured. Afterwards the ignition pills were ignited in the calorimeter without explosive.

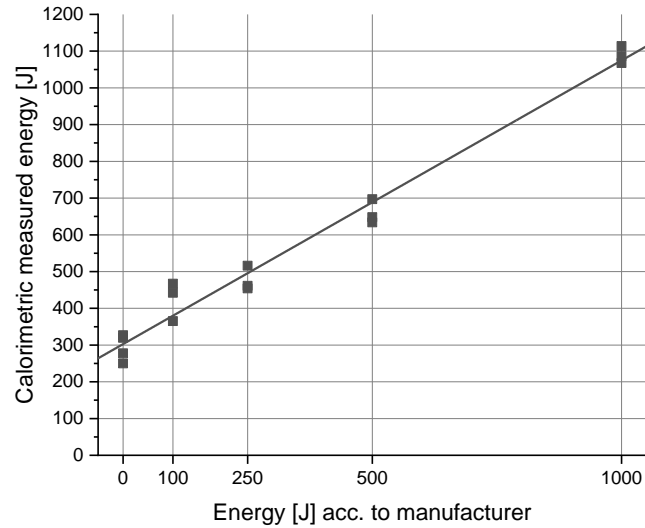

Fig. 9. Calorimetric measured energy of the chemical igniters against specified energy according to the manufacturer, three tests each except “0 Joule” with four tests

The weights are shown in Table 2 and the calorimetric values are plotted in Fig. 9 under “0 Joule” leading to values of $288 \text{ J} \pm 38 \text{ J}$, lying exactly around the extrapolated linear fit of the other tests.

Table 2: Weights of the chemical igniters, with and without explosive and difference (mass of explosive without ignition pill)

Sample number	Specified energy [J]	Gross weight, filled [g]	Gross weight, empty [g]	Difference/mass of explosive [g]	Ratio to 1.000 J
1	1 000	5.23	5.01	0.22	-
2	1 000	5.28	5.05	0.23	-
3	1 000	5.25	5.01	0.24	-
4	500	5.11	4.98	0.11	$\sim \frac{1}{2}$ of the mass
5	500	5.09	4.98	0.11	$\sim \frac{1}{2}$ of the mass
6	500	5.10	4.97	0.13	$\sim \frac{1}{2}$ of the mass
7	100	5.01	4.98	0.02	$\sim \frac{1}{10}$ of the mass
8	100	4.99	4.96	0.02	$\sim \frac{1}{10}$ of the mass
9	100	5.02	5.00	0.02	$\sim \frac{1}{10}$ of the mass

The exploding wire showed a low variation in the efficiency and in overall energy with the same set-ups: All the tests were carried out twice over a range from 6.6 J to 1 400 J. The comparison between the calorimetric and the electrical measurements showed, that the calorimetric values were 7% higher on average (see Fig. 10). This may be because of an insufficient calibrating method of the calorimeter or the ignition device, but it is still smaller than any variation of the other ignition sources and the only one, that could be with two methods at the same time.

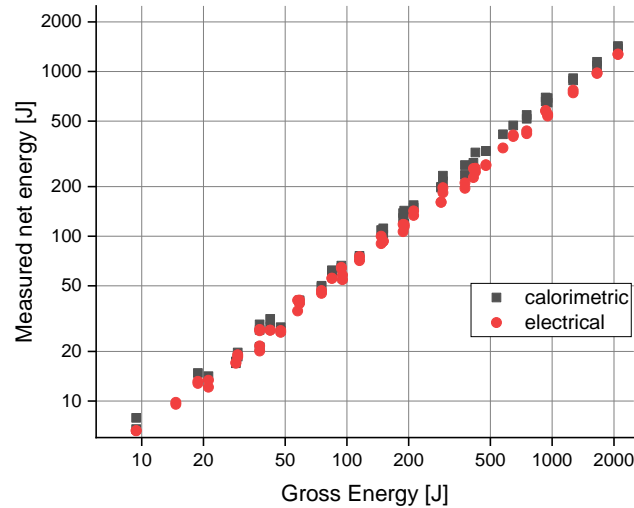

Fig. 10. Calorimetric measurements of exploding wire, calorimetric and electrical measured energy against the gross energy of the loaded capacitors (double-logarithmic scale)

3.2 Results of highspeed camera recordings

The surface-gap spark igniter is too fast for electrical measurements. To achieve an idea of the ignition procedure a camera with up to 1 000 000 fps was used, the cable length to the electrodes was 1,6 m with a cross-section of 4 mm², the capacitance was 220 μF, loading voltage 450 V and the pencil lead had a length of 10 mm and a diameter of 2 mm. It turned out, that the whole burning duration is less than 170 μs long, with a core-time (where one can clearly see a light) of about 60 μs (see Fig. 11). For gases the burning duration is not very crucial but for dusts this might be too short to ignite leading to the experimental determination of wrong safety characteristics.



Fig. 11. Full ignition procedure of a surface-gap spark, burning duration of less than 0.17 ms

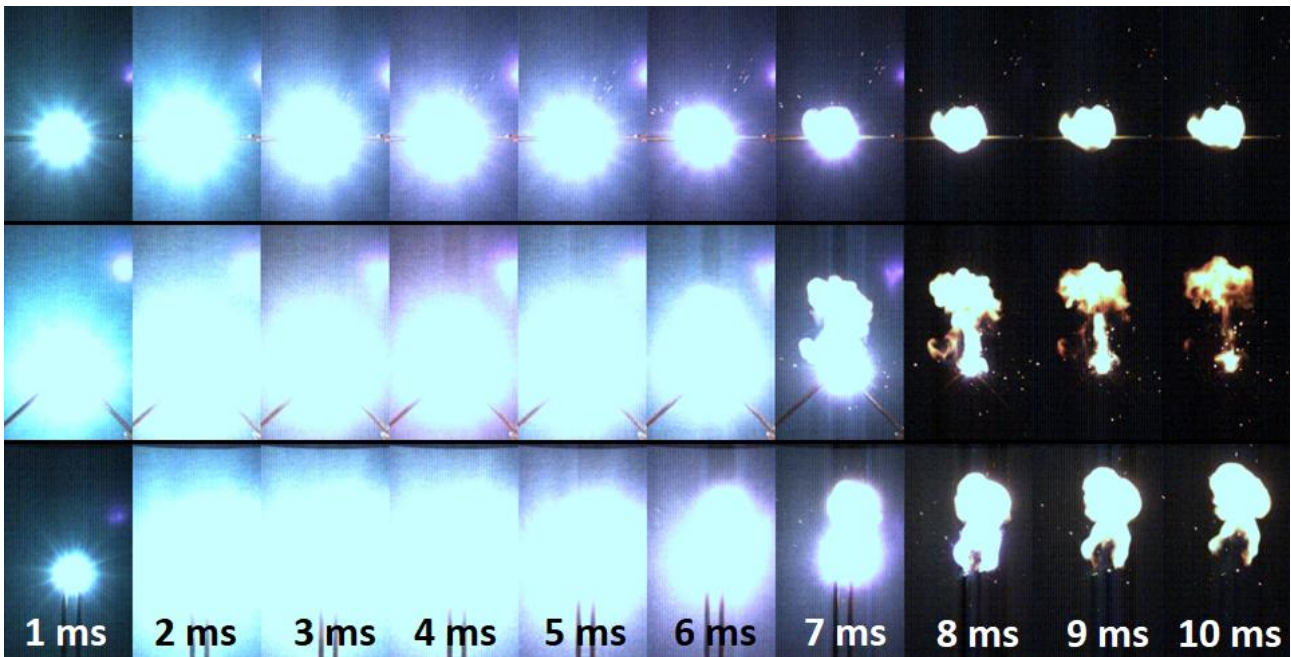

Fig. 12. Three different ignition procedures of the exploding wire with different electrode angles; 180° (adjacent) with 20.5 J in top row, 90° in the middle with 26.5 J and 0° (parallel) in the bottom row with 29.5 J

Fig. 12 is a slideshow of three ignition procedures with different angles of the electrode. One can clearly see the well-controlled ignition with adjacent (180°) electrodes staying in one place and light arcs pushed away from the electrodes if the angle varies. This leads to a higher variation of the net energy and the burning duration with increasing angles (see Fig. 13).

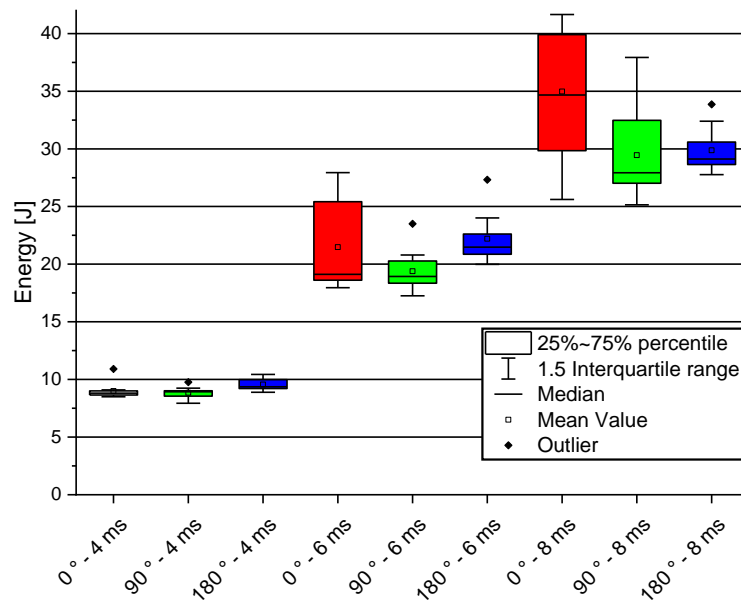

Fig. 13. Electrically measured ignition energy against ignition time and angle of the electrodes, ten tests were carried out for each set-up

The variation of the ignition energy changes clearly with different angle; parallel electrodes show a variation of 11.2% (max. 30.1%), orthogonal electrodes of 7.0% (max. 28.8%) and adjacent electrodes of 5.4% (max. 23.1%). There is another trend, that decreasing electrode angles increase the efficiency of the ignition system, otherwise identical set-ups cause a higher net energy with parallel electrodes than with adjacent ones.

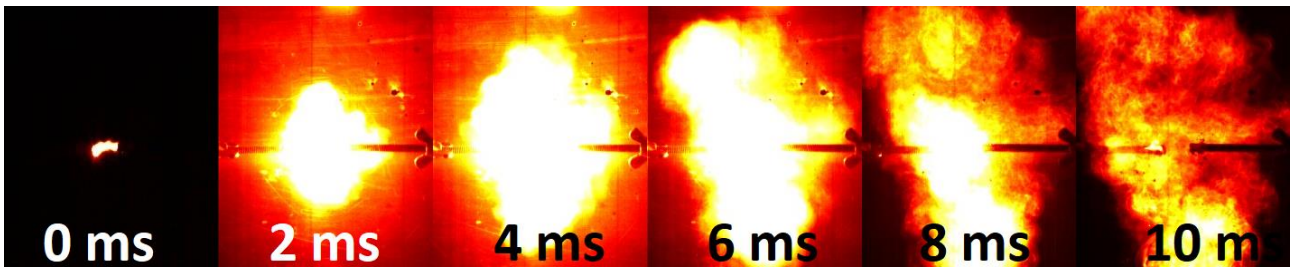

Fig. 14. Ignition procedure of an exploding wire with 820 J and an electrode angle of 180° (adjacent)

The above described correlation between increasing angle and decreasing variation does not apply for energies above ~50 J. Parallel electrodes show a variation of 3.0% (max. 12.1%), orthogonal electrodes of 3.2% (max. 13.9%) and adjacent electrodes of 2.6% (max. 11.5%).

The cause for this may be, that the energy amount is too big to last between the two electrodes and is pushed besides due to thermal and electromagnetic effects (see slideshow in Fig. 14). This causes a higher turbulence and therefore a higher variation, comparable to the variation of parallel electrodes. The trend with the efficiency is clearer with increasing energies; parallel electrodes show higher net energies with otherwise identical set-ups of the ignition system (see Fig. 15).

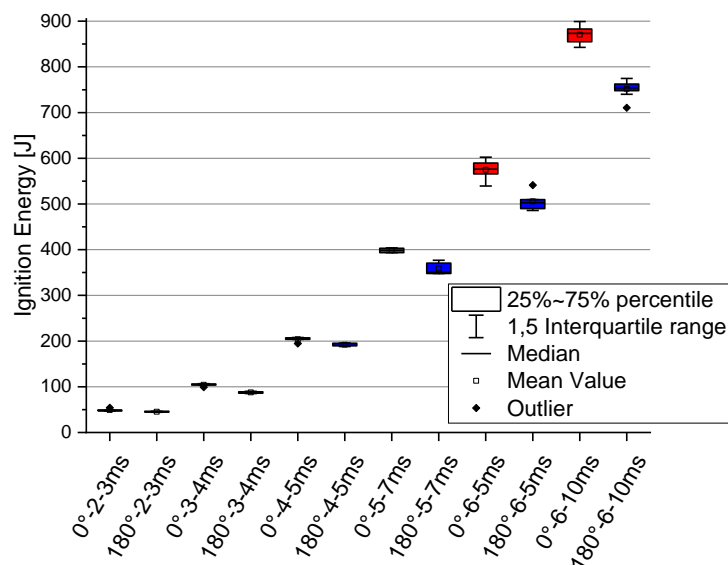

Fig. 15. Electrically measured ignition energy against angle of the electrodes, capacitance value ($2 \triangleq 940 \mu\text{F}$, $3 \triangleq 1880 \mu\text{F}$, $4 \triangleq 4700 \mu\text{F}$, $5 \triangleq 9400 \mu\text{F}$, $6 \triangleq 20680 \mu\text{F}$) and ignition time, unvaried loading voltage of 450 V

4. Conclusions

The exploding wire igniter has several advantages compared to the other common ignition sources used for explosion testing. Particularly the burning duration and the ignition energy can be adjusted fluently. The lower mean variance and measurable ignition energy in each ignition are another two features that make the exploding wire suitable for a standardized ignition source for hybrid mixtures. The angle of the electrodes can be varied to achieve a lower mean variation, but this causes much more effort and does only make sense for ignition energies below 50 J. The distribution of the ignition energy in space (ignition volume) is higher with parallel electrodes what might be an advantage, however the ignition volume is of different ignition sources under examination and will be published in the near future.

The burning duration of the surface-gap spark is probably too short for a dust explosion. Two other disadvantages of the surface-gap spark are that it is not possible to measure the net energy while in use and the many parameters influencing it.

Because of the unspecified ignition energies of the chemical igniter under 1.000 J it is not suitable for the determination of safety characteristics for gas explosions. With 1.000 J the energy is likely to drive the hybrid mixture into over-ignition in the gas-driven regions. For the dust-driven hybrid mixtures it may be suitable.

The induction spark does probably not provide enough energy for determining safety characteristics for explosion of hybrid mixtures with energies of around 10 J per second.

Acknowledgements

The authors would like to thank Daniel Kadoke from 8th division of BAM and Peter Löwe from 5th division of BAM for providing us with highspeed-cameras and supporting us with their long-term knowledge in highspeed-filming.

References

- [1] DIN EN 1839:2017 - Determination of the explosion limits for flammable gases and vapours, Beuth-Verlag, Berlin
- [2] Scheid, M., Kusche, C., Schröder, V., Barth, U. (2013). Tests on Suitability of the Ignition Source “Exploding Wire” for the Determination of Explosion Characteristics of Combustible Dusts in the 20-L-Sphere. *CHEMICAL ENGINEERING TRANSACTIONS VOL. 31, 2013*
- [3] Franke, H. (1978) - Bestimmung der Mindestzündenergie von Kohlenstaub/Methan/Luft-Gemischen, VDI-Berichte Nr. 304
- [4] Askar, E., Schröder, V. (2019) - The influence of strong ignition sources on the explosion and decomposition limits of gases, *Chemical Engineering Transactions Vol.75*
- [5] ASTM E 2079-00 - Standard Test Methods for Limiting Oxygen (Oxidant) Concentration in Gases and Vapors, ASTM International, West Conshohocken
- [6] Cashdollar, K., Zlochower, I., Green, G., Thomas, R., Hertzberg, M., (2000). Flammability of methane, propane, and hydrogen gases. *Journal of Loss Prevention in the Process Industries* 13 (2000) 327–340
- [7] DIN EN 14034:2006 - Determination of explosion characteristics of dust clouds, Beuth-Verlag, Berlin
- [8] ASTM 681-09 - Standard Test Method for Concentration Limits of Flammability of Chemicals (Vapors and Gases), ASTM International, West Conshohocken
- [9] DIN EN ISO 10156:2017 - Gas cylinders – Gases and gas mixtures – Determination of fire potential and oxidizing ability for the selection of cylinder valve outlets, Beuth-Verlag, Berlin