

# Determination of structural and damage detection system influencing parameters on the value of information

Structural Health Monitoring

2022, Vol. 21(1) 19–36

© The Author(s) 2020



Article reuse guidelines:

sagepub.com/journals-permissions

DOI: 10.1177/1475921719900918

journals.sagepub.com/home/shm



Lijia Long<sup>1,2</sup> , Michael Döhler<sup>3</sup> and Sebastian Thöns<sup>1,4</sup>

## Abstract

A method to determine the influencing parameters of a structural and damage detection system is proposed based on the value of information analysis. The value of information analysis utilizes the Bayesian pre-posterior decision theory to quantify the value of damage detection system for the structural integrity management during service life. First, the influencing parameters of the structural system, such as deterioration type and rate are introduced for the performance of the prior probabilistic system model. Then the influencing parameters on the damage detection system performance, including number of sensors, sensor locations, measurement noise, and the Type-I error are investigated. The pre-posterior probabilistic model is computed utilizing the Bayes' theorem to update the prior system model with the damage indication information. Finally, the value of damage detection system is quantified as the difference between the maximum utility obtained in pre-posterior and prior analysis based on the decision tree analysis, comprising structural probabilistic models, consequences, as well as benefit and costs analysis associated with and without monitoring. With the developed approach, a case study on a statically determinate Pratt truss bridge girder is carried out to validate the method. The analysis shows that the deterioration rate is the most sensitive parameter on the effect of relative value of information over the whole service life. Furthermore, it shows that more sensors do not necessarily lead to a higher relative value of information; only specific sensor locations near the highest utilized components lead to a high relative value of information; measurement noise and the Type-I error should be controlled and be as small as possible. An optimal sensor employment with highest relative value of information is found. Moreover, it is found that the proposed method can be a powerful tool to develop optimal service life maintenance strategies—before implementation—for similar bridges and to optimize the damage detection system settings and sensor configuration for minimum expected costs and risks.

## Keywords

Damage detection systems, value of information, deteriorating structures, probability of damage indication, decision theory

## Introduction

It is well known that structural health monitoring (SHM) can be beneficial for structural performance assessment over time.<sup>1</sup> Substantial research has been devoted to the development of SHM strategies and measurement techniques to reduce the various uncertainties associated with structural characteristics and performances. SHM results have been utilized for structural reliability assessments in various fields of engineering,<sup>2–5</sup> which comprise the utilization of monitoring data for reliability-based inspection planning, updating models, and the assessment of the monitoring uncertainty. However, only very recently, it is acknowledged

that the benefits of SHM in a life-cycle perspective prior to its implementation can be properly quantified by using the value of information (VoI) theory.<sup>6</sup>

<sup>1</sup>Department 7: Safety of Structures, BAM Federal Institute for Materials Research and Testing, Berlin, Germany

<sup>2</sup>Department of Civil Engineering, Aalborg University, Aalborg, Denmark

<sup>3</sup>University of Rennes, Inria, IFSTTAR, Rennes, France

<sup>4</sup>Department of Civil Engineering, Technical University of Denmark, Lyngby, Denmark

### Corresponding author:

Lijia Long, Department 7: Safety of Structures, BAM Federal Institute for Materials Research and Testing, 12205 Berlin, Germany.

Email: [lijia.long@bam.de](mailto:lijia.long@bam.de)

Decision-makers, such as infrastructure owners and operators, are often bothered with questions<sup>7,8</sup> like whether it is beneficial to perform an SHM experiment considering the economical aspect, and if so, when the SHM experiment should be implemented? How to design a monitoring and maintenance plan accordingly with different deterioration types and rates in different environment? How many sensors should be chosen? Where to install the sensors? When the benefit is not clearly specified, it is usually hard to convince the decision-makers to invest in SHM of large systems, since inappropriate SHM strategies may trigger unnecessary or inappropriate remedial activities, which may lead to a loss of economical and human resources. Most often, the value of SHM is only implicitly assumed. Decision-makers would like to utilize experience as a basis for identifying efficient strategies for performance monitoring without considering how the information shall be utilized for improving the decision basis for optimal life-cycle management of the structures.

To overcome this issue, there is a need to establish a better understanding of the quantification of the value of SHM before its implementation. Early approaches for the assessment of the value of SHM information have been developed from 2011 onwards.<sup>4,9–11</sup> Further focused research efforts of many authors, also within the European Union-funded COST Action TU1402 ([www.cost-tu1402.eu](http://www.cost-tu1402.eu)), resulted in comprehensive studies of many aspects for the quantification of the value of SHM.<sup>6,12–24</sup> These aspects include the quantification of the value of deterioration monitoring<sup>18,25,26</sup> and the quantification of the value of multiple SHM information.<sup>26,27</sup>

This article addresses the quantification of the value of damage detection system (DDS) information constituting an important part of the SHM research field. The quantification of the value of DDS information is parameterized to identify the optimal DDS configuration, the optimal DDS employment on a structural system, and the structural system characteristics for which DDS information provides the highest value. In this way, the authors aim at decision support for the employment of DDS by jointly analyzing the DDS system performance, the structural system performance and the associated benefits, costs, and consequences. The paper documents a 3-year research progress within the European Union-funded Marie Skłodowska-Curie Innovative Training Network project INFRASTAR ([www.infrastar.eu](http://www.infrastar.eu)) in conjunction with the findings of the COST Action TU1402. The novelty of this article encompasses:

1. A comprehensive and consistent formulation and elaboration of the Bayesian pre-posterior decision scenario model and its analysis.

2. A comprehensive and consistent analysis and parametric study of the value of DDS information in dependency of the DDS characteristics and structural system deterioration characteristics throughout the service life.
3. A detailed and comprehensive analysis of DDS characteristics.

This article starts with introducing the VoI theory in section “VoI theory.” Then the influencing parameters of the structural system such as deterioration type, deterioration rate, and deterioration initialing year for the performance of a prior probabilistic system model are discussed in section “Structural probabilistic system performance.” The DDS performance influencing parameters including number of sensors, sensor locations, measurement noise, and the Type-I error are presented in section “DDS information.” The integrity management actions are discussed in section “Integrity management actions.” The pre-posterior probabilistic model which is computed utilizing Bayes’ theorem to update the prior system model with the damage indication information is described in section “Pre-posterior updating with DDS information.” The utility modeling method is presented in section “Utility modelling and analysis.” With the developed approach, a case study on a statically determinate Pratt truss bridge girder is investigated to validate the method in section “Generic parametric analysis of the value of DDS information.” The results are discussed in section “Discussion.” This article ends with conclusion in section “Conclusion.”

## Methodology

### Vol theory

The VoI theory has been developed by Raiffa and Schlaifer.<sup>28</sup> The VoI analysis is rooted in the Bayesian definition of probability and utility-based decision theory to quantify the expected value of the utility increase related to yet unknown information.

The decision problems in the context of SHM for the life-cycle management of structures are illustrated in Figure 1. The essential decisions relate to whether implement SHM or not, when, at which locations and for which structural conditions to perform SHM. For different structures, different life-cycle phases may be considered in the decision analysis. For new structures, engineers need to think whether to integrate SHM into design or construction phases. While for existing structures, decisions about implementing SHM will be considered during the operation and maintenance phase and toward the end-of-service life. To figure out the decision of implementing SHM, further questions arise like: When should the SHM system been installed?

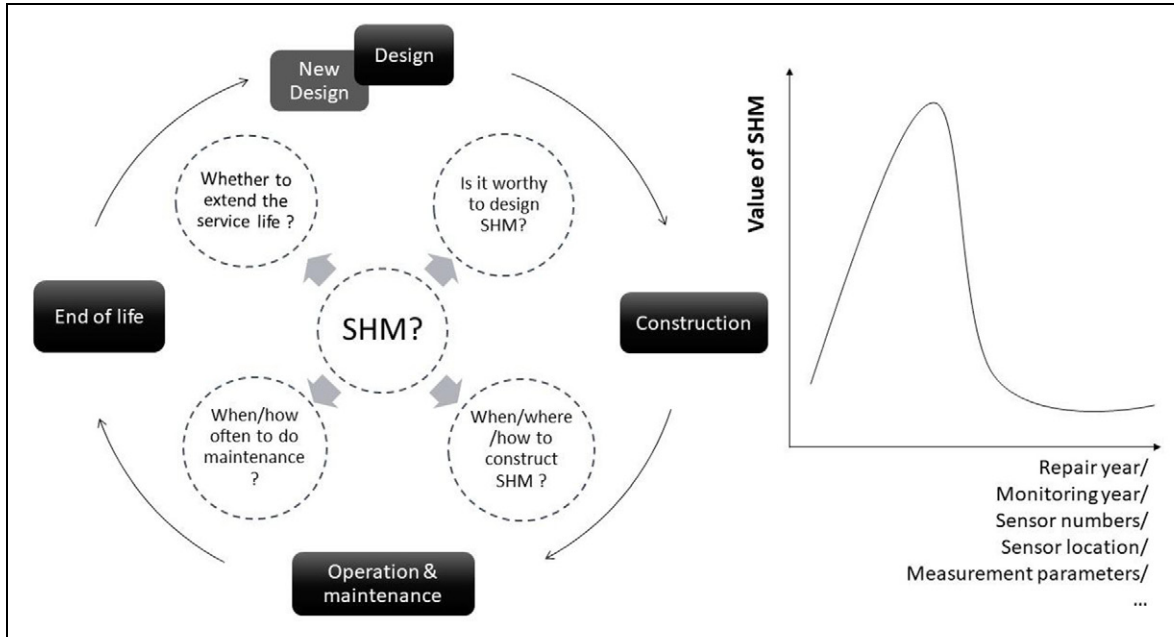

Figure 1. Decision problems in the context of SHM through life-cycle management of structures.

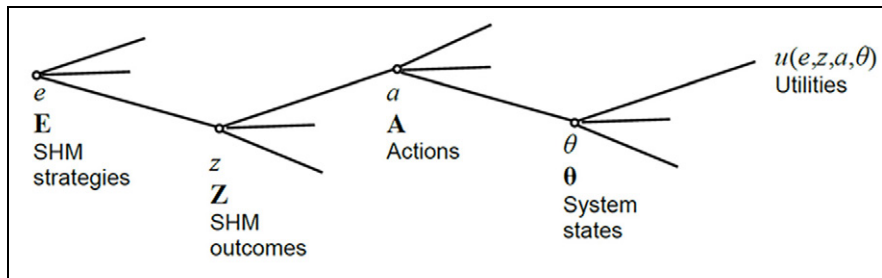

Figure 2. The classic format of decision tree<sup>23</sup> regards SHM.

Where to install the sensors? How many sensors to install? How to set measurement parameters? and Whether to extend service life? These questions can be answered with the utilization of the Bayesian decision and VoI analyses and an optimization of the expected benefits, the risk and the expected costs. By performing SHM, information about the states of the structural system are obtained, which will improve the state models. Actions such as repair and maintenance for example, based on the information acquired by SHM strategies like damage detection, change the physical properties and performance of the structural system. Both, the parameters of the SHM and the repair and maintenance strategies influence the expected benefits, costs, and the risk and in this way lead to different VoI.

The classic format of a decision analysis relating to experiments—or SHM—is shown in Figure 2, building upon the framework of Bayesian decision theory.<sup>28</sup> The decision-maker wishes to select a single action  $a$  from the

domain  $\mathbf{A} = \{a_1, \dots, a_m\}$  of potential actions; the consequences of adopting the terminal action  $a$  depend on the state of the system, which cannot be predicted with certainty. Each potential state will be labeled by a  $\theta$  with the domain  $\mathbf{\Theta} = \{\theta_1, \dots, \theta_m\}$ . To obtain further information on the importance of each state  $\theta$ , a single experiment or SHM strategy  $e$  from a family  $\mathbf{E} = \{e_1, \dots, e_m\}$  of potential SHM strategies should be selected. Each potential outcome of an SHM experiment  $e$  will be labeled by a  $z$  with domain  $\mathbf{Z} = \{z_1, \dots, z_m\}$ . The decision-maker assigns a utility  $u(e, z, a, \theta)$  to perform a particular  $e$ , observing a particular  $z$ , taking a particular action  $a$ , and then obtaining a particular  $\theta$ . The evaluation  $u$  takes into account of the costs (monetary and other) of SHM and the consequences (monetary and other) of the terminal action as well as the system states.

The VoI can be found as the difference between the maximum expected value of the utility obtained in pre-posterior analysis and the maximum value of the utility

obtained using only prior information, shown in equation (1). This means that a value to information is assigned as expected utility gain caused by the optimal decisions regarding information acquirement and actions with and without that information relative to the costs of collecting the information

$$\text{VoI}_e = \max_{\mathbf{e}} E_{Z|e} \left[ \max_{\mathbf{a}} E_{\theta|Z} [u(\mathbf{e}, Z, \mathbf{a}, \theta)] \right] - \max_{\mathbf{a}} E_{\theta} [u(\mathbf{a}, \theta)] \quad (1)$$

The VoI can be normalized in relation to the prior utility resulting in the relative VoI ( $\overline{\text{VoI}}_e$ )

$$\overline{\text{VoI}}_e = \frac{\text{VoI}_e}{\left| \max_{\mathbf{a}} E_{\theta} [u(\mathbf{a}, \theta)] \right|} \quad (2)$$

In this way, the identification of optimal SHM strategies is facilitated for both new and existing structures under a range of operating conditions and constraints. If the cost of this information is small in comparison to the potential benefit of the information, the experiment should be performed. If several different types of experiments are possible, the decision-maker must choose the experiment resulting the overall largest expected value of utility.<sup>29</sup> The pre-posterior Bayesian decision analysis is utilized to model and to assess the expected value of the utility relating to yet unknown information, which can be modeled and forecasted using the prior system-state models.

### Structural probabilistic system performance

For any structural model, failure occurs when the external load  $S$  exceeds the internal resistance (material strength)  $R$  due to increase of damage and degradation. Considering the resistance model uncertainty  $M_R$  and the loading model uncertainty  $M_S$ , the failure probability  $P(F_S)$  of a series system with  $n_j$  parallel subsystems consisting of  $n_i$  components can be written as equation (3)

$$P(F_S) = P \left( \bigcup_{j=1}^{n_j} \bigcap_{i=1}^{n_i} (M_{R,i,j} R_{i,j}(t) - M_{S,i,j} S_{i,j}) \leq 0 \right) \quad (3)$$

$R_{i,j}(t)$  is the time-variant resistance for a component, and  $S_{i,j}$  is the external loading on the component. The resistance (strength) will be degraded due to the increase of damage with time

$$R_{i,j}(t) = R_{i,j,0} (\Delta_{i,j} - D_{i,j}(t)) \quad (4)$$

$R_{i,j,0}$  is the initial resistance, and  $\Delta_{i,j}$  is the damage limit of the component.  $D_{i,j}(t)$  is the damage on a

component, which will be increasing with time. A general damage model is introduced by Mori and Ellingwood<sup>30</sup>

$$D_{i,j}(t) = \alpha(t - T_0)^\beta \quad (5)$$

where  $\alpha$  is the annual deterioration rate of a component,  $\beta$  is the deterioration type, and  $T_0$  is the deterioration initiating time. For  $\beta = 1$ , this corresponds to the most applied corrosion models and to the Palmgren–Miner fatigue model with a stationary stress process; for  $\beta = 0.5$ , the model is representative of diffusion-controlled deterioration; and for  $\beta = 2$ , the model approximates concrete deterioration caused by sulfate attack.

To calculate the probability of failure, a limit state function is introduced, when  $g_{i,j} \leq 0$  represents the component failure due to deterioration

$$g_{i,j} = M_{R,i,j} R_{i,j,0} (\Delta_{i,j} - \alpha(t - T_0)^\beta) - M_{S,i,j} S_{i,j}(t) \quad (6)$$

It is noted that for many structural systems, deterioration states of structural components are correlated.<sup>31</sup> Therefore, the correlation of the deterioration states should be accounted for. The deterioration process follows equation (4). Stochastic dependence can then be modeled<sup>32</sup> by introducing a correlation among the damage limit state, or among the parameters of the models describing the damage limit, for example, deterioration rate  $\alpha$ . The component failures caused by deterioration are likely to occur at different times depending on the nature of the deterioration process, which will show a lower statistical dependence than the failure events caused by overloading as all components normally fail during the same load event. The correlation coefficient for limit states of overloading failure is thus close to 1.0,<sup>31</sup> and the correlation coefficient of deterioration states among components is normally estimated less than 1.0.

### DDS information

SHM consists of a very wide range of activities, which should provide information of relevance for the management of existing and new structures for their life-cycle performance. SHM systems are designed to provide owners and operators with information about the health of a structure. A main issue of SHM is to develop approaches for damage diagnosis, involving for example, signal processing methods for model identification and feature extraction.<sup>33–35</sup>

An approach encompassing DDS and algorithms, which is used to evaluate the structural system performance with DDS information has been developed by Thöns.<sup>36</sup> The employed damage detection method,

which is the stochastic subspace damage detection (SSDD) method,<sup>37</sup> detects changes in the dynamic properties of a structure, for example, due to stiffness loss, from output-only ambient vibration measurements in a (healthy) reference state and in the current state. From these measurements, a test statistic is computed that compares both states. This results in a chi-square-distributed damage indicator, having a central chi-square distribution in the reference state and a non-central chi-square distribution in the damaged state. A threshold is set up for a desired Type-I error for a decision between both states.

The non-centrality parameter of the distribution in the damaged state can be obtained easily from measurements of the structure in the reference state and from model-based information on the damage within the theoretical framework of the method.<sup>38</sup> This allows in particular an efficient model-based computation of the probability of indication for any damage, without the need of recording or simulating data from the damaged structure.<sup>39</sup>

In general, the performance of the DDS depends on the following properties:

1. Properties of the measurement system, like number and positions of sensors, type of sensors, sampling frequency  $f_s$ , and measurement duration. These properties are typically set up by the user.
2. Stochastic system properties, like ambient excitation properties and the measurement noise level. These properties are not or only partially controlled by the user.

Besides these properties, the performance of the DDS strongly depends on the chosen damage detection method and its setup. This includes in particular the desired Type-I error for the indication threshold between healthy and damaged states, which also needs to be set for the SSDD method.

Note that the considered damage detection method is used as an example in this study, and any damage detection method can be used in our VoI framework if it can provide the probability of indication for the damages included in the employed deterioration model.

### Integrity management actions

Integrity management actions are the possible actions that the decision-maker can take during the service life of a structure to ensure safety and functionality, for example, maintenance, inspection, repair, and replace. The decision of theoretical optimal choice of integrity management actions can be derived in the form of decision rules, which relate an experimental outcome to an action. Decision rules can—once they are derived—

enhance significantly the computational efficiency. Examples of decision rules are:<sup>40</sup>

- If the monitoring outcome is above the threshold value, an inspection is made.
- If the inspection outcome is above a threshold value, a repair is made.
- If the expected value of damage size is above a threshold value, an inspection or repair is made.

### Pre-posterior updating with DDS information

Let  $\mathbf{D}$  denote the damage size of a structural system or component, which is the vector of degradation consisting of random variables of  $D_{i,j}$  from equation (5).  $f_D(\mathbf{D})$  denotes the probability density function of  $\mathbf{D}$ . Considering that a DDS is used to inspect a structure or structural component, the quality of the measurement can be represented by the probability density function for indication, given a damage size  $\rho(I|\mathbf{D})$ . It can then be used to calculate the probability of indicating the damage with size  $\mathbf{D}$ . The probability of indication of detecting damage is then given as

$$P(I) = \int_{\Omega_D} \rho(I|\mathbf{D})f_D(\mathbf{D})d\mathbf{D} \quad (7)$$

as referenced by Hong,<sup>41</sup>  $\Omega_D$  represents the domain of  $\mathbf{D}$ . Since the value of  $\rho(I|\mathbf{D})$  ranges from 0 to 1, to compute equation (7), a uniformly distributed random variable  $\mu$  can be introduced to form a limit-state function. The probability of no indication of detecting damage  $P(\bar{I})$  can be calculated by integrating in the region which is defined using the limit-state function  $g_U \leq 0$ . The limit-state function  $g_U$  is defined as the difference between the probability of indication given damage  $P(I|\mathbf{D})$  and  $\mu$

$$P(\bar{I}) = 1 - P(I) = \int_{\Omega_D} (1 - \rho(I|\mathbf{D}))f_D(\mathbf{D})d\mathbf{D} \quad (8)$$

$$g_U = P(I|\mathbf{D}) - \mu \quad (9)$$

The pre-posterior probability of failure if no damage is detected  $P(F_s|\mathbf{D} \cap \bar{I})$  can be written as equation (10) and solved by two joint limit-state functions of  $g_S$  and  $g_U$

$$P(F_s|\mathbf{D} \cap \bar{I}) = P(F_s|\mathbf{D}, \bar{I})P(\bar{I}) = P(g_S \leq 0 \cap g_U \leq 0) \quad (10)$$

where  $P(\bar{I})$  is the probability of no indication,  $P(\bar{I}|F_s, \mathbf{D})$  is the probability of no indication given damage and failure. The limit-state function  $g_S \leq 0$  can refer to equation (6).



### Utility modeling and analysis

Let  $u$  be the utility function considering the costs and benefits. The total costs are the sum of individual costs, for example, cost of consequences like failure, cost of actions like inspection, repair, and replacement, costs of monitoring. The failure costs should include both direct and indirect costs regarding fatalities, economic, environmental, and social impact. The monitoring costs include investment, installation, operation, and monitoring system replacement costs. While some individual costs like monitoring costs can be estimated referencing similar cases from literatures and standards, repair costs should be modeled carefully considering the damage status of the structure.

Data from damaged buildings suggest that the repair costs are dependent on the overall damage state,<sup>42-44</sup> the more overall damage is present in a structure, the higher are the repair costs for restoring the structure to the original state. The repair costs dependency on the damage state is modeled in most case, either as a linear function with a limit of repairable damage,<sup>42,43</sup> or as a non-linearly increasing function of damage.<sup>45</sup> In the article, the cost of repair is modeled as a non-linearly increasing function of damage, dependent on the initial investment cost of the bridge  $C_I$ , the service life  $T_{SL}$  and the repair year  $t_j$  following Higuchi,<sup>46</sup> yielding

$$C_R = \frac{C_I}{T_{SL} + 2 - t_j} \quad (11)$$

The repair action is performed when the probability of failure exceeds the target probability  $P_{Target}$ , which serves as a boundary to the decision analysis. The utility analysis will be formulated following the decision tree analysis.

The utility can be analyzed depending on the state of information acquirement at the time of the analysis. There are two types of analysis<sup>28</sup> named extensive form and normal form to compute the utility. In this article, the extensive form analysis is applied. If the probabilities of the various system states corresponding to different consequences of action have been estimated, which means that information on action  $\mathbf{a}$  and state  $\boldsymbol{\theta}$  are given. Assume  $\boldsymbol{\theta}$  in total has  $m$  states, the expected utility of action  $a_i$  can be calculated by

$$E_{\boldsymbol{\theta}}[u(a_i, \boldsymbol{\theta})] = \sum_{j=1}^m u(a_i, \theta_j) P(\theta_j) \quad (12)$$

$P(\theta_j)$  is the assigned prior probability at state  $\theta_j$ . After calculating all the expected utilities corresponding to the different actions, the optimal action will result in the one with highest expected utility, which is called prior utility  $U$

$$U = \max_{\mathbf{a}} E_{\boldsymbol{\theta}}[u(\mathbf{a}, \boldsymbol{\theta})] \quad (13)$$

If additional information becomes available, which means that a specific SHM experiment  $e$  has been implemented and a specific outcome of the experiment  $z$  is known. The expected utility is modeling by

$$E_{\boldsymbol{\theta}|z}[u(z, a_i, \boldsymbol{\theta})] = \sum_{j=1}^m u(z, a_i, \theta_j) P(\theta_j|z) \quad (14)$$

$P(\theta_j|z)$  is the posterior probability, given the outcome of  $z$ , which is updated by Bayes's rule. The maximum utility in this case is called posterior utility. When the SHM strategy or the experiment is planned but the result is still unknown, then the expected utility is modeled with forecasted information based on the prior models. The SHM experiment  $\mathbf{e}$  and the probability of each of the  $l$  outcomes of the experiment  $z$  will be assigned. The expected values of the utility should be found for each possible action  $\mathbf{a}$  for a specific experiment  $e$  and outcome  $z$ . The maximum utility is called pre-posterior utility  $U^*$ , which is calculated by

$$U^* = \max_{\mathbf{e}} E_{\mathbf{Z}|\mathbf{e}} \left[ \max_{\mathbf{a}} E_{\boldsymbol{\theta}|z}[u(\mathbf{e}, \mathbf{Z}, \mathbf{a}, \boldsymbol{\theta})] \right] \quad (15)$$

$$\begin{aligned} & E_{\mathbf{Z}|\mathbf{e}} \left[ \max_{\mathbf{a}} E_{\boldsymbol{\theta}|z}[u(\mathbf{e}, \mathbf{Z}, \mathbf{a}, \boldsymbol{\theta})] \right] \\ &= \max_{\mathbf{a}} \sum_{k=1}^l \sum_{j=1}^m u(\mathbf{e}, z_k, \mathbf{a}, \theta_j) P(\theta_j|z_k) P(z_k, e_i) \end{aligned} \quad (16)$$

$P(z_k, e_i)$  is the probability of outcome  $z_k$  from experiment of  $e_i$ .  $P(\theta_j|z_k)P(z_k, e_i)$  is the pre-posterior probability, which can be modeled as  $P(\theta_j \cap z_k)$ .

### Generic parametric analysis of the value of DDS information

The parametric analysis of the value of DDS information takes basis in a generic structural system under degradation. The generic and representative structural system constitutes a series system accounting for the dependence in the component failure modes and in the deterioration of the individual structural components. Such system is representative, as it takes basis in common assumptions for target reliability determination and code calibration.<sup>47,48</sup> The complete decision scenario encompassing the decision-maker, the decision point time, the temporal framing of the decision analysis, the specific structural system and component failure and deterioration models and their dependencies, the specific DDS information, and the utility models are introduced in the following sections.

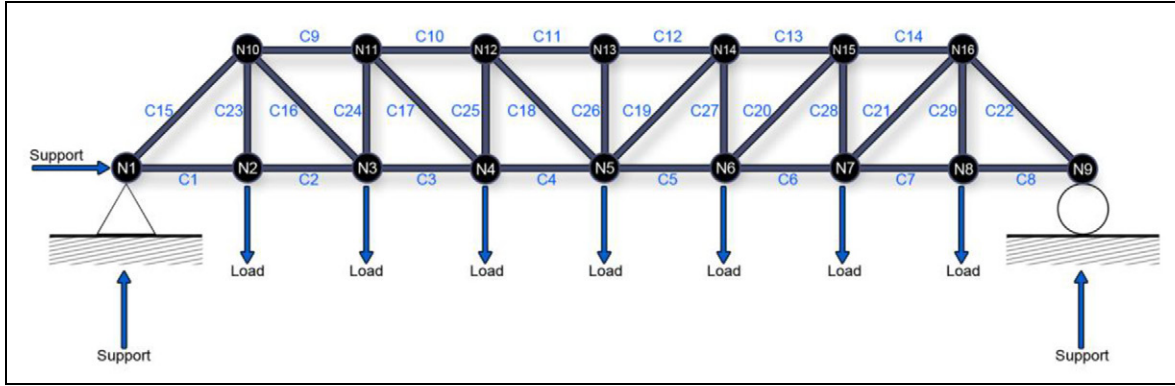

**Figure 3.** Illustration of truss bridge girder.

### Decision scenario

A Pratt truss girder as shown in Figure 3 is considered under operation and maintenance phase. It is assumed to experience an unusually high deterioration in the first 15 years of operation. For the remaining 35 years of the service life, a bridge manager wants to design a maintenance plan. The manager considers whether the bridge should be repaired regularly after certain times without SHM or is it worthwhile to do SHM before repairing directly to minimize the risk and expected costs. Therefore, a VoI analysis is performed to provide the decision basis. The basic decision problem is whether to choose  $e_0$ , that is, no SHM or  $e_1$ , that is, DDS. If implementing DDS, there will be a cost of monitoring  $C_M$  with outcome of chances  $z_1$  indication of damage or  $z_2$  no indication of damage. The outcome of DDS will be influenced by the deterioration type  $\beta$ , deterioration rate  $\alpha$ , point in time employment year  $t_m$ , number of sensors, sensor location, measurement noise, and Type-I error for indication threshold. So, the decision-maker is wondering how to design a monitoring and maintenance plan accordingly with different deterioration rates and environment? If choosing DDS, at which point in time during service life to implement it? How many sensors should be installed? Where to place the sensors? How does measurement noise affect the result? and How to set the Type-I error for the indication threshold for the DDS? Based on the varied information acquired by the DDS system outcome, the manager has two options of actions, either  $a_0$  do nothing or  $a_1$  repair the truss girder. When performing a repair action, there will be a repair cost  $C_R$ . Based on the choice of actions, the truss bridge girder could be either  $\theta_1$  safe or  $\theta_2$  failure state within the designed service life  $T_{SL}$  of 50 years. The failure of the truss will lead to the cost  $C_F$ , which account for the direct and indirect consequences. The respective decision tree is shown in Figure 4. With different combination of

deterioration rate  $\alpha$ , point in time employment year  $t_m$ , number of sensors, sensor location, measurement noise, Type-I error for indication threshold, and the decision tree branches will be expanded.

The costs model is shown in Table 1, considering the discount rate  $r$  in general for long-term regulations ranged between 0.01 to 0.05 per year;<sup>49</sup> here we adopt for our calculation a constant discount rate of  $r = 0.02$  per year. The initial investment cost is chosen for convenience as  $C_I = 100$  monetary units. The failure cost  $C_F$  and DDS cost  $C_M$  are set in relation to the initial investment costs. The normalized failure cost is set to  $C_F/C_I = 10$  and  $C_M/C_I = 0.001$  per sensor is assumed.

### Vol analysis

The value of DDS information when monitoring at year  $t_m$  is written as  $\text{VoI}(t_m)$

$$\text{VoI}(t_m) = U_{SL}^*(t_m) - U_{SL} \quad (17)$$

where  $U_{SL}$  is the expected service life utilities without monitoring.  $U_{SL}^*(t_m)$  is the expected service life utilities with monitoring at year  $t_m$ . Then the relative VoI will be:  $\overline{\text{VoI}}(t_m) = \text{VoI}(t_m)/|U_{SL}|$ . The expected service life utilities without monitoring  $U_{SL}$  is

$$U_{SL} = \max[U_F; U_{F,R}] \quad (18)$$

where  $U_F$  is the utility of doing nothing and fail,  $U_{F,R}$  is the utility of doing repair and fail. The utility of doing nothing and fail  $U_F$  is calculated as

$$U_F = - \sum_{t=1}^{T_{SL}} P(F_{S_t}) \cdot C_F \cdot \frac{1}{(1+\gamma)^t} \quad (19)$$

$$P(F_{S_t}) = P(g_S(t) \leq 0) \quad (20)$$

where  $P(F_{S_t})$  is the prior probability of system failure at year  $t$ . The utility of doing repair and fail  $U_{F,R}$  is

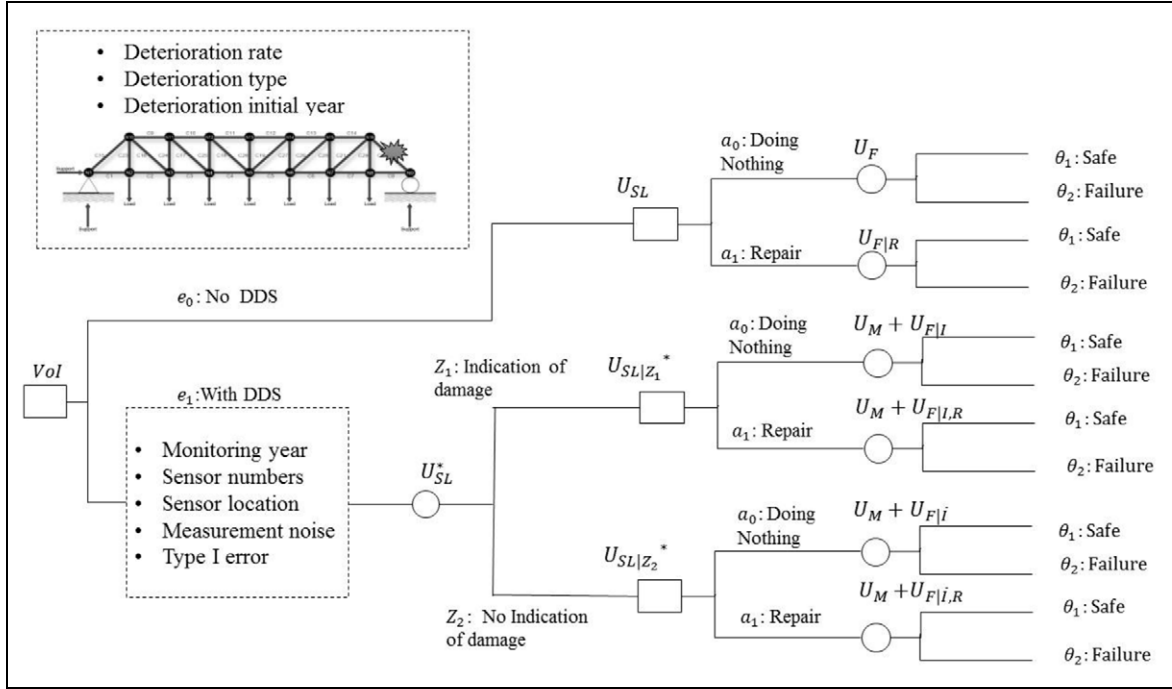

Figure 4. Illustration of decision tree.

Table 1. Costs model.

Discount rate $r$	Failure cost $C_F$	DDS cost (per sensor) $C_M$	Investment cost $C_I$
0.02	1000	0.1	100

DDS: damage detection system.

$$U_{F,R} = - \sum_{t=1}^{T_{SL}} P(F_{S_t}, R_{S_{t_j}}) \cdot C_F \cdot \frac{1}{(1+\gamma)^t} - \sum_{n=1}^{n_R} C_R \cdot \frac{1}{(1+\gamma)^{t_j}} \quad (21)$$

$$P(F_{S_t}, R_{S_{t_j}}) = \begin{cases} P(F_{S_t}), t < t_j = \arg(P(F_{S_{t_j}}) = P_{\text{Target}}) \\ P(F_{S_{(t-t_j)}}), t \geq t_j = \arg(P(F_{S_{t_j}}) = P_{\text{Target}}) \end{cases} \quad (22)$$

where  $P(F_{S_t}, R_{S_{t_j}})$  is the probability of system failure at year  $t$ , after repair event  $R_{S_{t_j}}$  at year  $t_j$ .  $t_j$  is the repair year when the prior probability of system failure  $P(F_{S_t})$  equals to the target probability  $P_{\text{Target}}$ . The system will behave like a new system after repair with same probabilistic characteristics as originally.  $n_R$  is the number of repair times during the service life. The expected service life utilities with monitoring  $U_{SL}^*(t_m)$  at  $t_m$  can be written as

$$U_{SL}^*(t_m) = U_M + \max[U_{F|I}; U_{F|I,R}] + \max[U_{F|\bar{I}}; U_{F|\bar{I},R}] \quad (23)$$

where  $U_M$  is the utility of monitoring,  $U_{F|I}$  is the utility of failure given indication of damage,  $U_{F|\bar{I}}$  is the utility of failure given no indication of damage,  $U_{F|I,R}$  is the utility of failure, given indication of damage and repair,  $U_{F|\bar{I},R}$  is the utility of failure given no indication of damage and repair. The utility of monitoring  $U_M$  is

$$U_M = - (1 - P(F_{S_{t_m}})) \cdot C_M \cdot \frac{1}{(1+\gamma)^{t_m}} \quad (24)$$

The utility of failure given indication of damage  $U_{F|I}$  is calculated as

$$U_{F|I} = - \sum_{t=1}^{T_{SL}} P(F_{S_t} \cap I_{t_m}) \cdot C_F \cdot \frac{1}{(1+\gamma)^t} \quad (25)$$

$$P(F_{S_t} \cap I_{t_m}) = \begin{cases} P(F_{S_t}), t < t_m \\ P(g_S(t) \leq 0 \cap g_U(t_m) \geq 0), t \geq t_m \end{cases} \quad (26)$$

$P(F_{S_t} \cap I_{t_m})$  is the pre-posterior probability of system failure at year  $t$  if doing monitoring and giving indication of damage at year  $t_m$  and doing nothing. The utility of failure given no indication of damage  $U_{F|\bar{I}}$  is calculated as



$$U_{F|\bar{I}} = - \sum_{t=1}^{T_{SL}} P(F_{S_t} \cap \bar{I}_{t_m}) \cdot C_F \cdot \frac{1}{(1+\gamma)^t} \quad (27)$$

$$P(F_{S_t} \cap \bar{I}_{t_m}) = \begin{cases} P(F_{S_t}), t < t_m \\ P(g_S(t) \leq 0 \cap g_U(t_m) \leq 0), t \geq t_m \end{cases} \quad (28)$$

where  $P(F_{S_t} \cap \bar{I}_{t_m})$  is pre-posterior probability of system failure at year  $t$  if doing monitoring and giving no indication of damage at year  $t_m$  and doing nothing.

The utility of failure given indication of damage and repair  $U_{F|I,R}$  is

$$U_{F|I,R} = - \sum_{t=1}^{T_{SL}} P((F_{S_t} \cap I_{t_m}), R_{S_{t_j}}) \cdot C_F \cdot \frac{1}{(1+\gamma)^t} - \sum_{n=1}^{n_{I,R}} C_R \cdot \frac{1}{(1+\gamma)^n} \quad (29)$$

$$P((F_{S_t} \cap I_{t_m}), R_{S_{t_j}}) = \begin{cases} P(F_{S_t}), t < t_m \\ P(F_{S_t} \cap I_{t_m}), t_m \leq t < t_j = \arg(P(F_{S_{t_j}} \cap I_{t_m}) = P_{\text{Target}}) \\ P(F_{S_{(t-t_j)}}), t \geq t_j = \arg(P(F_{S_{t_j}} \cap I_{t_m}) = P_{\text{Target}}) \end{cases} \quad (30)$$

where  $P((F_{S_t} \cap I_{t_m}), R_{S_{t_j}})$  is pre-posterior probability of system failure at year  $t$  and giving indication of damage at year  $t_m$  and repairing at year  $t_j$ . Here,  $t_j$  is the year when the  $P(F_{S_t} \cap I_{t_m})$  equals to the  $P_{\text{Target}}$ .  $n_{I,R}$  is the number of repair times during the service life after implementing DDS for 1 year at  $t_m$  and giving indication of damage.

The utility of failure given no indication of damage and repair  $U_{F|\bar{I},R}$  is

$$U_{F|\bar{I},R} = - \sum_{t=1}^{T_{SL}} P((F_{S_t} \cap \bar{I}_{t_m}), R_{S_{t_j}}) \cdot C_F \cdot \frac{1}{(1+\gamma)^t} - \sum_{n=1}^{n_{I,R}} C_R \cdot \frac{1}{(1+\gamma)^n} \quad (31)$$

$$P((F_{S_t} \cap \bar{I}_{t_m}), R_{S_{t_j}}) = \begin{cases} P(F_{S_t}), t < t_m \\ P(F_{S_t} \cap \bar{I}_{t_m}), t_m \leq t < t_j = \arg(P(F_{S_{t_j}} \cap \bar{I}_{t_m}) = P_{\text{Target}}) \\ P(F_{S_{(t-t_j)}}), t \geq t_j = \arg(P(F_{S_{t_j}} \cap \bar{I}_{t_m}) = P_{\text{Target}}) \end{cases} \quad (32)$$

where  $P((F_{S_t} \cap \bar{I}_{t_m}), R_{S_{t_j}})$  is pre-posterior probability of system failure at year  $t$  if doing monitoring and giving no indication of damage at year  $t_m$  and repairing at year

$t_j$ . Here,  $t_j$  is year when the  $P(F_{S_t} \cap \bar{I}_{t_m})$  equals to the  $P_{\text{Target}}$ .  $n_{I,R}$  is the number of repair times during the service life after implementing DDS for 1 year at  $t_m$  and giving no indication of damage.

### Structural probabilistic performance

The truss bridge girder has 29 components with 16 joint nodes. Assume a probabilistic extreme loading  $S$ , which is Weibull distributed with mean of 3.5 and standard deviation of 0.1, applied vertically on the truss and evenly distributed on the lower nodes 2, 3, 4, 5, 6, 7, 8 with  $1/7 S$ . Thus, the axial force on each beam element are calculated by the equilibrium equations. The truss's beams have similar geometrical and probabilistic properties.

The failure of a truss component can be the failure by yielding when it is under tension as well as failure by buckling when it is under compression. If the component is under tension, the critical strength is the yield strength  $\sigma_y$ , the corresponding tension resistance is  $R_y$ , which is related to the properties of materials.  $R_y$  is modeled as lognormal distributed with 0.1 coefficient of variation and the mean value is calibrated to a probability of system failure of  $10^{-6}$  disregarding any damage, considering the consequence of failure is large and the relative cost of safety measure is small.<sup>34</sup> If the component is under buckling, the critical strength is the buckling strength, which follows the Euler buckling formula

$$\sigma_b = \frac{\pi^2 EI}{AL^2} \quad (33)$$

where  $\sigma_b$  is the buckling strength,  $L$  is the column length,  $A$  is the cross-section area, which is  $(10/144) \text{ m}^2$  in this case,  $I$  is the cross-sectional moment of inertia,  $E$  is the Young's modulus, which is 14,400 MPa for calculation. The corresponding buckling resistance  $R_b$  is also modeled as lognormal distribution with mean of  $R_b = \sigma_b \cdot A$  and 0.07 standard deviation. The limit-state functions of 29 components can be formulated as follows. Due to the absence of redundancy, a series-system formulation is chosen for the truss bridge girder; the system limit-state function is the minimum of the  $n_i$  components limit-state function

$$g_S = \min_{i=1 \text{ to } n_i} (M_{R,i} R_{i,0} (\Delta_i - D_i(t)) - M_{S,i} S_i) \quad (34)$$

Then the probability of system failure  $P(F_S)$ , which is coupled with time-variant damage models describing continuously the deterioration process and structural resistance degradation throughout the service life can be written as

$$P(F_S) = P\left(\bigcup_{i=1}^{n_i} \left(M_{R,i} R_{i,0} (\Delta_i - \alpha(t - T_0)^\beta) - M_{S,i} S_i\right) \leq 0\right) \quad (35)$$

According to JCSS (Joint Committee on Structural Safety),<sup>50</sup> the resistance model uncertainty  $M_{R,i}$  is modeled as lognormal distributed with mean of 1 and standard deviation of 0.05; the loading model uncertainty  $M_{S,i}$  is lognormal distributed with mean of 1 and standard deviation of 0.1; and the damage limit of component  $\Delta_i$  is modeled as lognormal distributed with mean of 1 and standard deviation of 0.3. The annual deterioration rate  $\alpha$ , the deterioration type  $\beta$ , and the deterioration initiating time  $T_0$  are modeled accordingly to Long et al.<sup>51</sup>

According to literature<sup>52</sup> with general corrosion, damage is equated to the total amount of metal lost. This may be expressed in terms of thickness lost, for example an expression in mm per year, or mass lost, such as grams per square meter per year. Corrosion rate on a carbon steel surface,<sup>53</sup> in atmospheric environment for example, industrial environment is 0.025–0.050 mm per year and in marine environment is 0.125–1 mm per year. So that three different deterioration rates are selected in this article to present three different deteriorating conditions. It is assumed that the system is required to take repair actions when the probability of failure exceeds  $10^{-4}$  according to the same target reliability class with high costs of safety measures.<sup>50</sup>

As previously stated in section “Structural probabilistic system performance,” the correlation among deterioration states of structural components should be accounted for. For computation convenience, the stochastic dependence is modeled by introducing a correlation among the parameters of the models describing deterioration. The damage limit is fully correlated. Thus, the correlation of the initial resistances  $R_{i,0}$  and

the deterioration rate  $\alpha$  among 29 components,  $\rho_{R_{i,0}}$  and  $\rho_\alpha$  is assumed to 0.5. It should be noted that due to the non-redundancy of the truss structure, the dependency among the deterioration process of different components will not strongly influence the system reliability as, for example, shown by Thöns et al.<sup>36</sup>

The probability of component/system failure is calculated by Monte Carlo simulations based on Table 2. The prior probability of system failure will increase with time. The failure probabilities with a low deterioration rate and same initial year but varied deterioration types are shown in Figure 5(a). The failure probability of the diffusion-controlled type of deterioration will always be below the target probability during the entire service life requiring no repair. However, if the system is under corrosion and fatigue, it is required to do the first repair at year 25 and in total need to be repaired three times during service life. If it is the type of sulfate attack concrete deterioration, it needs to do the first repair at year 18 and in total to be repaired nine times, which is shown in Figure 5(b). The computation results of failure probabilities with same deterioration type of corrosion and fatigue but varied deterioration rate and initial year are shown in Figure 5(c).

### Properties of DDS

The DDS can detect stiffness loss in the elements of the structure. A connection to the damage states is made in this regard as follows. A stiffness loss  $dk_i$  is expressed as the relative change of ratio of the initial axial stiffness  $k_{i,0}$  for element  $i$

$$dk_i = 1 - \frac{k_i}{k_{i,0}} \quad (36)$$

**Table 2.** Summary of the prior probabilistic model parameters.

Variable	Description	Dim.	Dist.	Exp.value	SD
$R_y$	Yield resistance	MPa	LN	Cali.	CoV = 0.1
$R_b$	Buckling resistance	MPa	LN	Equation (33)	0.07
$M_{R,i}$	Resistance uncertainty	MPa	LN	1.0	0.05
$S_i$	Loading	MPa	WBL	3.5	0.1
$M_{S,i}$	Loading uncertainty	MPa	LN	1.0	0.1
$\Delta_i$	Damage limit	–	LN	1.00	0.3
$T_0$	Deterioration initial time	Year	Det.	15/10/5	–
$\beta$	Deterioration type	Diffusion-controlled deterioration Corrosion and fatigue Sulfate attack concrete deterioration	Det.	0.5 1 2	–
$\alpha$	Deterioration rate (/year)	Low $T_0 = 15$ Medium $T_0 = 10$ High $T_0 = 5$	LN LN LN	1.3E–5 7.6E–5 2.54E–4	0.001

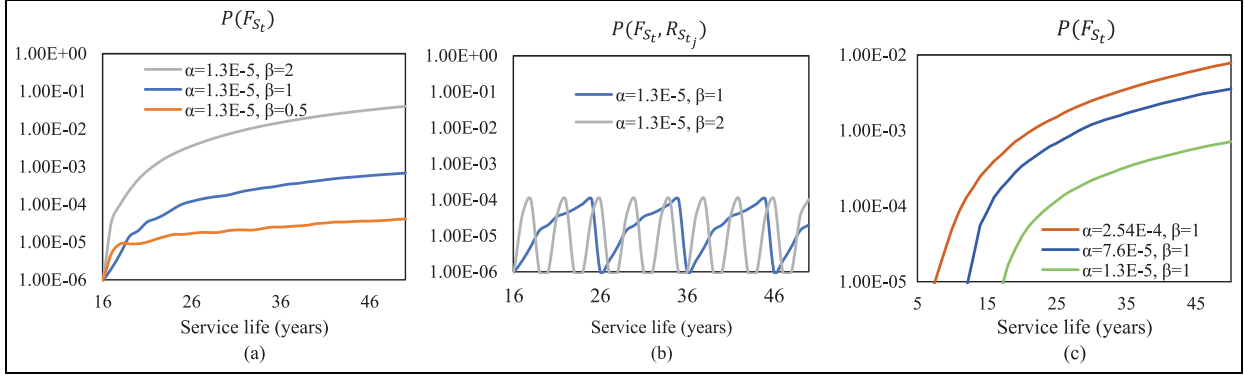

**Figure 5.** (a) Prior probability of system failure with varied deterioration types, (b) prior repair plan with varied deterioration types, and (c) prior probability of system failure with varied deterioration rate and initial year.

The element stiffness  $k_i$  has a relation with cross-section area  $A_i$ , length  $L$  and Young's modulus  $E$ ,  $k_i = E \cdot A_i(t) / L$ . The cross-section  $A_i$  is reduced due to the increase of damage states  $D_i$

$$A_i(t) = A_{i,0} - h(D_i(t)) \quad (37)$$

$A_{i,0}$  is the initial cross-sectional area,  $A_i(t)$  is the cross-sectional area at time  $t$ ,  $h$  is the function between damage state and the cross-section area. Then, the relation between damage state and stiffness loss can be expressed as

$$dk_i = 1 - \frac{A_{i,0} - h(D_i(t))}{A_{i,0}} \quad (38)$$

$$dk_i = \gamma \cdot h(D_i(t)) \quad (39)$$

$\gamma$  is the correction factor, in which  $\gamma = 1/A_{i,0}$ . There is small uncertainty about the cross-section area, length, and Young's modulus, so that the stiffness loss uncertainty will be very small, which is neglected. To simplify computation, we adopt  $dk_i = D_i(t)$ . The probability of damage indication is calculated for the SSDD method based on the described damage states.<sup>30</sup> Hereby, the following parameters of the detection system are considered.

The number of sensors, their location, and their noise properties influence the structural information content that is contained in the measurement data. In particular, it is well known that the number and locations of sensors can be optimized to obtain more precise information about the dynamic properties of structures.<sup>54</sup> An explicit link of the sensor placement to the performance of the considered damage detection method has been made by Döhler et al.<sup>55</sup> Thus, the number and location of sensors have a direct influence on the damage detection probabilities, and hence on the VoI that is examined in this article. Measurement noise (as a property of the used sensors) affects the

signal-to-noise ratio and thus the information content in the signals<sup>56</sup> and is therefore also an important factor for the examination of the VoI. The Type-I error rate is a user-defined value for the trade-off between a low false-alarm rate and a high probability of detection. It is a design parameter for any damage detection method, reflecting the applied reliability concept<sup>57</sup> and has therefore a direct influence on the decisions taken based on the outcome of the damage detection method. Hence, its influence on the VoI should also be examined.

Following the above argumentation, five scenarios of DDS settings are investigated. Within all the scenarios, the structural system is under deterioration type  $\beta = 1$  corresponding to corrosion or fatigue, which is reasonable for the deterioration of a steel truss bridge girder. For the reference scenario, the bridge is under low deterioration, the DDS is modeled with the acceleration sensors located in nodes 12, 13, 14 of the truss in Y-direction recording the vibration response and using the DDS algorithm. Based on the dynamic structural system model, a reference data set of length  $N = 10,000$  at a sampling frequency of 50 Hz is simulated in the undamaged state. Ambient excitation (white noise) is assumed at all degrees of freedom, whose covariance is the identity matrix. Measurement noise is added on the resulting accelerations with standard deviation at each sensor of 5% of the standard deviation of the signal. The Type-I error for the indication threshold is set as 1%.

Based on the reference scenario, scenario (a) varies the number of sensors between 1, 3, 5, and 8. Scenario (b) varies the sensor positions when the number of sensors is fixed with three sensors. Scenario (c) changes the measurement noise from 5% to 1%, 50% and 100%. Scenario (d) changes the Type-I error for indication threshold from 1% to 0.1% and 5%. Scenario (e) varies the deterioration rate  $\alpha$  from low to medium and high. A summary of the DDS parameters and deterioration scenarios is shown in Table 3.

**Table 3.** Summary of the sensor configuration and deterioration scenarios.

Scenario	Sensor number	Sensor node location	Measurement noise	Type-I error	Deterioration rate $\alpha$		
					Initial year	Mean	SD
Base	3	12, 13, 14	5%	1%	$T_0 = 15$	1.3E-5	0.001
(a)	1	13					
	3	11, 12, 13					
	5	11, 12, 13, 14, 15					
	8	11, 12, 13, 14, 15, 4, 5, 6					
(b)	3	4, 5, 6					
		2, 5, 8					
		2, 3, 4					
(c)		11, 13, 15					
		12, 13, 14	1%				
			50%				
			100%				
(d)			5%	0.1%			
				5%			
				1%			
(e)	3	12, 13, 14	5%	1%	$T_0 = 15$	1.3E-5	
					$T_0 = 10$	7.6E-5	
					$T_0 = 5$	2.54E-4	

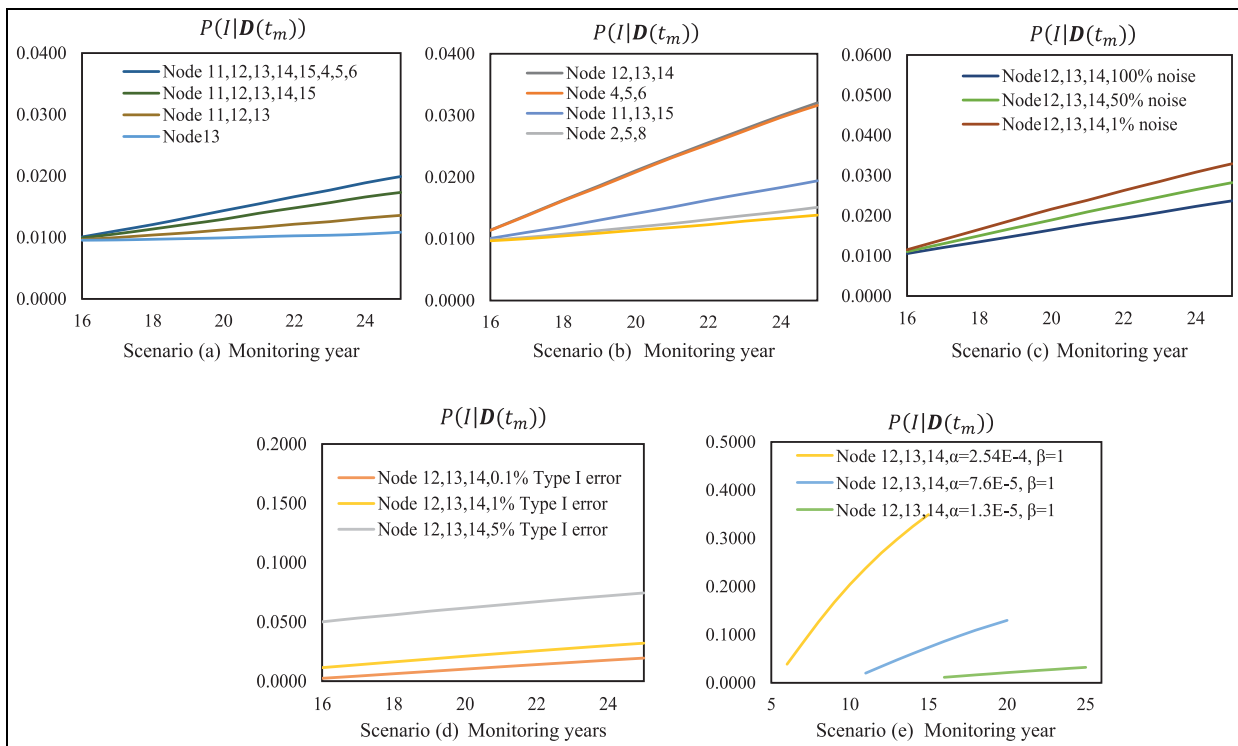

**Figure 6.** Probability of damage indication with varied scenarios (a) to (e).

The probability of damage indication in each monitoring year is computed and shown in Figure 6. The investigation of monitoring year is focused on the period from the initial deterioration year to the first scheduled repair year without monitoring from prior

analysis as shown in Figure 5(b), in order to plan monitoring before directly repair. Figure 6(a) shows that the probability of damage indication  $P(I|D(t_m))$  increases with the increasing number of sensors from 1, 3, 5 to 8 accordingly, which indicates that it is more probable to

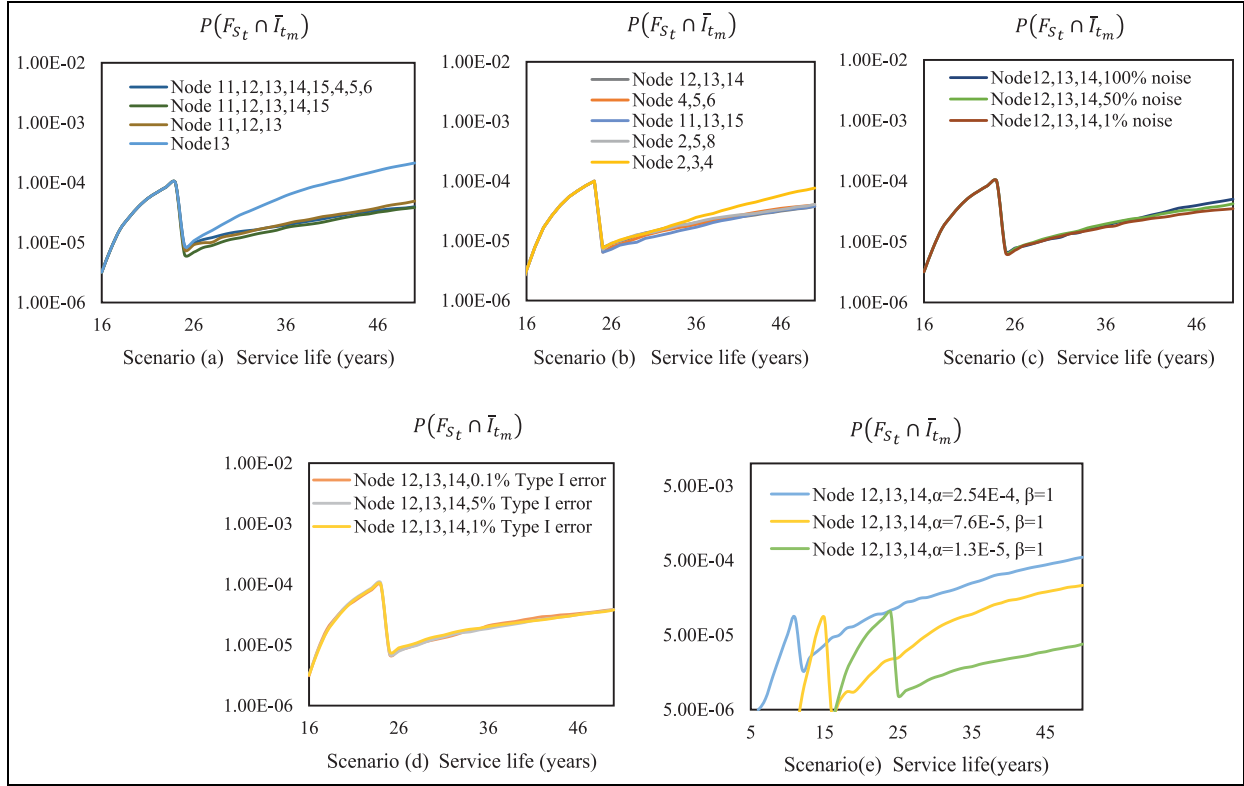

**Figure 7.** Pre-posterior probability of system failure during service life with varied scenarios (a) to (e) when monitoring and detecting no damage at a certain year.

detect the damage with more sensors. When installing three sensors, it is observed in (b) that the closer the sensor location is to the weakest components 11 and 12 which have the largest axial force from calculation, the larger the probability of damage indication will be. The maximum  $P(I|\mathbf{D}(t_m))$  during the service life will be the case when the sensors are located in nodes 12, 13, and 14 (components 11 and 12). It is noted that due to the symmetry of the truss bridge girder, the sensor positions in node 4, 5, and 6 will lead to the same curve as for the sensor locations in 12, 13, and 14. When increasing the measurement noise in scenario (c), the probability of damage indication  $P(I|\mathbf{D}(t_m))$  decreases, which means that it will be more difficult to detect damage when there is more noise. The probability of damage indication  $P(I|\mathbf{D}(t_m))$  increases when the Type-I error for indication threshold is increased shown in Figure 6(d). For the same setting of the DDS, the probability of damage indication  $P(I|\mathbf{D}(t_m))$  increases with higher deterioration rate, which is shown in Figure 6(e).

### Pre-posterior updating

The pre-posterior probability of system failure given damage detection information is computed following

section “Pre-posterior updating with DDS information” taking basis in the Bayesian updating methods. The results are shown in Figure 7 when a DDS is monitoring at a specific year with detecting no damage. When increasing the number of sensors (a), the updated probability of failure is much lower than in the case with only one sensor. However, it can be seen that the pre-posterior probability of system failure will not be lower if installing more than three sensors. Instead, the curve of the pre-posterior probability is similar if more than one sensor is installed, which can be explained that only sensor in a specific position provides sufficient information. When installing three sensors (b), if the sensor positions are far away from the weakest components 11 and 12 (nodes 12, 13, and 14), such as in node 2, 3, or 4, the updated probability of failure will be larger toward the end of the service life. Changes in the measurement noise (c) only have a small influence on the updated curve of the pre-posterior probability, which result in larger values toward to the end of the service life when the measurement noise is large. When increasing the Type-I error threshold (d), the updated pre-posterior probability of failure during service life shows only minor differences. When increasing the deterioration rate (e), the relative reduction of



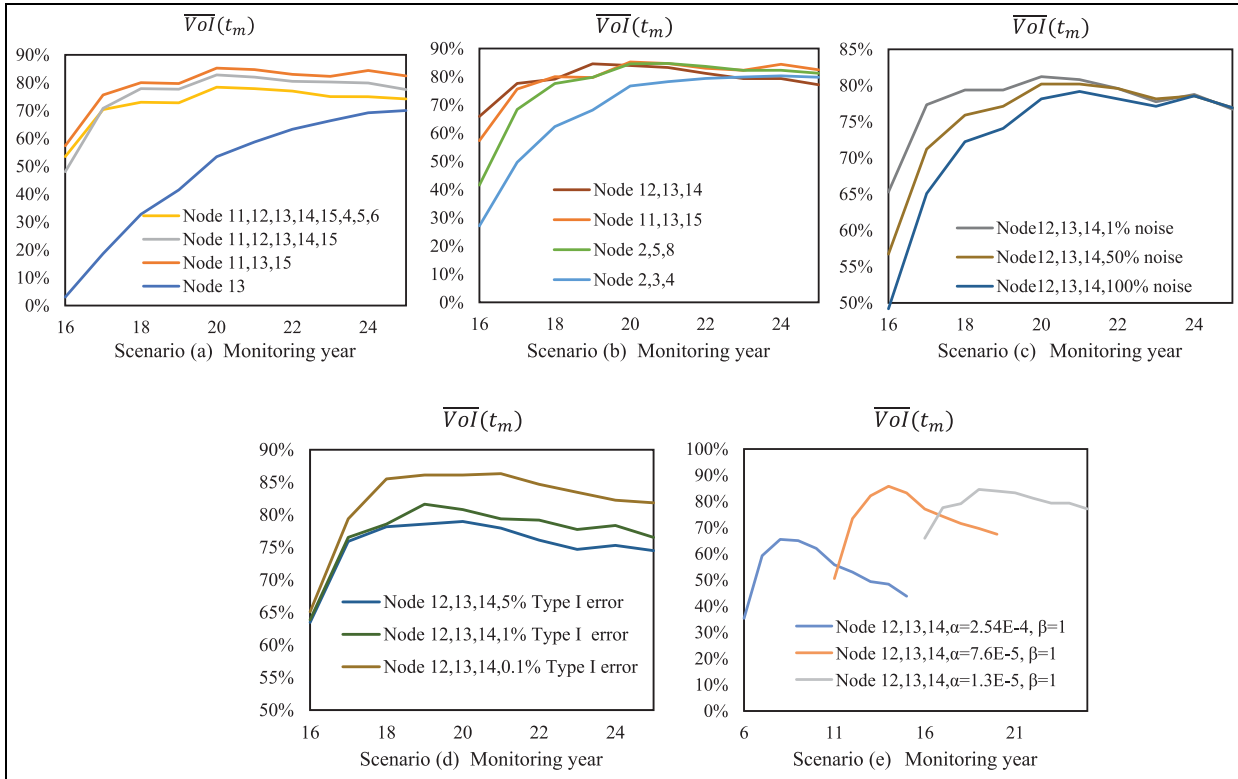

**Figure 8.** Relative value of information with varied scenarios (a) to (e) and different DDS monitoring year.

pre-posterior probability of failure given no damage indication is smaller.

### VoI analysis results

The VoI depending on the DDS monitoring year are computed following section “VoI analysis.” The relative VoI ( $\overline{\text{VoI}}$ ) for the considered DDS and structural system parameters is shown in Figure 8. When the deterioration rate is low, the  $\overline{\text{VoI}}$  is increasing fast from year 16 in the beginning and slowly decreases when reaching year 25. From Figure 8(a), the  $\overline{\text{VoI}}$  is increasing when increasing the number of sensors from 1 to 3, but when increasing the number from 3 to 5 to 8, the  $\overline{\text{VoI}}$  is decreasing. When there is more than one sensor, more sensors lead to a higher probability of damage indication, but it does not lead to higher  $\overline{\text{VoI}}$  because some sensors did not provide additional valuable information. In contrast, it will lead a lower  $\overline{\text{VoI}}$  because of higher sensor costs. The beneficial number of sensors is three sensors.

Figure 8(b) gives an indication of  $\overline{\text{VoI}}$  with changes of the sensor layout when only three sensors are selected. When the number of sensors is constant, the sensors which are located near the weakest components 11 and 12 will yield a higher probability of damage

indication, which results in a higher  $\overline{\text{VoI}}$ . The recommended sensor locations are subsequently in node 12, 13, and 14.

Figure 8(c) investigates the relationship between  $\overline{\text{VoI}}$  and DDS measurement noise. If the sensor number, positions are constant, then higher measurement noise leads to a lower probability of damage indication, because it will be harder to detect the damage. Hence, the  $\overline{\text{VoI}}$  will be lower.

Figure 8(d) describes how the  $\overline{\text{VoI}}$  behaves with the Type-I error threshold. The  $\overline{\text{VoI}}$  decreases when increasing the Type-I error threshold. Indeed, a higher Type-I error threshold results in more false alarms, and the system will detect more of the small damages. Then, the repair cost per time will be lower due to the early stage of damage, but more repairs may be needed during the whole service life, which results in higher total repair costs and a lower  $\overline{\text{VoI}}$ .

When increasing the deterioration rate from low to medium and high based on the reference scenario in Figure 8(e), the change of the  $\overline{\text{VoI}}$  is stronger with time when the deterioration is medium and high. This is because, the damage size will grow faster and larger with time than in low deterioration, which will lead to higher risk and repair costs. So that the choice of the right monitoring time will be important to help reduce

the risk and repair costs, resulting a strong influence on  $\overline{\text{VoI}}$ . The highest  $\overline{\text{VoI}}$  will appear when the deterioration rate is medium, which can be explained by avoiding high risks of structure failure when the damage is too high and unnecessary repair when the damage is too small. The optimized year to implement DDS will be year 19 when under low deterioration, year 14 under medium deterioration, and year 8 under high deterioration.

From Figure 8(a) to (c), the impact of the three measurement parameters: sensor number, sensor location, and measurement noise, is decreasing with monitoring time. They show a similar behavior since they all influence the structural information content and are directly related to the structural condition. For the sensor numbers, it is important to have a minimum number of sensors. However, increasing the number of sensors beyond the minimum number leads to a moderate decrease of the  $\overline{\text{VoI}}$ . Having sensor locations close to the weakest component increases the  $\overline{\text{VoI}}$ , but if the sensors are in the vicinity of the weak point, the influence on the  $\overline{\text{VoI}}$  is not strong. The effect of the measurement noise on  $\overline{\text{VoI}}$  can be neglected toward the end of the service life. This is due to the increase of damage size resulting in a more pronounced measurement signal, which is influenced less by the noise. However, in Figure 8(d), the effect of the Type-I error on the  $\overline{\text{VoI}}$  increases with monitoring time. This is because the system will barely have damage in the beginning, the probability of damage indication will be very small no matter what the Type-I error is. With increasing service life, the damage is growing to a more detectable size, the probability of damage indication will be affected more by the Type-I error. As shown in Figure 8(e), the most sensitive parameter over the entire service life of the system is the deterioration rate because it directly influences the risk of the structural failure and costs for repair.

With Figure 8(a) to (e), the optimal DDS and structural system can be identified as: three sensors in nodes 12, 13 and 14 with 1% measurement noise and 0.1% Type-I error threshold to be employed at year 14 of the service life on a truss girder with a medium deterioration rate.

## Discussion

The primary purpose of this study is to determine the structural and DDS influencing parameters on the value of DDS. Earlier research suggests that the value of SHM can be quantified,<sup>6</sup> previous application study focusses on methods of quantifying the VoI.<sup>58</sup> Our analysis provides a new insight into the relationship between VoI-based decision-making and DDS before its implementation. The results indicate that the

VoI-based decision support facilitates that optimal SHM and structural system parameters can be identified leading to the maximum expected value of the utility gain. The utility gain may encompass, for example, an increased benefit generation, reduced costs for the structural integrity management and reduced risk of structural failure. These results clearly support some of the earlier research<sup>53</sup> that the quantification of the value of the DDS information may serve as a basis for DDS design and employment optimization.

Within the scope of this article, DDS information and structural system parameters have been identified leading to the highest expected risk and cost reduction for the structural integrity management of a representative engineering structure. The VoI-based decision-support beyond the scope of this article may encompass various other decision scenarios such as the combination of different monitoring/measurement strategies and techniques to determine the optimal maintenance planning as well as service life extension.<sup>18,59</sup>

From the viewpoint of structural integrity management, there is no necessity for continuous monitoring with a DDS, as a single application in the service yields a significant risk and cost reduction, through achieving a significant value of DDS information. It should be noted that multiple DDS information may incorporate a high dependency and thus may prevent an increase of the VoI. However, multiple and continuous structural health information and their dependencies require further research.

The application of VoI-based decision on the truss girder has demonstrated its ability to support the design and employment of a DDS before implementation. The parametric analysis of the value of DDS information takes basis in a generic and representative structural system accounting for the dependence in the component failure modes and in the deterioration of the individual structural components. The choice of the structural system and a comprehensive generic deterioration model is representative for many—but not all—structural systems according to codes and standards. Besides, due to the complexity of the decision scenario and the decision analysis, assumptions focusing on fatigue and corrosion degradation in conjunction with well-justified repair and normalized cost models are applied. However, there are still many challenges ahead. Clearly, for a specific application, it is required to adjust the decision scenario including the calibration of the generic and normalized models, for example, with a more specific degradation modeling approach.

## Conclusion

This article introduces the VoI-based method to determine the structural system influencing parameters with

deterioration type and deterioration rate as well as DDS-influencing parameters including the number of sensors, sensor location, measurement noise, and Type-I error for indication threshold. Through quantification of the value of DDS, it is shown that the design of the DDS system (i.e. the number of sensors, sensor positions, noise, and indication threshold) can be optimized as well as its deployment time to achieve maximum expected life-cycle benefits.

This article facilitates comprehensive guidance for (a) designing DDS by sensor number, sensor location, (b) decision support for DDS employment by degradation mechanisms, and (c) for the DDS utilization by determining the optimal time of information acquirement.

The example of the deteriorating truss bridge girder under fatigue or corrosion illustrates that

1. It is cost and risk reduction efficient to implement DDS compared to the scenario when directly repairing without monitoring.
2. The structural deterioration rate is the most sensitive parameter effecting of relative VoI of DDS over the entire service life.
3. The optimal DDS employment year varies depending on the DDS and structural system properties.
4. The employment of only one DDS measurement in the service yields a high relative VoI.
5. The number of sensors should be chosen with optimization as more sensors do not lead to a higher relative VoI.
6. The sensor locations should be chosen with thorough consideration of the damage and failure scenarios of the structural system.
7. The measurement noise and the Type-I error for indication threshold should be controlled as small as possible in order to achieve the highest relative VoI.
8. The value of DDS information quantification can be a powerful tool to determine optimal settings and sensor employment.

It should be noted that only a finite set out of many possible sensor configurations have been analyzed in this study, and there might be other configurations which may lead to a slightly higher relative VoI. Nevertheless, the results can be used as an example to develop optimal lifetime maintenance strategies for similar bridges to optimize the DDS settings and sensor configuration for maximum expected utilities before implementation of the DDS.

### Acknowledgements

The grant is gratefully acknowledged. Furthermore, the support of COST Action TU1402 on Quantifying the Value of

Structural Health Monitoring is gratefully acknowledged. The authors would like to thank the reviewer for the insightful and constructive review.

### Declaration of conflicting interests

The author(s) declared no potential conflicts of interest with respect to the research, authorship, and/or publication of this article.

### Funding

The author(s) disclosed receipt of the following financial support for the research, authorship, and/or publication of this article: This research work was performed within the European project INFRASTAR ([infrastar.eu](http://infrastar.eu)), which has received funding from the European Union's Horizon 2020 research and innovation program under the Marie Skłodowska-Curie Grant (agreement no. 676139).

### ORCID iD

Lijia Long  <https://orcid.org/0000-0002-8729-3891>

### References

1. Sohn H, Farrar CR, Hemez FM, et al. *A review of structural health monitoring literature: 1996–2001*. Los Alamos, NM: Los Alamos National Laboratory, 2003.
2. Sørensen JD, Straub D and Faber MH. Generic reliability—based inspection planning for fatigue sensitive details—with modifications of fatigue load. In: *Proceedings of the 9th international conference on structural safety and reliability (ICOSSAR)*, Rome, 19–23 June 2005.
3. Enright MP, Hudak SJ, McClung RC, et al. Application of probabilistic fracture mechanics to prognosis of aircraft engine components. *AIAA J* 2006; 44: 311–316.
4. Thöns S. *Monitoring based condition assessment of offshore wind turbine structures*. PhD Thesis, ETH Zurich, Zurich, 2011.
5. Straub D. Reliability updating with equality information. *Probabilist Eng Mech* 2011; 26: 254–258.
6. Thöns S. On the value of monitoring information for the structural integrity and risk management. *Comput-Aided Civ Inf* 2018; 33: 79–94.
7. Cawley P. Structural health monitoring: closing the gap between research and industrial deployment. *Struct Health Monit* 2018; 17: 1225–1244.
8. Markmiller JFC and Chang F-K. Sensor network optimization for a passive sensing impact detection technique. *Struct Health Monit* 2010; 9: 25–39.
9. Pozzi M and Kiureghian AD. Assessing the value of information for long-term structural health monitoring. In: *Proceedings of the SPIE 7984, health monitoring of structural and biological systems 2011*, San Diego, CA, 18 April 2011.
10. Thöns S and Faber MH. Assessing the value of structural health monitoring. In: *Safety, reliability, risk and life-*

- cycle performance of structures and infrastructures*, New York, 16–20 June 2013.
11. Faber MH and Thöns S. On the value of structural health monitoring. In: *Safety, reliability and risk analysis*, Wroclaw, 14–18 September 2014.
  12. Thöns S and Stewart MG. On decision optimality of terrorism risk mitigation measures for iconic bridges. *Reliab Eng Syst Safe* 2019; 188: 574–583.
  13. Diamantidis D, Sykora M and Lenzi D. Optimising monitoring: standards, reliability basis and application to assessment of roof snow load risks. *Struct Eng Int* 2018; 28: 269–279.
  14. Ivanković AM, Thöns S and Matos JC. Introduction: the value of health monitoring in structural performance assessment. *Struct Eng Int* 2018; 28: 243.
  15. Leira BJ, Thöns S and Faber MH. Reliability assessment of a bridge structure subjected to chloride attack. *Struct Eng Int* 2018; 28: 318–324.
  16. Limongelli MG, Chatzi E and Anzllin A. Condition assessment of roadway bridges: from performance parameters to performance goals, 2018, [https://re.public.polimi.it/retrieve/handle/11311/1076763/342688/2017-09-15\\_Limongelli%20et%20a1\\_final.pdf](https://re.public.polimi.it/retrieve/handle/11311/1076763/342688/2017-09-15_Limongelli%20et%20a1_final.pdf)
  17. Leyder C, Dertimanis V, Frangi A, et al. Optimal sensor placement methods and metrics—comparison and implementation on a timber frame structure. *Struct Infrastruct E* 2018; 14: 997–1010.
  18. Qin J, Thöns S and Faber MH. On the value of SHM in the context of service life integrity management. In: *Proceedings of the 12th international conference on applications of statistics and probability in civil engineering, ICASP12*, Vancouver, BC, Canada, 12–15 July 2015.
  19. Bolognani D, Verzobio A, Tonelli D, et al. IWSHM 2017: quantifying the benefit of structural health monitoring: what if the manager is not the owner? *Struct Health Monit* 2018; 17: 1393–1409.
  20. Zonta D, Glisic B and Adriaenssens S. Value of information: impact of monitoring on decision-making. *Struct Control Health* 2014; 21: 1043–1056.
  21. Straub D. Value of information analysis with structural reliability methods. *Struct Saf* 2014; 49: 75–85.
  22. Konakli K and Faber MH. Value of information analysis in structural safety. In: *Proceedings of the second international conference on vulnerability, uncertainty, and risk: quantification, mitigation, and management*, Liverpool, 13–16 July 2014, pp. 1605–1614. Reston, VA: American Society of Civil Engineers.
  23. Thöns S, Schneider R and Faber MH. Quantification of the value of structural health monitoring information for fatigue deteriorating structural systems. In: *Proceedings of the 12th international conference on applications of statistics and probability in civil engineering, ICASP12*, Vancouver, BC, Canada, 12–15 July 2015.
  24. Thöns S, Limongelli M, Ivankovic AM, et al. Progress of the COST action TU1402 on the quantification of the value of structural health monitoring. In: *Proceedings of the 11th international workshop on structural health monitoring, IWSHM*, Stanford, CA, 12–14 September 2017.
  25. Long L, Alcover IF and Thöns S. Quantification of the posterior utilities of SHM campaigns on an orthotropic steel bridge deck. In: *Proceedings of the 12th international workshop on structural health monitoring 2019 (IWSHM 2019)*, Stanford, CA, 10–12 September 2019.
  26. Agusta A and Thöns S. Value of information-based inspection, monitoring, and damage detection system planning. In: *Proceedings of the 13th international conference on applications of statistics and probability in civil engineering (ICASP)*, Seoul, Korea, 26–30 May 2019.
  27. Thöns S. Quantifying the value of structural health information for decision support: TU1402 guide for scientists. COST Action TU1402, 2019, [www.cost-tu1402.eu/action/deliverables/guidelines](http://www.cost-tu1402.eu/action/deliverables/guidelines)
  28. Raiffa H and Schlaifer R. *Applied statistical decision theory*. Boston, MA: Harvard University Press, 1961.
  29. Faber MH. Chapter 7: Bayesian decision analysis. In: Faber MH (ed.) *Statistics and probability theory: in pursuit of engineering decision support*. Dordrecht: Springer, 2012, p. 151.
  30. Mori Y and Ellingwood BR. Reliability-based service-life assessment of aging concrete structures. *J Struct Eng* 1993; 119: 1600–1621.
  31. Straub D and Der Kiureghian A. Reliability acceptance criteria for deteriorating elements of structural systems. *J Struct Eng* 2011; 137: 1573–1582.
  32. Straub D. Reliability assessment of deteriorating structures: challenges and (some) solutions. In: *Proceedings of the 6th international symposium on life-cycle civil engineering (IALCCE)*, Ghent, 28–31 October 2018.
  33. Wang ML, Lynch JP, and Sohn H, *Sensor Technologies for Civil Infrastructures. Volume 1: Sensing Hardware and Data Collection Methods for Performance Assessment 2014*. Woodhead Publishing, 2014.
  34. Worden K, Farrar CR, Manson G, et al. The fundamental axioms of structural health monitoring. *P R Soc A* 2007; 463: 1639–1664.
  35. Brownjohn JMW. Structural health monitoring of civil infrastructure. *Philos T R Soc A* 2006; 365: 589–622.
  36. Thöns S, Döhler M and Long L. On damage detection system information for structural systems. *Struct Eng Int* 2018; 28: 255–268.
  37. Döhler M, Mevel L and Hille F. Subspace-based damage detection under changes in the ambient excitation statistics. *Mech Syst Signal Pr* 2014; 45: 207–224.
  38. Döhler M, Mevel L and Zhang Q. Fault detection, isolation and quantification from Gaussian residuals with application to structural damage diagnosis. *Annu Rev Control* 2016; 42: 244–256.
  39. Döhler M and Thöns S. Efficient structural system reliability updating with subspace-based damage detection information. In: *Proceedings of the 8th European workshop on structural health monitoring, EWASHM*, Bilbao, 5–8 July 2016.
  40. Nielsen J and Sørensen J. Methods for risk-based planning of O&M of wind turbines. *Energies* 2014; 7: 6645–6664.
  41. Hong HP. Reliability analysis with nondestructive inspection. *Struct Saf* 1997; 19: 383–395.



42. Ang AH-S and Lee J-C. Cost optimal design of R/C buildings. *Reliab Eng Syst Safe* 2001; 73: 233–238.
43. Federal Emergency Management Agency. *A benefit-cost model for the seismic rehabilitation of buildings*. Washington, DC: FEMA, 1992.
44. Wen Y and Kang Y. Minimum building life-cycle cost design criteria. II: applications. *J Struct Eng* 2001; 127: 338–346.
45. Mori Y and Ellingwood BR. Maintaining reliability of concrete structures. II: optimum inspection/repair. *J Struct Eng* 1994; 120: 846–862.
46. Higuchi S. *Cost-benefit based maintenance optimization for deteriorating structures*. Dissertation zur Erlangung des akademischen Grades Doktor–Ingenieur, Bauhaus-Universität Weimar, Weimar, 2008.
47. Vrouwenvelder ACWM. Developments towards full probabilistic design codes. *Struct Saf* 2002; 24: 417–432.
48. Faber MH and Sørensen JD. Reliability based code calibration—the JCSS approach. In: *Proceedings to the 9th international mechanisms for concrete structures in civil engineering ICASP* (ed Der Kiureghian), San Francisco, CA, 6–9 July 2003, pp. 927–935. Millpress Science Publishers.
49. Boardman AE, Greenberg DH, Vining AR, et al. *Cost-benefit analysis: concepts and practice*. Cambridge: Cambridge University Press, 2017.
50. Joint Committee on Structural Safety. *Probabilistic model code*. JCSS, 2006, [https://www.jcss.byg.dtu.dk/Publications/Probabilistic\\_Model\\_Code](https://www.jcss.byg.dtu.dk/Publications/Probabilistic_Model_Code)
51. Long L, Thöns S and Döhler M. The effects of deterioration models on the value of damage detection information. In: *Proceedings of the 6th international symposium on life-cycle civil engineering, IALCCE*, Ghent, 28–31 October 2018.
52. Tinnea J. *Corrosion control plan for bridges* (A NACE international white paper). Houston, TX: NACE International, 2012.
53. Davis J, Mills K and Lampman S. *Metals handbook. Vol. 1: properties and selection: irons, steels, and high-performance alloys*. Materials Park, OH: ASM International, 1990.
54. Papadimitriou C. Optimal sensor placement methodology for parametric identification of structural systems. *J Sound Vib* 2004; 278: 923–947.
55. Döhler M, Kwan K and Bernal D. Optimal sensor placement with a statistical criterion for subspace-based damage detection. In: Catbas F, Pakzad S, Racic V, et al. (eds) *Topics in dynamics of civil structures, volume 4*. New York: Springer, 2013, pp. 219–229.
56. Allahdadian S, Döhler M, Ventura CE, et al. On the influence of sample length and measurement noise on the stochastic subspace damage detection technique. In: Wicks A and Niezrecki C (eds) *Structural health monitoring, damage detection & mechatronics, volume 7*. Cham: Springer, 2016, pp. 35–46.
57. Schoefs F, Clément A and Nouy A. Assessment of ROC curves for inspection of random fields. *Struct Saf* 2009; 31: 409–419.
58. Neves AC, Leander J, González I, et al. An approach to decision-making analysis for implementation of structural health monitoring in bridges. *Struct Control Hlth* 2019; 26: e2352.
59. Thöns S, Faber MH and Val D. On the value of structural health monitoring information for the operation of wind parks. In: *Proceedings of the 12th international conference on structural safety and reliability*, Vienna, 6–10 August 2017, pp. 3008–3017. Vienna: IASSAR.