

09.03.2018

Pfizer Inc.
 La Jolla, CA, USA

SUSTAINABLE AND FLEXIBLE PRODUCTION OF HIGH QUALITY CHEMICALS AND PHARMACEUTICALS USING SMART SENSORS AND MODULAR PRODUCTION UNITS

Michael Maiwald, Patrick Gräber, Lukas Wander,
 Svetlana Guhl, Klas Meyer, Simon Kern

Bundesanstalt für Materialforschung und -prüfung (BAM)
 Division 1.4 Process Analytical Technology

Richard-Willstätter-Str. 11
 D-12489 Berlin, Germany

Safety in Technology and Chemistry Our Key Areas

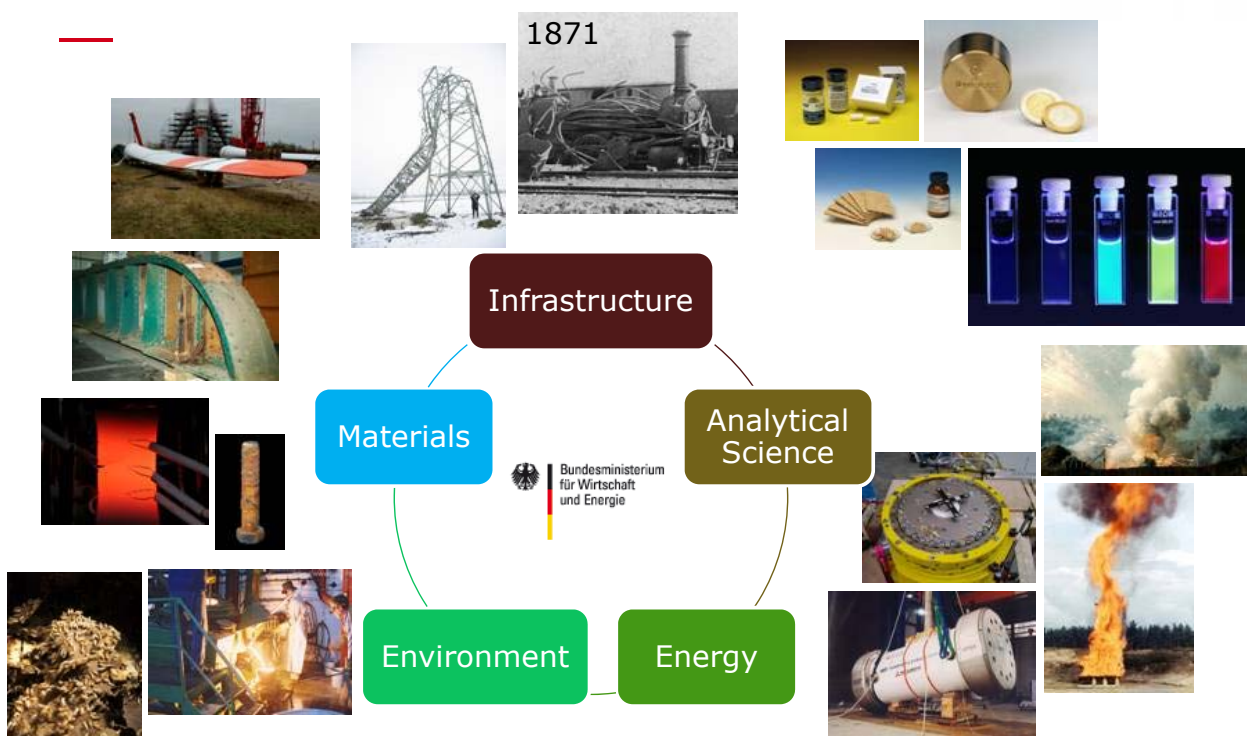

09.03.: BAM is a senior scientific and technical Federal institute with responsibility to Federal Ministry for Economic Affairs and Energy

Division 1.4: Process Analytical Technology

Our Key Areas

Gas Analysis

- Primary Reference Gas Mixtures
- Gas Analysis, Gas Metrology
- Certification of Sec. Gas Mixtures



Located in Berlin, Germany

Process Spectroscopy

- Online NMR Spectroscopy, qNMR
- Raman Spectroscopy and Microscopy
- NIR, MIR, FIR spectr., IR Microscopy
- Data Treatment: Statistics, Numerics
- Measurement Uncertainty Evaluation

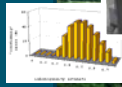

Inorganic Process Anal. Technol., XRF

- X-ray fluorescence Analysis (XRF)
- Laser-induced Breakdown (LIBS)
- Total Reflectance XRF (T-XRF)



07.2016

Process Analytical Technology

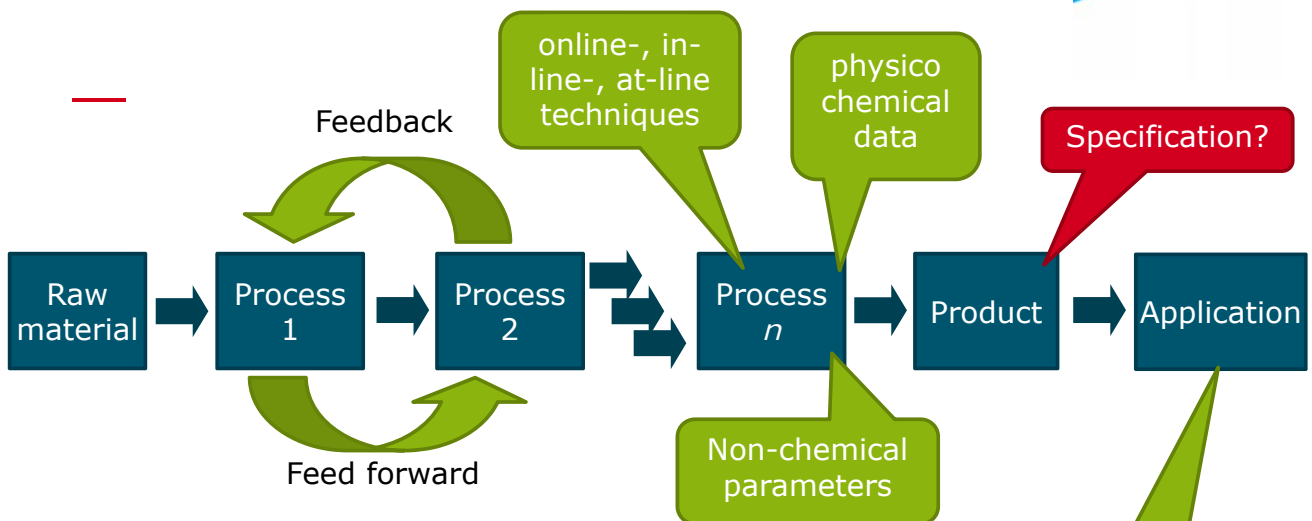

Motivation

- optimal design ("quality by design")
- demanded product quality with an optimum use of equipment, raw materials, and energy
- affordable quality costs

Quality by design

objective description of **quality**
→ comprehensive understanding

Innovation and Continual Improvement in Pharmaceutical and Biotechnology Sector

Towards Continuous Pharmaceutical Manufacturing



Innovation and Continual Improvement in Pharmaceutical and Biotechnology Sector

Business Plan for a Future ICH Guideline Q12

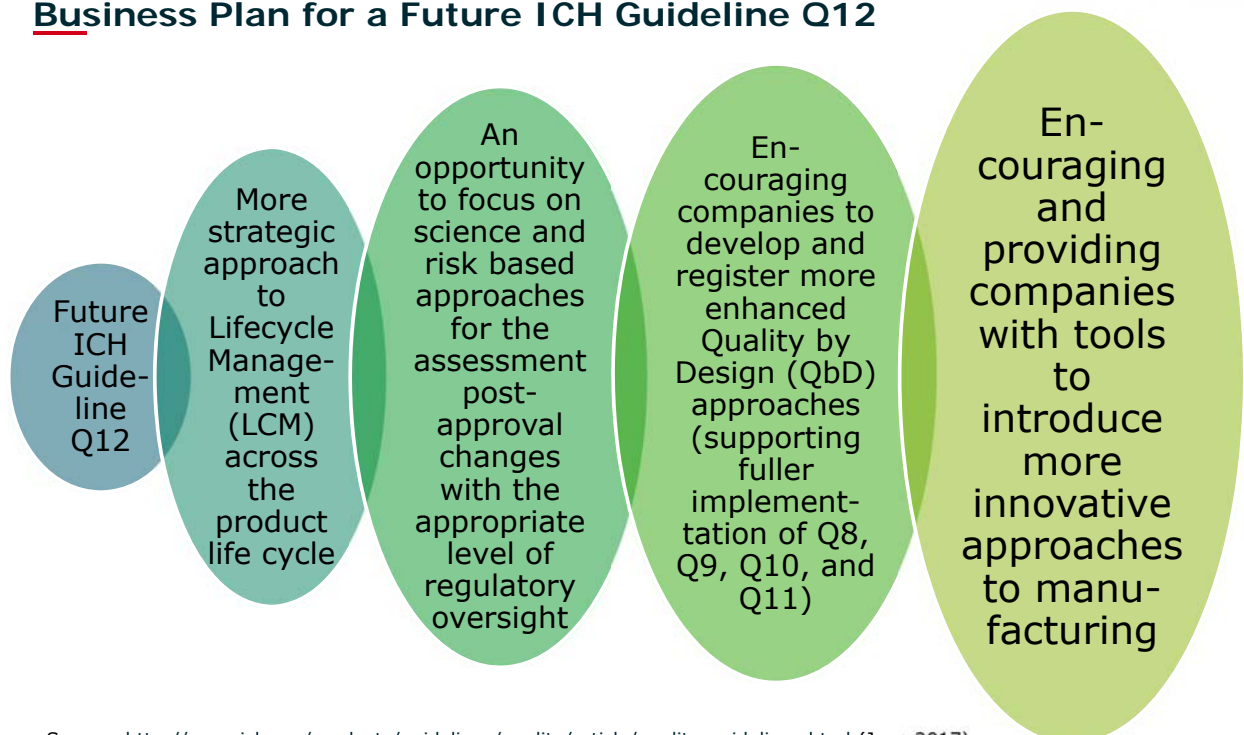

Source: <http://www.ich.org/products/guidelines/quality/article/quality-guidelines.html> (June 2017)

Online NMR Spectroscopy

What is NMR?

Nuclear Magnetic Resonance

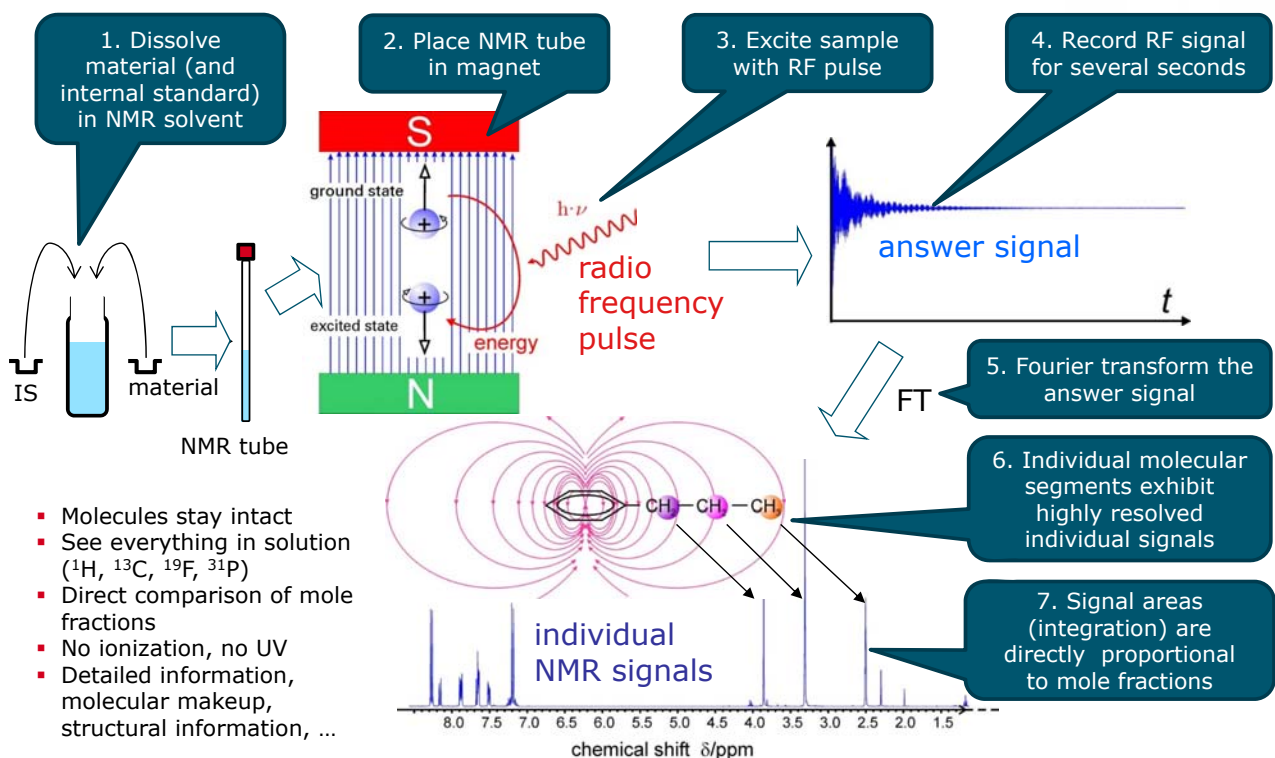

Reaction Monitoring in Lab-scale at BAM

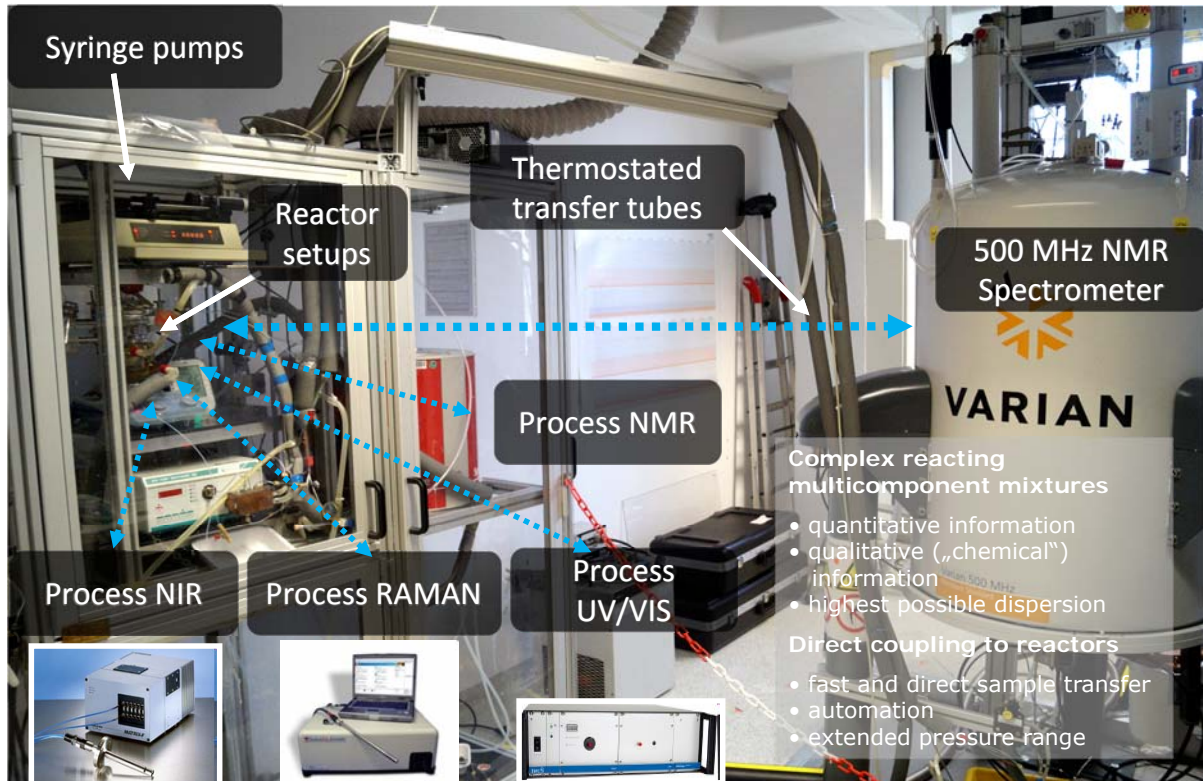

Online NMR Spectroscopy Flow scheme, thermostated bypass

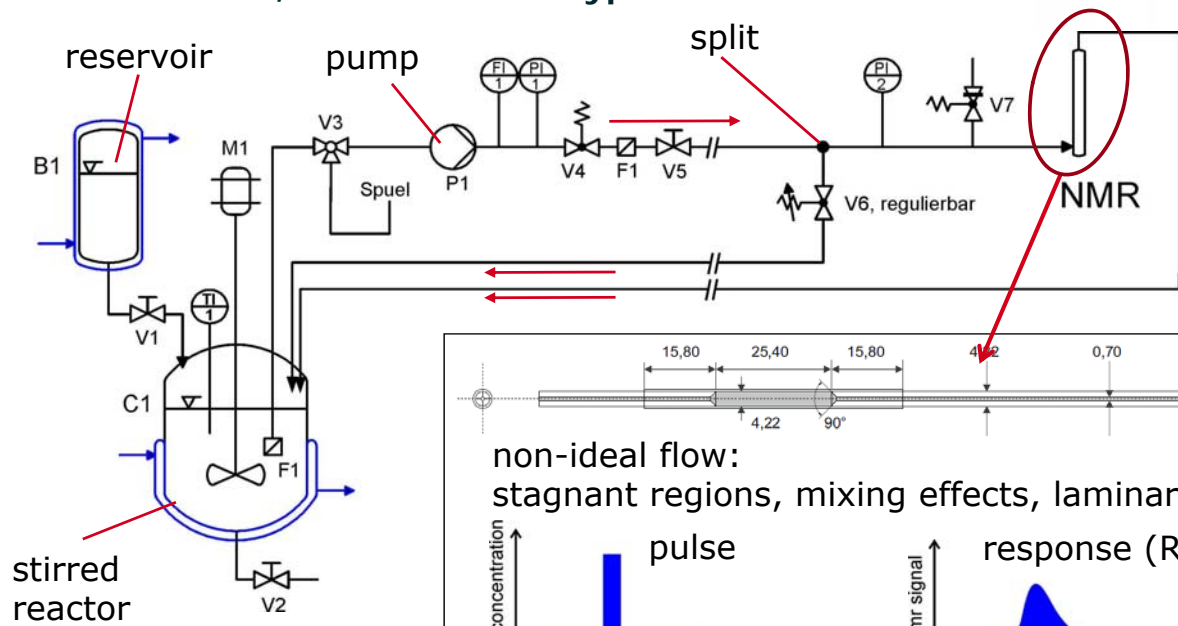

- Tubing:
- PEEK 0.25–0.75 mm ID
 - liquid thermostated

Process Analytical Technology for Intensified Processes

Examples from BAM, Berlin



Trends. Anal. Chem.
83 (2015) 39–52



Catalysis:
Hydroformylations of C12-alkenes in microemulsions

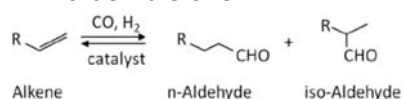

Meas. Sci. Technol. 28 (2017) 035501 + 035502



qNMR (Metrology):
Gases and condensed phases up to 1000 bar

J. Magn. Reson.
275 (2017) 1–10

Pharmaceuticals:
Liberation kinetics

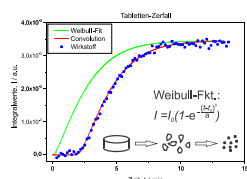

J. Mol. Structure. 1133 (2017) 18–23

CO₂ scrubbing

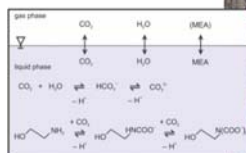

Klas Meyer, PhD
Humboldt University, Berlin, 2016

Method development:
Esterifications (model reactions)

J. Magn. Reson. 249 (2014), 53–62
Magn. Reson. Chem. 54 (2016) 513–520

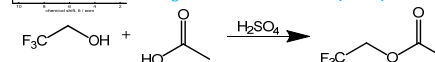

Catalysis:
Hydrogenations

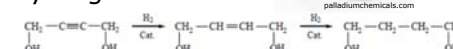

Reaction Engineering:
Lithiation reactions

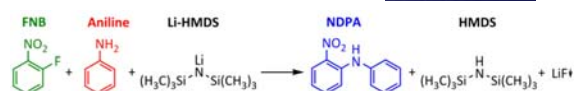

Reaction Engineering:
Photo reactions („click chemistry“)

J. Magn. Reson. 277 (2017) 154–161

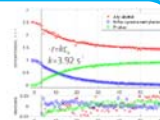
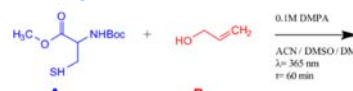

IIoT* and Industry 4.0

Intensified Processes, Hybrid Modular Plants

Smart Sensors and Actuators

*Industrial Internet of Things

Integrated Process Design and Intensified Processes

Current Trend: Hybrid Modular Plants

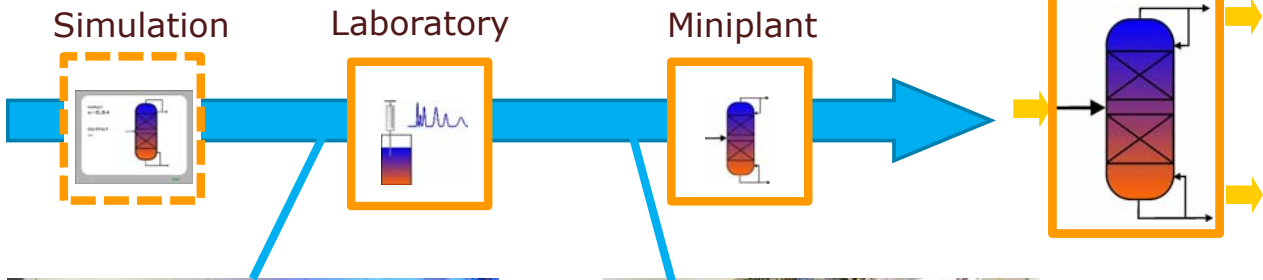

Micro Reaction Technology
(Example: Fraunhofer ICT, Pfingsttal/D)

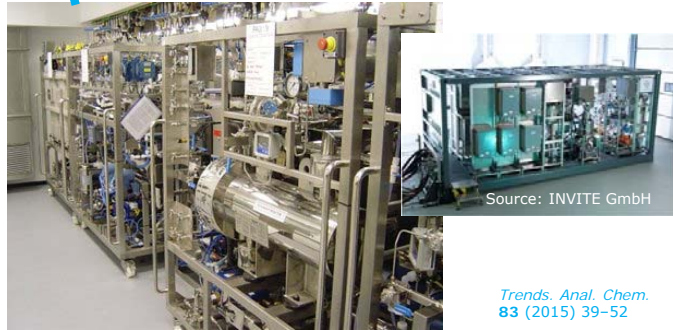

Modular Production
(Example: Foster Wheeler AG, Zug/CH)

Integrated Process Design and Intensified Processes

Example: Continuous Flow Production of Pharmaceuticals at MIT

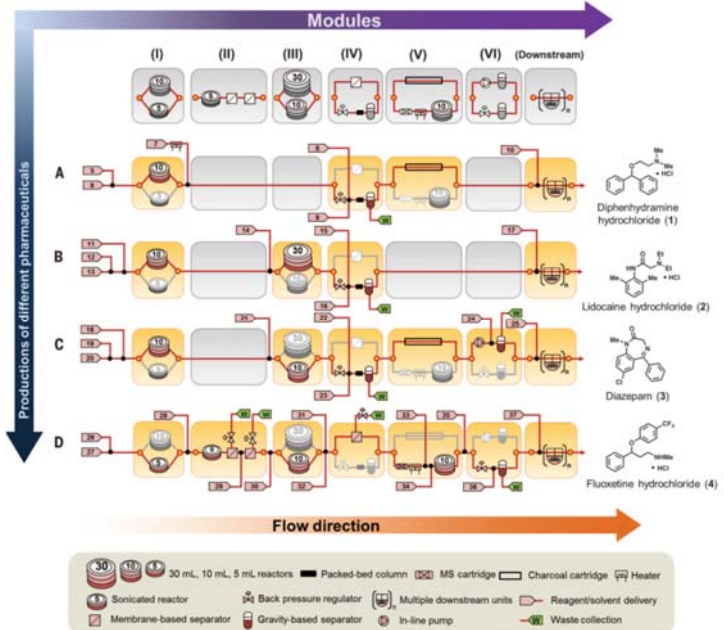
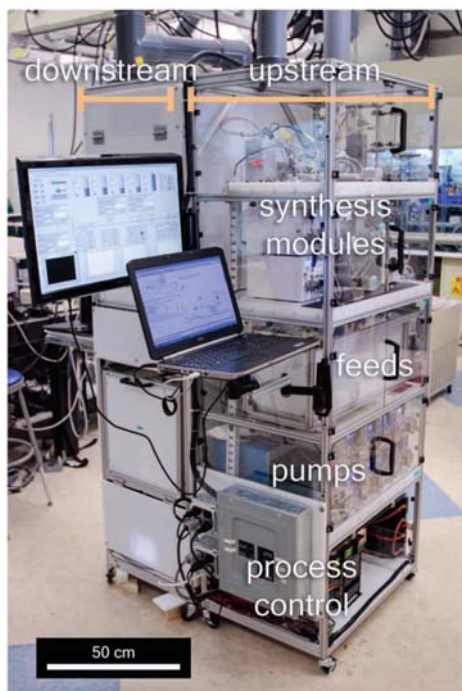

A. Adamo, R. L. Beingessner, M. Behnam et al., On-demand continuous-flow production of pharmaceuticals in a compact, reconfigurable system, *Science* 352(6281), 2016, 61-67

Process Automation

The Classical Automation Pyramid → is Outdated!

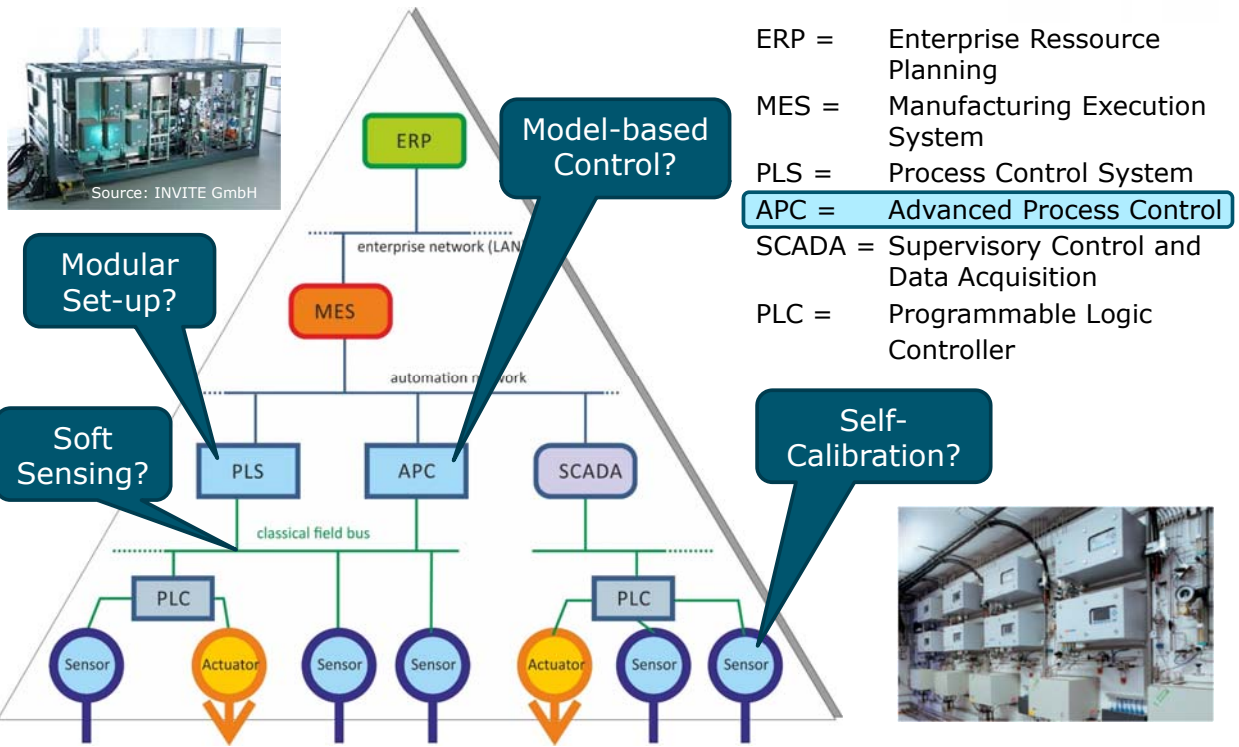

- ERP = Enterprise Resource Planning
- MES = Manufacturing Execution System
- PLS = Process Control System
- APC = Advanced Process Control
- SCADA = Supervisory Control and Data Acquisition
- PLC = Programmable Logic Controller

Current and future requirements to process sensors

Sensors go smart

- Smart process sensors are important parts of cyber-physical production systems and generate new business cases for users, instrument manufacturers, and service providers.
- „Smart“ sensors provide services within networks and use information out of the network.



- Use of „complicated“ sensors has to be simplified towards „plug and play“

„NAMUR Roadmap Prozess-Sensoren 4.0“



From Lousy Interfaces to "Industrie 4.0" Use of Runtime Environments



Trends. Anal. Chem.
83 (2015) 39–52



From Lousy Interfaces to "Industrie 4.0" Use of Runtime Environments



Trends. Anal. Chem.
83 (2015) 39–52

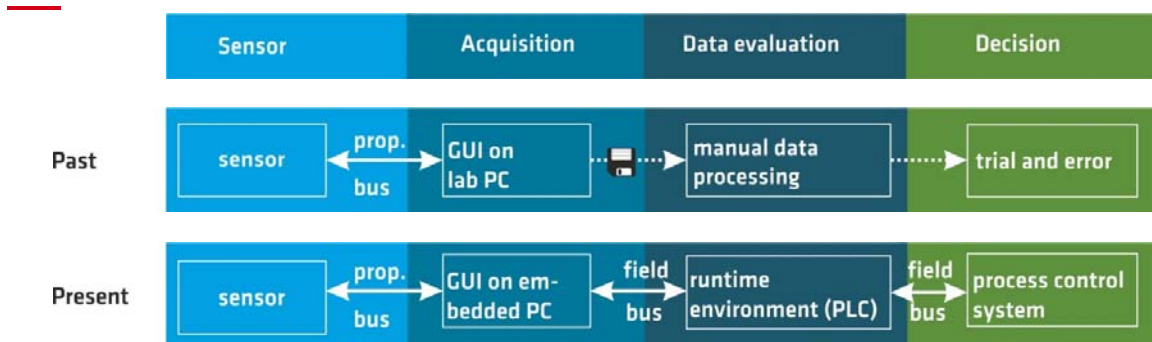

From Lousy Interfaces to "Industrie 4.0" Use of Runtime Environments

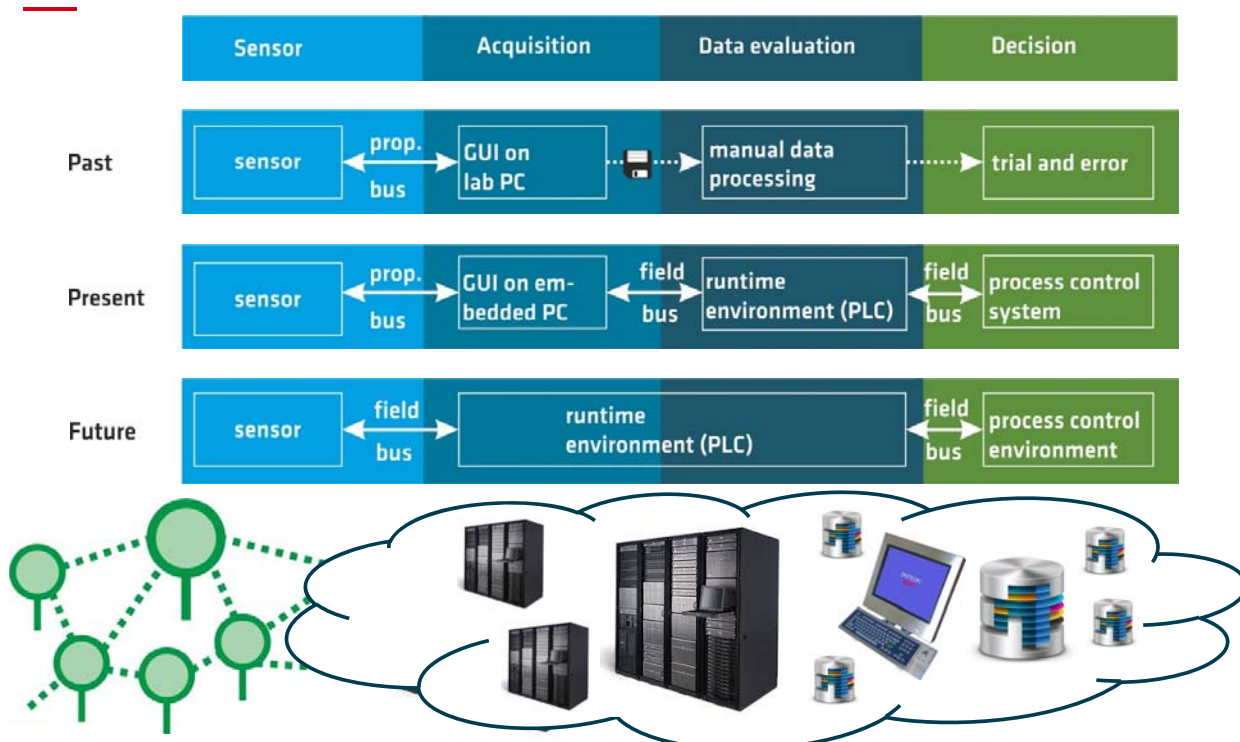

CONSENS

Integrated Control and Sensing for Sustainable
Operation of Flexible Intensified Processes
(2015–2017)

European Union's Horizon 2020 Research Program
www.consens-spire.eu

Continuous Lithiation Reaction Set-up

Flexible Intensified Continuous Plant

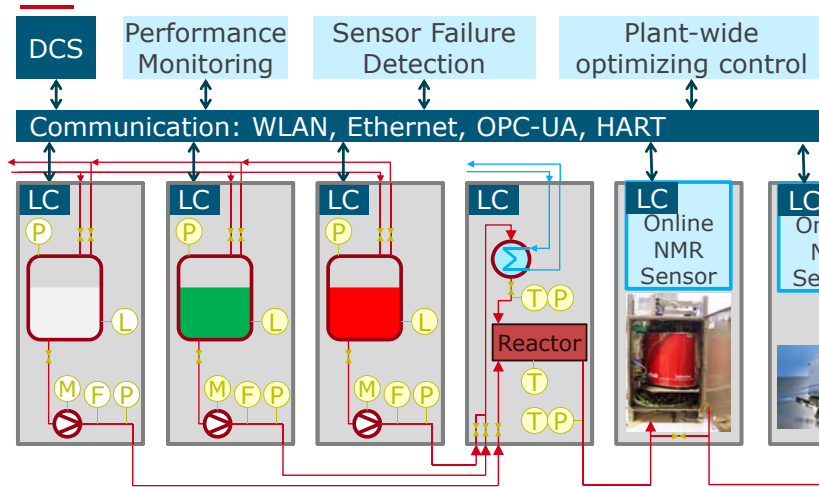

Containerized modular plant
Source: INVITE GmbH

- Standardized plant modules
- "Plug & Produce"
- Miniaturized flexible equipment
- Local control (LC)

- Fast and complex exothermic reaction
- Hazardous and inflammable substances
→ Explosion protection!
- Prone to fouling & clogging
- Multi-objective constrained optimization

Example: Lithiation reaction

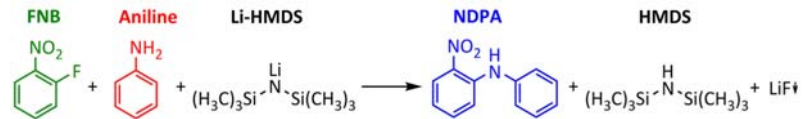

Automated NMR-Analyzer Module

Control and Safety Functions



Source: INVITE GmbH

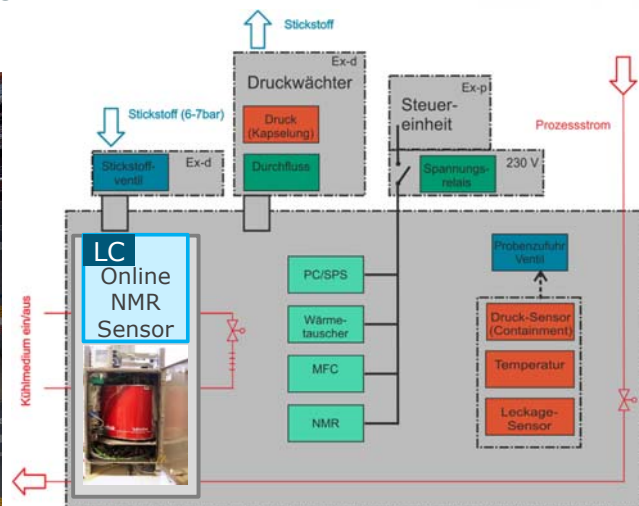

Automated NMR-Analyzer Module

Certification and Documentation



Power supply:
100 – 240 VAC, 10 A circuit breaker

Cooling medium:
1 – 5 °C

Sample feed:
28 °C, 10 bar
(flow cell tested to 50 bar, 100 bar expected)

Nitrogen purge:
6 - 7 bar, min. 140 L/min for purging (~ 2 min)
Leakage rate at 1.9 mbar: 35 L/min

EC Declaration of Conformity
EC Low voltage Directive



ATEX certificate



Operating instructions

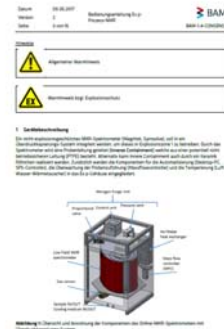

Ex II 2 G Ex pxb db ib IIB T3 Gb

Automated NMR-Analyzer Module

Communication and Data Analysis Concept

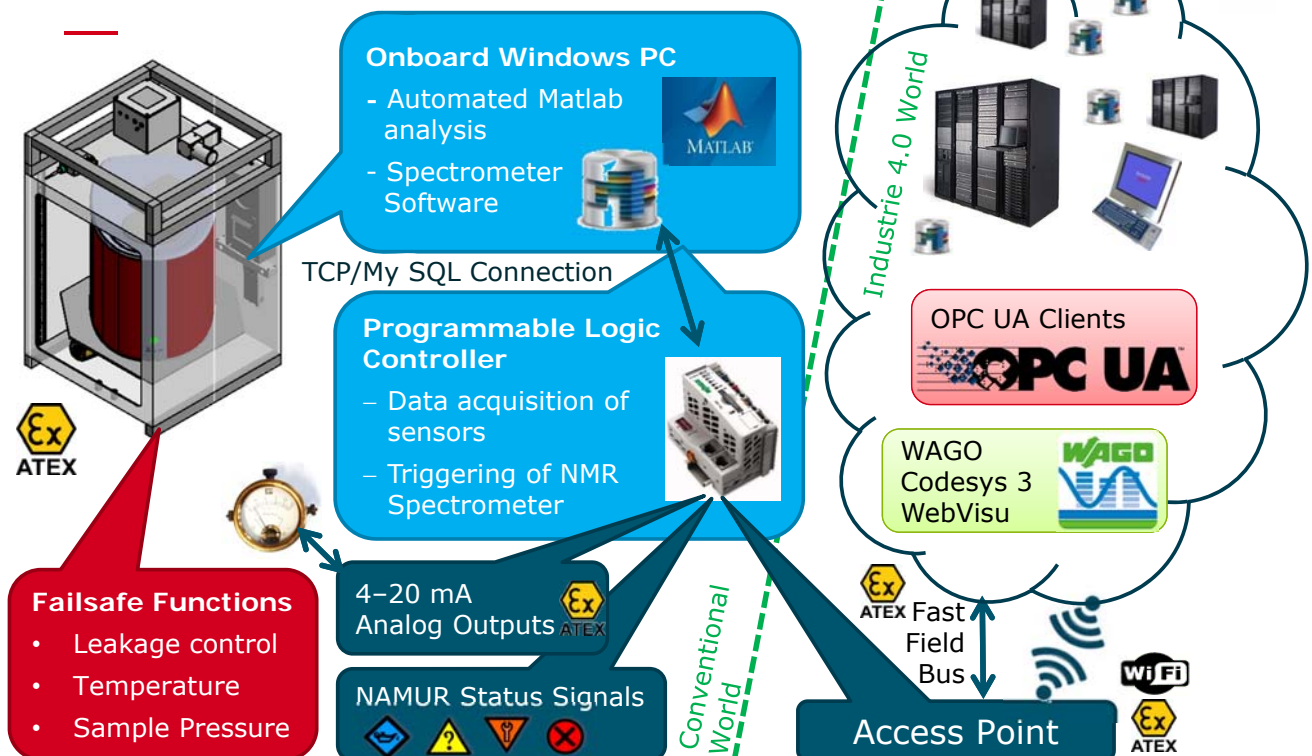

Automated NMR-Analyzer Module Visualization and Control Web Interface (Expert)



(1) NMR Spectra of Pure Components Samples of Pure Components (and Mixtures)



Given example: Lithiation reaction, Solvent THF

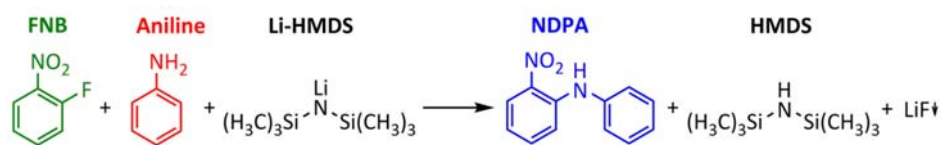

Low-field → NMR spectra	Pure Components
PLS-R	Calibration/validation
IHM	Pure Component Model development

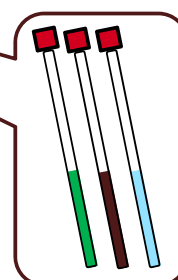

Proton NMR Spectra 500 MHz vs 43 MHz

Lab Experiments in Batch Along Reaction Co-ordinate

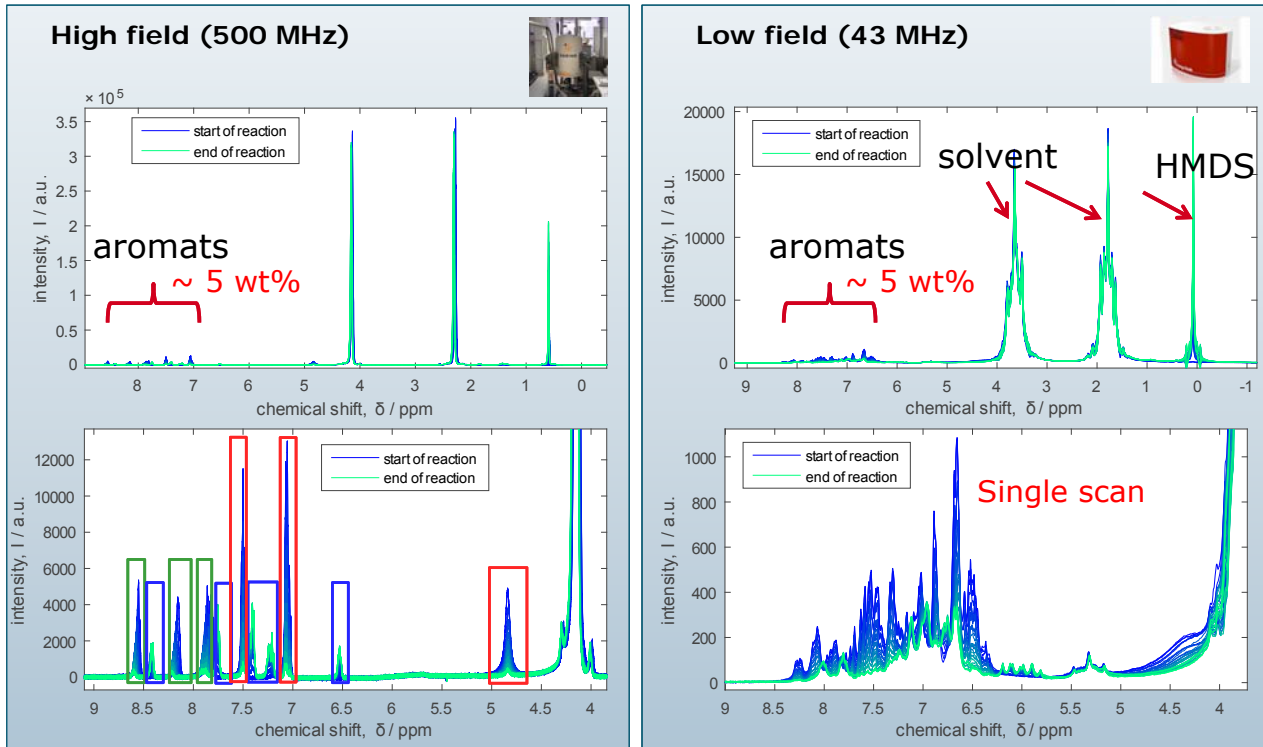

Data Processing for Low-field NMR in Matlab

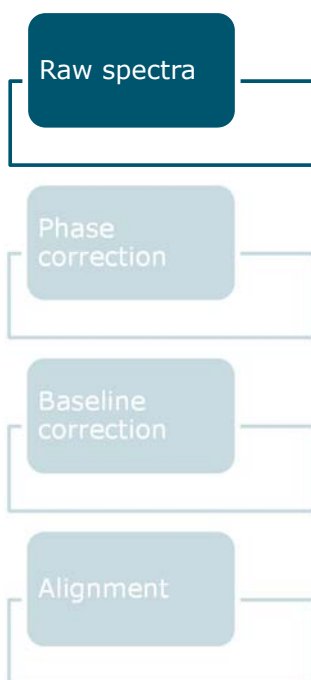

single scan
each 15s
in flow

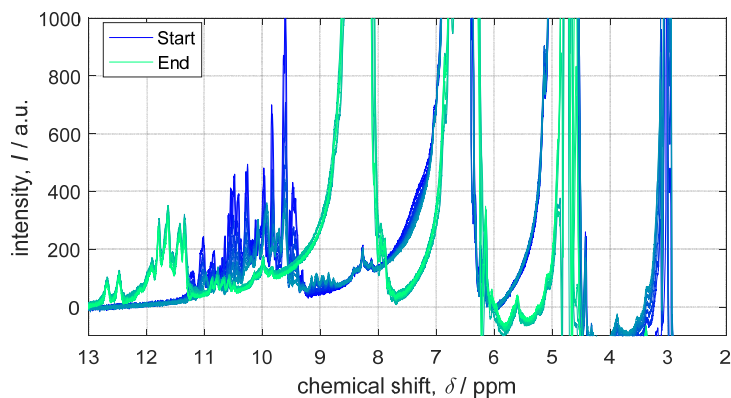
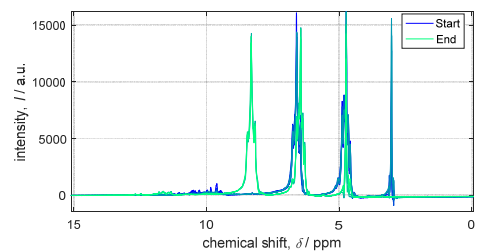

Data Processing for Low-field NMR in Matlab

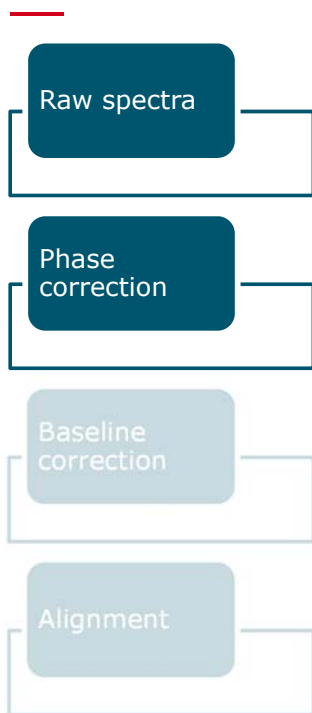

Entropy minimization method:

Chen et al., *J. Magn Reson.* **2002**, *158*, 164-168

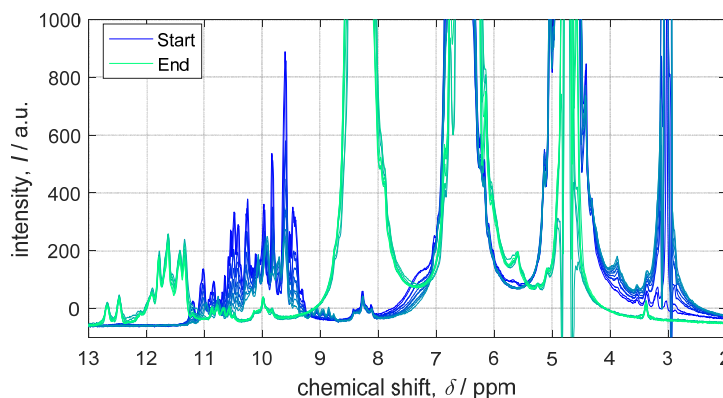
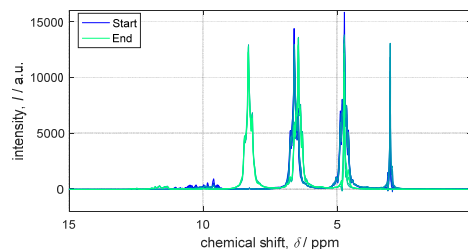

Data Processing for Low-field NMR in Matlab

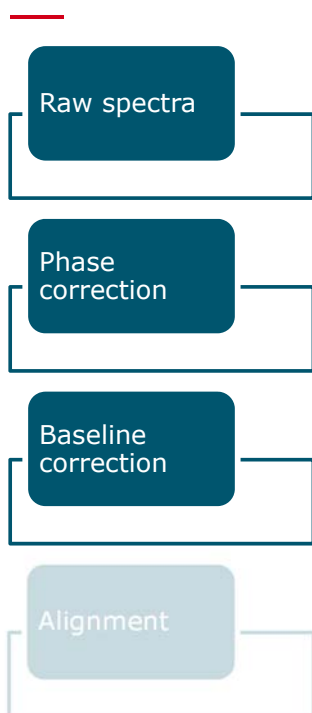

Low-order Polynomial fit:

Mazet et al., *Chemometrics Intell. Lab. Sys.* **2005**, *76*, 121-133.

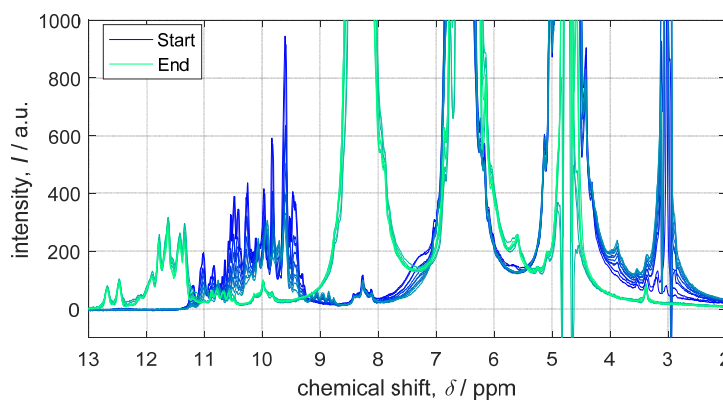
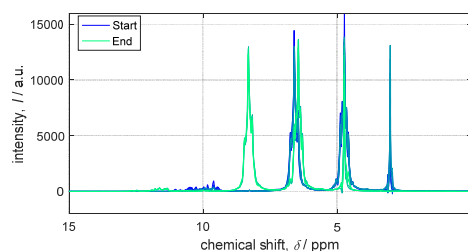

Data Processing for Low-field NMR in Matlab

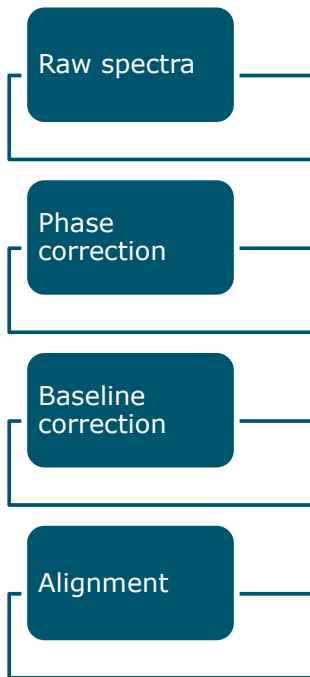

Alignment to reference signal (THF) using *icoshift*:
 Savorani et al., *J. Magn Reson.* **2010**, *2*, 190-202

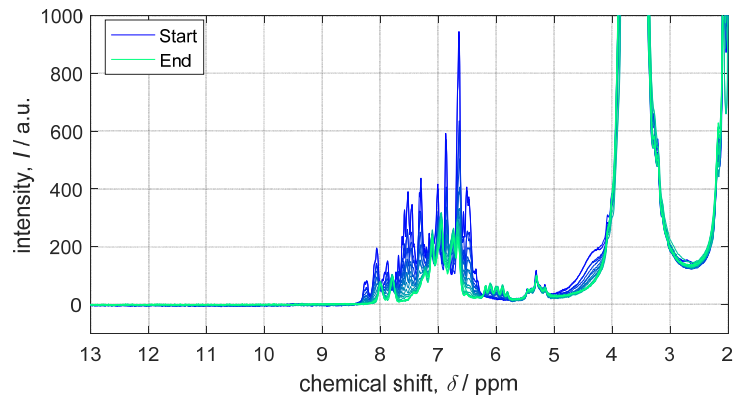
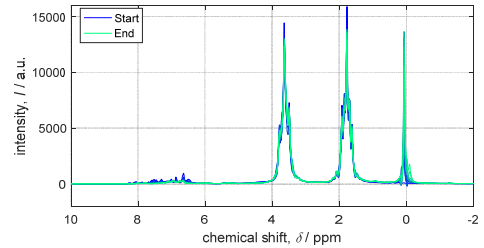

Indirect Hard Modeling (IHM)

- Modeling** peak fitting of pure component spectra → mixture model
- Analysis** “component fitting” → calculation of component area

- Group of peaks represent pure component spectra

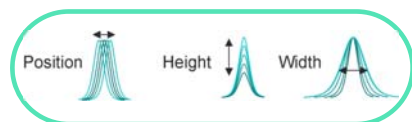

- Pseudo-Voigt function

$$V = \alpha \left[\beta \cdot \exp\left(-\ln(2) \frac{(x - \delta)^2}{\gamma^2}\right) + (1 - \beta) \frac{\gamma^2}{(x - \delta)^2 + \gamma^2} \right]$$

- α = peak maximum
- β = Gaussian-Lorentzian-ratio
- γ = half width
- δ = center position

Hard model for pure components

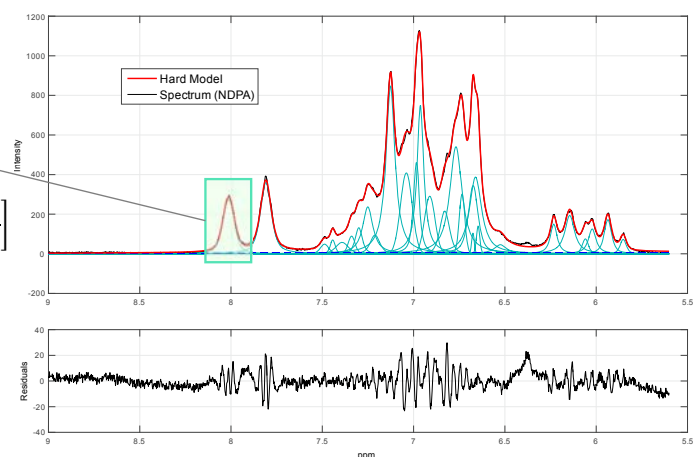

IHM – „Component Fitting“

Interpretation of Experimental Data with Pure Components

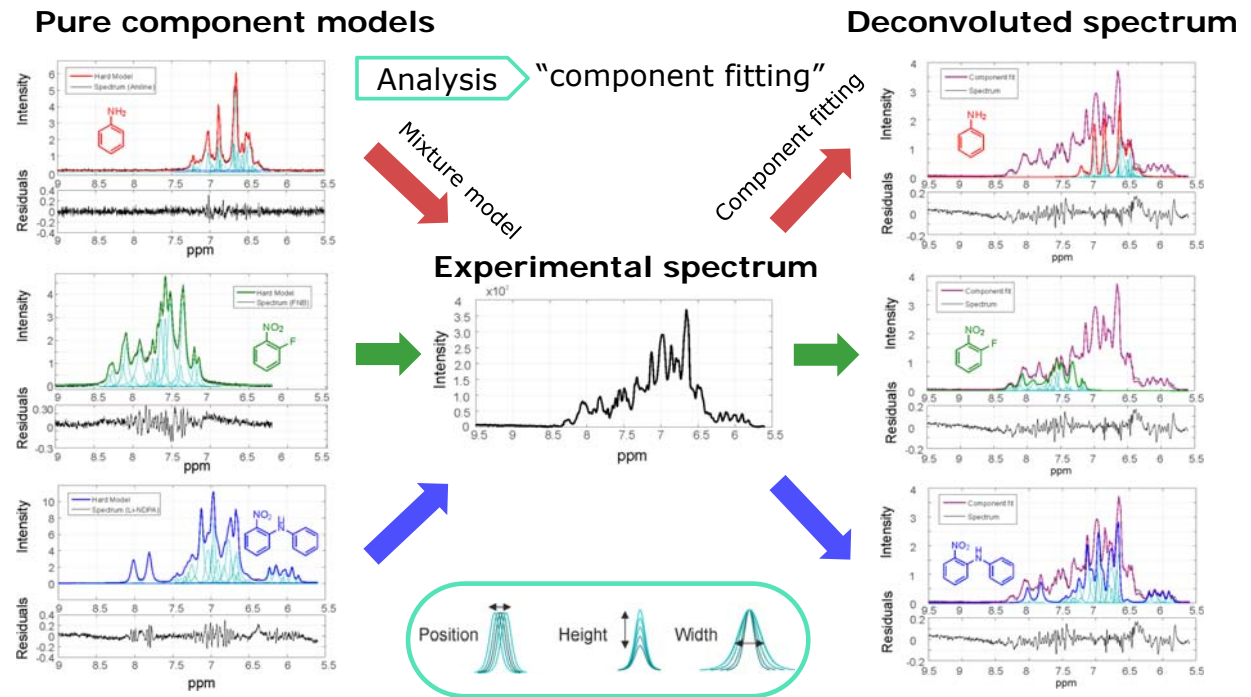

IHM – „Component Fitting“

Modular Exchangeability of Pure Components

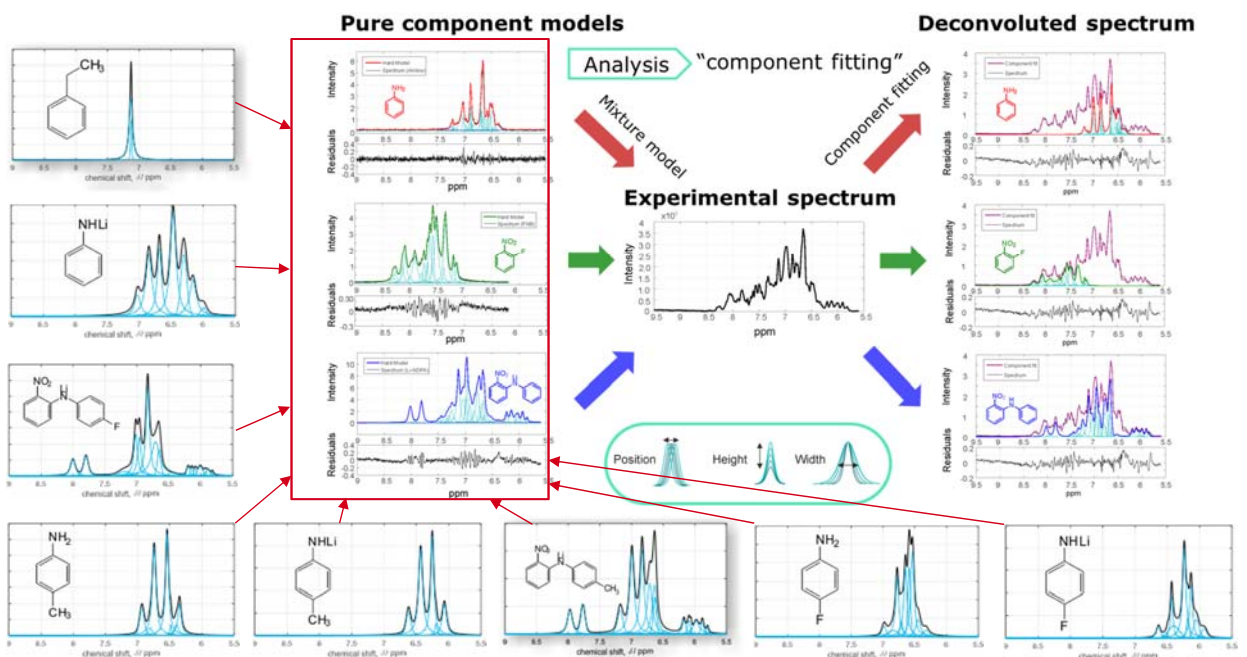

(2) Several Lab Experiments in Batch Along Reaction Co-ordinate, Validation with HF-NMR

IHM = Indirect Hard Modeling; PLS-R = Partial Least Squares Regression

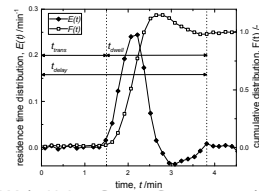
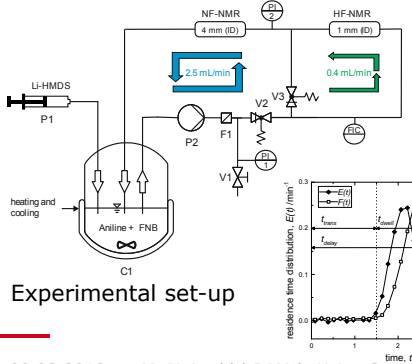
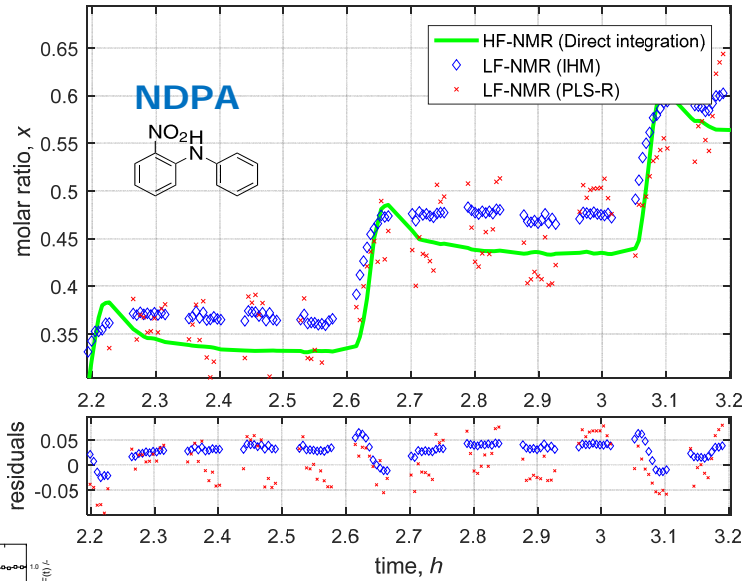
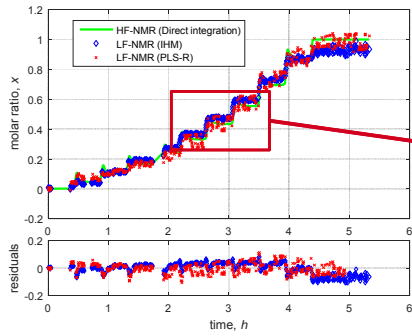

09.03.2018

M. Maiwald | BAM | „Using Smart Sensors and Modular Production Units?“ | Pfizer Inc., La Jolla, CA; USA

35

(2) IHM: External Validation PLS-R: Model Building

From Lab Experiments in Batch along Reaction Co-ordinate

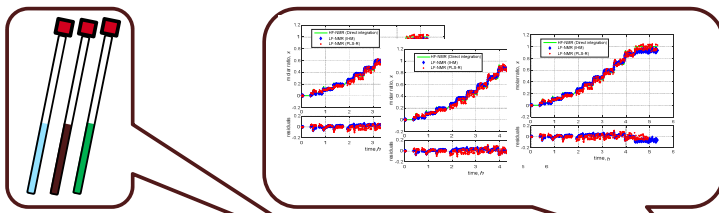

Low-field → NMR spectra	Pure Components	Batch Reaction
PLS-R	Calibration/validation to reference	
IHM	Pure Component Model development	Model parameterisation External validation

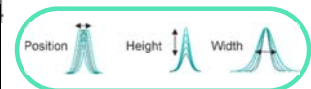

09.03.2018

M. Maiwald | BAM | „Using Smart Sensors and Modular Production Units?“ | Pfizer Inc., La Jolla, CA; USA

36

(2) Results: Reaction Characterization Lab Experiments in Batch along Reaction Co-ordinate

3 semi-batch reaction with varying starting concentrations

1500 Spectra for each HF- and NF-NMR

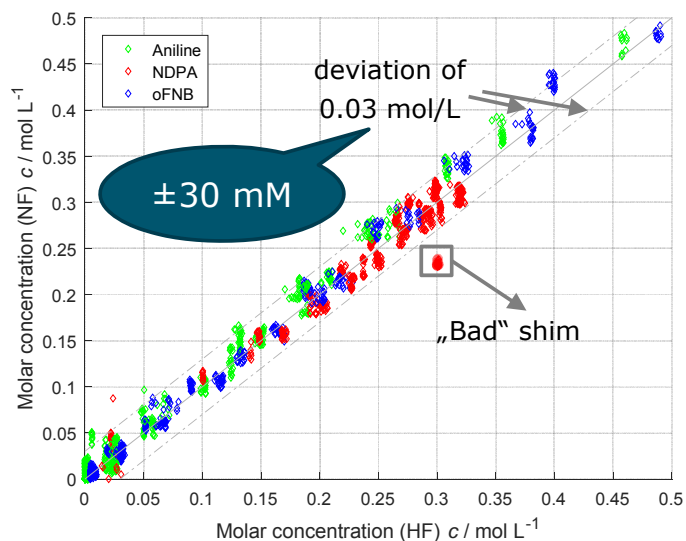

Classification of steady states

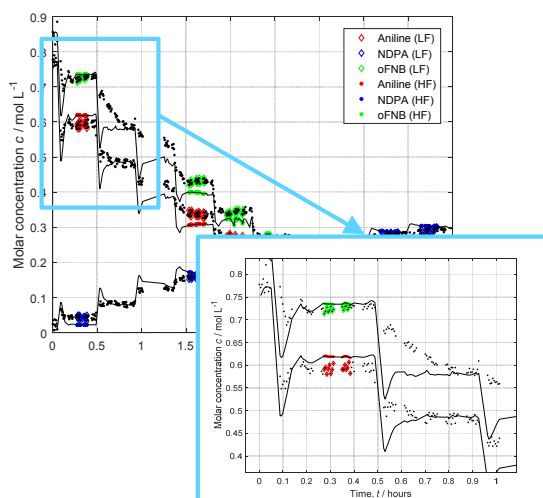

Reaction Scheme:

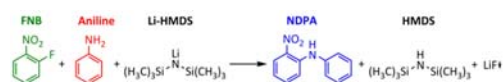

(3) Validation in Tube Reactor Continuous Lithiation Reaction Lab Set-up at BAM

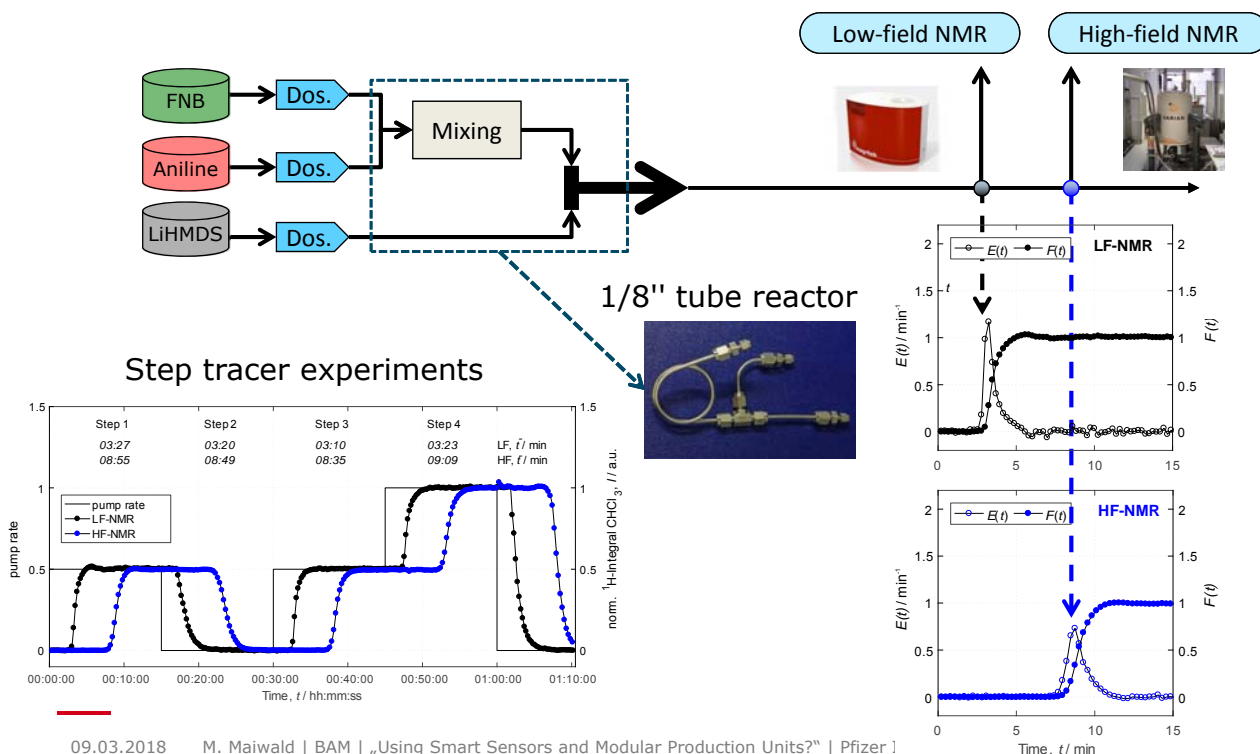

(3) Validation in Tube Reactor

Design of Experiments around Process Window

- Independent variation of flowrates / stoichiometric conditions

Reaction Scheme:

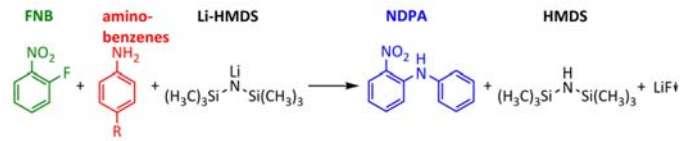

Coarse variation:

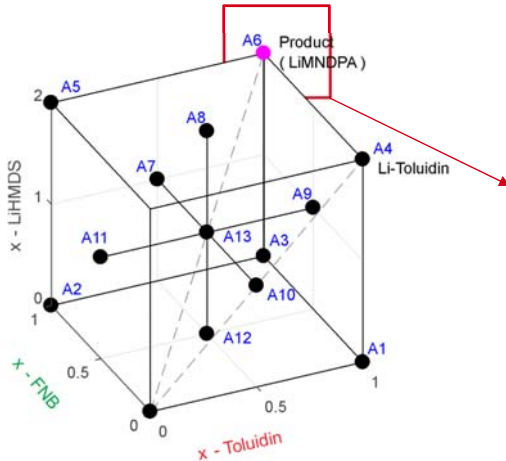

Fine variation:

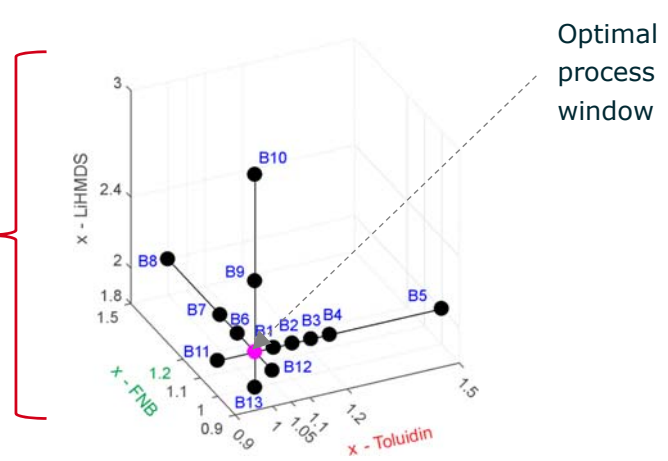

(3) Validation in Tube Reactor

Variation of Set-Points according to Experimental Design

Low-Field versus High-Field NMR Spectroscopy

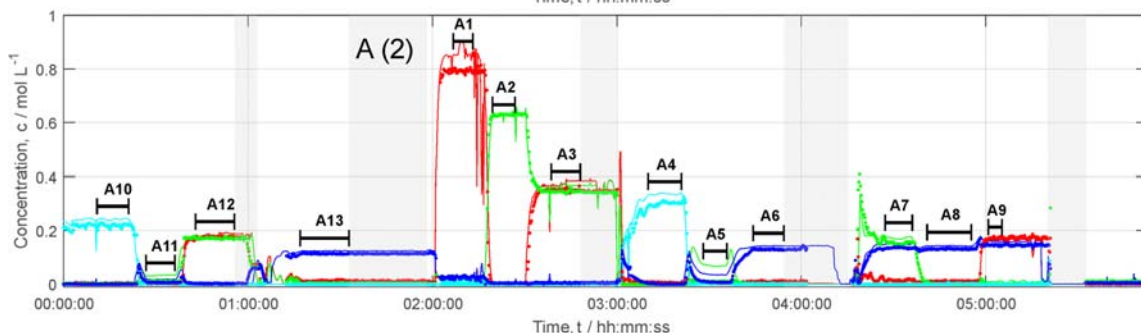
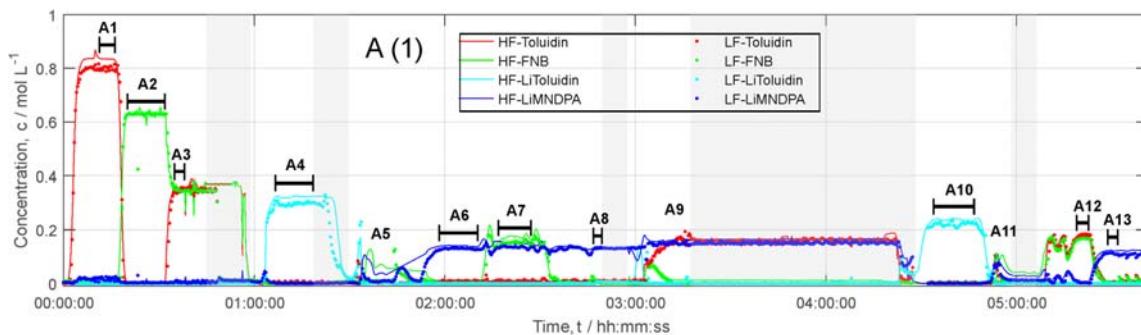

(3) Validation in Tube Reactor

Variation of Set-Points according to Experimental Design
Low-Field versus High-Field NMR Spectroscopy

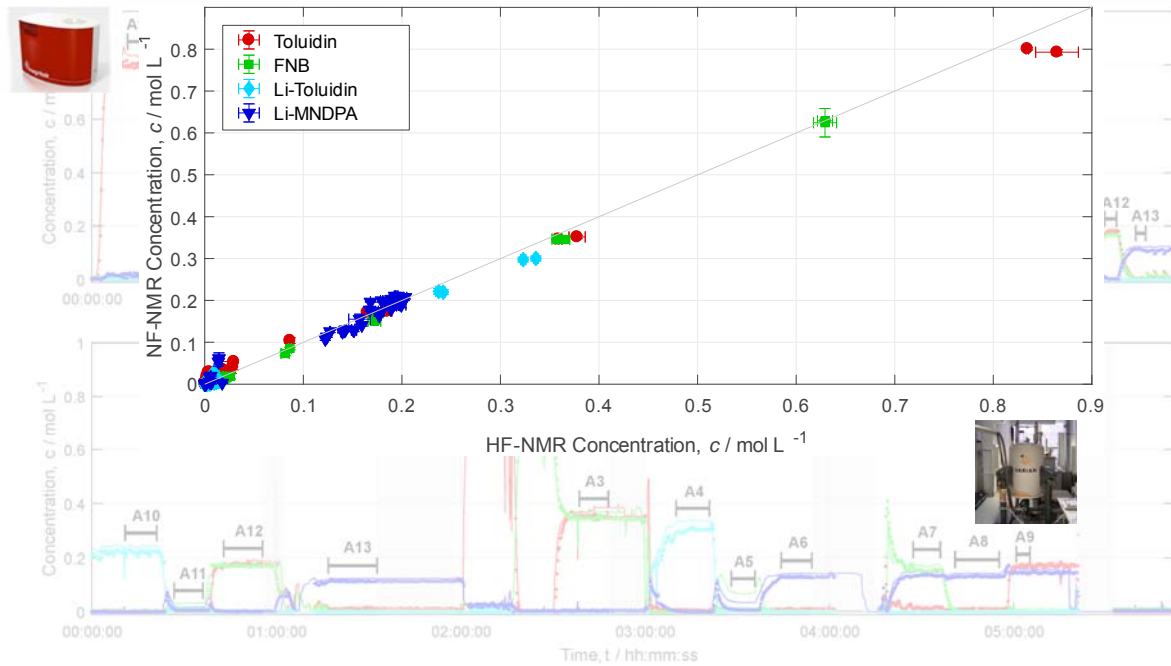

(3) IHM and PLS-R: External Validation

From Lab Experiments in Batch along Reaction Co-ordinate

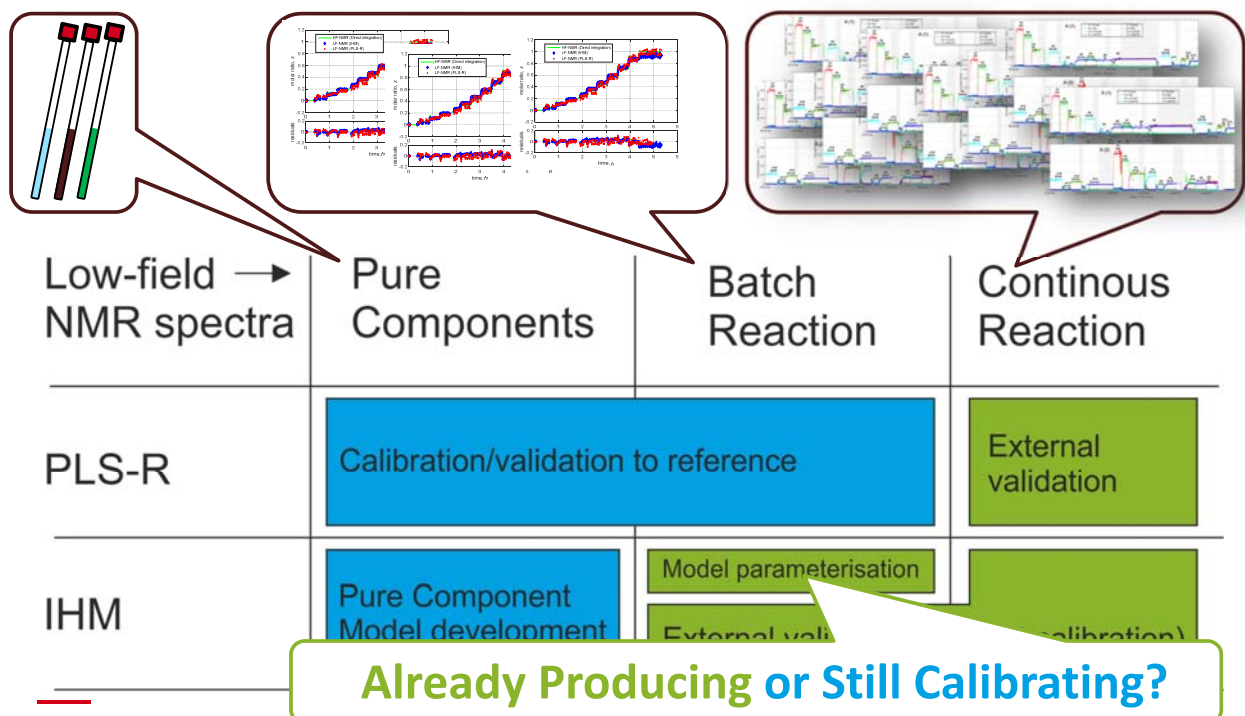

(4) Validation Runs in Modular Plant

Continuous Lithiation Reaction Set-up at Pilot Plant

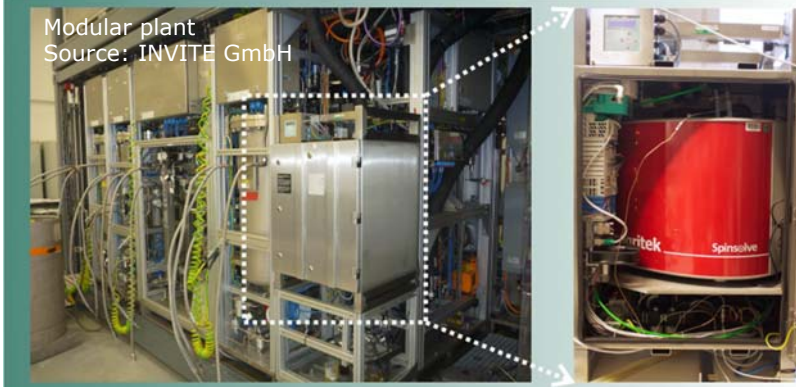

(4) Validation Runs in Modular Plant

Continuous Lithiation Reaction Set-up at Project Partner

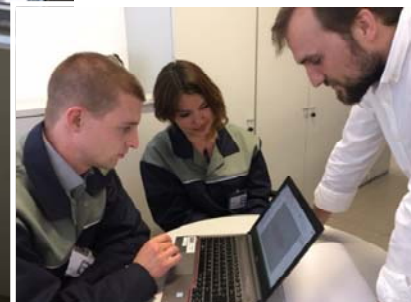

(4) Validation Runs in Modular Plant

First Field Tests at Pilot Plant



Lab
Experiments
PTFE Tube



Validation at Pilot
Plant
Ceramics Flow Cell



Containerized modular plant
Source: INVITE GmbH

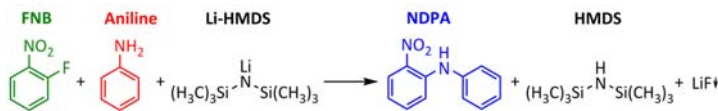
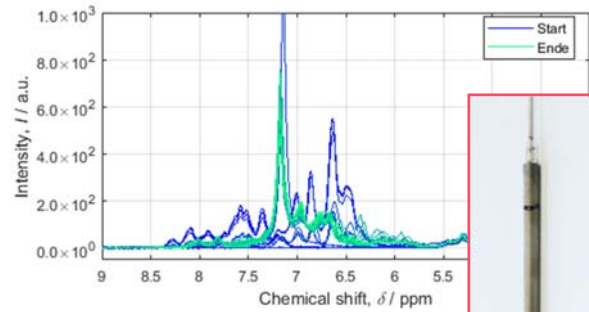
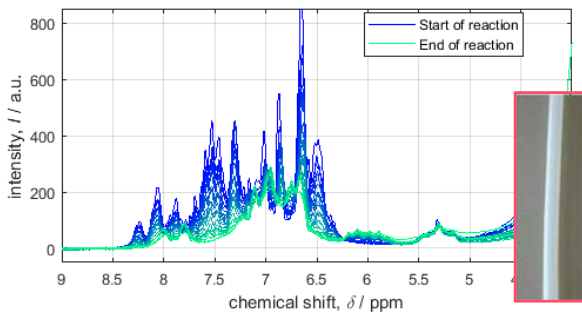

(4) Validation Runs in Modular Plant

Additional Component Found (Stabilizer at 10 wt-%)



- Stabilizer Ethylbenzene at 10 wt-% in Li-HMDS reagent
- Modular extension of IHM model from laboratory data successful



Containerized modular plant
Source: INVITE GmbH

Preliminary IHM Model from Lab

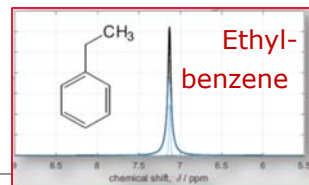
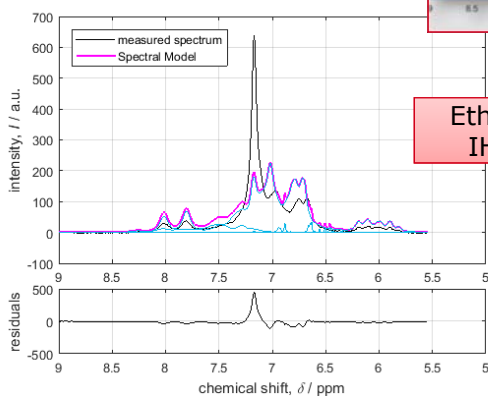

Ethylbenzene
IHM Model

Extended IHM Model
for Pilot Plant

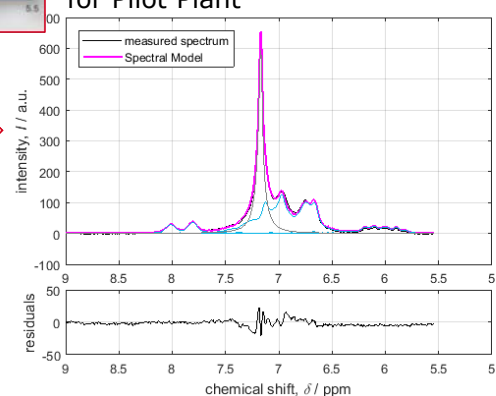

(4) Validation Runs in Modular Plant



Final Validation Runs in Pilot Plant

NMR Module
Five Components

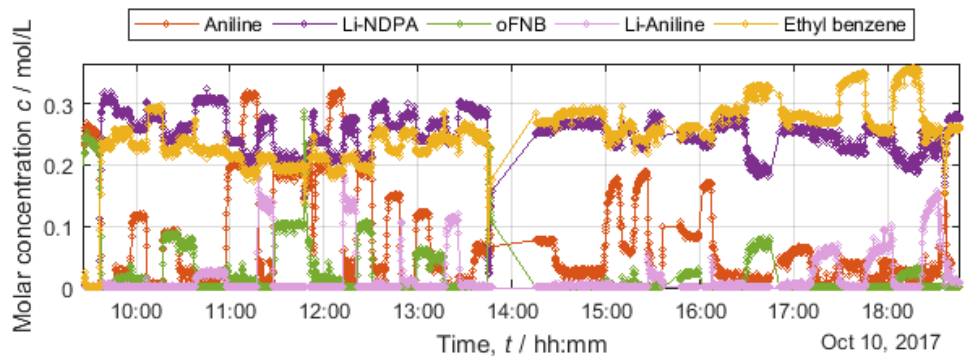

Flow Setpoints

iRTO Results

Iterative real-time optimization (iRTO) by Sebastian Engell and Anwesh Reddy Gottu Mukkula

TU Dortmund

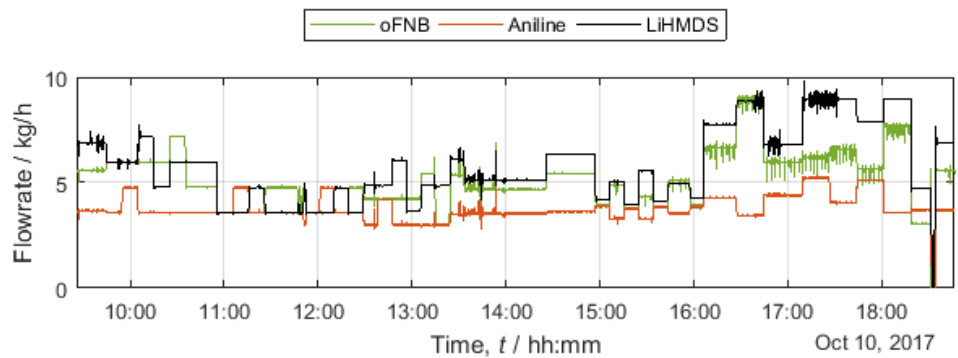

(4) Validation Runs in Modular Plant



Final Validation Runs in Pilot Plant

NMR Module
Five Components

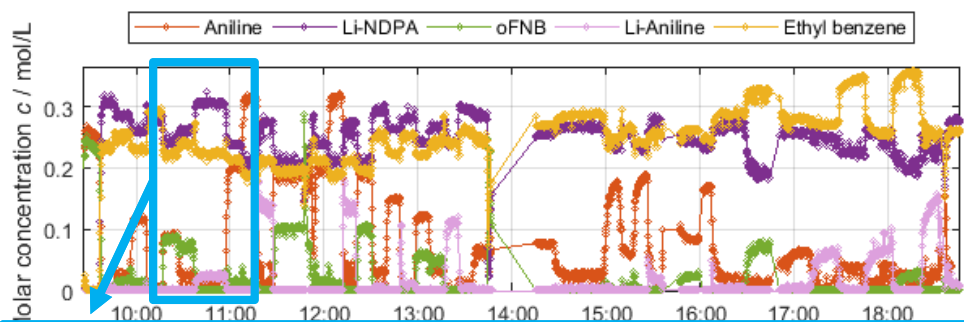

Flow Setpoints

iRTO Results

Iterative real-time optimization (iRTO) by Sebastian Engell and Anwesh Reddy Gottu Mukkula

TU Dortmund

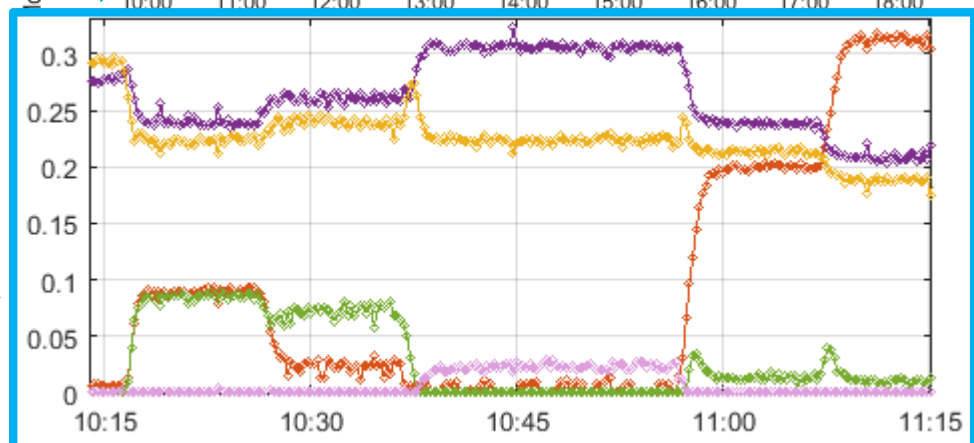

(4) Validation Runs in Modular Plant

Final Validation Runs in Pilot Plant

NMR Module

Five Components

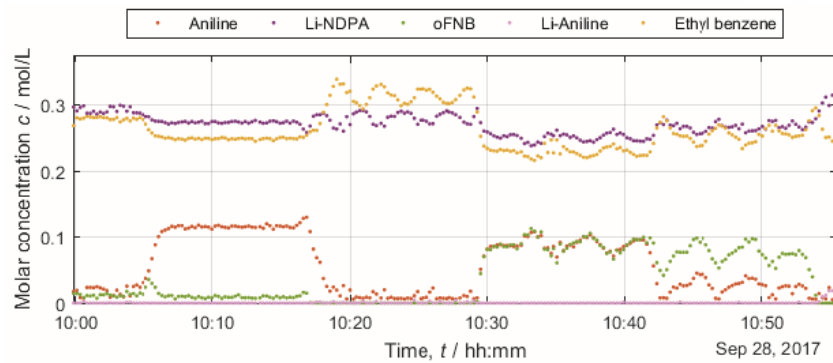

Unwanted oscillations of dosing pump

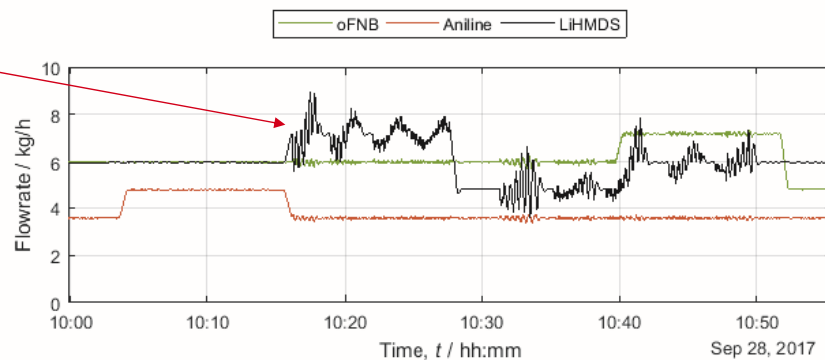

09.03.2018

M. Maiwald | BAM | „Using Smart Sensors and Modular Production Units?“ | Pfizer Inc., La Jolla, CA; USA

49

Wrap-up

Smart Sensors

- Integrated Process Design and Intensified Processes
→ Current Trend: Hybrid Modular Plants
- Smart process sensors and actuators are important parts of cyber-physical production systems
- Smart field devices generate new business cases for users, instrument manufacturers, and service providers.
- Use of „complicated“ sensors has to be simplified towards „plug and play“
- The classical automation pyramid is not suited for smart field devices

Smart NMR Analyzer Module

- Classical field integration and automation of NMR shown
- Physical Modeling (IHM) enables modular and calibration-free use of NMR
→ Validation instead of calibration

09.03.2018

M. Maiwald | BAM | „Using Smart Sensors and Modular Production Units?“ | Pfizer Inc., La Jolla, CA; USA

50

Modular Calibration

- Improvement of Physical Modeling (IHM)
- Derivation from „First Principles“ Methods (i.e., Quantum Mechanics)

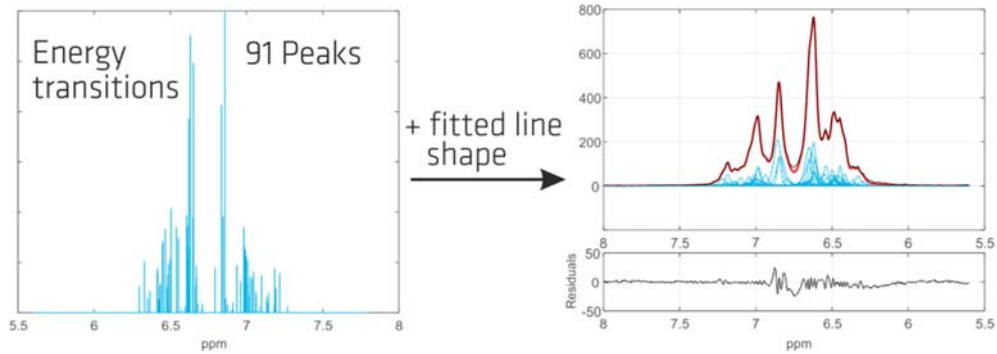

- „Semantic“ Models

Dissolution Studies by NMR Spectroscopy

Salt Screening and Salt Selection

Multi Component Salts and Polymorphism

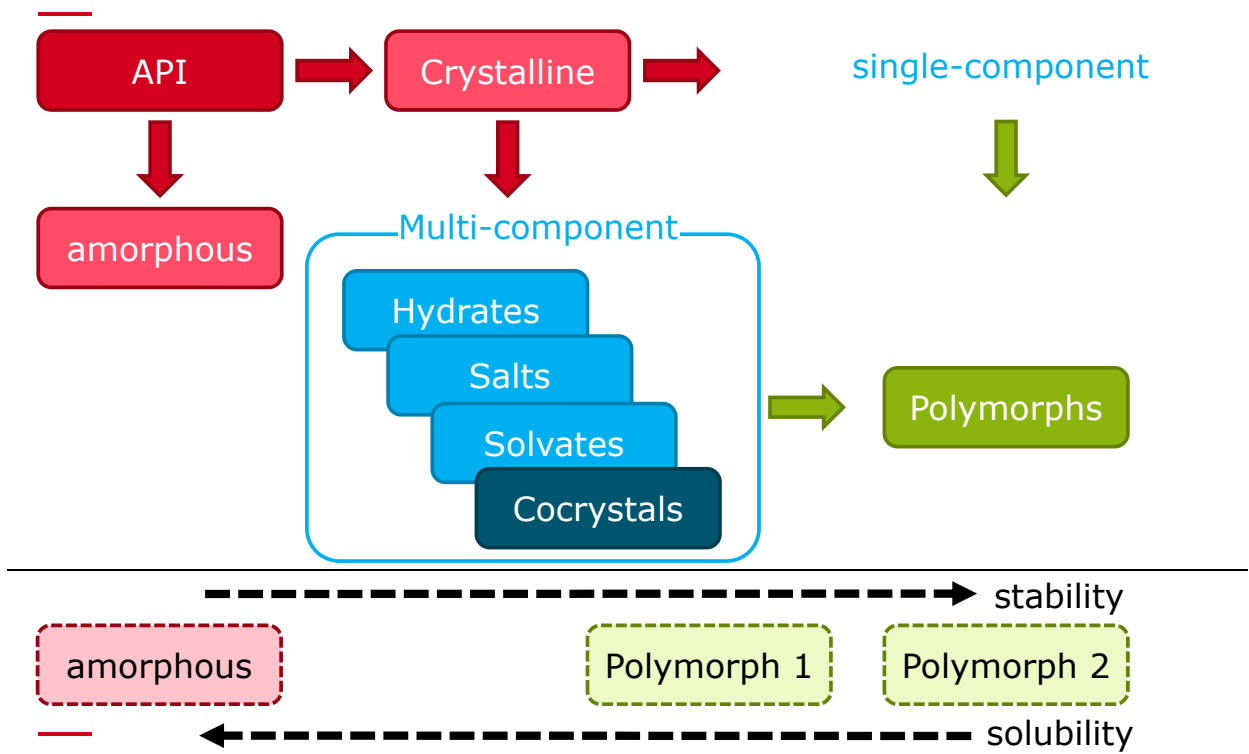

Mechanochemistry - Model systems

Metal organic compounds

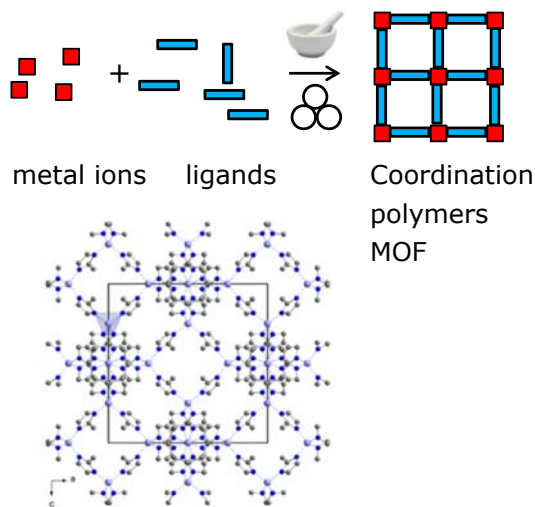

Cocrystals

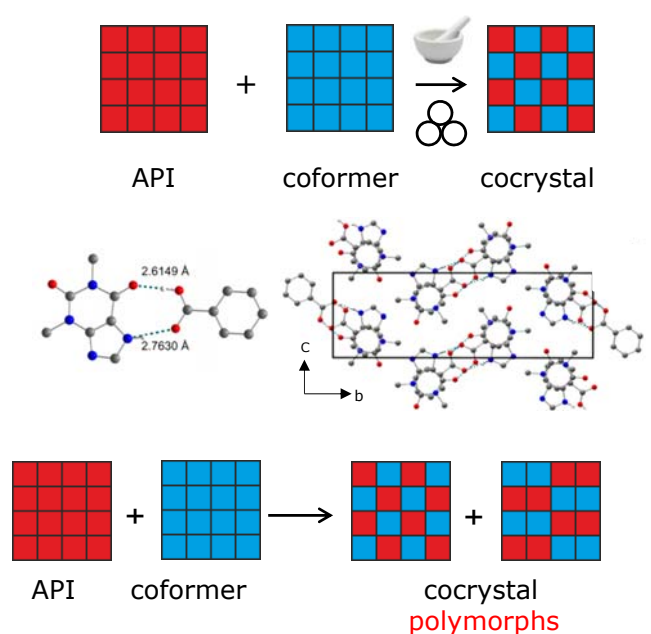

In situ - Let's look inside!

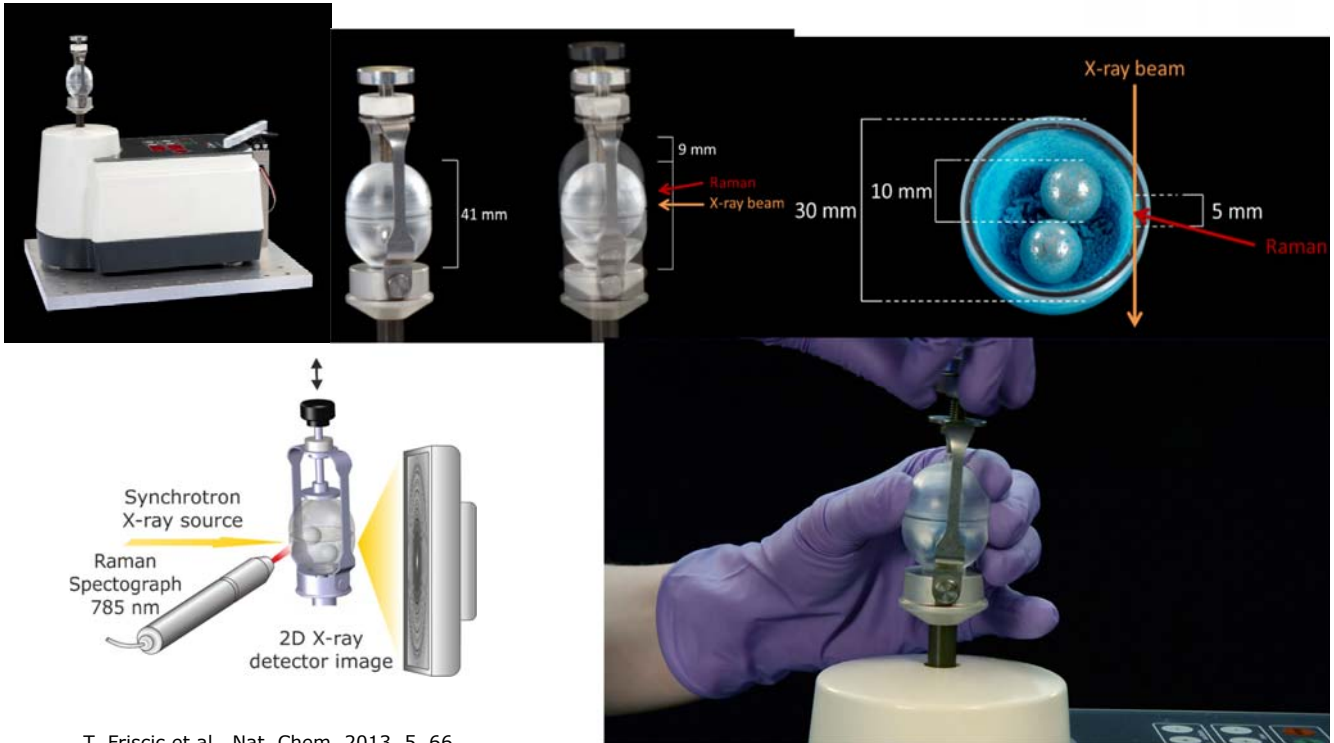

T. Friscic et al., Nat. Chem. 2013, 5, 66.

I. Halaz et al. Angew. Chem. Int. Ed. 2013, 52, 11538.

Angew. Chem. Int. Ed. 2015, 54, 1799.

Mechanochemistry - LAG

Further Example: Benzamide-Theophylline 1:1

LAG liquid-assisted grinding

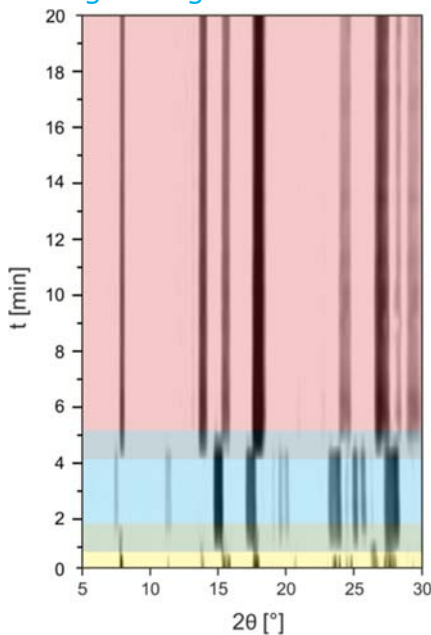

theophylline

benzamide

tp:ba cocystal I

tp:ba cocystal II

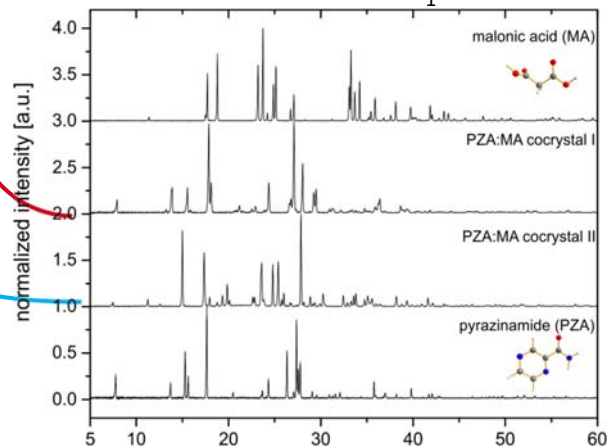
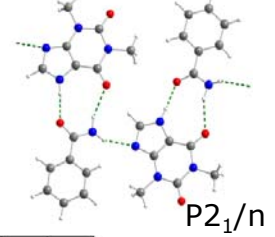
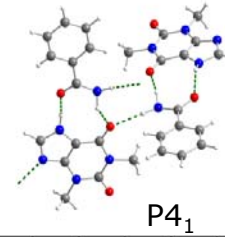
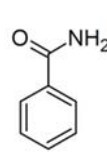
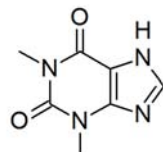

Cryst. Growth Des. 2016, 16, 1701.
Acta Cryst. 2016, C72, 217.

Study of Intrinsic Dissolution Rate by qNMR Spectroscopy

- Varian 500 MHz NMR spectrometer
- Online connection of dissolution vessel close to PhamEur
- $V = 60 \text{ mL}$, $T = 37 \text{ }^\circ\text{C}$, pH 4 buffer, $\omega = 100 \text{ min}^{-1}$
- Use of ordinary non-deuterated solvents

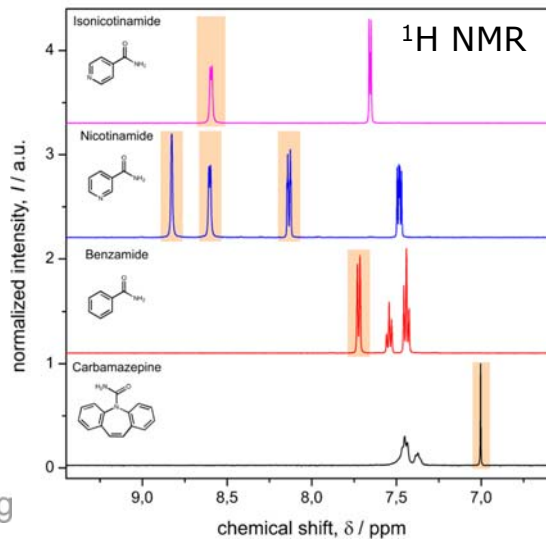
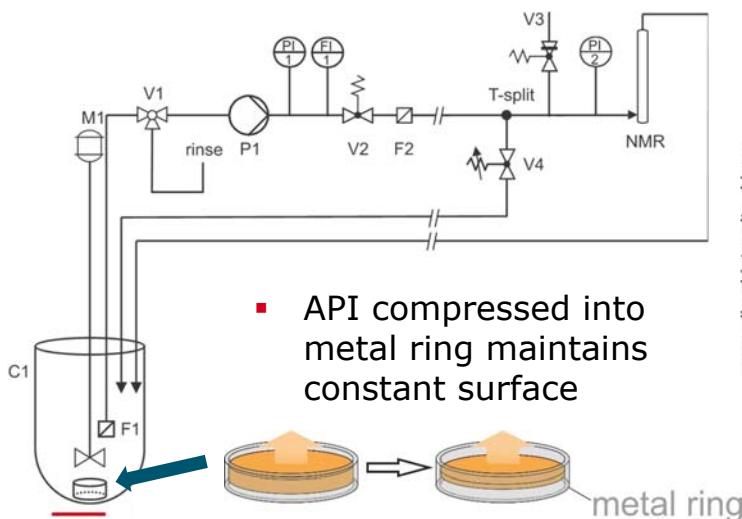

09.03.2018

M. Maiwald | BAM | „Using Smart Sensors and Modular Production Units?“ | Pfizer Inc., La Jolla, CA; USA

57

Study of Intrinsic Dissolution Rate by qNMR Spectroscopy

PhEur

NMR dissolution vessel

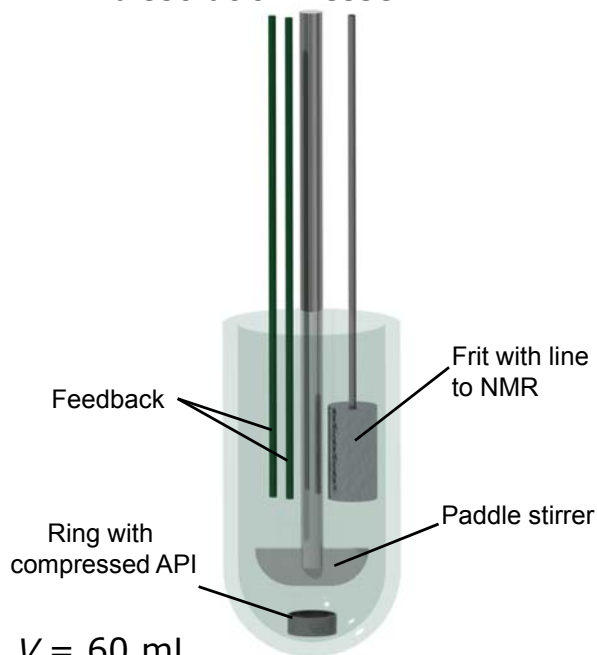
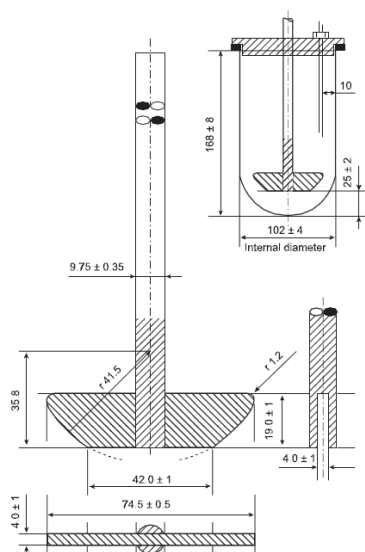

$V = 500 \text{ mL}$

$V = 60 \text{ mL}$

09.03.2018

M. Maiwald | BAM | „Using Smart Sensors and Modular Production Units?“ | Pfizer Inc., La Jolla, CA; USA

58

WET Solvent Suppression

Quantitative NMR Results down to 10 ppm API

WET = water suppression enhanced through T₁ Effects

- No netto magnetisation of solvent signal
- Selective attenuation of solvent signal combined with de-phasing by gradient pulse
- Works quantitatively while omitting transfer of magnetisation to labile protons

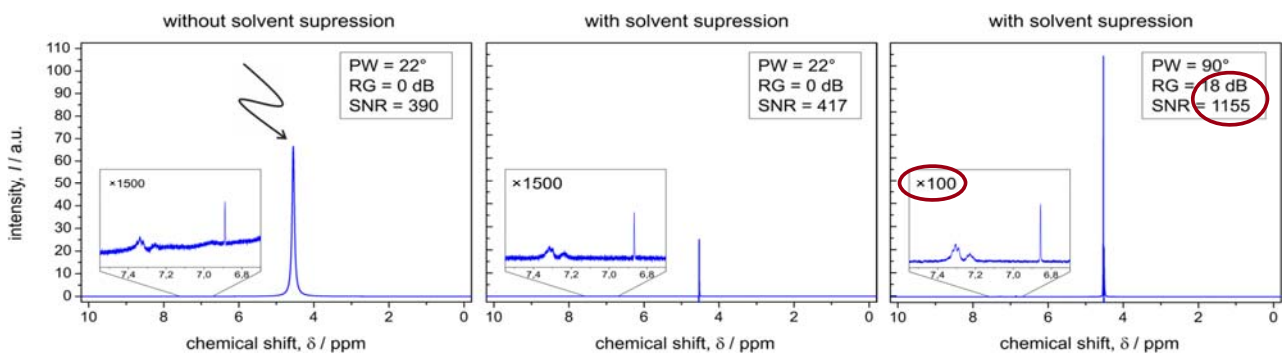
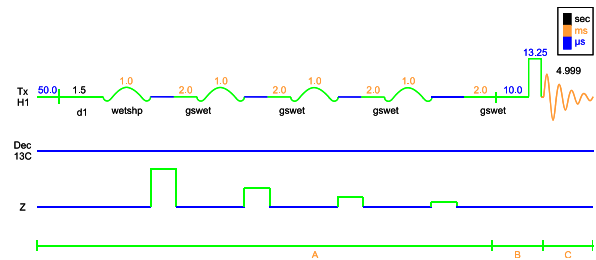

Limit of Detection and Quantification

Example Carbamazepine (according to DIN 32645)

Limit of Detection

$$x_{NG} = 11.7 \text{ mg / L}$$

Limit of Quantification

$$x_{EG} = 23.4 \text{ mg / L}$$

Standard deviation of procedure

$$s_{x0} = 6.435 \text{ mg / L}$$

Critical value of detected signal

$$y_k = 0.2488 \text{ a. u.}$$

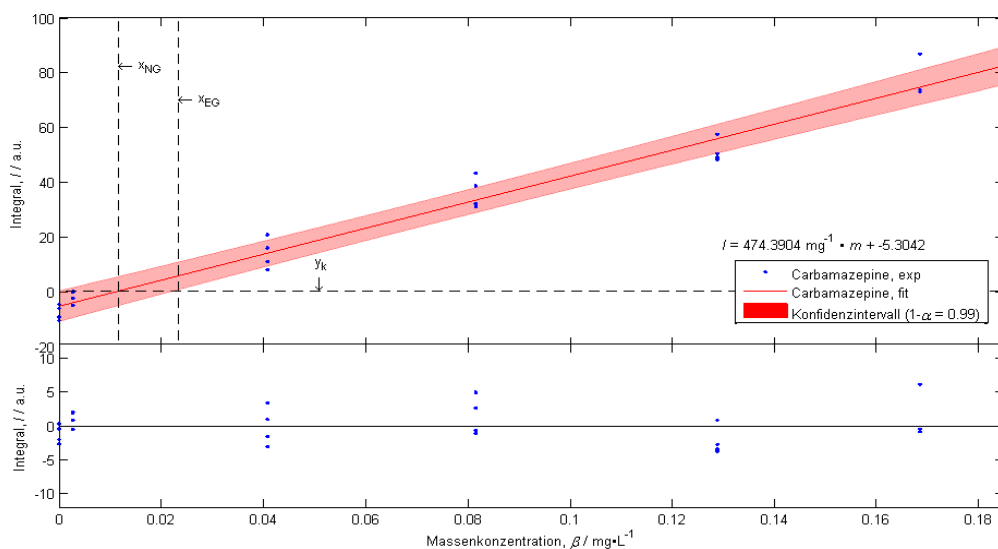
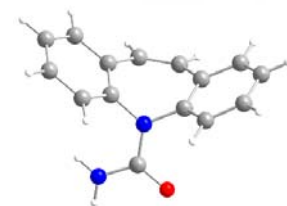

Intrinsic Dissolution Rates



Results for Carbamazepine (CBZ) Pure and Cocrystals

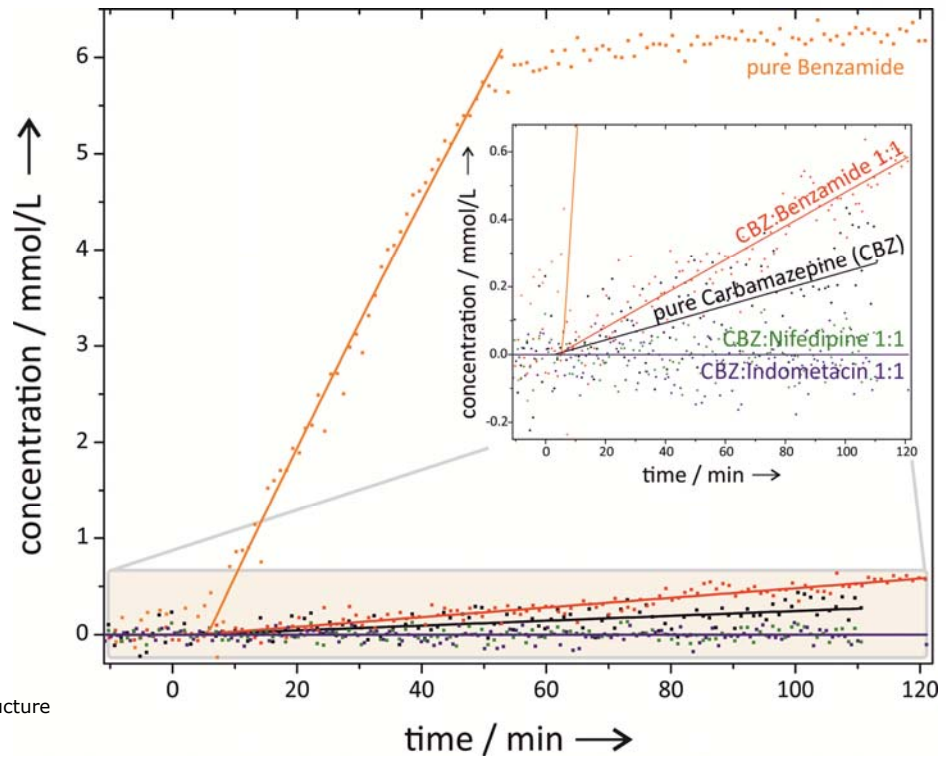

L. Batzdorf et al.,
Journal of Molecular Structure
1133 (2017) 18-23

Intrinsic Dissolution Rates



Further Example: Paracetamol-Theophyllin 1:1

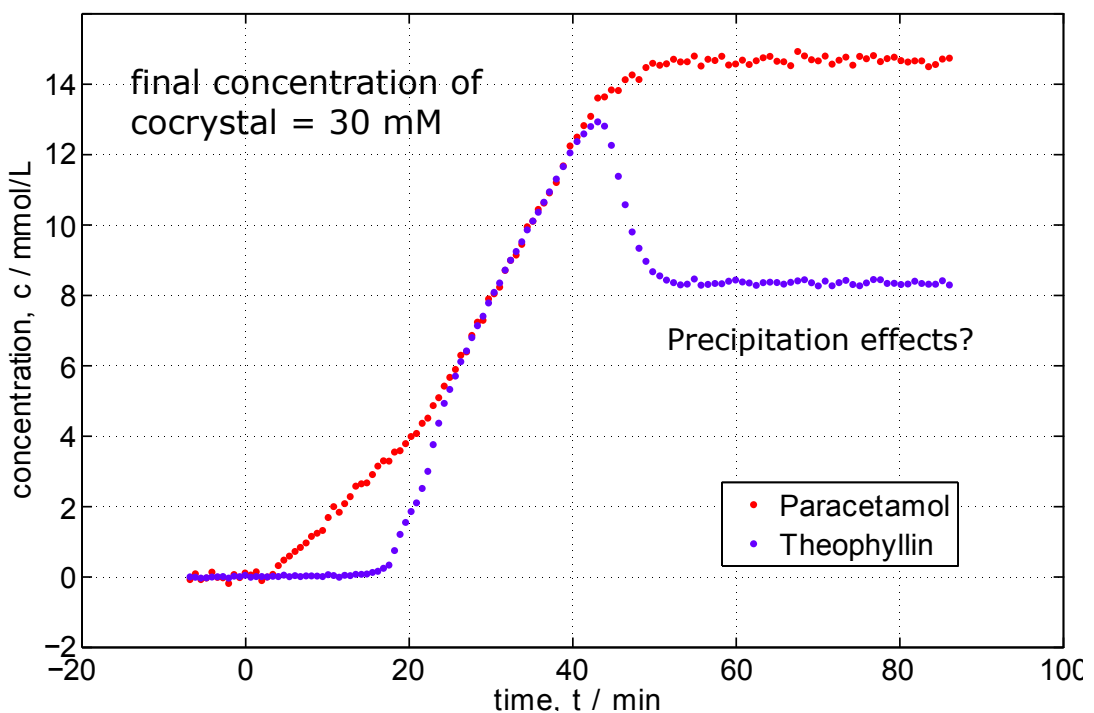

Liberation Kinetics from Drug Product

Fast Processes need Deconvolution of NMR Signals

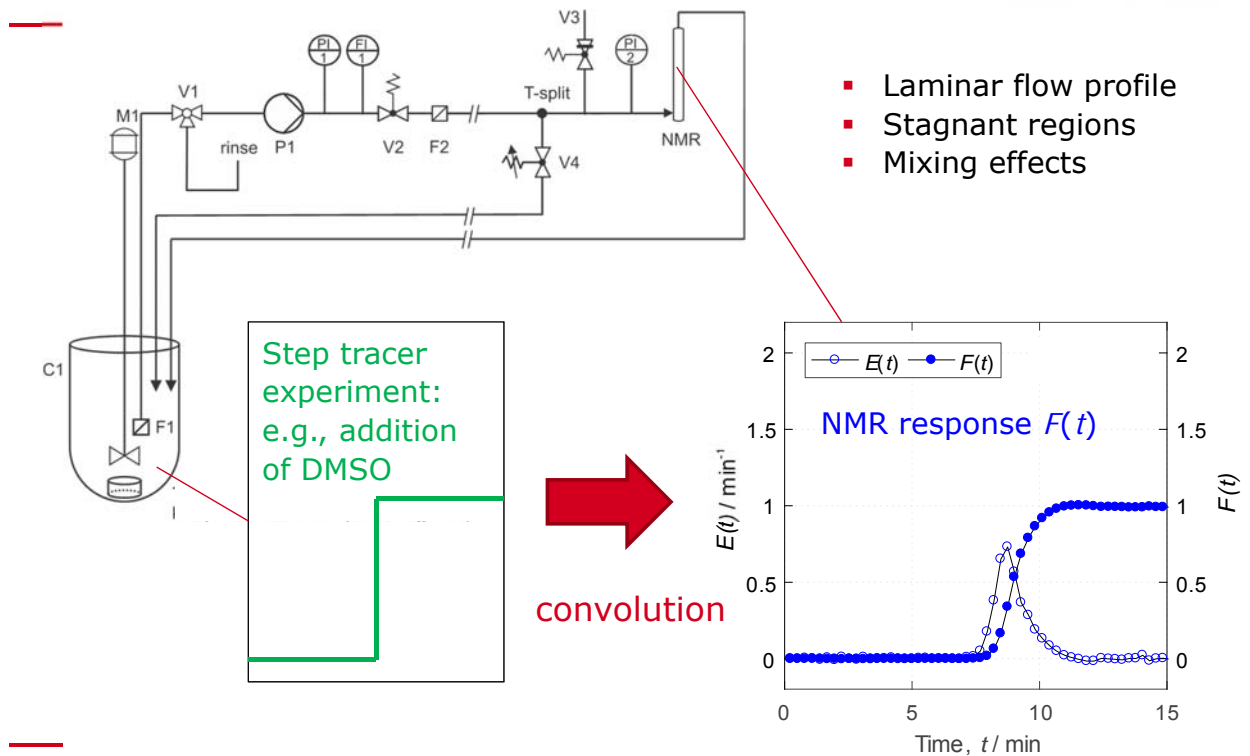

Liberation Kinetics from Drug Product

Example: Paracetamol Tablet

„Deconvolution“ of liberation kinetics by mixing behaviour of NMR bypass

Use of Weibull function

$$I = I_0 \left(1 - e^{-\frac{(t-t_0)^b}{a}} \right)$$

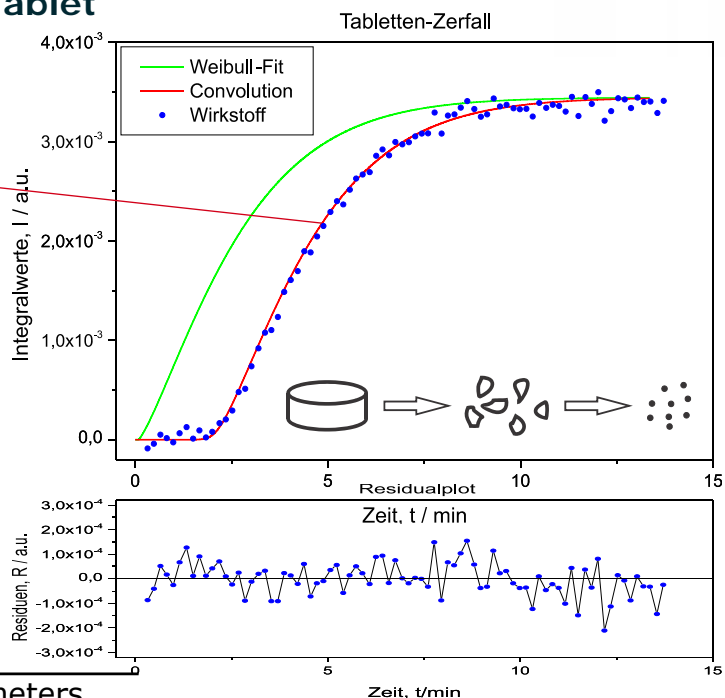

Determined Weibull parameters

$I_0 / \text{a.u.}$	t_0 / s	$a / -$	$b / -$
$3.44 \cdot 10^{-3}$	7.50	694.32	1.28

- Innovation and Continual Improvement in Pharmaceutical and Biotechnology aim at Continuous Pharmaceutical Manufacturing
- Lack of harmonised approaches for aspects for lifecycle management has hindered the anticipated innovation and continual improvement → Q12 (2018)?
- Process Analytical Technology, Integrated Process Design, and Intensified Processes are key technologies

Liberation Studies by qNMR

- Separate observation of API and cocystal builder is feasible
- Straightforward quantification via internal standard
- Dissolution rate is clearly influenced by cocystal builder
- Observation of fast processes like, e.g., liberation kinetics possible → using deconvolution



Thank You!

Franziska Emmerling BAM

Jürgen Kolz Magritek

Ullrich Koch Magritek

Juan Perlo Magritek

Mike Bernstein Mestrelab

Harald Pape PTB

Nicolai Zientek BAM

Clemens Minnich S-Pact

Dirk Engel S-Pact

Sebastian Engell TU Dortmund

Anwesh Reddy

Gottu Mukkula TU Dortmund

CONSENS – Integrated Control and Sensing for Sustainable Operation of Flexible Intensified Processes, funded by the European Union’s Horizon 2020 research and innovation programme under grant agreement N° 636942; www.consens-spire.eu