

21.-22.08.2017



SENSOR ROADMAP 4.0 – PROSPECTS TOWARDS A UNIFORM TOPOLOGY FOR PROCESS CONTROL AND SMART SENSOR NETWORKS

Michael Maiwald, Patrick Gräßer, Lukas Wander,
Svetlana Guhl, Klas Meyer, Simon Kern

Bundesanstalt für Materialforschung und -prüfung (BAM)
Division 1.4 Process Analytical Technology

Richard-Willstätter-Str. 11
D-12489 Berlin, Germany

Integrated Process Design and Intensified Processes

Current Trend: Hybrid Modular Plants

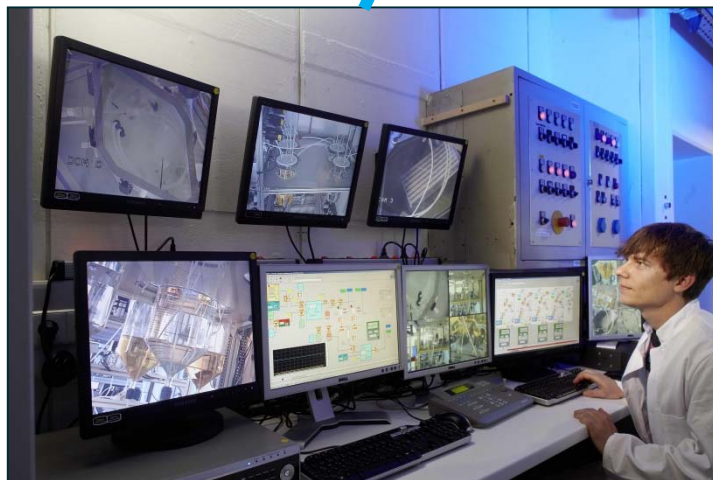
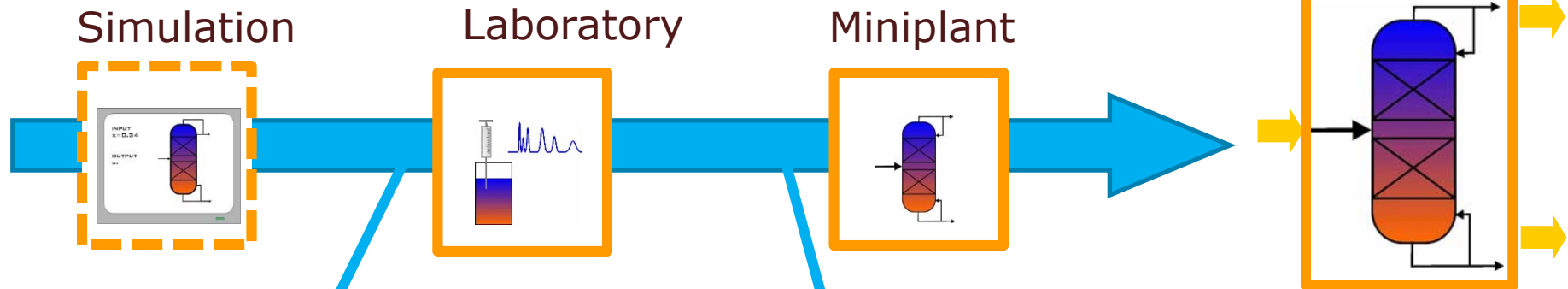

Micro Reaction Technology
(Example: Fraunhofer ICT, Pfinzta/D)



Modular Production
(Example: Foster Wheeler AG, Zug/CH)

Integrated Process Design and Intensified Processes

Example: Continuous Flow Production of Pharmaceuticals

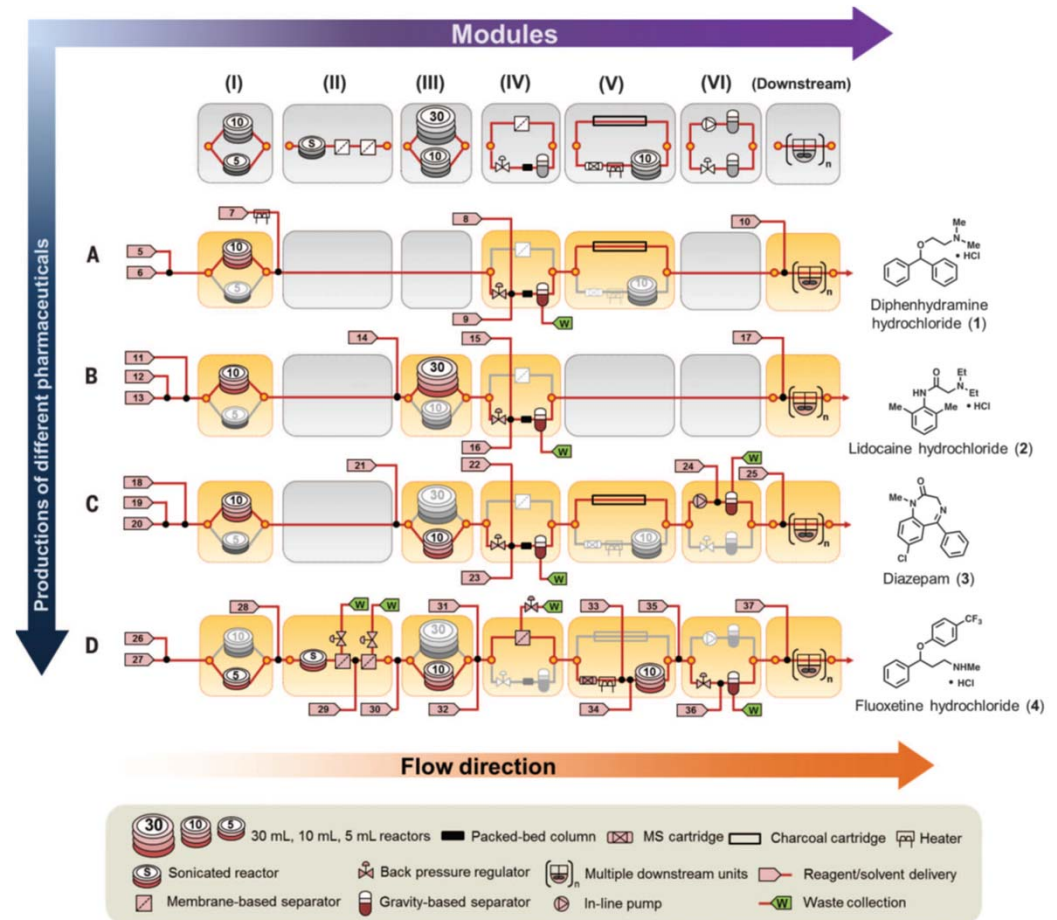
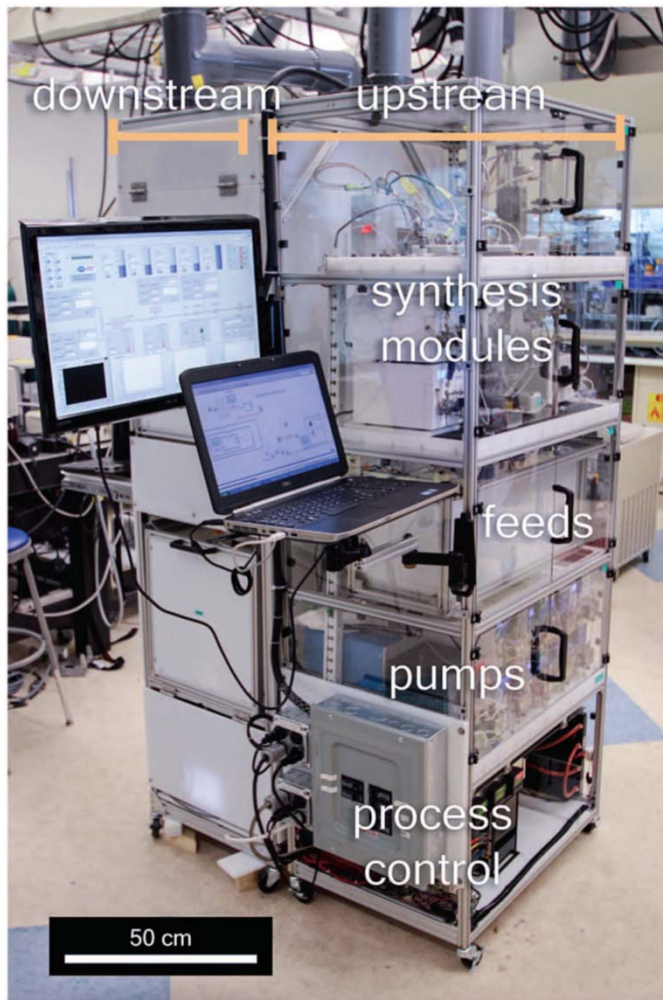

A. Adamo, R. L. Beingessner, M. Behnam et al., On-demand continuous-flow production of pharmaceuticals in a compact, reconfigurable system, *Science* 352(6281), 2016, 61-67

Process Automation

The Classical Automation Pyramid → is Outdated!

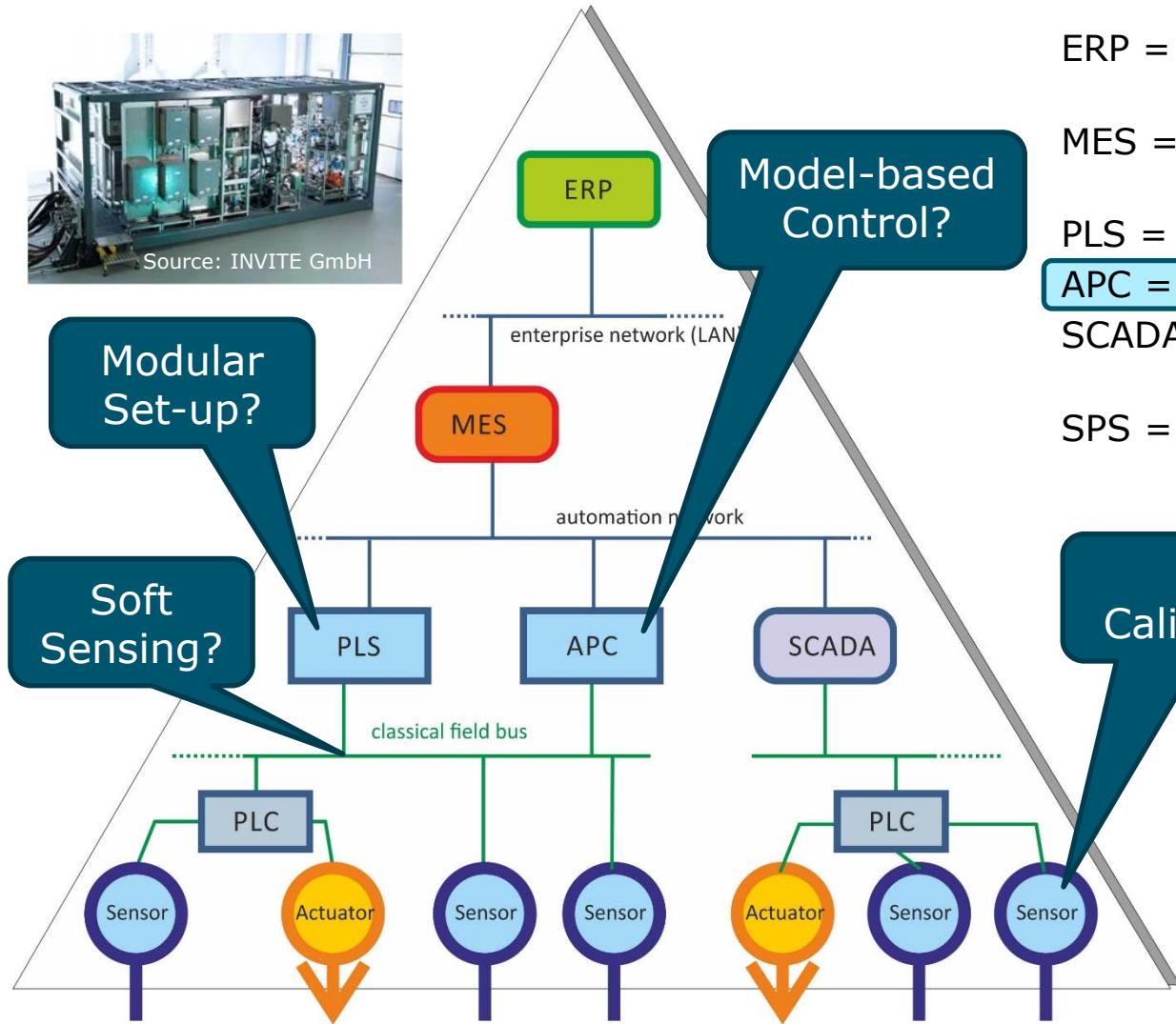

- ERP = Enterprise Ressource Planning
- MES = Manufacturing Execution System
- PLS = Prozessleitsystem
- APC = Advanced Process Control**
- SCADA = Supervisory Control and Data Acquisition
- SPS = Speicherprogrammierbare Steuerung



Success of Technology Roadmaps



The former technology roadmaps „Prozess-Sensoren 2005–2015“ (2006) and „Prozess-Sensoren 2015+“ (2009) were a valuable basis for all enterprises in the process industry

Current and future requirements to process sensors

Sensors go *smart*

- Smart process sensors are important parts of cyber-physical production systems and generate new business cases for users, instrument manufacturers, and service providers.
- „Smart“ sensors provide services within networks and use information out of the network.

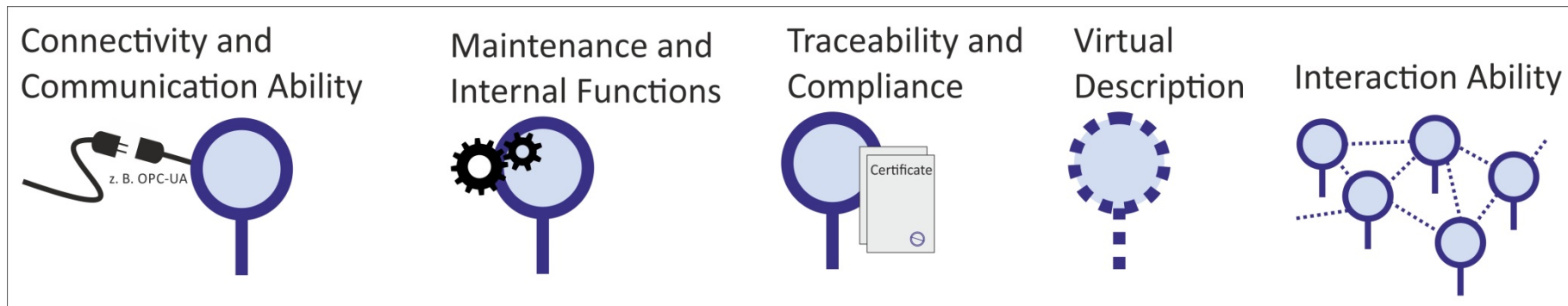

- Use of „complicated“ sensors has to be simplified towards „plug and play“

Continuous Engineering, Simulation

Towards Cyber-Physical Production Systems (CPPS)

“Cyber-Physical Systems (CPS) are integrations of computation with physical processes. Embedded computers and networks monitor and control the physical processes, usually with feedback loops where physical processes affect computations and vice versa”.

E. A. Lee, Cyber Physical Systems: Design Challenges, EECS Department, University of California, Berkeley, 2008

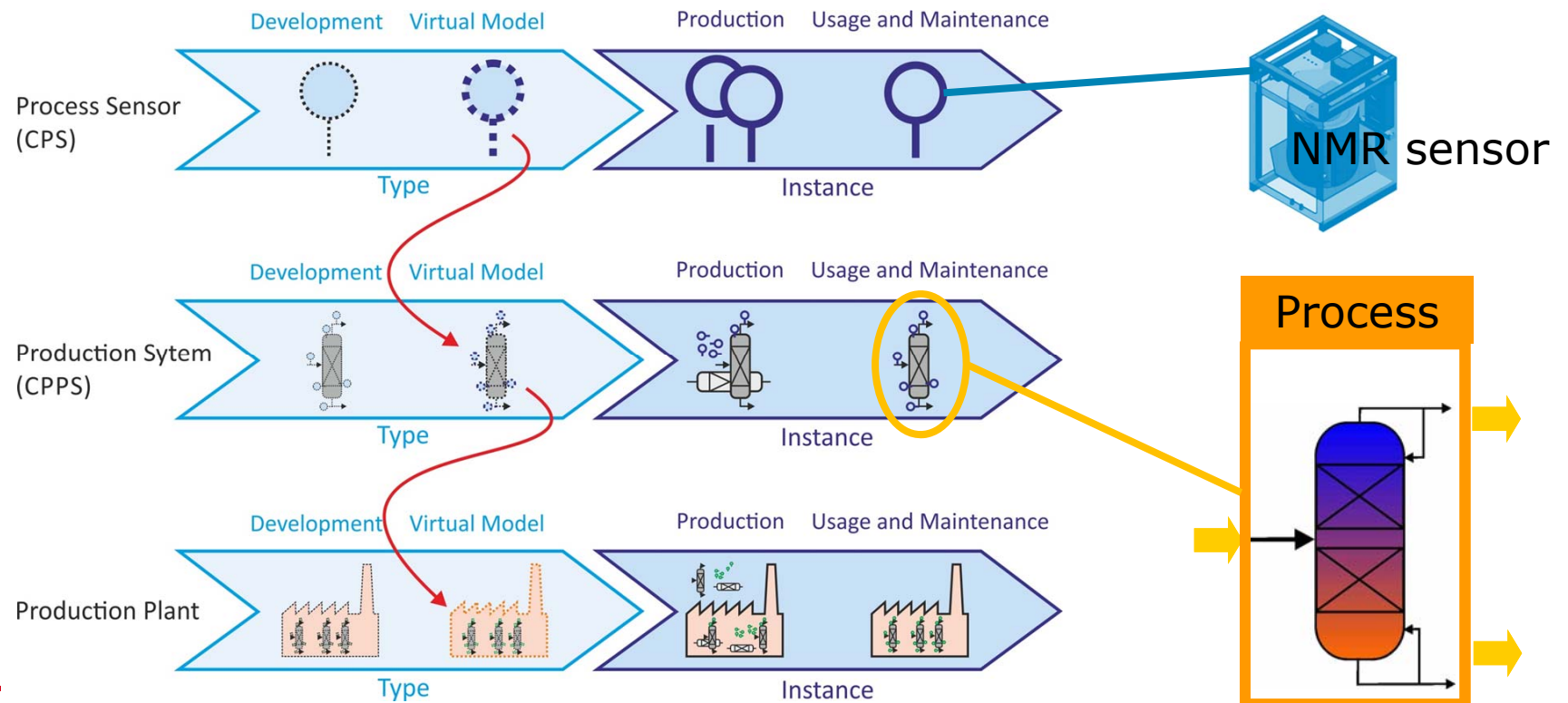

Maintenance and Internal Functions

Example: Revision Planning of Control Valves



Sensors in direct vicinity of valve

Revision schedule

Life time

Pressure sensor

Flow sensor

Concentration of abrasive particles

Turbidity sensor

Temperature sensor

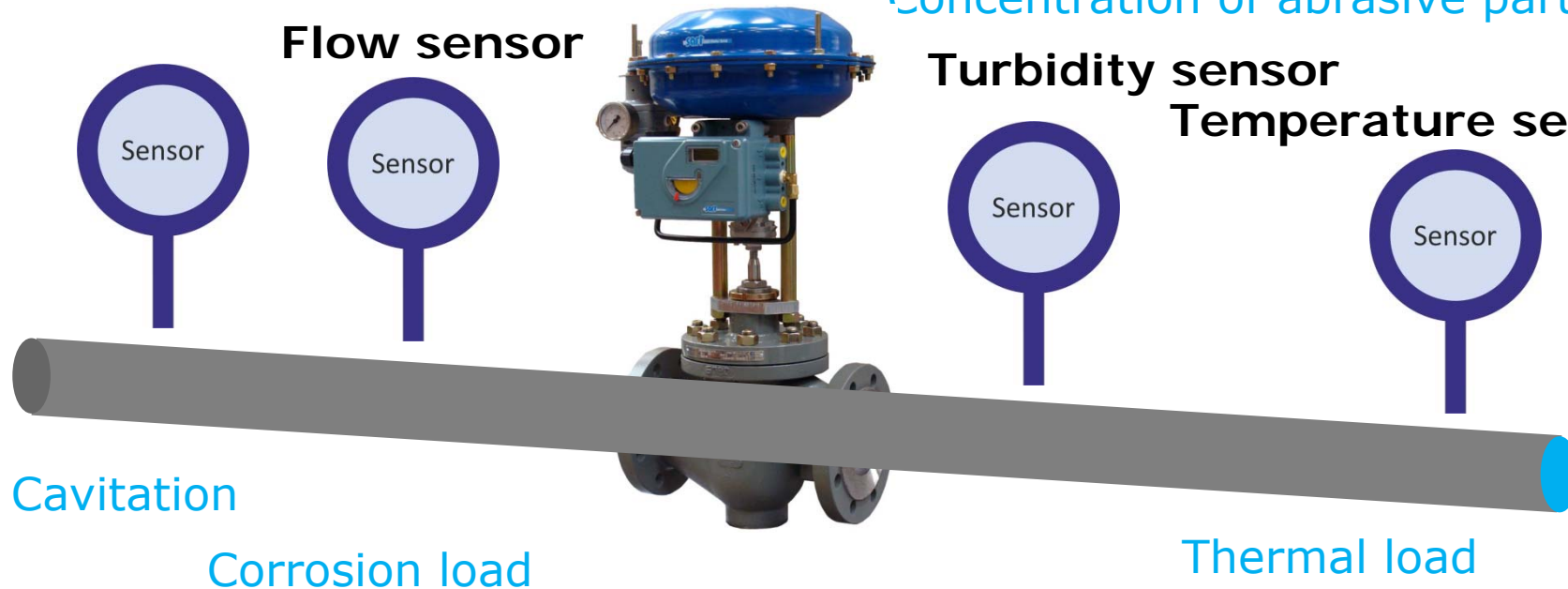

Maintenance actions are directly ordered by Enterprise Resource Planning (ERP) Software



Perspectives

Sensor Image within Industrie 4.0 Network

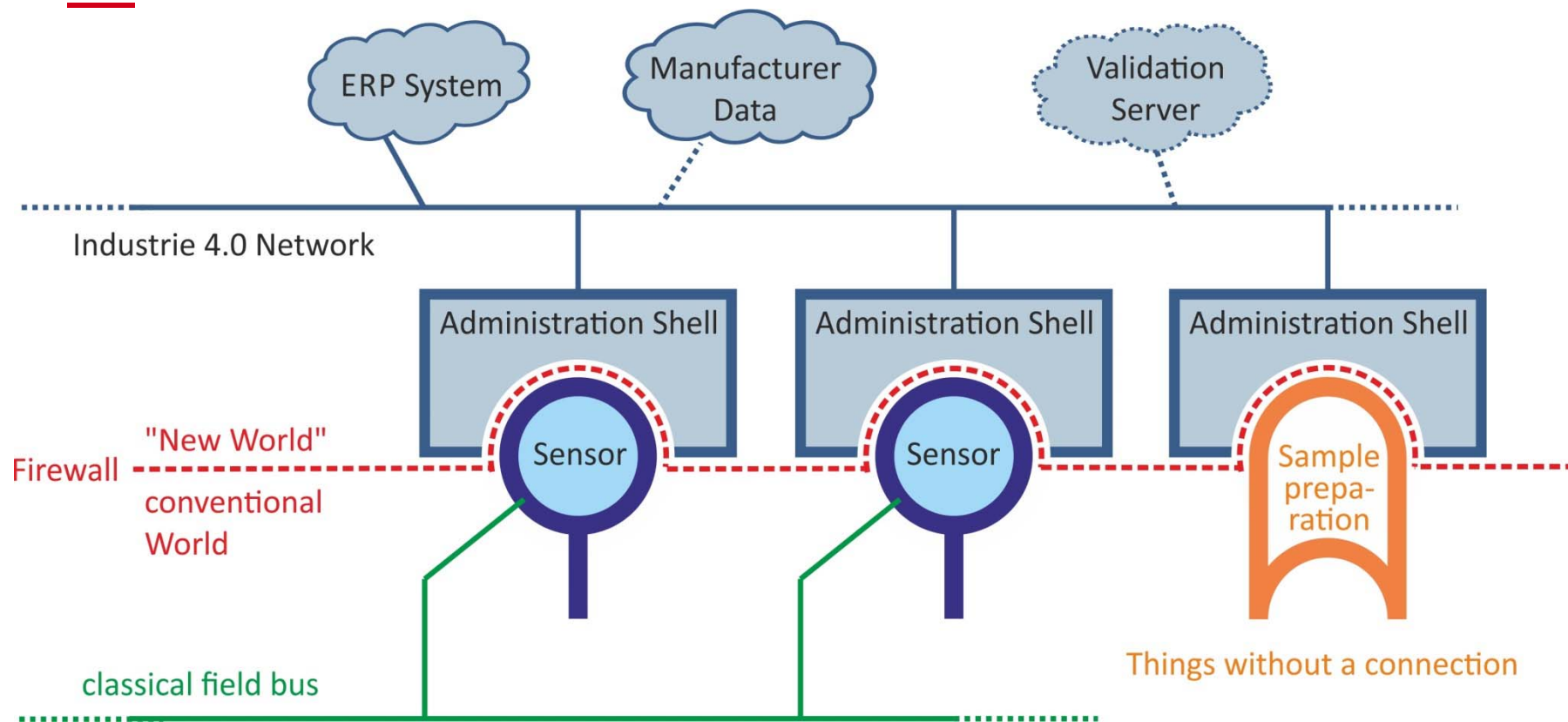

Perspectives II

Simplified programming using mobile devices

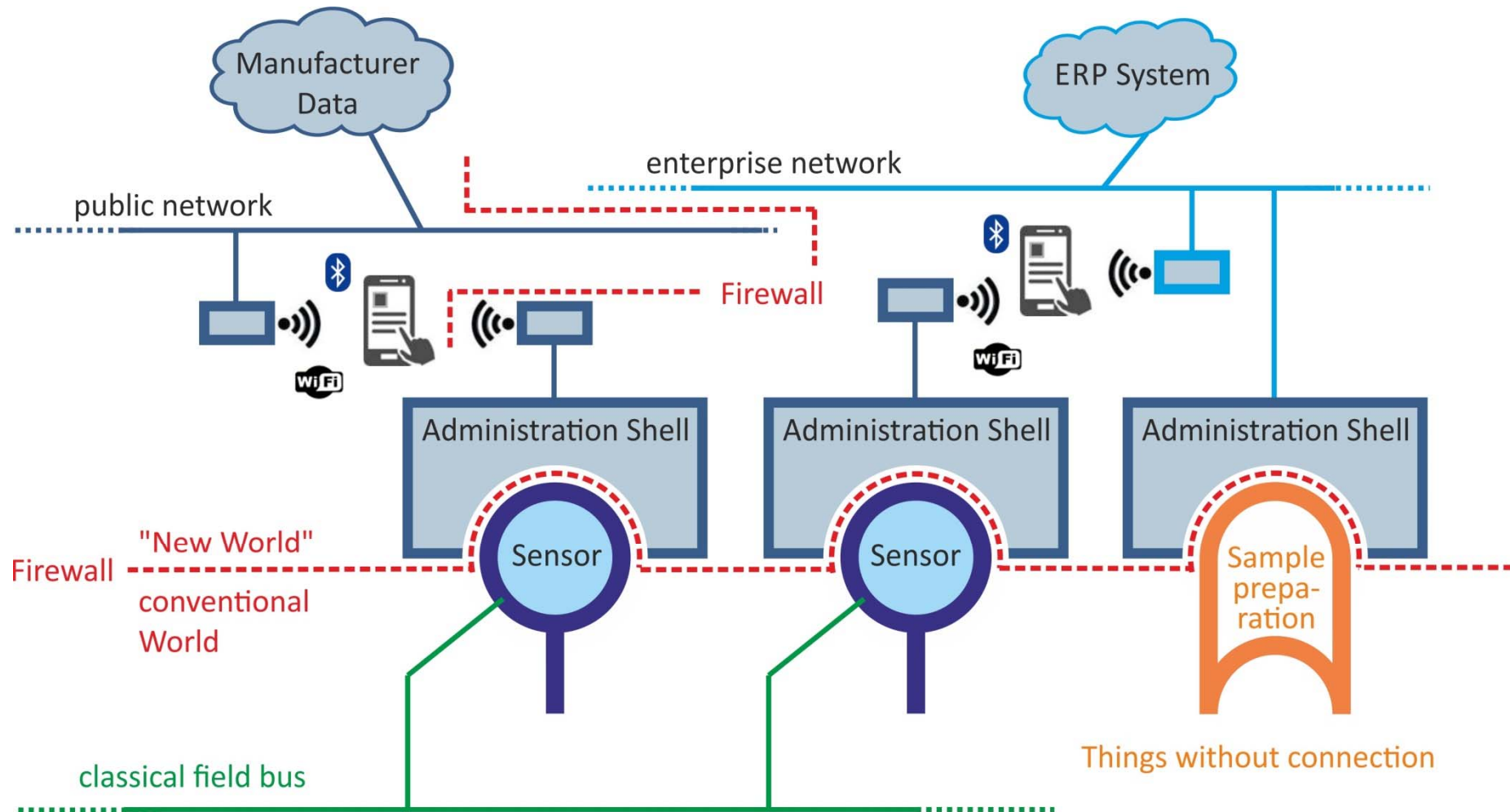

Perspectives IV

From Lousy Interfaces to "Industrie 4.0"

Use of Runtime Environments

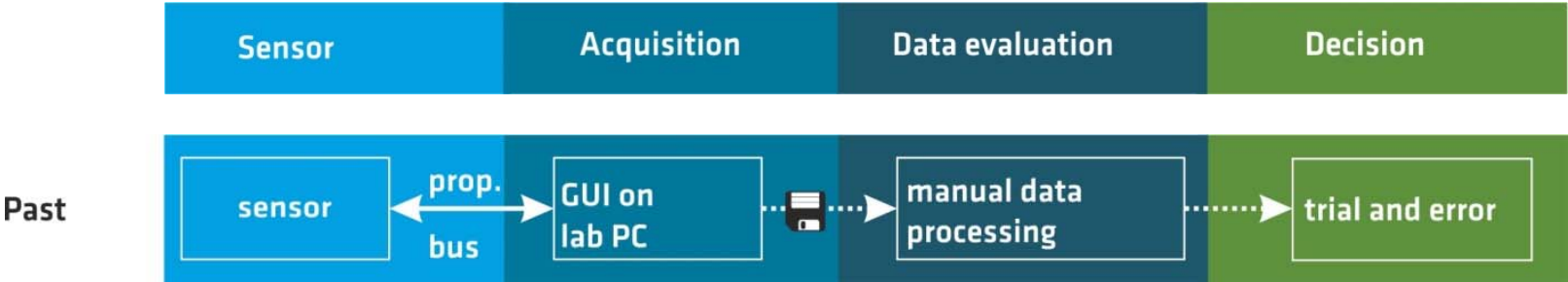

Perspectives IV



From Lousy Interfaces to "Industrie 4.0"

Use of Runtime Environments

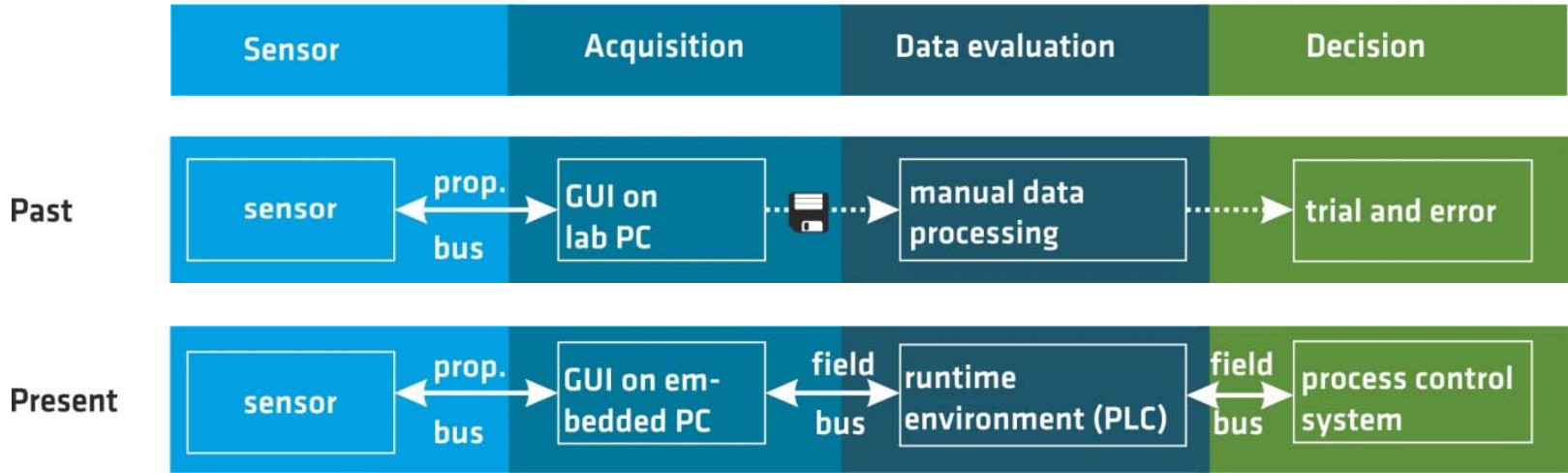

Perspectives IV



From Lousy Interfaces to "Industrie 4.0"

Use of Runtime Environments

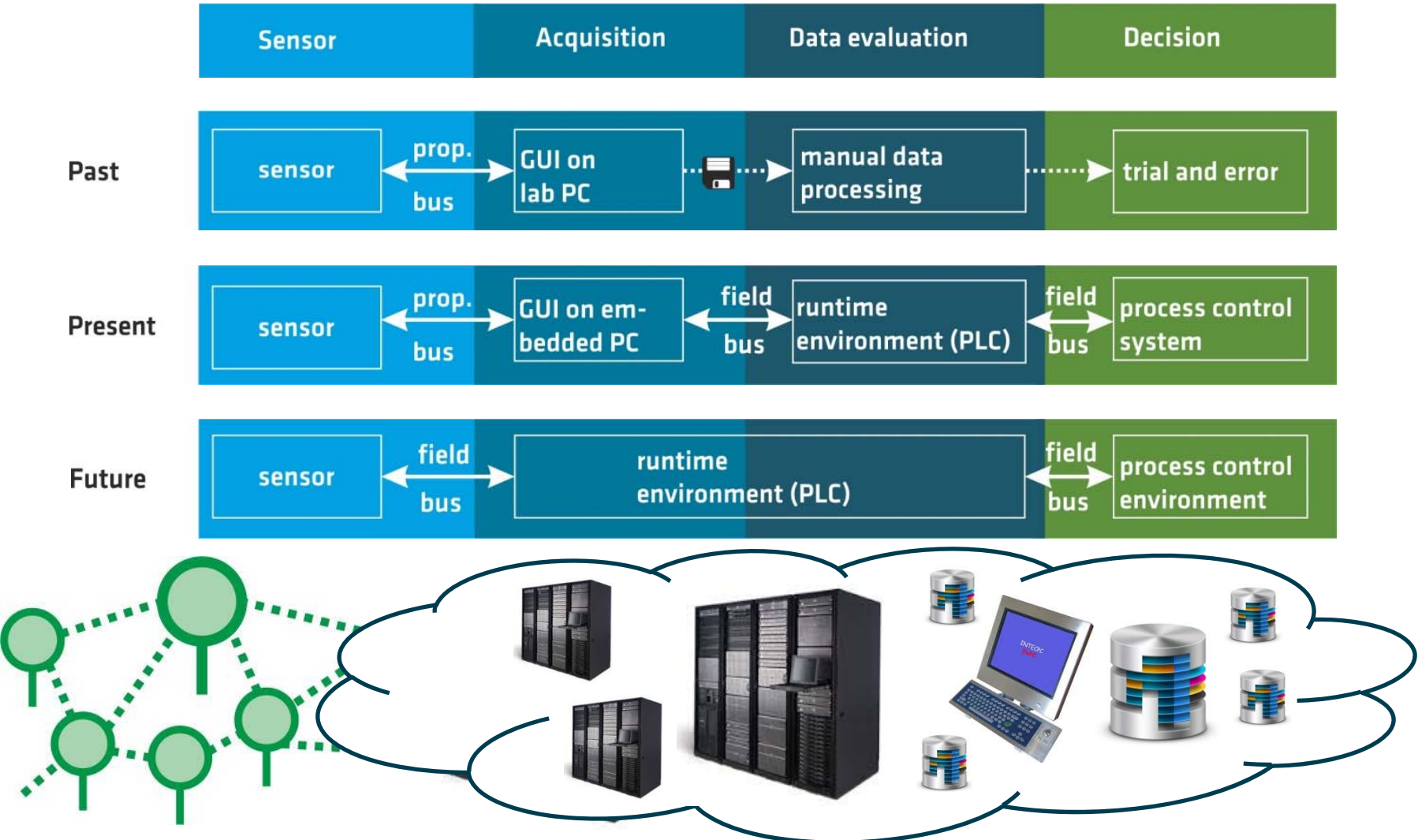

Example

CONSENS: Smart Online NMR Sensor
for Advanced Process Control

Process Analytical Technology for Intensified Processes



Examples from BAM, Berlin

Trends. Anal. Chem.
83 (2015) 39–52



Catalysis:
Hydroformylations of C12-alkenes
in micro emulsions

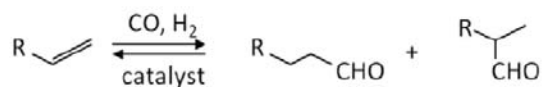

Alkene n-Aldehyde iso-Aldehyde

Meas. Sci. Technol. 28 (2017) 035501 + 035502



qNMR (Metrology):
Gases and
condensed phases
up to 1000 bar

J. Magn. Reson.
275 (2017) 1–10

Pharmaceuticals:
Liberation kinetics

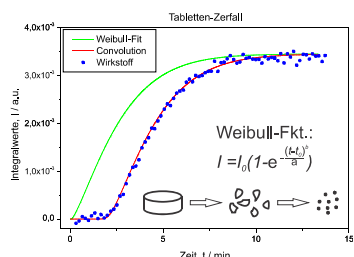

J. Mol. Structure. 1133 (2017) 18–23

CO₂ scrubbing

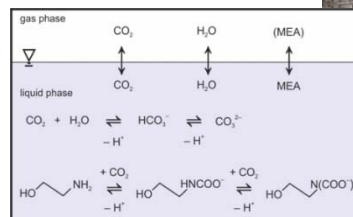

Klas Meyer, PhD
Humboldt University, Berlin, 2016

Method development:
Esterifications
(model reactions)

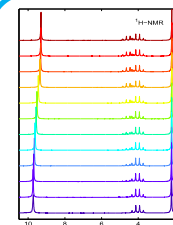

J. Magn. Reson. 249 (2014), 53–62
Magn. Reson. Chem. 54 (2016) 513–520

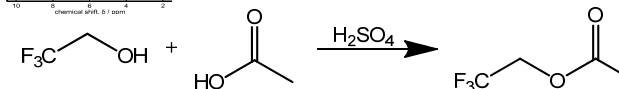

Catalysis:
Hydrogenations

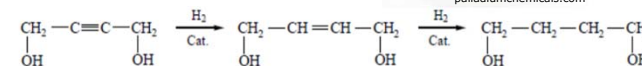

palladiumchemicals.com

Reaction Engineering:
Lithiation reactions

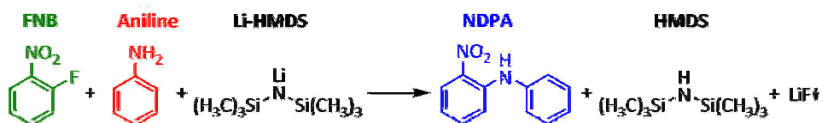
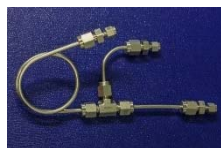

Reaction Engineering:
Photo reactions („click chemistry“)

J. Magn. Reson. 277 (2017) 154–161

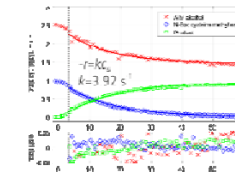
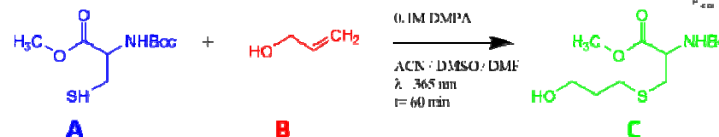

Continuous Lithiation Reaction Set-up

Flexible Intensified Continuous Plant

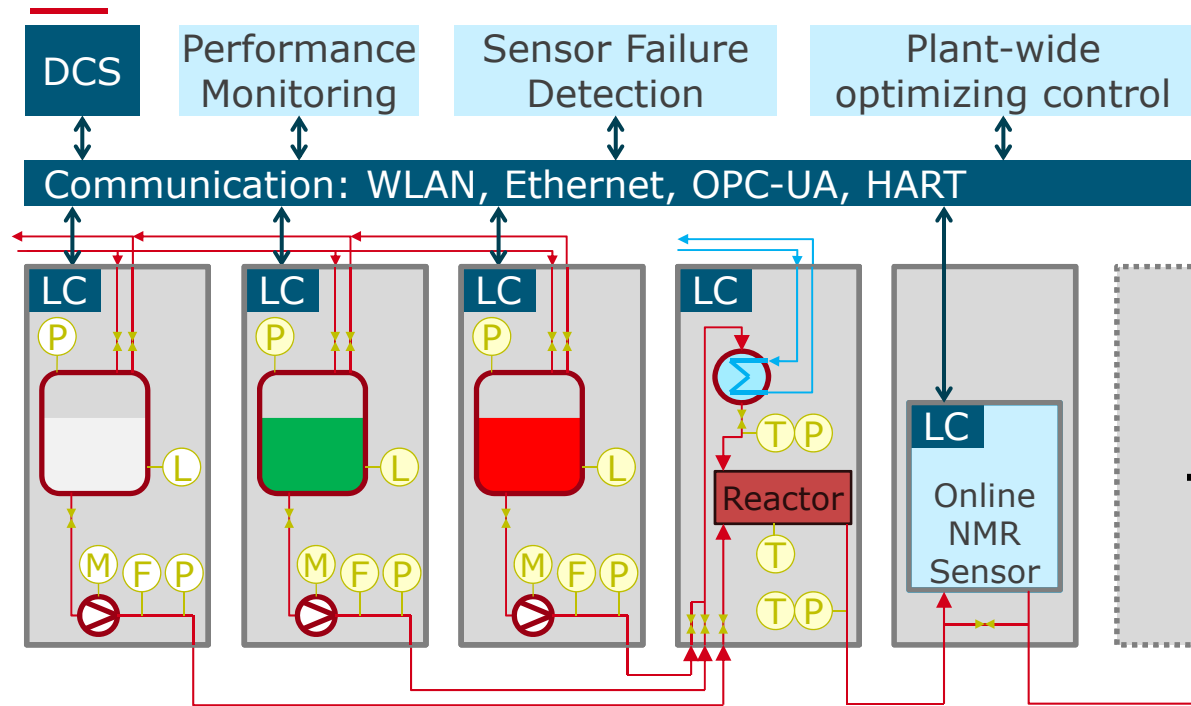

Containerized modular plant
Source: INVITE GmbH

- Standardized plant modules
- "Plug & Produce"
- Miniaturized flexible equipment
- Local control (LC)

- Fast and complex exothermic reaction
- Hazardous and inflammable substances
→ Explosion protection!
- Prone to fouling & clogging
- Multi-objective constrained optimization

Example: Lithiation reaction

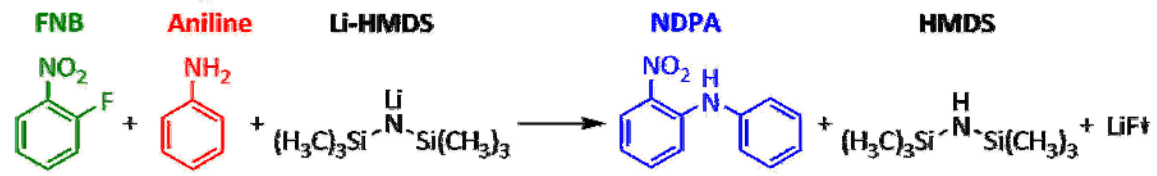

Conventional and Smart Functions



Enabling Runtime Environments



- Fail-safe Functions:**
- Leakage control
 - Temperature
 - Sample Pressure

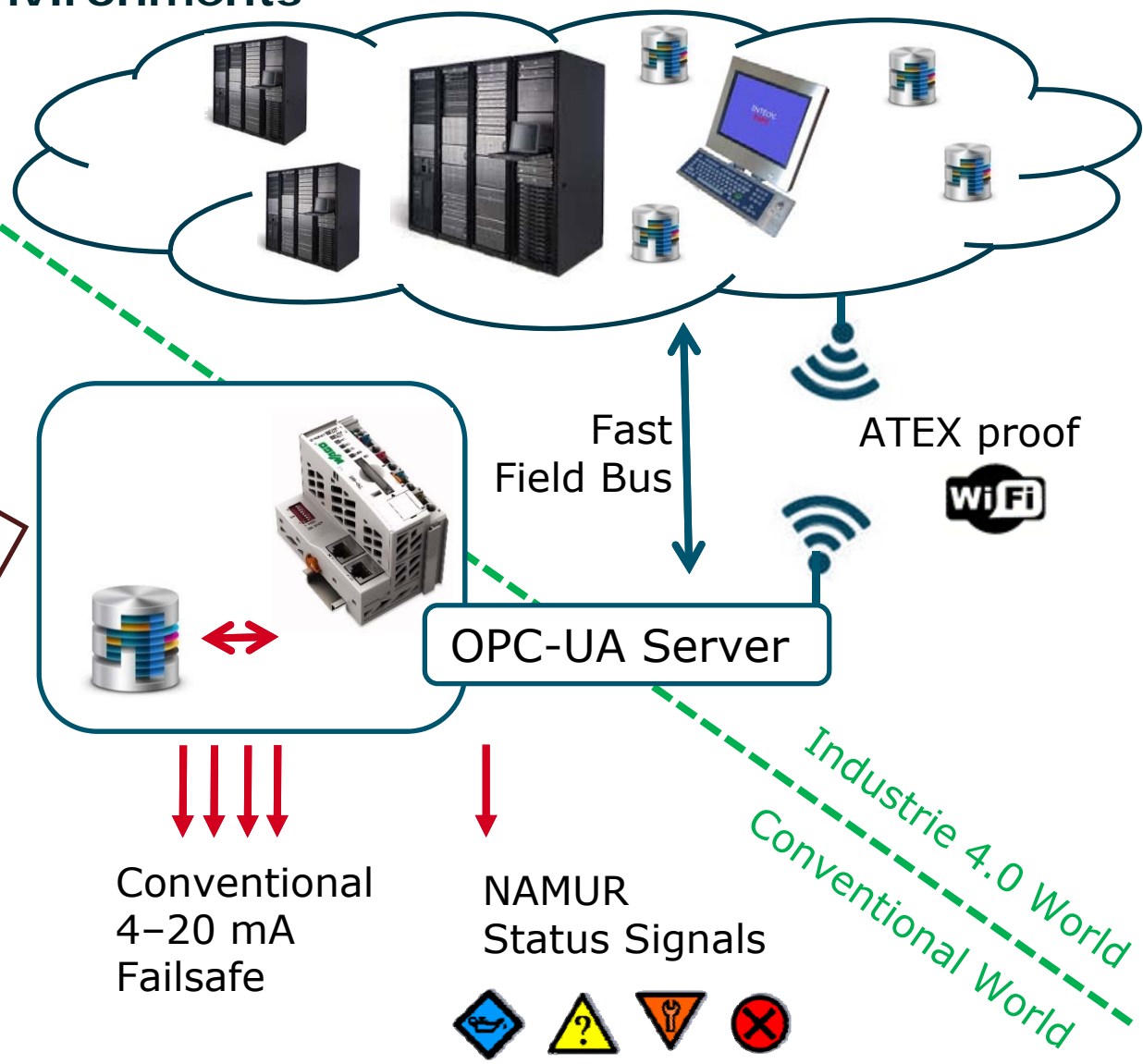

Reaction Monitoring in Lab-scale at BAM

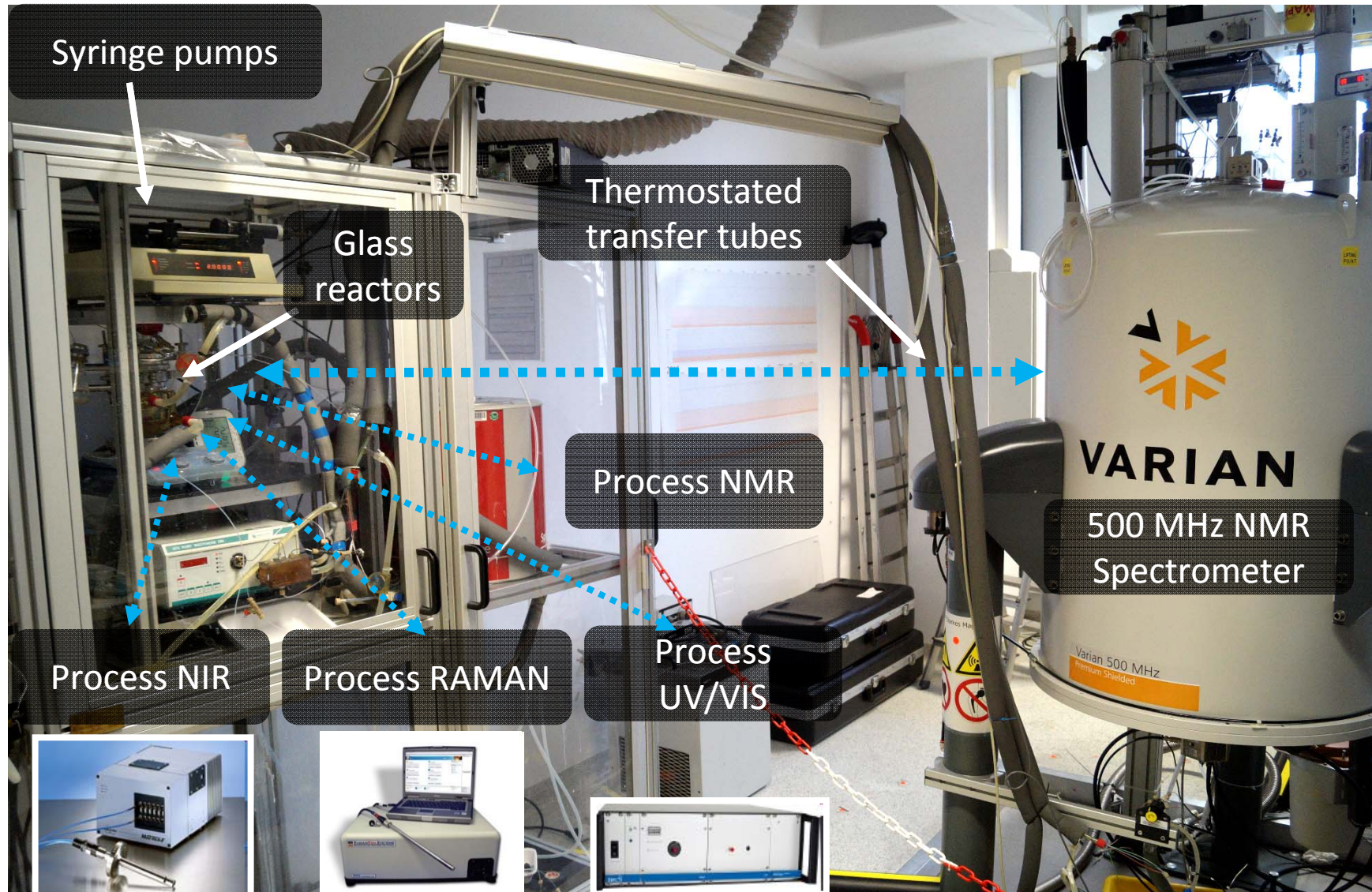

Nuclear Magnetic Resonance (NMR)

Direct Comparison Method → Calibration Free!

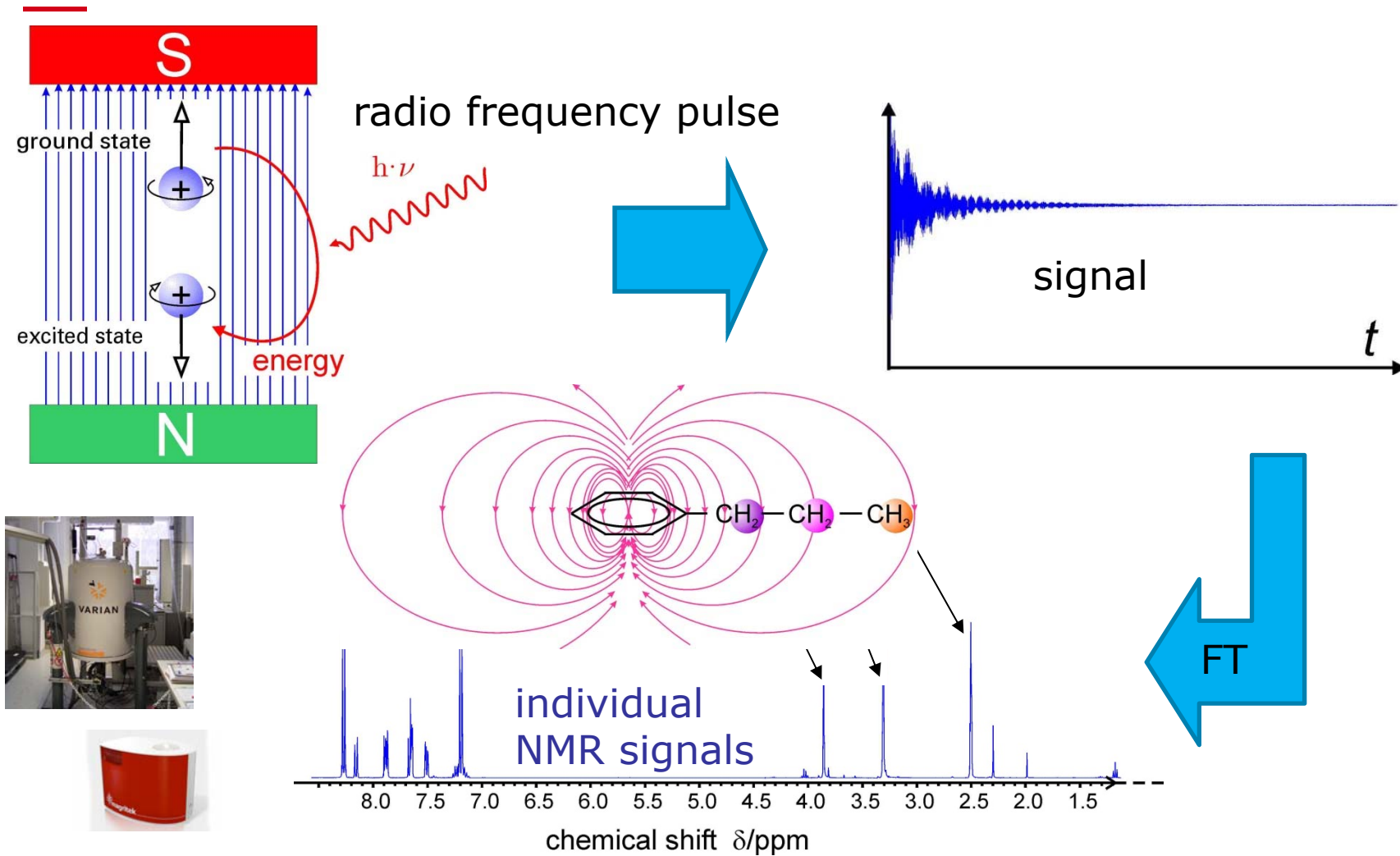

Proton NMR Spectra 500 MHz vs 43 MHz

Lab Experiments in Batch Along Reaction Co-ordinate

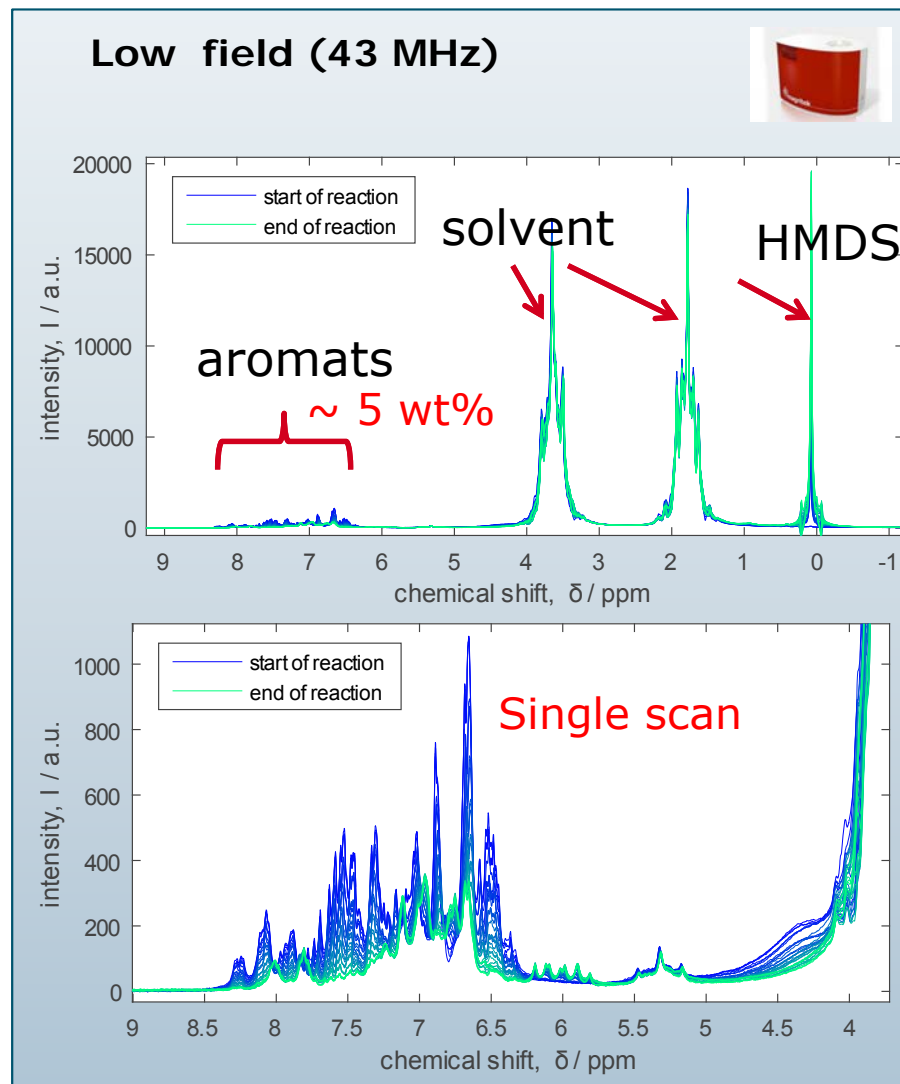
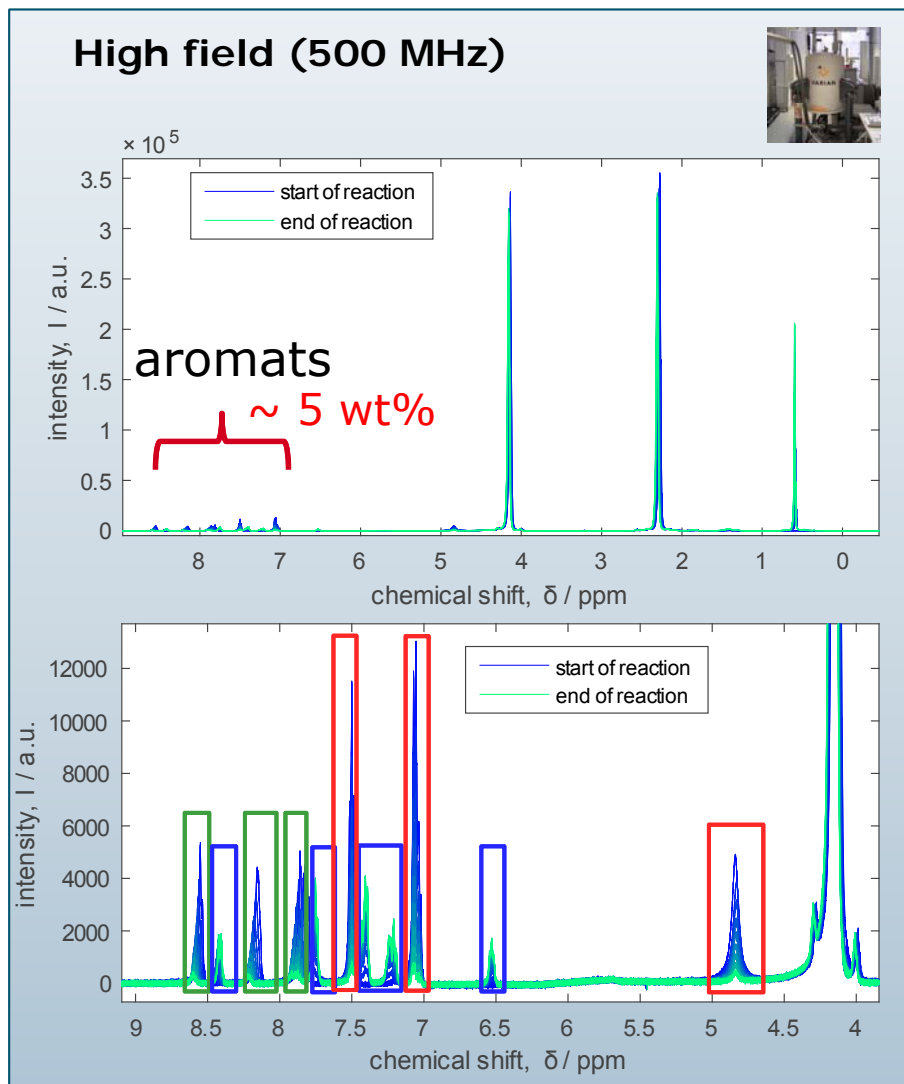

Data Processing for Low-field NMR in Matlab

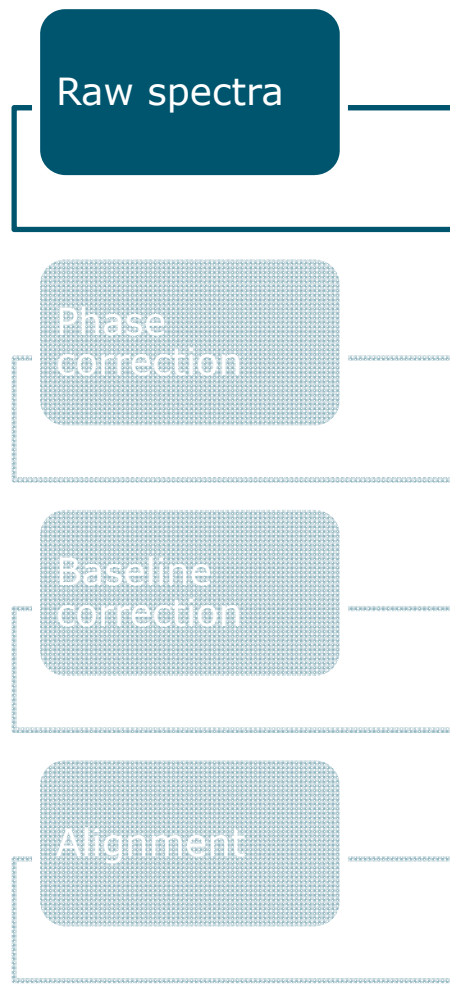

single scan
each 15s
in flow

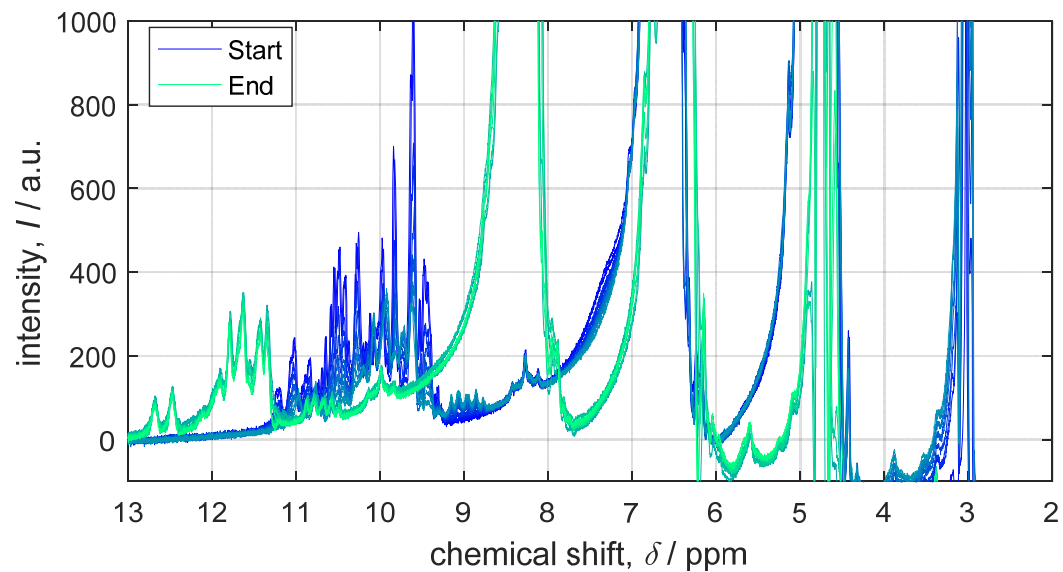
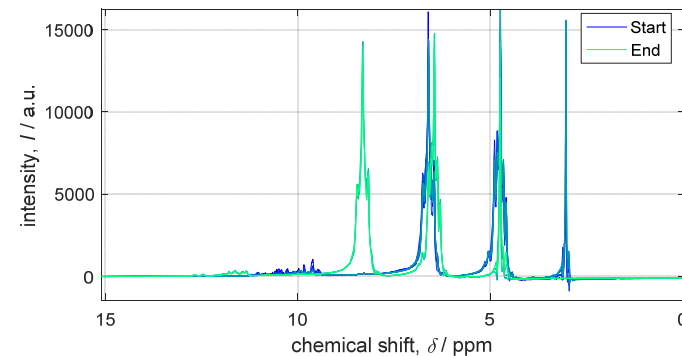

Data Processing for Low-field NMR in Matlab

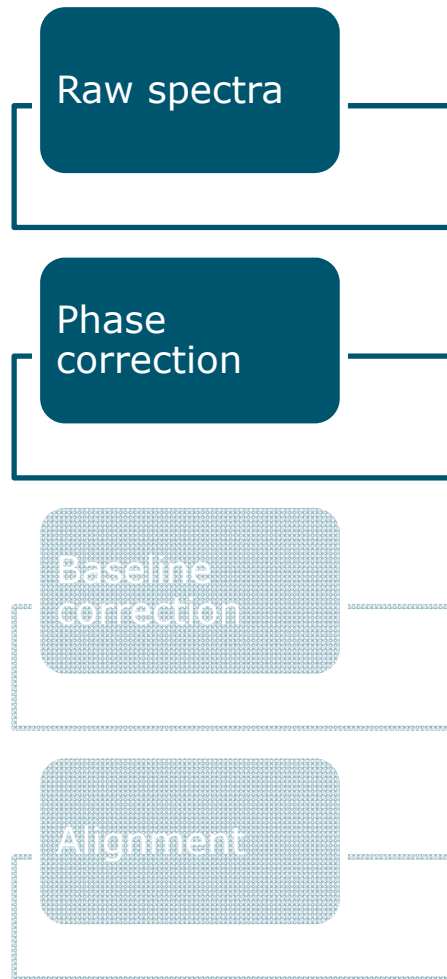

Entropy minimization method:

Chen et al., J Magn Reson. 2002, 158, 164-168

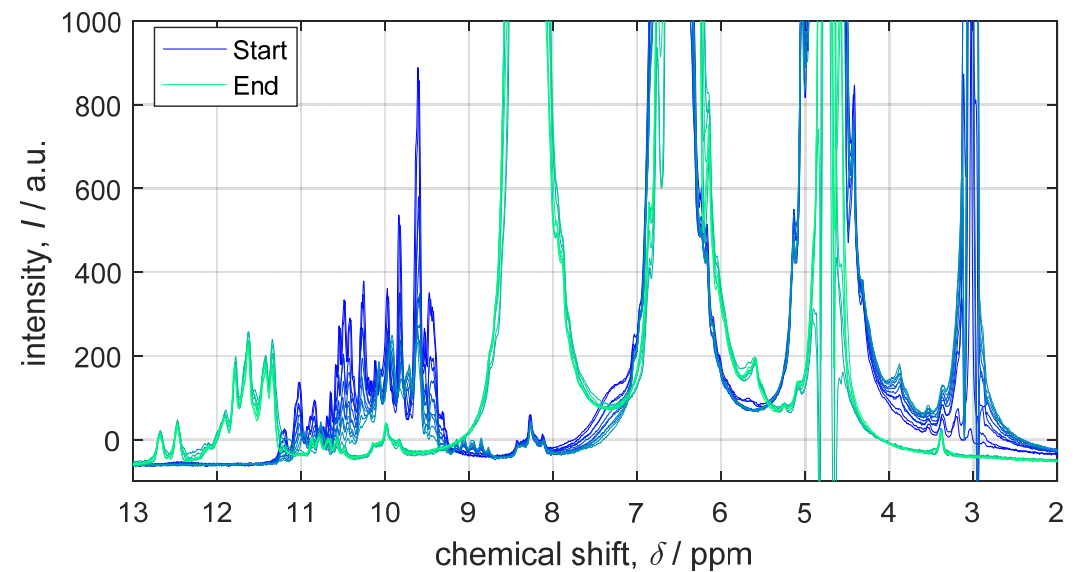
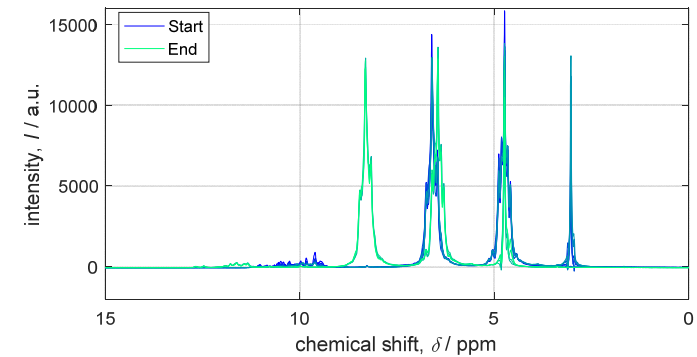

Data Processing for Low-field NMR in Matlab

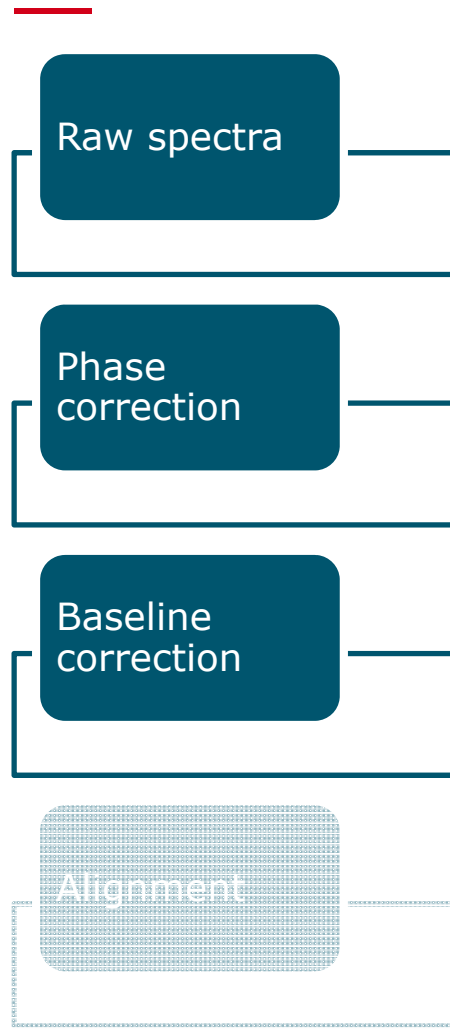

Low-order Polynomial fit:
Mazet et al., Chemometrics
Intell. Lab. Sys. **2005**, *76*,
121-133.

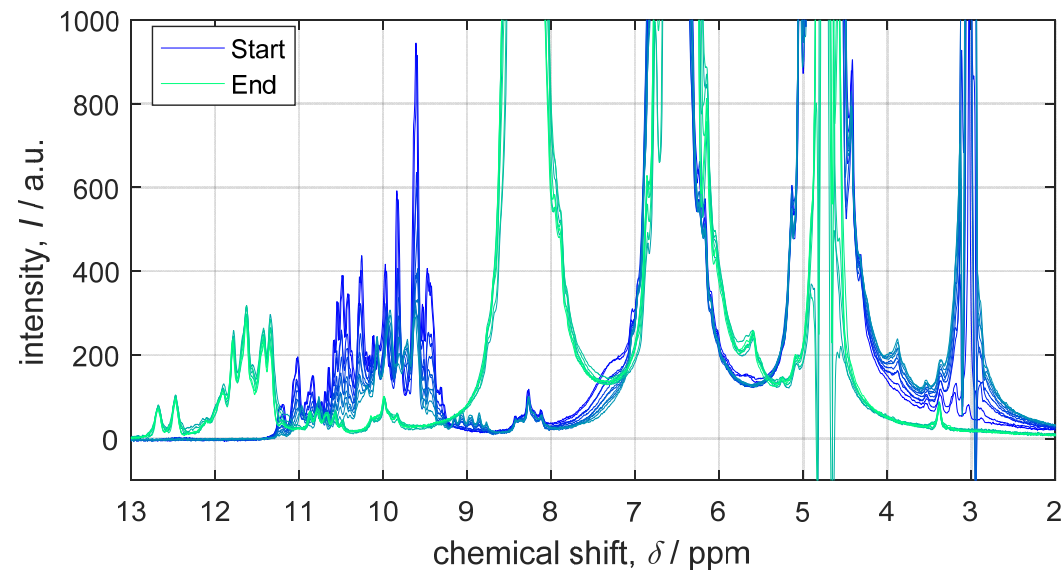
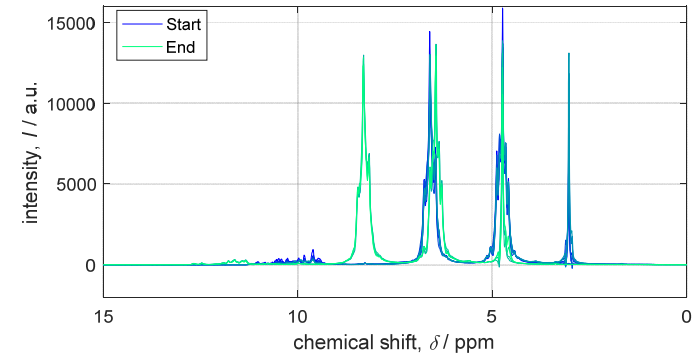

Data Processing for Low-field NMR in Matlab

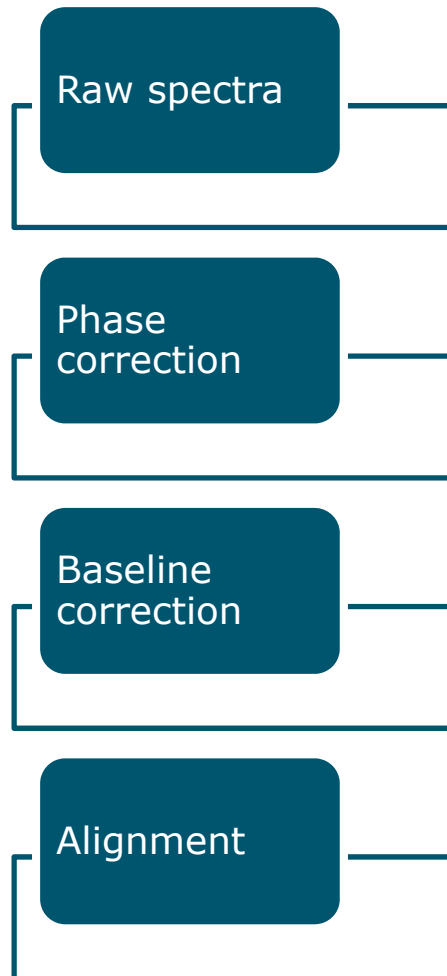

Alignment to reference signal (THF) using *icoshift*:

Savorani et al., J Magn Reson. 2010, 2, 190-202

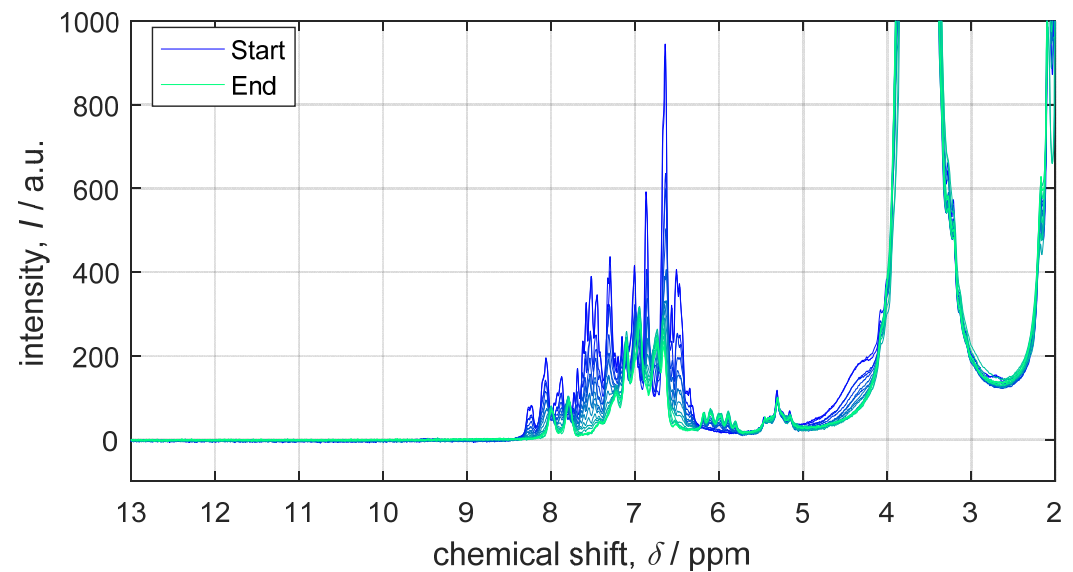
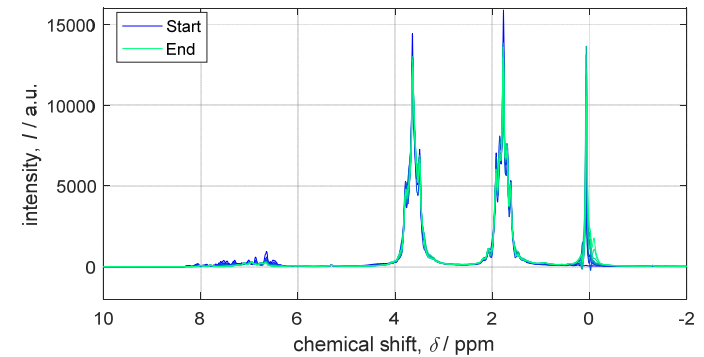

Indirect Hard Modeling (IHM)

- Modeling → peak fitting of pure component spectra → mixture model
- Analysis → “component fitting” → calculation of component area

- Group of peaks represent pure component spectra

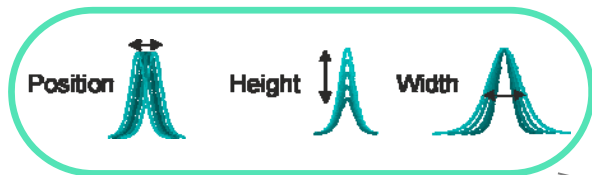

- Pseudo-Voigt function

$$V = \alpha \left[\beta \cdot \exp\left(-\ln(2) \frac{(x - \delta)^2}{\gamma^2}\right) + (1 - \beta) \frac{\gamma^2}{(x - \delta)^2 + \gamma^2} \right]$$

- α = peak maximum
- β = Gaussian-Lorentzian-ratio
- γ = half width
- δ = center position

Hard model for pure components

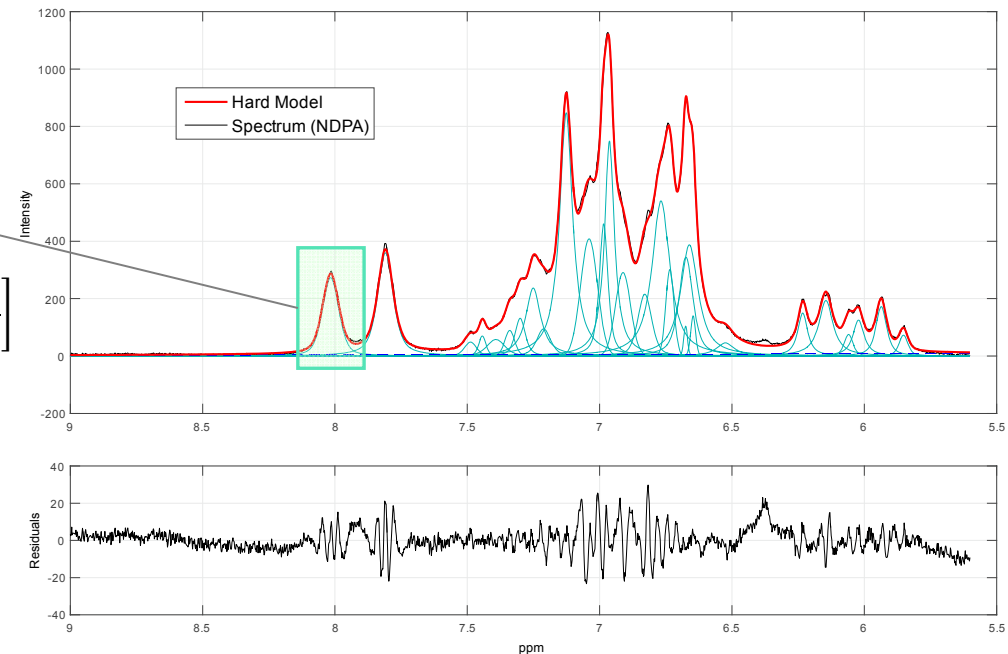

IHM – „Model Building“

Assignment of NMR Signals to Pure Components

Pure component models

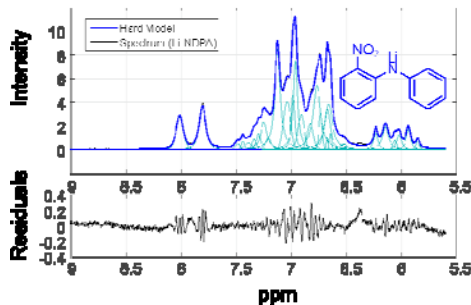
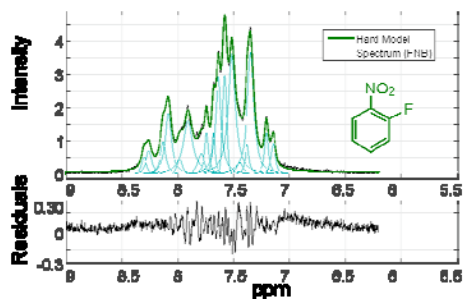
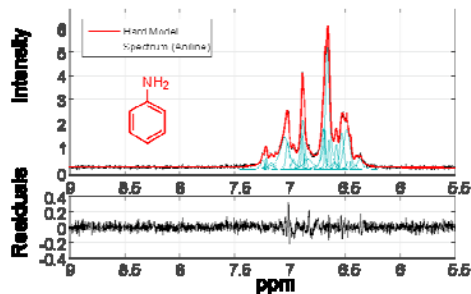

Mixture model

Component fitting

Experimental Spectrum

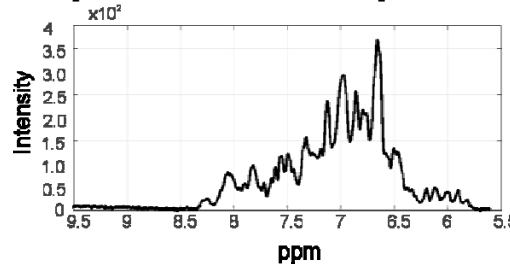

Modeling → Mixture model

No. components	3
Peaks per component	22, 21, 28
Degree of freedom (total free parameters)	292
Considered interacting peaks	25
Max. peak shift	0.01 ppm
...	...

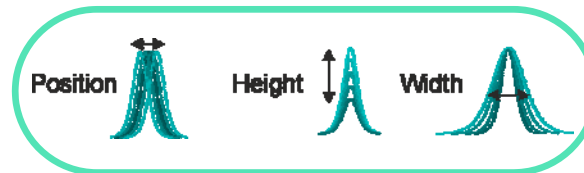

Peak area ratio for each pure component model is kept constant!

IHM – „Component Fitting“

Interpretation of Experimental Data with Pure Components

Pure component models

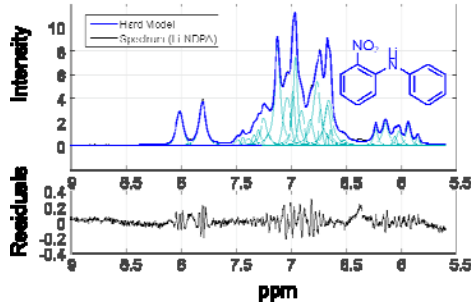
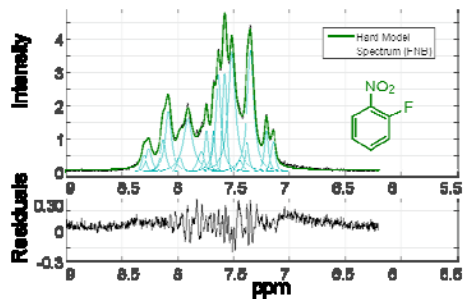
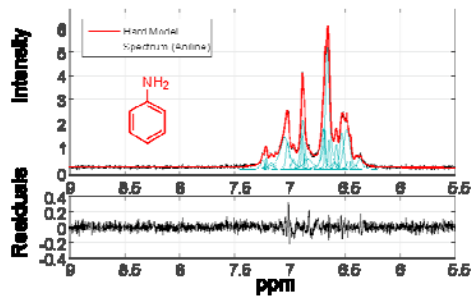

Analysis "component fitting"

Mixture model

Component fitting

Experimental spectrum

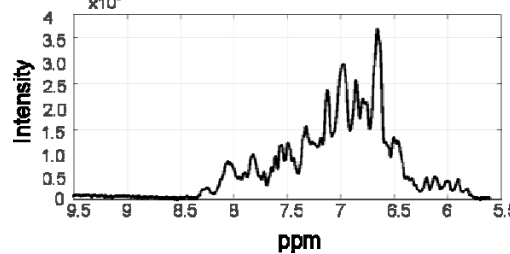

Deconvoluted spectrum

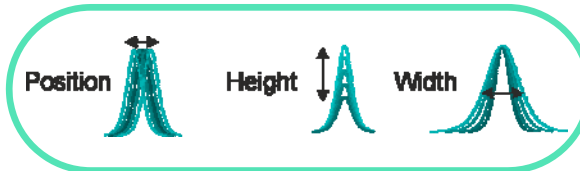
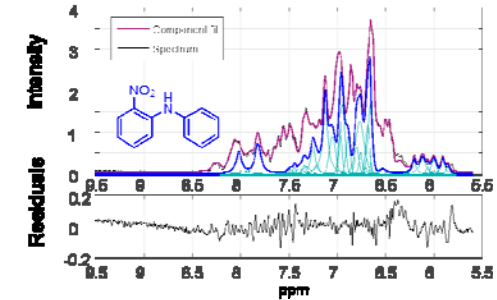
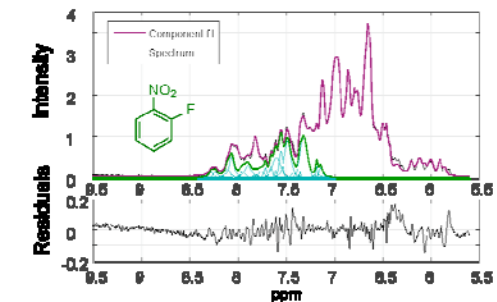
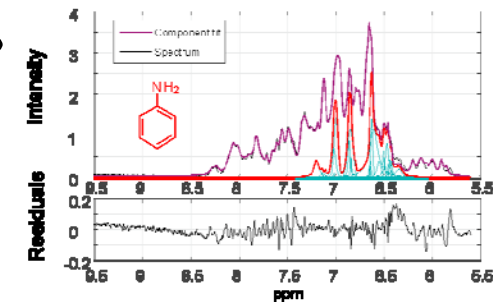

Model Building: IHM and PLS-R

Lab Experiments in Batch Along Reaction Co-ordinate

Validation with HF-NMR

IHM = Indirect Hard Modeling; PLS-R = Partial Least Squares Regression

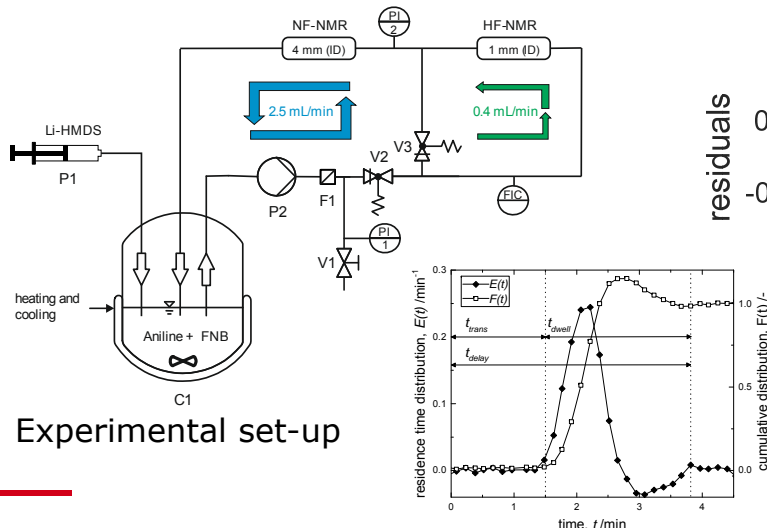
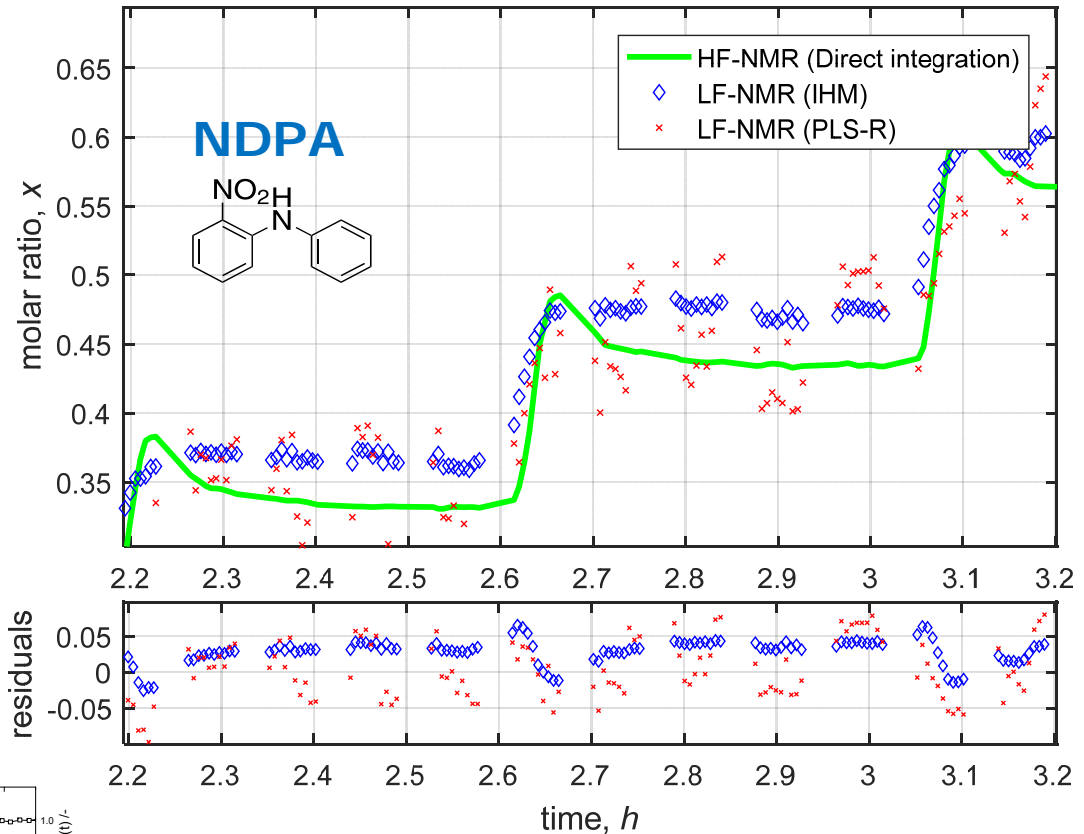
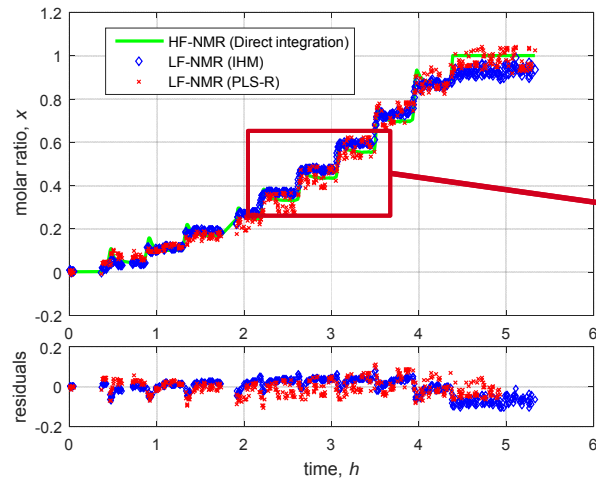

Experimental set-up

RTD of high field NMR
(Back-mixing)

Results: Reaction Characterization

Lab Experiments in Batch along Reaction Co-ordinate

3 semi-batch reaction with varying starting concentrations

1500 Spectra for each HF- and NF-NMR

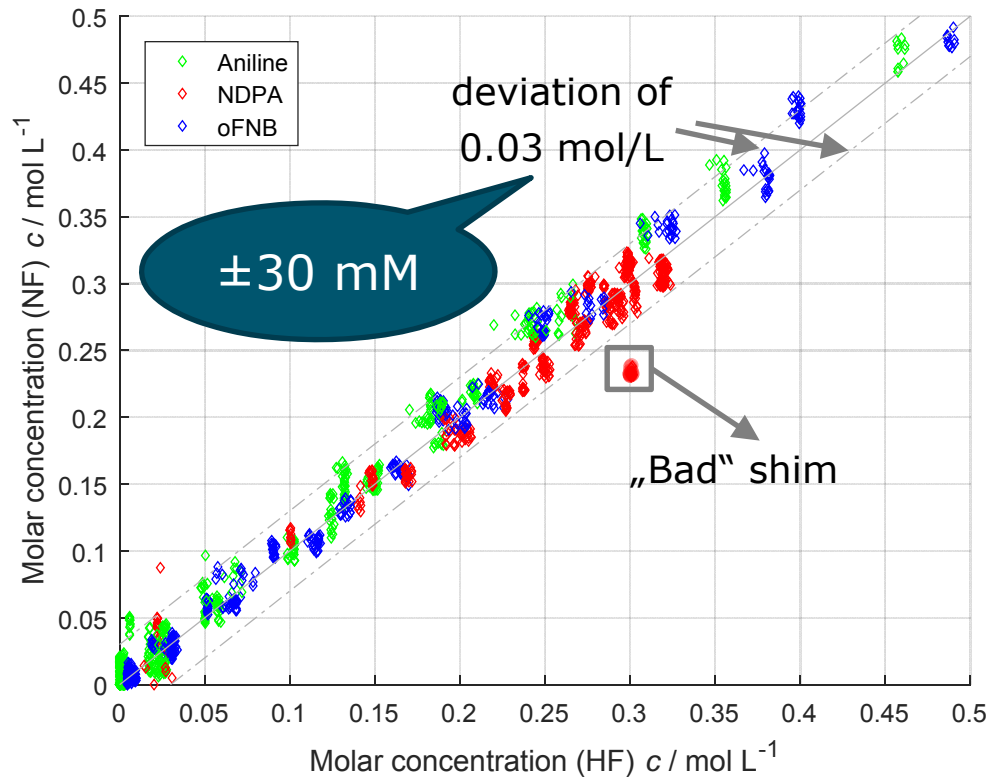

Classification of steady states

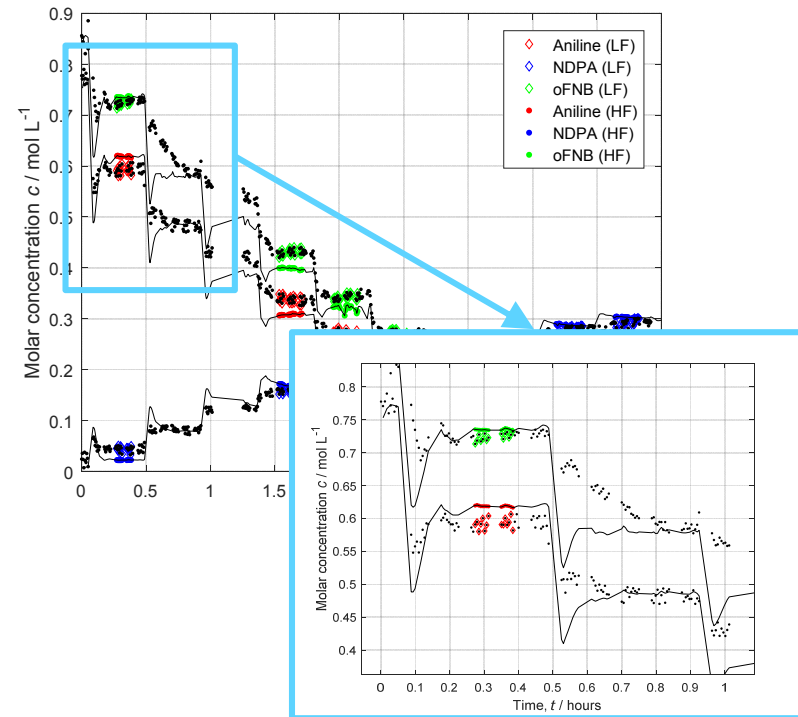

Reaction Scheme:

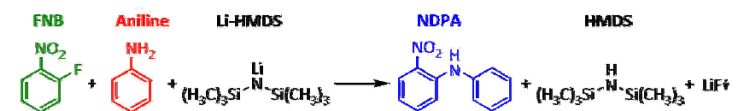

Validation of Lab Experiments in Tube Reactor

Continuous Lithiation Reaction Set-up at BAM

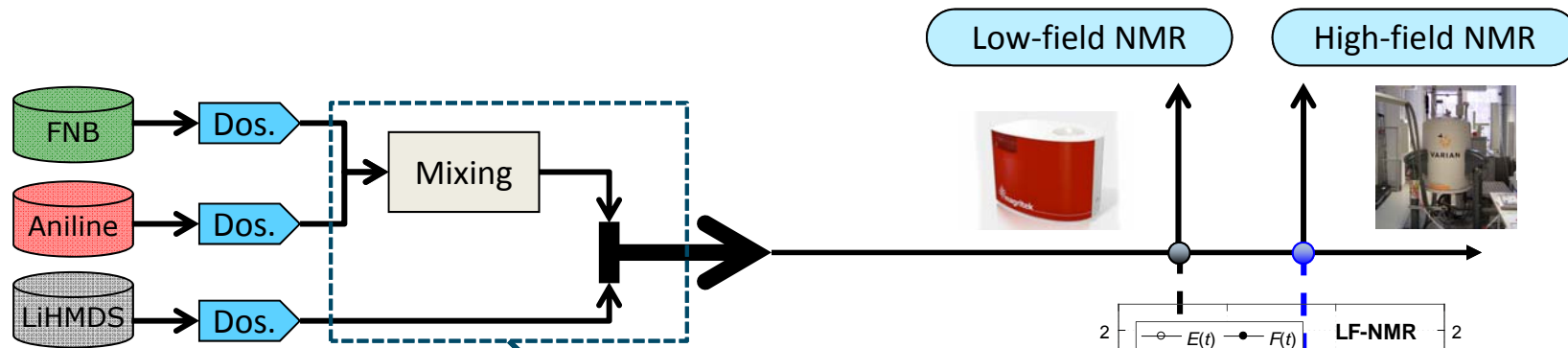

1/8" tube reactor

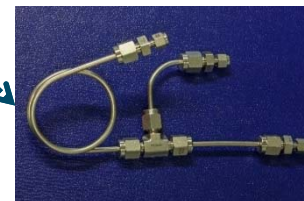

Step tracer experiments

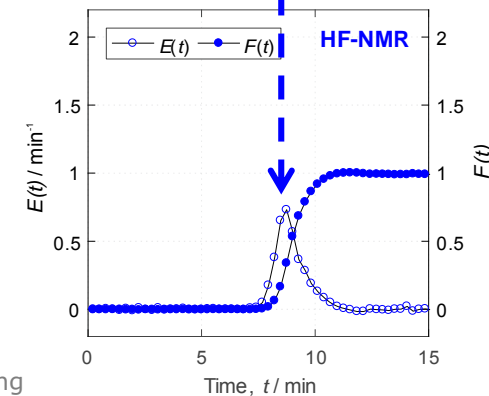
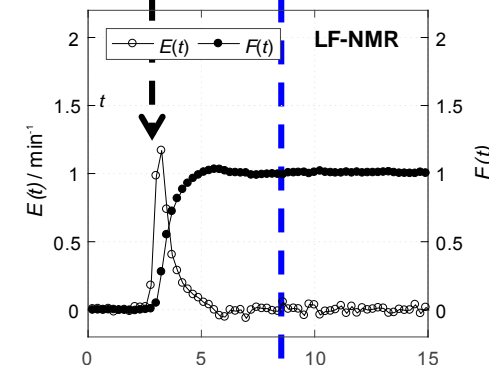
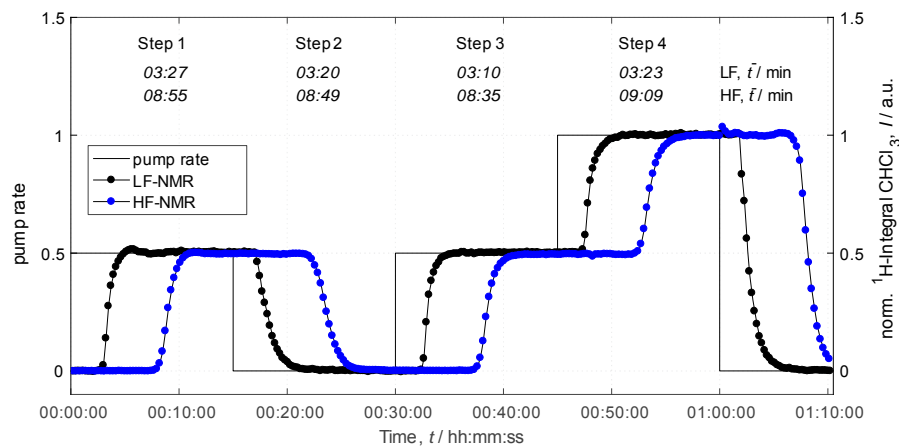

Experimental Design

Continuous Lithiation Reaction Set-up at BAM

- Independent variation of flowrates / stoichiometric conditions

Reaction Scheme:

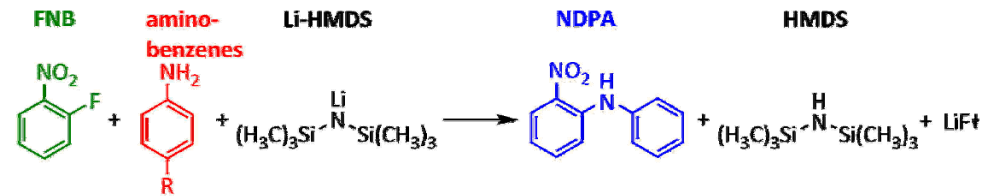

Coarse variation:

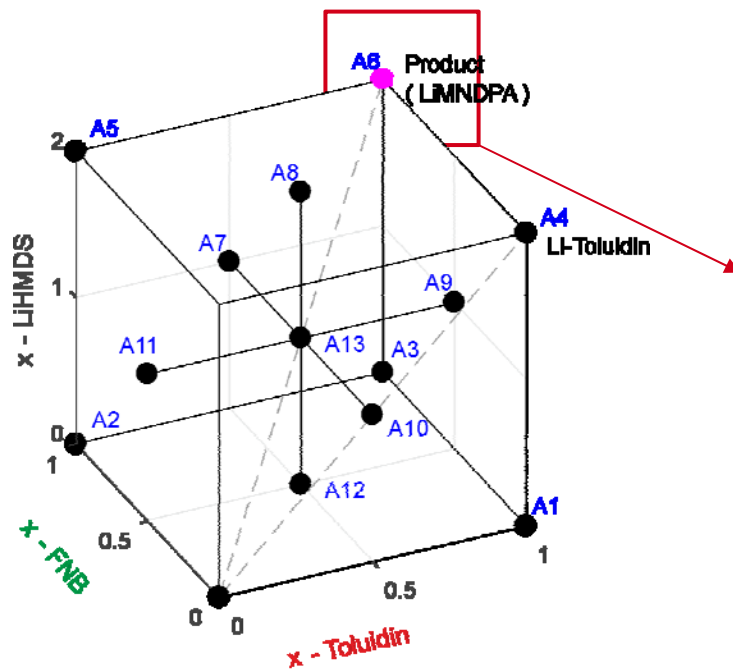

Fine variation:

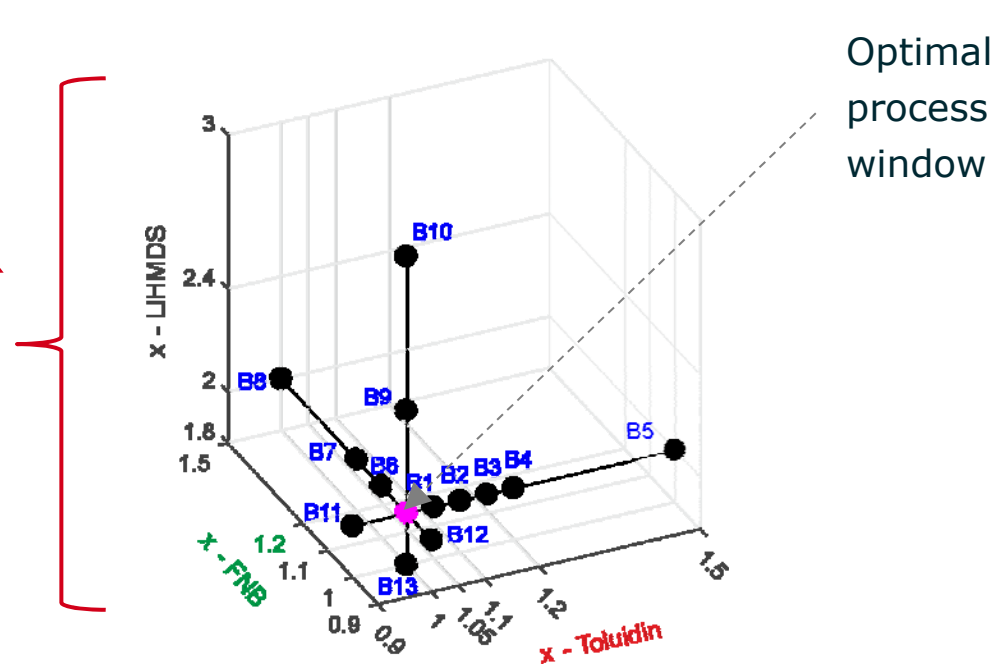

Validation Instead of Calibration

Variation of Set-Points according to Experimental Design

Low-Field versus High-Field NMR Spectroscopy

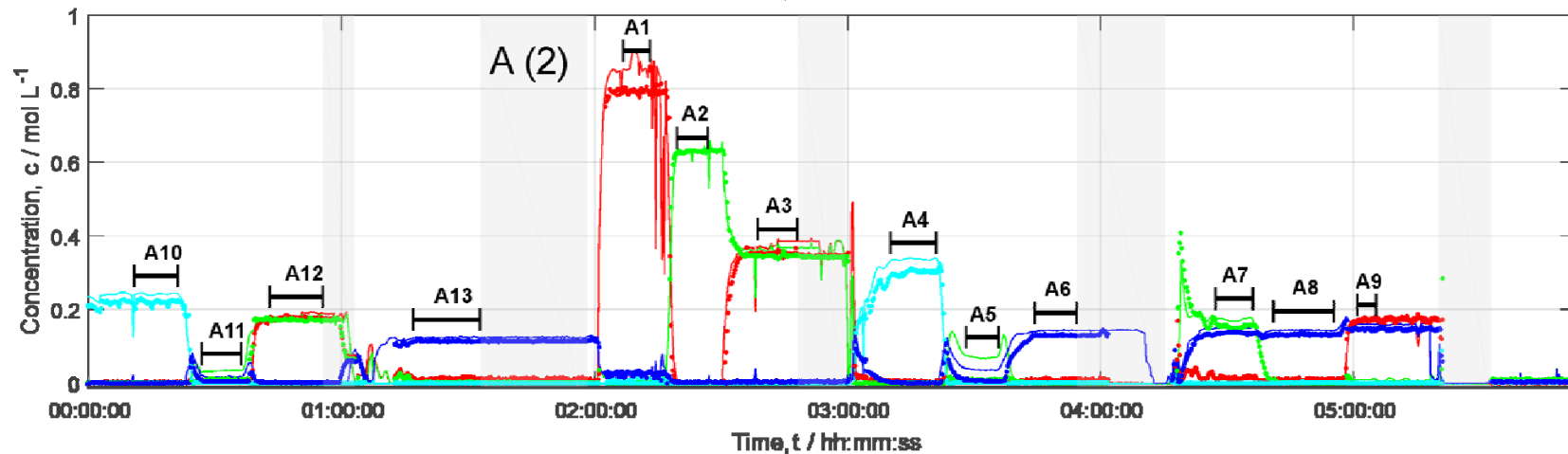
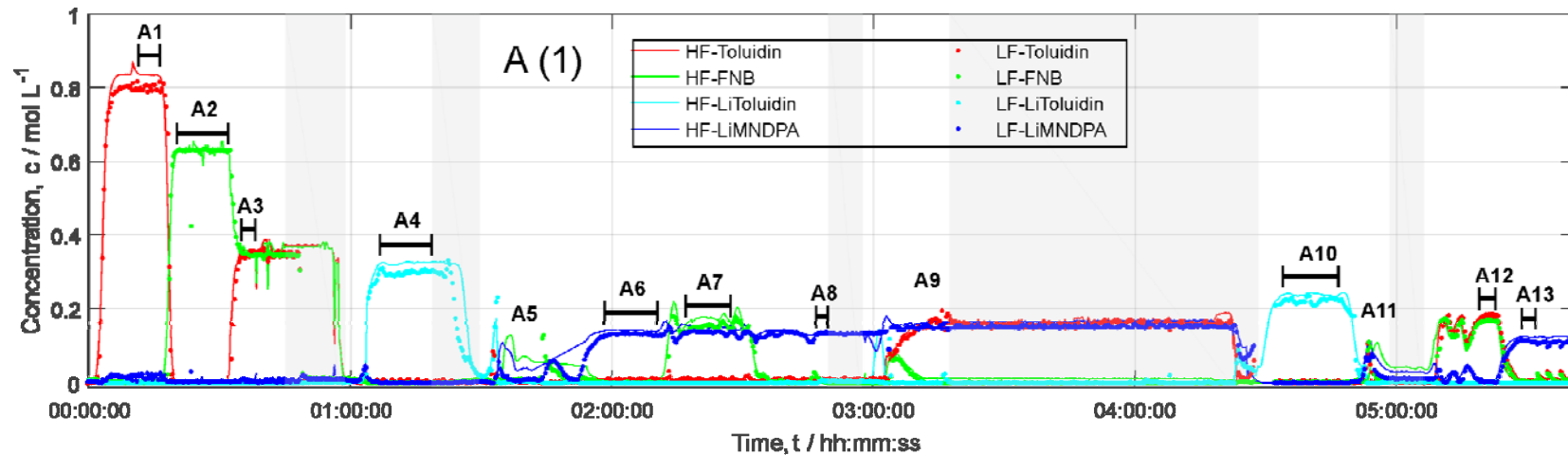

Validation Instead of Calibration

Variation of Set-Points according to Experimental Design

Low-Field versus High-Field NMR Spectroscopy

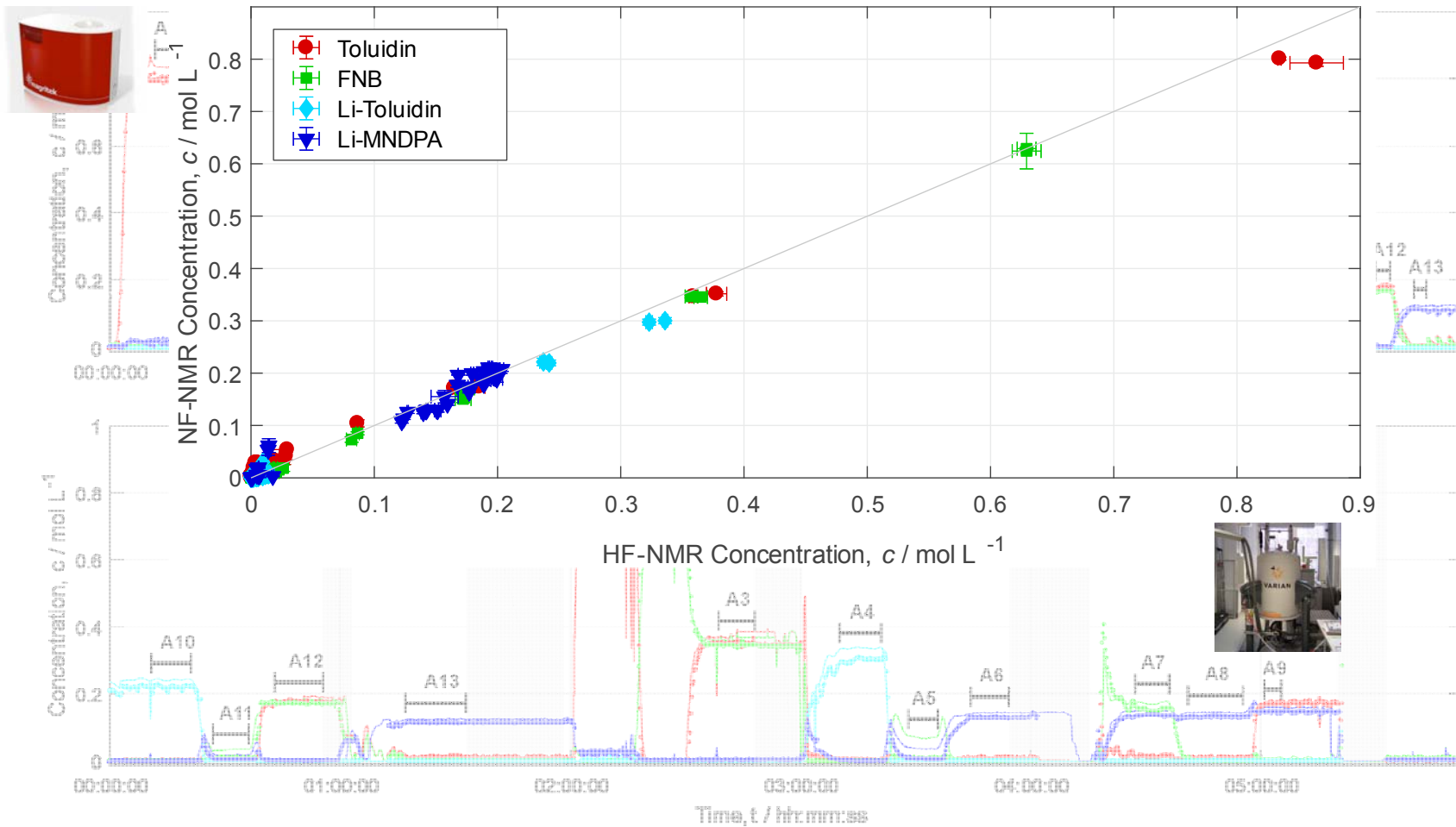

Example: Smart Online NMR Sensor Validation at Bayer/INVITE in Leverkusen

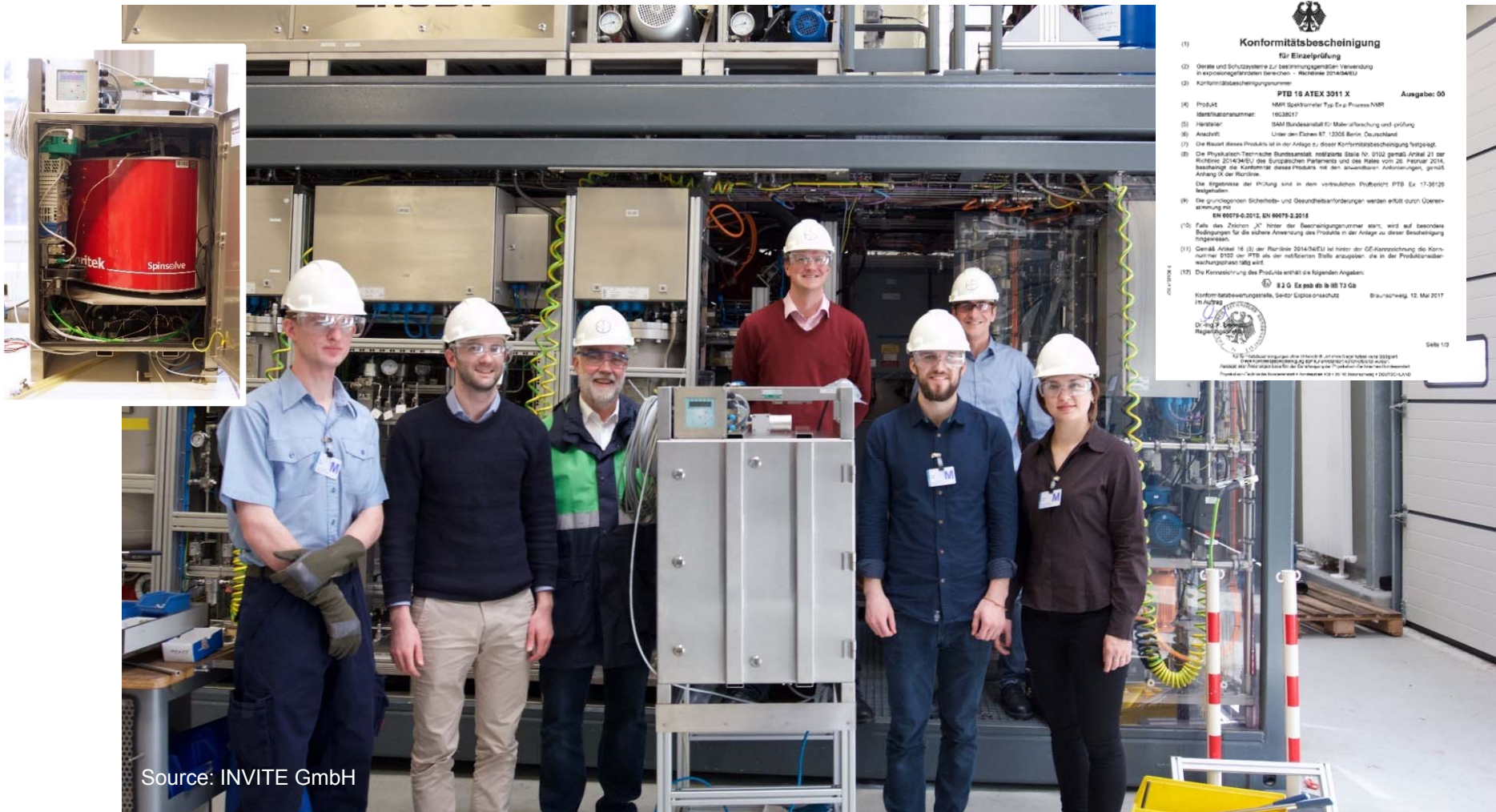

Source: INVITE GmbH



VDE

VDI/VDE-Gesellschaft
Mess- und Automatisierungstechnik



Thank You!

Jürgen Kolz

Ullrich Koch

Juan Perlo

Mike Bernstein

Magritek

Magritek

Magritek

MestreLab

Harald Pape

Clemens Minnich

Dirk Engel

NAMUR Roadmap Team

PTB

S-Pact

S-Pact

CONSENS – Integrated Control and Sensing for Sustainable Operation of Flexible Intensified Processes, funded by the European Union’s Horizon 2020 research and innovation programme under grant agreement N° 636942;
www.consens-spire.eu

THIS DOCUMENT IS PROVIDED "AS IS" WITH NO WARRANTIES WHATSOEVER, INCLUDING ANY WARRANTY OF MERCHANTABILITY, NONINFRINGEMENT, FITNESS FOR ANY PARTICULAR PURPOSE, OR ANY WARRANTY OTHERWISE ARISING OUT OF ANY PROPOSAL, SPECIFICATION OR SAMPLE.

Any liability, including liability for infringement of any proprietary rights, relating to use of information in this document is disclaimed. No license, express or implied, by estoppels or otherwise, to any intellectual property rights are granted herein. The members of the project CONSENS do not accept any liability for actions or omissions of CONSENS members or third parties and disclaims any obligation to enforce the use of this document. This document is subject to change without notice.

13. Kolloquium

21. und 22. November 2017 · Esslingen
mit Opening-Session am 20.11.2017

Themenschwerpunkt

**Prozessführung in der modernen
Produktion**

Brückenschläge von der Fertigungstechnik
zur Industrie 4.0



Veranstalter



Mit Unterstützung von FESTO AG & Co. KG und GDCh

FESTO



GESELLSCHAFT DEUTSCHER CHEMIKER



20.-22. November 2017
Esslingen bei Stuttgart

Themenschwerpunkt

**„Prozessführung in der
modernen Produktion –
Brückenschläge von der
Fertigungstechnik
zur Industrie 4.0“**

<http://arbeitskreis-prozessanalytik.de>