

# SCIENTIFIC REPORTS



OPEN

## Assuring quality in microplastic monitoring: About the value of clean-air devices as essentials for verified data

Charlotte Wesch<sup>1</sup>, Anna Maria Elert<sup>2</sup>, Manuel Wörner<sup>1</sup>, Ulrike Braun<sup>2</sup>, Roland Klein<sup>1</sup> & Martin Paulus<sup>1</sup>

Avoiding aerial microfibre contamination of environmental samples is essential for reliable analyses when it comes to the detection of ubiquitous microplastics. Almost all laboratories have contamination problems which are largely unavoidable without investments in clean-air devices. Therefore, our study supplies an approach to assess background microfibre contamination of samples in the laboratory under particle-free air conditions. We tested aerial contamination of samples indoor, in a mobile laboratory, within a laboratory fume hood and on a clean bench with particles filtration during the examining process of a fish. The used clean bench reduced aerial microfibre contamination in our laboratory by 96.5%. This highlights the value of suitable clean-air devices for valid microplastic pollution data. Our results indicate, that pollution levels by microfibres have been overestimated and actual pollution levels may be many times lower. Accordingly, such clean-air devices are recommended for microplastic laboratory applications in future research work to significantly lower error rates.

A high degree of quality assurance is a fundamental requirement to ensure global comparability of research results. However, well-established quality assurance schemes for microplastic (<5 mm)<sup>1</sup> investigations, including all steps of sampling, processing and analysis, are missing. This may be attributed to a lack of quality-tested long term microplastic monitoring programmes<sup>2</sup>. Recently, efforts to ensure different quality criteria have been put forward but are still in their initial stages and not broadly applied<sup>2</sup>.

So far, existing microplastic records have highlighted the prevalence of microfibres in environmental samples<sup>3,4</sup>. Fibres are the most common microplastic type monitored in sediments<sup>5,6</sup>, surface seawaters<sup>7</sup>, aquatic biota<sup>8,9</sup> as well as atmospheric fallout<sup>10</sup> and in indoor environments<sup>11</sup>. However, recent studies report about numerous sources of analytical errors like the misidentification of synthetic fibres with artificial cellulose or lignin fibres, due to insufficient spectroscopic measurements<sup>12–14</sup>. Moreover, microfibres in environmental specimens can be confounded with post-sampling contamination in the laboratory<sup>15</sup>. Without any prevention of potential background contamination a quantification of microfibres in environmental samples remains highly questionable.

Possible sources of background contamination with microfibres are numerous and can be caused by abrasions from synthetic clothing, inexpertly cleaned laboratory equipment, plastic tools used during processing, poorly sealed specimen or ambient air<sup>16–18</sup>. Some basic precautionary measures and methods to prevent aerial microfibre contamination have been recommended in the scientific literature: Clothing made of cotton should be worn<sup>5,12,19,20</sup>, air circulation should be avoided<sup>2</sup> and work spaces and tools need to be cleaned from any particle contamination<sup>8</sup>. The general elimination of microfibres from further analyses<sup>21</sup> has also been postulated, considering all fibres to be artefacts of sample processing<sup>22,23</sup>. However, this exclusion is no longer suitable to detect microfibres in environmental samples, as it distorts the factual results of contamination<sup>15,24,25</sup>. Thus, an analytical assessment of airborne contamination levels is needed considering the laboratory-specific pollution with microfibres<sup>17</sup>. Moist filter papers in Petri dishes exposed to the laboratory air could function as control blanks during an examination process<sup>2</sup>. To avoid fibre contamination in the laboratory, hermetic enclosure devices like plastic covers and a pyramid glove box were also tested to isolate all work spaces during processing<sup>25</sup>. Besides, textile fibre contamination

<sup>1</sup>Trier University, Department of Biogeography, Universitätsring 15, 54286, Trier, Germany. <sup>2</sup>Federal Institute for Material Research and Testing (BAM), Unter den Eichen 87, 12205, Berlin, Germany. Correspondence and requests for materials should be addressed to C.W. (email: [wesch@uni-trier.de](mailto:wesch@uni-trier.de))

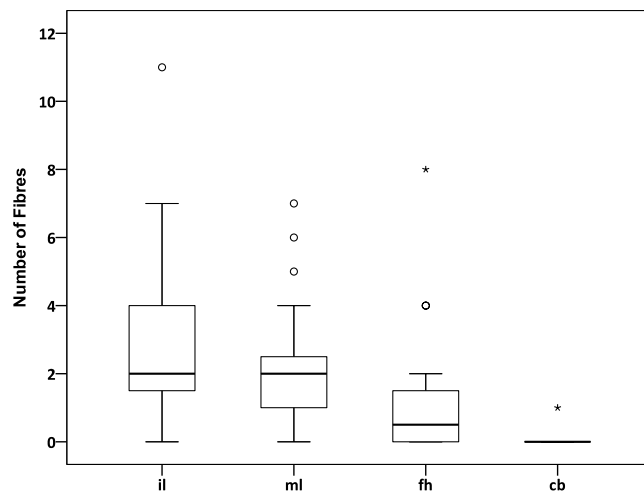

**Figure 1.** Number of aerial microfibrils monitored in the samples. The boxplots show the number of airborne fibres detected in the samples belonging to the four different setups (il = indoor laboratory; ml = mobile laboratory; fh = laboratory fume hood; cb = clean bench with particle filtration). The boxes cover the 25th and 75th percentile, including the median (horizontal line). The whiskers are set to default representing  $\pm 1.5 \times \text{IQR}$  (interquartile range).

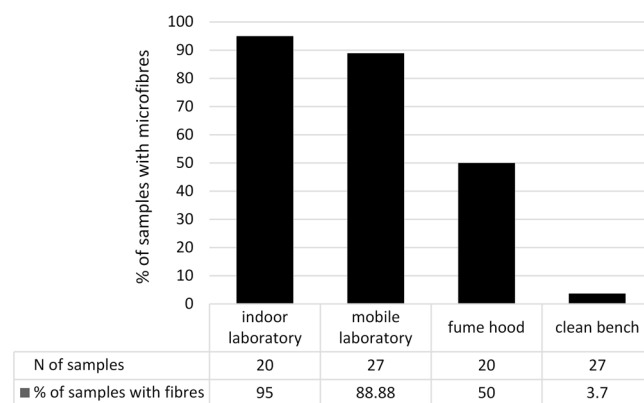

**Figure 2.** Percentage of samples with microfibre contamination. The figure shows the percentage of samples found with microfibre contamination indoors, in the mobile laboratory, the fume hood and on the clean bench with particle filtration. The number of samples exposed to the four different setups are represented as well. The entire list of samples exposed to the different setups can be found as Supplementary Tables S1 and S2.

was found to decrease, when processing was performed in a clean air flow cabinet<sup>23</sup>. Other studies used common laboratory clean-air devices like laminar flow cabinets<sup>20,26</sup> or fume hoods<sup>16,27</sup> during sample processing.

To assure the efficiency of laboratory clean-air devices in microplastic monitoring, we have tested and compared the airborne microfibre contamination of environmental samples in different experimental set ups: (1) indoor, (2) in a mobile laboratory, (3) within a laboratory fume hood and (4) on a clean bench with particles filtration. The object of this paper is to address the value of suitable clean-air devices for valid microplastic pollution data.

## Results

**Number of airborne fibres.** Airborne fibres contamination levels from different setups (indoor laboratory, mobile laboratory, fume hood, clean bench with particles filtration) were tested and compared. A total of 138 fibres appearances were counted in 54 of the overall 94 samples exposed to the four setups. Particle-shaped appearances were not found. All detected fibres were mostly black, blue or transparent. Figure 1 illustrates the number of fibres in the samples belonging to each setup. Microfibrils abundance ranged from zero to 11 fibres per sample. The highest frequency of fibres was observed in the samples of the indoor setup, as nearly all samples contained fibres (Fig. 2). Likewise, 24 of the 27 samples of the mobile laboratory setup contained fibres. In the fume hood setup (Fig. 3), on the other hand, fibres were only detected in 10 of 20 samples. One single fibre was discovered in the samples of the clean bench setup (Fig. 4).

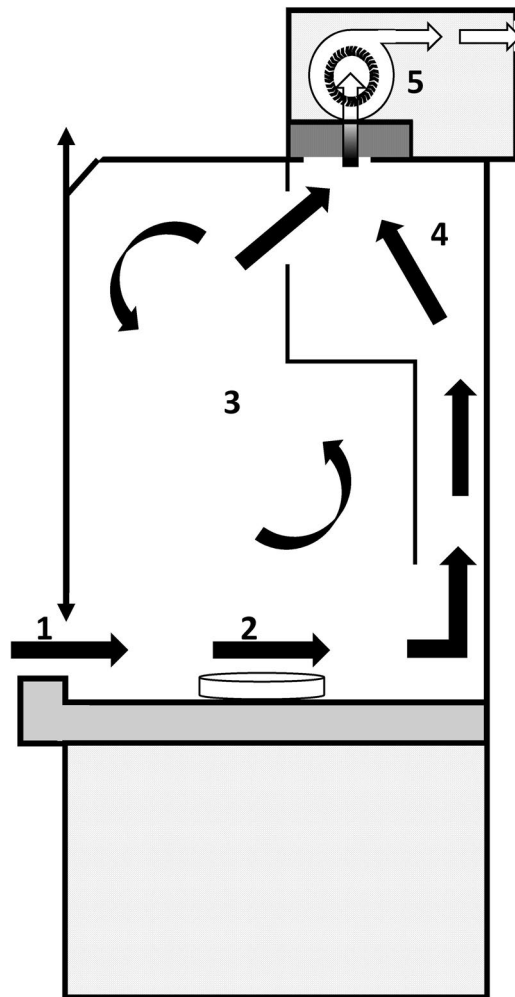

**Figure 3.** Image of a typical laboratory fume hood. A fume hood is a ventilated enclosure that provides protection of the operator and the environment from particularly hazardous substances like fumes, vapours, dusts and gases. During processing, ambient air flows into the fume hood through a vertically movable front sash (1). The unfiltered air flows across the work surface, over the sample (2) and circulates in the workspace (3). Air and all airborne contaminants are directed through an air exhaust duct (4) into the exhaust fan (5) and suctioned out of the fume hood.

**Statistics.** The sample size was tested to have an adequate power ( $>0.99$ ). The differences in samples size was due to varying availability of fish samples for our experimental setups. The statistical tests showed that the amount of fibres collected in all samples exposed to the four different setups were significantly different (Kruskal-Wallis;  $df=3$ ;  $p=0.000$ ). The number of microfibrils detected in the samples from the clean bench was significantly lower than the number of fibres collected either indoor (Wilcoxon Mann-Whitney U;  $Z=-6.089$ ;  $p=0.000$ ), in the mobile laboratory ( $Z=-6.012$ ;  $p=0.000$ ) or the fume hood ( $Z=-3.704$ ;  $p=0.000$ ). No significant difference was found between the number of fibres recorded indoor and in the mobile laboratory (Table S3). The number of fibres indoor and the mobile laboratory was not significantly correlated to the time of exposure to the ambient air (Fig. 5; linear regression analysis  $p > 0.05$ ).

**Types of airborne fibres.** Unfortunately, spectroscopic analyses could only be conducted for 13 of the 138 fibres, due to difficulties in handling the fibres during manual sample preparation and processing (e.g. loss of fibres or too small fibres), which is not unusual when dealing with tiny microfibrils<sup>28</sup>. Six fibres were confirmed as microplastics, with the plastic polymer types identified as polypropylene (PP) (Fig. 6), polyacrylonitrile (PAN) (Fig. 7; Figure S1) and polyethylene terephthalate (PET) (Figure S2). But, six more fibres could be identified as of natural origin by the presence of melanin or cellulose derivatives, as e.g. contained in animal or human hair (Fig. 8). No assignments could be obtained for the thirteenth fibre. The size of the detected microfibrils was between a few  $\mu\text{m}$  up to cm in length and from few  $\mu\text{m}$  up to  $50\ \mu\text{m}$  in thickness. Natural fibres however were, with up to  $100\ \mu\text{m}$ , generally thicker than the synthetic ones.

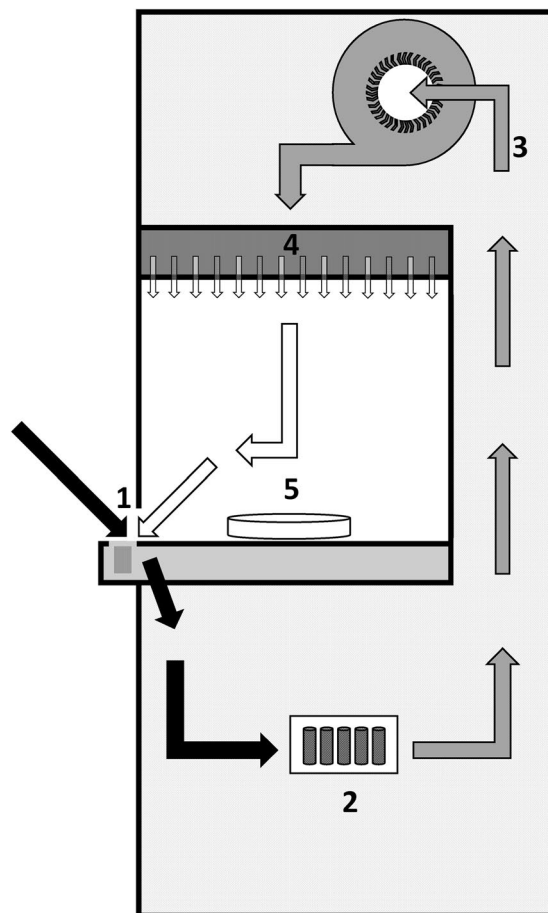

**Figure 4.** Image of a laboratory clean bench with particles- and activated carbon filtration. Clean benches provide a particle-filtered environment to protect samples from aerial contamination. Ambient air with floatable particles (black arrows) and filtered pure air (white arrows) are transported to suction slots (1) and passed through an activated carbon filter (2). Cleaned air is drawn by a radial fan (3) and pressed through a particle filter (Hosch-Filter) into the workspace (4). The filtered pure air flows gently (laminar flow) across the work surface over the sample (5) and towards the operator and then back into the suction slots.

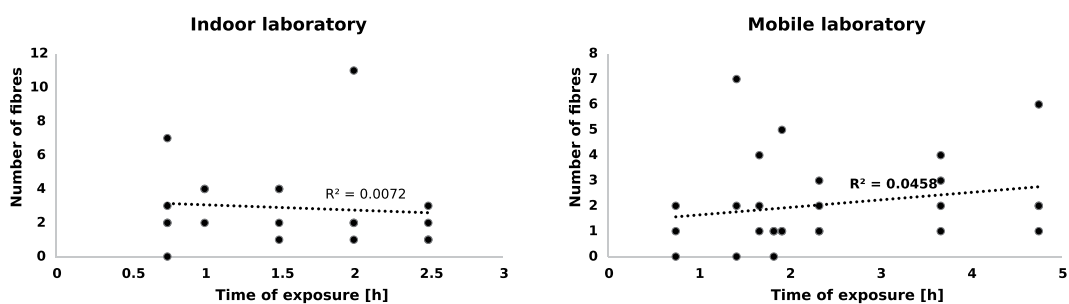

**Figure 5.** Linear regression analysis. Correlation between the number of fibres recovered on the filter papers and the time of exposure indoor (left) and in the mobile laboratory (right).

## Discussion

We highlight the need for greater attention to quality issues in order to identify and lower methodological errors in future microplastic investigations. Despite strict precautionary measures, the outcomes of our study indicate the high risk of aerial microfibre contamination of environmental samples during processing. Overall, common precautions like wearing 100% pure cotton lab coats and using non-plastic equipment were shown to be insufficient to ensure sample purity. Contamination of all but the clean bench setups were alarming. The single fibre found in the clean bench sample might have been released from laboratory equipment during processing. While

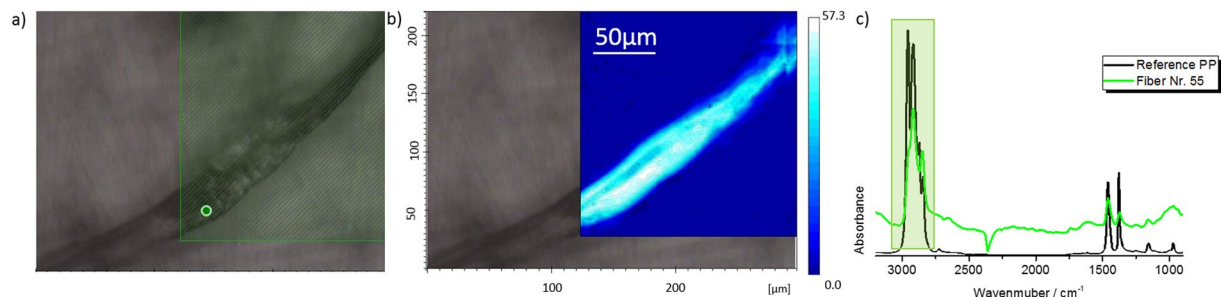

**Figure 6.** Optical image and spectra of an aerial fibre identified as polypropylene. The figure shows an optical image (a) with a corresponding FTIR chemical image integrated at 2800–3000  $\text{cm}^{-1}$  (b). Image c is showing a fibre spectra (green) with its corresponding spectra (black; PP reference).

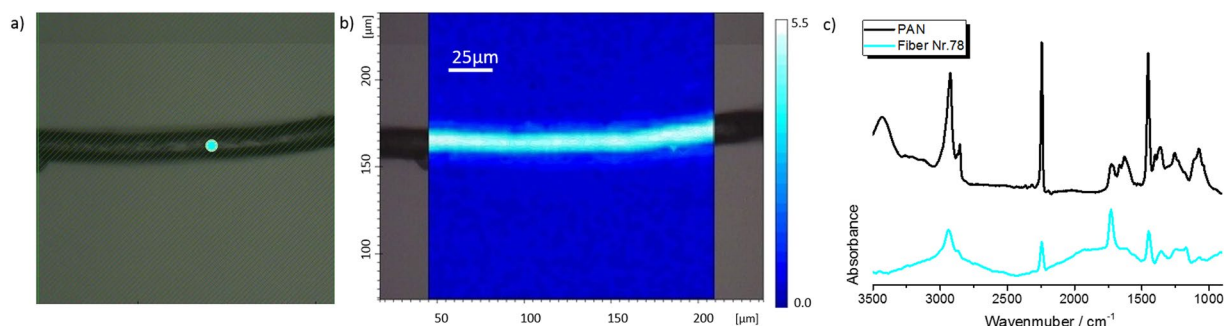

**Figure 7.** Optical image and spectra of an aerial fibre identified as polyacrylonitrile. The figure shows an optical image of a microfibre (a) with its corresponding FTIR chemical image (b), showing the PAN fibre at integration 2200–2300  $\text{cm}^{-1}$ . Image c shows the PAN reference spectrum (black) and the fibre's spectrum (light blue).

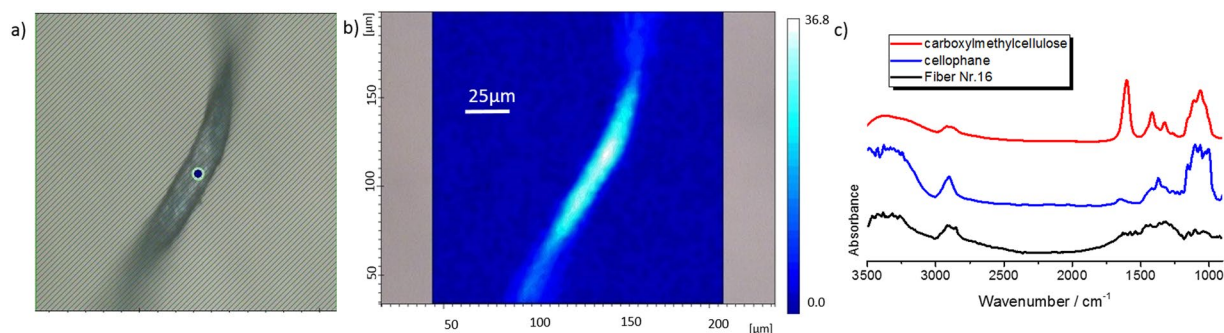

**Figure 8.** Optical image and spectra of an aerial fibre identified as cellophane. The figure shows an optical image of a microfibre (a) with corresponding FTIR chemical image (b), showing the studied fibre at integration 3000–2900  $\text{cm}^{-1}$ . CMC (red) and cellophane (blue) reference spectra with black corresponding to a microfibre (c).

the use of a laboratory fume hood reduces the contamination of specimens by almost 50%, it does not fully prevent it, as it is designed for the protection of the operator and ambient air from particularly hazardous substances, instead of protecting the sample from secondary contamination. Reason for the non-linear relationship between the number of fibres in the laboratory and the time of exposure, might be due to a variety of parameters. Movements in a room during processing (persons walking) for example might have an effect on the number of fibres settling down on the filter papers. Michele *et al.*<sup>25</sup> already found no significant dependency between the amount of fibres in a sample and the time of exposure to the ambient air within their investigations. Procedural blank outcomes of recent studies do not indicate significant contamination levels in comparison to the levels found in environmental samples<sup>10</sup>. However, following our results, only standardised clean working conditions using suitable clean-air devices with particle filtration provide a sufficiently effective method to significantly reduce airborne microfibre contamination.

The results of our spectroscopic analyses show that the microfibrils found in our samples were in equal parts of natural as well as of synthetic origin. Dris *et al.*<sup>10</sup> also found this relation of natural to synthetic fibres in samples from the atmospheric fallout. The polymer types PP, PET and PAN detected in our study are often used in sanitary and personal care products<sup>29</sup>, as well as in the clothing and packaging industry<sup>30</sup>. Accordingly, their presence in samples could be a contamination signature of laboratory environments.

Notwithstanding the urgent call for quality assurance systems in microplastic analyses, many monitoring research studies still apply error-prone methodology. Likewise, for all steps of sampling, sample handling, processing and preparation prior to analysis, suitable methods to prevent contamination are missing in current monitoring protocols, guidances (cf. Recommendations by NOAA Marine Debris Program<sup>19</sup> or Guidance on Monitoring of Marine Litter by MSFD TSGML<sup>2</sup>) and single research surveys. The MSFD TSGML<sup>2</sup> recommended that background contamination should be considered as negligible, if it comprises less than 10% of the overall microplastic average across all samples. Our results suggest, that this target can be easily achieved and background contamination can even be reduced by 96.5% if using suitable clean-air devices. However, these results are limited to our specific laboratory and the used safety workbench and we do not aim to provide accurate evidence for overestimations of microfibrils in the natural environment as a lot of scientific questions remain uncertain. We highly emphasise that more standardised research is needed and other variables should be taken into account as well.

Nevertheless, the predominance of microfibrils in environmental samples might be linked to aerial fibres contamination. Consequently, suitable clean-air devices with particles filtration, designed for the protection of biological specimens should be taken into consideration by scientist for microplastic laboratory applications. We suggest this working procedure to be implemented in standard operating procedures for microplastic analysis of environmental samples.

## Methods

**Experimental setup and design.** To verify the efficiency of clean-air devices in microplastic monitoring, we examined possible aerial contamination of environmental samples with microfibrils in four different test setups. Airborne contamination was tested (1) indoor (laboratory without clean-air facilities), (2) in a mobile laboratory (fully housed within a vehicle without clean-air facilities and designed to function while stationary at a sampling site), (3) a laboratory fume hood and (4) on a clean bench with particles- and activated carbon filtration (microbiological safety workbench; Type ASW-UP, BLEYMEHL Reinraumtechnik). The used clean bench removes particulates from ambient air by a gentle laminar flow of the filtered air, which streams vertically through the entire work space, reliably transporting all floatable particles to suction slots.

**Sample preparation and preventing contamination.** As samples, we used white filter papers (90 mm diameter) moistened with ultrapure water, imitating a moist surface of an aquatic environmental sample. Prior to the exposure, all filter papers were observed visually for any fibre contamination and prepared in cleaned glass Petri dishes on the clean bench to prevent any previous contamination. These Petri dishes were then exposed to the four different setups described above. In the laboratory, general precautionary measures were adopted like wearing clothing made of 100% cotton, avoiding air circulation in the laboratory and furthermore all work spaces as well as all used equipment was cleaned from any particle contamination with deionised water.

**Exposure and enumeration.** Exposure included all steps of a routine sample processing (as applicable for fish dissection) following the standard operating procedures (SOP)<sup>31, 32</sup> of the German Environmental Specimen Bank, providing high quality assurance standards for environmental monitoring. The period of exposure was analogous to the mean time needed for a standardised fish dissection and ranged between 0.75 and 4.75 hours. After processing, all samples were sealed temporarily in the Petri dishes. For counting all fibrous microplastics, the sealed samples were visually observed under a Greenough Stereo Microscope with Apochromatic Optics (Leica S8 APO). To ensure the accuracy of the counting, two independent observers enumerated them alternating for two minutes. After analysis, fibres which were easy to handle were transferred into small Eppendorf tubes for storage prior to spectroscopic analyses.

**Statistical data analysis.** We initially determined the optimal sample size with an adequate power to detect the statistical significance (G\*Power 3.1). Statistical data comparison was conducted using SPSS software (IBM SPSS Statistics 23.0). Data was tested for normal distribution using the Shapiro-Wilk test. As our data was not normally distributed, non-parametric tests were performed. The Kruskal-Wallis test was used to test the statistical significance of the differences of fibre contamination between the four different setups. Two tailed Wilcoxon Mann-Whitney U tests were applied to test for differences in quantity of fibres between the different setups. The relationship between the fibres recorded on the filter papers and the time of exposure was tested with linear regression analysis. The significance level (p) for the performed statistical tests was set at 0.05.

**Spectroscopic analysis.** Fourier Transform infrared (FTIR) spectroscopy was used to chemically characterise microfibrils, which were suggested to be of synthetic origin by their morphology. Measurements were carried out using a FTIR Vertex 70 spectrometer (Bruker) as beam source coupled with a Hyperion 3000 FTIR Microscope with a 15 x IR Objective (Bruker Corporation, Billerica, USA) and a 64 × 64 Focal Plane Array (FPA) detector. For analysis, fibres were uniformly spread on a KBr crystal and placed under a microscope equipped with a 15 × Objective (pixel resolution 2.7 µm). The measurements were performed in transmission mode in wavenumber range 3850–900 cm<sup>-1</sup> using a spectra resolution of 16 cm<sup>-1</sup>. OPUS 7.2 Software was used to acquire and analyse data. Zero filling factor 2, Blackman Harris three term windows function were chosen. The background was measured with the same parameters against the KBr window. No transformation or post-processing of the spectra were conducted. To differentiate the fibres chemistry, the special integration was applied. For PP

fibre CH-valence-stretching vibrations at 3000–2800 cm<sup>-1</sup> and for PAN fibres specific vibration of CN absorption band at 2260 cm<sup>-1</sup> were integrated.

**Data availability statement.** There are no restrictions on the availability of materials or information. Supporting raw data and materials that cannot be included in the printed version of the manuscript for reasons of space are available as Supplementary Information file that will be freely accessible on nature.com upon publication.

## References

1. Arthur, C. Baker, J. & Bamford, H. Proceedings of the International Research Workshop on the Occurrence, Effects, and Fate of Microplastic Marine Debris. Sept 9-11, 2008. NOAA Technical Memorandum NOS-OR&R-30. (2009).
2. MSFD Technical Subgroup of Marine Litter. Guidance on Monitoring of Marine Litter in European Seas. JRC - Joint Research Centre. EUR 26113 EN (2013).
3. Ivar do Sul, J. A. & Costa, M. F. The present and future of microplastic pollution in the marine environment. *Environmental Pollution (Barking, Essex: 1987)* **185**, 352–364 (2014).
4. Wright, S. L., Thompson, R. C. & Galloway, T. S. The physical impacts of microplastics on marine organisms: a review. *Environmental Pollution (Barking, Essex: 1987)* **178**, (483–492 (2013)).
5. Frias, J. P. G. L., Gago, J., Otero, V. & Sobral, P. Microplastics in coastal sediments from Southern Portuguese shelf waters. *Marine Environmental Research* **114**, 24–30 (2016).
6. Claessens, M., De Meester, S., Van Landuyt, L., De Clerck, K. & Janssen, C. R. Occurrence and distribution of microplastics in marine sediments along the Belgian coast. *Marine Pollution Bulletin* **62**, 2199–2204 (2011).
7. Lusher, A. L., Burke, A., O'Connor, I. & Officer, R. Microplastic pollution in the Northeast Atlantic Ocean: validated and opportunistic sampling. *Marine Pollution Bulletin* **88**, 325–333 (2014).
8. Lusher, A. L., McHugh, M. & Thompson, R. C. Occurrence of microplastics in the gastrointestinal tract of pelagic and demersal fish from the English Channel. *Marine Pollution Bulletin* **67**, 94–99 (2013).
9. Rochman, C. M. *et al.* Anthropogenic debris in seafood: Plastic debris and fibers from textiles in fish and bivalves sold for human consumption. *Scientific Reports* **5**, 14340 (2015).
10. Dris, R., Gasperi, J., Saad, M., Mirande, C. & Tassin, B. Synthetic fibers in atmospheric fallout: A source of microplastics in the environment? *Marine Pollution Bulletin* **104**, 290–293 (2016).
11. Dris, R. *et al.* A first overview of textile fibers, including microplastics, in indoor and outdoor environments. *Environmental Pollution (Barking, Essex: 1987)* **221**, 453–458 (2017).
12. Remy, F. *et al.* When Microplastic Is Not Plastic: The Ingestion of Artificial Cellulose Fibers by Macrofauna Living in Seagrass Macrophytodebris. *Environmental Science & Technology* **49**, 11158–11166 (2015).
13. Wesch, C., Barthel, A.-K., Braun, U., Klein, R. & Paulus, M. No microplastics in benthic eelpout (*Zoarces viviparus*): An urgent need for spectroscopic analyses in microplastic detection. *Environmental Research* **148**, 36–38 (2016).
14. Collard, F., Gilbert, B., Eppe, G., Parmentier, E. & Das, K. Detection of Anthropogenic Particles in Fish Stomachs: An Isolation Method Adapted to Identification by Raman Spectroscopy. *Archives of Environmental Contamination and Toxicology* **69**, 331–339 (2015).
15. Woodall, L. C. *et al.* Using a forensic science approach to minimize environmental contamination and to identify microfibres in marine sediments. *Marine Pollution Bulletin* **95**, 40–46 (2015).
16. De Witte, B. *et al.* Quality assessment of the blue mussel (*Mytilus edulis*): Comparison between commercial and wild types. *Marine Pollution Bulletin* **85**, 146–155 (2014).
17. Hidalgo-Ruz, V., Gutow, L., Thompson, R. C. & Thiel, M. Microplastics in the marine environment: a review of the methods used for identification and quantification. *Environmental Science & Technology* **46**, 3060–3075 (2012).
18. Duis, K. & Coors, A. Microplastics in the aquatic and terrestrial environment: sources (with a specific focus on personal care products), fate and effects. *Environmental Sciences Europe* **28**, 2 (2016).
19. Masura, J. Baker, J. Foster, G. & Arthur, C. Laboratory Methods for the Analysis of Microplastics in the Marine Environment. Recommendations for quantifying synthetic particles in waters and sediments. NOAA Marine Debris Program 1–31 (2015).
20. Van Cauwenberghe, L. & Janssen, C. R. Microplastics in bivalves cultured for human consumption. *Environmental Pollution (Barking, Essex: 1987)* **193**, 65–70 (2014).
21. ICES. OSPAR Request on Development of a Common Monitoring Protocol for Plastic Particles in Fish Stomachs and Selected Shellfish on the Basis of Existing Fish Disease Surveys. ICES Special Request Advice Book 1, 1–6 (2015).
22. Besseling, E. *et al.* Microplastic in a macro filter feeder: Humpback whale *Megaptera novaeangliae*. *Marine Pollution Bulletin* **95**, 248–252 (2015).
23. Foekema, E. M. *et al.* Plastic in North Sea Fish. *Environmental Science & Technology* **47**, 8818–8824 (2013).
24. Wesch, C., Bredimus, K., Paulus, M. & Klein, R. Towards the suitable monitoring of ingestion of microplastics by marine biota: A review. *Environmental Pollution (Barking, Essex: 1987)* (2016).
25. Michele, T., Digka, N., Anastasopoulou, A., Tsangaris, C. & Mytilineou, C. Anthropogenic microfibres pollution in marine biota. A new and simple methodology to minimize airborne contamination. *Marine Pollution Bulletin* (2016).
26. Wiesheu, A. C., Anger, P. M., Baumann, T., Niessner, R. & Ivleva, N. P. Raman microspectroscopic analysis of fibers in beverages. *Anal. Methods* **8**, 5722–5725 (2016).
27. Devriese, L. I. *et al.* Microplastic contamination in brown shrimp (*Crangon crangon*, Linnaeus 1758) from coastal waters of the Southern North Sea and Channel area. *Marine Pollution Bulletin* **98**, 179–187 (2015).
28. Löder, M. G. J. & Gerdtz, G. Methodology Used for the Detection and Identification of Microplastics - A Critical Appraisal in *Marine Anthropogenic Litter* (eds M. Bergmann *et al.*), Ch. 8, 201–227 (2015).
29. Leslie, H. A. Review of Microplastics in Cosmetics Scientific background on a potential source of plastic particulate marine litter to support decision-making. VU University Amsterdam. IVM Institute for Environmental Studies Report R14/29, 1–33 (2014).
30. Galloway, T. S. Micro- and Nano-plastics and Human Health in Marine Anthropogenic Litter (eds M. Bergmann *et al.*), Ch. 13, 343–366 (2015).
31. Klein, R. *et al.* Guideline for Sampling and Sample Treatment: Eelpout (*Zoarces viviparus*) (eds Environment Protection Agency; Berlin) (2015).
32. Klein, R., Paulus, M., Tarricone, K. & Teubner, D. Guideline for Sampling and Sample Treatment - Bream (*Abramis brama*) (eds Environment Protection Agency; Berlin) (2015).

## Acknowledgements

The authors Charlotte Wesch, Roland Klein and Martin Paulus are members of the interdisciplinary research training group “Cooperation of Science and Jurisprudence in Improving Development and Use of Standards for Environmental Protection - Strategies for Risk Assessment and Management,” funded by the German Research Foundation (DFG; Graduiertenkolleg 1319). Special thanks to Diana Teubner and Joscha Beninde for their

precious critique and proof reading. The authors acknowledge the ESB project team Trier for assisting in sample collection. The publication was funded by the Open Access Fund of Universität Trier and the German Research Foundation (DFG) within the Open Access Publishing funding programme.

### Author Contributions

C.W., M.W., R.K. and M.P. designed the study. C.W. conducted the laboratory sample exposure and wrote the main manuscript text. Statistical analysis and interpretation of exposure data was done by C.W., M.W., R.K. and M.P. A.E. and U.B. conducted the spectroscopic measurements and performed spectroscopic data analysis. Acquisition of data was done by C.W. and A.E. M.W., C.W. and A.E. designed all figures. All authors reviewed the manuscript critically for important intellectual content.

### Additional Information

**Supplementary information** accompanies this paper at doi:[10.1038/s41598-017-05838-4](https://doi.org/10.1038/s41598-017-05838-4)

**Competing Interests:** The authors declare that they have no competing interests.

**Publisher's note:** Springer Nature remains neutral with regard to jurisdictional claims in published maps and institutional affiliations.



**Open Access** This article is licensed under a Creative Commons Attribution 4.0 International License, which permits use, sharing, adaptation, distribution and reproduction in any medium or format, as long as you give appropriate credit to the original author(s) and the source, provide a link to the Creative Commons license, and indicate if changes were made. The images or other third party material in this article are included in the article's Creative Commons license, unless indicated otherwise in a credit line to the material. If material is not included in the article's Creative Commons license and your intended use is not permitted by statutory regulation or exceeds the permitted use, you will need to obtain permission directly from the copyright holder. To view a copy of this license, visit <http://creativecommons.org/licenses/by/4.0/>.

© The Author(s) 2017