

12.07.2017

LOW FIELD NMR SPECTROSCOPY FOR PROCESS CONTROL

Robust automated data preparation and analysis as prerequisites

Simon Kern and Michael Maiwald

Bundesanstalt für Materialforschung und -prüfung (BAM)
Division 1.4 Process Analytical Technology

Richard-Willstätter-Str. 11
D-12489 Berlin, Germany



This project has received funding from the European Union's Horizon 2020
research and innovation programme under grant agreement N° 636942

Safety in Technology and Chemistry



Our Key Areas

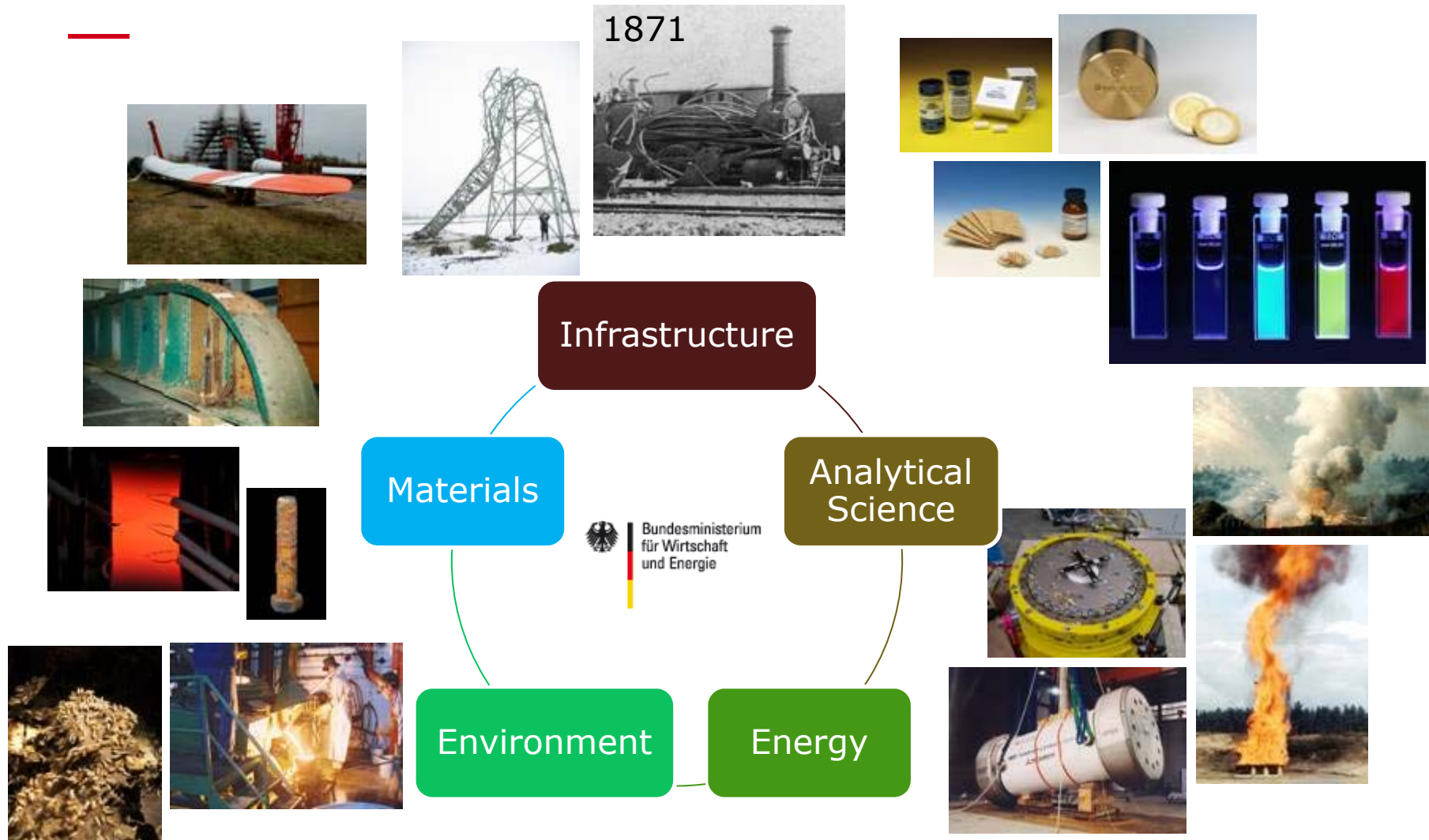

BAM is a senior scientific and technical Federal institute with responsibility to Federal Ministry for Economic Affairs and Energy

Division 1.4: Process Analytical Technology BAM

Our Key Areas

Gas Analysis

- Primary Reference Gas Mixtures
- Gas Analysis, Gas Metrology
- Certification of Sec. Gas Mixtures

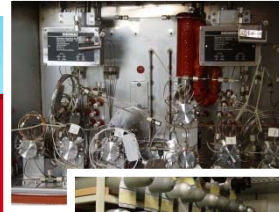

Located in Berlin, Germany

Process Spectroscopy

- Online NMR Spectroscopy, qNMR
- Raman Spectroscopy and Microscopy
- NIR, MIR, FIR spectr., IR Microscopy
- Data Treatment: Statistics, Numerics
- Measurement Uncertainty Evaluation

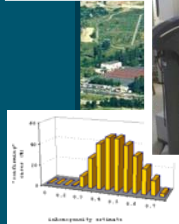

Inorganic Process Anal. Technol., XRF

- X-ray fluorescence Analysis (XRF)
- Laser-induced Breakdown (LIBS)
- Total Reflectance XRF (T-XRF)



Process Analytical Technology

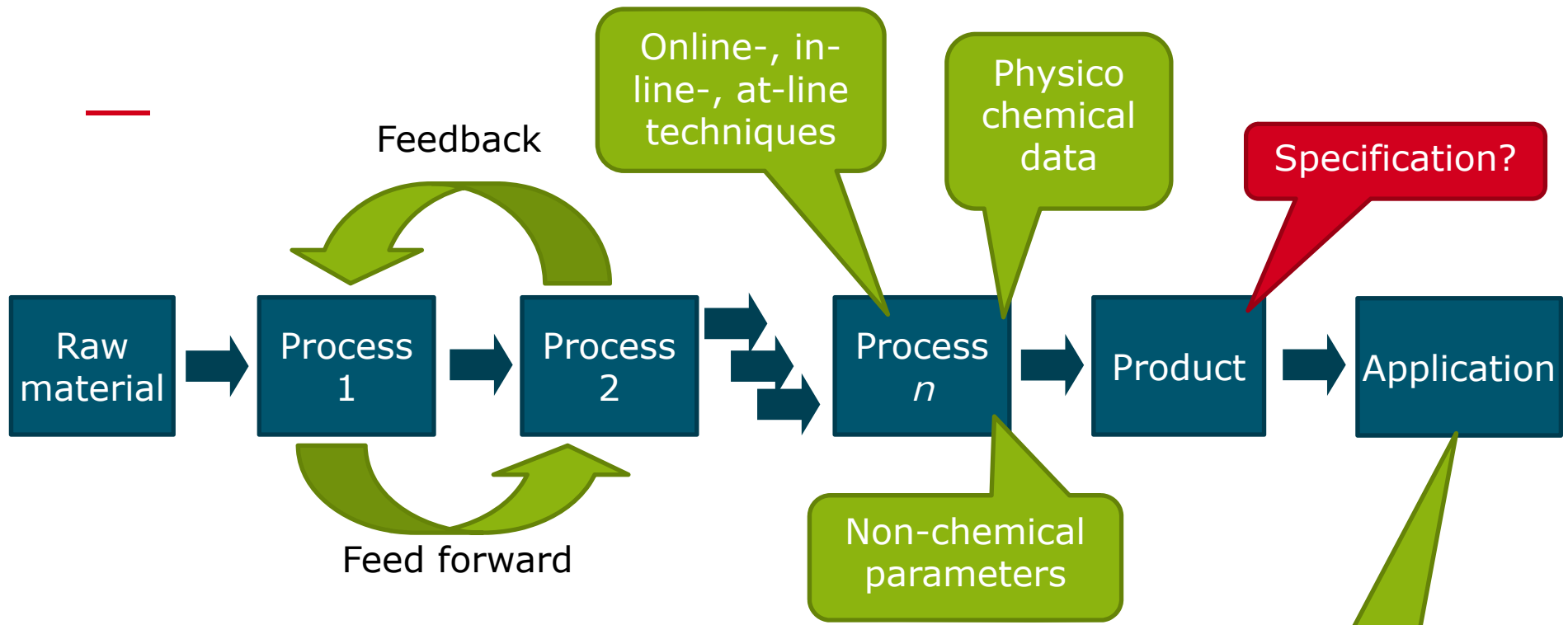

Motivation

- Optimal design ("quality by design")
- Demanded product quality with an optimum use of equipment, raw materials, and energy
- Affordable quality costs

Objective description of **quality**
→ comprehensive understanding

Process Analytical Technology

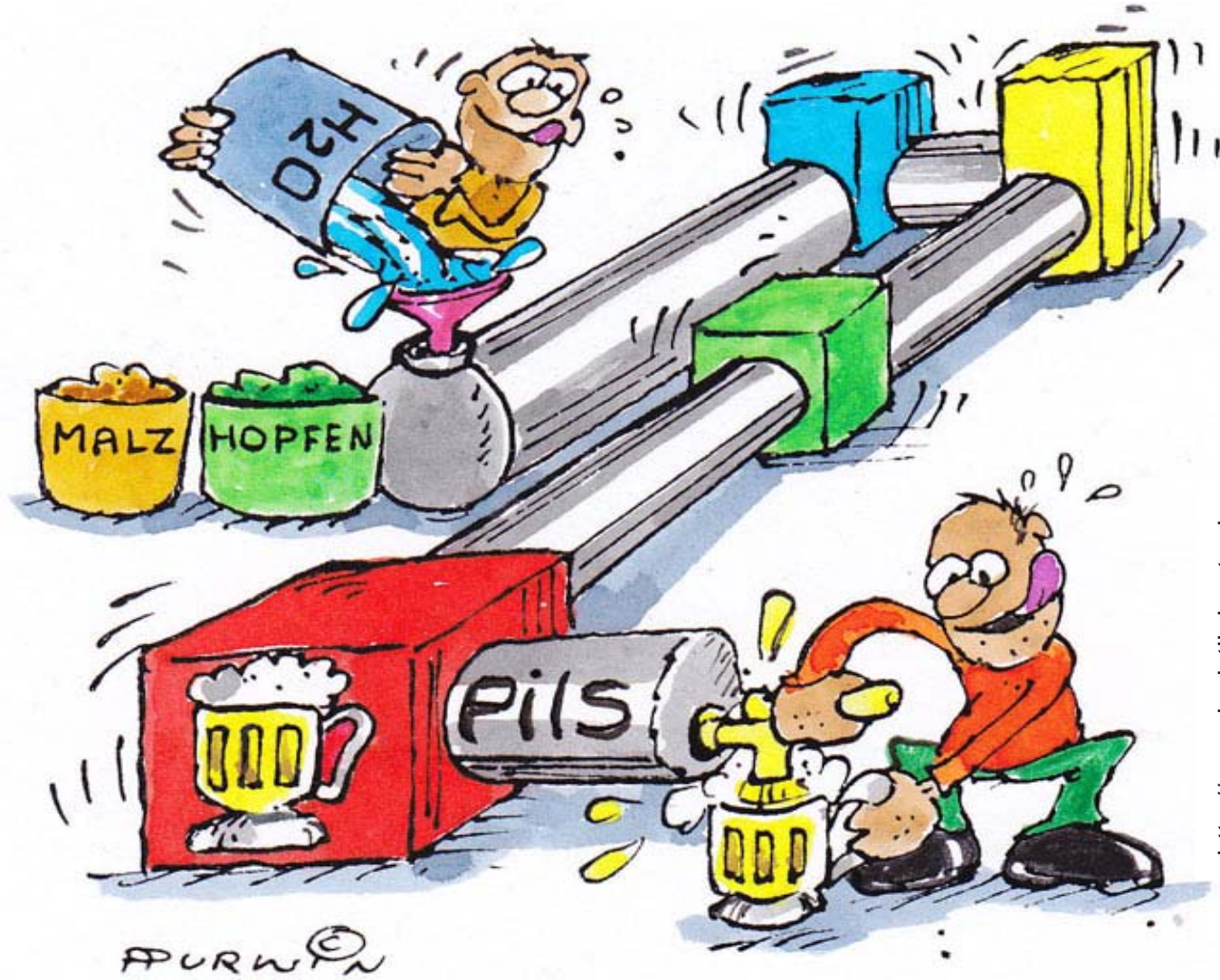

Raw material

- Motivati
- Optim
 - Dema
 - optim
 - mater
 - Afford

ification?

Application

<http://www.logistik-heute.de>
(07.01.2012)

n
ve
understanding

From Lousy Interfaces to "Industrie 4.0" BAM

Use of Runtime Environments

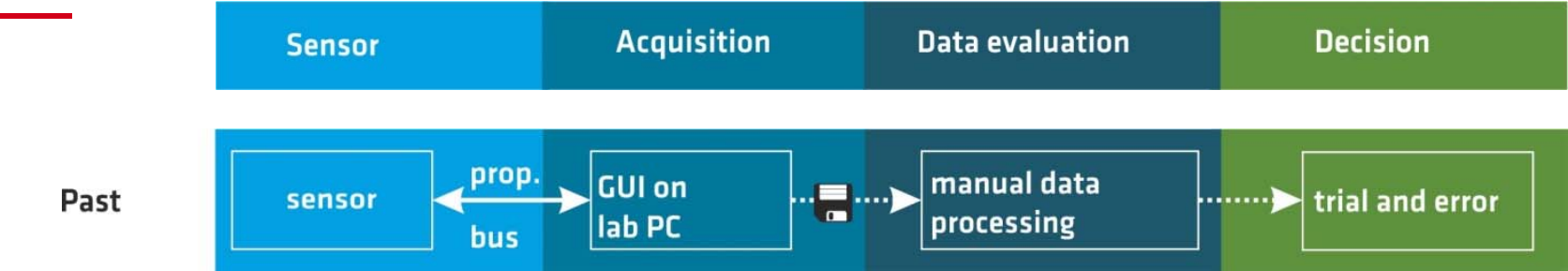

From Lousy Interfaces to "Industrie 4.0" BAM

Use of Runtime Environments

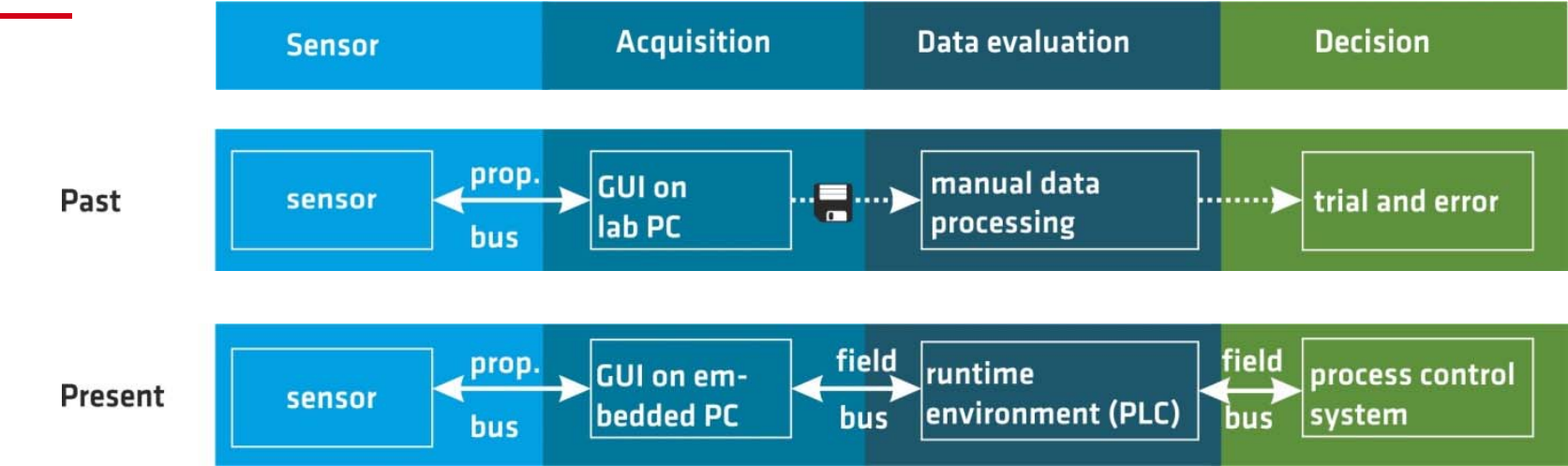

From Lousy Interfaces to "Industrie 4.0" BAM

Use of Runtime Environments

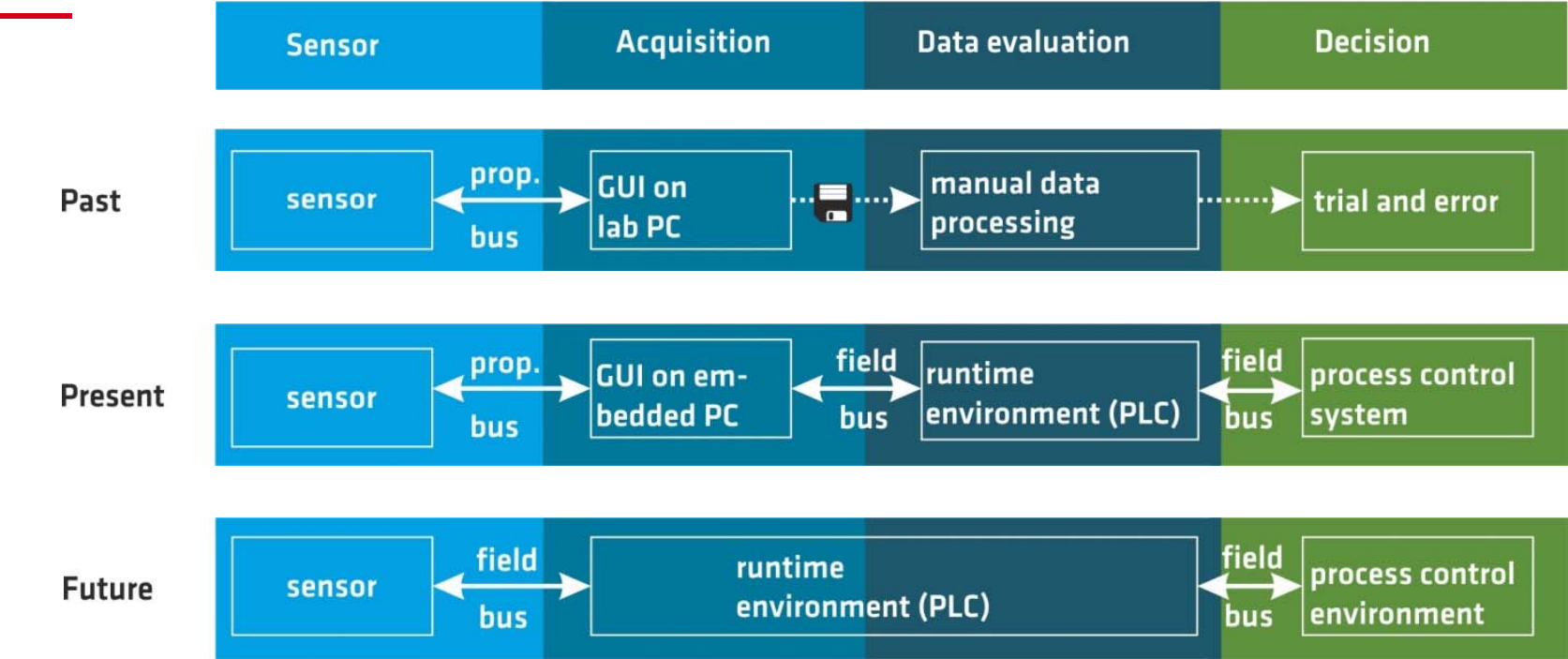

CONSENS: Smart Online NMR Sensor for Advanced Process Control



Flexible Intensified Continuous Plant

Characteristics

Miniaturized equipment

Intensified heat & mass transfer

Possibly modular setup

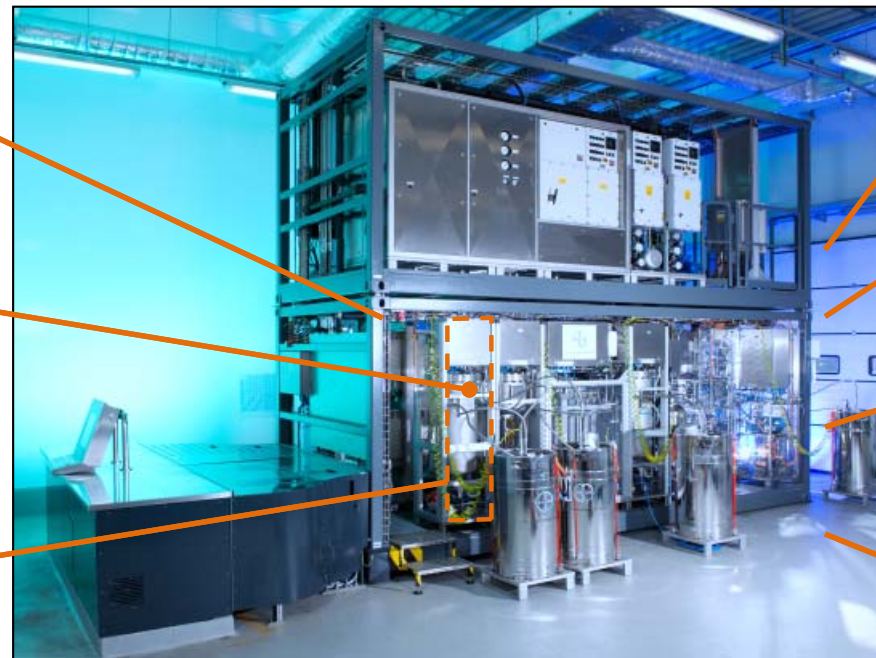

Benefits

Product uniformity

Sustainability

Fast adaption to market demand

Innovative products

Containerized modular plant Source: INVITE GmbH



Continuous Lithiation Reaction Set-up

Flexible Intensified Continuous Plant

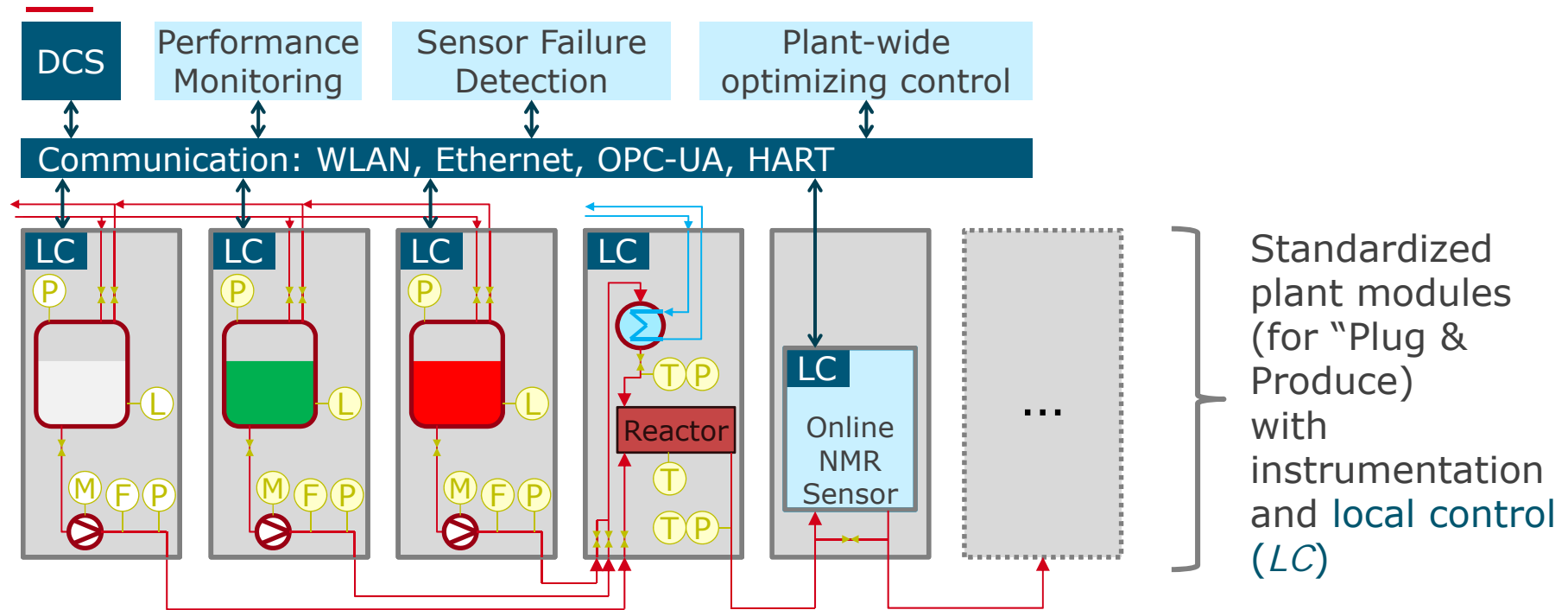

- Miniaturized flexible equipment
- Fast and complex exothermic reaction
- Hazardous and inflammable substances → Explosion protection!
- Prone to fouling & clogging
- Multi-objective constrained optimization

CONSENS: Case Study 1

Intensified Synthesis of Organic Compounds



Modular plant



Source: INVITE GmbH

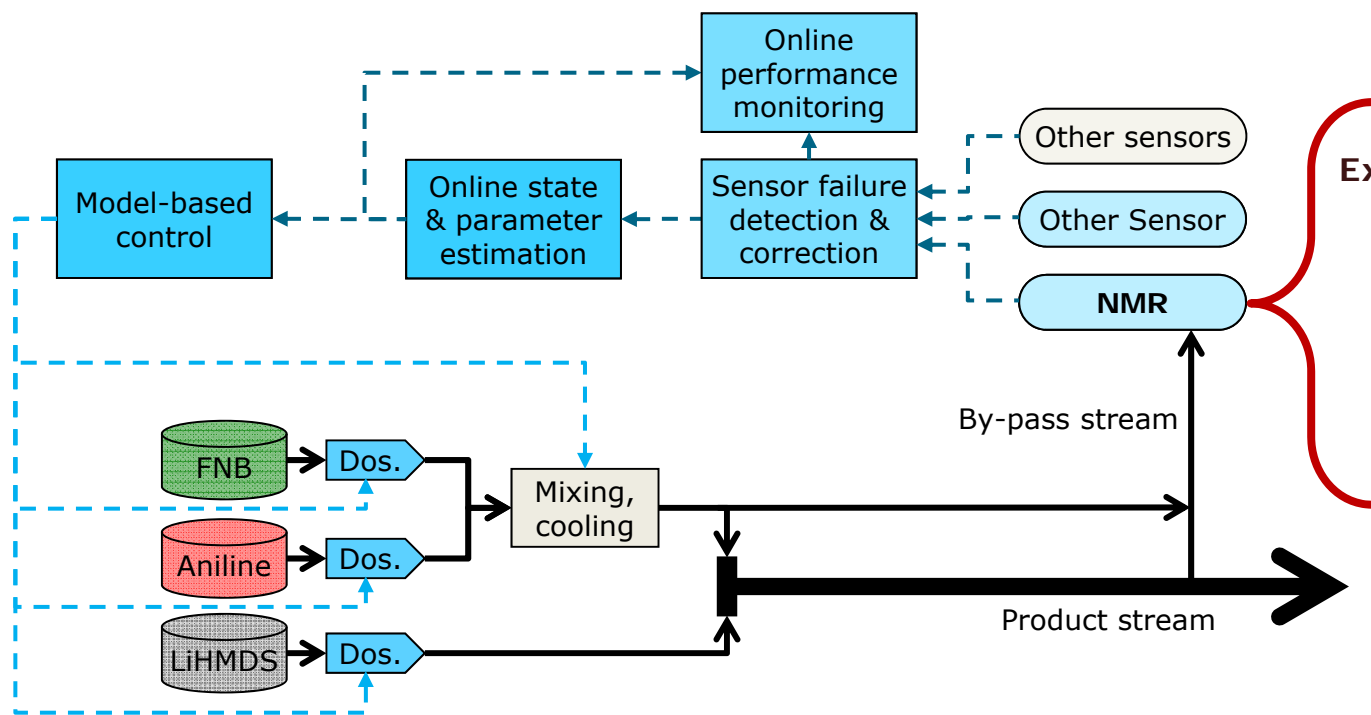

Explosion proof housing

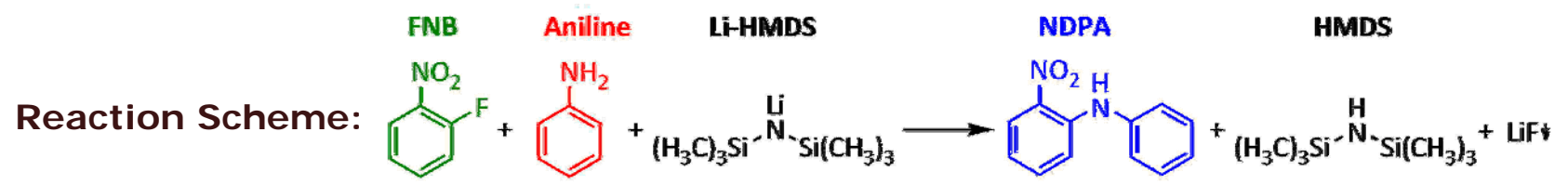
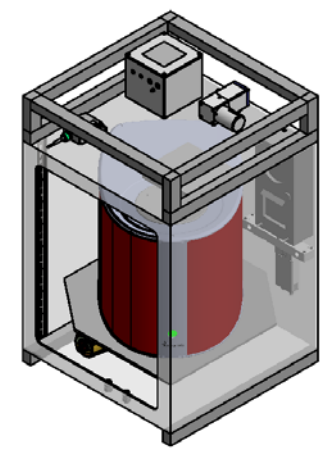

Conventional and Smart Functions



Enabling Runtime Environments

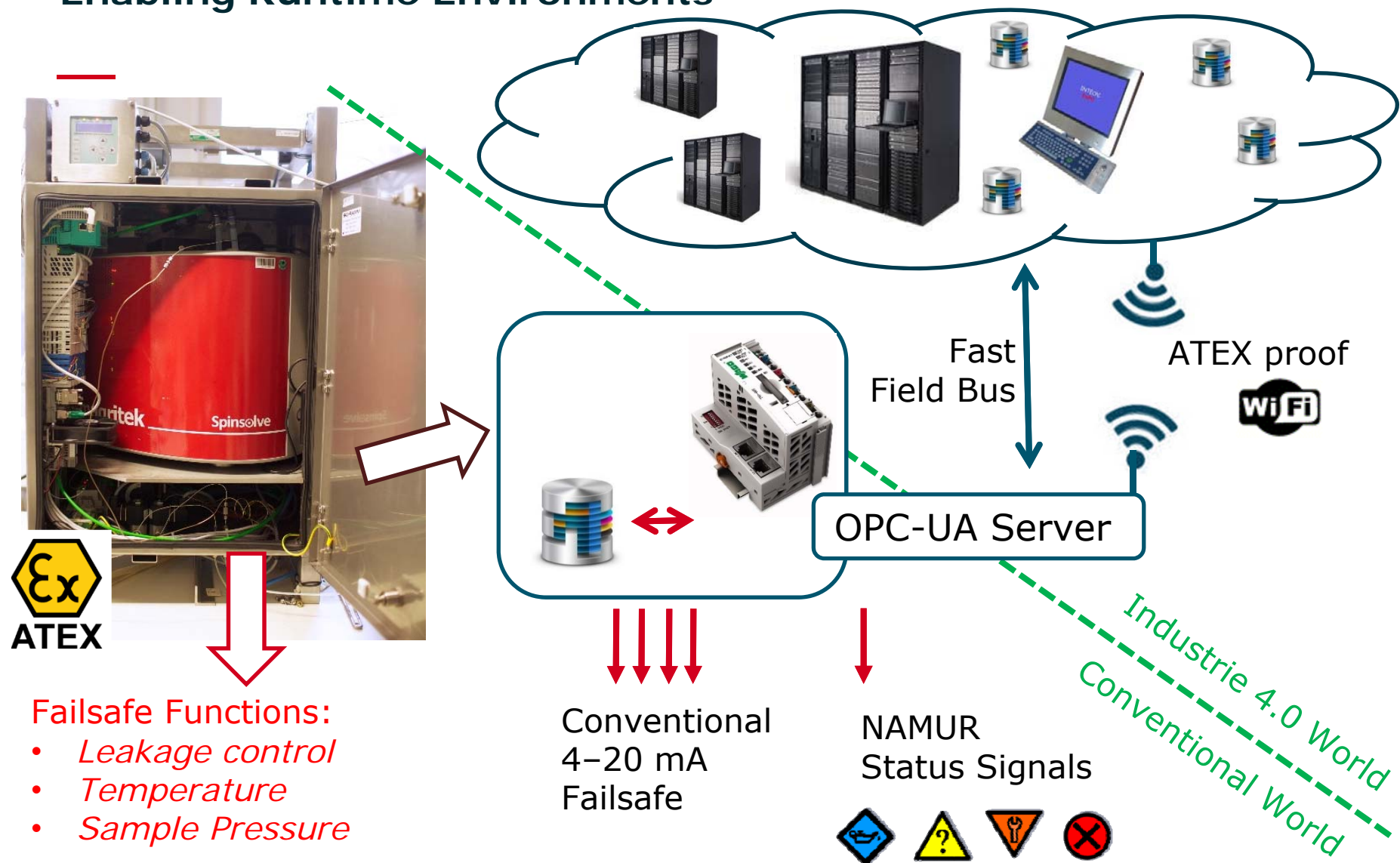

- Failsafe Functions:**
- Leakage control
 - Temperature
 - Sample Pressure

Reaction Monitoring in Lab-scale at BAM

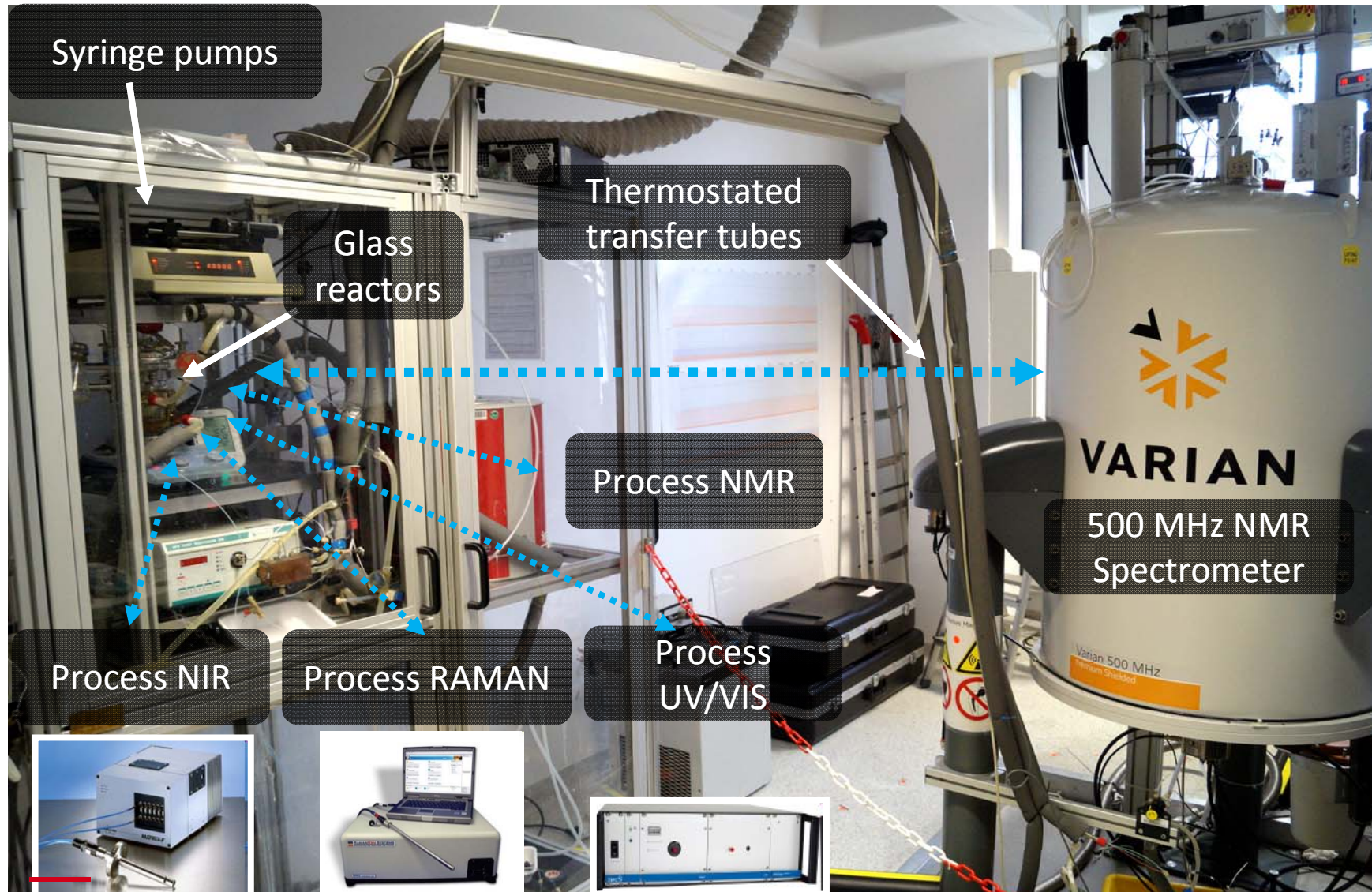

Nuclear Magnetic Resonance (NMR)

Direct Comparison Method → Calibration Free!

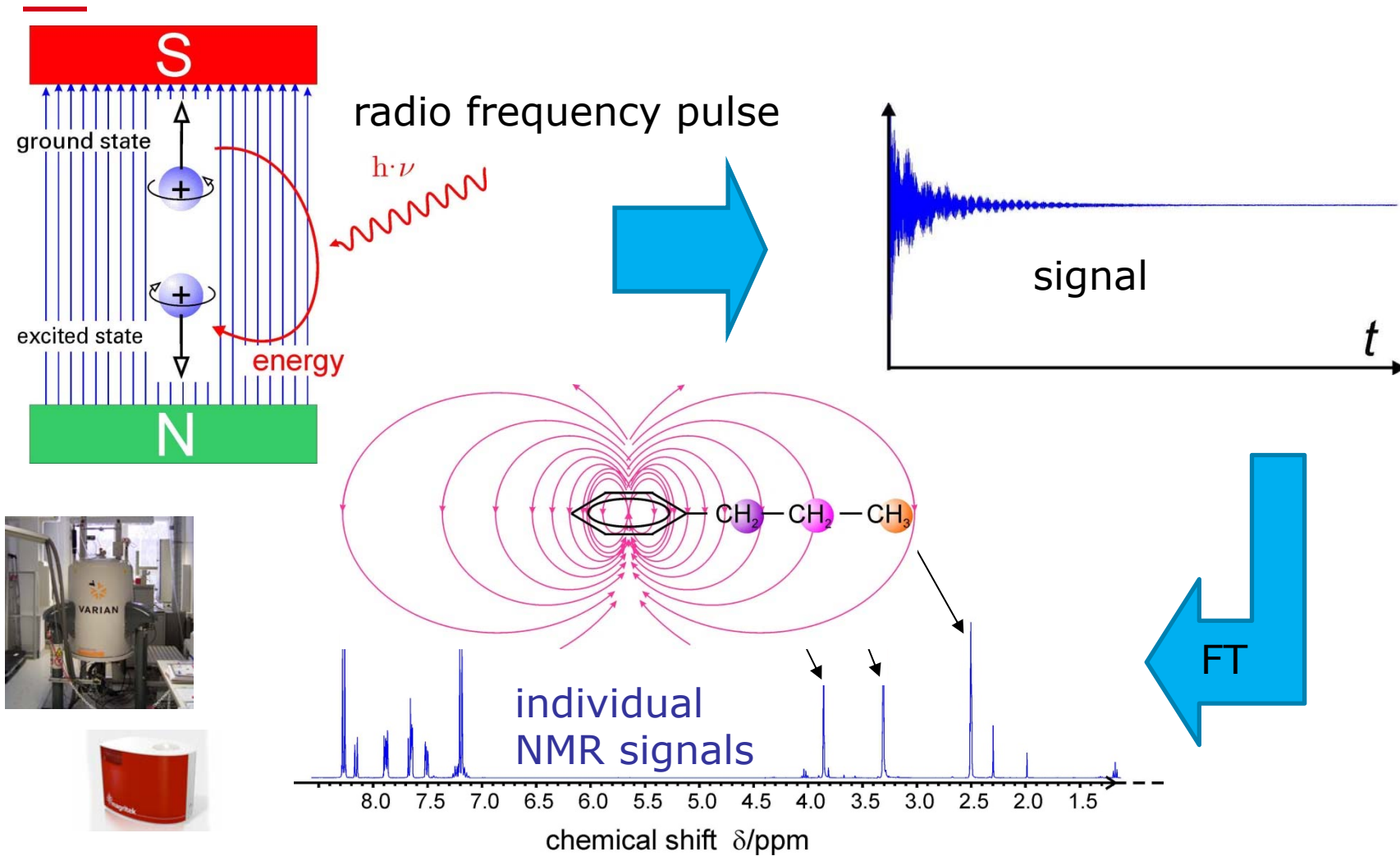

NMR Spectroscopy

Analogy to a Bell

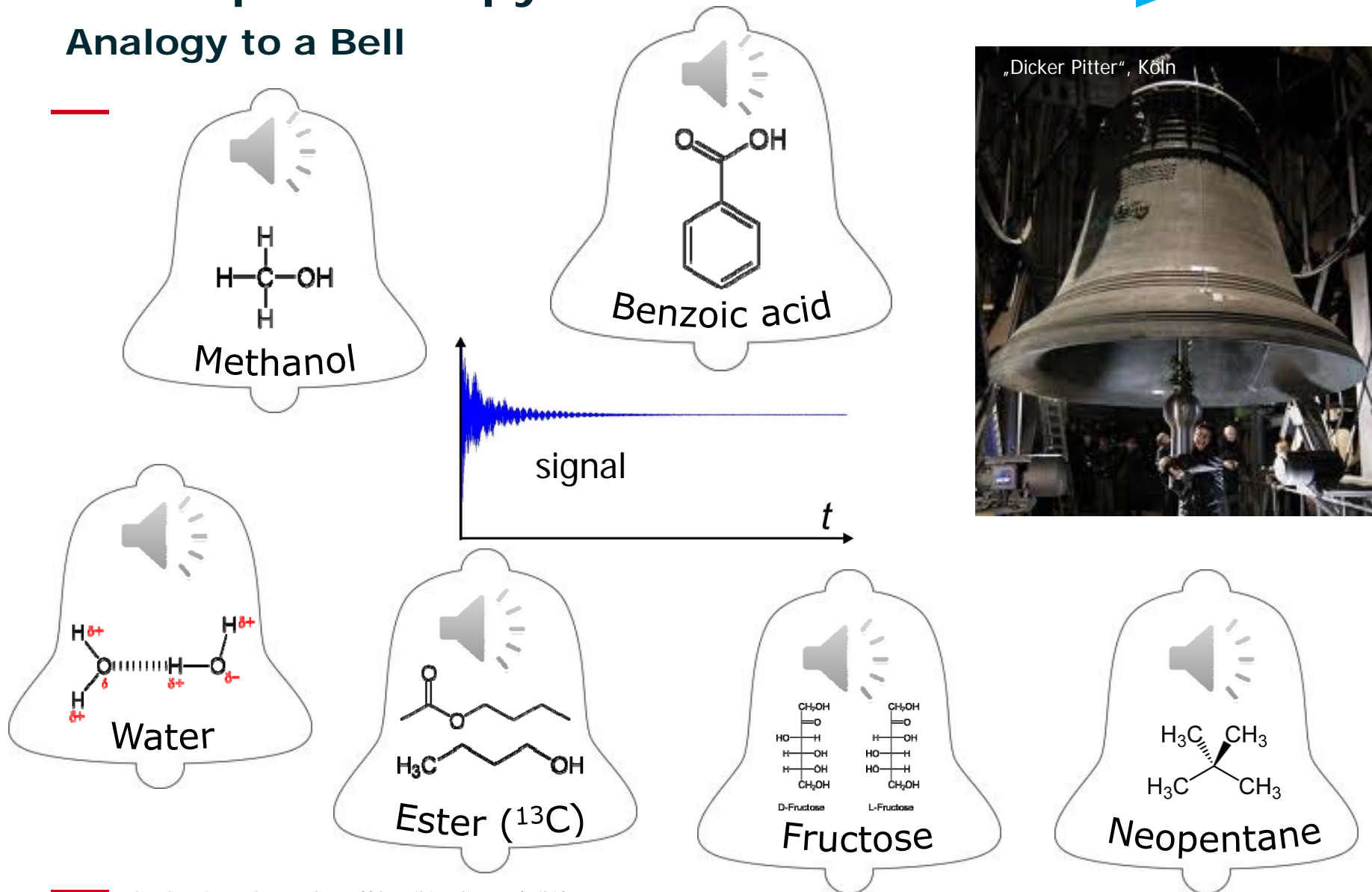

The diagram illustrates the analogy of NMR spectroscopy to a bell. Six chemical structures are shown inside bell-shaped containers, each with a speaker icon, representing different 'sounds' or signals. A central graph shows a signal over time (t).

- Methanol:** CO
- Benzoic acid:** O=C(O)c1ccccc1
- Water:** O (with partial charges δ^+ and δ^-)
- Ester (^{13}C):** CCCCC(=O)OCC
- Fructose:** C(C1C(C(C(O1)O)O)O)O (D-Fructose and L-Fructose)
- Neopentane:** CC(C)(C)C



Strukturformeln von <http://de.wikipedia.org/wiki/>

Reaction Monitoring on Lab Scale at BAM

Reaction Characterization in Lab

Lab Experiments in Batch along Reaction Co-ordinate

- Data in parallel acquired with high-field and low-field spectrometer
- „Fast“ and „slow loop“
- Li-HMDS was dosed stepwise



Experimental set-up

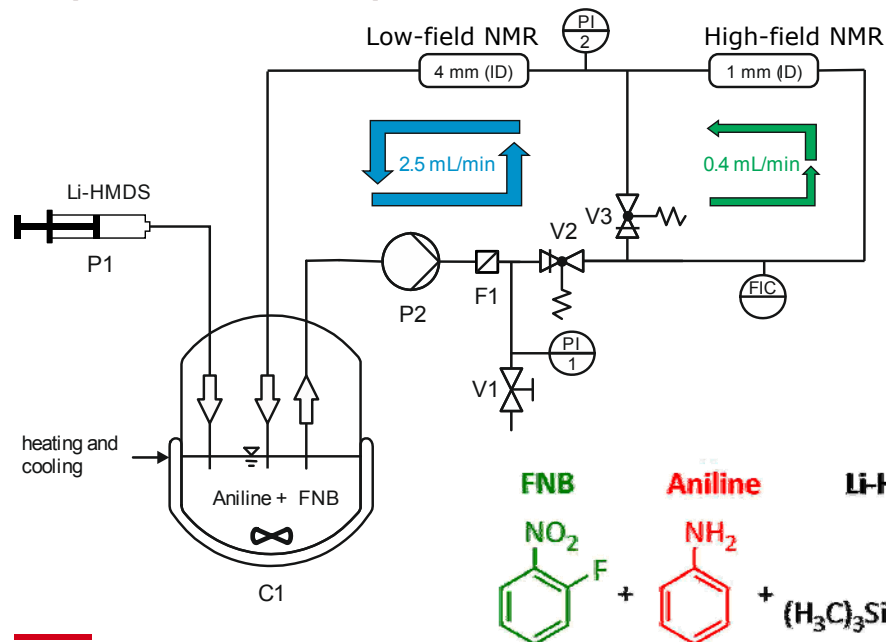

- Exothermic reaction
 → required cooling (28.5 °C)
- Li-HMDS in two-fold excess

Reaction Scheme:

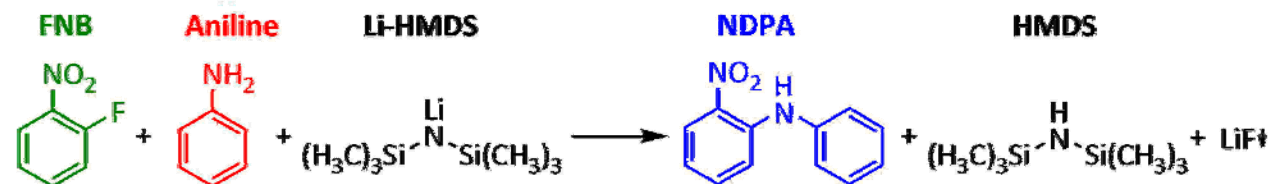

Online ^1H NMR Spectra of Lithiation Reaction Step

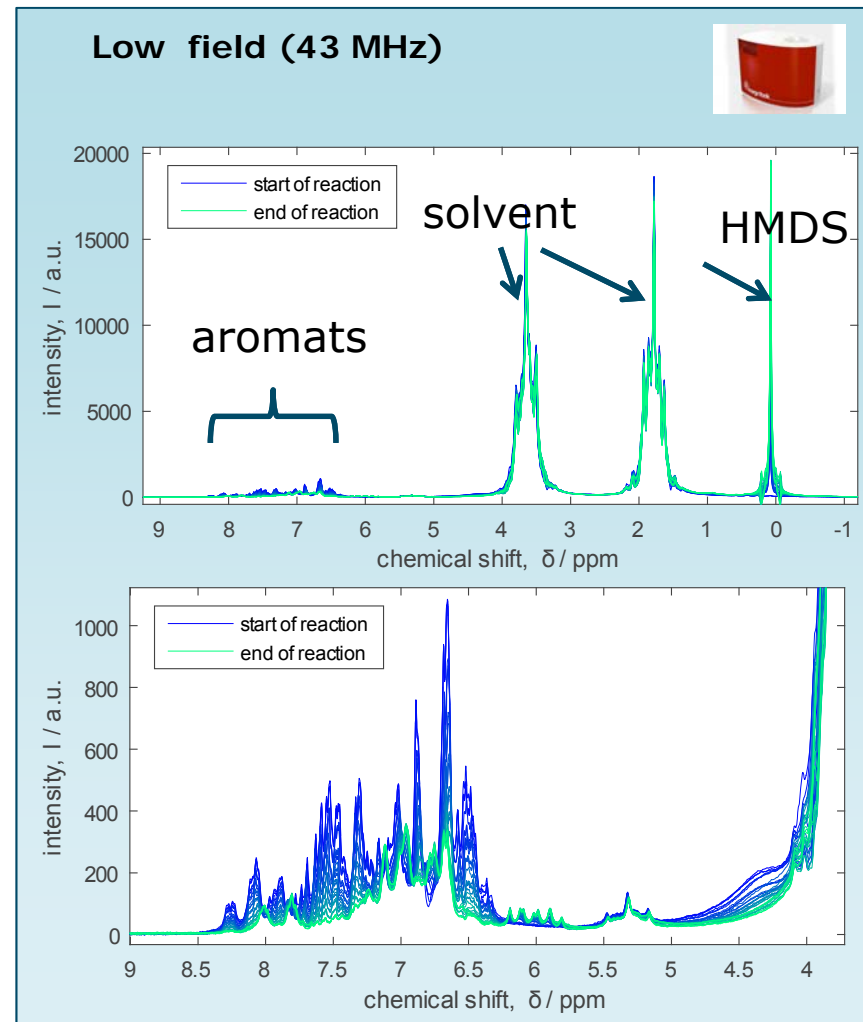
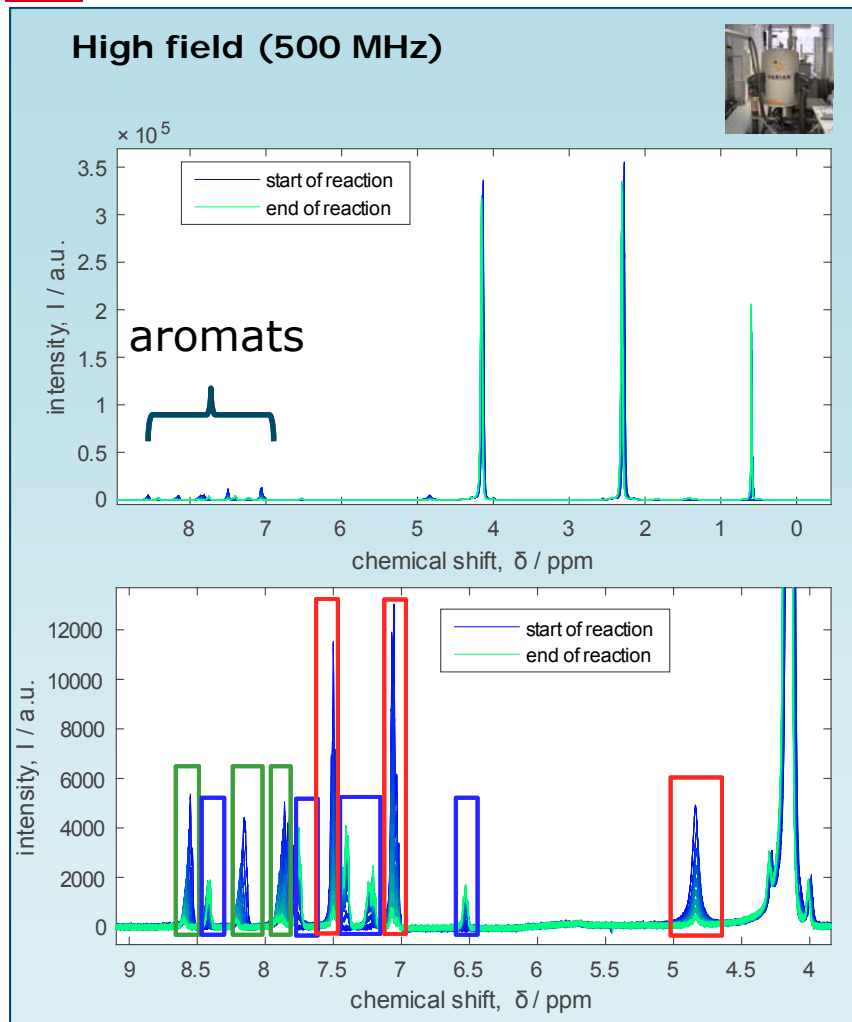

Data Processing for Low-field NMR in Matlab

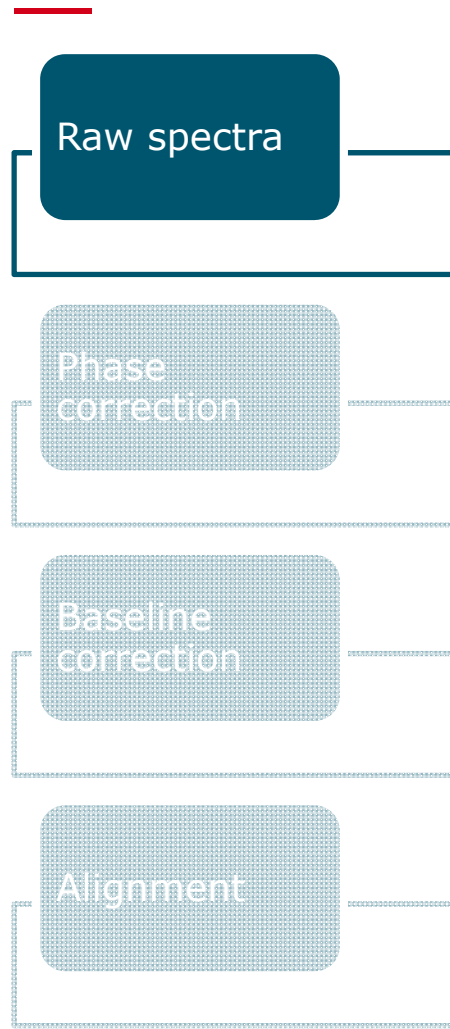

single scan
each 15s
in flow

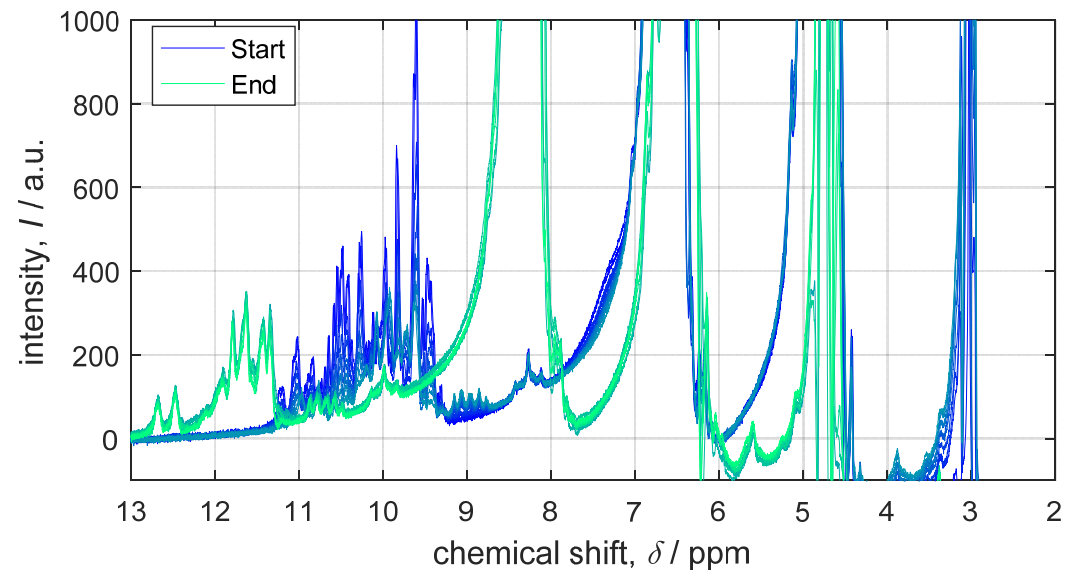
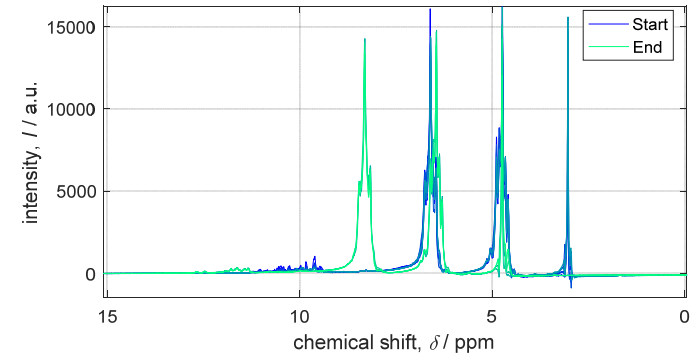

Data Processing for Low-field NMR in Matlab

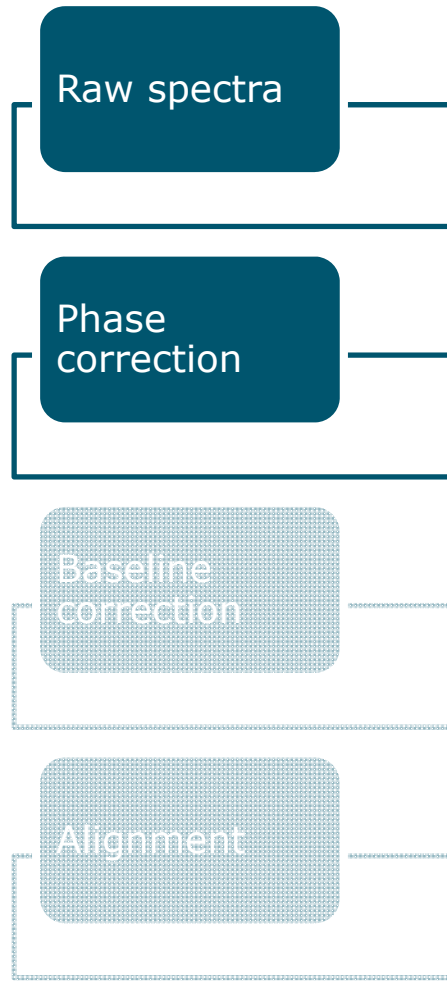

Entropy minimization method:
Chen et al., J Magn Reson.
2002, 158, 164-168

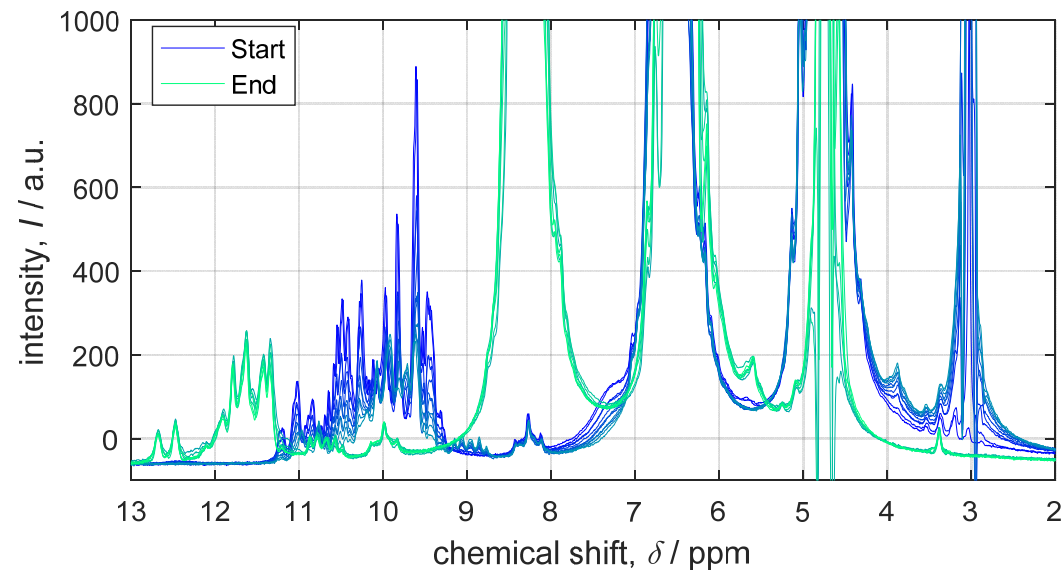
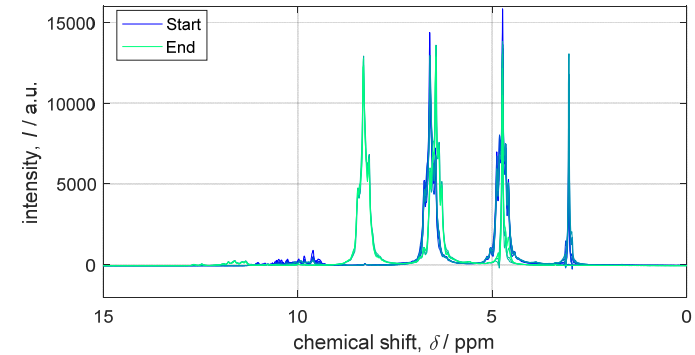

Data Processing for Low-field NMR in Matlab

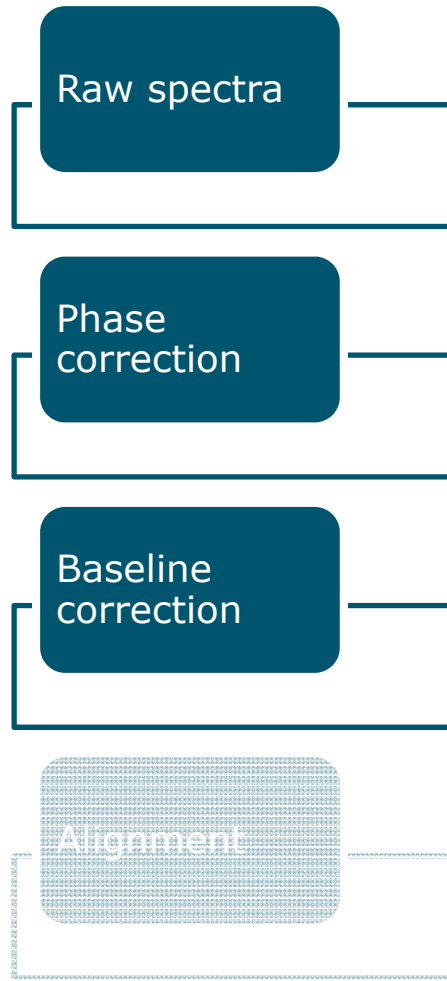

Low-order Polynomial fit:
Mazet et al., Chemometrics
Intell. Lab. Sys. **2005**, *76*,
121-133.

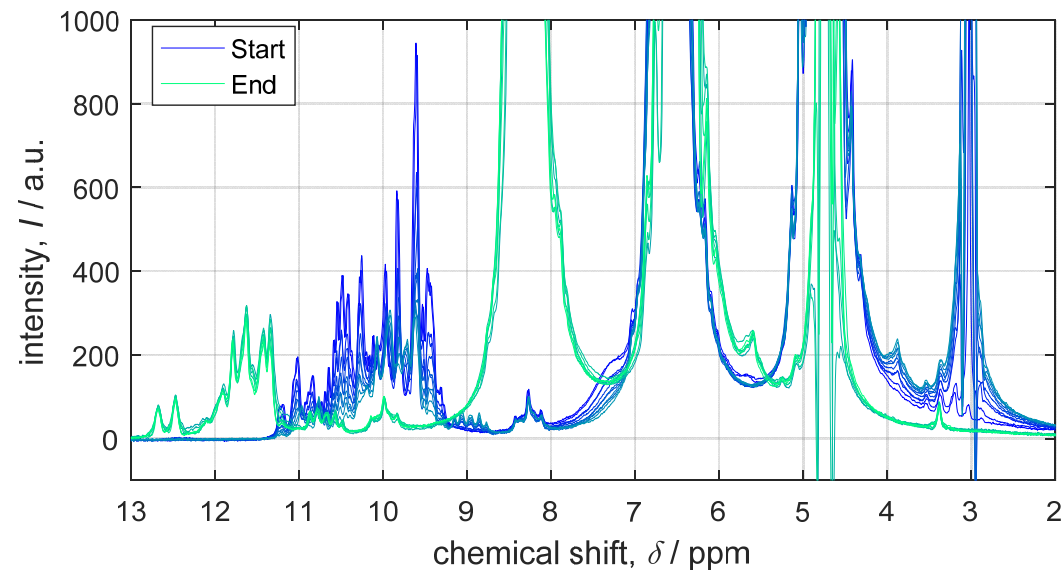
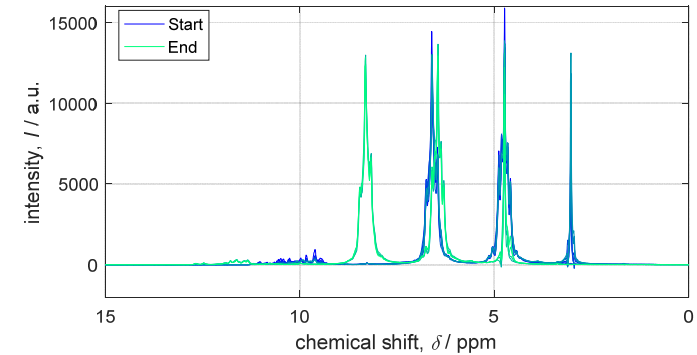

Data Processing for Low-field NMR in Matlab

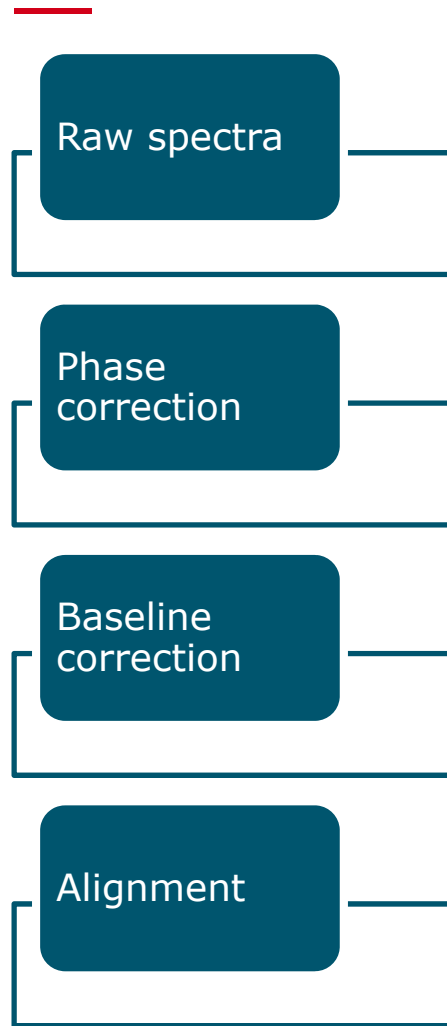

Alignment to reference signal (THF) using *icoshift*:
Savorani et al., J Magn Reson. **2010**, *2*, 190-202

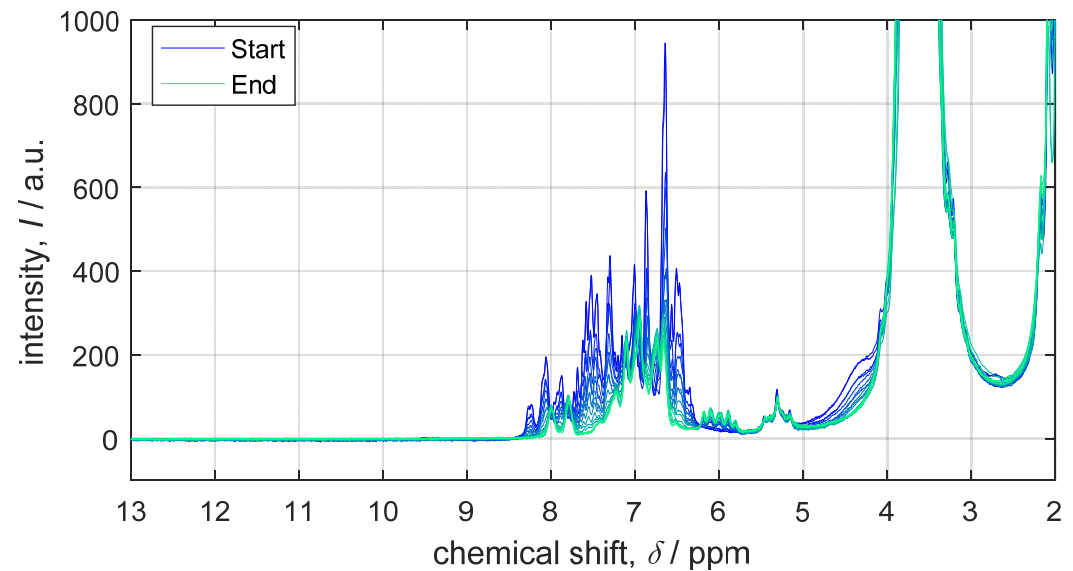
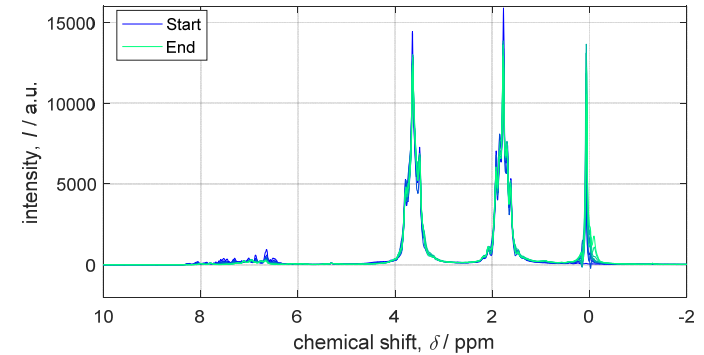

Challenges in Automated Data Analysis



Data pretreatment

Integration

MCR

Binning/ PLS-R

GSD/ Edited Sum

IHM

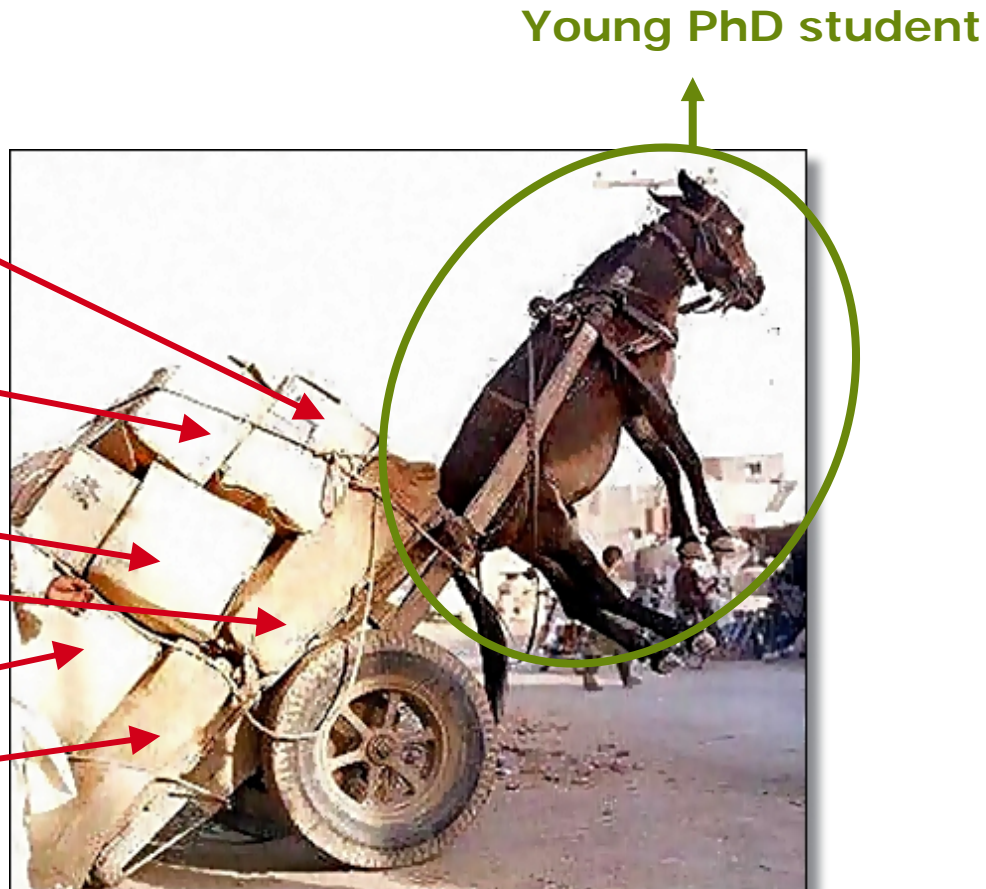

<http://collegeaffordology.com/>



Indirect Hard Modeling (IHM)

- Modeling → peak fitting of pure component spectra → mixture model
- Analysis → "component fitting" → calculation of component area

» Group of peaks represent pure component spectra

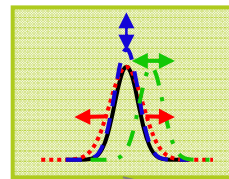

» Pseudo-Voigt function

$$V = \alpha \left[\beta \cdot \exp\left(-\ln(2) \frac{(x - \delta)^2}{\gamma^2}\right) + (1 - \beta) \frac{\gamma^2}{(x - \delta)^2 - \gamma^2} \right]$$

- α = peak maximum
- β = Gaussian-Lorentzian-ratio
- γ = half width
- δ = center position

Hard model for pure components

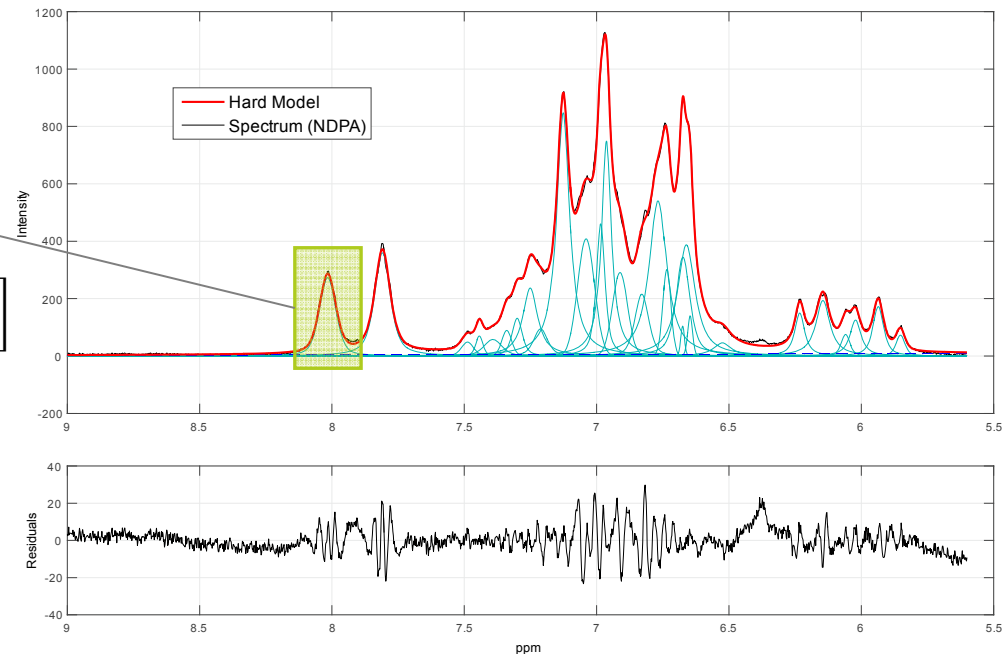

IHM – „component fitting“

Pure component models

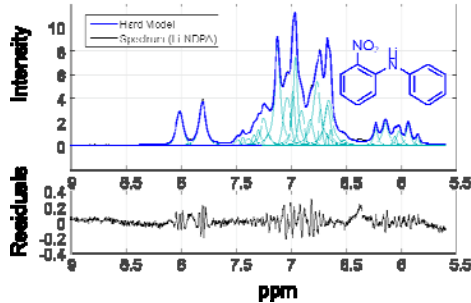
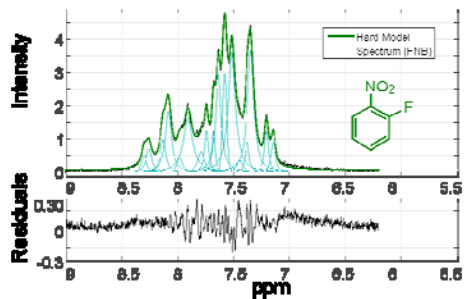
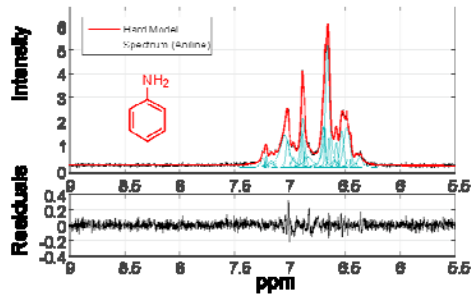

Mixture model

Component fitting

Experimental Spectrum

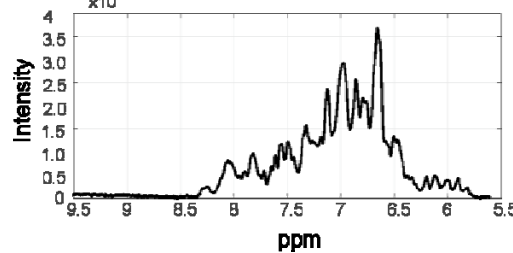

Modeling → Mixture model

| | |
|---|------------|
| No. components | 3 |
| Peaks per component | 22, 21, 28 |
| Degree of freedom (total free parameters) | 292 |
| Considered interacting peaks | 25 |
| Max. peak shift | 0.01 ppm |
| ... | ... |

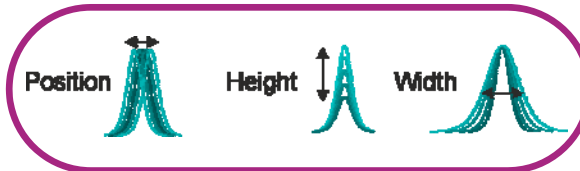

Peak area ratio for each pure component model is kept constant!

IHM – „component fitting“

Pure component models

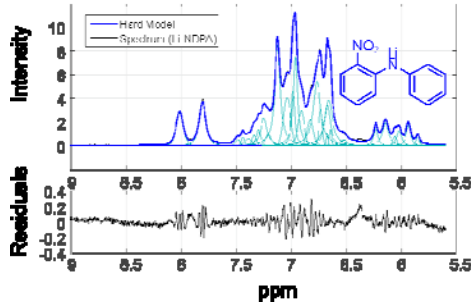
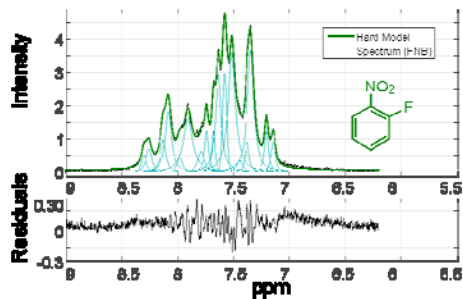
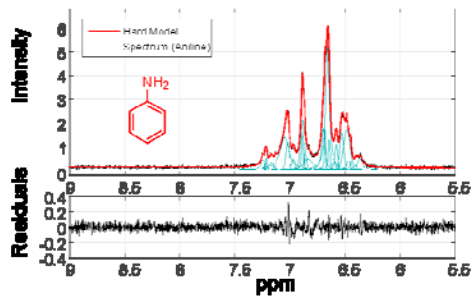

Analysis "component fitting"

Mixture model

Component fitting

Experimental Spectrum

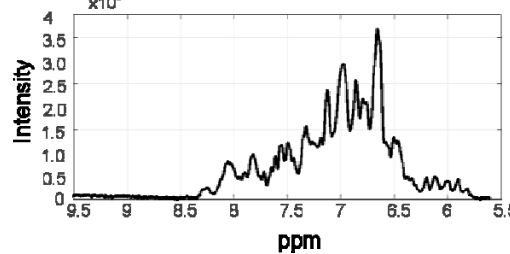

Deconvoluted spectrum

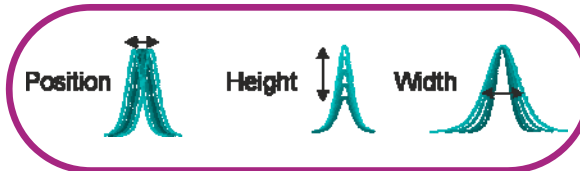
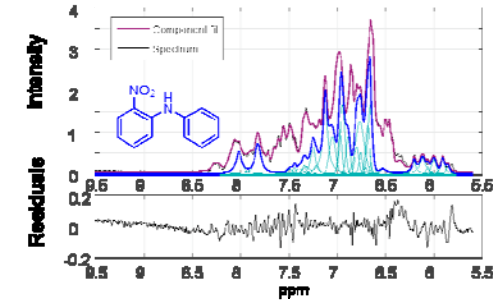
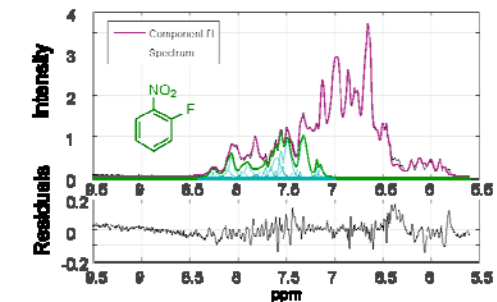
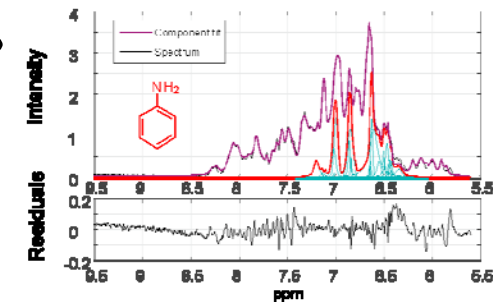

Results: Validation of IHM Model

Lab Experiments in Batch along Reaction Co-ordinate

- 3 semi-batch reaction with varying starting concentrations
- 1500 Spectra for each HF- and NF-NMR

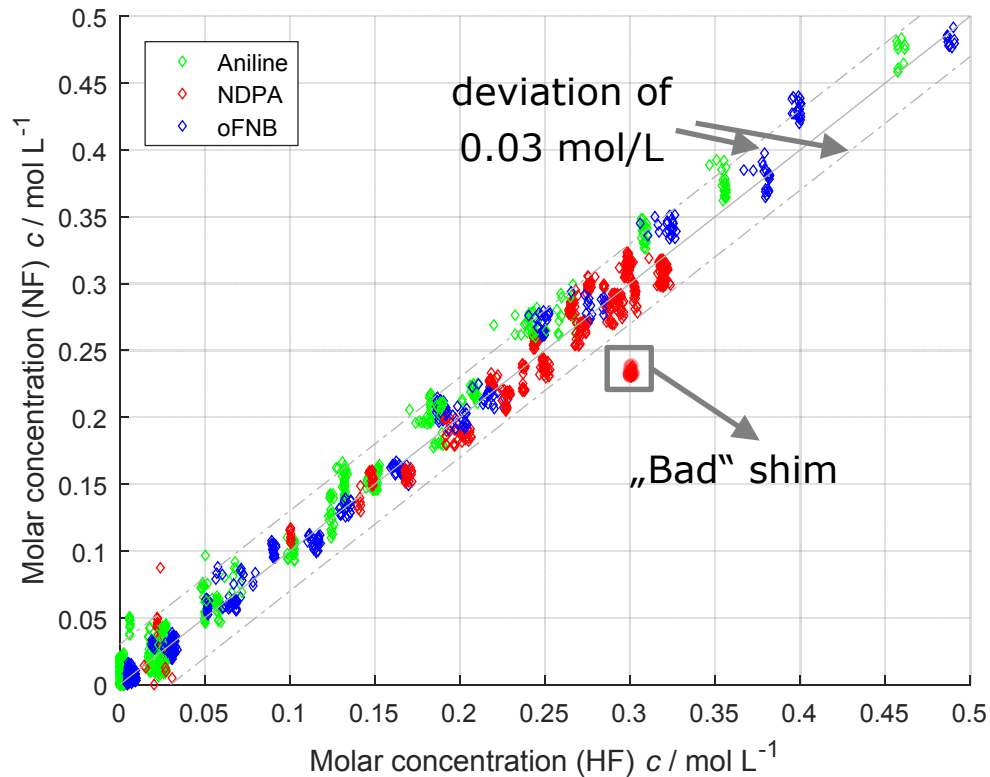

Classification of steady states

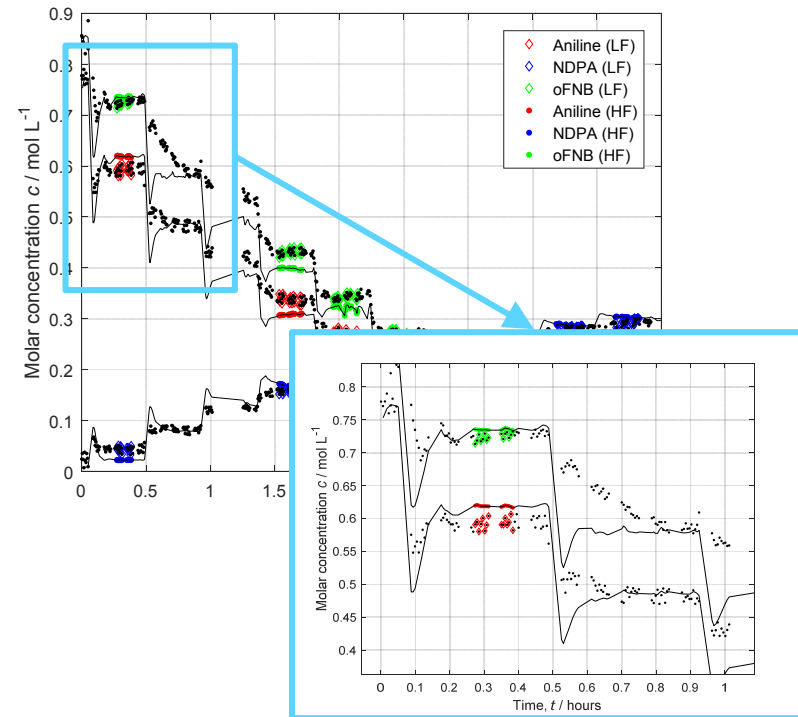

Reaction Scheme:

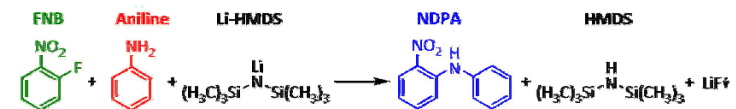

Results: Validation of IHM Model

Lab Experiments in Batch along Reaction Co-ordinate

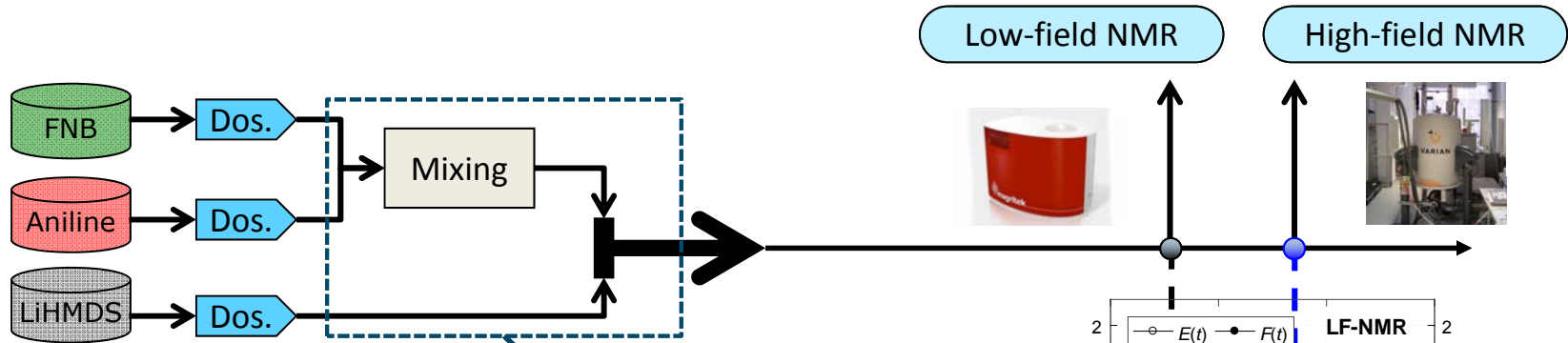

1/8" tube reactor

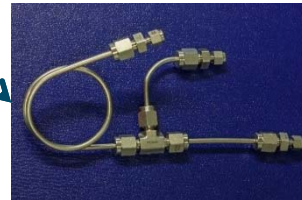

Step tracer experiments

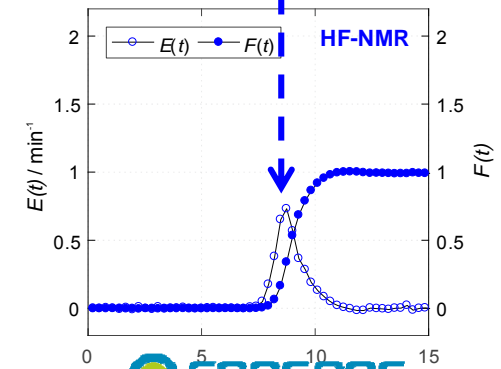
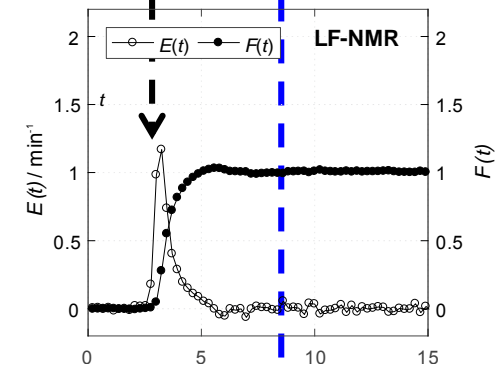
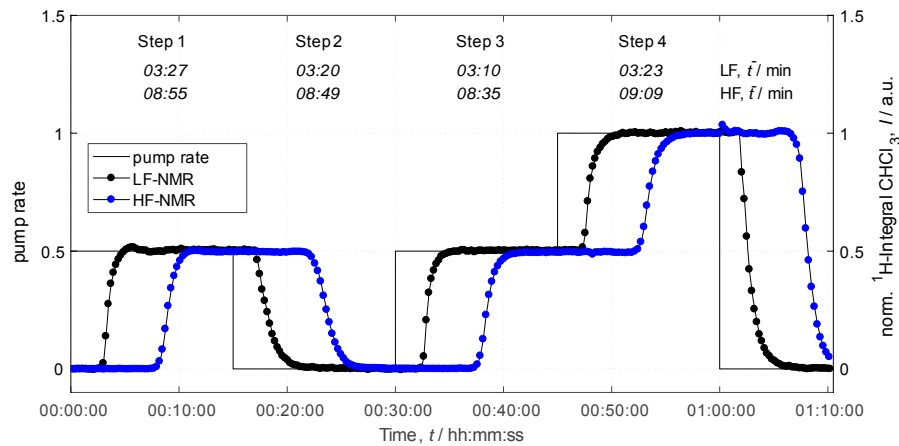

Monitoring of Continuous Aromatic Substitution Reaction by Low Field NMR

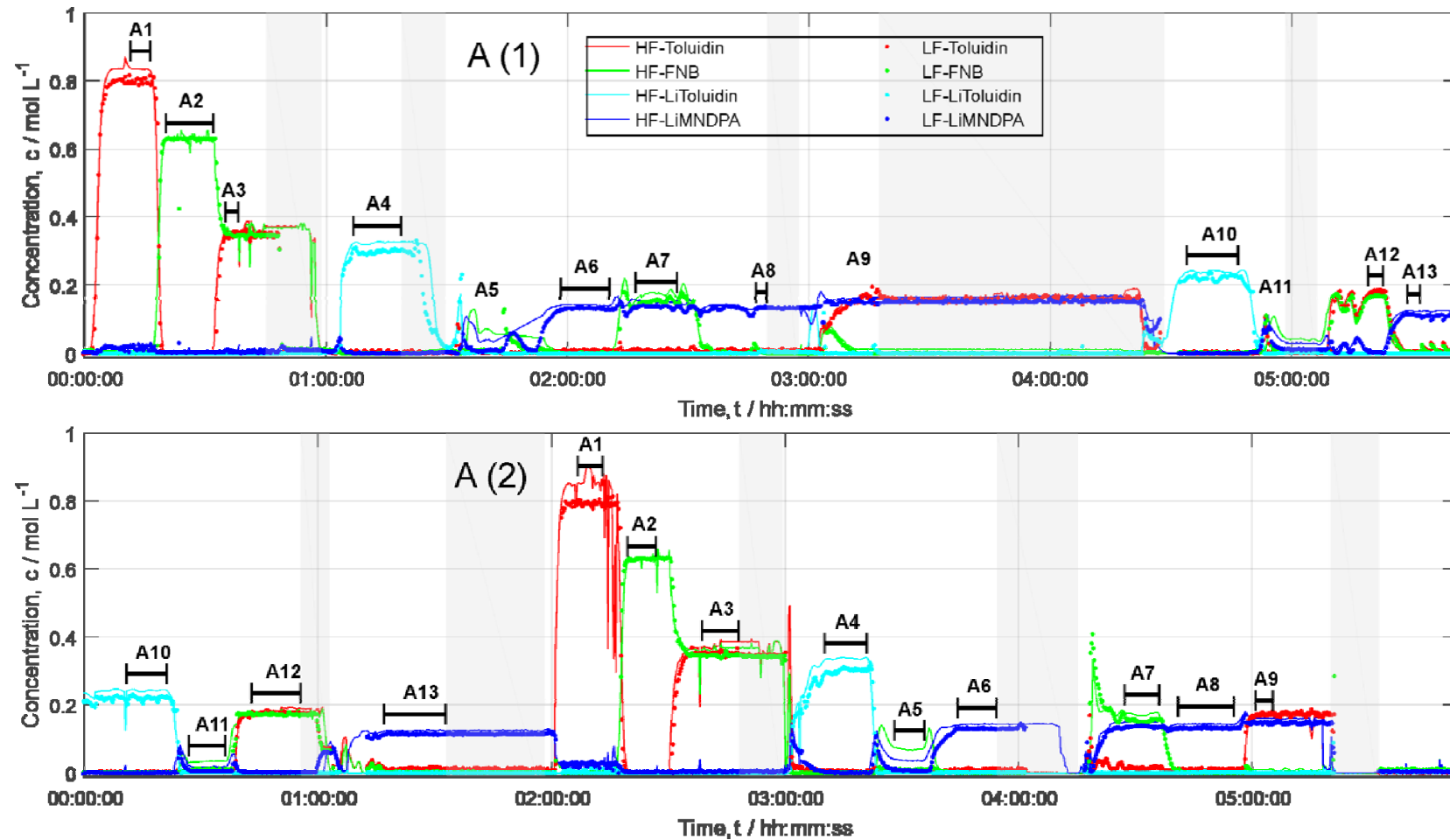

Monitoring of Continuous Aromatic Substitution Reaction by Low Field NMR

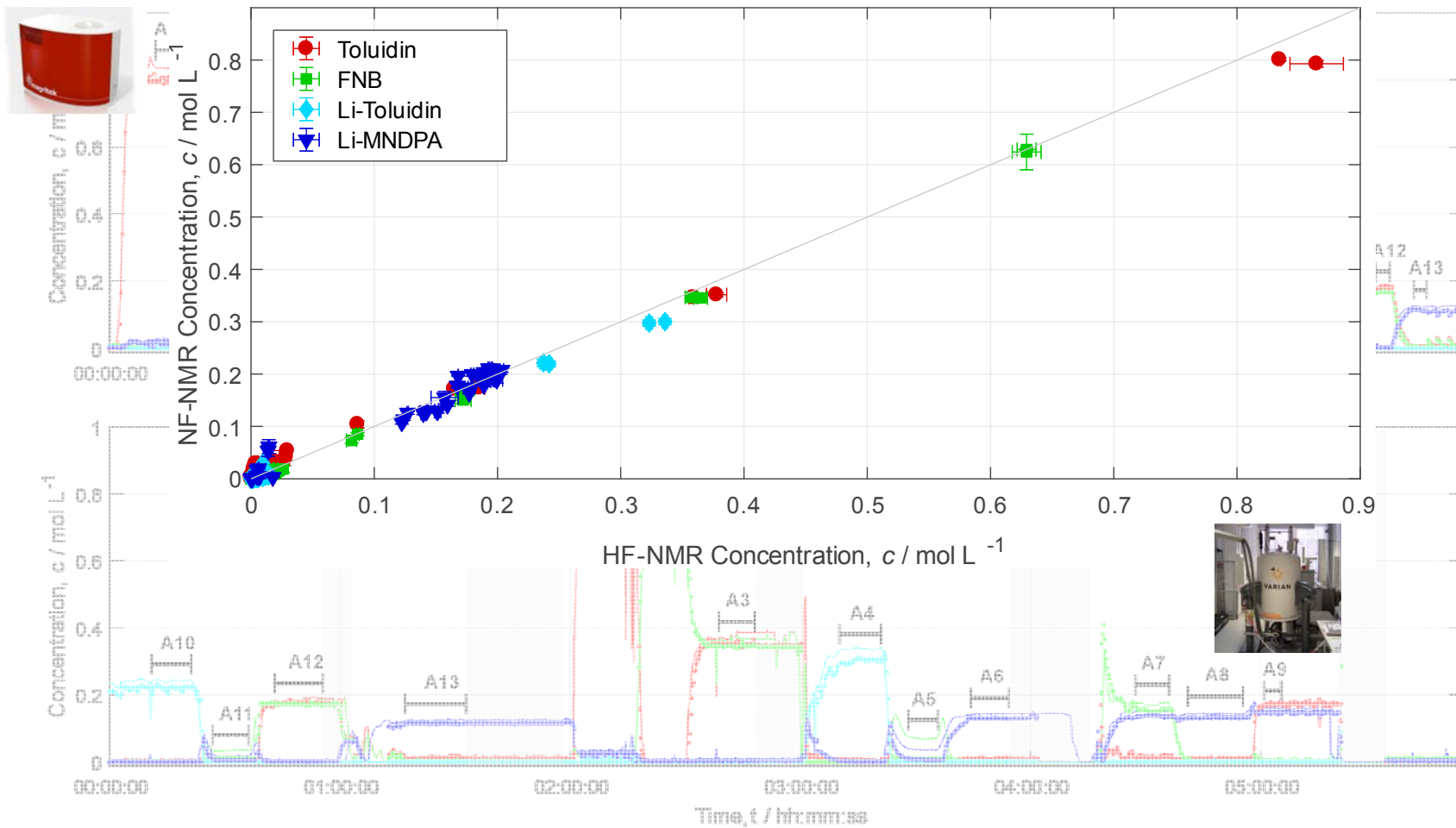

Problem: Overestimation of Components at Low Concentrations

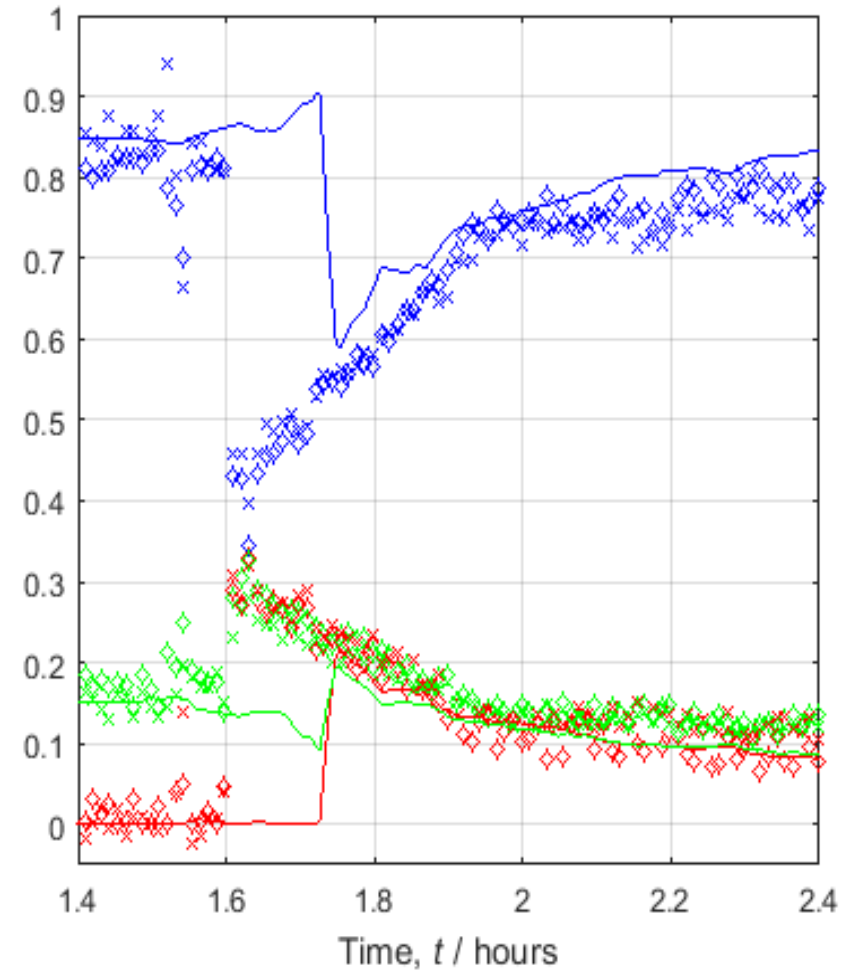
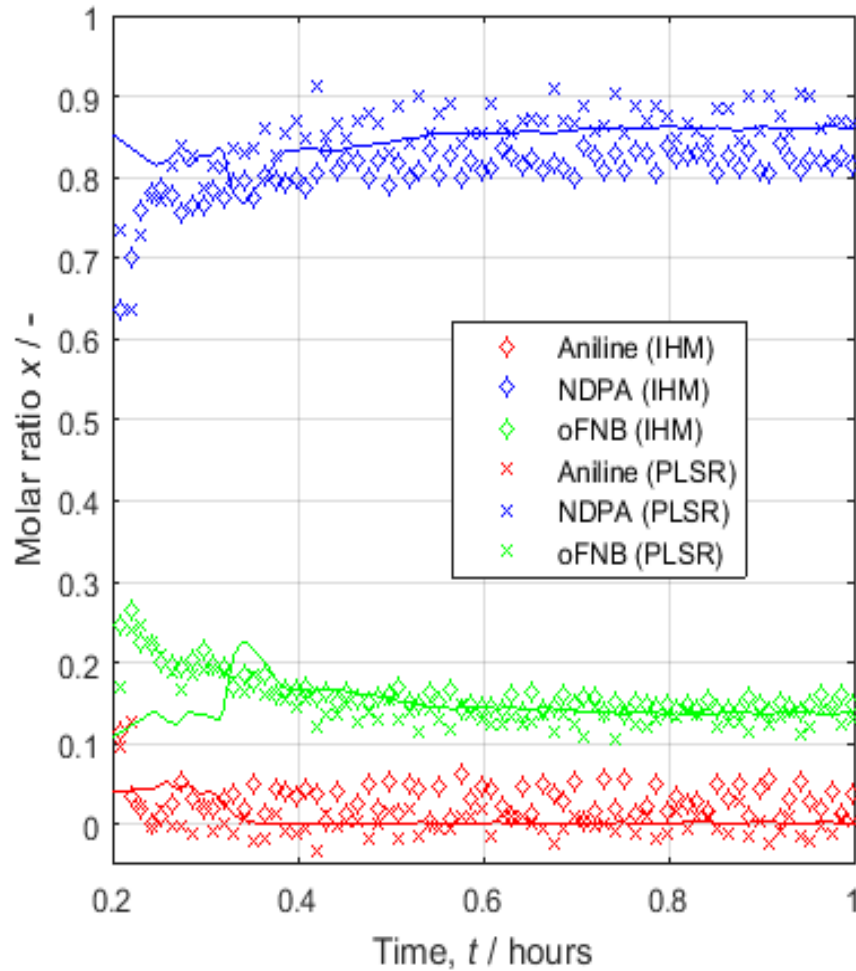

Challenges in Industrial Scale

Varying Peak Width

- Spectra for repeated batches vary, e.g., due to the quality of the respective shim

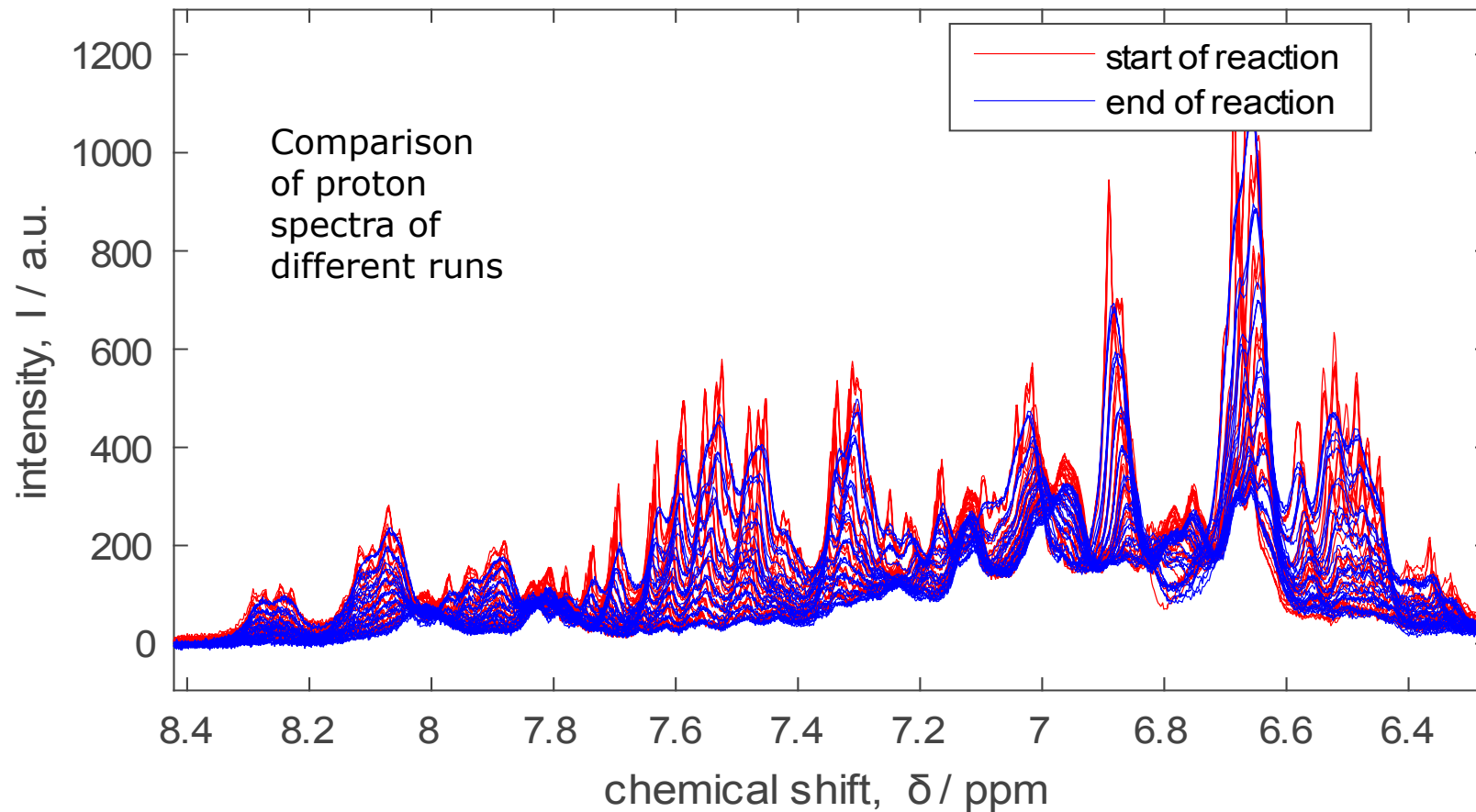

Challenges in Industrial Scale

Unknown Components

Model derived from Lab data

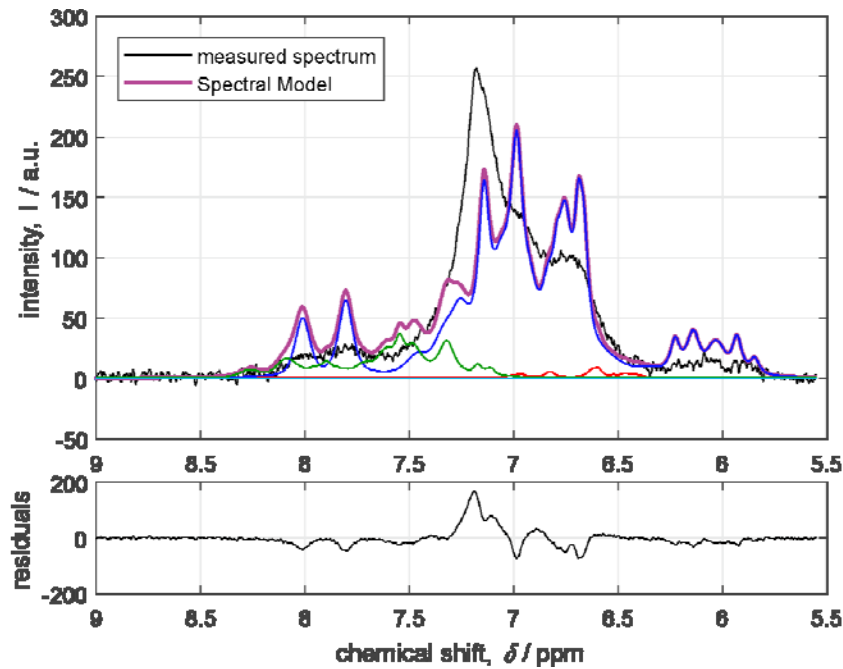

Model adaption to „process conditions“

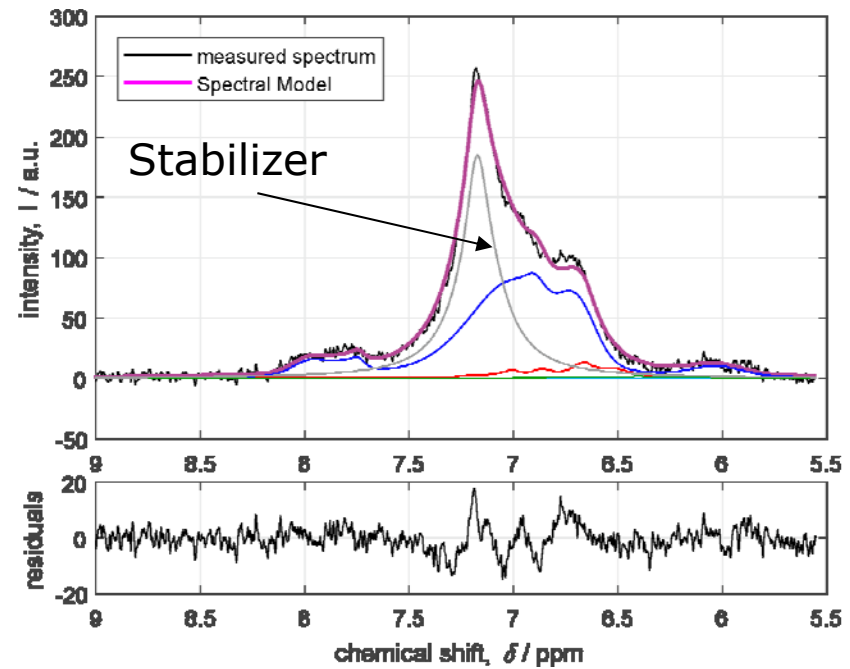

THANK YOU!

Jürgen Kolz

Ullrich Koch

Juan Perlo

Mike Bernstein

Magritek

Magritek

Magritek

MestreLab

Harald Pape

Clemens Minnich

Dirk Engel

Alfons Steil

PTB

S-Pact

S-Pact

PSG Petro Service

NMR Group at BAM

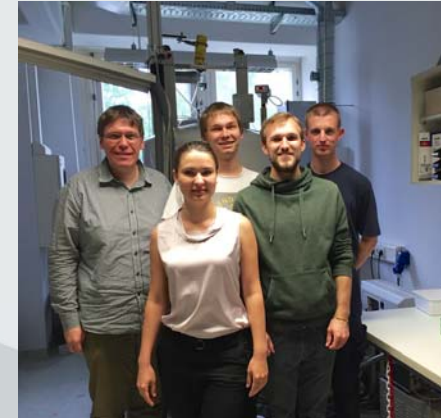

CONSENS – Integrated Control and Sensing for Sustainable Operation of Flexible Intensified Processes, funded by the European Union's Horizon 2020 research and innovation programme under grant agreement N° 636942.

www.consens-spire.eu

THIS DOCUMENT IS PROVIDED "AS IS" WITH NO WARRANTIES WHATSOEVER, INCLUDING ANY WARRANTY OF MERCHANTABILITY, NON-INFRINGEMENT, FITNESS FOR ANY PARTICULAR PURPOSE, OR ANY WARRANTY OTHERWISE ARISING OUT OF ANY PROPOSAL, SPECIFICATION OR SAMPLE.

Any liability, including liability for infringement of any proprietary rights, relating to use of information in this document is disclaimed. No license, express or implied, by estoppel or otherwise, to any intellectual property rights are granted herein. The members of the project CONSENS do not accept any liability for actions or omissions of CONSENS members or third parties and disclaims any obligation to enforce the use of this document. This document is subject to change without notice.

Backup

Integrated Process Design and Intensified Processes

Current Trend: Hybrid Modular Plants

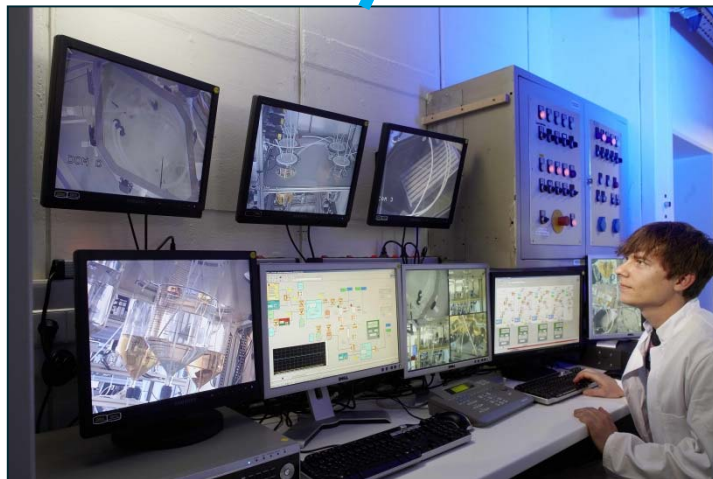
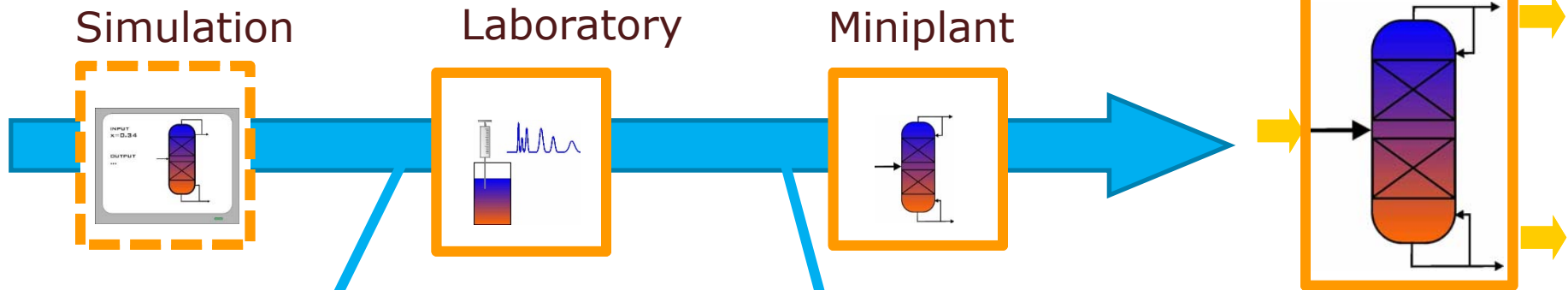

Micro Reaction Technology
(Example: Fraunhofer ICT, Pfinzta/D)



Modular Production
(Example: Foster Wheeler AG, Zug/CH)

Process Automation

The Classical Automation Pyramid → is Outdated!

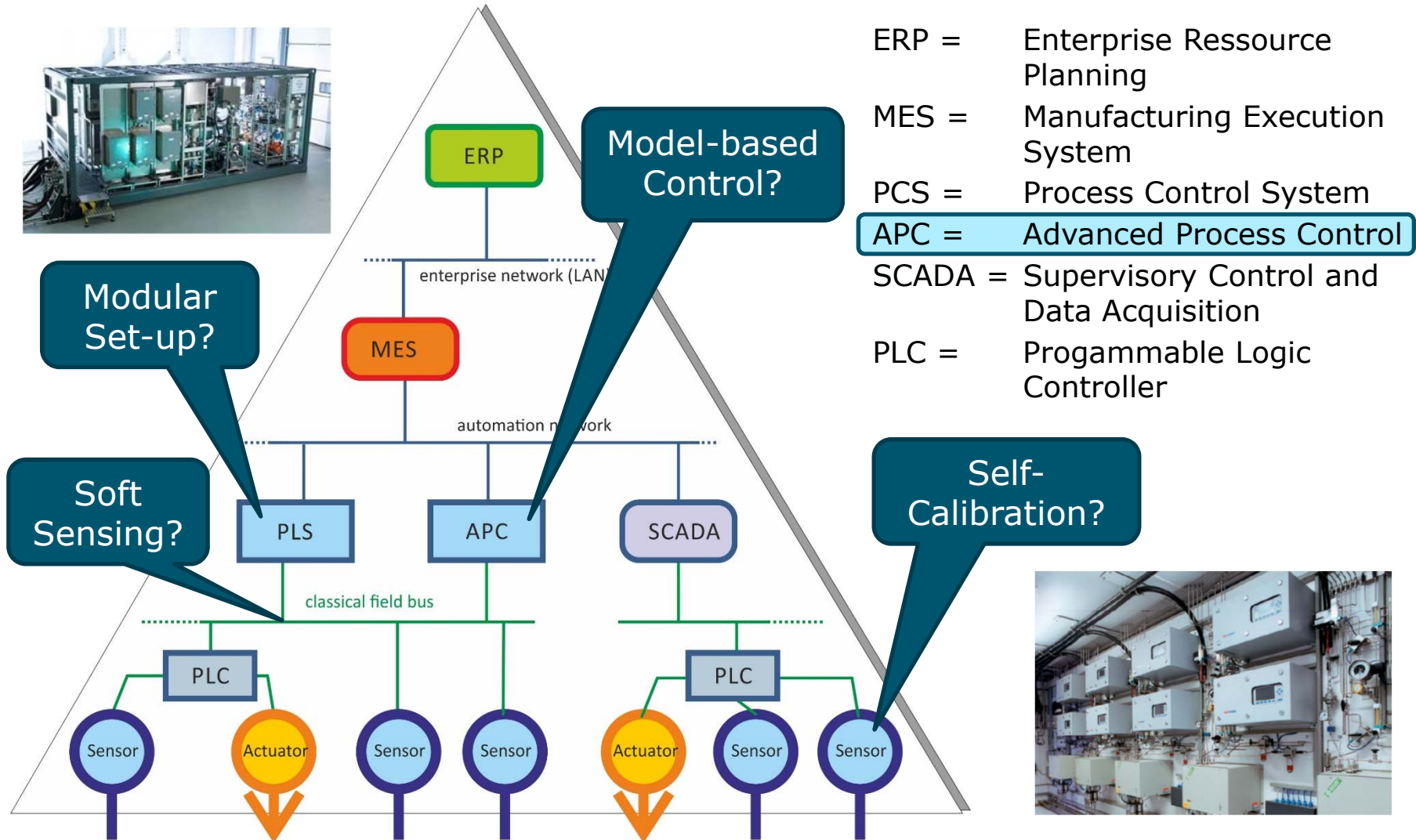

- ERP = Enterprise Resource Planning
- MES = Manufacturing Execution System
- PCS = Process Control System
- APC = Advanced Process Control**
- SCADA = Supervisory Control and Data Acquisition
- PLC = Programmable Logic Controller



Process Analytical Technology for Intensified Processes



Examples from BAM



Catalysis:
Hydroformylations of C12-alkenes in micro emulsions

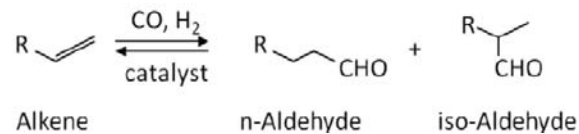

qNMR (Metrology):
Gases and condensed phases up to 1000 bar

Pharmaceuticals:
Liberation kinetics

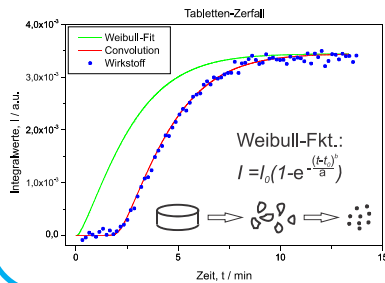

CO₂ scrubbing

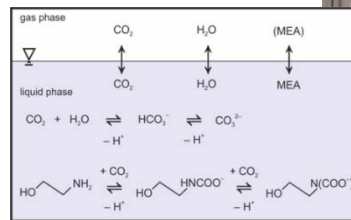

Method development:
Esterifications
(model reactions)

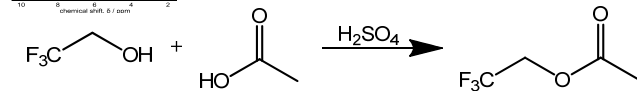
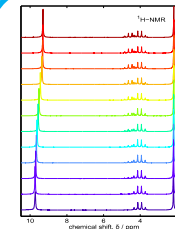

Catalysis:
Hydrogenations

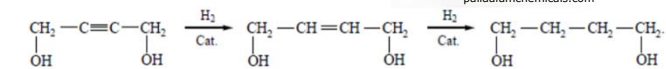

Reaction Engineering:
Lithiation reactions

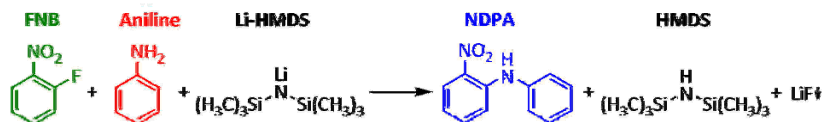

Reaction Engineering:
Photo reactions („click chemistry“)

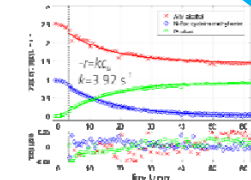
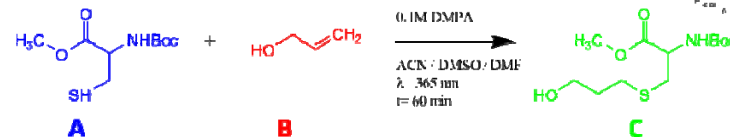

Experimental Design

Continuous Lithiation Reaction Set-up at BAM

- Independent variation of flowrates / stoichiometric conditions

Reaction Scheme:

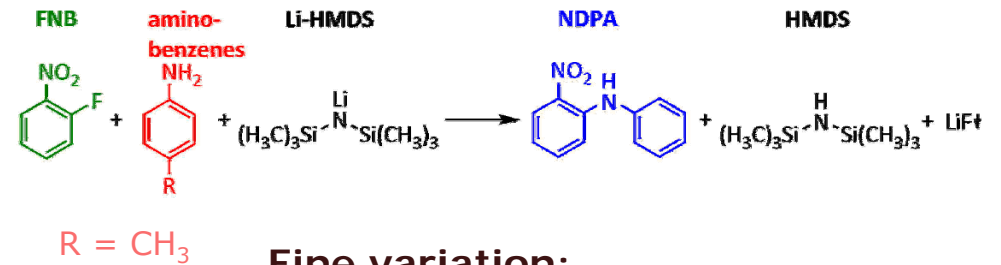

Coarse variation:

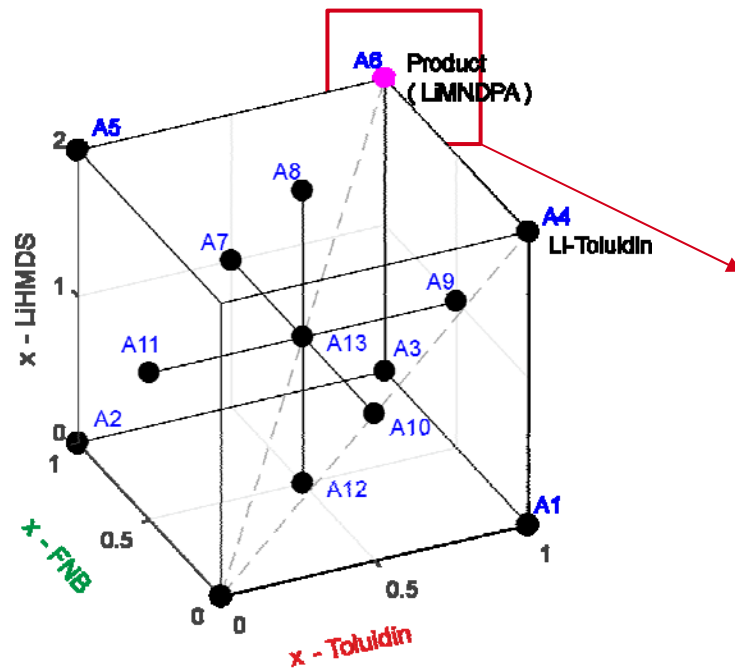

Fine variation:

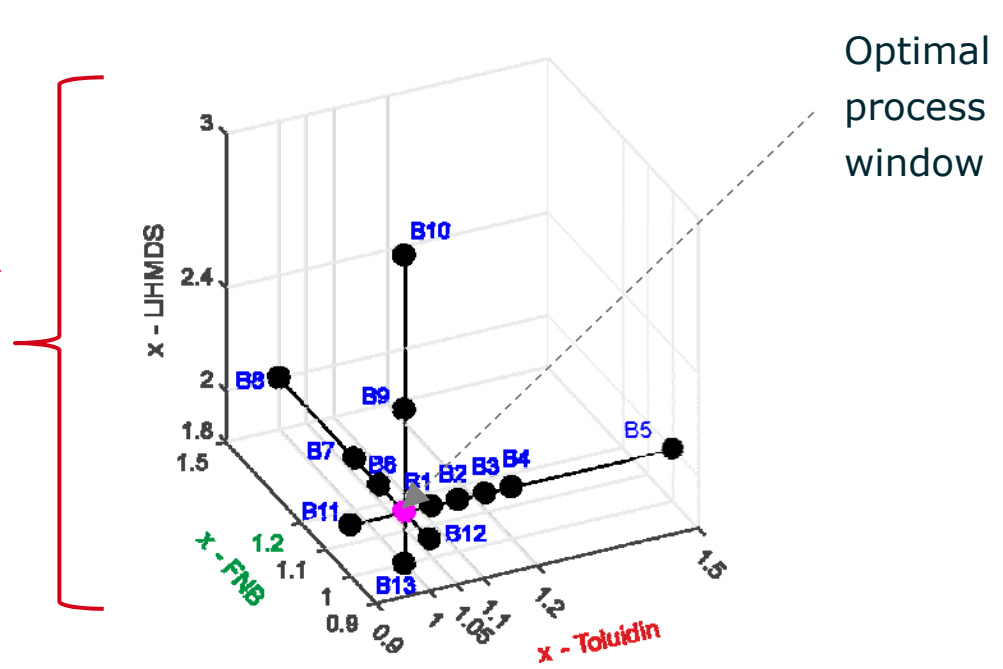

Smart NMR Sensor Concept



Module size:
850 x 570 x 570 mm



Safety devices

- Nitrogen purge control
- Leakage safeguard

Measuring Conditions

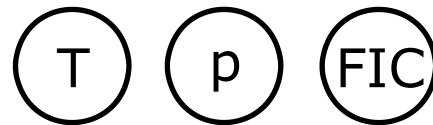

Data Acquisition

- Triggering
- Automated evaluation (Matlab)
- MySQL Database

Conventional
4–20 mA



Programmable
Fieldbus
Controller

www.wago.de

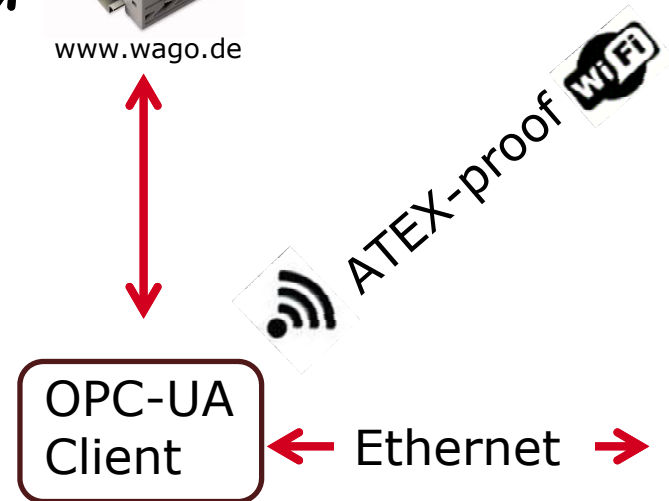

Online NMR Module: Data flows

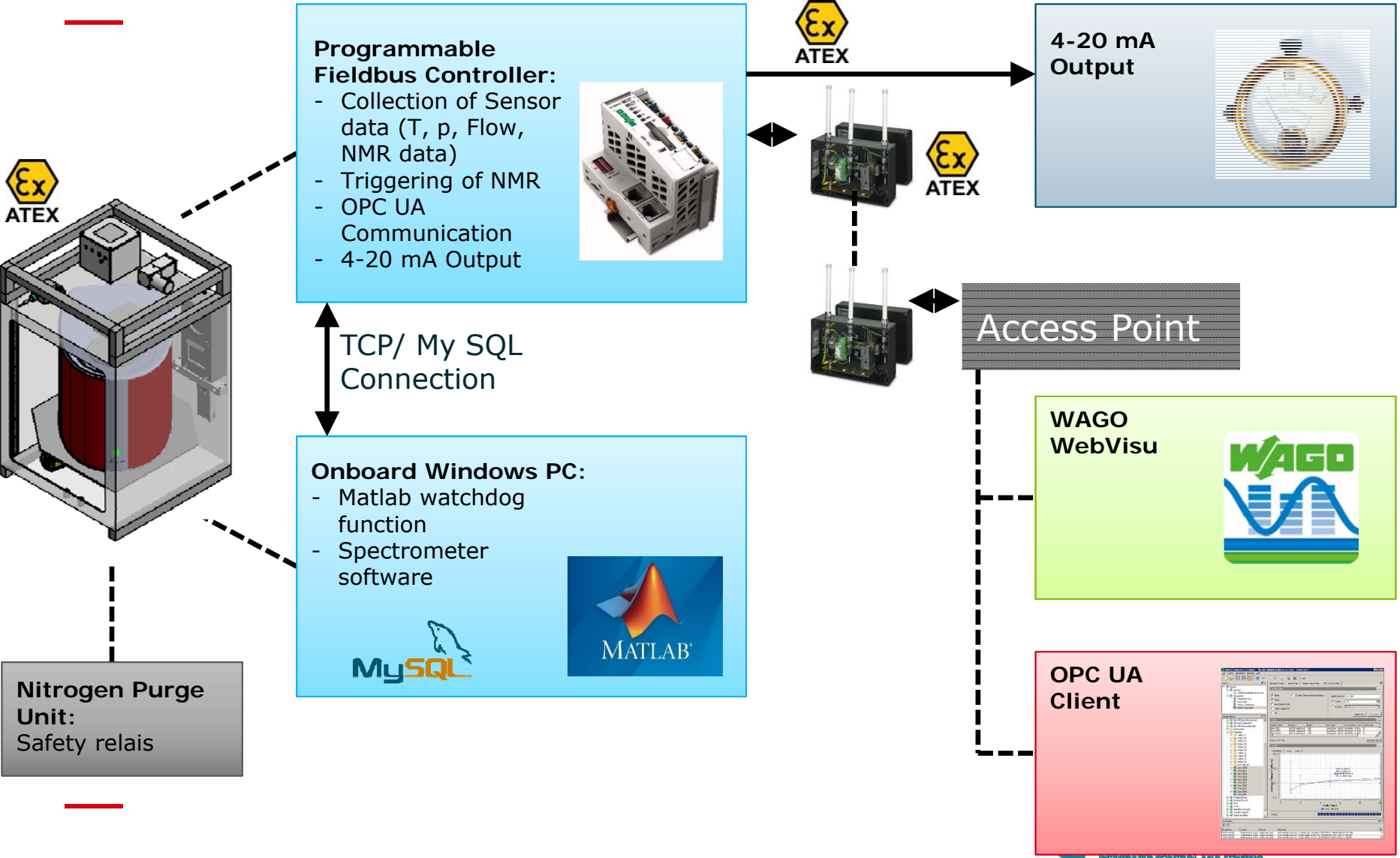

CONSENS: Deliverable of Fully Automated NMR Analyser



NMR Analyser at BAM

Set-up at INVITE, Leverkusen

Module size:
850 x 570 x 570 mm

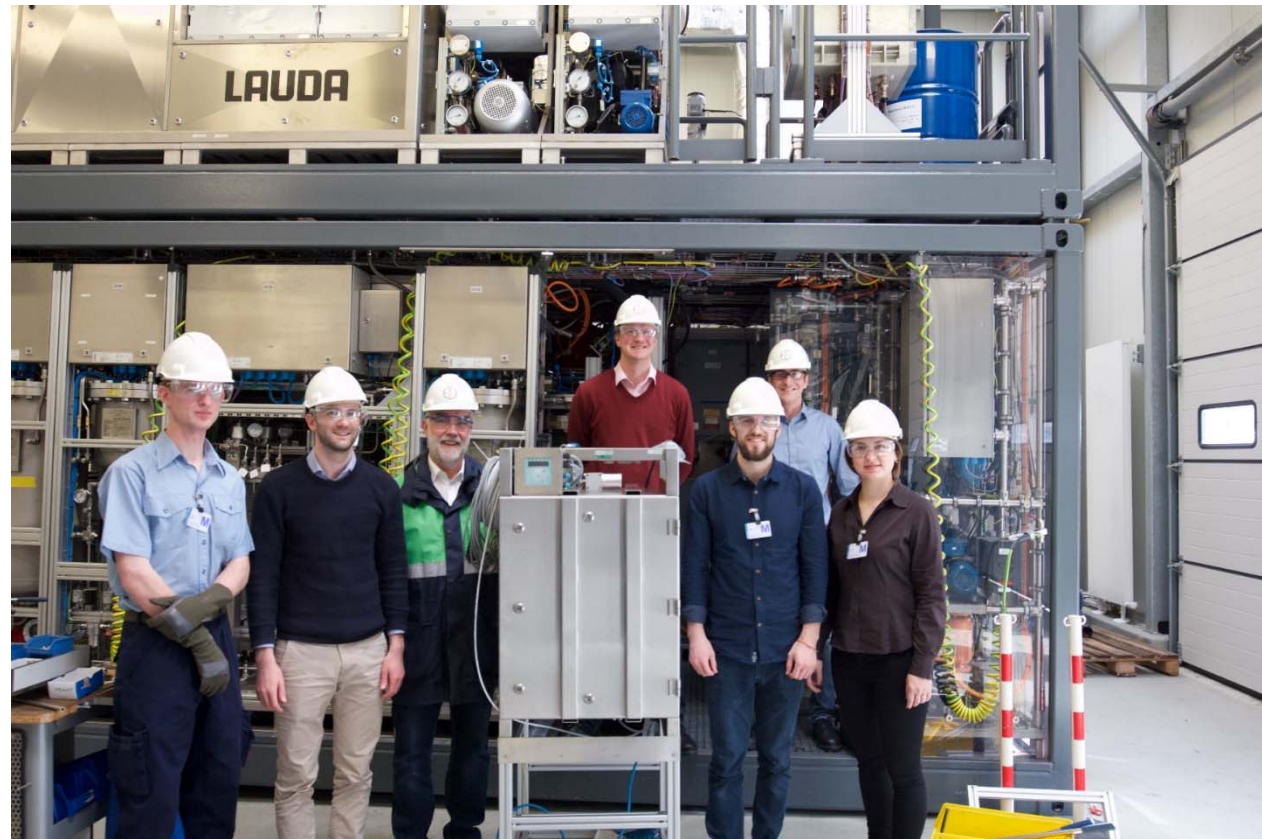

Closing the Gap ...

Key Attributes of Compact NMR Spectroscopy for Industrial Online Applications

Laboratory research

Chemical industry

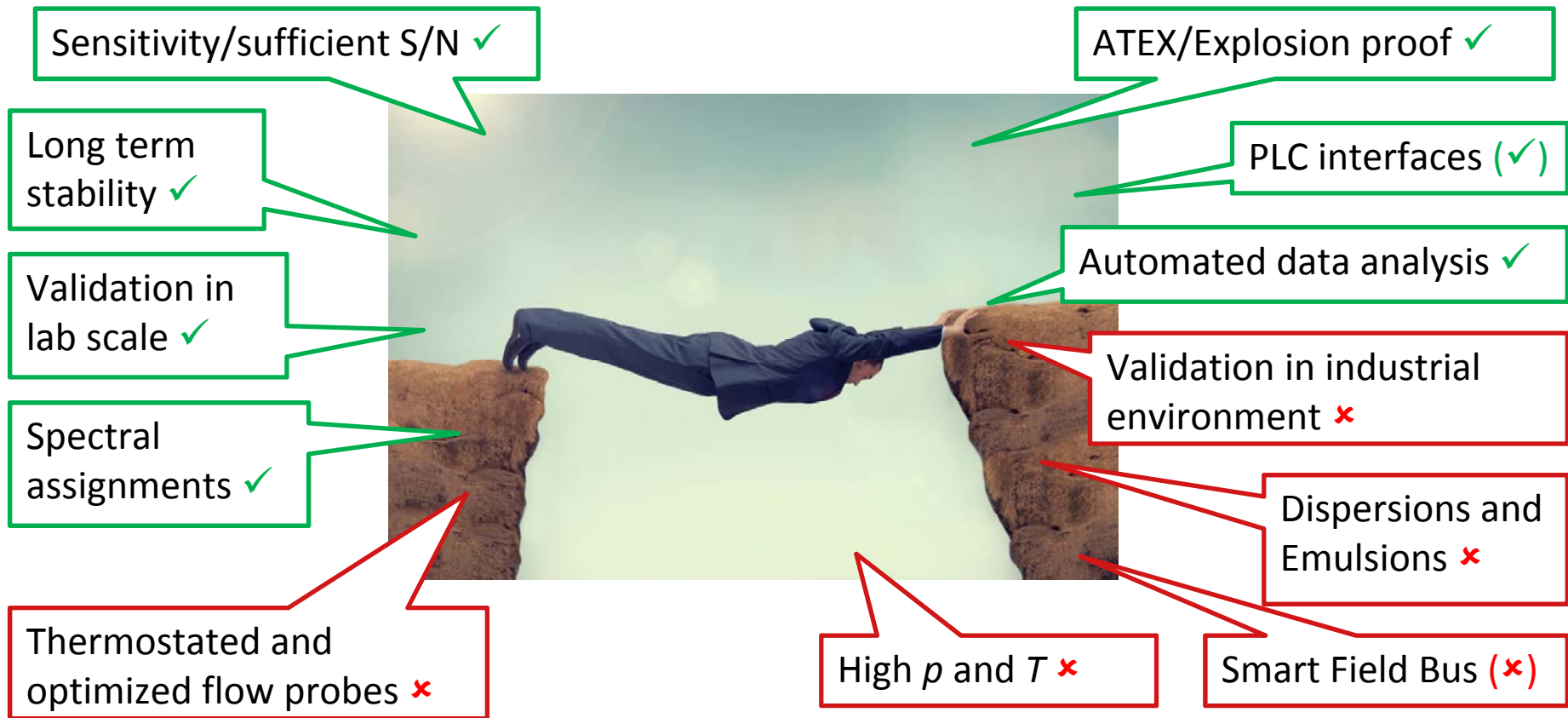

References



-
- K. Meyer, S. Kern, N. Zientek, G. Guthausen, M. Maiwald, Process control with compact NMR, *TrAC Trends in Analytical Chemistry*, October 2016, Vol.83:39–52, doi:[10.1016/j.trac.2016.03.016](https://doi.org/10.1016/j.trac.2016.03.016)
 - N. Zientek, C. Laurain, K. Meyer, A. Paul, D. Engel, G. Guthausen, M. Kraume, M. Maiwald, Automated data evaluation and modelling of simultaneous ^{19}F – ^1H medium-resolution NMR spectra for online reaction monitoring, *Magnetic Resonance in Chemistry*, 54 (2016) 513-520.
 - N. Zientek, C. Laurain, K. Meyer, M. Kraume, G. Guthausen, M. Maiwald, Simultaneous ^{19}F – ^1H medium resolution NMR spectroscopy for online reaction monitoring, *Journal of Magnetic Resonance*, 249 (2014) 53-62.
 - Meyer, K.; Ruiken, J. P.; Illner, M.; Paul, A.; Müller, D.; Esche, E.; Wozny, G.; Maiwald, M.; Process spectroscopy in microemulsions–Setup and multi-spectral approach for reaction monitoring of a homogeneous hydroformylation process. *Measurement Science and Technology* 2017, 28.

NMR-Grundlagen

Quantenmechanische Einschränkung

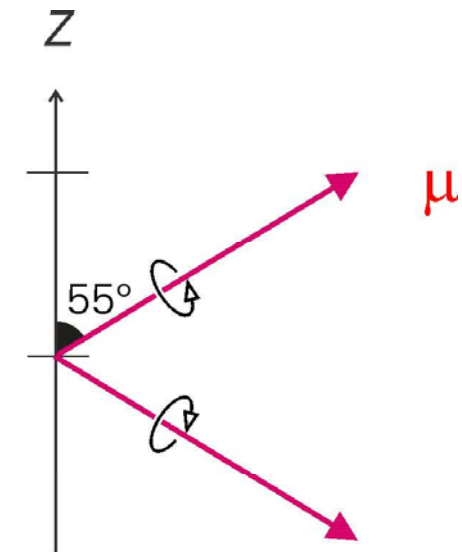
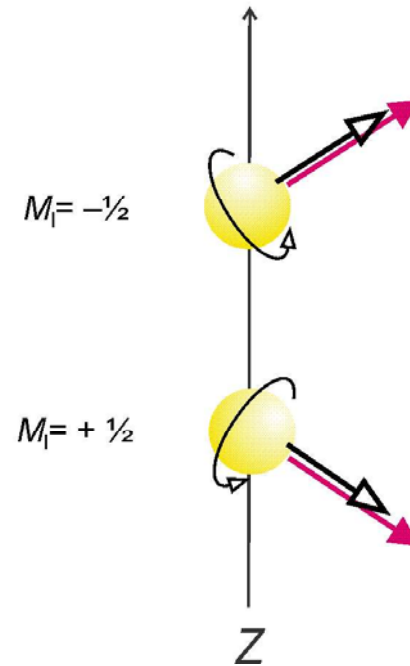
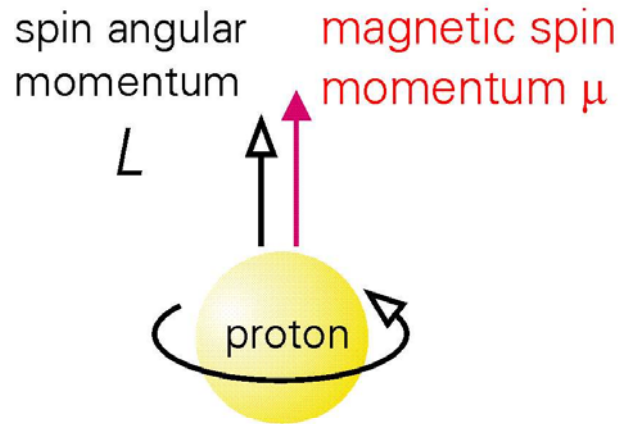

Quantenmechanische Einschränkung

Die Spins richten sich im Magnetfeld auf Kegelmänteln aus

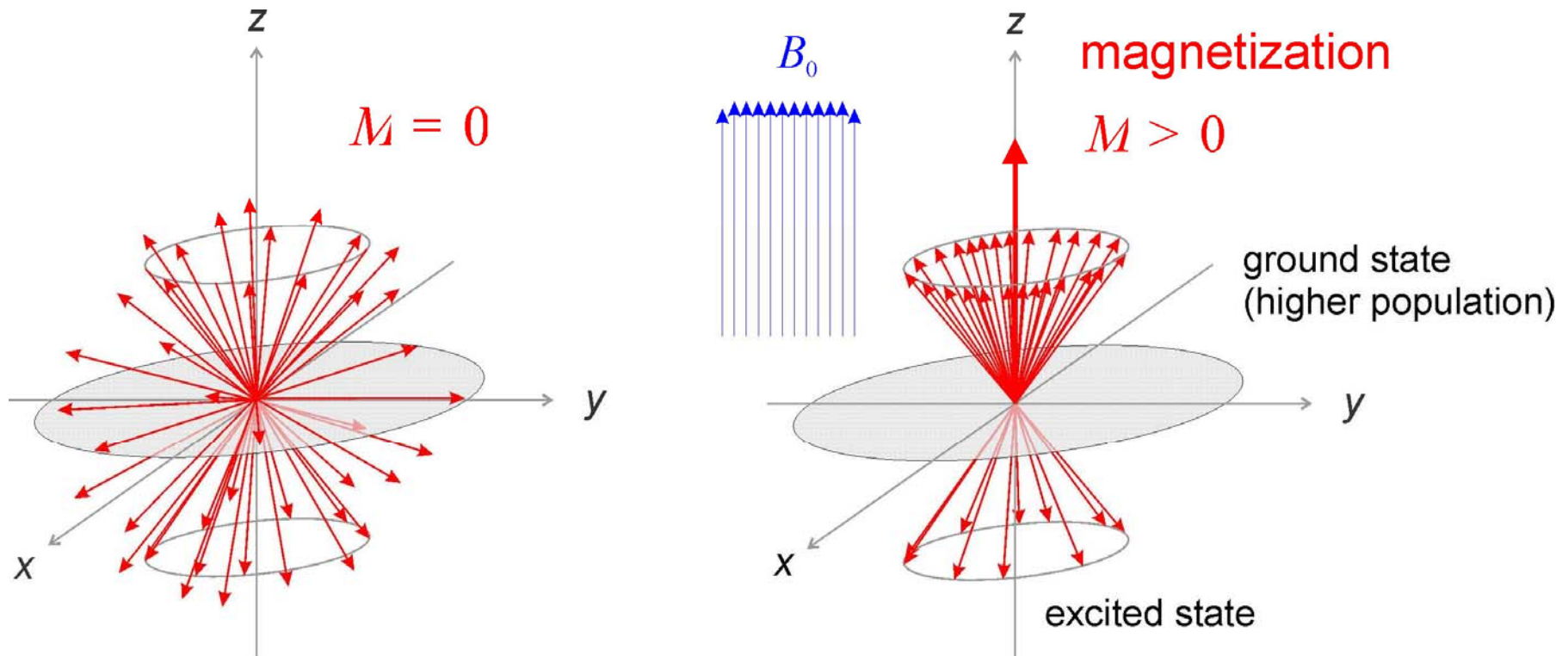

90°-Anregung mit Radiofrequenzpuls

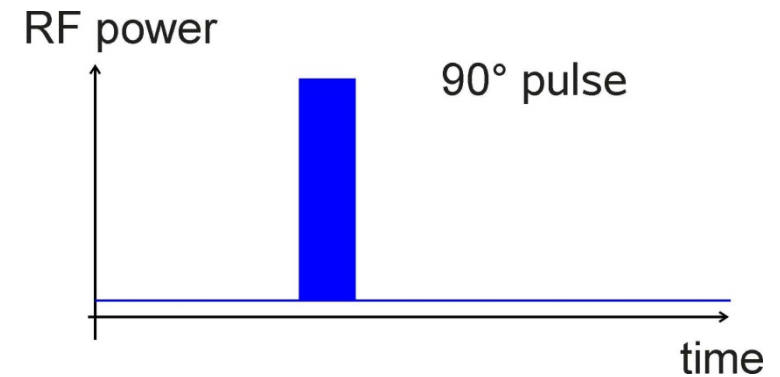
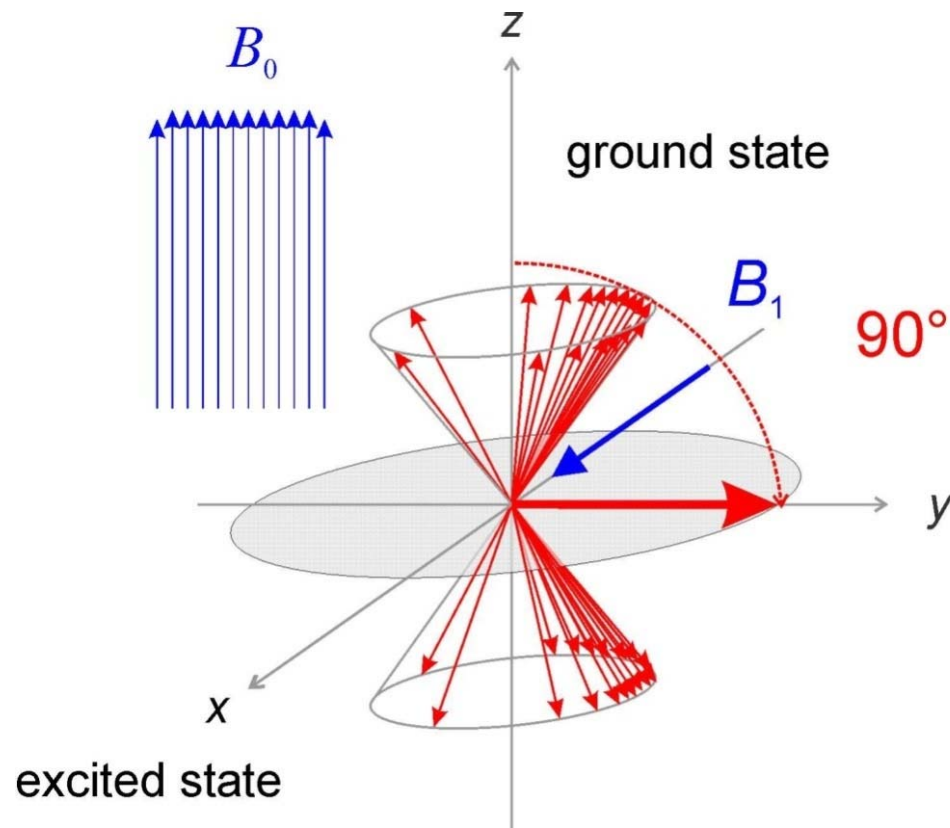

magnetization M shows into x-y-plane



Variation der Pulslänge (Kalibrierung)

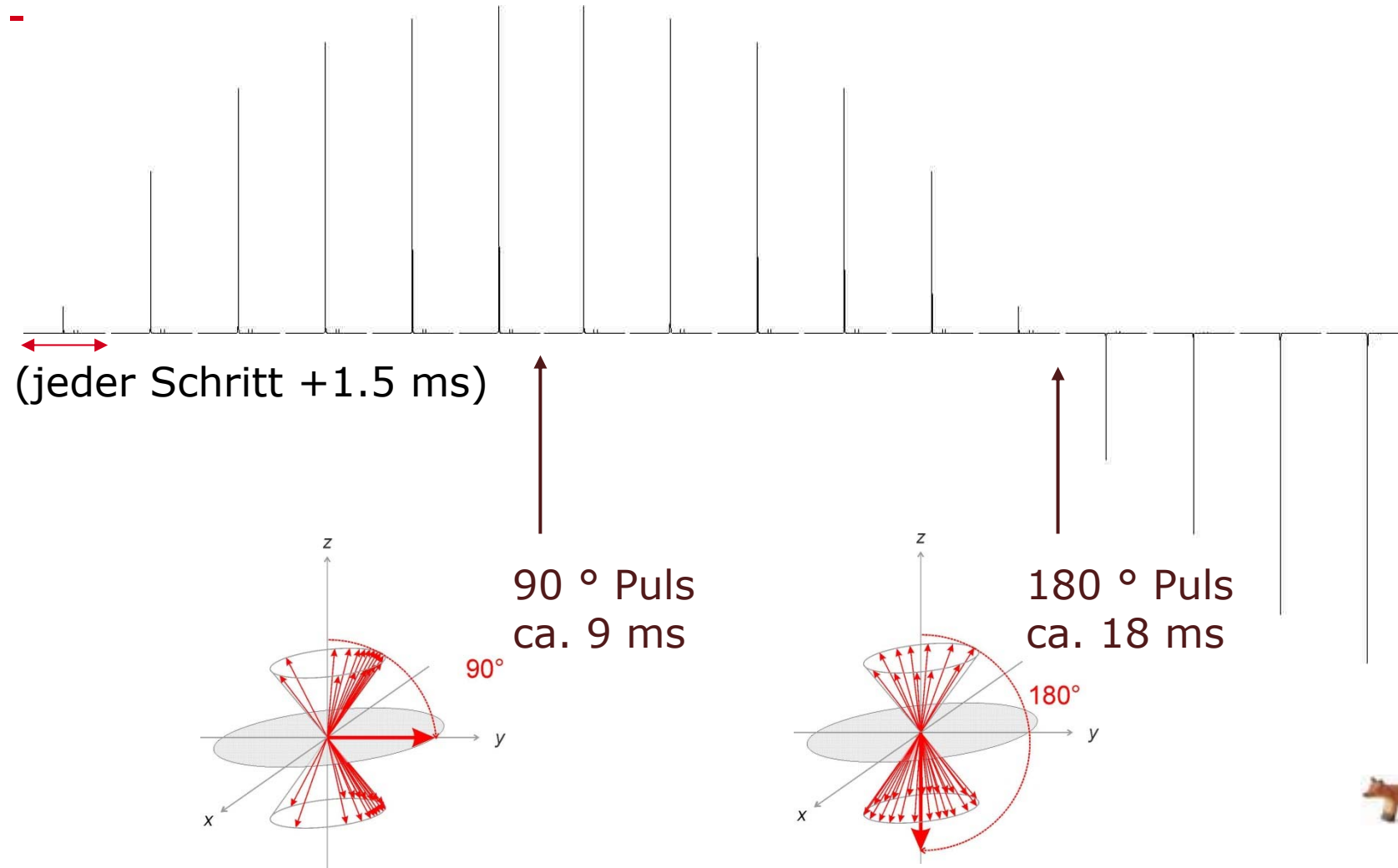

Relaxation

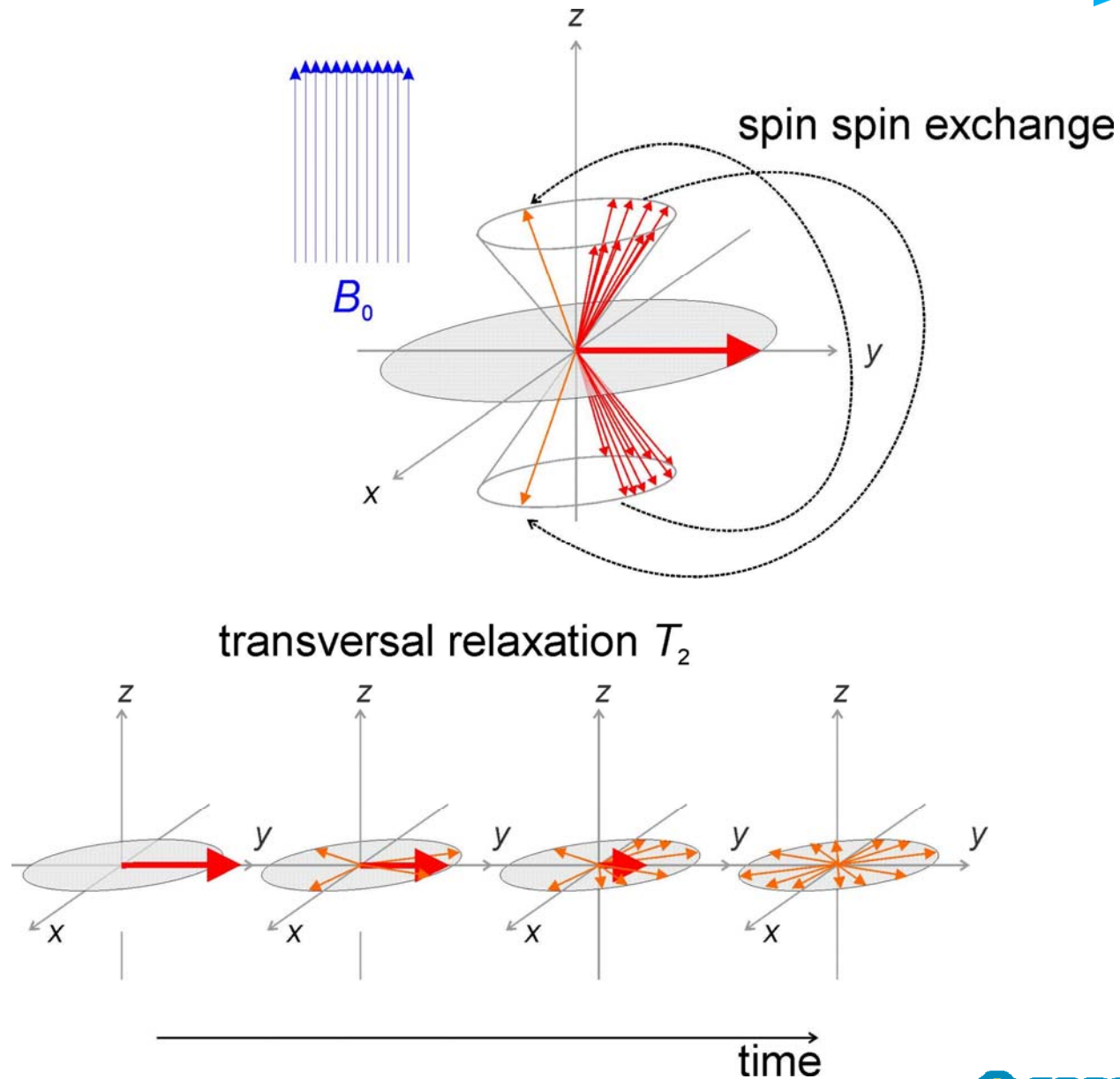

Relaxation

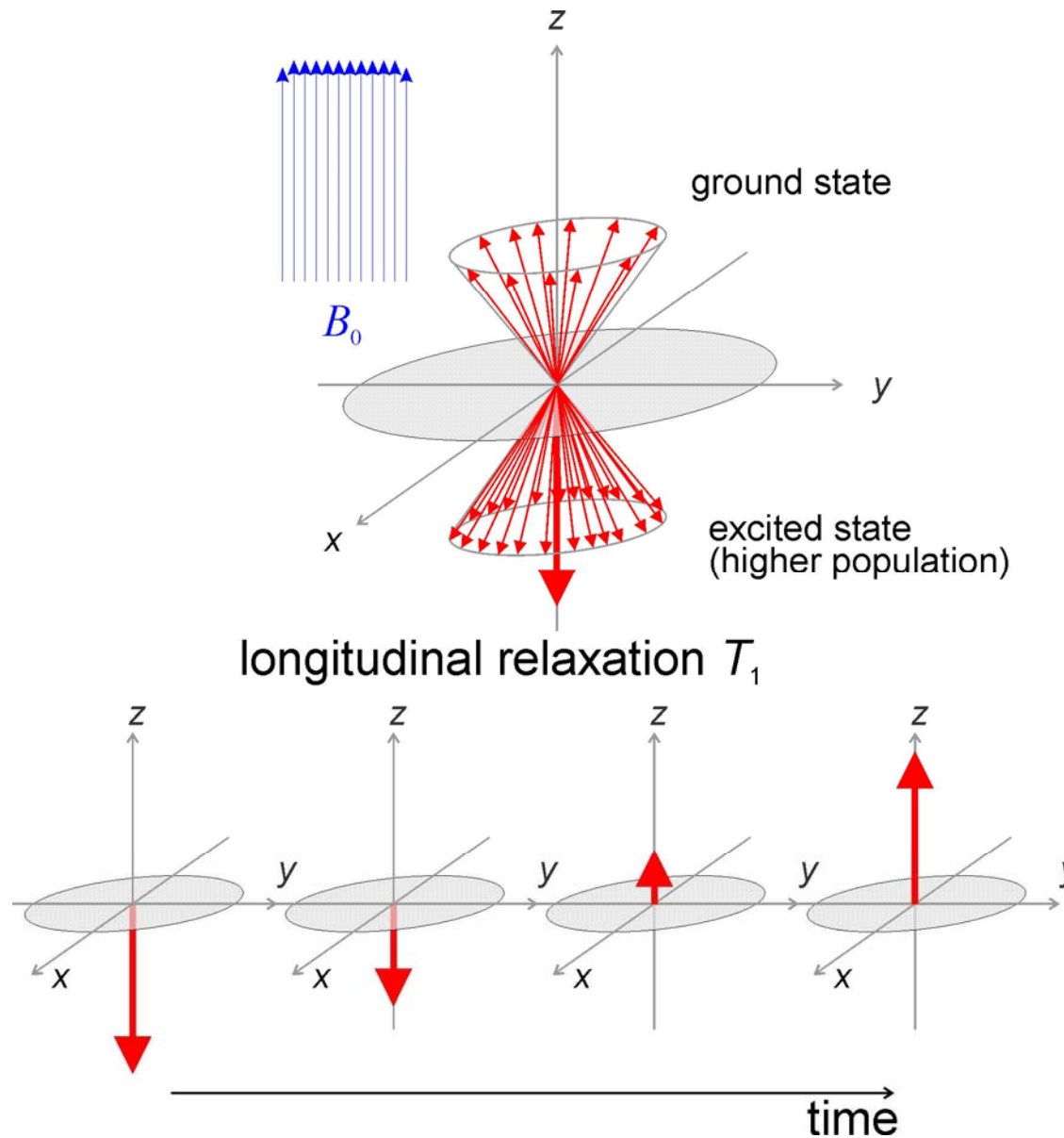

Chemische Verschiebung

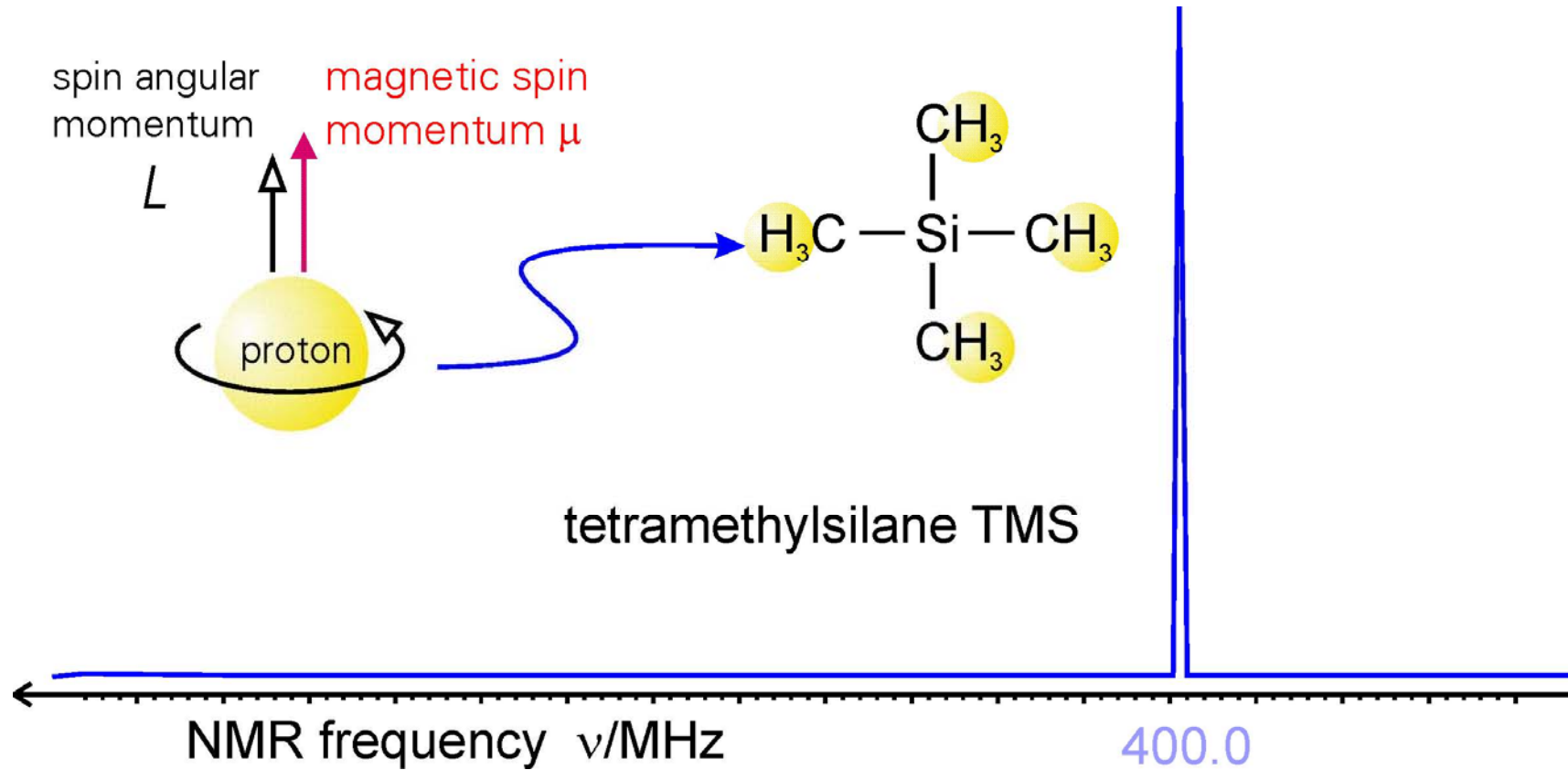

Chemische Verschiebung

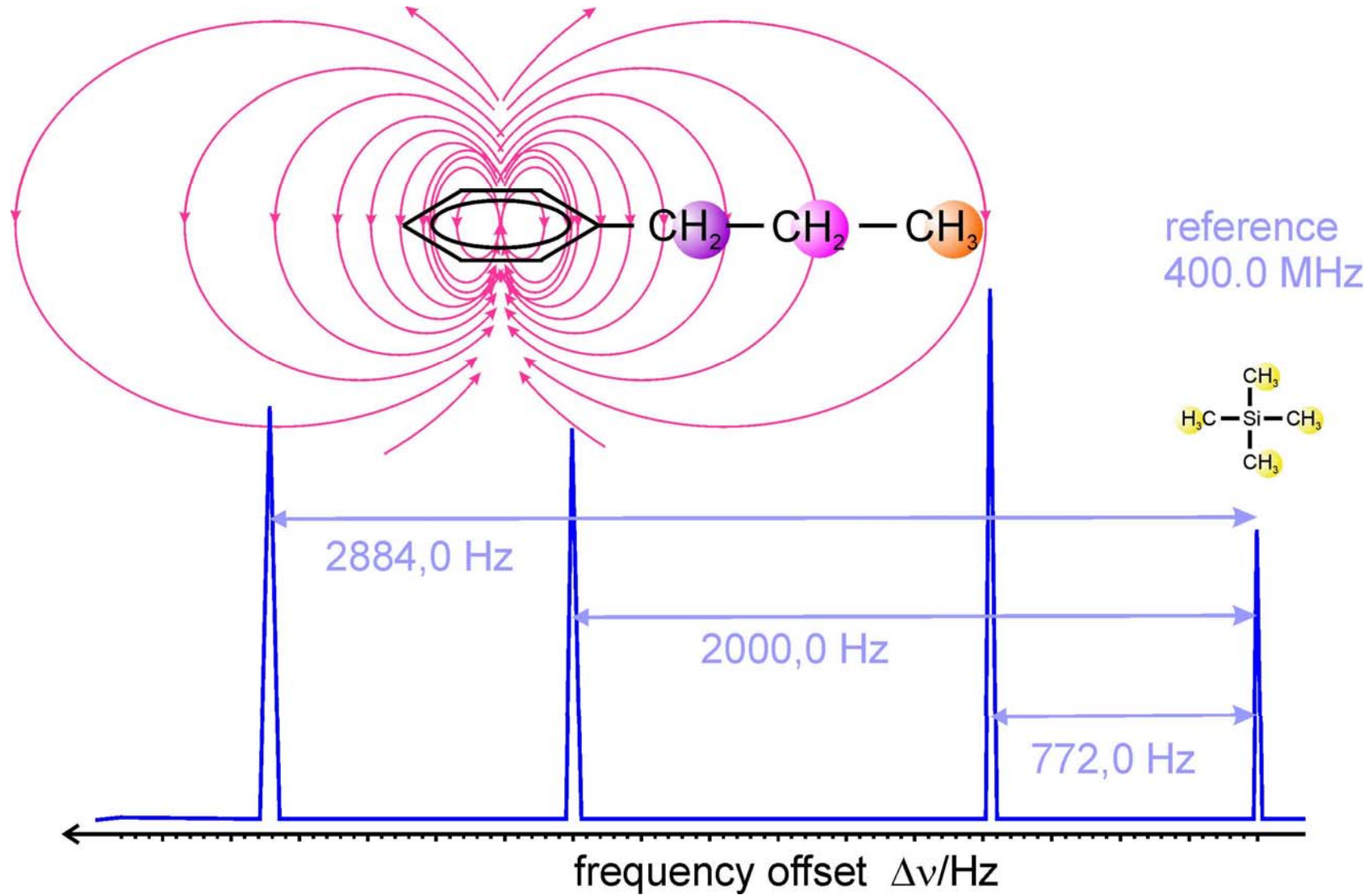

Chemische Verschiebung d-Skala

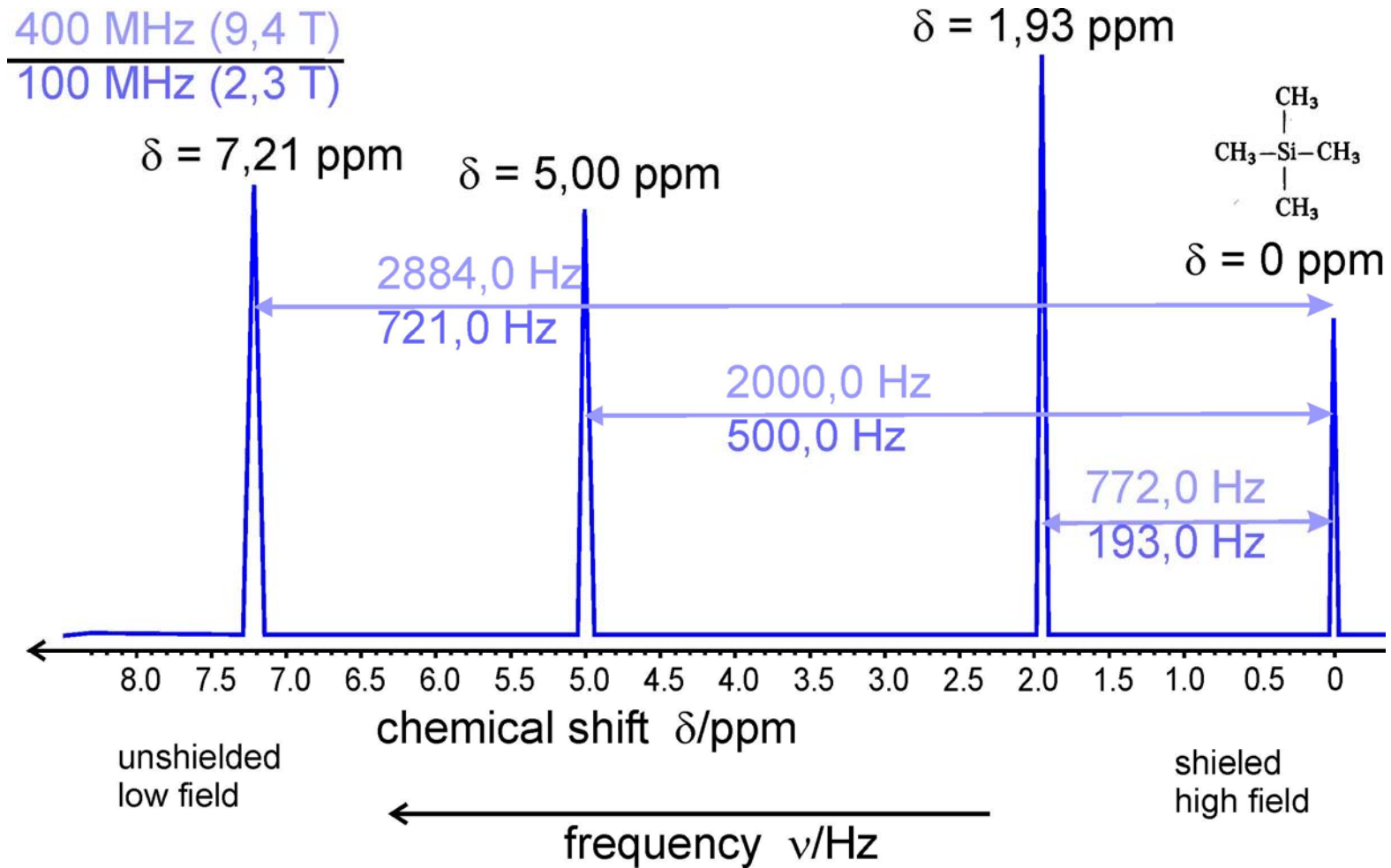

^1H -NMR-Spektrum von Ethanol

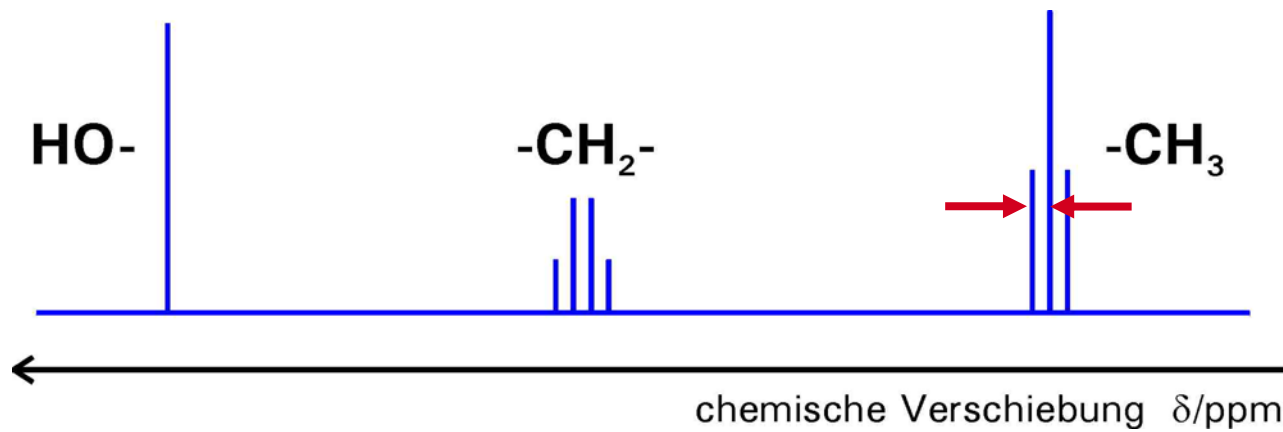
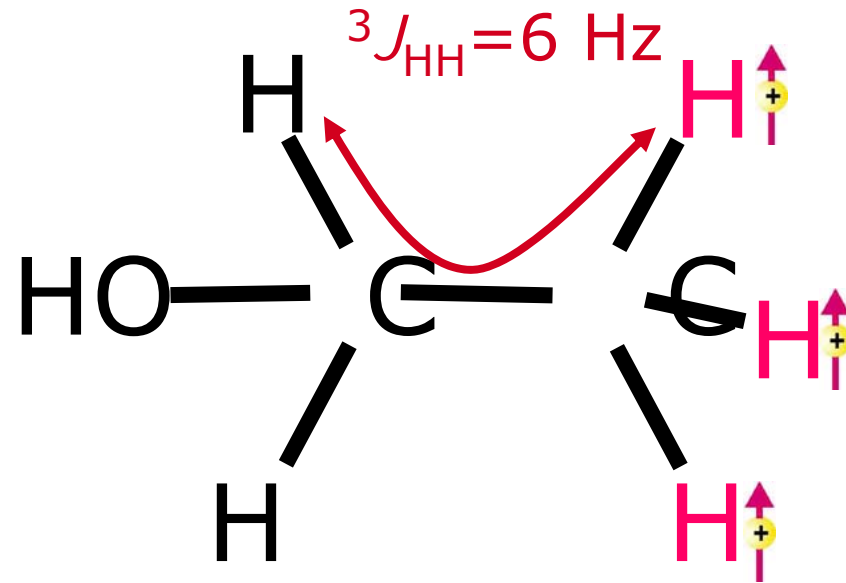
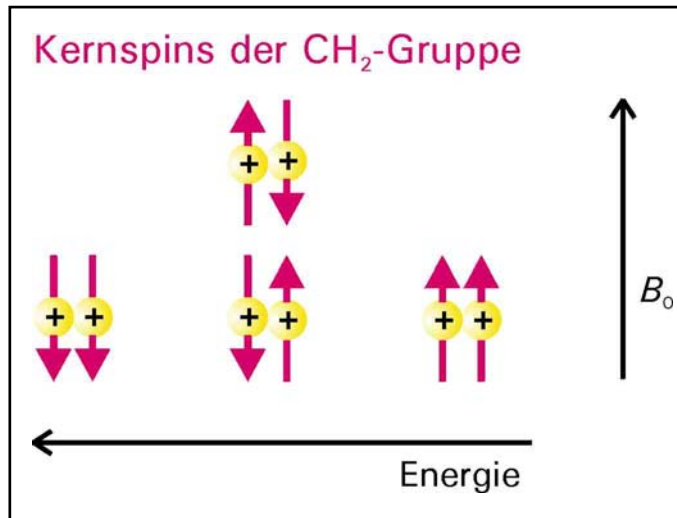

^1H -NMR-Spektrum von Ethanol

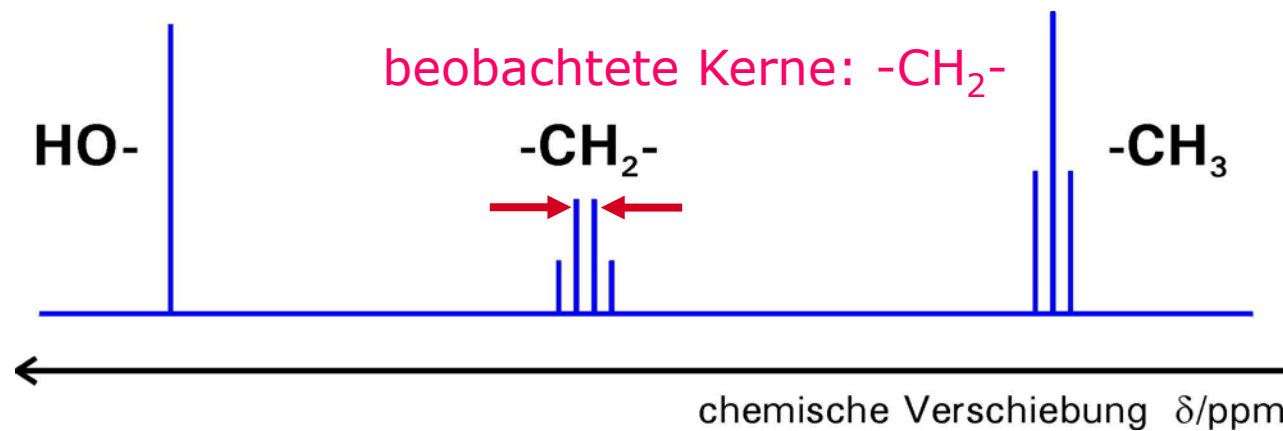
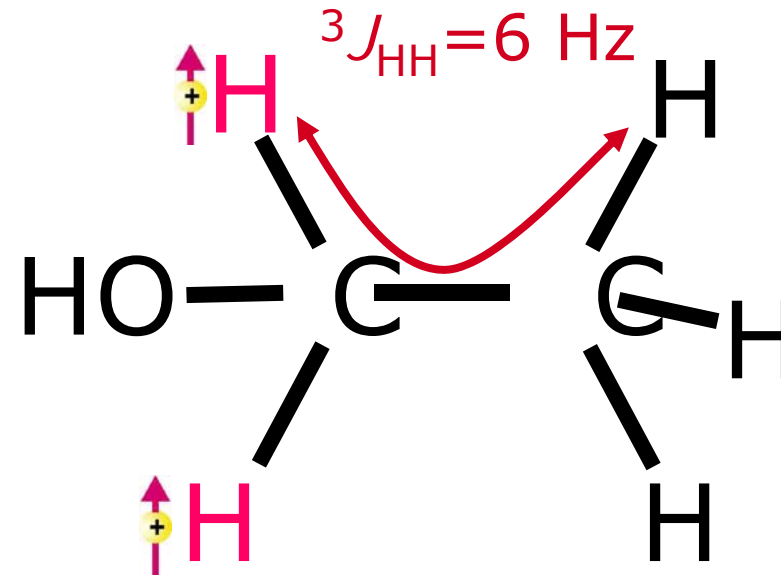
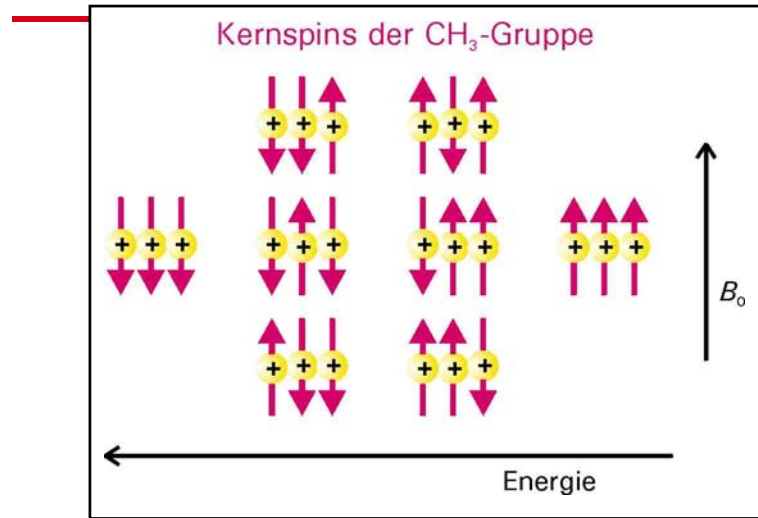

^1H -NMR-Spektrum von Ethanol

