

09.06.2017

Pharma-Talk
 June 8.–9. 2017, Berlin, Germany

USING SMART SENSORS AND MODULAR PRODUCTION UNITS FOR SUSTAINABLE AND FLEXIBLE PRODUCTION OF HIGH QUALITY CHEMICALS AND PHARMACEUTICALS

Michael Maiwald

Bundesanstalt für Materialforschung und -prüfung (BAM)
 Division 1.4 Process Analytical Technology

Richard-Willstätter-Str. 11
 D-12489 Berlin, Germany

Safety in Technology and Chemistry Our Key Areas

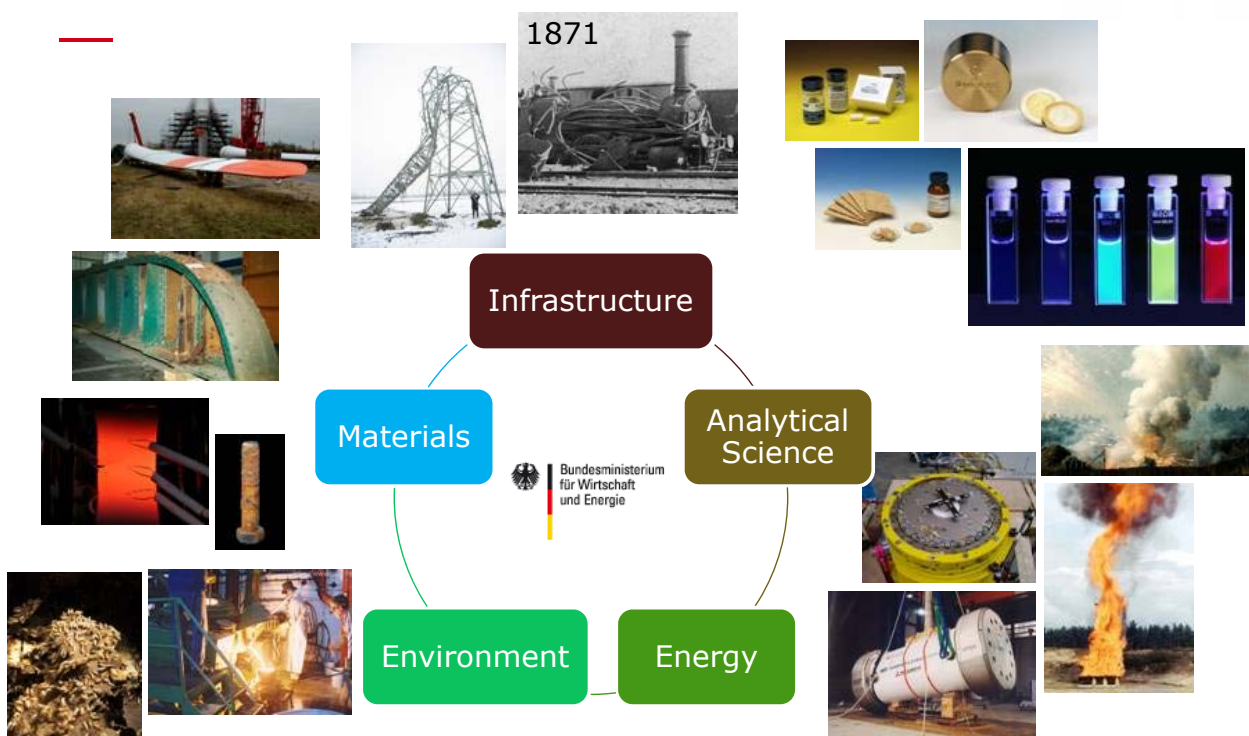

09.06.: BAM is a senior scientific and technical Federal institute with responsibility to Federal Ministry for Economic Affairs and Energy

PAT and Future Developments into Pharma Manufacturing

The Benefits, Increase Quality, Size and Increasing Speed of Production with Significant Reduction of Quality Costs

Innovation and Continual Improvement in Pharmaceutical and Biotechnology Sector

Towards Continuous Pharmaceutical Manufacturing



Innovation and Continual Improvement in Pharmaceutical and Biotechnology Sector

Business Plan for a New ICH Guideline Q12

Problems/Issues

- There is currently a **lack of a harmonized approach** on technical and regulatory considerations for lifecycle management
- The concepts in ICH Q8, Q9, Q10 and Q11 provide opportunities for a more science and risk-based approach for **assessing changes** across the life cycle
- Several **gaps** exist which limit full realisation of these intended benefits
- The envisioned post-approval “operational flexibility” has not been achieved
- The main emphasis to date has focused on early stages of the lifecycle
 - i.e., development through launch

Source: <http://www.ich.org/products/guidelines/quality/article/quality-guidelines.html> (June 2017)

Innovation and Continual Improvement in Pharmaceutical and Biotechnology Sector

Business Plan for a Future ICH Guideline Q12

Impacts 1

- Harmonise change management, leading to better availability and reliability of the supply by **enabling companies and regulators to manage CMC changes** in a more transparent and efficient manner across the product lifecycle
- Facilitate risk-based regulatory oversight and optimisation of resources for review and inspection
- Assist industry in **maintaining dossier conformance** while facilitating continual product and process improvement
- Emphasize the **use of the control strategy** as a key component of the regulatory commitment to facilitate linking the dossier, continual improvement and regulatory inspections
- Enhance **use of regulatory tools** for prospective change management
 - e.g. Post-Approval Change Management Protocol (PACMP), comparability protocols, application form

Source: <http://www.ich.org/products/guidelines/quality/article/quality-guidelines.html> (June 2017)

Innovation and Continual Improvement in Pharmaceutical and Biotechnology Sector

Business Plan for a Future ICH Guideline Q12

Impacts 2

- Help assure supply reliability by enabling strategic management of CMC changes which could mitigate shortages related to manufacturing and quality issues
- Support continual improvement of the manufacturing process and the control strategy which can result in decreased product variability
- Increase manufacturing efficiency
- Facilitate the introduction of innovations
- Support implementation of the validation lifecycle concept
- Enable control strategy lifecycle
 - e.g., model maintenance, analytical life cycle

Source: <http://www.ich.org/products/guidelines/quality/article/quality-guidelines.html> (June 2017)

09.06.2017

M. Maiwald

Modular Production Towards Continuous Manufacturing

Pharma Talk, Berlin 2017

7

Innovation and Continual Improvement in Pharmaceutical and Biotechnology Sector

Business Plan for a Future ICH Guideline Q12

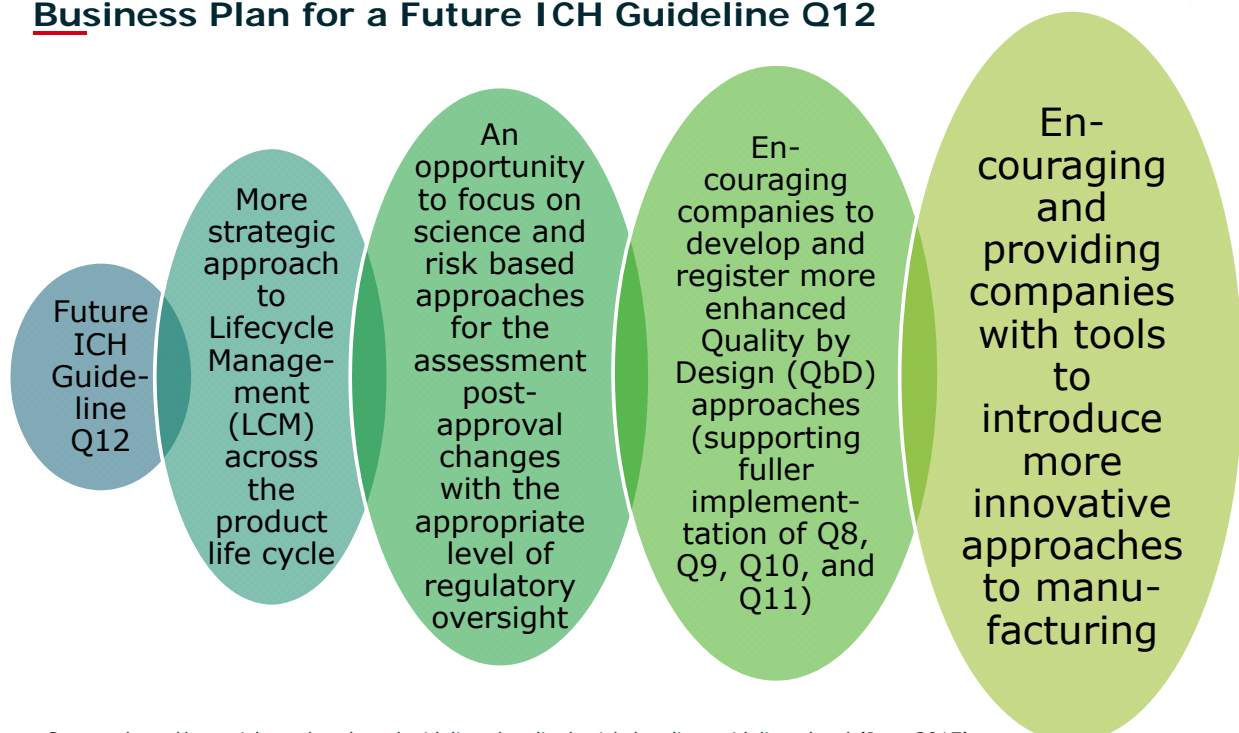

Source: <http://www.ich.org/products/guidelines/quality/article/quality-guidelines.html> (June 2017)

09.06.2017

M. Maiwald

Modular Production Towards Continuous Manufacturing

Pharma Talk, Berlin 2017

8

How will Industry 4.0 help shape the Pharmaceutical industry of tomorrow?

Using Smart Sensors and Model Based Data Evaluation Methods to Reduce Set-up Times and Costs

Contemporary Process Engineering Towards Cyber-Physical Production Systems (CPPS)

Process engineering focuses on the design, operation, control, and optimization of chemical, physical, or biological processes.

- Involves creating production facilities that translate raw materials into value-added products along the supply chain
- Conversions typically take place in repeated reaction and separation steps – either in batch or continuous processes.
- Computer aided tools: mass transfer, thermodynamic, kinetic, and other physical properties of treated materials
- Sufficient understanding of such properties is available and implemented in dynamic numeric models.

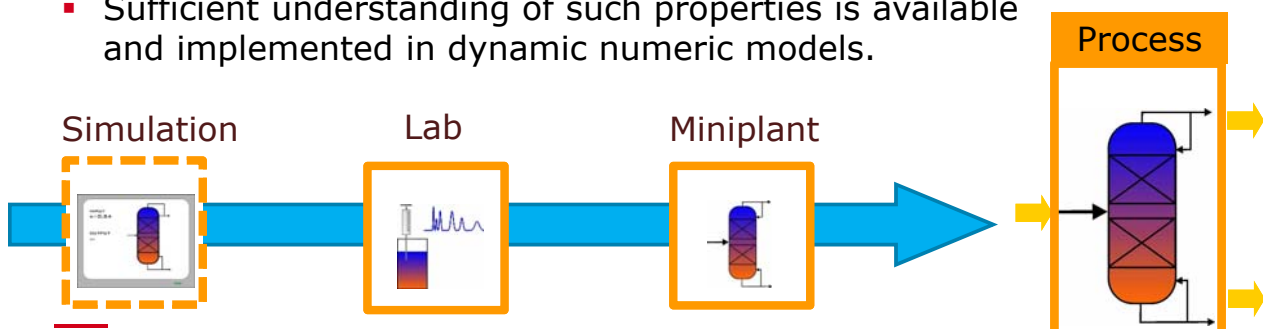

Integrated Process Design and Intensified Processes

Current Trend: Hybrid Modular Plants

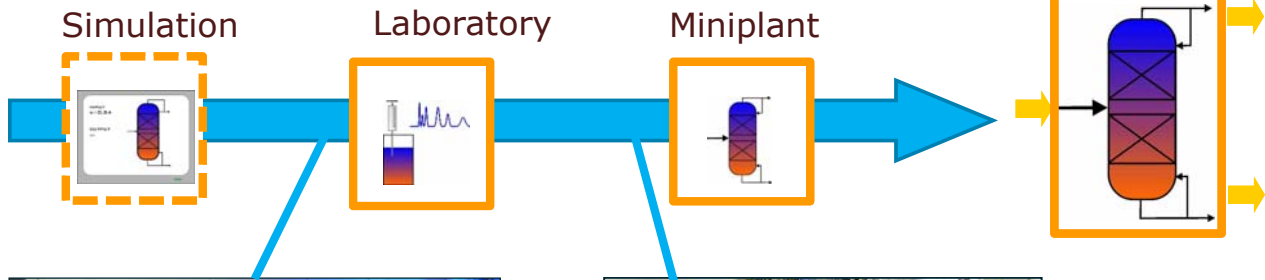

Micro Reaction Technology
(Example: Fraunhofer ICT, Pfinztal/D)

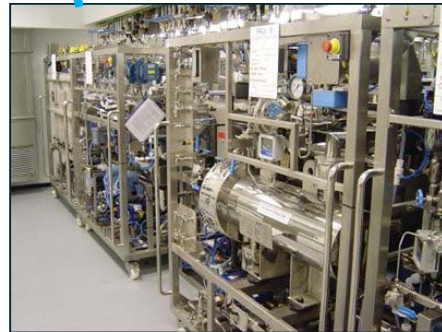

Modular Production
(Example: Foster Wheeler AG, Zug/CH)

Contemporary Process Engineering Towards Cyber-Physical Production Systems (CPPS)

“Cyber-Physical Systems (CPS) are integrations of computation with physical processes. Embedded computers and networks monitor and control the physical processes, usually with feedback loops where physical processes affect computations and vice versa”.

E. A. Lee, Cyber Physical Systems: Design Challenges, EECS Department, University of California, Berkeley, 2008

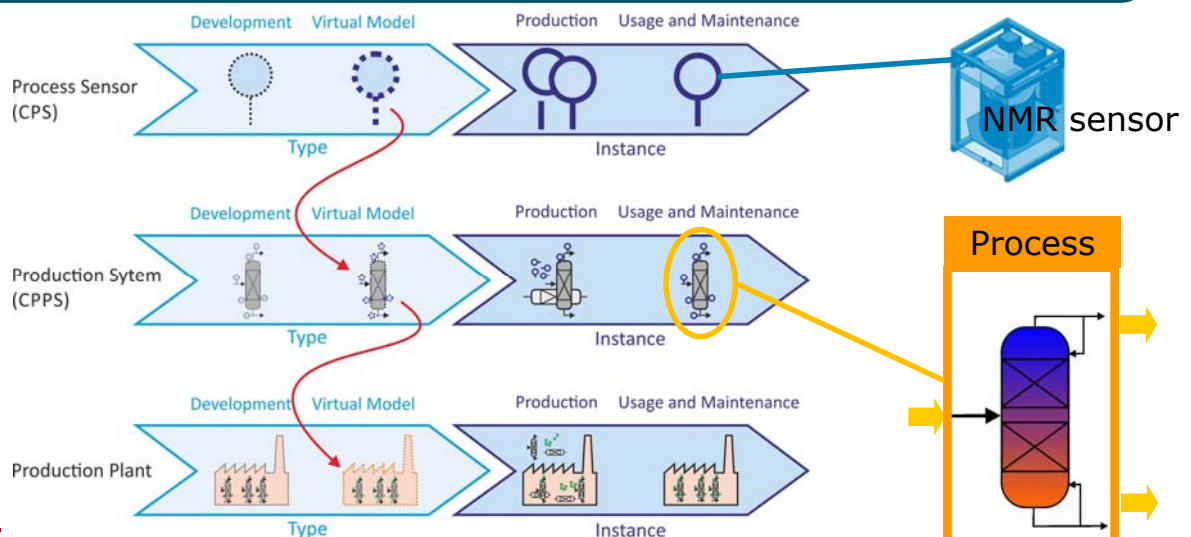

Process Automation

The Classical Automation Pyramid → is Outdated!

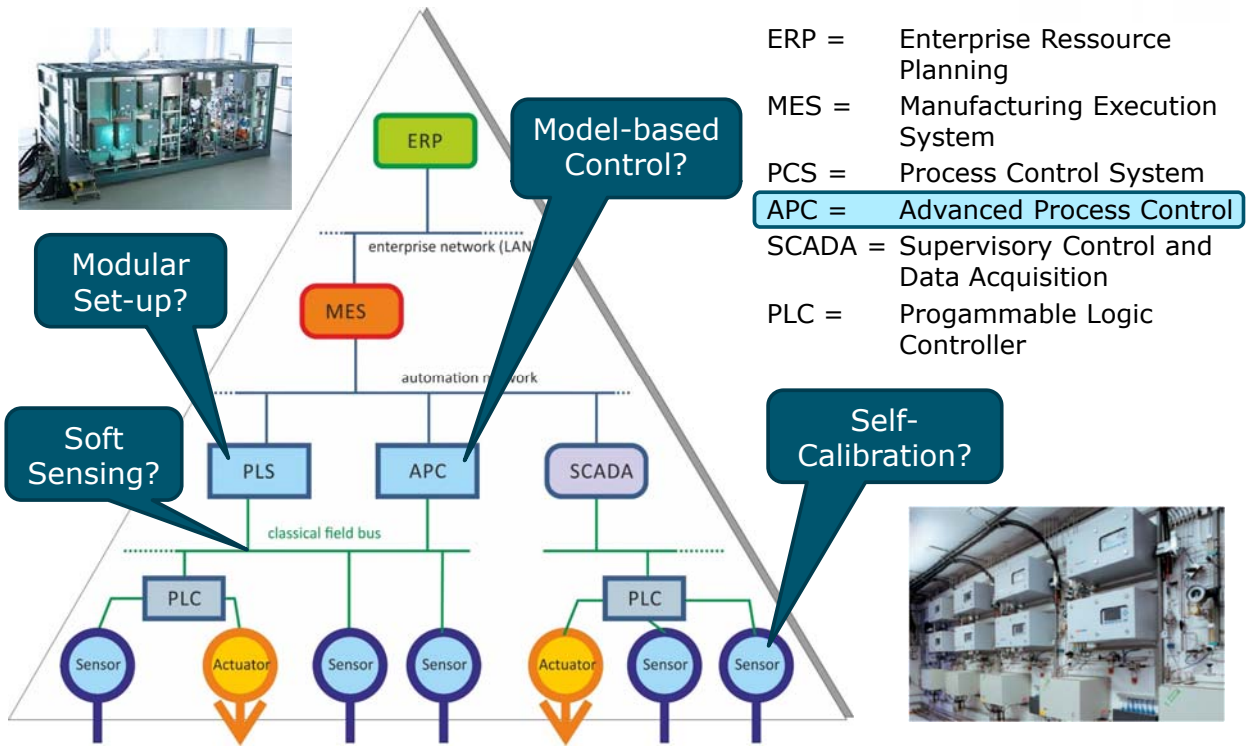

From Lousy Interfaces to "Industrie 4.0"

Use of Runtime Environments



From Lousy Interfaces to "Industrie 4.0" BAM

Use of Runtime Environments

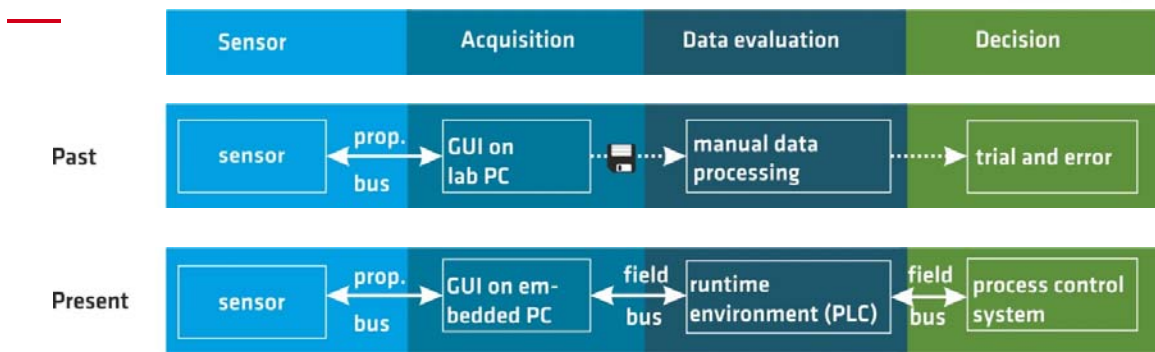

From Lousy Interfaces to "Industrie 4.0" BAM

Use of Runtime Environments

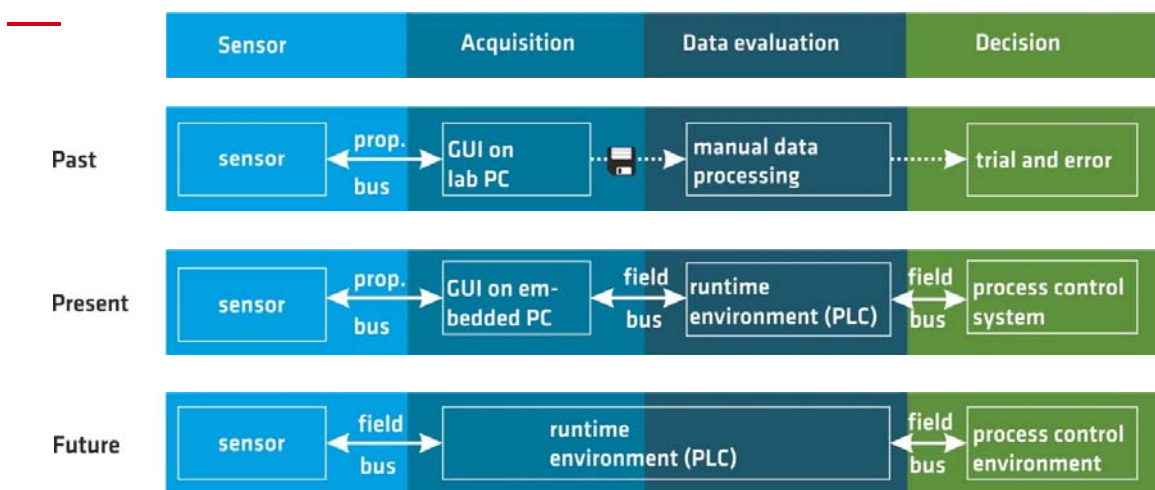

Current and Future Requirements to Smart Process Sensors

As Parts of Cyber-Physical Production Systems

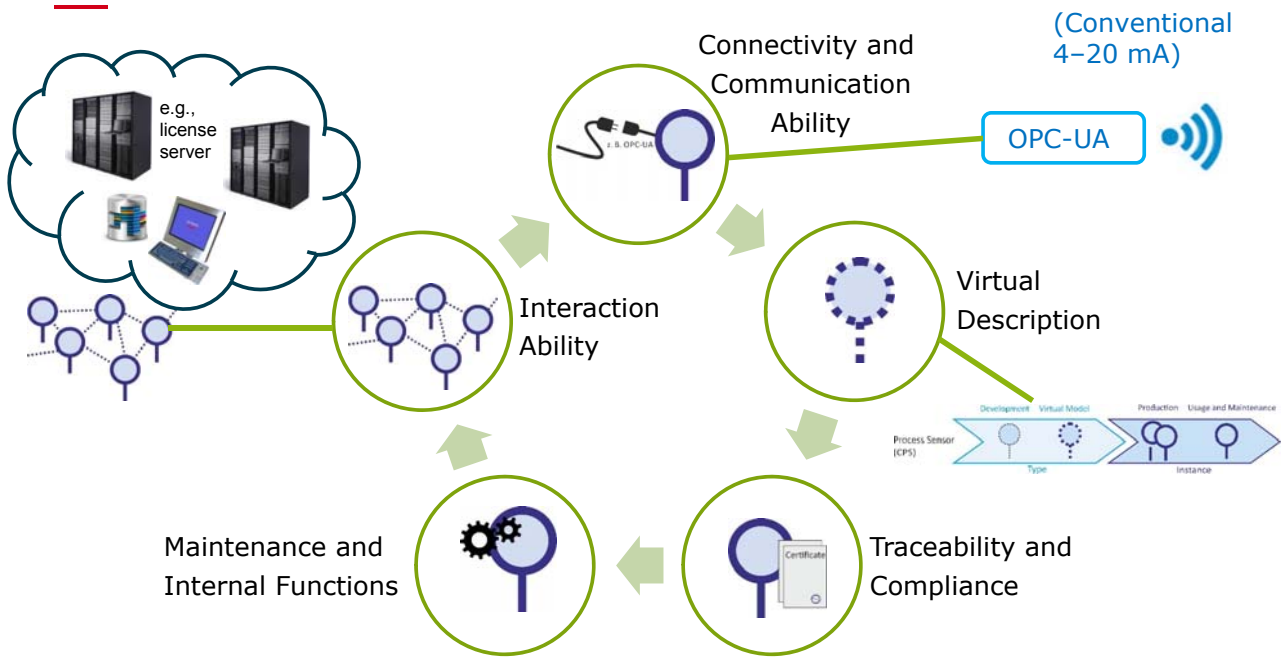

(Conventional 4–20 mA)

Technologie-Roadmap „Prozess-Sensoren 4.0“



Automation Pyramid Loses Contours

Decision Hierarchies are Retained

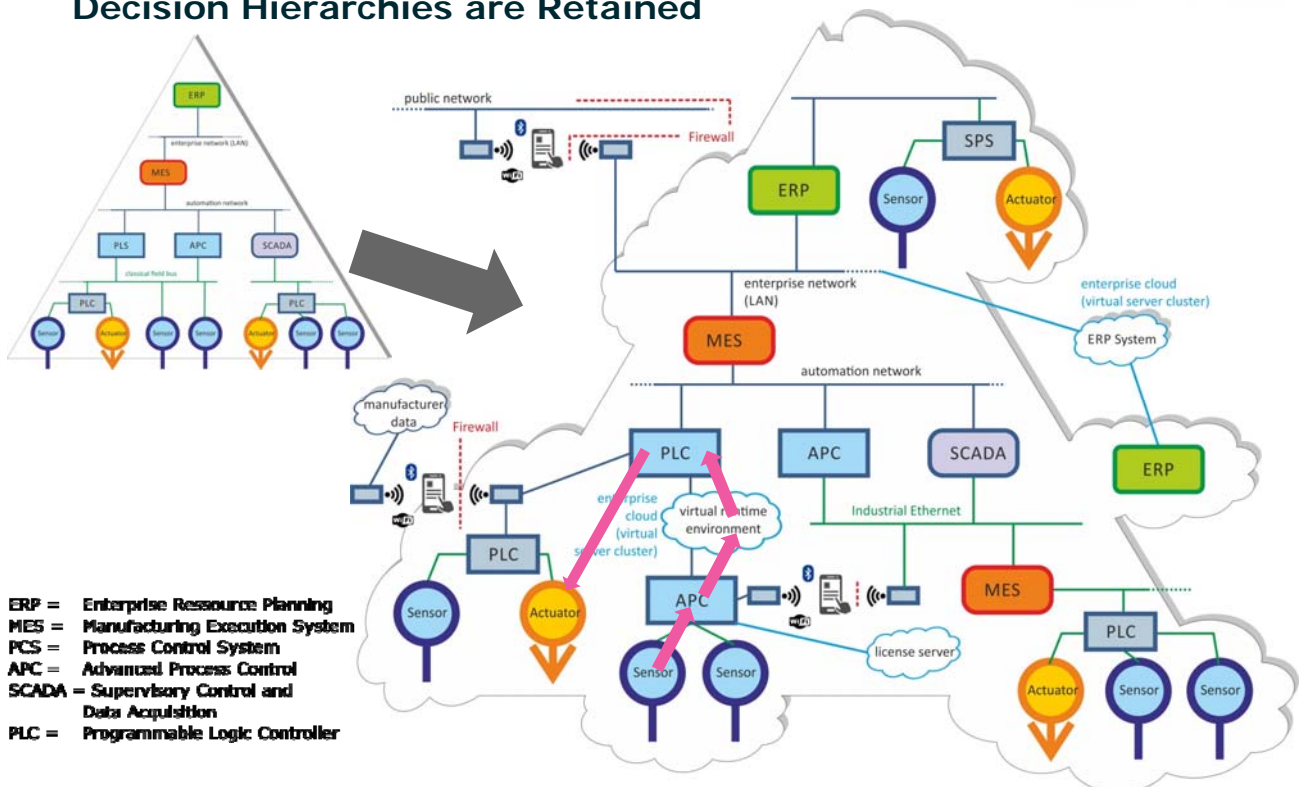

- ERP = Enterprise Resource Planning
- MES = Manufacturing Execution System
- PLS = Process Control System
- APC = Advanced Process Control
- SCADA = Supervisory Control and Data Acquisition
- PLC = Programmable Logic Controller

Integrated Process Design and Intensified Processes

Example: Continuous Flow Production of Pharmaceuticals

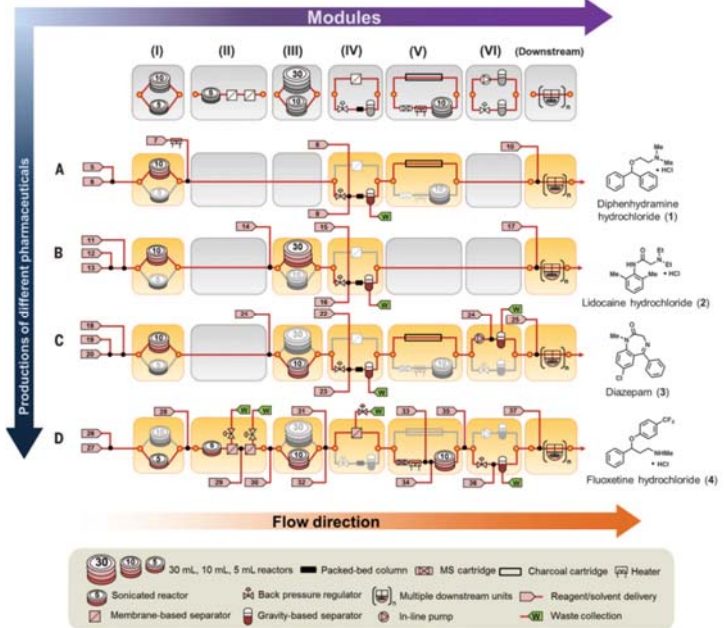
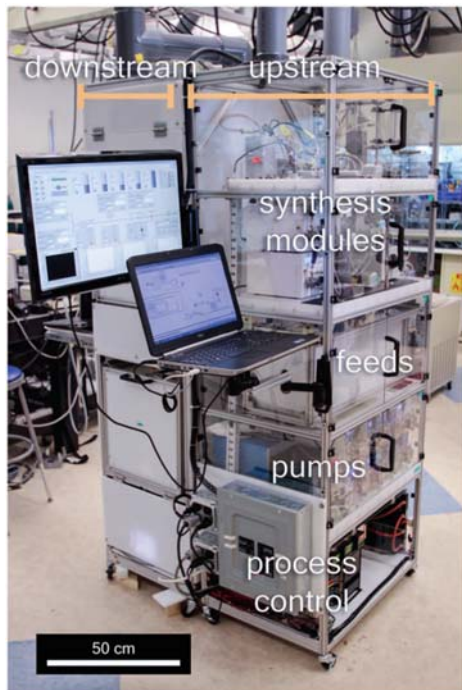

A. Adamo, R. L. Beingessner, M. Behnam et al., On-demand continuous-flow production of pharmaceuticals in a compact, reconfigurable system, *Science* 352(6281), 2016, 61-67

Process Analytical Technology for Intensified Processes

Examples from BAM, Berlin

Trends. Anal. Chem.
83 (2015) 39-52



Catalysis:
Hydroformylations of C12-alkenes in micro emulsions

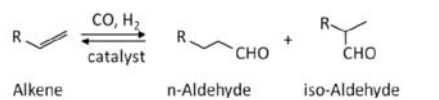

Meas. Sci. Technol. 28 (2017) 035501 + 035502



qNMR (Metrology):
Gases and condensed phases up to 1000 bar

J. Magn. Reson.
275 (2017) 1-10

Pharmaceuticals:
Liberation kinetics

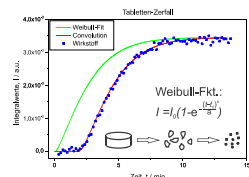

J. Mol. Structure. 1133 (2017) 18-23

CO₂ scrubbing

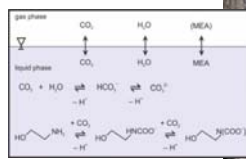

Klas Meyer, PhD
Humboldt University, Berlin, 2016

Method development:
Esterifications (model reactions)

J. Magn. Reson. 249 (2014), 53-62
Magn. Reson. Chem. 54 (2016) 513-520

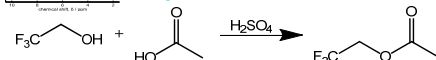

Catalysis:
Hydrogenations

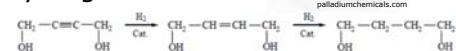

Reaction Engineering:
Lithiation reactions

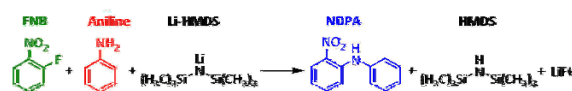

Reaction Engineering:
Photo reactions („click chemistry“)

J. Magn. Reson. 277 (2017) 154-161

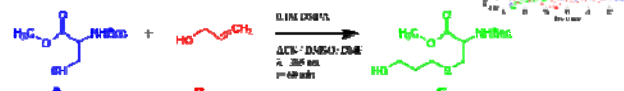

Modular Production Units for Continuous Manufacturing

Development of a Smart Online NMR Analyser

CONSENS: Smart Sensors for Advanced Process Control

Flexible Intensified Continuous Plant

Characteristics

Miniaturized equipment

Intensified heat & mass transfer

Possibly modular setup

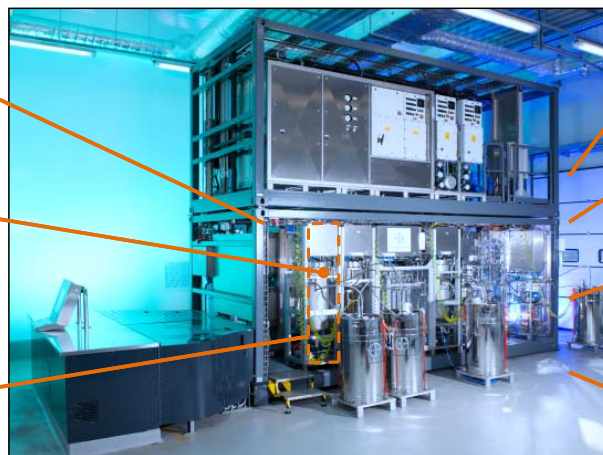

Benefits

Product uniformity

Sustainability

Fast adaption to market demand

Innovative products

Containerized modular plant Source: INVITE GmbH



Integrated Process Design and Intensified Processes

- Intensified continuous processes

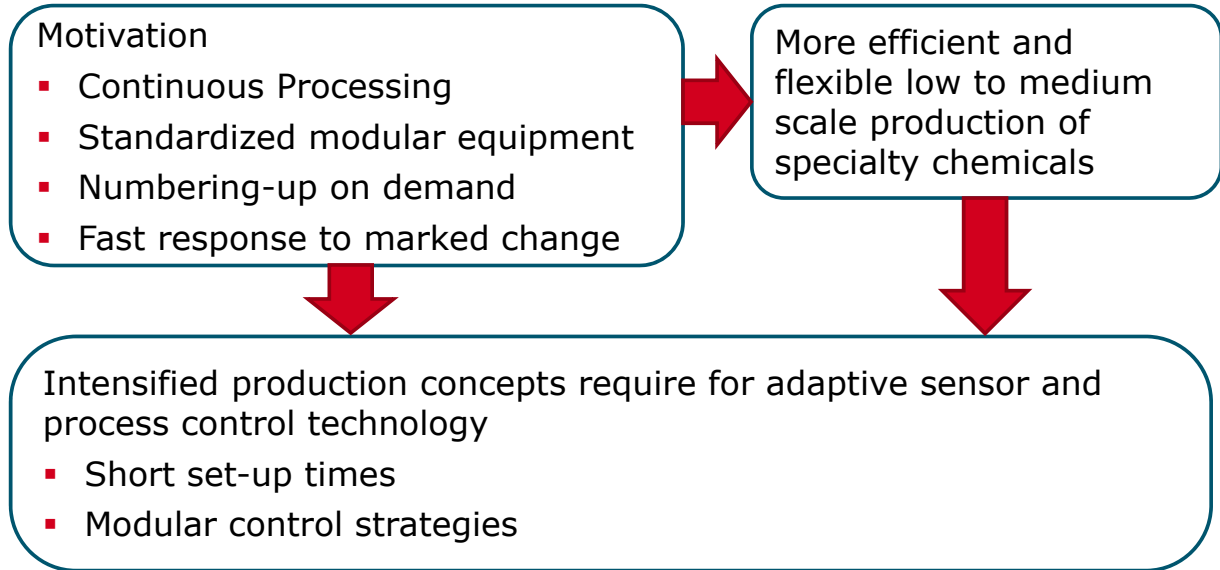

Continuous Lithiation Reaction Set-up Flexible Intensified Continuous Plant

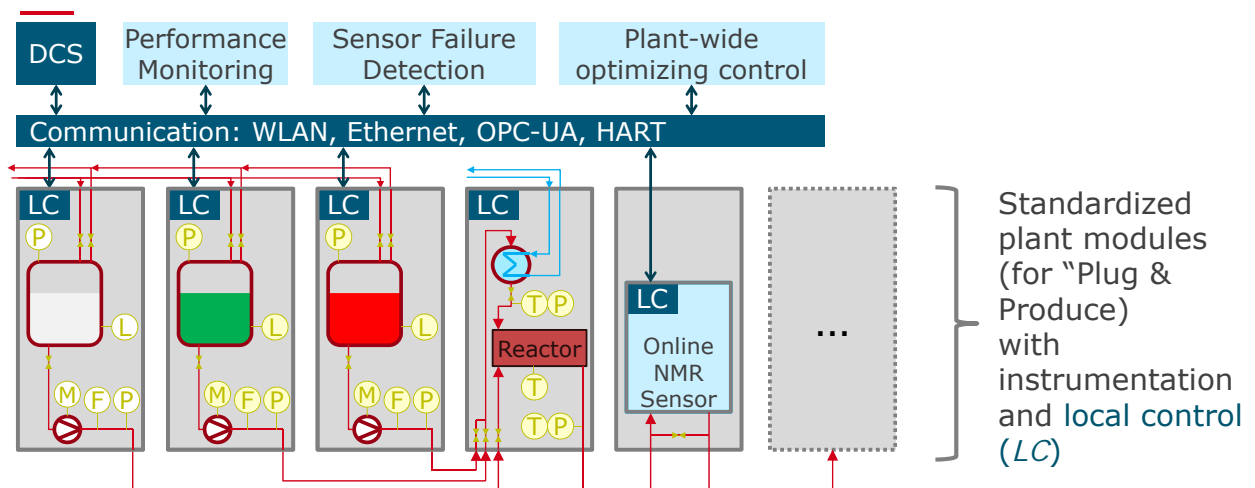

- Miniaturized flexible equipment
- Fast and complex exothermic reaction
- Hazardous and inflammable substances → Explosion protection!
- Prone to fouling & clogging
- Multi-objective constrained optimization

Continuous Lithiation Reaction Set-up

Validation Lab Experiments in Tube Reactor

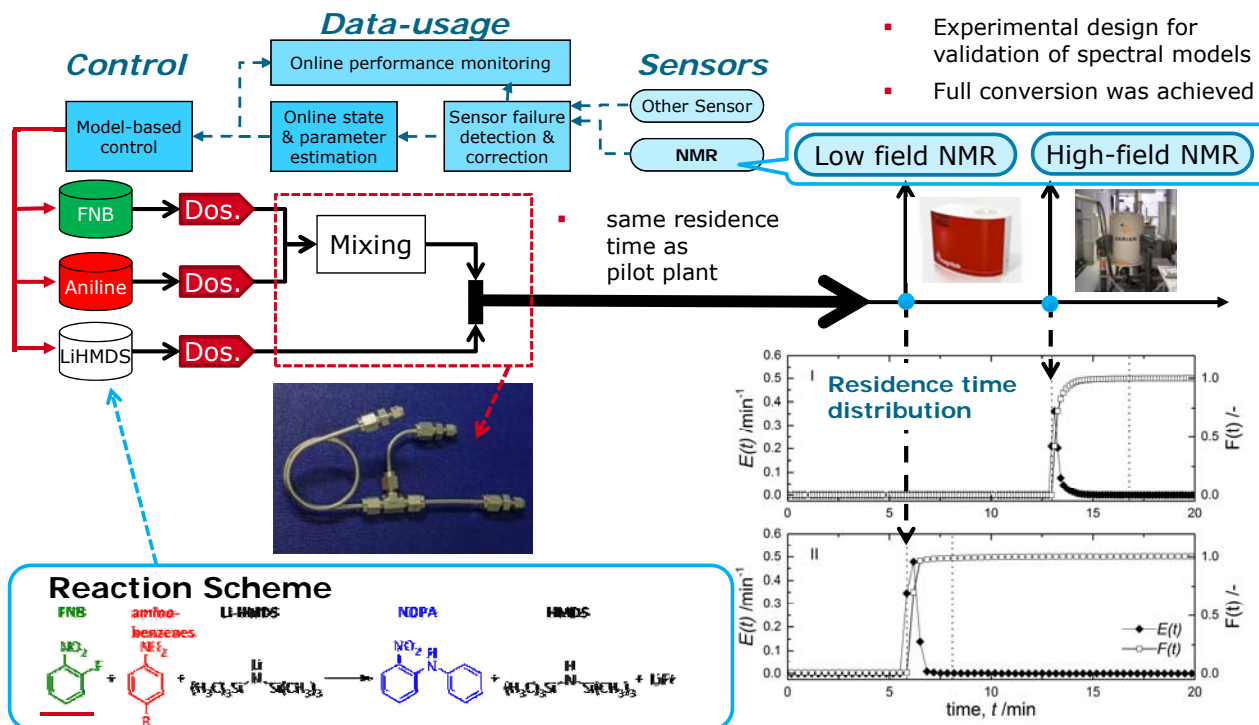

09.06.2017

M. Maiwald

Modular Production Towards Continuous Manufacturing

Pharma Talk, Berlin 2017

25

Reaction Monitoring in Lab-scale at BAM

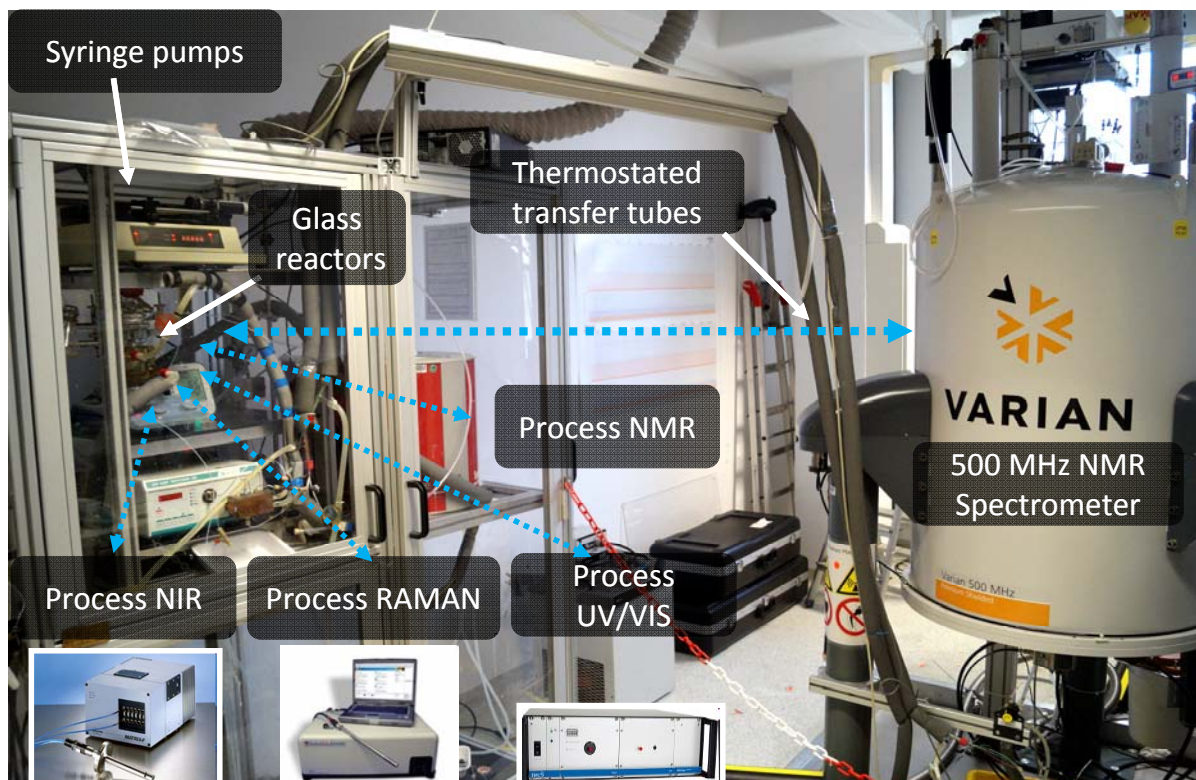

09.06.2017

M. Maiwald

Modular Production Towards Continuous Manufacturing

Pharma Talk, Berlin 2017

26

Nuclear Magnetic Resonance (NMR)

Direct Comparison Method → Calibration Free!

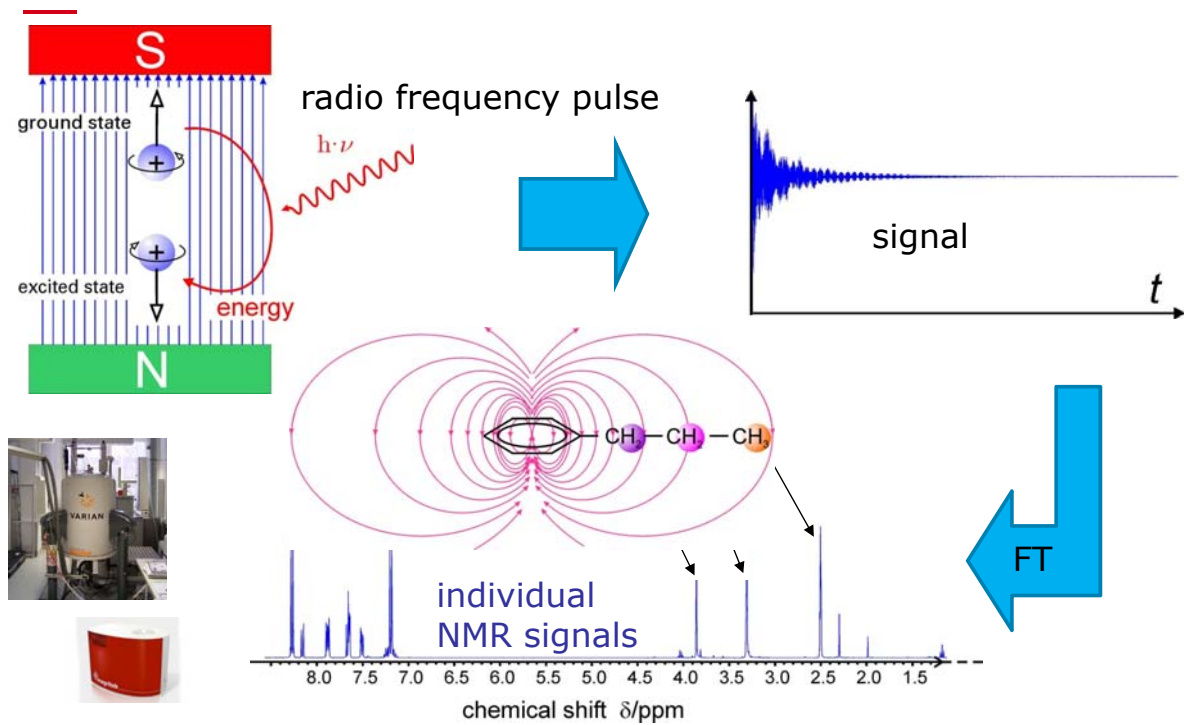

NMR Spectroscopy

Analogy to a Bell

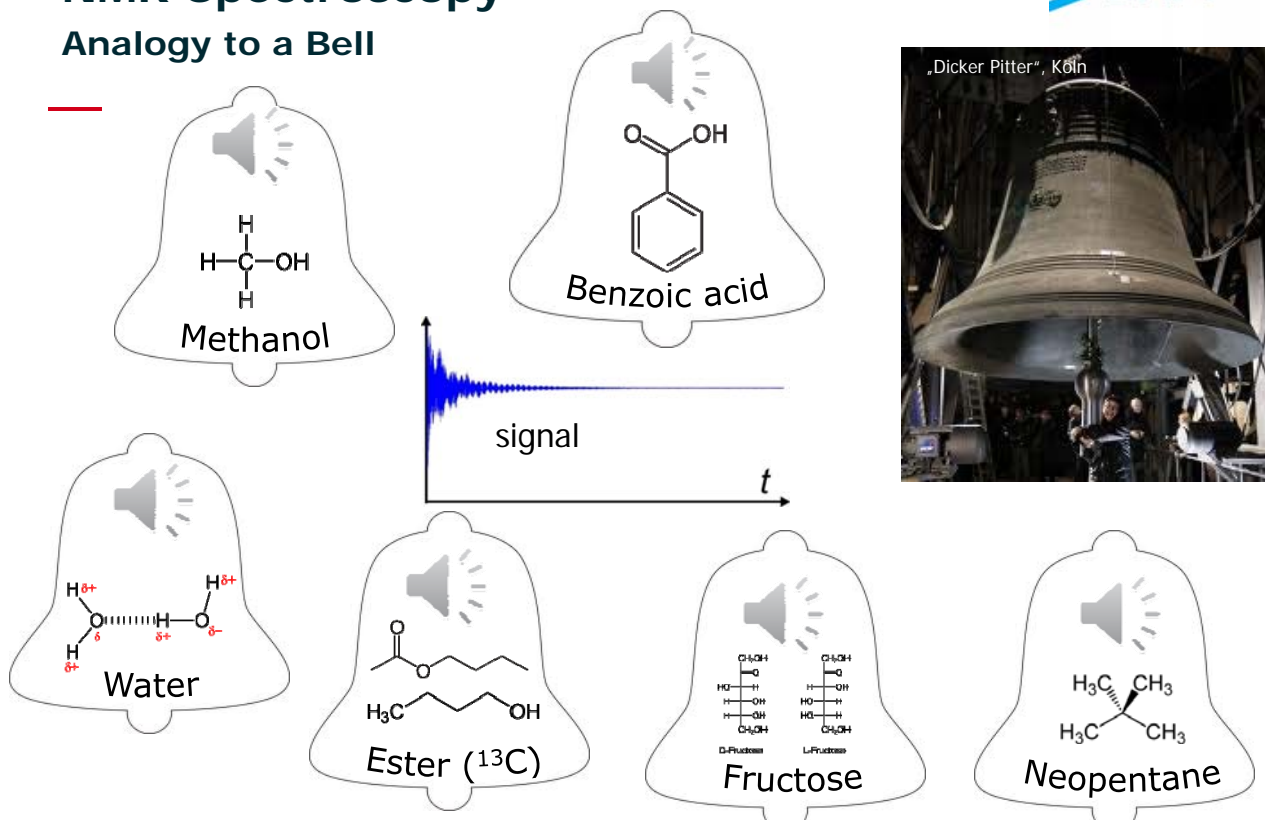

Reaction Characterization in Lab

Lab Experiments in Batch along Reaction Co-ordinate

- Data in parallel acquired with high-field and low-field spectrometer
- „Fast“ and „slow loop“
- Li-HMDS was dosed stepwise



Experimental set-up

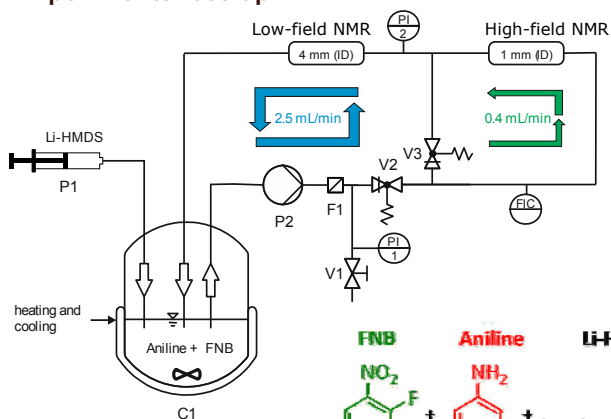

- Exothermic reaction
→ cooling required (28.5 °C)
- Li-HMDS in two-fold excess

Reaction Scheme:

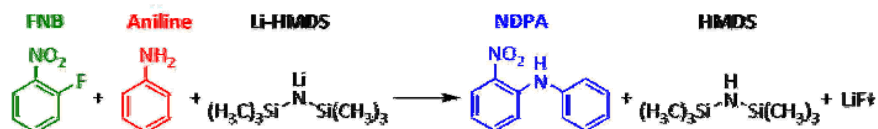

Online ¹H NMR Spectra of Lithiation Reaction Step

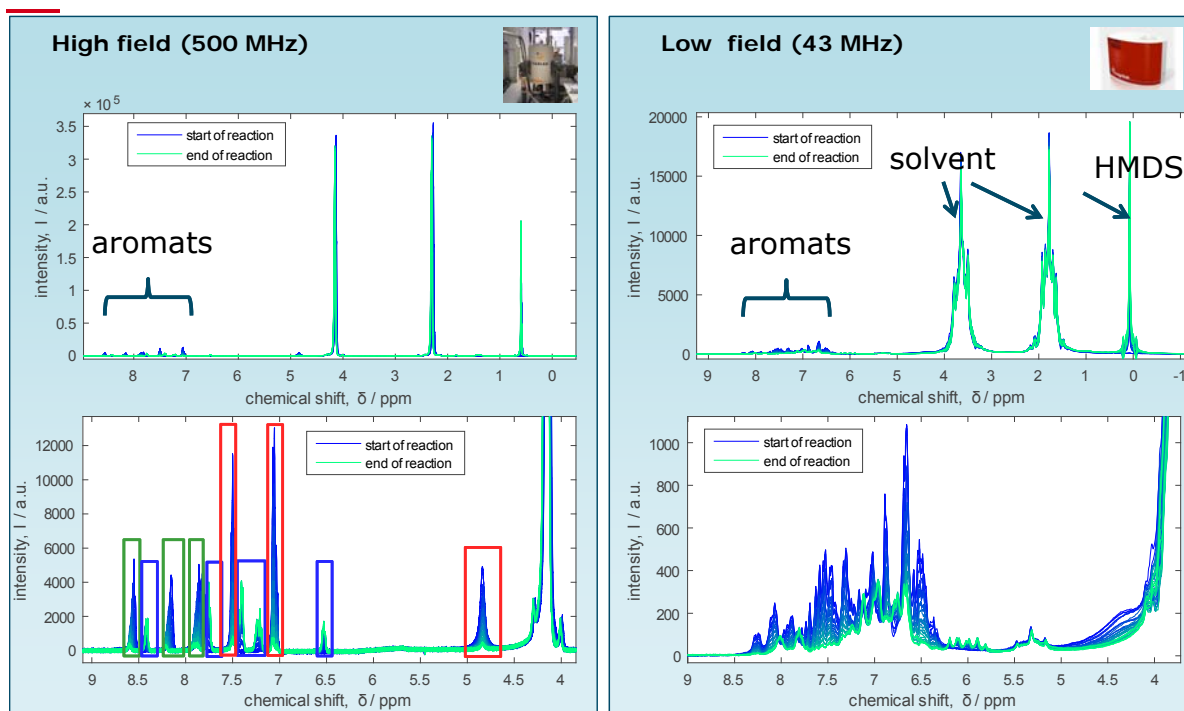

Data Processing for Low-field NMR in Matlab

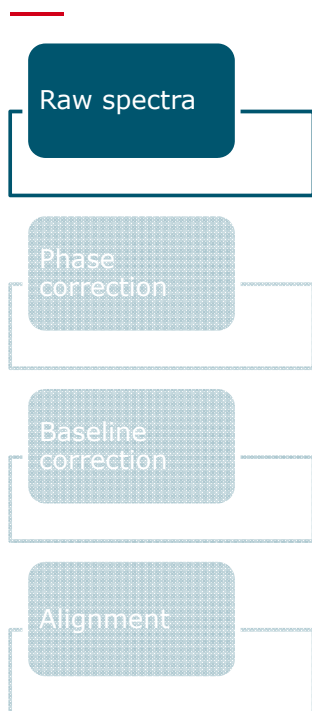

single scan
each 15s
in flow

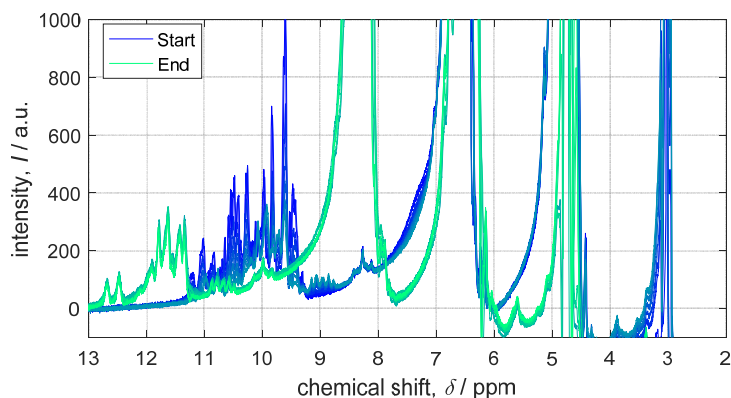
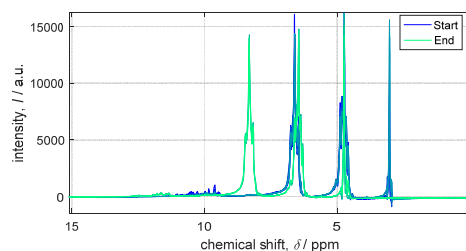

Data Processing for Low-field NMR in Matlab

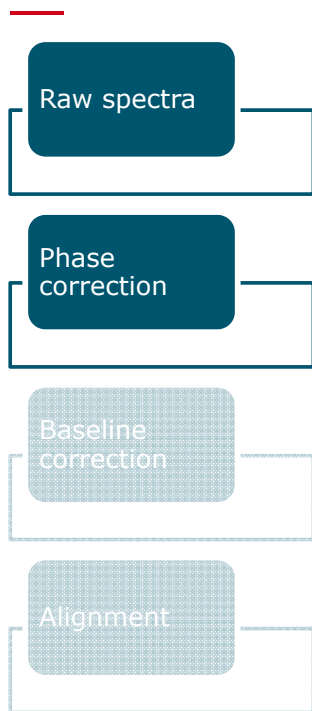

**Entropy minimization
method:**

Chen et al., *J Magn Reson.*
2002, *158*, 164-168

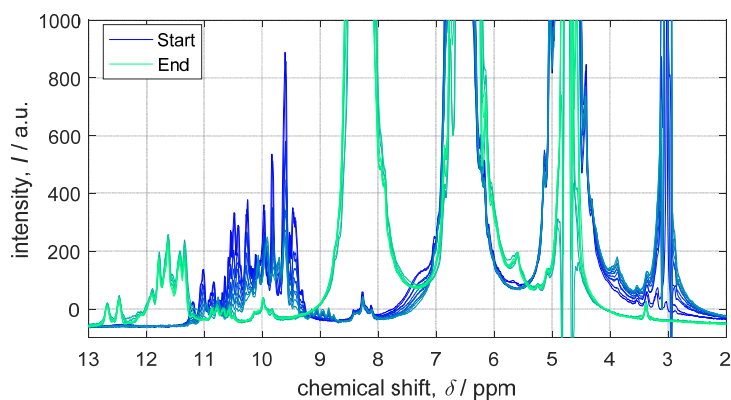
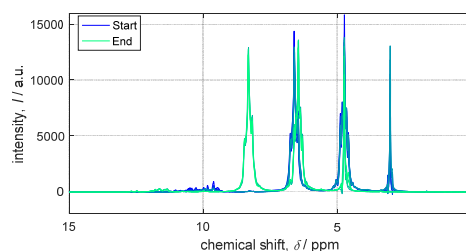

Data Processing for Low-field NMR in Matlab

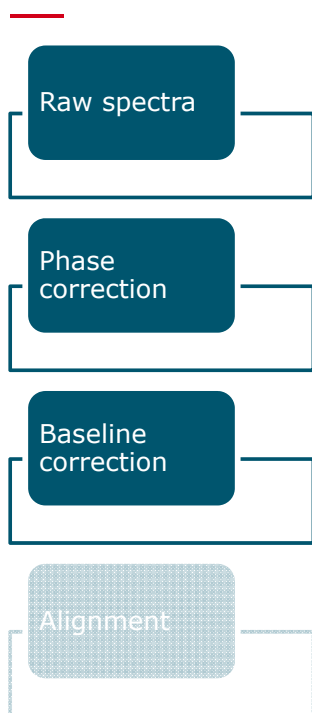

Low-order Polynomial fit:
Mazet et al., Chemometrics Intell. Lab. Sys. **2005**, *76*, 121-133.

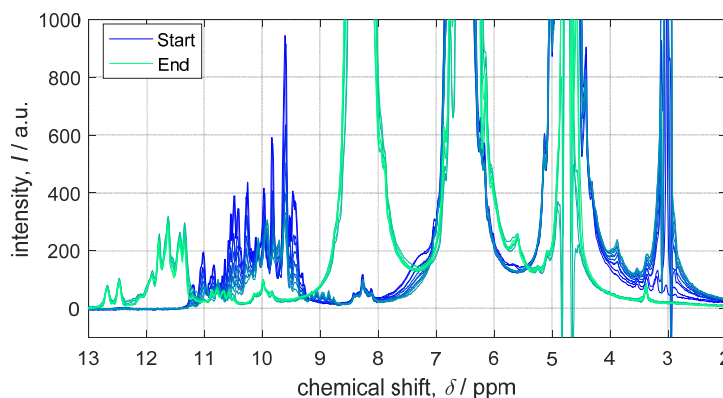
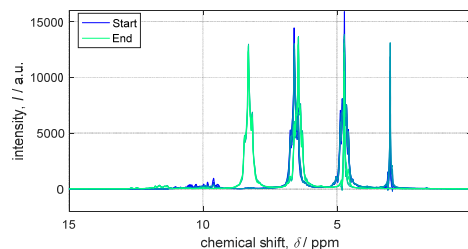

Data Processing for Low-field NMR in Matlab

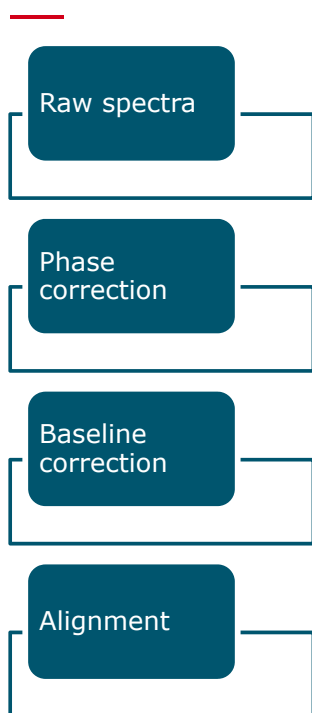

Alignment to reference signal (THF) using *icoshift*:
Savorani et al., J Magn Reson. **2010**, *2*, 190-202

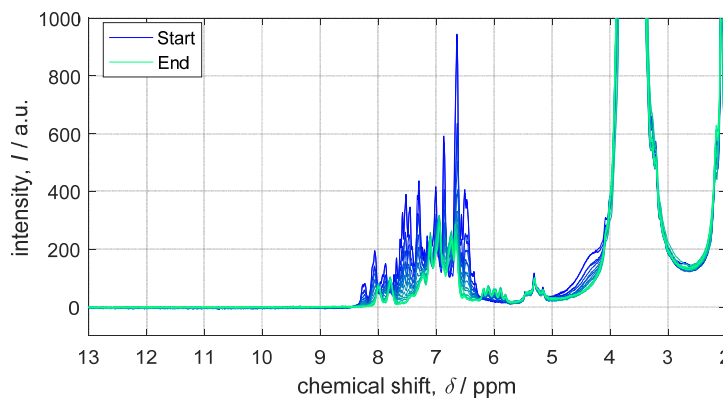
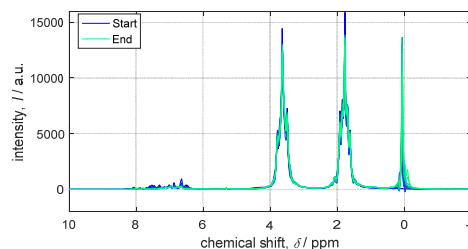

- Modeling** → peak fitting of pure component spectra → mixture model
- Analysis** → "component fitting" → calculation of component area

» Group of peaks represent pure component spectra

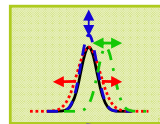

» Pseudo-Voigt function

$$V = \alpha \left[\beta \cdot \exp\left(-\ln(2) \frac{(x - \delta)^2}{\gamma^2}\right) + (1 - \beta) \frac{\gamma^2}{(x - \delta)^2 + \gamma^2} \right]$$

- α = peak maximum
- β = Gaussian-Lorentzian-ratio
- γ = half width
- δ = center position

Hard model for pure components

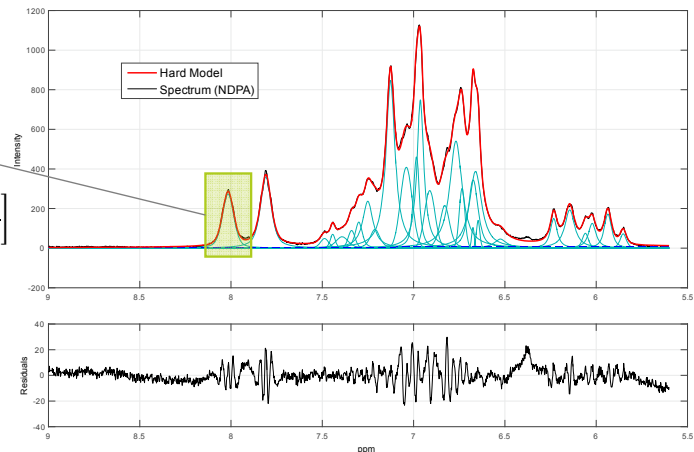

IHM – „Model Building“

Assignment of NMR Signals to Pure Components

Pure component models

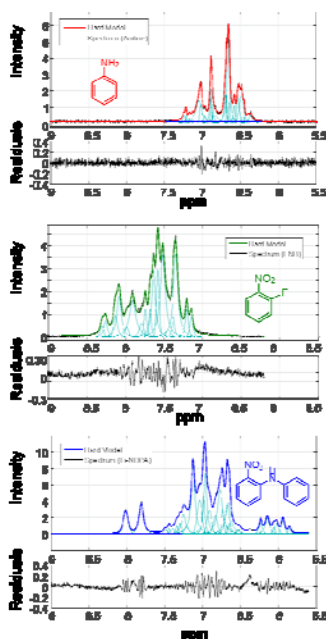

Modeling → Mixture model



Experimental Spectrum

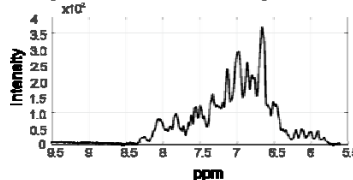

No. components	3
Peaks per component	22, 21, 28
Degree of freedom (total free parameters)	292
Considered interacting peaks	25
Max. peak shift	0.01 ppm
...	...



Peak area ratio for each pure component model is kept constant!

IHM – „Component Fitting“

Interpretation of Experimental Data with Pure Components

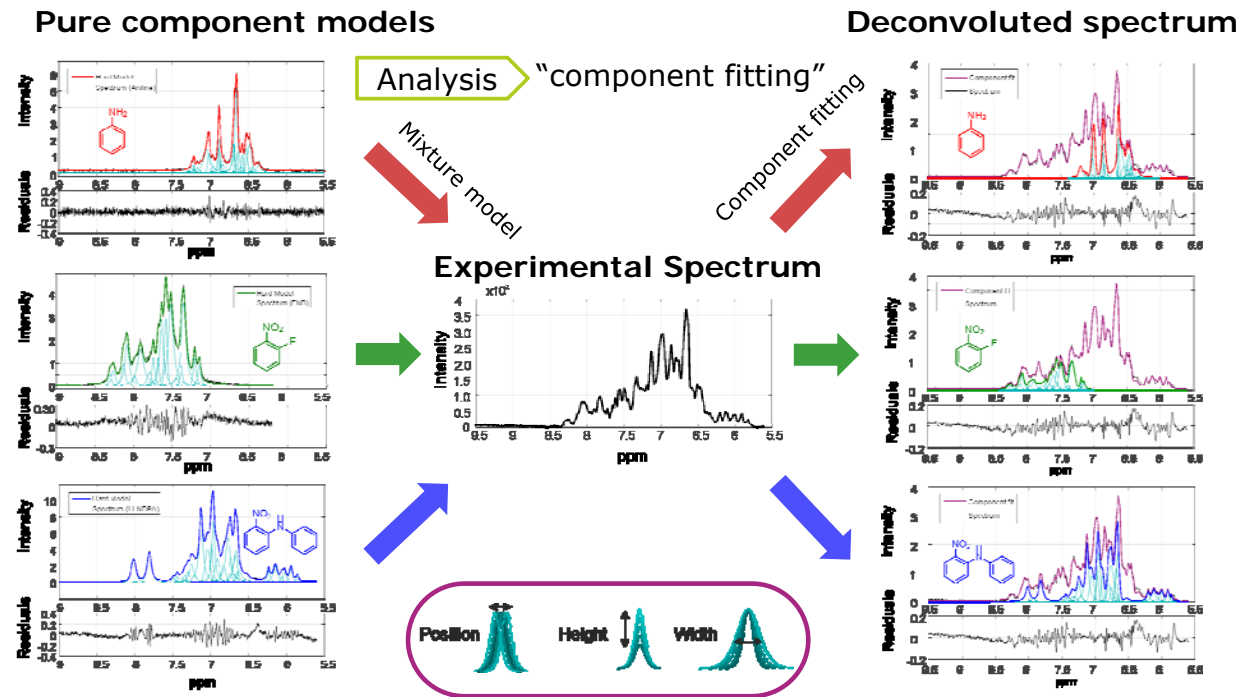

Results: Reaction Characterization

Lab Experiments in Batch along Reaction Co-ordinate

3 semi-batch reaction with varying starting concentrations

1500 Spectra for each HF- and NF-NMR

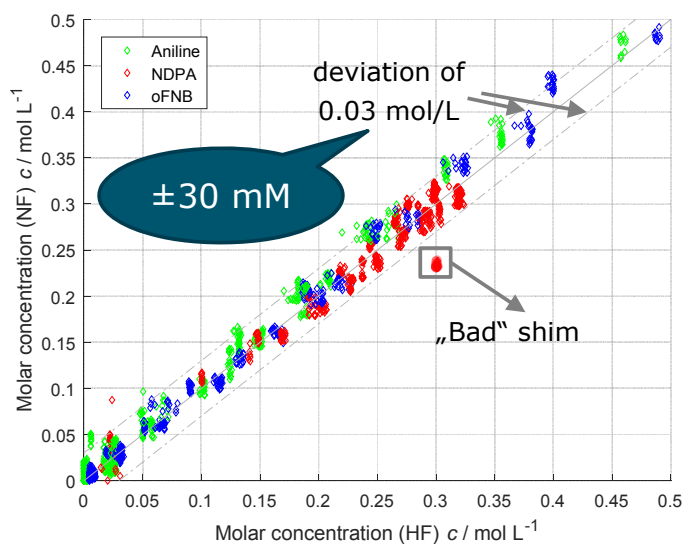

Classification of steady states

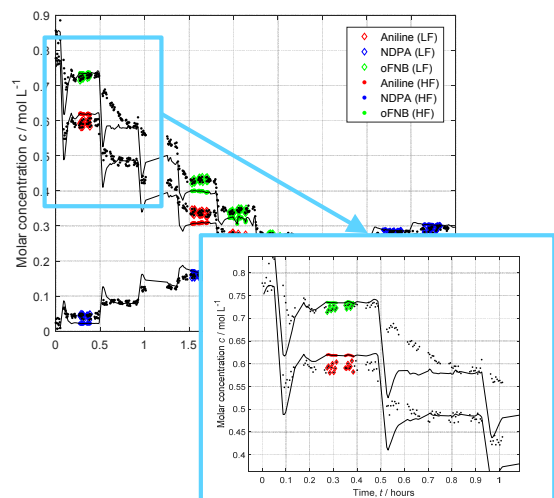

Reaction Scheme:

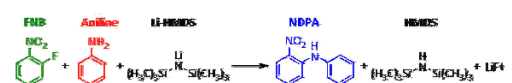

Validation of Lab Experiments in Tube Reactor

Continuous Lithiation Reaction Set-up at BAM

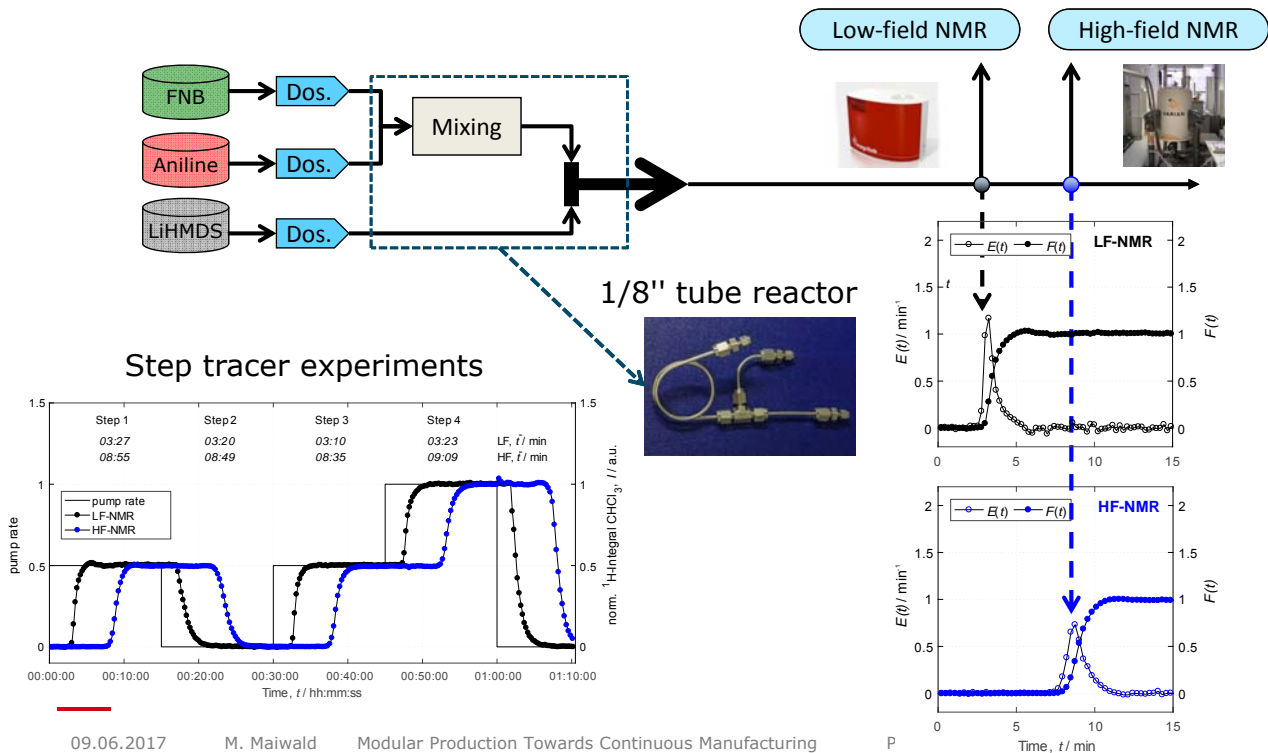

Experimental Design

Continuous Lithiation Reaction Set-up at BAM

- Independent variation of flowrates / stoichiometric conditions

Reaction Scheme:

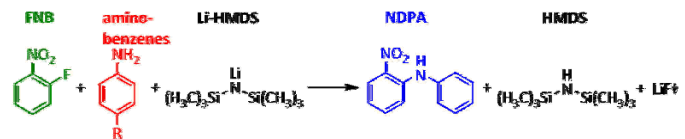

Coarse variation:

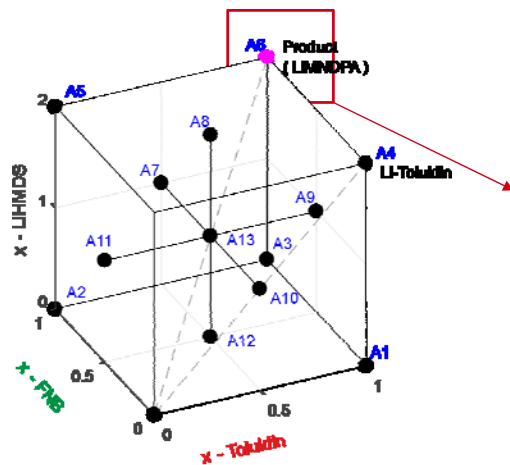

Fine variation:

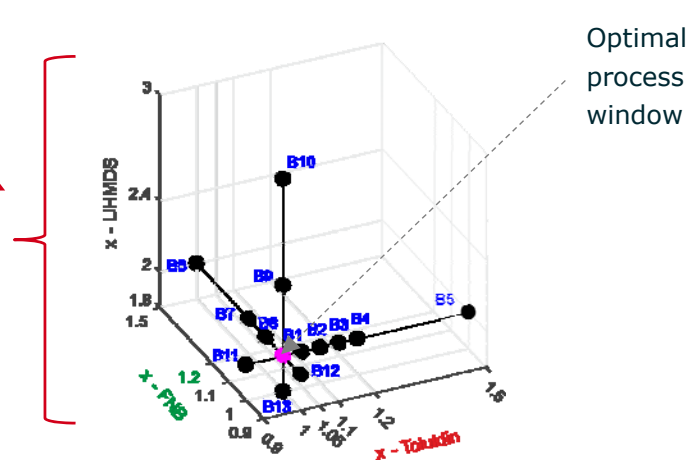

Validation Runs vs. Reference Method

Continuous Lithiation Reaction Set-up at BAM

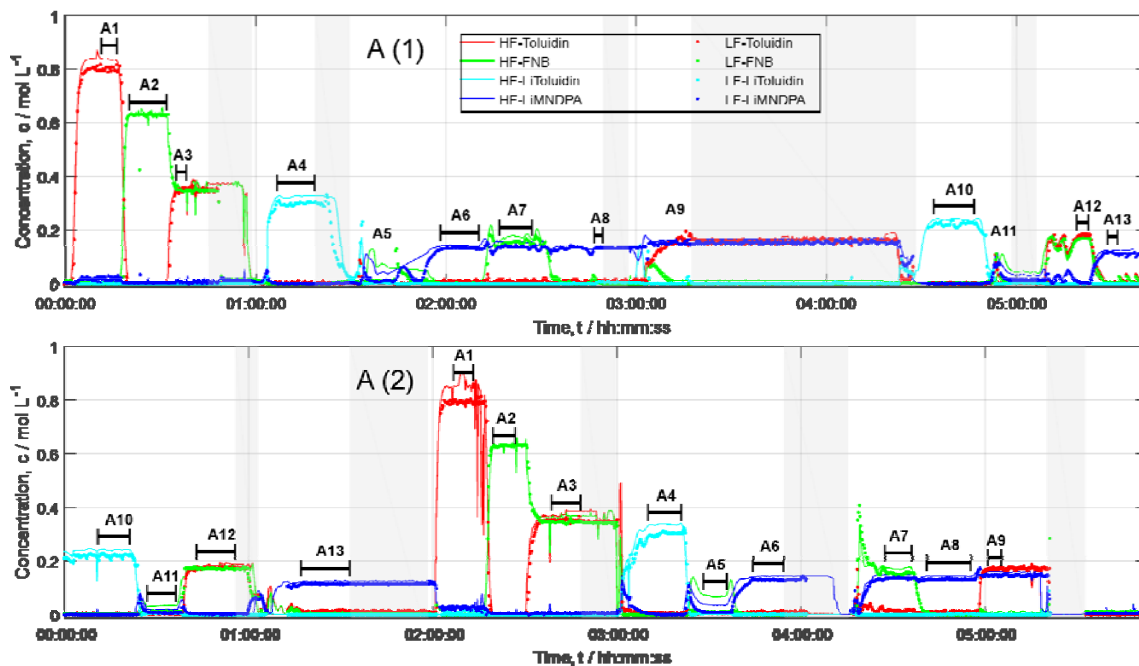

Validation Runs vs. Reference Method

Continuous Lithiation Reaction Set-up at BAM

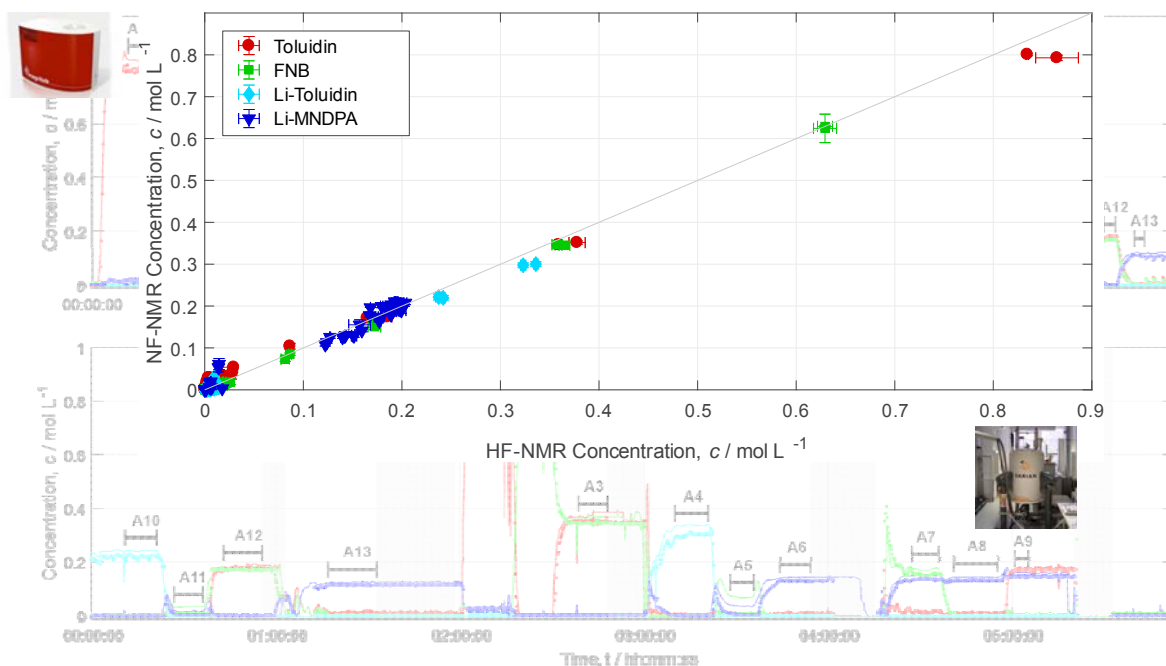

Validation Runs at Production Plant

Continuous Lithiation Reaction Set-up at Project Partner



May 2017

09.06.2017

M. Maiwald

Modular Production Towards Continuous Manufacturing

Pharma Talk, Berlin 2017

43

Validation Runs at Production Plant

Continuous Lithiation Reaction Set-up at Project Partner



June 2017

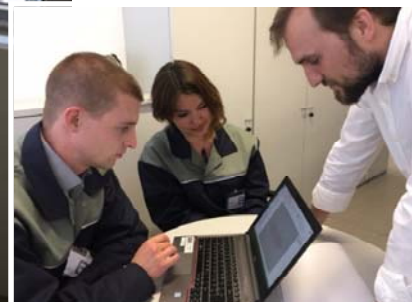

09.06.2017

M. Maiwald

Modular Production Towards Continuous Manufacturing

Pharma Talk, Berlin 2017

44

Conventional and Smart Functions



Enabling Runtime Environments

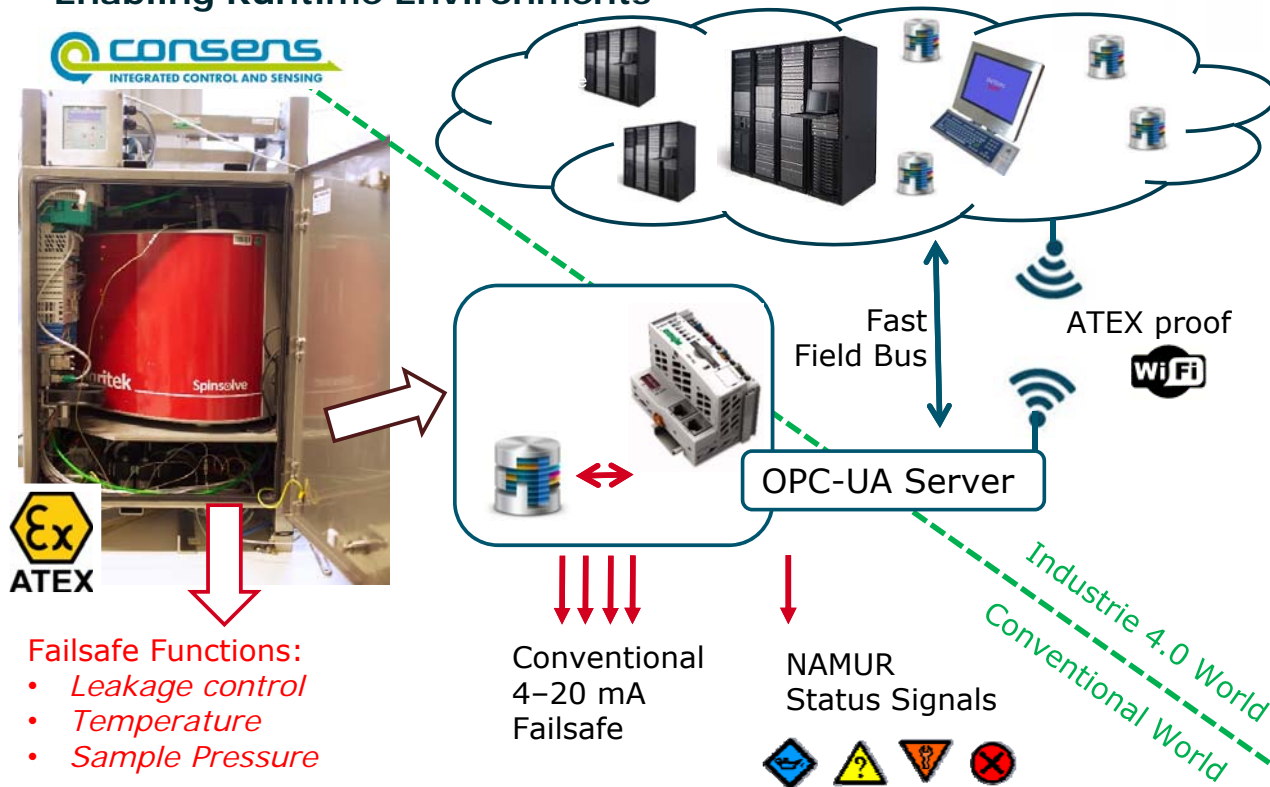

- Failsafe Functions:**
- *Leakage control*
 - *Temperature*
 - *Sample Pressure*

Acknowledgements



— Thank You!

Ulrich Panne
Simon Kern
Klas Meyer
Svetlana Guhl
Nicolai Zientek
Andrea Paul
Lukas Wander
Patrick Gräßer

BAM

Jürgen Kolz
Ullrich Koch
Juan Perlo

Magritek

Mike Bernstein

MestreLab

Harald Pape

PTB

Clemens Minnich
Dirk Engel

S-Pact



CONSENS – Integrated Control and Sensing for Sustainable Operation of Flexible Intensified Processes, funded by the European Union’s Horizon 2020 research and innovation programme under grant agreement N° 636942; www.consens-spire.eu