

12.05.2017

EuroPACT 2017
Potsdam, Germany

DESIGN AND VALIDATION OF A COMPACT NMR ANALYSER

Simon Kern, Svetlana Guhl, Klas Meyer, Andrea Paul,
Lukas Wander, Patrick Gräßer, and Michael Maiwald

Bundesanstalt für Materialforschung und -prüfung (BAM)
Division 1.4 Process Analytical Technology

Richard-Willstätter-Str. 11
D-12489 Berlin, Germany



CONSENS: Smart Online NMR Sensor for Advanced Process Control

Flexible Intensified Continuous Plant

Characteristics

Miniaturized equipment

Intensified heat & mass transfer

Possibly modular setup



Benefits

Product uniformity

Sustainability

Fast adaption to market demand

Innovative products

Containerized modular plant Source: INVITE GmbH



CONSENS: Case Study 1

Intensified Synthesis of Organic Compounds

Modular plant



Source: INVITE GmbH

Explosion proof housing

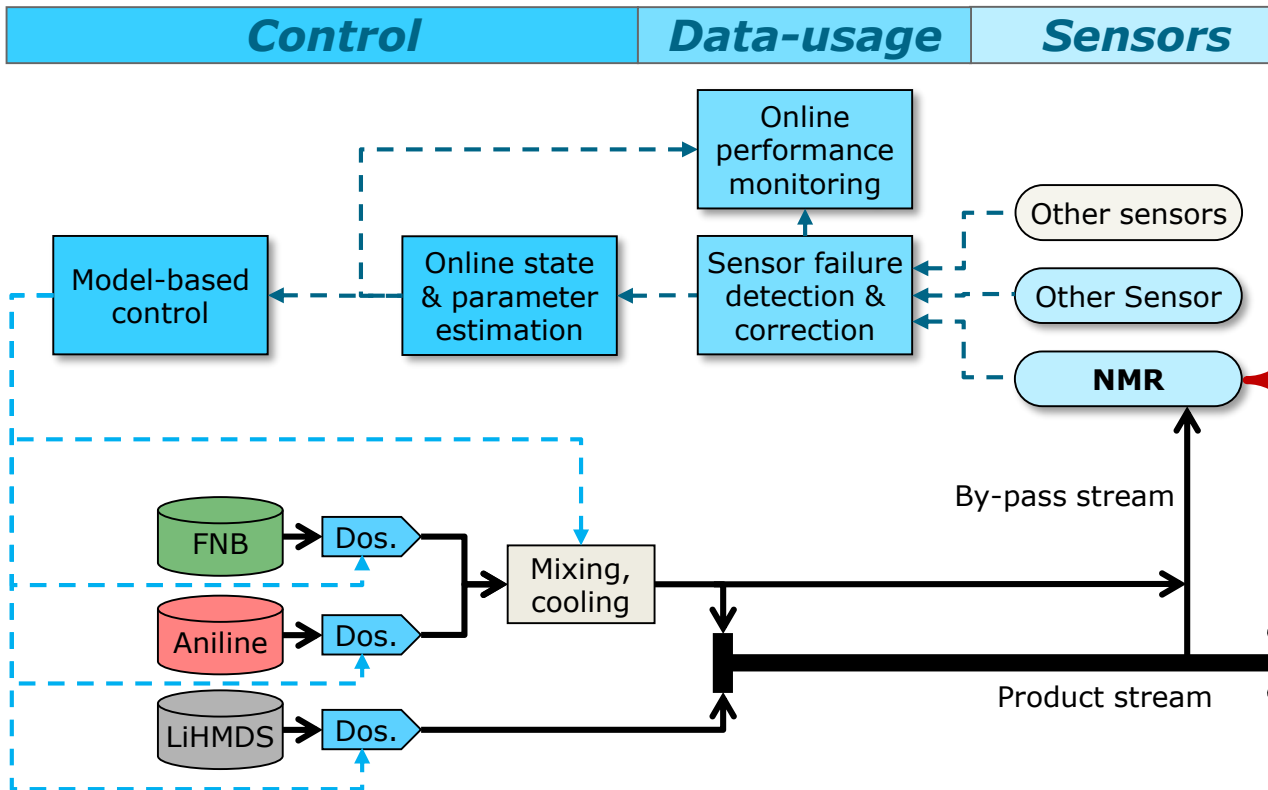
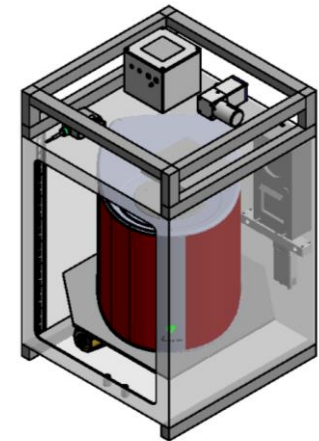

Reaction Scheme:

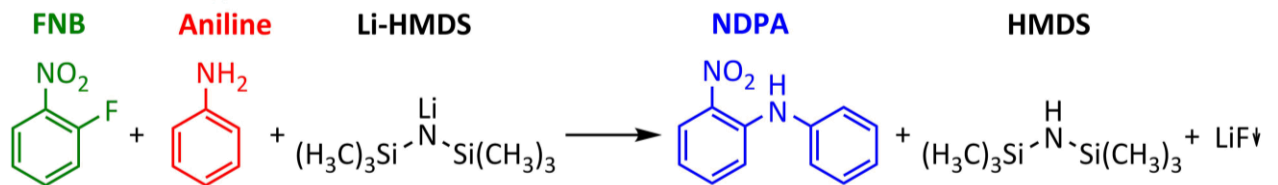

Reaction Monitoring on Lab Scale at BAM

Process Analytical Technology for Intensified Processes



Examples from BAM



Catalysis:
Hydroformylations of C12-alkenes
in micro emulsions

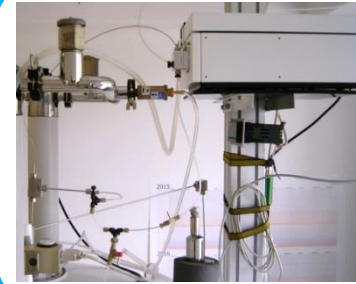
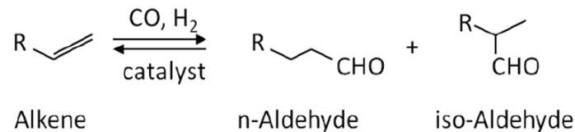

qNMR (Metrology):
Gases and
condensed phases
up to 1000 bar

Pharmaceuticals:
Liberation kinetics

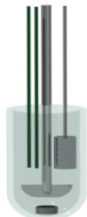
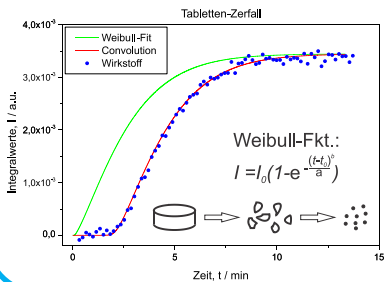

CO₂ scrubbing

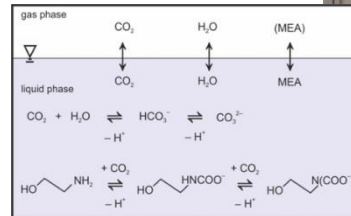

Method development:
Esterifications
(model reactions)

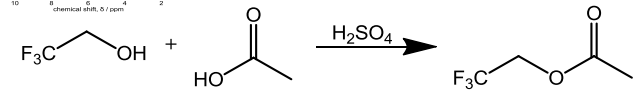
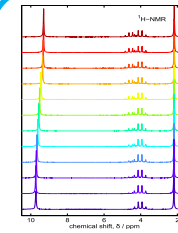

Catalysis:
Hydrogenations

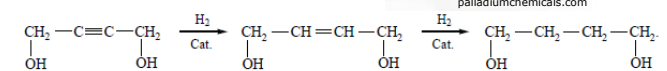

Reaction Engineering:
Lithiation reactions

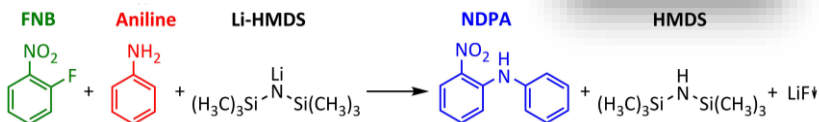
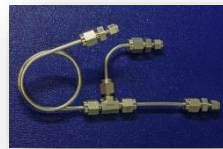

Reaction Engineering:
Photo reactions („click chemistry“)

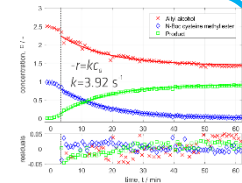
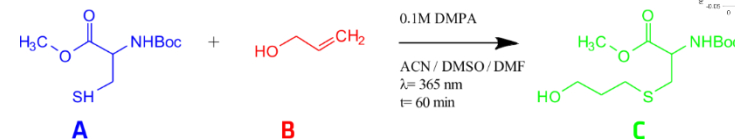

Reaction Monitoring in Lab-scale at BAM

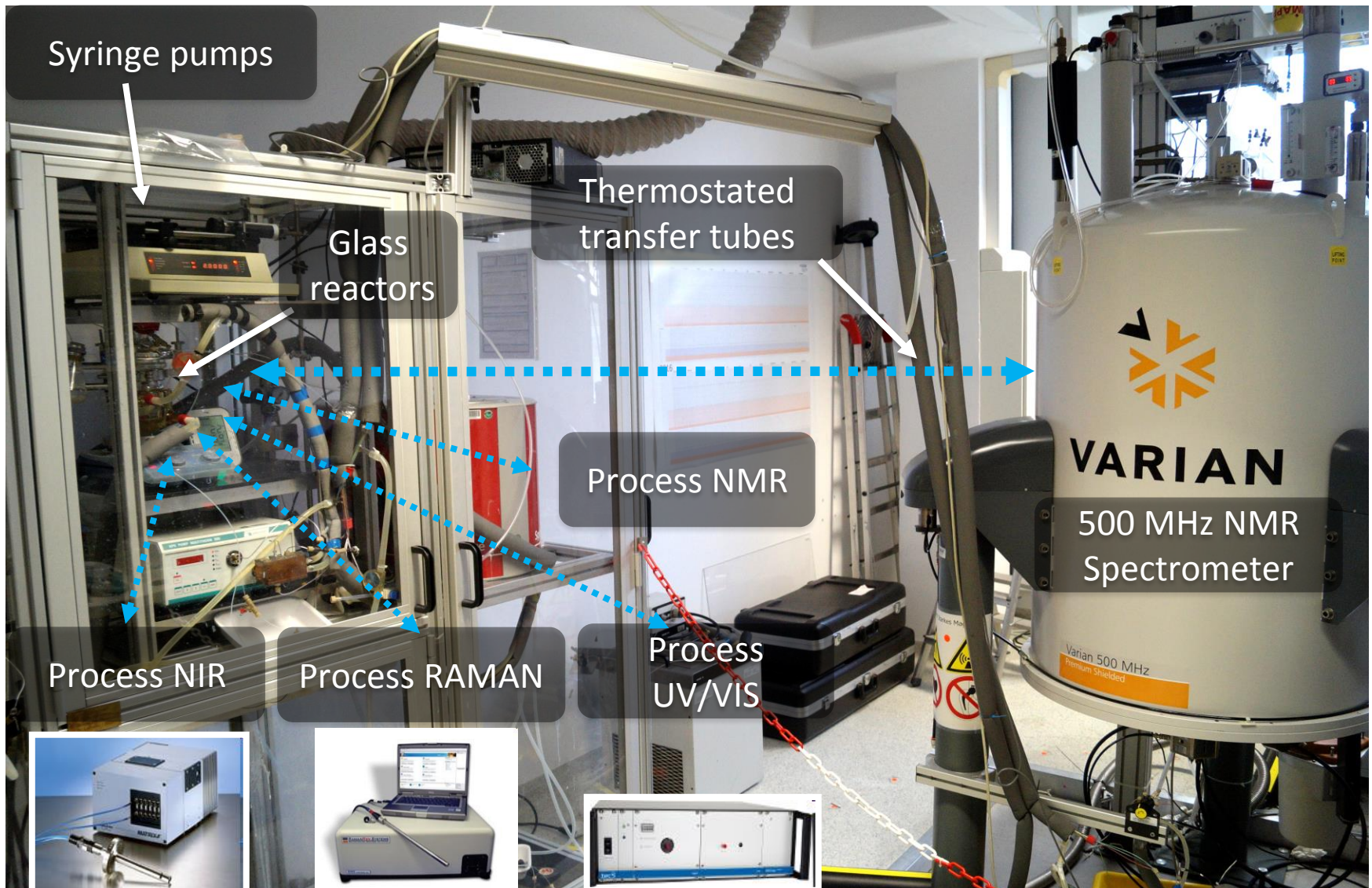

Reaction Characterization in Lab

Lab Experiments in Batch along Reaction Co-ordinate

- Data in parallel acquired with high-field and low-field spectrometer
- „Fast“ and „slow loop“
- Li-HMDS was dosed stepwise



Experimental set-up

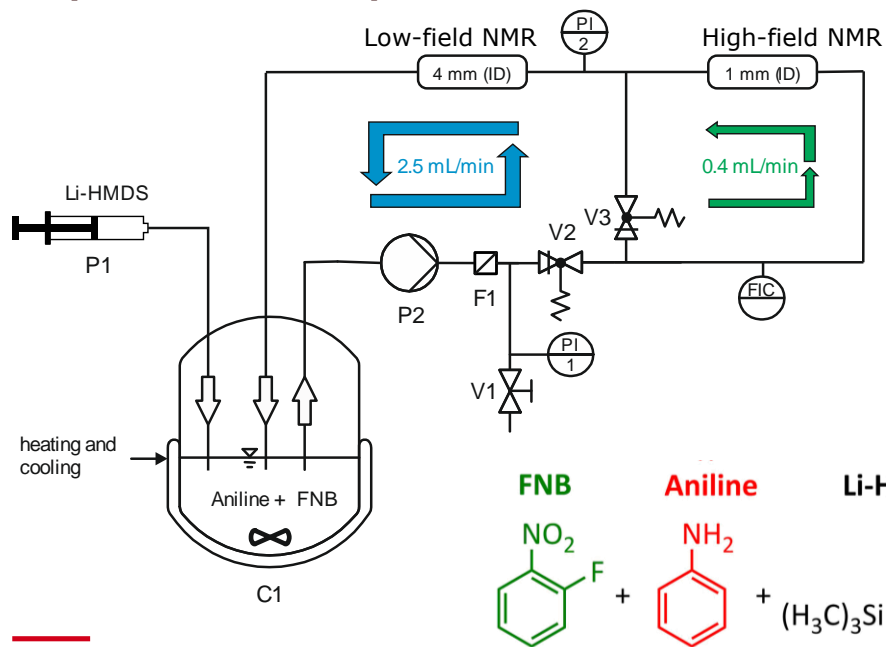

- Exothermic reaction
➔ required cooling (28.5 °C)
- Li-HMDS in two-fold excess

Reaction Scheme:

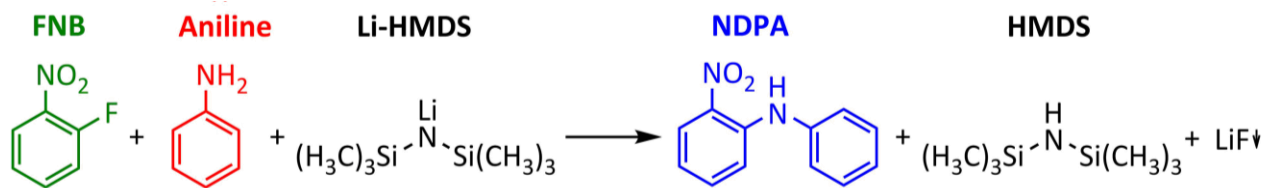

Online ^1H NMR Spectra of Lithiation Reaction Step

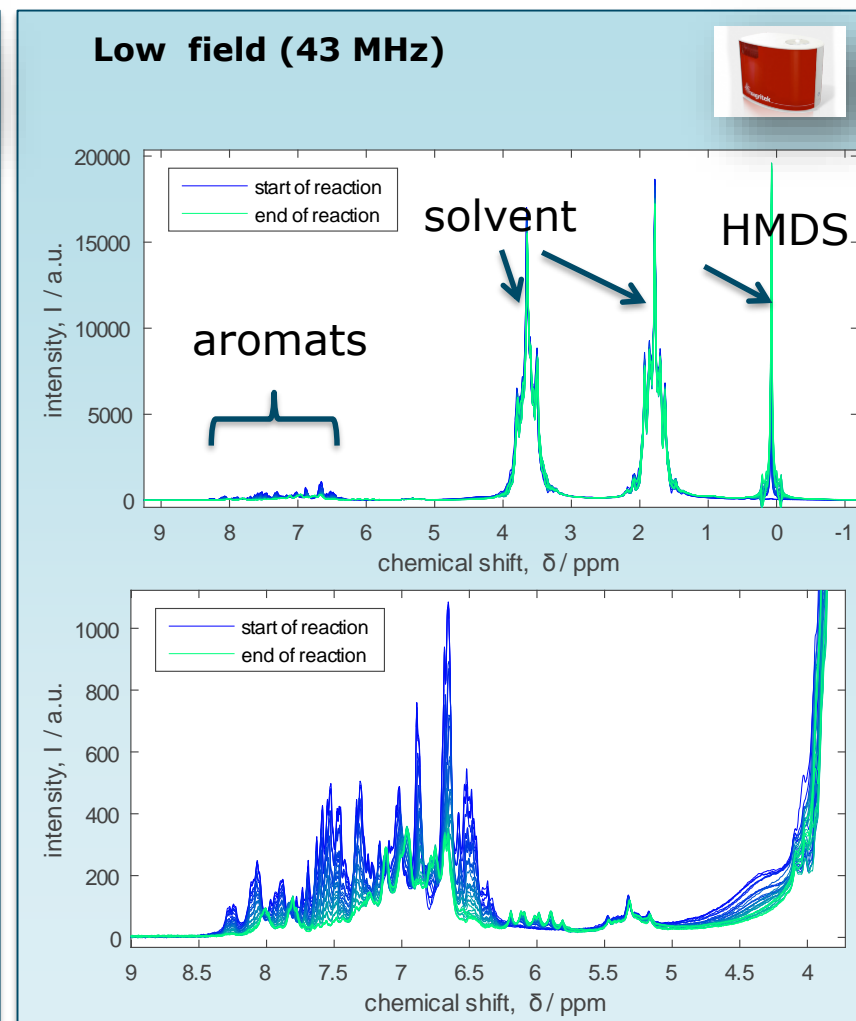
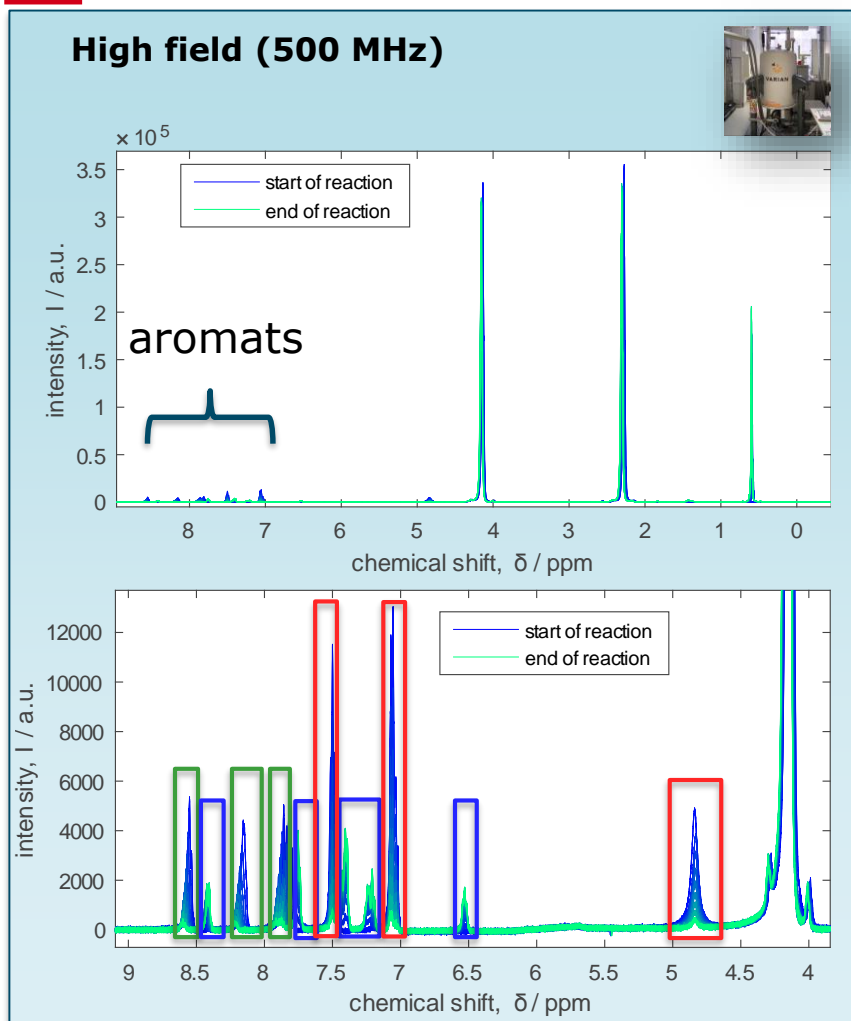

Data Processing for Low-field NMR in Matlab

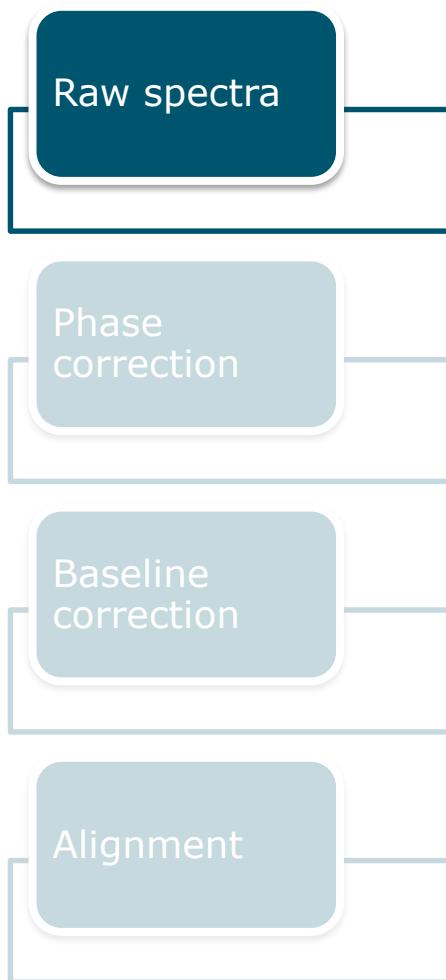

**single scan
each 15s
in flow**

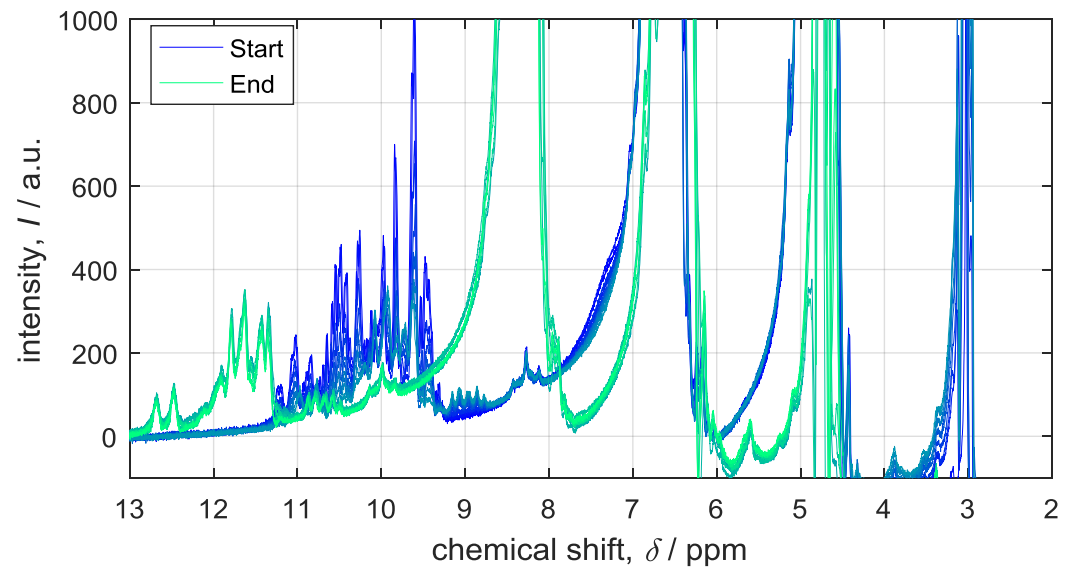
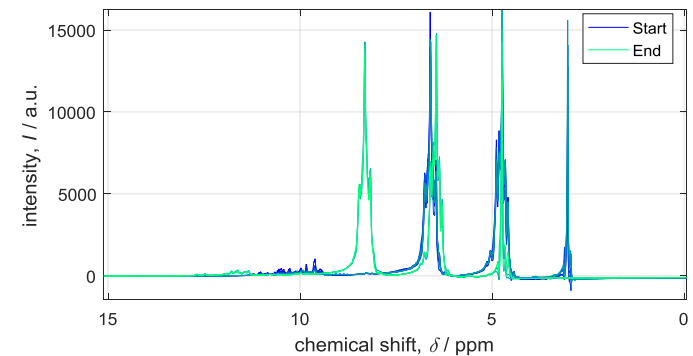

Data Processing for Low-field NMR in Matlab

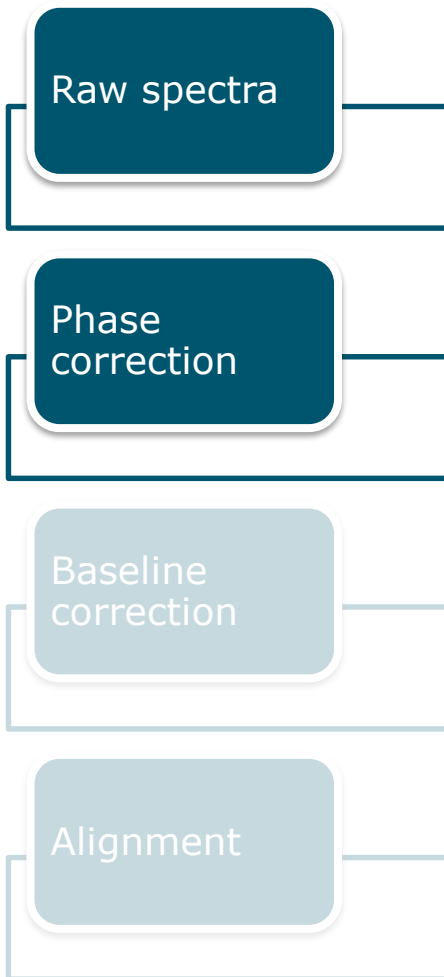

Entropy minimization method:

Chen et al., *J Magn Reson.*
2002, *158*, 164-168

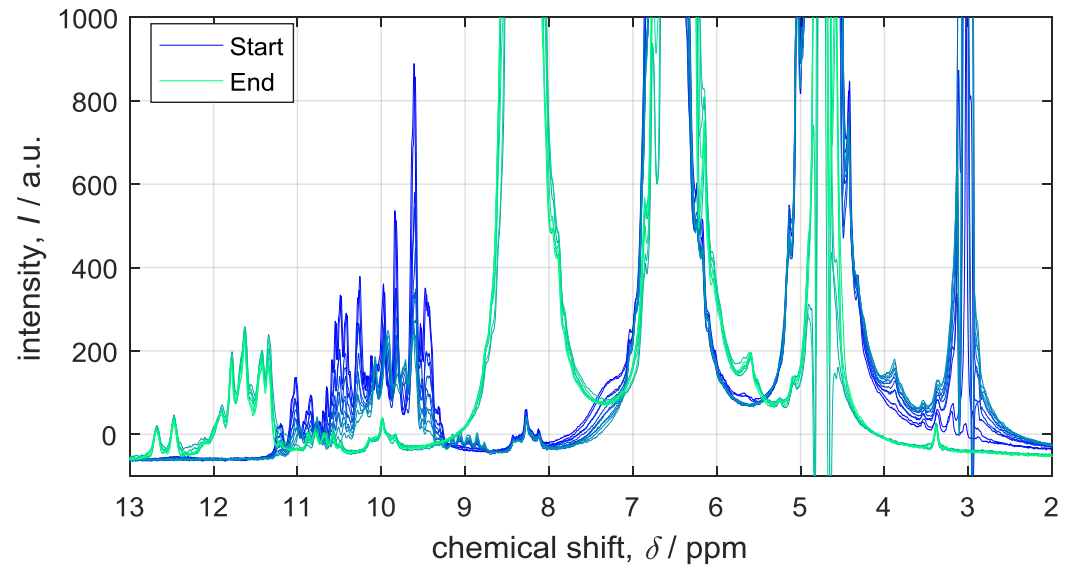
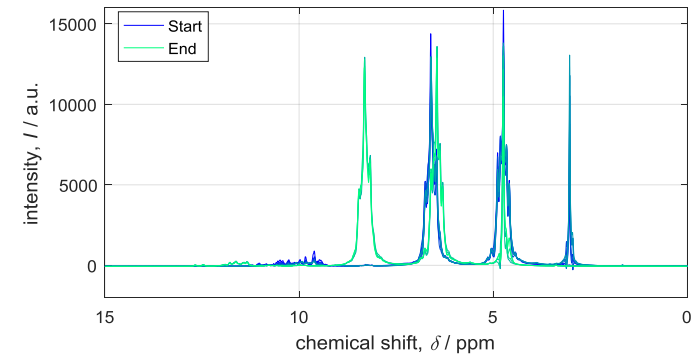

Data Processing for Low-field NMR in Matlab

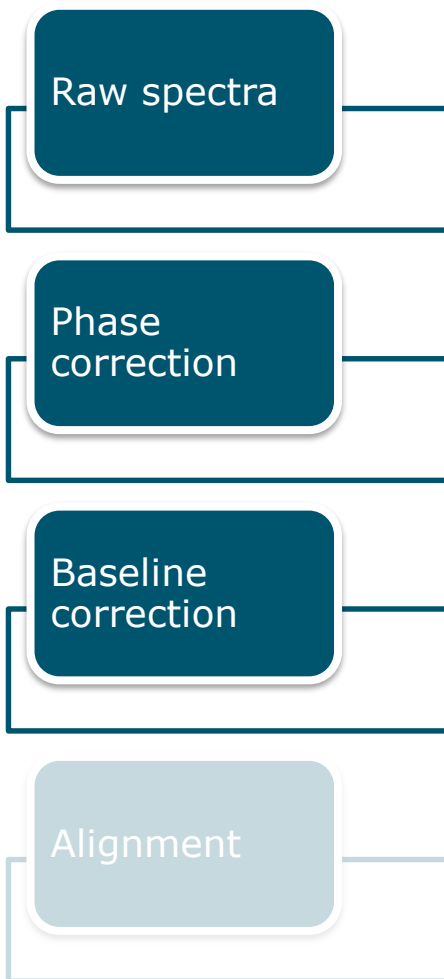

Low-order Polynomial fit:

Mazet et al., Chemometrics
Intell. Lab. Sys. **2005**, 76,
121-133.

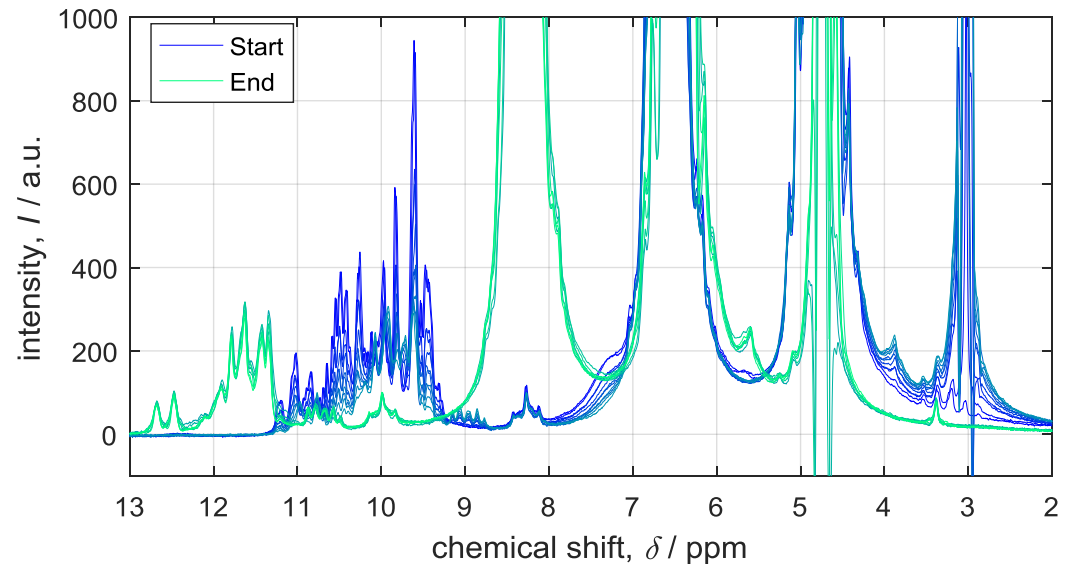
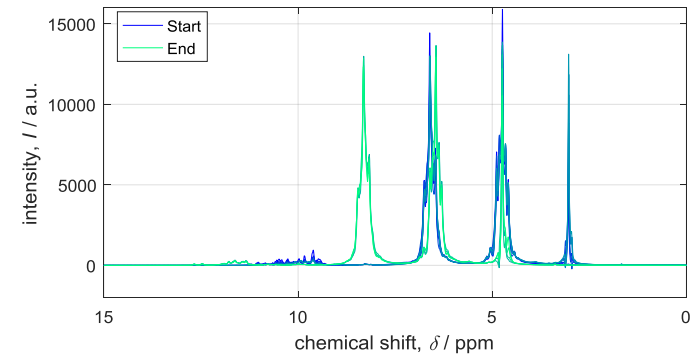

Data Processing for Low-field NMR in Matlab

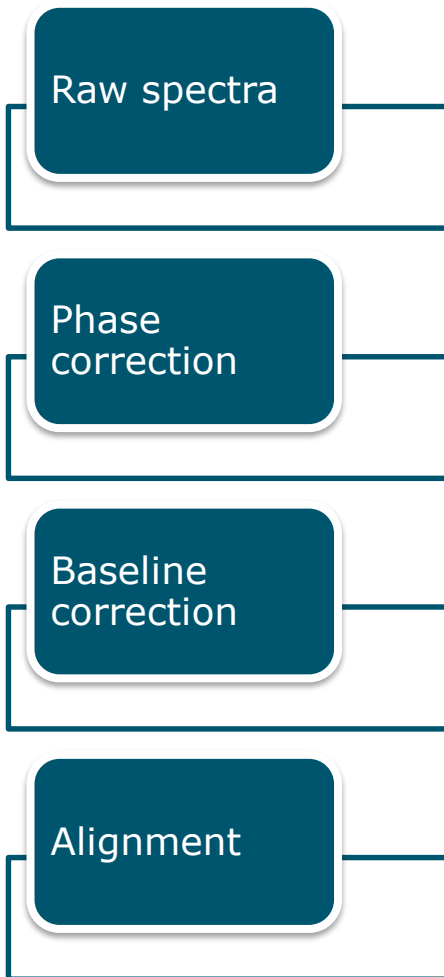

Alignment to reference signal (THF) using *icoshift*:

Savorani et al., J Magn Reson. **2010**, 2, 190-202

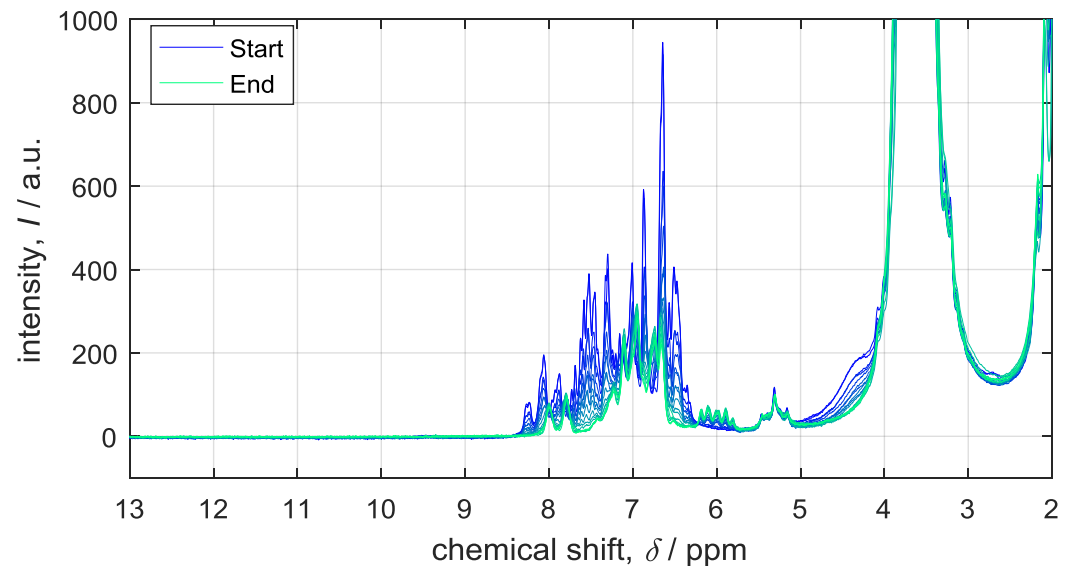
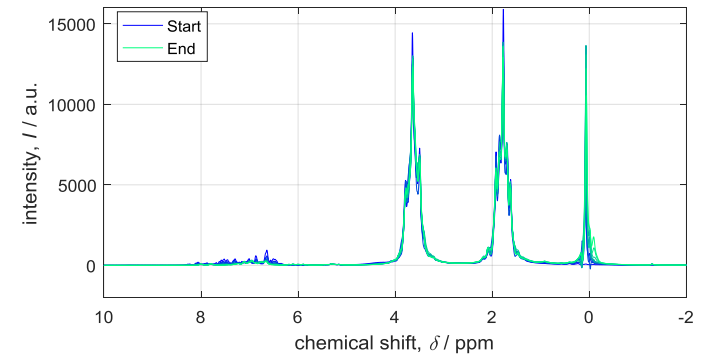

Challenges in Automated Data Analysis

Young PhD student

????

Data pretreatment

Integration

MCR

Binning/ PLS-R

GSD/ Edited Sum

IHM

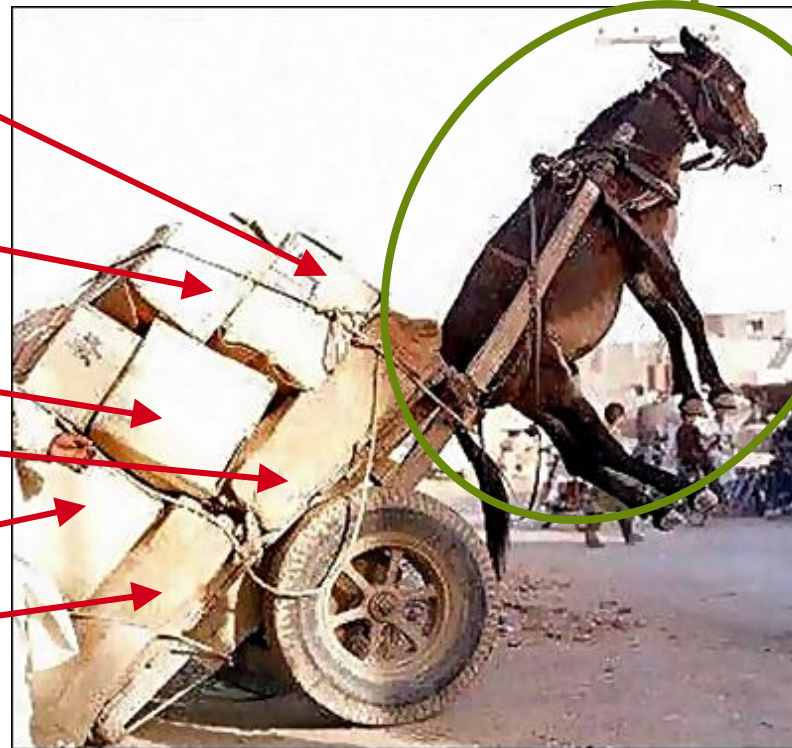

<http://collegeaffordology.com/>

Modeling → peak fitting of pure component spectra → mixture model

Analysis → "component fitting" → calculation of component area

- » Group of peaks represent pure component spectra

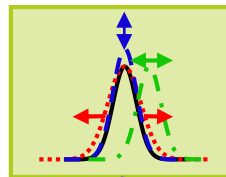

- » Pseudo-Voigt function

$$V = \alpha \left[\beta \cdot \exp\left(-\ln(2) \frac{(x - \delta)^2}{\gamma^2}\right) + (1 - \beta) \frac{\gamma^2}{(x - \delta)^2 + \gamma^2} \right]$$

α = peak maximum
 β = Gaussian-Lorentzian-ratio
 γ = half width
 δ = center position

Hard model for pure components

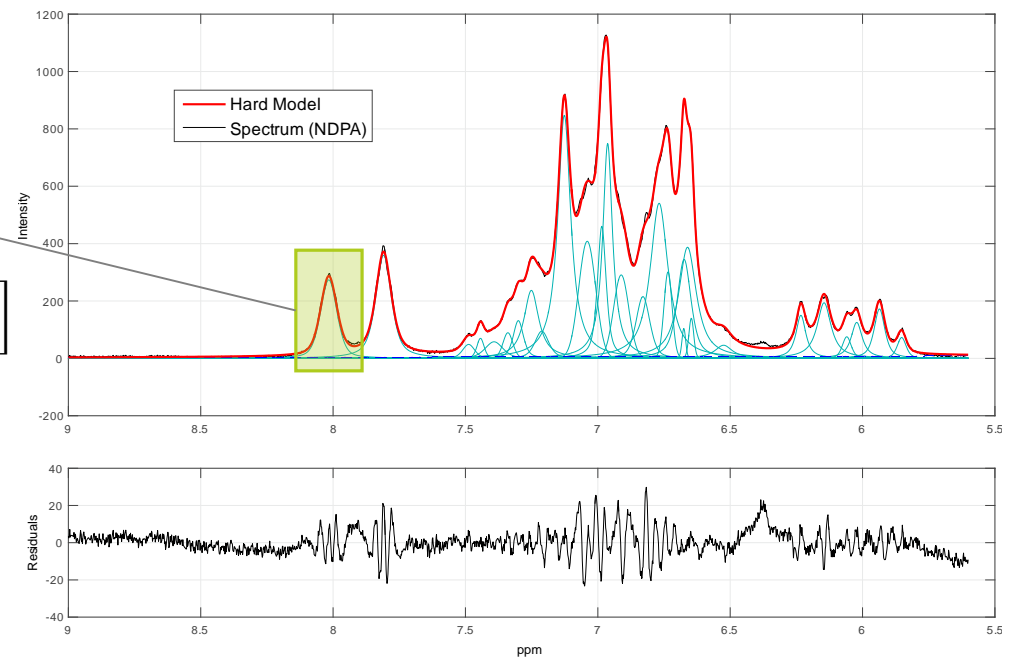

IHM – „component fitting“

Pure component models

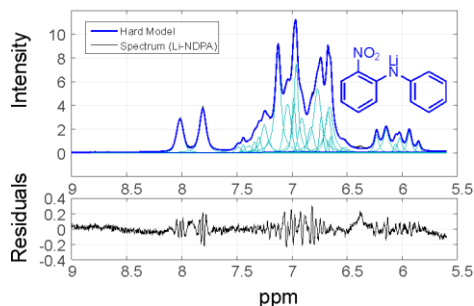
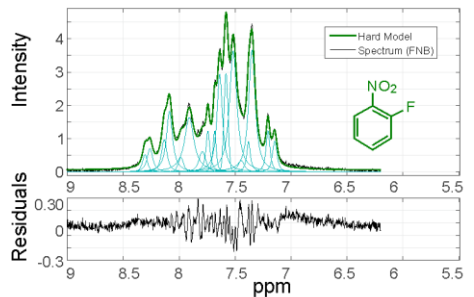
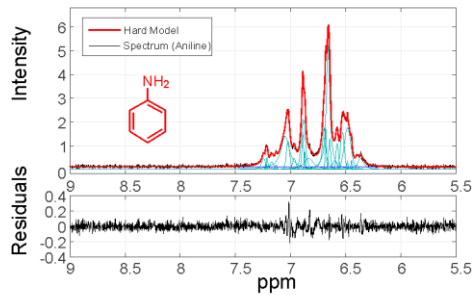

Mixture model

Component fitting

Experimental Spectrum

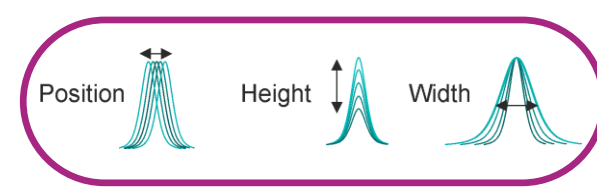
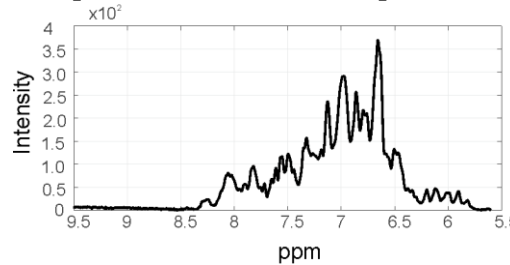

Modeling → Mixture model

| | |
|---|------------|
| No. components | 3 |
| Peaks per component | 22, 21, 28 |
| Degree of freedom (total free parameters) | 292 |
| Considered interacting peaks | 25 |
| Max. peak shift | 0.01 ppm |
| ... | ... |

Peak area ratio for each pure component model is kept constant!

IHM – „component fitting“

Pure component models

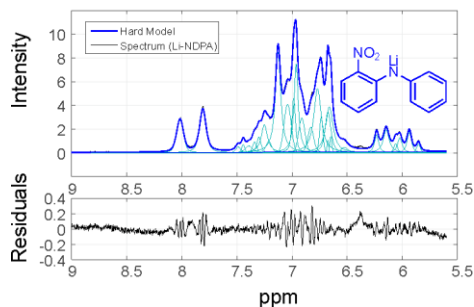
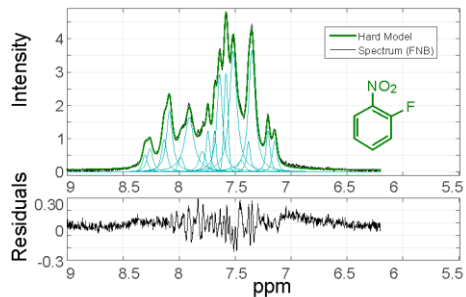
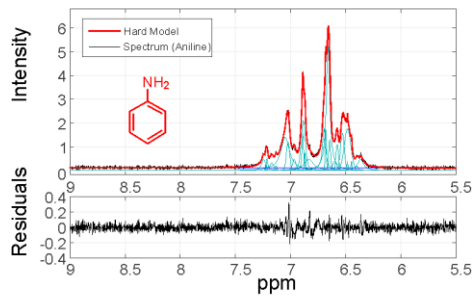

Analysis "component fitting"

Mixture model

Component fitting

Experimental Spectrum

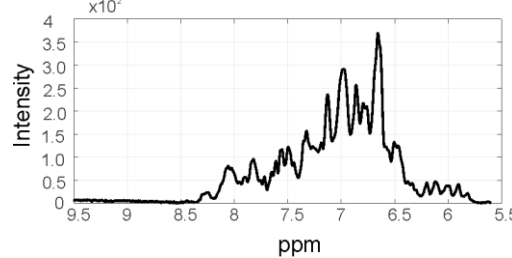

Deconvoluted spectrum

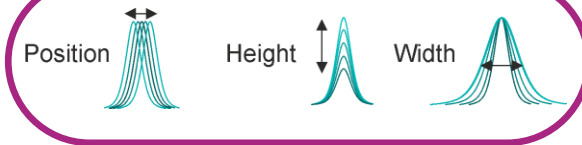
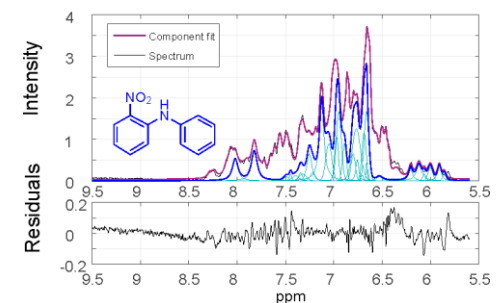
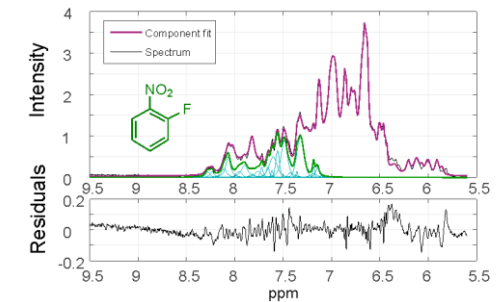
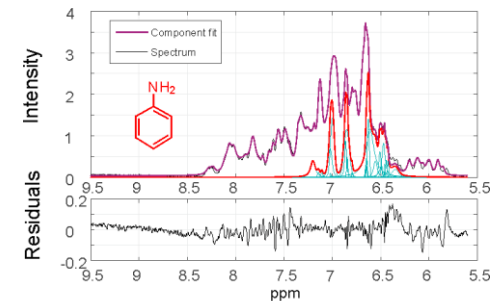

Results: Validation of IHM Model

Lab Experiments in Batch along Reaction Co-ordinate

- 3 semi-batch reaction with varying starting concentrations
- 1500 Spectra for each HF- and NF-NMR

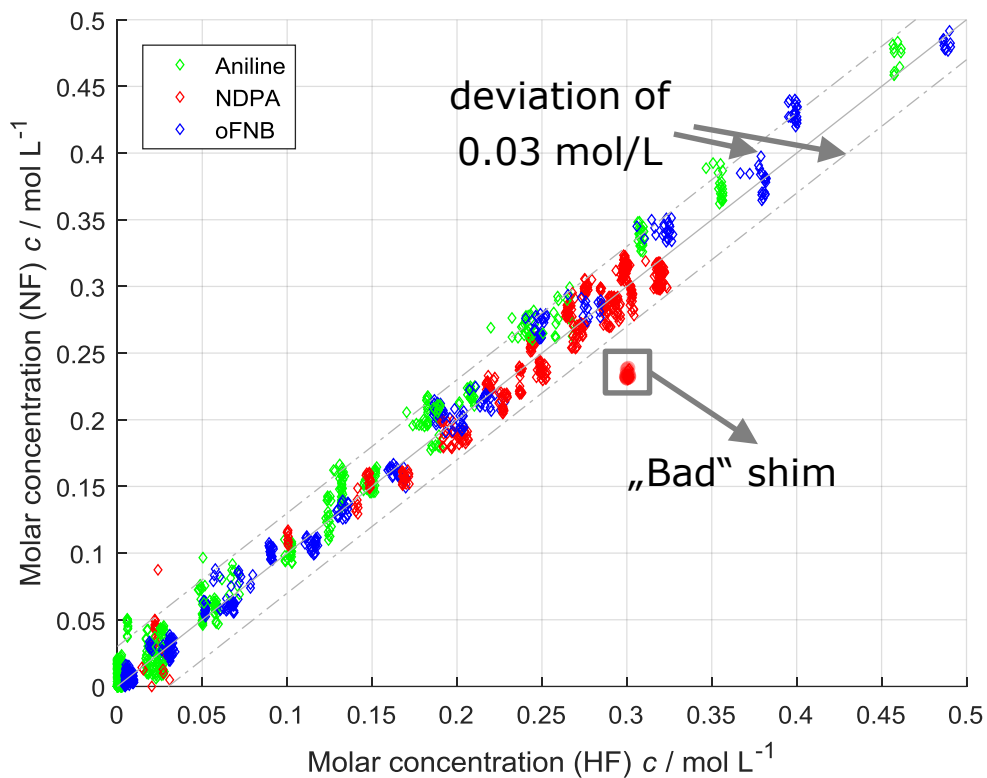

Classification of steady states

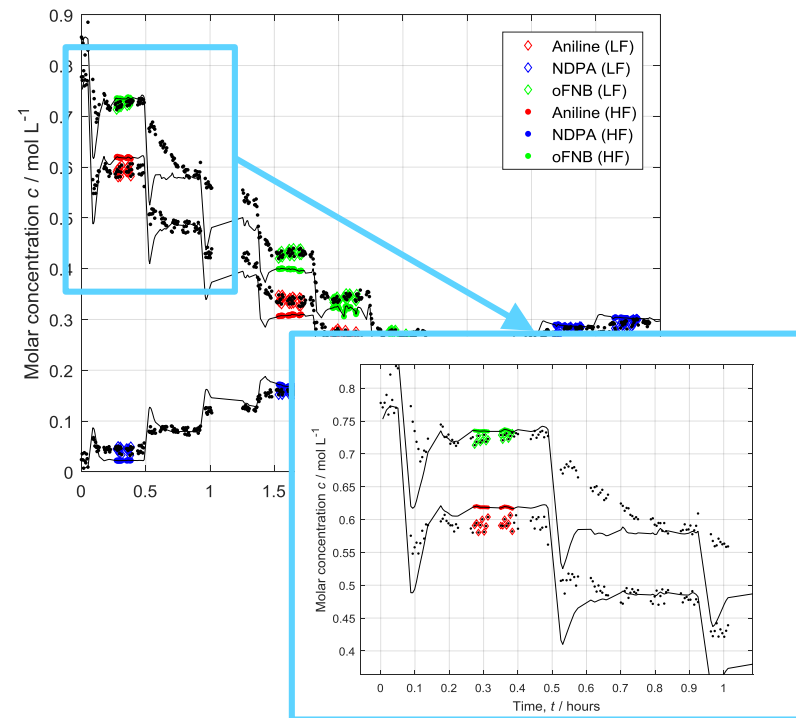

Reaction Scheme:

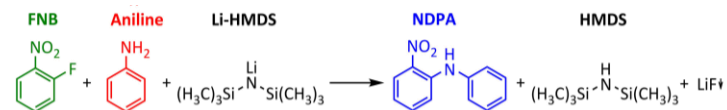

Results: Validation of IHM Model

Lab Experiments in Batch along Reaction Co-ordinate

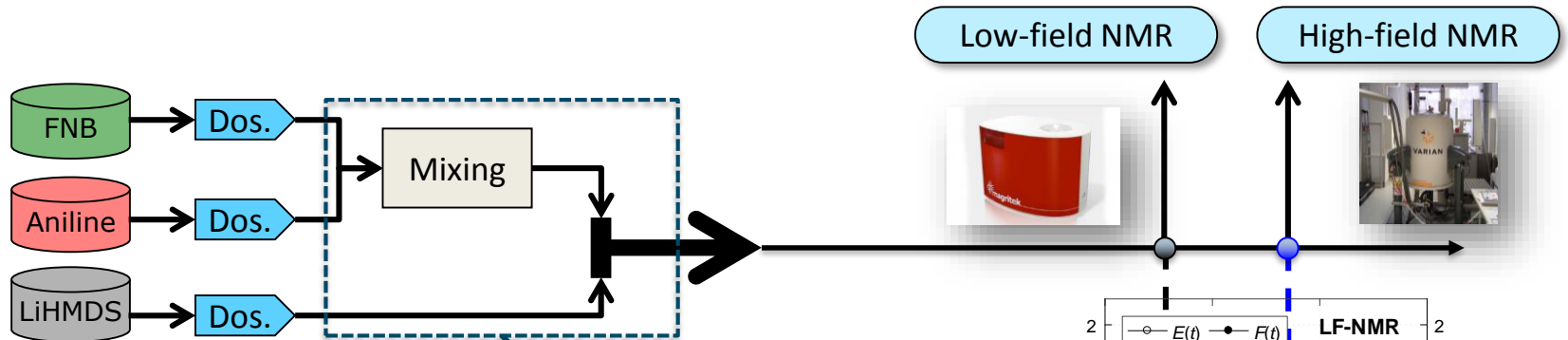

1/8" tube reactor

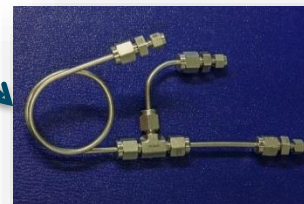

Step tracer experiments

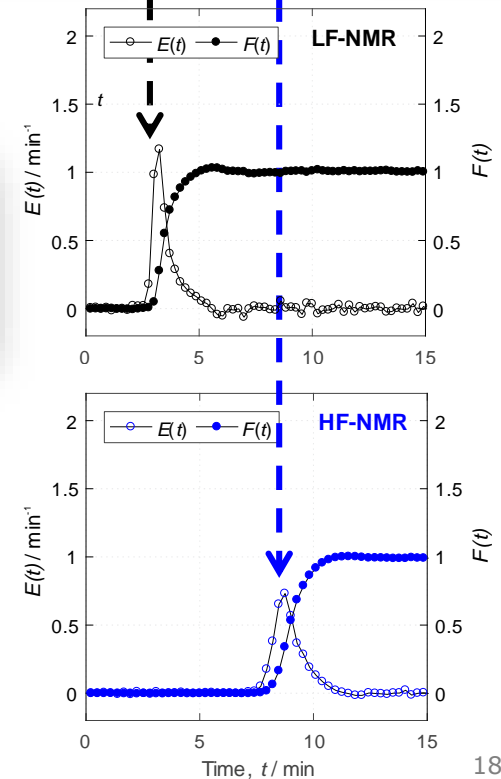
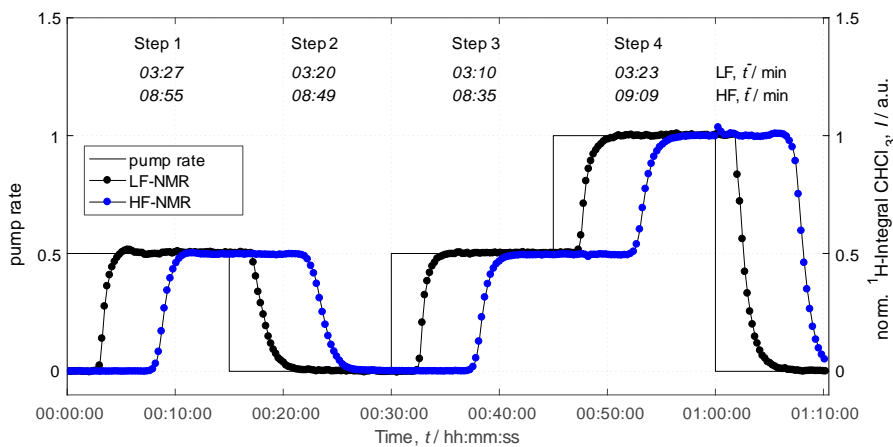

Experimental Design

Continuous Lithiation Reaction Set-up at BAM

- Independent variation of flowrates / stoichiometric conditions

Reaction Scheme:

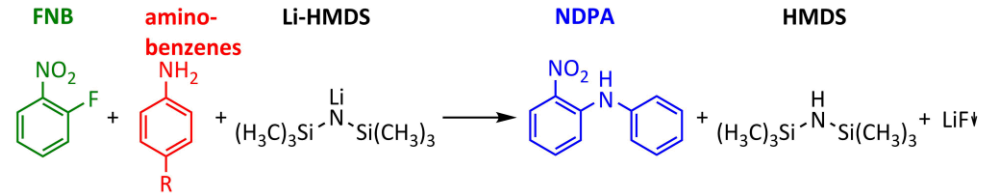

Coarse variation:

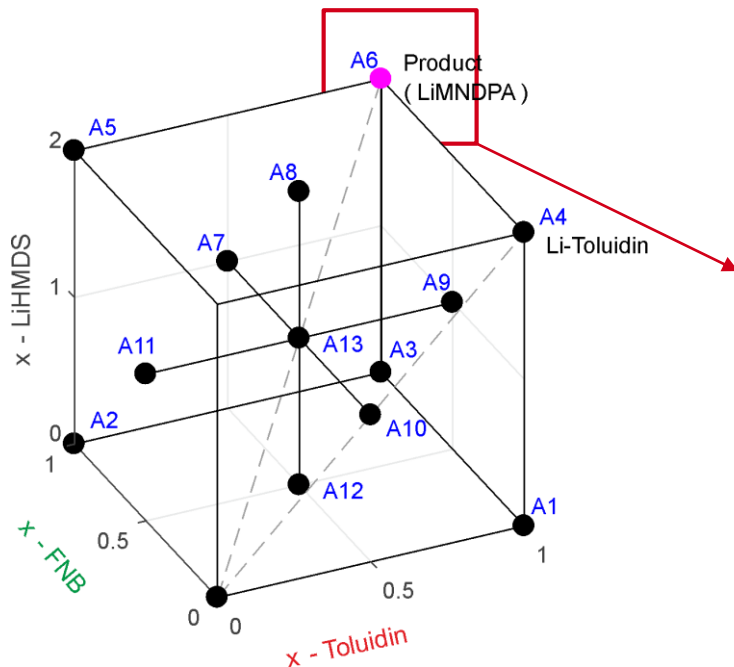

Fine variation:

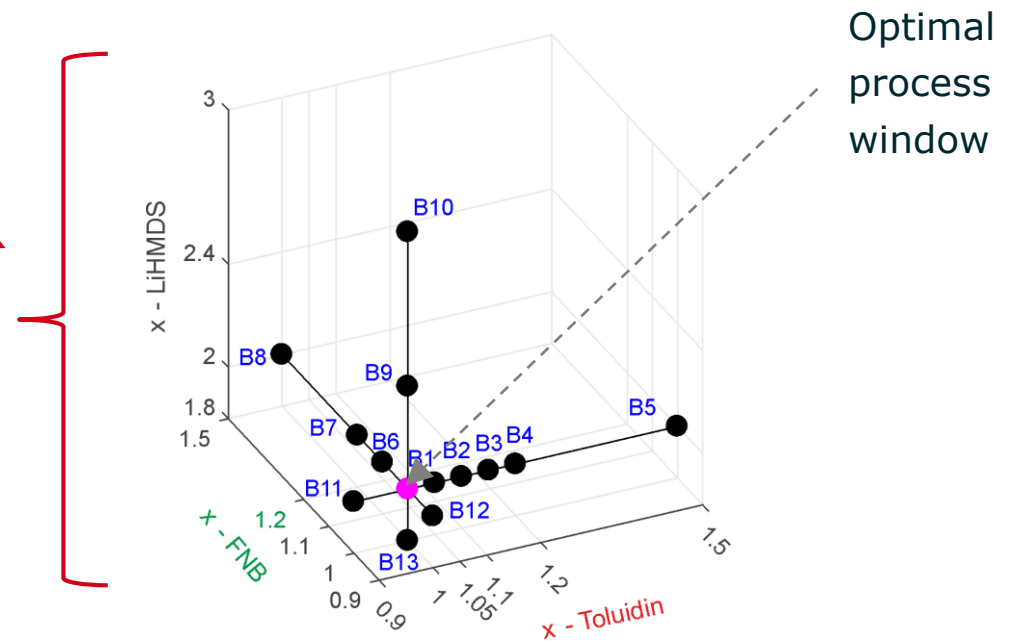

Monitoring of Continuous Aromatic Substitution Reaction by Low Field NMR

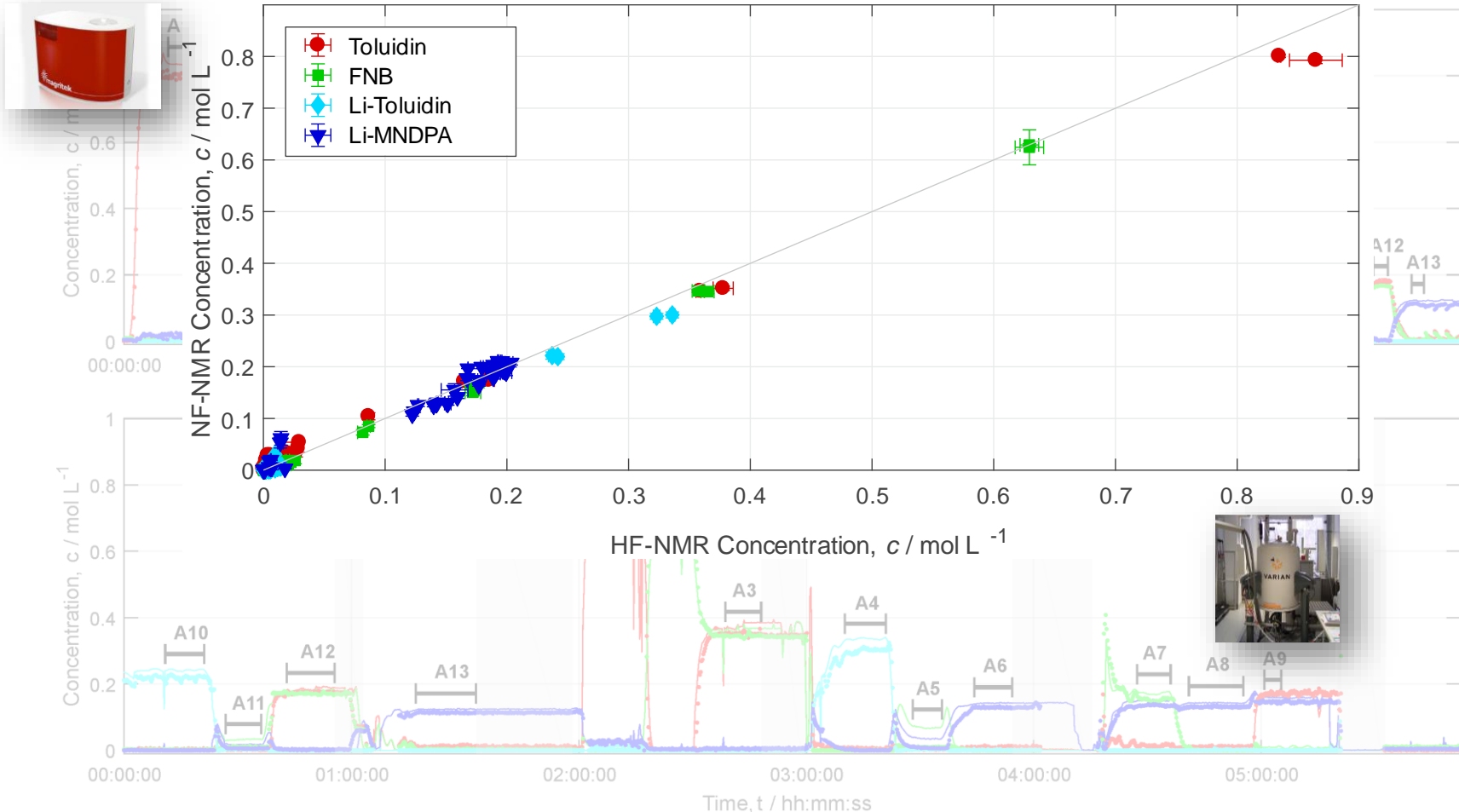

Smart NMR Sensor Concept

Current and Future Requirements to Smart Process Sensors As Parts of Cyber-Physical Production Systems

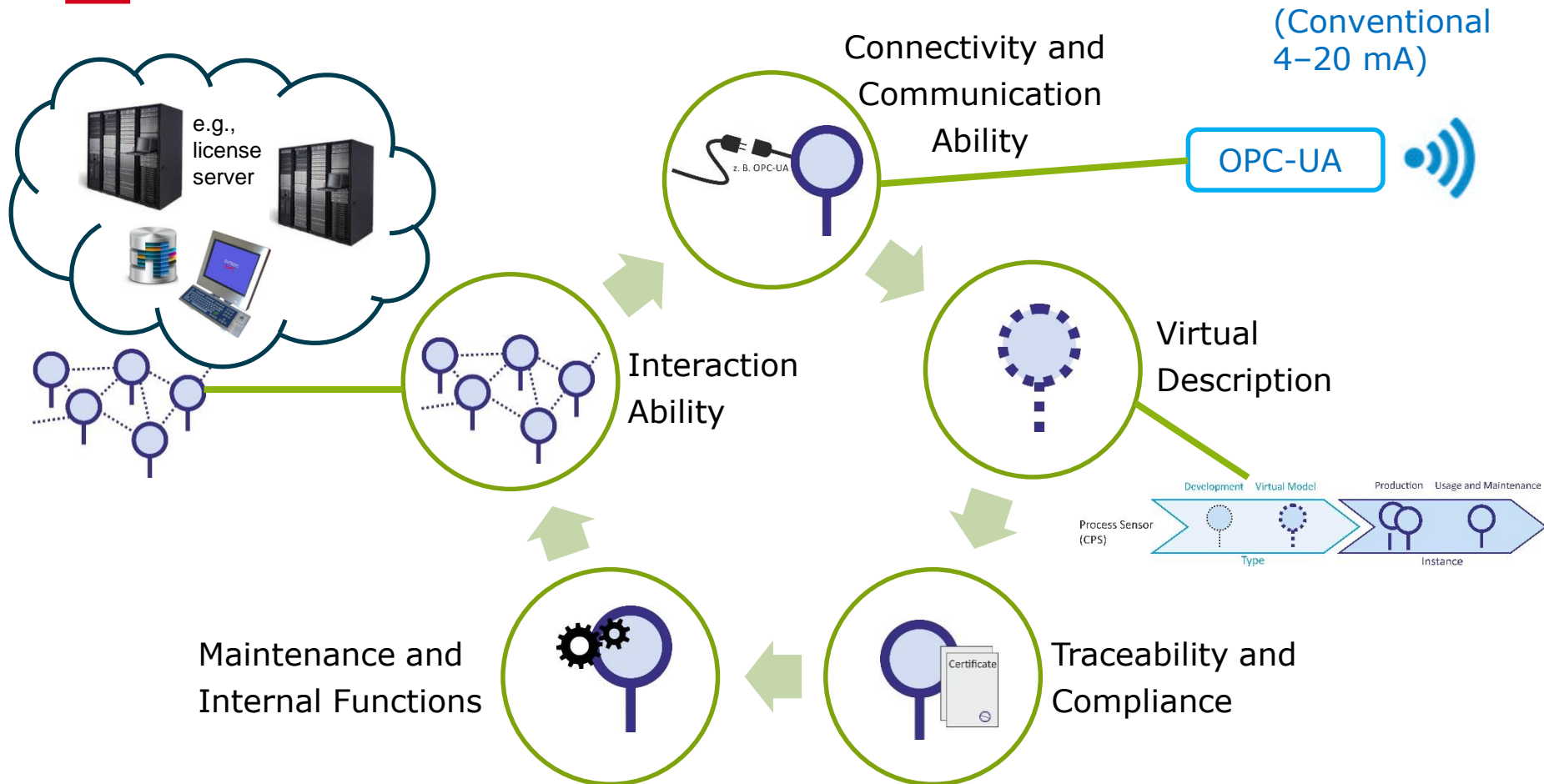

Online NMR Module: Data flows

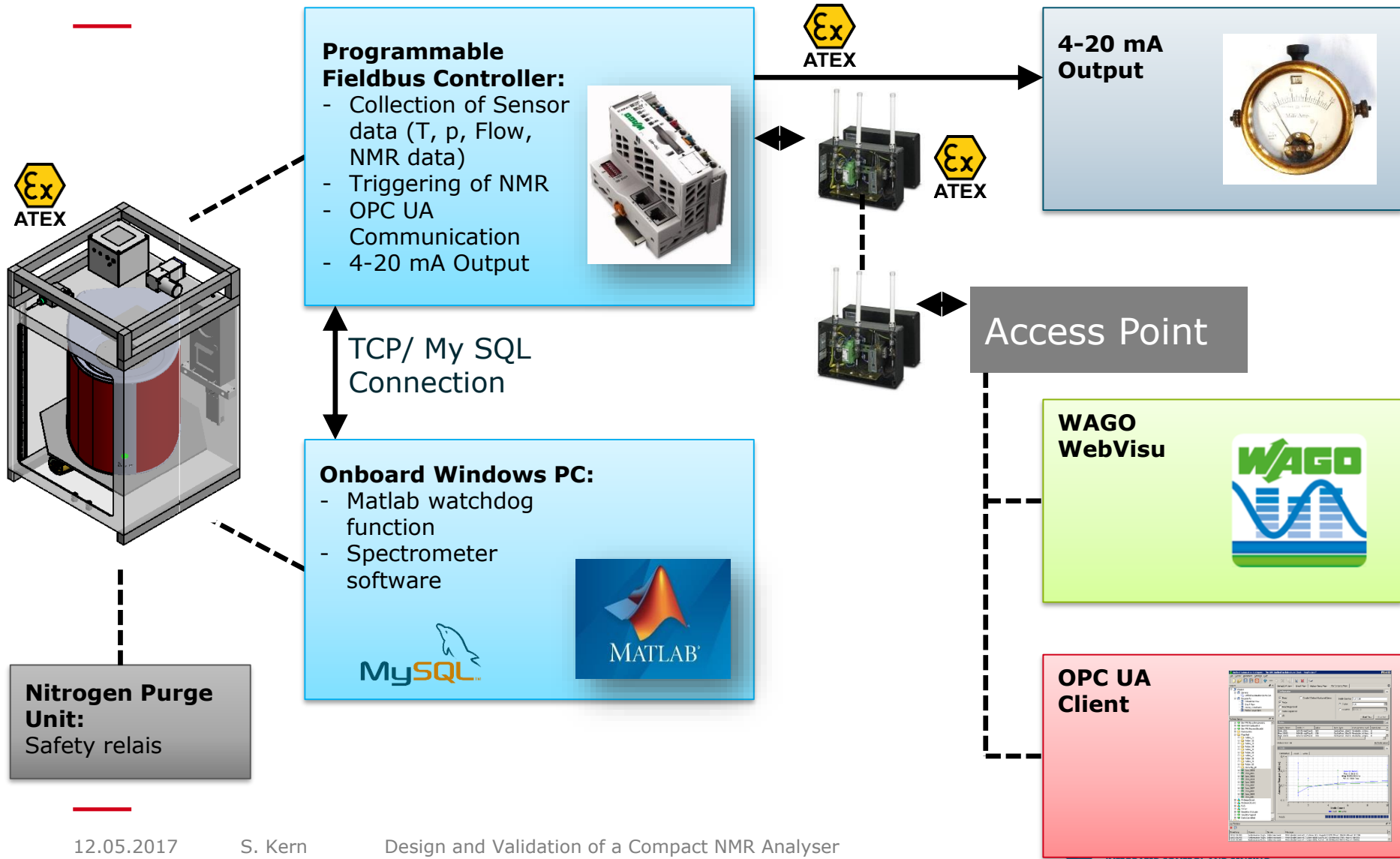

CONSENS: Deliverable of Fully Automated NMR Analyser

NMR Analyser at BAM

Set-up at INVITE, Leverkusen

Module size:
850 x 570 x 570 mm

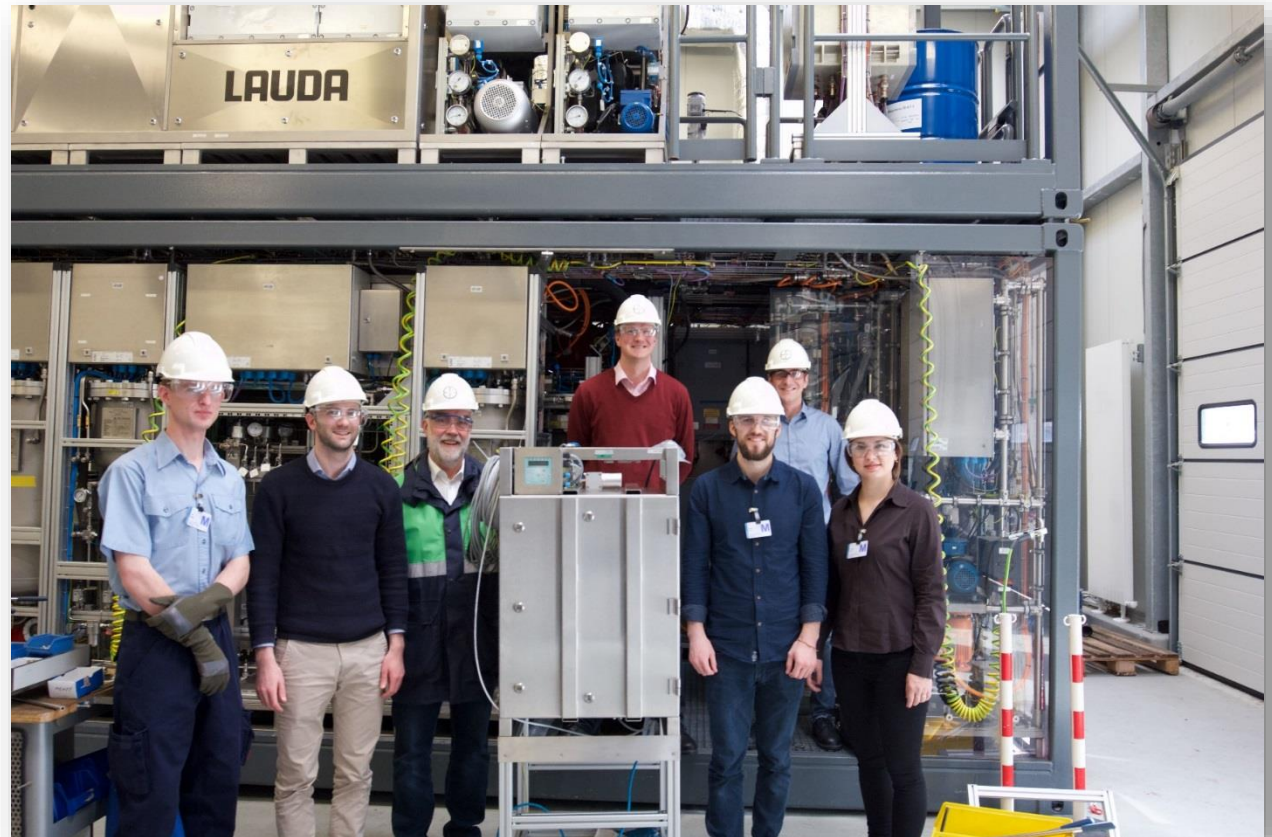

Closing the Gap ...

Key Attributes of Compact NMR Spectroscopy for Industrial Online Applications

Laboratory research

Chemical industry

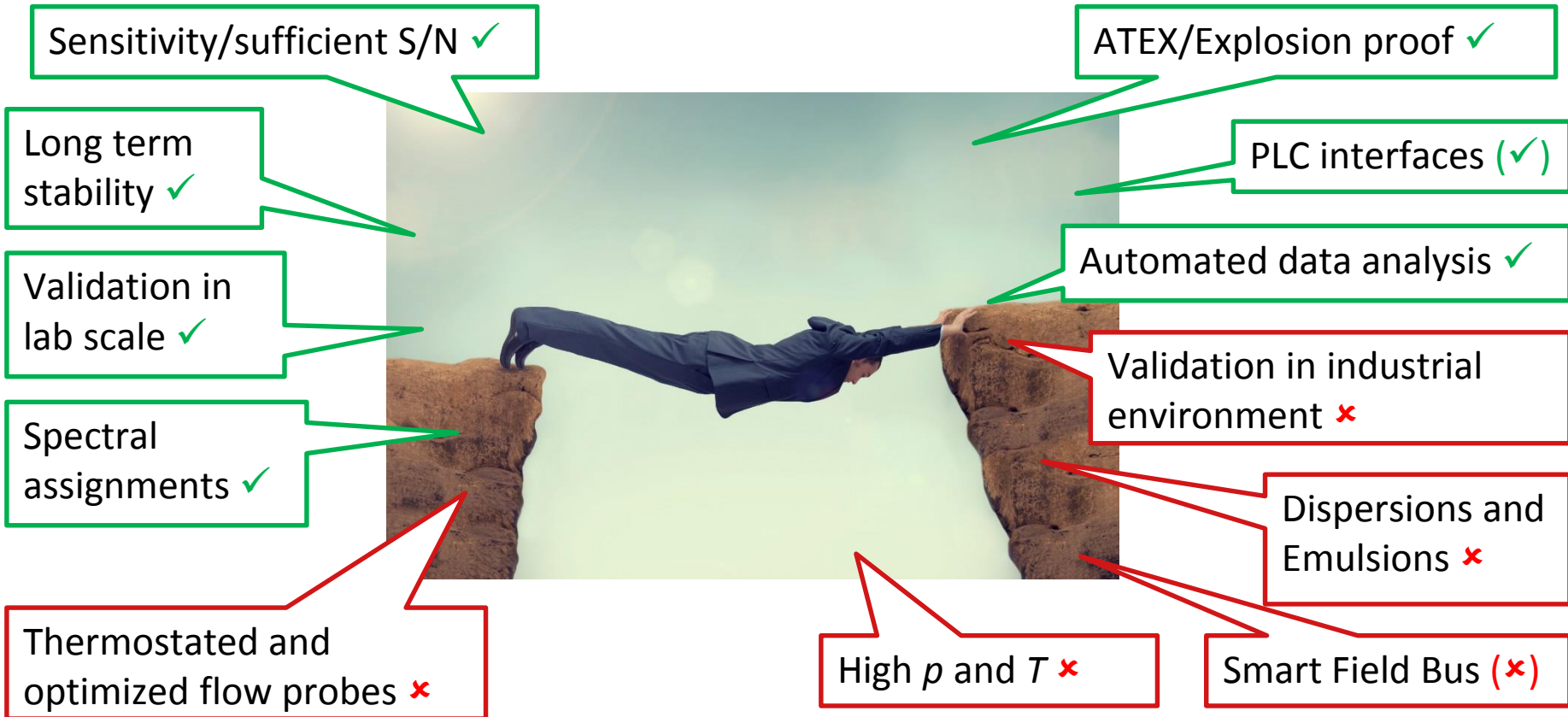

THANK YOU!

| | | | |
|----------------|-----------|-----------------|-------------------|
| Jürgen Kolz | Magritek | Harald Pape | PTB |
| Ullrich Koch | Magritek | Clemens Minnich | S-Pact |
| Juan Perlo | Magritek | Dirk Engel | S-Pact |
| Mike Bernstein | MestreLab | Alfons Steil | PSG Petro Service |

NMR Group at BAM

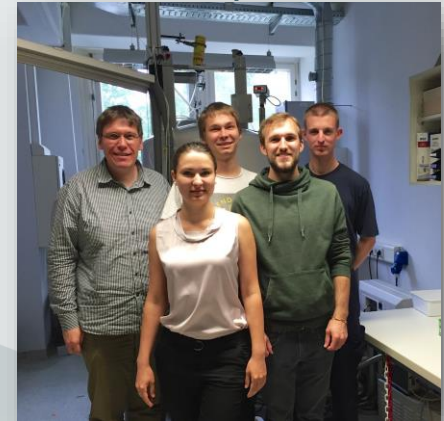

CONSENS – Integrated Control and Sensing for Sustainable Operation of Flexible Intensified Processes, funded by the European Union's Horizon 2020 research and innovation programme under grant agreement N° 636942.
www.consens-spire.eu

THIS DOCUMENT IS PROVIDED "AS IS" WITH NO WARRANTIES WHATSOEVER, INCLUDING ANY WARRANTY OF MERCHANTABILITY, NONINFRINGEMENT, FITNESS FOR ANY PARTICULAR PURPOSE, OR ANY WARRANTY OTHERWISE ARISING OUT OF ANY PROPOSAL, SPECIFICATION OR SAMPLE.

Any liability, including liability for infringement of any proprietary rights, relating to use of information in this document is disclaimed. No license, express or implied, by estoppels or otherwise, to any intellectual property rights are granted herein. The members of the project CONSENS do not accept any liability for actions or omissions of CONSENS members or third parties and disclaims any obligation to enforce the use of this document. This document is subject to change without notice.

Smart NMR Sensor Concept

Module size:
850 x 570 x 570 mm



Safety devices

- Nitrogen purge control
- Leakage safeguard

Measuring Conditions

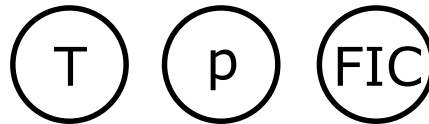

Data Acquisition

- Triggering
- Automated evaluation (Matlab)
- MySQL Database

Conventional
4–20 mA



Programmable
Fieldbus
Controller

www.wago.de



OPC-UA
Client



Ethernet

- Spectra for repeated batches vary, e.g., due to the quality of the respective shim
- fundamental acceptance criteria for online NMR spectroscopy:

 robust data pretreatment and evaluation strategy with the potential for automation

Comparison of proton spectra of different runs

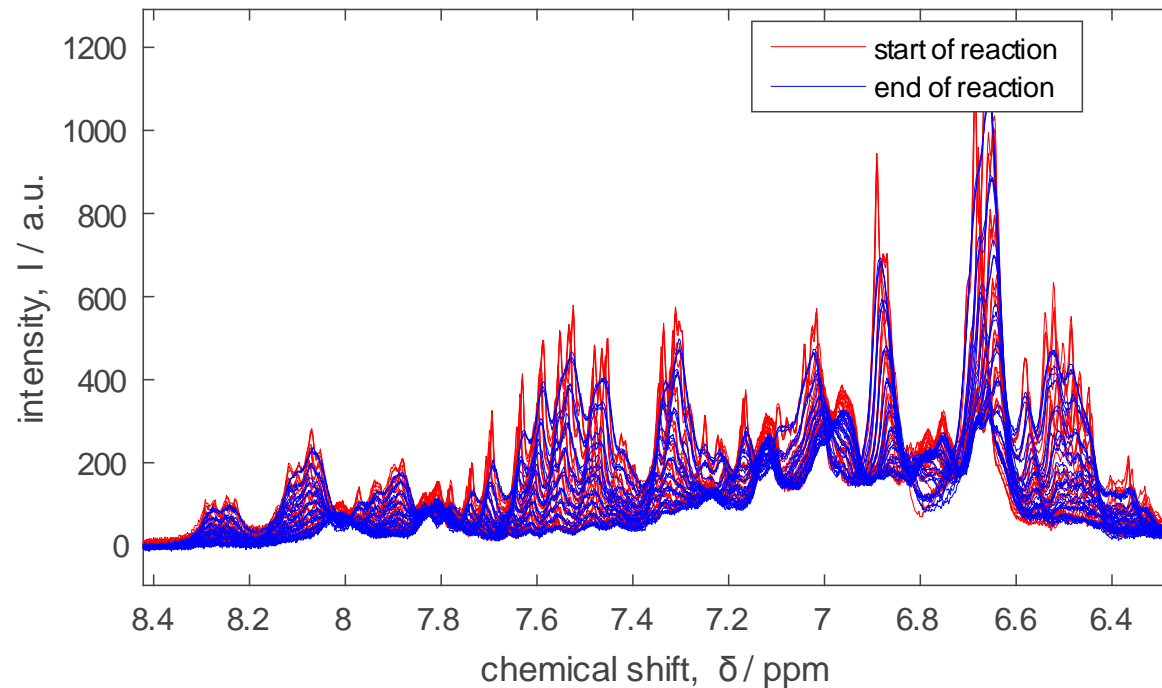

Contemporary Process Engineering

Towards Cyber-Physical Production Systems (CPPS)

“Cyber-Physical Systems (CPS) are integrations of computation with physical processes. Embedded computers and networks monitor and control the physical processes, usually with feedback loops where physical processes affect computations and vice versa”.

E. A. Lee, Cyber Physical Systems: Design Challenges, EECS Department, University of California, Berkeley, 2008

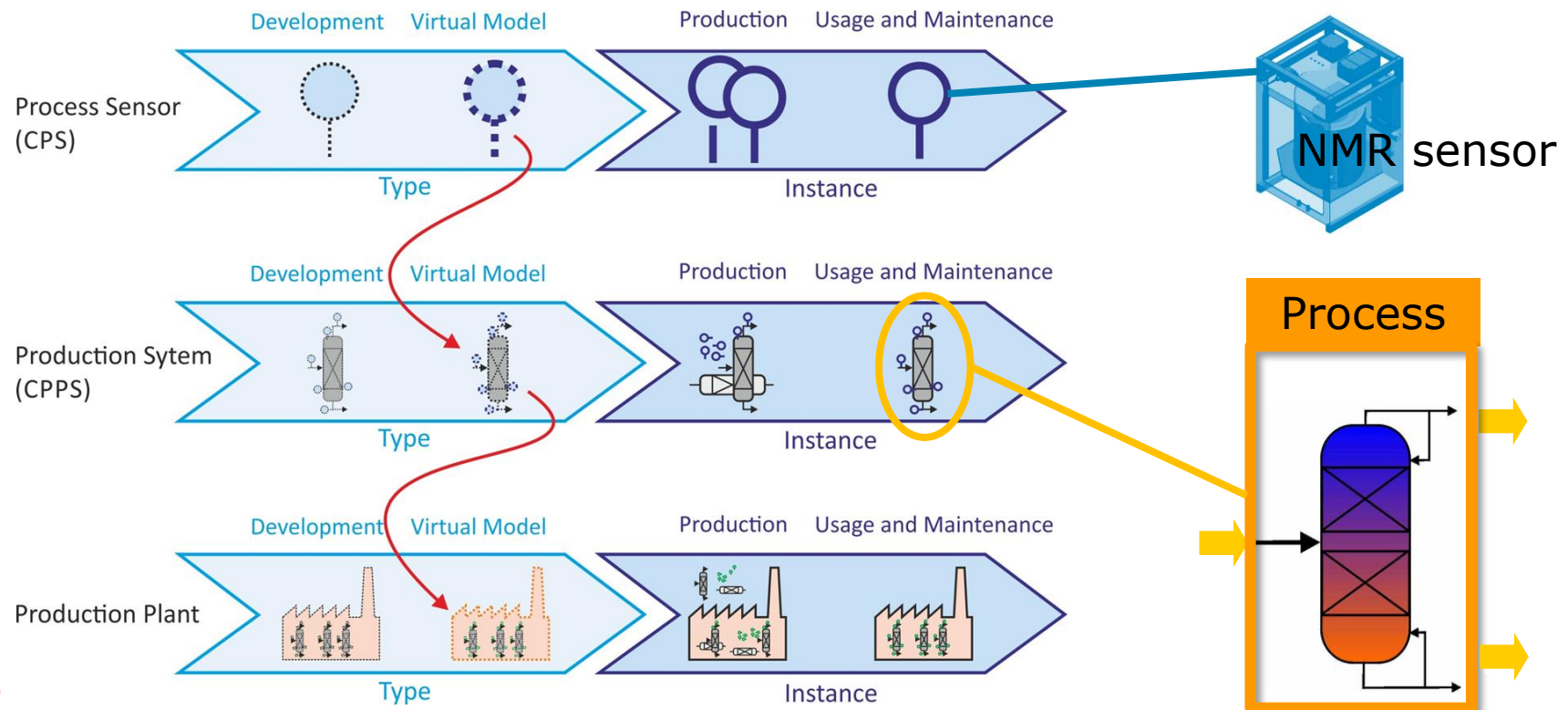

-
- K. Meyer, S. Kern, N. Zientek, G. Guthausen, M. Maiwald, Process control with compact NMR, *TrAC Trends in Analytical Chemistry*, October 2016, Vol.83:39–52, doi:[10.1016/j.trac.2016.03.016](https://doi.org/10.1016/j.trac.2016.03.016)
 - N. Zientek, C. Laurain, K. Meyer, A. Paul, D. Engel, G. Guthausen, M. Kraume, M. Maiwald, Automated data evaluation and modelling of simultaneous ^{19}F – ^1H medium-resolution NMR spectra for online reaction monitoring, *Magnetic Resonance in Chemistry*, 54 (2016) 513-520.
 - N. Zientek, C. Laurain, K. Meyer, M. Kraume, G. Guthausen, M. Maiwald, Simultaneous ^{19}F – ^1H medium resolution NMR spectroscopy for online reaction monitoring, *Journal of Magnetic Resonance*, 249 (2014) 53-62.
 - Meyer, K.; Ruiken, J. P.; Illner, M.; Paul, A.; Müller, D.; Esche, E.; Wozny, G.; Maiwald, M.; Process spectroscopy in microemulsions–Setup and multi-spectral approach for reaction monitoring of a homogeneous hydroformylation process. *Measurement Science and Technology* 2017, 28.