

Design and Validation of a Compact NMR Analyser

Svetlana Guhl¹, Klas Meyer¹, Simon Kern¹, Patrick Gräßer^{1,2}, Michael Maiwald¹

¹Bundesanstalt für Materialforschung und -prüfung (BAM), Richard-Willstätter-Str. 11, D-12489 Berlin, Germany

²Humboldt-Universität zu Berlin, Institut für Chemie, Brook-Taylor-Str. 2, D-12489 Berlin, Germany

Motivation

- Continuous processing
 - Standardized modular equipment
 - Numbering-up on demand
 - Fast response to market change
- More efficient and flexible
low to medium scale
production of specialty
chemicals

Intensified production concepts require for adaptive sensor and process control technology

Concept of Online NMR Analyzer

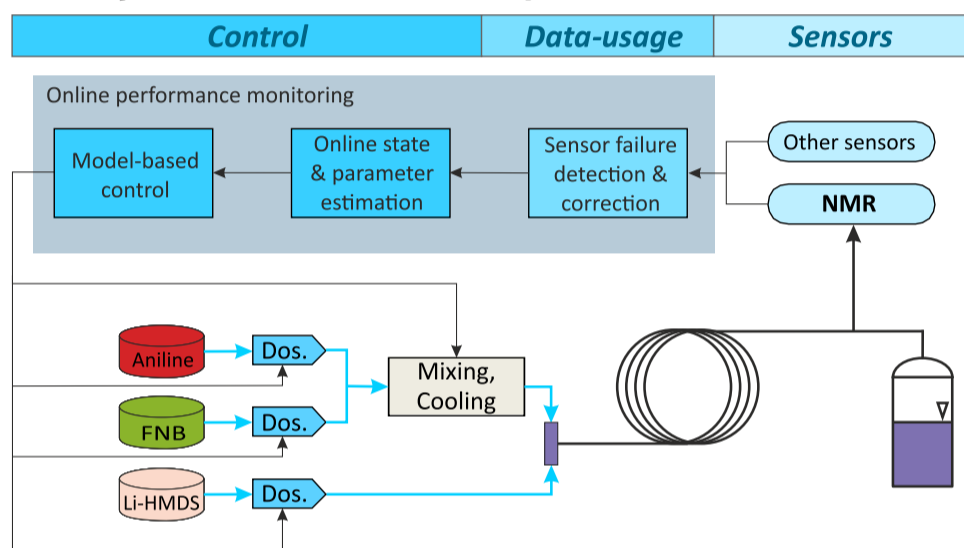
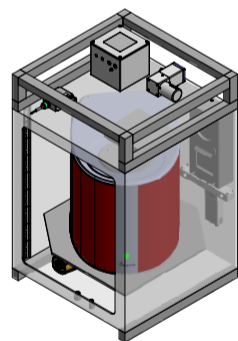

Fig. 1: Concept for process control within a continuous chemical production plant based on an Online-NMR Analyzer

- Compact module (850x570x570 mm)
- Commercial laboratory spectrometer
- ATEX certified safety concept
- Control and spectra evaluation included
- Adaptive communication standards:



Model Reaction and Specific Challenge

In the studied model reaction two aromatic substances (Eq. 1) are coupled initiated by a lithiation step [1]:

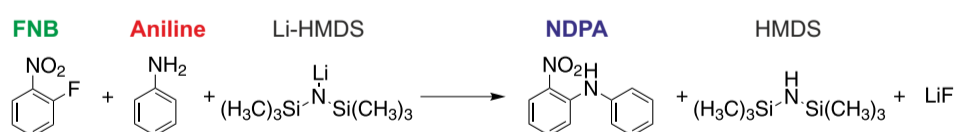

Eq. 1: Reaction scheme, FNB: 1-Fluoro-2-nitrobenzene, Li-HMDS: Lithium bis(trimethylsilyl)amide, NDPA: 2-Nitrodiphenylamine

Experimental setup for continuous reaction

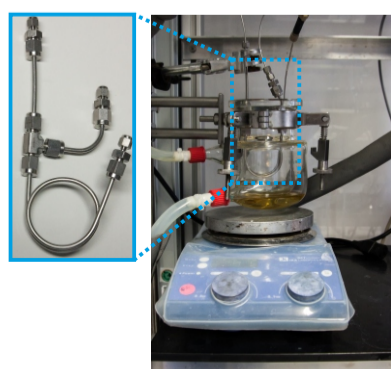

- Tubular reactor 1/8" stainless steel
- Temperature-controlled
- Syringe pumps for reactant feeds

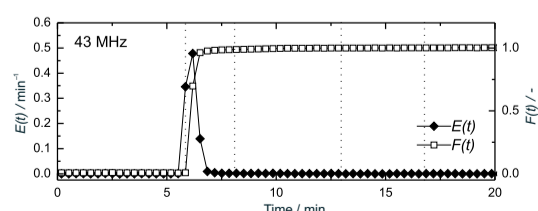

Fig. 2: Tubular reactor in thermostated bath (left), Residence time distribution of Low-field-NMR device hyphenated in a bypass setup (right)

Results laboratory experiments

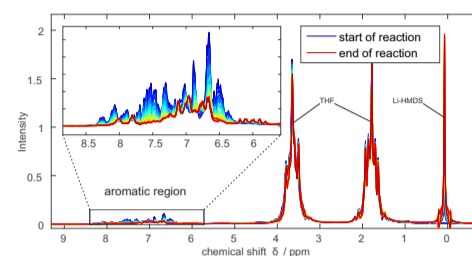

Fig. 3: Low-field NMR spectra (43 MHz)

- Data evaluation with Indirect Hard Modeling (IHM)
- Constrained variation of peak maximum, height and width

- Reaction was investigated under different constraints
- Mixture composition was adjusted by variation of feed rates leading to either a lack or excess of a certain component (Fig. 4)

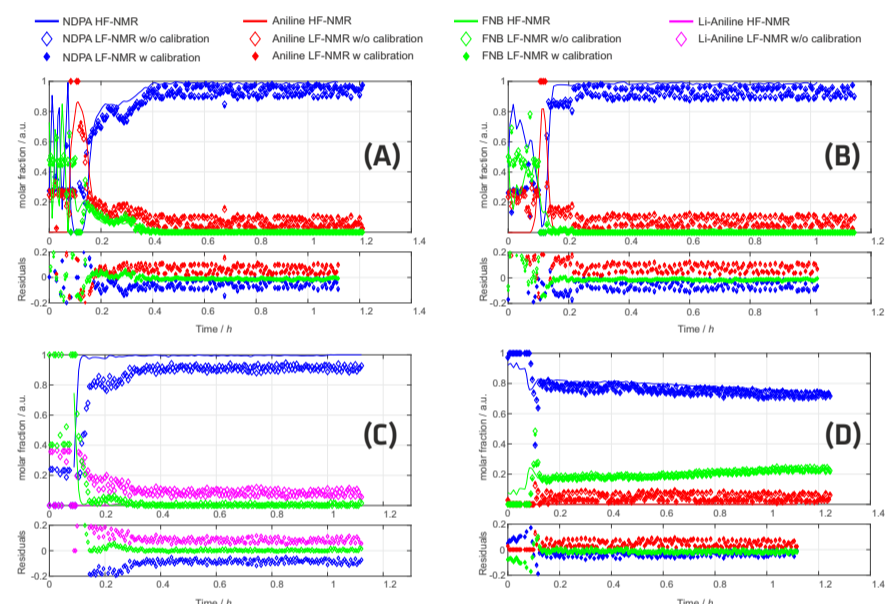

Fig. 4: Results of LF- and HF-NMR method on process runs at different amounts of Li-HMDS: (A) 20% less Li-HMDS, (B) 10% less Li-HMDS, (C) ideal conditions, (D) 10% excess of Li-HMDS.

- Data evaluation with calibrated and calibration-free models
- 500-MHz online NMR (HF-NMR) as a reference
- Dynamic process operation in laboratory scale (Fig. 5)

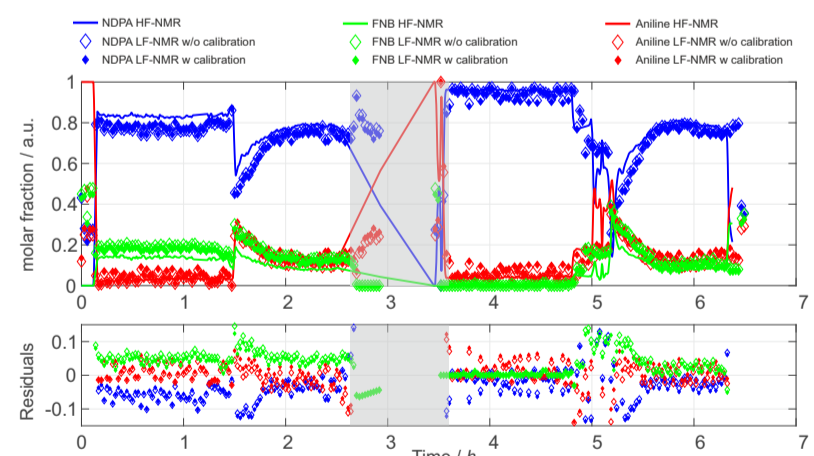

Fig. 5: Trend of molar fractions from LF-NMR model during study showing 6.5 hours of continuous operation at different setpoints compared to HF-NMR reference data.

Conclusions+Outlook

- Good agreement between LF- and HF-NMR method
- Low-field NMR is suitable for monitoring the model reaction
- ATEX proof housing is currently in construction
- Implementation in plant environment planned for 2017



This project has received funding from the European Union's Horizon 2020 research and innovation programme under grant agreement N° 636942