

RSC NMR and MolSpec Discussion Groups
"Low level detection and quantification by NMR"
Stevenage, United Kingdom

How far does the light shine? A check-up of quantitative high and low field NMR spectroscopy

Michael Maiwald, Claudia Peters, Klas Meyer, Simon Kern,
Svetlana Guhl, Patrick Gräber, Lukas Wander

2017 RSC NMR and
"Low level detection and
Stev

HOW FAR DOES THE LIGHT SHINE A CHECK-UP OF QUANTITATIVE H LOW FIELD NMR SPECTROSCOPY

Michael Maiwald, Claudia Peters, Klas Meyer
Svetlana Guhl, Patrick Gräber, Lukas Wander

29.03.2017

RSC NMR and MolSpec Discussion Groups
"Low level detection and quantification by NMR"
Stevenage, United Kingdom

HOW FAR DOES THE LIGHT SHINE? A CHECK-UP OF QUANTITATIVE HIGH AND LOW FIELD NMR SPECTROSCOPY

Michael Maiwald, Claudia Peters, Klas Meyer, Simon Kern,
Svetlana Guhl, Patrick Gräber, Lukas Wander

Bundesanstalt für Materialforschung und -prüfung (BAM)
Division 1.4 Process Analytical Technology

Richard-Willstätter-Str. 11
D-12489 Berlin, Germany

Safety in Technology and Chemistry Our Key Areas

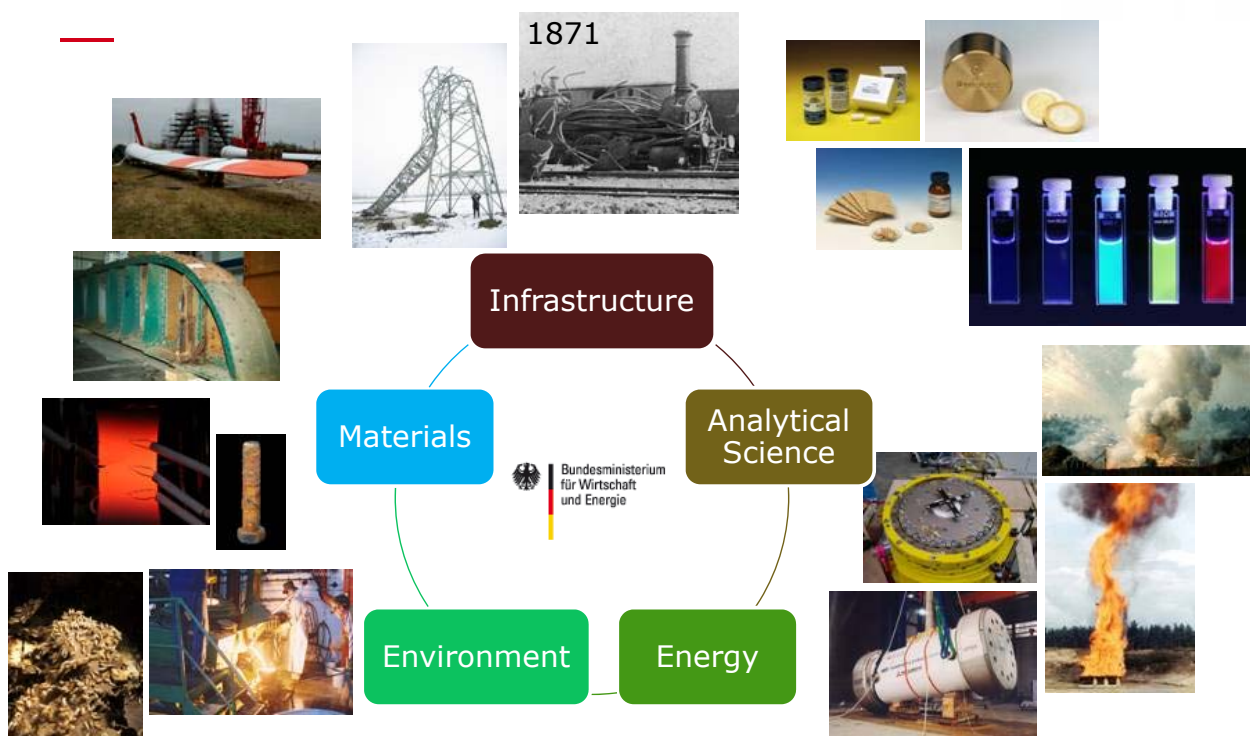

Our Key Areas

Gas Analysis

- Primary Reference Gas Mixtures
- Gas Analysis, Gas Metrology
- Certification of Sec. Gas Mixtures



Located in Berlin, Germany

Process Spectroscopy

- Online NMR Spectroscopy, qNMR
- Raman Spectroscopy and Microscopy
- NIR, MIR, FIR spectr., IR Microscopy
- Data Treatment: Statistics, Numerics
- Measurement Uncertainty Evaluation

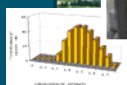

Inorganic Process Anal. Technol., XRF

- X-ray fluorescence Analysis (XRF)
- Laser-induced Breakdown (LIBS)
- Total Reflectance XRF (T-XRF)



NMR metrology

- International Metrology
- Purity assessment
- qNMR protocols



- CIPM Mutual Recognition Arrangement (CIPM MRA) framework for demonstration of international equivalence of
 - measurement standards
 - calibration and measurement certificates
- Represented by
 - National Metrology Institutes (NMI)
 - Designated Institutes (DI)
- Internationally recognized (peer-reviewed + approved) Calibration and Measurement Capabilities (CMCs)
- Approved CMCs and supporting technical data are publicly available from the CIPM MRA database (the KCDB) <http://www.bipm.org/en/cipm-mra/>
- CCQM-Working groups (CCQM: Comité consultatif pour la quantité de matière)

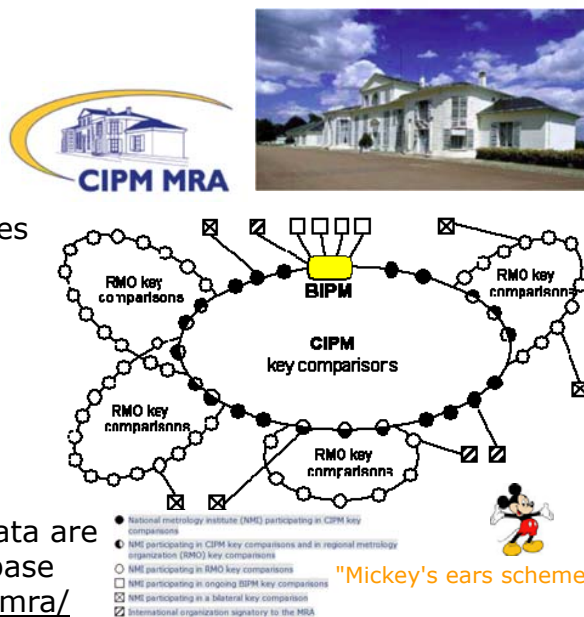

- 97 institutes from
 - 53 Member States
 - 40 Associates of the CGPM
 - 4 international organizations
- further 152 institutes designated by the signatory bodies

Purity assessment

Mass balance method (100 % method)

In organic analysis, purity is most usefully described in terms of the mass fraction of the main component present in the material.

- Several approaches that can be used to assign the mass fraction content, typically expressed in units of mg/g, of the main component of an organic compound
- Widely used:

Mass balance method*

$$x_A = 1000 - \sum_1^j x_i$$

Where x_A is the mass fraction of the main component (A) expressed in units of mg/g present in a material and x_i is the mass fraction in mg/g of each of the (1 ... j) impurities present in the material

*Mass Balance Method for the SI Value Assignment of the Purity of Organic Compounds; S. Westwood, T. Choteau, A. Daireaux, R.D. Josephs, and R.I. Wielgosz, Anal. Chem. 2013, 85, 3118

Purity Assessment

Mass balance method (100 % method)

w/ m%	comp.	type	Type (IUPAC)	qNMR*	other Methods
>99	PC	organic	main component	X	Direct methods‡
<1	IC	organic	chemically similar (identified)	X	
<1	IC		structurally related (not ident.)	X	
<1	IC	water	water	X	Karl-Fischer
<1	IC	solvent	residual org. solvents	X	
<1	IC	inorganic	non-volatiles and inorganics		gravimetry
<1	IC		unknowns		

PC = primary component, IC = impurity components

‡Methodologies to have the potential to estimate the mass- or mole fraction of the PC without necessarily quantifying any or all IC: titrimetry (including coulometry), gravimetry, *qNMR, and the thermal methods (freezing- and melting point depression, DSC, adiabatic calorimetry)

International Metrology

International traceability to the SI

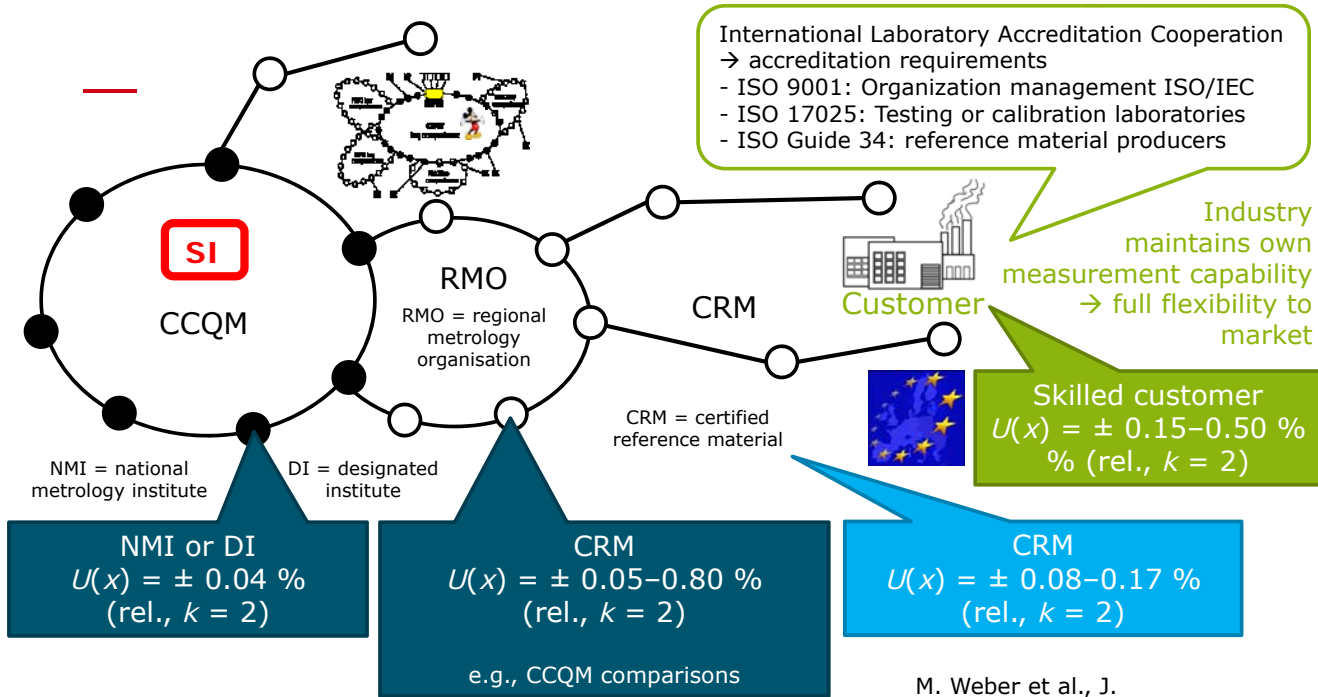

M. Weber et al., J. Pharm. Biomed. Anal. 93 (2014) 102-110

Primary calibrator

Secondary standard

Tertiary standard, calibrator

Fundamental relationship of qNMR

- signal intensity I_x is directly proportional to the number of nuclei N_x responsible for that particular resonance

$$I_x \sim N_x \quad \text{i.e.} \quad I_x = K_s N_x$$

where K_s is the spectrometer constant and remains the same for all resonances in an NMR spectrum.

- i.e.
$$\frac{I_x}{I_y} = \frac{N_x}{N_y} \quad \text{and for a molar ratio} \quad \frac{n_x}{n_y} = \frac{I_x}{I_y} \frac{N_y}{N_x}$$

- Factors that affect K_s are
 - pulse excitation (that should be uniform throughout the spectral width)
 - repetition time (should be 5–7 times T_1)
 - broad-band decoupling, which causes inherent distortion in intensity due to the Nuclear Overhauser Effect (NOE)

Relative primary analytical method

Completely described by mathematical equations

Uncertainty of measurements for molar ratio

$$\frac{n_x}{n_y} = \frac{I_x}{I_y} \frac{N_y}{N_x}$$

$$u_c \left(\frac{n_x}{n_y} \right) = \frac{n_x}{n_y} \sqrt{\left(\frac{u(I_x/I_y)}{I_x/I_y} \right)^2} \quad \text{with} \quad u \left(\frac{I_x}{I_{\text{Std}}} \right) = \sqrt{\frac{\sum_{k=1}^n (x_k - \bar{x})^2}{n(n-1)}}$$

where x_k represents the result of a single measurement k (out of n measurements) whereas \bar{x} is the mean value of these n measurements

Also for purity assessment

$$p_x = \frac{S_s}{S_{\text{IS}}} \frac{N_{\text{IS}}}{N_s} \frac{m_{\text{IS}}}{m_s} \frac{M_s}{M_{\text{IS}}} p_{\text{IS}}$$

P_x	: purity of sample
S	: area of signal
N	: number of ^1H for quantitative signal
m	: mass of sample
M	: molar mass
P_{IS}	: purity of IS

$$u_c(P_x) = P_x \sqrt{\left(\frac{u(I_x/I_{\text{Std}})}{I_x/I_{\text{Std}}} \right)^2 + \left(\frac{u(M_x)}{M_x} \right)^2 + \left(\frac{u(M_{\text{Std}})}{M_{\text{Std}}} \right)^2 + \left(\frac{u(m_x)}{m_x} \right)^2 + \left(\frac{u(m_{\text{Std}})}{m_{\text{Std}}} \right)^2 + \left(\frac{u(P_{\text{Std}})}{P_{\text{Std}}} \right)^2}$$

Relative primary analytical method

Completely described by mathematical equations

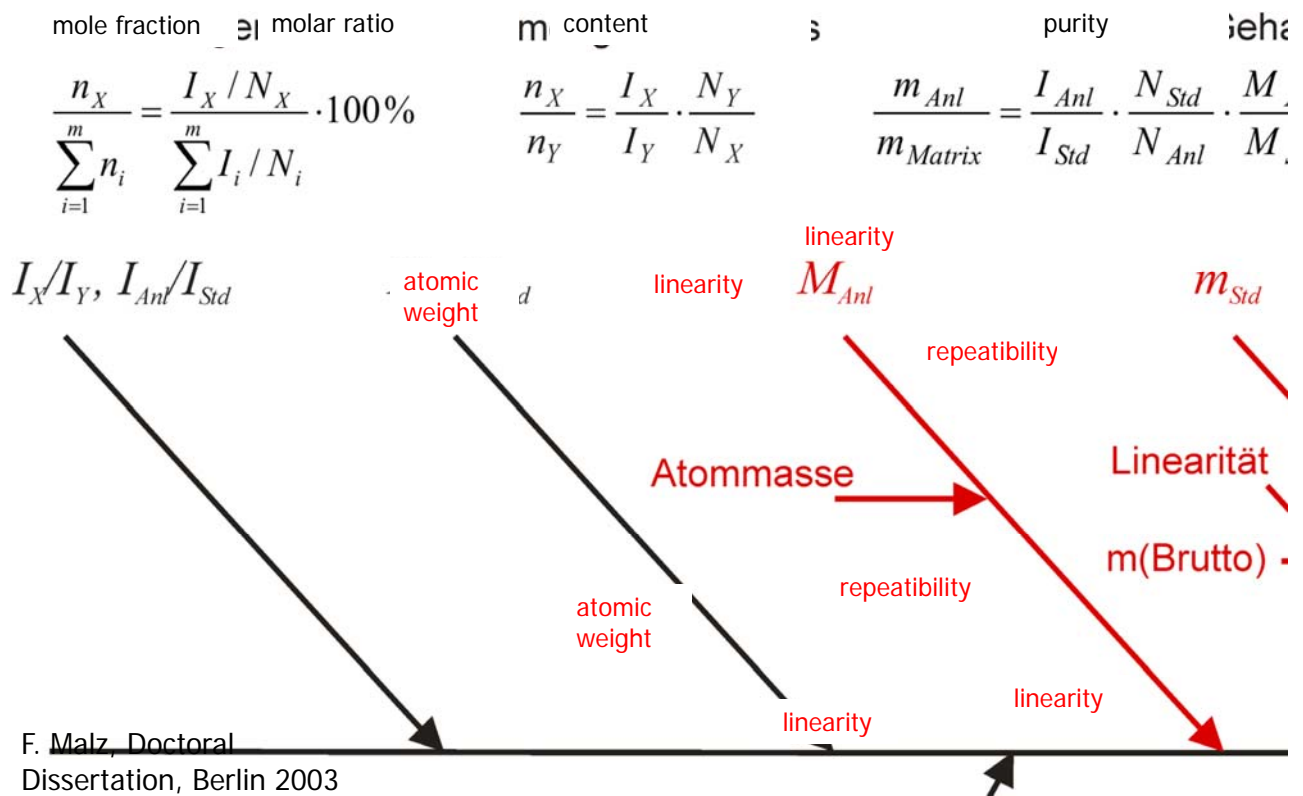

qNMR Protocols



3 key issues!

- Calibration needed, not validation
- Sample preparation (weighing) should be treated separately

Proposed method

- Assure **adequate selectivity** in appropriate solvent
 - e.g., one orienting measurement, selection of internal standard (database)
- Test of interactions/reactions between analyte and internal standard
 - This sample may be used for stability tests
- T_1 determination \rightarrow **quantitative relaxation**
- Determination of sufficient number of scans (**sufficient signal-to-noise**) and requirement on the minimum allowable sample weight

Where are we?

- LOD, LOQ for High Field and Low Field NMR Spectroscopy
- Other Quality Parameters



Precision: Example esterification

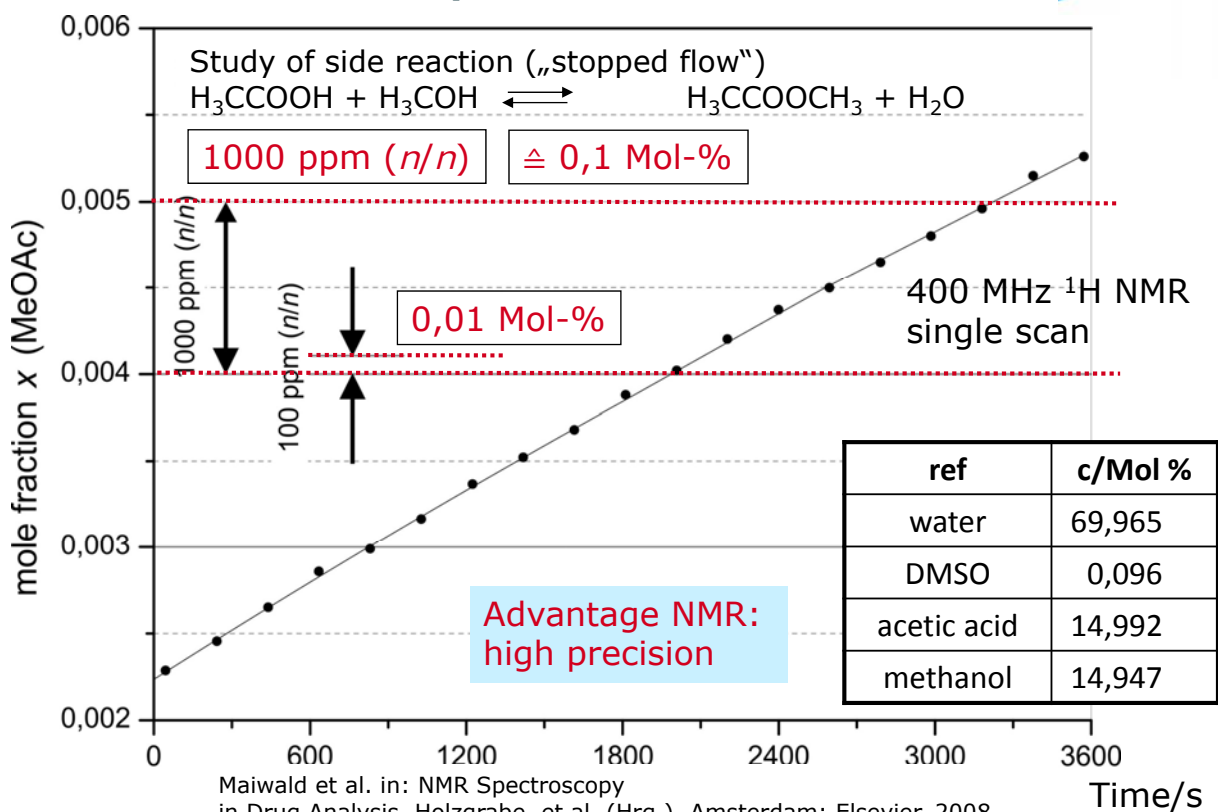

Absolute Quantification

Limit of Detection of Ethanol in Water

Absolute quantification by signal integration on basis of spectrometer electronics (single point calibration)

Reference

3,401 g/kg \approx 73,8 mmol/l
 1,139 g/kg \approx 24,7 mmol/l
 0,859 g/kg \approx 18,7 mmol/l
 0,239 g/kg \approx 05,2 mmol/l
 0,027 g/kg \approx 00,6 mmol/l

found

76,4 \pm 0,3 mmol/l
 25,7 \pm 0,3 mmol/l
 19,3 \pm 0,2 mmol/l
 05,3 \pm 0,2 mmol/l
 00,6 \pm 0,3 mmol/l

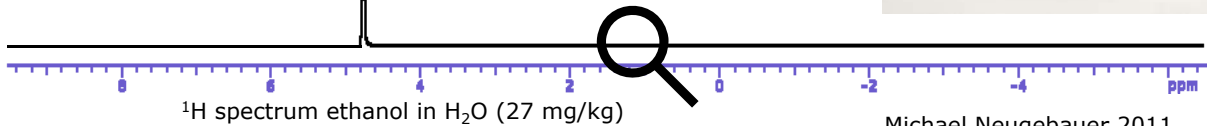

Michael Neugebauer 2011

Absolute Quantification

Limit of Detection of Ethanol in Water according to ISO 6143

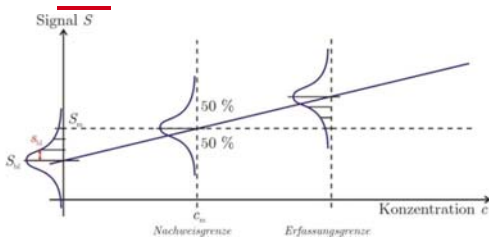

Limit of detection (LoD)
 3,3 mg/kg

Limit of quantitation (LoQ)
 10,9 mg/kg

500 MHz ^1H NMR
 without presat.
 single scan

ethanol in water

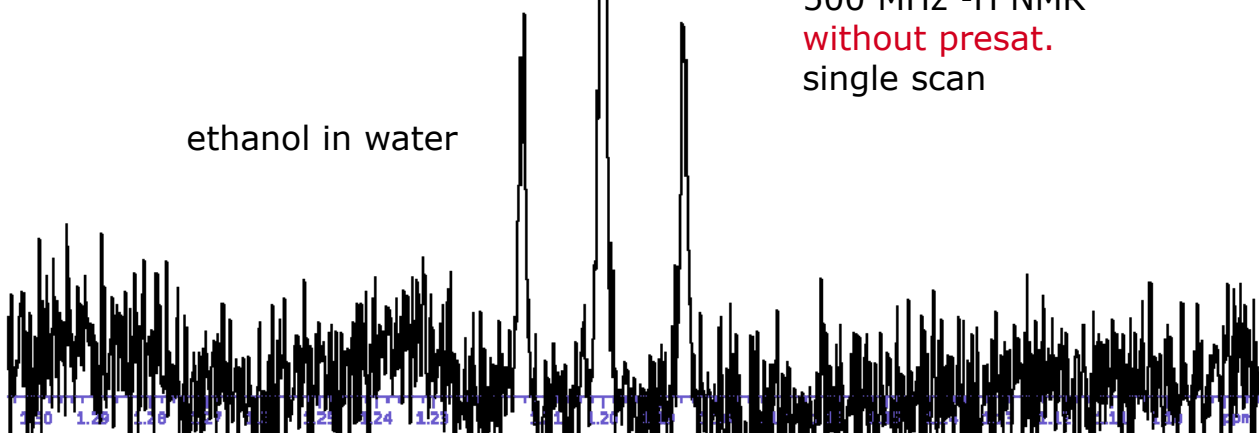

^1H spectrum ethanol in H_2O (27 mg/kg)

Michael Neugebauer 2011

Where are the limits for qNMR?

Physics and instrument

- S/N: dependent on
 - field (ω_0)
 - filling factor
 - volume (V_C)
 - filling factor (V_S / V_C)
 - temperature of coil (T_C)

Hoult, D. I.; Richards, R. E.
J Magn Res **24**, 71 (1976)

$$\frac{S}{N} = \underbrace{V_S \omega_0^4}_{\frac{\chi_0}{\gamma}} \underbrace{\frac{N_S \gamma \hbar^2 I(I+1)}{3k_B T_S} (B_1/i)_{xy} \left(\frac{p}{k_B T_C \sigma l}\right)^{\frac{1}{2}}}_{coil} \underbrace{\left(\frac{1}{\mu_r \mu_0 \rho}\right)^{\frac{1}{4}} \left(\frac{1}{\Delta f}\right)^{\frac{1}{2}} \frac{3}{5.05}}_{probe}$$

- Instrument electronics (amplifier circuits)
 - T-control of NMR console
 - Miniaturization
- Sample density (temperature dependent)
 - T-control of probe

NMR Spectroscopy

Improvements of acquisition time, stability, and linearity

PFG techniques (pulsed field gradient)
 ▶ time improvement

shaped pulses
 ▶ selective excitation

cryo/cold probes
 ▶ sensitivity x 3

flow through probes
 ▶ direct hyphenation

parallel NMR acquisition
 ▶ synchronous NMR experiments

high-field NMR > 950 MHz
 ▶ highest dispersion

Ultra-shielded cryo magnets
 ▶ no stray field

Improvement of coil design
 ▶ sensitivity

¹H field mapping
 ▶ technical solvents possible

direct digital detection
 ▶ no more artefacts

improved console concept
 ▶ no dead times

Improving the Performance of High-Precision qNMR Measurements by a Double Integration Procedure in Practical Cases

Torsten Schoenberger,^{*,†} Sonja Menges,[†] Michael A. Bernstein,[‡] Manuel Pérez,[‡] Felipe Seoane,[‡] Stanislav Sýkora,[§] and Carlos Cobas[‡]

[†]Bundeskriminalamt-KT12, 65173, Wiesbaden, Germany

[‡]Mestrelab Research, S.L Feliciano Barrera 9B–Baixo, 15706 Santiago de Compostela, Spain

[§]Extra Byte, Via Raffaello Sanzio 22C, Castano Primo I-20022, Italy

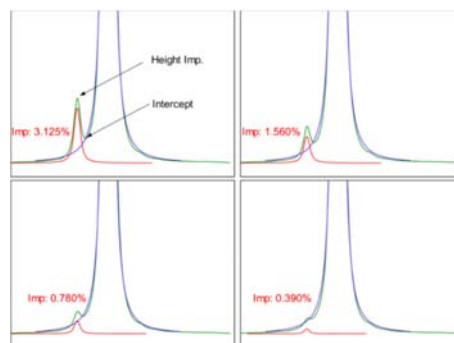
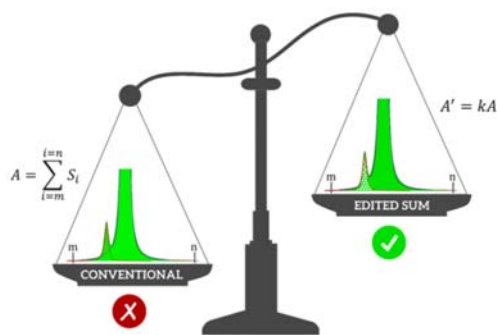

29.03.2017 M. Maiwald How far does the light shine?

RSC Discussion Meeting, Stevenage, UK 21

¹H- and ¹⁹F-NMR 43 MHz

Quasi-parallel acquisition

- Relative sensitivity of ¹⁹F-NMR: ~85 %
- 30% of important industrial chemicals and pharmaceuticals contain fluorine
- No influence of fluorine free solvents

Pulse sequence

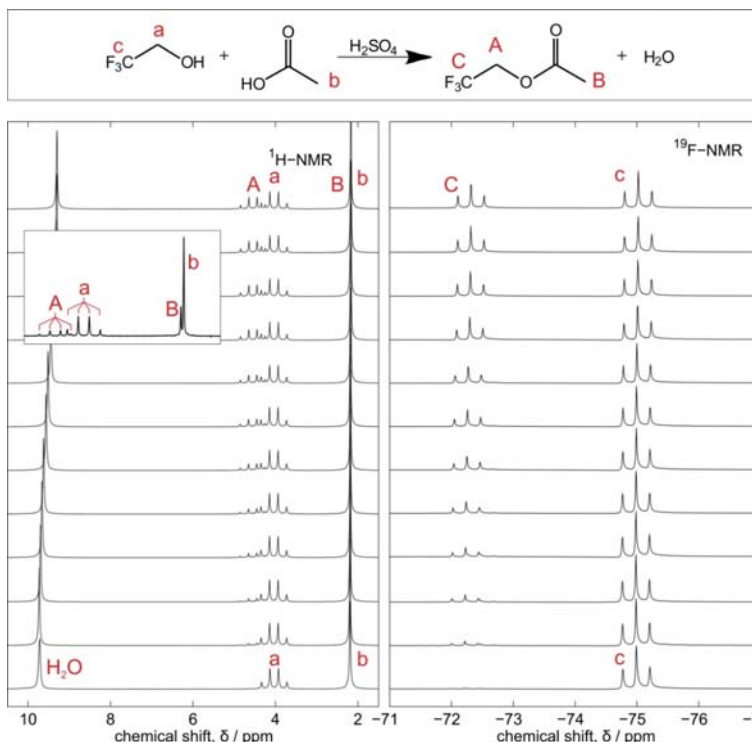
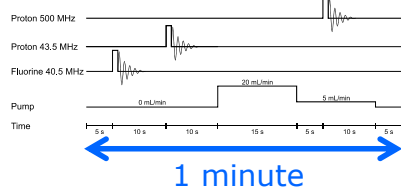

Zientek, N. et al. J Mag Res, 249 (2014) 53-62

29.03.2017 M. Maiwald How far does the light shine?

RSC Discussion Meeting, Stevenage, UK 22

Data for Calibration and Validation Of Experimental Runs

Preparing Ternary Mixtures of the Reactants
(projection into ternary diagram)

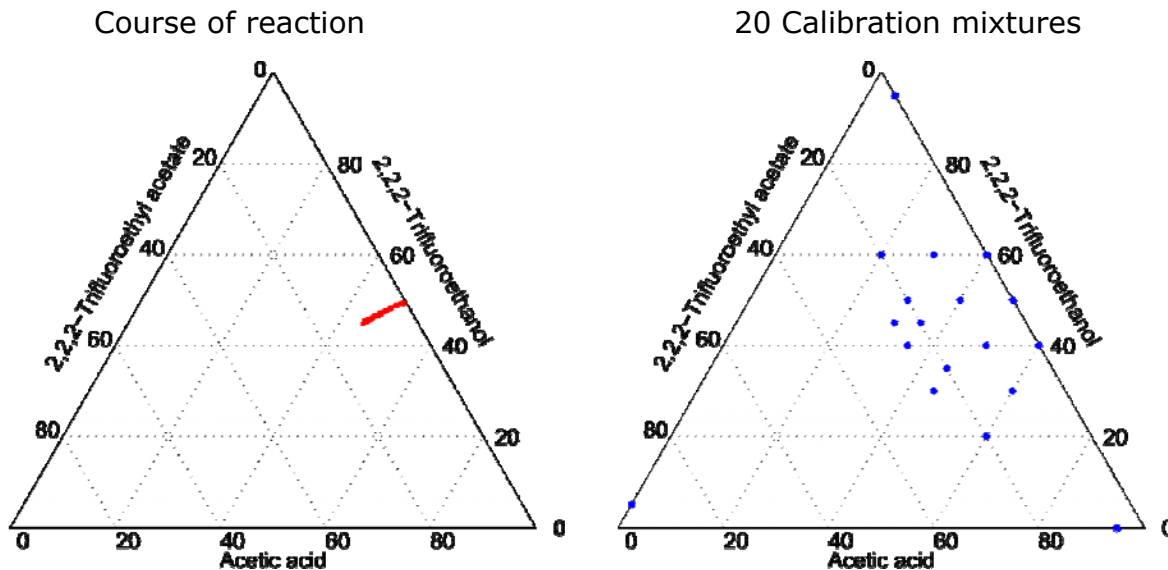

Simple Dewar Flow Cell Concept of a Flow Cell 1/16" PFA Tubing (ID 1 mm)

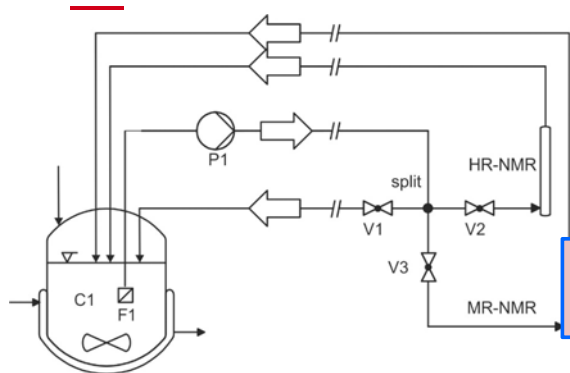

Advantages

- ☺ durable polymer tubing
- ☺ thermally decoupled

Disadvantage

- ☹ geometry not optimised

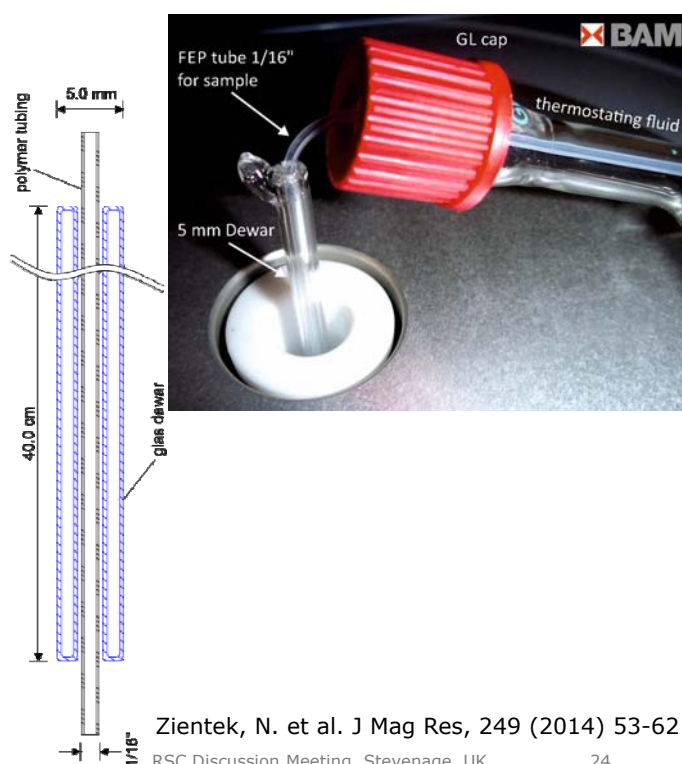

Zientek, N. et al. J Mag Res, 249 (2014) 53-62

LoD and S/N

Comparison HF/LF (5 mm) and

Analytical Sensitivities ¹H, ¹⁹F

Signal-to-noise ratios [35] for differently concentrated ethyl benzene solutions in acetone-d6 for MR-NMR with different sample geometries compared to HR-NMR spectrometer.

Ethylbenzene in CDCl ₃ : c/% (mass)	MR NMR		HR NMR
	5 mm glass ^a ID 4.2 mm	1/16" polymer tubing	5 mm glass ^a ID 4.2 mm
1	303	-	23,727
10	1939	60	n. a.

^a NMR tube: Deutero, Economic ID 4.20 ± 0.05 mm.

Detection limits (LOD) and quantification limits (LOQ) of 2,2,2-trifluoroethanol in deuterated water according to [36] in mol L⁻¹ of a MR-NMR with different sample geometries.

TFE in D ₂ O	Polymer tubing 0.04" ¹ H 43.5 MHz	Polymer tubing 0.04" ¹⁹ F 40.2 MHz	5 mm glass ^a ID 4.2 mm ¹ H 43.5 MHz	5 mm glass ^a ID 4.2 mm ¹⁹ F 40.2 MHz
LOD/mol L ⁻¹	0.043	0.112	0.019	0.016
LOQ/mol L ⁻¹	0.130	0.335	0.058	0.049
Analytical sensitivity/ L mol ⁻¹	74.6	57.0	1242	892

^a NMR tube: Deutero, Economic ID 4.20 ± 0.05 mm.

[35] T.D.W. Claridge, J.E. Baldwin, F.R.S. Williams, R.M. Williams (Eds.), High-Resolution NMR Techniques in Organic Chemistry, Pergamon, Bd. 19, Amsterdam, 1999. ISBN: 0-08-042799-5

[36] J. Moczak, A.M. Bond, S. Mitchell, G. Scollary, A statistical overview of standard (IUPAC and ACS) and new procedures for determining the limits of detection and quantification: application to voltammetric and stripping techniques, Pure Appl. Chem. 69 (1997) 297–328, <http://dx.doi.org/10.1351/pac199769020297>

Ethylbenzene in Acetone-d₆

5 mm glass tube HF vs. LF: factor of 78.3 (for 1% ethyl benzene) theoretical value of 72.3 since S/N varies with $B_0^{7/4}$

2,2,2-Trifluoroethanol in D₂O

Analytical sensitivities are reduced by a factor of 16.7 (¹H) and 15.7 (¹⁹F) comparing 5 mm glass tube (4.2 mm ID) to polymer tubing flow cell (1.02 mm ID)

Zientek, N. et al. J Mag Res, 249 (2014) 53-62

LoD 43 MHz

5 mm Glass ID 4.2 mm (*)

2,2,2-Trifluoroethanol in D₂O

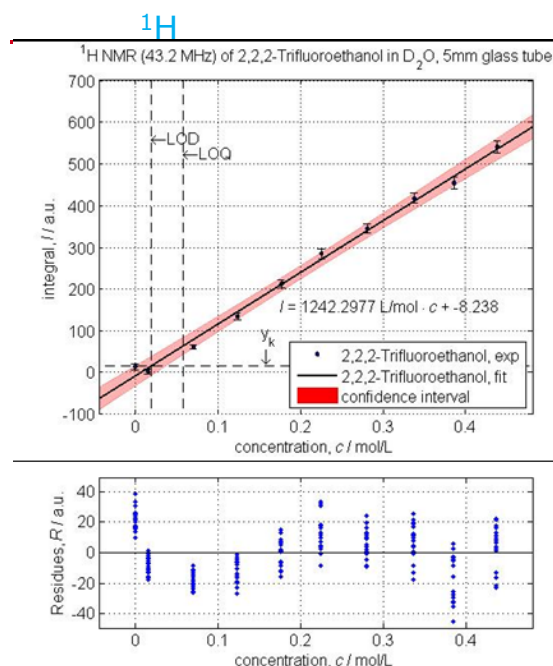

Figure B3: 5 mm glass*, ID 4.2 mm, ¹H 43.5 MHz

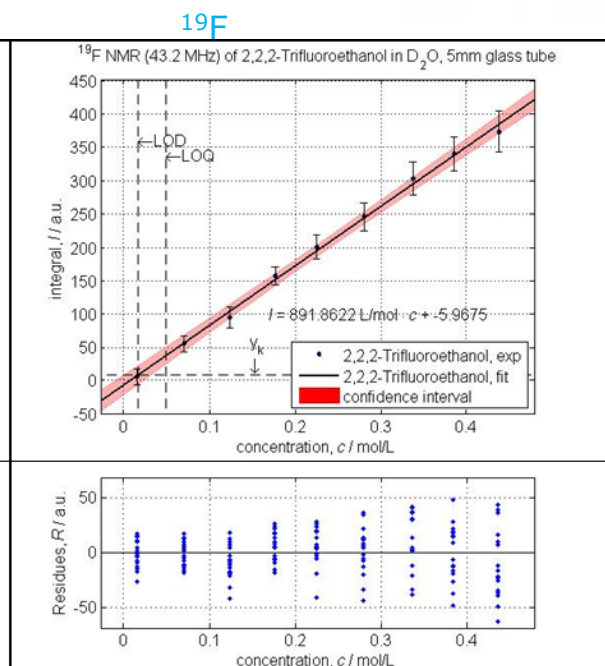

Figure B4: 5 mm glass*, ID 4.2 mm, ¹⁹F 40.2 MHz

LoD 43 MHz

Polymer Tubing ID 1 mm (0.04")



2,2,2-Trifluoroethanol in D₂O

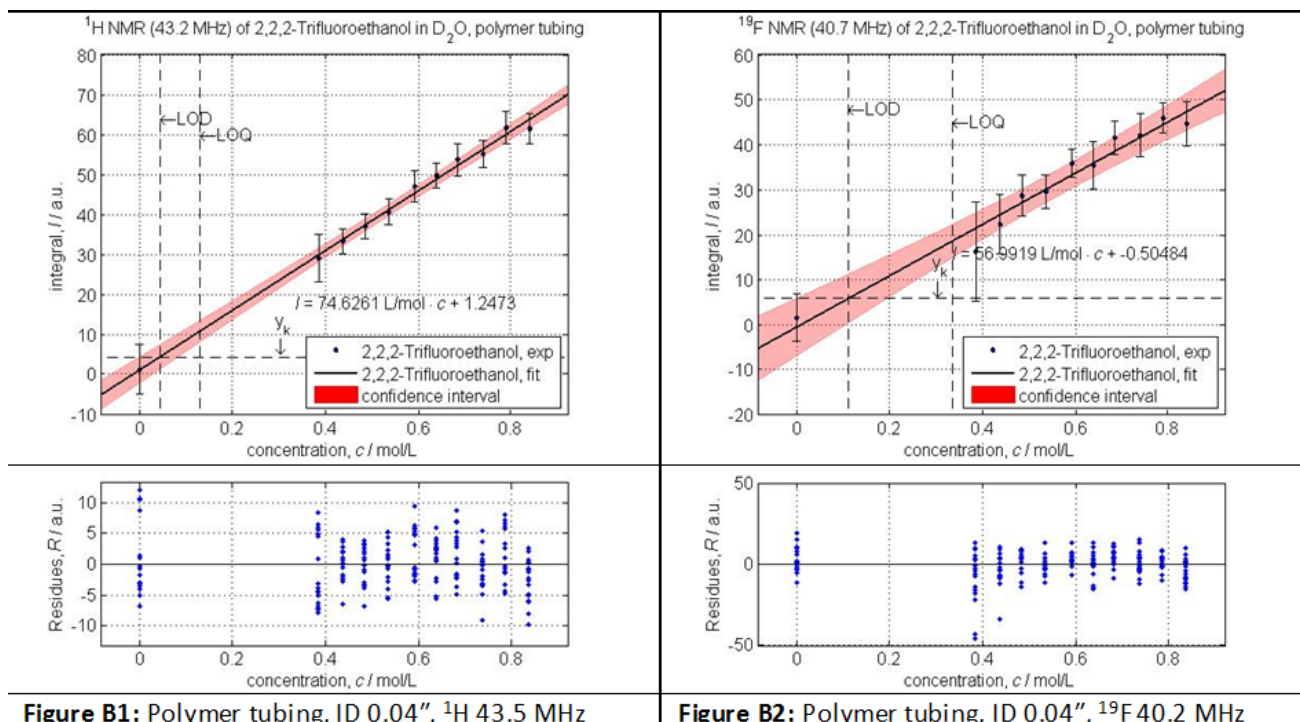

Figure B1: Polymer tubing, ID 0.04", ¹H 43.5 MHz

Figure B2: Polymer tubing, ID 0.04", ¹⁹F 40.2 MHz

LoD 500 MHz

5 mm Glass ID 4.2 mm (*)



2,2,2-Trifluoroethanol in D₂O

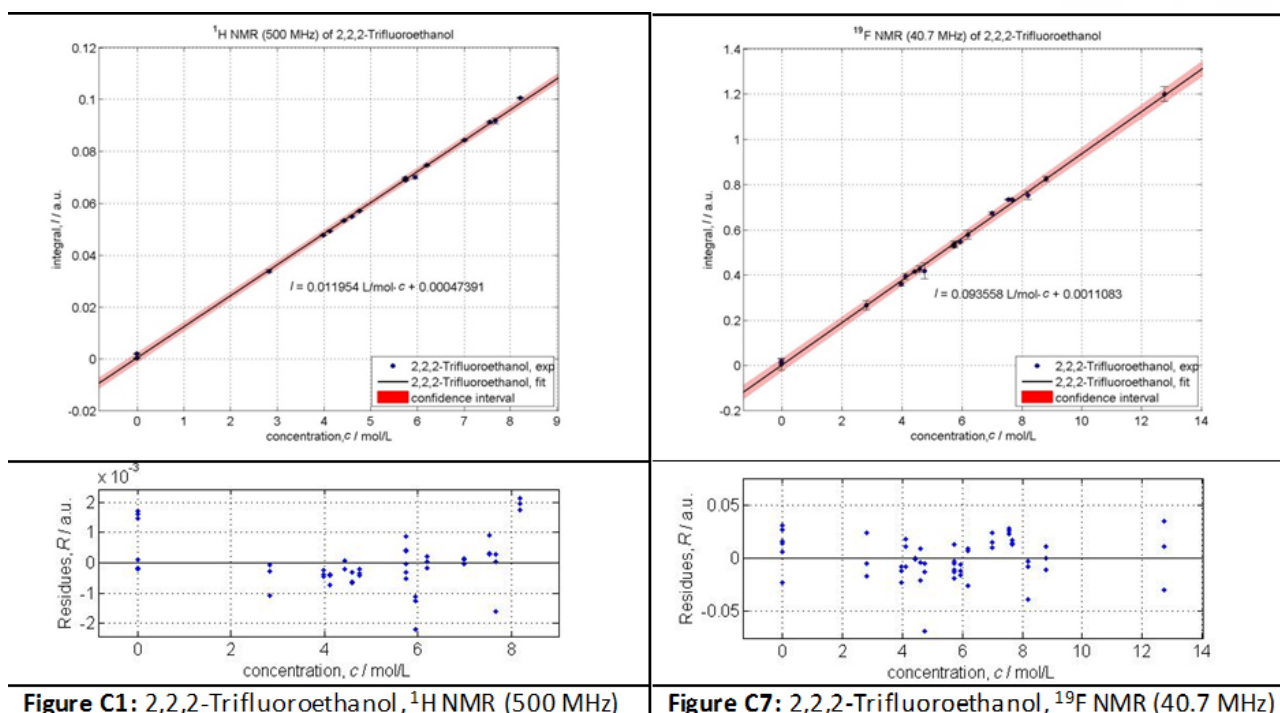
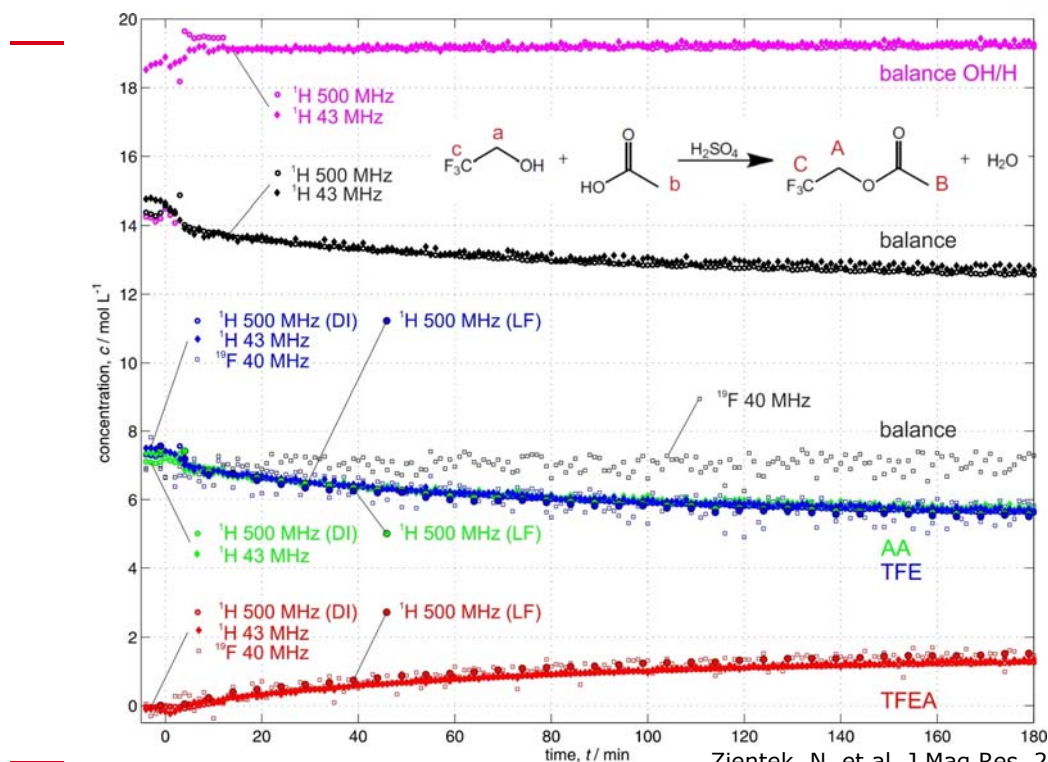

Figure C1: 2,2,2-Trifluoroethanol, ¹H NMR (500 MHz)

Figure C7: 2,2,2-Trifluoroethanol, ¹⁹F NMR (40.7 MHz)

Characterisation

Stability During Course of Reaction



Zientek, N. et al. J Mag Res, 249 (2014) 53-62

Long term stability and field drift

Long term stability
(intermediate reproducibility)

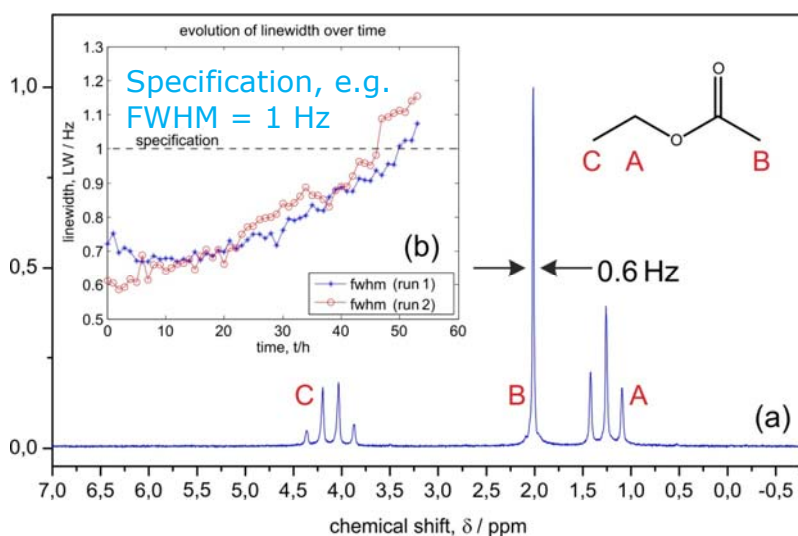
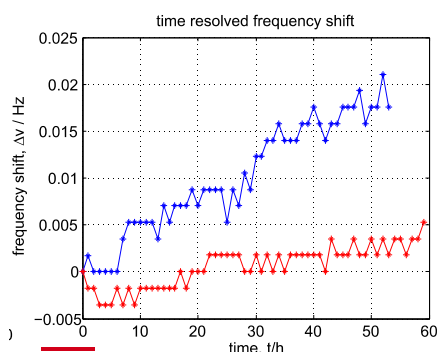

1/16" PFA Tubing (ID 1 mm)

Field drift

$Dd/dt < 0.02 \text{ Hz / h}$
(externally locked, ^{19}F)

Line shape and line shape stability

„What you see is what you get“



Conventional line shape test

→ limited in technical applications ☹️

Distribution moments → not defined for ideal Lorentzian signals ☹️

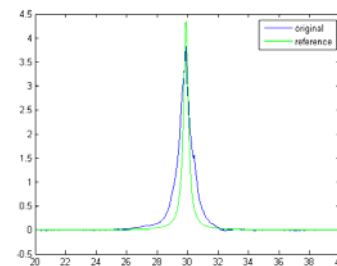

Real world line shapes (non-exponential decay)

$$s(t) = M_0 \cdot [\cos(2\pi\nu t) - i \cdot \sin(2\pi\nu t)] \cdot e^{-\frac{t}{T_2}} \cdot a(t)$$

Instrument function

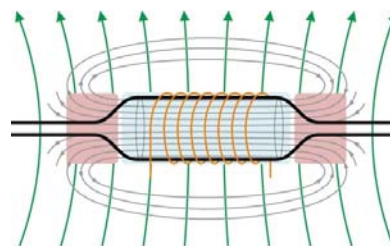

homogeneous B_1 B_0 field
inhomogeneous B_0 B_1 field

Line Shape Deconvolution Algorithm (LSDA) 😊

Reference Deconvolution

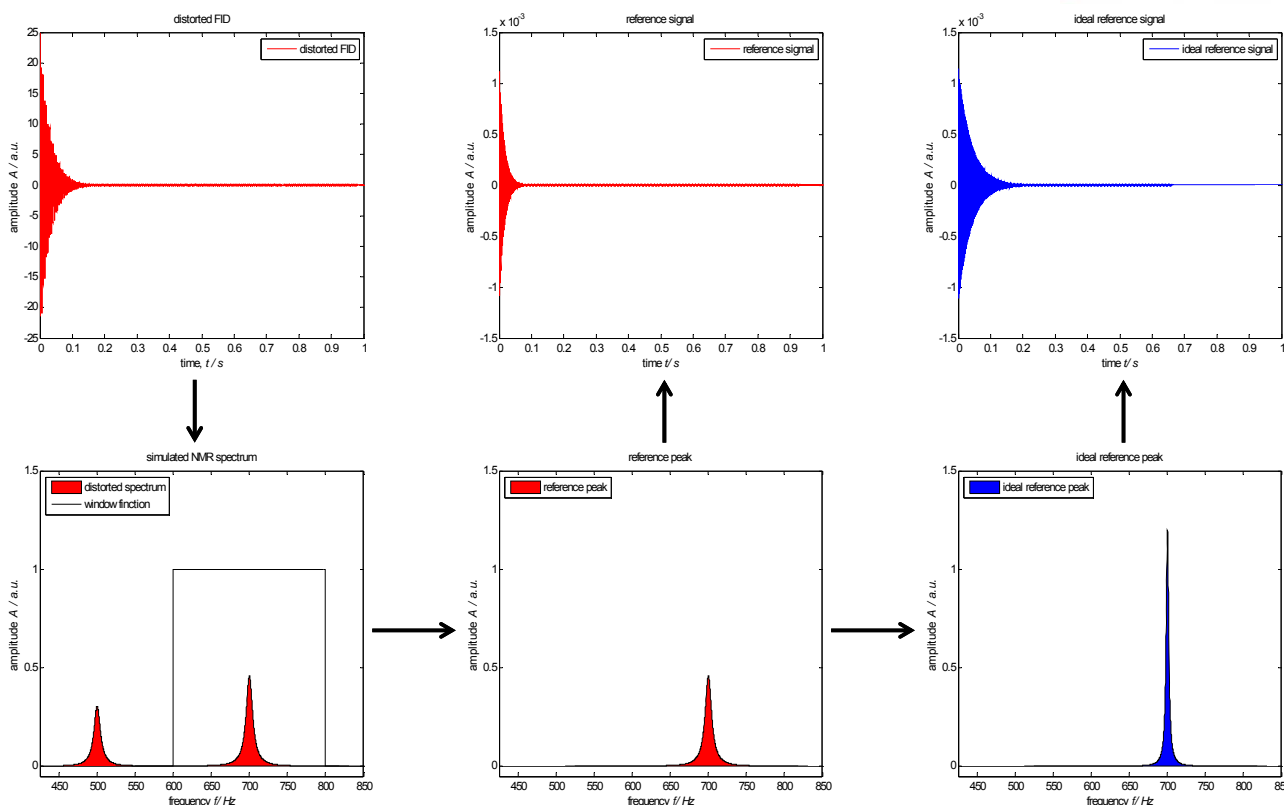

Reference Deconvolution

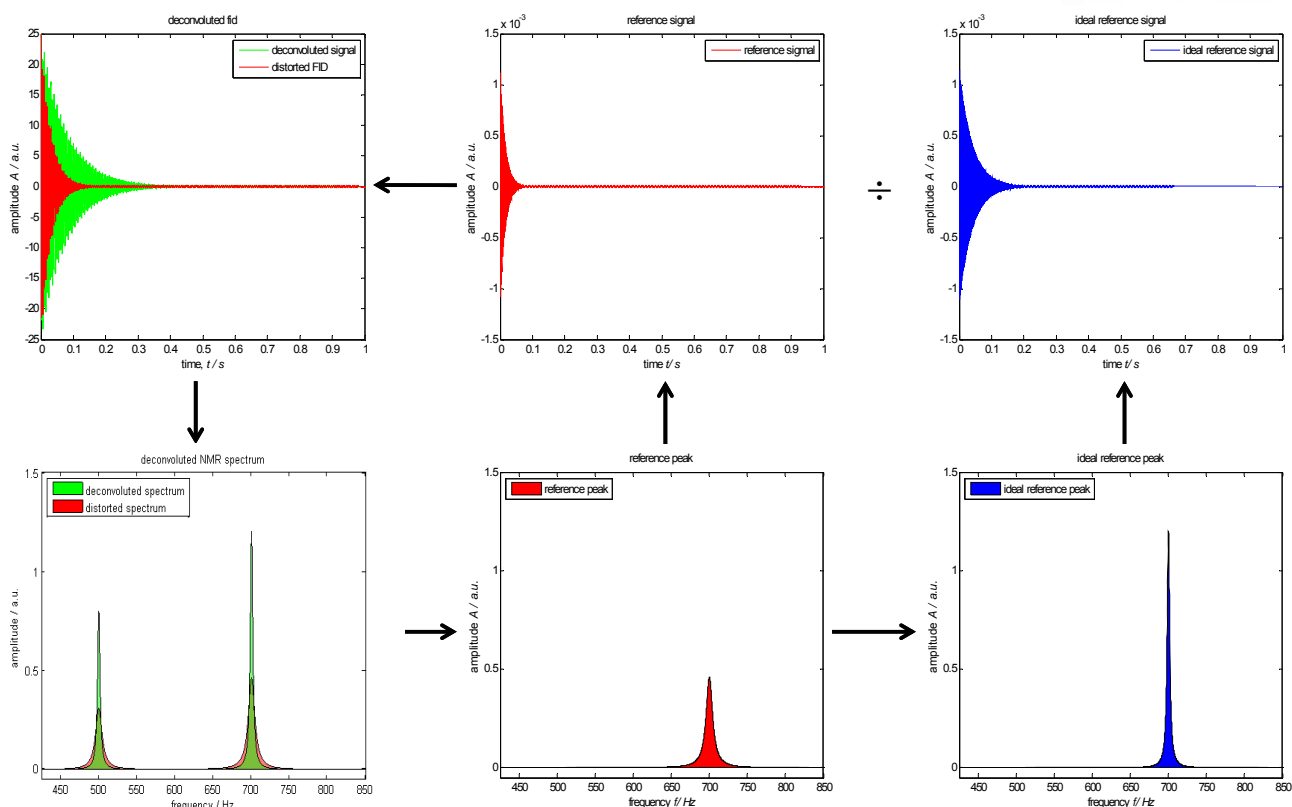

29.03.2017

M. Maiwald

How far does the light shine?

RSC Discussion Meeting, Stevenage, UK

33

Instrument Functions $a(t)$

Performance of hardware adequate

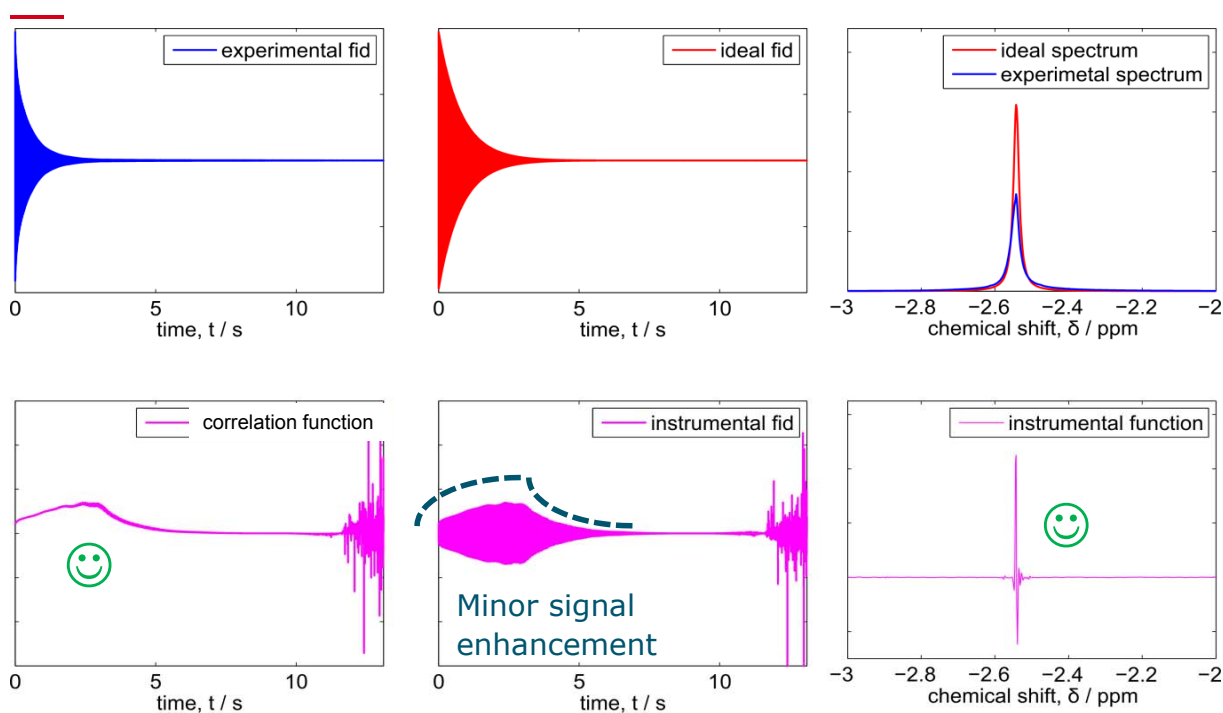

29.03.2017

M. Maiwald

How far does the light shine?

RSC Discussion Meeting, Stevenage, UK

34

Instrument Functions $a(t)$

Performance of hardware

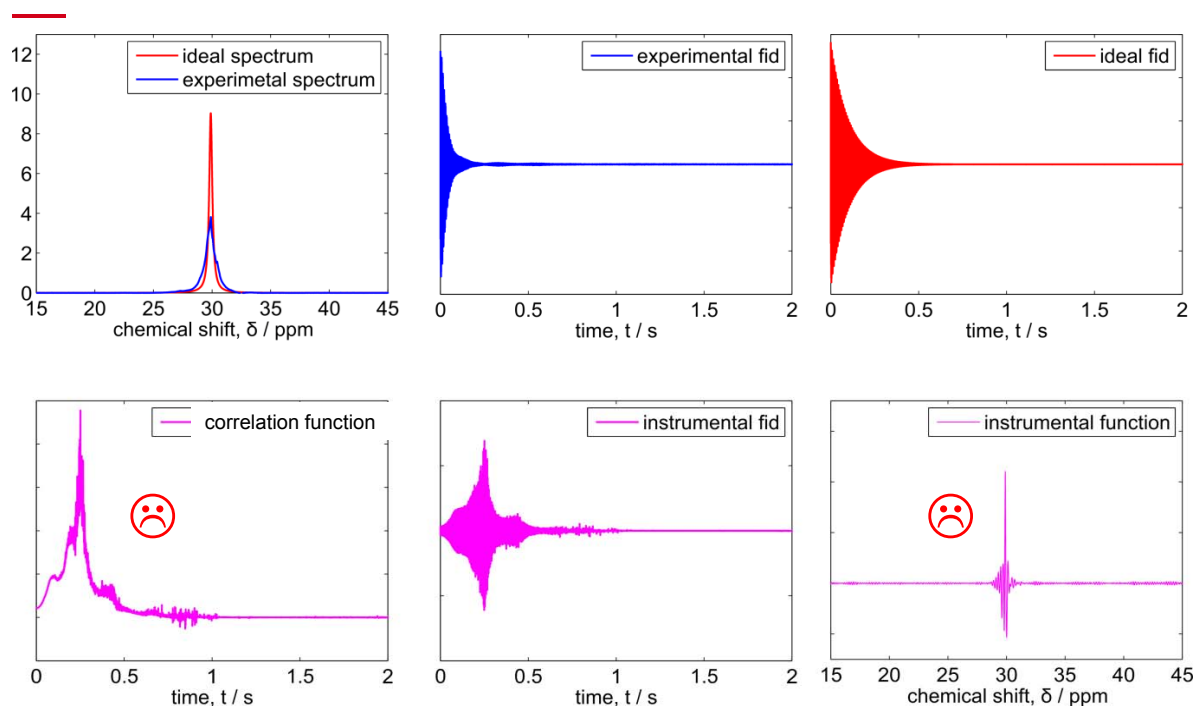

Practical MR NMR Standards

- Usable in open system
- Readily available
- No deuterated compounds

Others

- water
- cyclohexane
- chloroform

acetone

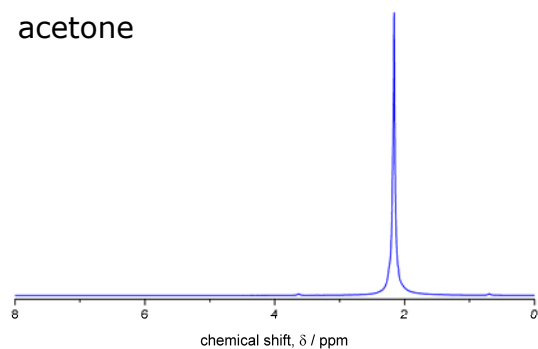

mesitylene

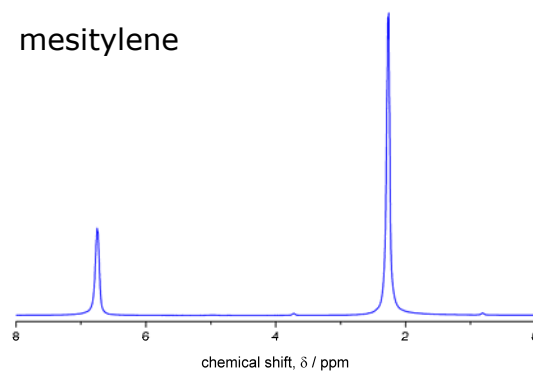

ethyl acetate

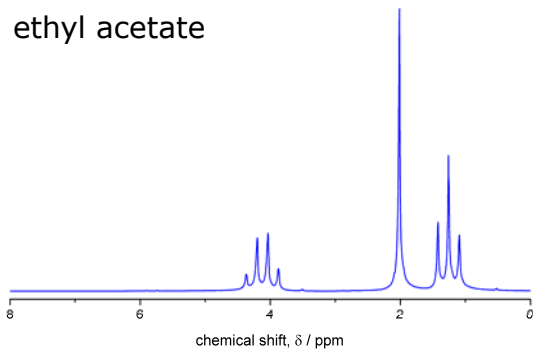

Instrument Functions $a(t)$

Comparison of different solvents

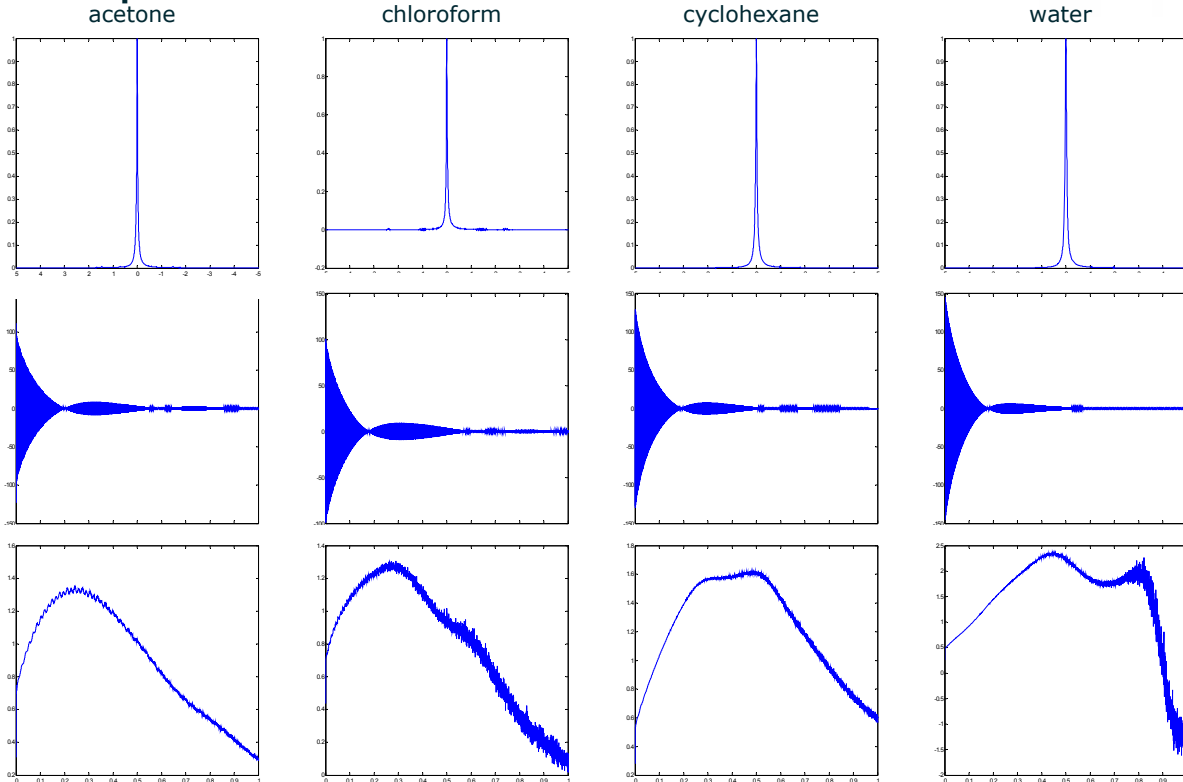

29.03.2017

M. Maiwald

How far does the light shine?

RSC Discussion Meeting, Stevenage, UK

37

NMR Data Acquisition

Phase stability ^1H and ^{19}F

^1H and ^{19}F
phase scatter

over 60 repeated
experiments

Physical
performance of
instrument
much better
than deteriorated
instrument
output after
internal „phase
correction“!
→ Was corrected
by manufacturer

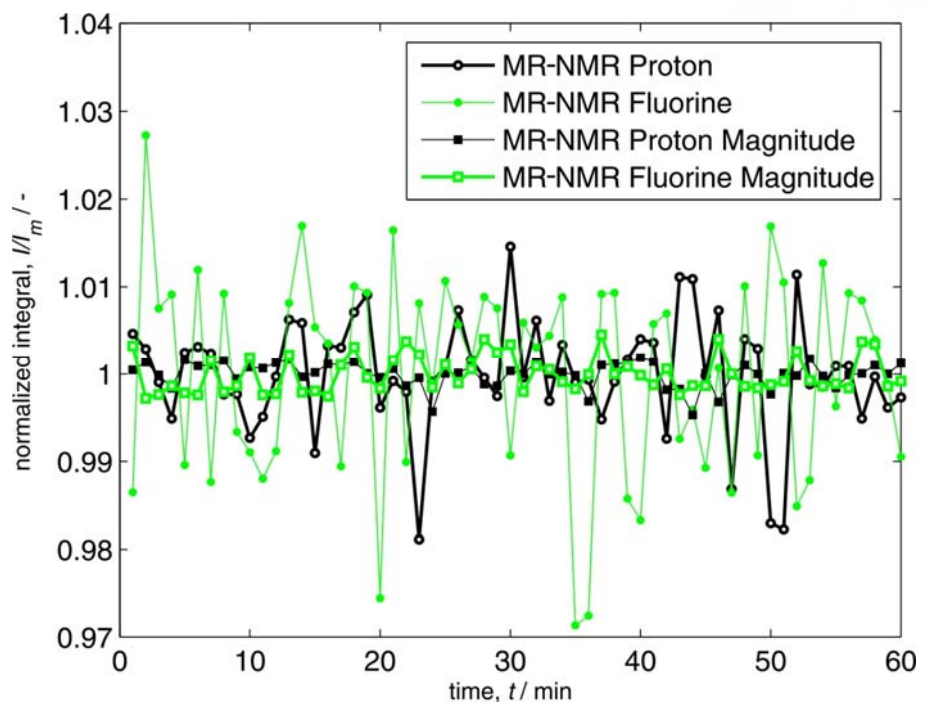

Zientek, N. et al. *J. Magn. Reson.*, 249 (2014), 53–62

29.03.2017

M. Maiwald

How far does the light shine?

RSC Discussion Meeting, Stevenage, UK

38

43 MHz NMR Spectroscopy

¹H MR NMR: Petrochemistry

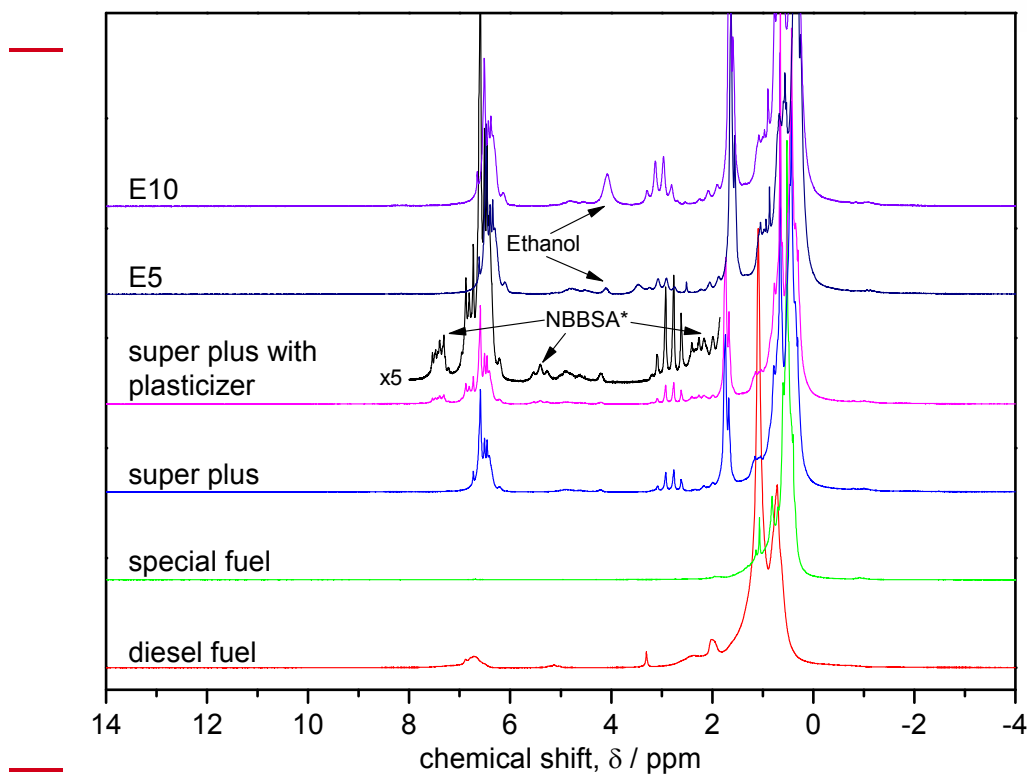

43 MHz NMR Spectroscopy

¹H MR NMR: Sugars

Maltose

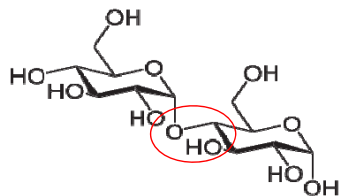

Trehalose

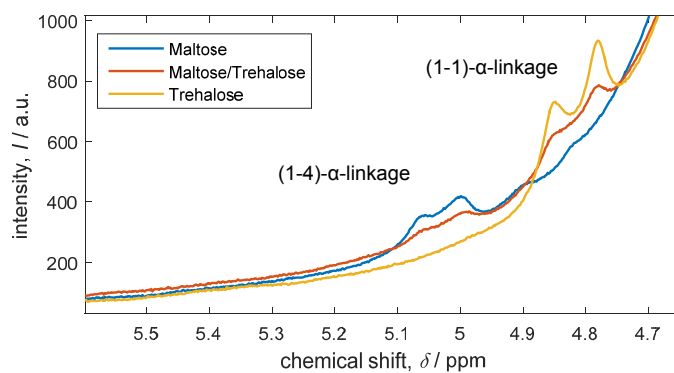
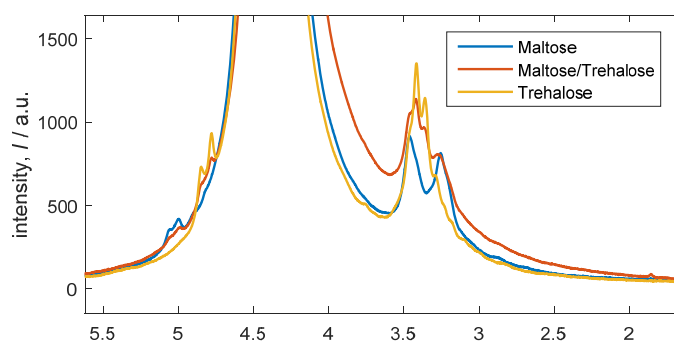
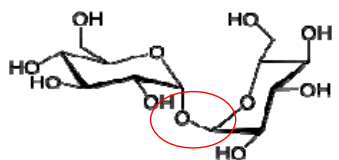

Improving Performance of qNMR

This just came up yesterday - promising?

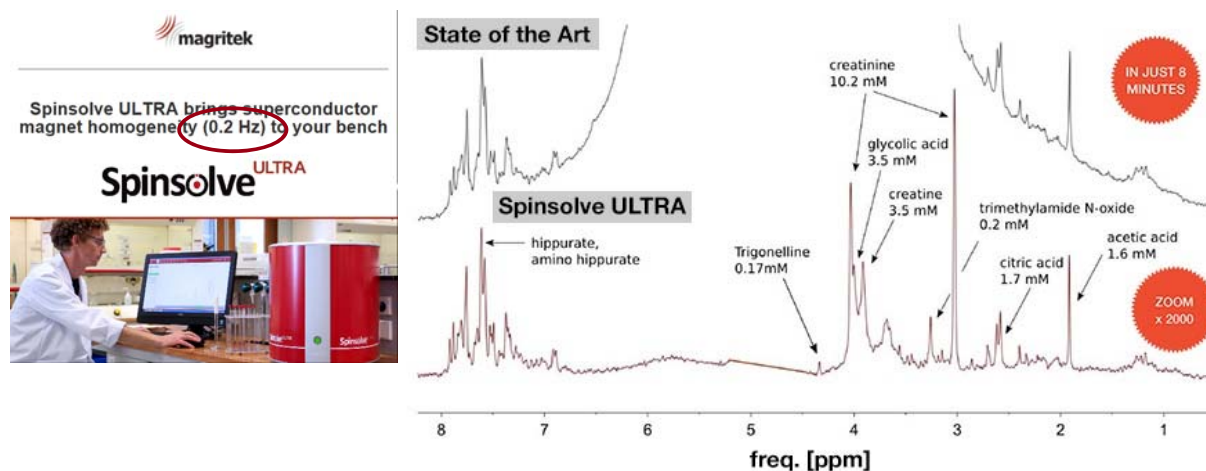

How far does the light shine?

- Towards Model-Based Data Analysis
- NMR for Industrial Automation



Process Analytical Technology for Intensified Processes



Examples from BAM



Catalysis:
Hydroformylations of C12-alkenes in micro emulsions

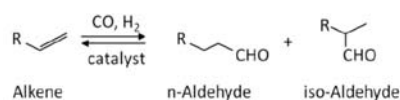

qNMR (Metrology):
Gases and condensed phases up to 1000 bar

Pharmaceuticals:
Liberation kinetics

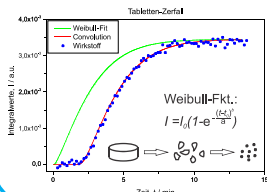

CO₂ scrubbing

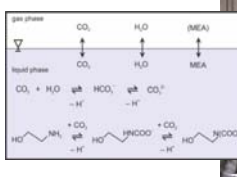

Method development:
Esterifications (model reactions)

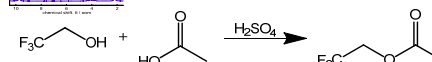

Catalysis:
Hydrogenations

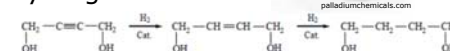

Reaction Engineering:
Lithiation reactions

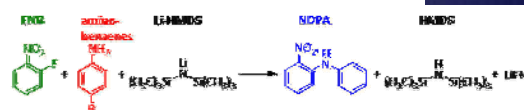

Reaction Engineering:
Photo reactions („click chemistry“)

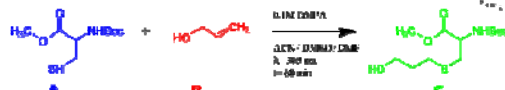

Reaction Monitoring in Lab-scale at BAM

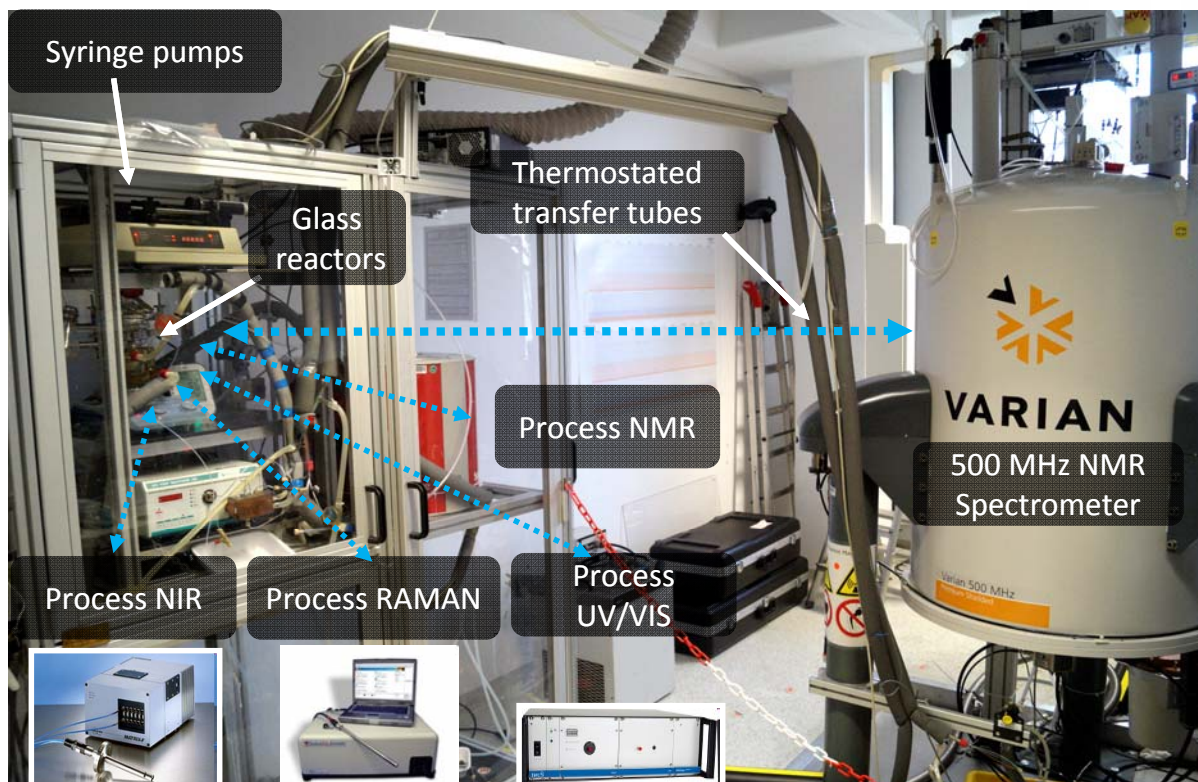

CONSENS: Case Study 1

Intensified Synthesis of Organic Compounds



Modular plant



Source: INVITE GmbH

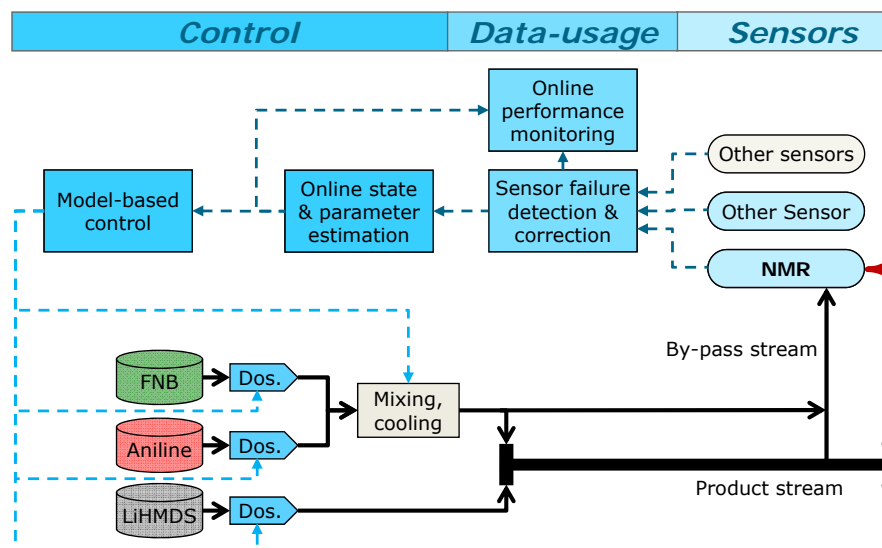

Explosion proof housing

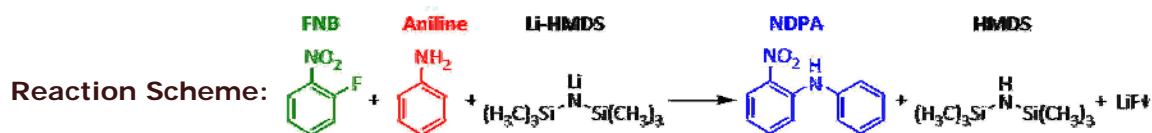
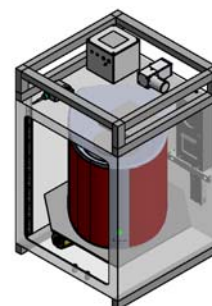

29.03.2017

M. Maiwald

How far does the light shine?

RSC Discussion Meeting, Stevenage, UK

45

Reaction Characterization in Lab

Lab Experiments in Batch along Reaction Co-ordinate



- Data in parallel acquired with high-field and low-field spectrometer
- „Fast“ and „slow loop“
- Li-HMDS was dosed stepwise



Experimental set-up

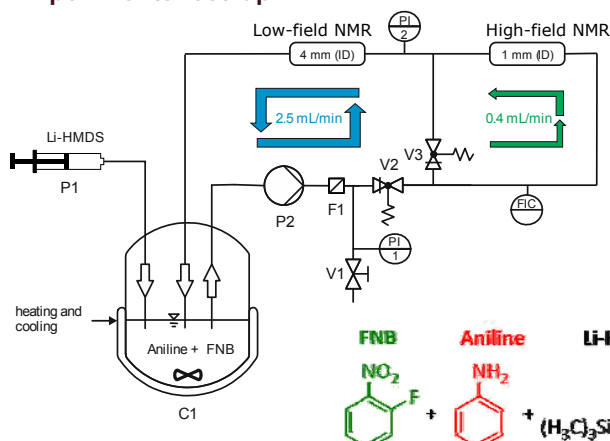

- Exothermic reaction
→ required cooling (28.5 °C)
- Li-HMDS in two-fold excess

Reaction Scheme:

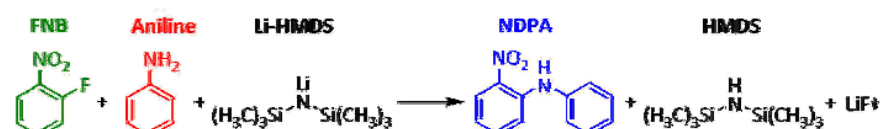

29.03.2017

M. Maiwald

How far does the light shine?

RSC Discussion Meeting, Stevenage, UK

46

Online ^1H NMR Spectra of Lithiation Reaction Step

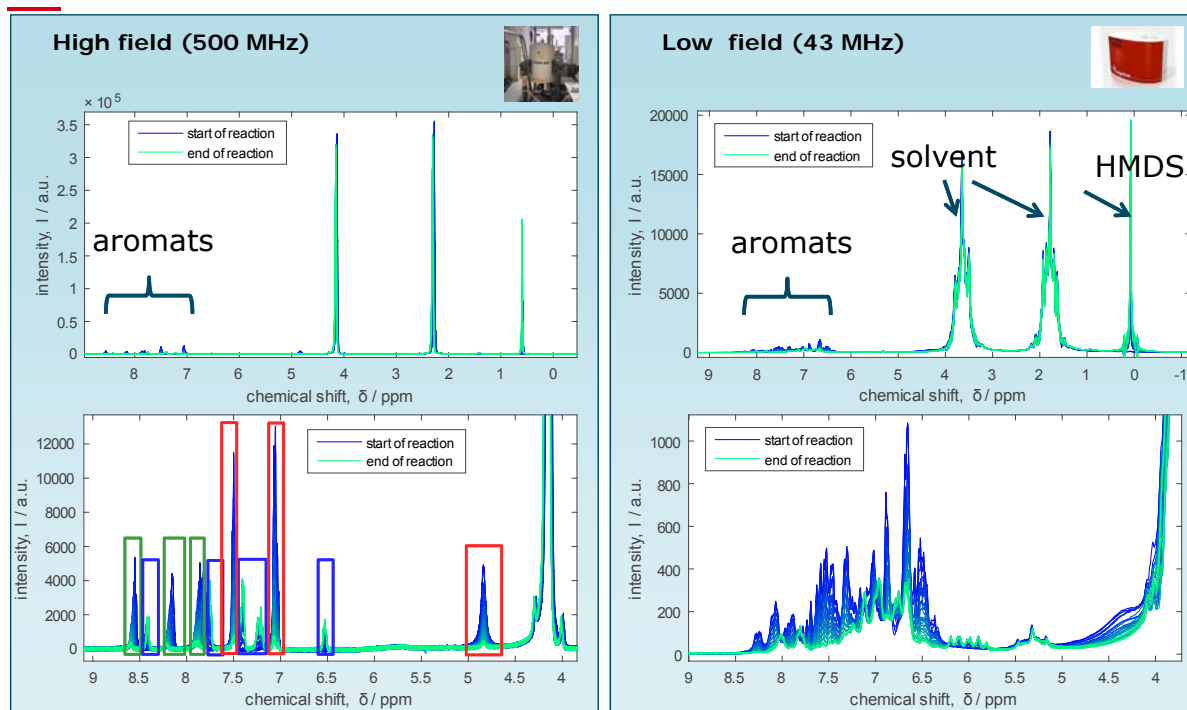

Data Processing for Low-field NMR in Matlab

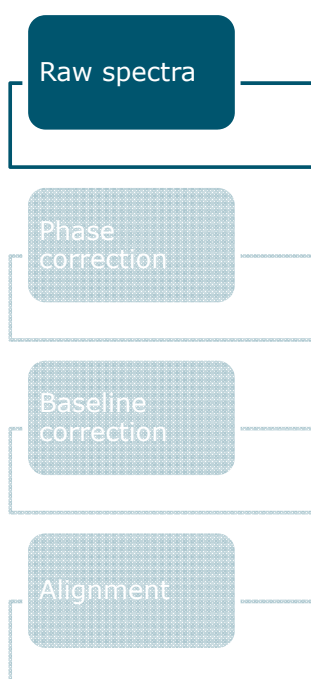

single scan
each 15s
in flow

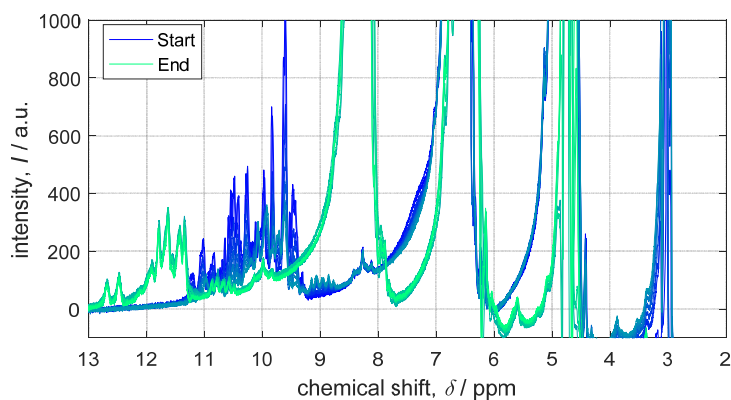
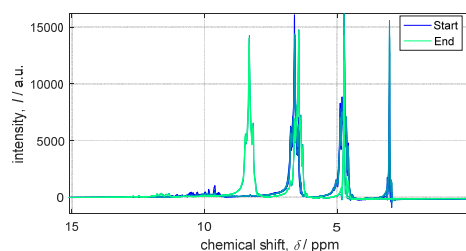

Data Processing for Low-field NMR in Matlab

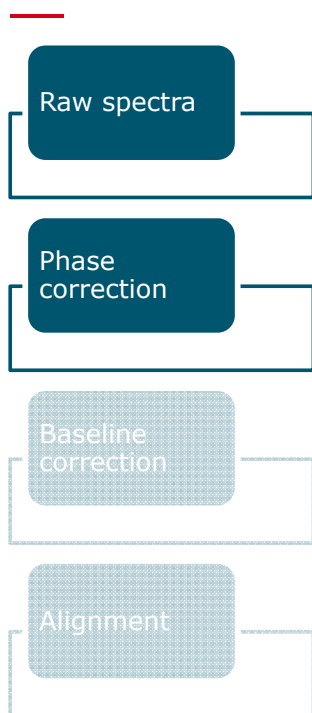

Entropy minimization method:

Chen et al., *J Magn Reson.* **2002**, *158*, 164-168

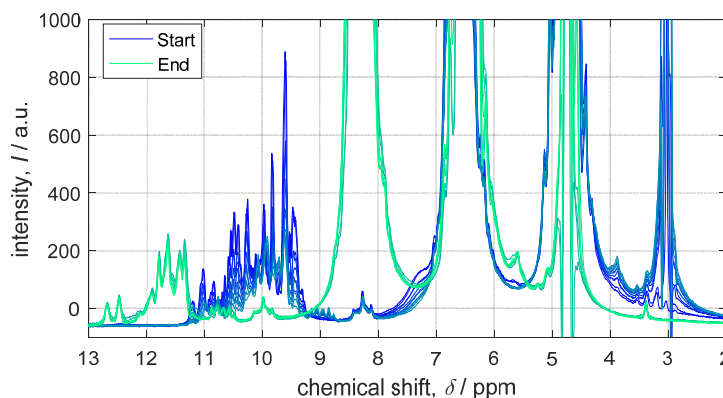
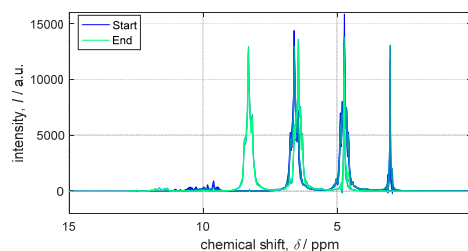

Data Processing for Low-field NMR in Matlab

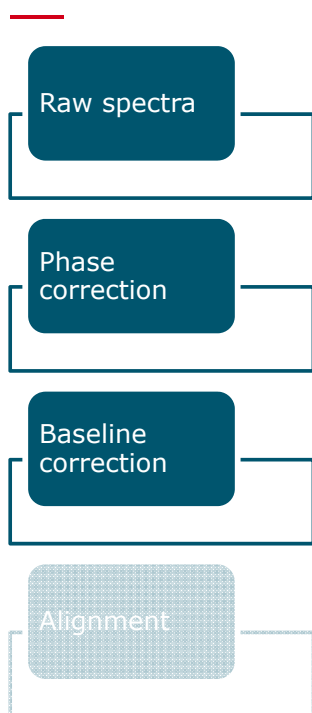

Low-order Polynomial fit:

Mazet et al., *Chemometrics Intell. Lab. Sys.* **2005**, *76*, 121-133.

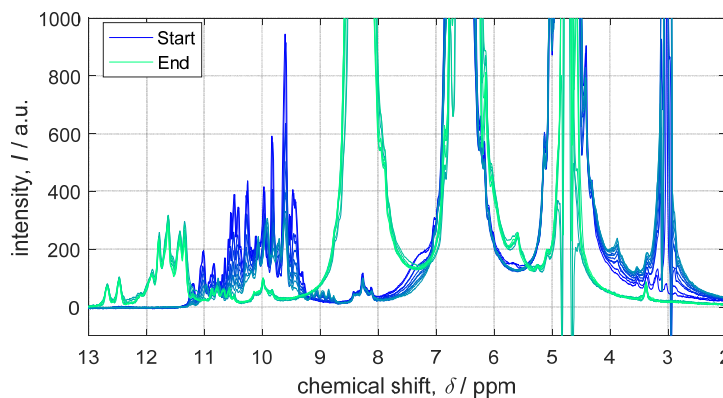
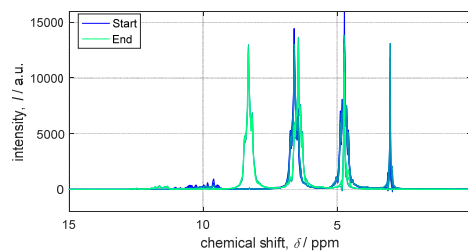

Data Processing for Low-field NMR in Matlab

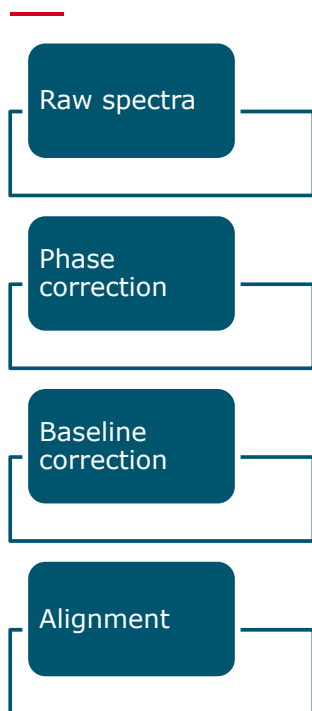

Alignment to reference signal (THF) using *icoshift*:
 Savorani et al., J Magn Reson. **2010**, *2*, 190-202

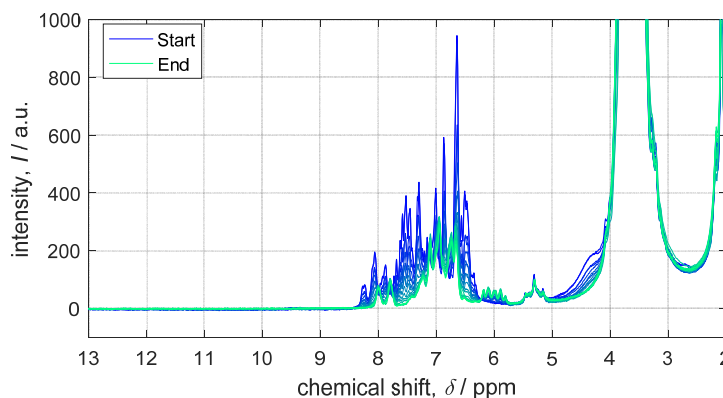
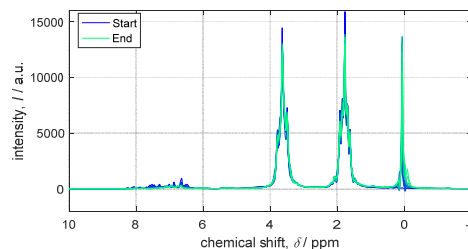

Indirect Hard Modeling (IHM)

- Modeling** > peak fitting of pure component spectra → mixture model
- Analysis** > "component fitting" → calculation of component area

» Group of peaks represent pure component spectra

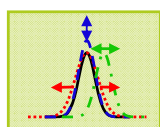

» Pseudo-Voigt function

$$V = \alpha \left[\beta \cdot \exp\left(-\ln(2) \frac{(x - \delta)^2}{\gamma^2}\right) + (1 - \beta) \frac{\gamma^2}{(x - \delta)^2 + \gamma^2} \right]$$

- α = peak maximum
- β = Gaussian-Lorentzian-ratio
- γ = half width
- δ = center position

Hard model for pure components

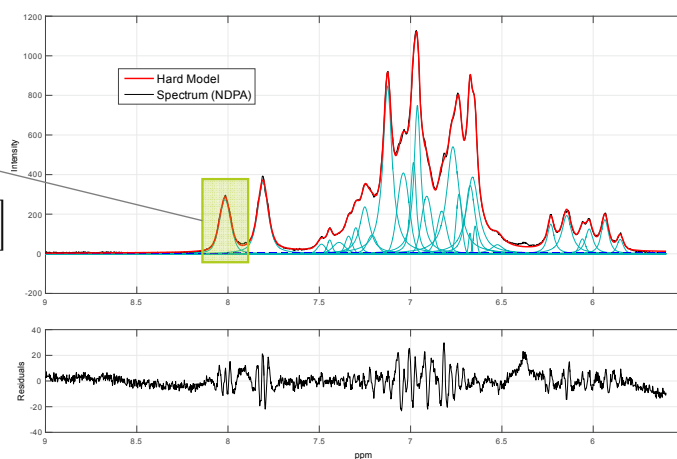

Indirect Hard Modeling (IHM)

How it Works

Pure Component Models

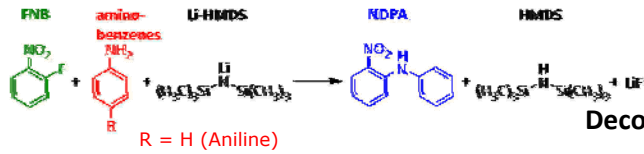
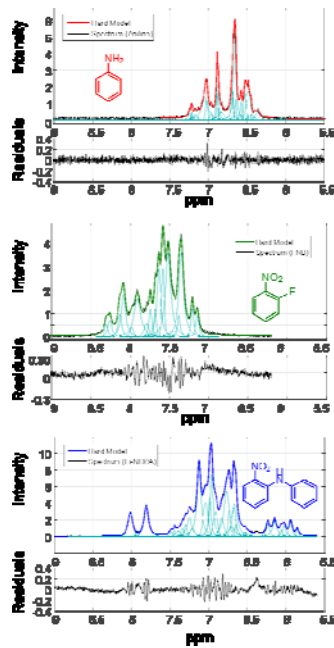

Deconvoluted Spectrum

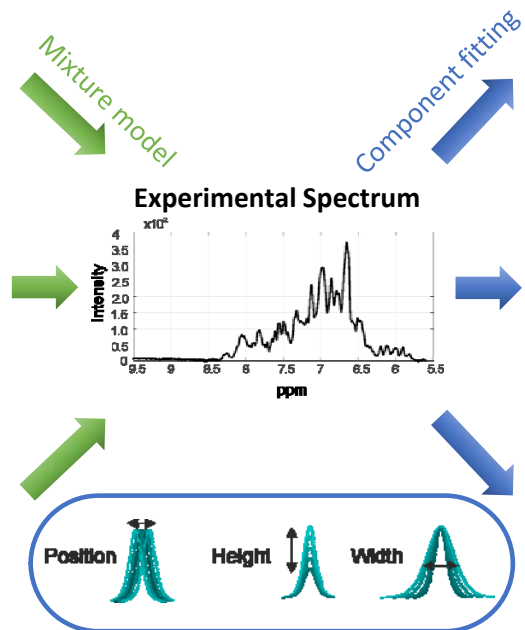
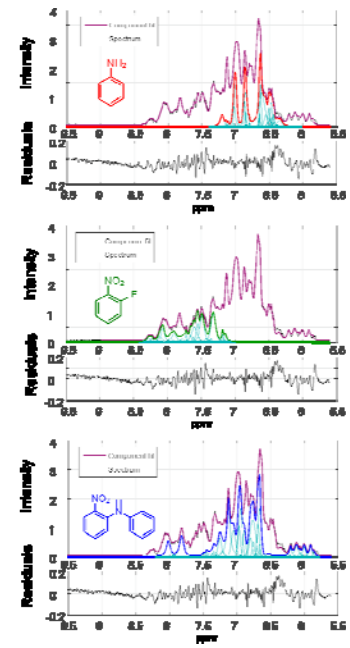

Results: Reaction Characterization

Lab Experiments in Batch along Reaction Co-ordinate

3 semi-batch reaction with varying starting concentrations

1500 Spectra for each HF- and NF-NMR

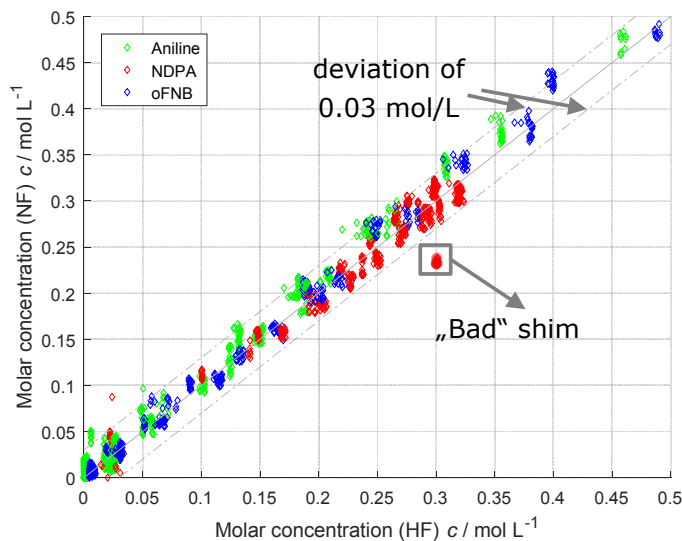

Classification of steady states

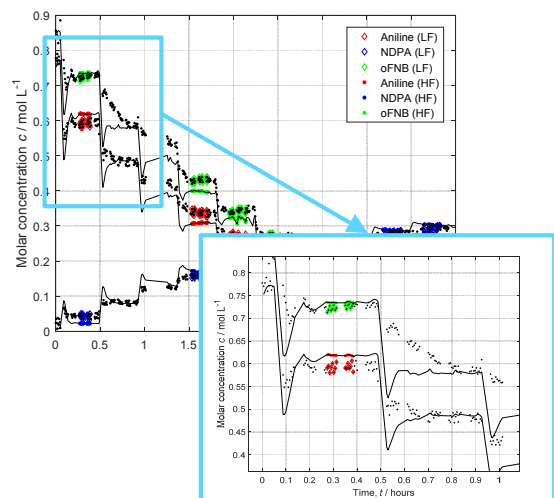

Reaction Scheme:

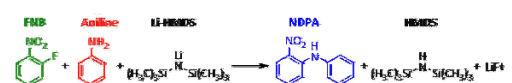

Validation of Lab Experiments in Tube Reactor

Continuous Lithiation Reaction Set-up at BAM

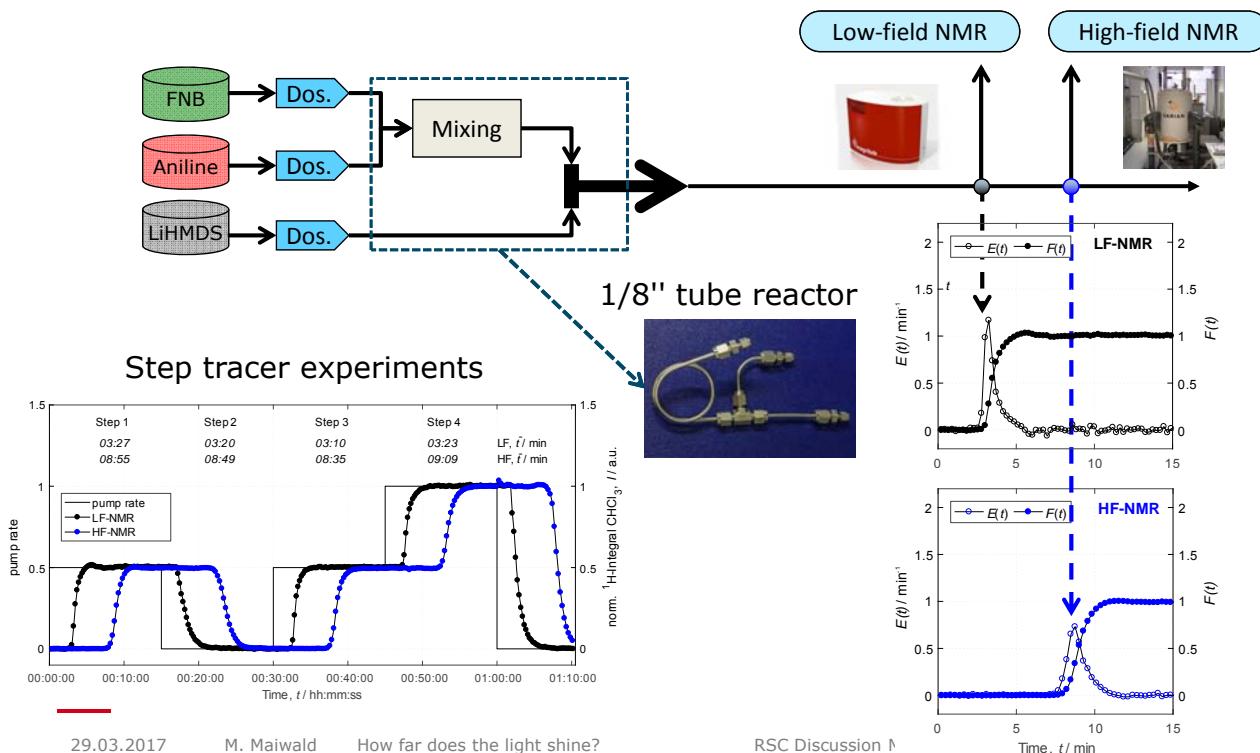

29.03.2017

M. Maiwald

How far does the light shine?

RSC Discussion 1

Experimental Design

Continuous Lithiation Reaction Set-up at BAM

- Independent variation of flowrates / stoichiometric conditions

Reaction Scheme:

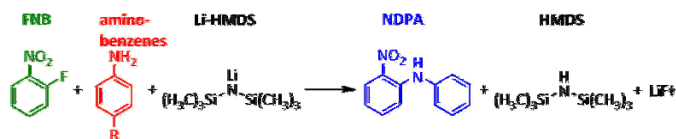

Coarse variation:

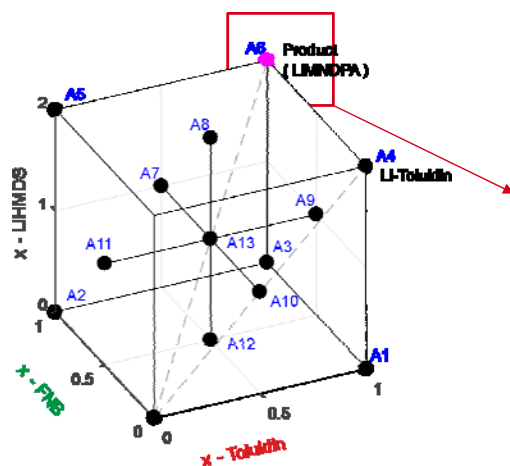

Fine variation:

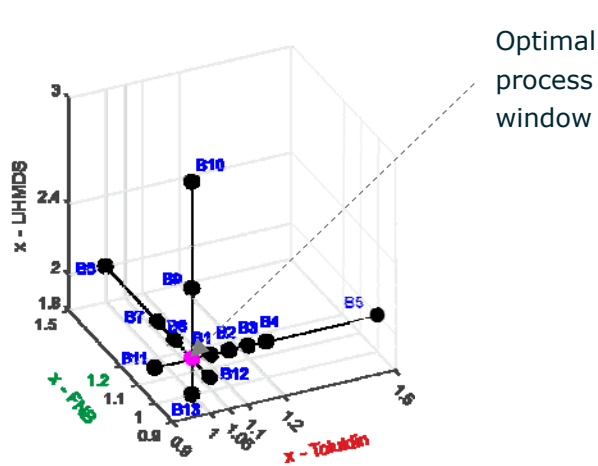

29.03.2017

M. Maiwald

How far does the light shine?

RSC Discussion Meeting, Stevenage, UK

56

Monitoring of Continuous Aromatic Substitution Reaction by Low Field NMR

Automated Validation Runs Using Syringe Pumps

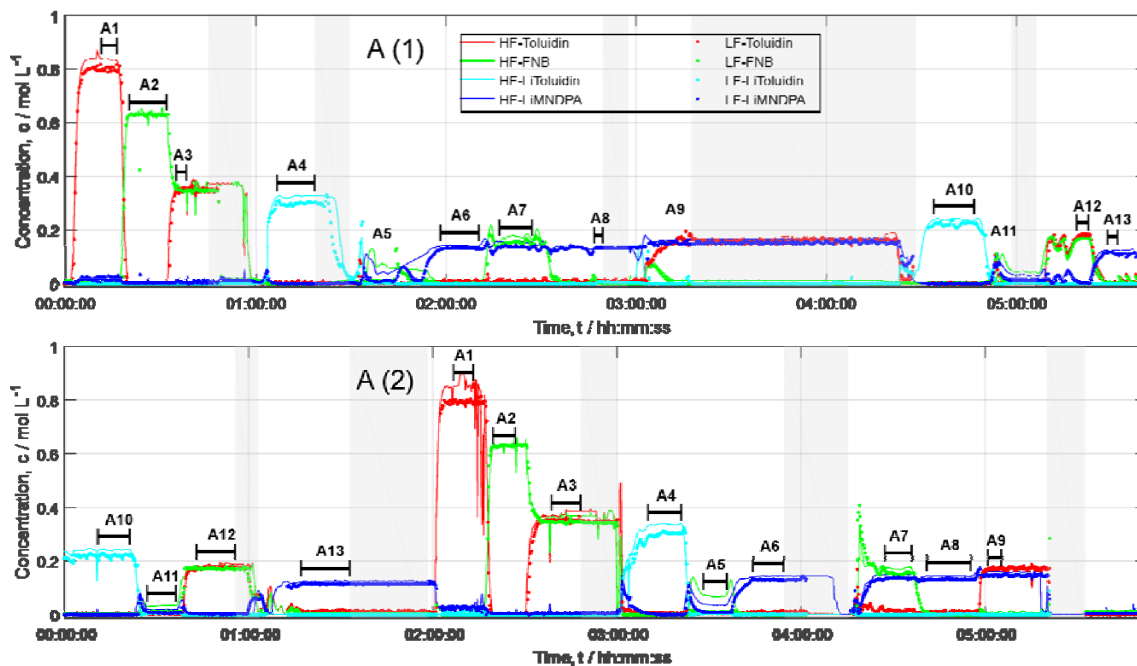

Monitoring of Continuous Aromatic Substitution Reaction by Low Field NMR

Automated Validation Runs Using Syringe Pumps

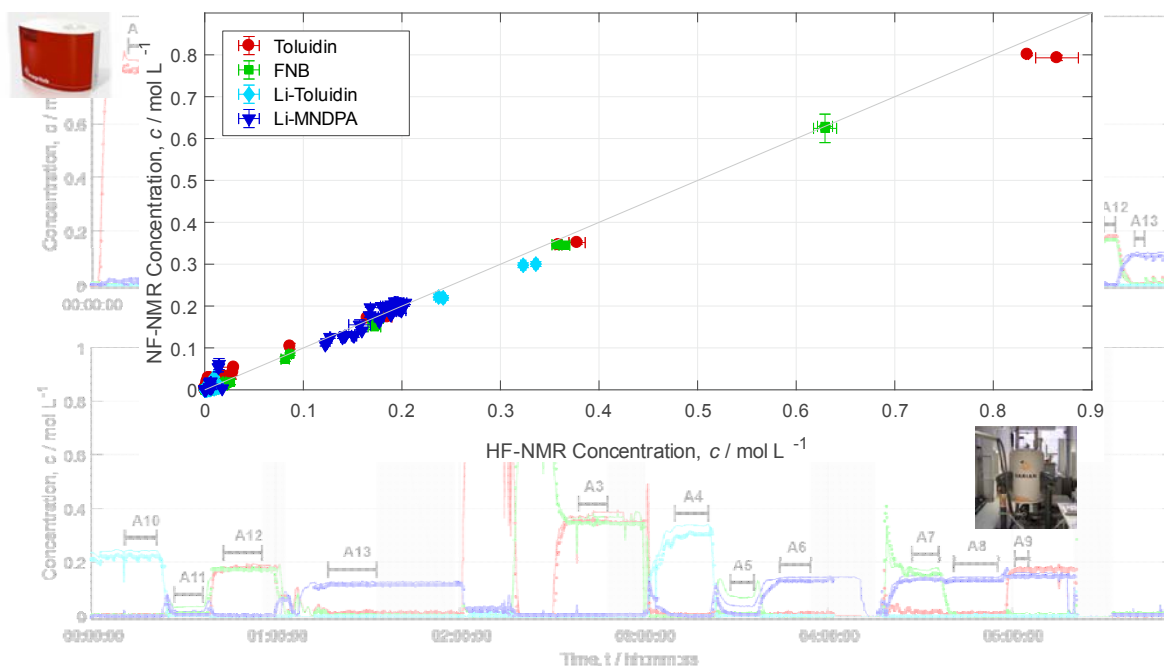

Critical Parameters for Online NMR Spectroscopy

	High resolution NMR	Benchtop NMR
<p>No deuterated solvents</p> <ul style="list-style-type: none"> No lock Shim Dominant solvent signal 	<ul style="list-style-type: none"> → high B_0 stability → ^1H field mapping → solvent suppression e.g., WET 	<ul style="list-style-type: none"> → ^{19}F lock/soft lock → ^1H solvent shim
<p>Quantitative pre-magnetisation</p>	<ul style="list-style-type: none"> → adequate flow rates/cell design (e.g., 1 mL/min) 	<ul style="list-style-type: none"> → adequate flow rates/cell design (e.g., 0.3 mL/min)
<p>Changing sample over time</p> <ul style="list-style-type: none"> „Solvatochromism“, i.e., shifting signals Re-adjusting shim 	<ul style="list-style-type: none"> → peak alignment 	<ul style="list-style-type: none"> → low sensitivity to susceptibility due to cell design

Communication Concept

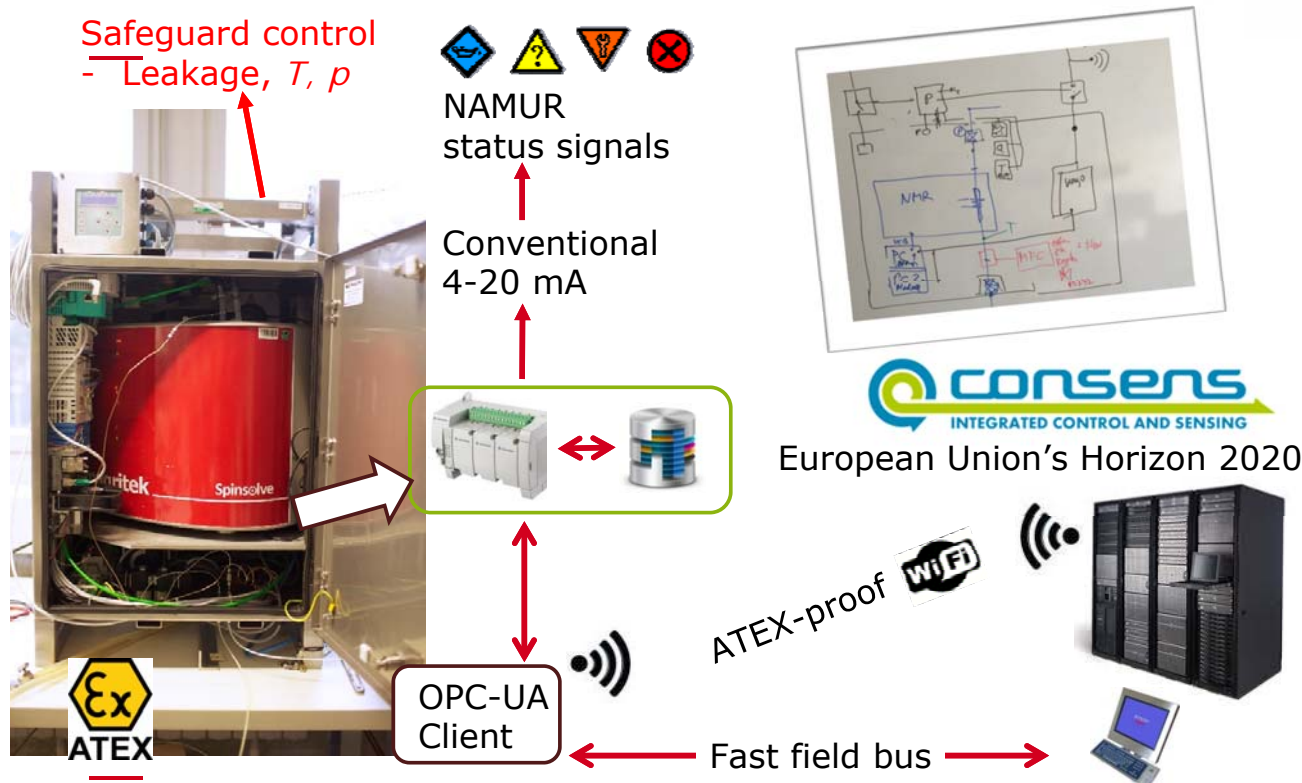

Thank You!

Jürgen Kolz
Ullrich Koch
Juan Perlo
Mike Bernstein

Magritek
Magritek
Magritek
MestreLab

Harald Pape
Clemens Minnich
Dirk Engel

PTB
S-Pact
S-Pact



CONSENS – Integrated Control and Sensing for Sustainable Operation of Flexible Intensified Processes, funded by the European Union’s Horizon 2020 research and innovation programme under grant agreement N° 636942; www.consens-spire.eu