

Dipl.-Ing. Sarah Drzymala

**Instrumental analysis, metabolism and  
toxicity of *cis*- and *trans*-zearalenone  
and their biotransformation products**

Die vorliegende Arbeit entstand an der Bundesanstalt für Materialforschung und -prüfung (BAM).

Impressum

**Instrumental analysis, metabolism and  
toxicity of *cis*- and *trans*-zearalenone  
and their biotransformation products**

2016

Herausgeber:

Bundesanstalt für Materialforschung und -prüfung (BAM)

Unter den Eichen 87

12205 Berlin

Telefon: +49 30 8104-0

Telefax: +49 30 8104-72222

E-Mail: [info@bam.de](mailto:info@bam.de)

Internet: [www.bam.de](http://www.bam.de)

Copyright© 2016 by

Bundesanstalt für Materialforschung und -prüfung (BAM)

Layout: BAM-Referat Z.8

ISSN 1613-4249

ISBN 978-3-9817853-9-5

# Instrumental analysis, metabolism and toxicity of *cis*- and *trans*-zearalenone and their biotransformation products

vorgelegt von  
Dipl.-Ing.  
Sarah Stephanie Drzymala  
geb. in Berlin

von der Fakultät III – Prozesswissenschaften  
der Technischen Universität Berlin  
zur Erlangung des akademischen Grades

Doktor der Ingenieurwissenschaften  
- Dr.-Ing. -

genehmigte Dissertation

Promotionsausschuss:

Vorsitzender: Prof. Dr. Juri Rappsilber  
Gutachter: Prof. Dr. Leif-Alexander Garbe  
Gutachter: Dr. Matthias Koch  
Gutachter: Prof. Dr. Roland Lauster

Tag der wissenschaftlichen Aussprache 10. Juli 2015

Berlin 2015



# Preface

This thesis was prepared from October 2011 to December 2014 at the Technische Universität Berlin (TU Berlin, Department of ‘Biotechnology’, ‘Institute of Bioanalytics’) in cooperation with the Federal Institute for Materials Research and Testing (BAM, Department of ‘Analytical Chemistry; Reference Materials’, Division ‘Food analysis’) under the supervision of Prof. Dr. Leif-Alexander Garbe. The presented results were published in international peer-reviewed journals [1-3], are accepted [4], under review [5, 6] or exist in their final manuscript version [7]. Several relevant X-ray crystal structures were determined and published as well [8, 9].



# Zusammenfassung

*trans*-Zearalenon (ZEN) ist ein nicht-steroidales östrogenwirksames Mykotoxin, das weltweit Getreide kontaminiert. Tiere und Menschen können nach Aufnahme von befallenen Lebens- oder Futtermitteln zahlreiche Mykotoxikosen entwickeln, die auf der östrogenen Wirkung von ZEN beruhen. Strukturell zeichnet sich ZEN durch eine *trans*-konfigurierte Doppelbindung aus, die unter Lichteinfluss in die *cis*-Form isomerisieren kann. Die vorliegende Arbeit untersucht die instrumentelle Analytik, den Metabolismus und die Toxizität von ZEN und *cis*-ZEN.

Der erste Teil der Arbeit beschäftigt sich mit der quantitativen Analytik von ZEN in Speiseölen. Zuverlässige Analysemethoden sind unabdingbar, da für ZEN in der Europäischen Union (EU) ein Grenzwert von 400 µg/kg in Speiseöl gilt. Ein umfassender Methodenvergleich zeigte, dass dynamisch kovalente Hydrazinchemie (DCHC) eine geeignete Probenvorbereitung ist. Darauf basierend, konnte eine *online*-Kopplung aus Festphasenextraktion (SPE) und Hochleistungsflüssigkeits-chromatographie (HPLC) entwickelt werden, die als Neuheit einen kovalenten SPE-Schritt nach dem DCHC Prinzip beinhaltet. Das automatisierte System erlaubt eine richtige, selektive und zuverlässige Bestimmung von ZEN in Speiseölen gemäß EU-Vorgaben, wobei der Arbeitsaufwand wesentlich reduziert ist.

Im Gegensatz zu ZEN fehlen für *cis*-ZEN Referenzstandards und analytische Methoden, woraus ein Datenmangel bezüglich des Vorkommens, des Abbauverhaltens und der Risiken resultiert. Daher wurden ein nativer und ein isotopenmarkierter *cis*-ZEN Standard synthetisiert und in eine bestehende Stabilisotopenverdünnungsanalyse HPLC Tandemmassenspektrometrie (HPLC-MS/MS) Methode implementiert. Mittels dieser Methode konnten nach Tageslichtexposition erhebliche Mengen *cis*-ZEN in ZEN kontaminiertem Speiseöl nachgewiesen werden. Daher sollte *cis*-ZEN als mögliche Lebensmittelkontaminante in Zukunft bei der Analyse von Lebens- und Futtermitteln Berücksichtigung finden.

Weiterhin wurde der *in vitro* Phase I Metabolismus von ZEN und *cis*-ZEN in Ratten- und Humanlebermikrosomen mittels HPLC-MS und HPLC-MS/MS untersucht. Der Phase I Metabolismus von *cis*-ZEN gleicht im Wesentlichen dem von ZEN. Reduktions- und Oxidationsreaktionen führen zur Bildung von  $\alpha$ - und  $\beta$ -*cis*-Zearalenol ( $\alpha$ -/ $\beta$ -*cis*-ZEL) sowie 13- und 15-OH-*cis*-ZEN. Als weitere bisher unbekannte Metabolite konnten *cis*-ZEN-11,12-oxid und ZEN-11,12-oxid aus

Inkubationen von Humanlebermikrosomen mit *cis*-ZEN bzw. ZEN identifiziert werden.

Die Östrogenität von *cis*-ZEN und seinen reduktiven Metaboliten wurde im E-Screen Assay untersucht. Dabei stellte sich heraus, dass *cis*-ZEN minimal östrogener ist als ZEN. Die Umwandlung von *cis*-ZEN zu  $\beta$ -*cis*-ZEL entspricht einer Detoxifizierung, während die Metabolisierung von *cis*-ZEN zu  $\alpha$ -*cis*-ZEL eine metabolische Aktivierung ist, da  $\alpha$ -*cis*-ZEL eine weitaus höhere östrogene Wirkung als *cis*-ZEN hat. Die katecholischen Metabolite weisen vermutlich eine erheblich geringere Östrogenität als ZEN oder *cis*-ZEN auf, wie beispielhaft für 15-OH-ZEN gezeigt werden konnte. Unabhängig von den östrogenen Effekten, kann von den katecholischen und epoxidischen Strukturen, die in dieser Arbeit nachgewiesen wurden, ein genotoxisches und karzinogenes Potential erwartet werden. Insbesondere die erstmals als Säugermetabolite beschriebenen Epoxide könnten die bisher vertretene Meinung, dass ZEN ausschließlich als endokriner Disruptor negative Effekte hat, fundamental ändern.



## Abstract

*trans*-Zearalenone (ZEN) is a non-steroidal estrogenic mycotoxin which frequently contaminates cereal grains worldwide. Ingestion of food and feed containing ZEN causes numerous mycotoxicoses in animals and possibly humans with pronounced estrogenic effects. Due to the *trans*-configured double bond, ZEN isomerizes to the *cis*-configuration upon the influence of light. This work investigates the instrumental analysis, metabolism and toxicity of ZEN and *cis*-ZEN.

The first part focused on the determination of ZEN in edible oils. Due to a maximum level of 400 µg/kg ZEN in the European Union (EU), reliable analytical methods are needed. A comprehensive method comparison proved dynamic covalent hydrazine chemistry (DCHC) to be the most suitable approach. Thus, an automated solid phase extraction (SPE) coupled online to high performance liquid chromatography (HPLC) was developed with the novelty of a covalent SPE step comprising the DCHC principle. The automated online system allows an accurate, selective and reliable quantification of ZEN in edible oils in compliance with EU performance criteria while significantly reducing workload and thereby personnel costs.

In contrast to ZEN, reference standards and analytical methods are missing for *cis*-ZEN which causes a lack of data on the occurrence, fate and risks of *cis*-ZEN. Therefore, a native and an isotopically labeled *cis*-ZEN standard were synthesized and implemented in an existing stable isotope dilution analysis HPLC tandem mass spectrometry (HPLC-MS/MS) method. Using this method, a large extent of *cis*-ZEN formation was observed for ZEN contaminated maize germ oils when exposed to daylight which confirms that *cis*-ZEN can be a relevant food contaminant and should be considered in the analysis of food and feed.

Furthermore, this work investigated the *in vitro* phase I metabolism of ZEN and *cis*-ZEN in rat and human liver microsomes by using HPLC-MS and -MS/MS analyses. The metabolic pathways of *cis*-ZEN were found to be essentially similar to ZEN including reduction and oxidation reactions generating  $\alpha$ - and  $\beta$ -*cis*-zearelenol as well as 13- and 15-OH-*cis*-ZEN. A previously unidentified oxidative metabolic pathway for both isomers of ZEN results in the formation of *cis*-ZEN-11,12-oxide and ZEN-11,12-oxide in human liver microsomes.

The estrogenicity of *cis*-ZEN and its reductive metabolites was assessed using the E-Screen assay. *cis*-ZEN proved to be slightly more estrogenic than ZEN.

Biotransformation of *cis*-ZEN to  $\beta$ -*cis*-ZEL corresponds to a detoxification, whereas metabolism to  $\alpha$ -*cis*-ZEL resembles a metabolic activation as its estrogenicity considerably exceeds that of *cis*-ZEN. The catecholic metabolites can be expected to show a decreased estrogenicity as demonstrated for 15-OH-ZEN. Independent of the estrogenic effects, the catecholic and epoxidic metabolites identified in this work can be expected to act genotoxic and carcinogenic. The epoxides in particular could fundamentally change the widely accepted view of ZEN causing adverse effects exclusively through endocrine disrupting actions.

# Contents

Zusammenfassung .....	VII
Abstract.....	IX
Abbreviations .....	XIII
1. Introduction .....	1
1.1. Zearalenone .....	1
1.2. Physical and chemical properties .....	1
1.3. <i>cis</i> -Zearalenone .....	2
1.4. Occurrence, human exposure and maximum limits .....	3
1.5. Mammalian metabolism .....	4
1.6. Toxicity .....	6
1.7. Estrogenicity.....	6
1.8. Instrumental analysis .....	8
1.9. Aims of the thesis .....	11
2. Results and discussion .....	13
2.1. Comparison of analytical methods for the determination of zearalenone in edible oils .....	13
2.2. Automated solid phase extraction coupled online with HPLC-FLD for the quantification of zearalenone in edible oil .....	30
2.3. Photochemical <i>trans</i> -/ <i>cis</i> -isomerization and quantitation of zearalenone in edible oils .....	46
2.4. Preparation of <sup>13</sup> C-labeled <i>cis</i> -zearalenone and its application as internal standard in stable isotope dilution analysis .....	67
2.5. <i>In vitro</i> phase I metabolism of <i>cis</i> -zearalenone .....	83
2.6. Oxidative <i>in vitro</i> phase I metabolism of <i>cis</i> -zearalenone.....	100
2.7. Estrogenicity of novel phase I and phase II metabolites of zearalenone and <i>cis</i> -zearalenone .....	119
3. Final discussion .....	131
3.1. Advances in the methodology on ZEN in edible oil .....	131
3.2. Investigations on the formation and occurrence of <i>cis</i> -ZEN .....	133
3.3. <i>In vitro</i> phase I metabolism of <i>cis</i> -ZEN .....	136
3.4. Estrogenicity of ZEN, <i>cis</i> -ZEN and their biotransformation products....	139
4. Conclusion and future perspectives .....	141

5. Bibliography .....	143
Publications .....	155
Acknowledgements .....	159

## Abbreviations

$\lambda$	Wavelength
a.u.	Arbitrary units
3 $\alpha$ -HSD	3 $\alpha$ -Hydroxysteroid dehydrogenase
3 $\beta$ -HSD	3 $\beta$ -Hydroxysteroid dehydrogenase
ACN	Acetonitrile
AFB <sub>1</sub>	Aflatoxin B <sub>1</sub>
bw	Body weight
CAD	Collision gas (instrument setting)
CCQM	Consultative Committee for Amount of Substance – Metrology in Chemistry)
CID	Collision induced decay
CE	Collision energy (instrument setting)
COMT	Catechol-O-methyltransferase
CEN	Committee Europeenne de Normalisation
cps	Counts per second
CUR	Curtain gas (instrument setting)
CXP	Cell exit potential (instrument setting)
DAD	Diode array detector
DCHC	Dynamic covalent hydrazine chemistry
DMEM	Dulbecco`s modified Eagle medium
DMSO	Dimethyl sulfoxide
DNA	Deoxyribonucleic acid
DP	Declustering potential (instrument setting)
EC	European Commission
EC <sub>50</sub>	Half maximal effective concentration
EP	Entrance potential (instrument setting)
ER	Estrogen receptor
ESI	Electrospray ionization
EU	European Union
EFSA	European Food Safety Authority
FL	Fluorescence
FLD	Fluorescence detector/detection
GC	Gas chromatography
GPC	Gel permeation chromatography

GS1/GS2	Gas ½ (instrument setting)
hCYP	Human cytochrome P450
HPLC	High performance liquid chromatography
HLM	Human liver microsomes
IAC	Immunoaffinity chromatography
IARC	International Agency for Research on Cancer
IBX	2-Iodoxybenzoic acid
i.e.	<i>id est</i>
ILC	Interlaboratory comparison
IS	Ion-spray voltage (instrument setting)
IT	Ion trap
IUPAC	International Union of Pure and Applied Chemistry
k	Rate constant
LD <sub>50</sub>	Lethal dose where 50 % of the test animals die
LLE	Liquid-liquid extraction
LOD	Limit of detection
LOQ	Limit of quantification
MCF-7	Michigan Cancer Foundation-7 (human breast cancer cell line)
mCPBA	3-Chloroperoxybenzoic acid
MeOH	Methanol
MIP	Molecularly imprinted polymer
MRM	Multiple reaction monitoring
MS	Mass spectrometry
MS/MS	Tandem mass spectrometry
NADPH	Nicotinamid adenine dinucleotide phosphate
NMR	Nuclear magnetic resonance spectroscopy
NOEL	No observed effect level
p.a.	<i>Pro analysi</i>
PE	Proliferative effect
R <sup>2</sup>	Square of correlation coefficient
RAL	Resorcylic acid lactone
RLM	Rat liver microsomes
rpm	Revolutions per minute
RSD	Relative standard deviation
RT	Room temperature
SIDA	Stable isotope dilution analysis

SPE	Solid phase extraction
S/N	Signal to noise
<i>spp.</i>	Several species
$t_R$	Retention time
UGT	Uridine-5'-diphospho-glucuronosyltransferase
USA	United States of America
UV	Ultraviolet
WHO	World Health Organisation
ZAL	Zearalanol
ZAN	Zearalanon
ZEL	Zearalenol
ZEN	Zearalenone





# 1. Introduction

## 1.1. Zearalenone

Zearalenone (ZEN) is a non-steroidal estrogenic mycotoxin which contaminates cereal crops worldwide. It has been implicated in numerous mycotoxicoses in farm animals and possibly humans exhibiting toxic effects in concentrations of less than 1 ppm. ZEN is biosynthesized in the *trans*-configuration by several molds of the *Fusarium* genus including *F. graminearum* (*Gibberella zeae*), *F. culmorum* and *F. cerealis*. These molds frequently colonize important cereal crops as maize, wheat, rice and soybeans [10]. ZEN can enter the food chain through contaminated food and feed and may cause economic losses at all levels. Due to its severe estrogenic effects and its prevalence, ZEN contamination is a major and reoccurring problem in agriculture and a concern to food safety.

## 1.2. Physical and chemical properties

ZEN ((3*S*,11*E*)-14,16-dihydroxy-3-methyl-3,4,5,6,9,10-hexahydro-1*H*-2-benzoxacy-clotetradecine-1,7(8*H*)-dione, Figure 1) was first characterized by Urry *et al.* in 1966 as a white, crystalline compound with a melting point of 164-165 °C [11]. Its molecular formula is C<sub>18</sub>H<sub>22</sub>O<sub>5</sub> and it has a molecular weight of 318 g/mol. Due to its lipophilic properties, ZEN is highly soluble in methylene chloride, ethyl acetate, acetonitrile and alcohols but not in water. UV absorption maxima are at 236 nm, 274 nm and 316 nm in ethanol. ZEN also shows fluorescence at an emission wavelength of 450 nm.

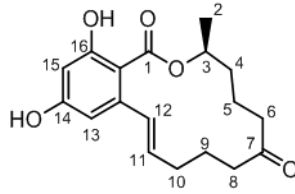
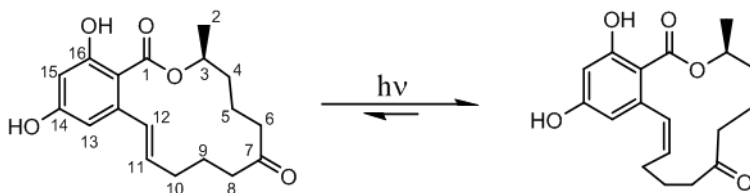


Figure 1. ZEN.

Structurally, ZEN is a resorcylic acid lactone (RAL) fused to a macrocyclic carbon ring which includes a methyl group, a ketone and a *trans* configured double bond. The trivial name zearalenone is derived from *Giberella zea*, resorcylic acid lactone, **-ene** for the presence of the non-aromatic double bond and **-one** for the keto group.

### 1.3. *cis*-Zearalenone

Isomerization at the C11-C12 double bond gives rise to *cis*-ZEN (Figure 2) [12, 13]. In principal, *cis*/*trans*-interconversion can be induced thermally, catalytically or photochemically. ZEN has been shown to readily isomerize to the *cis*-configuration upon the influence of light whereas information on temperature or catalysis dependent isomerization has never been reported. Although it is assumed that only the *trans*-isomer is biosynthesized by *Fusarium*, there are a few studies that report on the isolation of the *cis*-isomer from fungi cultures [14, 15].

Figure 2. Photoisomerization of ZEN (left) to *cis*-ZEN (right) at the double bond C11-C12.

Up to date, reference standards and analytical methods for *cis*-ZEN are lacking. Also, maximum levels for ZEN are in force but *cis*-ZEN is not considered. As a consequence, information on the occurrence, metabolism and toxicity of *cis*-ZEN is very scarce. Regarding the occurrence of *cis*-ZEN in food and feed, sugar beets,

ground corn and wet animal feed have been shown to be contaminated with *cis*-ZEN [16-18]. Furthermore, the estrogenicity of *cis*-ZEN has been investigated with varying results. Mirocha *et al.* and Peters *et al.* claimed an elevated estrogenicity of *cis*-ZEN in comparison to its *trans*-isomer in the uterotropic assay [12, 19] whereas Shier *et al.* found *cis*-ZEN to be less estrogenic than ZEN using human breast cancer cells of the MCF-7 (Michigan Cancer Foundation-7) type [20].

## **1.4. Occurrence, human exposure and maximum limits**

ZEN contamination can be found on cereal crops in temperate climates worldwide [21, 22]. The extent of ZEN contamination in food and feed can vary over a wide range and largely depends on the moisture conditions during harvest [23]. Up to date, ZEN has been detected in maize, barley, oats, sorghum, wheat, rice, rye, soy, bananas, beans, chilli, coriander, curry, fennel, millet, peppers, and walnuts. The most significant sources of ZEN are wheat, rye, oats and maize including the products made thereof. ZEN is not degraded during storage, grinding, conservation, cooking or baking [24].

Grains and grain products, for example bread and fine bakery ware, are supposed to be the largest contributor to ZEN exposure. Another notable contributor are vegetable oils with several studies proposing vegetable oils to account for 50 % of ZEN exposure [25]. Also, the high ZEN contents in fine bakery ware may be linked to the use of vegetable oils as ingredient. Breakfast cereals, beer and snacks are only of minor importance [25]. In order to protect consumers from health risks, maximum limits are in force in the European Union (EU) [26], ranging from 20 µg/kg (baby food) to 400 µg/kg (refined maize germ oil) as seen from Table 1. According to the European Food Safety Authority (EFSA), a tolerable daily intake of ZEN for humans is 0.25 µg/kg bw [25].

Table 1. Excerpt from EU commission regulation (EC) No 1126/2007 stating maximum levels for ZEN.

Product	Maximum level ( $\mu\text{g}/\text{kg}$ )
Unprocessed cereals other than maize	100
Unprocessed maize with the exception of unprocessed maize intended to be processed by wet milling	350
Cereals intended for direct human consumption, cereal flour, bran and germ as end product marketed for direct human consumption	75
Refined maize oil	400
Bread (including small bakery wares), pastries, biscuits, cereal snacks and breakfast cereals, excluding maize-snacks and maize-based breakfast cereals	50
Maize intended for direct human consumption, maize-based snacks and maize-based breakfast cereals	100
Processed cereal-based foods (excluding processed maize-based foods) and baby foods for infants and young children	20
Processed maize-based foods for infants and young children	20

---

## 1.5. Mammalian metabolism

### 1.5.1. Phase I metabolism

ZEN undergoes phase I metabolism as demonstrated by *in vitro* as well as *in vivo* studies. The first identified phase I metabolites were  $\alpha$ - and  $\beta$ -zearalenol (ZEL) which are reduced at C7. Both epimers were found in liver cell fractions from various animal species such as pig, cow, hen and sheep. Regarding the enzymology, 3 $\alpha$ - and 3 $\beta$ -hydroxysteroid dehydrogenases (3 $\alpha$ - and 3 $\beta$ -HSD) are responsible for the reduction of ZEN to both ZEL products [27, 28]. *In vivo*,  $\alpha$ - and  $\beta$ -ZEL were detected as relevant metabolites in pig, cattle, rats and rabbits. For humans, the conjugated form of  $\alpha$ -ZEL was proven in the urine of one volunteer after oral administration of ZEN [24].

Further reduction of the double bond between C11 and C12 to  $\alpha$ - and  $\beta$ -zearalanol (ZAL) was shown for goats, deer, lambs, sheep, horse and cattle [29]. Trace amounts were also found in pigs [30]. No  $\alpha$ -ZAL or  $\beta$ -ZAL formation was observed in *in vitro* studies up to date for the above mentioned species. Interestingly,  $\alpha$ -ZAL was approved as an anabolic agent for sheep and cattle in 1969 [31]. Marketed under the trade name Ralgro®, it is still widely used in the USA, Canada and several other countries but banned in the EU [32].

The existence of oxidative phase I metabolites was first proven in 2007 [33]. The major monohydroxylated ZEN metabolites generated by human liver microsomes (HLM) were 13- and 15-OH-ZEN [34]. These monooxygenation reactions are catalyzed by human cytochrome P450 (hCYP) isoform hCYP1A2 and to a lesser extent by hCYP3A4. In rat liver microsomes (RLM), further aliphatic hydroxylations were identified at C5, C8, C9 and C10 and at either C2, C3 or C4 [35]. Bravin *et al.* claimed to detect 8-OH-ZEN *in vivo* in urine of rats that were dosed with ZEN [36]. Investigations on the enzymology of aliphatic hydroxylation have not been reported so far.

### 1.5.2. Phase II metabolism

Several *in vitro* and *in vivo* studies demonstrated that ZEN is also subject to phase II metabolism. Both hydroxyl groups present in the ZEN molecule can be prone to glucuronidation by uridine-5'-diphospho-glucuronosyltransferases (UGT). Yet, the hydroxyl group at C16 is conjugated to a lesser extent, probably due to sterical hindrance. Glucuronidation also proceeds for the phase I metabolites of ZEN [37].

Pfeiffer *et al.* studied the enzymology of ZEN,  $\alpha$ -/ $\beta$ -ZEL and  $\alpha$ -/ $\beta$ -ZAL glucuronidation [38]. All compounds were good substrates for hepatic microsomes from pig, steer, rat, humans and eleven recombinant human UGTs with the 14-O-glucuronides being the preferred metabolites. UGT1A1, 1A3 and 1A8 showed the highest activity towards ZEN and its reductive metabolites. *In vivo* studies confirmed ZEN glucuronides for various animal species and also humans [39, 40]. Sulfation was recently investigated in a widely accepted *in vitro* model system for human intestinal absorption and metabolism using Caco-2-cells [41]. The 14-OH position of ZEN proved to be specifically sulfated.

## 1.6. Toxicity

ZEN has a low acute toxicity with LD<sub>50</sub> (lethal dose) values of >2,000-20,000 mg/kg bw after oral administration in mice, rats and guinea pigs (LD<sub>50</sub> of sodium chloride in rats 2,690 mg/kg bw [42]). It is more toxic after intraperitoneal injection with LD<sub>50</sub> values in the range of >500-5,500 mg/kg bw [24].

ZEN was shown to possess limited carcinogenicity. First results proved ZEN to cause hepatocarcinomas and pituitary adenomas in mice [43]. Rats did not show treatment-related tumors [44]. Based on these investigations the International Agency for Research on Cancer (IARC) has placed ZEN in the category 3 “limited evidence of carcinogenicity” [45]. Nevertheless, ZEN has been associated with increasing incidences of breast cancer in humans [46].

Studies on the genotoxicity show inconsistent results. ZEN did not induce mutations in the Ames test independent of metabolic activation [47]. Two studies using <sup>32</sup>P-postlabeling revealed deoxyribonucleic acid (DNA) adducts in the kidney and in the liver of mice after a single oral dose of ZEN [48, 49]. Bone marrow cells of mice showed chromosomal aberrations *in vivo* [50]. Further chromosomal aberrations and sister chromatid exchanges were found in Chinese hamster ovary cells *in vitro* which are in support of genotoxic effects of ZEN [51]. Furthermore, there is evidence that ZEN also acts hepatotoxic, haematotoxic and immunotoxic but the most relevant observed adverse effects are estrogenic. Due to the multitude of *in vitro* and *in vivo* studies, the estrogenicity of ZEN will be discussed separately in the following chapter.

## 1.7. Estrogenicity

### 1.7.1. *In vivo* studies

As early as 1928, marked physiological changes in the reproductive tract of swine after ingestion of moldy corn were reported [52]. After ZEN had been identified as

the causative compound, feed spiked with 0.5 mg/kg showed to cause hyperestrogenism in swine. Adverse effects included vulvovaginitis, uterine enlargement, prolonged or interrupted oestrus and infertility [53]. Daily doses as low as 0.02 mg/kg bw administered for eight consecutive days caused vulval swelling in young pigs [54]. Rodents seem to be less sensitive to ZEN with severe estrogenic effects at doses of 5-50 mg/kg bw in mice and rats. Young chicken showed no effects when dosed with 50 mg/kg bw daily for a time period of seven days and thus, appear to be the least sensitive species.

The *in vivo* “gold standard” in estrogenicity testing is the rodent uterotropic assay which has been applied to ZEN and its analogues. This assay measures the uterine growth after stimulation with potentially estrogenic chemicals. Ueno and Tashiro found the following order of ZEN and its reductive metabolites in terms of estrogenic activity:  $\alpha$ -ZAL >  $\alpha$ -ZEL >  $\beta$ -ZAL > ZEN >  $\beta$ -ZEL [55].

There are no studies that have been conducted in humans but ZEN has often been implicated in estrogen-related human pathologies. For example, ZEN and  $\alpha$ -ZAL have been linked to the occurrence of premature puberty of Puerto-Rican children from 1976 to 1984 [56]. Premature puberty and other symptoms that may be a consequence of ZEN exposure were also reported for China in 1995 [57], south-eastern Hungary in 1997 [58] and western Italy in 2010 [59].

### **1.7.2. *In vitro* studies**

*In vitro* investigations on the biological mode of action showed that ZEN and its analogues bind to the estrogen receptor (ER, including  $\alpha$  and  $\beta$ -receptor) and thereby elicit an estrogenic response [60]. In general, binding of endogenous hormones as 17 $\beta$ -estradiol to the ER prompts a reaction cascade: The receptors will dimerize, translocate to the cell nucleus and bind to estrogen responsive elements on the DNA. Eventually mRNA synthesis will be triggered and estrogen dependent proteins expressed. ZEN is an exogenous non-steroidal compound that intervenes in this sensitive cycle and is therefore categorized as an “endocrine disruptor”.

Further studies revealed that ZEN binds weakly to the sex steroid-binding globulin. Thus, the whole amount of ZEN present in blood can be expected to be delivered to cells activating the ER. The induction of cell proliferation upon binding of RALs to the ER has been investigated in MCF-7 cells. As a result the following estrogenic ranking was found:  $\alpha$ -ZEL > 17 $\beta$ -estradiol >  $\alpha$ -ZAL  $\approx$   $\beta$ -ZAL > ZEN >  $\beta$ -ZEL [20, 61]. The use of human cells *in vitro* might be the best approach to assess the risk for humans. It is thus notable, that the metabolism of ZEN strongly affects the estrogenicity with  $\alpha$ -ZEL being more potent than endogenous 17 $\beta$ -estradiol.

## 1.8. Instrumental analysis

Maximum levels for ZEN as low as 20  $\mu\text{g}/\text{kg}$  (Table 1) infer the requirement of sensitive, selective and reliable analytical procedures. Sample preparation is a vital step in the determination of an analyte as it is regarded as the main time factor in an analysis. Furthermore, the better the sample preparation, the wider the choice of the final detection system allowing for cheaper instruments as for example high performance liquid chromatography (HPLC) coupled to fluorescence detection (FLD) versus the more selective HPLC tandem mass spectrometry (MS/MS).

### 1.8.1. Sample preparation techniques for ZEN analysis

In case of solid matrices extraction of ZEN is usually done with a mixture of organic solvents and water. For example, the current reference method for the determination of ZEN in maize flour states a mixture of acetonitrile:water 84:16 (v/v) as extraction solvent [62]. Successive clean-up of the extract is usually achieved by immunoaffinity chromatography (IAC). The principle of IAC is based on the specific antibody-antigen reaction, whereby the analyte is retained in an antibody coated cartridge. Matrix compounds will pass through and can be discarded. Elution is achieved by applying organic solvents as methanol or acetonitrile that will denature the antibodies and consequently release the analyte. IAC offers a maximum in selectivity, while a major drawback is the expensiveness of the antibodies and, therefore, the cartridges, which are intended



for single use only. Furthermore, IAC is incompatible with organic solvents requiring a high dilution of the food extract with aqueous buffers.

Clean-up of liquid food extracts may also be achieved by applying solid phase extraction (SPE). SPE exploits the different affinity of compounds to a solid phase which may be based on hydrophobic, hydrophilic or ion-ion interactions. It is conducted in a cartridge format which, for ZEN, usually contains reverse phase materials like octadecyl modified silica. SPE is considered less expensive in comparison to IAC but also less selective.

Recently, molecularly imprinted polymers (MIPs) for ZEN have been introduced to the market as an alternative clean-up step to IAC or SPE. MIPs carry specific recognition sites which are considered to mimic the antibody-antigen binding. The working procedure is similar to that of IAC but MIP cartridges are less expensive. Further advantages of MIPs include their compatibility with organic solvents and long shelf-life. There are multiple publications on the synthesis of ZEN selective MIPs available. Yet, reports on the applicability to matrix samples are limited with only one literature report for cereal samples at the time [63].

In case of aqueous liquid matrices as drinking water, fruit juices or medicinal samples as blood and urine, reliable analysis of ZEN and its analogues can be achieved by applying liquid-liquid extraction (LLE) with organic solvents immiscible with water or SPE [64, 65]. LLE separates compounds based on their relative solubilities and can easily be applied to aqueous samples due to the pronounced differences in the polarity of ZEN and the matrix.

For fatty liquid matrices as margarines or edible oils on the other hand, the extraction of ZEN is much more challenging due to an apolar analyte in an apolar matrix. Studies on the redistribution of ZEN during dry and wet milling proved ZEN to be enriched in the oil fraction resulting in high contents of up to 4.6 mg/kg [66, 67]. Extraction of edible oils with organic solvents is critical as a significant part of the triglyceride matrix will be co-extracted. Several suggestions for the sample preparation of edible oils have been made ranging from rather unspecific LLE [68] over gel permeation chromatography (GPC) with subsequent IAC [69] to a more sophisticated approach based on dynamic covalent hydrazine chemistry (DCHC) [70].

GPC separates compounds by their hydrodynamic volumes and extracts ZEN as well as all compounds with similar hydrodynamic radii from the edible oil. Thus, an additional IAC step is required for clean-up. DCHC can be described as a SPE based on the covalent reaction of ZEN with hydrazine moieties bound to solid particles. Once ZEN is bound, the oily matrix can be removed before ZEN is released from the particles by acidic hydrolysis. As a maximum level for ZEN in edible oil applies but no reference method is available, a standardization procedure was recently initiated by the European Commission [71]. A comparison and evaluation of the current analytical techniques is not available and would be very valuable in this context.

### 1.8.2. Detection

Detection of ZEN has been conducted using thin layer chromatography, HPLC coupled with ultraviolet (UV), diode array (DAD), fluorescence or mass spectrometry (MS) detectors, and gas chromatography (GC) coupled with electron capture (ECD), flame ionization (FID) or MS detectors [72]. As ZEN is naturally fluorescent, the most common used detection system is HPLC-FLD although extensive clean-up is required. Excitation is done at 270-280 nm and fluorescent emission is carried out at 450-480 nm. Limits of detection (LOD) as low as 2 µg/kg can be accomplished by using HPLC-FLD [73]. Due to the development of multi-mycotoxin methods and a minimized need for sample clean-up, HPLC coupled to MS/MS instruments has become a fast and efficient alternative. Yet, a reliable quantification regardless of matrix effects requires isotopically labeled standards. For this reason, a deuterated ZEN standard has been published [74] and U-[<sup>13</sup>C<sub>18</sub>]-ZEN is commercially available. LODs below 1 µg/kg can be achieved by HPLC-MS/MS detection [75].

## 1.9. Aims of the thesis

### 1.9.1. Superior objectives

As briefly outlined in the introduction, distinct challenges remain the analysis of ZEN in edible oils and the scarce data basis on *cis*-ZEN in general. Therefore, this thesis follows four key aims:

- 1) advance in the methodology that is used on ZEN in edible oils
- 2) investigate the formation and occurrence of *cis*-ZEN
- 3) explore the metabolism of *cis*-ZEN in comparison to ZEN
- 4) assess the toxicity of ZEN, *cis*-ZEN and their biotransformation products

The key aims will be elaborated in the following paragraphs.

### 1.9.2. Advances in the methodology on ZEN in edible oil (aim 1)

Two issues align in the case of ZEN in edible oil: a problematic matrix/analyte combination and a maximum level in force which requires reliable monitoring. As a consequence, the European Commission recently appointed the European Committee for Standardization (CEN) to develop and validate a method for implementation as a European standard [71]. This process emphasizes the relevance of ZEN in edible oils as well as the need for a thorough evaluation of current methods.

Thus, the first objective was to evaluate quantitative state-of-the-art methods for ZEN in edible oils according to established EU performance criteria and sample handling characteristics. Besides an appropriate manual method, an automated method should be ideally available to monitor the current maximum level. Therefore, a second objective was to develop an automated system for the

determination of ZEN in edible oil with the previous method comparison being a substantial basis for the selection of the most automatization suitable method.

### **1.9.3. Formation and occurrence of *cis*-ZEN (aim 2)**

At present, knowledge on *cis*-ZEN is very scarce which is due to missing analytical standards and, consequently, missing analytical methods. Therefore, the synthesis of authentic standards (i. e. native and isotopically labeled compounds) was pursued in a first step. The authentic standards should then be implemented in existing analytical methods for ZEN to finally investigate the occurrence and formation of *cis*-ZEN. As no reports on the occurrence of *cis*-ZEN in edible oil are available, edible oil was chosen as a matrix.

### **1.9.4. Metabolism of *cis*-ZEN in comparison to ZEN (aim 3)**

As *cis*-ZEN has previously been reported to contaminate sugar beets, ground corn and wet animal feed [16-18] it may also be subjected to metabolic processes upon ingestion. Thus, investigations on the metabolism of *cis*-ZEN were pursued with a focus on the phase I metabolism in rat and human liver microsomes. Furthermore, comparisons to the *trans*-isomer should be drawn. The authentic standards obtained in “aim 2” will be an essential prerequisite for qualitative and quantitative metabolism investigations.

### **1.9.5. Toxicity of ZEN, *cis*-ZEN and their biotransformation products (aim 4)**

Studies on ZEN have revealed that metabolic activation and deactivation can take place which may also be the case for *cis*-ZEN. Thus, it is essential to investigate the toxicity of possible novel metabolites. Because ZEN is predominantly associated with estrogenic effects, the specific aim is targeted towards the assessment of the estrogenicity. Therefore, a frequently used *in vitro* model, the E-Screen assay, should be established in order to detect the estrogenic capacity of novel metabolites.

## 2. Results and discussion

### 2.1. Comparison of analytical methods for the determination of zearalenone in edible oils

Sarah S. Drzymala<sup>a</sup>, Martin Penkert<sup>b</sup>, Leif-Alexander Garbe<sup>c</sup>, Matthias Koch<sup>a</sup>  
**Food Additives and Contaminants, 2015**

*Final manuscript*

<sup>a</sup>*BAM Federal Institute for Materials Research and Testing, Richard-Willstätter-Str. 11, 12489 Berlin, Germany. E-mail:matthias.koch@bam.de; Tel.: +49 30 8104 1170*

<sup>b</sup>*Humboldt-Universität zu Berlin, Brook-Taylor-Str. 2, 12489 Berlin, Germany*

<sup>c</sup>*Technische Universität Berlin, Ackerstr. 76, 13355 Berlin, Germany*

#### 2.1.1. Abstract

Reliable analytical methods are needed for the determination of the *Fusarium* mycotoxin zearalenone (ZEN) in edible oils to control maximum levels in force. Therefore, five currently existing methods based on HPLC-fluorescence detection were compared in this study: liquid-liquid extraction (LLE), gel permeation chromatography in combination with immunoaffinity chromatography (GPC-IAC), dynamic covalent hydrazine chemistry (DCHC) in two different modifications (batch and column technique) and molecularly imprinted polymers (MIPs). A total of six well characterized oil samples including refined and virgin, spiked and naturally contaminated maize germ oils were investigated. The ZEN contents were assigned by a reference method on high metrological level consisting of stable isotope dilution assay (SIDA) HPLC-MS/MS. Method comparison was done considering performance criteria regarding precision (repeatability  $RSD_r$ ) and recovery laid down in the European Commission Regulation 401/2006. Furthermore, selectivity, sensitivity and sample handling were evaluated.  $RSD_r$  values of all tested methods did not exceed 13 % which is well below the allowed maximum of 25 %. Only three methods (GPC-IAC,

DCHC-batch and DCHC-column) invariably fulfilled the requested recovery values of EC 401/2006 (70-120 %). While the MIP method yielded recovery values constantly below 70 %, LLE showed acceptable recoveries only for refined maize oils. Due to its lacking selectivity LLE seems not to be applicable for virgin maize oils. GPC-IAC, the most selective method on one hand is otherwise the most demanding procedure in terms of cost and time efficiency. Taking into account all performance criteria the best alternative is the recently developed DCHC technique.

### 2.1.2. Introduction

Zearalenone (ZEN, (3*S*,11*E*)-14,16-dihydroxy-3-methyl-3,4,5,6,9,10-hexahydro-1*H*-2-benzoxacyclotetradecine-1,7(8*H*)-dione, Figure 3) is an estrogenic mycotoxin that contaminates food and feed worldwide. It is produced by several common soil fungi including *F. graminearum* (*Gibberella zea*), *F. culmorum* and *F. equiseti* [10]. ZEN is frequently associated with reproductive disorders in animals and possibly humans [25, 59, 76, 77]. Furthermore, ZEN was shown to possess hepatotoxic, haematotoxic, immunotoxic, genotoxic and carcinogenic effects in animal studies [24]. According to the European Food Safety Authority (EFSA), a tolerable daily intake of ZEN for humans is 0.25 µg/kg bw [25].

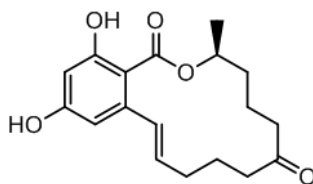


Figure 3. Structure of ZEN.

A variety of relevant crops and products thereof can be contaminated by ZEN including barley, oats, wheat, sorghum, rice and maize [66, 78]. Especially maize germ oils might provide a significant source of ZEN as recent findings suggest [67, 79]. The EFSA stated that vegetable oils make “an important contribution to the zearalenone exposure” in their 2011 evaluation on the risks of ZEN [25].

A maximum level of 400 µg/kg ZEN in refined maize germ oil applies in the European Union (EU) at present [26]. Yet, no official method is available for the determination. As a consequence, the EU commission appointed the European Committee for Standardization (CEN) with mandate M/520 to develop and validate a method for implementation as a European standard [71]. The targeted method shall be applicable for vegetable oils including refined maize oils.

Different techniques have been proposed for the determination of ZEN in edible oil including liquid-liquid extraction (LLE) with fluorescence detection (FLD) [68], gel permeation chromatography in combination with immunoaffinity chromatography (GPC-IAC) followed by FL detection or GPC with direct MS/MS detection [69] and dynamic covalent hydrazine chemistry (DCHC) with FL or MS/MS detection [70]. In order to simplify the latter technique (DCHC-batch) ready-to-use cartridges (DCHC-column) accompanied by a modified DCHC-method were developed at BAM in the framework of a joint research project [80]. Recently, molecularly imprinted polymers (MIPs) prepared for ZEN determination in edible oils have been introduced to the market. However, no application of MIPs has been reported in scientific journals up to date.

The natural fluorescence of ZEN allows the application of a FLD thus benefiting from the specificity, wide availability and low acquisition and maintenance costs of this detector. Nevertheless, this study employs stable isotope dilution assay (SIDA) LC-MS/MS as reference method because it is claimed as primary ratio method on high metrological level [81]. Due to high costs regarding the instrument as well as required isotope standards SIDA-HPLC-MS/MS is currently not considered as routine standard method in view of mandate M/520.

Thus, this work is aimed to present a comparative study on currently existing methods with FL detection for the determination of ZEN in edible oils. The methods are discussed with respect to official EU performance criteria which are laid down in European Commission Regulation 401/2006 [82].

### 2.1.3. Material and methods

#### Chemical reagents

Certified solutions of ZEN ( $100.4 \pm 0.6 \mu\text{g/mL}$ ) were used for spiking of maize germ oils and for the preparation of calibration standards in order to quantify ZEN in edible oil samples. A certified solution of U- $^{13}\text{C}_{18}$ -ZEN ( $25.1 \pm 0.7 \mu\text{g/mL}$ ) was obtained from Romer Labs (Tulln, Austria). Deionized water was supplied by a Seralpur PRO 90CN (Ransbach-Baumbach, Germany). All standard chemicals were of p. a. grade and all solvents HPLC grade. The term HPLC eluent refers to a freshly prepared mixture of acetonitrile:water 30:70 (v/v) containing 0.1 % formic acid.

#### Samples

A total of six maize germ oils were included in the study (Table 2): Three spiked oils and three naturally contaminated oils including one being the provisionally certified reference material ERM<sup>®</sup>-BC715.

Spiking was done by weighing different amounts of a certified ZEN solution into Erlenmeyer flasks. After removal of the solvent (acetonitrile) a blank maize germ oil was added gravimetrically to obtain  $50 \mu\text{g/kg}$ ,  $275 \mu\text{g/kg}$  and  $500 \mu\text{g/kg}$  ZEN contaminated edible oils. The Erlenmeyer flasks were ultrasonicated for 30 min to redissolve ZEN completely. All maize germ oil samples were stored tightly closed at  $4 \text{ }^\circ\text{C}$  in a dark place until further use.



Table 2. Maize germ oil samples included in the method comparison study and ZEN-content determined by SIDA-HPLC-MS/MS (n = 4).

Oil sample	Production	ZEN contamination	$\omega_{ZEN}$ ( $\mu\text{g}/\text{kg}$ )
ERM <sup>®</sup> -BC715	Refined	Natural	362 $\pm$ 6
S1	Refined	Spiked	50 $\pm$ 3
S2	Refined	Spiked	276 $\pm$ 2
S3	Refined	Spiked	504 $\pm$ 9
N1	Virgin	Natural	124 $\pm$ 8
N2	Refined	Natural	214 $\pm$ 3

## Analytical methods

### *GPC-IAC according to Kappenstein [69]*

4 g of the oil sample were weighed into a 25 mL volumetric flask and filled to the mark with the GPC mobile phase cyclohexane:ethyl acetate 1:1 (v/v). The solution was transferred to a GPC vial and 4 mL were injected into the automated GPC system (GPC VARIO II, LCTech, Dorfen, Germany) equipped with an autosampler, a fraction collector and a S-X3 Bio-Beads gel permeation column (500 mm x 40 mm, 50 g, 200-400 mesh). A flow of 5 mL/min was applied. The lipid containing first fraction of 125 mL was discarded. The following fraction of 60 mL was collected and evaporated to dryness in a vacuum centrifuge (Martin Christ Gefriertrocknungsanlagen, Osterode, Germany). The residue was dissolved in 1 mL methanol, diluted with 10 mL phosphate buffered saline (PBS, c = 0.1 M) and subjected to IAC ZearaStar columns (Romer Labs, Tulln, Austria). After slow elution the columns were washed with 2.5 mL PBS buffer twice. The residual buffer was removed by applying gentle vacuum. Elution of ZEN was achieved by applying 7.5 mL methanol to the column (three times 2.5 mL). The eluate was collected and evaporated to dryness at 50 °C in a gentle stream of nitrogen. The residue was redissolved in 1 mL of HPLC eluent.

### *Molecularly imprinted polymers (MIPs)*

AFFINIMIP® SPE Zearalenone cartridges (Polyintell, Val-de-Reuil, France) were employed for sample preparation. Before loading of the oil sample the cartridges were equilibrated with 3 mL cyclohexane. Then, 1 g of the oil sample was mixed with 2 mL cyclohexane and passed through the cartridge. The edible oil matrix is removed by washing twice with 3 mL of cyclohexane. After the cartridge has been dried under vacuum for 5 min it is washed again by addition of 3 mL of a acetonitrile:acetic acid:water mixture (40:2:58, v/v/v). ZEN is eluted by passing 3 mL methanol:acetic acid 98:2 (v/v) through the cartridge twice. The eluent is collected and evaporated to dryness at 50 °C. The residue was redissolved in 1 mL of HPLC eluent.

### *Dynamic covalent hydrazine chemistry (DCHC-batch) according to Siegel et al. [70]*

Prior to sample preparation the hydrazine functionalized polymer particles derived from Sigma-Aldrich (particle size 200-595 µm, Steinheim, Germany) were activated according to [70] by applying a solution of methanol:0.4 M HCl 90:10 (v/v).

For sample preparation 0.2 mL of the oil were added to a 2 mL reaction tube containing  $100 \pm 2$  mg of the activated polymer resin. After addition of 0.8 mL methanol, the reaction tube was shaken on a horizontal shaker at 400 rpm for 2 h. Then, the supernatant was taken off with a syringe and discarded. The oil matrix was removed by consecutive washing with methanol and *n*-heptane and dried in a gentle stream of nitrogen. A freshly prepared mixture of acetone:0.13 M HCl 70:30 (v/v) was added and the reaction tube is shaken for 2 h on a horizontal shaker at 400 rpm. The supernatant was taken off and directly filtered through a 4 mm syringe filter (pore size 0.2 µm, filter material: regenerated cellulose, Phenomenex®, Aschaffenburg, Germany) into a 1.5 mL HPLC vial with microinsert. The used resin was discarded but can generally be recycled up to three times.

*Modified DCHC-column procedure (DCHC-column)*

PP/PE-cartridges (volume: 1 mL, Chromabond®, Macherey-Nagel, Düren, Germany) were filled with  $400 \pm 2$  mg of hydrazine functionalized silica (particle size 40-63  $\mu\text{m}$ ) which were activated according to [70] before cartridge filling. 1 mL of the oil sample was mixed with 9 mL *n*-heptane acidified with 0.1 % acetic acid and passed through the cartridges by approximately 1 drop  $\text{s}^{-1}$ . Remaining oil matrix was removed by washing with 3 mL *n*-heptane, ethyl acetate and methanol, respectively. Successive elution of ZEN was achieved by pouring a freshly prepared solution of acetone:0.4 M HCl 95:5 (v/v) onto the column. The solution was kept in the column for 30 min before the drop speed was adjusted to 1 drop  $\text{s}^{-1}$ . The acetone solution was collected and evaporated to dryness at 50 °C. The residue was redissolved in 1 mL of HPLC eluent.

*Liquid-liquid extraction (LLE) according to Majerus et al. [68]*

2 g of the oil sample were added to 2 mL *n*-hexane in a 50 mL polypropylene centrifuge tube. ZEN was extracted from the oil/hexane mixture with 20 mL of an alkaline methanol solution (pH 9) containing 10 % of an aqueous 10 g/L ammonium hydrogen carbonate solution (v/v) for 30 min on a horizontal shaker IKA HS 501 digital (Staufen, Germany). After centrifugation at  $3,000 \times g$  for 10 min 5 mL of the upper alkaline methanol phase were transferred to a new reaction tube and evaporated to dryness at 40 °C in a nitrogen stream. The residue was redissolved in 1 mL of HPLC eluent.

*Analysis and detection by HPLC-FLD*

GPC-IAC, MIP, DCHC-batch, DCHC-column and LLE were compared utilizing HPLC equipped with fluorescence detection (FLD). HPLC-FLD analyses were done using an Agilent 1200 series HPLC (Böblingen, Germany). A Gemini-NX C18 column (150 x 2 mm, 3  $\mu\text{m}$  particle size, Phenomenex®, Aschaffenburg, Germany) in combination with a corresponding guard column was used at 50 °C oven temperature. The HPLC was equipped with a diode array detector (DAD)

and a FLD detector. The following chromatographic parameters were chosen: injection volume 10  $\mu\text{L}$ , flow rate 0.3 mL/min, solvent A: water + 0.1 % (v) formic acid, solvent B: acetonitrile + 0.1 % (v) formic acid. The following run conditions were chosen: 70 % A 0-30 min, 100 % B 30.1-36 min, 70 % A 36.1-43 min (re-equilibration). DAD detection was set to  $\lambda = 274 \text{ nm}$  whereas FLD detection was done at  $\lambda_{\text{Ex}} = 274 \text{ nm}$  and  $\lambda_{\text{Em}} = 456 \text{ nm}$ .

### *Liquid-liquid extraction with stable isotope dilution analysis HPLC-MS/MS*

Stable isotope dilution analysis (SIDA) in combination with HPLC-MS/MS was used as reference method. 50  $\mu\text{L}$  of U- $^{13}\text{C}_{18}$ -ZEN ( $\omega = 3.3 \mu\text{g/g}$ ) were weighed into 15 mL reaction tubes. After evaporation to dryness, 0.5 mL of the sample were added gravimetrically and diluted with 0.5 mL *n*-hexane. ZEN was extracted from the sample by LLE with 5 mL methanol:water 9:1 (v/v) for 30 min while shaken on a horizontal shaker (300  $\text{min}^{-1}$ ). The tubes were centrifuged at  $1,378 \times g$  and 1 mL of the upper methanol layer was transferred into a HPLC vial. The solution was evaporated to dryness and redissolved in 0.4 mL of elution solvent.

HPLC-MS/MS analyses were performed on an Agilent 1200 series HPLC hyphenated to an API 4000 QTRAP<sup>®</sup> hybrid mass spectrometer (AB Sciex, Foster City, USA). A Gemini-NX C18 column (150 x 2 mm, 3  $\mu\text{m}$  particle size, Phenomenex<sup>®</sup>) was used for separation in combination with a corresponding guard column. Chromatographic conditions were as follows: oven temperature 50  $^{\circ}\text{C}$ , injection volume 10  $\mu\text{L}$ , flow rate 0.3 mL/min, solvent A: water + 0.1 % (v) formic acid, solvent B: acetonitrile + 0.1 % (v) formic acid. The following run conditions were chosen: 62 % A 0-15 min, 95 % B 15.1-19 min, 62 % A 19.1-27 min (re-equilibration).

The mass spectrometer was operated in MRM mode with ESI (negative) detection. For native ZEN the monitored transitions were ( $m/z$ ) 317.1  $\rightarrow$  131.1 (quantifier), 317.1  $\rightarrow$  175.0 (qualifier). For the U- $^{13}\text{C}_{18}$ -ZEN ( $m/z$ ) 335.2  $\rightarrow$  140.2 was monitored.

The following ion source parameters were used: ion spray voltage: -4,000 V; desolvation temperature: 500  $^{\circ}\text{C}$ ; ion source gas 1: 50 arbitrary units (a. u.); ion

source gas 2: 50 a. u.; curtain gas: 20 a. u.. The optimized MRM compound specific parameters were (quantifier/qualifier/U-[<sup>13</sup>C<sub>18</sub>]-ZEN): declustering potential: -80/-80/-80 V; entrance potential: -10/-10/-10 V; collision energy: -42/-40/-42 V; collision cell exit potential: -13/-13/-7 V; dwell time: 50/50/50 ms.

Data acquisition was done using Analyst 1.5.2 software (AB Sciex, Foster City, USA).

### *Calibration and quantification*

External six-point calibration curves were obtained on the day of analysis by weighing variable amounts of the certified ZEN solution in the range of 20-600 µg/kg. For SIDA-HPLC-MS/MS constant amounts of U-[<sup>13</sup>C<sub>18</sub>]-ZEN (60 µg/kg final content) were added as well. The acetonitrile was removed by a gentle nitrogen stream and elution solvent was added gravimetrically. Each calibration level was analyzed in duplicate.

### *Validation data*

ZEN-recoveries from the six oil samples were determined for each methodology in relation to the SIDA-HPLC-MS/MS results (assigned values). Precision data (repeatability) was assessed by calculating the relative standard deviation (RSD<sub>r</sub>) obtained from four independent sample preparations for each oil sample.

## **2.1.4. Results and discussion**

### **General considerations**

Although a maximum level of 400 µg/kg ZEN in refined maize oil currently applies in the EU there is no official reference method for the analysis. In the light

of the call for tender (mandate M/520) issued by CEN, the focus of the present study is to compare five different sample preparation methods for ZEN in edible oil.

The selected methods include LLE as suggested by Majerus *et al.* [68], GPC-IAC as reported by Kappenstein *et al.* [69], DCHC-batch as proposed by Siegel *et al.* [70], an advanced DCHC-procedure using columns packed with hydrazine functionalized particles and MIPs which recently became commercially available.

### Recovery and precision

Recoveries and relative standard deviations from the results generated under repeatability conditions ( $RSD_r$ ) were determined for all investigated methods (Table 3). The mean recoveries including lowest and highest value are displayed in Figure 4. Therefore, the contents of ZEN as analyzed by SIDA-HPLC-MS/MS were set to 100 % and the recoveries of all other methods were determined relative to the SIDA-HPLC-MS/MS results. The suitability of this reference method was demonstrated by the analysis of the reference material ERM<sup>®</sup>-BC715 characterized in an interlaboratory comparison study (ILC) with 14 participants. The ZEN-content measured by SIDA-HPLC-MS/MS is in perfect agreement with the provisionally certified ZEN-content of  $362 \pm 18 \mu\text{g}/\text{kg}$  as result of the ILC.

According to the European Commission Regulation 401/2006 analytical procedures for official control of the ZEN maximum level should provide recoveries in the range of 70-120 % above  $50 \mu\text{g}/\text{kg}$  and 60-120 % below [82]. The official demands for recovery values are fulfilled by GPC-IAC, DCHC-batch and DCHC-column. The LLE approach results in 122 % recovery for oil sample N1 which is above the upper recovery limit. Opposed to the other samples included in this study, N1 is a virgin edible oil characterized by a more complex matrix (see Section 3.3). Majerus *et al.* did not report overestimations of ZEN, however, two edible oils were analyzed for their recovery data only. Siegel *et al.* performed the LLE according to Majerus *et al.* and experienced unacceptable recoveries for 3 of 4 edible oils. In our view, the LLE approach might be problematic for maize germ oils with a more complex matrix. An overestimation

of the ZEN contamination increases the risk of false positives for the manufacturer or seller when the measured value is near the maximum limit.

Table 3. Results of ZEN determination in six oil samples using GPC-IAC, MIP, DCHC-column, DCHC-batch and LLE as sample preparation methods displayed together with the standard deviation (n=4). Recovery values are referenced to the SIDA-HPLC-MS/MS results which were set to 100 %.

Oil sample		GPC-IAC	MIP	DCHC-column	DCHC-batch	LLE
ERM <sup>®</sup> -BC715	$\omega_{\text{ZEN}}$ ( $\mu\text{g}/\text{kg}$ )	259 $\pm$ 15	155 $\pm$ 14	293 $\pm$ 2	274 $\pm$ 3	294 $\pm$ 1
	RSD <sub>r</sub> (%)	5.9	8.9	0.8	0.9	0.4
	Recovery (%)	71	43	81	76	81
S1	$\omega_{\text{ZEN}}$ ( $\mu\text{g}/\text{kg}$ )	41 $\pm$ 1	29 $\pm$ 1	41 $\pm$ 1	45 $\pm$ 2	51 $\pm$ 1
	RSD <sub>r</sub> (%)	1.7	3.2	1.9	3.8	2.8
	Recovery (%)	85	58	83	90	103
S2	$\omega_{\text{ZEN}}$ ( $\mu\text{g}/\text{kg}$ )	201 $\pm$ 4	111 $\pm$ 6	215 $\pm$ 9	209 $\pm$ 6	214 $\pm$ 2
	RSD <sub>r</sub> (%)	2.0	5.2	4.0	2.6	1.1
	Recovery (%)	73	40	78	76	77
S3	$\omega_{\text{ZEN}}$ ( $\mu\text{g}/\text{kg}$ )	364 $\pm$ 11	220 $\pm$ 13	388 $\pm$ 6	379 $\pm$ 16	412 $\pm$ 5
	RSD <sub>r</sub> (%)	3.1	6.1	1.5	4.2	1.3
	Recovery (%)	72	44	77	75	82
N1	$\omega_{\text{ZEN}}$ ( $\mu\text{g}/\text{kg}$ )	98 $\pm$ 4	44 $\pm$ 5	105 $\pm$ 2	101 $\pm$ 2	152 $\pm$ 5
	RSD <sub>r</sub> (%)	3.7	12.1	2.1	1.6	3.5
	Recovery (%)	79	35	84	80	122
N2	$\omega_{\text{ZEN}}$ ( $\mu\text{g}/\text{kg}$ )	160 $\pm$ 10	155 $\pm$ 14	181 $\pm$ 2	172 $\pm$ 5	176 $\pm$ 2
	RSD <sub>r</sub> (%)	6.3	8.9	1.1	3.1	1.1
	Recovery (%)	75	43	85	80	83

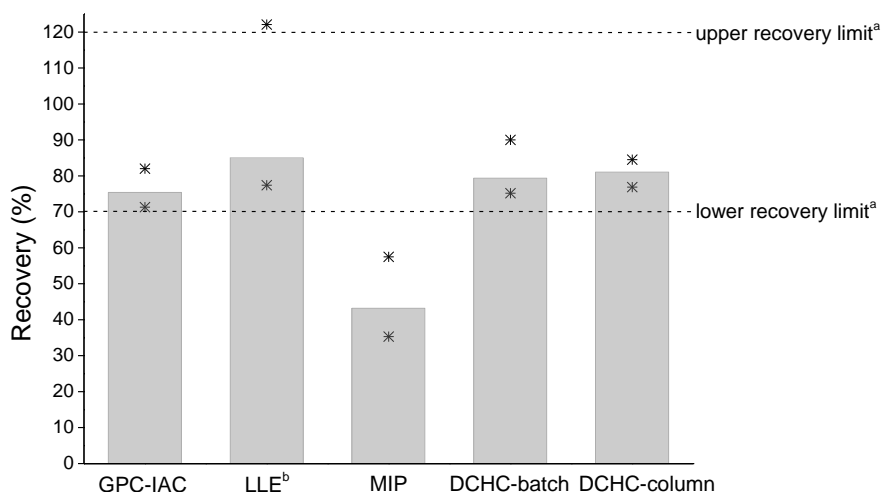


Figure 4. Mean recoveries for the five independent analytical methods including the highest and lowest value marked as asterisks.

<sup>a</sup>according to EU Commission Regulation (EC) 401/2006

<sup>b</sup>calculation of arithmetic average excluding the overestimation for N1

The MIP procedure fails to achieve an acceptable recovery for all tested oil samples. This result is obviously caused by a 35 – 40 % loss of ZEN in the second washing step where according to the protocol an acetonitrile:acetic acid:water mixture 40:2:58 (v/v/v) is applied. Thus, the manufacturer's protocol stating a recovery of 99.3 % for ZEN in edible oils could not be confirmed. If the retention of ZEN is due to hydrogen bonds between the phenolic hydroxyl groups and alkaline moieties of the MIP, the presence of water in organic solvent is capable to break these hydrogen bonds. Lucci *et al.* reported ZEN to be released from the MIP-column using acetonitrile:water 75:25 (v/v) [63]. In contrast, ZEN was retained when acetonitrile or a mixture of acetonitrile/methanol 93:7 (v/v) was applied. Thus, an optimization of manufacturer's washing mixture could yield great improvements.

Commission Regulation 401/2006 specifies the  $RSD_r$  to be  $\leq 25\%$  above a ZEN content of  $50\ \mu\text{g}/\text{kg}$  and  $\leq 40\%$  below which is met by all methods investigated in this study. In a descending order the mean  $RSD_r$  obtained are 6.9 % for MIP, 3.8 % for GPC-IAC, 2.7 % for DCHC-batch, 1.9 % for DCHC-column and 1.7 % for LLE ( $n = 24$  for each method). Regarding both DCHC procedures DCHC-column shows a slightly better precision in terms of the mean  $RSD_r$  which is



probably due to the easier handling of the columns compared to the manual handling of the particles in DCHC-batch.

In summary it can be stated that the investigated methods are adequately precise, yet, LLE and MIP do not comply with the recovery criteria for ZEN analysis as set by the European Commission Regulation 401/2006.

### Selectivity and sensitivity

A qualitative comparison of chromatograms obtained after applying the different methodologies is shown in Figure 5 and Figure 6 for oil samples S2 and N1. Regarding the refined maize germ oil sample S2, all methods show acceptable chromatograms. Co-extracted matrix can be observed, in particular for LLE, but does not interfere with the elution of ZEN allowing distinctive integration of the ZEN peak for all investigated methods.

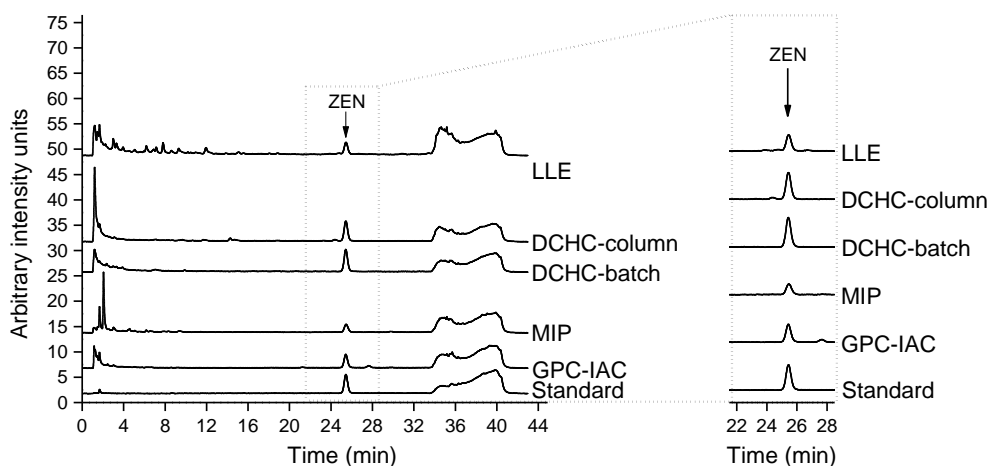


Figure 5. HPLC-FLD chromatograms of oil sample S2, a refined maize germ oil spiked with ZEN to a final content of 275  $\mu\text{g}/\text{kg}$ , as analyzed by GPC-IAC, MIP, DCHC-batch, DCHC-column and LLE. The lowest trace corresponds to a ZEN standard in elution solvent.

Stronger differences concerning the selectivity can be seen for the virgin maize germ oil sample N1 (Figure 6). In general, the refining process of vegetable oils removes or reduces turbidity compounds, pigments, free fatty acids and a significant part of aroma and flavor compounds. These compounds are retained in virgin edible oils, thus showing a more complex matrix.

Regarding LLE, a considerable amount of matrix is co-extracted as seen in the top trace in Figure 6. It should be noted that the baseline remained elevated by a factor of 2 to 3 compared to all other methods adversely affecting the limit of detection (LOD). As seen in the zoom of Figure 6, matrix co-elutes at the retention time of ZEN resulting in an over-determination of the recovery value (122 %). The matrix burden was visible to the eye as a yellowish cloudy sample solution which could not be cleared by additional membrane-filtration (0.2  $\mu\text{m}$ ) and centrifugation steps. A shorter HPLC column life can be expected.

GPC-IAC shows the highest level of selectivity compared to the other methods owed to the clean-up step which is based on a combination of size exclusion (GPC) to separate ZEN from the triglyceride matrix, and subsequently, the selective antigen-antibody interaction (IAC) to purify ZEN from the pre-cleaned extract. The MIP procedure, DCHC-batch and DCHC-column are sufficiently selective to enable correct integration of the ZEN peak. Yet, MIP has low recoveries suggesting that if ZEN recovery is optimized the matrix burden might increase as well.

Interestingly, differences in the quality of the matrix signals can be observed between both DCHC methods although both rely on the same chemical principle. The altered reactivity might be due to structural differences of the particles: DCHC-batch features a polystyrene divinylbenzene (PS-DVB) backbone while the DCHC columns are packed with a hydrazine functionalized silica.

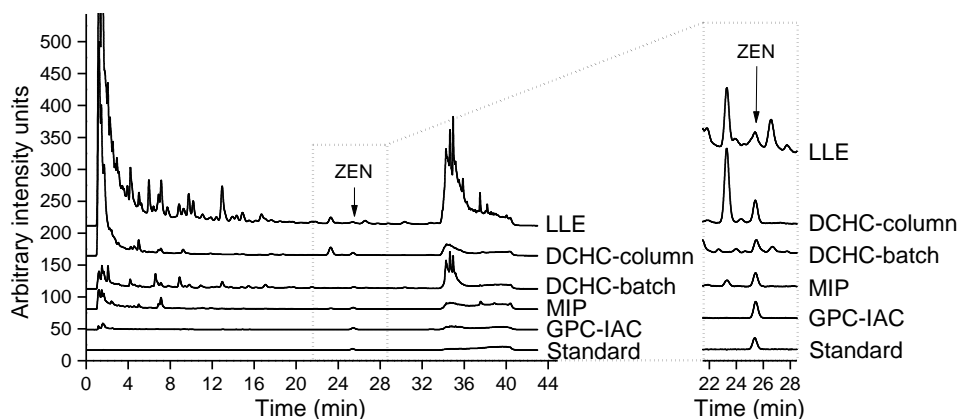


Figure 6. HPLC-FLD chromatograms of oil sample N1, a naturally ZEN contaminated virgin maize germ oil ( $\omega_{ZEN} = 124 \pm 8$  determined by LC-MS/MS), as analyzed by GPC-IAC, MIP, DCHC-batch, DCHC-column and LLE. The lowest trace corresponds to a ZEN standard in elution solvent.

In sum, all methods provided acceptable chromatograms for the analysis of ZEN in the refined maize germ oils S1, S2, S3, ERM<sup>®</sup>-BC715 and N2 as shown exemplarily by the chromatograms from oil sample S2. Difficulties were encountered for the virgin maize germ oil N1 when applying LLE due to a lack of specificity. Thus, the LLE approach might not be selective enough to accommodate for analysis of edible oils with matrices which are more complex than in refined maize oils. Regarding MIP, an optimized protocol should also be tested on virgin edible oils to evaluate a possible increase of interfering matrix components.

All sample preparation methods included in this study proved to be sensitive enough to analyze ZEN in the 50  $\mu\text{g}/\text{kg}$  range. However, the LLE and MIP approach will feature a lower sensitivity compared to the other procedures. In case of LLE the high background noise decreases the signal to noise ratio and therefore sensitivity while for the MIP procedure low recoveries increase the detection limit.

### Sample handling

The different analytical methods were further compared for certain handling characteristics (Table 4).

Table 4. Comparison of the different analytical methods regarding sample amount, approximate time required for sample preparation and organic solvent consumption per sample. If not stated otherwise numbers relate to one sample.

Sample preparation	Sample amount (g)	Price for solid sorbent (€)	Time for sample preparation and analysis (n=24) (d)	Consumption of organic solvents (mL)
GPC-IAC	4	11	4	284
LLE	2	-	1.5	20
MIP	1	7	1.5	19
DCHC-batch	0.2	6	2	12
DCHC-column	1	4	1	23

GPC-IAC requires the largest amount of sample, the longest time for sample preparation and analysis. Furthermore, the solvent consumption is about 12-24 fold higher compared to the other methods. GPC-IAC also requires a GPC system and single use IAC columns of about 11 € per column. Nevertheless, the high selectivity of the procedure can be translated into shorter chromatographic runs and thus shorter analysis times.

No special laboratory equipment is needed for LLE, MIP, DCHC-batch and DCHC-column. The MIP columns cost about 7 € per column. The columns used for the DCHC technique are not yet commercialized but a provisional price was calculated to be approximately 4 € based on 400 mg of hydrazine functionalized silica. DCHC-batch requires 100 mg of hydrazine functionalized resin per sample preparation correlated to a price of about 6 €. LLE can be considered as the cheapest method due to the fact that no solid sorbents are required.

Overall, GPC-IAC can be regarded as the most expensive and the most time consuming method. MIP, DCHC-batch, DCHC-column and LLE are comparable concerning the time needed to prepare and analyze multiple samples. In terms of cost-efficiency LLE is evaluated as the least expensive method.

### **2.1.5. Conclusion**

Five different analytical methods for the determination of ZEN in six maize germ oils based on HPLC-FL detection were tested in this study. GPC-IAC, DCHC-batch and DCHC-column unequivocally fulfill the performance criteria laid down in Commission Regulation 401/2006 on recovery and precision (repeatability,  $RSD_r$ ). GPC-IAC is the most selective method, but DCHC-batch and DCHC-column are superior to GPC-IAC concerning time effort and costs. LLE - the most affordable of the tested methods - provided adequate recovery and repeatability for refined maize oil samples but not for the virgin oil. MIPs yielded low recoveries which do not meet the EU performance criteria. Yet, the procedure is promising if the protocol can be optimized.

We conclude that reliable and cost-efficient HPLC-FLD methods are available as alternative to the accurate but expensive SIDA-HPLC-MS/MS method to quantify ZEN in edible oils. In particular, the recently developed DCHC technique based on selective solid phase extraction seems to be a promising method. To underpin its suitability further types of vegetable oils should be tested in the future.

### **2.1.6. Acknowledgements**

The authors would like to thank the Federal Ministry for Economic Affairs and Energy for funding the joint research project ZENOL (BMW, No. 01FS12033).

## 2.2. Automated solid phase extraction coupled online with HPLC-FLD for the quantification of zearalenone in edible oil

Sarah S. Drzymala<sup>a\*</sup>, Stefan Weiz<sup>b\*</sup>, Julia Heinze<sup>b</sup>, Silvia Marten<sup>b</sup>, Carsten Prinz<sup>a</sup>, Annett Zimathies<sup>a</sup>, Leif-Alexander Garbe<sup>c</sup>, Matthias Koch<sup>a</sup>

**Analytical and Bioanalytical Chemistry, 2015**

*Received December 16<sup>th</sup>, Accepted*

<sup>a</sup>*BAM Federal Institute for Materials Research and Testing, Richard-Willstätter-Str. 11, 12489 Berlin, Germany. E-mail:matthias.koch@bam.de; Tel.: +49 30 8104 1170*

<sup>b</sup>*KNAUER Wissenschaftliche Geräte GmbH, Hegauer Weg 38, 14163 Berlin, Germany*

<sup>c</sup>*Technische Universität Berlin, Ackerstr. 76, 13355 Berlin, Germany*

*\*These authors contributed equally to this project and should be considered co-first authors.*

### 2.2.1. Abstract

Established maximum levels for the mycotoxin zearalenone (ZEN) in edible oil require monitoring by reliable analytical methods. Therefore, an automated SPE-HPLC online system based on dynamic covalent hydrazone chemistry has been developed. The SPE step comprises a reversible hydrazone formation by ZEN and a hydrazone moiety covalently attached to a solid phase. Seven hydrazone materials with different properties regarding the resin backbone, pore size, particle size, specific surface area and loading have been evaluated. As a result, a hydrazone functionalized silica gel was chosen. The final automated online method was validated and applied to the analysis of three maize germ oil samples including a provisionally certified reference material. Important performance criteria for the recovery (70-120 %) and precision ( $RSD_r < 25\%$ ) as set by the Commission Regulation EC 401/2006 were fulfilled: The mean recovery was 78 % and  $RSD_r$  did not exceed 8 %. The results of the SPE-HPLC online method were further compared to results obtained by liquid-liquid extraction with stable isotope dilution analysis LC-MS/MS and found to be in good agreement. The developed SPE-HPLC online system with fluorescence detection allows a reliable, accurate

and sensitive quantification (limit of quantification: 30 µg/kg) of ZEN in edible oils while significantly reducing the workload. To our knowledge, this is the first report on an automated SPE-HPLC method based on a covalent SPE approach.

### 2.2.2. Introduction

Zearalenone (ZEN, Figure 7) is an estrogenic mycotoxin that contaminates cereal crops worldwide. Grains like wheat, barley, oats, sorghum and particularly maize are frequently contaminated. ZEN is biosynthesized by several *Fusarium* species including *F. graminearum* (*Gibberella zae*), *F. culmorum*, *F. cerealis* and *F. equiseti*. *In vitro* and *in vivo* studies demonstrate ZEN to be estrogenic, hepatotoxic, immunotoxic, and carcinogenic. Humans and animals are exposed to ZEN by ingestion of contaminated food and feed [21, 24].

Previous findings suggest that maize germ oils provide a significant source of ZEN [66, 67]. The EFSA confirmed that vegetable oils present “an important contribution to the zearalenone exposure” in an evaluation on the risks of ZEN [25]. Consequently, the European Union (EU) introduced a maximum level for ZEN in refined maize germ oil (400 µg/kg) in 2006 [26]. Although this maximum level applies, there is no standard procedure for the analysis of ZEN in edible oils available to date. Therefore, the European Committee for Standardization (CEN) issued mandate M/520 to develop and validate a method for implementation as a European standard [71].

Different strategies for the analysis of ZEN in edible oils have been proposed. Regarding sample preparation liquid-liquid partitioning [67, 68, 79], gel permeation chromatography, immunoaffinity clean-up [69] and dynamic covalent hydrazine chemistry (DCHC) [70] have been applied. A recent method comparison evaluated DCHC with fluorescence (FL) detection to be the best alternative among the proposed methods taking into account performance criteria as required by the EU and cost efficiency [5].

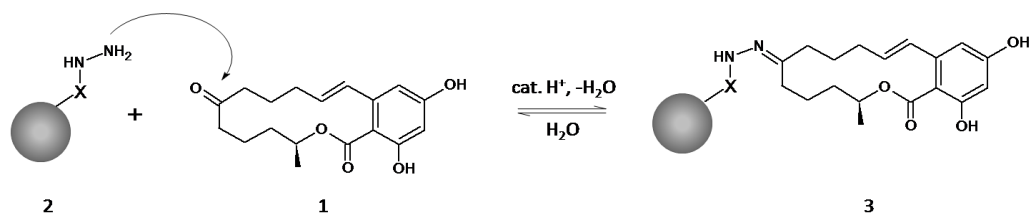


Figure 7. ZEN (1) and a hydrazine moiety (2) bound to a solid phase reversibly form a ZEN hydrazone (3).

DCHC represents a solid phase extraction (SPE) which retains the analyte based on the formation of covalent bonds rather than unspecific physisorption. ZEN contains an isolated keto group at C7 that readily reacts with hydrazine groups bound to a solid phase to form a ZEN hydrazone. Once ZEN is covalently bound to the solid phase, the oil matrix can be removed by several washing steps. In the last step, ZEN is released by displacement with acetone and analyzed by HPLC with FL detection.

In view of the official EU maximum level, the aim of the present study was to automate the quantification of ZEN in edible oils based on the DCHC approach. Whereas different online SPE-HPLC systems have been reported [83], this is the first study to automate a SPE based on covalent chemistry.

### 2.2.3. Materials and methods

#### Chemical reagents

Certified Biopure solutions of ZEN ( $100.4 \pm 0.6 \mu\text{g/mL}$ ) supplied by RomerLabs (Tulln, Austria) were used for spiking of maize germ oils and for the preparation of calibration standards in order to quantify ZEN in edible oil samples. A certified Biopure solution of U- $^{13}\text{C}_{18}$ -ZEN ( $25.1 \pm 0.7 \mu\text{g/mL}$ ) was obtained from Romer Labs. Deionized water was supplied by a Seralpur PRO 90CN (Ransbach-Baumbach, Germany). All standard chemicals were of p. a. grade and all solvents HPLC grade.



## Hydrazine functionalized materials

Hydrazine functionalized materials were bought from Alfa Aesar GmbH & Co KG (Karlsruhe, Germany), Biotage (Uppsala, Sweden), Sigma-Aldrich (Steinheim, Germany) and SiliCycle (Quebec City, Canada). Two materials (PS4 and PS5, Table 5) were synthesized according to the protocol of Emerson and colleagues [84]. As PS4 and PS5 were custom materials, important requirements of the online system in terms of particle size, pressure stability and capacity were taken into account.

All materials were characterized with regard to pore size, particle size, specific surface area and loading as shown in Table 5. Pore size and specific surface area were either as specified by the manufacturer or as determined by N<sub>2</sub> adsorption according to Brunauer, Emmett, and Teller (BET) on an ASAP 2010 instrument (Micromeritics, USA). Analysis of pore size and surface area was measured according to ISO 9277 and DIN 66134, respectively.

Table 5. Properties of the hydrazine functionalized materials (PS-DVB, polystyrene-divinylbenzene; SLC, silica; n.a., not analyzed).

Code	Solid phase	Pore diameter (nm)	Particle diameter ( $\mu\text{m}$ )	Specific surface area ( $\text{m}^2/\text{g}$ )	Hydrazine loading ( $\text{mmol}/\text{g}$ )
SLC1	Silica	6	40-63	248	0.8
SLC2	Silica	5	60	402	0.6 – 1.1
PS1	PS-DVB	3 - 6	200-595	29	1.5 – 3.0
PS2	PS-DVB	n. a.	75-150	n. a.	1.8 - 3.2
PS3	PS-DVB	n. a.	37-74	n. a.	1.8 – 2.2
PS4	PS-DVB	10	5-20	256	2.0 – 8.0
PS5	PS-DVB	100	5-20	217	1.0 – 4.0

### Edible oil samples

The developed SPE-HPLC online system was applied to the analysis of three refined maize germ oils: Two spiked oils (A and B) and the naturally contaminated provisionally certified reference material ERM<sup>®</sup>-BC715 (ERM) produced at BAM.

Spiking was done by weighing different amounts of a certified ZEN solution into Erlenmeyer flasks. After removal of the solvent (acetonitrile) a blank maize germ oil was added gravimetrically to obtain 100 µg/kg (oil A) and 602 µg/kg (oil B) ZEN contaminated edible oils. The Erlenmeyer flasks were ultrasonicated for 30 min to re-dissolve ZEN completely.

The provisionally certified reference material ERM<sup>®</sup>-BC715 was determined to contain  $362 \pm 18$  µg/kg in an interlaboratory comparison study with 14 participants. All maize germ oil samples were stored tightly closed at 4 °C in a dark place until further use.

### Kinetic experiments

Prior to the kinetic experiments all materials were activated. For this purpose 1.5 g of resin were weighed into 15 mL reaction tubes. The resin was shaken twice for 30 min in a fresh solution of 10 mL MeOH:0.4 M HCl 90:10 (v/v). The supernatant was discarded and the resin was washed with 15 mL methanol and diethyl ether. Finally, the resin was dried under a gentle stream of nitrogen.

The kinetic properties of the different hydrazine functionalized materials were tested manually in 2 mL reaction tubes to assess the suitability for the online process.  $100 \pm 2$  mg of functionalized, pre-treated material were weighed into the reaction tube. 1 mL of a solution of ZEN ( $c = 2$  mg/L) was added and the reaction tubes were shaken. Only PS2 required 5 % THF in order to swell the resin and make the pores accessible to ZEN. After  $t = 0, 5, 15, 30, 45, 60$  and 120 min, 20 µL of the supernatant were taken and transferred to a HPLC Vial to investigate the coupling process.

For investigation of the decoupling process, no supernatant was taken off during 120 min of coupling. Then, the supernatant was taken off and discarded. 1.6 mL methanol were added and the reaction tubes were vortexed for 10 s on a IKA Lab Dancer vortex (IKA, Staufen, Germany). After removal of the methanol, the resin was dried in a gentle nitrogen stream. 1 mL of a freshly prepared mixture of acetone:0.13 M HCL 70:30 (v/v) were added. The mixture was shaken and at  $t = 0, 5, 15, 30, 45, 60, 90$  and 120 min 20  $\mu\text{L}$  of supernatant were transferred to a vial for HPLC injection. Five-point calibration curves in the respective injection solvent were constructed to analyze the coupling and decoupling procedure. In order to calculate coupling rate constants, linear least squares regression of the term  $\ln(A/A_0) = -k \times t$  was performed with  $t$  being the incubation time (min),  $A$  the peak area and  $A_0$  the peak area at  $t = 0$  min.

Instrumental analysis was done on an Agilent 1200 series HPLC. A Eurospher II 100-3 C18 P column (150 x 2 mm, 3  $\mu\text{m}$  particle size; Knauer, Berlin, Germany) was used with a flow rate of 0.25 mL/min and an oven temperature of 50 °C. The mobile phase consisted of water with 0.1 % formic acid (A) and acetonitrile containing 0.1 % formic acid (B). An isocratic program was used starting at 62 % mobile phase A and 38 % mobile phase B. HPLC-FLD runtime was 15 minutes per sample and the injection volume was set to 10  $\mu\text{L}$ .

### **Online SPE-HPLC instrumentation**

The online SPE model consists of multiple modules from Knauer: an autosampler Optimas, two AZURA Assistants with three high pressure 6-Port/3-channel valves, one multiposition valve for eluent selection and one feed pump (P 4.1S). The three 6-port/3-channel valves enable (1) the pumping at circular flow, (2) the switch of the hydrazine cartridge in the flow or not and (3) the switch of the trapping cartridge between online SPE model or HPLC.

The 100 x 3 mm covalent SPE cartridge (further referred to as “hydrazine cartridge”) was filled with silica gel SLC1 and the 30 x 3 mm trapping cartridge was packed with 3  $\mu\text{m}$  Knauer Eurospher-II 100-3 C18P (“trapping cartridge”). The analytical HPLC was a PLATINblue system equipped with two P-1 pumps, a T1 column thermostat and a FLD RF-20Axs (Shimadzu, Kyoto, Japan). The

column oven which holds the analytical column, hydrazine and trapping cartridge was heated to 40 °C. As analytical column a Eurospher-II 100-3 C18P column, 150 x 3 mm, 3 µm particle size, utilized with the respective pre-column was applied.

### Online SPE-HPLC-FLD procedure

The online SPE-HPLC was performed as described in Table 6. Prior to injection the edible oil samples were diluted to a concentration of 0.72 to 0.74 g/mL with *n*-heptane in a 2 mL volumetric flask.

Table 6. Sequential steps of one SPE-HPLC online run. It should be noted that after the sample is eluted onto the analytical column (step 4) the hydrazine cartridge can be recycled in parallel.

Step	Description	Time (min)	Flow rate (mL/min)
1	Hydrazine cartridge conditioning with methanol:acetic acid 95:5 (v/v), injection of sample and coupling of ZEN by circulatory pumping	60	0.750
2a	Wash hydrazine cartridge with 2-propanol	8	1.000
2b	Flush system down to 15 % acetonitrile with 0.01 % acetic acid	12	0.750
3	Release of ZEN by switching to 20% acetone with 0.01 % acetic acid	40	0.075
4	Elute ZEN from hydrazine cartridge onto trapping cartridge and wash out acetone with 15 % acetonitrile with 0.01 % acetic acid	10	0.750
5	Focussed elution of ZEN onto analytical column/ parallel regeneration of hydrazine cartridge using methanol:acetic acid 95:5 (v/v)	20/ 120	0.750

The analytical HPLC employed the following parameters: flow rate 0.7 mL/min, solvent A: water, solvent B: acetonitrile. A linear gradient program is applied which starts at 70 % solvent A to 40 % solvent A at 20 min. Then the system is cleaned with 100 % B and re-equilibrated. FL detection was done at  $\lambda_{\text{EX}} = 276 \text{ nm}$

and  $\lambda_{Em} = 456$  nm. An external ten-point calibration was recorded after preparing different amounts of ZEN in water:acetonitrile 85:15 (v/v) ranging from 10 to 1,000  $\mu\text{g}/\text{kg}$  ( $R^2 = 0.999$ ).

### Validation parameters

The limit of detection (LOD) was determined as a signal to noise ratio of 3:1 and the limit of quantification (LOQ) was determined as a signal to noise ratio of 10:1. Calculation of the recovery was done according to the formula  $\omega_{\text{edible oil}}/\omega_{\text{known value}} \times 100$ . Regarding selectivity of the automated SPE-HPLC online coupling, interpretation of the chromatograms, i.e. presence/absence of interfering compounds was conducted visually.

### Reference method LC-MS/MS

Liquid-liquid extraction (LLE) with subsequent stable isotope dilution analysis (SIDA) in combination with HPLC-MS/MS was used as reference method. Therefore, 50  $\mu\text{L}$  of U- $^{13}\text{C}_{18}$ -ZEN ( $\omega = 3.3$   $\mu\text{g}/\text{g}$ ) were weighed into 15 mL reaction tubes. After evaporation to dryness, 0.5 mL of the sample were added gravimetrically and diluted with 0.5 mL *n*-hexane. ZEN was extracted from the sample by LLE with 5 mL methanol:water 9:1 (v/v) for 30 min while shaken on a horizontal shaker (300  $\text{min}^{-1}$ ). The tubes were centrifuged at 1,378 *g* and 1 mL of the upper aqueous (methanol) layer was transferred into an HPLC vial. The solution was evaporated to dryness and re-dissolved in 0.4 mL of elution solvent.

HPLC-MS/MS analyses were performed on an Agilent 1200 series HPLC hyphenated to an API 4000 QTRAP<sup>®</sup> hybrid mass spectrometer (AB Sciex, Foster City, USA). A Gemini-NX C18 column (150 x 2 mm, 3  $\mu\text{m}$  particle size, Phenomenex<sup>®</sup>) was used for separation in combination with a corresponding guard column. Chromatographic conditions were as follows: oven temperature 50  $^{\circ}\text{C}$ , injection volume 10  $\mu\text{L}$ , flow rate 0.3 mL/min, solvent A: water + 0.1 % (v) formic acid, solvent B: acetonitrile + 0.1 % (v) formic acid. The following run conditions were chosen: 62 % A 0-15 min, 95 % B 15.1-19 min, 62 % A 19.1-27 min (re-equilibration).

The mass spectrometer was operated in MRM mode with ESI (negative) detection. For native ZEN the monitored transitions were ( $m/z$ ) 317.1  $\rightarrow$  131.1 (quantifier), 317.1  $\rightarrow$  175.0 (qualifier). For the U- $^{13}\text{C}_{18}$ -ZEN ( $m/z$ ) 335.2  $\rightarrow$  140.2 was monitored.

The following ion source parameters were used: ion spray voltage: -4,000 V; desolvation temperature: 500 °C; ion source gas 1: 50 arbitrary units (a. u.); ion source gas 2: 50 a. u.; curtain gas: 20 a. u.. The optimized MRM compound specific parameters were (quantifier/qualifier/U- $^{13}\text{C}_{18}$ -ZEN): declustering potential: -80/-80/-80 V; entrance potential: -10/-10/-10 V; collision energy: -42/-40/-42 V; collision cell exit potential: -13/-13/-7 V; dwell time: 50/50/50 ms. Data acquisition was done using Analyst 1.5.2 software (AB Sciex, Foster City, USA).

Six-point calibration curves were obtained by weighing variable amounts of native ZEN in the range of 70-1,000  $\mu\text{g}/\text{kg}$  edible oil and a constant amount of 60  $\mu\text{g}/\text{kg}$  final content for U- $^{13}\text{C}_{18}$ -ZEN ( $R^2 = 0.997$ ). The acetonitrile was removed by a gentle nitrogen stream and elution solvent was added gravimetrically.

### 2.2.4. Results and discussion

#### Evaluation of hydrazine functionalized materials

Major challenges for the automation of the DCHC batch method arise from the reaction kinetics of the ZEN hydrazone formation and hydrolysis. According to the protocol of the manual DCHC method [70], 120 min are required for coupling of ZEN to the hydrazine moieties and 120 min for the hydrolytical release of ZEN. Therefore, seven different hydrazine materials were manually investigated for their coupling and decoupling kinetics.

Regarding coupling, a comparison of all seven materials over a 120 min time course is shown in Figure 8. As a result, five (SLC1, PS1, PS2, PS4, PS5) out of seven materials bind ZEN almost completely within 60 min which can be seen by the exponential decay curve, indicating pseudo first order kinetics. Two materials

either couple low amounts of ZEN (SLC2) or no ZEN at all (PS3). In general, polymer-bound reagents like PS3 will have most of the available hydrazine sites inside the pores. PS3 seems to exclude ZEN from its pores as no binding occurs. The addition of 5 % THF in order to promote swelling of the pores did not enhance ZEN binding for PS3.

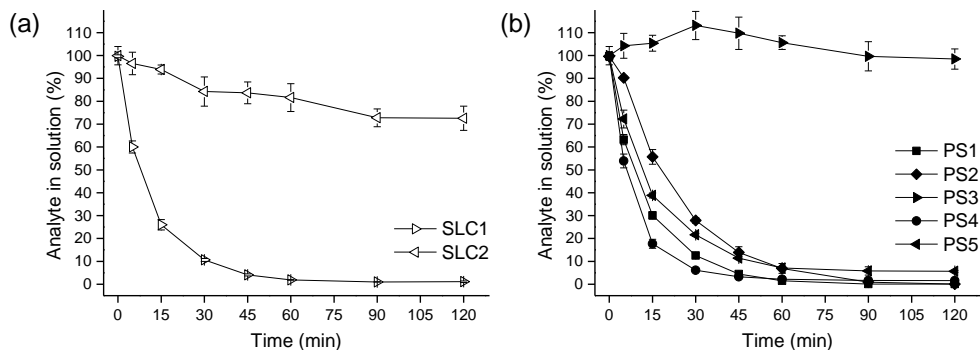


Figure 8. Time course of ZEN in the solvent supernatant upon coupling to the hydrazine functionalized silica (a) or PS-DVB (b) resins ( $n = 3$ ).

Coupling rates were calculated for the seven solid phases and summarized in Table 7. A ranking of the materials results in  $PS4 > SLC1 > PS1 > PS2 > PS5 >> SLC2 > PS3$ . Attempts to link the coupling rate to any of the material parameters from Table 5 showed no correlation.

Table 7. Coupling rate constants for the hydrazine functionalized materials included in this study ( $n = 3$ ).

Material	Coupling rate constant ( $10^{-4} \text{ min}^{-1}$ )
SLC1	$735 \pm 27$
SLC2	$35 \pm 1$
PS1	$700 \pm 17$
PS2	$429 \pm 10$
PS3	$\approx 0$
PS4	$842 \pm 60$
PS5	$323 \pm 19$

PS4 and SLC1 proved to be superior to the other materials in their coupling kinetics. Although PS4 shows the highest coupling rate constant it might bear problems in the automation since PS-DVB materials are less pressure resistant compared to silica materials. Furthermore, swelling can undesirably increase the system pressure. On the other hand silica functionalization is prone to cleavage due to acids or bases more easily. Therefore, it seemed adequate to include PS4 and SLC1 for assessing their decoupling kinetics. Figure 9 shows the decoupling of ZEN over a time course of 120 min where no significant differences between SLC1 and PS4 could be observed.

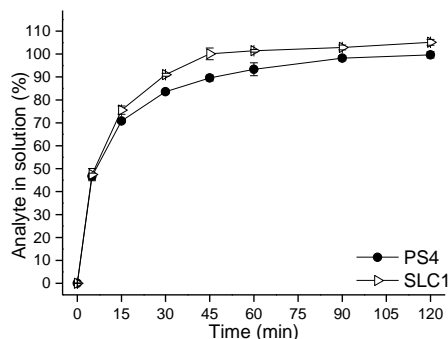


Figure 9. Time course of ZEN in the solvent supernatant upon decoupling from the hydrazine functionalized materials (n=3).

As SLC1 and PS4 display similar reaction kinetics the functionalized silica was finally selected as SPE material for the automated system based on its better suitability for automation, i.e. higher pressure stability and rigidity of the particles.

### Development of the automation setup

Due to the high viscosity of the edible oil, the first challenging step was the dilution of the sample for injection into the automated SPE-HPLC system. Apart from reducing the sample viscosity, the ZEN coupling reaction rate is the important parameter for an appropriate dilution solvent. Methanol, applied in the



manual DCHC method, was not possible due to phase separation. After testing several solvents the injection in the automated system was found to be satisfactorily using *n*-heptane as diluent for the edible oil.

Another critical aspect of the manual DCHC procedure was the use of HCl to supply the coupling reactions with catalytic protons. Due to its corrosiveness, HCl was replaced by acetic acid for the automated system. Thus, the hydrazine cartridge is activated prior to the coupling step by a mixture of methanol and acetic acid 95:5 (v/v).

Coupling and decoupling of ZEN each require about 60 min as seen in Figure 8 and Figure 9. Thus, after injection, the sample is pumped in circuit passing the activated hydrazine cartridge (Figure 10). After the coupling process, the circular flow of the sample is stopped and the by-pass valve opens to draw in 2-propanol in order to remove the oil matrix. The system is then flushed down to 15 % acetonitrile to prepare the decoupling process.

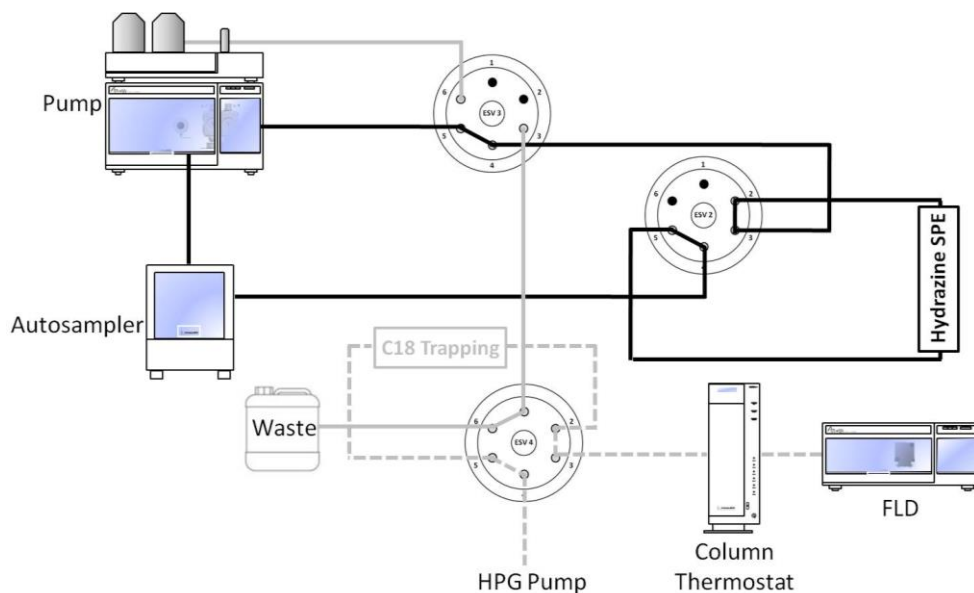


Figure 10. Principle of the automated SPE-HPLC online system in coupling mode (black line). The sample is injected and pumped in circuit for quantitative coupling of ZEN to the hydrazine functionalized groups of the hydrazine cartridge (HPG pump: high pressure gradient pump).

Decoupling is achieved by drawing in 20 % acetone which reacts with the hydrazine groups, thereby displacing and releasing ZEN. A focused elution of ZEN onto the analytical column is achieved by switching a trapping cartridge packed with octadecyl (C18) modified silica between the hydrazine cartridge and the analytical column where released ZEN will be retained (Figure 11). Prior to analytical chromatography the acetone is removed from the system to circumvent baseline problems. Finally, switching the trapping cartridge into the analytical system corresponds to the injection.

The HPLC pump begins to deliver a gradient of acetonitrile and water which ensures a chromatographic separation of ZEN from remaining matrix components. Parallel to the chromatographic analysis of the sample, the hydrazine cartridge is recycled for the next run in an HPLC independent circuit. Recycling and activation of the hydrazine cartridge are achieved in a single step by applying a mixture of methanol and acetic acid. Thereby, acetone is removed and the hydrazine moieties are converted to their corresponding acetates. One hydrazine cartridge can be reused up to 15 times without decreasing performance.

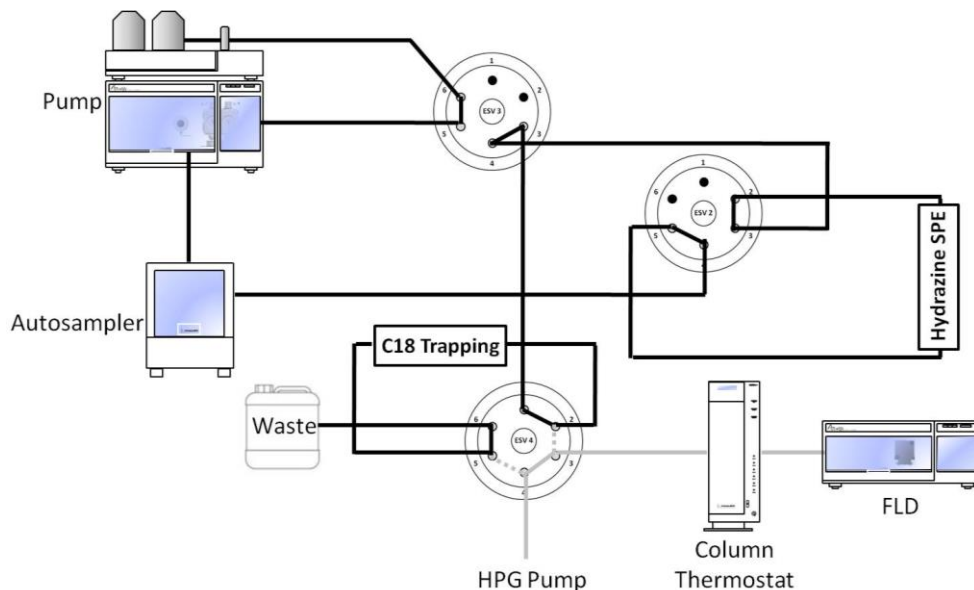


Figure 11. Principle of the automated SPE-HPLC online system in decoupling mode (black line). ZEN is displaced and released by an aqueous acetone solution to be retained on a C18 trapping cartridge for focused elution of ZEN onto the analytical column (HPG pump: high pressure gradient pump).

## Validation data

The ZEN recovery of the automated method was assessed by analyzing oil A, B and ERM<sup>®</sup>-BC715 using the online system in comparison to the known amounts. The respective recovery values were 78 %, 81 % and 74 % resulting in a mean recovery of 78 %. This average recovery is valid for refined maize germ oil over a range of 100-600 µg/kg. In Table 8 the spiked and analyzed ZEN contents of the three oil samples are summarized. According to the European Commission Regulation 401/2006, analytical procedures for official control of the ZEN maximum level should provide recovery values in the range of 70-120 % which is unequivocally met by the covalent SPE-HPLC online system. Furthermore, RSDs did not exceed 8 % which is well below 25 % as required by EC 401/2006. The mean repeatability RSD<sub>r</sub> (precision) was 4 %, being slightly higher than for the LC-MS/MS reference method (2 %). LOD and LOQ were determined to be 10 µg/kg and 30 µg/kg, respectively.

Table 8. ZEN in edible oil samples determined by automated SPE-HPLC online method and SIDA-LC-MS/MS reference method (n = 3). Oil A and B were spiked. Oil ERM is a provisionally certified European reference material with a natural ZEN content of 362 µg/kg ± 18 µg/kg as determined in an interlaboratory comparison study with 14 participants.

Edible oil	ZEN (µg/kg)	ZEN source	SPE-HPLC online method		SIDA-LC-MS/MS	
			ϖ <sub>ZEN</sub> <sup>a</sup> (µg/kg)	RSD (%)	ϖ <sub>ZEN</sub> (µg/kg)	RSD (%)
A	100	Gravimetrically spiked	100 ± 8	8	102 ± 4	4
B	602	Gravimetrically spiked	628 ± 4	1	625 ± 8	1
ERM	362 ± 18	Naturally contaminated	349 ± 6	2	362 ± 6	2

<sup>a</sup>values are corrected by the average recovery (78 %)

The covalent SPE approach proves to be of distinct selectivity as seen from the chromatograms of the three maize germ oils investigated in this study (Figure 12). Due to the general nature of the employed reaction all carbonyl group containing

compounds might react with the hydrazine moieties. Nevertheless, carbonyl groups connected to heteroatoms as in lactones or carboxylic acids show a higher electron density than isolated keto groups and will not react under the mild conditions employed for the online system [85-88].

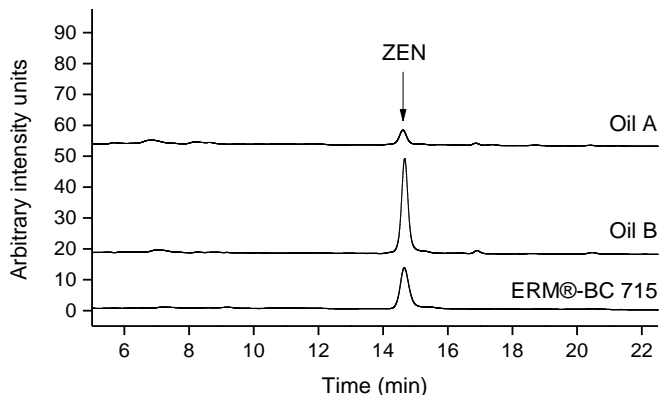


Figure 12. HPLC-FLD chromatograms of spiked maize germ oil A (100  $\mu\text{g}/\text{kg}$ ; upper trace), maize germ oil B (602  $\mu\text{g}/\text{kg}$ ; mid trace) and the provisionally certified reference material ERM<sup>®</sup>-BC715 (362  $\mu\text{g}/\text{kg}$ ; lower trace).

### 2.2.5. Conclusion

In summary, an accurate, selective and reliable SPE-HPLC online system for the quantification of ZEN in maize germ oils has been developed. Even though single steps of the automated procedure as for example the decoupling step (40 min) need to be accelerated, the system offers a reduction in workload thereby reducing personnel costs. Furthermore, performance criteria as requested by EC 401/2006 are unequivocally fulfilled. Thus, the developed SPE-HPLC online system contributes to the goal to control ZEN contamination in edible oils and, by this to improve the food safety system.

Due to the underlying principle of chemisorption the online system may be expanded to other liquid matrices that are prone to ZEN contamination like beer or milk [89, 90] or to other carbonyl containing analytes. The developed online system may also be used for automated preparative purification of carbonyl compounds when an automatic fraction collector is connected.

### **2.2.6. Acknowledgements**

The authors would like to thank the ZIM program (Zentrales Innovationsprogramm Mittelstand) of the Federal Ministry for Economic Affairs and Energy for funding (No. KF2201035SB1).

## 2.3. Photochemical *trans*-/*cis*-isomerization and quantitation of zearalenone in edible oils

Robert Köppen<sup>a</sup>, Juliane Riedel<sup>a</sup>, Matthias Proske<sup>a</sup>, Sarah S. Drzymala<sup>a</sup>, Tatjana Rasenko<sup>a</sup>, Vedat Durmaz<sup>b</sup>, Marcus Weber<sup>b</sup>, Matthias Koch<sup>a</sup>

**Journal of Agricultural Food and Chemistry**, 2012, 60, 11733-11740

Received September 1<sup>st</sup> 2012, Accepted November 10<sup>th</sup> 2012

DOI: 10.1021/jf3037775

<sup>a</sup>BAM Federal Institute for Materials Research and Testing, Richard-Willstätter-Str. 11, 12489 Berlin, Germany. E-mail:matthias.koch@bam.de; Tel.: +49 30 8104 1170

<sup>b</sup>Konrad-Zuse-Zentrum für Informationstechnik Berlin, Takustr. 7, 14195 Berlin, Germany

### 2.3.1. Abstract

The emphasis of the present work was to investigate the photochemical conversion of *trans*- to *cis*-zearalenone in edible oils under real-life conditions. For quantitation purposes a *cis*-zearalenone standard was synthesized and characterized for its identity and purity ( $\geq 95\%$ ) by <sup>1</sup>H-NMR, X-ray crystallography, HPLC fluorescence and mass spectrometric detection. In a sample survey of 12 edible oils (9 corn oils, 3 hempseed oils) from local supermarkets all corn oils contained *trans*-zearalenone (median 194  $\mu\text{g}/\text{kg}$ ), but no *cis*-zearalenone was detected. For alteration studies *trans*-zearalenone contaminated corn oils were exposed to sunlight over 4 and 30 weeks, revealing an obvious shift towards *cis*-zearalenone up to a *cis/trans* ratio of 9:1 by storage in colorless glass bottles. Irradiation experiments of *trans*-zearalenone in different organic solvents confirmed the preferred formation of *cis*-zearalenone possibly caused by entropic effects rather than by enthalpic entities as investigated by quantum chemical and classical force field simulations.

### 2.3.2. Introduction

Zearalenone is a non-steroidal mycotoxin produced by a variety of plant pathogenic *Fusarium* species, including *F. graminearum* (*Gibberella zeae*), *F. culmorum*, *F. cerealis*, *F. equiseti*, *F. rookwellense* and *F. semitectum* in zones of moderate climate [25, 91]. Despite a relatively low acute toxicity after oral administration zearalenone was shown to be estrogenic, hepatotoxic, haematotoxic, immunotoxic, genotoxic, teratogenic and carcinogenic [24].

Zearalenone is one of the worldwide most common mycotoxins in cereal grains and animal feed. Consequently, humans as well as animals are at risk of being exposed to zearalenone by consuming contaminated food products and feed [24, 92, 93]. Recent findings indicate that edible oils, particularly from corn, significantly contribute to the zearalenone intake [66, 67, 69]. Thus, an EU maximum level for zearalenone in refined corn oil of 400 µg/kg is currently in force [26].

Due to the ethylenic double bond between C11 and C12 in the 14-membered macrocyclic lactone ring two stereoisomeric forms are generally possible: *trans*- and *cis*-zearalenone (Figure 13). With the exception of very few studies [14] only the *trans*-isomer could be isolated so far from different *Fusarium* spp.. This led to the assumption that a highly isomer-specific pathway is involved in the fungal biosynthesis of zearalenone. In 1966 the structure of *trans*-zearalenone was elucidated using classical chemical, NMR and mass spectrometric analysis [11]. Since the 1970s it is known that a photochemical conversion of *trans*- to *cis*-zearalenone can easily be achieved by UV light irradiation as well as by sunlight [12, 13]. The structure of *cis*-zearalenone was primarily confirmed by NMR [12, 13] and recently by X-ray crystallography [94]. Reports on the occurrence of *cis*-zearalenone as natural product [14, 15] may be due to exposure of the *trans*-isomer to light [13].

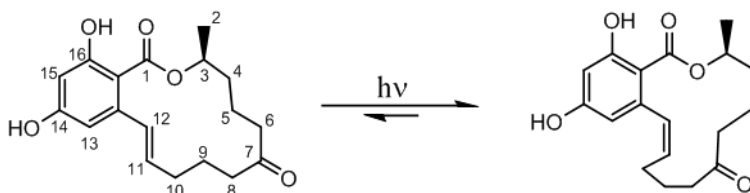


Figure 13. Stereoisomerization of *trans*-zearalenone (left) and *cis*-zearalenone (right) at the double bond C11-C12.

In mammals zearalenone is converted to  $\alpha$ - and  $\beta$ -zearalenol by reductive metabolism. It was shown that  $\alpha$ -*trans*-zearalenol exhibits an estrogenic potency about 70 times higher than *trans*-zearalenone and is slightly less potent than 17 $\beta$ -estradiol [95]. Substantial estrogenicity is retained in *cis*-analogs like *cis*-zearalenone and its metabolites  $\alpha$ - and  $\beta$ -*cis*-zearalenol. However, not entirely consistent results were obtained comparing several toxicological studies [12, 19, 20, 96].

According to IUPAC zearalenone is chemically defined as (3*S*,11*E*)-14,16-dihydroxy-3-methyl-3,4,5,6,9,10-hexahydro-1*H*-2-benzoxacyclotetradecine-1,7(8*H*)-dione representing only the *trans*-isomer. Consequently, worldwide all established maximum levels for zearalenone in food and feed apply to *trans*-zearalenone, whereas the *cis*-isomer is not considered.

Because only little is known about the occurrence, fate and risks associated with *cis*-zearalenone entering the food chain, a major problem could arise for the official control of foodstuffs and consumer protection [16]. Most of the various analytical methods for the determination of zearalenone in food and feed, based on HPLC coupled to fluorescence or mass spectrometric detection [97-99] were not developed and optimized to distinguish between *trans*- and *cis*-zearalenone. The separation and reliable quantitation of one or both zearalenone isomers strongly depends on the chromatographic conditions, posing a risk of non-comparable results and, consequently, leading to consumer health risks and economic problems.

For all these reasons, investigations into the formation, occurrence and quantitation of *cis*-zearalenone in food and feed are urgently needed. Thus, the objective of this work was to investigate the sunlight-induced conversion of *trans*-



to *cis*-zearalenone in edible oils and to quantitate *cis*-zearalenone by using a synthesized and characterized pure *cis*-zearalenone standard. To our knowledge this is the first report on the formation and quantitation of *cis*-zearalenone in edible oils.

### 2.3.3. Material and methods

#### Chemical reagents

All solvents and chemicals were of analytical grade and used without further purification. Solid *trans*-zearalenone (purity 99.8 %) used for photochemical isomerization was obtained from AppliChem GmbH (Darmstadt, Germany). Certified solutions of *trans*-zearalenone ( $100.7 \pm 0.8 \mu\text{g/mL}$ ) and fully  $^{13}\text{C}_{18}$  isotope labeled zearalenone ( $25.1 \pm 0.7 \mu\text{g/mL}$ ) in acetonitrile (ACN) for calibration purposes were supplied by Biopure, Romer Labs Diagnostic GmbH (Tulln, Austria). Ultrapure water provided by a Seralpur PRO 90CN (Ransbach-Baumbach, Germany) was used throughout the experiments.

#### Synthesis and characterization of *cis*-zearalenone

25 mg ( $78.5 \mu\text{mol}$ ) of *trans*-zearalenone (purity 99.8 %) were dissolved in 18 mL of ethyl acetate and irradiated for 8 h with ultraviolet light ( $\lambda = 350 \text{ nm}$ ) by using an universal UV lamp, type TL-900 (CAMAG, Muttenz, Switzerland). The irradiated zearalenone solution was redissolved in ACN:H<sub>2</sub>O (38:62, v/v) for the chromatographic separation of *cis*-zearalenone and residual *trans*-zearalenone. This purification was achieved by applying the solution on a 1200 series HPLC (Agilent, Böblingen, Germany) equipped with an automatic fraction collector. The column used was a 150 mm x 2 mm i.d., 3  $\mu\text{m}$ , Gemini-NX C18 (Phenomenex, Aschaffenburg, Germany) operated under isocratic conditions (ACN: H<sub>2</sub>O, 38:62, v/v) containing 0.1 % formic acid at a flow rate of 0.3 mL/min.

The purity of the isolated white powder (yield 16 mg; 64 %) was determined being  $\geq 95$  % by analytical HPLC-FLD and HPLC-MS/MS. In addition,  $^1\text{H-NMR}$  and X-ray crystallography have also been used to identify *cis*-zearalenone and to evaluate its purity.

### *$^1\text{H-NMR}$ spectroscopy*

A *cis*-zearalenone solution (13 mg/mL) was measured by  $^1\text{H-NMR}$  (500 MHz,  $\text{CDCl}_3$ ) on an AVANCE III 500 (Bruker Daltonik, Bremen, Germany). The chemical shifts ( $\delta$ ) in Figure 14 are given in parts per million, relative to tetramethylsilane.

### *X-ray crystallography*

Colorless crystals of *cis*-zearalenone, grown by slow evaporation of solvent (dichloromethane:*n*-hexane, 1:2 v/v) were measured on an APEX CCD area-detector diffractometer (Bruker, Karlsruhe, Germany) at 296 K using graphite monochromatized Mo  $K\alpha$  radiation ( $\lambda = 0.71073 \text{ \AA}$ ). The structure of *cis*-zearalenone, solved by direct methods and refined by full-matrix least squares calculation, was recently published [94].

### **Edible oil samples**

A total of 12 edible oils (9 corn oils and 3 hempseed oils) from different geographical origins produced in 2011/2012 were purchased in German retail markets in the spring of 2012 (Table 10). The sealed oil bottles each containing 0.25 to 1 L were stored at ambient temperature (23 °C) in a dark place until analysis.

## Alteration of edible oils by sunlight exposure

A naturally and a fortified contaminated corn oil were exposed to sunlight on a window sill inside the laboratory (4 and 30 weeks, respectively) to examine the isomerization process from *trans*- to *cis*-zearalenone depending on the exposure time and the bottle material. Sub-samples of 2 mL were withdrawn after defined time intervals and stored at 4 °C. After completing the time-driven stability studies all sub-samples were extracted and analyzed in a single HPLC sequence to minimize method-based uncertainties.

### *Natural corn oil for alteration*

For this study the oil sample no. 3 (Table 10) was used due to its high natural *trans*-zearalenone content of 323 µg/kg. It was stored in thin amber and colorless laboratory glass vials as well as in the original thick colorless bottle for 4 weeks. A weekly sampling was performed.

### *Fortified corn oil for alteration*

A corn oil sample containing a low natural *trans*-zearalenone content of 30 µg/kg was gravimetrically spiked with 600 µg/kg *trans*-zearalenone. This fortified corn oil was stored in a bottle of colorless laboratory glass for 30 weeks. After one month of weekly sampling, every second week sub-samples were withdrawn.

## Analysis of zearalenone

### *Method A (HPLC-MS/MS)*

50 µL internal standard (ISTD) solution were evaporated to dryness followed by addition of 0.5 mL edible oil and 0.5 mL *n*-hexane. Zearalenone was extracted

from oil with 5 mL of methanol:water (9:1, v/v) for 30 min using a horizontal shaker (300 oscillations/min). After centrifugation ( $1,378 \times g$ ) 1 mL of the upper aqueous layer was evaporated in a gentle stream of nitrogen at 30 °C and redissolved in 0.4 mL of HPLC-MS/MS eluent. All given volumes were gravimetrically controlled.

The liquid chromatographic system consisted of an 1200 series HPLC (Agilent, Böblingen, Germany) equipped with a vacuum degasser, a binary pump, a thermostatted column compartment set to 50 °C, and a 4000 QTRAP mass spectrometer (AB Sciex, Darmstadt, Germany). Solutions containing *trans*-/*cis*-zearalenone were applied (10 µL) to HPLC using the same chromatographic conditions as stated above for *cis*-zearalenone preparation supplemented by a guard column (4 mm x 2mm i.d., 3 µm) of the same material. MS/MS detection was performed by negative electrospray ionization (ESI-) using the multiple reaction monitoring (MRM) acquisition mode with a dwell time of 50 ms for each transition. The transitions monitored for native *trans*-/*cis*-zearalenone were (*m/z*) 317.1 → 131.1 (quantifier), 317.1 → 175.0 (qualifier) and 335.2 → 140.2 for the <sup>13</sup>C<sub>18</sub>-labeled *trans*- zearalenone. The optimized MRM-MS instrument parameters for each monitored transition were: ion spray voltage: -4,000 V; declustering potential: -80 V; desolvation temperature: 500 °C; ion source gas 1: 50 arbitrary units (a.u.); ion source gas 2: 50 a.u.; curtain gas: 20 a.u. and collision energy: -42 eV (qualifier: -40 eV).

### *Calibration and quantitation*

Certified standards of native and isotope labeled *trans*-zearalenone as well as synthesized *cis*-zearalenone were used for calibration. The *trans*- and *cis*-zearalenone contents in the edible oil samples were quantitated applying a six point calibration curve after linear regression established in a range of 10-520 µg/kg ( $R^2 = 0.9997$  for *trans*-zearalenone,  $R^2 = 0.9990$  for *cis*-zearalenone) by analyzing each calibration level in duplicate. According to Liao *et al.* [100] the limit of detection (LOD) was estimated being 0.5 µg/kg based on the peak area ratio of signal to noise (S/N) of 3, the corresponding limit of quantitation (LOQ) was 3 µg/kg (S/N = 10). The absolute zearalenone recovery from edible oil, controlled by spiking experiments, was found to be within the required range of 70-120 % according to EC 401/2006 [82]. Since there is no <sup>13</sup>C-labeled analog

available for *cis*-zearalenone, the analyte was determined by using the internal standard technique with  $^{13}\text{C}_{18}$ -*trans*-zearalenone as ISTD.

#### *Method B (DCHC-HPLC-FLD).*

A recently published method [70] initially developed for *trans*-zearalenone, was incorporated to extract and quantitate *trans*- and *cis*-zearalenone in edible oils based on dynamic covalent hydrazine chemistry (DCHC) using a hydrazine-functionalized macroporous polymer resin (Sigma-Aldrich, Steinheim, Germany). Zearalenone is selectively extracted from oil by shaking the sample (0.2 g), diluted in 0.8 mL methanol, with 100 mg of hydrazine-functionalized polymer resin for two hours. After covalent coupling the hydrazone bond formed allows a thorough washing of the solid-phase with methanol and *n*-heptane. Decoupling of zearalenone from the resin is achieved by applying an acetone containing elution mixture leading to highly purified extracts suited for HPLC fluorescence detection (FLD) analysis.

The chromatographic analysis was performed on a 1200 series HPLC equipped with vacuum degasser, binary pump, oven thermostat, diode array detector (DAD) and FLD (Agilent, Böblingen, Germany). Chromatographic run parameters were as follows: oven temperature: 50 °C, injection volume: 10  $\mu\text{L}$ , flow rate: 0.3 mL/min, solvent A: water + 0.1 % (v) formic acid, solvent B: ACN + 0.1 % (v) formic acid. The following linear gradient was used: 30-40 % B in 21 min, followed by 100 % B for 7 min and 30 % B for 7 min (re-equilibration). The HPLC column used was as stated in the section of *cis*-zearalenone characterization, FLD parameters were set to  $\lambda_{\text{EX}} = 276 \text{ nm}$ ;  $\lambda_{\text{EM}} = 456 \text{ nm}$ . This method separates *trans*- and *cis*-zearalenone ( $t_{\text{R}} = 21.7 \text{ min}$  and  $t_{\text{R}} = 22.8 \text{ min}$ , respectively) as the DCHC approach is applicable to *cis*-zearalenone as well.

#### *Calibration and quantitation*

In contrast to method A, external calibrations without  $^{13}\text{C}$ -labeled ISTD were established for HPLC-FLD analysis. The linear regression lines of *trans*- and *cis*-zearalenone in the range of 10-520  $\mu\text{g}/\text{kg}$  ( $R^2 = 0.9998$  for *trans*-zearalenone,

$R^2 = 0.9994$  for *cis*-zearalenone) were used for quantitation of zearalenone in edible oil samples.

### Molecular simulations

#### *Classical force field simulations*

Two strategies with different classical force fields and physical conditions were employed in order to investigate their suitability for the estimation of the steady state distribution of *trans*- and *cis*-zearalenone after interconversion. At first, the isomers were parameterized according to the Merck molecular force field (mmff) [101] and simulated with implicit water at 1500 °C using the Hybrid Monte-Carlo algorithm [102], which is known for an efficient sampling of the conformational space [103]. Afterwards, all geometries were minimized using the conjugate gradient method [104, 105]. In addition, the generalized amber force field (GAFF) [32] was used for molecular dynamics simulations with Gromacs [106-108] including explicit ffamber\_tip4pew water molecules and starting sampling from the most favorable energy minimized structure (global minimum) of each zearalenone isomer as provided by mmff above. Charges were assigned with the am1bcc method [109, 110] and the temperature of the canonical ensemble was coupled to 293 °C.

#### *Quantum-chemical simulations*

All quantum chemical analyses including geometry optimizations, single point energy calculations and  $pK_a$  value estimations were done by using Gaussian 09 program. The density functional theory was employed using Becke's three-parameter hybrid exchange functional along with the Lee-Yang-Parr correlation (B3LYP) [111, 112] in combination with the 6-31+G\* basis set [113]. Both acetonitrile and water were chosen as implicit solvents with a self-consistent reaction field (SCRF) [114] computed on the basis of the integral equation formalism for the polarizable continuum model (IEFPCM) [115, 116].

### 2.3.4. Results and discussion

#### *cis*-Zearalenone calibration standard

In order to ensure a reliable quantitation of *cis*-zearalenone in edible oils a corresponding calibration standard is necessary which is commercially not available. Thus, the first aim was to prepare *cis*-zearalenone and to characterize this compound for its chemical identity and purity. Based on previous studies [12, 117] a suitable method is the photochemically induced isomerization of the double bond of the macrocyclic lactone ring. Beside irradiation energy and reaction time, the *trans*-/*cis*-isomerization may also depend on the solvent. Different polar solvents were tested for their suitability to achieve a high conversion rate by irradiation of *trans*-zearalenone solutions with UV-light (Table 9). Although a clear correlation between solvent polarity and *cis*-/*trans*-isomerization rate could not be concluded, it was obvious that *n*-hexane representing the solvent with the lowest dipole moment, yielded the highest isomerization rate (5.18). In contrast, acetonitrile, often used as solvent for commercial zearalenone standards, showed the lowest *cis*-/*trans*-conversion rate (1.39) and, additionally, only 44 % remaining zearalenone after irradiation. It is supposed that further light-induced reaction products were preferably formed in the presence of acetonitrile. The highest zearalenone recovery was obtained by using methanol showing, however, a rather low isomerization rate (2.49). Because zearalenone is only slightly soluble in *n*-hexane, ethyl acetate was used as the best alternative for the photochemical synthesis of *cis*-zearalenone based on the results of Table 9. In addition, the irradiation time for synthesis was set to 8 h to avoid side-reaction products.

## 2 Results and discussion

Table 9. Isomerization of *trans*- to *cis*-zearalenone in different solvents (232  $\mu\text{g}/\text{kg}$ ) by irradiation with UV-light ( $\lambda = 350 \text{ nm}$ ) after 48 hours.

Solvent	Polarity $E^0(\text{Al}_2\text{O}_3)$	<i>cis</i> -/ <i>trans</i> -zearalenone ratio <sup>a</sup>		Total zearalenone recovery <sup>b</sup> (%)
		t = 0 h	t = 48 h	
Methanol	0.95	0.01	2.49	78.1
Acetonitrile	0.65	0.02	1.39	44.2
Ethyl acetate	0.58	0.01	4.80	73.8
<i>n</i> -Hexane	0.00	0.03	5.18	77.3

<sup>a</sup>Results are means based on measurements in duplicate.

<sup>b</sup>Sum of *trans*- and *cis*-zearalenone

Purified *cis*-zearalenone was subjected to  $^1\text{H}$ -NMR for structure elucidation measured in comparison to pure *trans*-zearalenone (Figure 14).

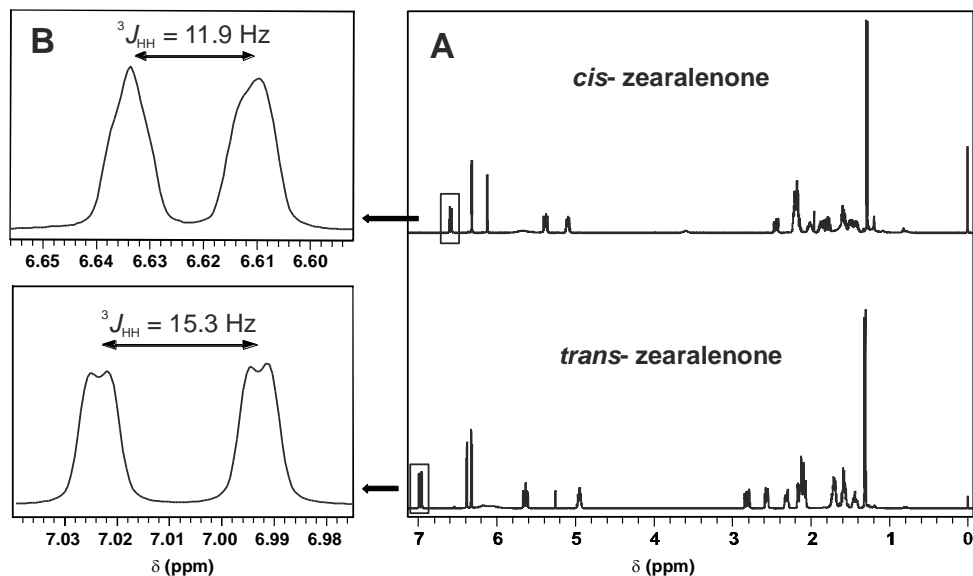


Figure 14. (A) Full  $^1\text{H}$ -NMR spectra of *cis*- and *trans*-zearalenone (500 MHz,  $\text{CDCl}_3$ ). (B) Signal splitting of the proton at C12 position showing the vicinal coupling constant  $^3J_{\text{HH}}$ .

*cis*-Zearalenone was identified by the vicinal H-H coupling constant  $^3J_{\text{HH}}$  of the proton at C12 position ( $^3J_{\text{HH}} = 11.9 \text{ Hz}$ ) being in the typical range of *cis* double bonds ( $^3J_{\text{HH}}$ : 6-14 Hz). For comparison, the  $^3J_{\text{HH}}$  of *trans*-zearalenone was measured  $^3J_{\text{HH}} = 15.2 \text{ Hz}$  (typical range of *trans* double bonds:  $^3J_{\text{HH}}$  11-18 Hz). The doublet-doublet splitting of the H12 proton of *trans*-zearalenone (Figure 14) is



caused by a long-range coupling to the proton at C13 position ( $^4J_{\text{HH}} = 1.6$  Hz) which is lower in the case of *cis*-zearalenone, indicating a torsion of the *cis*-zearalenone ring system. In addition, due to the change in the molecular shape the protons of the *cis* double bond and also other protons of *cis*-zearalenone undergo a shielding effect leading to an upfield shift compared to *trans*-zearalenone, e.g. *cis/trans* ( $\delta$  H11: 5.43/5.68 ppm;  $\delta$  H12: 6.62/7.01 ppm) confirming the results of other studies [12, 13].

A further unambiguous confirmation of the chemical composition and stereochemical structure of *cis*-zearalenone was obtained by single crystal X-ray structural analysis. Crystals of both zearalenone isomers belong to the centrosymmetric monoclinic P21 space group with two molecules in the elementary cell ( $V_{\text{cis-zearalenone}} = 851.7 \text{ \AA}^3$ ;  $V_{\text{trans-zearalenone}} = 819.0 \text{ \AA}^3$ ). In the crystal structures, an intramolecular hydrogen bond between the C16 hydroxyl group and the C1 carbonyl oxygen helps to stabilize the molecular conformation.

## Sample survey

Ten out of 12 analyzed edible oils (83 %) from German retail markets revealed measurable contents of *trans*-zearalenone. However, none of them exceeded the EU maximum level of 400  $\mu\text{g/kg}$  (Table 10). The results indicate that corn oils tend to have elevated zearalenone contents compared to hempseed oils. All 9 corn oils were found positive (median 194  $\mu\text{g/kg}$ ), confirming a previous study on zearalenone in corn oil reporting an average content of 170  $\mu\text{g/kg}$  (total samples: 38, pos. samples: 38) [69]. In addition, an obvious year-specific zearalenone contamination of the corn oils was observed, showing lower zearalenone contents for the oil samples produced in 2012.

The stable isotope dilution mass spectrometry SIDA-HPLC-MS/MS (Method A) was defined by CCQM (Consultative Committee for Amount of Substance – Metrology in Chemistry) as primary (ratio) method representing a high level of metrology [118]. However, the expensiveness caused by the instrumental equipment and use of a  $^{13}\text{C}$ -labeled internal standard makes this method applicable as a reference method rather than as a routine method. Reliable alternative methods are therefore needed, but currently there is no standard method available

for the determination of zearalenone in edible oil. A recently published method [70] based on a selective extraction of zearalenone and effective extract purification using hydrazine-functionalized polymer resins could be promising for standardization combining cost-efficiency and accuracy. To underpin its suitability all corn oil samples from 2011 were additionally analyzed by this Method B (Table 10). While comparable mean values of Method A and B were obtained, quite different measurement uncertainties were observed, leading to a failed F-test and consequently, preventing the applicability of a mean value t-test.

Table 10. Determination of *trans*-zearalenone in edible oils from retail markets in Germany.

No.	Type	Produced	<i>trans</i> -Zearalenone <sup>a</sup> (µg/kg)	
			Method A	Method B
1	Corn oil	2011	221.3 ± 14.5	230.4 ± 1.2
2	Corn oil	2011	259.6 ± 10.0	263.8 ± 0.7
3	Corn oil	2011	322.7 ± 14.9	309.1 ± 2.4
4	Corn oil	2011	257.9 ± 8.7	249.0 ± 3.4
5	Corn oil	2011	187.0 ± 10.7	205.8 ± 1.5
6	Corn oil	2011	170.3 ± 7.2	185.7 ± 4.2
7	Corn oil	2012	90.2 ± 2.1	n.a.
8	Corn oil	2012	92.7 ± 1.3	n.a.
9	Corn oil	2012	26.5 ± 0.1	n.a.
10	Hempseed oil	2011	n.q.	n.a.
11	Hempseed oil	2011	n.q.	n.a.
12	Hempseed oil	2011	22.8 ± 1.0	n.a.

n.q., not quantifiable, i.e. lower than LOQ (3 µg/kg); n.a., not analyzed

<sup>a</sup>The mean values and their corresponding standard deviations are given based on three independent replicates (n = 3).

It must be kept in mind that the extracts analyzed by Method A contained much more matrix components due to a simple liquid-liquid partitioning step possibly causing a poorer precision even by applying SIDA-HPLC-MS/MS. However, due to the selective MRM mode the integration of zearalenone in the chromatogram of Method A (Figure 15) is not influenced by matrix compounds. The almost matrix-

free chromatogram of Method B demonstrates the high extraction selectivity and efficient clean-up of the DCHC procedure.

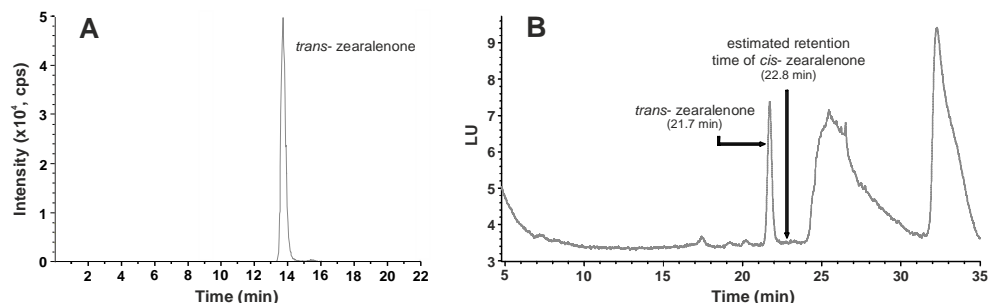


Figure 15. Chromatograms of corn oil no. 3 analyzed by (A) HPLC-MS/MS (Method A) and (B) DCHC-HPLC-FLD (Method B). The broad signals beginning at 24 min (Method B) are not caused by oil matrix but related to HPLC gradient (fast increase of solvent B (ACN) and reconditioning, respectively).

Zearalenone is produced by *Fusarium* spp. on cereal plants during the period of growth and, in this time exposed to sunlight. Due to the light-sensitivity of zearalenone at least small amounts of *cis*-zearalenone could be expected in zearalenone contaminated samples. Surprisingly, *cis*-zearalenone was not detected in any of the tested oil samples not even in oil no. 3 with the highest *trans*-zearalenone contamination. These findings suggest that the pre-harvest stage as well as the harvesting and oil production conditions do not contribute to the conversion of *trans*- to *cis*-zearalenone. However, many edible oils are packed and stored in colorless bottles exposing a risk of light-induced isomerization. Therefore, the (in)stability of *trans*-zearalenone during the storage and use phase of an edible oil was investigated.

### Alteration of edible oils by sunlight exposure

The alteration experiments were done under real-life conditions by storing the oils on a window sill inside the laboratory exposed to sunlight (day-night rhythm).

*Short-term stability study*

In a first step it was tested if a naturally *trans*-zearalenone contaminated corn oil (no. 3, Table 10) is principally susceptible for *trans/cis* isomerization during storage in different glass bottles over 4 weeks. The results of the weekly sampling in Figure 16 show a conversion of zearalenone strongly depending on storage time and bottle material. In both experiments using colorless glass containers a weekly increase of the *cis*-zearalenone content was observed reaching 21.4 % (original oil bottle) and 62.4 % (laboratory glass vial) after 4 weeks. Furthermore, a decrease of the total zearalenone content (sum of *trans*- and *cis*-zearalenone) was detected when using colorless glass containers. This was independent of the isomerization rate. At the end of the study only about 83 % of total zearalenone compared to zearalenone at  $t = 0$  min were quantitated, confirming the outcome shown in Table 9.

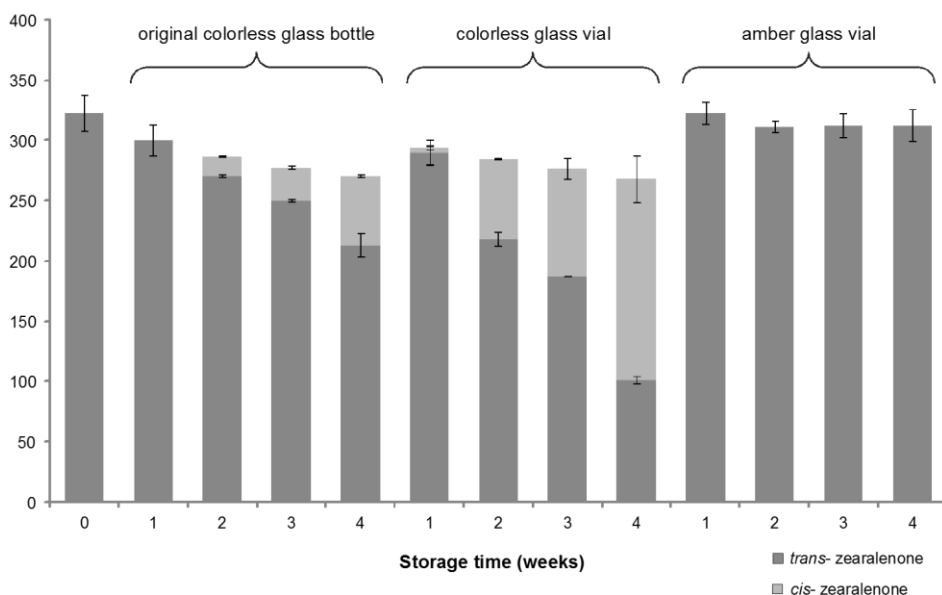
Zearalenone content ( $\mu\text{g}/\text{kg}$ )

Figure 16. Isomerization of a naturally *trans*-zearalenone contaminated corn oil (no. 3) over 4 weeks of sunlight exposure (day-night-rhythm), analyzed by SIDA-HPLC-MS/MS (Method A). The mean values and their corresponding standard deviations are given based on three independent replicates ( $n = 3$ ).

Quite different results were found when using amber glass vials. Here, neither an isomerization of *trans*-zearalenone nor a significant degradation over time were detected (Figure 16) leading to the conclusion that the isomerization as well as the degradation process of zearalenone are clearly related to a (sun)-light exposure which can be avoided by using amber glassware. While different processes took place in the oil depending on bottle material and storage time, no changes of oil color and turbidity were visible over the whole period of time.

#### *Long-term stability study*

After finding that *cis*-zearalenone can generally be derived from *trans*-zearalenone contaminated oils during real-life storage at sunlight, the formation of a *trans*-/*cis*-zearalenone equilibrium during a long-term storage was investigated in a second step. For that purpose a corn oil was spiked with *trans*-zearalenone to 630 µg/kg containing no detectable amounts of *cis*-zearalenone. The *trans*-zearalenone content, exceeding the EU maximum level of 400 µg/kg, was confirmed by an interlaboratory comparison study (median 627 µg/kg) including 15 participants [119], so a well characterized reference material could be used for this stability study. The *trans*-zearalenone reference value determined at  $t = 0$  min was slightly increased (Figure 17) but within the range of uncertainty, confirming the accuracy of Method A. During the first weeks a considerable decrease of *trans*-zearalenone and, consequently, an increase of *cis*-zearalenone occurred leading to a *cis*-to-*trans* zearalenone ratio of about 9:1 after 6 weeks. That indicates either a preferred formation of the *cis*-isomer or a hindered back-reaction of *cis*- to *trans*-zearalenone.

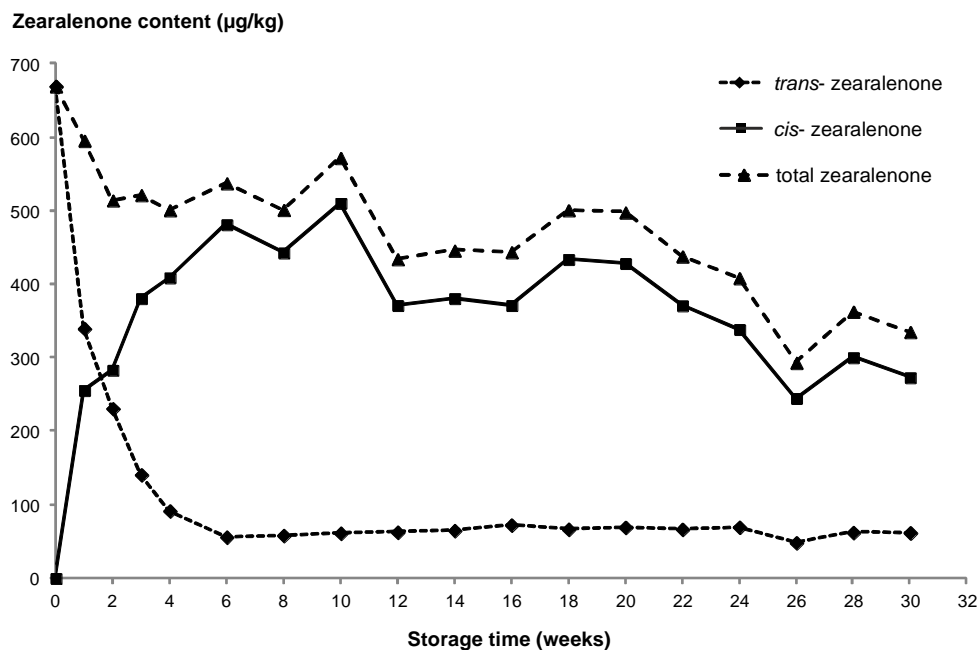


Figure 17. Light-induced isomerization of a corn oil fortified with *trans*-zearalenone ( $630 \mu\text{g}/\text{kg}$ ) over 30 weeks of sunlight exposure (day-night rhythm), analyzed by SIDA-HPLC-MS/MS.

The reaction starting phase can easily be described by kinetics of pseudo first order  $\ln(c/c_0) = -k \cdot t$  ( $c = \textit{trans}$ -zearalenone content at  $t > 0$ ;  $c_0 = \textit{trans}$ -zearalenone content at  $t = 0$ ;  $k = \text{reaction rate}$ ). The obtained reaction rate of  $k = 0.485 \text{ weeks}^{-1}$ , represented by the slope of the linear regression line, is slightly higher than the reaction rates resulting from the short-term stability study,  $k(\text{original bottle}) = 0.102 \text{ weeks}^{-1}$  and  $k(\text{colorless glass vial}) = 0.276 \text{ weeks}^{-1}$  possibly caused by using a different type of glass. After the 6th week the *trans*-zearalenone content remained stable ( $\sim 63 \mu\text{g}/\text{kg}$ ;  $\sim 10\%$  of the reference value at  $t = 0$ , Figure 17) until the end of the study, and with that, falling below the EU maximum level. On the other hand, after the first phase of increasing *cis*-zearalenone values until the 6th week ( $482 \mu\text{g}/\text{kg}$ ) a continuous decrease over the subsequent 24 weeks was observed leading to a final *cis*-zearalenone content of  $273 \mu\text{g}/\text{kg}$ . The total zearalenone content significantly decreased up to the end of the study ( $335 \mu\text{g}/\text{kg}$ ), i.e. a loss of about 50% compared to the zearalenone content at  $t = 0$ . Because this work was not intended to investigate the identity and/or the mechanism of (light-induced) degradation products, that issue should be the focus of a future study. Several fluorescent degradation products with shorter

retention times than zearalenone were detected by RP-C18 HPLC after irradiation of *trans*-zearalenone in organic solvents depending on the irradiation energy. However, the photochemical fate of zearalenone in a natural triglyceride matrix could be more complex, ranging from chemical degradation products to masking effects, e.g. matrix adsorption or conjugation.

A general conclusion drawn from the presented results is an obvious shift of the isomeric zearalenone ratio towards *cis*-zearalenone, possibly caused by an enhanced thermodynamic stability. Thus, quantum-chemical and classical force field simulation data were calculated in order to answer the question whether the formation of *cis*-zearalenone is preferred over the natural occurring *trans*-zearalenone.

### Molecular simulation results

Electron density computations of *trans*- and *cis*-zearalenone were in general consensus with the X-ray structure results showing an intramolecular hydrogen bond. However, whereas calculations revealed blurred boundaries between the electrons of *cis*-zearalenone a clear electron boundary was obtained for *trans*-zearalenone. This result possibly indicates keto-enol tautomerism and suggests resonance-stabilization in case of *cis*-zearalenone. This assumption was supported by comparing  $pK_a$  values computed for both zearalenone isomers and their tautomeric counterparts. These results indicate a significantly larger entropy of *cis*-zearalenone, possibly explaining its higher concentration at equilibrium.

Mean and minimal potential energies have been computed for artificial zearalenone derivatives by reducing the lactone ring size in order to see the enthalpic/sterical effect on the equilibrium distribution of *trans*- and *cis*-zearalenone after interconversion. The GAFF and mmff simulations demonstrate that a *cis*-isomer is favored only for small rings (< 10 atoms). On the basis of enthalpic entities resulting from classical force field simulations, it is not possible to explain the substantially higher preference of *cis*-zearalenone. This observation as well indicates the dominance of *cis*-zearalenone due to entropic reasons.

With this study it could be shown that edible oils from retail markets, especially corn oils, may contain remarkable amounts of *trans*-zearalenone depending on the year of production. A fast conversion to the possibly more stable *cis*-zearalenone isomer occurs if the oils are stored in colorless glass bottles exposed to sunlight. Official maximum levels currently only exist for *trans*-zearalenone despite studies revealing an estrogenic potential of *cis*-zearalenone. A chromatographic separation of *cis*- and *trans*-zearalenone requires an optimization of the HPLC conditions which is not part of the existing standard methods. Due to the almost identical fluorescence and mass spectrometric properties, it can be assumed, that routine laboratories as well as official control laboratories are not always aware of analyzing *trans*- or *cis*-zearalenone.

Overall, the issue of *cis*-zearalenone formation and occurrence in edible oils may gain significant importance for researchers, industry and legislative bodies to control official maximum levels by developing reliable analytical methods to unambiguously analyze *trans*- and *cis*-zearalenone. Certified reference materials can contribute to the quality assurance and therefore to food safety and consumer protection.

### 2.3.5. Acknowledgements

We gratefully thank Prof. C. Mügge from the Humboldt University of Berlin, Germany, for  $^1\text{H-NMR}$  measurements of *cis*-zearalenone.



## 2.3.6. Supporting information

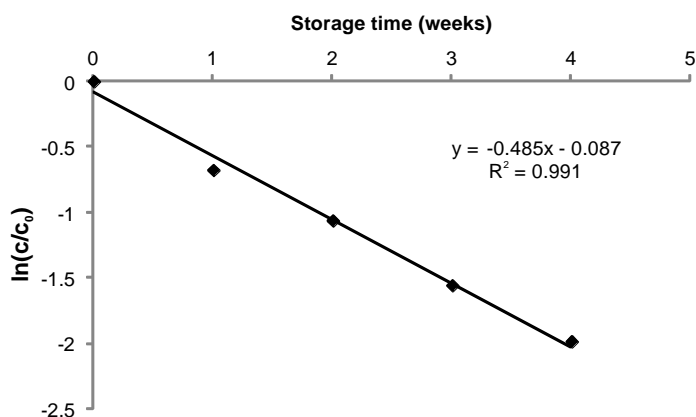


Figure 18. Pseudo first order kinetics for the isomerization of *trans*- to *cis*-zearalenone in a fortified corn oil (630  $\mu\text{g}/\text{kg}$ ) exposed to sunlight over the first 4 weeks:  $\ln(c/c_0) = -k \cdot t$  ( $c$  = *trans*-ZEN content at  $t > 0$ ;  $c_0$  = *trans*-ZEN content at  $t = 0$ ) The reaction (isomerization) rate  $k$ , represented by the slope the linear regression line, was  $k = 0.485 \text{ weeks}^{-1}$ .

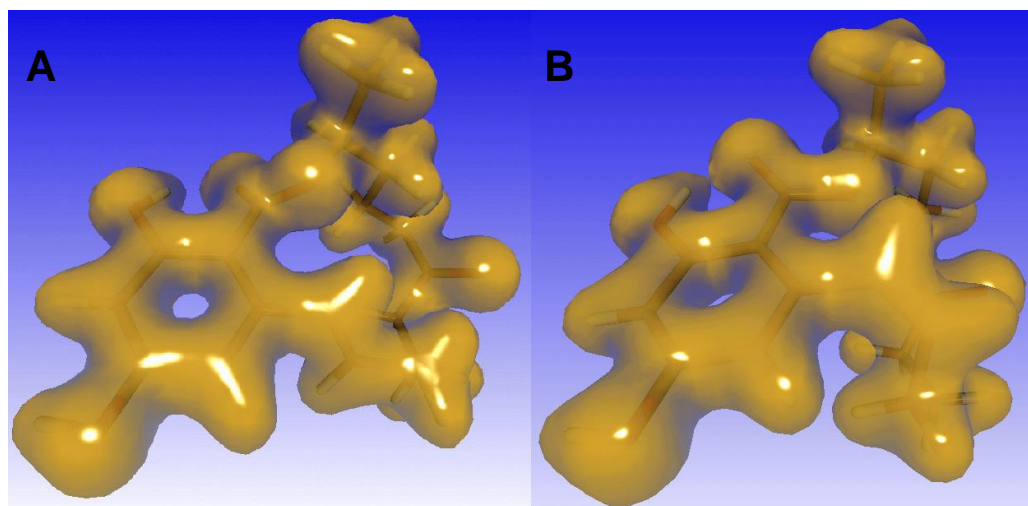


Figure 19. Electron density calculations computed with Gaussian 09\* revealed blurred boundaries between the electrons of the C<sub>16</sub> hydroxy hydrogen and the C<sub>1</sub> carbonyl oxygen in case of *cis*-zearalenone (B). In contrast, *trans*-zearalenone (A) shows a clear boundary between the C<sub>16</sub> hydroxy hydrogen and the C<sub>1</sub> carbonyl oxygen. This result possibly

## 2 Results and discussion

indicates keto-enol tautomerism and suggests resonance-stabilization of both involved oxygens. In order to confirm this assumption,  $pK_a$  values have been estimated for both zearalenone isomers as well as for two molecules obtained by transferring the C<sub>16</sub> hydroxy hydrogens to the respective C<sub>1</sub> carbonyl oxygen. With 7.69 and 7.67, the difference of  $pK_a$  values computed for *cis*-zearalenone and its modified form, respectively is indeed negligible, whereas the values computed for *trans*-zearalenone and its tautomeric counterpart differ considerably with 7.43 and 7.18, respectively.

\*) Gaussian 09, Revision A.02, Frisch, M. J.; Trucks, G. W.; Schlegel, H. B.; Scuseria, G. E.; Robb, M. A.; Cheeseman, J. R.; Scalmani, G.; Barone, V.; Mennucci, B.; Petersson, G. A.; Nakatsuji, H.; Caricato, M.; Li, X.; Hratchian, H. P.; Izmaylov, A. F.; Bloino, J.; Zheng, G.; Sonnenberg, J. L.; Hada, M.; Ehara, M.; Toyota, K.; Fukuda, R.; Hasegawa, J.; Ishida, M.; Nakajima, T.; Honda, Y.; Kitao, O.; Nakai, H.; Vreven, T.; Montgomery, Jr., J. A.; Peralta, J. E.; Ogliaro, F.; Bearpark, M.; Heyd, J. J.; Brothers, E.; Kudin, K. N.; Staroverov, V. N.; Kobayashi, R.; Normand, J.; Raghavachari, K.; Rendell, A.; Burant, J. C.; Iyengar, S. S.; Tomasi, J.; Cossi, M.; Rega, N.; Millam, J. M.; Klene, M.; Knox, J. E.; Cross, J. B.; Bakken, V.; Adamo, C.; Jaramillo, J.; Gomperts, R.; Stratmann, R. E.; Yazyev, O.; Austin, A. J.; Cammi, R.; Pomelli, C.; Ochterski, J. W.; Martin, R. L.; Morokuma, K.; Zakrzewski, V. G.; Voth, G. A.; Salvador, P.; Dannenberg, J. J.; Dapprich, S.; Daniels, A. D.; Farkas, Ö.; Foresman, J. B.; Ortiz, J. V.; Cioslowski, J.; Fox, D. J. Gaussian, Inc., Wallingford CT, 2009.

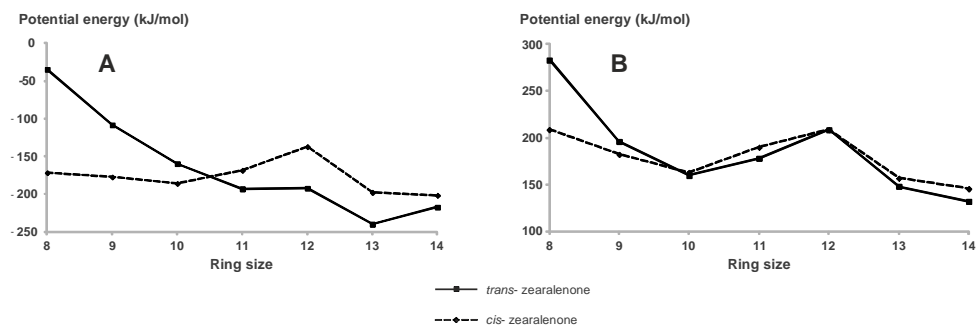


Figure 20. Minimal potential energies of *trans*- and *cis*-ZEN (ring size 14) and their artificial derivatives with smaller rings (down to eight ring atoms) in vacuum, simulated according to the generalized amber force field (GAFF) (A) and the Merck molecular force field (mmff) (B). The artificial ring sizes were built by successively omitting ring atoms together with their substitutes/hydrogens starting with C<sub>10</sub> followed by C<sub>9</sub>, C<sub>8</sub>, ..., and C<sub>5</sub>. The GAFF and mmff simulations demonstrate that for small cycloalkenes the *cis*-isomer is favored, i.e. the thermal equilibrium is supposed to be dominated by the *cis*-isomer which is somewhat intuitive. With increasing ring size, the *trans*-isomer becomes more favorable. According to these results which strongly correlate with respective mean potential energies, the *trans*-isomer is preferred by cyclic molecules with a ring size larger or equal to ten or eleven atoms depending on the utilized force field. As the ring grows further, its steric effect on the potential energy becomes more and more negligible, yielding smaller differences between the two isomers.

## 2.4. Preparation of $^{13}\text{C}$ -labeled *cis*-zearalenone and its application as internal standard in stable isotope dilution analysis

Sarah S. Drzymala<sup>a</sup>, Juliane Riedel<sup>a</sup>, Robert Köppen<sup>a</sup>, Leif-Alexander Garbe<sup>b</sup>, Matthias Koch<sup>a</sup>

**World Mycotoxin Journal, 2014, 7, 45-52**

Received June 25<sup>th</sup> 2013, Accepted September 2<sup>nd</sup> 2013

DOI: 10.3920/WMJ2013.1610

<sup>a</sup>BAM Federal Institute for Materials Research and Testing, Richard-Willstätter-Str. 11, 12489 Berlin, Germany. E-mail:matthias.koch@bam.de; Tel.: +49 30 8104 1170

<sup>b</sup>Technische Universität Berlin, Ackerstr. 76, 13355 Berlin, Germany

### 2.4.1. Abstract

Pure U- $^{13}\text{C}_{18}$ -labeled *cis*-zearalenone (*cis*-ZEN) has been prepared and characterized as internal standard (ISTD) for a reliable quantification of *cis*-ZEN in contaminated food and feed products. The *cis*-isomer of the naturally *trans*-configured *Fusarium* mycotoxin zearalenone is often neglected. However, isomerization easily occurs by exposure of ZEN to (UV-) light. Thus, the applicability of the new *cis*-ZEN ISTD was demonstrated in a long-term isomerization study comparing naturally *trans*-ZEN contaminated edible oil with spiked edible oil. To estimate the benefits of the newly prepared *cis*-ZEN ISTD, various approaches to quantify *cis*-ZEN by HPLC-MS/MS were compared. As a result, a significant bias was revealed if no appropriate *cis*-ZEN standards are used. Furthermore, the new ISTD was applied to the analysis of 15 edible oils by stable isotope dilution analysis in combination with HPLC-ESI-MS/MS. One of the maize germ oils showed the presence of *cis*-ZEN above LOD ( $> 0.3 \mu\text{g}/\text{kg}$ ), whereas two of 15 maize germ oils were found to be contaminated with *trans*-ZEN (range 17.0 - 31.0  $\mu\text{g}/\text{kg}$ ).

### 2.4.2. Introduction

Zearalenone (ZEN) is an estrogenic mycotoxin produced by molds of the *Fusarium* genus. Its predominant estrogenicity causes reproductive disorders in numerous animal species and possibly humans [25]. Furthermore, it was shown to act hepatotoxic, haematotoxic, immunotoxic, genotoxic, teratogenic and carcinogenic [24].

Humans and animals are exposed to ZEN by ingestion of contaminated food and feed. Cereal grains like wheat, barley, oats, sorghum and particularly maize are frequently contaminated [21, 24]. The preference of temperate climates allows *Fusarium* species to infest plants worldwide rendering ZEN contamination a global issue.

Due to the lipophilic character of ZEN, high amounts can be found in edible oils derived from contaminated cereals, especially maize with up to 4.6 mg/kg [67, 69, 79]. As a result, a maximum level of 400 µg/kg for ZEN in refined maize oil established by the European Union currently applies [26].

Although often neglected, ZEN may be present in two stereoisomeric forms. The double bond between C11 and C12 can convert its configuration from *trans* to *cis* (Figure 21). It is assumed that only the *trans*-isomer is biosynthesized by *Fusarium* species as biosynthetic pathways are stereoselective. Despite this fact, there are a few studies that report on the isolation of the *cis*-isomer from fungi-cultures [14, 15]. It has been shown that the conversion of *trans*-ZEN to *cis*-ZEN can easily be achieved by artificial UV-radiation [12] and by natural sunlight [13].

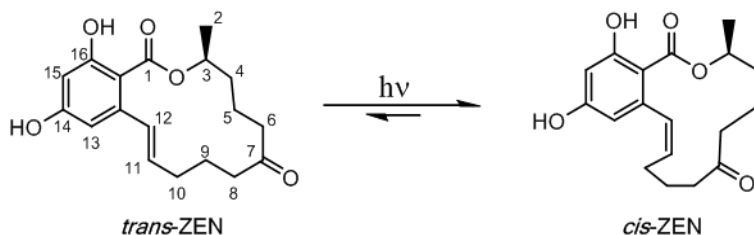


Figure 21. Photoisomerization of *trans*- and *cis*-ZEN at the double bond C11-C12.

Regarding the estrogenic activity of *cis*-ZEN several studies have been conducted in animals and *in vitro* [12, 19, 20, 96]. Though results are not consistent it can be assumed that substantial estrogenicity is preserved in *cis*-ZEN.

Overall, only little is known about the occurrence and risks associated with *cis*-ZEN contaminations in food and feed. There are a few reports on the occurrence, showing *cis*-ZEN to possibly occur in edible oils, ground corn and sugar beets [3, 16, 17]. Hence, there is a need for reliable methods to determine *cis*-ZEN in order to maximize the safety of foods and food products and therefore ensure consumer protection.

The available reports on ZEN used HPLC with fluorescence, voltammetric or -MS/MS detection [74]. For the latter, stable isotopically labeled standards are essential in order to achieve the maximum accuracy (trueness and precision) in a so-called stable isotope dilution assay (SIDA) using HPLC-MS/MS. Yet, neither native *cis*-ZEN calibration standards nor isotopically labeled standards are commercially available. Thus, the aim of this study was to prepare U-[<sup>13</sup>C<sub>18</sub>]-labeled *cis*-ZEN and to apply this novel compound as internal standard (ISTD) for the analysis of *cis*-ZEN in edible oils by SIDA-HPLC-ESI-MS/MS.

### 2.4.3. Materials and methods

#### Terms and definitions

In all following chapters the term ‘STD’ refers to a standard which is either native *trans*-ZEN or native *cis*-ZEN. The term ‘ISTD’ refers to an internal standard which is isotopically labeled. Thus, the term ISTD always applies to either U-[<sup>13</sup>C<sub>18</sub>]-*trans*-ZEN or U-[<sup>13</sup>C<sub>18</sub>]-*cis*-ZEN.

### Chemical reagents

All solvents were provided in analytical grade. *trans*-ZEN (provided as a powder, purity 99.8 %) was purchased from AppliChem GmbH (Darmstadt, Germany). A certified solution of U-[<sup>13</sup>C<sub>18</sub>]-*trans*-ZEN ((25.1 ± 0.7) µg/mL) was obtained from Romer Labs (Tulln, Austria). Deionized water was supplied by a Seralpur PRO 90CN (Ransbach-Baumbach, Germany). The term ‘elution solvent’ refers to a freshly prepared mixture of water:acetonitrile 68:32 (v/v).

### Preparation of native *cis*-ZEN

Native *cis*-ZEN used in this study was derived from an earlier work at BAM. 25 mg (78.5 µmol) *trans*-ZEN were dissolved in ethyl acetate (18 mL) and exposed to UV light ( $\lambda = 350$  nm) for 8 hours by using an universal UV lamp, type TL-900 (CAMAG, Muttenz, Switzerland). The irradiated solution was redissolved in elution solvent. *cis*-ZEN was purified using a 1200 series Agilent HPLC (Böblingen, Germany) coupled to an automatic fraction collector. A Gemini-NX C<sub>18</sub> column (150 mm x 2 mm, 3 µm particle size, Phenomenex®, Aschaffenburg, Germany) was used under isocratic conditions (water:acetonitrile 68:32 (v/v) containing 0.1 % formic acid) at a flow rate of 0.3 mL/min.

The purification yielded 16 mg (64 %) *cis*-ZEN with a purity of  $\geq 95$  % determined by analytical HPLC-FLD and HPLC-MS/MS. Unambiguous structure identification was done using <sup>1</sup>H-NMR with the vicinal H – H coupling constant <sup>3</sup>J<sub>HH</sub> of the proton at C12 shifted from 15.2 Hz to 11.9 Hz and X-ray-crystallography [94].

### Preparation of U-[<sup>13</sup>C<sub>18</sub>]-*cis*-ZEN

U-[<sup>13</sup>C<sub>18</sub>]-*cis*-ZEN has been prepared from commercially available U-[<sup>13</sup>C<sub>18</sub>]-*trans*-ZEN (Romer Labs). 0.5 g of the U-[<sup>13</sup>C<sub>18</sub>]-*trans*-ZEN solution in acetonitrile were weighed into a clear glass HPLC vial. The acetonitrile was removed in a

gentle stream of nitrogen using an evaporation station (Reacti-Therm Station™ III, Thermo Scientific, Waltham, USA). The residue was redissolved in 1 g of ethyl acetate for subsequent UV-radiation. In a series of pre-tests ethyl acetate was shown to yield the highest isomerization rates. The solution was agitated and ultrasonicated for one minute and then exposed to UV light ( $\lambda = 350$  nm) for 8 hours by using an universal UV lamp.

U- $^{13}\text{C}_{18}$ -*cis*-ZEN was purified using a 1200 series HPLC (Agilent) coupled to an automatic fraction collector Foxy Jr. (Teledyne Isco, Lincoln, USA). A Eurospher II 100-3 C18 P column (150 mm x 2 mm, 3  $\mu\text{m}$  particle size, Knauer GmbH, Berlin, Germany) was used at 50 °C oven temperature. The HPLC was equipped with a diode array detector (DAD) and a fluorescence detector (FLD). The following chromatographic parameters were chosen: injection volume 10  $\mu\text{L}$ , flow rate 0.3 mL/min, isocratic solvent conditions using acetonitrile:water 38:62 (v/v) with 0.1 % formic acid, runtime 15 min. DAD-detection was set to  $\lambda = 274$  nm whereas FL-detection was done at  $\lambda_{\text{Ex}} = 274$  nm and  $\lambda_{\text{Em}} = 456$  nm.

Structure confirmation was done in comparison to a native *cis*-ZEN calibration standard using retention time and absorbance spectra in combination with HPLC-MS/MS. The purity of the isolated U- $^{13}\text{C}_{18}$ -*cis*-ZEN (> 99 %) was assessed by means of HPLC-DAD/-FLD and HPLC-MS/MS detecting no remaining U- $^{13}\text{C}_{18}$ -*trans*-ZEN. The amount of purified U- $^{13}\text{C}_{18}$ -*cis*-ZEN (6.6  $\mu\text{g}$ ) was quantified by HPLC-FLD against a native *cis*-ZEN calibration standard.

### Long-term isomerization study

Two edible oils, one naturally contaminated and one spiked maize germ oil, were left on the window sill inside a laboratory with daylight exposure for three weeks.

As many retail edible oils are sold in clear glass bottles this study was also conducted using clear glass bottles representing a real life situation. A 2 mL sample was drawn every week and stored at 4 °C. All samples were extracted and analyzed in a single HPLC-MS/MS sequence applying the newly prepared ISTD.

The naturally contaminated maize germ oil was derived from previous investigations in our working group. Its *trans*-ZEN content was determined to be  $(260 \pm 20)$   $\mu\text{g}/\text{kg}$ . The spiked maize germ oil was found to contain no natural *trans*-ZEN. It was fortified at  $800 \mu\text{g}/\text{kg}$  and analyzed to contain  $(800 \pm 24)$   $\mu\text{g}/\text{kg}$  *trans*-ZEN.

### Sample survey

15 different edible oil samples, bottled in clear glass or plastic, were purchased from German retail markets as well as online shops. Edible oils included maize germ oil ( $n = 6$ ), soy bean oil ( $n = 3$ ), rice germ oil ( $n = 3$ ), wheat germ oil ( $n = 2$ ) and a mixture of maize germ oil with rapeseed oil intended for preparation of baby food ( $n = 1$ ). All samples were stored in a dark place at ambient temperature until analysis.

### Sample preparation

50  $\mu\text{L}$  of each *trans*- and *cis*-ZEN ISTD ( $3300 \mu\text{g}/\text{kg}$  for both), were weighed into 15 mL polypropylene-reaction tubes. After evaporation to dryness (evaporation station), 0.5 mL of the sample were added gravimetrically and diluted with 0.5 mL *n*-hexane. ZEN-isomers were extracted from the sample by liquid partitioning with 5 mL methanol:water 90:10 (v/v) for 30 min while shaken on a horizontal shaker ( $300 \text{ min}^{-1}$ ), type HS501 digital (IKA<sup>®</sup>, Staufen, Germany). The tubes were centrifuged at 1,378 g and 1 mL of the upper methanol layer was weighed into an HPLC vial. The solution was evaporated to dryness and dissolved in 0.4 mL of elution solvent.

### HPLC-MS/MS method

HPLC-MS/MS analyses were performed on an Agilent 1200 series HPLC hyphenated to an API 4000 QTRAP<sup>®</sup> hybrid mass spectrometer (AB Sciex, Foster City, USA). A Gemini-NX C18 column (150 x 2 mm, 3  $\mu\text{m}$  particle size,



Phenomenex®) was used for separation in combination with a corresponding guard column. Chromatographic conditions were as follows: oven temperature 50 °C, injection volume 10 µL, flow rate 0.3 mL, solvent A: water + 0.1 % (v) formic acid, solvent B: acetonitrile + 0.1 % (v) formic acid. The following run conditions were chosen: 62 % A 0-16 min, 95 % B 16.1-22 min, 62 % A 22.1-30 min (re-equilibration). *trans*-ZEN eluted at 12.2 min, *cis*-ZEN eluted at 13.6 min.

The mass spectrometer was operated in MRM mode with ESI(-) detection. For native *trans/cis*-ZEN the monitored transitions were ( $m/z$ ) 317.1 → 131.1 (quantifier), 317.1 → 175.0 (qualifier). For the two ISTD U-[<sup>13</sup>C<sub>18</sub>]-*trans/cis*-ZEN ( $m/z$ ) 335.2 → 140.2 was monitored.

The following ion source parameters were used: ion spray voltage: -4,000 V; desolvation temperature: 500 °C; ion source gas 1: 50 arbitrary units (a. u.); ion source gas 2: 50 a. u.; curtain gas, 20 a. u.. The optimised MRM compound specific parameters were (quantifier/qualifier/ISTD): declustering potential: - 80/- 80/- 80 V; entrance potential: - 10/- 10/- 10 V; collision energy: - 42/- 40/- 42 V; collision cell exit potential: - 13/- 13/- 7 V; dwell time: 50/50/50 ms.

Data acquisition was done using Analyst 1.5.2 software (AB Sciex, Foster City, USA).

## Calibration and quantification

Stock solutions of single analytes were prepared in acetonitrile and stored at -20 °C. Six-point calibration curves were obtained on the day of analysis by weighing variable amounts of native *trans*-ZEN and *cis*-ZEN in the range of 1.0 µg/kg – 1,000 µg/kg and constant amounts of U-[<sup>13</sup>C<sub>18</sub>]-*trans*-ZEN and U-[<sup>13</sup>C<sub>18</sub>]-*cis*-ZEN (60 µg/kg final content for both). The acetonitrile was removed by a gentle nitrogen stream and elution solvent was added gravimetrically. Each calibration level was analyzed in duplicate.

The limit of detection (LOD) was calculated according to DIN 32645 using the expression  $3\sigma/S$ , where  $\sigma$  is the standard deviation of the response and  $S$  is the slope of the calibration curve. The limit of quantification (LOQ) was determined

as LOD multiplied by 3.33. LOD was determined to be 0.35 µg/kg for *trans*-ZEN and 0.28 µg/kg for *cis*-ZEN. LOQ was determined to be 1.17 µg/kg for *trans*-ZEN and 0.93 µg/kg for *cis*-ZEN. The apparent recovery of *trans*- and *cis*-ZEN from edible oil was calculated as  $(104 \pm 4) \%$  and  $(104 \pm 2) \%$ , respectively, using a spiked maize germ oil blank matrix.

### **Investigation on different quantification approaches for *cis*-ZEN**

A maize germ oil that did not contain any detectable levels of *trans*- or *cis*-ZEN was spiked with *cis*-ZEN (290 µg/kg). The maize germ oil sample was prepared as described in ‘sample preparation’ and the *cis*-ZEN content was analyzed via HPLC-MS/MS considering different quantification approaches. These options included an analysis of *cis*-ZEN based on different combinations of STD and ISTD and external calibrations summarized in Table 11.

The same maize germ oil sample was also spiked with *trans*-ZEN (600 µg/kg) to confirm the trueness of the analytical method.

### **Response factor experiments**

Three different levels of calibration standards of *trans*- and *cis*-ZEN (15 µg/kg, 95 µg/kg, 210 µg/kg for both isomers) were measured under the MS conditions described in section ‘HPLC-MS/MS method’. The response factor was calculated as area divided by mass fraction.

## 2.4.4 Results and discussion

### Isotopically labeled U-[ $^{13}\text{C}_{18}$ ]-*cis*-ZEN

Pure U-[ $^{13}\text{C}_{18}$ ]-labeled *cis*-ZEN has been prepared as ISTD. The new internal standard was structurally identified in comparison to a native *cis*-ZEN STD, which was also prepared by light-induced isomerization of commercially available *trans*-ZEN. Native *cis*-ZEN was unambiguously identified by  $^1\text{H}$ -NMR and X-ray crystallography (see ‘materials and methods’). Due to the limited amounts of prepared U-[ $^{13}\text{C}_{18}$ ]-*cis*-ZEN (6.6  $\mu\text{g}$ ) no NMR or X-ray spectra could be recorded. Therefore, structure identification was carried out in comparison to the *cis*-ZEN STD using HPLC retention time and absorbance spectra in combination with HPLC-MS/MS.

The absorbance spectra of native and isotopically labeled compounds of both ZEN isomers are displayed in Figure 22. The *trans*-ZEN compounds show three characteristic absorption maxima at 236 nm, 274 nm and 316 nm. In contrast, both *cis*-ZEN standards exhibit a significant hypsochromic shift (maxima at 229 nm, 269 nm and 309 nm), confirming the identity of the newly prepared *cis*-ZEN ISTD. Different absorbance values between native and isotopically labeled ZEN compounds arise from different concentrations measured. However, no information is available regarding molar absorption coefficients of *cis*-ZEN compared to known values of *trans*-ZEN [120].

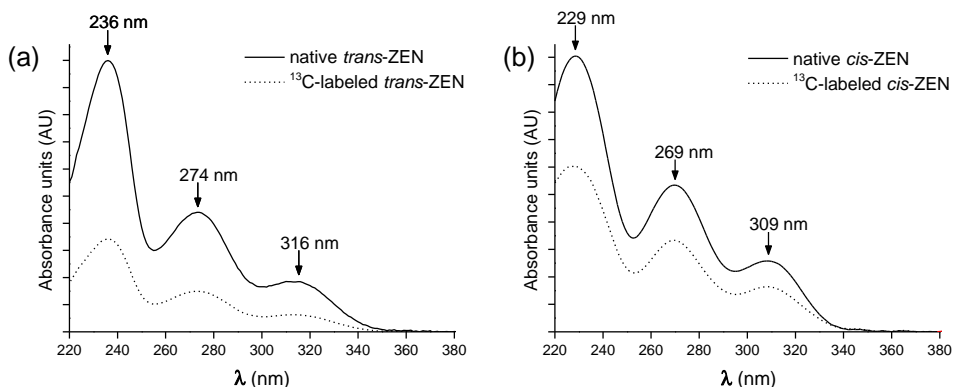


Figure 22. UV-absorbance spectra of native and  $^{13}\text{C}$ -labeled *trans*-ZEN (a) and native and  $^{13}\text{C}$ -labeled *cis*-ZEN (b).

### Long-term isomerization of ZEN in edible oils

U- $^{13}\text{C}_{18}$ -*cis*-ZEN was applied as ISTD in a long-term isomerization study in two maize germ oils of which one was spiked at 800  $\mu\text{g}/\text{kg}$  and one was naturally contaminated at 260  $\mu\text{g}/\text{kg}$ . An exposure of consumers to *cis*-ZEN may arise if *trans*-ZEN contaminated edible oils are stored or handled in the presence of (UV-) light.

A HPLC-MS/MS chromatogram of the spiked maize germ oil after three weeks is shown in Figure 23. While the *trans*- and *cis*-ZEN isomers are baseline separated, the co-eluting native and  $^{13}\text{C}$ -labeled compounds are distinguishable by their selective mass transitions in the MRM mode.

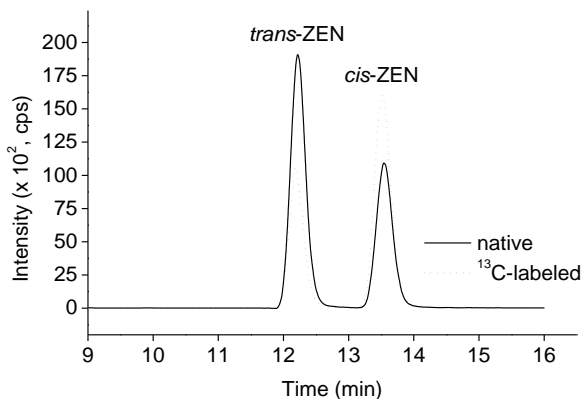


Figure 23. HPLC-MS/MS chromatogram of the spiked maize germ oil sample after three weeks upon exposure to daylight.

Figure 24 depicts the three week isomerization study, showing the spiked maize germ oil (a) and the naturally contaminated maize germ oil (b). Within the three-week interval a clear decrease in *trans*-ZEN can be seen. Simultaneously the *cis*-ZEN content increases significantly. After three weeks the ratio of *cis*-to-*trans* is about 1:3. Köppen *et al.* showed a vice-versa ratio after three weeks that was clearly on the side of *cis*-ZEN at about 3:1 [3]. This fact might be due to a discrepancy in meteorological conditions during the test periods and thus different intensities of light.

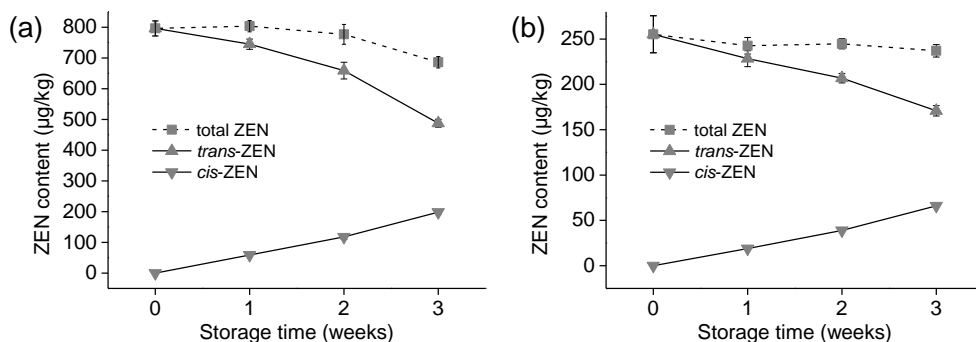


Figure 24. Daylight-induced *cis-trans* isomerization in spiked maize germ oil (a) and naturally contaminated maize germ oil (b) over three weeks. Analysis was done by SIDA-HPLC-MS/MS using the respective isotopically labeled internal standards for quantification of both ZEN-isomers ( $n = 3$ ). Error bars represent the standard deviation.

In general, the conducted long-term isomerization study confirmed the results of Köppen *et al.* showing the isomerization of *trans*- to *cis*-ZEN and, additionally, a significant loss of the total ZEN content (sum of *trans*- and *cis*-isomer) after exposure to sunlight. After three weeks we found slightly higher total ZEN contents for the spiked and the natural contaminated edible oil (86 % and 92 %, respectively) than Köppen and co-workers (approximately 81 %). The results indicate an additional way of degradation except *cis-trans*-isomerization.

### Quantification of *cis*-ZEN

Up to date isotopically labeled *cis*-ZEN is commercially not available. To circumvent this limitation several options can be considered, for example applying U- $[^{13}\text{C}_{18}]$ -*trans*-ZEN as ISTD or using an external calibration with native *cis*-ZEN as STD. Since native *cis*-ZEN cannot be purchased as well, a quantification of *cis*-ZEN via *trans*-ZEN as STD and ISTD or an external *trans*-ZEN calibration seems plausible. Thus, all these approaches were investigated for possible bias in quantification.

For this purpose, a maize germ oil that did not contain any detectable levels of *trans*- or *cis*-ZEN was spiked with *trans*-ZEN (600 µg/kg) and *cis*-ZEN (290 µg/kg). To confirm the trueness of the analytical method, *trans*-ZEN was

quantified using a *trans*-ZEN STD and U-[<sup>13</sup>C<sub>18</sub>]-*trans*-ZEN as ISTD. Indeed, the determined *trans*-ZEN value of (610 ± 24) µg/kg (n = 4) shows that the method is well suited to recover the spiked value (600 µg/kg).

The *cis*-ZEN results of all possible quantification approaches a - f are presented in Figure 25 including the limits for minimum trueness as stated in Commission Decision 2002/657/EC [121]. To meet the official requirements, the minimum trueness of quantitative analytical methods at levels ≥ 10 µg/kg should be in the range of -20 % to +10 % of the spiked value.

Table 11. Quantification approaches applied to the determination of *cis*-ZEN after HPLC-MS/MS analysis. Marked (checkmark) are the standards used for quantification of *cis*-ZEN.

	Quantification approach					
	a	b	c	d	e	f
native <i>cis</i> -ZEN	✓	✓			✓	
native <i>trans</i> -ZEN			✓	✓		✓
<sup>13</sup> C <sub>18</sub> - <i>cis</i> -ZEN	✓			✓		
<sup>13</sup> C <sub>18</sub> - <i>trans</i> -ZEN		✓	✓			

Figure 25 clearly demonstrates that only three of the six quantification approaches (a, b and e) fulfil the EU criteria. In contrast, *cis*-ZEN quantification approaches using *trans*-ZEN as STD may lead to a strong over-estimation of *cis*-ZEN (c, d and f). A one-sided t-test ( $f=3$ ,  $P=95\%$ ) confirmed statistically significant differences for the obtained mean values in comparison to the spiked value.

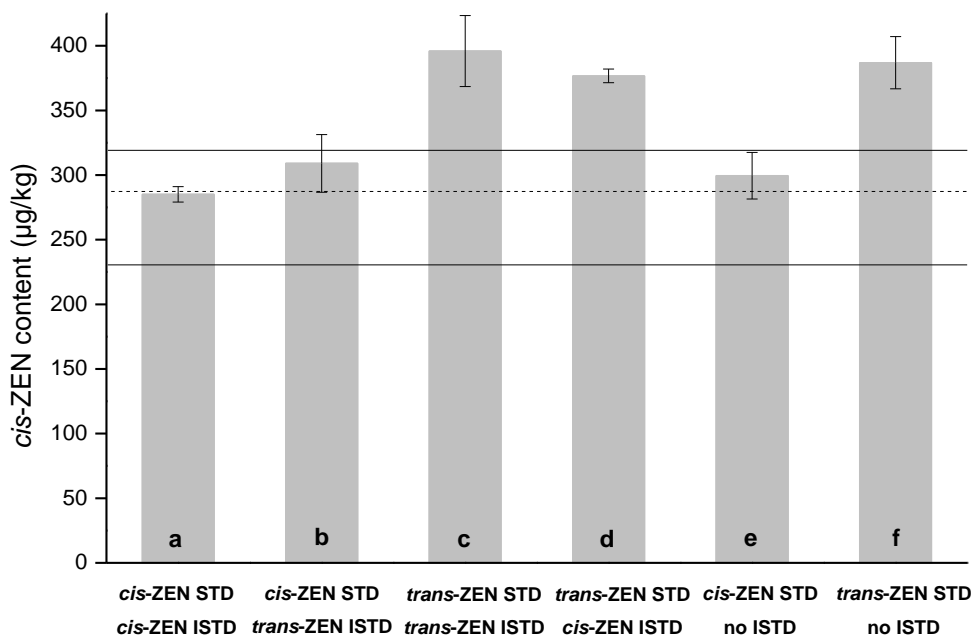


Figure 25. Determination of *cis*-ZEN in a spiked maize germ oil ( $n = 4$ ) by various quantification approaches (a - f). Error bars represent the standard deviation.

<sup>a</sup>according to EU commission regulation 657/2002.

The over-estimation when using *trans*-ZEN as STD can be attributed to differences between the isomers in LC retention time, resulting in different matrix effects as well as a difference in MS-response. Though several studies on diastereomers assume identical responses in MS analysis [122-124], we could not confirm or adopt this thesis to the *trans*-/*cis*-ZEN isomers under the MS conditions employed in this study. Response factors (RF) for both isomers at three different levels are displayed in Table 12.

## 2 Results and discussion

Table 12. Response factors<sup>a</sup> (RF) for *trans*- and *cis*-ZEN calibration standards at three different levels after HPLC-MS/MS analysis (n = 10).

Content ( $\mu\text{g}/\text{kg}$ )	RF <i>trans</i> -ZEN	RF <i>cis</i> -ZEN	RF difference <i>cis</i> - to- <i>trans</i> (%)
15	5,890 $\pm$ 210	7,800 $\pm$ 380	32.5
95	5,910 $\pm$ 180	7,520 $\pm$ 270	27.3
210	5,450 $\pm$ 230	6,910 $\pm$ 310	26.8

<sup>a</sup>RF calculates as area divided by mass fraction

Overall, a combination of *cis*-ZEN STD and *cis*-ZEN ISTD proved to be the best choice for determining *cis*-ZEN in edible oil. If no isotopically labeled *cis*-ZEN is available as ISTD, an external calibration via native *cis*-ZEN seems plausible. The use of *trans*-ZEN as STD may lead to a strong over-estimation of *cis*-ZEN in any case. Regarding the need to accurately quantify *cis*-ZEN in natural contaminated food and feed samples, we can recommend to at least apply a native *cis*-ZEN STD.

### Sample survey

The new U-[<sup>13</sup>C<sub>18</sub>]-*cis*-ZEN standard was applied to the analysis of 15 different edible oils by SIDA-HPLC-MS/MS (Table 13). *cis*-ZEN was detected in one maize germ oil (no. 6) above the LOD but below LOQ. It is not clear whether the *cis*-ZEN contamination is caused by light exposure of pre-existing *trans*-ZEN or if *cis*-ZEN was readily produced by the fungus and then transferred into the edible oil during processing. *trans*-ZEN was found in 2 out of 15 samples (13.3 %) in the range of 17.2  $\mu\text{g}/\text{kg}$  to 31.2  $\mu\text{g}/\text{kg}$ . The two positive samples were maize germ oils. None of the *trans*-ZEN contaminated samples exceeded the EU maximum level of 400  $\mu\text{g}/\text{kg}$ . Our sample survey suggests a low risk of *cis*-ZEN in food products from the supermarket.



Table 13. Sample survey of different edible oils from German retail markets and online shops (n = 3) as analyzed by HPLC-SIDA-MS/MS.

No.	Usage	Type of oil	<i>trans</i> -ZEN (µg/kg)	<i>cis</i> -ZEN (µg/kg)
1	Edible oil	Maize germ oil	n. d.	n. d.
2	Edible oil	Maize germ oil	n. d.	n. d.
3	Edible oil	Maize germ oil	31.2 ± 0.2	n. d.
4	Edible oil	Maize germ oil	n. d.	n. d.
5	Edible oil	Maize germ oil	n. d.	n. d.
6	Edible oil	Maize germ oil	17.2 ± 0.6	LOD < x < LOQ
7	Edible oil	Soy bean oil	n. d.	n. d.
8	Edible oil	Soy bean oil	n. d.	n. d.
9	Edible oil	Soy bean oil	n. d.	n. d.
10	Edible oil	Rice germ oil	n. d.	n. d.
11	Edible oil	Rice germ oil	n. d.	n. d.
12	Edible oil	Rice germ oil	n. d.	n. d.
13	Edible oil	Wheat germ oil	n. d.	n. d.
14	Edible oil	Wheat germ oil	n. d.	n. d.
15	Edible oil	Maize germ oil/ rapeseed oil	n. d.	n. d.

n. d. = not detected

### 2.4.5. Conclusion

In summary, we report the first preparation of U-[<sup>13</sup>C<sub>18</sub>]-*cis*-ZEN. The new isotopically labeled standard has been characterized and applied for a reliable and accurate quantification of *cis*-ZEN in edible oils with HPLC-MS/MS. A comparison of different quantification approaches for *cis*-ZEN revealed a significant bias if *trans*-ZEN is used as STD. In a sample survey *cis*-ZEN was detected in one edible oil sample from a retail market. The newly prepared U-[<sup>13</sup>C<sub>18</sub>]-*cis*-ZEN ISTD will be valuable for future investigations on the occurrence, fate and risks of *cis*-ZEN.

#### **2.4.6. Acknowledgements**

The authors would like to thank Dr. David Siegel for valuable suggestions on this manuscript.

## 2.5. *In vitro* phase I metabolism of *cis*-zearalenone

Sarah S. Drzymala<sup>a</sup>, Antje J. Herrmann<sup>a</sup>, Ronald Maul<sup>a, b</sup>, Leif-Alexander Garbe<sup>c</sup>, Matthias Koch<sup>a</sup>

**Chemical Research in Toxicology, 2014, 27(11), 1972-1978**

Received July 31<sup>st</sup> 2014, Accepted September 25<sup>th</sup> 2014

DOI: 10.1021/tx500312g

<sup>a</sup>BAM Federal Institute for Materials Research and Testing, Richard-Willstätter-Str. 11, 12489 Berlin, Germany. E-mail:matthias.koch@bam.de; Tel.: +49 30 8104 1170

<sup>b</sup>Leibniz-Institute of Vegetable and Ornamental Crops (IGZ), Theodor-Echtermeyer-Weg 1, 14979 Großbeeren, Germany

<sup>c</sup>Technische Universität Berlin, Ackerstr. 76, 13355 Berlin, Germany

### 2.5.1. Abstract

The present study investigates the *in vitro* phase I metabolism of *cis*-zearalenone (*cis*-ZEN) in rat liver microsomes and human liver microsomes. *cis*-ZEN is an often ignored isomer of the *trans*-configured *Fusarium* mycotoxin zearalenone (*trans*-ZEN). Upon the influence of (UV-) light, *trans*-ZEN isomerizes to *cis*-ZEN. Therefore, *cis*-ZEN is also present in food and feed. The aim of our study was to evaluate the *in vitro* phase I metabolism of *cis*-ZEN in comparison to *trans*-ZEN. As a result, an extensive metabolization of *cis*-ZEN is observed for rat and human liver microsomes as analyzed by HPLC-MS/MS and high-resolution MS. Kinetic investigations based on the substrate depletion approach showed no significant difference in rate constants and half-lives for *cis*- and *trans*-ZEN in rat microsomes. In contrast, *cis*-ZEN was depleted about 1.4 fold faster than *trans*-ZEN in human microsomes. The metabolite pattern of *cis*-ZEN revealed a total of 10 phase I metabolites. Its reduction products  $\alpha$ - and  $\beta$ -*cis*-zearalenol ( $\alpha$ - and  $\beta$ -*cis*-ZEL) were found as metabolites in both species with  $\alpha$ -*cis*-ZEL being a major metabolite in rat liver microsomes. Both compounds were identified by co-chromatography with synthesized authentic standards. A further major metabolite in rat microsomes was monohydroxylated *cis*-ZEN. In human microsomes, monohydroxylated *cis*-ZEN is the single dominating peak of the metabolite profile. Our study discloses three metabolic pathways for *cis*-ZEN: reduction of the keto group, monohydroxylation and a combination of both. Since these routes

have been reported for *trans*-ZEN, we conclude that the phase I metabolism of *cis*-ZEN is essentially similar to its *trans*-isomer. As *trans*-ZEN is prone to metabolic activation leading to the formation of more estrogenic metabolites, the novel metabolites of *cis*-ZEN reported in this study, in particular  $\alpha$ -*cis*-ZEL, might also show a higher estrogenicity.

### 2.5.2. Introduction

*trans*-Zearalenone (*trans*-ZEN) is an estrogenic mycotoxin that contaminates food and feed worldwide. It is produced by various molds of the *Fusarium* genus which can infest cereal crops including wheat, rye, oats, soybeans, rice and maize. Humans and animals are exposed to *trans*-ZEN by ingestion of contaminated food and feed. The spatial structure of *trans*-ZEN enables binding to the mammalian estrogen receptor thus causing reproductive disorders in numerous animal species and possibly in humans [25]. Thus, maximum levels have been established for this fungal toxin in the European Union (EU) and several countries worldwide [125]. In the EU maximum levels range between 20 and 400  $\mu\text{g}/\text{kg}$  depending on the commodity [26].

Concerning phase I metabolism, several mammalian *in vitro* and *in vivo* studies have shown that *trans*-ZEN is extensively metabolized via reduction and hydroxylation. Reduction products were found in various animal species and humans, in particular  $\alpha$ - and  $\beta$ -*trans*-zearalenol ( $\alpha$ - and  $\beta$ -*trans*-ZEL) [28, 39, 126, 127]. The estrogenic activity of  $\alpha$ -*trans*-ZEL exceeds that of *trans*-ZEN by approximately a factor of 80 thus linking the toxicity of *trans*-ZEN inevitably to its metabolism [20]. Several monohydroxylated metabolites were discovered in rat and human *in vitro* assays including one monohydroxylated ZEN being discovered in rat urine *in vivo* [33-36]. Various studies demonstrated that *trans*-ZEN is subject to phase II metabolism. Conjugation of *trans*-ZEN with glucuronic acid and sulfate was proven to be a major metabolic pathway in different animal species and humans *in vitro* as well as *in vivo* [40, 41, 128]. These reports also show that phase I metabolites of *trans*-ZEN are prone to conjugation reactions.

Although often ignored, ZEN can occur in two configurations. The double bond between C11 and C12 may isomerize from the *trans* to the *cis* configuration (Figure 26).

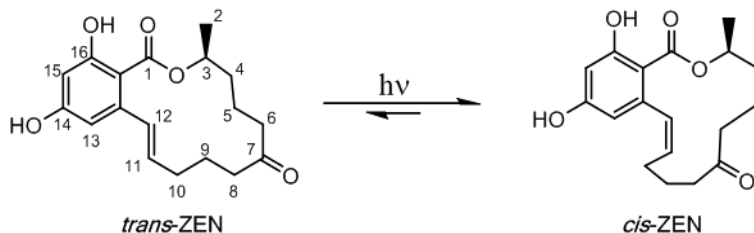


Figure 26. Photoisomerization of *trans*-ZEN to *cis*-ZEN at the double bond C11-C12.

Routes of entry into the food chain might arise from the production of *cis*-ZEN by fungi [14, 15] or upon exposure of *trans*-ZEN contaminated foods to (UV-) light. Although the detection of *cis*-ZEN in fungi cultures might be a consequence of exposition to daylight as biosynthetic pathways are generally stereoselective. To date, *cis*-ZEN has been detected in different commodities like ground maize, sugar beets and edible oils as well as in wet ground maize intended for animal feeding [3, 16, 17].

Despite the evidence of *cis*-ZEN occurrence in food and feed, its metabolism has never been investigated. Presumably, the lacking availability of authentic standards and missing adequate analytical methods have hampered a comprehensive investigation on *cis*-ZEN metabolism. In order to address this problem, we recently synthesized *cis*-ZEN and  $^{13}\text{C}$ -labeled *cis*-ZEN [1, 3]. Applying these standards, the aim of the present work is to investigate the *in vitro* depletion kinetics of *cis*-ZEN and to identify novel metabolites in rat and human liver microsomes.

### 2.5.3. Materials and methods

#### Terms and definitions

Throughout the entire manuscript the term zearalenone (ZEN) or zearalenol (ZEL) refers to both *cis*- and *trans*-isomers. When a certain isomer is considered it will be specified by either “*trans*” or “*cis*”.

#### Chemical reagents

*trans*-ZEN (white powder, purity 99.8 %) was purchased from AppliChem GmbH (Darmstadt, Germany). Zearalanone (purity 98.0 %),  $\alpha$ -*trans*-ZEL (no purity given) and  $\beta$ -*trans*-ZEL (no purity given) were derived from Sigma-Aldrich (Steinheim, Germany). NADPH tetrasodium salt was obtained from AppliChem GmbH (Darmstadt, Germany).  $MgCl_2$  was purchased from Avantor Performance Materials (Center Valley, PA, U.S.A).  $KH_2PO_4$  was derived from Merck (Darmstadt, Germany) and  $K_2HPO_4$  from Carl Roth (Karlsruhe, Germany). All standard chemicals were of p. a. grade and all solvents HPLC grade.

#### Microsomal source

Human and rat liver microsomes were purchased from BioreclamationIVT (Baltimore, USA). Rat liver microsomes (RLM) were prepared from Sprague-Dawley female rats. Human liver microsomes (HLM) were derived from a mixed gender pool of 50 donors. The total protein content, P450 concentrations and specific activities of different P450 isoforms were assumed as provided by the manufacturer. Regarding RLM the protein concentration was 23.7 mg/mL and the total P450 concentration 0.483 nmol/mg. For HLM, the protein concentration was 20.0 mg/mL and the total P450 concentration 0.411 nmol/mg,

## Preparation of native and $^{13}\text{C}$ -labeled *cis*-zearalenone

Native *cis*-ZEN was generated photochemically from *trans*-ZEN by a procedure reported earlier [3]. In summary, native *trans*-ZEN is dissolved in ethyl acetate and irradiated by UV-light ( $\lambda = 350$  nm) for 8 h. The irradiated solution is then subjected to preparative HPLC in order to separate the *trans*- from the *cis*-isomer and to obtain pure native *cis*-ZEN. U- $^{13}\text{C}_{18}$ -*cis*-ZEN was synthesized as described earlier [1] following the same procedure as for the preparation of native *cis*-ZEN. Purities were determined to be > 99 % for the native as well as the  $^{13}\text{C}$ -labeled standard as measured by HPLC-FLD.

## Microsomal incubations

Incubations of ZEN with either RLM or HLM were carried out at 37 °C in a volume of 0.2 mL. For kinetic investigations a mixture containing 1  $\mu\text{M}$  ZEN dissolved in DMSO, microsomes (final protein concentration 1 mg/mL), 0.1 mM  $\text{MgCl}_2$  and potassium phosphate buffer pH 7.4 0.1 M were pre-incubated for 5 min. The fraction of DMSO in the microsomal incubation volume was not higher than 1 %. Reactions were started by adding 6 mM NADPH. At different time points the reaction was quenched by addition of equal volumes of ice-cold acetonitrile containing internal standard. The respective fully  $^{13}\text{C}$ -labeled ZEN analogues were used for quantification of *cis*- and *trans*-ZEN. After the reaction was stopped the incubation mixtures were centrifugated in a Eppendorf mini Spin plus centrifuge (Hamburg, Germany) at  $11,650 \times g$  for 5 min. The supernatant was transferred to a HPLC vial and analyzed by HPLC-MS/MS. Negative controls lacked NADPH. Vehicle controls contained NADPH but no substrate. A control containing NADPH and substrate but without microsomes was performed as well. Control incubations were performed in duplicate, all other reactions were performed in triplicate.

In order to calculate depletion kinetics, the peak areas of *cis*- or *trans*-ZEN were determined and normalized to the value obtained at  $t = 0$  min. Rate constants  $k$  ( $\text{min}^{-1}$ ) were obtained by linear least squares regression of the term  $\ln(A/A_0) = -k \times t$ , with  $t$  being the incubation time (min),  $A$  the peak area and  $A_0$  the peak area

at  $t = 0$  min. Half-lives were calculated according to the expression  $t_{1/2} = \ln 2/k$  as reported by Obach and colleagues [129].

In contrast to the kinetic investigations, 10  $\mu\text{M}$  ZEN were used as substrate concentration for qualitative analysis to enhance signal intensity of the formed metabolites. The reaction was run for a time period of 120 min and then stopped by addition of 50  $\mu\text{L}$  ice-cold acetonitrile. Analysis was carried out by high-resolution mass spectrometry (HRMS). Phase I metabolites were identified by comparing chromatograms from vehicle control and negative control incubations to incubations in the presence of NADPH. Furthermore, incubations in the presence of NADPH were compared to incubations containing NADPH and substrate but without microsomes. All other conditions were as stated for the kinetic investigations.

### Metabolite synthesis: $\alpha$ - and $\beta$ -*cis*-zearalenol

In a series of pre-tests standards of  $\alpha$ -*trans*-ZEL and  $\beta$ -*trans*-ZEL were UV-irradiated separately at  $\lambda = 350$  nm. Each standard gave rise to one main irradiation product which was tentatively assigned  $\alpha$ -*cis*-ZEL or  $\beta$ -*cis*-ZEL depending on the configuration of the educt. The maximum *cis*-ZEL formation was observed after 24 h for  $\alpha$ -*trans*-ZEL and after 48 h for  $\beta$ -*trans*-ZEL. Irradiation in ethyl acetate yielded the highest *cis*-/*trans*-ZEL ratio ( $\alpha$ -ZEL 3.5,  $\beta$ -ZEL 3.6) when compared to heptane, acetonitrile, acetone and methanol confirming the results of Köppen *et al.* [3] for ZEN isomerization.

For final synthesis of the *cis*-ZELs a two step procedure was planned using sodium borohydride reduction of *trans*-ZEN and subsequent UV radiation. Due to the isomerization equilibrium of the *trans*- and *cis*-ZELs after irradiation, a suitable analytical method was developed to separate all four ZEL isomers in one run (Figure 27). The chromatographic system consisted of a SpectraSystem<sup>TM</sup> HPLC (Thermo Fisher Scientific, Waltham, MA, USA) including a pump P4000, a degasser SCM 1000F, an autosampler AS3000F, a DAD UV6000LP and a FLD Surveyor Plus with a Eurospher II 100-3 C18 P column (150 x 2 mm, 3  $\mu\text{m}$  particle size; Knauer GmbH, Berlin, Germany). 50 °C oven temperature, an injection volume of 10  $\mu\text{L}$ , a flow rate of 0.4 ml/min and a runtime of 30 min were



employed. Methanol:water 45:55 (v/v) containing 0.1 % formic acid was used as isocratic elution solvent. The DAD was set to  $\lambda = 274$  nm and fluorescence detection was done at  $\lambda_{\text{Ex}} = 274$  nm and  $\lambda_{\text{Em}} = 456$  nm.

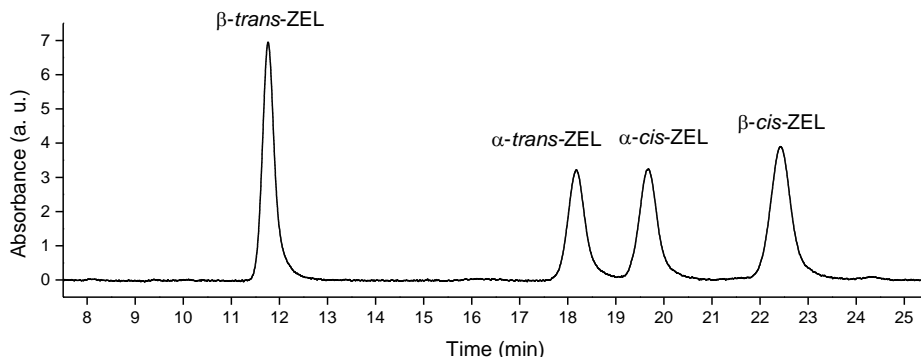


Figure 27. HPLC-DAD ( $\lambda = 274$  nm) chromatogram of  $\alpha$ -/ $\beta$ -*trans*-ZEL after UV irradiation for 12 h. The mixture of the four isomers can be well separated using a C18 column. Retention times differ from the metabolite patterns in Figure 29 and Figure 30 due to a different analytical column and method.

Final synthesis of both *cis*-ZEL isomers was carried out with 38 mg  $\text{NaBH}_4$  (1.0 mmol) which was added to a solution of 25 mg *trans*-ZEN (0.9 mmol) in 10 mL methanol. After 15 min at room temperature the reaction was stopped by dropwise addition of acetic acid (25 % in water) until no further gas formation could be observed. The completion of the reaction was confirmed by HPLC-FLD (chromatography conditions as stated above). The ratio of  $\alpha$ -*trans*-ZEL to  $\beta$ -*trans*-ZEL was calculated from HPLC-DAD peak area ( $\lambda = 274$  nm) as 33 : 67. The solution was evaporated to dryness, redissolved in ethyl acetate and split into 10 fractions in clear glass HPLC-vials which were directly exposed to UV light ( $\lambda = 350$  nm). The exposition was carried out for 24 hours by using an universal UV lamp, type TL-900 (CAMAG, Muttenz, Switzerland). The generated *cis*-isomers were purified from the *trans*-isomers using the chromatographic conditions as described above with the HPLC system connected to an automatic fraction collector Foxy Jr. (Teledyne Isco, Lincoln, NE, USA). The purification yielded 5.6 mg (22 %)  $\alpha$ -*cis*-ZEL in a purity of > 94 % and 7.0 mg  $\beta$ -*cis*-ZEL in a purity of > 99 %. Purities were determined by HPLC-UV analysis at  $\lambda = 274$  nm.

The accurate mass of the *cis*-ZELs was determined by HRMS ( $m/z$  319.157 for both) and matches the calculated exact mass for ZEL. Furthermore, the

configuration of the double bond C11-C12 was resolved by  $^1\text{H-NMR}$ . NMR spectra were recorded on a Bruker DMX-400 or a Bruker AVANCE III 500 spectrometer (Bruker Daltonik, Bremen, Germany) in  $\text{CD}_3\text{OD}$ . Proton chemical shifts were referenced to residual native methanol at 3.31 ppm. Complete assignments for proton resonances were performed in accordance to previously published works on  $\alpha$ - and  $\beta$ -*trans*-ZEL [130].

### $\alpha$ -*trans*-ZEL

$\delta/\text{ppm} = 1.16 - 1.94$  (m, 10H, H-4, H-5, H-6, H-8, H-9); 1.39 (d, 3H,  $-\text{CH}_3$ ,  $J = 6.1$  Hz); 2.32 (m, 2H, H-10); 3.76 (m, 1H, H-7); 4.96 (m, 1H, H-3); 5.70 (ddd, 1H, H-11,  $J = 15.4, 9.9, 4.6$  Hz); 6.22 (d, 1H, H-15,  $^4J_{(13,15)} = 2.5$  Hz), 6.37 (d, 1H, H-13,  $^4J_{(13,15)} = 2.5$  Hz), 7.12 (d, 1H, H-12,  $J_{(12,11)} = 15.4$  Hz).

### $\alpha$ -*cis*-ZEL

$\delta/\text{ppm} = 1.24 - 1.82$  (m, 10H, H-4, H-5, H-6, H-8, H-9); 1.35 (d, 3H,  $-\text{CH}_3$ ,  $J = 6.2$  Hz); 2.28 (m, 2H, H-10); 3.75 (m, 1H, H-7); 5.15 (m, 1H, H-3,  $J = 6.2$  Hz); 5.57 (ddd, 1H, H-11,  $J = 11.5, 11.2, 3.8$  Hz); 6.14 (d, 1H, H-15,  $^4J_{(13,15)} = 2.5$  Hz), 6.23 (d, 1H, H-13,  $^4J_{(13,15)} = 2.5$  Hz), 6.71 (d, 1H, H-12,  $J_{(12,11)} = 11.5$  Hz).

### $\beta$ -*trans*-ZEL

$\delta/\text{ppm} = 1.29 - 1.79$  (m, 10H, H-4, H-5, H-6, H-8, H-9); 1.34 (d, 3H,  $-\text{CH}_3$ ,  $J = 6.2$  Hz); 2.28 (m, 2H, H-10); 3.71 (m, 1H, H-7); 5.12 (m, 1H, H-3,  $J = 6.3$  Hz); 5.96 (ddd, 1H, H-11,  $J = 15.5, 8.4, 6.0$  Hz); 6.21 (d, 1H, H-15,  $^4J_{(13,15)} = 2.5$  Hz), 6.44 (d, 1H, H-13,  $^4J_{(13,15)} = 2.5$  Hz), 6.72 (d, 1H, H-12,  $J_{(12,11)} = 15.6$  Hz).

### $\beta$ -*cis*-ZEL

$\delta/\text{ppm} = 1.28 - 1.69$  (m, 10H, H-4, H-5, H-6, H-8, H-9); 1.36 (d, 3H,  $-\text{CH}_3$ ,  $J = 6.5$  Hz); 2.17 (m, 2H, H-10); 3.60 (m, 1H, H-7); 5.34 (m, 1H, H-3,  $J = 6.5$  Hz); 5.60 (ddd, 1H, H-11,  $J = 11.5, 10.1, 5.1$  Hz); 6.14 (d, 1H, H-15,  $^4J_{(13,15)} = 2.5$  Hz), 6.22 (d, 1H, H-13,  $^4J_{(13,15)} = 2.5$  Hz), 6.72 (d, 1H, H-12,  $J_{(12,11)} = 11.5$  Hz).

## HPLC-MS analysis

### *HPLC-MS/MS*

Kinetic experiments were analyzed on an Agilent 1200 series HPLC coupled to an API 4000 QTRAP<sup>®</sup> hybrid mass spectrometer (AB Sciex, Foster City, USA). A Gemini-NX C<sub>18</sub> column (150 mm x 2 mm, 3 μm particle size, Phenomenex<sup>®</sup>, Aschaffenburg, Germany) was used with a flow rate of 0.25 mL/min and an oven temperature of 50 °C. The mobile phase consisted of water with 0.1 % formic acid (A) and methanol containing 0.1 % formic acid (B). A gradient program was used starting at 50 % mobile phase B. Within 17 min B was raised to 60 % followed by an increase to 100 % at minute 18. Afterwards the column was re-equilibrated to starting conditions for 5 minutes. HPLC-MS/MS runtime was 24 minutes per sample and the injection volume was set to 10 μL.

The mass spectrometer was operated in multiple reaction monitoring (MRM) mode with negative electrospray ionization (ESI). For both native ZEN isomers the monitored transitions were (*m/z*) 317.1 → 131.1 (quantifier), 317.1 → 175.0 (qualifier). For the two internal standards U-[<sup>13</sup>C<sub>18</sub>]-ZEN (*m/z*) 335.2 → 140.2 was monitored. *trans*- and *cis*-ZEN were separated by chromatography and assigned via retention times.

The following ion source parameters were used: ion spray voltage: -4,000 V; desolvation temperature: 450 °C; ion source gas 1: 60; ion source gas 2: 60; curtain gas: 20. The optimized MRM compound specific parameters were (quantifier/qualifier/internal standard): declustering potential: - 65/- 65/- 65 V; entrance potential: - 10/- 10/- 10 V; collision energy: - 40/- 34/- 40 V; collision cell exit potential: - 9/- 6/- 9 V; dwell time: 50/50/50 ms. Data acquisition was done using Analyst 1.6.2 software (AB Sciex, Foster City, USA).

### HRMS

Qualitative metabolite profiling and accurate mass based analyses were done on an Agilent 1290 Infinity UPLC coupled to an Agilent 6230 Accurate-Mass Time-of-Flight MS. The column oven was set to 50 °C. Separation of the metabolites was achieved on an Ascentis Express F5 column (150 mm x 3 mm, 2.7 µm particle size, Sigma-Aldrich, Steinheim, Germany). The Ascentis F5 column separated *trans*- and *cis*-ZEN as well as the *cis*- and *trans*-isomers of  $\alpha$ - and  $\beta$ -ZEL using water with 0.1 % formic acid (A) and methanol containing 0.1 % formic acid (B) as solvents in a gradient program at a flow rate of 0.35 mL/min. A linear gradient was applied starting from 50 % B to 70 % at minute 18. Then the column was re-equilibrated for 8 min.

For ESI operation nitrogen was used as drying gas (350 °C, 10 L/min) and nebulizer gas (35 psi). The capillary, skimmer and octapole RF voltages were set at 3.7 kV, 65 V and 750 V, respectively. Data was acquired in the negative ionization mode within a range of 75 to 500 *m/z*. Automatic calibration was enabled by continuous post-column infusion of calibrant solution. Data analysis was done using MassHunter 6.0. Determination of the elemental composition of individual metabolites was based on accurate masses, typically better than 10 ppm mass accuracy.

### 2.5.4. Results

#### Depletion kinetics

In the presence of NADPH *cis*-ZEN is rapidly metabolized by rat liver microsomes (RLM) and human liver microsomes (HLM) which can be seen by the decrease of substrate concentration (Figure 28). In the absence of NADPH *cis*-ZEN levels remain constant. In order to investigate if changes in double bond configuration affect depletion kinetics, the degradation of *cis*-ZEN is displayed in comparison to *trans*-ZEN.

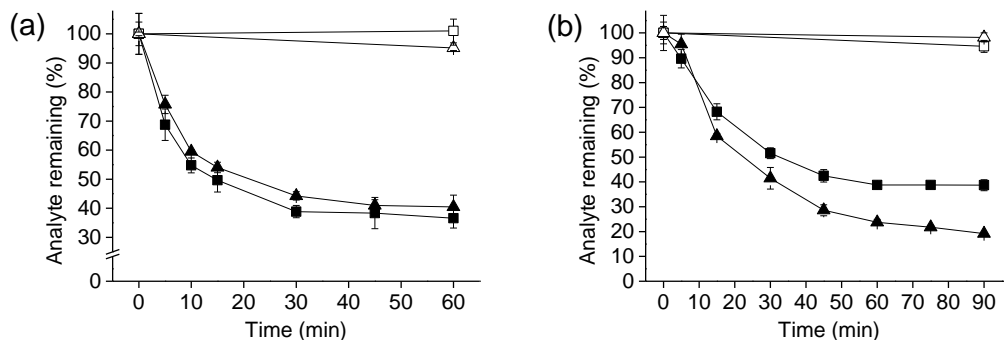


Figure 28. Depletion profile of 1  $\mu$ M *cis*-ZEN (triangle) and *trans*-ZEN (square) in RLM (a) and HLM (b). The corresponding NADPH depleted controls clearly show the dependence of phase I metabolism of *cis*-ZEN (blank triangle) and *trans*-ZEN (blank square) on NADPH as cofactor. Error bars represent the standard deviation ( $n = 3$  for samples containing NADPH;  $n = 2$  for controls).

Initial degradation constants and half-lives were calculated in approximation to first-order decay functions for RLM and HLM. In RLM the rate constants for *cis*- and *trans*-ZEN are comparable with values of  $41 \pm 3$  and  $45 \pm 3 \times 10^{-3} \text{ min}^{-1}$ , respectively. The half-lives were determined to be  $17 \pm 1$  min for *cis*-ZEN and  $15 \pm 1$  min for *trans*-ZEN. By contrast in HLM, *cis*-ZEN is metabolized about 1.4 fold faster than *trans*-ZEN with the rate constants being  $29 \pm 1 \times 10^{-3} \text{ min}^{-1}$  for *cis*-ZEN and  $20 \pm 1 \times 10^{-3} \text{ min}^{-1}$  for *trans*-ZEN which is also reflected in half-lives ( $24 \pm 1$  min for *cis*-ZEN and  $34 \pm 3$  min for *trans*-ZEN). A two-sided t-test ( $f = 4$ ,  $P = 95\%$ ) confirmed statistically significant differences for the half-lives of *cis*- and *trans*-ZEN in HLM.

### Metabolite profiles of *cis*-ZEN

Analysis of the RLM and HLM incubations of *cis*-ZEN by HRMS revealed a total of 10 unknown metabolites which are listed in Table 14.

## 2 Results and discussion

Table 14. Overview of compounds, metabolic reactions, retention times ( $t_R$ ), elemental formulas, observed masses and errors for *cis*-ZEN metabolites formed by RLM or HLM.

Compound	Metabolic reaction	RLM	HLM	$t_R$ (min)	Formula	$m/z$ observed	Mass error (mDa)
<i>cis</i> -ZEN				15.3	C <sub>18</sub> H <sub>21</sub> O <sub>5</sub>	317.142	+3
M1	+ O	x	x	6.5	C <sub>18</sub> H <sub>21</sub> O <sub>6</sub>	333.134	0
M2	+ O		x	7.5	C <sub>18</sub> H <sub>21</sub> O <sub>6</sub>	333.134	0
M3	+ O	x		8.5	C <sub>18</sub> H <sub>21</sub> O <sub>6</sub>	333.134	0
M4	+ O and + 2H	x		8.5	C <sub>18</sub> H <sub>23</sub> O <sub>6</sub>	335.151	+1
M5	+ O and + 2H	x		8.8	C <sub>18</sub> H <sub>23</sub> O <sub>6</sub>	335.151	+1
M6	+ O	x	x	10.0	C <sub>18</sub> H <sub>21</sub> O <sub>6</sub>	333.134	0
M7	+ O	x	x	10.7	C <sub>18</sub> H <sub>21</sub> O <sub>6</sub>	333.134	0
M8	+ O	x	x	10.7	C <sub>18</sub> H <sub>21</sub> O <sub>6</sub>	333.134	0
M9	+ 2H	x	x	13.1	C <sub>18</sub> H <sub>23</sub> O <sub>5</sub>	319.157	+2
M10	+ 2H	x	x	13.8	C <sub>18</sub> H <sub>23</sub> O <sub>5</sub>	319.157	+2

The chromatograms of the metabolite profiles of *cis*-ZEN formed by RLM or HLM as measured by HRMS are shown in Figure 29 and Figure 30. Peaks without designation were also observed in controls. All detected metabolites eluted prior to *cis*-ZEN.

Nine metabolites were detected in RLM incubations (Figure 29). The profile shows two dominating peaks, M6 and M10. The mass of M6 is increased by 15.992 amu corresponding to a monohydroxylation (+ O). Apart from M6 various smaller peaks display the same mass shift indicating different sites of hydroxylation (M1, M3, M7, M8). The second main peak, M10, displays a mass shift of + 2.015 amu which suggests a reduction (+ 2H). The same  $m/z$  is observed for the smaller peak M9. The remaining signals M4 and M5 are products of sequential reduction and monohydroxylation with mass shifts of + 18.009 amu.

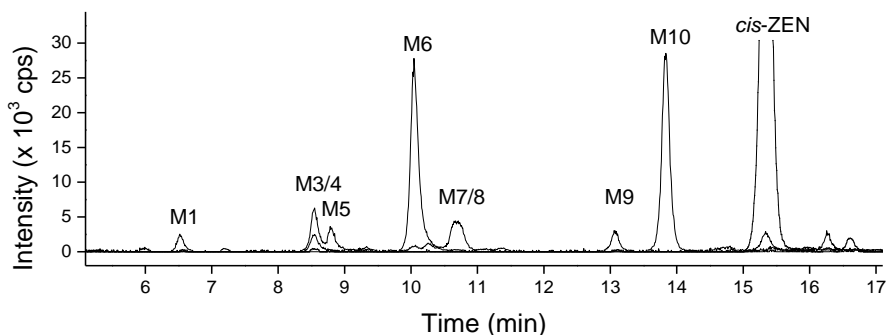


Figure 29. Overlay of extracted ion chromatograms which were obtained by analysis of 10  $\mu$ M *cis*-ZEN incubated with RLM. The four ion traces  $m/z$  319.157,  $m/z$  333.134,  $m/z$  335.152 and  $m/z$  317.342 were extracted and overlaid.

The metabolite pattern of *cis*-ZEN as catalyzed by HLM shows seven different metabolites (Figure 30). M6, a monohydroxylated *cis*-ZEN, is the most abundant peak. Several smaller peaks (M1, M2, M7, M8) also show a  $m/z$  corresponding to monohydroxylated *cis*-ZEN which suggests multiple sites of monohydroxylation. The reductive metabolites M9 and M10 are observed for HLM as well, with both peaks being less pronounced in HLM assays compared to RLM.

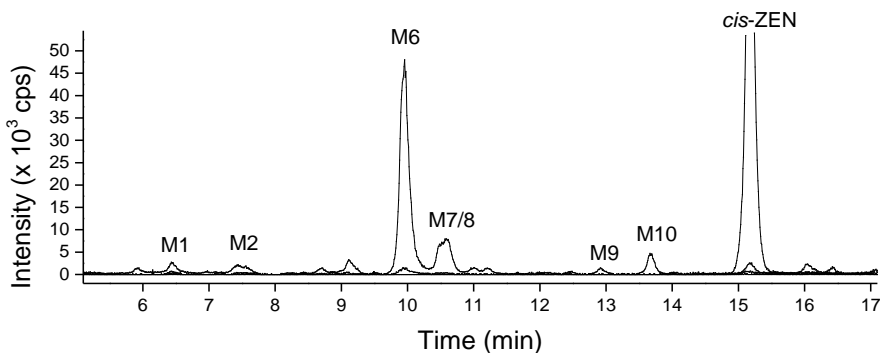


Figure 30. Overlay of extracted ion chromatograms which were obtained by analysis of 10  $\mu$ M *cis*-ZEN incubated with HLM. The four ion traces  $m/z$  319.157,  $m/z$  333.134,  $m/z$  335.152 and  $m/z$  317.342 were extracted and overlaid.

Overall, three different sets of mass increase can be concluded from Table 14: reduction (+ 2.015 amu, + 2H), monohydroxylation (+ 15.992 amu, + O) and a combination of reduction and monohydroxylation (+ 18.009 amu, + O and +2 H). The latter is only observed for RLM.

### Identification of *cis*-ZEN metabolites M9 and M10

M9 and M10 share a mass increase of 2.015 amu which can arise from two metabolic reactions: reduction of the double bond between C11 and C12 or reduction of the ketone. The reduction of the double bond would yield zearalanone which was excluded by co-chromatography of M9 and M10 with an authentic reference standard. The reduction of the keto group could be confirmed by co-chromatography with synthesized authentic reference standards of  $\alpha$ -*cis*-ZEL and  $\beta$ -*cis*-ZEL.

Structure identification of the synthetic *cis*-ZELs was achieved by  $^1\text{H}$ -nuclear magnetic resonance spectroscopy (NMR) and HRMS. HRMS showed a mass of  $m/z$  319.157 for both  $\alpha/\beta$ -isomers which matches the calculated exact mass.  $^1\text{H}$ -NMR allows to determine the configuration of the double bond at C11-C12 because the vicinal coupling constant between *cis* proton pairs is smaller than the corresponding constant between *trans* proton pairs at chemical double bonds. Thus, the two olefinic protons in  $\alpha$ -*trans*-ZEL give rise to a doublet with a vicinal coupling constant of  $^3J_{\text{HH,trans}} = 15.4$  Hz. In contrast,  $\alpha$ -*cis*-ZEL shows a coupling constant of  $^3J_{\text{HH,cis}} = 11.5$  Hz. Likewise  $^3J_{\text{HH,trans}} = 15.6$  Hz for  $\beta$ -*trans*-ZEL decreases to  $^3J_{\text{HH,cis}} = 11.5$  Hz in  $\beta$ -*cis*-ZEL. The observed magnitudes of the vicinal ( $^3J_{\text{HH}}$ ) coupling constants are in accordance with the typical ranges which are 6–14 Hz for *cis* and 12–18 Hz for *trans* olefinic protons.

#### 2.5.5. Discussion

The present study investigates the quantitative and qualitative phase I metabolism of *cis*-ZEN. Incubations with RLM or HLM show a depletion of *cis*-ZEN in the presence of NADPH. In the absence of NADPH *cis*-ZEN is not degraded implying a strong dependence on NADPH as cofactor for phase I metabolism of *cis*-ZEN. In order to investigate if the isomers differ concerning their depletion kinetics, the degradation of *cis*-ZEN was compared to *trans*-ZEN. As a result, depletion characteristics were comparable in RLM while HLM metabolized *cis*-ZEN 1.4 fold faster than *trans*-ZEN. Thus, in HLM phase I enzymes appear to have a higher affinity towards the *cis*-isomer.



The microsomal incubations were subjected to HRMS in order to characterize the resulting metabolites. A multitude of metabolites was generated as seen from the metabolite patterns (Figure 29 and Figure 30) with vast qualitative similarities in RLM and HLM. Assays using microsomes of both species yield the reduction products  $\alpha$ - and  $\beta$ -*cis*-ZEL as identified by a mass increase of 2.015 amu.  $\alpha$ -*cis*-ZEL was found as a main metabolite in RLM. By contrast,  $\alpha$ - and  $\beta$ -*cis*

-ZEL are of only minor abundance in HLM. Structure identification was conducted by co-chromatography with synthesized authentic standards which were characterized by HRMS and  $^1\text{H-NMR}$ . The microsomal transformation of *trans*-ZEN into the reduction products  $\alpha$ - and  $\beta$ -*trans*-ZEL has been described in the literature *in vitro* and *in vivo* [28, 39, 126, 127].  $\alpha$ -*trans*-ZEL formation can be regarded as a bioactivation reaction due to a higher binding affinity to the estrogen receptor than its precursor compound *trans*-ZEN. Thus, the estrogenicity of  $\alpha$ - and  $\beta$ -*cis*-ZEL should be investigated in the future.

Also, for the formation of monohydroxylated metabolites from *cis*-ZEN, considerable similarities for RLM and HLM are observed. Five isobaric metabolites with a mass shift indicating incorporation of a single oxygen atom are detected for each microsomal species suggesting multiple reaction targets for the metabolic enzymes of RLM and HLM. The site of hydroxylation cannot be determined due to missing reference compounds. Nevertheless, monohydroxylation can be concluded as the major phase I metabolic pathway in HLM with respect to metabolite abundance and intensity. This is underpinned by analysis of the same incubation mixtures by HPLC with UV detection (data not shown) which also showed several monohydroxylated peaks (assigned according to retention time) with similar relative intensities when compared to the HPLC-HRMS chromatograms.

Due to the similarities of monohydroxylated products formed by both microsomal species, RLM might be a potential model for studies of *cis*-ZEN hydroxylation in humans. Regarding *trans*-ZEN, oxidative metabolism was first reported in 2007. Since then, monohydroxylated derivatives of *trans*-ZEN were described repeatedly as metabolites formed by mammalian microsomes including RLM and HLM [33-36]. A monohydroxylated ZEN derivative was also found in rat urine demonstrating the presence of oxidative metabolites *in vivo* [36]. It should be subject to further studies to investigate if differences concerning the positions and

stereochemistry of the newly introduced hydroxyl groups exist between *cis*- and *trans*-ZEN.

A difference in RLM and HLM phase I metabolism of *cis*-ZEN can be found in sequential reduction and monhydroxylation. A mass increase of 18.009 amu is seen for two metabolites in RLM but not in HLM. Regarding the *trans*-isomer, successive hydroxylation and reduction has been reported for RLM and also for HLM [34, 35]. This finding cannot be attributed to a stereospecific metabolic difference of *cis*- and *trans*-ZEN as incubations of HLM with *trans*-ZEN did not reveal any + 18.009 amu metabolites either (data not shown).

A further question that can be answered from comparison of *cis*- and *trans*-ZEN metabolite profiles is, if *cis-trans* isomerization does occur during phase I metabolism. Chromatographic conditions were set up to separate not only *cis*- and *trans*-ZEN but also the *cis*- and *trans*-isomers of  $\alpha$ - and  $\beta$ -ZEL. As a result, it can be stated that incubations of *cis*-ZEN remained free of any *trans*-ZEN or *trans*-ZEL metabolites. Thus, it can be inferred that isomerization does not take place due to isomerases contained within the microsomal preparations or the chosen experimental conditions.

Regarding the enzymes involved we assume that 3 $\alpha$ - and 3 $\beta$ - hydroxysteroid dehydrogenase are involved in the reduction of *cis*-ZEN as these enzymes are responsible for the reduction of *trans*-ZEN [27, 131]. Human cytochrome P450 (CYP) 1A2 was shown to be highly active in the hydroxylation of *trans*-ZEN [34]. Thus, CYP1A2 may also be responsible for hydroxylation of *cis*-ZEN.

In conclusion, this study shows that *cis*-ZEN is extensively metabolized by RLM and HLM. From a qualitative point of view, *cis*-ZEN seems to be transformed following the same metabolic routes as *trans*-ZEN.  $\alpha$ -*cis*-ZEL is found as a major reductive metabolite of *cis*-ZEN which might also be a bioactivation as seen for  $\alpha$ -*trans*-ZEL formation from *trans*-ZEN. Toxicological studies are needed to further investigate if the formed metabolites are more or less potent than *trans*-ZEN in order to protect consumers from unexpected health risks.

### **2.5.6. Acknowledgements**

The authors would like to thank Prof. Dr. Monika Schreiner for the opportunity to use the HRMS facilities at IGZ Großbeeren.

## 2.6. Oxidative *in vitro* phase I metabolism of *cis*-zearalenone

Sarah S. Drzymala<sup>a</sup>, Martin Penkert<sup>b</sup>, Sebastian Beck<sup>b</sup>, Leif-Alexander Garbe<sup>c</sup>, Matthias Koch<sup>a</sup>

**Archives of Toxicology**

*Final manuscript*

<sup>a</sup>BAM Federal Institute for Materials Research and Testing, Richard-Willstätter-Str. 11, 12489 Berlin, Germany. E-mail:matthias.koch@bam.de; Tel.: +49 30 8104 1170

<sup>b</sup>Humboldt-Universität zu Berlin, Brook-Taylor-Str. 2, 12489 Berlin, Germany

<sup>c</sup>Technische Universität Berlin, Ackerstr. 76, 13355 Berlin, Germany

### 2.6.1. Abstract

Zearalenone (ZEN) is an estrogenic mycotoxin that contaminates important cereal crops worldwide. It possibly occurs in two isomeric forms: *cis* and *trans*. The present study investigates the oxidative *in vitro* phase I metabolism of *cis*-ZEN in human liver microsomes (HLM). Extracts of HLM incubations with pure *cis*-ZEN were analyzed by HPLC linear ion trap mass spectrometry. The resulting metabolites were identified in a three step strategy. Firstly, it was shown that *cis*- and *trans*-isomers of the ZEN type produce qualitatively identical product ion spectra. In a second step, tentative structures were assigned to the *cis*-ZEN metabolites by comparing their product ion spectra to previously published MS/MS data on oxidative *trans*-ZEN metabolites. Thirdly, selective chemical syntheses were conducted to confirm the tentatively assigned structures. Using this strategy three novel human phase I metabolites were identified: 13-OH-*cis*-ZEN, 15-OH-*cis*-ZEN and a *cis*-ZEN-11,12-oxide. The products obtained by chemical syntheses matched the assigned metabolites in terms of retention time, mass and product ion spectra. Overall, aromatic hydroxylation appears to be a major *in vitro* metabolic pathway in HLM with 13-OH-*cis*-ZEN being the major metabolite. Future investigations need to examine the toxicologic potential of the newly identified metabolites with emphasis on estrogenicity and genotoxicity.

### 2.6.2. Introduction

*trans*-Zearalenone (*trans*-ZEN) is an estrogenic mycotoxin produced by common soil fungi of the *Fusarium* genus. Important cereal crops like wheat, soybeans, rice and maize are prone to *trans*-ZEN contamination. *trans*-ZEN was shown to act hepatotoxic, immunotoxic, and carcinogenic, but it is most often associated with pronounced estrogenic effects [24]. Because *trans*-ZEN poses a food safety concern, maximum levels apply in the European Union (EU) and several countries worldwide. In the EU, maximum levels range between 20 and 400 µg/kg depending on the commodity [26].

*trans*-ZEN was shown to be readily metabolized to phase I and phase II metabolites by a number of *in vitro* and *in vivo* studies. For phase I metabolism, the first identified metabolites in different animal species and humans were found to be reduced at the keto group, yielding  $\alpha$ - and  $\beta$ -*trans*-zearalenol ( $\alpha$ - and  $\beta$ -*trans*-ZEL) [128]. The biotransformation of *trans*-ZEN to  $\alpha$ -*trans*-ZEL is of particular interest, as the estrogenicity of the  $\alpha$ -isomer exceeds that of the parent compound by a factor of 80 [20]. Oxidative metabolites of *trans*-ZEN comprise the products of aromatic hydroxylation, which are 13- and 15-OH-*trans*-ZEN, as well as products of aliphatic hydroxylation at C8, C9, C10 and C5 [34, 35]. In contrast to the reductive metabolites which have repeatedly been detected *in vivo*, the oxidative metabolites were identified *in vitro* only, except for one study that claims the discovery of a monohydroxylated *trans*-ZEN in rat urine [36]. Phase II metabolism also constitutes a major metabolic pathway for *trans*-ZEN. Different studies demonstrated the glucuronidation in animals and humans which gives rise to the 14- as well as the 16-O-ZEN-glucuronide. Sulfation of *trans*-ZEN has been shown to occur *in vitro* [41]. There are no reports on the sulfation of *trans*-ZEN *in vivo* up to date.

Although often ignored, the *trans*-configured double bond in ZEN isomerizes to the *cis*-configuration upon the influence of light (Figure 31) with the reaction equilibrium clearly shifted towards the *cis*-isomer [3]. Consequently, *cis*-ZEN has been found in *Fusarium* cultures and also in different food commodities like ground maize, sugar beets and edible oils as well as in wet ground maize intended for animal feeding [16-18, 94].

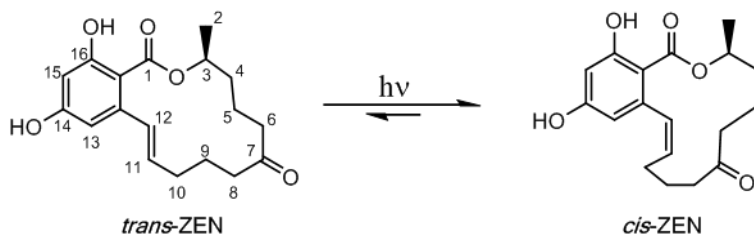


Figure 31. Photoisomerization of *trans*- and *cis*-ZEN at the double bond C11-C12.

A recent investigation focused on the *in vitro* phase I metabolism of *cis*-ZEN in rat and human liver microsomes (RLM and HLM). As a result it was shown that *cis*-ZEN is metabolized to the reductive metabolites  $\alpha$ - and  $\beta$ -*cis*-ZEL which was demonstrated by synthesis of authentic reference compounds. Numerous oxidative metabolites have been detected but the exact chemical structures remained unclear [2].

In 2012, Hildebrand *et al.* published detailed MS/MS data of various oxidative *trans*-ZEN metabolites obtained by using a linear ion trap mass spectrometer [132]. The presented product ion spectra differ significantly between the regioisomers raising the question if the provided data can be adopted for the *cis*-isomer to identify its oxidative metabolites. Thus, the aim of the present study was to

- (i) investigate if *cis*-/*trans*-isomers of the ZEN type show similar fragmentation patterns upon ESI-MS/MS analysis
- (ii) compare the MS/MS data from Hildebrand *et al.* to the product ion spectra of *cis*-ZEN metabolites
- (iii) confirm the tentatively identified metabolites by selective chemical synthesis

### 2.6.3. Materials and methods

#### Terms and definitions

Throughout the entire manuscript the term ZEN or ZEL refers to both *cis*- and *trans*-isomers. When a certain isomer is considered it will be specified by either “*trans*” or “*cis*”.

#### Chemical reagents

*trans*-ZEN (white powder, purity 99.8 %) was purchased from AppliChem GmbH (Darmstadt, Germany). Zearalanone (ZAN, purity 98.0 %),  $\alpha$ -*trans*-ZEL (no purity given) and  $\beta$ -*trans*-ZEL (no purity given) were derived from Sigma-Aldrich (Steinheim, Germany). Nicotinamide adenine dinucleotide phosphate (NADPH) tetrasodium salt was obtained from AppliChem GmbH (Darmstadt, Germany).  $MgCl_2$  was purchased from Avantor Performance Materials (Center Valley, PA, U.S.A).  $KH_2PO_4$  was derived from Merck (Darmstadt, Germany) and  $K_2HPO_4$  from Carl Roth (Karlsruhe, Germany). Iodoxybenzoic acid (IBX), ascorbic acid and *m*-chloroperbenzoic acid (*m*CPBA) were supplied by Sigma-Aldrich (Taufkirchen, Germany). All standard chemicals were of p. a. grade and all solvents HPLC grade.

#### Microsomal source

HLM were purchased from BioreclamationIVT (Baltimore, USA) and originated from a mixed gender pool of 50 donors. The total protein content, P450 concentrations and specific activities of different P450 isoforms were assumed as provided by the manufacturer with a protein concentration of 20.0 mg/mL and a total P450 content of 0.411 nmol/mg.

### Preparation of *cis*-ZEN and *cis*-ZELs

*cis*-ZEN was generated photochemically from *trans*-ZEN by a procedure reported earlier [3]. In summary, native *trans*-ZEN is dissolved in ethyl acetate and irradiated by UV-light ( $\lambda = 350$  nm) for 8 h. The irradiated solution is then subjected to preparative HPLC in order to separate the *trans*- from the *cis*-isomer and to obtain pure native *cis*-ZEN. The purity was determined to be  $> 99$  % as measured by HPLC-UV analysis at  $\lambda = 274$  nm.

*cis*-ZELs were synthesized as described in an earlier investigation [2]. Briefly, *trans*-ZEN was reduced to  $\alpha$ - and  $\beta$ -*trans*-ZEL with  $\text{NaBH}_4$ . The solution was then irradiated by UV-light ( $\lambda = 350$  nm) for 24 h to give rise to  $\alpha$ - and  $\beta$ -*cis*-ZEL. The generated *cis*-isomers were purified from the solution using HPLC-UV with an analytical column that provided a sufficient separation of the isomers. Purities were determined to be  $> 94$  % for  $\alpha$ -*cis*-ZEL and  $> 99$  % for  $\beta$ -*cis*-ZEL by HPLC-UV analysis at  $\lambda = 274$  nm.

### Microsomal incubations

Incubations of ZEN with HLM were carried out at  $37$  °C in a volume of  $0.2$  mL. A mixture containing  $10$   $\mu\text{M}$  ZEN dissolved in DMSO, microsomes (final protein concentration  $1$  mg/mL),  $0.1$  mM  $\text{MgCl}_2$  and  $0.1$  M potassium phosphate buffer pH  $7.4$  were pre-incubated for  $5$  min. The fraction of DMSO in the microsomal incubation volume was not higher than  $1$  %. Reactions were started by adding  $6$  mM NADPH. The reaction was run for a time period of  $60$  min and then extracted twice with  $500$   $\mu\text{L}$  ethyl acetate. The pooled extract was evaporated to dryness and redissolved in elution solvent. Negative controls lacked NADPH. Vehicle controls contained NADPH but no substrate. Control incubations were performed in duplicate, all other reactions were performed in triplicate. Phase I metabolites were identified by comparing chromatograms from vehicle control and negative control incubations to incubations in the presence of NADPH.



## Metabolite syntheses

### *Synthesis of 13-OH-cis-ZEN (M7) and 15-OH-cis-ZEN (M9)*

Aromatic hydroxylation of *cis*-ZEN was carried out using iodoxybenzoic acid (IBX) according to [133]. 1 mg *cis*-ZEN (3.1  $\mu$ M) was weighed into a glass tube and 1 equiv. IBX was added. Both substances were allowed to react in 1.5 mL DMSO under constant agitation. After 4 h the reaction was stopped with a 10 % aqueous ascorbic acid solution and directly analyzed by HPLC-MS/MS.

### *Synthesis of cis-ZEN-11,12-oxide (M10)*

Epoxidation occurs by adding a fresh solution of 100  $\mu$ M of *m*CPBA in 1 mL of chloroform to 100  $\mu$ M of *cis*-ZEN dissolved in 1.5 mL of chloroform. The reaction mixture was stirred for 48 h at 20 °C. After this the yellow solution was extracted with 1 mL of an aqueous solution of K<sub>2</sub>CO<sub>3</sub> (10 %) and 1 mL of water, followed by drying with Na<sub>2</sub>SO<sub>4</sub>. The organic layer was analyzed via HPLC-MS/MS.

## HPLC-MS/MS

HPLC separation was realized on an Agilent 1200 (Agilent, Böblingen, Germany) equipped with a micro vacuum degasser, capillary pump and micro well plate autosampler. The HPLC column was a 150 x 1 mm i.d., 5  $\mu$ m RP Luna C18 (Phenomenex®, Torrance, CA, USA) kept in an external column blockheater set to 50 °C (Jones Chromatography, Hengoed, Wales). Solvent A was deionized water with 0.1 % formic acid, and solvent B consisted of acetonitrile acidified with 0.1 % formic acid. A linear solvent gradient was applied, starting from 25 % B to 33 % B in 42 min, followed by 5 min of 99 % B. The initial 25 % B were then kept for 5 min for re-equilibration before the next injection. The injection volume was 5  $\mu$ L and the flow rate 80  $\mu$ L/min. MS/MS experiments were performed on a Linear Ion Trap Mass Spectrometer, LTQ XL system (Thermo Fisher Scientific Inc., Waltham, MA, USA). It was operated in negative electrospray ionization

(ESI) mode with a spray voltage of 5 kV and a capillary temperature of 275 °C. Ion optics were automatically tuned with solutions of *cis*- and *trans*-ZEN ( $\omega = 140 \mu\text{g}/\text{kg}$  for both). MS/MS was conducted at CID 35 (35 % of 5 kV). The following [M-H]<sup>-</sup>ions were extracted with an isolation width of  $m/z$  1.0:  $m/z$  317, 319, 321, 333, 335, 349 and 351. Analysis was done using the software Xcalibur Version 2.0.9.

### 2.6.4. Results

#### Comparison of fragmentation patterns of *cis*- and *trans*-isomers of the ZEN type

To evaluate if *cis*- and *trans*-isomers of the ZEN type show similar fragmentations after ESI ionization and collision induced decay (CID), authentic standards of three *cis*-/*trans*-pairs were compared: *cis*-/*trans*-ZEN,  $\alpha$ -*cis*-/*trans*-ZEL and  $\beta$ -*cis*-/*trans*-ZEL. The *trans*-isomers were all commercially available while the *cis*-isomers were synthesized in the course of our past investigations on *cis*-ZEN [2, 3]. The resulting product ion spectra of the *cis*- and *trans*-isomers of ZEN ([M-H]<sup>-</sup>,  $m/z$  317),  $\alpha$ -ZEL and  $\beta$ -ZEL ([M-H]<sup>-</sup>,  $m/z$  319 for both) are depicted in Figure 32.

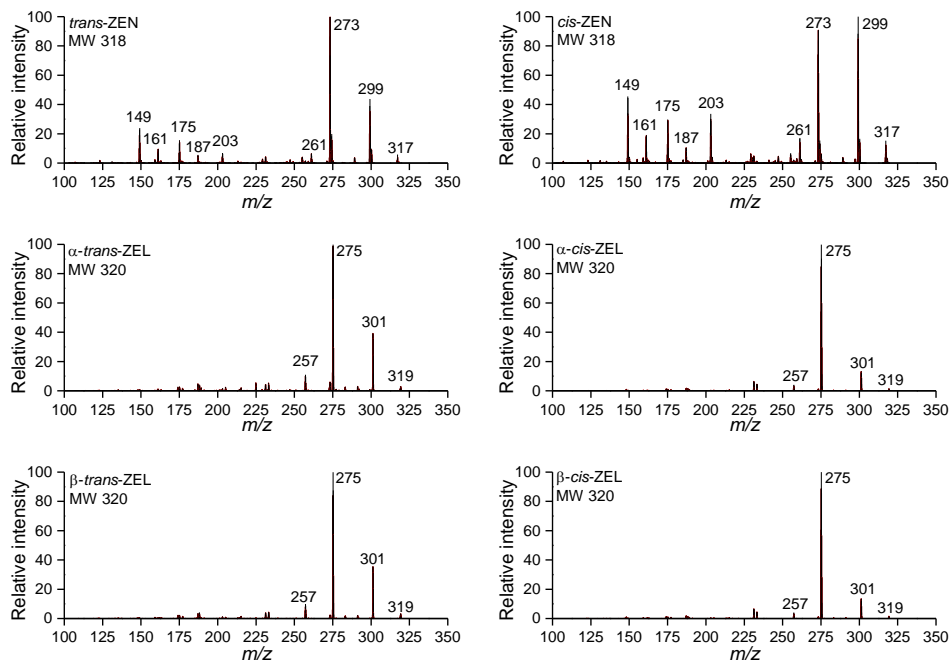


Figure 32. Comparison of product ion spectra of the *cis*- and *trans*- isomers of ZEN,  $\alpha$ -ZEL and  $\beta$ -ZEL after ESI negative ionization and CID.

The product ion spectra show that the *cis*- and *trans*-forms of each compound generate identical product ions with differing abundances. In the case of ZEN, for example, both isomers show product ions at  $m/z$  299 [M-H-H<sub>2</sub>O]<sup>-</sup>, 273 [M-H-CO<sub>2</sub>]<sup>-</sup>, 261 [M-H-CO-CO]<sup>-</sup>, 203 [M-H-CO<sub>2</sub>-H<sub>2</sub>O-C<sub>4</sub>H<sub>4</sub>]<sup>-</sup>, 187 [M-H-H<sub>2</sub>O-C<sub>7</sub>H<sub>12</sub>O]<sup>-</sup>. Further ions include  $m/z$  175, 161 and 149. Yet, *trans*-ZEN has a base peak of  $m/z$  273 whereas for the *cis*-isomer  $m/z$  299 is the most prevalent product ion. For  $\alpha$ -ZEL and  $\beta$ -ZEL, the *cis*-isomers also show the same product ions as the *trans*-isomers, confirming qualitatively identical fragments of each *cis*-/*trans*-pair. Prominent fragment ions are  $m/z$  301 [M-H-H<sub>2</sub>O]<sup>-</sup> and 275 [M-H-CO<sub>2</sub>]<sup>-</sup> for  $\alpha$ -*cis*- and  $\alpha$ -*trans*-ZEL as well as  $\beta$ -*cis*- and  $\beta$ -*trans*-ZEL. Taken together, it appears feasible to apply *trans*-isomer MS/MS data for the identification of the corresponding *cis*-isomers.

### Pattern of *cis*-ZEN metabolites generated by HLM

HLM were incubated with *cis*-ZEN in the presence of NADPH. The extracts were analyzed by HPLC-MS/MS. The resulting chromatogram as seen in Figure 33 reveals 12 metabolites M1-M12 which were not formed in controls. M1-M10 share a mass increase of +16 amu corresponding to a monooxygenation. M11 and M12 show a mass shift of +2 amu indicating a reduction. As authentic reference compounds with a mass increase of +2 amu were at hand (ZAN,  $\alpha$ - and  $\beta$ -*cis*-ZEL), metabolites M11 and M12 were identified as  $\alpha$ - and  $\beta$ -*cis*-ZEL by comparison of retention times, mass and product ion spectra of the  $[M-H]^-$  ions.

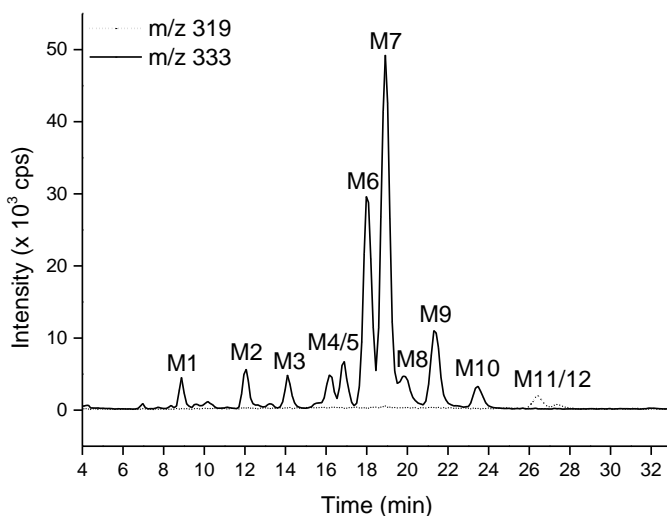


Figure 33. Overlay of extracted ion chromatograms that were obtained by analysis of 10  $\mu$ M *cis*-ZEN incubated with HLM. The ion traces  $m/z$  319 (dotted line) and  $m/z$  333 (solid line) were extracted and overlaid.

### Identification of oxidative *cis*-ZEN metabolites

A two step approach was pursued for the structural identification of the unknown oxidative *cis*-ZEN metabolites. Firstly, MS/MS data were recorded for the generated *cis*-ZEN metabolites and compared to MS/MS data provided for *trans*-

ZEN biotransformation products [132]. In a second step, specific chemical syntheses were carried out to confirm the structure of the *cis*-ZEN metabolites.

The previously published spectral information on oxidative *trans*-ZEN metabolites [132] and our data were both recorded on linear ion trap mass spectrometers. Throughout this study we applied identical MS parameters as reported (i.e. ESI negative ionization, normalized collision energy 35 %) to provide a high level of comparability. The reproducibility among the two instruments was investigated by comparison of the product ion spectra of *trans*-ZEN and  $\alpha$ -*trans*-ZEL which were included by Hildebrand *et al.* [132]. For *trans*-ZEN product ions of  $m/z$  299, 273, 261, 203, 187, 175, 161 and 149 are reported which is in perfect agreement with the product ion spectrum for *trans*-ZEN in Figure 32. Concerning  $\alpha$ -*trans*-ZEL product ions of  $m/z$  301, 275, 257 and 233 are provided which is identical to our  $\alpha$ -*trans*-ZEL product ion spectrum in Figure 32. Therefore, we conclude that a sufficient reproducibility is given among the two instruments.

Based on ESI-MS, MS/MS and HPLC elution order as reported by [132] we tentatively assigned structures to the oxidative *cis*-ZEN metabolites M7, M9 and M10. The product ion spectrum of M10 is characterized by a multitude of ions including a diagnostic  $m/z$  of 277 (Figure 34). The product ions including  $m/z$  277 match the MS/MS data reported for a *trans*-ZEN-11,12-oxide by [132]. We therefore conclude that the structure of M10 is a *cis*-ZEN-11,12-oxide. Selective chemical synthesis was conducted using *m*CPBA as a convenient epoxidation reagent [134]. The synthesis of the *trans*-ZEN-11,12-oxide has previously been achieved by applying *m*CPBA with NMR and MS data for structural proof [135]. The reaction of *m*CPBA with pure *cis*-ZEN yielded a compound with a molecular ion at  $m/z$  333 and a retention time as well as product ions corresponding to M10 (Figure 34) which strongly support the assigned structure. The chemical synthesis of epoxides using *m*CPBA retains the *cis/trans* configuration, implying that the synthesis with *cis*-ZEN yields a *cis* configured epoxide.

M7 and M9 share a lot of product ions as seen in Figure 34. Yet, M9 exhibits a product ion at  $m/z$  201 which is specific for hydroxylation at C15 [132]. The remaining product ions resemble the MS/MS data for 15-OH-*trans*-ZEN implying that M9 is 15-OH-*cis*-ZEN. M7 resembles the product ion spectrum of 13-OH-*trans*-ZEN with two distinctively intense  $m/z$  at 191 and 289. Thus, M7 is assumed to be 13-OH-*cis*-ZEN. For chemical synthesis, the reagent iodoxybenzoic acid has

been proven to be particularly useful in the hydroxylation of phenols under the conditions employed in this study [133, 136]. An aliphatic hydroxylation or epoxidation has not been reported for IBX to our knowledge. The reaction of pure *cis*-ZEN with IBX gave rise to two products with a molecular ion  $[M-H]^-$  at  $m/z$  333. The retention times and product ion spectra matched those of M7 and M9 (Figure 34), strongly supporting that M7 and M9 are monohydroxylations of the phenyl ring.

The yields of the hydroxylation and epoxidation reaction products were not sufficient to conduct NMR measurements. As the educt *cis*-ZEN has to be synthesized itself, it was only possible to utilize it in limited amounts.

The remaining metabolites M1-M6 and M8 cannot be assigned unequivocally. But, due to the fact that 13- and 15-OH-*cis*-ZEN have been designated and there are only two positions available for oxygenation of the aromatic ring, the remaining hydroxylations have to be located at the aliphatic moiety. The product ion spectra of M1-M6 and M8 can be found in the supplementary material.

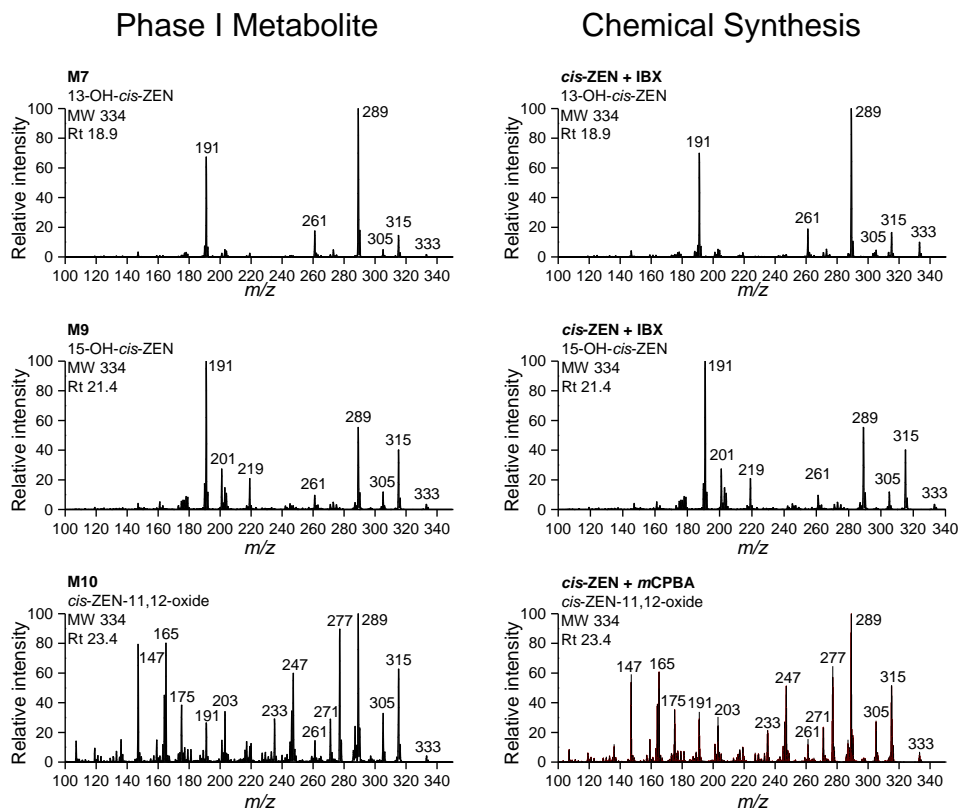


Figure 34. Product ion spectra of M7, M9 and M10 derived from incubations of *cis*-ZEN with HLM (left column) and product ion spectra of 13-OH-*cis*-ZEN, 15-OH-*cis*-ZEN and *cis*-ZEN-11,12-oxide as chemically synthesized (right column). Data were obtained by HPLC-ESI-MS/MS analysis.

## 2.6.5. Discussion

This study investigates the oxidative *in vitro* metabolism of *cis*-ZEN in HLM. As seen in Figure 33, incubations of pure *cis*-ZEN with HLM revealed a total of 12 metabolites which were designated M1-M12. LC-MS analysis showed M1-M10 to share a mass increase of +16 amu and M11 and M12 to share a mass shift of +2 amu. The latter were easily identified by comparison to reference compounds of  $\alpha$ - and  $\beta$ -*cis*-ZEL which were synthesized during past investigations [2]. Thus, M11

proved to be  $\alpha$ -*cis*-ZEL and M12  $\beta$ -*cis*-ZEL by comparison of retention times, MS and product ion spectra.

For the *cis*-ZEN metabolites carrying a mass increase of +16 amu, reference compounds are not available. For *trans*-ZEN on the other hand, major advances have been made recently in the structural elucidation of oxidative metabolites. The chemical structures were investigated by different approaches including NMR, MS/MS analysis of specifically deuterium labeled *trans*-ZEN, selective enzymatic methods and, in only a few cases, synthesis of reference compounds. In 2012, Hildebrand *et al.* compiled and published the MS/MS data of all oxidative *trans*-ZEN metabolites identified until then.

In order to advance the structural elucidation of the oxidative metabolites of *cis*-ZEN a three step strategy was applied in this study. Firstly, it was shown that *cis*- and *trans*-isomers of the ZEN type generate qualitatively identical product ions. The identical fragmentation behavior of geometric isomers like *cis*- and *trans*-ZEN has been frequently demonstrated [137-140].

In a second step, product ion spectra of the HLM generated *cis*-ZEN metabolites were compared to the previously published MS/MS data for oxidative *trans*-ZEN metabolites [132]. M7, M9 and M10 were tentatively assigned as 13-OH-*cis*-ZEN, 15-OH-*cis*-ZEN and *cis*-ZEN-11,12-oxide as their product ion spectra matched the MS/MS data for the corresponding *trans*-isomers. M1-6 and M8 show product ion spectra not matching any *trans*-isomer. This could possibly be due to insufficient chromatographic separation, a different phase I metabolism of *cis*-ZEN compared to *trans*-ZEN or phase I modifications of *cis*-ZEN that also occur for *trans*-ZEN but have not been identified for *trans*-ZEN so far.

Thirdly, selective chemical syntheses were conducted to confirm the tentatively assigned structures. Phenolic hydroxylation of pure *cis*-ZEN with IBX yielded two compounds with identical MS/MS data as M7 and M9, strongly supporting the previous assignment of 13- and 15-OH-*cis*-ZEN. Epoxidation of *cis*-ZEN using *m*CPBA generated a product with the characteristic MS/MS spectrum of M10 confirming the tentatively assigned epoxide structure. Thus, this three step strategy was suited to identify three novel *cis*-ZEN metabolites which will be discussed subsequently.



Aromatic hydroxylation of *cis*-ZEN appears to be a major metabolic route in HLM *in vitro* with 13-*cis*-ZEN representing the most pronounced peak in the chromatogram (Figure 33). For *trans*-ZEN, aromatic hydroxylation has also been identified as a major metabolic phase I pathway *in vitro* in HLM but 15-OH-*trans*-ZEN was more pronounced than its 13-OH-isomer [34].

In contrast to our previous study [2] where we postulated that the oxidative products are monohydroxylated, we now found an epoxidized *cis*-ZEN among the phase I metabolites. No diol formation ( $m/z$  351) was detected in HLM incubations which infers that the *cis*-11,12-oxide is either a poor substrate for epoxide hydrolases or that epoxide hydrolases were not present in the HLM used. Epoxides were further shown to directly bind to microsomal proteins possibly lowering the true amount of generated epoxide [141]. We also found a *trans*-11,12-epoxide in HLM incubations with *trans*-ZEN. As this is an interesting finding on *trans*-ZEN but not the focus of this study, the interested reader is kindly referred to the supplementary material where proof of a *trans*-11,12-oxide as phase I metabolite of HLM is shortly compiled. A *trans*-ZEN-11,12-oxide has been identified as a fungal metabolite [135] but neither a *cis*- nor a *trans*-epoxide have been reported as a mammalian biotransformation products so far.

Toxicologically, hydroxylation and epoxidation may lead to metabolites which are significantly more genotoxic or carcinogenic than the parent compound. Catecholic structures, as in the case of 13- and 15-OH-*cis*-ZEN for example, have been reported to generate DNA adducts after oxidation to quinones or the formation of reactive oxygen species through redox cycling [142]. DNA adduct formation has also been numerously demonstrated for epoxides being classified as “ultimate carcinogens or mutagens” due to the highly reactive epoxide function [143]. Thus, the toxicity of the catecholic *cis*-ZEN metabolites as well as the *cis*- and *trans*-epoxide should be assessed in future investigations.

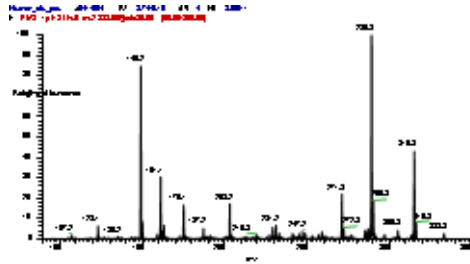
In summary, this study reports on the formation and identification of three oxidative phase I metabolites of *cis*-ZEN. The extensive formation of the catechol metabolites 13- and 15-OH-*cis*-ZEN infers that aromatic hydroxylation is a major metabolic route in the *in vitro* phase I metabolism of *cis*-ZEN. Furthermore, ZEN epoxides were identified as phase I metabolites for the first time. Future investigations need to examine the genotoxic potential of 13- and 15-OH-*cis*-ZEN

and especially the epoxides. Furthermore, the estrogenic activity of the newly identified metabolites should be investigated.

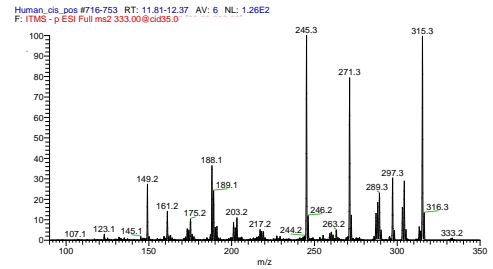
## 2.6.6. Supplementary material

Product ion spectra of unidentified metabolites with  $[M-H]^-$  at  $m/z$  333

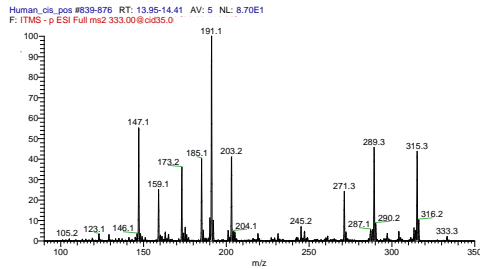
M1



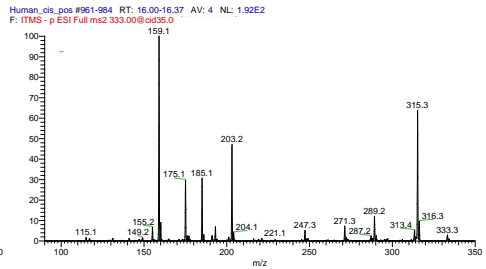
M2



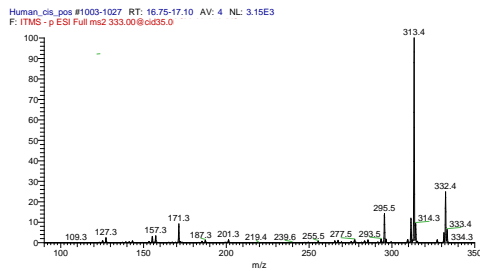
M3



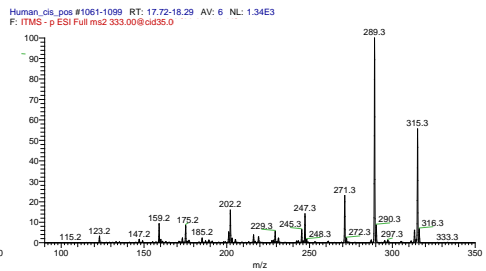
M4



M5

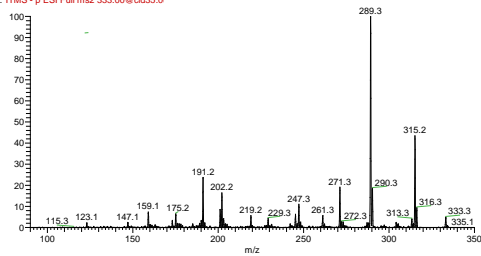


M6



### M8

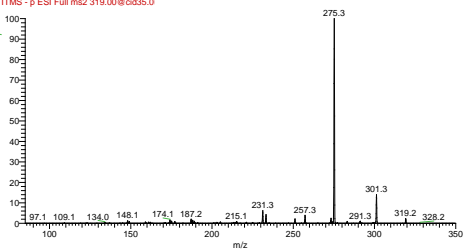
Human\_cis\_pos #1187-1201 RT: 19.87-20.11 AV: 3 NL: 2.07E2  
F: ITMS - p ESI Full ms2 333.00@cid35.0



### Product ion spectra of all metabolites with [M-H]<sup>-</sup> at m/z 319

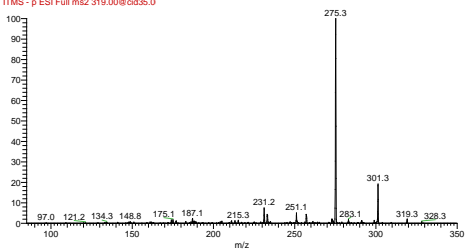
#### M11

Human\_cis\_pos #1533-1567 RT: 26.15-26.67 AV: 5 NL: 1.69E2  
F: ITMS - p ESI Full ms2 319.00@cid35.0



#### M12

Human\_cis\_pos #1598-1618 RT: 27.32-27.59 AV: 3 NL: 6.40E1  
F: ITMS - p ESI Full ms2 319.00@cid35.0



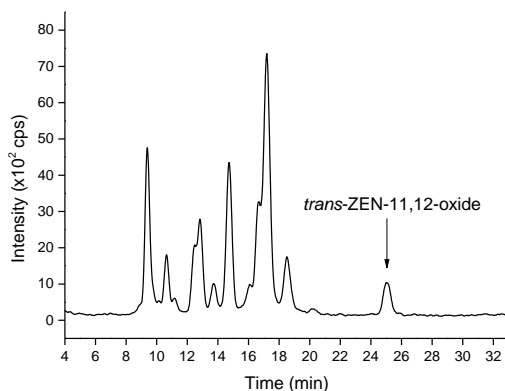
*trans*-ZEN-11,12-oxide in incubations of *trans*-ZEN with HLM

Figure 35. Extracted ion chromatogram ( $m/z$  333) obtained by incubation of 10  $\mu\text{M}$  *trans*-ZEN with HLM and successive HPLC-ESI-MS analysis.

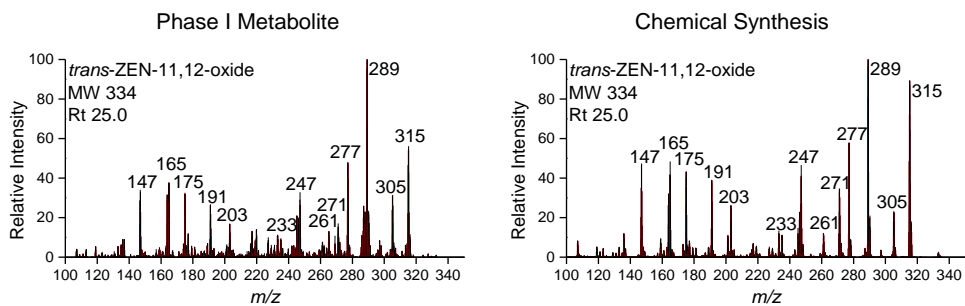


Figure 36. Product ion spectra of the metabolite eluting at 25.0 min derived from incubations of *trans*-ZEN with HLM (left) and product ion spectra of *trans*-ZEN-11,12-oxide as chemically synthesized using *m*CPBA (right). Data were obtained by HPLC-ESI-MS/MS analysis.

The extracted ion chromatogram (trace  $m/z$  333) depicted in Figure 35 shows a distinct peak at 25.0 min which gives the product ion spectrum displayed in Figure 36 on the lefthand side. The product ion spectra of this metabolite is in good agreement with the product ion spectra for *trans*-ZEN-11,12-oxide presented by Hildebrand *et al.* [132, 135]. Hildebrand *et al.* found a *trans*-ZEN-11,12-oxide as a fungal metabolite and confirmed the chemical structure by MS, MS/MS and NMR measurements of a synthetic reference compound. The *trans*-ZEN-11,12-oxide exhibits a diagnostic ion at  $m/z$  277 according to Hildebrand *et al.* which can clearly be seen in both product ion spectra in Figure 36. Other intense product ions reported include  $m/z$  147, 165, 175, 191, 203, 247, 271, 289, 305 and

315 which can all be matched to the spectra presented here. Furthermore, epoxidation of *trans*-ZEN was carried out by chemical synthesis using *m*CPBA. The product ion spectrum on the righthand in Figure 36 was obtained by analysis of the reaction product having the same retention time as the metabolite (25.0 min). Thus, the expected epoxidized *trans*-ZEN product shows the same retention time and a qualitatively similar spectrum to that of the metabolite, strongly supporting the structural identification.

## 2.7. Estrogenicity of novel phase I and phase II metabolites of zearalenone and *cis*-zearalenone

Sarah S. Drzymala<sup>a\*</sup>, Jennifer Binder<sup>b\*</sup>, Antje Brodehl<sup>a</sup>, Martin Penkert<sup>c</sup>, Mark Rosowski<sup>b</sup>, Leif-Alexander Garbe<sup>b</sup>, Matthias Koch<sup>a</sup>

**Chemical Research in Toxicology**

Received January 30<sup>th</sup> 2015

<sup>a</sup>BAM Federal Institute for Materials Research and Testing, Richard-Willstätter-Str. 11, 12489 Berlin, Germany. E-mail:matthias.koch@bam.de; Tel.: +49 30 8104 1170

<sup>b</sup>Technische Universität Berlin, Ackerstr. 76, 13355 Berlin, Germany

<sup>c</sup>Humboldt-Universität zu Berlin, Brook-Taylor Str. 2, 12489 Berlin, Germany

\*These authors contributed equally to this project and should be considered co-first authors.

### 2.7.1. Abstract

*trans*-Zearalenone (ZEN) and its *cis*-isomer (*cis*-ZEN) are nonsteroidal mycotoxins that elicit an estrogenic response upon binding to the estrogen receptor. This study compares the estrogenicity of eleven congeners including novel metabolites as 15-OH-ZEN, ZEN-14-sulfate,  $\alpha$ -*cis*-ZEL and  $\beta$ -*cis*-ZEL using the E-Screen assay. Overall, a change in the configuration from *trans* to *cis* retains significant estrogenic activity. In contrast, alterations of the resorcylic moiety of ZEN showed a markedly decreased estrogenicity when compared to ZEN. As sequential phase I and phase II reactions can occur *in vivo*, future work should investigate the estrogenicity of ZEN and *cis*-ZEN carrying multiple metabolic modifications.

### 2.7.2. Introduction, results and discussion

*trans*-Zearalenone (ZEN) is an estrogenic mycotoxin which is biosynthesized as a secondary metabolite by several molds of the *Fusarium* genus. ZEN contamination occurs worldwide and can be found on all major cereal crops including maize,

wheat, rice and soy. Humans and animals are exposed to ZEN by ingestion of contaminated food and feed. Although its acute toxicity is low, ZEN causes pronounced estrogenic symptoms including vulvovaginitis, uterine enlargement, prolonged or interrupted oestrus and infertility which are commonly summarized as hyperestrogenism [24]. Structurally, ZEN is a resorcylic acid lactone (RAL) fused to a macrocyclic carbon ring which includes a methyl group, a ketone and a *trans* configured double bond (Table 15). Upon the influence of UV- or daylight the double bond readily isomerizes to the *cis* configuration to yield *cis*-ZEN [3]. Therefore, *cis*-ZEN can also be found as a natural food contaminant.

*In vitro* studies showed that ZEN and *cis*-ZEN exert their estrogenic effects by competitive binding to the estrogen receptor (ER) with a higher affinity of the *cis*- compared to the *trans*-isomer [96]. Using a cell proliferation assay based on estrogen-sensitive human breast cancer cells (MCF-7), *cis*-ZEN was found to have a slightly lower estrogenic activity than its *trans*-counterpart [20]. *In vivo*, *cis*-ZEN showed stronger estrogenic effects than ZEN in the rodent uterotrophic assay [12]. Considering the estrogenicity of ZEN and *cis*-ZEN, it has to be taken into account that both are extensively metabolized. Early investigations on the metabolism of ZEN revealed reductive as well as glucuronidated products. The former comprise reduction at the C7 ketone yielding  $\alpha$ - and  $\beta$ -zearelenol (ZEL) as well as further reduction at the double bond to give rise to  $\alpha$ - and  $\beta$ -zearelanol (ZAL) [24]. In contrast to the less estrogenic  $\beta$ -isomers, both  $\alpha$ -isomers have been found to be significantly more estrogenic than ZEN inferring a metabolic activation [24].

For a long time, the reductive and glucuronidated metabolites of ZEN were the only known mammalian biotransformation products until recently several novel metabolites of ZEN as well as *cis*-ZEN were identified. For ZEN, extensive monohydroxylation of the aromatic moiety has been found by using human liver microsomes. Monohydroxylation was observed at C13 and C15 with 15-OH-ZEN being the major metabolite [128]. Furthermore, sulfation was shown to occur at the C14 hydroxyl group in a widely accepted *in vitro* model system for human intestinal absorption and metabolism using Caco-2-cells [41]. Regarding *cis*-ZEN, the reductive products  $\alpha$ - and  $\beta$ -*cis*-ZEL were revealed to be major metabolites formed by rat and human liver microsomes [2]. Thus, the aim of this study was to evaluate the estrogenicity of the above mentioned compounds for the first time.



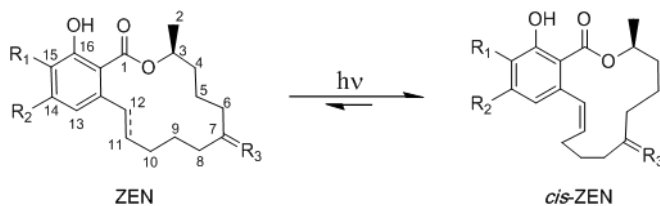
Estrogen-dependent growth of human MCF-7 cells has previously been found to be among the most sensitive assays for *in vitro* estrogenicity testing. Therefore, the MCF-7 cell proliferation assay was conducted as described in detail in the supporting information. The results of exposing MCF-7 cells to ZEN and eleven different ZEN congeners are ranked according to their estrogenic potency in Table 1. For a better comparison, previously reported EC<sub>50</sub> values for ZEN and its reductive metabolites by Shier *et al.* and Minervini *et al.* are listed as well [20, 61]. Furthermore, we also included 17- $\beta$ -estradiol in the E-Screen as the EC<sub>50</sub> has been numerously determined in MCF-7 cells and may thus serve as a measure for validity. As can be seen from Table 15, Minervini *et al.* reported 17- $\beta$ -estradiol to be somewhat less estrogenic compared to our result. Yet, other authors previously confirmed EC<sub>50</sub> values in the low pM range as found in this study [144].

Comparison of the EC<sub>50</sub> data for the reductive metabolites of ZEN resulted in a good agreement with the previous studies:  $\alpha$ -ZEL exhibits the highest estrogenic activity among the tested RALs. An increased estrogenicity of  $\alpha$ -ZEL compared to ZEN has been proven in different *in vitro* assays implying a metabolic activation of ZEN [61]. Indeed, our results show that  $\alpha$ -ZEL induced cell proliferation in lower concentrations than 17 $\beta$ -estradiol which was also reported by Minervini *et al.* [61]. The  $\beta$ -epimer of ZEL proved to be the least estrogenic reductive metabolite of ZEN which is also consistent with literature data [20, 61]. Thus, the C7 position has a major impact on the estrogenicity.

The influence of the hydroxyl group configuration at C7 can be observed for the ZAL series as well:  $\alpha$ -ZAL shows a higher estrogenic activity than  $\beta$ -ZAL. Apart from *in vitro* bioassays, a higher estrogenicity of  $\alpha$ - than  $\beta$ -ZAL has been reported for the mouse uterotrophic assay *in vivo* [145]. The higher estrogenicity of  $\alpha$ -isomers and lower activity of their  $\beta$ -counterparts is further confirmed by the EC<sub>50</sub> values for  $\alpha$ - and  $\beta$ -*cis*-ZEL, which are evaluated in the E-Screen assay for the first time.

## 2 Results and discussion

Table 15. EC<sub>50</sub> values (M) for ZEN, various ZEN congeners and 17-β-estradiol as calculated in this study (n = 4). Previously reported EC<sub>50</sub> values obtained by Shier *et al.* and Minervini *et al.* using the E-Screen are listed as well (RE, relative estrogenicity).



	R1	R2	C11-12	R3	EC <sub>50</sub>	95% CI	RE	EC <sub>50</sub> <sup>a</sup>	EC <sub>50</sub> <sup>b</sup>
α-ZEL	H	OH	trans	OH	1.1 x 10 <sup>-12</sup>	7.3 x 10 <sup>-13</sup> - 1.7 x 10 <sup>-12</sup>	563	1.2 x 10 <sup>-11</sup>	1.4 x 10 <sup>-12</sup>
17-β-estradiol					1.3 x 10 <sup>-12</sup>	6.0 x 10 <sup>-13</sup> - 2.9 x 10 <sup>-12</sup>	473	-	7.5 x 10 <sup>-11</sup>
α-cis-ZEL	H	OH	cis	OH	1.7 x 10 <sup>-11</sup>	9.9 x 10 <sup>-12</sup> - 3.1 x 10 <sup>-11</sup>	35.7	-	-
α-ZAL	H	OH	dihydro	OH	4.6 x 10 <sup>-11</sup>	9.7 x 10 <sup>-12</sup> - 2.2 x 10 <sup>-10</sup>	13.5	6.0 x 10 <sup>-11</sup>	1.7 x 10 <sup>-10</sup>
ZAN	H	OH	dihydro	O	4.7 x 10 <sup>-11</sup>	2.4 x 10 <sup>-11</sup> - 9.3 x 10 <sup>-11</sup>	13.3	4.4 x 10 <sup>-10</sup>	-
cis-ZEN	H	OH	cis	O	4.1 x 10 <sup>-10</sup>	1.2 x 10 <sup>-10</sup> - 1.4 x 10 <sup>-9</sup>	1.51	1.5 x 10 <sup>-9</sup>	-
ZEN	H	OH	trans	O	6.2 x 10 <sup>-10</sup>	2.6 x 10 <sup>-10</sup> - 1.5 x 10 <sup>-9</sup>	1.00	1.1 x 10 <sup>-9</sup>	3.1 x 10 <sup>-9</sup>
β-cis-ZEL	H	OH	cis	OH	1.0 x 10 <sup>-9</sup>	4.3 x 10 <sup>-10</sup> - 2.4 x 10 <sup>-9</sup>	0.62	-	-
β-ZAL	H	OH	dihydro	OH	1.2 x 10 <sup>-9</sup>	5.2 x 10 <sup>-10</sup> - 2.9 x 10 <sup>-9</sup>	0.51	3.1 x 10 <sup>-10</sup>	2.6 x 10 <sup>-10</sup>
β-ZEL	H	OH	trans	OH	1.1 x 10 <sup>-8</sup>	2.5 x 10 <sup>-9</sup> - 4.8 x 10 <sup>-8</sup>	0.06	2.5 x 10 <sup>-9</sup>	5.2 x 10 <sup>-9</sup>
15-OH-ZEN	OH	OH	trans	O	2.8 x 10 <sup>-8</sup>	1.7 x 10 <sup>-8</sup> - 4.6 x 10 <sup>-8</sup>	0.02	-	-
ZEN-14-sulfate	H	SO <sub>4</sub>	trans	O	5.1 x 10 <sup>-8</sup>	2.1 x 10 <sup>-8</sup> - 1.2 x 10 <sup>-7</sup>	0.01	-	-

CI, confidence interval

RE, relative estrogenicity

<sup>a</sup> Shier *et al.* [20]

<sup>b</sup> Minervini *et al.* [61]

The double bond in the macrocycle of ZEN presents a further structural element which may have an impact on the estrogenicity. It was previously hypothesized that saturation of the double bond increases flexibility of the macrolide ring whereas conversion to the *cis*-form decreases flexibility, predicting the order of

estrogenicity to be dihydro > *trans* > *cis* [20]. This rationale is not supported by our data. Although zearalanone (ZAN) shows a higher estrogenicity than ZEN, *cis*-ZEN is slightly more active than ZEN. Moreover,  $\alpha$ -ZAL is not only less estrogenic than  $\alpha$ -ZEL but also than  $\alpha$ -*cis*-ZEL. The  $\beta$ -configured RALs do not support the hypothesis either with  $\beta$ -ZAL being marginally less active than  $\beta$ -*cis*-ZEL.

The ZEN congeners tested in this study also allow conclusions on the estrogenic contribution of the resorcylic moiety. For example, hydroxylation at the C15 position of the phenyl ring results in a decrease in estrogenic activity implying a detoxification. There are no reports on the estrogenicity of catecholic ZEN metabolites available so far. However, catecholic metabolites of the A-ring of 17- $\beta$ -estradiol (2- and 4-OH-17- $\beta$ -estradiol), which is supposed to be the analog to the aromatic moiety of ZEN in binding to the ER, show less pronounced estrogenicity when compared to 17- $\beta$ -estradiol in the E-Screen assay [146]. It has been proven that the catechol estrogens 2- and 4-OH-17- $\beta$ -estradiol are methylated at the catecholic hydroxyl groups by catechol-O-methyltransferase (COMT), an enzyme which is highly active in MCF-7 cells [147]. After methylation the estrogenic effects of estradiol are terminated [148]. In contrast to the catechol estrogens, the ZEN catechols have been shown to be poor substrates for COMT [149]. This could explain that estrogenicity of 15-OH-ZEN is preserved to some extent.

In case of ZEN-14-sulfate, the phenolic hydroxyl group at C14 is blocked which leads to a substantial loss of estrogenicity when compared to ZEN. However, estrogenic activity is not completely abolished which is in contrast to endogenous estrone-sulfate where no binding to the ER was observed [150]. Yet, MCF-7 cells constitutively express steroid sulfatases in low levels which lead to the release of free estrone and subsequent estrogenic activity. Thus, future investigations should investigate if ZEN-14-sulfate is a possible substrate for steroid sulfatases.

As clearly described in the preceding sections, alterations on the ZEN molecule can markedly influence the biological properties in terms of estrogenicity. Alterations of the resorcylic moiety decrease the estrogenic activity in MCF-7 cells whereas an isomerization of the *trans*- to the *cis*-isomer is accompanied by a substantial preservation. Future investigations should focus on the estrogenic properties of combined phase I and II reactions on one molecule as ZEN and *cis*-ZEN are probably prone to sequential biotransformations *in vivo*.

### 2.7.3. Acknowledgements

The authors would like to thank Sandro Meyer and Luzia Reiners Schramm for the kind practical support and Prof. Lauster for the opportunity to conduct the experiments in his laboratory.

### 2.7.4. Supporting information

#### SI 1. Chemicals

Commercially available test compounds were purchased from the following suppliers: ZEN (purity 99.8 %, AppliChem GmbH, Darmstadt, Germany); 17- $\beta$ -estradiol (purity  $\geq$  98 %),  $\alpha$ -ZEL (purity  $\geq$  98 %),  $\beta$ -ZEL (purity  $\geq$  98 %),  $\alpha$ -ZAL (purity 97 %) and  $\beta$ -ZAL (purity 98 %, Sigma-Aldrich Chemie GmbH, Taufkirchen, Germany), ZAN (purity 98 %, Toronto Research Chemicals, Quebec, Canada). All other test compounds are not commercially available and were synthesized as described in the following chapters.

For performing the MTT assay 3-(4,5-dimethylthiazolyl-2)-2,5-diphenyltetrazolium-bromide (MTT) was supplied by Carl Roth (Karlsruhe, Germany).

#### SI 2. Synthesis of test compounds

15-OH-ZEN, ZEN-14-sulfate, *cis*-ZEN,  $\alpha$ -*cis*-ZEL and  $\beta$ -*cis*-ZEL are not commercially available and were chemically synthesized or biosynthesized.

*15-OH-ZEN*

15-OH-ZEN was synthesized using *m*-chloroperbenzoic acid (mCPBA) as previously reported by Pfeiffer *et al.* [135]. In brief, a fresh solution of 100  $\mu$ M of mCPBA in 1 mL of chloroform was added to 100  $\mu$ M of ZEN dissolved in 1.5 mL of chloroform. The reaction mixture was stirred for 48 h at 20 °C. After this the yellow solution was extracted with 1 mL of an aqueous solution of K<sub>2</sub>CO<sub>3</sub> (10 %) and 1 mL of water, followed by drying with Na<sub>2</sub>SO<sub>4</sub>. The organic layer was analyzed by HPLC-MS/MS consisting of an Agilent 1200 (Agilent, Böblingen, Germany) connected to a Linear Ion Trap Mass Spectrometer, LTQ XL system (Thermo Fisher Scientific Inc., Waltham, MA, USA). The HPLC unit was equipped with a micro vacuum degasser, capillary pump and micro well plate autosampler. The HPLC column was a 150 x 1 mm i.d., 5  $\mu$ m RP Luna C18 (Phenomenex®, Torrance, CA, USA) kept in an external column blockheater set to 50 °C (Jones Chromatography, Hengoed, Wales). Solvent A was deionized water with 0.1 % formic acid, and solvent B consisted of acetonitrile acidified with 0.1 % formic acid. A linear solvent gradient was applied, starting from 25 % B to 33 % B in 42 min, followed by 5 min of 99 % B. The initial 25 % B were then kept for 5 min for re-equilibration before the next injection. The injection volume was 5  $\mu$ L and the flow rate 80  $\mu$ L/min. The MS/MS system was operated in negative electrospray ionization (ESI) mode with a spray voltage of 5 kV and a capillary temperature of 275 °C. Ion optics were automatically tuned with a solution of ZEN ( $\omega$  = 140  $\mu$ g/kg). MS/MS was conducted at CID 35 (35 % of 5 kV). The [M-H]-ions at  $m/z$  317 and 333 were extracted with an isolation width of  $m/z$  1.0. Analysis was done using the software Xcalibur Version 2.0.9.

The extract contained 15-OH-ZEN as well as the highly unstable ZEN-11,12-oxide. Both were identified by their mass and product ion spectra according to Hildebrand *et al.* [132]. 15-OH-ZEN shows three distinctive product ions at  $m/z$  191, 201 and 219 which are clearly seen in Figure 37. The product ion spectrum of 15-OH-ZEN matches that of Hildebrand *et al.* for 15-OH-ZEN.

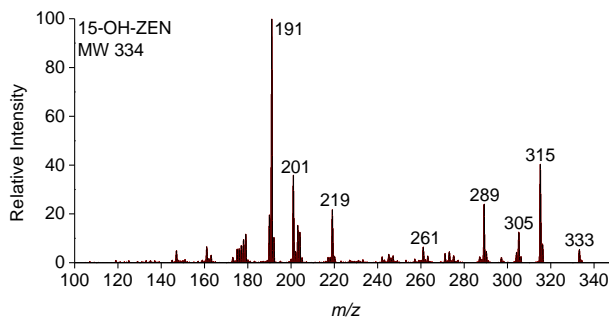


Figure 37. Product ion spectrum of 15-OH-ZEN as obtained after synthesis using *m*CPBA.

15-OH-ZEN was purified from the reaction mixture by preparative HPLC. The chromatographic system consisted of a SpectraSystem HPLC (Thermo Fisher Scientific, Waltham, MA, USA) including a pump P4000, a degasser SCM 1000F, an autosampler AS3000F and a DAD UV6000LP with a Gemini-NX C18 column (150 × 2 mm, 3 μm particle size; Phenomenex®). A 50 °C oven temperature, an injection volume of 10 μL, a flow rate of 0.4 mL/min, and a runtime of 30 min were employed. Acetonitrile:water 25:75 (v/v) containing 0.1 % formic acid was used as isocratic elution solvent. The DAD was set to  $\lambda = 274$  nm. The retention time, molecular mass and product ions of the purified 15-OH-ZEN were found to be identical to the compound shown in Figure 37 when analyzed on the LTQ XL instrument. The amount of isolated 15-OH-ZEN was calculated by HPLC-UV analysis integrating the peak area and using external ZEN calibration. The peak area was integrated for the first UV maximum at  $\lambda = 240$  nm assuming identical extinction coefficients for 15-OH-ZEN and ZEN. The purity of 15-OH-ZEN was found to be 95 % by HPLC-UV.

### *ZEN-14-sulfate*

Biosynthesis and isolation of zearalenone-14-sulfate were conducted according to Brodehl *et al.* [151] with a few alterations. The fungal strain *Aspergillus oryzae* DSM 1864 has been shown to transform ZEN to ZEN-14-sulfate. Cultivation for biotransformation was conducted analogous to Brodehl *et al.* with the exception that 1 mL ZEN solution with a concentration of 0.5 mg/mL was applied. The media was extracted by ethyl acetate and the purification of ZEN-14-sulfate was achieved by using HPLC-DAD coupled to an automatic fraction collector Foxy Jr.

(Teledyne Isco, Lincoln, USA). The chromatographic system and analytical column were identical to those used for purification of 15-OH-ZEN. The column oven was operated at 30 °C. The flow rate of the mobile phase was 0.35 mL/min and the injection volume was set to 20  $\mu$ L. Mobile phase A was water with 5 mM ammonium acetate and mobile phase B was acetonitrile/water (99 : 1 v/v) with 5 mM ammonium acetate. The linear gradient used was as follows: 0–15 min 30 % B, 15–16 min 30–100 % B, 16–19 min 100 % B, 19–19.5 min 100–30 % B, 19.5–27 min 30 % B. Structure confirmation was based on a comparison to a ZEN-14-sulfate standard using retention time and absorbance spectra in combination with HPLC-MS/MS. The transitions monitored for ZEN-14-sulfate were  $m/z$  397.1  $\rightarrow$  317.1 and  $m/z$  397.1  $\rightarrow$  175.0. The instrumentation and detailed settings are described in Brodehl *et al.* [151]. The ZEN-14-sulfate standard was kindly provided by Prof. Franz Berthiller (University of Natural Resources and Life Sciences, Vienna, Austria). The purity of the isolated ZEN-14-sulfate was assessed by HPLC-UV and found to be  $\geq$  99 %. The biosynthesized and isolated ZEN-14-sulfate was quantified by HPLC-DAD against a ZEN calibration standard assuming similar extinction coefficients. Furthermore, the content was confirmed by comparison with the ZEN-14-sulfate standard from Prof. Berthiller.

#### *cis-ZEN*

*cis-ZEN* (purity  $\geq$  99 % as measured by HPLC-UV) was prepared in our working group in a former study [3].

#### *$\alpha$ -cis-ZEL and $\beta$ -cis-ZEL*

*$\alpha$ -cis-ZEL* and  *$\beta$ -cis-ZEL* were chemically synthesized in the course of previous studies in our working group as described in detail elsewhere [2]. The purities were determined to be  $>$  94 % for  *$\alpha$ -cis-ZEL* and  $>$  99 % for  *$\beta$ -cis-ZEL* by means of HPLC-UV.

### SI 3. Media

Dulbecco's modified Eagle's medium (DMEM) with high glucose and phenol red was obtained from Biowest (Nuaille, France) and used for routine culture after supplementation with 5 % fetal calf serum (FCS, Biowest, Nuaille, France) and 100 µg/mL each penicillin and streptomycin (further referred to as “medium for routine culture”). Medium for the E-Screen assay was purchased from Sigma-Aldrich Chemie GmbH (further referred to as “experimental medium”) and contained 5 % stripped FCS and 100 µg/mL each penicillin and streptomycin.

### SI 4. Charcoal-dextran stripping of FCS

A 10 mL suspension consisting of 10 % charcoal (w/v) and 0.05 % dextran (w/v) in deionized water was added to 200 mL FCS. The pH of the FCS was previously adjusted to 4.2 with 4 M HCl. The mixture was stirred for 16 h at 4 °C and then centrifuged at 3200 rpm/min at 4 °C. The serum supernatant was transferred and the pH adjusted to 7.2 by using 4 M NaOH. Aliquots were stored at -20 °C after sterile filtration.

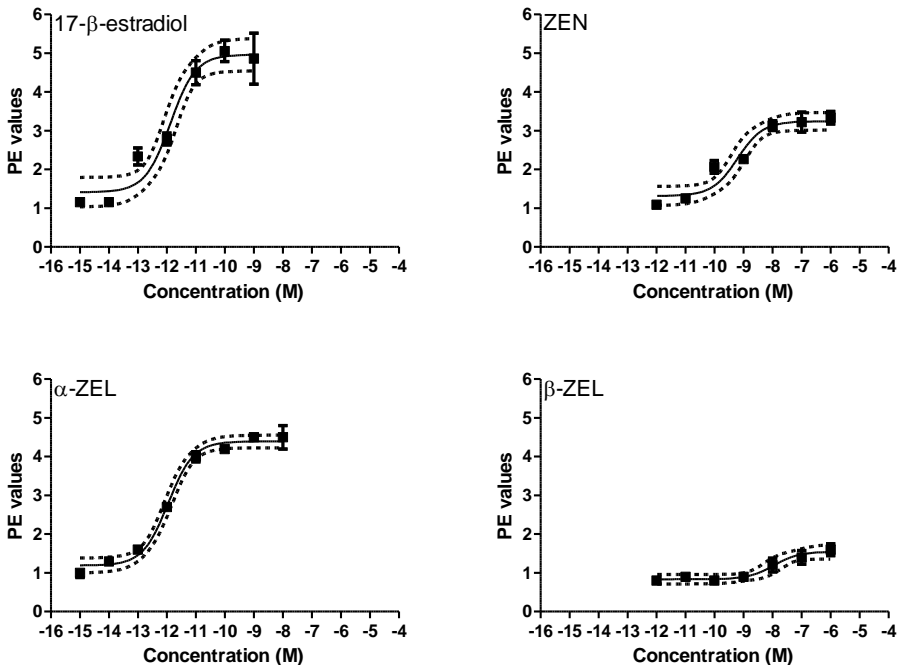
### SI 5. Cell proliferation assay

The MCF-7 cell proliferation assay was conducted according to Soto *et al.* [152] with a few modifications. Routine maintenance of MCF-7 cells was done in medium for routine culture at 37 °C with 5 % CO<sub>2</sub> in air at saturating humidity. For the E-Screen assay, sub-confluent grown cells were plated into 24-well plates at an initial cell number of 10,000 cells/well. The cells were allowed to attach for 24 h in 1 mL of a 1:1 mixture v/v of experimental medium and medium for routine culture. After cell attachment, the medium mixture was removed and the test compounds were added in experimental medium in quadruplicates. In detail, stocks of all test compounds were solubilized in ethanol and then diluted with experimental medium to the desired concentrations in the range of 10<sup>-15</sup> M to 10<sup>-5</sup> M, provided at intervals of one order of magnitude. The final ethanol content in culture wells did not exceed 0.5 % (v/v). Negative controls contained ethanol only.



After an incubation time of five days the cell number was assessed by the MTT assay. A MTT solution (20 mg MTT/mL dimethylsulfoxide (DMSO)) was added to each culture well resulting in 25  $\mu$ L MTT solution per 1 mL total medium volume. Subsequently, the cultures were incubated at 37 °C for 2 h before the medium was removed. Following thorough formazan solubilization in 200  $\mu$ L DMSO by shaking the 24-well plate for 10 min, 50  $\mu$ L of each well were transferred to a 96-well plate for measuring the optical density using a FLUOstar Omega plate reader (BMG Labtech, Durham, NC, USA) at  $\lambda = 580$  nm. Sigmoidal dose-response curves were obtained by plotting the optical density normalized to the negative control (proliferative effect, PE) versus the base 10 logarithm of the test compound concentrations. EC<sub>50</sub> values were calculated by GraphPad Prism® (GraphPad Software Inc., La Jolla, CA, USA) using non-linear regression and least-square fitting.

### SI 6. Graphs of proliferative effect (PE) values versus logarithmic concentration of test compounds



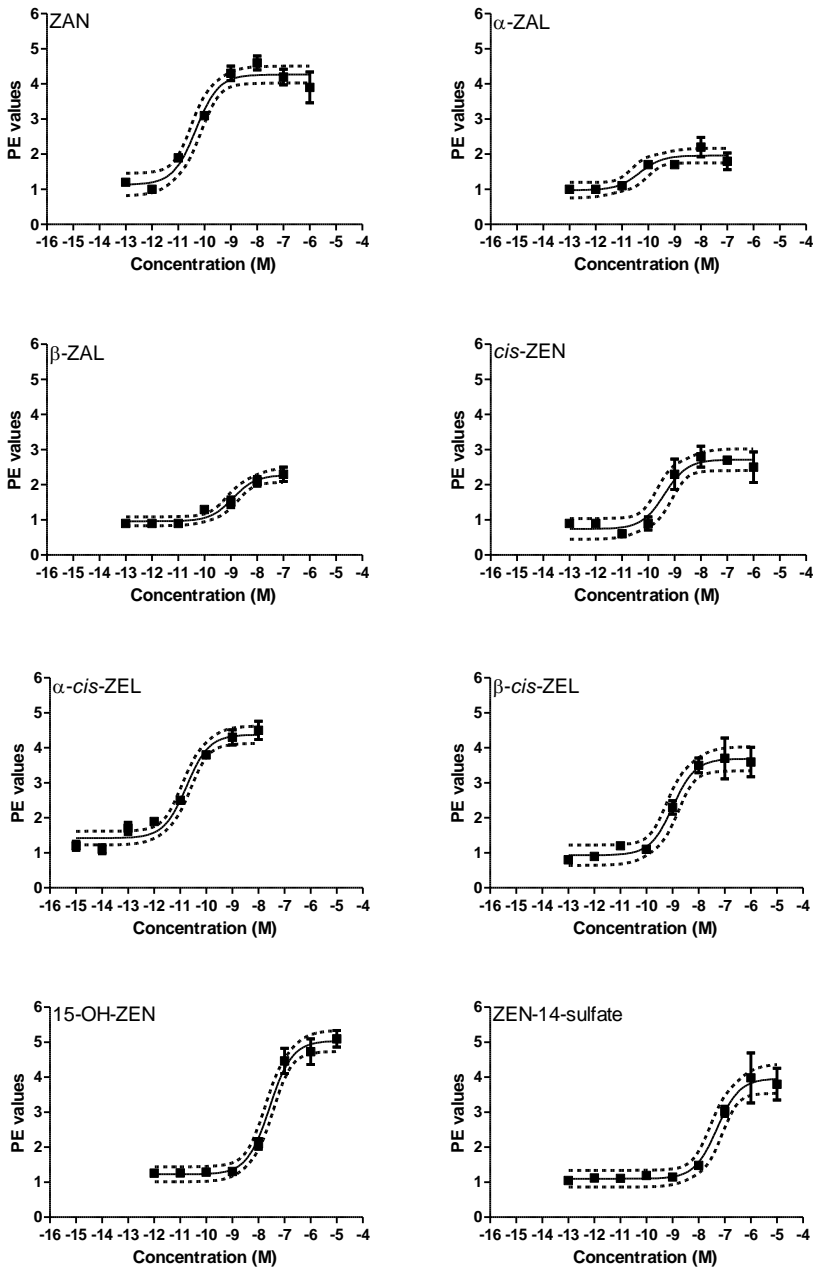


Figure 38. Concentration-response relationships for MCF-7 cells treated with ZEN congeners or 17 $\beta$ -estradiol. Data points are expressed as means with error bars representing the standard deviation (n = 4). Dashed lines depict the 95 % confidence intervals.

## 3. Final discussion

### 3.1. Advances in the methodology on ZEN in edible oil

In response to repeatedly high levels of ZEN in edible oils, the EU introduced a maximum level for refined maize germ oils in 2007 [26]. Although this maximum level applies, there is no official reference method for the analysis. Therefore, a thorough method comparison for ZEN in edible oil was conducted which is useful in two ways. Firstly, method comparison data is desperately needed in the light of mandate M/520 which calls for a validated method to standardize the “determination of zearalenone in vegetable oils including refined maize oil” [71]. Secondly, the collected data will be an ideal basis for the selection of a suitable method to be automated for the online detection of ZEN in edible oils.

Five current methods based on four different physico-chemical principles were assessed in the method comparison study: LLE, GPC-IAC, MIPs and DCHC in a batch and a column technique. Overall, recovery, precision, selectivity, sensitivity and sample handling were evaluated. In regard to the first two parameters, recovery and precision, European Commission Regulation 401/2006 lays down performance criteria which have to be met by methods for official control. Thus, the recovery should be in the range of 70-120 % and the  $RSD_r$  (precision) should be below 25 %. The test samples chosen for this study included spiked oils, naturally contaminated oils as well as native and refined edible oils.

Whereas a precision below 25 % is fulfilled by all investigated methods, the criteria for recovery are only met by three methods as seen in Figure 4: GPC-IAC and both DCHC versions. LLE showed a recovery of > 120 % for native edible oil due to co-eluting matrix compounds, and consequently a lack of selectivity. The recovery for MIPs was below 70 % for all tested edible oils. Therefore, LLE and MIPs cannot be considered as adequate methods for the official control of the ZEN maximum level in edible oils.

Regarding sample handling, GPC-IAC requires the largest amount of sample, consumes the most organic solvents, uses the most expensive solid sorbent (antibody coated columns) while also taking the longest time for sample preparation. Thus, it can be concluded that both DCHC methods which are less time and cost expensive seem to be more suited for routine monitoring of edible oils. In summary, both DCHC techniques are valuable alternatives for reliable determination of ZEN in edible oil. Nevertheless, testing of various types of edible oils and larger sample numbers are required to underpin the obtained results.

As sample preparation is often considered the most time-consuming step that has to be carried out by qualified personnel [153, 154], an automated method for the analysis of ZEN in edible oil is desirable to reduce labor costs and also human error. With regard to the EU performance criteria, GPC-IAC and both DCHC methods were discussed for automation, but GPC-IAC proved to be less suitable. Firstly, GPC-IAC is a dual procedure with expensive GPC instrumentation and IAC columns. Secondly, IAC columns require a phosphate buffered salt solution to sustain the antibody functionality which leads to clogging of HPLC capillaries. DCHC on the other hand does not require extra instrumentation as the hydrazine particles can be filled in conventional pre-columns for analytical HPLC. Also, the only critical solvent constituent is hydrochloric acid which has a higher chance of being replaceable than physiological salt buffers for IAC. Consequently, the DCHC approach was selected amenable for automation.

The major challenge in automating DCHC is posed by the reaction kinetics. The superior selectivity of DCHC is bought by the slow formation and hydrolysis of covalent bonds. The solution to this problem was to pump the oil sample diluted with *n*-heptane in circuit to ensure sufficient coupling of ZEN to the hydrazine functionalized particles. The decoupling step was also critical as the slow hydrolysis of ZEN with 10 % aqueous acetone led to baseline drifting in the subsequent HPLC step. This was overcome by employing a trapping cartridge between the hydrazine cartridge and analytical HPLC. The trapping cartridge “trapped” the released ZEN which allowed the acetone to be displaced by aqueous acetonitrile. Gradually increasing the acetonitrile proportion eluted ZEN from the trapping cartridge and led to a focused elution onto the analytical column.

The final online method allows for an accurate, selective and sensitive determination of *trans*-ZEN in maize germ oil while significantly reducing labor

costs. It meets EU performance criteria and is therefore suitable to monitor the current maximum level. The developed online method is the first to rely on covalent SPE which could be useful not only for quantitative purposes but also for the isolation of valuable keto group containing compounds (i.e. peptides) with a fraction collector connected. Nevertheless, the single steps of the automated analysis require a reduction in time or a higher degree of parallelization.

Overall, the method comparison study showed that there are adequate methods at hand to reliably determine ZEN in edible oils. Especially DCHC proved to be a versatile technique in response to mandate M/520 as it can be used in a batch, column and automated version depending on the analytical preferences of the operator. The batch version is a robust method which is significantly facilitated by adopting it to a column based procedure. The automated version maximally reduces workload. Thus, the undertaken studies provide detailed insight on the different methodologies used in the determination of ZEN in edible oil while also offering solutions to the EU wide standardization process in progress.

### **3.2. Investigations on the formation and occurrence of *cis*-ZEN**

Previous studies on the instrumental analysis of ZEN in food, especially edible oils, focused on the *trans*-isomer only, as it is the legislatively relevant compound. The isomerization and possible occurrence of the *cis*-form has long been ignored. Thus, calibration standards are not available and, consequently, analytical methods are missing. The first step towards the investigation of *cis*-ZEN occurrence was therefore the synthesis of a native and an isotopically labeled standard for implementation in the respective HPLC-FLD and SIDA-HPLC-MS/MS methods.

Syntheses of both standards follow the same experimental procedure: the native or isotopically labeled *trans*-isomer is irradiated by UV-light. The equilibrium of this reaction is on the side of the *cis*-isomer independently of the organic solvent used as studied for native ZEN (Table 9). Yet, the efficiency of *trans*- to *cis*-isomerization varies among solvents of different polarity. The most efficient *trans*- to *cis*-isomerization is observed for *n*-hexane, the solvent with the lowest dipole moment. More polar solvents such as methanol or acetonitrile show a less efficient

*cis*-ZEN formation. This finding proposes *cis*-/*trans*-isomerization to be dependent on hydrogen bonding as seen for other geometric isomers [155]. A possible more detailed explanation for the link between hydrogen bonding and an enhanced stability of the *cis*-isomer relative to the *trans*-isomer is offered by electron density calculations. These revealed blurred boundaries between the C<sub>16</sub> hydroxy hydrogen and the C<sub>1</sub> carbonyl oxygen of *cis*-ZEN indicating a stronger keto-enol tautomerism than for the *trans*-isomer where a charge separation was calculated (Figure 19). The preferred formation of *cis*-ZEN was also supported by quantum chemical and classical force field simulations which revealed that *cis*-ZEN may be stabilized by entropic effects rather than enthalpic entities.

Although the isomerization equilibrium favors the *cis*-isomer, the conversion is not quantitative which infers the need of a time-consuming preparative isolation of *cis*-ZEN. The sufficient separation of both isomers on a reverse phase octadecyl modified column in combination with 50 °C oven temperature for purification is the basis for quantification by FLD and also for MS/MS analysis as *cis*-ZEN and ZEN share the same mass transitions. Overall, 16 mg native *cis*-ZEN and 6.6 µg isotopically labeled *cis*-ZEN (quantified via the native standard) were obtained in purities of  $\geq 95\%$  and  $> 99\%$ , respectively.

To demonstrate the applicability of the isomer specific standards, different vegetable oils were investigated for their *cis*-ZEN and ZEN contents in two small sample studies (n = 12 for Table 10, n = 15 for Table 13) by DCHC-HPLC-FLD and/or SIDA HPLC-MS/MS. Especially maize germ oils contained high amounts of ZEN although no vegetable oil exceeded the maximum level of 400 µg/kg. Soy bean, rice, wheat and hempseed oil contained none or only little amounts of ZEN. *cis*-ZEN was detected in one maize germ oil only which is why a significant contribution of the preharvest, harvest and oil processing stages to the *cis*-/*trans*-isomerization can be ruled out. However, both sample studies were limited with regard to sample number and types of vegetable oils. In contrast, large extents of *cis*-ZEN formation were found in two “long-term stability studies” of ZEN contaminated maize germ oils stored near a window, i.e. with daylight exposition (Figure 17 and Figure 24). For example Figure 17 shows that a major part of ZEN isomerizes to the *cis*-configuration until a ratio of about 9:1 *cis*:*trans* at equilibrium.

The importance of isomer specific standards for the quantitative analysis of *cis*-ZEN was further underpinned by a strong-overestimation of the *cis*-ZEN content when applying a native *trans*-ZEN standard (Figure 25). The overestimation is due to a higher MS-response of *cis*-ZEN. Judging from the results, it can at least be recommended to use a native *cis*-ZEN standard for quantitative analysis when MS/MS instrumentation is used.

In view of the standardization process for the determination of ZEN in edible oils (M/520) which was discussed in the last chapter, authorities should choose an analytical method which is also able to analyze *cis*-ZEN simultaneously. DCHC, for example, will extract *cis*-ZEN from the edible oil as the hydrazine-hydrazone reaction is carbonyl selective. The co-extraction of *cis*-ZEN will also be the case for LLE. In contrast, it may not be possible to include *cis*-ZEN for MIPs and GPC-IAC due to their high degree of three dimensional shape selectivity.

Overall, it can be stated that authentic *cis*-ZEN standards are needed for various reasons. Firstly, laboratories can check, if the employed HPLC methods separate both isomers or not. Secondly, an accurate quantification of *cis*-ZEN via MS/MS detection is only possible with at least a native *cis*-ZEN standard - otherwise a significant bias can be expected. Eventually a broader data basis on *cis*-ZEN occurrence including more matrices is desirable which highlights the need for official methods to consider the *cis*-/*trans*-issue. Thirdly, *cis*-ZEN standards are valuable tools for further investigations on the metabolism and toxicology of *cis*-ZEN.

Further suggestions that can be derived from this work include that edible oils, ZEN standards and sample solutions should be stored in amber glass or plastic. ZEN standards and sample solutions are also prone to isomerization when stored with daylight exposition, falsifying test results upon their use. Regarding edible oils, especially maize germ oils are packaged in transparent glass or plastic bottles, which is negligent as long as the toxicological risk of *cis*-ZEN contamination is not comprehensively assessed.

### 3.3. *In vitro* phase I metabolism of *cis*-ZEN

As *cis*-ZEN can be generated naturally from ZEN upon the influence of light, it may be a contaminant of food and feed and thus prone to metabolic transformations after ingestion. For example, the previous chapter demonstrated that *cis*-ZEN can occur in maize germ oil. For this reason, the *in vitro* phase I metabolism of *cis*-ZEN was investigated using the authentic native *cis*-ZEN standard prepared in chapter 2.3. For kinetic experiments, where quantification of *cis*-ZEN is required, the authentic native standard was used in combination with the isotopically labeled standard (chapter 2.4) for SIDA HPLC-MS/MS analysis.

The kinetic investigations were conducted in RLM and HLM. A fast transformation of *cis*-ZEN was revealed in both microsomal species. The depletion of *cis*-ZEN was compared to that of ZEN showing no difference in RLM. In HLM on the other hand, *cis*-ZEN was depleted 1.4 fold faster than ZEN. Therefore, human metabolic enzymes seem to possess a higher activity towards the *cis*-isomer which could strongly influence the toxicity depending on a higher or lower activity of the metabolites.

Regarding the chemical characterization of the resulting metabolites, only HLM will be discussed subsequently as RLM and HLM showed vast qualitative similarities in their metabolite patterns. Overall, a total of five *cis*-ZEN phase I metabolites were identified: the reductive products  $\alpha$ - and  $\beta$ -*cis*-ZEL and the oxidative products 13-OH-*cis*-ZEN, 15-OH-*cis*-ZEN and *cis*-11,12-oxide. Furthermore, a ZEN-11,12-oxide was detected in HLM incubations with ZEN. The chemical structures of the phase I metabolites identified in this work are illustrated in Figure 39. The novel metabolites will be discussed comprehensively in comparison to the state of knowledge in the following paragraphs.



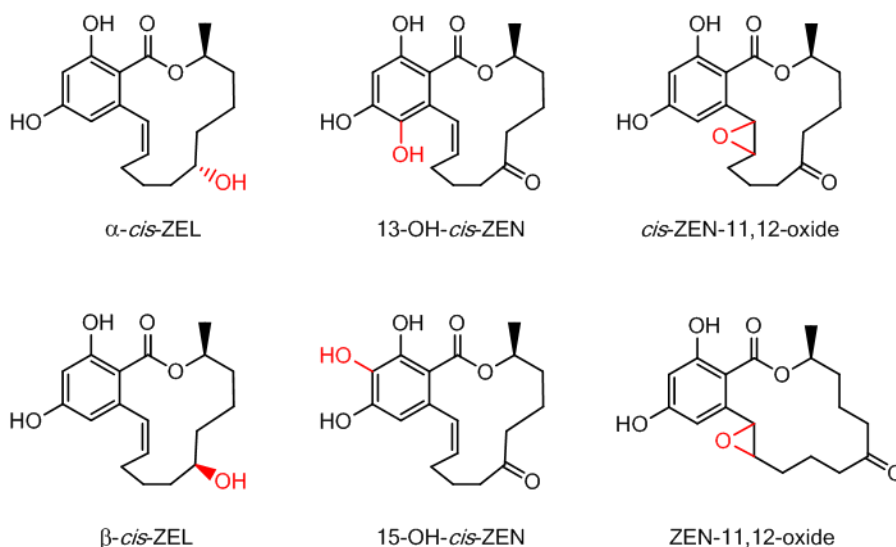


Figure 39. Novel *cis*-ZEN and ZEN metabolites identified after incubation of *cis*-ZEN or ZEN with HLM.

HLM incubations with *cis*-ZEN give rise to the minor metabolites  $\alpha$ - and  $\beta$ -*cis*-ZEL. Likewise for ZEN, its reductive products  $\alpha$ - and  $\beta$ -ZEL have been detected as phase I metabolites in HLM *in vitro* by Pfeiffer *et al.* [34]. In accordance to our results, the  $\alpha$ -product was more pronounced than the  $\beta$ -epimer. A difference can be found in the overall intensity which rendered  $\alpha$ -ZEL a main metabolite in the study by Pfeiffer *et al.*. Concerning *in vivo* data, results for one human volunteer showed the glucuronide of  $\alpha$ -ZEL to be a main metabolite in urine supporting a strong role for the reductive phase I biotransformation *in vivo*. Thus, the reduction of *cis*-ZEN to  $\alpha$ -*cis*-ZEL may also be observed *in vivo* (with subsequent phase II glucuronidation).

In general, xenobiotic metabolism is geared towards detoxification. But in case of the metabolization of ZEN to  $\alpha$ -ZEL a bioactivation reaction takes place as the estrogenic activity of  $\alpha$ -ZEL in human breast cancer cells exceeds that of ZEN and also that of the endogenous hormone 17 $\beta$ -estradiol [61]. Thus,  $\alpha$ - and  $\beta$ -*cis*-ZEL need to be investigated for their estrogenic potential.

Besides the reductive metabolites, the oxidative biotransformation products carrying a monooxygenation (+ O) modification were further characterized. 13-

and 15-OH-*cis*-ZEN were found in HLM incubations with 13-OH-*cis*-ZEN presenting the major metabolite. For the *trans*-isomer, Pfeiffer *et al.* reported the identification of 13- and 15-OH-ZEN in HLM *in vitro*. Interestingly, 15-OH-ZEN was more pronounced than 13-OH-ZEN. Although aromatic hydroxylation is a major metabolic pathway *in vitro*, the catecholic products of the *trans*-isomer have never been detected *in vivo*. But as modern HPLC-MS/MS instrumentation is often used, the transitions for oxygenated phase I or phase II metabolites may simply be missed. Usually, *in vivo* studies only include the prominent glucuronides of ZEN and ZEL without consideration of a possible + O addition [40, 156, 157].

The remaining metabolites with a monooxygenation modification could not be determined unambiguously. But as two catecholic products and one epoxide metabolite of *cis*-ZEN have been identified, only aliphatic monohydroxylations are to be considered as illustrated by Figure 40.

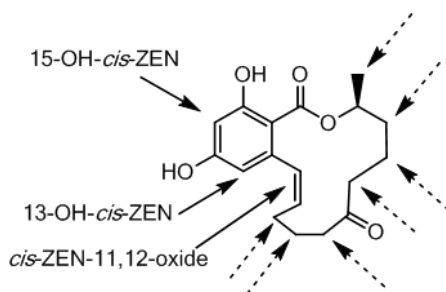


Figure 40. Oxygenation positions on the *cis*-ZEN molecule that have been identified (bold arrows with designation) and unidentified aliphatic monohydroxylation positions (dashed arrows).

Both, 13- and 15-OH-*cis*-ZEN, are toxicologically relevant as catecholic structures have been demonstrated to act genotoxic in two ways. Firstly, catechols may react with purine bases of the DNA to form depurinating adducts that generate highly mutagenic apurinic sites. This may lead to cancer initiation. Secondly, catecholic structures can generate oxygen radicals by metabolic redox cycling [142]. Oxygen radicals attack proteins and DNA or lead to membrane damage through lipid peroxidation.

Next to 13- and 15-OH-*cis*-ZEN as oxidative metabolites, a *cis*-ZEN-11,12-oxide was identified. A ZEN-11,12-oxide was also detected in incubations of HLM with

the *trans*-isomer. Epoxides are particularly important as they are highly reactive. It has been shown that they covalently bind or intercalate to DNA and other macromolecules disturbing cellular functions. For instance, the highly carcinogenic mycotoxin aflatoxin B<sub>1</sub> (AFB<sub>1</sub>) is metabolized to an AFB<sub>1</sub>-oxide which is considered to be the ultimate step towards its carcinogenicity. ZEN has been found to induce DNA adducts in the kidney and liver of mice as investigated by the <sup>32</sup>P-post-labeling method by two independent studies [48, 49]. When antioxidative  $\alpha$ -tocopherol was co-administered, DNA adduct formation was significantly decreased [49, 51]. Both, the *cis*-11,12-oxide and the ZEN-11,12-oxide were only minor metabolites but it has been demonstrated that epoxides bind to microsomal proteins present in the incubation mixture thereby lowering the true amount. Another possible fate of epoxides in microsomal incubation mixtures is diol formation catalyzed by epoxide hydrolases [158]. Yet, no diol formation (*m/z* 351) could be detected.

Overall, five new *cis*-ZEN metabolites were revealed by applying the *cis*-ZEN standard to rat and human microsomal incubations including reductive and oxidative metabolites. Also, a ZEN-11,12-oxide was found as a new mammalian *in vitro* metabolite of ZEN. The general metabolic pathways of ZEN and *cis*-ZEN, i. e. hydroxylations and reductions, appear to be essentially similar.

### 3.4. Estrogenicity of ZEN, *cis*-ZEN and their biotransformation products

A total of 11 congeners of ZEN and *cis*-ZEN including the reductive phase I metabolites of *cis*-ZEN were evaluated for their estrogenic potencies in the E-Screen assay. According to the EC<sub>50</sub> values, *cis*-ZEN is 1.5 times more estrogenic than ZEN. Notably,  $\alpha$ -*cis*-ZEL exhibits a 24 times higher estrogenicity when compared to *cis*-ZEN which can thus be termed a metabolic activation reaction.  $\beta$ -*cis*-ZEL is less estrogenic compared to *cis*-ZEN inferring a deactivation reaction. Nevertheless, it should be noted that  $\beta$ -*cis*-ZEL is still significantly more potent than other important environmental xenobiotics like coumestrol, the strongest phytoestrogen known (EC<sub>50</sub> ~ 10<sup>-8</sup> M using MCF-7 cells [159]), polychlorinated biphenyls (moderate growth stimulation at 10  $\mu$ M for Aroclor 1221 and 1254 in MCF-7 cells [160]) and bisphenol A (EC<sub>50</sub> ~ 10<sup>-7</sup> (M) using MCF-7 cells [161]).

Previous hypotheses stated a higher affinity to the ER the higher the flexibility of the macrocycle. This rationale was based on an estrogenicity ranking of ZEN > ZEN > *cis*-ZEN as found by Shier *et al.* using the MCF-7 cell proliferation assay [20]. Yet, only *cis*-ZEN was assessed and no confidence intervals are given. On the basis of the data obtained in this thesis including the *cis*-isomers of ZEN,  $\alpha$ - and  $\beta$ -ZEL, a decreasing estrogenicity of *cis*-configured congeners is not observed. Quite contrary, all three *cis*-isomers retain significant estrogenicity and *cis*-ZEN as well as  $\beta$ -*cis*-ZEL are slightly more potent than their *trans*-counterparts.

Further structure-activity relations can be deduced from the various *trans*-isomers that were assessed for their estrogenicity. For example, 15-OH-ZEN and ZEN-14-sulfate are both modified at the resorcylic moiety and show a decreased estrogenicity when compared to ZEN. Thus, the resorcylic residue can be considered a relevant structure in binding to the ER and seems to have a higher impact on the estrogenicity of RALs than a conversion from *trans* to *cis*. On the basis of this finding, the metabolism of *cis*-ZEN to catecholic metabolites, which could not be included in the E-Screen assay, may be predicted to be a metabolic deactivation reaction. A decreased estrogenicity may also be inferred for larger modifications of the phenolic hydroxyl groups as for example glucuronides.

Taken together, it was shown that *cis*-ZEN is about as potent as ZEN in terms of estrogenicity. Reductive transformations in phase I metabolism of *cis*-ZEN cannot be considered a detoxification as  $\beta$ -*cis*-ZEL preserves substantial estrogenic activity and  $\alpha$ -*cis*-ZEL is more potent than *cis*-ZEN. Implications for human and animal health upon ingestion of *cis*-ZEN may be expected. In contrast, modifications of the resorcylic moiety seem to consistently decrease the estrogenic activity which was shown for ZEN but may also be the case for *cis*-ZEN.

## 4. Conclusion and future perspectives

As a result of fungal infection, ZEN is a constant threat to all stages of the food chain. Due to its harmful effects, reliable analytical methods are required to investigate its occurrence and to monitor existing maximum levels. In case of edible oils, this work demonstrates that there are sophisticated methods at hand even if the particular analyte/matrix combination is challenging due to their similar polarities. The manual DCHC cartridge version could be a promising method in view of the ongoing standardization process. Moreover, the developed SPE-HPLC online coupling maps a new path in the automated quantitative analysis as it is based on a covalent SPE step.

Besides ZEN, a major part of this thesis was dedicated to its often neglected *cis*-isomer. *cis*-ZEN formation and occurrence were demonstrated in edible oil for the first time. Future investigations should expand *cis*-ZEN analysis to other matrices which would be greatly facilitated if researchers considered *cis*-ZEN in their methods on a routine basis. Investigations should also focus on different food processing techniques. For example, maize germ oil is frequently used in frying processes with the general possibility of *cis/trans*-isomerization by heat.

Lastly, studies on the phase I metabolism of *cis*-ZEN and ZEN revealed several human relevant metabolites which are a further step towards a better understanding of the inherent toxicity. While this thesis elucidates the estrogenicity of selected novel metabolites of ZEN and *cis*-ZEN, these compounds need to be assessed for their toxicity independent of their hormonal effects, i. e. genotoxicity and carcinogenicity. A prerequisite for such studies are authentic reference compounds for which convenient synthetic routes are provided by this work. Therefore, this thesis adds a significant part of knowledge on *cis*-ZEN and ZEN while also providing multiple starting points for future researchers that may entangle themselves with this intriguing molecule.



## 5. Bibliography

- [1] S. S. Drzymala, J. Riedel, R. Köppen, L. A. Garbe, M. Koch. Preparation of  $^{13}\text{C}$ -labelled *cis*-zearalenone and its application as internal standard in stable isotope dilution analysis. *World Mycotoxin J.* 2014;7:45-52.
- [2] S. S. Drzymala, A. J. Herrmann, R. Maul, D. Pfeifer, L. A. Garbe, M. Koch. *In Vitro* Phase I Metabolism of *cis*-Zearalenone. *Chem Res Toxicol.* 2014;27:1972-8.
- [3] R. Köppen, J. Riedel, M. Proske, S. S. Drzymala, T. Rasenko, V. Durmaz, et al. Photochemical *trans*-/*cis*-Isomerization and Quantitation of Zearalenone in Edible Oils. *J Agric Food Chem.* 2012;60:11733-40.
- [4] S. S. Drzymala, S. Weiz, J. Heinze, S. Marten, C. Prinz, A. Zimathies, et al. Automated solid phase extraction coupled online with HPLC-FLD for the quantification of zearalenone in edible oil. *Anal Bioanal Chem.* 2015.
- [5] S. S. Drzymala, M. Penkert, L.-A. Garbe, M. Koch. Comparison of analytical methods for the determination of zearalenone in edible oils. *Food Additives & Contaminants: Part A.* 2015.
- [6] S. S. Drzymala, J. Binder, A. Brodehl, M. Rosowski, L.-A. Garbe, M. Koch. Estrogenicity of novel phase I and phase II metabolites of zearalenone and *cis*-zearalenone. 2015.
- [7] S. S. Drzymala, J. Binder, A. Brodehl, M. Rosowski, L.-A. Garbe, M. Koch. Oxidative in vitro phase I metabolism of *cis*-zearalenone. *Chem Res Toxicol.* 2015.
- [8] S. S. Drzymala, W. Kraus, F. Emmerling, M. Koch. (3S)-14,16-Dihydroxy-3-methyl-3,4,5,6,9,10,11,12-octa-hydro-1H-2-benzoxacyclo-tetradecine-1,7(8H)-dione (zearalanone) monohydrate. *Acta Crystallogr Sect E* 2012;68:o1577.
- [9] S. S. Drzymala, W. Kraus, F. Emmerling, M. Koch. (3S,7R)-7,14,16-Trihydroxy-3-methyl-3,4,5,6,7,8,9,10,11,12-decahydro-1H-2-benzoxacyclotetradecin-1-one. *Acta Crystallogr Sect E* 2012;68:o3071.
- [10] R. W. Caldwell, J. Tuite, M. Stob, R. Baldwin. Zearalenone production by *Fusarium* species. *Appl Microbiol.* 1970;20:31-4.
- [11] W. H. Urry, H. L. Wehrmeister, E. B. Hodge, P. H. Hidy. The structure of zearalenone. *Tetrahedron Lett.* 1966;7:3109-14.
- [12] C. A. Peters. Photochemistry of zearalenone and its derivatives. *J Med Chem.* 1972;15:867-8.
- [13] C. O. Miles, A. F. Erasmuson, A. L. Wilkins, N. R. Towers, B. L. Smith, I. Garthwaite, et al. Ovine Metabolism of Zearalenone to  $\alpha$ -Zearalanol (Zeranol). *J Agric Food Chem.* 1996;44:3244-50.
- [14] K. E. Richardson, W. M. Hagler, C. J. Mirocha. Production of zearalenone, alpha- and beta-zearalenol, and alpha- and beta-zearalanol by *Fusarium* spp. in rice culture. *J Agric Food Chem.* 1985;33:862-6.

- [15] L. Muñoz, J. L. Castro, M. Cardelle, L. Castedo, R. Riguera. Acetylated mycotoxins from *Fusarium graminearum*. *Phytochemistry*. 1989;28:83-5.
- [16] M. R. Smyth, C. G. Bernhard Frischkorn. Simultaneous determination of the *trans* and *cis* forms of zearalenone in cereal products by high-performance liquid chromatography with voltammetric detection. *Anal Chim Acta*. 1980;115:293-300.
- [17] U. Bosch, C. J. Mirocha. Toxin production by *Fusarium* species from sugar beets and natural occurrence of zearalenone in beets and beet fibers. *Applied Environmental Microbiology*. 1992;58:3233-9.
- [18] U. Brezina, S. Kersten, H. Valenta, P. Sperfeld, J. Riedel, S. Dänicke. UV-induced *cis-trans* isomerization of zearalenone in contaminated maize. *Mycotoxin Res*. 2013;29:221-7.
- [19] C. J. Mirocha, S. V. Pathre, J. Behrens, B. Schauerhamer. Uterotropic activity of *cis* and *trans* isomers of zearalenone and zearalenol. *Applied Environmental Microbiology*. 1978;35:986-7.
- [20] W. T. Shier, A. C. Shier, W. Xie, C. J. Mirocha. Structure-activity relationships for human estrogenic activity in zearalenone mycotoxins. *Toxicol*. 2001;39:1435-8.
- [21] C. Maragos. Zearalenone occurrence and human exposure. *World Mycotoxin J*. 2010;3:369-83.
- [22] C. Placinta, J. D'mello, A. Macdonald. A review of worldwide contamination of cereal grains and animal feed with *Fusarium* mycotoxins. *Anim Feed Sci Technol*. 1999;78:21-37.
- [23] H.-M. Müller, J. Reimann, U. Schumacher, K. Schwadorf. Natural occurrence of *Fusarium* toxins in barley harvested during five years in an area of southwest Germany. *Mycopathologia*. 1997;137:185-92.
- [24] A. Zinedine, J. M. Soriano, J. C. Molto, J. Manes. Review on the toxicity, occurrence, metabolism, detoxification, regulations and intake of zearalenone: an oestrogenic mycotoxin. *Food Chem Toxicol*. 2007;45:1-18.
- [25] EFSA. EFSA Panel on Contaminants in the Food Chain. Scientific Opinion on the risks for public health related to the presence of zearalenone in food. *EFSA Journal* 2011. 2011;9(6):2197:124 pp.
- [26] Commission Decision. No 1126/2007 amending Regulation (EC) No 1881/2006 setting maximum levels for certain contaminants in foodstuffs as regards *Fusarium* toxins in maize and maize products. *Official Journal of the European Union* 2007;L255:14-7.
- [27] M. Olsen, H. Pettersson, K. H. Kiessling. Reduction of zearalenone to zearalenol in female rat liver by 3 alpha-hydroxysteroid dehydrogenase. *Acta Pharmacol Toxicol (Copenh)*. 1981;48:157-61.
- [28] H. Malekinejad, R. Maas-Bakker, J. Fink-Gremmels. Species differences in the hepatic biotransformation of zearalenone. *Vet J*. 2006;172:96-102.



- [29] A. F. Erasmuson, B. G. Scahill, D. M. West. Natural zearanol (alpha-zearalanol) in the urine of pasture-fed animals. *J Agric Food Chem.* 1994;42:2721-5.
- [30] P. Zöllner, J. Jodlbauer, M. Kleinova, H. Kahlbacher, T. Kuhn, W. Hochsteiner, et al. Concentration levels of zearalenone and its metabolites in urine, muscle tissue, and liver samples of pigs fed with mycotoxin-contaminated oats. *J Agric Food Chem.* 2002;50:2494-501.
- [31] R. S. Baldwin, R. D. Williams, M. K. Terry. Zearanol: a review of the metabolism, toxicology, and analytical methods for detection of tissue residues. *Regul Toxicol Pharmacol.* 1983;3:9-25.
- [32] S. Wang, X. H. Wang. Analytical methods for the determination of zearanol residues in animal products: a review. *Food Addit Contam.* 2007;24:573-82.
- [33] E. Pfeiffer, A. Heyting, M. Metzler. Novel oxidative metabolites of the mycoestrogen zearalenone in vitro. *Mol Nutr Food Res.* 2007;51:867-71.
- [34] E. Pfeiffer, A. Hildebrand, G. Damm, A. Rapp, B. Cramer, H. U. Humpf, et al. Aromatic hydroxylation is a major metabolic pathway of the mycotoxin zearalenone in vitro. *Mol Nutr Food Res.* 2009;53:1123-33.
- [35] A. A. Hildebrand, E. Pfeiffer, A. Rapp, M. Metzler. Hydroxylation of the mycotoxin zearalenone at aliphatic positions: novel mammalian metabolites. *Mycotoxin Res.* 2012;28:1-8.
- [36] F. Bravin, R. C. Duca, P. Balaguer, M. Delaforge. In vitro cytochrome p450 formation of a mono-hydroxylated metabolite of zearalenone exhibiting estrogenic activities: possible occurrence of this metabolite in vivo. *Int J Mol Sci.* 2009;10:1824-37.
- [37] D. E. Stevenson, R. P. Hansen, J. I. Loader, D. J. Jensen, J. M. Cooney, A. L. Wilkins, et al. Preparative enzymatic synthesis of glucuronides of zearalenone and five of its metabolites. *J Agric Food Chem.* 2008;56:4032-8.
- [38] E. Pfeiffer, A. Hildebrand, H. Mikula, M. Metzler. Glucuronidation of zearalenone, zearanol and four metabolites in vitro: formation of glucuronides by various microsomes and human UDP-glucuronosyltransferase isoforms. *Mol Nutr Food Res.* 2010;54:1468-76.
- [39] C. J. Mirocha, S. V. Pathre, T. S. Robison. Comparative metabolism of zearalenone and transmission into bovine milk. *Food Cosmet Toxicol.* 1981;19:25-30.
- [40] B. Warth, M. Sulyok, F. Berthiller, R. Schuhmacher, R. Krska. New insights into the human metabolism of the Fusarium mycotoxins deoxynivalenol and zearalenone. *Toxicol Lett.* 2013;220:88-94.
- [41] E. Pfeiffer, A. Kommer, J. S. Dempe, A. A. Hildebrand, M. Metzler. Absorption and metabolism of the mycotoxin zearalenone and the growth promotor zearanol in Caco-2 cells in vitro. *Mol Nutr Food Res.* 2011;55:560-7.

- [42] E. M. Boyd, M. M. Abel, L. M. Knight. The chronic oral toxicity of sodium chloride at the range of the LD50 (0.1 L). *Can J Physiol Pharmacol*. 1966;44:157-72.
- [43] P. National Toxicology. Carcinogenesis Bioassay of Zearalenone (CAS No. 17924-92-4) in F344/N Rats and B6C3F1 Mice (Feed Study). National Toxicology Program technical report series. 1982;235:1.
- [44] P. J. Becci, K. A. Voss, F. G. Hess, M. A. Gallo, R. A. Parent, K. R. Stevens, et al. Long-term carcinogenicity and toxicity study of zearalenone in the rat. *J Appl Toxicol*. 1982;2:247-54.
- [45] IARC. Some Naturally Occurring Substances: Heterocyclic Aromatic Amines and Mycotoxins. Monographs on the Evaluation of the Carcinogenic Risk of Chemicals to Humans. 1993;56:397-444.
- [46] Z. Yu, L. Zhang, D. Wu, F. Liu. Anti-apoptotic action of zearalenone in MCF-7 cells. *Ecotoxicol Environ Saf*. 2005;62:441-6.
- [47] T. Kuiper-Goodman, P. Scott, H. Watanabe. Risk assessment of the mycotoxin zearalenone. *Regul Toxicol Pharmacol*. 1987;7:253-306.
- [48] A. Pfohl-Leskowicz, L. Chekir-Ghedira, H. Bacha. Genotoxicity of zearalenone, an estrogenic mycotoxin: DNA adduct formation in female mouse tissues. *Carcinogenesis*. 1995;16:2315-20.
- [49] Y. Grosse, L. Chekir-Ghedira, A. Huc, S. Obrecht-Pflumio, G. Dirheimer, H. Bacha, et al. Retinol, ascorbic acid and  $\alpha$ -tocopherol prevent DNA adduct formation in mice treated with the mycotoxins ochratoxin A and zearalenone. *Cancer Lett*. 1997;114:225-9.
- [50] Z. Ouanes, S. Abid, I. Ayed, R. Anane, T. Mobio, E. E. Creppy, et al. Induction of micronuclei by Zearalenone in Vero monkey kidney cells and in bone marrow cells of mice: protective effect of Vitamin E. *Mutation Research/Genetic Toxicology and Environmental Mutagenesis*. 2003;538:63-70.
- [51] L. Ghedira-Chekir, K. Maaroufi, A. Zakhama, F. Ellouz, S. Dhouib, E. E. Creppy, et al. Induction of a SOS repair system in lysogenic bacteria by zearalenone and its prevention by vitamin E. *Chem Biol Interact*. 1998;113:15-25.
- [52] S. McNutt, P. Purwin, C. Murray. Vulvovaginitis in swine. *J Am Vet Med Assoc*. 1928;73:1928.
- [53] I. Schneweis, K. Meyer, G. Engelhardt, J. Bauer. Occurrence of zearalenone-4- $\beta$ -D-glucopyranoside in wheat. *J Agric Food Chem*. 2002;50:1736-8.
- [54] C. J. Mirocha, C. M. Christensen. Fungus metabolites toxic to animals. *Annu Rev Phytopathol*. 1974;12:303-30.
- [55] U. Yoshio, F. Tashiro.  $\alpha$ -Zearalenol, a major hepatic metabolite in rats of zearalenone, an estrogenic mycotoxin of *Fusarium* species. *Journal of Biochemistry*. 1981;89:563-71.

- [56] C. A. Sáenz de Rodriguez, A. M. Bongiovanni, L. C. d. Borrego. An epidemic of precocious development in Puerto Rican children. *The Journal of pediatrics*. 1985;107:393-6.
- [57] Y. Zhang, S. Zhu, W. Tong. Isolation of fusarium and extraction of its toxin from buckwheat grown in an area with "endemic breast enlargement" disease. *Zhonghua yu fang yi xue za zhi (Chinese journal of preventive medicine)*. 1995;29:273-5.
- [58] P. Szuets, A. Mesterhazy, G. Y. Falkay, T. Bartok. Early telarche symptoms in children and their relations to zearalenon contamination in foodstuffs. *Cereal Res Commun*. 1997:429-36.
- [59] F. Massart, G. Saggese. Oestrogenic mycotoxin exposures and precocious pubertal development. *Int J Androl*. 2010;33:369-76.
- [60] G. G. Kuiper, J. G. Lemmen, B. Carlsson, J. C. Corton, S. H. Safe, P. T. van der Saag, et al. Interaction of estrogenic chemicals and phytoestrogens with estrogen receptor beta. *Endocrinology*. 1998;139:4252-63.
- [61] F. Minervini, A. Giannoccaro, A. Cavallini, A. Visconti. Investigations on cellular proliferation induced by zearalenone and its derivatives in relation to the estrogenic parameters. *Toxicol Lett*. 2005;159:272-83.
- [62] European Committee for Standardization (CEN). Determination of zearalenone in maize based baby food, barley flour, maize flour, polenta, wheat flour and cereal based foods for infants and young children - HPLC method with immunoaffinity column cleanup and fluorescence detection. *Food analysis - Horizontal methods*. 2010;EN 15850:2010, Foodstuffs, CEN/TC 275.
- [63] P. Lucci, D. Derrien, F. Alix, C. Pérollier, S. Bayouhd. Molecularly imprinted polymer solid-phase extraction for detection of zearalenone in cereal sample extracts. *Anal Chim Acta*. 2010;672:15-9.
- [64] D. B. Prelusky, R. M. Warner, H. L. Trenholm. Sensitive analysis of the mycotoxin zearalenone and its metabolites in biological fluids by high-performance liquid chromatography. *Journal of Chromatography B: Biomedical Sciences and Applications*. 1989;494:267-77.
- [65] M. H. Choi, K.-R. Kim, J. K. Hong, S. J. Park, B. C. Chung. Determination of non-steroidal estrogens in breast milk, plasma, urine and hair by gas chromatography/mass spectrometry. *Rapid Commun Mass Spectrom*. 2002;16:2221-8.
- [66] M. Schollenberger, H. M. Muller, M. Rufle, S. Suchy, S. Plank, W. Drochner. Natural occurrence of 16 fusarium toxins in grains and feedstuffs of plant origin from Germany. *Mycopathologia*. 2006;161:43-52.
- [67] D. R. Lauren, M. A. Ringrose. Determination of the fate of three Fusarium mycotoxins through wet-milling of maize using an improved HPLC analytical technique. *Food Addit Contam*. 1997;14:435-43.

- [68] P. Majerus, N. Graf, M. Krämer. Rapid determination of zearalenone in edible oils by HPLC with fluorescence detection. *Mycotoxin Res.* 2009;25:117-21.
- [69] O. Kappenstein, H. S. Klaffke, I. Mehlitz, R. Tiebach, R. Weber, J. Lepschy, et al. Bestimmung von Zearalenon in Speiseölen mit GPC und LC-ESI-MS/MS. *Mycotoxin Res.* 2005;21:3-6.
- [70] D. Siegel, K. Andrae, M. Proske, C. Kochan, M. Koch, M. Weber, et al. Dynamic covalent hydrazine chemistry as a selective extraction and cleanup technique for the quantification of the *Fusarium* mycotoxin zearalenone in edible oils. *J Chromatogr A.* 2010;1217:2206-15.
- [71] European Committee for Standardization (CEN). M/520 Mandate for standardisation addressed to CEN for methods of analysis for mycotoxins in food, 2013.
- [72] M. N. Pascale. Detection methods for mycotoxins in cereal grains and cereal products. *Zbornik Matice srpske za prirodne nauke.* 2009:15-25.
- [73] S. Sforza, C. Dall'Asta, R. Marchelli. Recent advances in mycotoxin determination in food and feed by hyphenated chromatographic techniques/mass spectrometry. *Mass Spectrometry Reviews.* 2006;25:54-76.
- [74] B. Cramer, M. Bretz, H.-U. Humpf. Stable Isotope Dilution Analysis of the *Fusarium* Mycotoxin Zearalenone. *J Agric Food Chem.* 2007;55:8353-8.
- [75] F. Berthiller, R. Schuhmacher, G. Buttinger, R. Krska. Rapid simultaneous determination of major type A- and B-trichothecenes as well as zearalenone in maize by high performance liquid chromatography-tandem mass spectrometry. *J Chromatogr A.* 2005;1062:209-16.
- [76] K. Chang, H. J. Kurtz, C. J. Mirocha. Effects of the mycotoxin zearalenone on swine reproduction. *Am J Vet Res.* 1979;40:1260-7.
- [77] J. Fink-Gremmels, H. Malekinejad. Clinical effects and biochemical mechanisms associated with exposure to the mycoestrogen zearalenone. *Anim Feed Sci Technol.* 2007;137:326-41.
- [78] T. Tanaka, A. Hasegawa, S. Yamamoto, U. S. Lee, Y. Sugiura, Y. Ueno. Worldwide contamination of cereals by the *Fusarium* mycotoxins nivalenol, deoxynivalenol, and zearalenone. Survey of 19 countries. *J Agric Food Chem.* 1988;36:979-83.
- [79] M. Schollenberger, H. M. Muller, M. Ruffle, S. Suchy, C. Dejanovic, B. Frauz, et al. Simultaneous determination of a spectrum of trichothecene toxins out of residuals of biogas production. *J Chromatogr A.* 2008;1193:92-6.
- [80] J. R. P. ZENOL. "Development and validation of an innovative analytical method for the selective determination of zearalenone in vegetable oils". BMWi, No 01FS12033. 2013; funded by the Federal Ministry for Economic Affairs and Energy.

- [81] P. De Bièvre, H. S. Peiser. Basic equations and uncertainties in isotope-dilution mass spectrometry for traceability to SI of values obtained by this primary method. *Fresenius' J Anal Chem.* 1997;359:523-5.
- [82] Commission Regulation (EC) 401/2006. Laying down the methods of sampling and analysis for the official control of the levels of mycotoxins in foodstuffs. *Official Journal of the EU.* 2006;L 70:12-34.
- [83] J. Pan, C. Zhang, Z. Zhang, G. Li. Review of online coupling of sample preparation techniques with liquid chromatography. *Anal Chim Acta.* 2014;815:1-15.
- [84] D. W. Emerson, R. R. Emerson, S. C. Joshi, E. M. Sorensen, J. E. Turek. Polymer-bound sulfonylhydrazine functionality. Preparation, characterization, and reactions of copoly(styrene-divinylbenzenesulfonylhydrazine). *The Journal of Organic Chemistry.* 1979;44:4634-40.
- [85] O. L. Brady. The use of 2, 4-dinitrophenylhydrazine as a reagent for carbonyl compounds. *J chem Soc.* 1931:756-9.
- [86] S. M. van Leeuwen, L. Hendriksen, U. Karst. Determination of aldehydes and ketones using derivatization with 2,4-dinitrophenylhydrazine and liquid chromatography-atmospheric pressure photoionization-mass spectrometry. *J Chromatogr A.* 2004;1058:107-12.
- [87] R. Peters, J. Hellenbrand, Y. Mengerink, S. Van der Wal. On-line determination of carboxylic acids, aldehydes and ketones by high-performance liquid chromatography-diode array detection-atmospheric pressure chemical ionisation mass spectrometry after derivatization with 2-nitrophenylhydrazine. *J Chromatogr A.* 2004;1031:35-50.
- [88] H. Miwa. High-performance liquid chromatographic determination of mono-, poly- and hydroxycarboxylic acids in foods and beverages as their 2-nitrophenylhydrazides. *J Chromatogr A.* 2000;881:365-85.
- [89] P. Zöllner, D. Berner, J. Jodlbauer, W. Lindner. Determination of zearalenone and its metabolites  $\alpha$ - and  $\beta$ -zearalenol in beer samples by high-performance liquid chromatography tandem mass spectrometry. *Journal of Chromatography B: Biomedical Sciences and Applications.* 2000;738:233-41.
- [90] B. Shreeve, D. Patterson, B. Roberts. The 'carry-over' of aflatoxin, ochratoxin and zearalenone from naturally contaminated feed to tissues, urine and milk of dairy cows. *Food Cosmet Toxicol.* 1979;17:151-2.
- [91] R. Krska, H. Pettersson, R. Josephs, M. Lemmens, S. Mac Donald, E. Welzig. Zearalenone in maize: stability testing and matrix characterisation of a certified reference material. *Food Addit Contam.* 2003;20:1141-52.
- [92] G. Z. Omurtag. Fumonisin, trichothecenes and zearalenone in cereals. *Int J Mol Sci.* 2008;9:2062-90.
- [93] R. C. Schothorst, H. P. van Egmond. Report from SCOOP task 3.2.10 "collection of occurrence data of Fusarium toxins in food and assessment

- of dietary intake by the population of EU member states”: Subtask: trichothecenes. *Toxicol Lett.* 2004;153:133-43.
- [94] R. Köppen, J. Riedel, F. Emmerling, M. Koch. (3S,11Z)-14,16-Dihydroxy-3-methyl-3,4,5,6,9,10-hexa-hydro-1H-2-benz-oxacyclo-tetra-decine-1,7(8H)-dione (cis-zearalenone): a redetermination. *Acta Crystallography Section E Structure Reports Online.* 2012;68:o832.
- [95] C. Frizzell, D. Ndossi, S. Verhaegen, E. Dahl, G. Eriksen, M. Sorlie, et al. Endocrine disrupting effects of zearalenone, alpha- and beta-zearalenol at the level of nuclear receptor binding and steroidogenesis. *Toxicol Lett.* 2011;206:210-7.
- [96] D. T. Kiang, B. J. Kennedy, S. V. Pathre, C. J. Mirocha. Binding characteristics of zearalenone analogs to estrogen receptors. *Cancer Res.* 1978;38:3611-5.
- [97] European Committee for Standardization (CEN). CEN/TC 275 - Food Analysis - Horizontal methods. *Foodstuffs.* 2010;EN 15850.
- [98] P. Martos, W. Thompson, G. Diaz. Multiresidue mycotoxin analysis in wheat, barley, oats, rye and maize grain by high-performance liquid chromatography-tandem mass spectrometry. *World Mycotoxin J.* 2010;3:205-23.
- [99] A. K. Malik, C. Blasco, Y. Picó. Liquid chromatography–mass spectrometry in food safety. *J Chromatogr A.* 2010;1217:4018-40.
- [100] C.-D. Liao, L.-C. Chiueh, D. Y.-C. Shih. Determination of zearalenone in cereals by high performance liquid chromatography and liquid chromatography–electrospray tandem mass spectrometry. *J Food Drug Anal.* 2009;17:52-8.
- [101] T. A. Halgren. Merck molecular force field. I. Basis, form, scope, parameterization, and performance of MMFF94. *Journal of computational chemistry.* 1996;17:490-519.
- [102] S. Duane, A. D. Kennedy, B. J. Pendleton, D. Roweth. Hybrid monte carlo. *Physics letters B.* 1987;195:216-22.
- [103] A. Brass, B. J. Pendleton, Y. Chen, B. Robson. Hybrid Monte Carlo simulations theory and initial comparison with molecular dynamics. *Biopolymers.* 1993;33:1307-15.
- [104] R. Fletcher, C. M. Reeves. Function minimization by conjugate gradients. *The computer journal.* 1964;7:149-54.
- [105] M. R. Hestenes, E. Stiefel. *Methods of conjugate gradients for solving linear systems:* National Bureau of Standards Washington, DC; 1952.
- [106] B. Hess, C. Kutzner, D. Van Der Spoel, E. Lindahl. GROMACS 4: Algorithms for highly efficient, load-balanced, and scalable molecular simulation. *Journal of chemical theory and computation.* 2008;4:435-47.
- [107] D. Van Der Spoel, E. Lindahl, B. Hess, G. Groenhof, A. E. Mark, H. J. C. Berendsen. GROMACS: fast, flexible, and free. *Journal of computational chemistry.* 2005;26:1701-18.

- [108] H. J. C. Berendsen, D. van der Spoel, R. van Drunen. GROMACS: A message-passing parallel molecular dynamics implementation. *Computer Physics Communications*. 1995;91:43-56.
- [109] A. Jakalian, B. L. Bush, D. B. Jack, C. I. Bayly. Fast, efficient generation of high-quality atomic Charges. AM1-BCC model: I. Method. *Journal of computational chemistry*. 2000;21:132-46.
- [110] A. Jakalian, D. B. Jack, C. I. Bayly. Fast, efficient generation of high-quality atomic charges. AM1-BCC model: II. Parameterization and validation. *Journal of computational chemistry*. 2002;23:1623-41.
- [111] A. D. Becke. Density-functional thermochemistry. III. The role of exact exchange. *The Journal of chemical physics*. 1993;98:5648-52.
- [112] C. Lee, W. Yang, R. G. Parr. Development of the Colle-Salvetti correlation-energy formula into a functional of the electron density. *Physical Review B*. 1988;37:785.
- [113] W. J. Hehre, L. Radom, P. v. R. Schleyer, J. A. Pople. *Ab initio molecular orbital theory*: Wiley New York et al.; 1986.
- [114] J. Tomasi, M. Persico. Molecular interactions in solution: an overview of methods based on continuous distributions of the solvent. *Chemical Reviews*. 1994;94:2027-94.
- [115] E. Cancès, B. Mennucci, J. Tomasi. A new integral equation formalism for the polarizable continuum model: Theoretical background and applications to isotropic and anisotropic dielectrics. *The Journal of chemical physics*. 1997;107:3032-41.
- [116] M. Cossi, V. Barone, B. Mennucci, J. Tomasi. *Ab initio* study of ionic solutions by a polarizable continuum dielectric model. *Chemical Physics Letters*. 1998;286:253-60.
- [117] C. A. Peters. *cis-Zearalanone, cis-zearalenol, and cis-zearalene*. Google Patents; 1977.
- [118] Bureau Internatioal des Poids et Mesures (BIPM). Consultative Committee for Amount of Substance - Metrology in Chemistry (CCQM).
- [119] M. Koch, M. Proske, D. Siegel. Zearalenon in Speiseölen - Bericht zum Ringversuch. Federal Institute for Materials Research and Testing (BAM); Berlin, Germany, 2011.
- [120] E. W. Sydenham, P. G. Thiel, R. Vleggaar. Physicochemical data for some selected Fusarium toxins 1996.
- [121] Commission Decision. No 657/2002 implementing Council Directive 96/23/EC concerning the performance of analytical methods and the interpretation of results. *Official Journal of the European Union* 2002;L71.
- [122] D. Siegel, S. Merkel, W. Bremser, M. Koch, I. Nehls. Degradation kinetics of the Alternaria mycotoxin tenuazonic acid in aqueous solutions. *Anal Bioanal Chem*. 2010;397:453-62.
- [123] W. Liu, J. J. Gan. Separation and analysis of diastereomers and enantiomers of cypermethrin and cyfluthrin by gas chromatography. *J Agric Food Chem*. 2004;52:755-61.

- [124] W. Volkel, N. Wolf, M. Derelanko, W. Dekant. Slow oxidation of acetoxime and methylethyl ketoxime to the corresponding nitronates and hydroxy nitronates by liver microsomes from rats, mice, and humans. *Toxicol Sci.* 1999;47:144-50.
- [125] FAO (Food and Agriculture Organization). Regulations for Mycotoxins in Food and Feed in 2003. FAO Food and Nutrition Paper 81. 2004;FAO/UN: Rome, Italy, 2004.
- [126] S. Danicke, E. Swiech, L. Buraczewska, K. H. Ueberschar. Kinetics and metabolism of zearalenone in young female pigs. *J Anim Physiol Anim Nutr (Berl)*. 2005;89:268-76.
- [127] M. Olsen, K. H. Kiessling. Species differences in zearalenone-reducing activity in subcellular fractions of liver from female domestic animals. *Acta Pharmacol Toxicol (Copenh)*. 1983;52:287-91.
- [128] M. Metzler, E. Pfeiffer, A. Hildebrand. Zearalenone and its metabolites as endocrine disrupting chemicals. *World Mycotoxin J.* 2010;3:385-401.
- [129] R. S. Obach. Prediction of human clearance of twenty-nine drugs from hepatic microsomal intrinsic clearance data: An examination of in vitro half-life approach and nonspecific binding to microsomes. *Drug Metab Dispos.* 1999;27:1350-9.
- [130] W. B. Smith, W. H. Watson. A conformational investigation of zearalenone and the 6'-zearalenols by carbon and proton NMR spectroscopy. *Magnetic Resonance in Chemistry.* 1987;25:975-80.
- [131] H. Malekinejad, R. F. Maas-Bakker, J. Fink-Gremmels. Enzyme kinetics of zearalenone biotransformation: pH and cofactor effects. *Arch Toxicol.* 2005;79:547-53.
- [132] A. A. Hildebrand, E. Pfeiffer, G. Damm, M. Metzler. Combination of LC-MS 2 and GC-MS as a tool to differentiate oxidative metabolites of zearalenone with different chemical structures. *International Journal of Spectroscopy.* 2012;2012.
- [133] K. Nicolaou, T. Montagnon, P. Baran, Y.-L. Zhong. Iodine (V) reagents in organic synthesis. Part 4. o-Iodoxybenzoic acid as a chemospecific tool for single electron transfer-based oxidation processes. *J Am Chem Soc.* 2002;124:2245-58.
- [134] H. Heaney. Novel Organic Peroxygen Reagents For Use in Organic Synthesis. *Top Curr Chem.* 1993;164:1-19.
- [135] E. Pfeiffer, A. A. Hildebrand, C. Becker, C. Schnattinger, S. Baumann, A. Rapp, et al. Identification of an aliphatic epoxide and the corresponding dihydrodiol as novel congeners of zearalenone in cultures of *Fusarium graminearum*. *J Agric Food Chem.* 2010;58:12055-62.
- [136] A. Duschek, S. F. Kirsch. 2-Iodoxybenzoesäure—ein einfaches Oxidationsmittel mit einer Vielfalt an Anwendungsmöglichkeiten. *Angewandte Chemie.* 2011;123:1562-90.
- [137] D. Tsikas, A. Mitschke, F. M. Gutzki, H. H. Meyer, J. C. Frolich. Gas chromatography-mass spectrometry of cis-9,10-epoxyoctadecanoic acid



- (cis-EODA). II. Quantitative determination of cis-EODA in human plasma. *J Chromatogr B Analyt Technol Biomed Life Sci.* 2004;804:403-12.
- [138] T. Ichiyanagi, Y. Kashiwada, Y. Shida, Y. Ikeshiro, T. Kaneyuki, T. Konishi. Nasunin from eggplant consists of cis-trans isomers of delphinidin 3-[4-(p-coumaroyl)-L-rhamnosyl (1-->6)glucopyranoside]-5-glucopyranoside. *J Agric Food Chem.* 2005;53:9472-7.
- [139] G. S. Gorman, L. Coward, C. Kerstner-Wood, L. Cork, I. M. Kapetanovic, W. J. Brouillette, et al. In vitro metabolic characterization, phenotyping, and kinetic studies of 9cUAB30, a retinoid X receptor-specific retinoid. *Drug Metab Dispos.* 2007;35:1157-64.
- [140] L. Camont, C. H. Cottart, Y. Rhayem, V. Nivet-Antoine, R. Djelidi, F. Collin, et al. Simple spectrophotometric assessment of the trans-/cis-resveratrol ratio in aqueous solutions. *Anal Chim Acta.* 2009;634:121-8.
- [141] Y. Masubuchi, T. Nakano, A. Ose, T. Horie. Differential selectivity in carbamazepine-induced inactivation of cytochrome P450 enzymes in rat and human liver. *Arch Toxicol.* 2001;75:538-43.
- [142] E. Cavalieri, E. Rogan. Catechol quinones of estrogens in the initiation of breast, prostate, and other human cancers. *Ann N Y Acad Sci.* 2006;1089:286-301.
- [143] L. Ehrenberg, S. Hussain. Genetic toxicity of some important epoxides. *Mutation Research/Reviews in Genetic Toxicology.* 1981;86:1-113.
- [144] W. V. Welshons, K. A. Thayer, B. M. Judy, J. A. Taylor, E. M. Curran, F. S. Vom Saal. Large effects from small exposures. I. Mechanisms for endocrine-disrupting chemicals with estrogenic activity. *Environ Health Perspect.* 2003;111:994.
- [145] R. Hurd. Structure activity relationships in zearalenones. *Mycotoxins in human and animal health* Pathotox Publications, Inc, Park Forest South, Ill. 1977:379-91.
- [146] N. Schütze, G. Vollmer, I. Tiemann, M. Geiger, R. Knuppen. Catecholestrogens are MCF-7 cell estrogen receptor agonists. *J Steroid Biochem Mol Biol.* 1993;46:781-9.
- [147] J. Schneider, M. M. Huh, H. L. Bradlow, J. Fishman. Antiestrogen action of 2-hydroxyestrone on MCF-7 human breast cancer cells. *J Biol Chem.* 1984;259:4840-5.
- [148] F. F. Parl. *Estrogens, estrogen receptor, and breast cancer*: Ios Press; 2000.
- [149] E. Pfeiffer, D. Wefers, A. Hildebrand, S. Fleck, M. Metzler. Catechol metabolites of the mycotoxin zearalenone are poor substrates but potent inhibitors of catechol-O-methyltransferase. *Mycotoxin Res.* 2013;29:177-83.
- [150] L. Secky, M. Svoboda, L. Klameth, E. Bajna, G. Hamilton, R. Zeillinger, et al. The sulfatase pathway for estrogen formation: targets for the treatment and diagnosis of hormone-associated tumors. *Journal of drug delivery.* 2013;2013.

- [151] A. Brodehl, A. Möller, H. J. Kunte, M. Koch, R. Maul. Biotransformation of the mycotoxin zearalenone by fungi of the genera *Rhizopus* and *Aspergillus*. *FEMS Microbiol Lett.* 2014;359:124-30.
- [152] A. M. Soto, C. Sonnenschein, K. L. Chung, M. F. Fernandez, N. Olea, F. O. Serrano. The E-SCREEN assay as a tool to identify estrogens: an update on estrogenic environmental pollutants. *Environ Health Perspect.* 1995;103 Suppl 7:113-22.
- [153] I. S. Ibarra, J. A. Rodriguez, J. M. Miranda, M. Vega, E. Barrado. Magnetic solid phase extraction based on phenyl silica adsorbent for the determination of tetracyclines in milk samples by capillary electrophoresis. *J Chromatogr A.* 2011;1218:2196-202.
- [154] G. Theodoridis, C. K. Zacharis, P. D. Tzanavaras, D. G. Themelis, A. Economou. Automated sample preparation based on the sequential injection principle: Solid-phase extraction on a molecularly imprinted polymer coupled on-line to high-performance liquid chromatography. *J Chromatogr A.* 2004;1030:69-76.
- [155] F. Lewis, B. Yoon. The influence of intramolecular hydrogen bonding on the structure and E ↔ Z photoisomerization of urocanic acid derivatives. *Research on Chemical Intermediates.* 1995;21:749-63.
- [156] R. Sambuu, M. Takagi, S. Shiga, S. Uno, E. Kokushi, Z. Namula, et al. Detection of zearalenone and its metabolites in naturally contaminated porcine follicular fluid by using liquid chromatography-tandem mass spectrometry. *J Reprod Dev.* 2011;57:303-6.
- [157] A. Veršilovskis, J. Geys, B. Huybrechts, E. Goossens, S. De Saeger, A. Callebaut. Simultaneous determination of masked forms of deoxynivalenol and zearalenone after oral dosing in rats by LC-MS/MS. *World Mycotoxin J.* 2012;5:303-18.
- [158] P. Kremers, P. Beaune, T. Cresteil, J. De Graeve, S. Columelli, J.-P. Leroux, et al. Cytochrome P-450 Monooxygenase Activities in Human and Rat Liver Microsomes. *Eur J Biochem.* 1981;118:599-606.
- [159] A. Matsumura, A. Ghosh, G. S. Pope, P. D. Darbre. Comparative study of oestrogenic properties of eight phytoestrogens in MCF7 human breast cancer cells. *J Steroid Biochem Mol Biol.* 2005;94:431-43.
- [160] J. Li, S. Li. Natural and anthropogenic environmental oestrogens: the scientific basis for risk assessment. Breast cancer: evidence for xeno-oestrogen involvement in altering its incidence and risk *Pure Appl Chem.* 1998;70:1713-23.
- [161] M. Samuelsen, C. Olsen, J. Holme, E. Meussen-Elholm, A. Bergmann, J. Hongslo. Estrogen-like properties of brominated analogs of bisphenol A in the MCF-7 human breast cancer cell line. *Cell Biol Toxicol.* 2001;17:139-51.

## Publications

### Talks

**S. S. Drzymala**, M. Penkert, L.-A. Garbe, M. Koch, *In vitro* Metabolism of Zearalenone 2. BAM/BfR Kolloquium, Berlin, October 16<sup>th</sup> 2014.

**S. S. Drzymala**, A. Herrmann, J. Binder, J. Riedel, R. Köppen, R. Maul, L.-A. Garbe, M. Koch, *cis*-zearalenone: Instrumental Analysis, Metabolism and Toxicity, 36th Mycotoxin Workshop, Göttingen, June 16<sup>th</sup> 2014.

S. Marten, M. Koch, S. Risch, J. Heinze; **S. S. Drzymala**, Neuartiges selektives Online SPE Verfahren zur Bestimmung von Zearalenon in Speiseölen unter Verwendung von dynamisch kovalenter Hydrazinchemie, 42. Deutscher Lebensmittelchemikertag, Braunschweig, September 16<sup>th</sup>-18<sup>th</sup> 2013.

### Peer-review articles

**S. S. Drzymala**, J. Binder, A. Brodehl, M. Penkert, M. Rosowski, L.-A. Garbe, and M. Koch, Estrogenicity of novel phase I and phase II metabolites of zearalenone and *cis*-zearalenone. *Chemical Research in Toxicology*, submitted.

**S. S. Drzymala**, M. Penkert, S. Beck, L.A. Garbe, and M. Koch, Oxidative *in vitro* phase I metabolism of *cis*-zearalenone. *Archives of Toxicology*, final manuscript.

**S. S. Drzymala**, S. Weiz, J. Heinze, S. Marten, C. Prinz, A. Zimathies, L.A. Garbe, and M. Koch, Automated solid phase extraction coupled online with HPLC-FLD for the quantification of zearalenone in edible oil. *Journal of Analytical and Bioanalytical Chemistry* (2015), accepted.

**S. S. Drzymala**, M. Penkert, L.A. Garbe, and M. Koch, Comparison of analytical methods for the determination of zearalenone in edible oils. Food Additives & Contaminants: Part A (2015), final manuscript.

**S. S. Drzymala**, J. Riedel, R. Köppen, L.A. Garbe, and M. Koch, Preparation of <sup>13</sup>C-labelled *cis*-zearalenone and its application as internal standard in stable isotope dilution analysis. World Mycotoxin Journal 7 (2014) 45-52.

**S. S. Drzymala**, A.J. Herrmann, R. Maul, D. Pfeifer, L.A. Garbe, and M. Koch, In Vitro Phase I Metabolism of *cis*-Zearalenone. Chemical Research in Toxicology 27 (2014) 1972-8.

R. Köppen, J. Riedel, M. Proske, **S. S. Drzymala**, T. Rasenko, V. Durmaz, M. Weber, and M. Koch, Photochemical *trans*-/*cis*-Isomerization and Quantitation of Zearalenone in Edible Oils. Journal of Agricultural and Food Chemistry 60 (2012) 11733-40.

**S. S. Drzymala**, W. Kraus, F. Emmerling, M. Koch, (3*S*,7*R*)-7,14,16-Trihydroxy-3-methyl-3,4,5,6,7,8,9,10,11,12-decahydro-1*H*-2-benzoxacyclotetradecin-1-one. Acta Crystallographica Section E (2012) 68 (11), o3071.

**S. S. Drzymala**, W. Kraus, F. Emmerling, M. Koch, (3*S*)-14,16-Dihydroxy-3-methyl-3,4,5,6,9,10,11,12-octa-hydro-1*H*-2-benzoxacyclo-tetra-decine-1,7(8*H*)-dione (zea-ralanone) monohydrate. Acta Crystallographica Section E (2012) 68 (5), o1577.

### Non-peer-review articles

S. Weiz, S. Marten, J. Heinze, **S. S. Drzymala**, M. Koch, Unpolarer Analyt, unpolare Matrix: das Mykotoxin Zearalenon in Öl. Nachrichten aus der Chemie 61 (2013) 1241-3.

S. Weiz, S. Marten, J. Heinze, **S. S. Drzymala**, M. Koch, Zearalenon auf der Spur: Hochselektive Mykotoxin-Bestimmung in Speiseöl. Deutsche Lebensmittel-Rundschau 1 (2014) 24-7.



## Acknowledgements

Several people have contributed to making work on this thesis a genuine pleasure. My sincere gratitude belongs to my supervisors Herr Dr. Koch from the Federal Institute for Materials Research and Testing (BAM), division 1.7 ‘Food analysis’, and Prof. Dr. Leif-Alexander Garbe from the Technische Universität Berlin, ‘Institute of Bioanalytics’, for the unfailing support throughout every step of this work and the creation of an immensely productive atmosphere. I am very grateful to Herr Dr. Koch for receiving the chance to talk on an international conference.

My past and present colleagues of the division ‘Food analysis’ deserve profound thanks for their patient and unwavering help. I also like to thank my former co-PhDs Antje Brodehl, Dr. Paul Kuhlich, Katrin Kittler and Svenja Schloss for those congenial vibes in our office. Moreover, I am very thankful to Carsten Prinz and Annett Zimathies for their BET measurements, to Werner Kraus and Dr. Franziska Emmerling for their X-ray expertise and to Dr. Dietmar Pfeifer for performing NMR measurements (all BAM 1.3 ‘Structural Analysis’).

I also like to acknowledge several cooperation partners, which made progress possible when the ways and means at BAM were limited: Jennifer Binder, Dr. Mark Rosowski and Prof. Dr. Roland Lauster (Technische Universität Berlin) for the cell expertise; Dr. Ronald Maul (Leibniz Institute of Vegetable and Ornamental Crops, IGZ) for the possibility to work on the high resolution mass spectrometer at IGZ; Dr. Sebastian Beck (Humboldt Universität zu Berlin) for the possibility to work on the LTQ mass spectrometer. My deep gratitude also belongs to Dr. Stefan Weiz and Dr. Silvia Marten (Wissenschaftlicher Gerätebau Dr. Ing. Herbert Knauer GmbH) for their inherent motivation towards automizing covalent chemistry.

Furthermore, I greatly benefited from Dr. David Siegel (Bayer AG), Dr. Ronald Maul and Dr. Andreas Hildebrand (Karlsruher Institut für Technologie) who gave essential input at times and acted as catalysts to me. Finally, several interns, bachelor and master students have contributed greatly to this thesis, namely Constantin Recknagel (research internship), Antje Herrmann (research internship: ‘*In vitro* phase I metabolism of *cis*-zearealenone’), Martin Penkert (master thesis: ‘Comparison of analytical methods for the determination of zearealenone in edible oils’) and Julia Heinze (master thesis: ‘Development of an automated SPE-HPLC online coupling for the quantitative determination of zearealenone in edible oils’).